



# Durham E-Theses

---

## *The twistor description of integrable systems*

Strachan, Ian Alexander Becket

### How to cite:

---

Strachan, Ian Alexander Becket (1991) *The twistor description of integrable systems*, Durham theses, Durham University. Available at Durham E-Theses Online: <http://etheses.dur.ac.uk/5863/>

### Use policy

---

The full-text may be used and/or reproduced, and given to third parties in any format or medium, without prior permission or charge, for personal research or study, educational, or not-for-profit purposes provided that:

- a full bibliographic reference is made to the original source
- a [link](#) is made to the metadata record in Durham E-Theses
- the full-text is not changed in any way

The full-text must not be sold in any format or medium without the formal permission of the copyright holders.

Please consult the [full Durham E-Theses policy](#) for further details.

The copyright of this thesis rests with the author.  
No quotation from it should be published without  
his prior written consent and information derived  
from it should be acknowledged.

THE TWISTOR DESCRIPTION  
OF  
INTEGRABLE SYSTEMS

by

IAN ALEXANDER BECKET STRACHAN

A Thesis presented for the Degree of  
Doctor of Philosophy at the  
University of Durham.

Department of Mathematical Sciences  
University of Durham  
Durham  
England

August 1991



- 9 JUL 1992

# THE TWISTOR DESCRIPTION OF INTEGRABLE SYSTEMS

by

Ian Alexander Becket Strachan

Ph.D. Thesis 1991.

## Abstract

The theory of twistors and the theory of integrable models have, for many years, developed independently of each other. However, in recent years it has been shown that there is considerable overlap between these two apparently disparate areas of mathematical physics. The aim of this thesis is twofold; firstly to show how many known integrable models may be given a natural geometrical/twistorial interpretation, and secondly to show how this leads to new integrable models, and in particular new higher dimensional models.

After reviewing those elements of twistor theory that are needed in the thesis, a generalisation of the Yang-Mills self-duality equations is constructed. This is the framework into which many known examples of integrable models may be naturally fitted, and it also provides a simple way to construct higher dimensional generalisations of such models.

Having constructed new examples of  $(2 + 1)$ -dimensional integrable models, one of these is studied in more detail. Embedded within this system are the sine-Gordon and Non-Linear Schrödinger equations. Some solutions of this  $(2 + 1)$ -dimensional integrable model are found using the 'Riemann Problem with Zeros' method, and these include the soliton solutions of the SG and NLS equations. The relation between this approach and one based the Atiyah-Ward ansätze is discussed briefly.

Scattering of localised structures in integrable models is very different from scattering in non-integrable models, and to illustrate this the scattering of vortices in a modified Abelian-Higgs model is considered. The scattering is studied, for small speeds, using the 'slow motion approximation' which involves the calculation of a moduli space metric. This metric is found for a general  $N$ -lump vortex configuration. Various examples of scattering processes are discussed, and compared with scattering in an integrable model.

Finally this geometrical approach is compared with other approaches to the study of integrable systems, such as the Hirota method. The thesis closes with some suggestions for how the KP equation may be fitted into this geometrical/twistorial scheme.

---

# Contents

---

Abstract . . . . .	ii
Contents . . . . .	iii
Preface . . . . .	v
<b>I. Introduction . . . . .</b>	<b>1</b>
<b>II. Elements of Twistor Theory</b>	
2.1 Introduction . . . . .	10
2.2 The Geometry of Twistor Space . . . . .	11
2.3 The Geometry of Minitwistor Space . . . . .	18
2.4 The solutions of the Massless Field Equations . . . . .	21
2.5 The Twistor Correspondence for Gauge Fields . . . . .	25
2.6 The Atiyah-Ward Ansätze . . . . .	31
2.7 Generalisations of the Self-Duality Equations . . . . .	37
<b>III. The Twistor Description of Integrable Systems</b>	
3.1 Introduction . . . . .	44
3.2 Integrability . . . . .	45
3.3 Reductions of the self-duality equations . . . . .	48
3.4 The AKNS hierarchy and its Generalisation . . . . .	54
3.5 Higher Rank Gauge Groups . . . . .	64
3.6 Infinite Rank Gauge Groups . . . . .	73
3.6 Comments . . . . .	77

<b>IV. Solution Generating Techniques</b>	
4.1 Introduction . . . . .	79
4.2 The ‘Riemann Problem with Zeros’ Method . . . . .	80
4.3 Ansätze for Solutions . . . . .	84
4.4 (1 + 1)-Dimensional Soliton Equations . . . . .	87
4.4.1 The Sine-Gordon Equation . . . . .	88
4.4.2 The Non-Linear Schrödinger Equation . . . . .	93
4.5 The Relation with the Atiyah-Ward Ansätze . . . . .	96
<b>V. The Slow Motion Approximation</b>	
5.1 Introduction . . . . .	101
5.2 The vortex model and its static solutions . . . . .	103
5.3 Dynamics of the vortices . . . . .	152
5.4 Examples of Vortex motion . . . . .	112
5.5 Scattering in an Integrable Model in (2 + 1)-Dimensions . . . . .	115
5.5 Comments and Conclusions . . . . .	118
<b>VI. Outlook</b> . . . . .	124
<b>Appendix A</b> . . . . .	131
<b>Appendix B</b> . . . . .	134
<b>References</b> . . . . .	139

---

## Preface

---

This thesis is the result of work carried out in the Department of Mathematical Sciences at the University of Durham, between October 1988 and August 1991, under the supervision of Dr W.J.Zakrzewski and Dr R.S. Ward. No part of it has been previously submitted for any degree, either in this or any other university.

No claim of originality is made for the material presented in chapter I,II (excluding section 2.7), chapter III, section 3.1 to 3.3, or the appendices. The rest of the work is believed to be entirely original. The material in chapter V has been accepted for publication in *Journal of Mathematical Physics*,<sup>[1]</sup> part of the material in chapter IV has been published in *Physics Letters A*,<sup>[2]</sup> and the rest of the material is either in the form of a preprint<sup>[3]</sup> or is currently in preparation.<sup>[4,5]</sup>

I thank Richard Ward for his interest in my work, his careful supervision, and particularly for his many insights into twistor theory. In addition I would like to thank Patrick Dorey, Robert Leese, Paul Sutcliffe and Niall MacKay for many interesting conversations, and Gérard Watts and Wojciech Zakrzewski for their help in proof reading this thesis. I would also like to thank my parents, family and friends for their support. Financial support was provided by the Science and Engineering Research Council, whom I acknowledge with thanks.

The copyright of this thesis rests with the author. No quotations from it should be published without his prior written consent and informations derived from it should be acknowledged.

---

# Chapter I

---

## Introduction

---

This introduction provides a short outline of some of the historical development of the ideas used in the later chapters of this thesis. It describes the history of soliton theory and twistor theory, which first appeared during the 1960's. While both areas have physical motivations, both use a lot of sophisticated mathematics. Since the late 1970's, with the success of the twistor approach in constructing instanton solutions, there has been a large interplay between mathematics and physics. This has cumulated in the recent work on knot theory, which has benefited both from the mathematical and physical approaches.

The notion of integrability goes back to the work of Liouville, and the study of Hamiltonian systems (which also may be regarded as a one-dimensional field theory, with the phase space variables  $(p, q)$  being interpreted as the fields depending on one coordinate, namely time). Such systems are said to be completely integrable if there are  $N$  conserved quantities (where  $N$  is the number of degrees of freedom of the system). Examples of such completely integrable Hamiltonian systems are the equations for the Euler, Lagrange and Kowalevski spinning tops. However, the concept of integrability in higher dimensions developed much latter, and came from soliton theory.

Despite the large quantities of modern mathematics used in soliton theory today, the soliton was first discovered by accident by the naval architect, John Scott Russell, in August 1834 on the Edinburgh to Glasgow canal. In his own words<sup>[6]</sup>

I believe I shall best introduce this phenomenon by describing the circumstances of my own first acquaintance with it. I was observing the motion of a boat which was rapidly drawn along a narrow channel by a pair of horses, when the boat suddenly stopped-not so the mass of the water in the channel which it had put in motion; it accumulated round the prow of the vessel in a state of violent agitation, then suddenly leaving it behind, rolled forward with great



velocity, assuming the form of a large solitary elevation, a rounded, smooth and well-defined heap of water, which continued its course along the channel apparently without change of form or diminution of speed. I followed it on horseback, and overtook it still rolling on at a rate of some eight or nine miles an hour, preserving its original figure some thirty feet long and a foot to a foot and a half in height. Its height gradually diminished, and after a chase of one or two miles I lost it in the windings of the channel. Such, in the month of August 1834, was my first chance interview with that singular and beautiful phenomenon which I have called the Wave of Translation, a name which it now very generally bears.

He immediately noticed that this was a new phenomenon, and a major part of his subsequent work was on its many properties. Russell's work was slow to be accepted; both Sir John Herchel and Stokes gave other, incorrect, explanations. However, in the 1870's both Boussinesq and Rayleigh found the hyperbolic secant squared solution to the problem of water waves. This work was rederived in 1895 by Korteweg and deVries, and the basic equation

$$u_t + u_{xxx} + 6u \cdot u_x = 0$$

still bears their names (though often shortened to just the KdV equation). The 'great wave of translation' is essentially a nonlinear phenomenon, the tendency of waves to disperse or to form shock waves being, in some sense, balanced. This balancing of opposing forces is ubiquitous among equations with soliton solutions.

Another important equation to emerge in the 19<sup>th</sup> century was the sine-Gordon equation. It arose in the study of hyperbolic geometry,<sup>[7]</sup> where it is the condition for the metric

$$ds^2 = du^2 + dv^2 - 2 \cos \phi(u, v) \cdot du \cdot dv$$

to have constant negative curvature. Bäcklund and Bianchi developed a scheme to generate what now would be called a multi-soliton solution to this equation. The method used by Bäcklund, nowadays called the Bäcklund transformation, is a way to generate new solutions from old solutions. The same sine-Gordon equation also appeared in 1962, where Perring and Skyrme were using it as a toy model for a nonlinear meson field theory. At the time it did not receive much attention, though since then it has been much studied, both quantum mechanically and classically.



The two meson solution of Perrings and Skyrme was first found numerically, before the analytic solution was written down. A lot of progress in nonlinear theories has been made in this way. A prime example is the work of Fermi, Pasta and Ulam.<sup>[8]</sup> They were studying phonon interactions in a one dimensional anharmonic lattice, using one of the first computers, the MANIAC I at Los Alamos. The results obtained were unexpected, and like the work of Russell, and Perrings and Skyrme, largely ignored. However, this problem was then taken up by Kruskal and Zabusky,<sup>[9]</sup> though from a continuum point of view. In doing so they rederived the KdV equation, then proceeded to solve it numerically. They found that the solution to the initial value problem they were looking at broke up into a number of solitary waves, which kept their shape after an interaction with another solitary wave. They called such solitary waves 'solitons'.

The next idea to emerge was the infinite number of conservation laws associated with a soliton equation. A conservation law (in  $(1 + 1)$ -dimensions) is an equation like

$$\frac{\partial U}{\partial t} + \frac{\partial F}{\partial x} = 0,$$

$U$  is called the conserved density, and  $F$  the corresponding flux. Conservation Laws, other than for energy and momentum, were known to exist, Boussinesq having found the third such law for the KdV equation. Higher order laws were discovered by trial and error by Zabusky and Kruskal, and by Miura, who went on to show there exists an infinite number of such laws. The transformation he used is now known as the Miura transformation.<sup>[10]</sup>

Undoubtedly the most important discovery in soliton theory was the Inverse Scattering Transform (or IST for short), originally studied by Gardner, Greene, Kruskal and Miura in 1967.<sup>[11]</sup> Briefly, it involves writing the nonlinear equation as the integrability condition for an overdetermined linear system. One of these has the form of a scattering problem off a potential given by the initial value of the field. The other gives the time evolution of the scattering data. Both of these equations can be solved, and the solution to the original nonlinear equation reconstructed. This is shown schematically in Fig 1.1. The hard part is the first step; that of writing the equation as the integrability condition for an overdetermined linear system. At first this was done by guess work, though later it was put on a firmer footing by the work of Lax.<sup>[12]</sup>

The nonlinear Schrödinger (or NLS) and sine-Gordon (or SG) equations were then written in Lax form, and hence their multi-soliton found using the IST. So far the term

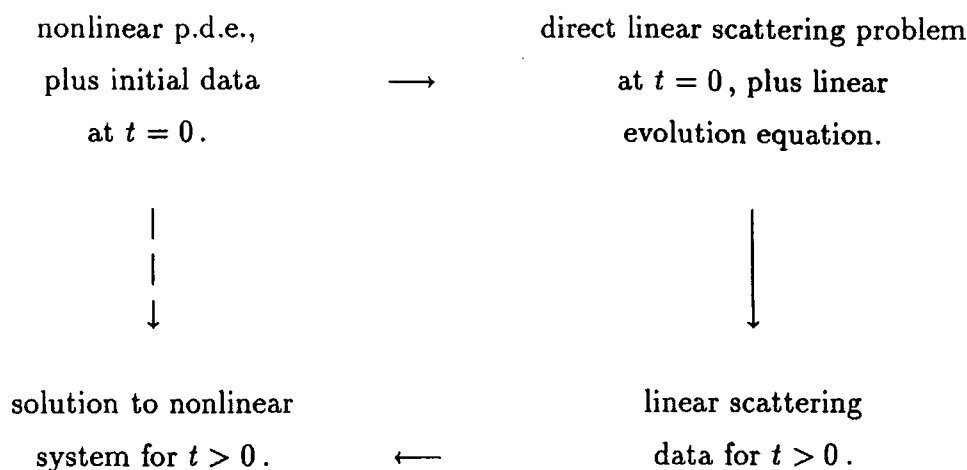

Fig 1.1. Flow diagram of the method of inverse scattering

'soliton' has not been defined. A loose definition would be that a soliton is a solution to a nonlinear system which

- Represents a wave of permanent form,
- is localised, decaying to zero or a constant at infinity,
- interacts strongly with other solitons but in such a way that after the interaction the individual solitons retain their original form.

A more technical definition would involve a detailed description of the IST, and will not be given here.

During the 1970's, it was shown by Ablowitz, Kaup, Newell and Segur<sup>[13]</sup> (hereafter referred to as AKNS) that once an equation was written as the compatibility conditions of a linear systems, then an infinite number, or hierarchy, of other equations could be derived, and all the 'flows' (i.e evolution with respect to a particular time variable) commuted. This scheme has become known as the AKNS hierarchy. A similar scheme known as the Derivative Non-Linear Schrödinger (or DNLS) hierarchy also exists, though in effect it is no different from the AKNS scheme. This can also be extended to  $(2 + 1)$ -dimensions, while retaining the notion of integrability. For example, the Korteweg deVries (or KdV) equation extends to the Kadomtsev-Petviashvili (or KP) equation, and the Non-Linear Schrödinger (or NLS) equation extends to the Davey-Stewartson (or DS) equation.

Parallel to the above developments was the work of Gardner,<sup>[14]</sup> and Zakharov and Faddeev.<sup>[15]</sup> They showed how the KdV equation could be interpreted as a completely

integrable Hamiltonian system. This formalism leads to the quantisation of such systems, as well as explaining the infinite number of conservation laws. Also worth mentioning is the work of the Kyoto school, in particular the bilinear formalism of Hirota, often called Hirota's direct method (see, for example [16]). Rather than writing the equation to be solved as the integrability condition of an over-determined linear system (as in the IST method), it is written in a so-called bilinear form. This enables the  $N$ -soliton solution (if one exists) to be written down very succinctly. This method also leads to the study of vertex operators, infinite dimensional symmetry algebras, and even string theory.<sup>[16,17]</sup>

Such ideas were not limited to applied mathematics. In theoretical physics many people started to study model field theories in two dimensions,<sup>[18]</sup> known as chiral and sigma models (these also have a natural geometrical structure, and are known as harmonic maps amongst differential geometers). It was found that such models (in Euclidean space) had localised "multi-lump" solutions, and, like the integrable soliton equations, could be written as the integrability condition for an over determined linear system. This enabled an infinite number of conserved (though non-local) charges and currents to be constructed.<sup>[19,20]</sup> Thus these models have a very similar structure to that of the integrable soliton equation.

With such a wide range of 'integrable' equations, from completely integrable dynamical systems to model field theories, together with the diverse methods and techniques that had been developed to solve them, there arose the need for a unified point of view, that could treat all the above systems on an equal footing. One such view came from the 'Twistor Programme' of Roger Penrose.

In 1967 Penrose introduced the idea of a twistor.<sup>[21]</sup> It was mainly an attempt to provide an alternative approach to the problem of the quantisation of gravity. The basic notion is that spacetime points are taken as derived objects, the twistors themselves being more basic. The aim of his 'Twistor Programme' is to replace spacetime, and the description of physical phenomena that take place in spacetime, by the properties of, and structures on, twistor space. This transformation to and from physical and twistor space is known as the Penrose Transform; the hope is that new insights, and hence a clearer understanding of the processes involved, may be obtained in doing so.

The concepts of the spacetime point, curvature, energy-momentum, angular momentum, quantisation, the structure of elementary particles, linear field theory and gauge field theory have all been formulated (to a greater or lesser extent) in terms of the twistor

concept.<sup>[22,23]</sup> The theory itself uses some very beautiful mathematics, both old (e.g. complex projective spaces, the Klein correspondence) and new (e.g. sheaf cohomology).

Penrose went on to show how the self-dual Einstein equations could be given a description in terms of a deformed twistor space, the so-called ‘nonlinear graviton construction’.<sup>[24]</sup> The self-dual Yang-Mills equations were shown by Richard Ward<sup>[25]</sup> to also admit a twistor interpretation; solutions to the self-dual equations correspond to holomorphic vector bundles over projective twistor space. There are two ways to construct such bundles; one is as an extension of line bundles, and this led to the Atiyah-Ward<sup>[26]</sup> ansätze  $\mathcal{A}_n$  for such fields, and the second is using the method of monads, which led to the Atiyah-Drinfeld-Hitchin-Manin (or ADHM) construction.<sup>[27]</sup>

The result of this work was the solution of the instanton problem; the construction of self-dual (or instanton) solutions to an  $SU(2)$  gauge theory of finite energy. It had been shown that the general solution must depend on  $8k - 3$  parameters (where  $k$  is the topological charge). A family depending on  $5k + 4$  (though for  $k = 1, 2$  these are not independent, owing to some extra symmetries) parameters had been found (the t’Hooft-Corrigan-Fairlie-Wilczek ansätze),<sup>[28]</sup> but not the full solution.

A problem that was being extensively studied in the early 80’s was the construction of monopoles. These are static solutions to a Yang-Mills-Higgs field theory on  $\mathbb{R}^{3+1}$ . An exact solution (in the BPS limit) of topological charge one had been found, but not the general solution, which depends on  $4k - 1$  parameters (for gauge group  $SU(2)$ ). Manton<sup>[29]</sup> noticed that the equations governing static monopoles (the Bogomolny equation) could be interpreted as the self-duality equation of a pure Yang-Mills field theory, under the assumption that none of the gauge fields depend on one of the coordinates. As such, the twistor techniques could be used to construct solutions, and the known charge one solution was rederived in this way. The first charge two solution (with an axial symmetry) was found by Ward,<sup>[30]</sup> and generalised to arbitrary charge (again with axial symmetry) by Prasad and Rossi.<sup>[31,32]</sup> Ward<sup>[33]</sup> then found a non-axially symmetric solution, and the method was generalised to a candidate solution depending on the full  $4k - 1$  parameters.<sup>[34]</sup> It was still an open problem whether this solution had the required smoothness properties, and this was finally answered through the work of Hitchin.<sup>[35,36]</sup>

Before the full solutions were found, the instanton and monopole equations were solved under the imposition of additional symmetries. In doing so it was noticed that the equations reduced to well known two dimensional integrable models. For example, the first

solutions of arbitrary topological charge were the  $SO(3)$  invariant  $SU(2)$  instantons constructed by Witten.<sup>[37]</sup> Here the equations finally reduce to the Liouville equation, whose general solution had been known since the 19<sup>th</sup> century. With higher rank gauge groups the result were the Toda lattice equations. Many other models, such as the chiral and sine-Gordon equations (both in two dimensions), were also found 'embedded' within the self-duality equation.<sup>[38]</sup> As such, they could all be solved using the Penrose correspondence. Also many of the techniques of soliton theory were given a twistor interpretation. Recently, the KdV and NLS equations were found to be a reduction of the self-duality equations, and their hierarchies given a twistor description.<sup>[39]</sup> Thus twistor theory provides a unified approach to disparate equations and techniques of soliton theory.

There are still many outstanding problems; for example, not all equations which are known to be integrable have been shown to fit into the twistor picture, the notable exceptions being the Davey-Stewartson and Kadomtsev-Petviashvili equations. While the one-dimensional soliton systems are well understood, the higher dimensional systems are not, nor is the notion of integrability, other than for the one-dimensional systems. The hope is that twistor theory will shed some light on these problems. Also the precise connection between the inverse scattering transform, the Ward correspondence and the Hirota construction needs clarifying. However, these problems, and many others, are currently being investigated.

With models in 2-Euclidean dimensions (chiral and  $\sigma$ -models) and in 3-Euclidean dimensions (magnetic monopoles) possessing localised 'lump'-like solutions, it is a natural question to ask how, on introducing a time variable (in such a way that the lumps of the underlying models are now the static solutions), these lumps interact with each other. Many of these models have 'topological stability', i.e. there exists some integer, depending only on the topology of the fields, which is constrained to be a constant. Such a number may loosely be thought of as the number of lumps. However such stability is not enough to avoid chaotic behaviour – as such extensions to higher dimensions destroys the integrability of the system.

One analytic approach to the study of such systems was proposed by Manton,<sup>[40]</sup> and is now known as the 'slow motion approximation', 'adiabatic approximation' or the 'geodesic approximation'. This involves computing a metric (induced by the integral defining the kinetic energy of the fields) on the finite-dimensional space of static solutions, or Moduli space. It is argued that for small speeds the time evolution of the fields may be

approximated by geodesic motion on the moduli space. This idea has been applied to a number of models,<sup>[41,42,43,44,1,45]</sup> as well as to the original case of magnetic monopoles.

---

This thesis is laid out as follows. Chapter II outlines some of the elements of twistor theory, in particular the Penrose correspondence between spacetime and twistor space, the treatment of massless free fields, and the construction of solutions to the Yang-Mills self-duality equations. Finally a generalisation of the standard twistor space is considered, and a system of integrable equations (generalisations of the self-duality equations) are constructed, corresponding to certain holomorphic vector bundles over this twistor space.

Chapter III shows how many known examples of integrable models fit into the twistor-geometric scheme described in chapter II. These include the completely integrable Hamiltonian dynamical systems, chiral and  $\sigma$ -models, as well as various soliton systems, and they all arise as dimensional reductions of the equations studied in previous chapter. In particular, the AKNS hierarchy is extended to  $(2 + 1)$ -dimensions, and examples associated with Hermitian symmetric spaces are constructed. Finally a hierarchy of models with gauge group  $SU(\infty)$  (interpreted as  $SDiff(\Sigma^2)$  for some 2-surface  $\Sigma^2$ ) are constructed. Before all this a definition of integrability is given.

In chapter IV one of the integrable  $(2 + 1)$ -dimensional models constructed in the previous chapter (with gauge group  $SU(2)$ ), and its associated hierarchy is studied in more detail. This involves showing how the generalised self-duality equations of chapter II may be solved using the 'Riemann Problem with Zeros' method. Then ansätze are developed to ensure that the fields have the correct spacetime symmetries, and hence are a solution of the  $(2 + 1)$ -dimensional hierarchy. This system contains both the sine-Gordon and Non-Linear Schrödinger equations as further reductions, and it is shown how the soliton solution to these may be constructed. For the sine-Gordon equation this requires the imposition of an algebraic constraint as well as a spacetime symmetry. Within this geometrical framework these two equations are very similar indeed, despite their superficial differences. The connection between this approach and the Atiyah-Ward ansätze is then discussed briefly.

The models described in chapters III and IV have the special property of being integrable. These are mathematically very special; most models are not integrable. In Chapter V the slow motion approximation, originally proposed for monopole scattering, is applied to a modified vortex model. As in the case of monopoles, the equations giving

the static solutions are integrable, and this enables the scheme to be completed. The approximation involves finding a metric on the (finite dimensional) space of static solutions. A formula for the general  $n$ -vortex scattering is derived, and an example of the interaction of two vortices is given. The interaction is fundamentally different from scattering in an integrable model, and this point is discussed.

Finally, chapter VI is an outlook on future research, and describes some of the connections between this and other approaches to the study of integrable systems. The appendices contain some of the mathematical definitions used in the thesis, and more details of some of the constructions.

## Chapter II

# Elements of Twistor Theory

### 2.1 Introduction - The Penrose Transform

Twistors first appeared in 1967 in a paper by Roger Penrose.<sup>[21]</sup> The fundamental idea behind the theory is that spacetime is not fundamental, but is a secondary structure whose properties are derived from an auxiliary manifold known as Twistor space. Physical structures on spacetime, such as solutions of the wave equation, then correspond to geometrical structures over twistor space. The Penrose transform is this transform of geometrical structures of (or on) twistor space, to properties of (or structures on) spacetime:

$$\begin{array}{ccc}
 \text{Geometric} & & \text{Physical} \\
 \mathcal{P} : \text{Structures on} & \longrightarrow & \text{equations on} \\
 \text{Twistor Space} & & \text{Spacetime}
 \end{array}$$

This transform may be defined succinctly using a double fibration

$$\begin{array}{ccc}
 & \mathbb{F} & \\
 \mu \swarrow & & \searrow \nu \\
 \mathbb{T} & & \mathbb{M}
 \end{array}$$

where  $\mathbb{F}$  is a fibre bundle over both  $\mathbb{T}$  and  $\mathbb{M}$ , with projections  $\mu$  and  $\nu$  respectively. The spaces involved are:

$\mathbb{T}$  : Twistor Space

$\mathbb{M}$  : Spacetime

$\mathbb{F}$  : The correspondence space between  $\mathbb{T}$  and  $\mathbb{M}$ .

Thus the Penrose transform between points of  $\mathbb{T}$  and the corresponding structure in  $\mathbb{M}$  is defined by the composite map  $\nu \circ \mu^{-1}$  between  $\mathbb{T}$  and  $\mathbb{M}$ .



The geometry of this will be explained in the next section, and in the following sections it will be shown how geometric objects over  $\mathbb{P}$ , like holomorphic line and vector bundles, correspond to solutions of various equations in spacetime, such as the helicity  $\frac{n}{2}$  equation and the self-dual Yang-Mills equations. Finally a generalisation of the standard twistor space will be considered which will be used in the next chapter to study certain integrable models.

Notable omissions in this chapter are the discussion of the conformal properties of spacetime, and how they may be derived from twistor space, and the importance of the local isomorphisms

$$\text{SL}(2, \mathbb{C}) \xrightarrow{2-1} O_+(1, 3)$$

and

$$\text{SU}(2, 2) \xrightarrow{2-1} O(2, 4) \xrightarrow{2-1} C(1, 3).$$

These, and many more details of the material found in this chapter, may be found in [22,23,46,47], and the references contained in them.

## 2.2 The Geometry of Twistor Space

Let  $M$  denote Minkowski space, and  $\mathbb{C}M$  complexified Minkowski space,  $\mathbb{C}M \cong \mathbb{C}^4$ , with metric  $ds^2 = dt^2 - dx^2 - dy^2 - dz^2$ . The spinor representation of the spacetime point  $x^\mu$  is

$$x^\mu \leftrightarrow x^{AA'} = \frac{1}{\sqrt{2}} \begin{pmatrix} x + iz & t - y \\ t + y & x - iz \end{pmatrix}.$$

Consider a spinor field  $\Omega^A(x^\mu)$  on Minkowski space, which satisfies the equation

$$\nabla_{A'}^{(A} \Omega^{B)} = 0, \tag{2.1}$$

where  $\nabla_{AA'} = \frac{\partial}{\partial x^{AA'}}$ . The symmetrization implies that there exists a spinor field  $\pi_{A'}$  such that

$$\nabla_{A'A} \Omega^B = -i\delta_A^B \pi_{A'},$$

and the absence of curvature in Minkowski space implies that

$$\nabla_{AA'}\pi_{B'} = 0,$$

and hence that the spinor  $\pi_{A'}$  is constant. Equation (2.1) is known as the twistor equation. The solution of this equation (in Minkowski space) is

$$\Omega^A = \omega^A - ix^{AA'}\pi_{A'}, \tag{2.2}$$

where  $\omega^A$  is a constant of integration. This gives the first definition of Twistor space, denoted by  $\mathbb{P}$ , namely the solution space to the twistor equation, so  $Z^\alpha \in \mathbb{P}$ , where

$$Z^\alpha = (\Omega^A, \pi_{A'}), \alpha = 0, 1, 2, 3.$$

As a vector space,  $\mathbb{P} \cong \mathbb{C}^4$ .

Twistor space may be equipped with an inner product

$$\begin{aligned} \Sigma : \mathbb{P} \times \mathbb{P} &\rightarrow \mathbb{R} \\ \Sigma(Z^\alpha, Z^\beta) &= \Omega^A \bar{\pi}_A + \bar{\Omega}^{A'} \pi_{A'}, \\ &= \omega^A \bar{\pi}_A + \bar{\omega}^{A'} \pi_{A'}, \\ &= Z^0 \bar{Z}^2 + Z^1 \bar{Z}^3 + \bar{Z}^0 Z^2 + \bar{Z}^1 Z^3, \\ &= \Sigma_{\alpha\beta'} Z^\alpha \bar{Z}^{\beta'}, \end{aligned}$$

where  $\bar{Z}^{\alpha'} \in \bar{\mathbb{P}}$  is the complex conjugate of  $Z^\alpha \in \mathbb{P}$ . Since the inner product  $\Sigma$  is non-degenerate, it may be used to identify  $\bar{\mathbb{P}}$  with  $\mathbb{P}^*$ , so that primed indicies do not appear.<sup>(47)</sup> Complex conjugation is then seen as a map to  $\mathbb{P}^*$  rather than to  $\bar{\mathbb{P}}$  :

$$Z^\alpha = (\omega^A, \pi_{A'}) \rightarrow \bar{Z}_\alpha = (\bar{\pi}_A, \bar{\Omega}^{A'}).$$

[In spinor theory one has spaces  $S, \bar{S}, S^*$  and  $\bar{S}^*$ , and conjugation is a map  $S \rightarrow \bar{S}$ ,

$$\alpha^A \in S \rightarrow \bar{\alpha}^{A'} \in \bar{S} \text{ s.t. } \bar{\alpha}^{A'} = \bar{\alpha}^A.]$$

Another, equivalent, definition of a twistor is in terms of the zero set of the spinor field  $\Omega^A$ , i.e.

$$\omega^A = ix^{AA'}\pi_{A'}. \tag{2.3}$$

This equation gives the correspondence between structures in  $\mathbb{M}$  and structures in  $\mathbb{P}$ . For

a general point in  $\mathbb{P}$ , the solution of this equation,  $x^{AA'}$ , will in general lie in  $\mathbb{CM}$  rather than in  $\mathbb{M}$ . The condition for the point to be a real spacetime point will be given below.

The general solution to (2.3) is given by

$$x^{AA'} = x_o^{AA'} + \lambda^A \pi_{A'},$$

where  $\lambda^A$  is an arbitrary spinor and  $x_o^{AA'}$  is a particular solution. This defines (for  $\pi_{A'} \neq 0$ ) a 2-plane in  $\mathbb{CM}$ . This has the properties that

- every tangent is null,
- any two tangents are orthogonal,
- the tangent bivector is self – dual.

This plane is called an  $\alpha$ -plane (a  $\beta$ -plane is similarly defined in terms of a dual twistor). The plane itself depends only on the proportionality class  $[Z^\alpha]$  of the twistor  $Z^\alpha$ . This enables the projective twistor space  $\mathbb{P}\mathbb{P}$  to be defined. Thus a point in  $\mathbb{P}\mathbb{P}$  corresponds to an  $\alpha$ -plane in  $\mathbb{CM}$ . The extra information in  $\mathbb{P}$  is the scale factor for the spinor  $\pi_{A'}$ . Since  $\mathbb{P} \cong \mathbb{C}^4$ , it follows that  $\mathbb{P}\mathbb{P}$ , and hence  $\mathbb{P}\mathbb{P}^*$  are isomorphic to the complex projective space  $\mathbb{CP}^3$  (to do this one excludes the point  $\omega^A = 0, \pi_{A'} = 0$ , for which (2.3) is trivially satisfied for any finite  $x^{AA'}$  in  $\mathbb{CM}$ ).

Suppose that an  $\alpha$ -plane, corresponding to a twistor  $Z^\alpha = (\omega^A, \pi_{A'})$ , contains a real point  $x_o^{AA'}$ , then

$$\omega^A \bar{\pi}_A = i x_o^{AA'} \bar{\pi}_A \pi_{A'}.$$

This implies that  $\Sigma = 0$ , and the twistor is said to be null. Conversely, if  $\Sigma = 0$ , then

$$\omega^A \bar{\pi}_A = ia, \quad a \in \mathbb{R}.$$

So

$$\omega^A = i x_o^{AA'} \pi_{A'},$$

where

$$x_o^{AA'} = \frac{1}{a} \omega^A \bar{\omega}^{A'}.$$

Hence  $x_o^{AA'}$  is a real point in the  $\alpha$ -plane. Thus, an  $\alpha$ -plane contains a real point if and only if the corresponding twistor is null. It follows that the  $\alpha$ -plane contains the whole

null geodesic given by

$$x^{AA'} = x_0^{AA'} + r\bar{\pi}^A\pi^{A'} \quad r \in \mathbb{R},$$

not just the single real point  $x_0^{AA'}$ .

Twistor space, and projective twistor space, naturally divides into three regions, depending on the sign of the inner product.

$$\begin{aligned} \mathbb{P}^+ \quad \text{and} \quad \mathbb{IP}^+ & \quad \text{if} \quad \Sigma > 0, \\ \mathbb{N} \quad \text{and} \quad \mathbb{IPN} & \quad \text{if} \quad \Sigma = 0, \\ \mathbb{P}^- \quad \text{and} \quad \mathbb{IP}^- & \quad \text{if} \quad \Sigma < 0. \end{aligned}$$

So a null twistor corresponds to a null geodesic in  $\mathbb{M}$ . Suppose that  $X^\alpha$  and  $Y^\alpha$  both belong to  $\mathbb{IPN}$ . It may be shown that the corresponding null geodesics in  $\mathbb{M}$  will meet if and only if  $X^\alpha\bar{Y}_\alpha = 0$ . Since  $X^\alpha\bar{X}_\alpha = 0$  and  $Y^\alpha\bar{Y}_\alpha = 0$ , the twistor  $Z^\alpha = \xi X^\alpha + \eta Y^\alpha$  also corresponds to a null geodesic in  $\mathbb{M}$ . The locus of such a null geodesic defines the null cone at the point of intersection of the two null geodesics corresponding to the twistors  $X^\alpha$  and  $Y^\alpha$ . The structure in  $\mathbb{IP}\mathbb{P}$  corresponding to this null cone is the proportionality class for the above  $Z^\alpha$  and is a projective line  $L_p \cong \mathbb{CP}^1$  which lies wholly in  $\mathbb{IPN}$ . This line in  $\mathbb{IP}\mathbb{P}$  has the equation  $\omega^A = ix^{AA'}\pi_{A'}$ , where  $x^{AA'}$  is the point at which the null cone is defined.

This correspondence may be extended further. Let two points  $p$  and  $q$  in Minkowski space be null separated. In  $\mathbb{IPN}$ , the lines  $L_p$  and  $L_q$  (corresponding to the points  $p$  and  $q$  respectively) will meet at a point which represents the connecting null geodesic in  $\mathbb{M}$ .

This completes the description of what lines in  $\mathbb{IPN}$  correspond to in  $\mathbb{M}$ . Next the geometry of arbitrary lines in  $\mathbb{IP}\mathbb{P}$  will be considered. This will lead to the famous Klein correspondence.

Let  $X^\alpha$  and  $Y^\alpha$  be two arbitrary points in  $\mathbb{IP}\mathbb{P}$ . The connecting line may be represented by the bivector, or Plücker coordinates,

$$P^{\alpha\beta} = X^\alpha Y^\beta - Y^\alpha X^\beta. \quad (2.4)$$

As in the case  $\alpha$ -planes, it is only the proportionality class  $[P^{\alpha\beta}]$  that determines the line. Thus the space of all bivectors is isomorphic to  $\mathbb{CP}^5$ , and the space of lines in  $\mathbb{IP}\mathbb{P}$  are just the simple bivectors (a bivector is simple if and only if it can be written in the form

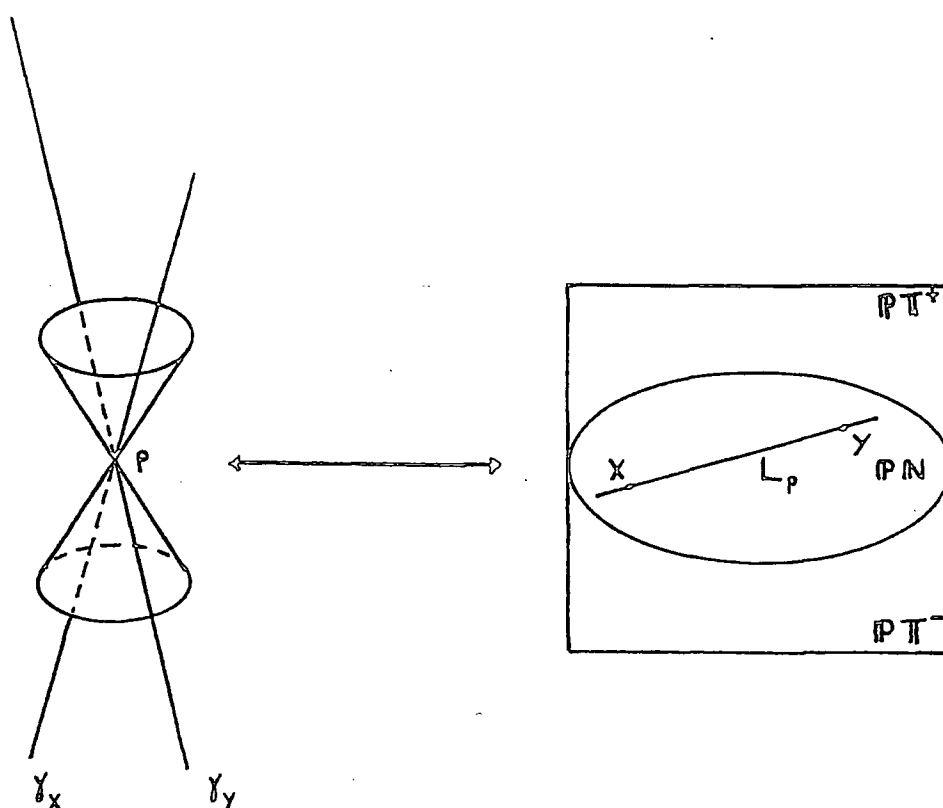

Fig 2.1 The correspondence between points in  $\mathbb{P}N$  and null geodesics in  $\mathbb{M}$ .

(2.4) for some vectors  $X^\alpha$  and  $Y^\alpha$ ). It may be shown that a bivector is simple if and only if

$$\epsilon_{\alpha\beta\gamma\delta} P^{\alpha\beta} P^{\gamma\delta} = 0.$$

This equation defines a (compact) quadric  $Q_4$  in  $\mathbb{C}P^5$ . So, the space of lines in  $\mathbb{P}\mathbb{P}$  is isomorphic to a compact complex manifold  $Q_4$  embedded in  $\mathbb{C}P^5$ . This is known as the Klein correspondence. By defining a conformal metric on  $Q_4$ , it is possible to identify  $Q_4$  with complexified, compactified Minkowski spacetime. So a line in  $\mathbb{P}\mathbb{P}$  corresponds to a point in compactified, complexified Minkowski space.

So far only complexified Minkowski space has been considered. To define a real point in this space one uses the Hermitian structure on  $\mathbb{P}\mathbb{P}$  (see [47]). Defining

$$P_{\alpha\beta} = \frac{1}{2} \epsilon_{\alpha\beta\gamma\delta} P^{\gamma\delta},$$

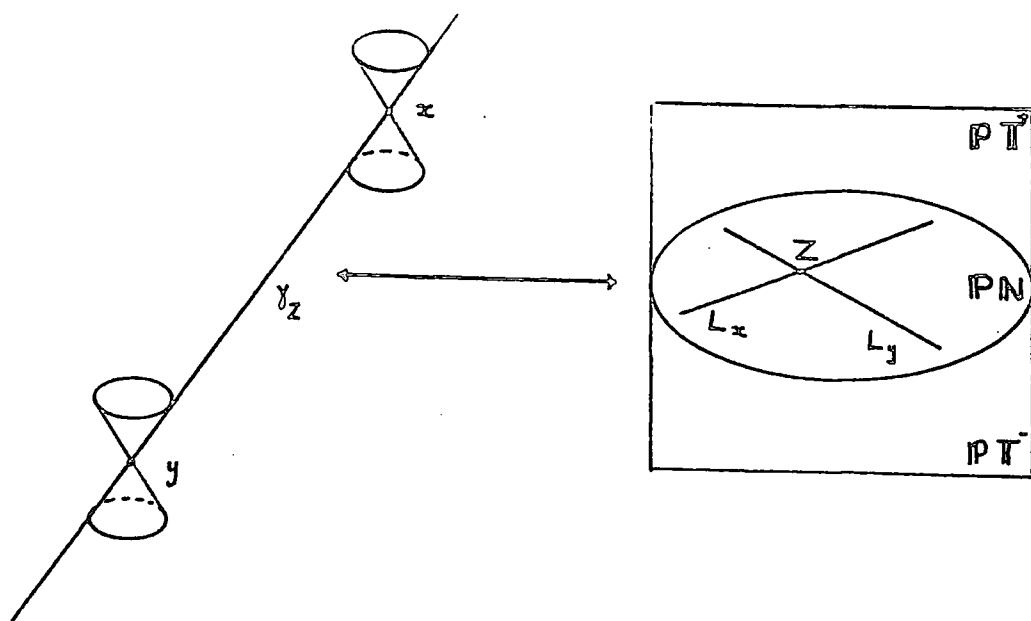

Fig 2.2 The correspondence between lines in  $\mathbb{IPN}$  and null geodesics in  $M$ .

one defines a line as real if

$$\bar{P}_{\alpha\beta} = \frac{1}{2}\epsilon_{\alpha\beta\gamma\delta}P^{\gamma\delta}. \quad (2.5)$$

One may then show that  $P^{\alpha\beta}$  is real if and only if all the points  $Z^\alpha$  on  $P^{\alpha\beta}$  are null. The space of projective bivectors satisfying (2.5) is the real projective space  $\mathbb{RP}^5$ , and the simple bivectors give a real quadric  $\mathbb{R}Q_4$ , embedded within  $Q_4$ .

In this thesis other spacetime signatures will be used, namely those for the spaces  $\mathbb{R}^4$  and  $\mathbb{R}^{2+2}$ . An equivalent way to define a real point is via a 'reality structure', and this will be used to define a real point for these spaces. This is an anti-holomorphic involution,

$$\begin{aligned} \sigma : Z^\alpha &\mapsto \sigma(Z)^\alpha, \\ \text{s.t. } (\sigma(Z)^0, \sigma(Z)^1, \sigma(Z)^2, \sigma(Z)^3) &= (\bar{Z}^1, -\bar{Z}^0, \bar{Z}^3, -\bar{Z}^2). \end{aligned} \quad (2.6)$$

Any line joining  $Z$  to  $\sigma(Z)$  is real, in the sense that it is invariant under the operation of  $\sigma$ . Moreover, the twistor equation  $\omega^A = ix^{AA'}\pi_{A'}$  is invariant under the operation if and

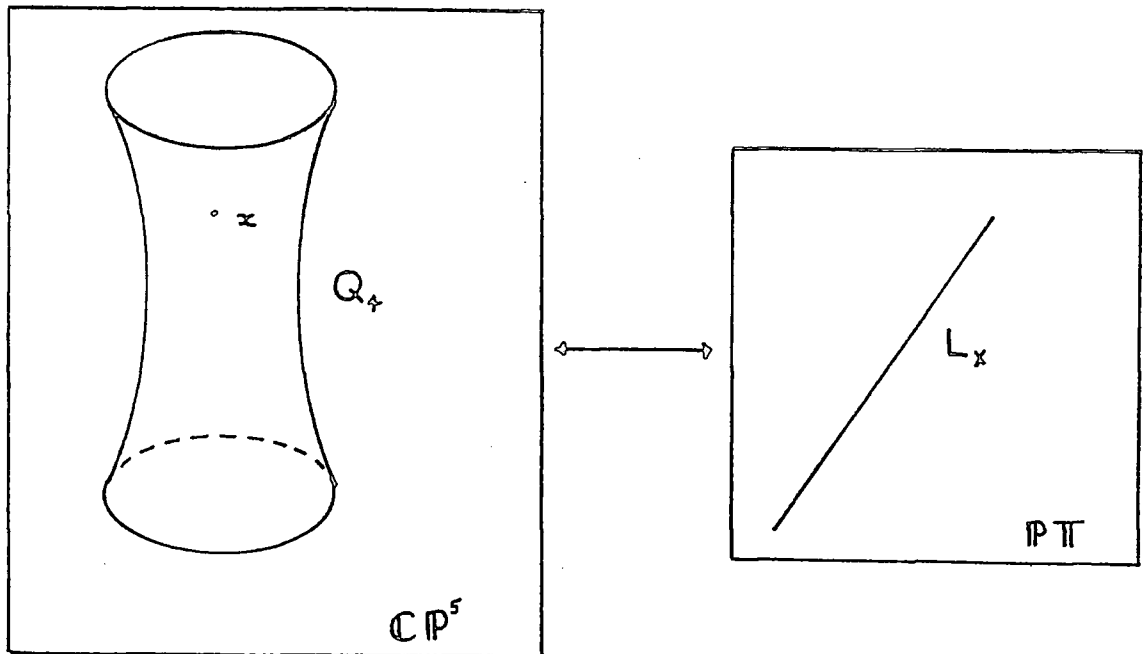

Fig 2.3 The Klein correspondence:

only if  $x^{AA'}$  satisfies

$$\begin{aligned} x^{11'} &= -\overline{x^{00'}}, \\ x^{10'} &= \overline{x^{01'}}. \end{aligned}$$

which implies

$$x^{AA'} = \frac{1}{\sqrt{2}} \begin{pmatrix} -ix^0 + x^3 & x^1 - ix^2 \\ x^1 + ix^2 & -ix^0 - x^3 \end{pmatrix}.$$

This corresponds to  $\mathbb{R}^4$ ; the different reality structure

$$(\sigma(Z)^0, \sigma(Z)^1, \sigma(Z)^2, \sigma(Z)^3) = (\overline{Z^1}, \overline{Z^0}, \overline{Z^3}, \overline{Z^2}) \tag{2.7}$$

gives the  $\mathbb{R}^{2+2}$  case. Such structures are not unique; the function defined by

$$(\sigma(Z)^0, \sigma(Z)^1, \sigma(Z)^2, \sigma(Z)^3) = (\overline{Z^0}, \overline{Z^1}, \overline{Z^2}, \overline{Z^3})$$

also gives  $\mathbb{R}^{2+2}$ .

If one removes the projective line  $\pi_0' = \pi_1' = 0$ , or line at infinity, from  $\mathbb{P}\Pi$ , the resulting space (denoted by  $\Pi^I$ ) corresponds to non-compactified space. This may also be thought of as a fibre bundle over  $\mathbb{C}\mathbb{P}^1$ , since now the  $\pi_{A'}$  are coordinates on a Riemann sphere. This description will be used in section 2.7 where a generalisation of twistor space will be constructed.

### 2.3 The Geometry of Minitwistor Space

One natural object that may be defined on  $\mathbb{M}$  is a Killing vector field

$$k^a \frac{\partial}{\partial x^a} \equiv \xi^{AA'} \frac{\partial}{\partial x^{AA'}},$$

and using equation (2.3) one may work out the corresponding structure on  $\Pi$ , namely the holomorphic vector field

$$V = \delta\pi_{A'} \frac{\partial}{\partial \pi_{A'}} + \delta\omega^A \frac{\partial}{\partial \omega^A}$$

where

$$\begin{aligned} \delta\pi_{A'} &= -\frac{1}{2} \{ \partial_{AA'} \xi^{AB'} \} \pi_{B'}, \\ \delta\omega^A &= i x^{AA'} \delta\pi_{A'} + \xi^{AA'} \pi_{A'}. \end{aligned}$$

For example, in  $\mathbb{M}$  the vector field  $\frac{\partial}{\partial z}$  corresponds to the holomorphic vector field

$$V = i \left\{ \pi_0' \frac{\partial}{\partial \omega^0} - \pi_1' \frac{\partial}{\partial \omega^1} \right\}. \quad (2.8)$$

Note that this is non-zero in the region  $\Pi^I$  of twistor space (see section 2.2), and this enables one to factor out by this field to form the well-defined quotient  $\Pi^I/V$ . This quotient is the holomorphic tangent bundle to the Riemann sphere, or  $T^{1,0}\mathbb{C}\mathbb{P}^1$  (this is also denoted by  $\mathcal{O}(2)$ : for an explanation of this see section 2.7), and is known as minitwistor space.

The vector field given by (2.8) annihilates the combination

$$\omega = \frac{1}{2} (\pi_0' \omega^1 + \pi_1' \omega^0),$$

and it follows that the relation between  $\mathbb{R}^{2+1}$  and minitwistor space is expressed (on



removing, for clarity, the prime superscripts) by

$$\omega = x^{AB} \pi_A \pi_B, \tag{2.9}$$

where

$$x^{AB} = \frac{1}{2} \begin{pmatrix} t+y & x \\ x & t-y \end{pmatrix}, \tag{2.10}$$

analogously to equation (2.3). So given  $x^{AB}$ , solving for  $(\omega, \pi_A)$  gives the corresponding structure in minitwistor space, and vice-versa. The homogeneous coordinates on minitwistor are  $(\omega, \pi_A)$ , where  $\pi_A$  are the homogeneous coordinates on the base space  $\mathbb{CP}^1$ , and  $\omega$  the fibre coordinate. These are defined up to equivalence

$$(\omega, \pi_A) \sim (\lambda^2 \omega, \lambda \pi_A), \quad \forall \lambda \in \mathbb{C} \setminus \{0\}.$$

Thus the space  $\Pi^I/V$  is isomorphic to the  $\mathcal{O}(2)$  line bundle on  $\mathbb{CP}^1$ , i.e. the holomorphic tangent bundle to the sphere.

This may be expressed in the following diagram:

$$\begin{array}{ccc} \Pi^I & \longleftrightarrow & \mathbb{CM} \\ V \downarrow & & \downarrow \frac{\partial}{\partial z} \\ \mathcal{O}(2) & \longleftrightarrow & \mathbb{C}^{2+1}. \end{array}$$

Minitwistor space was first introduced by Hitchin<sup>[35,36]</sup> in the study of monopoles on  $\mathbb{R}^3$  (though it dates back to the work of Weierstrass on minimal surfaces<sup>[7]</sup>). One may also factor out by the Killing vector field on  $\mathbb{R}^4$  to get  $\mathbb{R}^3$ , so getting a Penrose correspondence between  $\mathbb{R}^3$  and minitwistor space. The structure of minitwistor space is induced from that of twistor space itself, but one may start directly in  $\mathbb{R}^3$  by considering the complexification of the space of oriented straight lines, or, for  $\mathbb{R}^{2+1}$ , the complexification of the space of null planes.

So far one has actually been considering the complexification of  $\mathbb{R}^{2+1}$ ; to define a real point one needs a reality structure. Let  $\sigma$  be an antiholomorphic involution on  $\mathcal{O}(2)$ ,

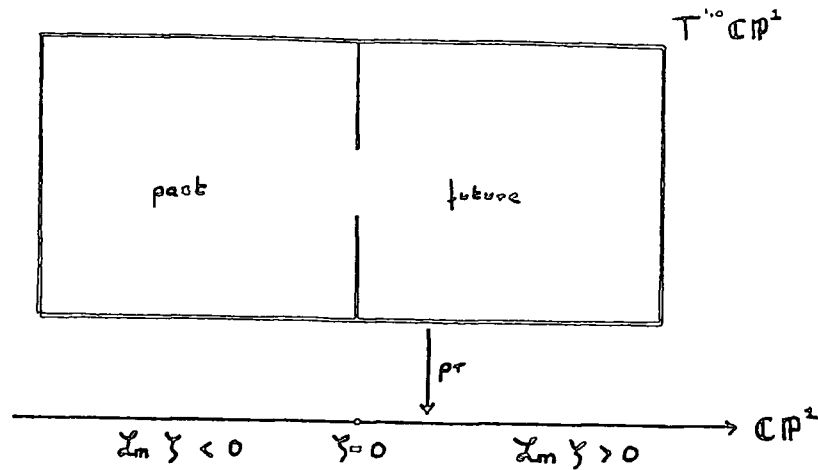

Fig 2.4 The Structure of minitwistor space.

or reality structure, defined by

$$\sigma(\omega, \pi_0, \pi_1) = (\bar{\omega}, \bar{\pi}_0, \bar{\pi}_1) \quad (2.11)$$

where  $\bar{\phantom{x}}$  denotes complex conjugation. The twistor equation (2.9) is invariant under this operation if and only if the matrix  $x^{AB}$ , and hence the spacetime point, is real. Different reality structures would correspond to different spacetime signatures, such as the positive-definite signature relevant to  $\mathbb{R}^3$ .

Defining non-homogeneous coordinates on  $\mathbb{P}$ ,  $\nu = \omega/\pi_0\pi_1$  and  $\xi = \pi_0/\pi_1$ , the twistor equation (2.9) becomes

$$\nu = x + \frac{1}{2}\xi(t+y) + \frac{1}{2}\xi^{-1}(t-y). \quad (2.12)$$

Solving this equation for  $x^{AB}$  for a particular point  $(\nu, \xi) \in \mathbb{P}$  gives the corresponding structure in  $\mathbb{R}^{2+1}$ . If  $\{\nu, \xi\}$  are both complex, the solution corresponds to a timelike line in  $\mathbb{R}^{2+1}$  with direction vector

$$(t, x, y) = (1 + |\xi|^2, -\xi - \bar{\xi}, 1 - |\xi|^2). \quad (2.13)$$

The orientation of the line is given by the imaginary part of  $\xi$  :

$$\text{Im } \xi > 0 \quad \text{line future pointing}$$

$$\text{Im } \xi < 0 \quad \text{line past pointing.}$$

Points with  $\{\nu, \xi\}$  both real correspond to real null planes. The remaining points in  $\mathbb{P}$

do not correspond to anything in  $\mathbb{R}^{2+1}$ . More details may be found in [48].

### 2.4 The solution of the Massless Field Equations

In 1904, Bateman,<sup>[49]</sup> extending the work of Whittaker,<sup>[50]</sup> gave an integral formula for the general solution to the wave equation  $\square\phi = 0$ ,

$$\phi(x, y, z, t) = \int_{-\pi}^{\pi} F(x \cos \theta + y \sin \theta + iz, y + iz \sin \theta + t \cos \theta, \theta) d\theta, \tag{2.14}$$

This, though unknown at the time, has a natural twistor interpretation, and generalises to massless free fields of arbitrary spin, and extends to fields coupled to a background self-dual gauge field. The complete description of massless fields involves hyperfunction theory and sheaf cohomology, details of which may be found in Ward and Wells.<sup>[46]</sup>

The geometry behind this integral comes from the double fibration:

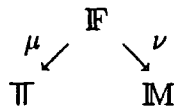

Starting with a holomorphic function  $f$  on  $\Pi$ , one pulls the function back to the space  $\mathbb{F}$ ; this will be denoted by the symbol  $\rho_X$ , so

$$\begin{aligned} \rho_X f(Z^\alpha) &= \rho_X f(\omega^A, \pi_{A'}) \\ &= f(ix^{AA'} \pi_{A'}, \pi_{A'}). \end{aligned}$$

To get a function on  $\mathbb{M}$  one integrates along the fibres on  $\nu$ , i.e. the dependence on  $\pi_{A'}$  is integrated out, leaving a function on  $\mathbb{M}$ . This function is constrained by the geometry inherent in the double fibration to satisfy some differential equation, as will be shown below. Conversely, one could think of the differential equations as having ‘disappeared’ into the holomorphic geometry of functions over twistor space.

So consider the integral

$$\begin{aligned} \phi(x) &= \frac{1}{2\pi i} \oint_{\Gamma} \rho_X f(Z^\alpha) \pi_{C'} d\pi^{C'}, \\ &= \frac{1}{2\pi i} \oint_{\Gamma} f(ix^{AA'} \pi_{A'}, \pi_{A'}) \pi_{C'} d\pi^{C'}. \end{aligned} \tag{2.15}$$

The contour  $\Gamma$  is any path on the Riemann sphere which avoids the singularities of the

integrand, and so cannot be shrunk continuously to a point without crossing a singularity. The example below will clarify the choice of contour.

From the special dependence on  $x$  in the above formula, it follows that

$$\frac{\partial^2 \phi}{\partial x^{AA'} \partial x^{BB'}} = \frac{1}{2\pi i} \oint (-1) \frac{\partial^2 f}{\partial \omega^A \omega^B} \pi_{A'} \pi_{B'} \pi_{C'} d\pi^{C'},$$

which implies  $\square \phi = 0$ .

For the integral to be well defined on  $\mathbb{CP}^1$ , the function  $f$  must be homogeneous of degree  $-2$  (the  $\pi_{A'}$  are homogeneous coordinates on  $\mathbb{CP}^1$  and so are defined only up to the equivalence

$$(\pi_{0'}, \pi_{1'}) \sim (\lambda \pi_{0'}, \lambda \pi_{1'}) \quad \forall \lambda \in \mathbb{C} \setminus \{0\},$$

and so  $\pi_{C'} d\pi^{C'}$  is homogeneous of degree  $+2$ . Thus if the field  $\phi$  is to independent of such changes, then  $f$  must be homogeneous of degree  $-2$ .) By introducing non-homogeneous coordinates on  $\mathbb{CP}^1$  and suitably parametrizing the contour, Bateman's formula (2.14) is recovered.

This extends to other zero rest mass equations, for example

$$\nabla^{CA'} \phi_{A' \dots B'} = 0$$

( $s$ -indices) which describes massless fields of helicity  $\frac{s}{2}$  has as a solution

$$\phi_{A' \dots B'}(x) = \frac{1}{2\pi i} \oint \pi_{A'} \dots \pi_{B'} \rho_X f(Z^\alpha) \pi_{C'} d\pi^{C'} \quad (2.16)$$

(where  $f$  is homogeneous of degree  $-s - 2$ ). Similarly, the equation

$$\nabla^{CA'} \psi_{A \dots B} = 0$$

( $s$ -indices) which describes massless fields of helicity  $-\frac{s}{2}$  has as a solution

$$\psi_{A \dots B}(x) = \frac{1}{2\pi i} \oint \rho_X \frac{\partial}{\partial \omega^A} \dots \frac{\partial}{\partial \omega^B} f(Z^\alpha) \pi_{C'} d\pi^{C'}, \quad (2.17)$$

(where  $f$  is homogeneous of degree  $+s - 2$ ).

**Example**

Let  $f(Z^\alpha) = \frac{1}{(A_\alpha Z^\alpha)(B_\beta Z^\beta)}$ , then, defining the spinors  $\alpha^{A'}$  and  $\beta^{A'}$  by

$$\begin{aligned} \rho_X(A_\alpha Z^\alpha) &= (iA_A x^{AA'} + A^A)\pi_{A'} \equiv \alpha^{A'}\pi_{A'} \\ \rho_X(B_\alpha Z^\alpha) &= (iB_A x^{AA'} + B^A)\pi_{A'} \equiv \beta^{A'}\pi_{A'}, \end{aligned}$$

the integral formula (2.15) gives

$$\phi(x) = \frac{1}{2\pi i} \oint_{\Gamma} \frac{1}{(\alpha^{A'}\pi_{A'})(\beta^{B'}\pi_{B'})} \pi_{C'} d\pi^{C'}.$$

Let A and B be the planes in  $\mathbb{P}^3$  with the equations  $A_\alpha Z^\alpha = 0$  and  $B_\alpha Z^\alpha = 0$  respectively, and let Q be the line  $A \cap B$ . It will be assumed that A and B are such that Q is a line, not a plane. Let R be any line which intersects A and B but not Q.

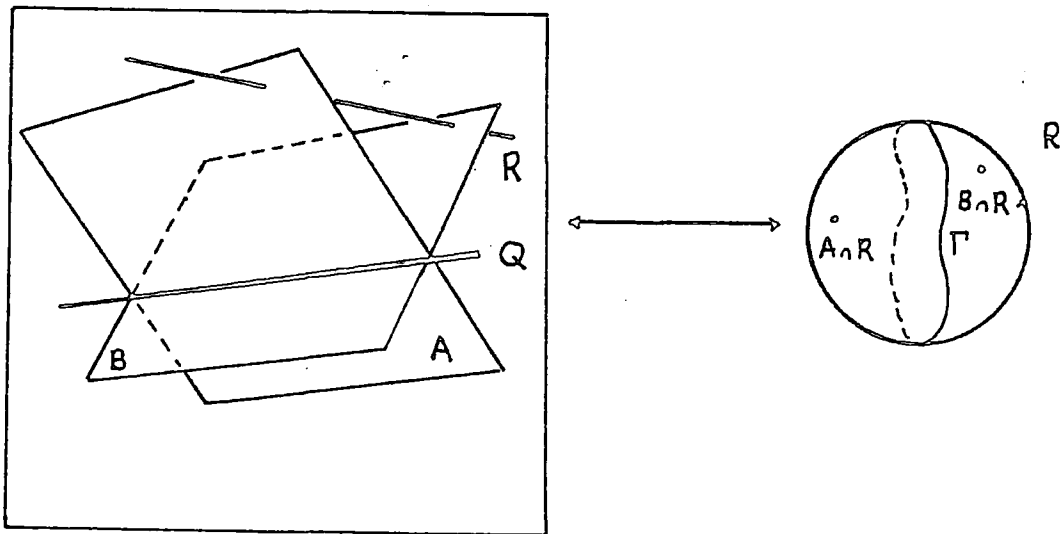

Fig 2.5 The planes A and B, the lines Q and R, and the contour  $\Gamma$ .

The line  $\mathbb{R}$  in  $\mathbb{P}\Pi$  is isomorphic to the Riemann sphere  $\mathbb{C}\mathbb{P}^1$ . Let  $U_A$  be the region  $\mathbb{R} - \{\mathbb{B} \cap \mathbb{R}\}$ , and let  $U_B$  be the region  $\mathbb{R} - \{\mathbb{A} \cap \mathbb{R}\}$ . Then these two open sets cover the sphere  $\mathbb{R}$ . The contour  $\Gamma$  used in the integration is any closed curve (assumed to have winding number one) in the intersection region  $U_A \cap U_B$ . In a more general situation where  $\mathbb{R}$  is covered with more than two open sets, a branched contour integral has to be used. More details of this and many other points may be found in [23].

Let  $z$  be a coordinate on  $\mathbb{C}\mathbb{P}^1$  defined by  $\pi_{A'} = \alpha_{A'} + z\beta_{A'}$ . Then

$$\begin{aligned}\phi(x) &= \frac{1}{2\pi i} \oint_{\Gamma} \frac{1}{(\alpha_{A'}\beta_{A'})z} dz \\ &= \frac{1}{\alpha_{A'}\beta_{A'}}\end{aligned}$$

(this, of course, assumes that  $\alpha_{A'}\beta_{A'} \neq 0$ ). It then follows from the definition of  $\alpha_{A'}$  and  $\beta_{A'}$  that

$$\phi(x) = \frac{2}{A_A B^A} \frac{1}{(x^a - q^a)(x_a - q_a)}$$

where  $q$  is the point corresponding to the line where the two planes  $A_\alpha Z^\alpha = 0$  and  $B_\alpha Z^\alpha = 0$  meet.

Note that if  $f$  is replaced by  $f + h_A - h_B$ , where  $h_A$  is holomorphic in  $U_A$  and  $h_B$  is holomorphic in  $U_B$ , then by Cauchy's theorem this gives the same answer as  $f$ . In cohomology terms, the integral only depends on the class of functions  $[f]$ , and the above transformation changes  $f$  by a coboundary, and so does not alter  $[f]$ . Such an  $f$ , homogeneous of degree  $n$ , belongs to the cohomology group  $H^1(\mathbb{P}\Pi, \mathcal{O}(n))$ . Thus the differential equations 'disappear' into the complex geometry of twistor space.

So to recap, as long as the line  $\mathbb{R}$  in  $\mathbb{P}\Pi$  avoids the singularity region  $\mathbb{Q}$ , then the fields given by these contour integrals will be non-singular. For example, if  $\mathbb{Q} \in \mathbb{P}\Pi^-$ , then the field  $\phi(x)$  will be non-singular for all lines  $\mathbb{R} \in \mathbb{P}\Pi^+$ . It may be shown that these fields have positive frequency, and so the notion of positive and negative frequency has a geometrical interpretation. More generally, the field  $\phi$  will be non-singular in any region of  $\mathbb{C}\mathbb{M}$  corresponding to any region  $\hat{U}$  that does not contain the line  $\mathbb{Q}$ .

Similar results hold for the correspondence between  $\mathbb{R}^{2+1}$  and minitwistor space; solutions of the wave equation  $\square\phi = 0$  on  $\mathbb{R}^{2+1}$  are given by the contour integral

$$\begin{aligned}\phi(x) &= \frac{1}{2\pi i} \oint \rho_X f(\omega, \pi_A) \pi_C d\pi^C, \\ &= \frac{1}{2\pi i} \oint f(x^{AB} \pi_A \pi_B, \pi_A) \pi_C d\pi^C,\end{aligned}$$

where  $f \in H^1(T^{1,0}\mathbb{CP}^1, \mathcal{O}(-2))$ .

## 2.5 The Twistor Correspondence for Gauge Fields

Before outlining the twistor correspondence for gauge fields, one first has to define the terms self-dual and anti-self-dual. Given a bivector, its dual is defined by

$$*F_{ab} = \frac{1}{2} \varepsilon_{ab}{}^{cd} F_{cd}.$$

As a consequence of the signature of Minkowski spacetime,  $**F_{ab} = -F_{ab}$ . Any bivector may be decomposed into a sum of its self-dual and anti-self-dual parts, or  $F_{ab} = F_{ab}^+ + F_{ab}^-$ , where

$$F_{ab}^\pm = \frac{1}{2} (F_{ab} \mp i * F_{ab}).$$

The bivector is said to be self-dual if  $F_{ab}^- = 0$ , and anti-self-dual if  $F_{ab}^+ = 0$ . The factors of  $i$  appear because of the signature of Minkowski space. One consequence of this is the absence of non-trivial  $su(N)$ -valued (anti)-self-dual fields. For if  $F_{ab}$  is an antihermitian matrix, then so is  $*F_{ab}$ , and so  $*F_{ab} = \pm i F_{ab}$  implies  $F_{ab} = 0$ . In this thesis the spaces  $\mathbb{R}^4$  and  $\mathbb{R}^{2+2}$  (equipped with the obvious metrics) will be used, and this problem does not arise. The notion of (anti)-self-duality appears naturally when the bivector  $F_{ab}$  is written in spinor form,

$$F_{ab} = \phi_{AB} \varepsilon_{A'B'} + \bar{\phi}_{A'B'} \varepsilon_{AB},$$

and hence

$$*F_{ab} = -i \phi_{AB} \varepsilon_{A'B'} + i \bar{\phi}_{A'B'} \varepsilon_{AB}.$$

The bivector is self-dual if  $\phi_{AB} = 0$ , and anti-self-dual if  $\bar{\phi}_{A'B'} = 0$ .

It is important to note that the essential information about the geometry of  $\mathbb{CM}$  is contained in the projective twistor space  $\mathbb{P}\Pi$ , not in  $\Pi$ . The extra structure in  $\Pi$  is a choice of scale for the spinor  $\pi_{A'}$  associated with with  $\alpha$ -plane. In fact,  $\Pi$  may be thought of as a line bundle with base space  $\mathbb{P}\Pi$ ,  $\pi_{A'}$  being the fibre coordinate. However, if  $X^b = \lambda^A \pi^{B'}$  is the tangent vector to the  $\alpha$ -plane, the spinor  $\pi_{A'}$  has to satisfy the equation

$$\begin{aligned} X^b \nabla_b \pi_{A'} &= 0 \\ \text{i.e. } \pi^{B'} \nabla_{BB'} \pi_{A'} &= 0. \end{aligned} \quad (2.18)$$

So, given a solution to this equation, a fibre bundle  $\Pi$  may be constructed. Conversely, a given bundle provides a solution to this equation. This leads to a way of encoding some additional structure on  $\mathbb{CM}$  as a bundle over projective twistor space,  $\mathbb{P}\Pi$ .

Consider the generalisation of (2.18), given by

$$\pi^{B'} D_{BB'} \Phi = \pi^{B'} (\nabla_{BB'} - i A_{BB'}) \Phi, \quad (2.19)$$

for some vector  $A_{BB'}$ . This is an overdetermined system of equations, unless the integrability condition

$$\nabla_{A(A'} A_{B')}^A = 0 \quad (2.20)$$

is satisfied.

So if the vector  $A_{AA'}$  satisfies (2.20), then the equation (2.19) is integrable on  $\alpha$ -planes. This defines a holomorphic line bundle over that part of  $\mathbb{P}\Pi$  corresponding to the region in  $\mathbb{CM}$  on which the vector  $A_{AA'}$  is defined. The fibre of this bundle is the vector space of solutions to (2.19).

On each  $\alpha$ -plane the equation

$$\pi^{A'} D_{AA'} \Phi = 0 \quad (2.21)$$

may be solved. Consider all the  $\alpha$ -planes through a point  $p \in \mathbb{CM}$ . Equation (2.21) enables the solution on different  $\alpha$ -planes to be compared, by comparing them at the point  $p$ . Thus the bundle, when restricted to the line  $L_X$  in  $\mathbb{P}\Pi$ , must be trivial.



From the field

$$\phi_{AB} = \nabla_{A'(A} A_{B)}^{A'},$$

it follows from (2.20) that  $\phi_{AB}$  satisfies Maxwell's equation

$$\nabla_{A'}^A \phi_{AB} = 0,$$

i.e. the field  $A_{AA'}$  is the potential from the Maxwell field  $\phi_{AB}$ . Conversely, given any anti-self-dual Maxwell field, its potential  $A_{AA'}$  may be found and hence the bundle constructed. This may be summarised as:

### Theorem 2.1

Let  $U$  be an open convex set in  $\mathbb{CM}$ . There is a natural one-to-one correspondence between

(a) anti-self-dual Maxwell fields on  $U$ ;

and

(b) complex line bundles  $\mathbf{E}$  over the corresponding region

$\hat{U}$  of  $\mathbb{P}\Pi$  such that  $\mathbf{E}$  restricted to the line  $L_x$  is trivial for all  $x \in U$ .

This is known as the twisted photon construction. This is another example of how the differential equations on  $\mathbb{CM}$  'disappear', under the Penrose correspondence, into the complex geometry of holomorphic bundles over projective twistor space. It is important to note that this is a local construction, over a region  $U$  of  $\mathbb{CM}$ . Global solutions, with particular boundary conditions, are harder to construct.

This theorem generalises to non-Abelian gauge groups of arbitrary rank, which is remarkable because the equations involved are non-linear. The result is:

**Theorem 2.2**

Let  $U$  be an open convex set in  $\mathbf{CM}$ . There is a natural one-to-one correspondence between

(a) anti-self-dual  $GL(N, \mathbb{C})$  gauge fields on  $U$ ;

and

(b) holomorphic rank- $N$  vector bundles  $\mathbb{E}$  over the corresponding region

$\hat{U}$  of  $\mathbb{P}\Pi$  such that  $\mathbb{E}$  restricted to the line  $L_X$  is trivial for all  $x \in U$ .

Suppose the region  $\hat{U}$  is covered by two convex sets  $W$  and  $\underline{W}$ . The bundle is determined by the  $N \times N$  transition matrix  $F(Z^\alpha)$ , holomorphic on the intersection  $W \cap \underline{W}$ . As in the last section, let  $\rho_X$  denote the pull back of the (now matrix valued) function  $F(Z^\alpha)$  from  $\Pi$  to the correspondence space  $\mathbb{F}$ . So let

$$\begin{aligned} G(x, \pi_{A'}) &= \rho_X F(Z^\alpha) \\ &= F(ix^{AA'} \pi_{A'}, \pi_{A'}). \end{aligned} \quad (2.22)$$

As a consequence of the bundle being trivial when restricted to the line  $L_X$ , the matrix  $G$  splits

$$G = \underline{H}.H^{-1}, \quad (2.23)$$

where  $H$  and  $\underline{H}$  are holomorphic in  $W$  and  $\underline{W}$  respectively. The gauge fields are then extracted from the formula

$$\begin{aligned} \pi^{A'} A_{AA'} &= H^{-1} \pi^{A'} \nabla_{AA'} H, \\ &= \underline{H}^{-1} \pi^{A'} \nabla_{AA'} \underline{H}. \end{aligned} \quad (2.24)$$

This last line follows from the fact that the operator  $\pi^{A'} \nabla_{AA'}$  annihilates  $G$ . It also follows from this that the fields  $A_{AA'}$  are well defined, i.e. linear in  $\pi_{A'}$ , as, since both expressions are holomorphic in their respective domains, they must be holomorphic on the whole of the Riemann sphere given by the projective line  $L_X$ . Also the functions are homogeneous, so, by an extension of Liouville's Theorem, both expressions must be linear in  $\pi_{A'}$ .

The splitting (2.23) is not unique. If  $\Lambda(x)$  is a non-singular matrix, then under the change

$$H \mapsto H.\Lambda,$$

$$\underline{H} \mapsto \underline{H}.\Lambda,$$

the function  $G$  does not change. However the fields  $A_{AA'}$  do change:

$$A_a \mapsto \Lambda^{-1}.A_a.\Lambda + \Lambda^{-1}.\nabla_a\Lambda, \tag{2.25}$$

which is just a gauge transformation.

So far the gauge group has been  $GL(N, \mathbb{C})$ . To get to the various subgroups, further conditions have to be imposed. The easiest subgroup to consider is  $SL(N, \mathbb{C})$ . This is done by making the bundle  $\mathbf{E}$  satisfy the further condition  $\det \mathbf{E}$  is trivial, or in terms of the patching matrix,  $\det F = 1$ . To go to a 'real' subgroup like  $SU(2)$ , a reality structure on  $\mathbb{P}\mathbb{P}$  has to be introduced.

So far the gauge fields have been constructed over Minkowski space  $\mathbb{M}$  or its complexified version  $\mathbb{CM}$ . However, as mentioned earlier, there are no non-trivial  $SU(2)$  anti-self-dual gauge fields on  $\mathbb{M}$ . However the twistor construction may be used to construct solutions to these equations on Euclidean  $\mathbb{R}^4$ , this class including the instanton and monopole solutions, and on the space  $\mathbb{R}^{2+2}$ . The self-duality equations on these spaces, as will be shown in chapters III, include large numbers of the two-dimensional integrable models.

Recall that a reality structure is an anti-holomorphic involution on  $\mathbb{P}\mathbb{P}$ , which was denoted in section 2.2 by the map  $\sigma : \mathbb{P}\mathbb{P} \rightarrow \mathbb{P}\mathbb{P}$ . It will be assumed that  $\sigma$  interchanges the regions  $W$  and  $\underline{W}$  that cover the region  $\hat{U}$  of twistor space. This involution lifts to the bundle  $\mathbf{E}$ , and defines a map  $\tau$  from  $\mathbf{E}$  to its dual,  $\mathbf{E}^*$ . For this to be well defined, the diagram

$$\begin{array}{ccc} \mathbf{E} & \xrightarrow{\tau} & \mathbf{E}^* \\ \downarrow & & \downarrow \\ \hat{U} & \xrightarrow{\sigma} & \hat{U} \end{array}$$

must commute, that is, the fibre of  $\mathbf{E}$  over  $Z$ , under  $\tau$ , gets mapped to the fibre of  $\mathbf{E}^*$  over  $\sigma(Z)$ .

Explicitly, the bundle  $\mathbf{E}$  is determined by the patching matrix  $F$  between  $W$  and  $\underline{W}$ , so  $\underline{\zeta} = F(Z).\zeta$ , and the dual bundle is similarly defined by  $\underline{\mu} = \mu.F(Z)^{-1}$ . The map

$\tau : \mathbb{E} \rightarrow \mathbb{E}^*$  is defined by

$$\begin{aligned} \tau(Z, \zeta) &= (\sigma(Z), \zeta^*) && \text{if } Z \in W, \\ \tau(Z, \underline{\zeta}) &= (\sigma(Z), \underline{\zeta}^*) && \text{if } Z \in \underline{W}, \end{aligned}$$

where  $*$  denotes the complex conjugate transpose. For consistency these must agree on the overlap  $W \cap \underline{W}$ ; so  $\underline{\zeta} = F(Z)\zeta$  must imply  $\zeta^* = \underline{\zeta}^* F(\sigma(Z))^{-1}$ , which implies that

$$\begin{aligned} F(Z) &= [F(\sigma(Z))]^*, \\ &\equiv F(Z)^\dagger \end{aligned} \tag{2.26}$$

The matrix  $G$ , defined by (2.23), also satisfies  $G = G^\dagger$ , and hence, in terms of the matrices  $H$  and  $\underline{H}$  that split the matrix  $G$ ,

$$\begin{aligned} \underline{H}.H^{-1} &= G = G^\dagger = (\underline{H}.H^{-1})^\dagger = H^{\dagger-1}.\underline{H}^\dagger \\ \text{or } H^\dagger.\underline{H} &= \underline{H}^\dagger.H \end{aligned}$$

Using the same argument that was used to show the gauge fields were well-defined it follows that

$$\begin{aligned} H^\dagger.\underline{H} &= \underline{H}^\dagger.H = \Xi(x^a), \\ &= \Xi^*. \end{aligned}$$

Under the gauge transformation (2.25),

$$\Xi \mapsto \Lambda^*.\Xi.\Lambda,$$

and this may be used to diagonalise  $\Xi$ . It will be assumed that this has been done, and that  $\Xi$  has  $p(+1)$ 's and  $q(-1)$ 's as its diagonal elements. It then follows from (2.24) that

$$A_a^* = -\Xi.A_a.\Xi^{-1},$$

and so defines a  $U(p, q)$  gauge field. So together with the condition  $\det F = 1$ ,  $SU(p, q)$  gauge fields may be constructed. The map  $\tau$  is called the real form, and if  $p = 0$  or  $q = 0$  the form is said to be positive. Note that to construct  $SU(2)$ -valued fields, the condition  $\det F = 1$  implies  $\det \Xi = 1$ , so  $\Xi = \pm \mathbb{1}$ , and hence  $A_a$  is  $SU(2)$ -valued. All this may be summarised in the following theorem:

**Theorem 2.3**

Let  $U$  be an open convex set in  $\mathbb{R}^4$ . There is a natural one-to-one correspondence between

- (a) real analytic anti-self-dual  $SU(N)$  gauge fields on  $U$ ;
- and
- (b) holomorphic rank- $N$  vector bundles  $\mathbb{E}$  over the corresponding region  $\hat{U}$  of  $\mathbb{P}\mathbb{T}$  such that
  - (i)  $\mathbb{E}$  restricted to the line  $L_x$  is trivial for all  $x \in U$ .
  - (ii)  $\det \mathbb{E}$  is trivial
  - (iii)  $\mathbb{E}$  admits a positive real form.

A similar result holds for anti-self-dual fields on  $\mathbb{R}^{2+2}$ .

**2.6 The Atiyah-Ward Ansätze**

The last section showed how a solution to the self-duality equations could be encoded within the geometry of a holomorphic vector bundle. In this section the correspondence will be used to construct explicit solutions to the duality equations, starting from such a bundle.

The self-duality equations have been solved using three different techniques:

- The Atiyah-Ward Ansätze,<sup>[26]</sup>
- The Method of Monads (or ADHM construction),<sup>[27]</sup>
- The ‘Riemann Problem with zeros’ method.<sup>[51]</sup>

The first two are different methods to construct the holomorphic bundle over twistor space that encodes the solution to the self-duality equation. The third is different, in the sense that rather than constructing a bundle, it constructs a solution to the linear problem by assuming that it has a particular form. However, as shown by Tafel,<sup>[52]</sup> from such a starting point it is possible to recreate the corresponding bundle, which turns out to be equivalent to one in the Atiyah-Ward class. In chapter IV the ‘Riemann Problem with zeros’ method will be used to solve the generalised self-duality equation that will be

constructed in the next section, and the connection between this and the Atiyah-Ward ansätze will be discussed.

The hardest part of the construction outlined above is the splitting of the bundle transition matrix; given this the rest of the construction is straight forward. In this section a series of ansätze, denoted by  $\mathcal{A}_n$ , originally proposed by Atiyah and Ward, will be given for the bundle's transition matrix. These have the property that they can easily be split, and in doing so, they convert a solution to a linear problem into the solution of the non-linear self-duality equations. The construction will be given for a gauge group of rank two, though the techniques may be extended to groups of higher rank.

As mentioned in the introduction, one of the ways to construct a holomorphic vector bundle is as an extension of a line bundle  $L_1$  by another line bundle  $L_2$ . This means that the following sequence of vector bundles is exact

$$0 \rightarrow L_1 \rightarrow \mathbf{E} \rightarrow L_2 \rightarrow 0.$$

Suppose that  $\mathbb{P}\Pi$  (or just some region  $\hat{U}$  of  $\mathbb{P}\Pi$ ) is covered by two coordinate charts,  $W$  and  $\underline{W}$ . The bundle  $\mathbf{E}$  is determined by a transition matrix  $F(Z^\alpha)$  on  $W \cap \underline{W}$  of the form

$$F = \begin{pmatrix} \Xi_1 & \Gamma \\ 0 & \Xi_2 \end{pmatrix}. \tag{2.27}$$

Here  $\Xi_1$  and  $\Xi_2$  are transition functions for the line bundles  $L_1$  and  $L_2$  respectively. The off diagonal element  $\Gamma$  belongs to the sheaf cohomology group  $H^1(\hat{U}, \mathcal{O}(L_1 \otimes L_2^{-1}))$ .

For the gauge group  $SL(2, \mathbb{C})$  (as opposed to  $GL(2, \mathbb{C})$ ),  $F$  has to satisfy the condition  $\det F = 1$ , which implies  $\Xi_1 = \Xi_2^{-1}$ . One may take<sup>[46]</sup>

$$\Xi_1(Z^\alpha) = \xi^k \exp f(Z^\alpha),$$

where  $\xi = \pi_0/\pi_1$  is a non-homogeneous coordinate on  $\mathbb{C}P^1$ ,  $f$  is a holomorphic function on the region  $W \cap \underline{W}$ , and  $k$  is the negative of the Chern number of the line bundle  $L_1$ .

Although such an upper-triangular transition matrix does not satisfy the condition  $F^\dagger = F$ , it is equivalent to one, denoted  $\tilde{F}$ , that does. This means it is possible to find

matrices  $K$  and  $\underline{K}$ , holomorphic in  $W$  and  $\underline{W}$  respectively, so that the combination

$$\tilde{F} = \underline{K}^{-1} \cdot F \cdot K$$

does satisfy  $\tilde{F}^\dagger = \tilde{F}$ . These equivalent matrices determine the same bundle, and give rise to the same gauge fields.

Although these upper triangular patching matrices do not generate all solutions to the self-duality equations, it has recently been shown that (in some appropriate sense) they form a dense subset in the set of all patching matrices.<sup>[53]</sup> However, the class does provide the matrices which gives rise to the instanton and monopole solutions, and as will be shown in chapter IV, the soliton solutions to various integrable models.

The freedom in the splitting corresponds to the freedom in the gauge. However there is a gauge, called the Yang  $R$ -gauge, which leads to a particularly nice form of the gauge potentials.

**Theorem 2.4**

Let  $B_a$  be a potential for an anti-self-dual  $GL(1, \mathbb{C})$ -gauge field (i.e. a complex Maxwell field), and let  $\{\Delta_r\}_{r=1-k}^{k-1}$  be a set of fields satisfying

$$\begin{aligned} \text{if } k > 1 : (\nabla_{A0'} + 2B_{A0'})\Delta_r &= (\nabla_{A1'} + 2B_{A1'})\Delta_{r+1} \\ &\text{for } 1 - k \leq r \leq k - 2; \\ \text{if } k = 1 : (\nabla_a + 2B_a)(\nabla^a + 2B^a)\Delta_0 &= 0. \end{aligned} \tag{2.28}$$

Suppose that  $B_a$  and  $\Delta_r$  are holomorphic on the region  $U$  of complexified spacetime. Let  $M$  be the  $k \times k$  matrix

$$M = \begin{pmatrix} \Delta_{1-k} & \dots & \Delta_0 \\ \vdots & \ddots & \vdots \\ \Delta_0 & \dots & \Delta_{k-1} \end{pmatrix}$$

i.e.  $M_{rs} = \Delta_{r+s-k-1}$  for  $1 \leq r, s \leq k$ . Let  $E, F$  and  $G$  be the corner elements of its inverse:  $E = (M^{-1})_{11}, F = (M^{-1})_{1k} = (M^{-1})_{k1}$  and  $G = (M^{-1})_{kk}$  (assume that  $\det M \neq 0$  on  $U$ ). Finally, define a gauge potential  $A_a$  (recall  $A_a dx^a = A_{AA'} dx^{AA'}$ ) by

$$\begin{aligned} A_{A0'} &= \frac{1}{2F} \begin{pmatrix} \tilde{\partial}_{A0'} F & 0 \\ -2\tilde{\partial}_{A1'} G & -\tilde{\partial}_{A0'} F \end{pmatrix}, \\ A_{A1'} &= \frac{1}{2F} \begin{pmatrix} -\tilde{\partial}_{A1'} F & -2\tilde{\partial}_{A0'} G \\ 0 & \tilde{\partial}_{A1'} F \end{pmatrix}, \end{aligned}$$

where  $\tilde{\partial}_a = \nabla_a - 2B_a$ . Then  $A_a$  is the potential for an anti-self-dual  $SL(2, \mathbb{C})$ -gauge field.

---

**Remarks**

- The Maxwell field  $B_a$  comes from splitting the function  $f$ , restricted to the line  $L_X$ ,

$$\begin{aligned} g &= \rho_X f(Z^\alpha) \\ &= f(ix^{AA'} \pi_{A'}, \pi_{A'}) \\ &= \underline{h} - h, \end{aligned}$$

where  $h$  and  $\underline{h}$  are holomorphic in  $U$  and  $\underline{U}$  respectively. The field  $B_a$  itself comes from



the equation

$$\pi^{A'} B_{AA'} = \pi^{A'} \nabla_{AA'} h = \pi^{A'} \nabla_{AA'} \underline{h}.$$

o The  $\Delta_r$  can be constructed using the integral formulae used in section 2.4. Let

$$\begin{aligned} \Omega(x, \pi_{A'}) &= \rho_X \Gamma(Z^\alpha) \\ &= \Gamma(ix^{AA'} \pi_{A'}, \pi_{A'}). \end{aligned}$$

The  $\Delta_r$  are defined by the formula

$$\begin{aligned} \Omega &= e^{\underline{h}+h} \sum_{r=-\infty}^{\infty} \Delta_r(x, y, z, t) \zeta^{-r}, \\ \text{i.e. } \Delta_r &= \frac{1}{2\pi i} \oint \Omega e^{-\underline{h}-h} \zeta^r \frac{d\zeta}{\zeta} \end{aligned} \quad (2.29)$$

These form the components of a massless field of helicity  $k - 1$  coupled to the Maxwell field  $B_a$ . For example, if  $k = 2$ , the field  $\phi_{A'B'}$  defined by

$$\begin{aligned} \phi_{0'0'} &= \Delta_1, \\ \phi_{0'1'} &= \Delta_0, \\ \phi_{1'1'} &= \Delta_{-1}. \end{aligned}$$

satisfied the equation  $(\nabla^{AA'} + 2B^{AA'})\phi_{A'B'} = 0$ .

o If  $f = 0$  (and so  $B_a = 0$ ), the  $\Delta_r$  are just components of a free field of helicity  $k - 1$ , and (2.29) is just (2.16) written in non-homogeneous coordinates. Once the  $\Delta_r$  are known, gauge potentials may be easily worked out. Thus the solution of a complicated nonlinear field theory is reduced to working out a solution to a linear problem.

The simplest case is when  $k = 1$ , and  $f = 0$ . From the Theorem it follows that the ansatz  $\mathcal{A}_1$  gives a solution which is determined purely from the single term  $\Delta_0$  given by the contour integral

$$\Delta_0 = \frac{1}{2\pi i} \oint \Omega \frac{d\zeta}{\zeta}, \quad (2.30)$$

which satisfies the equation  $\square \Delta_0 = 0$ . The above Theorem then gives the result

$$A_a = i\tilde{\sigma}_{ab} \nabla^b \log \Delta_0,$$

where the anti-symmetric  $\tilde{\sigma}_{ab}$  satisfy

$$\begin{aligned}\tilde{\sigma}_{01} &= \tilde{\sigma}_{23} = -\frac{1}{2}\sigma_1, \\ \tilde{\sigma}_{02} &= -\tilde{\sigma}_{13} = -\frac{1}{2}\sigma_2, \\ \tilde{\sigma}_{03} &= \tilde{\sigma}_{12} = \frac{1}{2}\sigma_3,\end{aligned}$$

the  $\sigma_i$  being the Pauli matrices. This solution is just the t'Hooft-Corrigan-Fairlie-Wilczek ansatz.<sup>[28]</sup> Taking as a solution to  $\square\Delta_0 = 0$ ,

$$\Delta_0 = \sum_{n=0}^k \frac{\lambda_n}{\delta_{ab}(x^a - x_n^a)(x^b - x_n^b)}, \quad \lambda_n > 0, \quad x_n \in \mathbb{R}^4.$$

gives the  $5k + 4$  parameter family of finite energy instantons of topological charge  $k$ . The higher ansätze  $\mathcal{A}_n$  are needed for the complete  $8k - 3$  parameter solution.

The next, and final, example gives the general form of the patching matrix which generates all the monopole solutions. Let  $f$  be real, i.e.  $f^\dagger = f$ , and

$$\Gamma = Q^{-1}\{e^f + (-1)^k e^{-f}\},$$

where  $Q = (\pi_0, \pi_1)P$  and  $P(Z^\alpha)$  is a homogeneous polynomial of degree  $2k$  which satisfies the condition  $P^\dagger = (-1)^k P$ . Then

$$\begin{aligned}\tilde{F} &= F\dot{K} \\ &= \begin{pmatrix} \zeta^k \cdot e^f & \Gamma \\ 0 & \zeta^{-1} \cdot e^{-f} \end{pmatrix} \cdot \begin{pmatrix} 0 & -1 \\ 1 & \zeta^k Q \end{pmatrix} \\ &= \begin{pmatrix} \Gamma & (-1)^k e^{-f} \\ \zeta^{-k} e^{-f} & Q e^{-f} \end{pmatrix}\end{aligned}$$

This does satisfy the condition  $\tilde{F}^\dagger = \tilde{F}$ .

### Example

With the above transition matrix, let  $k = 1$ ,

$$\begin{aligned}f = Q &= i\omega^1/\pi_1 - i\omega^0/\pi_0 \quad \text{and} \\ \Gamma &= 2f^{-1} \sinh f.\end{aligned}$$

This gives  $\Delta_0 = r^{-1} \sinh r$ , where  $r^2 = x^2 + y^2 + z^2$ , and hence the Higgs field

$$\phi = ir^{-2}(r \coth r - 1)(x\sigma_1 + y\sigma_2 - z\sigma_3).$$

This is just the well-known charge one monopole.

## 2.7 Generalisations of the Self-Duality Equations

In section 2.2 the projective twistor space  $\mathbb{P}\Pi$  was shown to be isomorphic to the space  $\mathbb{C}\mathbb{P}^3$ , which corresponds to complexified compactified Minkowski space. To describe non-compactified spacetime, the 'point at infinity' has to be removed, and this corresponds to removing a single projective line from  $\mathbb{C}\mathbb{P}^3$ , such as the line  $\{\pi_0 = \pi_1 = 0\}$ , and the resulting complex manifold was denoted  $\Pi^I$ . This manifold may be thought as a fibre bundle over the Riemann sphere. Letting  $\{\pi_A : A = 0, 1\}$  (removing the prime superscript) be homogeneous coordinates on the Riemann sphere; then  $\Pi^I$  may be described by the relation

$$\Pi^I = \{(\pi_0, \pi_1, \omega^0, \omega^1); \omega^0, \omega^1 \in \mathbb{C}\} / \sim,$$

where  $\sim$  is the equivalence relation defined by

$$(\pi_0, \pi_1, \omega^0, \omega^1) \sim (\lambda\pi_0, \lambda\pi_1, \lambda\omega^0, \lambda\omega^1), \quad \forall \lambda \in \mathbb{C} \setminus \{0\}.$$

This makes  $\Pi^I$  into a fibre bundle over  $\mathbb{C}\mathbb{P}^1$  with the projection onto the base space being defined by  $pr(\pi_A, \omega^A) = \pi_A$ .

This suggests the following generalisation of Twistor space, an extension of the ideas of Mason and Sparling.<sup>[54]</sup> Let the space  $\Pi_{m,n}$  be defined, for  $m, n = 1, 2, \dots$ , by

$$\Pi_{m,n} = \{(\pi_0, \pi_1, \omega^0, \omega^1); \omega^0, \omega^1 \in \mathbb{C}\} / \sim,$$

where  $\sim$  is the equivalence relation defined by

$$(\pi_0, \pi_1, \omega^0, \omega^1) \sim (\lambda\pi_0, \lambda\pi_1, \lambda^m\omega^0, \lambda^n\omega^1), \quad \forall \lambda \in \mathbb{C} \setminus \{0\}.$$

This makes the space  $\Pi_{m,n}$  into a fibre bundle over  $\mathbb{C}\mathbb{P}^1$  (the projection onto the base space being defined by  $pr(\pi_A, \omega^A) = \pi_A$ ), with each fibre being a copy of  $\mathbb{C}^2$ . So  $\Pi_{1,1}$  is just  $\Pi^I \cong \mathbb{C}\mathbb{P}^3 \setminus \{\text{a projective line}\}$ .

In what follows it will be convenient to introduce inhomogeneous coordinates on  $\Pi_{m,n}$ .

The sphere  $\mathbb{C}\mathbb{P}^1$  may be covered by two coordinate patches defined by

$$\begin{aligned} U &= \{\pi_A \in \mathbb{C}\mathbb{P}^1 : \pi_0 \neq 0\} \\ \underline{U} &= \{\pi_A \in \mathbb{C}\mathbb{P}^1 : \pi_1 \neq 0\}. \end{aligned} \quad (2.31)$$

So over  $U$  and  $\underline{U}$  one has coordinates

$$\begin{aligned} (\xi, \eta_0, \eta_1) &= \left( \frac{\pi_1}{\pi_0}, \frac{\omega^0}{\pi_0^m}, \frac{\omega^1}{\pi_0^n} \right), \\ (\underline{\xi}, \underline{\eta}_0, \underline{\eta}_1) &= \left( \frac{\pi_0}{\pi_1}, \frac{\omega^0}{\pi_1^m}, \frac{\omega^1}{\pi_1^n} \right), \end{aligned}$$

respectively. On the overlap region  $U \cap \underline{U}$  these are related by

$$(\underline{\xi}, \underline{\eta}_0, \underline{\eta}_1) = (\xi^{-1}, \xi^{-m}\eta_0, \xi^{-n}\eta_1). \quad (2.32)$$

Let  $\Gamma(\mathcal{B})$  be the space of global holomorphic sections of a bundle  $\mathcal{B}$ . A point  $\rho \in \Gamma(\Pi_{m,n})$  may be written over  $U$  as

$$\begin{aligned} \rho(\xi) &= (\hat{\eta}_0, \hat{\eta}_1), \\ &= \left( \sum_{i=0}^m x_i \xi^i, \sum_{j=0}^n t_j \xi^j \right). \end{aligned} \quad (2.33)$$

These are clearly holomorphic over  $U$ , and using (2.32) they are also holomorphic over  $\underline{U}$ , and hence form a global holomorphic section of  $\Pi_{m,n}$ . If higher or lower powers of  $\xi$  were included then the section would have poles at  $\underline{\xi} = 0$  ( $\xi = \infty$ ) and  $\xi = 0$  respectively. Thus  $\Gamma[\Pi_{m,n}] \cong \mathbb{C}^{m+n+2}$ . This correspondence is shown diagrammatically in Fig.2.6.

On  $\Pi_{m,n}$  it is possible to define a non-vanishing holomorphic vector field

$$V = \pi_0^m \frac{\partial}{\partial \omega^0} + \pi_1^n \frac{\partial}{\partial \omega^1},$$

or, in terms of the inhomogeneous coordinates  $U$ , as

$$V = \frac{\partial}{\partial \eta_0} + \xi^n \frac{\partial}{\partial \eta_1}.$$

Since this is non-vanishing there is a well defined quotient  $\Pi_{m,n}/V$ , which is isomorphic to  $\mathcal{O}(m+n)$ , the complex line bundle of Chern class  $(m+n)$  over the Riemann sphere.

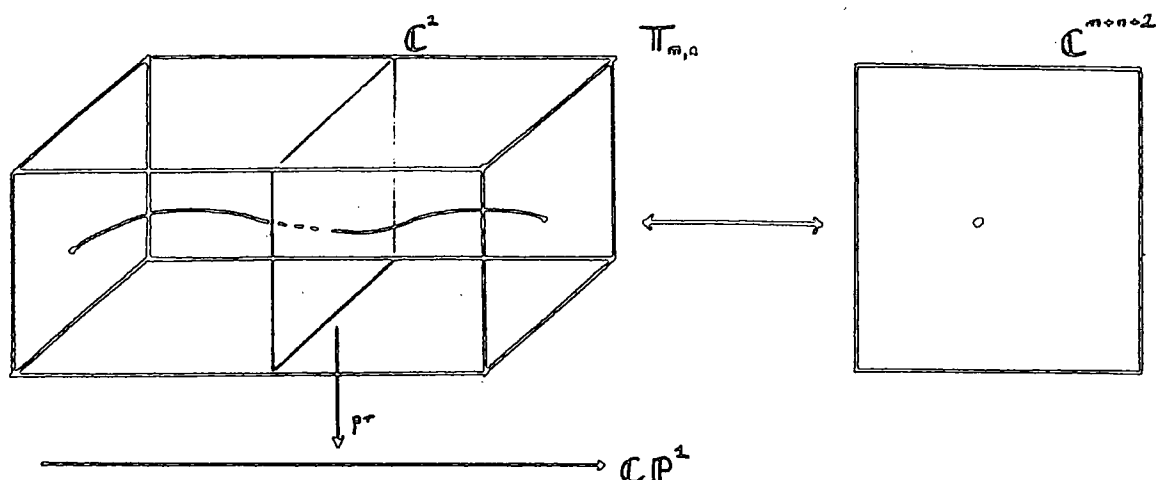

Fig 2.6 The Correspondence between  $\mathbb{C}^{m+n+2}$  and  $\Pi_{m,n}$ .

The coordinates  $(\xi, \eta)$  on  $\mathcal{O}(m+n)$  are defined from those on  $\Pi_{m,n}$  by  $\eta = \xi^n \eta_0 - \eta_1$  (and hence satisfies the equation  $V(\eta) = 0$ ), and similarly the global holomorphic section of  $\mathcal{O}(m+n)$  may be written in terms of the sections of  $\Pi_{m,n}$ . Let  $\hat{\eta} \in \Gamma[\mathcal{O}(m+n)]$  be defined by

$$\begin{aligned} \hat{\eta} &= \xi^n \hat{\eta}_0 - \hat{\eta}_1, \\ &= \sum_{i=1}^m x_i \xi^{i+n} + (x_0 - t_n) \xi^n - \sum_{j=0}^{n-1} t_j \xi^j. \end{aligned}$$

Note that this only depends on  $x_0 - t_n$ , i.e. the dependence on  $x_0 + t_n$  has been factored out. This corresponds to a symmetry on  $\mathbb{C}^{m+n+2}$  generated by  $\frac{\partial}{\partial x_0} - \frac{\partial}{\partial t_n}$ . For the simplest example, with  $m = n = 1$  one has  $\Pi_{1,1}/V \cong \mathcal{O}(2)$ , which is just the 'minitwistor' space first studied by Hitchin. All this may be summarised in the following diagram:

$$\begin{array}{ccc} \Pi_{m,n} & \longleftrightarrow & \Gamma[\Pi_{m,n}] \cong \mathbb{C}^{m+n+2} \\ V \downarrow & & \downarrow \frac{\partial}{\partial x_0} - \frac{\partial}{\partial t_n} \\ \mathcal{O}(m+n) & \longleftrightarrow & \Gamma[\mathcal{O}(m+n)] \cong \mathbb{C}^{m+n+1}. \end{array}$$

One could factor out by other non-vanishing vector fields on  $\Pi_{m,n}$ , but the field considered here is special in the sense that physically it corresponds to the removal of a single degree of freedom, namely the dependence on  $x_0 + t_n$ , rather than several such combinations.

Next holomorphic vector bundles will be constructed over  $\Pi_{m,n}$ . These will correspond to a system of differential equations on  $\mathbb{C}^{m+n+2}$  which generalise the well-known Yang-Mills self-duality equations. Factoring out by the vector field  $V$  gives rise to the Bogomolny hierarchy introduced by Mason and Sparling, which they used to give a twistor description to the AKNS soliton hierarchy. Here it will be assumed that such a symmetry does not exist, and this will generate a family of integrable models in  $(2+1)$  dimensions, which contains the AKNS hierarchy as a special case.

The construction of such bundles is standard. Let  $\mathbb{E}$  be a holomorphic vector bundle over  $\Pi_{m,n}$  with structure group  $GL(N, \mathbb{C})$ , with the further property that it is trivial when restricted to any global holomorphic section, i.e. an element  $\rho$  of  $\Gamma[\Pi_{m,n}]$ . Explicitly, let the bundle be defined by the patching matrix  $F(\xi, \eta_A)$  between the regions of  $\Pi_{m,n}$  over  $U$  and  $\underline{U}$ . The triviality condition implies that the bundle may be split

$$F(\xi, \hat{\eta}_A) = \underline{\Phi}(\xi, x_i, t_j) \cdot \Phi^{-1}(\xi, x_i, t_j), \quad (2.34)$$

where  $\Phi$  and  $\underline{\Phi}$  are holomorphic in  $U$  and  $\underline{U}$  respectively, and  $\hat{\eta}_A$  are defined by (2.33).

The polynomials  $\hat{\eta}_A$ ,  $A = 0, 1$  are annihilated by the following differential operators

$$\begin{aligned} K_k &= \xi \frac{\partial}{\partial x_{k-1}} - \frac{\partial}{\partial x_k} & k = 1, \dots, m, \\ L_l &= \xi \frac{\partial}{\partial t_{k-1}} - \frac{\partial}{\partial t_k} & l = 1, \dots, n. \end{aligned}$$

These operators annihilate the left hand side of (2.34), so

$$\Phi^{-1} K_k \Phi = \underline{\Phi}^{-1} K_k \underline{\Phi},$$

and similarly for the operators  $L_l$ . The right hand side of this is holomorphic in  $\underline{U}$ , and the left hand side is holomorphic in  $U$ . Hence the whole expression is holomorphic over  $\mathbb{C}\mathbb{P}^1$  and so, by an extension to Liouville's Theorem, it must be linear in  $\xi$ . This defines  $GL(N, \mathbb{C})$ -valued functions (or gauge potentials):

$$\begin{aligned} \Phi^{-1} K_k \Phi &= \xi A_{k-1} - D_k, \\ \Phi^{-1} L_l \Phi &= \xi C_{k-1} - B_k. \end{aligned}$$

Rearranging gives a family of linear operators  $\mathcal{K}$  and  $\mathcal{L}$ ,

$$\begin{aligned}\mathcal{K}_k \Phi &= 0 \quad k = 1, \dots, m, \\ \mathcal{L}_l \Phi &= 0 \quad l = 1, \dots, n,\end{aligned}$$

defined by

$$\begin{aligned}\mathcal{K}_k &= \xi \left[ \frac{\partial}{\partial x_{k-1}} - A_{k-1} \right] - \left[ \frac{\partial}{\partial x_k} - D_k \right], \\ \mathcal{L}_l &= \xi \left[ \frac{\partial}{\partial t_{l-1}} - C_{l-1} \right] - \left[ \frac{\partial}{\partial t_l} - B_l \right].\end{aligned}\tag{2.35}$$

The gauge potential  $A, B, C, D$  are  $gl(N, \mathbb{C})$ -valued functions of  $x_i$  and  $t_j$ . Similar equations also hold for  $\Phi$ . The splitting (2.34) is not unique, different splittings will give gauge equivalent fields, the gauge transformation being  $A_k \mapsto g^{-1} \cdot A_k \cdot g - g^{-1} \cdot \frac{\partial g}{\partial x_k}$ , etc., where  $g(x_i, t_j) \in GL(N, \mathbb{C})$ .

The differential equations which these gauge fields satisfy may be found by equating the coefficients of the various powers of  $\xi$  in the following ‘integrability’ conditions

$$\begin{aligned}[\mathcal{K}_k, \mathcal{K}_{k'}] &= 0, \\ [\mathcal{K}_k, \mathcal{L}_l] &= 0, \\ [\mathcal{L}_l, \mathcal{L}_{l'}] &= 0.\end{aligned}\tag{2.36}$$

Once again, if  $n = m = 1$  then these are just the self-duality equations for a  $GL(N, \mathbb{C})$ -valued gauge field on  $\mathbb{C}^4$ , and if the bundle is symmetric under the action of  $V$ , the reduced system is just the Bogomolny equations. The equations (2.36) thus forms an integrable system of equations, whose solutions may be constructed using the above Penrose correspondence. In the next section it will be shown how to construct various integrable hierarchies of equations in  $(2 + 1)$  dimensions using these equations.

Other generalisations of the self-duality equations have been considered.<sup>[55]</sup> In particular by generalising twistor space from (a region of)  $\mathbb{C}P^3$  to (a region of)  $\mathbb{C}P^q$ . The twistor space considered here may also be obtained by factoring out by an appropriate number of non-vanishing holomorphic vectors fields from  $\mathbb{C}P^q$ , so the system of equations (2.36) could be considered as a reduction of such a system, just as minitwistor space is a reduction (under a particular symmetry) of twistor space. However it is convenient to use  $\Pi_{m,n}$  (as will be shown in the next chapter) since the dimension of the twistor space is independent of the particular values of  $m$  and  $n$ .

One could also consider the following generalisation of the above; let  $\Pi_{m_1, m_2, \dots, m_N}$  be defined, for  $m_i = 1, 2, \dots$ , by

$$\Pi_{m_1, m_2, \dots, m_N} = \{(\pi_0, \pi_1, \omega^1, \dots, \omega^N); \omega^i \in \mathbb{C}\} / \sim,$$

where  $\sim$  is the equivalence relation defined by

$$(\pi_0, \pi_1, \omega^1, \dots, \omega^N) \sim (\lambda\pi_0, \lambda\pi_1, \lambda^{m_1}\omega^1, \dots, \lambda^{m_N}\omega^N), \quad \forall \lambda \in \mathbb{C} \setminus \{0\}.$$

The resulting complex manifold, which again is a reduction of the projective space  $\mathbb{C}P^q$  (for some large enough  $q$ ), and has complex dimension  $N + 1$ . However, if  $m_i = 1 \forall i$ , then

$$\underbrace{\Pi_{1, \dots, 1, \dots, 1}}_{q-1 \text{ terms}} \cong \mathbb{C}P^q \setminus \{\text{a projective line}\}$$

and this may be compactified by adding in the missing projective line.

The above construction yields  $GL(N, \mathbb{C})$ -valued gauge fields, and as in the self-dual case, to obtain  $SU(N)$ -valued fields further conditions on the bundle have to be imposed.

**Theorem 2.5**

There is a natural one-to-one correspondence between

- (a) Real analytic solutions of (2.36) over a convex region  $U$  of  $\mathbb{R}^{m+n+2}$  with gauge group  $SU(N)$  and
- (b) holomorphic rank  $N$  vector bundles  $\mathbf{E}$  over the corresponding region  $\hat{U}$  of  $\Pi_{m,n}$  such that:
  - (i)  $\mathbf{E}|_U$  is trivial for all real sections corresponding to points in  $U$ ,
  - (ii)  $\det \mathbf{E}$  is trivial,
  - (iii)  $\mathbf{E}$  admits a reality structure.



The only part of the Theorem that requires elucidation is the definition of reality structure. This is the antiholomorphic involution on  $\mathbb{P}_{m,n}$  defined by

$$\sigma(\pi_A, \omega^A) = (\bar{\pi}_A, \bar{\omega}^A),$$

where the bar denotes the complex conjugate. Those sections  $\rho \in \Gamma[\mathbb{P}_{m,n}]$  which are preserved by the action of  $\sigma$  are called the real sections, and form a subset  $\Gamma_{\mathbb{R}} \subset \Gamma[\mathbb{P}_{m,n}]$ . These are still given by (2.33) but now  $x_i, t_j \in \mathbb{R}$ , so  $\Gamma_{\mathbb{R}} \cong \mathbb{R}^{m+n+2}$ .

Again, this lifts to the bundle over  $\mathbb{P}_{m,n}$ . Let  $\hat{U}$  be any region of  $\mathbb{P}_{m,n}$ , and let  $W$  and  $\underline{W}$  be a cover for  $\hat{U}$  such that

$$\begin{aligned} \sigma(W) &= W, \\ \sigma(\underline{W}) &= \underline{W}. \end{aligned}$$

Note that this differs from the usual reality structure which interchanges  $W$  and  $\underline{W}$ . The map  $\tau : \mathbb{E} \rightarrow \mathbb{E}^*$ , is defined as before:

$$\begin{aligned} \tau(Z, \zeta) &= (\sigma(Z), \zeta^*), & \text{if } Z \in W, \\ \tau(Z, \underline{\zeta}) &= (\sigma(Z), \underline{\zeta}^*), & \text{if } Z \in \underline{W}. \end{aligned}$$

Again, these must be consistent on the overlap region  $W \cap \underline{W}$ , so  $\underline{\zeta} = F(Z)\zeta$  must imply  $\underline{\zeta}^* = \zeta^* F(\sigma(Z))^{-1}$  (since  $\sigma$  does not interchange  $W$  and  $\underline{W}$ ), so

$$\begin{aligned} F(Z) &= [F(\sigma(Z))^{-1}]^*, \\ &\equiv F(Z)^\dagger, \end{aligned}$$

in contrast to equation (2.26).

In the next chapter the integrable system (2.35) will be used to construct integrable models in  $(2 + 1)$ -dimensions that generalise the standard AKNS and DNLS hierarchies in  $(1 + 1)$ -dimensions.

---

## Chapter III

---

# The Twistor Description of Integrable Systems

---

### 3.1 Introduction

The object of this chapter is to show how many of the integrable equations in mathematical physics may be obtained from the self-duality equations for a Yang-Mills theory in 4 dimensions, with various gauge groups and spacetime signatures.<sup>[39]</sup> Since these equations are integrable (by means of the Penrose transform of chapter II), the host of models that are obtained as a reduction of the duality equations may be solved by this method. Indeed, many of the standard techniques from soliton theory, such as the inverse scattering transform, Bäcklund transformations and hierarchies may also be interpreted in terms of twistors.<sup>[39,52,56]</sup> It seems likely that this is more than just a bookkeeping exercise, and the properties of these apparently disparate integrable equations may be more fully understood within the geometry of the twistor picture.

There are many different approaches to the study and construction of integrable models, and each has its own strengths and weaknesses. The construction that will be considered here is based on the AKNS scheme, where the integrable system is expressed as the compatibility (or integrability) condition for an over determined linear system. Owing to the form of this condition, it is often called a zero curvature condition. This overdetermined system has a direct twistorial interpretation, and has the advantage that it may be generalised from  $(1 + 1)$ -dimensions to  $(2 + 1)$ -dimensions. In this chapter it will be shown how this construction works, initially with the gauge group  $sl(2, \mathbb{C})$ , or one of its real subgroups. Solutions to some of these equations will be constructed geometrically in the next chapter, using the 'Riemann problem with zeros' method to achieve (effectively) the splitting of the pulled back bundle that was central to the construction described in the previous chapter.

The construction may be extended by using larger gauge groups. In a series of papers Fordy and his collaborators have shown how the AKNS scheme works particularly effectively when the Lie algebra is one associated with an Hermitian symmetric space. Using the substitution  $\xi \rightarrow \partial_y$ , they constructed example of integrable models in  $(2 + 1)$ -dimensions, which include the KP and DS equations. While such a procedure does not have a twistorial interpretation (though it is generally accepted that one must exist), there is a different family of models in  $(2 + 1)$ -dimensions associated with these Hermitian symmetric spaces, and these will be constructed here, and these do have a very natural twistorial description. The necessary mathematical definitions and properties of Hermitian symmetric spaces have been relegated to Appendix A. Finally a family of higher dimensional integrable models are constructed using the gauge group  $SU(\infty)$ .

However, before explaining all this in detail it is necessary to clarify the distinction between 'solubility' and 'integrability'.

### 3.2 Integrability

The concept of integrability has proved to be extremely useful in one and two dimensions. For example, the following systems are all 'integrable':

- completely integrable dynamical systems,
- $(1 + 1)$ -dimensional 'soliton' systems such as the KdV, NLS, etc.,etc.,
- $(2 + 0)$ -dimensional field theories such as chiral and  $\sigma$ -models.

However, it is less clear whether the idea is as useful in dimensions greater than two. Indeed, it is not entirely clear what integrability means in these higher dimensional theories, as some definitions are only applicable in two dimensions.

There is a quagmire of different definitions of integrability, ranging from the classical Liouville definition in terms of a sufficient number of functions which Poisson bracket commute with each other and with a Hamiltonian, to modern definitions in terms of algebraic geometry. The term 'solubility' denotes the existence (perhaps under particular boundary conditions) of a solution, while the term 'integrability' refers to something special, or extra property of the system or solution (for example, being able to write the solution in closed form in terms of elementary functions). So integrability implies solubility, but not visa-verse. Indeed, most equations are not integrable, though the

integrable ones do appear frequently in the study of non-linear phenomenon, if only as a first approximation.

One therefore wants a universal definition of integrability, which contains the more stricter requirements as special cases, holding under certain conditions. This definition should then cover both integrable dynamical systems (with a finite number of degrees of freedom) as well as field theories (which have an infinite number of degrees of freedom) in both Euclidean in Minkowski metrics. One such definition which is extremely powerful is the following:

**Definition**

A system of equations is integrable if it may be written as the compatibility conditions for an overdetermined linear system of a certain type.

That is, an equation is integrable if there is a family of operators  $\mathcal{L}_i, i = 1, \dots, N$ , such that the compatibility conditions

$$[\mathcal{L}_i, \mathcal{L}_j] = 0, \quad i \neq j = 1, \dots, N, \tag{3.1}$$

imply the original equation or equations. The operators may depend on a spectral parameter or a differential operator, and equating the coefficients of different powers of these in (3.1) then leads to the integrable equation. Many examples of this construction will be given in the rest of this chapter. If the operators  $\mathcal{L}_i$  depend on a spectral parameter rather than a (pseudo)-differential operator, then they have a natural twistorial interpretation, and it is these, and hence those integrable models which are derived from such models, that will be considered here.

One such system that falls into the above scheme is the Yang-Mills self-duality equation

$$F_{\mu\nu} = \frac{1}{2}\epsilon_{\mu\nu}^{\alpha\beta} F_{\alpha\beta} \tag{3.2}$$

on a Euclidean space with metric  $ds^2 = dz.d\bar{z} + dw.d\bar{w}$ .<sup>[57]</sup> This may be written in the following overdetermined linear system:

$$\begin{aligned} \{D_{\bar{z}} - \xi D_w\}s &= 0 \\ \{D_{\bar{w}} + \xi D_z\}s &= 0, \end{aligned} \tag{3.3}$$

where  $D_\mu \equiv \partial_\mu + A_\mu$  is the covariant derivative of the Yang-Mills field, and  $\xi$  is the spectral parameter. Such a description is central to the twistor description, and solution,

of the self-dual Yang-Mills fields. However, one must add the following caveat; the self-duality equations (3.2) are defined in any spacetime but they may only be written in an overdetermined form (and hence are integrable in) spacetimes which are also self-dual. In this case (3.3) takes the concise form

$$\mathbb{F} \wedge \omega(\xi) = 0,$$

where  $\mathbb{F}$  is the field strength written as a two-form, and  $\omega$  is a non-degenerate two-form which defines the background self-dual space.<sup>[58]</sup> Plebanski<sup>[59]</sup> has shown that any self-dual spacetime (one for which  $R_{ab} = 0$  and whose Weyl tensor is self-dual) can be given in terms of the metric

$$ds^2 = \Omega_{,y^i z^j} dy^i dz^j, \quad y^i = \tilde{y}, y, \quad z^j = \tilde{z}, z,$$

where  $\Omega(y, \tilde{y}, z, \tilde{z})$  satisfies the equation (see also section 3.6)

$$\Omega_{,y\tilde{y}} \Omega_{,z\tilde{z}} - \Omega_{,z\tilde{y}} \Omega_{,y\tilde{z}} = 1.$$

The 2-form  $\omega(\xi)$  is then defined by

$$\omega(\xi) = d\tilde{y} \wedge d\tilde{z} + \xi(\Omega_{,y\tilde{y}} d\tilde{y} \wedge dy + \Omega_{,z\tilde{y}} d\tilde{y} \wedge dz + \Omega_{,y\tilde{z}} d\tilde{z} \wedge dy + \Omega_{,z\tilde{z}} d\tilde{z} \wedge dz) + \xi^2 d\tilde{z} \wedge dz.$$

Such forms play a fundamental role in the Non-Linear Graviton construction.

As an example, consider the non-self dual spacetime  $\mathbb{R}^2 \times S^2$ , (equipped with the standard metric) under an axial symmetry, equation (3.3) (with gauge group  $SU(2)$ ) simplifies to

$$\nabla^2 \rho = e^\rho - 1, \tag{3.4}$$

which is known not to be integrable.<sup>[60]</sup> However, (3.4) has been shown to be soluble, in the sense that with certain boundary conditions solutions have been proved to exist.<sup>[61]</sup>

In the next section many known examples of integrable models will be derived from over determined linear system (3.3), but before then it is perhaps worth mentioning that the wave equation  $\square\phi = 0$  may also be derived from the self-duality equation, with gauge group  $U(1)$ . This is not normally thought of as integrable, but one may construct explicit solutions (and more importantly, all solutions<sup>[46]</sup>) to this fundamental equations, and it is integrable using the above definition.

Twistor theory is a very powerful tool in the study of such systems, as it does two important tasks simultaneously:

- it provides a systematic way to generate and categorise integrable systems, and gives such systems a geometrical interpretation.
- it provides a way to construct explicit solutions to these equations.

More significantly, it gives a definite structure to the solution space  $\mathcal{M}$  of solutions (sometimes called the moduli space, see chapter V), by relating it with some geometrical structure over a region of twistor space, via the Penrose transform. For example, for the wave equation this is expressed as the isomorphism

$$\mathcal{M}_{\text{wave equation}} \cong H^1(Z, \mathcal{O}(-2)),$$

or more generally for any integrable model

$$\mathcal{M}_{\text{integrable model}} \cong \text{some natural geometrical structure over twistor space.}$$

Such a description is central to the twistorial construction of the solution, but it may be of use when one needs to manipulate the total structure of the solution space, as, for example, in quantizing a classical system.

### 3.3 Reductions of the self-duality equations

The term ‘reduction’ means the process of reducing the number of variables in an equation.<sup>[38,62]</sup> There are two different types of reduction;

(A) Dimensional reduction.

This involves reducing the number of independent variables by factoring out by a subgroup of the Poincaré group. This is possible only if the original equations are Poincaré invariant, which the Yang-Mills self-duality equations are.

(B) Algebraic reduction.

This involves reducing the number of dependent variables by imposing algebraic constraints on the dependent fields. This, however, must be done in a manner consistent with the original equations.

In both cases, a reduction is possible only because of the existence of certain symmetries. Complete classification of reductions, especially those involving algebraic reductions, is clearly a large problem. The rest of this section, and the next, outlines some of the reductions possible from the Yang-Mills self-duality equations. Some of the resulting equations are well-known integrable systems whose properties have been known for some time. However, the fact that they arise as a reduction from a common system provides a unifying idea to these otherwise disconnected equations.

### SO(3)-Invariant Instantons

Historically, the first instanton solution to be constructed was the Belavin-Polyakov-Schwartz-Tyupkin solution, which has topological charge one. The first solutions with topological charge not equal to unit are the SO(3) invariant SU(2) instantons, which were constructed by Witten.<sup>[37]</sup> Later Manton showed these were gauge equivalent to solutions of the t'Hooft-Corrigan-Fairlie-Wilczek ansätze, which were shown in chapter II to be just the Atiyah-Ward ansatz  $\mathcal{A}_1$ . The methods were generalised to higher order gauge groups by Lesnov and Saveliev,<sup>[63,64]</sup> and by Bais and Weldon.<sup>[65]</sup> The construction ultimately rests in solving the Toda field equations

$$\nabla^2 \phi_\alpha = \sum_{\beta} K_{\alpha\beta} \exp \phi_\beta. \quad (3.5)$$

Here  $K_{\alpha\beta}$  is the Cartan matrix of the Lie algebra of the gauge group. These Toda equations are an important example of non-linear integrable differential equation, and have been much studied. The simplest example is the Liouville equation, which is a special case of the Toda equations when the group is SU(2). Another way to reduce the self-duality equations to the Toda equations, which also generalises to affine Lie algebras, will be given in section 3.5.

### Chiral models

An alternative way of writing the self-duality equations is to express the gauge field in terms of a gauge group-valued field, commonly denoted  $J$ . By writing  $A_\mu = J^{-1} \partial_\mu J$  (if  $J \in \mathcal{G}$ , then  $A_\mu \in \mathcal{Lie} \mathcal{G}$  automatically) the equations then take the chiral form

$$\partial_{\bar{z}} \{ J^{-1} \partial_z J \} + \partial_{\bar{w}} \{ J^{-1} \partial_w J \} = 0. \quad (3.6)$$

By requiring that the matrix  $J$  is independent of one or two coordinates, this reduces to the chiral model in 3 and 2 dimensions respectively.

So far all the reductions mentioned have only involved reduction by a subgroup of the Poincaré group; no algebraic constraints (subject, of course, to being consistent with the equations in question) have been imposed. To reduce the well known chiral model to a non-linear  $\sigma$  model, such as the  $\mathbb{C}P^n$  models, an algebraic constraint has to be applied. For example, applying the constraint  $J^2 = 1$  gives the equation of motion  $[P, \square P] = 0$ , where  $J = 1 - 2P$ . This has been extensively studied by Din, Horvath and Zakrzewski.<sup>[66,18]</sup>

### Magnetic Monopoles

This reduction is achieved by requiring that the gauge fields  $A_\mu$  are independent of one of the coordinates, say  $x_4$ . The equations then become<sup>[29]</sup>

$$F_{\mu\nu} = \varepsilon_{\mu\nu}{}^\alpha D_\alpha \phi, \tag{3.7}$$

where  $\phi = A_4$ . These equations are the Bogomolny equations for a Yang-Mills-Higgs system on  $\mathbb{R}^{3+1}$ , where they describe static field configurations known as monopoles. The general solution of topological charge  $n$ , which may be shown to depend on  $4n - 1$  parameters, may be generated from the Atiyah-Ward ansätze  $\mathcal{A}_n$ .

Before the general solution was found, the equations were solved under an additional symmetry. This involves imposing a rotational symmetry around a particular axis. The equations that result are known as the Ernst equation,

$$\frac{1}{r} \partial_r \{r J^{-1} \partial_r J\} + \partial_z \{J^{-1} \partial_z J\} = 0. \tag{3.8}$$

As well as being applicable to monopoles, this equation also is of importance in General Relativity. Static, radial symmetric solutions of the vacuum Einstein equations may be constructed from solutions to the Ernst equation,<sup>[67]</sup> and these have some remarkable transformation properties.<sup>[68,69]</sup>

Rather than assuming a translational symmetry, one could assume a rotational symmetry, generated by  $\partial_\theta$ . The solutions of the equations are known as hyperbolic monopoles (see chapter V), since the space on which they are defined is of constant negative curvature. These have been studied by Atiyah,<sup>[70]</sup> and also by Nash.<sup>[71]</sup>



### The Nahm Equation

To end this section, a reduction down to one dimension will be considered. By requiring that the gauge field depend only on one coordinate, say  $t$ , the self-duality equation becomes

$$\frac{d}{dt} A_\alpha = -\frac{1}{2} \varepsilon_{\alpha\beta\gamma} [A_\beta, A_\gamma], \tag{3.9}$$

where  $\alpha, \beta, \gamma$  are group, not spacetime, indices. This remarkable equation is, in a sense, the ‘dual’ or ‘reciprocal’ to equation (3.7),<sup>[72]</sup> and this provides an alternative method of constructing monopole solutions, the ADHMN method.<sup>[73]</sup> This is based on the ADHM method of constructing bundles over twistor space by using the method of monads, rather than constructing the bundle as an extension, which is the basis of the Atiyah-Ward ansätze.

With the gauge group  $SU(2)$  these equations become Euler’s equations for a spinning top

$$\begin{aligned} f_t &= 2gh, \\ g_t &= 2hf, \\ h_t &= 2fg. \end{aligned} \tag{3.10}$$

For larger gauge groups they become the Toda molecule equations. Other reductions lead to further completely integrable dynamical systems.<sup>[74]</sup>

All the equations mentioned above are elliptic, reflecting the positive-definite metric on  $\mathbb{R}^4$ . These reductions are summarised on Table 1. The twistor construction itself is fundamentally independent of the spacetime signature, which just arises from a reality structure on twistor space. Thus the duality equations on  $\mathbb{R}^{2+2}$  are just as integrable as those on  $\mathbb{R}^4$ . Reductions of these lead to parabolic and hyperbolic equations, reflecting the indefinite metric on  $\mathbb{R}^{2+2}$ .

### A Modified Chiral Models in $(2 + 1)$ -dimensions

Taking the self-duality equations on  $\mathbb{R}^{2+2}$  with the assumption that none of the gauge fields depend on one of the coordinates, say  $x_4$ , the equations become

$$D_\mu \phi = \frac{1}{2} \varepsilon_{\mu\alpha\beta} F^{\alpha\beta}, \tag{3.11}$$

where  $\phi = A_4$ . This is similar to the monopole equation (3.7), but the metric is not positive-definite, having signature  $\{-++\}$ , and the convention  $\varepsilon_{012} = -1$  is adopted.

Symmetry group or generator	Name of reduced equation	Equation	
$\frac{\partial}{\partial x}$	Monopole equation	$F_{\mu\nu} = \varepsilon_{\mu\nu}{}^\alpha D_\alpha \phi$	
$\frac{\partial}{\partial \theta}$	Hyperbolic monopoles	$F_{\mu\nu} = \varepsilon_{\mu\nu}{}^\alpha D_\alpha \phi$	
$\frac{\partial}{\partial x}, \frac{\partial}{\partial \theta}$	Ernst Equation	$\frac{1}{r} \partial_r (r J^{-1} \partial_r J) + \partial_z (J^{-1} \partial_z J) = 0$	
$\frac{\partial}{\partial t}, \frac{\partial}{\partial z}$	Chiral Model	$\partial_x (J^{-1} \partial_x J) + \partial_y (J^{-1} \partial_y J) = 0$	
$\frac{\partial}{\partial t}, \frac{\partial}{\partial z}$ with algebraic constraints	$\mathbb{C}P^n$ models non-linear $\sigma$ models	— —	
SO(3)	Toda equations	$\square \phi_\alpha = \sum_\beta K_{\alpha\beta} \exp \phi_\beta$	
[ SO(3)	Liouville equation	$\nabla^2 \rho = e^\rho$	]
$\frac{\partial}{\partial x}, \frac{\partial}{\partial y}, \frac{\partial}{\partial z}$	Nahm equation	$\frac{d}{dt} A_\alpha = -\frac{1}{2} \varepsilon_{\alpha\beta\gamma} [A_\beta, A_\gamma]$	

Table 1 Reductions of the self-duality equations on  $\mathbb{R}^4$ .

† This is a special case of the Toda equations, with gauge group  $SU(2)$ .

This equation also arises as the Bogomolny equation for a system with Lagrangian density

$$\mathcal{L} = \frac{1}{2} \text{Tr} F_{\mu\nu} F^{\mu\nu} - \text{Tr} D_\mu \phi D^\mu \phi. \tag{3.12}$$

Note the relative minus sign between the two terms. As a result of this, the conserved energy functional for this Lagrangian is not positive definite. Moreover, for solutions to (3.11), it is identically zero.

As in the case of magnetic monopoles, it is possible to rewrite (3.11) in chiral form. Explicitly let  $J : \mathbb{R}^{2+1} \rightarrow \text{SU}(2)$  be a solution of the equations<sup>[48]</sup>

$$\begin{aligned} A_t &= A_y = \frac{1}{2} J^{-1} (J_t + J_y) \\ A_x &= -\phi = \frac{1}{2} J^{-1} J_x. \end{aligned} \tag{3.13}$$

The resulting equation is

$$\eta^{\mu\nu} \partial_\mu (J^{-1} \partial_\nu J) + V_\alpha \varepsilon^{\alpha\mu\nu} \partial_\mu (J^{-1} \partial_\nu J) = 0, \tag{3.14}$$

where  $V_\alpha = (0, 1, 0)$ . This equations, although it appears not to arise from any Lagrangian, does have a conserved energy functional. The equation has soliton solutions, both wave-like and lump-like.<sup>[75,76]</sup>

The second term in (3.14) is known as a torsion term, since it contains mixed derivatives. Such a term, which breaks the Lorentz invariance of the equation (it has a residual  $\text{SO}(1,1)$  symmetry, but not the full  $\text{SO}(2,1)$  symmetry needed for Lorentz invariance) is needed for the system to be integrable.<sup>[77]</sup> This gives weight to the conjecture that integrable, Lorentz invariant equations do not exist in dimensions greater than two.

Some solutions to (3.14) may be generated using the ‘Riemann problem with zeros’ method,<sup>[51,75]</sup> and these include the soliton solutions. Details of this construction may be found in the next chapter. Since (3.13) are differential equations, the  $J$  description of the equation (3.11) contains more information than is contained in the gauge fields. In terms of the Penrose correspondence, solutions to (3.13) correspond to framed holomorphic vector bundles, while the bundles corresponding to solutions to (3.11) are unframed.<sup>[78]</sup> The extra information in the  $J$  descriptions correspond to the details of this framing.

### Further Reductions

From this chiral model with torsion other models may be obtained by a further reduction. For example, looking at static solutions, or a solution independent of one of the space coordinates leads to chiral models on  $\mathbb{R}^2$  and  $\mathbb{R}^{1+1}$  respectively. By factorising by  $x\partial_y - y\partial_x$  (a rotation) or by  $t\partial_y + y\partial_t$  (a Lorentz boost) gives the Ernst equation on  $\mathbb{R}^{1+1}$  or  $\mathbb{R}^2$ .

By starting with the full self-duality equations on  $\mathbb{R}^{2+2}$  and factoring out by  $\partial_\theta$  rather than by  $\partial_z$  leads to the equation (written in chiral form)

$$\frac{1}{r}\partial_r(rJ^{-1}\partial_r J) + \partial_x(J^{-1}\partial_x J) - \partial_t(J^{-1}\partial_t J) + \text{torsion term} = 0,$$

the analogue of the hyperbolic monopole equation. Although integrable, this does not appear to have any physical applications.

### Soliton Equations

The KdV and Non-Linear Schrödinger equations have recently been shown to be reduction of the self-duality equations under two translational symmetries, one null, and the other non-null,<sup>[39]</sup> the different equations coming from the groups  $SL(2, \mathbb{R})$  and  $SU(2)$  respectively. Under a null translational symmetry, the equations so obtained are parabolic rather than hyperbolic, the other null coordinate playing the rôle of time (i.e. with  $\partial_x + \partial_y$  as a null symmetry, the equations are parabolic with  $(x + y)$  being interpreted as time).

Another well known soliton equation, the sine-Gordon equation, arises from a reduction with two non-null translations, and an algebraic constraint on the fields. These three fall into the AKNS scheme, which provides a systematic way to study integrable models and their associated hierarchies. The details of this scheme will be outlined in the next section, together with the closely related DNLS hierarchy, and shown how they may be generalised from  $(1 + 1)$ -dimensions to  $(2 + 1)$ -dimensions. These new systems have a natural interpretation as reductions of the generalised self-duality equations constructed in the last chapter.

Table 2 shows a summary of some of these reductions from  $\mathbb{R}^{2+2}$ .

Symmetry group or generator	Name of reduced equation	Equation
$\frac{\partial}{\partial z}$	Chiral model with torsion	$\partial_x(J^{-1}\partial_x J) + \partial_u(J^{-1}\partial_v J) = 0$
$\frac{\partial}{\partial z}, \frac{\partial}{\partial y}$	Chiral Model on $\mathbb{R}^{1+1}$	$\partial_x(J^{-1}\partial_x J) - \partial_t(J^{-1}\partial_t J) = 0$
$\frac{\partial}{\partial z}, \frac{\partial}{\partial \theta}$	Ernst Equation on $\mathbb{R}^{1+1}$	$\frac{1}{r}\partial_r(rJ^{-1}\partial_r J) - \partial_x(J^{-1}\partial_x J) = 0$
$\frac{\partial}{\partial \theta}$	—	$\frac{1}{r}\partial_r(rJ^{-1}\partial_r J) + \partial_u(J^{-1}\partial_v J) = 0$
$\frac{\partial}{\partial \theta}, \frac{\partial}{\partial \phi}$	—	$\frac{1}{r}\partial_r(rJ^{-1}\partial_r J) + \frac{1}{R}\partial_R(RJ^{-1}\partial_R J) = 0$
$\frac{\partial}{\partial z}, \frac{\partial}{\partial u}$	$SL(2, \mathbb{R}) \Rightarrow$ KdV $SU(2) \Rightarrow$ NLS	$u_t = \frac{1}{4}u_{xxx} + 3uu_{xx}$ $-i\psi_t = \psi_{xx} + 2 \psi ^2\psi$
$\frac{\partial}{\partial z}, \frac{\partial}{\partial x}$ with algebraic constraints	sine-Gordon equation	$\phi_{yy} - \phi_{tt} + \sin \phi = 0$

Table 2 Reductions of the self-duality equations on  $\mathbb{R}^{2+2}$ .

### 3.4 The AKNS Hierarchy and its Generalisation

As mentioned earlier, a characteristic feature of many integrable models is that they be written as the integrability conditions for a system of linear differential operators. The AKNS hierarchy starts with a linear system of the form<sup>[13]</sup>

$$\begin{aligned} \Phi_x &= [\xi \cdot A + Q(x, t_n)]\Phi \equiv \mathcal{A}_x \Phi, \\ \Phi_{t_n} &= \left[ \sum_{i=0}^{n+1} B_{n-i}(x, t_n) \xi^i \right] \Phi \equiv \mathcal{A}_{t_n} \Phi, \quad n \geq 1. \end{aligned} \tag{3.15}$$

For fixed  $n$  the integrability conditions for this system yields a system of equations which is said to be the  $n^{\text{th}}$  member of the hierarchy. The hierarchy itself is the set of all such models. This system, and its generalisation which will be constructed, are reductions of the system constructed in section 2.7, hence the use of the same Greek letter  $\Phi$  in the above equations.

The matrices  $A$ ,  $Q(x, t_n)$  and  $B_{n-i}(x, t_n)$  belong to the Lie algebra  $sl(2, \mathbb{C})$ , and  $A$  and  $Q$  are of the form

$$\begin{aligned} A &= \kappa \begin{pmatrix} 1 & 0 \\ 0 & -1 \end{pmatrix}, \quad \kappa \text{ constant}, \\ Q &= \begin{pmatrix} 0 & q(x, t_n) \\ p(x, t_n) & 0 \end{pmatrix}. \end{aligned} \tag{3.16}$$

The variables  $x$  and  $t_n$  are space and time respectively. The  $B_{n-i}$ , as well as the integrable equation itself, are determined by requiring that each of the coefficients of  $\xi$  in the integrability condition for (3.15), namely

$$[\partial_x - \mathcal{A}_x, \partial_{t_n} - \mathcal{A}_{t_n}] = 0, \tag{3.17}$$

are identically zero. This assumes that  $\xi$ , which is known as the spectral parameter, is a constant. Such a system gives rise to families of integrable models in  $(1 + 1)$  dimensions, such as the KdV, mKdV and NLS hierarchies. One may also modify the system (3.15) and/or enlarge the Lie algebra, and the resulting systems includes such equations as the DNLS equations and the Boussinesq hierarchy.

Thus for each value of  $n$  one gets an integrable model, so given some initial field configuration one may evolve it (since these systems are parabolic with  $t_n$  acting as time)

using the integrable model defined by  $n$ , and such evolution is referred to as the  $n^{\text{th}}$  order flow. These flows are not independent; they have the important property that they commute, i.e. evolving some configuration with respect to the  $n^{\text{th}}$  order flow, followed by an evolution with respect to the  $m^{\text{th}}$  order flow results in the same field configuration as would be obtained by evolving the fields with respect to the  $m^{\text{th}}$  order flow first, followed by the  $n^{\text{th}}$  order flow. This shown schematically in Figure 3.1.

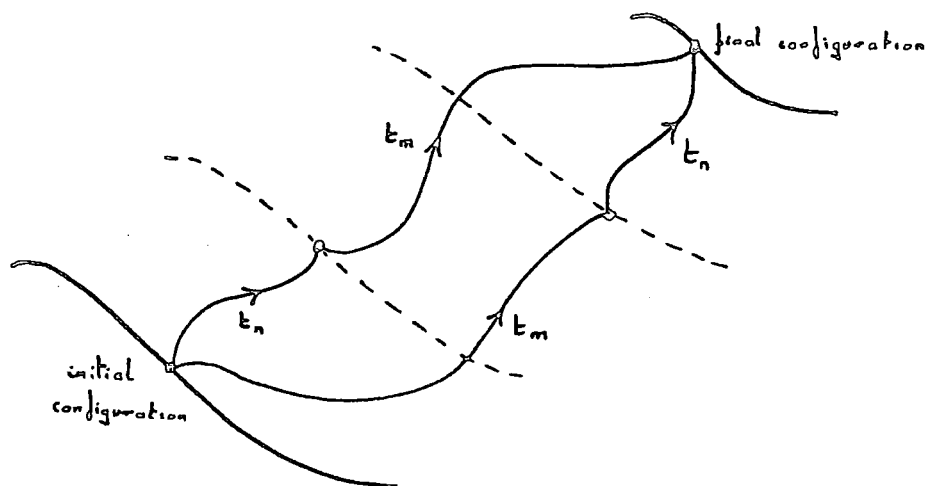

Fig 3.1. Commuting Flows

These systems have a Hamiltonian structure; the equations of motion for the fields  $p$  and  $q$  may be written in the form

$$q_{t_n} = \frac{\delta H_n}{\delta p},$$

$$p_{t_n} = -\frac{\delta H_n}{\delta q},$$

where  $H_n = \int \mathcal{H}_n dx$ , the integrand being a conserved Hamiltonian density. These may be generated systematically. For a solution  $Q$  of (3.15) define matrices  $P_i$  by requiring them to satisfy the integrability conditions for<sup>[79]</sup>

$$\Phi_x = [\xi \cdot A + Q(x, t_n)] \Phi,$$

$$\Phi_{t_n} = \left[ \sum_{i=0}^{\infty} P_i(x, t_n) \xi^{-i} \right] \Phi.$$

The defines the matrices in  $P_i$  in terms of the fields  $p$  and  $q$ . The quantites  $\mathcal{H}_n$ , are then

defined by

$$\kappa^{n-1} \cdot \mathcal{H}_n = \frac{1}{n+1} \text{Tr}(A \cdot P_{n+2}).$$

One may also show that there are an infinite number of conserved quantities associated with each member of the hierarchy. The existence of an infinite number of conserved quantities is often taken as a definition of integrability.

Thus all these are integrable models in  $(1 + 1)$ -dimensions, and so the question arises whether there is a generalisation to higher dimensions. One way that this has been achieved is to replace the spectral parameter  $\xi$  by a differential operator such as  $\partial_y$ . This leads to systems such as the KP and DS equations.<sup>[80]</sup> In doing so products of matrices (rather than just commutators of matrices) appear, so the procedure is no longer Lie-algebraic. However a different generalisation is possible which avoids this problem, and this will be considered here.

The coefficients of the two highest powers of  $\xi$  (namely  $\xi^{n+2}$  and  $\xi^{n+1}$ ) in (3.17) are required to vanish, and these are

$$\begin{aligned} [A, B_{-1}] &= 0, \\ [A, B_0] + [Q, B_{-1}] &= 0. \end{aligned}$$

One possible choice of solution is  $B_{-1} = A$ ,  $B_0 = Q$ . This is a natural solution (though not unique<sup>[81,82]</sup>) and leads to local expressions for the resulting integrable equation. Using the choice, (3.15) may be rewritten

$$\begin{aligned} \Phi_x &= [\xi \cdot A + Q] \Phi, \\ \Phi_{t_n} &= \left[ \xi^n (\xi \cdot A + Q) + \sum_{i=0}^{n-1} B_{n-i} \xi^i \right] \Phi. \\ &= \xi^n \Phi_x + \left[ \sum_{i=0}^{n-1} B_{n-i} \xi^i \right] \Phi. \end{aligned}$$

The generalisation considered here involves replacing  $\partial_x$  in the second equation by  $\partial_y$ , so the linear system becomes:

$$\begin{aligned} \Phi_x &= [\xi \cdot A + Q(x, y, t_n)] \Phi, \\ \Phi_{t_n} &= \xi^n \Phi_y + \left[ \sum_{i=0}^{n-1} B_{n-i} \xi^i \right] \Phi. \end{aligned} \tag{3.18}$$

It will shown below that such a system is a special case of generalised self-duality equations constructed in the previous chapter, and hence the solutions correspond to bundles over



the twistor space  $\mathbb{P}_{1,n}$ . The same procedure works for other systems, such as the DNLS hierarchy,<sup>[83]</sup> which corresponds to bundles over the twistor space  $\mathbb{P}_{2,2n}$ . Of course, if the symmetry  $\partial_x = \partial_y$  is imposed, the systems revert to their standard forms. In terms of the twistor picture this is equivalent to factoring out by a holomorphic vector on  $\mathbb{P}_{m,n}$  and so considering bundles over  $\mathcal{O}(m+n)$  instead.

In Chapter II it was shown that the following system of equations

$$\begin{aligned} [\mathcal{K}_k, \mathcal{K}_{k'}] &= 0 & k, k' &= 1, \dots, m, \\ [\mathcal{K}_k, \mathcal{L}_l] &= 0 & k &= 1, \dots, m, \quad l = 1, \dots, n, \\ [\mathcal{L}_l, \mathcal{L}_{l'}] &= 0 & l, l' &= 1, \dots, n, \end{aligned} \tag{3.19}$$

where

$$\begin{aligned} \mathcal{K}_k &= \xi \left[ \frac{\partial}{\partial x_{k-1}} - A_{k-1} \right] - \left[ \frac{\partial}{\partial x_k} - D_k \right], \\ \mathcal{L}_l &= \xi \left[ \frac{\partial}{\partial t_{l-1}} - C_{l-1} \right] - \left[ \frac{\partial}{\partial t_l} - B_l \right], \end{aligned} \tag{3.20}$$

were integrable by means of a Penrose transform to an auxiliary complex manifold  $\mathbb{P}_{m,n}$  known as Twistor space. As the rest of this section will show, this system is very large, in the sense that it contains many examples of integrable models, and thus provides a systematic way to study these systems.

Consider the system of equations (3.20) corresponding to the space  $\mathbb{P}_{1,n}$ . To this impose the symmetry generated by  $\frac{\partial}{\partial x_0}$  (so there is a gauge in which the fields, and  $\Phi$ , are independent of  $x_0$ ), and the following gauge conditions;

$$\begin{aligned} C_{i-1} &= 0, & i &= 1, \dots, n, \\ A_0 &= -A, \\ D_1 &= Q, \end{aligned}$$

where  $A$  and  $Q$  are given by (3.16), but now the functions  $p$  and  $q$  depend on all the coordinates except  $x_0$ . On relabelling  $x_1 \equiv x$  and  $t_0 \equiv y$  the linear operators (3.20) become

$$\begin{aligned} \Phi_x &= [\xi.A + Q]\Phi, \\ \Phi_{t_i} &= \xi\Phi_{t_{i-1}} + B_i.\Phi, & i &= 1, \dots, n. \end{aligned} \tag{3.21}$$

By systematically eliminating  $\Phi_{t_j}, j = 1, \dots, (n - 1)$ , one is left with the system

$$\begin{aligned} \Phi_x &= [\xi.A + Q]\Phi, \\ \Phi_{t_n} &= \xi^n \Phi_y + \left[ \sum_{i=0}^{n-1} B_{n-i} \xi^i \right] \Phi, \quad n \geq 1. \end{aligned}$$

This is precisely the system (3.18). Thus the solution of such a system may be naturally encoded within the geometry of holomorphic vector bundles over the space  $\mathbb{P}_{1,n}$ .

To find the corresponding differential equations one has to solve (3.17), and this yields the following equations:

$$\begin{aligned} \partial_y Q &= [A, B_1], \\ \partial_x B_{n-i} &= [A, B_{n-i+1}] + [Q, B_{n-i}], \quad i = 1, \dots, (n - 1), \\ \partial_{t_n} Q &= \partial_x B_n + [B_n, Q]. \end{aligned} \tag{3.22}$$

These simplify further by decomposing  $sl(2, \mathbb{C}) \cong h \oplus m$ , where  $h$  is the Cartan subalgebra, so in particular  $A \in h$  and  $Q \in m$ . On writing  $B_i = B_i^h + B_i^m$ , where  $B_i^h \in h$  and  $B_i^m \in m$ , equation (3.22) decomposes:

$$\begin{aligned} \partial_y Q &= [A, B_1^m], & (3.22)(a) \\ \partial_x B_{n-i}^m &= [A, B_{n-i+1}^m] + [Q, B_{n-i}^h], \quad i = 0, \dots, (n - 1), & (3.22)(b) \\ \partial_x B_{n-i}^h &= [Q, B_{n-i}^m], \quad i = 1, \dots, (n - 1), & (3.22)(c) \\ \partial_{t_n} Q &= \partial_x B_n^m + [B_n^h, Q]. & (3.22)(d) \end{aligned}$$

These may be solved systematically. The solution to equation (3.22)(a) is given by

$$B_1^m = \frac{1}{2\kappa} \begin{pmatrix} 0 & q_y \\ -p_y & 0 \end{pmatrix}, \tag{3.23}$$

and hence (3.22)(c) has solution

$$B_1^h = \frac{-1}{2\kappa} \partial_x^{-1} \partial_y [p.q] \cdot \begin{pmatrix} 1 & 0 \\ 0 & -1 \end{pmatrix}. \tag{3.24}$$

The rest of the procedure is similar. Equation (3.22)(b) gives  $B_i^m$  and equation (3.22)(c) gives, after integration,  $B_i^h$ . Once all the  $B_i$  have been constructed in terms of the matrix

$Q$  the equation of motion itself is given by (3.22)(d). Note that  $B_1^h$  contains the pseudo-differential operator  $\partial_x^{-1}$ , and hence implicitly contains information about the boundary conditions. This is a generic feature of the models considered here; the hierarchies are all of the form

$$\partial_{t_n} \underline{\psi} = P_n(\underline{\psi}),$$

where  $P_n$  is a polynomial function of  $\underline{\psi} = (p, q)$ , its derivatives and the pseudo-derivative  $\partial_x^{-1}$ . They may be written in a local form by introducing a potential function, as the examples constructed below will illustrate.

Example  $n = 1$  (2<sup>nd</sup> order flow)

When  $n = 1$ , the only matrix that needs to be constructed is  $B_1$  which is given by (3.23) and (3.24). The equation of motion gives the following (2 + 1)-dimensional integrable system:

$$\begin{aligned} 2\kappa \partial_t q &= \partial_{xy} q - 2\partial_x^{-1} \partial_y [p \cdot q] \cdot q, \\ -2\kappa \partial_t p &= \partial_{xy} p - 2\partial_x^{-1} \partial_y [p \cdot q] \cdot p. \end{aligned} \tag{3.25}$$

By introducing a potential function  $V(p, q)$  defined by

$$\partial_x V(p, q) = 2\partial_y [p \cdot q]$$

these may be written in the local form

$$\begin{aligned} 2\kappa \partial_t q &= \partial_{xy} q - V(p, q) \cdot q, \\ -2\kappa \partial_t p &= \partial_{xy} p - V(p, q) \cdot p. \end{aligned}$$

One may impose algebraic constraints on the fields  $p$  and  $q$ , for example  $q = -\bar{p} = \psi$ . This corresponds to using the gauge group  $su(2)$  rather than  $sl(2, \mathbb{C})$ . The equations then become (with  $\kappa = i/2$ )

$$\begin{aligned} i\partial_t \psi &= \partial_{xy} \psi + V(\psi, \bar{\psi}) \cdot \psi, \\ \partial_x V &= 2\partial_y |\psi|^2. \end{aligned}$$

With the symmetry  $\partial_x = \partial_y$  these reduce to the Non-Linear Schrödinger equations. This was first shown to be a reduction of the Yang-Mills self-duality equation by Mason and Sparling.<sup>[39]</sup> They in fact showed something stronger; that the NLS equation was equivalent to (rather than just contained within) the  $su(2)$  self-duality equations in (2+2) dimensions with a null and a non-null translational symmetry.

**Example**  $n = 2$  (3<sup>rd</sup> order flow)

The expressions are best written in terms of 2 potential functions (for general  $n$  one needs  $n$  such functions)  $V_1$  and  $V_2$ ,

$$\begin{aligned} (2\kappa)^2 \partial_t q &= \partial_{xxy} q - 2\partial_x[V_1 \cdot q] + 2V_2 \cdot q, \\ (2\kappa)^2 \partial_t p &= \partial_{xxy} p - 2\partial_x[V_1 \cdot p] - 2V_2 \cdot p, \end{aligned}$$

with the potential functions being defined by

$$\begin{aligned} \partial_x V_1 &= \partial_y [p \cdot q], \\ \partial_x V_2 &= q \partial_{xy} p - p \partial_{xy} q. \end{aligned}$$

With the symmetry  $\partial_x = \partial_y$  these expression become local,

$$(2\kappa)^2 \partial_t q = \partial_{xxx} q - 6pq \partial_x q,$$

with a similar expression for  $q$ . With the algebraic constraints  $p = q$  or  $q = 1$  these reduce to the KdV and mKdV equations respectively.<sup>[84]</sup>

Mason and Sparling have shown that the KdV equations may also be obtained as a reduction of the self-duality equations (i.e. from bundles over  $\mathbb{P}_{1,1}$  rather than over  $\mathbb{P}_{1,2}$ ) by using the matrices

$$\begin{aligned} A &= \begin{pmatrix} 0 & 0 \\ 1 & 0 \end{pmatrix}, \\ Q &= \begin{pmatrix} q & 1 \\ q_x - q^2 & -q \end{pmatrix}, \end{aligned}$$

with the other matrix being given by the equations (3.22). Such a choice for the constant matrix is fundamentally different from choosing it to be purely diagonal (and hence in the Cartan subalgebra of  $sl(2, \mathbb{C})$ ), and corresponds to a 'highest weight' in the algebra. This approach (along the lines of Drinfel'd and Sokolov<sup>[85]</sup>) has been generalised by Bakas and Depireux.<sup>[86]</sup> From the view point of the AKNS hierarchy, it is more natural to think of the KdV equations as a third order flow.

---

Many more examples could be constructed using different gauge conditions. For example with the symmetry  $\frac{\partial}{\partial x_0}$  (and in a gauge where all the potentials are independent of  $x_0$ ) and the gauge conditions

$$\begin{aligned} B_i &= 0, & i &= 1, \dots, n, \\ A_0 &= -A, \\ D_1 &= Q, \end{aligned}$$

the repetition of the above procedure gives the system

$$\begin{aligned} \Phi_x &= [\xi.A + Q]\Phi, \\ \xi^n \Phi_{t_0} &= \Phi_{t_n} + \left[ \sum_{i=1}^n \xi^i C_{n-i} \right] \Phi. \end{aligned}$$

At first sight it looks as if this is a new system, a generalisation of the so-called ‘negative order’ flows. However, the simplest case  $n = 1$  shows that this is not the case, the corresponding integrable system is given by (3.25). Thus this equation contains both the positive and negative flows as special cases. The standard case negative flow is recovered by setting  $\partial_t = 0$  in (3.25), and the positive flow by setting  $\partial_x = \partial_y$ . With the first of these, and the condition  $q = -\bar{p} = \psi$  the system (3.25) becomes

$$\begin{aligned} \partial_{xy}\psi &= -V(x, y).\psi, \\ \partial_x V(x, y) &= 2\partial_y |\psi|^2. \end{aligned} \tag{3.26}$$

This is a ‘complexified’ sine-Gordon equation, for with the further algebraic constraints

$$\begin{aligned} V &= 4 \cos \theta, \\ \psi &= \frac{1}{2} \partial_x \theta, \end{aligned} \tag{3.27}$$

the equations reduce to the sine-Gordon equation  $\theta_{xy} + 4 \sin \theta = 0$ . The form of the algebraic constraint is very special. One may (by taking higher values of  $n$ ) construct a hierarchy of integrable models of which (3.26) is the first. But the constraint (3.27) which reduces (3.26) to the sine-Gordon equation is only consistent with this first equation. As mentioned at the beginning of section 3.3, algebraic reductions have to be done in a manner that is consistent with the original equations, and this is an example where (3.27) can only be applied to one member of the hierarchy.

Consider next the system (3.20) corresponding to the twistor space  $\mathbb{P}_{2,2n}$ . As before, impose the symmetry generated by  $\frac{\partial}{\partial x_0}$  and the conditions

$$\begin{aligned} B_i &= 0, & i &= 1, \dots, 2n, \\ D_i &= 0, & i &= 1, 2, \\ A_0 &= -A, \\ A_1 &= -Q. \end{aligned}$$

Relabeling  $x_2 = x$  and  $t_0 = y$  and repeating the procedure used above yields the system

$$\begin{aligned} \Phi_x &= [\xi^2 \cdot A + \xi \cdot Q] \Phi, \\ \Phi_{t_{2n}} &= \xi^{2n} \Phi_y - \left[ \sum_{i=1}^{2n} C_{2n-i} \xi^i \right] \Phi. \end{aligned} \tag{3.28}$$

If  $\partial_x = \partial_y$  then the system becomes the standard form of the DNLS hierarchy.

**Example  $n = 1$  (2<sup>nd</sup> order flow)**

It will be convenient to make the assumptions that  $C_1^h = C_0^m = 0$ . With these the integrability conditions for (3.28) are

$$\partial_x C_0^h = [Q, C_1^m], \tag{3.28)(a)}$$

$$\partial_y Q = -[A, C_1^m] - [Q, C_0^h], \tag{3.28)(b)}$$

$$\partial_{t_{2n}} Q = -\partial_x C_1^m. \tag{3.28)(c)}$$

These may be solved, giving the integrable system

$$2\kappa \partial_t q = -\partial_{xy} q - 2\partial_x [V(p, q) \cdot q],$$

$$2\kappa \partial_t p = \partial_{xy} p - 2\partial_x [V(p, q) \cdot p],$$

$$2\kappa \partial_x V = \partial_y [p \cdot q].$$

The third and higher order flows could also be constructed, though the expressions tend to get complicated quite quickly. Imposing the algebraic constraint  $q = -\bar{p} = \psi$  and setting  $\kappa = i/2$  gives the following generalisation to  $(2 + 1)$ -dimensions of the DNLS equation,

$$-i\partial_t \psi = [\partial_y \psi + 2i\partial_x^{-1} \partial_y |\psi|^2 \cdot \psi]_x, \tag{3.29}$$

written without the use of an external potential.

The negative order flows of the DNLS hierarchy may also be constructed. Indeed, many more examples, both new and old, can be constructed using the above methods. Also the general case, corresponding to the space  $\mathbb{P}_{m,n}$  with  $m$  and  $n$  arbitrary, has not been considered at all. In the next section these methods will be extended to larger gauge groups.

### 3.5 Higher Rank Gauge Groups

In the last section it was shown how a large number of integrable systems, together with their associated hierarchies, could be interpreted in terms of reductions (both dimensional and algebraic) of the equations with result from holomorphic vector bundles over the twistor space  $\mathbb{P}_{m,n}$ . All these were associated with the gauge group  $sl(2, \mathbb{C})$ , or one of its real forms. The twistor construction itself is independent of the gauge group - any Lie group will suffice. The reduction methods however, become considerably more complicated as the rank of the gauge group increases. In this section it will be shown how one may deal systematically with such higher rank groups.

One of the most important sets of integrable models are the Toda field equations, which have been much studied, both classically and quantum mechanically. To each simple Lie algebra, or affine Lie algebra, there is a corresponding integrable, Lorentz invariant, 2-dimensional system, and these may all be obtained as reductions of the self-duality equations. The following argument is due to Ward.<sup>[38]</sup>

Let  $\{H_a, E_a, E_{-a}\}$  be Chevalley basis for  $\mathfrak{g}$ , a simple Lie algebra, with commutator relations

$$\begin{aligned} [H_a, E_{-b}] &= -K_{ba} E_{-b}, & [E_a, E_{-b}] &= \delta_{ab} H_b, \\ [H_a, E_b] &= K_{ba} E_b, & [H_a, H_b] &= 0, \end{aligned}$$

where  $K_{ba}$  is the Cartan matrix. With the following ansätze for the gauge potentials:

$$\begin{aligned} A_y &= \sum_a f_a(y, z) H_a & A_z &= \sum_a g_a(y, z) H_a \\ A_u &= \sum_a e_a(y, z) E_a & A_v &= \sum_a e_a(y, z) E_{-a} \end{aligned} \tag{3.30}$$

$$e_a(y, z) = \log 2\phi_a(y, z)$$

the self-duality equations

$$\begin{aligned} [D_y - \xi D_v]\Psi &= 0, \\ [D_u + \xi D_z]\Psi &= 0, \end{aligned} \quad (\text{where } D_\mu = \partial_\mu + A_\mu)$$

with the symmetry  $\partial_u = \partial_v = 0$  are equivalent to the Toda equations

$$\partial_y \partial_z \phi_a = - \sum_{b=1}^{\text{rank } \mathfrak{g}} K_{ab} \exp \phi_b$$

(note that these may also be obtained as  $SO(3)$ -invariant instantons<sup>[63,64]</sup> with gauge group  $G$ ). With a slight modification, one may also obtain the affine Toda equations

$$\partial_y \partial_z \phi_a = - \sum_{b=0}^{\text{rank } \mathfrak{g}} \bar{K}_{ab} \exp \phi_b,$$

where  $\bar{K}_{ab}$  is the Cartan matrix of the affine algebra corresponding to the simple (non-affine) Lie algebra  $\mathfrak{g}$ .

Note that the gauge potential (3.30) had to be in a particular form for the argument to work smoothly. While direct computation may easily be done with matrices of small rank, with large matrices other, more algebraic, methods have to be used. In section 3.4 it was the decomposition  $\mathfrak{g} = \mathfrak{h} \oplus \mathfrak{m}$  that enabled equation (3.22) to decouple, and hence be solved. Of course this decomposition may be used for higher rank groups, but the commutator  $[e_{+\alpha}, e_{+\beta}]$  which is trivially zero for  $sl(2, \mathbb{R})$  is now no longer zero. However, for a class of Lie algebras associated with Hermitian symmetric spaces there is a subset  $\Theta^+$  of the positive roots  $\Phi^+$  for which  $[e_{+\alpha}, e_{+\beta}] = 0$ . Using such algebra Fordy and his collaborators<sup>[79,80,83,84]</sup> have constructed integrable systems using the AKNS and DNLS scheme. As shown in section 3.4 these admit a generalisation to  $(2+1)$ -dimensions (corresponding to the twistor spaces  $\Pi_{1,n}$  and  $\Pi_{2,2n}$ ), and these will be constructed here.

Recall that a homogeneous space of a Lie group  $G$  is any differentiable manifold  $M$  on which  $G$  acts transitively ( $\forall p_1, p_2 \in M \exists g \in G$  s.t.  $g.p_1 = p_2$ ). For a given  $p_0 \in M$ , let  $K$  be defined by

$$K = K_{p_0} = \{g \in G : g.p_0 = p_0\}.$$

The manifold  $M$  may be identified with the coset space  $G/K$ , and the Lie algebra  $\mathfrak{g}$  of  $G$  decomposes as  $\mathfrak{g} = \mathfrak{k} \oplus \mathfrak{m}$ , where  $\mathfrak{m}$  may be identified with the tangent space  $T_{p_0}(G/K)$ ,



and  $[\mathfrak{k}, \mathfrak{k}] \subset \mathfrak{k}$ . If the further conditions

$$[\mathfrak{k}, \mathfrak{m}] \subset \mathfrak{m},$$

$$[\mathfrak{m}, \mathfrak{m}] \subset \mathfrak{k}$$

holds the  $\mathfrak{g}$  is called a symmetric algebra, and  $\mathbb{G}/\mathbb{K}$  is said to be a symmetric space.

Hermitian symmetric spaces are very special, and have many interesting differential/geometric properties. Here it is the algebraic properties of the associated algebra  $\mathfrak{g}$  that will be important. Explicitly:

(i)  $\exists A \in \mathfrak{h}$  (the Cartan subalgebra of  $\mathfrak{g}$ ) s.t.  $\mathfrak{k} = \mathcal{C}_{\mathfrak{g}}(A) = \{B \in \mathfrak{g} : [B, A] = 0\}$ ,

(ii)  $\exists \Theta^+ \subset \Phi^+$ , a subset of the positive root system, s.t.  $\mathfrak{m} = \text{span}\{e_{\pm\alpha}\}_{\alpha \in \Theta^+}$ , and

$$[h, e_{\alpha}] = \pm a e_{\alpha} \forall h \in \mathfrak{h} \text{ and } \alpha \in \Theta^{\pm},$$

(iii)  $[e_{\alpha}, e_{\beta}] = 0 \forall \alpha, \beta \in \Theta^+$  or  $\alpha, \beta \in \Theta^-$ .

More details may be found in [87] and in Appendix A.

The starting point to construct integrable models associated with these Hermitian symmetric spaces is again (3.18) :

$$\Phi_x = [\xi.A + Q(x, y, t_n)]\Phi,$$

$$\Phi_{t_n} = \xi^n \Phi_y + \left[ \sum_{i=0}^{n-1} B_{n-i} \xi^i \right] \Phi,$$

but now the gauge potentials will be  $\mathfrak{g}$ -valued matrices. The constant matrix  $A \in \mathfrak{h}$  is the element that generates the algebra  $\mathfrak{k}$  (see condition (i)), and  $Q(x, y, t) \in \mathfrak{k}$ . Again, it will be useful to decompose the matrices  $B_i$  with respect to the decomposition  $\mathfrak{g} = \mathfrak{k} \oplus \mathfrak{m}$ , i.e. let  $B_i = B_i^{\mathfrak{k}} + B_i^{\mathfrak{m}}$ , where  $B_i^{\mathfrak{k}} \in \mathfrak{k}$  and  $B_i^{\mathfrak{m}} \in \mathfrak{m}$ .

The integrability conditions yield a set of equations similar to (3.22), the only difference is that the label  $h$  on the matrices is now  $k$ , e.g. (3.22)(c) now reads

$$\partial_x B_{n-i}^{\mathfrak{k}} = [Q, B_{n-i}^{\mathfrak{m}}], \quad i = 1, \dots, (n-1).$$

One may expand  $Q$  in terms of the basis for  $\mathfrak{k}$ ,

$$Q = \sum_{\alpha \in \Theta^+} (q^{\alpha} e_{\alpha} + p^{\alpha} e_{-\alpha}),$$

and systematically solve equations (3.22)(a), (b), (c) and (d).

The first iteration yields the matrix  $B_1$ :

$$B_1^m = \frac{1}{a} \sum_{\alpha \in \Theta^+} (q_y^\alpha e_\alpha - p_y^\alpha e_{-\alpha}),$$

$$B_1^k = -\frac{1}{a} \sum_{\alpha, \beta \in \Theta^+} \partial_x^{-1} \partial_y \{q^\alpha \cdot p^\beta\} \cdot [e_\alpha, e_{-\beta}],$$

and this immediately gives the equations for the second order flow:

$$Q_t = \partial_x B_1^m + [B_1^k, Q].$$

Since  $\alpha + \beta - \gamma$  is either not a root, or  $\alpha + \beta - \gamma \in \Theta^+ \forall \alpha, \beta, \gamma \in \Theta^+$  since  $(\alpha + \beta - \gamma)(A) = a$ , this last equation decouples :

$$a \sum_{\alpha \in \Theta^+} q_t^\alpha e_\alpha = \sum_{\alpha \in \Theta^+} q_{xy}^\alpha e_\alpha + \sum_{\beta, \gamma, \delta \in \Theta^+} q^\beta \cdot \partial_x^{-1} \partial_y \{q^\gamma \cdot p^\delta\} \cdot [e_\beta, [e_\gamma, e_{-\delta}]],$$

$$-a \sum_{\alpha \in \Theta^+} p_t^\alpha e_{-\alpha} = \sum_{\alpha \in \Theta^+} p_{xy}^\alpha e_{-\alpha} + \sum_{\beta, \gamma, \delta \in \Theta^+} p^\beta \cdot \partial_x^{-1} \partial_y \{p^\gamma \cdot q^\delta\} \cdot [e_{-\beta}, [e_{-\gamma}, e_\delta]].$$

These simplify further by using the definition of the Riemann curvature tensor:

$$R^\alpha_{\beta\gamma-\delta} e_\alpha = [e_\beta, [e_\gamma, e_{-\delta}]],$$

$$R^{-\alpha}_{-\beta-\gamma\delta} e_{-\alpha} = [e_{-\beta}, [e_{-\gamma}, e_\delta]],$$

and by using the linear independence of the  $e_\alpha$ 's. The resulting integrable system is

$$a q_t^\alpha = q_{xy}^\alpha + \sum_{\beta, \gamma, \delta \in \Theta^+} R^\alpha_{\beta\gamma-\delta} \cdot q^\beta \cdot \partial_x^{-1} \partial_y \{q^\gamma \cdot p^\delta\},$$

$$-a p_t^\alpha = p_{xy}^\alpha + \sum_{\beta, \gamma, \delta \in \Theta^+} R^{-\alpha}_{-\beta-\gamma\delta} \cdot p^\beta \cdot \partial_x^{-1} \partial_y \{p^\gamma \cdot q^\delta\}.$$

As in section 3.4, if the symmetry  $\partial_y = \partial_x$  is imposed, these simplify to the equations studied by Fordy and Kulish,<sup>[79]</sup> and correspond to bundles over the minitwistor space  $\mathcal{O}(2)$ . Note how the nonlinear terms have a geometrical origin as the curvature of the homogeneous manifold  $\mathbf{G}/\mathbf{K}$  at the point  $p_0$ .

The third order flow may similarly be constructed; the equation itself is rather long:

$$\begin{aligned} a^2 \cdot q_t^\alpha &= q_{xxy}^\alpha + a \cdot S_x^\alpha - R^\alpha_{\beta\gamma-\delta} q^\beta \partial_x^{-1} T^{\gamma\delta}, \\ a^2 \cdot p_t^\alpha &= p_{xxy}^\alpha + a \cdot T_x^\alpha + R^{-\alpha}_{-\beta-\gamma\delta} \partial_x^{-1} T^{\gamma\delta}, \end{aligned}$$

where

$$\begin{aligned} S^\alpha &= R^\alpha_{\beta\gamma-\delta} q^\beta \cdot \partial_x^{-1} \partial_y \{q^\gamma \cdot p^\delta\}, \\ T^\alpha &= R^{-\alpha}_{-\beta-\gamma\delta} p^\beta \cdot \partial_x^{-1} \partial_y \{p^\gamma \cdot q^\delta\}, \end{aligned}$$

and

$$a^2 \cdot T^{\beta\gamma} = q^\beta \cdot p_{xy}^\gamma - p^\gamma \cdot q_{xy}^\beta + a \cdot (q^\beta T^\gamma - p^\gamma S^\beta).$$

This may be written in local form by introducing potential functions, as in section 3.4.

One may similarly derive integrable systems in  $(2 + 1)$ -dimensions for the generalised DNLS hierarchy given by (3.28).

### Examples

These Hermitian symmetric spaces have been completely classified, and Table 3 shows all the possible cases (this has been taken from Helgason, where many more details of these spaces may be found). The compact spaces correspond to the reduction  $p^\alpha = \overline{q^\alpha}$ , and the noncompact spaces correspond to  $p^\alpha = -\overline{q^\alpha}$  (in both cases  $a = i$ ). Such reductions are consistent since the Riemann curvature tensor has the property

$$\overline{(R^\alpha_{\beta\gamma-\delta})} = R^{-\alpha}_{-\beta-\gamma\delta}.$$

Examples from some of the families of Hermitian symmetric spaces will now be given.

#### A III $SU(r + s)/S[U(r) \times U(s)]$

Examples of the second and third order flows, corresponding to the simplest case ( $r = s = 1$ ) have already been calculated, albeit in a different guise, in section 3.4 (the constants  $\kappa$  and  $a$  are related by  $2\kappa = a$ ). If  $r = 1$  and  $s$  is arbitrary, then the corresponding space is in fact the complex projective space  $\mathbb{C}P^s$ , and in such spaces the Riemann curvature tensor is determined from the Gaussian curvature  $K$ , which is a

Name	Noncompact	Compact	Rank	Dimension
A III	$SU(p, q)/S[U(p) \times U(q)]$	$SU(p + q)/S[U(p) \times U(q)]$	$\min(p, q)$	$2pq$
BD I	$SO(p, 2)/SO(p) \times SO(2)$	$SO(p + 2)/SO(p) \times SO(2)$	$\min(2, p)$	$2p$
D III	$SO^*(2n)/U(n)$	$SO(2n)/U(n)$	$[\frac{1}{2}n]$	$n(n - 1)$
C I	$Sp(n, \mathbb{R})/U(n)$	$Sp(n)/U(n)$	$n$	$n(n + 1)$
E III	—	—	2	32
E VII	—	—	3	54

Table 3 Irreducible Hermitian Symmetric Spaces

constant. The resulting system is

$$i \cdot q_t^\alpha = q_{xy}^\alpha + K \left\{ \sum_{\beta, \gamma \in \Theta^+} g_{\beta, -\delta} \partial_x^{-1} \partial_y [q^\beta \overline{q^\gamma}] \right\} \cdot q^\alpha,$$

and its complex conjugate. The quantity  $g_{\beta, -\delta}$  is the metric (with respect to the root vector basis) of the projective space.

A non-trivial example occurs when  $r = s = 2$ . The linear problem is generated by the following choice for the potentials  $A$  and  $Q$ :

$$A = \frac{1}{2}i \left( \begin{array}{cc|cc} 1 & 0 & 0 & 0 \\ 0 & 1 & 0 & 0 \\ \hline 0 & 0 & -1 & 0 \\ 0 & 0 & 0 & -1 \end{array} \right)$$

$$Q = \left( \begin{array}{cc|cc} 0 & 0 & q_1 & q_2 \\ 0 & 0 & q_4 & q_3 \\ \hline -\bar{q}_1 & -\bar{q}_4 & 0 & 0 \\ -\bar{q}_2 & -\bar{q}_3 & 0 & 0 \end{array} \right)$$

which leads to the equations:

$$iq_i^1 = q_{xy}^1 + 2q^1 \cdot \partial_x^{-1} \partial_y [ |q^1|^2 + |q^2|^2 ] + 2q^4 \cdot \partial_x^{-1} \partial_y [ q^1 \bar{q}^4 + q^2 \bar{q}^3 ],$$

$$iq_i^2 = q_{xy}^2 + 2q^2 \cdot \partial_x^{-1} \partial_y [ |q^1|^2 + |q^2|^2 ] + 2q^3 \cdot \partial_x^{-1} \partial_y [ q^1 \bar{q}^4 + q^2 \bar{q}^3 ],$$

and two more obtained by the interchange  $1 \leftrightarrow 3$  and  $2 \leftrightarrow 4$ , together with the complex conjugate equations.

C I  $Sp(n)/U(n)$

An example corresponding to the space  $Sp(2)/U(2)$  may easily be constructed from the previous example by using the same  $A$  and  $Q$ , but with the constraint  $q_4 \equiv q_2$ , so the off-diagonal blocks are symmetric. The reason that this works is that there is an inclusion

$$\frac{Sp(n)}{U(n)} \subset \frac{SU(2n)}{S[U(n) \times U(n)]},$$

and so one may think of the resulting equations for a C I space as a reduction of those for a A III space.

D III  $SO(2n)/U(n)$

With  $n = 2$  and the following matrix representations

$$\xi \cdot A + Q = \left( \begin{array}{cccc|cccc} \frac{i\xi}{2} & 0 & 0 & 0 & 0 & q_1 & q_3 & q_6 \\ 0 & \frac{i\xi}{2} & 0 & 0 & -q_1 & 0 & q_2 & q_5 \\ 0 & 0 & \frac{i\xi}{2} & 0 & -q_3 - q_2 & 0 & q_4 & \\ 0 & 0 & 0 & \frac{i\xi}{2} & -q_6 - q_5 - q_4 & 0 & & \\ \hline 0 & \bar{q}_1 & \bar{q}_3 & \bar{q}_6 & -\frac{i\xi}{2} & 0 & 0 & 0 \\ -\bar{q}_1 & 0 & \bar{q}_2 & \bar{q}_5 & 0 & -\frac{i\xi}{2} & 0 & 0 \\ -\bar{q}_3 - \bar{q}_2 & 0 & \bar{q}_4 & & 0 & 0 & -\frac{i\xi}{2} & 0 \\ -\bar{q}_6 - \bar{q}_5 - \bar{q}_4 & 0 & & & 0 & 0 & 0 & -\frac{i\xi}{2} \end{array} \right)$$

one may construct the following integrable model:

$$iQ_t = Q_{xy} - \left\{ \partial_x^{-1} \partial_y [Q \cdot \bar{Q}] \right\} \cdot Q - Q \cdot \left\{ \partial_x^{-1} \partial_y [\bar{Q} \cdot Q] \right\},$$

together with the complex conjugate equation.  $Q$  is the top corner block matrix in  $Q$ ,

$$Q = \begin{pmatrix} 0 & q_1 & q_3 & q_6 \\ -q_1 & 0 & q_2 & q_5 \\ -q_3 & -q_2 & 0 & q_4 \\ -q_6 & -q_5 & -q_4 & 0 \end{pmatrix}.$$

As with the C I family, this is a reduction of one of the A III family, which follows from the relation

$$\frac{SO(n)}{U(n)} \subset \frac{SU(2n)}{S[U(n) \times U(n)]},$$

where now the off-diagonal blocks are skew-symmetric. Another consistent reduction is to take  $q_4 \equiv q_5 \equiv q_6 \equiv 0$ . the resulting model is just the equation associated with  $\mathbb{C}P^3$ ,

since there is an accidental isomorphism

$$\frac{SO(6)}{U(3)} \cong \frac{SU(4)}{S[U(1) \times U(3)]} \cong \mathbb{C}P^3.$$

Further examples for the BD I spaces and the two exceptional cases E III and E VIII could also be constructed, using suitable matrix representations.

So far all these examples belong to the AKNS hierarchy, but the procedure also works for the generalised DNLS hierarchy given by (3.28). The simplest example, corresponding to the space  $SU(2)/S[U(1) \times U(1)] \cong \mathbb{C}P^1$  has already been worked out in section 3.4, the equation (3.29) being

$$-i\partial_t\psi = [\partial_y\psi + 2i\partial_x^{-1}\partial_y|\psi|^2 \cdot \psi]_x.$$

---

As stressed earlier, such reductions are possible due to the algebraic properties of Hermitian symmetric spaces. Such structures are not necessary for integrability, they just make the manipulations easier. In the above examples it was the condition  $[e_\alpha, e_\beta] = 0 \forall \alpha, \beta \in \Theta^+$  that simplified the calculations. Relaxing this condition (and hence the spaces involved will no longer be Hermitian symmetric) leads to the introduction of terms which depend on the non-vanishing torsion, this being defined by

$$T_{\alpha\beta} = [e_\alpha, e_\beta],$$

in addition to the Riemann curvature tensor. Examples of integrable models with this non-vanishing torsion are the  $N$ -wave hierarchy, where the equations are associated with spaces such as

$$\frac{SU(n)}{S[U(n_1) \times \dots \times U(n_m)]}, \quad \sum_{i=1}^m n_i = n.$$

There may also be fitted into the above scheme, and generalised to higher dimensions, though the results are not presented here.

There are still many interesting questions and problems with these higher dimensional integrable systems. For example nothing has been said about their Hamiltonian structure (if one exists) or even a possible classical  $r$ -matrix structure.<sup>[79]</sup> Such structures underlie many two dimensional integrable models, but how, if at all, they survive the generalisation to  $(2 + 1)$ -dimensions has not been investigated at all.

### 3.6 Infinite Rank Gauge Groups

In recent years there has been much interest in infinite rank groups, and their Lie algebras. As well as being interesting in their own right, the use of them as gauge groups has shown connections between hitherto disconnected areas, such as the self-dual Einstein and self-dual Yang-Mills equations.<sup>[58,88,89,90,91]</sup> Also various linearisations occur in the large  $N$  limit of  $SU(N)$  field theories, Nahm equations,<sup>[92]</sup> Toda fields<sup>[93]</sup> etc.etc.. In this section the group  $SDiff(\Sigma^2)$ , the group of volume preserving diffeomorphisms of the 2-surface  $\Sigma^2$  will be used as the gauge group for various models. This may be identified with  $SU(\infty)$ , though the limiting procedure is subtle, reflecting the different topologies of the surface, and this aspect will not be discussed here.

Let  $\Sigma^2$  be a 2-surface with local canonical (or symplectic) coordinates  $\sigma_0$  and  $\sigma_1$ , so the volume element is given by  $dA = d\sigma_0 \cdot d\sigma_1$ . For example, if  $\Sigma^2 = S^2$ , the 2-sphere, then  $\sigma_0 = \phi, \sigma_1 = \cos \theta$ , where  $\theta$  and  $\phi$  are the standard angles on the sphere. An element of the corresponding Lie algebra  $sdiff(\Sigma^2)$  may be written using Hamiltonian functions.<sup>[94]</sup> That is, if  $L_f \in sdiff(\Sigma^2)$  then this may be written as

$$L_f = \frac{\partial f}{\partial \sigma_1} \frac{\partial}{\partial \sigma_0} - \frac{\partial f}{\partial \sigma_0} \frac{\partial}{\partial \sigma_1},$$

and, as may be easily checked, this satisfies the relations

$$\begin{aligned} [L_f, L_g] &= L_{\{f,g\}}, \\ [L_f, g] &= \{f, g\}, \end{aligned}$$

where  $\{f, g\}$  is the Poisson bracket

$$\{f, g\} = \frac{\partial f}{\partial \sigma_0} \frac{\partial g}{\partial \sigma_1} - \frac{\partial f}{\partial \sigma_1} \frac{\partial g}{\partial \sigma_0}.$$

The element  $L_f$  transforms  $(\sigma_0, \sigma_1) \rightarrow (\sigma_0 - \frac{\partial f}{\partial \sigma_1}, \sigma_1 + \frac{\partial f}{\partial \sigma_0})$  and infinitesimally this preserves the volume form  $d\sigma_0 \wedge d\sigma_1$ . The function  $f$  may be expanded in terms of a suitably chosen basis, for example, if  $\Sigma^2 = T^2$ , the 2-torus, one may take as a basis the functions

$$f_{m_0, m_1} = \exp[i(m_0 \sigma_0 + m_1 \sigma_1)],$$



or if  $\Sigma^2 = S^2$ , the 2-sphere, one may take a basis of spherical harmonics

$$f_{lm} = Y_{lm}(\theta, \phi).$$

Thus to each gauge field  $A_i(x) \in \text{sdiff}(\Sigma^2)$  there is a function  $a_i(x, \sigma)$  so that

$$A_i(x) \longleftrightarrow L_{a_i}.$$

The associated field strength  $F_{ij}$  corresponds to  $L_{f_{ij}}$ , where

$$f_{ij} = \partial_i a_j - \partial_j a_i + \{a_i, a_j\}.$$

Next two examples will be given to show the use of such Lie algebras.

### Example

Taking twistor space to be  $\mathbb{C}P^{N+1}$  implies, by the construction of chapter II, that there exists the following family of linear operators corresponding to certain holomorphic bundles over the twistor space:

$$\mathcal{L}_k = \left( \frac{\partial}{\partial y_k} + A_k \right) + \lambda \left( \frac{\partial}{\partial x_k} + B_k \right), \quad k = 1, \dots, N.$$

Imposing the symmetry  $\frac{\partial}{\partial y_k} = 0$  and the gauge condition  $B_k = 0$  gives rise to the following integrability conditions for such systems (using the notation  $\partial_i = \frac{\partial}{\partial x_i}$ ):

$$\begin{aligned} \partial_i A_j - \partial_j A_i &= 0, \\ [A_i, A_j] &= 0. \end{aligned}$$

If the gauge group is taken to be  $\text{SDiff}(\Sigma^2)$  then the first of these may be solved by taking  $a_i = \partial_i \Omega$  (recall  $A_i \leftrightarrow L_{a_i}$ ), and the second implies

$$L_{\{\partial_i \Omega, \partial_j \Omega\}} = 0,$$

so  $\{\partial_i \Omega, \partial_j \Omega\}$  must be independent of the surface coordinates  $\sigma_0, \sigma_1$ , and so must be a function of the  $x_i$  only. Taking this function to be 1 (for  $i < j$ ) gives the system of equations

$$\{\partial_i \Omega, \partial_j \Omega\} = 1, \quad i < j, \quad i, j = 1, \dots, N. \tag{3.31}$$

The first such equations, for  $N = 2$ , is just the Plebanski's First Heavenly Equation<sup>[59]</sup> (which is equivalent to the self-dual Einstein equations for a 4-d spacetime with coordinates  $(x_1, x_2, \sigma_0, \sigma_1)$ ), and so (3.31) may be regarded as an associated hierarchy.

In general one has

$$\{\partial_i \Omega, \partial_j \Omega\} = M_{ij}(x). \tag{3.32}$$

Under certain conditions this may be reduced to the above form. If there exist functions  $G_i(x)$  so that

$$G_i \cdot G_j = M_{ij}, \quad i < j, \tag{3.33}$$

then performing the coordinate transformation

$$x_i \longrightarrow w_i, \quad \frac{\partial w_i}{\partial x_i} = G_i \quad (\text{no sum})$$

reduces (3.32) to (3.31). However (3.33) is (except for the simplest case when  $N = 2$ ) an overdetermined system, so such transforming (3.32) to (3.31) by using such a simple coordinate transformation is not possible. Examples of such a construction may be found in [58,88].

**Example**

In this second example the minitwistor space  $\mathcal{O}(N)$  will be used. This implies the existence (under certain gauge condition) of the system

$$\mathcal{L}_k = \partial_k - A_k + \lambda \partial_{k+1}, \quad k = 0, \dots, N - 1.$$

The integrability conditions of such a system are

$$\begin{aligned} \partial_{j+1} A_i - \partial_{i+1} A_j &= 0, \\ \partial_i A_j - \partial_j A_i + [A_i, A_j] &= 0. \end{aligned}$$

As in the previous example, the firsts of these may be solved by introducing a single function  $\Omega$ , such that  $a_i = \partial_{i+1} \Omega$ . The second equations then implies

$$\square_{ij} \Omega + \{\partial_i \Omega, \partial_j \Omega\} = H_{ij}(x). \tag{3.34}$$

[For brevity the linear differential operator

$$\square_{ij} \equiv \partial_{i+1} \partial_j - \partial_{j+1} \partial_i$$

has been introduced. The simplest operator,  $\square_{01} = \partial_1^2 - \partial_0 \partial_2$  is just the (2+1)-dimensional wave operator.]

The function  $\Omega$  is only defined up to an additive function of  $x$  alone, i.e.  $\Omega \rightarrow \Omega + M(x)$ . Under such a change this last equations becomes

$$\square_{ij}\Omega + \{\partial_i\Omega, \partial_j\Omega\} = H_{ij} - \square_{ij}M.$$

So if one can solve the following system for  $M(x)$

$$H_{ij}(x) = \square_{ij}M(x),$$

then (3.34) becomes

$$\square_{ij}\Omega + \{\partial_i\Omega, \partial_j\Omega\} = 0. \tag{3.35}$$

In the simplest case ( $N = 2$ ) when there is only one such equations, this is always possible.

These examples seem to be connected to the theory of hyper-Kähler hierarchies.<sup>[95]</sup>

One important subalgebra of  $sdiff(\Sigma^2)$  is the Lie algebra  $su(2)$ . This is clearly illustrated by taking  $\Sigma^2 = S^2$ , a two sphere, and a basis consisting of spherical harmonics. In general

$$\begin{aligned} [Y_{lm}, Y_{l'm'}] &= L_{\{Y_{lm}, Y_{l'm'}\}}, \\ &= f_{ll'mm'}^{l''m''} \cdot Y_{l''m''}. \end{aligned}$$

However, as may be easily checked by using appropriately normalised spherical harmonics, the functions  $Y_{l=1,m}$  satisfies the relations

$$\begin{aligned} [L_{1,0}, L_{1,m}] &= m \cdot L_{1,m}, \\ [L_{1,1}, L_{1,-1}] &= L_0, \end{aligned}$$

with all other commutators (with  $l = 1$ ) being zero. These are the  $su(2)$  commutator relations, and so the set  $\{Y_{l=1,m}, m = +1, 0, -1\}$  is a representation of this algebra, hence  $su(2)$  may be embedded within  $sdiff(S^2)$ ,  $su(2) \hookrightarrow sdiff(S^2)$ .

So any  $A(x) \in su(2)$  may be expressed as an element of  $sdiff(S^2)$  by first writing it in terms of the basis  $\{\sigma^+, \sigma^3, \sigma^-\}$ ,

$$\begin{aligned} A(x) &= A^m(x)\sigma^m, \quad m = (+, 3, -), \\ &\rightarrow A^m(x)Y_{l=1,m}. \end{aligned}$$

Thus it should be possible to express models that arise from  $su(2)$  gauge groups (such as the NLS and SG equations) in this form, using the above procedure.

### 3.7 Comments

The aim of this chapter has been two fold:

- To show how many existing examples of integrable models may be given a natural twistorial interpretation, which provides a natural geometrical setting for such models.
- To show that this geometrical picture provides a natural framework in which to construct new examples of integrable models, including generalisations from  $(1 + 1)$  to  $(2 + 1)$ -dimensions.

Much work remains to be done, both on the systematic classification of models which arise from this twistor-geometrical description, as well as the construction and properties of the solutions to these models. As has been mentioned earlier, the understanding of how (if at all) such systems as the KP and DS equations can be fitted naturally into the above scheme remains an important outstanding problem.

---

## Chapter IV

---

# Solution Generating Techniques

---

### 4.1 Introduction

In this chapter explicit solutions of the generalised self-duality equations derived in chapter II will be constructed, and in particular solutions of the  $(2 + 1)$ -dimensional integrable equation

$$\begin{aligned} i\partial_t\psi &= \partial_{xy}\psi + V(\psi, \bar{\psi})\cdot\psi, \\ \partial_x V &= 2\partial_y|\psi|^2, \end{aligned} \tag{4.1}$$

which arises as a dimensional reduction of such generalised systems. To recapitulate, the corresponding linear system for (4.1) is

$$\begin{aligned} \Phi_x &= [\xi\cdot A + Q(x, y, t)]\Phi, \\ \Phi_t &= \xi\cdot\Phi_y + B(x, y, t)\cdot\Phi. \end{aligned} \tag{4.2}$$

Here  $A, B$  and  $Q$  are  $su(2)$ -valued matrices and  $A$  and  $Q$  are of the form

$$\begin{aligned} A &= \frac{i}{2} \begin{pmatrix} 1 & 0 \\ 0 & -1 \end{pmatrix}, \\ Q &= \begin{pmatrix} 0 & \psi \\ -\bar{\psi} & 0 \end{pmatrix}. \end{aligned} \tag{4.3}$$

This system has two well known integrable equations embedded within it. Namely, if the symmetry  $\partial_x - \partial_y = 0$  is imposed then (4.1) reduces to the Non-Linear Schrödinger

equation

$$i\partial_t\psi = \partial_x^2\psi + 2|\psi|^2\psi,$$

and if the symmetry  $\partial_t = 0$  is imposed then (4.1) becomes

$$\begin{aligned}\partial_{xy}\psi &= -V(\psi, \bar{\psi})\psi, \\ \partial_x V &= 2\partial_y|\psi|^2.\end{aligned}$$

This is a ‘complexification’ of the sine Gordon equation, for if the algebraic constraints  $V = 4 \cos \phi$  and  $\psi = \frac{1}{2}\partial_x\phi$  are imposed it becomes the sine-Gordon equation,  $\partial_{xy}\phi + 4 \sin \phi = 0$ .

The solutions will be constructed in two stages:

- Solution of the generalised self-duality equations will be constructed using the ‘Riemann Problem with Zeros’ method.
- Ansätze will be given for the arbitrary functions that appear in the above to ensure that the gauge fields have the correct symmetries, and are gauge equivalent to (4.3).

The corresponding hierarchies (of which (4.1) is the lowest member) may be similarly solved. It will turn out that given a solution (4.1), then solutions to the hierarchy may be obtained by a simple change of variable. This is similar to how Hirota’s method works, and this will be commented on in chapter VI.

## 4.2 The ‘Riemann Problem with Zeros’ Method

Recall the twistor construction of gauge fields in chapter II. Fundamental in this is the double fibration

$$\begin{array}{ccc} & \mathbb{F} & \\ \mu \swarrow & & \searrow \nu \\ \Pi & & \mathbb{M}. \end{array}$$

One starts with a holomorphic vector bundle on  $\Pi$ , then this is restricted to a global holomorphic section, and hence becomes an object defined on  $\mathbb{F}$ . This is then split, providing a solution  $\Phi$  (again a function on  $\mathbb{F}$ ) of the equations

$$\begin{aligned}\mathcal{K}_k \Phi &= 0 \quad k = 1, \dots, m, \\ \mathcal{L}_l \Phi &= 0 \quad l = 1, \dots, n,\end{aligned}\tag{4.4}$$

from which the gauge fields (functions on  $\mathbb{M}$ ) may be extracted.

The hardest part of the construction is the splitting of the pull-backed bundle on  $\mathbb{F}$ , and the Atiyah-Ward ansätze define a certain class of bundles on  $\mathbb{T}$  for which this splitting may (relatively) easily be achieved. Another approach is the so-called ‘Riemann Problem with Zeros’ method. Rather than starting with a bundle on  $\mathbb{T}$ , the starting point is an ansatz for the solution  $\Psi$  of the equations

$$\begin{aligned}\mathcal{K}_k \Psi &= 0 & k &= 1, \dots, m, \\ \mathcal{L}_l \Psi &= 0 & l &= 1, \dots, n.\end{aligned}$$

The reason for the change in notation between this and (4.4) is as follows: the twistor construction implies that  $\Phi$  is a holomorphic function of the spectral parameter, while the ansatz for  $\Psi$  involves  $N$ -distinct simple poles (see below). From  $\Psi$  one may reconstruct  $\Phi$  (though not uniquely, due to gauge invariance), and thence the bundle, which turns out to be one in the Atiyah-Ward class  $\mathcal{A}_N$ . This will be explained in more detail later in this chapter.

Consider the generalised self-duality equations associated with the space  $\mathbb{T}_{m,n}$  (and in the gauge where  $A_k = 0$  and  $C_l = 0$ ):

$$\begin{aligned}\left[ \frac{\partial}{\partial x_k} - \xi \frac{\partial}{\partial x_{k-1}} \right] \Psi &= \tilde{D}_k \Psi, & k &= 1, \dots, m, \\ \left[ \frac{\partial}{\partial y_l} - \xi \frac{\partial}{\partial y_{l-1}} \right] \Psi &= \tilde{B}_l \Psi, & l &= 1, \dots, n\end{aligned}\tag{4.5}$$

(the reason for the tildes is that these fields are not the fields  $B$  and  $Q$  of (4.2), but are gauge transformations of these).

All the remaining gauge fields may be written in terms of a single  $SU(2)$ -valued function  $J(x, y)$  defined by

$$J = \Psi^{-1} \Big|_{\xi=0},\tag{4.6}$$

so

$$\begin{aligned}\tilde{D}_k &= -J^{-1} \frac{\partial J}{\partial x_k}, \\ \tilde{B}_l &= -J^{-1} \frac{\partial J}{\partial y_l}.\end{aligned}$$

To ensure that the gauge potentials are  $su(2)$ -valued the matrix  $J$  has to have unit de-

terminant ( $\det J = 1$ ) and also the 'reality' condition

$$\Psi(x, y, \bar{\xi})^{\text{c.c.t.}} = \Psi(x, y, \xi)^{-1}, \quad (4.7)$$

where 'c.c.t.' denotes the complex conjugate transpose. These are the last vestiges of the conditions (b)(ii) and (b)(iii) in Theorem 2.5.

The 'Riemann Problem with Zeros' gives a way of generating new solutions,  $\Psi(\xi)$ , from an old solution,  $\Psi_o(\xi)$ . It is assumed that  $\Psi$  is of the form

$$\Psi(\xi) = \left[ \mathbb{1} + \sum_{k=1}^N \frac{n^k \otimes m^k}{\xi - \xi_k} \right] \cdot \Psi_o(\xi), \quad (4.8)$$

where  $m^k, n^k$  and  $\xi_k$  are functions of all the  $x$  and  $t$  coordinates. It will suffice here to take  $\Psi_o = \mathbb{1}$ , the trivial solution.

So, in coordinates,  $\Psi$  has the form

$$\Psi(\xi)_{ab} = \delta_{ab} + \sum_{k=1}^N \frac{n_a^k m_b^k}{\xi - \xi_k}.$$

The 'reality' condition (4.7) imposes constraints on the vectors  $m$  and  $n$ . Rearranging (4.7) gives

$$\sum_{b=1}^2 \Psi(\xi)_{ab} \Psi(\bar{\xi})_{bc}^{\text{c.c.t.}} = \delta_{ac},$$

and the right hand side of this is clearly holomorphic in  $\xi$ . The left hand side appears to have simple poles at  $\xi = \xi_k$  and  $\xi = \bar{\xi}_k$ . In order to avoid a contradiction, the residues at these poles have to be zero, and this gives an equation for  $n$  in terms of  $m$ , namely

$$n_a^k = - \sum_{l=1}^N (\Gamma^{-1})^{kl} \bar{m}_a^l,$$

where

$$\Gamma^{kl} = \sum_{a=1}^2 \frac{\bar{m}_a^k m_a^l}{\xi_k - \xi_l}.$$

The equations for  $m$  come from the differential equations (4.5).



Again, the expressions involved are holomorphic, so the second and first order poles must be removable. The absence of second order poles implies that the  $\xi_k$  must depend implicitly on the coordinates  $x_k$  and  $y_l$ , i.e. they are given by the roots of an equation of the form

$$h[\xi, \hat{\eta}_0(\xi), \hat{\eta}_1(\xi)] = 0,$$

for some smooth function  $h(\xi, \eta_0, \eta_1)$ . For simplicity the following notation will be used:

$$\begin{aligned}\hat{\eta}_0^k &\equiv \hat{\eta}_0(\xi_k) = \sum_{i=0}^m x_i \xi_k^i, \\ \hat{\eta}_1^k &\equiv \hat{\eta}_1(\xi_k) = \sum_{j=0}^n y_j \xi_k^j.\end{aligned}$$

In the rest of this chapter it will suffice to take

$$h = \prod_{k=1}^n (\xi - \xi_k),$$

where the  $\xi_k$  are complex constants.

The absence of first order poles implies that two-component object  $m_a^k$  is a function of the real global holomorphic sections at the point  $\xi_k$ , i.e. a function of  $\hat{\eta}_0^k$  and  $\hat{\eta}_1^k$ . Without loss of generality one may set  $m_1^k = 1$ ,  $m_2^k = f_k(\hat{\eta}_0^k, \hat{\eta}_1^k)$ , where  $f_k(\eta_0, \eta_1)$  is a holomorphic function of twistor coordinates  $\eta_0$  and  $\eta_1$  (possibly with singularities).

To ensure that  $\det J = 1$ , one has to divide  $J$  by  $\sqrt{\alpha}$ , where  $\alpha$  is given by

$$\alpha = \det \Psi|_{\xi=0} = \prod_{k=1}^N \bar{\xi}_k / \xi_k.$$

Finally, this gives the formula for  $J^{-1}$ ,

$$(J^{-1})_{ab} = \frac{1}{\sqrt{\alpha}} \left\{ \delta_{ab} + \sum_{k,l=1}^N \frac{1}{\xi_k} (\Gamma^{-1})^{kl} \bar{m}_a^l m_b^k \right\}. \quad (4.9)$$

The above details have been taken from [51,75].

### 4.3 Ansätze for solutions

The method described above will now be used to construct solutions to (4.1). This corresponds to the space  $\Pi_{1,n}$ , if one is to study solution to the associated hierarchy as well. The following lemma provides a sufficient condition for the functions  $f_k$  so that the resultant gauge fields, after gauge transformations, are a solution of the system (4.2) with  $A$  and  $Q$  being in the form (4.3).

**Lemma<sup>(4)</sup>**

Let the functions  $f_k$  in the above construction be given by the product

$$f_k(\hat{\eta}_0, \hat{\eta}_1) = f_k^0(\hat{\eta}_0) \cdot f_k^1(\hat{\eta}_1),$$

where

$$f_k^0(\hat{\eta}_0) = \exp[i\hat{\eta}_0],$$

and  $f_k^1$  are arbitrary holomorphic functions of the one complex variable. Then the matrix  $J$ , given by (4.9), generates fields (4.6) which are gauge equivalent to

$$A = \frac{i}{2} \begin{pmatrix} 1 & 0 \\ 0 & -1 \end{pmatrix},$$

$$Q = \begin{pmatrix} 0 & \psi \\ -\bar{\psi} & 0 \end{pmatrix},$$

and where the function  $\psi$  is independent of  $x_0$ . This then gives a solution to the generalisation of the AKNS hierarchy given by (4.2).

**Proof**

With the above ansätze, the functions  $f_k$  are of the form

$$f_k(\xi) = \exp[ix_0] \cdot \exp[i\xi x_1] \cdot f_k^1(\hat{\eta}_1).$$

  
 independent of  $x_0$

It then follows from the general form of (4.9) that

$$J = \begin{pmatrix} g & h \exp[-i \cdot x_0] \\ -\bar{h} \exp[i \cdot x_0] & \bar{g} \end{pmatrix}, \quad |g|^2 + |h|^2 = 1,$$

where  $g$  and  $h$  are independent of  $x_0$ . Using (4.6), this gives the following set of gauge potentials:

$$\begin{aligned} \tilde{D}_1 = \tilde{Q} &= \begin{pmatrix} p & q \cdot \exp[-ix_0] \\ \bar{q} \cdot \exp[ix_0] & -p \end{pmatrix}, \\ \tilde{B}_i &= \begin{pmatrix} r_i & s_i \cdot \exp[-ix_0] \\ \bar{s}_i \cdot \exp[ix_0] & -r_i \end{pmatrix}, \end{aligned}$$

with  $p, q, r_i$  and  $s_i$  all having no dependence on  $x_0$ . Recall that the potentials are only defined only up to the gauge transformation  $A_k \mapsto g^{-1} \cdot A_k \cdot g - g^{-1} \cdot \frac{\partial g}{\partial x_k}$  etc.. Choosing  $g$  to be

$$g = \begin{pmatrix} \exp\left[\frac{ix_0}{2}\right] & 0 \\ 0 & \exp\left[-\frac{ix_0}{2}\right] \end{pmatrix}$$

removes the  $x_0$  dependence in the above fields, and in addition gives rise to a non-zero matrix  $A$  (formerly zero):

$$A = \frac{i}{2} \begin{pmatrix} 1 & 0 \\ 0 & -1 \end{pmatrix}.$$

The gauge transformed fields will be written without the tilde. This construction gives the matrices  $Q$  and  $B$  for the linear system

$$\begin{aligned} \partial_{x_1} \Psi &= [\xi \cdot A + Q] \Psi, \\ [\partial_{y_l} - \xi \partial_{y_{l-1}}] \Psi &= B_l \Psi, \quad l = 1, \dots, m. \end{aligned}$$

However the resultant matrix  $Q$  in general will not be in the skew symmetric form, but may be gauge transformed into one that is. This is achieved with

$$g = \begin{pmatrix} \exp \int p dx_1 & 0 \\ 0 & \exp - \int p dx_1 \end{pmatrix}.$$

As this is independent of  $x_0$  the matrix  $A$  remains unchanged. Finally one is left with a solution to the system (4.2):

$$\psi = q \cdot \exp 2 \int p dx_1.$$

The matrices  $B_i$  are also left without any dependence on  $x_0$ , as required. Solutions of

(4.1) are given by putting  $m = 1$  in the above construction. Higher values will give solutions to the associated hierarchy.

**Example**

Taking the space  $\Pi_{1,1}$  and  $\xi_{k=1} = a + ib$  gives the following solution to (4.1),

$$\psi = -2b \frac{e^{iax} \bar{f}}{e^{-bx} + e^{bx} |f|^2},$$

where  $f \equiv f_{k=1}^1(\hat{\eta}_1)$  is a holomorphic function of  $y + (a + ib)t$ . Note that for fixed  $y$  and  $t$ ,  $\psi \rightarrow 0$  as  $x \rightarrow \pm\infty$ .

•  $f = \exp c\hat{\eta}_1$ , where  $c$  is a real constant.

With this  $f$  the solution is

$$\psi = -b \exp[i(ax + bct)] \operatorname{sech}[bx + c(y + at)],$$

and so  $|\psi|$  is an extended wave, whose wave front is the line  $bx + c(y + at) = 0$ .

•  $f = 2 \cosh[c\hat{\eta}_1]$ , where  $c$  is a positive real constant.

For fixed  $t$  the function has the properties

$$f \approx \exp\{+c[y + (a + ib)t]\}, \text{ as } y \rightarrow +\infty,$$

$$f \approx \exp\{-c[y + (a + ib)t]\}, \text{ as } y \rightarrow -\infty.$$

Thus for large  $|y|$  the solution looks like a linear wave (as above). More detailed analysis shows that the wavefront of  $|\psi|$  is v-shaped, rounded at the tip.

One of the advantages of this computational scheme is that it is easier to compute solutions than it is to find the equation it satisfies. In what follows the one soliton solution will be constructed for the  $n^{\text{th}}$  order flow of the NLS hierarchy (i.e. the standard AKNS hierarchy in  $(1 + 1)$  dimensions). There is not a closed formula for the corresponding  $n^{\text{th}}$  order flow evolution equation, though one knows that it may be computed using the techniques used in chapter II, that is, by iteration.

### 4.4 (1 + 1)-Dimensional Soliton Equations

In this section the soliton solutions to the Sine-Gordon and the Non-Linear Schrödinger equations will be constructed using the above methods. These may be encoded in bundles over minitwistor space, so rather than using  $\mathbb{P}_{1,n}$  the symmetry will be factored out from the start, leaving  $\mathcal{O}(1+n)$  (see chapter II). At this point there is a slight clash in notation. The  $r^{\text{th}}$ -order flow corresponds to the twistor space  $\mathcal{O}(r)$ , not  $\mathcal{O}(r+1)$ . Thus the second order flow comes from  $n = 1$ .

A slight change of notation will be used here for the global holomorphic sections. This amounts to nothing more than a change in the inhomogeneous coordinates on  $\mathbb{C}\mathbb{P}^1$ , the expressions, if written in homogeneous coordinates remain unchanged. The global holomorphic section of  $\mathcal{O}(2)$  are given by equation (2.11), namely

$$\hat{v} = x + \xi u + \xi^{-1}v, \tag{4.10}$$

where  $u = \frac{1}{2}(t + y)$  and  $v = \frac{1}{2}(t - y)$ . The corresponding spacetime has the metric  $ds^2 = dt^2 - dx^2 - dy^2$ . Recall that (for real  $x, y, t$ ) given a point  $(\xi, \nu) \in \mathcal{O}(2)$  with  $(\xi, \nu)$  complex, then the solution of (4.10) is a timelike line in  $\mathbb{R}^{2+1}$  with direction vector

$$(t, x, y) = (1 + |\xi|^2, -\xi - \bar{\xi}, 1 - |\xi|^2). \tag{4.11}$$

The orientation of the line is given by the imaginary part of  $\xi$  :

$$\begin{aligned} \text{Im } \xi > 0 & \quad \text{line future pointing} \\ \text{Im } \xi < 0 & \quad \text{line past pointing.} \end{aligned}$$

Points with  $\{\nu, \xi\}$  both real correspond to real null planes, and the remaining points in  $\mathcal{O}(2)$  do not correspond to anything in  $\mathbb{R}^{2+1}$ . Similarly the global holomorphic section of  $\mathcal{O}(1+n)$  will be parametrised by

$$\hat{v} = \sum_{i=-1}^n \xi^i x_i,$$

for some  $x_i \in \mathbb{R}, i = -1, \dots, n$ .

The form of (4.9) is unchanged after going from  $\Pi$  to a minitwistor space. The only change is that now the functions  $m_a^k$  are functions of the single variable

$$\hat{\nu}^k \equiv \hat{\nu}(\xi_k) = \sum_{i=-1}^n \xi_k^i x_i,$$

and the  $\xi_k$  satisfy the equation

$$h[\xi, \hat{\nu}(\xi)] = 0.$$

#### 4.4.1 The Sine-Gordon Equation

The integrability condition for the linear system

$$\begin{aligned} \left\{ \partial_u + \xi \begin{pmatrix} i & 0 \\ 0 & -i \end{pmatrix} \right\} \Psi &= \begin{pmatrix} 0 & -\frac{1}{2}\phi_u \\ \frac{1}{2}\phi_u & 0 \end{pmatrix} \Psi \\ \xi \partial_v \Psi &= -i \begin{pmatrix} \cos \phi & \sin \phi \\ \sin \phi & -\cos \phi \end{pmatrix} \Psi, \end{aligned} \quad (4.12)$$

yield the sine-Gordon equation

$$\phi_{uv} + 4 \sin \phi = 0. \quad (4.13)$$

[Note the change  $A \rightarrow 2A$  and the relabelings of  $x$  and  $y$  by  $u$  and  $v$ , compared with the system (4.2). These superficial changes are to make the above agree with the standard form of the Lax pair, as found, for example, in [96].]

This is clearly a dimensional reduction of the self-duality equations with the symmetry  $\partial_w = \partial_r$  :

$$\begin{aligned} [\partial_u + A_u - \xi(\partial_r + A_r)]\Psi &= 0, \\ [\partial_w + A_w - \xi(\partial_v + A_v)]\Psi &= 0, \end{aligned} \quad (4.14)$$

with the following gauge potentials

$$\begin{aligned} A_r &= \begin{pmatrix} -i & 0 \\ 0 & i \end{pmatrix} & A_w &= -i \begin{pmatrix} \cos \phi & \sin \phi \\ \sin \phi & -\cos \phi \end{pmatrix} \\ A_u &= \begin{pmatrix} 0 & \frac{1}{2}\phi_u \\ -\frac{1}{2}\phi_u & 0 \end{pmatrix} & A_v &= 0. \end{aligned} \quad (4.15)$$

Under a gauge transformation with  $g = \text{diag}(e^{ix}, e^{-ix})$ , where  $x = r + w$ , the gauge fields

transform to

$$\begin{aligned}
 A_r &= 0 & A_w &= -i \begin{pmatrix} \cos \phi - 1 & e^{-2ix} \sin \phi \\ e^{2ix} \sin \phi & 1 - \cos \phi \end{pmatrix} \\
 A_u &= \begin{pmatrix} 0 & \frac{1}{2} e^{-2ix} \phi_u \\ -\frac{1}{2} e^{2ix} \phi_u & 0 \end{pmatrix} & A_v &= 0,
 \end{aligned} \tag{4.16}$$

and these gauge potentials may be generated from a  $J$  of the form

$$J = \begin{pmatrix} \cos \frac{1}{2} \phi & e^{-2ix} \sin \frac{1}{2} \phi \\ -e^{2ix} \sin \frac{1}{2} \phi & \cos \frac{1}{2} \phi \end{pmatrix},$$

where  $A_u = J^{-1} \partial_u J$ ,  $A_w = J^{-1} \partial_x J$ , and with  $J$  satisfying the equation

$$\partial_x (J^{-1} \partial_x J) - \partial_w (J^{-1} \partial_u J) = 0 \tag{4.17}$$

which arises from the integrability conditions for (4.14).

So solving the inverse scattering problem is directly equivalent to constructing a matrix of this form. Note that the spectral parameter of the inverse problem is the coordinate on the base space  $\mathbb{C}P^1$  of the twistor space  $\mathcal{O}(2)$ .

### Lemma<sup>[3]</sup>

If  $f_k = \exp(-2i\nu_k)$ , and the set of complex constants  $\{\xi_k\}$  is invariant under the operation  $\xi \mapsto -\bar{\xi}$ , then the  $J$  defined by (4.9) is of the form

$$J = \begin{pmatrix} \cos \frac{1}{2} \phi & e^{-2ix} \sin \frac{1}{2} \phi \\ -e^{2ix} \sin \frac{1}{2} \phi & \cos \frac{1}{2} \phi \end{pmatrix}, \tag{4.18}$$

and so generates a solution of the sine-Gordon equation.

### Proof

It should first be pointed out that the form of  $J$  is not unique. If  $J$  satisfies (4.17), then, if  $g \in \text{SU}(2)$  is a constant matrix, so does the matrix  $J.g^{-1}$ . It will turn out that to get  $J$  into the form (4.18), such a transformation is required.

Under the action of the operation  $\xi \mapsto -\bar{\xi}$ , the set of constants  $\{\xi_k\}$  (assumed to be invariant under this operation) splits into two disjoint sets; one consisting of pure-imaginary numbers, and the other consisting of ordered pairs,  $\{(\xi, -\bar{\xi}), \text{Re } \xi > 0\}$ . It is assumed that there are  $m$  distinct constants which are pure-imaginary.

From the above definition of  $f_k$ , it follows that

$$\begin{aligned} f_k &\equiv \exp(-2i\nu_k) \\ &= \exp(-2ix) \cdot \tilde{f}_k(y, t), \end{aligned}$$

and from (4.9), the function  $\alpha$  has the form

$$\begin{aligned} \alpha &\equiv \prod_{i=1}^n \tilde{\xi}_k / \xi_k \\ &= (-1)^m. \end{aligned}$$

Using the fact that  $J$  is  $SU(2)$ -valued, these, together with the general formula (4.9), imply that  $J^{-1}$  has the form

$$J^{-1} = (-1)^{-\frac{m}{2}} \begin{pmatrix} a & -b \exp(-2ix) \\ (-1)^m \bar{b} \exp(2ix) & (-1)^m \bar{a} \end{pmatrix}, \quad |a|^2 + |b|^2 = 1.$$

The functions  $a$  and  $b$  depend only on  $y$  and  $t$  and are

$$\begin{aligned} a &= 1 + \sum_{k,l=1}^n \xi_k^{-1} \cdot (\Gamma^{-1})^{kl} \\ b &= - \sum_{k,l=1}^n \xi_k^{-1} \cdot (\Gamma^{-1})^{kl} \cdot \tilde{f}_k. \end{aligned}$$

Under the transform  $J \mapsto J \cdot g^{-1}$ , with  $g = \text{diag}(\alpha^{\frac{1}{2}}, \alpha^{-\frac{1}{2}})$ , the matrix  $J^{-1}$  becomes

$$J^{-1} = \begin{pmatrix} a & -b \cdot \exp(-2ix) \\ \bar{b} \cdot \exp(2ix) & \bar{a} \end{pmatrix} \Leftrightarrow J = \begin{pmatrix} \bar{a} & b \exp(-2ix) \\ -\bar{b} \exp(2ix) & a \end{pmatrix}.$$

This changes the fields  $A_\mu$  by a rigid gauge transformation.

If  $a$  and  $b$  are real, one may define a new function  $\phi(y, t)$  by  $a = \cos \frac{\phi}{2}$ ,  $b = \sin \frac{\phi}{2}$  (since now  $a^2 + b^2 = 1$ ), and so  $J$  is of the form (4.18), and hence gives a solution to the sine-Gordon equation. It thus remains to show the reality of these functions.



For simplicity, consider the special case where the  $\xi_k$  are all pure-imaginary, so  $\xi_k = ip_k$  for  $p_k \in \mathbb{R}$ . It then follows from their definition that the functions  $\tilde{f}_k$  are real-valued. The matrix  $\Gamma$  then becomes

$$\Gamma^{kl} = \frac{i}{p_k + p_l} \cdot (1 + \tilde{f}_k \cdot \tilde{f}_l),$$

and this has the property that

$$\overline{\Gamma^{kl}} = -\Gamma^{kl}.$$

The reality of  $a$  then follows:

$$\begin{aligned} \bar{a} &= 1 + \sum_{k,l=1}^n \overline{-ip_k^{-1} \cdot (\Gamma^{-1})^{kl}} \\ &= 1 + \sum_{k,l=1}^n (-1)(-ip_k)^{-1} \cdot (-1)(\Gamma^{-1})^{kl} = a. \end{aligned}$$

So  $a$ , and similarly  $b$ , are real. The general case works in the same way, though now the individual terms in the summation are either real (corresponding to those  $\xi_k$  which are pure-imaginary), or occur in pairs (corresponding to the pairs  $(\xi, -\bar{\xi})$ ), the sum of the terms in each pair being real. Hence the overall summation yields a real answer, even though the individual terms may be complex.

---

### Examples

The 1-soliton solution may be obtained with  $k = 1, \xi = ip, p \in \mathbb{R}$ : the above method yields (after the rescalings  $y \rightarrow -2y$  and  $t \rightarrow -2t$ , which reduces the sine-Gordon equation (4.13) to the normal form  $[\partial_y^2 - \partial_t^2] \phi = \sin \phi$ )

$$\begin{aligned} \phi &= 4 \tan^{-1} \exp \left[ \frac{1+p^2}{2p} y - \frac{1-p^2}{2p} t \right] \\ &= 4 \tan^{-1} \exp \left[ \pm \frac{y-vt}{\sqrt{1-v^2}} \right]. \end{aligned} \tag{4.19}$$

where  $v = \frac{1-|\xi|^2}{1+|\xi|^2}$ . The solution is a kink or an antikink, depending on the sign of  $\text{Im } \xi$ ,

$$\begin{aligned} \text{Im } \xi > 0 & \quad \text{kink,} \\ \text{Im } \xi < 0 & \quad \text{antikink.} \end{aligned}$$

The velocity vector of the solution is

$$(v_t, v_x, v_y) = (1 + |\xi|^2, 0, 1 - |\xi|^2).$$

These are precisely the twistor relations (4.11). So the velocity vector of the solution, and whether it is a kink or an antikink, has a natural interpretation in terms of the geometry of  $\mathcal{O}(2)$  a kink is generated from a constant  $\xi$  corresponding to the direction of a future pointing timelike line whose direction vector is the same as the velocity vector of the kink. Similarly, an antikink is generated from a constant  $\xi$  corresponding to the direction of a past pointing timelike line.

The breather solution is generated from the pairs  $(\xi, -\bar{\xi})$ . This yields the solution

$$\phi = 4 \tan^{-1} \left\{ \frac{\cot \mu \sin \Theta_I}{\cosh \Theta_R} \right\},$$

where

$$\begin{aligned} \Theta_R &= \frac{\cos \mu}{\sqrt{1 - v^2}}(y - vt), \\ \Theta_I &= \frac{\sin \mu}{\sqrt{1 - v^2}}(t - vy), \\ v &= \frac{1 - |\xi|^2}{1 + |\xi|^2} \quad \text{and} \quad \xi = |\xi|e^{i\mu}. \end{aligned}$$

Again the velocity vector of the breather has a natural interpretation in term of the geometry of  $\mathcal{O}(2)$  this being the sum of the direction vectors corresponding to  $\xi$  and  $-\bar{\xi}$ . The amplitude of the breather is governed by the argument of  $\xi$ .

On  $\mathcal{O}(2)$  there is a natural involution corresponding to the signature of  $\mathbb{R}^{2+1}$ , namely  $\xi \mapsto \bar{\xi}$ . This reverses the sign of  $\text{Im}\xi$ , and so has the effect of interchanging kinks and antikinks. The modulus  $|\xi|$  remains unchanged, so this involution does not change the velocity of the kinks and antikinks. For breathers, it reverses the sign of  $\mu$ , but this does not change the form of the solution; in effect there is no such thing as an antibreather.

There is a second natural involution on  $\mathcal{O}(2)$ ,  $\xi \mapsto \bar{\xi}^{-1}$ , or inversion in the unit circle. This keeps (anti)kinks as (anti)kinks, and breathers as breathers. It does, however, reverse the velocity of each (anti)kink or breather.

This all extends to the general soliton solution, which consists of an arbitrary number of kinks, antikinks and breathers. The lemma assumes that all the solitons are superimposed at  $t = 0$ ; this may be easily extended to give solitons at arbitrary positions by replacing  $f_k = \exp(2i\nu_k)$  by  $f_k = \exp(2i\nu_k + c_k)$  for arbitrary constants  $c_k$ .

#### 4.4.2 The Non-Linear Schrödinger Equation

In chapter II it was shown that the NLS equation was contained within the Yang-Mills self-duality equations for gauge group  $SU(2)$ . This was first shown by Mason and Sparling. In fact they showed that the NLS equation, under appropriate symmetries and ignoring a degenerate case, was equivalent to the self-duality equations.

##### Theorem

The self-duality equations, with gauge group  $SU(2)$  and a null and a non-null translational symmetry, are equivalent (ignoring a degenerate case) to the linear system

$$\begin{aligned}\Psi_x &= [\xi \cdot A + Q]\Psi, \\ \Psi_u &= \xi \Psi_x + B\Psi,\end{aligned}\tag{4.20}$$

with  $A$  and  $Q$  given by (4.3) and

$$B = \frac{1}{i} \begin{pmatrix} |\psi|^2 & \psi_x \\ \bar{\psi}_x & -|\psi|^2 \end{pmatrix},$$

the integrability condition of which is the Non-Linear Schrödinger equation

$$i\psi_u = \psi_{xx} + 2|\psi|^2\psi,\tag{4.21}$$

with the null coordinate  $u$  playing the rôle of time.

---

After using a gauge transformation to transform  $A$  to zero the linear system (4.20) becomes

$$\begin{aligned}\Psi_x - \xi \Psi_u &= \tilde{Q}\Psi, \\ \Psi_u - \xi \Psi_x &= \tilde{B}\Psi.\end{aligned}$$

Thus the  $J$ -description of the fields may be used, as above.

**Lemma**<sup>[2]</sup>

If  $f_k = \exp(i\xi_k \nu_k)$ , (no sum), and  $\{\xi_k\}$  are a set of complex constants, then the gauge fields, given by (4.9) and (4.6), provide, after a gauge transformation, solutions of the Non-Linear Schrödinger equation.

**Proof**

Since  $f_k = \exp(-iv) \tilde{f}_k(x, u)$ , it follows from the general solution (4.9) that  $J$  has the form

$$J = \begin{pmatrix} a & be^{-iv} \\ -\bar{b}e^{iv} & \bar{a} \end{pmatrix}, \quad |a|^2 + |b|^2 = 1,$$

where  $a$  and  $b$  depend only on the coordinates  $x$  and  $t$ . This generates gauge fields

$$\begin{aligned} \tilde{B} &= \begin{pmatrix} p & q e^{-iv} \\ \bar{q} e^{iv} & -p \end{pmatrix}, \\ \tilde{Q} &= \begin{pmatrix} r & s e^{-iv} \\ \bar{s} e^{iv} & -r \end{pmatrix}, \end{aligned}$$

where  $p, q, r$  and  $s$  depend only on the  $x$  and  $u$  coordinates. After a gauge transformation with

$$g = \begin{pmatrix} \exp(-i\frac{1}{2}v) & 0 \\ 0 & \exp(i\frac{1}{2}v) \end{pmatrix}$$

(which removes the  $v$  dependence in the above fields) the fields are, perhaps after a further gauge transformation to put  $Q$  into a skew form, in the form (4.3), and hence contain a solution to the Non-Linear Schrödinger equation (4.21).

**Example**

Take  $k = 1$  and  $\xi_{n=1} = a + ib$ , then the above method gives the familiar one soliton solution:

$$\psi = -b \exp[i(a^2 - b^2)u + iax] \operatorname{sech}(2abu + bx). \tag{4.22}$$

In the above example the gauge fields are automatically in the form (4.3) so the solution may just be read off from the entries in  $Q$  without further gauge transformations.

The general solution (4.9) is derived from the following ansatz:

$$\Psi = \mathbb{1} + \sum_{k=1}^N \frac{n^k \otimes m^k}{\xi - \xi_k},$$

where  $m^k$  and  $n^k$  are two-component vectors functions of the coordinates. The generalised self-duality equations (4.14), together with a condition (equation (4.7)) needed to ensure the gauge fields are  $su(2)$ -valued, give equations for  $m^k$  and  $n^k$  which lead to the solution (4.9). Note that the matrix  $\Psi$  has simple poles at the points  $\{\xi_k\}$ . The same solution may be derived by ‘adding’ the poles one-by-one, in which case one takes

$$\Psi = \left\{ \mathbb{1} + \frac{m^N \otimes n^N}{\xi - \xi_N} \right\} \cdot \Psi_o,$$

where  $\Psi_o$  is a known solution with  $N-1$  simple poles. Then  $J = \Psi^{-1}|_{\xi=0} \equiv J_o \cdot g^{-1}$ , where  $J_o = \Psi_o^{-1}|_{\xi=0}$  and  $g$  depends on the constant  $\xi_n$  as well as the spacetime coordinates. Then in terms of the gauge fields

$$A_\mu = g A_\mu^o g^{-1} - \partial_\mu g \cdot g^{-1},$$

and  $A_\mu^o$  is the gauge field corresponding to  $\Phi_o$ . This is just the ‘dressing’ of Zakharov and Shabat,<sup>[97]</sup> which gives a way to ‘add’ soliton solutions together to give a multi-soliton solution. Thus the lemma gives the  $N$ -soliton solution to the Non-Linear Schrödinger depending on the  $N$  complex (i.e.  $2N$  real) parameters  $\{\xi_k\}$ .

The Non-Linear Schrödinger equation is just one of a infinite hierarchy of integrable equations, and using the techniques of chapter III these may be easily constructed, the first few being

$$\begin{aligned} i\psi_{t_2} &= \psi_{xx} + 2|\psi|^2\psi, \\ -\psi_{t_3} &= \psi_{xxx} + 6|\psi|^2\partial_x\psi, \\ -i\psi_{t_4} &= \psi_{xxxx} + [|\psi|^2\partial_x\psi]_x + 2[\bar{\psi}_{xx}\psi + \psi_{xx}\bar{\psi}]\psi + 6|\psi|^6 - 2|\psi_x|^2\psi, \\ &\vdots \\ i^{n-1}\psi_{t_n} &= \psi_{x\dots x} + \text{nonlinear interaction terms} . \end{aligned}$$

The  $n^{\text{th}}$  order flow corresponds to the twistor space  $\mathcal{O}(n)$ . The solution to these may easily be constructed, or more accurately, given a solution to the first, a solution to the

$n^{\text{th}}$  may be obtained by simply replacing  $\hat{v} = x + \xi u + \xi^{-1}v$  by

$$\hat{v} = \xi^{-1}v + x + \sum_{i=1}^{n-1} \xi^i t_i,$$

where  $t_n$  describes the  $n^{\text{th}}$  order flow. This is very similar to the Hirota's construction of hierarchies.<sup>[16]</sup>

The single soliton solution for the  $n^{\text{th}}$  flow may thus be constructed, this being

$$\psi|_{n^{\text{th}} \text{ order flow}} = -\frac{b \exp(i[Rt_n + ax])}{\cosh(It_n + bx)}, \tag{4.23}$$

where

$$\begin{aligned} R &= \Re(a + ib)^n, \\ I &= \Im(a + ib)^n, \\ \xi_{k=1} &= a + ib. \end{aligned}$$

Note it is easier to construct solutions to the  $n^{\text{th}}$  order flow, using this method, than to construct the nonlinear partial differential equation it satisfies. All these flows commute, i.e. given some field configuration and evolving it with respect to  $t_n$  and then by  $t_m$  results in the same configuration as evolving with respect to  $t_m$  first, followed by  $t_n$ .

Various other equations may be obtained as special cases of the above. For example solutions of the modified KdV equation  $-\phi_t = \phi_{xxx} + 6\phi^2\phi_x$  are just the real valued solutions of the 3<sup>rd</sup> order NLS equation. Such an algebraic reduction is only consistent with odd order flows. For example, consider the 4<sup>th</sup> order NLS flow. If  $\psi$  was real valued, then the right hand side would be real valued, and the left hand side would be pure imaginary - a contradiction unless  $\psi = 0$ . For the one lump solution this requires  $a = 0$ , from which follows the vanishing of  $R$ . By using a Miura transformation the associated solution of the KdV equation may be found.

#### 4.5 The relation with the Atiyah-Ward Ansätze

To discuss the relations between the 'Riemann Problem with Zeros' and the Atiyah-

Ward Ansätze it is convenient to change the coordinates on  $\mathcal{O}(2)$  :

$$\begin{aligned}\xi &\mapsto \lambda = \frac{\xi - i}{\xi + i} \\ \nu &\mapsto \eta = \bar{z}\lambda^2 - 2it\lambda - z, \quad z = x + iy.\end{aligned}\tag{4.24}$$

The upper and lower half-planes of the  $\xi$ -space transform under this Möbius transformation to the regions

$$\begin{aligned}U &= \{|\lambda| \leq 1\} \\ \hat{U} &= \{|\lambda| \geq 1\} \cup \{\infty\},\end{aligned}\tag{4.25}$$

and the reality structure  $\xi \mapsto \bar{\xi}$  changes to  $\lambda \mapsto \bar{\lambda}^{-1}$ . The holomorphic sections of the bundle  $\mathcal{O}(2)$  that are preserved by this reality structure are known as real sections, and these take the form  $\eta = \bar{z}\lambda^2 - 2it\lambda - z$ . The self-duality equations under a translational symmetry (sometimes called the Bogomolny equations) in these new coordinates are

$$\begin{aligned}[\partial_z + \frac{1}{2}i\lambda^{-1}\partial_t]\Phi &= A_z \cdot \Phi, \\ [\partial_{\bar{z}} - \frac{1}{2}i\lambda\partial_t]\Phi &= A_{\bar{z}} \cdot \Phi.\end{aligned}\tag{4.26}$$

Recall from chapter II that solutions of (4.26) are generated from rank two vector bundles  $\mathbf{E}$  over  $\mathcal{O}(2)$  satisfying:

- I for every real section  $\sigma$  of  $\Pi$ ,  $\mathbf{E}|_{\sigma}$  is trivial,
- II  $\det \mathbf{E} = 1$ , and  $\mathbf{E}$  has a reality structure.

Explicitly, in terms of a patching matrix  $F$  between the regions  $U$  and  $\hat{U}$ , condition II is

$$\begin{aligned}\det F &= 1 \\ F^\dagger &= F,\end{aligned}\tag{4.27}$$

where  $F^\dagger(\eta, \lambda) = F(-\bar{\lambda}^2\eta, \bar{\lambda}^{-1})^*$ , and  $*$  denotes the complex conjugate transpose of the matrix. To recover the gauge fields, the matrix  $F$  is split:

$$F(\bar{z}\lambda^2 - 2it\lambda - z, \lambda) = \underline{\Phi} \cdot \Phi^{-1},\tag{4.28}$$

where  $\Phi$  is holomorphic in  $U$  and  $\underline{\Phi}$  is holomorphic in  $\hat{U}$ . The gauge fields are then extracted from the  $\Phi$  and the  $\underline{\Phi}$ . Condition I implies that the splitting is possible, and the choice of  $H$  and  $\hat{H}$  corresponds to the choice of gauge.

The functions  $\Phi$  and  $\underline{\Phi}$  are related to  $\Psi$ , the ansatz defined by

$$\Psi = \mathbb{1} + \sum_{k=1}^N \frac{R_k}{\lambda - \lambda_k} \tag{4.29},$$

by the relations

$$\begin{aligned} \Phi &= H \cdot \Psi, \\ \underline{\Phi} &= \underline{H} \cdot \Psi, \end{aligned}$$

where  $H$  and  $\underline{H}$  are chosen so that  $\Phi$  and  $\underline{\Phi}$  have the required analyticity properties. Recall from chapter II, section 6 that two patching matrices  $\tilde{F}$  and  $F$  are equivalent (that is, if they generate the gauge equivalent fields) if  $\tilde{F} = \underline{K}^{-1} \cdot F \cdot K$  for  $K$  and  $\underline{K}$  analytic in  $U$  and  $\underline{U}$  respectively. Using this equivalence, and the freedom inherent the choice of  $\underline{H}$  and  $H$ , one may show that (4.29) (with  $N$ -poles) is equivalent to the class  $\mathcal{A}_N$  of Atiyah-Ward ansätze, i.e. patching matrices of the form:

$$\mathcal{A}_N : \quad F_N = \begin{pmatrix} \lambda^N & \Gamma_N \\ 0 & \lambda^{-N} \end{pmatrix}. \tag{4.30}$$

Details of this may be found in [52,56]

### Examples

#### The one Kink solution to the sine – Gordon equation

This is given by the patching matrix (4.30), with

$$\begin{aligned} \Gamma(\eta, \lambda) &= \frac{1}{(\lambda - \alpha)(\lambda^{-1} - \alpha)} (h + h^\dagger), \quad (\alpha \in \mathbb{R}), \\ h &= \exp \left[ \frac{2i\eta}{1 - \alpha^2} \right]. \end{aligned}$$

This generates the one kink solution (4.19).

#### The one soliton solution to the NLS Equation



This is again given by (4.30), with

$$\Gamma(\eta, \lambda) = \frac{1}{(\lambda - \alpha)(\lambda^{-1} - \bar{\alpha})} (h^{-1} + h^\dagger),$$

$$h = \exp \left[ \frac{\lambda \eta}{(1 - \alpha)^2} \right],$$

and  $\alpha$  is related to  $\xi_{n=1}$  by

$$\frac{\alpha + 1}{\alpha - 1} = i\xi_{n=1}.$$

The gauge fields are calculated in terms of the function  $\Delta_0$  defined by

$$\Delta_0 = \oint_{|\lambda|=1} \Gamma[(x - iy)\lambda - 2it - (x + iy)\lambda^{-1}, \lambda] \frac{d\lambda}{2\pi i \lambda}$$

$$= \frac{1}{1 - \alpha \bar{\alpha}} \exp[-iv] \exp[i(b^2 - a^2)u + iax] \cosh b[x + 2au],$$

which is automatically a solution of the (2 + 2)-dimensional wave equation

$$[\partial_u \partial_v - \partial_x^2 + \partial_z^2] \Delta_0 = 0.$$

In Yang's R-gauge (corresponding to a particular choice in the 'splitting' in the construction of chapter II), the gauge fields have simple expressions in terms of  $\Delta_0$  (see Theorem 2.4). In general, one has to perform gauge and coordinate transformations in order to extract  $\psi$ , the solution to the non-linear Schrödinger equation, from these fields. However, the profile  $|\psi|$  may be easily obtained using Prasad's formula for the length of the Higgs field, a gauge invariant quantity. In the present notation this is given by

$$2\text{Tr}(QQ^\dagger) = [\partial_u \partial_v - \partial_x^2 + \partial_z^2] \log \Delta_0$$

$$= -|\psi|^2.$$

Note that in this example the off-diagonal element in the patching matrix for sin-Gordon one kink satisfies the equations

$$\partial_z \Gamma = 0$$

$$\partial_x \Gamma + 2i\Gamma = [0],$$

where  $[0]$  denotes the zero class in the cohomology group. These illustrate how the two symmetries (given by the Killing vectors  $\partial_z$  and  $\partial_x$ ) manifest themselves in terms of

the element of the cohomology group that generates the gauge field. While the first is essentially trivial, expressing the fact that the bundle is over minitwistor space rather than the twistor space  $\mathbb{C}P^3$ , the second is non-trivial. Its form is related to the way the  $x$  coordinate enters the matrix  $J$ ; the gauge fields (4.15) are independent of  $x$ , while the  $J$  matrix they are derived from does not. Similar remarks apply to the Non-Linear Schrödinger equation. In terms of the twistor construction, the two equations are very similar, an example of the unifying rôle of the twistor construction.

---

## Chapter V

---

# The Slow Motion Approximation

---

### 5.1 Introduction

In this chapter the time behaviour of localised structures is studied in more than one spatial dimension. There are a few known examples of integrable models in  $\mathbb{R}^{2+1}$ , for example the Davey-Stewartson and Kadomtsev-Petviashvili equations, and the integrable models constructed in chapter III. None of these, however, are Lorentz invariant, and it has been conjectured that such models only exist in  $(1 + 1)$  dimensions. So in general, a model in  $\mathbb{R}^{n+1}$  will not be integrable. A subclass of such models are those for which the equations for the static localised solutions are integrable, and it is these models that are the subject of this chapter.

The classic example of such a model is provided by the monopole model in  $\mathbb{R}^{3+1}$ , defined by the action

$$S = \int d^{3+1}x \frac{1}{2} \text{Tr} \{ D_\mu \phi D^\mu \phi \} + \frac{1}{4} \text{Tr} \{ F_{\mu\nu} F^{\mu\nu} \}. \quad (5.1)$$

The corresponding equations of motion for this model are a set of coupled second order hyperbolic partial differential equations, and are not integrable. The localised static solutions are given by the solution to the Bogomolony equation

$$F_{\mu\nu} = \frac{1}{2} \varepsilon_{\mu\nu}{}^\alpha D_\alpha \phi.$$

These are a set of first order elliptic equation which can (in BPS limit  $|\phi| \rightarrow 1$  as  $r \rightarrow \infty$ ) be solved. As was stated in chapter III, this equation arises as reduction of a pure  $SU(2)$  gauge theory on Euclidean  $\mathbb{R}^4$  under the action of a translational symmetry. It is important to note that the space of static solutions (under physically reasonable boundary



conditions) forms a finite dimensional manifold, denoted  $\mathcal{M}_n^o$ , and called the moduli space. In the above example  $\dim \mathcal{M}_n^o = 4n - 1$ , where the parameters may be interpreted as  $3n$  positions and  $(n - 1)$  relative phases.

Since the equations of motion for the monopoles is Lorentz invariant, it is possible to boost a static field configuration to obtain a time dependent one. Apart from such trivial solutions, no time dependent solutions are known. One analytic approach to the time evolution of the monopole equations and other nonintegrable models is the slow-motion (or adiabatic) approximation originally proposed by Manton<sup>[40]</sup> for monopole scattering. This involves calculating the geodesic motion on the finite-dimensional parameter space of static solutions (the moduli space), with metric induced by the kinetic energy. This serves as an approximation to the time evolution of the system for sufficiently low velocities. The metric has now been found for the scattering of BPS monopoles by Atiyah and Hitchin,<sup>[98]</sup> using twistor techniques, and the idea has also been applied to a variety of other models, notably the  $\mathbb{C}\mathbb{P}^N$  models<sup>[42,43]</sup> and even maximally-charged black holes.<sup>[45]</sup>

The slow motion approximation consists of the following steps:

- I Find the manifold  $\mathcal{M}_n^o$ ;
- II Find the metric on  $\mathcal{M}_n^o$ ;
- III Find the geodesics on  $\mathcal{M}_n^o$ ;
- IV For each point  $m \in \mathcal{M}_n^o$  find the static solution;
- V use III and IV to describe the evolution of the solution.

The moduli space thus plays a vital rôle in the approximation, which is why this chapter is concerned with models whose static solutions are explicitly known.

The model that this will be applied to is an Abelian Higgs model in  $(2+1)$  dimensions at critical coupling, whose static solution are known as vortices. However, such a model on a flat spacetime background has no known solution. Indeed, the equations giving the static solution (which arise as a dimensional reduction of a  $SU(2)$  gauge theory on  $S^2 \times \mathbb{R}^2$  under a spherical symmetry) are not integrable. By reformulating the model on a particular curved spacetime it is possible to find the static solution. This is not as arbitrary as it might first appear; it has been shown<sup>[99]</sup> (using Painlevé analysis) that there is only one metric for which this happens.

On a curved spacetime with metric

$$ds^2 = -dt^2 + g_{\mu\nu} dx^\mu dx^\nu, \quad (\mu, \nu = 1, 2),$$

the static vortex solutions would be constructed from the solutions to the equation

$$\square \rho = e^{2\rho} - 1,$$

where  $\square$  is the Laplace-Beltrami operator for the metric  $g_{\mu\nu}$ . In terms of the scalar curvature  $R$  of the 2-manifold on which  $g_{\mu\nu}$  is defined,

$$\nabla^2 \rho' = e^{2\rho'} - \frac{\sqrt{g}}{2}(R + 2),$$

where  $\rho' = \rho + \frac{1}{2} \ln \sqrt{g}$ . So if  $R = -2$  this reduces to Liouville's equation

$$\nabla^2 \rho' = e^{2\rho'},$$

which is integrable, and its solutions are known in closed form. With this background metric explicit vortex solutions may be constructed, and the slow-motion approximation applied to them. The static solutions satisfy the self-duality equations in  $\mathbb{R}^4$  under an  $SO(3)$  symmetry, and are constructed in Appendix B, where the notations used in this chapter is also defined.

## 5.2 The Vortex Model and its static solutions

The vortex model under consideration is defined by the action

$$S = \int_{\mathcal{D}} d^{2+1}x \sqrt{|g|} \left( \frac{1}{2} D_i \phi \overline{D^i \phi} + \frac{1}{8} F_{ij} F^{ij} + \frac{1}{4} (1 - |\phi|^2)^2 \right), \quad (5.2)$$

where  $\mathcal{D}$  is the spacetime  $\mathbb{R} \times \Delta$  with metric

$$ds^2 = -dt^2 + \frac{4}{(1 - x^2 - y^2)^2} (dx^2 + dy^2), \quad -\infty < t < \infty, \quad (5.3)$$

$$0 \leq x^2 + y^2 < 1.$$

The static solutions in the gauge  $A_0 = 0$  are giving by the solutions of the Bogomolny

equations

$$\begin{aligned} D_\mu \phi \pm i \varepsilon_\mu{}^\nu D_\nu \phi &= 0, \\ \varepsilon^{\mu\nu} \partial_\mu A_\nu &= \pm [1 - |\phi|^2]. \end{aligned} \tag{5.4}$$

The vortex solutions (incorporating the correct boundary conditions) are

$$\begin{aligned} \phi &= \frac{df}{dz} \left( \frac{1 - z\bar{z}}{1 - f\bar{f}} \right) \\ A_\mu &= \varepsilon_\mu{}^\nu \partial_\nu \ln \left( \frac{1 - z\bar{z}}{1 - f\bar{f}} \right). \end{aligned} \tag{5.5}$$

where

$$f = \prod_{i=0}^n \frac{z - a_i}{1 - \bar{a}_i z}, \quad a_i \in \Delta. \tag{5.6}$$

These coming ultimately from the solution to the Liouville equation

$$\nabla^2 \rho = e^{2\rho}. \tag{5.7}$$

Let  $\mathcal{C}^o$  be the space of finite energy solutions. Because of the topological charge,  $\mathcal{C}^o$  decomposes into a disjoint union of subspaces  $\mathcal{C}_n^o$ , each labelled by its topological charge  $n$ . Of more physical interest is the moduli space  $\mathcal{M}_n^o$  of solutions, where gauge equivalent solutions are identified:

$$\mathcal{M}_n^o \cong \mathcal{C}_n^o / \mathcal{G}, \tag{5.8}$$

where  $\mathcal{G}$  is the group of gauge transformations. Because the solution is characterised by the number and position of the Higgs zeros, and the vortices are classically indistinguishable,

$$\dim \mathcal{M}_n^o = 2n \tag{5.9}$$

and

$$\mathcal{M}_n^o \cong \Delta^n / S_n, \tag{5.10}$$

where  $S_n$  is the permutation group acting on the  $\alpha_i$ 's. [Technically, one has to exclude the cases where two or more zeros coincide. However, it will turn out that the metric on  $\mathcal{M}_n^o$  may be extended by continuity to include such points.]

For example, consider the space  $\mathcal{M}_2^0$ . This may be written as  $\mathcal{M}_2^0 \cong \Delta \times \tilde{\Delta}$ , so  $\underline{\alpha} \in \mathcal{M}_2^0$  may be written as  $(\alpha_{\text{cen}}, \alpha_{\text{rel}})$ , where  $\alpha_{\text{cen}} \in \Delta$  defines the position of the centre of the vortex pair, and  $\alpha_{\text{rel}} \in \tilde{\Delta}$  defines the relative positions of the two vortices. The space  $\tilde{\Delta}$  is the space  $\Delta$  with  $z$  and  $-z$  identified, and so may be thought of as a cone. Using the freedom in  $f$  to fix its value to be 0 at the centre, taken to be the origin ( $z = 0$ ), charge 2 vortices are defined by

$$\begin{aligned} f &= z \left( \frac{z-a}{1-\bar{a}z} \right) \left( \frac{z+a}{1+\bar{a}z} \right) \\ &= z \left( \frac{z^2-a^2}{1-\bar{a}^2 z^2} \right), \quad a \in \Delta. \end{aligned} \tag{5.11}$$

Note that the points  $-a$  and  $a$  define the same vortex configuration. Figure 5.1 shows the energy density as a function of position for two different vortex solutions with topological charge 2. In the first, the two zeros of the Higgs field coincide at the origin ( $a = 0$ ); and in the second, the two zeros are distinct ( $a = 0.8$ ).

### 5.3 Dynamics of the Vortices

Time is now introduced in such a way that the vortex solutions described above represent static solutions of the field equations in the gauge  $A_0 = 0$ . The (2+1)-dimensional action is

$$S = \int_{\mathcal{D}} d^{2+1}x \sqrt{|g|} \left( \frac{1}{2} D_i \phi \overline{D^i \phi} + \frac{1}{8} F_{ij} F^{ij} + \frac{1}{4} (1 - |\phi|^2)^2 \right),$$

where  $\mathcal{D}$  is the spacetime  $\mathbb{R} \times \Delta$  with metric

$$ds^2 = -dt^2 + \frac{4}{(1-x^2-y^2)^2} (dx^2 + dy^2), \quad -\infty < t < \infty. \tag{5.12}$$

The Lagrangian system is now written as a Hamiltonian system. The gauge condition  $A_0 = 0$  becomes a constraint on the Hamiltonian system, and using Dirac's methods for constrained systems<sup>[100]</sup> leads to a constraint on the time evolution of the fields, namely

$$\left. \frac{\delta S}{\delta A_0} \right|_{A_0=0} = 0, \quad \Rightarrow \quad \frac{1}{2\sqrt{g}} \partial_\mu (\sqrt{g} g^{\mu\nu} \dot{A}_\nu) - \text{Im}(\bar{\phi} \dot{\phi}) = 0. \tag{5.13}$$

Here  $\mu, \nu = 1, 2$ , i.e. the spatial coordinates on the disc  $\Delta$ , and the dots denote  $\frac{\partial}{\partial t}$ . The symbol  $\sqrt{g}$  refers to the metric on  $\Delta$  rather than the metric on  $\mathcal{D}$ . Since the metric on

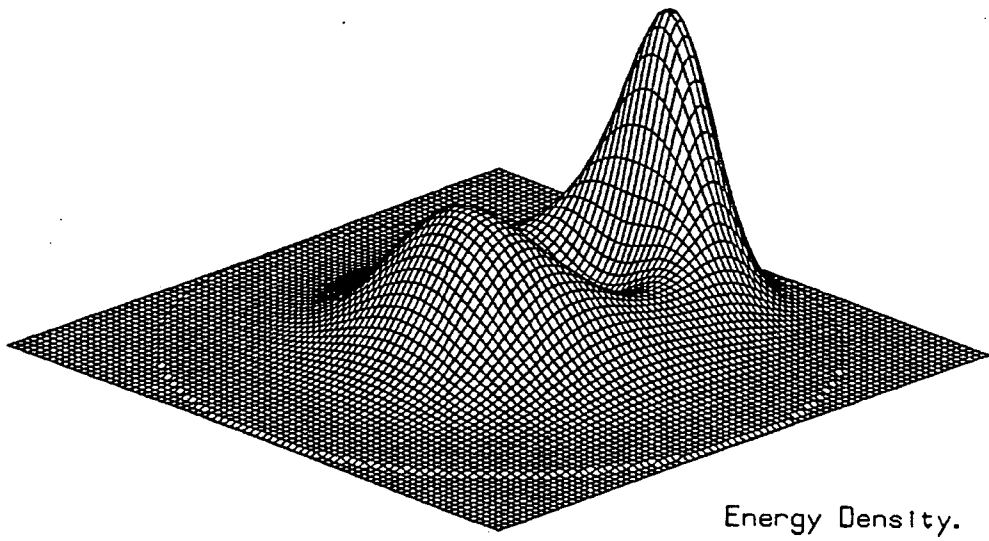
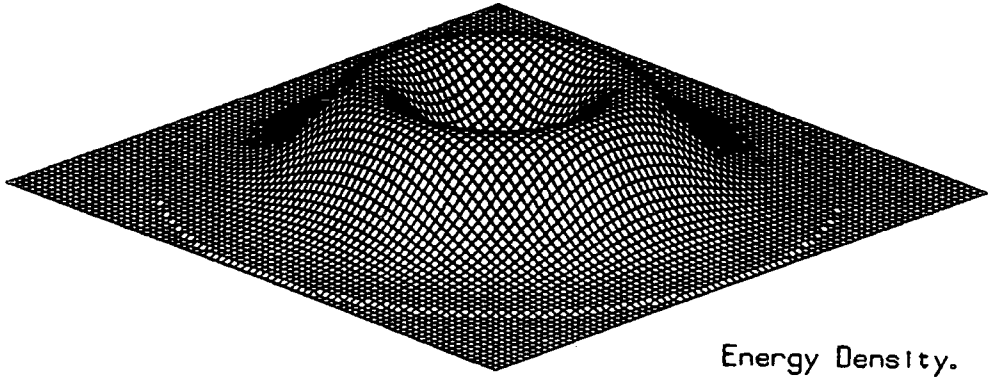

Fig 5.1 Examples of charge 2 vortices.



$\Delta$  is of the form  $ds^2 = \Omega(x, y) (dx^2 + dy^2)$ , then  $\sqrt{g} = \Omega$ , so  $\sqrt{g} g^{\mu\nu} = \delta_{\text{flat}}^{\mu\nu}$ , where  $\delta_{\text{flat}}^{\mu\nu}$  is just the Kronecker delta, so

$$\partial_\mu \sqrt{g} g^{\mu\nu} = \sqrt{g} g^{\mu\nu} \partial_\mu.$$

Using this, the constraint may be written as

$$\frac{1}{2} g^{\mu\nu} \partial_\mu \dot{A}_\nu - \text{Im}(\bar{\phi} \dot{\phi}) = 0. \quad (5.14)$$

With this, there are well-defined kinetic and potential energies  $T$  and  $V$ ,

$$\begin{aligned} T &= \int_{\Delta} d^2x \sqrt{g} \left( \frac{1}{2} |\dot{\phi}|^2 + \frac{1}{4} g^{\mu\nu} \dot{A}_\mu \dot{A}_\nu \right) \\ V &= \int_{\Delta} d^2x \sqrt{g} \left( \frac{1}{2} D_\mu \phi \overline{D^\mu \phi} + \frac{1}{8} F_{\mu\nu} F^{\mu\nu} + \frac{1}{4} (1 - |\phi|^2)^2 \right). \end{aligned} \quad (5.15)$$

The evolution of the fields has a mechanical analogy of a particle moving in the potential  $V$  with kinetic energy  $T$ .

The space of finite potential energy field configurations  $\mathcal{C}$  and the moduli space of gauge-equivalent configurations  $\mathcal{M}$  still decompose into a disjoint union of subspaces, each labelled with its topological charge, but now they have infinite dimensions (the spaces  $\mathcal{C}^o$  and  $\mathcal{M}^o$  defined above now being finite-dimensional subspaces). The kinetic energy defines a metric on the space  $\mathcal{C}$ , though some tangent vectors may have infinite length. The constraint equation (5.14) has a geometrical interpretation in terms of the configuration space  $\mathcal{C}$ . Given a point  $p = (\phi, A_\mu) \in \mathcal{C}$  and tangent vector (assumed to have finite length)  $\dot{p} = (\dot{\phi}, \dot{A}_\mu) \in T_p \mathcal{C}$ , equation (5.14) ensures that  $\dot{p}$  is orthogonal to the gauge group orbit through  $p$ , and hence lies in  $T_p \mathcal{M}$ .

Within each  $\mathcal{M}_n$  there is a finite-dimensional subspace given by the surface of minimum potential energy. This is just the moduli space of  $S^2$ -invariant instantons discussed in section 2, denoted by  $\mathcal{M}_n^o$ . There is an approximation, due to Manton,<sup>[40]</sup> for the slow-motion evolution of the fields. This assumes that low-velocity motion initially tangential to the surface  $\mathcal{M}_n^o$  will remain tangential, and follow geodesic motion on it, with metric induced on the surface by the kinetic energy  $T$ . So for a point  $p = (\phi, A_\mu) \in \mathcal{M}_n^o$  and

tangent vector  $\dot{p} = (\delta\phi, \delta A_\mu) \in T_p \mathcal{M}_n^o$ , satisfying equation (5.14), there is a metric on  $\mathcal{M}_n^o$  given by

$$d^2s = \int_{\Delta} d^2x \sqrt{g} \left( \frac{1}{2} \delta\phi \overline{\delta\phi} + \frac{1}{4} g^{\mu\nu} \delta A_\mu \delta A_\nu \right). \tag{5.16}$$

It will turn out that this metric is finite for all directions in the space  $T_p \mathcal{M}_n^o$ . This is to be contrasted with the moduli space metric for the  $\mathbb{C}P^1$  model where there are some directions in the (finite-dimensional) moduli space for which the metric diverges.<sup>[42,43,101]</sup>

The vector  $\dot{p}$  must satisfy the linearised Bogomolny equations around the solution corresponding to  $p$ . Writing the perturbation as

$$\begin{aligned} \delta\phi &= \phi h, & h(z, \bar{z}) &\in \mathbb{C} \\ \delta A_\mu &= a_\mu, \end{aligned} \tag{5.17}$$

and linearising both (5.4) and (5.14), gives

$$\begin{aligned} \partial_\mu h + i \varepsilon_\mu{}^\nu \partial_\nu h - i a_\mu + \varepsilon_\mu{}^\nu a_\nu &= 0, \\ \varepsilon^{\mu\nu} \partial_\mu a_\nu + |\phi|^2 (h + \bar{h}) &= 0, \\ g^{\mu\nu} \partial_\mu a_\nu + i |\phi|^2 (h - \bar{h}) &= 0. \end{aligned} \tag{5.18}$$

The original boundary conditions applied to these new fields imply  $h + \bar{h} = 0$  on  $\partial\Delta$ .

Using the identities  $\sqrt{g} g^{\mu\nu} = \delta_{\text{flat}}^{\mu\nu}$  and  $\sqrt{g} \varepsilon^{\mu\nu} = \varepsilon_{\text{flat}}^{\mu\nu}$ , and eliminating  $a_\mu$  between these equations yields

$$\nabla^2 h = 2e^{2\rho} h, \tag{5.19}$$

where  $\rho$  is the solution of equation (5.7). This is just the linearisation of the Liouville equation and this fact will be used to construct its solution. In terms of  $h$ , the metric (5.16) takes the remarkably simple form

$$ds^2 = \int_{\Delta} d^2x \partial_{\bar{z}} (h \partial_z \bar{h}). \tag{5.20}$$

Here  $\partial_z$  and  $\partial_{\bar{z}}$  are the partial derivatives with respect to the complex coordinates introduced on  $\Delta$ . Note the cancellation of the factor  $\sqrt{g}$ . This expression is valid for any metric.

It now remains to solve the linearised Liouville equation (5.19), subject to the constraint that the metric (5.16) is finite. Recall the general solution to the Liouville equation  $\nabla^2 \rho = e^{2\rho}$  is given by

$$\rho = -\ln \frac{1}{2}(1 - f\bar{f}) + \frac{1}{2} \ln \left| \frac{df}{dz} \right|^2. \quad (5.21)$$

Under an infinitesimal change  $f \mapsto f + \delta f$  (where  $\delta f$ , like  $f$ , is an analytic function),  $\rho \mapsto \rho + \delta \rho$  where

$$\delta \rho = \frac{f\delta\bar{f} + \bar{f}\delta f}{1 - f\bar{f}} + \frac{1}{2} \left[ \left( \frac{\partial_z \delta f}{\partial_z f} \right) + \overline{\left( \frac{\partial_z \delta f}{\partial_z f} \right)} \right]. \quad (5.22)$$

This is a solution of (5.19). Taking

$$\delta f_1 = \frac{\partial f}{\partial \alpha_i^R}, \quad \delta f_2 = \frac{\partial f}{\partial \alpha_i^I},$$

(where  $\alpha_i = \alpha_i^R + i\alpha_i^I$  is one of the zeros of the Higgs field), and constructing  $h$  from  $\delta f_1 - i\delta f_2$  gives, up to a constant factor

$$h^{(i)} = \frac{f}{1 - f\bar{f}} \overline{\partial_{\bar{\alpha}_i} f} + \frac{\bar{f}}{1 - f\bar{f}} \partial_{\alpha_i} f + \frac{1}{2} \left[ \frac{\partial_z \partial_{\alpha_i} f}{\partial_z f} + \overline{\frac{\partial_z \partial_{\bar{\alpha}_i} f}{\partial_z f}} \right]. \quad (5.23)$$

Note that this has singularities at the zeros of the field  $\phi$  and nowhere else. It also has the property that  $h^{(i)} = 0$  on  $\partial\Delta$ . Expanding  $f$  as a Taylor series around the zero  $\alpha_i$  (note that, by definition of the zeros of the Higgs field,  $\left. \frac{df}{dz} \right|_{z=\alpha_i} = 0$ ),  $f$  takes the form

$$f = \beta_0^{(i)} + \beta_2^{(i)}(z - \alpha_i)^2 + \beta_3^{(i)}(z - \alpha_i)^3 + \dots \quad (5.24)$$

With this expansion  $h^{(i)}$  may be written

$$h^{(i)} = \sum_{r,s=-1}^{\infty} c_{rs}^{(i)} (z - \alpha_i)^r (\bar{z} - \bar{\alpha}_i)^s. \quad (5.25)$$

The following properties of the coefficients  $c_{rs}^{(i)}$ , which follow from (5.23) and (5.24), will be used to show the convergence of the metric (5.20) :

$$\begin{aligned} c_{-1,s}^{(i)} &= 0, \text{ for } s = -1, \dots, \infty, s \neq 0, \\ c_{r,-1}^{(i)} &= 0, \text{ for } r = -1, \dots, \infty. \end{aligned} \quad (5.26)$$

The coefficient  $c_{-1,0}^{(i)}$  depends only on the multiplicity of the zero  $\alpha_i$ . Assuming this

multiplicity to be  $m_i$ , then around  $z = \alpha_i$

$$\partial_z f = (z - \alpha_i)^{m_i} \tilde{f}$$

$$\frac{\partial_z \partial_{\alpha_i} f}{\partial_z f} = \frac{-m_i}{(z - \alpha_i)} + (\text{nonsingular terms}),$$

and hence  $c_{-1,0}^{(i)} = -\frac{1}{2}m_i$ . It will be assumed from now on that  $m_i = 1$  for all  $i$ . Repeating this procedure for each Higgs zero  $\alpha_i$  gives as a solution of (5.19),

$$h = \sum_{i=1}^n c_i h^{(i)}, \quad |c^{(i)}| \ll 1. \tag{5.27}$$

The arbitrary constants  $c_i$  are related to the shift in the positions of the zeros of the Higgs field

$$\phi \mapsto \phi + \delta\phi = \phi(1 + h), \quad c_i = 2\delta\alpha_i + O(\delta\alpha^2).$$

Substituting these equations into (5.20) yields

$$ds^2 = 4 \sum_{r,s} \int_{\Delta} d^2x \partial_z (h^{(r)} \partial_z \bar{h}^{(s)}) d\alpha_r d\bar{\alpha}_s. \tag{5.28}$$

Using Green's Theorem and remembering that  $h^{(r)}$  and  $\partial_z h^{(s)}$  have singularities at  $z = \alpha_r$  and  $z = \alpha_s$  respectively, this becomes

$$\begin{aligned} ds^2 = & 2i \sum_r \oint_{C(r,\epsilon)} dz h^{(r)} \partial_z \bar{h}^{(r)} d\alpha_r d\bar{\alpha}_r \\ & + 2i \sum_{r \neq s} \left( \oint_{C(r,\epsilon)} dz + \oint_{C(s,\epsilon)} dz \right) h^{(r)} \partial_z \bar{h}^{(s)} d\alpha_r d\bar{\alpha}_s, \end{aligned} \tag{5.29}$$

where  $C(r, \epsilon)$  is a circle of radius  $\epsilon$  around the point  $\alpha_r$ . Using the expansion (5.25), and (5.26), these integrals are finite and the metric reduces to

$$\begin{aligned} ds^2 = & 2\pi \sum_{r=1}^n \overline{c_{0,1}^{(r)}} d\alpha_r d\bar{\alpha}_r \\ & + 2\pi \sum_{r \neq s} \overline{\tilde{c}_{0,1}^{(sr)}} d\alpha_r d\bar{\alpha}_s. \end{aligned} \tag{5.30}$$

where  $\tilde{c}_{ij}^{(rs)}$  are the coefficients in the expansion of  $h^{(r)}$  around  $z = \alpha_s$ . The coefficients  $c_{0,1}^{(r)}$  and  $\tilde{c}_{0,1}^{(sr)}$  have simple expressions in terms of  $\beta_2^{(r)}$  and  $\beta_3^{(r)}$  (again this assumes  $m_i = 1$ ,

the result may be easily generalised), namely

$$\overline{c_{0,1}^{(r)}} = \frac{3}{4} \partial_{\bar{\alpha}_r} \left[ \frac{\beta_3^{(r)}}{\beta_2^{(r)}} \right], \quad \overline{c_{0,1}^{(sr)}} = \frac{3}{4} \partial_{\bar{\alpha}_s} \left[ \frac{\beta_3^{(r)}}{\beta_2^{(r)}} \right].$$

Thus the metric  $\mathcal{M}_n^o$  is given by

$$ds^2 = \frac{3}{2} \pi \sum_{r,s=1}^n \partial_{\bar{\alpha}_s} \Psi^{(r)} d\alpha_r d\bar{\alpha}_s, \tag{5.31}$$

where  $\Psi^{(r)}$  is defined as

$$\Psi^{(r)} = \frac{\beta_3^{(r)}}{\beta_2^{(r)}}.$$

From the reality of the metric,  $\Psi^{(r)}$  satisfies

$$\partial_{\bar{\alpha}_s} \Psi^{(r)} = \partial_{\alpha_r} \bar{\Psi}^{(s)}. \tag{5.32}$$

At first sight the metric appears to depend on the particular rational function  $f$ . Under the change

$$f \mapsto \frac{f - c}{1 - \bar{c}f},$$

the coefficients change  $\beta_n^{(r)} \mapsto \tilde{\beta}_n^{(r)}$ . However, since  $\beta_1^{(r)} = \tilde{\beta}_1^{(r)} = 0$ ,  $\tilde{\Psi}^{(r)} = \Psi^{(r)}$ , and so the metric depends only on the positions of the zeros of the Higgs field, and not on the particular rational function that generates the field.

From the general expression (5.31) it is easy to show that the metric is Kähler. Recall that a metric  $ds^2 = g_{a\bar{b}} dz^a d\bar{z}^b$  is Kähler if and only if the corresponding Kähler 2-form  $K = \frac{-i}{2} g_{a\bar{b}} dz^a \wedge d\bar{z}^b$  is closed, i.e.  $dK = 0$ . Here

$$K = -\frac{3\pi i}{4} \partial_{\bar{\alpha}_s} \Psi^{(r)} d\alpha_r \wedge d\bar{\alpha}_s,$$

and so, making use of the reality condition (5.32),

$$\begin{aligned} dK &= (\partial + \bar{\partial})K \\ &= -\frac{3\pi i}{4} \partial_{\alpha_t} \partial_{\bar{\alpha}_s} \Psi^{(r)} d\alpha_t \wedge d\alpha_r \wedge d\bar{\alpha}_s \\ &\quad - \frac{3\pi i}{4} \partial_{\bar{\alpha}_t} \partial_{\bar{\alpha}_s} \Psi^{(r)} d\bar{\alpha}_t \wedge d\alpha_r \wedge d\bar{\alpha}_s \\ &= -\frac{3\pi i}{4} \partial_{\alpha_t} \partial_{\alpha_r} \bar{\Psi}^{(s)} d\alpha_t \wedge d\alpha_r \wedge d\bar{\alpha}_s \\ &= 0. \end{aligned} \tag{5.33}$$

This calculation deals with the generic case where the Higgs field has only simple zeros, the details can easily be changed to deal with multiple zeros.

### 5.4 Examples of Vortex motion

The simplest motion possible is that of a single charge 1 vortex. On symmetry grounds the metric describing the motion must be a (two-dimensional) space of constant negative curvature. However this does not give the value of the scalar curvature. The vortex is generated by

$$f = \left( \frac{z - \alpha}{1 - \bar{\alpha}z} \right)^2. \tag{5.34}$$

Using the above methods gives

$$\begin{aligned} ds^2 &= \frac{3\pi}{(1 - \alpha\bar{\alpha})^2} d\alpha d\bar{\alpha}, \\ &= \frac{1}{2} \frac{3\pi}{2} \frac{4d\alpha d\bar{\alpha}}{(1 - \alpha\bar{\alpha})^2}. \end{aligned} \tag{5.35}$$

This gives the vortex an effective mass of  $\frac{3\pi}{2}$ .

Before considering general two-vortex motion, the motion of  $n$  superimposed vortices will be derived. Again by symmetry, the motion should be described by geodesics in a space of constant curvature. Using

$$f = \left( \frac{z - \alpha}{1 - \bar{\alpha}z} \right)^{n+1},$$

to generate the vortices (note that the corresponding Higgs field has an  $n^{\text{th}}$  order zero at  $z = \alpha$ , so (5.31) has to be modified to deal with the multiple zero) one finds

$$ds^2|_{n\text{-superimposed vortices}} = \frac{1}{2} \frac{\pi n(n+2)}{2} \frac{4d\alpha d\bar{\alpha}}{(1 - \alpha\bar{\alpha})^2}. \tag{5.36}$$

Note that as  $n \rightarrow \infty$ , the scalar curvature tends to 0, and that the effective mass does not grow linearly with the number of vortices. Both these metrics are of constant negative curvature, and the geodesics in such spaces are just sections of circles (including the circle at infinity) that intersect the boundary at right angles.

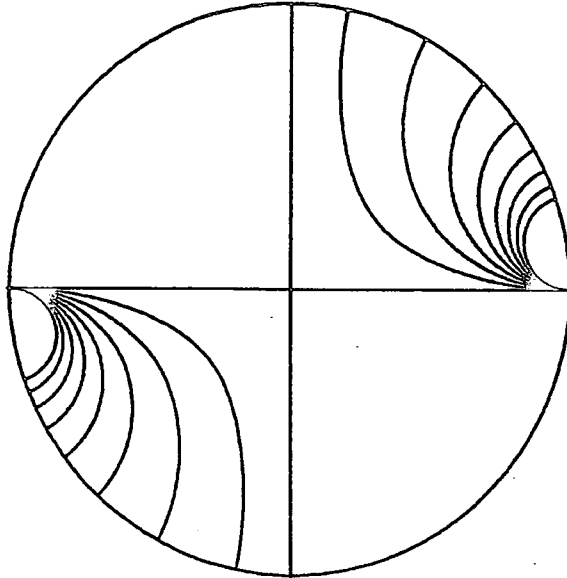

Fig 5.2. The trajectories of the points  $\phi^{-1}(0)$  for  $h = 0, 2, 4, \dots, 16$ .

Because the model is not defined on a flat spacetime it is no longer possible to decompose the metric into a part describing the motion of the centre of mass, and a part describing the relative motion (for a discussion of this point see [102]). However, one may easily calculate the relative motion, assuming that the centre of a vortex pair (as defined below) remains fixed. As the disc is maximally symmetric, this may be taken, without loss of generality, to be the origin.

Explicitly, consider the charge 2 vortex system, where the Higgs field has zeros at  $\alpha_1$  and  $\alpha_2$ . From these one may construct the rational function  $f$  (see Appendix B). Here  $\alpha_{cen} \in \Delta$  describes the position of the centre of vortex pair, and  $\alpha_{rel} \in \tilde{\Delta}$  describes the

relative position of the two vortices. These are defined in terms of  $\alpha_1$  and  $\alpha_2$  by

$$\alpha_1 = \frac{\alpha_{rel} + \alpha_{cen}}{1 + \bar{\alpha}_{cen} \cdot \alpha_{rel}},$$

$$\alpha_2 = \frac{-\alpha_{rel} + \alpha_{cen}}{1 - \bar{\alpha}_{cen} \cdot \alpha_{rel}}.$$

Under a Möbius transformation

$$\alpha \mapsto \alpha' = e^{i\theta} \cdot \left\{ \frac{\alpha + \alpha_o}{1 + \bar{\alpha}_o \cdot \alpha} \right\}, \quad \alpha_o \in \Delta,$$

the coordinates  $\alpha_{rel}$  and  $\alpha_{cen}$  have the following transformations

$$\alpha_{cen} \mapsto \alpha'_{cen} = e^{i\theta} \cdot \left\{ \frac{\alpha_{cen} + \alpha_o}{1 + \bar{\alpha}_o \cdot \alpha_{cen}} \right\},$$

$$\alpha_{rel} \mapsto \alpha'_{rel} = \alpha_{rel},$$

where

$$e^{i\theta} = \frac{1 + \bar{\alpha}_{cen} \cdot \alpha_o}{1 + \alpha_{cen} \cdot \bar{\alpha}_o}.$$

To find the metric describing this relative motion with the centre of the vortex pair fixed, one may, without loss of generality, fix  $\alpha_{cen} = 0$ . The vortices are then generated by equation (5.11). The parameters  $a$  are not the positions of the zeros of the Higgs field, but are related to them by  $a = \alpha \lambda(\alpha, \bar{\alpha})$ , where  $\lambda$  is a real-valued function given by

$$\lambda^2 = \frac{-1 - |\alpha|^4 + \sqrt{1 + 14|\alpha|^4 + |\alpha|^8}}{2|\alpha|^4}.$$

Using REDUCE to calculate the coefficients  $\beta_2$  and  $\beta_3$  gives the relative motion metric to be:

$$ds^2 = \frac{1}{2} \frac{4\pi|\alpha|^2}{(1 + |\alpha|^2)^2} \left[ 1 + \frac{4(1 + |\alpha|^4)}{\sqrt{1 + 14|\alpha|^4 + |\alpha|^8}} \right] \frac{4d\alpha d\bar{\alpha}}{(1 - |\alpha|^2)^2}, \quad (5.37)$$

where  $\alpha = |\alpha|e^{i\tilde{\theta}} \in \tilde{\Delta}$ . For large  $|\alpha|$  (i.e.  $1 - |\alpha| \ll 1$ ) the metric is approximately given by

$$ds^2 \approx \frac{1}{2} 3\pi \frac{4d\alpha d\bar{\alpha}}{(1 - |\alpha|^2)^2},$$

so asymptotically the effective mass is twice that of a single vortex. This would be expected on physical grounds since the interaction between two well separated vortices is negligible. In general, the effective mass depends on the distribution of energy in the configuration, not just the total energy.



Because of the identification of opposite points, the space  $\tilde{\Delta}$  can be mapped onto the space  $\Delta$  using the conformal map  $\alpha \mapsto \omega = \alpha^2$ , and the metric (5.37) becomes

$$ds^2 = \frac{2\pi}{(1 - |\omega|^2)^2} \left[ 1 + \frac{4(1 + |\omega|^2)}{\sqrt{1 + 14|\omega|^2 + |\omega|^4}} \right] d\omega d\bar{\omega} \tag{5.38}$$

$$\equiv \Omega(|\omega|) d\omega d\bar{\omega}.$$

where  $\omega = |\omega|e^{i\theta} \in \Delta$ . Around the point  $\omega = 0$ , the metric is flat, thus the space is smooth and does not contain a conical singularity that might have been expected from identifying opposite points. Because of the existence of the Killing vector  $\frac{\partial}{\partial \theta}$ , there is a conserved ‘angular momentum’

$$h = \Omega(|\omega|) |\omega|^2 \frac{d\theta}{d\tau}, \tag{5.39}$$

where  $\tau$  is an affine parameter along the geodesic. For the special case  $h = 0$ , the geodesics are just given by straight lines through the origin. As such a geodesic passes through the origin,  $\theta$  changes by  $\pi$ , and so mapping back to the space  $\tilde{\Delta}$ ,  $\tilde{\theta}$  changes by  $\frac{\pi}{2}$ . So in a head-on collision of vortices, the scattering angle is  $90^\circ$ . For  $|\omega|$  close to 1, the metric on  $\Delta$  is approximated by

$$ds^2 \approx \frac{6\pi}{(1 - |\omega|^2)^2} d\omega d\bar{\omega},$$

and so, as stated above, the geodesics intersect the boundary at right angles. Apart from these, other geodesics have to be computed numerically. Figure 5.2 shows some examples of geodesics for several different values of  $h$ , and figure 5.3(a)(b) shows the evolutions of a two-vortex system with a non-zero value for  $h$ .

### 5.5 Scattering in an Integrable Models in (2 + 1)-Dimensions

The scattering behaviour in non-integrable models, like the modified Abelian Higgs system studied in this chapter, is radically different from that in integrable models. As an example of an integrable model, consider the modified chiral model which appeared in chapter III;

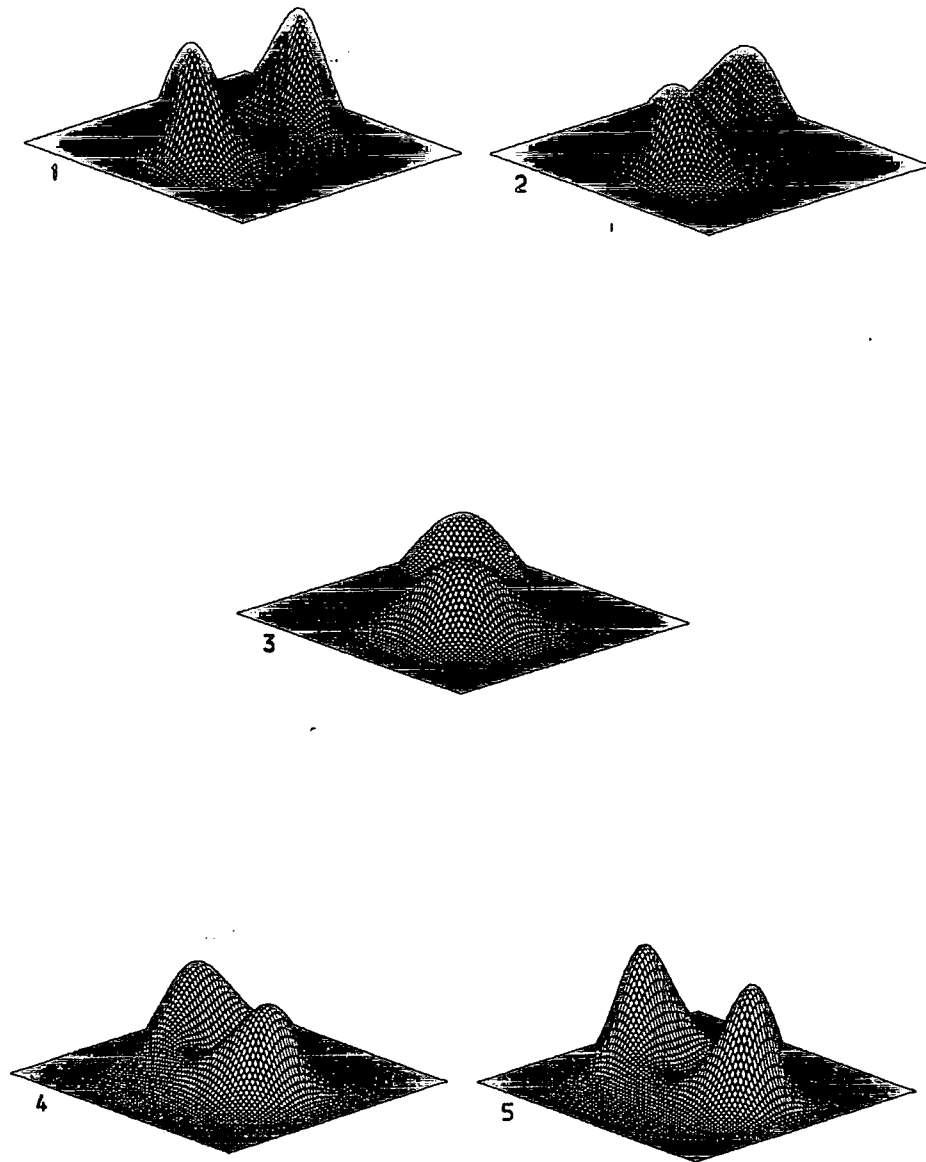

Fig 5.3(a). Plots of the energy density during the evolution of a two-vortex system, the time interval between each plot being the same.

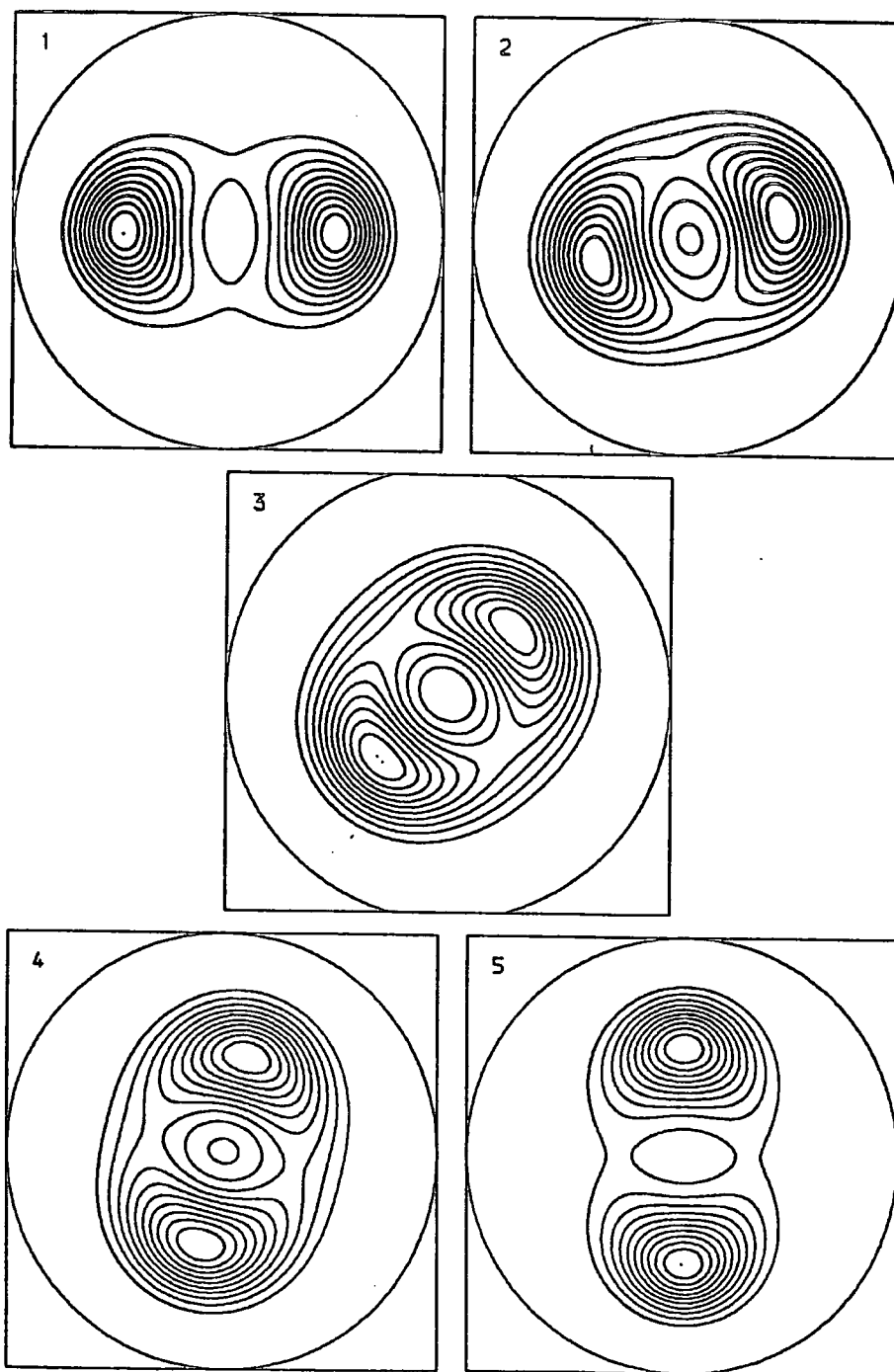

Fig 5.3(b). The last figure redrawn as a contour plot.

$$(\eta^{\mu\nu} + V_\alpha \varepsilon^{\alpha\mu\nu}) \partial_\mu (J^{-1} \partial_\nu J) = 0,$$

where  $\eta^{\mu\nu} = \text{diag}(-1, +1, +1)$ ,  $\varepsilon^{\alpha\mu\nu}$  is the alternating tensor (defined by  $\varepsilon^{012} = 1$ ) and  $J(x, y, t)$  is an  $SU(2)$ -valued matrix. Solutions to this equations may be constructed using the ‘Riemann Problem with Zeros’ technique described in chapter IV. This model has a conserved energy functional,

$$E(J) = -\frac{1}{2} \text{Tr} [(J^{-1} \partial_x J)^2 + (J^{-1} \partial_y J)^2 + (J^{-1} \partial_t J)^2].$$

This is a positive-definite functional of the field  $J$ .

Figure 5.4(a)(b) shows this energy for the scattering of a two lumps configuration, in the rest frame of one of the lumps. The second lump passes through the first with a constant speed (i.e. without the experience of a phase shift, as occurs in  $(1+1)$ -integrable models such as the sine-Gordon and Non-Linear Schrödinger equations). This is in contrast to the behaviour in the modified Abelian Higgs model. Here, as may be seen from Fig 5.2 and Fig 5.3(a)(b), non-trivial scattering occurs, and even  $90^\circ$  scattering occurs in a head on collisions (in the centre of mass frame).

Preliminary numerical studies of this integrable model shows it to have a very rich structure; richer than the family of solutions given by the ansätze used in the ‘Riemann Problem with zeros’ method.

## 5.6 Comments and Conclusions

In this section the properties of the metric constructed above are discussed and compared with those obtained from other models. Firstly the accuracy of the slow motion approximation is considered for vortices in flat space. It is a remarkably good approximation; the results obtained are in close agreement with numerical calculations.<sup>[44,103,104]</sup> The vortex models have an intrinsic scale set by the asymptotic size of the Higgs field, and the possibility of changing this and other scales is then discussed. Unlike monopoles defined on a hyperbolic space,<sup>[70]</sup> it turns out that the vortex model is only integrable for special values of the parameters.

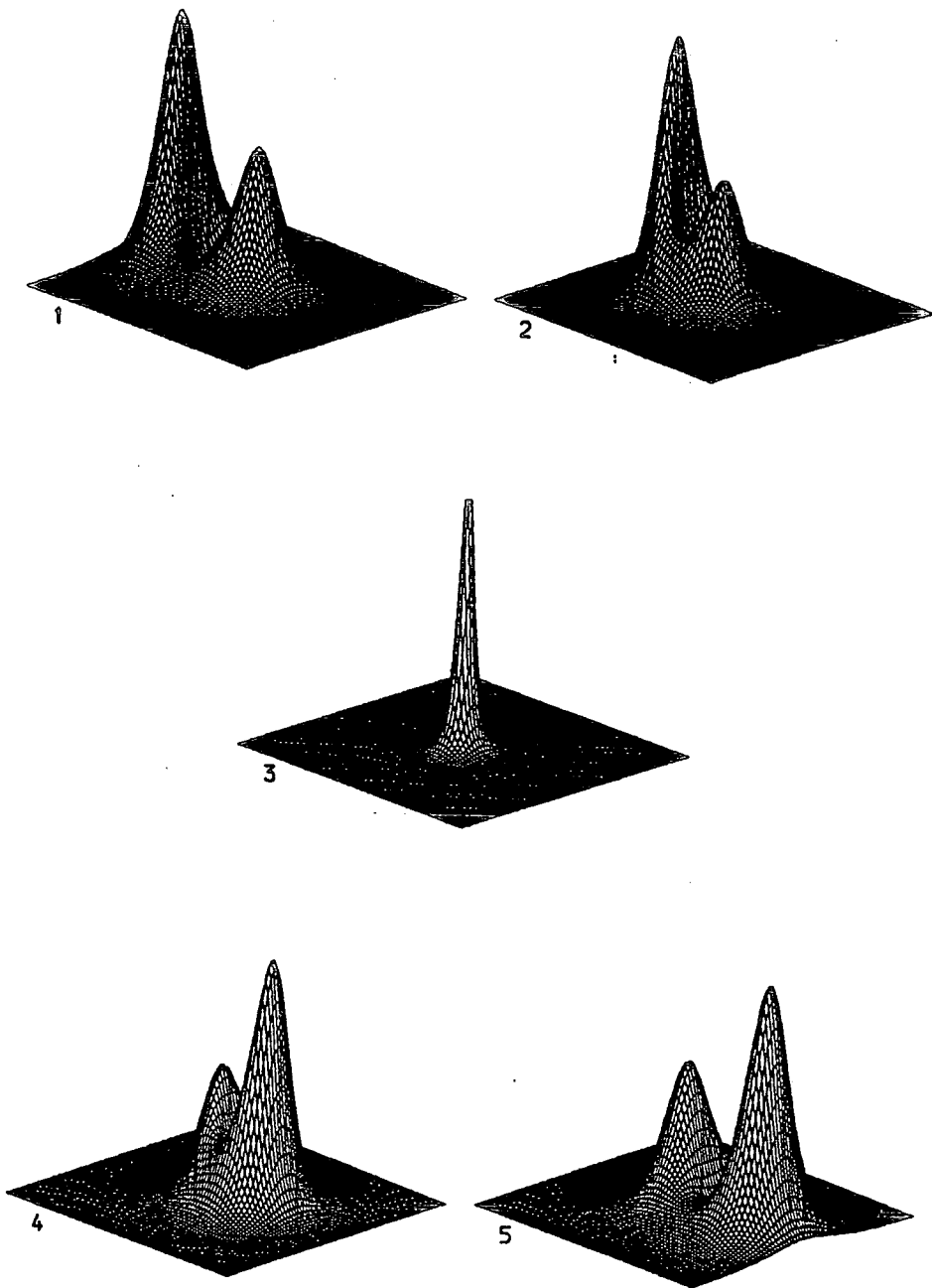

Fig 5.4(a). Scattering in an Integrable Model in  $(2 + 1)$ -Dimensions - Surface Plot.

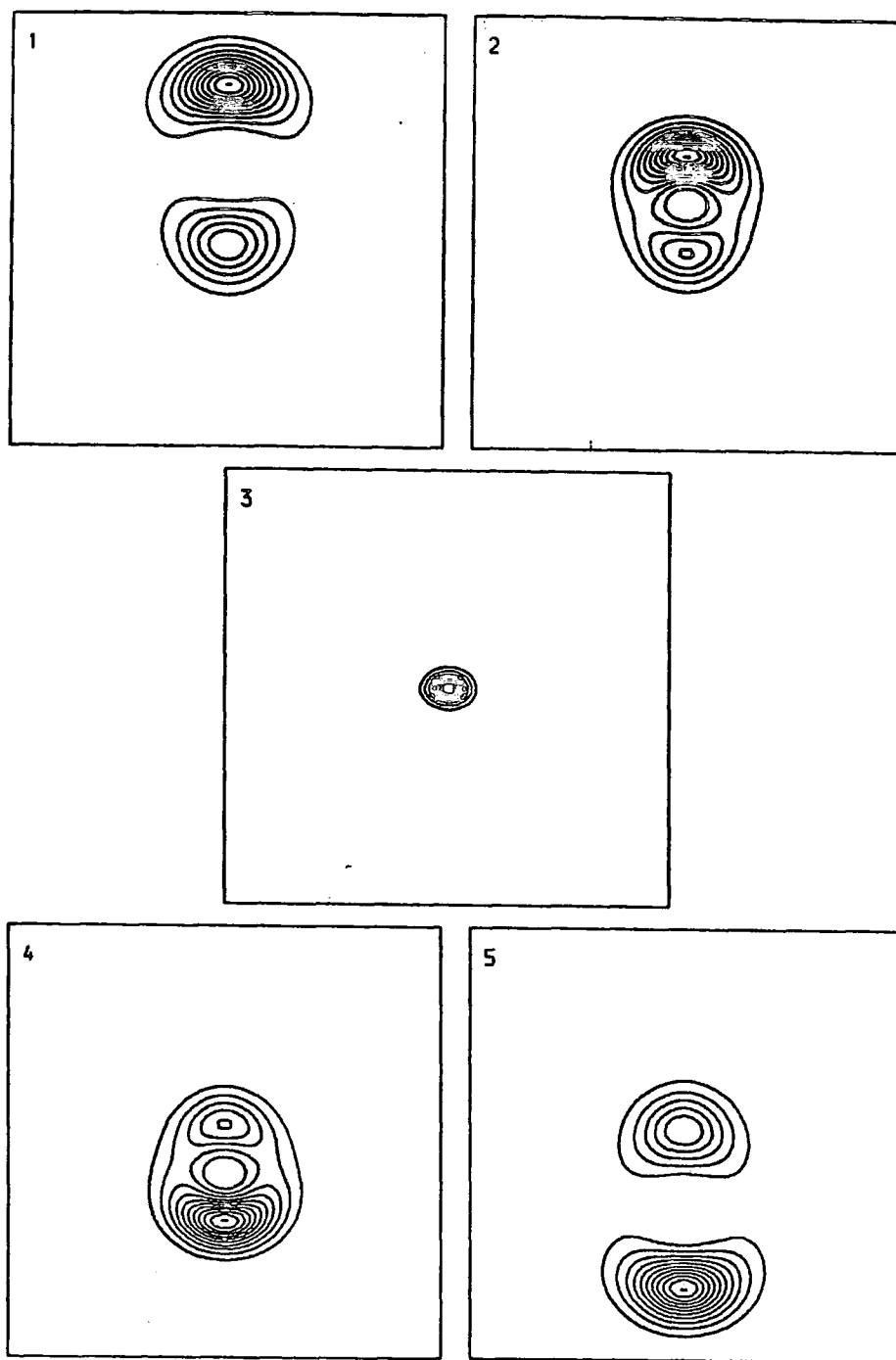

Fig 5.4(b). Scattering in an Integrable Model in  $(2 + 1)$ -Dimensions - Contour Plot.

Since the motion of the vortices described by geodesics on moduli space is just an approximation to the true motion, it is important to know exactly how good the approximation is. In effect, it ignores radiation; the motion only excites those modes (finite in number) which parametrize the static solutions. Numerical studies (which involve numerical integration of the full second-order field equations) for vortex scattering,<sup>[103]</sup> and  $\mathbb{C}\mathbb{P}^1$  soliton scattering,<sup>[44,104]</sup> have shown that for slow velocities the amount of radiation is very small. Further, for the  $\mathbb{C}\mathbb{P}^1$  model the trajectories are in excellent agreement with the geodesic paths obtained using the slow-motion approximation. For monopole scattering it has been shown<sup>[105]</sup> that if  $v$  is the speed of the monopole, the amount of radiation emitted goes like  $v^5$ , and is negligible for small speeds. As Ruback has pointed out,<sup>[41]</sup> due to the spontaneously broken symmetry the approximation should be better for vortices than for monopoles since there are only massive excitation modes. Hence there is a mass gap in the energy spectrum, so for small velocities these massive modes would not be excited. Thus in other models the approximation has been shown to be extremely good, and there is no reason to suppose that it should not be so for this modified vortex model.

A common feature of the moduli space metrics used to describe soliton scattering is that they are all Kähler, and as one might have suspected the metric constructed above also has this property. It is often possible to show a metric is Kähler without having to calculate it explicitly. For the Atiyah-Hitchin metric, describing charge 2-monopole scattering, it was the hyper-Kähler property that enabled the metric to be found. The  $\mathbb{C}\mathbb{P}^1$  metric is formally Kähler,<sup>[43,101]</sup> but unless some of the free parameters are fixed the expressions involved diverge. This motion is less well behaved than monopole or vortex motion - there is the possibility of the  $\mathbb{C}\mathbb{P}^1$  solitons becoming spikes in finite time.<sup>[44]</sup> Ultimately this is due to the lack of scale; the  $\mathbb{C}\mathbb{P}^1$  model in 2 dimensions is conformally invariant. In the gauge theory examples, including the model considered here, the metric is well-defined. The solutions have a scale fixed by the asymptotic size of the Higgs field,  $|\phi|_{asy}$ , and this has the effect of stabilising them.

As was said in the introduction, the metric for vortices in flat space has not been found, owing to the absence of static solutions in closed form. However, by symmetry the metric for the relative motion of 2 vortices has to be of the form

$$ds^2 = f(r) dr^2 + g(r) d\theta^2, \quad 0 \leq \theta < \pi,$$

and recently it has been shown<sup>[102]</sup> that  $g(r) = r^2 f(r)$  with  $f(r) \propto r^2$  for  $r \ll 1$ , which

is in agreement with numerical evidence.<sup>[103]</sup> This is of the same form as (5.37), ignoring powers of  $r^5$  and above, so the two models have the same behaviour around the origin. The  $90^\circ$  scattering of vortices in both models is just a consequence of the symmetry of the moduli space (via the Killing vector  $\frac{\partial}{\partial \theta}$ ) rather than any detailed knowledge of the function  $f(r)$ . The metric (5.37) cannot be embedded isometrically in Euclidean  $\mathbb{R}^3$ , though (like for flat vortices) it may be thought of as conical in shape.

From now on consider just the equations in 2 dimensions, with no time. As mentioned above, the vortices have a scale associated to them, given by the value of  $|\phi|_{asy}$ . It is possible to change its value while still retaining the integrability of the model. Consider the flat line element in  $\mathbb{R}^4$  written in the form

$$ds^2 = \frac{r^2}{R^2} \left[ \frac{R^2}{r^2} (dr^2 + dx^2) + R^2 (d\theta^2 + \sin^2 \theta d\phi^2) \right],$$

where  $R$  is an arbitrary positive constant. Repeating the arguments of section 2 there is a conformal equivalence

$$\mathbb{R}^4 - \mathbb{R}^1 \sim S^2(R) \times \mathbb{H}^2(R).$$

Here  $S^2(R)$  is a 2-sphere of radius  $R$ , and  $\mathbb{H}^2(R)$  is a two-dimensional hyperbolic space of constant negative curvature  $-2R^{-2}$ . Under this reduction, the action is of the same form as (5.2), but the Higgs potential becomes

$$\frac{1}{4}(R - |\phi|^2)^2.$$

The reduction fixes the value of  $|\phi|_{asy}$  as well as the curvature of the space. It is possible to rescale the Higgs field so that  $|\phi|_{asy} = 1$ , but unlike in flat space, this rescaling changes the curvature from  $-2R^{-2}$  to  $-2$ . Thus models obtained in this way with different values of  $R$  are essentially the same. This is to be contrasted with hyperbolic monopoles.<sup>[71]</sup> These use the conformal equivalence

$$\mathbb{R}^4 - \mathbb{R}^2 \sim S^1 \times \mathbb{H}^3,$$

where  $S^1$  is the unit circle and  $\mathbb{H}^3$  is a three-dimensional space of constant negative curvature. The reduction does not fix  $|\phi|_{asy}$ ; it remains a free parameter. In terms of instantons on  $\mathbb{R}^4$ , the instanton number is  $c_2(A) = 2n|\phi|_{asy}$ , where  $n$  is the monopole



number. This leads to the possibility of fractionally charged instantons.<sup>[106]</sup> Also, by carefully taking certain limits,<sup>[71,107,70]</sup> it is possible to obtain the normal monopoles from hyperbolic monopoles. This is due to the freedom in the Higgs field, in the vortex case this is absent, and it is not possible to get normal vortices in this manner. One could envisage a family of monopole and vortex models, parametrized by  $|\phi|_{asy}$  and the scalar curvature of the space. Consider a graph with axes  $-R$  and  $|\phi|_{asy}$ . For monopoles the model is integrable at each point, while for vortices the model is only integrable along the line  $|\phi|_{asy} + R = 0$ , which are essentially the same model since one may move from one point to another by simple scaling. It would be interesting to know if it would be possible to obtain information about solutions and their moduli spaces at points  $(|\phi|_{asy}, R)$  with  $0 < |\phi|_{asy} + R \ll 1$ , i.e. for models which are not integrable but are in some sense close to an integrable one.

The metric constructed here shares common features with other metrics that have been found. Although numerical studies of the full second order equations have not been done, from the arguments above one would expect the results to be in close agreement those obtained using this approximation.

---

## Chapter VI

---

### Outlook

---

Rather than collecting together the individual comments and conclusions from the preceding chapters, this chapter is more speculative in character, and outlines some connections between the geometrical view propounded in this thesis and other approaches to the study of integrable systems. It should be emphasised that these are mainly observations and not rigorous results. Making more sense of these tentative comments will be an important area of future research.

One of the most successful techniques in soliton theory is Hirota's Direct method, which enables the  $N$ -soliton solution for many integrable models to be written down succinctly. For a review see [16]. As an example, consider the KdV equation  $u_t + 6uu_x + u_{xxx} = 0$ . In Hirota's method this is written in a so-called bilinear form

$$(D_x D_t + D_x^4) f \circ f = 0,$$

where

$$u = 2 \frac{\partial^2 \ln f}{\partial x^2},$$

and

$$D_x^k g \circ f = \left( \frac{\partial}{\partial x} - \frac{\partial}{\partial x'} \right)^k g(x) f(x') \Big|_{x=x'}.$$

The  $N$ -soliton solution is given by

$$f = \sum_{\mu_1=0}^1 \dots \sum_{\mu_n=0}^1 \exp \left( \sum_{i>j} A_{ij} \mu_i \mu_j + \sum_{i=1}^N \mu_i \eta_i \right), \quad (6.1)$$

where  $\eta_i = k_i x - k_i^3 t$ , and

$$\exp A_{ij} = \left[ \frac{k_i - k_j}{k_i + k_j} \right]^2,$$

the  $k_i$  are constants.

It is important to note that this method makes no use of the associated over determined linear system, which is why it is called Hirota's direct method. Recall that from the geometrical point of view, the  $N$ -soliton solution may be encoded in a holomorphic vector bundle over the twistor space  $\mathcal{O}(3)$ .

Note that the general solution depends on the combination  $kx - k^3 t$  which may be seen as half of a global holomorphic section of the bundle  $\mathcal{O}(3)$ . Thus it appears that these two approaches – the geometrical/twistorial approach and the Hirota Bilinear formalism – are, in some way, connected. It therefore seems important to understand the geometrical meaning of the Hirota D-operator. [Similar remarks apply to the NLS equations; the general  $N$ -lump solution depends on the combination  $kx + k^2 t$ , which seems to suggest a connection with the mini-twistor space  $\mathcal{O}(2)$ .]

More striking is the similarity in the way the two approaches deal with the associated hierarchies. It was first shown by Sato that a solution to the KdV hierarchy could be constructed from (6.1) by replacing  $\eta_i = k_i x - k_i^3 t$  by

$$\eta_i = \sum_{j \text{ odd}} k_i^j t_j,$$

where  $t_1 = x$ , and  $t_{n>1}$  are 'times' which define the various commuting flows. This is to be compared with the construction in chapter IV; given a solution to the NLS equations, the corresponding solution to the hierarchy could be constructed using a similar change.

One of the major problems in the twistor description of integrable systems, as has been constantly stated throughout this thesis, is that there is no (satisfactory) interpretation for equations such as the KP and DS systems, which occur via the substitution of the spectral parameter by a differential operator. The Hirota method for the KP hierarchy involve the combination

$$\eta_i = \sum_{j=1}^{\infty} k_i^j x_j. \quad (6.2)$$

This suggest (if the above argument carries any weight) that the twistor space  $\mathcal{O}(\infty)$  might be involved. This is in contrast with the ideas of Mason,<sup>[91]</sup> where the KP equation

is shown to be associated with twistor space rather than a minitwistor space. Extending his argument to include the entire hierarchy would mean introducing the space  $\mathbb{C}P^\infty$  which would not explain the appearance of the combination (6.2).

Such  $(2 + 1)$ -dimensional integrable models arise from linear operators of the form

$$\mathcal{L}_x = \partial_x + \sum_{n=0}^N S_n(x, y, t) \partial_y^n.$$

Consider the following rather formal ‘argument’:

$$\begin{aligned} \partial_x \Phi &= \sum_{n=0}^N S_n(x, y, t) \partial_y^n \Phi, \\ &= \left[ \sum_{n=0}^N S_n(x, y, t) \partial_y^n \Phi \cdot \Phi^{-1} \right] \Phi, \\ &= \left[ \sum_{m=0}^{\infty} y^m B_m^N(x, t) \right] \Phi. \end{aligned}$$

Thus the variable  $y$  plays the rôle of the spectral parameter. Such a linear system may be incorporated into a twistorial interpretation by using the space  $\Pi_{\infty, \infty}$ . The ‘argument’ has several flaws: one has to start with a known solution  $(S_n, \Phi)$ , and so this the above is not much use from a computational point of view. Also expanding the combination  $\sum_{n=0}^N S_n(x, y, t) \partial_y^n \Phi \cdot \Phi^{-1}$  as a power series in  $y$  is rather formal, and would be very hard to invert.

However it does have some interesting features. The gauge group is kept the same throughout – there is no need to change the gauge group midway.<sup>[66]</sup> Also the dimension of the twistor space (and the dimension of the gauge group) remains finite and constant as  $N$  tends to infinity in  $\mathcal{O}(N)$ , it is only the Chern number of the bundle (or the degree of the internal ‘twisting’ of the bundle) that grows. Also the idea that the spectral parameter could play the rôle of a new coordinate is interesting, and deserves further study. It is analogous to the way in which the discrete basis of, say,  $SU(N)$  becomes continuous (becoming the coordinates of the surface  $\Sigma^2$  in  $SDiff(\Sigma^2)$ ) as  $N$  tends to infinity.

Again, it must be stressed that this is not a rigorous proof, but it does suggest possible avenues for future research.

Understanding of the KP equation from the twistor view point would also involve an understanding of vertex operators. A solution to the KP hierarchy may be 'created' from the 'vacuum' by the application of such a vertex operator, and such operators are central to many areas of mathematical physics.<sup>[16,17]</sup>

An alternative approach to the study of the KP equations and its hierarchy is by way of the scalar Lax equation.<sup>[108]</sup> Let  $\Lambda$  be the pseudo-differential operator

$$\Lambda = \partial + u_2\partial^{-1} + u_3\partial^{-2} + u_4\partial^{-3} + \dots,$$

where  $\partial = \frac{\partial}{\partial x_1}$  and  $\partial^{-1}$  is an inverse to  $\partial$  satisfying the generalised Leibniz rule

$$\partial^{-n} f(x) = \sum_{l=0}^{\infty} (-1)^l \frac{(n+l-1)!}{l!(n-1)!} f^{(l)}(x) \partial^{-n-l}, \quad (n > 0).$$

For any pseudo-differential operator  $\Omega$ , the differential operator  $[\Omega]_+$  is defined to be the pure differential part of  $\Omega$ , i.e. if  $\Omega = \sum_{n=-\infty}^N a_n \partial^n$  then  $[\Omega]_+ = \sum_{n=0}^N a_n \partial^n$ . The algebra of pseudo-differential operators is associative, so with the definition of the Lie bracket given by  $[\Omega, \Omega'] = \Omega \Omega' - \Omega' \Omega$  it forms a Lie algebra (the Jacobi identity follows from the associativity of the algebra).

The scalar Lax equation is

$$\frac{\partial \Lambda}{\partial x_n} = [B_n, \Lambda], \tag{6.3}$$

with

$$B_n = [\Lambda^n]_+. \tag{6.4}$$

For example

$$\begin{aligned} B_1 &= \partial, \\ B_2 &= \partial^2 + 2u_2, \\ B_3 &= \partial^3 + 3u_2\partial + (3u_3 + 3u_{2,x}), \end{aligned}$$

and in general  $B_n = \sum_{j=0}^n b_{nj} \partial^j$  with  $b_{nn} = 1, b_{nn-1} = 0$ . This gives rise to an infinite series of equations known as the KP hierarchy.

From (6.3) and (6.4) the following infinite set of equations may be derived for the differential operators  $B_n$ ,

$$F_{m,n} \equiv \frac{\partial B_m}{\partial x_n} - \frac{\partial B_n}{\partial x_m} + [B_m, B_n] = 0, \quad m, n = 1, \dots, \infty, \quad (6.5)$$

this being equivalent to (6.3). Such a system has gauge symmetries and also Bäcklund transformation, and these may be used to construct various solutions.<sup>[109,110]</sup> Next it will be shown how this can be given a natural interpretation in terms of the twistor space  $\mathcal{O}(\infty)$ .

Given the twistor space  $\mathcal{O}(N)$  there exist the following set of linear equations

$$\mathcal{L}_r \Phi \equiv \left\{ \left[ \frac{\partial}{\partial t_r} - B_r \right] - \lambda \left[ \frac{\partial}{\partial t_{r+1}} - \tilde{B}_{r+1} \right] \right\} \Phi = 0, \quad r = 1, \dots, N.$$

corresponding to a certain class of holomorphic vector bundles over  $\mathcal{O}(N)$ . In what follows it is assumed that this construction holds for the above Lie algebra of differential operators.

Next the condition  $B_r = \tilde{B}_r, r = 1, \dots, N$  is imposed, and for notational simplicity  $\tilde{B}_{N+1}$  will be denoted by  $B_{N+1}$ . The system corresponding to  $\mathcal{O}(\infty)$  is just the large  $N$  limit of this system. The integrability conditions for such an overdetermined linear system are

$$[\mathcal{L}_r, \mathcal{L}_s] = 0, \quad \forall r, s = 1, \dots, \infty.$$

which imply the following

$$\begin{aligned} F_{r,s} &= 0, \\ F_{r+1,s+1} &= 0, \\ F_{r,s+1} + F_{r+1,s} &= 0. \end{aligned}$$

For these to hold for all  $r$  and  $s$  one requires  $F_{r,s} = 0 \quad \forall r, s = 1, \dots, \infty$ , and this is just the KP hierarchy as defined above.

**Example**

Consider just the linear system corresponding to the minitwistor space  $\mathcal{O}(2)$ , the

holomorphic tangent bundle to the Riemann sphere. The integrability conditions are

$$F_{1,2} = 0,$$

$$F_{1,3} = 0,$$

$$F_{2,3} = 0.$$

Using the above definitions of  $B_n$ , the first two of these yield the trivial scaling relations

$$u_{2,x} = u_{2,t_1},$$

$$u_{3,x} = u_{3,t_1},$$

and the third gives the KP equation itself

$$\frac{\partial}{\partial x} \left( \frac{\partial u_2}{\partial t_3} - \frac{1}{4} \frac{\partial^3 u_2}{\partial x^3} - 3u_2 \frac{\partial u_2}{\partial x} \right) - \frac{3}{4} \frac{\partial^2 u_2}{\partial t_2^2} = 0.$$

Thus the KP equation is a reduction of the Bogomolny equations.

This gives a geometrical explanation of the appearance of the term  $\sum_{n=0}^{\infty} \lambda^n t_n$  in the solution of the KP hierarchy, as this is a global holomorphic section of the bundle  $\mathcal{O}(\infty)$ .

All the integrable systems studied in this thesis have been classical, but the concept of integrability is extremely important in certain quantum field theories. Whether twistor theory, originally invented to provide an alternative approach to the problem of quantum gravity, will turn out to be of use for such integrable quantum field theories is an extremely important question, and one that has gained very little attention.

---

## Appendix A

---

In this appendix some definitions and properties of Lie algebras, symmetric and Hermitian symmetric spaces are presented. Full details may be found in Helgason.<sup>[67]</sup>

### A.1 Simple Lie Algebras

In terms of the Cartan-Weyl basis, a complex simple Lie algebra  $\mathfrak{g}$  has the commutator relations:

- (i)  $[h_i, h_j] = 0, \quad \forall h_i, h_j \in \mathfrak{h},$
- (ii)  $[h, e_\alpha] = \alpha(h).e_\alpha, \quad \forall h \in \mathfrak{h}, \quad \alpha \in \Phi,$
- (iii)  $[e_\gamma, e_{-\gamma}] = h_\gamma, \quad \text{where } h_\gamma \in \mathfrak{h},$
- (iv)  $[e_\gamma, e_\beta] = N_{\gamma,\beta}e_{\gamma+\beta}, \quad \text{if } 0 \neq \gamma + \beta \in \Phi,$   
 $= 0 \quad \text{if } 0 = \gamma + \beta \notin \Phi.$

The subset  $\mathfrak{h} \subset \mathfrak{g}$  is the Cartan subalgebra, and  $l$  is, by definition, the rank of the algebra. The set  $\Phi$  are the roots of the space, these being linear maps

$$\alpha : \mathfrak{h} \longrightarrow \mathbb{C},$$

$$\alpha(h_i) = \alpha_i.$$

The corresponding vectors  $e_\alpha$  are called root vectors, and this may be decomposed into  $\Phi^+$  and  $\Phi^-$ , the positive and negative roots, respectively. The coefficients  $N_{\gamma,\beta}$  are the most complicated part of the algebra, and they satisfy the conditions

$$N_{-\alpha,-\beta} = -N_{\alpha,\beta}, \quad N_{\alpha,\beta} = N_{\beta,-\alpha-\beta} = N_{-\alpha-\beta,\alpha}.$$

A different basis, called the Chevalley basis, is often useful for algebraic purposes. It is defined in terms of the above by:

$$E_\alpha \equiv \sqrt{2/\alpha^2}.e_\alpha,$$

$$H_\alpha \equiv \frac{2\alpha_i h_i}{\alpha_j \alpha_j},$$



and these satisfy the relations:

$$\begin{aligned} [H_a, E_{-b}] &= -K_{ba}E_{-b}, & [E_a, E_{-b}] &= \delta_{ab}H_b, \\ [H_a, E_b] &= K_{ba}E_b, & [H_a, H_b] &= 0, \end{aligned}$$

where  $K_{ba}$  is the Cartan matrix, defined by

$$K_{ab} = \frac{2\alpha^a \cdot \beta^b}{(\alpha^b)^2}.$$

## A.2 Homogeneous and Symmetric Spaces

A homogeneous space of a Lie group  $G$  is any differentiable manifold  $M$  on which  $G$  acts transitively ( $\forall p_1, p_2 \in M \exists g \in G$  s.t.  $g.p_1 = p_2$ ). For a given  $p_0 \in M$ , let  $K$  be defined by

$$K = K_{p_0} = \{g \in G : g.p_0 = p_0\}.$$

The manifold  $M$  may be identified with the coset space  $G/K$ , and the Lie algebra  $\mathfrak{g}$  of  $G$  decomposes as  $\mathfrak{g} = \mathfrak{k} \oplus \mathfrak{m}$ , where  $\mathfrak{m}$  may be identified with the tangent space  $T_{p_0}(G/K)$ , and  $[\mathfrak{k}, \mathfrak{k}] \subset \mathfrak{k}$ .

If, in addition,  $[\mathfrak{k}, \mathfrak{m}] \subset \mathfrak{m}$ , then  $G/K$  is said to be a reductive homogeneous space. These have naturally defined connections and torsion and curvature tensors. At the fixed point  $p_0$ , these tensors are given purely in terms of the Lie bracket;

$$\begin{aligned} [R(X, Y)Z]_{p_0} &= -[[X, Y]_{\mathfrak{k}}, Z], \\ T(X, Y)_{p_0} &= -[X, Y]_{\mathfrak{m}}, \end{aligned} \quad \text{where } X, Y, Z \in \mathfrak{m},$$

where the subscripts on the commutators refer to the component of that particular subspace.

If  $\mathfrak{g}$  satisfies all the conditions

$$\begin{aligned} \mathfrak{g} &= \mathfrak{k} \oplus \mathfrak{m}, & [\mathfrak{k}, \mathfrak{k}] &\subset \mathfrak{k}, \\ [\mathfrak{k}, \mathfrak{m}] &\subset \mathfrak{m}, & [\mathfrak{m}, \mathfrak{m}] &\subset \mathfrak{k}, \end{aligned}$$

(i.e. all the above, and the further condition  $[\mathfrak{m}, \mathfrak{m}] \subset \mathfrak{k}$ ), then  $\mathfrak{g}$  is called a symmetric algebra, and  $G/K$  is said to be a symmetric space. Since now  $[\mathfrak{m}, \mathfrak{m}] \subset \mathfrak{k}$  automatically, the torsion is identically zero, and the Riemann curvature tensor is just defined by

$$[R(X, Y)Z]_{p_0} = -[[X, Y], Z],$$

or, introducing a basis  $X_i \in T_{p_0}(G/K)$ , by

$$R(X_k, X_l)X_j = R_{jkl}^i X_i.$$

On a symmetric space there is a natural metric given by the Killing form of the algebra,

$$g(X, Y) = \text{Tr}(\text{ad}X.\text{ad}Y),$$

$$g_{ij} = g(X_i, X_j),$$

and indices may be raised and lowered in the usual way.

In certain special cases it is possible to equip a symmetric space with a complex structure. This is a linear map endomorphism  $J : \mathfrak{m} \rightarrow \mathfrak{m}$  such that  $J^2 = -1$ . This implies that  $\mathfrak{m}$  must be even dimensional (as a real vector space).

A Hermitian symmetric space is one where such a structure exists. They have many interesting differential/geometric properties, more of which may be found in Helgason. Here it is the algebraic properties of the associated algebra  $\mathfrak{g}$  that will be important. Explicitly:

- (i)  $\exists A \in \mathfrak{h}$  (the Cartan subalgebra of  $\mathfrak{g}$ ) s.t.  $\mathfrak{k} = C_{\mathfrak{g}}(A) = \{B \in \mathfrak{g} : [B, A] = 0\}$ ,
- (ii)  $\exists \Theta^+ \subset \Phi^+$ , a subset of the positive root system, s.t.  $\mathfrak{m} = \text{span}\{e_{\pm\alpha}\}_{\alpha \in \Theta^+}$ , and
 
$$[h, e_{\alpha}] = \pm a e_{\alpha} \forall h \in \mathfrak{h} \text{ and } \alpha \in \Theta^{\pm}, \text{ for some constant } a,$$
- (iii)  $[e_{\alpha}, e_{\beta}] = 0 \forall \alpha, \beta \in \Theta^+$  or  $\alpha, \beta \in \Theta^-$ .
- (iv)  $J = \text{ad}A$  for a particular scaling of  $A$ .

Given this basis, the Riemann curvature tensor is defined by

$$R_{\beta\gamma-\delta}^{\alpha} = [e_{\beta}, [e_{\alpha}, e_{-\delta}]],$$

$$R_{-\beta-\gamma\delta}^{-\alpha} = [e_{-\beta}, [e_{-\alpha}, e_{\delta}]].$$

These satisfy the hermiticity condition

$$\overline{(R_{\beta\gamma-\delta}^{\alpha})} = R_{-\beta-\gamma\delta}^{-\alpha}.$$

These Hermitian symmetric spaces have been completely classified, there being four

different infinite families, labelled A III, BD I, D III and C I, together with two exceptional cases, labelled E III and E VII. These families are summarised in chapter III, table 3.

---

## Appendix B

---

This appendix describes the construction of the finite energy axially symmetric  $SU(2)$  instantons. These are used in chapter V, where they are interpreted as static vortices in a modified Abelian Higgs model in  $(2+1)$ -dimensions. The details have been taken from [37,1,62].

Consider the spherically-symmetric, finite-action solutions of  $SU(2)$  gauge theory in Euclidean  $\mathbb{R}^4$ , with action

$$S = \frac{1}{4} \int d^4x F_{\mu\nu} F^{\mu\nu}. \quad (\text{B.1})$$

Under an  $SO(3)$  symmetry, the self-duality equations  $F = *F$  reduce to the Bogomolny equations for an Abelian Higgs model at critical coupling, with a  $U(1)$  gauge field  $A_\mu$  and a complex-valued Higgs field  $\phi$ . The space on which this model is defined is not flat, but has constant negative curvature. To understand how this occurs, consider the flat line element on  $\mathbb{R}^4$ , written in the form

$$\begin{aligned} ds^2 &= dt^2 + dr^2 + r^2(d\theta^2 + \sin^2\theta d\phi^2) \\ &= r^2(r^{-2}(dr^2 + dt^2) + d\theta^2 + \sin^2\theta d\phi^2). \end{aligned} \quad (\text{B.2})$$

Since the self-duality equations are conformally invariant in  $\mathbb{R}^4$ , their solutions are also solutions in the space with metric

$$ds^2 = r^{-2}(dr^2 + dt^2) + d\theta^2 + \sin^2\theta d\phi^2. \quad (\text{B.3})$$

This is the line element for the space  $S^2 \times \mathbb{H}^2$ , where  $\mathbb{H}^2$  is a two-dimensional hyperbolic space of constant negative curvature  $-2$ . The metric (B.3) is singular along the line  $r = 0$ . Removing this singular line from  $\mathbb{R}^4$  gives the conformal equivalence

$$\mathbb{R}^4 - \mathbb{R}^1 \sim S^2 \times \mathbb{H}^2. \quad (\text{B.4})$$

To impose a spacetime symmetry in a gauge theory is problematical, due to the gauge symmetry. One requires a set of gauge potentials which (in some gauge) depend only on

the coordinates on  $\mathbb{H}^2$ , and which respects the axial symmetry. The most general axially symmetric  $su(2)$  potentials are

$$A_j^a = \frac{\phi_2 + 1}{r^2} \varepsilon_{jak} x_j + \frac{\phi_1}{r^3} [\delta_{ja} r^2 - x_j x_a] + \frac{A_1 x_j x_a}{r^2},$$

$$A_0^a = \frac{A_1 x^a}{r},$$

where  $\phi_0, \phi_1, A_0$  and  $A_1$  only depend on  $r$  and  $t$ , i.e. the coordinates on  $\mathbb{H}^2$ . Note how the spacetime indices  $j$  and  $k$  are mixed with the group index  $a$ . Full details may be found in [62].

One then calculates the action given such fields, and integrating over the 2-sphere yields

$$S = 8\pi \int_{t=-\infty}^{\infty} dt \int_{r=0}^{\infty} dr \left[ \frac{1}{2} (D_\mu \phi_i)^2 + \frac{1}{8} r^2 F_{\mu\nu}^2 + \frac{1}{4} r^{-2} (1 - \phi_1^2 - \phi_2^2) \right]. \quad (\text{B.5})$$

In what follows it will be useful to conformally map the space  $\mathbb{H}^2$  onto the unit disc  $\Delta$  (the symbol  $\Delta$  will be used to denote the interior of the disc without any metrical structure). A similar ball picture was used by Nash<sup>[71]</sup> in the construction of hyperbolic monopoles. In these new coordinates (B.5) becomes (where  $\mu, \nu = 1, 2$  and  $\phi = \phi_1 + i\phi_2$ )

$$S = 8\pi \int_{\Delta} d^2x \sqrt{g} \left( \frac{1}{2} D_\mu \phi \overline{D^\mu \phi} + \frac{1}{8} F_{\mu\nu} F^{\mu\nu} + \frac{1}{4} (1 - |\phi|^2)^2 \right), \quad (\text{B.6})$$

the metric on the unit disc being given by

$$ds^2 = \frac{4}{(1 - x^2 - y^2)^2} (dx^2 + dy^2), \quad (x^2 + y^2 < 1), \quad (\text{B.7})$$

and the covariant derivative and the field tensor being defined by

$$D_\mu \phi = \partial_\mu \phi - i A_\mu \phi$$

$$F_{\mu\nu} = \partial_\mu A_\nu - \partial_\nu A_\mu. \quad (\text{B.8})$$

For finite energy one imposes the conditions  $|\phi| \rightarrow 1$  and  $D_\mu \phi \rightarrow 0$  as  $\sqrt{x^2 + y^2} \rightarrow 1$ . These imply that  $A_\mu$  tends to pure gauge as  $\sqrt{x^2 + y^2} \rightarrow 1$ , and so  $F_{\mu\nu} \rightarrow 0$ .

The Bogomolny argument still works in the curved space. Let  $F_{\mu\nu} = \varepsilon_{\mu\nu} B$ , so  $B = \varepsilon^{\mu\nu} \partial_\mu A_\nu$ , and let

$$\begin{aligned} Q &= \sqrt{g} g^{\mu\nu} (D_\mu \phi \pm i \varepsilon_\mu^\alpha D_\alpha \phi) \overline{(D_\nu \phi \pm i \varepsilon_\nu^\beta D_\beta \phi)} \\ &= 2\sqrt{g} g^{\mu\nu} D_\mu \phi \overline{D_\nu \phi} \pm 2i\sqrt{g} \varepsilon^{\mu\nu} \overline{D_\mu \phi} D_\nu \phi. \end{aligned} \quad (\text{B.9})$$

Here  $\varepsilon_{\mu\nu}$  is the volume element

$$\begin{aligned} \varepsilon_{\mu\nu} dx^\mu \wedge dx^\nu &= \sqrt{g} d^2 x \\ &= \frac{4}{(1-x^2-y^2)^2} dx \wedge dy. \end{aligned} \quad (\text{B.10})$$

In terms of  $B$  and  $Q$  the action (B.6) may be written as

$$S = 8\pi \int_{\Delta} d^2 x \left[ \frac{1}{4} Q + \frac{1}{4} \sqrt{g} [B \mp (1 - |\phi|^2)]^2 \pm \frac{1}{2} \sqrt{g} B \mp \frac{1}{2} i \sqrt{g} \varepsilon^{\mu\nu} \partial_\mu [\bar{\phi} D_\nu \phi] \right]. \quad (\text{B.11})$$

Note that  $\sqrt{g} \varepsilon^{\mu\nu} = \varepsilon_{\text{flat}}^{\mu\nu}$ , where  $\varepsilon_{\text{flat}}^{\mu\nu}$  is just the alternating symbol. Thus

$$\sqrt{g} \varepsilon^{\mu\nu} \partial_\mu = \partial_\mu \sqrt{g} \varepsilon^{\mu\nu}.$$

Using this result (together with the divergence theorem and the boundary conditions on  $\partial\Delta$ ), the last term in (B.11) integrates to zero. The first two terms of (B.11) are clearly positive, so

$$\begin{aligned} S &\geq \pm 4\pi \int_{\Delta} d^2 x \sqrt{g} B \\ &= \pm 4\pi \int_{\Delta} d^2 x \partial_\mu [\varepsilon_{\text{flat}}^{\mu\nu} A_\nu]. \end{aligned}$$

Using the divergence theorem and boundary conditions this becomes

$$\begin{aligned} S &\geq \pm 4\pi \oint_{\partial\Delta} ds_\mu \varepsilon_{\text{flat}}^{\mu\nu} \frac{1}{i} \frac{\partial_\nu \phi}{\phi} \\ &= \pm 8\pi^2 \frac{1}{2\pi i} \oint_{\partial\Delta} ds \frac{1}{\phi} \frac{d\phi}{ds}. \end{aligned}$$

This last term is just  $8\pi^2$  times the winding number of the map

$$\phi|_{r=1} : \partial\Delta \cong S^1 \rightarrow S^1, \quad (\text{B.12})$$

and hence is equal to  $8\pi^2 n$  for some integer  $n$ . This integer is the topological charge of

the field configuration. Thus

$$S = 8\pi \int_{\Delta} d^2x \left[ \frac{1}{4}Q + \frac{1}{4}\sqrt{g}[B \mp (1 - |\phi|^2)]^2 \right] \pm 8\pi^2 n \quad (\text{B.13})$$

$$\geq 8\pi^2 |n|,$$

the upper sign being chosen for  $n > 0$ , and the lower sign for  $n < 0$ .

Equality occurs if and only if

$$D_{\mu}\phi \pm i\varepsilon_{\mu}{}^{\nu}D_{\nu}\phi = 0, \quad (\text{B.14})$$

$$\varepsilon^{\mu\nu}\partial_{\mu}A_{\nu} = \pm[1 - |\phi|^2].$$

These Bogomolny equations are just the self-duality equations on  $\mathbb{R}^4$ , under the reduction by  $\text{SO}(3)$ . In terms of instantons on  $\mathbb{R}^4$ , the topological charge is equal to the second Chern (or instanton number),  $c_2(A) = n$ . Equations (B.14) were first solved by Witten,<sup>[37]</sup> and it is interesting to note that Taubes<sup>[61]</sup> has proved that all finite-energy solutions are in fact solutions of these first order-equations. The solutions of (B.14) are known as vortices, or antivortices, depending on choice of sign in the equations. The vortex solutions (corresponding to the positive sign in equation (B.14)) will be constructed below. The gauge condition  $\nabla_{\mu}A^{\mu} = 0$  is imposed and so

$$A_{\mu} = \varepsilon_{\mu}{}^{\nu}\partial_{\nu}\psi, \quad (\text{B.15})$$

where  $\psi$  is a real-valued function. Writing  $\phi = e^{\psi}u$  gives the following equations for  $u$  and  $\psi$ :

$$\partial_{\mu}u + i\varepsilon_{\mu}{}^{\nu}\partial_{\nu}u = 0 \quad (\text{B.16})$$

$$\nabla^2\psi = \sqrt{g}(u\bar{u}e^{2\psi} - 1).$$

Here  $\nabla^2$  is just the flat-space Laplacian. If complex coordinates  $z$  and  $\bar{z}$  are introduced on  $\Delta$ , defined by  $z = x + iy$  and  $\bar{z} = x - iy$ , then  $\partial_{\mu} + i\varepsilon_{\mu}{}^{\nu}\partial_{\nu}$  is the Cauchy-Riemann operator: the functions it annihilates are those which are functions of  $z$  alone. Hence  $u$  must be a complex-analytic function. Using the argument principle, the topological charge defined above is equal to the number of zeros of the analytic function  $u$ . Making the substitution  $\psi = \rho - \frac{1}{2}\ln(u\bar{u}) - \frac{1}{2}\ln\sqrt{g}$  in the second equation gives the Liouville

equation:

$$\nabla^2 \rho = e^{2\rho}. \quad (\text{B.17})$$

It is the integrability of this equation that underpins the solubility of the model. The general solution of Liouville's equation is given in terms of an arbitrary complex-analytic function  $f$ . Explicitly,

$$\rho = -\ln \frac{1}{2}(1 - f\bar{f}) + \frac{1}{2} \ln \left| \frac{df}{dz} \right|^2. \quad (\text{B.18})$$

To avoid singularities in the Higgs field one takes  $u = \frac{df}{dz}$ . With this choice for  $u$ , the fields take the form

$$\begin{aligned} \phi &= \frac{df}{dz} \left( \frac{1 - z\bar{z}}{1 - f\bar{f}} \right) \\ A_\mu &= \varepsilon_\mu{}^\nu \partial_\nu \ln \left( \frac{1 - z\bar{z}}{1 - f\bar{f}} \right). \end{aligned} \quad (\text{B.19})$$

The most general analytic function which satisfies the boundary condition  $|f| < 1$  for  $|z| < 1$  and  $|f| = 1$  for  $|z| = 1$  is given by

$$f = \prod_{i=0}^n \frac{z - a_i}{1 - \bar{a}_i z}, \quad a_i \in \Delta. \quad (\text{B.20})$$

However, the function  $f$  is not uniquely determined, the fields being invariant under the change

$$f \mapsto \frac{f - c}{1 - \bar{c}f}, \quad c \in \Delta. \quad (\text{B.21})$$

So  $f$  depends on  $2n$  real parameters, rather than the  $2n + 2$  parameters that might at first be expected. The topological charge of this solution (the number of zeros of  $\frac{df}{dz}$ ) is just  $n$ . Let  $\alpha_i, i = 1, \dots, n$  be the positions of the zeros of the Higgs field (counted with multiplicities). These are related to the parameters  $a_i$  appearing in (B.20) by the set of equations

$$\left. \frac{df}{dz} \right|_{z=\alpha_i} = 0, \quad i = 1, \dots, n.$$

By inverting these equations one may express the  $a_i$  as functions of the  $\alpha_i$ , though not uniquely, because of equation (B.21).



---

## References

---

- [1] I. A. B. Strachan, *Low-velocity scattering of vortices in a Modified Abelian Higgs Model*. To appear in *J. Math. Phys.*
- [2] I. A. B. Strachan, *Phys. Lett. A* **154** (1990) 123.
- [3] I. A. B. Strachan, *A Twistor Approach to the Sine-Gordon Equation*. Durham preprint DTP-90/49.
- [4] I. A. B. Strachan, *Integrable Hierarchies in  $(2 + 1)$ -Dimensions and their Twistor Description*. In preparation.
- [5] I. A. B. Strachan, *A New Family of Integrable Models in  $(2 + 1)$ -Dimensions Associated with Hermitian Symmetric Spaces*. In preparation.
- [6] J. S. Russell, *Report on Waves*. (14<sup>th</sup> Meeting of the BAAS, London. 1844)
- [7] L. P. Eisenhart, *A Treatise on the differential geometry of curves and surfaces*. (Ginn & Co., Boston. 1909).
- [8] A. Fermi, J. Pasta and S. Ulam, *Studies of nonlinear problems*. (Los Alamos Report LA 1940.)
- [9] N. J. Zabusky and M. D. Kruskal, *Phys. Rev. Lett.* **15** (1965) 240.
- [10] R. M. Miura, *J. Math. Phys.* **9** (1968) 1202.
- [11] C. S. Gardner, J. M. Greene, M. D. Kruskal and R. M. Miura, *Phys. Rev. Lett.* **19** (1967) 1095.
- [12] P. D. Lax, *Comm. Pure Appl. Math.* **21** (1968) 467.
- [13] M. J. Ablowitz, D. J. Kaup, A. C. Newell and H. Segur *Stud. Appl. Math.* **53** (1974) 249.
- [14] C. S. Gardner, *J. Math. Phys.* **12** (1971) 1548.
- [15] V. E. Zakharov and L. D. Faddeev, *Funct. Anal. Appl.* **5** (1971) 280.

- [16] A. C. Newell, *Solitons in Mathematics and Physics*, SIAM, Philadelphia (1985).  
Ed. A. P. Fordy, *Soliton Theory: a survey of results*, Manchester University Press, (1990).
- [17] Ed. Lepowsky et.al. *Vertex operators in Mathematics and Physics*, Springer-Verlag (1983).
- [18] W. J. Zakrzewski, *Low Dimensional Sigma Models*, Adam Hilger, Bristol (1989).
- [19] M. Lüscher and K. Pohlmeyer, *Nucl. Phys.* **B137** (1978) 46.
- [20] E. Brézin, C. Itzykson, J. Zinn-Justin and J-B. Zuber, *Phys. Lett.* **B82** (1979) 442.
- [21] R. Penrose, *J. Math. Phys.* **8** (1967) 345.
- [22] R. Penrose and W. Rindler, *Spinors and spacetime, Vol. I* (Cambridge University Press, Cambridge, (1984).
- [23] R. Penrose and W. Rindler, *Spinors and spacetime, Vol. II* (Cambridge University Press, Cambridge, (1986).
- [24] R. Penrose, *Gen. Rel. Grav.* **7** (1976) 31.
- [25] R. S. Ward, *Phys. Lett.* **61A** (1977) 81.
- [26] M. F. Atiyah and R. S. Ward, *Comm. Math. Phys.* **55** (1977) 117.
- [27] M. F. Atiyah, N. J. Hitchin, V. G. Drinfel'd and Yu. I. Manin  
*Phys. Lett.* **A65** (1978) 185.
- [28] E. Corrigan and D. B. Fairlie, *Phys. Lett.* **67B** (1977) 69.
- [29] N. S. Manton, *Nucl. Phys.* **B135** (1978) 319.
- [30] R. S. Ward, *Comm. Math. Phys.* **79** (1981) 317.
- [31] M. K. Prasad, *Comm. Math. Phys.* **24** (1983) 1233.
- [32] M. K. Prasad and P. Rossi, *Phys. Rev. Lett.* **46** (1981) 806.
- [33] R. S. Ward, *Phys. Lett.* **B102** (1981) 136.
- [34] E. Corrigan and P. Goddard, *Comm. Math. Phys.* **80** (1981) 575.
- [35] N. J. Hitchin, *Comm. Math. Phys.* **83** (1982) 579.
- [36] N. J. Hitchin, *Comm. Math. Phys.* **89** (1983) 145.
- [37] E. Witten, *Phys. Rev. Lett.* **38** (1977) 121.

- [38] R. S. Ward, *Phil. Trans. R. Soc. A* **315** (1985) 451.  
— in *Springer Lecture Notes in Physics*, # 280  
(Springer-Verlag, 1987), p106.  
— in *Twistors in Mathematics and Physics*, eds. T.N.Bailey & R.J.Baston,  
(Cambridge University Press, Cambridge, 1990).
- [39] L. J. Mason and G. A. J. Sparling, *Phys. Lett.* **137A** (1989) 29.
- [40] N. S. Manton, *Phys. Lett.* **110B** (1982) 54.
- [41] P. J. Ruback, *Nucl. Phys.* **B296** (1988) 669.
- [42] R. S. Ward, *Phys. Lett.* **158B** (1985) 424.
- [43] I. Stokoe and W. J. Zakrzewski, *Z. Phys. C* **34** (1987) 491.
- [44] R. A. Leese, *Nucl. Phys.* **B344** (1990) 33
- [45] P. J. Ruback and G. W. Gibbons, *Phys. Rev. Lett.* **57** (1986) 1492.
- [46] R. S. Ward and R. O. Wells, *Twistor Geometry and Field Theory* (Cambridge University Press, Cambridge, (1990).
- [47] S. A. Huggett and K. P. Tod, *An Introduction to Twistor Theory* (Cambridge University Press, Cambridge, (1985).
- [48] R. S. Ward, *J. Math. Phys.* **30** (1989) 2246.
- [49] H. Bateman, *Proc. Lond. Math. Soc.*(2) **1** (1904) 451.
- [50] E. T. Whittaker, *Math. Ann.* **57** (1903) 331.
- [51] P. Forgács, Z. Horvath and L. Palla, *Nucl. Phys.* **B229** (1983) 77
- [52] J. Tafel, *J. Math. Phys.* **30** (1989) 706.  
— *J. Math. Phys.* **31** (1990) 1234.
- [53] L. J. Mason, E. T. Newman and J. S. Ivancovich, *Comm. Math. Phys.* **130** (1990) 139.
- [54] L. J. Mason and G. A. J. Sparling *Twistor Correspondences for Nonlinear Schrödinger and Korteweg de Vries Hierarchies*, Oxford preprint.
- [55] R. S. Ward, *Nucl. Phys.* **B236** (1984) 381.
- [56] L. J. Mason, S. Chakravarty and E. J. Newman, *J. Math. Phys.* **29** (1988) 1005.

- [57] A. A. Belavin and V. F. Zakharov, *Phys. Lett.* B73 (1978) 53.
- [58] Q-Han Park *2d-Sigma Model approach to 4d Instantons*,  
UMDEPP-90-270, DAMTP R90/22.
- [59] J. F. Plebanski, *J. Math. Phys.* 16 (1975) 2395.
- [60] M. P. Joy and M. Sabir, *J. Phys.* A22 (1989) 5153.
- [61] A. Jaffe and C. Taubes, *Vortices and Monopoles* (Birkhäuser, Boston. 1980).
- [62] N. S. Manton and P. Forgács, *Comm. Maths. Phys.* 72 (1980) 15.
- [63] A. N. Leznov and M. V. Saveliev, *Phys. Lett.* B83 (1979) 314.
- [64] A. N. Leznov and M. V. Saveliev, *Comm. Math. Phys.* 74 (1980) 111.
- [65] F. A. Bais and H. A. Weldon, *Phys. Lett* B79 (1978) 297.
- [66] A. M. Din, Z. Horvath and W. J. Zakrzewski, *Nucl. Phys.* B233 (1984) 269.
- [67] L. Witten, *Phys. Rev* D19 (1979) 718.
- [68] N. M. J. Woodhouse and L. J. Mason, *Nonlinearity* 1 (1988) 73.
- [69] N. M. J. Woodhouse, *Class. Quantum Grav.* 4 (1987) 799.
- [70] M. F. Atiyah, *Proc. International Colloquium on vector bundles*  
(Tata Institute, Bombay, 1984).
- [71] C. Nash, *J. Math. Phys.* 27 (1986) 2160.
- [72] E. Corrigan and P. Goddard, *Annals of Physics.* 154 (1984) 253.
- [73] W. Nahm, *Monopoles in quantum field theory* ed. N. S. Craigie, P. Goddard  
and W. Nahm.(World Scientific, Singapore, 1982).
- [74] S. Chakravarty, M. J. Clarkson and P. A. Clarkson  
*Phys. Rev. Lett.* 65 (1990) 1085.
- [75] R. S. Ward, *J. Math. Phys.* 29 (1988) 386.
- [76] R. A. Leese, *J. Math. Phys.* 30 (1989) 2072
- [77] R. S. Ward, *Nonlinearity* 1 (1988) 671.
- [78] R. S. Ward, *Comm. Math. Phys.* 128 (1990) 319.
- [79] A. P. Fordy and P. P. Kulish, *Comm. Math. Phys.* 89 (1983) 427.

- [80] C. Athorne and A. P. Fordy, *J. Math. Phys.* **28** (1987) 2016.
- [81] A. D. W. B. Crumey, *Comm. Math. Phys.* **108** (1987) 631.
- [82] A. D. W. B. Crumey, *Comm. Math. Phys.* **111** (1987) 167.
- [83] A. P. Fordy, *J. Phys.* **A17** (1984) 1235.
- [84] C. Athorne and A. P. Fordy, *J. Phys.* **A20** (1987) 1377.
- [85] V. G. Drinfel'd and V. V. Sokolov, *Jour. Sov. Math* **30** (1985) 1975.  
 \_\_\_\_\_ *Soviet Math. Dokl.* **23** (1981) 457.
- [86] I. Bakas and P. A. Delpireux, *Mod. Phys. Lett.* **A6** (1991) 399.
- [87] S. Helgason, *Differential Geometry, Lie Groups and Symmetric Spaces*, 2<sup>nd</sup> ed.  
 Academic Press, New York, (1978).
- [88] K. Yamagishi and G. F. Chapline, *Class. Quant. Grav.* **8** (1991) 427.
- [89] R. S. Ward, *Class. Quant. Grav.* **7** (1990) L217.
- [90] L. J. Mason, E. T. Newman, *Comm. Math. Phys.* **121** (1989) 659.
- [91] L. J. Mason, *H space – a universal integrable system?*  
 Oxford preprint; Twistor Newsletter.30
- [92] R. S. Ward, *Phys. Lett.* **B234** (1990) 81.
- [93] R. S. Ward, *Class. Quant. Grav.* **7** (1990) L95.
- [94] D. B. Fairlie and C. K. Zachos, *Phys. Lett.* **B224** (1989) 101.
- [95] K. Takasaki, *J. Math. Phys.* **30** (1989) 1515.
- [96] P. G. Drazin, *Solitons* (Cambridge University Press, Cambridge, 1983).
- [97] V. E. Zakharov and A. B. Shabat, *Func. Anal. Appl.* **13** (1980) 166.
- [98] M. F. Atiyah and N. J. Hitchin, *The Geometry and Dynamics of Magnetic Monopoles* (Princeton University Press, Princeton, 1988).
- [99] J. Schiff, *J. Math. Phys.* **32** (1991) 753.
- [100] P. A. M. Dirac. *Lectures on Quantum Mechanics*.
- [101] P. J. Ruback, *Comm. Math. Phys.* **116** (1988) 645.

- [102] T. M. Samols, *Ph.D. thesis, Cambridge 1990*.  
— *Vortex Scattering*, DAMTP preprint 1991.  
— *Phys. Lett.* 244B (1990) 285.
- [103] E. P. S. Shellard and P. J. Ruback, *Phys. Lett.* 209B (1988) 262.
- [104] R. A. Leese, M. Peyrard and W. J. Zakrzewski, *Nonlinearity* 3 (1990) 773
- [105] N. S. Manton and T. M. Samols, *Phys. Lett.* 215B (1988) 559.
- [106] P. Forgács, Z. Horvath and L. Palla, *Phys. Rev. Lett.* 46 (1981) 392.
- [107] M. F. Atiyah, *Comm. Math. Phys.* 93 (1984) 437.
- [108] G. B. Segal and G. Wilson, *Pub. Math. I.H.E.S.* 61 (1985) 5.
- [109] L-L Chau, J. C. Shaw and H. C. Yen, *Solving the KP hierarchy by Gauge Transformations*, Preprint UCDPHYS-PUB-91-11, March 1991.
- [110] J. Matsukidaira, J. Satsuma and W. Strampp, *J. Math. Phys.* 31 (1990) 1426.

