



Durham E-Theses

Antimetabolic effects of plant proteins on homopteran insect pests

Powell, Kevin Steven

How to cite:

Powell, Kevin Steven (1993) *Antimetabolic effects of plant proteins on homopteran insect pests*, Durham theses, Durham University. Available at Durham E-Theses Online: <http://etheses.dur.ac.uk/5757/>

Use policy

The full-text may be used and/or reproduced, and given to third parties in any format or medium, without prior permission or charge, for personal research or study, educational, or not-for-profit purposes provided that:

- a full bibliographic reference is made to the original source
- a [link](#) is made to the metadata record in Durham E-Theses
- the full-text is not changed in any way

The full-text must not be sold in any format or medium without the formal permission of the copyright holders.

Please consult the [full Durham E-Theses policy](#) for further details.

Antimetabolic Effects of Plant Proteins on Homopteran Insect Pests

By
Kevin Steven Powell
MSc (Nottingham)

The copyright of this thesis rests with the author.
No quotation from it should be published without
his prior written consent and information derived
from it should be acknowledged.

Submitted for the Degree of
Doctorate of Philosophy

Department of Biological Sciences
University of Durham

1993



28 MAR 1994

The copyright of this thesis rests with the author. No quotation from it should be published without his prior consent and information derived from it should be acknowledged.

Abstract

Homopteran insect pests can cause severe economical damage to crop plants by both direct physical means and as vectors of plant viral diseases. They are notoriously difficult insects to control by conventional methods, primarily due to their ability to evolve resistance-breaking biotypes within a relatively short time period. The production of genetically modified crop plants, expressing insecticidal genes, offers a novel method of control for a wide range of insect species. Once suitable gene products, such as plant-derived proteins, have been identified as having insecticidal effect against specific insects *in vitro*, their effect can be determined *in vivo* by expressing the relevant gene in transgenic plants.

Insect feeding trials were carried out to determine the effects of incorporating a range of plant-derived proteins into artificial diets fed to planthopper, leafhopper and aphid pests and to aphids *in planta*. The lectins *Galanthus nivalis* agglutinin (GNA) and wheat germ agglutinin (WGA), and the enzyme soybean lipoxigenase (LPO) were shown to exhibit significant antimetabolic effects towards first and third instar nymphs of rice brown planthopper (*Nilaparvata lugens* Stål) when incorporated into artificial diet at 0.1% {w/v}, 0.1% {w/v} and 0.08% {w/v} levels respectively. The lectin GNA was also shown to exhibit a significant antimetabolic effect towards third instar nymphs of the rice green leafhopper (*Nephotettix cinciteps* Uhler) and the peach potato aphid (*Myzus persicae* Sulzer). A number of inert proteins, lectins, protein inhibitors and enzymes also tested showed relatively little or no effect towards both insects. The mechanism of action of all three effective proteins was examined using BPH as a model insect. As judged by honeydew production, the proteins all had a deterrent effect on insect feeding. However, subsequent toxic effects are also indicated. When fed sub-optimal concentrations of effective proteins in combination no synergistic or additive effects were observed, indicating that pyramiding the genes of these effective proteins would be of no advantage in protecting the crop against BPH.

Abbreviations

ASA	<i>Allium sativum</i> agglutinin
BPH	Rice brown planthopper (<i>Nilaparvata lugens</i>)
<i>Bt</i>	<i>Bacillus thuringiensis</i>
BSA	Bovine serum albumin
Chase	<i>Streptomyces griseus</i> chitinase
ConA	Concanavalin A
CpTI	Cowpea trypsin inhibitor
GLH	Rice green leafhopper (<i>Nephotettix cinciteps</i>)
GNA	<i>Galanthus nivalis</i> agglutinin
GTC	Grace's insect tissue culture media
HGA	Horse gram agglutinin
JCA	Jacalin agglutinin
LCA	<i>Lens culinaris</i> agglutinin
LPO	Soybean lipoxygenase
LYZ	Lysozyme (Chicken egg white)
NPA	<i>Narcissus pseudonarcissus</i> agglutinin
OSA	<i>Oryza sativa</i> agglutinin
OVA	Ovalbumin
PBS	Phosphate buffered saline
PHA	Phytohaemagglutinin
PPA	Peach potato aphid (<i>Myzus persicae</i>)
PPO	Potato polyphenolase oxidase
PSA	<i>Pisum sativum</i> agglutinin
STA	<i>Solanum tuberosum</i> agglutinin
TGA	<i>Tulipa gesneriana</i> agglutinin
WAI	Wheat α -amylase inhibitor
WGA	Wheat germ agglutinin
YLS	Yeast-like symbiont
YMA	Yeast morphology agar

Dedication

I dedicate this thesis to Mayssa and Yasmin for encouragement and support.

Acknowledgements

I would like to thank a number of colleagues in the department, particularly my supervisor Dr. John Gatehouse and Drs. Vaughan Hilder, Angharad Gatehouse, Ying Shi, Mr. Mingbo Wang and Miss Gillian Davidson, for extensive advice and encouragement, and Professor Donald Boulter for use of department facilities. I also wish to thank Mrs. Christine Richardson and Jackie Spence for advice on electron and light microscopy techniques and Mr. David Brown and Dr. Arpad Pusztai of the Rowett Research Institute, Aberdeen for carrying out amino acid analysis and for encouraging me in the field of lectin research.

I would like to thank Drs. Bernard Betts and John Pickett for supplying planthopper and leafhopper insect cultures. Grateful thanks is expressed to Drs. W. Peumans and E. van Damme, Katholieke Universiteit, Leuven, Belgium for supplying various lectins and GNA antibodies, Dr. Bonjawat, Chulalongkorn University, Bangkok, Thailand for supplying rice lectin and to Dr. G.S. Khush, IRRI, Philippines for supplying rice seed. This research was supported by a grant from the Rockefeller Foundation, (Rice Biotechnology Programme), which is gratefully acknowledged.

Memorandum

Parts of this work have been included in the following publication:

Powell, K.S., Gatehouse, A.M.R., Hilder, V.A. and Gatehouse, J.A., 1993. Antimetabolic effects of plant lectins and plant and fungal enzymes on the nymphal stages of two important rice pests, *Nilaparvata lugens* and *Nephotettix cinciteps*. *Entomol. Exp. & Appl.* 66: 119-126.

Table of Contents

Abstract	3
Abbreviations	4
Dedication	5
Acknowledgements	5
Memorandum	6
List of Figures	11
List of Tables	14
List of Plates	15
CHAPTER ONE	17
1.1 INTRODUCTION	17
1.1.1 General Introduction	17
1.1.2 Rice	17
1.2 Planthoppers and Leafhoppers	18
1.2.1 Synonyms	19
1.2.2 Synonyms	19
1.2.3 Geographical distribution	20
1.2.4 Host plant specificity	20
1.2.5 Morphology and life cycle	21
1.2.5.1 Nilaparvata lugens	21
1.2.5.2 Nephottetix cinciteps	21
1.2.5.3 Myzus persicae	22
1.3 Feeding physiology	22
1.4 Stimulants and antifeedants	23
1.5 Crop damage	23
1.5.1 Crop damage	23
1.5.2 Virus vector	24
1.6 Control measures	25
1.6.1 Insecticides	25
1.6.2 Biological control	28
1.6.3 Conventional plant breeding	28
1.6.3.1 Resistance mechanisms	30
1.6.4 Cultural control	30
1.6.5 Genetically manipulated crop resistance	31
1.6.5.1 Potential plant derived insecticidal genes	32
1.6.6 Integrated pest management	35
1.6.7 Screening potential insecticidal genes	35
1.7 Artificial diets for Homoptera	36
1.8 Intracellular symbionts of Insecta	36
1.8.1 Intracellular symbionts of Homoptera	36
1.9 General aims and objectives	39
CHAPTER TWO	40
2.1 MATERIALS AND METHODS	40
2.1.1 Chemicals and materials	40
2.1.2 Maintenance of insect stock cultures	40
2.1.2.1 Nilaparvata lugens	40
2.1.2.2 Nephottetix cinciteps	41

2.1.2.3	Myzus persicae.....	41
2.2	Enzyme assays.....	41
2.2.1	Measurement of enzyme activity in adult insect gut.....	41
2.2.1.2	Preparation of adult gut homogenate.....	41
2.2.2.3	α -amylase activity.....	42
2.2.2.4	Trehalase activity.....	42
2.2.2.5	Invertase activity.....	42
2.2.2.6	Protease activity.....	43
2.2.2.7	Carbohydrase activity.....	43
2.3	In vitro insect bioassays.....	43
2.3.1	Artificial diet preparation.....	43
2.3.2	Hatching bioassays.....	44
2.3.2.1	Using eggs oviposited on host plant (Method 1).....	44
2.3.2.2	Using eggs oviposited on plant (Method 2).....	44
2.3.2.3	Combined oviposition and hatching bioassays.....	46
2.3.3	Artificial diet comparison bioassays.....	47
2.4	In vitro protein feeding trials.....	50
2.4.1	Feeding trials using first instar BPH.....	50
2.4.2	Feeding trials using third instar nymphs.....	50
2.4.3	Pressurised bioassays.....	50
2.4.4	Dose response determination.....	51
2.4.5	Pyramid feeding trials.....	51
2.4.6	Determination of antimetabolic activity.....	51
2.4.7	Statistical methods.....	53
2.4.8	Peach potato aphid bioassays.....	53
2.4.8.1	Pilot bioassays.....	53
2.4.8.2	In vitro protein feeding trials.....	53
2.4.8.3	Aphid development feeding trials.....	54
2.5	In planta feeding trials.....	54
2.6	Mechanism of action of anti-metabolites.....	57
2.6.1	Determination of protein uptake.....	57
2.6.2	Examination of insect ultrastructure.....	57
2.6.2.1	Light microscopy.....	58
2.6.2.2	Electron microscopy.....	59
2.7.1	Light microscope examination for morphological changes in gut ultrastructure.....	60
2.7.2	Electron microscope examination for morphological changes in gut ultrastructure.....	60
2.8	Immunological studies.....	60
2.8.1	Immunohistochemical staining.....	60
(i)	DAB technique.....	60
(ii)	Avidin-Biotin technique.....	61
2.9	Intracellular Symbionts of BPH.....	61
2.9.1	Distribution of yeast-like symbionts.....	61
2.9.2	Isolation and continuous culture of yeast-like symbionts.....	62
2.10	Assessing antifeedant activity.....	62
2.10.1	Analysis of honeydew.....	62
2.10.1.2	Ninhydrin analysis of BPH honeydew.....	62
2.10.1.3	Quantitative analysis of BPH honeydew.....	63
(i)	In vitro.....	63
(ii)	In planta.....	63

2.10.1.4	Qualitative analysis of BPH honeydew	64
CHAPTER THREE	68
3.1	RESULTS AND CONCLUSIONS	68
3.1.1	Enzyme assays	68
3.2	In vitro insect bioassays	69
3.2.1	Hatching bioassays	69
3.2.1.1	Using eggs removed from the host plant (Method 1)	70
3.2.1.2	Using eggs removed from the host plant (Method 2)	70
3.2.1.3	Combined oviposition and hatching bioassays	71
	(a) Effect of oviposition media on oviposition	71
	(b) Effect of oviposition medium on nymphal emergence	74
	(c) Effect of artificial diet and oviposition media on nymph survival rates	74
	(d) Effect of artificial diet and oviposition media on adult female survival	76
3.2.2	Artificial diet comparison bioassays	76
3.3	In vitro protein feeding trials	78
3.3.1	Feeding trials using first instar BPH	78
3.3.2	Feeding trials using third instar nymphs	88
3.3.3	Pressurised insect bioassays	94
3.3.4	Dose response determination	102
3.3.5	Pyramid feeding trials	103
3.3.6	Peach potato aphid bioassays	111
	3.3.6.1 Pilot feeding bioassays	111
	3.3.6.2 In vitro protein feeding trials	112
	3.3.6.3 In vitro aphid development feeding trials	117
3.4	In planta insect feeding trials	117
3.5	Mechanism of action of antimetabolites	118
3.5.1	Determination of protein uptake	118
	(a) Fluorescent microscopy studies	118
3.5.2	Examination of insect ultrastructure	126
	3.5.2.1 Light microscopy studies	126
	(i) Preliminary studies	126
	(ii) Morphological features of GNA-fed insects	127
	3.5.2.2 Electron microscope studies	130
3.6	Immunological studies	130
3.6.1	Fluorescent microscopy studies	130
3.6.2	Immunohistochemical studies	133
3.7	Intracellular symbionts of BPH	133
3.7.1	Distribution of yeast-like symbionts	138
3.7.2	Isolation and continuous culture of YLS	138
3.8	Antifeedant activity	139
3.8.1	Honeydew analysis	139
	3.8.1.2 Ninhydrin analysis of BPH honeydew	139
	3.8.1.3 Quantitative analysis of honeydew	144

3.8.1.4	Qualitative analysis of BPH honeydew.....	155
(i)	Analysis of honeydew from rice feeding insects.....	155
(ii)	Analysis of honeydew from insects feeding on artificial diet control.....	156
(iii)	Analysis of honeydew produced by insects feeding on proteins.....	156
CHAPTER FOUR	163
4.1	DISCUSSION.....	163
(i)	Rearing and bioassay system.....	163
(ii)	Protein feeding trials.....	164
(iii)	Mechanism of action.....	164
(iv)	Gene combinations.....	167
(v)	In planta studies.....	168
5.0	REFERENCES.....	171

List of Figures

Number	Description	Page
1	Regions of a rice plant usually inhabited by adult insect pests.	27
2	Insect pest species present at different growth stages of the rice plant.	27
3	Hatching chamber designed to allow BPH eggs to hatch <i>in vitro</i> .	48
4	Dual purpose hatching and feeding chamber.	48
5	Combined oviposition and feeding chamber.	49
6	Schematic presentation of pressurised feeding chamber designed to allow sap-sucking insects to feed on artificial diet under simulated sap pressure.	56
7	Schematic representation of floating humidity chamber used in honeydew analysis experiments.	65
8	Hatching viability of BPH eggs <i>in vitro</i> without access to artificial diet.	73
9	Hatching viability of BPH eggs <i>in vitro</i> with access to artificial diets MMD-1 or MED-1	73
10	Effect of varying the sucrose concentration, of artificial diet MED-1, on the survival of first instar BPH nymphs.	80
11	Effect of varying the sucrose concentration, of artificial diet MMD-1, on the survival of first instar BPH nymphs.	80
12	Effect of varying the pH of the artificial diet, MMD-1, on the survival of first instar BPH nymphs.	82
13	Effect on first instar BPH nymphs, of incorporating <i>Galanthus nivalis</i> agglutinin or wheat germ agglutinin at 0.1% concentration {w/v} into the artificial diet MMD-1	85
14	Effect on first instar BPH survival, of incorporating cowpea trypsin inhibitor at 0.1% concentration {w/v} into the artificial diet MMD-1.	87
15	Effect on third instar BPH survival, of incorporating either wheat germ agglutinin or <i>Galanthus nivalis</i> agglutinin at 0.1% concentration {w/v} into the artificial diet MMD-1.	93

16	Effect on third instar BPH survival, of incorporating soybean lipoxygenase at 0.08% concentration {w/v} into the artificial diet MMD-1.	93
17	Effect on third instar BPH survival of incorporating <i>Galanthus nivalis</i> agglutinin at 0.1% concentration {w/v} into the artificial diet MMD-1, supplied under either ambient or simulated sap pressure conditions.	98
18	Dosage response curves of <i>Galanthus nivalis</i> agglutinin fed <i>in vitro</i> to third instar BPH nymphs.	105
19	Dosage response curves of wheat germ agglutinin fed <i>in vitro</i> to third instar BPH nymphs.	105
20	Dosage response curves of soybean lipoxygenase fed <i>in vitro</i> to third instar BPH nymphs.	107
21	Dosage response curves of the mannose binding lectins; <i>Galanthus nivalis</i> agglutinin, <i>Narcissus pseudonarcissis</i> agglutinin and <i>Allium sativum</i> agglutinin fed <i>in vitro</i> to third instar BPH nymphs.	107
22	Effect on third instar BPH survival of incorporating <i>Galanthus nivalis</i> agglutinin and soybean lipoxygenase either singly or in combination at suboptimal concentrations into artificial diet MMD-1.	109
23	Effect on third instar BPH survival of incorporating <i>Galanthus nivalis</i> or wheat germ agglutinin either singly or in combination at suboptimal concentration into artificial diet MMD-1.	109
24	Effect on third instar BPH survival of incorporating wheat germ agglutinin or soybean lipoxygenase either singly or in combination, at suboptimal concentration into artificial diet MMD-1.	110
25	Effect on (a) adult <i>Myzus persicae</i> (peach potato aphid (PPA)) survival and (b) fecundity of PPA of feeding artificial diet DM66, supplied under ambient pressure conditions.	114
26	Effect on second generation first instar PPA survival when fed on artificial diet DM66 supplied under either ambient or simulated sap pressure conditions.	116
27	Effect on first instar PPA survival when fed on artificial diet DM66 incorporated with <i>Galanthus nivalis</i> agglutinin supplied under simulated sap pressure conditions.	116

28	Effect on first instar PPA body dimensions of incorporating either <i>Galanthus nivalis</i> agglutinin or wheat α -amylase inhibitor into artificial diet DM66 supplied under simulated sap pressure conditions, as measured using image analysis.	120
29	Effect on (a) adult PPA survival and (b) PPA fecundity when feeding on transgenic tobacco plants expressing the <i>Galanthus nivalis</i> agglutinin gene.	122-4
30	Honeydew production, in terms of (a) total droplet number and (b) total volume, by adult BPH feeding on <i>Galanthus nivalis</i> agglutinin or <i>Pisum sativum</i> agglutinin <i>in vitro</i> .	148
31	Honeydew production, in terms of (a) total droplet number and (b) total volume, by adult BPH feeding on wheat germ agglutinin <i>in vitro</i> .	150
32	Honeydew production, in terms of (a) total droplet number and (b) total volume, by adult BPH feeding on soybean lipoxygenase <i>in vitro</i> .	152
33	Honeydew volume production, by adult BPH, after feeding on either artificial diet, MMD-1, or rice plants after 24 hours.	153
34	Amino acid composition of honeydew produced by adult BPH feeding on rice plants or artificial diet MMD-1 after 24 hours, as measured by amino acid analyser.	158
35	Amino acid composition of honeydew produced by adult BPH feeding on either <i>Galanthus nivalis</i> agglutinin, wheat germ agglutinin or soybean lipoxygenase incorporated into artificial diet MMD-1 at 0.1% {w/v} concentration.	159
36	Amino acid composition of honeydew produced by adult BPH feeding on <i>Galanthus nivalis</i> agglutinin incorporated into artificial diet MMD-1 at 0.1% {w/v} concentration and composition of MMD-1 prior to feeding as measured by amino acid analyser.	160
37	Amino acid composition of honeydew produced by adult BPH feeding on wheat germ agglutinin incorporated into artificial diet MMD-1 at 0.1% {w/v} concentration and composition of MMD-1 prior to feeding as measured by amino acid analyser.	161
38	Amino acid composition of honeydew produced by adult BPH feeding on soybean lipoxygenase incorporated into artificial diet MMD-1 at 0.1% {w/v} concentration and composition of MMD-1 prior to feeding as measured by amino acid analyser.	162

List of Tables

Number	Description	Page
1	Artificial diet composition.	45
2	Hatching, survival and oviposition data from BPH fed on selected artificial diet and oviposition media.	75
3	Mortalities of first instar BPH nymphs when fed artificial diet, MMD-1, with selected proteins incorporated at 0.1% concentration {w/v}.	83
4	Mortalities of third instar BPH nymphs when fed artificial diet, MMD-1, with selected proteins incorporated at known % concentration {w/v}.	90
5	Mortalities of third instar GLH nymphs when fed artificial diet, MMD-1, with selected proteins incorporated at known % concentration {w/v}.	91
6	Third instar BPH development and survival rates when fed artificial diet, MMD-1, supplied under either ambient or simulated sap pressure.	96
7	Mortalities of third instar BPH when fed artificial diet, MMD-1, with selected protein incorporated at 0.1% concentration {w/v}, supplied under simulated sap pressure.	99

List of Plates

Number	Description	Page
1	Aphid-clip cage used in <i>in planta</i> feeding trials.	55
2	GNA expressing transgenic tobacco plants used in aphid feeding trial.	56
3	Replicated floating humidity chambers used for quantitative determination of BPH honeydew.	65
4	Parafilm sachet used for collection of honeydew samples from adult BPH feeding on host plant (rice).	66
5	Replicated honeydew collection sachets on rice plant.	67
6	Micrographs showing fluorescein stained honeydew produced by adult BPH feeding on (a) control artificial diet MMD-1 or (b) 0.1% {w/v} fluorescein labelled GNA incorporated into MMD-1, after 48 hours	125
7	Micrographs of transverse section of (a) the midgut and (b) the hindgut region of an adult female BPH after feeding on artificial diet MMD-1 for 5 days.	128
8	Micrographs of transverse section of the midgut region of an adult female BPH after feeding on (a) artificial diet MMD-1 or (b) GNA incorporated at 0.1% {w/v} concentration in MMD-1.	129
9	Electron micrograph of the mid-gut region of an adult BPH (a) after feeding on GNA incorporated at 0.1% concentration {w/v}.	131
10	Autofluorescence observed in (a) midgut epithelium and (b) yeast like symbiont packed areas of the abdominal region of an adult BPH after feeding for 48 hours on artificial diet MMD-1.	132
11	Micrograph of the transverse section of the abdomen of either a (a) control diet fed adult BPH or (b) GNA fed insects treated using the DAB immunohistochemical technique.	134-5
12	Micrograph of the transverse section of the abdomen of either (a) a control diet fed adult BPH or (b) GNA fed insect, treated using the Avidin-biotin immunohistochemical technique.	136-7
13	Micrograph showing yeast-like symbionts present in a homogenate smear of an adult BPH.	140
14	Micrograph showing yeast-like symbionts present in the abdominal region of an artificial diet fed adult BPH.	140

- 15 Photograph showing three-day-old colonies of yeast-like symbionts isolated from adult BPH and cultured on yeast morphology agar. 141
- 16 Electron micrograph showing yeast-like symbionts isolated from a single yeast colony cultured on yeast morphology agar. 141
- 17 Photograph showing ninhydrin stained honeydew droplets produced by adult BPH feeding on *Galanthus nivalis* agglutinin or *Pisum sativum* agglutinin after 24 hours duration. 142
- 18 Photograph showing ninhydrin stained honeydew droplets produced by adult BPH feeding on wheat germ agglutinin or soybean lipoxygenase, after 24 hours duration. 142
- 19 Photograph showing honeydew droplets produced by adult BPH feeding on *Galanthus nivalis* agglutinin after 24 hours duration. 146

CHAPTER ONE

1.1 INTRODUCTION

1.1.1 General Introduction

Genetic engineering offers a novel approach to the control of sap-sucking insects, belonging to the order Homoptera, by improving resistance of the host plant through the introduction of foreign primary gene products, which confer enhanced resistance. A number of lectins and enzymes have been shown to exhibit antimetabolic or insecticidal effects towards other insect groups, when fed in artificial diets (Shukle and Murdock, 1983; Gatehouse *et al.*, 1984; Huesing *et al.*, 1991). However to date no such compounds have been shown to be effective against insects within the order Homoptera.

The present study describes *in vitro* bioassays which identify potential insecticidal proteins (i.e. primary gene products), whose encoding genes could be selected for inclusion into the rice genome, to enhance host plant resistance towards the economically important insect pests *Nilaparvata lugens* and *Nephotettix cinciteps*. *Myzus persicae*, the peach potato aphid (PPA), was also used as a model insect in order to examine the efficacy of suitable protein genes *in planta*.

1.1.2 Rice

Domesticated rice, *Oryza sativa* L., is the world's single most important food crop (David, 1992). It is mainly a subtropical and tropical crop but can grow as far North as 53° and up to 2500m elevation as either a dryland or flooded crop. Rice is a staple food crop in many regions, but in particular in Asia which produces 90-95% of the world rice crop (Greenland, 1984; David, 1992), and it is the main source of calories for 2.7 billion people (Anon, 1991) representing over 52% of the world population (IRRI, 1992). Approximately 148 million ha⁻¹, more than 10% of the world total arable land, is cultivated with rice and 520 million tons of grain are produced globally (Bonman, Khush and Nelson, 1992; IRRI, 1993a). By the year 2020 it is estimated that 60% more rice will need to be produced in order to feed the forecast increase in world population (IRRI, 1993b) to around 4.3 billion rice consumers (Anon, 1991).

Rice is a host plant for more diseases and pests than any other cereal crop. Losses due to rice pests at IRRI during 1964-1979 were 40%. Over 100 insect pests are known to attack rice (Khush, 1977a; Pathak, 1977) around 20 of which are of major importance economically (Gallun and Khush, 1980; Pathak, 1977), including a group of sap-sucking pests known as Planthoppers and Leafhoppers (Hemiptera: Delphacidae and Cicadellidae), which includes the rice brown planthopper (BPH) and the rice green

leafhopper (GLH). Both pests attack the two main sub groups of Asian rice, the indica (long grain) and the japonica (short grain), and it has been forecast that BPH will still remain as one of the five major important rice pests in temperate regions like Japan by the year 2000 although GLH will not pose a serious threat (Mochida, 1992).

1.2 Planthoppers and Leafhoppers

There are 22 species of Delphacidae found in rice (Wilson and Claridge, 1991) and sixteen species within the genus *Nilaparvata* (Mochida and Okada, 1979), of which *Nilaparvata lugens* Stål (BPH) is the only species that causes serious economic damage to rice. The rice brown planthopper (BPH) has been described as the most destructive pest of rice in Asia (Hongasprung, 1987) and is included amongst the 5 major insect pests of rice worldwide (Khush, 1990). Its main host plant is *Oryza sativa* L. (paddy rice) but a number of secondary host plants are cited in the literature (Hasewaga, 1955). However BPH does not survive well on these secondary hosts. Claridge and Morgan (1987) suggest there are two separate species of *N. lugens*, one which associates with *Oryza* spp. and the other with a graminaceous weed, *Leersia alexandria*, and these differ in their acoustic mating signals

The earliest reference to BPH as a rice pest occurs in AD 697 (Dyck and Thomas, 1979). Sporadic occurrences have been recorded since then but BPH became an important pest during the early 1970's, with the introduction of high-yielding japonica rice varieties and changes in pesticide regimes and agronomic practices. Prior to 1969 BPH was only considered a major pest in its temporary habitat of Korea and Japan, from which it migrates in the summer as it cannot overwinter in temperate regions (Mochida, 1992). The availability of early maturing photoperiod-insensitive high-yielding varieties has enabled farmers to grow rice crops successively throughout the year, thus providing BPH with a stable and favourable habitat. With the introduction of improved varieties farmers have begun to use improved agronomic practices (e.g. large scale cultivation of short stem varieties, high tillering varieties, higher plant number per unit area, improved irrigation facilities and increased use of nitrogen based fertilisers).

Broad-spectrum insecticides used in the control of rice stem borer and paddy borer decimated the natural enemies of GLH and BPH elevating them from secondary to major pests. In the tropics, where pests and predators show overlapping generations, disruption in their interactions can cause catastrophic synchronisation of pest populations (Heong, 1992). During the period 1969-1971 although there was a 33-fold increase in pesticide use (with often 4-7 applications per season (Metcalf, 1980)) there was only a corresponding 1.5 increase in yield. An increase in the area of cropped rice, and the introduction of systemic insecticides has resulted in BPH resurgence as the balance between natural enemies and BPH in the ecosystem has been disturbed.

Nephotettix cinciteps (GLH) is regarded as of lesser importance economically as a rice pest due to its more restricted geographical distribution, however it is regarded as an important pest of paddy rice in Japan (Mochida, 1992).

1.2.1 Synonyms

Synonyms for *Nilaparvata lugens* (Stål, 1854) include:

- 1854 *Delphax lugens* Stål
- 1863 *Delphax sordescens* Motschulsky
- 1903 *Liburnia sordescens* Melichar
- 1906 *Delphax oryzae* Matsumura
- 1906 *Kalpa aculeata* Distant
- 1906 *Nilaparvata greeni* Distant
- 1907 *Delphax ordovix* Kirkaldy
- 1907 *Delphax parysatis* Kirkaldy
- 1907 *Dicranotropis anderida* Kirkaldy
- 1907 *Delphacodes anderida* Muir
- 1917 *Delphacodes parysatis* Muir
- 1917 *Liburnia oryzae* Matsumura
- 1932 *Nilaparvata oryzae* Esaki et Hashimoto
- 1935 *Hikona formosana* Matsumura
- 1945 *Nilaparvata sordescens* Kuwayama

(after Hasegawa, 1955; Mochida and Okada, 1979)

1.2.2 Synonyms

Synonyms for *Nephotettix cinciteps* Uhler include:

- 1896 *Selenocephalus cinciteps* Uhler
- 1902 *Nephotettix cinciteps* Matsumura
- 1903 *Nephotettix apicalis* Melichar
- 1905 *Nephotettix apicalis* Motschulsky var. *cinciteps*
- 1930 *Nephotettix apicalis cinciteps* Esaki and Hashimoto
- 1932 *Nephotettix bipuntuatus cinciteps* Esaki and Hashimoto
- 1954 *Nephotettix bipunctatus* Fabricius forma *cinciteps* Esaki and Ito
- 1956 *Nephotettix cinciteps* Linnavouri

(after Nasu, 1967)

1.2.3 Geographical distribution

BPH is primarily a pest of tropical and subtropical rice growing regions, where it can multiply all year round, but can also occur in temperate regions following long distance migrations (Kuno, 1979; Kisimoto, 1977; 1987; Mochida, 1992).

BPH is distributed in the following geographic range:

Cambodia, China, Bangladesh, India, Sri Lanka, Thailand, Vietnam, Malaysia, Korea, Japan, Indonesia, Philippines, Australia, Fiji, Papua New Guinea, Solomon Islands, Caroline and Mariana Islands, Sarawak, New Caledonia and Taiwan (Okada, 1977; Mochida and Okada, 1979).

GLH is distributed in Japan, Taiwan, Korea and China (Nasu, 1967).

PPA is primarily a pest of temperate regions and is distributed worldwide in the Americas, Australasia, Asia, Europe and Africa (CIE, 1979).

1.2.4 Host plant specificity

The major host plant for BPH is cultivated rice (*O. sativa* L.), however other potential host plants include wild rice species (including *O. alta* and *O. australinsis*), *Leersia* spp., *Echinola* spp., *Eleusine* spp., *Dactyloctenium* spp., *Saccharum officinarum* and *Zizania lonifolia* (Hasegawa, 1955; Mochida and Okada, 1971; Zaherudden and Prakash Rao, 1985).

Nephotettix cinciteps Uhler. can feed on a variety of host plants including rice. In Spring its main weed host is *Alopecurus equalis*, which is a common weed of rice paddies. Adults of the Spring generation then migrate to immature rice during early summer. Other host plants include *Poa annua*, *Leersia* spp., *Phragmites communis*, *Avena fatua*, *Phalaris arundinacea* and *Panicum crusgalli* (Nasu, 1967).

The primary host for *Myzus persicae* is peach with around 110 secondary hosts including brassicas, potato, tobacco, cereals, vegetables, sugar beet and chrysanthemums (van Emden, 1972; Hill, 1987).

1.2.5 Morphology and life cycle

1.2.5.1 Nilaparvata lugens

The adult rice brown planthopper (BPH) is brown in colour and is a sucking insect with a body length of 2-3.5mm (the females are generally larger than the male of the species (Hill, 1983)), belonging to the suborder Homoptera, series Auchenorrhyncha, superfamily Fulgoridae and family Delphacidae. As the name implies BPH can move by hopping, walking and flying. Fifth instars can hop up to 21cm (Mochida, 1970).

The preoviposition of adult females is 2-4 days in the field situation. Females can oviposit approximately 1500 eggs (Suenaga, 1963) but the mean number of eggs laid by any one individual is around 150 (Mochida, 1964a). Twenty-four hours after emergence one male can copulate with up to 9 females in 24 hours and one female can copulate twice in her lifetime. Eggs are laid in groups of 1-62 (Mochida, 1964b) in the lower part of the rice stem in the mid-region of the outer sheath with the operculum protruding (Nalinakumari and Mammen, 1975). Throughout the life cycle BPH prefer to feed in the lower regions of the rice plant, but when plants are heavily infested the pest can be found in the upper regions of the plant. However there is unlikely to be any interspecific competition between BPH and GLH due to differences in vertical distribution on the host (Rubia and Heong, 1989). The egg stage is 7-11 days in the tropics and the nymphal stage is 10-15 days. BPH has five nymphal stadia (Esaki and Hashimoto, 1937), requiring 2-3 days for each nymphal stage, which are distinguished from one another by their body size (Nalinakumari and Mammen, 1975) and shape of the mesonotum and metanotum (Okada, 1977, Mochida and Okada, 1979). The precise duration of each stage depends on environment and rice cultivar.

The temperature range for normal adult behaviour is 9-32°C, but optimal development occurs at 25-29°C (Bae, 1966; Bae and Pathak, 1970), and the relative humidity required is 70-95 %. Temperature and humidity affect hatchability, survival rate, egg period, nymphal period and preoviposition period (Harukawa, 1951). Both male and female adults can appear in brachypterous or macropterous forms and wing form appears to be dependent on nutrient availability and quality (Kisimoto, 1965) or nymphal density (Morooka, Ishibashi and Tojo, 1988). Macropterous forms have higher lipid contents than brachypterous adults presumably as a potential stored energy source for long distance migration (Kim *et al.*, 1973; Padgham, 1983).

1.2.5.2 Nephottetix cinciteps

The rice green leafhopper (GLH) has a flatter body than BPH and adults are green in colour, 3-5mm long and its vertex is characterised by a submarginal black band on the tip of the elytra (Grist, 1986). It has five nymphal stadia, each lasting 2-3 days that are

white or pale green in colour. Three generations can arise in a rice paddy in one season and the fourth instar nymphs enter diapause in the autumn. Females lay on average 100-200 eggs (Nasu, 1967), depending on environmental conditions, and eggs are laid in leaf sheaths (Hill, 1983).

1.2.5.3 *Myzus persicae*

There are over 4000 aphid species described mostly from temperate regions, with very few in the tropics (Dixon, 1985). *Myzus persicae* Sulzer, peach potato aphid (PPA), is a pale green or pink aphid with a barrel shaped body, the adult being 1.25-2.5mm in length (Hill, 1983) with prominent frontal tubercles and the abdominal dorsum characterised by a dark patch. In the UK it overwinters as immature and adult stages on various crops and weeds or as eggs on peach. Eggs hatch in early spring and wings develop in the third generation when aphids migrate to a variety of summer hosts (Gatwick, 1992), one adult being able to establish new colonies on several plants.

PPA has 4 nymphal stages, nymphal duration is between 1-2 days per instar reaching maturity in 5-8 days. Female adults can be either alatae or apterous. Apterous can produce young 1-2 days after maturation and viviparous production can continue up to 26 days. Aphids can multiply very rapidly. On average females produce 80 nymphs, mean reproduction rate being 4.08 nymphs per a day (Sylvester, 1954).

Aphids can induce systemic effects on the host plants particularly those feeding on graminaceous hosts but in general more damage arises from virus transmission. PPA causes damage by sap-sucking, injecting toxic saliva during probing (Miles, 1990), removing water and nutrients, causing pseudogalling on peach leaves and acting as a viral vector, but aphid colonies tend not to be large and the more serious crop damage results from virus inoculation rather than direct feeding.

1.3 Feeding physiology

Both nymphal and adult stages of sap-sucking hemiptera have specialised mouthparts in the form of stylets and piercing and sucking organs that enable them to feed on phloem sap of the host plant. Sites of penetration are determined by the plant's surface texture. At the site of penetration BPH first secretes a coagulable saliva that forms a gel covering the stylet bundle to form a stylet sheath (Sogawa, 1973; 1977), then it probes the plant tissues with its stylets. Stylets penetrate intracellularly and the stylet bundles and sheath go directly into the phloem sieve element and during penetration the disruption and degeneration of plant cell organelles results in cell death (Spiller, 1990).

1.4 Stimulants and antifeedants

It is thought that there are secondary metabolites present in the rice plant which act as probing and sucking stimulants for planthoppers and leafhoppers. C-glycosylflavones (Kim, Koh and Fukami, 1985) and salicylic acid in combination with sucrose (Sogawa, 1974) have been shown to promote deeper stylet probing under bioassay conditions. Having probed into the plants the insects are then thought to be able to detect sucking stimulants, in the form of amino acids, particularly aspartic acid, glutamine, glutamic acid, alanine, asparagine and valine (Saxena and Puma., 1979a; Sogawa, 1970; 1972) and sucrose (Sakai and Sogawa, 1976), in the phloem sap. Sucrose is also reported as being phagostimulatory for aphids (Srivastava and Auclair, 1971).

A number of compounds including silicic acid, salicylic acid (Sogawa, 1974) oxalic acid, *trans*-aconitic acid (Kim *et al.*, 1975; Koh *et al.*, 1977) and aromatic amines (Kurata and Sogawa, 1976) have also been identified as potential sucking inhibitors, which may be present in other parts of the rice plant enabling the insect to differentiate between phloem sap and other plant tissue. *Trans*-aconitic acid also affects the hatchability of emerging nymphs (Saxena and Puma, 1979) which may explain why although BPH can oviposit on barnyard grass but the nymphs cannot utilise it as a host plant. Having recognised the phloem BPH sucks the sap and during feeding excretes a liquid honeydew droplet at a rate of 1.43-2.0 μ l per hour (Khan and Saxena, 1984).

1.5 CROP DAMAGE

1.5.1 Crop damage

BPH has a high potential fecundity, high adaptability to its host in various growth stages and high tolerance to overcrowding (Kuno, 1979) making it a high risk pest. It can also fly for several hours to migrate (Padgham, 1983), and can be carried across the East China sea to Japan surviving up to 15 days without food supply (Kusakabe and Hirao, 1976). Macropterous female forms arise on older plants for this purpose (Iwange and Tujo, 1988).

Light BPH infestations can affect the agronomic characteristics of the crop by decreasing tillering, reducing plant height, reducing the number of productive tillers, reducing plant vigour, decreasing panicle number, and increasing the number of unfilled grains per panicle and decreasing total grain weight (Bae and Pathak, 1970; Khush, 1977a). Heavy planthopper infestations can completely destroy the rice crop by producing the symptom known as " Hopperburn " (Kisimoto, 1960) this begins with yellowing of older leaf blades and extends to all parts of the plant which turn brown and

die. Up to 38% yield loss in one season in Korea was attributed to hopperburn (Lee and Park, 1977). Hopperburn is thought to be the result of a decrease in the rate of translocation of photosynthates to the root system as a result of stylet insertion and removal of phloem sap by the pest. BPH infestation increases the rate of ethylene production in rice which may retard growth (Sogawa, 1982). BPH also excretes a phytotoxic saliva in the form of a stylet sheath which may result in localised yellowing of plant tissue. However damage from phytotoxic excretions is minimal compared to damage occurring as a result of physical extraction of plant nutrients from the phloem sap.

Minor secondary infections could also arise when honeydew droplets excreted during feeding by the hopper evaporate on the leaf causing a concentrated sugar deposit on which sooty moulds could develop. The site of stylet penetration can also act as a suitable site for secondary infection by pathogens. As a result of BPH infestation the host plant is in a weaker physiological state which also reduces the plants resistance to attack from other pests or pathogens.

1.5.2 Virus vector

Over 80% of insect vectors of plant viruses are found within the suborder Homoptera and 40% of these belong to the Auchenorrhyncha (Forbes and MacCarthy, 1969). Ten of the eleven insect species known to transmit viruses to rice are in the leafhopper and planthopper group (Heinrichs, 1979a). Both nymph and adult leafhopper and planthoppers can transmit viruses that are inoculated into the vascular bundles (Heinrichs, 1979a) and these are generally circulative viruses.

Grassy stunt virus (GSV), first identified at IRRI in 1962, is one of the two most devastating viral diseases affecting rice and is transmitted solely by BPH. It causes severe stunting, excessive tillering and yellowing of the foliage (Rivera, Ou and Ida, 1966; Ou, 1985). Total annual world losses due to BPH and the grassy stunt virus disease are estimated at US\$ 300 million (Dyck and Thomas, 1979). Mass screening of thousands of germplasm accessions for resistance to GSV has found only one highly resistant wild line *Oryza nivara*, which is controlled by a single dominant gene (Ou, 1985) and this has been successfully incorporated into improved varieties and breeding lines (Khush, 1990). BPH is also a vector for ragged stunt (Mochida, Wahuyu and Surjani, 1979) and wilted stunt (Medrano and Heinrichs, 1983) virus diseases that are of lesser economic importance than GSV. The rice viruses transmitted by BPH are transmitted via the salivary glands (Lösel, 1987). However direct feeding damage by BPH is more common than damage due to GSV transmission.

Nephotettix cinciteps causes more damage indirectly as a viral vector than by direct feeding and transmits rice dwarf, rice gall dwarf, yellow dwarf, transitory yellowing, bunchy stunt and waika viruses (Conti, 1987). Rice dwarf viruses result in severe

stunting, vein swelling and excessive tillering and up to 93% losses due to yellow dwarf virus transmission has been observed in field trials (Ou, 1985). However since the late 1970's GLH is regarded as no longer a serious vector of yellow dwarf virus, although in 1990 it still occurred in an area of around 22, 000 ha⁻¹ in Japan (Mochida, 1992).

Myzus persicae is the most important virus vector species in the Homopteran order transmitting 71 stylet borne and 11 circulative viruses (Forbes and MacCarthy, 1969) and important viruses include potato leaf roll virus, potato virus yellows and sugar beet yellows.

1.6 Control measures

The adverse impact of homopteran pests on rice and other crops has been lessened to some degree using a variety of control measures:

1.6.1 Insecticides

Insecticide-induced resurgence of BPH has been said to contribute to the elevation of the pest from a secondary to a major pest due to improper use of phosphate, carbamate and pyrethroid insecticides (Heinrichs and Mochida, 1983). Regular spraying of BPH, using government subsidised pesticides, rather than determining field levels of the insect, has lead to induced pesticide resistance (Whitten and Oakeshott, 1991). Sub-lethal doses of insecticide can affect BPH physiology by increased fecundity, altered sex ratio, decreased nymphal period, increased adult longevity and increased feeding (Chelliah and Uthamasamy, 1982; Holt, Wareing and Norton, 1992). Insecticide use may also induce changes in host plant physiology making it more favourable to the pest (Holt *et al.*, 1992). Exogenous application of synthetic organochemicals can also dramatically effect the natural predators of BPH, of which there are a wide range (Chiu, 1979) causing an increase in natural enemy mortality.

There are a number of social, economic, agronomic and environmental considerations associated with the use of insecticides to control BPH. Development of resistance to BPH is enhanced by the short generation time of the hopper allowing several populations to occur in one growing season and overlap throughout the year in the monsoon tropics (Khush, 1977) requiring prolonged use of insecticides to control the pest. Farmers in the Philippines may spray at least 4 times per season and improper handling and overuse can cause acute (decreased cholinesterase levels) and chronic (increased cardiovascular abnormalities) health problems (IRRI, 1992). This results in more expense to the farmer, increased labour use and environmental pollution. Insecticide use in Asia can be relatively expensive, particularly for peasant farmers, who often produce the rice crop for their own consumption. Total insecticide expenditure for rice in 1988 has been estimated to be US\$ 9.1 x10⁻⁸ (Woodburn, 1990).

Effective control with insecticides can be difficult as the two most popular direct application methods used, broadcast and foliar, can be hampered by the crop density (Haslam, 1985) and can enhance resurgence of BPH (Heinrichs, 1979). GLH are more successfully controlled by foliar application as the pest is very active on foliage and readily contacts the insecticide residue whereas BPH prefers the lower stem region (Figure 1), however resistance has still arisen to GLH.

Appropriate timing of insecticide application can be exasperated as several stages may be present on the plants BPH can feed on several growth stages of rice from tillering through to panicle production (Figure 2) and the insecticides may not have enough residual activity to kill emerging nymphs. Also in the tropics where continuous and staggered rice cropping is used this may allow pests to migrate to nearby nursery crops (Heinrichs, 1979).

Acetylcholinesterase (AChE) found at the cholinergic synapse plays a major role in the insect central nervous system and it is the target of organophosphate and carbamate insecticides (Toutant, 1989). Organophosphates can be inhibited by cholinesterases which hydrolyse and confer resistance to these substances (van Asperen, 1962). Esterases within the BPH and GLH have been shown to be effective in the development of resistance of the insect to a number of insecticides (Miyata, 1983; Hama, 1976; Chang and Whalon, 1987). Resistance has developed to all major groups of insecticides used routinely, particularly in Japan where pesticides are used in abundance, against BPH including organophosphates (Hosada, 1983), organochlorines, carbamates (Endo *et al.*, 1988a; Endo, Masuda and Kazano, 1988b) and pyrethroids (Whalon, van De Baan and Untung, 1990; Miyata, 1989; Miyata *et al.*, 1989). BPH are said to be more difficult to control than other hoppers by insecticidal means (Heinrichs, 1979) and the most appropriate form of insecticidal control recommended at the moment is carbamates (Woodburn, 1990). The indiscriminate use of insecticides has exasperated the problem of BPH control allowing the emergence of resistance biotypes to arise rapidly. The use of synergistic insecticide combinations could delay the development of resistant biotypes within the BPH population (Ozaki, 1983).

In aphids resistance to insecticides can be conferred by elevated esterase levels which can break down most insecticides into harmless biproducts. In the UK there has been an increase in highly resistant sector of the *Myzus persicae* aphid (PPA) population as the less resistant aphids are killed by insecticide application (Smith and Furk, 1989). Field resistance to PPA occurred in the 1970's and 75% of the UK aphid population are moderate to highly resistant (Denholm, pers. comm) and some aphids cannot be controlled by any commercially available aphicide (Gatwick, 1992).

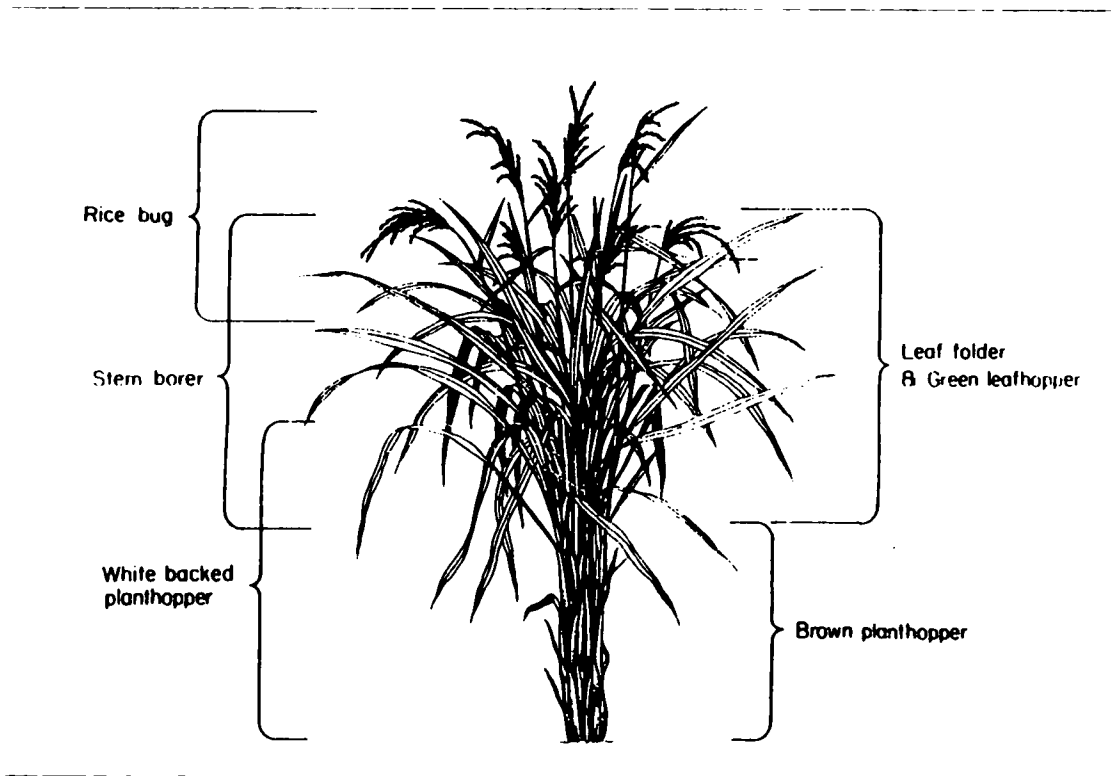

Figure 1: Regions of a rice plant usually inhabited by adult insect pests

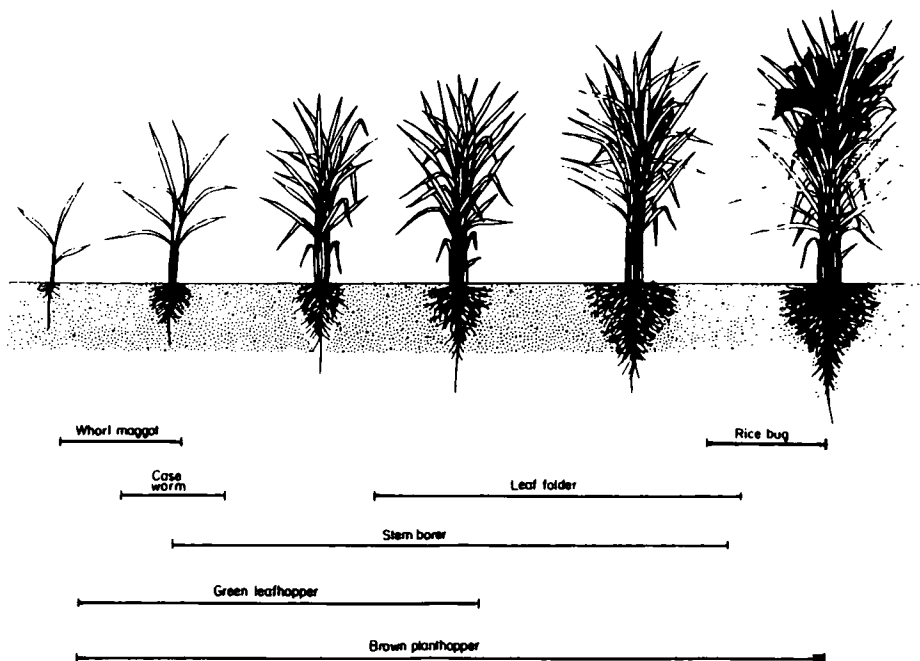

Figure 2: Insect pest species present at different growth stages of the rice plant

Novel plant derived insecticides such as neem extract are being tested in field trials and they have been shown to decrease mating, hatchability, reproductive potential and development of BPH (Saxena, 1987; Kareem *et al.*, 1989) and deter feeding and settling of aphids when incorporated into artificial diets (Griffiths *et al.*, 1978). Neem extracts have the important advantage of being non-toxic to mammals making them more acceptable to the consumer.

The overuse of pesticides in S.E. Asia is highlighted in Indonesia where losses in rice production due to pests were estimated at \$US 1.75 billion, during the period 1974-1986 (Whitten, 1992). In 1986, the Indonesian government imposed a ban on 57 pesticides and implemented an IPM training programme which resulted in rice yield increases of 12% (Hadfield, 1993).

1.6.2 Biological control

Even though there are over 79 species of natural enemies to BPH so far identified (Chiu, 1979; Peter, 1988), including spiders (IRRI, 1974, Lee and Park, 1977), egg parasitoids (Fowler, 1987; Fowler *et al.*, 1991, Claridge, Claridge and Morgan, 1987) and entomopathogenic fungi (Aguda and Rombach, 1985), which have good potential for the biocontrol of BPH, to date no form of biological control has been fully effective in controlling BPH in the field. However by using selective insecticides, lower application rates of insecticides and more suitable cultural control practices the damage incurred by the natural BPH predators could be minimised. Unfortunately socio-economic constraints generally make these management practices difficult to implement. Novel forms of "biological" control including insect growth regulators (IGR's), such as chitin synthesis inhibitors, are currently being developed for use against BPH (Mochida, 1992). Recent studies where a chitin synthesis inhibitor has been used as field spray on over 1 million ha⁻¹ of rice crop resulted in a depression of the BPH population (Du *et al.*, 1990).

1.6.3 Conventional plant breeding

The introduction of a single dwarfing gene into rice in 1966, by crossing a dwarf Chinese rice with an Indonesian variety was largely responsible for the green revolution (Anon, 1991), however with the introduction of these new varieties some pests such as BPH and GLH rose in importance. At the International Rice Research Institute (IRRI) programmes for breeding resistance to BPH were initiated in 1968 (Khush, 1977a). The sources of resistance used were rice varieties having poor agronomic traits (e.g. tall plants, relatively weak stem and low yields) which were crossed with other varieties with more suitable agronomic characters.

The resistance of rice varieties to BPH is based on major genes and the first genes for resistance were identified as the dominant gene *Bph1* and the recessive gene *bph2*

(Athwal *et al.*, 1971) and two further resistance genes were identified as Bph 3 and bph4 (Lakshminarayana and Khush, 1977). Recently three more genes have been identified and designated as bph-5 (Khush and Virmani, 1985), Bph-6 and bph-7 (Kabir and Khush, 1988). As these genes were identified they have been incorporated into breeding lines and following the release of IR26 in 1973 a number of resistant varieties were released (Khush, 1979). Resistance to IR26 broke down within 3 years (Khush, 1990) due to the emergence of host resistance-breaking biotypes of BPH, showing farmers that they could not rely wholly on inherently resistant cultivars to control BPH.

Seven genes for resistance to GLH have been identified and have been incorporated and maintained for a number of years in breeding lines (Khush, 1990). Resistance to both BPH and GLH is due to simply inherited single genes making breeding programmes easier, but the resistance is more unstable than polygenic resistance (Athwal *et al.*, 1971).

It was originally believed that BPH belonged to the same general biotype, however in 1973 the emergence of a new BPH biotype to which the variety Mudgo was susceptible changed this view. Since then 4 biotypes of BPH have been identified, three in the Philippines and one in Asia (Gallun and Khush, 1980) and only one rice variety (Ptb33) is known to be resistant to biotypes 1-3 (Khush, 1977a) and resistance is controlled by a single dominant and one recessive gene (Fernando *et al.*, 1977; Sidhu *et al.*, 1978). When BPH feeds on Ptb33 it has been shown to have a decreased feeding rate and nymphal development and survival is retarded (Senguttuvan Gopalan and Chelliah, 1991). It is important to note that IRRI's division of biotypes, according to virulence patterns with respect to rice cultivars with known genes for resistance, is not accepted by some workers (Claridge and Den Hollander, 1980; Den Hollander and Pathak, 1981).

Plant breeding is limited by the extent of available genetic variability in interbreeding germplasm, for example only 300 resistant varieties have been identified by IRRI after screening 40,000 germplasm entries (Senguttuvan, *et al.*, 1991). It also takes several years to produce a resistant cultivar and this can be destroyed by resistance-breaking biotypes within a relatively short time. Recent attempts to map the genes for BPH resistance using RFLP have proved inconclusive (Bennet *et al.*, 1993).

Wild rice germplasm is a richer source of BPH resistance genes than cultivated varieties (Romana *et al.*, 1989; Romana and Heinrichs, 1989; Chau and Saxena, 1989) and some resistance genes may be transferred from the wild to cultivars (Oka, 1992). Wide crosses are now available to more than one rice pest including BPH and wild germplasm is a good source of multiple resistance (IRRI, 1988) and the use of embryo rescue to cross wild with cultivated varieties may also improve the usable crop gene pool.

In view of the fact that varieties with major genes for BPH resistance have only a limited life span IRRI have adopted a broad strategy for maintaining host resistance including pyramiding major genes, multiline varieties, sequential release of major gene varieties and horizontal resistance (Khush, 1979). In Japan major genes for resistance

from indica rice have been incorporated into japonica rice by backcrossing (Kaneda, Iikeda and Kobayashi, 1977). But no japonica varieties with resistance to BPH have yet been released (Mochida, 1992)

1.6.3.1 Resistance mechanisms

Resistance mechanisms for BPH and GLH are mainly due to antibiosis (resulting in reduced feeding and population build-up) and antixenosis (non-preference: resulting in reduced oviposition and preference) (Pathak and Khush, 1979; Alam, 1978, Saxena and Khan, 1989). One physical resistance mechanism found in resistant varieties is believed to be due to altered levels in the chemical composition of plant surface wax causing reduced settling and feeding (Woodhead and Padgham, 1988). However, it is thought that gustatory stimuli rather than mechanical barriers are the main resistance mechanism in resistant cultivars, as probing is more prevalent on resistant varieties and more sap is ingested on susceptible varieties (Khan and Saxena, 1988).

More than 20,000 secondary metabolites have been described in plants and one of their roles is as a defensive mechanism against predators and pathogens (Waterman, 1992) mainly acting as antifeedants. The biochemical mechanism of resistance of rice to BPH is thought to reside in altered levels of non-protein secondary plant metabolites such as silicic acid, oxalic acid (Khan and Saxena, 1988), *trans*-aconitic acid (Koh *et al.*, 1977) and aromatic amines (Kurata and Sogawa, 1976) which have been shown to inhibit sucking. Fisk (1980) has shown HCN and phenolic acid release from host plants confers resistance to the planthopper *Perigrinus madis*. The absence or reduction in the levels of probing stimulants such as salicylic acid and flavonoids may be another gustatory stimuli which affects resistance. Indole alkaloids in barley decrease feeding rate, survival and reproductive index of the aphid *Schizaphis graminum* (Zuñiga and Corcurea, 1986). Altered amino acid levels effects BPH feeding, particularly low asparagine levels which deters probing (Pathak, 1977).

In the aphid *Acyrtosiphon pisum* the sugar/amino acid ratio appears to play a major role in the resistance of lucerne to the pest (Rahbé *et al.*, 1988). Hydroxamic acid from maize acts as a feeding deterrent towards the cereal aphid *S. graminum* (Argañón *et al.*, 1983). Whilst some amino acids (histidine, glutamic acid and arginine) act as feeding deterrents to *Myzus persicae* others (methionine, asparagine, isoleucine, leucine and tryptophan) appear to act as feeding stimulants (Mittler, 1967a). Also polysaccharides and monosaccharides stimulate probing in *M. persicae* and *Acyrtosiphon pisum* (Cambell and Dreyer, 1990).

1.6.4 Cultural control

There are a number of cultural control methods (Oka, 1979) available for use against BPH, however crop production economics limit the implementation of a number of them. For instance, raising the field water level at the correct stage in the BPH life cycle will cause eggs to drown at 100% relative humidity, whereas draining water from the rice paddy will result in desiccation of the BPH eggs.

BPH and GLH are phototropic (Abenes and Khan, 1990) and the use of light traps, to examine the development of the pest population throughout the season, may act as a good indicator for effective insecticide timing. However sampling in order to determine population size is difficult due to aggregated distribution of BPH (Dyck *et al.*, 1979).

Changes in cultural practices are part of the reason for an increase in BPH numbers. Decreasing the use of nitrogen fertiliser and increasing the plant spacing will create a habitat less favourable to the planthopper. Nitrogen fertilisers trigger an ovipositional response in BPH (Whalon *et al.*, 1990) and this may be due to the fact that nitrogen fertiliser application can affect the balance of amino acids in the phloem sap (Chino, Hayashi and Fukomorita, 1987; Hayashi and Chino, 1986). Increasing nitrogen will increase the BPH population (Medrano and Henrichs, 1983) by increasing fecundity and nymphal development rate (Mochida and Dyck, 1977). Sequential cropping of rice produces ideal conditions for the rapid build-up of the BPH population and crop rotation with annual non-host plants for BPH, such as sweet potato or soybean, would help to prevent this. The change to direct seeding, high seedling rates, more tillers per square metre and field flooding has also led to an increase in the BPH problem (Norton and Way, 1990). Strip cropping with grasses will favour populations of parasites of the BPH egg stage, whereas destruction of weeds to make the microclimate less favourable for BPH can also decrease the natural predator population.

1.6.5 Genetically manipulated crop resistance

Conventional plant breeders transfer genes between closely related plants which can be crossed sexually. Using genetic engineering, in theory, genes from any organism can be inserted in a functional form into the genome of any plant. The only novel approach available in the foreseeable future to control BPH is through the use of genetic engineering, by improving resistance of the host plant with the introduction of foreign primary gene products, which confer resistance, into transgenic rice plants. Recent advances in molecular biology have provided the techniques for genetic modification of plants (Jaworski *et al.*, 1986). The two main research areas in this field at the present time are using endotoxins from *Bacillus thuringiensis* (*Bt*) and various plant proteins with putative insecticidal properties.

Bt is a spore-forming bacterium which produces δ -endotoxins which are highly specific to certain insect gut systems and act by binding to protein receptor sites on the insect gut epithelial-derived membrane vesicles and thereby disrupting the cell membrane. *Bt* spore formulations have been used for a number of years as a field spray to control certain Lepidoptera such as the diamond back moth. However there are constraints to its use, including its high production costs and instability as a field spray and field resistance has already developed in the diamond back moth against *Bt* endotoxin (McGoughey, 1985) primarily due to excessive use by the farmer.

In order to make *Bt* more effective in the field, commercial companies (particularly Monsanto) have now developed transgenic plants expressing the *Bt* gene and currently up to 95% of commercial research in the use of bioinsecticides is concentrated on *Bt* gene introduction into transgenic crops (Busch *et al.*, 1991). The *Bt* gene has been tested in a variety of crop species, including potato causing high mortality towards Colorado beetle and potato tuber moth (Peferoen *et al.*, 1990) and tobacco causing reduced feeding by *Manduca sexta* larvae (Vaeck *et al.*, 1987). *Bt* is highly toxic towards rice stem borers when fed in artificial diets (Attathom *et al.*, 1993; Bottrell *et al.*, 1993) possibly by binding to brush border membrane vesicles (Lee *et al.*, 1993). *Bt* endotoxins appear to be species-specific in their action and four pathotypes have been identified towards the Coleoptera, Lepidoptera/Diptera, Lepidoptera and Diptera insect orders (Peferoen *et al.*, 1990; Li, Carroll and Ellar, 1991) but no strains of *Bt* have yet been reported that show toxicity to Homopteran pests. The high degree of host specificity of *Bt*, while making them ecologically and environmentally friendly is also a serious drawback (Kirschbaum, 1985). Monophagous rice pests may adapt rapidly to *Bt* toxins and it would be more useful to engineer plants which are resistant to more than one pest by incorporating more than one type of resistance gene, or pyramiding genes, in order to obtain an enhanced protective effect.

1.6.5.1 Potential plant derived insecticidal genes

Plants often have their own defence mechanism against pests in the form of protein inhibitors (Duffey and Felton, 1989; Gatehouse *et al.*, 1993), crushing the leaves of some plants results in increased levels of protease's inhibitors (Green and Ryan, 1972). Many insects have been found to contain mid-gut proteases as digestive enzymes (Christeller *et al.*, 1989; Johnston *et al.*, 1993). A number of protein protease inhibitors have been identified to date (Ryan, 1981), none of which have been shown to be effective against Homoptera. The serine protease inhibitors inhibit serine protease digestive enzymes, such as trypsin and chymotrypsin, and when present in the insect gut, cause disruption in amino acid metabolism. A classic example of this group is the cowpea trypsin inhibitor (CpTI), a Bowman-Birk inhibitor, which has been shown to be effective in artificial diet against *Callosobruchus maculatus*, (Gatehouse *et al.*, 1979) and has been expressed in transgenic tobacco plants up to a level of 1% total soluble protein to provide enhanced

resistance to several lepidoterans including *Heliothis virescens* (Hilder *et al.*, 1987; Hilder *et al.*, 1989). CpTI has also shown antimetabolic effects against members of the Orthoptera. Under controlled environmental conditions the inclusion of the CpTI gene does not adversely affect a number of yield factors (Hilder *et al.*, 1991). Recent field trials suggest that although CpTI provides significant protection it does not offer the high degree of protection that *Bt* does against *Helicoverpa zea* (Hoffman *et al.*, 1992). The mechanism of action of CpTI is still not clear (Gatehouse *et al.*, 1992) however clearly it is not toxic to mammals, according to recent rat feeding trials (Pusztai *et al.*, 1992). Soybean kunitz trypsin inhibitor (Kunitz, 1945) has shown activity against yellow stem borer extracts and research is ongoing to express the gene in transgenic rice (Bennett *et al.*, 1993). Soybean also has Bowman-Birk type protease inhibitors (Odani and Ikeno, 1972). Protease inhibitors have also been isolated in rice embryos (Horiguchi and Kitagishi, 1971) and cysteine protease inhibitors isolated from rice seed, such as oryzacystatin, strongly inhibit gut proteases (which attack the thiol groups), primarily in insects with acid gut pH such as rice weevil and red flour beetle (Khush and Toenniessen, 1992).

The presence of α -amylase inhibitors can lead to a decrease in carbohydrate metabolism in insects which produce α -amylase. Wheat α -amylase inhibitor has been shown to inhibit the digestive enzyme α -amylase in *Tribolium confusum* and *C. maculatus* (Gatehouse *et al.*, 1986) and *Tenebrio molitor* L. (Applebaum, 1964a), but some insects can detoxify the inhibitor *in vivo* (Gatehouse *et al.*, 1986).

Chitinase acts mainly as a defence against microbial pathogens by degrading or lysing cell walls (Duffey and Felton, 1989) but also causes disruption in the peritrophic membrane which lines the insect gut wall of certain insects by catalysing the hydrolysis of β -1, 4-N-acetyl-D-glucosamine linkages of chitin which are also present in insect exoskeleton.

The enzyme lipoxygenase has been isolated from wheat (Guss, Richardson and Stahmann, 1967), soybean (Christopher, Pistorius and Axelrod, 1970) and other plants and at least five isoenzymes of soybean lipoxygenase have been identified to date. The enzyme catalyses the hyperoxidation of *cis-cis*-pentadiene moieties in unsaturated fatty acids (Axelrod, 1974) and soybean lipoxygenase has been shown to retard larval growth of *Manduca sexta* fed on artificial diet containing the protein (Shukle and Murdock, 1983).

Polyphenol oxidase is found in a wide range of plants and can be induced by pest or microbe attack. It acts by catalysing the oxidation of phenols to electrophilic o-quinones which are alkylators of nucleophiles such as the -SH, -NH₂ and NH amino acid functional groups (Duffey and Felton, 1989). It has been shown to affect larval development in *Heliothis zea* and *Spodoptera exigua* possibly by crosslinking with the gut wall, dietary proteins or digestive enzymes and hence reducing digestive capabilities (Duffey and Felton, 1989).

A group of carbohydrate binding proteins termed lectins (sometimes termed agglutinins due to their ability to agglutinate cells) are found in over thirty phyla, including plants, invertebrates and bacteria. They have various roles in nature including acting as plant defence compounds against fungi, nematodes and insects. In plants they are generally localised within the seeds but can be found in vegetative regions (Pusztai, 1992). The specific mechanism of action of plant derived lectins is not yet clearly determined (Rüdiger, 1981), but they are thought to act by binding to receptor sites within the gut wall, binding with glycoproteins, glycolipids or polysaccharides (Chrispeels and Raikhel, 1991; Kocourek and Horejsí, 1983) causing disruption to the insects metabolism and they may also affect carbohydrase digestive enzymes which are present in the alimentary tract of certain insect species (Yu, 1989). Lectins differ in their carbohydrate binding specificity (Moreira *et al.*, 1991) and there are at least six groups classified.

The group of lectins which bind to N-acetyl glucosamine (GlcNAc) residues are widely distributed in graminaceous plants (Peumans, Stinissen and Carlier, 1983). Wheat germ agglutinin (WGA) has been shown to retard development of the cowpea seed weevil (*C. maculatus*), the European corn borer and the Southern corn rootworm in artificial diet bioassays (Huesing, Murdock and Shade, 1991; Czapla and Lang, 1990) and has been tested in transgenic plants. Rice lectin, which has the same sugar-binding specificity of WGA has also been shown to be antimetabolic towards *C. maculatus* (Murdock, 1991; Huesing, Murdock and Shade, 1991). N-acetylgalactosamine (GalNAc) binding lectins, include some graminaceous lectins (Cammue, Stinissen and Peumans, 1985) and the leguminous lectins such as peanut, soybean, horse gram and *Phaseolus vulgaris* (PHA) lectins. PHA lectin has been reported to be effective against *C. maculatus* in artificial diet feeding trials by binding to its midgut epithelium (Gatehouse *et al.*, 1984; 1989) but this may have been due to the presence of an amylase inhibitor (Murdock *et al.*, 1991).

An important criteria for selecting proteins with insecticidal properties to introduce into transgenic crops is whether the proteins are toxic to mammals. Rat-feeding trials suggest that certain lectins such as PHA, Concanavalin A (ConA) and WGA cause disruption, elongation and fragmentation of gut microvilli (King, Pusztai and Clarke, 1980a) due to lectin binding in the non-crypt regions of the small intestinal microvilli (King, Pusztai and Clarke, 1980b) and affecting leucine uptake and protein digestion (Pusztai, 1986).

One of the main problems with controlling BPH by genetic engineering is that the target insect is a phloem feeder and thus an appropriate promoter and leader sequence is required to direct expression of the inhibitor or toxin in phloem sap (Toenniniessen, 1990). Rice sucrose synthase gene (Rss-1), which has been shown to direct phloem specific expression of GUS and snowdrop lectin genes in transgenic tobacco (Shi *et al.*, 1993), is a likely candidate. Also as much of the transformation work carried out to date

has been carried out on model dicotyledonous crops, such as tobacco, it is not yet clear whether the promoters used will function in monocotyledons (e.g. rice) or what, if any, yield penalties may be incurred. There has been a general failure in the use of the *Agrobacterium* vector system to infect monocotyledons due to poor wound response (Potrykus, 1991). However, the production of fertile transgenic rice plants has been achieved recently by direct gene transfer methods such as electroporation into protoplasts (Shimamoto *et al.*, 1989; Toriyama *et al.*, 1988) although it remains difficult to get whole plant regeneration. However it has been forecast that genetically engineered rice should be commercially available by the year 2000 (Webb and Morris, 1992).

There are a number of advantages of incorporating insect resistance into transgenic plants (modified after Hilder, Gatehouse and Boulter, 1990):

- (i) Continuous protection is afforded to the plant removing the necessity of timing required by conventional insecticide treatment,
- (ii) Protection can be directed towards specific areas of the plant,
- (iii) Incorporated proteins only affect pests which feed on the host plant and if digested should not affect pest predators,
- (iv) Reduced development costs compared with say novel conventional insecticides which can cost around £60 million to develop (Denholm, pers. comm),
- (v) Less environmental pollution, as no surface run off or leaching of chemicals occurs,
- (vi) Desired genes can be transferred into host plants without the co-transfer of undesirable traits (as often occurs in conventional plant breeding) and
- (vii) Reduced labour costs as there would be no requirement for repeated applications.

1.6.6 Integrated pest management

Integrated pest management (IPM) is a strategy that combines a number of the most suitable and compatible traditional and modern control measures available in order to maintain pests below their economic injury levels (Umeh, Joshi and Ukwungwu, 1992). However economic injury levels, and therefore economic thresholds, are poorly described for rice pests (Dyck *et al.*, 1981) making IPM difficult to implement.

A combination of all the aforementioned control techniques would appear to be the most desirable in the future for control of BPH. Genetic engineering provides a new tool for control and if used widely can enable the more effective use of other control methods (Toenniessen, 1992). IPM is currently widely used as a method of controlling rice pests in China (Du *et al.*, 1990) but in Asian countries as a whole only 3.7% of rice farmers practice IPM (Anon, 1991).

1.6.7 Screening potential insecticidal genes

In order to screen a wide range of potentially insecticidal single gene products the normal procedure is to initially screen proteins using either *in vivo* methods (i.e. foliar application or transgenic crop plants) or *in vitro* methods using artificial diet systems.

1.7 Artificial diets for Homoptera

Holistic diets for rearing insects axenically (House, 1974a) have been used experimentally for over 75 years (Vanderzant, 1974) and a nutritionally complete diet for most insects must contain lipogenic factors, fatty acids, ten amino acids, sugar, cholesterol, inositol, inorganic salts and B vitamins (Vanderzant, 1974; Chapman, 1982). Work carried out by Carter (1927), on rearing leafhoppers on artificial diets using an artificial membrane, paved the way for research into the nutritional requirements of homopteran insects. It was not until the early 60's, when Mittler and Dadd (1962) reared the aphid *Myzus persicae* through successive generations on a completely artificial diet, that the basic nutritional requirements of the order were identified. Auclair (1965) also developed a similar diet on which he could successfully rear the aphid *Acyrtosiphon pisum* through successive generations. Using these original diet formulations extensive work on rearing aphids on holicidic diet has been carried out to determine optimum levels of diet components (Rahbé *et al.*, 1988) even to the extent that Akey and Beck (1975) have been able to rear *Acyrtosiphon pisum* using a programmable/automated feeding system.

The first attempts to rear rice leafhoppers and planthoppers on artificial diets were carried out by Japanese workers (Mitsuhashi, 1974, 1979; Mitsuhashi and Koyama, 1972, 1975, 1977; Koyama, 1979, 1981) who claimed that several rice leafhoppers and planthoppers, including *Nilaparvata lugens* could be successfully reared on artificial diets. Some claims suggest that survival was improved as compared with rearing planthoppers on the host plant itself (Koyama, Mitsuhashi and Nasu, 1981). Specific nutritional requirements of BPH for amino acids (Koyama, 1985a), sugars (Koyama, 1985b) and vitamins (Koyama, 1986) have also been reported.

1.8 Intracellular symbionts of Insecta

Microbial symbionts play an important role in the nutritional physiology of some insects, and by using antimetabolic proteins against insect pests the potential exists for disturbing the symbiotic balance of pest and microbe.

1.8.1 Intracellular symbionts of Homoptera

Around 10% of known insect species harbour extracellular or intracellular non-parasitic micro-organisms (Douglas, 1989). Intracellular microbes fall into two categories; the guest micro-organisms, present in a variety of cells and the symbionts which are restricted to specialised cells called mycetocytes, aggregates of which are called mycetomes. Most symbionts are found in mycetomes beneath the digestive tract within the abdomen (Houk, 1987). Mycetocyte symbionts are housed in mycetomes and are transmitted transovarially, i.e. from mycetocytes to the ovary and incorporated into the oocytes. The mycetocytes may protect the symbionts from the insects defence system as escaped symbionts are destroyed by haemocytes and bactericidal lysozyme in aphids (Hinde, 1970, 1971). Guest organisms have no observed beneficial effect whereas symbionts, as the term implies, are distinctly advantageous to the host insect. Symbionts are generally restricted to some groups of insects in orders which thrive on nutritionally poor diets, such as the Dictyoptera, Pn্থiraptera, Coleoptera and Homoptera (Phaff and Starmer, 1987; Douglas, 1989). Symbionts are found in all Homoptera feeding on plant sap (Buchner, 1965) which is a diet of relatively poor nutritional quality.

Most homopteran symbionts are prokaryotes and one or two morphological types are present, as in the Aphididae group, but in the leafhopper/planthopper group symbionts are generally eukaryotic and up to six morphotypes may be present. It has proved difficult to determine the taxonomy and phylogeny of the symbionts as most are difficult to purify and isolate in standard media. However, recently, some prokaryotic symbionts isolated from aphids have been classified by DNA sequencing as *Buchnera* species (Munson *et al.*, 1991, Lau and Baumann, 1992a; 1992b) belonging to the sub group Proteobacteria. Symbionts of leaf- and planthoppers are vaguely described as "yeast-like symbionts" (YLS) in the literature based on their characteristic yeast-like morphology when observed microscopically, but no taxonomical studies have been reported; however the presence of ergosterol in YLS of the smaller brown planthopper characterises them as eukaryotes.

In order to determine the specific roles of these symbionts investigations have been carried out using aposymbiotic insects, produced by various methods including heat treatment (Lee and Hou, 1987; Noda and Saito, 1979), lysozyme injection (Ehrhardt, 1966; Ishikawa, 1982) and antibiotic treatment (Mittler, 1971; Griffiths and Beck, 1974; Douglas 1992a, Prosser and Douglas, 1992b, Rahbé *et al.*, 1992). The role of symbionts in aphid nutrition is contradictory (Srivastava, 1987). Possible nutritional roles of symbionts suggested from these studies include provision of amino acids, sterols (Ehrhardt, 1968; Griffiths and Beck, 1977, Ishikawa, 1982), vitamin B (Mittler, 1988) and nitrogen upgrading and nitrogen recycling. However caution must be applied when interpreting results from these treatments as they can directly affect the insect

metabolism by disruption of mitochondria (Griffiths and Beck, 1974; Houk and Griffiths, 1980).

Some insects metabolise nitrogen (N) from waste products such as uric acid which can be converted to ammonia and then recycled to form nitrogenous compounds such as amino acids. Evidence to suggest symbiont involvement has been shown in aposymbiotic cockroaches which have a twenty fold higher concentration of uric acid than symbiotic cockroaches (cited in Douglas, 1989). Phloem sap is poor in amino acids, essential for insect growth and aphids therefore must ingest large amounts; and one aphid can require the contents of 5,200 sieve elements, the equivalent of 2.1 μ l sap per day (Dixon, 1985). Douglas (1988) suggests that symbionts can metabolise N in artificial diets to upgrade N into compounds of greater or more utilizable value to the host. Methionine and tryptophan are synthesised by aphids as these can be detected in the honeydew of insects fed on diet omitting these amino acids (Douglas, 1992a, Douglas and Prosser, 1992; Prosser, Simpson and Douglas, 1992b). *Myzus persicae* can develop normally on diets with specific essential amino acids omitted (Mittler, 1971), suggesting that it relies on symbionts for the amino acids histidine, isoleucine and methionine. The aphid symbiont *Buchnera* identified in *Acyrtosiphon pisum* is metabolically active and can utilise a variety of carbon sources including glutamate and aspartate (Whitehead and Douglas, 1993) possibly in the synthesis of essential amino acids for the host. Different biotypes of *Acyrtosiphon pisum* differ in their amino acid requirement (Srivastava and Auclair, 1971) and this may be the difference in symbionts supplying diverse amino acids (Klingauf, 1987).

Insects, unlike mammals, cannot synthesise sterols (Clayton, 1964; Vanderzant, 1974), which are essential components of lipid bilayers for rigidity and a precursor of the moulting hormone, 20-hydroxyecdysone, (Fredenhagen *et al.*, 1987). No insect devoid of symbionts can synthesise sterols (House, 1974b) although some aphids and hoppers can develop normally on cholesterol free diets. Prokaryotes cannot synthesise substantial amounts of sterol and it seems likely that prokaryotic symbionts of aphids do not provide sterol to the host; it is more likely to have been derived from fungal contaminants producing ergosterol after stylet insertion into artificial diets (Noordink and Harrewijn 1988). However Ehrhardt (1968) extracted free and esterified lipids from *Neomyzus circumflexus* with intact symbionts and not aposymbiotic aphids. Eukaryotes, such as yeasts can synthesise sterol, however evidence concerning YLS's in planthoppers is contradictory. Hou and Lee (1984) showed that when cholesterol was added to the diet of aposymbiotic BPH it was detrimental to the insect, however when cholesterol or a cholesterol precursor (β -sitosterol) was injected into the small brown planthopper this improved insect survival (Noda and Saito, 1979). Suggestions that symbiotes may be involved in provision of certain B vitamins was provided by Dadd (1985) who showed that aphids did not require all seven B vitamins in their artificial diet for normal development.

Some other suggested non-nutritional functions of symbionts include production of anti microbial substances, insecticide resistance, protein synthesis (Ishikawa, 1982), viral transportation (Nasu, 1965; Fredehagen *et al.*, 1987, Laubscher, Jaffer and von Wechmar, 1992) and hormone synthesis (Nuorteva, 1954). Recent studies have shown that symbionts of *Acyrtosiphon pisum* can synthesis a protein called symbionin (Moroika and Ishikawa, 1992), which is localised in the bacteriocyte (Fukatsu and Ishikawa, 1992), although its function has not been determined.

When resistant and susceptible strains of *Myzus persicae* were treated with the insecticide parathion there were notable differences in symbiont size and number suggesting that symbionts may play a role in insecticide resistance (Von Amiressami and Petzhold, 1977), but differences between strains are not universal and their possible involvement remains uncertain (Ball and Bailey, 1978).

1.9 General aims and objectives

- a) Rear the hompteran pests *Nilaparvata lugens* (BPH), *Nephotettix cinciteps* (GLH) and *Myzus persicae* (PPA) through successive generations on artificial diet and develop a reproducible *in vitro* bioassay.
- b) Having found the optimal dietary requirements needed for insect development, test a wide range of proteins, against BPH, GLH and PPA in *in vitro* feeding trials to determine any antimetabolic or insecticidal properties, and identify possible single gene products which could be used for insertion into the genome of suitable host plants by genetic engineering.
- c) Investigate the mechanisms of action of antimetabolic plant derived proteins towards homopteran pests using BPH as a model insect.
- d) Develop *in planta* feeding trials using transgenic host plants expressing a suitable potential insecticidal gene and PPA as a model insect pest.

CHAPTER TWO

2.1 MATERIALS AND METHODS

2.1.1 Chemicals and materials

Galanthus nivalis (snowdrop) agglutinin (GNA), fluorescein labelled GNA and ABC-Vectastain® Diagnostic Kits were obtained from Vector Laboratories, Bretton, Peterborough, UK. *Solanum tuberosum* agglutinin (STA), cowpea trypsin inhibitor (CpTI) and wheat α -amylase inhibitor (WAI) were purified at Durham University using standard techniques (Gatehouse, Gatehouse and Boulter, 1980; Kashlan, 1980) and their purity was checked by SDS-page. *Narcissus pseudonarcissus* agglutinin (NPA), *Allium sativum* agglutinin (ASA) and *Tulipa gesneriana* agglutinin (TGA) and GNA antibodies were donated by Drs. W. Peumans and E. van Damme, Catholic University of Leuven, Belgium and *Oryza sativa* agglutinin (OSA) by Dr. Boonjawat, Chulalongkorn University, Bangkok, Thailand. Bovine serum albumin (BSA), horse gram agglutinin (HGA), jacalin agglutinin (JCA), *Lens culinaris* agglutinin (LCA), *Pisum sativum* agglutinin (PSA), *Phaseolus vulgaris* agglutinin (PHA), wheat germ agglutinin (WGA), soybean lipoxygenase (LPO), ovalbumin (OVA), *Streptomyces griseus* chitinase (Chase), potato polyphenol oxidase (PPO), concanavalin A (Con A), chicken egg white lysozyme (LYZ), dietary and buffer components, reagents and Parafilm M membrane were obtained from Sigma London Chemical Company Ltd, Dorset or BDH Ltd, Poole, Dorset. The purity

Oryza sativa L. var. Taichung Native 1 seed was kindly supplied by The International Rice Research Institute, Manila, Philippines and *Nicotiana tabacum* var. Samsun NN seed was obtained from Agricultural Genetics Company, Applied Plant Technology, Babraham, Cambridge, UK.

2.1.2 Maintenance of insect stock cultures

Three types of insects were maintained for research work under the following conditions:

2.1.2.1 *Nilaparvata lugens*

A culture of *Nilaparvata lugens* Stål, rice brown planthopper (BPH), obtained from a laboratory culture held at Rhône-Poulenc Ltd, Essex, was reared and maintained under controlled growth room conditions of 16 hour daylength (from artificial lighting), $25 \pm 2^\circ$ C and 75-85% relative humidity, following a modified version of Bae and Pathak (1970). The insects were maintained on 40-60 day old rice (*Oryza sativa* L.) plants of the susceptible variety Taichung Native 1 (TN1) held in rearing cages consisting of a

galvanised iron frame (46cm x 51cm x 75cm) enclosed within a mesh surround. Plants were watered daily both to ensure optimal growth and maintain high humidity around the plant stem. New rice plants were introduced at 7-10 day intervals to maintain the stock culture.

2.1.2.2 *Nephotettix cinciteps*

A culture of *Nephotettix cinciteps* Uhler, rice green leafhopper (GLH), originating from the same source as the BPH culture, was reared following a modified version of Sugimoto (1977) under the same conditions as BPH (above) with the exception of the design of the rearing cage. The GLH stock cultures were maintained within perspex rearing cabinets (24cm x 24cm x 39cm), in order to ensure that stock cultures of BPH and GLH were not mixed.

2.1.2.3 *Myzus persicae*

A stock culture of *Myzus persicae* Sulzer, peach potato aphid (PPA), obtained from a chinese leaf field trial in Newcastle, U.K, was reared under growth room conditions of 16 hour daylength, $21\pm 2^{\circ}\text{C}$ and 50% relative humidity. The insects were maintained on *Nicotiana tabacum* plants of the variety Samsun NN.

2.2 Enzyme assays

2.2.1 Measurement of enzyme activity in adult insect gut

2.2.1.2 Preparation of adult gut homogenate

Alimentary tracts were removed from adult, male and female, *Nilaparvata lugens*, which were removed directly from the host plant whilst feeding, by dissection under ice cold (4°C) distilled water. Homogenates were prepared according to a modified method of Gatehouse and Anstee (1983) as follows:

Homogenisation was carried out in distilled water using an electronic homogeniser with a teflon pestle (with a clearance of 0.1-0.15mm) with 10 passes of the plunger at 1000 rev/min. The homogenisation tube was surrounded by ice (4°C) throughout the procedure. The resulting homogenate was then centrifuged at 9000xg for 5 minutes and the supernatant retained for enzyme assays. Each enzyme preparation contained the alimentary tracts from 100 adults homogenised to a final volume of 100 μl . All homogenates were freshly prepared for each enzyme assay to delay enzyme deterioration. The crude gut homogenates of BPH, were made into serial dilutions, and examined for a number of digestive enzymes. All assays were carried out in triplicate.

The methods employed for each enzyme are described as follows:

2.2.2.3 α -amylase activity

α -amylase assays on the crude gut enzyme preparations were carried out using a modified version of Bernfield's (1955) assay as follows:

A DNSA (dinitrosalicylic acid) solution was first prepared by dissolving 1g of DNSA in 20 ml 2M NaOH and 30g Rochelles salt (potassium sodium (+) tartrate). This mixture was then made up to 100ml in distilled water and stored at 4°C.

10 μ l enzyme (i.e. gut homogenate) was incubated with 50 μ l substrate solution (1% potato starch solution in 50mM Na₂HPO₄ buffer pH 6.5) in the presence of 80 μ l buffer for 5 minutes at 30°C, in sealed Eppendorf tubes. The reaction mixture was terminated with the addition of 100 μ l DNSA reagent, followed by boiling at 100°C for 5 minutes in a waterbath. 1ml of water was then added to the solution, mixed and left to stand at room temperature to allow colour development. The absorbance was read at 490 nm. The α -amylase activity was expressed as mg maltose liberated /15 min at 25°C/50 μ l enzyme.

2.2.2.4 Trehalase activity

Trehalase assays on the crude gut homogenate were carried out using a modified version of Derr and Randall (1966) as follows:

125 μ l of enzyme was incubated with 125 μ l substrate (0.14M trehalose) in the presence of 0.5ml 0.1M NaOH maleate/NaOH buffer pH 6.5 (Dawson *et al.*, 1986) for 15 minutes at 30°C, in sealed Eppendorf tubes. The reaction was stopped by heating tubes to 100°C in a water bath for 10 minutes.

Trehalase activity was determined by estimating the glucose liberated from the trehalose during the reaction using the glucose-oxidase method of Werner, Rey and Wielinger (1970). After cooling in an ice bath the absorbance was read at 560nm and glucose content calculated by reference to a standard solution of glucose (9.1ml glucose/100ml).

2.2.2.5 Invertase activity

Assays to detect the presence of invertase in the crude gut homogenate were carried out using a modified version of Fisk and Shambaugh (1954) and Khan (1964). This method is a further modification of an α -amylase assay technique (Sumner, 1925). The method employed was as follows:

10 μ l enzyme was incubated with 50 μ l substrate (2.5% {w/v} sucrose in 80 μ l phosphate buffer pH 6.5) for 15 minutes at 35°C. The reaction was terminated with 100 μ l DNSA, followed by boiling for 5 minutes at 100°C. 1ml of water was then added and allowed to cool to room temperature for 5 minutes. The absorbance was read at 540nm.

2.2.2.6 Protease activity

Trypsin activity was measured using BAPNA (α -N-benzoyl-DL-arginine-p-nitroanilide HCl) as a substrate (after Erlanger, Kokowsky and Cohen, 1961):

667.0 μ l buffer (0.2M Tris HCl/0.2M Glycine/NaOH) was equilibrated with 20 μ l enzyme (= homogenate) for 5 minutes at 30°C. Then 66.7 μ l of substrate (BAPNA = 15.75mg/ml BAPNA solubilised in dimethyl sulphoxide) was added the mixture was incubated at 30°C for 15 minutes. The absorbance was read at 410nm. Measurement of p-nitroaniline released was determined by reference to a standard calibration graph of p-nitroaniline solution serially diluted from a stock solution containing 1.2 μ mol/ml of p-nitrophenyl aniline.

2.2.2.7 Carbohydrase activity

Activity of α -D glucosidase, β -D glucosidase, α -D galactosidase and β -D galactosidase were measured, by estimating the p-nitrophenyl liberated by hydrolysis of the relevant p-nitrophenyl glycoside, using a modified version of Gatehouse and Anstee (1983) and Gatehouse, Fenton and Anstee (1985) method as follows:

To measure the activity of α -D- glucosidase, 200 μ l 0.1M McIlvaines buffer (pH 5.4), 50 μ l substrate (51.2mM p-nitrophenyl α -D-glucopyranoside and 50 μ l gut homogenate) were incubated at 30°C \pm 1°C for 5 minutes in sealed Eppendorf tubes. The reaction was terminated by the addition of 800 μ l 50mM NaOH and the absorbance read at 405nm.

Activity of β -D-glucosidase: Was measured as for α -D-glucosidase except for the substrate used which was p-nitrophenyl- β -D-glucopyranoside.

Activity of α -D-galactosidase: Was measured as for α -D-glucosidase except for the substrate used which was 35mM p-nitrophenyl- α -D-galactopyranoside.

Activity of β -D-galactosidase: Was measured as for α -D-glucosidase except for the substrate used which was 35mM p-nitrophenyl- β -D-galactopyranoside.

2.3 *In vitro* insect bioassays

A number of pilot *in vitro* artificial diet bioassays were carried out initially using BPH as a model insect in order to design a suitable bioassay system in which a range of proteins could be screened for insecticidal activity:

2.3.1 Artificial diet preparation

The artificial diets used were prepared according to the recipes noted in Table 1. The diet ingredient cystine and tyrosine were first dissolved in a small volume of 1N HCl, and

riboflavin was dissolved by gentle heating in distilled water prior to being added to the diets.

All diets used are rich in nutrients and to avoid micro-organism contamination and subsequent deterioration diets were filtered through a Millipore filter of 0.2µm pore size, dispensed into 10ml plastic clip-top containers and stored at -20°C to avoid deterioration of sodium ascorbate which is unstable at temperatures above -20°C. No antibiotics were incorporated into the diet in order to avoid possible adverse effects on intracellular symbionts present in the insect abdominal regions. Diet was kept for a maximum of four weeks.

2.3.2 Hatching bioassays

In order to determine the feasibility of rearing BPH through successive generations on artificial diet oviposition and hatching bioassays were set up:

2.3.2.1 Using eggs oviposited on host plant (Method 1)

Ten adult BPH pairs were placed on a 40-60 day old *Oryza sativa* plants of the susceptible variety Taichung Native 1 (TN1). The adults were allowed to mate and oviposit for 4 days after which time the adults were removed. Eggs laid in the stem of the plant were removed by careful dissection, in distilled water, using a binocular microscope and a cold light source. Eggs were then transferred in water using a Pasteur pipette and placed in a "Hatching Chamber" (Figure 3). The hatching chamber consisted of a 35mm plastic petri-dish base lined with moist Whatman No. 1 filter paper, in order to maintain humidity. Thirty eggs were placed in each hatching chamber and the chamber was then covered with stretched Parafilm membrane. The hatching chambers were incubated in a Gallenkamp cooled illuminated incubator (25±2°C, light regime 16L:8D). Ten replicates of each chamber were set up and daily observations were made of nymph emergence.

2.3.2.2 Using eggs oviposited on plant (Method 2)

BPH eggs were collected as above and placed into hatching chambers. But instead of a single Parafilm membrane a double layer of Parafilm was stretched and placed over the open end of the hatching chamber (Figure 4). This formed a feeding sachet (Mittler and Dadd, 1964; Dadd and Mittler, 1965) into which was encapsulated, aseptically, 200µl of an artificial diet. The artificial diets used were based on a modification of Mitsuhashi (1974) diets for planthoppers, which were in turn a further modification of Mittler and Dadd (1962) and Ehrhardt (1968) diets for rearing aphids.

Table 1: Artificial Diet Composition

Ingredient	<i>^aMMD-1 mg/l</i>	<i>^aMED-1 mg/l</i>	<i>^bDM66 mg/l</i>
KH ₂ PO ₄	-	5000	5000
MgCl ₂ . 6H ₂ O	-	2000	2000
MgSO ₄ . 7H ₂ O	1230	-	-
K ₂ HPO ₄	7500	-	-
Sucrose	50000	50000	150000
L-alanine	1000	1000	1000
γ amino butyric acid	-	200	-
L-arginine hydrochloride	2700	4000	2700
L-asparagine	5500	3000	5500
L-aspartic acid	1400	1000	1400
L-cysteine	400	500	400
L-cystine HCl	-	50	-
L-glutamic acid	1400	2000	1400
L-glutamine	1500	6000	1500
Glycine	800	200	800
L-histidine	800	2000	-
DL-homoserine	-	8000	800
L-iso-leucine	800	2000	800
L-leucine	800	2000	800
L-lysine hydrochloride	1200	2000	1200
L-methionine	800	1000	400
L-phenylalanine	400	1000	400
L-proline	800	1000	800
DL-serine	800	1000	800
L-threonine	1400	2000	1400
L-tryptophan	800	1000	800
L-tyrosine	400	200	400
L-valine	800	2000	800
Thiamine hydrochloride	25	25	25
Riboflavin	5	50	5
Nicotinic acid	100	100	100
Pyridoxine hydrochloride	25	25	25
Folic acid	5	10	5
Calcium pantothenate	50	50	50
Inositol	500	500	500
Choline Chloride	500	500	500
Biotin	1	1	1
Sodium ascorbate	1000	1000	1000
FeCl ₃ .6H ₂ O	22.28	22.28	15
CuCl ₂ .2H ₂ O	2.68	2.68	4
MnCl ₂ .4H ₂ O	7.93	7.93	8
ZnCl ₂	11.88	3.96	8
CaCl ₂ .2H ₂ O	31.15	31.15	
pH (adjusted with KOH)	6.5	6.5	7.0

(ref: ^aMitsubishi, 1974; ^bDadd and Mittler, 1966)

The diet formulations used are from hereon referred to as MED-1 and MMD-1 and are described in Table 1. Ten eggs were placed in each hatching chamber and incubated in a Gallenkamp cooled illuminated incubator ($25\pm 2^{\circ}\text{C}$, light regime 16L:8D) and the treatments were replicated ten times. Feeding sachets and diets were replaced daily, to ensure a fresh supply and reduce microbial contamination, and daily records were maintained of nymphal emergence.

2.3.2.3 Combined oviposition and hatching bioassays

Oviposition bioassays were carried out to determine whether BPH could lay eggs through an artificial membrane into a liquid artificial oviposition media and to determine the hatching viability of eggs oviposited away from the host plant. If successful this method could lay the basis of rearing BPH through successive generations on an artificial diet.

A combined oviposition/feeding chamber (Figure 5) was prepared following a modifications of Fulton and Chamberlin (1934) and Mitsuhashi (1970) oviposition chambers as follows:

The base of a plastic petri dish (8.5cm diameter) was filled to capacity with oviposition liquid media. Two forms of liquid media were tested, one a 5% sucrose solution {w/v} and a second a 5% sucrose {w/v}/0.004M salicylic acid solution. A control of distilled water was also used for each bioassay. A single layer of Parafilm membrane was then stretched over the top of the petri dish thus forming an oviposition chamber in which to collect the BPH eggs.

A plastic feeding cage, 60mm diameter x 46mm height, (as shown in Figure 5) was then placed over the oviposition chamber. Across the top of the feeding chamber a stretched double layer of Parafilm membrane was placed. Into each feeding sachet was placed 500 μl of liquid artificial diet, either MED-1 or MMD-1. Each of the two liquid diet treatments and the control was replicated three times. During the oviposition period the insects were kept incubated in a Gallenkamp cooled incubator ($25\pm 2^{\circ}\text{C}$, light regime 16L:8D). The insects were allowed to feed on the artificial diet, through the feeding sachet, and oviposit through the membrane into the oviposition media. Daily records were taken of adult survival and the number of eggs oviposited into the media. Diet, oviposition media and Parafilm membranes were renewed daily.

Eggs were removed daily, from the oviposition media, after any eggs that were hanging in the Parafilm membrane had been carefully forced down into the media using a Pasteur pipette. On removal from the media, using a Pasteur pipette, the eggs were then transferred to a hatching chamber (Figure 4) and covered with a single layer of Parafilm. Then a 200 μl droplet of artificial diet (corresponding to the diet on which the adults were fed) was placed on the membrane and covered with a second stretched piece of membrane to form a nymph feeding chamber (Figure 4). The rate and number of eggs

emerging as first instar nymphs were then recorded along with the maximum survival length of the nymphs on the diets. Diet was changed daily to avoid diet contamination and deterioration. Humidity was maintained within the chamber by the addition of 100 μ l sterile distilled water to the filter paper on alternate days.

2.3.3 Artificial diet comparison bioassays

To determine the most suitable artificial diet formulation on which to rear BPH nymphs. A number of bioassays were carried out in which two artificial diets, MED-1 and MMD-1 were tested. The sucrose concentration {w/v} and pH of each diet was also varied in order to determine the optimum levels required for insect development.

Five newly emerged first instar BPH nymphs were removed from the host plant using a fine paintbrush and placed in a feeding chamber (Figure 4), and 200 μ l of artificial diet, either MED-1 or MMD-1, was placed in the feeding sachet and incubated in a Gallenkamp cooled incubator ($25\pm 2^{\circ}\text{C}$, light regime 16L:8D). A control in which no diet was placed in their feeding sachet was also set up and ten replicates for each treatment and control were used. Diet was changed daily and records of nymphal survival and development were recorded daily.

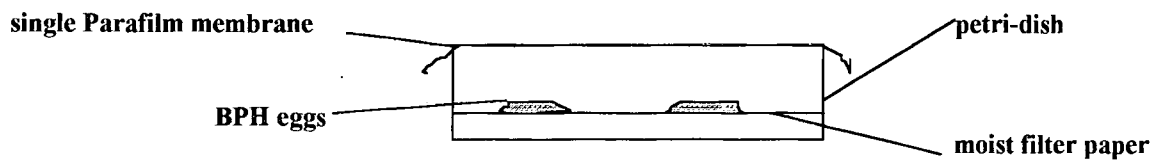

Figure 3: Hatching chamber designed to allow BPH eggs to hatch *in vitro* away from the host plant environment

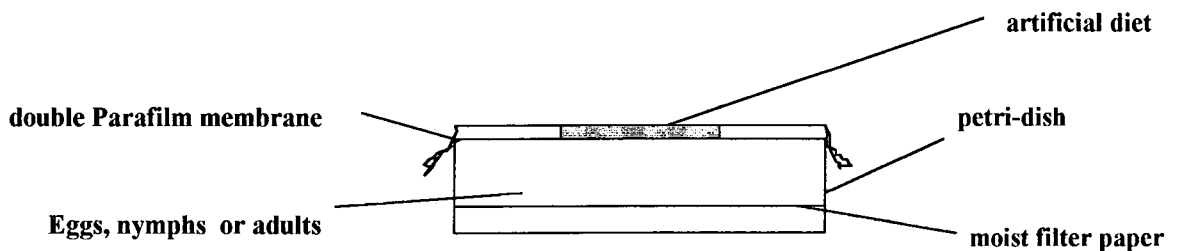

Figure 4: Dual purpose feeding and hatching chamber:

- (i) For use as a modified hatching chamber to allow BPH eggs to hatch and newly emerged nymphs to feed directly on artificial diet
- (ii) For use as a feeding chamber for hoppers and aphids in artificial diet feeding trials

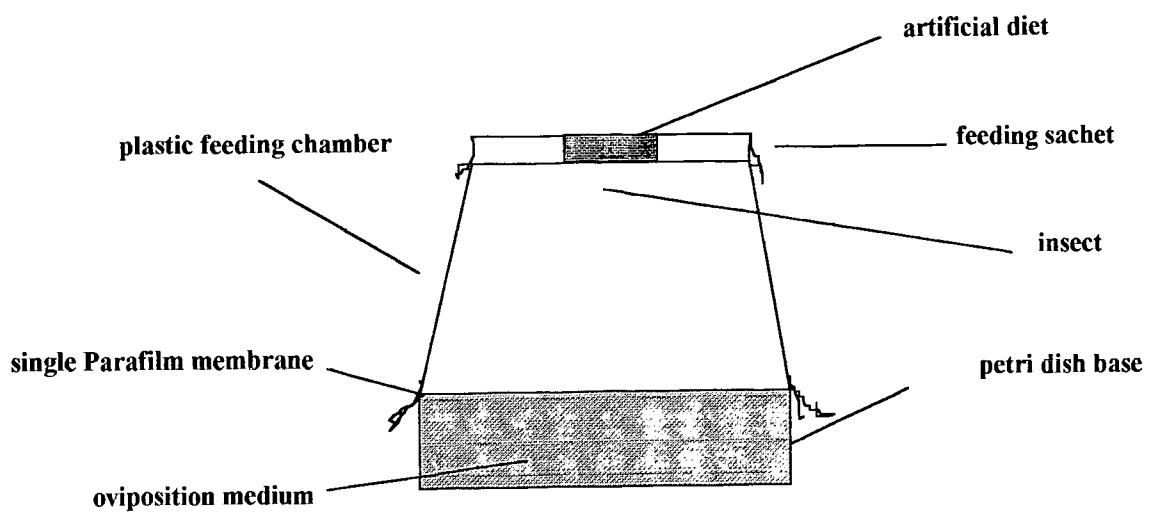

Figure 5: Combined oviposition/feeding chamber to enable adult BPH to feed on artificial diet and oviposit eggs away from the host plant

2.4 In vitro protein feeding trials

Having determined the most suitable diet formulation on which to rear the insects feeding trials were carried out to determine the potential insecticidal properties of a range of plant and fungal derived proteins by incorporating them into artificial diets and feeding them to BPH, GLH or PPA.

2.4.1 Feeding trials using first instar BPH

Newly emerged first instar BPH nymphs were removed from the host plant by gently tapping the plant stem. Five nymphs were transferred to each bioassay vessel (Figure 4) using a fine paintbrush, to minimise damage to the nymphs. Test proteins or test enzymes were incorporated into the artificial diet at 0.1% concentration {w/v} (as this was a concentration which would be achievable in transgenic plants), unless otherwise stated, and 200µl of liquid treatment was placed in each feeding sachet. Two controls, one of artificial diet and no diet at all (i.e. a dry feeding sachet) or 200µl distilled water were included in all bioassays. Ten replicates were set up for each treatment and control.

The feeding chambers were housed in a "Gallenkamp" cooled incubator (25±2°C, light regime 16L:8D). Diets and membrane sachets were changed daily to ensure a fresh nutrient supply and minimise possible diet contamination or deterioration. The number of nymphs surviving was recorded daily.

2.4.2 Feeding trials using third instar nymphs

The above method was carried out for later bioassays using third instar BPH nymphs or third instar *Nephotettix cinciteps*, rice green leafhopper (GLH), as opposed to first instars which, due to their relatively small size, are less easily handled and prone to damage during transference. The same number of replicates were tested as for the first instar technique (Section 2.4.1).

2.4.3 Pressurised bioassays

As BPH and GLH are both phloem feeders and may imbibe sap under turgor pressure when feeding on the host plant, an improved bioassay method was devised whereby diet could be supplied to nymphs under pressure. This was done by inverting a column of sterile distilled water of constant volume (35cm³), housed in a plastic cylinder (diameter 3.0cm, height 5.5cm), above the feeding sachet (Figure 6). Using this bioassay system only one previously tested protein, GNA, at 0.1% {w/v} concentration, was tested in bioassay against third instar BPH nymphs replicates and other details were as previously stated (Section 2.4.2). Three other selected proteins LYZ, TGA and OSA were tested

using this method at concentrations of 0.1% {w/v}. Replicates and controls were as previously stated (Section 2.4.2).

2.4.4 Dose response determination

Selected proteins which appeared to exhibit significant anti metabolic effect towards BPH, or had similar carbohydrate specificities, were tested in feeding trials at four concentrations (within the range 0.0125 - 0.1% {w/v}) in order to determine a possible dose-response effect. These proteins were tested using the pressure bioassay method with replicates and other details as described earlier (Section 2.4.3).

2.4.5 Pyramid feeding trials

Selected proteins, were fed in combination at optimal concentration , as determined by the LC_{50} value from dose response curves, (Section 2.4.4) to third instar BPH to determine whether by using a combination of proteins, with different specificities, an additive or synergistic effect occurred. These feeding trials were carried out using the pressure bioassay system and replicates and controls as described earlier (Section 2.4.3).

2.4.6 Determination of antimetabolic activity

To determine the effectiveness of a particular treatment the increase in mortality, corrected according to Abbot (1925), was used. Corrected mortality is calculated on the day when all the nymphs in the 'no diet' control are dead, and it compares the mortality of nymphs fed on treatment to the nymphs fed on diet alone. It is calculated by the following equation:

$$\% \text{ (CM) Corrected mortality} = \frac{(a - b)}{a} \times 100$$

{Where a = number of surviving insects fed on diet only

b = number of surviving insects fed on diet + treatment }

An arbitrary figure of >50% corrected mortality was taken as an indication of substantial anti metabolic, insecticidal or toxic effect. Where results of a bioassay indicated a test protein with a corrected mortality of >50%, the bioassay was repeated 2-3 times in order to ensure the result was valid and not as a result of other factors (e.g. diet contamination or weak source population).

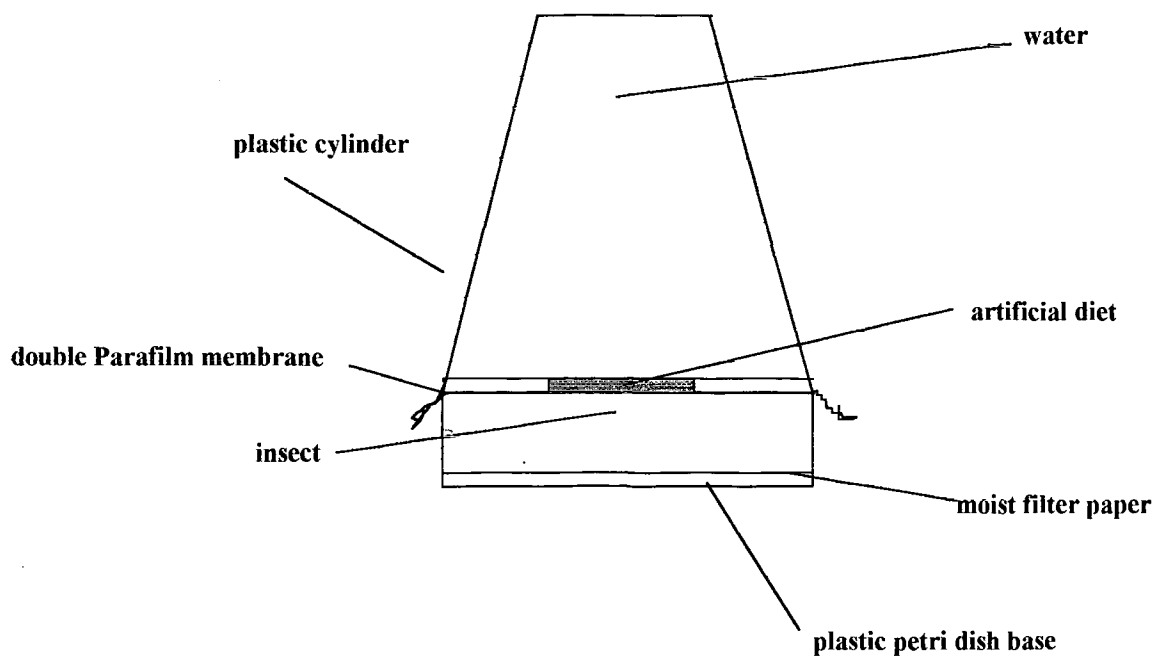

Figure 6: Schematic representation of a pressurised feeding chamber designed to allow sap-sucking insects to feed on artificial diet supplied under simulated sap turgor pressure.

The choice of time point at which to compare control and experimental treatments in artificial diet bioassays is largely arbitrary. The choice of day on which all 'no diet' controls died was made as it was expected to take into account any between trial variation in the fitness of insect populations.

2.4.7 Statistical methods

Survival frequencies on treatment and control diets were subjected to statistical analysis by a G-test of independence, a 2x2 test of independence (Sokal and Rohlf, 1973). Yates correction was applied to the data where appropriate. The null hypothesis under test was that survival was independent of treatment ($H_0: CON=TR$).

Quantitative honeydew analyses and aphid body development measurements were subjected to statistical analysis by an unpaired t-test, which compares the means of two groups and determines the likelihood of the observed values occurring by chance and *in planta* aphid bioassay survival data was analysed by a repeated measures ANOVA using StatView software.

2.4.8 Peach potato aphid bioassays

2.4.8.1 Pilot bioassays

In order to determine which was the most suitable artificial diet bioassay system on which to rear *Myzus persicae*, peach potato aphid (PPA), and design a suitable system for use in protein feeding trials for aphids, bioassays were carried out using modified versions of the ambient bioassay and the pressurised bioassay systems (Section 2.4.1 and 2.4.3) using the artificial diet DM66 (Table 1). DM66 has a higher sucrose concentration than MMD-1 as fluid intake on 5% sucrose is lower for PPA and the optimal range for survival is 10-20% (Mittler, 1967a). Five apterous parthenogenic female adults were removed from the host plant and transferred to the ambient feeding chamber (Figure 4) and allowed to feed on artificial diet for 10 days. As new progeny were produced five newly emerged nymphs were removed and placed in a second identical feeding chamber or the modified pressure bioassay vessel (Figure 6) and allowed to feed for a further 10 days. Daily adult survival, nymphal survival and nymph emergence were recorded. A control in which insects were fed no diet was used in all experiments and ten replicates were set up per treatment and control. Insect feeding trials were conducted in a Gallenkamp cooled illuminated incubator ($25 \pm 2^\circ\text{C}$, light regime 16L:8D).

2.4.8.2 *In vitro* protein feeding trials

The bioassay method described in Section 2.4.8.1 was carried out using selected proteins which were incorporated into the artificial diet at 0.1% {w/v} concentration. The same replicate number and environmental conditions were used as described above and daily records of adult and nymphal survival and nymph emergence were recorded.

2.4.8.3 Aphid development feeding trials

A feeding trial as described earlier (Section 2.4.8.2) was carried out using selected proteins incorporated at 0.1% {w/v} concentration in artificial diet DM66 supplied under simulated sap pressure and fed to first instar PPA nymphs. After 4 days the trial was terminated and measurements of surviving nymphs body dimensions (length and width) were made using a Microscale Image Analyser. Controls, replicates and other details were as described earlier (Section 2.4.8.2).

2.5 *IN PLANTA* FEEDING TRIALS

In the absence of transgenic rice material it was not possible to carry out *in planta* bioassays using BPH or GLH as their main host plant is rice. However as it was possible to express suitable proteins in dicotyledon crops (i.e. Tobacco) a model homopteran pest, *Myzus persicae*, peach potato aphid (PPA), was used.

Ten parthenogenic apterous late instar PPA, were placed on the uppermost surface of a leaf of a transformed GNA expressing tobacco plant, using a fine camel hair paintbrush. A control plant not expressing GNA was also used. The insects were then housed within a plastic clip-cage (Plate 1) which was modified after Honeybourne (1969). Four clip-cages were used per plant (Plate 2) and 4 plants were used per treatment and control. Observations of adult survival and fecundity were taken at daily intervals and the trial was terminated after 10 days.



Plate 1: Aphid clip-cage used in *in vivo* feeding trials.



Plate 2: GNA transgenic tobacco plant on which an aphid feeding trial is being carried out.

2.6 MECHANISM OF ACTION OF ANTI-METABOLITES

In order to determine the possible mechanism of action of selected effective proteins batches of 2-3 day old adult female brachypterous BPH were removed from the host plant and allowed to feed, on either diet alone or diet with protein incorporated at 0.1% {w/v}, (as described in Section 2.4.2) for a period of 5 days. Controls were set up of adult BPH which were removed after 5 days feeding on the host plant. Remaining live insects were then removed and examined using various techniques:

2.6.1 Determination of protein uptake

In order to confirm that a protein is imbibed and digested by the insect, and to observe any possible binding sites, two adult female BPH were fed with fluorescein-labelled GNA, incorporated at 0.1% {w/v} in artificial diet MMD-1, and allowed to feed (using method described in Section 2.4.3) for 48 hours. The feeding chamber was modified in that the filter paper lining the base of the chamber was unmoistened. Control insects were fed with MMD-1 diet alone. After 48 hours the filter paper disk was removed and examine under a fluorescent microscope and any fluorescence appearing on the disc would indicate the excretion of GNA in the BPH honeydew. Insects were removed and unstained histological sections of the abdominal region were prepared in Karnovsky's fixative and LR White Resin as described in Section 2.6.2.1 and examined using fluorescence microscopy.

2.6.2 Examination of insect ultrastructure

In order to examine, the mode of protein toxicity in terms of possible binding site regions or ultrastructural changes occurring within the insects due to the presence of effective proteins in the diet preliminary examination of the BPH was carried out using various histological techniques for light and electron microscopical investigation in order to familiarise the author with the abdominal region of the insect:

2.6.2.1 Light microscopy

Adult female BPH or eggs were removed from the host plant and fixed for three hours in either Bouin's mixture (Bouin, 1897) or Carnoy's fluid (1887) which were prepared as follows:

Bouin's fluid:	Saturated aqueous picric acid	75ml
	Formalin	25ml
	Acetic acid	5ml

Carnoy's fluid:	Absolute alcohol	60ml
	Chloroform	30ml
	Acetic acid	10ml

Prior to fixation the head, legs and wings were removed, from each insect to aid penetration of the fixative. Fixed material was then washed in an alcohol series, dehydrated, orientated and embedded in either paraffin wax or embedded overnight in a 1:1 LR White resin/absolute alcohol solution overnight and then 2 days in LR resin at room temperature, then polymerised overnight at 60°C in LR resin. LR white embedded sections were cut at 1µ using a glass microtome, heat fixed in distilled water on a glass microscope slide and stained with 1% toluidine blue. Paraffin embedded sections were cut at 5-10µ using a metal microtome, dewaxed in xylene for 5 minutes rehydrated in a graded alcohol series (1 minute wash in absolute, 95% and 70% alcohol) rinsed in distilled water and stained with haematoxylin for 5 minutes. Samples were then rinsed in distilled water and left for 15 seconds in alkaline-alcohol before another rinse. Sections were dehydrated in 70% alcohol and 95% alcohol (1 minute each solution) and counterstained in eosin for 15 seconds. Samples were then given 10 seconds in 95% alcohol, 25 seconds in absolute alcohol and two minutes in xylene before being dried on a 45°C hotplate and mounted in DPX. LR White embedded sections were stained with 1% toluidine blue. All stained sections were examined using a high powered light microscope.

2.6.2.2 Electron microscopy

The following fixative was used in all electron microscope work:

Karnovsky's fixative (Karnovsky, 1965) was prepared from two stock solutions;

*Solution A:	Paraformaldehyde	2g
	Distilled water	40ml
	1M NaOH	2-6 drops
Solution B:	25% gluteraldehyde	10ml
	0.2M sodium cacodylate-NaOH, pH 7.3	50ml

* Paraformaldehyde and distilled water were warmed with continuous stirring and NaOH added dropwise till precipitate had dissolved.

Solutions A and B were kept separate at 4°C prior to use and then mixed at 1:1 ratio. Adult female insects were decapitated, legs and wings removed, to improve penetration of fixative, and the remaining body segment was fixed for 1.5 hours at 0-4°C, and post fixed with 1% {w/v} osmium tetroxide in sodium cacodylate (pH 7.3) for 3 hours at 0-4°C.

Samples were then dehydrated, at room temperature, through a graded series of ethanol solutions: 15 minutes in each of 70% {v/v} and 95% {v/v} ethanol and 30 minutes in absolute alcohol. After 30 minutes in a 1:1 propylene oxide/absolute alcohol mixture followed by 30 minutes in propylene oxide, tissue was infiltrated with a 1:1 propylene oxide/Araldite epoxy resin mixture for 30 minutes in a 45°C oven. Tissue was then placed in Araldite in glass sample tubes at 45°C for 30 minutes with the lids open. Following Araldite infiltration specimens were then embedded in Araldite in foil dishes and polymerised for 12 hours at 45°C followed by 48 hours at 60°C.

The Araldite mixture consisted of:

Araldite	10ml
Dodecyl succinic anhydride	10ml
Dibutyl phthalate	1ml
2, 4, 6-tri (dimethylaminomethyl) phenol	0.5ml

Silver-silver gold sections of the gut and abdomen regions were cut using a Reichert NK ultratome Model Om U2 or U3 using glass knives prepared using a LKB 7800 Knifemaker. Sections were expanded with chloroform vapour and mounted on uncoated or coated copper grids (size 150). Sections were stained with uranyl acetate and lead citrate for 3 minutes each before examination under a Philips EM 400T transmission electron microscope.

Some sections for light microscope were also prepared in the above manner and thicker sections (1 μ) were cut as described above, mounted on glass slides and stained with toluidine blue (1%) and mounted in DPX.

2.7.1 Light microscope examination for morphological changes in gut ultrastructure

GNA fed insects and control insects were prepared as described in Section 2.6.2.1, using Carnoy's fixative and LR White resin, and stained with either toluidine blue (1%) or Gram stain and examined under a high power light microscope.

2.7.2 Electron microscope examination for morphological changes in gut ultrastructure

GNA fed insects and control insects were prepared as described in section 2.6.2.2 and stained with uranyl acetate and lead citrate and examined using a Philips EM 400T transmission electron microscope.

2.8 Immunological studies

To identify possible binding site regions insects were examined using immunohistochemical staining techniques:

2.8.1 Immunohistochemical staining

In order to identify a possible site of action of an effective protein against the BPH two immunohistochemical staining procedures were used (after Mayer and Walker, 1987; Harlow and Lane, 1988; Shaw, 1988):

(i) DAB technique

1 μ thick sections were prepared as described in Section 2.6.2.1, and mounted on treated glass microscope slides (slides were treated with 2% 3-aminopropyltriethoxysilane in acetone for 15 seconds, rinsed in acetone then distilled water and allowed to dry in a dust free environment). Endogenous peroxidase activity was blocked with 1% hydrogen

peroxide in absolute methanol for 30 minutes followed by two five minute washes in distilled water. Free reactive aldehyde groups were blocked by incubation with 0.5mg/ml sodium borohydride in PBS for three 5 minute periods. Sections were then gently rinsed four times for 5 minutes in PBS. Non-specific binding sites were blocked by incubation with 1% BSA in PBS for 20 minutes. After blocking solution was removed a 1:1000 dilution of the primary antibody monospecific rabbit anti-GNA immunoglobulin G (IgG), in 1% BSA-PBS was applied and sections incubated for 60 minutes, followed by six four-minute washes in PBS/0.5% Triton X-100. Sections were then incubated for one hour with a 1:2000 dilution of the secondary antibody anti rabbit IgG, in 1% BSA-PBS. Six four-minute washes in PBS containing 0.5% Triton X-100 followed. Sections were then stained with DAB (*prepared as described below) for 10 minutes and rinsed in tap water and mounted in DPX. Sections were examined using a high power light microscope.

* Preparation of DAB staining solution:

Six mg DAB was dissolved in 10ml of 50mM Tris buffer (pH 7.6) (which was warmed gently to aid solubility), filtered and 10 μ l 30% hydrogen peroxide added prior to use.

(ii) Avidin-Biotin technique

Sections were prepared as described earlier (Section 2.6.2.1) and mounted on treated glass slides and stained immunohistochemically for the presence of GNA using a Vectastain® ABC Kit (Vector Laboratories, Peterborough, UK). After staining sections were mounted in DPX and examined under a high power light microscope.

2.9 Intracellular Symbionts of BPH

As described earlier (Section 1.8.1) it is believed that intracellular yeast-like symbionts (YLS) play a vital role in the nutritional capabilities of BPH, and in order to investigate the possibility that effective proteins may in some way interfere with their symbiotic relationship the identification and isolation of the symbionts was attempted:

2.9.1 Distribution of yeast-like symbionts

Confirmation of the presence of YLS in the abdominal region was carried out by light and electron microscopy examination (Section 2.6.2.1 and 2.6.2.2).

2.9.2 Isolation and continuous culture of yeast-like symbionts

Ten brachypterous BPH female adults were removed from the host plant, surface sterilised in 70% ethanol for three minutes, and homogenated in 5ml 0.9% saline and a fresh smear was taken, stained using the Gram stain method and examined for yeast-like symbionts under a high power light microscope. The Gram stain method used was as follows (modified from Steel and Cowan, 1965):

Smears were stained with oxalate crystal violet for 30 seconds, washed in tap water and stained in Lugol's iodine for 60 seconds. Iodine was drained off the slide by gentle blotting and the sample was decolourized for 30 seconds with 95% ethanol, before washing for two seconds in tap water. Smears were then counterstained with dilute carbol fuchsin for 5 seconds, rinsed in tap water and allowed to dry.

One ml of the remaining homogenate was inoculated using a Pasteur pipette into 20ml of filter-sterilised Grace's insect tissue culture medium (GTC) (Grace, 1962) and incubated at 25°C for three days. After three days 0.5ml of inoculated GTC medium was subcultured onto yeast morphology agar (YMA) and reincubated at 25°C. Plates were examined daily for yeast growth. Isolated YLS colonies were examined using light and electron microscope techniques.

The above procedure was also carried out using BPH eggs which had been dissected from the stem of the host plant.

2.10 ASSESSING ANTIFEEDANT ACTIVITY

The possibility that effective proteins may be acting as antifeedants was examined using the following techniques:

2.10.1 Analysis of honeydew

The quantitative and qualitative analysis of honeydew excreted by homopteran pests can indicate the relative amounts of diet and treatment imbibed and therefore indicate whether a protein incorporated into the diet is acting as feeding deterrent:

2.10.1.2 Ninhydrin analysis of BPH honeydew

Two, three-day old brachypterous, female BPH adults were removed from the host plant and transferred into a 35mm diameter plastic petri-dish base lined with Whatman No.1 filter paper onto which any excreted honeydew would be absorbed. A feeding sachet (Section 2.3.2.2), with 200µl MMD-1 diet and 0.1 % {w/v} protein enclosed, was then

placed over the dish forming a feeding chamber. Holes were made at 1 cm intervals along the edge of the petridish, which was then floated in a standard petridish base the base of which was covered with distilled water. This was then covered in a single Parafilm layer thus forming a floating humidity chamber (Figure 7) and the chamber was then incubated for 24 hours in a Gallenkamp cooled incubator ($25\pm 2^{\circ}\text{C}$, light regime 16L:8D). Three feeding chambers were placed into each humidity chamber, and 10 replicates were prepared for each treatment and control (Plate 3). After 24 hours insects were removed from the chambers and filter papers were sprayed with 0.2% Ninhydrin reagent in order to detect the presence of amino acids (Rosen, 1957).

2.10.1.3 Quantitative analysis of BPH honeydew

(i) In vitro

In order to examine the quantity of honeydew excreted by BPH when feeding, as an indirect indicator of the quantity of liquid diet imbibed, the following method was used:

Floating humidity chambers were set up as described earlier (Section 2.10.1.2), with the omission of the basal filter paper lining. Two adult brachypterous female BPH were placed in each feeding chamber and the same replication and environmental procedures were carried out as earlier described. After 24 and 36 hours honeydew droplets excreted onto the base of the feeding chamber were counted, diameter measured and total volume measured using a micropipette. The honeydew collected was retained for amino acid analysis.

(ii) In planta

In order to compare the quantity of honeydew excreted by BPH feeding on the host plant with that of the artificial diet the following method was used (after Pathak, Saxena and Heinrichs, 1982):

Two, three-day old, adult brachypterous females were placed on a rice stem and enclosed within a Parafilm sachet (Pathak, Saxena and Heinrichs, 1982) designed for the collection of honeydew (Plate 4). Ten replicates were used per plant (Plate 5) and plants were incubated in a controlled environment growth room ($25\pm 2^{\circ}\text{C}$, light regime 16L:8D, relative humidity 70-80%). After 24 hours honeydew was collected using a micropipette, and the mean volume produced per insect was calculated and samples were retained for amino acid analysis.

2.10.1.4 Qualitative analysis of BPH honeydew

Samples, collected using the method described earlier (Section 2.10.1.3), from insects feeding on known concentrations of GNA, LPO and WGA were analysed for total hydrolyzed amino acid content, by the Rowett Research Institute, Aberdeen using an amino-acid analyser.

Control samples of artificial diet were also analysed to determine the relative quantities of amino acids utilised by control diet and treatment fed insects.

Honeydew samples collected from insects feeding on the host rice plant (Section 2.10.1.3) were also analysed for total amino acid content in order to compare the amino acid profiles of honeydew produced from insects feeding *in planta* and *in vitro*.

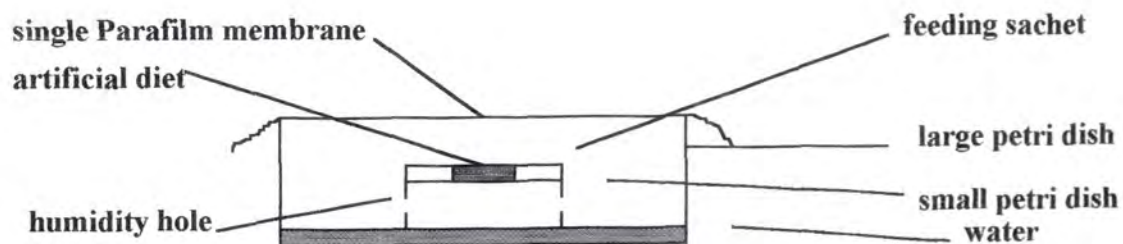

Figure 7: Schematic representation of floating humidity chamber used in qualitative and quantitative determination of BPH honeydew excretion

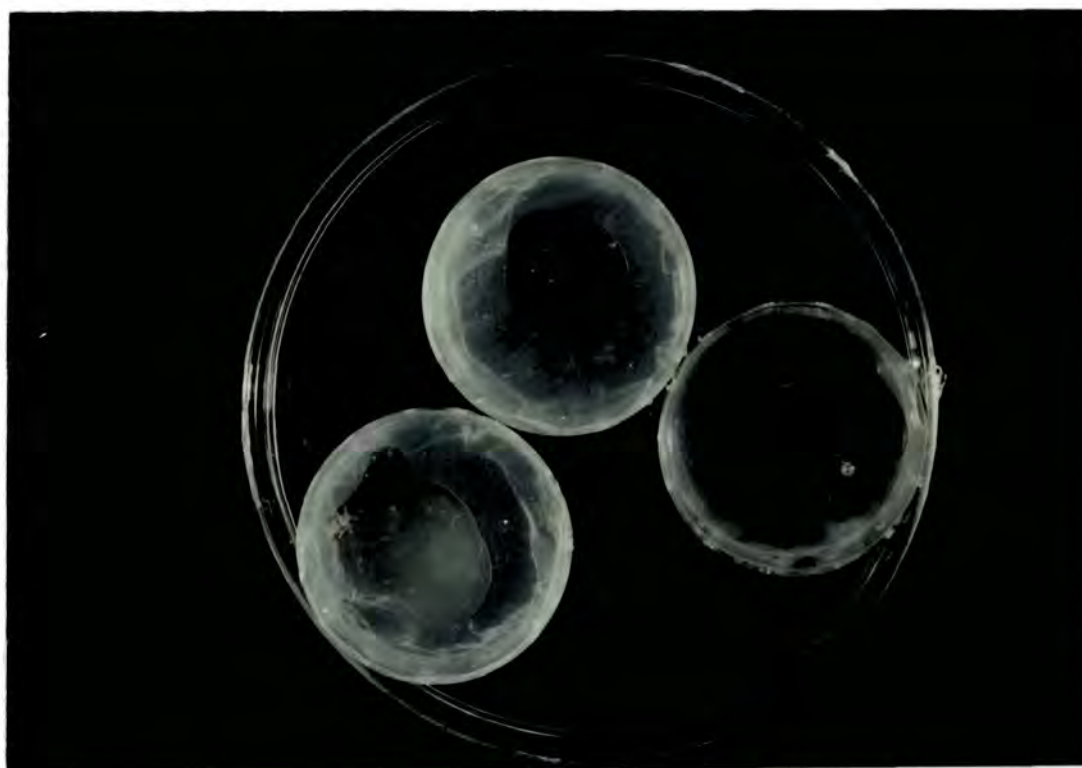

Plate 3: Replicated floating humidity chambers used for qualitative and quantitative determination of BPH honeydew excretion



Plate 4: Parafilm sachet used to collect honeydew samples from adult BPH feeding on host plant (rice).



Plate 5: **Replicated honeydew collection sachets on rice plant.**

CHAPTER THREE

3.1 RESULTS AND CONCLUSIONS

3.1.1 Enzyme assays

Gut homogenates from adult, *Nilaparvata lugens* (rice brown planthopper, (BPH)), were tested for the presence of a wide range of digestive enzymes, using the appropriate substrates as described in the Methods section. The following activities were assayed:

α -amylase
Trehalase
Invertase
Trypsin
 α -D Glucosidase
 β -D Glucosidase
 α -D Galactosidase
 β -D Galactosidase

No activity was detected for any of these enzymes. The inability to detect any digestive enzymes was disappointing as the presence of a digestive enzyme could give a possible indication of a protein which may be used to inhibit the particular enzyme. However the absence of digestive enzymes was not unexpected as BPH feeds on plant sap which is a diet of poor and unbalanced nutritional quality lacking a suitable protein source and hence there is no requirement for certain enzymes (such as proteases) within the gut. According to Terra (1990) except for dimer (i.e. sucrose) hydrolysis - no food digestion is necessary in sap-suckers.

It may be that other digestive enzymes not assayed for could be present or enzymes are present in the insects salivary glands, which were not examined, or the detection levels were not sensitive enough to detect low levels of activity. An alternative method to locate digestive enzymes might be to use histochemical techniques, which have been used to locate enzymes successfully in the mid-gut of mammals (Lorenzsonn, Agresti and Olsen, 1972).

Because it was very difficult to isolate complete alimentary tracts of hoppers without damaging the fine gut membrane, and possibly losing gut contents including digestive enzymes, an alternative approach for enzyme detection may be to collect and analyse BPH honeydew. Invertase has been detected in the honeydew of the aphid *M. rosae* (cited in Ponsen, 1987) using this technique.

Several types of digestive enzymes exist in insects including proteases, carbohydrases, lipases, amylases and glycosidases (Applebaum, 1985) and these are generally secreted by the midgut epithelium (Dadd, 1970a). Insects that feed on nutritionally "normal" diets (ie: containing proteins and complex carbohydrates) generally

have a full compliment of digestive enzymes but phloem feeding Homoptera which feed on nutritionally unbalanced diets, generally lack mid-gut digestive enzymes but may have salivary digestive enzymes.

Saliva normally functions within the insect buccal cavity and foregut region, but in sap-suckers it can also be ejected externally. Sogawa (1965) suggested that the primary functions of planthopper and leafhopper salivary glands were secrete digestive enzymes and produce material to form the salivary sheath. To date no workers have characterised any digestive enzymes in the gut of *N. lugens*, although enzyme activity in the form invertase, glucosidase and galactosidase have been reported in the salivary glands of BPH and GLH (IRRI, 1975). Enzyme activity has also been reported in other Homopteran insects, in particular invertase has been detected in at least two phloem feeding leafhoppers (Saxena, 1954) *Tettigella spectra* and *Parabolocratrus porrectus* both being insects which feed on *Oryza sativa L.* as a secondary host plant. Protease has been detected in the alimentary tract of the potato leafhopper *Empoasca flavescens* (Nuorteva, 1954) and the sugar cane leafhopper *Pyrilla perpusilla* (Fulgoroidea: Hemiptera) (Agarwal, 1975). In *Myzus persicae* enzymes have been detected in salivary glands in the form of peroxidase and polyphenoloxidase which act as detoxicants (Miles and Peng, 1989; Peng and Miles, 1988; 1991), the hydrolases pectinase and cellulase which are believed to soften cell walls and aid intercellular penetration by the stylets (Miles, 1990) and peptidase (Bramstedt, 1948).

Other workers have detected digestive enzymes in other insect orders for example α -amylase in *Tribolium confusum* (Gatehouse *et al.*, 1986), trehalase in *Melanoplus differentialis* (Derr and Randall, 1966) and *Blaberus discordalis* (Gilby, Wyatt and Wyatt, 1967), invertase in *Aedes aegypti* (Fisk and Shambaugh, 1954) and *Saissetia olea* (Ishaaya and Swirski, 1976) and carbohydrases in *Callosobruchus maculatus* (Gatehouse and Anstee, 1983; Gatehouse *et al.*, 1985), *Locusta migratoria* (Morgan, 1975) and *Schistocerca gregaria* (Evans and Payne, 1964). Proteases have been characterised in the midgut of *Costelytra zealandica* (Christeller *et al.*, 1989) and *Aedes aegypti* (Fisk and Shambaugh, 1952). In the plant kingdom there are a number of secondary metabolites including alkaloids and tannins which are antimetabolic towards insects due to their action on insect digestive enzymes (Evans, *et al.*, 1985; Goldstein, 1987).

3.2 In vitro insect bioassays

3.2.1 Hatching bioassays

Pilot *in vitro* feeding trials were carried out, to determine whether BPH could be reared for successive generations, in the absence of the host plant, in order to design a suitable bioassay in which proteins could be screened for insecticidal properties. Initially BPH

eggs were removed, by dissection from the host plant, and reared in hatching chambers using two methods:

3.2.1.1 Using eggs removed from the host plant (Method 1)

Using method one, eggs were removed from the host plant, placed in a hatching chamber on moist filter paper (Figure 3) and hatching viability over a period of 10 days was recorded. This hatching bioassay was carried out in duplicate and the results of one bioassay are shown in Figure 8. The range of nymphal emergence was 3-10 days in both bioassays and the maximum hatching percentage was 39% (Fig. 8). These results are a marked improvement compared with Heong (1987) who achieved 28% hatching of BPH *in vitro* on moist filter paper. A control to estimate percentage hatching on the host plant would have been a useful comparison, but this was not possible as in order to count the number of eggs inserted into the rice stem dissection of the host plant would be required and this would damage the eggs and the host plant. The results obtained suggest that some factor other than temperature was responsible, in the bioassay system used, for producing relatively poor hatchability. One reason for this could be that during the plant dissection and transfer of eggs to the hatching chamber some damage was inflicted to the eggs. Another reason may be that eggs became desiccated due to a lower humidity in the hatching chamber, as planthoppers have been shown to be sensitive to humidity in the egg stage.

Data available in the literature (Suenaga, 1963) suggests that at 25°C on the host plant up to 91.5% hatchability can be achieved. Therefore this method of removing eggs directly from the host plant in order to obtain first instar nymphs is not ideal, compared with allowing the eggs to hatch *in vivo* and obtaining nymphs directly from the host plant. The poor results obtained in this bioassay would make it difficult to use as a routine method for producing large numbers of nymphs for subsequent insect bioassays. Based on this conclusion further investigations were carried out to try and improve the hatching viability of eggs removed from the host plant, by modifying the hatching chamber to allow nymphs to obtain diet directly on emergence thus preventing death from starvation after emergence. The results obtained using the modified hatching chamber are described below:

3.2.1.2 Using eggs removed from the host plant (Method 2)

Although this method was essentially the same as that described earlier (Section 3.2.1.1) with the exception of including artificial diet and reducing the number of eggs per hatching chamber, the hatching percentage achieved was higher (Figure 9). When artificial diet, MED-1, was supplied 69% of the eggs hatched and using the MMD-1 diet hatching was only marginally higher at 72%, and not significantly different. The duration of hatching was 2-8 days, which is similar to the result obtained using the earlier method.

One possible reason why the hatching percentage appears higher is that in the earlier experiment is that the egg population may have had poor viability prior to hatching, as the eggs were not removed from the same rice plant and were not oviposited by the same female adult BPH. Female BPH show high variability in the number of eggs they oviposit (Suenaga, 1963) and the viability of eggs hatched may vary between females. Another possible reason for the poor hatching viability, using the earlier method, may be that the humidity in the hatching chamber was lower due to there being only a single layer of Parafilm present over the chamber and once this is punctured by stylet penetration moisture may evaporate from the hatching chamber. BPH eggs are prone to desiccation in low humidity conditions in the field situation and no doubt the same environmental effect can affect eggs in the hatching chamber.

Having established that results obtained in hatching bioassays were highly variable, depending on the method used, and that eggs were prone to damage during dissection from the host plant a combined oviposition and hatching bioassay was designed. To remove the need for the host plant as an oviposition site BPH adult females were allowed to oviposit into ovipository media through a Parafilm M membrane. Adults were caged within a feeding chamber which fitted on top of the oviposition chamber (Figure 5), and allowed to feed on either of two formulations of artificial diets (Table 1). The results of these bioassays are discussed in Section 3.2.1.3.

3.2.1.3 Combined oviposition and hatching bioassays

The results of the bioassays carried out to examine BPH preference for ovipository media, adult survival artificial diet/oviposition media and viability of eggs laid in artificial media are summarised in Table 2.

(a) Effect of oviposition media on oviposition

The combination of 5% {w/v} sucrose and 0.004M salicylic acid, as an ovipository medium, appeared to stimulate adult BPH to oviposit, whether the adults were provided with MMD-1 or MED-1 artificial diets. The mean number of eggs produced per adult was 2.8 (MMD-1) or 3.8 (MED-1) when using the combination of salicylic acid and sucrose as an oviposition media. No eggs were oviposited into the control oviposition chamber, containing distilled water, for either treatment.

Using a 5% sucrose concentration {w/v} alone as an oviposition media fewer eggs were oviposited, than in the sucrose/salicylic acid media, when using both MMD-1 and MED-1 artificial diets. The mean number of eggs oviposited in 5% sucrose was 2.0 (MMD-1) or 2.7 (MED-1) eggs per adult. Using both formulations of oviposition media the number of eggs hatched per female was very low compared with the rate of egg production on the host plant which can be up to a maximum of 1472 eggs per adult (Suenaga, 1963).

Figure 8: Graph to show the hatching viability of BPH eggs removed from the host plant and allowed to hatch in a plastic hatching chamber without access to artificial diet, (30 eggs per replicate, 10 replicates per treatment).

Figure 9: Graph to show the hatching viability of BPH eggs removed from the host plant and allowed to hatch in a plastic hatching chamber with access to artificial diet, MED-1 or MMD-1, (10 eggs per replicate, 10 replicates per treatment).

Figure 8

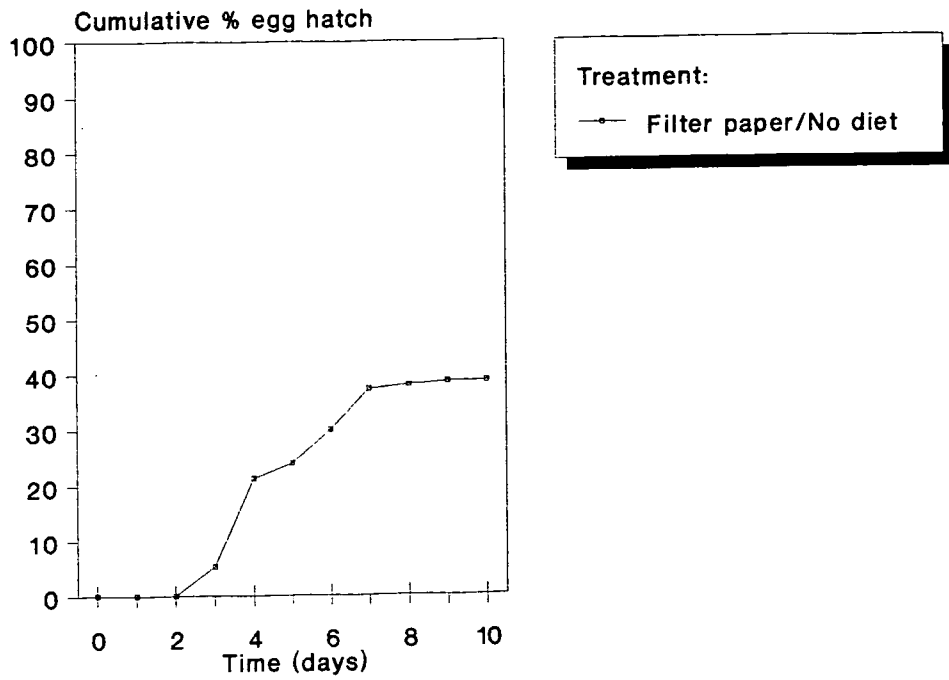
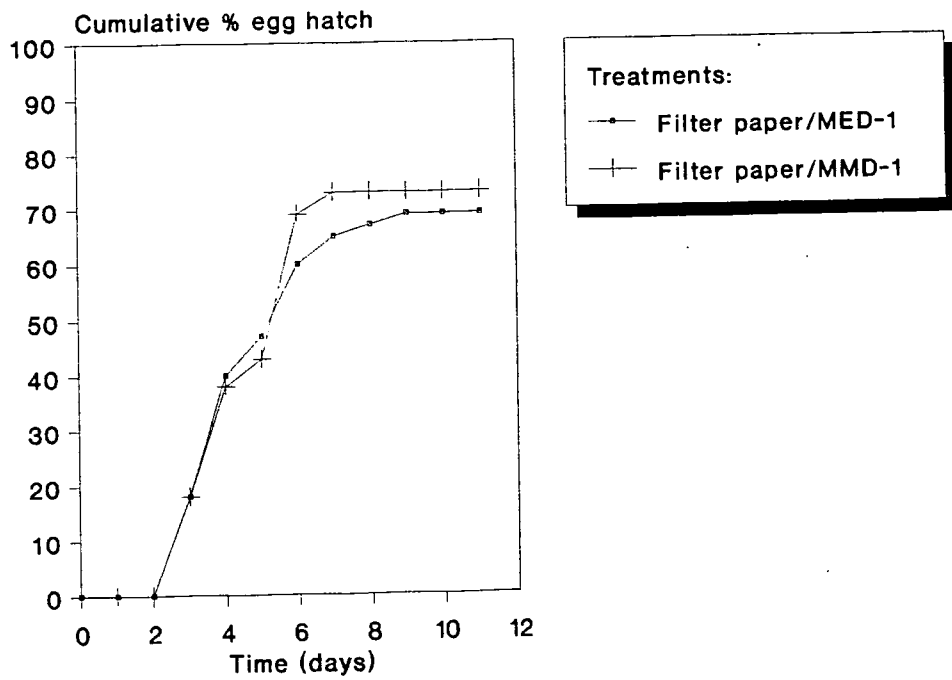

Figure 9



Salicylic acid in combination with sucrose as an oviposition media has previously been shown to stimulate oviposition and probing for BPH but not GLH, however although acting as a probing stimulant salicylic acid has also been shown to act as a sucking inhibitor (Sekido and Sogawa, 1976).

The limited numbers of eggs produced by this method made it unsuitable for rearing large numbers of BPH nymphs for subsequent bioassays. GLH was not tested using this method as other workers have shown that this insect cannot oviposit in an oviposition chamber (Hou and Lin, 1979).

(b) Effect of oviposition medium on nymphal emergence

When using the combination of 5% sucrose and 0.004M salicylic acid as an oviposition media and MMD-1 or MED-1 as an artificial diet no nymphs emerged after 12 days. Therefore the presence of 0.004M salicylic acid appeared to delay nymphal emergence or reduce egg viability dramatically. Saxena and Puma (1979b) have shown that if BPH eggs are incubated for three days in the antifeedant 0.5% *trans*-aconitic acid prior to hatching the hatching % is reduced. It may be the case that salicylic acid is therefore acting as an antifeedant in this case and further investigations would need to be carried out in order to confirm this possibility.

When 5% sucrose was used, as an oviposition medium with either MMD-1 or MED-1 as artificial diets the % of eggs which hatched to produce viable first instar nymphs was 31.1% and 44.4% respectively. The duration of nymphal emergence on eggs oviposited in 5% {w/v} sucrose solution by adults reared on MED-1 diet was 7-14 days, whereas the duration of nymphal emergence of eggs oviposited into the same medium by adults reared on MMD-1 diet was 7-17 days.

The hatchability of eggs oviposited in the 5% sucrose {w/v} oviposition media was higher than results obtained in the earlier methods used (where eggs were removed from the host plant). However hatchability was still low compared with hatchability on the host plant. Other workers have found similarly poor results when using egg collecting devices (Mitsubishi, 1970) and some hoppers, such as GLH, do not oviposit at all.

(c) Effect of artificial diet and oviposition media on nymph survival rates

The maximum survival of nymphs which were oviposited, into 5% {w/v} sucrose, from adults reared on MED-1 artificial diet was 4 days compared to 5 days for adults reared on MMD-1 (Table 2). The latter diet slightly increased longevity of nymphs in this bioassay.

Table 2: Comparison of hatching and oviposition data resulting from thirty BPH female adults fed on selected artificial diets (MMD-1, MED-1) and given access to selected oviposition media (sucrose = 5% {w/v}, salicylic acid = 0.004M).

Artificial Diet	Oviposition Media	Eggs per adult (mean)	% Eggs hatched	Days to hatching	Adult survival (maximum-days)	Nymph survival (maximum - days)
MED-1	Sucrose/salicylic acid	2.8	0	-	4	-
MMD-1	Sucrose/salicylic acid	3.8	0	-	8	-
MED-1	Sucrose	2.7	44	10	6	4
MMD-1	Sucrose	2.0	31	9	18	5

(d) Effect of artificial diet and oviposition media on adult female survival

Adult females only survived for up to 6 days when the oviposition medium, 5% sucrose {w/v}, and the diet MED-1 were available to the insects, whereas when 5% sucrose {w/v} (oviposition medium) and MMD-1 were made available the adult survived for a maximum of 18 days (Table 2). The diet MMD-1 appeared to increase adult survival when compared to the diet MED-1.

When 0.004M salicylic acid and 5% sucrose {w/v} were used as an oviposition medium the maximum survival length of the adults was reduced to 4 days and 8 days for adults fed on MED-1 and MMD-1 diets respectively. Therefore salicylic acid appeared to increase adult mortality.

Whilst BPH could oviposit away from the host plant, the number of eggs that emerged into the first nymphal stage was relatively low and hence this method could not be used to produce large numbers of nymphs to be used in subsequent bioassays. However, by incorporating artificial diet into the bioassay, results appeared to show that adult BPH could survive for a longer period on MMD-1 diet than MED-1 diet. For subsequent bioassays I decided to examine the effect of the two artificial diets on development and survival of first instar nymphs removed directly from the host plant. The results of these bioassays are described:

3.2.2 Artificial diet comparison bioassays

Initially MED-1 diet was examined in bioassay at four different sucrose concentrations of 5%, 10%, 20% and 30% {w/v}. Results, presented in Figure 10, show that there was little effect on BPH nymphal survival when the sucrose concentration was varied in the diet. At all the four sucrose concentrations examined nymphal survival was over 60% higher than the control at day 2 of the experiment (Figure 10). The maximum length of survival of nymphs on all four treatments tested was 5 days only one day longer than the control. This is relatively low when compared with the insects natural life cycle (Section 1.2.5.1).

These results are somewhat surprising when compared with work carried out by Koyama (1981) and Mitsuhashi (1979) who claim that they could successfully rear BPH to adulthood on MED-1, and that there is no difference in survival when comparing both MMD-1 and MED-1 artificial diets. However Mitsuhashi (1970, 1974) states that growth of BPH on MED-1 is poor, particularly in the first instar.

Having determined that MED-1 seemed a relatively poor artificial diet on which to rear BPH, a second diet formulation MMD-1 was examined using the same bioassay procedure. Two sucrose concentrations, 5% and 30%, in the diet were tested and it was found that 30% sucrose in the diet resulted in marginally higher nymphal survival at day

4 than the 5% sucrose concentration (Figure 11), but this was not significant ($p > 0.05$). This is not too surprising when one considers that the sucrose concentration of rice phloem sap collected by laser stylectomy of BPH whilst feeding is within the range 17-22% {w/v} (Chino *et al.*, 1982).

Having shown that MMD-1, at either 5% or 30% sucrose concentration {w/v}, was a suitable media on which to rear BPH nymphs for several days a bioassay was carried out to establish the pH optimum of the diet. It was decided to use 5% sucrose solution {w/v} for subsequent pH comparison bioassays as Koyama (1985a) has shown that larval development is retarded at higher sucrose concentrations and Sogawa (1972) suggests that at this level sucrose is phagostimulatory.

The effect of diet pH was examined using MMD-1 which was adjusted to either pH 6.5 or pH 8.0 and fed to first instar nymphs. Results show that the pH 8.0 diet treatment gave a corrected mortality value of 11.5% compared with the control treatment (pH 6.5 diet). There was therefore no significant difference ($p > 0.05$) difference in % survival of artificial diet fed insects when the pH is varied within this range (Figure 12). Other workers have used MMD-1 at pH 6.5 to rear a range of planthoppers (Mitsuhashi, 1974) successfully. However one might expect that a pH 8.0 diet would be more suitable for the insect as this corresponds to the pH of rice phloem sap (Fukomorita and Chino, 1982). Sakai and Sogawa (1976) claim that at 5-10% sucrose level ingestion of artificial diet by BPH is low and at 20% ingestion is at its highest and the optimal pH range for ingestion is 5-7.

When survival of first instar nymphs on MED-1 and MMD-1 diets were compared, the MMD-1 diet gave the best results of the diets tested. However, this diet is unlikely to be optimal for BPH. It may not be possible to produce a truly optimal artificial diet for BPH when one considers that the sucrose and amino acid levels within the rice plant actually fluctuate depending on the environmental conditions prevailing (Chino, Hayashi and Fukomorita, 1987). In the field situation the surface texture of the rice plant plays a part in plant selection by BPH (Cook *et al.*, 1987) and it is possible that, as the texture of the feeding sachet membrane is dissimilar to the plant surface, feeding may be reduced in the bioassay system used here. The growth stage of the rice plant also affects the rate of feeding and BPH plant selection.

There are two extraneous factors which may have affected the mortality of nymphs used in these bioassays. Research carried out on aphids has shown that the presence of toxins in distilled water in which the artificial diet is prepared can increase larval mortality (Adams and van Emden, 1972) and the distilled water used here was not examined for toxin presence. Other workers have noted that volatiles from plastic feeding chambers can retard the development of both host plant and insect in bioassays using barley plants and the greenbug, *Toxoptera graminum* (Chada, 1962). However preliminary feeding trials carried out using glass and plastic feeding chambers (results not

included) showed that there were no deleterious effects on insect survival when using the plastic vessels.

Having found a suitable artificial diet on which to rear first instars, subsequent bioassays were designed in which a number of plant derived proteins could be tested for possible antimetabolic or insecticidal effect towards either BPH, GLH or PPA.

3.3 *In vitro* protein feeding trials

Initially a range of proteins, including inert proteins, lectins, enzymes and enzyme inhibitors, were tested against first instar *Nilaparvata lugens*, rice brown planthopper (BPH) nymphs. In later bioassays third instar BPH and *Nephotettix cinciteps*, rice green leafhopper (GLH), nymphs were used in preference to first instar nymphs because they were easier to handle, less prone to damage during handling and could be reared for a longer duration. A modified bioassay system was established for PPA which is a polyphagous insect and has a different feeding behaviour and life cycle to BPH and GLH. Initially a wide range of proteins were tested against BPH nymphs and selected proteins were tested against GLH and PPA.

The results of *in vitro* protein feeding trials against all three insects are discussed:

3.3.1 Feeding trials using first instar BPH

In feeding trials using first instar BPH nymphs MMD-1 artificial diet could support development up to and including the fourth instar with a maximum survival of 14 days. Some insects could survive for up to 4 days in the absence of diet, presumably as a result of food reserves acquired from the host plant prior to removal for feeding trials.

Seven proteins were tested against first instar BPH nymphs (Table 3). Of the lectin treatments tested both GNA and WGA showed significant antimetabolic effects ($p < 0.001$), when incorporated at a level of 0.1% {w/v}, with corrected mortalities values in the range of 56-93% and 58-96% respectively (mean corrected mortality values from three bioassays are presented in Table 3). For both lectins the survival period was significantly reduced and followed clearly that of starved nymphs (Figure 13). Of the other lectins tested, *Pisum sativum* agglutinin (PSA) showed no significant effect ($p > 0.05$) and *Phaseolus vulgaris* agglutinin (PHA) showed a less significant ($p < 0.05$) antimetabolic effect in comparison (as illustrated in Table 3). The enzyme inhibitor, cowpea trypsin inhibitor (CpTI), and the inert protein, ovalbumin (OVA), showed no significant effect ($p > 0.05$) on nymphal mortality. Bovine serum albumin (BSA) significantly enhanced insect survival ($p < 0.001$) suggesting that the insects may be utilising the protein as a nutrient source and this could be utilised as a dietary component in further artificial diet studies. Figure 14 shows the mortality curves for CpTI treatments emphasising the null effect of the CpTI treatment.

Figure 10: Graph to show the effect of varying the sucrose concentration of the artificial diet MED-1, on the survival of first instar BPH nymphs, (5 nymphs per replicate, 10 replicates per treatment).

Figure 11: Graph to show the effect of varying the sucrose concentration of the artificial diet MMD-1 on the survival of first instar BPH nymphs, (5 nymphs per replicate, 10 replicates per treatment; $G_{adj} = 3.064$, $p > 0.05$).

Figure 10

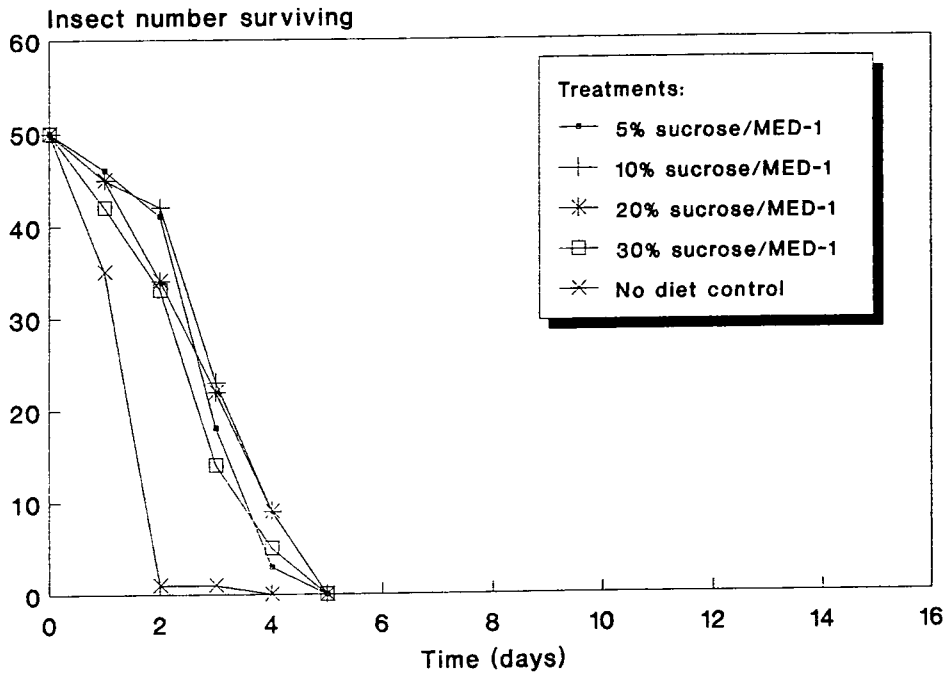

Figure 11

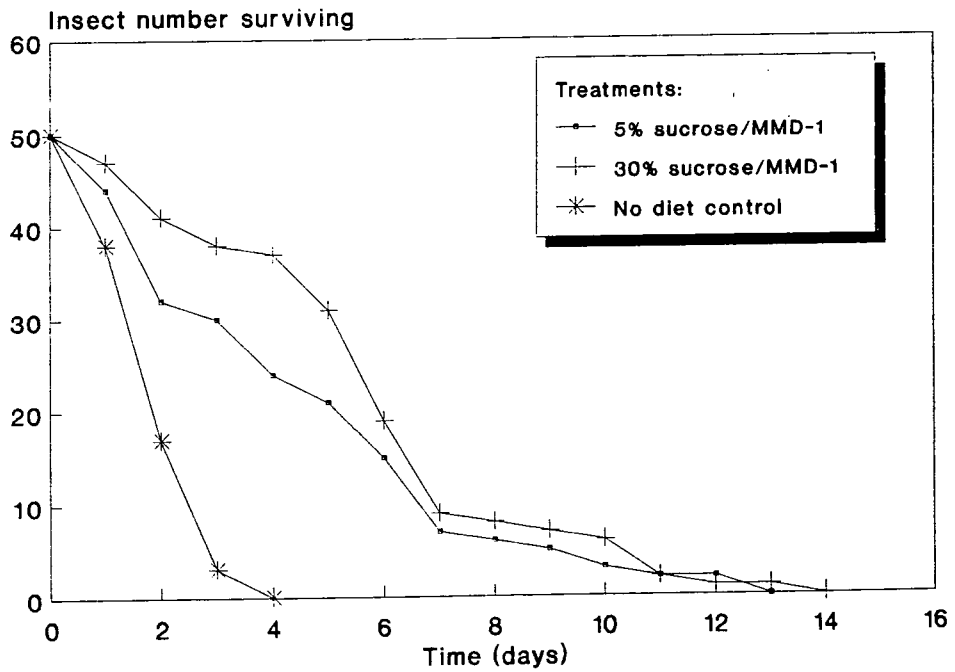

Figure 12: Graph to show the effect of varying the pH of the artificial diet, MMD-1, on first instar BPH survival, (5 nymphs per replicate, 10 replicates per treatment, $G_{adj} = 0.16$, $p > 0.05$).

Figure 12

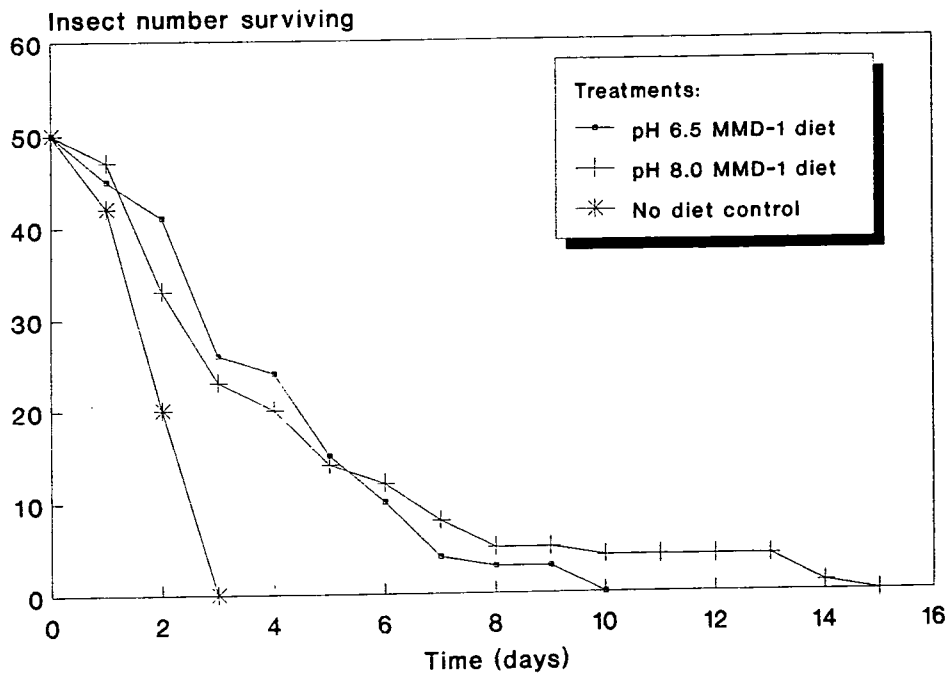

Table 3: Mortalities of first instar nymphs of *Nilaparvata lugens* when fed on an artificial diet, MMD-1, with a protein incorporated at 0.1% concentration {w/v}. (5 nymphs per replicate, 10 replicates per treatment).

Treatment	% Corrected Mortality	<i>G adj</i>	<i>PHo: Con = Tr</i>
Inert proteins			
OVA	4	0	>0.05
BSA	-138	12.554	<0.001
Lectins			
GNA	76	42.224	<0.001
PHA	27	4.528	<0.05
PSA	-10	0.164	>0.05
WGA	75	42.80	<0.001
Enzyme Inhibitors			
CpTI	-13	0.160	>0.05

Figure 13: Graph to show the effect, on first instar BPH survival, of incorporating (a) wheat germ agglutinin (WGA) and (b) *Galanthus nivalis* agglutinin (GNA) at 0.1% concentration {w/v}, into the artificial diet MMD-1, (5 nymphs per replicate, 10 replicates per treatment).

Figure 13a

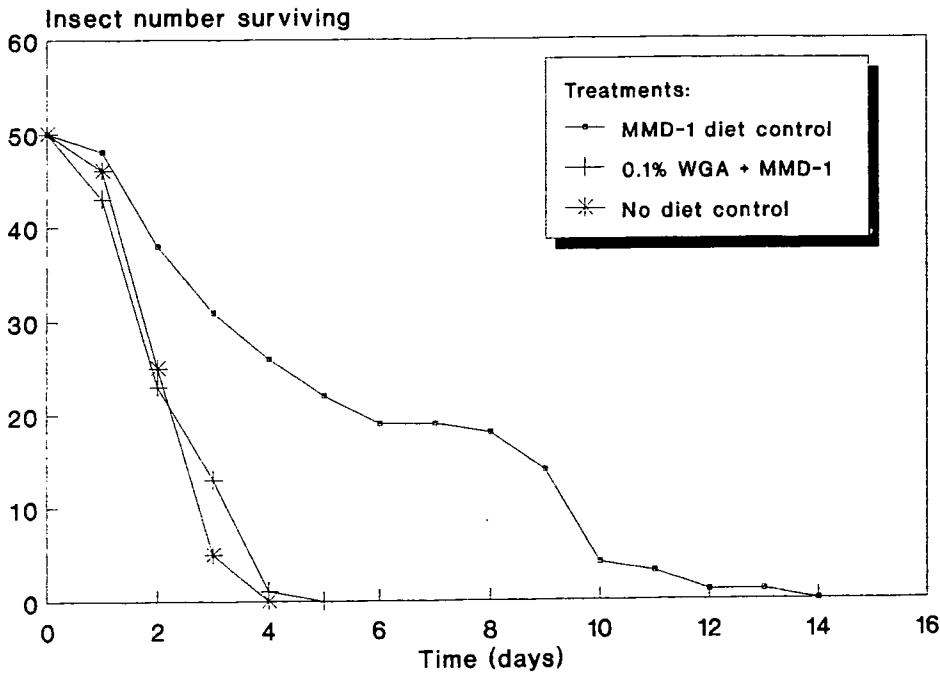

Figure 13b

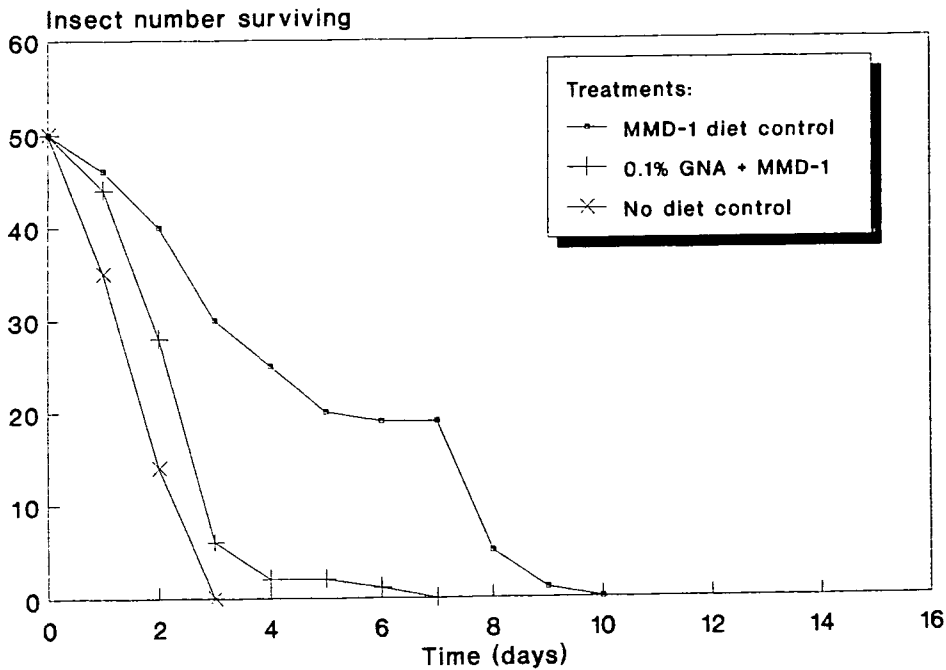
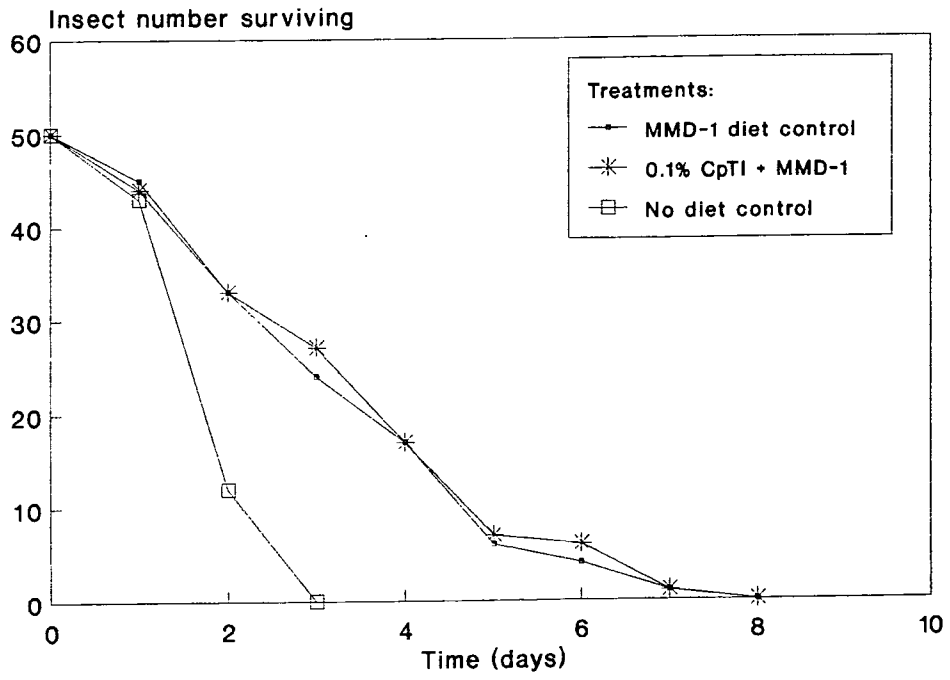

Figure 14: Graph to show the effect, on first instar BPH survival, of incorporating cowpea trypsin inhibitor (CpTI) at 0.1% concentration {w/v}, into the artificial diet MMD-1, (5 nymphs per replicate, 10 replicates per treatment).

Figure 14



3.3.2 Feeding trials using third instar nymphs

Feeding trials were repeated with third instar BPH nymphs to confirm and extend the results obtained with first instar nymphs. MMD-1 diet could not support the development of these insects beyond the fifth instar to the adult stage, however, even though development was retarded, nymphs could survive for a maximum of 20 days on diet alone, allowing sufficient time in which to test a range of proteins for potential insecticidal properties. Mitsuhashi (1974) found that BPH could only develop to the fourth instar when fed on MMD-1. Over the first four days of each bioassay nymphal survival when starting the bioassay with third instars was considerably higher on the diet only control than when using first instars. This could be due to the fact that first instar nymphs are easily damaged when handled and smaller nymphs may be prone to drowning in water droplets formed due to the high humidity in the feeding chambers. Koyama (1981) has shown that first instars of other planthopper insects are affected by poor humidity. Third instar BPH may also be physiologically more adaptable to a diet change than first instars. Some BPH nymphs could survive for a maximum period of 6 days in the absence of diet.

This bioassay system was also used for *Nephotettix cinciteps* (rice green leafhopper; GLH). GLH nymphs could not be supported to the adult stage on MMD-1 diet and survived only for a maximum of 15 days. Mitsuhashi (1974) found that GLH could not develop beyond the fourth instar on MED-1 diet. This is probably due to the fact that GLH requires a cholesterol source in its diet which is not included in the MMD-1 diet formulation. However Hou and Lin (1979) found that even when rearing GLH on an artificial diet containing a sterol source mortality was high in the first three instars, and they suggest the absence of turgor pressure is an important factor in nymph survival. In the absence of diet GLH nymphs could survive for a maximum of 6 days. In all, sixteen proteins were tested against third instar BPH nymphs (Table 4) and three proteins against third instar GLH nymphs (Table 5):

Lectins

The lectins, horse gram agglutinin (HGA), jacalin agglutinin (JCA), concanavalin A (Con A), *Solanum tuberosum* agglutinin (STA) and *Phaseolus vulgaris* agglutinin (PHA) showed no significant ($p > 0.05$) antimetabolic effect on BPH nymphal mortality, when tested at levels of 0.1% {w/v} with corrected mortality values well below the 50% level. However, the lectins GNA and WGA showed significant antimetabolic effect ($p < 0.001$) towards BPH nymphs (Figure 15) with corrected mortalities in the range of 69-89% and 71-82% respectively (mean corrected mortality values from 3 bioassays are presented in Table 4). This confirms the results obtained when testing the same lectins against first instar BPH (Table 2). *Lens culinaris* agglutinin (LCA) showed a less significant effect ($p < 0.05$) on insect mortality.

Of the two lectins tested against GLH nymphs, only GNA showed significant antimetabolic effects ($p < 0.001$), with a corrected mortality of 87%, and WGA no significant ($p > 0.05$) antimetabolic effects (Table 5).

Enzyme inhibitors

The enzyme inhibitor wheat α -amylase inhibitor (WAI) showed no significant antimetabolic effect (> 0.05) towards third instar BPH nymphs (Table 4).

Enzymes

When tested against third instar BPH nymphs the enzyme soybean lipoxygenase V (LPO) showed significant antimetabolic effect ($p < 0.001$), in replicated bioassays with corrected mortalities of 100% (results not presented). However the result obtained using this enzyme preparation could not be substantiated, as it was discovered that the commercial preparation used was found to contain 2.3M ammonium sulphate which when tested separately in feeding trials also showed significant toxic effect against third instar BPH nymphs (data not presented), with corrected mortalities of up to 100%.

A second commercial preparation of LPO (soybean lipoxygenase 1-B), free from ammonium sulphate, was therefore tested against third instar BPH nymphs and it showed a significant ($p < 0.001$) antimetabolic effect (Figure 16), when incorporated at 0.08% {w/v} concentration, with corrected mortalities in the range of 55-92%, whereas the enzymes potato polyphenol oxidase (PPO) and *Streptomyces griseus* chitinase (Chase) showed no significant ($p > 0.05$) antimetabolic effect. When tested against GLH nymphs, soybean lipoxygenase (LPO) showed no significant ($p > 0.05$) antimetabolic effect (Table 5). BPH and GLH have different feeding behaviours, feeding on different regions of the rice plant, the stem and the leaf respectively, and thus the antimetabolic effect of LPO on BPH may be related to the different stylet structures of the two insect genera.

Table 4. Mortalities of third instar nymphs of *Nilaparvata lugens* when fed on an artificial diet with a protein incorporated at known % concentration {w/v}. (5 nymphs per replicate, 10 replicates per treatment).

Treatment	% Corrected Mortality	G adj	PHo:Con=Tr
Lectins¹			
GNA	79	104.642	<0.001
WGA	78	61.724	<0.001
LCA	22	4.336	<0.05
Con A	30	1.980	>0.05
HGA	28	2.726	>0.05
JCA	-3	0	>0.05
PHA	0	-	-
STA	-2	0	>0.05
Enzyme Inhibitors¹			
WAI	-4	0	>0.05
Enzymes			
Chase ²	0	-	-
PPO ³	12	0.330	>0.05
LPO ⁴	85	63.724	<0.001

1 Treatment incorporated at 0.1% {w/v}

2 Treatment incorporated at 0.09% {w/v}

3 Treatment incorporated at 0.02% {w/v}

4 Treatment incorporated at 0.08% {w/v}

Table 5. Mortalities of third instar nymphs of *Nephotettix cinciteps* when fed on an artificial diet with a protein incorporated at known % concentration {w/v}. (5 nymphs per replicate, 10 replicates per treatment).

Treatment	% Corrected Mortality	G adj	PHo: Con = Tr
Lectins¹			
GNA	87	11.11	<0.001
WGA	15	0.674	>0.05
Enzymes²			
LPO	5	0.052	>0.05

1 Treatment incorporated at 0.1% {w/v}

2 Treatment incorporated at 0.08% {w/v}

Figure 15: Graph to show the effect, on third instar BPH survival, of incorporating either wheat germ agglutinin (WGA) or *Galanthus nivalis* agglutinin (GNA) at 0.1% concentration {w/v}, into the artificial diet MMD-1, (5 nymphs per replicate, 10 replicates per treatment).

Figure 16: Graph to show the effect, on third instar BPH survival, of incorporating soybean lipoxigenase (LPO), at 0.08% concentration {w/v}, into the artificial diet MMD-1, (5 nymphs per replicate, 10 replicates per treatment).

Figure 15

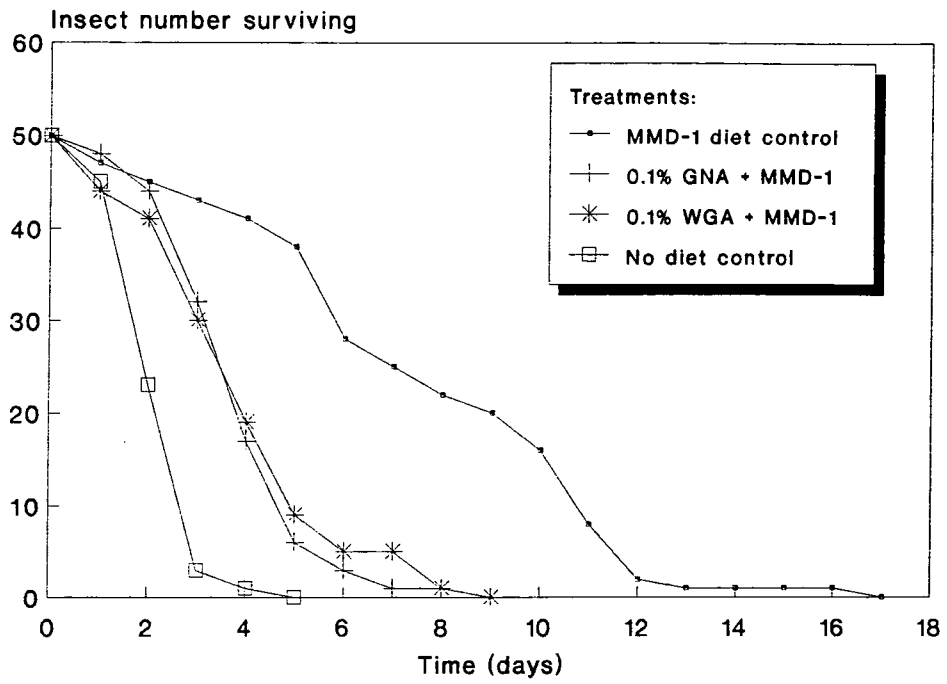
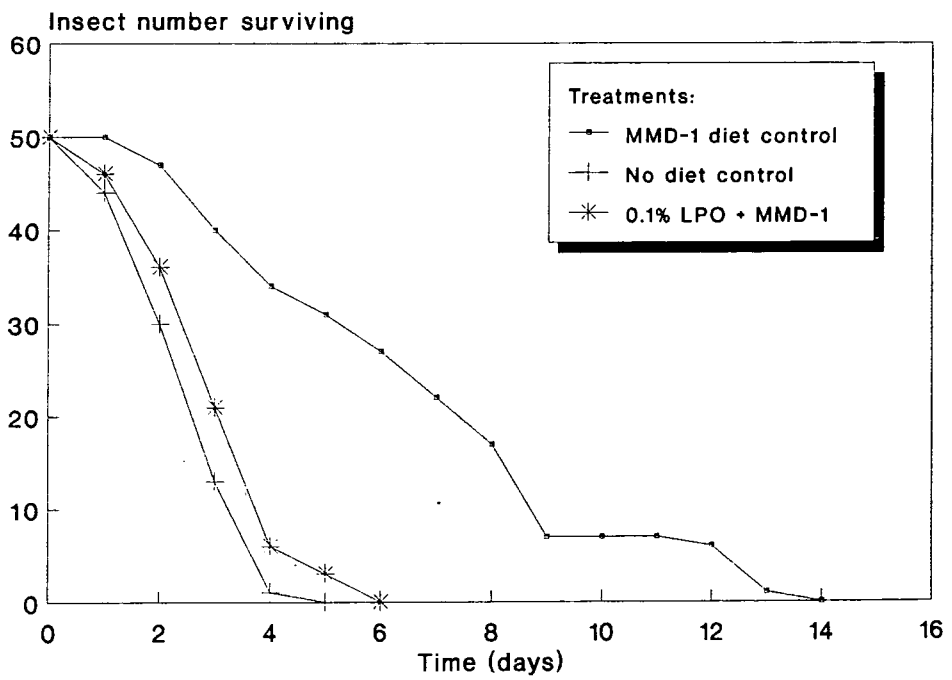

Figure 16



3.3.3 Pressurised insect bioassays

In insect diet bioassays in which proteins were tested and artificial diets compared the nymphs never developed to the adult stage on artificial diet. A bioassay was designed in which diet was supplied to the insect under simulated sap turgor pressure, to determine whether this would increase the amount of diet the insect could imbibe and hence improve the insects rate of development.

Pilot bioassays were carried out to determine whether survival or development of third instar BPH nymphs would be enhanced when pressure was applied to the diet, since nymphs failed to develop to adulthood when artificial diet was supplied under ambient pressure, and thus the bioassay system, although valid, was suboptimal. Mean corrected mortality and development data from three bioassays comparing the effect of diet supplied under ambient pressure and diet supplied under simulated sap pressure (SSP) are summarised in Table 6. Up to 48% of nymphs reached adulthood on artificial diet when the pressurised bioassay system was used, compared with no nymphs reaching adulthood with diet supplied under ambient conditions. Nymph survival was significantly improved ($p < 0.001$) when diet was supplied using the pressurised diet technique.

BPH can no doubt imbibe diet, probably by sucking, under ambient pressure conditions as under these conditions survival was enhanced in earlier bioassays (Section 3.2.2) but there is an obvious improvement in survival and development rates when applying pressure to the diet. This may be because by increasing the pressure applied to the diet this indirectly increases BPH feeding through an increased uptake in phagostimulants. Longevity of the aphid, *Aphis fabae*, increases when feeding on 10% sucrose {w/v} supplied via a Parafilm feeding sachet under 2kg/cm^2 pressure (van Emden, 1967) and *Myzus persicae* and *Brevicoryne brassicae* showed significant increases in adult longevity and larviposition when diet is supplied pressurised up to 2 atmospheres (Wearing, 1968). Aphids possess, within the head region, a cibarial-pharyngeal food pump which assists the passage of liquid food, by muscular action, through the pharynx to the oesophagus (Auclair, 1963). When insects feed on the host plant, phloem sap probably passes through the stylet to the food pump by capillary force and turgor pressure and the amount of sap ingested must therefore depend on both the level of sap pressure, stylet dimensions and the sap viscosity. Mittler (1967b) measured the sap flow rate through the severed stylet bundle of *Oncopeltus fasciatus* and showed that sap is under considerable turgor pressure and it would not be necessary for the bug to suck plant sap. Mittler (1970) has also shown that *Myzus persicae* feeding on host plants imbibe twice as much plant sap and excrete twice as much honeydew as insects feeding on artificial diet, resulting in a doubling of body size and he suggests, without any firm evidence, that this may be due to sap pressure from the host plant.

When diet was supplied under pressure it could support the development of a proportion of the BPH nymphs to the adult stage whereas under ambient pressure conditions no adults developed. All adults which developed on artificial diet were also macropterous. This may be due to some nutritional deficiency in the diet as some work on *Myzus persicae* (Mittler and Kleinjan, 1970) has indicated that poor nutrition enhances apterous production in aphids. The production of brachypterous adults in *Laodelphax striatellus* (smaller brown planthopper) is dependent on the level of the B vitamin, folic acid, in the artificial diet (Mitsuhashi and Koyama, 1974).

As no insects reached the adult stage when supplying diet to nymphs under ambient pressure, the modified "pressurised" insect bioassay system was therefore considered a better model for the situation *in planta*.

Only one of the previously tested proteins, GNA, was tested against third instar BPH nymphs using this method (Figure 17). When testing GNA at 0.1% concentration {w/v} results were similar when compared with the same protein supplied under ambient pressure, with corrected mortalities of 69% (ambient pressure) and 73% (simulated sap pressure). This is somewhat surprising as one might expect that with phloem turgor pressure more protein would be made available to the nymphs resulting in a further increase in mortality. One possible reason why this did not occur maybe that the protein is unpalatable to the insect, acting as a sucking deterrent or antifeedant and thus preventing the insect from imbibing more diet and hence more protein. However if this were the case the results from the control (i.e. no diet) and the treatment (i.e. GNA) should be similar as in effect the insect would be suffering from starvation. Another mechanism could be that at a GNA concentration of 0.1% {w/v} there is sufficient GNA present to block all the relevant receptor sites, either in the gut membrane or at other binding sites, therefore any increase in the concentration would have little or no effect. Evidence from dose response curves (Section 3.3.4) indicate that increasing the GNA concentration above 0.05% {w/v} will have little effect on insect mortality.

Following the comparative success of this method, against the earlier ambient pressure bioassay, it was used in feeding trials to test the proteins lysozyme (LYZ), *Tulipa gesneriana* agglutinin (TGA), and *Oryza sativa* agglutinin (OSA). OSA and TGA had no significant effect on nymph mortality ($p > 0.05$) whilst LYZ significantly increased mortality ($p < 0.05$) when tested at 0.1% {w/v} concentration but not as significantly as GNA. Mean corrected mortalities, for LYZ, from two bioassays are shown in Table 7.

Table 6: Summary of third instar BPH nymph development and survival rates when fed on artificial diet, MMD-1, supplied under either ambient (AP) or simulated sap pressure (SSP). (Mean of 3 bioassays, n=50).

Mean % nymphs reaching adulthood under SSP	Mean % nymphs reaching adulthood under AP	Mean maximum insect survival (days) under SSP	Mean maximum insect survival (days) under AP	% Corrected Mortality of SSP fed BPH at Day 5	Gadj	PH ₀ : Con= Tr
42±4	0	20±3	18±2	119	135.022	<0.001

Figure 17: Graph to show the effect, on third instar BPH survival, of incorporating *Galanthus nivalis* agglutinin (GNA) at 0.1% concentration {w/v}, into the artificial diet MMD-1, supplied under either ambient or simulated sap pressure conditions. (5 nymphs per replicate, 10 replicates per treatment).

Figure 17

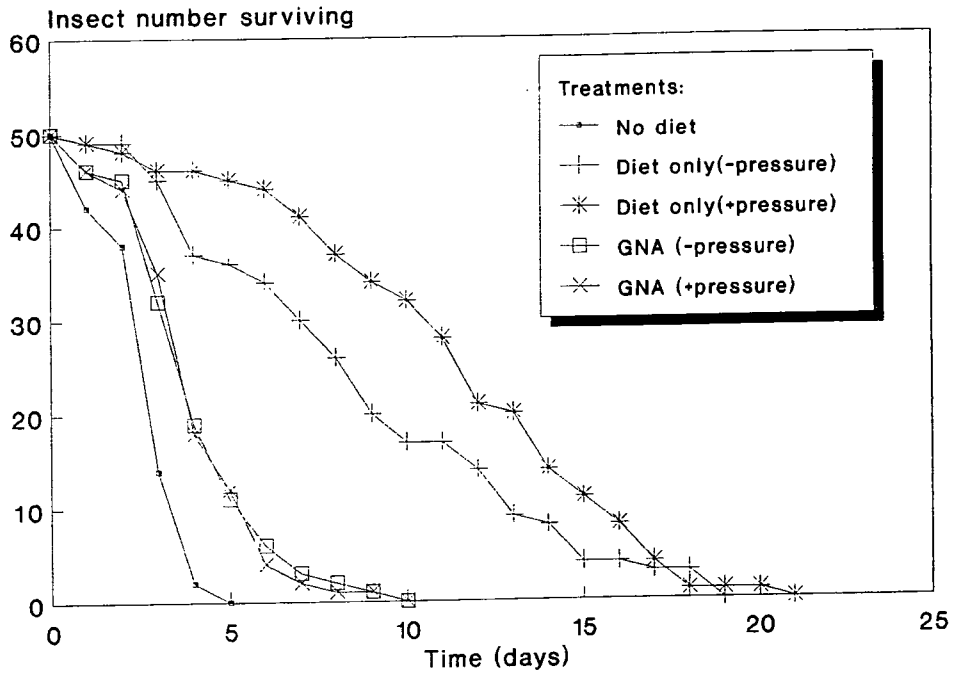

Table 7: Mortalities of third instar nymphs of *Nilaparvata lugens* when fed on an artificial diet, MMD-1, with a protein incorporated at 0.1% concentration {w/v}, supplied under simulated sap pressure. (5 nymphs per replicate, 10 replicates per treatment).

Treatment	% Corrected Mortality	Gadj	PHo: Con = Tr
Lectins			
TGA	38	3.284	>0.05
OSA	15	1.138	>0.05
GNA	73	42.598	<0.001
Enzymes			
LYZ	23	7.96	<0.05

Conclusions to *in vitro* protein feeding trials

All three proteins, GNA, WGA and LPO which showed highly significant ($p < 0.001$) effects, on BPH mortality, have been shown by other workers to produce antimetabolic effects towards other insect orders (Shukle and Murdock, 1983., Huesing, 1991., Gatehouse, pers. comm.) but not as yet in the Homopteran order of pests. Other proteins and enzymes tested here showed either less significant ($p < 0.05$) or no significant ($p > 0.05$) antimetabolic effects, suggesting that the mechanism of action of GNA, WGA and LPO are quite specific. The two most effective lectins have different sugar binding specificities, GNA binding specifically to mannose residues (van Damme, Allen and Peumans, 1987) and WGA to N-acetylglucosamine (GlcNAc) residues, and it is interesting to note that other lectins with similar binding specificities showed little or no antimetabolic effect in comparison. ConA, LCA and PSA, although having primary specificity for mannose, did not appear to affect BPH survival, this may be due to the fact that these lectins also bind to glucose and differ in their subunit structure and binding site configuration (Lis and Sharon, 1981). In recent studies where the pea aphid, *Acyrtosiphon pisum*, was fed a range of proteins in artificial diets (Rahbé and Febvay, 1992; 1993) the lectins PSA, ConA and LCA showed strong lethal and inhibitory properties towards the insect, whereas WGA was not effective. TGA although mannose specific (Oda and Minami, 1986) also inhibits L-fucose equally well (van Damme, Allen and Peumans, 1988) and this may be an important factor in determining its null effect against BPH.

Lectins with different sugar-binding specificities can affect insect development, and lectins with similar specificities can vary in their degrees of toxicity. LCA, PSA, STA, HGA and PHA have all been tested *in vitro* against the southern corn rootworm (SCR) and European corn borer (ECB) and found to be non-toxic, whereas WGA was lethal towards ECB at 2% level and inhibited SCR larval growth (Czapla and Lang, 1990). Habibi, Backus and Czapla (1992) have tested 14 lectins against potato leafhopper and found WGA significantly reduced insect survival when incorporated within the range 0.2-1.5% {w/w}, however they also found that LCA, PSA, HGA and PHA significantly reduced survival and one lectin actually improved survival. However antibiotic was incorporated into the artificial diet in their feeding trials and it is worth considering whether this was detrimental to the insects symbionts which may in turn have affected the insects physiology and hence the effectiveness of the lectins. Huesing (1991) screened seventeen plant lectins, using an artificial seed diet system and found that 5 lectins with either N-acetylgalactosamine (GalNAc) or GlcNAc binding specificity caused significant delays in development of the bruchid beetle *C. maculatus*. The most active lectins in the GlcNAc group being WGA (which delayed development at 0.1% concentration by 22 days) and OSA. Huesing, Murdock and Shade (1991a) proposed that the differing degrees in GlcNAc binding lectin toxicity against *C. maculatus*, was

related to molecular size and binding site number. All six WGA isolectins appear to be equally detrimental to the growth of *C. maculatus* (Huesing, Murdock, Shade, 1991a) and both OSA and WGA have similar biological activity against *C. maculatus* (Huesing, Murdock and Shade, 1991b). OSA has 78% sequence homology with WGA isolectin A and lower homologies with the other WGA isolectins, the same number (four) of carbohydrate binding sites and the same molecular weight (36,000). This does not explain why OSA, although having the same specificity as WGA and 4 times the agglutinating activity, did not significantly effect the mortality of BPH and suggests that some other factor apart from carbohydrate-binding specificity is involved in determining anti-metabolic effect.

With regards to the mechanism of action of WGA and GNA it seems plausible to suggest that either the lectins are acting against specific, and as yet unidentified, digestive enzymes present in either the salivary glands or alimentary canal, or they are causing disruption of the gut membrane by binding to specific receptor sites or they have some anti-feedant properties. Gatehouse *et al.*, (1984) suggested that *Phaseolus vulgaris* lectin binds to the midgut epithelial cells of *C. Maculatus*. Chrispeels and Raikhel (1991) suggest that WGA affects insect development by binding to chitin in the peritrophic membrane and interfering with nutrient uptake and the tolerance of *Acanthoscelides obtectus* to PHA has been attributed to the inability of lectin molecules to pass through the peritrophic membrane pores in order to bind to the midgut epithelium. However, this is purely speculation and cannot be the mechanism involved against the homopteran pests tested here as they do not need a peritrophic membrane to protect the midgut as they feed on a liquid diet, although they do possess a perimicrovillar membrane (Forbes and MacCarthy, 1969) which could act as a barrier to lectin molecules and potential binding sites. If the effective lectins are acting by binding to the midgut epithelium of BPH this could not be observed either by LM or EM techniques discussed later (Section 3.5).

One important factor to consider when selecting a suitable candidate protein for use as a transgenic protectant is whether the protein is toxic to mammals. Although a number of lectins, including PHA and WGA have been shown to retard growth and initiate morphological changes in rat small intestine GNA, only binds transiently to the brush border of this animal (Pusztai *et al.*, 1990).

Of the enzymes, enzyme inhibitors and inert proteins tested only the enzymes LPO and LYZ showed significant antimetabolic effects towards BPH nymphs whilst Chase, CpTI, BSA, OVA, PPO and WAAI, showed little or no antimetabolic effect. Recent studies have shown that, Chase, CpTI, BSA and LYZ were not effective against the aphid *Acyrtosiphon pisum* in artificial diet feeding trials (Rahbé and Febvay, 1992, 1993).

With regards to the possible mechanism of action of LPO against BPH one can only speculate until further experimental work has been carried out. The first experimental evidence that soybean lipoxygenase was insecticidal was shown when *M. sexta* were fed



LPO at 1-4% concentration and larval growth was inhibited (Shukle and Murdock, 1983). Three possible mechanisms of action were suggested from this work:

- (i) Lipoxidase destroys unsaturated fatty acids carotenoids and steroids which might affect artificial diet components,
- (ii) Unsaturated fatty acids produced by lipoxidase may be indirectly or directly toxic towards the insect,
- (iii) Lipid components of the insect gut cellular membrane may be destroyed.

Duffey and Felton (1989) further suggested that LPO mechanisms include :

- (iv) impairment of insects ability to digest food
- (v) reduction in protein digestibility
- (vi) decrease amino acid availability
- (vii) decreased enzyme activity

I would like to speculate further and suggest that LPO may be affecting the production of lipoproteinaceous material which is essential in the production of stylet sheaths by the BPH when feeding, thereby LPO may be either preventing efficient stylet probing or may cause blocking of the stylet pathway resulting in insect starvation. However there is no current evidence to support this claim.

3.3.4 Dose response determination

Initially dosage-response curves were constructed for the proteins, GNA, WGA and LPO as these proteins had exhibited significant insecticidal properties towards third instar BPH *in vitro* in protein feeding trials. Dose response relationships were also examined for the mannose-binding lectins *Allium sativum* agglutinin (ASA) and *Narcissus pseudonarcissus* agglutinin (NPA) which have the same sugar binding specificity as GNA but differ in their molecular configuration.

Dose response relationships were shown when feeding the proteins LPO, GNA, WGA, ASA and NPA at known concentrations within the range 0.0125 and 0.1% {w/v}, to third instar BPH. When comparing the dose response curves of GNA and WGA the concentration giving 50% mortality or the LC₅₀ values are very similar being 0.025% and 0.02% {w/v} respectively (Figure 18 and 19). The enzyme LPO had a higher LC₅₀ value of 0.05% {w/v} (Figure 20), this value was surprising considering the high corrected mortality values observed at 0.1% concentration in earlier feeding trials (Section 3.4.2). A possible explanation for this may be that as a different commercial batch of LPO was used in the dose response feeding trials, compared with that used in the initial feeding trials and unfortunately the original batch was not retained in order to compare its enzyme activity.

When comparing the dosage response curves of the mannose-binding lectins GNA, NPA and ASA there appeared to be a correlation between the molecular structure of the lectin and its LC_{50} value. These mannose binding lectins are serologically identical but have different molecular structures (van Damme, Allen and Peumans, 1988). In dose-response determination the tetramer, GNA appeared the most effective in terms of its lethal concentration with an LC_{50} value of 0.025%, whereas the trimer NPA and the dimer, ASA had higher LC_{50} 's of 0.07% and >0.1% respectively (Figure 21).

3.3.5 Pyramid feeding trials

As the proteins GNA, WGA and LPO all exhibited antimetabolic activity towards BPH *in vitro* (Section 3.4.2) these proteins were tested in combination *in vitro*, using the modified pressure feeding method, in order to determine whether a combination of proteins would result in an enhanced synergistic or additive effect. When GNA and LPO were tested in combination at sub-optimal concentrations, of 0.025% {w/v} and 0.05% {w/v} respectively, (as determined by dosage response curves - Section 3.3.4) no significant additive or synergistic effect on mortality could be measured (Figure 22). The corrected mortality of the combined protein treatment being 54%, as compared with corrected mortalities of 54% and 46% for the single protein treatments of GNA and LPO respectively. When GNA and WGA were tested in combination at optimal concentrations of 0.025% {w/v} and 0.02% {w/v} again no significant additive or synergistic effect could be measured (Figure 23). The corrected mortality values for the combined protein treatment being 94%, and the values from GNA and WGA were 41% and 88% respectively. The combination of LPO and WGA also appeared to have no apparent additive or synergistic effect (Figure 24), with the corrected mortality for the combination being 51%, compared with 28% and 50% for the single treatments LPO and WGA, tested at concentrations of 0.05% {w/v} and 0.02% {w/v}, respectively.

Assuming that both proteins in each pyramid bioassay have different mechanisms of action these results would seem surprising as one might expect either a synergistic or additive effect. However if we assume, as suggested from honeydew excretion measurements (discussed later in Section 3.8) that one or both proteins is acting as an antifeedant one would not expect that a combination of the two would result in an additive or a synergistic effect as the insect would be deterred from feeding on the mixture due to the presence of antifeedant(s). As all three combinations used in these feeding trials showed no significant effect (i.e. an additive or synergistic effect) this suggests that all three proteins are to some degree acting as feeding deterrents or antifeedants.

Figure 18: Graph to show the dose response relationship when incorporating *Galanthus nivalis* agglutinin (GNA), at concentrations within the range 0.0125-0.1% {w/v}, into the artificial diet MMD-1, supplied under simulated sap pressure to third instar BPH. (5 nymphs per replicate, 10 replicates per treatment).

Figure 19: Graph to show the dose response relationship when incorporating wheat germ agglutinin (WGA), at concentrations within the range 0.0125-0.1% {w/v}, into the artificial diet MMD-1, supplied under simulated sap pressure to third instar BPH. (5 nymphs per replicate, 10 replicates per treatment).

Figure 18

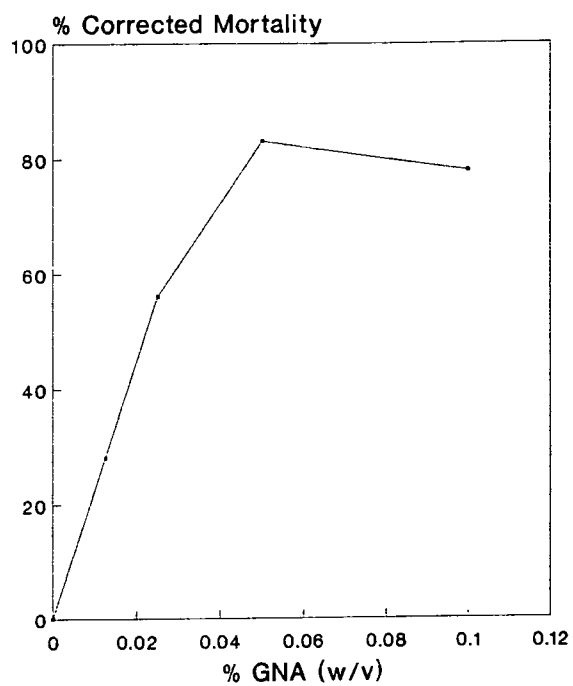

Figure 19

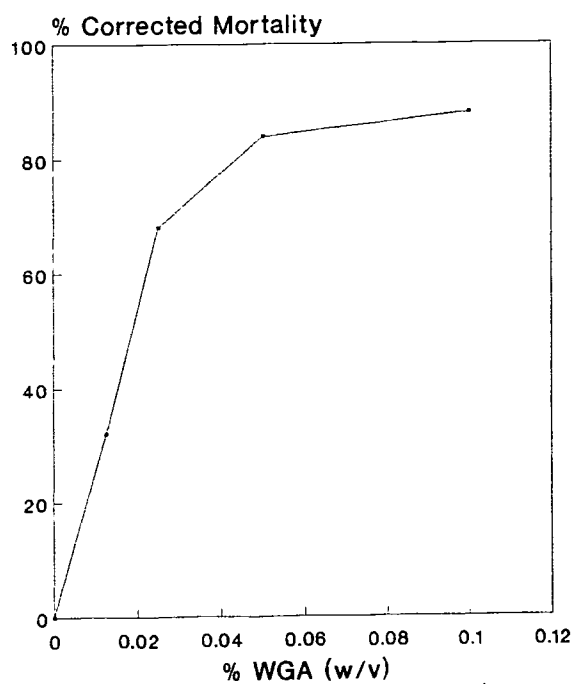

Figure 20: Graph to show the dose response relationship when incorporating soybean lipoxygenase (LPO), at concentrations within the range 0.0125-0.1% {w/v}, into the artificial diet MMD-1, supplied under simulated sap pressure to third instar BPH. (5 nymphs per replicate, 10 replicates per treatment).

Figure 21: Graph to show the dose response relationship when incorporating, the mannose binding lectins *Galanthus nivalis* agglutinin (GNA), *Allium sativum* agglutinin (ASA) and *Narcissus psuedonarcissus* agglutinin (NPA) at concentrations within the range 0.0125-0.1% {w/v}, into the artificial diet MMD-1, supplied under simulated sap pressure to third instar BPH. (5 nymphs per replicate, 10 replicates per treatment).

Figure 20

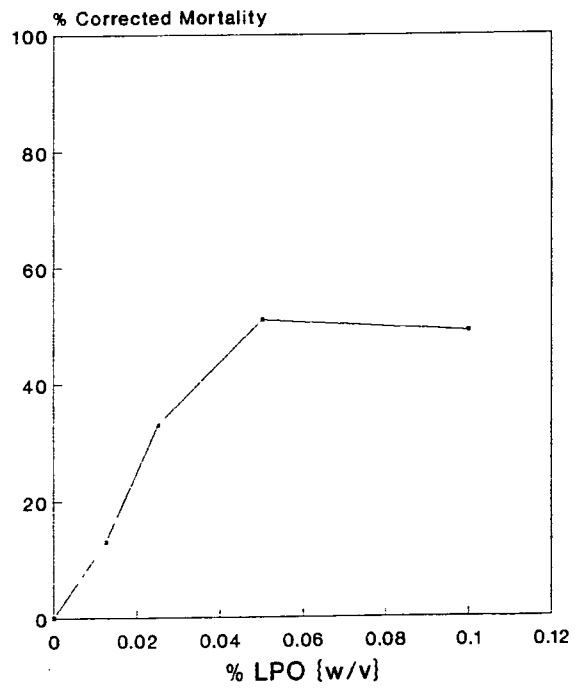

Figure 21

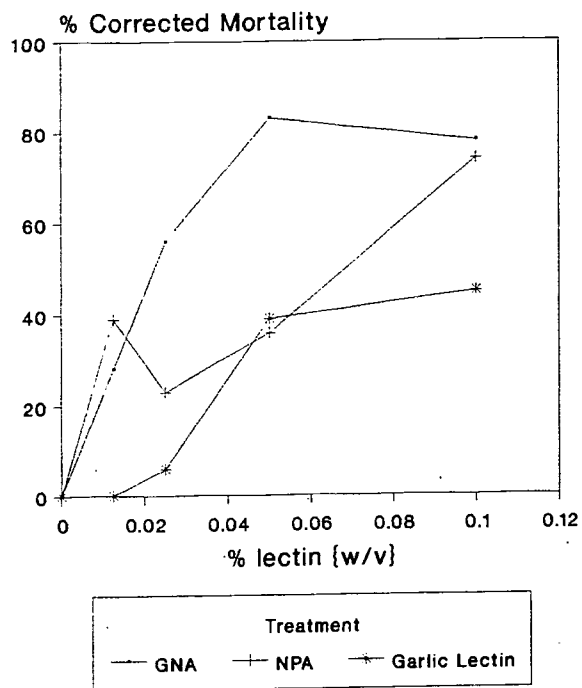

Figure 22: Graph to show the effect, on third instar BPH survival, of incorporating *Galanthus nivalis* agglutinin (GNA), at 0.025% and soybean lipoxygenase (LPO) at 0.05% {w/v} concentration either singly or in combination into artificial diet MMD-1. (5 nymphs per replicate, 10 replicates per treatment).

Figure 23: Graph to show the effect, on third instar BPH survival, of incorporating *Galanthus nivalis* agglutinin (GNA), at 0.025% and wheat germ agglutinin (WGA) at 0.02% {w/v} concentration either singly or in combination into artificial diet MMD-1. (5 nymphs per replicate, 10 replicates per treatment).

Figure 22

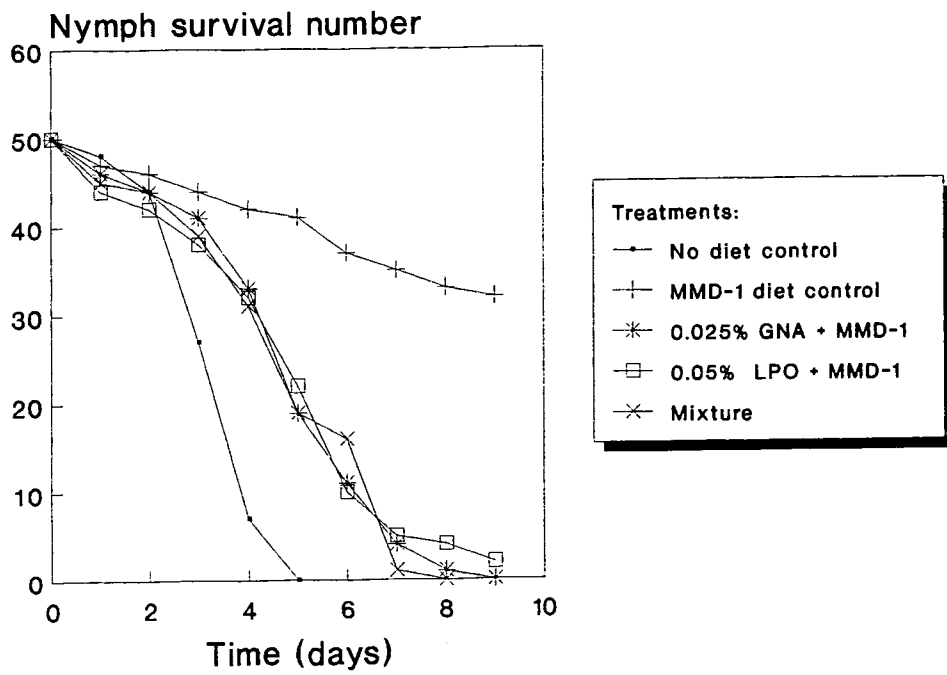

Figure 23

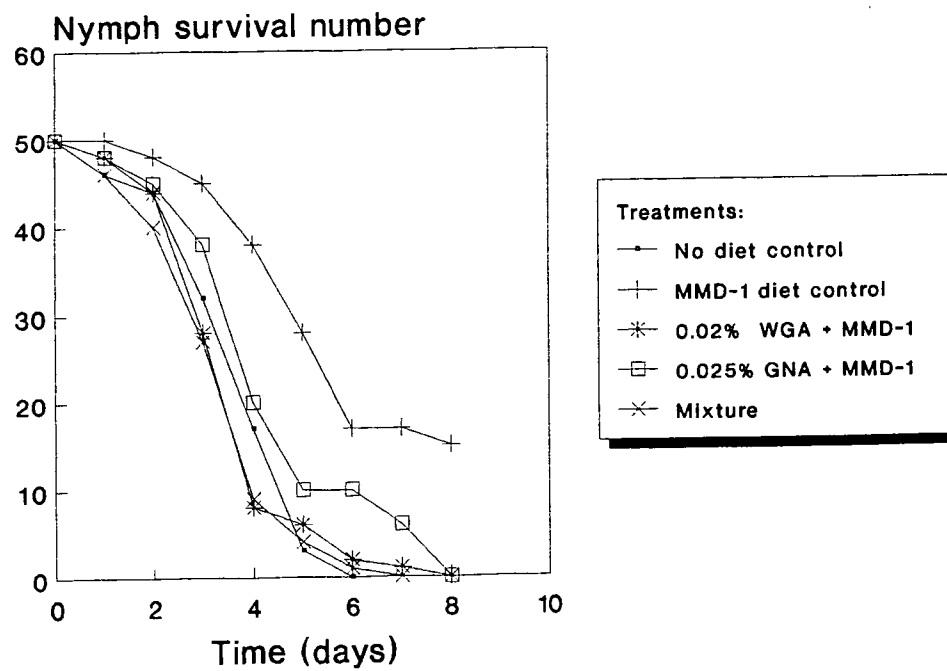

Figure 24

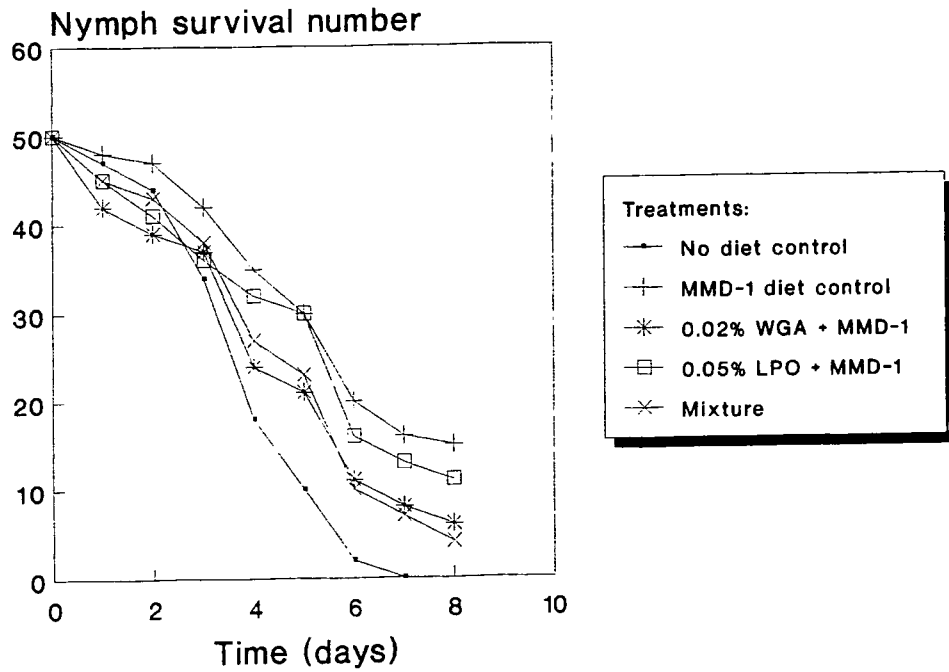

Figure 24: Graph to show the effect, on third instar BPH survival, of incorporating *Galanthus nivalis* agglutinin (GNA), at 0.025% and soybean lipoxygenase (LPO) at 0.05% and wheat germ agglutinin (WGA) at 0.02% {w/v} concentration either singly or in combination into artificial diet MMD-1. (5 nymphs per replicate, 10 replicates per treatment).

The idea of combining more than one protein to provide enhanced insecticidal effect against pests and delay resistance breakdown, in transgenic crop plants, termed pyramiding, has been demonstrated by other workers. The first demonstration of the pyramid gene approach to pest control was shown by the successful introduction of the CpTI and PSA gene combination by cross breeding transgenic tobacco lines, resulting in an additive protection against the lepidopteran pest *Heliothis virescens* (Boulter *et al.*, 1990) *in vivo*. Their results implied that a multigene multimechanistic effect can be used in transgenic plants as a novel form of crop protection. However my results suggest that this would not be a feasible approach, for BPH, using the protein combinations described here due to their probable antifeedant properties cancelling out or masking any synergistic or additive effects.

3.3.6 Peach potato aphid bioassays

As both BPH and GLH are monophagous pests of rice, and during the research period no transgenic rice was available to carry out *in vivo* feeding trials a "model" polyphagous homopteran pest, *Myzus persicae* (PPA), was used for further protein bioassays. PPA can feed and be reared for successive generations on tobacco plants which are "model" plants for genetic manipulation. A suitable *in vitro* bioassay was first designed in order to rear PPA away from the host plant and test proteins for insecticidal properties towards it:

3.3.6.1 Pilot feeding bioassays

Initial artificial diet feeding trials were performed in order to compare PPA survival and development on artificial diet DM66 (Table 1) when supplied under either ambient or simulated phloem sap pressure. Adult survival, fecundity and nymphal survival rates were recorded daily. When fed artificial diet, supplied under ambient pressure, adult PPA could survive for a maximum period of 8 days (Figure 25a), as compared with the control (starved) adults which survived for up to 3 days. Fifty adult PPA produced a total of 160 nymphs (Figure 25b) over the 8 day bioassay, representing a mean reproductive rate of 3.2 nymphs per adult during that period.

When the newly emerged nymphs were transferred to fresh feeding chambers and given access to the artificial diet DM66 supplied under ambient pressure conditions they could survive for up to 9 days (Figure 26) but did not fully develop to produce any progeny during that period, whereas control nymphs reared in the absence of diet, survived only for 3 days. These results indicated that successive generations of PPA could not be reared on DM66 artificial diet supplied under ambient pressure. When newly emerged nymphs were transferred to fresh feeding chambers and given access to artificial diet DM66, supplied under simulated sap pressure conditions, they could survive up to 10 days (Figure 26) and although there was no significant difference ($p > 0.05$) in mortality when compared with the ambient fed aphids the nymphs developed

to the adult stage and began to produce progeny after 5 days producing a total of 4 nymphs. However these new second generation progeny could only survive for a maximum of six days on artificial diet and consequently did not reach maturity. This modified method did therefore enable at least two aphid generations to be reared successively and this rearing method was therefore used in subsequent feeding trials, when testing proteins for potential insecticidal properties towards PPA. Holidic diets have been used successfully for aphid rearing since the early 1960's and the diet DM66 has proved a successful artificial diet for rearing up to eight different aphid genera (Kreiger, 1971). Other workers have reared *Myzus persicae* on a modified DM66 diet under ambient pressure for 3 successive generations (Ke and Qin, 1983) and some research groups claim that *Myzus persicae* can be reared on artificial diet for up to 45 successive generations under ambient conditions (Mittler and Koski, 1976). Klingauf and de Coll (1982) could rear the barley aphid *Diuraphis* on Ehrhardts (1968) diet for six generations under ambient pressure but found a reduced fecundity after two generations and when comparing survival on the host plant suggested that the artificial diet had been suboptimal.

Attempts at rearing *Myzus persicae* on phloem exudate from *Amsinckia douglasiana* have shown that development on artificial diet is better in comparison with development of insects reared on phloem sap from the host plant (Magayorsky, Singh and Mittler, 1979), but this may have been due to a difference in the amino acid concentrations or the presence of feeding deterrents in the phloem exudate.

3.3.6.2 *In vitro* protein feeding trials

Having observed the antimetabolic effects of GNA against BPH and GLH *in vitro* this lectin was tested against peach potato aphid (PPA). One day old PPA nymphs produced by adults feeding on DM66, supplied under ambient pressure, were chosen for feeding trials in order to eliminate any nutritional effects from the host plant.

When first instar PPA nymphs were fed GNA incorporated at 0.1% concentration {w/v} into artificial diet DM66, supplied under simulated sap pressure the following observations were made: first instar PPA nymphs could survive for up to 8 days compared with nymphs reared on the control diet alone, which survived for 13 days (Figure 27). In the absence of diet nymphs could survive for up to 2 days. The corrected mortality for GNA fed nymphs on day 2 of the trial was 33%, which represented a significant difference ($p < 0.001$) to the control diet fed nymphs. After 9 days feeding on control diet alone PPA had developed to maturity and began to produce new progeny which when transferred to fresh feeding chambers, survived for up to 6 days (results not shown), whereas GNA fed nymphs did not survive beyond the eighth day, did not develop to the adult stage and, therefore, did not produce progeny.

Graph 25a: Graph to show the effect, on adult *Myzus persicae*, peach potato aphid (PPA), survival when feeding on artificial diet DM66, supplied under ambient pressure conditions. (5 nymphs per replicate, 10 replicates per treatment).

Graph 25b: Graph to show the effect, on adult *Myzus persicae*, peach potato aphid (PPA) fecundity when feeding on artificial diet DM66, supplied under ambient pressure conditions. (5 nymphs per replicate, 10 replicates per treatment).

Figure 25a

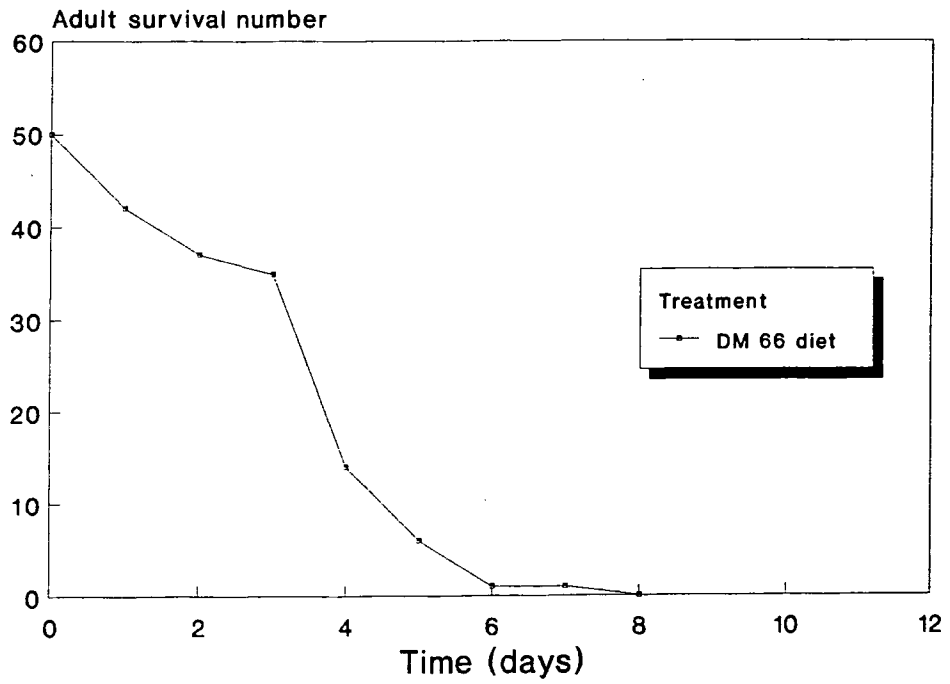

Figure 25b

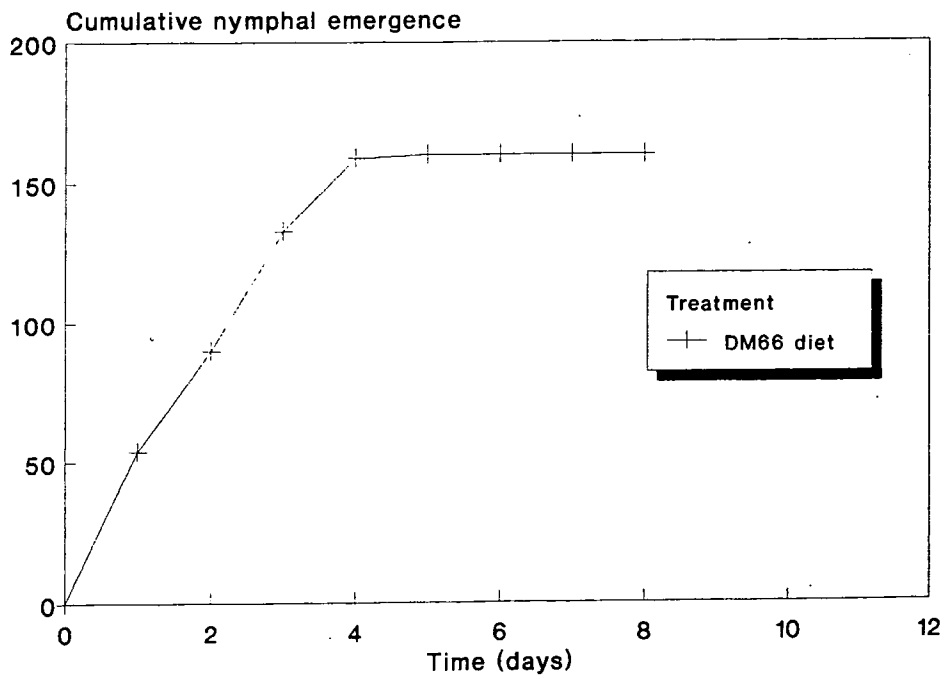

Figure 26: Graph to show the effect, on second generation first instar PPA survival, when feeding on artificial diet DM66 supplied under either ambient or simulated sap pressure conditions. (5 nymphs per replicate, 10 replicates per treatment; $p > 0.05$).

Figure 27: Graph to show the effect, on first instar PPA survival and fecundity, of incorporating *Galanthus nivalis* agglutinin (GNA) at 0.1% {w/v} concentration into artificial diet DM66 supplied under simulated sap pressure conditions. (5 nymphs per replicate, 10 replicates per treatment; $G_{adj} = 11.088$, $p < 0.001$).

Figure 26

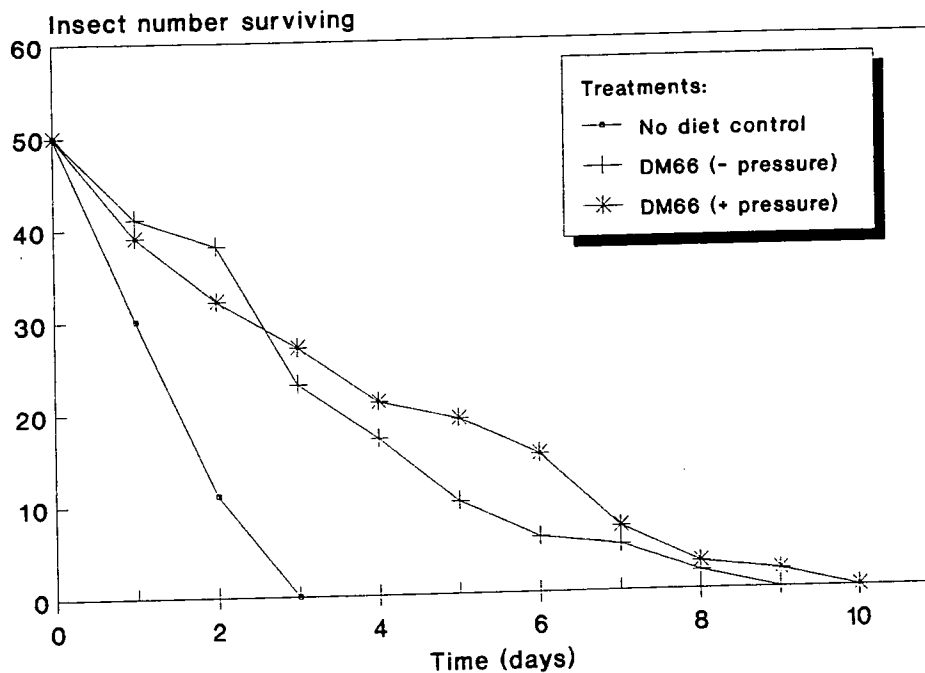
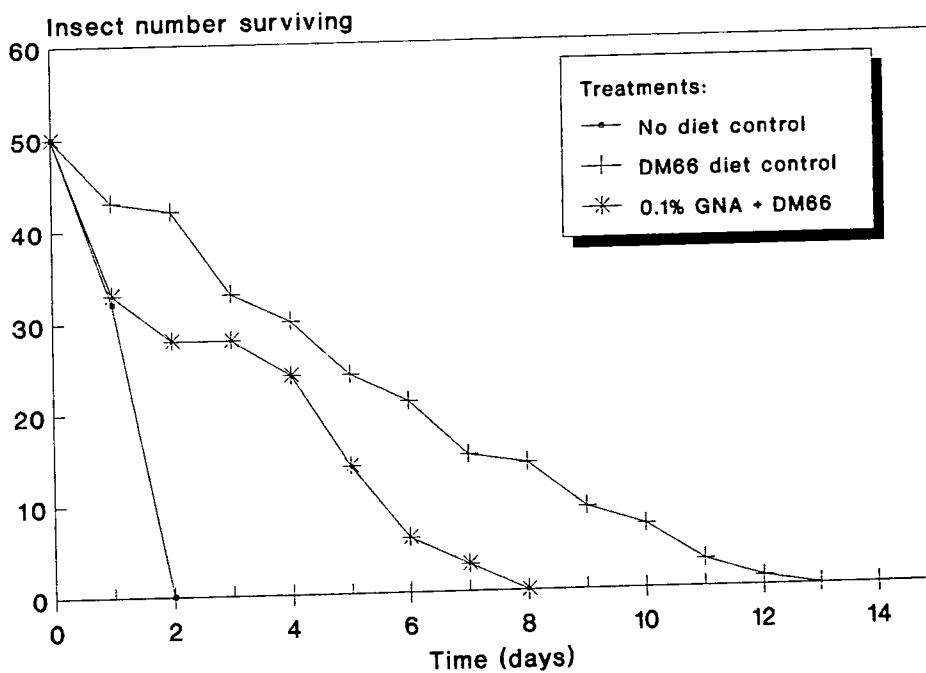

Figure 27



3.3.6.3 *In vitro* aphid development feeding trials

Having observed that in *in vitro* protein feeding trials GNA incorporated at 0.1% {w/v} concentration reduced PPA survival and delayed development more detailed studies, were carried out using image analysis techniques, to examine the effect of GNA on development by using body size as a development parameter:

PPA nymphs feeding on 0.1% GNA {w/v} incorporated in artificial diet showed a significant reduction in mean body length ($p < 0.001$), after 4 days, with a mean body length of 0.61mm when compared with a controls of artificial diet-fed nymphs and nymphs fed with 0.1% WAAI {w/v} (which has no significant effect on mortality - data not presented) with mean body lengths of 0.86 mm and 0.81mm respectively (Figure 28). The mean body width of PPA feeding on GNA was 0.26 mm which was significantly lower ($p < 0.001$) than control diet and WAAI fed nymphs, having mean body widths of 0.38mm and 0.37mm respectively (Figure 28). Thus it would appear that GNA, not only effects nymphal mortality significantly (Section 3.3.6.2) but also significantly reduces body size resulting in delayed development, which would in turn effect fecundity and the rate of population build up in the field situation. Aphid body size is a highly variable character subject to wide ranges (Sylvester, 1954).

3.4 *In planta* insect feeding trials

Having observed that GNA affected both mortality and development of PPA nymphs *in vitro*, feeding trials were carried out using transgenic tobacco plants expressing GNA at levels of 1.07-1.56% levels of total soluble protein in leaves, to determine whether GNA had the same effect *in vivo*. Clip cages were used to confine PPA adults to the upper surface of tobacco leaves, and adult survival and nymphal production were measured.

Over a ten-day period adult PPA mortality on GNA transformed tobacco plants was slightly lower when compared with control untransformed plants (Figure 29a) indicating that GNA had only a marginal effect on adult mortality. However, the fecundity of adults feeding on GNA transformants was significantly reduced compared with the adults feeding on control tobacco plants (Figure 29b). Mean production of nymphs per adult was 9.3 on control plants and 6.8 nymphs on GNA expressing plants over the trial period. This may reflect the fact that development is delayed, as indicated in the artificial diet bioassay (Section 3.3.6.3), resulting in 1-2 days delay in nymph production.

The clip cage method is a useful tool for examining the effect of insecticidal proteins *in planta* and has been used successfully by Dewar, Read and Thornhill (1988) to measure aphicide effectiveness against resistant clones of *Myzus persicae*. The present assay could be modified by putting the clip-cage on the lower surface of the leaves, since this is the preferred feeding site for PPA. Also, it might have been advantageous to have used a gene construct in which the GNA-encoding gene was expressed under the control

of a phloem-specific promoter, in order to ensure that the GNA was being expressed in the preferred feeding region (i.e. the phloem) of the target pest, although histochemical staining of the plants showed that GNA was present in the phloem sap (Shi, pers. comm.).

GNA has been expressed in tobacco and caused reduced biomass and decreased leaf damage by some pests of other insect orders (cited in Gatehouse *et al.*, 1992) and recently phloem-specific promoters have been used to express GNA in transgenic tobacco plants (Shi *et al.*, 1993).

3.5 MECHANISM OF ACTION OF ANTIMETABOLITES

Two approaches were taken to investigate the mechanism of action of antimetabolic proteins:

- (1) Examine the abdominal ultrastructure of BPH using various histo- and immunohistochemical techniques to determine whether the mode of action of proteins was to bind to specific regions, such as the midgut epithelium or the cell walls of yeast-like symbionts.
- (2) Analyse quantitatively and qualitatively honeydew excreted by BPH during feeding to determine whether the proteins acted as feeding deterrents or affected the utilisation of amino acids.

The results of ultrastructural and excretion studies are discussed below:

3.5.1 Determination of protein uptake

(a) Fluorescent microscopy studies

Before investigating the mode of action of specific proteins preliminary studies involved feeding fluorescein labelled GNA to adult BPH over a 48 hour period in order to substantiate the claim that the protein is imbibed by the insect.

No fluorescence was observed, using a fluorescent microscope, when examining filter paper disks from feeding chambers of insects feeding for 48 hours on control artificial diet (Plate 6a). Filter paper disks, removed from the feeding chambers of insects feeding on 0.1% {w/v} fluorescein-labelled GNA, showed the presence of fluorescent areas indicating the presence of excreted GNA in honeydew droplets (Plate 6b). These results indicate that GNA is imbibed by adult BPH and excreted to some degree. Further studies could be made by modifying this technique in order to determine the quantity of GNA imbibed and the quantity of GNA excreted in the insects honeydew.

Figure 28: Graph to show the effect, on first instar PPA body dimensions as measured by image analysis, of incorporating either *Galanthus nivalis* agglutinin (GNA) or wheat α -amylase inhibitor (WAAI) at 0.1% {w/v} concentration into artificial diet DM66 supplied under simulated sap pressure conditions. (5 nymphs per replicate, 10 replicates per treatment; Error bars represent SEM).

*(a) Unpaired t-test for aphid body length, mm.
Significance of difference*

Treatment	P-value
Control, WAAI	0.0637
Control, GNA	<0.0001

*(b) Unpaired t-test for aphid body width, mm.
Significance of difference*

Treatment	P-value
Control, WAAI	0.4500
Control, GNA	<0.0001

Fig. 28

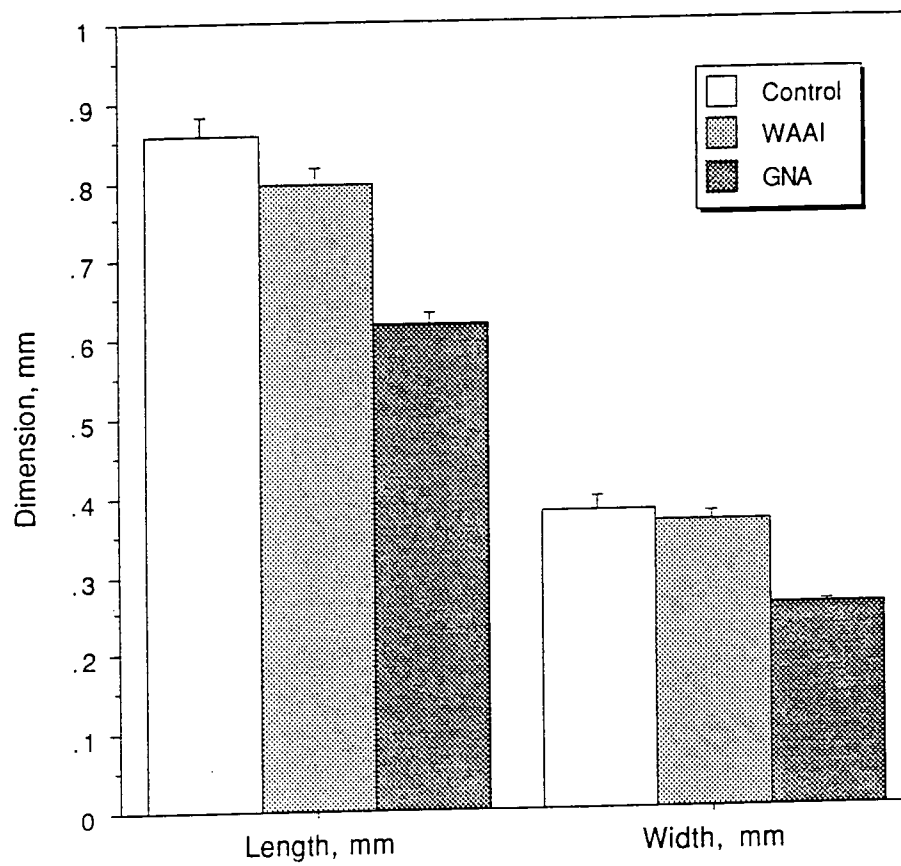

Figure 29a: Graph to show the effect, on adult PPA survival when feeding on *Galanthus nivalis* agglutinin (GNA) expressing transgenic tobacco plants. (Sample size: 10 aphids per replicate, 4 replicates per plant; 4 plants per treatment; Error bars represent SEM; repeated measures ANOVA treatment p-value= .1624).

FIGURE 29a

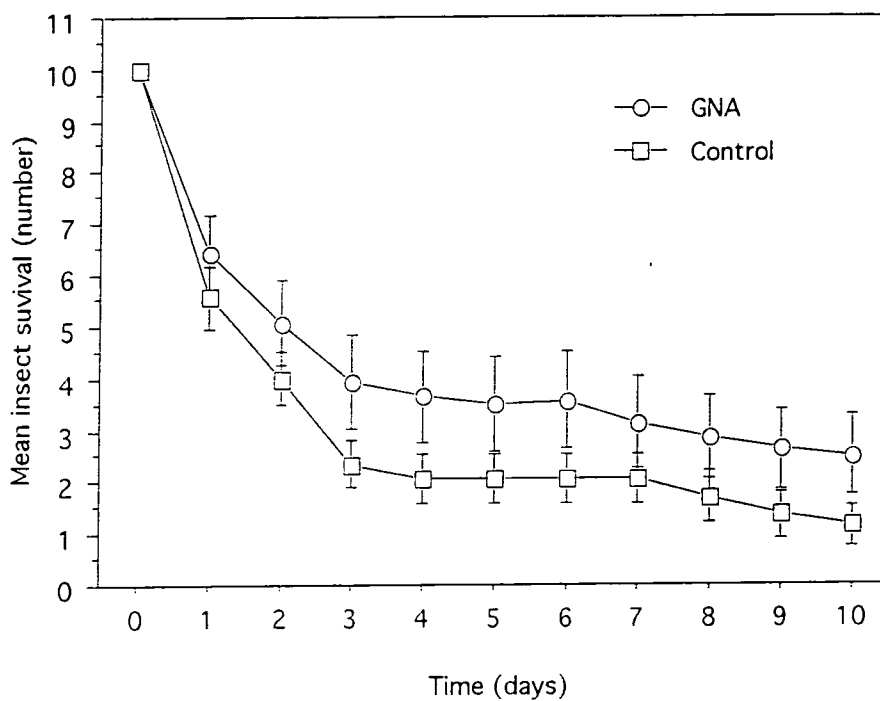

Figure 29b: Graph to show the effect, on adult PPA fecundity when feeding on *Galanthus nivalis* agglutinin (GNA) expressing transgenic tobacco plants. (Sample size: 10 aphids per replicate, 4 replicates per plant; 4 plants per treatment).

Figure 29b

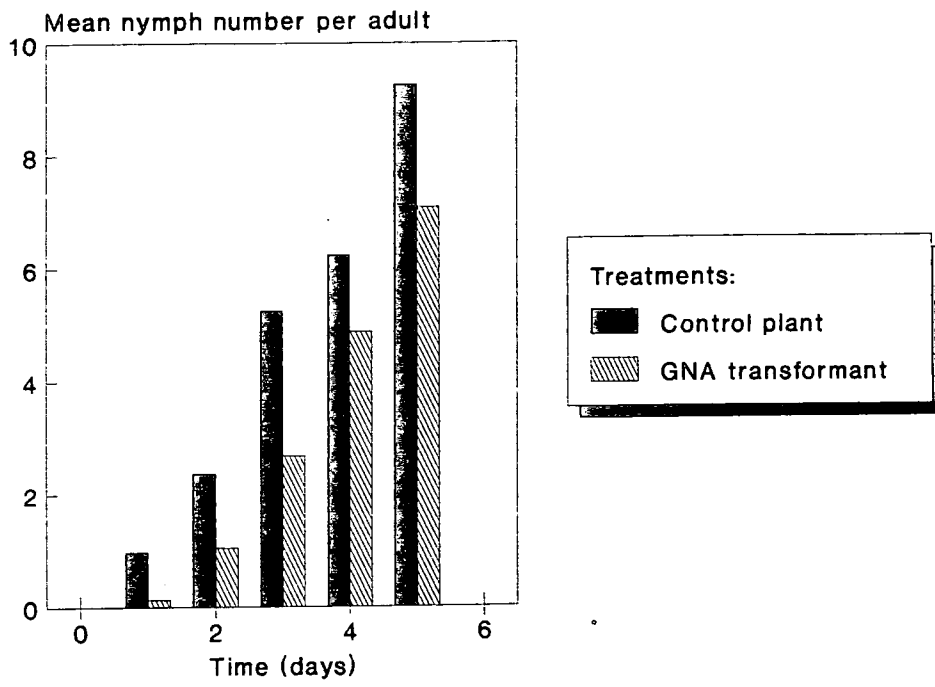
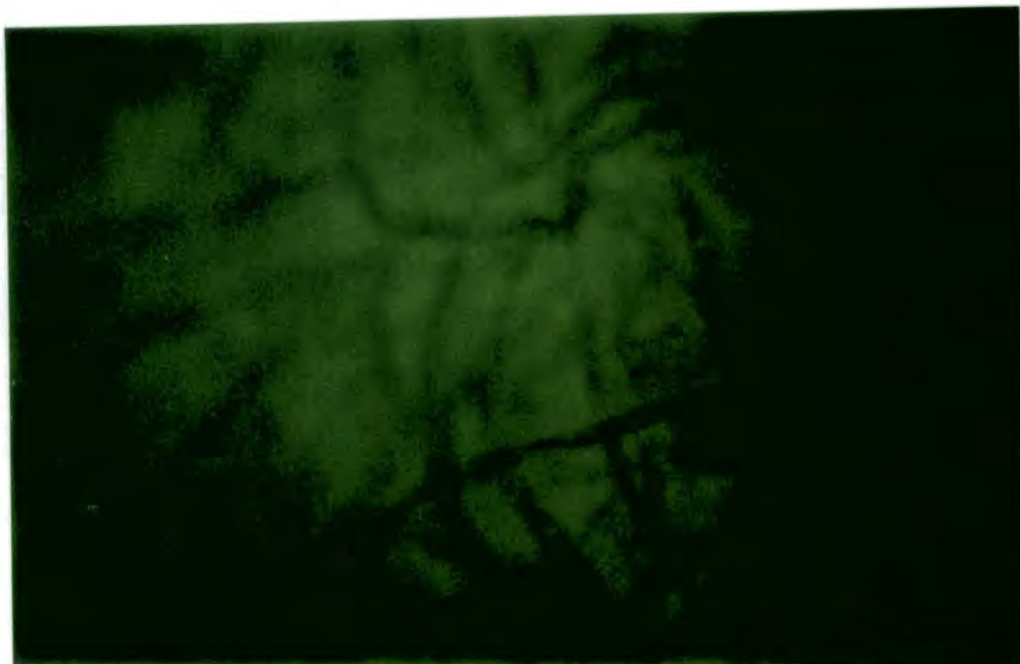
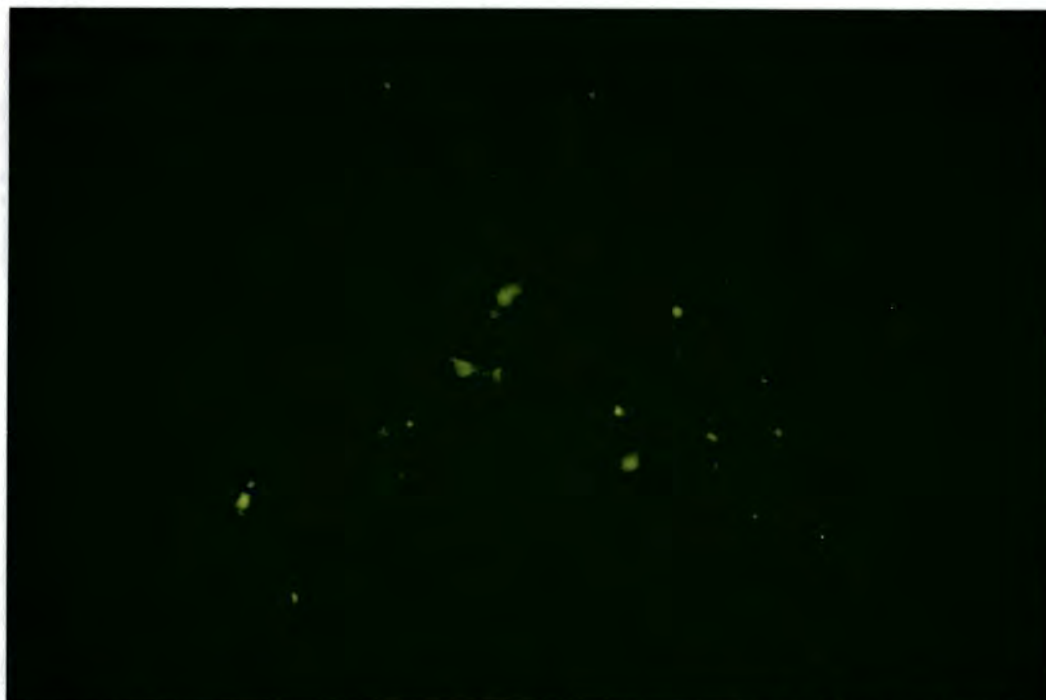

Plate 6



- (a) Micrograph showing a control filter paper disk removed from an insect feeding chamber in which two adult BPH were allowed to fed on control artificial diet MMD-1 for a 48 hour period. Disks were examined under a high powered (x100) fluorescent microscope and no fluorescence was observed.



- (b) Micrograph showing a treatment filter paper disk removed from an insect feeding chamber in which two adult BPH were allowed to fed on 0.1% GNA {w/v}, incorporated into artificial diet MMD-1, for a 48 hour period. Disks were examined under a high powered (x100) fluorescent microscope and fluorescence was observed as yellow regions.

3.5.2 Examination of insect ultrastructure

Pilot studies were carried out to establish histological methods suitable for preserving BPH tissue sections and to identify morphological characteristics of the insect's abdominal region, using light or electron microscopical techniques.

3.5.2.1 Light microscopy studies

(i) Preliminary studies

Superior results were achieved using either Carnoy's fixative or Karnovsky's fixative rather than Bouin's fixative and ultrastructural features of the BPH abdominal region were better preserved when using LR White resin embedding material as compared with paraffin wax. The ultrastructure of transverse sections of midgut and hindgut regions of adult BPH, prepared in Carnoy's fixative and LR White resin and stained with 1% toluidine blue are shown in Plate 7.

On dissecting the BPH a long midgut which folded over on itself several times, and enlarged to join a sac-like hind gut could be observed, which is a common feature of insects feeding on plant sap (Forbes and MacCarthy, 1969). Malpighian tubules were also observed in BPH during dissection and a muscular sucking pump was observed at the light microscope level (results not shown). The gross features of the alimentary canal of BPH were similar to those described for *Myzus persicae* (Forbes, 1963; 1964). Aphids possess a cibarial-pharyngeal food pump within the head which assists the passage of liquid food, by muscular action, through the pharynx to the oesophagus (Auclair, 1963). Hemipteran insects require a unique digestive system in order to utilise the liquid phloem sap diet they imbibe, and generally the lower the protein content of the diet the longer is the alimentary canal (House, 1974b). In insects, unlike mammals, sugars passively diffuse through the midgut epithelium and into the haemolymph (Dadd, 1985) but some sap feeding insects possess a filter chamber to allow excess water and sugar to circumvent the stomach and be eliminated, whereas fats and proteins are retained for further digestion. Malpighian tubules were observed in the adult BPH indicating a more specialised excretion system than that of *Myzus persicae*, in which they are absent. No peritrophic membrane associated with the midgut could be clearly distinguished, in abdominal sections of adult BPH, at the light microscope level. Except for hemiptera, chitinous peritrophic membranes encapsulating the midgut lumen are universal amongst most insects their role being to protect midgut cells from food abrasion, act as a physical barrier for micro-organisms, and act as a permeability barrier for digestive enzymes and products. The majority of Fulgoroidea lack a peritrophic membrane (Dadd, 1970b; House, 1974b) as their diet is liquid and unlikely therefore to cause abrasion, but the midgut is ensheathed by a perimicrovillar lipid membrane which

maintains a constant distance from the microvillar membrane (Forbes and MacCarthy, 1969).

(ii) Morphological features of GNA-fed insects

Lectins fed to mammals and birds have been shown to cause gross changes in gut morphology (Pusztai, King and Clarke, 1980a). Studies were carried out to determine whether GNA had similar effects on the gut of BPH.

Adult BPH insects were fed on GNA incorporated into artificial diet at 0.1% concentration {w/v} for five days and abdominal sections were examined under a light microscope for ultrastructural changes in morphology. No distinct gross morphological changes in the midgut epithelium or in the yeast-like symbionts could be distinguished at the light microscope level when comparing the control diet fed insects (Plate 8a) with GNA fed insects (Plate 8b).

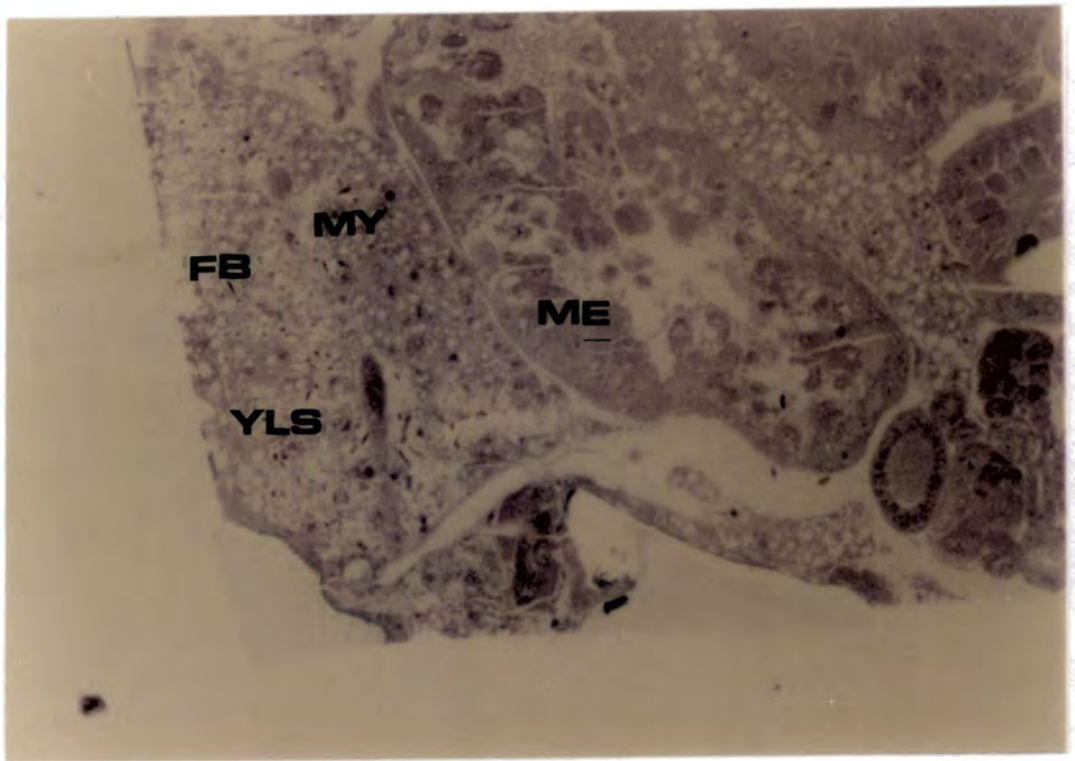

Plate 7a: Micrograph of transverse sections of the abdominal region of an adult female brachypterous BPH after feeding on the artificial diet MMD-1 for 5 days, showing the midgut epithelium (ME) and mycetocytes (MY) harbouring the yeast-like symbionts (YLS) in the fat body region (FB). (Thin sections were prepared in Carnoys fixative, embedded in LR white resin, stained with 1% toluidine blue and observed using a light microscope (x 20)).

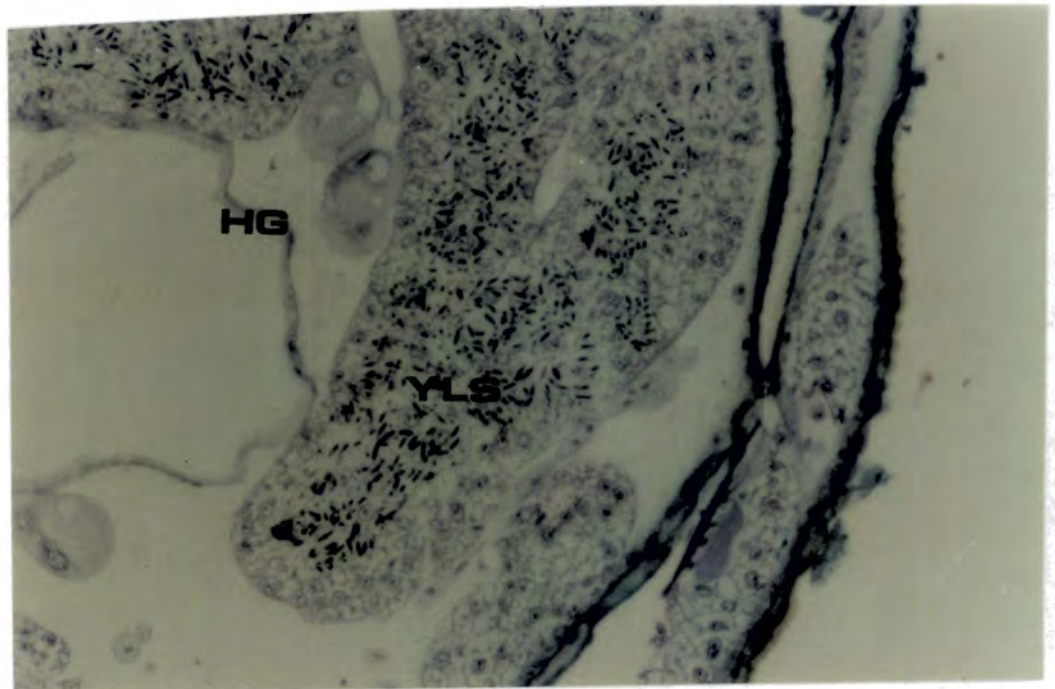

Plate 7b: Micrograph of transverse sections of the abdominal region of an adult female brachypterous BPH after feeding on the artificial diet MMD-1 for 5 days, showing the hindgut (HG) and mycetocytes housing yeast-like symbionts (YLS). (Thin sections were prepared with Carnoys fixative, embedded in LR White resin, stained with 1% toluidine blue and observed using a light microscope (x 40)).

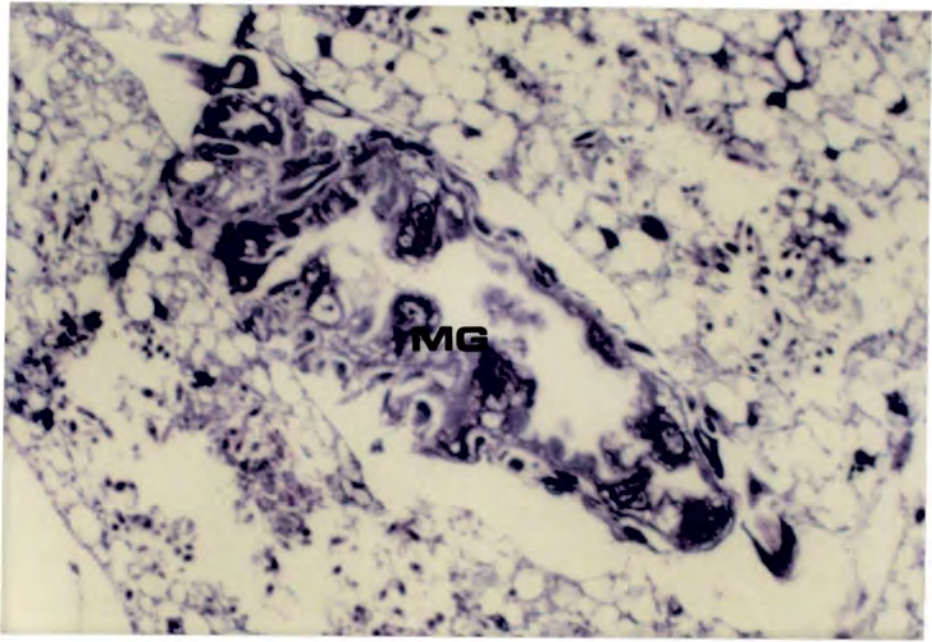

Plate 8a: Micrograph showing a transverse section of the abdominal region of an adult female brachypterous BPH after feeding on the artificial diet MMD-1 for 5 days, showing the midgut (MG) region. (Thin sections were prepared with Carnoys fixative, embedded in LR White resin, stained with 1% toluidine blue and observed using a light microscope (x 40)).

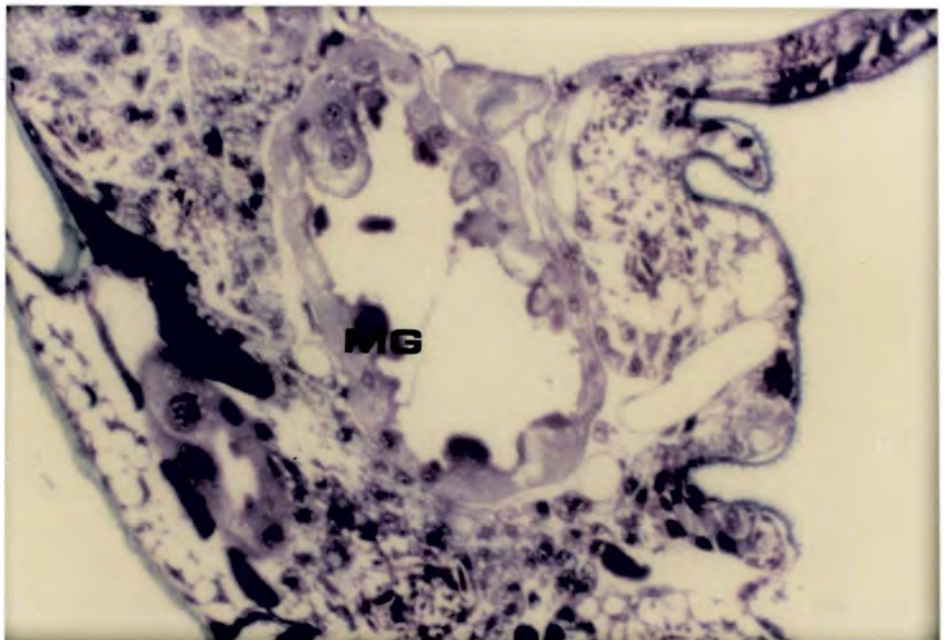

Plate 8b: Micrograph showing a transverse section of the abdominal region of an adult female brachypterous BPH after feeding on GNA incorporated at 0.1% {w/v} in the artificial diet MMD-1 for 5 days, showing the midgut (MG) region. (Thin sections were prepared with Carnoys fixative, embedded in LR White resin, stained with 1% toluidine blue and observed using a light microscope (x 40)).

3.5.2.2 Electron microscope studies

As no distinct morphological differences in the abdominal region of BPH fed on GNA could be observed at the light microscope level, sections were prepared and examined using electron microscope (EM) techniques. At the EM level there also appeared to be no distinct morphological differences in the midgut between protein fed and control diet fed insects after 5 days of treatment. An electron micrograph showing the midgut epithelial cells of a GNA-fed insect is shown in Plate 9. The midgut epithelium appears as a single layer of epithelial cells containing prominent nucleolus and densely packed mitochondria aggregated near the apical region of the cells. Electron dense inclusions are evident and these are similar in appearance to those described by Forbes (1963; 1964), as lipid spheres, in *Myzus persicae* midgut epithelial cells. Closely packed microvilli are evident on the midgut epithelial cells and a perimicrovillar membrane was observed surrounding the midgut villi which appeared to be disrupted in both control and GNA fed insect sections suggesting that some other factor other than the lectin presence, possibly the fixation technique, caused this feature. The intracellular detail of the yeast-like symbionts (YLS) stained very densely using this technique both in control and protein fed insects. Electron micrographs showing the fine structure of YLS prepared from thin sections of a YLS colony fixed on an agar block shows more detail than when examining the YLS *in vivo*.

Other workers have shown that some lectins affect mammalian gut morphology. At the electron microscope level the lectin PHA causes morphological changes to the rat small intestine by disrupting the microvilli making them appear fragmented, vesiculated and stunted (King, Pusztai and Clarke, 1992), but no such morphological changes were noted in the insect sections examined.

3.6 Immunological studies

Having observed no distinct morphological changes within the abdominal regions of GNA-fed insects, when compared with control artificial diet fed insects, further studies using immunohistochemical techniques were carried out in order to identify possible binding site regions of *Galanthus nivalis* agglutinin (GNA).

3.6.1 Fluorescent microscopy studies

Histological sections from the abdominal region of BPH after feeding on GNA incorporated into artificial diet MMD-1 at 0.1% concentration {w/v} or control diet fed insects, for 48 hours, showed marked autofluorescence of both the midgut epithelium and the yeast-like symbionts (Plate 10). Therefore no conclusions regarding possible binding sites of GNA could be drawn from this experimental technique.

Plate 9: Electron micrograph showing the midgut region of an adult BPH after feeding on GNA, incorporated into artificial diet MMD-1 at, 0.1% concentration {w/v}, for 5 days;

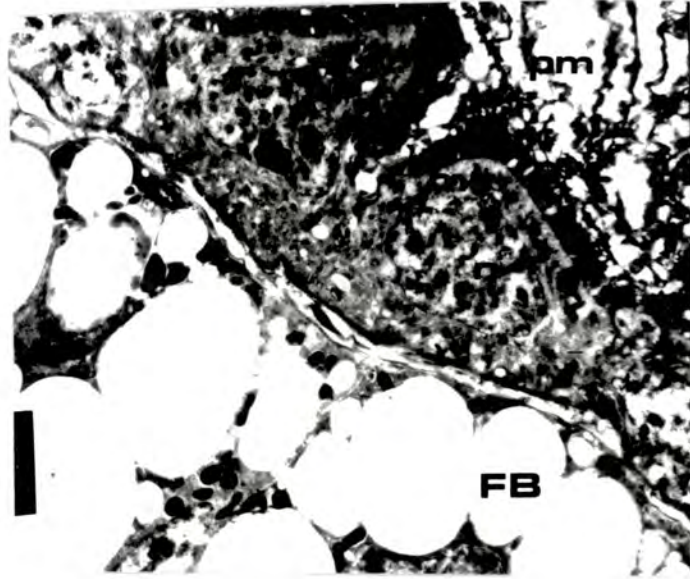

(a) the midgut epithelial cells (ME), cell nucleus (N), densely packed microvilli (MV) and fat body cells (FB) can be observed along with a disrupted perimicrovillar membrane (PM); (x3,600)

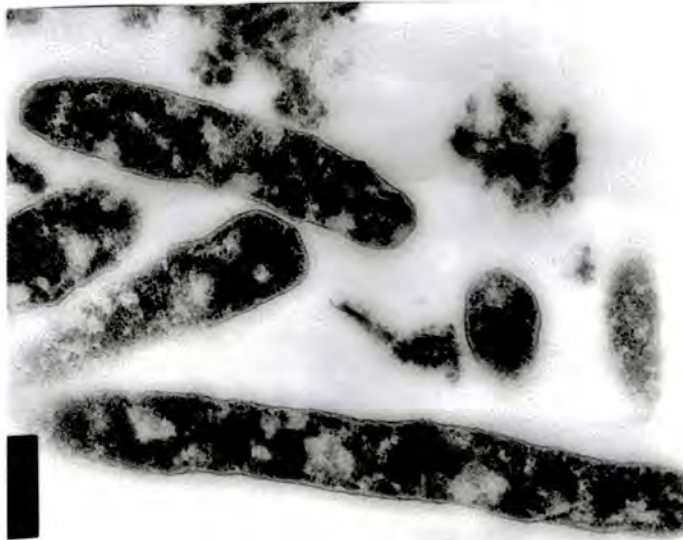

(b) Yeast-like symbionts (YLS) were observed in the fat body regions. (x17,000).

Plate 10: Micrograph showing a control thin section of the abdominal region of an adult female brachypterous BPH after feeding on control artificial diet MMD-1, for 48 hours. Sections were examined under a high powered (x 40) fluorescent microscope and autofluorescence was observed in the (a) midgut (MG) and (b) yeast-like symbiont (YLS) regions.

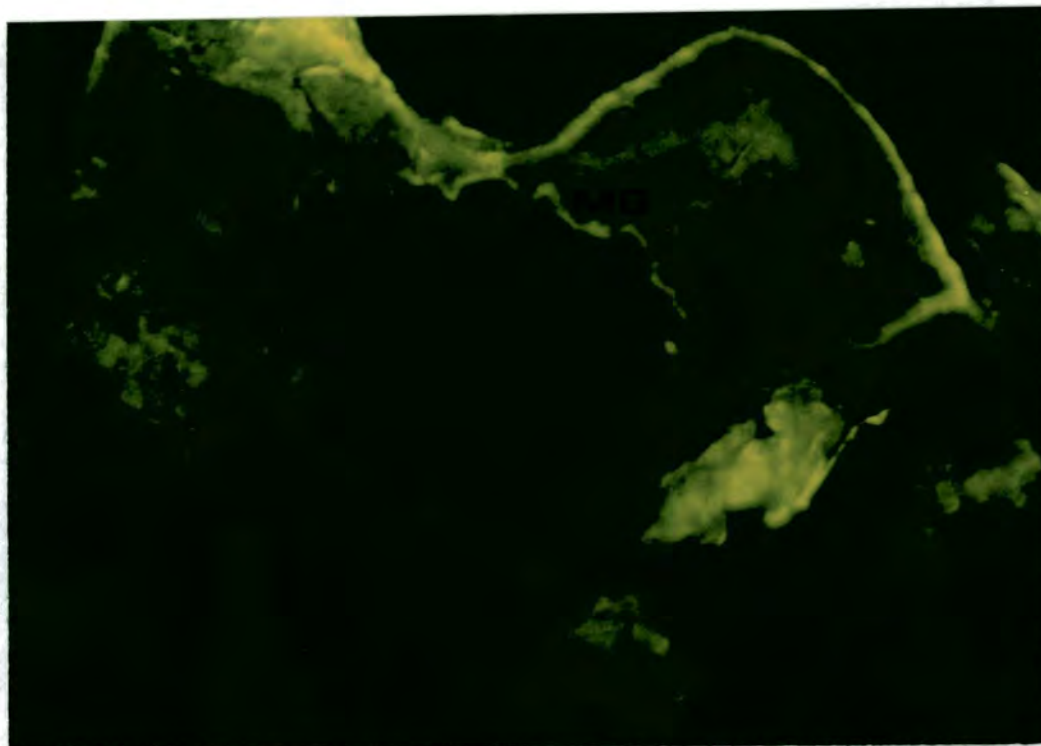

(a)

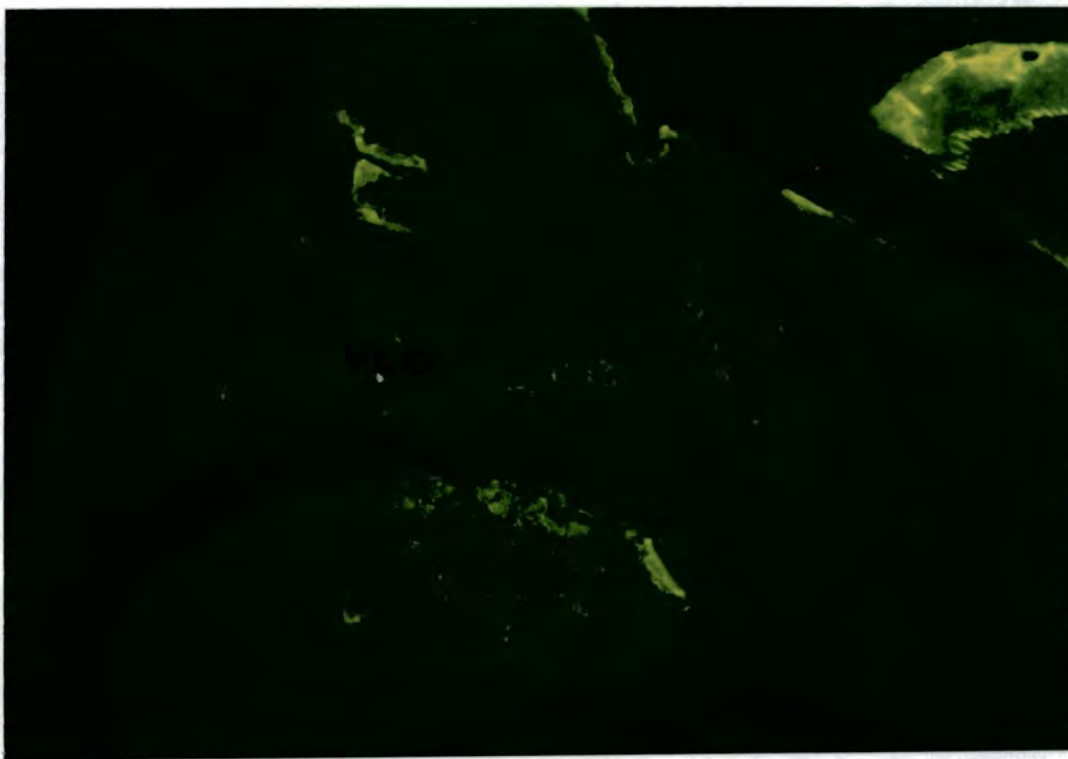

(b)

3.6.2 Immunohistochemical studies

At the light microscope level the midgut region of abdominal sections from control diet fed BPH were not stained using either the DAB or the ABC immunohistochemical techniques using anti-GNA primary antibodies indicating no non-specific antibody binding (on sections incubated with primary and secondary antibodies) as shown in Plate 11a and Plate 12a. However the yeast-like symbionts (YLS) did appear to stain darker than the rest of the section indicating that some component in the microbial cell wall, possibly the presence of endogenous peroxidases, was responsible for this artefact, and thus preventing specific binding of anti-GNA antibodies to YLS being visualised by this technique.

Abdominal sections prepared from BPH feeding for 5 days on GNA incorporated in artificial diet, MMD-1, at 0.1% {w/v} concentration showed staining of the midgut region (Plate 11b) and yeast-like symbionts (results not shown) when using both primary and secondary antibodies together, and when using only the secondary antibody (Plate 11c), when using the DAB immunohistochemical technique. Staining in the midgut region using the secondary antibody alone differed from insects fed on control diet, and suggests that GNA has had an effect on these cells, but prevents specific binding of the primary antibody from being demonstrated.

However using the ABC-Vector immunohistochemical technique abdominal sections prepared from adult BPH feeding for 5 days on GNA, incorporated in the artificial diet MMD-1 at 0.1% concentration {w/v}, showed staining of the midgut region when using both primary (anti-GNA) and secondary antibodies together (Plate 12b), but no staining when using only the secondary antibody (Plate 12c). The specific binding of anti-GNA primary antibody suggests that GNA may be binding to the midgut epithelial cells. The type of fixative, embedding medium and heat treatment used in immunohistochemical techniques can result in tissue damage, protein denaturation and subsequent loss of antigenicity and enzyme activity (Murray and Ewen, 1990) and further work would be desirable to confirm these results.

3.7 Intracellular symbionts of BPH

The location of yeast-like symbionts (YLS) in fat bodies of the abdominal region has been examined using both light and electron microscopical techniques (discussed earlier-Section 3.5). However using immunohistochemical techniques I could not verify whether or not GNA was binding to the cell wall of the YLS due to secondary binding. Therefore in order to study whether the YLS were the possible site of action for GNA, the YLS were isolated in artificial media, in order to use the isolates to demonstrate *in vitro* lectin binding.



Plate 11a: Micrograph of a transverse section of the abdominal region of an adult BPH after feeding on control diet for 5 days. Sections were treated using the DAB immunohistochemical technique and incubated with both primary and secondary antibodies. No staining was observed in the midgut epithelium cells (ME) but yeast-like symbionts (YLS) appear darker than surrounding tissue. (x 40).

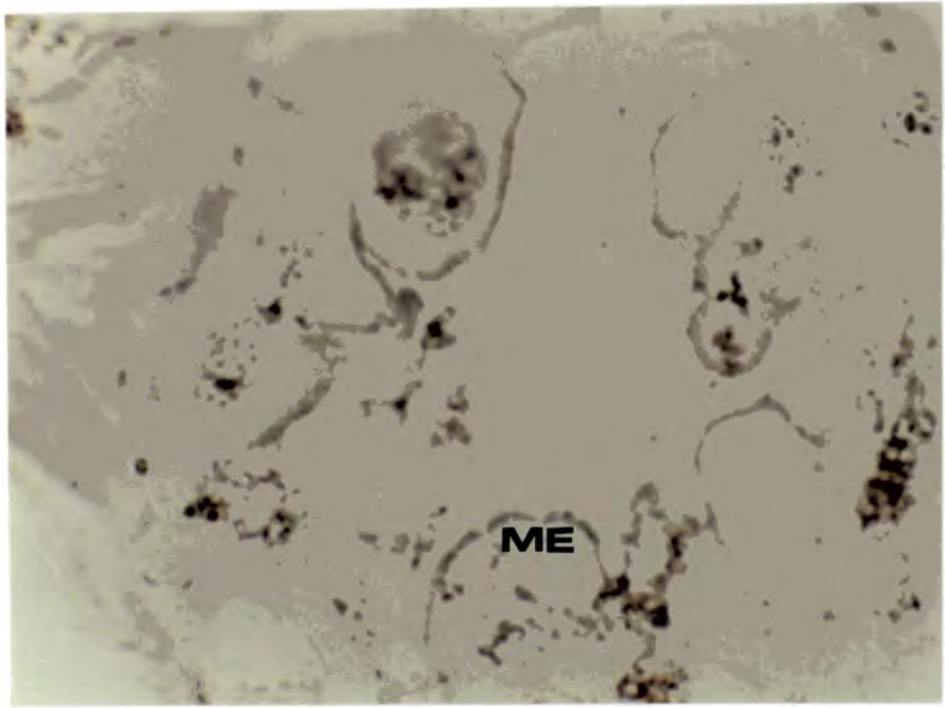

Plate 11b: Micrograph of a transverse section of the abdominal region of an adult BPH after feeding on GNA, incorporated into artificial diet MMD-1 at 0.1% concentration, for 5 days. Sections were treated using the DAB immunohistochemical technique and incubated with both primary and secondary antibodies. Staining was observed in the midgut epithelium cells (ME). (x 100).

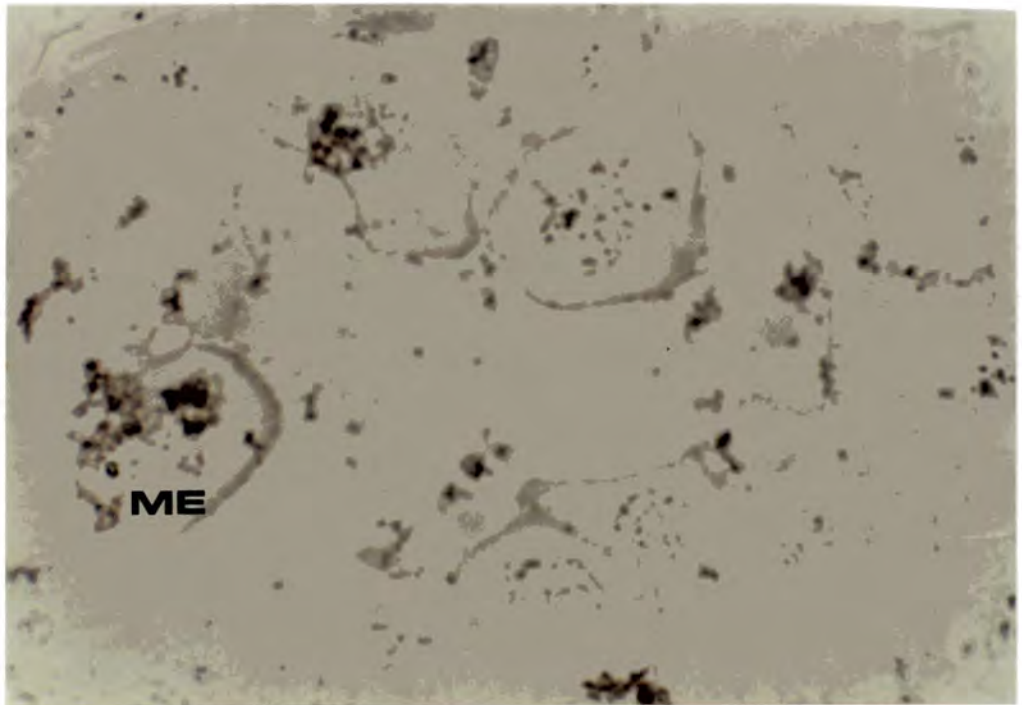

Plate 11c: Micrograph of a transverse section of the abdominal region of an adult BPH after feeding on GNA, incorporated into artificial diet MMD-1 at 0.1% concentration, for 5 days. Sections were treated using the DAB immunohistochemical technique and incubated with secondary antibody. Staining was observed in the midgut epithelium cells (ME) (x 100).

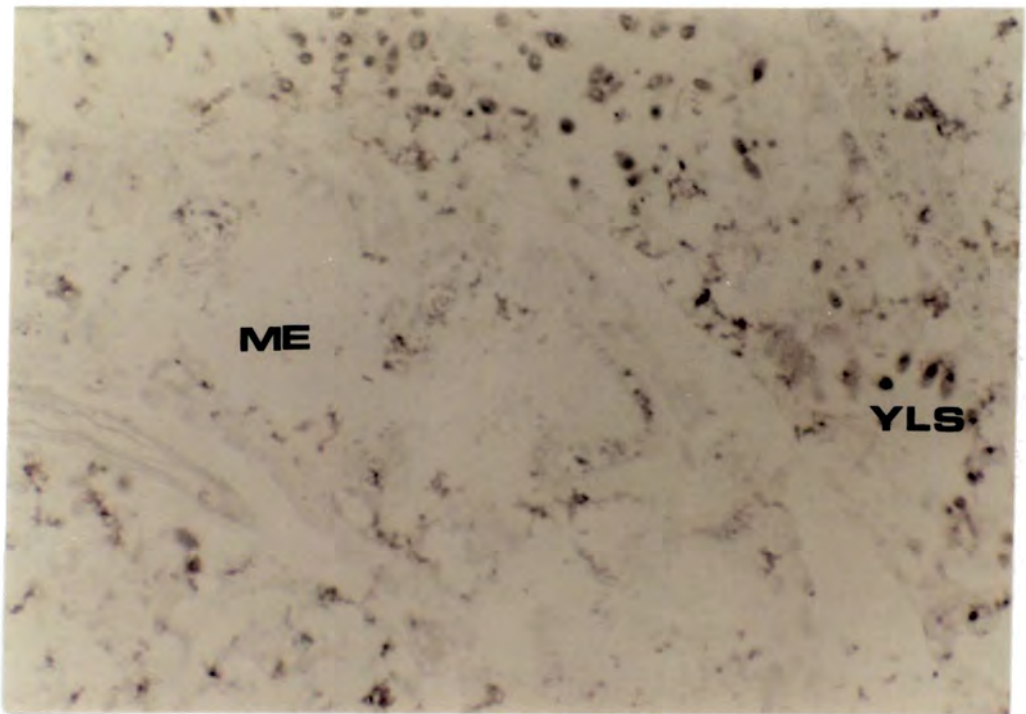

Plate 12a: Micrograph of a transverse section of the abdominal region of an adult BPH after feeding on control diet for 5 days. Sections were treated using the avidin-biotin immunohistochemical technique and incubated with both primary and secondary antibodies. No staining was observed in the midgut epithelium cells (ME) but yeast-like symbionts (YLS) appear darker than surrounding tissue. (x 100).

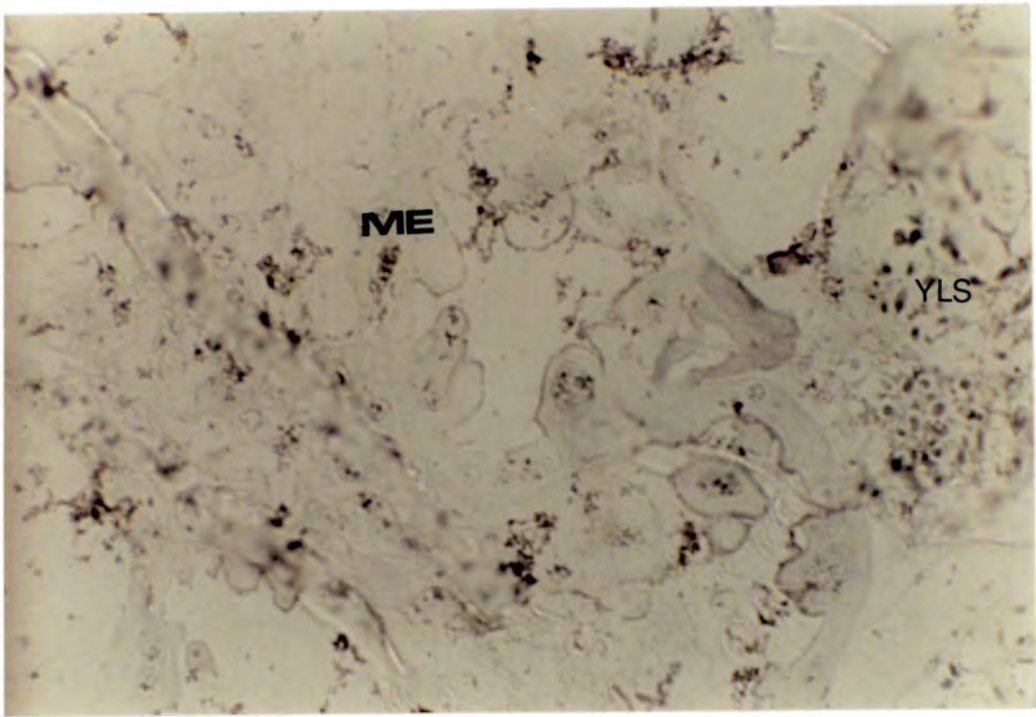

Plate 12b: Micrograph of a transverse section of the abdominal region of an adult BPH after feeding on GNA, incorporated into artificial diet MMD-1 at 0.1% concentration {w/v}, for 5 days. Sections were treated using the avidin-biotin immunohistochemical technique and incubated with both primary and secondary antibodies. Staining was observed in the midgut epithelium cells (ME) and yeast-like symbionts (YLS) appeared darker than surrounding tissue. (x 40).

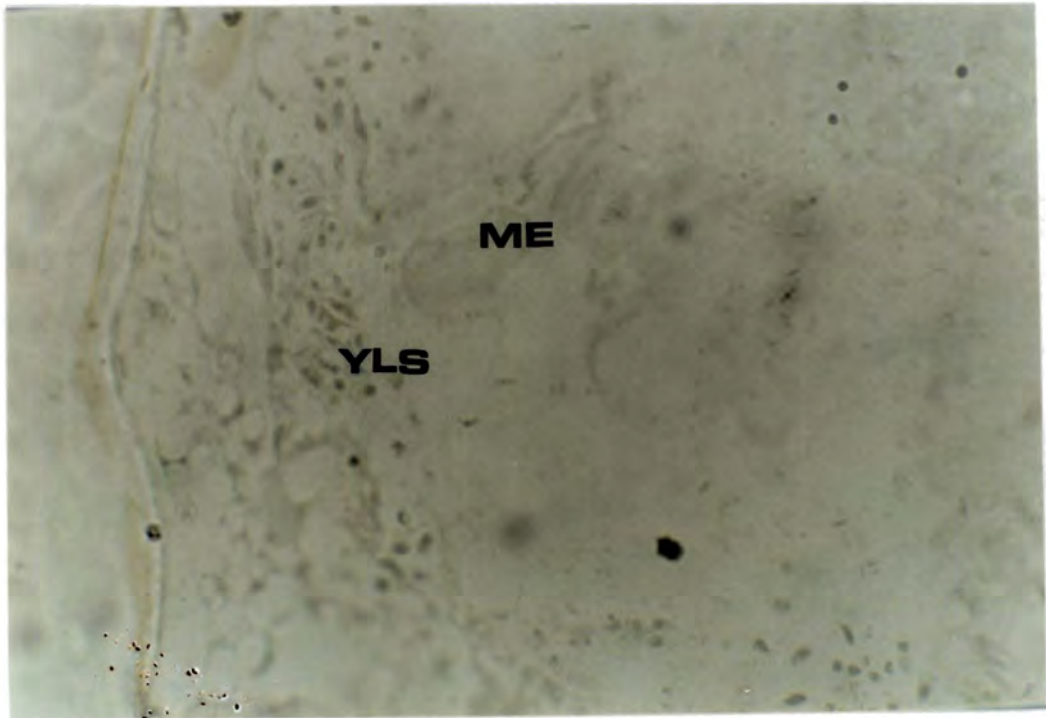

Plate 12c: Micrograph of a transverse section of the abdominal region of an adult BPH after feeding on GNA, incorporated into artificial diet MMD-1 at 0.1% concentration {w/v}, for 5 days. Sections were treated using the avidin-biotin immunohistochemical technique and incubated with secondary antibody. No staining was observed in the midgut epithelium cells (ME) and yeast-like symbionts (YLS) appeared darker than surrounding tissue (x 100).

3.7.1 Distribution of yeast-like symbionts

Yeast-like symbionts (YLS) of similar morphology to those observed in the fat bodies of the abdomen housed in mycetocyte structures (Plate 14) were also observed at the light microscope level in direct adult BPH homogenate smears (Plate 13) after staining using the Grams technique. YLS, of similar morphology to those observed in adult homogenates, were also observed in BPH eggs (results not shown). The YLS and mycetocytes observed were similar in size and morphology to those described by other authors in the abdomen, embryo, ovaries and eggs of rice planthoppers *Nilaparvata lugens* (Nasu *et al.*, 1981; Chen *et al.*, 1981; Lee and Hou, 1987) and *Laodelphax striatellus* (Noda, 1977; Kusumi *et al.*, 1979, Saxena, Barrion and Caoile, 1990). YLS stained brown-red with PAS reaction indicating the presence of carbohydrates on the cell surface (results not shown). Noda (1977) showed a similar reaction with *Laodelphax striatellus* yeast-like symbionts.

3.7.2 Isolation and continuous culture of YLS

Yeast-like symbionts (YLS) similar in morphology to those observed in adult homogenate smears were also observed in gram stain smears taken from Graces insect tissue (TC) culture medium, after 5 days incubation with an inoculum of adult BPH homogenate (results not shown). After 3 days incubation of yeast morphology agar (YMA) plates, with an inoculum from the BPH homogenate inoculated Graces TC Medium, colonies with a characteristic rough yellow appearance were observed (Plate 15). On staining these colonies showed a similar characteristic YLS morphology and some showed budding indicative of vegetative propagation (results not shown). YLS were maintained in continuous culture for several months on YMA agar. Electron micrographs prepared from YLS colonies cultured on YMA agar, show the fine structure of YLS (Plate 16).

Reports in the literature indicate that YLS are present in the abdominal region of a number of rice leaf and planthoppers. The YLS described here are similar in morphology to the N-1 yeast-like symbionts of BPH previously reported (Nasu *et al.*, 1981) using a similar method to isolate BPH symbionts using an agar/tissue culture/antibiotic mixture and yeast morphology broth. However they do not describe the morphology of isolated colonies nor claim continuous culture. Mitsuhashi (1975) describes the isolation of a yeast-like organism (YLO) from the smaller brown planthopper, *Laodelphax striatellus* but could not maintain a continuous culture.

The rationale behind isolating the yeast-like symbionts from BPH was to examine *in vitro* the agglutinating activity of lectins against the yeasts. Patchett, Kelly and Kroll (1991) have shown that a variety of N-acetyl galactosamine binding lectins can bind to various bacterial suspensions, and the degree of binding is probably related to the different cell

surface characteristics of the bacteria which may impede the lectins access to N-acetyl binding sites on the cell surface. Cell walls of yeasts are largely polysaccharide-protein complexes made up of the polysaccharides glucose or mannose. Mannans exist in yeasts as covalent complexes with proteins and can be found as integral components of the yeast cell wall (Farkas, 1989; Fleet, 1991). Therefore lectins have the potential for binding to yeast cell surfaces. Unfortunately time constraints did not allow further studies to be carried out to explore this possibility.

3.8 Antifeedant activity

In vitro feeding trials indicated that the mortality curves for first and third instar *Nilaparvata lugens*, rice brown planthopper (BPH), nymphs, feeding on GNA, WGA or LPO had similar trends to that of starved nymphs, indicating that the proteins may be acting as antifeedants. In order to examine this hypothesis honeydew excreted by BPH whilst feeding on selected proteins was analysed both quantitatively and qualitatively.

3.8.1 Honeydew analysis

Honeydew excreted by female brachypterous BPH adults, feeding on either control artificial diet MMD-1 or on the same diet with 0.1% protein incorporated into it was analysed using three techniques discussed below:

3.8.1.2 Ninhydrin analysis of BPH honeydew

The lectins, GNA, WGA and the enzyme LPO were all incorporated into artificial diet at 0.1% {w/v} concentration and fed to adult female brachypterous BPH over a period of 24 hours and controls were established by feeding BPH either artificial diet or PSA incorporated at 0.1% {w/v} concentration in artificial diet. A semi-qualitative and semi-quantitative analysis of insect honeydew excreted onto filter paper was determined by spraying with ninhydrin reagent to detect the presence of free amino acids. Staining of amino acids was indicated by the appearance of purple spots after 4-5 hours. The size and quantity of purple spots indicated the amount of honeydew excreted and the relative feeding period. Larger spots indicating that the insect feeds for a longer duration and hence excretes more honeydew. The relative total quantity of amino acid present in the honeydew of adult BPH feeding on control and protein incorporated diet, as indicated by the area of purple coloration, are shown in Plates 17 and 18. When fed on GNA, WGA and LPO far less filter paper area is stained by the ninhydrin and the purple spots appear much smaller when compared with the stained area of filter paper disks from the feeding chamber of control artificial diet fed insects. In contrast the insects fed on PSA appeared to excrete similar amounts of honeydew in comparison with the control (Plate 17).

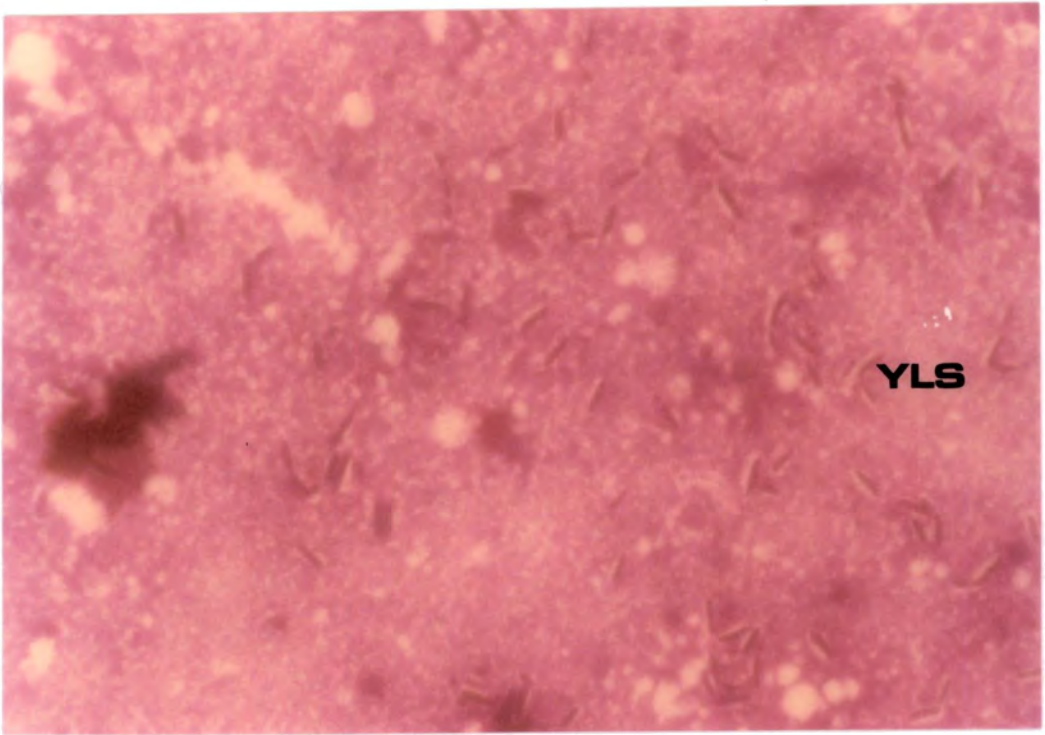

Plate 13: Micrograph showing yeast-like symbionts (YLS) present in a direct homogenate smear of an adult BPH. Preparation was stained using Grams stain and observed using a light microscope (x100).

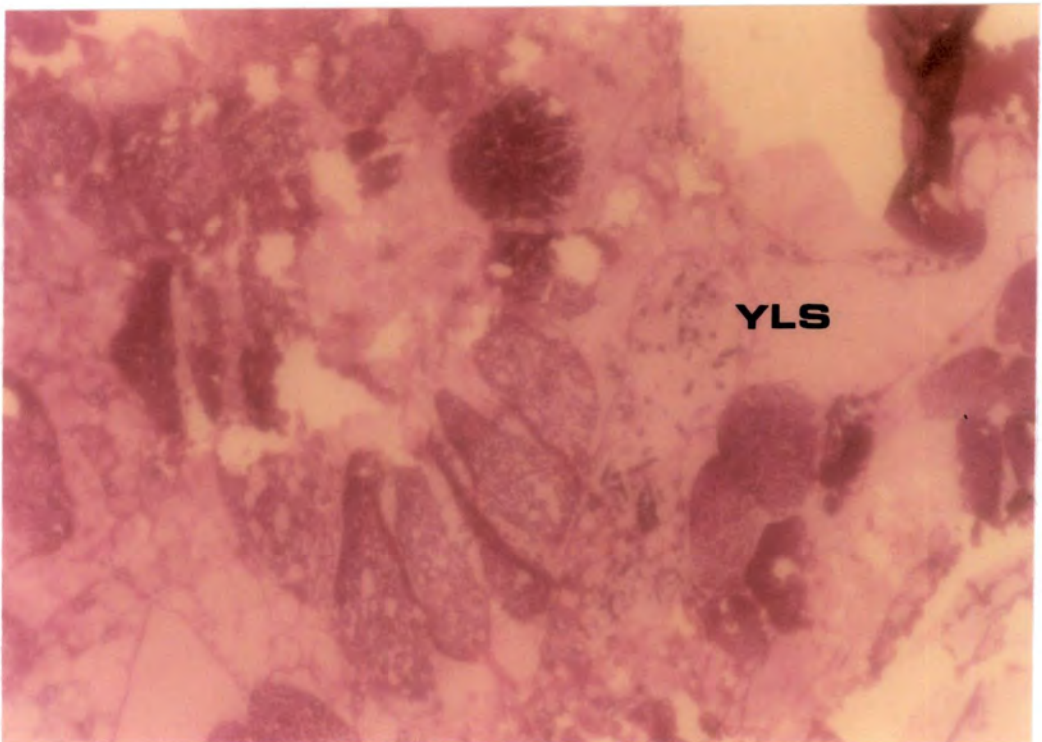

Plate 14: Micrograph showing yeast-like symbionts (YLS) present in the abdominal region of artificial diet, MMD-1, fed adult BPH. Preparation was prepared in Carnoys fixative, LR White resin, stained using Grams stain and observed using a light microscope (x40).



Plate 15: Three-day old colonies of yeast-like symbionts (YLS) isolated from adult BPH homogenates previously incubated in Graces insect tissue culture medium for 5 days and subcultured on yeast morphology agar (YMA).

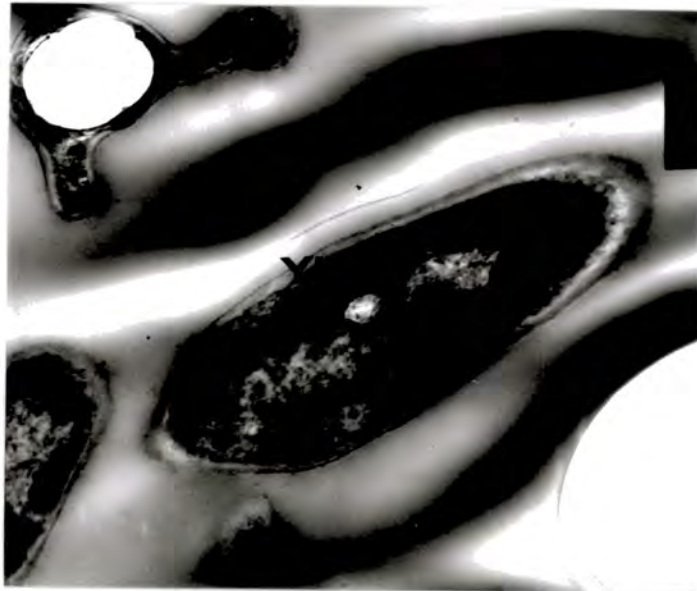

Plate 16: Electron micrograph showing a longitudinal section of a yeast-like symbiont (YLS) isolated from a single yeast colony cultured on yeast morphology agar (YMA). Sections were prepared in Karnovsky fixative, araldite resin and stained with lead citrate and uranyl acetate (x18000).

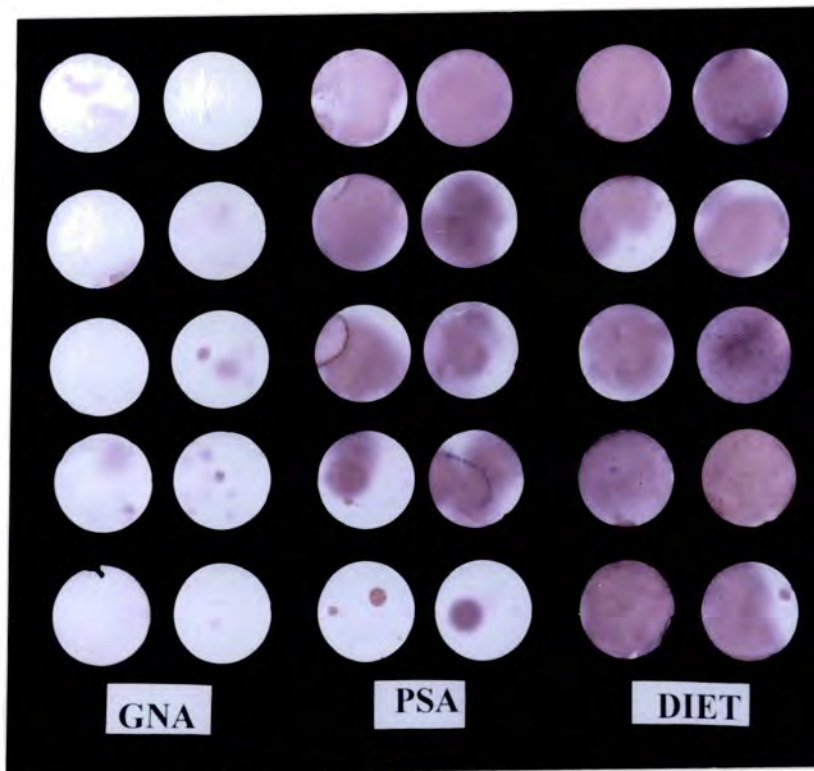

Plate 17: Photographs showing the relative quantities of amino acid rich honeydew produced, determined by the purple areas stained with Ninhydrin reagent, by adult BPH feeding on *Galanthus nivalis* agglutinin (GNA) or *Pisum sativum* agglutinin (PSA) incorporated into artificial diet MMD-1, at 0.1% {w/v} concentration.

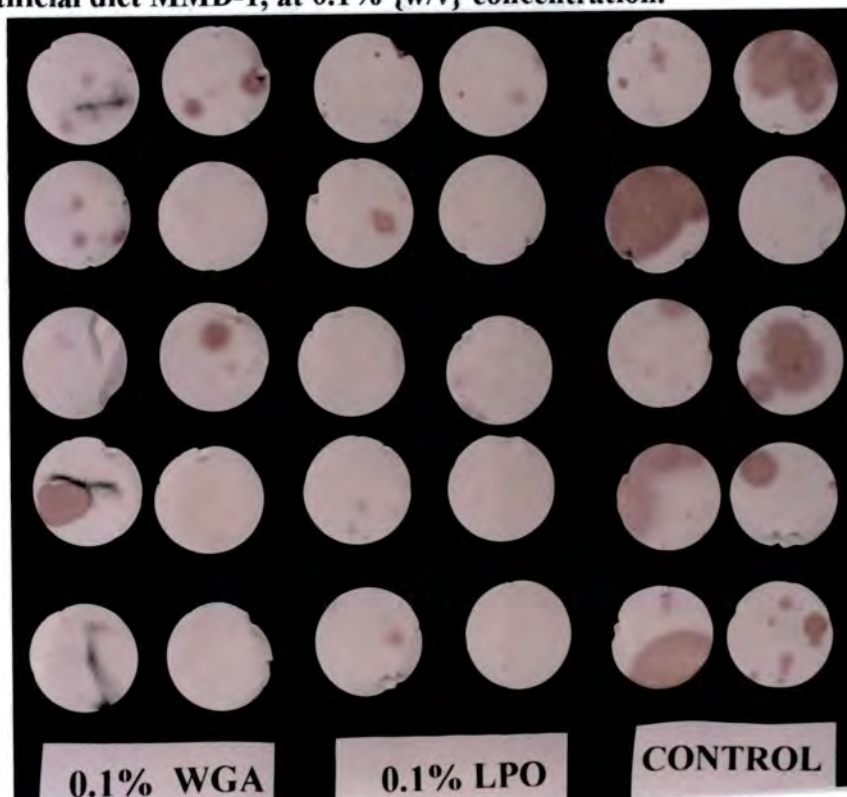

Plate 18: Photographs showing the relative quantities of amino acid rich honeydew produced, determined by the purple areas stained with Ninhydrin reagent, by adult BPH feeding on wheat germ agglutinin (WGA) or soybean lipoxygenase (LPO) incorporated into artificial diet MMD-1, at 0.1% {w/v} concentration.

These results indicate that the insects feeding on GNA, WGA or LPO are either excreting less honeydew and feeding for shorter time periods or that the honeydew excreted has a lower amino acid content. If insects are excreting less honeydew this would indicate that they are initially imbibing less diet in the presence of the protein, indicating that the protein(s) may have feeding deterrent properties. If excreting less amino acids in the honeydew this would indicate that the proteins were affecting amino acid utilisation.

The ninhydrin method, used here, although only a relatively crude semi-quantitative method of analysing honeydew production is nonetheless a useful preliminary indicator of possible antifeedant or feeding deterrent properties. Using the same technique barnyard grass has been shown to contain a secondary metabolite (later identified as being *trans*-aconitic acid (Koh *et al.*, 1977)) which acted as an antifeedant, causing BPH to excrete very few honeydew droplets (Kim *et al.*, 1975). Theoretically the same technique could also be used to determine honeydew production *in vivo* and hence feeding rates on the host plants expressing the relevant insecticidal genes. Using the ninhydrin method, but modified as a honeydew clock, Padgham and Woodhead (1989) have shown that BPH feeds within the first few hours on the susceptible rice variety TN1 but feeding is delayed on resistant rice varieties. Also on TN1, BPH feeding is predominantly from the phloem as opposed to the xylem on wild rice and *Leersia*. When rice plants can be transformed to express an insecticidal gene it would be possible to examine BPH honeydew production using this method *in planta* which would provide an indication as to whether antifeedant phenotype can be expressed in the transgenic plant. A more detailed method of analysing the feeding activity of phloem feeders both on the host plant and on artificial diets is to measure the insects feeding behaviour, in terms of probing and sucking activities, using the electrical penetration graphs (EPG's). This method developed by Tjallingii (1978) allows one to analyse the relative durations of hemipteran feeding and probing activities. Karim and Saxena (1991), stained GLH honeydew on filter paper using bromocresol green to indicate the presence of basic honeydew and also found a correlation between phloem feeding and honeydew production when comparing the insect's EPG's. The use of EPG's would provide more detailed analysis of BPH feeding activities in the presence of insecticidal proteins either *in vivo* or *in vitro* and should be considered in future studies.

Results of honeydew analysis using the ninhydrin method indicated that GNA, WGA and LPO may have feeding deterrent properties and in order to substantiate this detailed quantitative and qualitative analysis of BPH honeydew was carried out:

3.8.1.3 Quantitative analysis of honeydew

Adult BPH were fed on artificial diets for 24 hours with the effective protein treatments GNA, WGA and LPO and a control protein PSA, incorporated in the artificial diet MMD-1 at 0.1% {w/v} concentration, and the quantity of honeydew excreted was determined. Eight bioassays were carried out and in all of the "honeydew" bioassays insects feeding on artificial diet alone excreted more honeydew, in terms of both total volume and droplet number/size, than insects feeding on the effective proteins GNA, WGA and LPO, when these proteins were incorporated at levels of 0.1% {w/v}. The results of selected bioassays are discussed below:

When GNA or PSA were incorporated into artificial diet, MMD-1, at 0.1% concentration {w/v} fed to insects over a 24 hour period, the honeydew volume and droplet number from GNA fed insects was significantly reduced when compared with control diet and PSA fed insects honeydew (Figure 30a). GNA fed insects produced 96% less honeydew droplets than control diet fed insects. A photograph of a bioassay feeding chamber from one replicate emphasises the dramatic effect that GNA has on honeydew production (Plate 19). As the honeydew droplets, produced by GNA fed insects were too small ($<0.5\mu\text{l}$) they could not be quantified but twenty diet fed insects produced $63\mu\text{l}$ honeydew after 24 hours (Figure 30b). Insects feeding on the lectin, PSA, (shown in earlier bioassays to be non-toxic to BPH) produced the same number of honeydew droplets as control diet fed insects (Figure 30a) and although the total honeydew volume excreted was 30% lower than the control (Figure 30b) this was not significant ($p>0.05$) and earlier bioassays indicate that this difference is not biologically significant as PSA does not effect insect mortality (Section 3.3.1). This bioassay was continued for a further 12 hours and the total volume of honeydew produced after 36 hours feeding was quantified. After 36 hours the total number of honeydew droplets and the total volume of honeydew excreted by GNA fed insects was 64% and 78% less, respectively than the control fed insects (Figure 30a and 30b) indicated that GNA, although initially appears to act as a feeding deterrent, the insect appears to tolerate the presence of the protein with time, although it still reduces the amount of diet imbibed significantly ($p<0.001$). Honeydew production, in terms of total droplet number and total volume, from insects feeding on PSA was 29% and 35% less respectively compared with the control, indicating no significant change ($p>0.05$) in the rate of diet imbibed after 36 hours.

When the lectin WGA was incorporated into artificial diet, MMD-1, at 0.1% concentration {w/v} and fed to insects over a 24 hour period, the honeydew volume and droplet number from WGA fed insects was also markedly reduced when compared with control diet fed insects, producing 45-54% less honeydew volume than control diet fed insects and 51-60% fewer honeydew droplets. The results of one bioassay are summarised in Figure 31a and 31b.

When the enzyme LPO was incorporated into artificial diet, MMD-1, at 0.1% concentration {w/v} and fed to insects over a 24 hour period, the honeydew volume and droplet number from LPO fed insects was also markedly reduced when compared with control diet fed insects honeydew producing 54-73% less honeydew volume than control diet fed insects and 37%-50% fewer honeydew droplets. The results of one bioassay are summarised in Figure 32a and 32b.

The fact that the total honeydew droplet number and total honeydew volume produced by insects feeding on GNA, WGA or LPO is significantly smaller than that of control diet fed insects indicates that the insect is feeding for shorter periods of time, imbibing less artificial diet and hence excreting less honeydew. This is an indication that the presence of either GNA, LPO or WGA in the diet appears to act as a feeding deterrent preventing adult BPH from feeding at its normal rate. In terms of antifeedant activity, as determined by the a reduction in the total quantity of honeydew excreted, GNA appears to be a stronger antifeedant than LPO or WGA over a 24 hour period at the 0.1% concentration {w/v} .

Recent experiments where *Myzus persicae* was fed on GNA expressing and non-GNA expressing tobacco plants provided further evidence, that GNA acts as an antifeedant on the basis of the reduced volume of honeydew excreted (Shi *et al.*, 1993). Work by Eisemann and co-workers (1993) suggests that WGA exhibits antifeedant properties and retards growth of the larvae of the blowfly, *Lucilia cuprina*, an insect which feeds on animal tissue fluid.

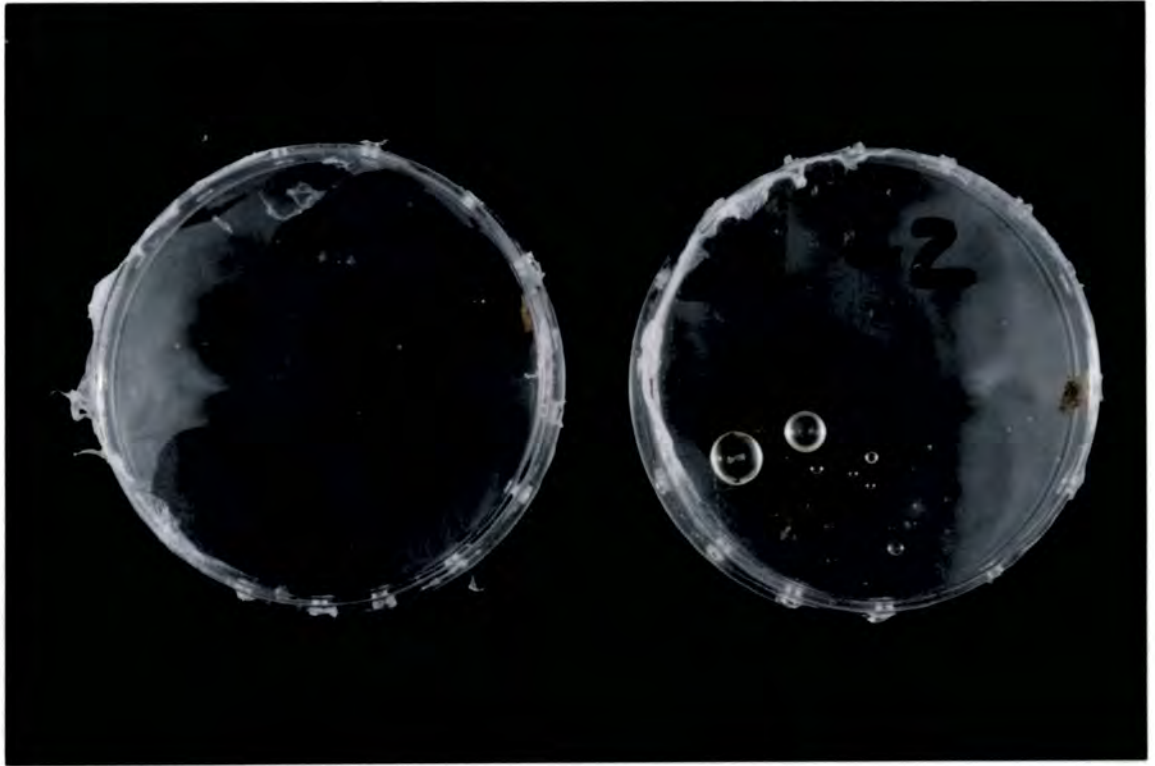

Plate 19: Honeydew droplets produced in the feeding chambers of adult BPH, after feeding on GNA incorporated in artificial diet (G2) at 0.1% concentration {w/v} or artificial diet alone (C2).

Figure 30: Honeydew droplets produced, in terms of (a) droplet number and (b) total volume by adult BPH, after feeding on GNA or PSA incorporated in artificial diet, MMD-1, at 0.1% concentration {w/v} or artificial diet alone.

*(a) Unpaired t-test for honeydew droplet number, mm.
Significance of difference (p-values).*

Treatment	0-24 hrs	24-36 hrs	0-36 hrs
Control, PSA	.2136	.5306	.1764
Control, GNA	0.0005	.3518	.0017

*(b) Unpaired t-test for honeydew droplet volume, μ l.
Significance of difference (p-values).*

Treatment	0-24 hrs	24-36 hrs	0-36 hrs
Control, PSA	.5999	.2833	.4018
Control, GNA	0.0345	.0406	.0241

Fig. 30a

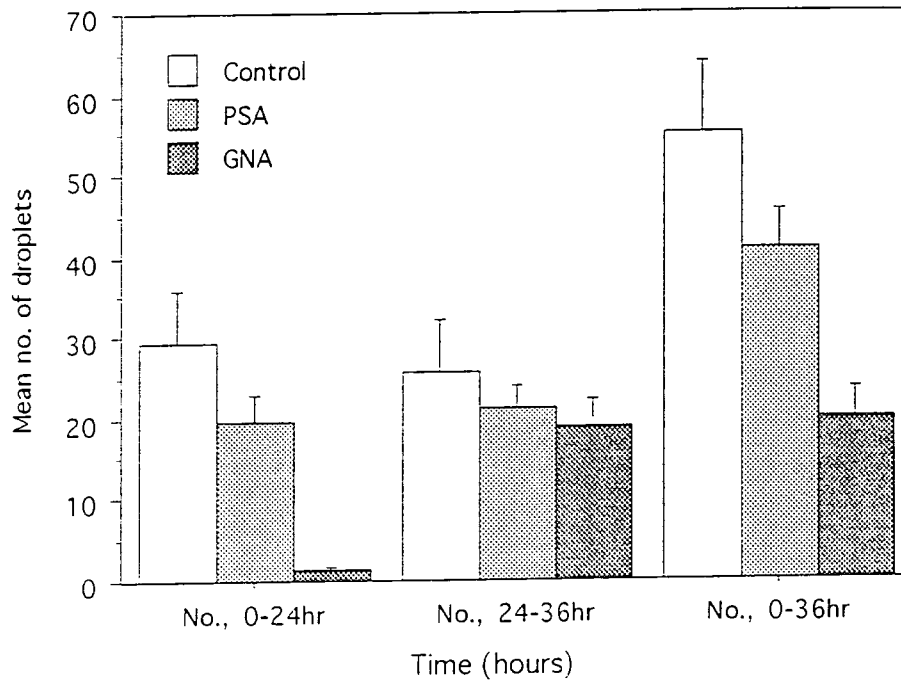

Fig. 30b

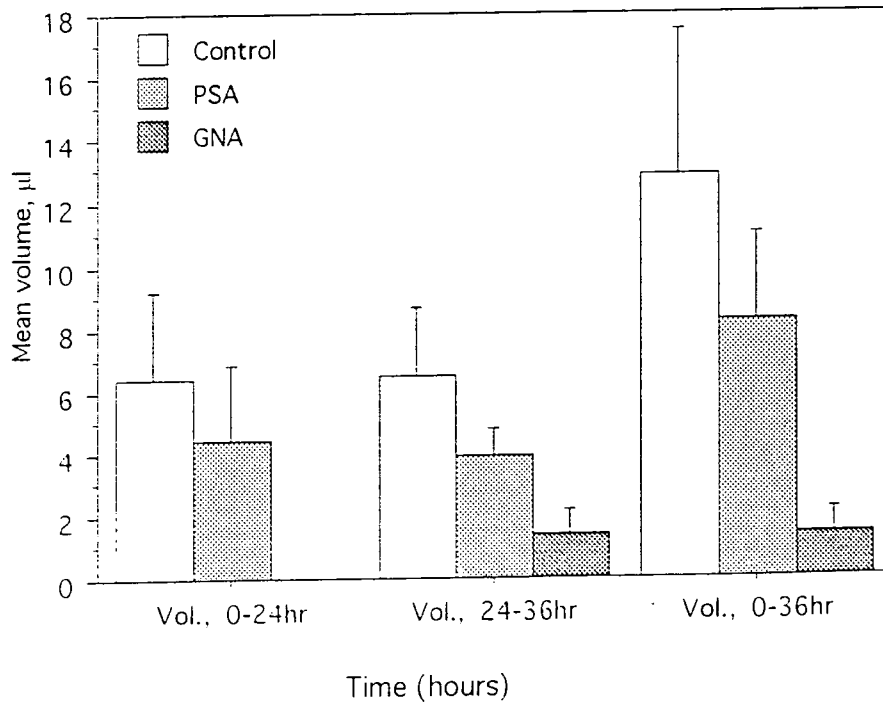

Figure 31: Honeydew droplets produced, in terms of (a) droplet number and (b) total volume by adult BPH, after feeding on WGA incorporated in artificial diet, MMD-1, at 0.1% concentration {w/v} or artificial diet alone.

*(a) Unpaired t-test for honeydew droplet number, mm.
Significance of difference.*

Treatment	P-value
Control, WGA	.0137

*(b) Unpaired t-test for honeydew droplet volume, μ l.
Significance of difference.*

Treatment	P-value
Control, WGA	.2342

Fig. 31a

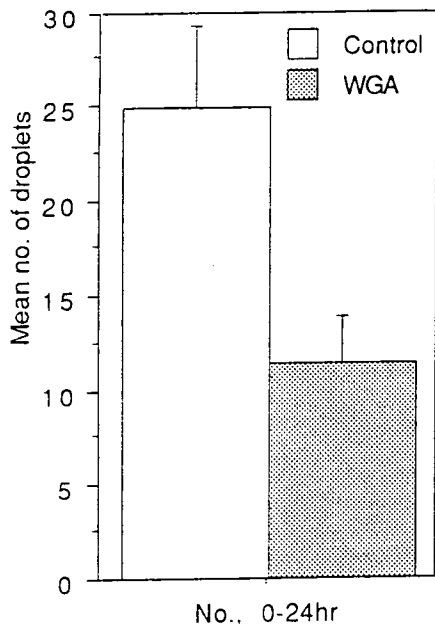

Time (hours)

Fig. 31b

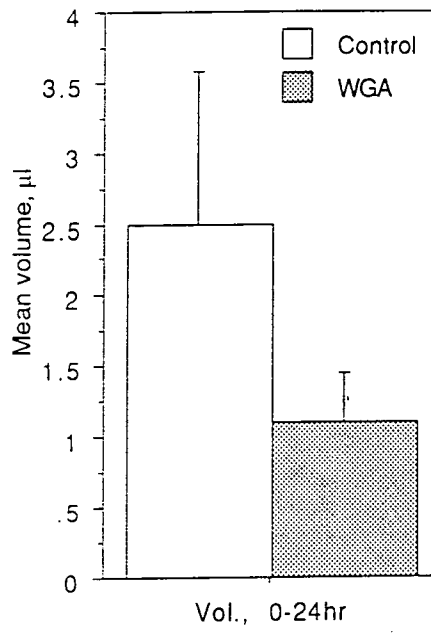

Time (hours)

Figure 32: Honeydew droplets produced, in terms of (a) droplet number and (b) total volume by adult BPH, after feeding on LPO incorporated in artificial diet, MMD-1, at 0.1% concentration {w/v} or artificial diet alone.

*(a) Unpaired t-test for honeydew droplet number, mm.
Significance of difference.*

Treatment	P-value
Control, LPO	.0178

*(b) Unpaired t-test for honeydew droplet volume, μ l.
Significance of difference.*

Treatment	P-value
Control, LPO	.2520

Fig. 32a

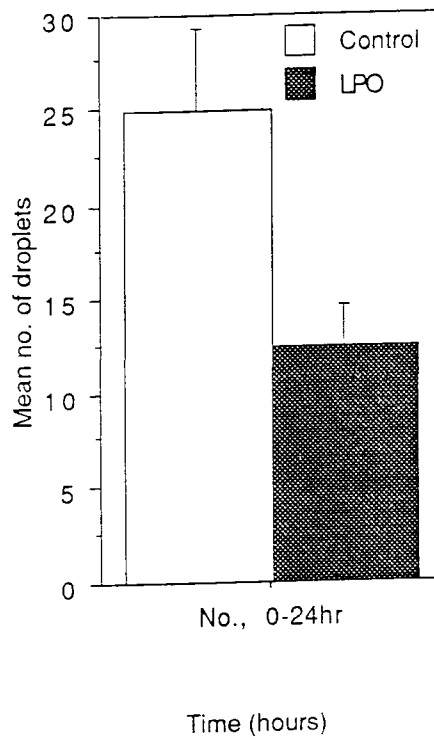

Fig. 32b

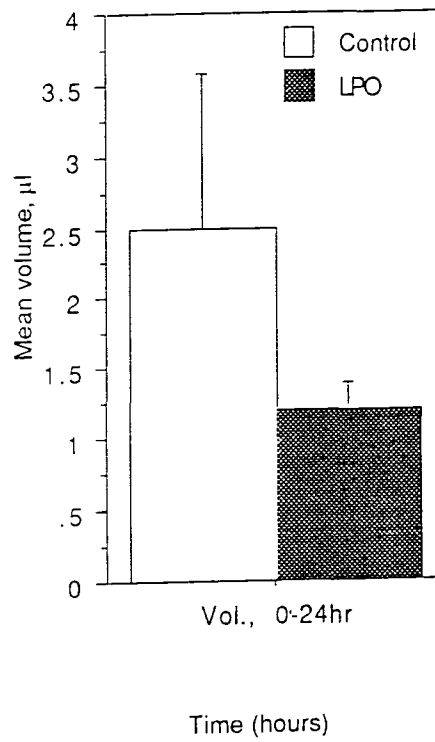
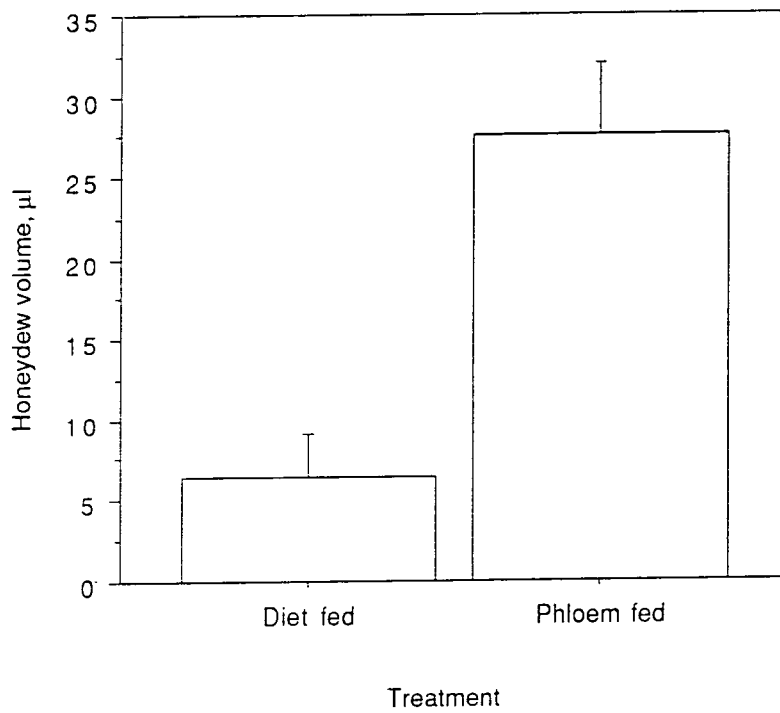

Figure 33. Mean volume of honeydew produced by twenty adult BPH over a 24 hour period, feeding on rice plants or artificial diet. (Error bars represent SEM)



When comparing the volume of honeydew excreted by adult BPH feeding on either host plants or artificial diet over a 24 hour period (Figure 33) there is significantly more honeydew produced by plant fed insects compared to diet fed insects. This suggests that the artificial diet may be supra optimal, in terms of the quantity of dietary components present, and insects therefore excrete less honeydew because they need to imbibe smaller quantities of artificial diet in comparison with plant sap in order to obtain the required levels of nutrients. An alternative explanation, may be that the insect imbibes less artificial diet because it is less palatable than rice phloem sap. Sogawa (1972) has shown that BPH excrete more honeydew in the presence of phagostimulatory amino acids and sucrose and this may indicate that amino acid or sugar levels in the artificial diet are higher than in the rice sap. *Myzus persicae* feeding on artificial diet can modify their levels of diet imbibed depending on the concentration of dietary sucrose (Mittler and Meikle, 1991) according to honeydew volumes measured in mineral oil. Van den Hueval, Boerma and Peters (1991) has shown that the volume of honeydew excreted by PPA (again measured by collecting honeydew droplets in mineral oil) on the host plant is two to three times more than when feeding on artificial diets. It is possible that as the balance of amino acids in the artificial diet and the rice sap differ this affects sucking rate and hence the amount of honeydew produced. By severing the front leg of aphids and collecting the exudate in oil, using this method Downing (1978) showed that PPA ingest phloem sap at several times greater osmotic concentration than the haemolymph, but the gut can reduce this concentration to make it equal to that of the haemolymph. Ho (1980) observed that the aphid *A. fabae* excreted the same rate of honeydew on host plant and artificial diet but diet-fed aphids were smaller in body size.

Using the Parafilm sachet method described here one could compare the rates of honeydew excretion of BPH feeding on susceptible control plants and transgenic plants expressing insecticidal proteins. Using this technique it has been demonstrated that BPH excrete more honeydew on susceptible rice varieties than resistant ones (Pathak, Saxena and Heinrichs, 1982; Khan and Saxena, 1988). Another alternative method of determining diet uptake rates is by differential weighing of diet feeding sachets after aphid feeding, using this method PPA has been shown to imbibe twice as much plant sap as artificial diet (Mittler, 1970).

The use of EPG's would compliment the two quantitative methods of honeydew analysis investigated here as a thorough analysis of salivation, probing and sucking activities of insects *in vitro* and *in vivo* could be carried out. Various studies have been carried out on aphids, GLH (Kawabe and McClean, 1980) and BPH (Khan and Saxena, 1988) using this technique. Kurata and Sogawa (1976) found a high correlation between high inhibition of sucking and high percentage mortality of BPH and this would support my results in that all the effective proteins examined showed both feeding deterrent effects and their use *in vitro* protein feeding trials resulted in significantly higher BPH mortality rates. If as indicated by the analysis of BPH honeydew excretion rates the

effective proteins are acting as feeding deterrents this may involve binding to chemoreceptor sensilla. These have been observed on sensory structures on tarsal segments of BPH (Lösel, 1987; Lösel and Goodman, 1987) and are thought to play a role in feeding site and oviposition site location.

3.8.1.4 Qualitative analysis of BPH honeydew

Honeydew collected, over a 24-hour period, from adult brachypterous female BPH feeding on either the host plant, the artificial diet (MMD-1) or effective proteins incorporated into the artificial diet at 0.1% {w/v} were divided into 10 μ l aliquots and analysed for total amino acid content by the Rowett Research Institute, Aberdeen. Control samples of artificial diet were also analysed in order to determine the relative quantity of each amino acid utilised by the insects, in order to establish whether the presence of either GNA, WGA or LPO incorporated into artificial diet affected amino acid utilisation.

(i) Analysis of honeydew from rice feeding insects

The results of amino acid analysis of duplicate samples of honeydew produced by BPH adults feeding on the susceptible rice variety TN1 or the artificial diet (MMD-1) are shown in Figure 34 and can be compared to the original artificial diet amino acid composition. Twenty amino acids are incorporated into the artificial diet MMD-1 (Table 1) and honeydew and diet samples were analysed for the presence of sixteen of these, the exceptions being asparagine, cysteine, glutamine, methionine and tryptophan, as these could not be determined by routine analysis on the small quantity of sample available. Fifteen amino acids were detected in honeydew from rice-feeding BPH, the predominant ones being aspartate, glutamate, alanine and glycine. In comparison, the predominant amino acids present in the honeydew from artificial diet fed insects were aspartate, glutamate, glycine, alanine, threonine and arginine. The analysis shows that although the same amino acids could be detected in both artificial diet honeydew and honeydew from rice feeding insects samples there were differences in terms of individual amino acid concentrations and total amino acid concentration. The total concentration of amino acids present in honeydew produced by BPH feeding from phloem sap was 5-fold lower than that from the original artificial diet. Unfortunately as no pure phloem sap was available for analysis a direct comparison between that and the artificial diet could not be made.

The purpose of analysing the amino acid composition of honeydew from insects feeding on the host plant was really as a pilot study to determine the amino acid composition of rice phloem sap itself, as it is notoriously difficult to obtain pure sap from graminaceous plants directly. Mittler (1957) obtained phloem sap by severing the stylet of the aphid *T. salignus* with a razor blade and compared it with honeydew (collected

using a capillary tube) excreted by the insect and found that the amino acid compositions were equivalent although lower in the honeydew. He also noted that the only sugar in the phloem sap was sucrose but in the honeydew sucrose, glucose, fructose and melezitose were found. No attempt was made to determine the sucrose content of BPH honeydew. However, to assess the significance of the differences in honeydew from insects fed on plants and MMD-1 diet one would need to compare the amino acid profiles of pure rice phloem sap with the artificial diet. Unfortunately the only reliable method for obtaining pure rice phloem sap is by laser stylectomy (Kawabe, Fukomorita and Chino, 1980) and this was not possible due to technical limitations.

(ii) Analysis of honeydew from insects feeding on artificial diet control

The relative concentrations of each amino acid present in the artificial diet (MMD-1) and the honeydew excreted by adult BPH feeding on the same diet were compared to determine the relative quantities of each amino acid utilised. All the amino acids with the exceptions of tyrosine, valine and phenylalanine appear to be utilised to some degree by the insects when the amino acid profiles of the diet and honeydew are compared and the mean total reduction in amino acid concentration is 25% within the range of 0-70% (Figure 34). It would therefore seem reasonable to hypothesise that tyrosine, valine and phenylalanine are non-essential amino acid constituents for the insects diets. The amino acid concentrations of aspartate, arginine, glutamate and threonine are reduced by between 45-70% indicating that these are important dietary components for the BPH.

(iii) Analysis of honeydew produced by insects feeding on proteins

The amino acid profiles of honeydew collected from adult BPH feeding on artificial diet in which either GNA, WGA or LPO was incorporated were compared with that of insects feeding on artificial diet alone. There was a marked reduction in the concentration of all amino acids in the honeydew produced by insects feeding on each protein treatment when compared with the control fed insects honeydew (Figure 35).

When comparing the amino acid concentrations of the artificial diet with the honeydew from insects feeding on GNA there was a mean reduction in total amino acid concentration of 80%, within the range of 68-92%. Compared with the honeydew from control fed insects the mean total amino acid concentration was reduced by 66% within the range of 30-84%. Histidine was the least utilised of all the amino acids detected (Figure 36).

When comparing the amino acid concentrations of the artificial diet with the honeydew from insects feeding on WGA there was a mean reduction in total amino acid concentration of 85%, within the range of 41-97%. Compared with the honeydew from control fed insects the total concentration of amino acid was reduced by 82% within the

range of 49-94%. Proline (49%) and phenylalanine (50%) were the least utilised of all the amino acids (Figure 37).

When comparing the amino acid concentrations of the artificial diet with the honeydew from insects feeding on LPO there was a mean reduction in total amino acid concentration of 93%, within the range of 80-98%. Compared with the honeydew from control fed insects the total concentration of amino acid was reduced by 89% within the range of 80-93% (Figure 38). If we assume that the quantity of honeydew excreted by the BPH is roughly equivalent to the quantity of artificial diet imbibed, from the above results obtained it would seem evident that the insect is compensating for the feeding deterrent effect of the protein by utilising more of the amino acid in the diet. It would appear therefore that presence of GNA, WGA or LPO does not directly affect the utilisation of amino acids by the insect, suggesting that the proteins play some other role in disrupting the insects nutritional physiology.

Figure 34: Amino acid concentrations detected, using an amino acid analyser, in honeydew produced by adult BPH feeding on either artificial diet (MMD-1) or rice sap.

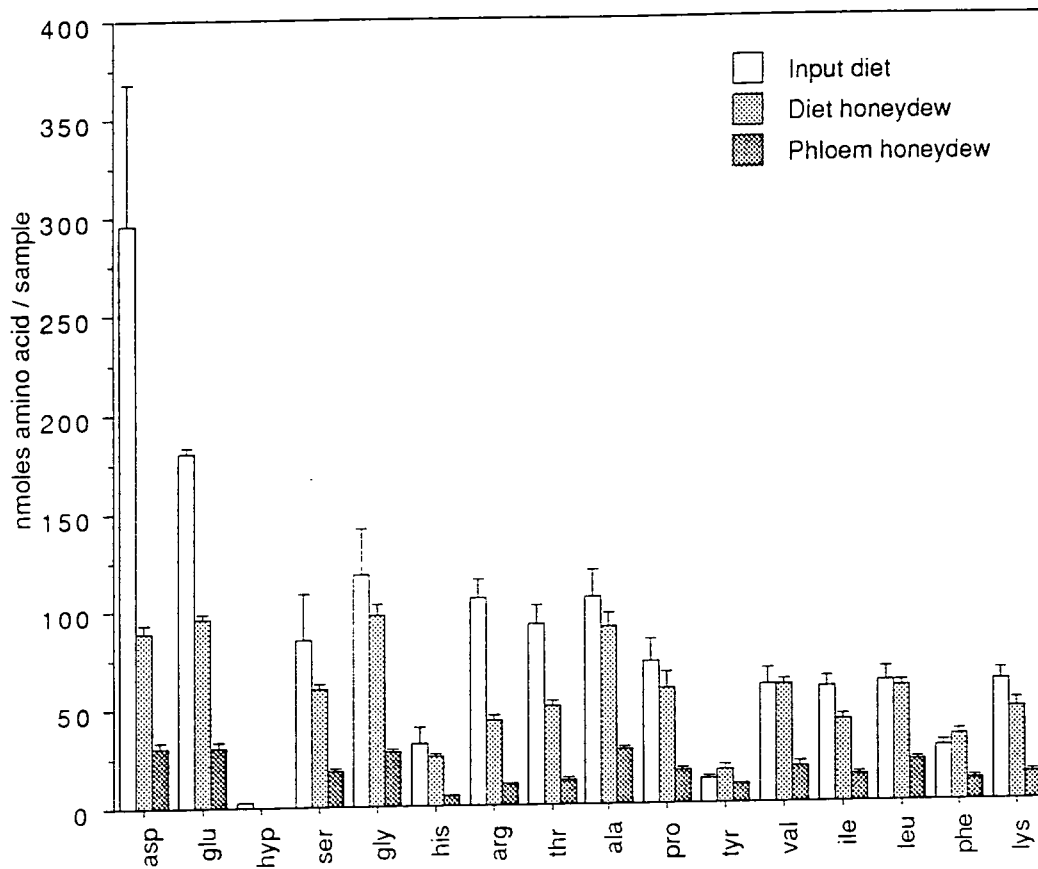

Figure 35: Comparison of the amino acid concentrations detected, using an amino acid analyser, between honeydew produced by adult BPH feeding on either GNA, WGA or LPO incorporated at 0.1% concentration {w/v} in artificial diet MMD-1. Samples were collected after feeding on the diets for 24 hours.

nmoles
amino acid
/sample

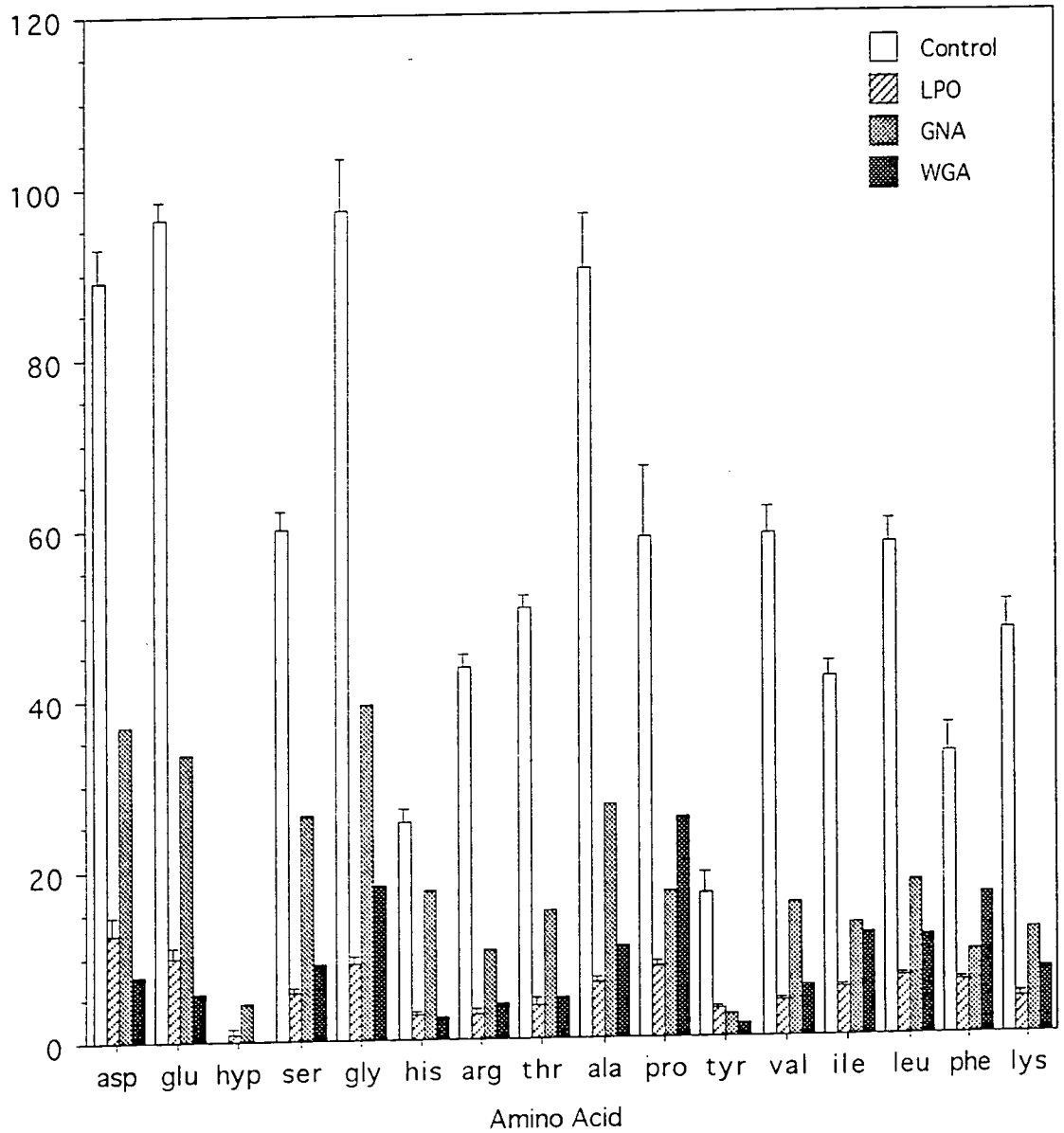

Figure 36: Amino acid concentrations detected, using an amino acid analyser, in honeydew produced by adult BPH feeding on GNA incorporated into artificial diet (MMD-1) at 0.1% concentration.

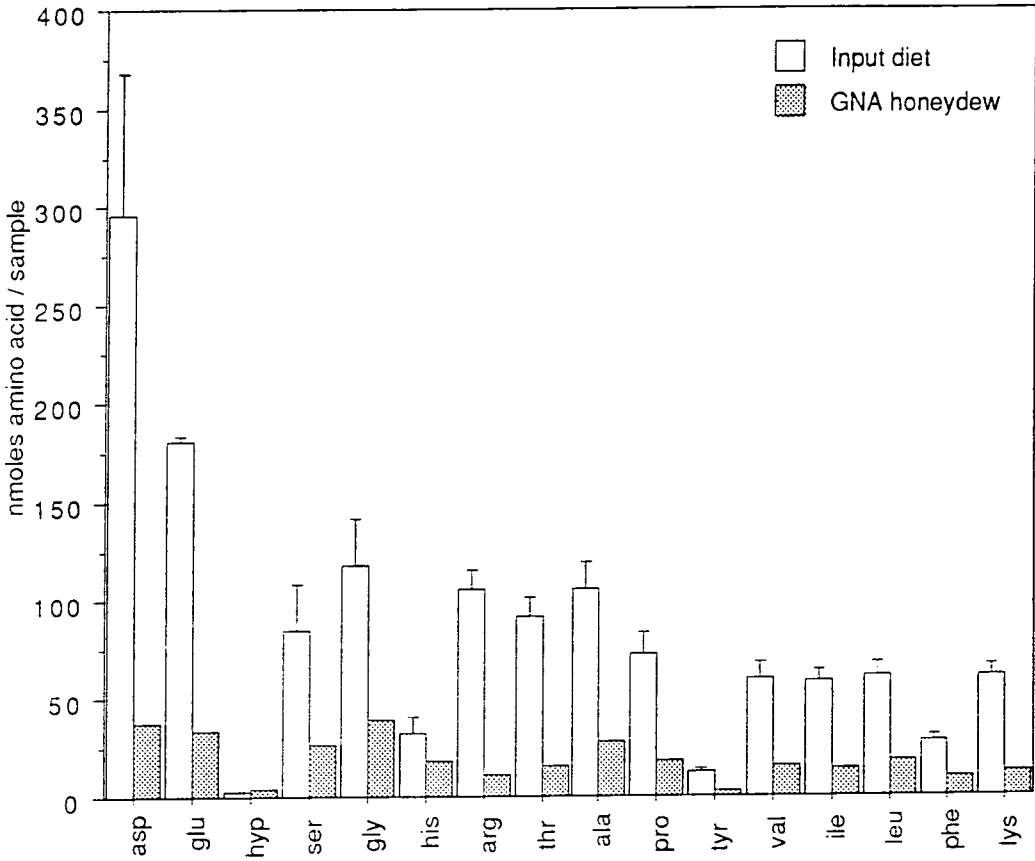

Figure 37: Amino acid concentrations detected, using an amino acid analyser, in honeydew produced by adult BPH feeding on WGA incorporated into artificial diet (MMD-1) at 0.1% concentration.

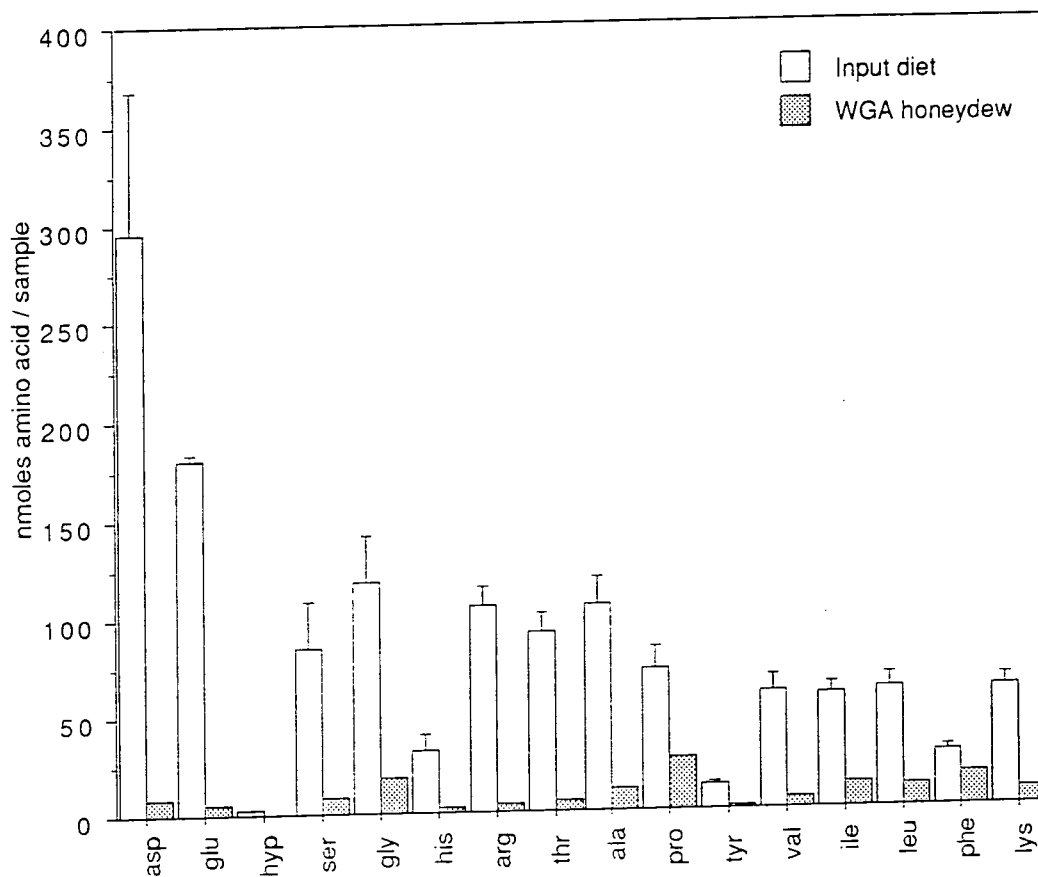
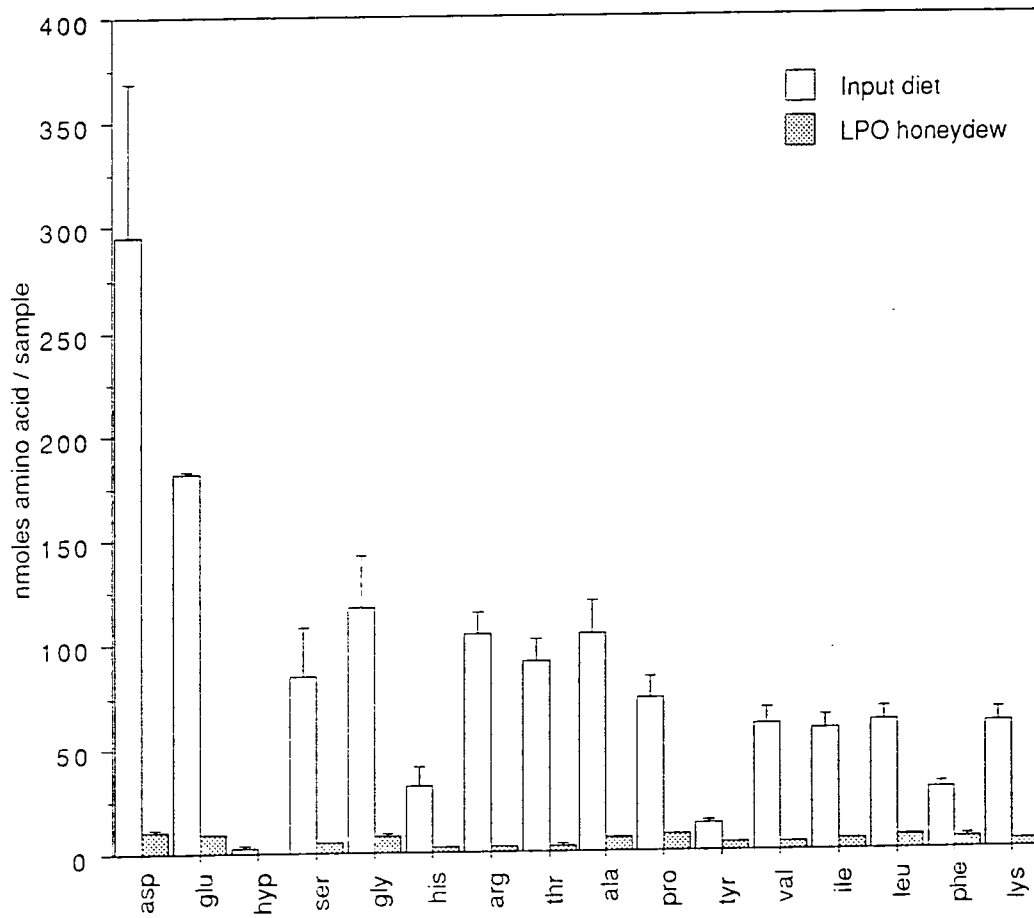

Figure 38: Amino acid concentrations detected, using an amino acid analyser, in honeydew produced by adult BPH feeding on LPO incorporated into artificial diet (MMD-1) at 0.1% concentration.



CHAPTER FOUR

4.1 DISCUSSION

The overall aim of this research project was to examine the potential insecticidal and antifeedant properties of plant derived proteins against homopteran pests, primarily of cultivated rice, with a view to selecting suitable genes for introduction into transgenic rice. To instigate this main research aim five approaches were taken:

- (i) To identify a suitable method for rearing successive generations of *Nilaparvata lugens*, the rice brown planthopper (BPH), *in vitro*, and to develop a reproducible *in vitro* artificial diet bioassay model,
- (ii) to test a wide range of plant (and selected fungal and animal) derived proteins for potential antimetabolic properties towards BPH nymphs,
- (iii) to identify the mechanism(s) of action of effective (i.e. antimetabolic) proteins against BPH,
- (iv) to test selected proteins *in vitro* at sub-optimal concentrations in combination to determine whether an additive or synergistic protective effect could be attained,
- (v) having identified potential proteins whose encoding genes could be included in the rice genome to provide protection to specific homopteran rice pests, to develop an *in planta* bioassay in order to establish whether inclusion of the specified gene(s) provided the desired protection towards the target homopteran pests.

All five of the aims of this research have been achieved at least to some degree.

(i) Rearing and bioassay system

With regards to rearing successive generations of BPH, in the absence of the host plant, some initial difficulties in achieving reasonably high hatching viability in hatching chambers and oviposition chambers were resolved by using oviposition media and artificial diets in combination. However, using these initial methods, rearing BPH directly from the egg stage were rather cumbersome, and hatching rates were much lower when compared with egg viability on the host plant. Other workers (Mitsuhashi 1974, 1979) have shown a degree of success in rearing a variety of leafhoppers and planthoppers on oviposition media but observed that BPH lays very few eggs into artificial media.

In order to have available enough first instar nymphs to use in artificial diet comparison feeding trials I decided to remove first instar nymphs directly from the host plant and using these nymphs tested two formulations of artificial diets, supplied under ambient pressure, to determine the insects optimal dietary requirements. The artificial diet MMD-1 proved superior to MED-1, and enabled first instar BPH nymphs to go through to the fourth instar. Even though adulthood could not be reached, survival was sufficiently good over a reasonable time period to allow a range of proteins to be assayed for potential antimetabolic effects against first and third instar BPH nymphs. Subsequent bioassays were modified in that third instar BPH nymphs were used in preference to first instars, due to their poor survival rates, and a pressurised bioassay system, simulating sap turgor pressure, was developed which enabled BPH to be reared successfully to adulthood indicating that near optimal nutritional requirements had been met, and sufficient survival levels (ie: around 50%) could be measured on the day when corrected mortality levels were calculated.

(ii) Protein feeding trials

Of the 20 proteins tested *in vitro*, three, *Galanthus nivalis* agglutinin (GNA), wheat germ agglutinin (WGA) and soybean lipoxygenase (LPO) were identified which showed a relatively high degree of antimetabolic effect towards BPH, whilst a range of other proteins were shown to have relatively little or no toxic effect with the exception of *Narcissus pseudonarcissus* agglutinin (NPA) and *Allium sativum* agglutinin (ASA) which showed concentration dependent effects. GNA, NPA and ASA are all mannose binding lectins and this could explain why they all exhibit antimetabolic effect towards BPH.

Selected proteins, GNA, WGA and LPO, were also tested in *in vitro* feeding trials against *Nephotettix cinciteps*, the rice green leafhopper (GLH), and only one, GNA, appeared to show significant antimetabolic effects towards the insect. This highlights the fact that the proteins tested are quite specific in their mechanism of action and their effectiveness is dependent, in part, on the feeding physiology of the target insect. BPH and GLH feed on different regions of the host plant (Rubia and Heong, 1989) and have been shown to have different dietary requirements (Mitsuhashi, 1974; Hou and Lin, 1979).

(iii) Mechanism of action

One would expect that the mechanism of action of all three effective proteins to be different to one another due to their different specificities. Three proteins were effective against BPH but only one, GNA, was also toxic towards nymphs of the rice green leafhopper and peach potato aphid. GNA, although not appearing to effect survival of

PPA as dramatically *in vitro* as it did for BPH and GLH, did retard nymphal development and also delayed reproduction, both *in vitro* and *in vivo*.

Although BPH and GLH are both phloem-feeding pests of rice, they select specific regions of the plant on which to feed (unless overcrowding occurs); BPH inhabits the stem region while GLH inhabits the leaf region of the host plant, whereas PPA feeds on a wide host range and preferentially feeds on the underside of leaves. This could indicate that the insects feeding habits and digestive mechanisms are subtly different from one another which could explain the different results obtained with the three genera of sap-sucking insects.

All three proteins, found to be effective against BPH, have different specificities but all appear to act initially as feeding deterrents as established by detailed qualitative and quantitative analysis of honeydew excreta. However, the three effective proteins clearly differ in their mode of action, as indicated by the degree of feeding deterrence, highlighted by the quantitative and qualitative analysis of honeydew production. Analysis of amino acid profiles from honeydew produced from protein-fed insects revealed differences in the amino acid profiles and hence amino acid utilisation rates. Further studies, examining the probing and sucking activities of BPH, using electrical penetration graphs (EPG's) techniques and labelled dietary constituents could provide conclusive evidence of the feeding deterrent effect of these proteins.

It is possible that some of the effective proteins are not only acting as feeding deterrents but also having a toxic effect. If GNA or WGA were binding to glycoprotein receptors, on the midgut epithelial cells, this may interfere with nutritional absorption and digestive processes across the midgut microvilli, as has been indicated in mammalian studies (Pusztai *et al.*, 1990), and further studies would need to be carried out to examine this possibility. Recent studies have shown that WGA not only acts as a feeding deterrent, towards the blowfly larvae *Lucilla cuprina*, but also binds to the midgut apical cells (Eisemann *et al.*, 1993). Lectin binding may also result in bacterial overgrowth of midgut cells resulting in secondary endotoxaemia as indicated in rat feeding trials (King, Pusztai and Clarke, 1990a). WGA and GNA have different sugar-binding specificities these being, N-acetyl- β -D-glucosaminy and D-mannosyl residues respectively (Allen, Neuberger and Sharon, 1973; van Damme *et al.*, 1987), and it may be that they are either binding to specific carbohydrate receptor sites within the alimentary tract, or binding to unidentified digestive enzymes or having a purely antifeedant role.

The other lectins tested in the present study showed either a marginal or no antimetabolic effect towards BPH, and it seems plausible to suggest that the effective lectins have a quite specific, and as yet undetermined mechanism of action.

Gatehouse *et al* (1984; 1989) demonstrated the binding of *Phaseolus vulgaris* lectin to the midgut epithelial cells of the coleopteran *Callosobruchus maculatus*, although the physiological relevance of this observation has been called into question by later results showing that the *Phaseolus* α -amylase inhibitor and not the lectin, was the major toxic

seed component towards *C. maculatus* (Huesing *et al.*, 1991). Whilst WGA has been shown to retard the development of *Callosobruchus maculatus* and the homopteran potato leafhopper *Empoasca flavescens* in artificial diet bioassays (Huesing *et al.*, 1991a, Habibi *et al.*, 1992) other workers have shown that WGA is not toxic towards the phloem feeder *Acyrtosiphon pisum* (Rahbé and Febvay, 1993). GNA has been shown to be insecticidal to several different Coleoptera, including *C. maculatus* in recent studies (Gatehouse *et al.*, in preparation).

It is unlikely that GNA is acting purely as an antifeedant against BPH, as quantitative analysis of honeydew from GNA fed insects indicates that if the insect feeds on GNA for more than 36 hours it gradually adapts to the protein and imbibes more. Also when fed fluorescein-labelled GNA, BPH excretes labelled-GNA in its honeydew after 48 hours indicating that the lectin does indeed pass through the alimentary tract. More detailed quantitative studies using either fluorescein-labelled GNA or radioactive-labelled GNA might allow one to examine how much GNA is imbibed and the relative proportion which is retained within the alimentary tract. Indirect immunofluorescence studies could also be carried out in order to elucidate possible binding sites of specific proteins.

Immunohistochemical studies at the light and electron microscope level, designed to identify potential mechanism of actions of the protein GNA, highlighted possible binding sites within the abdominal region, but no major morphological changes within the midgut epithelium or the yeast-like symbiont (YLS) regions. However technical difficulties in carrying out detailed histological studies on such a small insect could have masked distinct morphological changes within the abdominal area, and one should not discount the possibility that GNA may in fact be causing disruption of the mid gut epithelial cells or else affecting the symbionts present in the fat body cells of the abdomen. Further histochemical investigations would need to be carried out in this area before any firm conclusions could be drawn. Yeast-like symbionts similar in morphology to those described by other workers (Nasu *et al.*, 1981) were successfully isolated from whole body homogenates of BPH and could be used in further binding studies.

A different mechanism of action is presumably involved in the observed toxicity of lipoxygenase to the BPH, since in soybean, this enzyme catalyses the hyperoxidation of *cis-cis* pentadiene moieties in unsaturated fatty acids (Axelrod, 1974) to form conjugated diene hydroperoxides (Duffey and Felton, 1989). Hydroperoxides are strongly reactive electrophiles that covalently bind to functional groups of amino acids causing a reduction in protein nutritional quality or enzymatic activity. They can also release volatile C6 or C5 aldehydes which may react with nucleophile moieties. Lipoxygenase has also been shown to retard the development of *Manduca sexta* fed on artificial diet containing the enzyme (Shukle and Murdock, 1983), by acting on linoleic acid (an unsaturated fatty acid necessary for insect growth and development) to produce toxic levels of linoleic hydroperoxide (Duffey and Felton, 1989). The planthopper/leafhopper group of insects feed

by means of stylet probing and during feeding a stylet sheath is produced by the insects to aid in plant penetration. In the case of BPH, the production of lipoproteinaceous material in the salivary gland region is essential in stylet sheath formation. It may be that the presence of lipoxygenase in the diet disrupts this production in some way, preventing efficient feeding or blocking the stylet pathway, and resulting in reduced diet consumption and hence reduced honeydew output. Future workers may consider examining the ultrastructure of the stylets to determine any possible binding site within this region.

(iv) Gene combinations

The long term aim of this research project was to produce transgenic rice plants which express selected proteins to provide resistance to specific homopteran pests, namely *Nilaparvata lugens* and *Nephotettix cinciteps*. One could argue that the high degree of pest specificity of single proteins, although ecologically and economically important, could provide a drawback to their acceptance by the grower. For instance, many of the resistant varieties introduced by IRRI are attractive to rice farmers because they confer multiple resistance to not only BPH but other pests and diseases. In order to make the use of transgenic plants more attractive both on a practical and economic level it would be desirable if a combination of proteins which provide synergistic or additive effect against a particular insect could be transferred into plants to confer higher degrees of resistance. Boulter *et al* (1990) have shown that cowpea trypsin inhibitor (CpTI) and *Pisum sativum* agglutinin (PSA) when expressed in combination (i.e. gene pyramiding) in transgenic tobacco plants produced enhanced resistance to the lepidopteran pest *Heliothis virescens*.

Alternatively if two or more genes, encoding different proteins, could be incorporated into the rice genome to confer resistance to other insect groups like the Lepidoptera, which includes the economically important rice stem borers, *Chillo spp.*, this would be particularly desirable to the farmer. If a single protein, such as GNA, were to be found to produce antimetabolic or insecticidal effects against other Homopteran pests of rice such as *Nephotettix spp.* (the green leafhoppers), *Sogatella furcifera* Horv. (whitebacked planthopper), *Laodelphax striatellus* Fallèn. (smaller brown planthopper) and *Inazuma dorsalis* Motschulsky. (zig-zag striped leafhopper), this could prove equally desirable as these are important rice pests. As many sap suckers are also the vectors of economically important viral diseases then crop losses due to viral infection may also be reduced, depending on the rates of viral acquisition and transmission, giving the crop in effect multiple resistance.

When incorporating the gene into the host plant the level of gene expression must be high enough so that the pest consumes a lethal dose of protein before the plant incurs unacceptable damage. The presence of a gene must also not reduce crop growth, development and yield characteristics to unacceptable levels (Kirschbaum, 1985),

however recent results indicate that the inclusion of the CpTI gene in tobacco does not confer significant yield penalties.

There is a danger that insects may overcome the influence of a protein, as has been shown in *C. maculatus* which may have overcome plant protease inhibitors by fulfilling their protein requirements through alternative pathways insensitive to inhibition (Applebaum, 1964b). Since BPH is notorious in producing resistance-breaking biotypes to resistant rice cultivars and insecticides, by different physiological mechanisms, there is therefore a possibility that the pest may develop resistance to a single protein. However this may require a significant alteration in the insects gut physiology and as the proteins identified here as being effective against BPH are novel to the host plant it would seem unlikely that resistance would arise rapidly. However one could speculate that as lectins have been discovered in rice (Teraoka *et al.*, 1990), there may be a biotype or sub-population of BPH which could be present and may have a resistance mechanism to cope with certain lectins, assuming that the insect imbibes the rice lectin during feeding. When rice lectin (OSA) was tested *in vitro* against BPH it appeared to have no significant metabolic effect whereas its related lectin WGA, with the same carbohydrate specificity, did.

Three protein combinations were tested *in vitro* against BPH and neither combination appeared to show significant additive or synergistic effects indicating that their use as a multimechanistic protective mechanism *in planta* against this pest would be unlikely. However this does not exclude the possibility that the protein combinations may produce enhanced protection against other rice pests, and further testing of selected proteins against rice pests from other insect orders would further our knowledge in this area.

(v) *In planta* studies

Having identified suitable proteins exhibiting antimetabolic properties towards sap-sucking rice pests, these could, in theory, be incorporated into the genome of the rice plant and expressed in the phloem sap enabling *in planta* testing to be carried out against BPH and GLH. Although a number of proteins showing antimetabolic effects have been shown to be effective in artificial diet insect bioassays, this does not mean that the same effect can be transferred to the crop plant. After all, the artificial diet is designed to produce optimal nutrients for growth, and the diet used in these experiments did not appear to provide optimal nutrient requirements, as indicated by honeydew analysis, and in the field BPH might not be in an "optimal" dietary situation, as environmental factors, such as crop physiology, would affect the nutritional balance of rice phloem sap.

As no transgenic rice plants were available during the course of this project, this delayed establishment of *in planta* feeding trials, against BPH and GLH, and in order to examine the effect of GNA against homopteran pests *in planta* a suitable model homopteran insect, *Myzus persicae*, peach potato aphid (PPA), was selected for further

feeding trials. PPA is a polyphagous pest which can feed on *Nicotiana tabacum* plants which are readily amenable to genetic manipulation. GNA was selected for testing, primarily due to its low mammalian toxicity compared to WGA and LPO, initially *in vitro* against PPA and it was found not only to affect aphid mortality but also to retard development significantly.

In planta feeding trials were carried out and when PPA fed on GNA expressing tobacco plants, nymphal development and fecundity was retarded resulting in delayed population build-up. Recent results, by other workers, have shown that PPA feeding, either on leaf-discs from GNA expressing tobacco plants or the whole plants, also have a reduced fecundity and development is retarded. (Hilder *et al.*, submitted). These results demonstrate not only that GNA can be expressed at suitably high levels within the phloem of a suitable host plant to provide protection towards specific homopteran pests, but also that the antimetabolic effects of the lectin GNA are not restricted to the leafhopper/planthopper homopteran insects but also have the potential to provide protection towards the Aphidae, an important group of primarily temperate crop pests.

The clip-cage method of *in planta* bioassay would clearly be unsuitable to use for the host plant rice and a different bioassay design would be necessary for the sap-feeders BPH which prefer to feed in the stem region of the host plant (unlike PPA which feeds on the plant leaves). One possible design would be to house experimental insects on the host plant within cylindrical perspex containers or Parafilm sachets wrapped around the rice stem, and record insect survival, fecundity and development rates on a daily basis.

This research is of wide significance in that it highlights the first reported (Shi *et al.*, 1991; Hilder *et al.*, 1991) example of lectins and enzymes showing an antimetabolic effect against Homopteran pests, although since these results were first reported other workers have shown that related proteins affect other homopteran pests (Habibi, *et al.*, 1992; Rahbé and Febvay, 1993). As at least one of these proteins, GNA, has been shown to be effective against other Homoptera, such as the Aphidae, the field is wide open to produce other transgenic crop plants. It may also be technically difficult to express proteins in the phloem sap at the appropriate level to be effective. However preliminary indications are that lectins can be expressed at least at 1% total soluble plant protein level which should be sufficiently high as to confer protection as the proteins used here are effective at much lower levels 0.1% {w/v} *in vitro*.

There remain several unanswered questions to this research and I believe that the following aspects need to be emphasised in future research in this area:

- (i) Are the proteins GNA, WGA and LPO effective against other Homopteran pests of rice and other crops?
- (ii) Are the antimetabolic proteins effective against BPH and GLH *in planta*?

- (iii) What is the specific mechanism of action of the antimetabolic proteins?
- (iv) Is there any likelihood that beneficial insects could be affected by the presence of foreign protein genes in the host plant.?

5.0 REFERENCES

- Abbot, W.S., 1925. A method of computing the effectiveness of an insecticide. *J. Econ. Entomol.* 18:266-267.
- Abenes, M.L.P. and Khan, Z.R., 1990. Attraction of rice leafhoppers and planthoppers to different light colours. *Int. Rice. Res. Newsl.* 15 (2):32-33.
- Adams, J.B. and van Emden, H.F., 1972. Chapter 2: The biological properties of aphids and their host plant relationships. In: *Aphid Technology* (Eds: H.F. van Emden), Academic Press, London, UK. pp.47-104.
- Agarwal, A.K., 1975. Digestive enzymes of sugarcane leafhopper, *Pyrilla perpusilla* WLK. (Fulgoridae: Hemiptera). *Appl. Ent. Zool.* 10 (2):140-142.
- Aguda, R.M. and Rombach, M.C., 1985. Mortality of adult brown planthopper (BPH) in different types of cages used for bioassays of entomopathogenic fungi. *Int. Rice Res. Newsl.* 10(2):17-18.
- Akey, D.H. and Beck S.D., 1975. Programmable automated system for continuous rearing of the pea aphid, *Achyrthosiphon pisum*, on holicidic diets. *Ent. Exp. & Appl.* 18:1-16.
- Alam, M.S., 1978. Resistance to biotype 3 of the brown planthopper, *Nilaparvata lugens* (Stål) in rice varieties. PhD thesis. Cornell University, USA.
- Allen, A.K., Neuberger, A. and Sharon, N., 1973. The purification, composition and specificity of wheat germ agglutinin. *Biochem. J.* 131:155-162.
- Anon., 1991. The future written in a grain of rice. *Economist.* March:83-84.
- Applebaum, S.W., 1964a. The action pattern and physiological role of *Tenebrio* larval amylase. *J. Ins. Physiol.* 10:897-906.
- Applebaum, S.W., 1964b. Physiological aspects of host specificity in the Bruchidae- I. General considerations of development compatibility. *J. Insect. Physiol.* 10:805-810.
- Applebaum, S.W., 1985. Chapter 7: Biochemistry of digestion. In: *Comprehensive insect physiology, biochemistry and pharmacology Vol. 4. Regulation: Digestion, Nutrition, Excretion.* (Eds: G.A., Kerkut and L.I. Gilbert). pp. 279-311.
- Argandoña, V. H., Corcuera, L.J., Niemeyer, H.M. and Campbell, B.C., 1983. Toxicity and feeding deterrence of hydramic acids from Graminae in synthetic diets against the greenbug *Schizaphis graminum*. *Ent. Exp & Appl*, 34: 134-138.
- Athwal, D.S., Pathak, M.D, Bacalangco, E.H. and Pura, C.D., 1971. Genetics of resistance to brown planthoppers and green leafhoppers in *Oryza sativa* L. *Crop Science.* 2 (September-October):747-751.
- Attathom, T., Chongrattanamateekul, W, Chanpaisaeng, J. and Siriyan, R. 1993. Insecticidal activity of local strains of *Bacillus thuringiensis* against rice stem borers. *Abstracts. 6th. Ann. Meeting. Intl. Prog. Rice. Biotech*, February 1-5, 1993, Chiang Mai, Thailand. p.25.
- Auclair, J.L., 1963. Aphid feeding and nutrition. *Ann. Rev. Ent.* 8:439-477.
- Auclair, J.L., 1965. Feeding and nutrition of the pea aphid, *Achyrthosiphon pisum* (Homoptera: Aphidae), on chemically defined diets of various pH and nutrient levels. *Annales. Ent. Soc. Amer.* 58 (6):855-875.
- Axelrod, B., 1974. Chapter 13: Lipoxygenases. In: *Food Related Enzymes: ACS Adv. Chem. Ser.* (Eds. E.L. Kothny). 136:324-348.
- Bae, S.M., 1966. Studies on some aspects of the life history and habitats of the brown planthopper, *Nilaparvata lugens* (Stål), Delph, Hom. MSc Thesis, University of Philippines. Philippines.

- Bae, S.H. and Pathak, M.D., 1970. Life history of *Nilaparvata lugens* (Homoptera: Delphacidae) and susceptibility of rice varieties to its attacks. *Annales. Ent. Soc. Amer.* 63 (1):149-155.
- Ball, B.V. and Bailey, L. 1978. The symbiotes of *Myzus persicae* (Sulz.) in strains resistant and susceptible to demeton-S-methyl. *Pesticide Sci.* 9:522-524.
- Bennett, J., Arora, N., Bhatnagar, R.K., Chandel, G., Ehtesham, N.Z., Fattah, Goel, F.A., Majumder, K., Mohan, M., Molina Guerva, P., Nair, S., Selvapandiyam, A., Patwal, P., Sharma, R. and Singh, K., 1993. Plant biology: plant stress resistance. In: *ICGEB Activity Report - 1992*. pp.53 -58.
- Bernfield, P., 1955. Amylases, α and β . In: *Methods in Enzymology*. (Eds: S.P. Colowick and N.O. Kaplan.) Academic Press, NY, USA. pp.149-158.
- Bonman, J.M., Khush, G.S. and Nelson, R.J., 1992. Breeding rice for resistance to pests. *Ann. Rev. Phytopath.* 30:507-28.
- Bottrell, D.G., Aguda, R., Gould, F.L. and Demayo, C., 1993. Potential strategies for prolonging usefulness of *Bacillus thuringiensis* genes in engineered rice. *Abstracts. 6th. Ann. Meeting. Intl. Prog. Rice. Biotech*, February 1-5, 1993, Chiang Mai, Thailand. p.58.
- Bouin, P. 1897. *Arch. Anat. Morph. Exp.* 1:225.
- Boulter, D., Edwards, G.A, Gatehouse, A.M.R, Gatehouse, J. and Hilder, V. A., 1990. Additive protective effects of different plant-derived insect resistance genes in transgenic tobacco plants. *Crop Protection.* 9 (October):351-354.
- Bramstedt, F., 1948. Uber die Verdauungsphysiologie der aphiden. *Zeit. Natur.* 3b: 14-24.
- Buchner, P., 1965. *Endosymbiosis of Animals with Plant Microorganisms*. Interscience, New York, USA.
- Busch, L., Lacy, W.B, Burkhardt, J. and Lacy, L.R., 1991. Chapter 8: Emerging trends and issues in biotechnology. In: *Plants, Power and Profit. Social, Economic and Ethical Cosequences of the New Biotechnologies*. Blackwell, Oxford, UK.
- Cambell, B.C. and Dreyer, D.L., 1990. The role of plant matrix polysaccharides in aphid-plant interactions. In: *Aphid-Plant Genotype Interactions*. (Eds: R.K. Campbell and R.D. Eikenbary). Elsevier, Amsterdam. pp.149-170.
- Cammue, B., Stinissen, H.M. and Peumans, W.J., 1985. Leaves of the wild grass *Agropyrum repens* contain an N-acetylgalactosamine-specific lectin. In: *Lectins, Vol. IV*. Walter de Gryter and Co, Berlin, Germany. pp.607-616.
- Carnoy, J.B. 1887. *Cellule* 3:276.
- Carter, W., 1927. A technique for use with Homopterous vectors of plant diseases, with special reference to the Sugar Beet Leafhopper, *Eutettix tenallus* (Baker) . *J. Agr. Res.* 34:449-451.
- Chada, H.L., 1962. Toxicity of cellulose acetate and vinyl plastic cages. *J. Econ. Entomol.* 55(b): 970-972.
- Chang, C.K. and Whalon, M.E., 1987. Substrate specificities and multiple forms of esterases in the brown planthopper, *Nilaparvata lugens* (Stål). *Pest. Biochem & Physiol.* 27:30-35.
- Chapman, R.F., 1982. Chapter V. Nutrition. In: *The Insects: Structure and Function*. Hodder and Staughton, Kent, UK. pp.84-99.
- Chau, L.M. and Saxena, R.C., 1989. Reaction to brown planthopper (BPH) of varieties originating from *Oryza officinalis*. *Int. Rice. Res. Newsl.* 14(6): 9-10.
- Chelliah, S. and Ulthamaswamy, S., 1986. Insecticide induced resurgence of insect pests of rice. *Oryza.* 23(2):71-82.

- Chen, C-C., Cheng, L-L., Kuan, C-C. and Hou, R.F., 1981. Studies on the intracellular yeast-like symbiote in the brown planthopper, *Nilaparvata lugens* Stål. 1. Histological observations and population changes of the symbiote. *Z. Ang. Ent.*, 91: 321-327.
- Chino, M., Fukumorita, T, Kawabi, S. and Ando, Y. 1982., Chemical composition of rice phloem sap collected by "Insect Technique". *Proc. 9th. Plant. Nutrition. Colloquim.* (Ed: A. Scaife) 1:105-110.
- Chino, M., Hayashi, H. and Fukumorita, T., 1987. Chemical composition of rice phloem sap and its fluctuation. *J. Plant. Protect*, 10 (9-16):1651-1661.
- Chiu, S.C., 1979. Biological control of the brown planthopper. In: *Brown Planthopper: Threat to Rice Production In Asia*. International Rice Research Institute, Manila, Philippines. pp.335-355.
- Chrispeels, M. J. and Raikhel, N. V., 1991. Lectins, lectin genes and their role in plant defence. *Plant Cell*, 3:1-9.
- Christeller, J. T., Shaw, B. D., Gardiner S. E. and Dymock, J., 1989. Partial purification and characterisation of the major midgut proteases of grass grub larvae *Costelytra zealandica*, (Coleoptera: Scarabaeidae). *Insect. Biochem*, 19 (3):221-231.
- Christopher, J., Pistorius, E. and Axelrod, B., 1970. Isolation of an isoenzyme of soybean lipoxigenase. *Biochim. Biophys. Acta*, 198:12-19.
- CIE, 1979. *Distribution maps of pests*. Map no. 45. Commonwealth Institute of Entomology, CAB, UK.
- Claridge, M.F., Claridge, L.F. and Morgan, J.C., 1987. *Anagrus* egg parasitoids of rice-feeding planthoppers. *Proc. 6th Auchen. Meeting*. Turin, Italy, 7-11 Sept. 1987. pp.617-621.
- Claridge, M.F. and den Hollander, J., 1980. The "Biotypes" of the Rice Brown Planthopper, *Nilaparvata lugens*. *Ent. Exp & Appl*, 27:23-30.
- Claridge, M.F. and Morgan, J.C., 1987. The brown planthopper, *Nilaparvata lugens* (Stål), and some related species: A biotaxonomic approach. *Proc. 2nd Int. Workshop on Leafhoppers and Planthoppers of Economic Importance*. Utah, USA, 28 July - 1 Aug, 1986. (Eds: M.R. Wilson and L.R. Nault). CIE, London. pp. 19-32.
- Clayton, R.B., 1964. The utilization of sterols by insects. *J. Lipid. Res.*, 5: 3-19.
- Cook, A.G., Woodhead, S, Magalit, V. and Heinrichs, E.A., 1987. Variation in feeding behaviour of *Nilaparvata lugens* on resistant and susceptible rice varieties. *Ent. Exp & Appl*, 43:227-235.
- Conti, M., 1987. Reoviruses of grasses and cereals and their vectors. *Proc. 2nd Int. Workshop on Leafhoppers and Planthoppers of Economic Importance*. Utah, USA. 28 July - 1 Aug, 1986. (Eds. M.R. Wilson and L.R. Nault). CIE, London. pp. 93-100.
- Czapla, T.M. and Lang, B.A., 1990. Effect of plant lectins on the larval development of European corn borer (Lepidoptera: Pyralidae) and Southern corn rootworm (Coleoptera: Chrysometodia). *J. Econ. Entomol*, 83(6):2480-2485.
- Dadd, R.H., 1970a. Chapter 2: Arthropod nutrition. In: *Chemical Zoology. Vol V. Arthropoda A*. (Eds: M. Florkin and B.T. Scheer). Academic Press. pp.35-89.
- Dadd, R.H., 1970b. Chapter 4: Digestion in insects In: *Chemical Zoology. Vol V. Arthropoda A*. (Eds: M. Florkin and B.T. Scheer). Academic Press. pp.117-145.
- Dadd, R.H., 1985. Nutrition: Organisms. In: *Comprehensive Insect Physiology, Biochemistry and Pharmacology, Vol 4*. (Eds. G.A. Kerkut and L.I. Gilbert). Pergamon Press, Oxford, UK. pp.279-312.

- Dadd, R.H. and Mittler, T.E., 1965. Studies on the artificial feeding of the aphid *Myzus persicae* (Sulzer) III. Some major nutritional requirements. *J. Ins. Physiol*, 11:717-743.
- Dadd, R.H. and Mittler, T.E., 1966. Permanent culture of an aphid on a totally synthetic diet. *Experientia*, 22: 832-833.
- David, C.C., 1992. Chapter 1: The world rice economy: Challenges ahead. In: *Rice Biotechnology*. CAB International, UK. pp.1-18.
- Dawson, R.M.C., Elliot, D.C., Elliot, W.H. and Jones, K.M., 1986. *Data for Biochemical Research*. Third Edition. Clarendon Press, Oxford, UK.
- Derr, R.F. and Randall, D.D., 1966. Trehalase of the differential grasshopper, *Melanoplus differentialis*. *J. Ins. Physiol*, 12:1105-1114.
- Dewar, A.M., Read, L.A. and Thornhill, W.A., 1988. The efficacy of novel and existing aphicides against resistant *Myzus persicae* on sugar beet in the laboratory. *Proc. Vol. Brighton Crop Protection Conference. Pests and Diseases*. November 21-24, 1988. BCPC, England. pp.477-482.
- Dixon, A.F.G., 1985. *Aphid Ecology*. Blackie and Son Ltd, Glasgow, UK.
- Douglas, A.E., 1988. Sulphate utilisation in an aphid symbiosis. *Insect. Biochem*. 18:599-605.
- Douglas, A.E., 1989. Mycetocyte symbiosis in insects. *Biol. Rev*, 64:409-434.
- Douglas, A.E., 1992a. Requirement of pea aphids (*Acyrtosiphon pisum*) for their symbiotic bacteria. *Ent. Exp. & Appl*, 65:195-198.
- Douglas, A.E., 1992b. Microbial brokers of insect-plant interactions. *Proc. 8th Int. Symp. Insect-Plant Relationships*. (Eds: S.B.J. Menken, J.H. Visser and P. Harrewijn). Kluwer Academic, Netherlands. pp.329-336.
- Douglas, A.E. and Prosser, W.A., 1992. Synthesis of the essential amino acid tryptophan in the pea aphid (*Acyrtosiphon pisum*) symbiosis. *J. Insect. Physiol*, 38(8):565-568.
- Downing, N., 1978. Measurements of the osmotic concentration of stylet sap, haemolymph and honeydew from an aphid under osmotic stress. *J. Exp. Biol*, 77:247-250.
- Du, Z., Wang, F, Guo, C., Gu, Z, Zeng, J. and Sun, J., 1990. The studies of integrated control of rice diseases and pests in China. *Sci. Agric. Sinica*, 23(6):19-26.
- Duffey, S.S. and Felton, G.W., 1989. Chapter 20: Plant enzymes in resistance to insects. In: *Biocatalysis in Agricultural Biotechnology*. American Chemical Society. pp.287-314.
- Dyck, V.A., Htun, T., Dulay, A.C., Salinas, G.D., Orlido, J.R., and Orlido, G.C. 1981. Economic injury levels for rice insect pests. *Agri. Res. J. Kerala*, 19(2):75-85.
- Dyck, V.A., Misra, B.C., Alam, S., Chen, C.N., Hsieh, C.Y. and Rejesus, R.S., 1979. Ecology of the brown planthopper in the tropics In: *Brown Planthopper: Threat to Rice Production in Asia*. International Rice Research Institute, Manila, Philippines. pp.61-100.
- Dyck, V.A. and Thomas, B., 1979. The brown planthopper problem. In: *Brown Planthopper: Threat to Rice Production in Asia*. International Rice Research Institute, Manila, Philippines. pp.3-20.
- Ehrhardt, P., 1966. Die wirkung von lysozyminjektionen auf aphiden und deren symbioten. *Z. Vgl. Physiol*, 53, 130-141. (In German).
- Ehrhardt, P., 1968. Nachweis einer durch symbiontische mikroorganismen bewirkten sterinsynthese in künstlich ernährten aphiden (Homoptera, Rhynchota, Insecta). *Experientia*, 24:82-83. (In German)

- Eisemann, C.H., Donaldson, R.A., Pearson, R.D., Cadagon, L.C., Vuocolo, T. and Tellam, R.L., 1993. Larvicidal activity of lectins on *Lucilia cuprina*: Mechanism of action. *Ent. Exp. & Appl.* (In press).
- Endo, S., Hagata, T., Kawabe, S. and Kazano, H., 1988. Changes of insecticide susceptibility of the white-backed planthopper *Sogatella furcifera* Horváth. (Homoptera: Delphacidae) and the brown planthopper *Nilaparvata lugens* Stål. (Homoptera: Delphacidae). *Appl. Ent. Zool*, 23 (4):417-421.
- Endo, S., Masuda, T. and Kazano, H., 1988b. Development and mechanism of insecticide resistance in rice brown planthoppers selected with Malathion and MTMC. *J. Pest. Sci*, 13 (2):239-245
- Erlanger, B. F., Kokowsky, N. and Cohen, W., 1961. The preparation and properties of two new chromogenic substrates of trypsin. *Arch. Biochem. Biophys*, 95:271-278.
- Esaki, T. and Hashimoto, S., 1937. Studies on rice leafhoppers. I. Biology and natural enemies. *Noji. Kairyō. Shiryo*, 127:1-135. (In Japanese).
- Evans, S.V., Gatehouse, A.M.R. and Fellows, L.E., 1985. Detrimental effects of 2-5-Dihydroxymethyl-3-4-dihydroxypyrrolidine in some tropical legume seeds on larvae of the bruchid *Callosobruchus maculatus*. *Ent. Exp & Appl*, 37:257-261.
- Evans, W.A.L. and Payne, D.W., 1964. Carbohydrases of the alimentary tract of the desert locust *Schistocerca gregaria* Forsk. *J. Ins. Physiol*, 10:657-674.
- Farkas, V., 1989. Chapter 9: Polysaccharide metabolism In: *The Yeasts, Vol 3 Metabolism and Physiology of Yeast*. (Eds: A.H. Rose and J.S. Harrison). Academic Press, London. pp.317-359.
- Febvay, G., Delobel, B. and Rahbé, Y., 1988. Influence of the amino acid balance on the improvement of an artificial diet for a biotype of *Acyrtosiphon pisum* (Homoptera: Aphididae). *Can. J. Zool*, 66:2449-2453.
- Fernando, H., Senadhera, D., Elikawela, Y., de Alwis, H.M. and Kudagamage, C., 1979. Varietal resistance to the BPH in Sri Lanka. In: *Brown Planthopper: Threat to Rice Production in Asia*. International Rice Research Institute, Manila, Philippines. pp.241-250.
- Fisk, F.W. and Shambaugh, G.F., 1952. Protease activity in adult *Aedes aegypti* mosquitoes as related to feeding. *Ohio. J. Sci*, 52 (2):80-88
- Fisk, F.W. and Shambaugh, G.F., 1954. Invertase activity in adult *Aedes aegypti* mosquitoes. *Ohio. J. Sci*, 54 (4):237-239.
- Fisk, J., 1980. Effects of HCN, phenolic acids and related compounds in *Sorghum bicolor* on the feeding behaviour of the planthopper *Peregrinus maidis*. *Ent. Exp & Appl*, 27:211-222.
- Fleet, G.H., 1991. Chapter 5: Cell walls. In: *The Yeasts. Vol. 4. Yeast Organelles*. (Eds: A.H. Rose and J.S. Harrison). Academic Press, London. pp.199-277.
- Forbes, A.R., 1963. The morphology, histology and fine structure of the gut of the green peach aphid, *Myzus persicae* (Sulzer). PhD thesis. University of California, Berkeley, USA.
- Forbes, A.R., 1964. The morphology, histology and fine structure of the gut of the green peach aphid, *Myzus persicae* (Sulzer) (Homoptera: Aphididae). *Memoirs. Entomol. Soc. Canada*, 36:5-32
- Forbes, A.R. and MacCarthy, H.R., 1969. Morphology of the Homoptera, with emphasis on virus vectors In: *Viruses, Vectors and Vegetation*. (Ed: K. Maramorosch). John Wiley, pp.211-234.
- Fowler, S.V., 1987. Field studies on the impact of natural enemies in BPH populations on rice in Sri Lanka. *Proc. 6th Auchen Meeting*. Turin, Italy. 7-11 Sept. 1987. pp.567-574.

- Fowler, S.V., Claridge, M.F, Morgan, J.C, Peries, I.D.R. and Nugaliyadde, L., 1991. Egg mortality of the BPH, *Nilaparvata lugens* (Homoptera: Delphacidae) and green leafhoppers, *Nephotettix spp.* (Homoptera: Cicadellidae), on rice in Sri Lanka. *Bull. Ent. Res*, 81:161-167.
- Fredenhagen, A., Kenny, P., Kita, M., Komusra, H., Naya, Y., Nakanishi, K., Nishiyama, K., Sugiura, M. and Tamura, S., 1987. Role of intracellular symbiotes in planthoppers In: *Pesticide Science and Biotechnology. Proc. 6th. Int. Cong. Pest. Chem.* Ottawa, Canada. 10-15 August 1986. (Eds., R. Greenlaugh and T.R. Roberts). Blackwell, Oxford, UK. pp.101-108.
- Fukatsu, T. and Ishikawa, H., 1992. Synthesis and localization of symbionin, an aphid endosymbiont protein. *Ins. Biochem. Molec. Biol*, 22(2):167-174.
- Fukomorita, T and Chino, M., 1982. Sugar, amino acid and inorganic contents in rice phloem sap. *Plant & Cell Physiol*, 23 (2):273-283.
- Fulton, R.A. and Chamberlin, J.C, 1934. An improved technique for the artificial feeding of the beet leafhopper with notes on its ability to synthesize glycerides. *Science*, 79 (2050):346-348.
- Gallun, R.L. and Khush, G.S., 1980. Chapter 4: Genetic factors affecting expression and stability of resistance. In: *Breeding Plants Resistant to Insects.* (Eds: F. G. Maxwell and P. R. Jennings). John Wiley and Sons. pp.64-85.
- Gatehouse, A.M.R. and Anstee, J.H., 1983. The presence and partial characterisation of carbohydrase enzymes in the gut of *Callosobruchus maculatus*. *Experientia*, 39:1013-1015.
- Gatehouse, A.M.R., Dewey, F.M, Dove, J, Fenton, K.A. and Pusztai, A., 1984. Effect of seed lectins from *Phaseolus vulgaris* on the development of larvae of *Callosobruchus maculatus*; mechanism of toxicity. *J.Sci. Food Agric.* 35:373-380.
- Gatehouse, A.M.R., Fenton, K.A. and Anstee, J.H., 1985. Carbohydrase and esterase activity in the gut of larval *Callosobruchus maculatus*. *Experientia*, 41:1022-1025.
- Gatehouse, A.M.R., Fenton, K.A, Jepson, I. and Pavey, D.T., 1986. The effects of α -amylase inhibitors on insect storage pests: Inhibition of α -amylase *in vitro* and effects on development *in vivo*. *J. Sci. Food. Agric*, 37:727-734.
- Gatehouse, A.M.R., Gatehouse, J.A. and Boulter, D., 1980. Isolation and characterisation of trypsin inhibitors from cowpea. *Phytochem*, 19:751-756.
- Gatehouse, A.M.R., Gatehouse, J.A, Dobie, P, Kilminster, A.M. and Boulter, D., 1979. Biochemical basis of insect resistance in *Vigna unguiculata*. *J. Sci. Food. Agric*, 35:949.
- Gatehouse, A.M.R., Hilder, V.A. and Gatehouse, J.A., 1992. Control of insect pests by plant genetic engineering. *Proc. Royal. Soc. Edinburgh*. 99B ((3/4), 51-60.
- Gatehouse, A.M.R., Hilder, V.A, Powell. K.S, Boulter, D., and Gatehouse, J.A., 1992. Potential of plant derived genes in the genetic manipulation of crops for insect resistance. *Proc. 8th Int. Symp. Insect-Plant Relationships, Dordrecht.* (Eds: S.B.J. Menken., J.H. Visser and P. Harrewijn). Kluwer Academic, Netherlands. pp.221-233.
- Gatehouse, A.M.R., Minney, B.H, Dobie, P. and Hilder, V.A., 1990. Biochemical resistance to bruchid attack in legume seeds: Investigation and exploitation. In: *Bruchids and Legumes: Economics, Ecology and Coevolution.* Kluwer Academic publishers. Netherlands. pp.241-256.
- Gatehouse, A.M.R., Shackley, S.J, Fenton, K.A, J. Bryden, J. and Pusztai, A., 1989. Mechanism of seed lectin tolerance by a major insect storage pest of *Phaseolus vulgaris*, *Acanthoscelides obtectus*. *J. Sci. Food. Agric.* 47: 269-280.

- Gatehouse, A.M.R., Shi, Y., Powell, K.S., Brough, C., Hilder, V.A., Hamilton, W.D.O., Newell, C.A., Fairweather, A., Boulter, D. and Gatehouse, J.A., 1993. Approaches to insect resistance using transgenic plants. *Proc. Royal. Soc.* (In Press),
- Gatwick, M., 1992. Chapter 11: Potato Aphids. In: *Crop Pests In The UK. Collected Edition of MAFF Leaflets*. Chapman and Hall, London, UK. pp.60-66.
- Gilby, A.R., Wyatt, S.S. and Wyatt, G.R., 1967. Trehalases from the cockroach, *Blaberus discoidalis*. Activation, solubilization and properties of the muscle enzyme and some properties of the intestinal enzyme. *Acta. Biochim. Polonica*, 14 (1):83-100.
- Goldstein, W.S., 1987. Tannin inhibition of cowpea beetle, *Callosobruchus maculatus*, larval gut β -glucosidase. In: *Insect-Plants. Proc. 6th.Int. Symp. on Insect-Plant Relationships*. (Ed: V. Labeyrie, G. Fabres and D. Lachaise). Dr. W. Junk, Dordrecht, Netherlands. p. 390.
- Grace, T.D.C., 1962. Establishment of four strains of cells from insect tissues grown *in vitro*. *Nature*, 4843: 788-789.
- Green, T.R. and Ryan, C.A., 1972. Wound-induced proteinase inhibitor in plant leaves: a possible defense mechanism against insects. *Science*. 175:776-777.
- Greenland, D.J., 1984. Exploited Plants - Rice. *Biologist*, 31 (4):219-225.
- Griffiths, D.C., Greenaway, A.R. and S. Lloyd., 1978 The influence of repellent materials and aphid extracts on settling behaviour and larviposition of *Myzus persicae* (Sulzer) (Hemiptera: Aphidae). *Bull. Ent. Res.* 68: 613-619.
- Griffiths, G.W. and Beck, S.D., 1974. Effects of antibiotics on intracellular symbiotes in the pea aphid, *Acyrtosiphon pisum*. *Cell. Tiss. Res.*, 148:287-300.
- Griffiths, G.W. and Beck, S.D., 1977. *In vivo* sterol biosynthesis by pea aphid symbiotes as determined by digiton and electron microscope autoradiography. *Cell & Tissue Res.* 176: 179-190.
- Grist, D.H., 1986. *Rice*. 6th Edition pp.324-353.
- Guss, P.L., Richardson, T. and Stahmann, M. A., 1967. The oxidation-reduction enzymes of wheat III isoenzymes of lipoxidase in wheat fractions and soybean. *Cereal Chemistry*. 44:607-610.
- Habibi, J., Backus, E.A. and Czaplá, T.H., 1992. Effect of plant lectins on survival of potato leafhopper *Proc. XIX. Int. Cong. Entomol.* Beijing, China. June 28 - July 4, 1992. pp.373.
- Hadfield, P., 1993. Japanese aid may upset Cambodia's harvests. *New Scientist*, 13 March 1993. pp.5.
- Hama, H., 1976. Modified and normal cholinesterases in the respective strains of carbamate-resistant and susceptible green rice leafhoppers, *Nephotettix cinciteps* Uhler. (Hemiptera: Cicadellidae). *Appl. Ent. Zool*, 11 (3):239-247.
- Harlow, E.D. and Lane, D., 1988. *Antibodies- A Laboratory Manual*.
- Harukawa, C., 1951. Effect of environmental temperature upon rice leafhoppers. *Botyu-Kagaku. Bull. Inst. Ins. Control*, 16 (1):1-10. (In Japanese).
- Hasegawa, H., 1955. Some notes on the Japanese species of the genus *Nilaparvata* Distant. (Homoptera, Delphacidae). *Bull. Nat. Inst. Agric. Sci. Tokyo*, 5:118-138. (In Japanese).
- Haslam, D.W., 1985. Taxonomic studies of some planthopper and leafhopper pests of rice. PhD thesis University of Cardiff, UK.
- Hayashi, H. and Chino, M., 1986. Effect of nitrogen nutrition and light on the chemical composition of rice phloem sap. In: *Phloem Transport*. Alan, R. Liss Inc. pp.465-468.
- Hayashi, H. and Chino, M., 1990. Chemical composition of rice phloem sap from the uppermost internode of the rice plant. *J. Plant. Physiol*, 21(2):247-251.

- Heinrichs, E.A., 1979a. Chemical control of the brown planthopper. In: *Brown Planthopper: Threat to Rice Production In Asia*. IRRI, Manila, Philippines. pp. 145-273.
- Heinrichs, E.A., 1979b. Chapter 16: Control of leafhopper and planthopper vectors of rice viruses. In: *Leafhopper Vectors and Plant Disease Agents*. (Eds: K. Maramorosch and Harris, K.F). Academic Press, NY, USA. pp. 529-560.
- Heinrichs, E.A. and Mochida, O., 1983. From secondary to major pest status: The case of insecticide-induced rice brown planthopper, *Nilaparvata lugens*, resurgence. *Proc. XV. Pacific Science Congress*, New Zealand.
- Heong, K.L., 1987. Age-specific survival rates of the rice brown planthopper *Nilaparvata lugens* (Stål) in the laboratory. *MARDI. Res. Bull*, 15 (2):135-140.
- Heong, K.L., G.B. Aquino and A.T. Barrion., 1992. Population dynamics of plant- and leafhoppers and their natural enemies in rice ecosystems in the Philippines. *Crop Protection*. 11: 371-379.
- Hilder, V.A. and Gatehouse, A.M.R., 1991. Phenotypic cost to plants of an extra gene. *Transgenic. Res*, 1: 54-60 (1991).
- Hilder, V.A., Gatehouse, A.M.R and Boulter, D., 1989. Potential for exploiting plant genes to genetically engineer insect resistance, exemplified by the cowpea trypsin inhibitor gene. *Pestic. Sci*, 27:165-171.
- Hilder, V.A., Gatehouse, A.M.R. and Boulter, D., 1990. Genetic engineering of crops for insect resistance using genes of plant origin. In: *Genetic Engineering of Crop Plants*. (Eds: G.W. Lycett and D. Grierson). pp.51-66.
- Hilder, V.A., Gatehouse, A.M.R, Gatehouse, J.A., Powell K.S. and Boulter, D. 1991. Beyond *Bt* endotoxin: Higher plant genes which enhance insect resistance in transgenic plants. In: *Program and Abstracts. Molecular Biology of Plant Growth and Development. Intl. Soc. Plant. Mol. Biol. Third. Intl. Cong.* Tucson, Arizona, USA. 6-11 October 1991.
- Hilder, V.A., Gatehouse, A.M.R., Sheerman, S.E., Barker, R.E. and Boulter, D., 1987. A novel mechanism of insect resistance engineered in tobacco. *Nature*, 330 (6144):160-163.
- Hilder, V.A., Gatehouse, A.M.R., Gatehouse, J.A., Gatehouse, L., Hamilton, W.D.O., Merryweather, A., Newell, C., Powell, K., Van Damme, E., Shi, Y. and Boulter, D., 1993. Transgenic tobacco plants with added protection against aphids. (Submitted).
- Hill, D.S., 1983. *Agricultural Insect Pests of the Tropics and Their Control*. Second Edition. Cambridge University Press, UK.
- Hill, D.S., 1987. *Agricultural Insect Pests of Temperate Regions and Their Control*. Cambridge University Press, UK.
- Hinde, 1970., Structural and physiological studies of the mycetome symbiotes of aphids. PhD thesis. University of Sydney, Australia.
- Hinde, R., 1971. The control of mycetome symbiotes of the aphids *Brevicoryne brassicae*, *Myzus persicae* and *Macrosiphum rosae*. *J. Insect. Physiol*, 17:1791-1800.
- Ho, S.H., 1980. A comparison of the excretion rates of *Aphis fabae* on artificial diets and on bean plants. *Ann. Appl. Biol*, 96:133-136.
- Hoffman, M.P., Zalom, F.G, Wilson, L.T, Smilanick, J.M, Malyj, L.D, Kiser, J, Hilder, V.A. and Barnes, W.M., 1992. Field evaluation of transgenic tobacco containing genes encoding *Bacillus thuringiensis* δ -endotoxin or cowpea trypsin inhibitor: Efficacy against *Helicoverpa zea* (Lepidoptera: Noctuidae). *J. Econ. Entomol.* 85: 2516-2522.

- Holt, J., Wareing, D.R. and Norton, G.A., 1992. Strategies of insecticide use to avoid resurgence of *Nilaparvata lugens* (Homoptera: Delphacidae) in tropical rice: A simulation analysis. *J. Econ. Entomol.* 85(5):1979-1989.
- Honeyborne, C.H.B., 1969. An investigation of the responses of aphids to plants with growth regulators. PhD thesis, University of Reading.
- Hongusaprug, W., 1987. Taxonomic study on some rice planthoppers of the family Delphacidae in Thailand. *Proc. 6th. Auchen. Meeting.* Turin, Italy. 7-11 Sept 1987. pp.193-206.
- Horiguchi, T. and Kitagishi, K., 1971. Studies on rice seed protease. V. Protease inhibitor in rice seed. *Plant & Cell. Physiol*, 12:907-915.
- Hosada, A., 1983. Decrease in susceptibility to organophosphorus and carbamate insecticides in the brown planthopper. *Jap. J. Appl. Ent. Zool*, 27:55-62.
- Hou, R.F. and Lin, L.C., 1979. Artificial rearing of the rice green leafhopper *Nephotettix cincteps* on a holcic diet. *Ent. Exp & Appl*, 25:158-164.
- Hou, R.F. and Lee, Y.H., 1984. Effect of high-temperature treatment on the brown planthopper, *Nilaparvata lugens* with reference to the physiological roles of its yeast-like symbiote. *Chinese. J. Ent.* 4,107-116.
- Houk, E.J., 1987. Symbionts. In: *World Crop Pests: Aphids Their Biology, Natural Enemies and Control. Vol 2A.* (Eds: A.K. Minks and P. Harrewijn). Elsevier, Amsterdam. pp.123-129.
- Houk, E.J. and Griffiths, G.W., 1980. Intracellular symbiotes of the Homoptera. *Ann. Rev. Entomol*, 25:161-187.
- House, H.L., 1974a. Chapter 1: Nutrition. In: *The Physiology of Insecta. Second Edition. Volume V.* (Ed: M. Rockstein.) Academic Press, London, UK. pp.1-62
- House, H.L., 1974b. Chapter 2: Digestion. In: *The Physiology of Insecta. Second Edition. Volume V.* (Ed: M. Rockstein). Academic Press, London, UK. pp.63-117.
- Huesing, J.E. Jnr, 1991. Lectins as plant chemical defenses against insects. PhD thesis. Purdue University, USA.
- Huesing, J.E., Murdock, L.L. and Shade, R.E., 1991a. Effect of wheat germ isolectins on development of cowpea weevil. *Phytochem*, 30 (3):785-788.
- Huesing, J.E., Murdock, L.L. and Shade, R.E., 1991b. Rice and stinging nettle lectins: insecticidal activity similar to wheat germ agglutinin. *Phytochem*, 30(11):3565-3568.
- Huesing, J.E., Shade, R.E, Chrispeels, M.J. and Murdock, L.L., 1991. α -Amylase inhibitor, not phytohaemagglutinin, explains resistance of common seeds to cowpea weevil. *Plant. Physiol*, 96:993-996.
- IRRI., 1975. *IRRI Research Highlights. 1974.* International Rice Research Institute, Manila, Philippines.
- IRRI., 1989. *IRRI Annual Report 1988.* International Rice Research Institute, Manila, Philippines.
- IRRI., 1992. *IRRI 1990-1991: A continuing adventure in rice research* International Rice Research Institute, Manila, Philippines.
- IRRI., 1993a. *Rice Facts.* International Rice Research Institute. Manila. Philippines.
- IRRI., 1993b. Breeding rice varieties for sustainable food production. *IRRI. Reporter.* International Rice Research Institute. Manila, Philippines. 1:pp.1.
- Ishaaya, I. and Swirski, E., 1976. Trehalase, invertase and amylase in the black scale *Saissetia oleae*, and their relation to host adaptability. *J. Insect. Physiol*, 22:1025-1029.
- Ishikawa, H., 1982. Host symbiont interactions in the protein synthesis in the pea aphid *Acyrtosiphon pisum*. *Insect Biochem*, 12, 613-622.

- Iwanaga, K. and Tujo, S., 1988. Comparative studies on the sensitivities to nymphal density, photoperiod and rice plant stage in two strains of the brown planthopper, *Nilaparvata lugens* Stål (Homoptera: Delphacidae). *Jpn. J. Appl. Ent.*, 32:68-74. (In Japanese).
- Jaworski, E.G., Fraley, R.T, Rogers, S.G, Horsch, R.B, Beachy, R.N. and Chua, N-H., 1986.. Chapter 24: Genetic transformation of plants. In: *Protein Engineering*. (Eds: M. Inouye. and R. Sharma). Academic Press, UK. pp. 383-393.
- Johnston, K.A., Gatehouse, J.A. and Anstee, J.H., 1993. Effects of soybean protease inhibitors on the growth and development of larval *Helicoverpa armigera*. *J. Insect. Physiol.* 39 (8):657-664.
- Kabir, M.A. and Khush, G.S., 1988, Genetic analysis of resistance to brown planthopper in rice (*Oryza sativa* L.) *Plant Breeding*. 100:54-58.
- Kaneda, C., Ikeda, R. and Kobayashi, A., 1977. Breeding for resistance to the brown planthopper in Japan. In: *The Rice Brown Planthopper*. ASPAC, Taiwan, pp.124-134.
- Kareem, A.A., Saxena, R.C, Boncodin, M.E.M. and Malayba, M.T., 1989. Effect of neem seed and leaf bitters on oviposition and development of green leafhopper (GLH) and brown planthopper (BPH). *Int. Rice Res. Newsl*, 14(6):26-27.
- Karim, A.N.R.M. and Saxena, R.C., 1991. Feeding behaviour of three *Nephotettix* species (Homoptera: Cicadellidae) on selected resistant and susceptible rice cultivars, wild rice and graminaceous weeds. *J. Econ. Ent.*, 84(4):1208-1215.
- Karnovsky, M.J., 1965. A formaldehyde-glutaraldehyde fixative of high osmolarity for use in electron microscopy. *J. Cell. Biol.*, 27:137-138A.
- Kashlan, N.B., 1980. Studies on the structure and function of some enzyme inhibitors from plants. PhD thesis, University of Durham, UK.
- Kawabe, S., Fukomorita, T. and Chino, M., 1980. Collection of rice phloem sap from homopterous insects severed by YAG laser. *Plant & Cell. Physiol.* 21(7):1319-1327.
- Kawabe, S. and McClean, D.L., 1980. Electronic measurement of probing activities of the green leafhopper of rice. *Ent. Exp & Appl*, 27:77-82.
- Ke, L-D. and Qin J-D, 1983. Rearing *Myzus persicae* of Beijing on an artificial diet. *Acta. Entomol. Sinica*, 26(1):17-23. (In Chinese).
- Khan, M.A., 1964. Studies on the secretion of digestive enzymes in *Locusta migratoria* L. II. Invertase Activity. *Ent. Exp & Appl*, 7:125-130.
- Khan, Z.R. and Saxena, R.C., 1984. Technique for demonstrating phloem or xylem feeding by leafhoppers (Homoptera: Cicadellidae) and planthoppers (Homoptera: Delphacidae) in rice plant. *J. Econ. Entomol.*, 77: 550-552.
- Khan, Z.R. and Saxena, R.C., 1988. Probing behaviour of three biotypes of *Nilaparvata lugens* (Homoptera: Delphacidae) on different resistant and susceptible rice varieties. *J. Econ. Entomol.*, 81 (5):1338-1345.
- Khush, G.S., 1977a. Disease and insect resistance in rice. *Adv.Agron*, 29:265-341.
- Khush, G.S., 1977b. Breeding for resistance in rice. *Ann. New York. Acad. Sci.*, 28:296-308.
- Khush, G.S., 1979. Genetics of breeding for resistance to the brown planthopper. In: *Brown Planthopper: Threat to Rice Production in Asia*. IRRI, Manila, Philippines. pp. 321-332
- Khush, G.S., 1990. Genetics of and breeding for resistance to diseases and insects of rice. *Intl. Symp. Molecular and Genetic Approaches to Plant Stress*, UNIDO, New Delhi, India, 14-17 September, 1990.

- Khush, G.S. and Toenniessen, G.H., 1992. Chapter 28: Biotechnology and pest management in 2000 AD. In: *Pest Management and the Environment in 2000*. (Eds: A.A.S.A. Kadir and M.S. Barlow). CAB International, Wallingford, UK. pp. 348-359.
- Khush, G.S. and Virmani, S.S., 1985. Breeding for resistance in rice. In: *Progress in Plant Breeding I*. (Ed: G.E. Russell). Blackwell Publications, UK. pp.239-279.
- Kim, M., Ichikawa, T., Koh, H., Fukami, H. and Ishii, S., 1973. Lipid in the brown planthopper, *Nilaparvata lugens* (Homoptera: Delphacidae) I. Lipid contents and composition in two wing forms, brachypterous and macropterous. *Appl. Ent. Zool*, 8(1): 36-43.
- Kim, M., Koh, H.S. and Fukami, H., 1985. Isolation of C-glycosylflavones as probing stimulant of planthoppers in rice plant. *J. Chem. Ecol*, 11 (4):441-452.
- Kim, M., Koh, H.S., Ichikawa, T., Fukami, H. and Ishii, S., 1975. Anti-feedant of barnyard grass against the brown planthopper, *Nilaparvata lugens*, (Stål.) (Homoptera: Delphacidae). *Appl. Ent. Zool*, 10 (2):116-122.
- King, J.P., Pusztai, A. and Clarke, E.M.W., 1980a. Immunocytochemical localisation of ingested kidney bean (*Phaseolus vulgaris*) lectins in rat gut. *Histochem. J*, 12:201-208.
- King, J.P., Pusztai, A. and Clarke, E.M.W., 1980b. Kidney bean (*Phaseolus vulgaris*) lectin induced lesions in rat small intestine I. Light microscope studies. *J. Compar. Physiol*, 90:585-595.
- King, J.P., Pusztai, A. and Clarke, E.M.W., 1982. Kidney bean (*Phaseolus vulgaris*) lectin induced lesions in rat small intestine. *J. Compar. Physiol*, 92:357-373.
- Kirschbaum, J.B., 1985. Potential implication of genetic engineering and other biotechnologies to insect biochemistry. *Ann. Rev. Entomol*, 30:51-70.
- Kisimoto, R., 1960. Hopperburn injury formation of the brown planthopper. *Jap. J. Plant. Protect*, 14 (9):377-382. (In Japanese)
- Kisimoto, R., 1965. Studies on the polymorphism and its role in the population growth of the brown planthopper. *Bull. Shikoku. Agr. Exp. Sta. Japan*, 13:1-106. (In Japanese)
- Kisimoto, R., 1977. Bionomics, forecasting of outbreaks and injury caused by the rice brown planthopper. . In: *The Rice Brown Planthopper*. ASPAC, Taiwan, pp.27-41.
- Kisimoto, R., 1987. Ecology of planthopper migration. *Proc. 2nd. Int. Workshop on Leafhoppers and Planthoppers of Economic Importance*. Utah, USA. July 28th - August 1st, 1986. (Eds. M.R. Wilson and L.R. Nault). CIE, London. pp.41-54.
- Klingauf, F.A., 1987. Chapter 4.3: Feeding adaptation and excretion. In: *World Crop Pests: Aphids Their Biology, Natural Enemies and Control. Vol 2A*. (Eds: A.K. Minks and P. Harrewijn). Elsevier, Amsterdam. pp.225-248.
- Klingauf, F. and de Coll, O., 1982. Zucht von *Diuraphis noxia*. *Zeit. Ang. Entomol*, 93: 234-238. (In German).
- Kocourek, J. and Horejsí, V., 1983. A note on the recent discussion on definition of the term "lectin". In: *Lectins, Vol. III*. Walter de Gruyter and Co., Berlin, Germany.
- Koh, H. S., Kim, Obata, T., Fukami, H. and Ishii, S., 1977. Antifeedant in barnyard grass against the brown planthopper-*trans*-aconitic acid. In: *The Rice Brown Planthopper*. ASPAC, Taiwan. pp.117-123.
- Koyama, K., 1979. Rearing of the brown planthopper, *Nilaparvata lugens* Stål (Hemiptera: Delphacidae) on a synthetic diet. *Jpn. Appl. Ent. Zool*, 23:39-40.
- Koyama, K., 1981. Survival of the larvae of the brown planthopper *Nilaparvata lugens* (Stål) (Hemiptera: Delphacidae) on sugar solutions. *Jap. J. Appl. Ent. Zool* (In Japanese). 25:125-126.

- Koyama, K., 1985a. Nutritional physiology of the brown planthopper *Nilaparvata lugens* Stål. (Hemiptera: Delphacidae) I. Effect of sugars on development. *Appl. Ent. Zool*, 20(3):292-298.
- Koyama, K., 1985b. Nutritional physiology of the brown rice planthopper *Nilaparvata lugens* Stål. (Hemiptera: Delphacidae) II. Essential amino acids for nymphal development. *Appl. Ent. Zool*, 20(4):424-430.
- Koyama, K., 1986. Nutritional physiology of the brown rice planthopper *Nilaparvata lugens* Stål. (Hemiptera: Delphacidae) III. Essential vitamins for nymphal development. *Appl. Ent. Zool*, 21(2):252-257.
- Koyama, K., Mitsuhashi, J. and Nasu, S., 1981. Rearing of the planthopper, *Sogatella longifurcifera* Esaki et Ishihara (Hemiptera: Delphacidae) on a synthetic diet. *Jpn. J. appl. Ent. Zool*, 25:198-200. (In Japanese).
- Kreiger, P., 1971. Rearing several aphid species on synthetic diet. *Annales. Ent. Soc. Amer*, 64:1176-1177.
- Kunitz, M., 1945. Crystallisation of a trypsin inhibitor from soybean. *Science*, 101:668-9.
- Kuno, E., 1979. Ecology of the brown planthopper in temperate regions. In: *Brown Planthopper: Threat to Rice Production in Asia*. International Rice Research Institute, Manila, Philippines. pp.45-60.
- Kurata, S. and Sogawa, K., 1976. Sucking inhibitory action of aromatic amines for the rice plant- and leafhoppers (Homoptera: Delphacidae, Deltocephalidae). *Appl. Ent. Zool*, 11 (2):89-93.
- Kusakabe, S. and Hirao, J., 1976. Tolerance for starvation in the brown planthopper, *Nilaparvata lugens* Stål (Hemiptera: Delphacidae). *Appl. Ent. Zool*, 11(4):369-371.
- Kusumi, T., Suwa, Y, Kita, H. and Nasu, S., 1979. Symbiotes of planthoppers: I. The isolation of intracellular symbiotes from the smaller brown planthopper, *Laodelphax striatellus* Fallén (Hemiptera: Delphacidae). *Appl. Ent. Zool*. 14 (4): 459-463.
- Lai, C.Y. and Baumann., 1992a. Sequence analysis of a DNA fragment from *Buchnera aphidicola* (an endosymbiont of aphids) containing genes homologous to dnaG, rpoD, cysE and secB. *Gene*, 119:113-118.
- Lai, C.Y. and Baumann., 1992b. Genetic analysis of an aphid endosymbiont DNA fragment homologous to the mpA-rpmH-dnaA-dnaN-gyrB region of eubacteria. *Gene*, 113:175-181.
- Lakshminarayana, A. and Khush, G. S., 1977. New genes for resistance to the brown planthopper in rice. *Crop Science*, 17 (January-February):96-100.
- Lee, J.D. and Park, J.S., 1977. Biology and control of the brown planthopper *Nilaparvata lugens*, in Korea. In: *The Rice Brown Planthopper*. ASPAC, Taiwan, pp. 199-213.
- Lee, H.Y. and Hou, R.F., 1987. Physiological roles of a yeast-like symbiote in reproduction and embryonic development of the brown planthopper, *Nilaparvata lugens* Stål. *J. Insect. Physiol*, 33,(11):851-860.
- Lee, M.K., Aguda, R, Gould, F. and Dean, D.H., 1993. Determination of receptor binding properties of various δ -toxins to rice stem borer midguts. *Abstracts. 6th. Ann. Meeting. Intl. Prog. Rice. Biotech*, February 1-5, 1993, Chiang Mai, Thailand. p.28
- Li, J., Carroll, J. and Ellar, D.J., 1991. Crystal structure of insecticidal δ -endotoxin from *Bacillus thuringiensis* 2.5Å resolution. *Nature*, 353:815-821.
- Lis, H. and Sharon, N., 1981. Chapter 10: Lectins in higher plants. In: *The Biochemistry of Plants Vol 6*, pp.371-447.

- Lorenzsonn, V., Agresti, H. and Olsen, W.A., 1972. A method for the ultrastructural localization of sucrase. *13th. Annual. EMSA. Meeting.* pp.6-7.
- Lösel, P.M., 1987. The effect of nitromethylene heterocycles on the feeding of the rice brown planthopper *Nilaparvata lugens* (Stål). *Proc. 6th. Auchen. Meeting.* Turin, Italy. 7-11 Sept. 1987. pp.285-292.
- Lösel, P.M. and Goodman, L.J., 1987. External morphology of sensory structures on the tarsi of the rice brown planthopper. *Proc. 6th. Auchen. Meeting.* Turin, Italy, 7-11 Sept. 1987. pp.209-212.
- Magayorossy, A.C., Singh, D. and Mittler, T.E., 1979. Rearing of the aphid *Myzus persicae* on phloem exudate from *Amsinckia douglasiana* plants infected with curly top virus. *Ent. Exp & Appl.* 26:339-342.
- Mayer, R.J. and Walker, J.H., 1987. *Immunochemical Methods in Cell and Molecular Biology.* Academic Press.
- McGoughey, W.H., 1985. Insect resistance to the biological insecticide *Bacillus thuringiensis*. *Science.* 229:193-195.
- Medrano, F. G. and Heinrichs, E. A., 1983. *Nilaparvata lugens.* pp.361-372. IRRI Unpublished Report.
- Metcalf, R.L., 1980. Changing role of insecticides in crop protection. *Ann. Rev. Entomol.* 25:219-256.
- Miles, P.W., 1990. Aphid salivary secretions and their involvement in plant toxicoses. In: *Aphid-Plant Genotype Interactions.* (Eds. R.K. Campbell and R.D. Eikenbary). Elsevier, Amsterdam, Netherlands. pp.131-147.
- Miles, P.W. and Peng, Z., 1989. Studies on the salivary physiology of plant bugs. *J. Ins. Physiol.* 35(11):865-872.
- Mitsuhashi, J., 1970. A device for collecting planthopper and leafhopper eggs (Hemiptera: Delphacidae and Deltocephalidae) *Appl. Ent. Zool.* 5 (1):47-49
- Mitsuhashi, J., 1974. Methods for rearing leafhoppers and planthoppers on artificial diets. *Rev. Plant. Protect. Res.* 7:57-67.
- Mitsuhashi, J., 1975. Cultivation of intracellular yeast like organisms in the smaller brown planthopper, *Laodelphax striatellus* Fallen (Hemiptera: Delphacidae). *Appl. Ent. Zool.* 10(3): 243-245.
- Mitsuhashi, J., 1979. Chapter 10: Artificial rearing and aseptic rearing of leafhopper vectors: Applications in virus and MLO research. In: *Leafhopper Vectors and Plant Disease Agents.* (Eds: K. Maramorosch and K. F. Harris). Academic Press, New York, USA. pp.369-412
- Mitsuhashi, J. and Koyama, K. 1972. Artificial reraring of the smaller brown planthopper, *Laodelphax striatellus* Fallen, with special reference to rearing conditions for the first instar nymphs. *Jap. J. Appl. Ent. Zool.* 16: 8-17.
- Mitsuhashi, J. and Koyama, K., 1974. Folic acid as a dietary factor affecting the wing morph of the planthopper, *Laodelphax striatellus*, (Hemiptera, Delphacidae). *Ent. Exp & Appl.* 17:77-82.
- Mitsuhashi, J. and Koyama, K., 1975. Oviposition of smaller brown planthopper, *Laodelphax striatellus*, (Hemiptera, Delphacidae) into various carbohydrate solutions through a parafilm membrane. *Appl. Ent. Zool.* 10(2):123-129.
- Mitsuhashi, J. and Koyama, K., 1977. Effects of amino acids on the oviposition of the smaller brown planthopper, *Laodelphax striatellus*, (Hemiptera, Delphacidae) *Ent. Exp. & Appl.* 22:156-160.
- Mittler, J.E., 1957. Studies on the feeding and nutrition of *Tuberolahnus salignus* (Gmelin) (Homoptera, Aphidae) - II. The nitrogen and sugar composition of ingested phloem sap and excreted honeydew. *J. Exp. Biol.* 34: 74-84.

- Mittler, T.E., 1967a. Effect of amino acid and sugar concentrations on the food uptake of the aphid *Myzus persicae*. *Ent. Exp. & Appl*, 10:39-51.
- Mittler, T.E., 1967b. Flow relationships for hemipterous stylets. *Annales. Ent. Soc. Amer*, 60:1112-4.
- Mittler, T.E., 1970. Uptake rates of plant sap and synthetic diet by the aphid *Myzus persicae*. *Annales. Ent. Soc. Amer*, 63:1701-1705.
- Mittler, T.E. 1971. Dietary amino acid requirements of the aphid *Myzus persicae*. *J. Nutrition*, 101:1023-1028.
- Mittler, T.E., 1988. Chapter 8.13: Applications of artificial feeding techniques for aphids. In: *World Crop Pests: Aphids Their Biology, Natural Enemies and Control. Vol 2B*. (Eds: A.K. Minks and P. Harrewijn). Elsevier, Amsterdam. pp.145-170.
- Mittler, T.E. and Dadd, R.H., 1962. Artificial feeding and rearing of the aphid *Myzus persicae* (Sulzer) on a completely defined synthetic diet. *Nature*, 195:404
- Mittler, T.E. and Dadd, R.H., 1964. An improved method for feeding aphids on artificial diets. *Annales. Ent. Soc. Amer*, 57:139-140.
- Mittler, T. E. and Kleinjan, J. E., 1970. Effect of artificial diet composition on wing-production by the aphid *Myzus persicae*. *J. Ins. Physiol*, 16:833-850.
- Mittler, T.E. and Koski, P., 1976. Development of mericidic and oligidic diets for rearing the aphid *Myzus persicae*. *J. Ins. Physiol*, 22:1135-1141.
- Mittler, T.E. and Meikle, T., 1991. Effects of dietary sucrose concentration on aphid honeydew carbohydrate levels and rates of excretion. *Ent. Exp. & Appl*, 59:1-7.
- Miyata, T., 1983. Detection and monitoring methods for resistance in arthropods. Based on biochemical characteristics. In: *Pest Resistance to Pesticides*. (Eds;G. P. Georgiou and T. Saito). Plenum Press, London. pp. 99-116.
- Miyata, T., 1989. Problems in the control of insecticide-resistant rice plant- and leafhoppers. *Pestic. Sci*, 26:261-269.
- Miyata, T., Saito, T., Kassai, T. and Ozaki, K., 1989. *In vitro* degradation of Malathion by the small brown planthopper, *Laodelphax striatellus* (Fallén), and the rice brown planthopper, *Nilaparvata lugens* (Stål) (Hemiptera: Delphacidae). *Appl. Ent. Zool*, 24 (2):240-241.
- Mochida, O., 1964a. On oviposition in the brown planthopper, *Nilaparvata lugens* (Stål) (Hom., Auchenorrhyncha) II The number of eggs in an egg group especially in relation to the fecundity. *Jap. J. Appl. Zool*, 8 (2):141-148.
- Mochida, O., 1964b. On oviposition in the brown planthopper, *Nilaparvata lugens* (Stål.) (Hom., Auchenorrhyncha) I. Oviposition and environmental factors with special reference to temperature and rice plant. *Bull. Kyushu Agr. Exp. Sta*, 10 (3 & 4):257-285.
- Mochida, O., 1970. A red-eyed form of the brown planthopper *Nilaparvata lugens* (Stål) (Hom., Auchenorrhyncha) *Bull. Kyushu Agric. Exp. Sta*, 15:141-273.
- Mochida, O., 1992. Chapter 5: Management of insect pests of rice in 2000. In: *Pest Management and the Environment in 2000*. (Eds: A.A.S.A. Kadir and H.S. Barlow). CAB International, UK. pp. 67-81.
- Mochida, O. and Dyck, V.A., 1977. Bionomics of the brown planthopper *Nilaparvata lugens*. In: *The Rice Brown Planthopper*. . ASPAC, Taiwan, pp.192-198.
- Mochida, O. and Okada, T., 1971. A list of the Delphacidae (Homoptera) in Japan with special reference to host plants, transmission of plant diseases and natural enemies. *Bull. Kyushu - Agric. Expt. Sta*. XV(4):737-843.
- Mochida, O. and Okada, T., 1979. Taxonomy and biology of *Nilaparvata lugens* (Hom., Delphacidae) . In: *Brown Planthopper: Threat to Rice Production In Asia*. IRRI, Manila, Philippines. pp.21-44.

- Mochida, O., Wahyu, A. and Surjani, T. K., 1979. Some considerations on screening resistant cultivars /lines of the rice plant to the brown planthopper, *Nilaparvata lugens* (Stål) (Hom., Delphacidae) . *Paper Presented at IRRC*, April 16-20, 1979. IRRI, Los Banos, Philippines. pp.1-9.
- Moreira, R.D.A., Ainouz, I.L., Oliveira, J.T.A.D. and Cavada, B.S., 1991. Plant lectins, chemical and biological aspects. *Mem. Inst. Oswaldo. Cruz. Rio de Janeiro, Brasil.* 86(11):211-218.
- Morgan, M. R. J., 1975. A qualitative survey of the carbohydrates of the alimentary tract of the migratory locust, *Locusta migratoria migratoroides*. *J. Ins. Physiol.* 21:1045-1053.
- Moroika, S., Ishibashi, N. and Tojo, S., 1988. Relationships between wing-form response to nymphal density and black coloration of adult body in the brown planthopper, *Nilaparvata lugens* (Homoptera: Delphacidae). *Appl. Ent. Zool.* 23 (4):449-458.
- Moroika, M. and Ishikawa, H., 1992. Mutualism based on stress: selective synthesis and phosphorylation of a stress protein by an intracellular symbiont. *J. Biochem.* 111, 431-435.
- Munson, M.A., Baumann, P. and M.G. Kinsey, 1991. *Buchnera* gen.nov. and *Buchnera aphidicola* sp. nov., a taxon consisting of the mycetocyte-associated, primary endosymbionts of aphids. *Int. J. Sys. Bact.* 41(4): 566-568.
- Murray, M.B. and Ewen, S.W.B., 1990. A novel method for optimum biopsy specimen preservation for histochemical and immunohistochemical analysis. *Anatomic. Pathology*, 95(2):131-136.
- Nalinakumari, T and Mammen, K. V. 1975. Biology of the brown planthopper, *Nilaparvata lugens* (Stål) (Delphacidae, Hemiptera). *Agri. Res. J. Kerala.* 13 (1):53-55.
- Nasu, S., 1965. Electron microscope studies on transovarial passage of rice dwarf virus. *Jap. J. Appl. Entomol. Zool.* 9:225-237.
- Nasu, S., 1967. Chapter 27: Rice Leafhoppers. In: *The Major Insect Pests of the Rice Plant*. Proc. Symp. International Rice Research Institute, Manila, Philipinnes. Sept 1964. . John Hopkins Press, Baltimore, England.
- Nasu, S., Kusumi, T, Suwa, Y. and Kita, H., 1981. Symbiotes of planthoppers: II. Isolation of intracellular symbiotic microorganisms from the brown planthopper, *Nilaparvata lugens* Stål, and immunological comparision of the symbiotes associated with rice planthopper (Hemiptera: Delphacidae). *Appl. Ent. Zool.* 16: 88-93.
- Noda, H., 1977. Histological and histochemical observation of intracellular yeastlike symbiotes in the fat body of the smaller brown planthopper, *Laodelphax striatellus*, (Homoptera: Delphacidae). *Appl. Ent. Zool.* 12(2):134-141.
- Noda, H. and Saito, T., 1979. The role of intracellular yeast-like symbiotes in the development of *Laodelphax striatellus* (Homoptera: Delphacidae). *Appl. Ent. Zool.* 14:453-458.
- Noda, H., Sogawa, K. and Saito, T., 1973. Amino acids in honeydews of the rice planthoppers and leafhoppers (Homoptera: Delphacidae, Deltocephalidae). *Appl. Ent. Zool.* 8 (3):191-197.
- Noordink, J. Ph.W. and Harrewijn, P., 1988. Chapter 8.7: Use of Isotopes. In :*World Crop Pests: Aphids Their Biology, Natural Enemies and Control. Vol 2B.* (Eds: A.K. Minks and P. Harrewijn). Elsevier, Amsterdam. pp.83-
- Norton, G.A. and Way, M.J. 1990, Rice pest management systems-Past and Future. In: *Pest Management In Rice.* (Eds: B.T. Grayson, M. B. Green and L. G. Copping). Elsevier Science Publishing, England. pp. 1-14.

- Nuorteva, P., 1954. On the significance of proteases and amylases in the life of *Empoasca flavescens* F. (Hom., Typhlocybidae). *Annales. Ent. Fennici*, 20 (2):76-79.
- Oda, Y. and Minami, K., 1986. Isolation and characterization of a lectin from tulip bulbs *Tulip gesneriana*. *Eur. J. Biochem*, 159:239-245.
- Odani, S. and Ikenaka, T., 1972. Studies on soybean trypsin inhibitors. IV. Complete amino acid sequences and the anti-proteinase site of Bowman-Birk soybean proteinase inhibitor. *J. Biochem*, 71:839-848.
- Oka, H.I., 1992. Chapter 3: Genetic diversity of wild and cultivated rice. In: *Rice Biotechnology*. CAB, Wallingford, UK. pp.55-81.
- Oka, I.N., 1979. Cultural control of the brown planthopper. In: *Brown Planthopper: Threat to Rice Production in Asia*. IRRI, Manila, Philippines. pp.357-369.
- Okada, T., 1977. Taxonomic characters of identification of the rice brown planthopper (*Nilaparvata lugens*) and its related species in the Asian and Pacific region. In: *The Rice Brown Planthopper*. ASPAC, Taiwan. pp.1-23.
- Ou, S.M., 1985. *Rice diseases*. Second Edition. Commonwealth Agriculture Bureau, Commonwealth Mycological Institute, U.K.
- Ozaki, K., 1983. Suppression of resistance through synergistic combinations with emphasis on planthoppers and leafhoppers infesting rice in Japan. In: *Pest Resistance to Pesticides Challenges and Prospects*. (G.P. Georgiou and T. Saito). Plenum Press, New York. pp. 595-612.
- Padgham, D.E., 1983. The influence of the host plant on the development of the adult brown planthopper, *Nilaparvata lugens* (Stål) (Hemiptera: Delphacidae) and its significance in migration. *Bull. Ent. Res*, 73:117-128.
- Padgham, D.E. and Woodhead, S., 1989. Feeding responses of the brown planthopper, *Nilaparvata lugens*, to resistant and susceptible host plants. *Bull. Ent. Res*, 79:309-318.
- Pathak, P.K., Saxena, R.C. and Heinrichs, E.A., 1982. Parafilm sachet for measuring honeydew excretion by *Nilaparvata lugens* on rice. *Annales. Entomol. Soc. Amer*, (April): 194-195.
- Patchett, R.A., Kelly, A.F. and Kroll, R.G., 1991. The adsorption of bacteria to immobilized lectins. *J. Appl. Bact*, 71:277-284.
- Pathak, M.D., 1977. Defense of the rice crop against insect pests. *Annals. NY. Acad. Sci*, pp.287-296.
- Peferoen, M., Jansens, S., Reynaerts, A. and Leemans, J., 1990. Chapter 14: Potato plants with engineered resistance against insect attack. In: *The Molecular and Cellular Biology of the Potato*. (Eds: M.E. Vayda and W.D. Park). CAB International, UK. pp.193-204.
- Peng, Z. and Miles, P.W., 1988. Studies on the salivary physiology of plant bugs: Function of the catechol oxidase of the rose aphid. *J. Ins. Physiol*, 34(11):1027-1033.
- Peng, Z. and Miles, P.W., 1991. Oxidases in the gut of an aphid *Macrosiphum rosae* (L) and their relation to dietary phenolics. *J. Ins. Physiol*, 37(10):779-787.
- Peter, C., 1988. New records of natural enemies associated with the brown planthopper, *Nilaparvata lugens* (Stål). *Current science*, 57(19): 1087-1088.
- Peumans, W., Stinissen, H. and Carlier, A., 1983. Speculations about a physiological role of some plant lectins In: *Lectins Volume III*. Walter de Gruyter and Co., Berlin, Germany. pp.583-601.
- Phaff, H.J. and Starmer, W.T., 1987. Chapter 5: Yeasts associated with plants, insects and soil. In: *The Yeasts: Biology of Yeasts. Vol 1, 2nd Edition*. (Eds: A.H. Rose and J.S. Harrison). Academic Press, London. pp.123-173.

- Ponsen, M.B., 1987. 2.1: Light microscopy. In: *World Crop Pests: Aphids Their Biology, Natural Enemies and Control. Vol 2B.* (Eds: A.K. Minks and P. Harrewijn). Elsevier, Amsterdam. pp.45-46.
- Potrykus, I. 1991. Gene transfer to plants: Assessment of published approaches and results. *Ann. Rev. Plant. Physiol. Mol. Biol.* 42:205-225.
- Prosser, W.A. and A.E. Douglas., 1992. A test of the hypothesis that nitrogen is upgraded and recycled in an aphid (*Acyrtosiphon pisum*) symbiosis. *J. Ins. Physiol.* 38(2): 93-99.
- Prosser, W.A., Simpson. S.J. and Douglas, A.E., 1992. How an aphid (*Acyrtosiphon pisum*) symbiosis responds to variation in dietary nitrogen. *J. Ins. Physiol.* 38(4):301-307.
- Pusztai, A., 1986. The biological effect of lectins in the diet of animals and man. In: *Lectins, Vol 5.* Walter de Gruyer and Co., Berlin, Germany. pp.317-327.
- Pusztai, A., 1991. *Plant Lectins.* Cambridge University Press, UK.
- Pusztai, A., Ewen, S.W.B., Grant,G., Peumans, E.J.M. Van Damme., Rubio, L. and Bardocz, S., 1990. The relationship between survival and binding of plant lectins during small intestinal passage and their effectiveness as growth factors. *Digestion.* 46 (suppl.2): 308-316.
- Pusztai, A., Grant,G., Bardocz, S., Brown, D.J., Stewart, J.C., Ewen, S.W.B., Gatehouse, A.M.R. and Hilder, V.A., 1992. Nutritional evaluation of the trypsin (EC 3.4.21.4) inhibitor from cowpea (*Vigna unguiculata* Walp.). *Brit. J. Nutr.* 68:783-791.
- Rahbé, Y. and Febvay, G., 1992. Effect of certain proteins on *A. pisum* (Harris) growth and development. Potential influence on aphid-plant interactions. *Proc. 8th Int. Symp. Insect-Plant Relationships.* (Eds: S.B.J. Menken, J.H. Visser and P. Harrewijn). Kluwer Academic , Netherlands. pp.301-303.
- Rahbé, Y., Delobel, B.,Febvay, G, Nardon, C. and Nardon, P., 1992. Are aphid bacterial endosymbionts involved in the biosynthesis of aphid peculiar triglycerides? Paper presented at Endocytobiology Meeting, 1992, Kyoto, Japan.
- Rahbé, Y. and Febvay, G., 1993. Protein toxicity to aphids: an *in vitro* test on *Acyrtosiphon pisum*. *Ent. Exp. & Appl.* 67:149-160.
- Rahbé, Y., Febvay, G., Delobel, B. and Bournoville, R., 1988. *Acyrtosiphon pisum* performance in response to sugar and amino acid composition of artificial diets, and its relation to lucerne varietal resistance. *Ent. Exp. & Appl.* 18:283-292.
- Rivera, C.T., Ou S.H. and Iida, T.T., 1966. Grassy stunt disease of rice and its transmission by the planthopper *Nilaparvata lugens* Stål. *Plant. Disease. Reporter,* 50(7):453-456.
- Romena, A.M. and Heinrichs, E.A., 1989. Wild species of *Oryza* spp. as sources of resistance to rice insects. *J. Pl. Protect. Tropics,* 6(3):213-221.
- Romena, A.H., Medrano, F., Sunio, L., Camanag, E., Viajante, V. and Saxena. R.C., 1989. Resistance of wild rices to insect pests. *Int. Rice. Res. Newsl,* 14(5):15-16.
- Rosen, H., 1957. A modified ninhydrin colorimetric analysis for amino acids. *Archs. Biochem. Biophys.* 67: 10-15.
- Rubia, E. G. and Heong, K. L., 1989. Vertical distribution of two hopper species on rice plants. *Int. Rice. Res. Newsl,* 14 (6):31-32.
- Rüdiger, H., 1981. Lectins - An Introduction. In: *Lectins - Biology, Biochemistry, Clinical Biochemistry, Vol.1.* Walter de Gruyter, Berlin, Germany. pp.3-16.
- Ryan, C. A., 1981. Proteinase Inhibitors In: *The Biochemistry of Plants, Vol.6.* Academic Press. pp.351-370.

- Sakai, T. and Sogawa, K., 1976. Effects of nutrient compounds on sucking response of the brown planthopper, *Nilaparvata lugens* (Homoptera: Delphacidae). *Appl. Ent. Zool.* 11:(2):82-88.
- Saxena, K. N., 1954. Feeding habits and physiology of digestion of certain leafhoppers (Homoptera: Jassidae). *Experientia* 10 (9):383-384.
- Saxena, R.C., 1987. ICIPE-IRRI Research project on the rice brown planthopper, *Nilaparvata lugens* (Stål). *ICIPE Annual Report*, Kenya. pp.19-28.
- Saxena, R.C., Barrion, A.A. and Caoile, A.S., 1990. Morphology and reproduction of yeast-like endosymbiotes of the whitebacked planthopper, *Sogatella furcifera* (Horváth) (Homoptera: Delphacidae). *Philipp. Ent.* 8(2):727-730.
- Saxena, R.C., and Khan, Z.R., 1989. Factors affecting resistance of rice varieties to planthopper and leafhopper pests. *Agric. Zool. Rev.* 3:97-132.
- Saxena, R.C., and Puma, B.C., 1979a. Basis of plant resistance-Rice brown planthopper. *Paper Presented at ICIPE Ann. Res. Conf*, Nairobi, Kenya. June3-13, 1979.
- Saxena, R.C., and Puma, B.C., 1979b. Effect of *trans*-aconitic acid a barnyard grass allelochemical on hatching of eggs of brown planthopper and green leafhopper. In: *Proc. 10th. Ann. Conf. Pest. Control*. Philippines.
- Saxena, R.C., Zhang, Z.T. and Boncodin, M.E.M., 1989. Effect of neem oil on courtship signals and mating behaviour of brown planthopper females. *Int. Rice. Res. Newsl*, 14(6):28-29.
- Sekido, S. and Sogawa, K., 1976. Effects of salicylic acid on probing and oviposition of the rice plant- and leafhoppers (Homoptera: Delphacidae and Deltocephalidae). *Appl. Ent. Zool*, 11 (2):75-81.
- Senguttuvan, T., Gopalan, M. and Chelliah, S., 1991. Impact of resistance mechanisms in rice against the brown planthopper, *Nilaparvata lugens* Stål. (Homoptera: Delphacidae). *Crop Protection*, 10:125-128.
- Shaw, C.H., 1988. *Plant Molecular Biology - A Practical Approach*. IRL Press, Oxford, UK.
- Shi, Y., Powell, K.S, Wang, M.B, Hilder, V.A, Gatehouse, A.M.R, Gatehouse, J.A. and Boulter, D., 1991. Genetically engineered rice resistance to the brown planthopper. In: *Abstracts. 5th. Ann. Meeting. Intl. Prog. Rice Biotechnology*. USA. October 2-5, 1991.
- Shi, Y., Wang, M.B, Hilder, V.A, Gatehouse, A.M.R, Boulter, D. and Gatehouse, J.A. 1993. Use of the rice sucrose synthase-1 promoter to direct phloem-specific expression of β -glucuronidase and snowdrop lectin genes in transgenic tobacco plants. *Plant. J.* (In press).
- Shimamoto, K. Teruda, R., Izawa, T. and Fujimoto, H., 1989. Fertile transgenic rice plants regenerated from transformed protoplasts. *Nature* 338:274-276.
- Shukle, R.H. and Murdock, L.L., 1983. Lipoxigenase, trypsin inhibitor and lectin from soybeans: effects on larval growth of *Manduca sexta* (Lepidoptera: Sphingidae) . *Env. Entomol*, 12 (3):787-791.
- Sidhu, G.S. and Khush, G.S., 1978. Genetic analysis of brown planthopper resistance in twenty varieties of rice, *Oryza sativa* L., *Theor. Appl. Genet*, 53:109-203.
- Smith, S. and Furk, C., 1989. The spread of the resistant aphid. *Brit. Sugar Beet Review*, 57:4-6.
- Sogawa, K., 1965. Studies on the salivary glands of rice plant leafhoppers. I. Morphology and Histology. *Jap. J. Appl. Ent. Zool.* 9(4):275-289.
- Sogawa, K. 1970. Effect of asparagine on feeding of the brown planthopper. *Jpn. J. Appl. Entomol. Zool*, 14 (2): 107 (In Japanese).

- Sogawa, K., 1972. Studies on the feeding habits of the brown planthopper. III Effects of amino acids and other compounds on the sucking response. *Jap. J. Appl. Ent. Zool*, 16:1-7. (In Japanese).
- Sogawa, K., 1973. Feeding of the rice plant- and leafhoppers. *Rev. Plant. Protec. Res.*, 6:31-43.
- Sogawa, K., 1974. Studies on the feeding habits of the brown planthopper, *Nilaparvata lugens* (Stål) (Hemiptera: Delphacidae) IV. Probing stimulant. *Appl. Ent. Zool*, 9 (4):204-213.
- Sogawa, K., 1977. Feeding physiology of the brown planthopper In: *The Rice Brown Planthopper*. ASPAC, Taiwan. pp.95-117.
- Sogawa, K., 1982. The rice brown planthopper: Feeding physiology and host plant interactions. *Ann. Rev. Entomol*, 27:49-73.
- Sokal, R.R. and Rohlf, F.S., 1973. *Introduction to Statistics*. W.H. Freeman and Co, San Fransisco, USA. pp.286-303.
- Spiller, N.J., 1990. An ultrastructural study of the stylet pathway of the brown planthopper, *Nilaparvata lugens*. *Ent. Exp. & Appl*, 54:191-193.
- Srivastava, P.N. and Auclair, J.L., 1971. Influence of sucrose concentration on diet uptake and performance by the pea aphid, *Acyrtosiphon pisum* *Annales. Ent. Soc. Amer*, 64:739-43.
- Srivastava, P.N., 1987. 2.2: Nutritional Physiology. In: *World Crop Pests: Aphids Their Biology, Natural Enemies and Control. Vol 2A*. (Eds: A.K. Minks and P. Harrewijn). Elsevier, Amsterdam. pp.99-121
- Steel, K.J. and Cowan, S.T., 1965. *Manual for the identification of medical bacteria*. Cambridge University Press, London, UK. pp.141.
- Suenaga, H., 1963. Analytical studies on the ecology of two species of planthoppers, the white back planthopper (*Sogata furcifera* Horváth) and the brown planthopper (*Nilaparvata lugens* Stål) with special reference to their outbreaks. *Bull. Kyushu Agric. Exp. Sta.* 8 (1):139-149.
- Sugimoto, A., 1977. A method of mass rearing rice green leafhoppers In: *The Rice Brown Planthopper*. ASPAC, Taiwan. pp.248-255.
- Sumner, J. B., 1925. A more specific reagent for the determination of sugar in urine. *J. Biol. Chem*, 65:393-395.
- Sylvester, E.S., 1954. Insectary life history and apterous instar morphology of *Myzus persicae* (Sulzer) (Homoptera, Aphidae). *Annales. Entomol. Soc. Amer*, 47:397-406.
- Teraoka, T., Sakakibara, T, Den, E, Hosokawa, D. and Watanabe, M., 1990. A novel rice lectin specific to mannoside/glucoside residues in rice seedlings. *Agric. Biol. Chem*, 54 (11):3053-3056.
- Terra, W.R., 1990. Evolution of digestive systems of insects. *Ann. Rev. Entomol.* 35: 181-200.
- Tjallingii, W.F., 1978. Electronic recording of penetration behaviour by aphids. *Ent. Exp. & Appl*, 24:521-530.
- Toenniessen, G.H., 1990. Rice Biotechnology: Progress and Prospects. In: *Pest Management In Rice*. (Eds: B.T. Grayson., M.B. Green and L.G. Copperty). Elsevier, London. pp.514-536.
- Toenniessen, G.H., 1992. Chapter 11: Potentially useful genes for rice genetic engineering. In: *Rice Biotechnology*, CAB, UK. pp.253-280.
- Tonyama, K., Arimoto, Y., Uchimaya, H. and Hinata, K., 1988. Transgenic rice plants after direct gene transfer into protoplasts. *Biotech.* 6:1072-1074.
- Toutant, J.P., 1989. Insect acetylcholinesterases-catalytic properties, tissue distribution and molecular forms. *Progress in Neurobiology*, 32(5):423-446.

- Umeh, E.D.N., Joshi, R.C. and Ukwangwu, M.N., 1992. Biology, status and management of rice insect pests in Nigeria. *Crop Protection*, 11(5):408-413.
- Vaeck, M., Reynaerts, A., Höfte, H., Jansens, S., de Beuckeleer, M., Dean, C., Zabeau, M., van Montagu, M. and Leemans, J. 1987. Transgenic plants protected from insect attack. *Nature*, 328:33-37.
- Van Asperen, K., 1962. Study of housefly esterases by means of a sensitive colorimetric method. *J. Ins. Physiol*, 8:401-416.
- Van Damme, E.J.M., Allen, A.K. and Peumans, W.J., 1987. Isolation and characterization of a lectin with exclusive specificity towards mannose from snowdrop (*Galanthus nivalis*) bulbs. *FEBS Lett*, 215:140-144.
- Van Damme, E.J.M., Allen, A.K. and Peumans, W.J., 1988. Related mannose specific lectins from four different species of Amaryllidaceae. *Physio. Plantarum*, 73:52-57.
- Van Emden, H.F., 1967. An increase in the longevity of adult *Aphis fabae* fed artificially through parafilm membranes on liquids under pressure. *Ent. Exp. & Appl*, 10:166-170.
- Van Emden, H.F., 1972, Chapter 3: Aphids as Phytochemists. In: *Biochemical Aspects of Plant and Animal Coevolution*. (Ed. J.B. Harborne). Academic Press, London. pp.25-43.
- Van Den Heuvel, J.F.J.M, Boerma, T.M. and Peters, D., 1991. Transmission of potato leaf roll virus from plants and artificial diets by *Myzus persicae*. *Phytopath*, 81(2):150-154.
- Vanderzant, E.S., 1974. Development, significance and application of artificial diets for insects. *Ann. Rev. Entomol.* 19:139-160.
- Von Amiressami, M. and Petzhold, H. 1977. Symbioseforschung und insektizidresistenz. Ein licht und elektronenmikroskopischer beitrag zur klarung der insektizidresistenz von aphiden unter beruicksichtigung der mycetom-symbioten bei *Myzus persicae* Sulz. *Zeit. Ang. Entomol.* 82: 252-259. (In German).
- Waterman, P.G., 1992. Roles for secondary metabolites in plants. In: *Secondary Metabolites: Their function and Evolution*. Ciba Foundation Symposium. 171. John Wiley and Sons, Chichester, UK. pp. 255-276.
- Wearing, C.H., 1968. Responses of aphids to pressure applied to liquid diet behind parafilm membrane. Longevity and larviposition of *Myzus persicae* (Sulz.) and *Brevicoryne brassicae* (L.) (Homoptera: Aphidae) feeding on sucrose and sinigrin solutions. *N. Z. Jl. Sci. Technol*, 11:105-121.
- Webb, K.J. and Morris, P., 1992. Chapter 2. Methods of Plant Transformation. In: *Plant Genetic Manipulation for Crop Protection*. (Eds: A.M.R. Gatehouse, V.A. Hilder and D. Boulter.). CAB International, UK. pp.7-44.
- Werner, W., Rey, H.G. and Wielinger, H., 1970. Über die eigenschaften eines neuen chromogens für die blutzuckerbestimmung nach der GOD/POD-methode. *Z. Anal. Chem.* (In German). 252:224-228.
- Whalon, M. E., van de Baan, H. E. and Untung, K., 1990. Resistance management of brown planthopper, *Nilaparvata lugens* in Indonesia. pp.155-165. In: *Pest Management In Rice*. (Eds: B.T. Grayson., M.B. Green and L.G. Copping). Elsevier Science Publishers Ltd. England.
- Whitehead, L.F. and Douglas, A.E., 1993. A metabolic study of *Buchnera* the intracellular bacterial symbionts of aphids. *J. Gen. Micro.* (In press).
- Whitten, M.J., 1992. Chapter Two: Pest management in 2000: What we might learn from the twentieth century In: *Pest Management and the Environment in 2000*. (Eds: A.A.S.A. Kadir and H.S. Barlow). CAB International, UK. pp.9-44.

- Whitten, M.J. and Oakeshott, J.G., 1991. Opportunities for modern biotechnology in control of insect pests and weeds with special reference to developing countries. *FAO. Plant. Prot. Bull.*, 39(4):155-181.
- Wilson, M.R. and Claridge, M.F., 1991. *Handbook for the Identification of Leafhoppers and Planthoppers of Rice*. CAB International, Wallingford, Oxon, UK.
- Woodburn, A.T., 1990. The current rice agrochemicals market. In: *Pest Management in Rice*. (Eds: B.T. Grayson, M.B. Grayson and L.G. Copping). Elsevier Science ishers Ltd. England. pp15-30
- Woodhead, S. and Padgham, D.E., 1988. The effect of plant surface characteristics on resistance of rice to the brown planthopper, *Nilaparvata lugens*. *Ent. Exp. & Appl.* 47:15-22.
- Yu, S.J., 1989. β -glucosidase in four phytophagous Lepidoptera. *Insect Biochem* 19(1):103-108.
- Zaheruddeen, S.M. and Prakasa Rao, P.S., 1985. A method to obtain naked viable eggs of rice brown planthopper, *Nilaparvata lugens* (Stål). *Science & Culture*, 51(5):165-166.
- Zúñiga, G.E. and Corcuera, L.J. 1986. Effect of gramineae in the resistance of barley seedlings to the aphid *Rhopalosiphum padi*. *Ent. Exp & Appl.* 40: 259-262.

