



A STUDY OF THE VARIATION OF  
LIGHT DISTRIBUTION DUE TO  
THE CHANGE OF POSITION OF THE FILAMENT.

June 1, 1923.

A Thesis submitted to the Electrical Engineering  
Department of the Massachusetts Institute of Technology  
as a Partial Requirement for the Degree of Bachelor  
of Science.

By .....

*W. J. Drisko* .....

.....

Under the Direction of  
Professor W. J. Drisko.

ACKNOWLEDGMENT.

The authors wish to express their deep appreciation of the invaluable advice, criticism, suggestion and assistance offered by Professor William J. Drisko, under whose direction this thesis was carried out.

They are also very grateful to Messrs. Issac Mark, Jr., '22, and Arthur L. Flanders, '22, and also to the Physics Department of the Institute in supplying much of the necessary apparatus used in this work.

## CONTENTS.

	Page
Title Page . . . . .	1
Acknowledgment . . . . .	2
Contents . . . . .	3
Foreword . . . . .	5
Object . . . . .	8
Automobile Headlight Regulation. . . . .	9
(a) I.E.S. 1922 Limits & Specifications . . . . .	20
(b) Massachusetts Specifications. . . . .	21
Analysis of Paraboloidal Reflecting Surface. . . . .	24
Description of Apparatus. . . . .	50
(a) The Illuminometer. . . . .	55
(b) The Room. . . . .	55
(c) Key to Drawing of Device. . . . .	57
(d) Blue Prints. . . . .	58
(e) Photographs of Device. . . . .	64
Method of Procedure. . . . .	66
Key to Data & Graphs . . . . .	74
Data & Graphs. . . . .	75
Conclusion . . . . .	.191
Bibliography . . . . .	.197

FOREWORD

Foreword.

In problems concerning automobile headlighting, a light source of relatively large dimensions is required which tends to reduce intrinsic brilliancy and glare and improve diffusion. But the effectiveness of an illuminant when used with parabolic reflectors or lenses depends largely upon its concentration into small dimensions. In fact, the nearer the illuminant approaches zero dimensions, the nearer do the resultant affects approximate the sharply outlined beams so important in light projection.

For general commercial propositions, where the effectiveness of beam, low initial cost and maintenance are to be considered, it is found that the silver polished parabolic reflector of metal proves to be the most satisfactory.

As far as the light source is concerned, it is found that bulbs with either one or two point contacts with V shaped filaments of coiled tungsten wire are most desirable.

Since proper headlighting today forms a very important part of every automobile, it is very important, therefore, that the various factors which enter

into the proper adjustment and maintenance of the lighting equipment should be well understood by all motorists.

With the ever increasing average driving speed, the congestion of our streets, and the great reliability of the car of today, headlights must be provided that will illuminate the road for several hundred feet in front of the car, and which will not project glaring rays of light into the eyes of approaching drivers or pedestrians, or in other words, an adequate headlight controlling device should be provided on every car.

Efficient controlling devices not only improve the road illumination for the user of the device but they also create conditions such that other users of the road are not put in jeopardy by glare. However such devices require a careful adjustment of the incandescent lamp in the focus of the reflector.

All, or nearly all headlamps are provided with an arrangement whereby the position of the bulb may be changed with respect to the focus of the parabolic mirror. Usually the focusing adjustment is accomplished by moving the bulb backward or forward with respect to

the reflector.

A considerable amount of study has already been made on the variation of light distribution by moving the bulb forward or backward with respect to the focus of the parabolic reflector, but no one had ever tested, as far as the authors could ascertain, the variation of light distribution by moving the bulb in a sidewise and up and down directions with respect to the reflector.

They have, therefore, endeavored to find out just how much variation of light distribution will be produced by moving the bulb in three dimensions separately and simultaneously with respect to the focus of the reflector.

As this thesis is, in a way, the continuation of the thesis, written by messrs. Issac Mark, Jr., and Arthur L. Flanders, entitled "The Design and Construction of a Device for Testing Automobile Headlights and Other Light Projecting Units," (Electrical Engineering Department Thesis, M.I.T., June 1922.) therefore, no attempt has been made to include any detailed description and discussion of any topics and apparatus which have already been treated in their thesis.

OBJECT.

The object of this thesis is to find out what effect the change of position of the filament with respect to the focus of the parabolic mirror will produce on light distribution.



AUTOMOBILE HEADLIGHT REGULATION

### Automobile Headlight Regulation.

The introduction of powerful electric headlights on automobiles created the necessity for regulating measures to restrict their use, and the past year has seen a tremendous advance in legislation respecting automobile headlights.

The prime object of practically all headlights legislation has been the reduction of glare in order to make it safe for the approaching driver or pedestrian. A secondary consideration has been to provide sufficient light so distributed on the road to enable the driver to see clearly any objects which might cause him trouble or in other words, to make it safe for the driver.

Many states passed laws prohibiting glaring headlights; but what constitutes a glaring headlamp, and how can you measure it? The same lamp viewed on a brightly lighted city street or a dark country road may prove comfortable or exceedingly trying to look at.

Realizing the necessity of some definite measurable units to meet this situation, the Illuminating Engineering Society, cooperating with the Society of Automotive Engineers, made some very extensive and thorough

investigations and tests. As a result of these, they drew up a tentative specification for the performance of head lamps on the road in measurable terms, that is, beam candle power.

This specification states that the light projected ahead of an automobile shall not exceed 2400 candle power directly in front of the car at an elevation of one degree above the horizontal through the headlamps, or any point above that, nor 800 candle power one degree above the horizontal and four degrees to the left of the axis of the car. Also, that the light projected ahead of the car must be at least 4800 candle power, and preferably 10,000 somewhere between the horizontal and one degree below the horizontal.

Certain other specifications as to spread, etc., have been added, but these two main requirements are the ones on which most of the later headlight regulation has been based. Slight modifications have been made by various states. To date, California, Connecticut, Iowa, Delaware, Maine, Maryland, Massachusetts, Nebraska, New York, Ohio, Pennsylvania, Wisconsin, and the Province of Ontario, Canada, have legislation embodying the above requirements, and these States have 45 per

cent of the total automobile registration in the United States, and 40 per cent in Canada. These various laws may be typified and grouped as follows:

(A) The law for Oregon states that:

Lights on from  $\frac{1}{2}$  hour after sunset to  $\frac{1}{2}$  hour before sunrise.

A substantial object must be clearly discernible 200 feet directly ahead, and 100 feet directly ahead and 7 feet to the right of the axis.

Lights must be so adjusted or operated to avoid dangerous glare or dazzle.

Lights must be dimmed when a vehicle is approaching, or put out and spotlight use instead.

(B) The Law for Wisconsin states:

At 100 ft. ahead at a height of 60 inches not more than 2400 candle power.

At 100 ft. ahead, 7 ft. to left and at a height of 60 inches not more than 800 candle power.

Any other lights at 100 ft. ahead and at a height of 60 inches not more than 800 candle power.

(C) States declaring the distance ahead at which headlights must be visible:

Arizona.....	Reasonable
Connecticut.....	500 feet
Delaware.....	200 feet
Florida.....	200 feet
Georgia.....	Reasonable
Idaho.....	200 feet
Illinois.....	200 feet
Indiana.....	200 feet
Iowa.....	500 feet
Maryland.....	200 feet
Mississippi.....	200 feet
Missouri.....	500 feet
Montana.....	200 feet
Nebraska.....	Reasonable
Nevada.....	Reasonable
New Jersey.....	250 feet
New York.....	250 feet
Oregon.....	500 feet
Pennsylvania.....	200 feet
Rhode Island.....	200 feet
South Carolina.....	200 feet
Vermont.....	200 feet
Virginia.....	100 feet
Washington.....	500 feet
Wyoming.....	500 feet

(D) The following States have practically no headlight laws:

1. Arkansas. (Counties and cities may regulate headlights)
2. Colorado. (Must have lights at onehalf hour after sunset)
3. Louisiana. (Same as Arkansas)
4. Oklahoma. (Same as Arkansas)
5. Tennessee. (none)
6. Texas. (Present law not upheld by courts)

## (E) States limiting the Max. Candle-power of the lamp:

Arizona.....	32	c.p.
California.....	32	c.p.
Connecticut.....	21	c.p.
Iowa.....	32	c.p.
Maine.....	32	c.p.
Maryland.....	32	c.p.
Massachusetts.....	21	c.p.
Michigan.....	32	c.p.
Minnesota.....	32	c.p.
Missouri.....	36	c.p.
Nebraska.....	24	c.p.
New Jersey.....	24	c.p.
New York.....	24	c.p.
Ohio.....	32	c.p.
Pennsylvania.....	32	c.p.
Utah.....	32	c.p.
Washington.....	27	c.p.
West Virginia.....	32	c.p.
Wisconsin.....	32	c.p.

(F) States declaring that a substantial object must  
be distinguished at a certain distance ahead:

California.....	200	feet
Delaware.....	25	feet
Iowa.....	75	feet
Kentucky.....	200	feet
Maine.....	200	feet
Massachusetts.....	160	feet
Michigan.....	200	feet
Minnesota.....	200	feet
Missouri.....	150	feet
New York.....	200	feet
Ohio.....	200	feet
Oregon.....	200	feet
Pennsylvania.....	200	feet
Utah.....	200	feet
Washington.....	150	feet
West Virginia.....	200	feet
Wisconsin.....	200	feet

(G) States Regulating Spotlights:

Beam not to be directed on highway more than a given distance ahead except when swung 30 degrees or more to right or left.	
Arizona.....	100 feet
Minnesota.....	100 feet
Utah.....	100 feet
Wisconsin.....	50 feet

Beam not to be directed on highway more than a given distance ahead.	
Nebraska.....	30 feet
Michigan.....	200 feet and to right of center
New Hampshire.....	30 feet
North Dakota.....	30 feet
Oregon.....	75 feet
South Dakota.....	50 feet

Beam not to be directed more than a given distance ahead when approaching vehicle is in sight.	
Connecticut.....	60 feet and to right of center
Indiana.....	50 feet
Maryland.....	30 feet and to right of center
Ohio.....	50 feet
Vermont.....	30 feet
Washington.....	75 feet 6 ft. to right of center

Iowa- Beam shall not be directed to left of center of road when meeting car.

Missouri- Beam must not be directed into eyes of approaching driver in country. May be used in cities in emergency.

Wyoming- In case of emergency or in rounding curves, spotlight may be used.

New Jersey- Spotlight permitted only for reading signs.

Beam shall be so directed that at a certain distance ahead it shall not be over a certain height above road.

California.....	42 in.	at any distance
Delaware.....	48 in.	at 75 feet (at left of center)
Massachusetts.....	24 in.	at 30 ft.
Maine.....	24 in.	at 30 ft.
Pennsylvania.....	42 in.	at 75 ft. (and directed to right of center)
West Virginia.....	42 in.	at 75 ft.

(H) List of lenses legal in all States which publish approved lenses.

Bausch & Lomb....	both new and old type
Clamert.....	type A.....
Controlite.....	.....
Conophore.....	in Noviol & clear type
Dillon.....	.....
Full Ray.....	.....
Holophane.....	both new and old type and No. 855.
Legalite.....	both new and old type
Liberty.....	.....
Macbeth.....	in Amber and L type..
McKee.....	Amber and clear type.
National.....	.....
Osgood.....	.....
Patterson Lenz..	style B.....
Raydex.....	both new and old type
Sun Ray.....	Standard type.....
Violet Ray.....	.....



Table I \*

Name of States	Hrs. after Sunset & Before Sunrise	Numbers Visible	Spotlight on Road Ft. Ahead	Beam Swing Degs.	Front Light Visible in Ft.	Additional
1. Alabama.....	$\frac{1}{2}$	50 ft.	...	...	...	Lights need not be lit under st. light.
2. Georgia.....	I	Plainly	...	...	...	lights must be always lit.
3. Idaho.....	I	...	...	...	200	.....
4. Illinois.....	I	50 ft.	...	...	200	Dimmed at 250 ft. unless equipped with lenses.
5. Indiana.....	$\frac{1}{2}$	100 ft.	50	...	200	Need not burn lights while stand in town.
6. Kansas.....	I	....	...	...	...	Lenses or dimmers.
7. Minnesota.....	I	....	100	30	200	Lenses 32 c.p.
8. Mississippi...	$\frac{1}{2}$	....	...	...	200	.....
9. Montana.....	I	100 ft.	...	...	200	.....
10. New Mexico....	I	....	...	...	...	.....
11. Rhode Island..	$\frac{1}{2}$	60 ft.	...	...	200	.....
12. S. Dakota.....	$\frac{1}{2}$	....	50	...	...	Must have lens or dimmers.
13. Virginia.....	I	Plainly	...	...	100	.....
14. Wyoming.....	I	50 ft.	...	...	500	Must use dimmer.

\* In above table blanks indicate those portions of law which are not effective in that particular state.

Table II\*

Name on State	(a)	(b)	(c)	(d)	(e)	(f)	(g)	Additional
1. Arizona.....	I	75	42	100	30	...	32	.....
2. Florida.....	$\frac{1}{2}$	200	48	...	..	200	..	IF not equipped with lens, dimmers must be used.
3. Kentucky....	...	75	42	...	..	200	..	.....
4. Michigan....	I	75	42	200	..	...	32	May use dimmers.
5. Missouri....	$\frac{1}{2}$	..	42	...	..	500	36	Spotlights must be used in country.
6. Nevada.....	I	..	42	...	..	...	..	Lenses or dimmers must be used.
7. New Hampshire	..	75	42	30	..	...	..	.....
8. N. Carolina..	$\frac{1}{2}$	75	42	...	..	...	..	.....
9. N. Dakota...	...	75	42	30	..	...	..	.....
10. S. Carolina.	$\frac{1}{2}$	75	42	...	..	200	..	.....
11. Utah.....	$\frac{1}{2}$	75	42	100	30	200	32	.....
12. Vermont.....	$\frac{1}{2}$	75	42	30	..	200	..	.....
13. Washington..	$\frac{1}{2}$	75	42	75	..	500	27	.....
14. West Virginia	...	75	42	..	..	200	32	.....
15. Wisconsin...	...	..	60	50	30	...	32	Max. 21 c.p. for spotlight, 32c.p. for headlights.

18

From (a) hour after sunset to (a) hour before sunrise, display at least two lighted lamps on the front of such vehicle and also display a red light visible from the rear. All lights over 4 c.p. equipped with reflectors shall be so arranged, designed, diffused or deflected that no portion of the beam of light shall at a point (b) feet or more ahead of the lamps rise more than (c) inches above the level surface on which the vehicle stands. Spotlight must be so constructed that the center of the beam does not strike the highway at a greater distance than (d) feet ahead of the vehicle except when beam is swung (e) degrees to right or left no limitation is placed upon the height to which the beam may be raised. The lights of the front lamps shall be visible (f) feet ahead. Maximum candle power of lamps is (g) candle power.

\* Where a blank occurs in above table, that portion of the law is omitted.

The following States publish a list of lawful lenses and devices for limiting the beam. The standard is practically the I.E.S. recommendation. 45% of the total registration of automobiles in this country are represented by this list.

Name of State	Specification
I. California....	Spotlights at 100 ft. shall not throw beam over 42 in. high.
2. Connecticut...	Limit of 2I c.p. lamps. Spotlight to right of center and must
3. Delaware.....	hit road not over 30 feet ahead of vehicle.
4. Iowa.....	List not out of date. At 75 ft. or more ahead, beam shall not
5. Maine.....	rise over 48 in.
6. Maryland.....	At 75 ft. or more ahead, beam shall not rise over 42 in.
7. Massachusetts.	Max. 32 c.p. Spotlight to right of center of road.
8. Nebraska.....	At 75 ft. ahead, not over 42 in. Max. 32 c.p. Spotlights not
9. New Jersey....	more than 2 ft. above road 30 ft. ahead.
10. New York.....	At 75 ft. ahead not over 42 in. Max. 32 c.p.
II. Ohio.....	Spotlight on road not over 30 ft. ahead.
12. Pennsylvania..	Maximum 2I c.p. gas-filled.
	At 75 ft. or more ahead, beam shall not use over 42 in. Spotlights
	not more than 30 ft. in front of vehicle. Max. lamps 24 c.p.
	Beam not more than 56 in. above road. No spotlight can be used
	for driving purposes. Max. lamps 24 c.p.
	At 75 ft. ahead beam must not higher than 42in. Max. 24 c.p.
	Spotlight same as headlight.
	At 75 ft. ahead beam must not be higher than 42in. Max. 32 c.p.
	At 75 ft. or more ahead of lamps beam must not be more than
	42 in. Max. 32 c.p. Spotlight shall not extend to left of
	center of road.

61

Table III

Specifications for Motor Vehicle Headlight Beam as Drafted by the I.E.S.

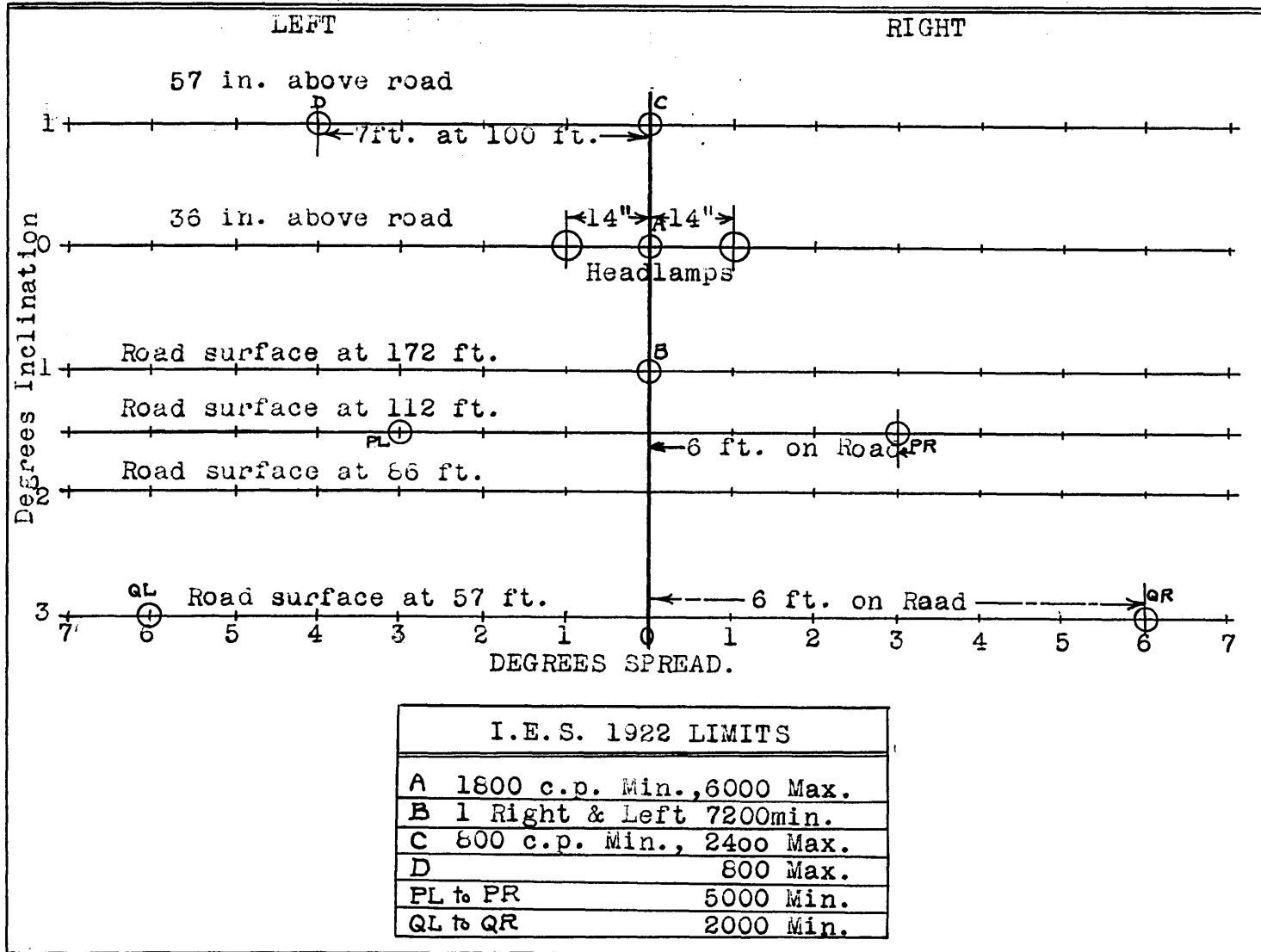

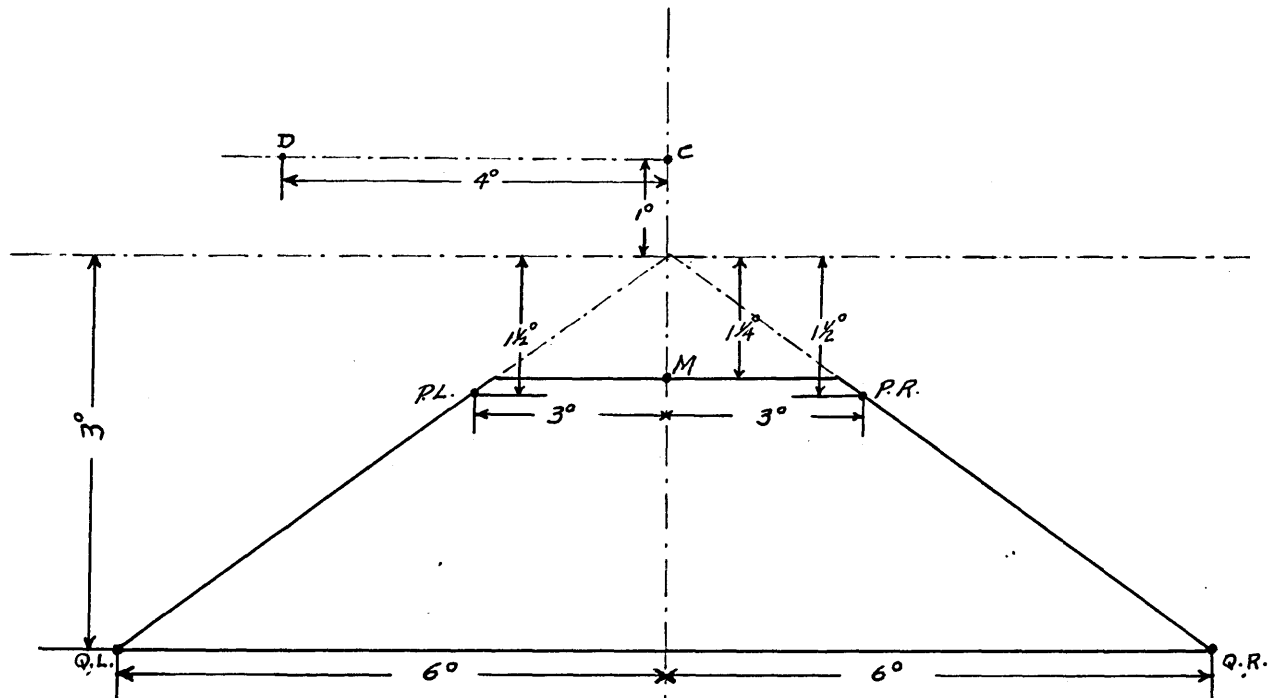

Massachusetts Specifications Test Point Locations

Apparently, the most general means of obtaining a beam of light from a mazda lamp is by the use of a parabolic reflector. In order to take a relatively narrow beam from such a device and turn it down toward the road, also spread it out somewhat, a considerable number of auxiliary devices have been developed in the form of cover glasses, etc. Many of the States test these various devices and issue lists of the ones approved for use in the State. In such cases, the maximum candle power of the lamps to be used with each device is specified.

Many of these cover glasses, or lenses, have been approved by all States issuing lists. See (H). Besides these there are some 115 other makes which have been approved by some States, but not by others.

There is an increasing tendency in the various States to limit the candle power of the lamps. Massachusetts and Connecticut limit this to 21 c.p. for any device. In fact, the Massachusetts law goes so far as to require the use of 21 c.p. gas-filled lamps. It has been thoroughly demonstrated that a 21 c.p. lamp with a good headlight device gives an excellent driving light.

Until recently, no matter what headlight device or lamps were used, it was necessary to accurately focus each lamp, and when a lamp burn out it was necessary to focus the replacing lamp. Many people did not understand how to do this, and many of the head lamps did not have good facilities for doing it. so there has been a demand for a headlamp and a Mazda lamp each made so accurately that it would not be necessary to refocus. Advances in the manufacture of brass lamp parts as well as in Mazda lamps has enabled the production of a unit such as that of the new Willes Saint-Claire car lamps.

Nearly 80 per cent of the glaring headlights in use today are due to the fact that they not properly focused.

ANALYSIS OF PARABOLOIDAL REFLECTING SURFACE



ANALYSIS OF PARABOLOIDAL REFLECTING SURFACEPoint Source

A parabolic curve rotated about its axis generates a surface of revolution that has the useful property of reflecting light originating at its focus into a beam of light that is in general parallel with the axis. If the light source is a mere point then the beam is made up of a bundle of rays each strictly parallel to the axis, and there is neither convergence nor divergence of the light. The beam is thus cylindrical in form and of unvarying intensity at all distances, except as the light is scattered or absorbed by the medium through which it moves. The demonstration of these characteristics has been often made in books on photometry or geometry, and it would not be here repeated if there were not several useful principles of optics involved that are not so well known.

These principles, which will be explained shortly enable us to analyze any section of a reflecting surface and find out in detail how it acts, what it can do, and what it cannot do. Also, they bring to light some interesting and useful properties of the paraboloid and related surfaces that seem to have escaped previous notice.

In the science of applied optics there is a phenomenon known as coma, by virtue of which the image of a point becomes not a point but two straight lines, perpendicular to one another in direction and lying in different planes. There is thus no single plane that will show an image that resembles the object, and it may be doubted if we are justified in calling either line an image of the generating point. Coma, in a camera, gives an image of a bright source some distance from the axis of the lens as a diffused point of light with a comet-like tail, and sharp definition is not possible in this part of the field. The rules that govern coma, in the simpler cases at least, are in themselves very simple, and because of this simplicity they are convenient (and powerful) instruments for the exploration of optical surfaces.

#### Meridian Line

Let us take not a parabolic surface but the parabolic curve itself and see how it acts as a reflector. It may be necessary, in order to form a mental picture, to imagine that the curve has some little width and a flat surface on the concave side so that there will be something to reflect light. From the focal point of the curve draw a straight line at random to some point P on

the surface as in Fig. 1, and call the length of this line  $p$ , then if  $a$  is the angle measured clockwise from the axis up to the line  $p$  we have the following equations:

Equation of parabola

$$p = F \sec^2 \frac{a}{2} \quad (1)$$

Radius of curvature at point P

$$R = 2F \sec^3 \frac{a}{2} \quad (2)$$

where  $F$  is the focal length of the parabola as ordinarily considered in geometry.

Let us draw two rays of light parallel to the normal at P, Fig. 1, and find what they do after reflection at the two points  $P_1$  and  $P_2$  on the curve near P. According to a rule of elementary optics the two reflected rays will converge at a point on the normal, half the radius  $R$  from the point P. This point may properly be said to be the principal focus of the section of curve  $P_1, P, P_2$ , and designating this principal focal length by  $f$  we get

$$\begin{aligned} f &= \frac{R}{2} \\ &= F \sec^3 \frac{a}{2} \end{aligned} \quad (3)$$

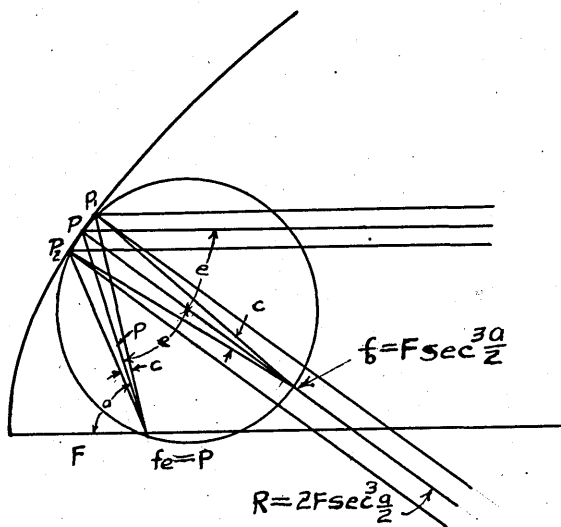

Fig. 1.

It will be observed that  $f_0$  is measured along the normal, and hence does not coincide with what we ordinarily call the focus of the parabolic curve. Also, as the angle  $\alpha$  is changed  $f_0$  will change, so that each section of curve will have a principal axis, or normal, varying in direction and a principal focal length that varies in magnitude.

Consider the points  $P_1$  and  $P_2$  to be fixed, and rotate the incident rays counter-clockwise in the plane of the curve to some new position at an angle  $e$ , keeping the two rays always parallel to one another. The reflected rays will rotate in the opposite direction through the same angle  $e$  and the angle of convergence  $c$  will remain constant. The distance between the parallel incident

rays will decrease by the factor  $\cos e$  as they are rotated through the angle  $e$ , and if the rotation is made equal to 90 deg. the two will coincide in position. When the points  $P$  and  $P'$  are fixed then the angle of convergence  $c$  of the reflected rays is fixed and independent of the angle of incidence.

We have for normal incidence the length

$$P_1 P_2 = 2 f_0 \tan c \quad (4)$$

and at any angle of incidence  $e$ , we have the length

$$P_1 P_2 \cos e = 2 f_e \tan c \quad (5)$$

where  $f_e$  is the focal length or distance to the new converging point. Upon comparing equations (4) and (5) we get the relation

$$f_e = f_0 \cos e \quad (6)$$

which shows that as  $e$  is varied the point of convergence moves in a circle that has a diameter  $f_0$  and is tangent to the surface at the point of reflection.

If the parallel incident rays, Fig. 1, are rotated until they are parallel to the axis of the parabolic curve, we have

$$2 e = a$$

$$e = \frac{a}{2}$$

and

$$f_{a/2} = f_0 \cos \frac{a}{2} \quad (7)$$

and also, if we substitute for  $f$  its value in terms of  $F$  and  $\sec \frac{a}{2}$  as found in equation (3), we get

$$\begin{aligned} f_{\frac{a}{2}} &= F \sec^3 \frac{a}{2} \cos \frac{a}{2} \\ &= F \sec^2 \frac{a}{2} \end{aligned} \quad (8)$$

which is the length of the radius vector  $p$  as defined by the equation of the parabola itself. The focal point of the entire parabolic curve, therefore, lies on the locus of foci of the element  $P, P_2$  but it is a secondary or special focus.

A point source of light placed at any point of the circular locus will have such of its light as strikes the parabolic curve at the point of tangency to the circle reflected in a parallel beam. The focus of the parabola acquires its optical importance from the fact that it lies on the common crossing point of all the circular loci that may be drawn at different parts of the parabolic curve, and therefore it becomes the principal focus of the parabolic curve taken as a whole.

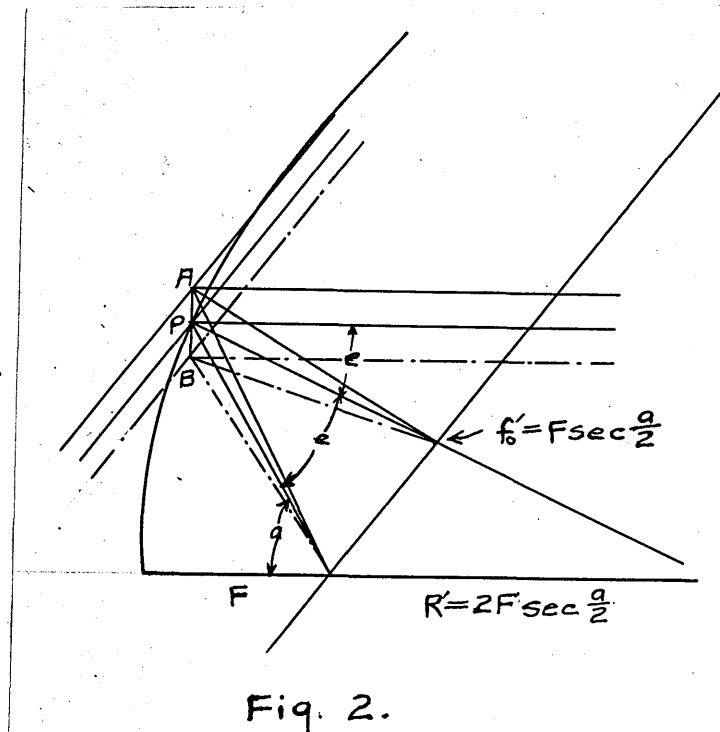

### Straight Line

The curvature of a paraboloidal surface is not the same for an elemental line in the surface and in a plane through the axis (the meridian section) as it is for a second line at right angles (known as the sagittal section). This is apparent when we remember what curves are formed by a plane intersecting a paraboloid. If the intersecting plane is perpendicular to the axis the curve of intersection is a circle; if the plane is parallel to the axis the curve is identical with the generating parabola, but of course is shifted to one side of the original axis. A plane that is neither parallel nor perpendicular to the axis intercepts the paraboloid in an ellipse.

and it is evident that the second, or sagittal, line just mentioned is a section of an ellipse. We might solve for this ellipse and thus find the normal and radius of the element in question, but there is a much simpler way of finding 1st characteristics.

Every normal to points in a surface of revolution intercepts the axis of revolution, and we may define the radius of sagittal curvature at a point P, Fig. 2, as being the point of intersection of two adjacent normals such as those erected at A and B on a line in the surface at right angles to the parabolic section. The intersection of the normals is at the axis, and the length of a normal to a point on a parabolic curve is

$$R' = 2 F \sec \frac{a}{2} \quad (9)$$

where  $a$  is the angle between the axis and the radius vector to the point at which the normal is erected.

The principal focal length of the sagittal element is therefore half the length of the normal, or

$$f'_0 = F \sec \frac{a}{2} \quad (10)$$

By equation (3) the expression for the principal focus in the meridian plane was found to contain  $\sec^3 \frac{a}{2}$  as a factor; and as  $\sec^3 \frac{a}{2}$  is always greater than  $\sec \frac{a}{2}$  when  $a$  is less 180 deg., the length of  $f_0$  is always greater



than  $f'$ .

If we imagine the parabolic curve and its axis to lie in the plane of the paper, Fig. 2, then point A will be above the paper and B will be below it, and parallel planes can be passed through A and B parallel to the plane of the paper and separated by the distance AB. Pass a plane perpendicular to the above planes, so that it contains the center of curvature  $R'$ , the principal focal point  $f_0'$  of the line AB, and the line AB itself. A pair of rays parallel to the normal and incident at A and B will after reflection intersect at a distance  $f'$  as found above, and the reflected rays will lie in the perpendicular plane just erected. It is desired to trace these reflected rays and find their intersection as the parallel incident rays are rotated in their respective planes but kept parallel to one another.

At the points A and B erect lines that are perpendicular to both the incident and reflected rays (one line lies in the horizontal plane through A and the other in the horizontal plane through B) and at  $f_0'$  erect a common perpendicular to the two reflected rays (this lies in the plane of the paper).

Planes passed through these perpendiculars will pass obliquely between the three parallel planes

through A, P and B and the intersection of the two oblique planes will be on the normal through  $f_0'$ . As the incident rays are rotated through angle  $e$ , the reflected rays will be rotated in an opposite direction through the same angle and as they always lie in the oblique planes their intersection will fall on the intersection of the planes, and the focal length will be

$$f_e' = f_0' \sec e \quad (11)$$

The right-hand member of this equation indicates a straight line as the locus of foci, and in this case the focal length increases with increasing values of  $e$ . If we rotate the pair of incident rays until they are parallel to the axis of the parabola we have

$$2e = a$$

and

$$e = \frac{a}{2}$$

therefore

$$f_{\frac{a}{2}}' = f_0' \sec \frac{a}{2} \quad (12)$$

and substituting for  $f_0'$  from equation (10) we get the special condition

$$f_{\frac{a}{2}}' = F \sec^2 \frac{a}{2} \quad (13)$$

which shows that the locus of foci passes through the focal point of the parabola.

#### Element of Surface

So far we have considered the optical properties

of lines in the surface of the paraboloid, but what of the surfaces as such?

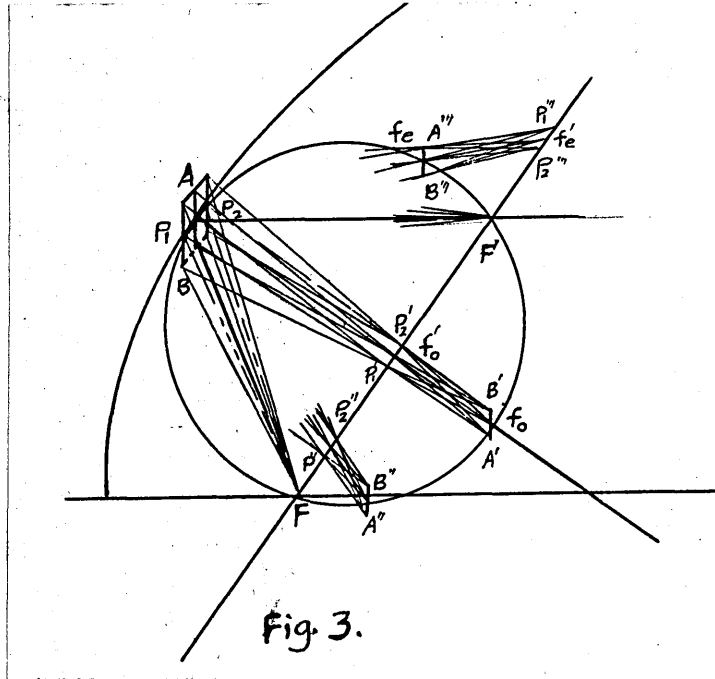

Fig. 3.

In Fig. 3 the two elemental lines  $P_1$ ,  $P_2$  and  $AB$  have been taken to locate and define an element of the reflecting surface. A bundle of incident parallel rays normal to the surface will be reflected into a line focus at  $f_0'$  and into another line focus at  $f_0$  as defined by equations (10) and (3) and these two line foci will be perpendicular to one another (similar to Sturm's conoid). In Fig. 3,  $P_1$ ,  $P_2$  represent the line image at  $f_0'$  that lies on the straight line locus of  $f_2'$ , and hence it is in the plane of the paper. The light, after passing through  $P_1$ ,  $P_2$  forms a second line image  $A'B'$  perpendicular

to the plane of the paper and having its center on the circular locus of  $f_e$ . It is evident that as neither  $A'B'$  nor  $P_1, P_2$  are common focal points for the two defining lines in the surface of the reflector, neither will do as a location for a source of light to form a parallel beam. If the incident bundle of parallel rays is rotated upward from the axis of the parabola, the focal lines will rotate into lower positions on the straight line and circle, as  $P_1'', P_2''$  and  $A'' B''$ , Fig. 3. The two lines are now shorter and closer together, and if the upward rotation is continued until the incident light is parallel to the axis of the paraboloid the focal lines will merge into a point at the crossing point of the circle and the line; that is, at the focus of the paraboloid. Therefore, it is proved that the entire paraboloid will reflect into a parallel beam the light that originates at its focus.

If the incident parallel rays are rotated downward beyond the focus of the paraboloid, Fig. 3, the focal point will separate into two focal lines as before, except that  $P_1''', P_2'''$  which has previously been the closer of the two to the reflecting surface now is farther away than  $A''' B'''$  but they are in the plane of the paper and perpendicular to it just as before.

There is one particular condition that has been found useful in practice without the user always realizing fully just what takes place. The two focal line loci meet at  $F'$  and this point has identical properties with regard to the element of surface as has point  $F$ . When light from a point source at  $F'$ , travelling parallel to the axis of the paraboloid, strikes the elemental surface  $P_1 P_2 AB$  it will be reflected in a beam of parallel rays, and this beam will pass through the focus  $F$ , so that the two points  $F$  and  $F'$  are optically symmetrical in one respect, but  $F'$  as a source point is limited to a small area while  $F$  is general for the entire surface.

#### Use of the $F'$ Point

When a lamp is placed near the  $F'$  positions of the parabolic reflector it will give the ideal beam for illuminating either a highway or a wall or any rectangular area that must be illuminated from a point well to one side of the center.

#### Locus of $F'$

From the construction of Fig. 3 it is evident that  $F$  and  $F'$  are equally distant from the reflecting element. In Fig. 4 this relation has been used to construct the locus of all points  $F'$  for the entire reflecting surface.

The rectangular form of parabolic equation is

$$y = 4Fx \tag{14}$$

and the length of a radius vector is

$$p = F+x \tag{15}$$

If the coordinates of the point P are x and y then the coordinates of F' are  $x + (F+x)$  and y, or  $2x + F$  and y.

$$y = 2F(x - F) \tag{16}$$

for the locus of F'; that is, F' moves along a parabola having a focal length of  $\frac{1}{2} F$  and having its vertex at the focal point of the reflector.

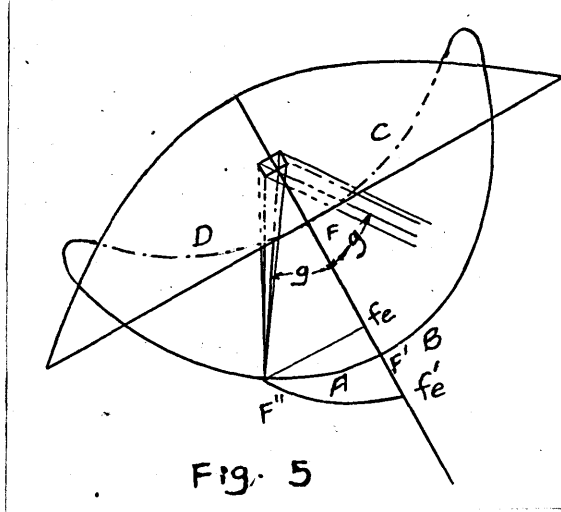
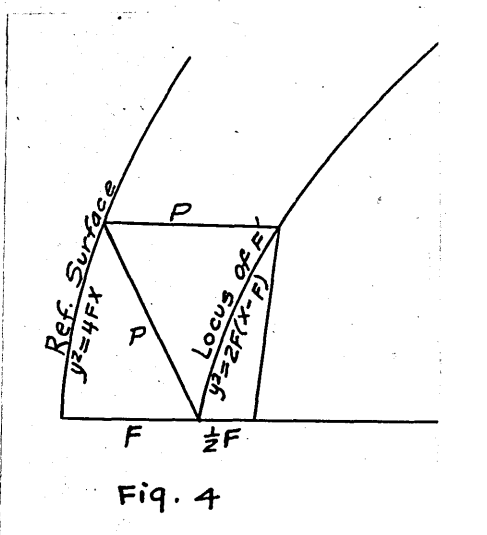

Parabolic Cylinder Reflector

In Fig. 6 the line  $V_0 P_0 E_0$  is parabolic in form, while  $V_0 V$ , the transverse axis, and  $E_0 E$ , the upper edge of the reflector, are straight lines. Let us call any parabolic curve in the surface parallel to  $V_0 P_0 E_0$  a sectional line, and any straight line in the surface parallel to  $V_0 V$  an elemental line. It will be noted that whereas the meridian lines of the paraboloid, previously discussed, all passed through the axis of the surface of revolution, in the case of the parabolic cylinder the sectional lines are parallel and have no crossing points. Also, the elemental lines in the case of the latter reflector are all straight parallel lines.

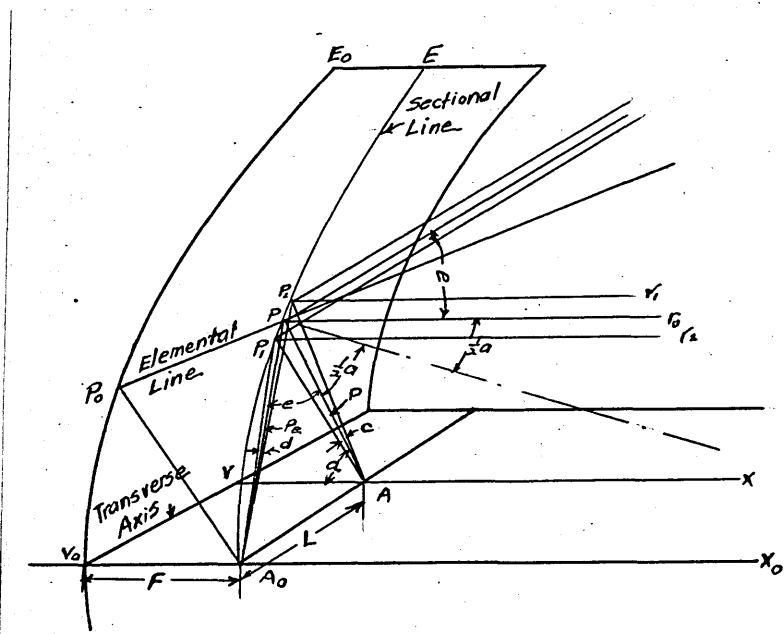

Fig. 6.

Any incident rays as  $r_0$ , Fig. 6, parallel to the axis of projection  $V_0 X_0$  will be reflected to the focal point A of the parabolic section V P E. Similarly, parallel rays  $r_1$ ,  $r_2$  in the same sectional plane will converge on the point A. Call the angle of convergence  $c$  and the distance from the point of reflection to the focal point P then

$$P \tan \frac{c}{2} = PP_1 \cos \frac{\alpha}{2} = PP_2 \cos \frac{\alpha}{2} \quad (17)$$

Where the points  $P$ ,  $P_1$  and  $P_2$  are close together on the sectional line. The incident ray lies in the intersection of a horizontal plane (determined by the elemental line  $P_0 P$  and the ray  $r_0$  which is parallel to the axis  $V_0 X_0$ ) and a vertical plane cutting the surface along the parabolic sectional lines. After reflection at the point P the ray  $r_0$  lies in an oblique plane determined by the element line  $P_0 P$  and the radius vector  $p$ . If the ray  $r_0$  is rotated in the horizontal plane through the angle  $e$  the reflected ray will rotate through the same angle  $e$  in the oblique plane and pass through point  $A_0$  of Fig. 6. Similarly, incident ray  $r_1$  and  $r_2$  will after reflection converge on A, and when rotated each in its own horizontal plane through the angle  $e$  the reflected rays will pass through  $A_0$  which is thus a converging or focal point, providing only that the distance  $P, P_2$  is extremely small.

The convergence of the rays is changed by the



rotation through the angle  $e$ . The length of the radius vector from A to P is

$$P = F \sec^2 \frac{\alpha}{2}$$

While the radius vector from A to P is

$$p_e = F \sec^2 \frac{\alpha}{2} \cdot \sec e \quad (18)$$

therefore

$$p_e = p \sec e$$

also

$$p \tan \frac{c}{2} = p_e \tan \frac{d}{2} \quad (19)$$

and we get the relation

$$c = d \sec e \quad (20)$$

after substituting the small angle  $e$  for  $\tan e$  and angle  $d$  for  $\tan d$ .

It will be shown shortly that the three rays  $r_0, r_1$  and  $r_2$  must be rotated through slightly different angles in order actually to converge upon the point  $A_0$ , and the latter is therefore not a focal point for the element  $P_1, P, P_2$ . We may place a point source at  $A_0$  and the reflected rays at  $P_1, P$  and  $P_2$  will lie in parallel horizontal planes but the values of  $e$  will become smaller as we pass from  $P_1$  to  $P$  and to  $P_2$ .

The physical significance of equation (19) is that a point source of light may be moved along the line  $A A_0$  and the reflected rays from various points in  $P_0, P$

will rotate in fixed planes that are parallel, or to take a different viewpoint, a fixed point source will have such of its light as strikes on a given elemental line  $P_0 P$  reflected at various angles in a single plane. This gives the fanlike beam previously mentioned, but it remains to be seen what the other properties of this fan beam are, and in particular how the angle of spread  $e$  is influenced by the proportions of the reflector.

In Fig. (7) a ray originating at  $A$  and being reflected at the point  $P$  is shown as taking the direction  $P r'_0$  after reflection.

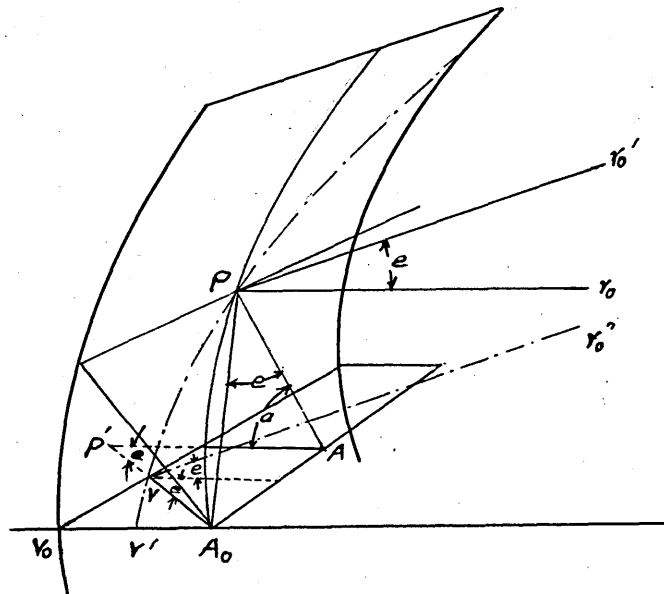

Fig. 7.

The angle between  $Pr_0'$  and  $P r_0$ , a parallel to the principal axis  $V_0 A_0$ , is  $e$ , which we will call the angle of spread. It is useful to know how to cut the end of the cylinder so that the same maximum spread  $e$  will be obtained from all points along the ends. In Fig. 7 the triangle  $A_0 P A$  is shown rotated down into the horizontal plane, using the locus  $A_0 A$  as an axis, and the point  $P$  falls on  $P'$ . The length of the radius vector  $A P$  is  $A V$  (the focal length) plus  $XV$ , and therefore  $VP'$  is equal to  $XV$ . The triangle  $A_0 P' A$  is shown more clearly in Fig. 9. If the line  $V_0 V$  is considered to be a plane mirror, then  $P'$  is the image of  $X$ , and if  $V' r_0''$  is extended backward it will intercept the  $V_0 A_0$  axis at  $A_0'$ . The latter point is a common crossing point for all rays reflected in the same horizontal plane, and therefore  $A_0'$  is a virtual image of  $A_0$ . Thus a ray from  $A_0$  striking the reflector in the same horizontal plane as  $P$  will have the same  $XV$  distance and by the construction in dotted lines in Fig. 9 it is evident that for any angle  $f$ , which is different from  $e$ , the virtual image of  $A_0$  will fall on the same point.

When thus we regard  $A_0'$  as the light source; and if a total spread of say 50 deg. is desired an arc of 50 deg. swung about  $A_0'$  will include the necessary reflecting surface, 25 deg. on each side of the axis, and the ends will

be formed by vertical planes cutting the parabolic cylinder.

The end piece of the cylinder will themselves be parabolic in outline, with the apex of the parabola at the transverse axis of the reflector.

Given a parabolic cylinder with a section defined by

$$Y^2 = 4 F X$$

and a desired spread of beam of  $2 e$  degrees, the outline of the end pieces will be the parabola.

$$Y^2 = 4 F X \cos e \quad (21)$$

and the oblique section of the reflector where it is joined by the end piece will of course have the same form but the developed form of the reflector end (dotted curve V'P, Fig. (7)) will not be parabolic. The ordinates of the developed curve Fig. (9) will be the developed length of the parabola of equation (21) and the abscissa will be the abscissa of the original sectional line times  $\tan e$  or

$$X' = X \tan e \quad (22)$$

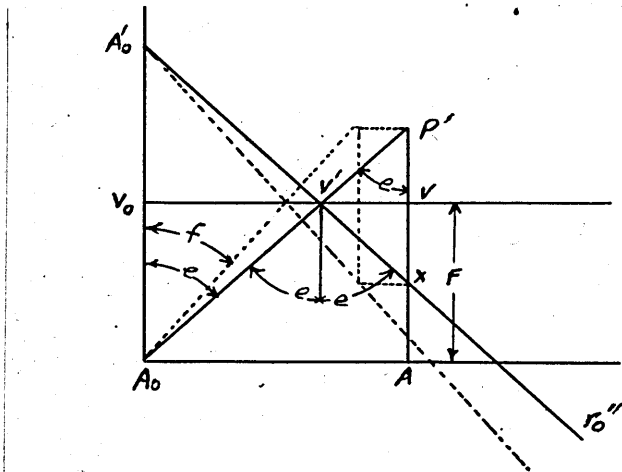
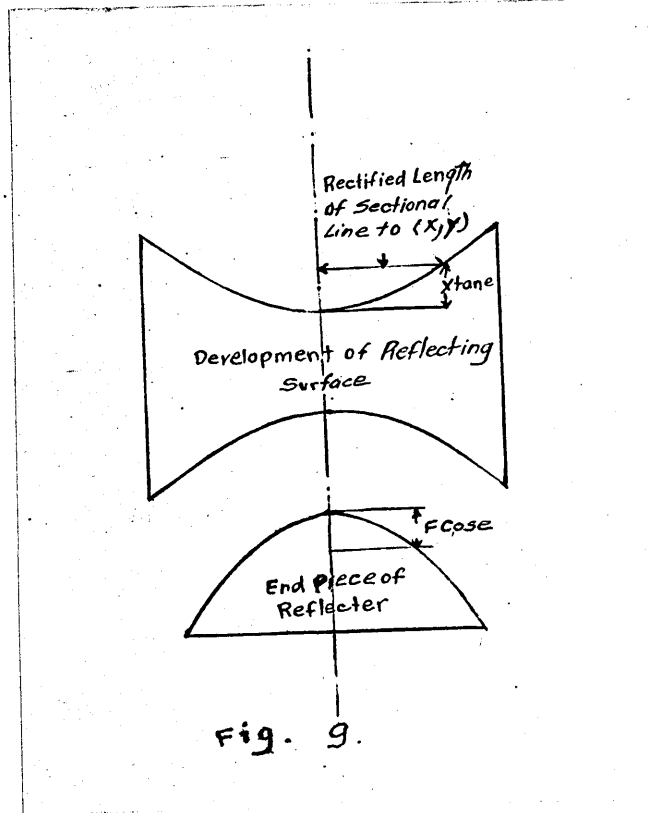

Fig. 8



### Distribution of Light from Point Source

In Fig. 10 let  $I$  be the intensity of radiation in candles given off uniformly in all directions by the point source at  $A_0$ . At any point  $P$  Fig. 10, the normal illumination is

$$E_n = \frac{I}{R_e^2} \quad (23)$$

and from equation (18), after substituting the cosines for the secants, the expression for normal illumination at distance  $P_e$  is

$$E_n = \frac{1}{F^2} \cos^4 \frac{a}{2} \cdot \cos^2 e \quad (24)$$

After reflecting at the point  $P$  the illumination on a normal surface will decrease as the inverse distance, hence at a distance  $D$  the illumination  $E_n'$  is in the proportion

$$\frac{E_n'}{E_n} = \frac{\rho_e}{D} \quad (25)$$

after substituting from (23) we get

$$E_n' = \frac{I}{\rho_e D} \quad (26)$$

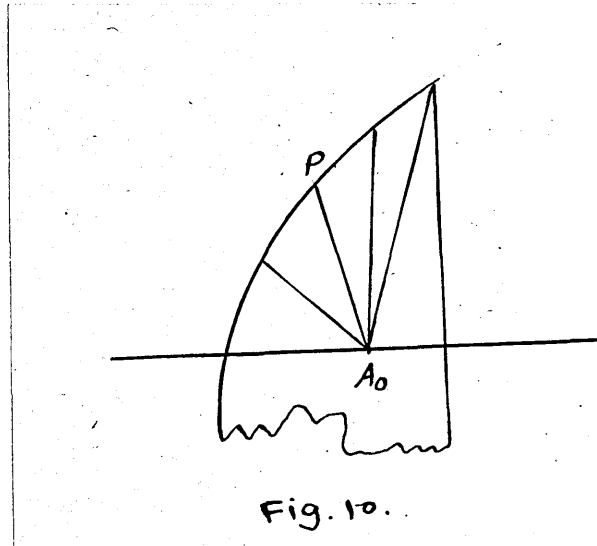

### The Spherical Source

In Fig. (11), two sections \$P\_1\$ and \$P\_2\$ of a parabolic mirror are shown reflecting two images of the spherical light source located at the focal point of the mirror. At increasing distances the two images \$A\_1\$ and \$A\_2\$ which in this case are circular, will touch as they come into contact with the extended axis of the mirror; and at this point all of the mirror within the zone through \$P\_1\$ and \$P\_2\$ will be active; that is, it will reflect light through this point of contact. All the area outside of \$P\_1\$

and  $P_2$  will be inactive in reflecting light to the axis at the particular distance  $L_0$  and the apparent beam strength is therefore

$$I = \pi \cdot BmY^2 \quad \text{candles} \quad (27)$$

Where  $B$  is the brilliancy of the source in candles per square inch;  $M$  is the coefficient of reflection of the mirror;  $Y$  is the radius in inches of the outer edge of the active area.

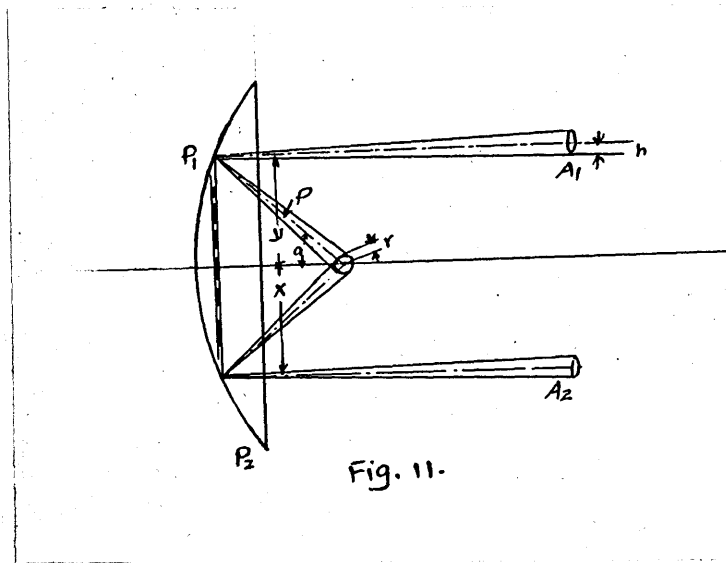

The radius of the image  $A_1$  is proportional to the radius  $r$  of the source and is also proportional to the distance  $L_0$ , and inversely proportional to the radius vector  $p$  from the focal point to the point  $P$ , on the mirror.

Therefore

$$h = \frac{12 r L_o}{\rho} \quad (28)$$

Where  $L_o$  is expressed in feet and the other dimensions are in inches.

Rearranging we have

$$L_o = \frac{h \rho}{12 r} \quad (29)$$

and at the point of contact of the image  $A$ , with the axis, we have

$$\begin{aligned} h &= y \text{ inches} \\ &= 2 F \tan \frac{a}{2} \text{ inches} \end{aligned} \quad (30)$$

Therefore in terms of  $F$ ,  $r$  and  $a$

$$L_o = \frac{F^2 \tan \frac{a}{2} \sec^2 \frac{a}{2}}{6 r} \text{ feet} \quad (31)$$

or in terms of  $F$ ,  $r$  and  $y$

$$L_o = \frac{y(4F^2 + y^2)}{48 F r} \text{ feet} \quad (32)$$

and in terms of  $F$  and  $a$  the intensity on the axis is

$$I = 4\pi B m F^2 \tan \frac{a}{2} \text{ candles} \quad (33)$$

or in terms of  $y$

$$I = 4\pi B m Y^2 \text{ candles} \quad (34)$$

Equation (31) maybe written

$$L_o = \frac{y^2}{12 \sin a} \text{ feet} \quad (35)$$

In case the radius  $Y$  of the mirror is constant and the angle  $a$  varies, the lowest value of  $L_o$  occurs when  $\sin a$  is maximum, that is  $a=90^\circ$ ; and for angles equally below



or above  $90^\circ$  as  $60^\circ$  and  $120^\circ$  the values of  $L_0$  are the same.

Let the radius of the light source subtend an angle  $e$  from the edge of the mirror, then the beam from this point, which fixes the boundaries of the inverse square region, has a divergence  $e$  either way from the axis and we can write

$$L_0 = y \cot e \quad (36)$$

for the point where the inverse square region has zero width.

At some greater distance  $L$  measured from the search light, the half width is

$$\frac{W}{2} = (L - L_0) \tan e \quad (37)$$

The apparent angular width here is  $e'$ , giving

$$\tan e' = \frac{W}{2L} \quad (38)$$

### The Disc Source

By the same mathematical treatments the following equations can be derived.

$$I_B = \pi R^2 m B \quad (39)$$

$$R = \frac{2F}{1 - \cos 90^\circ} = 2F \text{ inches} \quad (40)$$

The intensity of the radiation at an angle  $a$  is

$$I_a = I_0 \cos a \quad \text{candles} \quad (41)$$

and the foot candle curve close to the mirror may be found from the expression

$$E = \frac{m I_0 \cos a}{(F + X)^2} \quad \text{foot candles} \quad (42)$$

DESCRIPTION OF APPARATUS

Description of Apparatus

In the apparatus used by Mark and Flanders, motion was given to the bulb in one direction only, along the horizontal axis of the bulb. In order to obtain motion in all three planes at right angles to each other a special device was employed.

A quarter-inch shaft was mounted perpendicular to a steel plate 2-5/8" long, 2" wide and 1/2" thick, as shown in Fig. 1. This shaft was threaded with a 1/4"-20 thread at one end, and a dial was fixed at the other end.

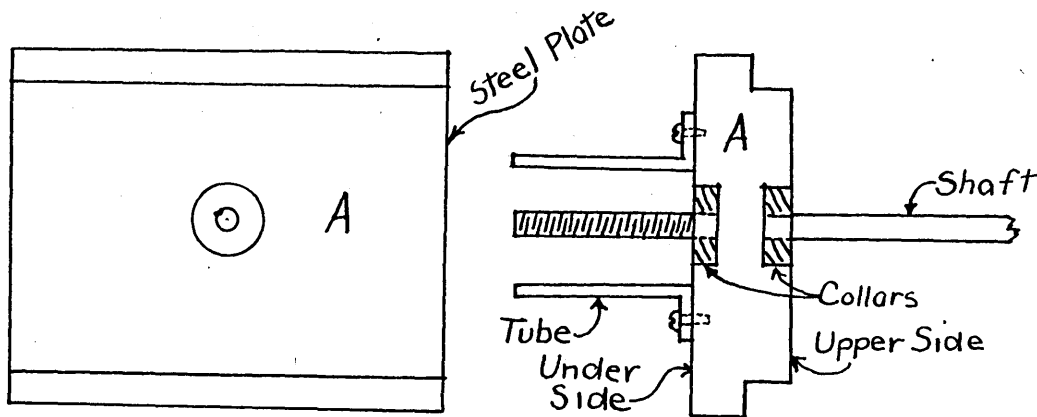

Figs 1 and 2

To the under side of the plate was fixed a tube 5/8 inches inside diameter, concentric with the shaft, which Fig. 2 shows.

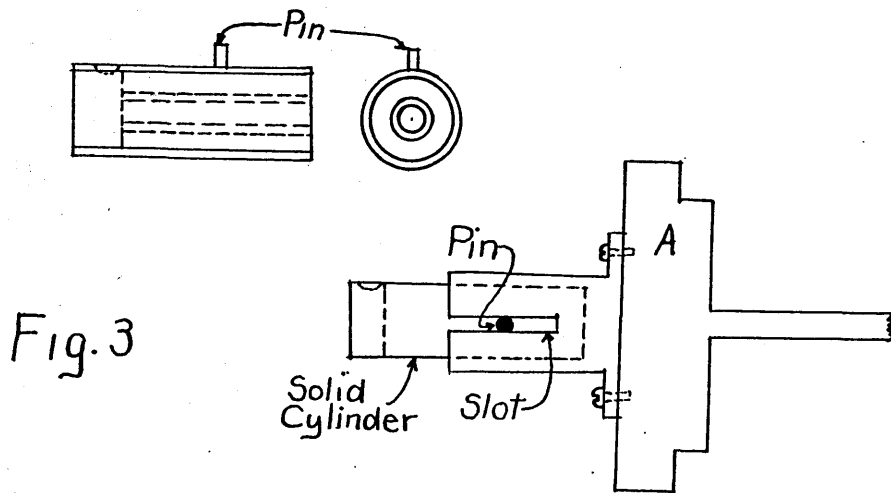

Fig. 3

A solid cylinder,  $\frac{1}{2}$ " in diameter and  $1\frac{1}{4}$ " long was drilled and tapped to fit the threaded end of the shaft. Over this cylinder was fitted and soldered a tube  $\frac{1}{2}$ " in inside diameter,  $\frac{5}{8}$ " outside diameter and  $1\frac{5}{8}$ " long, so that it just slid snugly inside of the tube which was fixed to the plate. A slot was now cut in the last mentioned tube and a pin slightly smaller in diameter than the width of the slot was fixed in the solid cylinder, projecting a short distance so that it could slide in the slot. When mounted on the shaft, the solid cylinder could be given motion along the axis of the shaft by turning the shaft. Its rotation in the direction in which the shaft was being turned was prevented by the pin in the slot, which is shown by figure 3.

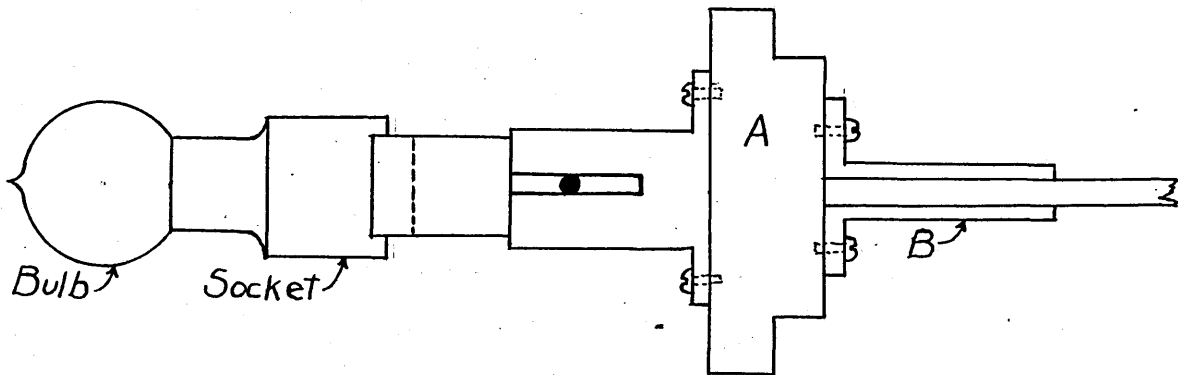

Fig. 4

To the outer end of the tube on the solid cylinder is fixed the socket for holding the bulb. An additional bearing in the form of a tube fastened to plate A is made use of to hold the shaft more rigidly, as indicated by B. This, then, is the complete apparatus for giving the bulb a motion along its horizontal axis.

In order to give the bulb motion in a plane at right angles to the horizontal axis, the plate A is mounted by means of guides upon another plate, C. Plate C has a rectangular hole cut in the center so that the bulb and tube may pass thru it and can move along the length of the plate. Plate C and the apparatus mounted on it are shown by Fig. 5, a and b.

In one end of plate A, a  $\frac{1}{4}$ "-20 hole is drilled and tapped. A shaft and dial similar to the

other shaft used is fitted into this hole. The shaft passes thru a small block of steel which is held by two screws to the top of plate C. A collar soldered to the shaft on each side of the block prevents the shaft from sliding thru the hole in the block when it is turned. Thus the shaft can have only rotational motion and not axial. Hence when the shaft is turned, it pulls or pushes plate A in its guides along the top of plate C.

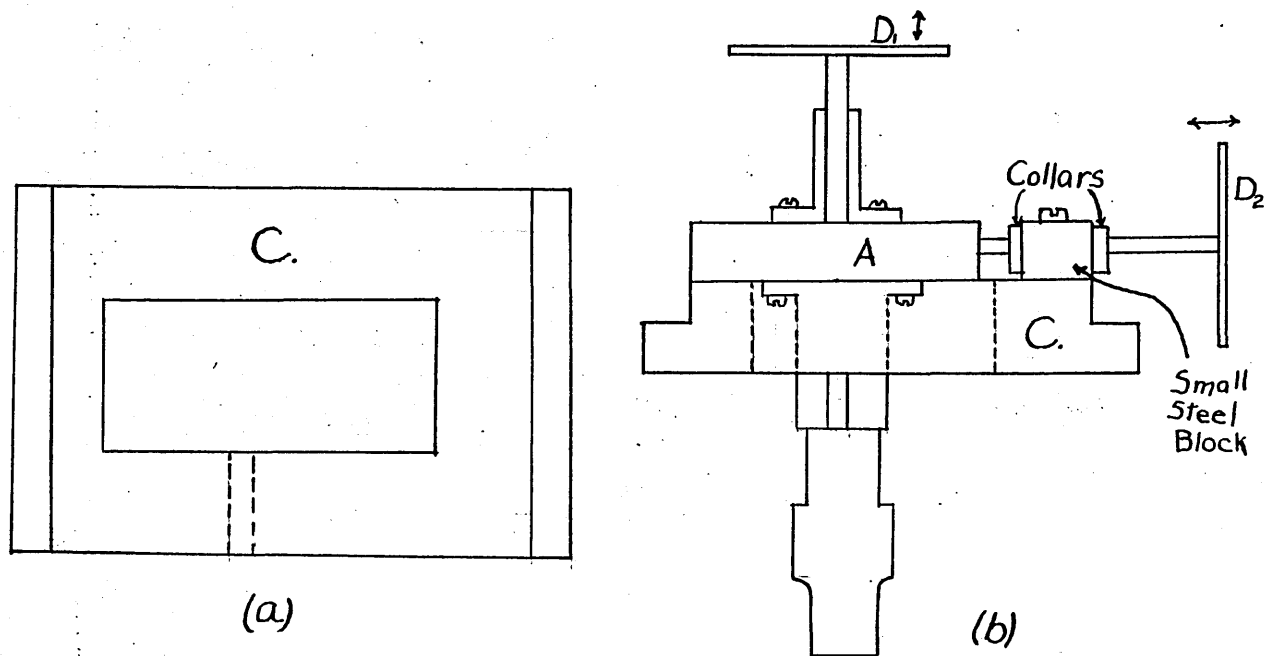

Fig. 5

Finally to obtain motion in the third plane at right angles to the other two, the same procedure is carried out as has just been described for plate A.

Plate C is now mounted on the base plate E in such a manner that both the rectangular hole in E and the guides for C mounted on E are at right angles to the hole in C and the guides for A mounted on C. (See sectional view of assembly drawing) Plate C is moved in its guides by a shaft mounted on the base plate in the same manner that plate A was moved.

Base plate E is fastened to the lamp by four bolts and a circular plate, the center of which has been cut out.

#### The Illuminometer

In measuring the intensity of the light from the headlights, a Macbeth Illuminometer was made use of. The description, principle, mechanical construction and operation of the illuminometer will not be given here since a booklet accompanies each instrument put out by the manufacturer which gives all the information necessary.

#### The Room

The room in which the thesis was carried out was about 75 feet long, 10 feet wide and 15 feet high. All windows were covered and the room was made as light-tight as possible.

The headlights were placed at one end and the illuminometer and test plate were placed exactly

60 feet away from them at the other end. The walls in that half of the room in which the illuminometer was placed were painted black to reduce reflection to a minimum. Reflection from the floor was prevented by placing a low, black, solid, fence-like structure on the floor in the path of the light, about half way between the test plate and the headlights. In this way the true value of the intensity of the beam was found without being affected by the surroundings.



Part List and Key to  
Drawing of Device for Moving Bulb.

Piece No.	No. Wanted	Name	Material
1	2	Base Plate	Steel
2	2	Middle Plate	Steel
3	2	Top Plate	Steel
4	4	Guides for (3)	Steel
5	6	Graduated Dial	Brass
6	4	Guides for (2)	Steel
7	6	Rods	Steel
8	24	Guides for (7)	Steel
Not Shown	28	Cap Screw (Dia. $\frac{7}{16}$ )	Steel

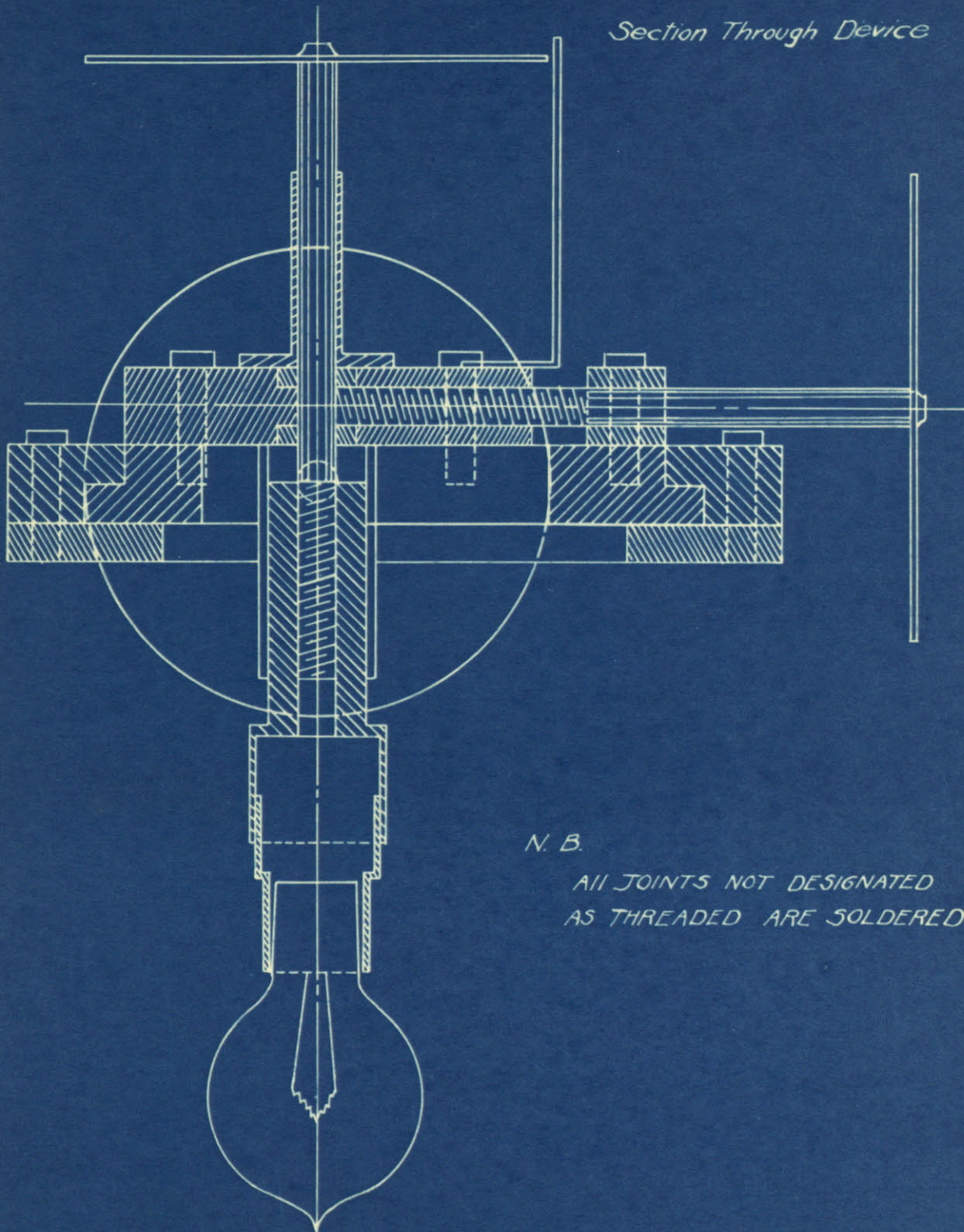
*DEVICE FOR MOVING BULB**Scale Full Size**Section Through Device**N. B.**ALL JOINTS NOT DESIGNATED  
AS THREADED ARE SOLDERED*

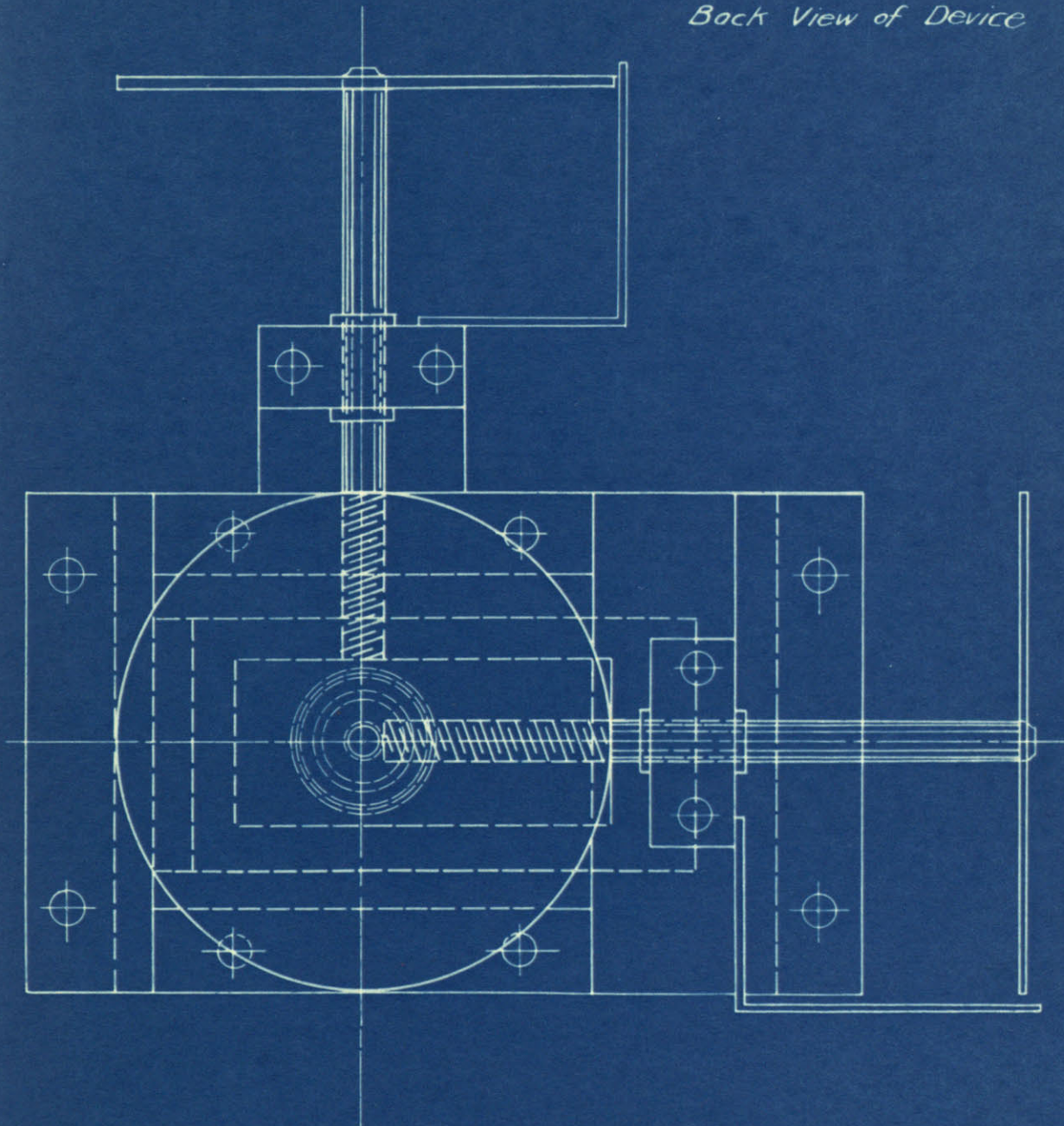
*DEVICE FOR MOVING BULB**Scale Full Size**Back View of Device*

# STEEL TOP PLATE AND GUIDE

Scale Full Size

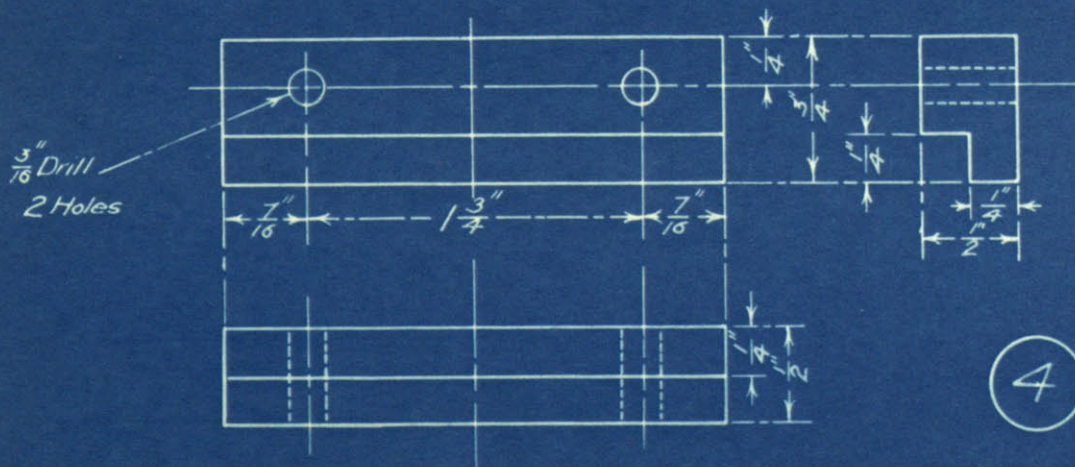
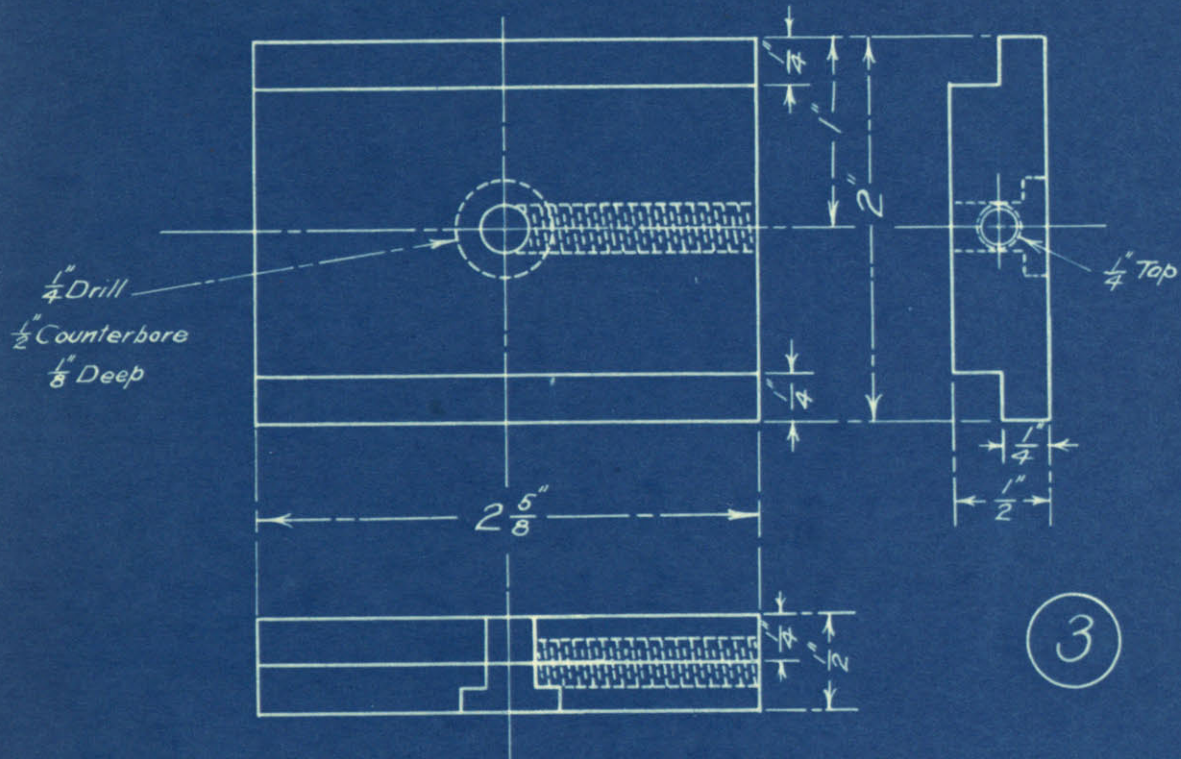

## STEEL MIDDLE PLATE

Scale Full Size

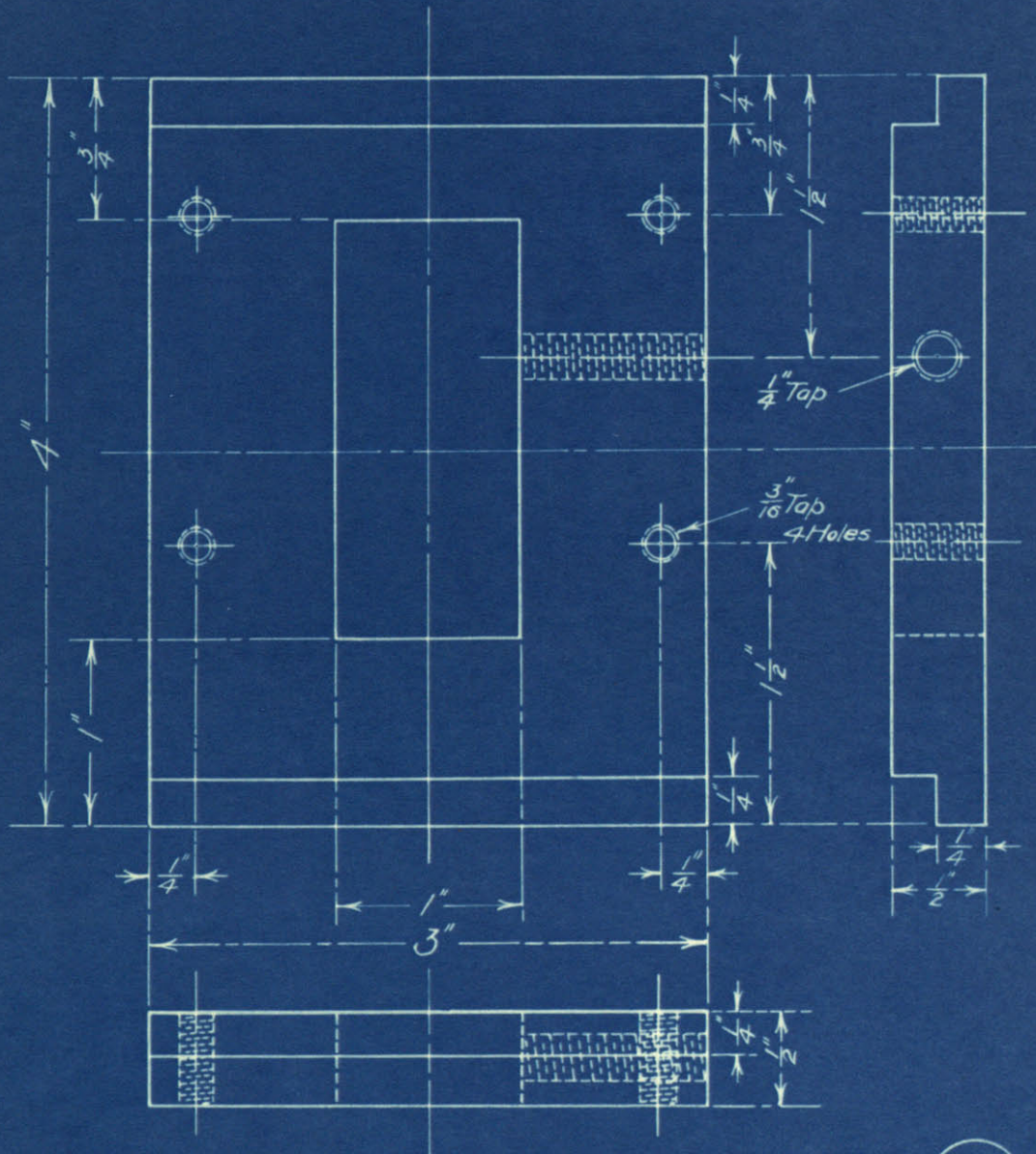

(2)

# STEEL BASE PLATE

Scale Full Size

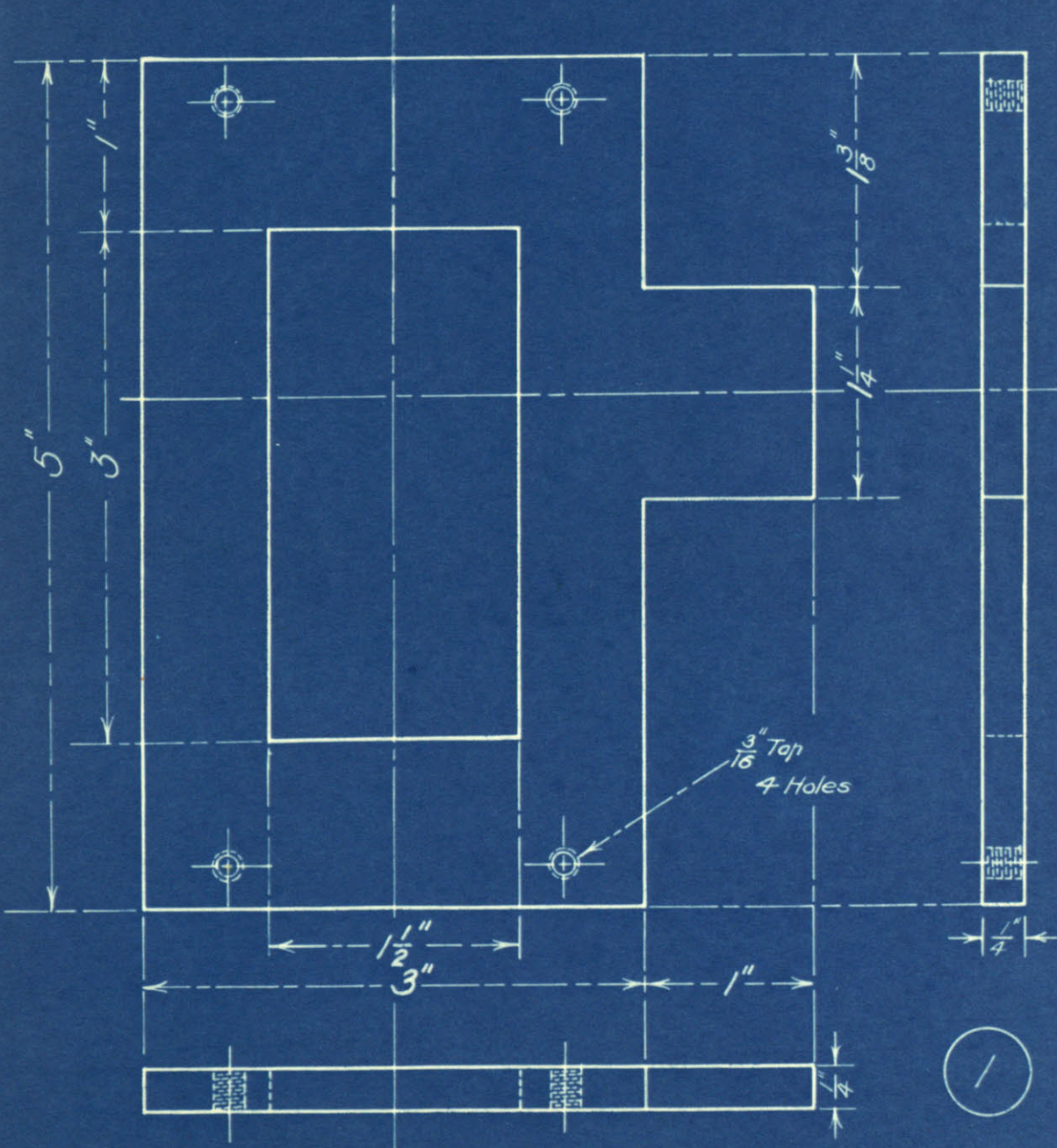

## BRASS DIAL

Scale Full Size

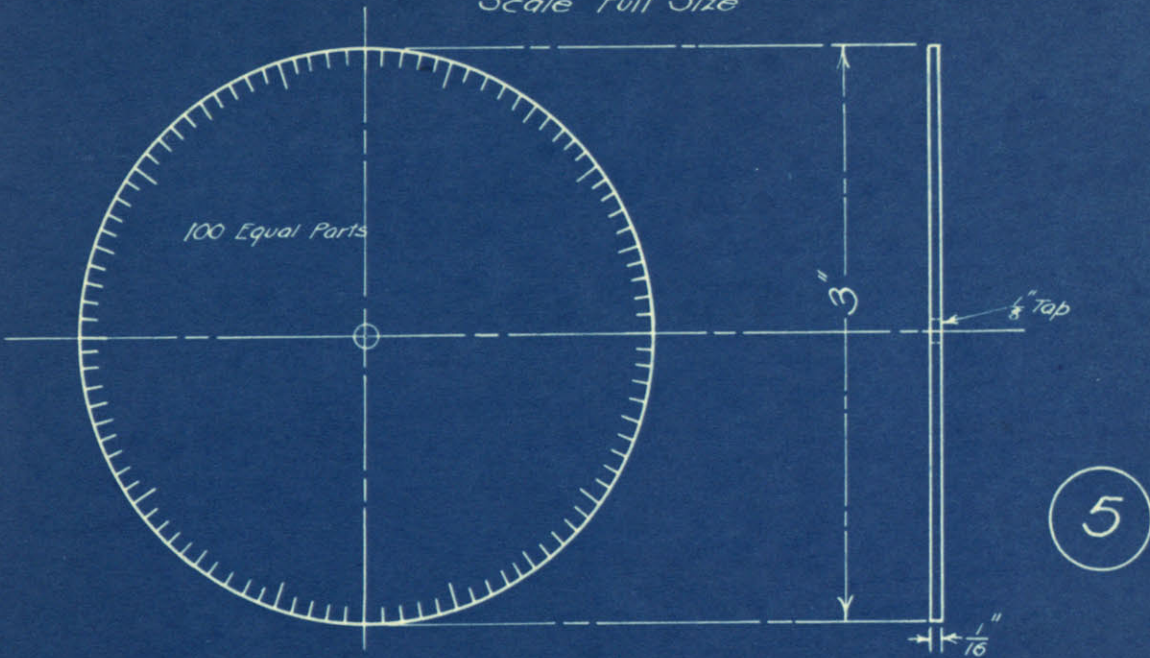

## STEEL GUIDE

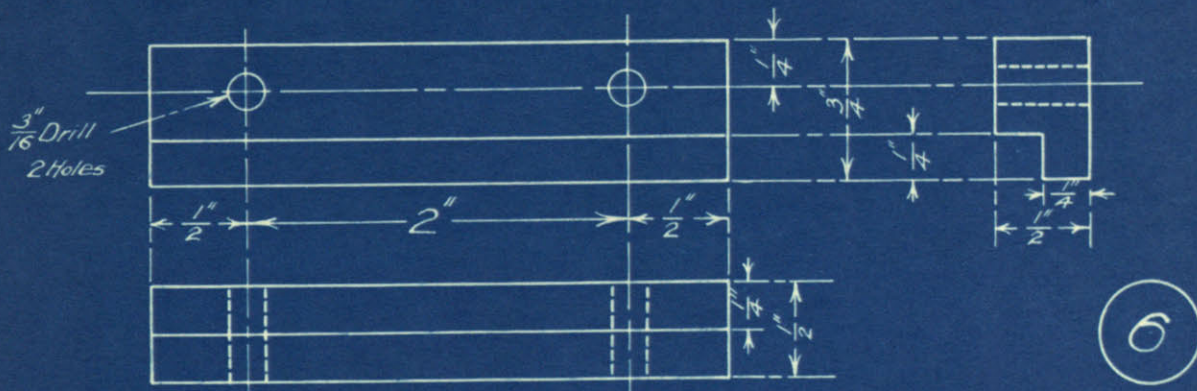

## STEEL ROD

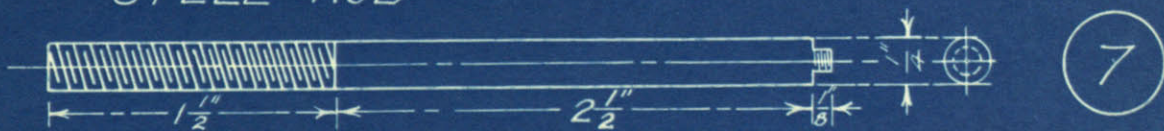

## STEEL GUIDE

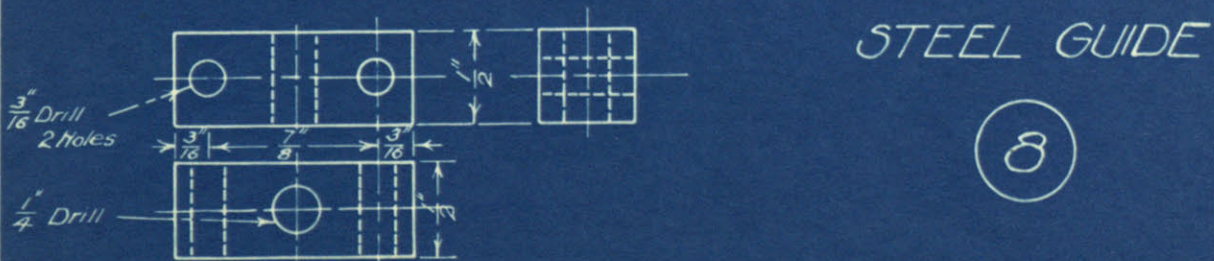

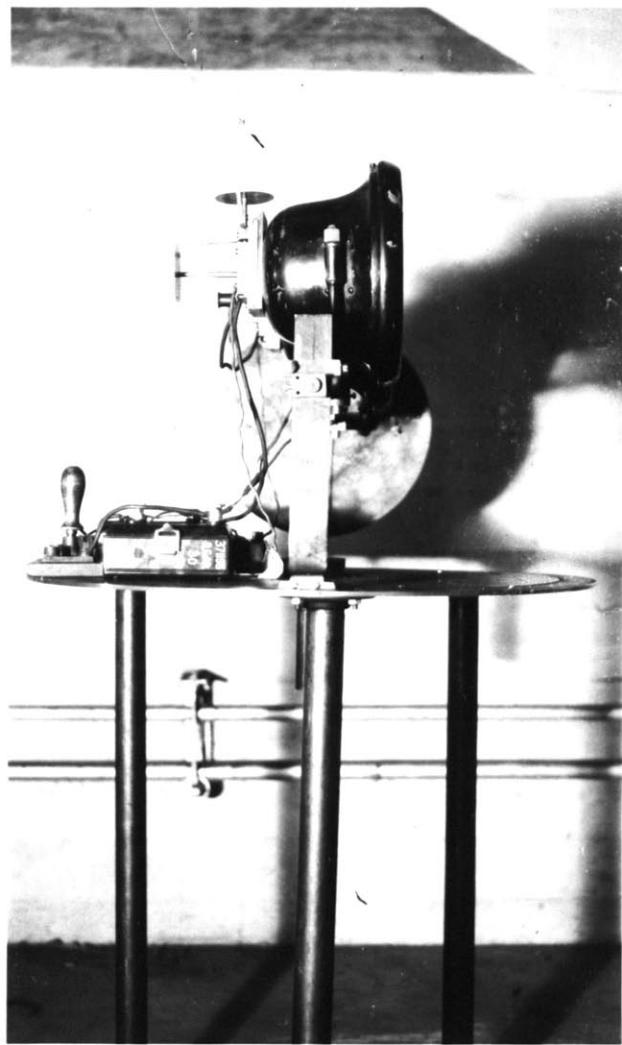

*End View*

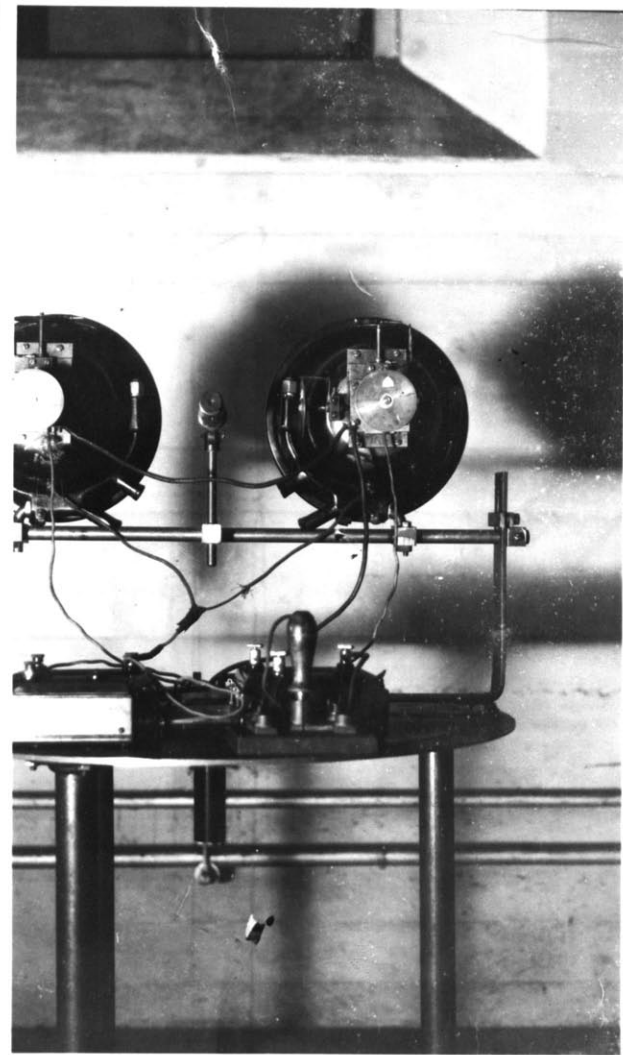

*Back View*



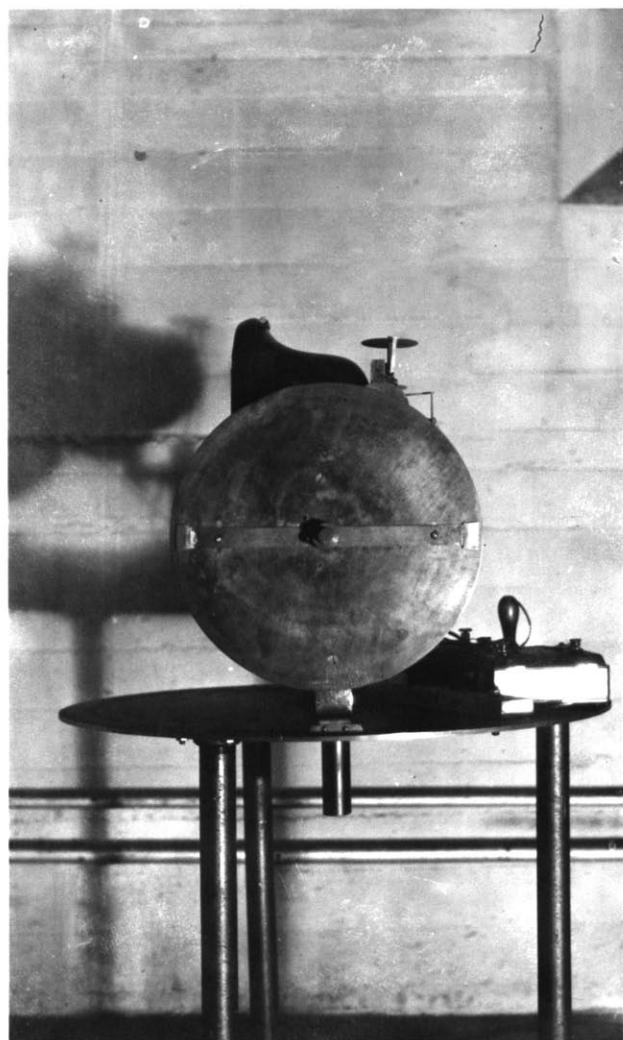

*END VIEW*

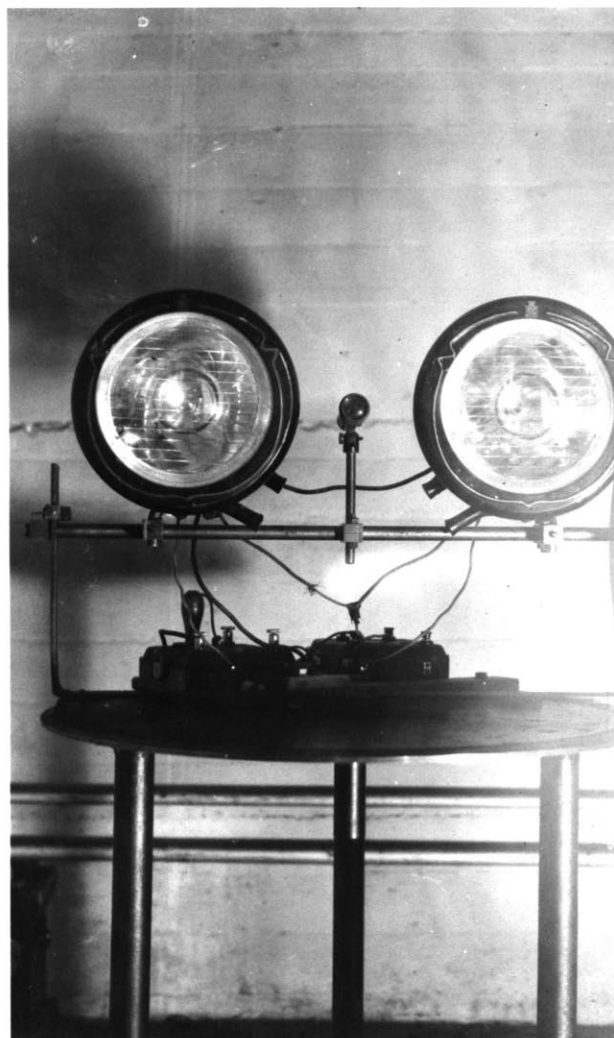

*Front View*

65a.

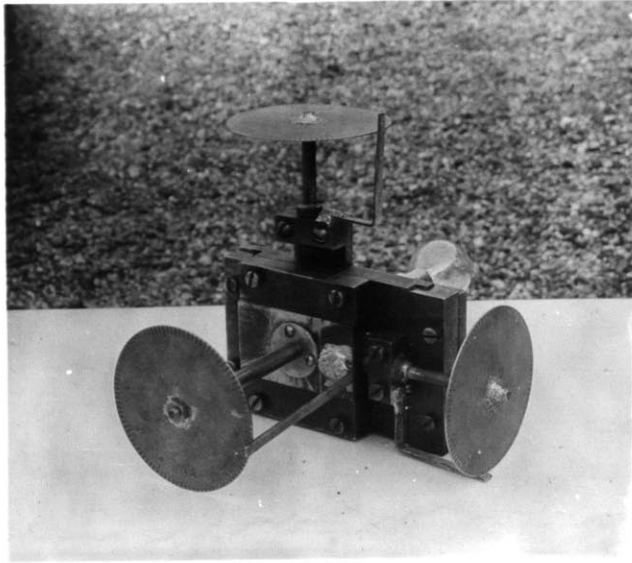

*Back View*

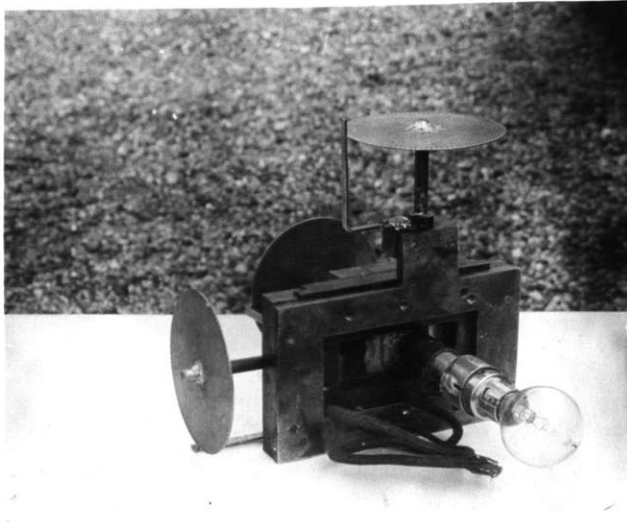

*Front View*

METHOD OF PROCEDURE

### Method of Procedure

1. Mounting of the apparatus(The description of the table and spacing of lamps and telescope is given by Mark and Flanders in their thesis-Automobile Headlights).

2. The beams from the headlights were made horizontal by placing a large white Beaver-board about five feet in front of the lamps, parallel to the face of the lamps and perpendicular to the floor. A point in the horizontal plane was sighted on the board thru the telescope. Thru the point parallel to the floor, a pencil line was drawn. Each lamp was then separately adjusted until its brightest spot fell upon this line. The board was then moved sixty feet away from the lamps and the pencil line made to coincide with the horizontal hair line of the telescope by tipping the entire mounting of the lamps.

3. Focusing of lamps by means of the focusing card.

The focusing card consists of a circular card the same size as a lens. About two inches on each side of the center in the same vertical line are two small holes about  $\frac{1}{4}$ " in diameter. The lamp is focused by replacing one lens with the card and covering the other lamp. The bulb is then moved along its axis until the V shaped images of the filament formed on a surface about 25' from the

lamp are on top of each other. At this point the lamp is in focus.

4. The center of the bright spot of each headlight was made to coincide with the original telescope point on the Beaver-board by turning each lamp about its vertical axis.

5. The Beaver-board was now removed and replaced by the white test plate which was mounted in a vertical plane upon a tripod. The center of the test plate was made to coincide with the center of the telescope.

6. Runs without lenses were now made according to the figure 1 given below:

7. The intensity on the test plate was measured for each setting of the bulbs by an illuminometer. Throughout the test the voltage across the bulbs was maintained constant at 6 volts.

8. With the lenses in place, the test plate was placed in each of the positions shown by Fig. 2. For each of these positions runs were made according to Fig. 1-(a)

View From the Back of the Lamp

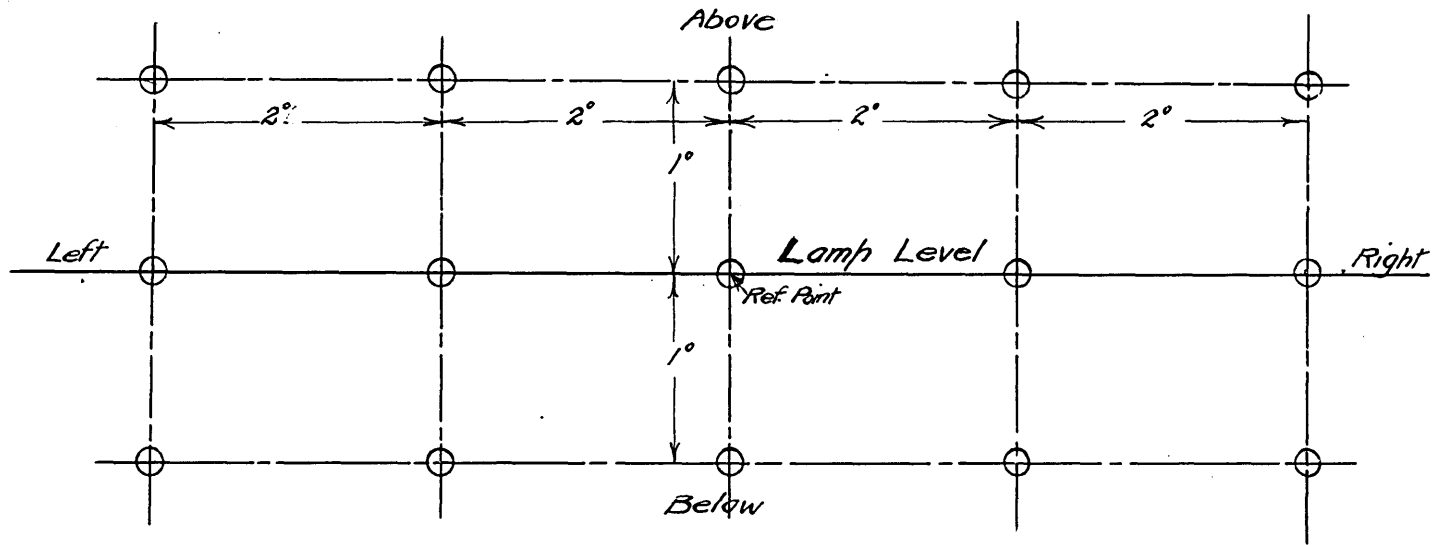

Figure I

View From the Back of the Lamp

Figure 1A.

Point 1.	X= 0	Y= 0	Z = 0
Point 2.	X= 0	Y = 0	Z =+70
Point 3.	X= 0	Y= 0	Z =+140
Point 4.	X= 0	Y = 0	Z=-70
Point 5.	X= 0	Y = 0	Z=-140
Point 6.	X= 0	Y=-70	Z = 0
Point 7.	X= 0	Y=-140	Z = 0
Point 8.	X= 0	Y=+70	Z = 0
Point 9.	X= 0	Y=+140	Z = 0
Point 10.	X= 0	Y=+70	Z =+70
Point 11.	X= 0	Y=+70	Z=-70
Point 12.	X= 0	Y=-70	Z=-70
Point 13.	X= 0	Y=-70	Z=+70

## View from the back of the lamp.

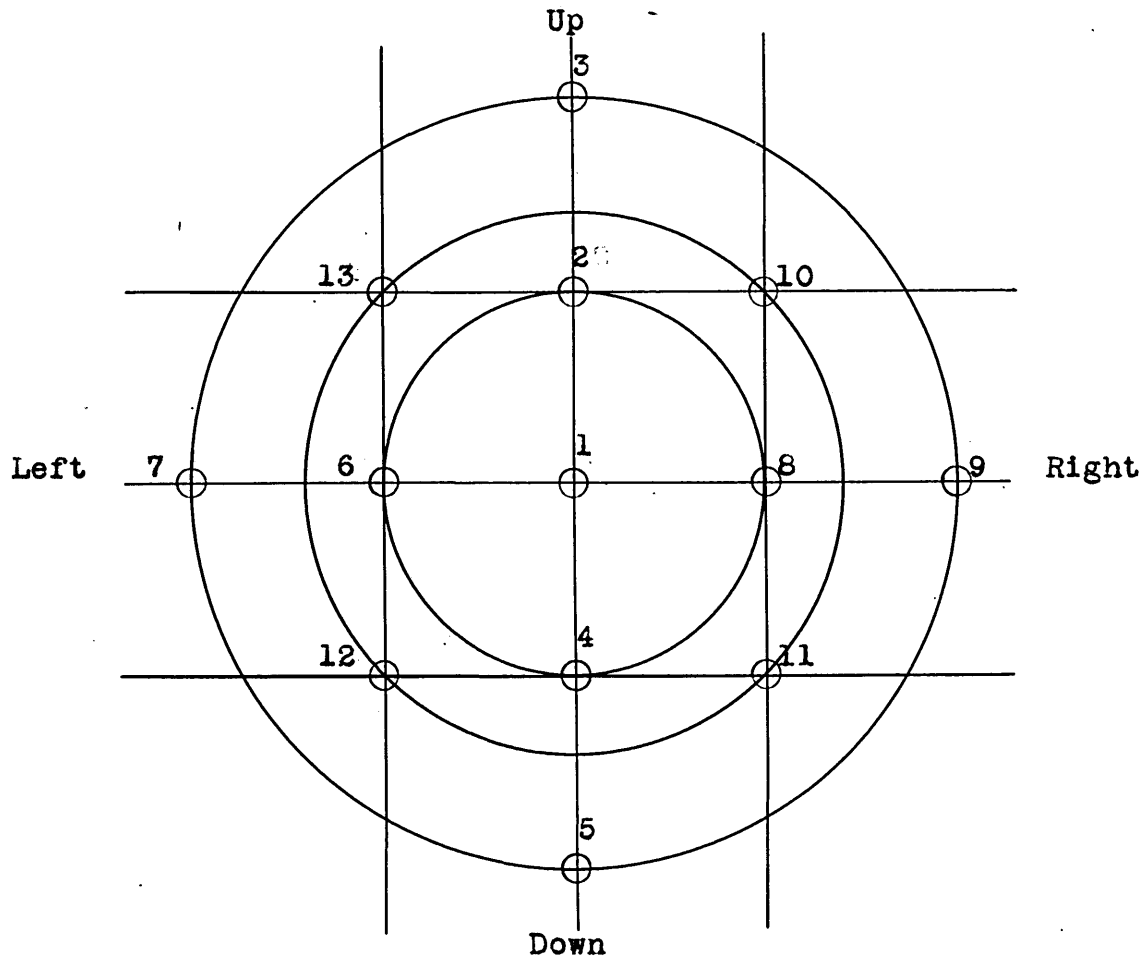
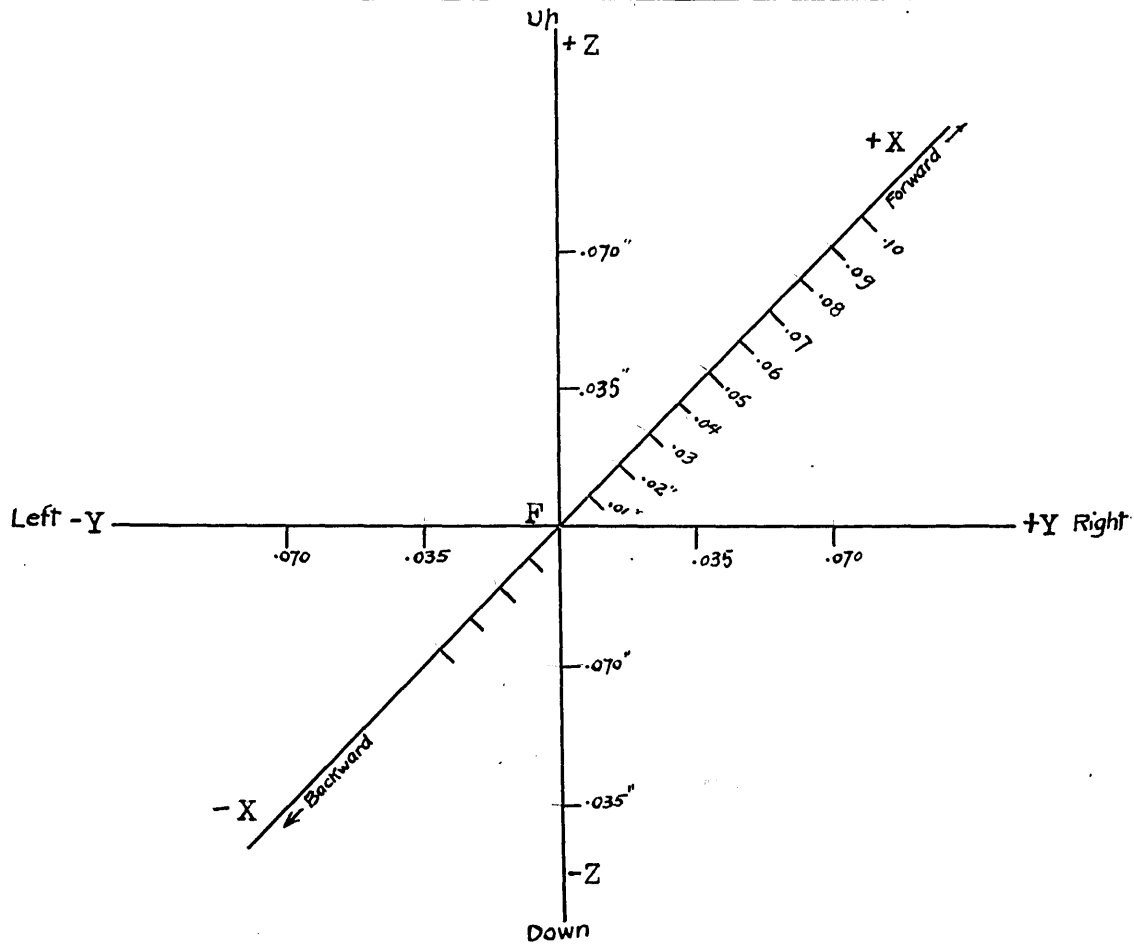

Figure 1B.

Position	Specifications
Z Axis +140	0.070 Inch above Point F.
Z Axis +70	0.035 Inch above Point F.
Z Axis -70	0.035 Inch below Point F.
Z Axis -140	0.070 Inch below Point F.
Y Axis +140	0.070 Inch Right of Pt. F.
Y Axis +70	0.035 Inch Right of Pt. F.
Y Axis -70	0.035 Inch Left of Pt. F.
Y Axis -140	0.070 Inch Left of Pt. F.



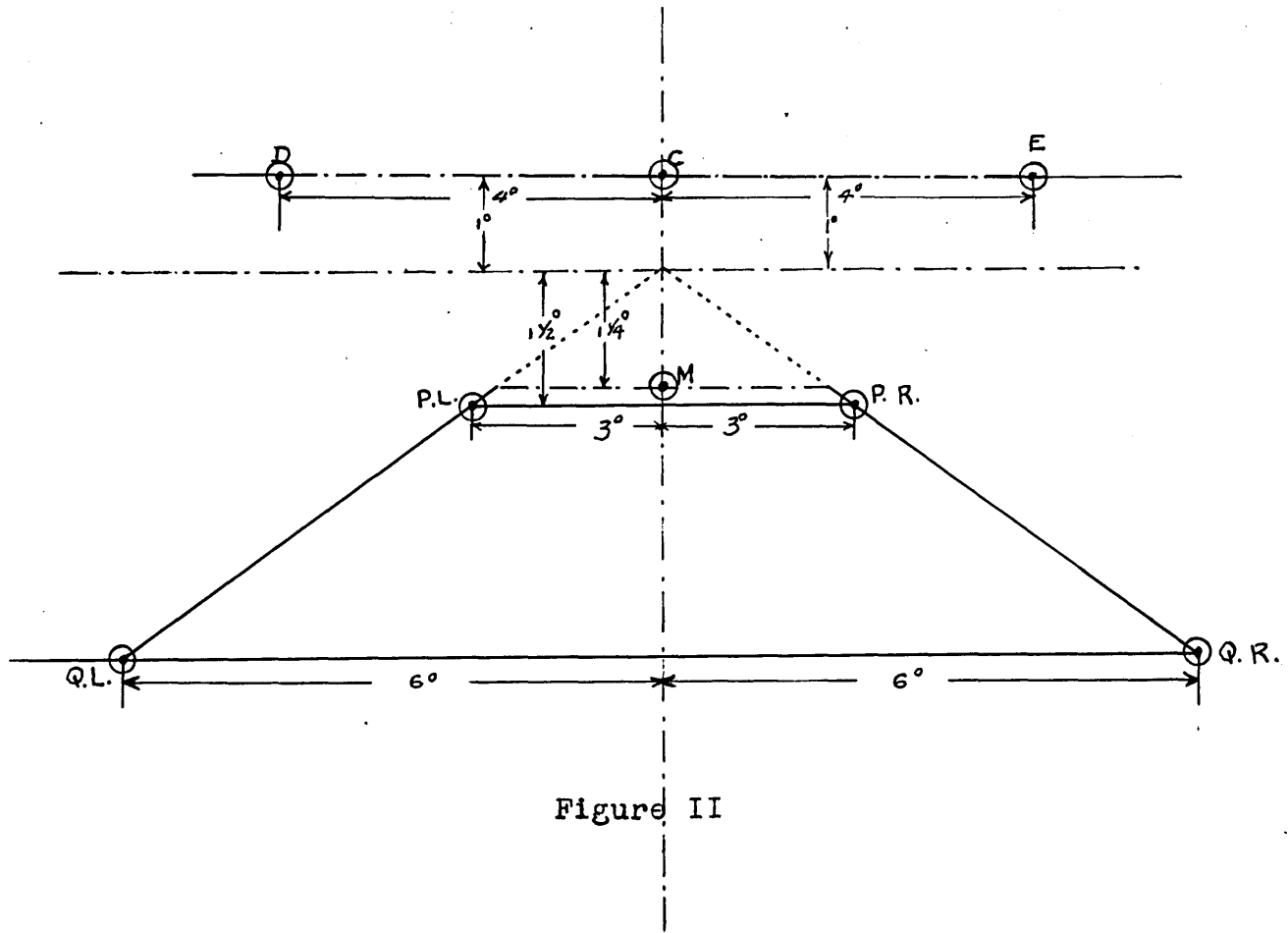

Figure II

72

SPECIFICATIONS OF POINTS TESTED.

- Point C. In the median vertical plane parallel to the lamp axes, one degree of arc above the level of the lamps.
- Point D. Four degrees of arc to the left of this plane and one degree of arc above the level of the lamps.
- Point E. Four degrees of arc to the right of this plane and one degree of arc above the level of the lamps
- Point M. In the median vertical plane parallel to the lamp axes, one and one-quarter degrees of arc below the level of the lamps.
- Point PL. Three degrees of arc to the left of this plane and one and one-half degrees of arc below the level of the lamps.
- Point.PR. Three degrees of arc to the right of this plane and one and one-half degrees of arc below the level of the lamps.
- Point QL. Six Degrees of arc to the left of this plane and three degrees of arc below the level of the lamps.
- Point QR. Six degrees of arc to the right of this plane and three degrees of arc below the level of the lamps.

KEY TO GRAPHS AND DATA.

F. = Principal focus

Reference Point. This point is located at 60 feet from the lamps, at lamp level, and mid-way between the two filaments.

2° Right of REF. P. Point two degrees right of reference point in plane through reference point perpendicular to axis of bulbs.

2° Left of Ref. P. Point two degrees left of reference point in plane through reference point perpendicular to axis of bulbs.

2° Left of Ref. P. & 1° Above Ref.P. Point two degrees left of reference point and one degree above lamp level.

2° Right of Ref. P. & 1° Below Point two degrees right of reference point and one degree below lamp level.

Ordinates. Intensity in foot-candle.

Ordinates x (60)<sup>2</sup> = beam candle power.

Abscissae - position of the two filament with respect to their foci.

In these runs the filaments were kept with "V" in the horizontal plane,

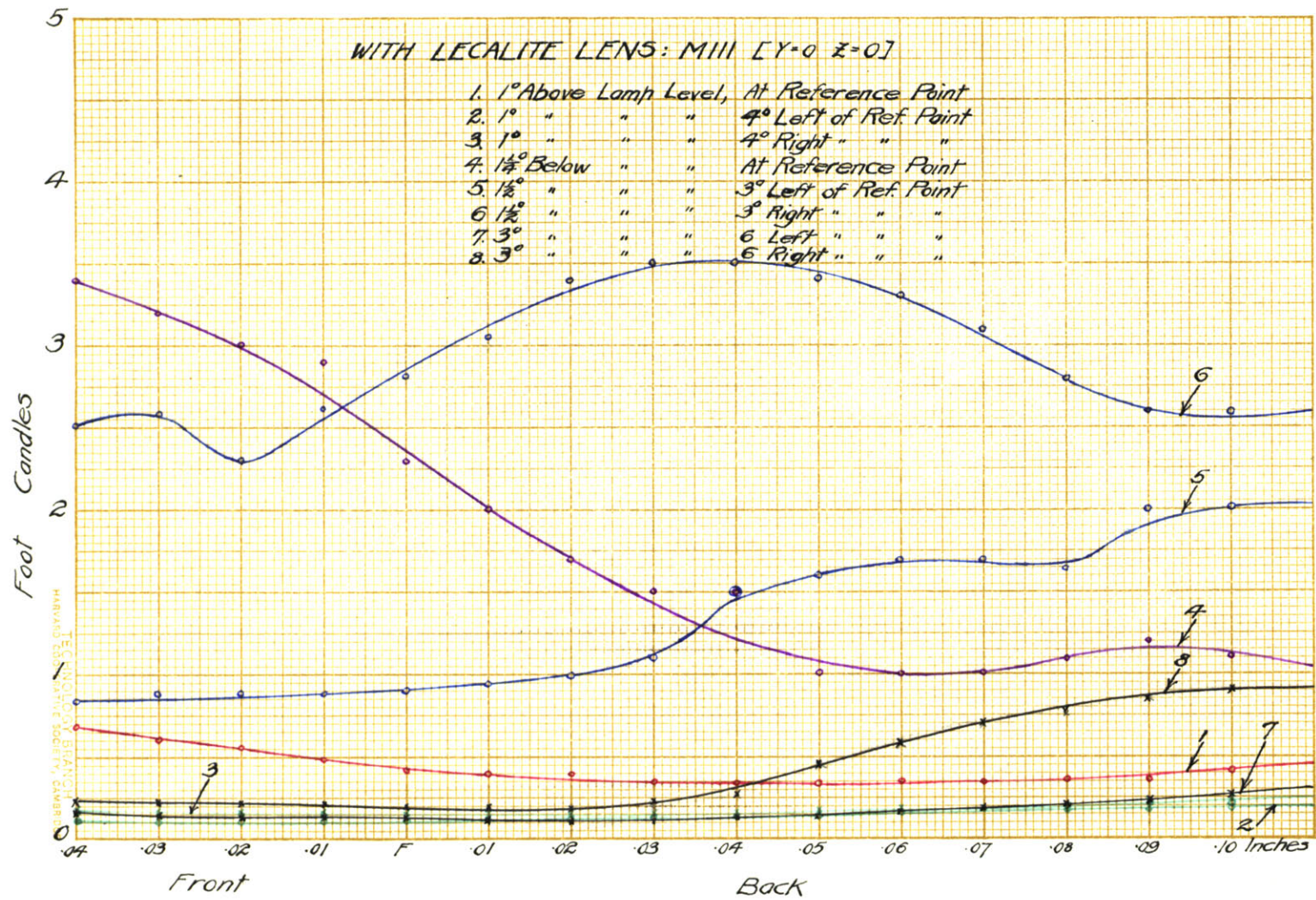

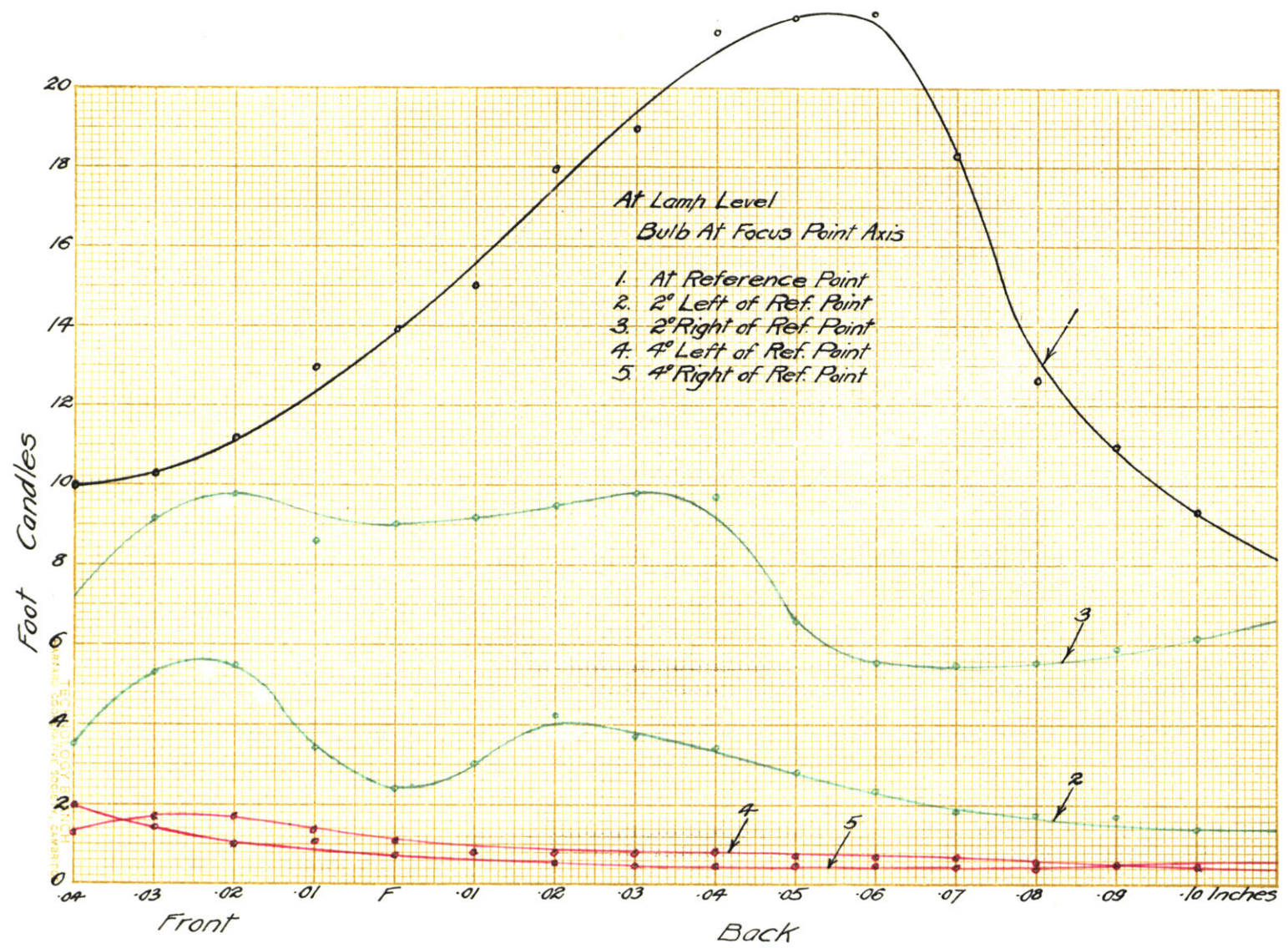

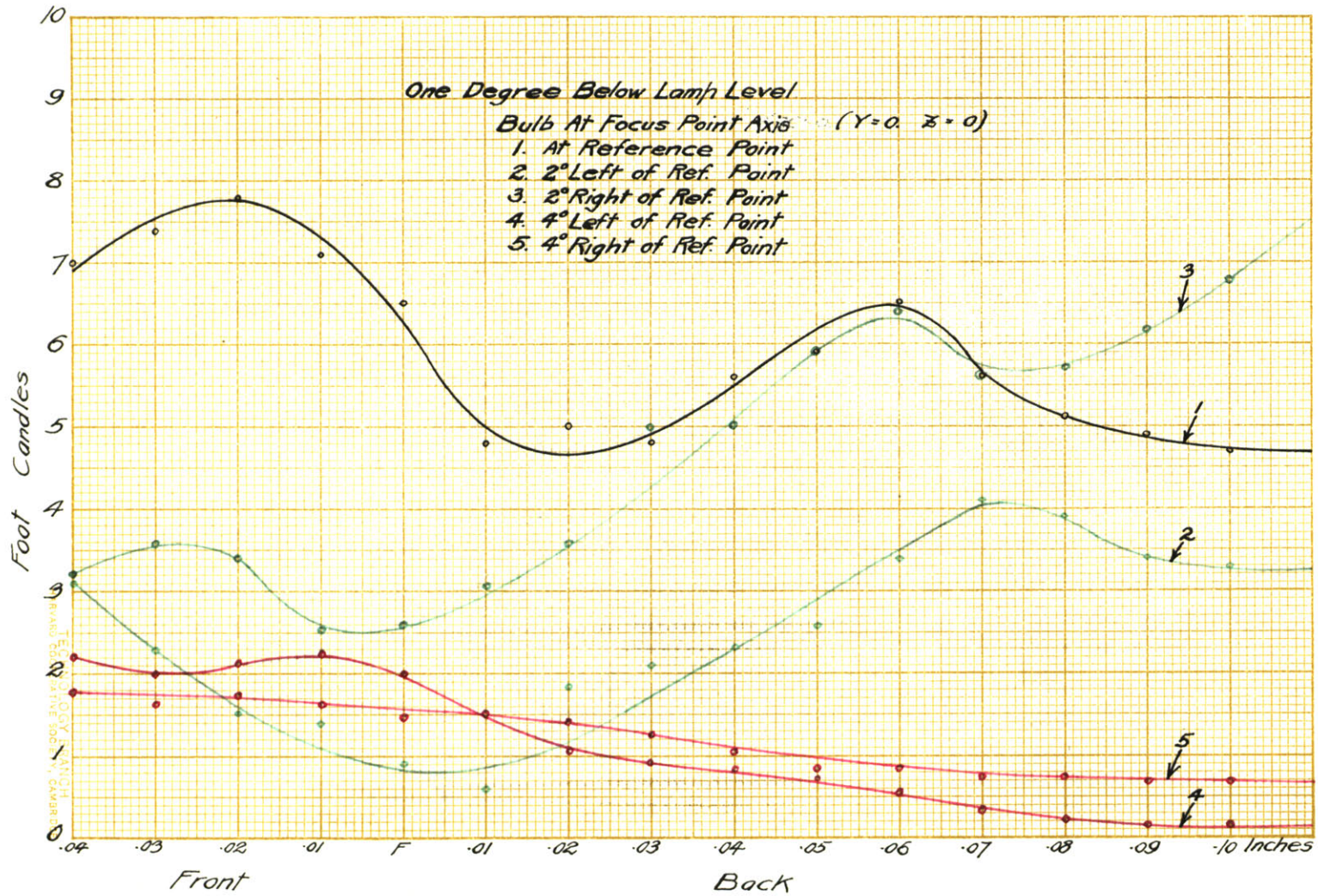

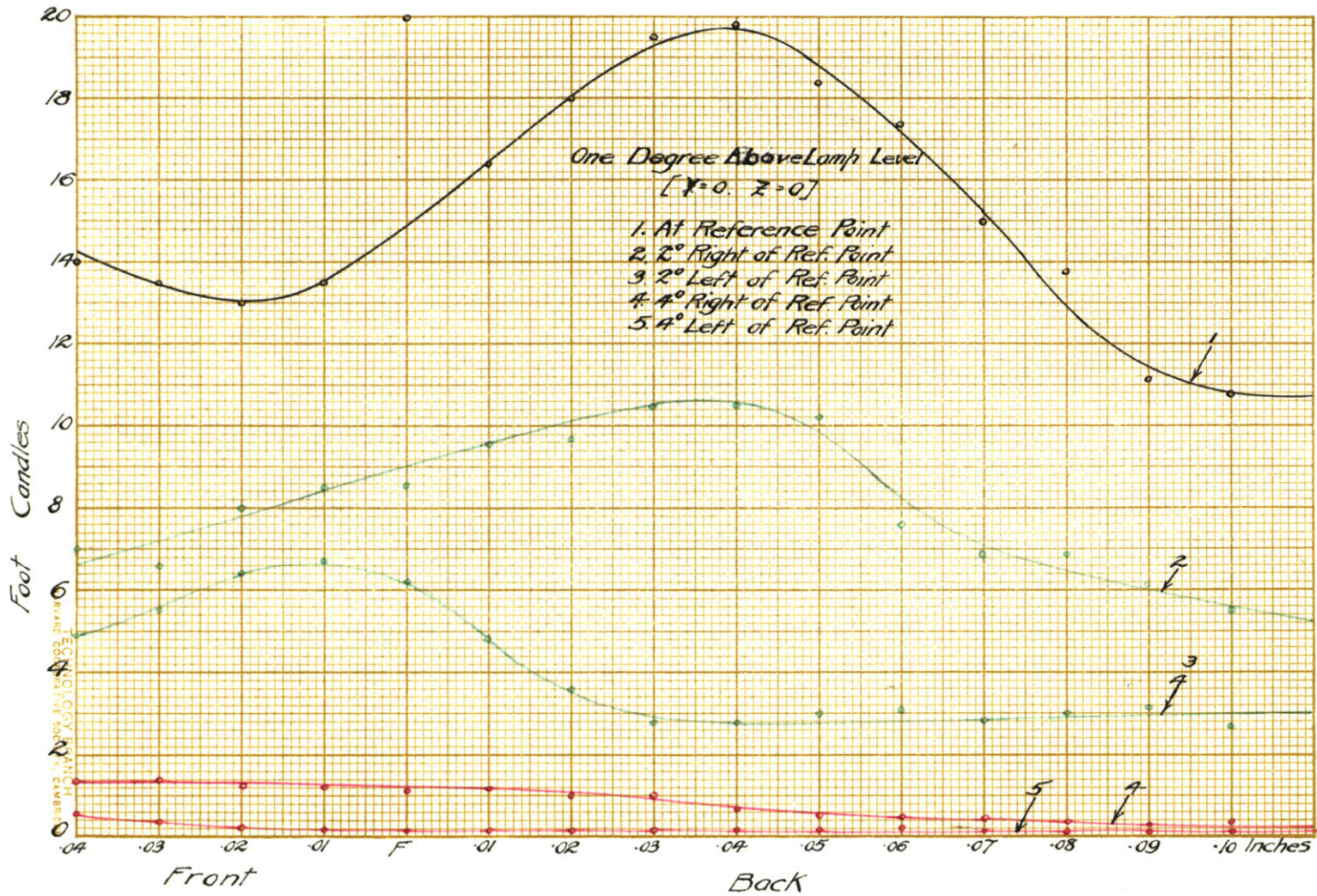

At Lamp Level & In Centre

X	Y = 0 Z = 0	Y = -70 Z = +70	Y = -70 Z = -70	Y = +70 Z = +70	Y = +70 Z = -70
80	10.0	8.6	15.2	6.0	14.1
60	10.3	8.8	15.6	6.6	12.0
40	11.2	9.6	15.8	9.2	13.8
20	13.0	9.0	15.8	11.5	17.5
F	14.0	10.5	17.5	12.2	22.5
20	15.0	16.0	18.9	13.4	18.4
40	18.0	11.4	20.7	11.3	24.8
60	18.9	11.6	26.1	10.8	30.5
80	21.8	12.8	26.2	11.0	28.5
100	22.0	14.0	27.1	14.0	33.5
120	22.2	12.4	27.0	14.2	23.4
140	18.3	10.0	20.5	11.9	20.3
160	12.6	9.2	16.2	11.2	16.2
180	11.0	7.0	11.1	10.6	13.0
200	9.4	6.0	10.0	7.2	9.6

Front

Back



At Lamp Level & In Centre

X	Z = 0				Y = 0			
	Y = +140	Y = +70	Y = -70	Y = -140	Z = +140	Z = +70	Z = -70	Z = -140
80	12.0	10.4	11.0	9.4	9.2	8.0	15.7	12.4
60	10.2	10.7	9.4	9.2	9.3	8.5	15.8	11.2
40	12.1	12.0	9.1	10.0	7.6	10.0	16.1	11.6
20	13.4	15.2	12.0	10.6	8.6	11.4	17.6	13.2
F	17.3	20.0	13.6	10.0	9.4	13.0	19.0	16.2
20	17.4	21.2	17.4	14.1	12.0	15.0	21.8	14.7
40	17.6	26.0-	17.6	15.0	10.0	16.4	27.0	19.0
60	17.7	28.1	19.8	17.2	8.0	17.0	30.0	20.0
80	19.5	32.0	25.5	17.3	10.0	18.2	29.8	21.3
100	20.3	34.5	27.5	15.9	9.8	18.6	29.4	19.3
120	20.2	25.2	23.0	14.4	10.3	15.0	27.4	15.8
140	17.0	20.0	16.7	12.0	8.5	11.6	24.8	11.8
160	12.4	19.8	12.8	10.0	7.2	8.8	19.0	10.6
180	11.4	17.3	10.8	8.0	5.5	8.5	15.2	9.8
200	10.0	12.2	10.0	6.0	4.7	6.6	10.3	7.0

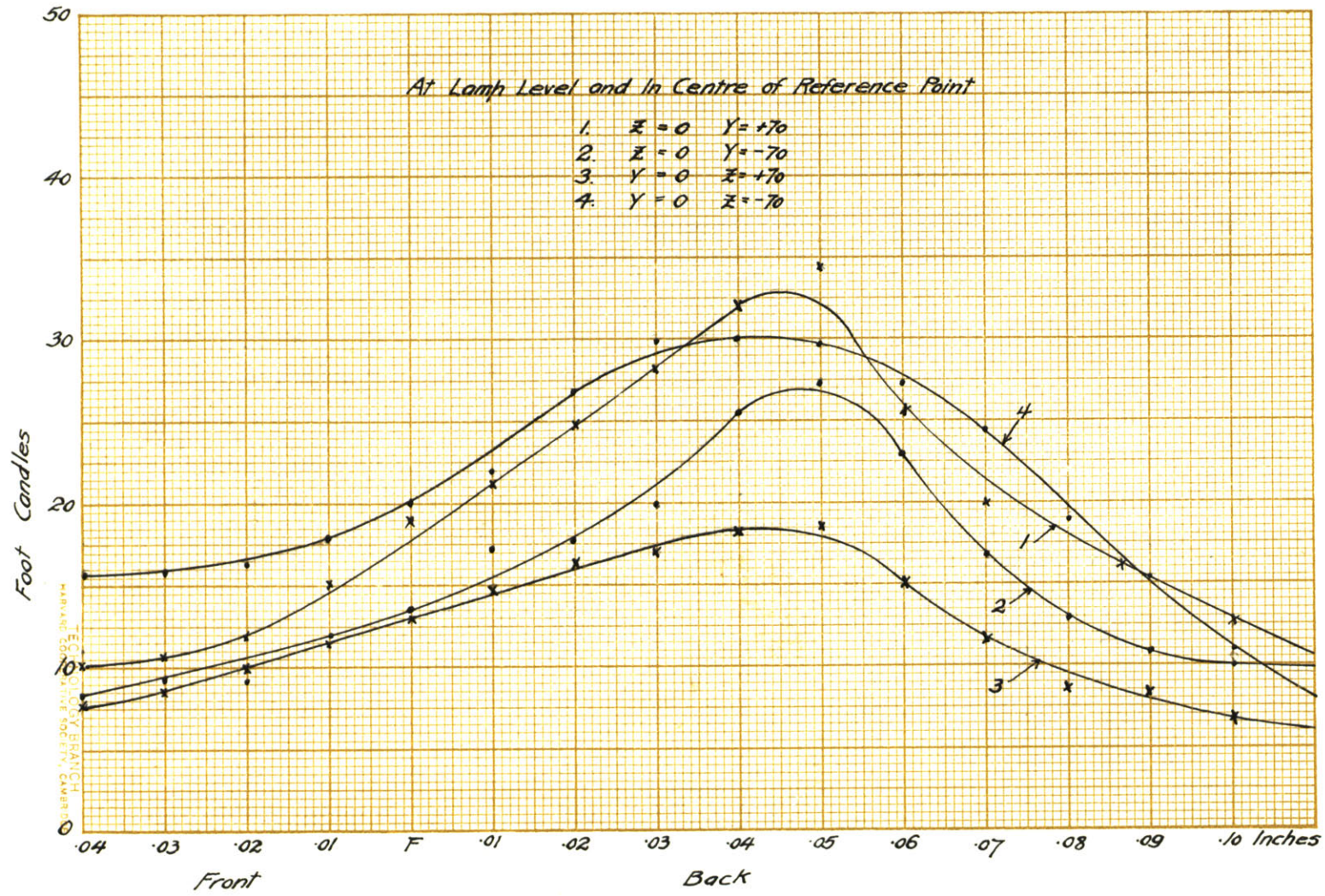

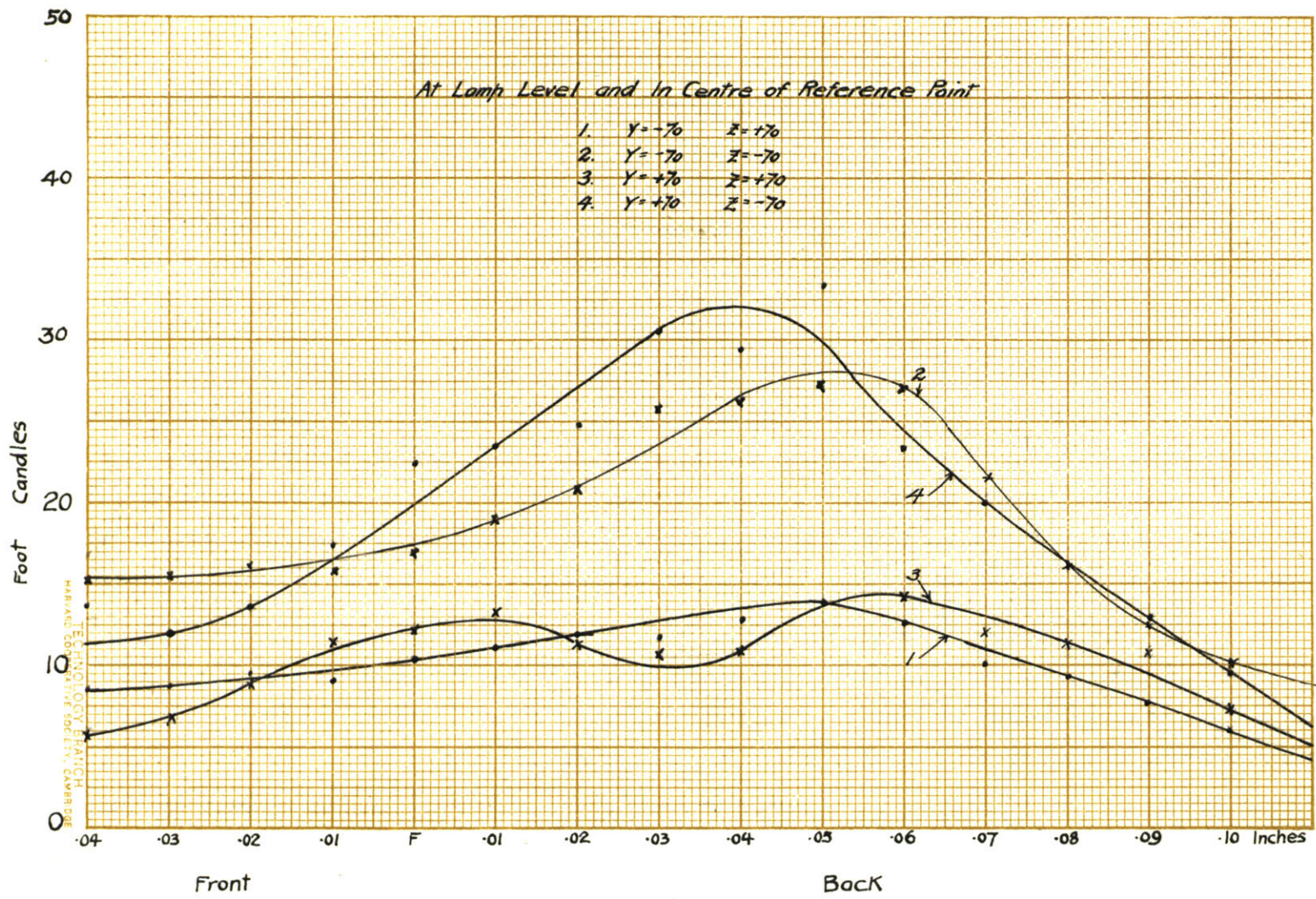

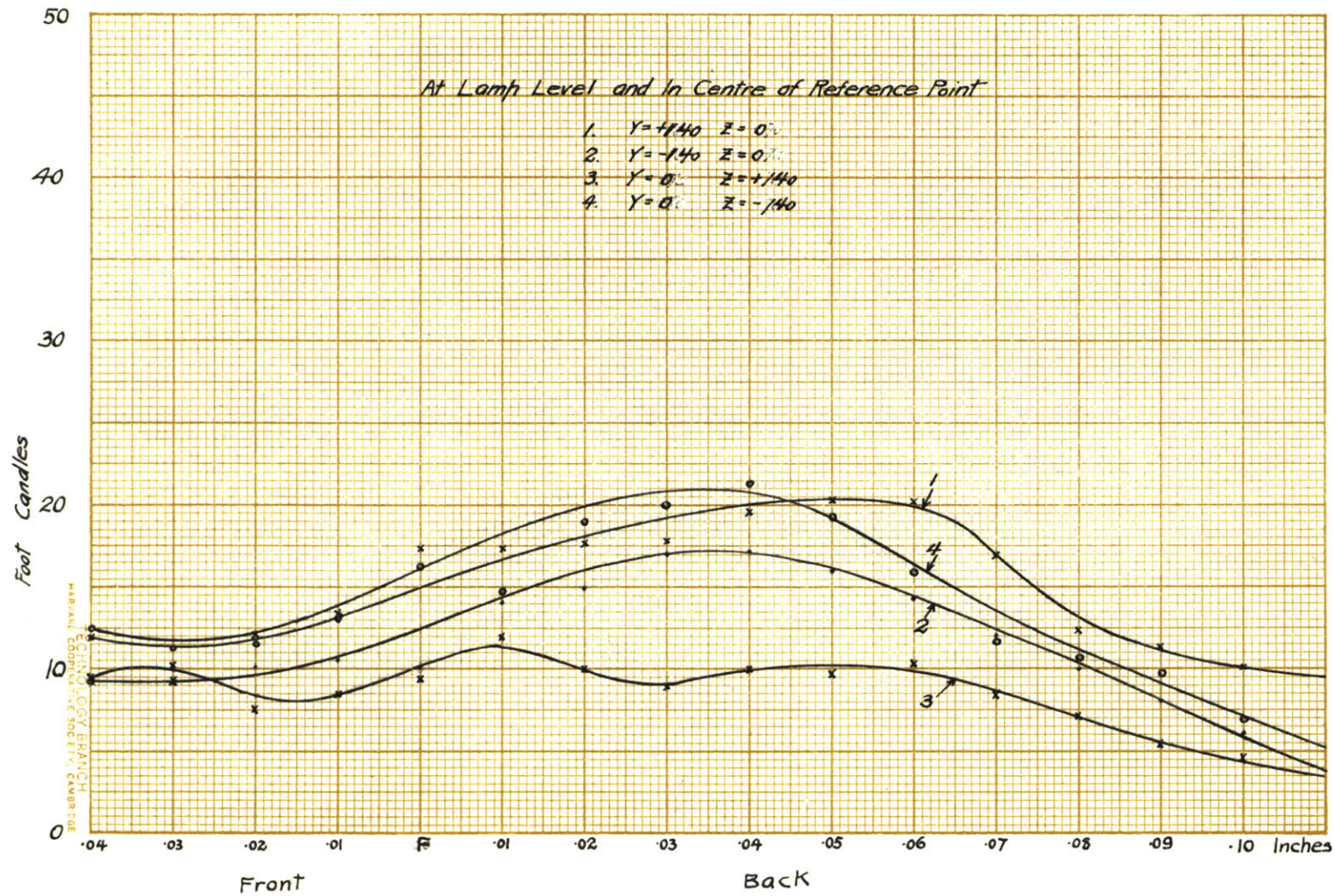

At Lamp Level & Two Degrees Left of Reference Point

X	Y= 0 Z= 0	Y=-70 Z=+70	Y=-70 Z=-70	Y=+70 Z=+70	Y=+70 Z=-70
80	3.6	4.5	3.9	3.0	4.6
60	5.3	4.9	4.2	3.9	5.3
40	5.5	5.3	4.8	3.5	5.6
20	3.4	5.35	5.6	4.15	6.1
F	2.4	7.0	7.3	4.6	7.0
20	3.0	7.4	9.1	4.9	7.6
40	4.25	7.0	9.6	5.2	8.0
60	3.7	6.0	10.5	4.1	9.5
80	3.4	6.2	12.2	3.5	10.3
100	2.7	5.5	13.0	3.7	8.3
120	2.3	7.5	11.4	4.2	7.0
140	1.86	6.4	10.5	4.8	6.4
160	1.76	7.0	11.0	3.75	4.7
180	1.70	6.6	12.0	2.55	4.3
200	1.40	5.0	10.0	2.13	3.2

Front

Back

At Lamp Level & Two Degrees Left of Reference Point

X	Z = 0				Y = 0				
	Y = +140	Y = +70	Y = -70	Y = -140	Z = +140	Z = +70	Z = -70	Z = -140	
Front	80	3.00	2.75	3.9	5.3	1.90	1.97	3.65	4.8
	60	3.50	3.20	4.3	6.7	2.10	2.10	4.70	5.6
	40	3.80	3.75	4.6	7.7	2.25	2.30	5.2	5.7
	20	4.90	4.60	4.7	8.2	2.50	2.80	6.0	5.8
	F	4.10	5.10	5.1	7.4	3.50	3.10	7.4	6.9
Back	20	4.90	6.00	6.4	7.2	4.00	4.22	9.2	7.2
	40	4.20	6.40	9.0	8.0	4.30	5.60	10.1	9.2
	60	3.35	6.80	8.5	8.4	4.15	5.80	13.6	10.0
	80	3.01	7.20	9.0	11.6	3.50	5.40	12.6	12.2
	100	2.95	5.70	11.6	12.9	2.90	5.35	11.6	11.2
	120	2.70	4.00	12.4	13.6	2.60	4.40	10.0	8.6
	140	2.50	3.80	11.7	14.2	2.50	3.40	9.0	7.4
	160	1.60	3.00	11.0	12.7	2.20	2.55	8.0	6.4
	180	1.40	2.65	10.0	11.4	1.99	2.20	7.0	5.3
	200	1.36	2.45	9.7	10.0	1.95	1.94	5.9	4.5

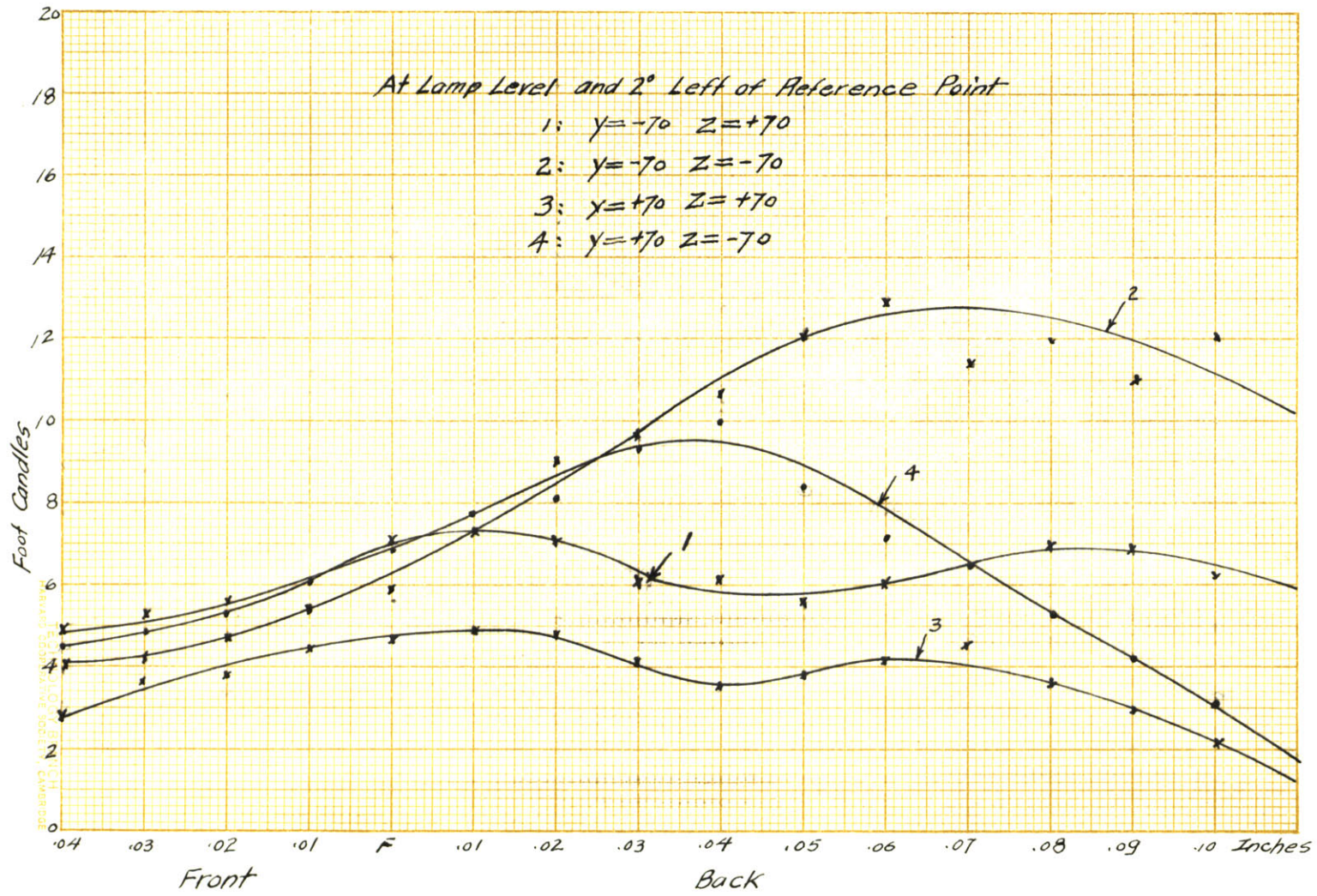

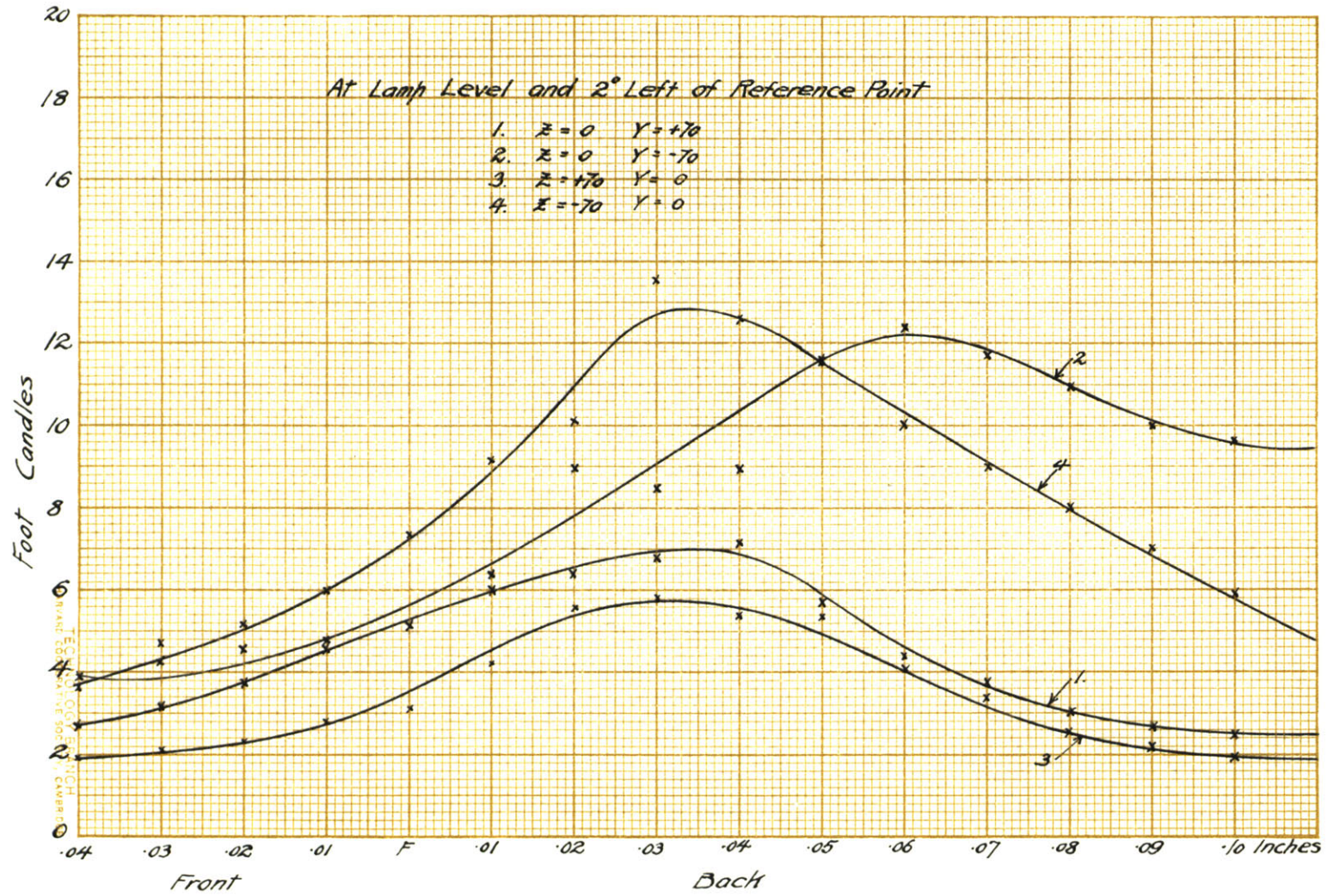



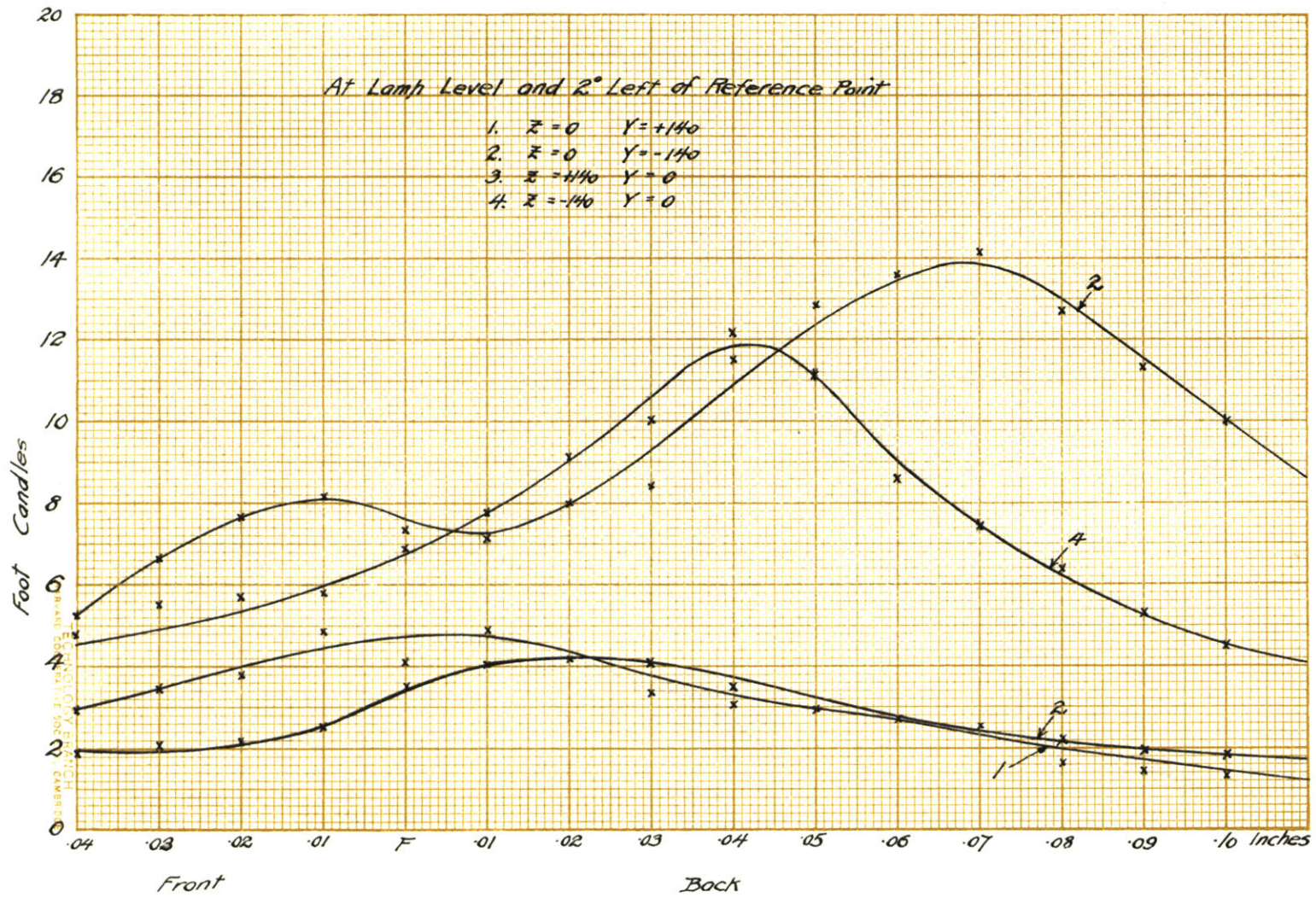

At Lamp Level & Two Degrees Right of reference Point

X	Y= 0 Z= 0	Y=-70 Z=+70	Y= -70 Z -70	Y=+70 Z=-70	Y=+70 Z=+70	
80	3.5	3.70	3.9	5.2	5.5	
Front	60	9.2	4.4	3.4	6.7	7.4
	40	19.8	4.4	3.1	9.1	7.6
	20	8.6	5.0	2.35	9.2	8.4
	F	19.0	6.0	1.72	11.3	10.0
Back	20	9.2	6.9	1.50	11.4	8.8
	40	9.5	7.6	1.00	13.4	8.4
	60	9.8	6.4	1.00	13.0	7.4
	80	9.7	5.3	1.05	9.6	6.6
	100	6.6	4.0	1.06	8.0	6.8
	120	5.8	2.35	1.48	8.4	6.4
	140	5.5	1.87	1.94	10.4	6.6
	160	5.6	2.1	2.1	10.5	6.0
	180	5.9	2.1	2.4	10.5	5.5
	200	6.2	2.2	2.4	11.8	6.3

At Lamp Level & Two Degrees Right of Reference Point

X	Z = 0				Y = 0				
	Y = +140	Y = +70	Y = -70	Y = -140	Z = +140	Z = +70	Z = -70	Z = -140	
Front	80	5.9	5.6	4.2	3.15	3.80	7.2	5.5	5.40
	60	7.0	6.70	5.0	3.00	4.40	7.0	6.8	5.75
	40	9.2	6.70	5.9	2.75	4.40	6.4	6.8	4.70
	20	12.0	9.10	5.0	2.55	4.40	6.6	6.8	4.20
	F	11.1	10.0	4.9	1.87	3.40	7.6	5.1	2.80
Back	20	11.0	11.1	4.3	1.30	3.10	7.0	5.0	2.10
	40	11.6	11.4	3.0	1.31	2.75	7.1	3.4	2.22
	60	12.4	12.0	3.1	1.36	2.15	6.4	3.6	2.35
	80	12.6	14.6	2.14	1.40	2.10	5.0	2.95	2.10
	100	14.5	10.0	2.10	1.60	2.30	5.6	2.42	2.20
	120	12.6	8.7	2.20	1.40	2.34	4.8	2.34	2.62
	140	10.5	9.2	2.20	1.55	2.63	4.6	2.85	3.50
	160	10.5	9.4	2.63	1.54	2.90	4.9	3.50	3.90
	180	13.0	9.2	2.80	1.65	2.95	4.5	4.75	3.70
	200	9.3	8.8	2.95	2.00	4.10	5.1	5.80	4.50

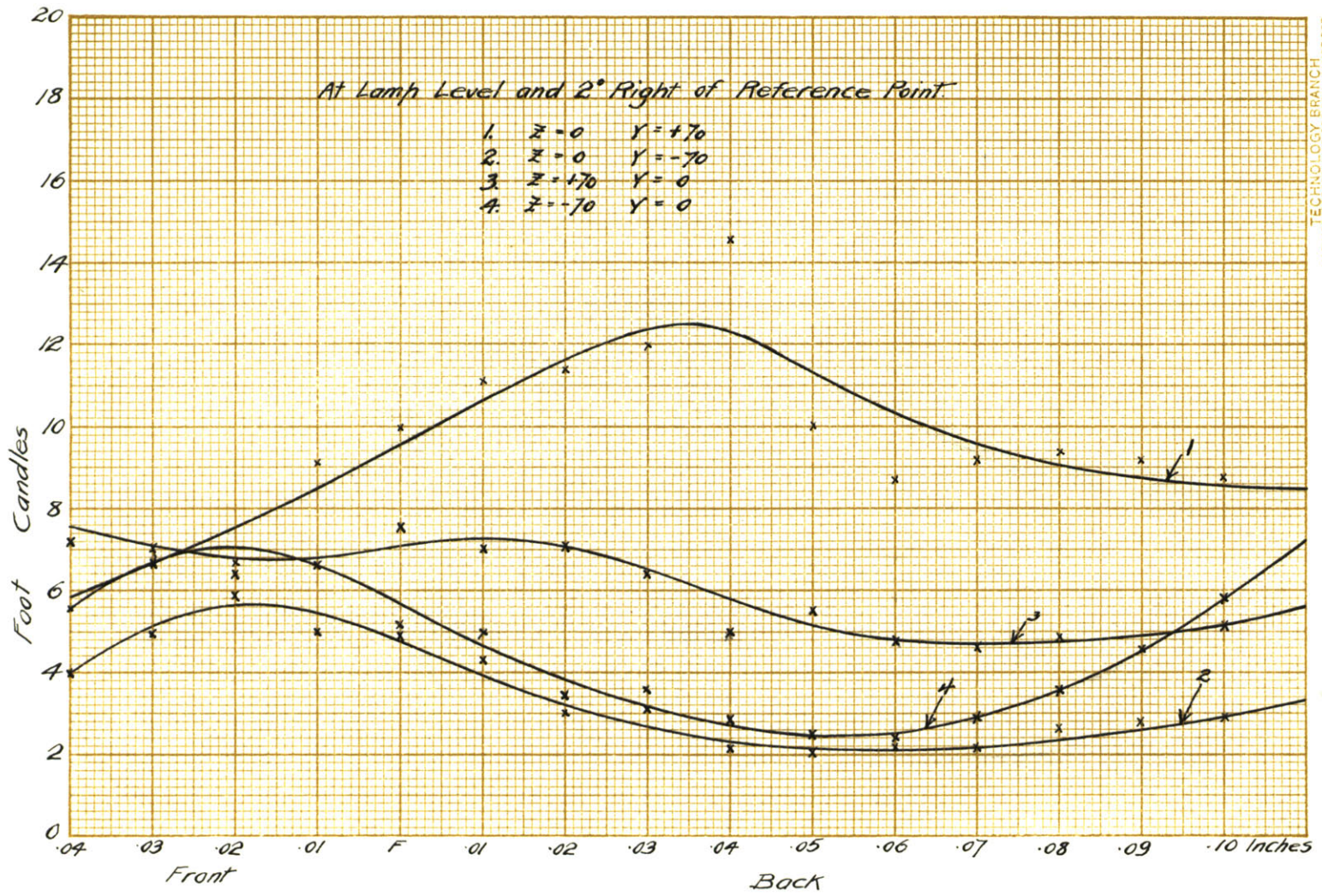

TECHNOLOGY BRANCH  
HARVARD COOPERATIVE SOCIETY, CAMBRIDGE

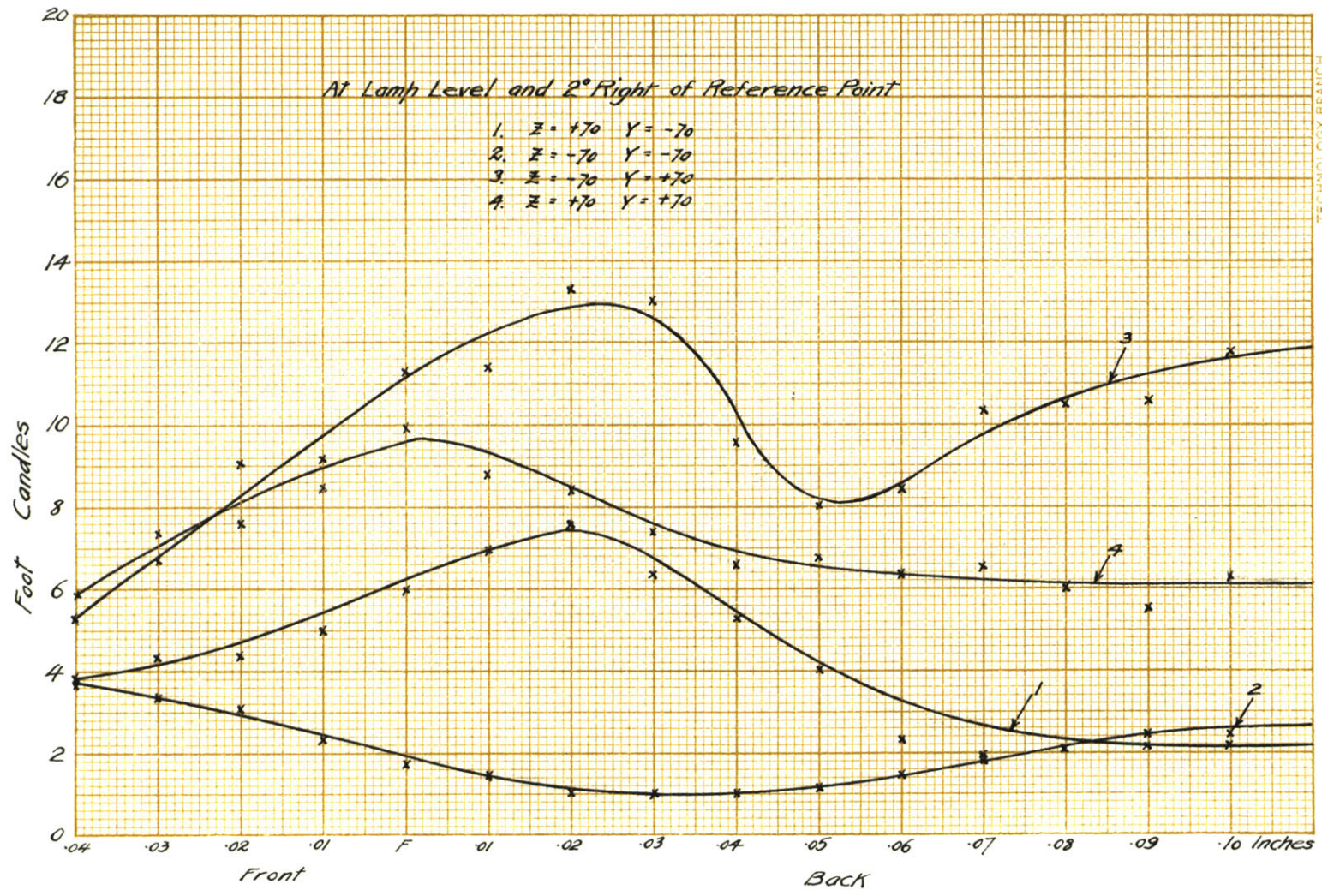

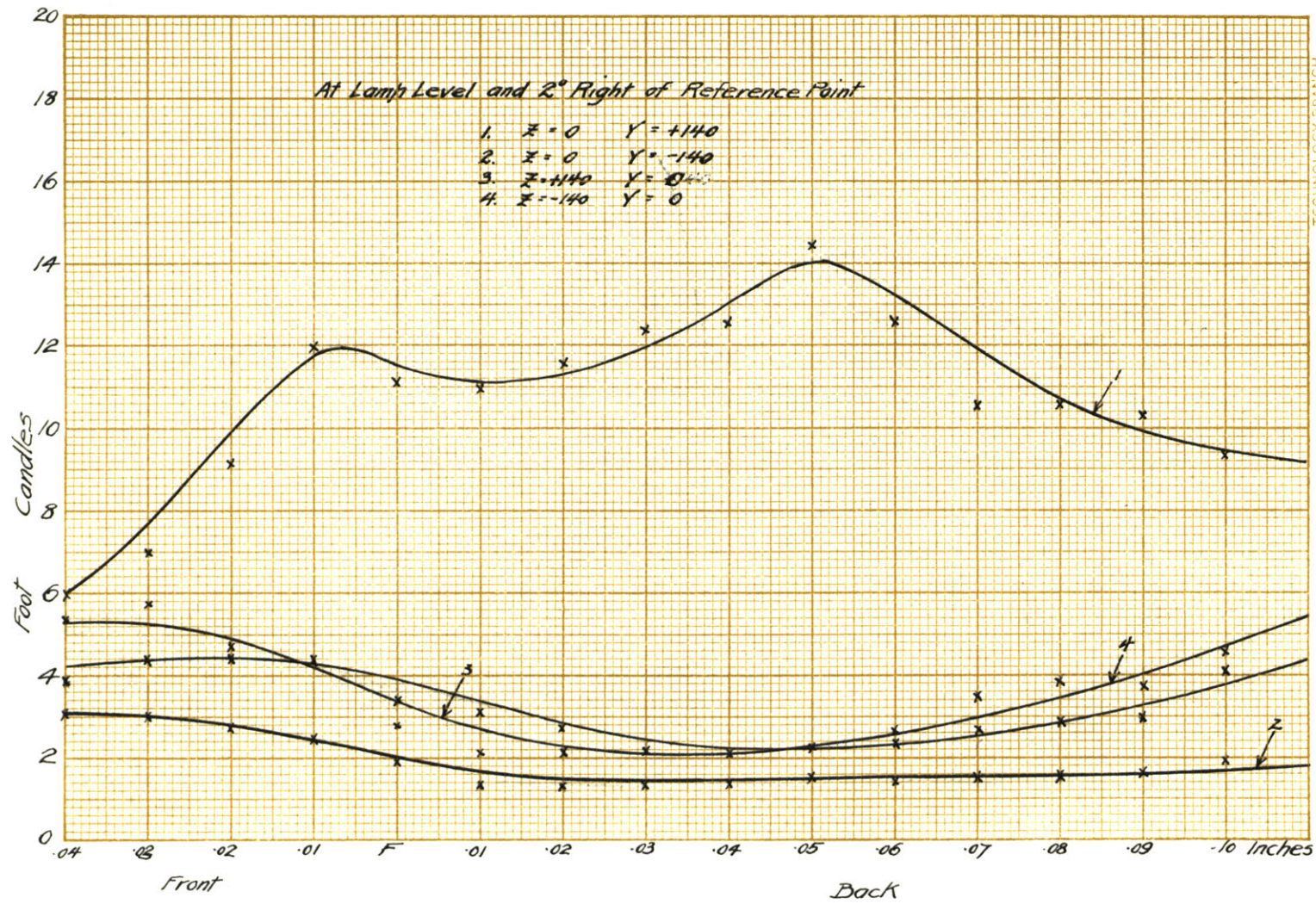

At Lamp Level & Four Degrees Left of Reference Point

X	Y= 0 Z= 0	Y=+70 Z=+70	Y=+70 Z=-70	Y=-70 Z=-70	Y=-70 Z=+70
80	1.91	0.268	0.227	1.62	1.92
60	1.43	0.240	0.222	1.40	1.40
40	1.00	0.228	0.220	1.15	1.05
20	1.10	0.188	0.220	1.00	1.04
F	0.68	0.157	0.198	0.90	0.96
20	0.76	0.188	0.182	0.80	0.60
40	0.51	0.219	0.178	0.90	0.53
60	0.47	0.163	0.148	0.81	0.43
80	0.50	0.157	0.141	0.63	0.41
100	0.46	0.177	0.155	0.49	0.41
120	0.43	0.178	0.161	0.52	0.43
140	0.45	0.205	0.150	0.59	0.48
160	0.43	0.205	0.152	0.52	0.47
180	0.41	0.205	0.162	0.48	0.46
200	0.40	0.215	0.152	0.47	0.64

Front

Back

At Lamp Level & Four Degrees Left of Reference Point

X	Z = 0				Y = 0			
	Y = +140	Y = +70	Y = -70	Y = -140	Z = +140	Z = +70	Z = -70	Z = -140
80	0.250	0.370	1.68	5.40	0.76	1.15	2.03	1.00
60	0.230	0.237	1.66	3.12	0.72	1.08	1.85	0.84
40	0.167	0.194	1.45	2.85	0.36	0.84	1.24	0.48
20	0.151	0.192	1.23	2.32	0.34	0.80	1.22	0.58
F	0.176	0.160	1.10	2.20	0.33	0.67	1.21	0.67
20	0.133	0.162	1.18	2.15	0.25	0.64	0.91	0.54
40	0.136	0.170	0.81	2.20	0.24	0.70	0.78	0.45
60	0.114	0.132	0.64	2.00	0.24	0.43	0.84	0.49
80	0.112	0.133	0.48	2.55	0.25	0.35	0.77	0.50
100	0.114	0.156	0.46	2.66	0.26	0.40	0.51	0.47
120	0.104	0.186	0.45	2.50	0.31	0.40	0.64	0.31
140	0.118	0.210	0.64	2.35	0.31	0.40	0.82	0.30
160	0.142	0.180	0.48	1.70	0.35	0.40	0.63	0.31
180	0.142	0.185	0.41	1.79	0.36	0.50	0.51	0.32
200	0.160	0.200	0.44	2.18	0.42	0.52	0.40	0.33

Front

Back



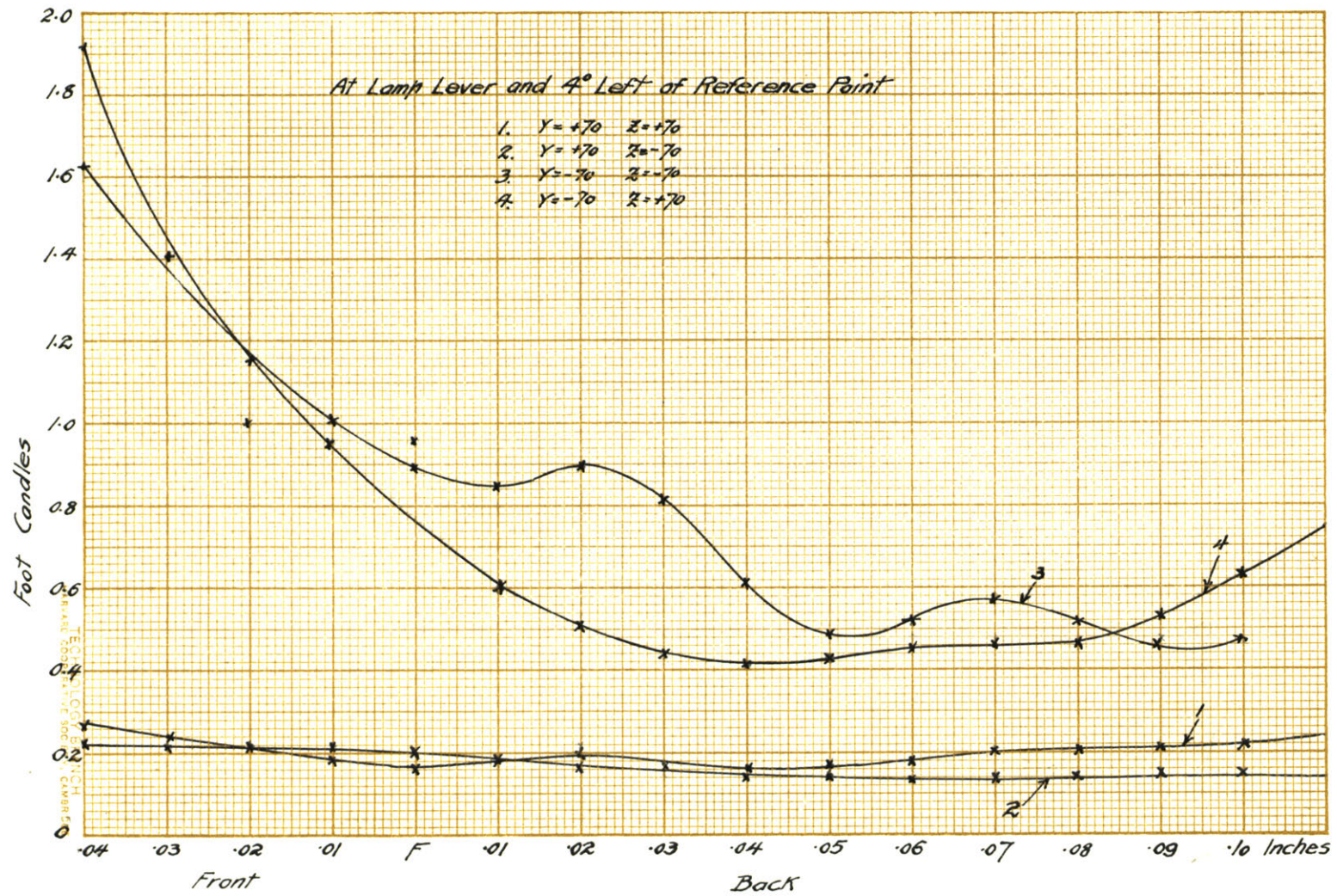

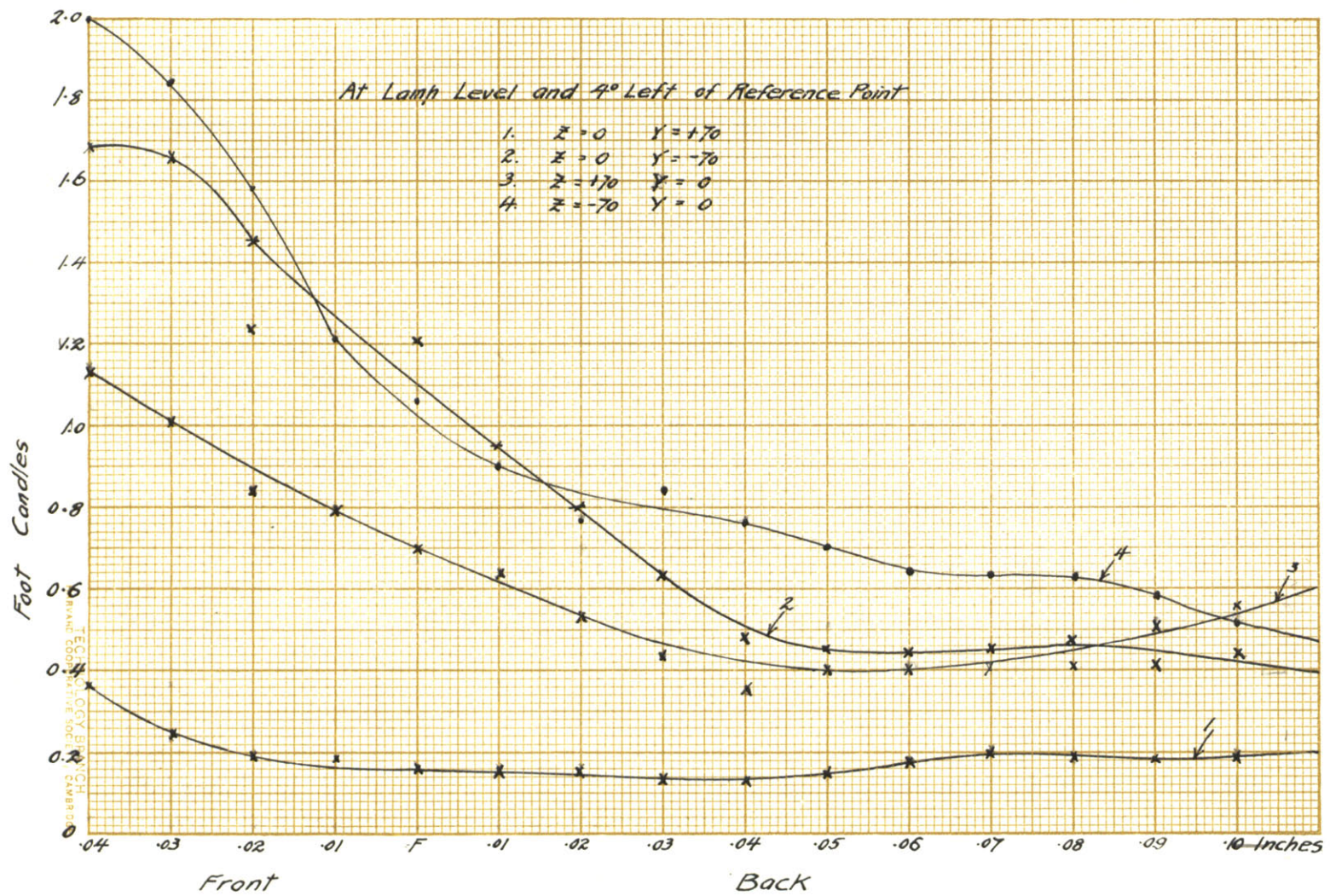

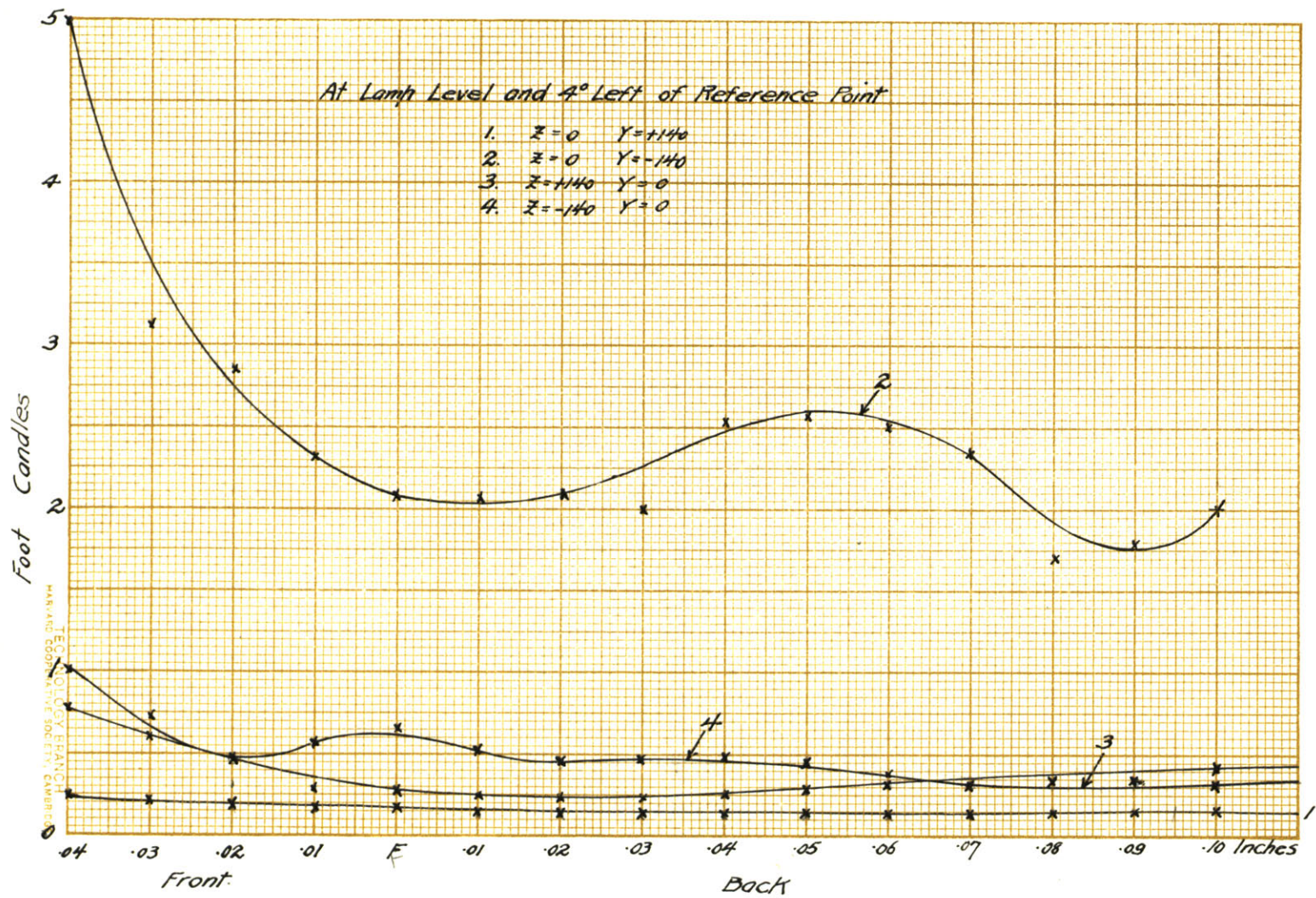

At Lamp Level & Four Degrees Right of Reference Point

X	Y = 0 Z = 0	Y = -70 Z = +70	Y = -70 Z = -70	Y = +70 Z = -70	Y = +70 Z = +70
80	1.35	0.63	0.43	1.60	1.49
60	1.70	0.45	0.44	1.45	1.50
40	1.70	0.42	0.40	1.45	1.24
20	1.40	0.36	0.32	1.35	1.00
F	1.05	0.40	0.32	1.05	0.88
20	0.84	0.42	0.27	0.78	0.82
40	0.83	0.43	0.26	0.74	0.80
60	0.83	0.40	0.25	0.78	0.76
80	0.84	0.33	0.23	0.37	0.70
100	0.68	0.32	0.26	0.37	0.56
120	0.68	0.27	0.22	0.35	0.44
140	0.62	0.26	0.149	0.32	0.43
160	0.53	0.24	0.194	0.35	0.53
180	0.52	0.24	0.182	0.41	0.54
200	0.45	0.25	0.182	0.54	0.72

Front

Back

At Lamp Level & Four Degrees Right of Reference Point

X	Z = 0				Y = 0			
	Y = +140	Y = +70	Y = -70	Y = -140	Z = +140	Z = +70	Z = -70	Z = -140
80	3.30	1.31	0.36	0.33	2.00	2.10	0.68	1.00
60	4.80	1.20	0.30	0.28	1.75	1.75	0.76	1.05
40	5.10	1.20	0.35	0.28	1.10	1.35	0.48	0.96
20	4.00	1.20	0.35	0.24	0.70	0.76	0.38	0.62
F	3.20	1.00	0.36	0.30	0.51	0.62	0.37	0.44
20	3.30	0.78	0.38	0.28	0.48	0.60	0.37	0.44
40	3.20	0.72	0.32	0.31	0.46	0.56	0.36	0.43
60	3.60	0.73	0.36	0.31	0.48	0.59	0.36	0.45
80	3.86	0.72	0.35	0.31	0.32	0.60	0.42	0.48
100	3.70	0.70	0.33	0.28	0.29	0.47	0.38	0.39
120	4.20	0.64	0.36	0.29	0.34	0.43	0.38	0.35
140	4.50	0.68	0.32	0.26	0.30	0.40	0.38	0.39
160	4.54	0.53	0.32	0.22	0.34	0.40	0.41	0.41
180	4.50	0.53	0.26	0.25	0.34	0.35	0.34	0.41
200	4.40	0.60	0.28	0.25	0.37	0.38	0.33	0.40

100

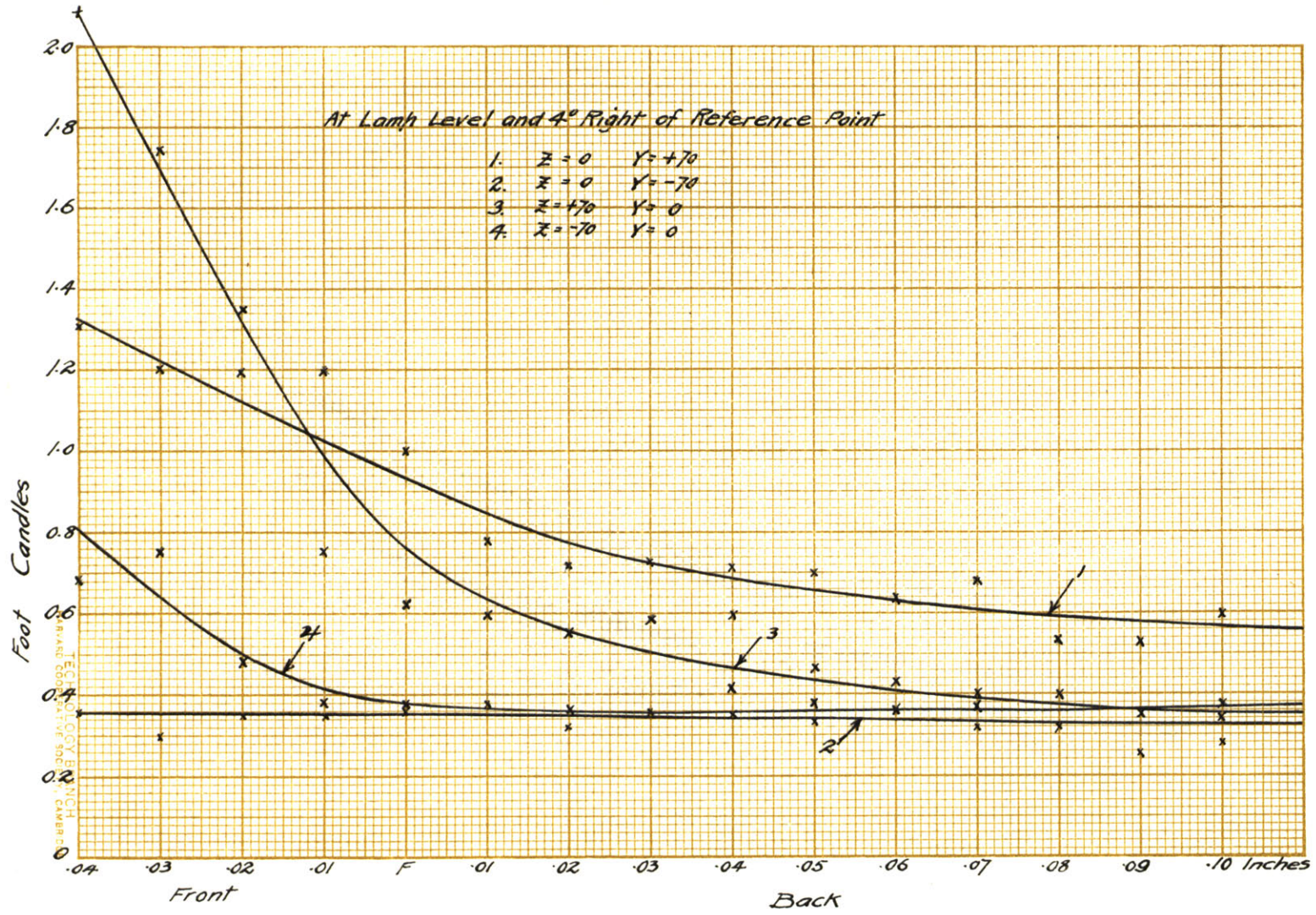

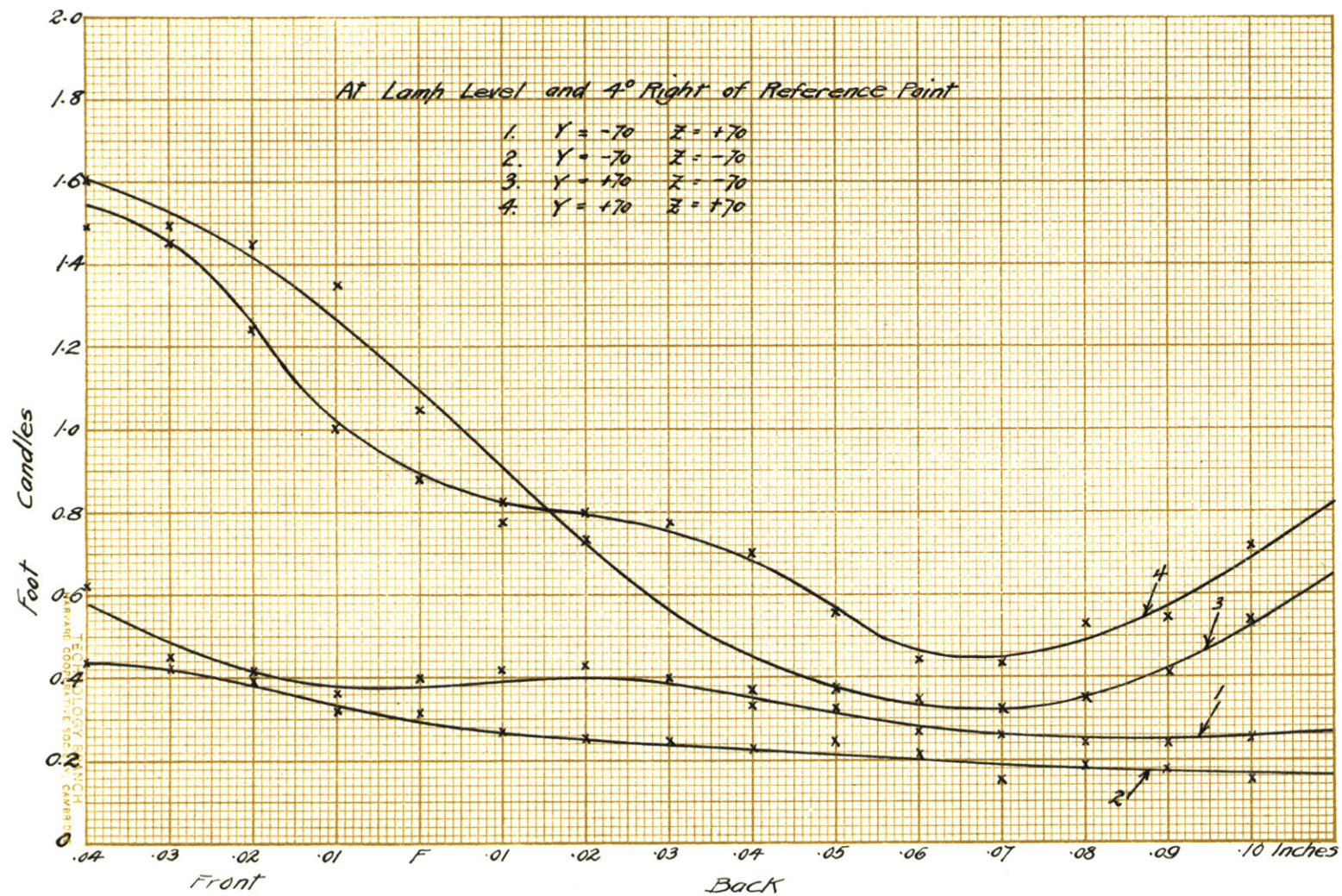

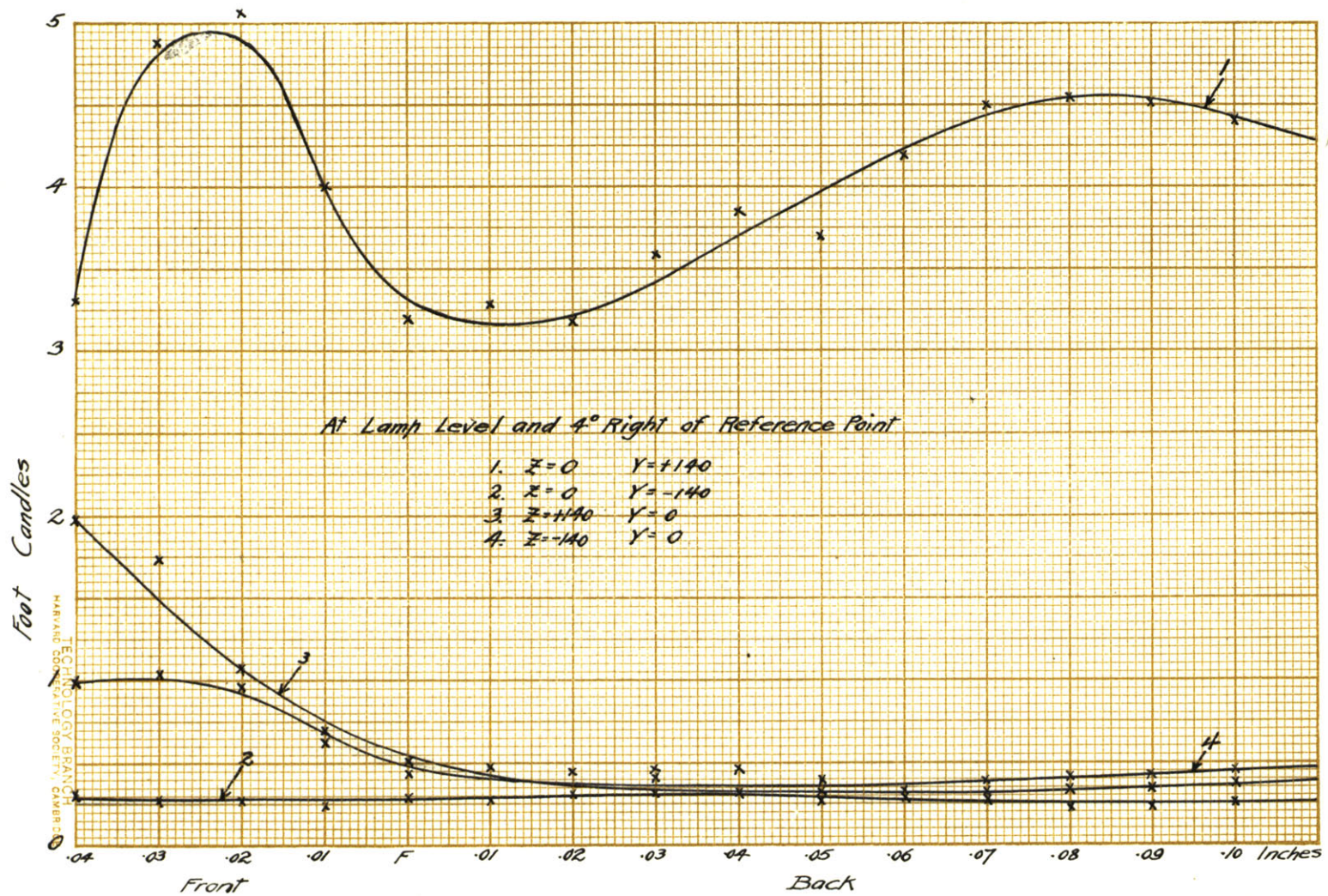



One Degree Above Lamp Level & At Centre Of Reference Point

X	Y = 0 Z = 0	Y = -70 Z = +70	Y = -70 Z = -70	Y = +70 Z = -30	Y = +70 Z = +70	
80	14.0	10.4	12.0	7.1	9.4	
Front	60	13.5	11.1	11.5	9.6	8.7
	40	13.0	13.7	11.6	10.0	9.5
	20	13.5	14.4	11.5	13.5	13.0
	F	20.0	18.8	13.5	14.0	16.3
Back	20	16.4	18.0	13.3	16.0	16.6
	40	18.0	16.2	13.6	15.0	17.5
	60	19.5	19.4	14.0	12.5	16.5
	80	19.8	20.6	12.0	9.4	17.3
	100	18.4	18.0	12.5	10.0	17.0
	120	17.4	16.0	13.0	10.2	13.6
	140	15.0	12.4	16.7	8.6	12.2
	160	13.8	11.5	13.0	8.2	8.6
	180	11.1	10.2	12.0	7.1	7.4
	200	10.8	10.5	11.0	6.2	6.7

One Degree Above Lamp Level & At Reference Point

X	Z = 0				Y = 0				
	Y = +140	Y = +70	Y = -70	Y = -140	Z = +140	Z = +70	Z = -70	Z = -140	
Front	80	8.6	10.0	11.6	10.0	6.8	10.0	9.0	4.7
	60	8.4	12.2	14.4	8.2	7.8	10.5	10.5	4.6
	40	8.2	14.8	16.1	9.8	8.6	10.6	12.0	5.4
	20	8.4	17.5	16.4	10.6	10.2	13.0	14.4	6.8
	F	10.8	19.6	18.0	10.8	12.5	16.4	16.2	7.4
Back	20	9.5	20.5	22.7	16.0	12.8	15.8	16.1	7.4
	40	9.2	20.5	24.5	16.0	14.0	11.8	16.5	7.6
	60	9.2	24.0	24.5	15.0	13.5	13.4	16.0	6.4
	80	9.1	23.5	24.8	16.0	12.5	16.0	16.0	4.8
	100	9.0	23.0	24.2	15.2	12.7	18.0	13.0	4.2
	120	6.8	20.5	24.1	15.0	10.5	12.5	13.6	4.1
	140	6.0	17.5	22.8	15.3	8.8	10.2	10.2	4.2
	160	5.8	15.5	22.5	13.5	8.0	9.0	8.3	4.0
	180	5.2	14.0	16.8	13.0	8.0	9.2	8.6	4.4
	200	4.2	11.0	14.6	13.5	7.2	9.0	7.8	4.1

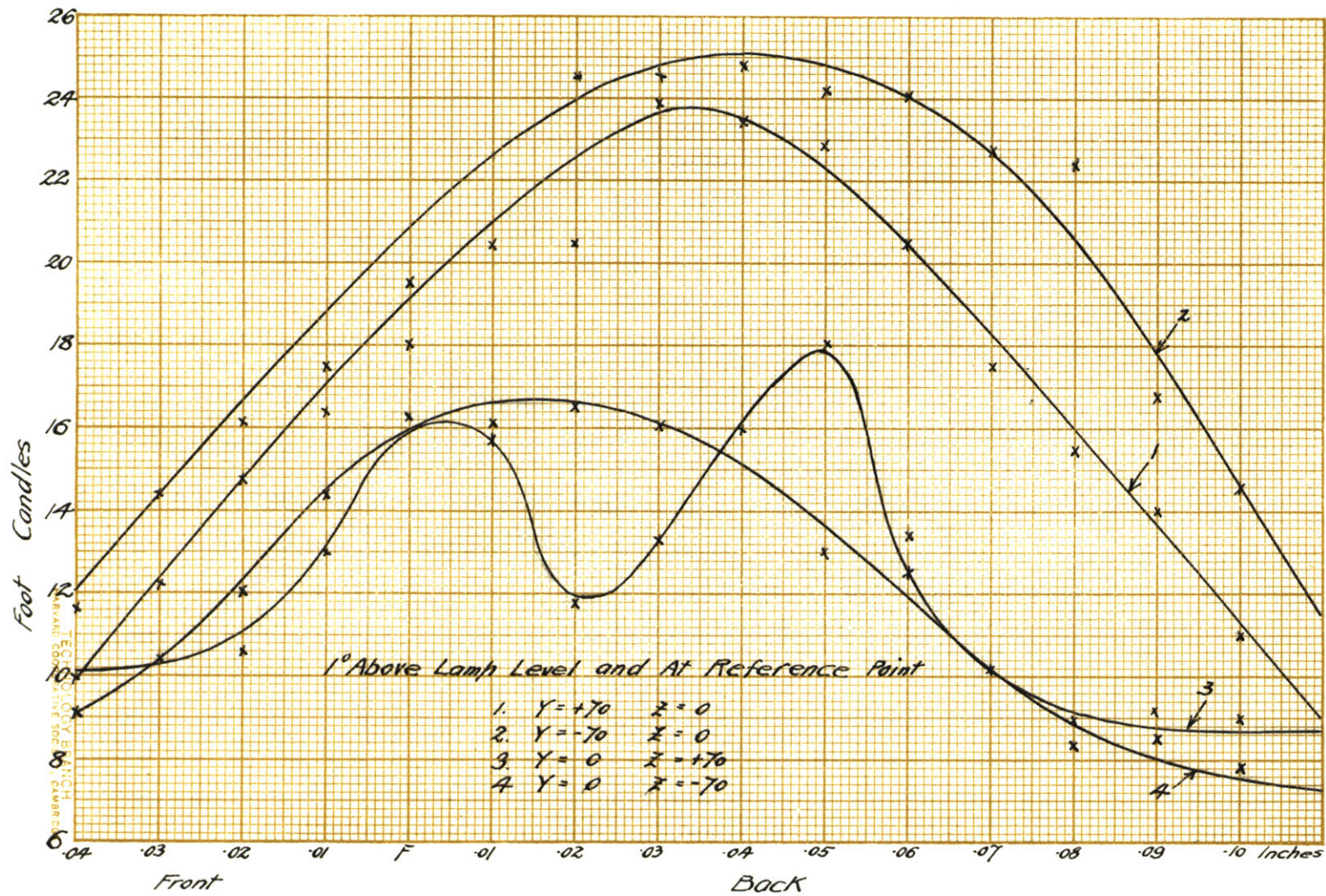

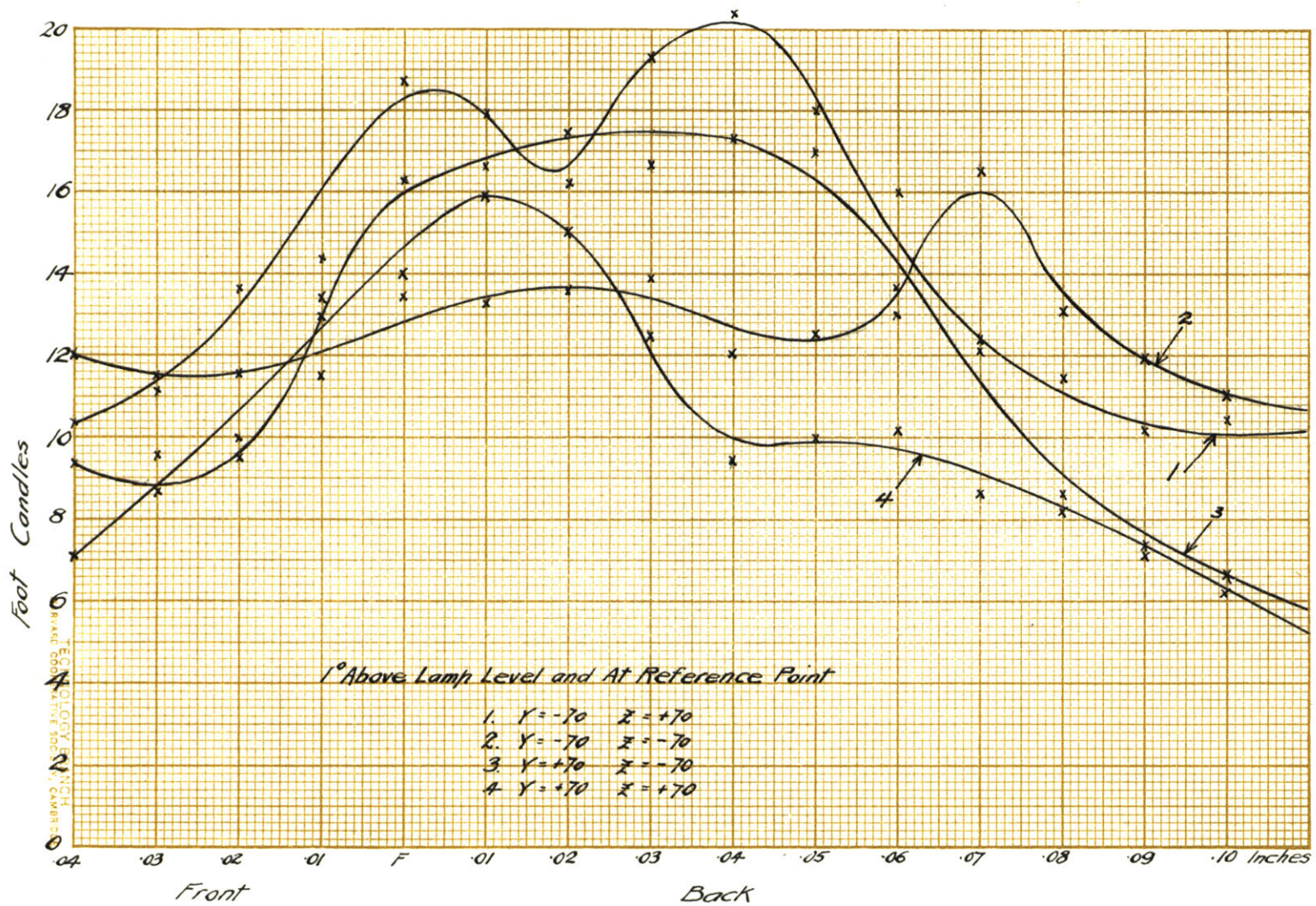



One Degree Above Lamp Level & Two Degrees Left of Reference Point

X	Y=0 Z=0	Y=-70 Z=+70	Y=-70 Z=-70	Y=+70 Z=-70	Y=+70 Z=+70
80	4.9	3.4	3.3	2.65	3.50
60	5.5	2.65	4.2	2.55	3.60
40	6.4	2.5	4.5	2.60	3.00
20	6.7	2.5	4.4	2.65	3.00
F	6.2	2.3	4.4	2.66	2.90
20	4.8	2.6	4.7	2.60	3.00
40	3.6	2.9	4.8	2.7	3.10
60	2.8	3.7	5.2	2.65	3.3
80	2.8	4.0	5.3	2.75	3.62
100	3.0	3.8	6.4	2.9	3.50
120	3.0	4.2	6.4	2.4	3.70
140	2.8	3.7	6.7	2.80	3.00
160	3.0	4.7	6.6	2.95	2.80
180	3.1	4.5	7.0	3.14	2.85
200	2.7	3.8	8.2	3.00	2.10

One Degree Above Lamp Level & Two Degrees Left of Reference Point

X	Z = 0				Y = 0				
	Y = +140	Y = +70	Y = -70	Y = -140	Z = +140	Z = +70	Z = -70	Z = -140	
Front	80	1.60	2.05	6.2	5.7	3.9	3.7	6.7	3.0
	60	1.54	2.15	4.2	6.0	4.0	4.7	6.0	2.7
	40	1.80	2.65	5.0	6.2	4.0	4.9	6.0	2.6
	20	2.00	2.85	5.2	7.8	4.3	5.2	6.2	2.5
	F	2.05	3.00	4.9	10.0	4.2	4.3	6.1	2.5
Back	20	2.05	3.67	3.9	14.0	3.5	3.4	4.5	2.5
	40	2.10	3.10	5.0	10.0	2.9	3.5	4.0	4.6
	60	2.25	2.85	6.4	10.0	3.2	3.2	3.6	3.0
	80	2.15	3.32	7.4	13.1	3.1	2.4	2.9	3.3
	100	2.13	3.00	9.0	13.4	3.2	2.2	2.4	4.5
	120	1.88	2.70	9.2	14.2	2.9	2.0	3.1	4.8
	140	1.50	2.70	9.2	16.0	2.4	2.1	3.2	5.0
	160	1.50	2.45	10.2	17.0	2.4	2.5	4.0	5.0
	180	1.50	2.45	12.0	18.0	2.8	2.5	5.5	4.4
	200	1.32	2.30	12.4	18.0	2.9	2.6	6.6	3.3

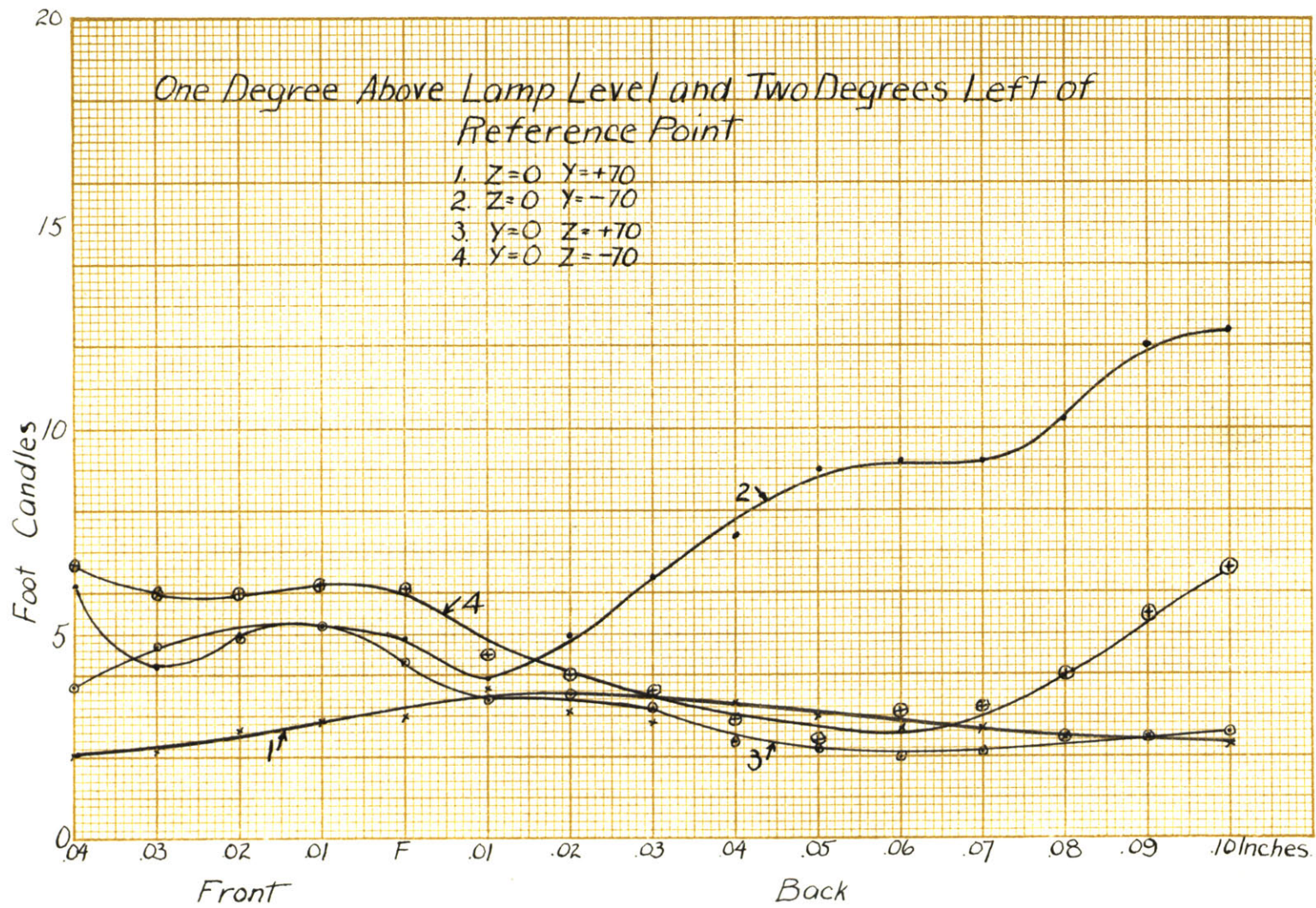

TECHNOLOGY BRANCH  
 HARVARD CORPORATION OF SOCIETY, CAMBRIDGE



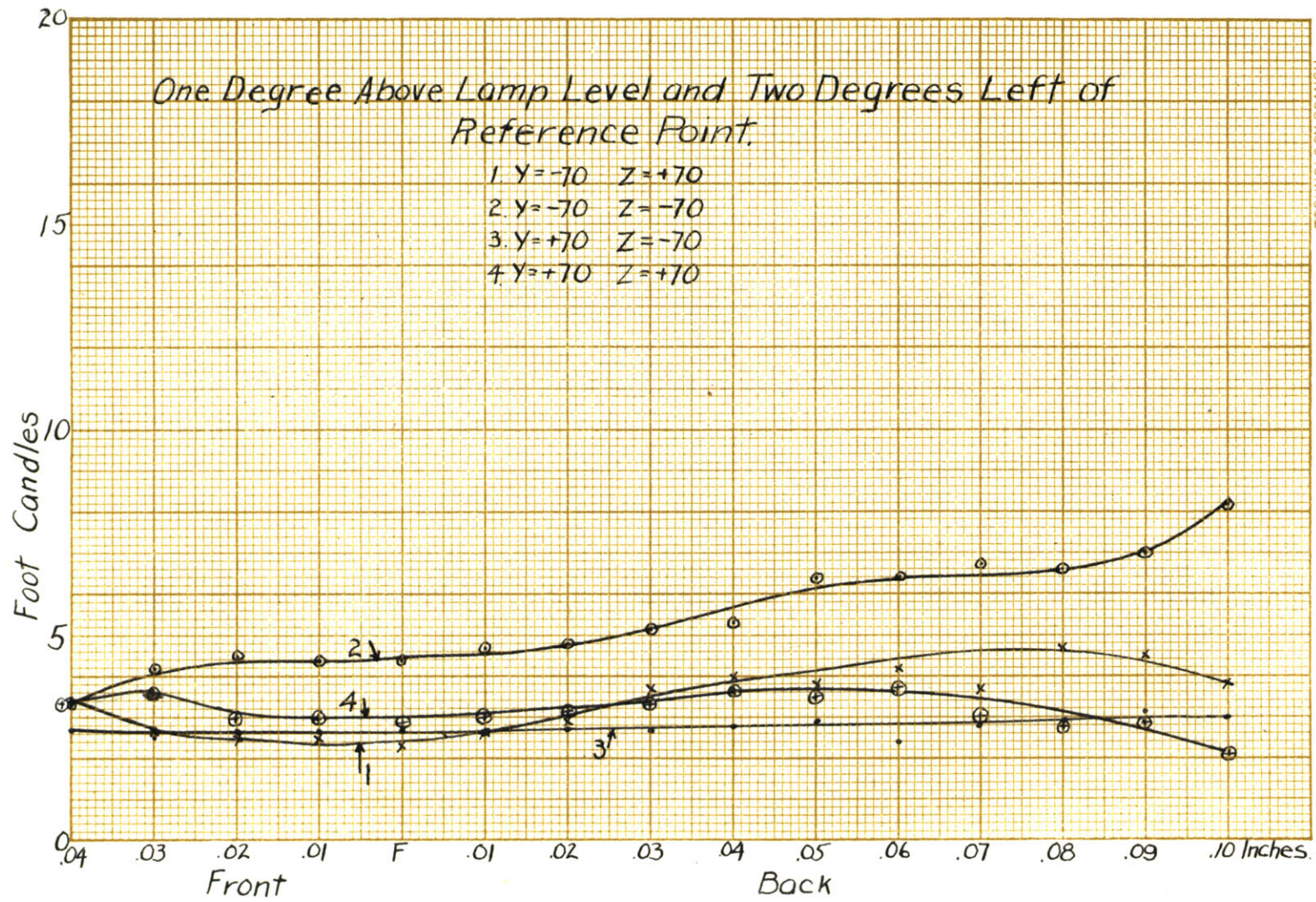

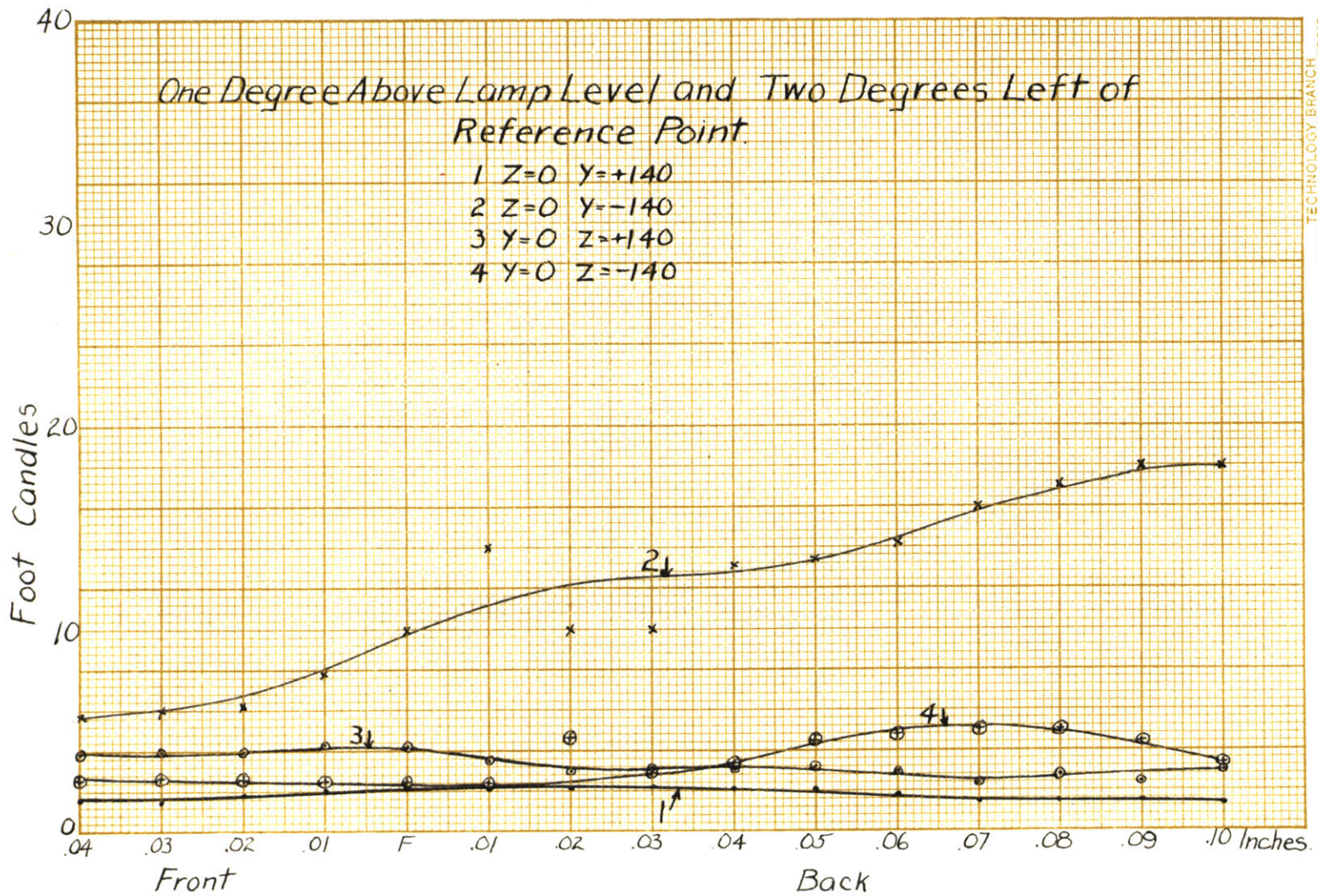

TECHNOLOGY BRANCH  
MARINE COOPERATIVE SOCIETY, CAMBRIDGE

One Degree Above Lamp Level & Two Degrees Right of Reference Point

X	Y = 0 Z = 0	Y = -70 Z = +70	Y = -70 Z = -70	Y = +70 Z = -70	Y = +70 Z = +70	
Front	80	7.0	5.60	3.2	6.8	8.4
	60	6.6	6.30	3.30	6.7	9.6
	40	8.0	7.20	2.90	6.6	10.1
	20	8.5	7.20	2.56	6.4	10.8
	F	8.5	7.10	2.13	7.0	11.0
	20	9.6	7.60	2.35	8.0	8.6
Back	40	9.7	6.40	1.92	10.0	9.1
	60	10.5	7.60	1.56	7.2	11.0
	80	10.5	4.70	1.38	7.0	8.4
	100	10.2	3.00	1.18	9.0	8.2
	120	7.6	2.30	1.42	8.4	6.2
	140	6.9	2.35	1.28	8.6	8.0
	160	6.9	2.65	1.54	7.4	8.5
	180	6.1	2.55	1.80	7.7	8.2
	200	5.5	2.20	2.00	8.8	6.6

One Degree Above Lamp Level & Two Degrees Right Of Reference Point

X	Z = 0				Y = 0				
	Y=+140	Y=+70	Y=-70	Y=-140	Z=+140	Z=+70	Z=-70	Z=-140	
80	7.8	7.8	5.0	3.0	3.4	6.3	5.4	4.9	
Front	60	9.6	8.0	5.6	3.7	3.8	7.8	5.3	4.7
	40	12.0	7.8	5.5	3.2	3.9	9.0	6.3	4.1
	20	11.8	9.1	4.1	2.6	3.9	8.0	6.4	3.7
	F	12.1	8.5	3.3	2.3	3.9	8.1	6.8	3.6
Back	20	12.7	10.6	3.8	2.8	4.3	7.8	7.2	4.0
	40	13.2	11.0	3.6	1.8	4.3	8.0	7.6	4.0
	60	12.5	13.3	2.1	1.3	4.5	8.6	6.8	3.3
	80	12.8	11.7	1.7	1.3	3.4	7.4	3.9	3.1
	100	10.5	12.3	1.7	1.1	3.6	5.7	3.3	3.5
	120	10.6	12.9	1.9	1.3	3.7	4.2	4.2	4.0
	140	11.2	12.4	2.3	1.3	3.6	5.3	4.8	3.9
	160	14.0	13.2	2.2	1.2	3.5	6.2	4.4	3.6
	180	16.6	12.6	2.1	1.4	3.8	5.1	4.5	4.3
	200	16.0	11.5	3.1	1.5	4.0	5.2	5.7	4.0

115

1

2

3

4

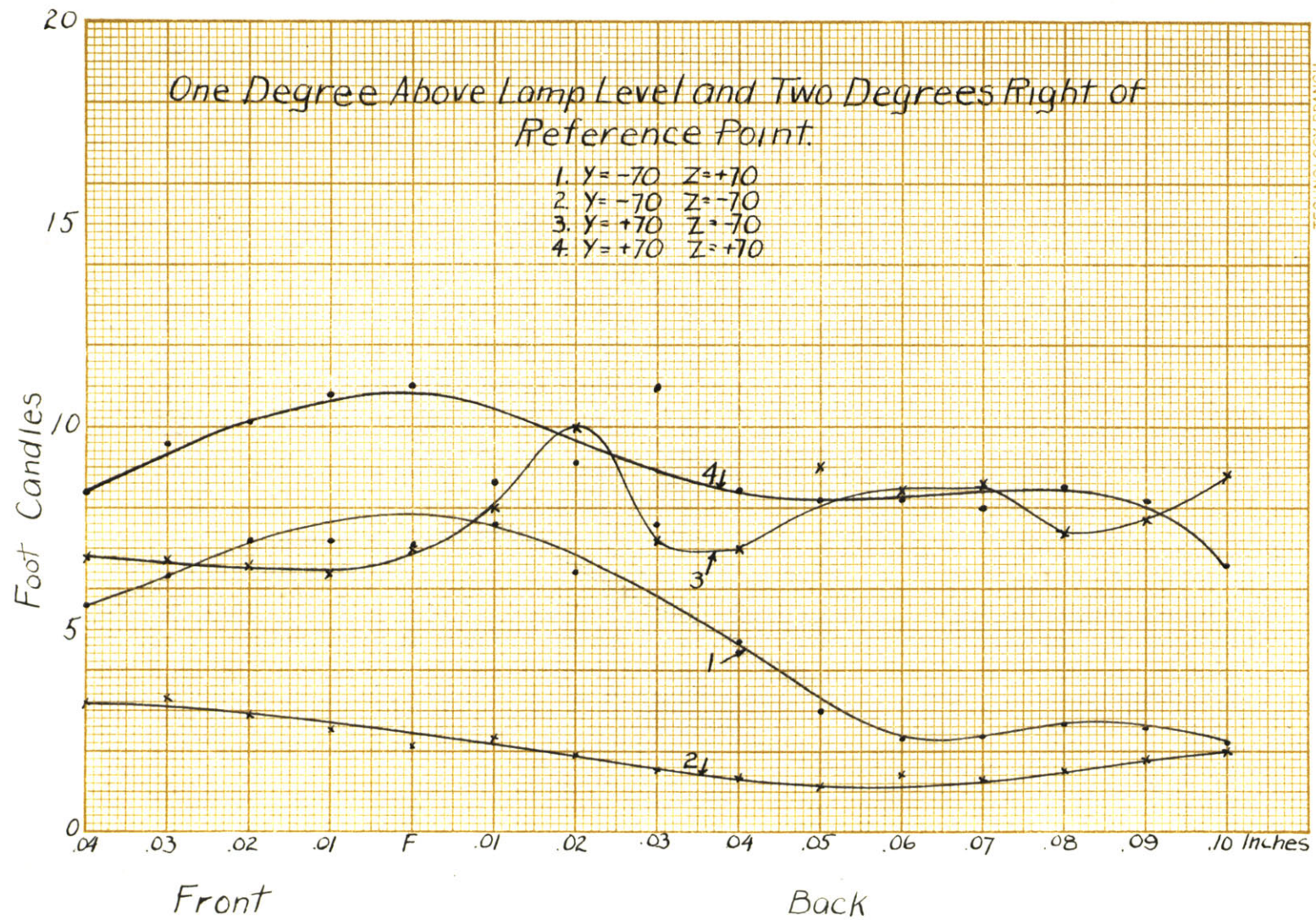

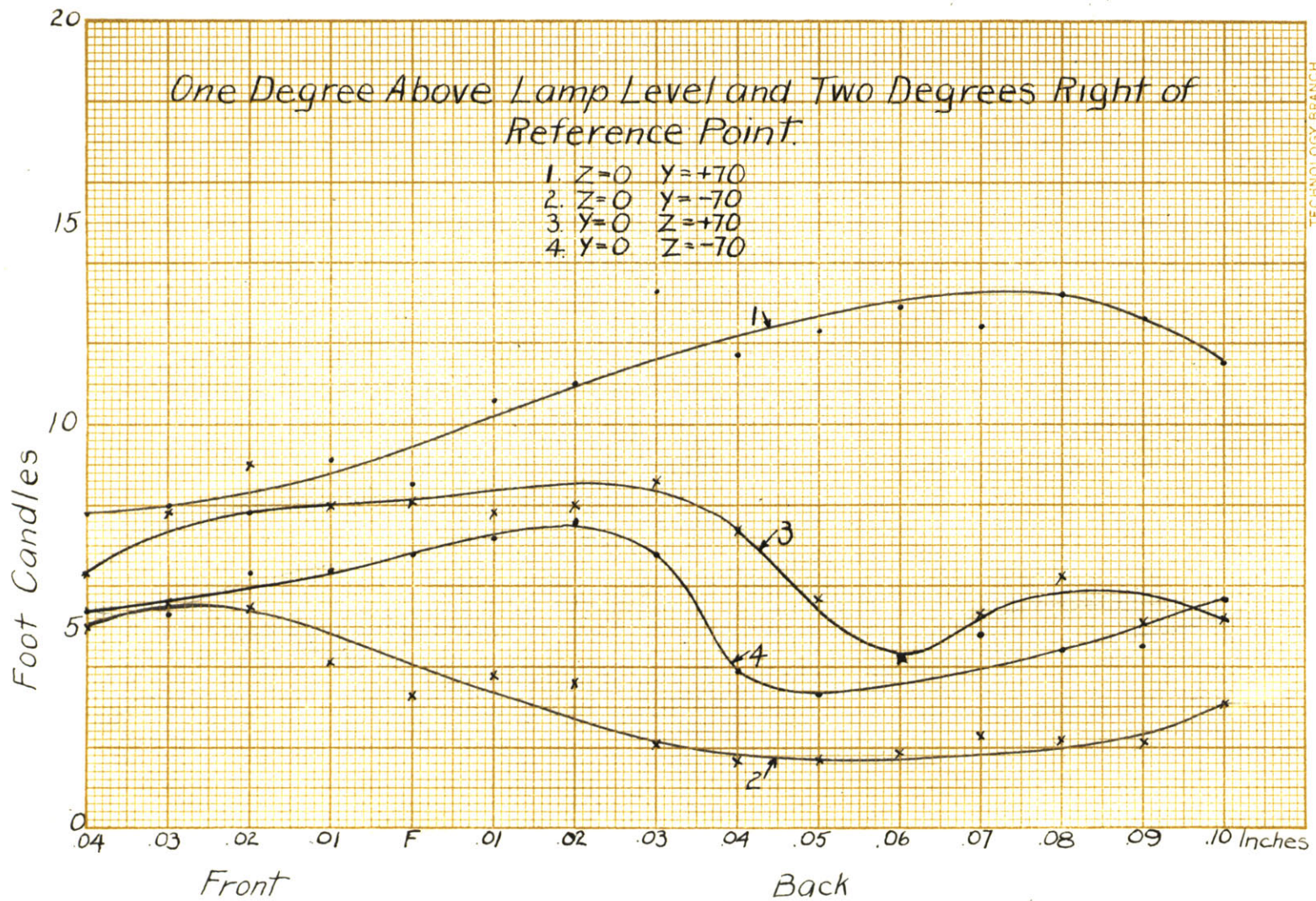

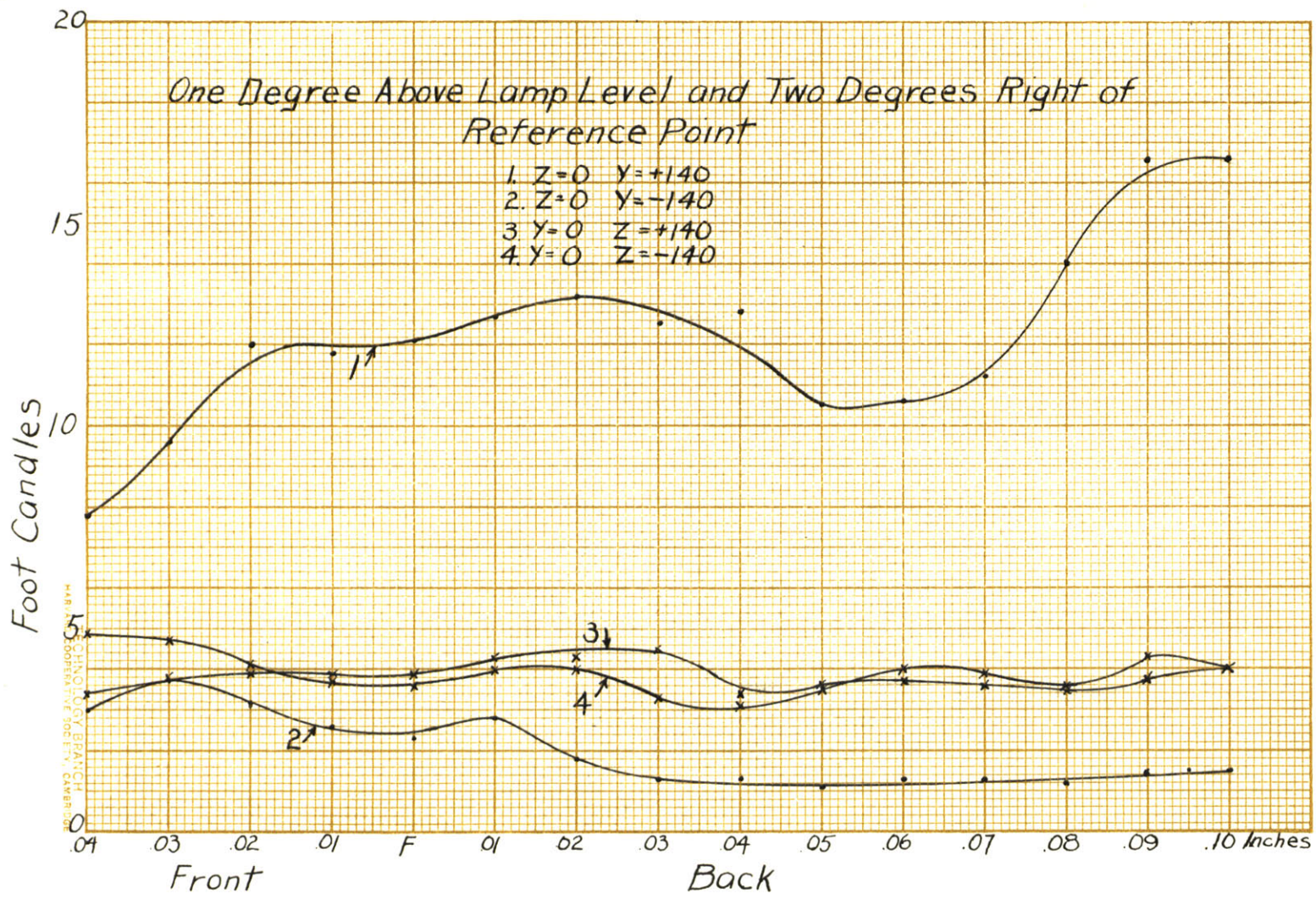

One Degree Above Lamp Level & Four Degrees Right Of Reference Point

X	Y=0 Z=0	Y=-70 Z=+70	Y=-70 Z=-70	Y=+70 Z=-70	Y=+70 Z=+70
80	1.40	1.80	0.70	1.90	4.60
60	1.41	2.30	0.76	2.14	4.50
40	1.21	1.72	0.37	2.15	4.60
20	1.20	1.30	0.36	1.56	4.60
F	1.10	1.06	0.22	1.40	3.40
20	1.15	1.05	0.22	1.84	2.25
40	1.00	0.60	0.20	1.48	1.80
60	1.00	0.48	0.16	1.30	2.40
80	0.67	0.27	0.14	1.28	2.25
100	0.53	0.26	0.13	1.58	1.78
120	0.47	0.21	0.14	1.80	1.52
140	0.45	0.20	0.14	1.86	1.73
160	0.34	0.19	0.14	1.52	1.82
180	0.29	0.20	0.15	1.78	1.47
200	0.36	0.21	0.20	2.30	1.30

Front

Rack



One Degree Above Lamp Level & Four Degrees Right of Reference Point

X	Z = 0				Y = 0				
	Y=+140	Y=+70	Y=-70	Y=-140	Z=+140	Z=+70	Z=-70	Z=-140	
Front	80	3.6	3.2	0.62	0.43	2.20	3.00	1.15	0.75
	20	3.8	4.1	0.72	0.37	2.10	3.3 5	1.10	0.74
	40	4.8	4.1	0.60	0.34	1.95	2.95	1.10	0.50
	20	5.1	2.6	0.56	0.25	1.62	1.80	0.96	0.39
	F	4.5	2.1	0.46	0.20	1.10	1.42	0.88	0.34
Back	20	4.6	3.1	0.35	0.22	0.88	1.38	0.88	0.29
	40	4.9	2.3	0.46	0.23	0.79	1.36	0.63	0.26
	60	4.4	2.03	0.35	0.22	0.74	1.14	0.39	0.20
	80	3.3	2.00	0.28	0.22	0.47	0.94	0.30	0.20
	100	3.3	2.05	0.27	0.22	0.33	0.86	0.29	0.15
	120	3.8	2.45	0.30	0.21	0.32	0.71	0.32	0.15
	140	4.1	2.55	0.27	0.20	0.36	0.48	0.27	0.17
	160	4.8	2.64	0.23	0.29	0.39	0.40	0.22	0.20
	180	4.6	2.63	0.20	0.18	0.38	0.33	0.23	0.18
	200	4.6	2.72	0.23	0.20	0.43	0.29	0.25	0.20

120

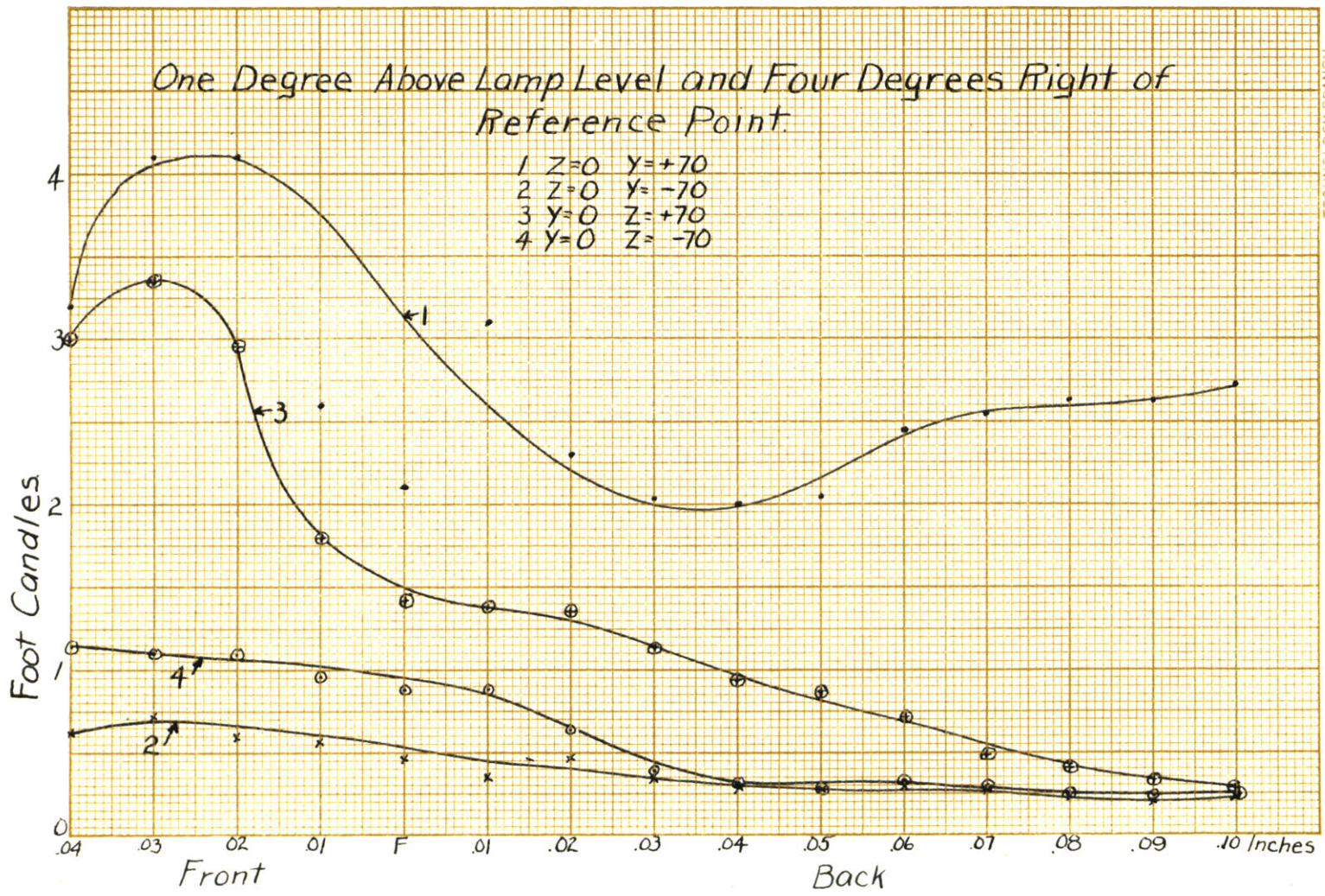

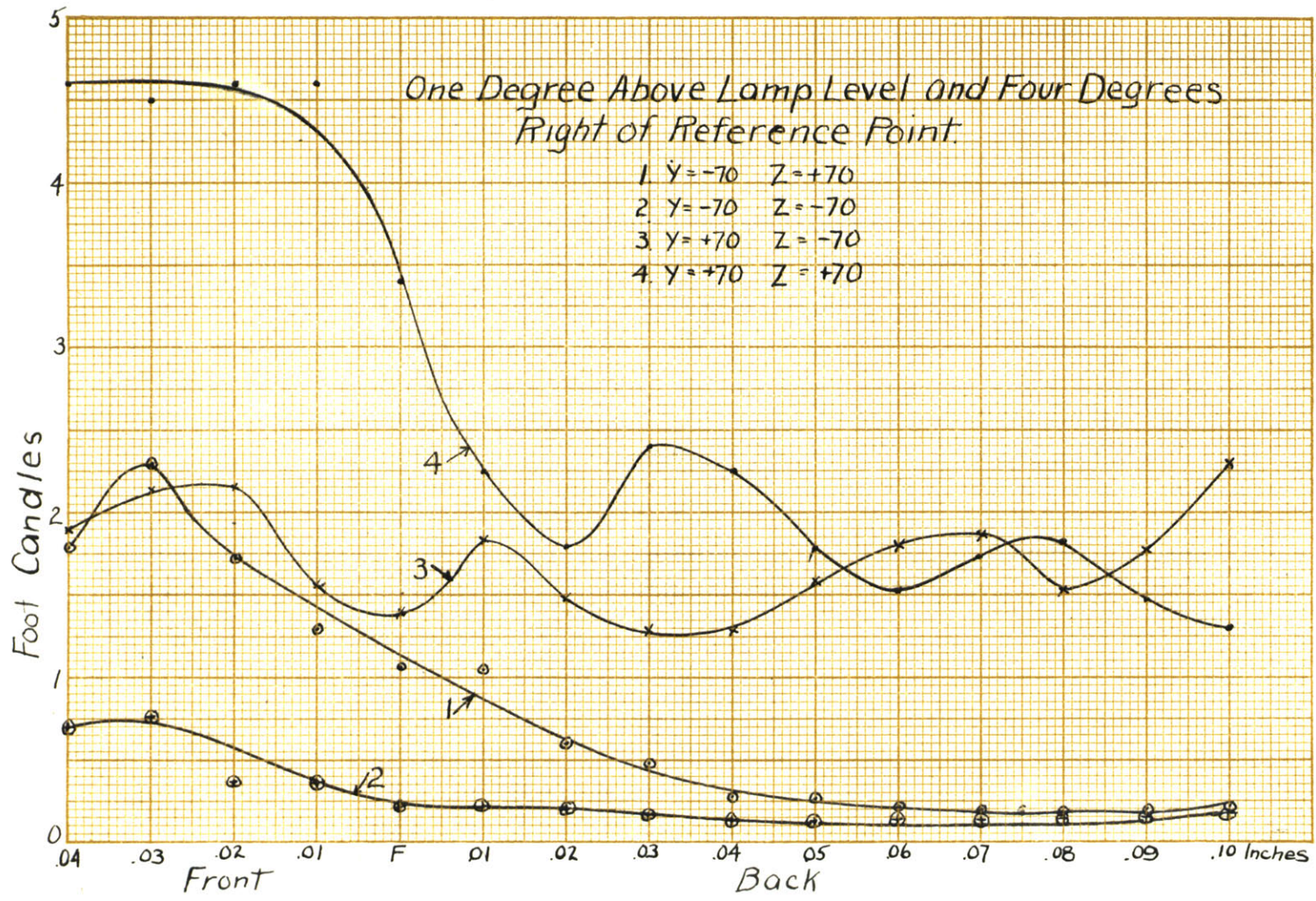

TECHNOLOGY BRANCH  
HARVARD COOPERATIVE SOCIETY, CAMBRIDGE

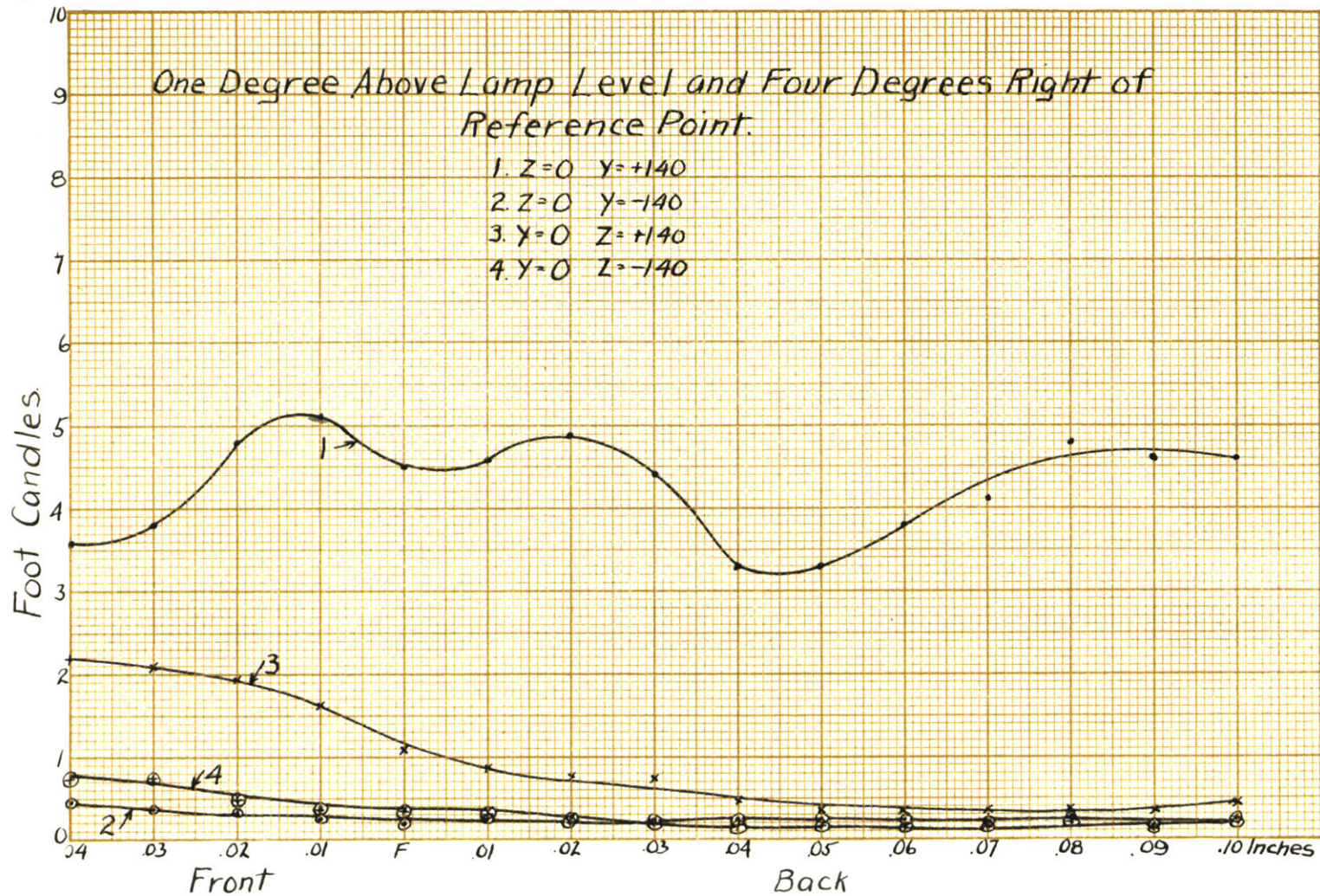

One Degree Above Lamp Level & Four Degrees Left of Reference Point

X	Y = 0 Z = 0	Y = -70 Z = +70	Y = -70 Z = -70	Y = +70 Z = -70	Y = +70 Z = +70	
Front	80	0.55	2.3	1.32	0.19	0.44
	60	0.36	1.6	1.12	0.12	0.40
	40	0.21	1.25	0.82	0.11	0.25
	20	0.17	0.90	0.78	0.11	0.19
	F	0.14	0.76	0.63	0.12	0.14
Back	20	0.13	0.41	0.55	0.12	0.12
	40	0.13	0.31	0.52	0.12	0.11
	60	0.13	0.24	0.33	0.11	0.11
	80	0.12	0.28	0.20	0.11	0.11
	100	0.13	0.25	0.14	0.11	0.10
	120	0.19	0.27	0.14	0.12	0.11
	140	0.10	0.31	0.12	0.11	0.13
	160	0.09	0.39	0.13	0.11	0.11
	180	0.11	0.15	0.20	0.12	0.12
	200	0.19	0.52	0.28	0.11	0.13

One Degree Above Lamp Level & Four Degrees Left of Reference Point

X	Z = 0				Y = 0			
	Y = +140	Y = +70	Y = -70	Y = -140	Z = +140	Z = +70	Z = -70	Z = -140
80	0.17	0.27	1.20	3.5	0.64	0.50	0.42	0.31
60	0.15	0.18	0.92	2.5	0.46	0.26	0.23	0.18
40	0.13	0.13	0.78	1.74	0.31	0.22	0.14	0.12
20	0.13	0.12	0.58	1.58	0.24	0.14	0.14	0.11
F	0.13	0.13	0.50	1.62	0.18	0.13	0.13	0.12
20	0.12	0.11	0.46	1.50	0.17	0.12	0.13	0.11
40	0.11	0.11	0.41	1.52	0.15	0.12	0.13	0.10
60	0.11	0.11	0.36	1.40	0.14	0.13	0.12	0.11
80	0.11	0.11	0.37	1.20	0.14	0.12	0.12	0.10
100	0.11	0.12	0.30	1.26	0.14	0.13	0.11	0.11
120	0.11	0.11	0.30	1.38	0.14	0.13	0.11	0.11
140	0.11	0.10	0.18	1.60	0.15	0.13	0.12	0.10
160	0.10	0.11	0.18	1.70	0.15	0.14	0.12	0.10
180	0.11	0.11	0.20	1.80	0.16	0.14	0.11	0.10
200	0.12	0.10	0.17	1.86	0.20	0.13	0.11	0.12

Front

Back

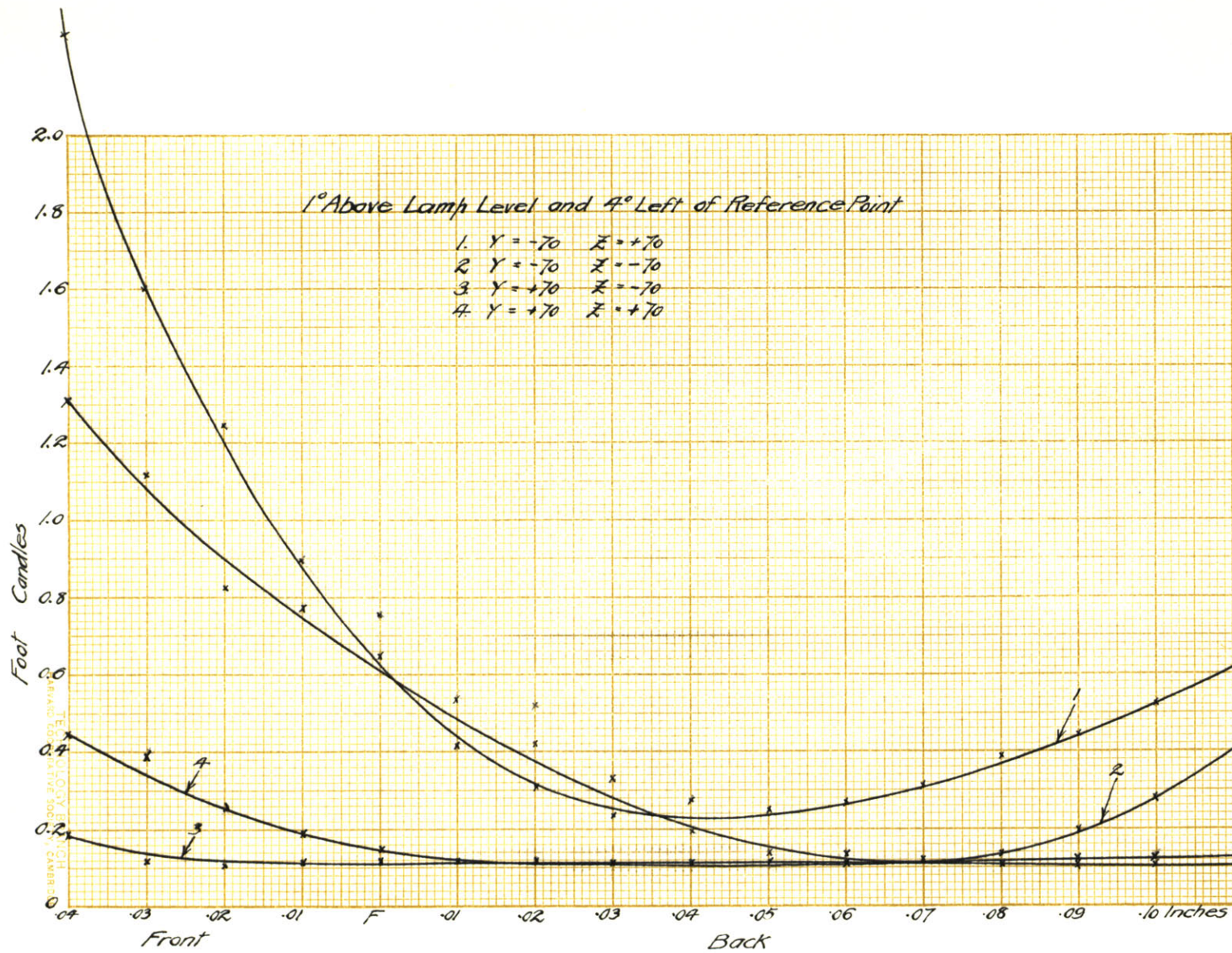

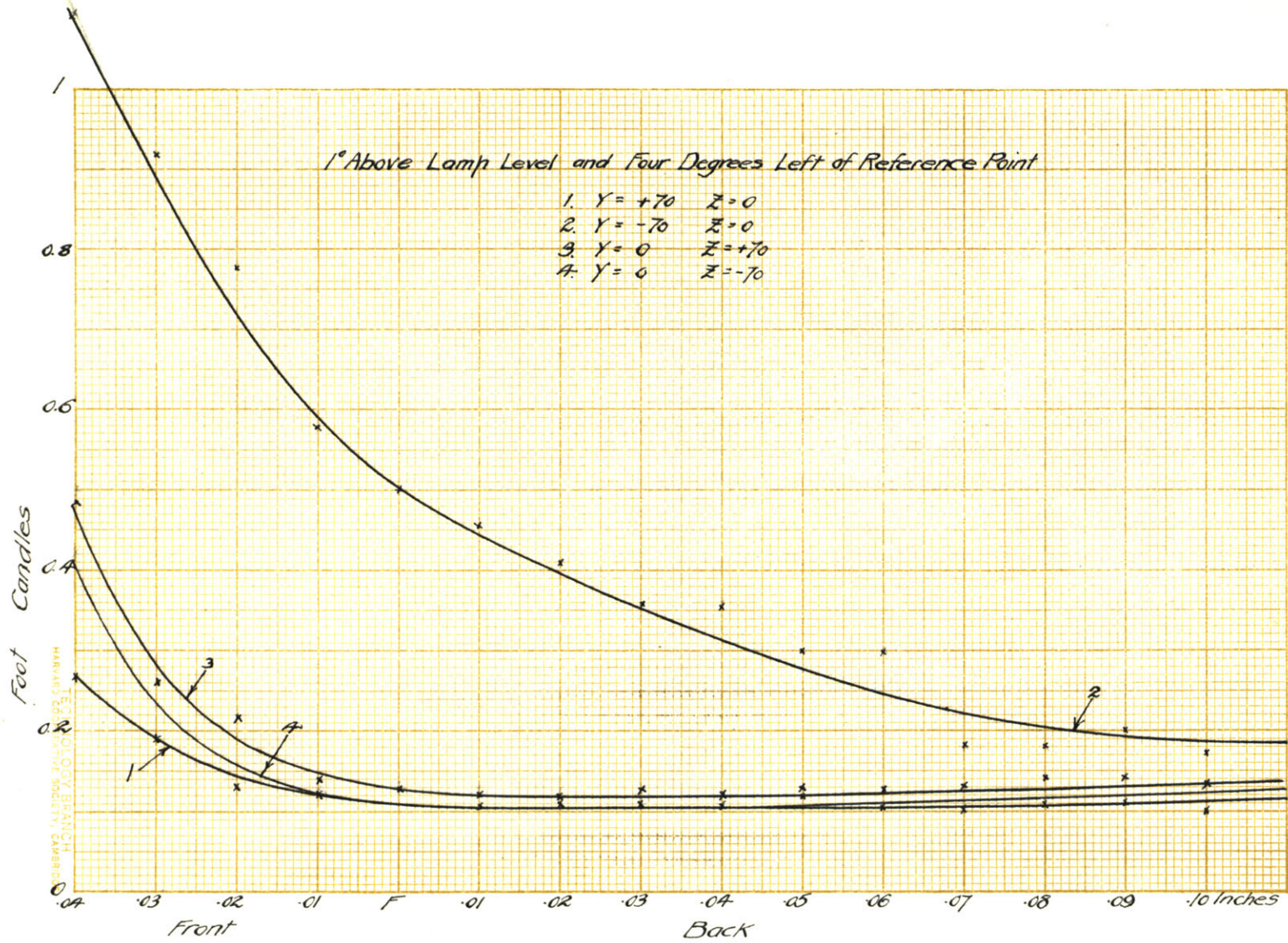



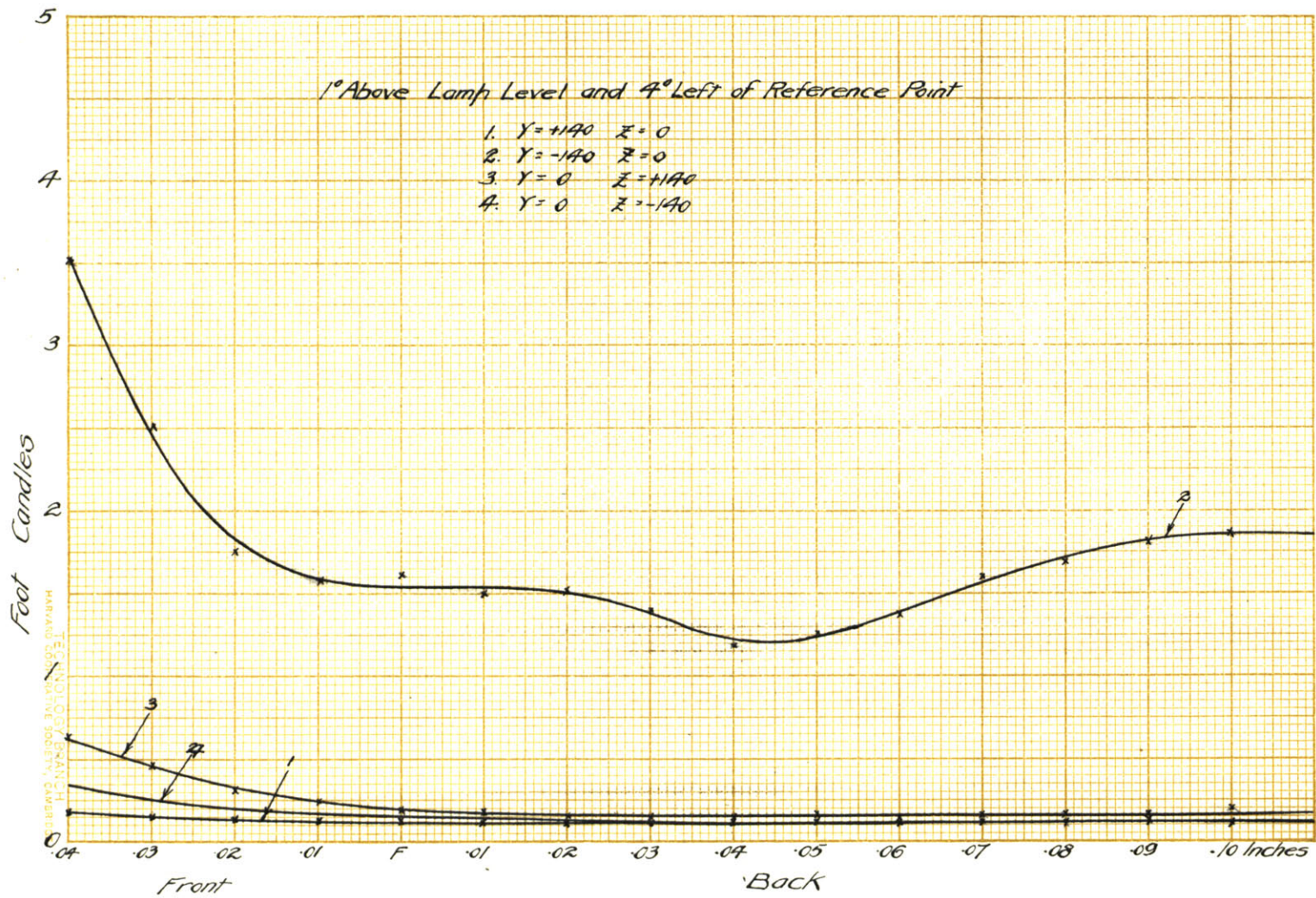

One Degree Below Lamp Level & At Centre of Reference Point

X	Y = 0	Y = -70	Y = -70	Y = +70	Y = +70	
	Z = 0	Z = +70	Z = -70	Z = -70	Z = +70	
Front	80	7.0	4.4	7.9	11.5	5.7
	60	7.4	4.8	8.0	9.6	4.75
	40	7.8	4.45	8.6	11.0	4.2
	20	7.1	4.25	9.8	10.0	3.1
	F	6.5	3.6	9.5	9.6	2.7
Back	20	4.8	2.72	8.0	9.4	2.36
	40	5.0	1.85	7.6	8.3	2.25
	60	4.8	1.95	7.3	7.9	2.5
	80	5.6	2.8	9.0	9.0	3.0
	100	5.9	3.3	12.8	8.5	3.75
	120	6.5	3.6	11.7	7.4	3.7
	140	5.6	3.95	9.5	6.9	4.2
	160	5.1	4.3	9.5	7.0	4.1
	180	4.9	4.2	10.0	7.1	3.35
	200	4.7	4.0	10.5	6.2	3.25

One Degree Below Lamp Level & At Centre of Reference Point

X	Z = 0				Y = 0				
	Y=+140	Y=+70	Y=-70	Y=-140	Z=+140	Z=+70	Z=-70	Z=-140	
Front	80	6.4	7.2	6.9	6.4	3.2	5.6	10.3	17.4
	60	6.6	6.7	5.6	5.8	3.6	4.6	9.5	19.1
	40	6.0	5.9	4.4	4.5	2.9	3.5	9.0	20.0
	20	5.0	5.3	3.8	4.2	2.3	3.1	10.0	20.7
	F	4.8	4.7	3.7	3.7	1.96	2.73	9.1	19.8
Back	20	4.3	4.5	3.25	3.4	1.74	2.13	8.7	19.0
	40	3.85	3.6	3.1	3.35	1.64	1.90	7.4	16.8
	60	3.9	3.6	3.0	3.65	1.55	2.3	8.2	17.0
	80	4.2	4.7	4.3	4.3	1.75	2.55	11.5	19.2
	100	4.7	6.0	5.6	5.7	2.5	2.9	14.1	17.5
	120	4.4	5.5	4.7	5.9	2.67	3.14	12.6	18.0
	140	4.0	5.1	4.6	5.65	2.38	3.2	10.2	17.7
	160	4.1	5.0	5.1	5.35	3.2	3.5	9.6	15.8
	180	3.6	5.7	5.5	4.40	3.0	3.6	8.7	13.0
	200	3.4	5.0	6.0	4.30	2.8	3.8	8.0	12.0

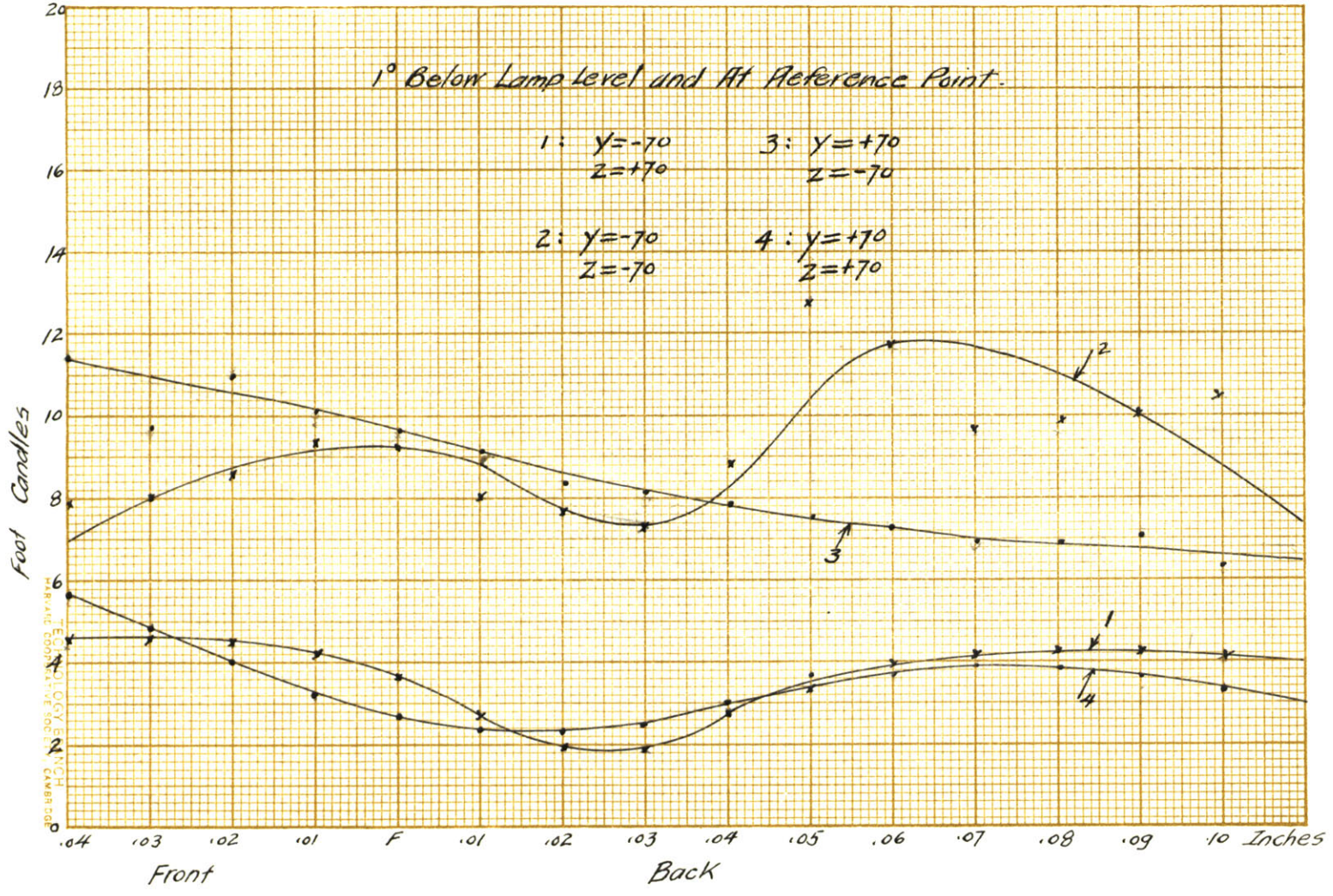

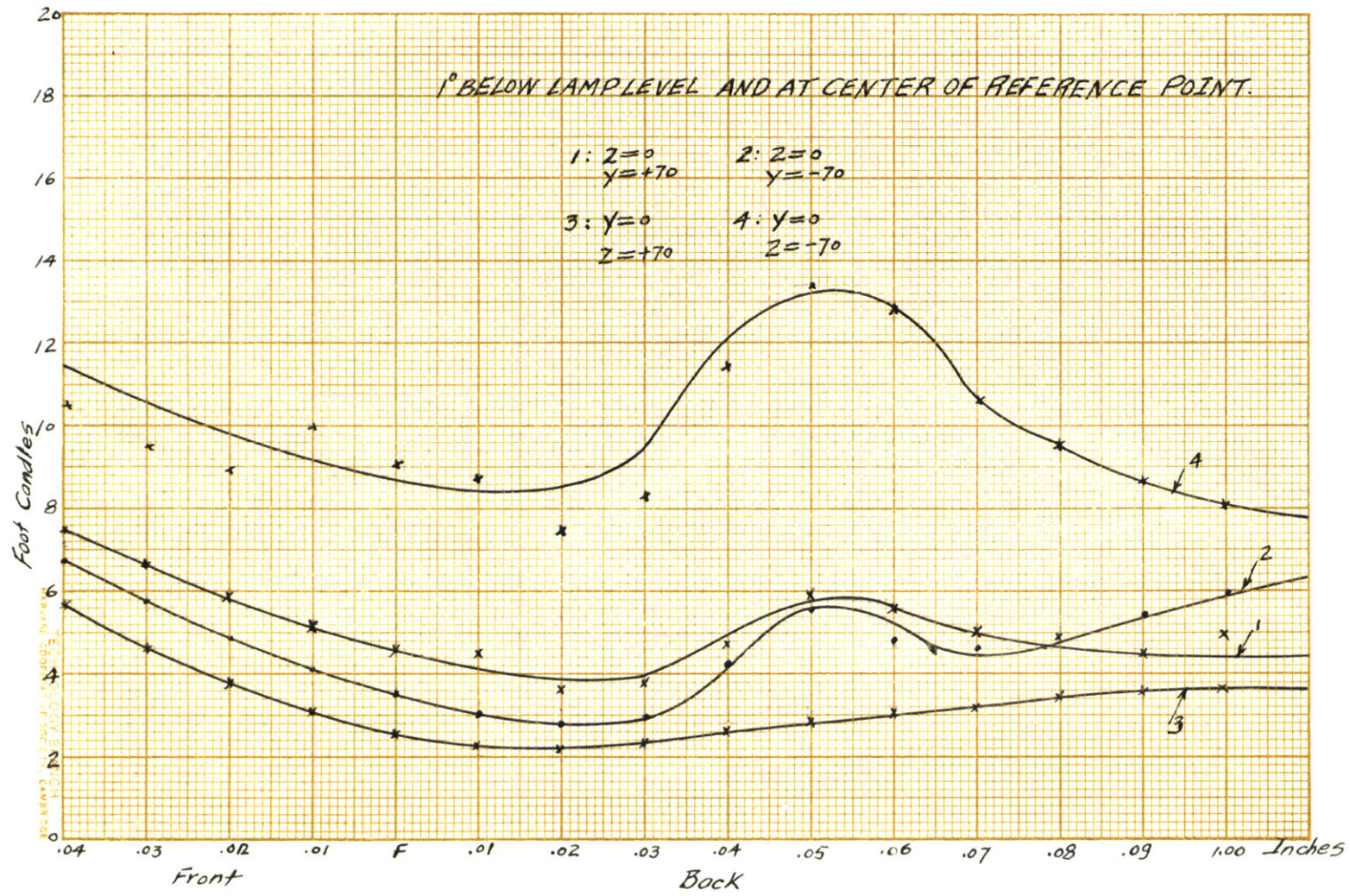

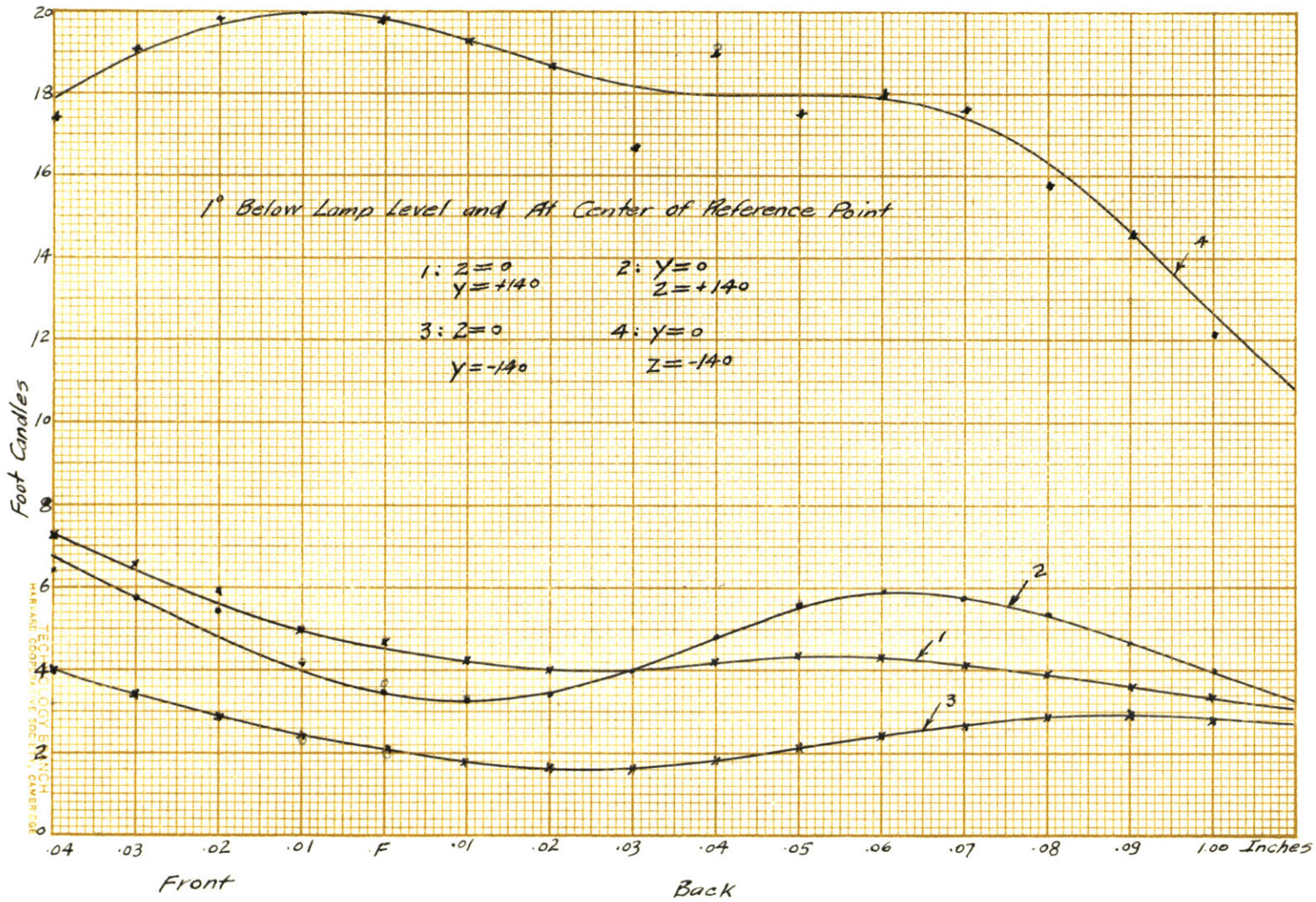

One Degree Below Lamp Level & Two Degrees Left of Reference Point

X	Y = 0 Z = 0	Y = -70 Z = +70	Y = -70 Z = -70	Y = +70 Z = -70	Y = +70 Z = +70	
80	3.1	1.50	2.5	2.31	1.43	
Front	60	2.3	1.48	2.1	2.4	1.40
	40	1.76	1.46	3.1	2.21	1.15
	20	1.7	1.81	3.0	2.35	1.73
	F	1.45	2.36	3.0	2.20	1.90
Back	20	1.3	3.10	3.1	2.50	2.80
	40	1.83	3.61	3.4	2.65	2.3
	60	2.1	3.88	3.7	2.95	1.97
	80	2.32	4.1	4.3	2.83	1.18
	100	2.57	4.25	4.8	2.9	1.63
	120	3.4	3.85	5.5	2.45	1.38
	140	4.1	3.1	6.7	1.92	0.97
	160	3.9	2.55	7.4	1.85	1.02
180	3.4	2.76	6.4	1.71	0.97	
200	3.3	3.0	5.9	1.5	1.03	

One Degree Below Lamp Level & Two Degrees Left of Reference Point

X	Z = 0				Y = 0				
	Y=+140	Y=+70	Y=-70	Y=-140	Z=+140	Z=+70	Z=-70	Z=-140	
Front	80	1.89	1.9	1.33	1.65	1.43	2.08	3.6	3.0
	60	1.92	2.3	1.57	1.60	1.65	1.84	4.1	2.80
	40	2.00	2.15	1.63	1.8	1.50	1.32	3.1	2.85
	20	2.30	2.38	1.70	2.18	1.70	1.28	3.5	2.65
	F	2.5	2.40	2.1	2.53	1.74	1.22	2.87	2.30
Back	20	2.56	2.46	2.38	2.80	1.94	1.15	2.55	2.55
	40	2.43	2.76	3.2	3.60	2.05	1.35	2.24	3.1
	60	2.1	2.90	3.9	3.80	2.10	1.10	2.03	3.6
	80	1.8	3.30	4.35	4.5	2.16	1.88	2.20	4.6
	100	1.66	3.00	4.6	5.3	2.35	2.10	1.50	4.9
	120	1.13	2.3	5.1	5.1	2.1	2.65	2.33	5.2
	140	0.95	2.2	4.5	5.0	2.21	2.5	2.55	4.5
	160	0.86	1.88	3.7	4.8	2.16	3.1	2.63	4.0
	180	0.79	1.71	3.5	4.6	2.33	2.77	2.50	4.3
	200	0.73	1.59	3.3	4.5	2.78	3.1	2.50	3.1



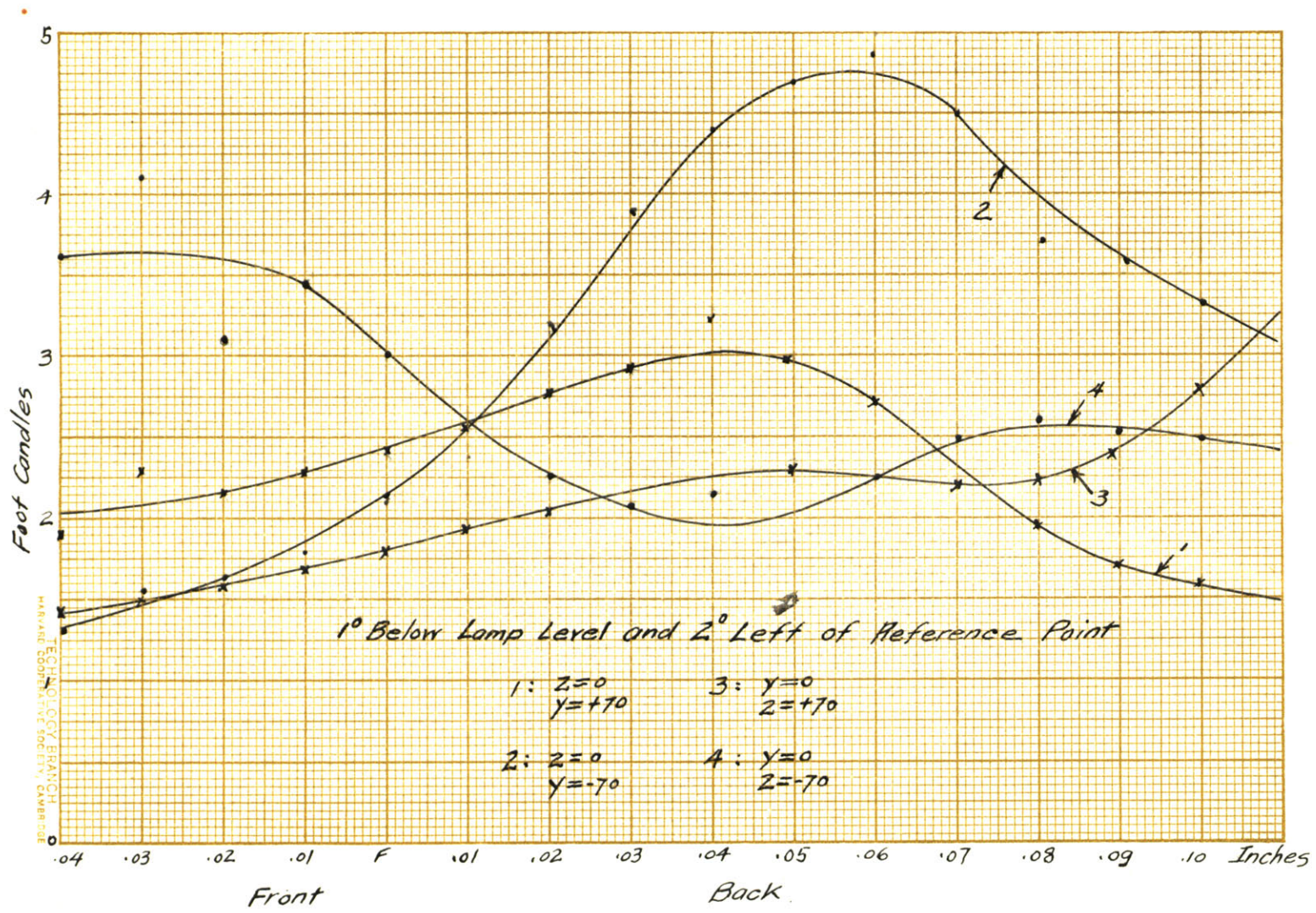

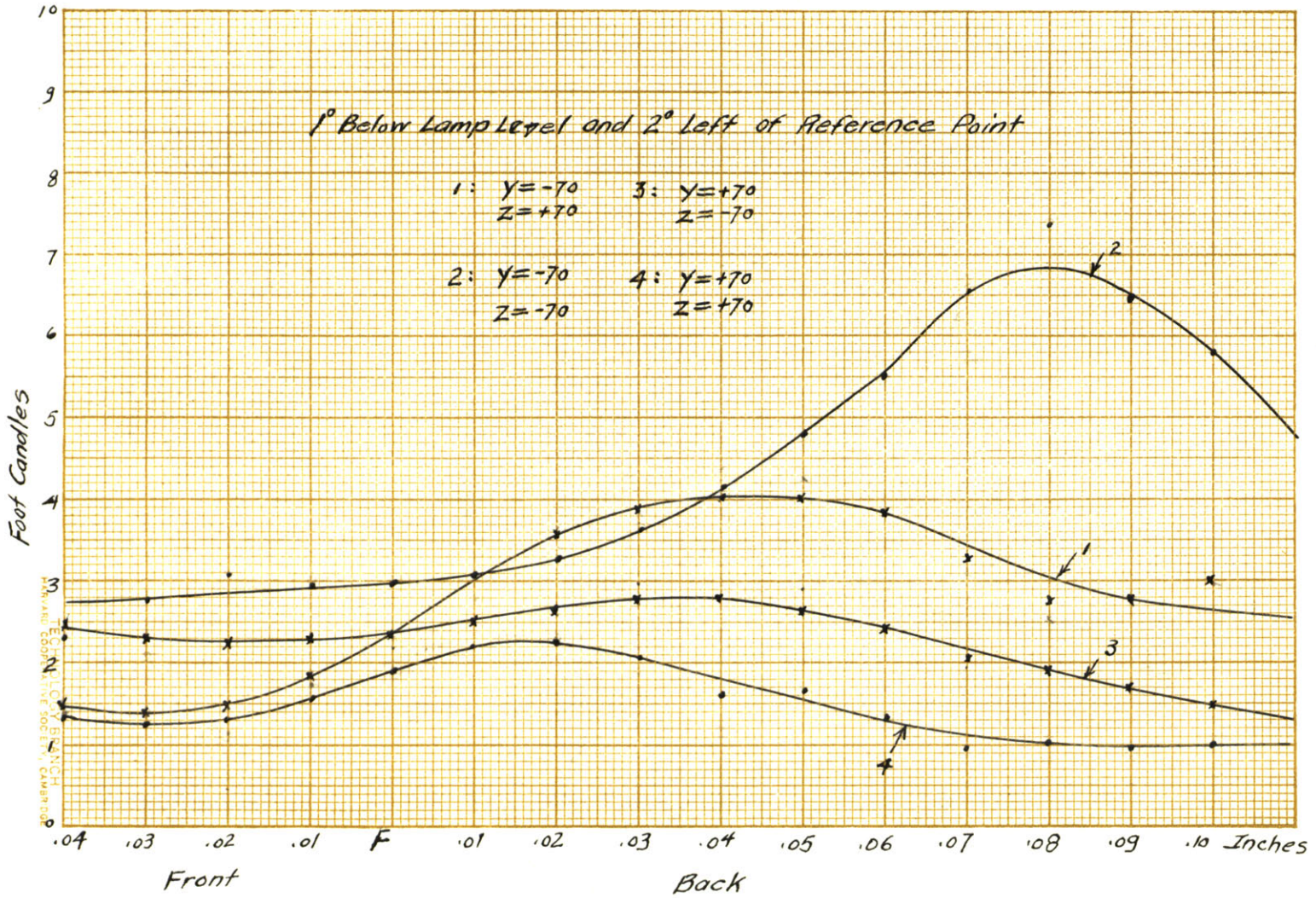

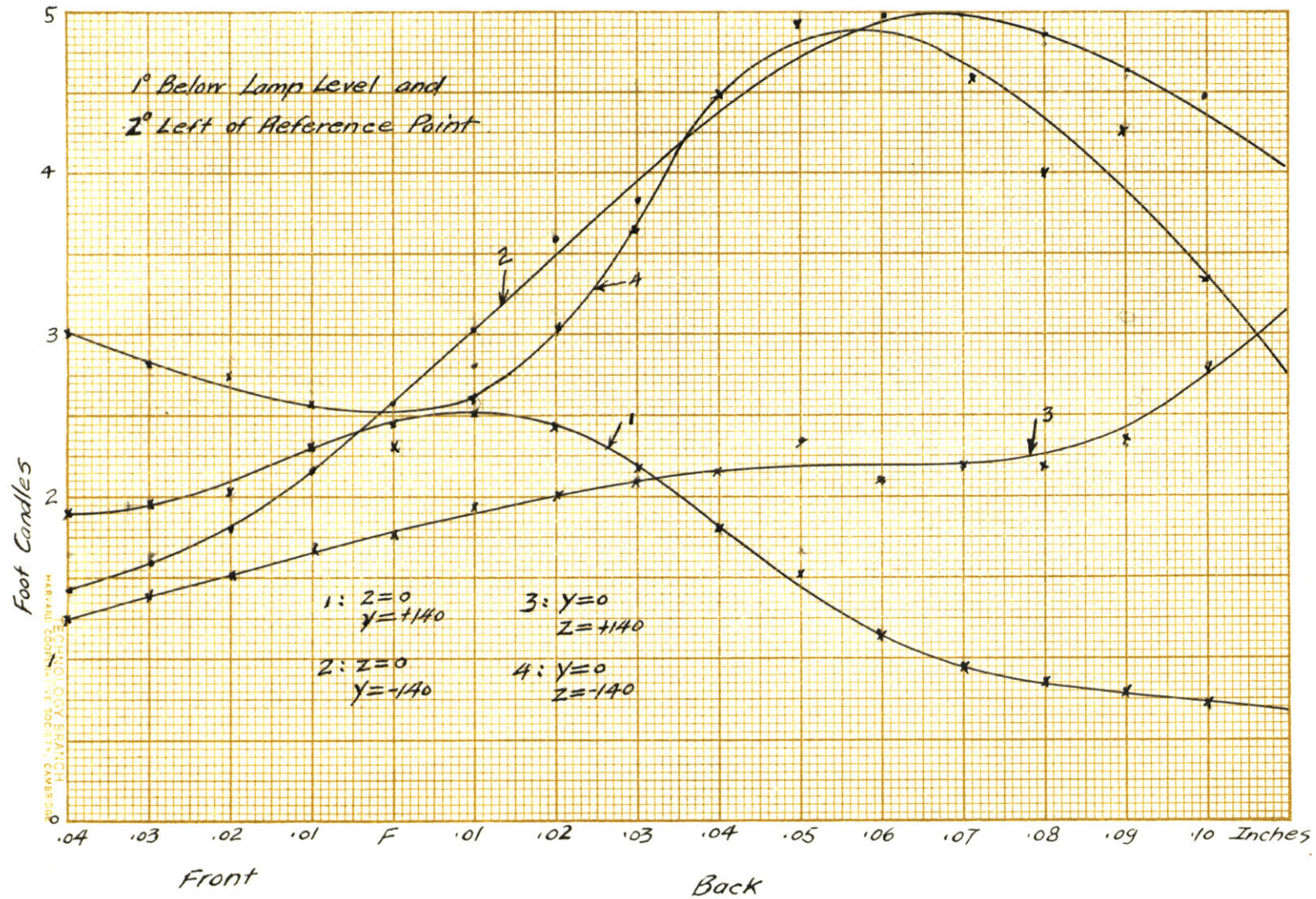

One Degree Below Lamp Level & Two Degrees Right of Reference Point

X	Y = 0 Z = 0	Y=-70 Z=+70	Y=-70 Z=-70	Y=+70 Z=-70	Y=+70 Z=+70
80	3.2	2.75	6.2	7.4	6.7
Front 60	3.6	2.80	7.6	9.0	6.2
40	3.4	2.60	8.8	11.0	5.6
20	2.5	2.34	10.0	12.0	4.9
F	2.6	2.17	8.5	12.0	4.1
20	3.1	2.05	8.9	12.1	4.1
40	3.6	1.91	10.0	12.6	4.4
60	5.0	2.12	8.9	16.1	5.3
80	5.0	2.11	7.0	15.0	4.9
100	5.9	2.21	5.5	13.5	5.1
Back 120	6.4	2.63	3.8	14.5	5.0
140	5.6	2.63	4.30	13.6	5.6
160	5.7	2.80	5.70	14.5	5.5
180	6.2	3.00	4.30	14.0	6.0
200	6.8	3.10	4.90	12.2	6.1

One Degree Below Lamp Level & Two Degrees Right of Reference Point

X	Z = 0				Y = 0				
	Y = +140	Y = +70	Y = -70	Y = -140	Z = +140	Z = +70	Z = -70	Z = -140	
Front	80	6.6	6.4	3.7	3.4	1.70	2.75	9.8	14.3
	60	7.6	6.6	3.5	2.6	2.12	2.65	11.0	15.3
	40	9.2	8.2	3.1	2.95	2.14	2.4	15.7	14.5
	20	8.8	9.4	2.9	2.8	1.95	2.4	14.7	15.5
	F	8.4	10.5	2.8	2.2	2.86	2.14	14.0	17.5
Back	20	8.6	10.0	2.24	1.86	1.70	1.74	13.7	17.0
	40	8.4	10.5	1.92	2.38	1.63	1.67	12.4	17.0
	60	10.0	9.6	2.25	2.38	1.63	2.10	15.0	14.7
	80	11.0	9.7	2.35	2.35	1.68	2.40	16.5	16.5
	100	7.4	9.6	2.5	2.20	1.76	2.95	15.0	15.0
	120	8.7	9.4	3.9	2.35	1.77	3.10	16.1	13.3
	140	7.0	9.0	4.2	2.50	1.98	3.20	16.3	13.5
	160	6.8	9.0	4.8	2.95	2.60	3.50	14.8	15.6
	180	6.4	9.1	5.2	2.31	2.60	4.20	16.2	13.0
	200	6.4	10.0	4.3	2.35	2.66	4.40	14.5	12.1

140

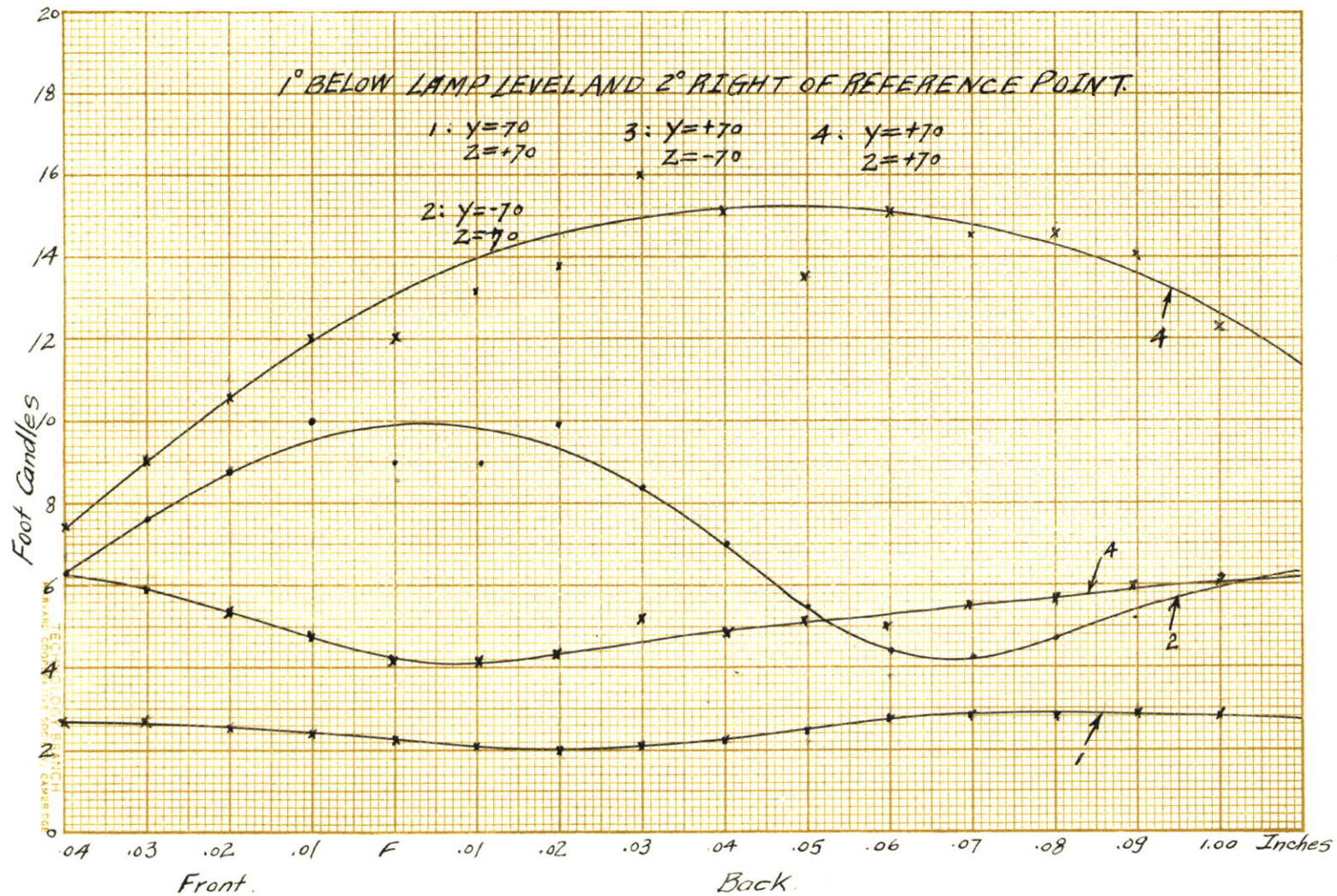

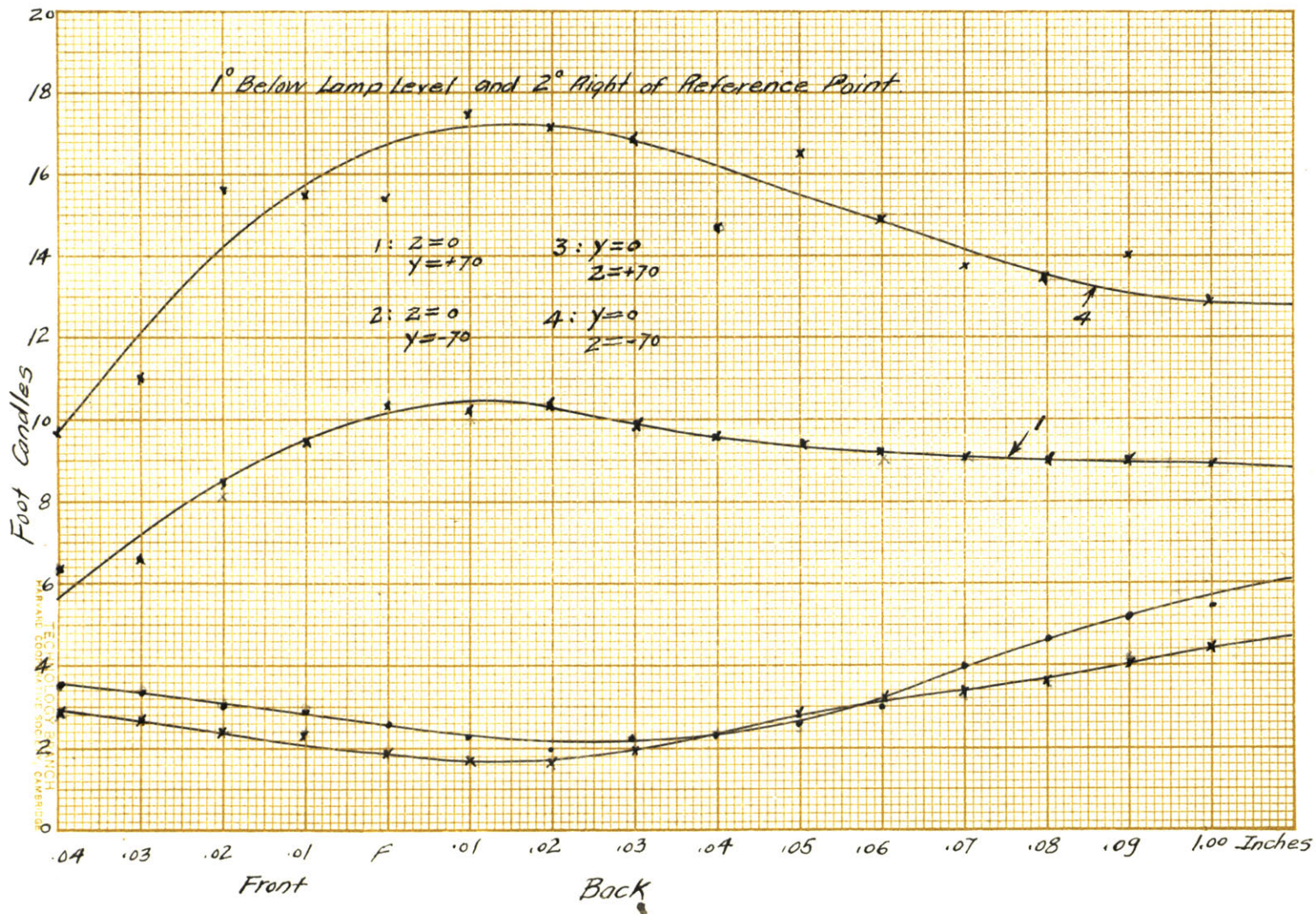

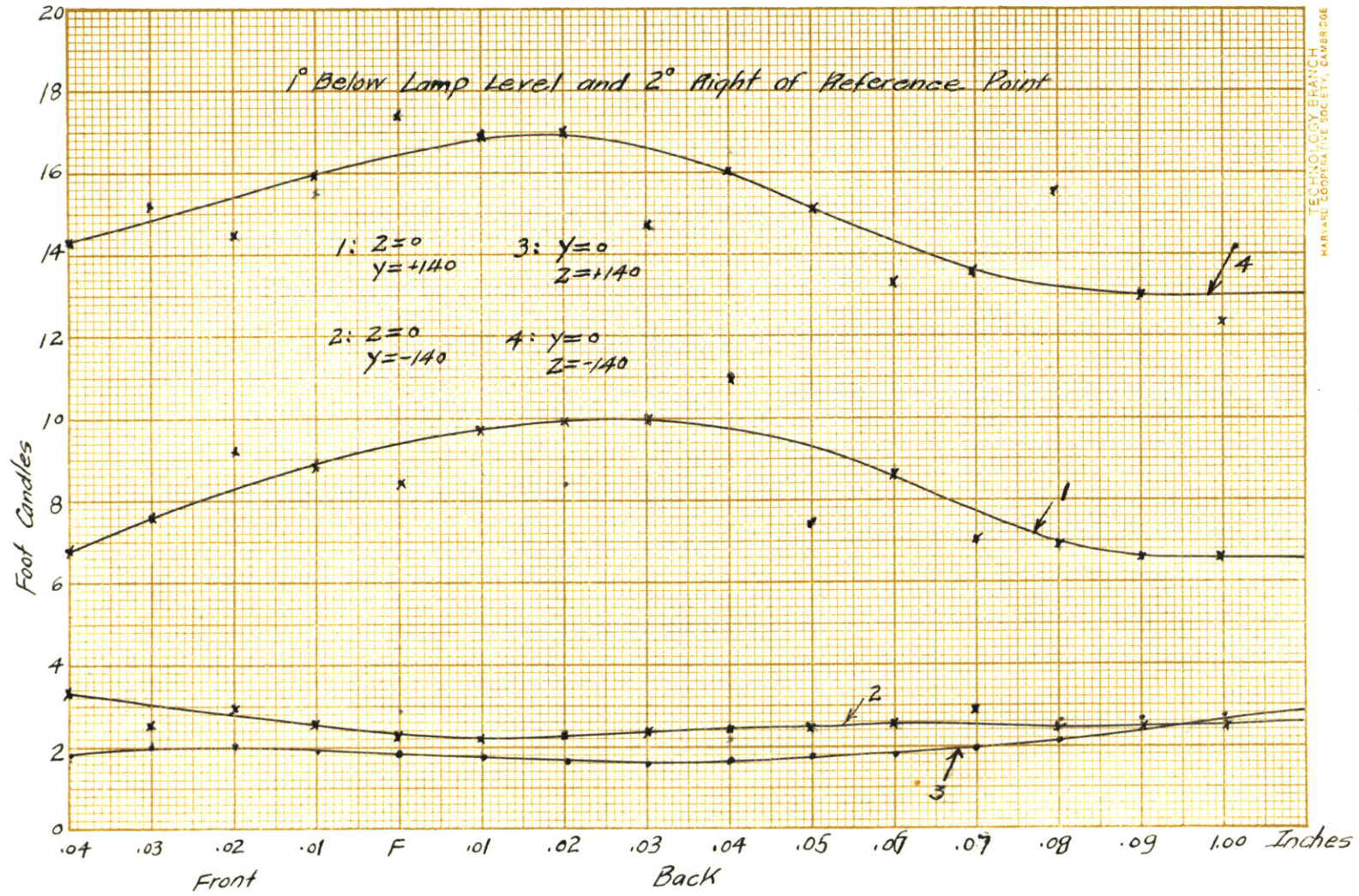

TECHNOLOGY BRANCH  
HARVARD COOPERATIVE SOCIETY, CAMBRIDGE



One Degree Below Lamp Level & Four Degrees Left of Reference Point

X	Y = 0 Z = 0	Y = -70 Z = +70	Y = -70 Z = -70	Y = +70 Z = -70	Y = +70 Z = +70	
80	2.10	1.78	2.55	2.23	1.79	
Front	60	2.00	2.06	2.74	2.18	2.04
	40	2.14	2.23	2.98	2.45	2.18
	20	2.28	2.24	2.65	2.70	2.00
	F	2.00	2.43	2.65	2.70	2.48
20	1.54	2.35	2.72	2.33	2.51	
40	1.06	2.65	2.81	2.43	2.15	
60	0.91	2.68	3.10	2.31	1.81	
80	0.81	2.95	2.97	2.33	1.53	
100	0.72	2.80	3.15	2.02	1.21	
Back	120	0.55	2.25	2.30	1.66	0.79
	140	0.36	1.72	1.80	1.17	0.46
	160	0.20	1.11	1.53	0.87	0.38
	180	0.16	0.95	1.33	0.64	0.31
	200	0.18	0.80	1.18	0.47	0.29

One Degree Below Lamp Level & Four Degrees Left of Reference Point

X	Z = 0				Y = 0				
	Y = +140	Y = +70	Y = -70	Y = -140	Z = +140	Z = +70	Z = -70	Z = -140	
Front	80	1.79	2.0	1.69	1.96	1.70	2.31	2.06	2.14
	60	1.90	1.84	1.65	2.03	1.75	2.20	2.35	2.15
	40	2.00	1.69	1.69	2.04	1.86	1.83	2.36	2.80
	20	1.82	1.52	1.98	2.06	1.60	1.80	2.56	2.45
	F	1.70	1.90	2.07	2.20	1.44	1.65	1.89	2.90
Back	20	1.85	1.80	2.30	2.43	0.98	1.20	1.80	2.54
	40	1.65	1.72	2.35	2.68	0.66	0.78	1.60	1.97
	60	1.50	1.56	2.50	2.75	0.38	0.33	1.13	1.52
	80	0.98	1.52	2.66	3.08	0.31	0.23	1.10	1.22
	100	0.69	1.48	2.72	3.20	0.16	0.17	0.98	0.95
	120	0.39	1.10	2.57	3.10	0.12	0.13	0.81	0.62
	140	0.33	0.81	2.06	2.76	0.92	0.11	0.45	0.44
	160	0.27	0.64	1.51	2.35	0.90	0.10	0.40	0.39
	180	0.25	0.47	1.33	1.97	0.86	0.10	0.23	0.29
	200	0.16	0.36	1.21	1.72	0.83	0.12	0.14	0.19

145

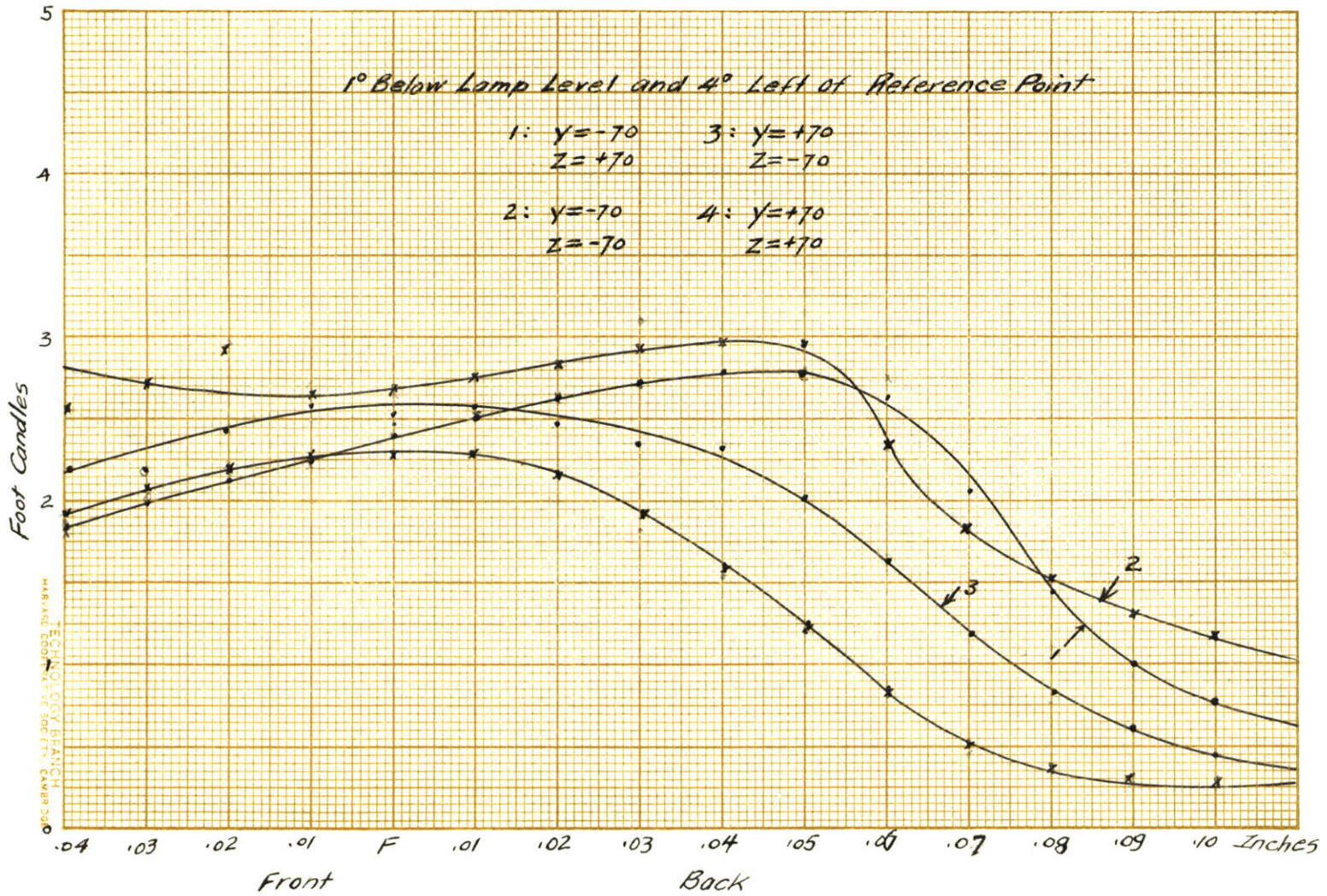



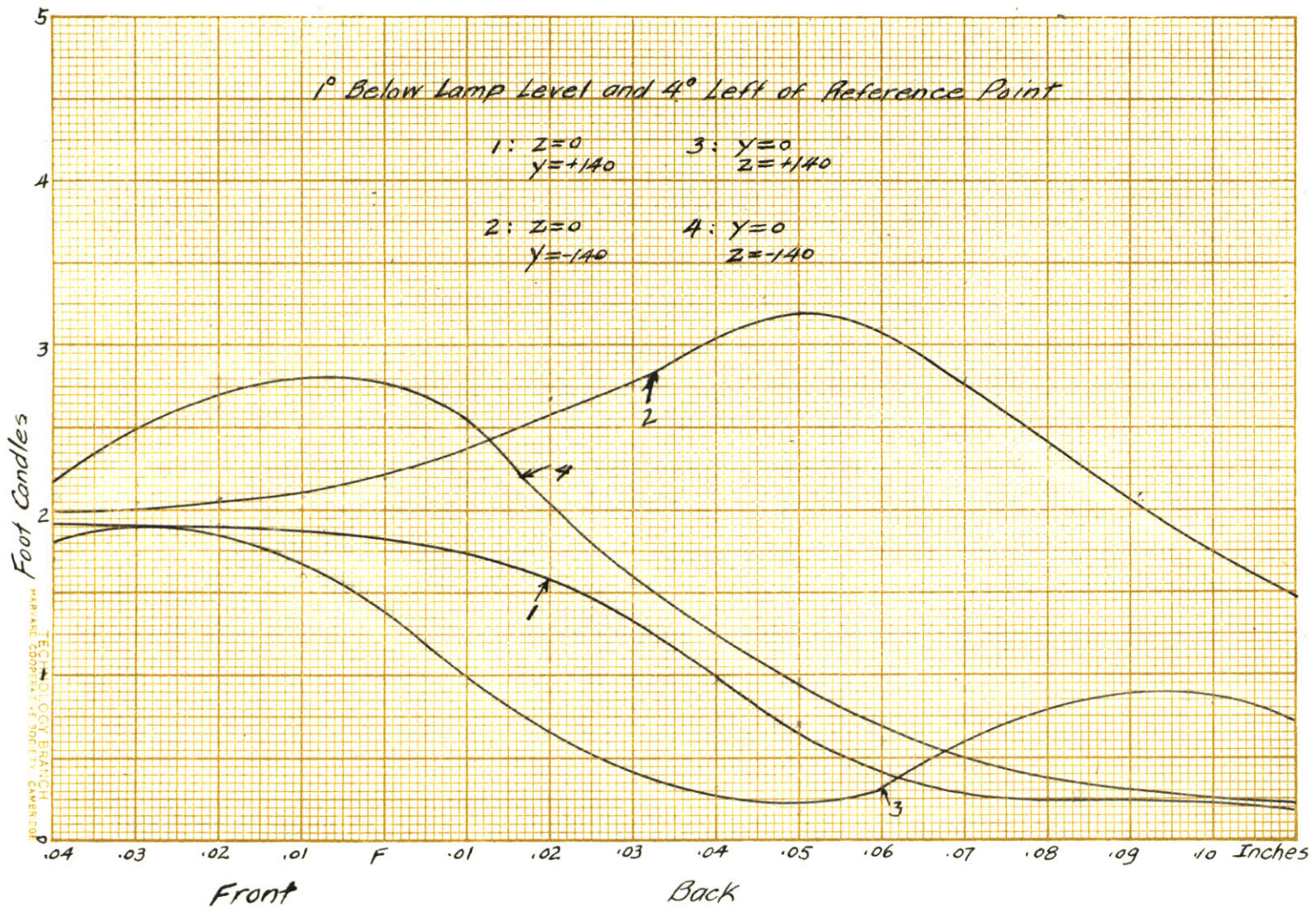

One Degree Below Lamp Level & Four Degrees Right of Reference Point

X	Y = 0 Z = 0	Y = -70 Z = +70	Y = -70 Z = -70	Y = +70 Z = -70	Y = +70 Z = +70	
80	1.78	0.58	1.9	4.6	1.54	
Front	60	1.62	0.46	2.05	4.30	1.44
	40	1.75	0.52	1.03	2.70	1.28
	20	1.62	0.41	1.03	2.70	1.28
	F	1.48	0.39	0.86	1.90	1.14
Back	20	1.48	0.395	0.64-	2.10	1.04
	40	1.42	0.38	0.54	2.34	0.90
	60	1.25	0.37	0.42	2.15	0.88
	80	1.06	0.39	0.30	1.72	0.62
	100	0.83	0.32	0.25	1.36	0.54
	120	0.86	0.275	0.24	1.42	0.53
	140	0.72	0.285	0.25	1.66	0.50
	160	0.74	0.28	0.22	1.60	0.56
180	0.68	0.265	0.215	1.10	0.70	
200	0.69	0.30	0.22	1.74	0.82	

One Degree Below Lamp Level & Four Degrees Right of Reference Point

X	Z = 0				Y = 0				
	Y=+140	Y=+70	Y=-70	Y=-140	Z=+140	Z=+70	Z=-70	Z=-140	
Front	80	2.5	2.23	1.10	0.91	0.98	1.30	3.50	2.45
	60	2.5	1.76	1.20	0.96	0.88	1.30	3.40	3.20
	40	2.2	1.76	0.92	0.83	0.78	1.55	4.25	2.70
	20	2.05	1.70	0.54	0.58	0.63	1.42	2.95	2.35
	F	1.90	1.40	0.32	0.44	0.45	1.26	2.06	2.15
Back	20	1.94	1.35	0.31	0.38	0.33	1.06	1.87	2.38
	40	1.88	1.35	0.28	0.44	0.31	0.89	1.92	1.93
	60	2.15	1.28	0.27	0.36	0.31	0.96	2.00	1.62
	80	0.36	0.89	0.22	0.36	0.30	0.68	1.60	1.68
	100	1.68	0.66	0.24	0.36	0.29	0.43	1.25	1.60
	120	1.66	0.62	0.23	0.32	0.29	0.40	1.20	1.86
	140	1.62	0.70	0.24	0.28	0.30	0.45	1.12	1.40
	160	2.00	0.78	0.21	0.25	0.36	0.51	1.40	1.04
	180	2.15	0.47	0.22	0.24	0.50	0.55	0.86	1.40
	200	2.40	0.72	0.26	0.25	0.62	0.68	1.08	1.46

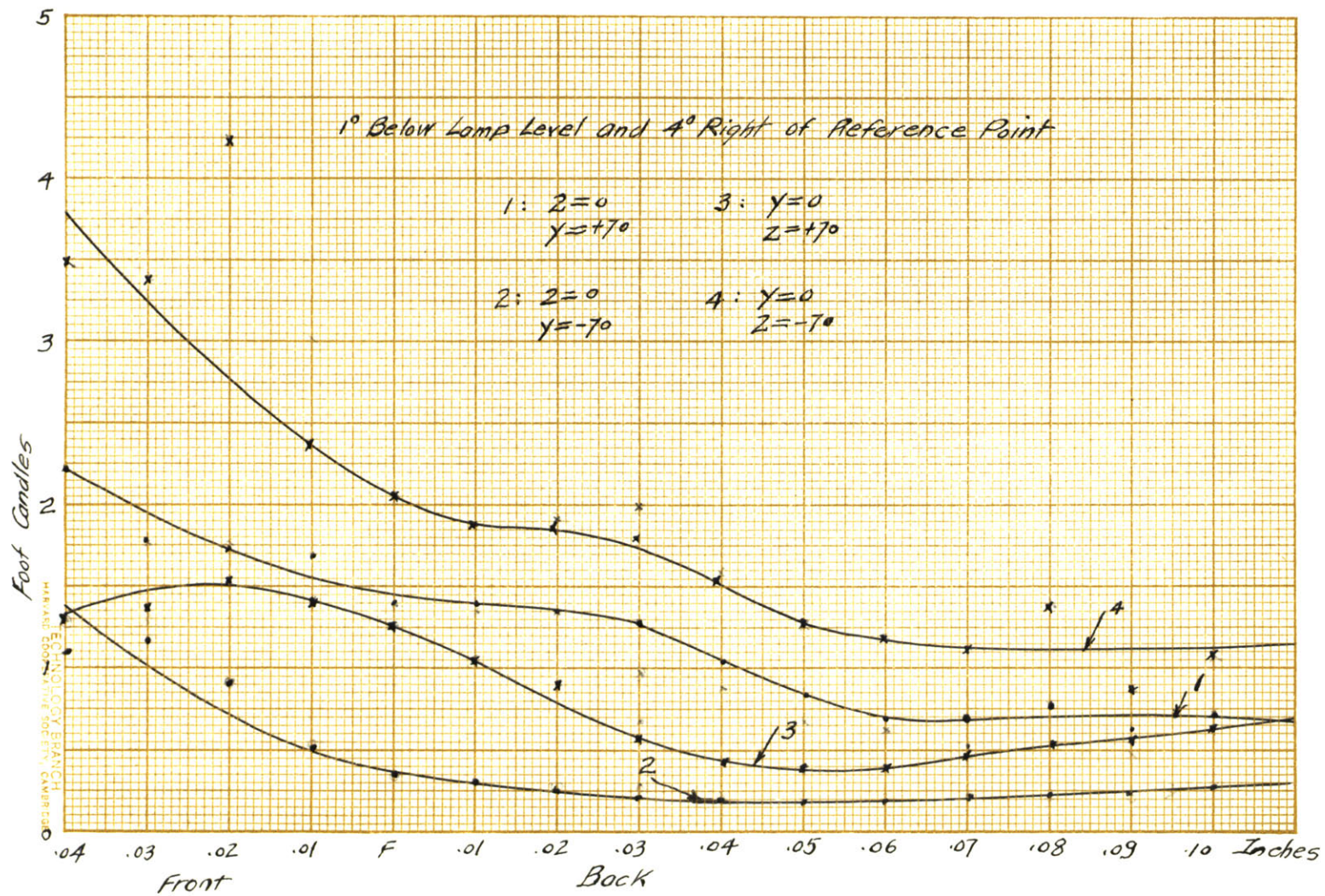



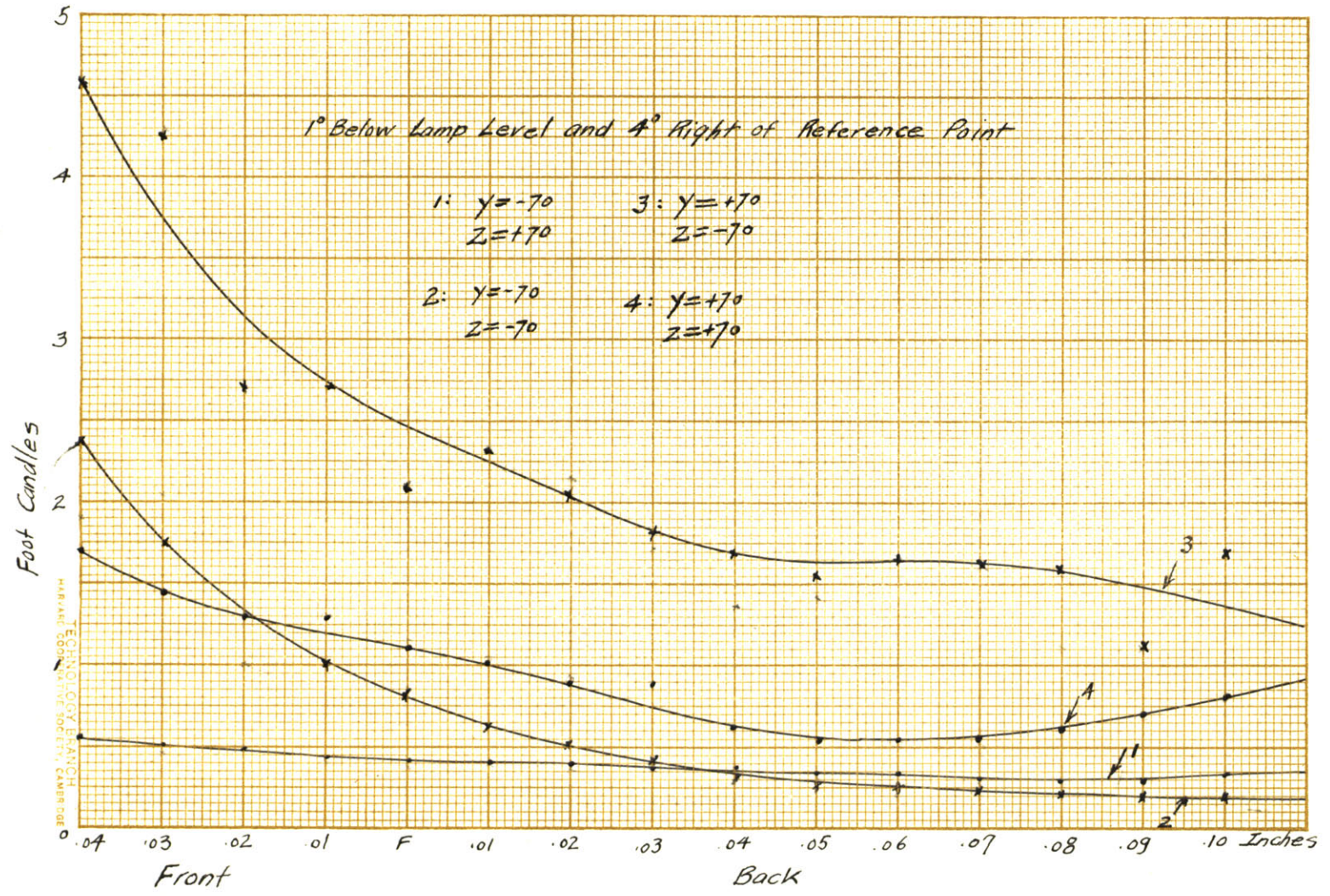

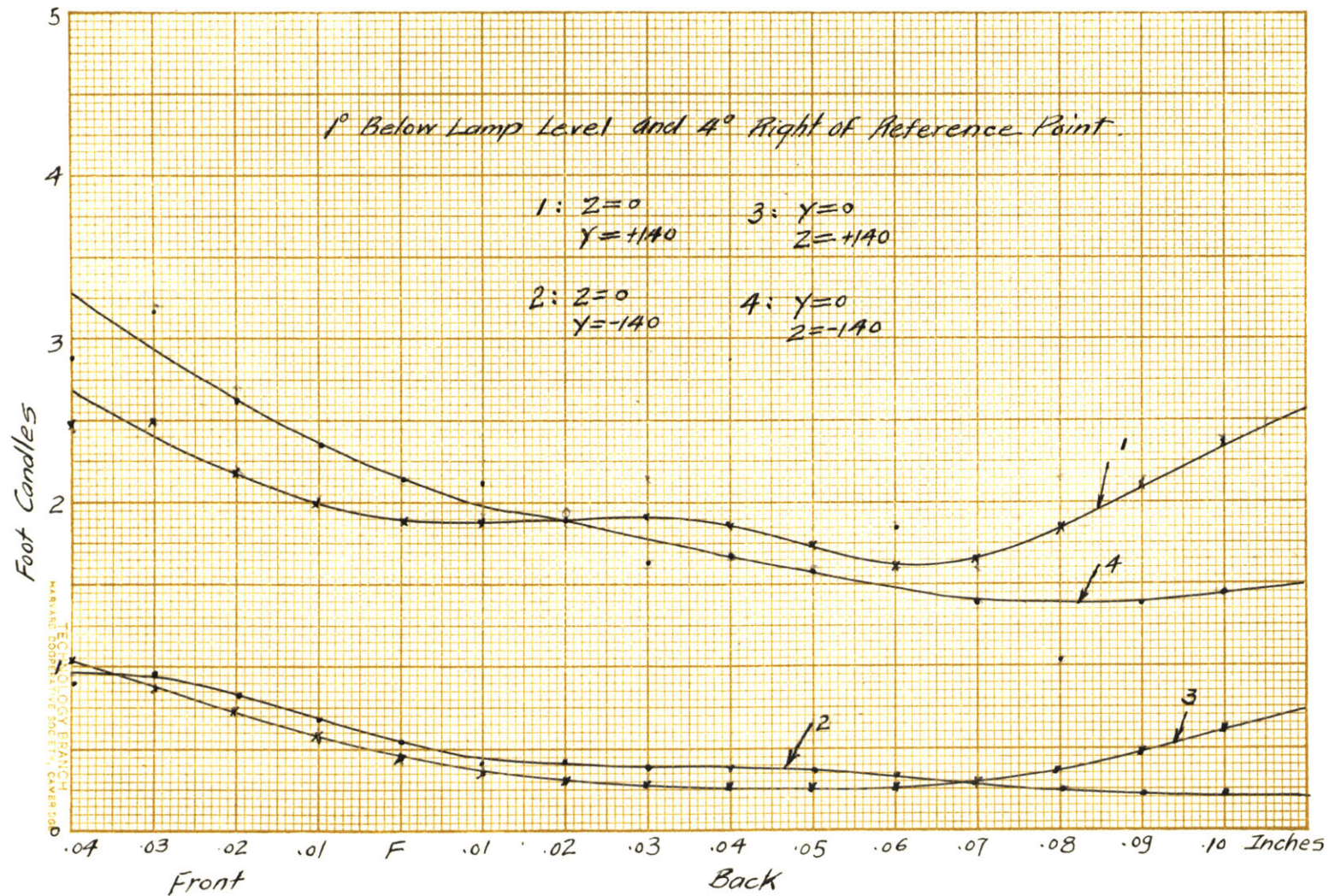

With Lens, 1 Degree Above Lamp Level & At Reference Point

X	Y= 0	Y=-70	Y=-70	Y=+70	Y=+70
	Z= 0	Z=+70	Z=-70	Z=-70	Z=+70
80	.68	.26	.60	1.20	.50
60	.60	.25	.51	1.50	.42
40	.56	.25	.44	1.4	.42
20	.48	.25	.39	1.24	.35
F	.42	.25	.38	1.16	.35
20	.40	.23	.35	1.00	.32
40	.39	.22	.38	0.85	.31
60	.34	.22	.36	.80	.31
80	.34	.22	.44	0.63	.31
100	.34	.25	.44	0.57	.31
120	.35	.26	.51	0.56	.31
140	.35	.30	.51	0.56	.32
160	.36	.28	.57	0.62	.32
180	.36	.30	.60	0.64	.32
200	.43	.34	.59	0.68	.32

Front

Back

With Lens, 1 Degree Above Lamp Level & At Reference Point

X	Z = 0				Y = 0			
	Y = +140	Y = +70	Y = -70	Y = -140	Z = +140	Z = +70	Z = -70	Z = -140
80	.86	.94	.47	.30	.35	.49	.52	1.60
60	.76	.96	.42	.26	.33	.45	.67	1.40
40	.58	.76	.40	.24	.32	.42	.82	1.35
20	.50	.64	.36	.23	.27	.35	.92	1.30
F	.42	.58	.55	.23	.27	.33	1.21	1.10
20	.46	.54	.32	.26	.26	.32	1.37	1.02
40	.40	.48	.32	.26	.28	.29	1.23	1.10
60	.44	.35	.32	.31	.27	.29	1.23	1.00
80	.39	.38	.32	.32	.25	.26	1.25	0.88
100	.37	.42	.29	.34	.24	.28	1.13	0.86
120	.33	.39	.33	.35	.24	.32	1.06	0.78
140	.33	.39	.36	.37	.25	.32	0.97	0.82
160	.39	.38	.39	.39	.27	.33	0.81	0.80
180	.43	.40	.38	.38	.25	.35	0.78	0.90
200	.46	.48	.43	.43	.27	.34	0.64	0.96

Front

Back

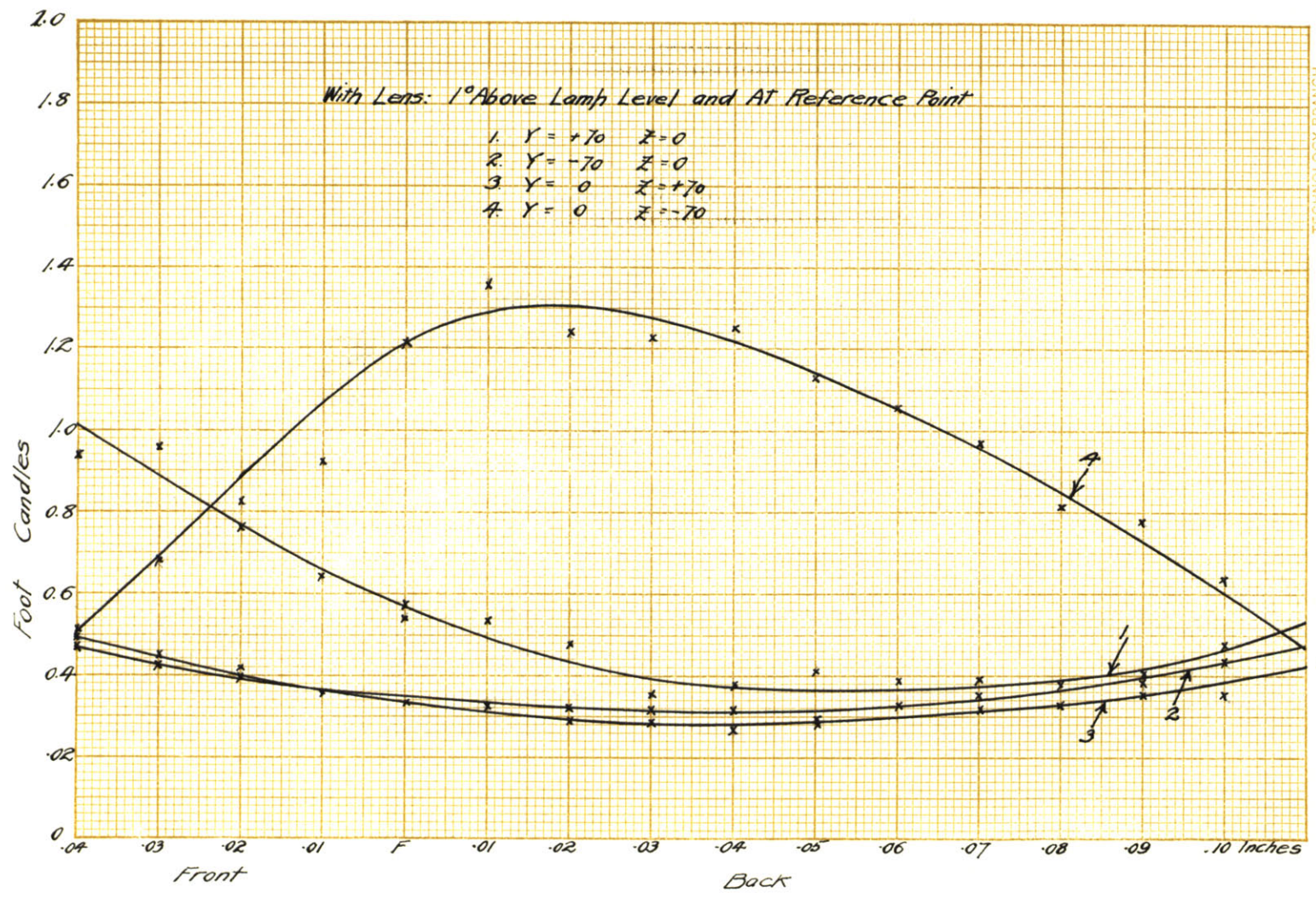



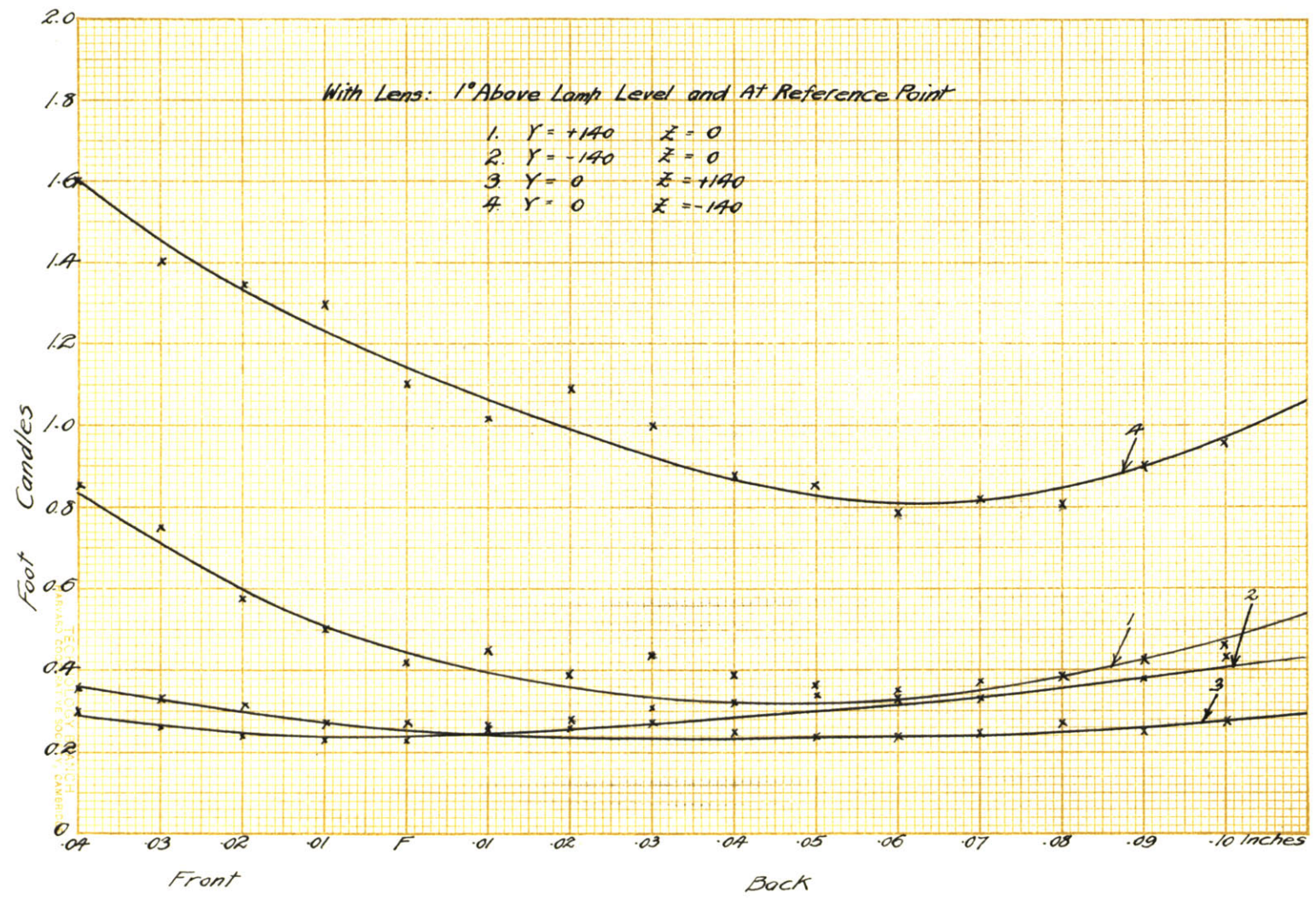

With Lens, 1 Degree Above Lamp Level & 4 Degrees Left of Ref. Point

X	Y = 0	Y = -70	Y = -70	Y = +70	Y = +70	
	Z = 0	Z = +70	Z = -70	Z = -70	Z = +70	
Front	80	.10	.07	.12	.09	.06
	60	.12	.07	.12	.09	.07
	40	.12	.09	.13	.10	.08
	20	.12	.10	.14	.10	.07
	F	.12	.09	.15	.10	.07
Back	20	.13	.11	.17	.11	.09
	40	.13	.10	.16	.11	.08
	60	.14	.11	.15	.13	.09
	80	.14	.10	.17	.14	.08
	100	.14	.10	.16	.13	.09
	120	.16	.10	.20	.16	.10
	140	.18	.11	.22	.15	.10
	160	.17	.11	.24	.16	.11
	180	.18	.22	.22	.17	.14
	200	.19	.12	.28	.20	.14



With Lens, 1 Degree Above Lamp Level & 4 Degrees Left of Ref. Point

X	Z = 0				Y = 0				
	Y = +140	Y = +70	Y = -70	Y = -140	Z = +140	Z = +70	Z = -70	Z = -140	
Front	80	.14	.10	.08	.08	.06	.10	.10	.11
	60	.12	.10	.08	.10	.05	.11	.11	.11
	40	.13	.10	.09	.09	.06	.11	.12	.11
	20	.14	.10	.09	.09	.06	.10	.12	.12
	F	.13	.12	.10	.09	.06	.11	.14	.13
Back	20	.14	.13	.10	.09	.06	.13	.15	.14
	40	.12	.12	.12	.10	.07	.13	.14	.15
	60	.13	.11	.11	.10	.08	.16	.16	.14
	80	.14	.13	.12	.10	.07	.14	.17	.15
	100	.13	.14	.13	.11	.08	.14	.17	.16
	120	.15	.14	.14	.11	.09	.16	.18	.16
	140	.15	.15	.14	.13	.09	.17	.18	.18
	160	.17	.17	.15	.13	.11	.16	.18	.19
	180	.18	.15	.15	.16	.12	.18	.24	.19
	200	.22	.20	.15	.15	.14	.18	.22	.24

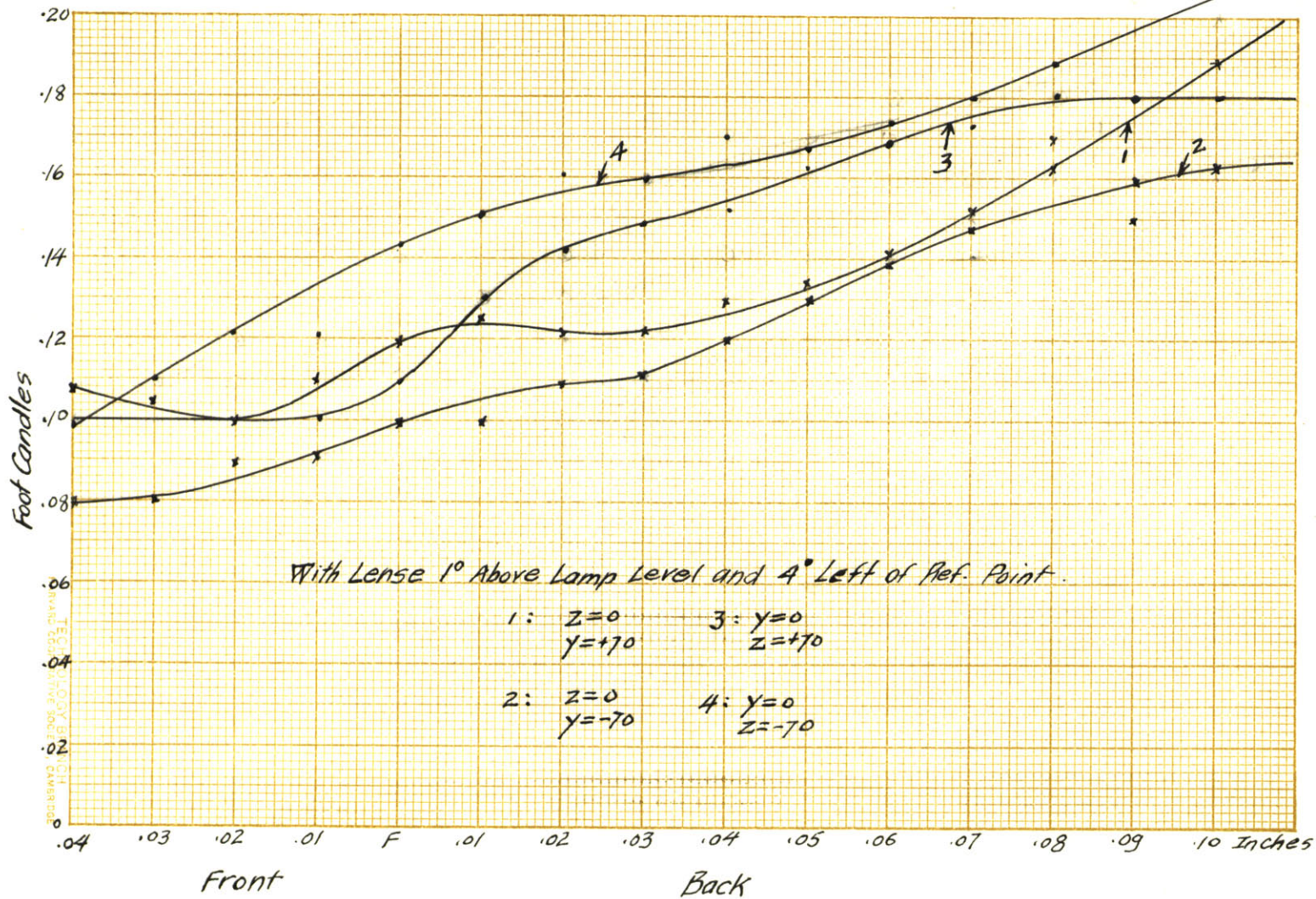

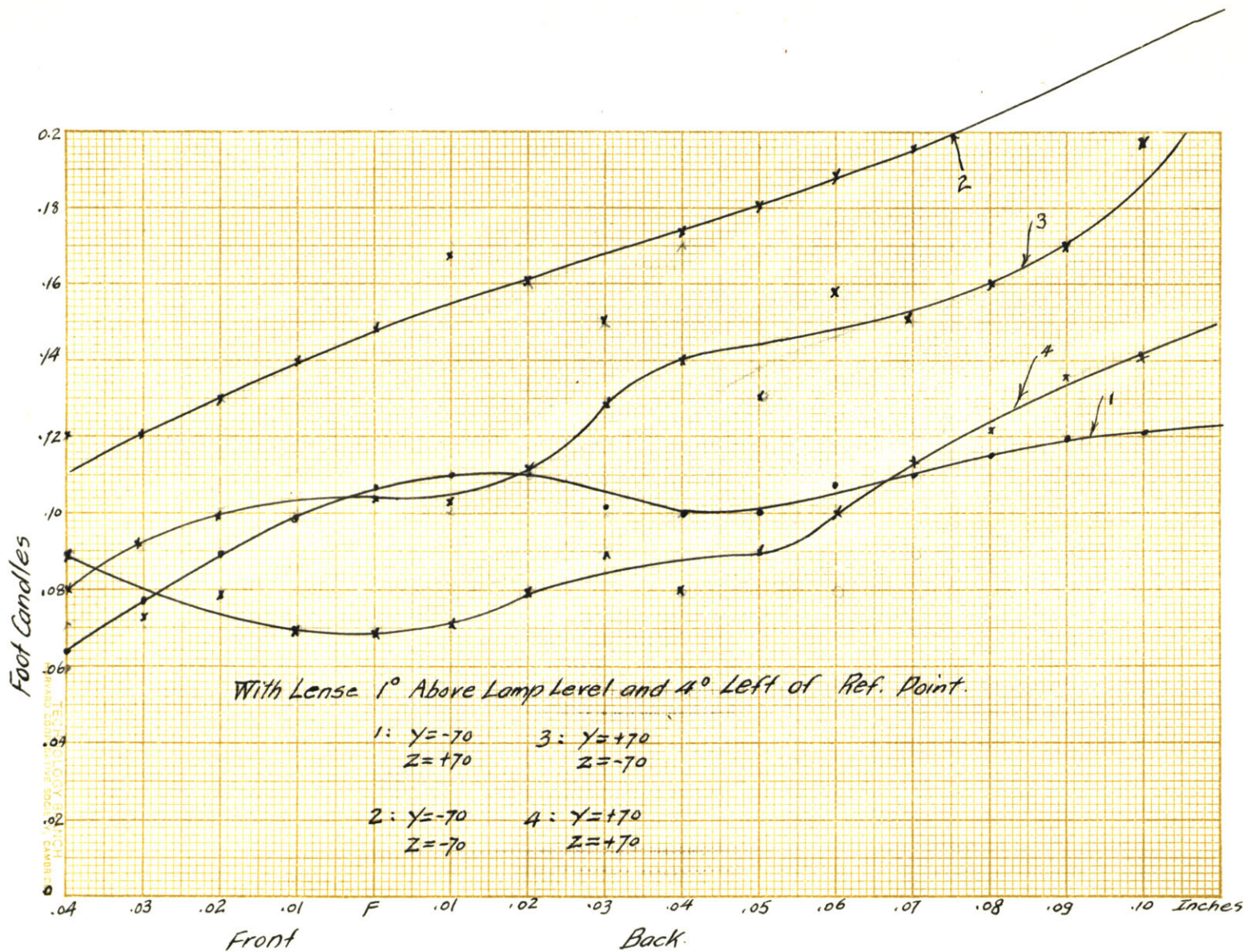

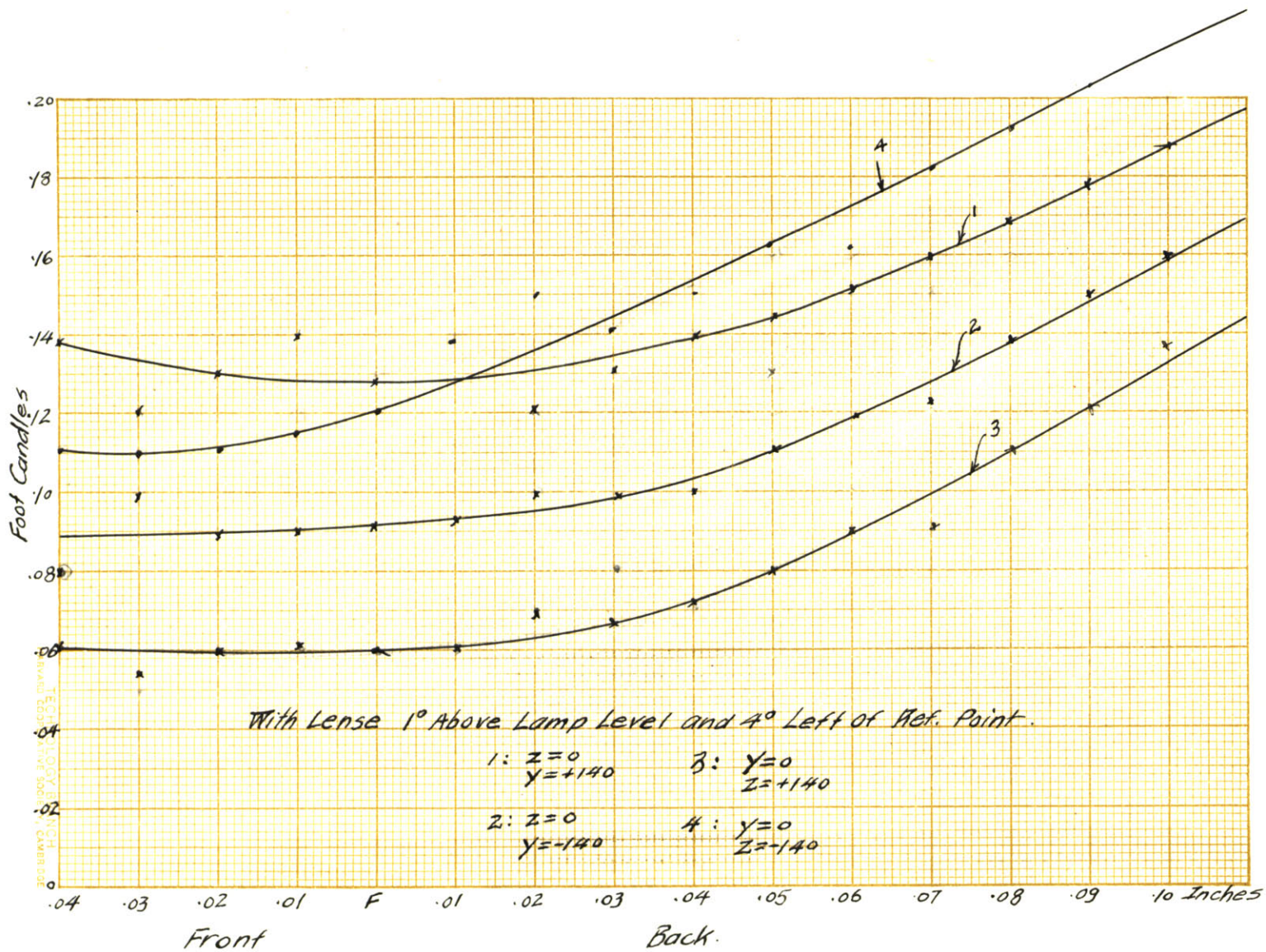

With Lens, 1 Degree Above Lamp Level & 4 Degrees Right of Ref. Point

X	Y=0 Z=0	Y=-70 Z=+70	Y=-70 Z=-70	Y=+70 Z=-70	Y=+70 Z=+70	
Front	80	.16	.11	.47	.40	.07
	60	.12	.12	.56	.40	.08
	40	.12	.11	.56	.35	.08
	20	.11	.11	.46	.35	.09
	F	.11	.12	.47	.32	.09
Back	20	.11	.13	.45	.25	.09
	40	.11	.13	.43	.22	.10
	60	.14	.13	.40	.22	.10
	80	.14	.15	.38	.23	.11
	100	.14	.14	.36	.18	.12
	120	.16	.16	.37	.17	.13
	140	.17	.18	.40	.16	.14
	160	.20	.20	.41	.15	.16
	180	.18	.19	.42	.15	.17
	200	.20	.19	.45	.15	.17

With Lens, 1 Degree Above Lamp Level & 4 Degrees Right of Ref. Point

X	Z 0	Y 70	Y -70	Y -140	Y 0	Z 70	Z -70	Z -140	
	Y 140				Z 140				
Front	80	.08	.08	.25	.36	.07	.09	.20	.22
	60	.07	.08	.23	.32	.07	.09	.19	.23
	40	.07	.08	.20	.32	.07	.09	.20	.26
	20	.08	.09	.17	.27	.07	.09	.17	.24
	F	.09	.10	.18	.24	.07	.09	.18	.26
Back	20	.09	.10	.17	.25	.09	.09	.20	.27
	40	.10	.11	.18	.25	.09	.12	.20	.29
	60	.11	.12	.16	.24	.10	.12	.22	.28
	80	.11	.13	.16	.23	.10	.13	.23	.26
	100	.12	.14	.18	.23	.11	.14	.23	.30
	120	.14	.14	.20	.22	.12	.14	.25	.34
	140	.16	.19	.20	.23	.12	.15	.29	.39
	160	.18	.18	.22	.24	.14	.18	.30	.40
	180	.20	.19	.23	.26	.15	.18	.28	.38
	200	.21	.18	.23	.29	.16	.17	.32	.48

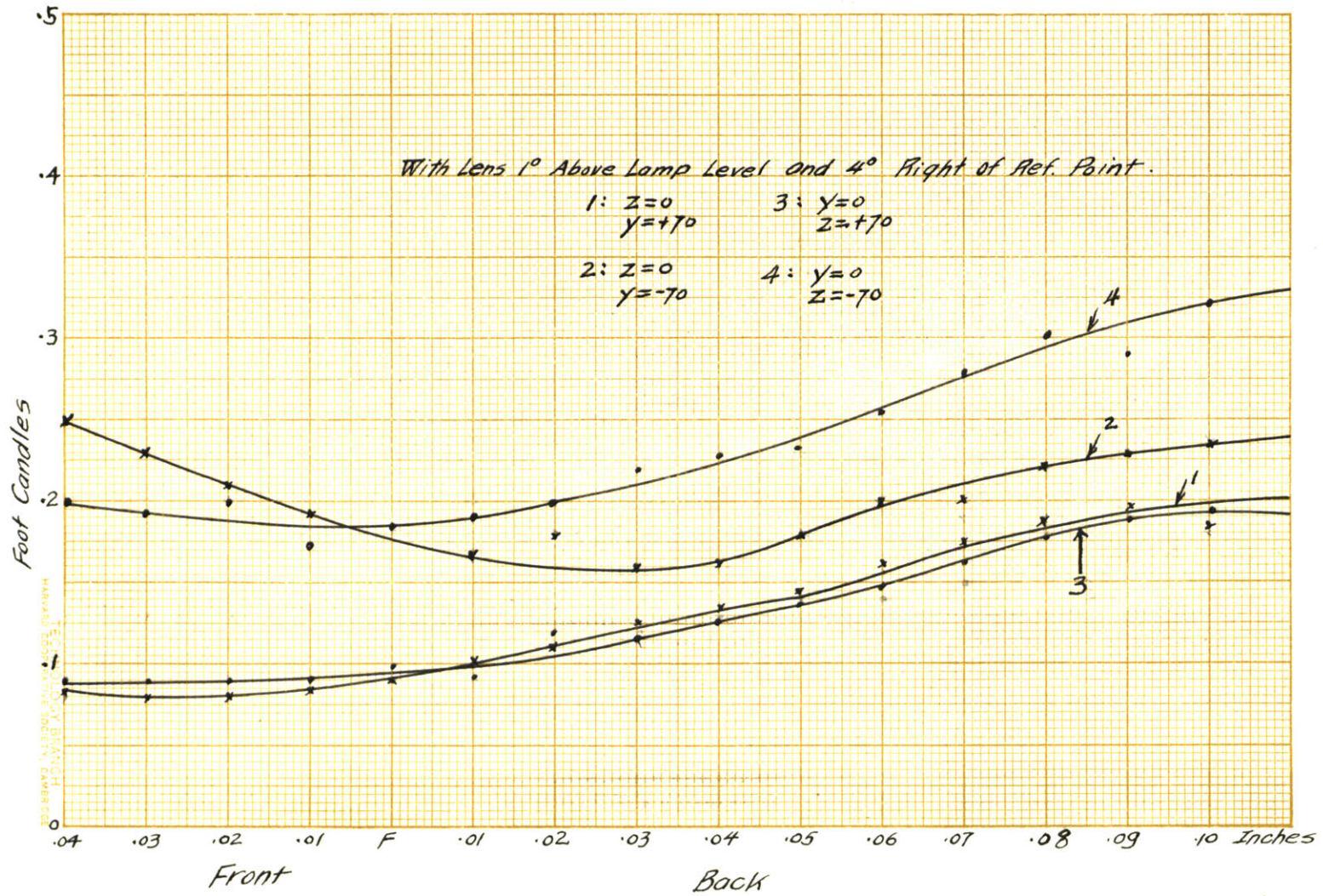

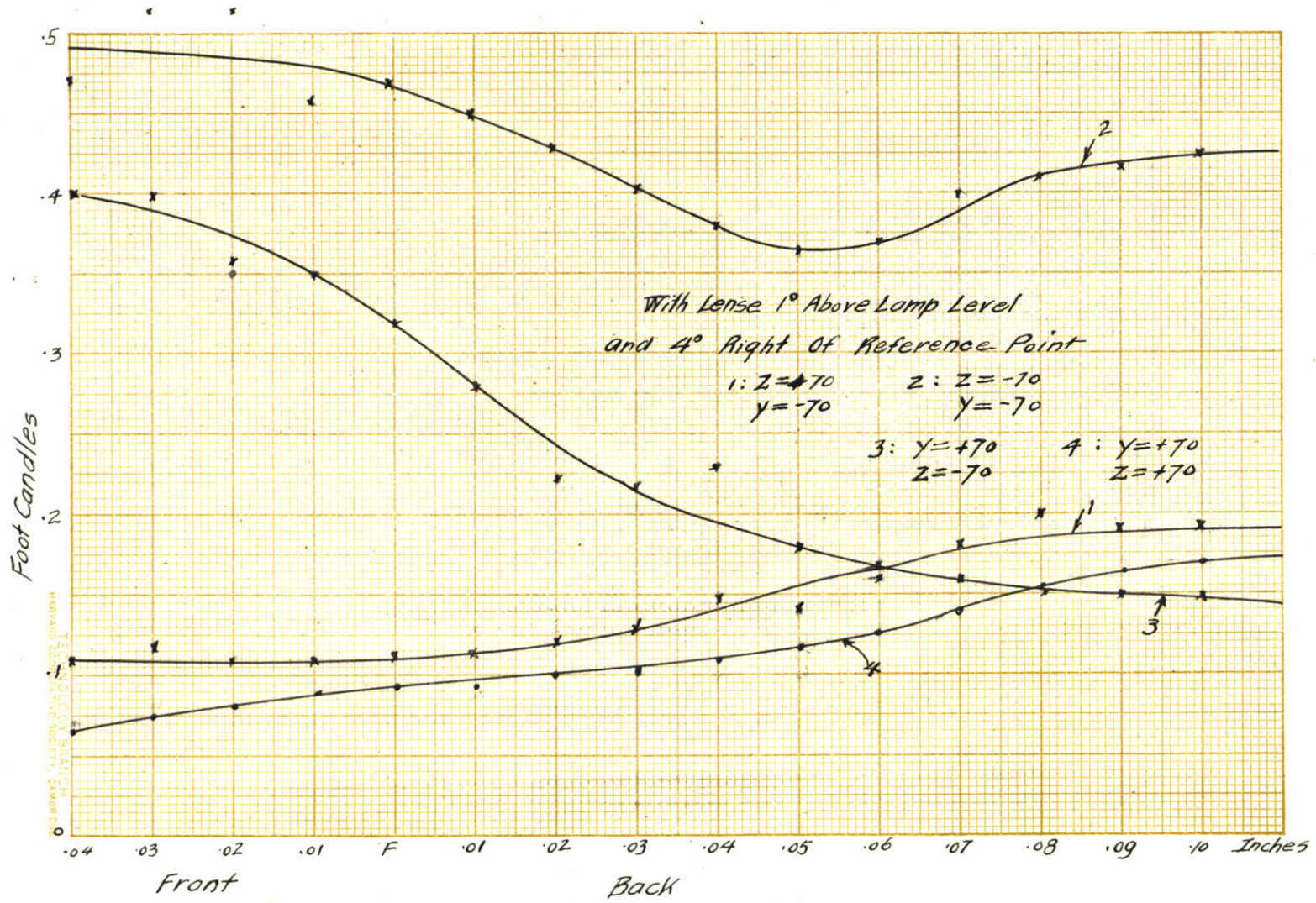



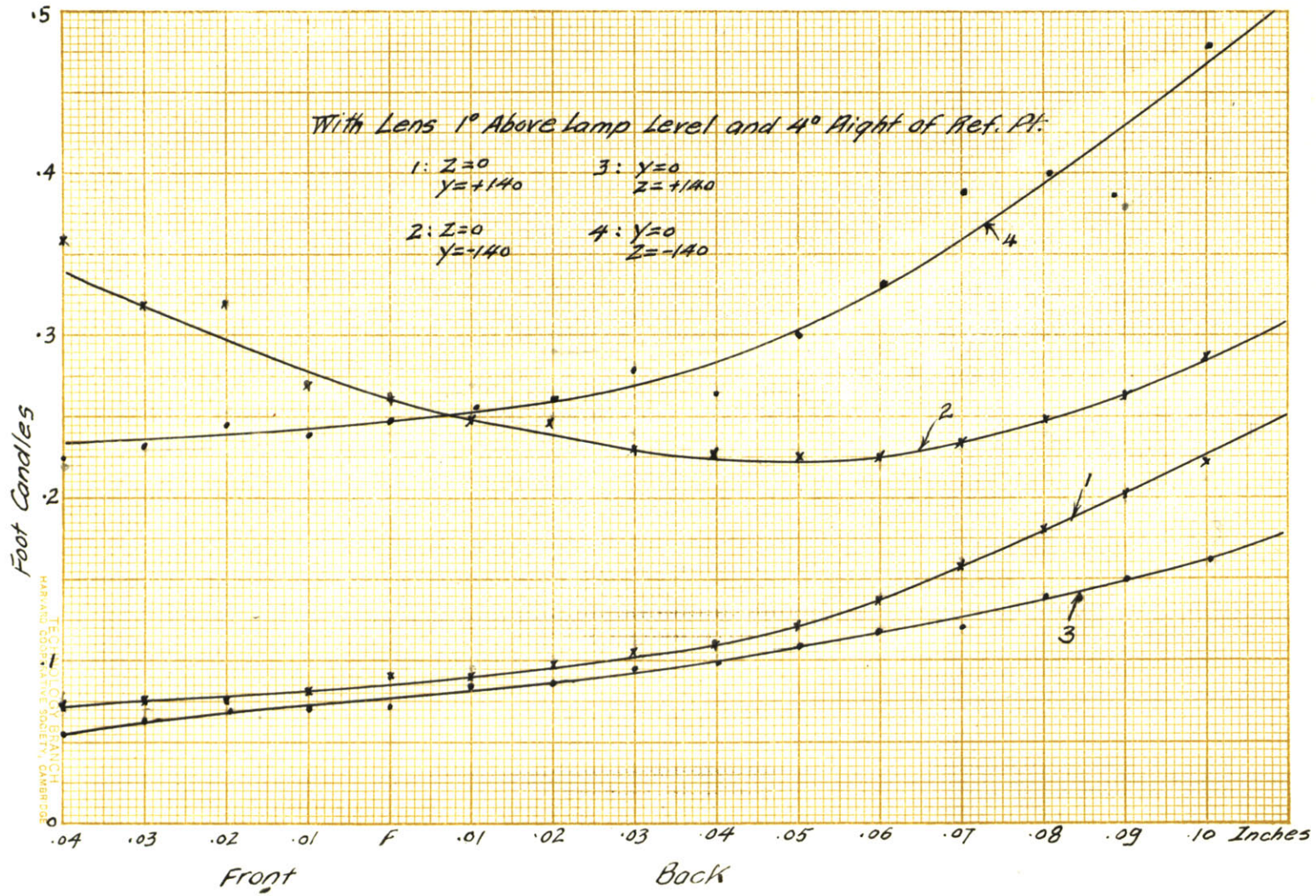

With Lens,  $1\frac{1}{4}$  Degrees Below Lamp Level & At Ref. POINT

X	Y= 0 Z= 0	Y=-70 Z=+70	Y=-70 Z=-70	Y=+70 Z=-70	Y=+70 Z=+70
80	3.4	1.2	3.5	6.8	5.0
60	3.2	1.2	3.3	5.8	4.6
40	3.0	1.0	3.0	4.9	3.7
20	2.9	1.0	2.8	4.7	3.2
F	2.3	0.9	2.9	4.5	2.7
20	2.0	0.9	2.7	4.3	2.1
40	1.7	0.9	2.1	4.1	2.0
60	1.5	0.9	3.3	4.2	1.6
80	1.5	0.9	2.2	3.8	1.5
100	1.0	1.1	2.1	3.6	1.5
120	1.0	1.2	1.8	3.3	1.4
140	1.0	1.3	1.8	3.3	1.3
160	1.1	1.4	1.8	3.7	1.3
180	1.2	1.4	1.8	3.7	1.4
200	1.1	1.8	1.7	3.7	1.3

Front

Back

With Lens,  $1\frac{1}{4}$  Degrees Below Lamp Level & At Reference Point

X	Z = 0				Y = 0				
	Y = +140	Y = +70	Y = -70	Y = -140	Z = +140	Z = +70	Z = -70	Z = -140	
Front	80	3.7	4.2	1.2	0.8	1.8	2.1	1.0	3.1
	60	3.3	3.6	1.2	0.8	1.6	2.0	3.3	3.4
	40	2.8	2.9	1.1	0.7	1.2	1.9	2.8	3.1
	20	2.4	2.3	1.0	0.7	1.1	1.5	2.5	3.0
	F	2.3	2.0	0.8	0.6	0.8	1.2	2.4	3.2
Back	20	2.1	1.7	0.8	0.7	0.7	1.1	2.3	2.2
	40	1.9	1.6	0.8	0.6	0.6	0.9	2.1	3.3
	60	1.8	1.6	0.7	0.7	0.6	0.9	2.2	3.0
	80	1.7	1.7	1.0	0.7	0.5	0.8	2.3	2.9
	100	1.5	1.7	1.1	0.8	0.5	0.7	2.3	3.0
	120	1.5	1.7	1.1	0.8	0.5	0.8	2.1	2.8
	140	1.4	1.5	1.1	0.7	0.7	0.8	2.0	1.4
	160	1.4	1.3	1.1	0.7	0.7	0.9	1.8	2.2
	180	1.3	1.3	1.2	0.8	0.7	1.0	1.8	2.1
	200	1.2	1.3	1.3	0.6	0.8	1.0	1.8	1.7

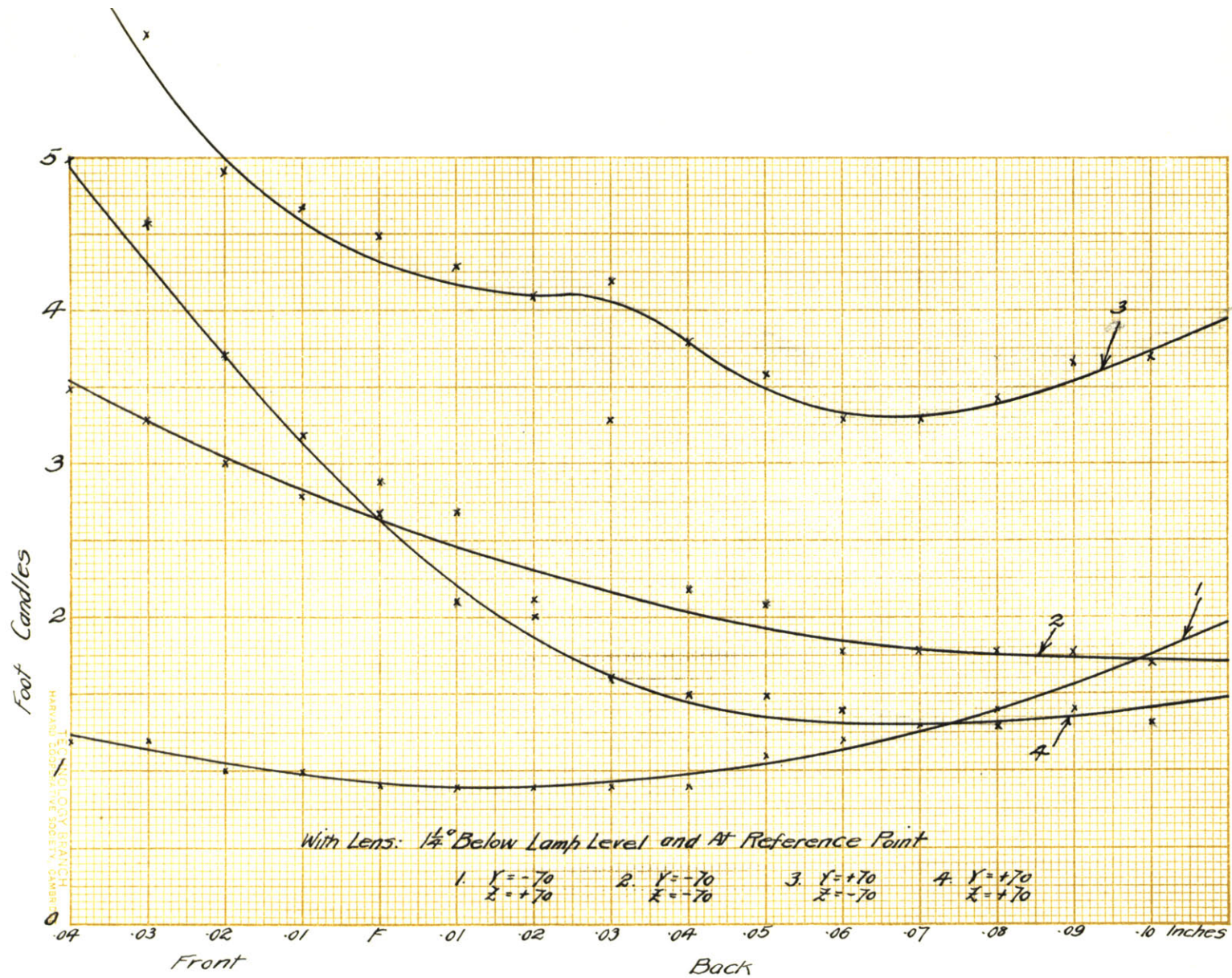

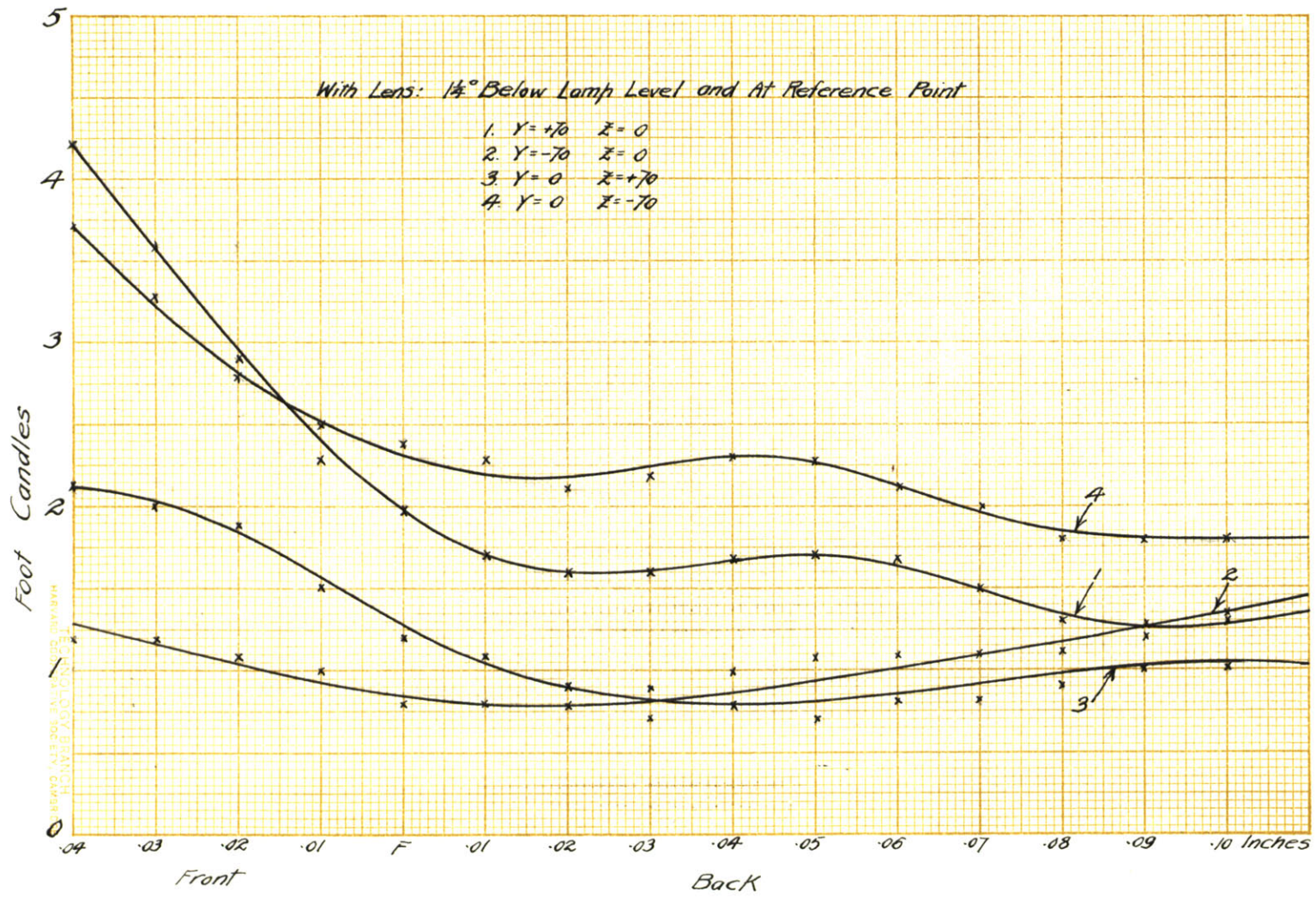

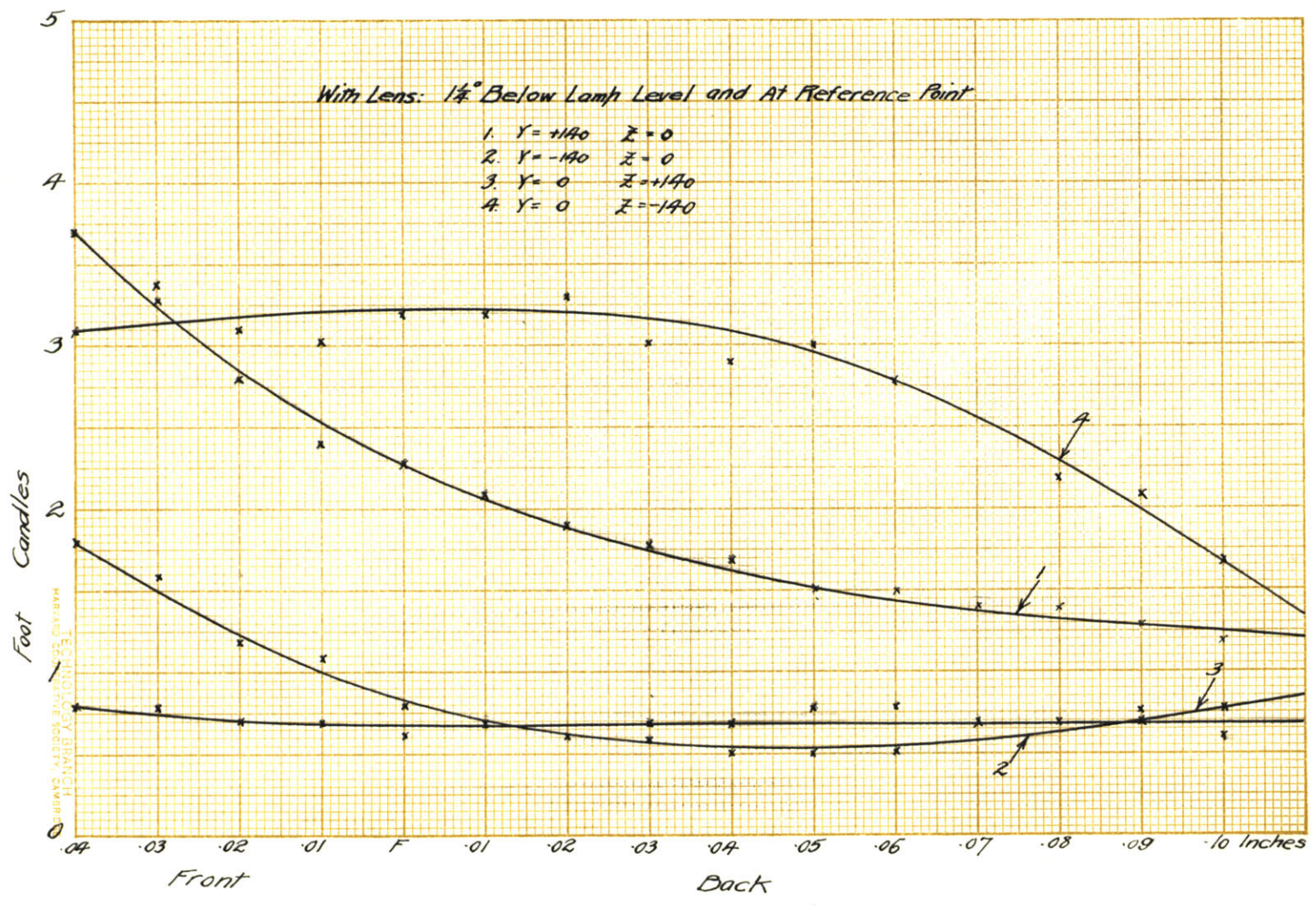

With Lens, One Degree & Half Down & Three Degrees Right of Reference Point

X	Y = 0 Z = 0	Y = -70 Z = +70	Y = -70 Z = -70	Y = +70 Z = -70	Y = +70 Z = +70
80	2.5	2.3	4.2	1.9	1.2
60	2.6	2.5	4.2	2.0	1.4
40	2.3	2.7	4.2	2.1	1.5
20	2.7	2.8	4.5	2.5	1.4
F	2.8	2.5	4.3	2.5	1.7
20	3.0	2.9	4.4	2.5	1.4
40	3.4	2.7	4.7	2.5	1.6
60	3.5	2.3	5.4	2.4	1.7
80	3.5	2.2	4.7	2.5	1.4
100	3.4	2.2	4.4	2.4	1.6
120	3.3	2.0	4.3	2.0	1.5
140	3.1	1.7	3.7	1.8	1.6
160	2.8	1.4	3.5	1.8	1.6
180	2.6	1.5	3.6	1.7	1.6
200	2.6	1.8	3.7	1.7	1.7

Front

Back

With Lens, One Degree & Half Down & Three Degrees Right of Reference Point

X	Z = 0				Y = 0				
	Y=+140	Y=+70	Y=-70	Y=-140	Z=+140	Z=+70	Z=-70	Z=-140	
Front	80	1.0	1.5	3.3	4.9	1.5	1.8	2.6	2.6
	60	1.3	1.7	3.8	5.6	1.3	1.9	2.9	2.5
	40	1.5	2.0	3.8	5.5	1.2	2.0	3.5	3.2
	20	1.4	2.3	4.1	5.2	1.2	2.2	3.6	3.2
	F	1.4	2.3	4.1	5.1	1.1	2.3	3.8	3.8
Back	20	1.5	2.4	4.5	5.1	1.2	2.5	4.0	4.1
	40	1.7	3.7	4.5	5.5	0.9	2.5	4.2	5.0
	60	2.0	3.2	4.0	5.3	0.9	2.2	4.1	4.8
	80	1.9	3.5	4.0	5.0	0.7	1.9,	4.4	4.4
	100	2.0	3.4	4.0	4.5	0.8	2.0	4.2	5.0
	120	2.0	3.5	4.1	4.8	1.0	2.3	4.4	4.5
	140	1.9	3.3	3.8	3.5	1.0	1.9	3.9	4.5
	160	1.7	3.1	3.1	3.9	1.0	1.7	3.8	4.8
	180	1.6	3.2	2.3	3.0	1.1	1.6	3.5	3.3
	200	1.4	2.4	3.5	2.4	1.2	1.8	2.5	3.6

175



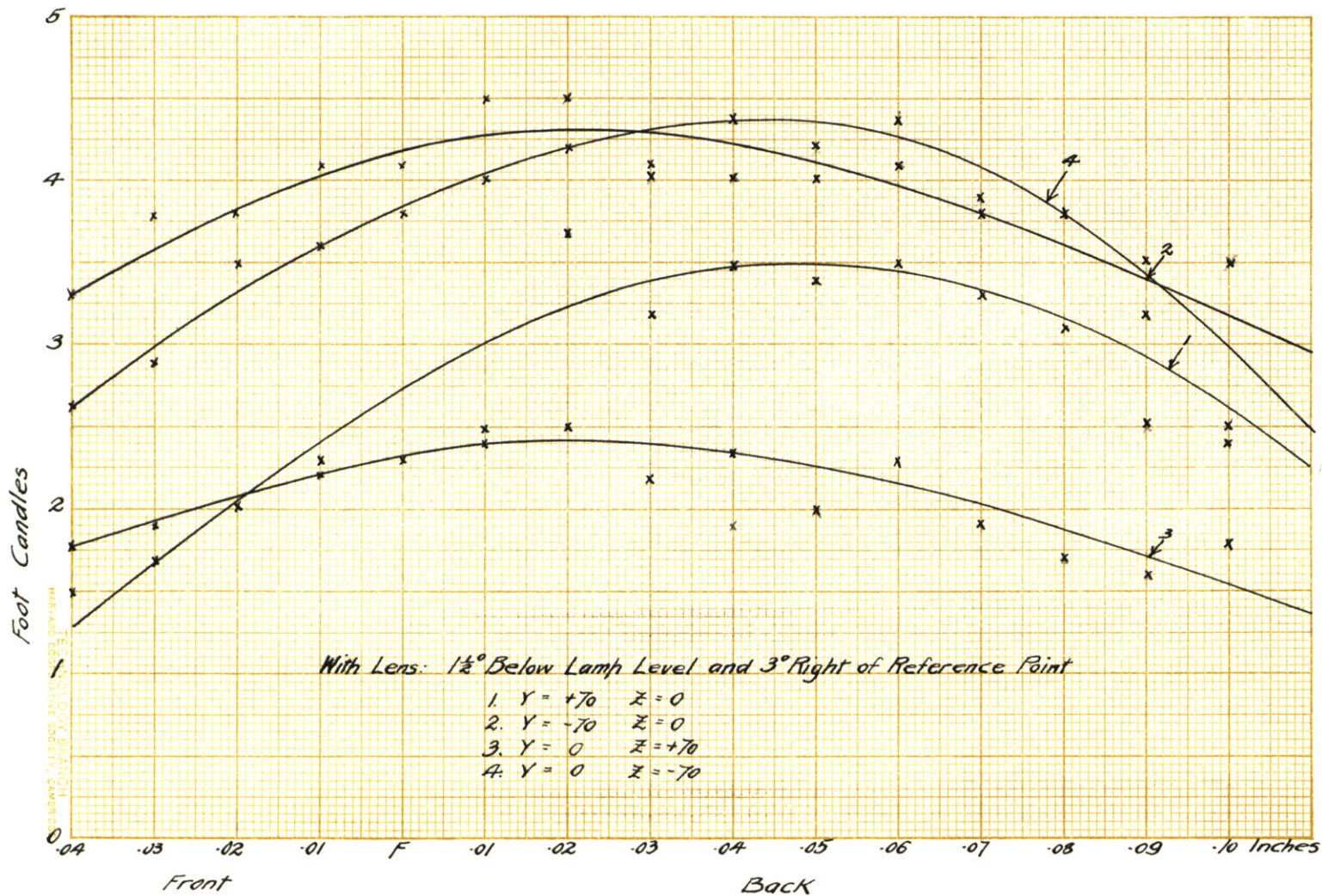

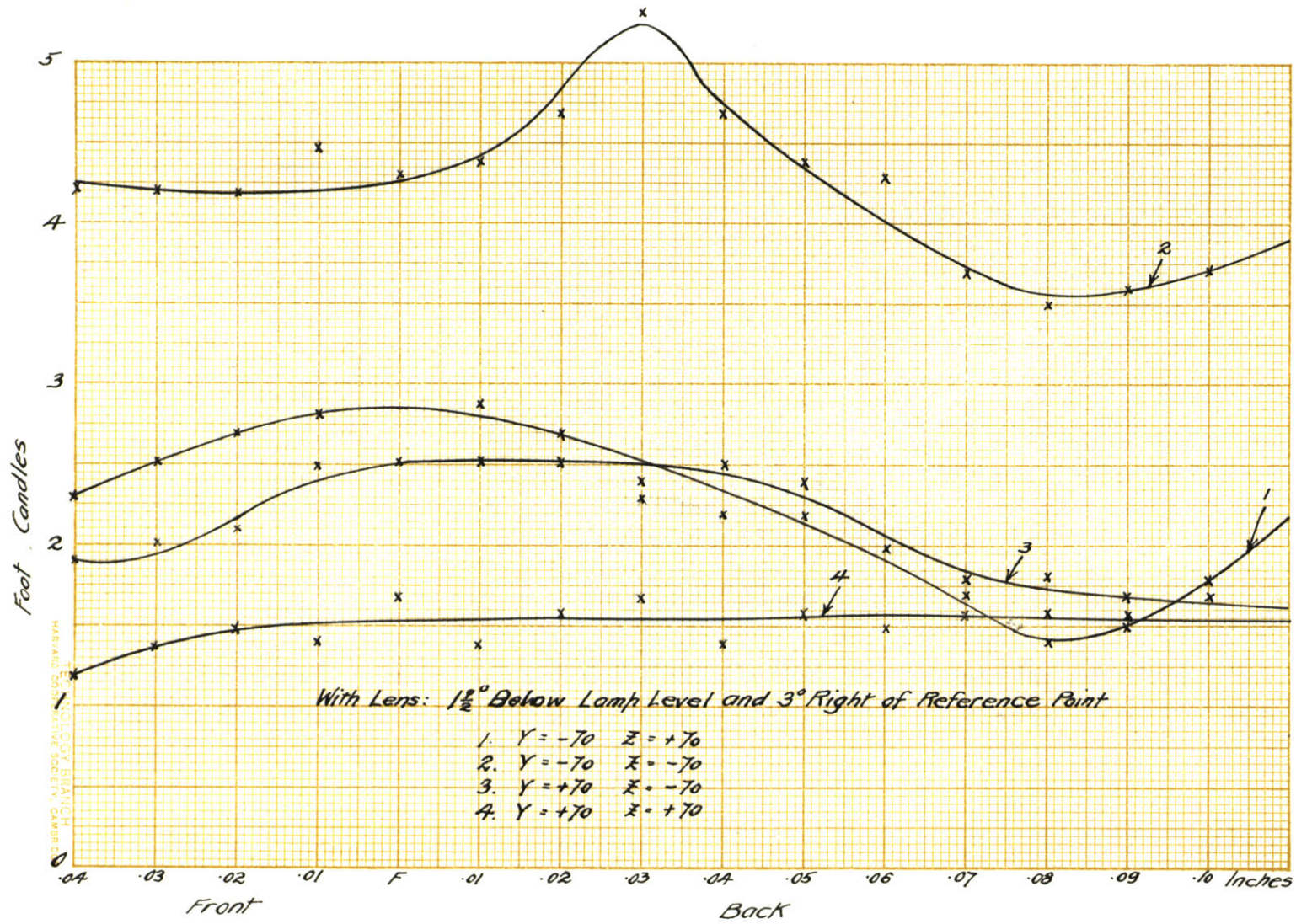

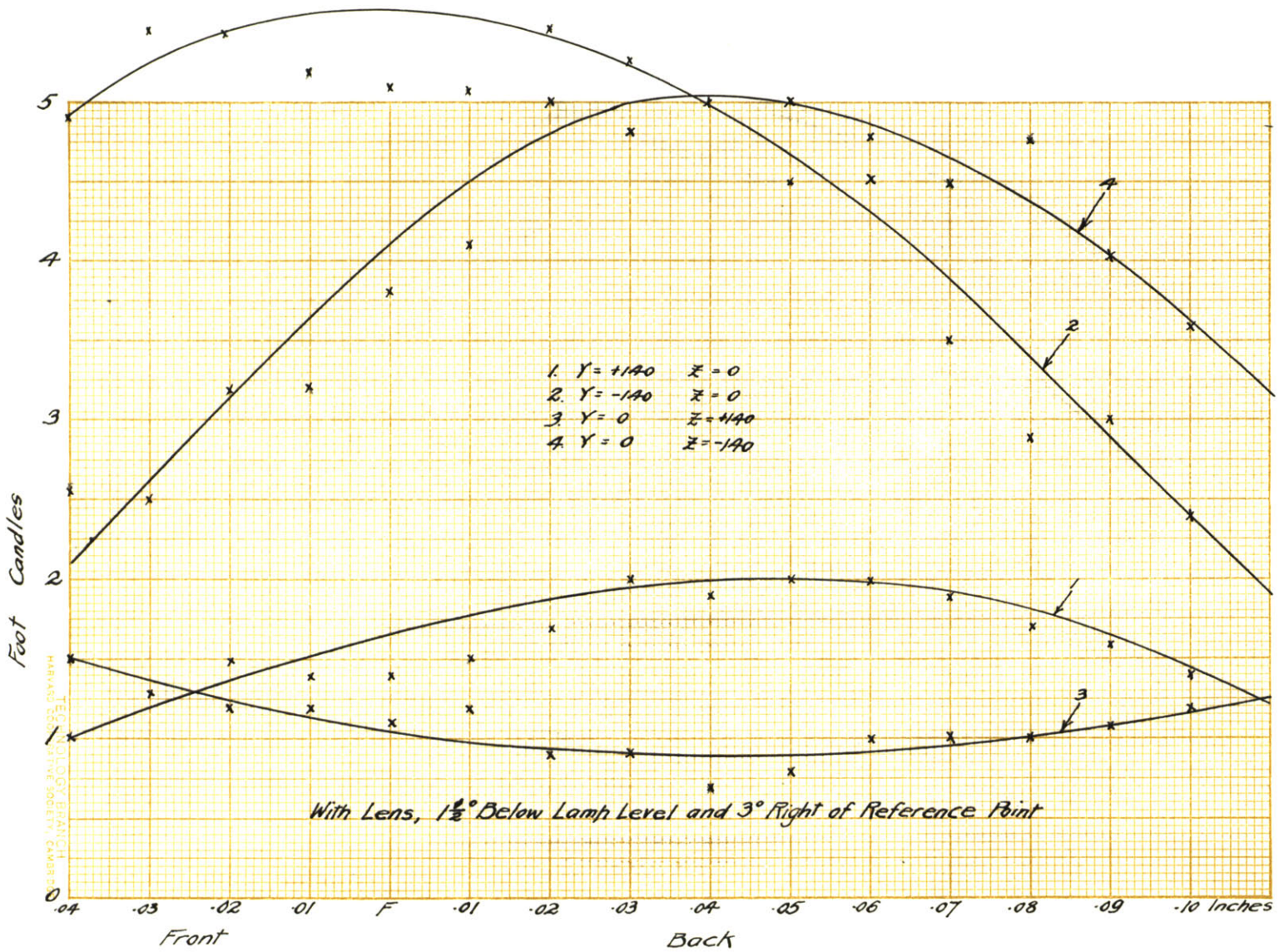

With Lens,  $1\frac{1}{2}$  Degrees Down & Three Degrees Left of Reference Point

X	Y = 0 Z = 0	Y = -70 Z = +70	Y = -70 Z = -70	Y = +70 Z = -70	Y = +70 Z = +70	
Front	80	0.84	0.90	0.50	1.10	1.10
	60	0.88	0.84	0.52	1.00	1.10
	40	0.88	0.74	0.52	1.00	1.10
	20	0.86	0.74	0.51	0.90	1.20
	F	0.90	0.90	0.51	0.90	1.30
Back	20	0.95	1.00	0.52	1.10	1.60
	40	1.00	1.20	0.55	1.10	1.70
	60	1.10	1.24	0.58	1.00	2.00
	80	1.50	1.36	0.62	1.15	2.20
	100	1.60	1.44	0.74	1.20	2.40
	120	1.70	1.70	0.88	1.30	2.80
	140	1.70	1.62	0.90	1.74	3.10
	160	1.64	1.46	1.00	1.60	3.20
	180	2.00	1.38	1.06	1.70	3.16
	200	2.00	1.30	1.10	1.70	2.80

With Lens,  $1\frac{1}{2}$  Degrees Down & Three Degrees Left of Reference Point

X	Z = 0				Y = 0				
	Y = +140	Y = +70	Y = -70	Y = -140	Z = +140	Z = +70	Z = -70	Z = -140	
Front	80	2.10	1.30	0.85	0.74	0.62	0.74	1.00	1.00
	60	2.40	1.40	0.90	0.70	0.62	0.74	1.00	1.10
	40	2.55	1.50	0.96	0.60	0.55	0.78	1.47	0.90
	20	3.10	1.70	1.00	0.55	0.53	0.76	1.30	1.00
	F	3.10	2.00	1.04	0.60	0.55	0.72	1.44	1.20
Back	20	3.50	2.20	1.32	0.70	0.53	0.75	1.50	1.40
	40	3.80	2.30	1.55	0.85	0.55	0.75	1.70	1.60
	60	4.00	2.30	1.70	0.95	0.55	0.80	2.00	1.70
	80	4.00	2.20	1.74	0.92	0.57	0.90	2.10	2.00
	100	3.80	2.50	1.76	1.00	0.60	1.00	2.20	2.65
	120	4.00	2.50	1.74	1.20	0.70	1.14	2.50	2.05
	140	3.60	2.20	1.64	1.30	0.80	1.20	2.50	2.00
	160	3.40	2.40	1.70	1.10	0.85	1.30	2.50	2.00
	180	3.20	2.50	1.72	1.10	1.10	1.76	2.10	2.07
	200	3.10	2.30	1.66	1.10	1.15	1.74	2.10	1.80

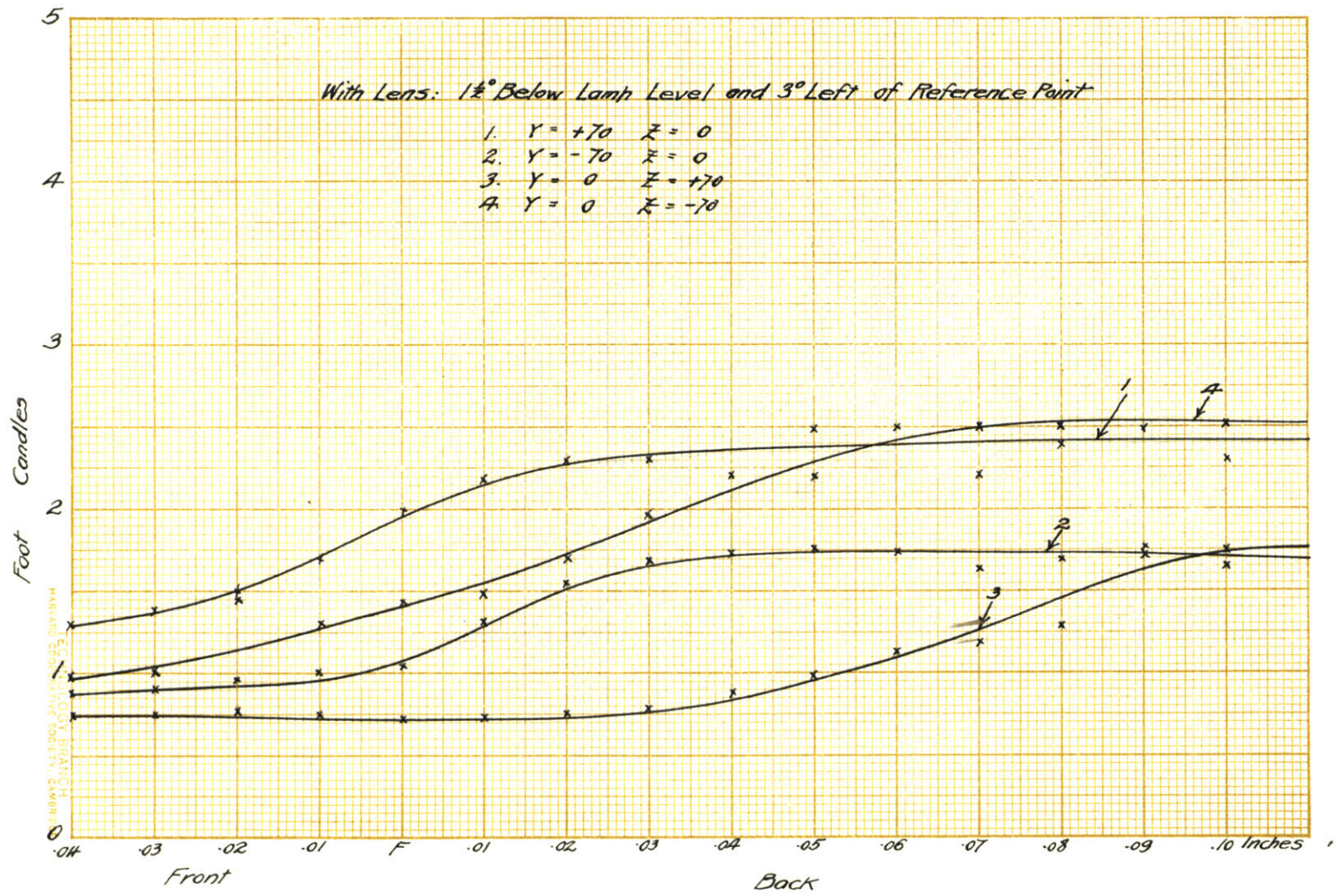







With Lens, 3 Degrees Below Lamp Level & 6 Degrees Right of Ref. Point

X	Y = 0 Z = 0	Y = -70 Z = +70	Y = -70 Z = -70	Y = +70 Z = -70	Y = +70 Z = +70
80	.23	.37	.23	.08	.12
60	.23	.38	.30	.08	.13
40	.20	.34	.31	.08	.14
20	.22	.23	.28	.10	.16
F	.22	.30	.29	.10	.14
20	.20	.33	.27	.10	.15
40	.18	.38	.29	.10	.16
60	.20	.60	.29	.16	.15
80	.26	.72	.28	.25	.22
100	.45	.90	.28	.33	.31
120	.57	1.63	.33	.31	.35
140	.70	1.35	.64	.31	.38
160	.75	1.40	.70	.43	.42
180	.84	1.20	1.01	.45	.61
200	.90	1.15	.99	.51	.86

Front

Back

With Lens, 3 Degrees Below Lamp Level & 6 Degrees Right of Ref. Point

X	Z = 0				Y = 0			
	Y = +140	Y = +70	Y = -70	Y = -140	Z = +140	Z = +70	Z = -70	Z = -140
80	.36	.11	.22	.27	.21	.18	.12	.12
60	.47	.11	.19	.31	.22	.19	.12	.12
40	.45	.12	.21	.42	.25	.20	.11	.11
20	.48	.11	.22	.36	.24	.20	.12	.10
F	.42	.12	.24	.44	.24	.21	.12	.12
20	.39	.13	.31	.63	.25	.24	.12	.12
40	.52	.14	.47	.78	.34	.31	.14	.13
60	.54	.23	.56	.99	.32	.41	.16	.14
80	.63	.37	.69	1.21	.36	.45	.20	.14
100	.72	.41	.78	1.56	.40	.61	.24	.17
120	.89	.99	.90	1.81	.60	.74	.31	.16
140	1.04	.88	1.06	1.90	.62	.90	.29	.19
160	1.32	.61	1.43	1.45	.65	1.05	.62	.23
180	1.21	.99	1.85	1.66	.74	1.27	.58	.28
200	1.65	.53	1.68	1.80	.80	1.36	.55	.27

Front

Back

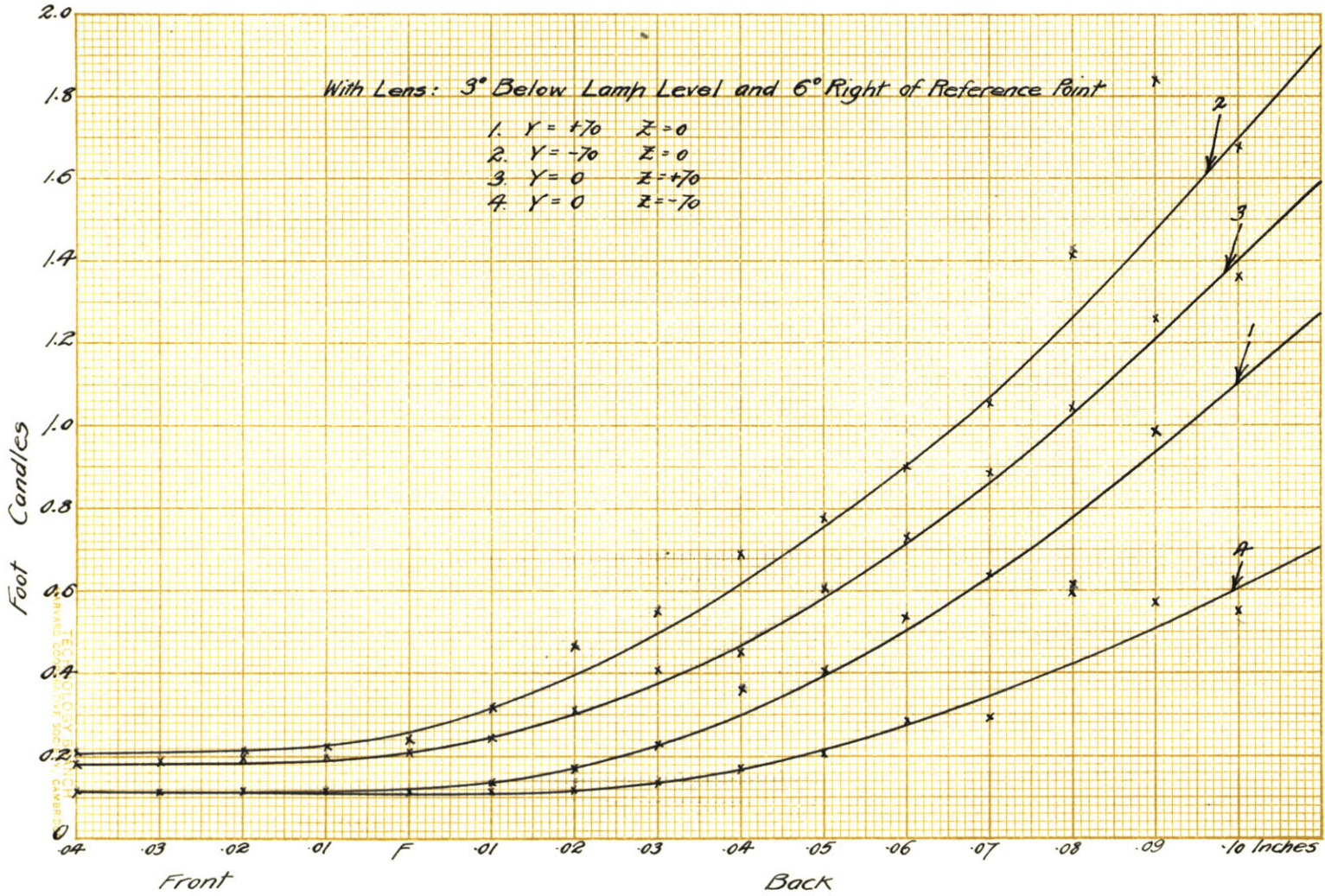



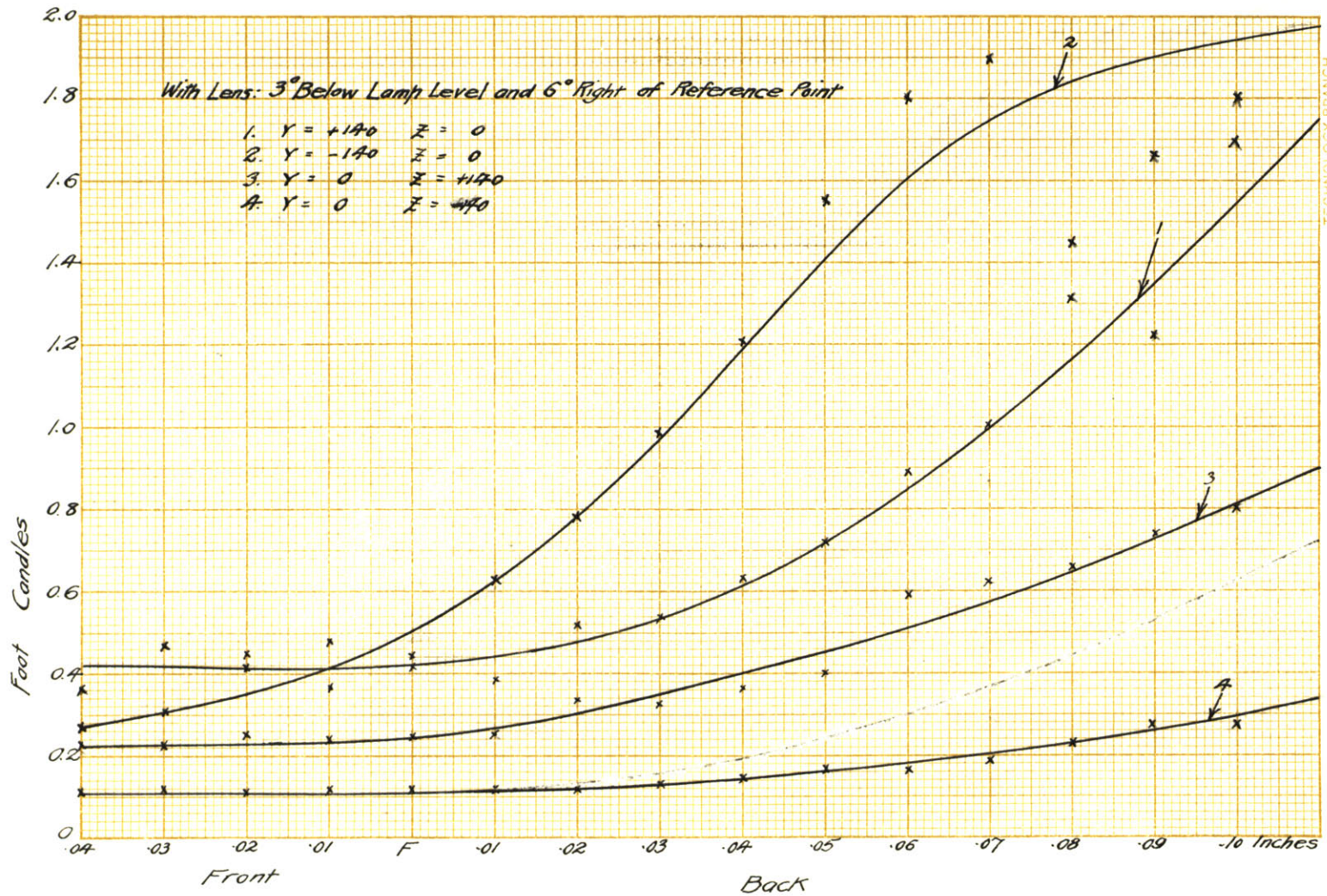

With Lens, 3 Degrees Below Lamp Level & 6 Degrees Left of Reference Point

X	Y = 0 Z = 0	Y = 0 Z = +140	Y = 0 Z = +70	Y = 0 Z = -70	Y = 0 Z = -140
80	.160	.220	.200	.270	.192
60	.156	.220	.164	.250	.156
40	.164	.222	.164	.200	.144
20	.164	.192	.168	.130	.128
0	.152	.192	.154	.128	.130
20	.148	.210	.144	.128	.124
40	.156	.204	.168	.120	.120
60	.174	.200	.174	.124	.124
80	.148	.200	.172	.124	.120
100	.144	.200	.184	.124	.120
120	.136	.240	.240	.124	.128
140	.140	.240	.270	.132	.140
160	.164	.260	.380	.134	.116
180	.200	.300	.370	.132	.130
200	.240	.400	.320	.124	.152

Front

Back

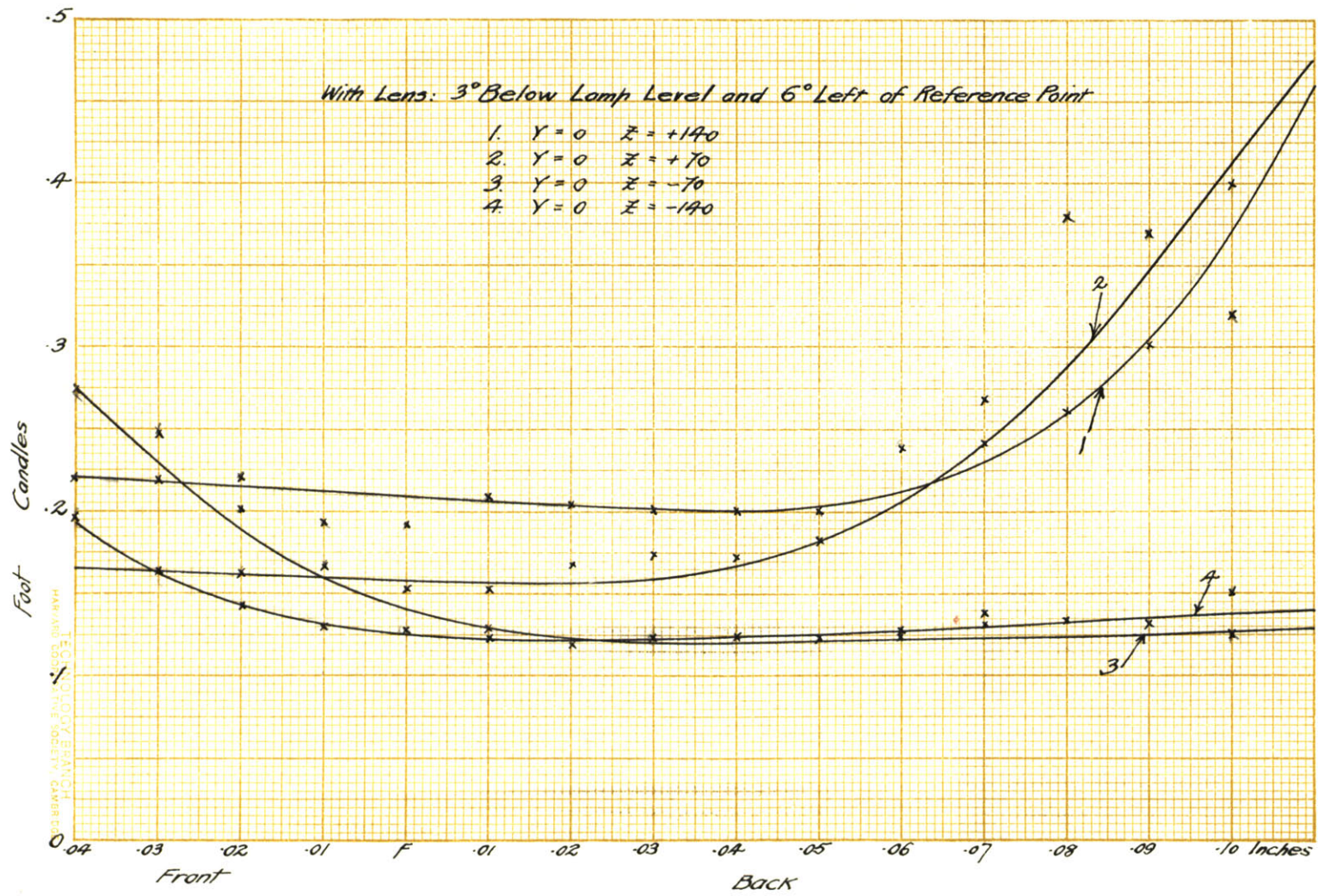

CONCLUSIONS



\*RESULTS OBTAINED: USING MECALITE LENS M.III

Position	Ft Candles at 60 Ft.	Apparent C.P.
1 Above Lamp Level & At Reference Point	0.430	1550
1 Above Lamp Level & 4 Left of Ref. Point	0.122	440
1 Above Lamp Level & 4 Right of Ref. Point	0.151	544
1 $\frac{1}{4}$ Below Lamp Level & At Reference Point	1.920	6900
1 $\frac{1}{2}$ Below Lamp Level & 3 Right of Ref. Point	3.020	10880
1 $\frac{1}{2}$ Below Lamp Level & 3 Left of Ref. Point	0.900	3240
3 Below Lamp Level & 6 Right of Ref. Point	0.210	727
3 Below Lamp Level & 6 Left of Ref. Point	0.172	620

192

\* In making the tests, a pair of gas-filled Mazda C. Lamp, having 21 mean spherical candle power rating and 6 volts, were used. Voltage ( 6 volts ) was kept constant throughout the runs.

COMPARISON OF OBTAINED RESULTS WITH THOSE SPECIFIED BY  
 MASSACHUSETTS SPECIFICATIONS & ILLUMINATION ENGINEERING SOCIETY'S SPECIFICATIONS.

Point	Obtained Results in Candle Power	Massachusetts Specifications In Apparent Candle Power	I. E. S. Specifications In Candle Power
C	1550	Shall not exceed 2400	Not more than 2400
D	440	Shall not exceed 800	Not more than 800
E	544	Shall not exceed 800	Not more than 800
M	6900	Not less than 6400	Not specified
PL	3240	Not less than 4400	Not less than 2500
PR	10880	Not less than 4400	Not less than 2500
QL	620	Not less than 1000	Not less than 1000
QR	727	Not less than 1000	Not less than 1000

## Conclusion.

## (a). Runs Without Lens.

The maximum intensity ( 33 foot-candles ), at lamp level and reference point, occurs at  $X=-0.05$  inch,  $Y=0.035$  inch and  $Z=0$ .

The general shape of all the curves is gradually increasing when the bulbs are moved backward from the front of the focus point. It reaches the maximum intensity at 0.05 inch back from the focus point, then it gradually decreases.

Intensity decreases as the bulbs are moved, in any direction away from the X axis.

When the lamps are moved four degrees left or right of the reference point, the general shape of the curves is different from that mentioned above. It is gradually decreasing as the bulbs moving backward and it reaches the minimum value at  $-0.05$  inch from the focus point, then it increases slowly again.

The general shape of the curves from the runs when the lamps are one degree above lamp level and at reference point, is similar with those at lamp level. Its maximum intensity is 24.0 foot-candles at the position  $X=-0.05$  inch,  $Y=0.035$  inch and  $Z=0$ .

But as soon as the lamps are moved two degrees or four degrees left or right of the reference point, the shape of the curves is entirely changed. Its maximum intensity is at 0.04 inch front of the focus point then it decreases as the bulbs moving backward.

The general shape of the curves obtained from the runs when the lamps are one degree below lamp level and at four degrees left or right of reference point, is gradually decreasing as the bulbs moving backward. Its minimum value occurs at -0.05 inch from the focus point. It is just in the opposite direction when the lamps are two degrees left or right of the reference point but its slope increment is very small.

In a word, the bulbs give maximum intensity at any point when they are placed at the position  $X=-0.05$  inch,  $Y=-0.035$  inch and  $Z=0$ , in the parabolic reflectors used in this test.

(b). Runs With Lens.

The intensity variations obtained from the runs with lens are more uniform than otherwise. Their maximum values occur at one and half degrees below lamp level instead of at lamp level as in the runs without lens. Of course, these are the desired characteristics of the lens. Although no great difference in light

intensity results in placing the bulb in back of in front of the focal point, however, the position at the back of the focal point gives somewhat slightly greater intensity.

Bibliography

- "Automobile Lighting from the Lighting Viewpoint",  
E.S.Clark, Bulletin, Auto Eng. Soc., April 1916, Page 45.
- "Automobile Headlamp", E.J.Edwards,  
Transactions, I.E.S. Vol. XII, Page 172.
- "Automobile Headlights and Glare Reducing Devices,"  
L.C.Porter, General Electric Review, Sept. 1918.
- "Automobile Headlight Regulation," L.C.Porter &  
R.W.Jordan, General Electric Review, Feb. 1922.
- "Automobile Headlight Problem again,"  
E.J.Edwards, General Electric Review, Sept. 1917.
- "A Survey of the Automobile Headlamp Situation,"  
W.F.Little, Transactions, I.E.S. Vol. XII, page 123.
- "A Survey of Voltage Condition in Automobile Lighting,"  
H.H.Magdsick, & H.Karg, Trans. I.E.S. Vol.XV, page 519.
- "Studies in the Projection of Light", Frank Benford,  
General Electric Review, February, March, 1923.
- "Studies in The Projection of Light continued,"  
F.Benford, General Electric Review, April & May, 1923.
- "Connecticut Headlight Law and Method of Enforcement,"  
Automobile Topics, January 17, 1920.

- "Photometric Measurements of Projectors,"  
S.C.Porter, Light Journal, Vol. 4, page 7.
- "Present Practice in Automobile Headlighting,"  
R.C.Rogers, Trans. I.E.S., Vol. XII, page 158.
- "Present Status of Automobile Headlighting Regulations,"  
Transactions, I.E.S. Vol. XVI, page 469.
- "Proposed Regulations for Incorporation in Model Law  
in Regard to Headlamps on Motor Vehicles,"  
L.B.Marks, Trans., I.E.S., Vol. XIV, page 100.
- "Report of 1916-17 Committee on Automobile Headlighting,"  
Trans., I.E.S., Vol. XIII, page 259.
- "Report of 1917-18 Committee on Automobile Headlighting  
Specifications," Trans., Vol. XIV, page 64.
- "Report on 1918-19 Committee on Automobile Headlight  
Specification," Trans., I.E.S., Vol. XIV, page 500.
- "Road Illumination by Means of Auto Headlamps,"  
Trans., I.E.S., Vol. XII, page 179.
- "Size of Auto Headlights on 1915-21 Cars,"  
Motor Record, December 1921.
- "State Regulation of Motor Car Headlamps,"  
Journal A.I.E.E., March 1922.

"Determination by Various Observers of the Desired Road Illumination from Automobile Headlamps," H.H.Magdsick & R.N.Falge, Trans., I.E.S., Vol. XVI, page 507.

"Electric Headlight Tests," S.G.Scrughan, Railway Electric Eng., Vol. 5, page 349.

"Footcandle Meter used to Measure Glaring Headlights," Motor Life, January, 1920.

"Headlamp Glare Problem," J.R.Cravath, Trans., I.E.S., Vol. XII, page 188.

"Headlight Tests," C.F.Harding & A.M.Tapping, Journal, A.I.E.E., Vol. 29, page 1053.

"Improved Mazda Automobile Headlight Lamps," L.C.Porter, General Electric Review, January, 1920.

"Incandescent Headlights and Projectors," P.S.Bailey, Trans., I.E.S., Vol. X, page 271.

"Interim Report of Committee on Motor Vehicle Lightinh," Trans., I.E.S., Vol. XVII, page 103.



"Meeting the Federal Headlighting Requirements,"

L.C.Porter, Railway Elec. Eng., Vol 7, page 468.

"Motor Car Headlights- Ideal Requirements and Practical Solutions," M.A.Garrard, Illuminating Eng.(British) April 1921.

"Motor Vehicle Headlights in Massachusetts,"

A.W.Devine, Trans., I.E.S., Vol. XVI, page 507.

"Motor Car Headlights and Rear Lights in Relation to Traffic Requirements," J.W.T.Walsh,

Illuminating Eng.(British), April 1920.

"New York State Automobile Headlight Law,"

F.M.Hugo, Trans., I.E.S., Vol. XIV, page 61.