



LUND UNIVERSITY

Go with the flow

visually mediated flight control in bumblebees

Linander, Nellie

2017

Document Version:
Other version

[Link to publication](#)

Citation for published version (APA):

Linander, N. (2017). *Go with the flow: visually mediated flight control in bumblebees*. Lund University, Faculty of Science, Department of Biology.

Total number of authors:

1

General rights

Unless other specific re-use rights are stated the following general rights apply:

Copyright and moral rights for the publications made accessible in the public portal are retained by the authors and/or other copyright owners and it is a condition of accessing publications that users recognise and abide by the legal requirements associated with these rights.

- Users may download and print one copy of any publication from the public portal for the purpose of private study or research.
- You may not further distribute the material or use it for any profit-making activity or commercial gain
- You may freely distribute the URL identifying the publication in the public portal

Read more about Creative commons licenses: <https://creativecommons.org/licenses/>

Take down policy

If you believe that this document breaches copyright please contact us providing details, and we will remove access to the work immediately and investigate your claim.

LUND UNIVERSITY

PO Box 117
221 00 Lund
+46 46-222 00 00

Go with the flow

visually mediated flight control in bumblebees

NELLIE LINANDER

FACULTY OF SCIENCE | DEPARTMENT OF BIOLOGY | LUND UNIVERSITY



Go with the flow

Go with the flow

visually mediated flight control in bumblebees

Nellie Linander



LUND
UNIVERSITY

DOCTORAL DISSERTATION

by due permission of the Faculty of Science, Lund University, Sweden.
To be publicly defended in the Blue Hall, Ecology Building, Sölvegatan 37, Lund,
Sweden, on Friday 15th September 2017 at 10:00 for the degree of Doctor of
Philosophy, Department of Biology.

Faculty opponent

Dr. Sanjay P Sane

National Centre for Biological Sciences, Tata Institute of Fundamental Research,
Bangalore, India

Organization LUND UNIVERSITY Department of Biology, Sölvegatan 35, 22362 Lund, Sweden Author: Nellie Linander	Document name DOCTORAL DISSERTATION	
	Date of issue: 2017-08-21	
	Sponsoring organization	
Go with the flow: Visually mediated flight control in bumblebees		
<p>Despite their small brains and tiny eyes, flying insects are capable of detecting and avoiding collisions with moving obstacles, and with remarkable precision they navigate through environments of different complexity. For this thesis, I have investigated how bumblebees use the pattern of apparent image motion that is generated in their eyes as they move through the world (known as optic flow), in order to control flight. I analysed the speed and position of bumblebee (<i>Bombus terrestris</i>) flight trajectories as they negotiated arenas of different dimensions and visual complexity. I also investigated the impact of optic flow on bumblebee learning flights, a special kind of flight designed to memorise the location of the nest or a newly discovered food source. The general aim of my research has been to understand how flying insects use vision to actively control their flight.</p> <p>The viewing angle at which optic flow is measured has important consequences for flight in densely cluttered environments, where timely control of position and speed are necessary for effective collision avoidance. I therefore investigated when, and how, bumblebees respond to sudden changes in the magnitude of optic flow. My results reveal that the visual region over which bumblebees measure optic flow is determined by the location in the frontal visual field where they experience the maximum magnitude of translational optic flow. This strategy ensures that bumblebees regulate their position and speed according to the nearest obstacles, allowing them to maximise flight efficiency and to minimise the risk of collision. My results further demonstrate that, when flying in narrow spaces, bumblebees use optic flow information from nearby surfaces in the lateral visual field to control flight, while in more open spaces they rely primarily on optic flow cues from the ventral field of view. This result strengthens the finding that bumblebees measure optic flow for flight control flexibly in their visual field, depending on where the maximum magnitude of translational optic flow occurs. It also adds another dimension to it by suggesting that bumblebees respond to optic flow cues in the ventral visual field if the magnitude is higher there than in the lateral visual field. Thus, the ability to flexibly use the surrounding optic flow field is of great importance when it comes to the control of cruising flight. For this thesis I also investigated the impact of ventral and panoramic optic flow on the control of learning flights in bumblebees. The results show that the presence of ventral optic flow is important for enabling bumblebees to perform well-controlled learning flights. Whether panoramic optic flow cues are present or not does not strongly affect the overall structure of the learning flight, although these cues might still be involved in fine-scale flight control. Finally, I found that, when the availability of ventral optic flow is limited to certain heights, bumblebees appear to adjust their flight parameters to maintain the perception of ventral optic flow cues.</p> <p>In summary, the results compiled in this thesis contribute to a better understanding of how insects use visual information to control their flight. Among other findings, my results emphasize the importance of a being able to flexibly measure optic flow in different parts of the visual field, something that enhances bees' ability to avoid collisions.</p>		
Key words: insect, vision, <i>Bombus terrestris</i> , flight control, optic flow, centring, flight speed, height, viewing angle, learning flight		
Classification system and/or index terms (if any)		
Supplementary bibliographical information		Language: English
ISSN and key title		ISBN: 978-91-7753-165-4 (print) 978-91-7753-166-1 (online)
Recipient's notes	Number of pages:	Price
	Security classification	

I, the undersigned, being the copyright owner of the abstract of the above-mentioned dissertation, hereby grant to all reference sources permission to publish and disseminate the abstract of the above-mentioned dissertation.

Signature

Nelli Lin

Date

20170726

Go with the flow

visually mediated flight control in bumblebees

Nellie Linander



LUND
UNIVERSITY

Front cover by Emil Nilsson

Back cover by Erik Linander

Illustrations by Nellie Linander

Copyright Nellie Linander

Faculty of Science | Department of Biology

ISBN 978-91-7753-165-4 (print)

ISBN 978-91-7753-166-1 (pdf)

Printed in Sweden by Media-Tryck, Lund University
Lund 2017



Till mina barn, Noel och Norah

Contents

List of papers	10
Author contributions	11
English summary	13
Swedish summary	15
1. Introduction	17
2. What can a bee see?	21
2.1. Structure and optics of the compound eye	21
2.2. Visual acuity	23
3. Visually guided flight control	27
3.1. Optic flow	27
3.2. Neural processing of optic flow	28
3.3. Optic flow dependent behaviours	30
3.3.1. The optomotor response	30
3.3.2. Speed control	31
3.3.3. Altitude control	32
3.3.4. The centring response	33
3.4. Optic flow is measured flexibly within the visual field	34
3.5. Flight control in open environments	37
4. Learning flights and the importance of optic flow	43
4.1. Finding the way home	43
4.2. What is a learning flight?	45
4.3. The role of optic flow in visual control of learning flights	45
5. Concluding remarks	49
References	51
Thank you	59
Paper I - IV	

List of papers

- I. Linander, N., Dacke, M. and Baird, E. (2015). Bumblebees measure optic flow for position and speed control flexibly within the frontal visual field. *J. Exp. Biol.* 218, 1051-1059.
Doi:10.1242/jeb.107409.
- II. Linander, N., Baird, E. and Dacke, M. (2016). Bumblebee flight performance in environments of different proximity. *J. Comp. Physiol. A* 202, 97-103.
Doi:10.1007/s00359-015-1055-y.
- III. Linander, N., Baird, E. and Dacke, M. (2017). How bumblebees use lateral and ventral optic flow cues for position control in environments of different proximity. *J. Comp. Physiol. A* 203, 343-351.
Doi:10.1007/s00359-017-1173-9.
- IV. Linander, N., Dacke, M., Baird, E. and Hempel de Ibarra, N. The role of optic flow in visual control of bumblebee learning flights. *Manuscript to be submitted.*

Papers I, II and III are reprinted with permission from the publishers.

Author contributions

- I. Conceived and designed the experiments: NL, EB, MD. Conducted the experiments: NL. Analysed the data: NL and EB. Wrote the manuscript: NL, with input from EB and MD.
- II. Conceived and designed the experiments: NL, EB, MD. Conducted the experiments: NL. Analysed the data: NL and EB. Wrote the manuscript: NL, with input from EB and MD.
- III. Conceived and designed the experiments: NL, EB, MD. Conducted the experiments: NL. Analysed the data: NL, supervised by EB. Wrote the manuscript: NL, with input from EB and MD.
- IV. Conceived and designed the experiments: NL and NHI. Conducted the experiments: NL. Analysed the data: NL. Wrote the manuscript: NL, with input from NHI, EB and MD.

*By prevailing over all obstacles and distractions, one may unfailingly
arrive at his chosen goal or destination.*

Christopher Columbus

English summary

Go with the flow: visually mediated flight control in bumblebees.

Despite their small brains and tiny eyes, flying insects are capable of detecting and avoiding collisions with moving obstacles, and with remarkable precision they navigate through environments of different complexity. For this thesis, I have investigated how bumblebees use the pattern of apparent image motion that is generated in their eyes as they move through the world (known as optic flow), in order to control flight. I analysed the speed and position of bumblebee (*Bombus terrestris*) flight trajectories as they negotiated arenas of different dimensions and visual complexity. I also investigated the impact of optic flow on bumblebee learning flights, a special kind of flight designed to memorise the location of the nest or a newly discovered food source. The general aim of my research has been to understand how flying insects use vision to actively control their flight.

The viewing angle at which optic flow is measured has important consequences for flight in densely cluttered environments, where timely control of position and speed are necessary for effective collision avoidance. I therefore investigated when, and how, bumblebees respond to sudden changes in the magnitude of optic flow. My results reveal that the visual region over which bumblebees measure optic flow is determined by the location in the frontal visual field where they experience the maximum magnitude of translational optic flow. This strategy ensures that bumblebees regulate their position and speed according to the nearest obstacles, allowing them to maximise flight efficiency and to minimise the risk of collision. My results further demonstrate that, when flying in narrow spaces, bumblebees use optic flow information from nearby surfaces in the lateral visual field to control flight, while in more open spaces they rely primarily on optic flow cues from the ventral field of view. This result strengthens the finding that bumblebees measure optic flow for flight control flexibly in their visual field, depending on where the maximum magnitude of translational optic flow occurs. It also adds another dimension to it by suggesting that bumblebees respond to optic flow cues in the ventral visual field if the magnitude is higher there than in the lateral visual field. Thus, the ability to flexibly use the surrounding optic flow field is of great importance when it comes to the control of cruising flight. For this thesis I also investigated the impact of ventral and panoramic

optic flow on the control of learning flights in bumblebees. The results show that the presence of ventral optic flow is important for enabling bumblebees to perform well-controlled learning flights. Whether panoramic optic flow cues are present or not does not strongly affect the overall structure of the learning flight, although these cues might still be involved in fine-scale flight control. Finally, I found that, when the availability of ventral optic flow is limited to certain heights, bumblebees appear to adjust their flight parameters to maintain the perception of ventral optic flow cues.

In summary, the results compiled in this thesis contribute to a better understanding of how insects use visual information to control their flight. Among other findings, my results emphasize the importance of a being able to flexibly measure optic flow in different parts of the visual field, something that enhances bees' ability to avoid collisions.

Swedish summary

Att följa flödet: hur insekter kontrollerar sin flygning med hjälp av optiskt flöde.

För ungefär 350 miljoner år sedan utvecklade de första insekterna förmågan att flyga och har sedan dess dominerat våra terrestra miljöer. Trots sina pyttesmå hjärnor och avsaknad av avancerade kontrollinstrument så lyckas flygande insekter på många vis utkonkurrera modern flygteknik. Humlor och bin kan till exempel leta upp en födokälla långt ifrån sitt bo, återvända hem igen och sedan upprepa denna resa flera gånger om utan problem. Dessutom är flygande insekter extremt akrobatiska då de obehindrat navigerar genom de mest svårforcerade och komplexa miljöer. Hur kan insekter flyga så snabbt och smidigt utan att krascha? För att kontrollera sin flygning använder de sig av något som kallas för optiskt flöde, vilket är det bildflöde som passerar ögat då insekten rör sig genom sin omgivning. För att undvika kollisioner måste flyghastighet och position kontrolleras mycket noggrant, men hur går detta till? Hur tillförlitliga är insekters flygkontrollsystem i olika typer av miljöer eller då en dynamisk omgivning ställer höga krav på en snabb reaktionsförmåga? I denna avhandling har jag undersökt dessa frågor genom att studera hur humlor (*Bombus terrestris*) navigerar i flygtunnlar av olika bredd och komplexitet. Jag har också undersökt hur optiskt flöde påverkar humlors förmåga att utföra inlärningsflygningar, en karakteristisk flygning speciellt utformad för att humlan skall kunna memorera och hitta tillbaka till sitt bo.

För en insekt som flyger framåt med oförändrad hastighet är det optiska flödet inte konstant över hela synfältet. Det snabbaste bildflödet upplevs 90 grader i sidled, vinkelrätt mot flygriktningen. Om det optiska flödet mäts vid denna punkt i synfältet skulle en insekt alltså få ut maximal information om förändringar i hastigheten av optiskt flöde, exempelvis orsakat av ett potentiellt kollisionsobjekt. Det vore dock opraktiskt att mäta optiskt flöde vid denna laterala synvinkel, då insekten i så fall inte kan förbereda sig på förändringar i sin flygriktning. Synvinkeln vid vilken optiskt flöde mäts, har således viktiga konsekvenser för flygning i komplexa miljöer där en snabb reaktionsförmåga är avgörande för att undvika kollisioner. Jag har därför undersökt när och hur humlor reagerar på plötsliga förändringar i sin omgivning. Resultaten visar att synvinkeln inte är konstant utan snarare beror på var i synfältet det starkaste bildflödet förekommer. Genom att hela tiden kontrollera sin flygning

utefter det starkast tillgängliga bildflödet, säkerställer humlorna att de reagerar på potentiella kollisionsobjekt oavsett var i synfältet de befinner sig.

Tidigare studier av insekters flygkontroll har nästan uteslutande genomförts i smala flygtunnlar. Eftersom mycket lite är känt om hur insekter kontrollerar sin flygning i öppna miljöer designade jag en studie i syfte att undersöka just detta. Jag tränade humlor att flyga genom tunnlar av varierande bredd och noterade hur avståndet mellan väggarna påverkade deras flygkontroll. Resultaten visar att då tunnelbredden ökar så blir humlornas hastighets- och positionskontroll allt mer variabel. Vidare visar resultaten att i trånga utrymmen använder sig humlor främst av det optiska flöde som genereras från laterala ytor (såsom väggarna i en flygtunnel), medan i mer öppna miljöer så styrs flygningen av information från marken. Detta tyder på att humlor använder sig av - och mäter - optiskt flöde flexibelt över en stor lateral och ventral yta.

När bin, humlor och getingar lämnar sina bon för första gången utför de en så kallad inlärningsflygning, speciellt utformad för att insekterna skall kunna memorera och hitta tillbaka till sitt bo igen. Inlärningsflygningarna består av bågar, eller slingor, av ökande radie centrerade runt boet. För att insekten ska få ut maximal information om boets läge måste dessa inlärningsflygningar noggrant kontrolleras. Hur går detta till? Jag har undersökt hur ventralt och panoramiskt optiskt flöde påverkar kontrollen av dessa flygningar hos humlor. Resultaten visar att förekomsten av ventralt optiskt flöde är viktig för humlornas förmåga att utföra en inlärningsflygning. Så länge tillgången på ventralt optiskt flöde är tillräcklig kan humlorna kontrollera sin flygning även då panoramiskt optiskt flöde helt saknas. Vidare visar resultaten att humlorna kan justera sina flygkontrollparametrar så att de bibehåller den mängd ventralt optiskt flöde som är nödvändig för att memorera boets läge i förhållande till omgivningen.

Sammanfattningsvis bidrar de resultat som sammanställts i denna avhandling till en ökad förståelse för hur insekter kontrollerar sin flygning. Bland annat betonar resultaten vikten av att flexibelt kunna mäta optiskt flöde i olika delar av synfältet, något som ökar humlans förmåga att undvika kollisioner i flykten.

1. Introduction

Insects were the first animals to evolve active flight, some 350 million years ago, and have since then been the most numerous phyla on earth. Despite their miniature brains and lack of sophisticated control instruments, flying insects in many ways outperform manmade flying machines and human aviators. A honeybee, for example, with a brain containing no more than 950 000 neurons (Menzel and Giurfa, 2001), has an incredible ability to localise a food source far away from its nest, return back home and then repeat its journey over and over again with the same success. Furthermore, the foraging flights of these insects are highly aerobic. They elegantly navigate over open meadows as well as through densely vegetated forests without crashing. How is this controlled?

The focus of my research is to understand how flying insects use the pattern of apparent image motion that is generated in their eyes as they move through the world (known as optic flow) in order to control their flight. How do insects regulate their flight speed and position in relation to nearby surfaces? How do they solve complex spatial tasks such as flying through tunnels with changing optic flow fields? I use the buff-tailed bumblebee (*Bombus terrestris*) as a model species. These insects can be trained to fly back and forth between a food source and their nest – making it possible for me to study their flight. The main aim of my research is to understand how flying insects use vision to actively control their flight in environments of different proximity and complexity.

For an insect flying forward at constant speed, the magnitude of translational optic flow is not constant over the entire visual field. Instead, it is greatest at an angle of 90 degrees from the direction of motion and decreases to a value of zero in the direction of flight (Gibson, 1950). This means that the relative difference in the magnitude of translational optic flow caused by a change in the proximity of the environment (for example an obstacle) would be larger, and presumably easier for the insect to detect, in the lateral visual field. However, the larger the angle at which changes in translational optic flow are detected, the less time an insect has to adjust its flight before encountering the objects that induce these changes. Thus, the viewing angle at which optic flow is measured has important consequences for flight control. In **paper I**, I investigate the effect of sudden changes in the magnitude of optic flow on

position and speed control in bumblebees, and when these changes are detected. My results reveal that the visual region over which bumblebees respond to optic flow cues for flight control is not dictated by a set viewing angle, but rather depends on where in the frontal visual field the highest magnitude of translational optic flow is detected. This flexibility allows bumblebees to adjust their position and speed in response to changes in the proximity of the environment as soon as they are detected, irrespective of where in the visual field they may occur.

Most studies investigating insect flight control have been conducted in narrow tunnels, and very little was previously known about how insects control their flight in open spaces. In **paper II**, I investigate how the proximity of nearby surfaces affect optic flow-based flight control strategies in bumblebees. Bees were trained to fly along a set of tunnels, and I evaluated how the distance between the walls affected their flight control. I found that, as tunnel width increases lateral position and flight speed become more variable. I also found that optic flow information from the ground has an increasing influence on flight speed control as the distance between the walls increases, suggesting that bumblebees measure optic flow flexibly over a large lateral and ventral field of view depending on where the highest magnitude of optic flow occurs. A consequence of this strategy is that, when flying in narrow spaces, bumblebees use optic flow information from nearby lateral surfaces to control flight, while in more open spaces they rely primarily on optic flow cues from the ground.

To further investigate the role of ventral optic flow cues for flight control, I compared flight trajectories of bumblebees flying in absence and in presence of ventral optic flow cues (**Paper III**). I also investigated the effect of ventral optic flow on flight control when lateral optic flow was minimised. The results demonstrate that bumblebees control their position by balancing the magnitude of lateral optic flow when flying through tunnels up to 120 cm in width, while in wider tunnels lateral optic flow seems to be of less relevance. In more open environments, the bees rather rely on ventral optic flow cues to control their flight position and to steer along straight tracks. Thus, in parallel with paper I and II, these results support the hypothesis that bumblebees measure optic flow for flight control flexibly in their visual field depending on where the maximum magnitude of translational optic flow occurs. For an insect encountering a mix of cluttered and open environments, it is indeed advantageous to measure optic flow in the field of view where the information is most abundant.

When leaving the nest for the first time, bees and wasps perform so-called learning flights in order to memorise the location of the nest (for a review see Zeil et al., 1996). These flights are characterised by a succession of arcs or loops of increasing radius centred around the nest and by an incremental increase in flight speed. This requires precise control of the flight manoeuvres. In **paper IV**, I investigate the impact of optic flow cues on the control of bumblebee learning flights. The results

show that the presence of ventral optic flow cues is important for conducting well-controlled learning flights. Whether panoramic optic flow cues are present or not does not affect their flight performance substantially. When I varied the ground pattern to display ventral optic flow cues only up to a certain height, bumblebees adjusted their flight and flew at lower heights, presumably to maintain the perception of ventral optic flow cues. To conduct the learning flight at a lower flight height when ventral optic flow is lost at higher altitudes could be an adaptive strategy to cope with different ground textures, enabling the bees to complete the learning flight and gain maximum information about the nest location in all types of terrain.

What can a bee see?

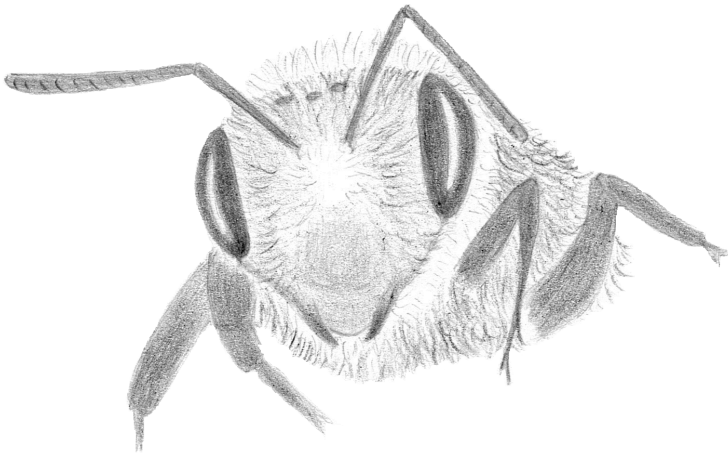

2. What can a bee see?

2.1. Structure and optics of the compound eye

Bees, along with all other insects, have compound eyes that consist of many individual optical units called ommatidia. Each ommatidium contains a transparent cornea (the most outer layer of the eye that forms the hexagonal facets), a transparent crystalline cone and a rod shaped rhabdom of light-sensitive visual cells (Land and Nilsson, 2012). Within each rhabdom, there are typically eight photoreceptive cells that are sensitive to different wavelengths of light. In most hymenoptera, four of the visual cells in each ommatidium are maximally sensitive to yellow-green light (535 nm), two are maximally sensitive to blue light (430 nm), and two are maximally sensitive to UV-light (340 nm) (Menzel and Backhaus, 1991; Briscoe and Chittka, 2001; Peitsch et al., 1992). Thus, bees are trichromats with a shifted sensitivity towards shorter wavelengths.

There are two types of compound eyes found in insects; apposition compound eyes (Fig. 1a) that are commonly found in diurnal insects such as honeybees and bumblebees, and superposition compound eyes (Fig. 1b) that are commonly found in nocturnal insects such as moths and fireflies (Land and Nilsson, 2012). In the apposition compound eye, each ommatidium forms a tiny inverted image representing one point in space. The superposition compound eye has the potential to collect light over many optical units and pool this information to a single deep lying erect image, making them more sensitive than apposition eyes. Consequently, this type of eye is most commonly encountered in nocturnal insects or in those that are active under dim light regimes, although they are also found in diurnal insects, such as beetles (Caveney and McIntyre, 1981; McIntyre and Caveney, 1998).

As this thesis investigates how bumblebees - a diurnal insect with apposition eyes - control their flight with the aid of visual cues I will, from here on, focus on the anatomy and function of the apposition compound eye.

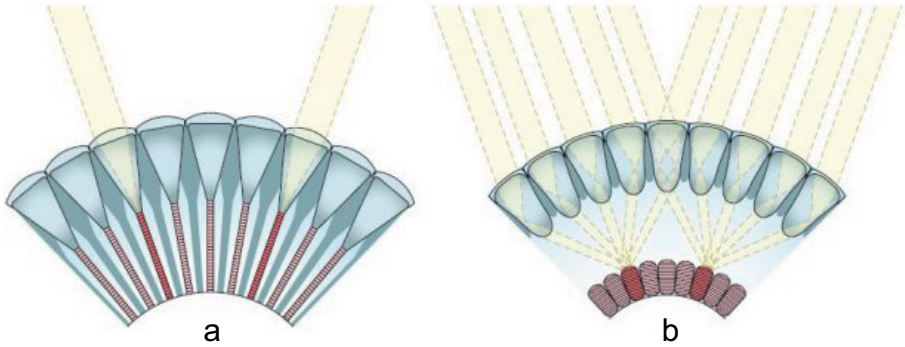

Fig. 1. Two types of compound eyes. (a) An apposition compound eye, where light reaches the photoreceptors from one single ommatidium that collects light over a small field of view. (b) A superposition compound eye, where light is collected over many optical units and superimposed onto single photoreceptors in the retina. Image courtesy of Dan-Eric Nilsson.

In an apposition compound eye, the lens and the clear crystalline cone refract incoming light and converge the rays onto the tip of the rhabdom (Land and Nilsson, 2012). The rhabdom has a higher refractive index than surrounding tissue and therefore guides the light as it travels down the rhabdom to the light sensitive retinal cells. In each of these cells, the photopigments are packed into finger-like structures called microvilli. When the photopigments in the microvilli absorb light, they activate a chain of events (the so-called photo-transduction cascade) that causes a change in the electrical potential across the cell membrane. It is this change in potential that is signalled to the brain, via nerve axons at the inner tip of the rhabdom (reviewed in Giurfa, 2007). In an apposition compound eye, each ommatidium is separated from its neighbouring units by a layer of pigment cells, which ensure that only light that enters parallel to the longitudinal axis of the ommatidium reaches the receptor cells. As a consequence of the optic structure, and the fact that each rhabdom is innervated by one axon only, each individual unit of the compound eye gives information about one small area in the field of view (Land and Nilsson, 2012). Thus, each ommatidium provides one single point of intensity information that together creates a pattern of darker and lighter dots. This information is then combined to form a single image in the brain. The finer the pattern of dark and light dots and the larger the number of dots, the better the quality of the image is.

Usually, different regions of the compound eye are used for different functions. In honeybees for example, colour discrimination is performed using the ventral, frontal and lateral visual field, while the dorsal eye region appears to lack this capability (Srinivasan, 2009; for a review see Lehrer, 1998). Self-generated image motion (optic flow) on the retina of the bee eye can be detected in the ventral, frontal and lateral regions of the eye. Ventral and lateral eye regions of the honeybee eye are also used for odometry (Lehrer, 1998). In bumblebees (*Bombus terrestris*), regulation of flight speed

and lateral distance to the surroundings is undertaken in the lateral and the ventral visual field, while regulation of flight height is undertaken in the ventral field of view (e.g. Baird et al., 2010; Linander et al., 2015, 2016, 2017).

2.2. Visual acuity

Visual acuity is most commonly defined as the finest grating that an eye can resolve, and the unit is cycles per degree (one cycle is one dark and one light stripe). The individual stripes of a grating can only be reliably resolved if the image of each stripe is projected onto a separate receptor (and if the contrast difference is sufficiently large for the system to detect a difference between the intensity of the stripes). One major limiting factor for visual acuity is the inter-receptor angle ($\Delta\theta = s/f$), where s is the distance between the receptors and f the focal length, which is the distance between the image on the retina and the nodal point (the point where rays of light passes without being bent by the lens) (Fig. 2 (lower)) (Nilsson and Land, 2012). The smaller the distance between the receptors, the finer gratings can be resolved. In an apposition compound eye, where the ommatidia are the sampling units, the inter-receptor angle is equivalent to the inter-ommatidial angle ($\Delta\theta = D/R$, where D is the diameter of the facet lens and R is the radius of the curvature of the corneal surface) (Fig. 2 (upper)). The smaller the inter-ommatidial angle – the better the resolution (Land, 1997).

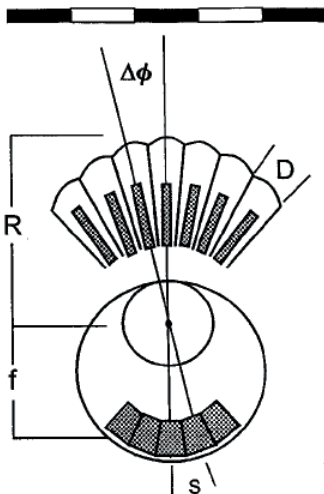

Fig. 2. The relationship between acuity in an apposition compound eye (upper) and a simple or camera-type eye (lower). $\Delta\theta$ = the angle between the receptor units, R = the radius of curvature of the compound eye, D = the diameter of the facet lens, f = the focal length of a simple eye, s = the separation between the receptors. Drawing modified from Land, 1997.

One of the ways to improve the resolution of a compound eye is therefore to increase the number of ommatidia (Kirschfeld, 1976; Land, 1992). Fruit flies, with rather few ommatidia (about 750), have relatively poor resolving capability compared to dragonflies that have the largest number of ommatidia among insects (about 30 000) (Simmons and Young, 2010). A worker honeybee has around 5500 ommatidia per eye (Seidl and Kaiser, 1981; Goodman, 2003) and the eye of an average bumblebee worker (*Bombus terrestris*) contains around 5656 ommatidia (Streinzer and Spaethe, 2014). Even so, the resolving capability of these insects is poor in comparison to that of most vertebrates (Land and Nilsson, 2012). In a Y-maze experiment, where honeybees were trained to discriminate between horizontal and vertical gratings, visual acuity was estimated to 0.26 cycles/deg. (Srinivasan and Lehrer, 1988). Using a similar technique, Macuda et al. (2001) assessed the visual acuity in bumblebees (*Bombus impatiens*) and reported an angular acuity of approximately 0.35 cycles/deg. for horizontal gratings and 0.36 cycles/deg. for vertical gratings. There are, however, distinct differences in the optical quality between the eyes of individual bumblebee workers (*Bombus terrestris*) (Spaethe and Chittka, 2003). Workers with twice the thorax width have about 50% more ommatidia and facets that are about 50% larger in diameter compared to their smaller sisters. Consequently, the larger bumblebees can resolve two points with a minimum angular separation of 3.5 deg. (i.e. 0.29 cycles/deg.), while smaller bumblebees can resolve two points with a minimum angular separation of 7 deg. (i.e. 0.14 cycles/deg.) (Spaethe and Chittka, 2003). Moreover, one also has to consider the behavioural context when assessing visual acuity. When investigating visual acuity in *Bombus terrestris*, Chakravarthi et al. (2016) found the best acuity to be approximately 0.21 cycles/deg. when the bees were tested in a Y-maze set-up. The same acuity has also been defined for bumblebees flying through a flight tunnel lined with sinusoidal gratings (Chakravarthi et al., under revision).

The major limiting factor for high visual acuity in a compound eye, is that each ommatidium works as a separate tiny optical unit with its own lens. Since there is often a need to fit many ommatidia in each eye (to improve resolution), the lenses consequently become very small (the value of D in Fig. 2 is very small). The reason why a small eye with many small lenses result in poor spatial acuity is that diffraction increases as lens diameter decreases (Land and Nilsson, 2012). Diffraction is a blurring-effect arising from the wave properties of light. When light is passing through an opening (such as the pupil/facet of an eye) it will slightly bend at the edges of the opening. The extent of bending depends on the size of the wavelength relative to the opening. The bending of light will be almost unnoticeable if the opening is much larger than the light's wavelength. The smaller the opening gets, the more bent the passing light will become, leading to a blurred pattern of light around the brightest spot. The central bright circular region is known as the airy disk, and the size of this bright spot is thus limited by the wavelength of light and the size of the

aperture. Consequently, the smaller the aperture of the eye (the diameter of the facets lenses), the more diffraction becomes a problem for visual acuity. Furthermore, a small lens diameter decreases the amount of photons (light) available to the photoreceptor (Nilsson, 1989).

In summary, in order to improve resolution in a compound eye, the ommatidia need to be densely packed, which results in poor spatial acuity due to the limited size of the many lenses. Thus, due to the anatomical constraints and the optics of compound eyes, bees have comparably poor visual acuity. Moreover, since the distance between the bee's two eyes is so small it cannot rely on binocular disparity for depth perception. But how is it then possible for bees to safely navigate through highly complex environments without crashing? This is the focus of the next chapter.

Visually guided flight control



3. Visually guided flight control

3.1. Optic flow

When an animal moves through its environment, the image of the world moves across its retina creating a pattern of apparent image motion known as optic flow (Gibson, 1950). During rotational self-motion, there is no correlation between the distance to objects in the environment and the angular velocity at which they move across the eye, which results in a uniform flow-field. During translational motion, the magnitude of optic flow varies inversely with the distance to surfaces, such that objects that are closer appear to move faster than those that are further away. Furthermore, the magnitude of optic flow is not constant over the entire visual field. Instead, it increases from a value of zero at a viewing angle of 0° with respect to the point towards which translational movement is directed (known as the focus of expansion). The magnitude of optic flow reaches a maximum at a viewing angle of 90° and decreases again to zero at a viewing angle of 180° (Gibson, 1950). Flying insects rely on these properties of optic flow to extract important information about their orientation, speed and position in relation to objects in the environment (Koenderink, 1986; Lappe, 2000; Taylor and Krapp, 2007), without the need for depth perception.

Considering the small size of the insect brain and the complexity of the environments in which they navigate and the often high speeds at which they fly, it is easy to imagine that insect flight control systems need to be effective and fast operating. There are several studies on bees suggesting that behaviours controlled by motion vision are mediated and driven by green-sensitive photoreceptors only (e.g. Lehrer et al., 1985; Lehrer et al., 1988; Spaethe et al., 2001; Chittka and Tautz, 2003), and most insect eyes, including those of the Hymenoptera, are dominated by receptors sensitive in the green parts of the light spectrum (Wakakuwa et al., 2007). For bees, it has been shown that achromatic vision is mediated primarily by green-sensitive photoreceptors, while colour vision is a result of the comparison between signals derived from green-, blue-, and UV-sensitive receptors (Lehrer et al., 1988; Briscoe and Chittka, 2001). Motion vision thus effectively relies on a ‘colour blind’ input to the visual system. Ignoring chromatic input serves to make the processing of visual

information perceived during flight faster (Skorupski and Chittka, 2010). When comparing response time in the three spectral classes of photoreceptors in the bumblebee, Skorupski and Chittka (2010) found that the green-sensitive photoreceptors generated significantly faster responses than both blue- and UV-sensitive photoreceptors. Motion vision in insects thus appears to rely only on the faster green-sensitive receptors. In accordance, it has been found that rapidly flying insects, for example several families of Diptera (flies), also have the fastest photoreceptors (Laughlin and Weckström, 1993). To further simplify the visual processing, the flight control system of bees appears to be largely insensitive to spatial frequency and contrast of the visual scenery. Honeybees flying in tunnels of constant width will maintain a constant flight speed irrespective of whether the spatial period of the gratings lining the walls is changed (Srinivasan et al., 1996; Baird et al., 2005) or if the contrast of the pattern is changed (Baird et al., 2005). The same holds true for position control (Kirchner and Srinivasan, 1989; Srinivasan et al., 1991). Fruit flies have also been reported to adjust their flight speed in relation to the change in image velocity rather than spatial frequency (David, 1982; Fry et al., 2009). This suggests the presence of a motion-processing pathway that is highly robust to changes in visual scenes, ensuring that flight is controlled primarily based on the distances to nearby surfaces and not upon their particular visual properties, such as contrast or visual texture.

There are, however, other results suggesting that the bumblebee flight control system is not completely insensitive to spatial frequency (Dyhr and Higgins, 2010). By studying bumblebee flight control in tunnels where the walls are displaying a broader variety of spatial frequencies, it has been shown that position control is affected by spatial frequency. In this study, bees were flying through a tunnel lined with sinusoidal patterns of different spatial frequencies (detectable to bumblebees). If the spatial frequency varied by a factor of at least 2.5 between the two walls, the bees were flying closer to the high spatial frequency wall.

3.2 Neural processing of optic flow

The neural processing of optic flow has been most extensively studied in flies (for reviews see Frye and Dickinson, 2001; Borst and Haag, 2002; Borst et al., 2010). The first model of a motion vision circuit was proposed by Hassenstein and Reichardt on the basis of behavioural experiments investigating the properties of the optomotor response in weevil beetles (Hassenstein and Reichardt, 1956; Reichardt, 1961). This model is therefore commonly referred to as the 'Hassenstein-Reichardt model' or the 'Reichardt detector model' (for reviews see Borst and Egelhaaf, 1989; Borst and Euler, 2011). This model suggests that motion-computing circuits, the elementary motion

detectors (EMDs), compute motion in a local area of the visual field. The elementary motion detectors consist of two subunits (symmetrically mirrored), which serve to detect a change in light intensity at one point in space and correlate it with a change in light intensity at a neighbouring point. Thus, input from a minimum of two spatially separated photoreceptors is required to detect motion. In each mirror-symmetric subunit of the EMD signals are sent down two arms, and depending on the direction of motion the signal from one arm will lead or lag behind that from the other arm. Additionally, the signal from one arm is multiplied by the signal received from the other arm, after one of them has been delayed in time. Thus, within each EMD subunit the delayed signal from one arm is multiplied with the un-delayed signal from the other arm (and vice versa). The resulting output of the two subunits is then subtracted to make up the final EMD output. Due to the subtraction of the responses, the output is positive for one direction and negative for the other. This type of neural circuit, which correlates the time-shifted signals from two neighbouring points in space, can provide reliable information about the direction of motion within a small area of the insect's visual field. The Reichardt detector model has been successfully applied to motion vision in many invertebrates (for a review see Borst and Euler, 2011). However, the actual visual processing in the insect brain is most likely more complicated than this, and more detailed models of motion detection has been proposed (for reviews see Borst and Egelhaaf, 1989; Borst, 2000; Haag et al., 2004; Borst and Euler, 2011; Yonehara and Roska, 2013). Theoretically, however, all motion detectors have three minimum requirements; (1) the detector needs at least two inputs, (2) these inputs need to be asymmetric in time and (3) interact in a non-linear way.

Ever since the Reichardt detector model was first proposed, there has been a keen interest in finding the neural circuitry underlying motion vision in insects, and the first neurons to be identified were the lobula plate tangential cells (LPTCs) (for a review see Clifford and Ibbotson, 2002). LPTCs are the last neurons in the wide-field motion vision pathway and are responsible for combining the signals from the EMDs. LPTCs are direction selective and often tuned to different patterns of optic flow. The most extensively studied tangential cells are the horizontal system (HS) cells and the vertical system (VS) cells (for a review see Borst, 2014). HS cells increase their firing rate in response to motion in the front-to-back direction and decrease it in response to back-to-front motion, whereas VS cells respond in the same way to motion the vertical plane (depolarize in response to downward motion and hyperpolarize during upward motion). The output of the LPTCs can therefore control flight behaviours such as head movements and steering manoeuvres (for a review see Egelhaaf et al., 2012). Furthermore, important networks exist between LPTCs, both within one hemisphere and between hemispheres of the visual system. For example, when a fly is rotating around its body axis, the direction of image motion will be different in the two eyes, i.e. a front-to-back flow field across one eye and back-to-front flow field

across the other eye. For the brain to reliably interpret this movement as rotational, both directions of optic flow need to be distinguished. This is possible due to networks connecting the different LPTCs (e.g. Egelhaaf et al., 2002; Egelhaaf, 2006; Haag and Borst, 2002, 2003, 2005 and 2007).

Neurologically, the visual system is not as well studied in bees as it is in flies. In the fly brain, the optic lobe (which receives input from the photoreceptors) is the primary integration centre for processing visual information. The optic lobe consists of three brain areas – the lamina, the medulla and the lobula complex – where the third brain area is divided into an anterior localised lobula and a posterior localised lobula plate (for a review see Borst and Euler, 2011). In flies, the pooling of EMD signals by LPTCs occurs in the lobula plate (Clifford and Ibbotson, 2002). In bees, however, the lobula is not divided and bees are thus lacking the posterior lobula plate found in flies. Large-field directionally selective motion detecting neurons similar to LPTCs can however be found in the lobula of honeybees (DeVoe, 1982; Paulk et al., 2009). These neurons appear to have similar functions to the LPTCs in flies (Paulk, 2008; Paulk et al., 2009). Thus, available data on bees suggest that the principles for image motion processing are likely to be similar for bees and flies, even if the details are not fully understood in bees.

3.3. Optic flow dependent behaviours

Research over the past decades has revealed the existence of a variety of behavioural responses in insects that rely on visual motion information. When it comes to flight control, bees use optic flow in order to control flight speed, height above ground, lateral position and to keep a straight flight course (e.g. Baird et al., 2010; Dyhr and Higgins, 2010; Portelli et al., 2010; Portelli et al., 2011; Linander et al., 2015, 2016, 2017, for reviews see Srinivasan et al., 1996; Srinivasan and Zhang, 2000; Srinivasan, 2011). In addition, optic flow cues are also used by insects for take-off and landing (e.g. Srinivasan et al., 2000b; Franceschini et al., 2007; Breugel and Dickinson, 2012; Baird et al., 2013), and to gauge distance travelled (e.g. Esch and Burns, 1995; Srinivasan et al., 2000a; Hrncir et al., 2003; Si et al., 2003; Collett et al., 2006).

3.3.1. The optomotor response

Motion processing in insects has been studied extensively over the past years, most frequently through the optomotor response (for a review see Srinivasan, 2011). This response was first studied in flies and refers to a turning response oriented in the same direction as the large-field image motion of the environment (Götz, 1975; Reichardt

and Poggio, 1976). This reaction serves to stabilize flight and orientation in relation to the environment. If an insect flying along a straight track gets blown off course it must be able to compensate for this unintended change in order to reach its original goal. An insect flying tethered inside a striped drum will thus turn in the direction in which the drum is rotated. The strength of the optomotor response depends primarily on the spatial frequency of the stripes (the angular period), and not on the angular velocity of the drum (Reichardt and Poggio, 1976).

3.3.2. Speed control

Several studies have shown that honeybees regulate flight speed by holding the magnitude of optic flow about a given set point (e.g. Srinivasan et al., 1996; Baird et al., 2005). By holding the magnitude of optic flow constant, flight speed is automatically controlled and adjusted according to the distance to nearby obstacles. For example, when honeybees are flying in a tapered tunnel (hour glass shaped), they slow down as they approach the narrowest section of the tunnel and accelerate when the tunnel gets wider again (Srinivasan et al., 1996). Honeybees flying in tunnels with moving patterns on the walls will fly faster when the patterns move in the direction of flight and higher pattern velocities will elicit higher flight speeds (Baird et al., 2005). Similarly, flight speed also decreases with higher pattern velocities when the pattern is moving against the direction of flight. Thus, flight speed varies linearly with pattern velocity and the change in flight speed is approximately equal to the change of pattern velocity. Honeybees and bumblebees also fly faster when translational optic flow cues are minimised (by removing the vertical contrast components from the visual field), but flight speed becomes more variable when these visual cues are minimised (Baird et al., 2005; Baird et al., 2010).

The results above are further supported by my own studies, showing that bumblebees fly significantly faster when the translational optic flow is asymmetric (weak in one eye and strong in the other) than when optic flow cues are strong in both eyes (Fig. 3) (Linander et al., 2015). When optic flow cues are weak in both eyes, bumblebees fly significantly faster than in the two previously described conditions. However, the variation in flight speed is much larger, suggesting that the bees have difficulties regulating their speed in this situation. Furthermore, as the proximity to nearby surfaces increases, flight speed also increases (Fig. 3).

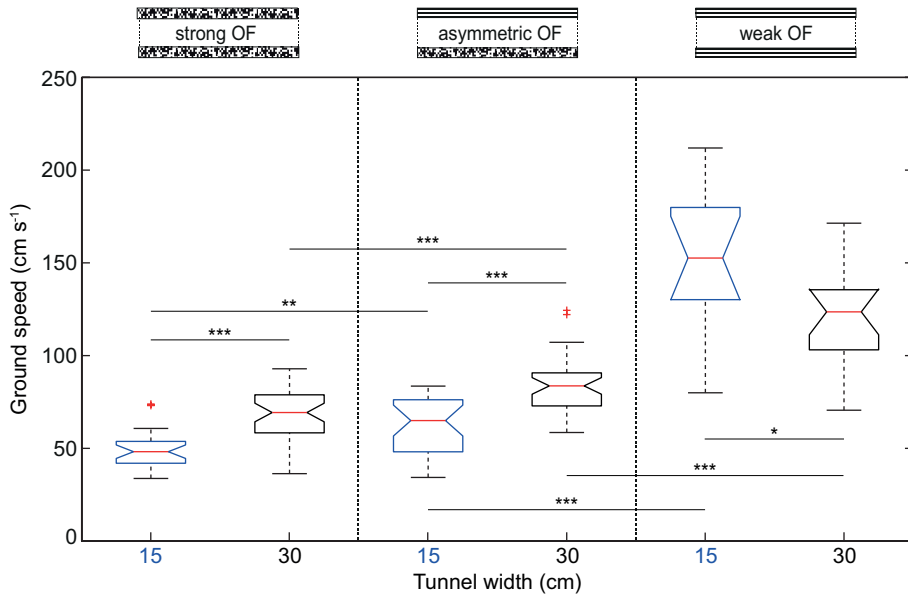

Fig. 3. Effect of asymmetric translational optic flow cues on speed control. Average flight speed of bees flying in a 15 cm (boxes outlined in blue) or 30 cm (boxes outlined in black) wide tunnel, lined with either checks on both walls (strong optic flow), stripes on one wall and checks on the other (asymmetric optic flow), or stripes on both walls (weak optic flow). Boxes indicate the extent of the 25%-75% interquartile range, the red horizontal line indicates the median, whiskers indicate the full extent of the data and red crosses represent outliers. Stars indicate the level of significance: * $p < 0.05$, ** $p < 0.01$, *** $p < 0.001$. Figure from Linander et al., 2015.

3.3.3. Altitude control

Bees and flies use image motion in their ventral visual field to control height above ground (Baird et al., 2006; Portelli et al., 2010; Straw et al., 2010). For example, honeybees flying in a tunnel with axial stripes (weak optic flow cues) on the floor, fly faster and lower than bees flying in a tunnel with checkerboard patterns (strong optic flow cues) on the floor (Baird et al., 2006). Honeybees flying along a high-roofed tunnel, part of which is equipped with a moving floor, will fly above the stationary part of the floor at a given height until they encounter the moving part of the floor (Portelli et al., 2010). If the floor is moving in the direction of flight, the bees will descend and fly at a lower height, thus gradually restoring ventral image velocity to a similar value to the one they perceived when flying over the stationary part of the floor. This is achieved not by increasing their flight speed but by lowering their flight height. By maintaining the magnitude of ventral optic flow around a desired set point, flight speed to height ratio is kept constant at the same time as flight speed and altitude will be automatically adjusted to fit the spatial layout of the environment.

While bees regulate altitude by maintaining a fixed value of image velocity beneath them, fruit flies use a combination of three reflexes for the same purpose; 1) edge

tracking, 2) wide-field stabilization, and 3) expansion avoidance (Straw et al., 2010). Firstly, altitude is established based on nearby horizontal edges and the fly tends to stay at the same height as these features. Secondly, flies respond to wide-field motion by moving in the same direction, i.e. vertical, forward, and lateral visual motions elicit movement in the same direction. Lastly, flies have been shown to avoid strong ventral image expansion by flying upward away from any strong stimulus in the ventral visual field.

3.3.4. The centring response

The ability to safely travel between obstacles is critical for fast flying animals, but how is this behaviour controlled? One of the most studied hypotheses is the ‘optic flow balancing hypothesis’, suggesting that bees flying between nearby obstacles (such as the walls of a corridor) will adjust their position by balancing the magnitude of image motion experienced in each eye, resulting in a centred flight trajectory (e.g. Kirchner and Srinivasan, 1989; Srinivasan et al., 1991; Srinivasan et al., 1996; Dyhr and Higgins, 2010; Linander et al., 2015; Linander et al., 2017). This hypothesis was first investigated by training honeybees to fly through tunnels with either stationary or moving walls lined with a vertical stripe pattern (Kirchner and Srinivasan, 1989). When the walls are stationary, the bees will maintain an equal distance to both walls. When the pattern on one of the walls moves in the same direction as the bee (thereby reducing the magnitude of optic flow in the eye closest to the moving wall), it flies closer to the moving wall to balance the speed of retinal image motion. If the pattern on the wall instead moves against the direction of flight, the bee flies closer to the stationary wall.

The same behavioural response is observed when bumblebees fly through tunnels with stationary walls lined with high contrast patterns generating different magnitudes of optic flow (Linander et al., 2015). If both walls are lined with a pattern generating strong optic flow cues (i.e. checkerboards), the bee will centre along the midline of the flight tunnel. When presented with asymmetric optic flow cues (i.e. horizontal stripes on one wall and checkerboard on the other), the bumblebees adjust their flight trajectories so that they fly further away from the wall that generates higher translational optic flow (Fig. 4). This suggests that bumblebees, just as honeybees, control their position when flying between obstacles by balancing the magnitude of optic flow experienced in each eye. When both walls are lined with a pattern that minimises translational optic flow cues (i.e. horizontal stripes) the trajectories are more spread across the tunnel’s width (Fig. 4). Some bees even flew from wall to wall, suggesting that they were no longer able to control their position (Linander et al., 2015).

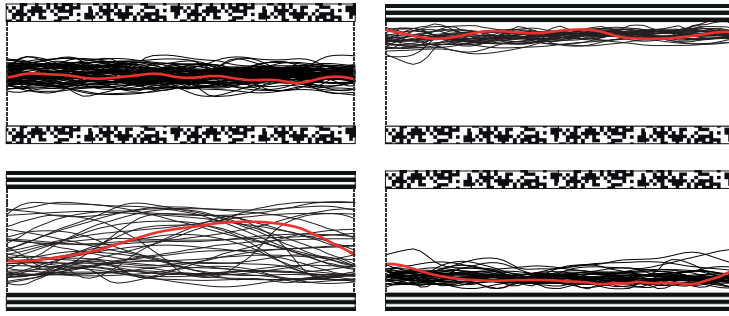

Fig. 4. Effect of asymmetric translational optic flow cues on the centring response. Raw flight trajectories for bees flying in 30 cm wide tunnels lined with either checks on both walls (upper left), stripes on one wall and checks on the other (right hand side), or stripes on both walls (lower left). A typical flight trajectory for each condition is highlighted in red. Figure modified from Linander et al., 2015.

Recently, an additional strategy has been proposed for how bees navigate between obstacles in cluttered environments (Baird and Dacke, 2016). Orchid bees trained to fly through gaps of different dimensions use the brightness gradient across the aperture to locate the point that gives them greatest clearance from the edges. They also rely on brightness cues to detect gaps that are large enough to fly through. This brightness-based guidance strategy is an effective way to find safe gaps for an insect flying in a densely vegetated forest (Baird and Dacke, 2016).

3.4. Optic flow is measured flexibly within the visual field

By utilising information contained in the pattern of translational optic flow, insects have developed computationally simple strategies for solving the rather complex problem of controlling flight and avoiding collisions with nearby obstacles. Although we now understand quite a lot about how insects use translational optic flow cues for position and speed control, one thing that has remained uninvestigated is how they use this information to detect and respond to changes in the proximity of the environment, such as those which might occur when flying from an open field into cluttered forest. The key lies in understanding where in the visual field translational optic flow for flight control is being measured.

For an insect flying forward at constant speed, the magnitude of translational optic flow is not constant over the entire visual field (see subchapter 3.1). Thus, the viewing angle at which optic flow is measured has important consequences for flight in densely cluttered environments, where timely control of position and speed are necessary for effective collision avoidance. In an early attempt to investigate where in the visual field optic flow is measured for position control, honeybees' response to a

black bar presented in an otherwise featureless flight tunnel was investigated (Srinivasan et al., 1991). The bees deflected away from the bar only once they had flown past it, suggesting that they were measuring optic flow for position control in the lateral visual field. However, more recently, honeybees (Portelli et al., 2010), blowflies (Kern et al., 2012) and bumblebees (Baird et al., 2010) have been shown to use more frontal regions of the visual field to detect changes in optic flow. In the latter study, aimed at defining the minimum viewing angle at which bumblebees measure translational optic flow for flight speed control, the changes in translational optic flow were laterally symmetric, meaning that the same change occurred in both the left and the right visual fields at the same time. This study did not address where in the visual field bumblebees measure translational optic flow for position control, something that would require a sudden change in optic flow that occurs on only *one* side of the visual field. To investigate the effect of such ‘asymmetrical’ changes in translational optic flow, I trained bumblebees to fly through a corridor displaying patterns generating either symmetrical or asymmetrical optic flow fields. The bees then encountered a unilateral change in the magnitude of optic flow, causing the flow field to change from symmetric to asymmetric or vice versa (Fig. 5). The effect on both flight speed and position control was recorded.

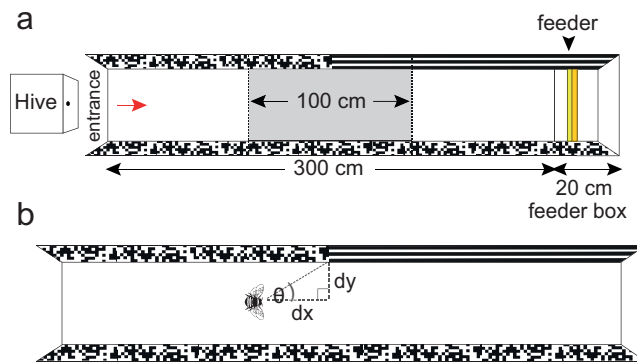

Fig. 5. Experimental set-up. (a) Schematic diagram of the flight tunnel (300 cm long, 30 cm wide and 30 cm high). The bumblebee hive was placed at one end of the flight tunnel (bees could enter anywhere along the opening of the tunnel) and a two-compartment feeder (marked in yellow), covering the whole width of the tunnel, was placed in a recess at the far end of the tunnel. A high-speed camera recorded trajectories of bees flying over the central (100 cm) section of the tunnel, indicated by the grey area. (b) Illustration of the calculation of the viewing angle (θ) occupied by the unilateral pattern change when the bees adjusted their flight speed and position in response to the abrupt change in the magnitude of optic flow. In this condition the bees are flying from symmetric to asymmetric optic flow cues (Schecks→A). Drawing modified from Linander et al., 2015.

The results show that, when bumblebees experience a sudden unilateral increase in the magnitude of optic flow (when the pattern on one wall changes from horizontal stripes to checks), they adjust their lateral position well before they reach the change itself, that is, when the change occurs at a low frontal viewing angle (Fig. 6a). In contrast, when the magnitude of optic flow on one of the walls decreases (when the

pattern on one wall changes from checks to horizontal stripes), bumblebees do not adjust their lateral position until the change occupies a larger, more lateral viewing angle (Fig. 6b). Similar to the effect on lateral position, a unilateral increase in optic flow causes a reduction in flight speed already when the change occupies a very low visual angle (Fig. 6c). A unilateral decrease in optic flow causes the bees to accelerate, but only once they have flown past the location where the magnitude of optic flow decreased (Fig. 6d). Similar results were obtained for bumblebees flying in a 15 cm wide tunnel (Linander et al., 2015).

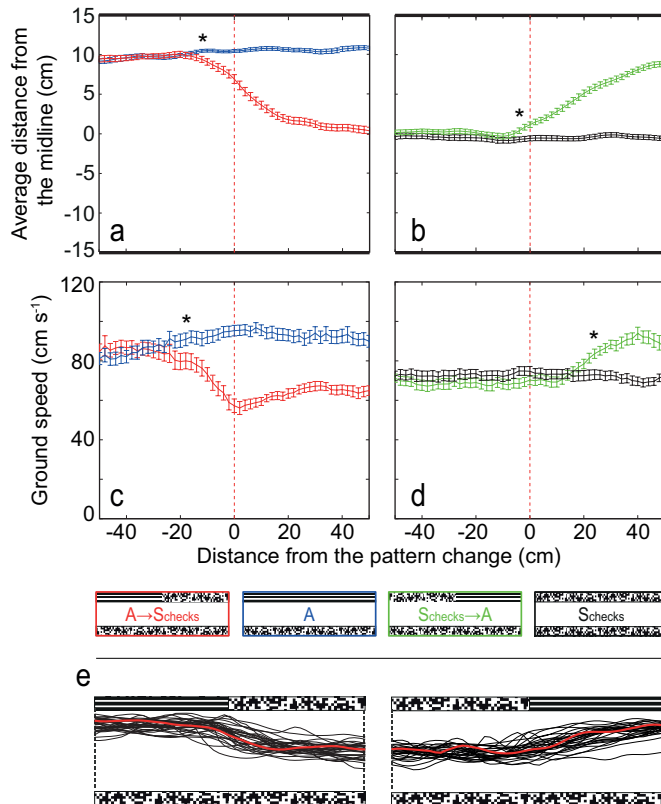

Fig. 6. Effect of an asymmetric change in optic flow on lateral position and flight speed. Average lateral position (a and b) and flight speed (c and d) of bees flying along a 30 cm wide tunnel (from left to right), where the magnitude of optic flow suddenly changes along the left (upper) wall. Red lines represent condition A→Schecks (bees are flying from an asymmetric to a symmetric optic flow field, causing the magnitude of optic flow to increase unilaterally), blue lines represent control condition A (asymmetric optic flow), green lines represent condition Schecks→A (bees are flying from a symmetric to an asymmetric optic flow field, causing the magnitude of optic flow to decrease unilaterally), and black lines represent control condition Schecks (symmetric optic flow). The red dotted line illustrates the point in the tunnel where the unilateral pattern-change occurred, generating an asymmetric change in the magnitude of translational optic flow. Means are calculated over 2 cm bins, error bars represent the standard error of the mean. Asterisks indicate where the lateral position/speed of the bees in condition A→Schecks or Schecks→A deviates significantly from the lateral position/speed in the corresponding control condition (A or Schecks, respectively). (e) Raw flight trajectories for the conditions A→Schecks and Schecks→A. A typical flight trajectory for each condition is highlighted in red. Figure modified from Linander et al., 2015.

In summary, unilateral *increases* in the magnitude of optic flow causes adjustments in position and reductions in flight speed when they occupy very narrow viewing angles (position: 14 and 27 deg. in the 15 and 30 cm wide tunnels respectively; speed: 9 and 16 deg. in the 15 and 30 cm wide tunnels respectively). The response to a unilateral *decrease* in optic flow is initiated much later, when the change occupies much larger viewing angles (position: 106 and 75 deg. in the 15 and 30 cm wide tunnels respectively; speed: 159 and 157 deg. in the 15 and 30 cm wide tunnels respectively). Thus, there are large differences in the viewing angles at which bumblebees react to changes in optic flow.

The findings of this study indicate that the visual angle at which optic flow cues are measured for position and speed control varies depending on where in each frontal visual field the *highest magnitudes of translational optic flow* are experienced. Thus, bumblebees do not appear to be measuring translational optic flow cues at one set location in each eye. Instead, they appear to use these cues as soon as they can be detected, irrespective of their exact angular location. Even when the strongest optic flow cues have passed a large viewing angle ($> 90^\circ$), bumblebees seem to be able to use them to control position and flight speed. The apparent flexibility and sensitivity of the bumblebee's optic flow measuring system ensures that they are able to detect and respond to changes in the proximity of on-coming obstacles. In a cluttered environment, the bees will thus regulate their position and speed according to the nearest obstacles, allowing them to maximise flight efficiency and to minimise the risk of collision.

3.5. Flight control in open environments

Studies investigating insect flight control have mainly been conducted in 1 m to 2 m long tunnels that are less than 40 cm wide. When flying along these relatively narrow tunnels, bumblebees (Dyhr and Higgins, 2010; Linander et al., 2015) and honeybees (Kirchner and Srinivasan, 1989; Srinivasan et al., 1991) appear to balance the magnitude of the lateral optic flow experienced in each eye, causing them to fly along the midline of the tunnel. In nature, however, bees very often fly in open environments when for example flying over meadows in-between patches of denser vegetation. In the first study to be conducted in a wider tunnel, Serres et al. found that honeybees flying in a 95 cm wide tunnel will still fly along the midline if both the feeder and the entrance are centred (Serres et al., 2008b). When the feeder and the entrance are instead placed on the same side of the tunnel, the bees will adopt a wall-following behaviour, suggesting that bees do not necessarily need to balance the lateral optic flow when flying along wider corridors. This wall-following behaviour is thought to be mediated by a system that strives to maintain the unilateral magnitude

of optic flow constant (Serres et al., 2008b). In one of my studies, however, I found that in absence of a visible feeder, bumblebees will balance the translational optic flow input experienced in each eye when negotiating tunnels up to at least 120 cm in width (Linander et al., 2017). But how is flight controlled when the distance to the nearby lateral surfaces become much larger? Since the magnitude of translational optic flow decreases with the distance to surrounding surfaces, it might not be possible for bees to balance the optic flow input perceived in each eye when flying in open environments. As a part of this thesis, I designed two studies to investigate how the proximity of nearby surfaces affect flight speed and position control in bumblebees (Linander et al., 2016; Linander et al., 2017). In these studies *Bombus terrestris* were trained to fly along a tunnel changing incrementally from 60 cm to 240 cm in width.

The results suggest that increases in the distance between the tunnel walls affect flight speed (Linander et al., 2016) as well as the control of lateral position (Linander et al., 2017). The effect of tunnel width on flight speed, however, decreases as the tunnel gets wider. While flight speed increases with increasing tunnel width between the 60 cm and 120 cm wide tunnels, this relationship become weaker between the 120 cm and 180 cm wide tunnels and is absent between the 180 cm and 240 cm wide tunnels (Fig. 7a, b). This non-proportional relationship between tunnel width and the increase in flight speed indicates that bumblebees are not only using the optic flow generated by the walls to control flight. It has been shown that, in addition to using optic flow from the lateral field of view, honeybees can also use optic flow in their ventral visual field to control flight (Baird et al., 2006, Portelli et al., 2010; Portelli et al., 2011). It is therefore possible that, like honeybees, bumblebees use ventral optic flow cues to control flight. If this were the case, we would expect flight speed to vary with height such that bumblebees that fly further from the ground should also fly faster. Indeed, my results reveal a strong positive relationship between flight speed and height in the wider tunnels, but not in the narrower tunnels, where the influence of the tunnel walls is still large (Fig. 7c) (Linander et al., 2016).

For open environments, its reasonable to expect an increasing influence of the optic flow generated in the ventral field of view, considering the large proportion of the visual field that the ground occupies in relation to the lateral surfaces. Thus, as the distance between the walls increases, the optic flow that is being used to control flight *speed* is being increasingly dominated by information from the ground (Linander et al., 2016).

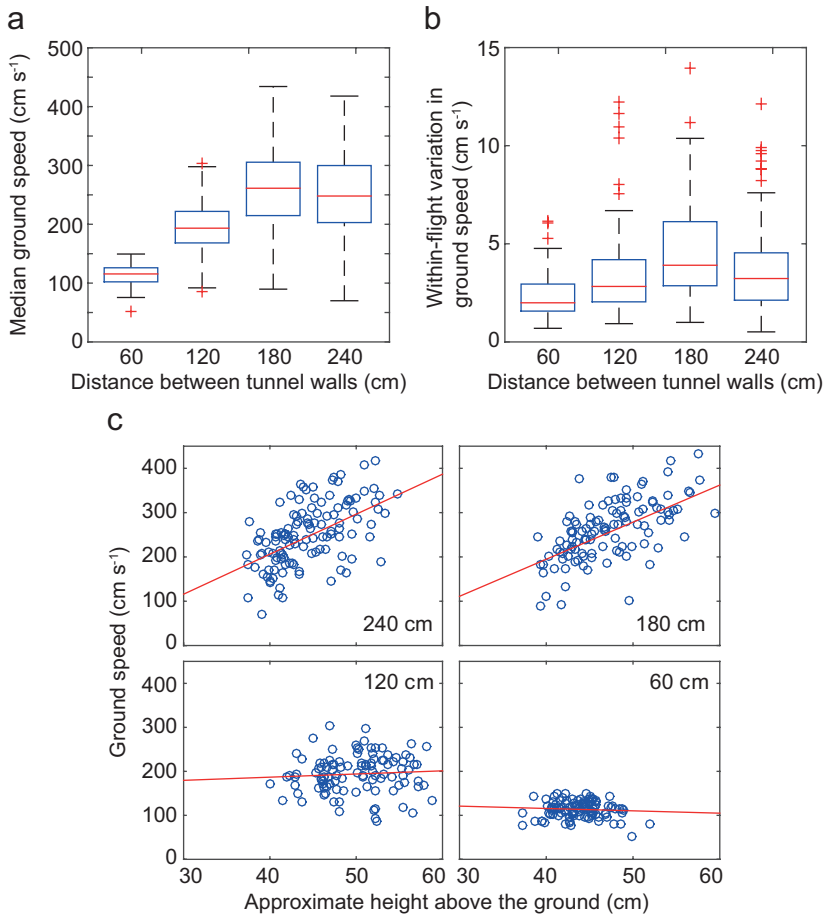

Fig. 7. The effect of tunnel width on flight speed control. (a) The median flight speed of bees flying in tunnels of different widths. Boxes indicate the extent of the 25%-75% interquartile range, the red horizontal line indicates the median, whiskers indicate the full extent of the data and red crosses represent outliers. (b) The within-flight variation (interquartile range) of flight speed for each flight trajectory (other details as in a). (c) Median flight speed as a function of the median height flown above the ground. Red lines indicate a linear regression fit to the data. Figure modified from Linander et al., 2016.

To further investigate if ventral optic flow cues are also being used to control flight *position* in wider environments, I compared flight trajectories of bumblebees flying over a patterned floor (generating strong optic flow cues) with trajectories of bumblebees flying over a featureless white floor (generating negligible optic flow cues) in tunnels of different widths (60, 120, 180 and 240 cm) (Linander et al., 2017). The results show that, in the presence of ventral optic flow cues, bumblebee flight trajectories are more densely centred around the midline and the within-flight variation in lateral position is smaller compared to when ventral optic flow is absent (Fig. 8). The flight paths are also straighter in presence of strong ventral optic flow

cues. Together, these results show that ventral optic flow improves position control and helps bumblebees to maintain straighter flight trajectories. When lateral optic flow cues were minimised (by replacing the wall patterns with two uniformly grey walls) the bumblebees still safely navigated down the tunnel to the food reward (see Linander et al., 2017 for further details). This indicates that the bees are able to control their flight position based on ventral optic flow cues alone.

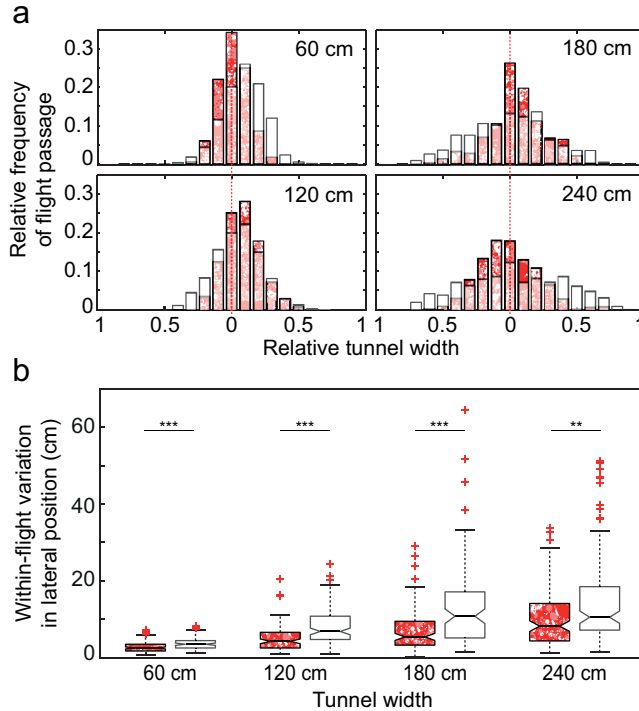

Fig. 8 The effect of ventral optic flow on lateral position. The floor was either white, or lined with a red dead leaves pattern. Both walls were lined with a dead leaves pattern. (a) The relative frequency of flight passage in tunnels of different width. The plot contains data from two conditions: *dark patterned bars* represent flights over a patterned floor, *white transparent bars* represent flights over a white floor (light red patterned areas represent overlap between the two data sets). Each bar corresponds to a longitudinal strip that has a relative width of 5% of the tunnel diameter. The red dotted line represents the midline of the tunnel. (b) Within-flight variation (interquartile range) in lateral position for bees flying in a tunnel lined with dead leaves pattern on the floor (patterned boxes) or of bees flying over a white floor (white boxes). Boxes indicate the extent of the 25%-75% interquartile range, the horizontal line indicates the median, whiskers indicate the full extent of the data and red crosses represent outliers. Asterisks indicate the significance level: ** p < 0.01, *** p < 0.001. Figure from Linander et al., 2017.

From the ventral optic flow field, insects can get information about their forwards, backwards, lateral or rotational movements over the ground. When flying on a perfectly straight course, a bumblebee will experience a ventral optic flow field moving exclusively in the front-to-back direction. However, as soon as the bee is translating slightly towards the right or the left side the ventral optic flow field vectors

will gain a leftwards or rightwards component. In combination with the well-studied optomotor response (Götz, 1975; Reichardt and Poggio, 1976), that compensates for unintended deviations off course by generating a turning response with the same direction as the rotational optic flow field, changes in the translational component of the ventral optic flow field can also provide the bee with information to correct for unwanted deviations in their flight course. In the bees' natural environment, the ability to keep a straight course towards a food source (or a nest), well away from obstacles, would result in more efficient and safer foraging flights.

In most terrestrial environments, the ground is heavily textured and can provide insects with clearly perceivable ventral optic flow information. The only time when this might change is when flying over a flat texture-less surface such as a pond or a lake. Honeybees trained to fly over still water tend to fly so low that they eventually crash into the water surface (Heran and Lindauer, 1963), indicating that they do not cope well in environments poor in ventral optic flow. Honeybees trained to collect food on a boat in the middle of a lake had less success recruiting foragers than bees trained to collect food on land (Tautz et al., 2004). Furthermore, honeybees are generally hesitant to fly over water and will most likely chose a detour over land if possible (Pahl et al., 2011). My results also indicate that bumblebees prefer to fly over surfaces that generate strong ventral optic flow cues, rather than over a texture-less ground (Linander et al., 2017), and is thereby consistent with previous observations. Suggestively, the honeybees' preference to fly over land may, in part, be due to their reliance on ventral optic flow cues to control their flight in open environments.

Altogether, my results suggest that, in open environments, bumblebees use ventral optic flow cues to control flight speed (Linander et al., 2016) and lateral position (Linander et al., 2017). This further supports the hypothesis that bumblebees measure optic flow for flight control flexibly in their visual field, depending on where the maximum magnitude of translational optic flow occurs (Linander et al., 2015). It also adds another dimension to it by suggesting that bumblebees do measure optic flow in the ventral visual field if the magnitude is higher there than in the lateral visual field. While the availability of optic flow cues in the lateral visual field might be very variable depending on the distance to nearby lateral surfaces, the availability of ventral optic flow cues depends only on the height at which the insect flies. It is therefore logical that bees will benefit from using ventral optic flow as a cue for flight control when flying in open environments.

Learning flights and the importance of optic flow



4. Learning flights and the importance of optic flow

We have now understood the importance of being able to control flight speed, height and position in space for bees in cruising flight. These three flight control parameters are particularly important when bees perform learning flights, a special kind of flight designed to memorise the location of the nest or a newly discovered food source. How optic flow influences the control of learning flights in bumblebees will be the focus of this chapter.

4.1. Finding the way home

Bees, together with most hymenopteran insects, can forage far away from their nest. In order to find their way back home, these insects have to pinpoint the exact location of their nest in relation to its surroundings. If the insect wishes to revisit a newly discovered food source, it also needs to remember the direction and distance to this particular place. Some insects solve this problem by leaving pheromone trails (for example several ant species (for a review see Jackson and Ratnieks, 2006)), while other walking and flying insects, such as desert-wood-ants and bees, primarily rely on visual cues to find their way home (for reviews see Collett et al., 2006; Warrant and Dacke, 2011; Zeil, 2012; Webb and Wystrach, 2016).

It is known that bees possess a visually driven odometer that monitors the distance flown by integrating the amount of optic flow experienced during a given flight (e.g. Esch and Burns, 1995; Srinivasan et al., 1997; Srinivasan et al., 1998; Cheng et al., 1999; Esch et al., 2001; Si et al., 2003; Tautz et al., 2004; Dacke and Srinivasan, 2007). Honeybees trained to forage in narrow tunnels, generating rich optic flow cues, thus tend to overestimate the actual distance flown to a food source compared to bees trained outdoors in their natural environment (Esch et al., 2001; Srinivasan et al., 2000a; Si et al., 2003). However, when flying through a tunnel lined with horizontal stripes that generate negligible translational optic flow cues, honeybees communicate that they have flown a very short distance. Estimation of distance flown

is consequently dependent on the proximity of the environment since the magnitude of optic flow depends on the distance to nearby surfaces. When bees are trained in a wider tunnel but tested in a narrower one, they will search for the reward at a shorter distance from the entrance, and when trained in a narrow tunnel but tested in a wider one, they will search further into the tunnel (Srinivasan et al., 1996; Srinivasan et al., 1997). When the translational optic flow cues in the tunnel are minimised, bees are unable to pinpoint the previous location of a reward, and instead fly from one end of the tunnel to the other. Estimation of distance flown is also dependent on flight height. Bees flying low will experience a higher magnitude of optic flow and thereby estimate a larger distance than a bee flying higher above the ground (Srinivasan et al., 2000a).

To find the exact location of the nest or food source, a stable environmental landmark is a good indicator of its position (at least for an animal relying on vision for its navigation). One of the first studies to demonstrate the use of landmarks was Tinbergen's homing experiment in the digger wasp (*Philanthus triangulum*) (Tinbergen, 1932). A circle of pinecones was placed around an active wasp nest and once a wasp left the nest to forage, the pinecones were displaced to a fake nest 30 cm away from the true nest. As a result of this displacement of the landmarks, the homecoming wasp landed in the centre of the pinecone ring, away from its true nest. Many later studies have confirmed the use of landmarks in insect navigation and that insects can learn a broad variety of visual features such as landmark size, colour, motion cues, edge orientation and symmetry (e.g. Lehrer et al., 1988; Menzel and Backhaus, 1991; Srinivasan et al., 1994; Giurfa et al., 1996; Horridge, 1996; Ronacher, 1998; Ernst and Heisenberg, 1999; Dittmar et al., 2010).

Consequently, a combination of short-range cues (landmarks) and long-range cues (visual odometry) would be the ideal solution to guide an insect to various known goals. Indeed, it has been shown that bees trained to forage in a tunnel generating strong optic flow cues with a landmark positioned directly above the feeder searched much more accurately when both odometric and landmark cues were available than when only odometric cues were available (Vladusich et al., 2005). When odometric cues were absent, however, bees searched for much shorter time around the vicinity of the landmark compared to when odometric cues were present. When the two cues were set in conflict, by shifting the position of the landmark in the tunnel, bees used landmark cues rather than odometric cues. These results suggest that bees pay attention to both odometric- and landmark cues in a very flexible and dynamic way when learning the location of a goal.

4.2. What is a learning flight?

When leaving the nest for the first time, bees and wasps perform learning flights in order to memorise the location of the nest (e.g. Tinbergen, 1932; Lehrer, 1991, 1993; Collett and Lehrer, 1993; Collett, 1995; Zeil, 1993a; Zeil et al., 1996; Hempel de Ibarra et al., 2009). During these flights, wasps fly in a very characteristic pattern of continuously expanding arcs where height, lateral displacement and flight speed are continuously increased (for a review see Zeil et al., 1996). By arcing around the goal in this stereotyped manner, wasps keep the nest within their visual field throughout the flight, which simplifies the learning of the nest position. This arc-shaped flight pattern also creates a motion parallax centred around the nest that can be used to estimate the distance to various landmarks in relation to the nest (Zeil et al., 1993a, b).

Lately, learning flights have also been studied in bumblebees (Hempel de Ibarra et al., 2009; Collett et al., 2013; Philippides et al., 2013; Riabinina et al., 2014; Linander et al., manuscript). Whilst learning flights in wasps are quite stereotyped, bumblebee learning flights are much more variable. The most repeatable sections of their learning flights are loops interspersed with segments of straight flight (Philippides et al., 2013, Collett et al., 2013). Whilst variable in size and shape, loops increase in diameter over the duration of the flight and they usually end at or close to the nest (Philippides et al., 2013). During the learning flight, bumblebees face the nest many times, presumably to acquire visual information about the relationship between the nest and its surroundings (Philippides et al., 2013). Recordings of learning flights under natural conditions show that, to do this, bumblebees actively adjust their body and head orientations (that are closely associated), with the result that they often diverge from the flight direction (Philippides et al., 2013, Riabinina et al., 2014). Thus, during a learning flight, bumblebees not only need to fly forwards but also sideways, with instances of hovering or backwards flight but it is not clear what information they use to control these complex manoeuvres. Do they use the same translational optic flow-based strategies that are used to control cruising flight (see chapter 3)?

4.3. The role of optic flow in visual control of learning flights

Previous studies, undertaken to investigate learning flights in bumblebees, were conducted in natural environments where bees are likely to take advantage of surrounding sensory information, and manipulations are more difficult to control (e.g. Hempel de Ibarra et al., 2009). Although bees are known to use optic flow to extract information about the spatial layout of the nest surroundings (Dittmar et al.,

2010, Mertes et al., 2014, Riabinina et al., 2014), its role in controlling the complex manoeuvres performed during learning flights remains unclear. I therefore designed a study investigating the role of translational optic flow in the control of learning flights, with a focus on the importance of translational optic flow cues in different parts of the visual field (Linander et al., manuscript (paper IV)). I recorded learning flights of bumblebees (*Bombus terrestris*) in an artificial environment where I manipulated the optic flow presented in the bee's ventral and panoramic field of view.

My results show that, in presence of rich optic flow information in the ventral and panoramic visual fields, bumblebees conducted well-controlled learning flights consisting of small loops concentrated around the nest, followed by larger loops as they increased their distance away from the nest. Whilst initially staying close to the nest exit, lateral distance from the nest and flight height increased as the flight progressed (Fig. 9a, b). Additionally, flight speed increased with lateral distance from the nest and with flight height (Fig. 9c, d). This is consistent with earlier reports showing that loops of bumblebee learning flights tend to grow in size during a flight, and that larger loops are flown at higher speeds compared to smaller loops (Philippides et al., 2013, Collett et al., 2013). These studies, however, did not measure the height of the learning flights. My results add another dimension by demonstrating a strong correlation between flight speed and height above the ground (Fig. 9c). Thus, bumblebees appear to hold the magnitude of ventral optic flow around a desired set point by increasing flight speed as they gain altitude. This indicates that ventral optic flow cues are important for the control of learning flights, just as has been shown for the control of cruising flight (Baird et al., 2006; Portelli et al., 2010; Linander et al., 2016; Linander et al., 2017). As the bumblebees flew further away from the nest exit, they also increased their flight height (Fig. 9e). Altogether, this indicates that when the bees loop away from the nest, they fly higher and faster, and when they come back towards the nest they fly lower and slower. By matching the height above ground with lateral distance from the nest the bees will view the nest at a rather constant elevation in their field of view. This could possibly facilitate the extraction of visual information.

What happens then, when ventral or panoramic optic flow cues disappear? Figure 10 displays a raw flight trajectory for each condition when (a) both ventral and panoramic optic flow cues are present, (b) only panoramic optic flow cues are present, and (c) when only ventral optic flow cues are present.

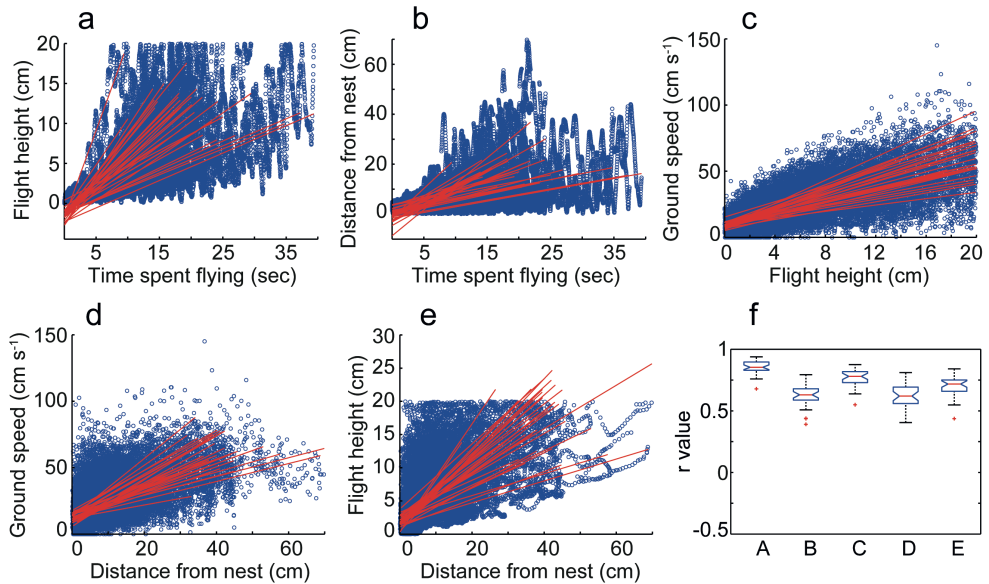

Fig. 9. Flight control in presence of strong ventral and panoramic optic flow cues. (a) Flight height as a function of time spent flying. (b) Lateral distance from the nest as a function of time spent flying. (c) Flight speed as a function of height flown above the surface of the arena. (d) Flight speed as a function of lateral distance from the nest. (e) Flight height as a function of lateral distance from the nest. Red lines indicate a linear regression fit to the data for each flight. (f) The associated means of the correlation coefficient (r) are plotted as boxplots. Blue boxes indicate the extent of the 25%-75% interquartile range, the red horizontal line in the box indicates the median, whiskers indicate the full extent of the data and red crosses represent outliers. Figure modified from Linander et al., manuscript (paper IV).

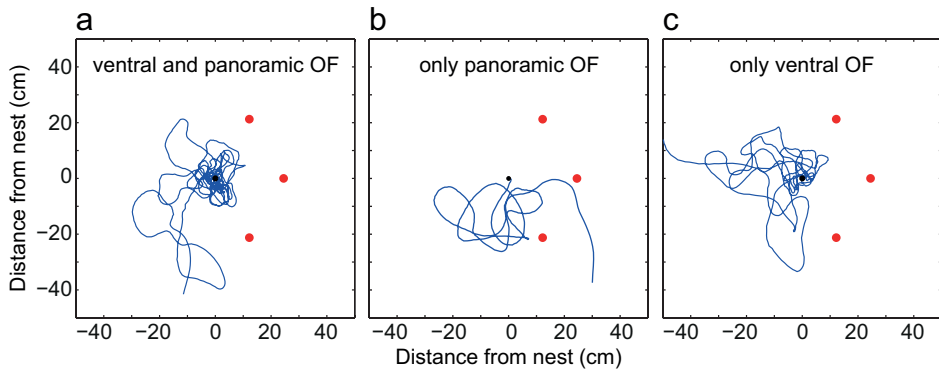

Fig. 10. Examples of flight trajectories as viewed from above. The blue line represents one example trajectory from each condition for when (a) both ventral and panoramic optic flow cues (OF) are present, (b) only panoramic optic flow cues (OF) are present, and (c) when only ventral optic flow cues (OF) are present. The red dots mark the position of the landmarks that surrounded the nest exit (black dot). Figure modified from Linander et al., manuscript (paper IV).

When ventral optic flow cues are absent, the bumblebees are unable to perform a proper learning flight (Fig. 10b; for more details see Linander et al., manuscript (paper IV)). The looping flight pattern disappears, and flight height and lateral position around the nest exit become very variable. Moreover, the duration and path length of the flights become shorter and there is no longer any correlation between flight speed and height above ground. Ventral optic flow thus appears to play an important role in the control of learning flights, but how important is the panoramic optic flow field? My results demonstrate that, as long as the bees can resolve the texture in the ventral visual field, they can control their learning flights (in terms of height and lateral distance from the nest) even when panoramic optic flow is absent (Fig. 10c; for more details see Linander et al., manuscript (paper IV)). However, the duration and path length of the flights are significantly shorter in absence of panoramic optic flow. This indicates that although panoramic optic flow cues are not essential they seem to enable fine-scaled control of the different manoeuvres during learning flights.

When ventral optic flow is only available up until certain heights above the ground (limited by the ability of the bees to resolve the pattern on the ground), bumblebees appear to adjust flight height to maintain the perception of the ventral optic flow cues (Linander et al., manuscript (paper IV)). This is similar to observations made for the control of cruising flight in honeybees (e.g. Portelli et al., 2010). Conducting the learning flights at lower altitudes, to prevent losing the perception of ventral optic flow cues, could be an adaptive strategy to continue the learning process throughout the flight and thus obtain the necessary visual information. Although I did not investigate the functional consequences of these adjustments (for example whether they affected the learning of the nest position), it seems that bumblebees can cope with different ground textures, enabling them to complete the learning flight and gain maximum information about the nest location.

In summary, bumblebees use cues derived from ventral and panoramic image motion in order to accurately control their learning flights. More specifically, I show that the ventral optic flow cues are important for the control of learning flights in bumblebees. In the absence of ventral optic flow cues, the flights become very variable in terms of flight height and lateral distance from the nest, and the looping pattern disappears. Whether panoramic optic flow cues are present or not does not strongly affect the overall structure of the learning flight, but these cues might still be involved in fine-scale flight control. Finally, when the availability of ventral optic flow is limited to certain heights, bumblebees appear to adjust their flight parameters to maintain the perception of ventral optic flow cues.

5. Concluding remarks

In conclusion, the results compiled in this thesis contribute to a better understanding of how insects control flight. Among other findings, my results emphasize the importance of a being able to flexibly measure optic flow in different parts of the visual field. I show that, the visual region over which bumblebees respond to optic flow cues is not dictated by a set viewing angle. Instead, the bees appear to use the maximum magnitude of optic flow experienced in their frontal visual field (chapter 3.4 and paper I). This flexibility allows bumblebees to adjust their flight in response to changes in the environment as soon as they are detected, irrespective of where in the visual field they may occur. In narrow environments, bumblebees control flight based on translational optic flow cues generated by nearby lateral surfaces. In wider environments, however, where the lateral optic flow becomes unreliable, they benefit from using ventral optic flow cues instead. Bumblebees thus measure optic flow flexibly over a large lateral and ventral field of view (chapter 3.5 and paper II, III). Furthermore, I show that the availability of ventral optic flow cues is important for bumblebees' ability to perform a well-controlled learning flight, and they therefore adjust their flight parameters as to maintain sufficient ventral optic flow information throughout the flight (chapter 4.3 and paper IV).

I bet many of you have been fascinated by a fly's ability to escape your attempts to catch it. Despite their simple nervous systems flying insects are efficient in predicting and preventing collisions (with for example malicious human hands). The work presented in this thesis enables a deeper understanding about insect navigation and how they manage to avoid collisions. But the flight performance of small insects is not only interesting from a biological point of view. Knowledge about how insects use optic flow cues to control different parameters of flight is useful for engineers striving to develop smaller and more efficient autonomous robots. Some optic flow based behaviours such as flight stabilization, flight odometry and the control of speed and position has already been implemented in flying robots (e.g. Srinivasan et al., 1999; Iida, 2003; Argyros et al., 2004; Ruffier and Franceschini, 2005; Serres et al., 2008a; Srinivasan et al., 2009). Bio-inspired flight control is and will be an interesting research topic providing engineers with inspiration for designing future autopilot systems with the ability to handle unexpected events.

References

- Argyros, A. A., Tsakiris, D. P. and Groyer, C. (2004). Bio-mimetic centering behavior: Mobile robots with panoramic sensors. *IEEE Robotics and Automation Magazine, Special Issue on Panoramic Robotics* 11(2), 21-30.
- Baird, E. and Dacke, M. (2016). Finding the gap: a brightness-based strategy for guidance in cluttered environments. *Proc. Biol. Sci.* 283(1828), 20152988.
- Baird, E., Srinivasan, M. V., Zhang, S. W. and Cowling, A. (2005). Visual control of flight speed in honeybees. *J. Exp. Biol.* 208, 3895-3905.
- Baird, E., Srinivasan, M. V., Zhang, S. W. and Cowling, A. (2006). Visual Control of Flight Speed and Height in the Honeybee. *Lecture Notes in Computer Science* 4095, 40-51.
- Baird, E., Boeddeker, N., Ibbotson, M. and Srinivasan, M. V. (2013). A universal strategy for visually guided landing. *PNAS* 110(46), 18686-18691.
- Baird, E. and Dacke, M. (2012). Visual flight control in naturalistic and artificial environments. *J. Comp. Physiol. A* 198, 869-876.
- Baird, E., Kornfeldt, T. and Dacke, M. (2010). Minimum viewing angle for visually guided ground speed control in bumblebees. *J. Exp. Biol.* 213, 1625-1632.
- Borst, A. (2000). Models of motion detection. *Nature Neuroscience* 3, 1168.
- Borst, A. (2014). Fly visual course control: behaviour, algorithms and circuits. *Nature Reviews Neuroscience* 15, 590-599.
- Borst, A. and Egelhaaf, M. (1989). Principles of visual motion detection. *Trends Neurosci.* 12, 297-306.
- Borst, A. and Euler, T. (2011). Seeing things in motion: models, circuits, and mechanisms. *Neuron* 71, 974-994.
- Borst, A. and Haag, J. (2002). Neural networks in the cockpit of the fly. *J. Comp. Physiol. A* 188, 419-437.
- Borst, A., Haag, J. and Reiff, D. F. (2010). Fly motion vision. *Annu. Rev. Neurosci.* 33, 49-70.
- van Breugel, F. and Dickinson M. H. (2012). The visual control of landing and obstacle avoidance in the fruit fly *Drosophila melanogaster*. *J. Exp. Biol.* 215, 1783-1798.
- Briscoe, A. D. and Chittka, L. (2001). The evolution of color vision in insects. *Ann. Rev. Entomol.* 46, 471-510.
- Caveney, S. and McIntyre, P. (1981). Design of graded-index lenses in the superposition eyes of scarab beetles. *Phil. Trans. R. Soc. London B* 294, 589-632.

- Chakravarthi, A., Baird, E., Dacke, M. and Kelber, A. (2016). Spatial Vision in *Bombus terrestris*. *Front. Behav. Neurosci.* 10, 17.
- Chakravarthi, A., Kelber, A., Baird, E. and Dacke, M. (under revision). High contrast sensitivity for visually guided flight control in bumblebees. Submitted to *J. Comp. Physiol. A*.
- Cheng, K., Srinivasan, M. and Zhang, S. (1999). Error is proportional to distance measured by honeybees: Weber's law in the odometer. *Anim. Cogn.* 2(1), 11-16.
- Chittka, L. and Tautz, J. (2003). The spectral input to honeybee visual odometry. *J. Exp. Biol.* 206, 2393-2397.
- Clifford, C. W. and Ibbotson, M. R. (2002). Fundamental mechanisms of visual motion detection: Models, cells and functions. *Prog. Neurobiol.* 68, 409-437.
- Collett, T. S. (1995). Making learning easy: the acquisition of visual information during the orientation flights of social wasps. *J. Comp. Physiol. A* 177, 737-747.
- Collett, M., Collett, T. S. and Srinivasan, M. V. (2006). Insect Navigation: Measuring Travel Distance across Ground and through Air. *Curr. Biol.* 16(20), R887-R890.
- Collett, T. S. and Lehrer, M. (1993). Looking and learning: a spatial pattern in the orientation flight of the wasp *Vespa vulgaris*. *Proc. Roy. Soc. Lond. B* 252, 129-134.
- Collett, T. S., Hempel de Ibarra, N., Riabinina, O. and Philippides, A. (2013). Coordinating compass-based and nest-based flight directions during bumblebee learning and return flights. *J. Exp. Biol.* 216, 1105-1113.
- Curcio, C. A., Sloan, K. R., Kalina, R. E. and Hendrickson, A. E. (1990). Human photoreceptor topography. *J. Comp. Neurol.* 292, 497-523.
- Dacke, M. and Srinivasan, M. V. (2007). Honeybee navigation: distance estimation in the third dimension. *J. Exp. Biol.* 210, 845-853.
- David, C. T. (1982). Compensation for height in the control of groundspeed by *Drosophila* in a new, 'barber's pole' wind tunnel. *J. Comp. Physiol. A* 147, 485-493.
- DeVoe, R. D., Kaiser, W., Ohm, J. and Stone, L. S. (1982). Horizontal movement detectors of honeybees: directionally-selective visual neurons in the lobula and brain. *J. Comp. Physiol.* 147, 155-170.
- Dittmar, L., Stürzl, W., Baird, E., Boeddeker, N. and Egelhaaf, M. (2010). Goal seeking in honeybees: matching of optic flow snapshots? *J. Exp. Biol.* 213(17), 2913-2923.
- Dyhr, J. P. and Higgins, C. M. (2010). The spatial frequency tuning of optic-flow-dependent behaviors in the bumblebee *Bombus impatiens*. *J. Exp. Biol.* 213, 1643-1650.
- Egelhaaf, M. (2006). The neural computation of visual motion information. In: *Invertebrate vision*, ed. Warrant, E. and Nilsson D. E. pp. 399-461. Cambridge: Cambridge University Press.
- Egelhaaf, M. (2012). Spatial vision in insects is facilitated by shaping the dynamics of visual input through behavioral action. *Frontiers in Neural Circuits* 6, 108.
- Egelhaaf, M., Kern, R., Krapp, H. G., Kretzberg, J., Kurtz, R. and Warzecha, A. K. (2002). Neural encoding of behaviourally relevant visual-motion information in the fly. *TRENDS in Neurosciences* 25(2), 96-102.

- Ernst, R. and Heisenberg, M. (1999). The memory template in *Drosophila* pattern vision at the flight simulator. *Vision Res.* 39, 3920-3933.
- Esch, H. E. and Burns, J. E. (1995). Honeybees Use Optic Flow to Measure the Distance of a Food Source. *Naturwissenschaften* 82, 38-40.
- Esch, H. E., Zhang, S. W., Srinivasan, M. V. and Tautz, J. (2001). Honeybee dances communicate distance measured by optic flow. *Nature* 411, 581-583.
- Franceschini, N., Ruffier, F. and Serres, J. (2007). A bio-inspired flying robot sheds light on insect piloting abilities. *Curr. Biol.* 17, 329-335.
- Fry, S. N., Rohrseitz, N., Straw, A. D. and Dickinson, M. H. (2009). Visual control of flight speed in *Drosophila melanogaster*. *J. Exp. Biol.* 212, 1120-1130.
- Frye, M. A. and Dickinson, M. H. (2001). Fly Flight: A Model for the Neural Control of Complex Behavior. *Neuron* 32, 385-388.
- Gibson, J. J. (1950). *The Perception of the Visual World*, ed. Carmichael, L. Boston, MA: Houghton Mifflin.
- Giurfa, M. (2007). Behavioral and neural analysis of associative learning in the honeybee: a taste from the magic well. *Journal of Comparative Physiology* 193(8), 801-824.
- Giurfa, M., Eichmann, B. and Menzel, R. (1996). Symmetry perception in an insect. *Nature* 382, 458-461.
- Goodman, L. (2003). Form and Function in the Honeybee. Cardiff, UK: International Bee Research Association. In: Srinivasan, M. (2011). Honeybees as a Model for the Study of Visually Guided Flight, Navigation, and Biologically Inspired Robotics. *Physiol. Rev.* 91, 413-460.
- Götz, K. G. (1975). The optomotor equilibrium of the *Drosophila* navigation system. *J. Comp. Physiol. A* 85, 235-266.
- Haag, J. and Borst, A. (2002). Dendro-dendritic interactions between motion sensitive large-field neurons in the fly. *J. Neurosci.* 22, 3227-3233.
- Haag, J. and Borst, A. (2003). Orientation tuning of motion-sensitive neurons shaped by vertical-horizontal network interactions. *J. Comp. Physiol. A Neuroethol. Sens. Neural. Behav. Physiol.* 189(5), 363-370.
- Haag, J. and Borst, A. (2005). Dye-coupling visualizes networks of large-field motion-sensitive neurons in the fly. *J. Comp. Physiol. A Neuroethol. Sens. Neural. Behav. Physiol.* 191(5), 445-454.
- Haag, J. and Borst, A. (2007). Reciprocal inhibitory connections within a neural network for rotational optic-flow processing. *Front. Neurosci.* 1, 111-121.
- Haag, J., Denk, W. and Borst, A. (2004). Fly motion vision is based on Reichardt detectors regardless of the signal-to-noise ratio. *PNAS* 101(46), 16333-16338.
- Hassenstein, B. and Reichardt, W. Z. (1956). Systemtheoretische Analyse der Zeit-, Reihenfolgen-, und Vorzeichenauswertung bei der Bewegungsperzeption des Rüsselkäfers *Chlorophanus*. *Z. Naturforsch.* 11b, 513-524.

- Hempel de Ibarra, N., Philippides, A., Riabinina, O. and Collett, T. S. (2009). Preferred viewing directions of bumblebees (*Bombus terrestris* L.) when learning and approaching their nest site. *J. Exp. Biol.* 212, 3193-3204.
- Horridge, G. A. (1996). The honeybee (*Apis mellifera*) detects bilateral symmetry and discriminates its axis. *J. Insect Physiol.* 41, 755-764.
- Hrncir, M., Jarau, S., Zucchi, R. and Barth, F. G. (2003). A stingless bee (*Melipona seminigra*) uses optic flow to estimate flight distances. *J. Comp. Physiol. A* 189, 761-768.
- Iida, F. (2003). Biologically inspired visual odometer for navigation of a flying robot. *Robotics and Autonomous Systems* 44(3-4), 201-208.
- Jackson, D. E. and Ratnieks, F. L. W. (2006). Communication in ants. *Curr. Biol.* 16(15), R570-R574.
- Kern, R., Boeddeker, N., Dittmar, L. and Egelhaaf, M. (2012). Blowfly flight characteristics are shaped by environmental features and controlled by optic flow information. *J. Exp. Biol.* 215, 2501-2514.
- Kirchner, W. H. and Srinivasan, M. V. (1989). Freely flying honeybees use image motion to estimate object distance. *Naturwissenschaften* 76, 281-282.
- Kirschfeld, K. (1976). The resolution of lens and compound eyes. In: *Neural Principles in Vision*, ed. Zettler, F. and Weiler, R. pp. 354-370. Berlin: Springer.
- Koenderink, J. J. (1986). Optic flow. *Vision Res.* 26, 161-180.
- Land, M. F. (1992). The evolution of eyes. *Annu. Rev. Neurosci.* 15, 1-29.
- Land, M. F. (1997). Visual acuity in insects. *Annu. Rev. Entomol.* 42, 147-177.
- Land, M. F. and Nilsson, D. E. (2012). *Animal eyes* (2nd edition). Oxford University Press.
- Laughlin, S. B. and Weckström, M. (1993). Fast and slow photoreceptors - a comparative study of the functional diversity of coding and conductances in the Diptera. *J. Comp. Physiol. A* 172, 593-609.
- Lappe, M. (2000). *Neuronal Processing of Optic Flow*. San Diego, CA: Academic Press.
- Lee, A. B., Mumford, D. and Huang, J. (2001). Occlusion Models for Natural Images: A Statistical Study of a Scale-Invariant Dead Leaves Model. *International Journal of Computer Vision* 41(1), 35-59.
- Lehrer, M. (1990). How bees use peripheral eye regions to localize a frontally positioned target. *J. Comp. Physiol. A* 167, 173-185.
- Lehrer, M. (1991). Bees which turn back and look. *Naturwissenschaften* 78, 274-276.
- Lehrer, M. (1993). Why do bees turn back and look? *J. Comp. Physiol. A* 172, 549-563.
- Lehrer, M. (1998). Looking all around: Honeybees use different cues in different eye regions. *J. Exp. Biol.* 201, 3275-3292.
- Lehrer, M., Srinivasan, M. V. and Horridge, G. A. (1988). Motion cues provide the bee's visual world with a third dimension. *Nature* 332, 356-357.
- Lehrer, M., Wehner, R. and Srinivasan M. V. (1985). Visual scanning behaviour in honeybees. *J. Comp. Physiol.* 157, 405-415.

- Linander, N., Baird, E. and Dacke, M. (2016). Bumblebee flight performance in environments of different proximity. *J. Comp. Physiol. A* 202, 97-103.
Doi: 10.1007/s00359-015-1055-y.
- Linander, N., Baird, E. and Dacke, M. (2017). How bumblebees use lateral and ventral optic flow cues for position control in environments of different proximity. *J. Comp. Physiol. A* 203, 343-351.
Doi:10.1007/s00359-017-1173-9
- Linander, N., Dacke, M. and Baird, E. (2015). Bumblebees measure optic flow for position and speed control flexibly within the frontal visual field. *J. Exp. Biol.* 218, 1051-1059.
Doi: 10.1242/jeb.107409.
- Linander, N., Dacke, M., Baird, E. and Hempel de Ibarra, N. The role of optic flow in visual control of bumblebee learning flights. *Manuscript to be submitted*. (Paper IV).
- Macuda, T., Gegear, R. J., Laverty, T. M. and Timney, B. (2001). Behavioural assessment of visual acuity in bumblebees (*Bombus impatiens*). *J. Exp. Biol.* 204, 559-564.
- McIntyre, P. and Caveney, S. (1998). Superposition optics and the time of flight in onitine dung beetles. *J. Comp. Physiol. A* 183, 45-60.
- Menzel, R., and Backhaus, W. (1991). Colour vision in insects. In: *Vision and visual dysfunction. The perception of colour*, ed. Gouras, P. pp. 262-288. London: MacMillan.
- Menzel, R. and Giurfa, M. (2001). Cognitive architecture of a mini-brain: the honeybee. *Trd. Cog. Sci.* 5, 62-71.
- Mertes, M., Dittmar, L., Egelhaaf, M. and Boeddeker, N. (2014). Visual motion-sensitive neurons in the bumblebee brain convey information about landmarks during a navigational task. *Front. Behav. Neurosci.* 8, 335.
- Meyer-Rochow, V. B. (1981) Electrophysiology and histology of the eye of the bumblebee *Bombus hortorum* (L.) (Hymenoptera: Apidae). *Journal of the Royal Society of New Zealand* 11(2), 123-153.
- Nilsson, D. E. (1989). Optics and evolution of the compound eye. In: *Facets of Vision*, ed. Stavenga, D. G. and Hardie, R. C. pp. 30-75. Berlin: Springer.
- Paulk, A. C. (2008). Segregation of Visual Information in the Bee Brain. PhD thesis. Graduate interdisciplinary program in insect science. The University of Arizona.
- Paulk, A. C., Dacks, A. M., Phillips-Portillo, J., Fellous, J-M. and Groenenberg, W. (2009). Visual Processing in the Central Bee Brain. *The Journal of Neuroscience* 29(32), 9987-9999.
- Peitsch, D., Fietz, A., Hertel, H., de Souza, J. and Ventura, D. F. (1992). The spectral input systems of hymenopteran insects and their receptor-based colour vision. *J. Comp. Physiol. A* 170, 23-40.
- Philippides, A., Hempel de Ibarra, N., Riabinina, O., and Collett, T. S. (2013). Bumblebee calligraphy: the design and control of flight motifs in the learning and return flights of *Bombus terrestris*. *J. Exp. Biol.* 216, 1093-1104.
- Portelli, G., Ruffier, F. and Franceschini, N. (2010). Honeybees change their height to restore their optic flow. *J. Comp. Physiol. A* 196, 307-313.

- Portelli, G., Ruffier, F., Roubieu, F. L. and Franceschini, N. (2011). Honeybees' speed depends on dorsal as well as lateral, ventral and frontal optic flows. *PLoS ONE* 6(5), e19486.
- Reichardt, W. (1961). Autocorrelation, a principle for the evaluation of sensory information by the central nervous system. In: *Sensory Communication*, ed. Rosenblith, W. A. pp. 303-317. New York, London: MIT Press and John Wiley and Sons.
- Reichardt, W. and Poggio, T. (1976). Visual control of orientation behaviour in the fly. Part I. A quantitative analysis. *Q. Rev. Biophys.* 9(3), 311-375, 428-438.
- Riabina, O., Hempel de Ibarra, N., Philippides, A. and Collett T. S. (2014). Head movements and the optic flow generated during the learning flights of bumblebees. *J. Exp. Biol.* 217, 2633-2642.
- Ronacher, B. (1998). How do bees learn and recognize visual patterns? *Biol. Cybern.* 79, 477-485.
- Ruffier, F. and Franceschini N. (2005). Optic flow regulation: the key to aircraft automatic guidance. *Robotics and Autonomous Systems* 50(4), 177-194.
- Seidl, R. and Kaiser, W. (1981). Visual-field size, binocular domain and the ommatidial array of the compound eyes in worker honey bees. *J. Comp. Physiol.* 143, 17-26.
- Serres, J. R., Dray, D., Ruffier, F. and Franceschini, N. (2008a). A vision-based autopilot for a miniature air vehicle: joint speed control and lateral obstacle avoidance. *Auton. Robot.* 25, 103-122.
- Serres, J. R., Masson, G. P., Ruffier, F. and Franceschini, N. (2008b). A bee in the corridor: centering and wall-following. *Naturwissenschaften* 95, 1181-1187.
- Simmons, P. and Yong, D. (2010). *Nerve Cells and Animal Behaviour* (3rd edition). Cambridge University Press.
- Si, A., Srinivasan, M. V. and Zhang, S. (2003). Honeybee navigation: properties of the visually driven 'odometer'. *J. Exp. Biol.* 206, 1265-1273.
- Skorupski, P. and Chittka, L. (2010). Differences in Photoreceptor Processing Speed for Chromatic and Achromatic Vision in the Bumblebee, *Bombus terrestris*. *J. Neurosci.* 30(11), 3896-3903.
- Spaethe, J. and Chittka, L. (2003). Interindividual variation of eye optics and single object resolution in bumblebees. *J. Exp. Biol.* 206, 3447-3453.
- Spaethe, J., Tautz, J. and Chittka, L. (2001). Visual constraints in foraging bumblebees: Flower size and color affect search time and flight behavior. *PNAS* 98(7), 3898-3903.
- Srinivasan, M. V. (2009). Honeybees as a model for vision, perception and "cognition." *Annu. Rev. Entomol.* 55, 267-284.
- Srinivasan, M. V. (2011). Honeybees as a Model for the Study of Visually Guided Flight, Navigation, and Biologically Inspired Robotics. *Physiol. Rev.* 91, 413-460.
- Srinivasan, M. V., Chahl, J. S., Weber, K., Venkatesh, S., Nagle, M. G. and Zhang, S. W. (1999). Robot navigation inspired by principles of insect vision. *Robotic Autonomous Systems* 26, 203-216.

- Srinivasan, M. V. and Lehrer, M. (1984). Temporal acuity of honeybee vision: behavioural studies using moving stimuli. *J. Comp. Physiol.* 155, 297-312.
- Srinivasan, M. V. and Lehrer, M. (1988). Spatial acuity of honeybee vision and its spectral properties. *J. Comp. Physiol.* 162, 159-172.
- Srinivasan, M. V., Lehrer, M., Kirchner, W. H. and Zhang, S. W. (1991). Range perception through apparent image speed in freely flying honeybees. *Visual Neurosci.* 6, 519-535.
- Srinivasan, M. V., Thurrowgood, S. and Soccol, D. (2009) From visual guidance in flying insects to autonomous aerial vehicles. In: *Flying Insects and Robots*, ed. Floreano, D., Zufferey J-C., Srinivasan, M. V. and Ellington, C. pp. 15-28. Berlin, Heidelberg: Springer-Verlag.
- Srinivasan, M. V. and Zhang, S. (1993). Evidence for Two Distinct Movement-Detecting Mechanisms in Insect Vision. *Naturwissenschaften* 80, 38-41.
- Srinivasan, M. V. and Zhang, S. (1997). Visual control of honeybee flight. In: *Orientation and Communication in Arthropods*, ed. Lehrer, M. pp. 95-114. Berlin: Birkhauser Verlag.
- Srinivasan, M. V. and Zhang, S. (2000). Visual navigation in flying insects. *Int. Rev. Neurobiol.* 44, 67-92.
- Srinivasan, M. V., Zhang, S. W. and Bidwell, N. (1997). Visually mediated odometry in honeybees. *J. Exp. Biol.* 200, 2513-2522.
- Srinivasan, M. V., Zhang, S. W., Altwein, M. and Tautz, J. (2000a). Honeybee navigation: Nature and calibration of the odometer. *Science* 287, 851-853.
- Srinivasan, M. V., Zhang, S., Chahl, J. S., Barth, E. and Venkatesh, S. (2000b). How honeybees make grazing landings on flat surfaces. *Biol. Cybern.* 83, 171-183.
- Srinivasan, M. V., Zhang, S. W., Lehrer, M. (1998). Honeybee navigation: odometry with monocular input. *Animal behaviour* 56, 1245-1259.
- Srinivasan, M. V., Zhang, S. W., Lehrer, M. and Collett, T. (1996). Honeybee navigation en route to the goal: visual flight control and odometry. *J. Exp. Biol.* 199, 237-244.
- Srinivasan, M. V., Zhang, S. W. and Witney, K. (1994). Visual discrimination of pattern orientation by honeybees: performance and implications for cortical processing. *Phil. Trans. R. Soc. Lond. B* 343, 199-210.
- Straw, A. D., Lee, S. and Dickinson, M. H. (2010). Visual Control of Altitude in Flying *Drosophila*. *Curr. Biol.* 20(17), 1550-1556.
- Streinzer, M. and Spaethe, J. (2014). Functional morphology of the visual system and mating strategies in bumblebees (Hymenoptera, Apidae, *Bombus*). *Zool. J. Linn. Soc.* 170, 735-747.
- Tautz, J., Zhang, S., Spaethe, J., Brockmann, A., Si, A. and Srinivasan, M. (2004). Honeybee odometry: performance in varying natural terrain. *PLoS Biol.* 2(7), e211.
- Taylor, G. K. and Krapp, H. G. (2007). Sensory Systems and Flight Stability: What do Insects Measure and Why? *Advances in Insect Physiology* 34, 231-316.
- Tinbergen, N. (1932). Über die Orientierung des Bienenwolfes (*Philanthus triangulum* Fabr.). *Z. Vergl. Physiol.* 16, 305-334.

- Vladusich, T., Hemmi, J. M., Srinivasan, M. V. and Zeil, J. (2005). Interactions of visual odometry and landmark guidance during food search in honeybees. *J. Exp. Biol.* 208, 4123-4135.
- Wakakuwa, M., Stavenga, D. G. and Arikawa, K. (2007). Spectral Organization of Ommatidia in Flower-visiting Insects. *Photochemistry and Photobiology* 83, 27-34.
- Warrant, E. and Dacke, M. (2011). Vision and visual navigation in nocturnal insects. *Annu. Rev. Entomol.* 56, 239-254.
- Webb, B. and Wystrach, A. (2016). Neural mechanisms of insect navigation. *Curr. Opin. in Insect Science* 15, 27-39.
- Wei, C. A., Rafalko, S. L., and Dyer, F. C. (2002). Deciding to learn: modulation of learning flights in honeybees, *Apis mellifera*. *J. Comp. Physiol. A* 188, 725-737.
- Yonehara, K. and Roska, B. (2013). Motion Detection: Neuronal Circuit Meets Theory. *Cell* 154, 1188-1189.
- Zeil, J. (1993a). Orientation flights of solitary wasps (*Cerceris*; Sphecidae; Hymenoptera): I. Description of flight. *J. Comp. Physiol. A* 172, 189-205.
- Zeil, J. (1993b). Orientation flights of solitary wasps (*Cerceris*; Sphecidae; Hymenoptera): II. Similarities between orientation and return flights and the use of motion parallax. *J. Comp. Physiol. A* 172, 207-222.
- Zeil, J., Kelber, A., and Voss, R. (1996). Structure and function of learning flights in ground-nesting bees and wasps. *J. Exp. Biol.* 199, 245-252.
- Zeil, J. (2012). Visual homing: an insect perspective. *Curr. Opin. Neurobiol.* 22(2), 285-293.

Thank you

1st of August 2012, this is when I started my journey as a PhD student at Lund University. I knew very little about insect flight control, and I had no idea what the future would bring. Today, almost exactly five years ago, I know a lot more about insect flight control, and I have gained so many lovely memories. This book is the result of a journey that I could not have made without you.

To my supervisors...

Marie and **Emily**, without you this thesis would not exist! You have guided me, taught me, supported me, encouraged me, laughed with me and comforted me when needed, corrected me and praised me. **Marie**, thank you for always being there, no matter what. When I was super pregnant, and had difficulties getting to the office, you offered to come to my place for meetings. We've also had a lot of productive discussions while taking long walks with my children and your dog. Thank you for supporting me and teaching me how to combine academia and family-life. **Emily**, thank you for making me believe in my own ability, even when it comes to my weakest assets (technology). You've spent countless hours helping me with Matlab, camera calibrations and other stuff that makes my brain boil. Marie and Emily, thank you for bringing me to Africa to work with the dung beetles. This was one of the highlights during my years with you...even if I got ran over by a cow and completely lost my orientation.

To my family...

Emil, tack för att du alltid ställt upp för mig. Du har aldrig ifrågasatt varför jag, klockan 22 på kvällen, behöver åka in till jobbet för att bygga om en flygtunnel. Då jag behövt jobba helger så har du alltid ställt upp och tagit hand om Noel (och även Norah efter att hon föddes). Du har med engagemang och intresse lyssnat på alla mina Science Slam (inte bara en gång). Då jag var höggravid med Noel och behövde en film för att demonstrera optiskt flöde, så satte du en go-pro kamera på huvudet och cyklade genom skogen (inte bara en gång... utan tills jag var nöjd med filmen). Tack för att du följde med till England så att jag kunde genomföra min sista delstudie där. Du tog ett jätteansvar för Noel, och stöttade mig på alla tänkbara vis. Du har

varit mitt absolut största stöd genom åren. Du har lyssnat på min klagosång och delat min glädje. **Noel**, min älskade son, du ger mig så mycket energi och kärlek att hjärtat håller på att svämma över. Tack vare dig återvänder jag till jobbet varje morgon med ny energi (även om nattsömnen kunde varit bättre). Och kanske är det inte en slump att ett av dina första ord var just ”humla”. **Norah**, min älskade dotter, du är en riktig glädjespridare som alltid ler och skrattar. Jag är tacksam för att du är så positiv och utan protester låtit mig slutföra det sista arbetet med avhandlingen. **Mamma** och **Pappa** tack för att ni alltid tror på mig och visar genuint intresse för det jag gör. Pappa, tack för att du la ner din själ i att illustrera optiskt flöde i en av dina fina målningar som nu pryder baksidan av denna bok. **Beckie**, älskade syster, tack för att du är lika knäpp som jag. Då jag varit urlless på mina humlor, struliga analyser, eller avhandlingsskrivandet så har jag alltid kunnat ringa dig för att komma på andra tankar.

To my friends...

You know who you are, so I won't mention you all by name (none mentioned none forgotten). Your support has meant the world to me! Relaxing evenings, fun parties, epic trips – time spent with you helped me recharge my batteries.

My productivity has also been boosted by wonderful winter days and summer evenings in the stable. The greatest friend and therapist of them all, my horse Nora, indeed deserve a special thanks.

To my colleagues and collaborators...

Natalie, thank you for taking me under your wings during my master project. It all started there... my love for bees. And thank you for co-supervising my last PhD project, and taking care of my family and me during my stay in Exeter.

To everybody in the Vision Group (former and present), thank you for being who you are. Thank you for jointly creating the world's best working environment. **Dan**, you've always participated in my doctoral student progress meetings (doktorandsamtal) with great enthusiasm. **Eric**, thank you for being such a lovely person. Only you are allowed to call me 'smelly-nelly' and I will actually miss it. **Almut**, thanks for being so friendly. Whenever I run into you, we always have a little conversation about whatever comes up. **Ronald**, thank you for all the fun teaching moments we shared together! **Carina** and **Eva**, thank you for being my 'bodyguards'. When I developed an allergy to the bumblebees you made sure that we had a functional safety routine. Whenever I got stung you came running to the green house, made sure that I had taken my pills and sat down with me for a while. **Therese**, thank you for being such a good friend! You've always been there for me, professionally and personally. I really enjoyed the time we spent living together. **Anna S**, oh the fun times we've had together; here in Lund, in Zurich, in Berlin.

Thank you for all the joyful memories. And thank you for helping me understand (at least superficially) how neural processing of visual information works in the insect brain. Therese and Anna, you are also my biggest sport supporters. You've followed my races online, cheered for me and encouraged me. Speaking of races... thank you **Jochen, Inga, John** and **Gavin** for running St. Hans Extreme with me. It was a tough race, but I enjoyed the beer and burger afterwards. **Jochen** and **Cara**, I will never forget our eventful climbing evenings. It helped me to clear my mind and get on top of things. To my office mates throughout the years, **Aravin, Nele, Inga** and **Joao**, thank you for putting up with me. Aravin, thanks for all the spiritual conversations and delicious Indian food. Nele, my friend, thank you for all the fun parties and relaxing evenings. Inga, thank you for always bringing me treats, ensuring a steady weight increase throughout my two pregnancies. Speaking about treats... **Atticus**, I'm amazed by your baking skills! Thank you for providing the Vision Group with pastry every now and then. **Mindaugas** and **Peter**, thank you for always taking care of music and other 'behind-the-scene' duties at various parties. And thank you for answering my questions about optics and vision in general. **Julien Lecoecur, Jochen, Gavin** and **Tomasz** thank you for answering my Matlab-related questions. **Mindaugas, Atticus, Andrea, John** and **Anna S** thank you for organising the BLAM-conference together with me. I had a lot of fun during my two years in the organising committee. **Basil**, thank you for being such a caring person. I appreciate how you pop by my office every now and then, just to ask how things are. And thank you **Basil** and **Christine** for all the nice dinners we had in Malmö. **Rachel** and **Sissel**, thank you for the fun times we've had at the RIN-conferences. And **Sissel**, thanks for the advice regarding parental leave and for all the fun conversations. Another master of fun conversations is **Ola**; thank you for always being so cheerful. **Erik H**, thank you for nice discussions in the lunchroom, it is relaxing to sometimes talk about something else than science. **Stanley** and **Tini**, thank you for always providing great company, at and away from the University. **Miriam** and **Martin**, I'm grateful that I got to know you and your kids. Thank you for giving Noel all your old toys, it made him so happy. **Cynthia** (and **Kevin**), thank you for nice dinners in Malmö and for taking care of our cats from time to time. **Andrea, Carola, Atticus, John, Nicola, Ana-Carolina, Therese, Viktor, Meire** and **Julien M**, thanks for nice dinner parties, lunches and coffee breaks. **Johanna, Lana, Mike, James, David, Anna H, Anna B, Pierre, Mikael** and **Sandra**, thanks for fun conversations at the Friday pubs, lunches and coffee breaks.

... And to all of you Vision Group members that I don't know that well yet (either you just arrived or you started while I was on maternity leave), thank you for being around. Thanks for nice conversations in the lunchroom or for just lending me your card whenever I forgot mine (cause it happens a lot).

Johan Ahlgren, thank you for helping with the data tracking for paper III and IV. You saved me a lot of long hours and you did an excellent job. **Ylwa** and **Katarina**, thank you for helping me with various administrative matters. **Åsa Grunning**, thank you for supporting me and giving me the opportunity to participate in countless popular science events, and for always cheering for me during all of my Science Slams. **Jonas Palm**, thank you for help with layout and printing. Lastly, without the workshop staff my work would not have been possible. Thank you **Stefan, Lars** and **Anders** for hanging lamps, designing feeders and building the set-up in the green house.

Last but not least...

Dear **bumblebees**, I love you. I know our love is not always mutual. You sting me, and make me take my cortisone pills, but somehow we managed to go on and create this thesis together. You've been the most important players in this game, and you played it well.



Visually mediated flight control in bumblebees

Despite their small brains and tiny eyes, bees are phenomenal when it comes to controlling flight. The work presented in this thesis describes how bumblebees control flight, and it contributes to an overall deeper understanding about collision avoidance in flying insects.

