



Durham E-Theses

The Anglo-Saxon churches of Canterbury archaeologically reconsidered

Blockley, Kevin

How to cite:

Blockley, Kevin (2000) *The Anglo-Saxon churches of Canterbury archaeologically reconsidered*, Durham theses, Durham University. Available at Durham E-Theses Online: <http://etheses.dur.ac.uk/4320/>

Use policy

The full-text may be used and/or reproduced, and given to third parties in any format or medium, without prior permission or charge, for personal research or study, educational, or not-for-profit purposes provided that:

- a full bibliographic reference is made to the original source
- a [link](#) is made to the metadata record in Durham E-Theses
- the full-text is not changed in any way

The full-text must not be sold in any format or medium without the formal permission of the copyright holders.

Please consult the [full Durham E-Theses policy](#) for further details.

**THE ANGLO-SAXON CHURCHES
OF CANTERBURY
ARCHAEOLOGICALLY RECONSIDERED**

BY KEVIN BLOCKLEY, MIFA

MPhil 2000

ABSTRACT

The Anglo-Saxon churches of Canterbury have been reconsidered from an archaeological perspective with a view to understanding their layout, function, and development. Canterbury cathedral was excavated in 1993, revealing four Anglo-Saxon phases, commencing with Augustine's first church in 597. In the early 9th century the cathedral was re-built on a larger scale, re-built in the mid 10th century, and finally saw the addition of an apsed western structure with hexagonal stair towers in the early 11th century. St Augustine's abbey complex comprised the church of Sts Peter & Paul and the chapel of St Mary in the early 7th century, and saw the addition of St Pancras chapel probably during the first half of the 7th century. Later additions included at least three phases of cloisters, the earliest of which may have been built in the mid 8th century, and a further chapel, free-standing tower, and rotunda built in the mid 11th century.

Further east was St Martin's church interpreted as a Roman mausoleum, used by Queen Bertha for Christian worship in the 6th century, and perhaps expanded in the early 7th century by Augustine.

The thesis has been divided into two sections. Section 1 provides an introduction to Canterbury's Anglo-Saxon churches, a detailed presentation of the evidence from excavations, a summary of the historical and written sources, an interpretation of each church with parallels and dating evidence, and is concluded by a general discussion of their design, development and topographical layout. Section 2 provides thematic discussion of the wider setting of Anglo-Saxon occupation in Canterbury which started in the mid 5th century, and a critical review of 20 sites claimed as Anglo-Saxon monasteries. It also has a discussion of the Continental parallels, identifying distinct area of influence for Canterbury's Anglo-Saxon churches, and ends with some suggestions for further research.

**THE ANGLO-SAXON CHURCHES
OF CANTERBURY
ARCHAEOLOGICALLY RECONSIDERED**

BY KEVIN BLOCKLEY, MIFA

The copyright of this thesis rests with the author. No quotation from it should be published in any form, including Electronic and the Internet, without the author's prior written consent. All information derived from this thesis must be acknowledged appropriately.

SUBMITTED FOR AN M.PHIL. THESIS

**UNIVERSITY OF DURHAM
DEPARTMENT OF ARCHAEOLOGY**

2000

2



26 APR 2002

CONTENTS

<i>Acknowledgements</i>	6
<i>List of illustrations</i>	7
<i>List of tables</i>	10
<i>Declaration</i>	11
<i>Statement of copyright</i>	11

SECTION 1: CANTERBURY'S ANGLO-SAXON CHURCHES

<i>Chapter 1</i>	<i>General introduction</i>	12
	Introduction	12
	Research design	12
	The context of Canterbury's churches	13
	Objectives of this study and selection of churches	14
	Past studies	16
	Christianity in Britain AD 312-1066: a brief outline	17
	Presentation of information	20
<i>Chapter 2</i>	<i>Assessment of the excavation records</i>	22
	Introduction	22
	Canterbury cathedral	22
	St Augustine's abbey complex	24
	St Martin's church	26
	General assessment of the archive	26
<i>Chapter 3</i>	<i>The evidence from excavation</i>	28
	Introduction	28
	Canterbury cathedral	28
	St Augustine's abbey complex	41
	St Martin's church	75
	Summary of the archaeological evidence for Anglo-Saxon churches in Canterbury	79
<i>Chapter 4</i>	<i>Historical and written sources</i>	81

	Introduction	81
	<i>Bede's Ecclesiastical History of the English People</i>	82
	Canterbury cathedral	85
	St Augustine's abbey	93
	Summary of the evidence from the historical and written sources	99
<i>Chapter 5</i>	<i>Interpretation, parallels, and dating</i>	102
	Introduction	102
	Canterbury cathedral	102
	St Augustine's abbey complex	117
	St Martin's church	128
<i>Chapter 6</i>	<i>General discussion</i>	129
	Introduction	129
	The design of the 6th-7th century churches	129
	Development of the church complex	137
	Topographical development	139
 SECTION 2: THEMATIC DISCUSSIONS 		
<i>Chapter 7</i>	<i>The wider setting of Anglo-Saxon Canterbury</i>	142
	Introduction	142
	Decline of the Roman town	143
	Anglo-Saxon structures	148
	Possible Anglo-Saxon church and graveyard	152
	Other possible Anglo-Saxon settlements nearby	153
	Interpretation of the intra- and extra-mural settlements	155
<i>Chapter 8</i>	<i>Anglo-Saxon monasteries</i>	161
	Introduction	161
	Abingdon	163
	Brandon	165
	Burgh Castle	167
	Eynsham abbey	169
	Flixborough	171
	Glastonbury abbey	173
	Glastonbury Tor	178
	Hartlepool	180

	Hoddum	183
	Iona	186
	Jarrow	189
	Lindisfarne	192
	Monkwearmouth	194
	Tintagel	196
	Tynemouth	199
	Whitby	200
	Whithorn	205
	Winchester	212
	Conclusions	215
<i>Chapter 9</i>	<i>Continental parallels</i>	223
	Introduction	223
	Period 1: Augustine's early Kentish churches (6th and 7th century) ...	225
	Period 2: expansion (8th and 9th century)	230
	Period 3: later additions (11th century)	234
<i>Chapter 10</i>	<i>Conclusions</i>	238
	Introduction	238
	The excavated evidence and written sources	238
	Anglo-Saxon Canterbury	241
	The British and Continental parallels	242
	Further avenues of research	243
	End note	246
<i>Appendix A</i>	<i>List of excavations</i>	247
	<i>Abbreviations and bibliography</i>	250
	<i>Illustrations</i>	265

ACKNOWLEDGEMENTS

This thesis was researched and written between 1995 and 1999 on a part-time basis.

The seeds of interest were originally sown after I co-directed excavations (with Paul Bennett) in Canterbury cathedral in 1993 for the Canterbury Archaeological Trust. Discussions with Martin Biddle (the cathedral's Archaeological Consultant) set me off on an MA assessing the material available for study. This was upgraded to an MPhil in 1997 researching Section 1 of this thesis. A final upgrading to a Ph.D. in 1998 saw the completion of the thesis with the addition of Section 2. The Ph.D was submitted in 1999, but the examiner's recommended that the thesis be resubmitted in revised form. This was not possible, given my work commitments, and the thesis was resubmitted in 2000 as an M.Phil.

Supervision of the thesis was undertaken by Martin Millett, Helena Hamerow (early sections only), and Pam Graves (all then at Durham University), without whom this thesis would never have seen the light of day.

I am deeply indebted to Paul Bennett, Martin Biddle, Richard Gem, and Tim Tatton-Brown, for constant support and encouragement over the last five years.

Many libraries and institutions have helped with access to archives and books, as have the excavators of the sites mentioned in the text. They are too numerous to mention individually here.

The research was funded by myself and Cambrian Archaeological Projects Limited, with small grants from the Department of Archaeology at the University of Durham, and the Rosemary Cramp Fellowship. I am indebted to all of these.

Kevin Blockley, Llanidloes, 2000

LIST OF ILLUSTRATIONS

Note: All illustrations are together at the end of the thesis, starting at page 263.

- Fig 1 Alignment/topography of Canterbury's Anglo-Saxon churches
- Fig 2 Canterbury cathedral: location plan showing previous excavations
- Fig 3 Canterbury cathedral: location plan of 1992-93 excavations
- Fig 4 St Augustine's abbey: location plan of Anglo-Saxon churches
- Fig 5 St Augustine's abbey: location plan of 1874-1984 excavations
- Fig 6 Canterbury cathedral: phased plan of Anglo-Saxon remains
- Fig 7 Canterbury cathedral: plan of Period 1 features
- Fig 8 Canterbury cathedral: plan of Period 2A and 2B features
- Fig 9 Canterbury cathedral: plan of Period 2C features
- Fig 10 St Augustine's abbey: phased plan of the Anglo-Saxon remains
- Fig 11 Sts Peter & Paul: plan of the surviving remains in 1995
- Fig 12 St Pancras: detailed plan of the Anglo-Saxon remains
- Fig 13 St Martins: detailed plan of the Romano-British and Anglo-Saxon remains
- Fig 14 Reconstructed layout of Period 1 churches in the study
- Fig 15 Canterbury cathedral: tentative reconstructed layout of Period 2A foundations
- Fig 16 Canterbury cathedral: tentative reconstructed layout of Period 2A church
- Fig 17 Cirencester and Werden, Germany
- Fig 18 Canterbury cathedral: tentative reconstructed layout of Period 2C Church
- Fig 19 St Maurice d' Agaune, Switzerland and Sr Cyriakus, Gernrode, Germany
- Fig 20 Canterbury cathedral: tentative layout of Anglo-Saxon crypt
- Fig 21 Canterbury cathedral: tentative layout of cathedral church and baptistry
- Fig 22 St Augustine's abbey: Wulfric's octagon
- Fig 23 Holy Sepulchre, Jerusalem
- Fig 24 Basilica of Saint-Pierre, Geneva, Switzerland
- Fig 25 Paletine Chapel, Aachen, Germany
- Fig 26 St Bénigne abbey, Dijon, France
- Fig 27 St-Sauviour, Charroux, France
- Fig 28 Ottmarsheim, Alsace, France
- Fig 29 Rochester, Lyminge, Reculver, Bradwell-on-Sea
- Fig 30 Development plan of St Augustine's abbey
- Fig 31 Development plans of Glastonbury abbey
- Fig 32 Development plans of Wells
- Fig 33 Development plans of Winchester Old Minster
- Fig 34 Development plans of St Oswald's abbey, Gloucester

- Fig 35 Location plan of Anglo-Saxon occupation in Canterbury
- Fig 36 Abingdon: plan of Anglo-Saxon foundations
- Fig 37 Brandon: plan of Anglo-Saxon settlement
- Fig 38 Burgh Castle: general plan of Anglo-Saxon features
- Fig 39 Burgh Castle: detailed plan of Anglo-Saxon features
- Fig 40 Eynsham abbey: plan of the Anglo-Saxon phases
- Fig 41 Flixborough: plan of Anglo-Saxon features
- Fig 42 Glastonbury abbey: interpretation plan of Anglo-Saxon monastery
- Fig 43 Glastonbury abbey: general plan of Anglo-Saxon churches
- Fig 44 Glastonbury abbey: phase plans of the Anglo-Saxon churches
- Fig 45 Glastonbury Tor: location plan of Anglo-Saxon features
- Fig 46 Glastonbury Tor: detailed plan of Anglo-Saxon features in Areas R-Y
- Fig 47 Hartlepool: general plan of Anglo-Saxon features, Period 1
- Fig 48 Hartlepool: plan of Anglo-Saxon features of Phase 1, Period 1
- Fig 49 Hartlepool: plan of Anglo-Saxon features in Area A
- Fig 50 Iona: general plan of monastic enclosure
- Fig 51 Jarrow: general plan of Anglo-Saxon foundations
- Fig 52 Lindisfarne: plan of possible Anglo-Saxon monastic enclosure
- Fig 53 Lindisfarne: general plan of possible timber churches
- Fig 54 Monkwearmouth: plan of Anglo-Saxon foundations, Phase 1
- Fig 55 Monkwearmouth: plan of Anglo-Saxon foundations, Phase 2A
- Fig 56 Monkwearmouth: plan of Anglo-Saxon foundations, Phase 2B
- Fig 57 Monkwearmouth: plan of Anglo-Saxon foundations, Phase 3
- Fig 58 Tintagel: general plan of the island
- Fig 59 Tintagel: plan of Site A
- Fig 60 Tintagel: plan of Site B and C
- Fig 61 Tintagel: plan of Site D
- Fig 62 Tynemouth: plan of features north of the church
- Fig 63 Tynemouth: plan of features below the church
- Fig 64 Whitby: general plan of Anglo-Saxon features north of the abbey
- Fig 65 Whithorn: plan of settlement, Period I/0
- Fig 66 Whithorn: plan of settlement, Period I/1
- Fig 67 Whithorn: plan of settlement, Period I/2
- Fig 68 Whithorn: plan of settlement, Period I/4
- Fig 69 Whithorn: plan of settlement, Period II/2
- Fig 70 Whithorn: plan of settlement, Period II/4
- Fig 71 Whithorn: plan of settlement, Period II/7
- Fig 72 Whithorn: plan of settlement, Period III/1
- Fig 73 Whithorn: plan of settlement, Period III/2
- Fig 74 Whithorn: plan of settlement, Period III/3

Fig 75	Winchester: plan of Building E
Fig 76	St Peter's, St John's in the Lateran, and St Paul's, Rome
Fig 77	St Giovanni a Porta Latina, Rome
Fig 78	St Pancrazio, Rome
Fig 79	Reconstruction of the eastern chancel arrangement in Rome
Fig 80	San Vincenzo al Voltuno, phase plans. Italy
Fig 81	San Cornelia, Phase 2. Italy
Fig 82	San Cornelia, plan and sections. Italy
Fig 83	San Cornelia, Phase 3. Italy
Fig 84	St Agata dei Goti, Rome
Fig 85	St Peter's, Altenburg, Italy
Fig 86	Ulrichsberg, Austria
Fig 87	Grand-Saconnex, Geneva, Switzerland
Fig 88	La Madeleine, Geneva, Switzerland
Fig 89	Saint-Gervais, Geneva, Switzerland
Fig 90	Notre-Dame, St-Maurice, Switzerland
Fig 91	Saint-Martin d' Angers, France
Fig 92	St Justus, Lyon, France
Fig 93	Basilica de Zarita de los Canes, Guadalajara, Spain
Fig 94	Lorsche, Hessen, Germany
Fig 95	Notre-Dame, Rouen, France
Fig 96	St Johann, Müstair, Switzerland
Fig 97	St Peter's, Soest, Germany
Fig 98	Mainze abbey, Germany
Fig 99	St Justinus, Höchst, Germany
Fig 100	Reichenau-Oberzell, Switzerland
Fig 101	St Cyriakus, Gernrode, Germany
Fig 102	Fritzlar cathedral, Germany
Fig 103	Cologne cathedral, Germany
Fig 104	Fulda abbey, Germany
Fig 105	Paderborn cathedral, Germany
Fig 106	Echtenach abbey, Luxembourg
Fig 107	Helmarshausen abbey, Germany
Fig 108	Location of British sites mentioned in the thesis
Fig 109	Location of Continental churches mentioned in the thesis

LIST OF TABLES

Table 1	Anglo-Saxon churches in and around Canterbury	14
Table 2	Information available on Canterbury's Anglo-Saxon churches	15
Table 3	Chronological table of major ecclesiastical events during the Anglo-Saxon period	21
Table 4	List of pre-Conquest charters of St Augustine's abbey (after Kelly 1995)	101
Table 5	Status and date of the early churches	130
Table 6	Check list of surviving features in the churches	132
Table 7	Anglo-Saxon structures excavated in Canterbury	150
Table 8	Summary of human bones from Anglo-Saxon contexts	151
Table 9	Chronological table comparing Anglo-Saxon churches and settlement evidence for Canterbury	160
Table 10	List of excavated sites claimed to be monastic, showing details of start date, my reassessment and whether published or not	216
Table 11	List of excavated monastic sites (after my reassessment) showing structural types present and dates	217
Table 12	Stages of monastic development against dated sites with defined layout	222

DECLARATION

The material contained within this thesis has not previously been submitted at this or any other university and is entirely the sole research of the author.

STATEMENT OF COPYRIGHT

The copyright of this thesis rests with the author. No quotation from it should be published without their prior written consent and information derived from it should be acknowledged.

SECTION 1: CANTERBURY'S ANGLO-SAXON CHURCHES

CHAPTER 1: GENERAL INTRODUCTION

Introduction

This chapter is intended as a general introduction presenting an outline of the research, a brief review of the potential of Canterbury's Anglo-Saxon churches, followed by a very brief outline of Christianity in Britain between AD 312 and 1066.

Research design

The present piece of research is intended to go into greater depth than previous studies of Canterbury's Anglo-Saxon churches, looking at the layout, function, and development of a group of churches. The author, being a practising field archaeologist with expertise in excavation records and the interpretation of *in-situ* remains, and as co-director of the cathedral excavations in 1993, is interested in undertaking this research to provide a fuller understanding of the development of Anglo-Saxon churches in Kent from the earliest ecclesiastical buildings of Augustine, through the changes demanded by late 8th to 10th century ecclesiastical reforms, and the various continental influences that played upon the Church.

The main objectives, which have been expanded, are as follows:

- Assessment of visible remains, published sources, and site archives
- Production of accurate plans
- Present the excavated evidence
- Study of layout and metrical analysis
- Study of the development of each of the churches
- Interpretation of their liturgical arrangement
- Assessment of known documentary and written sources

- Look at continental parallels
- Study the development of Anglo-Saxon churches in relationship to Canterbury

The context of Canterbury's churches

An outline of the Roman Christian mission to Britain is given below, but it is pertinent here to define the part played by each of Canterbury's churches that are included in the research, adding evidence of documented events that may be traceable in the archaeological record.

Substantial remains of Anglo-Saxon date have been revealed by excavation beneath the cathedral, the first phase of which may be the church built by Augustine in 597. The cathedral was in a key position to reflect, in its later re-modelling, the changing needs of the ecclesiastical community during the reforms of the late 8th-10th centuries. Indeed, Archbishop Wulfred of Canterbury was instrumental in the introduction of reforms at the Chelsea synod in 816, and he is likely to have put his theories into practice at his own cathedral. Documented events at the cathedral, such as a rebuilding by Archbishop Oda between 942 and 958, and the form of the late Anglo-Saxon cathedral, as described by the monk Eadmer prior to a disastrous fire in 1067, may well be traceable in the excavated remains.

The monastery of Sts Peter & Paul is also well documented, with various major phases of the church or cloisters being closely dated. The documentary and written sources are mainly Bede and a group of pre-Conquest charters (for the early phases) and later descriptions, by the 11th-century monk Gocelin, detailing the alterations undertaken by Wulfric in 1050 and subsequent demolition of the Anglo-Saxon church prior to the Norman re-building. The construction date of the church of Sts Peter & Paul remains uncertain, but is known to have been underway before Augustine died in 604 or 605; between 616 and 624 a chapel dedicated to St Mary was built to the east of the church of Sts Peter & Paul; between 1006 and 1023x7 Abbot Aelfmaer rebuilt the cloisters; in 1050 abbot Wulfric started the construction of his octagonal structure linking the church of Sts Peter & Paul with the chapel of St Mary. All of these major events, and many smaller ones relating to the burial of archbishops and kings at the monastery, may be traced in the archaeological remains.

Objectives of this study and selection of churches

The churches of Canterbury (Fig 1) are considered of vital importance to our understanding of the foundation and subsequent development of Anglo-Saxon ecclesiastical architecture. Canterbury was the first see to be established and the monastic complex outside the city was the burial place of the early archbishops and kings of Kent. Surviving Anglo-Saxon churches in and around Canterbury are shown in Table 1.

Church/chapel	in city	out of city	continuing in use
Cathedral	<i>yes</i>		<i>yes</i>
St Mary		<i>yes</i>	<i>no</i>
St Martin		<i>yes</i>	<i>yes</i>
St Mildred	<i>yes</i>		<i>yes</i>
St Pancras		<i>yes</i>	<i>no</i>
Sts Peter & Paul		<i>yes</i>	<i>no</i>

Table 1: Anglo-Saxon churches in and around Canterbury

In selecting churches for study it was felt that were four main criteria:

1. The survival of Anglo-Saxon standing fabric, for detailed study or re-assessment.
2. Archaeological excavation which enabled the various elements of the church to be phased.
3. Documentary or written evidence of at least two phases of activity which would add to the dating of particular phases as revealed by the standing fabric or excavated remains.
4. The survival of unpublished excavation records that could add further information to that already widely known.

It was decided that any churches not fulfilling two or more of these criteria would not produce enough data for further study (Table 2).

Canterbury cathedral, which underwent major excavations in 1993, has four main

phases to the Anglo-Saxon church, which survived as foundation-walls below the present cathedral. Several charters and various pieces of written evidence are available that may relate to the excavated remains.

Site	<i>in situ</i> remains	excavation	written sources	unpublished records
Cathedral	<i>no</i>	<i>yes</i>	<i>yes</i>	<i>no</i>
Sts Peter & Paul	<i>yes</i>	<i>yes</i>	<i>yes</i>	<i>no</i>
St Mary	<i>yes</i>	<i>yes</i>	<i>yes</i>	<i>no</i>
St Pancras	<i>yes</i>	<i>yes</i>	<i>no</i>	<i>yes</i>
St Martin	<i>yes</i>	<i>yes</i>	<i>yes</i>	<i>no</i>
St Mildred	<i>yes</i>	<i>no</i>	<i>no</i>	<i>no</i>

Table 2: Information available on Canterbury's Anglo-Saxon churches

The monastic complex known as St Augustine's abbey, comprising the church of Sts Peter & Paul, associated cloisters, chapel of St Mary and the later Anglo-Saxon linking structure constructed by Wulfric, revealed by excavation, comprises five main structural phases. Documentary and written sources are also numerous and may be related to the excavated remains. Fragments of surviving fabric of the church of Sts Peter & Paul have been preserved, offering the opportunity for further study.

The chapel of St Pancras, to the east of the main monastic complex at St Augustine's abbey, has considerable fragments of masonry surviving. Extensive excavations have revealed at least two phases of Anglo-Saxon work. The 1974-5 excavations have still to be published in full. These records are now available for study and may add considerable detail to the published information on the Anglo-Saxon church.

The church of St Martin, some 250 m to the east of St Augustine's abbey, has two main phases of early fabric, which are remarkably well preserved. The earliest may relate to the Roman Christian use of the building, the second phase perhaps to an expansion in the 7th century.

The church of St Mildred, on the west side of the city, has only one wall surviving, with megalithic quoin stones at either end, but no other traces of Anglo-Saxon fabric. No contemporary written sources are known.

The only church of those noted above which does not fulfil two of the criteria for inclusion in the study is therefore the church of St Mildred.

All of the Anglo-Saxon structures under study have phases of post-Anglo-Saxon rebuilding, but these are not discussed in detail here unless they have a significant bearing on the Anglo-Saxon fabric. A full list of all excavations and publications, relating to the buildings under study, is given in Appendix A.

Past studies

Previous research on Canterbury's Anglo-Saxon cathedral has been limited to discussion of the documentary and written sources, since no traces of the Anglo-Saxon fabric were recorded until the 1993 excavations (Blockley 1994; Blockley *et al* 1997). Discussion (references cited below) has centred mainly around a description of the Anglo-Saxon cathedral written by the English monk Eadmer in the 1120s, from his childhood memories as a novice in the cathedral. These discussions have suggested plans for the cathedral, crypt, style of the oratory at the west end, location of altars and the flanking towers (Willis 1845a, 1-31; Scott 1881; Baldwin Brown 1925; Hope 1918; Taylor 1969b; Parsons 1969; Gem 1970; Gilbert 1970; Taylor 1975, 154-8; Woodman 1981, 13-22; and Brooks 1984, 37-59). These are returned to later when the documentary and written sources are discussed. Suffice it here to note that since we now have firm evidence for substantial parts of the Anglo-Saxon cathedral much more can be added to what has been written.

St Augustine's abbey, subject to several excavations over the last 150 years, has had many reports and plans of the Anglo-Saxon remains published. The main works include Hope 1915a; Hope 1917; Potts 1926; Peers & Clapham 1927; Potts 1928; and Potts 1934 for the early excavations on the churches of Sts Peter & Paul and the chapel of St Mary. More recent work on Sts Peter & Paul is reported by Saunders (1978). A very useful survey of the early excavation campaigns up to 1947 was reported by Margaret Sparks, a local historian (Sparks 1984), who produced a plan showing the areas of excavation and sequence of recovery. Richard Gem undertook a more recent archaeological/architectural discussion of the remains. He has set out a re-phasing for the Anglo-Saxon remains, based on published information (Gem 1992).

The chapel of St Pancras although excavated in 1974-5 remains largely unpublished,

although earlier work is reported (Routledge 1882; and Hope 1902). Work in 1972 is also published (Sherlock & Woods 1988).

The church of St Martin, still in use today, has seen little excavation (Routledge 1897), but extensive recording of the standing fabric (Jenkins 1965; and Tatton-Brown 1980).

Apart from the standard works on Anglo-Saxon churches (Baldwin Brown 1925; Clapham 1930; Taylor & Taylor 1965), no detailed discussion and comparative study of the early Kentish churches was attempted until 1965 when Fletcher provided plans of the 7th-century churches and compared these with the church of St Peter-on-the-Wall, Bradwell, Essex (Fletcher 1965). The various architectural details of the plan were discussed by Fletcher and continental parallels suggested. More recently Eric Fernie has produced a broader view of the development of Anglo-Saxon churches, adding newly available information on documentary and excavated remains (Fernie 1983). He also includes a section which discusses the function of various parts of the churches of Kent and Essex, and provides a brief discussion of continental parallels. The most recent contribution to the development of Anglo-Saxon churches is that by Richard Gem, who has taken the period 735-870, and looked at the evidence for buildings against a background of ecclesiastical reforms (Gem 1993).

These pieces of earlier work are integrated and discussed in more detail in Chapter 3, and Chapters 5-8 where they relate to specific churches under discussion.

Christianity in Britain AD 312-1066: a brief outline

This section is included here to provide some general background information regarding early (pre-Anglo-Saxon) Christianity, its re-introduction to Britain, and its development up to the Norman Conquest, so that the study may be fitted into a broader framework (Table 3).

Although Christianity had been officially adopted throughout the Roman Empire in 312, very little trace of Christian places of worship has been located in Britain. The only generally recognised Roman 'churches' are those at Silchester, Icklingham, Suffolk, and Richborough (Thomas 1981). The main problem of recognising even a major church is that these may not have been housed in structures that would be recognised as ecclesiastical. Many of the bishops presumably had large residences that served a

combination of functions, including suites of rooms for accommodation, administration, and worship. Without a distinctive form of architecture these individual elements defy detection, unless specific finds or decoration survive.

We know that three British bishops attended the Council of Arles in 314, and British clergy were also in attendance at the Council of Rimini in 359. It remains probable, however, that even in 4th-century Britain, Christianity was still only a minor religion.

After the removal of Imperial authority in 410 and the gradual rise of (pagan) Anglo-Saxon control, Christianity suffered a major setback. During the next two centuries the Church was stifled and no Christian structures were built that have been recognised as such.

The first mission to convert the Anglo-Saxons to Christianity started when Pope Gregory I, in the Spring of 596, sent Augustine from his house in Rome with 40 monks (Bede, *HE* II.1 - Colgrave & Mynors 1969, 132-4). Augustine arrived in Kent in the Spring of 597. The choice of Canterbury for the first metropolitan see was perhaps logical in that King Æthelberht of Kent was married to a Christian Frankish princess named Bertha. She had, on her marriage, brought with her a bishop, Liudhard, as her chaplain. Bertha and Liudhard had practised their religion in the small Roman Christian structure dedicated to St Martin, just outside the city walls of Canterbury. Æthelberht had therefore been in close contact with Christians since his marriage to Bertha (at least a decade before Augustine's arrival), and as such was Augustine's safest method of entry into Britain. Augustine presumably used the Roman Christian structure of St Martin, until the conversion of Æthelberht in 597, after which he received another building in Canterbury, said to have been built by Roman Christians (Bede, *HE* II.1 - Colgrave & Mynors 1969, 132-4). This Augustine re-built and consecrated to Christ, the Holy Saviour (the cathedral), establishing here his episcopal see. To the east, outside the city he built a monastery dedicated to Sts Peter & Paul (now known as St Augustine's Abbey); construction began in the opening years of the 7th century, but was not completed by the time of Augustine's death in 604 or 605. The church was dedicated in 613.

In 601 further missionaries were sent to Britain after Augustine's request for help. Gregory's plan was to establish two primary ecclesiastical centres; one in London the other in York. Each metropolitan see was then to have 12 bishops consecrated in other places. Augustine only managed to establish three (Canterbury, Rochester and London)

by the time of his death in 604. Indeed Gregory's plans were not carried out to the letter; the intended metropolitan see of London had been set up by Augustine in Canterbury, and York was not raised to metropolitan status until 735.

The Christian mission faced a major set back in 616, after the death of Æthelberht, when a pagan uprising forced the bishops of London and Rochester to flee to Gaul. Although Eadbald, Æthelberht's son, was converted and the bishops recalled, ten years passed before the mission was able to spread beyond the south-east. Æthelberht's daughter was married to Edwin, the King of Northumbria, and accompanied by Paulinus (who had joined the mission in 601) as her chaplain (in much the same way that Bertha had been accompanied by her chaplain). Paulinus baptised Edwin and his advisors in 627 at York (the final episcopal see to be established by the Gregorian mission). This encouraged further church building in the north, but was halted when Edwin was killed in battle in 632, and Paulinus retreated to Rochester.

In the year 635, Oswald as the new King of Northumbria, invited the Irish monks of Iona to send a mission to his kingdom. Celtic Christianity had been spreading from Ireland, to the West Country, Wales and Scotland during the 6th century. The most significant of these missions was lead by Columba who landed on Iona in 563, establishing there a monastery with his twelve monks. Celtic Christianity was quite distinct from the Gregorian mission of the Roman Church, not least in their calendar of festivals; the Irish having lost touch with Rome for over 100 years. Although the spread of Christianity had been largely orchestrated by Augustine in the south-east, the Celtic northern monasteries, which had been growing throughout the 6th and early 7th centuries were the new driving force behind the conversion of the British from 636. By the mid 7th century Lindisfarne was as important an ecclesiastical centre as Canterbury. These two centres, Roman in the south and Celtic in the north, were to remain essentially separate (but not without contact) until the appointment of Theodore, as Archbishop of Canterbury in 668, after which time the entire English Church was obedient to Canterbury.

The establishment of further dioceses were discussed at the conference of bishops at Worcester in 672, but none came to fruition. Several new sees were created in the 670s and 680s, and with the inclusion of Sherborne in 705, the dioceses were all in place. The two important northern monasteries, Monkwearmouth and Jarrow, had been founded in

674 and 681 respectively. York attained metropolitan status in the year 735.

Danish attacks started in 793, in the north of Britain, and gained in intensity during the 9th century. By c. 900 five of the seventeen dioceses that had been present in the 8th century had gone. The south of England did suffer from attacks, but not to the extent that was experienced in the northern districts. Kent suffered an attack in 796, on several occasions between 835 and 893, and again between 991 and 1016. Many of these directly affected Canterbury cathedral, most notably the raids of 850 or 851, 892-3, and 1011.

A number of ecclesiastical reforms, aimed at regulating the life of the clergy, were introduced during the 8th and early 9th century, both on the Continent and at home. These were largely undertaken by Boniface and Chrodegang (the latter wrote the *Regula Canonicorum*, a rule for cathedral clergy at Metz). This was followed by Charlemagne's programme of reforms set out in 789 and two synods near Aachen in 816 and 817 where further uniform observances replaced earlier rules (Gem 1993). In England, Wulfred (Archbishop of Canterbury) was instrumental in bringing about new reforms, after consultation with Pope Leo III, at the Chelsea synod in 816. By the mid 10th century the reform movement had gained momentum and a standardised Rule (*Regularis Concordia*) was agreed at a conference held at Winchester in 970. Canterbury's churches, particularly the cathedral and St Augustine's abbey were greatly affected by these changes which are reflected in their ground plans and development.

With the Norman Conquest in 1066 came a major reorganisation of the English Church.

Presentation of information

It must be noted at this point that although the thesis is presented in sections, exploring three main elements of the research (the evidence from excavation, the historical sources, and an interpretation with parallels and dating), that the process of reasoning has been interactive rather than inductive, drawing on the full range of knowledge. This comes about mainly because the archaeological evidence is often fragmentary and the archaeological dating very poor.

CHRISTIANITY:
(General dates)

CELTIC][ROMAN

- Columba to Iona [563
- [597 Augustine to Britain
- [601 Further missionaries from Rome
- [604/605 Augustine dies
- [616 Setback after death of Æthelberht
- [627 Edwin baptised at York
- [632 Edwin killed
- [635 Oswald invites monks of Iona to send mission
- [668 English church united to Rome
- [672 Further diocese discussed at Worcester (none came)
- [670 & 680 Several new sees established
- [674 Monkwearmouth founded
- [681 Jarrow founded
- [705 Sherborne founded
- [735 York upgraded to metropolitan status
- [793 Danish attacks started
- [796 Kent attacked
- [816 Synod of Chelsea (Reforms)
- [835-893 Several attacks
- [850/851 Raid on Canterbury
- [c. 900 5 out of 17 diocese gone
- [970 *Regularis Concordia*
- [991-1016 Viking attacks
- [1011 Raids on Canterbury

Table 3: Chronological table of major ecclesiastical events during the Anglo-Saxon period

CHAPTER 2: ASSESSMENT OF THE EXCAVATION RECORDS

Introduction

This chapter will briefly review all documented observations and excavations for each of the churches, details the location, extent and date of such work. Also included will be information of any published excavation reports and the extent and location of original site archives. The object of the assessment is to look at all available sources of information relating to the excavated remains, to see where further research should be targeted.

Canterbury cathedral

Excavation evidence

Early excavations inside the cathedral are limited to antiquarian observations in the Norman crypt in 1889 and 1895 (Routledge *et al* 1889, 245; Gem 1982, fig 1, 3; and papers in the Society of Antiquaries, Fairweather Bequest), and small-scale excavations at the western end of the crypt in March 1979 (Tatton-Brown 1979, fig 4, 276-8), followed by recording of the crossing area and western end of the crypt (Strick 1982, fig 5, 5, 25). No Anglo-Saxon fabric was revealed by this work (Fig 2).

Extensive excavations have been conducted in the cathedral in 1992-3 by the Canterbury Archaeological Trust. Eight trial trenches were dug in 1992 (six in the nave and two in the south-west transept), as part of an assessment programme. This was followed, in 1993, by excavation of the south-west transept and large areas of the nave, prior to the insertion of a new heating system and re-flooring (Fig 3).

The 1993 excavations were undertaken between 4 January and 20 June 1993 (Blockley 1994 and forthcoming). Here, work was limited by the extent of the proposed disturbance from new heating pipes, and it was not originally planned to excavate below a depth of 0.44 m. Soon, however, it was noted that the majority of the burials had been exhumed before a re-flooring of the nave and south-west transept in 1787. Anglo-Saxon foundations were also being located just below the 1787 floor bedding. It was, therefore,

decided to excavate as many of the grave 'clearance pits' as possible, within the original time-scale of the project, to get a clearer view of the Anglo-Saxon foundations that were being uncovered (further details with plans are given in Chapter 3). A large number of foundations were excavated, and stratigraphy recorded in the sides of the clearance pits. Four main phases were defined in the development of the Anglo-Saxon cathedral.

Within the cathedral precincts a number of excavations have also been conducted. A machine-dug trench in the angle between the south wall of the nave and south-west transept, was recorded in 1973 (Jenkins 1990, 117-22), where drystone masonry foundations were erroneously thought to represent Anglo-Saxon fabric. This is now considered by the author to have been part of a Romano-British building, at a marked angle to the alignment of the Anglo-Saxon cathedral (Blockley *et al* 1997, fig 7). Outside St Gabriel's chapel a trench was excavated between 1978 and 1980 so that the chapel could be damp-proofed. Here was found a Romano-British tessellated floor, possibly part of a shrine (Rady 1990, 80-105). On the north side of the cathedral, outside the north-west transept a small site was excavated in 1982 (Rady 1990, 106-16). Further afield, but in the precinct, four sites have been excavated; the Aula Nova (1978-9), Linacre Garden (1979-80), Almonry Yard (1979), and Archbishop's Palace (1992). These sites do not add to our knowledge of the Anglo-Saxon cathedral, but information on the earlier Romano-British sites in the area does help us gain an understanding of the layout of the land surrounding the cathedral.

A geophysical survey was undertaken in the Great Cloister in 1995, north of the Anglo-Saxon remains found in 1993, in an attempt to locate further traces of the Anglo-Saxon cathedral or associated structures. The survey, conducted by Jonathan Berry a research student at the University of Durham, failed to reveal anything that could be interpreted as part of the Anglo-Saxon cathedral. It did, however, trace a wide feature extending diagonally across the cloister. This is interpreted as a Roman street at right angles to the one located beneath the nave in 1993.

The archive

All archives relating to the 1992 and 1993 excavations are held at the offices of the Canterbury Archaeological Trust.

St Augustine's abbey complex

Background to previous work

This site contains the remains of the church of Sts Peter & Paul, the chapel of St Mary, the chapel of St Pancras, and a small chapel at the west end of the site (Fig 4). An octagonal structure was later built, linking the church of Sts Peter & Paul with the chapel of St Mary. To the north is a complex of cloisters.

Over 31 excavations have been undertaken in the abbey and its precincts over the last 150 years. Of these, only those that have revealed traces of Anglo-Saxon occupation are discussed here. A general summary plan locating the various excavations has been published (Sparks 1984, fig 2), with a discussion of the rediscovery and excavation of the abbey site, up to 1947 (Sparks 1984). This was an historical review, rather than an archaeological re-assessment, but invaluable for placing the various excavations into context (Fig 5).

Church of Sts Peter & Paul (Fig 4)

This church was excavated at various times, as land became available for study. The north porticus of the church of Sts Peter & Paul, and Wulfric's octagonal structure were first investigated in 1914-15 (Hope 1915a; Hope 1917). The nave of the church and porticus of St Martin were cleared in 1921-2 (Potts 1926; Peers & Clapham 1927; Potts 1928). The cloisters were excavated between 1928 and 1930 (Potts 1934). The site was taken into guardianship in 1938 and 1941, after which excavations were conducted in the nave of the Norman abbey between 1955 and 1958. These located a charnel chapel to the church of Sts Peter & Paul, re-examined part of the nave of the latter church, and excavated the foundations of a tower south-west of the churches (Saunders 1978). Further land was taken into guardianship in 1961.

Chapel of St Mary (Fig 4)

The west wall of this chapel was located during the 1914-15 excavations on the church of Sts Peter & Paul (Hope 1915a; Hope 1917). No further traces of the church remain to be found because of later disturbance.

Chapel of St Pancras (Fig 4)

To the east of the chapel of St Mary lay the chapel of St Pancras. This structure was first investigated in 1881 (Routledge 1882), and again in 1900 (Hope 1902). Further work was undertaken in 1902. No other work appears to have been done on, or near the chapel of St Pancras, until 1972 when a trench was excavated to the south of the church, and the south porticus was investigated (*Medieval Archaeol*, 17, 144; Sherlock and Woods 1988, fig 6). Further excavations followed in 1974-5 (*Medieval Archaeol*, 20, 163-4), and remain unpublished.

General discussion of the layout of the Anglo-Saxon monastic complex has been undertaken by Richard Gem, who has compiled a reliable plan from the various published plans (and an anonymous one by 'WS' showing the extent of the plaster floor in the nave). He has also undertaken the task of re-interpreting the remains from the published material and producing a valuable set of reconstruction drawings (Gem 1992). These are particularly helpful in understanding his postulated development of the structures. No original archive material was studied in his re-interpretation and this is an obvious next stage for work on this site, particularly if the 1950s records can be located.

The archive

A search has been conducted by the author for unpublished archive material relating to all previous excavations at the abbey. Original copies of Rev. Pott's notebooks (around 1910-1925) are held at the cathedral library, Canterbury. Also held is a considerable quantity of correspondence relating to the early excavations (letters between 1899 and 1932). English Heritage, Dover Castle store, has holdings of unpublished material (site note books, photographs and correspondence) relating to the excavations of 1955-8 and 1960-78. Original drawings appear to have been separated from this archive, and can not be found. Some photographs (presumably of the 1920s) of the remains of the cloister are also held in Dover. The Royal Commission on Historical Monuments, based at Swindon, has microfilm copies of much of the Canterbury Cathedral Library archive, but no original

material.

Archive material relating to the 1974-5 excavation of St Pancras chapel is held at the Royal Museum, Canterbury. This was found amongst a mass of material donated to the museum after the death of Frank Jenkins (the excavator of the site). Richard Cross of the Canterbury Archaeological Trust has catalogued the archive, and the author has studied the material. A few pages of original notes on St Pancras chapel, written by W Hope around 1900, are held in the cathedral library, Canterbury.

St Martin's church

The church of St Martin, some 250 m east of the chapel of St Pancras, is still used for services today (Fig 1). A small-scale excavation was undertaken in 1896, examining a small area inside the chancel and nave, and outside to the south of the chancel (Routledge 1897). An original plan and elevation drawn in 1896 is in the cathedral library, Canterbury. Small-scale excavation was conducted in 1954 (Jenkins 1965).

Great interest has been taken into the date of the various parts of the church (Tatton-Brown 1980). A good set of elevations and a plan accompany the article by Tim Tatton-Brown, and a more extensive set of original elevation drawings are housed at the offices of the Canterbury Archaeological Trust.

General assessment of the archive

The archive material available for the three sites under discussion (Canterbury cathedral, St Augustine's complex, and St Martin's church) varies considerably in its quality and quantity.

The archives for sites in the cathedral and its precinct are good and available from the Canterbury Archaeological Trust. A considerable amount of new information, on the various phases of the Anglo-Saxon cathedral, has been gained from the recent excavations. The archaeological work in the nave and south-west transept in 1993 was co-directed by the author who has undertaken the research and preparation of the final report on the site (Blockley *et al* 1997). Research for the publication has been limited to that suitable for inclusion in the excavation report, and has scope for expansion to form a considerable part of the thesis.

Archives for excavations on St Augustine's abbey site, between 1845 and 1931, are

poor and little new information can be gained from a detailed study. Excavations since 1955 are better recorded and, should the original drawings of the 1950s sites be found, might add new details to what is already published. English Heritage is soon to undertake recording of the *in-situ* Anglo-Saxon fabric (Judith Roebuck, pers comm) and this will add new information not in previous reports.

Records of the 1970s work on St Pancras chapel will be of key importance for a more detailed understanding of this building. The original site records have been located and will be the subject of further study by the author. English Heritage also plan to undertake a survey of the standing fabric shortly (Judith Roebuck, pers comm) and this would supplement the research considerably.

St Martin's church is well recorded and little can be gained from further recording. The church does, however, occupy a pivotal role in the development of this group of churches and is thus to be included in the research.

CHAPTER 3: THE EVIDENCE FROM EXCAVATION

Introduction

This chapter is divided into three main sections, each detailing the evidence from one church or complex of churches (firstly the cathedral, secondly the churches at St Augustine's abbey, and finally the church of St Martin). A concluding section summarises the evidence for Canterbury's Anglo-Saxon churches. Within each of the first three sections the material is detailed by period, with subdivision of the detail into an introductory summary, description of the remains (in a smaller type-face), followed by the dating evidence and an interpretation of the excavated remains. A concluding summary of the evidence presented for each church or group of churches is given at the end of each of the three main sections.

The material presented is in summary form and is not intended as an exhaustive report.

Canterbury cathedral

Introduction

Excavations in the cathedral's nave and south-west transept during 1993, although extensive, were limited to a depth of 0.44 m, save where 1787 grave clearance pits were excavated. Here, a clear view of the underlying stratigraphy was available to a depth of up to 1.8 m. Very few *in-situ* Anglo-Saxon deposits were excavated; the record comprising detailed plans, and the sides of grave clearance pits drawn as sections. Numerous wall-foundations were located relating to the Anglo-Saxon cathedral. These have been phased from the stratigraphic sequence, although some foundations remain 'floating' or of uncertain phase since they could not be directly related with other structural features. By a combination of the stratigraphy and composition of the foundations, it has been possible to arrive at a phasing of the Anglo-Saxon deposits. Few contemporary finds were recovered and dating the individual phases of the cathedral is not possible without reference to the historical and written sources.

The excavated remains of the Anglo-Saxon cathedral have been divided into four main structural phases (Fig 6). The first phase comprises a small church (Period 1), whilst the second-fourth phases represent a total re-building (Period 2A) of the early church, with subsequent re-build (Period 2B) and later additions (Period 2C). These period numbers differ from those cited in the definitive publication (Blockley *et al* 1997), since here only the Anglo-Saxon phases are considered. The phasing (Fig 6) is as follows:

- Period 1 - small church, probably built 597
- Period 2A - total re-building and expansion of the church,
- Period 2B - re-building/repair
- Period 2C - additions to the church

Construction materials for the Anglo-Saxon churches were largely of re-used Roman materials. In particular the Hythe stone, Marquise stone and Roman tile are all likely to have been derived from nearby Roman masonry buildings.

None of the Anglo-Saxon fabric remains to be seen today, and the excavated remains comprised solely wall-foundations below the present cathedral. The entire Anglo-Saxon cathedral and its adjacent claustral buildings appear to have been demolished to ground level when the Norman cathedral was built between 1071 and 1077.

Period 1 (Fig 7)

The location of the early church

The Period 1 cathedral was constructed on raised ground, formed by the build-up of Romano-British deposits. These levels comprised a metalled street and adjacent timber and masonry buildings, to a depth of at least 1.15 m, and possibly spanning the 1st century to the late 3rd-4th centuries. To the east and west of this occupation, the ground level dropped away. Other Romano-British buildings in the area include a possible temple beneath St Gabriel's chapel, some 70 m east of the Roman street noted above. The raised area would have formed a linear ridge extending north-east/south-west across the site, forming an ideal, well-drained and prominent location for the first church. The latter sat at a marked angle to the Roman alignment.

Layers of 'dark earth' and rubble overlay the Romano-British occupation, and were cut by the Period 1 church. These deposits are similar to those located in other areas of the

city. The latest pottery from these layers is datable to *c.* 450-550, suggesting that the dark earth had started to develop from the mid 5th or mid 6th century. Such deposits have been recorded extensively throughout the city where they are thought to have been developing from as early as the 4th century onwards (Blockley *et al* 1995, 260-3). Cutting into the dark earth layers were the first Anglo-Saxon timber structures dating from the mid 5th century onwards. Further dark earth layers also continued to develop throughout the Anglo-Saxon occupation of the city (Blockley *et al* 1995, 263-4).

Description of the early church (Fig 7)

Only small sections of the Period 1 church were located because of later disturbances. However, four wall-foundations were recorded near the east end of the present nave and in the north aisle. The south wall-foundation of the church comprised a trench filled with closely-packed fragments of Hythe stone and Roman tile bonded in brown clay. It was 0.75 m wide, with a widening on its south side towards the west end, to 1.4 m. This foundation was visible in the side of a 1787 clearance pit to a depth of 0.55 m, but it continued below that level to an unknown depth. Set on top of the foundation was a 0.25 m height of Roman tile and sandstone fragments (248) bonded in yellow mortar.

In the north aisle, wall-foundation 605 was 0.9 m wide and cut to a depth of 0.35 m into a layer of dark earth. This foundation was built of random fragments of Hythe stone and Roman tile bonded in yellow-brown clay, similar to the foundation below wall 248. Wall 638 sat on a foundation (640), 0.8 m wide, of closely packed fragments of Hythe stone and occasional fragments of Roman tile. The foundation cut to a depth of over 0.4 m into the dark earth, and was of very similar construction to that below wall 248. Wall 638 measured 0.65 m in width and survived to a height of 0.25 m. It was built of well-laid Roman tiles set in buff, gritty mortar. To the east of wall 638, and also in the north aisle, were a number of features cutting into the dark earth. Butting up to the wall was a 1 m. wide foundation (643) comprising an area of closely-set, pitched rubble (mainly flint nodules and Roman tile fragments), three courses of which were visible. This feature presumably represents a further foundation, but with the mortared section removed by later activity. In the angle between walls 638 and 643 was a posthole and possible timber slot, the latter apparently cut by foundation 643. These two elements may represent constructional features related to the Period 1 church.

A contemporary construction spread of mortar, visibly similar to the mortar in wall 638, may indicate the original ground level to the west of the church. The level of this spread lay at 9.3 m O.D. To the east, inside the church, dark earth layers lay at a height of 9.74 m O.D. These levels indicate that the floor of the church must have been set 0.44 m above the contemporary ground surface to the west of the church, and that a flight of steps may therefore have been required at the west end. No internal floors survived later disturbance, but these may have been constructed of *opus signinum*, fragments of which were recovered from demolition deposits sealing the Period 1 church.

Dating evidence

Dating of the church is limited to a sherd of pottery dating to *c.* 450-550, recovered from a layer of dark earth cut by the church, and a sherd of pottery dating to *c.* 650-850, located in a possible construction layer inside the church. The first date provides a *terminus post quem*, but no firm *terminus ante quem* can be given from this evidence.

Interpretation of the excavated remains (Fig 7)

Of the walls located in the excavations that have been assigned to Period 1, the following interpretation is proposed. The building is aligned east-west, on the same axis as the later Anglo-Saxon phases of the cathedral, and is therefore postulated as the earliest phase of the Anglo-Saxon church. Wall 605 probably marked the west end of the nave; wall 638 forming part of a *narthex*, with a cross wall between. Too little of wall 248 was excavated to be certain of the function of the widened foundation, although it may have been part of a pilaster buttress. It lay far too close to the west end to have marked the junction of nave and chancel and may indicate that this was originally an external wall on the south side of the nave. A reconstruction of the ground plan shows the church to have been similar to the monastic church of Sts Peter & Paul, although a little larger. An eastern apse seems likely to have been part of the original layout, but remains unexcavated beneath the crossing of the present cathedral. The reconstructed plan of the church suggests a length of around 32 m and width of 22 m, inclusive of an eastern apse. Further discussion of the layout is presented in Chapter 5.

A *terminus post quem*, from a sherd of pottery in a dark earth layer cut by the church, of the mid 5th to mid 6th century indicates that the first phase cathedral is not well dated by the finds, and can only be broadly dated AD 500-800. However, on the basis of the historical and written sources (Chapter 4), and stylistic grounds (Chapter 5), this phase is most likely to have been that built by Augustine in 597.

Period 2A*The re-built church (Fig 8)*

Substantial foundations were located of this phase, comprising the south aisle wall, the south nave arcade, the north arcade, two transverse walls and a rectangular western annex. The building, from the western annex and the east end of the south aisle,

measured 50.5 m in length, and was probably 24 m wide externally.

Before the construction of the new church the Period 1 church was demolished. As a preparatory to expansion, the walls of the Period 1 church were robbed to just below the level of the contemporary ground surface. Extensive dumps of rubble, apparently from the robbing of a Roman masonry building, were deposited to the west of the Period 1 church to produce a level building site. The ground level after dumping lay at 9.93 m O.D. and the level of the dump layers inside the church lay at 9.86 m O.D. Given the additional floor inside the church (removed by later activity), these levels were consistent with construction levels south of the Period 2A church.

Outside the church, construction levels sealed dump deposits of dark soil. The marked difference between dump deposits beneath the church and outside it (visible to the west and south), may indicate the location of an earlier barrier and possible intermediate phase of activity to the west of the Period 1 church. One theory (Martin Biddle, pers comm) is that there may have been a structure to the west of the Period 1 church (?atrium), unseen in the excavation, and destroyed by the walls of the Period 2A church. Insufficient areas have been excavated to enable these areas to be fully understood.

Description of the church (Fig 8)

The south foundation (173B) only survived for part of its width, the remainder having been cut away by later wall-foundations. It was constructed to a depth of over 1.3 m, with an external batter of 20 degrees off the vertical, and comprised flint nodules, occasional small fragments of chalk, Roman tile and small quantities of limestone, bonded in hard, slightly pebbly, white mortar. The stones were not laid in courses and the wall comprised over 50% mortar. Two lifts, or work horizons were noted, one 0.35 m below the top of the surviving foundation, the other at 0.65 m. At the west end of the wall (what was originally the external south-west corner of the south aisle) was a Hythe stone quoin measuring 0.48 m by 0.34 m.

The construction trench for the wall was visible, although much disturbed by later grave cutting, and measured 0.35 m wide at the lower face of the foundation. The upper level of the cut was destroyed by the later graves.

Wall 168 further east, thought to have been a continuation of the south aisle wall, was of slightly different build. It comprised a lower level of rammed clay with flint rubble and charcoal flecking up to 0.15 m thick; secondary layer of green-grey sandy mortar and three layers of flints in soft white mortar, and upper course 0.45 m thick of similar material to wall 173B. A smooth surface, with grey staining, was noted on top of the foundation. This was presumably a break in construction between the foundation and the wall proper. It lay at 9.95 m O.D., close to the level of the contemporary ground surface. An eastern termination of the foundation was noted (presumably forming the external south-east corner of the south aisle) where the construction

trench terminated 1 m west of a further masonry structure (165, described below). An insubstantial wall-foundation (127) was noted between the two foundations described above, presumably acting as a link wall. It was cut to a depth of only 0.48 m, and comprised a bipartite fill of black loam with off white mortar flecks and flint fragments, overlain by grey gravel and loam in off white mortar. Later features had destroyed both external faces, so the width of the foundation is unknown.

The south arcade foundation was located at the east end of the nave, between two projected cross walls. It measured 3.1 m in width and was of unusual construction in that it enveloped the levelled remains of the Period 1 south nave foundation. The north face (245) was 0.45 m wide, comprising flint nodules and Roman tile set in fairly hard white mortar, cut down beside and butted up to the outer face of the earlier foundation. Construction of the south face (226) was similar to 245, but founded to a greater depth (0.2 m deeper). Between the two faces, bonding into 226, was a rubble core (227) comprising five distinct layers as follows: soft white mortar with Roman tile and fragments of *opus signinum*; flint rubble in brown loam with soft white mortar and small fragments of burnt chalk; lens of grey/white loam with burnt chalk and soft white mortar; and compact white mortar with burnt chalk. Later features had removed much of the central area of this wall-foundation. No construction trench was visible on the south side because of later disturbances; on the north side the foundation cut through a layer of dark earth of Period 1, and butted up to the side of the construction trench.

A 34 m stretch of the north arcade foundation (569) was uncovered. Its north edge was not visible, being under a later wall. The foundation was cut to a depth of over 1.6 m, and comprised twelve courses of flint nodules, and occasional fragments of Roman tile and rounded Hythe stone pebbles. The upper seven courses were particularly distinct, each having flint nodules at the base of the course with a thick layer of mortar above. Lenses of dark soil often divided the courses, where material had collapsed from the sides of the construction trench. One well-preserved section through the foundation and adjacent deposits showed a construction trench projecting 0.35 m south. At a depth of 0.65 m the foundation-wall stepped out to fill the entire width of the trench, above which was a backfill of several thin layers of mixed mortar and grey loam. A contemporary construction layer of off-white gritty mortar sealed the rubble levelling material and was visibly similar to mortar in the north arcade foundation.

A grave was noted in the north arcade foundation, constructed as an integral part of the foundation and not cut into it later. The grave was 2.13 m long, 0.63 m wide and 0.84 m deep. A reasonably smooth finish was given to the sides of the grave, which was constructed close the south edge of the wall. The burial had been removed during the 1787 clearance of the nave.

Two cross foundations (604 and 656), 8.95 m apart internally, were built as an integral part of the north arcade foundation. The distinctive coursing noted in the latter wall continued through into wall-foundation 604. Foundation 656 was only partly uncovered, since it had been badly robbed and lay beneath a later flight of steps.

On the west end of the church was a rectangular annex, measuring 9.9 m by 3 m internally. This was located in plan below a number of clearance pits. The west foundation (599) was 2.2 m wide, comprising

abundant flint nodules, fragments of Roman tile, sparse fragments of Marquise stone and lumps of Roman buff mortar. The south foundation (557) was only partly traced, but of similar build to 599. A fragment of masonry (548) to the north may represent the north wall of the annex. It comprised flint nodules and Roman tile bonded in white mortar.

A further foundation (676) constructed of flint nodules and Roman tile bonded in off-white mortar, was located. It ran parallel with the north arcade foundation for a distance of at least 3 m, and cut through the same levelling deposits. It was undoubtedly part of the Period 2A church, but its function remains uncertain.

Probable mausoleum (Fig 8)

Masonry structure 165, cut into the Period 2A levelling deposits, to an unknown depth. The walls were built of flint nodules, fragments of Roman tile and a fragment of turned limestone of Roman date, bonded in fairly hard off-white mortar. A fragment of shallow foundation (127, noted above) butted its north-west corner, representing a linking wall between the external south-east corner of the south-aisle, and structure 165. This, and the fact that the south wall of 165 stepped in at contemporary ground level (from 0.8 m width to 0.6 m), suggests that the structure continued above ground level. On the south-west corner was a possible buttress projecting 0.2 m from the face of the foundation. Internally the wall was rendered with a skin of *opus signinum*, 0.01-0.015 m thick, in turn covered with a thin coating of buff mortar. On the surface of the buff mortar were a black pigment and a layer of lime scale. The structure measured 3.4 m in width, internally, but is of uncertain length.

The structure had been backfilled with rubble in the Norman period, but since it projected beneath a flight of later steps it was not possible to excavate the interior to check its depth. A core sample was, therefore, taken through the backfill. This showed a foundation raft of flint overlain by two layers of Roman tiles; presumably the floor of the structure, some 1.2 m below contemporary ground level.

Other features of Period 2A (Fig 8)

Butting up to the external face of the south aisle wall-foundation were deposits of rubble, 1.2 m deep. The material, comprising numerous layers of Roman robbing material (mortar waste, flint and tile), appears to have been dumped into a cutting at some date after the construction of the south foundation. This interpretation is confirmed by the location of a thin skin of black soil (construction trench backfill) adhering to the outer face of the foundation. The rubble may have been deposited after robbing the Roman masonry building which was located extending south from beneath the Anglo-Saxon foundation.

Foundation-wall 329, located some 2.7 m south of the cathedral's south wall, was built of flint nodules and Roman tile set in pinkish-white mortar. It sat on top of the rubble noted above, with later disturbance all around removing any traces of a face. It was, therefore, not possible to say in which direction the wall ran. However, survival of the rubble to the north of this foundation, and dark earth to the east and west, indicate that the structure is likely to have extended to the south. Its function remains uncertain.

Dating evidence

Datable material was sparse, comprising one sherd of pottery, dating to *c.* 875-1050, in a dark earth layer south of the church (this layer was, however, badly disturbed by later graves), and a residual sherd, *c.* 630-70, from the dump levels butting up to the external face of the south aisle wall. The construction trench for the south wall-foundation was sealed by a Period 2B hearth dated by archaeomagnetic dating to the first half of the 10th century.

Interpretation of the excavated remains (Fig 8)

Expansion in Period 2A was extensive to the west, more than doubling the length of the church. The location of the early church was considered important in the re-build, in that the levelled walls were encased or followed closely perhaps on all four sides. The form of the eastern end remains unknown, although expansion and the construction of a crypt seem likely during this phase (more discussion of this will be given in Chapter 5).

The external length of the nave after re-building measured 43.6 m. After inclusion of the western annex (5.7 m in length), and possible eastern apse of unknown size, the final external length of the church may have been around 57 m.

It is possible to establish the layout of the church with reasonable certainty since large areas have been excavated inside the cathedral. The main body of the nave was flanked by arcades, which divided the nave from the side aisles. The two cross walls at the east end of the nave, forming a near perfect square (8.95 m wide internally), with the north and south sides defined by the arcades, may be interpreted as the foundation for a centrally-placed tower. At the west end was a squared annex, perhaps indicating a raised gallery. No transepts are thought to have projected from the central tower, since *in-situ* dark earth deposits south of the cathedral preclude this possibility.

Inside the nave a length of wall (676), certainly not part of a grave, may represent the foundation for an ambo or pulpit, or perhaps the foundation for a gallery projecting from the north arcade wall.

On the south side of the cathedral, the structure with a floor set 1.2 m below ground level is interpreted as a probable mausoleum for important burial outside the church.

Period 2B

Possible re-building of the church (Fig 8)

Alterations or a re-building of the Period 2A church are indicated by an offset tile course on the south aisle wall. The extent of the proposed re-building is unknown, because of later robbing of the walls, but may have been extensive. The re-building is placed into this phase, rather than in Period 2C, since the latter incorporated a layer of Hythe stone chippings over the foundations; none was located here.

Details of the remains (Fig 8)

A single layer of Roman tiles was located, set just above the contemporary ground surface, bedded in off-white mortar. The tile course projected some 0.08 m from the face of the Period 2A wall-foundation, and is interpreted as a re-build of the south wall, rather than a string course of the Period 2A church.

Other features of Period 2B (Fig 8)

South of the cathedral was located a hearth (347). It comprised a burnt patch of clay, sealing the top of the backfilled construction trench of Period 2A, and in turn cut by a charnel pit thought to have been contemporary with the construction of the Period 2C church. This sequence indicates that the hearth is likely to relate to the Period 2B cathedral.

Dating evidence

Archaeomagnetic samples from the hearth provided a date of 900-970 at 95% confidence (920-58 at 68% confidence). The hearth may well have been associated with construction work on the Period 2B cathedral. It provides a *terminus ante quem* for the Period 2A church, and a *terminus post quem* for the Period 2C charnel pit.

Interpretation of the remains

The proposed re-building of the church does not appear to have involved expansion or addition, but may have been limited to alterations or repairs. The fact that the string course on the south wall projected so far (0.8 m) from the external face of the wall is taken as indicating a distinct phase of re-building. If the tile course had been part of the original build of the Period 2A wall, then it is more likely that the tiles would have been offset into the face of the wall; in a similar manner to the walls of Period 2C noted below.

Period 2C

Additions to the church (Fig 9)

During this period the rectangular annex on the western end of the Period 2A church was demolished and replaced by a large western structure with a deep 'stilted' apse and flanking hexagonal tower(s). On the south-east corner was added a square porticus (possibly also matched on the north-east corner). The western ends of the arcade foundations were also strengthened at the same time.

The western structure; construction levels (Fig 9)

The entire western structure was built in a large foundation pit, rather than employing individual trenches for each of the foundations. Several areas of the pit were seen in section by the removal of selected 1787 clearance pits. In the area of the apse the construction pit was cut to a depth of up to 1.55 m, rising to 0.8 m over the Period 2B levelled annex, and increasing in depth again south of that foundation to over 1.3 m in depth.

Sealing levelled foundation 557 was a sequence of three thin layers of Hythe stone chippings and dark soil (554-6). The apse foundation-wall (429) and link foundation-wall (354) were constructed over these deposits, a thin layer of grey mortar spreading from the base of the foundations into the pit. The foundations had been constructed to around 10.1 m O.D. - approximately the level of the contemporary ground surface.

Butting up to the foundations, in the base of the pit, was a layer of Marquise stone chippings (525), waste from the dressing of stone. The final backfilling of the pit, with brown rubbly loam, was then undertaken before the walls were taken above foundation level. Layers sealing the pit's backfill, and lapping over the top of the foundations, were of white mortar and Hythe stone chippings.

Strengthened foundation 570, was set into a trench 0.5 m deeper than the apse construction pit. Backfill was of a similar material, interleaved with the fill of the apse pit.

Spreads of construction material, comprising a number of layers of mortar waste and tile chips, spread over dark soils into which the apse construction pit had been cut. These layers spread from the level at the junction of the foundations with the superstructure. West of the hexagonal tower was a further construction feature (366), comprising a depression with charcoal and mortar backfill. The mortar from the latter was visibly similar to that from the hexagonal tower foundations.

The western structure; foundations (Fig 9)

The foundations of the apse were smoothly curved on the inside whilst the exterior was polygonal, having seven facets. It measured 9.6 m in length and 7.8 m in width, internally. The tower, four sides of that were located, must have been six-sided to judge from its plan. It measured 3.8 m internally from face-to-face, and 4.2 m corner-to-corner.

All of the wall foundations of the extension were constructed to a similar level, between 9.93 m and 10.1

m O.D. throughout. These foundations were built of flint nodules, with some fragments of Roman tile and Marquise stone, bonded in a very hard white mortar. No attempt had been made to course the foundation, which comprised a high proportion of mortar to stone, perhaps up to 50%.

The eastern terminal ends of the apse foundation incorporated large quoin stones of re-used Roman materials, including two blocks of marquise stone, one measuring 1.2 m by 0.35 m by 0.8 m, and a block of Hythe stone, measuring 0.9 m by 0.85 m by 0.6 m. All were dressed, two showing signs of Lewis holes, and had presumably been robbed from a monumental building in the Roman city. The south terminal had been robbed of its large stones. The internal face of the foundation-wall, but not the quoins, was covered with a rough render, which was apparently still damp when the pit was backfilled, the layers adhering to it. A skin of dirty grey trampled mortar sealed the top of the foundations. The foundations of the hexagonal tower varied in thickness from 2.2 m to 2 m. The widths of other foundations varied greatly. Foundation 354 was 1.7 m wide, with a stepping in of the foundations at ground level; on the east side by 0.25 m and the west by 0.45 m. The result would have been a link wall 1.25 m thick. The apse foundation ranged in thickness from 2.6 m at its terminal end to 1.9 m near the apex of the apse. A 0.25-0.3 m step on the exterior face of the apse foundations was visible, keeping the polygonal shape. Three constructional postholes were noted moulded into the stepped foundation, undoubtedly holes for a scaffold structure used for the building of the upper sections of the apse.

A course of ashlar blocks had been set in white mortar, over the apse foundations; all had been robbed leaving their impressions in the mortar. Internally the blocks measured up to 1 m in length, averaged 0.45 m wide, and followed the fairly smooth curve of the foundations below. Externally the blocks were around 0.8 m long, and were laid in straight sets to retain the polygonal shape. The scars on the northern arm of the apse were particularly well preserved, one with a small corner fragment of Hythe stone still *in situ*. It was also noted that the blocks had been laid with the flat face outermost, presumably for their visual appearance, or to take a layer of render. The wall proper at this level would have measured 1.6 m wide, perhaps with an external chamfer above ground level suggesting a wall thickness of c. 1.5 m.

The strengthened foundations set into the west end of the Period 2A arcade foundations were of a similar build to the other walls of the western structure. Foundation 570 was founded to a depth of 1.85 m and was keyed into the north-west corner of the north arcade foundation. Foundation 581, strengthening the south arcade foundation, was similar in build to 570, but its upper 0.15 m were added to the foundation after most of the apse construction pit had been backfilled, the mortar from the final section of the foundation spreading out to seal the backfill of the pit.

Some modifications were also undertaken on the south wall of the church, at its junction of the hexagonal tower, and a row of re-used Roman tiles set vertically on the face of the wall.

South-east porticus (Fig 9)

On the south-east corner of the church was found a porticus. It comprised a fragment of wall-foundation (167), constructed of flint nodules and fragments of Roman tile, bonded in white mortar. On the surface was a

thin layer of Hythe stone chippings, similar to those on the other foundations of Period 2C. Sealing the chippings was a layer of white mortar similar to that sealing the apse and hexagonal tower foundations. The masonry survived to a depth of 0.45 m and sat upon a raft of rubble, containing much Roman robbing material. The eastern edge of the porticus survived, as did the south-east corner of its foundation. The north side was not located because of later disturbances. Assuming that the porticus extended up to the south wall of the church, it would have measured 7 m north-south, and at least 5.5 m east-west. A layer of intact dark earth in the present south aisle precludes the structure extending more than 8.5 m east-west.

Other features of Period 2C (Fig 9)

A small pit (327) was located just south of the cathedral. It contained fragments of several crania from human skulls. This may have been a charnel pit, dug to bury bones disturbed during the construction of the western structure. The pit cut down onto a hearth though to have been related to the Period 2B church. The latter provides a *terminus post quem* of the mid 10th century for the pit.

The Anglo-Saxon cathedral was destroyed by fire in 1067. No evidence for this catastrophe was located in the excavations, perhaps because of the thorough dismantling of the building and removal of debris before the construction of the Norman cathedral.

Dating evidence for the Period 2C cathedral

A securely stratified piece of pottery was recovered from dark earth cut by the apse foundation pit, and sealed by spreads of construction material. This sherd is dated *c.* 900-950. The charnel pit post-dates the Period 2B hearth, dated by archaeomagnetic dating to 900-970. We therefore have a *terminus post quem* for the Period 2C extension of the early-mid 10th century. Period 2C must also pre-date the 1067 fire when the final phase of the Anglo-Saxon cathedral was destroyed by fire.

Interpretation of the excavated remains (Fig 9)

The western structure was undoubtedly a deep apsed chapel (confirmed by the written sources, Chapter 4) with flanking hexagonal towers. The size and position of the towers, on the outer western corners of the cathedral suggest they were employed as stair-turrets giving access to the upper sections of the western structure. The stair-turrets would also have given access to a raised chapel in the apse via north and south passages between the apse and the stair turrets. If the chapel was raised on a gallery then the area beneath it and the flanking passages, as far east as the nave proper, would have been covered and acted as ancillary space. No crypt was located here, because of the presence of construction

spreads of mortar sealing the construction pit. No central or axial tower is thought to have been part of the plan of the western structure, since the foundations of the apse terminals were too shallow to have taken such a weight. The large strengthening piers, added during this phase at the west end of the nave, presumably helped support the gallery, and other structures above.

It is possible to postulate, given that a chapel was part of the plan of the Period 2B western apse, that a raised chapel may have been included in the Period 2A western annex.

The porticus located on the south-east corner of the cathedral may also have been ancillary space for a further altar. A similar, matching porticus may have been built on the north-east corner. Alternatively, this could be the foundation for a corner tower.

Summary of Anglo-Saxon remains at Canterbury cathedral (Fig 6)

The Period 1 cathedral, cut through 'dark earth' deposits, may have measured 32 m in length by 22 m in width and was constructed of re-used Roman building materials. The wall-foundations were rubble, but the upper walls (where they have survived) were of Roman tiles bonded in yellow mortar. Internal dating evidence suggests the building was built after *c.* 450-550, and is likely to have been the church built by Augustine in 597.

The Period 2A cathedral was a major re-building and expansion westwards. Wall-foundations are all that survived, indicating a structure perhaps 50.5 m long and probably 24 m wide, divided into a nave, square central tower, and a western annex. The eastern end was not located. Also of this period was a probable mausoleum, just outside the Anglo-Saxon cathedral, to the south.

A projecting tile course on the south wall, may indicate a re-building of the cathedral (Period 2B). A hearth, thought to have been contemporary with Period 2B dates to 900-970 at 95% confidence (920-58 at 68% confidence).

Period 2C, represented by the addition of a western structure with stilted polygonal apse and flanking hexagonal-turrets, and porticus or tower(s) at the eastern end. A sherd of pottery in a layer cut by the Period 2C cathedral provides a *terminus post quem* of 900-950. The Period 2B hearth dating to 900-970 would tend to confirm this. The Period 2C cathedral was burnt down in 1067 (historical and written sources are discussed in Chapter 4).

St Augustine's abbey complex

Introduction

A number of individual structures were built at St Augustine's abbey, and these have been given the following names for ease of reference: church of Sts Peter & Paul; chapel of St Mary; western chapel (at the west end of the site); cloisters; south-west tower; Wulfric's octagonal structure; and chapel of St Pancras. Most of these are in keeping with previous reports on the site (Figs 4 and 10).

All of the structures are described individually, and by period, rather than as a group. Period numbering has been allocated after consideration of the available dating evidence for the various elements of the complex, and will be standard throughout this section on St Augustine's abbey complex. The periods proposed here broadly follow the three general phases established by Richard Gem (7th century; 8th-11th centuries; and mid 11th century) (Gem 1992), with the addition of an extra phase to distinguish between the two 7th century churches (Sts Peter & Paul, built in the opening years of the 7th century, and the chapel of St Mary, built between 616 and 624). The 8th-11th century phase allocated by Richard Gem has also been divided, with the addition of a sub-phase to allow for a division of the complex development of the cloisters. Any further sub-division of the development is not possible given the lack of original site notes available for study. The phasing (Fig 10) is presented as follows:

- Period 1A - church of Sts Peter & Paul, early 7th century
- Period 1B - chapel of St Mary, built between 616-24
- Period 2 – expansion of the church
- Period 2A - early range of cloisters
- Period 2B - later range of cloisters
- Period 3 - mid 11th century additions

Descriptions of the various elements of the building will be related, wherever possible, to the year of excavation, and published sources quoted. This will enable readers to trace information back to one of the numerous publications on the remains. Where it is preferable to use the wording of the original publication, rather than change the meaning of the description, these have been placed in quotation marks. Letters have been added to

some of the walls described below, these are not from any of the original site records, but have been included for ease of internal reference in this report.

Traces of Romano-British occupation have been recorded beneath the west end of the abbey complex (Saunders 1978, 28-9, 49-50).

Church of Sts Peter & Paul, Period 1A

The church (Fig 10)

This structure, excavated at intervals between 1914 and 1958, measured at least 18 m in length (less the presumed apsidal east end) by 17.5 m in width. The major part of the north wall-foundation of the north porticus was located, as were parts of the western *narthex*, the south-west corner of the south porticus, the west wall-foundation of the nave, part of the north wall-foundation of the nave, and fragments of internal partitions in both the north and the south porticus. A number of tombs were located in the building.

The north porticus and three of its tombs are still visible today, below a modern canopy. Also visible, although apparently re-set at a higher level, is the west wall of the nave.

Description of the church (Fig 10)

Parts of the north porticus were located during the 1914-15 excavations (Hope 1915a). The north wall-foundation (A) of the porticus survived for a length of 17.6 m, with a corner visible at the west end (the original north-west corner of the church). The east end was cut through by a later re-build. Foundation A was 0.53 m thick, and constructed of re-used Roman tiles, and faced on both sides with a thin coat of plaster (Hope 1915a, 387).

Three tombs (described below) were set against the south face of the foundation. A patch of "an early cement floor, with a bright red surface of pounded Roman tile" was located to the west of the central tomb (Hope 1915a, 388). To the west of the west tomb was a foundation (B), extending south from wall-foundation A, only 0.34 m wide with plaster on both faces (Hope 1915a, 388). It should also be noted that immediately east of the east tomb was a further foundation (C), also extending south from foundation A. Survival of *in-situ* walling, over foundation C, was noted where the tomb butted up to it. These two foundations, presumably divided the north side of the church into three porticus. Traces of the east porticus were marked only by the continuation of foundation A to the east of partition C. The central porticus measured 8.84 m east-west, whilst the west porticus measured 7 m east-west. The west porticus showed traces of a "concrete platform" on the east side of the room, against wall-foundation B (Hope 1915a, 388).

Part of the north wall-foundation (D) of the nave survived, just south of the central porticus, but largely cut away by later masonry. Here, on the south face of the foundation, was recorded a jamb constructed of

Roman tile. Eastwards of this point, the foundation was set back 0.38 m for a length of 1.82 m (Hope 1915a, 390). This apparently marked the doorway from the nave into the central porticus. It was recorded that foundation D was wider than foundation A, although the full width of the former was never established.

As noted above three tombs survived along the north side of the central porticus (Hope 1915a, 396-99). All three tombs had been broken into in 1091 and the contents removed for re-burial (see historical account below).

The eastern tomb, which butted the east side of the porticus, was outwardly "a flat-topped rectangular mass of concrete," raised 0.91 m above the level of the floor. It measured 0.91 m in width, but was damaged by a later foundation, which had cut through it; the surviving tomb, was consequently in two parts. Having removed the intruding foundation, the excavators were able to record the tomb's construction. The top of the tomb comprised a 0.66 m thick layer of Roman tile fragments bonded in white mortar, resting upon an underlying layer of "pink cement" which enclosed the coffin.

The coffin was 2.04 m long, with sides 0.45 m deep, and had a coped lid with a flattened ridge 0.15 m broad and rounded ends. The total depth of the coffin was 0.66 m, and the width was about 0.6 m. It is thought that the coffin was made of wood (long since decayed), and that the interior of the tomb was a cast of the external form of the coffin. The pink cement was poured over the coffin, to a depth of 0.15 m, after the coffin had been placed in the grave. The grave was cut to a depth of 0.58 m and floored with a similar material. It was also recorded that the foot of the coffin lay 0.76 m from the west face of wall C.

The central of the three tombs was 2.16 m in length and 0.91 m in width. A gap of 0.58 m was left between this tomb and the one to the east. The top of the tomb sat only 0.7 m above the floor, and was constructed of "white cement." It was not possible for the excavators to view the interior since it was too close to a later foundation to the south, even though there was a hole in the tomb, low down on the south side.

To the west of the central tomb was a further tomb, with a gap of 0.63 m between the two. The latter was 2.83 m long, 0.91 m wide and had a bevelled top 0.15 m above the floor. A breach had been made in the north side of the tomb, by cutting into foundation A. This breach enabled the interior to be recorded by the excavators. A large wooden coffin (long since decayed) had been laid in the grave, which cut through the floor, onto a bed of white cement. "The body of the coffin was then surrounded up to its depth with semi-fluid white cement, and upon this when sufficiently set there was laid along the sides at the level of the lid a line of pieces of Roman brick. These were placed horizontally on the south side, but on the wall side they were laid aslant. " The sloping sides of the lid were then covered with concrete to a depth of 0.19 m above the ridge of the coffin.

The interior of the tomb, similar to the eastern tomb, was a cast of the coffin, but a finer cement had been used for the tomb, resulting in a better cast of the decayed coffin. This measured 2.31 m in length, was 0.81 m wide and 0.5 m tall from the ridge of the lid. The ends were formed of pieces of planking 0.06-0.07 m thick, squared at the bottom and gabled at the top. The bottom was made of three planks; the central one 0.5 m wide, and side planks 0.15 m wide canted up outwardly at a small angle. The coped lid was 0.05 m narrower

than the body of the coffin, and formed of two thick planks increasing in thickness from 0.02 m at the ridge to 0.08 m at the edge, which was chamfered on the under side. It is also recorded that the cement had even preserved, in places, an imprint of the wood grain on the coffin.

It is also interesting to note that the foot of the coffin projected 0.22 m beyond the end of the tomb, projecting under the pink floor, and that the ends and south side of the tomb were coated with plaster (Hope 1915a, 399).

Excavations during 1921-2 (Potts 1926; Peers & Clapham 1927; Potts 1928) concentrated on uncovering the nave, south porticus and west end of the church.

The 1926 report by Reverend Potts gives little in the way of details recovered by excavation, save a note that there was a *narthex* or anti-chamber on the west (Potts 1926, 99). It is said to have had a centrally-placed doorway, with a "little buttress on each side" built of Roman tile. These buttresses are now thought to have been later additions to the original church (Saunders 1978, 48). Mention is also made of a tomb (of Archbishop Berhtwald, discussed further below) on the north side of the nave, west of the doorway into the central northern porticus: "The south side of a tomb of Roman brick which we have found may be his" (Potts 1926, 107).

Some further information is provided by the Peers and Clapham report of 1927. This account adds a little detail to the Period 1A church. The north wall of the nave was set in hard pebbly mortar, and the floors were of "plaster coloured pink by the admixture of pounded brick," that in the nave being particularly well-preserved (Peers & Clapham 1927, 204). A plan was included with this report, locating the various foundations uncovered up to 1922. Included in this plan is the south-west corner of the church, a partition dividing the south porticus, the west wall of the nave (with central doorway) and the west wall of the *narthex*, also with a central doorway. Unfortunately none of these are described.

The Reverend Potts report of 1928 adds no new detail to the Period 1A church, but an informative, phased plan of the structural remains does show a further fragment of foundation not noted before. This is situated on the south side of the church, adjacent to the dividing foundation in the south porticus, and is part of the south wall-foundation, with a junction, or pilaster buttress, extending from its south face (Potts 1928, fold-out figure).

A plan of the surviving floor is held in the English Heritage archive, signed W.S. and this has been used to plot the extent of surviving floor. The plan is not dated, but must have been drawn after the 1921-2 excavations since details of the south porticus and *narthex* are included.

It was not until the 1957-8 re-examination of the early church that more details were added (Saunders 1978, 44-52). This work was limited to three small trenches in the church, one extending east-west across the *narthex*, another in the body of the nave, and the final one at the east end of the nave. A well, cutting through the floor of the nave, had part of its lining removed and the section recorded. Rubble was also removed from the area north of the Period 1A church; firstly, to look at the relationship between the external face of the church and the walls adjacent to it; secondly, to establish the character of other walls to the west of the porticus.

The investigation north of the church proved that later walls butted the north wall of the church. The character of the walls further west was also established, and will be discussed below in a later phase.

In the *narthex* it was noted that the floor was of white concrete mixed with chalk and gravel with a thin layer of broken brick over the top. This floor is thought to have replaced the original one, which may have worn rapidly in the doorway. Below the floor was mixed soil and rubble over a layer of tiles. These deposits sealed a compacted chalk, thought to represent the continuous footings of the west wall of the *narthex*. Note is made that the northern external buttress appears to have been butt-jointed to the main wall. The footings of the door jamb were built on a chalk foundation (Saunders 1978, 47-8).

The well section revealed a floor, calculated to have been around 0.91 m beneath the floor of the Norman church. The section revealed a sequence of fine layers. The uppermost was an *opus signinum* floor (2), light red in colour containing considerable quantities of chalk and brick chippings. Below this was a floor of concreted brick chippings, with a dark red to black finish (4). The floor was uneven and stepped down 0.07 m to the east. The gap between the two floors was filled with broken tiles over white mortar (3). Three layers, of white mortar, buff mortar and a lens of black soil lay below floor 4. Underneath these was a further floor of brick chippings (7), laid over brown soil (Saunders 1978, 46).

A small trench in the nave, against the Norman north aisle foundation located the tomb of Archbishop Berhtwald (Saunders 1978, 48). The outer face of the brick-lined grave had been cut away by a later foundation trench, but seven courses of tiles, laid in pale yellow, pebbly mortar remained. Adhering to the bottom tile course, and filling the foundation trench for the tomb, was a pink-buff mortar (11). The nave floor had been remade a number of times. The final floor was a pink, crushed brick, with a hard surface (2), bedded on white mortar (3). Towards the east end of the trench the floor was patched with a "paler pink brick chip surface." An earlier floor (4) lay below, comprising brick chips, bedded on white mortar and a layer of broken Roman tile fragments (5). Patches of chalk and yellow clay patched the worn surface of floor 4.

A further trench, at the east end of the nave, revealed a further sequence of layers, cut by Wulfric's octagonal structure, but these were much disturbed (Saunders 1978, 48-9). Features relating to later phases of the church will be discussed below. All that could be seen of the Period 1A church were make-up layers (4, 6, and 8) and possibly the later floor (2).

It must be added that although the successive floor levels in the nave have all been described under Period 1A, it is likely that some of the upper floors may well relate to later phases of the Anglo-Saxon building.

Possibly contemporary with the Period 1A church, and only just cut by the Period 2 vestibule, was a grave (37), on line with the central axis of the church (Saunders 1978, 44-5). It lay around 14 m west of the church, between the Period 2 vestibule, and the Period 3 western chapel, and was cut by both of the latter structures. The grave contained the skeleton of an adult whose head and neck had been removed in the construction of the western chapel. The excavator reported that the grave was notable since stones had been positioned at the head and feet. The left foot was pressed up against a small stone at the end of the grave, the right foot lay on a stone, and another stone was found between the legs, about 0.05 m above the ankle. A shroud is thought to have been around the skeleton. A sherd of Ipswich type cooking pot was located in the grave.

A further burial, also earlier than the Period 2 vestibule, was located at the east end of the excavation trench. Only the western end was visible in section, revealing a skull resting on a pillow of stones (Saunders 1978, 45).

The author visited the site in November 1995 to prepare a detailed record of the surviving northern part of the church. A stone-for-stone plan was drawn to a scale of 1:20, two profiles drawn to a scale of 1:10 through the westernmost tomb, and a context record sheet prepared for each element of the structural remains. The latter detailed the dimensions, materials used, structural relationships observed, and attempted to interpret the remains. A total of 15 contexts was allocated (Fig 11). Details observed, where they add to the descriptions above, are presented here.

The north wall (1) is much as described after the 1914-15 excavation. All that can be added is that the wall survives to a height of 0.90 m, comprising 11 courses of re-used Roman tile and brick bonded in buff mortar. Five further courses of similar material lay below the level of the gravel laid around the remains to prevent the growth of weeds. The mortar in wall 1 contains large quantities of gravel, and some river-rounded flints, up to 0.03 m across. It was noted that some of the Roman tiles had *opus signinum* still adhering to their surfaces, indicating their re-use from Roman masonry structures. An external render of pink mortar survives on wall 1 to the north of its junction with cross-wall 3. Walls 2, 3, and 4 are of similar materials to wall 1, and are of one build with it. Wall 2 (the west wall of the church) survives to a height of 0.05 m (with one course of tile above the gravel and at least three below), and with a small offset on the internal face of the foundations; wall 3 (dividing the western and central porticus) survives to a height of 0.37 m (with four courses above the gravel and two below); wall 4 (dividing the central and eastern porticus) survives to a height of 0.9 m and has similar coursing to wall 1. This wall differs only in that below the third course of tiles the wall is bonded with white, gravelly mortar containing marine molluscs. This would indicate that the sand use in the mortar may have derived from the coast or an estuary.

Inside the central north porticus, between cross-wall 3 and the eastern wall 4, are the three tombs already detailed above. The eastern tomb (11) survives to a height of 1 m, of which the upper 0.5 m comprises seven courses of re-used Roman tile bonded in white, gravelly mortar, the lower 0.5 m comprises flint nodules bonded in buff mortar. The lower section surrounded the wooden coffin (detailed above), whilst the tile layers lay over the top of the burial. The internal south face of the upper 0.5 m of the tomb is rendered in white, gravelly mortar, suggesting that this section stood above the level the floor in the porticus. The central tomb (10) has three upper courses of re-used Roman tile bonded in buff mortar containing flint and gravel, overlying a lower section comprising flint nodules in mortar (presumably the base of the tomb surrounding the wooden coffin). The internal south face of the tomb is rendered with white mortar down to the wider 'footings' below. The western tomb (9) differs in that the upper 'roof' section comprises re-used Roman tile pitched vertically with a stepped effect on the south side. A white mortar render is visible on the south face and over the step.

In the west porticus a further tomb had been built in the north-west corner. This was not noted on any of the published plans until 1927 (Peers & Clapham 1927, plate X), but has more recently been omitted from

plans (for example Saunders 1978, fig 8; Gem 1992, fig 4). This tomb (6) has only three sides surviving, the fourth having been cut away by one of the foundations for the Norman rebuild. It comprises walls 0.30-0.33 m thick, founded to a depth of 0.83 m, built of mixed re-used Roman tile, frequent flint nodules and some mudstone fragments set in buff, gravelly mortar, butting walls 1 and 2. The material is roughly coursed into seven layers. Internally the grave is 2.78 m long, with evidence of a 'moulded' roof (Fig 11) surviving in both corners, perhaps indicating the location of a wooden coffin similar to the three tombs in the central porticus. The tomb appears to be bonded with masonry feature 7.

Feature 7 is rectangular internally, measuring 0.65 m east-west, with two good 'square' corners surviving on the north side. The feature comprises material very similar to tomb 6, of which it appears to form an integral part. The west wall is 0.25 m thick, the east wall 0.6 m thick, and the north wall 0.65 m thick. A cluster of six tiles on the surface of feature 7 may represent a recent resetting of the tiles. A patch of *opus signinum* is visible between this tile setting and the north face of the feature. The two side (east and west) walls of feature 7 have previously been interpreted as wall foundations (Gem 1992, fig 4). Feature 7 is perhaps tentatively interpreted as the foundation for an altar, contemporary with tomb 6, below which was a setting for relics. It is uncertain when this tomb was added to the porticus, and no named burial is known here.

In the north-east corner of the west porticus is a block of masonry (8). It comprised eight courses of re-used Roman tile and brick, with flint and mudstone fragments, bonded in dirty white/buff mortar containing some burnt flint. A poorly coursed masonry (15) is situated between wall 3 and masonry 8. No evidence survives to indicate that this masonry represents a further tomb, although the space between feature 7 and wall 3 (2.8 m) would have been sufficient for a further burial.

Dating evidence for the Period 1A church

To judge from the plan of the church (Fig 10) this is thought to have been one of the early churches of the Gregorian mission, built soon after the arrival of Augustine in 597. Confirmation of this comes from the location of important burials in the north porticus. Bede mentions the church of Sts Peter & Paul, built as a monastery, and in which Augustine was buried with the other archbishops and kings of Kent (Bede, *HE* I and II - see Chapter 4 for full references). This church was dedicated not later than 619 (Chapter 4). Goscelin, writing in the mid 11th century tells us of the location of tombs which were cleared before a remodelling of the east end of the church in 1050 (Chapter 4). He recorded the location of the tombs of Augustine, Deusdedit, Honorius, Justus, Mellitus and Laurence in the north porticus. The latter three have been located during excavations against the north wall of the porticus, and interpreted as such with reference to the historical sources (for details see Chapter 4). The layout of further burials are discussed

more fully in Chapter 4, suffice to note here that the evidence for the identification of the Period 1A church as that of Sts Peter & Paul, built by Augustine in the opening years of the 7th century is very strong.

Interpretation of the excavated remains (Fig 10)

The excavated parts of the church represent the nave, north and south porticus, and *narthex* to the west. An eastern apse would almost certainly have formed part of the original plan. Further discussion of the layout is given in Chapter 5.

Church of Sts Peter & Paul, Period 2

The expanded church (Fig 10)

Expansion of the church in this period was considerable, with a westward extension of the nave, addition of a new *narthex*, possible enlargement of the north porticus, and construction of the cloisters to the north. The full length of the expanded church measured at least 38 m (less the presumed apsidal east end).

Visible today are the remains of the *narthex* and vestibule, although presumably set at a higher level than found.

Description of the church (Figs 4 and 10)

Excavations in 1914-15 first uncovered traces of walls to the north of the Period 1A church (Hope 1915a). The north wall of the Period 1A porticus was demolished and a new wall built some 3.65 m to the north. Only the outer face of the wall survived disturbance by later foundations. A patch of "red cement floor" survived north of the original north wall, close to the gap between the eastern tomb and the central one (Hope 1915a, 388). Further east was traced a length of north-south wall thought to have been the return from the north-east corner of the church. This is now open to doubt, since Saunders' re-examination of walls in this area suggests they were not all contemporary (Saunders 1978, 44), being bonded with different mortars. An apse postulated to the east of this was later proven to have been part of a later flight of steps of the Wulfred period. The western extent of the Period 2 north wall was not located in these excavations.

After the demolition of the north wall of the Period 1A porticus, the north face of the eastern tomb, standing to a height of 0.91 m above floor level, was "roughly plastered over" (Saunders 1978, 397).

Other walls were also located, one apparently "crossing" the Period 1A church, another extending west of the Period 1A north wall. The excavators report that much of the Period 2 north wall was preserved as a base for the Norman aisle wall, being distinguished by its different coloured mortar, rubble masonry and the "rudely laid herring-bone" (Saunders 1978, 389).

At the east end of the nave was recorded a wall-foundation 0.64 m wide. Saunders also investigated this foundation in 1957-8, who recorded a section through the feature (15) (Saunders 1978, 49). It cut through the Period 1A floor make-up layers noted above to a depth of *c.* 0.5 m, and was constructed of layered material. The lowest level was of mortar and rubble, followed by gravel and a layer of stones with another layer of whitish mortar and rubble above. The foundation was sealed by floors relating to a later phase of the church (these are discussed further under Wulfric's octagon, Period 3, below).

The 1927 report by Potts & Clapham provides a plan of the possible northern extension and western additions. No details, however, are given of the fabric of the walls. The report notes that "the east wall of the original *narthex* was pulled down and its area added to the nave, while a larger *narthex*, of the full width of the nave and aisles, was added to the west" (Potts & Clapham 1927, 210-11). The plan, however, shows an extension the same width as the nave, not taking in the width of the aisles. An archive plan, in the cathedral library, Canterbury, shows the *narthex* the full width of the church (drawn by Hope in 1917). One may conclude that the 1927 publication plan must have been changed, without alteration of the text to suit. The report continues, "A forecourt of equal width, and 68 ft [20.72 m] in length was laid out to the west of the *narthex*, and into it, opening by two doorways from the *narthex*, projected an oblong porch or vestibule, containing a flight of steps, and having in front of it a second flight [of steps] descending to the level of the ground in the forecourt." No evidence is presented for the forecourt and two flights of steps.

The only details given in the 1927 report are stones used in the west foundation of the Period 2 *narthex* (Potts & Clapham 1927, 211). Reported are very large stones, one a "great sandstone shaft" 2.89 m long, "and tapered, with a socket hole in its top." This was removed and set up nearby (and still stands today at the west end of the site). Another stone was a "great sand-stone boulder, which, when taken out, was found to have on its underside a number of grooves made by the sharpening of knives..."

A "gateway tower" is also noted at the west end of the forecourt, containing many empty graves (Potts & Clapham 1927, 211, fig 2). This was undoubtedly the same masonry found in 1955-7 by Saunders, and thought to have been of Norman build (Saunders 1978, 42).

The latter excavations also noted that at least the northern buttresses on the entrance into the Period 1A church, had been added (Saunders 1978, 48). This was presumably done when the west end was remodelled in Period 2. Saunders also noted that the "second *narthex* appeared to have been about 4 ft 6 in [1.4 m] below the floor level of the church." Unfortunately the section cut through this area was not published (and cannot now be traced).

The west wall of the vestibule consisted of four roughly laid courses of flint with some re-used Roman tile, bonded in whitish-grey mortar. The was recorded as being slightly less than 0.60 m wide "with no regularities." The west face was rendered with mortar and had an offset. The inner face had a distinct batter and was slightly curved. Below the offset were trench-built foundations, 0.72 m wide, and 0.91 m deep, and comprised re-used material, including an "enormous sarsen or sandstone block" at least 2.92 m long (Saunders 1978, 43). This is presumably the same stone recorded by Peers & Clapham (above). On the south-west corner of the vestibule was a "thin buttress bonded onto the wall." The internal floor level was above the

level of the offset, but nothing of it survived. No trace of the steps noted in the earlier excavation survived.

A stone bench is recorded on the north side of the church (Peers & Clapham 1927, 216), "extending between the enlargement of the archbishop's porticus and the foundations under notice [west wall of the cloister], are the remains of a stone bench against which the original plastering of the wall appeared to stop." Little trace of this could be found in the 1957-8 excavations (Saunders 1978, 44).

The author undertook detailed recording of the surviving masonry in the area of the north porticus in 1995. The north wall of the Period 1A porticus had been partly demolished, adjacent to the eastern tomb in the central porticus, and the western face of wall 4 rendered with yellow mortar (Fig 11).

To the north of the Period 1A church were originally recorded numerous wall foundations thought to represent an expanded north porticus. These foundations did not survive well for recording in 1995, and largely lay below the gravel surface laid around the remains. Five walls were recorded in the 1914-15 excavations, extending northwards from the north wall of the porticus, and a further wall extending west (Peers & Clapham 1927, plate X; Gem 1992, fig 4). Fig 11 shows the survival of the remains as recorded in 1995. From west to east, the first two walls no longer survive; the third wall survives as an area of large blocks of ragstone and mudstone (14), with no mortar bonding (a single large stone lies to the west of this wall); the fourth and fifth walls survive as four monumental blocks of ragstone and mudstone, probably re-used from a Roman building. These stones measure up to 0.5 m tall and 1.05 m long. No mortar bonding survives. One of the stones crosses the line of Period 1A north wall (1), indicating that this is part of a later build. No further interpretation would be reliable given the disturbed nature of these walls.

Dating evidence of the Period 2 expansion

A sherd of Ipswich type cooking pot was found in the backfill of a grave cut by the foundations of the vestibule. Nigel Macpherson-Grant's extensive research into the Anglo-Saxon pottery of Canterbury suggests that Ipswich-type wares, previously dated in the range *c.* 650-850, can now be refined to *c.* 750-850 in East Kent and further afield (Nigel Macpherson-Grant, pers comm).

The expansion of the church probably took place either in the mid 8th century, in 978 when the church was rededicated, or in 1006-23x7 when a documentary source mentions work on the burial porticus (see Chapter 4 for fuller details of the documentary/written sources which provide the above dates). The sherd of pottery in the grave pre-dating the vestibule of the expanded church indicates that one of the latter two dates is most likely.

Interpretation of the Period 2 excavated remains

Expansion in Period 2 was restricted to the addition of two rooms to the west and the probable enlargement of the north porticus.

Western chapel, Periods 2 and 3

The chapel (Fig 10)

To the west of the church of Sts Peter & Paul lay a small chapel, of at least two phases of construction. The location of a "gateway tower" was excavated in the 1920s, and reported by Potts & Clapham in 1927. They, however, gave no details, save that empty graves were located in the structure. It was supposed that these graves were of Anglo-Saxon bishops and abbots, translated in the Norman period (Potts & Clapham 1927, 211). Excavations by Saunders in 1957-8 have shown these to have been added at a later (Norman) date (Saunders 1978, fig 7, 51-2). Passing mention to this structure was made in a paper read in 1925, but note is only made of the graves therein (Potts 1926, 109).

Description of the chapel (Fig 10)

Excavations in 1955-7, have shown that the earliest phase, perhaps relating to Period 2 of the church of Sts Peter & Paul, was represented by two parallel chalk footings, 3 m apart. The northern foundation (28) was 1.14 m wide and comprised rammed chalk and courses of flint, whilst the southern foundation (27) was slightly narrower, with layers of chalk and gravel. Both foundations cut into a deep layer of cemetery soil (13) that was found to have been extensive over the western part of the site (Saunders 1978, 41). Sealing the Period 2 foundations was the Period 3 circular foundation attached to a chapel to the east (Saunders 1978, 41-2).

The earliest levels of the Period 3 chapel were perhaps built to the east of the Period 2 chapel, so that the latter remained standing until the addition of a circular foundation. The body of the chapel was entirely exposed in 1955-7, but found to have been much disturbed by previous excavations. However, it was possible to see a uniform spread of mortar and gravel, with the mutilated remains of a flattened apse at the west end. A little upstanding wall core survived in the apse. The remains of the mortar spread indicated the extent of the chapel, suggesting internal dimensions of 6 m by 4.87 m. The surviving upstanding walling of the apse consisted of a core of layers of buff mortar, gravel and rubble, re-used Roman tile and lumps of *opus signinum* with a thin layer of light brown mortar capping it (31). The core rested on a foundation of chalk and rubble (34), 1.37 m wide and nearly 0.60 m deep (Saunders 1978, 42).

The floor of the chapel, of which around two-thirds survived, comprised a layer of whitish-buff mortar with a layer of flints at the bottom (33). Foundations revealed on the south side were 0.38 m deep and 1.29 m wide, and of chalk and rubble. The outer edge of the foundation was also seen on the north side, where it had been trench built (Saunders 1978, 42-3). It was noted that the floor was smooth with only the occasional fragments of flints, tile and ragstone [Hythe stone] protruding from it. A sherd of Stamford ware, "unlikely to be much before the mid 11th century," was found embedded in the floor. Above the floor were patches of

orange clay and chalk. The floor of the chapel is thought to have been 0.60 m below the postulated floor level in the Period 2 vestibule (Saunders 1978, 43).

Built against the flattened apse (noted above), and lapping over the remains, was a circular foundation (29). It comprised a 1.37 m deep foundation made up of layers of chalk, flint and mortar, buff mortar, gravel and flints, light brown mortar and capped by chalk. On top of the chalk was a thin floor of light orange mortar.

Two parallel walls sealing the circular foundation are thought to have been of early Norman build (Saunders 1978, 42), and are not therefore discussed here. These are undoubtedly the walls located in the 1920s and thought then to represent an Anglo-Saxon "gateway tower" (Peers & Clapham 1927, 211), but the evidence provided by Saunders is unequivocal (Saunders 1978, 42).

Dating evidence for the western chapel

A sherd of Stamford ware from the Period 3 floor provides a construction date shortly before the mid-11th century (Saunders 1978, 60, sherd viii).

Interpretation of the excavated remains

The western chapel, in Period 2, does not survive in enough detail to be certain of its form or layout. The Period 3 remains, however, were much better preserved and perhaps represent the foundations to a chapel with an apsed western end, and adjoining circular tower.

Chapel of St Mary, Period 1B

The chapel (Fig 10)

Little of the chapel of St Mary has survived because of the construction of an extensive crypt at the east end of the abbey complex in the Norman period.

All that remains is the west wall of the nave, still visible today. This was first located during the 1914-15 excavations and described as "a wall 25 in [0.63 m] thick, constructed of Roman bricks" with a doorway 1.98 m wide in the middle (Hope 1915a, 379, fig 3). One minor detail not published until 1927 was that the doorway had an external rebate (Potts & Clapham 1927, 212).

Although no detailed description of the wall was published, site inspection in March 1997 revealed that the present upper surface of the wall is of pink mortar, preserving the impressions of the overlying, but removed, tile course. Other details noted, but not recorded before, are that the surviving height of the west wall is 0.4 m, comprising six

courses of re-used Roman tiles bonded in pink mortar containing abundant flecks of crushed red tile. Only the external face is visible, the interior being covered by the adjacent (modern) gravel walkway. The face of the wall below the doorway is set 0.12 m in from the face of the chapel's west wall, whilst an offset at a lower level in the doorway projects only 10 mm from the face of the west wall. Much of the original pointing is still intact, although small areas have been re-pointed in buff mortar, presumably by the Ministry of Works.

Date of the chapel

The chapel is known to have been built by Eadbald between 616 and 624, and dedicated to the Virgin (see Chapter 4 for fuller details of the historical and written sources).

Interpretation of the excavated remains

Only the west wall of this chapel was located. Because of its location it must be the chapel of St Mary, built by Eadbald between 616 and 624.

Cloister area, Periods 2A and 2B

The cloisters (Fig 10)

This area was under excavation between 1927 and 1930. First mention of the results was in a note by Clapham (Potts 1934, 191-4). He reported that the Anglo-Saxon cloisters had probably been built in at least three phases.

The excavated remains (Fig 10)

The first structure to be uncovered was a rectangular building, measuring 8.23 m by 5.18 m, the foundations of which were located to the north of the cloister. This building lay at an acute angle to the alignment of the church (Potts 1934, 191).

It was found difficult to disentangle the various phases of the cloister, but thought to represent two successive lay-outs of a claustral plan (Potts 1934, 192-3). The earliest was thought to post-date the proposed expanded north porticus. The plan represented an internal square 12.80 m east-west, and "perhaps rather less from north to south though the exact north line is indeterminate." Four alleys were proposed, one on the south side nearly 3.35 m wide, on the west "rather wider." The remaining early walls (on the north, east and west sides) were interpreted as ranges of buildings; the eastern being 5.56 m wide, the western being 4.72 m wide and the north side being uncertain.

It is not thought that all of the early phase walls were contemporary since some walls were built of

ragstone [Hythe stone] and Roman brick, and "at one point have well-built mortar-rendered footings of square section." These were also laid in yellow mortar.

A second phase was represented by thicker walls on the east, north and west sides of the court, which had been "slightly enlarged on the west and perhaps north side and the south alley may have been entirely dispensed with." It was also noted that the thick north wall was made up of two parallel walls, the phasing of which was not determined, but probably represents two phases of build.

Walls of the later phase are described as having been of two types "which do not appear to differ in date, one type is substantially built on megalithic foundations, which include Roman stones, the other type has been built in a trench with lightly sloping sides filled with mortar and small material, a foot or so thick, on which stood the actual wall." The level of the contemporary ground surface is said to have risen on the north side of the cloister.

A structure not noted in the 1934 report, but located on a plan dated 1938 (held in the National Monuments Record archive, Swindon) shows the corner of a building to the north-east of the complex noted above. A description of the walls is given in a notebook, kept by the Reverend Potts, which also provides a drawing with dimensions. The fragment is described as a pre-Conquest building on the site of the later refectory. It had "brick quoins at the north-east corner" (on the plan this is the north-west corner). The walls were 0.58 m wide, surviving to a height of four courses measuring a total of 0.38 m. Alignment of the walls is more in keeping with the cloisters and church than the nearby building.

Dating evidence for the cloisters

No internal dating evidence has been recovered for the cloister complex, but the earliest phase of walls may have been built in the 8th century (see Chapter 5 for a full discussion of the layout), with a documented re-building by abbot Aelfmaer between 1006 and 1017/22 (see Chapter 4 for details).

Interpretation of the excavated remains

The excavated walls, including two buildings a little to the north represent at least two phases of cloisters.

South-west tower, Period 3

The tower (Fig 10)

Excavations in 1955-7 revealed the foundations of a massive tower to the south-west of the churches (Saunders 1978, 32-5). Two foundation-walls survived the Norman re-building of the abbey. The surviving foundations, on the south and west sides of the structure, had arched foundations resting on piers at the corners of the building. These cut

into the Period 1-2 cemetery. The foundations of this tower are visible today, but wrongly labelled Norman.

Description of the tower (Fig 10)

The construction trenches for the foundations was noted to have been undercut, to provide broader foundations for the walls above. Construction of the piers was uneven and of flint and ragstone rubble and some re-used Roman material bedded in hard orange mortar. Nearer ground level the foundations were coursed and with large water-worn pieces of ragstone between predominant flints. Note was made that the southern arch, of rough pitched stones had been constructed over the earth without any timber centering. The western arch was only half a true arch, with less care being taken with the foundations.

A further trench, excavated to locate the west face of the west foundation, successfully noted that the foundation had been trench built, to a width of 2.74 m. Reconstruction of the plan, given three surviving internal corners, suggests a structure around 3.81 m square internally. Part of the structure remained standing to a height of 0.91-1.22 m. The later, Norman, re-building of the abbey had removed the interior of the tower, and large parts of the east and north foundations.

Other fragments of masonry to the east of the south-west tower were thought to have been part of a further Anglo-Saxon tower, but later excavation proved these to have been Norman (*Medieval Archaeology*, 22, 158-9).

Dating evidence

The tower may have been built in the mid 11th century, since a large donation for building work is recorded for 1047 (see Chapter 4 for further details of the historical and written sources).

Interpretation of the remains

The south-west tower was probably a freestanding structure of some height, to judge from the nature of the foundations.

Wulfric's octagonal structure, Period 3

The octagon (Fig 10)

The octagonal structure was built to replace the east end of the church of Sts Peter & Paul, linking it with the chapel of St Mary. Excavations were largely conducted between 1914 and 1915, and the results published in 1915 (Hope 1915a). The structure, a circular crypt with an octagonal exterior, had been sealed by tons of earth beneath the Norman

crossing.

Visible today are all parts of the octagon that are situated between the two later Norman arcade foundations.

Description of the structure (Fig 10)

The central, open space of the crypt, measures 7.62 m in diameter, enclosed by a ring of eight piers, each 2.59 m thick, and expanding in width from 1.52-2.08 m on the inside to 2.44-3.45 m on the outside. Similar diverging sides may be seen on the spaces between the piers, from 1.06-1.52 m inside to 2.05 m outside. These spaces open onto an ambulatory 1.83 m wide. An opening on the west side, 2.97 m wide, gives onto the nave of the church of Sts Peter & Paul. All of the masonry is said to have been of "rough pieces of thin oolitic sandstone, carefully laid, and faced with a thin layer of mortar or plaster" (Hope 1915a, 379-80). To the north and south the arcade foundations of the Norman abbey cut through the foundations of the building.

The crypt was cut to a depth of 1.67 m from the top of the foundations. On the north-west and north faces was noted a 0.61 m offset, on the outside, of the building. Thickening of the west foundation was recorded, oversailing a "thick wall of earlier date" (Hope 1915a, 380, 389) measuring some 2.13 m wide with good facing stones to the east side and a rough finish to the west. This was further investigated in 1957-8 and found to have been part of the original octagonal building (Saunders 1978, 48-9). Details of this re-examination will be given below.

Also located in the 1914-15 excavations was a flight of two steps, adjacent to the western face of the building. This was originally interpreted as an apse on the east end of the church of Sts Peter & Paul (Hope 1915a, 386-7, fig 5), but this view changed on reflection (Peers & Clapham 1927, 215-6).

A later account of the octagonal structure (Peers & Clapham 1927, 212-18) introduces further details, after continued excavations in 1921-2. The crypt was cut to a depth of 0.81 m below the level of the floor in the church of Sts Peter & Paul. "A solid platform of rammed chalk was then laid down over the whole area, and on this were laid the foundations of the new building." The internal diameter of the "rotunda" measured 16.46 m (this contrasts with measurements given in Hope 1915a, of around 12.04 m diameter). To judge from the 1982 Department of the Environment survey the larger of the two measurements is closer to the true scale. More accurate on site measurements will be undertaken for the metrical analysis proposed later in the research.

Of the eight piers, each has sides radiating from the centre of the building, with a slight curve on both the inner and outer faces. Several of the piers shows "signs of the nascence of an outward curve in the surviving stone at the top (some 5 ft [1.52 m] above the chalk floor), which seems to indicate a series of barrel-vaults over the aisle and between the piers, and having a groin intersection opposite the openings" (Hope 1915a, 214).

The exterior south and south-east faces of the building showed signs of pilaster buttresses, 1.44 m across, and presumably also mirrored on the north and north-east faces. On the west side of the building, where a doorway was noted, a ramp of chalk is now recorded. This was interpreted as the base for a flight of steps,

from the church of Sts Peter & Paul down into the crypt of the rotunda.

Alterations to the original design, during construction, were recorded. These include the addition of a stair-tower foundation on the south face of the building, presumably also mirrored on the north face, and the addition of an outer skin of masonry, 0.6 m wide, to the exterior face of the foundations. "The various sections of this work were apparently added piecemeal, as they are normally separated by straight joints." When located in 1914-15 this was described as an offset foundation (Hope 1915a, 380). The foundations were more fully understood after the 1957-8 excavations (see below).

Outside the building was located an area of masonry foundations, attached to the south-west foundations of the rotunda, and interpreted as part of a contemporary re-building of the church of Sts Peter & Paul. On the north-west side of the building was recorded the lower two steps of an entrance into the rotunda, from the claustral area. This arrangement was imperfectly understood, and has been the subject of some confusion, originally interpreted as an early apse (Hope 1915a, 386-7).

More recent excavations in 1957-8, were designed to look at the later foundations towards the east end of the church of Sts Peter & Paul (Saunders 1978, 48-9). It was found that the west face of the octagon was built of coursed ragstone bonded in orange mortar. Against this had been built a 2.13 m wide foundation (Saunders 1978, fig 9, section c-d, wall 17), originally located in the early excavations. This had been interpreted as an earlier wall-foundation by the 1914-15 excavators, or perhaps an addition, according to the 1921-2 excavations. It was clear, from the 1957-8 work, that although foundation 17 butted the west foundation-wall of the octagon, it overlay the same foundation raft of chalk, in a wide foundation pit, and "appears to have been intended from the beginning." Across the entrance to the crypt, the foundation was made up of a different form (Saunders 1978, fig 9, section e-f, wall 18). This comprised layers of rubble and buff mortar laid on rubble and chalk with white mortar and gravel below. The east face of the foundation had been revetted with fragments of ragstone.

The 1957-8 trench was cut to sufficient depth to note that the foundation pit for the octagon had cut through the "natural ground," but the base of the chalk foundation raft was not located. A possible scaffold posthole was recorded in the nave of the church, 1 m west of the foundation (Saunders 1978, fig 9, section e-f, context 16).

Against the west face of the foundation were noted two layers; one of "yellow sand with a red (brick dust) surface," and the other a layer of "purplish white mortar and flints" (layers 12 and 13 respectively). It was suggested that these may indicate late floors within the nave of the church of Sts Peter & Paul (Saunders 1978, 49). These layers also sealed the Period 2 wall foundation at the east end of the nave.

Dating evidence

This structure, linking the church of Sts Peter & Paul with the chapel of St Mary, is documented as having been started by Wulfric around 1050, but not completed by his death in 1059 (see Chapter 4 for historical and written sources).

Interpretation of the octagonal structure

The excavated remains represent a barrel-vaulted crypt (as suggested by traces of a springing on the upper edge of several of the piers) with an ambulatory. The rounded foundation set against the south face of the structure (presumably mirrored on the north side) is thought to represent the foundation for a vice (spiral stair) giving access to upper floors in the structure. These features, and the substantial foundations, imply a structure of some height; perhaps a rotunda with gallery and clerestory levels (fuller interpretation of the remains is presented in Chapter 5).

Chapel of St Pancras*The chapel (Fig 12)*

This chapel has undergone three partial excavations, with a further excavation to the south (Fig 12). The findings from each of the excavations will be described in turn, followed by the results of a recent study, by the author, of the original site archives of unpublished material.

Parts of the Anglo-Saxon chapel still remain as a monument. Visible are the walls of the nave, parts of the western porch, and the nave south porticus, the outline of the north porticus, and slight traces of the side walls of the eastern apse. The standing chancel arch, and squared chancel are later medieval additions.

Preliminary excavations were undertaken in 1881 on the south side of the chapel, in the grounds of the Kent and Canterbury Hospital. Features recorded were the western porch, south wall of the nave, south porticus, and traces of the south wall of the apse (Routledge 1882). Areas to the north, inside the chapel, were unavailable for excavation at the time. The remains were not only thought to have been of Roman date, but were also claimed as the first church dedicated to Augustine. A further excavation was undertaken in 1900 and 1901, by St John Hope (Hope 1902). The main area excavated was the interior of the nave, down to the level of the 'concrete' floor, and a narrow trench around the outside of the walls of the nave and west porch (plan of trenches held in Jenkins' archive, Canterbury Museum) (Fig 12). In 1972 a long trench was dug by the late Dr Frank Jenkins, from the east wall of the nave and extending south for some 45 m. During 1974 and 1975 more extensive excavations were also undertaken by the late Dr

Frank Jenkins. This campaign cut five trenches in the nave, four trenches in the chancel, and 13 trenches around the perimeter of the chapel.

None of the late Dr Frank Jenkins' excavations on St Pancras chapel were published, save the short notes detailed below. On the death of Dr Jenkins his extensive collection of excavation records and research papers were deposited, by his wife, with Canterbury Museum. These have now been catalogued by Richard Cross of the Canterbury Archaeological Trust, and studied by the author. The final section on St Pancras chapel is the result of that study in March 1997.

The 1881 excavations (Fig 12)

The western porch was constructed of "Roman tiles and sea-shore mortar" with buttresses on the north-west and south-west angles. Inside the porch, at a depth of 0.35 m, was a medieval tiled floor, beneath which were a number of well-preserved burials. The description of the burials, with stone surrounds and chamfered Portland stone covers, suggest that these were also of medieval date. On the east side of the porch, entering the nave, was a Norman doorway (now thought to be re-used Romanesque masonry, inserted during the 14th century renovation of the chapel).

A full length of the south wall of the nave was recorded, and a partially blocked doorway noted, with a later surround, leading from the nave into the south porticus. Walls of the latter were of "Roman tiles, coated in the lower part with a facing of concrete, and the upper part with thick plaster." Inside the porticus, against the east wall, was an altar, probably of the same date as a medieval floor also located in the porticus, "but built on older foundations." Traces of the original doorway from the nave were noted. A mix of finds, of all dates was found in the porticus, including a late Tudor window and fragments of Roman pottery. More in keeping with the present research, the excavators located "a floor of concrete, shewing in parts marks of fire." (what was thought to be fire marks is now known to be a reddish surface coat on the concrete floor). The floor is said to have extended under the altar, and to have been traced in the adjacent nave. Further traces of floor were found "at the approach to the chancel, where we discover something like steps." Note was made that the floor in the south porticus lay at the same level as in the nave.

At the east end of the south wall was recorded a later external buttress, and part of the early chancel opening, with *in-situ* "Roman pillar." The foundations of the chancel wall are also noted, with the "commencement of an apse." The plan records the location of an original "buttress" on the chancel wall, just west of the springing of the apse.

It was recorded that the foundation-walls were 0.50 m wide, composed of "Roman tiles bonded by salmon-coloured mortar, and in others by mortar made from sea-shells and pebbles, and even later material." This comment is informative, and the different mortars are still noticeable today.

The excavators were doubtless excited by their discovery and wished to continue recording to the north, "but at this interesting point we are warned off by the owner of the adjacent ground."

1900-1901 excavations (Fig 5)

Excavation resumed in 1900, following the purchase of land to the north of the 1882 discoveries. The publication of the results (Hope 1902) notes that a cottage occupied the site of part of the nave, and that the area of the chancel had previously been dug to depth, and infilled with chalk as the bedding place for pigs. A further swine house abutted the west end of the cottage. After removal of these later features the entire area of the chapel was excavated, down to the level of the Anglo-Saxon concrete floor.

A comprehensive plan was obtained, with a nave 12.97 m long and 8.11 m wide, and a chancel divided from the nave by a colonnade of four columns. The southern of the columns survived, with moulded base, and the bedding for the adjacent one. Of the columns on the northern side of the chancel arch, only one fragment survived, displaced with other rubble in the nave.

The original west doorway was recorded, 2.33 m wide. It is noted that the doorway was narrowed to 1.98 m, after the walls had been built to a height of 0.91 m. External buttresses, projecting 0.36 m, flanked the doorway; similar buttresses being situated on the western corners of the nave.

At the eastern end of the chapel, traces of the chancel were recorded as running for a distance of 3.04 m, as far as a buttress, beyond which the apse began. Only small fragments of the latter survived, on either side of the chancel.

Added to the nave were the western porch, and porticus to north and south. The western porch was extended from the buttresses flanking the west doorway. The north wall of the porch survived of a height of 3.35 m (perhaps because it had been re-used as part of the wall dividing the monk's cemetery from the lay cemetery to the south). Also located in the porch was the "impost and springing of the western arch of entrance." This doorway measured 1.93 m wide, and 2.35 m high "up to the impost, which was formed of two projecting courses of brickwork." The arch was therefore calculated as being 3.35 m in height. Buttresses on the south and north faces of the porch, in line with the west wall, are recorded as having been abandoned during construction. The "finished portions cut away."

Regarding the north and south porticus; the northern one was only partly located by the foundations of its western wall, and the blocked doorway from the nave; the south porticus is as reported in 1882, above. Doorways into the porticus, are said to have been inserted when the porticus were added. The cutting of the doorways necessitated the removal of external buttresses, clearly seen on the north side. The foundations of the northern wall and buttresses are shown on the published plan (Hope 1902).

Returning to the eastern end of the nave, the chancel arch had its side openings blocked with re-used Roman tiles.

Large amounts of rubble, from the destroyed walls of the chapel, were located both inside the nave, and outside. The collapsed masonry within the nave was built of "Roman bricks, hardly any of which are whole," assumed to have been taken from a Roman building. Also of interest is the record that in two places, one on either side of the nave, that the "usual regularity of the courses is broken by a rude attempt at herring-bone work." Pink mortar was noted adhering to many of the tiles.

A fallen portion of a segment of the chancel arch was located, "turned entirely in brick," and faced with a fine white plaster, bearing traces of whitewash.

The various mortars used in the walls were investigated. It was found that all of the standing walls of the nave and chancel were built with bright yellow mortar, which was also noted in the fallen portions of the chancel and its segment of arch. The west porch, north and south porticus, and blocking of the side opening in the chancel arch, were, on the other hand, bonded with white mortar containing clean gravel. To confuse what appeared to have been the simple addition of features, using a different mortar, was the fact that fragments of fallen nave walling, further west, were also bonded in white mortar. Recording of the west wall of the nave showed the first 0.91 m height of the wall was bonded with yellow mortar, and the adjacent porch with white mortar. Above this level the butt joint between the porch and nave is transferred to a true bond, and both walls are carried up with white mortar. The conclusion reached from these different mortars, was that the chapel had been only partly built before a change in the layout was adopted, and the construction work continued in white mortar. More recent excavations have changed this view dramatically (see below).

The floor of the chapel is recorded as of "white cement," 0.15 m thick. The survival of the floor was good against the north wall, "with a surface coat of a pinkish colour, but... so thin as to be readily scratched with a shovel..." A medieval tile floor overlay the mortar floor.

No floor survived in the chancel since this area had been cut to a depth of around 0.91 m to form a pig-sty.

Some pages of a notebook, written by W Hope in 1900, are held in Canterbury cathedral library. These take the form of a diary, and record some measured sketches. Of note is the external buttress, half way along the north wall of the nave, which, from the notebook, measured 0.53 m wide, and projected some 0.35 m from the face of the wall. The foundation below the north wall projected some 0.15 m beyond the face of the wall.

1972 excavations (Fig 12)

A trench, excavated to the south of the chapel in 1972, is not recorded as having found any features relating to the chapel. The location of this trench is shown in a more recent publication (Sherlock & Woods 1988, fig 6). A layer of soil between the foundations of the exterior face of the south wall of the nave and south porticus, was cut by a grave containing a *sceatta* and a later Roman coin. The grave was sealed by construction debris from the porticus. It was suggested that the original building "may have been Roman, and that it was re-built and added to when the church was founded." (*Medieval Archaeol*, 17, 144).

Provided that the grave containing the *sceatta* was also cut by the porticus (or sealed by construction waste), then we have a *terminus post quem* (for the construction of the porticus) of the mid-late 8th century.

1974-5 excavations (Fig 12)

The excavations of 1974-5 remain unpublished, save two interim notes (*Medieval Archaeol*, 20, 163-4; Jenkins 1976, 4-5). Both of these notes were taken from the same text, but the latter has an extra three paragraphs detailing the 14th century fabric. The following tentative sequence of the Anglo-Saxon phases

(not related to the phasing of the St Augustine's abbey remains described above) was detailed in the interim notes (taken *in toto* from Jenkins 1976):

"Period I. The first church, built of re-used Roman bricks rarely complete, laid in regular courses in yellow mortar, consisted of a rectangular nave and a chancel in the form of a stilted apse. The latter was divided off from the nave by a single arched opening. Access to the nave was through a west door between external square pilaster buttresses. The angles of the nave were clasped by similar buttresses and there were also two intermediate ones symmetrically placed along the north and south sides of the nave. The floor was of clay laid directly on the surface of the underlying Roman deposits. The interior faces of the nave walls were rendered over with smooth white plaster. The foundations throughout were of flints laid in courses without mortar, capped by a footings course of Roman bricks to form external and internal offsets at the original ground level. At that level close to the south wall of the nave lay a coin of the House of Constantine I, the only dateable find in a stratified context relating to the building.

"The apse was brick-built, polygonal above ground and rested on similar flint foundations laid in a trench which was semi-circular on plan.

"Period II. The length of time the earliest church was in use is not clear, but enough time elapsed for a depth of about 9 in [0.23 m] of soil to accumulate on the contemporary ground level, before the building underwent extensive alterations. The work was carried out in re-used Roman bricks rarely complete, laid in fairly regular courses in white mortar, and rested on the walls of the original building which had been reduced in height in places to only a few courses. The irregular heights of the earlier walls suggests that the church had either stood in a ruinous state for some time, or had been deliberately demolished by the builders preparatory to carrying out the structural alterations.

"An external porticus was built against the south wall of the nave and another was provided in the same position on the north wall. A porticus was also built against the south wall of the chancel, access to which was provided by a door through that wall close to the south west corner of the chancel. New brick-built jambs were inserted in the west door of the nave to reduce the width, and a west porch added with an external door of the same width as the other. A bed of concrete was laid in the nave to raise the floor level by about 6 in [0.15 m] thus effectively concealing the plaster face on the lowest parts of the Period I walls. The walls which had flanked the original chancel arch were now built up to a higher level to support a triple arcade, of which the base and the lower part of one of the columns still survived *in situ*.

" Whilst this version of the church was in use, burials were inserted in the chancel, and the area along the outside of the building to the south was in use as a cemetery, where at least three graves appear to belong to the late 7th-8th century.

"When the remains of the arcade were examined in 1900 it was suggested that soon after it was built it developed a structural weakness so that it became necessary to wall up the outer arches. Today the brickwork in the space between the southernmost arch is less complete but it still stands to a height of eight courses above which the surviving column is based. It is also noteworthy that the bricks are laid in the same kind of white mortar. Also in 1900, a large fragment of a wall containing a segment of an arch turned in Roman

bricks was found where it had fallen across the east end of the nave. It was identified at the time as that part of the east wall, which contained the chancel arch.

"There seems to be no valid reason for disputing this, but it is rather odd that the brickwork was laid in yellow mortar, which implies that it belonged to the Period I work. It is reasonable to think that if the arch was replaced by a tripartite arcade then the whole structure would have been built with white mortar, but it clearly was not. The only possible explanation for this variation in the type of mortar seems to be that the builders were skilled enough to remove much of the Period I work, namely the piers of the arch and the flanking walls, but left the gable *in situ* supported by heavy timbers until the four columns were set up. It is therefore possible that in adopting this method of construction the builders inadvertently weakened the structure, and eventually due to the weight of the gable, settlement cracks revealed the fault which had to be remedied by walling up the outer arches of the arcade.

"Period III. In this structural phase building alterations seem to have been confined mainly to the chancel. The brick-built walls of the Period II structure, including the apse, were now incorporated in the walls of the new chancel. These were built of flint, stone and mortar, within those of the earlier structure so that the chancel was slightly narrower than before. The south door was blocked up and presumably at this time the porticus to which it gave access was demolished.

"It was found that the foundations of the new south wall had been sunk into the south side of one of the graves in the chancel. The skull was surrounded by large flints, which seems to have been a later Saxon custom. Others were found in the cemetery. As the grave clearly antedates the chancel wall it is possible that the latter was built in late Saxon times. On the other hand if this work was carried out when new masonry jambs were inserted into the west door of the nave, and as they are carved in 12th century style it is possible that the rebuilding could have taken place in early Norman times."

The remainder of the note described Period IV alterations, in the 14th century, and need not be discussed here.

Although the text presented in 1976 provided a phasing of St Pancras chapel, it is evident that some of the phasing remained unclear to the author, particularly regarding the arrangement of the porticus extending south of the chancel. These inconsistencies are clear if one looks at the plans presented with the note. This shows four period plans of the chapel; a porticus is shown extending off the chancel in Period I, and a rebuilding of this porticus is indicated in Period III. The text, as we have seen above, contradicts these plans, clearly stating that the porticus was added in Period II, and the doorway to the porticus blocked up in Period III. The author was still, therefore, forming his ideas regarding the phasing of the chapel in 1976.

The author's study of unpublished material on St Pancras Chapel (Fig 12)

Material available for study in 1997 included several drafts of a report (by Dr Jenkins) on the 1974-5 excavations (none of which are complete), with accompanying plans, sections, elevations, and some supporting documentation. It is unfortunate that the report was

never finally completed before Dr Jenkins' death since the introductory pages of text are missing. The report, however, is more consistent in its discussion of the phasing, having ironed out most of the problems of the porticus extending off the chancel (noted above), and forms a very useful body of material to enable a fuller analysis to be put forward. There still remain some inconsistencies between Dr Jenkins 'final' draft texts and the 'publication' drawings, and it is clear from correspondence (held in the archive) between the (then) DoE and Dr Jenkins that the 'publication' drawings were not seen as the final set of figures. Dr Jenkins' report does not include detailed description of the Romano-British deposits, the Anglo-Saxon and later graves, and the later features such as the hospital bone pit, etc. The report is also in need of extensive editing before it is suitable for publication. However, sufficient information is in the report, or figures to allow a reliable sequence to be put forward for the chapel of St Pancras.

Below is a description of the construction and phasing of the chapel, drawn freely from Dr Jenkins' most recent draft reports, but re-written by myself, and with my own interpretations and comments incorporated where necessary. Discussion of the various interpretations of the phasing are left until Chapter 5, suffice to note here that the phasing presented below is the definitive version. The past tense is used to describe the excavated remains of St Pancras chapel, as excavated in 1974-75, since the author is interpreting the material second-hand, not having seen the excavations in progress.

Introduction

The preservation of Anglo-Saxon layers in the chapel was badly affected by later structures having been built in the 19th century. The chancel in particular had been the site of pig pens, and here the floor of the chapel had been totally destroyed and the ground dug over to a considerable depth (over 1 m in places). Excavations around the perimeter of the church in 1900-1901 had also badly damaged the archaeology so that little of the external stratigraphy could be related to the walls of the chapel.

Two phases of Anglo-Saxon build were identified by the excavations, overlying Romano-British deposits, whilst the chapel was re-built in the second half of the 14th century and again towards the end of the 15th century.

Pre-chapel deposits (Fig 12)

The first phase of the chapel was built over the top of Romano-British deposits, comprising a scatter of pits and gullies cutting into an "occupation" soil which had built up over the natural sub-soil (yellow brickearth) to a depth of 0.3 m [Sec 1, L4; Sec 2, L4; Sec 3, L4; Sec 4, L3/4; Sec 5, L4; Sec 8, L2]. No evidence was found

for Romano-British burials either close to the church or further south in the long 1973 trench. The latter did, however, locate part of a Roman road extending east-west towards the city.

The "occupation" soil contained pottery dating to the late 1st and 2nd century, and the 2nd and early 3rd century, whilst the pits and gullies contained pottery dating to the late 2nd or 3rd century. A coin of Constantius II (issued AD 337-61) was also found in the soil. The latest pit contained early 4th century pottery and a coin of Antoninus Pius, and is dated by a radiocarbon sample of carbonised twigs to (HAR 3749) 1650 \pm 70 BP (cal AD 260-450 at 68% confidence, or cal AD 230-560 at 95% confidence).

Period 1 (Fig 12)

A near full ground plan of the first phase of the chapel has now been obtained from the combined excavations. Evident in this phase is a two cell building comprising a rectangular nave and apsidal-ended chancel. No porticus were part of the original layout.

The foundations comprised medium-sized flint nodules, laid level without mortar, measuring 0.76 m wide, and contained the occasional pieces of Roman brick pitched on edge and two lumps of *opus signinum*. These foundations were four or five courses deep, cut to a depth of around 0.56 m, although deeper where they cut into Romano-British features onto the underlying natural brickearth. The upper layer of the foundations comprised a levelling layer of Roman brick. Projecting from the south wall foundation, at intervals of 3.96 m, were three buttress foundations. The westernmost buttress (on line with the west wall) measured 0.56 m wide and projected 0.35 m, whilst the two further east projected up to 0.80 m. A further buttress was thought to have been sited on the south-east corner of the nave (to judge from the spacing of the buttresses), but this was not proven since a large buttress had been added onto this corner of the chapel in the 14th century.

The north wall foundations of the nave were not investigated in 1974-75, but were uncovered during the 1900-1901 excavations (Hope 1902). Here, Hope does not show a regular spacing of buttresses as on the south wall, but a centrally placed buttress half way along the north wall. This is also recorded in one of Hope's diaries, dated 1900, now held in Canterbury cathedral library. This records that the buttress foundation was 0.53 m wide and projecting some 0.35 m. To judge from the plan, and the sketch in his notebook, it was apparently an original buttress pre-dating the north porticus which was added in Period 2. Dr Jenkins dismissed the centrally-placed buttress on the north wall, by ignoring its existence, and argued for there having been regularly-spaced buttresses similar to those on the south wall. The present author favors the theory of a centrally-placed buttress on the north wall, simply because this is based on the excavated evidence, especially since Hope shows both a surviving buttress and its foundation (Hope 1902, fig between p 223 and 224).

Any attempt at locating a buttress on the north-east corner was thwarted since a larger buttress had been added here in 14th century (since removed). The buttress rebuilt here by the Ministry of Works in 1962, as part of the Period 1 build, has no firm archaeological evidence.

The west wall was only partly investigated. Sealed by the Period 2 porch was a Period 1 buttress projecting around 0.9 m from the face of the foundations. A matching buttress was located by Hope sealed by the north

wall of the Period 2 porch (Hope 1902, 229).

Although the majority of the foundations of the eastern apse had been robbed of its stone when the chancel was extended in the 14th century, the side walls were retained and incorporated into the later build. Here the foundations were similar to those of the nave, capped with a layer or two of Roman brick.

The upstanding walls of the chapel were built of re-used Roman bricks, rarely complete, offset from their foundations both internally and externally by around 0.1 m, producing walls 0.56 m thick. The Period 1 walls were bonded entirely in yellow mortar, in contrast with the Period 2 walls which were built using white mortar throughout (this corrects Hope's erroneous view that the two mortars, both yellow and white, were part of the chapel's first phase). The walls of the nave survived to a height of around 0.76 m, the upper 0.3 m of which had been re-built by the Ministry of Works in 1962 in white mortar. In contrast, the south wall of the chancel survived embedded in the 14th century chancel re-build to a height of around 1.52 m.

The surviving parts of the chancel wall indicated that it was polygonal externally, over a smoothly-curving foundation. No evidence of the internal face was located. This was either butted by 14th century fabric (on the south wall), or totally robbed, so it is not known if this was polygonal or smoothly-curving. In the surviving south elevation was evidence for a doorway in the Period 1 chancel. This had been largely re-built in Period 2 when a new east jamb was built using white mortar. However, two courses of tile, on line with and below the re-built east jamb, were set in yellow mortar indicating the location of the east side of a Period 1 doorway. No matching west jamb survived. Also visible in the south elevation was the stub of a buttress, measuring around 0.53 m across, and set 2.8 m from the south-east corner of the nave, just before the start of the springing of the apse.

Part of a matching north buttress was also found by Dr Jenkins, although its full width and length were not located. Also on the north side of the chancel was a patch of masonry at the west end of the chancel's north wall, located by Hope in 1900-1901, possibly representing the west jamb of a doorway (Hope 1902), facing that on the south wall (this is further discussed below since it may relate to the Period 2 works).

The east wall of the nave, dividing nave and chancel, incorporated evidence for the Period 1 chancel arch. Here two plinths 0.91 m square were located built of Roman bricks, each originally having a height of 0.28 m, with responds 0.56 m thick rising from the plinths. Part of the wall below the south plinth was of crude herring-bone work. The nave side of the plinths were in line with the internal face of the offset part of the wall footings, whilst on the east side the plinths overhung the footings by 0.13 m. Below the chancel opening were the lowest two courses of the walls. Each end of the brickwork was bonded with the corresponding plinth. The upper surface of the brickwork was level with the surface of the clay floor in the nave.

The width between the plinths was 2.54 m to a height of 0.23 m, above which the opening was apparently about 2.64 m wide where each side of the opening was the squared end of the 0.56 m thick wall. Hope does not mention that he uncovered part of the top of each plinth in the chancel, but these parts are shown in his plan (Hope 1902).

All of the walls were plastered internally above floor level, whilst externally the plaster appears to have been replaced in Period 2.

The original floor of the church was laid over the Romano-British deposits, and (according to Dr Jenkins' interpretation) no attempt was made to level the ground before the laying of the floor. This unevenness may in part have been the result of digging the trenches for the foundations of the chapel. The floor comprised a layer of pale yellow loamy clay, 0.08-0.13 m thick, presumably derived from the natural brickearth. The floor extended over the internal offset wall foundations, sealing a thin layer of yellow mortar dropped by the builders. Between this mortar and the floor, in one place, was a thin seam of dark soil. Where portions of the floor had gone a horizontal 'slot' was noted on the interior faces of the walls, between the yellow mortar spread on the foundations and the plaster on the walls. The wall plaster was white with a smooth finish, surviving in places to a height of 0.13 m above the floor. The floor in the chancel is thought to have been set at the same level as in the nave, although no evidence for this survived the extensive disturbance of the 19th century pig pens.

The floor sealed six clay filled postholes, close to the internal faces of the walls of the nave. These were spaced 2.75 m apart adjacent to the south wall (the probable posthole in the south-east corner being sealed beneath a later floor), with 2 m gaps between this row of postholes and those at the foot of east and west walls. The postholes were interpreted as part of a perimeter of post settings for the scaffold erected to build the walls.

Discussion of the reconstructed ground plan and layout of the chapel are presented in Chapter 5.

Period 1A (Fig 12)

A sub-phase designated Period 1A by Dr Jenkins is thought to have been a minor building project not long after the construction of the Period 1 chancel. It was represented by the partially robbed foundation of a wall, laid from the ground level contemporary with the founding of the chapel. The lower courses of the foundation lay in a shallow trench around 0.2 m deep. It is thought that this wall extended from the buttress on the south wall of the chancel, south for a distance of 3.66 m. However, the northern 2.6 m of the foundation was cut away by the Period 2 porticus. Dr Jenkins does not state in his draft report if the foundation was also seen in the side of a later grave cutting through the east wall of the porticus, but the detailed plan suggests that the wall foundation was found there.

This foundation is not interpreted as part of a Period 1 porticus, since no south wall extended off the south end of the foundation, and no matching foundation was found for a west wall, despite these areas of stratigraphy being intact. Jenkins suggested that the wall may have been built to divide the earliest part of the cemetery into eastern and western areas. The present author is not convinced by this theory. At first sight the plan of the burials indicates a clustering east of the foundation, but a number of these graves need not all have been dug in Period 1-1A and some may have been added in Period 2. The location of at least one early grave west of the foundation [G2], cut by the Period 2 porticus, certainly adds weight to the theory that no porticus was built here in Period 1-1A. In conclusion the foundation cannot be seen as a dividing wall in the graveyard, and its function remains unknown.

Graves associated with Period 1-1A (Fig 12)

Thirty-one graves can be detected on the plan that are almost certainly early medieval, and pre-date later medieval stone coffins. Comparison of plans and sections, however, indicates that not all of the graves were marked on the plan (one section for example shows eight graves, compared with only four on the plan). It is also difficult to be absolutely certain of the phasing of the graves, save where there is stratigraphic evidence (i.e. graves cut by Period 2 porticus, or shown in section as being sealed by a Period 2 layer). A number of the graves could, therefore, equally have been cut in Period 2, or later (see my discussion of the graves in the chancel below). This is almost certainly the case with Pit 4, Trench VII, where a number of skulls were found. This feature may well have been a charnel pit cut to bury bones dug up during the construction of the Period 2 porticus foundations. It was cut through by a later medieval sarcophagus.

To the east of the foundation butting up to the south side of the chancel, twelve graves are shown on the site plan, three of which contained large stones. The excavated section shows three of these cutting to variable depths, the northern of which cut through a Romano-British pit. Two of the graves are sealed by later building waste. Other graves cutting from higher up in the stratigraphic sequence are undoubtedly later medieval in date.

To the west of the foundation, along the south side of the chapel, thirteen graves are shown on the site plan. Four of the graves lay very close to the foot of the south wall, between the buttresses, and three other graves were cut through by the porticus added on to the chapel in Period 2 (one by the chancel south porticus, three by the nave south porticus - only two of which are shown on the plan). Only one of the graves south of the nave contained large stones.

West of the chapel, immediately south of the Period 2 porch, were four graves containing large stones, probably all relating to the Period 1 or Period 2 chapel.

Within the chancel four graves were recorded, the two closest to the centre being designated 14th century by the excavator, who was of the opinion that the southern pair were Anglo-Saxon. Stratigraphically the southernmost burial was thought by the excavator to have pre-dated the re-building of the chancel in the 14th century, and the two southern burials are shown as having been disturbed to a depth of around 0.6 m by the wide foundation cut of the 14th century chancel (sec G-H, I-J). The southern burial [G3] had been cut to a considerable depth (around 1.37 m below contemporary ground level), whilst the other grave [G4] was cut to a depth of around 0.7 m (more in keeping with the depth of the Anglo-Saxon graves outside the church). A coffin stain was located in grave 3, in which were found the remains of a skeleton with associated large stones around its head. It is remarkable that a combination of a wooden coffin and large stones were recorded in this grave. Such stones may have been placed around the head to protect the face when the grave was backfilled, and this would not have been necessary if a coffin had been used (Boddington 1996, 38-42).

Dr Jenkins also based his dating of the southern grave on the fact that large stones were placed in the grave, and that such burials are always of pre-Conquest date. It is, however, now known that similar large stones have been found in post-Conquest graves. Examples are known from the excavation of St Andrew's church, York, dating to the 12th century (Daniell 1997, 161, plate 9). For a nearby example, the Norman

priory of St Gregory in Canterbury yielded several such burials (particularly in the lay cemetery), where stones were placed in the grave (Martin Hicks, pers comm).

The present author interprets all four graves in the chancel as additions in the 14th or 15th centuries. The southern grave may have been dug hard up against the south wall of the chancel, undermining it a little. Here the grave cut to a much greater depth than the 14th century foundations (the grave cut to 1.37 m, and the wall foundation to only 0.9 m). Such a deeply-cut grave is more likely to be 14th-15th century than Anglo-Saxon (early graves on the site were seldom over 0.5 m deep). It is also possible that the graves cut through the 14th century construction trench and that the cuts were not noticed by the excavator. The presence of a decayed wooden coffin and large stone introduces further doubt about the reliability of the recording and interpretation of the graves. Finally, the four graves appear to have been arranged in a row across the chancel, with no evidence of intercutting, and therefore all are probably of 14th or 15th century date.

Skeletal analysis was not undertaken on any of the material, as the preservation of the bones was generally poor. A few bones are shown in three of the graves in the chancel, but none of the other graves have bones drawn on the plan. Dr Jenkins noted, however, that one of the burials cut by the Period 2 nave south porticus, and sampled for radiocarbon dating, contained parts of the skull and slivers of the long bones.

Dating evidence

The first phase of the chapel is undated by pottery, save to say that it post-dated Romano-British features which contained pottery dating to the early 4th century, and perhaps continuing into the early 5th century to judge from the results of the radiocarbon dating (see date above).

Two other pieces of dating evidence of Anglo-Saxon date are available, both from graves. A grave cut by the south-east corner of the Period 2 nave south porticus was sampled for radiocarbon dating. Here a human bone produced a date of (HAR 3710) 1130±90 BP (cal AD 780-1000 at 68% confidence, cal AD 680-1040 at 95% confidence). A silver *sceat* was also found in a grave "a few feet to the east of the south chapel" (probably the grave centrally placed in Trench V). The grave is said to have cut a layer of soil that had built up during the life of the Period 1 chapel, but pre-dating the Period 2 extensions. The coin was found "where the left hand of the corpse had rested on the bottom of the grave" in a decayed purse also containing a coin of Helena (late 3rd century). The *sceat* was identified by the late Stuart Rigold as being minted either in AD 720 or 740, who also reported that since it was only slightly worn it was consequently probably buried a few years after AD 750. We therefore have a *terminus post quem* for the Period 2 additions to the chapel of the mid-late 8th century. This does not, however,

provide a *terminus ante quem* for the Period 1 chapel, which remains undated.

A broad date for Period 1 of St Pancras chapel can be tentatively suggested on typological and dedicatory grounds and this will be discussed in Chapter 5.

Interpretation of the excavated remains (Fig 12)

A reconstruction of the ground plan is relatively easy, given the amount of excavation undertaken on the site. In Period 1 the chapel comprised a two cell building with nave 12.97 m long and 8.11 m wide internally, and a stilted apsidal chancel around 7.3 m long internally, divided from the nave by a chancel arch 2.64 m wide. A doorway was sited in the south wall of the chancel, and perhaps also in the north wall. Further discussion of the plan and layout is presented in Chapter 5.

Period 2 (Fig 12)

Construction work on the chapel in Period 2 was extensive, and comprised the rebuilding of substantial parts of the nave, replacement of the chancel arch with a screen, and the addition of a western porch, north and south porticus off the nave, and a porticus south of the chancel (and perhaps also matching porticus to the north). All of the Period 2 masonry was bonded with white mortar, in contrast to the Period 1 work, which was bonded, with yellow mortar. The ground level outside the chapel, from which the Period 2 works were undertaken, had risen by around 0.15 m above the level of the contemporary ground surface in Period 1.

Re-building of nave walls was undertaken on a large scale employing re-used Roman bricks. Internally the chancel arch was replaced by a screen comprising four columns forming a central opening flanked by two narrower ones. The best preserved part of the screen was at the south end, where an *in situ* column base survived. Much of the upper portion of the chancel arch had collapsed, and part of this was found by Hope in 1900-1901. Hope reported that the chancel arch of Roman brick bonded in yellow mortar was uncovered (Hope 1902, 231), and Dr Jenkins argued convincingly that this was part of the original chancel arch (upwards of the springing of the arch) which had survived re-building in Period 2, this section being supported whilst the remainder of the screen was built below. Given the evidence of the yellow mortar this seems a logical interpretation.

The stylobate for the southern pair of the four columns remained. It consisted of two regular courses of re-used Roman bricks, bonded with white mortar. The square south end of the stylobate was butted to the lowest course of the Period 1 walling forming the south side of the rectangular opening in which the colonnade was constructed. The straight joint between the stylobate and the earlier brickwork was plainly visible. Also the courses of the brickwork of the two periods of building were not at the same level (Fig 12).

The southernmost one of the four columns was (and is still) *in situ* on the stylobate, and consists of the rectangular plinth and part of the shaft (0.4 m in diameter). The column next to it had gone before Hope's

excavations in 1900-1901. Today a portion of a wall stands on the stylobate and consists of re-used Roman bricks laid in regular courses. Owing to damage part of the north-east section of this wall, originally 1.22 m long (according to Hope), has now gone. At that time the north end of the wall contained a cast of the south side of the plinth, column, and shaft above, and of the spread of mortar remaining as a stylobate where the column had stood. Hence as the position of the column was known, it was deduced that the south side opening was 1.22 m wide, as presumably was the north one. The width of the central opening was, therefore, calculated as being 2.44 m wide (Hope 1902, 288, 232-3).

Hope had thought that the side openings were walled up with brick, perhaps because the central one had shown signs of weakness (Hope 1902, 228). Jenkins suggested that the side openings contained low walls above which the nave and the chancel were inter-visible, following David Parsons' earlier interpretation (Parsons 1969, 180).

Hope found the remains of a third column shaft collapsed in the nave, along with the upper portion of another retaining the half-round necking (astragal) from which the capital rose (Hope 1902, 228).

The *in situ* column fragment is cut from limestone with *Ditrupe* tubes, originally quarried from the Calcaire Grossier formation near Paris (Worssam & Tatton-Brown 1990, 59, 66-7). The profile of the shaft base has led Dr Tom Blagg to conclude that it was carved in the Anglo-Saxon period for use in the chapel, rather than being a re-used Roman fragment (Blagg 1981). It is likely that this had been quarried in Roman times and brought to Canterbury for use in the city, being not only re-used, but re-worked in the Anglo-Saxon period (discussion will be expanded further in Chapter 5).

A new floor was part of the Period 2 alterations, and comprised a "concrete-like white mortar containing some flints and random pieces of Roman bricks pitched on one edge in a slanting position." The new floor was laid directly over the Period 1 clay floor, and was badly disturbed by later features. One particularly well preserved patch in the south-east corner of the nave was in near original condition. It was 0.15 m thick, and "retained a thinly applied, reddish coloured, surface coating."

The construction work of Period 2 included the laying of two layers of brickwork below the central opening of the screen, and in the doorway into the western porch, to allow for the increased height of the new floor. The surface of these openings and the floors in the nave and nave south porticus were recorded as being identical.

The western porch, added in Period 2, measured 3.2 m long by 2.89 m wide internally, butting up to the west external face of the Period 1 chapel. Because of the presence of medieval stone-built coffins against the internal wall faces of the porch, only the area south of the porch was investigated to any depth. Here the footings of the south wall partly sat on top of a reduced Period 1 buttress, to a depth of 0.15 m, stepping down to 0.46 m deep further west for the remainder of its length. The foundation, which had a slight offset from its overlying wall, comprised regular courses of re-used Roman bricks laid with a similar mortar to that used to coat the exterior face of the footings. The south wall of the porch survived to a height of 0.76 m in 1900-1901, but the upper 0.3 m was re-built by the Ministry of Works in 1962. Two buttresses were situated on the western corners of the porch, and in 1974-75 only the three lowest courses of this part of the wall

survived, comprising broken brickwork where the southern buttress had been cut away.

In Period 2 the western doorway of the nave was narrowed to 2 m in width, to match the size of the western doorway of the porch. Two regular courses of re-used Roman bricks had been added in the doorway to bring the level of the new tread up to the level of the new floor in the nave. Next 0.2 m wide jambs were built with re-used Roman bricks. These jambs, Dr Jenkins recorded, were not rebated for a door.

The nave south porticus cut through the build-up of deposits, which had developed outside the church. It also cut through three burials (only two are shown on the plan) which had been dug whilst the Period 1 building was standing. The construction of the porticus entailed the cutting away of part of two Period 1 buttresses on the south wall. The foundation of the west wall of the porticus was exposed externally for the entire length and depth, but the inner side was not examined. The foundation comprised flints of medium size laid in four level layers without mortar, similar to the foundations of the Period 1 nave, but cutting from a higher level. The inner side of the east wall was not exposed, but the exterior face was exposed for a length of 2.44 m from the south wall of the nave. The foundation here was totally different from the west wall foundation in that it was built of regular courses of re-used bricks, and faced with mortar. Unfortunately the reason for the difference between the two foundations was not established during the course of the excavation. Parts of the foundations of the west wall and the south-east buttress had subsided slightly into underlying Period 1 graves.

The east and west walls of the porticus butted up to the south wall of the Period 1 nave. The present standing walls of the nave south porticus survive to a height of 0.6 m, built of regular courses of re-used Roman bricks bonded with white mortar. Like the west porch the south porticus measures 3.2 long by 2.89 m wide internally. Two buttresses, each 0.4 m long, extend south of the porticus. Both the east wall foundation and the south-east buttress were off-set slightly from the walls above, to judge from the section drawings.

Inside the nave south porticus excavation of the western half revealed that the modern turf (laid by the Ministry of Works after 1945) overlay the remaining portions of the Period 2 "concrete" floor. Routledge in 1881 had excavated the disturbed areas to a depth of 0.15 m and here the layers below the concrete floor were recorded in 1974-75 (Fig 12). Dr Jenkins in a draft of his report noted that the area enclosed by the Period 2 porticus was provided with a level surface around 0.13 m below the contemporary ground level. He also noted that a grave parallel with the nave south wall and 0.1 m out from the external off-set foundation was visible. Because of this the builders had disinterred the burial and had filled in the empty grave with soil containing small pieces of building rubble.

The floor of the nave south porticus, at the north end, overlay a very thin seam of dark soil, covering the waste yellow mortar dropped by the builders of the Period 1 chapel onto the offset foundation. Southwards the floor overlay the filled in empty grave. Southwards from this it overlay the surface of the remaining lower part of the pre-southern porticus soil and that of a large patch of dirty yellow clayey loam. The latter was interpreted as a "dirty clay floor" in the section drawing, but Dr Jenkins appears to have changed his interpretation of the layer since his report does not mention a floor. The author interprets this layer as up-cast from digging the Period 2 foundation trenches.

The portion of floor surviving *in situ* in the north-east corner of the nave south porticus retained a thinly applied reddish coloured surface coating, identical to that in the nave, and on the same level, implying that the two floors were contemporary.

A side altar was installed against the east wall of the south porticus in a central position. It is possible that the altar had a foundation comprising mortar and flints having the same thickness as the remaining portions of floor on either side, but this was not certain since the floor was left intact.

A doorway was cut through the south wall of the nave, to provide access to the nave south porticus. The base of the doorway, around 1 m wide, survived to a height of 0.13 m above the footings of the Period 1 south wall, the remaining upper section being lost after the top 0.48 m of the wall was rebuilt by the Ministry of Works in 1962. The squared east jamb was built with re-used Roman bricks bonded in white mortar (Hope 1902), whilst the west jamb had been largely destroyed by later alterations to the doorway in the 14th century.

The nave north porticus was not investigated in Dr Jenkins' excavations, and is shown here as drawn by Hope, mirroring the nave south porticus.

The chancel south porticus was added in Period 2, and said by Dr Jenkins to have been entered through a doorway inserted in the chancel south wall. It has, however, been established above that a doorway was also sited here in Period 1, but that no porticus is thought to have been part of the Period 1 plan of the chapel. The new Period 2 east jamb of the doorway comprised re-used Roman bricks set in white mortar, surviving to a height of 1 m, above and on line with the Period 1 east jamb set in yellow mortar (Fig 12). No west jamb survived and it was calculated by Dr Jenkins that this doorway was probably around 1 m wide, like those of the nave south and north porticus. The surviving east jamb was 1.7 m from the west wall of the chancel, too great a gap for a doorway, and it is perhaps best to follow Dr Jenkins' theory of a narrower doorway (see also chancel north porticus below).

The chancel south porticus had been demolished down to its foundations, which comprised compacted white mortar with occasional medium sized flints. The west wall lay on line with the east side of the nave, but much of this area had been disturbed by a late medieval buttress. The east wall overlaid the robbed out Period 1 wall extending south of the chancel. This wall had been removed and the construction trench backfilled with soil (some flints survived in the base of the trench - Fig 12). A grave (not shown on the plan) and a large medieval pit cut through the south wall foundation of the porticus, whilst the east wall foundation was cut by at least two graves (one of which is shown on the plan). The foundations for these walls were evidently much shallower than the other porticus foundations of Period 2, being only 0.38 m deep. The west wall foundation cut to a depth of about 0.1 m deeper than the east wall foundation, perhaps to allow for a slope in the ground surface.

To judge from the remaining foundations, the chancel south porticus measured 2.9 m east-west by 2.1 m north-south. Because of the later intrusions no floor survived in the porticus.

Dr Jenkins had noted that no matching north porticus was ever built off the chancel. The author disagrees with this theory. A small chapel was added to the north side of the chancel in the 14th century, destroying all earlier deposits. This may well have represented a re-building of the remains of an earlier, Anglo-Saxon, north

porticus. The only masonry located here was recorded by Hope in 1900-1901 (Hope 1902 figure). A short length of wall is shown projecting along the north wall of the chancel for a distance of around 0.68 m. This could, perhaps, have been the west jamb of a doorway into a north porticus. Given this masonry fragment, if one subtracts the 0.7 m west jamb from the 1.7 m width of the surviving opening on the south wall of the chancel (see above), the doorway would have been 1 m wide.

It is uncertain which graves were added in Period 2, and these have been considered in the discussion of the Period 1-1A graves, above. A charnel pit (Pit 4 in Trench VII) containing a number of skulls was dug to the west of the nave south porticus, perhaps to bury human bones removed during the digging of foundations in Period 2.

Dating evidence

It has already been noted above that the Period 2 nave south porticus overlay a grave yielding a radiocarbon date of AD 780-1000 (at 68% confidence) (full details above). A further earlier grave cut in Period 1 contained a *sceat* dating to AD 720 or 740, and probably out of circulation a few years after AD 750. The coin provides a *terminus post quem* for the Period 2 re-building of the chapel of the mid-late 8th century.

Interpretation of the excavated remains (Fig 12)

The ground plan of the Period 2 re-building indicates that the Period 1 nave and chancel were rebuilt to the same plan, with the addition of a western porch, north and south porticus off the nave, and a south porticus off the chancel, possibly also matched by a north porticus. Further discussion of the layout will be presented in Chapter 5.

Summary of the Anglo-Saxon remains at St Augustine's abbey (Fig 10)

The excavated remains and standing fabric at St Augustine's abbey represent four churches/chapels. The earliest structure, the Period 1A church dedicated to Sts Peter & Paul was built in the opening years of the 7th century, and may have measured around 29 m in length and 19 m in width. This was followed, in Period 1B, by the addition of the chapel of St Mary, to the east, between 616 and 624, of which only the west wall survived. Period 2 saw the westward expansion of the church of Sts Peter & Paul, the construction of the two-phase cloisters on the north side of the church, and a chapel to the west. This expansion appears to have been undertaken in a number of phases between the 8th and 11th century (see the dating evidence above for the various elements). The final

phase, Period 3, is represented by the rebuilding of the western chapel, construction of a substantial free-standing tower, to the south-west of the church, and the linking of the church of Sts Peter & Paul with the chapel of St Mary, by the construction of a substantial rotunda, with crypt. Period 3 structures are of a mid-11th century date.

After the construction of the rotunda the complex of three churches/chapels (with some reconstruction of the plan) may have measured around 92 m in length.

The fourth chapel, that of St Pancras was built a little way to the east of the main complex, and on a slightly different alignment. The first phase of the chapel is undated, but the second phase was probably in the mid-late 8th century. As such it would equate with Period 2 of the main abbey complex.

St Martin's church

Introduction

The extant church of St Martin has been the subject of very little excavation, but much speculation, and extensive recording of the standing fabric. All of the remains described below are visible, save features revealed by excavation.

In 1897, a paper was published on excavations undertaken during the previous year (Routledge 1897); the building was also the subject of limited excavation in 1954 (Jenkins 1965); and recording of the standing fabric in 1980 (Tatton-Brown 1980).

The Rev. Charles Routledge's paper set out the evidence of the standing fabric and then presented the following four theories for the phasing of the chancel and nave (Routledge 1897, 16):

- A Roman date for the chancel, and a later Roman date for the nave.
- A Roman date for the nave, and a later Roman date for the chancel.
- A Roman date for the chancel, and a Saxon date for the nave.
- An early Saxon date for the chancel, and a later Saxon date for the nave.

He gave weight to the theory that the chancel of St Pancras (rather than the church of St Martin) was part of the Roman church dedicated to St Martin, and mentioned by Bede (Chapter 4), and that the nave was also probably of Roman build, although he sets out the arguments for its possible Saxon date (Routledge 1897, 19-28).

Frank Jenkins, in his paper published in 1965, set out the arguments supporting the phasing of the chancel being earlier than the nave, but in his conclusions cast doubt on

the Roman date of the chancel (Jenkins 1965, 15). Harold Taylor added his voice to the various opinions, favoring a sub-Roman or early Anglo-Saxon, rather than Roman date for the chancel and a 7th century date for the nave (Taylor 1965, 143).

Tatton-Brown, after extensive stone-by-stone recording of the masonry, considered the chancel to be of later Roman date, and the nave to have been built in the early years of the 7th century.

It is impossible to better Tim Tatton-Brown's analysis without further excavations, so the phasing followed in this thesis is that the chancel is part of a late Roman structure, whilst the nave dates to the first half of the 7th century (Tatton-Brown 1980).

The following account presents information separately for each of the two main elements of the church (the late Roman structure, and the Anglo-Saxon nave). Within each of these sections the facts are related to one of the three papers above. It must be noted here that the dating of these two phases is based solely on the evidence of the construction techniques and the materials used. No dating evidence was recovered from either of the excavations.

Roman structure

The Roman element of the building is represented by a single cell, with a small room to the south, fragments of which were recorded in 1896, in the nave and chancel of the present church (Routledge 1897). Further work was undertaken in the chancel in 1954 (Jenkins 1965).

1896 excavations (Fig 13)

After temporary removal of the choir stalls in the chancel, excavation was started but soon stopped because of the presence of burial vaults and graves. Plaster was stripped from the walls to a height of around 2.3 m and the walls recorded. For a distance of 6 m the walls were built of evenly-laid Roman tiles. In the south wall were recorded two blocked doorways; one with a square head, the other round headed. The squared doorway, which can be seen more easily from outside, has "jambs of Roman tiles, with a lintel and sill formed of massive blocks of green sandstone." It measures 1.82 m high and 1.01 m wide. The round headed doorway also measured 1.82 m high but only 0.63 m wide, and had an arch formed of blocks of ragstone. The span at the springing of the arch is a little wider than the width of the doorway. Imposts are formed of two Roman tiles; the upper overhanging the lower, and the lower overhanging the jamb. A layer of plaster lines the doorway. Internally the jambs are of Roman tiles with some ragstone, whilst outside they are almost entirely of Roman tiles. The latter doorway was recognised as an insertion into an earlier wall.

A change in the masonry of the south wall, around 2.05 m east of the round headed doorway, suggests a termination of the original building, interpreted in 1897 as the start of an apse.

A patch of floor was removed in the south-east corner of the nave, revealing the foundations of a wall running parallel with the south wall of the nave. This foundation was made up of mainly flints, about 0.45 m wide and 0.43 m deep in an extremely fragmentary condition. This fragment of foundation was interpreted as a westward continuation of the south wall of the chancel. A composite section was published showing the foundations in relationship to the surviving wall above, which measured 0.66 m across (Routledge 1897, opposite page 6). Similar foundations are reported to have been found by Reverend Livett, noting that the recent finds "correspond exactly with the foundation of the chancel wall below the brick footings thereof" (in the north-west corner of the chancel) (Routledge 1897, 6-7).

Outside the chancel, on the south side of the church, was excavated a trench in the angle between the nave and chancel. Here, adjacent to the square headed doorway, were traces of two foundations, extending south from the chancel. The southern side was, unfortunately, destroyed by burials. These two walls were set 1.44 m apart, measured 0.66 m in width, and had been built entirely of Roman tiles. The western wall extended 0.2 m below the east wall of the nave. Between the two excavated walls, was a floor of *opus signinum*. The structure was presumably part of a small annex.

It was clear to the excavator that the annex was an integral part of the south wall of the chancel, the foundations being similar and bonded together. The walls "rested upon a footing-course of one brick, which forms the top of the shallow foundation of flints and stones." It is also noted that the brick footing continued along the base of the chancel wall, under the sill of the square headed doorway, and "was irregular in its projection." The two walls located by excavation were seen to have originally been bonded into the south face of the chancel wall. "Every alternate course shows a broken brick, and every other course the clean edge of a brick." The bonding could not be traced above the lower edge of the lintel. A pilaster buttress, built of Roman tiles, was noted on the south wall, towards the east end of the early masonry.

A coloured ground plan and elevation of the south wall of the chancel by G M Livett, dated 1896, is held in Canterbury cathedral library. The elevation drawing includes a section through the excavated annex to the south of the chancel.

1954 excavations (Fig 13)

Further excavations in 1954, although of a limited nature, added details to help understand the development of the chancel (Jenkins 1965). The results are summarised below.

Detailed study of the exterior south wall of the chancel revealed that the buttress on the east end of the early wall had been largely re-built in the 19th century. Above the re-built buttress, however, is a vertical edge of Roman tiles, indicating the original eastern extent of the south wall. On the interior face of the wall, a vertical scar was noted, around 0.6 m from the east end of the early wall, where the regular tile coursing ended.

The north wall is of similar build to that on the south, but with a large section missing due to its removal

when the vestry was built. The author (the late Frank Jenkins) recorded seeing evidence of the west wall (below the chancel arch), as noted by Reverend Livett (detailed above), but that this evidence is now hidden behind wall plaster.

When the modern chancel floor was removed in 1954, it was found that it rested on natural soil, and no original floor survived, "except a line of mortar along the base of the south wall" (Jenkins 1965, 14).

At the east end of the chancel, workmen had dug a hole in front of the sanctuary steps. Here, it is recorded, was proof of the eastern wall of the early building. Just beneath floor level were located three broken courses of Roman tiles, projecting "from the south wall into which they were bonded." The tiles rested on foundations of flint and mortar, laid on flints and loam, in a trench 0.6 m deep. It appears that the upper course did not survive well, but the lower foundation extended for a distance of 1.37 m from the south wall. Graves had destroyed the foundations beyond this point. Against the north wall, however, the foundations were recorded again. All that survived here were courses of broken tile bonded into the north wall, and projecting from its base, and resting on foundations of flint and mortar. The eastern edge of the wall-foundation was not located.

Anglo-Saxon, Period 1

The Anglo-Saxon element of the church is represented by a westward expansion of the Roman structure, forming the nave of the church, whilst the original Roman structure appears to have been retained to serve as the chancel of the church. Recording work in 1896 (Routledge 1897) and 1980 (Tatton-Brown 1980) are detailed below.

1896 recording (Fig 13)

The west wall of the nave was constructed of ragstone and Roman tiles, with no attempt at regular coursing. In the centre, over the main west doorway, was noted a blocked up opening (Routledge 1897, 3) some 5.18-5.28 m above the floor, and around 2.18 m wide. Windows were noted, either side of the doorway, with signs of the original arches turned in Roman tiles, and with vousoirs of ragstone bonded in pink mortar. These windows had been extended upwards in the Norman period. Each measures 0.81 m wide, and splays towards the outside. Excavations at the foot of the west wall, on the north side of the nave, were undertaken in an attempt to locate an early floor, but burial vaults and skeletons were too numerous.

North and south walls of the nave are recorded as being of similar materials to the west wall, and "behind the woodwork are considerable pieces of pink plaster, remarkable for its hardness and texture." This is composed of lime mortar, sand and pounded Roman tile, in almost equal proportions.

Excavation was also undertaken, outside, against the east end of the south wall of the nave, adjacent to a "nearly circular feature" of uncertain function. This revealed that the south wall, of Roman tile and ragstone, sat on a foundation of "concrete" (Routledge 1897, 14-15).

1980 recording (Fig 13)

Recent work (Tatton-Brown 1980) has been restricted to detailed recording of the walls, and the preparation of an accurate plan, rather than further excavation. The drawings in the report show all of the features noted in the 1897 and 1965 reports. This detailed record of the fabric will be returned to later in the research.

An interesting study of the stone used in the two phases of work at St Martin's is informative. In the Roman part of the building a number of fragments of Marquise oolite have been recorded, as well as fragments of Calcaire Grossier (Worssam & Tatton-Brown 1990, 59). The Anglo-Saxon nave employs large quantities of Calcaire Grossier, mainly in the lower quoins on the south-east corner, and on the buttresses of the south wall, many of it containing *Ditrupe*, thus placing the quarry site near Paris (Worssam & Tatton-Brown 1990, 66-7). The western jamb of an inserted Anglo-Saxon doorway in the south wall of the Roman building also contains a fragment of Marquise stone with an Anglo-Saxon inscription. It is probable that all of the imported stone mentioned above was originally brought into Britain in the Roman period, and that where it is found in Anglo-Saxon churches it is re-used material.

Interpretation and date of the remains

As discussed above two early phases have been located at St Martin's church. No dating evidence was recovered from the two excavations, and the date of the two phases under discussion is based solely on architectural details, and the materials used. Until more extensive excavations are undertaken, the date of the two elements discussed here follow that set out by Tim Tatton-Brown (Tatton-Brown 1980): the chancel is interpreted as part of the Roman structure recorded by Bede, whilst the nave probably represents an expansion in the first half of the 7th century, after the arrival of Augustine.

An inscription incorporate into the western jamb of the blocked south doorway was originally dated to 600-50 (Taylor & Taylor 1965, 143). The inscription reads [HON]ORE OMNIV(M) S(AN)C(T)ORV(M), translated as 'in honour of all the saints or 'in honour of All Saints'. It is likely to record the dedication of a church or altar, and has recently been re-dated to pre c. 900 (Tweddle *et al*, 137, ill 57).

Summary of the archaeological evidence for Anglo-Saxon churches in Canterbury

The evidence of the Anglo-Saxon churches in Canterbury offers a unique view of the early Gregorian mission to Britain, led by Augustine in 597, and the subsequent development of the cathedral and abbey complex over a period of 469 years.

St Martin's church has a presumed Roman element, perhaps originally constructed as a

mausoleum, and re-used in the 6th century by Bertha as a place of worship with her chaplain before the arrival of Augustine. Canterbury cathedral has now revealed traces of what appears to be Augustine's first cathedral church, and the abbey site has yielded invaluable information on the church of Sts Peter & Paul, the burial site of the early Archbishops and kings of Kent, started a year later.

Both the cathedral and abbey site underwent considerable expansion throughout the Anglo-Saxon period, culminating in large, complicated structures. The cathedral was totally rebuilt, perhaps in the first half of the 9th century, and a major western structure added in the early 11th century. At St Augustine's abbey, the church of Sts Peter & Paul was not demolished for re-building, but added to at intervals, ending with a row of four churches/chapels, two of which were linked after the construction of a rotunda in the mid 11th century.

Both sites saw major additions to their layout shortly before the Conquest; the cathedral with an apsidal-ended western structure; the abbey with its rotunda. These were very adventurous schemes echoing Ottonian-period architecture on the Continent (these are discussed further in Chapter 5).

CHAPTER 4: HISTORICAL AND WRITTEN SOURCES

Introduction

In this chapter it is intended to summarise the results of previous research on the main historical and written sources for the Anglo-Saxon churches of Canterbury. This is, by design, not an exhaustive account of all the available material, which (for Canterbury cathedral) has already been discussed in detail (Brooks 1984) and recently summarised (Brooks 1995). It is instead designed as an outline to provide information to help understand the date, layout, and development of the Anglo-Saxon churches of Canterbury. This section is thus based on secondary sources, taken to be correct, and no attempt has been made to go back to the original documents.

Throughout this thesis the following editions/translations have been used:

Bede's *Ecclesiastical History of the English People*, completed in 731 (Bede *HE* - Colgrave & Mynors 1969) provides us with a description of the re-introduction of Christianity from Rome and Ireland, using for the early part of the work transcriptions of earlier chronicles by Gildas. Part of this remarkable account gives us some insight of the early years of Christianity in Britain and the Gregorian mission led by Augustine. This work also has implications for the interpretation of the cathedral, the church of Sts Peter & Paul, and the church of St Martin. Bede's information on the church in Canterbury came from Abbot Albinus of St Augustine's Abbey.

Byrhtferth of Ramsey's *Life of St Oswald*, written in the late 10th century (Graves 1975), is a work largely about St Oswald, but including a brief description of Oda's career (being Oswald's uncle), including a reference to Oda's restoration of the cathedral between the years 941 and 958.

Goscelin's *Historia Translationis S Augustini Episcopi*, written before his death in 1107, provides a contemporary account of the translation of early burials from the church of Sts

Peter & Paul during three successive building campaigns in the 11th century. Works of William Thorne (died after 1397) and Thomas of Elmham (left the abbey in 1414), both monks of St Augustine's, will be cited where appropriate. These are less informative than Goscelin's account, but provide occasional information about the Anglo-Saxon abbey.

Eadmer, a monk at the cathedral, gives us a partial view of the pre-conquest cathedral in a number of his works (*Vita Sancti Bregowini*; *De Reliquiis Sancti Andoeni...*; *Liber miraculorum Sancti Dunstani*; *Epistola ad Glasonienses de corpore S. Dunstani*; *Historia Nororum in Anglia*; and *Vita Sancti Wilfridi*), providing a description of the location in the Anglo-Saxon cathedral of the various altars which had contained relics of early saints (Wilmart 1935). Other pieces of information on the fire of 1067 and Lanfranc's re-building of the cathedral in 1071-7, are retrieved from some of the numerous Anglo-Saxon charters which have survived (Brooks 1984). These will be introduced in the text as required, rather than listed here.

Charters, for both the cathedral and St Augustine's abbey, have been extensively discussed in the past. The main published works are by Nicholas Brooks, for the cathedral (Brooks 1984), and Susan Kelly, for the abbey (Kelly 1995), whilst Sawyer is an invaluable source of material (Sawyer 1968).

The details of the historical and written sources will commence with an assessment of Bede's account of the Gregorian mission and the suggested re-use of a Roman Christian structure. Following this will be an account of the written sources for each of the churches, integrating an interpretation of the material, with reference to the excavated remains. A summary will conclude the chapter.

Bede's Ecclesiastical History of the English People

Part of Bede's account of ecclesiastical history provides us with details of Pope Gregory's mission to re-convert the English to Christianity (Bede *HE* - Colgrave & Mynors 1969). This work is henceforth cited as Bede *HE* (with reference to the original book and chapter numbers, ie *HE* I.25; *HE* II.4, etc). Those sections of relevance to the present study; ie that provide us with information on the likely date, function or layout of

structures, are detailed below, including references to St Martin's church, the cathedral, and the church of Sts Peter & Paul. Bede's account in *HE* (Books I and II) is as follows:

So Augustine, strengthened by the encouragement of St Gregory, in company with the servants of Christ, returned to the work of preaching the word, and came to Britain. At that time Æthelberht, king of Kent, was a powerful monarch. The lands over which he exercised his suzerainty stretched as far as the great river Humber, which divides the northern from the southern Angles. Over against the east district of Kent there is a large island called Thanet, which, in English reckoning, are 600 hides in extent. It is divided from the mainland by the river Wantsum, which is about three furlong wide, can be crossed in two places only, and joins the sea at either end. Here Augustine the servant of the Lord, landed with his companions, who are said to have been nearly 40 in number. They had acquired interpreters from the Frankish race according to the command of Pope St Gregory.

Augustine sent to Æthelberht to say that he had come from Rome bearing the best news, namely the sure and certain promise of eternal joy in heaven and an endless kingdom with the living and true God to those who received it. On hearing this the king ordered them to remain on the island where they had landed and provide them with all things necessary until he had decided what to do about them. Some knowledge about the Christian religion had already reached him because he had a Christian wife of the Frankish royal family whose name was Bertha. He had received her from her parents on condition that she should be allowed to practise her faith and religion unhindered, with a bishop named Liudhard whom they had provided for her to support her faith. Some days afterwards the King came to the island... Then he said to them: 'Your words and the promises you bring are fair enough, but because they are new to us and doubtful, I cannot consent to accept them and forsake those beliefs which I and the whole English race have held so long. But as you have come on a long pilgrimage and are anxious, I perceive, to share with us things which you believe to be true and good, we do not wish to do you harm; on the contrary, we will receive you hospitably and provide what is necessary for your support; nor do we forbid you to win all you can to your faith and religion by your preaching.' So he gave them a dwelling in the city of Canterbury, which was the chief city of all his dominions... (*HE* I.25).

As soon as they had entered the dwelling-place allotted them, they began to imitate the way of life of the apostles and of the primitive church. They were constantly engaged in prayers, in vigils and fasts; they preached the word of life to as many as they could; they despised all worldly things as foreign to them; they accepted only the necessities of life from those whom they taught; in all things they practised what they preached and kept themselves prepared to endure adversities, even to the point of dying for the truths they proclaimed. To put it briefly, some, marvelling at their simple and innocent way of life and the sweetness of their heavenly doctrine, believed and were baptised. There was near by, on the east of the city, a church built in ancient times in honour of St Martin, while the Romans were still in Britain, in which the queen who, as has been said, was a Christian, used to pray. In this church they first began to meet and chant the psalms, to pray, to say mass, to preach, and to

baptise, until, when the king had been converted to the faith, they received greater liberty to preach everywhere and to build or restore churches. At last the king, as well as others, believed and was baptised, being attracted by the pure life of the saints... (*HE* I.26).

After Augustine had, as we said before, received his episcopal see in the royal city, he with the help of the king restored a church in it, which, as he was informed, had been built in ancient times by the hands of the Roman believers. He dedicated it in the name of the holy Saviour, our Lord and God, Jesus Christ; and there he established a dwelling for himself and all his successors. He also founded a monastery not far from the city, to the east, in which Æthelberht, encouraged by him, built from its foundations the church of the Apostles St Peter and St Paul and endowed it with various gifts, so that the bodies of Augustine himself and all the bishops of Canterbury and the kings of Kent might be placed in it. The church was consecrated, not by Augustine but by his successor Laurence. (*HE* I.23).

On the death of our father Augustine, a man beloved of God, his body was buried outside the church of the apostles St Peter and St Paul mentioned already, for it was not yet either finished or consecrated. But as soon as it was consecrated, the body was carried inside and honourably buried in the chapel on the north side. In it the bodies of all the succeeding archbishops have been buried with the exception of two, Theodore and Berhtwold, whose bodies were placed in the church itself because there was no more room in the chapel [*porticus*]. Almost in the middle of the chapel is an altar dedicated in honour of the pope St Gregory, at which a priest of that place celebrates a solemn mass in their memory every Saturday. This is the epitaph inscribed on Augustine's tomb: 'Here lies the most reverend Augustine, first Archbishop of Canterbury, who was formerly sent hither by St Gregory, bishop of Rome; being supported by God in the working of miracles, he led King Æthelberht and his nation from the worship of idols to faith in Christ and ended the days of his office in peace; he died on the twenty-sixth day of May during the reign of the same king [either 604 or 605].' (*HE* II.3).

From this account we gain considerable information on the layout of the church of Sts Peter & Paul: the north porticus for the burial of archbishops, with its altar to Gregory and inscribed epitaph on Augustine's tomb; the south porticus for the burial of the kings of Kent; and the fact that two later archbishops were buried in the nave. St Martin's church is mentioned, with regard to Queen Bertha and her priest, Liudhard, as is the cathedral church. Both structures are said to have been re-used Roman churches.

There is no question that the people of Kent would have recognised a Roman masonry building, since these were the only masonry structures in England before the arrival of Augustine and the construction of the first churches. It is perhaps pertinent here, however, to question Bede's identification of these two presumed Roman structures. The east end of St Martin's church is a good candidate for a Roman structure, on architectural

grounds (Chapter 3), and since this church saw little expansion throughout the Anglo-Saxon period its recognition (in the early 8th century, by Bede's informant Abbot Albinus of St Augustine's abbey) as a Roman building was probably correct. The identification of a Roman building re-used as Augustine's first cathedral is more in doubt. As noted above (Chapter 3), the building underwent considerable re-building, so that by the time Bede was writing the original Augustinian church was no longer visible, and the re-use of large quantities of Roman building materials must have made identification between earlier Anglo-Saxon work and extant Roman work impossible (this is discussed in more detail in Chapter 5).

Canterbury cathedral

Save the account by Bede (noted above) the four main written sources discussed below for Canterbury cathedral are: the *Anglo-Saxon Chronicle*, Eadmer's various works, a charter by Archbishop Wulfric, and Byrhtferth of Ramsey's *Life of St Oswald*. It is not possible in the current study to present a list of the charters for the cathedral (as I have done for St Augustine's abbey below), because of the large quantity of charters available. Material pertinent to the understanding of the development of the cathedral are discussed below; for fuller information the reader is referred to the two main published works on the charters (Brooks 1986; Sawyer 1968).

Anglo-Saxon Chronicle

The tomb of St Ælfheah, to the north of the altar of Christ, is not mentioned by Eadmer, but recorded in the *Anglo-Saxon Chronicle* (Whitelock 1961, D1023). St Ælfheah's body was translated from London to Canterbury in 1023.

Eadmer's works

The principal description of the Anglo-Saxon cathedral is that of the English monk, Eadmer, who, in the final decade of the 11th century and through the 1120s, produced an account of the location in the cathedral of the various altars which had contained relics of the early saints (Wilmart 1935; Brooks 1984). Eadmer had been a child novice at Canterbury when the old cathedral had been gutted by the fire of 1067, but he must have known particularly well those parts of the surviving shell which had been retained in use

until replaced by the building of the new Norman cathedral (1071-7).

Eadmer's works have been translated and used by a number of historians in the past to try and identify the form of the Anglo-Saxon cathedral from the descriptions given in the documents (no part of it had been located until the author's excavations in 1993). Willis first translated much of Eadmer's work relating to the cathedral, and presented the material in sub-divisions of the evidence into paragraphs (Willis 1845, 1-19). Wilmart has translated Eadmer's *De Reliquiis...* (Wilmart 1935). The principal work, however, is by Taylor who has further elaborated the discussion, keeping to the sub-divisions set out by Willis in 1845, and presenting a table of the various works of Eadmer and Osbern, with a note of which paragraphs are taken from each work (Taylor 1969b, table A). Others have also discussed the material (Parsons 1969; Gem 1970; Gilbert 1970; Brooks 1984; Woodman 1981). These will be returned to, where they contribute to our understanding of the possible layout of the cathedral, during discussion of the main paper (Taylor 1969b).

For ease of reference I will adhere to Taylor's sub-divided numbering of the text (15a-k). The translation is that presented in Taylor's work (1969b, 105-6), which is in fact a translation by Willis, with slight emendation (these variations being presented as footnotes in Taylor's paper). These differences of translation are given below (not verbatim) in square brackets.

Translation of Eadmer's description of the cathedral

15a. This was the very church (asking patience for a digression) which had been built by Romans, as Bede bears witness in his history; and which was duly arranged in some parts in imitation of the church of the blessed Prince of the Apostles, Peter, in which his relics are exalted by the veneration of the whole world. [This is to say the church known as Old St Peter's at Rome].

15b. The venerable Odo had translated the body of the blessed Wilfrid Archbishop of York from Ripon to Canterbury and had worthily placed it in a more lofty receptacle, to use his own words, that is to say in the great altar which was constructed of rough stones and mortar close to the wall of the eastern part of the presbytery.

15c. Afterwards another altar was placed at a convenient distance before the aforesaid altar and dedicated in honour of our Lord Jesus Christ, at which the "devine mysteries" were daily celebrated. In this altar the blessed Elphege had solemnly deposited the head of St Swithin which he had brought with him when he was

translated from Winchester to Canterbury, and also many relics of other saints.

15d. To reach these altars there was an ascent of several steps from the choir of the singers, because there was beneath them a crypt, which the Romans call a confessionary. [Willis says: "To reach these altars, a certain crypt which the Romans call a confessionary had to be ascended by means of several steps from the choir of the singers. This crypt was fabricated beneath in the likeness..."].

15e. Within, the crypt had at the east end an altar in which was enclosed the head of the blessed Furseus, as of old it was asserted. Moreover the single passage which ran westward from the curving part of the crypt reached from thence up to the resting place of the blessed Dunstan, which was separated from the crypt itself by a strong wall. [Willis says: "Moreover the single passage *of entrance* which ran westward...", but since no such words occur in Latin, it incorrectly changes Eadmer's meaning]. For that holy father was interred before the aforesaid steps at a great depth in the ground, and at the head of the saint stood the matutinal altar.

15f. Thence the choir of the singers was extended westward into the body of the church, and shut out from the multitude by a proper enclosure.

15g. In the next place, beyond the middle of the length of the body, there were two towers which projected above the aisles of the church. [Willis says: "which projected beyond the aisles of the church." The Latin is 'ultra', which could mean the towers projected *above* or *beyond* the aisles]. The south tower had an altar in the midst of it, dedicated in honour of the blessed pope Gregory. At the side was the principal door of the church which as of old by the English so even now is called SUTHDURE and is often mentioned by this name in the law books of the ancient kings. For all disputes from the whole kingdom which cannot legally be resolved within the hundreds of the counties, or even in the king's court, must be settled here as if in the high king's court.

15h. Opposite to this tower, and on the north, the other tower was built in honour of the blessed Martin and had cloisters about it for the use of the monks. And as the first tower was devoted to legal contentions and judgements of this world, so in the second the younger brethren were instructed in the knowledge of the offices of the church, for the different seasons and hours of the day and night.

15i. The extremity of the church was adorned by the oratory of Mary, the blessed Mother of God, which oratory was so constructed that access could only be had to it by steps. At its eastern part there was an altar consecrated to the worship of that Lady, which had within it the head of the blessed virgin Austroberta.

15j. When the priest performed the "devine mysteries" at this altar he had his face turned towards the east, towards the people who stood below. Behind him to the west was the pontifical chair constructed with

handsome workmanship and of large stones and cement, and far removed from the Lord's table, being contiguous with the wall of the church, which embraced the entire area of the building.

15k. And this was the plan of the church of Canterbury. These things we have shortly described in order that men of the present and future generations when they find them mentioned in writings of old and perceive that the existing things do not coincide with their narratives may know that all these old things have passed away and that new ones have taken their place. For after the innumerable vicissitudes which this church underwent the whole was finally consumed in our own days by fire as we have above related.

The layout of the cathedral based on Eadmer's works (Figs 18, 20 and 21)

This section draws freely from Eadmer's description of the cathedral set out above, but with the addition of details from his other works (also cited above). The various features noted below are from Eadmer's *De Reliquiis*, unless otherwise stated. Each section of the church is detailed below in a similar order to that set out by Eadmer.

The baptistry

East of the main church was located the baptistry of St John, built by Archbishop Cuthbert (740-60), so close as to be almost touching it. This is reported by Eadmer in his *Vita Bregowini* (Scholz 1966; Taylor 1969b, 126; Brooks 1984, 40), and is confirmed by other sources (Corpus Christi College, Cambridge MS 44; Christ Church cartulary of c. 1090), including a land grant of King Coenwulf of Mercia (798-821) (Brooks 1984, 39). This structure has never been located by excavation and is only known through written records.

The baptistry, as well as containing a baptismal font, also contained the graves of many of the later archbishops, and according to Eadmer was used for judicial ordeals, and as an archive for charters and books (Eadmer's *Vita Bregowini* - Scholz 1966, 144). A transcription relating to the burial of archbishops up to the time of Cuthbert is given below in the discussion of St Augustine's Abbey.

Although the form of the baptistry is unknown, previous authors have suggested that it may have been modelled on Continental forms (summarised in Taylor 1969b, figs 3 and 4).

The sanctuary

Since a large number of the altars and relics described by Eadmer were contained within the sanctuary, this part of the church is better known. This area was termed "presbytery" by Eadmer. Against the far end of the apse was the eastern altar, dedicated to St Wilfrid, of rough stonework and mortar, in which were the relics of St Wilfrid of York, translated from Ripon by Archbishop Oda (942-58). At a "convenient distance" to the west of this altar was the principal altar of our Lord Jesus Christ, which was used daily to celebrate the "divine mysteries". Contained within this altar were the remains of many relics of saints, including the head of St Swithin, said to have been translated here by Archbishop Ælfheah on his elevation from Winchester to Canterbury in (1005). To the south of the altar of Christ was located the shrine of St Oda, marked by a "pyramid" (probably a cross-shaft or column of stone). Several steps are mentioned leading from the choir of the singers to the sanctuary, presumably because of the underlying crypt.

The crypt

Eadmer likens the crypt to the Roman-style confessionary. This arrangement can be paralleled at Old St Peter's Rome, where the sanctuary was remodelled by Pope Gregory between 590 and 604 (Taylor 1969b, fig 1). Indeed, Eadmer visited Rome with Archbishop Anselm in 1009 and may have taken note of the similarities between the two. Of Canterbury, he mentions an altar, said by tradition to contain the head of St Fursey, set at the eastern end of the crypt, and that a single passage lead westwards up to the tomb of St Dunstan, separated from the crypt itself by a strong wall. The location of this tomb was in front of the sanctuary steps, at great depth, and that the matutinal altar, in the choir above, lay at the head of the tomb.

The choir

The choir extended from the foot of the sanctuary steps, westwards into the body of the church, and was divided from the laity by an enclosure. Within the choir was the matutinal altar, used for the morning masses, and situated at the head of Dunstan's memorial.

The central towers

These towers lay beyond the middle of the church, and projected *above* or *beyond* the aisles. The south tower, which was also the principal entrance into the church, had an altar dedicated to St Gregory in its midst. This tower was used for courts which could not be resolved in the hundreds, shire or king's court. The northern tower was dedicated to St Martin, and had the cloister on either side. This tower was used for instruction of the younger brethren.

It is possible that the foundations of the Period 2C porticus, located in the 1993 excavations may represent the south tower noted by Eadmer.

The oratory of St Mary

The oratory of the Virgin was situated at the west end of the church, accessible only by steps, and was therefore elevated, so that the priest at the altar of the Virgin looked down onto the laity. Behind the altar, against the west wall of the chapel, was situated the archbishop's throne (*cathedra*), built with fine workmanship from large stones mortared together.

During the excavations in 1993 the foundations for a substantial western structure, incorporating a polygonal apsed chapel with flanking hexagonal stair-turret(s) were located (dating to Period 2C). This is without doubt the oratory of St Mary described by Eadmer.

Eadmer's description of the 1067 fire and the re-building of the cathedral from 1071

This section is as presented by Taylor maintaining his section headings (Taylor 1969b, 103-4).

14. [AD 1067] After these things, and while misfortunes fell thick upon all parts of England, it happened that the City of Canterbury was set on fire by the carelessness of some individuals and that the rising flames caught the mother church thereof. How can I tell it? The whole was consumed, and nearly all the monastic offices that appertained to it, as well as the church of the blessed John the Baptist where as aforesaid the remains of the archbishops were buried.

16a. In the conflagration, however, by the Divine mercy and the intercession of the pious Dunstan it happened that two houses indispensable necessary to the existence of the brethren remained unhurt: the

refectory, namely, and the dormitory as well as the cloisters which were attached to them.

16b. After this, there was erected over the resting place of the blessed man a house of small magnitude, and in this were performed daily over his body masses together with other services.

17a. Now after the lamentable fire the bodies of the pontiffs (namely Cuthbert, Bregwin, and his successors) rested undisturbed in their coffins for three years until that most energetic and honourable man Lanfranc, abbot of Caen, was made Archbishop of Canterbury... He pulled down all that he found of the burnt monastery, whether buildings or the wasted remains of buildings, and, having dug out their foundations from under the earth he constructed others in their stead.

17b. He ordered the said archbishops to be raised and placed in safety until the new church had been completed, in which they could be honourably placed. And this was done.

17c. As for the church which the aforesaid fire combined with its age had rendered completely unserviceable, he set about to destroy it utterly and erect a more noble one.

17d. And in the space of seven years he raised this new church from the very foundations and rendered it nearly perfect.

17e. But before the work began he commanded that the bodies of the saints which were buried in the eastern end of the church should be moved to the western part where the oratory of the blessed Virgin Mary stood. Wherefore after three days fast the bodies of those most precious of priests of the Lord, Dunstan and Elphege, were raised and in the innumerable multitude conveyed to the destination place of interment and there decently buried. To which I Eadmer can bear witness for I was a boy at the school.

18. But in the process of time as the new work begun on the church proceeded it became necessary to take down the old work where the bodies of the saints just mentioned were deposited. Having prepared therefore the refectory of the brethren for the celebration of the Divine service we all proceeded thither from the old church in festal procession bearing with honour and reverence our glorious and sweet fathers Dunstan and Elphege.

19. When the high altar of the old church was taken down the relics of the blessed Wilfrid were found and placed in a reliquary. But after some years the brethren were of the opinion that they ought to have a more permanent resting place and accordingly a sepulchre was prepared for them on the north side of an altar in which they were reverently enclosed.

20. After a few years the bodies of the pontiffs Cuthbert, Bregwin, and their successors, were brought into the newly founded church and placed in the north part upon a vault, each in a separate wooden coffin, and there daily the mystery of the Sacrifice was celebrated.

Here we have a remarkable story of the translation of the bodies of the saints into the oratory of Mary at the west end of the Anglo-Saxon cathedral, whilst Lanfranc started the re-building of the church, presumably from the east end. Later the bodies were moved as work progressed westward. This fits very well with the story told by the foundations of the Norman cathedral, as excavated by the author in 1993. The church was re-built from east to west, with a marked break in the foundations just short of the western apse of the Anglo-Saxon cathedral. The western chapel, therefore, remained standing during the first phase of building work on the site. The second phase of foundations, westwards, was then completed after the demolition of the western chapel, followed by the laying of the floor in the nave. No temporary graves were noted in the make-up below the apsed chapel, and it is possible that the bodies were simply covered over, rather than dug-in, since it was not intended that this be their final resting place.

Archbishop Wulfred's charter

Between 808 and 813 Archbishop Wulfred prepared a charter setting out his recent reforms of the community at Christ Church (CS 342). Here he stated that he rebuilt (*reaedificando refici*), with the help of all the clergy, the holy monastery of the church of Canterbury (*sanctum monasterium Durovernensis ecclesiae*).

...by renewing and restoring [it] for the honour and love of God.

Given that Wulfred was instrumental in bringing forward major reforms in the Church (Chapter 1), it is logical that we take this charter literally. It remains uncertain, however, if this refers to a rebuilding of the monastic complex or more extensive work on the cathedral and cloistral buildings.

During the excavations in 1993 a major phase of re-building for the cathedral was discovered (Period 2A). This phase is dated after the mid 7th century by pottery, and before the first half of the 10th century by an archaeomagnetic date (Chapter 3). Admittedly this is a broad timescale, but the size of the church in Period 2A would not be out of place in a 9th century date (Chapter 3). It is, therefore, a possibility that the Period

2A re-building of the cathedral may equate with Wulfred's restoration of the church in the early years of the 9th century.

Byrhtferth of Ramsey's *Life of St Oswald*

The account of Oda's restoration of the cathedral (Graves 1975) is a little more forthcoming. Oda is said to have

...cast down by stages what was decayed through old age, that is the beams, the roofs and the walls in part; this he subsequently ordered to be raised higher by twice five feet and ten measurements of feet. (*Bis quinis et denis passibus pedum*).

Brooks interprets this as meaning the walls were heightened by 20' (Brooks 1984, 53), but one should not, perhaps, take this literally. During this work a miracle is said to have occurred: whilst the cathedral was without a roof no heavy rain fell within the city walls.

This work on the cathedral may tentatively be related to the Period 2B alterations/rebuilding of the cathedral located in the 1993 excavations. This phase is dated to no earlier than the mid 10th century (Chapter 3), and would equate well with Oda's restoration between 941 and 958.

St Augustine's Abbey

Bede's account of the foundation of the church of Sts Peter & Paul has been discussed above. The remaining works of reference used for St Augustine's Abbey are the pre-Conquest charters, Goscelin's *Historia Translationis S Augustini Episcopi*, William Thorne's *Chronicle of St Augustine's Abbey, Canterbury and St Peter, Westminster*, Thomas of Elmham's *Historia Monasterii S Augustini Cantuariensis*, and Eadmer's *Vita Bregowini*...

Charters

A total of 39 Anglo-Saxon charters survive relating to St Augustine's abbey. These have been summarized recently by Susan Kelly (Kelly 1995), who has undertaken an extensive study of the documents (Kelly 1986).

Of the 39 charters (Table 4) Susan Kelly suggests charters 1, 2, 3, 4, 5, 14, 16, 33, 34, and 39 are probably forgeries (Kelly 1995, xxxiii-xxxiv). The two earliest charters (nos 1 and 2) set out that Æthelberht granted land east of Canterbury for the foundation of a

monastery in honour of Sts Peter & Paul in the year 605. These, as noted above, are thought to be forgeries, perhaps of pre-Conquest charters which survived in single-sheet form into the 14th century, although they may have been total fabrications. The date does not fit well with the date of Augustine's death on the twenty-six of May in the year 604 or 605 (*HE* II.3) - Bede recorded that the abbey had been started before Augustine died, and that work was complete and the church dedicated in 619. The closest one can get to a date for the start of building work on the monastery is the opening years of the 7th century.

Most of the charters relate to the granting of land to the monastery. Notable exceptions include the granting of privileges (nos 10, 15, 32, 33, and 35), whilst food-rent is noted in nos 24 and 25. Kelly has interpreted these food-rents as an indication of the desperate times that the monastery was in after Viking raids (Kelly 1995, xvii).

One of the only charters relating to building work at the abbey is no. 37, dating to ?1047. This charter sets out that Archbishop Eadsige granted the monastery land at Littlebourne, 100 marks for building a tower, and also gave a psalter, and two chalices (also discussed below under William Thorne's *Chronicle of St Augustine's Abbey, Canterbury and St Peter, Westminster*). The tower in question is linked by Gem (Gem 1992, 67) to the construction of the freestanding south-west tower (Chapter 3, Period 3).

Goscelin's *Historia Translationis S Augustini Episcopi*

Goscelin detailed building work undertaken by three abbots at St Augustine's abbey during the 11th century (Goscelin, in Migne 1880). This material has been presented before by Hope, where the original Latin text is also given (Hope 1915a), but sections are repeated here since the descriptions add significantly to an understanding of the burials in the north porticus that are no longer visible. The first mention is of Abbot Aelfmaer's (1006-1023x7) work. Goscelin says:

...he took down the arches and columns, religiously built, with Roman elegance, over the bodies of the saints, and, as far as he dared, prepared a way for their translation: with the columns and arches themselves he ornamented the cloister of his monastery.

From this we may perhaps postulate that Period 2B of the cloisters (located in the excavations between 1927 and 1930) may be attributed to Abbot Aelfmaer in the first quarter of the 11th century.

The next phase of work on St Augustine's Abbey recorded by Goscelin was Abbot Wulfric's demolition of the east end of the church of Sts Peter & Paul, and west end of the chapel of St Mary, so that a new construction could be built linking the two buildings. This work began around 1049, but was not completed by the death of Wulfric in 1059. Goscelin recorded Abbot Wulfric's work saying:

...he threw down the western part of the oratory of the holy mother of God, together with the 'porches' (*porticibus*) with which it was surrounded, and, when the cemetery of the brethren hard by had been cleansed, he takes the whole space between the two churches for the building, raises walls, and constructs columns and arches. Kent rejoiced in this new work, although the want of skill of the builders had made it unsuitable for a monastic habitation.

It was not until the first Norman abbot (Scotland) was elected that further work was undertaken in 1073. Goscelin says:

This man, after he like the rest of his predecessors had been established in his monastery, when he began to put forth his great mind to the building of his church now further to be lengthened, was sorely troubled by the work already standing [and] awkwardly extended; he was troubled also by the narrow space for the proposed plan. He was afraid moreover of the judgement of the mother of god against the previous abbot for her church which he had overthrown: he was afraid of the danger of ruin with respect to the old monastery consumed by long decay. In the midst of these anxieties he is carried off to Rome on a royal embassy to Pope Alexander. There, after the king's business had been settled, he receives from the same pope council and benediction concerning the translation of the saints, the pulling down and building up of his basilica according to his own wishes, and with the sanction of the gracious Being on high... Then the faithful abbot, amazed and thankful in consequence of the testimony of so great a man, hastens home, and pulls down the unfinished portion of the new work. But the remaining part of the Virgin oratory of the exalted Mary awaited his attack.

During this work the translation of the remains of several important burials took place.

All save St Adrian were

...placed in a western tower [probably the western chapel] of the monastery before the altar of the Holy Mother of God, until the new church being rebuilt they could be re-deposited with new honour.

The death of Scotland in 1087 delayed the building work, and the bodies of the archbishops in the north porticus remained in place until Archbishop Wido continued the work in 1091. Goscelin says of Wido's demolition of the porticus:

...when such great heaps of stones, beams, leaden roofs, which had overwhelmed the sacred bodies, had been removed, all the sepulchral monuments of those men, although they were fragile and of

tilework, and also the sculptures and angelic images with the Majesty of the Lord, wonderfully wrought over the tomb of the noble Austin, appeared unhurt, while all acclaimed the wonderful works of God. Meanwhile the south wall remained near which lay the kindly Austin and the holy Deusdedit, and this being at length loosened by much battering, while it was believed that it must certainly crush the saints, straightaway by the unspeakable mercy of God it made a sort of leap, and fell down flat, all in one solid mass, to the south, against those who were pushing it.

Despite the demolition work the bodies of the archbishops were safely translated. Goscelin describes in detail the resting places of the archbishops in the north porticus. Only the three northern tombs remain visible today, the remainder having been destroyed by a sleeper foundation for the Norman abbey, and it is important here to detail their removal in 1091. Goscelin says:

It is a sacred duty to let posterity hear, what is no longer to be seen, in what position the saints formerly rested here. Austin first of all occupied the south side of his aisle, and with his sacred feet was pressing the eastern wall. On his left his first successor and companion Laurence, as has been shown, was stretched out in a similar space, only removed from him by so much as the altar of their most blessed patron Gregory was occupying, claiming as its own one on either side. The other part of the breadth of the north, on the left of the good Laurence, received the holy Adrian. But the virgin of Christ Mildred, the one jewel of the fathers, by the north wall corresponded in a like place with Austin on the south. Of the translation of these [saints] we have above declared. At her head, as at that of the blessed Austin, stood an altar. But at the sacred head of Laurence, Mellitus, as his next successor, projected into the middle of the church. Mellitus makes room at his head for the righteous Justus, according to his succession to himself. On the right of Justus is blessed Honorius, the successor of Justus, and on the right of Honorius the holy and God-given Deusdedit was placed in the order of his succession. He indeed deserved a resting place on the same south wall at the head of mightiest Austin; only the door in the middle by which one entered divided them. Yet all the tombs of those angels of God were so separated that a passage between each of them was possible.

Thus we have the location of six archbishops in the original north porticus, and two further burials in the expanded porticus. Goscelin also records the finding of a further (unnamed) tomb beneath the altar of St Gregory.

Now in taking up the body of the blessed Laurence, while it was being decided that the pavement which lay before St Gregory's altar, between him and the renowned Austin, should first be taken up, so that an easier exit might be prepared for the saint from the tomb broken through the side, wonderful to say the hardness of the bricks mocked the iron tools and the wits of them all... At length the stubborn strength yields to frequent blows, yet the very strong construction of the brickwork is not broken up. But, wondrous sight, a sort of wooden boarding nailed together, about the size of a large door, is taken out entire. And while from the pavement thus pulled up this

boarding is torn out and lifted up, a small sepulchral crypt, which was hidden before or even under the altar itself, is disclosed by a small stone being pulled up in a like manner. A small opening being thus made, thus straightway a prodigious vapour of sweetness never before experienced, boiled up, not only smote the bystanders in the face as a mighty blast, but blew through the whole cloister of the monastery and the brethren resident therein with a new aroma of spices... Under the same altar of St Gregory then, the most holy body of the buried man lay towards the east wall hard by, as did those of Austin and Laurence, and lying exactly in the middle as the son of both fathers, was as it were cherished under the wings of each.

These remains were enclosed in a lead coffin, and being the burial of an unknown person was named Deonotus (Hope 1915a, 394). Next the burials of Augustine and Mellitus were removed, 'fragrant vapour' being recorded from these also. The following details are recorded:

On the Monday following, the site being cleared, the building of the nave of the church goes on. A great column is founded in the northern rank in the very place whence the richest treasure, the body of Austin, was taken up. That [column] encloses in a spacious cavity, as sacred relics, the hallowed bricks of his tomb or little crypt. Of the pavement laid below, on which the most blessed body lay, the bright purple tiles, united together in a level flooring, and reeking with nard or saffron hue, are eagerly stripped off and enclosed in the altar of the new porch of the blessed Gregory... Under these tiles lying on the top was found most pure earth, half a foot thick, from the foundation that projected from the old wall of the Augustinian porticus. This earth, too, the odour of Austin penetrating the tiles, was fragrant with marvellous sweetness. The earth taken out about the flints of the aforesaid foundation they decided should be distributed through the sacred tombs of Laurence, Mellitus, and Justus, which had escaped the ruination of the ecclesiastical structure, and so be preserved.

The 'pure earth' is almost certainly the black soil noted in the 1957-8 excavations, and located over large areas of the city (for example the dark earth recorded below the cathedral, Chapter 3).

Goscelin also recorded the site of one further burial, placed in the nave of the church, because of the lack of space in the north porticus.

Theodore too the seventh, a noble follower of the high Roman tradition, was buried on the right side of Austin with only the internal wall of the church between them, because the porch as yet not enlarged could not hold all.

This places the expansion of the porticus after the death of Archbishop Theodore in 690. The expansion was presumably undertaken before the burial there of Abbot Adrian who died in 709 or 710. Archbishop Berhtwald, who died in 731, was buried in the nave (this tomb was located during the 1957-8 excavations, Chapter 3), presumably indicating

that in a place had been reserved for him, even though the north porticus had been built. It can be seen that the burial of archbishops and abbots in the 8th century has great bearing on the date of the expanded north porticus, and this will be returned to later.

When the church had been cleared of burials, and not all are mentioned by Goscelin (for example the tomb recorded in the western part of the north porticus, and the unlocated burials of Archbishops Tatwine and Northhelm in 743 and 739 respectively), further building work continued. Goscelin records:

So when the aforesaid church had been thus emptied of its relics, it is thrown down and levelled to the ground, and soon on that very front that was battered down the forepart of the new 'hall' is erected and embraces all that interior of the old site with much more room.

William Thorne's *Chronicle of St Augustine's Abbey, Canterbury and St Peter, Westminster*

Thorne writing in the 14th century, before his death in 1397, records that a donation of 100 marks was made to St Augustine's Abbey in 1047 (Thorne, trans Davies 1934). This is also discussed above as charter no. 37 (Kelly 1995, xx).

Thomas of Elmham's *Historia Monasterii S Augustini Cantuarensii*

Thomas recorded that the church was rededicated to Sts Peter & Paul, by Archbishop Dunstan, in the year 978 (Elmham, in Hardwick 1858, 22). Gem has suggested that this may be the time that remodelling had taken place, particularly if a full monastic community was attached by that date (Gem 1992, 63). This may well be the time of expansion to the west and the rebuilding of the north porticus.

Eadmer 's *Vita Bregowini...*

Eadmer confirms that no further archbishops were buried in the abbey after Northhelm in 739 (Scholz 1966, 139-40), since Archbishop Cuthbert built a baptistry east of the cathedral (740-760). He recorded:

...built a church on the east part of the great church, almost touching the same, and solemnly hallowed it in honour of the blessed John Baptist. He constructed this church to this end: that baptisms might be held therein and inquiries of courts of justice appointed for the divers causes which are wont to be held in the church of God for the correction of evil-doers; also that the bodies of the archbishops might be buried in it, the ancient custom being thus taken away by which hitherto

they were wont to be buried outside the city in the church of the blessed apostles St Peter and St Paul, where are laid the bodies of all his [ie Cuthbert's] predecessors.

Thus, all archbishops after the mid 8th century were buried in the cathedral, rather than in the church of Sts Peter & Paul.

Summary of the evidence from the historical and written sources

Although there are always great problems in relating historical texts to excavated data, such comparison can be informative, providing the results are treated with caution. The historical and written sources presented above add significantly to our understanding of the possible dates, layout and function of the various churches under study.

The earliest references are from Bede who includes mention of the presumed Roman structure dedicated to St Martin, later extended to form St Martin's church, the conversion of Æthelberht to Christianity, establishment of the cathedral, and the construction of the abbey church of Sts Peter & Paul outside the city walls.

Information on the layout of the cathedral in the 11th century comes mainly from Eadmer's description of the location of altars and relics, but includes considerable details of the layout of the church. This includes the central towers, and the chapel of the Virgin Mary at the west end, that fit well with the foundations located by the author's excavations in 1993. Eadmer's description of the cathedral following the fire of 1067, the temporary transfer of the saints' bodies to the chapel of St Mary, and the cathedral's subsequent re-building by Lanfranc, can also (in part) be traced in results of the 1993 excavations.

Writers such as Wulfred and Byrhtferth of Ramsey provide evidence of re-building work at the cathedral in the 9th and 10th centuries respectively. These can only be tentatively attributed to two phases of re-building noted in the 1993 excavations. Caution must be sounded, here, because of the paucity of dating evidence from the excavations, and the temptation to link the two historical texts and the two archaeologically excavated re-builds of the church.

St Augustine's abbey complex, particularly the church of Sts Peter & Paul, was the subject of much writing by Goscelin, who recorded three phases of construction at the abbey during the 11th century, and the translation of saints' bodies, by three successive abbots. These add invaluable information regarding the layout of the church, providing

some dates for these alterations, and pin-point the location of several important tombs.

Charter	brief date	description
1	605	Æthelberht (king of Kent) grants land east of city for monastery
2	605	Æthelberht (king of Kent) grants land east of city for monastery
3	605	Æthelberht (king of Kent) grants land at Sturry to the monastery
4	?	Augustine (bishop) grants privileges to the monastery
5	618	Eadbald (king of Kent) grants 30 sulungs at Northbourne to the monastery
6	675	Hlothhere (king of Kent) grants 3 sulungs in Stodmarsh to the monastery
7	686	Eadrik (king of Kent) grants 3 sulungs in Stodmarsh to the monastery
8	689	Oswine (king of Kent) grants 1 sulung (iron mining) to the monastery
9	696 or 711	Wihtried (king of Kent) and Æthelburh (wife) grant 5 sulungs at Littlebourne
10	699	Wihtried (king of Kent) grants privileges to churches and monasteries of Kent
11	762	Æthelberht II (king of Kent) confirms exchange of half mill rights at Wye for land at Chart
12	762	Dunwald (minister) grants <i>villa</i> near Queningate to the monastery
13	c. 762 or 763	Eadberht II (king of Kent) grants 6 sulungs at Mongeham to the monastery
14	765 x 792	Offa (king of Mercia) grants 2 hides at Beauxfield to abbot Æthelnoth
15	? 792	Offa (king of Mercia) confirms privileges to the churches of Kent
16	? 804	Coenwulf (king of Mercia) and Cuthred (king of Kent) grant 20 sulungs at West Lenham, and 13 swine-pastures in the Weald to their kinsman Eanberht
17	826	Wulfred (archbishop) supervises exchange of land between Minster-in-Thamet with St Augustine's abbey
18	836	Ecgbert (king of West Saxons) grants 1 sulung (<i>on Scirdum</i>) to a <i>clericus</i> at the monastery
19	7838	Æthelwulf (king of West Saxons) grants 5 sulungs at Lenham to abbot Wernoth and his <i>familia</i>
20	845	Æthelwulf (king of West Saxons) grants 1 sulung to priest-abbot of the monastery
21	850	Æthelwulf (king of West Saxons) grants 40 hides at Lenham to Ealhere (<i>princeps</i>)
22	861	Æthelberht (king of West Saxons) grants 3 sulungs at Martin to abbot Diernoth and his <i>familia</i>
23	c. 848	Eadbald grants land at Burmarsh to the monastery
23A	c. 848	Winemund grants land at Burmarsh and Snavewick to the monastery
24	c. 850	Ealhburh grants food-rent from land at Brabourne to the monastery
25	c. 850	Lulle grants food-rent from land at Nackington to the monastery
26	925	Athelstan (king) restores 14 sulungs in Thanet to the monastery
27	944	Edmund (king) grants 2 sulungs at Sibertswold to minister at the monastery
28	946	Eadred (king) grants one and a half hides at Swalecliffe to Heresige. Heresige transfers the land to the monastery
29	963 x 971	Edgar (king) grants 4 sulungs at Pumstead to the monastery
30	990	Æthelred (king) grants 2 hides at Sibertswold to minister of the monastery
31	c. 990 x 1005	Wulfric (abbot) and Ealdred (son of Lyfing) make agreement about land at <i>Clife</i>
32	?	Cnut (king) grants financial and judicial privileges to the monastery
33	?	Cnut (king) grants body of St Mildrith and the estates of her church to the monastery
34	1042 x 1045	Edward (king) grants Thanet to the monastery
35	1042 x 1050	Edward (king) grants financial and judicial privileges to the monastery
36	?1047	Edward (king) grants 1 sulung at Littlebourne to Eadsige (archbishop)
37	?1047	Eadsige (archbishop) grants land at Littlebourne to the monastery, and 100 marks for a tower
38	1048 x 1050	Æthelric Bigga bequeaths land at Bodsham and Wilderton to the monastery
39	1053 x 1066	Edward (king) confirms previous grant of land at Fordwich to the monastery

Table 4: List of pre-Conquest charters of St Augustine's abbey (after Kelly 1995)



CHAPTER 5: INTERPRETATION, PARALLELS, AND DATING

Introduction

This chapter will look in detail at each of the churches in turn, focusing on an interpretation of the layout of each structure, both in terms of the liturgical arrangement of their plans, and where possible, the units of measurement employed. Also included will be a section on British and continental parallels, and a summary of the dating evidence. More general discussion of layout, particularly where it involves more than one of the churches in the study, is retained to Chapter 6; for instance the layout and function of various elements of the early (Augustinian) churches, their later development, and their topographical layout.

Material for this chapter is drawn from the author's analysis of the excavated remains at Canterbury cathedral, Richard Gem's analysis of the Anglo-Saxon phases of the church of Sts Peter & Paul (Gem 1992), and the author's recent detailed recording of the *in-situ* remains of the latter church in 1995. Many historians and archaeologists have discussed the Anglo-Saxon churches in the past and their material, where incorporated, is acknowledged with references. Save individual reports of the churches, detailed in Chapter 3, the following have undertaken general studies, particularly on the layout of the early churches around Canterbury: Micklethwaite (1898); Peers (1901); Peers & Clapham (1927); Clapham (1930); Fletcher (1965); and Taylor & Taylor (1965). More general works on the development of Anglo-Saxon churches, for example by Fernie (1983), are introduced where most appropriate.

It should be noted that many of the reconstructed ground plans given below are very tentative, but I have attempted to present something that is as consistent as possible with the excavated evidence and known parallels as an hypothesis for future testing.

Canterbury cathedral

Of the four main structural phases identified from the author's excavations at Canterbury cathedral, three phases (Periods 1, 2A, and 2C) have survived with a sufficiently intact

ground plan to suggest parallels and dating. In only one of these was the ground plan well enough preserved to enable a study of its layout and metrical analysis to be undertaken (Period 2A).

Period 1

General layout of the early cathedral

It has already been established that wall 605 probably formed the west wall of the *nave*, and wall 638 formed part of a *narthex*, with a cross wall between. Too little of wall 248 was excavated to be certain of the function of the widened foundation, although it may have been part of a pilaster buttress. It lay far too close to the west end to have marked the junction of nave and chancel and may indicate that this was originally an external wall on the south side of the nave. The reconstructed ground plan (Fig 14) has been based on the proportions of the church of Sts Peter & Paul (Fig 14). This church provides the best-preserved ground plan of the early Kentish churches built by Augustine, whilst the apse is based on St Mary's church, Reculver (Dowker 1878; Taylor 1968; Fig 29). These proportions suggest that the external wall of the north and south porticus of the cathedral may have been removed by the foundations of the Period 2A re-build.

The main difference between the church of Sts Peter & Paul and the Period 1 cathedral, is the proportions of the *narthex* which in the former is the same width as the nave, certainly not narrower. That at the cathedral was narrower than the nave, perhaps forming a third of the width of the west end.

The church, as reconstructed, may have measured 32 m in length by 22 m in width, inclusive of an eastern apse. Such apses are known on the other early Kentish churches of St Pancras, Canterbury (Fig 14); St Mary, Reculver (Fig 29); and St Andrew, Rochester (Livett 1889; Hope 1898; Fig 29). This latter feature is highly likely to have been part of the original layout, but remains unexcavated below the crossing of the present cathedral.

The cathedral, like the other early Kentish churches noted above (and including the church of Sts Peter & Paul), appears to have been divided into a nave, with small *narthex* at the western end, apse at the east end, and porticus to north and south. The porticus of the Period 1 cathedral were never intended to house burials, all episcopal and royal burials were placed in the porticus of the church of Sts Peter and Paul until the Baptistery of St John was built by Archbishop Cuthbert in 740-60 (Chapters 3 and 4; Fig 21). The

porticus at the cathedral may have been used to house altars, but not enough is known of the layout to be certain. Further discussion of the porticus, nave, sanctuary and apse are presented in Chapter 6 where information from all of the churches is pulled together.

Kentish parallels (Figs 14 and 29)

Kentish churches built between *c.* 597 and *c.* 669 include Sts Peter & Paul, St Mary, and St Pancras, all at St Augustine's abbey; St Martin, Canterbury; St Mary, Reculver (Dowker 1878; Taylor 1968); St Andrew, Rochester (Livett 1889; Hope 1898); St Mary, Lyminge (Taylor 1969a); and Minster-in-Sheppey (Harrison 1884; Taylor & Taylor 1965). All are of a similar size and proportions, with a ratio of 1 to 1.6, save Reculver with a ratio of 1 to 1.4 (Taylor 1978, fig 745, 1032-4). The naves of Reculver, St Martin and St Pancras measure 7 m, 7.5 m, and 8 m wide respectively. The cathedral nave probably measured around 10 m in width, with other elements proportionately larger. A further church at Lydd, of pre-Conquest date, has been discussed recently (Tatton-Brown 1989a, 254), favoring an Anglo-Saxon date. This view is not universally accepted and a Romano-British date has also been put forward (Fletcher & Jackson 1968; Fernie 1983, 72). The church was of basilical form, but not enough survives for comparison with those noted above.

Romano-British Christian church, reported by Bede

It should be noted that no continuity between the Romano-British occupation and the Period 1 church was found in the excavated area (Blockley *et al* 1997, 11-12). A layer of destruction rubble and 'dark earth' overlay the Roman remains and was cut by the Period 1 Anglo-Saxon church. Bede tells us that Æthelberht gave two Roman churches, one as the later cathedral, the other the church of St Martin (Chapter 4). The latter is thought to have a Roman element (Chapter 3). No such claim, however, can be justified from the excavated remains below the cathedral. If such a structure existed, then it probably lies to the east of the nave, as for example at St Martins' (Chapter 3; Fig 14), Stone-by-Faversham (Taylor 1969c, 575-7, figs 283-4; Taylor & Yonge 1981, 118-45); and Wells cathedral (Rodwell 1984, fig 6), all being sites claimed as Roman mausolea. At Canterbury a possible 3rd-century Roman temple lay beneath St Gabriel's chapel, around 70 m east of the excavated remains of the Period 1 church (Rady 1990, 86-90), but this

lay on a different alignment to the Anglo-Saxon remains being more in keeping with other Roman structures and streets known in that part of the city.

None of the Roman structures located in the area of the cathedral can be considered as candidates for a Roman Christian church. It has been established (Blockley *et al* 1997, figs 3 and 7) that the Romano-British street and adjacent buildings below the cathedral lay at an angle of 30° to the cathedral (Fig 2), and it would have been very difficult to adapt a structure on the old Roman alignment to fit with the new one on the Anglo-Saxon alignment. A masonry structure located by Frank Jenkins in 1973 in the external angle between the south-west transept and nave (Jenkins 1990, 118-21), and interpreted by the excavator as an Anglo-Saxon building, is now thought to be part of a Romano-British structure (Jenkins 1990).

One explanation for the apparent anomaly between Bede's account and the excavated remains, is that Bede's informant, Albinus, an abbot at St Augustine's abbey, mistook the date of the church. By way of comparison Dowker thought that the Reculver church was of Roman date, being built of re-used Roman materials (Dowker 1878). Most of the Period 1 cathedral was undoubtedly built of re-used Roman materials (to judge from the re-use of material for the foundations) and had been standing for around 130 years at the time of writing (*c.* 731), lending it an appearance of some antiquity. A further consideration is that the only known masonry structures standing in England during the 7th century were the stone churches and the ruinous Romano-British buildings. All other buildings were of timber, as for example the 7th and 8th century sunken-floored buildings and hall-type structures in Canterbury (Blockley 1981, 6; Blockley *et al* 1995, figs 134, and 180, and table 3). A further possibility is that Bede used the term 'recuperare' in its legal sense of reclaiming lost Church property: in the case of the site of a church, built in Roman times and left to decay and fall into ruin. Augustine may have reclaimed the ground on which the building stood, rather than using part of an existing building in his new church. Indeed, if a serviceable, or repairable, church had survived in the city Queen Bertha would not have travelled out of the city to St Martin's to worship.

Allocation of the Period 1 church to Augustine

In either scenario discussed above - the re-use of part of an existing building or the recovery of its site - there can be little reason to doubt that the Period 1 church located

beneath the cathedral is that built by Augustine in 597. Given that the various cathedrals (four Anglo-Saxon phases including a major re-building, and two later re-builds) have all been on the same site, it is unlikely that Augustine's cathedral lies elsewhere. Augustine's church must surely have been venerated and retained in any later re-building - precisely as revealed by the excavation where the outline of the Period 1 church was carefully retained at the heart of the Period 2A re-build.

Indeed, there would be a major problem of interpretation if the first phase Period 1 church located by the excavations were not that of Augustine. Augustine's church would surely have survived the 7th century, probably with porticus being added, but without major re-building, and any new church built in the later 7th or early 8th century (before 731) would surely have been known by Bede. A late 8th century date is possible, although this would almost certainly have been recorded, as was the baptistry of St John built by Archbishop Cuthbert between 740 and 760.

Dating evidence

The dating evidence is sparse for the Period 1 church, but the few sherds of pottery located indicates that the church was built after the mid 5th to mid 6th century (for details see Chapter 3).

On stylistic grounds, although the remains are fragmentary, the four wall fragments may be reconstructed to form a building that closely resembles known 7th century churches of Kent in terms of layout and construction techniques. The location of the first phase church was also considered important by the builders in the second phase (Period 2A); the walls of the latter encasing or following closely the walls of the former. We know that Augustine established a cathedral-church here soon after 597. The first phase church, forming the core of the subsequent re-builds, is thus considered to be that constructed by Augustine soon after 597.

Period 2A

General layout of the re-built cathedral (Fig 15)

Expansion in Period 2A was extensive to the west, more than doubling the length of the church. The location of the early church was considered important in the re-build, in that the levelled walls were encased or followed closely perhaps on all four sides. the form of

the eastern end of the church remains unknown, although an expansion and construction of a crypt is a distinct possibility during this phase.

It is possible to establish with reasonable certainty, the general layout of the Period 2A foundations. Areas of *in-situ* 'dark earth' and levelling deposits survived at various points in the nave and south-west transept, and may be used to indicate areas where walls could not have been present. For example a study of these deposits precludes the Period 2A cathedral from having a tripartite western end. By similar reasoning no structural remains could have projected south from the church, save in the area of wall 329 some 15 m east of the south-west corner of the church. The main body of the cathedral measured 43.6 m in length externally, with a 5.7 m annex to the west and a possible eastern apse of unknown size. The full external length could have been around 57 m.

The possible function of the various elements of the church in Period 2A may be surmised here. Given that the later western apse, built in Period 2C, was used as a chapel, then the Period 2A annex may have incorporated such a function. It is possible that a western doorway was located below a first floor gallery that contained such a chapel. A raised chapel is partly based on evidence for the adjacent stair towers and also on Eadmer's description (Chapter 4). Eadmer's description of the main entrance (in the Period 2C arrangement) being on the south wall perhaps reduces the possibility of an entrance at the west end in the Period 2A church. This does not preclude the chapel having been sited on a raised gallery, supported from below by a central pier situated over a sleeper foundation. A central support would have been required to enable the gallery above to have been set at a height of around 5 m above the nave floor - if the gallery had been supported by a single arch then the floor of the gallery would have been placed at an unduly high level (around 9 m). The annex was 6 m deep (from the inner estimated face of the west end of the nave), ample space for the location of a *cathedra* against the west wall, and an altar in front.

A consideration against the theory of a raised chapel, is that no stair-towers were located in the Period 2A plan, but these may have been situated in areas not available for excavation.

Further distinctive features of the plan are the cross wall-foundations and wide arcade foundations forming a near perfect square measuring 8.95 m internally. The thickness of the south arcade foundation (3.1 m) may have been limited to the area between the two

cross wall-foundations. No arcade foundation of this phase was located west of this point, but comparison with the surviving north arcade foundation suggests that the main arcade foundations may have measured around 2 m in width. This is based on the understanding that the north wall of the Norman nave was apparently designed to lie just north of, or against, the outer face of the north arcade foundation of the Anglo-Saxon cathedral. The central square may represent the foundations for a central tower. If such a tower existed then there remains a possibility that transepts flanked it, however, the *in-situ* 'dark earth' to the south of the church precludes the possibility of structural remains south of the cathedral at this point. The likelihood of a continuous transept, spanning the width of the church, has also been ruled out. This may have been possible if the central square foundation had been hard up against the east end of the church, rather than part way down the nave. Such an arrangement was present at North Elmham, Norfolk (Taylor 1975, fig 7) and numerous churches on the Continent, such as Cologne (Doppelfeld & Weyers 1980, fig 10) and Gernrode (Taylor 1975, fig 8).

On the north side of the nave was wall 676. The length of the wall (over 5.5 m) indicates that it was not part of a stone-lined grave, and it is tentatively interpreted as the base for an ambo or pulpit. A similar wall at Hexham, in the 7th century, is interpreted as an ambo foundation (Morris 1979, fig 6, 142). It may, on the other hand, be the foundation for a gallery projecting from the north arcade wall.

The structure to the south-east of the church, with its floor set 1.2 m below ground level, is of uncertain function. It is certainly not deep enough to have formed part of a crypt, unless it was part of a sub-crypt with raised area above, as in the Norman cathedral. Alternatively it may have been a baptismal pool. Given the depth, this may be a possibility, though the internal render of *opus signinum* was far too thin to have been waterproof. Its most likely function was that of a mausoleum, for important burials outside the main body of the church.

Although no crypt was located in the excavations, Eadmer mentions one, likening it to a Roman-style confessionary (Chapter 4). Tentative reconstructions of the crypt by Willis, Brown, Scott, and Hope are presented by Taylor (1969b, figs 2-3), who adds his own interpretation based on excavations during and after the Second World war - here, a ring crypt follows the curve of the apse with a central passage leading to the tomb of St Peter (Taylor 1969b, fig 1). See also Fig 20 for my hypothetical layout of the crypt.

The reconstructed plan and section (Fig 16)

The reconstructed plan and possible liturgical layout are shown in Fig 16. Wall thicknesses of *c.* 1.25 m have been used, although no complete widths were recovered in the Period 2A structure. Since the north wall of the annex was offset a little to the north the walls of the superstructure have been so placed on the foundations to allow the north and south walls of the annex to line up with a row of piers (or columns) along the outer limit of their foundations. This also allows space for the grave in the north arcade foundation to lie inside the nave space. The extra foundations that were added to the west end of the arcade in Period 2C provide a further confirmation of the alignment of piers over the arcade foundations. These had cut away only part of the width of the arcade foundations, presumably below the line of the intended piers.

A pier spacing of 4 m has been used in the reconstructed plan since this measurement is consistent with the division of the church into seven bays. The west annex is also of a similar size (one bay), whilst the central tower area is equal to two bay spaces. Towards the east end the final bay is apparently longer. An increased number of piers, producing narrower spaces between piers, was looked at but does not fit with the plan.

The western annex is shown as a raised gallery chapel, extending to the full height of the nave, although it may have been shorter. If an eastern crypt was present it has not been shown because of the lack of information.

A screen is shown on the west side of the tower, defining the limit of the monk's choir, whilst the altar and *cathedra* are shown in the gallery chapel. These interpretations are aided by Eadmer's description of the Anglo-Saxon cathedral, before its destruction by fire in 1067 (Chapter 4).

Parallels (Fig 17)

The general layout of the Period 2A cathedral at Canterbury can be paralleled both at home and on the Continent, although British examples of this size of church are few. The church of Brixworth, partly uncovered by excavation, measured 45 m by 17.5 m (inclusive of the eastern square choir, sanctuary and external ring-crypt). The evidence of the nave arcade arches, and details from the excavation of the porticus, suggest that six porticus extended along either side of the Brixworth church, but were not inter-

connected. A western two-storey annex forms part of the plan, between the two western porticus (Audouy 1984). Dating of this church is not easy, with radiocarbon dates covering a wide span. Various dates have been suggested: Michael Audouy suggests construction perhaps as early as the first half of the 8th century (Audouy 1984, 32); Richard Gem tentatively suggests a date of the mid to late 8th century (Gem 1993, 41); whilst Eric Fernie prefers a later date of *c.* 800-60 (Fernie 1983, 65-9). Whatever the true date, it is certainly only one step removed from the Kentish mould (typified by Period 1A of the church of Sts Peter & Paul, Canterbury, and Period 1 of Canterbury cathedral), with porticus opening onto the nave, rather than having aisles, but with a distinctive square choir between the nave and sanctuary. The present author favours a date in the 8th century.

Developing on from this type can be seen the longer church with aisles, as represented by the early or mid 9th century church at Cirencester interpreted by Richard Gem (Gem 1993, fig 5). This structure measured 55 m by 16 m (including the eastern crypt), comparing well with Canterbury's Period 2A cathedral which measured *c.* 50.5 m by *c.* 24 m. The external lengths of the naves at Cirencester (Fig 17) and Canterbury are 41 m and 43.6 m respectively.

A similar scale of building developed at Winchester where the final phase of the minster measured 76 m in length by the late 10th century (Kjolbye-Biddle 1993, fig 2.3). Notwithstanding the impressive appearance of the minster at Winchester, the structure developed over six phases, retaining throughout its 7th century element (Fig 33). The significance of the churches at Canterbury and Cirencester is that they represent one major phase of building to a developed style of plan. Other churches reaching a considerable size, but through additions rather than an original planned layout, are Glastonbury abbey (Fig 31) and Sherborne abbey. Glastonbury grew gradually, much as the church of Sts Peter and Paul, Canterbury, with additions over several phases uniting existing structures (Radford 1981; Rahtz 1993, fig 53). At Sherborne the 8th century abbey remained standing with the cathedral added to its east end *c.* 1050 (Gibb 1975, fig 11).

Continental parallels are numerous in the Carolingian period; only the closest in terms of layout and design are being cited here. Werden abbey in Nordrhein-Westfaen, Germany (Oswald *et al* 1966, 368-71; Heitz 1980, fig 111) is very close in scale to the

Period 2A cathedral at Canterbury (Fig 17). Its length measures 53 m by 21.7 m (inclusive of an eastern crypt). The nave alone measures around 42 m externally. The aisles are divided by foundations, but enough survives of the superstructure to be certain that these were for responds rather than solid walls. Werden abbey dates to *c.* 840-75.

For parallels to the central tower at Canterbury one must turn to other Continental examples. Reichenau-Oberzell has a central tower *c.* 896 (Jacobsen *et al* 1991, 344-6; Heitz 1980, 124-6). A further example is the parish church of Höchst, dating to 826-47 (Oswald *et al* 1966, 124; Heitz 1980, 137). These two are smaller than Period 2A at Canterbury, but suffice to show the presence of a central tower in Carolingian churches. Having noted these two examples and the presence of central towers in the Carolingian period it must be stated that, generally, the evidence of central towers in the Carolingian period is sparse, perhaps because this area of the church was often re-built (or indeed taken down if found to have been structurally unsound or in need of extensive repairs).

Parallels for the Period 2A western annex at Canterbury include the Cirencester church, but are more numerous on the Continent. Perhaps the best example is St Cyriacus at Gernrode (Jacobsen *et al* 1991, 143-4). Here the short annex is flanked by stair towers and was founded in 961 (although this is a little outside our date range for the Period 2A structure it presents a good parallel for the Canterbury ground plan). Earlier examples are St Peter at Soest (Jacobsen *et al* 1991, 391-2) dating to *c.* 800 and Mainz abbey (Oswald *et al* 1966, 193-5) dating to 805.

Internal western galleries, presumably performing a similar function to the annex, are known nearer to home at Wing and Deerhurst (Fernie 1983, figs 37; Rahtz *et al* 1997, fig 108, respectively). The function of the western gallery is discussed further below.

Internal features in Period 2A are also worthy of consideration. A wall along the north side of the nave, already noted as being a possible ambo or pulpit foundation, can be paralleled at the 7th century church at Hexham (Bailey 1976, 47-67). No other British parallel could be found and one must turn to Byzantine churches of North Africa or Italy/Asia Minor for similar structures. Three Byzantine churches in Tripolitania show evidence of a pulpit in the nave (Perkins & Goodchild 1953, 6). In the second phase church of Sabratha the pulpit lay on the north side of the nave; in the first phase church of Lepcis Magna (*loc cit*, fig 8) the pulpit was placed centrally in the nave; and the pulpit in the third phase church at Lepcis Magna (*loc cit*, fig 13) lay along the south side of the

nave. These examples are divided into those with single or double flights of steps (the Sabratha example had one flight, those at Lepcis had two). The single flight may also be paralleled at the 6th century churches of St Hana's, Salonica and Hagia Sophia, Constantinople. No such pulpits are known in Pre-Byzantine Tripolitania or elsewhere in North Africa. For the ambo at Old St Peter in Rome see Willis (1845, fig 1). Alternative functions, such as a gallery for singers, may be possible.

Parallels for the possible mausoleum may be cited at Repton, Derbyshire, where an 8th century mausoleum stood (Biddle 1986, fig 8; Taylor 1987, 243; Blair 1992, fig 10.9 for a general location of the mausoleum and church). This measured *c.* 5.2 m square internally, set around 1.4 m into the ground. Recent excavations have shown that the mausoleum was an integral part of a larger structure, extending to the west (Martin Biddle, *pers comm*), and was not a free-standing structure. Entrance into the Repton mausoleum was from the west, with windows or light wells being provided on the other three sides. At Canterbury the west wall was solid, with evidence for a continuation above ground level, indicating the possibility of a window being sited above ground level on the west wall, but certainly no doorway. The structure was, however, set to one side of the church, rather than on the main axis, so an entrance should not be expected from any particular side, although the south would seem most likely. The location of the Canterbury structure, to one side of the cathedral, rather than at the east end, may have been necessary for a variety of reasons. For instance, when the second phase church was built, there already stood a building close to the east end of the cathedral (the baptistry of St John, built by Archbishop Cuthbert in *c.* 740-60) (Chapter 4). A crypt may also have been built in this phase at the east end of the church (similar to that on the east end of the Cirencester church), with insufficient room between it and the baptistry for a mausoleum.

Dating evidence

The date of this phase of the church has been detailed above and need not be repeated here, suffice to say Period 2A probably dates to before the first half of the 10th century (Chapter 3).

Dating this phase by reference to parallels cited above, one can see a close similarity in terms of size and layout with the churches of Cirencester and Werden. The former is dated from typology alone to the early to mid 9th century, whilst the latter dates to *c.* 840-

75, on documentary evidence. Other churches, cited for their central towers, although smaller in size, also date to the 9th century. Gernode, cited as a parallel for the annex is later than these at 961. In conclusion parallels suggest a date in the mid 9th century for Period 2A at Canterbury. Historical sources (Chapter 4) indicate extensive work undertaken by Wulfred between 803 and 813.

Re-building in the early part of the 9th century would fit well with the reform of the Church in the 8th and early 9th century, both on the Continent and at home. Chrodegang (who wrote the *Regula Canonicorum* - a rule for clergy at Metz) largely undertook these reforms. This was followed by Charlemagne's programme of reforms set out in 789 and two synods near Aachen in 816 and 817 where further uniform observances replaced earlier rules (Gem 1993). In England Archbishop Wulfred was instrumental in bringing about new reforms, after consultation with Pope Leo III, at the Chelsea synod in 816. Wulfred's documented re-building of Canterbury cathedral's monastery, between 803 and 813, would fit well with these reforms. It is, however, uncertain what was re-built. For a full discussion of Wulfred's charter and the word 'monasterium' as used in the charter see Brooks and Foot (Brooks 1984, 51-2; Foot 1992, 121-25). If the majority of the monastic establishment was re-built to fit into line with new reforms, then it is highly likely that the cathedral was re-built at the same time. Such a re-building of the cathedral in (Period 2A) would fit well, if being a little earlier, than the known Continental parallels cited above, particularly Werden (c. 840-75).

Period 2B

Re-building of the cathedral

Little can be said about the re-building of the church in Period 2B from the excavation, since so few traces survived. All that was recorded was a re-building of part of the south wall of the cathedral, and the location of a hearth to the south of the church.

Dating evidence

The date of this phase of the church has been detailed above and need not be repeated here, suffice to say Period 2B probably dates to the first half of the 10th century (Chapter 3). This would fit well with Oda's documented re-building work between 942 and 958 (Chapter 4).

Period 2C

General layout of the additions to the cathedral (Fig 18)

The layout of the foundations added in Period 2C may be interpreted as follows. The western structure was doubtless a deep chapel with flanking hexagonal stair towers (documented by Eadmer as housing the *cathedra* and an altar to the Virgin Mary, Chapter 4). Consideration of the size and position of the towers, on the outer western corners of the cathedral suggest they were employed as stair-turrets giving access to upper sections of the western structure. The stair-turrets would also have given access to a raised chapel in the apse via north and south passages between the apse and the stair-turrets. If the chapel were raised on a gallery then the area beneath it and the flanking passages, as far east as the nave proper, would have been covered and acted as ancillary space. No subterranean crypt could have been sited here, because of the location of construction spreads of mortar and stone chippings at ground level.

The western structure, incorporating the apsed chapel, presumably replaced the earlier (Period 2A) annex. It was architecturally sophisticated with rounded interior and polygonal exterior both in its foundations and above, with flanking hexagonal stair-turrets and linking corridors. It is not thought that a central tower was part of the plan of the western structure, since the foundations of the apse terminals were too shallow to have taken such a weight.

It is most unlikely that a western entrance was situated below the chapel, and Eadmer's description (Chapter 4) of the main entrance on the south tower adds weight to this hypothesis. Flanking doorways, may however, have been sited at the west end of the aisles, through the walls linking the chapel with the stair-turrets. Should this be the case, it may be the reason why the stair-turrets were not built in the external angle of the apse and nave. The area beneath the raised chapel may have functioned as a ground-floor 'crypt' (*cf* Quirk 1957, 48-9, on westworks; Kjolbye-Biddle 1993, 18), perhaps with its own altar, although none is documented.

The large strengthened pier bases, added during this phase at the west end of the nave, were presumably intended to help carry the gallery above. A pier foundation also seems likely to have been placed between the two strengthening pier bases, although this area was not available for excavation. This intermediate pier would have been required to

enable the gallery above to have been set at a height of around 5 m above the nave floor - if the gallery had been supported by a single arch then the floor of the gallery would have been placed at an unduly high level (around 9 m).

The area below the chapel and the corridors extending from the stair-turrets to the chapel, may have been vaulted. A reconstruction of the ground plan and longitudinal section are given in Fig 18. It must be noted that the foundations do allow for a variety of reconstructions of the western end. An alternative interpretation would be that the apse continued as far as the west wall of the nave, interrupting the linking corridor between the stair-turrets in Fig 18.

The possible existence of flanking square towers at the west end of the aisles must be born in mind, although the narrow linking walls between the apsed chapel and the stair-turrets do not support this hypothesis. More significant perhaps, is the fact that there is insufficient space between the chapel and the stair-turret for a square tower, without the tower having imposed unduly on the plan of the stair-turret. The excavated remains show that the linking wall butted the stair-turret's foundations, suggesting that care had been given to the laying out of the six-sided turret and that they had been intended to stand as significant features of the western structure, rather than being partly integrated into an adjacent square tower.

The porticus located on the south-east corner of the church may also have been ancillary space for a further altar. A similar, matching porticus may have been built on the north-east corner. Alternatively, this could be the foundation for one of the towers described by Eadmer, in which was set the main entrance into the cathedral (Chapter 4).

Parallels (Fig 19)

Western apses are rare in Britain, examples being known by excavation at St Oswald's priory, Gloucester, dating to the 10th century (Heighway 1980; Fig 34); and Capel Maelog near Llandrindod Wells, Powys, where a late 13th century example has recently been excavated (Britnell 1990). An extant western apse can be seen at St Giles, Langford, Essex (Pevsner 1965, 258), and a documentary reference to a western apse is given for the 7th-8th century minster church at Abingdon (Taylor 1969b, 118-19), but the excavations have so far failed to reveal any traces of the bi-polar arrangement. For a catalogue and discussion of the area at the western end of Anglo-Saxon churches see

Wickham-Crowley (1992, 122-58).

None of these parallels, however, compare with the western apse at Canterbury, which was designed as part of a western structure. For parallels one must turn, therefore, to the Continent.

Two authors have addressed the bi-polar arrangement of apses on the Continent in recent years. Carol Heitz notes that these were not confined to Germany, and contrary to popular belief were quite widespread in central France (Heitz 1980, 166-7). Werner Jacobsen in his recent study cites numerous examples of bi-polar apses in the 8th and 9th centuries (Jacobsen 1992, 192-259). Those discussed by Jacobsen are: Fulda abbey (*c.* 802-19), with a large west transept; St Maurice d'Agaune (787), with ring-passage crypts in both apses (see also Heitz 1980; Fig 19); Cologne cathedral (*c.* 800), with large west transepts (see also Doppelfeld & Weyers 1980, fig 11); Paderborn cathedral (*c.* 836), with large west and east transepts; Echternach abbey (late 9th century), with an apse added to the west end of an earlier nave; Fritzlar cathedral (date uncertain, but probably built before 774 and with a *terminus ante quem* of 1079).

Later examples of bi-polar apses include Memleben (*c.* 980-1015), with west and east transepts and St Cyriakus at Gernrode (already noted as a parallel for Period 2A at Canterbury). The western apse at Gernrode replaced the earlier western annex in the 12th century (Jacobsen *et al* 1991, 143-4; Taylor 1975, figs 8-9, 142; Fig 19).

Churches with western apses, but a squared eastern choir, include Reichenau-Oberzell, with an apse added to the west end of the nave in the 11th century.

The closest parallels to Canterbury, of those cited above, are St Maurice d'Agaune (787) and Gernrode in the 12th century. The manuscript plan for the monastery, *c.* 820, in the Chapter Library of St Gall, is perhaps a reasonably close parallel for Canterbury's western structure in Period 2C (Conant 1978, fig 17; Jacobsen 1992; and Heinz 1988, fig 279 for the excavated plan of the church at St Gall). The plan was drawn shortly after the 816 Council near Aachen and was intended as a model for the ideal monastery.

Given the wide time-span of bi-polar churches, one must consider the combination of a western chapel (not necessarily an apse) in conjunction with substantial stair-turrets. The obvious parallel here is St Cyriakus at Gernrode (961) cited above in the Period 2A discussion, but considered rather late for that phase. Werner Jacobsen (*pers comm*) has commented on the Period 2C western structure. He notes that, typologically, it could be

placed in the first half of the 10th to first half of the 11th century, but that seldom is there a combination of apse and stair-towers.

In conclusion the Period 2C layout probably fits best within the style of the Ottonian Period.

Dating evidence

The final phase of the Anglo-Saxon cathedral, Period 2C, is given a *terminus post quem* of the early-mid 10th century (for details see Chapter 3). Period 2C has numerous Carolingian and Ottonian parallels on the Continent, with St Maurice d'Agaune in 787 and Gernrode's 12th century phases being the best. Bi-polar churches unfortunately span a wide time-scale (largely bracketed by the two cited here) and the western apse alone cannot be used for dating. The plan of the ideal monastery of St Gall falls within this time (c. 820), but is too early for Canterbury's Period 2C since Period 2A probably dates to the early 9th century and there was also a re-build in Period 2B. The apse with its large stair-turrets would be more in keeping with a date in the second half of the 10th century (note Gernrode's stair-turrets in 961) or first half of the 11th century.

The entire Anglo-Saxon cathedral was destroyed by fire in 1067. This final phase, perhaps after the Danish sacking of the cathedral in 1011, and after peace was established when Cnut became king, could therefore have been built either by Archbishops Lyfing (1013-20) or Æthelnoth (1020-38). In 1023, under Cnut, the body of St Ælfheah was returned to the cathedral for burial. This was perhaps a likely time for re-consecration (and perhaps re-building).

It is perhaps worth noting that the three main phases of re-building traced in the archaeological record (attributed to Archbishops Wulfred, Oda, and either Lyfing or Æthelnoth), fall within the three main high-points in the cathedral's gathering of wealth under Wulfred, Oda and Æthelnoth (Brooks 1984, 313).

St Augustine's abbey complex

This section will follow the format established in Chapter 3, discussing each church/area of the complex in turn, with a final section devoted to the chapel of St Pancras.

Church of Sts Peter & Paul, Period 1A

General layout of the church (Figs 10, 14 and 30)

The fragmentary remains of this church have been interpreted by the excavators as forming parts of a nave, a western *narthex*, and north and south porticus. Much of the floor (a thin layer of *opus signinum*) survived *in-situ*, as did the doorways into the *narthex*, nave, and northern porticus.

As noted above, the main difference between the remains of the Period 1 cathedral and the Period 1A church under discussion is that the *narthex* in the former may have been only a third of the width of the church, whilst the latter church had a *narthex* probably the full width of the nave, certainly not narrower.

The church of Sts Peter & Paul measured 17.5 m in width and at least 18 m in length. To this can be added the eastern sanctuary and apse perhaps bringing the full external length of the building close to 29 m. By comparison, Period 1 of the cathedral measured an estimated 22 m in width and 32 m in length. An apse is added to the reconstruction based on the evidence of other early Kentish churches (see discussion and references for the Period 1 cathedral, above).

The major difference in the original planning of the church of Sts Peter & Paul is that, unlike the cathedral, it was built with the intention of housing tombs in the north and south porticus. We know from the historical and written sources (Chapter 4) that the north porticus was for the burial of archbishops (up to 740-60 after which the archbishops were buried in the baptistry of St John, built to the east of the cathedral by Archbishop Cuthbert). We also know that the central north porticus held the tombs of five archbishops, with an altar at the head (west end) of the two tombs against the east wall, and a third altar to Gregory between the two eastern tombs, against the east wall of the porticus. A sixth tomb, below ground level, lay beneath the altar of Gregory (Chapter 4). A further tomb lay in the western section of the north porticus, but it is not known for whom it was built. A number of important burials are known to have been housed in the central south porticus, but have not been located by excavation. The tombs of two archbishops lay in the nave, hard up against the north wall. Other tombs were undoubtedly set in the church, but are not recorded in the historical sources.

Cut by the Period 2 westward expansion of the church was a grave (14 m west of the church, and aligned on its axis) which may well have been contemporary with Period 1A.

A cemetery was situated west of the church, but all save a few of the graves were badly disturbed by later building work, and not complete enough for detailed analysis (Saunders 1978, appendix 5, 60). The bones recovered included those from men, women and children, indicating a lay cemetery. The excavators, however, thought that the grave was an important one, given the unusual arrangements of stones in the fill (Chapter 3). The burial yielded a sherd of Ipswich type cooking pot (Saunders 1978, fig 13, no 3), probably dating to *c.* 650-850 (Macpherson-Grant pers comm). One further point worthy of consideration is that the area west of the church may, at least during Period 1, have been part of the monastic graveyard, the secular burials being added later.

Parallels and attribution of the church to Augustine (Fig 14)

Parallels for Period 1A of the church are similar to those for the Period 1 cathedral (discussed above).

To judge from the plan of the church (Fig 14), this is thought to have been one of the early churches of the Gregorian mission, built soon after the arrival of Augustine in 597. Confirmation of this comes from the location of important burials in the north porticus. Bede mentions the church, built as a monastery, and in which Augustine and the other archbishops and kings of Kent were buried. This church was dedicated not later than 619 (Chapter 4). Goscelin, writing in the mid 11th century tells us of the location of tombs which were cleared before the remodelling of the east end. He recorded the location of the tombs of Augustine, Laurence, Mellitus, Justus, Deusdedit and in the north porticus. The latter three have been located during the excavations against the north wall of the porticus. The Period 1A church is therefore clearly the monastery of Augustine, the construction of which started in the opening years of the 7th century and was dedicated in 619. Further comparison with other churches is presented in Chapter 6.

Church of Sts Peter & Paul, Period 2

Layout of the church (Fig 30)

This phase of the church incorporates an expansion to the west, construction of an extended north porticus, and addition of a wall across the east end of the nave.

The Period 1A party wall dividing the nave from the *narthex* was presumably demolished and the nave extended by a further 6 m internally. The original west wall of

the Period 1A *narthex* may have been retained, since the excavation records show that the buttresses beside the doorway were added later (perhaps in Period 2). Saunders noted that the floor of the new *narthex* lay around 1.37 m below the nave floor (Saunders 1978, 48), leading Gem to tentatively suggest that the new *narthex* may have had two main levels, possibly a sanctuary area with an altar, with gallery above, and crypt below. The idea of a western sanctuary would be in keeping with many Anglo-Saxon churches, particularly the Period 2A cathedral with its western annex.

Also built in this phase was a western vestibule, around 5 m wide and 7.5 m long (internally), with a centrally-placed doorway in its west wall and two doorways leading into the new *narthex*. The latter measured around 7.5 m long, bringing the total length of the excavated remains of the Period 2 church to around 32 m.

Two cross walls recorded in the western section of the north porticus (Gem 1992, fig 4) are now in doubt. This area was drawn by the author in 1995, revealing three sides of a masonry-built tomb and an adjacent feature (possibly to house relics). These features preclude the existence of walls in this area of the porticus. The recent recording has confirmed that the north wall of the porticus was demolished, at least adjacent to the central section of the north porticus. Here, the section of north wall to the east of the tomb of Laurence had been cut through and rendered over. Too little survived of the walls north of the porticus to be certain of their phasing, so it is not possible to confirm the location of the extended porticus. That the porticus was extended is not in doubt, with the recovery of two tombs in the early excavations, fitting well with the historical sources.

The wall inserted across the east end of the nave, did not replace any earlier foundations, and has been tentatively interpreted as one side of a low tower (Gem 1992, 66), or the foundation for a screen across the nave (Gem 1997, fig 37).

Original excavation plans of the masonry foundations drawn in 1955-7 could not be located rendering a discussion of the metrical layout null and void.

Dating evidence

Although dating evidence is sparse, pottery recovered from a layer cut by the Period 2 *narthex* indicates that this phase dates to after *c.* 750-850 (for details see Chapter 3). It has been suggested that the expansion took place either in the mid 8th century, in 978 when the church was rededicated, or the early 11th century when the church was

rededicated once more (Chapter 4). The former date is perhaps an unlikely time for the expansion of a burial porticus that essentially became obsolete with the construction of Cuthbert's baptistry at the cathedral in 740-60. The 10th or 11th century dates are more likely, with the early 11th century (1006-1023x7 under Abbot Aelfmaer) being favoured by the author, as this is the date of documented work on the burial porticus (Chapter 4). This may, however, be an over simplification of the expansion of the church that may have been undertaken over a number of phases.

Western chapel, Periods 2 and 3

Layout of the chapel (Fig 30)

Very little of the Period 2 chapel survived to enable an interpretation of its remains. Period 3, however, offers more scope for the imagination. The remains appear to represent a small ?mortuary chapel with an apsed west end and adjoining circular tower. The chapel was presumably single storey, but the tower may have been quite tall, to judge from the size of the foundations. For a tentative reconstruction see Gem (1992, fig 7).

The building lay on the alignment of the churches of Sts Peter & Paul, and St Mary, and doubtless formed part of the family of churches/chapels that had built up gradually. Parallels for this linear family of churches are discussed in Chapter 6.

Dating evidence

A sherd of pottery from the Period 3 floor in the chapel provides a construction date shortly before the mid-11th century (Chapter 3), making the later phase of the chapel broadly contemporary with Wulfric's octagonal structure.

Chapel of St Mary, Period 1B

Very little of this chapel was located, save the west end wall, with a centrally-placed doorway, and a nave at least *c.* 8 m wide (Figs 22 and 30). Thus, the church may have approached the scale of the church of Sts Peter & Paul to the west. Not enough survives to enable metrical analysis to be undertaken. Little can be said regarding the layout, since few remains have survived later building work. It is assumed that this chapel had an apsed east end, and perhaps porticus to north and south. Certainly Goscelin notes porticus

in his account of the demolition of the west end of the chapel (Chapter 4).

The chapel is known to have been built by Edbald between 616 and 624, and dedicated to the Virgin (Chapter 4). It lay to the east of the church of Sts Peter & Paul, on the same linear alignment, and was part of the family of churches/chapels noted above.

Cloister area, Periods 2A and 2B

Layout of the cloisters (Fig 30)

The foundations excavated to the north of the church of Sts Peter & Paul appear to represent a central (presumably grassed) area, surrounded on four sides by walkways, and with ranges of monastic buildings on three sides. Two further buildings lay to the north, on a markedly different alignment to the cloisters. At least three phases are present.

Leaving the phasing aside for the moment, the south side of the cloister is centred on the section of the porticus housing the remains of the early archbishops, whilst the eastern walkway is aligned on the steps in the north-west angle of Wulfric's octagonal structure. This may be taken to imply that one phase of the cloisters may be assigned to Wulfric in the mid 11th century. On the other hand we have a written source informing us of Abbot Aelfmaer's rebuilding work between 1006 and 1023x7 (Chapter 4), when the north porticus appears to have been rebuilt and some of the stone re-used in the cloister.

The published plans are inadequate for detailed analysis of the phasing of the remains, and only after further excavation would it be possible to suggest refinements.

No internal dating evidence was recovered from the excavations, and the final phasing will be discussed below, integrating information from the development of the complex and historic sources.

South-west tower, Period 3

To judge from the style and size of the foundations this structure was a freestanding tower of some considerable height (Fig 30).

A documentary source showing a large donation for building work in 1047 (Chapter 4) may tentatively be related to this structure (Gem 1992, 67).

Wulfric's octagonal structure, Period 3

Layout of the rotunda (Figs 22 and 30)

This remarkable structure, documented as having been started by Wulfric around 1050, but never completed by his death in 1059, was built to link the church of Sts Peter & Paul with the chapel of St Mary.

It is estimated that a gap of up to 11 m may have lain between the two buildings, given the estimated length of the church of Sts Peter & Paul (23 m in Period 1A). This gap may have been as little as 7 m if the chapel of St Mary had a *narthex* extending west of the *in-situ* west wall. The octagonal structure, therefore, spanned the area between the east end of the nave of the church of Sts Peter & Paul (just east of the Period 2 cross wall interpreted as the foundation for the west side of a low tower), and butting the west wall of the chapel of St Mary.

The intended result would have been a church around 76 m in length from the west end of the Period 2 vestibule to the east end of the chapel of St Mary.

The foundations excavated represent a barrel-vaulted crypt with an ambulatory. The rounded foundations set against the south face of the structure (presumably mirrored on the north side) are thought to represent the foundations for a vice (spiral stair) giving access to upper floors in the structure. These features, and the substantial foundations, imply a structure of some considerable height; perhaps a rotunda with gallery and clerestory levels (Gem 1992, 69-70). The rotunda measured 16.46 m diameter internally.

Three previous attempts have been made to interpret the octagonal structure and provide parallels. In 1927 Peers & Clapham suggested that a close parallel was the church of St Bénigne at Dijon in Lombardy (Peers & Clapham 1927, 213-14). St Bénigne was begun in 1001 (Conant 1978, 108), shortly after St William of Volpiano became abbot in 990, and dedicated in 1018. Unfortunately the church is only known from the engraving by Dom Urbain Plancher, 1739 (Conant 1978, fig 109), and its crypt as re-built in 1858. For a sketch restoration drawing see Conant 1978, fig 108. The rotunda of the church of St Bénigne measured 16.75 m internally, close to that of Wulfric's rotunda, but with two concentric rows of columns (for the excavated plan see Fernie 1988, fig 4), as opposed to Canterbury's thick wedge-shaped piers. St Bénigne, as reconstructed, stood to a height of four storeys (inclusive of the crypt), with circular stair-towers flanking the north and south sides.

In 1983 Eric Fernie put forward a suggested cross-section through Wulfric's rotunda, indicating a crypt, and upper storey (Fernie 1983, fig 92). As reconstructed by Fernie one flight of steps led down from the nave of the church of Sts Peter & Paul, flanked by two flights of stairs to the upper floor. Fernie has noted that the Dijon parallel is misleading in that the rotunda was a subsidiary building lying to the east of the church of St Bénigne, rather than a central feature. For a church with a rotunda as a central element he cites the church of St-Sauveur, at Charroux in Vienne, consecrated in 1047 (Fernie 1983, fig 93). The latter, Fernie argues, has a rotunda which forms the crossing, and such an arrangement may have been planned at Canterbury (less the transepts) (Fernie 1983, 159). This church was much larger than the Canterbury example, measuring around 38 m in internal diameter, and had three concentric rows of columns/piers.

The third writer, Richard Gem, has taken the interpretation of Wulfric's octagonal structure further, suggesting it had a crypt and two floor levels above, the whole being surmounted by a clerestory level (Gem 1992, fig 7). Gem, quite rightly, points out that a massive wall lay across the west end of the rotunda barring an entrance into the crypt directly from the east end of the nave, and suggesting that access may have been via the two flanking stair towers. Gem also suggests a central rotunda surrounded by a vaulted ambulatory, and a first floor level around 3 m above the floor of the crypt reached by a flight of steps at the east end of the nave. The design is thought to have been derived from the Aachen tradition, such as the contemporary Ottmarsheim in Alsace that was dedicated in 1049 (Gem 1983; Heitz 1987, 158-61).

The author has an alternative view of access to the crypt. Stairways may have been provided at the west end of the chapel of St Mary, where two doorways could have been sited one in each corner of the nave. This would have retained access within the church, rather than having less convenient access from external doorways in the stair towers. The stair towers may simply have provided for internal circulation between the various floor levels of the rotunda, either from nave to upper floor, or crypt to upper floor, and there is no reason to suggest external doors.

There is perhaps no need to rule out the Dijon parallel on the grounds that it performed a different function to Wulfric's rotunda, but instead see it as having had an influence on later design.

Having looked at the plans of the above-noted parallels, the development of the church

of Sts Peter & Paul may have followed on from the sequence of influences presented here (Figs 23-28):

- i) Church of the Holy Sepulchre in Jerusalem (Fig 23), dating to the 4th century (Conant 1978, fig 262)
- ii) Funerary basilica of Saint-Pierre in Geneva (Fig 24), dating to c. 600 (Conant 1978, 151; Jannet & Sapin 1996)
- iii) Palatine Chapel (minster) at Aachen (Fig 25), largely dating to 792-805 (Jacobsen *et al*, 1991, 14-18; Conant 1978, 108)
- iv) St Bénigne abbey at Dijon (Fig 26), dedicated in 1018 (Peers & Clapham 1927, 213-14; Conant 1978, 108)
- v) Church of St-Sauviour at Charroux (Fig 27), dedicated 1047 (Fernie 1983, fig 92)
- vi) Ottmarsheim in Alsace (Fig 28), dedicated 1049 (Heitz 1987, 158-61)

Wulfred need not have known of more than the contemporary churches of Charroux or Ottmarsheim, perhaps visiting the latter whilst attending the synod of Rheims (Gem 1992, 69).

Dating evidence

There is no doubt that this is the structure built by Wulfred from around 1050, as noted in the historical sources (Chapter 4).

Architectural stonework from St Augustine's abbey

A total of eleven fragments of architectural stonework were recovered from the site during the various excavations at the abbey. These have recently been published in full (Tweddle *et al* 1995, 127-37) so the details need not be repeated here. In summary, all of the stones were found either in later contexts on the site, or reused in subsequent foundations. Although the stone are residual finds, they are fairly closely datable and can be reviewed with a view to obtaining a fuller understanding of the architectural style of the churches.

The earliest fragment was from a lathe-turned baluster argued as dating to the 7th

century (Tweddle *et al* 1995, no 8, 133, ill 50). This is likely to have come from either the church of Sts Peter & Paul (Phase 1A), or St Mary's chapel (Phase 1B, built 616-24). Such a baluster would probably have come from a window.

Four fragments are dated to the 9th century and comprise a possible trial piece (Tweddle *et al* 1995, no 10, 134-5, ill 54-6), and fragments of three capitals from free-standing columns (Tweddle *et al* 1995, nos 3-5, 128-32, ill 29-40). The latter, all in *Ditrupe* limestone from the Paris Basin, are dated to the 9th century. These are discussed as being unusual in pre-Conquest architecture in south-east England; the only other examples being found at Reculver (St Mary's church) and St Pancras chapel.

The capitals sat on columns measuring around 0.34 m diameter. Such columns would have been too slender to have been part of a triple arch between the nave and sanctuary and may be better seen as part of a screen across the nave. Richard Gem has recently postulated such a screen in the first phase of the church of Sts Peter & Paul (Gem 1997, fig 37). The suggested date of the recovered capitals precludes them having been from the first phase church, but they could well have been added during a subsequent remodeling of the church (Phase 2).

The remaining fragments are from a 11th century runic inscription (Tweddle *et al*, no 11, 135, ill 58), a grave cover or panel dating to the 10th-11th centuries (Tweddle *et al* 1995, no 9, 133-4, ill 51-3), a cross shaft (Tweddle *et al* 1995, no 1, 127-8, ill 20-3) dating to the 10th-11th centuries, a grave cover (Tweddle *et al* 1995, no 2, 128-31, ill 24-8) thought to be 11th century, and perhaps Norman in date, and two fragments of baluster in Marquise oolite from the Boulonnais area of France (Tweddle *et al* 1995, nos 6 and 7, 132-33, ill 46-50). The baluster fragments are dated to the 10th-11th centuries, and were probably from windows in one of the churches or adjacent buildings.

Chapel of St Pancras

Layout of the church (Fig 14)

This chapel conforms broadly to the plan of the other early churches at Canterbury cathedral (Period 1) and Sts Peter & Paul (Period 1A). Period 1 of the chapel was a simple nave and apsed chancel, whilst Period 2 saw the addition of north and south

porticus to the nave and a south porticus to the chancel (probably also matched on the north side). The church measured around 9.1 m wide (16.4 m after the addition of the porticus) by 22.5 m in length (externally), including the estimated length of the apse. Compared with the Period 1 cathedral measuring an estimated 22 m by 32 m, and Period 1A of Sts Peter & Paul measuring 17.5 m by an estimated 29 m.

Excavation has revealed that the first phase chapel had a single chancel arch, replaced in the second phase with a triple arch supported on four stone columns. These columns have been studied by Bernard Worssam and Tim Tatton-Brown who have concluded that the stone for the *in situ* fragment of column is of foraminiferal limestone with *Ditrupea* tubes, originally quarried from the Calcaire Grossier (Middle Eocene) formation of the Paris Basin (Worssam & Tatton-Brown 1990, 59, 66-7). Tom Blagg has cast doubt on the attribution of a Roman date, suggesting instead that they were "...carved in the Roman tradition, but a tradition transmitted not from Roman Britain, but through the ecclesiastical architecture of the late Roman and Byzantine Mediterranean." (Blagg 1981, 50-3). He also notes that the columns from the 7th century church of St Mary at Reculver are not Roman but of the same date as the church (Blagg 1981, 52). The stone for the Reculver columns, is of Marquise oolite from the Boulonnais area of France. A more recent discussion of the column bases follows Tom Blagg's interpretation of the influence and suggests a late 7th or 8th century date (Tweddle *et al*, 136, ill 59-60). This is consistent with my interpretation of the date of the second phase of the chapel (mid-late 8th century) when the columns were added and much of the structure rebuilt.

The layout, including possible proportions, location of the principal altar, and planning of the porticus, etc will be considered in Chapter 6.

Dating evidence

Dating evidence is sparse, indicating a mid-late 8th century date for the construction of the Period 2 south porticus (Chapter 3). Period 1 remains undated, but may relate to the time when interest in the cult of St Pancras was revived under Pope Honorius (625-38) (Gem 1992, 59). Charles Thomas has suggested that this chapel, rather than St Martin's church, was that used by Queen Bertha before the arrival of Augustine, and that Period 1 is indeed a Roman phase (Thomas 1981, 170-74). This is not born out by the known phasing and the author favours St Martin's as the church of Bertha, with St Pancras chapel

being a new foundation in the 7th century.

Church of St Martin

General layout of the remains

It is now widely accepted that the first phase of St Martin's church can be allocated to the Roman period, with the re-use of a Roman mausoleum in the 6th century as the chapel used by Queen Bertha, and referred to by Bede. This was probably added to in the 7th century by Augustine; the Roman element being retained as the sanctuary of the later church (and still in use today).

The layout and proportions of the church and its Roman phase will be discussed further in Chapter 6.

CHAPTER 6: GENERAL DISCUSSION

Introduction

In this chapter it is intended to undertake a much wider discussion of the layout and development of the churches, drawing information together from the five churches under study, and comparing these with other churches of a similar date. This section will, therefore, have a different layout to the previous ones, in that it will not be divided into the individual churches, but introduce topics that have been touched upon in previous chapters, deserving of wider discussion. Topics include: 1) the design of the 6th-7th century churches, 2) the development of the church complex, and 3) topographical development.

The design of the 6th-7th century churches

From the excavated remains (Chapter 3), and interpretations (Chapter 6) we have the partial plans of five churches/chapels built in the 6th and 7th centuries (the Cathedral, Sts Peter & Paul, St Mary, St Pancras, and St Martin). This material will be compared with the remains of the early phases of the Kentish churches of St Mary at Reculver, St Andrew at Rochester, Minster-in-Sheppey, and St Mary at Lyminge, and the Essex church of St Peter at Bradwell-on-Sea. Table 5 sets out the status and date of these churches.

The dates given below (Table 5) are those presented by Bede for Canterbury's churches (Canterbury cathedral, Sts Peter & Paul, and St Mary), or dated from excavation/interpretation (St Pancras and St Martin). The dates of the Kentish churches are from written sources (Rochester); when land was given for building the church (Lyminge and Reculver); the founding of a religious house and the date of the first abbess (Minster-in-Sheppey). The date provided for Bradwell-on-Sea is from the date of the consecration of a bishop, recorded by Bede, or an additional church built by Archbishop Theodore (Fernie 1983, 38).

Site	status	date
<i>Canterbury churches in the study:</i>		
Cathedral	cathedral church	soon after 597
Sts Peter & Paul	abbey church	consecrated 619
St Mary	abbey chapel	616-624
St Pancras	abbey chapel	?2nd quarter 7th century
St Martin	mausoleum, church	Roman and ?early 7th century
<i>Other early Kentish churches:</i>		
Rochester	cathedral church	consecrated 604
Lyminge	abbey church	c. 633
Reculver	abbey church	c. 669
Minster-in-Sheppey	abbey church	after 664-c. 670
<i>Essex church:</i>		
Bradwell-on-Sea	minster church	c. 653 or 669

Table 5: Status and date of the early churches

All of the churches listed are likely to have been built between the end of the 6th century and the end of the third quarter of the 7th century, and as such form an interesting group spanning around 75 years. References are cited above, in the discussion of the Period 1 phase of the cathedral, and need not all be repeated here unless they support the discussion, or where new references are introduced.

The plans of the churches vary (Figs 14 and 29). All have a nave, chancel and (where they survive) an apsed sanctuary, but the porticus and western *narthex* differ quite markedly, perhaps as an indicator of function. By far the most complete of the churches is that at Reculver, which will be described here to identify the general layout.

The Reculver church, set in the centre of a Roman fort, but on a markedly different alignment to the Roman walls, comprises an eastern cell with a stilted apse. The inner face of the apse is smoothly semi-circular, but the external face has nine sides of a 16-sided polygon. The nave is rectangular, with three doorways centrally placed in the west,

north, and south walls. Pilaster buttresses lay adjacent to the external corners and doorways. The junction between the nave and chancel has a triple arch, the central section of which frames a foundation (set on the *opus signinum* floor) measuring around 2.13 m by 0.91 m, and interpreted as the site of an altar (probably the only one in the church). That the altar was sited at the east end of the nave suggests that this area was the sanctuary, and it is likely that a low screen may have been erected across the nave in line with the west end of the porticus. Richard Gem has also tentatively postulated a similar arrangement for the church of Sts Peter and Paul (Gem 1997, fig 37). This would then free the apsed area, which has a low stone bench internally, for use as the chancel for the clergy, perhaps with the abbot's chair set in the apex of the apse. The chair would have been fine in this location until the trend for prominent shrines situated east of the high altar became common place from the mid 7th century in larger churches (Radford 1959, 127-9). Two porticus were built as an integral part of the original church, to north and south of the chancel. Each has an external doorway in the east wall of the porticus, and an internal doorway leading into the chancel, just inside the chancel-arch (these are thought by Eric Fernie to be later additions to the original plan, but since this is not founded on new stratigraphic information I will follow the original excavator's idea that the porticus are early). The fact that the eastern porticus were entered only externally from the east or from the chancel implies that they were probably used as sacristies, rather than for burial. Two original windows survived in the north wall of the north porticus. Since the altar lay very close to the columns, effectively blocking the central opening as a through route, it is likely that this is where the priest stood when performing ceremonies, facing the congregation westward across the altar. This also indicates that any passage for the clergy was via the side openings of the chancel-arch.

Thus, from the discussion of the plan of Reculver church we have the basic layout of the early churches. This plan (Fig 29) comprised a nave for the laity, and officiating areas for the clergy. The latter comprising a sanctuary with principal altar, two porticus used as sacristy, and a chancel.

Table 6 shows a checklist of the various features in the Reculver church applied to the other churches in the discussion.

When considering the other churches against the plan of the Reculver church, one is aware of the problems of interpreting partial plans. Taking each major element of the

church in turn (apse, nave, walls and windows, chancel-arch, porticus, and *narthex*) the various features will be noted, and the implications for the layout discussed where appropriate.

Four of the churches had a stilted apse at the eastern end that at Reculver having an *in-situ* stone bench. It seems reasonable, even in the case of Bradwell-on-Sea in Essex to reconstruct an apse for all of the churches in the study, save St Martin's church (the latter being a re-used Roman structure). Where the chancel/nave junction has survived, three examples have the chancel slightly narrower than the nave (St Pancras, Rochester, and Lyminge), whilst two examples have a chancel the same width as the nave (Reculver and Bradwell-on-Sea).

Church	apse	nave	arch	porticus	altar(s)	floor	buttresses
Cathedral	-	<i>yes</i>	-	-	-	-	<i>yes</i>
Sts Peter & Paul	-	<i>yes</i>	-	<i>yes</i>	-	<i>yes</i>	<i>yes</i>
St Mary	-	-	-	-	-	-	-
St Pancras	<i>yes</i>	<i>yes</i>	<i>yes</i>	<i>added</i>	<i>yes</i>	<i>yes</i>	<i>yes</i>
St Martin*	<i>no</i>	<i>yes</i>	-	<i>no</i>	-	-	<i>yes</i>
Rochester	<i>yes</i>	<i>yes</i>	-	-	-	-	-
Lyminge	<i>yes</i>	<i>yes</i>	-	?	-	-	-
Reculver	<i>yes</i>	<i>yes</i>	<i>yes</i>	<i>yes</i>	<i>yes</i>	<i>yes</i>	<i>yes</i>
Minster-in-Sheppey	-	<i>yes</i>	-	-	-	-	-
Bradwell-on-Sea	-	<i>yes</i>	<i>yes</i>	<i>yes</i>	-	-	<i>yes</i>

* St Martin's church has a Roman building re-used as its chancel

NOTE: The lack of a particular feature of the church is only indicative of the lack of survival, and does not suggest that that element was never built (where this element was probably never part of the original design *no* is used in the table).

Table 6: Check list of surviving features in the churches

Nine of the churches had evidence of the nave, although not all examples were very complete. The sizes vary, not many having complete lengths: St Pancras 12.97 m x 8.11 m; St Martin 12.7 m x 7.5 m; Reculver 11.27 m x 7.3 m; Minster-in-Sheppey 15.18 m x 7.9 m; Bradwell-on-Sea 15.11 m x 6.55 m. The churches with incomplete naves, where

only the width survives measure: St Mary's chapel 8 m minimum; Lyminge 5.48 m; Rochester 8.7 m; Sts Peter & Paul 7.5 m by over 12.5 m long. No dimensions are available for the size of the cathedral nave, because of the limited areas uncovered, but given the proportions, it is estimated that it may have measured 10 m in width. It must be born in mind, however, that widths of over around 8 m were difficult to span because of the problems of finding timbers long enough. Canterbury cathedral and Rochester do show that this was achieved, but any widths beyond these may have been difficult to span, and the use of proportions for comparative sizes may be unreliable.

The height of the nave walls, and details of their windows, have seldom survived, save at Minster-in-Sheppey, St Martins, and Bradwell-on-Sea. At Minster-in-Sheppey the north wall of the nave survives to a height of 11.27 m, with a projecting string course (externally) at a height of 4.88 m above the floor, above which are four original round-headed windows, 0.6 m wide by 1.5 m tall, splaying internally to 1.6 m by at least 2.1 m, and with heads about 6.4 m above the floor. At St Martin's church the walls of the nave survive to a height of 7 m, with two round-headed windows on the west wall, 2.9 m above the floor. Each window originally measures around 0.8 m wide by 1.3 m tall, internally, but the external appearance is not known since they are sealed by the addition of a tower in the 14th century. The bases of the windows are at around 3 m above the floor. At Bradwell-on-Sea the nave walls survive to a height of 7.3 m with five windows surviving. Those on the north and south walls are 0.9 m square, widening to 1.5 m internally, with flat timber heads. Above the west door the window is similar to the others, but with the more usual round head in tile. The bases of the side windows are around 3.8 m above the floor. Comparing the three buildings the walls survive to varying degrees, and some may have been reduced in height during later re-building. The level of the windows is, however, considered particularly important, and these again vary considerably. Heights from the floor are 2.9 m (St Martin), 3.8 m (Bradwell-on-Sea), and 4.88 m (Minster-in-Sheppey). This implies a considerable variation in the overall height of the churches. The low level of the windows at St Martin's church may have been planned to fit with the proportions of the re-used Roman mausoleum as a chancel, rather than employing a tall nave that would have dwarfed the old structure. Alternatively, since both Minster-in-Sheppey and Bradwell-on-Sea were taller and longer than St Martin's, this may be a result of proportional layout, with the emphasis on a tall nave in relation to

its length.

Chancel arches survived (partially) at only three of the churches (Reculver, Bradwell-on-Sea, and St Pancras). At Reculver the triple chancel-arch, drawn before its demolition in 1805, and published by Taylor & Taylor (1965, fig 248) had three openings, the two side ones narrower and slightly shorter than the central. The height of the arch was 4.5 m, on tapering columns 3.7 m tall. The columns have been studied in detail by Tom Blagg who considers them to be of the same date as the church, not re-used Roman columns (Blagg 1981, fig 7; Tweddle 1995, 46-61). At Bradwell-on-Sea there is some controversy about the chancel-arch. Taylor considered it to have had a triple opening, with arches around 5.8 m above the floor. Fernie has followed the same interpretation, but was criticised by Rodwell who states that there is little doubt that there were only two arches. However, if only two arches had existed this would have made it difficult to site an altar at the east end of the nave in the proposed plan, unless the altar was set away from the central column. Furthermore, if the chancel had had a double arch this would have necessitated a central column on the axis of the church - a most unlikely probability.

The next important element of the church, perhaps indicating the status and function of the church, is the porticus. Four of the churches had porticus surviving (Sts Peter & Paul; St Pancras, probably added in the mid-late 8th century; Reculver; and Bradwell-on-Sea). The original porticus at Reculver, it has been established above, were set at the east end of the nave, with eastern doorways (externally) and doorways into the chancel, and are interpreted as sacristies. The remaining porticus at Reculver were added in the 8th century. At Sts Peter & Paul three porticus survived to north and south of the nave, all of one phase (confirmed by the author during detailed recording in 1995). The central section of porticus, with central doorways from the nave, held the tombs of five archbishops (in the north porticus), and King Æthelberht, Queen Bertha, and chaplain Liudhard (in the south porticus). Two altars lay in the north porticus, one against the east wall, the other at the head of Augustine's tomb, whilst the altar in the south porticus lay against the east wall. A further burial is known in the western porticus. The eastern porticus did not survive later re-building. The Bradwell-on-Sea porticus had been largely destroyed. All that can be said of them is that the doorway from the north porticus entered into the chancel, whilst the doorway from the south porticus entered into the east end of the nave, interpreted as the area of the sanctuary. They may thus have performed different

functions in the liturgy of the church, but perhaps still both remain sacristies. The St Pancras porticus, being 8th century additions will not be discussed in detail here, save to note that the south doorway from the second phase porticus entered the chapel east of the chancel arch. A parallel on the Continent of burials in porticus is at the church of St Laurent in Lyon, France (Colvin 1991, fig 114). Here, the north (colonnaded) porticus had many burials added soon after the church was built in the late 6th century, so that by the end of the 7th century the porticus was full of tombs, and the burials had spread over most of the north aisle.

Further discussion of side chambers on the church of St Martin, Utrecht, and their possible function and parallels between Anglo-Saxon and Frankish traditions, have been discussed by Rijntjes (1996). He concluded that one should not try to compare function (and possible names) of such rooms, between the Roman and Byzantine liturgical requirements. Cherry, however, discussed porticus in just these terms, suggesting that one porticus was a vestry (*diconicon*) with access from the chancel, and the other for making offerings (*prothesis*) with access from the nave (Cherry 1976, 163). Smith argued further that the small flanking rooms were not *pastophoria* (comprising a *prothesis* and a *diaconicon*), and that we should not impose such terms on our churches since they imply explicit functions relating to the liturgy of the church (Smith 1990, 181). It is perhaps best if we discuss the possible functions of the eastern porticus flanking the apse without giving them names relating to early North Syrian or later Byzantine architecture. The function of the porticus in the study group varies widely. The east porticus, where they survived, were not related to burial, this was evidently retained for the central north and south porticus (as at Sts Peter & Paul). The incomplete plans of the eastern porticus make general comments difficult. However, where the porticus have doorways providing access into the sanctuary area, these may have been used as vestries, and for the preparation of the Eucharist. External doorways do not imply lay access to the eastern porticus, especially where the only other doorway leads into the sanctuary.

Only at Reculver is the site of an altar known from excavation. At Sts Peter & Paul the north porticus and south central porticus held altars (as noted above, and recorded by early writers). It is envisaged that the principal altar would have been situated at the east end of the nave, with the celebrant facing the laity westward across the altar. A later altar was added in the porticus south of the nave at St Pancras, again thought to have been

added in the 8th century.

Regarding doorways leading north and south from the chancel, it is important to note that an earlier doorway, contemporary with the first phase of St Pancras chapel, was recorded in the south wall of the chancel. This is interpreted by the author as an exterior doorway providing the clergy with access to the chancel, similar to the doorways at Bradwell-on-Sea (north side), Lyminge (north side), Reculver (north and south sides), and St Martin's (south side). Both the St Pancras and St Martin's examples were not associated with porticus.

Narthexes were recorded at three churches (the cathedral, Sts Peter & Paul, and St Pancras). The *narthex* at the cathedral was only partly uncovered but sufficient to postulate that it probably extended to form an area a third of the width of the nave. At Sts Peter & Paul the *narthex* was probably the full width of the nave, certainly not narrower. Both are thought to have been *exo-narthex*, having a roofline lower than that of the nave, rather than the full height of the nave continued west to form an *eso-narthex*. The *narthex* at St Pancras was added later. It is obvious from the near complete church plans of Sts Peter & Paul and Reculver, that porticus and *narthex* were not standard features, rather they were built as and when required to perform a particular function. The eastern porticus appear to have been used as sacristies. Where required, the western and central porticus were for burial (as at Sts Peter & Paul). They would not have been necessary, at least in the early stages of the other churches (as shown by Reculver and St Pancras). *Narthex* appear also to have been added only when required, rather than as a standard fitting. At both the cathedral and St Peter & Paul the volume of people using the churches may have been greater and required this extra space.

Fernie has argued that the plan of these churches was remarkably standard (Fernie 1983, 40-1), but the present author finds this too simplistic. We have established above that considerable variation of the plan occurs, depending upon the status and function of the church. The basic plan of nave, sanctuary, and chancel is standard, but the size of the church, location and number of porticus, *narthex*, and subsidiary altars, vary considerably providing sufficient variation in the plan to be important indicators of status.

Development of the church complex

A marked difference has been established between the development of the two main complexes - the cathedral church and St Augustine's abbey.

Although two churches are known to have been built on the cathedral site; the cathedral church itself (*c.* 597), and the baptistry of St John to the east (740-60), the cathedral saw major re-building of Augustine's original church in the early 9th century, rather than piecemeal development (although it must be said that nothing is known of the development of the east end of the cathedral). This re-building had retained in its core the foundations of the early structure, but to all outward appearances the cathedral was a totally new building, expanded considerably to the west and perhaps also the east, and much wider than the original church. This was no chance preservation, but the careful fossilisation of the outline of the original nave in the foundations of the tower of the rebuilt church. The reason for the retention of Augustine's foundations is clear. Being the primary cathedral of the Gregorian mission to England, the church had gained the status of a 'relic' in its own right, and the clergy doubtless wished to perpetuate, as closely as possible, the site of the original altar. In the final phase of the cathedral there appears to have been a substantial church, with major apsed west end, and a separate baptistry, built around 740-60 to the east. The latter may, however, have been linked to the main church by covered walkways, thereby unifying the complex.

By way of contrast to the major re-building of the cathedral, the church of Sts Peter & Paul saw piecemeal development. Additions were made to the west of the church and the north porticus expanded, but the main body of the nave maintained its original width, being added to at intervals rather than being totally re-built. Before the mid 11th century the complex comprised three churches/chapels on one alignment, all closely spaced, comprising a western chapel, the church of Sts Peter & Paul, and the chapel of St Mary. Further east was the chapel of St Pancras, perhaps best considered out of the main complex for this discussion. It was not until the mid 11th century, with the construction of Wulfric's octagon, that two of the churches were linked in an attempt to create a unified structure.

The development of St Augustine's abbey complex is similar to the development of other Anglo-Saxon churches that comprised a 'family of churches'. For a parallel to this type of piecemeal development of the site, with a family of churches laid out in a

'string,' Glastonbury abbey offers a site with a build-up over several phases (Radford 1981; Rodwell 1984, fig 10; Rahtz 1993, fig 53), whilst Wells cathedral offers a comparative site with a string of churches (Rodwell 1984, figs 5, 6, and 9). The 'linear family' is discussed by Rodwell who provides plans of the topographical layout of Glastonbury, Wells and St Augustine's, Canterbury (Rodwell 1984, fig 9, 15-21). Taylor noted the arrangement of churches in a family was common in monastic complexes in Ireland and on the Continent (Taylor 1969c, 197). Winchester Old Minster is an example of additions to an existing structure, (Biddle 1986, fig 12; Kjolbye-Biddle 1993, fig 2.3), as is St Oswald's priory in Gloucester (Heighway and Bryant 1986, fig 129). Neither of these two comprised a family of churches, but at both sites individual liturgical structures were later linked (church, and crypt at Gloucester; church, tomb, and tower at Winchester).

At Glastonbury the plan is complex and imperfectly understood, being reconstructed from slight traces of foundations (Fig 31). The early church at Glastonbury was the *Vetusta Ecclesia*, an early church dedicated to St Mary, possibly built of timber, which survived until a fire of 1184, but now sadly destroyed by later building. This is of uncertain date, but was perhaps a 7th century structure. From the late 7th/early 8th century a four-cell church (dedicated to Sts Peter & Paul) is interpreted from the excavated remains east of the *Vetusta Ecclesia*, and with a small masonry burial crypt further east still. The church is not dissimilar to the plan of the 7th and 8th century churches of Kent. Later in the 8th century (c. 760) an atrium is thought to have linked the churches of Sts Peter & Paul and *Vetusta Ecclesia*, and the west and east end remodelled - the west end having porticus added. The final Anglo-Saxon phase was the extensive rebuilding of the east end, by Abbot Dunstan c. 1000, including the addition of two eastern porticus, and a gate-chapel to the west of the complex.

Wells has produced evidence of the cathedral church of St Andrew, with its eastern apse, and the late Anglo-Saxon chapel of St Mary built immediately to the east, incorporating the remains of a middle Anglo-Saxon burial chamber, probably on the site of a Roman mausoleum (Fig 32). A holy well lies 50 m to the east (Rodwell 1984, fig 6).

At Winchester the Old Minster developed gradually between c. 648 and c. 993-4, and with the New Minster being built alongside c. 901-3, but not demolished until 1093-4 (Fig 33). The narrow nave of the Old Minster was retained through five or six phases of

additions incorporating the church of Sts Peter & Paul, the tomb of St Swithin and St Martin's tower. The result was a remarkable church *c.* 73 m in length with no side aisles, but with a multitude of side altars and a substantial westwork.

St Oswald's abbey church at Gloucester, developed in six main phases between *c.* 890 and 1086 (Fig 34). The early church is to a standard plan (a nave, chancel and two side porticus), but with the inclusion of an apsed west end forming a fifth cell. Later phases include a 'freestanding' crypt with chapel above, reconstructed as square in plan, and in subsequent phases linked to the main body of the church.

From the brief overview above it can be seen that St Augustine's abbey complex developed in a similar way to the other Anglo-Saxon churches noted above, with a gradual development, and additions to the original plan, over several centuries. This is in marked contrast to the development of Canterbury's Anglo-Saxon cathedral which, from the evidence of the areas excavated, appears to have undergone major re-building at an early stage in its development. Additions were added, however, but the overriding impression is of the original church having been engulfed in the foundations of the rebuilt cathedral.

Topographical development

The reasons for siting the churches in this study appear self explanatory. Each is considered briefly below producing parallels where necessary in chronological order of their construction.

St Martin's church, just over 0.5 km east of the city, is interpreted as the remains of a late Roman mausoleum, re-used by Queen Bertha for Christian worship (recorded by Bede), and later added to in the 7th century by Augustine. The site lies on St Martin's Hill, close to known early Romano-British cremation cemeteries to the south on the Roman road from Canterbury to the Roman fort at Richborough (Day 1980, fig 7). The choice of this structure for worship, rather than the documented Roman Christian building in Canterbury, may imply that of the structures available, only that to the east of the city was in a safe enough state for regular use, particularly at a time (later 6th century) when the only structures being built were of timber. The continued use of the old Roman element, with a nave added to the west end in the 7th century, is perhaps a statement of Augustine's high regard for its previous Christian use by Queen Bertha. When the king

had been converted, Bede records 'they received great liberty to preach everywhere and to build or restore churches' (Bede *HE*, I.33).

Bede tells us that Canterbury cathedral was sited in the Romano-British city on the site of a Romano-British Christian structure. A choice of site in the city, close to Æthelberht's palace, would have been an ideal location. Here, the church lay in the north-eastern section of the walled city, under the protective wing of Æthelberht, at a time when Augustine was trying to establish the Church in an essentially pagan country.

This part of the Roman city is not known in detail, but there were clearly established Roman streets in the area and the church was built astride one of them, but at a markedly different alignment to the Roman street pattern. This implies that the streets may not have been totally visible, being covered with building rubble from decaying Roman buildings and 'dark earth' that had developed in the city. There were certainly traces of levelled Roman buildings in the area, and below the church, and the land to either side of the Roman street appears to have been considerably lower than in the immediate area of the street where Roman occupation had built up to a considerable depth. The site chosen was, therefore, well drained and prominent, probably being visible from some distance in the walled city. This part of the Roman city was also less densely built-up, as far as one can tell from the limited excavations in the area, with all of the taller Romano-British municipal buildings to the south-west. It would, consequently, have been a relatively simple job to clear space for the site of Æthelberht's palace and the subsequent cathedral complex built in *c.* 597.

The monastic church of Sts Peter & Paul, built soon after the arrival of Augustine in 597, and consecrated no later than 616, lay in the heart of the later Roman inhumation cemetery, on the north side of the Roman road from Canterbury to the Roman fort at Richborough (Day 1980, fig 7). It is clear why the abbey was placed outside the city walls. Since it was intended to use a number of the porticus of the church for the burial of archbishops and the kings of Kent, then by law the church must lay outside the city walls. Late Roman law forbade burial of the dead, whether inhumation or cremation within settlement areas, particularly walled towns, and this was a custom taken over by the pagan Anglo-Saxons (Brooks 1984, 81; Salway 1993, 492; but see below for a 5th century burial in the city). The actual choice of the site, for many there must have been outside the walls, may have been dictated by tradition, being the site of earlier burial.

Other areas outside the city, however, had been used for burial in the Romano-British period, but by placing the abbey of Sts Peter & Paul to the east of the city, just outside Roman Quenin Gate (Day 1980, fig 2) provided easy access between, and in effect linked, the two principal structures of the cathedral and abbey together. It was certainly Augustine's intention that the two institutions maintain close ties, and their siting greatly aided this. Indeed the first abbot at the church was Laurence who accompanied Augustine to England in 597. Many of the duties in the cathedral were shared - the monks of the abbey performing many of the daytime offices to free the secular clergy of the cathedral to undertake their pastoral duties (Brooks 1984, 87-93). It was certainly Bede's impression that the two churches were regarded as one "*Ecclesia Cantuariorum*" (*HE*, preface).

St Pancras church, within the abbey precincts, was interpreted by the late Stuart Rigold as the parish church of the St Augustine's abbey complex (Rigold 1977, 74), although Nicholas Brooks has since recorded that it never gained parochial status, and is perhaps best seen as a cemetery chapel (Brooks 1984, 36), associated with the lay cemetery to the south and east of the abbey.

SECTION 2: THEMATIC DISCUSSIONS

CHAPTER 7: THE WIDER SETTING OF ANGLO-SAXON CANTERBURY

Introduction

This section is intended to place the development of the sites under discussion (Canterbury cathedral, St Augustine's abbey complex and St Martin's church) into an overall chronological framework of the town's development. The task will be undertaken by looking at the results of excavation within and around the city over the last 50 years, with reference to published information on charters, and put forward a framework for the development of the Anglo-Saxon town.

Numerous excavations have been conducted in the city that provide a wealth of information on the Anglo-Saxon period. In June 1942 a German air raid destroyed a large area of the eastern quarter of the city. Between 1948 and 1960 the Canterbury Excavation Committee (CEC) carried out excavations in this area before redevelopment and the laying out of car parks. Professor Frere, directing the CEC located Anglo-Saxon structures below Simon Langton Yard and to the rear of the Marlowe Theatre (Fig 35) (summarised in Blockley *et al* 1995, fig 2, table 3, 346-7). In 1976 the formation of the Canterbury Archaeological Trust (CAT) saw major area excavations being undertaken as areas previously laid out for car parking were redeveloped. These excavations have yielded traces of many Anglo-Saxon structures centred on the Marlowe Car Park north-west of Rose Lane (Fig 35) (Blockley *et al* 1995). The major sites are referred to below as areas MI, MII, MIII, and MIV for the excavations in the Marlowe Car Park, and MT for the Marlowe Theatre site. Since the MI-MIV sites (excavated by the author of this thesis) produced one of the best sequences of Anglo-Saxon structures found in an urban setting, frequent references will be made to the final report on these sites (Blockley *et al* 1995).

Decline of the Roman town

The Roman town occupied an important geographical position close to a navigable section of the river Stour where a safe harbor would have been situated at Fordwich 3 km north-east of the city. It was also sited with good communications by road and was built on the site of an important pre-Roman settlement. The town was constituted a *civitas* capital in the mid-1st century.

The masonry defensive walls of Roman Canterbury enclose an area of around 52.6 ha (130 acres) and were built *c.* 270-90 (Frere *et al* 1982, 19). At this time the river Stour ran along the outside of the north-western perimeter of the Roman town.

The largest body of data from excavations that provides information on Canterbury's Late Roman occupation is from the author's excavations in the Marlowe Car Park area. This central area included part of the public baths and adjacent *portico*, and parts of a number of town houses, shops and streets (detailed further below).

Little is known of other Late Roman buildings elsewhere in the city, although several sites have recorded pits, streets and courtyards etc of Late Roman date. One late timber-framed building was recorded on area R, west of Canterbury Lane (Frere & Stow 1983, 73, fig 24). The excavators noted that the structure was built over the Roman street, and "clearly dates to a period after the breakdown of civic discipline, but does not appear to be of Jutish or Anglo-Saxon date. It is probably to be assigned to around the middle of the fifth century on general grounds, ...". This building was sealed by a layer of dark earth (Frere & Stow 1983, 154, layer 2 in fig 26). The present author feels that the date assigned to this building is too late. Coins of Arcadius were found in one of the timber slots of the building, and also in the dark earth sealing the building (Frere & Stow 1983, 154). These coins (both illegible) date to 395-408, indicating that the building is certainly of later 4th century or early 5th century in date, but not as late as suggested by the excavators. The building would be best placed in the first quarter of the 5th century, but no later.

On the Marlowe Car Park areas a major building programme was undertaken around 300-320. A brick-lined sewer was built down the side of one of the Roman streets and the timber structures fronting onto the street rebuilt. The bath-house underwent major alterations as did the adjacent *protico*. Also during this rebuilding a lane was laid down

over a demolished section of the baths *portico* and a large masonry building with bath wing constructed.

In the early 4th century masonry buildings in areas away from the core of the Roman town were being abandoned and partly dismantled (areas MI and MIV). Overlying this phase were deposits of dark earth dating to the second quarter of the 4th century onwards. This need not represent a total abandonment of the intra-mural settlement, but certainly a drastic reduction of population in some areas (Blockley *et al* 1995, 265-6).

By *c.* 360-70 the public baths in the core of the Roman town (area MII) saw major changes with a number of rooms going out of use, and the area being flooded by layers of silt from a nearby street sewer. Semi-industrial building and possible shop stalls were built inside the baths and its portico soon after the flooding (Blockley *et al* 1995, 188 - 204).

From *c.* 375 to the early 5th century further floors were laid down in the portico, and timber buildings were built on top of the silted up street (area MII). Dating evidence indicates that these structures continued in use into the first quarter of the 5th century and were then sealed by dark earth deposits (Blockley *et al* 1995, 264).

The evidence from the Marlowe Car Park excavations is of a shrinking population in the town, although not necessarily a breakdown of control or of the commercial framework until the late 4th-early 5th century. Certainly wealthy people must have inhabited the town at the end of the 4th and into the 5th century. Evidence comes from a hoard of silver found at Westgate Gardens, two of the pieces being incised with the Chi-Rho monogram, suggesting a Christian community in the vicinity (*J Roman Stud* 53 (1963) 'Roman Britain in 1962', 158, 163, plate XVI).

The possible reduction of population as revealed by the excavations is mirrored in the bronze coinage by a drop in the coins lost in the early 4th century. This compares well with overall trends for English coin losses in the early 4th century (Reece 1972, fig 1; Reece 1973, 230-31, where the distribution of coins according to the length of each phase produced a figure of only 8% of the total coins lost between 294 and 330). Continued occupation to the early 5th century is also reinforced by the coinage found, with hoards being deposited *c.* 395-6 on area MI and *c.* 395-402 on area MIII (Blockley *et al* 1995, 927-30).

Dark earth deposits were frequently noted by the City Engineer, James Pilbrow, in

municipal drainage trenches dug in the 1860s (Pilbrow 1871) and has been encountered frequently since then overlying Late Roman levels on many sites throughout the city (Blockley *et al* 1995, 260-64). Further, its existence is not exclusive to Canterbury, since ubiquitous dark earth seals the final Roman deposits in many of the subsequently re-occupied Late Saxon and Early Medieval towns of Britain and Europe (see for example analysis of dark earth in London by Macphail 1981, 309-31).

The dark earth is assumed to be an anthropogenic deposit since, in Canterbury at least, there would have been insufficient time for such a depth of soil (up to 0.9m on the Marlowe area) to have developed naturally (Blockley *et al* 1995, 260). Certainly dark earth was present on all of the Marlowe Car Park areas MI and MIV as early as the second quarter of the 4th century if not earlier, presumably as a consequence of a shrinkage of population within the Roman town walls. Its implications for variations in land use spatially and temporally are considerable. Analysis of pottery sherds from the deposits has indicated that the dark earth is not a midden-like deposit (Blockley *et al* 1995, 261). At Southwark Harvey Sheldon has argued that the dark earth was imported as a growing medium for market gardening (Sheldon 1978, 40), whilst in London the severe abrasion noted on the pottery from the dark earth was taken as indicative of intensive tillage (Macphail 1981).

The dark earth would certainly appear to represent far more than mere abandonment of the towns of later Roman Britain. The deposit is neither exclusively Anglo-Saxon nor Late Roman. It would appear to represent the changing nature of the town during the Late Roman period rather than a sudden abandonment at the onset of Saxon raiders. Late Roman buildings in the Marlowe Car Park area were being renovated on areas MII, MIII and MT, and a timber building being built on area MII at the same time that dark earth was present on areas MI and MIV (Blockley *et al* 1995, 262).

From the work undertaken so far it would seem that dark earth in Canterbury could have developed to great depth over wide areas in a restricted time span. A combination of the colonisation of weeds, and decay of thatched roofs and timber could have started the development of dark earth, perhaps added to by localised gardens.

In the Marlowe Car Park area large spreads of dark earth have been excavated and this has shown that the deposit is stratified and developed in different areas at different times, as follows:

- Area MI from the second quarter of 4th century
- Area MII from the first quarter of the 5th century
- Area MIII from the first quarter of the 5th century
- Area MIV from the second quarter of the 4th century
- Area MT from the second quarter of the 4th century

Many sites excavated within the city have located dark earth layers. Those published comprise the following sites:

- East side of Canterbury Lane, overlying a Late Roman building possibly of early 5th century date (Frere & Stow 1983, 229 and p. 87ff)
- Bus station, overlying Roman bank behind town wall (Frere & Stow 1983, 137)
- No 44 Watling Street, overlying timber building on street, and yielding late 4th century pottery (Frere *et al* 1987, 121)
- Nos 77-79 Castle Street (CAT Annual Report for 1978-79, 11)
- No 3 Beer Cart Lane (CAT Annual Report for 1979-80, 12)
- No 69a Stour Street (CAT Annual Report for 1981-82, 9)
- Nos 2-3a Marlowe Avenue (CAT Annual Report for 1981-82, 17; Frere *et al* 1987, 127)
- Nos 36-37 Stour Street (CAT Annual Report for 1986-87, 10)
- Adelaide Place (CAT Annual Report for 1986-87, 12; CAT Annual Report for 1994-95, 8)
- No 76 Castle Street (CAT Annual Report for 1988-89, 2)
- Longmarket (poor survival) (CAT Annual Report for 1989-90, 16)
- No 26a Hawks Lane (CAT Annual Report for 1990-91, 7)
- St Georges Clocktower (CAT Annual Report for 1991-92, 2)
- St Mildred's Tannery (CAT Annual Report for 1991-92, 8)
- Canterbury Cathedral (CAT Annual Report for 1992-93, 2; Blockley *et al* 1995, 11-12)
- Diocesan House (CAT Annual Report for 1992-93, 7)

- Hospital Lane (CAT Annual Report for 1994-95 10) .

It is evident from the above list that dark earth was widespread throughout the city, but no sites north-west of the river Stour have yet produced evidence of such deposits. This contrasts with the location of Anglo-Saxon structures (below).

It may seem an anomaly that the Simon Langton Yard site is not included on the list of sites with dark earth, since it is both centrally placed and produced several Anglo-Saxon structures. This site was apparently cleared of Roman stone buildings before the Anglo-Saxon structures were built (Blockley *et al* 1995, 338).

The Anglo-Saxon structures post-dated and cut into the Late Roman dark earth. It is also evident, however, that dark earth continued to build up during the Anglo-Saxon occupation of the area. One particularly well-preserved sequence of dark earth layers had developed, on area MI, in which the sequence of construction of the Anglo-Saxon structures could be established (Blockley *et al* 1995, 280). On the MT site were further layers of dark earth the most recent of which sealed levels containing a gold *tremissis* dated to *c.* 480 and thought to have been deposited after *c.* 490-500 (Blockley *et al* 1995, 264).

After the abandonment of the Roman town in the first quarter of the 5th century the Roman street system became covered with dark earth and rubble from collapsing masonry buildings. Although the town was re-settled in the mid 5th century it may have taken some years before a new street system was established. Certainly the Roman roads leading up to the Roman town were re-used (and indeed run along the same lines today), but the internal street system was totally new, following none of the original Roman streets (Ordnance Survey 1990).

The earliest Roman streets found in the city relate to around the mid 1st century east of the St George's Street Baths (Frere & Stow 1983, 70) and around A.D. 70, north west of the later Roman theatre (Tatton-Brown 1978; Bennett 1981a, 279). These streets were maintained throughout the life of the Roman town and although covered by dark earth deposits from the first quarter of the 5th century on Marlowe Car Park area MII (Blockley *et al* 1995, 264), may have functioned as tracks between the ruinous Roman buildings. Two Anglo-Saxon structures were built over the minor streets on Marlowe Car Park areas MIII and MT, leaving enough space for foot

passage only.

Anglo-Saxon structures

Anglo-Saxon finds have been recorded over extensive areas of Canterbury. Pits and associated finds have been found outside the Roman town walls to the west at Westgate Court Farm and to the east in Christ Church College (Fig 35). Neither of these external sites has produced evidence for buildings to date, although extensive settlements probably lie in each of these areas. Inside the town walls the picture is a different one.

A total of 49 structures dating to between *c.* 450 and *c.* 1050 have been excavated in Canterbury. These are summarised in Table 7. The majority of these were found in the central area of the city around the Marlowe Car Park and Simon Langton Yard (Fig 35). Outliers to these are three structures off Castle Street, five structures in Longmarket, one structure off St Georges Street and one at St Radigund's.

No structures have been found in the north-western part of the city beyond the river Stour, or in the southern part of the city. These areas have seen little large-scale excavation, however, and future work may bring further information to light. Given the spread of occupation located so far there seems little reason to doubt that the interior of the city was extensively inhabited. The picture presented by the structures coincides with the location of dark earth deposits (above).

It will be seen below that the vast majority of buildings excavated to date are sunken featured structures and it is apparent that the larger hall-type buildings that one would expect in a thriving Anglo-Saxon town are missing from the archaeological record. These may well lie in areas of the city not yet evaluated by any large-scale excavations. It must also be noted that such buildings are difficult to detect on sites where later disturbance has destroyed much of the site, making interpretation of postholes difficult.

The earliest datable Anglo-Saxon material in Canterbury comes from a number of pits containing substantial pottery sherds underlying the first structures on area MI. These are thought to date to shortly before *c.* 450 (Blockley *et al* 1995, fig 385, 894-896).

Of the seven early buildings constructed on areas MI, MIV and MT all are sunken

featured structures. The earliest of these is possibly building S30 on MT, dating to shortly before *c.* 450, whilst the remaining six structures (one on area MI and five on area MIV) were built *c.*450 or shortly afterwards. Pottery dating suggests a short-term occupation for this phase with a possible hiatus before the next phase of buildings.

A slightly smaller number of sunken featured structures were built in the second phase of development during the first half of the 6th century (three on area MI, two on area MIII, and one on area MIV).

In the third phase, during the second half of the 6th century, the area occupied by structures appears to have expanded geographically, and examples have been found in various places throughout the city (Fig 35). Within the Marlowe areas an increase in activity is evident in this phase with three structures on MI, two on MII, one on MIII, two on MIV, and one on MT. Notable structures on these sites include one with a complex arrangement of stakeholes in the base (structure 5 on area MI), two re-using parts of Roman buildings (structure 7 on area MI and structure 15 on area MIII), and one with a timber building surrounding the sunken feature (structure 24 on area MIV).

Further expansion contemporary with the third phase of Anglo-Saxon occupation on the Marlowe sites is evident from single examples of similar, sunken featured, structures being excavated elsewhere within the city. At Castle Street part of an Anglo-Saxon structure was found in the Roman temple precinct, built up against one of the walls of the portico (Bennett 1981b, 9). At Stour Street, also in the same temple precinct, there was another Anglo-Saxon structure (Bennett 1981b). At St Radigund's Street, just inside the city walls on the north side of the city, there was a single structure with associated pits built on the junction of two Roman streets (Rady 1987, fig 16, 15).

The next phase of Anglo-Saxon occupation during the first half of the 7th century saw major changes in building forms, with the addition of two earthfast timber buildings to the range of structures in previous phases. The total number of structures excavated in this phase is six; four sunken featured structures on area MIV, and two earthfast buildings on area MI.

Location	450-475/500	500/520-550	550-575/600	600-650	650-675/700	850-1050
Simon Langton Yard	-	-	-	-	6	-
Marlowe Car Park	7	6	9	6	2	3
Castle/Stour Street	-	-	2	-	-	1
St Georges	-	-	1	-	-	-
St Radigunds	-	-	1	-	-	-
Longmarket	-	-	-	-	-	5
Totals	7	6	13	6	8	9

Table 7: Anglo-Saxon structures excavated in Canterbury

A further marked change in the layout of the structures appears to have taken place on the MI site in the second half of the 7th century with the demolition of the earthfast buildings and the construction of a single, well-developed form of sunken featured structure. A single sunken structure was also built on the MIV site. Around 100m to the south-east of the Marlowe complex, on the Simon Langton School Yard site, six sunken featured structures were excavated of a similar date (Blockley *et al* 1995, 336-44) (Fig 35).

A distinct gap in occupation is apparent (from the dating of the pottery) between *c.* 725 and *c.* 850. The dating of the pottery may be imprecise, however, and could be presenting a false picture of the development (see further discussion below). Around 875-900 area MI saw the construction of an earthfast timber building producing ample evidence to interpret the structure as a smithy (Blockley *et al* 1995, 351-54). This building functioned until *c.* 950. The remaining structures in this period were all large sunken featured structures (probably cellars inside timber buildings). On area MIII was a deep clay-lined cellar, with evidence of a timber building surrounding it, in use between *c.* 925-75 (Blockley *et al* 1995, 359-61). On the Slatters Hotel Yard site (adjacent to area MT) part of a similar cellar was excavated which was broadly contemporary with the cellar on area MIII (Blockley *et al* 1995, 365-6). It is evident from the pottery that the area was reorganised around the mid 9th century with the introduction soon afterwards of cellared structures.

Around *c.* 1050-1100 many of the Roman masonry walls and their foundations on

the Marlowe sites were extensively robbed for reuse of stone. The stone robbing started *c.* 1050/1080 and had ceased by *c.* 1100.

The final site on which Anglo-Saxon structures have been located is the Longmarket. Here, in an area situated between the cathedral and the Marlowe sites, were found five buildings provisionally dated to the 9th-10th century (Rady 1991, 16-17). These comprised three sunken features structures and two larger cellar-like buildings. The latter were contemporary and connected by a doorway in the party wall. Loom weights from the backfill of some of the structures again attests spinning and weaving as on the Marlowe sites.

Possible Anglo-Saxon church and graveyard

A number of stray human bones were found in several Anglo-Saxon contexts on the Marlowe excavations (Blockley *et al* 1995, 1261-2) (Table 8). Also found were the disturbed human remains of at least three individuals in the backfill of a robber trench (*c.* 1050/80) to a Roman building on area MI. These are interpreted as the disturbed remains of Anglo-Saxon graves pre-dating the construction of a timber church in the Norman period (below).

Site	context	date	bones present
MT	structure 30	6th century	stillborn child assorted adult bones
MI	dark earth	first half 7th century	clavicle of adult
MI	robber trench	first half 7th century	stillborn child femur of adult
MI	structure 10	second half 7th century	bones of hand
MI	robber trench	<i>c.</i> 1050/80-1100	three disturbed adults foot bones assorted adult bones

Table 8: Summary of human bones from Anglo-Saxon contexts

These finds, save the two stillborn children, are indicative of an established burial ground adjacent to the MI site from at least as early as the first half of the 7th century

(Blockley *et al* 1995, 372-2). These would be Christian rather than pagan burials given the location of the site in the centre of the town. The interpretation placed on these remains is that they represent part of a graveyard associated with a church (probably timber). This interpretation is strengthened by the fact that in the Norman period a timber church was built on area MI with associated burials (see below).

A timber church, with adjacent graves, was built in the Norman period on area MI, perhaps in the early years of the 12th century, after the robbing phase noted above (Blockley *et al* 1995, 375-8). This was later rebuilt in stone. Interestingly an early 12th century date is suggested for this structure by the documentary sources for the timber church of St Mary Bredin. Although this evidence is later than the research topic it does have an important bearing on the overall interpretation of the site so I will briefly set out the evidence. The Norman church was founded by William, son of Hamo, son of Vitalis (who came over with the Conqueror and is depicted on the Bayeux Tapestry) (Urry 1959; Rigold 1960). Both the name 'bredin' (O.E. board) and Christ Church rental 'X2' (c. 1180) (Urry 1967, 213, note 2), which states that the church was of wood '*ecclesia lignea*', and the Christ Church Rental F of c. 1206 which states that it 'used to be made of wood' suggests a mid 12th century wooden church. The earliest stone church was therefore of the late 12th or early 13th century (ie between c. 1180 and 1206). Stuart Rigold has argued that the church may have been founded before c. 1137, "Since much circumstantial evidence suggests that it became almost impossible to found a new parish after some date quite early in the 12th century, ..." (Rigold 1960, 175). This is confirmed by recent studies into the parochial system in an urban setting which indicates that parishes were fully established in early medieval towns by the late 11th and early 12th century. Only in new towns were totally new parishes required and in such cases only small numbers were created, as at Salisbury where three parishes were provided. This compares well with the number of parishes in early medieval towns. For example Norwich had between 23 and 25 churches (within the city walls) by the time of the Conquest (Atherton *et al*, 1996, 66). Canterbury had six churches within the city walls (one in each ward, but not counting those attached to the cathedral), as well as a small church over each of the five city gates (Tatton-Brown 1982, 83).

The documentary confirmation of a church on area MI from the early 12th century

adds weight to the interpretation that the human bones found in the Anglo-Saxon levels on MI perhaps indicate the location nearby of an Anglo-Saxon predecessor. The date of the postulated Anglo-Saxon church remains uncertain, with human bones being found in contexts dating from the first half of the 7th century onwards.

These early finds of human remains are at first sight unusual, since it is often recorded that human burial within the town walls was against the law until the mid 8th century. It was said that only after Archbishop Cuthbert returned from Rome (in 740-41) with papal approval to build his baptistry next to the cathedral that burials were allowed inside the town walls (Brooks 1984, 34-5). Brooks does, however, cast some doubt on this noting that it was probably a story concocted in the post-conquest period (Brooks 1984, 81-2). It is also well established that 7th century Christian burials have been found within the walls at Winchester (Biddle 1975, 303-5).

In conclusion, I feel that the evidence for an Anglo-Saxon church just to the north of the MI site is a distinct possibility from as early as the first half of the 7th century. This would have provided the focal point for much of the occupation in the Marlowe Car Park area.

Other possible Anglo-Saxon settlements nearby

Very few Anglo-Saxon burials have been excavated in the area, but those that have been found lie outside Canterbury's city walls in the area of Roman cemeteries. Little is known of the extra-mural settlements (see Hawkes 1982, fig 30). This figure shows clearly the location of Romano-British burials alongside the principal Roman roads into Canterbury and the location of pagan Anglo-Saxon burials within the Roman cemeteries. The line of the Roman road north of the churches of Sts Peter & Paul and St Pancras to the Queningate is incorrect. This road is known to run to the south of the churches to Burgate (Fig 35).

More recent finds indicate further Anglo-Saxon burials near Westgate Court Farm, just outside Westgate on the south-west side of the city. Here, were found four possible burials (one cremation, two inhumations, and one uncertain). These are datable by pottery to the late 6th or early 7th century, with glass cups, a *sceatta* dated to *c.* 700, and a fine gold pendant of early 7th century date (Frere *et al* 1987, 68-73). A contemporary settlement may be situated nearby, but no traces have been found to

date. This hypothesis has not been put forward before and remains to be confirmed by excavation.

Of the settlements outside the city only excavations at Christ Church College have revealed good evidence. Here, the remains are situated outside the city to the east of the cathedral and immediately north of St Augustine's abbey. The occupation extended over a considerable area (Fig 35). Pits containing pottery dating to *c.* 740-850 were found in excavations east of the medieval cellarer's range (Hicks & Bennett 1995, 2). Further north below the east end of the medieval brewhouse/bakehouse were further remains of pits yielding 8th to 10th century finds (Hicks & Bennett 1995, 3). The pits are interpreted as dividing into two groups. The largest group provides evidence of metalworking waste, principally from iron working, whilst the smaller number of pits yield animal and fish bones, and find indicating domestic occupation (Hicks & Bennett 1995, 4). Clearly these finds represent part of an extensive settlement.

The most recent excavation in Christ Church College, on the site of the old television building just to the north of the medieval brewhouse/bakehouse, discovered the best information for a settlement to date. The site produced a ditch contained finds dating from *c.* 575-700/725, and numerous waste pits containing pottery and other finds dating from the mid 8th to mid-late 9th centuries. Industrial waste recovered includes evidence for both iron smelting and smithing. The site has been interpreted by the excavator, Mark Houlston, who suggests that the pits were arranged to respect boundaries around buildings that did not survive because of later truncation of deposits (Houlston pers comm). He also notes that the finds indicate limited trade, the only evidence being pottery from Ipswich, and that this may indicate that the settlement was established in a service capacity to the nearby abbey of St Augustine's. Because of the industrial nature of the finds from most of the Christ Church College sites, the author postulates that the excavations to date lie in an industrial quarter of an Anglo-Saxon settlement (specialising in iron working), serving the needs of the abbey community from the early 7th century.

The other nearby site producing Anglo-Saxon material is Diocesan House, situated between the Christ Church College sites and the city wall. Here, excavations in 1992 located dark earth deposits containing late 5th- or early 6th-century pottery. Later pits

of middle to late Anglo-Saxon date cut into the dark earth (Hutcheson 1993, 7).

The finds from Christ Church College and Diocesan House perhaps form part of an extensive settlement extending from Queningate (a Roman gate in the city wall east of the cathedral) eastwards towards to the northern area of the abbey complex. Indeed a market is known from a charter in 762, just inside the city walls at Queningate (Brooks 1984, 26).

Interpretation of the intra- and extra- mural settlements

To suggest functions for the Anglo-Saxon structures is difficult, but some interpretations can be put forward based on the finds associated with some of the structures.

Of the 49 structures located to date throughout the city the first three phases of buildings, dating from *c.* 450 to *c.* 575/600, are all sunken featured structures. The first two phases of structures (up to *c.* 520/550) were situated on Marlowe areas MI, MIII, and MT. It is only in the third phase (up to *c.* 575/600) that expansion saw buildings being erected to the north-west in the Roman temple complex, and in the far northern part of the city near St Radigund's Street. Only more extensive, and very careful excavation may reveal the full spread of these structures throughout the city, suffice to note that the early centre of occupation from *c.* 450-520/50 lay just inside the city walls not far from Ridingate.

The sunken featured structures produced evidence of spinning and weaving, and many had hearths in the base of the hollow indicating cooking. Fragments of gold sheet and a gold Tremissis however, also hint at elaborate crafts being practised - perhaps representing the raw material of a goldsmith after *c.* 495-500 on area MT.

This evidence is indicative of a well-established, thriving community before the arrival of Augustine in 597. The few burials that have been recorded of this date were located largely outside the city walls in area of Roman cemeteries. The spread of structures pre-dating the arrival of Augustine comprise three phases of sunken featured structures from the Marlowe Car Park excavations, and four other sunken featured structures: one at St Radigunds, two in Castle Street, and one in St Georges Street. Finds and pits at Christ Church College also indicate occupation commencing shortly before the arrival of Augustine to the east of the city. These tentative

fragments do add up to a fairly extensive spread of occupation starting in the Marlowe Car Park area around 450 and expanding around 550 to other areas of the city.

Only one pagan (mass) burial is known inside the city, at 69A Stour Street, within the Roman temple precinct. This comprised a family group of an adult male and female, two juvenile females and a dog. These had been laid in a deep pit with an organic lining. Found with the skeletons was a large number of late Roman bracelets of bronze, silver, bone and ivory, together with some keys. Other finds, such as some glass beads were interpreted as perhaps Continental imports (Bennett 1981b, 9). The burial has been dated to the early 5th century from the associated finds. Interpretation of the burial in a Late Roman or early Anglo-Saxon context is difficult, given that burials were normally placed outside the city walls. Given that the late Roman phase near the Roman baths continued into the first quarter of the 5th century, and the earliest Anglo-Saxon settlers were in residence by *c.* 450, this indicates that the burial group may date to the intervening period, *c.* 425-450.

The arrival of Augustine is often cited as the impetus for urban growth (Brooks 1984, 23; Tatton-Brown 1982, 82). Even though the evidence presented above is of a thriving community before his arrival. There is no firm evidence, from the archaeological record, that the establishment of Augustine's metropolitan see at Canterbury at the end of the 6th century, gave any immediate boost to the economy of the city.

After this date, equivalent to the fourth phase of Anglo-Saxon occupation on the Marlowe sites, *c.* 600-650, the first earthfast timber buildings were built on MI and the overall number of sunken featured structures was reduced in the Marlowe Car Park areas. This may imply that the main centre of occupation shifted, but in fact the construction of sunken featured structures continued at Simon Langton Yard in the second half of the 7th century (Table 7) and at Longmarket after 850 (Table 7). The long timber building is typical of a hall-type structure, as found on many Anglo-Saxon settlements, whilst the finds from the sunken featured structures indicate that both spinning and weaving were undertaken as in previous phases of occupation.

The postulated timber church and graveyard adjacent to area MI started by the early 7th century might have provided a focal point for the settlement. The Roman street system did not continue through to the Anglo-Saxon period, being buried by the

dark earth deposits in the early 5th century, and a new street plan gradually emerged. The dog-leg in the street system over the site of the Roman theatre was firmly established by *c.* 1200 (Urry 1967, Blockley *et al* 1995, fig 236), and may well extend back beyond that date to the Anglo-Saxon period. Nicholas Brooks has already postulated that the Roman theatre may have been used as a prominent meeting place and seat for Æthelberht's *imperium* (Brooks 1984, 24). A more likely possibility, until further evidence is forthcoming, is that the Roman theatre may have served as one of the major market centres in the city from fairly early in the life of the Anglo-Saxon settlement. The latter is also purely speculative as there is no evidence of this from the archaeological record.

Bede (*HE* II) records a fire that destroyed much of the town sometime between 616 and 624. No evidence of this was found in the excavated structures. The first post-Roman mint in England was established in Canterbury in *c.* 630.

The settlement outside the city walls, between the cathedral and St Augustine's abbey, appears to have started in the early 7th century. Its status, from what has been excavated to date, appears to indicate an industrial area (but with domestic activity nearby), perhaps serving the abbey of Sts Peter & Paul.

Occupation in the next phase, *c.* 650-675/700 is apparently sparse in the Marlowe area, but with several structures being built to the east in Simon Langton Yard. It is interesting to note that all of the structures are sunken featured, with the one on MI being a particularly well developed type. The latter was found with loom weights and other finds indicative of spinning and weaving.

Before the final phase of occupation attested by the excavations is an apparent hiatus between *c.* 725 and *c.* 850. Throughout the city this period sees a marked decline in standards of pottery manufacture (Blockley *et al* 1995, 895). This is thought, however, to have come to an end from *c.* 775 to 800, with a return to growth and the introduction of pottery from East Anglia (Blockley *et al* 1995, 896). The hiatus has been postulated from the pottery evidence from the Marlowe Car Park Excavations, but this may be presenting an incorrect picture of Canterbury's development. Tom Blagg has argued that a hiatus would be out of step with urban revival in western Europe and southern England in particular (Blockley *et al* 1995, 21), and that perhaps the Marlowe sites were peripheral at this time.

This apparent hiatus, as understood from the archaeological record, is unlikely to be a true reflection of the development of the city. The *Anglo Saxon Chronicle* records that the town was burnt down in 756. For such a fire to have taken hold and burn much of the town indicates that the housing must have been reasonably dense. If the housing had been scattered then the fire would have been easier to control through the selective demolition of buildings. A market is recorded just inside the Queningate in a charter of 762 (Brooks 1984, 26). The first mint of Offa's new silver coinage was set up at Canterbury in 766 (Tatton-Brown 1984a, 7). The historical and numismatic evidence suggests continued prosperity and growth. The archaeological record is lacking regarding street frontage sites at this date, but it is likely that a more organised street frontage layout had been established by the 8th century, the structures located to date being situated to the rear of these properties.

The final phase of structures, c. 850-1050, are mainly cellars located over a wide area of Canterbury. These are interpreted as following a similar pattern to the 8th century structures to the rear of street frontage properties. The only structure located that differs was the earthfast building on MI, interpreted as a smithy. Given the danger of fire with timber framed and thatched buildings the location of a smithy well away from the more densely occupied street frontage properties seems logical.

The 9th century development of Canterbury is well known from Nicholas Brooks' discussion of the charter evidence (Brooks 1984, 26-30). Various land transactions relating to estates within the city walls are recorded particularly in the low-lying western quarter where the river breached the city wall. This breach probably took place after the end of the Roman occupation of the city (partly as a result of the post-Roman sea level rise, and presumably also from the lack of maintenance of the river defences/banks). With the river flowing through the city this provided the inhabitants with an easily guarded location for water mills. Ninth century transactions relating to the marshy, western quarter of the city include: six acres of land given in 804 to the monastery at Lyminge as a refuge during Viking raids, and 30 acres given by King Coenwulf to Archbishop Wulfred in 814 (Brooks 1984, 26).

Many parcels of land changed hands during the 9th century, including buildings with land sold in 823, 845, 859, and 868 (Brooks 1984, 27). A charter also records a narrow strip of land, measuring 7ft wide, purchased off a burgage plot. Even though

the plot was only 7ft wide the local byelaw stipulated that at least 2ft of room be left between properties as eavesdrip was maintained (Brooks 1984). The 9th century city was obviously controlled effectively by well-organised civic bodies and guilds (Brooks 1984, 28-30).

A comparative, chronological table has been drawn up to help show the relationship between the Anglo-Saxon churches and settlement evidence in Canterbury (Table 9).

Chronology	450 475 500 525 550 575 600 625 650 675 700 725 750 775 800 825 850 875 900 925 950 975 1000 1025 1050 1075
CHURCHES:	
Cathedral	dark earth [597+ (1)] [803-13 (2A)] [942-58 (2B)] [1023+ (2C)] [1067-] [1075
St John the Baptist	[740-60 (Documentary evidence)
St Peter & Paul	[Early 7th (1A)] [(1B)] [1006-23/7 (2)] [1050 (3)] [1073
St Mary	[616/24] [1050 (3)] [1073
Western Chapel	[1050 (3)] [1073
SW tower	[2nd quarter 7th (1)] [Mid 8th (2)]
St Pancras	[397+ (Roman)] [(Bertha)] [597+ (Anglo-Saxon)]
St Martin	

Chronology	450 475 500 525 550 575 600 625 650 675 700 725 750 775 800 825 850 875 900 925 950 975 1000 1025 1050 1075
CANTERBURY SITES:	
Marlowe Car Park	[----7-----] [----6-----] [----9-----] [----6-----] [----2-----] [----pits and finds-----] [----3-----]
Longmarket	[----1-----] [----6-----] [----5-----]
Westgate Court Farm	[----pits and finds-----]
Christchurch College	[----finds and ditch-----] [----sceatta, finds and pits-----]
St Radigunds	[----1-----] [----6-----]
Simon Langton Yard	[----2-----] [----6-----]
Castle/Stour Street	[----1-----] [----1-----]
St Georges	

Table 9: Chronological table comparing Anglo-Saxon churches and settlement evidence for Canterbury

CHAPTER 8: ANGLO-SAXON MONASTERIES

Introduction

In this section it is intended to present a summary of the published archaeological material relating to excavated Anglo-Saxon monasteries so that a comparative body of data is available to help interpret the development of Canterbury's Anglo-Saxon churches. This is, by design, not an exhaustive account from original site records, but a review of the readily available secondary sources. Sites which are not Anglo-Saxon, such as Tintagel (Celtic) or Iona (Irish) are included in the study which looks broadly at all monasteries between the 6th and mid 11th centuries.

The review considers sites with structural evidence of monastic remains. Sites with only churches (rather than monastic remains) are also not included since British churches have been discussed in Chapters 5 and Continental churches in Chapter 9.

A total of 20 sites have been identified by the author over the Anglo-Saxon period, which are claimed by their excavators to have been part of a monastic complex (Fig 108). These are as follows:

- Abingdon, Berkshire
- Brandon, Suffolk
- Burgh Castle, Suffolk
- Canterbury cathedral, Kent (Chapters 3-5)
- Canterbury, St Augustines, Kent (Chapters 3-5)
- Eynsham abbey, Oxfordshire
- Flixborough, Lincolnshire
- Glastonbury abbey, Somerset
- Glastonbury Tor, Somerset
- Hartlepool, Cleveland
- Hoddum minster, Dumfries
- Iona abbey, Argyll
- Jarrow, co. Durham

- Lindisfarne, co. Durham
- Monkwearmouth, co. Durham
- Tintagel, Cornwall
- Tynemouth, co. Durham
- Whitby, Yorkshire
- Whithorn, Wigtownshire
- Winchester, Hampshire

The sites above were chosen after reference to Rosemary Cramp's review of monastic sites (Cramp 1976, 201-52), a trawl through the national journals, and finally updated after discussion with specialists in the field. Details of the two Canterbury sites are not repeated here, because of their detailed presentation in Chapters 3 and 5.

The material available for study varies enormously. Some of the sites were excavated many decades ago and the quality of the site records and reports leave much to be desired, others are awaiting final publication, and a few are recent sites with little or no published accounts to date. The material also covers many diverse elements of monastic sites. For example, we have the extensive excavation of the monasteries at Jarrow and Monkwearmouth; a partially known church plan at Glastonbury abbey; part of a "monastic town" at Whithorn; and sites with buildings but neither a church nor burials as at Hartlepool, Tintagel, and Tynemouth.

Each of the sites will be reviewed in turn (omitting Canterbury's sites), providing a plan of the excavated remains, summary of the published results, a brief summary of the historical and written sources, and an initial reinterpretation wherever possible. In particular I will try to establish if any of the sites are likely not to be monastic. In many cases this will be obvious, particularly where good historical/written sources are known or the remains of an abbey or other diagnostic ancillary building have been found. In other instances, however, the monastic nature of the site it will not be so clear-cut. For example, in the case of a possible early monastic site where a recognisable plan would not have been established, or where the remains are peripheral to the core of the monastery. The following criteria have been used to access this latter group:

- The survival of reliable historical/written sources for the site
- Finds of a particularly monastic/ecclesiastical nature (eg stylii, etc)
- Buildings forms that may represent a specific type of monastic dwelling (eg cells, etc)

To identify a site as monastic I have required at least two of the above criterion to be present for a site. The finds category is perhaps the most difficult to use to determine the function of a site. A combination of the above should, in most cases, provide sufficient grounds to judge the function of the site.

The sites are presented below in alphabetical order. The concluding part of this section will aim to present a short discussion of the various site types.

Abingdon

Patchy and incomplete foundations of the Anglo-Saxon church were excavated by the Berkshire Archaeological Society in 1922 under the direction of Charles Peers and Alfred Clapham. No report was ever published save a brief note in *Antiquaries Journal* 2 (1922) 386-8, but Martin Biddle has summarised the site from the excavators' notes (Biddle *et al* 1968, 60-7). Gabrielle Lambrick also presented a summary of the documentary sources (Biddle *et al* 1968, 26-34, 42-59).

Historical and written

Three main manuscripts are known collectively as *Chronicon Monasterii de Abingdon* (Cotton MSS, Claudius C ix, Claudius B vi, and Vitellius A xiii (p. 68, Appendix II, nos 2-4). These provide accounts of the area around St Helen's Church and the present abbey site (over 400 m apart) representing perhaps part of a double monastery with the nunnery at St Helens.

Of the abbey site the documents describe the first Anglo-Saxon monastery founded at Abingdon by Hean *c.* 675. Gabrielle Lambrick considers that the documents are unreliable historically and misleading (Biddle *et al* 1968, 42-3). They provide details of the layout of the monastery with its double apse (Vitellius A xiii). A refectory is mentioned twice as are burials. Also noted is a wall surrounding the site, rather than a cloister walk, with regular gaps between it and the monk's living

quarters. The documents agree that by the mid 10th century the community of the early Anglo-Saxon monastery had abandoned the church and the fabric was in a poor state. Æthelwold arrived at Abingdon about 954 and built a new church. This may have had a rounded or circular eastern end – “rotundus” but this is not clear. The abbey church had, by 977, a porticus on the north side, and porticus “on the east” by the late 11th century.

It can be seen from the above that although some details of architectural significance are recorded in the documents, Gabrielle Lambrick finds them potentially misleading when interpreting the layout of the monastery (Biddle *et al* 1968, 42-3). Rosemary Cramp, however, feels that the manuscripts, although somewhat distorted and selective in detail, may well be describing Hean’s abbey (Cramp 1976, 216).

The excavated remains (Fig 36)

Fragments of six unconnected areas of substantial foundations were recorded below the Norman church (Biddle *et al* 1968, fig 12, 62-65). These were tentatively interpreted as possibly representing one main phase of the pre-Conquest church, perhaps parts of an eastern apse (1.37 m wide), the north and south walls of the nave and the western end of the nave (1 m wide). The relationship with the overlying Norman church shows that the early foundations are certainly Anglo-Saxon in date.

The church measured at least 61 m long and 17.38 m wide. No firm dating evidence was found, although Martin Biddle suggested tentatively that the church might be of 9th century date, given the parallel at Cirencester (Gem 1993, fig 5; Fig 17).

Burials found in the cloister-garth were noted in more than one layer and this was thought to be too dense for the restricted use of a burial ground in a Benedictine monastery. Also recorded were burials under the cloister walls and adjacent buildings. Many of the burials were, therefore, thought to have been Anglo-Saxon. No conventual buildings were found and these were thought to have lain south of the Norman cloister and beyond, perhaps on the site of the 7th century monastery.

Interpretation

The excavated remains are certainly Anglo-Saxon, although no internal dating evidence is available to refine this. The foundations may well represent more than one building. The size of the foundations, however, are more indicative of a later Anglo-Saxon structure, dating to no earlier than the 9th century. Clearly defined are the presbytery with its apse and a substantial nave.

The main point of the documentary sources, relating to a rebuilding in the mid 10th century, can be seen as reliable. Given the documented rebuilding it is possible that the pre-Conquest foundations located may be that of Æthelwold's rebuilding of the abbey around 954.

Brandon

Excavations started at Staunch Meadow, Brandon in 1979 revealing a small medieval chapel within a 70 m by 40 m enclosure. Further work between 1980 and 1982 saw large areas recorded as rescue excavations, which were ongoing at the time of writing in 1988 (Carr *et al* 1988).

Historical and written

No documentary sources have been studied to date for this site. As far as is possible to determine from the published summary note this site was considered to be monastic because of the type and quality of the finds recovered (Carr *et al* 1988, 374)

The excavated remains (Fig 37)

Up to 25 timber buildings have been excavated revealing a church with associated graveyard, industrial area, and occupation areas. No final publication has been prepared and only a brief summary has been published.

One of the buildings has been identified as a church only by its association with burials. It is, otherwise, a form common to Anglo-Saxon sites and does not suggest a church on its own.

The church was a three-cell timber building with a total length of 24.5 m (Carr *et al* 1988, 374). The main structural elements of the building were planks set into trenches. The central nave cell measured *c.* 14 m by 6.5 m and had opposed central

doorways, whilst a doorway in the east wall gave access to the eastern cell or chancel (c. 5 m by 4.3 m) which probably contained a single burial. The chancel had a small doorway on the south side. The western cell is thought to be a later addition. The summary notes that the three main doorways were substantial with a trench across the threshold, indicating prefabricated doorframes. These are thought to have been necessary for impressive doors to be hung. The report noted evidence (although it does not say in what form) for an insubstantial structure at the eastern end of the nave, interpreted as the site of an altar.

This church went out of use during the life of the settlement, and is thought to have been moved further north in the settlement adjacent to a second cemetery (although the building had not been located at the time of writing) (Carr *et al* 1988).

The cemetery south of the church was totally excavated and produced at least 220 inhumations, of mixed age and sex. The second cemetery to the north, interpreted as a second phase of burial in the settlement, was only partly excavated revealing 30 inhumations and a small mortuary structure (represented by a clay pad measuring 2 m by 3.5 m).

The finds from the site are reported as being exceptional, comprising mainly Ipswich ware, glass vessels, window glass, a large number of bronze pins, bone implements, styli, a Coptic bowl, decorated metalwork in silver and gold, Tating Ware vessels, and a gold plaque of St John the Evangelist.

Dating of the excavated remains falls broadly between 600 and 900. The excavators interpret the site as having been deserted in the last quarter of the 9th century, with the settlement then shifting south to the adjacent river bank.

The settlement appears to have been divided into two main parts. The northern area was characterised by a network of large enclosure ditches, a dense level of occupation, and small buildings. By contrast the southern area comprised groups of larger buildings with fewer ditches. Between the two areas was an east-west ditch with a formal entrance, across which stood the church and cemetery (Carr *et al* 1988, 377). The authors also suggested that the finds and structures are indicative of a monastic community, with the closest parallel for similar finds being the Whitby abbey excavations.

Interpretation

Until the site is published and more details are available little can be added to the brief summary of the site above. The layout of the buildings is no different to many Anglo-Saxon settlements with associated church and graveyard, and the finds could easily be those associated with a church rather than a monastery. I see no justification to identify this site as monastic.

Burgh Castle

This site is situated inside a Roman fort extending over nearly 2.5 ha. Limited excavations were conducted by Charles Green in 1960-61 following the discovery, during ploughing, of Anglo-Saxon plaster and skeletons in 1957-8. Since Charles Green died in 1972 no report was published of his findings save brief notes in *Medieval Archaeology* 3 (1959) 299; 5 (1960) 319; 6-7 (1962-3) 311). The only published work is a summary prepared by Rosemary Cramp from the excavator's site notes (Cramp 1976, 212-15). The finds were not assessed at this stage and await publication.

Historical and written sources

Bede recorded that Fursa came from Ireland (*HE* III.19) after 630. After some time he received from Sigeberht, the East Anglian king, a site for a monastery "pleasantly situated close to the woods and the sea, in a Roman camp which was in England called Cnobheresburgh". His successor, King Anna and his nobles, endowed it with still finer buildings and gifts. No records survive to indicate that the site survived after the 8th century (Cramp 1976, 212).

The excavated remains (Figs 38-39)

Two main areas of Anglo-Saxon features were recorded. In the north-east corner of the Roman fort was an area of "huts". Rosemary Cramp reported on the layers in the area of the huts (Cramp 1976, 214). These comprised a Roman floor lying on the natural sand, overlain by a destruction layer, in turn sealed by a layer of sandy clay (possibly a floor) which was cut by postholes and associated with a spread of fish waste (mainly oysters). Above this level was "a smooth brown layer" into which the

hut footings were cut. The layer sealed a pit containing a fragment of Ipswich ware, “above which was a layer of dark earth associated with later Anglo-Saxon material”. Professor Cramp notes that she is uncertain from the evidence seen whether the layer accumulated after the occupation of the huts.

The huts were stratigraphically of two phases, with hut 4 earlier than Hut 5 and Hut 3 earlier than Hut 1. The structures varied in internal dimensions as follows:

- Hut 2 was 4.26 m by 3.0 m
- Hut 3 was 5.48 m by 3.0 m
- Hut 4 was 7.3 m by 4.26 m
- Hut 5 was 6.1 m by 3.0 m
- Hut 7 was 7.3 m by 4.26 m

The huts appear to have had rammed earth floors, and Hut 5 was cut to a depth of nearly 0.3 m. Although the huts had slots around their perimeter and flint packing stones on either side, no postholes were recorded. The interpretation provided by the excavator was of “wattle-and-daub bee-hives” (Cramp 1976, 214).

The following finds are noted by Rosemary Cramp: Hut 2 antler tines, a spindle whorl and a bronze key; Hut 5 fragments of slag, and several iron objects indicating a probable smithy. The postholes north-east of the huts were associated with a floor level and a large quantity of “roughly painted plaster”. Charles Green has interpreted these as indicating a church, but Rosemary Cramp suggests that they could have been part of a public building in the monastery, for example the refectory. Professor Cramp interpreted the huts as either oval cells or workshops.

In the south-west angle of the Roman fort was recorded at least 144 inhumations and a number of charnel pits. The southern limits of the graveyard were found, but the excavator thought that the full extent in other directions was not established. He interpreted the area south of the graves as being the site of a church, but no further information was supplied to back up this interpretation (Cramp 1976, 212).

A glass kiln is shown on the published plan (Fig 38) but this is not discussed by Professor Cramp.

Interpretation

Little can be re-interpreted from the account presented by Rosemary Cramp, given that she alone has had access to the excavator's notes. The written sources tally well with the location of the site and there is no reason to doubt Bede's account. If the site of the church, south of the cemetery is accepted then Charles Green may have located the site of Fursa's church. Although the excavated material is a little lacking in detail, I see no reason why this site should not be monastic, with a potential church site adjacent to the graveyard, and bee-hive-like structures to the north-east.

Given the spread of Anglo-Saxon material in two areas of the Roman fort, it is likely that the monastic enclosure completely filled the interior of the Roman fort. Given the lack of restrictions of space the monastic settlement may have included a workshop area, perhaps indicated by the huts in the north-east corner of the fort, and comprising at least a smithy and possible antler workshop/weaving shed.

Eynsham abbey

The monastic site at Eynsham, Oxfordshire was excavated by the Oxford Archaeological Unit between 1989 and 1992. This work followed trial excavations in the 1960s and 1970s (Gray & Clayton 1978). Several phases of occupation were recorded, four of which were Anglo-Saxon in date. Although the site is as yet unpublished (a draft report is with English Heritage at the moment) three interim publications have been prepared by the excavator Graham Keevill (Keevill 1992; 1993; 1995), and a note published in *Medieval Archaeol* 35 (1991) 180-83.

Historical and written sources

The minster church is first documented in 864, but is thought to have been in existence by the 7th century (Blair 1987, 87-93). The abbey was founded in 1005. King Æthelred II granted Æthelmar, one of his elder statesmen, permission to establish a Benedictine house. Its first abbot was Ælfric, a leading theologian of the day (Acevedo 1992). For the charter evidence of the 9th century minster see Sawyer (1968) and Birch (1887), and for the 1005 foundation of the abbey see Slater (1907).

The excavated remains (Fig 40)

Prehistoric activity dating to the Bronze Age underlay the monastery. The earliest Anglo-Saxon features were of early Anglo-Saxon date, when at least 5 sunken-featured structures were built (Keevill 1992, 196). Post-built halls replaced the early structures in the 8th century, one of which measured 14 m by 6 m and was associated with a pit containing two *sceattas*, dated *c.* 720. One of the halls was enclosed by gullies indicating property divisions aligned on the main axis of the Bronze Age enclosure. The mid-late Anglo-Saxon features are thought to have been a “minster” phase (the term is not defined). These structures continued in use to 1005 when the abbey was founded.

The first phase of the possible abbey structures comprised three ranges of domestic buildings surrounding a courtyard. The southern range was a hall measuring 22 m by 8m with other buildings extending north and east of it with three mortar mixers in a small courtyard. A further, larger courtyard lay to the east of this complex (Keevill 1992, 196).

Finds noted in the 1992 report include an ivory casket, an ivory figurine from a crucifixion scene (perhaps St John the Evangelist). The latter is incomplete and possibly from an abbey workshop (Keevill 1992, 1960).

Interpretation

The mid-late Anglo-Saxon “minster” phase is attested by written sources at least as early as 864. No specifically monastic buildings or finds, however, were located in the excavations during this phase of the site. It cannot, therefore, be classed as monastic at this time.

There is no evidence to link the excavated structures with the early 11th century abbey, and the excavator is of the opinion that the structures are domestic in nature (Keevill 1992, 196). It is possible, therefore, that the courtyard located may have been on the fringes of the monastery.

No further interpretations can be suggested given the lack of information seen so far, and the brief nature of the reports.

Flixborough

The site at Flixborough is that of an Anglo-Saxon settlement with a possible monastic phase. Remains were first located in 1933 by Derrick Riley but thought, from the pottery, to be Romano-British (Loveluck, pers comm). Evaluation excavations have been conducted in 1988 by Kevin Leahy (Scunthorpe Museum) locating inhumations (Leahy 1999), and in 1989 by the Humber Archaeology Unit. The latter work resulted in a two-year excavation followed in 1994/95 by further evaluation work. A number of interim reports have been published (for example *Current Archaeology* 126 (1991) 244-47; *Antiquity* 72 (1998) 146-61). The remains date from the Neolithic to the 14th century.

The final report on the excavations is currently being prepared by Chris Loveluck who has supplied me with unpublished background information and summary notes of the site (as of 26 October 1998). The summary below has been prepared from those notes and after further correspondence with Chris Loveluck. Text in quotation marks is taken from the October 1998 text. Chris Loveluck has advised me that Ben Whitwell's article in *Current Archaeology* is "extremely out of date and in many cases wrong".

Historical and written sources

No historical or written sources are known for the site, and the interpretation of a monastic phase in the mid 8th-mid 9th century has been established only from a study of the finds (details below).

The excavated remains (Fig 41)

Excavation of an extensive area (75 m by 55 m) has been undertaken revealing that the Anglo-Saxon settlement spans the period of 7th century to 1050.

An interim article on the site (*Current Archaeology* 126 (1991) 244-47) has reported that the site may have been "founded by St Etheldreda, also called St Audrey, the daughter of King Anna of Essex, who passed through the district in about AD 670 whilst fleeing from her husband". No direct evidence is presented to indicate that the Flixborough site was related to any neighbouring monastery.

The sequence established by Chris Loveluck has been divided as follows: "five

major phases reflecting a complex evolution from a Middle Saxon secular high-status estate centre of the late 7th-early 8th century, to a monastic settlement between the mid 8th-mid 9th centuries, and finally a Late Saxon/Anglo-Scandinavian secular high-status centre – a nascent ‘manor’ – between the 10th and 11th centuries”.

In the postulated monastic phase (phase 3b in the site phasing), the settlement comprised seven timber buildings (occupying similar areas to earlier Anglo-Saxon phases on the site), a large ditch, yard deposits, and dump/demolition deposits (Fig 41).

The artefacts recovered from this phase comprise large quantities of animal bones, and finds some of which make their first appearance on site in this phase. This latter category comprise styli, Ipswich ware pottery. Craft activities include textile manufacture, ironworking, and non-ferrous metalworking. Environmental remains recovered from this phase reflect a “radically different” proportion of domestic remains. These comprised cattle, sheep and pigs, where the cattle “massively outweigh sheep and pigs in the exploitation pattern”. The exploitation of wild fowl starts to increase relative to domestic fowl.

Chris Loveluck’s most recent idea on the possible monastic phase (22 June 1999) are as follows: “Phases 3b-4ii- possible family monastery – or continuing aristocratic centre with a literate element ...”.

In a recent article discussing the site at Flixborough, the styli are mentioned as being particularly significant indicators of literacy and site status (Leahy 1999, 92-4). Kevin Leahy notes that twenty-seven styli have been found at Flixborough, six at Whitby, and two at Jarrow. He goes on to say that the large number of styli at Flixborough “suggests that the site was a monastery, or at least had a strong clerical presence” (Leahy 1999, 93).

Interpretation

The interpretation of the Anglo-Saxon settlement at Flixborough is very similar to the site at Brandon, both have extensive structural remains, and are clearly high-status sites with evidence of literacy.

I would feel that insufficient evidence has been presented, so far, to indicate a monastic phase of occupation at Flixborough.

Glastonbury abbey

This site has seen a considerable number of excavation campaigns between 1904 and 1979. Firstly St John Hope undertook the excavation of ten small-scale trenches in 1904. In 1907 the abbey was sold and a series of larger-scale excavations undertaken. Philip Rahtz records that 34 seasons of excavations took place between 1908 and 1979 and published a plan of the areas (Rahtz 1993, fig 42). Much of the work remains unpublished.

Francis Bond undertook excavations between 1908 and 1922, but was dismissed from the job after his written work took on a mystic approach. Between 1951 and 1963 Raleigh Radford undertook further excavations. The final campaign was directed by Bill Wedlake in 1978 and 1979. No published account of the 1970s work has ever appeared in print. Philip Rahtz has summarised the results of the excavations (Rahtz 1993). This publication forms the basis of this summary, with additional information from Rosemary Cramp and Raleigh Radford (Cramp 1976; Radford 1981).

Historical and written sources

Professor Cramp has summarised the historical sources and reported that although the pre-Conquest sources are copious they are largely suspect (Cramp 1976, 241-2). Great claims have been laid for the foundation of the monastery by the Irish church, but these need not have been founded earlier than the 7th century. Sources comprise: William of Malmesbury, *Gesta Pontificum* (Hamilton 1870, 197-8); Adam of Domerham, *Historia de Rebus Glastoniensis* (Hearne 1727, 49); William of Malmesbury, *Vita Sancti Dunstani* (Stubbs 1874, 271),

The land of the abbey came into English hands when king Cenwalh gave two hides at Meare to the Anglo-Saxon bishop Beorhtwald in 670 (*Historia de Rebus Glastoniensis*). After the division of the Wessex see in 705 Aldhelm of Sherborne influenced king Ina to build a church at Glastonbury (this is the first phase church discussed above) (*Gesta Pontificum*). The second phase church has been dated to around 760 by Raleigh Radford who reported: "An appropriate date for the addition of the atrium, and for phase 2 as a whole, is indicated by the record that Abbot Tica,

who died about 760, ‘obtained for himself a notable tomb in the right corner of the great church, over against the entry into the Old Church [*vetusta ecclesia*]’. The position *indicated* is near the south-west angle of the atrium” (Radford 1981, 118). Around 940 king Edmund appointed Dunstan as abbot of Glastonbury. The third phase of expansion of the abbey church is attributed to him. From c. 943 to 956 Dunstan restored Glastonbury. His biographer mentions that he enlarged Ina’s stone church adding to it considerably, and making its width square with its length, and adding porticus and aisles (*Vita Sancti Dunstani*). He also enclosed the old cemetery with a stone wall, and raised the area within into a mound, and built the claustral ranges of buildings (*Vita Sancti Dunstani*; Cramp 1976, 242). A fire on the 25 May 1184 destroyed virtually the entire monastery, save a 12th century chapel and bell-tower (Radford 1981, 110).

The excavated remains (Figs 42-44)

The Anglo-Saxon features survived at a depth of around 2 m since they had been buried beneath vast dumps of clay derived from the foundations of the 13th century abbey. Clearly all features beneath the later foundations had been cut away, and an early timber church (see below) was lost when the Lady Chapel crypt was built, but the preservation was otherwise good. The layout of the Anglo-Saxon monastery is shown in Fig 42. The various elements comprised a row of three churches (the central one having been lost to the later crypt), the east range of the cloisters, part of a cemetery, and the eastern stretch of the *vallum monasterii*.

There is some controversy as to the date of the earliest church on the site, but this perhaps dates to the 7th century (Rahtz 1993, 71-6). This was a timber-built church “*vetusta ecclesia*”, dedicated to St Mary, lost when it was destroyed by fire in 1184 (detailed further in the written sources below). The site of this church was venerated by the construction of the Lady Chapel crypt soon after the fire.

The excavated sequence described below is that interpreted by Philip Rahtz (1993, 76-82). He has faced the doubly difficult task of attempting to interpret other people’s site records, and piecing together the disjointed foundations of a number of phases of fabric dissected by later foundations. Phasing of the walls and foundations was undertaken with reference to different mortar types. The phase numbering below has

been introduced by me in an attempt to identify the three main excavated phases.

Sts Peter & Paul (Figs 42-44)

The first phase excavated remains were of a mortar floor, surfaced with red brick-tempered mortar. Adjacent walls have been interpreted as forming parts of the nave, presbytery, and north and south porticus of a small church. The nave and presbytery were separated by a step. The eastern and western extents of the church were not found, although the plan indicates that the *hypogeum* or burial crypt may have been built in this phase, if not already present. (Rahtz 1993, fig 53).

The *hypogeum* was a small stone structure, backfilled with rubble, beneath the third phase tower. It comprised a rectangular area c. 4 m by 1.5 m internally “at least partly below the ground level”. The entrance was at the western end, with a base stone on the north side showing two iron dowels for a door. The plan (Fig 43) shows paving at the eastern end, and a vertical stone slab on the outside against the east wall. A gap in the walls is noted on the north and south sides. This structure has been interpreted as a “raised chapel with a shrine above and crypt entered by a narrow stair in the centre of the rising flight” (Radford 1981, 117). It has also been compared with the 7th-8th century *hypogeum* at Poitiers in south-west France (Rahtz 1993, fig 55, lower). Philip Rahtz added: “There are also at the east end of both structures a slab on the outer side of the wall. At Poitiers this was seen as part of an arrangement by which the martyr’s tomb could be viewed through the head of a window at the eastern end; and a similar function is envisaged for the comparable slab at Glastonbury. The two ragged gaps in the north and south walls are also similar to the recesses at Poitiers, for the setting of stone coffins” (Rahtz 1993, 79).

A distinct mauve mortar was used in the second phase thereby identifying these as additions to the first phase structure. To the west of the church were two right-angled walls interpreted as the corners of two further porticus added to the north and south of the church. Two east-west walls bonded with the right-angled walls were interpreted as part of an atrium, with a threshold in the north wall marked by a flat slab. To the east of the church was added a squared eastern end with small eastward extensions abutting the entrance to the *hypogeum*.

The third phase also had a different mortar to the other phases. The walls represented a major phase of rebuilding at the eastern end of the church. Two further porticus were added to the north and south, one of which incorporated evidence for an eastward extension (north side) and a possible screen (south side). At the same time the *hypogeum* was filled with rubble and paved over and a “wide and deep foundation made around this area for the tower ...”. In the nave a wall was added across the church with an integral doorway and steps up to the choir.

The phasing of the above has been established with reference to the written sources (detailed below). Suffice to note here, that the first phase has been attributed to King Ina *c.* 720, the second phase to *c.* 760, and the third phase to Abbot Dunstan 940-57.

St John the Baptist (Fig 42)

This chapel was also built by Dunstan to the west of the church of Sts Peter & Paul. It is said to be aligned not on the latter church, but with the variant alignment of the *vetusta ecclesia*. The excavated chapel was thought to have been a medieval replacement of the original perhaps burnt down in 1184. Philip Rahtz notes “Set in the west wall at sill level were two stones with grooves *c.* 10cm deep. These may have been used to key in the lower side slabs of an open arch, wide enough to allow foot passage. All this suggests that the chapel was originally the westerly point of access firstly to the raised cemetery area of Dunstan’s layout and subsequently to the string of churches to the east. This would imply that it was really a gatehouse with a throughway, and a chapel above, in an upper storey” (Rahtz 1993, 79).

Other features (Fig 42)

Several other features have been planned but not discussed in the publication (Rahtz 1993, fig 45). These include two pillars to the north-east of St John the Baptist, a pillar north-east of the *vetusta ecclesia*, and five other pillars, a well and “Arthur’s Grave” south of the *vetusta ecclesia*. South of the churches was a cemetery wall, with an early cemetery to the west end, and ?oratory and postholes at the east end. Further south still was the chapel of St Michael in the cemetery, and parts of the east range of the cloisters in line with the eastern end of the church of St Peter & Paul. The south

and west sides of the cloister range are postulated. East of this complex was the *vallum monasterii* comprising a bank inside a ditch. Glass furnaces are plotted just inside the *vallum monasterii*, with “industrial activity” further south (Rahtz 1993, fig 45).

Raleigh Radford published an interim report of the excavations at Glastonbury abbey 1909-1964 (Radford 1981). This provides some valuable details on the *vallum monasterii*. Behind the bank, westwards towards the cloisters, a soil layer had developed which “was later cut into by a glass furnace of the 9th or 10th century” (Radford 1981, 114). He goes on to say that “It is difficult to allow less than two hundred years for the accumulation of this layer, placing the date of the bank and ditch at least *c.* 700 at the latest”.

Interpretation

The interpretation of the development of the church of Sts Peter & Paul was undertaken by Raleigh Radford and has been used as the principal plan used in subsequent publications (Radford 1981, figs 2-4; Rahtz 1993 fig 56).

The best starting point for any reinterpretation of the plan of the church is from Philip Rahtz’s plot of excavated foundations (Rahtz 1993, fig 53). This shows all foundations in block plans, as found and without the clutter of postulated wall lines. If this is used in conjunction with his fig 51 which showing the Anglo-Saxon foundations and shading areas destroyed by 11th-12th century and 13th-14th century foundations, one has the basis of a plan for further interpretation. The problems faced next, given these two plans, is that we do not know what has destroyed the remaining sections of wall where the later foundations have not removed them. Have they been cut away by graves, or are the foundations very shallow? Are the areas inside the third phase porticus intact or destroyed? Problems such as these make further interpretation impossible with any certainty. Given the information that Raleigh Radford would have had in his head, if not in his site notes, to aid his interpretation of the development of the church, I see no reason to change these plans.

The dating of the various phases have been proposed from the historical sources as follows: *c.* 720 for the first phase, *c.* 760 for the second phase and *c.* 1000 for the third phase (Radford 1981, figs. 2-4). My interpretation of the dating evidence varies

little from this. I would place the first phase to shortly after 705 (in line with the written sources); the second phase to before 760 (to allow time for the building to have stood for some time before the burial), say the mid 8th century; and the third phase to the mid 10th century, given Dunstan's documented restoration 943-956.

The supposedly early (British) features such as a timber building in the graveyard and the *vallum mansterii*, are not securely dated and Philip Rahtz has noted that "the key dating evidence for the immediate post-Roman period in the west, the imported east Mediterranean pottery, was conspicuously absent" (Rahtz 1970, 1).

Glastonbury Tor

Excavations on the Tor at Glastonbury were undertaken between 1964 and 1966 by Philip Rahtz in an attempt to explore further sites on the "island" and help put the discoveries at the abbey site into a broader context (Rahtz 1970).

Several areas were excavated on the summit of the Tor and on the shoulder just below the summit, revealing several phases of occupation, two of that are pertinent to the present topic. These are Periods 1 and 2, representing 6th century timber buildings and metal working, and a late Saxon or early medieval monastic settlement, respectively (Rahtz 1970, 11).

Historical and written sources

The earliest references to the Tor are 12th-14th century in date, providing a hint at least that the Tor was thought of as a monastic site from at least the 12th century (Rahtz 1970, 7, but no sources are given for the early references).

The excavated remains (Figs 45-46)

The first period was represented by several distinct features (Fig 45). Some of these were of uncertain phase (argued in the report as being Period 1) and included two graves and an adjacent pit and postholes at the northern edge of the summit, and some steps and a hollow way towards the western edge. The graves were aligned north-south and were perhaps pre-Christian (Rahtz 1970, 12-14). The more securely dated features of Period 1 comprised two areas of occupation, one at the eastern edge of the summit the other at the southern edge. The only difference between the two

areas was that the southern area yielded imported Mediterranean pottery, although Philip Rahtz concluded that both areas were likely to have been contemporary (Rahtz 1970, 16). Other areas of the summit had been totally destroyed by later phases of activity.

The eastern complex lay in a man-made hollow, well defined at the east side, but perhaps originally extending further westwards, the features here having been destroyed by the later church. A hearth lay on the north side of the hollow that was provided with a screen, to judge from postholes and stakeholes recorded on the eastern and northern sides. A carefully constructed cairn on the south side of the hollow is of uncertain function.

The southern platform was a man-made terrace extending along the southern side of the summit. This area was clearly much disturbed by natural fissures. A well-defined timber-slot was recorded, as were several postholes and stakeholes, two hearths, and platforms. These have been tentatively interpreted as part of five timber structures, as follows:

- Structure with timber slot, 6 m by 4.8 m
- Structure with hearths, 9.1 m by 7.6 m
- Possible structure to the east of the latter, ?7.6 m by ? 6 m
- Platform to west (above steps), uncertain size
- Platform to west (above steps), uncertain size

The excavator recorded that the common feature of the structures was that they had a common occupation layer of silt spread throughout them, containing many animal bones, ash and charcoal. The hearths were interpreted as metal working hearths, although no metal waste was found in them. Two crucible fragments were, however, recovered 2.75 m to the north-west in the same structure, showing signs of bronze working residues. Ten sherds of imported Mediterranean pottery were found in the southern area dating to the 6th century.

A flight of steps approached the summit from the west leading to a hollow-way that gave access to the southern structures.

Various interpretations of the Period 1 occupation were put forward by the excavator. Firstly, that the site could be part of a late Roman temple or sub-Roman

pagan shrine. Secondly, that the Tor was a small Celtic Christian monastic site. Thirdly, that the site was a “defensive or quasi-military” settlement. The interpretation favoured by Philip Rahtz was that it was the defensive stronghold of a local king (Rahtz 1970, 22, and footnote 57).

Period 2 is represented on the summit by a lone feature - a cross base (Fig 45). However on the shoulder to the west was a well-stratified sequence comprising platforms or terraces cut into the rock, interpreted as representing four buildings (Fig 45). These are thought to represent a Christian settlement, perhaps a hermitage. Two small buildings were interpreted as monastic cells for the hermits, whilst a posthole building set in a prominent position on the shoulder of the Tor was interpreted as a possible church or chapel, although nothing was found to confirm this hypothesis.

None of the pottery from Period 2 features was closely dateable. On the present evidence Philip Rahtz suggests that, locally, pottery is virtually non-existent before *c.* 950 in the area, and “that Period 2 ended some time before the Conquest, or in Norman times, but may have begun considerably earlier” (Rahtz 1970, 31). A fragment of cross head found in this phase was dated by Raleigh Radford to the 10th or 11th century (Radford in Rahtz 1970, 48).

Interpretation

The interpretations suggested by the excavator are well argued and couched in such a way as to be tentative, sounding warnings where necessary. Little more could be added unless further excavations were undertaken.

Hartlepool

Excavations at Church Close, Hartlepool during 1984 and 1985 uncovered large areas in the centre of the town revealing two periods of Anglo-Saxon occupation interpreted as part of a monastic community. The results of the work have been fully published (Daniels 1988, 158-210). This summary is based on that report.

Historical and written sources

The double monastery at Hartlepool was established in the *c.* 647 by Abbess Hieu, and given to Abbess Hilda by Bishop Aidan of Lindisfarne *c.* 650 (*HE* IV.23). Hilda

left Hatlepool monastery in 657 to found the monastery at Whitby. Hartlepool was identified in the 19th century as the site of the Anglo-Saxon monastery after a graveyard was located with namestones (Cramp 1976, 222-23; Daniel 1988, 202). Apart from the Church Close site Anglo-Saxon remains are known at the following locations in Hartlepool:

- Pre-Conquest skeletons were recorded at Gladstone Street in the 19th century
- A “plausibly” monastic cemetery recorded at Cross Fields in the 19th century

The excavated remains (Figs 47-49)

The two periods of Anglo-Saxon occupation were quite distinct in that the Period 1 structures were earthfast, and the Period 2 structures were free-standing. Period 1 was divided into four phases dated to between the mid 7th and the mid 8th century, and Period 2 to the mid-late 8th century. The Anglo-Saxon structures were sealed by a thick layer of ploughsoil that indicated a distinct change in occupation of the site (Daniels 1988, 158).

The Anglo-Saxon occupation were divided as follows:

Period 1, Phase I (Fig 48)

This phase was represented by two timber structures and a boundary. The latter comprised deep post-pits, “presumably with a fence line of some type linking the pits”. The report records that the buildings were small, measuring some 11.2 sqm and 14.85 sqm in area. This phase is dated to the 640s (Daniels 1988, 161).

Period 1, Phase II

In this phase the boundary was replaced by a palisade trench, two large post-pits interpreted as possible timber cross bases, and five buildings. The complete examples of the latter measured 9.57 sqm, 16.25 sqm, and 19.14 sqm in areas. A termination date of 700 is given for this phase (Daniels 1988, 162).

Period 1, Phase III

By this phase the palisade had been removed and three buildings constructed beyond the original enclosure. Six timber buildings were recorded in this phase, the three

complete examples measuring 10.66 sqm, 12.96 sqm, and 13.52 sqm in area. This phase is dated to post-700 (Daniels 1988, 172).

Period 1, Phase IV

The final phase of occupation in Period 1 comprised four buildings, with the complete example measuring 16.66 sqm in area. This phase is tentatively dated to the second quarter of the 8th century onwards (Daniels 1988, 172).

Period 2

As noted above, this period saw a major change in the type of building construction techniques, going from earthfast to free-standing structures. Most of the buildings were stone-footed with pathways between. Although eight of the Period 1 timber buildings had been robbed, presumably for re-use of the timber, two of the Period 1 buildings were retained and has stone footings added. A mid 8th century date is postulated for one of the buildings in this phase, with the life of the settlement “petering out by the later 8th century” (Daniels 1988, 175).

Discussion

The finds associated with the Anglo-Saxon occupation date from the mid 7th century to the late 8th century. Industrial activity was attested by the presence of crucibles and moulds with residues of high quality silver and copper alloy. An ecclesiastical connection was suggested from the presence of casting moulds for a small free-armed cross, a ribbon animal, and an apocalyptic calf of St Luke (Cramp in Daniels 1988, 187-90). Also found was a name-stone from a cemetery (Cramp in Daniels 1988, 194). The latter was not dated in the publication, but may be similar to stones found in excavations in the 19th century near St Hilda’s church, which comprised comprised eight gravemarkers predominantly dating to the mid 7th to mid 8th century (Cramp 1984, 97-101).

The excavator has interpreted the buildings as being small and largely having only had one doorway. When compared with structures usually found on Anglo-Saxon sites, the absence of hall-type structures was notable. The site lacked the space for accommodating a family unit. He postulates: “There remains only one population

group which might have been accommodated; the monastic community of Abbess Hilda” (Daniels 1988, 206).

The occupation at Church Close was clearly secular and set apart from the monastic buildings, which must have been sited elsewhere (Daniels 1988, 208).

Interpretation

Given the evidence of the finds and unusually high proportion of small structures at Church Close, the interpretation of the site as one of the residential and industrial areas of the monastic community seems plausible. Likewise the dating evidence appears sound.

It would, however, be worth sounding one word of caution when interpreting the function of the settlement from a single area excavated. The small timber buildings recorded could form part of an industrial area with large communal buildings (halls) having been sited elsewhere. For example, at Canterbury large areas of the Anglo-Saxon town have been excavated revealing 49 timber structures of Anglo-Saxon date. All but six of these were small sunken features structures, whilst two earthfast ‘halls’ were recorded and four large cellars (perhaps part of larger structures) (see Chapter 7, above).

The combination of written sources, ecclesiastical finds (albeit from a manufacturing area), and the type of buildings located, leads me to support the excavator’s interpretation of the site.

Hoddon minster

The monastery at Hoddon has been identified by the location of a large number of monumental sculptures perhaps indicating that the site was founded in the latter half of the 7th century or the first half of the 8th century (Lowe 1991, 11). The church, now in ruins, was been excavated in 1915 and re-examined by Radford in the 1950s, the latter dating the building to *c.* 700 (Radford 1953, 180-1; 1967, 117).

Because the site was being destroyed by quarrying, geophysical surveys and excavations were undertaken in 1991 and reported promptly by the excavator (Lowe 1991).

Historical and written sources

Hoddum is known traditionally as the place where Rhydderch ap Tydwal, ruler of Strathclyde, met Kentigern in *c.* 573 after the latter's return from exile in Wales (*Vita cap* 32). It is also said that Kentigern's see was temporarily established at the site and that churches were constructed and priests and clerics ordained (*Vita cap* 33). The link between Kentigern and Hoddum is viewed with suspicion by Jackson, who maintains that it is an invention based on later dedication evidence (Jackson 1958, 321).

No other written or historical sources are known for the site.

The excavated remains

The site is bounded to the south by the River Annan, and to the north and east (and possibly west) by a ditch. The enclosure is said to be similar in area to the monastic enclosure at Iona. The ditch was around 2.6-3 m wide and 1 m deep, and traced for 250 m. A palisade slot or fence line lay adjacent to the inside of the ditch, whilst the remains of a bank was found in places (Lowe 1991, 14).

Inside the enclosure was excavated a large number of buildings all apparently fairly evenly spaced and close to the enclosure ditch. In Area 5 was found a substantial timber building measuring 16.5 m long by 4.8-6.9 m wide, with a setting for a secondary oven in the northern half. Part of the primary clay floor survived. Radiocarbon dates from the structure indicate that it dated to the 7th or 8th centuries (Lowe 1991, 14-17).

Area 6 produced a sunken-featured building measuring around 7.8 m by 5.8 m and up to 0.75 m deep. A possible porch entrance structure lay on the south-east corner, and an oven took up much of the central area of the building. The structure has been interpreted as a possible smoke house (Lowe 1991, 17).

Area 7 was occupied by an extensive scatter of postholes from at least three timber buildings, whilst a stone-built corn drying kiln lay over the top of the enclosure bank. Several phases of construction were recorded. (Lowe 1991, 17-19).

In Area 8 were three sunken-featured structures, a pre-bank stone building and a large timber building. The three sunken structures were considered late in the sequence since they overlie the enclosure bank and ditch, the larger of which is

thought to have been associated with metal working. The substantial timber building, measuring 8.5 m by 3.2 m, was later constructed inside the larger sunken-featured building, which was associated with smithing waste. The large sunken-featured structure is thought to have been medieval (Lowe 1991, 19-21). The enclosure bank in Area 8 was well preserved and yielded “a crude cross-incised pebble” (Lowe 1991, fig 6, 20). Sealed by the bank was a stone building with a “subterranean element” measuring 4.5 m by 2.6 m set 0.7-0.8 m into the ground. A stone flagged floor lay in the base of the building. The stone used for the construction of the structure is thought to have been re-used Roman material, since it contained fragments of two inscriptions (Lowe 1991, figs 7 and 8, 21-23). Timber from the structure has been radiocarbon dated to 525-625 (Lowe 1991, 23). A possible timber structure lay to the south, perhaps associated with the stone building.

Finds recovered from a plough-damage survey around the church comprised fragments of a grave cover, a grave marker, and a cross-shaft of 8th–9th century date. Also found were a Carolingian denier of Louis the Pious (819 x 822), and a *styca* of Aethelred II of Northumbria (c. 841 x 844). Human bones indicated an extensive graveyard, whilst structural remains were located east of the graveyard (Lowe 1991, fig 10, 25).

The remains have been interpreted as part of a “service-sector” of a monastery with zones for different food processing activities (Lowe 1991, 25).

Interpretation

Given the structural evidence alone and the lack of historical evidence, it would be difficult to identify this site as monastic. However, the recovery of several grave markers, and cross-slabs over the last two-hundred years adds significantly to the status of the site. (Lowe 1991, appendix I, 27-34).

On balance, and using my original criterion for monastic sites, I feel insufficient evidence has been provided so far to identify the site as monastic, rather than a high-status settlement.

Iona abbey

The monastery that St Columba founded on Iona is still clearly distinguishable on the eastern side of the island because of its particularly well-preserved monastic enclosure (Fig 50). The summary below is based on Anna Ritchie's publication on Iona (Ritchie 1997).

Historical and written sources

The 9th century abbot of Iona, Adomnán, wrote the *Life of Columba* between 688 and 692, nearly 100 years after Columba's death, and provides one of the most important sources of information about the saint (for *Life of Columba* see Sharpe 1995). Adomnán had at his call an earlier *Book of the Miracles of Columba*, written by the 7th century abbot, Cummene Find. This, unlike Adomnán's work, did not survive.

Adomnán says that Columba came to Argyll in 563 with twelve companions. He makes passing mention of a number of details about the monastery in his work on Columba. Of the monastery he noted a church with a side chamber or chapel, and two sleeping places for the monks. Two buildings are mentioned that were used personally by Columba; the first was his sleeping place with a stone pillow, the second his writing place. There was also a communal building and a guest house. Also mentioned were barns beyond the main complex, and several burials, including Columba's marked with his stone pillow (*Life of Columba*, III, 23). Adomnán makes a single reference to the monastic vallum (*Life of Columba*, III, 29). Of Columba's writing-hut we are told that it was "constructed on higher ground" (*Life of Columba*, III, 22) and that he [Columba] was sitting "in tegoriolo tabulis subfulto" The latter is interpreted as "in the hut that was supported on planks" or "in his raised wooden hut". We are also told that Columba could see Mull from inside his hut and could hear shouting from the other side of the Sound of Iona (*Life of Columba*, I, 25).

The excavated remains (Fig 50)

The monastic vallum is clearly visible today, particularly near the north-west corner. The main monastic enclosure forms a large sub-rectangle with an annex at the south end, the latter being ploughed out and traced only by geophysical prospection (G, H, and J in Fig 50). The main monastic enclosure covers an area of up to 8 ha, with a

further 1 ha being enclosed by the southern annex (Ritchie 1997, 39).

In the north-west corner of the enclosure the earthwork comprises an inner bank around 1.8 m tall, a ditch and an outer bank around 1.2 m tall. A section was cut across the vallum, along its western side in 1956, and this showed that the ditch was cut into the solid rock (Trench D in Fig 50). The ditch was found to be about 4 m wide, but its base was never located because of the high water level (Ritchie 1997, 36). The ramparts were each about 4 m wide and constructed of stones and earth.

A trench excavated in 1973 at point J in the southern annex found the ditch to be 3 m wide and over 2 m deep (Trench J east of St Columba Hotel in Fig 50).

Only one section of the ditch has been dated. In 1979 a trench was cut near St Oran's Chapel (Trench F in Fig 50), prior to an extension of the graveyard (Ritchie 1997, 40). This trench cut through a ditch on the southern annex that proved to be 5-6 m wide and 3 m deep. Samples of peat and wood from the ditch were dated to 600-635, and replaced a smaller, earlier ditch dated to the Columban period. The latter was 2 m wide and 1.2 m deep.

Trench F was extended into the enclosure and located a number of postholes forming half of a possible circular wooden structure (M in Fig 50) dated broadly to between the 7th and 12th centuries (Ritchie 1997, 40).

Excavations that have revealed evidence of the monastery are as follows. Beneath the medieval bakehouse (K in Fig 50) was found around sixty postholes, possibly indicating the remains of a rectangular building, dated by radiocarbon to the 8th century or earlier (Ritchie 1997, 40). Postholes and slots were also found west of the abbey church, but formed no discernible pattern. South of Tòrr an Aba (L in Fig 50) were excavated traces of a foundation trench for an undated plank-built structure.

From Adomnán's description of Columba's writing-hut (above) it has been assumed that this would have been located on Tòrr an Aba (Hill of the Abbot). Excavations here in 1956 and 1957 found a substantial stone revetment along the foot of the western side of the Tòrr, perhaps to increase the size of the top of the outcrop. A structure was also found on top comprising rough foundations of a sub-rectangular building measuring 3.8 m by 2.8 m, internally (Ritchie 1997, 41). The excavators recorded some small-diameter burnt stakes along the footing of the west wall and suggested that the stone base had been topped with turf, which supported either a low

wattle wall or a “wigwam” roof. The inside floor area was very rough and at one end, the surface bedrock had been shaped to form a low ‘bench’, and there was a setting of stone slabs forming a box about 0.8 m long, which was interpreted as the support for a stone or wooden “table top”. (Ritchie 1997, 41). The building remains undated, but the hut was later demolished and the top of the Tòrr levelled with earth and beach pebbles, and into this deposit was set a medieval stone cross.

North of the abbey have been found traces of workshops for metal- and glass-working. Patches of cobbling and burning were found associated with sherds of imported pottery and three clay moulds for making inlaid glass studs (at P in Fig 50; Ritchie 1997, 41-2). The imported pottery, E-ware from south-west France, provides a date in the late 6th and early 7th centuries, whilst a sherd of north African manufacture, dating to the late 5th and early 6th centuries, was found just outside the north boundary wall of the abbey (N in Fig 50).

The focus of the early buildings is all from within the monastic enclosure, and as Ritchie points out, the early church probably stood around the site of the later abbey “otherwise it is difficult to explain why the great high crosses of the 8th century should be positioned outside the west end of the later church” (Ritchie 1997, 43). Traces of earlier foundations were found beneath the nave during restoration work, “but they could not be identified with confidence” (Ritchie 1997, 43).

Interpretation

To judge from the few dates obtained from the excavations, the monastic enclosure at Iona appears to fit well with Columba’s monastery in the second half of the 6th century.

No definite buildings of Columban date were found, although some of the structures located pre-date the 8th century, for example the structure beneath the bakehouse, and a enclosure ditch near St Oran’s Chapel (above).

No doubt exists that this is a monastic site, although of Irish origin, rather than Anglo-Saxon.

Jarrow

Numerous excavations, mainly to the south of the Anglo-Saxon churches, were undertaken by Rosemary Cramp in 1963, 1965-7, 1969-71 and 1973.

Two axially-aligned churches are known to have stood in the Anglo-Saxon period at Jarrow (see below). Limited excavation in the nave of St Paul's church, in 1973, revealed the original internal dimensions of the larger, western church. The eastern church survives to this day. The majority of the excavations, however, have concentrated on the area south of the churches.

Although various interim reports were published, the most extensive of which appeared in 1969 (Cramp 1969), the most up-to-date account was published in 1976 (Cramp 1976), whilst a phased summary appeared in 1994 (Cramp 1994). It is largely the 1976 publication that was used for the summary of the 1963-71 excavations south of the churches, a note in *Archaeol J* 133 (1976) for the recording inside the western church in 1973, with more recent ideas on phasing being introduced from the 1994 publication.

The monasteries at Jarrow and Monkwearmouth were "thought of as one monastery in two places..." (*Archaeol J* 133 (1976) 220, figs 30 and 34).

Historical and written sources

In 681 King Egfrith made a land donation for the building of a monastery at Jarrow, which commenced in 682 under the guidance of the prior, Ceolfrid. The church was consecrated in 685, and two axially-aligned churches are known to have stood on the site (Plummer 1846). The monastery appears to have been burnt down, perhaps after Viking attacks on Northumberland in 874-5 (Cramp 1969, 24).

The excavated remains (Fig 51)

The western church (Fig 51)

Recording work was undertaken prior to reflooring of the nave of the church in 1973. This confirmed that the church as recorded in 1769 was likely to have been the original western church, with foundations surviving below the 19th century rebuilding levels. The 1769 plan showed "a two-storeyed western porch, a long narrow nave, with a north arcade of blocked round headed arches, and to the south

the remains of two porticus... the outlines of two further porticus are dotted in..." (*Archaeol J* 133 (1976) 222). The recording work in 1973 recovered only a slight trace of the southern porticus, whilst to the north was a narrow aisle only 1.52 m wide. The main body of the church measured 5.6 m wide and 19.8 m long, internally, from the western tower to the western side of the narrower chancel.

The eastern church (Fig 51)

The eastern of the two churches survives as the chancel of the present church. It measures 4.57 m wide by 12 m long, internally. The walls are of coursed sandstone blocks, incorporating re-used Roman material, with massive side-alternating quoins similar to those at Monkwearmouth and Escomb (*Archaeol J* 133 (1976), 223).

The surviving church incorporates various original features. These include a doorway in the south wall, now blocked, and with traces of a first-floor doorway above and a possible western gallery internally (Taylor & Taylor 1965, 338-49). Excavations adjacent to the doorway, externally, have failed to locate any traces of a connecting structure (*Archaeol J* 133 (1976), 224).

The eastern church has been interpreted as a funerary chapel, sited in the middle of an early cemetery and with doors opening to north and south (Cramp 1994, 289).

The cemetery and other structures (Fig 51)

Around 15.25 m south of the two churches were two masonry buildings (Fig 51, A and B), whilst in the space between the two ranges of buildings was a cemetery.

Building A measured 27.89 m by 7.93 m externally, and had originally been divided into two rooms (Fig 51). The floor was of mortar with a top coating of *opus signinum*. Centrally placed in the larger of the two rooms was an "octagonal stone base of red sandstone surrounded by fragments of a shaft carved with heavy plant scrolls and interlace". This is interpreted as a lectern base (Cramp 1976, 236).

Later in the life of the building the dividing wall was removed and a large stone-lined drain inserted across the room and the annex to the south. The small annex was excavated in 1973, and found to contain a pile of Roman tiles and their chippings on the floor. It had a partially paved floor, "at a lower level than that of the main room and dished pebble-lined settings for what have been interpreted as areas for standing

large butts or storage vessels” (Cramp 1976, 237). The excavator is of the opinion that the annex was added after the demolition of the dividing wall in Building A, but no stratigraphic relationship survived to be certain.

Building A had eaves drip drainage on the south, west and east sides, and a stone slated roof with lead flashing. Also evident from the excavated remains is that the building had coloured glass windows on the north side, plain glass on the south side, and was internally rendered with cream plaster. The structure is interpreted as a refectory, with a servery or storeroom to the south. The building had been destroyed by fire.

Building B measured 7.93 m wide by 8.29 m long externally, and was subdivided into three rooms (Fig 51). The west room has a well centrally placed at its western end and the setting for a seat placed against the east wall. At the eastern end the building was divided into two small rooms, “by a grooved stone, which probably held a wooden screen” (Cramp 1976, 238). The northern most room had an *opus signinum* floor and centrally placed against the east wall a possible altar setting. The southern room, entered via a doorway in the south wall, was partly paved and had a small wash basin in the south-east corner. Building B was burnt down.

It has been postulated that Buildings A and B were probably built on the same modules, in the first phase of development (Cramp 1994, 289).

Finds from the larger of the two rooms included a stylus, stick pin, and a small whetstone. The excavator interpreted that this room may have been used as a place for assembly and writing and that the two small rooms served as a “private suite perhaps used by the abbot or a senior monk. We have, therefore, a type of ‘cell’ composed of oratory and living room” (Cramp 1976, 239).

Small huts are postulated as having been sited south of the stone buildings, downslope towards the river. One of these “huts” was excavated in 1973, revealing evidence of glass working and a coin of Eanbald 796-830, whilst a row of huts was found further south still (Cramp 1976, 239).

A further building (D) was located to the south-east. It was reported as having had “some pretensions” in that its walls were built of well-shaped ashlar blocks, similar to those used for Building B and the eastern of the two churches. The structure also employed *opus signinum* and painted plaster. Later occupation of this building, dated

by coins of Eanred and Redwulf to the first half of the 9th century, were found associated with glass waste, much window glass and bronze tools. This structure was interpreted as originally have been a guest house for the visiting laity, later declining in importance to a workshop in the 9th century (Cramp 1976, 239-41).

Recent excavations north of the monastery have located two curving ditches, interpreted by the excavator as part of the *vallum monasterum* enclosing an area of around one quarter of one hectare (Speak 1991, 62, fig 6). No dating evidence was found to prove that the features were pre-Conquest in date, and the ditches appear to have been open into the 13th century (Speak 1991, 75).

Interpretation

Final interpretation of the various elements of this monastic site will have to await full publication. Comments about the layout and development of the monastery will be presented at the end of this section of the thesis, where both Jarrow and Monkwearmouth can be seen together.

Lindisfarne

Early excavations and clearance in and around the medieval priory was undertaken in the 1850s and 1880s, and in the first quarter of this century and in the 1960s. More recent work has been undertaken jointly by the University of Leicester and St David's University College, Lampeter. This comprised an excavation prior to a new museum in 1977, followed by work in 1980. Since 1983 the team has carried out excavations, fieldwalking and surveys twice a year (O'Sullivan 1989, 125-6).

The summary below has been prepared from various interim publications (O'Sullivan 1989; O'Sullivan & Young 1995).

Historical and written sources

Bede records that Bishop Finan (651-61) built a timber church at Lindisfarne, that was dedicated to St Peter by Archbishop Theodore (668-90), and encased in lead by Bishop Eadberht (688-98) (*HE* III.25). This is the eastern of the two churches, which is said to have been moved to Norham by Bishop Ecgrid (830-45) (*HE* III.25).

No direct written references refer to the second church, save to note that St Peter's

was recorded by Bede as the “greater church”, indicating that at least two churches formed part of the monastery.

The excavated remains

Deirdre O’Sullivan’s survey work indicates that the monastic settlement may be extensive, and comprise a number of individual chapels and graveyards spread over a wide area (O’Sullivan 1989, 141) (Fig 52). She also presented a possible course of the *vallum monasterii*, and the results of extensive geophysical surveys around the priory, on Heugh Hill to the south, and on St Cuthbert’s Island. It must be noted, however, that excavated remains were almost totally lacking when she published her 1989 paper, and the conclusions were very speculative.

John Blair’s research has focused mainly on the churches at Lindisfarne. He has argued that the topographical and architectural evidence indicates two churches at Lindisfarne (Blair 1991, 47; Blair 1992, fig 10.9). He argues that the current parish church (St Mary’s) and the 11th century priory church (St Peter’s) are on the sites of earlier, Anglo-Saxon churches (Fig 53). The western church of St Mary has two fragments of masonry surviving from the pre-12th century rebuilding, argued by Blair as perhaps being Anglo-Saxon (Blair 1991, 49, fig 1).

The eastern of the two churches is St Peter’s church that was investigated by Charles Peers in the 1920s revealing early foundations west of the crossing piers. These have been plotted by John Blair (Blair 1991, fig 2). The original 7th century church is thought to have been of timber (below).

The sites of two cross bases and a stone-lined well are known on the axis of the churches, although the two churches themselves are axially-aligned but off-centre (Blair 1991, fig 2).

In 1995 English Heritage published a book on Lindisfarne. No new evidence for the monastery was presented, but further interpretation of the standing fabric of the parish church and priory church was included (O’Sullivan & Young). The foundations mentioned by John Blair were noted, as were traces of an earlier, rounded arch over the sanctuary arch in St Mary’s parish church (Plate 23), and external quoining on the east wall of the nave (Plate 24). Traces of the standing fabric, along with the foundations below both churches, have been interpreted as

possibly Anglo-Saxon in date. As such they are thought to have been later Anglo-Saxon, rather than part of the early monastery.

Interpretation

I would suggest that the foundations located by Peers below St Peter's church presumably related to a rebuilding of the church after its earlier timber phase was moved in the mid 9th century. The early phase of masonry located at St Mary's church, and interpreted by Blair as perhaps Anglo-Saxon, may represent the original church on the site but only further work will establish this.

Monkwearmouth

Trial excavations were undertaken in 1959, 1960 and 1961 prior to development of the area south of the church of St Peter. More extensive excavations were undertaken in 1962 and 1963, and in 1966, 1967, 1969 and 1971. Further excavation was planned at the time that Professor Cramp wrote her summary (Cramp 1976). She also noted that previous development of the town had destroyed much of the stratification.

The monasteries at Monkwearmouth and Jarrow were "thought of as one monastery in two places..." (*Archaeol J* 133 (1976) 220, figs 30 and 34). The phasing of the excavated buildings follows Rosemary Cramp's most recent publication (Cramp 1994).

Historical and written sources

Land was granted by King Ecgfrith to Benedict Biscop *c.* 673 to found a monastic community at Monkwearmouth. Building work was started within two years of this following the Bishop's visit to Gaul to seek masons to build the church in the Roman manner (*HA*, 5; *HAA*, 6). A further visit to Gaul took place nearer the time of consecration to obtain glass makers for glazing the windows of the refectories and dormitories (*HA*, 9 and 15; *HAA*, 25). The church of St Peter was consecrated in 685. Three churches are mentioned at the site and "of many oratories" added by Biscop's successor Coelfrid (*HA*, 8).

The excavated remains (Figs 54-57)

Regarding the surviving church at Monkwearmouth. All that survives is the western tower, the west wall of the church and the tall, narrow nave (Taylor & Taylor 1965, 432-46). In Phase 1, prior to the building of the porch in Phase 2, some form of *narthex* may have been situated at the western end of the church (Cramp 1994, 283). The form of the eastern end of the chancel is unknown, although the eastern end of the church was used as a funerary "porticus" (Cramp 1994, 284). The church is a similar size to that at Jarrow, being 5.6 m by 19.8 m internally.

South of the church excavations revealed a long building (B) extending north-south across the area and smaller structures nearby (A and D). To the east of Building B was a cemetery interpreted as the site of the monastic graveyard, to judge from the fact that the occupants were all men (where this was distinguishable). To the west of Building B a further area of burials comprised men, women and children, indicating a probable lay cemetery (Cramp 1976, 231).

A good cobbled path extended southwards down the slope from the church, whilst "areas of gravel paths seem to indicate that the possible cemetery was traversed by paths". Shrines or *martyria* were thought to have been sited in the monastic cemetery, for example "Building A". This was a round-ended structure, the floor of which measured 3.66 m by 3.2 m. The floor was sunk 0.3 m into the ground surface and was lined with "a fine white concrete [presumably mortar] with a thin skim of powdered brick. It had carried a wattle-and-daub superstructure, the main stakes holes of which survived at 1 ft [0.3 m] intervals in the curved ends. Debris from the superstructure showed clearly curved surfaces". The building was compared with timber structures at Tynemouth, the Glastonbury *hypogaeum*, and the Northampton Anglo-Saxon mortar mixers (Cramp 1976, 233). A niche was noted at the western end of Building B, and a stone-filled hole beneath later burials.

A small structure (D), of possible Anglo-Saxon date, lay in the south-east corner of the site. Its walls were of flat stones with clay bonding (Cramp 1976, 233).

Building B was found extending for some 33.5 m south of the church (Cramp 1994, fig 2). The walls were of limestone blocks, clay bonded, and overlain by stone set in cream mortar. The building "seems to have had some sort of mortared floor... Thin slabs of mortar with a fine brick-red facing were found in the destruction levels

of the building...” Destruction rubble from the building indicate that the roof was of limestone slates, and that the windows were glazed (Cramp 1976, 233). Professor Cramp interpreted this building as follows: “In its primary phase... could be envisaged as a one-storey corridor joining the church to a range of buildings, as yet undetermined, further south... It could have served the same function as a cloister walk: for reading, writing and meditation”. A later phase of walls (H and IV) were built in later Anglo-Saxon times, the foundations being reused in the medieval phases (Cramp 1976, 234). The wall is shown joined to wall K in Fig 54 (after Cramp 1994, fig 2).

The late arrangement of walls south of the church are shown in Figs 55-57 (after Cramp 1994, figs 3-5). No dates are given with the phasing, save that the western porch was probably added before Eosterwine was buried there in c. 685/6 (Cramp 1994, 286). Also noted are that the enclosure wall (4) was bonded to the porch and wall H was of similar build to the latter (Cramp 1994, 286).

Interpretation

Interpretation of Building B and the graveyard to either side seem plausible. Building A, however, is best interpreted as a mortar-mixer rather than a shrine, being remarkably similar to those at found at Northampton (Williams 1979), and perhaps relating to the construction of Building B and its floors.

Tintagel

Excavations were undertaken at Tintagel in the 1930s by Raleigh Radford, but have not been fully published due to the loss of the original archives. Several groups of buildings were excavated producing finds dating from c. 350 to c. 850. The buildings are on a promontory divided from the mainland by a natural cleft in the rocks bounded by a 2.43 m high pile of stones and a 7.62 m wide ditch (Radford 1935) (Fig 58). Site A has been postulated as the site of the monastery, although no church has been located (Radford 1935; 1962, 9). The best summary of the site has been produced by Rosemary Cramp (Cramp 1976, 209-12). Excavations undertaken on the lower terrace of Tintagel Island in the 1990s have been reported recently (Harry & Morris 1997, 1-143).

Historical and written sources

No early historical sources are known identifying a monastery at Tintagel. The excavator originally classed this site as monastic perhaps because of the presence on site of a later medieval church and earlier human burials.

The excavated remains (Figs 59-61)

A *vallum manasterii* is postulated on the line of the defences “separating the ecclesiastical city from the world outside” (Radford 7-8).

Site A comprised a complex of several structures divided into four main periods, the latter of which was cut by a medieval chapel (Fig 59). The earliest phase, represented by two individual structures, was interpreted as a late 4th century farmstead (Cramp 1976, 209). It was the second phase structure, comprising a long room 14.6 m by 4.87 m, with small stones laid herringbone-fashion, that Raleigh Radford interpreted as part of a Celtic monastery. The walls of the latter were in contrast to the first phase in that they employed herringbone masonry. Raleigh Radford reported “No similar building has been found on this site and as this appears to be the earliest part of the Celtic monastery it may represent the original cell” (Radford 1935).

Site B, situated down the slope from Site A, was interpreted as the living quarters of the monks (Radford 1962, 14-16) (Fig 60). The excavator reported “The uppermost of these chambers was two-storied, with a gabled roof running out from the cliff face, into which holes for the beams of the upper floor and roof had been cut”. The next door room was large with a sloping floor, and an external bench of stone on the on the lower side. Further down the terrace was a structure with a stone-paved floor, showing signs of heat crazing, interpreted as a “sweat house or bath”. The excavator also interpreted the lower buildings as “probably a separate hall or refectory serving the group of buildings” (Radford 1962, 16). Site C, north-west of Site B, revealed a further range of buildings interpreted as cells (Fig 60).

Site D, on the northern part of the plateau, was interpreted as having had “relations with the outside world” (Fig 61). It contained a corn drying kiln, “and other indications of agricultural use” (Radford 1962, 12).

Site E was located in the centre of the plateau but no coherent plan was obtained.

Site F comprised two buildings. The excavator reported that “The main lower room has a low base on the upper long side. The front of the masonry shews a series of slots, which imply a heavy wooden superstructure, probably cupboards or presses, suggesting that this room was a library” (Radford 1962, 13-14).

Site G was only partly investigated.

The most important finds from the site were fragments of imported Mediterranean pottery. The excavator has reported that the only element missing from the site is a church, but that this must have been near to Site A, where four graves were found (Radford 1962, 9).

Excavations in the 1990s were undertaken on the lower terrace close to Radford’s Site C. These have produced a well-dated sequence of structures starting in the later 4th to 5th centuries (Harry & Morris 1997, 120-1).

Interpretation

Rosemary Cramp cast doubt on the interpretation of this site as monastic, noting that “The layout of Tintagel is not paralleled on other monastic sites in Anglo-Saxon England”. (Cramp 1976, 212). Ian Burrow took this one stage further (Burrow 1974). Here, Ian Burrow looked at the two main classes of evidence - the finds and the buildings. Regarding the finds he noted that although imported wares from the site formed an important collection, indicating occupation from the 5th-7th centuries, that the lack of later material indicted that the occupation was relatively short-lived (Burrow 1974, 99). The buildings, forming at least eight groups, are difficult to date closely since much of the pottery was not well stratified, “being found lying outside the buildings in unsealed layers” (Radford 1962, 8).

The status and function of this site must be cast in serious doubt. Indeed, Charles Thomas interprets the site as a seasonal Royal Stronghold (Thomas 1993, 85-9). The results of the 1990s excavations are not conclusive enough to support the stronghold theory and the authors noted that it is dangerous to draw too many conclusions from the small areas excavated (Harry & Morris 1997, 122).

This site can no longer be seen as monastic.

Tynemouth

One winter's season of excavation was undertaken in 1963 to the north of the priory church, before the reduction of ground levels for a new road, followed by some limited excavation inside the nave and crossing of the church the following year. The excavations revealed a sequence of structures dating from the pre-Roman Iron Age through to the 16th century. Pertinent to this thesis was a phase of rectangular timber buildings tentatively interpreted by the excavator as being between the 2nd-century occupation and the building of the Norman church *c.* 1090-1130 (Jobey 1967, 33-104).

Historical and written sources

No reliable independent dating is proposed from the written sources, although a monastery is thought to have been established on the headland by the 8th century (*HE* V.6), whilst it is traditionally reported that King Oswin (who died in 651) was buried there (Craster 1907, 41-3; *Vita Oswini*, iv, 12-15).

The excavated remains (Figs 62-63)

The excavations revealed three rectangular timber buildings and an oval timber building (Jobey 1967 42-49, figs 1 and 2).

Building 1 was an oval structure 4.26 m wide internally, and comprising a 0.23 m wide curving slot 0.18 m deep cutting into the bedrock. The eastern end was not located (Fig 62).

Building 2 was rectangular measuring 5.18 m wide by 9.1 m long internally. The foundations were reported as having been irregular trenches with closely set post-impressions. A doorway lay on the south wall. A possible fence line was interpreted as having extended along the east of the building (Jobey 1967, 44).

Building 3 was similar to Building 2, but on a slightly different alignment.

Building 4 was of different construction to Buildings 2 and 3 in that it had a substantial sill beam, with evidence for a doorway on the southern side. All of these buildings appear to have been systematically dismantled.

The dating evidence from these structures is very sparse. Pottery dating to the 2nd century was found in the wall slots of Buildings 2 and 4, and some masons chippings

near Building 4. A coin of Ethelred II of Northumbria dating to 841-844 was found in 17th century levelling layers over the buildings (Jobey 1967, 46).

Interpretation

Given the lack of finds and dating evidence it is very problematic assigning these buildings to the Anglo-Saxon period, and even less secure interpreting them as part of a monastic phase of occupation. Certainly the small oval structure is interesting, if incomplete and difficult to interpret, but otherwise the buildings could well have been secular. The buildings could equally have been later Romano-British, or perhaps workmen's structures relating to the construction of the post-Conquest priory.

Whitby

Excavations were undertaken north of Whitby abbey between 1920 and 1925 and summarized in 1943 (Peers & Radford 1943). Philip Rahtz undertook limited excavations in 1958, north of the 1920s excavations in Paylors Field (Rahtz 1962). To this work may be added Philip Rahtz's reinterpretation of the early work and redrawing of the plan of the 1920s excavations (Cramp 1976, fig 5.6), and Rosemary Cramp's work plotting the finds north of the abbey (Cramp 1976, fig 5.8) and also publishing a reconsideration of the site (Cramp 1993).

The most recent work at Whitby comprises a phase of evaluations undertaken English Heritage during the 1990s. The work is not yet published and will be followed in 1999 with research based excavations. Matt Busby at English Heritage (pers comm February 1999) has kindly discussed the interim results of the projects as follows: Evaluations undertaken in the early 1990s have indicated an extensive Anglian period settlement over much of the headland and town. This has been found in the 1993-95 work in particular, much of it involving cliff-edge recording. The original site archives of the earlier excavations are fragmented and not accurately transcribed. Matt Busby suggests that Hilde's monastery may be in Whitby, rather than to the north of 13th century church, and that the results of the previous work are no longer valid. Rosemary Cramp does not, however, consider that sufficient information has been found so far to doubt the location of Hilde's monastery on the headland (Cramp 1993, 64). Further information is taken from an English Heritage

research design for the Whitby Abbey Headland Project, Southern Anglian Enclosure (Wilmott 1999).

The summary account of the earlier excavations presented below follows that set out by Rosemary Cramp in 1976 which utilized Philip Rahtz's lettering of the buildings (Cramp 1976, 223-29).

Historical and written sources

The monastery at Whitby was founded in 657 on land donated by King Oswiu (*HE* III.24). The site was an important burial place for the Northumbrian royal house, and part of the epitaph of Ælflæd, daughter of Oswiu, was found during the 1920s excavations.

William of Malmesbury recorded that King Edmund pillaged St Hild's bones from Whitby to Glastonbury c. 944. He also recorded that the monastery was reoccupied by Reinfrid of Evesham between 1072 and 1078 and described the abbey at this time as containing "oratories to nearly forty, whereby the walls and altars, empty and roofless had survived the destruction of the pirate-host" (Atkinson 1878, 1).

The excavated remains (Fig 64)

Although Matt Busby has indicated that the results of evaluation work in the 1990s have shown that previous interpretations are no longer valid (pers comm February 1999), the English Heritage work is not yet supported by published evidence. The results of previous work are, therefore, presented below, followed by a brief summary of the English Heritage work.

Anglo-Saxon structures were recorded both to the south and north of the medieval abbey. To the south were located traces of a building with "rough stone foundation laid in clay and bits of fire reddened clay from wattle-and-daub construction", beneath and at a marked angle to the overlying late 12th century outer parlour (Peers & Radford 1943, 27-8). The area to the north of the abbey was more extensively excavated revealing at least seven buildings, and the sparse remains of many more. The limit of the occupation to the south and north was not determined, although the extent to the north-east was perhaps defined by the present road which is thought to have followed the line of the monastic boundary. The latter was located in the 1920s

excavations identified as a possible *vallum monasterii* (Cramp 1976, fig 5.7).

To the north of the abbey the buildings comprised the following: Buildings A and B measured around 5.58 m by 3.4 m. Each had a stone hearth towards the east end. They have been interpreted as having been divided into a living room at the east end around 3.4 m square, with a bedroom to the south-west and a paved area with drain in the north-west corner (perhaps a lavatory) running into a drain outside the building (Cramp 1976, 227). Each had a doorway in the south wall. These structures were compared with Building B at Jarrow.

Building C and D were reported as having been of similar type to Buildings A and B.

A larger rectangular building (E) was situated to the north of Buildings A-D. It measured 14.32 m by 5.79 m internally and was tentatively interpreted as “a guest house or merely a store house”. The east wall was rebuilt when Building H was built to the east.

Building F was a small square structure measuring 5.8 m square. Although this building was not discussed in the excavation report, Rosemary Cramp’s analysis of the finds plot indicated that the building may have been located over the northern limit of the Anglo-Saxon burial ground. She also reported that the finds comprised styli, needles, pins and a quern stone indicating domestic activities associated with the early 9th century occupation of the site (Cramp 1976, 227).

At the western end of the site an L-shaped building was located, divided into two rooms (G1 and G2). Room G1 measured 6.4 m by 3.4 m and G2 measured 6.1 m by 3.4 m. A hearth was located in G1 “divided into two sections three feet [0.91 m] wide by eight feet [2.44 m] long suggesting that this was an industrial building perhaps a smithy”. The finds recovered from the area were “associate with female activities” (Cramp 1976, 228). The other finds, however, were not indicative of metalworking, and included two broken grave-cover slabs (probably residual from earlier levels), dress fastenings, loom weights, and stylii.

Of the other structures, Building H contained a hearth, whilst Building J, represented by a long length of wall between Buildings A and F, was thought possibly to have been early in the sequence. Unfortunately no finds were plotted for either area. Building L, to the west of Building E, represented by a number of small rooms,

yielded a scatter of finds “with some earlier evidence, such as the *sceatta*, and traces of spinning, writing and possibly copying or reading” (Cramp 1976, 228).

East of the possible *vallum monasterii* was a scatter of finds indicating that buildings in that area “were used for the same purpose as elsewhere on the site... In particular the area produced a very large number of coins and two book clasps”. (Cramp 1976, 228).

Between the west wall of the north transept and the west wall of the nave, Rosemary Cramp has interpreted the finds plot here as indicating “the focus of important Anglo-Saxon burials” whilst grave slabs were also found “which would best be inset in walls”. She goes on to report that it is possible that “part of the Anglo-Saxon church once stood here” and “that Philip Rahtz’s plan, in removing the burial evidence, does not in this place give a true picture of the site” (Cramp 1976, 228).

A combination of Philip Rahtz’s plan and Rosemary Cramp’s finds plot produced evidence that the structures were of different periods. Many of the graves showed at least three different forms and alignments, some burials cut through buildings and paths. Some of the buildings clearly post-dated the cemetery “and this could be associated with a replanning of the site in which ranges of buildings seem to be aligned along paths... Possibly at this time buildings were constructed outside the old enclosure...”. She goes on to add that “It is interesting to note, however, that not only the late coins but *sceattas* were found here, and that as elsewhere there were finds from under the “Saxon paving” (Cramp 1976, 228; Rahtz 1976, 461).

Rosemary Cramp has interpreted the finds, after undertaking a plot of them, as indicating that Building G1/G2 is not a smithy, but otherwise functions were impossible to determine. She notes that “the rooms to which finds can be assigned seem to have been used for a variety of domestic activities of the female inmates: spinning, weaving, sewing, book production and cookery”. She interprets the area as possibly comprising the *domunculae* (small houses made for prayer and reading). Elsewhere, “perhaps to the south of the medieval church where foundations were noted, there could have been large communal buildings for both the male and female sections of the community” (Cramp 1976, 229).

Alfred Clapham’s guide to Whitby abbey indicated that several carved stones were found in the 1920s excavations, as well as “three gilt bronze or copper plaques from

book covers with intersecting crosshead forms and elaborate interlacement” (Clapham 1952, 11-12).

The 1958 excavation showed there to be “Saxon occupation in at least one area outside the Abbey grounds” (Rahtz 1962, 612).

Interim results of English Heritage’s work in the 1990s has been summarised for in a research design for further work (Wilmott 1999, 5-11). This reports that recent evaluations in the area east of Abbey Lands Farm “have identified evidence for a southern Anglian focus”...which incorporates a cemetery occupied over a long period. The finds from the cemetery were sparse, but included an 8th century *sceatta* from a feature cutting one of the latest burials. Evidence for the “ritual use of quartz pebbles gives a connection with a practice typical of Celtic monasticism” (Wilmott 1999, 7). North and east of the cemetery is evidence for structures (Wilmott 1999, 7). The southern line of the monastic boundary was identified in the evaluation trenching as a substantial ditch extending east-west across the site. Occupation was found extending well outside the boundary, and including evidence of industrial activity (Wilmott 1999, 8).

Interpretation

Evidence from the 1920s excavations and subsequent interpretations by Rosemary Cramp and Philip Rahtz have come down in favor of the remains being part of the domestic quarters of the monastic complex.

Recent evaluations on the headland by English Heritage, however, have indicated that this idea may need to be re-evaluated.

The location of burials below the paving and some of the buildings is not necessarily indicative of a monastic site, although the location of finds such as stylii and book clasps does add weight to the monastic theory. The discovery of part of the epitaph of Ælflæd, daughter of Oswiu, is also very good evidence for the monastery, although it must be added that this stone could have been displaced from its original site.

The identification of the function of buildings or areas of occupation, based on evidence from a plot of small finds is, I feel, difficult to justify. Many of the finds were undoubtedly from the topsoil, rather than within stratified contexts. My

experience is that finds can move some distance if not well sealed in their original contexts, especially on a site such as Whitby abbey occupied over several centuries.

Having set out the difficulties of assigning functions to the buildings, the location of burials and inscriptions, Ælflæd's epitaph in particular, and the discovery of finds such as the stylii and book clasps and plaques, lend much weight to the argument that this is the site of the monastery. I would, therefore, having reviewed the evidence, support the interpretation that the excavated remains form part of the monastic settlement.

It will be for English Heritage to counter the strong arguments in favor of the monastery with new, published information.

Whithorn

Whithorn has seen a number of phases of excavations in and around the ruined church since the late 19th century. Brief details of the early work are presented below, with main references given to published sources, but much of this work has been overshadowed by the major phase of excavations in 1984-91 by Peter Hill (Hill 1997). His report will, therefore, form the main focus of the summary.

As early as the 1880s some recording of masonry near the parish church were undertaken and the medieval Lady Chapel located. Also found was the *Latinus* stone, "bearing the only contemporary, written evidence of the original Christian community at Whithorn" (Hill 1997, 9, and Appendix 1).

Raleigh Radford excavated in 1949-51 and 1953 in and around the ruined church and adjacent to the Lady Chapel locating a small oratory (Radsford 1957, 181).

Between 1957 and 1967 P R Ritchie excavated a narrow trench adjacent to the ruined church and an area excavation adjacent to the Lady Chapel. The results of this work remain unpublished (Hill 1997, 10).

Further excavations were conducted in 1972 and 1975 by C J Tabraham, comprising trenching to the north-west of the church and test pits to the south-west (Tabraham 1979), the latter located deep stratigraphy later subsumed by the 1984-91 excavations.

The most extensive excavations at the abbey, directed by Peter Hill, were conducted between 1984 and 1991, producing a remarkable sequence of occupation

dating from the Late Roman period to the 19th century. The results form the largest body of data from a monastic site, doubly important here since the results have been published in full (Hill 1997).

Historical and written sources

A good range of historical material survives for this site (Hill 1997, 1-25). The early material comprised the following three sources (in the date range of this thesis):

- Inscription on the *Latinus* stone
- Two references by Bede (*HE* III.iv, xii; *HE* V.xxiii, 16)
- *Miracula Nynie Episcopi*

The *Latinus* stone “bearing the only contemporary, written evidence of the original Christian community at Whithorn” has been dated to the mid-5th century, but its precise meaning is controversial (Hill 1997, 9, and Appendix 1).

Bede’s work covers Nynia and his church (*HE* III.iv, xii) and the establishment of a new Northumbrian diocese and the appointment of Pecthelm as bishop (*HE* V.xxiii, 16). (Hill 1997, 1).

Miracula Nynie Episcopi (the Miracles of Bishop Nynia) was written at Whithorn around the late 8th century. The *Miracula* records Nynia’s visit to Rome for consecration, his miraculous cures, miraculous growth of vegetables, and his death and subsequent cures and visions (Hill 1997, 1-3).

A further work, a prose life in Latin (*Vita Niniani* – the Life of Ninian) was written between 1154 and 1160. It covers similar material to *Miracula*, but with a slightly different selection of stories, and need not be repeated here (Hill 1997, 1-3).

The excavated remains (Figs 65-74)

As noted above the excavation produced several phases of occupation, the first three of which concern us here. They comprise the following:

- Later Roman occupation, Period IA
- The first *monasterium*, Period IB
- The developed *monasterium*, Period IC

- The Northumbrian minster, Period II
- Rebuilding of the *monasterium* after fire, Period III

Period IA

This phase is represented by a small number of Roman finds. A roadway was recorded extending across the area (dating to the 4th or 5th century) leading towards a small stone building. The *Latinus* stone, ascribed to the mid-5th century was located in the northern part of the site (Hill 1997, 26-7).

Period IB (Fig 66)

This period represented a distinct phase of development of the early *monasterium*.

Phase 1 deposits represented intensive occupation to the south of an enclosure ditch thought to define the presumed focus (Inner Precinct) at the eastern end of the hill (Hill 1997, 27). This occupation was in the form of evidence for cultivation and the construction of a path and terraces of small stake-walled buildings. The structures, measuring around 8 m long by 5 m wide, were found to have had insubstantial foundations and bowed side walls. Finds include Mediterranean imports which “could have included the personal possessions of the putative émigrés” (Hill 1997, 28). Iron working is attested by the location of smithing waste (Hill 1997, 30). Dating evidence indicated that this phase perhaps started at the end of the 5th or early 6th century and ended *c.* 550 (Hill 1997, 28).

Period IC (Figs 67-68)

In this period the *monasterium* was developed.

Phases 2-4 comprised successive buildings, graves, and shrines, within “a double, curvilinear enclosure system” dating to *c.* 550 to *c.* 730 (Hill 1997, 30). It will be seen from Fig 67 that the Inner Precinct was extended westward from that postulated in Phase 1, and that the first recorded boundary to the Outer Zone was first located in Phase 4 (Fig 68). The Inner Zone was characteristic in that it produced shrines, graves, open spaces and industrial debris. The Outer Zone, by comparison produced only small sub-rectangular buildings and domestic waste (Hill 1997, 31). The buildings excavated were similar in size to those of Phase 1, but saw the introduction

• Phase 4	Major renovation of church	750-60
• Phase 5	Door moved and arcade repaired	785
• Phase 6	Arcade replaced	810
• Phase 7	Internal fittings removed, arcade decaying or removed	835-40
	Fire	845

Period II buildings were rectangular with opposed doorways in their long walls, and were built of timber, save the chapel which was built in stone. Most of buildings (both the halls and the smaller buildings) conformed to structural types found on Anglo-Saxon sites (Hill 1997, 44). The halls are interpreted as having been a range of guest quarters rather than barns, to judge from the finds, (Hill 1997, 46). The smaller buildings are reported as having been from two distinct traditions: i). Small, timber-walled, sub-rectangular structures with opposed doorways, starting towards the end of Period I and continuing into Period III; ii). Wattle- or wicker-walled structures with a new pattern of internal features and a single doorway. Finds from the smaller buildings were similar to those from the halls (Hill 1997, 46). The church, however, is noted as having been unique, and is thought to have developed around an existing monument at the centre of an earlier shrine (Hill 1997, 44-5).

The construction of the church commenced with the building of two timber oratories in Phases 1 and 2, which were later joined into a single structure in Phase 3. During Phase 3 a “focal monument stood in the western part of the eastern oratory and was to lie between an eastern ‘chancel’ and a western ‘nave’ throughout the subsequent evolution of the building (Hill 1997, 45). An altar was postulated at the east end of the nave, from the survival of a stone structure. This was moved further east later in the life of the church. The church had rows of vertical postholes to north and south, interpreted as “arcades supporting extended eaves”, or “freestanding pylons aligned with other boundaries of posts or stones” as recorded elsewhere on the site (Hill 1997, fig 4.1).

The burial chapel is reported as having been of unusual construction, comprising “thick clay walls supported by a wide stone plinth”. The chapel had at least two windows, to judge from coloured glass found in the building, and five burials

“seemingly high-status” (Hill 1997, 45). The chapel was interpreted as having been a gateway into the western part of the Inner Precinct, and also to have been used as a mortuary for the display of the deceased laity awaiting burial. Four graves lay at the east end of the chapel, cutting through an earlier grave, with the inhumations having been placed in wooden “chest coffins”. East of the chapel was a densely populated graveyard for infants and young children.

The finds recovered from the Period II occupation are indicative of only local trade, with this period ending in “crisis and destruction” in the mid-9th century (Hall 1997, 48).

Period III (Figs 72-74)

This phase saw the rebuilding of the *monasterium* in the mid-9th century when a distinct change of finds is recorded from previous phases. Waste from the manufacture of antler combs was found throughout Period III occupation and extending into the late 12th century (Hill 1997, 48).

Three main phases of activity were identified in this period. Phase 1 saw the reconstruction of the chapel and erection of a new timber church. Parts of the Outer Zone were interpreted as having been flooded, with small wattle buildings occupying the level higher ground (Fig 72). In Phase 2 the church was demolished and a cluster of wattle buildings built on top, and slightly smaller timber buildings built over the Period I timber structures (Fig 73). In Phase 3 the entire settlement appears to have been reorganised with “a densely-packed band of buildings” running across the excavated area at 45° to the Period 2 buildings (Hill 1997, 48). A bank and path delineated the eastern limit of the new settlement area (Fig 74). The conclusion reached regarding the new layout, was that the Period 3 settlement perhaps abandoned the “inferred principal church and founder’s shrine” from the Inner Precinct of the new *monasterium* (Hill 1997, 48-9). Phase 2 may have ended in the late 10th century, whilst Phase 3 may have ended in the later 10th/earlier 11th century (Hill 1997, 49).

The small buildings excavated in Period III are similar to those of Period II, with differences of internal details. It is reported that one group of buildings has earth floors and no hearths, whilst the other had paving, pits and hearths associated with

large pots (Hill 1997, 49).

The new layout in Phase 3 was interpreted by the excavator as possibly indicating that the buildings were focused around a market to the west of the original Inner Precinct, or perhaps that a new ritual focus lay to the west of the original centre. Whatever the interpretation, the new layout was thought to have been “Celtic” (Hill 1997, 54-5).

The finds from Period III are reported as having been a small specialised group, indicating continuing Anglian and Anglo-Scandinavian contacts in the later 9th and perhaps earlier 10th centuries, with Scandinavian influences in the 10th century. The finds also indicated Irish and Irish/Norse influence in the later 10th century (Hill 1997, 52).

Period IV

The next period of occupation dates from c. 1000 x 1050-1250 x 1300. The dating evidence for the start of this period is not secure, but is “ascribed with some caution” to the first half of the 11th century (Hill 1997, 211).

Phase 1 in this period was represented by the dismantling of Period III buildings, drainage of the flooded land and construction of small buildings focusing on the same postulated focal point as in Period III (Hill 1997, 211).

The excavator interpreted the buildings as having been new types introduced at the start of Period IV by “a new, potentially Hiberno-Norse or Irish, community” (Hill 1997, 59).

Interpretation

The report on excavations at Whithorn presents a plausible account of the development of an important site. The interpretation of the layout in Periods I-IV, however, relies heavily on the site of the “putative principal church” in the Inner Precinct. This, together with the interpreted Outer Zones which may have changed its focus later in Period III, may I feel be stretching the evidence too far at times. The excavated areas were quite large, but given the postulated size of the settlement was a relatively small area of the whole.

Having noted this reservation, the overall phasing appears reliable and I have no doubt that Hill has excavated part of a monastic town. None of the buildings excavated need have been monastic, and all are perhaps best seen as lay buildings to the south of the monastic core of the settlement.

Winchester

Extensive excavations on the Old Minster have been undertaken in the 1960s, identifying several phases of building. The monastic complex was probably situated to the south below the present cathedral, although this has yet to be proven by excavation. The New Minster was built to the north of the Old Minster in 903 with its monastic quarters to the west (Quirk 1961, fig 6). East of the New Minster were located traces of extensive buildings claimed to have been part of the pre-Conquest monastery (Biddle 1972, 118-23). Here were located traces of a substantial masonry building (Building E), first discovered by Dean Kitchin in 1885, and fully excavated by Martin Biddle in 1970.

Historical and written sources

A discussion of the early history of the New Minster (*Liber Monasterii de Hyda* and *Liber Vitae*) has been published R N Quirk (Quirk 1961). In summary the arrangement of the monastic site was redesigned between the reigns of King Alfred and Edward the Elder to form the New Minster and the Nun's Minster. The construction of the New Minster was started under King Alfred just before his death, and taken over by his son Edward the Elder who is said to have completed the work in two years. The New Minster was dedicated in 903 to the Trinity, St Mary and St Peter and St Paul.

Since the land on which the New Minster was built lay very close to the Old Minster Edgar (959-73) tried to create a single monastic enclosure to include the Old Minster, the New Minster, and also a nunnery (Nun's Minster). The latter was founded by Queen Ælswytha, apparently east of the New Minster. The monastic buildings were apparently extensively renovated when Æthelwold restored the monastery between 965 and 995 (Willis 1845; Quirk 1957; Biddle 1974).

The excavated remains (Fig 75)

The structural evidence revealed by the 1970s excavations was as follows:

Phase A (Fig 75)

This phase was represented by a single north-south wall set on a markedly different alignment to the underlying Romano-British structures. It was interpreted by the excavators as the first phase of the Anglo-Saxon sequence of Building E. The wall lay in the area of what subsequently became the core of the south-western part of the building complex and was interpreted as having been a boundary wall (Biddle 1972, 118).

Phase B (Fig 75)

In this phase a small rectangular building 13 m by 9 m was built, apparently straddling the Phase A wall. A long series of internal floors was recorded, and the dating evidence indicated that this phase was not later than the 10th century (Biddle 1972, 118).

Phase C (Fig 75)

In Phase C the Phase B structure may have been retained and a boundary wall added to the south, replacing the Phase A wall (Biddle 1972, 118).

Phase D (Fig 75)

A marked expansion of the building complex was undertaken in Phase D, with the addition of a 34 m long range 9 m wide. In this phase Building E took the form of a south range and parts of the west and east range of a courtyard complex with a covered walk around three sides (Biddle 1972, 118-19). The south range was divided into two by a partition wall.

Phase E (Fig 75)

In Phase E the south range was rebuilt and extended in size to the south and east making the structure 47 m long and 11 m wide. Also added in this phase were four masonry piers in the western half of the range to create a "pillared hall" (Biddle 1972,

119).

Phase F (Fig 75)

Phase F walls were interpreted as having been added to support the building because of structural problems. The new wall comprised thick foundations added to the west and north of the south range and insertion of a bench around the south and east walls of the pillared hall (Biddle 1972, 120).

Phase G (Fig 75)

Later insertions were grouped together in this general phase, but may not all have been added at the same time. They comprised dividing walls in the west range, further dividing wall across the eastern room in the south range and walls in the east range (Biddle 1972, 120).

The general layout was interpreted by Martin Biddle as representing three sides of a four-sided courtyard block, the fourth side perhaps having been found in 1961-2 near the boiler-house as Building D (Biddle 1972, fig 6).

Pottery from Building E date almost entirely to the later 10th and 11th centuries, whilst the demolition of the building took place in the early 12th century (Biddle 1972, 122).

The excavator has published that all phases of Building E were entirely domestic (Biddle 1972, 122). It was originally interpreted in 1961 that Buildings A-D formed the conventual buildings of New Minster (Biddle 1962, 165-72). However, he is now of the opinion, having excavated Building E, that this is no longer the case, and that Building E is "much better suited to the requirements of a great monastic house, and it may now be suggested that the later phases of Building E represent the conventual buildings, in fact the cloister, of New Minster in the period c. 1066-1100, and that Buildings A-C were lesser parts of the same complex" (Biddle 1972, 123). He goes on to say that "It is perhaps possible that Phase E, with the insertion of the pillared hall that could have been used as the refectory, marks the conversion of the structure for use by the whole community". Phase D was therefore, assigned as representing the pre-Conquest claustral arrangement, "which seems to have lain further west in the

area burnt down in 1066” and that “Building E at Phase D may have been the infirmary of the New Minster...”(Biddle 1972, 123; Biddle 1975b, 134).

Interpretation

Given the fact that only interim reports have been produced for the excavations at Winchester, it is difficult to attempt any valid reinterpretation of the remains. This must await full publication.

The interim report Phase D of Building E, claimed as possibly the pre-Conquest infirmary cloister, provides us with a plausible enough structure in a well-stratified sequence. I would favour this being part of the reorganisation of the minster at the time of King Edgar.

Conclusions

Of the 20 sites claimed as monastic from the excavated remains, I have reassessed the status of the sites from the available published sources and suggest that five of these were probably not monastic, or require further evidence in support of the theory. These are Brandon, Flixborough, Hoddom, Tintagel and Tynemouth (Table 10).

The excavated site at Brandon is no different from many Anglo-Saxon settlements, and the ecclesiastical finds could be related solely to the possible church. No written sources are known for a monastery at Brandon. The arguments set out against a monastic phase at Brandon can be equally applied to the Anglo-Saxon settlement at Flixborough. The site at Hoddom has no reliable written sources to identify a monastery, and the excavated evidence is lacking. The arguments for a monastery at Hoddom are based on the monumental sculpture. Tintagel’s monastic status has been doubted by Rosemary Cramp and Ian Burrow, who put forward convincing arguments against the monastic theory (Cramp 1976, 209; Burrow 1974). This is compounded by the fact that no documentary/written sources are known for Tintagel. The remains at Tynemouth are not well dated, and I would strongly argue that the buildings could date to the Roman-British or even post-Conquest period. The structures could also be secular, and nothing from the site gives a hint at the monastic status postulated by the excavator.

Site	date	monastic	interim	fully published
Abingdon	c.954>	yes	yes	---
Brandon	600-900	no	yes	---
Burgh Castle	630>	yes	yes	---
Canterbury cathedral	597>	yes	---	yes
Canterbury, St Augustines	597>	yes	---	yes
Eynsham abbey	1005>	yes	yes	---
Flixborough	7 th -1050	no	yes	---
Glastonbury abbey	c.705>	yes	---	yes
Glastonbury Tor	6 th C	yes	---	yes
Hartlepool	7 th -8 th C	yes	---	yes
Hoddon	7 th -8 th	no	yes	---
Iona	563>	yes	---	yes
Jarrow	685-875	yes	yes	---
Lindisfarne	?7 th -8 th C	yes	yes	---
Monkwearmouth	c.685>	yes	yes	---
Tintagel	5 th -7 th C	no	yes	---
Tynemouth	uncertain	no	---	yes
Whitby	657>	yes	---	yes
Whithorn	7 th C>	yes	---	yes
Winchester	mid 10 th C>	yes	yes	---

Table 10: List of excavated sites claimed to be monastic, showing details of start date, my reassessment and whether published in interim or full

The remaining 15 sites cover a diverse range of structures and a considerable time-span (Table 11). I have divided the 15 sites into four broad structural forms to aid interpretation and discussion. The site types identified comprise the following: churches; cloisters/courtyards; monastic buildings; and settlements.

Site	structures	date (source)
Abingdon	masonry church	c.954 (written)
Burgh Castle	timber structures and inhumations	630 (written)
Canterbury cathedral	four phases of cathedral	597-1067 (written)
St Augustines	five phases of church with cloisters	c.600-1050 (written)
Eynsham abbey	domestic courtyard	1005 (written)
Glastonbury Tor	timber buildings	? after c.950 (finds)
Glastonbury abbey	three phases of church and buildings	8 th -10 th C(written)
Hartlepool	timber buildings	7 th -8 th C (finds)
Iona	monastic enclosure and structures	563 (written)
Jarrow	masonry church and other buildings	685-875 (written)
Lindisfarne	two axial churches	7 th -8 th C(written)
Monkwearmouth	masonry church and other buildings	c.685-9 th C (written)
Whitby	stone founded structures	657 onwards (written)
Whithorn	monastic settlement	7 th -11 th C (finds)
Winchester	infirmary cloister	mid 10 th C (written)

Table 11: List of excavated monastic sites (after my reassessment) showing structural types present and dates.

Churches (5 sites)

This category comprises the cathedral church at Canterbury, the masonry abbey churches at Abingdon, St Augustine's abbey, and Glastonbury, and the timber churches at, Lindisfarne and Whithorn.

Comparison between these churches is perhaps difficult given the wide date ranges covered, and the diverse nature of the influences upon their design. Abingdon as a mid-10th century church compares well in size (over 61 m long) with Canterbury cathedral's Period 2A church (reconstructed at least 57 m long) and dating to the early 9th century.

Unlike the large scale rebuilding at Canterbury cathedral, Glastonbury abbey developed over a number of phases in a similar manner to the gradual development at

St Augustine's abbey. At each of these sites an axially-planned arrangement of churches was developed. The main difference between these two sites is that Glastonbury was a British foundation whilst St Augustine's was Roman. However, if the plan of the early 7th century phase at St Augustine's is compared with the early 8th century phase at Glastonbury close similarities appear in that both have porticus flanking the nave.

The timber churches recorded at Lindisfarne and Whithorn vary in status. At Whithorn the church and adjacent burial chapel were identified as lying just inside the Inner [ecclesiastical] Zone, but the principal church was thought to lie some distance from these structures. The buildings are acknowledged as being unique in terms of their form and construction. At Lindisfarne the two churches located formed the focal churches of the monastic complex. These are not known from detailed excavation and little is known of this site.

Cloisters/courtyards (5 sites)

The cloister category has been used very broadly to encompass the monastic cloister at St Augustine's abbey, Glastonbury, the possible enclosed area at Jarrow and Monkwearmouth, the infirmary cloister at Winchester, and the domestic courtyard at Eynsham.

By far the best plan we have of a cloister is from St Augustine's abbey, although the excavation records are too poor to allow adequate interpretation of the various phases. The earliest of the cloisters at St Augustine's abbey may date to the 8th century, with documented re-building in the early 11th century and also in the mid 11th century when Wulfric's octagonal structure was built.

At Glastonbury The partial plan of the mid 10th-century cloister has been pieced together and was apparently much larger than at St Augustine's abbey. At Jarrow the area between the two churches and the range of buildings to the south was occupied by a cemetery. The space between (around 12.5 m wide) would not be incompatible with a small cloister, although no structures were found to the west and east enclosing the area.

At Monkwearmouth the long building (B) extending south of the church was interpreted as perhaps performing a similar function to a cloister walkway, perhaps

connecting the church with a range of buildings further south. This may indicate that a form of enclosed courtyard lay adjacent to Building B, presumably on the site of the monastic cemetery east of the building. Both Jarrow and Monkwearmouth were founded in the late 7th century at a time when a regular claustral layout may not have been established.

At Winchester a cloister located at the east of the New Minster was interpreted by the excavators as the early 10th century infirmary cloister. Its width was around 25 m (Phase D).

Monastic buildings (5 sites)

The term monastic building has been used here to include any ecclesiastical building closely associated with a monastic church, or the putative site of a monastic church. It comprises the structures at St Augustine's abbey, Jarrow, Glastonbury and Winchester.

At St Augustine's abbey there were at least three phases of cloisters, but the records do not allow any phasing to be established with certainty. The south side of the cloister is centred on the north porticus of the church of Sts Peter & Paul, and the eastern walkway is aligned on the steps of Wulfric's mid 10th century octagonal structure. Parts of all four walkways were recorded. At Jarrow two buildings were excavated, built on the same modules. Building A was interpreted as a refectory with a servery or storeroom to the south, and Building B as an assembly or writing room with small private suite at the east end comprising an oratory and living room.

At Glastonbury the location of the west, south and east ranges was established, but only the 10th century east range was recorded in plan. The records are not adequate to interpret the remains further.

At Winchester the south range and parts of the east and west ranges of buildings of the possible infirmary cloister were excavated (Phase D dating to the early 10th century). No further interpretation for the use of the individual buildings was established.

Settlements (6 sites)

The monastic sites excavated which revealed evidence of a secular settlement comprise Brandon, Burgh Castle, Glastonbury Tor, Hartlepool, Jarrow, Whitby, and Whithorn.

At Brandon timber buildings were excavated over an extensive area. The structures were no different to the usual timber building found on many Anglo-Saxon settlement sites. The excavator did indicate, however, that he thought that these buildings could represent a variety of functions – cells for prayer, refectory, dormitory, kitchen, etc. Full analysis of the excavations is awaited.

At Burgh Castle seven huts were recorded and interpreted as cells or workshops.

At Glastonbury Tor the Period 2 two small timber structures were interpreted as cells for hermits. The dating of this phase is uncertain, and given as after *c.* 950.

At Hartlepool two main phases of distinctly different structures were excavated. Although finds were indicative of casting ecclesiastical objects the structures were interpreted as being secular buildings accommodating the monastic community.

At Jarrow the only non-ecclesiastical structures were small cells south of the monastic buildings, and a larger high status building interpreted as possible guest quarters. The eastern end of Building B was interpreted as the cell of an important member of the monastic community. Other small buildings to the south were not all excavated, although one produced evidence of glass working. It is possible that these could have performed a variety of functions, some being workshops others being for private prayer and contemplation.

At Whitby none of the buildings excavated need have been ecclesiastical and I would suggest that they were all secular perhaps housing part of the monastic community, perhaps serving as cells for the monks.

At Whithorn the multitude of buildings excavated has been interpreted as forming part of the secular settlement of the monastic town, just outside the monastic core of the settlement. Buildings were probably used as workshops, guest quarters, etc.

Development of the monastic complex

The development of the monasteries discussed above cover a varied and long history. Some basic similarities can be observed, however, without stretching the information

too far.

The possible cell-like buildings share a common pattern, being small structures – as at Burgh Castle, Hartlepool, Jarrow, and Whitby. Examples comprise the eastern end of Building B at Jarrow with its oratory and a living space with small wash basin, and a number of the small structures at Whitby that had possible lavatories attached. Similar-sized structures at Hartlepool and Whithorn may have had similar functions. All are seen as early (7th century) within the development of Anglo-Saxon monasteries.

It is my interpretation that the monasteries developed in an evolutionary manner, and in order to show this I have devised a simple three-stage plan (Stages A-C).

In Stage A we can see the monastic buildings as a scatter of individual buildings, such as those recorded at St Augustine's abbey, and Burgh Castle (both early 7th century sites). This fits in well with the location of cell-like structures at a similar date (see above). A development of the monastic plan is seen in Stage B with the sites of Jarrow and Monkwearmouth around 685. At Jarrow a range of two buildings lay opposite the church, whilst at Monkwearmouth the long narrow building extended south of the church perhaps linking with further buildings to the south. Both Jarrow and Monkwearmouth may be interpreted as having had a much more organised layout of buildings than in Stage A, with the Monkwearmouth structure perhaps being seen as a proto-cloister walk. The developed cloister can be seen in Stage C with sites such as St Augustine's abbey perhaps from the 8th century onwards (rebuilt in 1006 and 1023x7), Glastonbury abbey from the mid 10th century, and Winchester (possible infirmary cloister) from the early 10th century. Little comparison can be made between these three sites since they all differ in design and layout, but there are perhaps enough similarities to suggest that Stage C marks the fully developed Anglo-Saxon monastic cloister.

Outside influences in different areas of the country would have provided independent stimulus for change (particularly when the north and south of the country are considered). However, the monastic reform movement in the 8th and early 9th century influenced significantly the layout of monasteries in Britain. It is clear, for example, that a regular claustral plan had been established by the mid 8th century, as at Lorsch in Hessen, Germany built *c.* 760-7 (Fig 94) (Oswald *et al* 1966, 179-82).

One should not expect a regular layout of monastic buildings around a cloister until the early 740s when Boniface was convening a series of reform synods (Gem 1993, 30-31). It is the early period sites up to the mid 7th century that are the most difficult to identify from the archaeological record. These early sites are likely to have been varied in their layout and as such encompassed in Stage A.

Given the theory set out above the sites showing defined layouts can be placed into the three stages as follows (Table 12):

Stage	sites	date
A (irregular layout)	Cantebrury, St Augustines	possibly 8 th C
	Burgh Castle	630
B (some planning)	Jarrow	685
	Monkwearmouth	c. 685
C (planned)	Canterbury, St Augustines	1006 and 1050
	Glastonbury abbey	mid 10 th C
	Winchester	early 10 th C

Table 12: Stages of monastic development against dated sites with defined layout

From Table 12 it is possible to see that Stage A spans the early monastic period in Britain, perhaps up to the mid 7th century. Stage B is evident in the late 7th century and would logically extend up to the start of the reform movement in the 740s. Stage C would cover all later development up to the end of the Anglo-Saxon period.

An alternative to the above theory is that all of the monastic sites pre-dating the reforms in the 740s varied in their layout, and that the trends noted above could be reflecting by regional patterns dependant upon outside influences. Confirmation either way will have to await excavation of more monasteries in a scattering of locations around the country.

CHAPTER 9: CONTINENTAL PARALLELS

Introduction

In this chapter it is intended to look at a variety of Continental parallels in an attempt to locate influences which may have shaped the development of Canterbury's Anglo-Saxon churches. For a location map of the churches see Fig 109.

Little work has been done studying the relationship between Continental and Anglo-Saxon churches. In 1965 Eric Fletcher published an article on the early Kentish churches (Fletcher 1965) in which he discussed Syrian influences. In 1978 Kenneth Conant published his general work on Carolingian and Romanesque architecture (Conant 1978). In 1993 Richard Gem published an article covering the period 735-870 where a number of Continental parallels were given for Anglo-Saxon churches (Gem 1993), whilst in 1997 he published plans of two late 6th and early 7th century churches in France. One of the most comprehensive studies to date is Eric Fernie's book on Anglo-Saxon architecture, which gives a Syrian parallel for the early Kentish church, and a number of Continental parallels for later Anglo-Saxon churches. No attempt has ever been made to look comprehensively at the Continental churches in relation to Canterbury's Anglo-Saxon churches.

Having undertaken the research for this chapter, I have found that there is a wealth of material available, which further research could add significantly to. This chapter, however, will aim to present the main points of development that I have identified from the sources noted below (fuller references are provided throughout the chapter).

The main areas of research in Continental Europe comprised Austria, Belgium, France, Germany, Italy, Luxembourg, Portugal, Spain and Switzerland. The following libraries were visited during the research for this chapter: the Ashmolean Library in Oxford, Birmingham University Library, the Courtauld Institute, and the Society of Antiquaries Library in London. The latter was found to contain by far the best collection of books and journals. The published material available for each country varied enormously. It was not possible to be comprehensive and other people's

conclusions have been taken at face value.

By far the best research material was obtained from the two *Vorromanische Kirchenbauten* volumes (Oswald *et al* 1966; Jacobsen *et al* 1991) which cover a vast area including Austria, Belgium, Germany, Hungary, Luxembourg, Switzerland, and parts of Czechoslovakia and Poland. A similar quality and detail was available for Spain and Portugal in the *Hispania Antiqua* series (Schlunk & Hauschild 1978). Neither France nor Italy has a similar corpus of detailed information published. France, however, has a number of summary publications by Carol Heitz which present the churches well, but in a less academic format. The wide ranging *Antiquité Tardive 4* (AnTard 1996) was investigated. Italy has a selection of material, mainly by Richard Krautheimer, relating largely to early Christian sites in Rome (for example his five volume *Corpus Basilicarum Christianarum Romae*), whilst the British School at Rome have published two monographs on recent church excavations.

A search was undertaken at the Society of Antiquaries for archaeological journals from Italy, as follows: *Archaeologia Traiectina*, *Arte Medievale*, *Centro Italiano di Studi Sull'Alto Medioevo*, *Civitta Catholica*, *Papers of the British School at Rome*, *Rivista di Archaeologia Cristiana*, and *Studi Antichita Christiana*. Individual volumes from the *American Journal of Archaeology* and *The Art Bulletin* were also used where necessary.

This chapter will, on a number of occasions, refer back to Chapter 4 (historical and written sources) and Chapter 5 (interpretation, parallels, and dating). Chapter 5 was specifically designed to provide sufficient parallels for interpreting and dating Canterbury's Anglo-Saxon churches, whilst the current chapter is intended to look specifically, and in greater detail, at the general trends of possible outside influences.

It is intended to look at the churches chronologically and by broad type, and then to draw some general conclusions at the end of each church section. The chronological phases used for this are based on Canterbury's Anglo-Saxon churches as follows:

- Period 1: Augustine's early Kentish church (6th and 7th century)
- Period 2: expansion (8th and 9th century)
- Period 3: later additions (11th century)

Period 1: Augustine's early Kentish church (6th and 7th century)

The Kentish church (Figs 14 and 29)

The form of the early Kentish church has been established above (Chapters 5 and 6, Figs 14 and 29). It can be seen that the plans of the churches vary, but all have a rectangular nave, chancel and (where they survive) an apsed sanctuary. The porticus and western *narthex* differ quite markedly, perhaps as an indicator of function. By far the most complete of the churches is that at Reculver (c. 669), which will be used as a model for this chapter (Fig 29). It is close in shape and size to excavated fragments of Canterbury cathedral (soon after 597) and the abbey church of Sts Peter & Paul (consecrated 619).

These churches were founded from soon after 597 (Canterbury cathedral) to perhaps into the second quarter of the 7th century (St Pancras). Table 5 (Chapter 6) shows the date of Canterbury's other Anglo-Saxon churches and similar churches of the same type in Kent and Essex. This particular layout appears, therefore, to have been in use from soon after 597 into the third quarter of the 7th century. Many of the churches continued in use, with additions, throughout the Anglo-Saxon period, and Canterbury cathedral was not rebuilt until the early years of the 9th century.

Italy (Figs 76-85)

Given that Augustine was sent from Rome on his mission to England this is perhaps a fitting place to start the search for parallels. The early Christian churches in Rome, however, were Constantinian basilicas built in the 4th century (Old St Peter's, St John's in the Lateran, and St Paul's, Fig 76). These were T-shaped basilicas of a type that was not built after 400, until a Carolingian revival of the type at the end of the 9th century (Krautheimer 1942, 2).

All of the other early medieval churches in Rome are basilical in form (Krautheimer 1937; Krautheimer *et al* 1959; Krautheimer *et al* 1967; Krautheimer *et al* 1970; Krautheimer *et al* 1977), but some do share similarities with the Kentish churches in that they have small rooms flanking the sanctuary/choir. Examples include the following churches: S Giovanni a Porta Latina, built around 500 (Fig 77) (Krautheimer 1936, 493). This church is at first glance similar to churches in Ravenna, but the apse has only three sides – a much more common feature of

Byzantium. Krautheimer also notes that a fore choir is never found in Ravenna, but has parallels in Constantinople and the Eastern provinces of Byzantium (Krautheimer 1936, 493). San Pancrazio, built between 625 and 638, has side rooms flanking a choir that projects into the nave (Nestori 1960, 216) (Fig 78). In neither of these churches do the rooms have access from outside, as in the Kentish churches.

A good example of the style of church in Ravenna is the north-east chapel of Sant'Apollinare in Classe, started between 532 and 536 and dedicated in 549 (Krautheimer 1965, 195-6).

Whilst discussing side rooms it is worth noting that Mathews has interpreted the arrangement of the chancel for its liturgical function (Mathews 1962). He sees the screened-off areas at the eastern ends of aisles as functional elements related to the external performance of the Mass (Mathews 1962, 73). He quotes S Marco and S Pietro in Vincoli (Rome) as two of many such churches that show this arrangement. S Marco dates to 439-40 and S Pietro perhaps to 550-650. Fig 79 shows his interpretation, which may be reflected in the planning of the eastern porticus of the Kentish churches. He notes that the arrangement appears to have been introduced in the 5th century and lasted into the 9th century (Mathews 1962, 94).

Turning now to churches without side aisles, of the few published excavations on early medieval churches in Italy, the British School at Rome has published two sites (San Vincenzo al Volturno, Molise and Santa Cornelia, Etruria Meridionale). San Vincenzo al Volturno's "South Church" saw five main phases of construction (Fig 80) (Hodges 1993, 180-83). The first phase was a funerary chapel with a long, narrow nave, an apse at the western end and a *narthex* at the eastern end, and was built sometime between the third quarter of the 5th and mid-6th centuries. The church appears to have been in use throughout the later 6th and 7th century and had burials associated with it (Phase 2). During Phase 3 an ambulatory was added to the church which, after a number of improvements, went out of use by the late 8th to early 9th century. The Phase 4 successor was on a different scale to the previous phases in that its western end was totally rebuilt as a small chapel and the eastern end was given over to secular functions (perhaps stabling on the ground floor and accommodation above).

Santa Cornelia was the first church built by Pope Hadrian I and was dedicated in

c. 780 (Figs 81-82) (Christie 1991, 175). This church had an atrium to the east and an apse to the west and a separate baptistery structure to the north-west. The church was somewhat squat, measuring 16 m and 14. m wide. Similar squat churches are known in Rome: Sant'Agata dei Goti, built in the 6th century (Fig 84); Sant'Angelo in Peschiera; and San Clement (Krautheimer 1937; Krautheimer 1977, respectively). Santa Cornelia and San Clement were both given wide naves to counter the reduced length (Christie 1991, 176-7). It is interesting to note the reconstructed plan shows side rooms flanking the chancel (as noted above at other churches). Santa Cornelia was built to a larger scale in the mid 11th century when it measured 26 m long by 16.5 m wide, not inclusive of a *narthex* across the eastern end of the church (Fig 83). By this time the church was monastic and had a range of cloisters to the south.

A church with a plan remarkably similar to the early Kentish type is known in North Italy. This is the parish church of St Peter, Altenburg, given a probable 5th century date (Oswald *et al* 1966, 21). The church has a small nave, an eastern apse and two small eastern porticus flanking the chancel (Fig 85), each of which has an external doorway.

Austria (Fig 86)

Geographically close to the North Italian church at Altenburg (above) is the small early Christian church at Ulrichsberg, Kärnten, dated to the end of the 5th or early 6th century (Fig 86) (Oswald *et al* 1966, 356-7). The church has a rectangular nave, eastern apse, western *narthex* and porticus on the north side only. The plan is very similar to St Peter's church at Altenburg (noted above) only 160 km to the east.

Switzerland (Figs 87-90)

Remaining geographically and typologically close to the North Italian and Austrian churches are four parish/cemetery churches in Switzerland that bear close similarities to the early Kentish church. Three are in Geneva: Grand-Saconnex, La Madeleine, and Saint-Gervais, whilst the fourth, Notre-Dame in St-Maurice, lies 70 km east of Geneva close to the Italian border.

Grand-Saconnex (Fig 87) dates to the 5th/6th century (Jacobsen *et al* 1991, 153). It has a simple nave, eastern apse, porticus to north and south, and a western *narthex*.

La Madeleine's first church contains burials dating to the late 5th-6th century, whilst the second church dates to around 600 (Bonnett 1986, 44-7; Jacobsen *et al* 1991, 140-41; Reynaud 1998, 239). Like the Austrian church at Ulrichsburg, La Madeleine has north porticus and a western *narthex* (Fig 88). These are used here for burials. Also evident from the plan is an eastern porticus to the south of the apse. By contrast to these two small churches is the larger-scale Saint-Gervais that dates to the 5th-6th century (Bonnet & Privati 1994, 55-62) (Fig 89). This has a complex of porticus at the eastern end two flanking the apse and two flanking the chancel. Extensions were added in the second phase encircling the north, south and west sides of the church. Unfortunately the location of doorways is not known.

The final parallel in Switzerland is Notre-Dame at St-Maurice (Fig 90). This is a small church dating to the 7th century, with a nave, two eastern porticus, and a reconstructed eastern apse (Oswald *et al* 1966, 296-7).

France (Fig 91-92)

Moving west, into France, is the burial church of Saint-Martin in Angers, dating to the 6th/7th century (Fig 91) (Reynaud 1998, 238; Saalman 1962, 14, fig 4). This church has a nave, chancel, eastern apse, and a single porticus flanking the south side of the chancel (with an external doorway). On north side is a long porticus extending the entire length of the church.

The basilica of St Justus in Lyon was on Augustine's route to England (Fig 92). Phase 1 dates to the late 4th or early 5th century, and Phase 2 to the 6th century (Gem 1997, 91-2). The second phase may have been what Augustine saw under construction in the 590s, but is far more elaborate than what he subsequently built in Canterbury, with outer porticoes and transepts (Chapter 5 and 6).

Spain and Portugal (Fig 93)

Research into Spanish churches has located only basilical style buildings, and no small churches of the early Kentish type. The closest church found was the Basilica de Zarita de los Canes, Guadalajara (Spain), recorded as being built by Leovigildo in honour of his son Recaredo in 578 and destroyed between 580 and 583 (Fig 93) (Palol 1967, 90-3; Schlunk & Hauschild 1978, 169-71). The church has a nave, side

aisles, western *narthex*, eastern apse and two small transepts. The latter feature mark the church as different from the Kentish type.

Conclusions (Figs 85-91)

From the research undertaken, and the churches presented above, it is clear that those most like Augustine's churches in Kent lie in the areas of Northern Italy, Southern Austria, Southern Switzerland, and France. These churches are particularly close in design with their nave (sometimes with a chancel), eastern apse, and eastern porticus. No churches of the Kentish type have been found in Germany, and it has been noticed that the simple early church in Germany is closer in plan to the first phase of the Old Minster at Winchester (Fig 33; with its nave, small rectangular sanctuary and two small porticus).

The churches forming the postulated group similar to the Kentish church, and offering the closest parallels throughout Europe are as follows:

- St Peter, Altenburg, North Italy, probably 5th century (Fig 85)
- Ulrichsberg, Kärnten, Austria, end of 5th/early 6th century (Fig 86)
- Grand-Saconnex, Geneva, Switzerland, 5th/6th century (Fig 87)
- La Madeleine, Geneva, Switzerland, 6th-7th century (Fig 88)
- Saint Gervaise, Geneva, Switzerland, late 6th-7th century (Fig 89)
- Notre-Dame, St Maurice, Switzerland, 7th century (Fig 90)
- St Martin, Angers, France, 6th/7th century (Fig 91)

These churches clearly first appear during the 5th century and continued being built into the 7th century.

Although some areas researched were lacking in published material, the picture that has emerged consistently presents us with a variety of small churches, all bearing close similarities with our Kentish type. They all cluster in a narrow band across central Europe, in the Alpine region, but perhaps extending west across France to Angers.

One may postulate that the external source of influence for Augustine's early churches in Canterbury was most likely to have come from the Alps and Eastern France, with the centre of the influence at Geneva, where three churches are known

with similar plans.

The original sources of influence for our parallels in the Alps is perhaps even more complex and worthy of a PhD thesis of its own. However, the tradition appears not to have come from Rome, since no churches of the type have been found, but perhaps from Byzantium via Ravenna. It is in Byzantium that the eastern porticus is a common element of the church plan. Krautheimer has noted that by the time of Pope Gregory Rome was in a bad state, and it was only through him (Gregory) that Rome “became the missionary centre of Western and Central Europe” (Krautheimer 1980, 62). Rome was at this time “an outer province of the Eastern Roman, or Byzantine, Empire, ruled from Ravenna by a Byzantine viceroy” (Krautheimer 1980, 62) and churches “with strikingly Byzantine and Eastern accents” were built in Rome in the early 6th century (Krautheimer 1980, 75). None of the church plans in central Italy (and Rome in particular) come close to those of the Alps for our work on parallels, but the contact with Byzantium may well have influenced the Alpine churches with their small eastern porticus.

Period 2: expansion (8th and 9th century)

Expansion at Canterbury’s Anglo-Saxon churches takes two main forms. The first, at St Augustine’s abbey, saw extensions being added to the original church the most significant of which was the addition of a cloister, perhaps during the 8th century (Chapter 5). The second, at the cathedral, involved the entire rebuilding of the early church on a much larger, impressive scale probably in the early 9th century (Chapter 5). These two major expansions will be investigated in more detail here to set the development into a broader Continental framework.

St Augustine’s abbey

On the abbey site no major re-building took place on the church on such a grand scale as the cathedral, but the first phase of the cloisters were added sometime between the 8th century and early 11th century (Fig 10). The phasing is very imprecise, but at least three phases of cloisters are evident from the plan, and we have two documented re-builds of the cloister, one between 1006 and 1023x7, another in the mid 11th

century (Chapter 5). There remains a good probability that the first phase of the cloisters dates to the 8th century in line with ecclesiastical reforms (Gem 1993).

No extensive work has been undertaken to look for Continental parallels for the cloisters at St Augustine's abbey. Richard Gem, however, has noted that at Lorsche in Hessen, Germany, the first monastery was built in 760-64 (Fig 94) (Gem 1993, 31).

A trawl of material was undertaken in an attempt to find 8th century cloisters built after the reformation of the church from the mid-8th century with the following results:

- Lorsche, Hessen, Germany, 760-64 (Fig 94)
- Notre-Dame, Rouen, France, 760-70 (Fig 95)
- St Johann, Müstair, Switzerland, end 8th century (Fig 96)

The monastic cloister at Lorsche was reported by Gem who noted that “the first monastery was built *c.* 760-7 with a fully developed claustral plan: the founders were the English missionary Boniface and his disciples” (Gem 1997, 104). Unfortunately, this is not correct since Gem mentions elsewhere that Boniface died in 754, and that archbishop Chrodegang founded the monastery of Lorsche in 760-64, transferring to a new site with a larger church in 767-74 (Gem 1993, 31). The first church complex built in 760-64 is that published in 1966 (Oswald *et al* 1966, 182). The cloisters extend north of the church and have ranges of buildings along the east and west sides. The cloister garth measures 15.5 m square with walkways around all four sides, each of which varies in width (Fig 94).

At Notre-Dame, Rouen, the excavated plan shows a complex of ecclesiastical sites comprising two large churches (Fig 95), comprising the cathedral of Notre-Dame to the south and the basilica of Saint-Etienne to the north, and a number of claustral ranges (Maho 1993, fig 1). That to the south of Notre-Dame is particularly significant for discussion of the cloisters at St Augustine's abbey since they were built shortly after archbishop Remigius introduced reforms in 760 (Maho 1993, 24-5). The cloisters were built shortly afterwards (760-770) and comprised a western “gallery” of timber posts on sandstone foundations, and an eastern “gallery” of stone. On the south side was a structure interpreted as a library (Maho 1993, 25). At the end of the 8th or early in the 9th century significant changes to the layout were undertaken in

the complex. These comprised reconstruction of the northern cloisters (to the north of Saint-Etienne) and additions to the south cloisters of Notre-Dame. The latter comprised the construction of a stone tower in the north-east angle of the cloister garth, interpreted as an archive (mentioned in written sources), an insertion of a water supply (Maho 1993, 27). The cloister garth at Notre-Dame measures 20 m east-west by at least 20 m north-south, with known ranges of buildings on the east and west sides, and walkways on three sides. The form of the south side remains unknown. The entire complex was destroyed by fire during a Viking raid in 841.

A similar cloister complex to that at Notre-Dame in Rouen is known at Saint-Wandrille, France in the mid 8th century, from historical records (Conant 1978, 45; Maho 1993, 26).

St Johann, Müstair the monastic cloister was to the south of the church complex and is datable to the end of the 8th century (Jacobsen *et al* 1991, 295-6). The cloister garth measures some 37 m east-west by 31 m north-south (Fig 96) with walkways around all four sides. On the inside of the garth are a number of structures, comprising a range along the south side, structures in the south-east and north-west corners, and a possible free-standing tower in the north-east corner. A substantial west range of buildings is known. The scale of the plan of the cloister at Müstair at the end of the 8th century is far greater than at Lorsch in 760-64 or Notre-Dame in 760-70, and may simply mark a rapid development of cloister design.

Conclusions

Parallels for 8th century cloisters are not numerous but well spread, with one example each in Germany, France, and Switzerland. Given the date of the examples noted, there is every reason to be optimistic that the first phase of the cloisters at St Augustine's abbey date to the mid-late 8th century. As such they would fit well with ecclesiastical reforms being undertaken at that time.

Canterbury cathedral

Expansion at Canterbury comprised extensive changes at the cathedral when the church was re-built in the early years of the 9th century (Fig 16), perhaps as part of Wulfred's documented re-building between 803 and 813 (Chapter 5). The main body

of the cathedral measured 43.6 m by around 24 m, with a western *narthex* 14 m by 6 m externally.

Continental parallels have been looked at briefly in Chapter 5, but not all of the sites were illustrated in that section and more extensive work has been undertaken to look at the wider setting. The parallels, in order of date, with additional figures illustrating all sites are as follows:

- St Peter's, Soest, Germany, *c.* 800 (Fig 97)
- Mainz abbey, Germany, 805 (Fig 98)
- Werden abbey in Nordrhein-Westfaen, Germany, *c.* 840-75 (Fig 17)
- St Justinus, Höchst, Main, Germany, second quarter 9th century (Fig 99)
- Reichenau-Oberzell, Switzerland, for its tower of *c.* 896 (Fig 100)
- St Cyriakus at Gernrode, Germany, for its short annex with stair towers of 961 (Fig 101)

St Peter's, Soest in Germany represents a substantial church with a western *narthex* dating to *c.* 800 (Fig 97) (Jacobsen *et al* 1991, 391-2). The plan at Soest is incomplete, but the early western *narthex* (9.5 m by 3 m externally) bears a striking resemblance to that at Canterbury.

At Mainz abbey in Germany, the nave of the church built in 805 measured some 32 m by 50 m, with an eastern apse and a small western *narthex* (Fig 98) (Oswald *et al* 1966, 195). The latter measures 15 m by 7 m externally.

The abbey church at Werden in Germany, measured 53 m by 21.7 m, inclusive of the eastern crypt, and the nave alone measured 42 m long (Fig 17). No western *narthex* is present, but the church does compare well in terms of size.

Moving to Switzerland we have an example of two churches with towers at the east end. One is St Justinus, Höchst (Fig 99), in the second quarter of the 9th century, the other Reichenau-Oberzell (Fig 100), around 896 (Oswald 1966, 124; Koshi 1994, respectively). The scale of the churches is smaller than at Canterbury. Richard Gem in his review of my report on Canterbury cathedral noted that no known tower of this date is known when not buttressed laterally with transepts, but that otherwise the church would fit well in the early years of the 9th century (Gem 1998, 233-4). I would maintain, however, that the tower at Canterbury is buttressed by the side aisles

and postulated cross walls in the aisles (Fig 16) and that there is no reason why a tower could not have been part of the plan in the early 9th century. Though no parallels could be found for towers without transepts, this does not preclude such a tower at Canterbury.

Back in Germany at St Cyriakus, Gernrode, we have a further large church with a western narthex, dating to c. 961. The main body of the church measures around 31 m by 22 m with a western *narthex* measuring 10 m by 4.5 m. The latter church is included, even though the date is later than at Canterbury.

Conclusions

It can be seen from the Continental parallels noted above that all of the churches of any size with a western narthex, lie in Northern and Central Germany (Soest, Mainz, Werden, and Gernrode). No similar churches were found in any of the other areas listed in the introduction to this chapter (above). Parallels for early towers are in Central Germany (Höchst) and Switzerland (Reichenau-Oberzell).

Period 3: later additions (11th century)

The final phases of both Canterbury cathedral and St Augustine's abbey both saw extensive additions to their plans. At Canterbury a substantial western structure was added in the early years of the 11th century (Chapter 5), whilst at St Augustine's a rotunda structure was built around 1050 (Chapter 5).

These two major building programmes will be investigated in more detail here to set the development into a broader Continental framework.

Canterbury cathedral

The western structure and two eastern towers were added to the cathedral in the first half of the 11th century. Since the western structure incorporated an apse, and an eastern apse is known from written sources (Chapter 4) the result was that the cathedral became bi-polar (Fig 18). Continental parallels were looked at in Chapter 5 but have been extensively added to here to form a picture of a range of possible influences.

A large number of bi-polar plans have been found, most notably in Germany, but

with examples also in France, Spain and Portugal. They are, in order of date:

- Bruñel, Quesada Spain, 4th century (not illustrated)
- San Pedro Alcántara, Málaga, Spain, 475 (not illustrated)
- Casa Herrera, Mérida, Spain, *c.* 500 (not illustrated)
- Torre de Palma, Monforte de Alemtejo, Portugal, 6th century (not illustrated)
- El Germo-Espiel, Cordoba, Early 7th century (not illustrated)
- Fritzlar cathedral, Germany, probably before 774 (Fig 102)
- St Maurice d'Agaune, Switzerland, 787 (Fig 103)
- Cologne cathedral, Germany, *c.* 800 (Fig 103)
- Fulda abbey, Germany, *c.* 802-19 (Fig 104)
- Paderborn cathedral, Germany, *c.* 836 (Fig 105)
- Echternach abbey, Luxembourg, late 9th century (Fig 106)
- Helmarshausen abbey, Germany, 997-1011 (Fig 107)
- St Cyriakus, Gernrode, Germany, 12th century (Fig 19)

It can be seen from the above list that the Spanish and Portuguese examples of bipolar churches are all early examples dating to the 4th and early 7th centuries (Palol 1967; Schlunk & Hauschild 1978). These have not been included in the following discussion because they are too early to have had any direct influence on Canterbury's churches (given the later sequence from Germany).

The remainder of the churches span a considerable time-scale, and are centred on Germany, with one example in Switzerland. These churches first appear in the later 8th century, the earliest of which is Fritzlar cathedral, perhaps before 774 (Fig 102) and whose western apse is known from excavation (Jacobsen 1992, 225). Shortly afterwards Saint-Maurice d'Agaune was built in 787 (Fig 19) and excavated to reveal two substantial apses, both with crypts (Jacobsen 1992, 200-203). Around 800 Cologne cathedral was built (Fig 103) with its apses opening off substantial transepts (Jacobsen 1992, 203-12), whilst at Fulda abbey *c.* 802-19 (Fig 104) the church has a massive transept flanking the western apse (Jacobsen 1992, 193-9). At Paderborn cathedral, *c.* 832 (Fig 105) the eastern apse is stilted, whilst the western apse is shorter (Jacobsen 1992, 212-8). In the late 9th century Echternach was built (Fig 106). The final two examples, from Germany and Luxembourg, are later in date.

Helmarshausen dates to 991-1011 (Fig 107) and has a large rectangular nave without transepts, and an apse springing from each end, the western of which has a crypt (Oswald *et al* 1966, 411-2). St Cyriakus, Gernrode, dates to a period after that for which we are looking at parallels (the apse was added in the 12th century). However, it is so much like the cathedral plan at Canterbury, with its flanking stair towers (Fig 18) (Jacobsen *et al* 1991, 143-4), and the previous 10th century phase is close to Canterbury's earlier plan (above).

Werner Jacobsen has noted that the plan at Canterbury, with its combination of an apse and stair towers is seldom seen (Jacobsen *pers comm*). In the examples above stair towers may be seen at Cologne around 800, and Gernrode in the 12th century.

Conclusions

The research undertaken makes it clear that like the Period 2 cathedral at Canterbury, the Period 3 bi-polar plan appears to have been derived from Germanic influences. The resultant plan, however, is unique rather than a copy of any particular Continental church.

St Augustine's abbey

The rotunda structure was built by Wulfred to link the eastern end of the church of Sts Peter & Paul with the western end of St Mary's chapel (Chapter 5). This work was started around 1049 but never completed (Chapter 4).

In Chapter 5 several parallels were cited and a possible chronological sequence of circular churches proposed as follows:

- Church of the Holy Sepulchre, Jerusalem, 4th century (Fig 23)
- Funeral basilica of Saint-Pierre, Geneva, Switzerland *c.* 600 (Fig 24)
- Palatine Chapel at Aachen, Germany 792-805 (Fig 25)
- St Bénigne abbey, Dijon, France 1018 (Fig 26)
- St-Saviour's Charroux, France 1047 (Fig 27)
- Ottmarsheim, Alsace, France 1049 (Fig 28)

Rotunda structures are far from rare, and a number of others are known (Krautheimer 1965; Jannet & Sapin 1996). There are examples from Palestine and

Jordan (Mount Garizim, 484), Asia Minor (Hierapolis, early 5th century), Italy (S Stefano on the via Latina, 468-83 and Santa-Constanza, 350 in Rome, and San Vitale in Ravenna, 546-8), and Croatia (St Donat in Zadar, probably early 9th century).

Conclusions

With the examples of rotunda of St Bénigne in Dijon, St-Saviour in Cherroux and Ottmarsheim in Alsace there is little need to look far for influences to Wulfric's design. The influences for the rotunda at St Augustine's abbey are clearly from France, and is in marked contrast with the Germanic influences playing on the 9th and 11th century cathedral at Canterbury (above).

CHAPTER 10: CONCLUSIONS

Introduction

The aims of this thesis, as set out in Chapter 1, were to look at the layout, function, and development of Anglo-Saxon churches at Canterbury from an archaeological perspective. To achieve these aims the thesis was divided into two sections. The first looked at four main areas of research: the evidence from excavations (Chapter 3), the historical and written sources (Chapter 4), an interpretation of the evidence with parallels and dating evidence (Chapter 5), and a general discussion on the design and development of the churches (Chapter 6). The second section was designed to undertake thematic discussions to set the Anglo-Saxon churches at Canterbury into a wider setting, hence the three chapters: the wider setting of Anglo-Saxon Canterbury (Chapter 7), Anglo-Saxon monasteries (Chapter 8), and Continental parallels (Chapter 9).

In this final chapter it is intended to undertake three main tasks: to briefly summarise the conclusions of the previous chapters, to draw together a number of threads that have developed over several chapters, and to suggest possible avenues for future research.

With the above in mind I have divided this chapter into a number of parts so that various aspects of the research can be addressed in turn.

The excavated evidence and written sources

Canterbury's cathedral

It has been established that Augustine had the first phase of the cathedral in 597 built as a new building, re-using Romano-British materials, but not as an addition to any existing Romano-British structure (Chapter 3). This phase has been interpreted as similar in plan to the churches of Sts Peter & Paul at St Augustine's abbey, and St Mary's at Reculver (Chapter 5). The plan is typical of the early Kentish church built by Augustine and his successors in the late 6th and 7th centuries, with excavated

examples being St Pancras church in St Augustine's abbey, St Andrew's cathedral in Rochester, St Mary's in Lyminge, and St Peter's at Bradwell-on-Sea, Essex (Chapter 5). Written and historical sources provide the foundation date for the church in 597.

In the second phase the cathedral saw major re-building on a large scale including a central tower towards the eastern end, a small mausoleum, and a squared western *narthex*. The latter is interpreted as perhaps supporting a first-floor chapel (Chapter 5). Dating evidence was sparse but an early 9th century date was favoured after looking at the British and Continental parallels (Chapters 5 and 9 respectively) and the written and historical sources (Chapter 4). The latter indicates that Wulfred was the most likely candidate as patron for the second phase re-building between 808 and 813 (Chapter 4). The parallels will be discussed below.

The third phase of the cathedral probably saw a major re-building, but little of this survived to be excavated (Chapter 3). A hearth, however, from this phase provided a radiocarbon date of 900-70, which fits very well with the written and historical sources which records Oda's re-building work at the cathedral between 942 and 958 (Chapter 4).

Finally, the cathedral was expanded with the addition of an apsed western structure with flanking hexagonal stair towers, and square towers at the eastern end (Chapter 3). Written and historical sources, mainly Eadmer, confirm that the western apse was the chapel of St Mary, and also reported a number of key altars and other features in the cathedral (Chapter 4). Dating of the final phase was difficult, but after research into Continental parallels (Chapters 5 and 9) this was thought to date to the first half of the 11th century, before the cathedral was destroyed by fire in 1066 (Chapter 4).

St Augustine's abbey complex

The first phase of the church of Sts Peter & Paul was similar in plan to St Mary's church at Reculver, and was built by Augustine in the early years of the 7th century, being dedicated no later than 619 (Chapters 3 and 4). The church served the monastery, whilst north and south porticus were used as burial chapels for the archbishops and kings of Kent.

St Mary's chapel, which has been largely destroyed by later building work, was

built east of the church of Sts Peter & Paul. This is recorded as having been added between 616 and 624 (Chapter 4).

In the second phase the church of Sts Peter & Paul was extended, with a westward expansion of the nave, addition of a western *narthex*, and possible enlargement of the north porticus. This is in marked contrast to the cathedral that was totally re-built in its second phase, and is more in keeping with the gradual development of the churches as at Winchester Old Minster and Glastonbury abbey. The construction of the cloisters is also a possibility at this time. The date of the second phase is uncertain, although a mid 8th-century date would seem appropriate and fit well with ecclesiastical reforms at that time (Chapter 5).

The cloisters underwent at least two phases of alterations/re-building, but the phasing is so poor that no reliable dates can be allocated (Chapter 3). The cloisters are, however, reported in written sources as having been re-built by Aelfmaer between 1006 and 1017/22 (Chapter 4). This may, therefore be represented by the second phase of the cloister.

In the mid 11th century three main changes were made to the complex. A small western chapel with a western apsed end and adjoining circular tower was built (Chapter 3), dated by pottery from beneath the structure. The square south-west tower constructed (Chapter 3), the latter dated by a written source which recorded building work in 1047 (Chapter 4). The third project undertaken was the building of the octagonal structure linking the western end of St Mary's chapel and the eastern end of the church of Sts Peter & Paul. This was started by Wulfric around 1050, but not completed by his death in 1059 (Chapter 4).

St Pancras church, east of St Mary's, was perhaps built in the second quarter of the 7th century, but no firm dating evidence was found (Chapter 5). It was re-built in the mid-late 8th century, and perhaps served as a burial chapel (Chapter 3).

St Martin's church

This church, east of St Augustine's abbey, was first built in the Roman period, probably as a mausoleum, and was extended westwards (probably by Augustine) in the 7th century to form a church (Chapter 3). Written sources attest to the Roman

element having been used as a chapel, in the 6th century, by Queen Bertha (Chapter 4).

Anglo-Saxon Canterbury

Research into the Late Roman and Anglo-Saxon occupation of Canterbury has established that the decline of the Roman town started in the early 4th century, and was complete by the first quarter of the 5th century (Chapter 7). The town appears to have been re-settled in the mid 5th century by a population building sunken-featured structures that were cut through layers of dark earth. Roads leading up to the town were re-used, but internally a new street layout was gradually established (Chapter 7).

Of the 49 Anglo-Saxon timber structures excavated in Canterbury, 27 were apparently in use before the end of the 6th century, and these were spread over a wide area of the town (Chapter 7). The evidence from the excavations, of spinning, weaving, and a goldsmith all argue for a well-established, thriving community before the arrival of Augustine in 597 (Chapter 7).

In the second half of the 7th century a marked change in layout appears on Marlowe Area I, although sunken-featured buildings were still being built at other sites. A possible timber church and graveyard were found at the edge of Marlowe Area I by the early 7th century and perhaps acted as a focal point for the settlement in this area of the town.

Outside the Anglo-Saxon town evidence of at least two settlements has been found. One lay on the south-west side of the town near Westgate and comprised a number of burials and pottery dating to the late 6th or early 7th century. The other was on the east side of the town at Christ Church College, established shortly before the arrival of Augustine. A market is known from a charter in 762, just inside the town walls at Queningate (Chapter 7).

There is no evidence from excavations to suggest that the arrival of Augustine at the end of the 6th century gave any immediate boost to the economy of the town, although the first mint was established in the town in 630 (Chapter 5). It was not until around the mid 9th century, however, that the central area of the town was re-organised with the introduction soon afterwards of cellared structures. This is likely to have been influenced by the establishment of an organised street system, with

buildings along the street frontages and pits and cellars to the rear. The charter evidence of land purchases suggests that by the early 9th century the town was efficiently controlled by well-organised civic bodies and guilds (Chapter 7).

The British and Continental parallels

Augustine's early Kentish church (6th and 7th centuries)

The initial phase of the cathedral and the monastic church of Sts Peter & Paul are both interpreted as having been built by Augustine, whilst the first phase at St Pancras was built by one of Augustine immediate successors. Similar churches are known to have been built in Kent (and one in Essex) during the late 6th and 7th centuries. For example at St Mary's in Reculver, St Andrew's cathedral in Rochester, St Mary's in Lyminge, and St Peter's in Bradwell-on-Sea, Essex (Chapter 5).

Continental influences have been researched in Chapter 9 with the result that the focal point of influence appears to have been Northern Italy, Southern Austria, Southern Switzerland, and France. The closest parallels first appear during the 5th century and continued to be built into the 7th century. The most likely influences apparently came from the Alps and Eastern France, with the centre of influence at Geneva (Chapter 9).

Expansion (8th and 9th centuries)

The first phase of the cloisters at St Augustine's has parallels on the Continent that support the theory that the first phase of the cloisters may date to the mid 8th century. Examples have been excavated at Lorsche, Germany (dated 760-64), Notre-Dame, Rouen, France (dated 760-70), and St Johann, Müstair, Switzerland (dated end of 8th century). Those at St Augustine's would, therefore, be well placed in the mid 8th century and as such are a rare survival in Britain. It is also worth noting that a small structure located at an angle to the cloisters may represent an earlier, perhaps pre-claustral, layout (Chapter 3).

The re-building of Canterbury cathedral in the early years of the 9th century has parallels both at home (Chapter 5) and on the Continent (Chapter 9). In Britain the parallels are Brixworth (for scale) and Cirencester (Chapter 5), although the dating of each of these is controversial (although perhaps late 8th century and early 9th century

respectively). On the Continent, a wide search throughout Europe has found parallels with a western *narthex* in Germany (5 examples) and a tower in Switzerland and Germany (1 example in each country). All of the Continental parallels date to the 9th century save one (St Cyriacus, Gernrode in 961). It is clear that the influence for the 9th century re-building at the cathedral was in Northern and Central Germany.

Later additions (11th century)

Two major building projects, one at the cathedral and the other at St Augustine's, were undertaken in the 11th century.

At the cathedral, the addition of a western apsed structure, making the church bi-polar, has no adequate parallels in Britain. Continental parallels were presented in Chapter 9. This found several early bi-polar churches in Spain in the 5th and 6th centuries, but those closer both in date and geographically were in Germany (7 examples) and Switzerland (1 example). All but one date to the 8th to late 10th/early 11th century. The influence for the final Anglo-Saxon phase at the cathedral was, therefore, in Germany.

Wulfric's octagonal structure linking the two churches of Sts Peter & Paul and St Mary was started around 1050 and has no parallels in Britain. Continental parallels discovered a long line of similar structures stretching back to the Church of the Holy Sepulchre, Jerusalem in the 4th century. Examples were also found in Palestine, Jordan, Asia Minor, and Italy during the 5th and 6th centuries. Around 600 a circular basilica was built in Genoa, and at Aachen in 792-805. The closest structures in terms of dating, however, were at Dijon in 1018, Charroux in 1047 and Ottmarsheim in 1049, and it is these three structures that are most likely to have influenced Wulfred. Unlike Canterbury cathedral's two major building phases, influenced by Germanic churches, Wulfred was clearly receptive to contemporary influence from churches in France.

Further avenues of research

Whilst undertaking the research for this thesis I have found that the entire topic is under-researched. To be more specific, the following areas may be particularly fruitful avenues for future research:

The development of Anglo-Saxon churches

The study of Canterbury's Anglo-Saxon churches has shown that only a small number of scientifically-excavated churches have been published to enable the development of Anglo-Saxon churches to be established with a high degree of accuracy. When sites excavated over the last few decades are published, such as Winchester Old Minster, Wells cathedral, Monkwearmouth monastery, and Jarrow monastery, a far larger body of detailed data will be available.

This will undoubtedly provide sufficient information to enable a wider understanding of the development of Anglo-Saxon ecclesiastical architecture to be put forward for different areas of the country. It will then be informative to ask why, for instance, some churches were fully re-built (Canterbury's second phase), whilst others were added to over several centuries (St Augustine's abbey, Winchester Old Minster, Glastonbury abbey). A better picture of Continental influences in different parts of the Britain could also be researched to look for patterns of influence.

Anglo-Saxon monasteries

A large body of data is now available on excavated Anglo-Saxon monasteries. When excavations at Monkwearmouth and Jarrow are published it will be a good time for more extensive research on the development of monasteries.

It may be particularly instructive to compare assemblages of finds from well documented monastic sites, with finds from sites which are not easily identifiable as monastic (eg Brandon, Flixborough, Hartlepool, Hoddom, Tintagel, and Tynemouth) because of the lack of written and historical sources and the lack of obviously ecclesiastical buildings. The results could help identify monastic sites when the more obvious ecclesiastical characteristics are missing.

English Heritage's current research excavations near Whitby abbey may provide the impetus for such research.

Continental parallels

The information available on early medieval churches varies enormously from country to country. For instance the two-volume *Vorromanische Kirckenbauten* (Oswald *et al* 1966; Jacobsen *et al* 1991) provide good coverage of Austria, Belgium, Germany, Hungary, Luxembourg, Switzerland, and parts of Czechoslovakia and Poland. Likewise, the *Hispania Antiqua* volume on early medieval churches (Schlunk & Hauschild 1978) provides good coverage of Spain and Portugal. In contrast, France and Italy lack similar detailed publications. In France summary publications have been produced, but these fall short of what is required here, since they lack references to original excavation reports, etc. In Italy no attempt has been made to provide even a summary of the evidence.

There is, consequently, a great need for the collation of information on early medieval churches in France and Italy. Research into the French churches could be aimed at producing a detailed account of all early medieval churches with comprehensive references, using as a starting point the published summaries. Italian churches will need similar research. This material is undoubtedly available for study, dispersed in numerous journals, as internal reports for government departments, and as archive reports with archaeological bodies. To access this material would require the research to be undertaken in the country concerned. In Italy the British School at Rome and the regional offices of the *Notiziario della Soprintendenza archeologica* (government archaeological body) could be invaluable sources of information.

St Augustine's abbey cloisters

The cloister plan is very poorly understood because of the early date of the excavation, and none of the phases is dated internally. The research has indicated a possible pre-claustral building, a mid 8th century date for the first phase of the cloisters from Continental parallels, a second phase which may date to between 1006 and 1017/22 from charter evidence, and a final phase perhaps associated with Wulfred's rotunda around 1050.

A programme of research excavations at St Augustine's abbey could follow the research undertaken for this thesis. Ideally the entire area of the available cloister would be surveyed and then excavated. This would provide the chance to record and

phase the structures properly and obtain dating evidence.

End note

The results of the research have been both productive and rewarding and have achieved the aims that the thesis set out to accomplish. Our understanding of the development of Canterbury's Anglo-Saxon churches has been significantly extended after a detailed reconsideration of the evidence from the archaeological excavations, by setting the results into the wider context of Anglo-Saxon occupation in Canterbury, and after research into parallels in Britain and on the Continent.

APPENDIX A
LIST OF EXCAVATIONS

Date	Description	Director(s)	Publications
<i>Canterbury cathedral and precincts:</i>			
1889	West end of Crypt	C F Routledge	Routledge <i>et al</i> 1889, 295
1979	West end of Crypt	T W T Tatton-Brown	Tatton-Brown 1979, 276-8
1973	Outside Nave/S-W Transept	F Jenkins	Jenkins 1990, 117-22
1978-9	Aula Nova	P Bennett	Unpublished
1978	Outside Gabriel's Chapel	J Rady	Rady 1990, 80-105
1979	Almonry Yard	P Bennett	Unpublished
1979-80	Linacre Garden	J Driver	Driver 1990, 37-59
1982	Outside N-E Transept	J Rady	Rady 1990, 106-16
1992-3	Eight evaluation trenches	T Allen	Blockley <i>et al</i> 1997
1993	Nave and S-W Transept	K Blockley, P Bennett	Blockley & Bennett 1993, 1-4 Blockley 1994, 124-30 Blockley <i>et al</i> 1997
1993	Outside nave	G Shand	Blockley <i>et al</i> 1997
St Augustine's abbey complex:			
1845	Abbot's Hall and Nave	Butterfield	<i>Archaeol Cantiana</i> , iv, 63-64
1867-9	Kitchen, Refectory, Cloister	'College'	<i>StACOP</i> , 102, 103
1881	St Pancras Chapel	C F Routledge	Routledge 1882, 103-7
1885	Site St Augustine's Altar	A J B Hope	<i>StACOP</i> , 1887
1900	Crypt, N Transept, Chapter House, Infirmary	C F Routledge, St J Hope	<i>StACOP</i> , 227 <i>Archaeol Cantiana</i> , 1902, 222-37
1901-3	Crypt Chapels, N Transept, E Chapel, Abbot Dygon's Chapel, Slype, Chapter House, Crypt cleared, Infirmary	C F Routledge, S Evans	Routledge 1902, 238-43 Evans 1904, 1-8 Detsicas 1981, 72-84 <i>StACOP</i> , 280 <i>StACOP</i> , 283 <i>StACOP</i> , 285 <i>StACOP</i> , 290
1900-2	St Pancras Chapel	C F Routledge W St J Hope	Routledge 1902, 222-37 Hope 1902, 222-37

			<i>StACOP</i> , 227
			<i>StACOP</i> , 283
			<i>StACOP</i> , 285
1907	Infirmery, Chapter House	S Evans	<i>StACOP</i> , 306
1914-15	Monk's Choir, Wulfric's Octagonal Structure, N Porticus, N Aisle,	R U Potts, W St J Hope	<i>StACOP</i> , 327-9 <i>StACOP</i> , 331-2 Hope 1915a, 377-400 Hope 1915b, 294-6 Hope 1917, 1-26
1918	Abbot Roger's Tomb	R U Potts	<i>StACOP</i> , 377 Potts 1920, 139-47
1920-22	Kitchen, Refectory, Nave, S Aisle, St Anne's Chapel, West Front, S-W Tower, S Porticus, Nave	R U Potts	<i>StACOP</i> , 346 Potts 1921, 117-26
1924	S Aisle Nave, S Transept, Royal Tombs, Western Tower,	R U Potts	<i>StACOP</i> , 354 Potts 1925, 211-3 Potts 1926, 97-112 Peers & Clapham 1927, 201-17 Potts 1928, 65-66
1927-31	Cloister	R U Potts	<i>StACOP</i> , 368 <i>StACOP</i> , 371 <i>StACOP</i> , 373 Potts 1934, 179-94
1955-58	W end Nave, Tower, W Chapel, Nave	A D S Saunders	<i>Medieval Archaeol</i> , 2, 1958, 186-7 <i>Medieval Archaeol</i> , 22, 1978, 25-63
1960	E of N Transept, N of Choir	A D Saunders	<i>Archaeol Cantiana</i> , 100.
1972	Hospital Site Trenches S of St Pancras Church	F Jenkins, D Sherlock	<i>Medieval Archaeol</i> , 17, 1973, 144
1974-75	S side Lady Chapel and Nave	D Sherlock	<i>Medieval Archaeol</i> , 19, 1975, 230 Sherlock 1981, 63-5
1974-75	St Pancras Chapel	F Jenkins	<i>Medieval Archaeol</i> , 20, 1977 163-64, 182
1976-78	S of Nave, S Tower, W end Nave	H M Woods	<i>Medieval Archaeol</i> , 21, 1978, 225-6 <i>Medieval Archaeol</i> , 22, 1978,

158-9

Archaeol Cantiana, 92, 1977,

228-99

Sherlock & Woods 1988

St Martin's Church:

1896 Limited excavations

C F Routledge, G M Livett *Archaeol Cantiana*, 22,

1897, 1-28

1954 Chancel

F Jenkins

Jenkins 1965, 11-15.

Tatton-Brown 1980, 12-18

**ABBREVIATIONS AND BIBLIOGRAPHY
TO REFERENCES IN THE THESIS**

Abbreviations

- CS* *Cartularium saxonicum*, (ed W de Gray Birch), 3 vols, 1885-93.
HA Bede's *Historia Abbatum*.
HAA Bede's *Historia Abbatum auctore Anonymo*.
HE (parts I-IV) Bede's *Historia Ecclesiastica Gentis Anglorum*.
StACOP *St Augustine's College Occasional Papers*.
Vita cap *Vita S Kentigern*, by Jocelyn S Furness (Historians of Scotland 5: A P
 Forbes Lives of S Ninian (S Kentigern 1874).

Bibliography

- AnTard 1996 *Antiquité Tardive: Les Églises Doubles et laes Familles D'*
Églises 4. Belgium.
 Acevedo C M 1992 Ælfric of Cerne Abbas, *Medieval World* 5, 39-9.
 Atherton I, Fernie E, Harper-Bill C & Smith H (eds) 1996 *Norwich Cathedral:
 Church, City and Diocese, 1096-1996*. London.
 Atkinson J C (ed) 1878 *Whitby Cartulary I*, Edinburgh (Surtees Society 69).
 Audouy M 1984 Excavations at the Church of All Saints' Brixworth,
 Northamptonshire 1981-2, *J Brit Archaeol Ass* 137, 1-44.
 Bailey R N 1976 The Anglo-Saxon Church at Hexham, *Archaeol Aeliana*, 5 ser 4,
 47-67.
 Baldwin Brown G 1925 *The Arts in Early England* 2, *The Anglo-Saxon
 Architecture*. London (2nd edn).
 Bennett P 1981a 68-69 Stour Street, *Archaeol Cantiana* 97, 279-81.
 Bennett P 1981b 69A Stour Street, *Canterbury Archaeol Trust Annu Rept 1980-81*,
 8-10.
 Biddle M 1962 Excavations near Winchester Cathedral, 1961, *Archaeol J* 119,
 150-194.

- Biddle M 1972 Excavations at Winchester, 1970: 9th interim report, *Antiq J* **52**, 93-131.
- Biddle M 1974 The archaeology of Winchester, *Scientific American* **230**, pt 5, 33-43.
- Biddle M 1975a Excavations in Winchester 1971: 10th interim report, *Antiq J* **55**, 303-5.
- Biddle M 1975b *Felix Urbs Winthonia: Winchester in the age of Monastic Reform, Tenth-Century Studies*, (ed D Parsons), 123-40.
- Biddle M 1986 Archaeology, Architecture, and the Cult of Saints in Anglo-Saxon England, *The Anglo-Saxon Church*, (eds L A S Butler & R K Morris), CBA Res Rept **60**, 1-31.
- Biddle M, Lambrick H T & Myres J N L 1968 The Early History of Abingdon, Berkshire, and its Abbey, *Medieval Archaeol* **12**, 26-69.
- Birch W de Grey 1887 *Cartularium Saxonicum*, ii, No. 509.
- Blagg T F C 1981 Some Roman Architectural Traditions in the Early Saxon Churches of Kent, *Collectanea Historica: Essays in Memory of Stuart Rigold*, (ed A Detsicas), 50-3.
- Blair J 1987 Saint Frideswide Reconsidered, *Oxoniensia* **52**, 71-127.
- Blair J 1991 The Early Churches at Lindisfarne, *Archaeol Aeliana 5 ser* **19**, 47-53.
- Blair J 1992 Anglo-Saxon Minsters: a Topographical Review, *Pastoral Care Before the Parish*, (eds J Blair & R Sharpe), 226-66.
- Blockley K 1981 The Marlowe Excavations 1978-80: A Summary, *Canterbury Archaeol Trust Annu Rept 1980-81*, 5-7.
- Blockley K 1994 Canterbury Cathedral, *Current Archaeology* **136**, 124-30.
- Blockley K & Bennett P 1993 Canterbury Cathedral, *Canterbury Archaeol Trust Annu Rept 1992-3*, 1-6. Canterbury.
- Blockley K, Blockley M, Blockley P, Frere S S & Stow S 1995 *Excavations in the Marlowe Car Park and Surrounding Areas*. Canterbury.
- Blockley K, Sparks M & Tatton-Brown T W T 1997 *Canterbury Cathedral Nave Archaeology, History and Architecture*. Canterbury.
- Boddington A 1996 *Raunds Furnells: The Anglo-Saxon church and churchyard*, English Heritage Archaeol Rep **7**. London.

- Bonnet C 1986 *Geneva in Early Christian Times*. Geneva.
- Bonnet C & Privati B 1994 La crypte de Saint-Gervaise de Genève, in *Edifices & Peintures*, (ed C Sapin), 55-62. D'Auxerre.
- Britnell W J 1990 Capel Maelog, Llandrindod Wells. Powys: Excavations 1984-87, *Medieval Archaeol* **34**, 27-96.
- Brooks N 1984 *The Early History of the Church of Canterbury, Christ Church from 597-1066*. Cambridge.
- Brooks N 1995 The Anglo-Saxon Cathedral Community, 597-1070, *A History of Canterbury Cathedral*, (eds P Collinson, N Ramsay & M Sparks), 1-37. Oxford.
- Burrow I C G 1974 Tintagel – Some Problems, *Scot Archaeol Forum* **5**, 99-103.
- Carr R D, Tester A & Murphy P 1988 The Middle-Saxon settlement at Staunch Meadow, Brandon, *Antiquity* **62**, 371-77.
- Cherry B 1976 Ecclesiastical architecture, *The Archaeology of Anglo-Saxon England*, (ed D M Wilson), 151-200. London
- Christie N 1991 *Three South Etrurian Churches*, British School of Rome Monograph, **4**. Rome.
- Clapham A 1930 *Early Romanesque Architecture Before the Conquest*. Oxford.
- Colgrave B & Mynors R A B 1969 *Bede, HE*. Oxford.
- Colvin H 1991 *Architecture and the after life*. Yale.
- Conant K J 1978 *Carolingian and Romanesque Architecture 800-1200* (2nd rev ed). London.
- Cramp R 1976 Monastic sites, *The Archaeology of the Anglo-Saxon England* (ed D M Wilson) 201-52. London.
- Cramp R 1976 Appendix B. Analysis of the finds register and location plan of Whitby Abey, *The Archaeology of Anglo-Saxon England* (ed D M Wilson) 453-58. London.
- Cramp R 1984 *Corpus of Anglo-Saxon Stone Sculpture, I, County Durham and Northumberland*.
- Cramp R 1993 A Reconsideration of the Monastic Site of Whitby, *The Age of Migrating Ideas: Early Medieval Art in Northern Britain & Ireland*, (eds R M Spearman & J Higgitt), 64-73. Edinburgh.

- Cramp R 1994 Monkwearmouth and Jarrow in their Continental Context, *Church Building in Ancient Times* (ed K Parfitt) 279-94. London.
- Craster H H E (ed) 1907 *The history of Northumberland* 8, Newcastle and London.
- Daniell C 1997 *Death and Burial in Medieval England 1066-1550*. London.
- Daniels R 1988 The Anglo-Saxon Monastery at Church Close, Hartlepool, Cleveland, *Archaeol J* 145, 158-210.
- Day M R 1980 The Roman Period in the Parishes of St Martin and St Paul, *The Parish of St Martin and St Paul*, (ed M Sparks), 5-11. Canterbury.
- Doppelfeld O & Weyers W 1980 *Die Augsgrabungen im Dom zu Köln*.
- Dowker G 1878 Reculver Church, *Archaeol Cantiana* 12, 248-68.
- Driver J C 1990 Excavations at Linacre Garden, Canterbury, *Excavations in the Cathedral Precincts*, 2, *Linacre Gardens, 'Meister Omers' and St Gabriel's Chapel*, (eds J C Driver, J Rady & M Sparks), 37-59. Maidstone.
- Elmham Thomas of *Historia Monasterii S Augustini Cantuarensis*, in Rolls Series, (ed C Hardwick), 1858.
- Evans S 1904 Excavations at St Augustine's Abbey, Canterbury, *Archaeol Cantiana* 26, 1-8.
- Fernie E 1983 *The Architecture of the Anglo-Saxons*. London.
- Fletcher E 1965 Early Kentish Churches, *Medieval Archaeol* 9, 16-31.
- Fletcher E & Jackson E D C 1968 Excavations at the Lydd Basilica, *J Brit Archaeol Ass* 31, 20.
- Foot S 1992 Anglo-Saxon Minsters: a Review of Terminology, *Pastoral Care Before the Parish*, (eds J Blair & R Sharpe), 212-25.
- Frere S S & Stow S 1983 *Excavations in the St George's Street and Burgate Areas*. Maidstone.
- Frere S S, Stow S & Bennett P 1982 *Excavations on the Roman and Medieval Defences of Canterbury*. Maidstone.
- Frere S S, Bennett P, Rady J & Stow S 1987 *Canterbury Excavations: Intra- and Extra-Mural sites 1949-55 and 1980-84*. Maidstone.

- Gem R D H 1970 The Anglo-Saxon Cathedral Church at Canterbury: A Further Contribution, *Archaeol J* **127**, 196-201.
- Gem R D H 1982 The Significance of the 11th-century Rebuilding of Christ Church and St Augustine's, Canterbury, *The Development of Romanesque Architecture*, (eds N Coldstream & P Draper), 1-19.
- Gem R D H 1992 Reconstructions of St Augustine's Abbey, Canterbury, in the Anglo-Saxon Period, *St Dunstan his Life, Times and Cult*, (eds N Ramsey, M Sparks & T W T Tatton-Brown), 58-73.
- Gem R D H 1993 Architecture of the Anglo-Saxon Church, 735 to 870: From Archbishop Egbert to Archbishop Ceolnoth, *J Brit Archaeol Ass* **146**, 29-66.
- Gem R D H (ed) 1997 *St Augustine's Abbey Canterbury*. London.
- Gem R D H 1998 Review of Canterbury Cathedral Nave: Archaeology, History and Architecture, *JBAA* **151**, 232-5.
- Gibb J H P 1975 The Anglo-Saxon Cathedral at Sherborne, *Archaeol J* **132**, 71-110.
- Gilbert E C 1970 The Date of the Late Saxon Cathedral at Canterbury, *Archaeol J* **132**, 71-110.
- Goscelin *Historia Translationis S Augustini Episcopi*, *Patrologia Latina*, (ed J P Migne), Tom CLV, 1880. Paris.
- Graves E B 1975 *A Bibliography of English History to 1485*.
- Gray M and Clayton N 1978 Excavations on the Site of Eynsham Abbey, 1971, *Oxoniensia* **43**, 100-22.
- Grierson P 1952-4 The Canterbury (St Martin's) Hoard of Frankish and Anglo-Saxon Coin-ornaments, *British Numismatic J* **27**, 39-51.
- Hamilton N E S A (ed) 1870 *William of Malmesbury's Gesta Pontificum*, London.
- Harrison J P 1884 Saxon remains in Minster church, Isle of Sheppey, *Archaeol J* **41**, 54-7.
- Harry R & Morris C D 1997 Excavations on the Lower Terrace, Site C, Tintagel Island 1990-94, *Antiq J* **77**, 1-143.
- Hawkes S C 1982 Anglo-Saxon Kent c. 425-725, *Archaeology in Kent to AD 1500*, (ed P Leach), CBA Res Rept **48**, 64-78. London.
- Hearne T (ed) 1727 *Historia de Rebus Glastoniensis*, Oxford.
- Heighway C M 1980 Excavations at Gloucester. Fifth Interim Report: St Oswald's

- Priory 1977-8, *Antiq J* **60**, 207-26.
- Highway C M & Bryant R 1986 A reconstruction of the 10th century church of St Oswald, Gloucester, *The Anglo-Saxon Church*, (eds L A S Butler & R Morris), CBA Res Rept **60**, 188-95.
- Heitz C 1980 *L'Architecture Religieuse Carolingienne: Les Formes et Leurs Fonctions*. Paris.
- Heitz C 1987 *La France Pré-Romane: Archéologie et architecture religieuse du haut Moyen Age (IV siècle - an Mille)*. Paris.
- Heitz C 1988 *L'Architecture Religieuse*, *Ars Helvetica* **3**. Paris.
- Hicks M & Bennett P 1995 Christ Church College, *Canterbury Archaeol Annu Rep* 1993-94, 1-4.
- Hill P 1997 *Whithorn & St Ninian: The Excavation of a Monastic Town 1984-91*. Stroud.
- Hodges R (ed) 1993 *San Vincenzo al Volturno, I*, British School of Rome Monograph, **7**. Rome.
- Hope W H St J 1898 The Architectural History of the Cathedral Church and Monastery of St Andrew at Rochester, *Archaeol Cantiana* **23**, 194-328.
- Hope W H St J 1902 Excavations at St Austin's Abbey, Canterbury, *Archaeol Cantiana* **25**, 222-37.
- Hope W H St J 1915a Recent Discoveries in the Abbey Church of St Austin at Canterbury, *Archaeol* **66**, 377-400.
- Hope W H St J 1915b Recent Discoveries at St Austin's Abbey, Canterbury, *Archaeol Cantiana* **31**, 294-7.
- Hope W H St J 1917 Recent discoveries in the abbey church of St Austin of Canterbury, *Archaeol Cantiana* **32**, 1-26.
- Hope W H St J 1918 The First Cathedral Church at Canterbury, *Antiq J* **30**, 136-58.
- Huggins P J & Bascombe K N 1992 Excavations at Waltham Abbey, Essex, 1985-1991: Three Pre-Conquest Churches and Norman Evidence, *Archaeol J* **149**, 282-343.
- Hutcheson A 1993 Diocesan House, *Canterbury Archaeol Trust Annu Rept* 1992-93, 6-7. Canterbury.

- Houlston M 1999 Christ Church College, *Canterbury Archaeol Trust Annu Rept 1996-97*, 1-4.
- Jackson K 1958 The Sources for the Life of St Kentigern, in *Studies in the Early British Church*, (ed N K Chadwick), 273-357. Cambridge.
- Jacobsen W 1992 *Der Klosterplan von St Gallen und die karolingische Architektur: Entwicklung und Wandel von Form und Bedeutung im fränkischen Kirchenbauten zwischen 751 und 840*.
- Jacobsen W, Schaefer L & Sennhauser H R 1991 *Vorromanische Kirchenbauten: Katalog der Denkmäler bis zum Ausgang der Ottonen, Nachtragsband, Veröffentlichungen des Zentralinstituts für Kunstgeschichte in München III/2*. Munich.
- Jannet M & Sapin C (eds) 1996 *Guillaume de Volpiano et L'Architecture des Rotundes*. Dijon.
- Jenkins F 1965 St Martin's Church at Canterbury: a survey of the earliest structural features, *Medieval Archaeol* 9, 11-15.
- Jenkins F 1976 The Church of St Pancras at Canterbury, *Canterbury Archaeol Trust Annu Rept 1975-6*, 4-5. Canterbury.
- Jenkins F 1990 Excavations by the Cathedral Nave, August 1973, *Excavations in the Cathedral Precincts*, 2, *Linacre Gardens, 'Meister Omers' and St Gabriel's Chapel*, (eds J C Driver, J Rady & M Sparks), 117-22. Maidstone.
- Jobey G 1967 Excavations at Tynemouth Priory and Castle, *Archaeol Aeleana* 45, 33-104.
- Keevill G D 1992 The Rediscovery of Eynsham Abbey, Oxfordshire: Archaeological Investigations 1989-92, *Medieval Europe 1992 Pre-Printed Papers: Religion and Belief*, 195-200.
- Keevill G D 1993 Abbeys and Archaeology in Eynsham, 1989-92, *The Eynsham Record* 10, 5-17.
- Keevill G D 1995 *In God's House and in Harvey's House: Excavations at Eynsham Abbey 1991-93*, Thames Valley Monograph 6.
- Kelly S E 1986 *The Pre-Conquest History and Archive of St Augustine's Abbey, Canterbury*. (Unpublished PhD thesis, University of Cambridge).

- Kelly S E (ed) 1995 *Charters of St Augustine's Abbey, Canterbury and Minster-in-Thanet*. Anglo-Saxon Charters 4. London.
- Kjølbye-Biddle B 1986 The 7th century minster at Winchester interpreted, *The Anglo-Saxon Church*, (eds L A S Butler & R K Morris), 196-209. London.
- Kjølbye -Biddle B 1993 Old Minster, St Swithun's Day 1093, *Winchester Nine Hundred Years*, (ed J Crook), 13-20. Chichester and Winchester.
- Koshi von K 1994 Zu baugeschichtlichen Fragen und architektonischen Analysen Der St Georgeskirche von Oberzell auf der Bodensee-Insel Reichenau, *Zeitschrift für Schweizerische Archaologie und Kunstgeschichte*, **15(3)**, 173-212.
- Krautheimer R 1936 An Oriental Basilica in Rome: S Giovanni a Porta Latina, *American J Archaeol*, **40**, 485-495.
- Krautheimer R 1937 *Corpus Basilicarum Christianarum Romae: The Early Christian Basilica of Rome (IV-IX Cent)*, **I**. Rome.
- Krautheimer R 1942 The Carolingian Revival of early Christian Architecture, *The Art Bulletin*, **24**, 1-38.
- Krautheimer R 1965 *Early Christian and Byzantine Architecture*. London.
- Krautheimer R, Frankl W & Corbett S 1959 *Corpus Basilicarum Christianarum Romae: The Early Christian Basilica of Rome (IV-IX Cent)*, **II**. Rome.
- Krautheimer R, Corbett S & Frankl W 1967 *Corpus Basilicarum Christianarum Romae: The Early Christian Basilica of Rome (IV-IX Cent)*, **III**. Rome.
- Krautheimer R, Corbett S & Frankl W 1970 *Corpus Basilicarum Christianarum Romae: The Early Christian Basilica of Rome (IV-IX Cent)*, **IV**. Rome.
- Krautheimer R, Corbett S & Frazer A K 1977 *Corpus Basilicarum Christianarum Romae: The Early Christian Basilica of Rome (IV-IX Cent)*, **V**. Rome.
- Krautheimer R 1980 *The Times of Gregory the Great*. Rome.
- Leahy K 1999 The Middle Saxon Site at Flixborough, North Lincolnshire, in *Northumberland's Golden Age*, (eds J Hawkes & S Mills), 87-94.
- Livett G M 1889 Foundations of the Saxon Church at Rochester, *Archaeol Cantiana* **17**, 261-78.
- Loveluck C P 1998 A high-status Anglo-Saxon settlement at Flixborough, Lincolnshire, *Antiquity* **72**, 146-61.

- Lowe C 1991 New Light on the Anglian 'Minster' at Hoddom, *Trans Dumfriesshire & Galloway Nat Hist & Antiq Soc*, 3rd series, **66**, 11-35.
- Macphail R 1981 Soil and botanical studies of the 'dark earth', *The Environment of Man: the Iron Age to the Anglo-Saxon Period*, (ed M Jones & G Dimbleby), 309-32. Oxford.
- Maho J le 1993 Le groupe épiscopal de Rouen du Ive au Xe siècle, *Medieval Art and Architecture at Rouen*, 20-30.
- Mathews T F 1962 An Early Roman Chancel Arrangement and its Liturgical Function, *Rivista Arcaheologia di Cristiana*, **38**, 73-95.
- Micklethwaite J T 1898 Some further notes on Saxon churches, *Archaeol J* **55**, 340-3.
- Morris R 1979 *Cathedrals and Abbeys of England and Wales*. London.
- Nestori A 1960 La Basilica di San Pancrazio in Roma, *Rivista di Archaeologia Cristiana*, **36**, 213-48.
- O'Sullivan D 1989 The Plan of the Early Christian Monastery on Lindisfarne: A Fresh Look at the Evidence, *St Cuthbert, His Cult and His Community to AD 1200*, (eds G Bonner, *et al*), 125-42. Southampton.
- O'Sullivan D & Young R 1995 *Lindisfarne Holy Island*. London.
- Ordnance Survey 1990 *Historical Map & Guide: Roman and Medieval Canterbury*. London.
- Oswald F, Schaefer L & Sennhauser H R 1966 *Vorromanische Kirchenbauten: Katalog der Denkmäler bis zum Ausgang der Ottonen*, Veröffentlichungen des Zentralinstituts für Kunstgeschichte in München **3**. Munich.
- Palol P de 1967 *Arqueologia Christiana de la España Romana*. Madrid.
- Parsons D 1969 The Pre-Conquest Cathedral at Canterbury, *Archaeol Cantiana* **74**, 175-84.
- Parsons D 1983 Sites and Monuments of the Anglo-Saxon Mission in Central Germany, *Archaeol J* **140**, 280-321.
- Peers C R 1901 On Saxon churches of the St Pancras type, *Archaeol J* **58**, 402-34.
- Peers C R & Clapham A W 1927 St Augustine's Abbey Church, Canterbury, before the Norman Conquest, *Archaeologia* **77**, 201-17.

- Peers C R & Radford C A R 1943 The Saxon Monastery of Whitby, *Archaeologia* **89**, 27-88.
- Perkins J B W & Goodchild R G 1953 The Christian Antiquities of Tripolitania, *Archaeologia* **94**, 1-84.
- Pevsner N 1965 *Essex: Buildings of England* (2nd ed revised by E Radcliffe).
- Phillips D 1985 *Excavations at York Minster, II, The Cathedral of Archbishop Thomas of Bayeux*.
- Pilbrow J 1871 Discoveries made during Excavations at Canterbury in 1868, *Archaeologia* **43**, 151-64.
- Plummer C (ed) 1846 *Historia Abbatum, auctore Baeda*, 2 vols. Oxford.
- Potts R U 1920 St Austin's Abbey, Canterbury, *Archaeol Cantiana* **34**, 139-47.
- Potts R U 1921 The Latest Excavations at St Augustine's Abbey, Canterbury, *Archaeol Cantiana* **35**, 117-26.
- Potts R U 1925 A Saxon Burial Cross Found in St Austin's Abbey, *Archaeol Cantiana* **37**, 211-13.
- Potts R U 1926 The tombs of the kings and archbishops in St Austin's abbey, Canterbury, *Archaeol Cantiana* **38**, 97-112.
- Potts R U 1928 A note on the plan of St Augustine's Abbey church, *Archaeol Cantiana* **40**, 65-6.
- Potts R U 1934 The plan of St Austin's abbey, Canterbury, *Archaeol Cantiana* **46**, 179-94.
- Quirk R N 1957 Winchester Cathedral in the Tenth Century, *Archaeol J* **114**, 28-68.
- Quirk R N 1961 Winchester New Minster and its Tenth-Century Tower, *JBAA* **24**, 16-54.
- Radford C A R 1935 Tintagel: the castle and the Celtic monastery – interim report, *Antiq J* **15**, 401-19.
- Radford C A R 1953 Hoddum, *Trans Dumfrieshire Galloway Natur Hist Antiq Soc* **31**, 174-97
- Radford C A R 1957 Excavations at Whithorn (Final Report), *Trans Dumfrieshire Galloway Natur Hist Antiq Soc* **34**, 131-94.
- Radford C A R 1959 The Bishop's Throne in Norwich Cathedral, *Archaeol J* **116**, 115-32.

- Radford C A R 1967 The Early Church in Strathclyde and Galloway, *Medieval Archaeol* **11**, 105-26.
- Radford C A R 1969 Presidential Address: The Celtic Monastery in Britain, *Archaeol Cambrensis* **111**, 1-24.
- Radford C A R 1981 Glastonbury Abbey before 1184: interim report on the excavations 1908-64, *Medieval Art and Architecture at Wells and Glastonbury*, 110-34.
- Rady J 1987a Adelaide Place, *Canterbury Archaeol Trust Annu Rept 1986-87*, 12-14.
- Rady 1987b Excavations at St Martin's Hill, Canterbury, 1984-85, *Archaeol Cantiana* **104**, 123-218.
- Rady J 1990 Excavations around St Gabriel's Chapel, *Excavations in the Cathedral Precincts, 2, Linacre Gardens, 'Meister Omers' and St Gabriel's Chapel*, (eds J C Driver, J Rady & M Sparks), 80-105. Maidstone.
- Rady J 1991 Longmarket, *Canterbury Archaeol Trust Annu Rept 1989-90*, 15-19.
- Rahtz P 1962 Whitby 1958, *Yorks Archaeol J* **160**, 604-18.
- Rahtz P 1970 Excavations on Glastonbury Tor, Somerset, 1964-6, *Archaeol J* **127**, 1-81.
- Rahtz P 1976 Appendix C. The building plan of the Anglo-Saxon monastery of Whitby Abbey, *The Archaeology of the Anglo-Saxon England* (ed D M Wilson) 459-62. London.
- Rahtz P 1993 *English Heritage book of Glastonbury*. London.
- Rahtz P 1997 *Excavations at St Mary's Church, Deerhurst, 1971-73*. London.
- Reece R 1972 A Short Survey of the Roman Coins Found on Fourteen Sites in Britain, *Britannia* **3**, 269-76.
- Reece R 1973 Roman Coinage in the Western Empire, *Britannia* **4**, 227-51.
- Reynaud J-F 1998 *Londunum Christianum*.
- Rigold S E 1977 Litus Romanum - the Shore forts as mission stations, *The Saxon Shore* (ed D E Johnston), CBA Res Rept **18**, 70-5.
- Rigold S E 1960 Review of *The Normans in Canterbury* by W Urry 1959, *Medieval Archaeol* **4**, 174-5.

- Rijntjes R 1996 *Porticus or pastophorion? Eighth-century St Martin, Utrecht, between Anglo-Saxon and Frankish traditions, Utrecht: Britain and the Continent: Archaeology, Art and Architecture*, BAA Conference Transactions, **28**, 49-57.
- Ritchie A 1997 *Iona*. London.
- Rodwell W 1984 *Churches in the Landscape: Aspects of Topography and Planning, Studies in Late Anglo-Saxon Settlement*, (ed M Faull), 1-23.
- Routledge C F 1882 Roman foundations at St Pancras, Canterbury, *Archaeol Cantiana* **14**, 103-7.
- Routledge C F 1897 St Martin's church, Canterbury, *Archaeol Cantiana* **22**, 1-28.
- Routledge C F 1902 Excavations at St Austin's Abbey, Canterbury, *Archaeol Cantiana* **25**, 238-43.
- Routledge C F, Robertson W A S & Stoppard J B 1889 The Crypt of Canterbury Cathedral, *Archaeol Cantiana* **18**, 253-4.
- Saalman H 1962 *Medieval Architecture: European Architecture 600-1200*. London.
- Salway P 1993 *The Oxford Illustrated History of Roman Britain*. Oxford.
- Salter H E (ed) 1907 *Eynsham Cart.* (O.H.S. xlix), i, 19-28.
- Saunders A D 1978 Excavations in the Church of St Augustine's Abbey, Canterbury 1955-58, *Medieval Archaeol* **22**, 25-63.
- Sawyer P H (ed) 1968 *Anglo-Saxon Charters: an annotated list and bibliography*, British Academy. London.
- Schlunk H & Hauschild T (eds) 1978 *Hispania Antiqua: Die Denkmäler der Frühchristlichen und westgotischen Zeit*. Madrid.
- Scholz B W (ed) 1966 Eadmer, *Vita Bregowini...*, in *Traditio* **22**, 139-40.
- Scott G G 1881 *History of English Church Architecture*. London.
- Sharpe R 1995 *Adomnán of Iona: Life of St Columba*. London.
- Sheldon H 1978 The 1972-74 Excavations: their contribution to Southwark's History, *Southwark Excavations 1972-74* **1**. London.
- Sherlock D & Woods H 1988 *St Augustine's Abbey: report on excavations, 1960-78*. Maidstone.

- Skinner F G 1967 *Weights and Measures: their ancient origins and their development in Great Britain up to AD 1855*.
- Smith J C 1990 Form and Function of the Side Chambers of Fifth- and Sixth-Century Churches in Ravenna, *J Soc Architect Hist* **49**, 181-204.
- Speak S 1991 Excavations at Church Bank, Jarrow, 1989-91, *Archaeol Aeliana*, 5 ser **19**, 59-85.
- Sparks M 1984 The Recovery and Excavation of the St Augustine's Abbey Site, 1844-1947, *Archaeol Cantiana* **100**, 325-44.
- Sparks M & Tatton-Brown T W T 1987 The History of the Ville of St Martin's, Canterbury, *Archaeol Cantiana* **104**, 200-12.
- Strick H J A 1982 Remains of the Lanfranc Building in the Great Central Tower and the North-West Choir/Transept Area, *The Development of Romanesque Architecture*, (eds N Coldstream & P Draper), 20-6.
- Stubbs W 1874 *Memorials of Dunstan*, London (Rolls Series, **63**).
- Tabraham C J 1979 Excavations at Whithorn Priory, Wigtown District, 1972 and 1975, *Trans Dumfriesshire Galloway Natur Hist Soc*, **54**, 28-38.
- Tatton-Brown T W T 1978 Excavations at 77-79 Castle Street, Stage II, *Archaeol Cantiana* **94**, 275-7.
- Tatton-Brown T W T 1979 Canterbury Cathedral, *Archaeol Cantiana* **95**, 276-8.
- Tatton-Brown T W T 1980 St Martin's Church in the 6th and 7th Centuries, *The Parish of St Martin and St Paul, Canterbury*, (ed M Sparks), 12-18. Canterbury.
- Tatton-Brown T W T 1982 Canterbury and the early medieval towns in Kent, *Archaeology in Kent to AD 1500*, (ed P Leach), CBA Res Rept **48**, 79-86. London.
- Tatton-Brown T W T 1984a The Towns of Kent, *Anglo-Saxon Towns in Southern England*, (ed J Haslam), 1-36. Chichester.
- Tatton-Brown T W T 1984b Three Great Benedictine Houses in Kent: Their Buildings and Topography, *Archaeol Cant*, **100**, 171-88.
- Tatton-Brown T W T 1989 Church Building on Romney Marsh in the Later Middle Ages, *Archaeol Cantiana* **107**, 253-65.

- Tatton-Brown T W T undated *Topographical Maps of Canterbury AD 400, 1050, 1200, 1500 & 1700*. Canterbury.
- Taylor H M 1968 Reculver Reconsidered, *Archaeol J* **125**, 291-6.
- Taylor H M 1969a Lyminge Churches, *Archaeol J* **126**, 257-60.
- Taylor H M 1969b The Anglo-Saxon Cathedral Church at Canterbury, *Archaeol J* **126**, 101-30.
- Taylor H M 1969c The Special Role of the Kentish Churches in the Development of pre-Norman (Anglo-Saxon) Architecture, *Archaeol J* **126**, 192-8.
- Taylor H M 1975 Tenth-Century Church Building in England and on the Continent, *Tenth-Century Studies: Essays in Commemoration of the Millennium of the Council of Winchester and Regularis Concordia*, (ed D Parsons), 141-68. London.
- Taylor H M 1978 *Anglo-Saxon Architecture* **3**. Cambridge.
- Taylor H M 1987 St Wystan's Church, Repton, Derbyshire: A Reconstruction Essay, *Archaeol J* **144**, 205-45.
- Taylor J & Taylor H M 1965 *Anglo-Saxon Architecture*. Cambridge.
- Taylor H M & Yonge D D 1981 The Ruined Church at Stone-by-Faversham: A Reappraisal, *Archaeol J* **138**, 118-45.
- Thomas C 1981 *Christianity in Roman Britain to AD 500*. London.
- Thomas C 1993 *Tintagel: Arthur and Archaeology*. London.
- Thorne W Chronicle of Saint Augustine's Abbey, Canterbury, (trans A J Davies), 1934. Oxford.
- Tweddle D 1995 The Date and Stylistic Context of the Reculver Fragments, *Corpus of Anglo-Saxon Stone Sculpture*, **4, South East England**, (eds D Tweddle, M Biddle & B Kjølbye-Biddle), 46-61. London.
- Tweddle D, Biddle M & Kjølbye-Biddle B 1995 *Corpus of Anglo-Saxon Stone Sculpture*, **4, South East England**. London.
- Urry W 1959 *The Normans in Canterbury*.
- Urry W 1967 *Canterbury under the Angevin Kings*.
- Whitelock D 1961 *Anglo-Saxon Chronicle*.
- Wickham-Crowley K M 1992 *Ancillary Space in Anglo-Saxon Churches*. (Unpublished MA thesis, University of Durham).

- Williams J H 1979 *St Peter's Street, Northampton: Excavations 1973-76*.
Northampton.
- Willis R 1845a *The Architectural History of Canterbury Cathedral*. London.
- Willis R 1845b *Architectural history of Winchester Cathedral, Proc Royal Archaeol
Inst. Winchester*.
- Wilmart A 1935 *Revue des Sciences religieuses* **15**, 364-6.
- Wilmott T 1999 *Whitby Abbey Headland Project, Southern Anglian Enclosure:
Research Excavation Project Design 1999*. Internal document of English Heritage,
Central Archaeology Service, May 1999.
- Worsam B C & Tatton-Brown T W T 1990 *The Stone of the Reculver Columns
and the Reculver Cross, Stone: Quarrying and Building in England AD 43-1525*
(ed D Parsons), 51-69. Chichester.
- Woodman F 1981 *The Architectural History of Canterbury Cathedral*. London.

**THE ANGLO-SAXON CHURCHES
OF CANTERBURY
ARCHAEOLOGICALLY RECONSIDERED**

BY KEVIN BLOCKLEY, MIFA

ILLUSTRATIONS

CANTERBURY
circa 1050

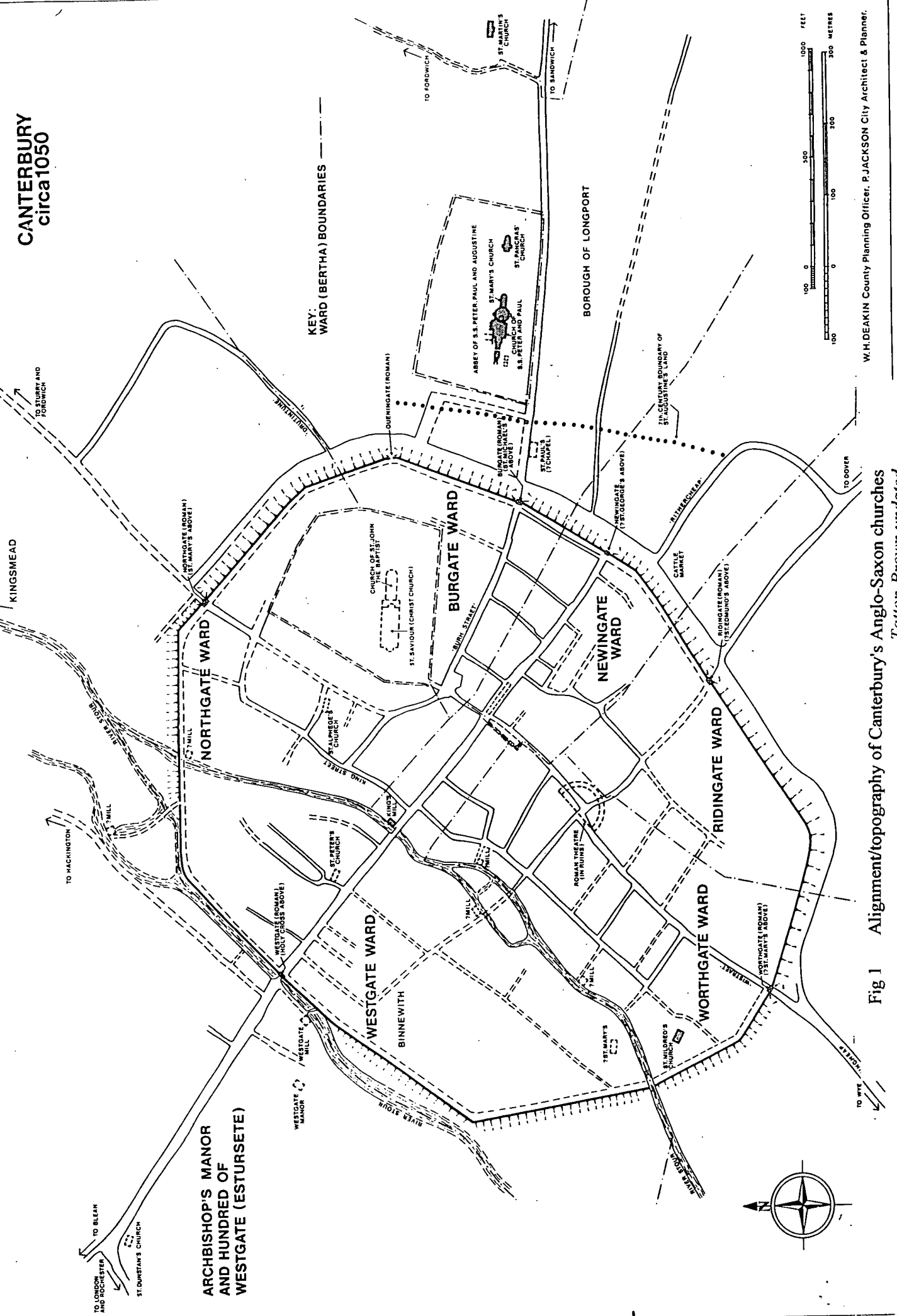

W.H.DEAKIN County Planning Officer, P.JACKSON City Architect & Planner.

Fig 1 Alignment/topography of Canterbury's Anglo-Saxon churches
Taiton-Brown undated

CHRISTCHURCH PRIORY & THE ARCHBISHOP'S PALACE

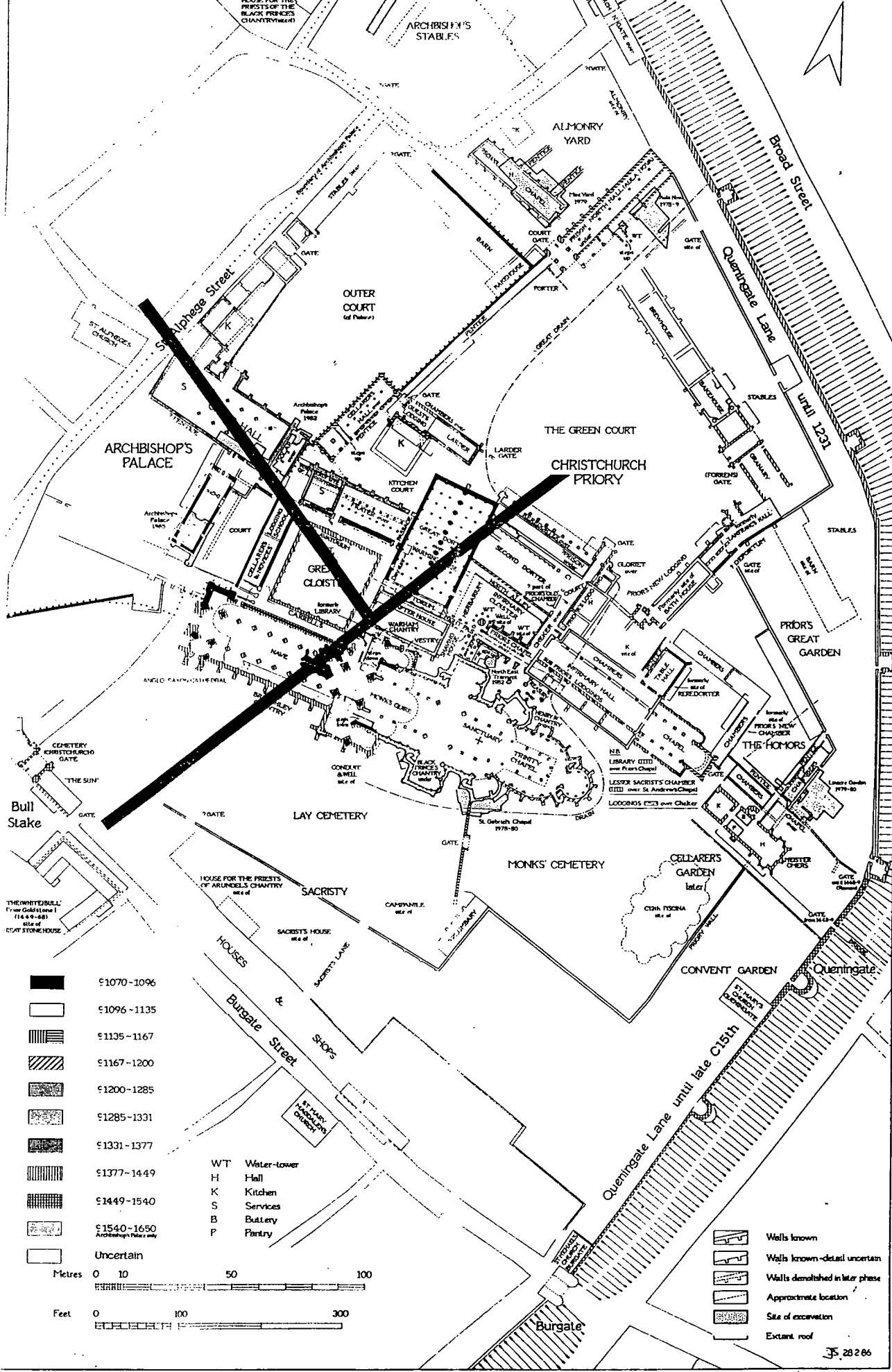

Fig 2 Canterbury cathedral: location plan showing previous excavations
Blockley et al 1997

CANTERBURY CATHEDRAL 1993

Location of excavated areas

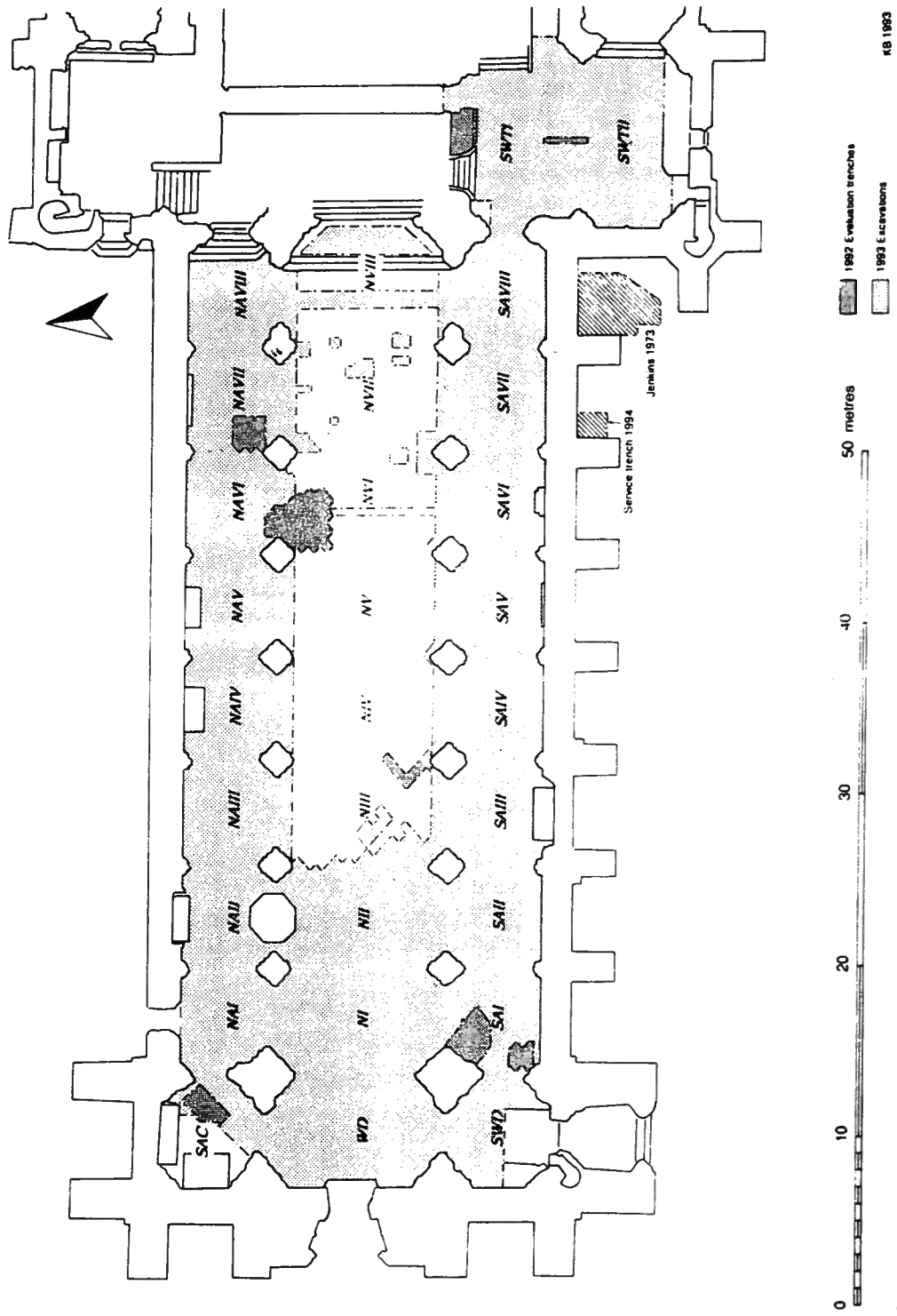

Fig 3 Canterbury cathedral: location plan of 1992-93 excavations
Blockley et al 1997



Fig 4 St Augustine's abbey: location plan of Anglo-Saxon churches
Taiton-Brown 1984b

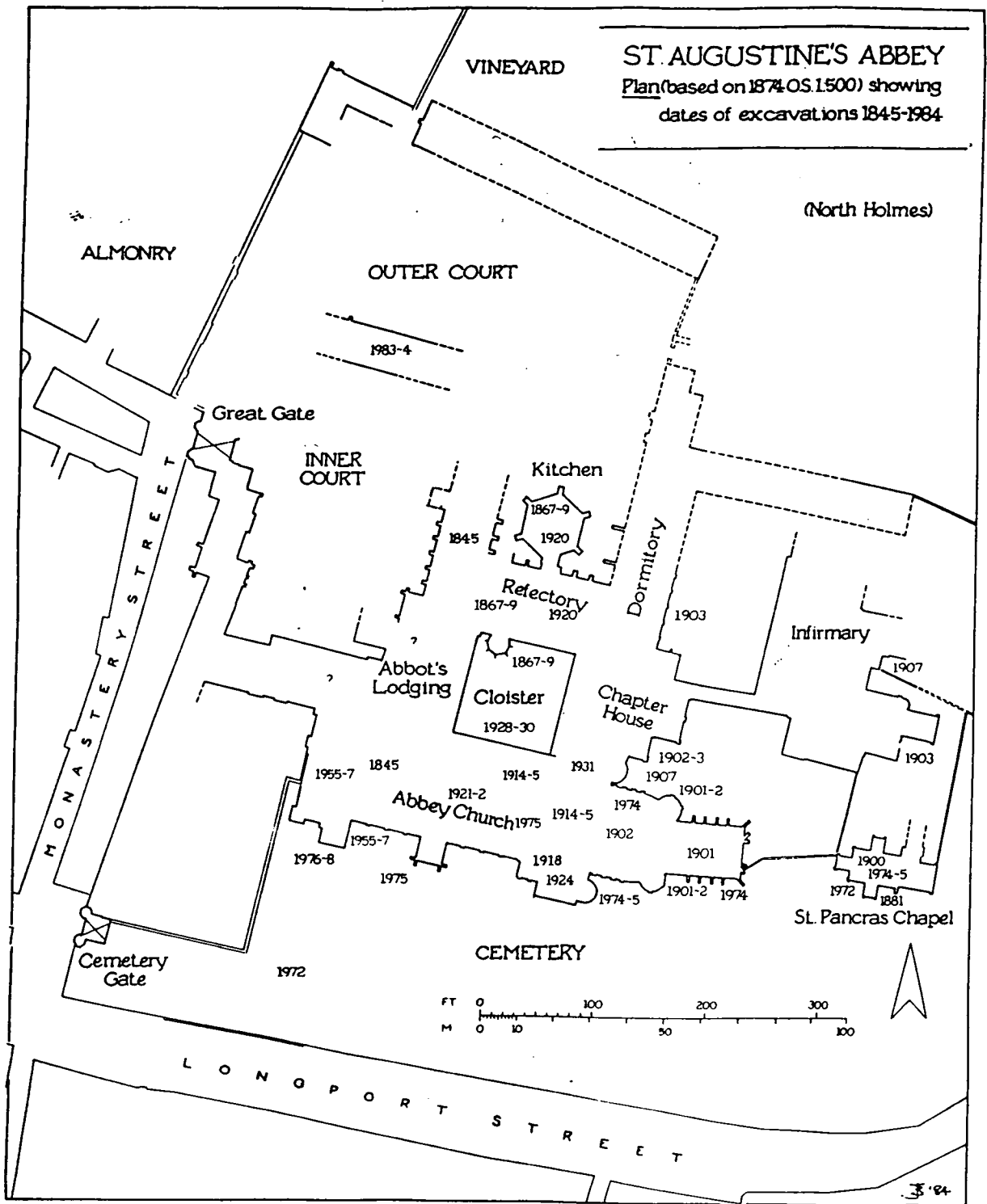

Fig 5 St Augustine's abbey: location plan of 1874-1984 excavations
 Sparks 1984

Canterbury Cathedral Anglo-Saxon phases

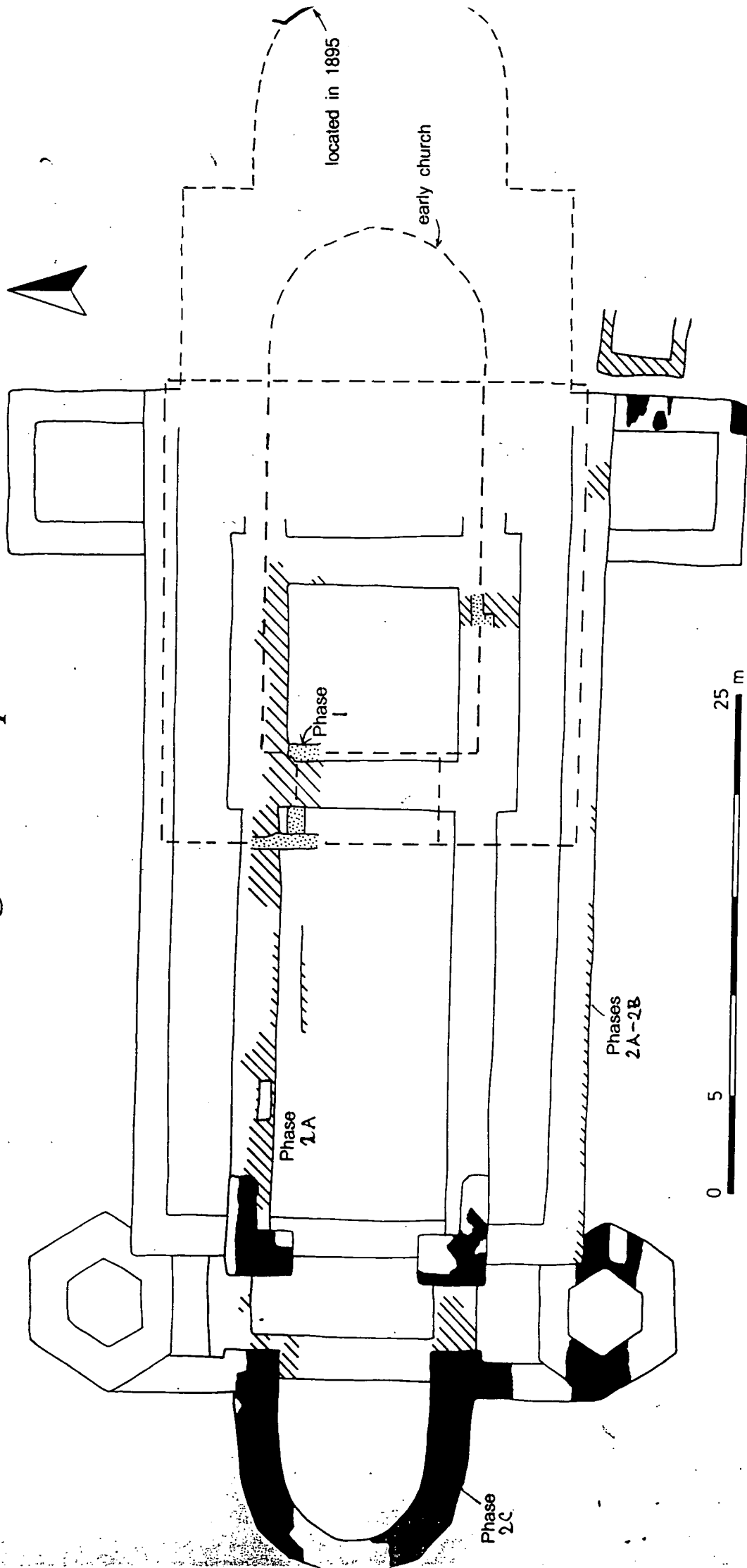

Fig 6 Canterbury cathedral: phased plan of Anglo-Saxon remains
Blockley et al 1997

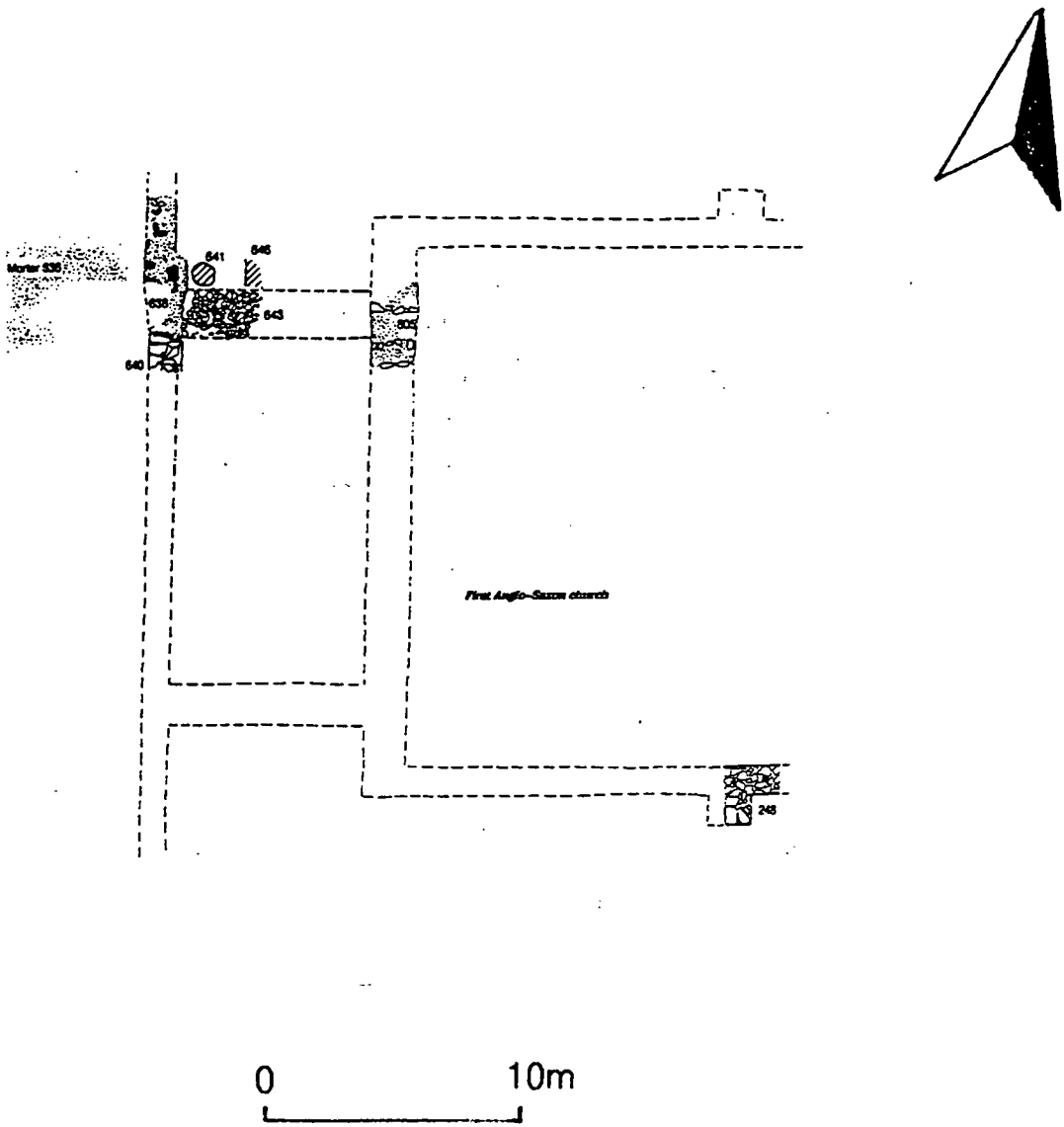

Fig 7 Canterbury cathedral: plan of Period 1 features
Blockley et al 1997

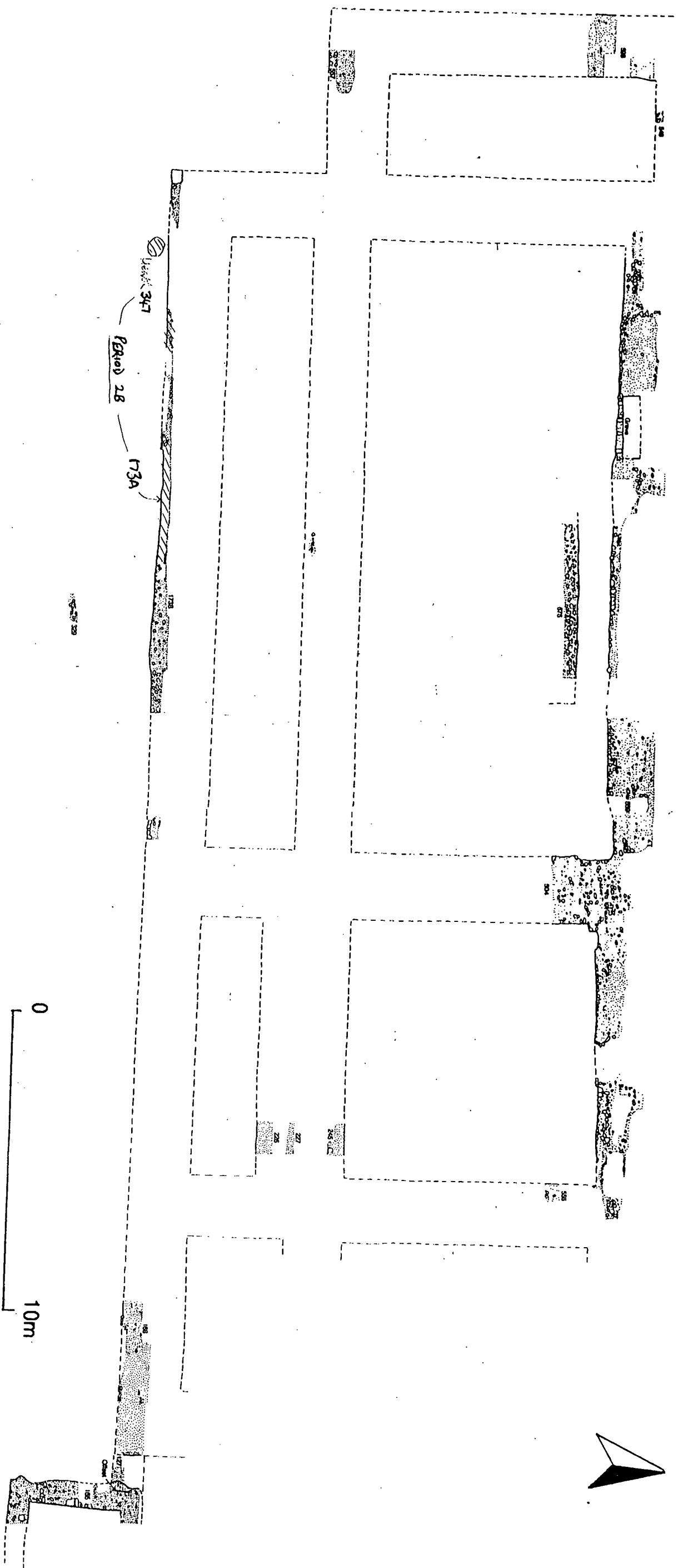
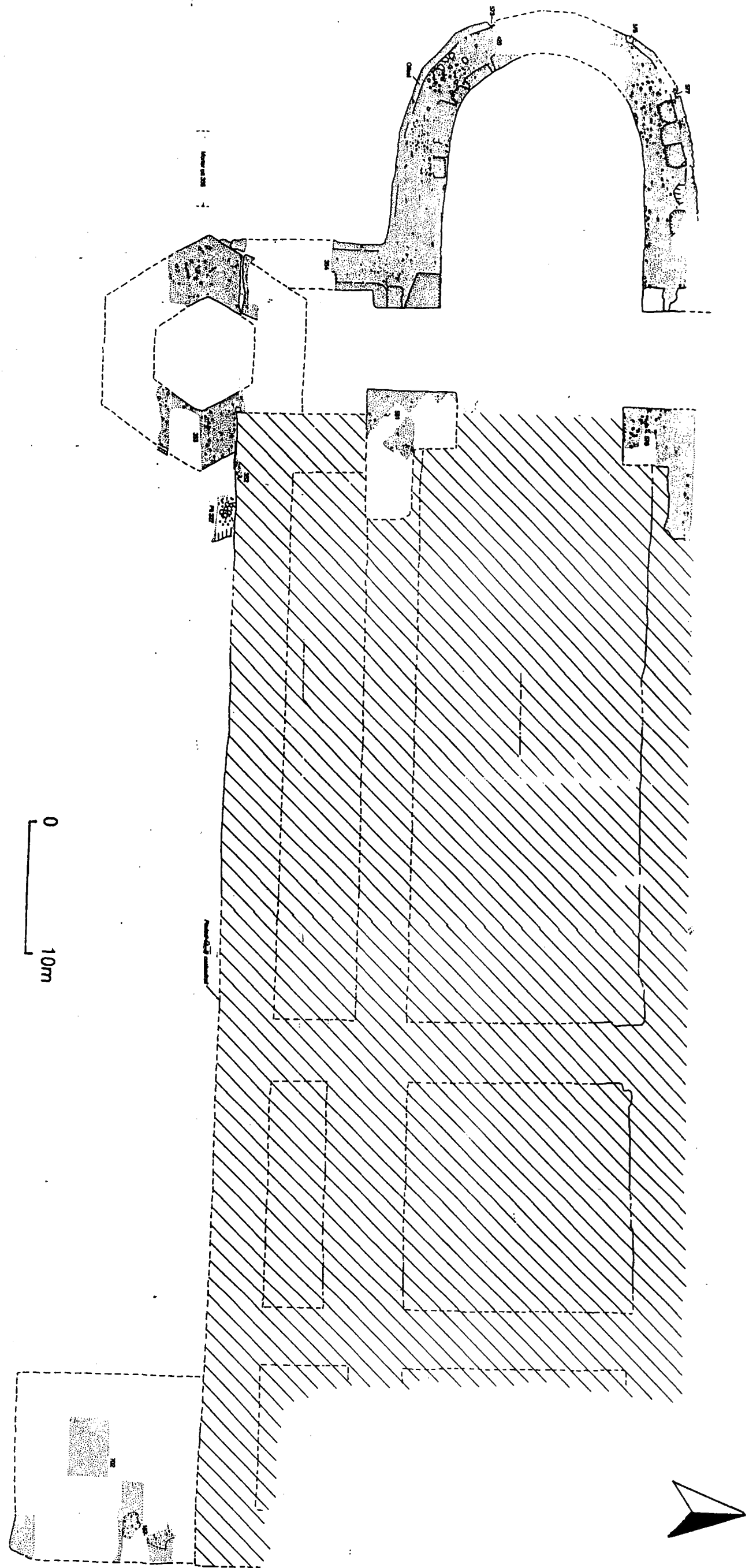





Fig 8 Canterbury cathedral: plan of Period 2A and 2B features
 Blockley et al 1997

Fig 9 Canterbury cathedral: plan of Period 2C features
Blockley et al 1997



-  7th century
-  8th-11th centuries
-  Mid 11th century

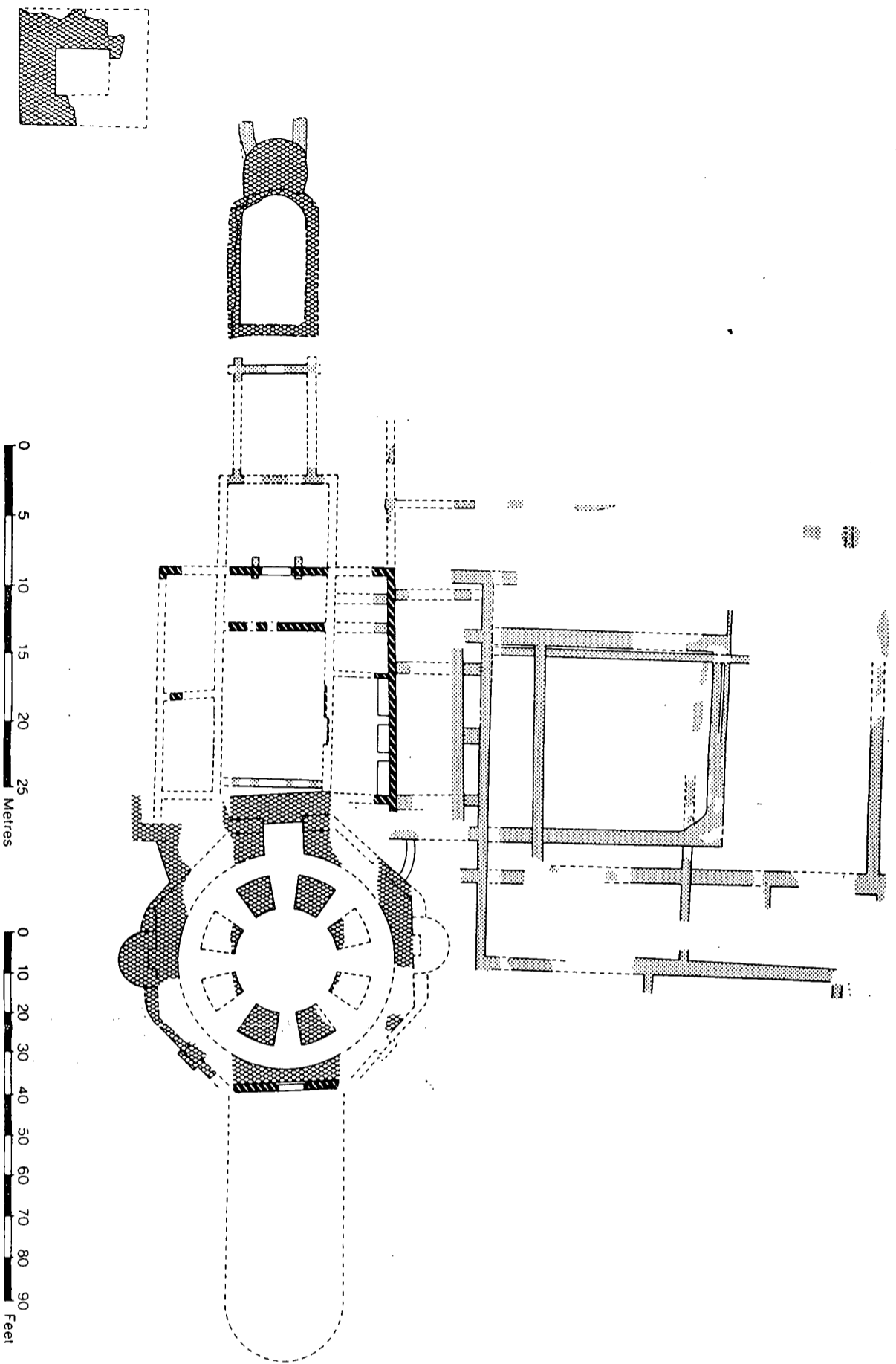
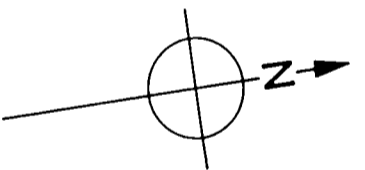

Fig 10 St Augustine's abbey: phased plan of the Anglo-Saxon remains
Gem 1992

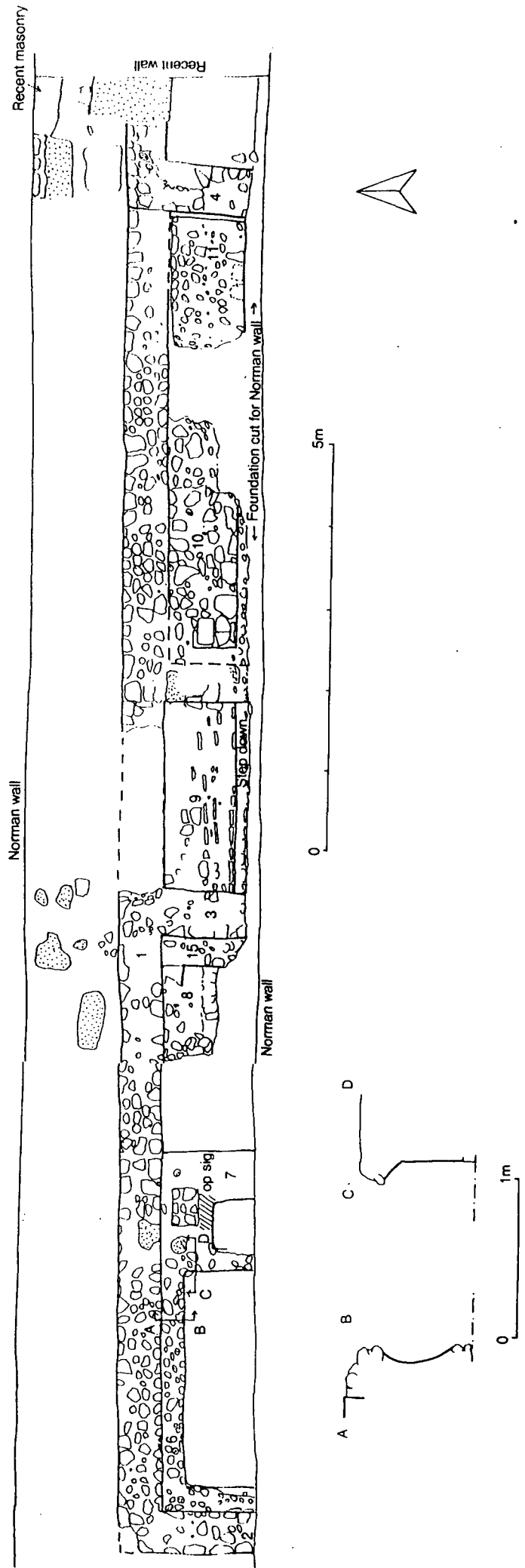

Fig 11 Sts Peter & Paul: plan of the surviving remains in 1995
(north wall and vaults in north porticus)

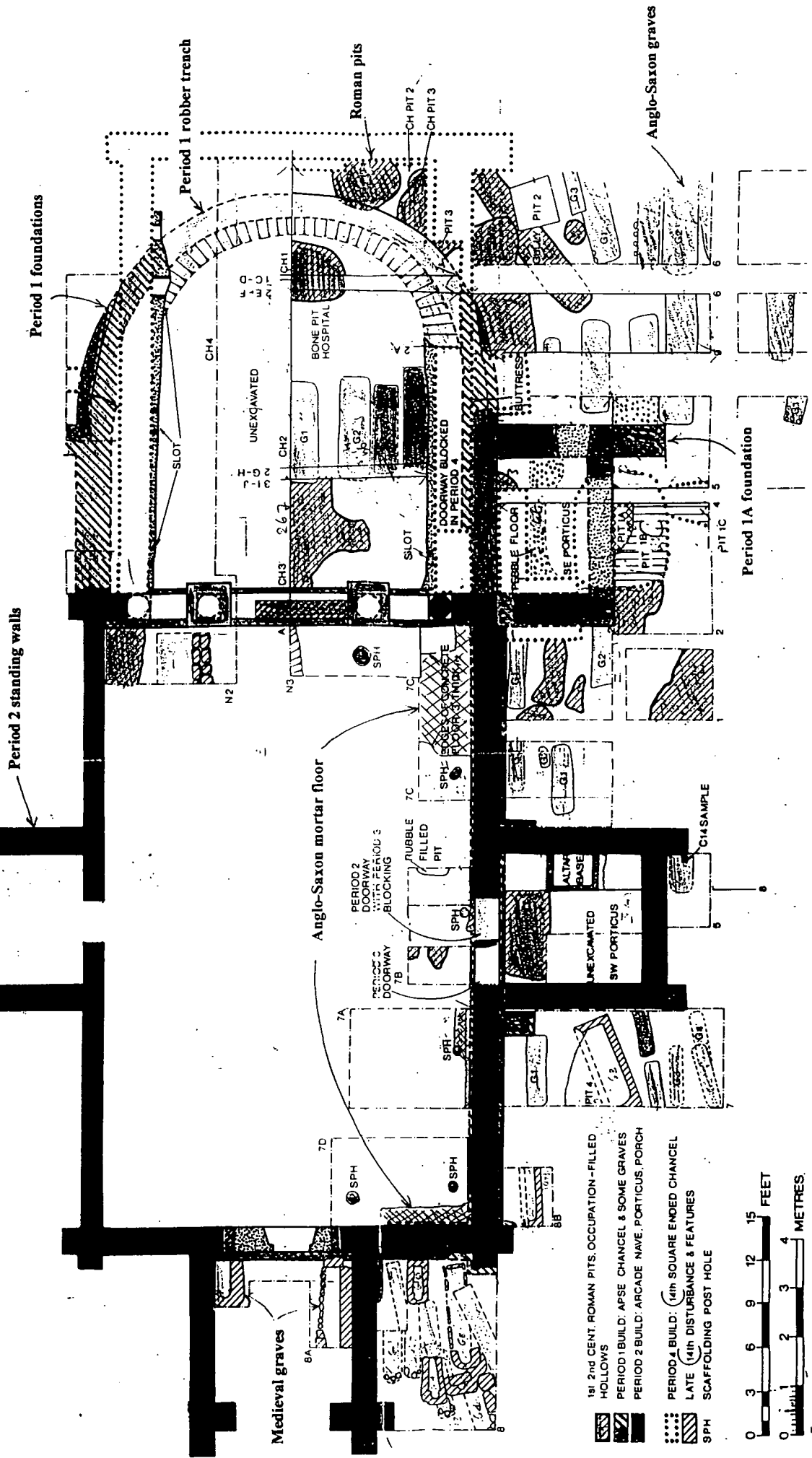

Fig 12 St Pancras: detailed plan of the Anglo-Saxon remains

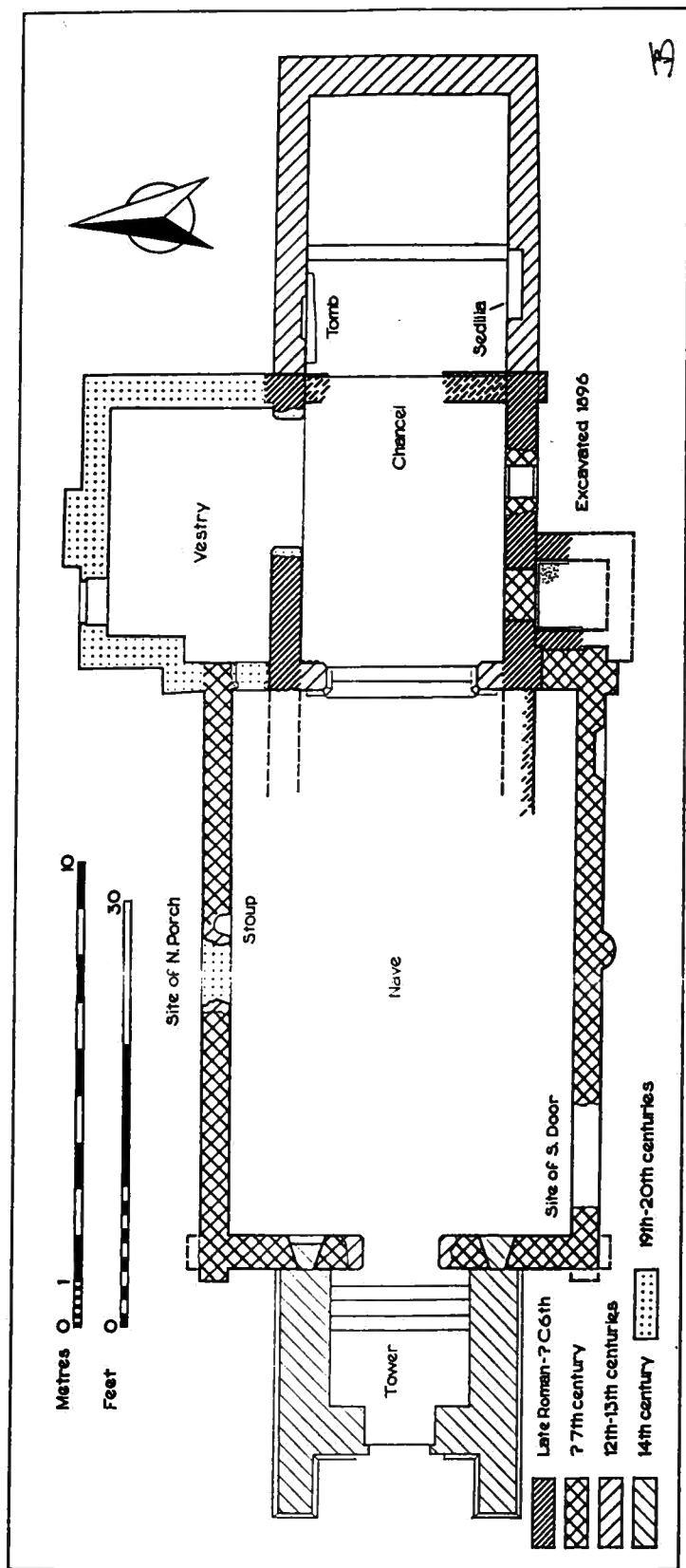
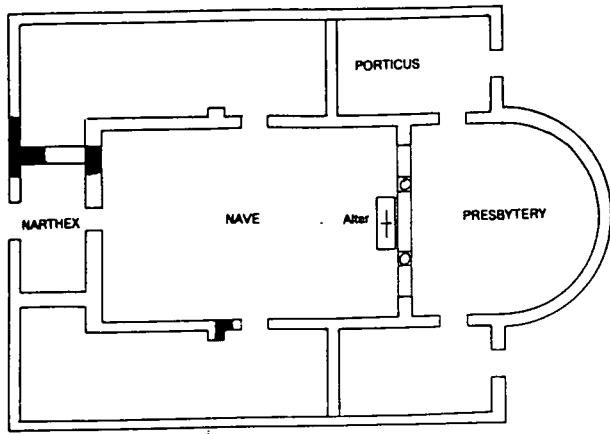
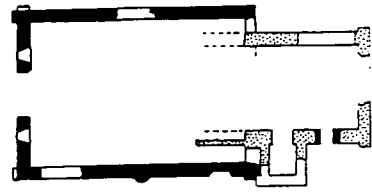

Fig 13 St Martins: detailed plan of the Romano-British and Anglo-Saxon remains
Tatton-Brown 1980



Canterbury cathedral



St Martins

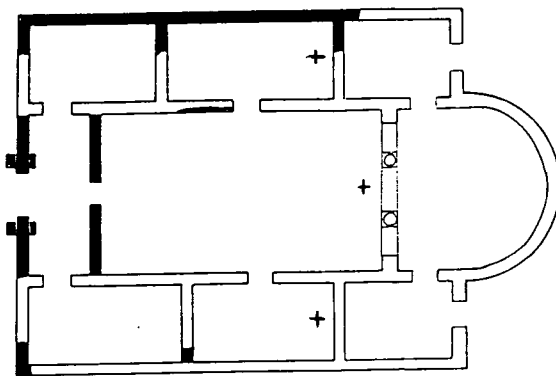

St Peter and St Paul Canterbury

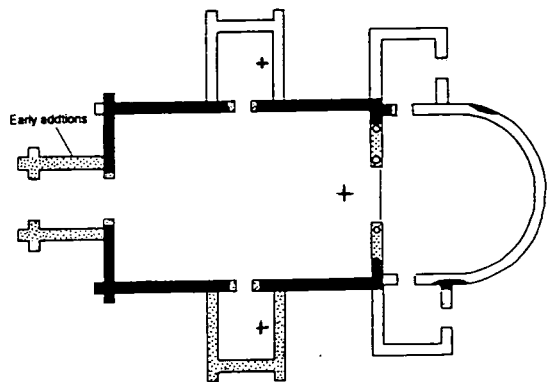

St Pancras Canterbury



KB 1993

Fig 14 Reconstructed layout of Period 1 churches in the study
St Martins after Tatton-Brown 1980
Sts Peter & Paul and St Pancras after Taylor 1965

foundations

Layout based on a grid of 10 Roman Feet

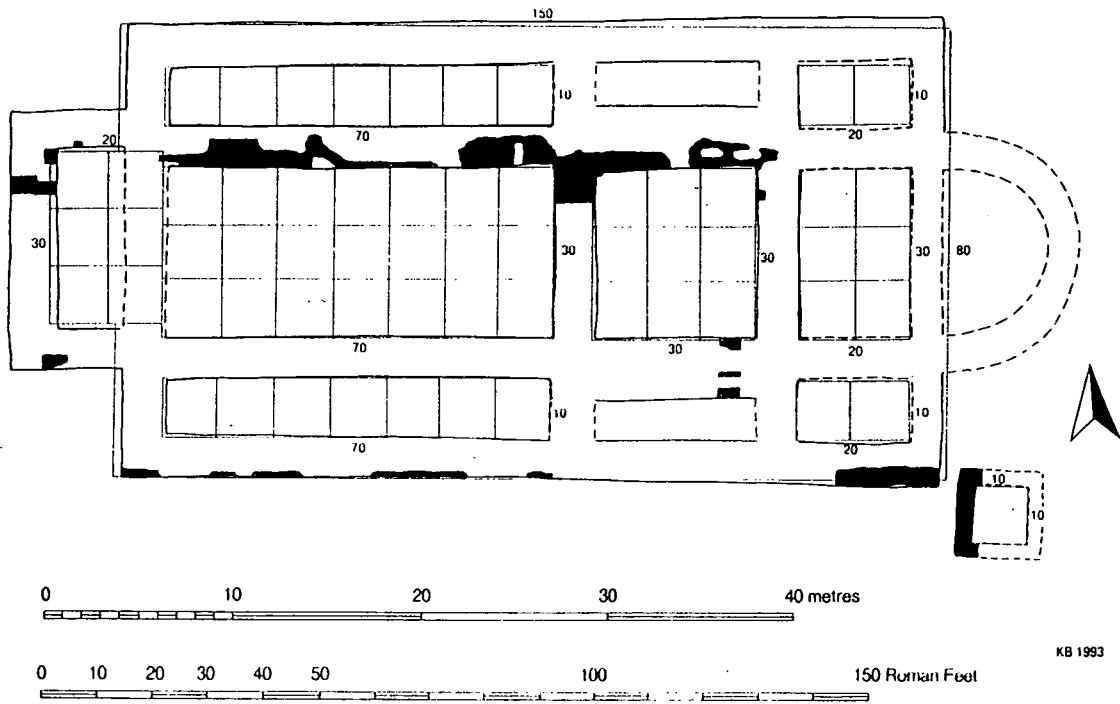
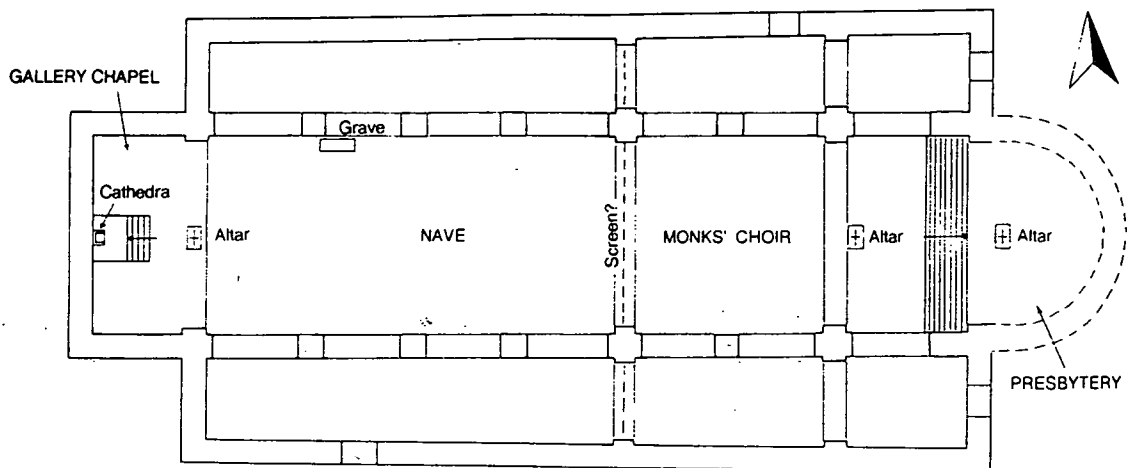
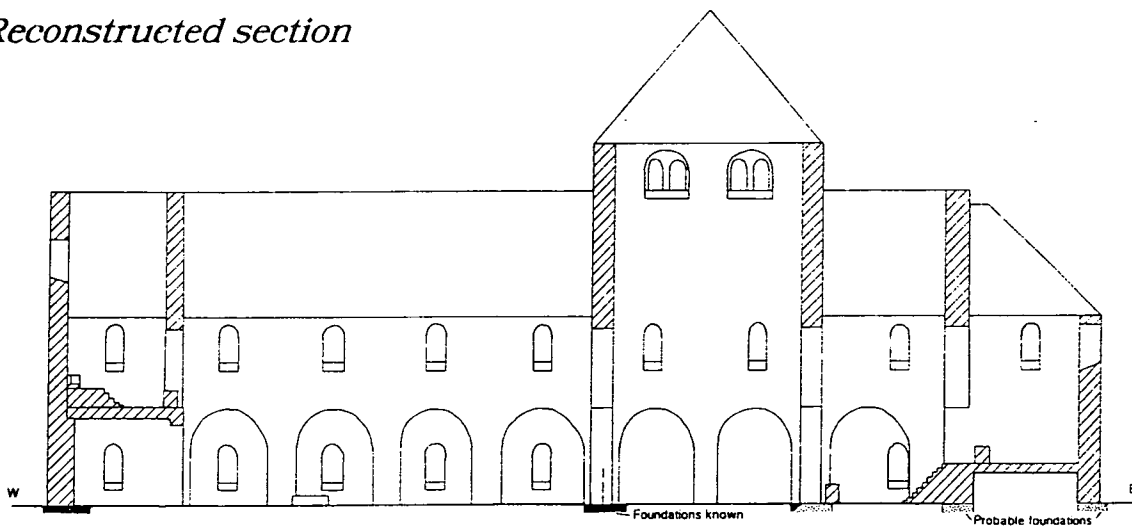

Fig 15 Canterbury cathedral: tentative reconstructed layout of Period 2A foundations

Reconstructed plan and liturgical layout



Reconstructed section



0 10 20 30 40 metres

KB 1994

Fig 16 Canterbury cathedral: tentative reconstructed layout of Period 2A church

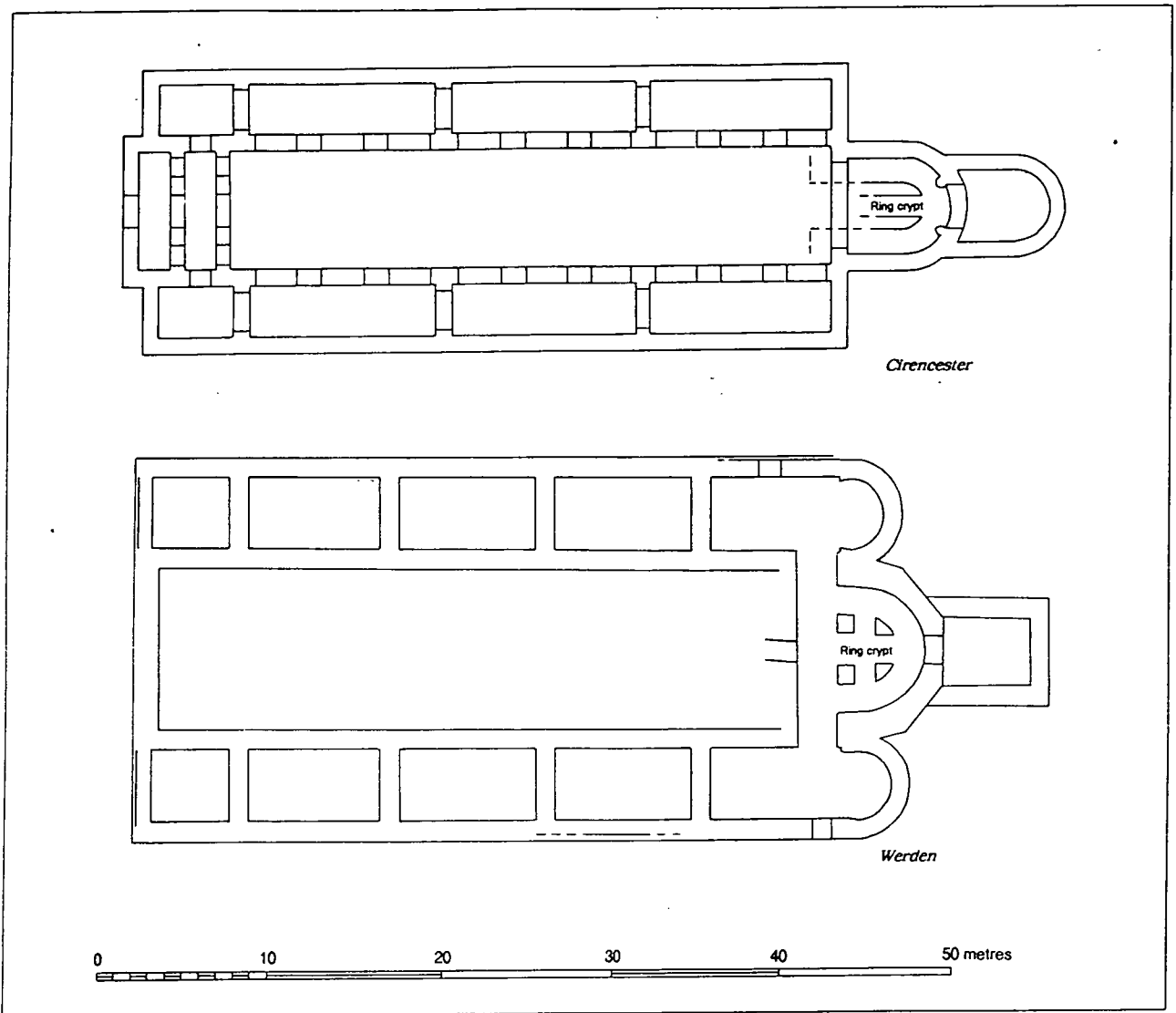

Fig 17 Cirencester and Werden, Germany
After Gem 1993

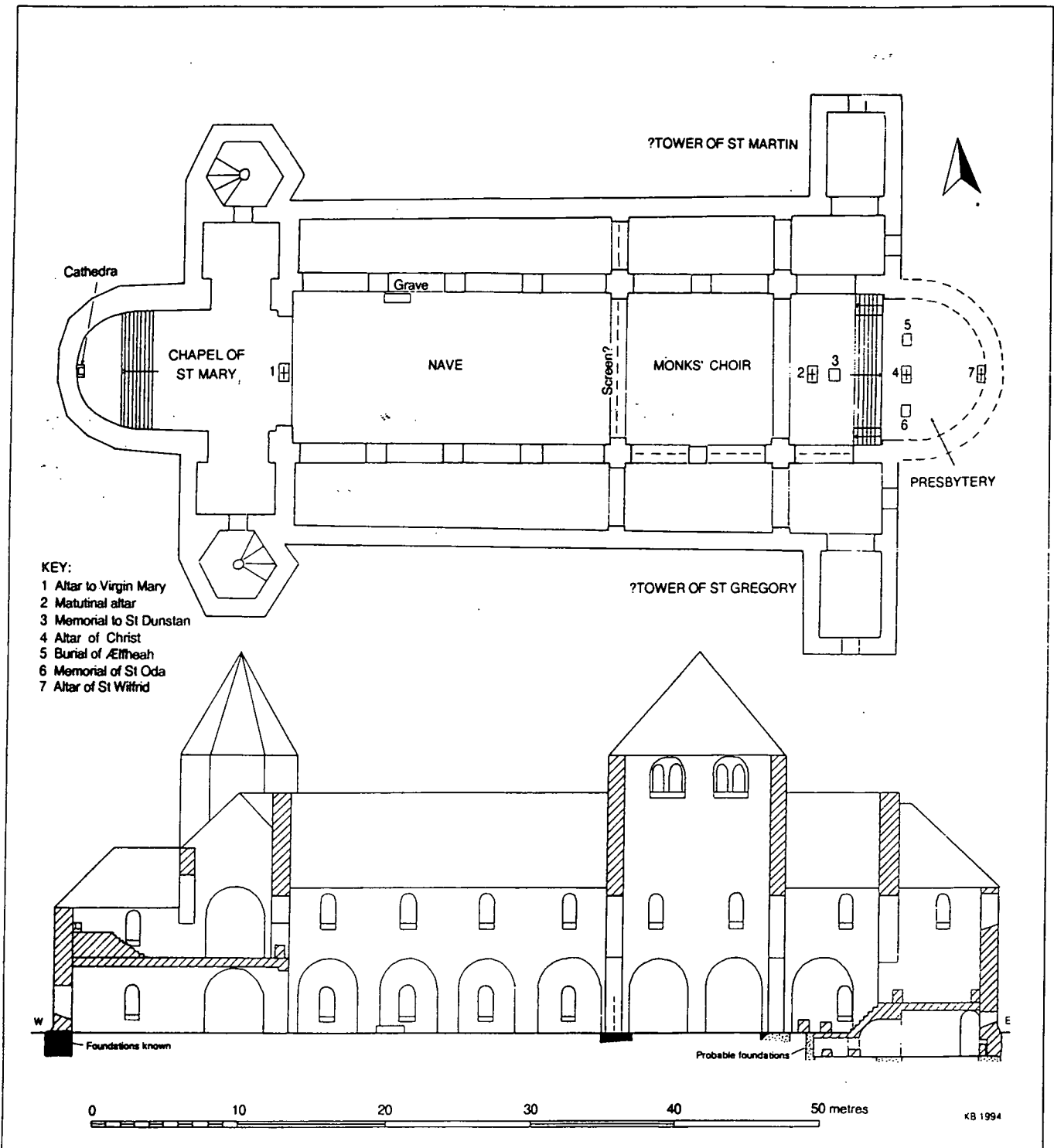

Fig 18 Canterbury cathedral: tentative reconstructed layout of Period 2C Church

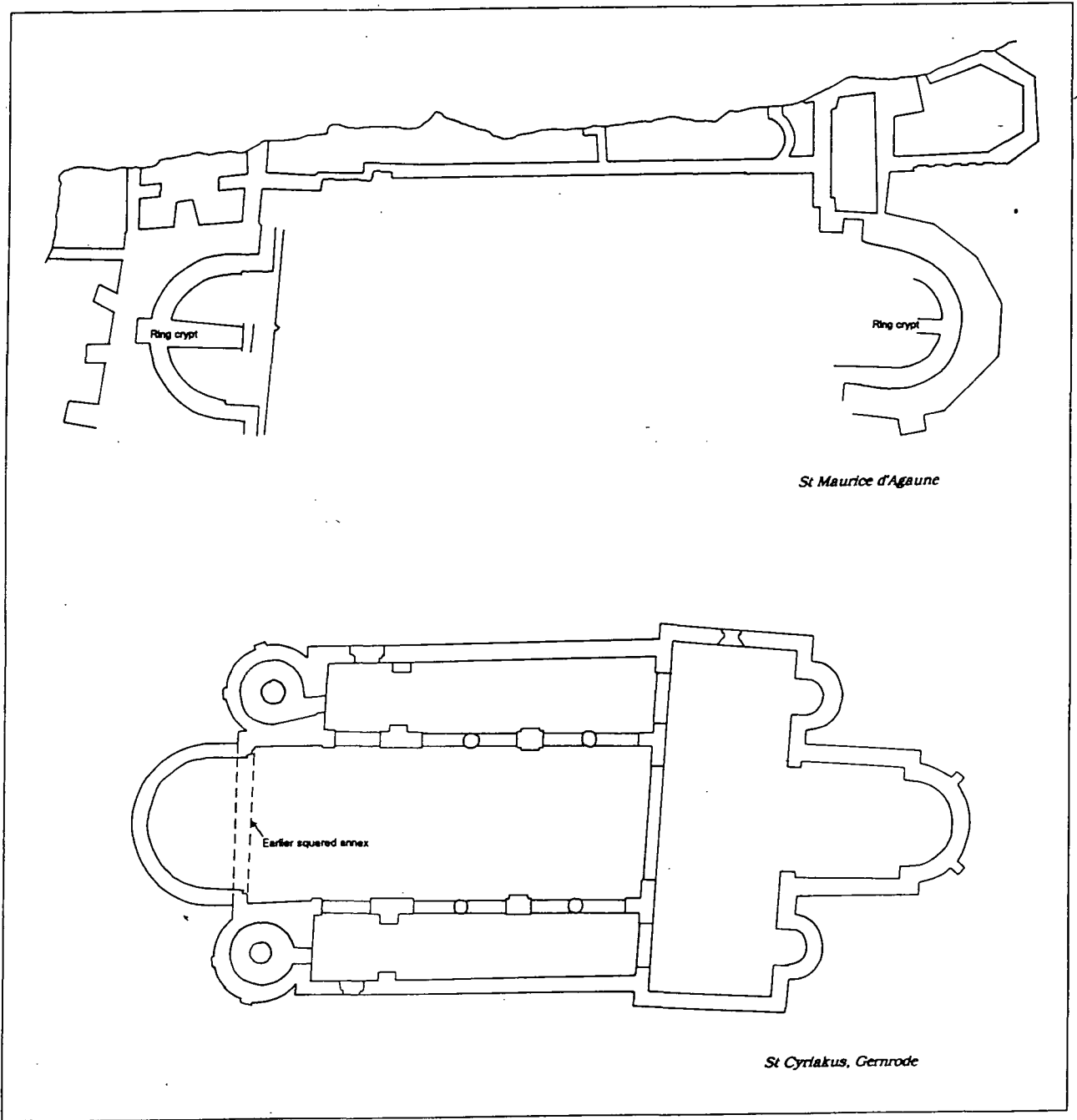

Fig 19 St Maurice d'Agaune, Switzerland and St Cyriakus, Gemrode, Germany
St Maurice d'Agaune after Jacobsen 1992
St Cyriakus after Jacobsen et al 1991

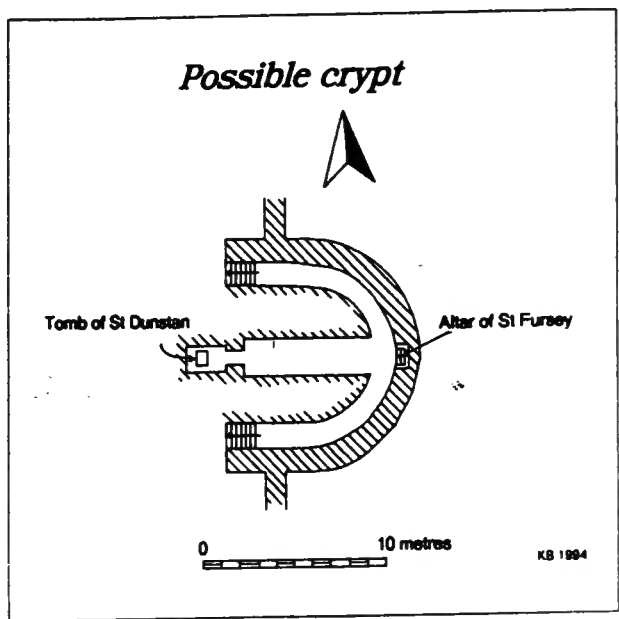

Fig 20 Canterbury cathedral: tentative layout of Anglo-Saxon crypt

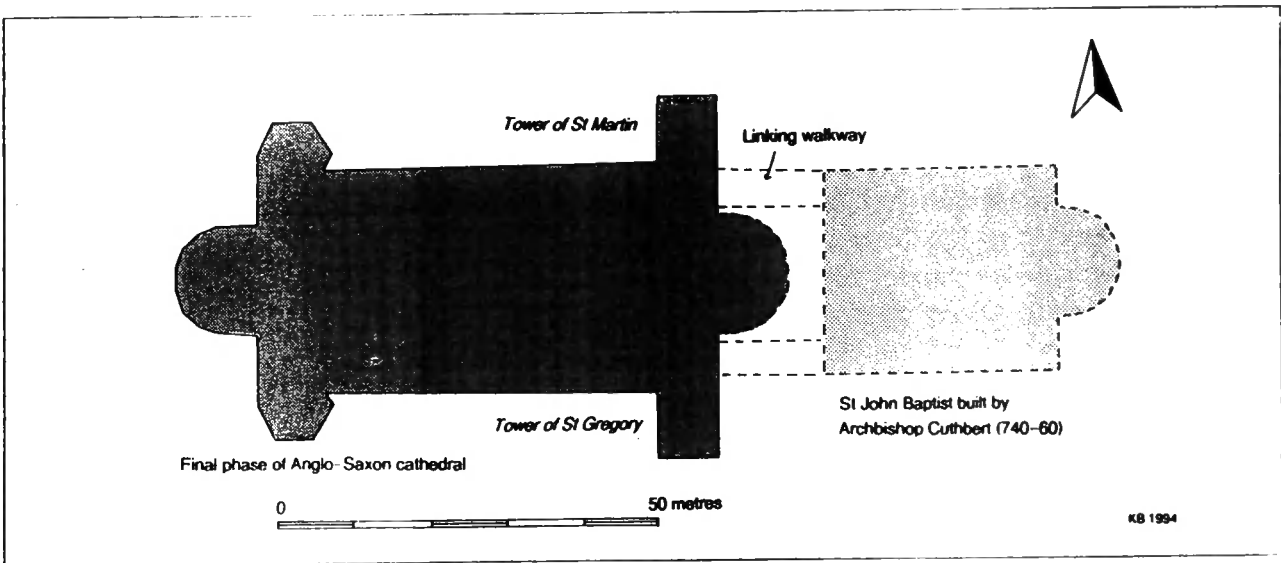

Fig 21 Canterbury cathedral: tentative layout of cathedral church and baptistry

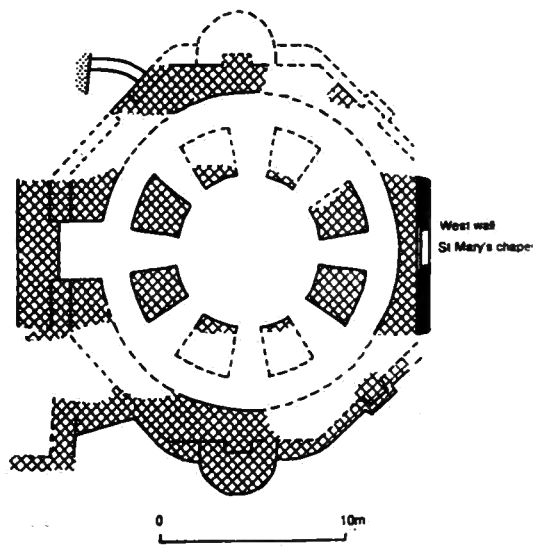

Fig 22 St Augustine's abbey: Wulfric's octagon
Gem 1992

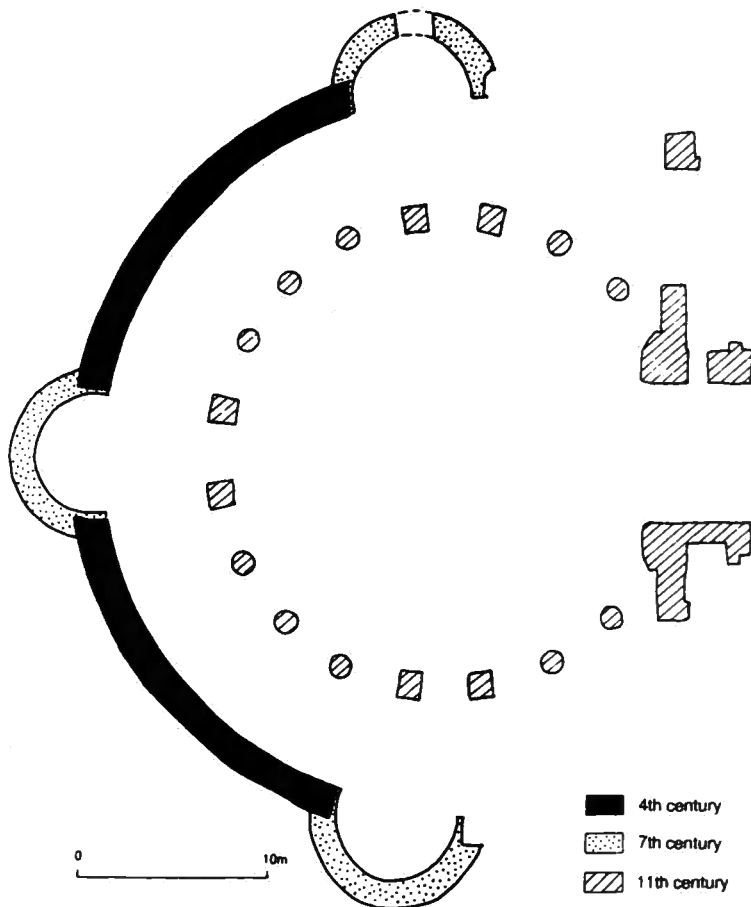

Fig 23 Holy Sepulchre, Jerusalem
Conant 1978

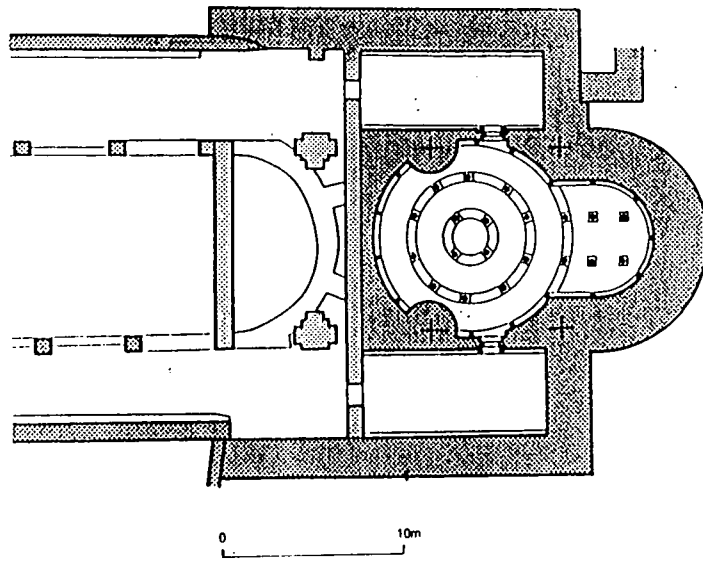

Fig 24 Basilica of Saint-Pierre, Geneva, Switzerland
Jannet & Sapin 1996

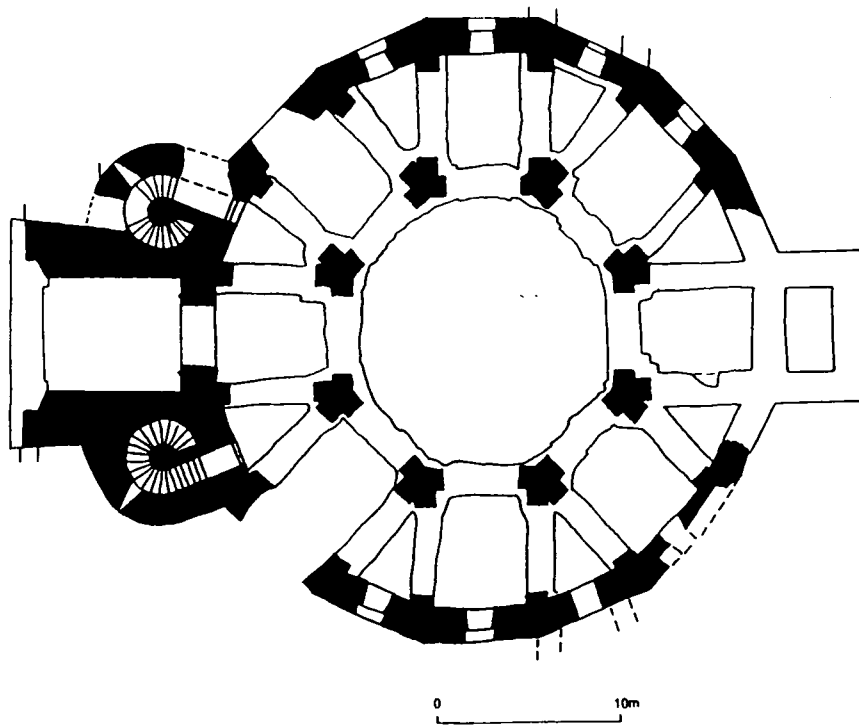

Fig 25 Palatine Chapel, Aachen, Germany
Jacobsen et al 1991

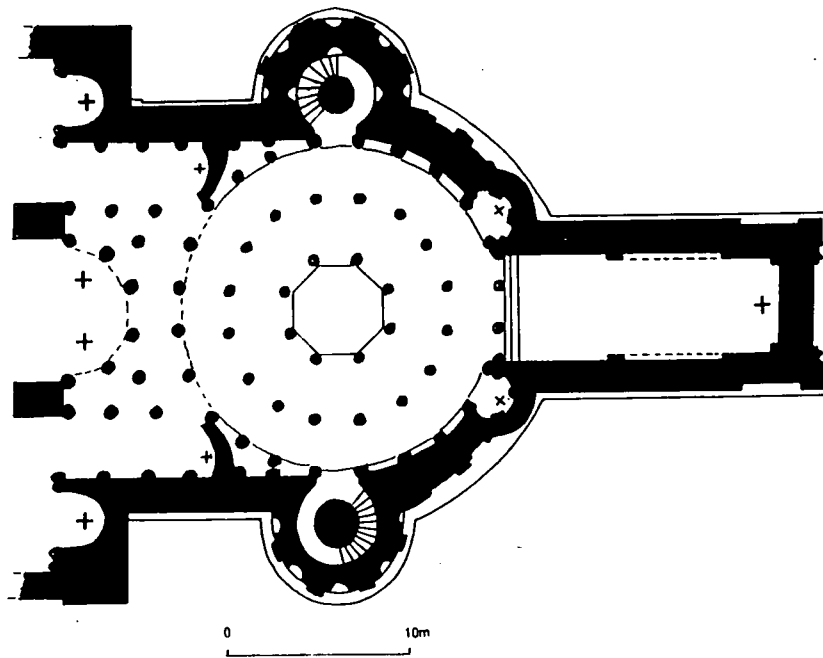

Fig 26 St Bénigne abbey, Dijon, France
Conant 1978

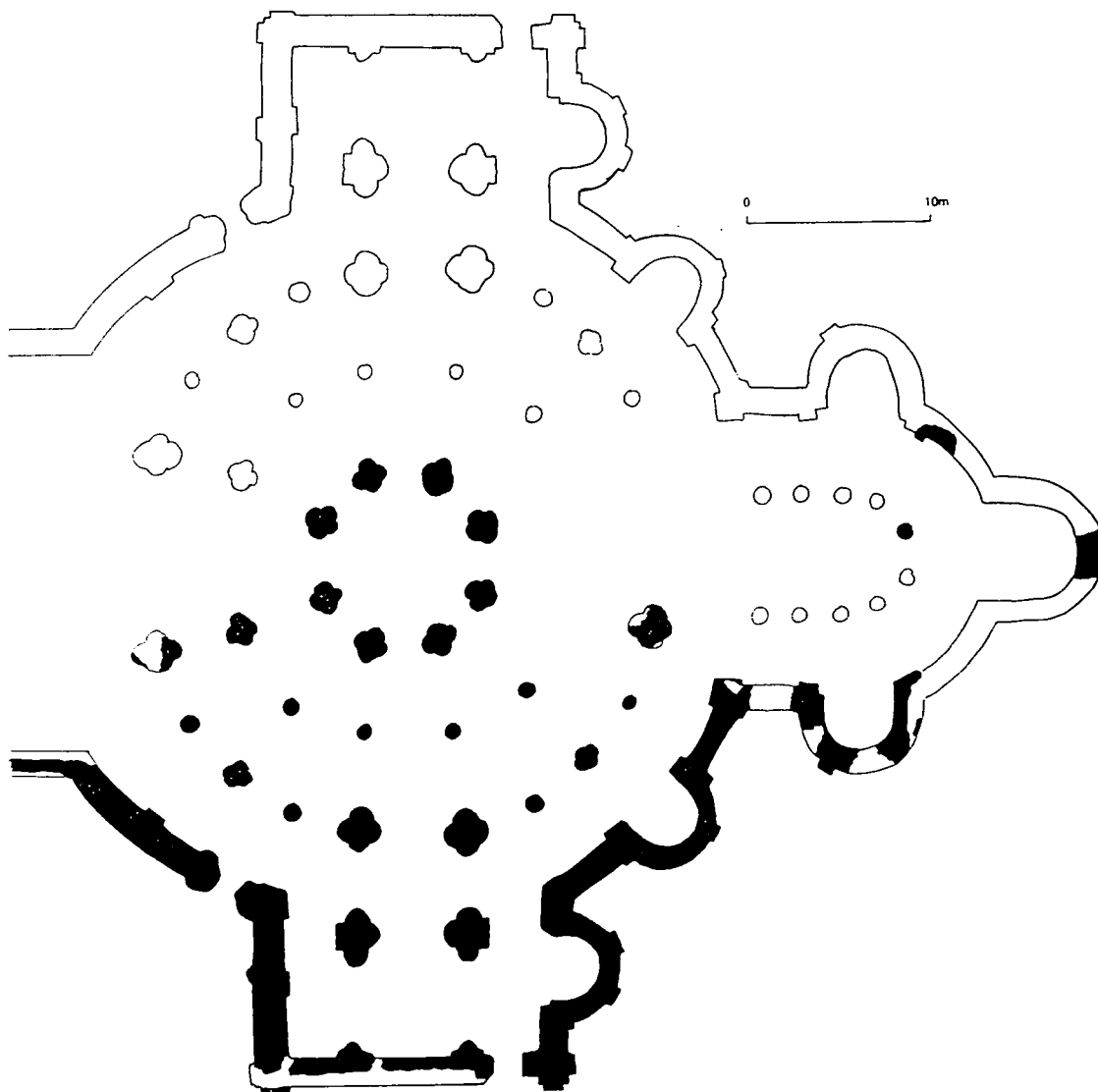

Fig 27 St-Sauviour, Charroux, France
Fernie 1983

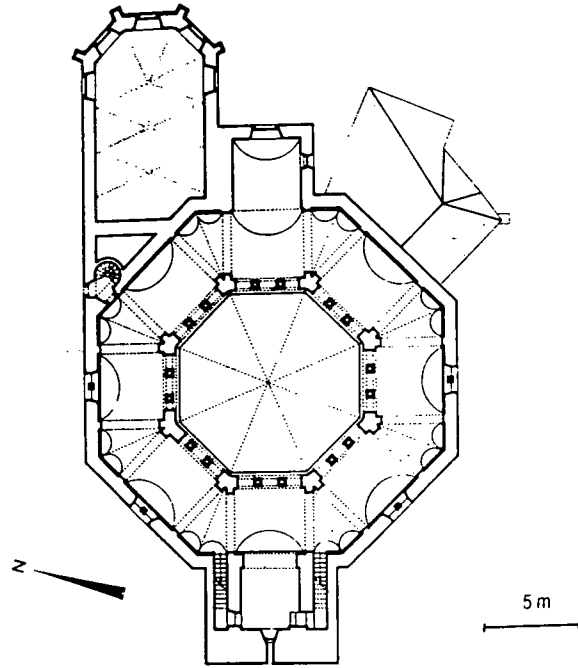
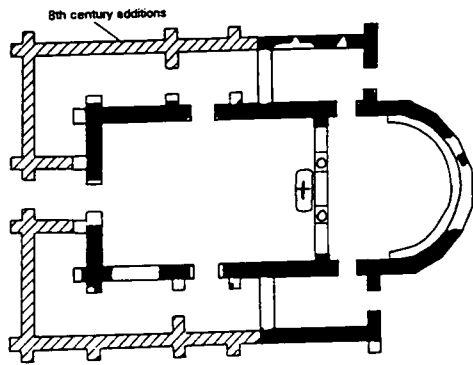
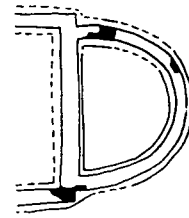

Fig 28 Ottmarsheim, Alsace, France
Heitz 1987



Reculver



Rochester

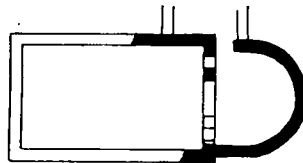

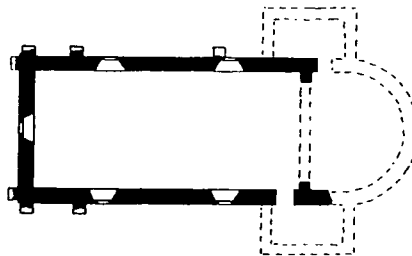

Lyminge



Bradwell-on-sea

Fig 29 Reculver, Rochester, Lyminge, and Bradwell-on-Sea
Reculver after Fletcher 1965
Rochester after Livett 1889
Lyminge after Taylor 1969a
Bradwell-on-sea after Taylor 1965

-  7th century
-  8th-11th centuries
-  Mid 11th century

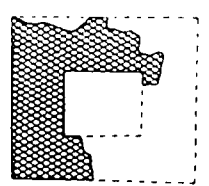
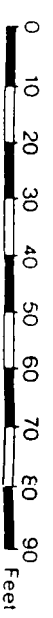
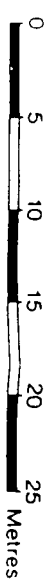
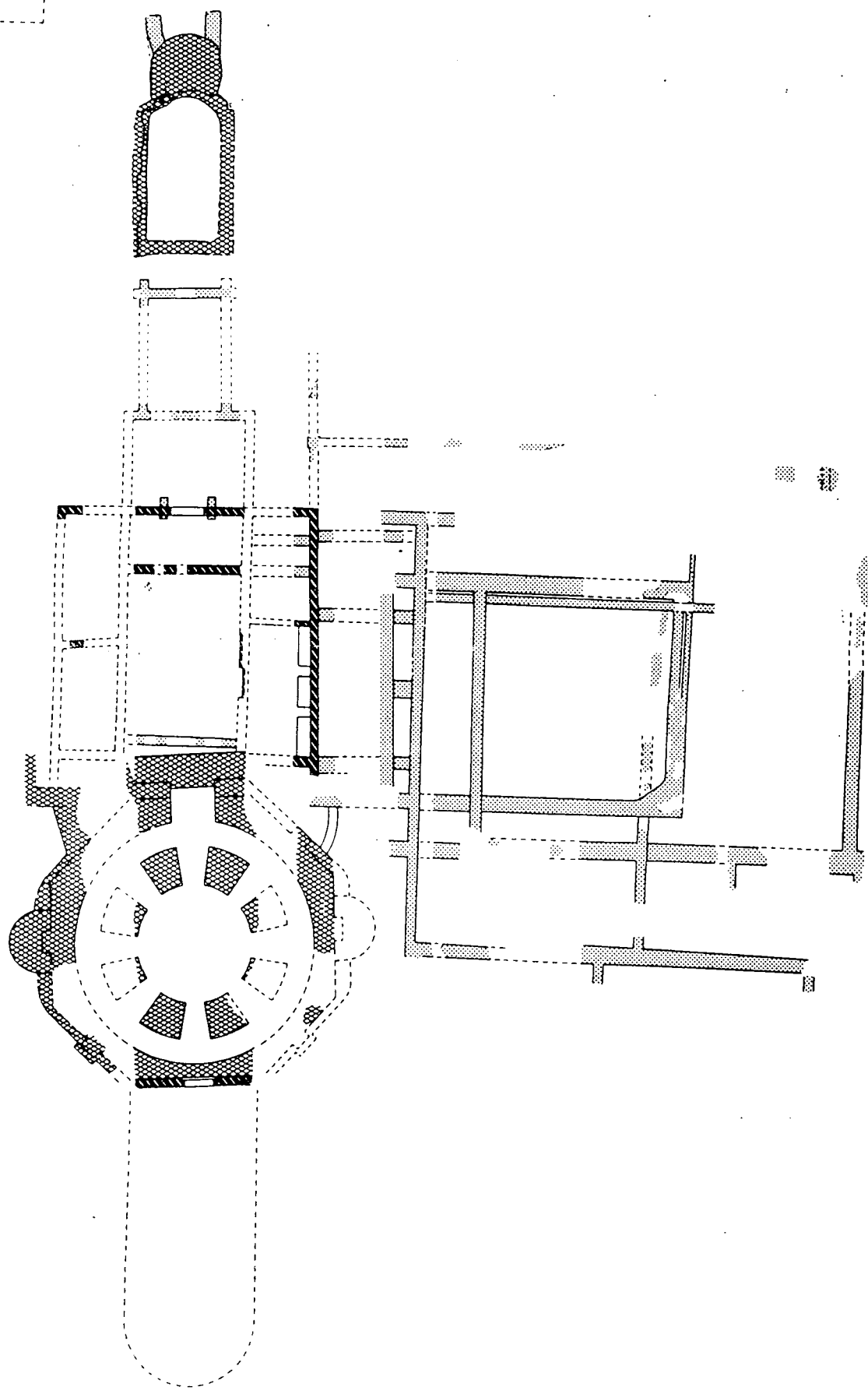
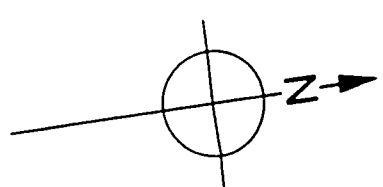

Glastonbury Abbey

'*Vetusta
Ecclesia*'

St Mary

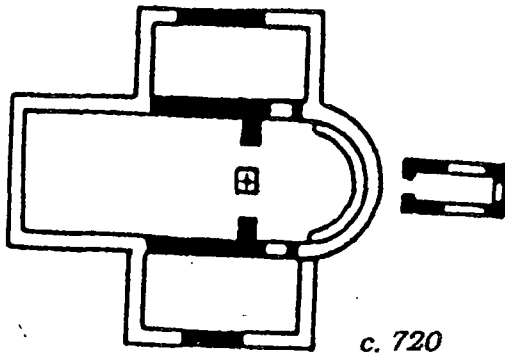

c. 720

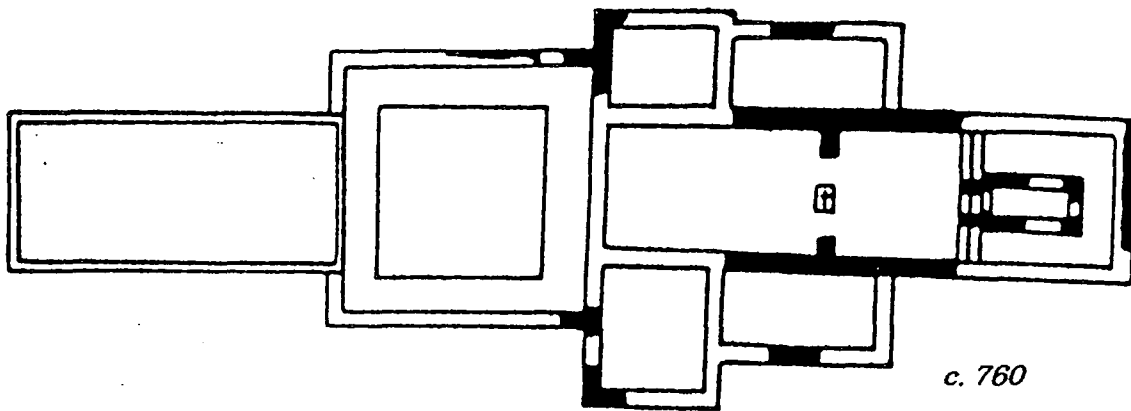

c. 760

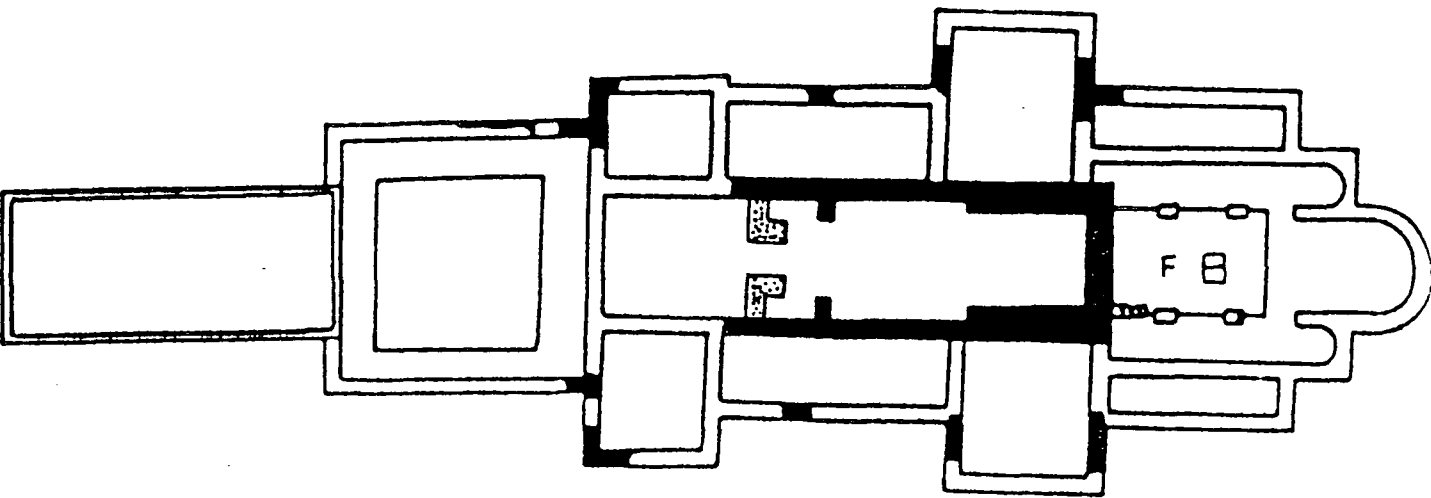

c. 1000

Fig 31 Development plans of Glastonbury abbey
Rahz 1993

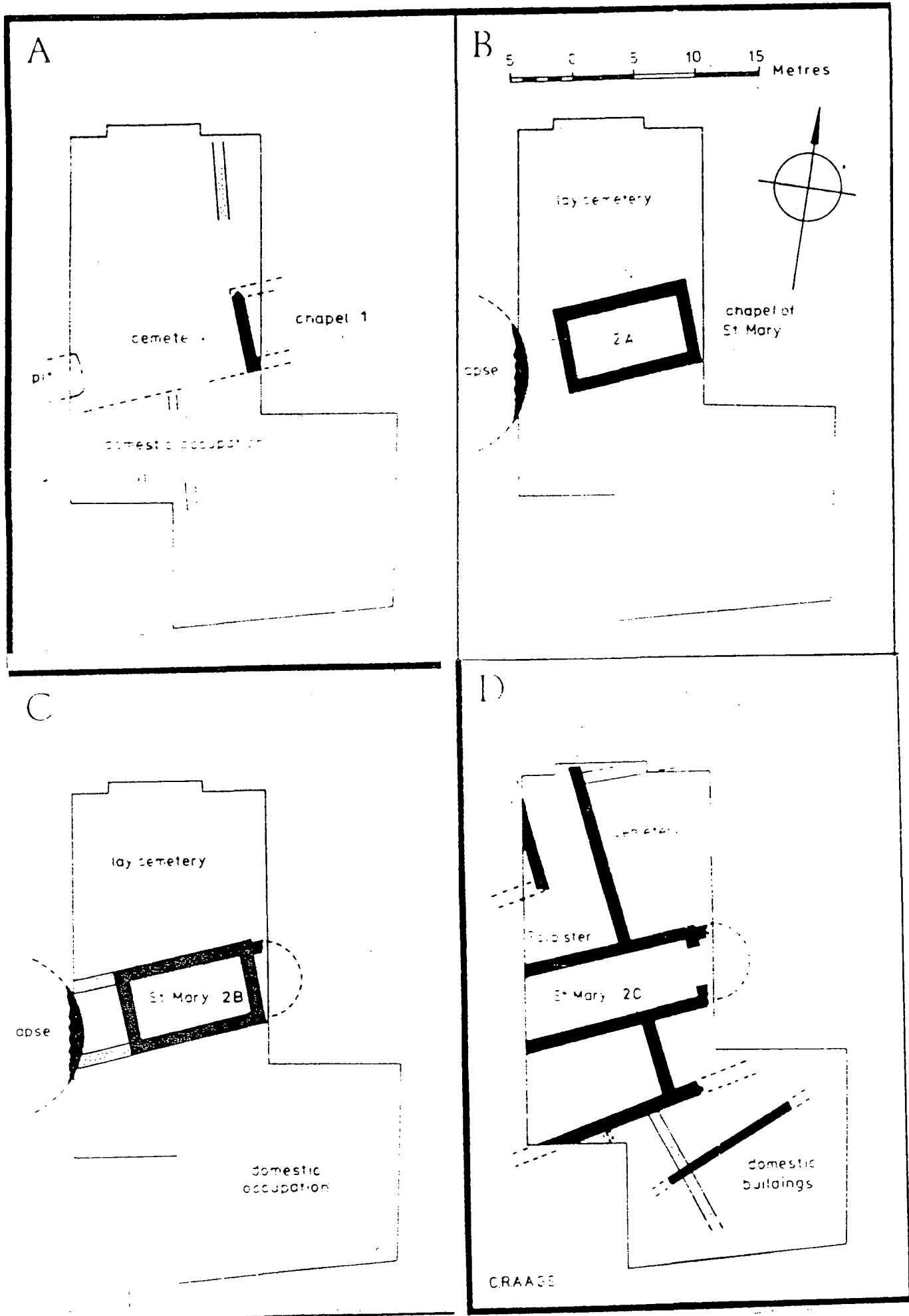

Fig 32 Development plans of Wells
 A Middle Saxon; B Late Saxon I; C Late Saxon II; D Saxo-Norman
Radford 1981

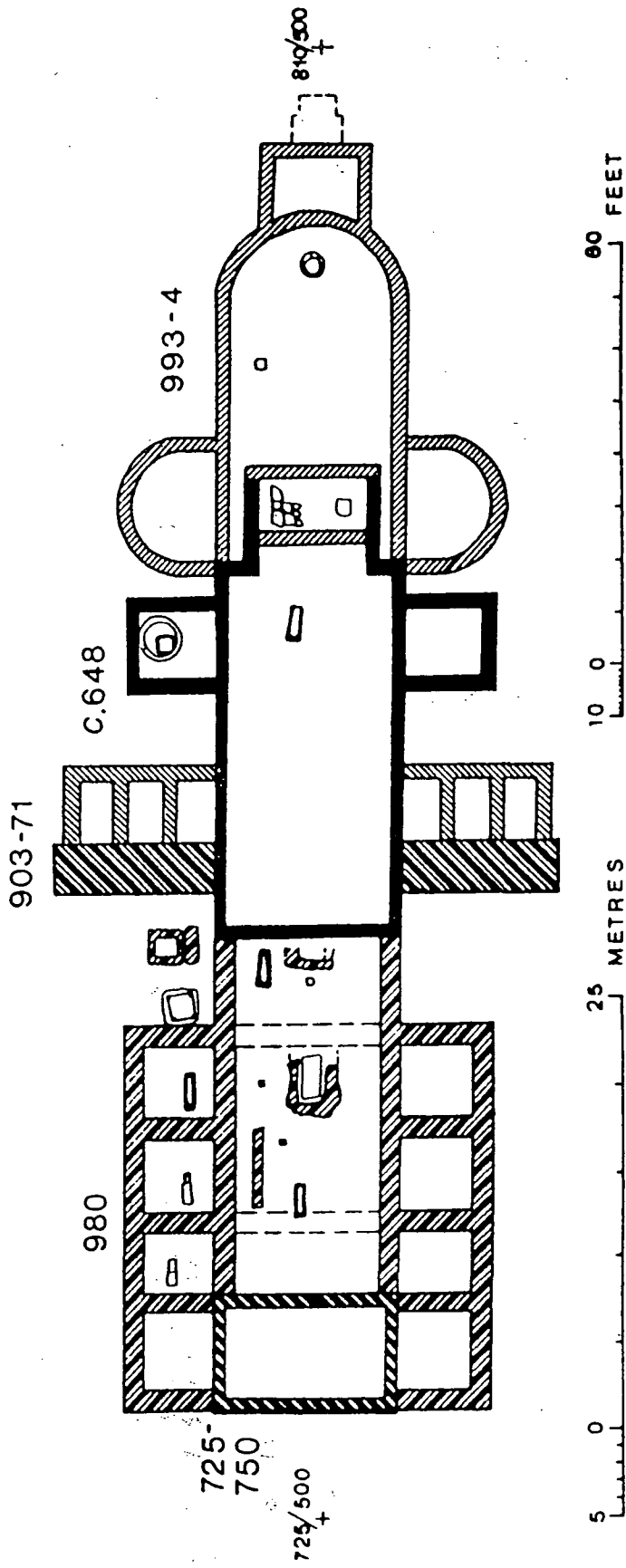
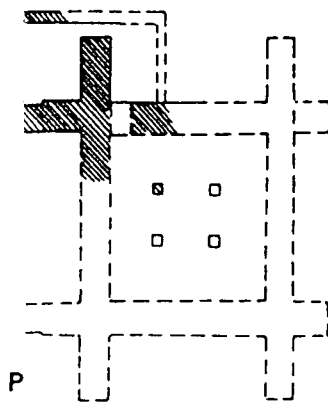
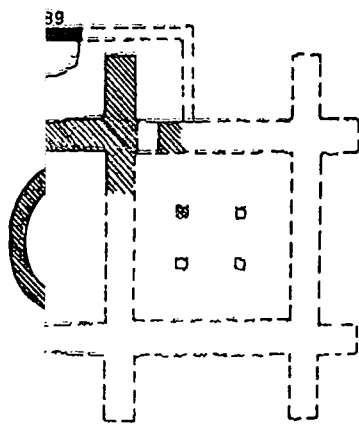
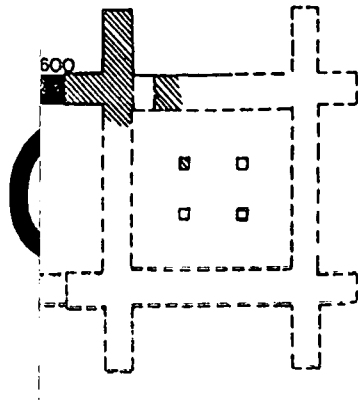

Fig 33 Development plans of Winchester Old Minster
Kjølbye-Biddle 1986



S^r

ACH PERIOD
SURVIVING/ROBBED

ED FROM PREVIOUS PERIOD

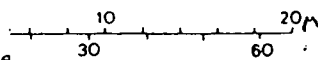

Fig 34 De

CANTERBURY circa 1050

Key to Anglo-Saxon occupation:

- 1 Simon Langton Yard - 6 structures
- 2 Marlowe Car Park MI - 11 structures, burials and possible church
- 3 Marlowe Car Park MII - 2 structures
- 4 Marlowe Car Park MIII - 4 structures
- 5 Marlowe Car Park MIV - 13 structures
- 6 Marlowe Theatre MT - 2 structures
- 7 Longmarket - 5 structures
- 8-10 Castle Street/Stour street - 3 structures
- 11 St Georges - 1 structure
- 12 St Radigunds - 1 structure
- 13 Westgate Court Farm - pits and finds
- 14 Diocesan House - finds and ditch
- 15 Chrst Church College - finds and industrial remains

KEY:
WARD (BERTHA) BOUNDARIES - - - - -

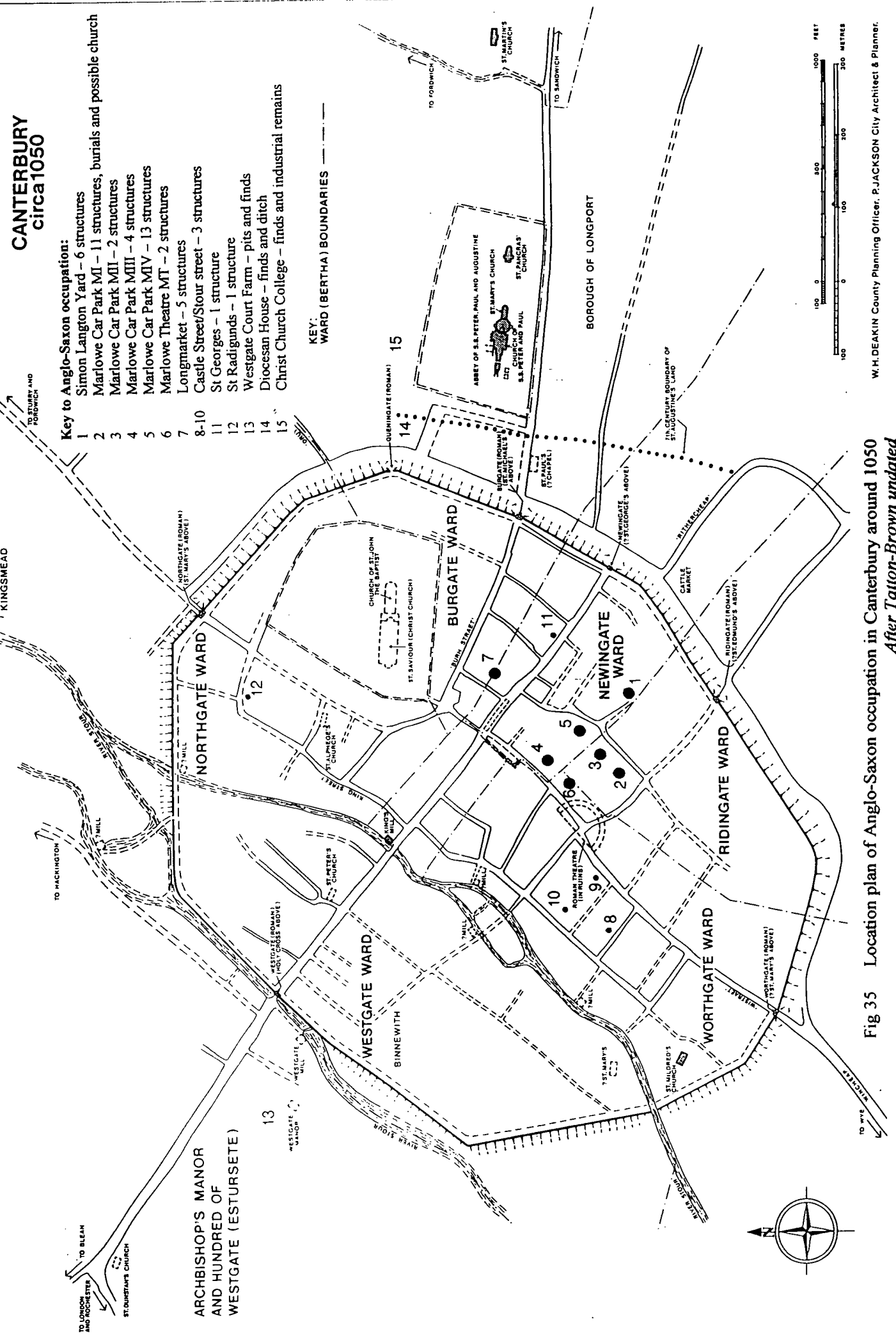
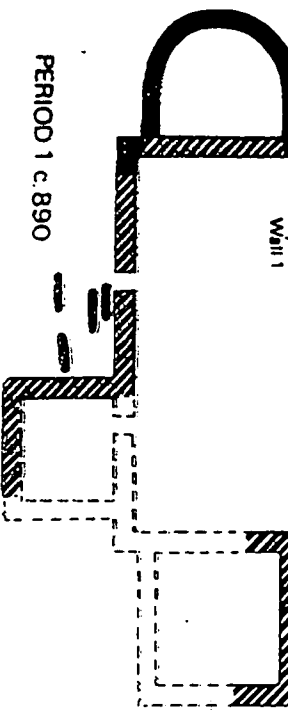
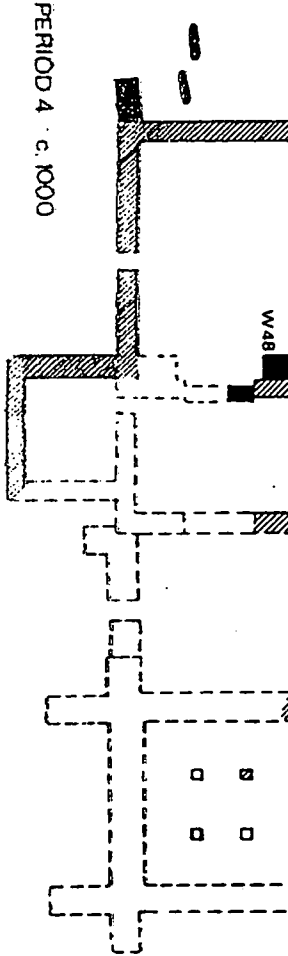

Fig 35 Location plan of Anglo-Saxon occupation in Canterbury around 1050
After Tatton-Brown undated



PERIOD 1 c. 890



PERIOD 4 c. 1000

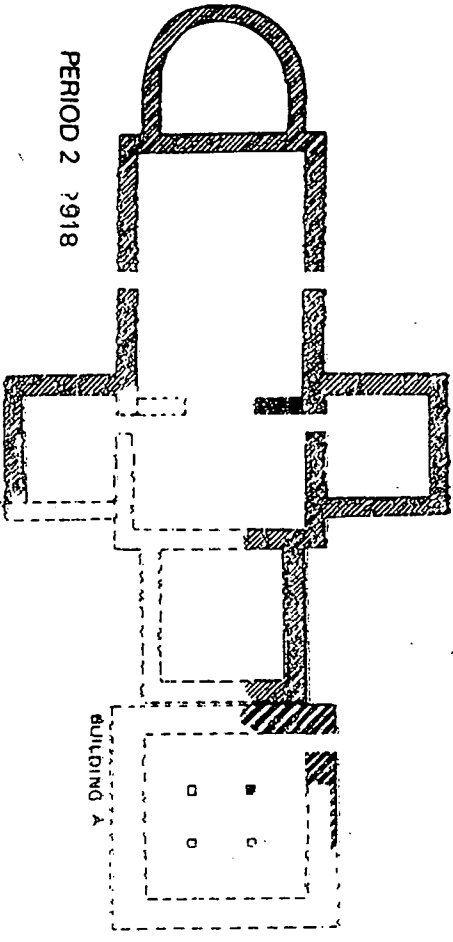

PERIOD 2 c. 918

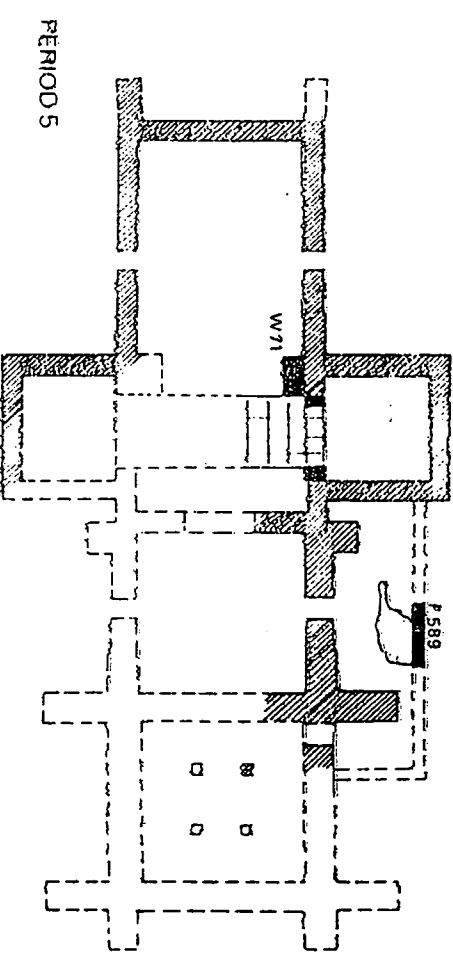

PERIOD 5

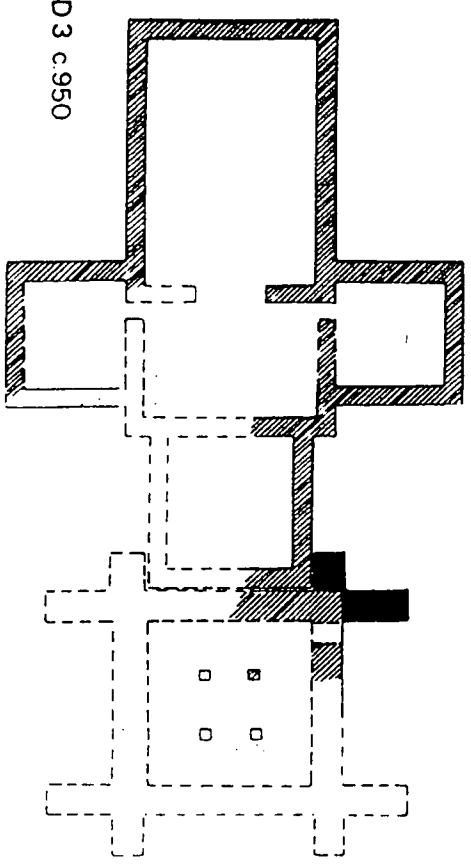

PERIOD 3 c. 950

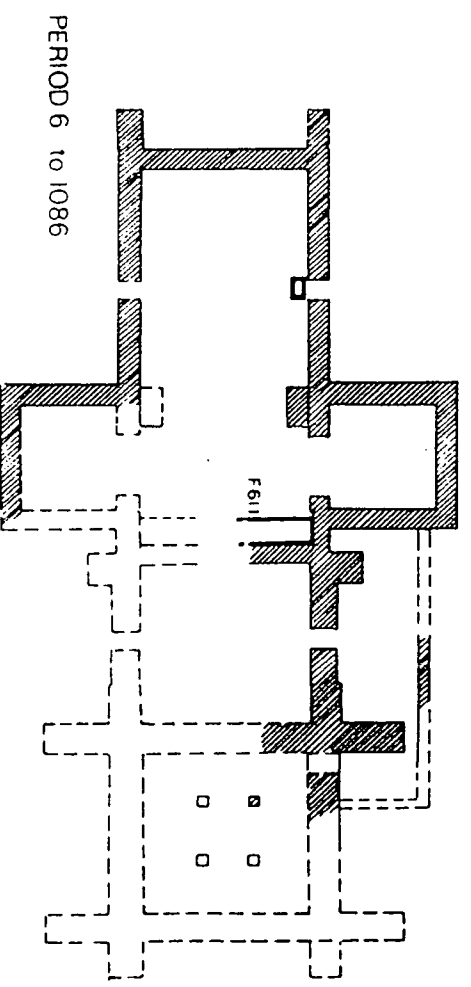

PERIOD 6 c. 1086

ABINGDON ABBEY EXCAVATIONS IN 1922

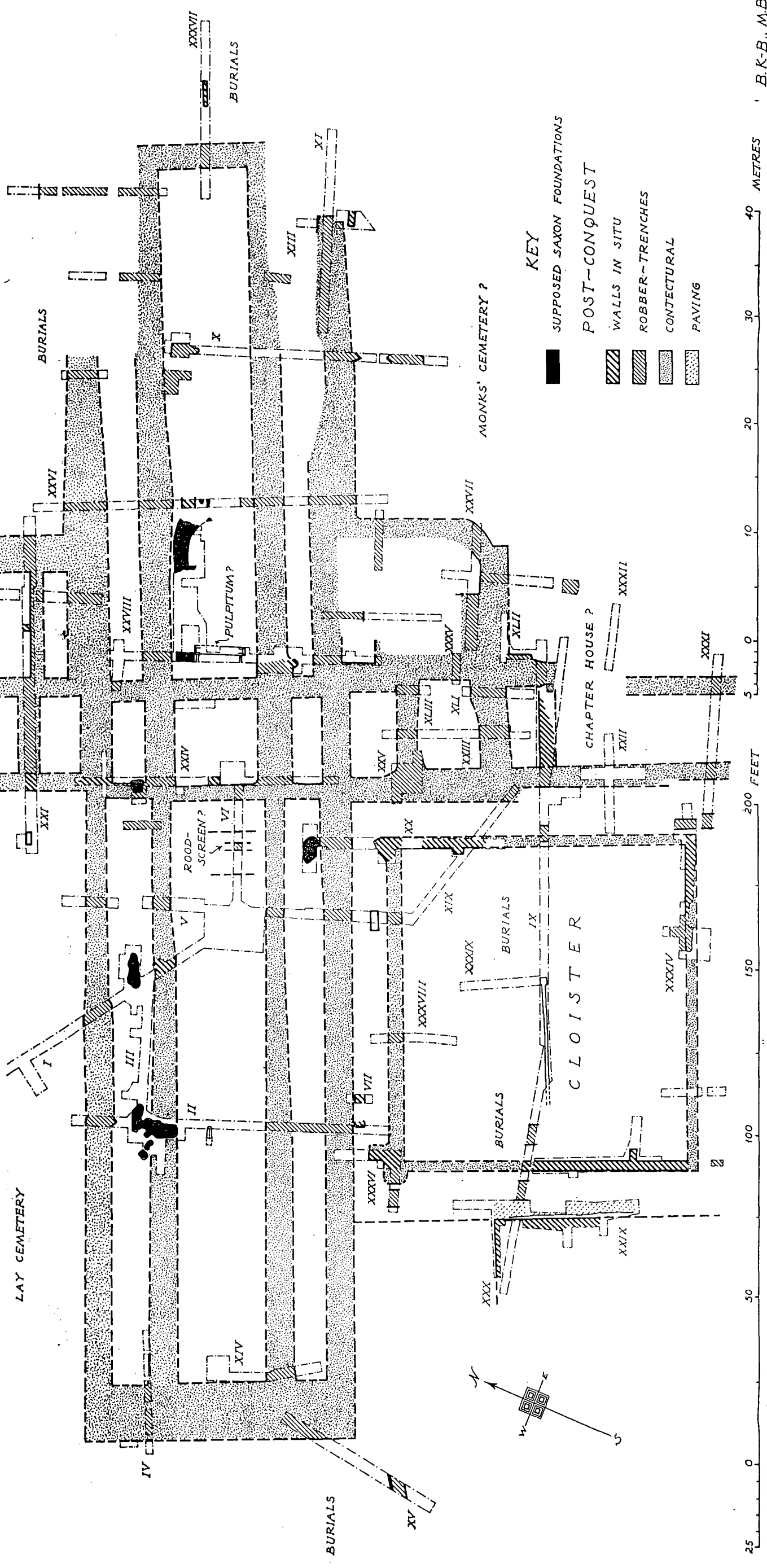

BRANDON
STAUNCH MEADOW

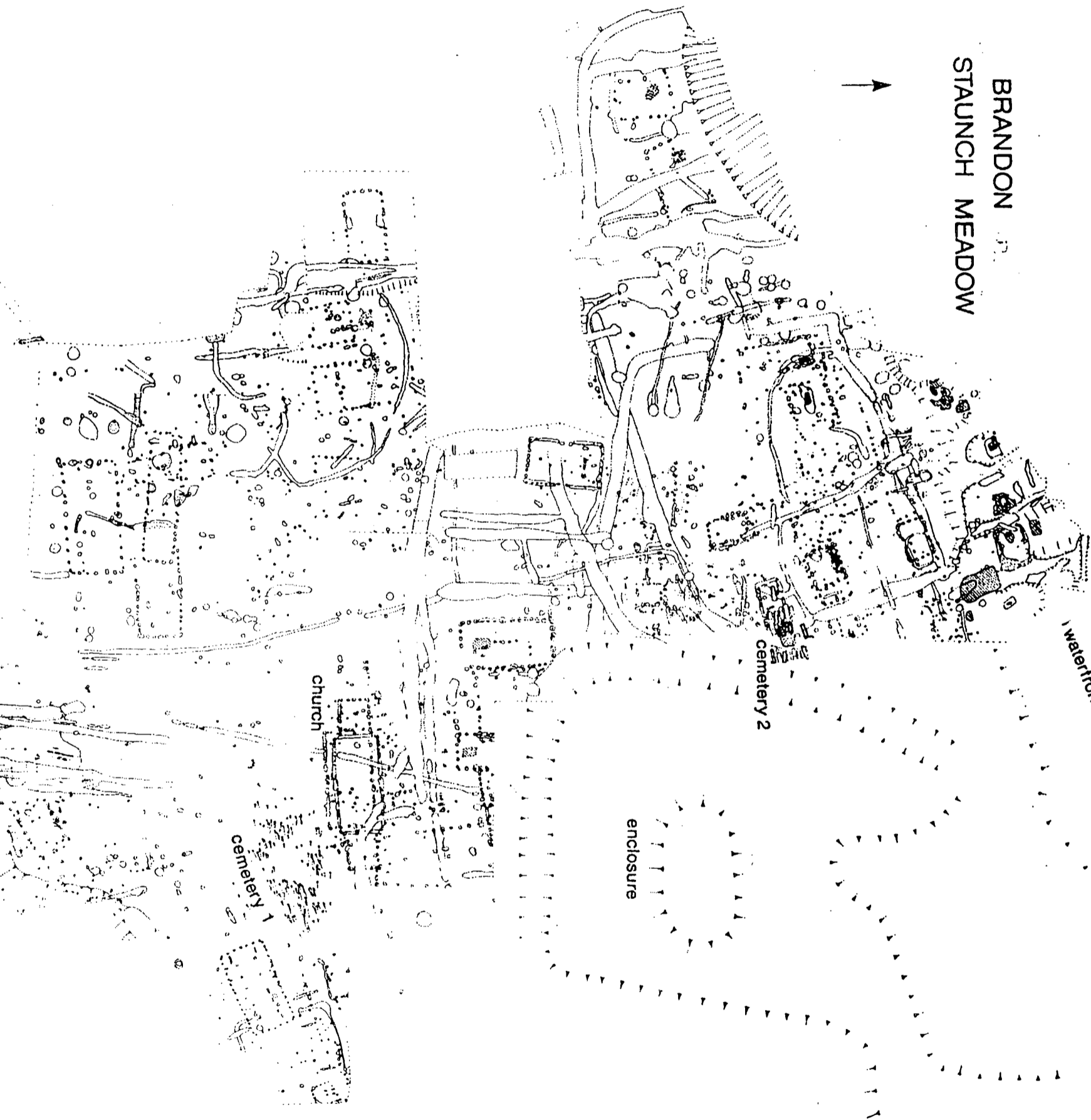

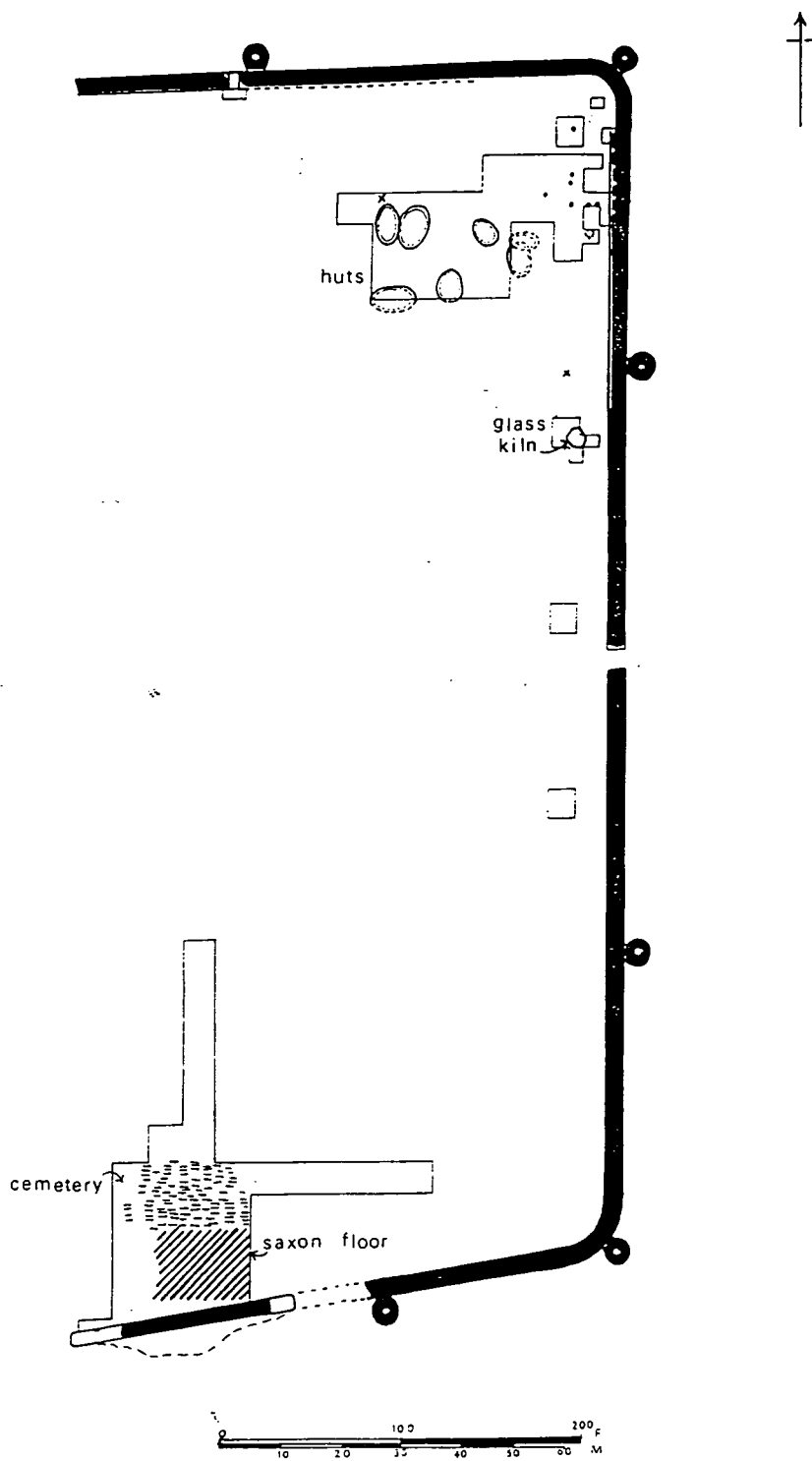

Fig 38 Burgh Castle: general plan of Anglo-Saxon features
Cramp 1976

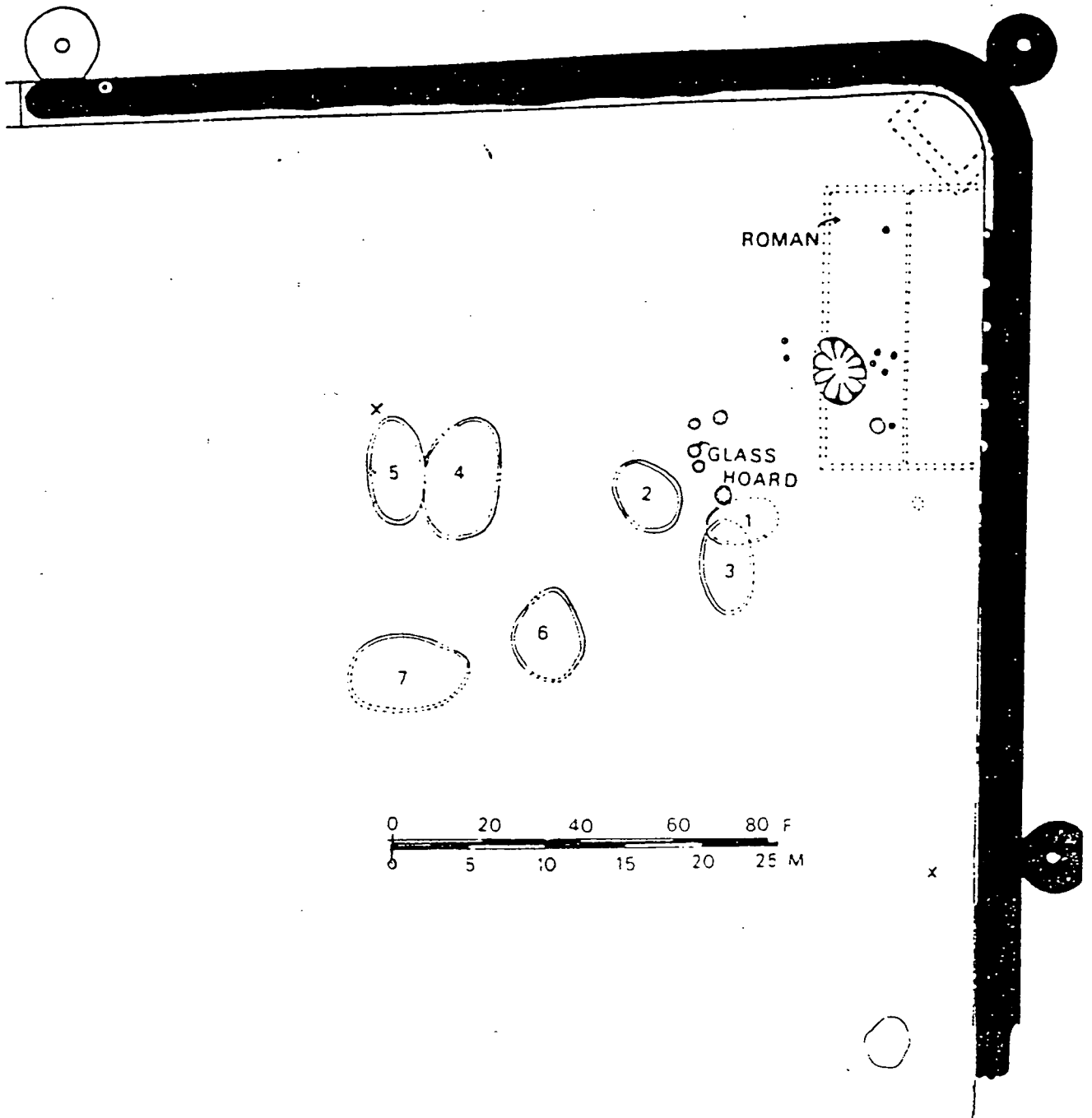
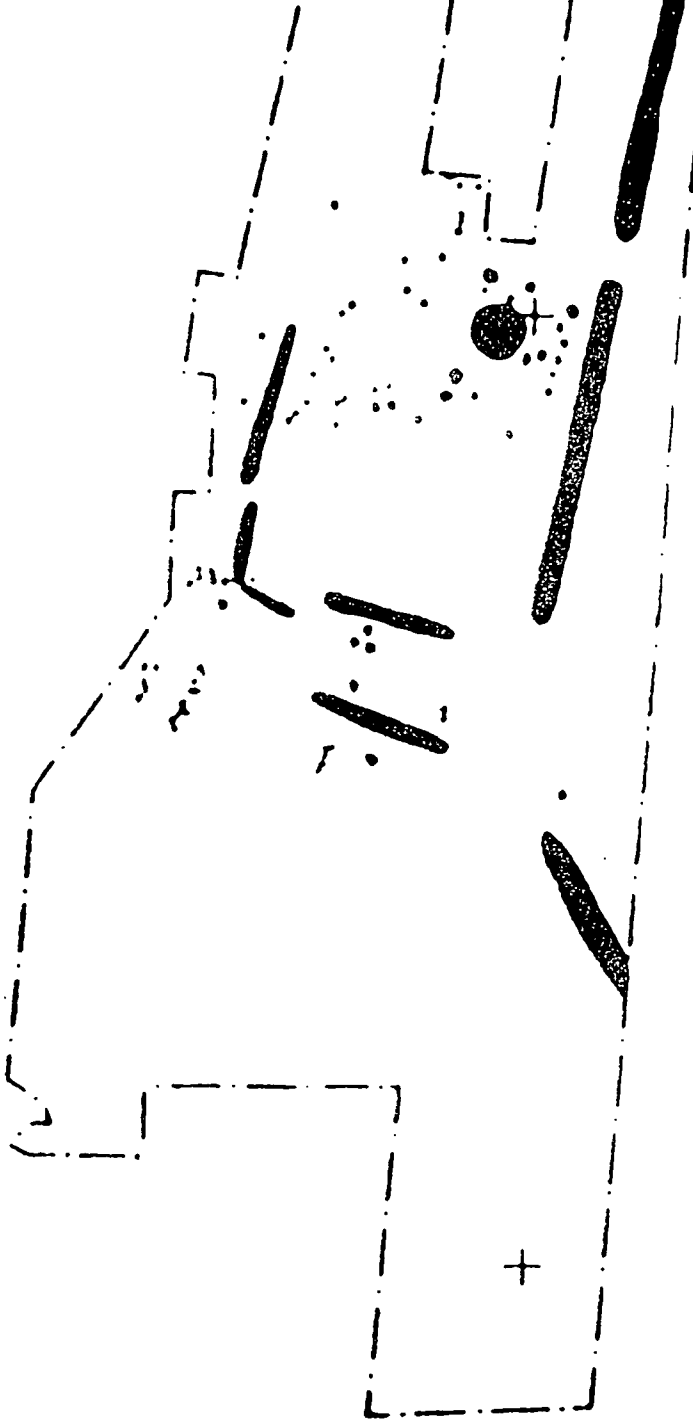
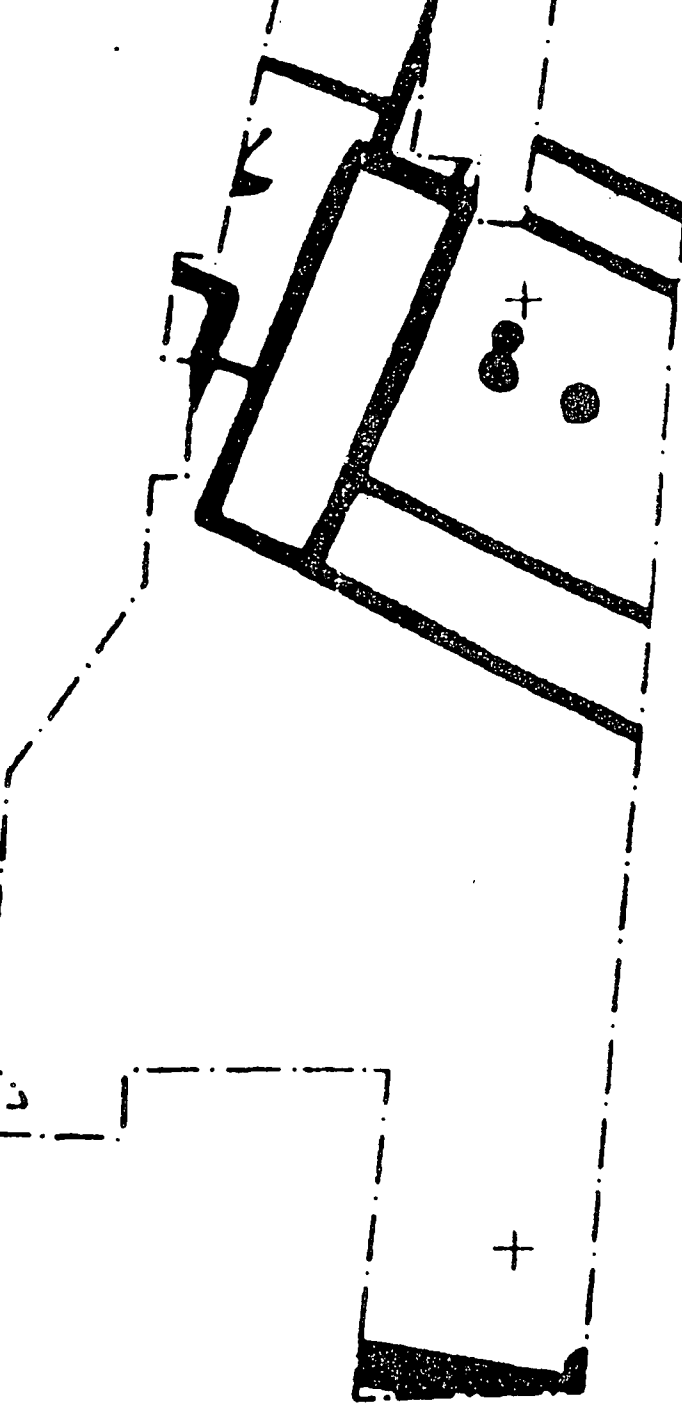

Fig 39 Burgh Castle: detailed plan of Anglo-Saxon features
Cramp 1976

Mid Saxon



Late Saxon Abbey



Early Saxon

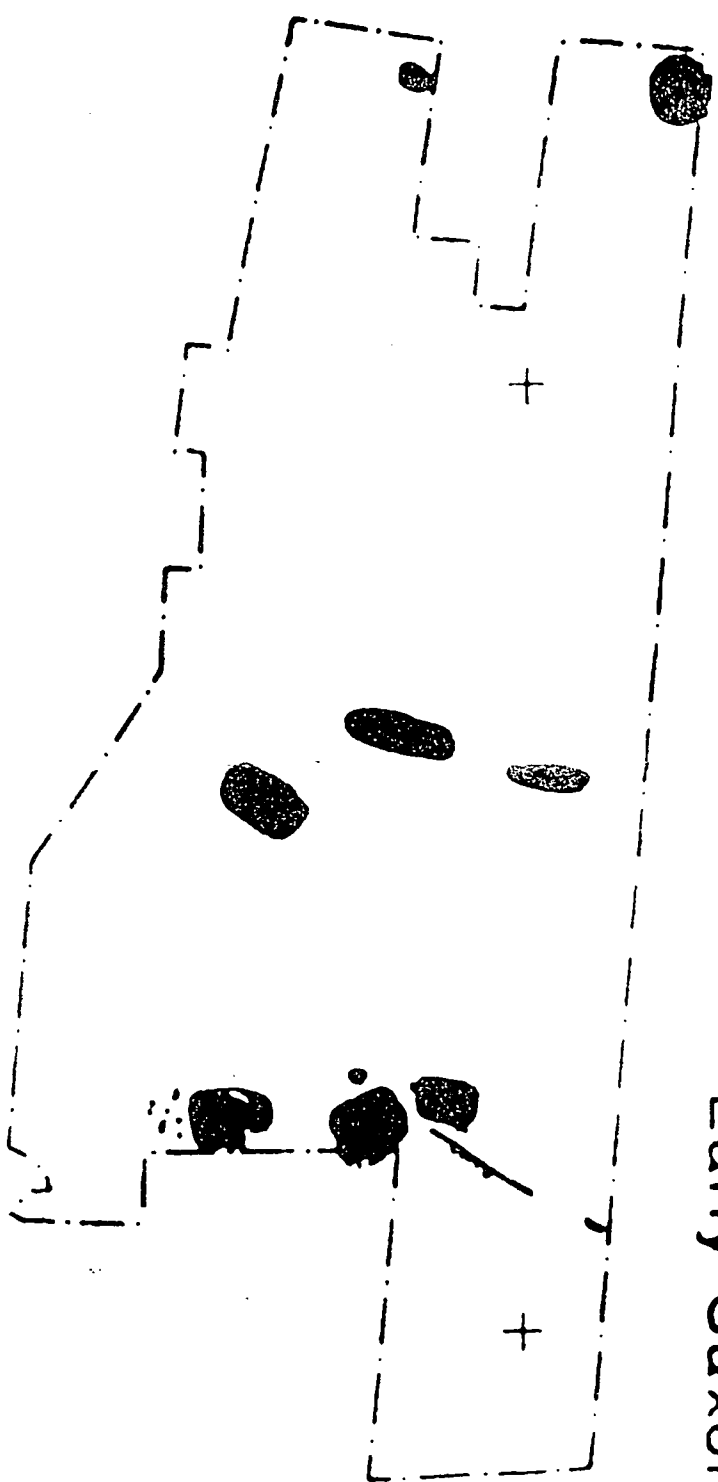

Mid-Late Saxon (minster phase)

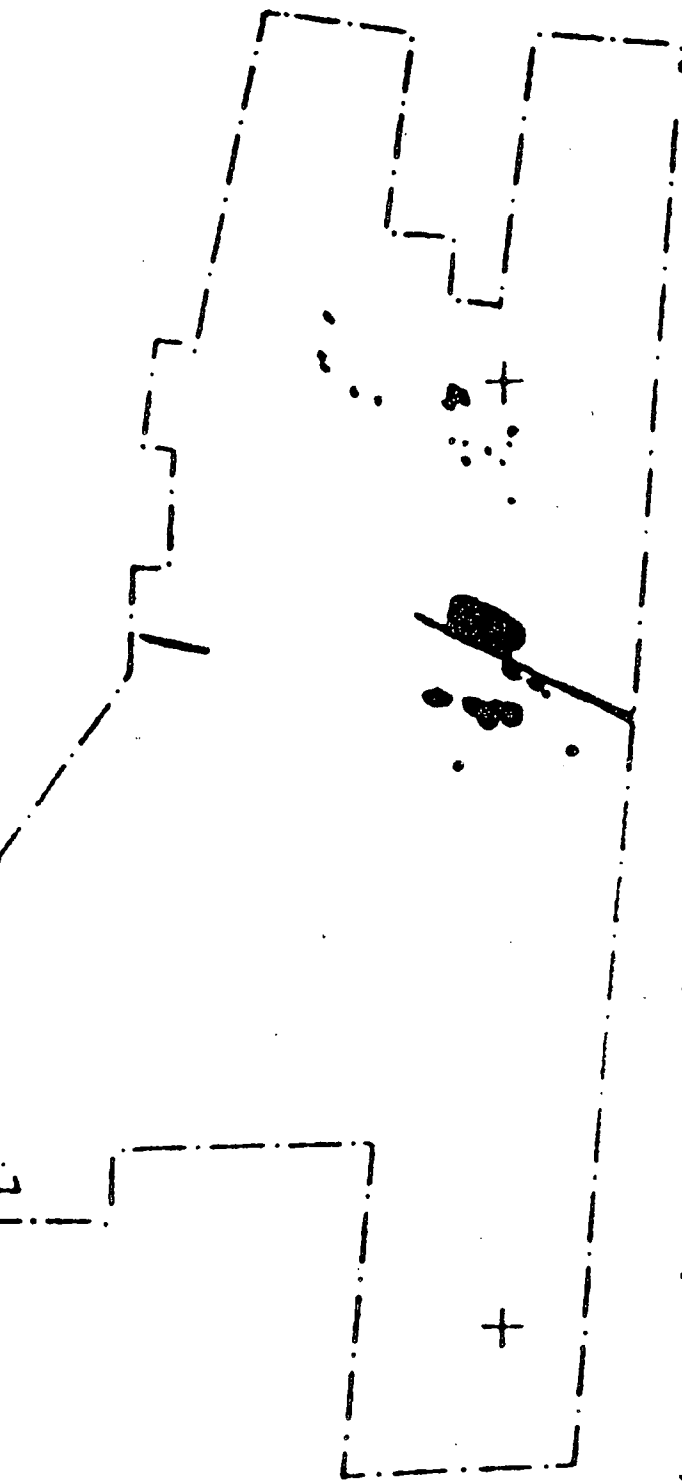

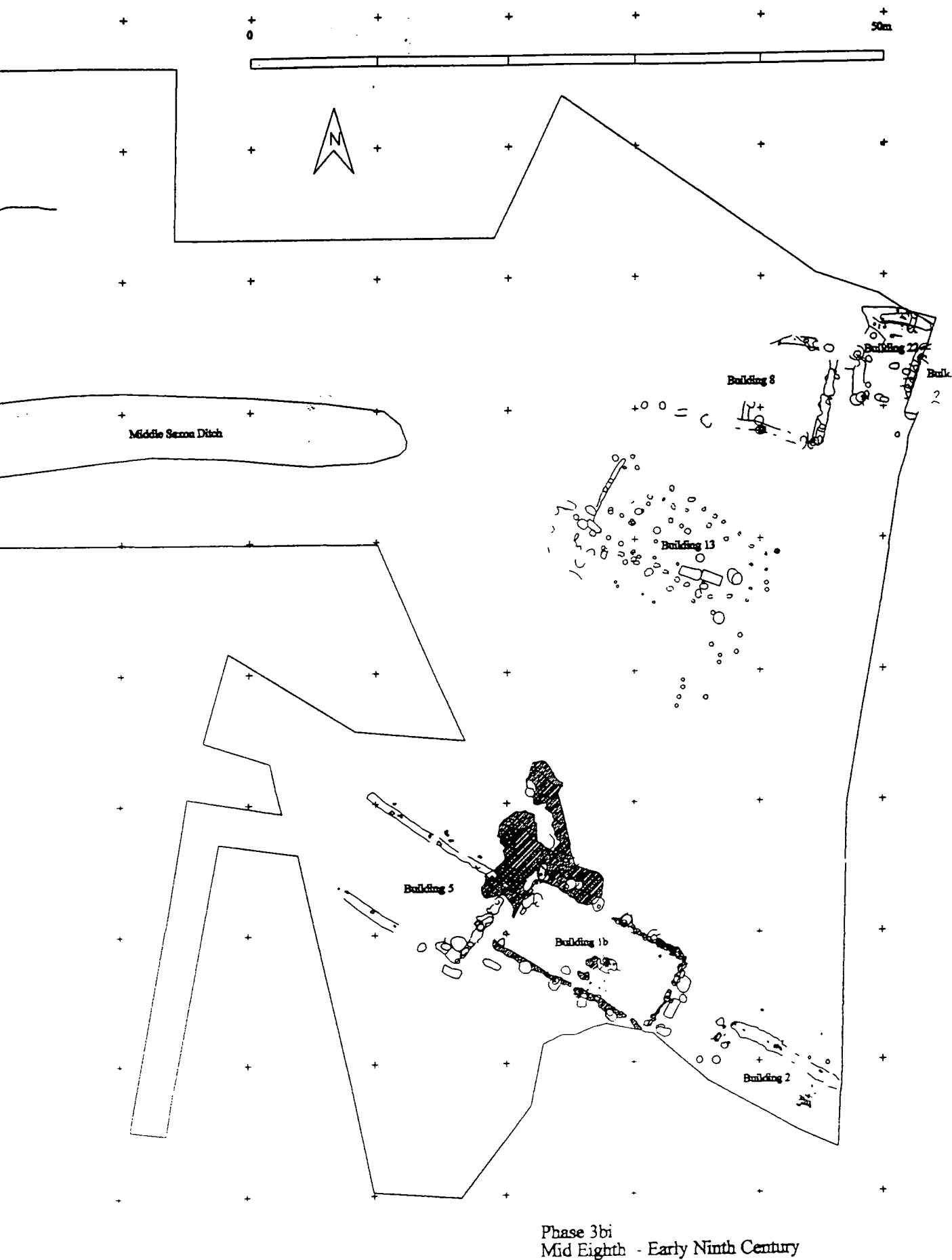

Fig 41 Flixborough: plan of Anglo-Saxon features
Loveluck unpublished

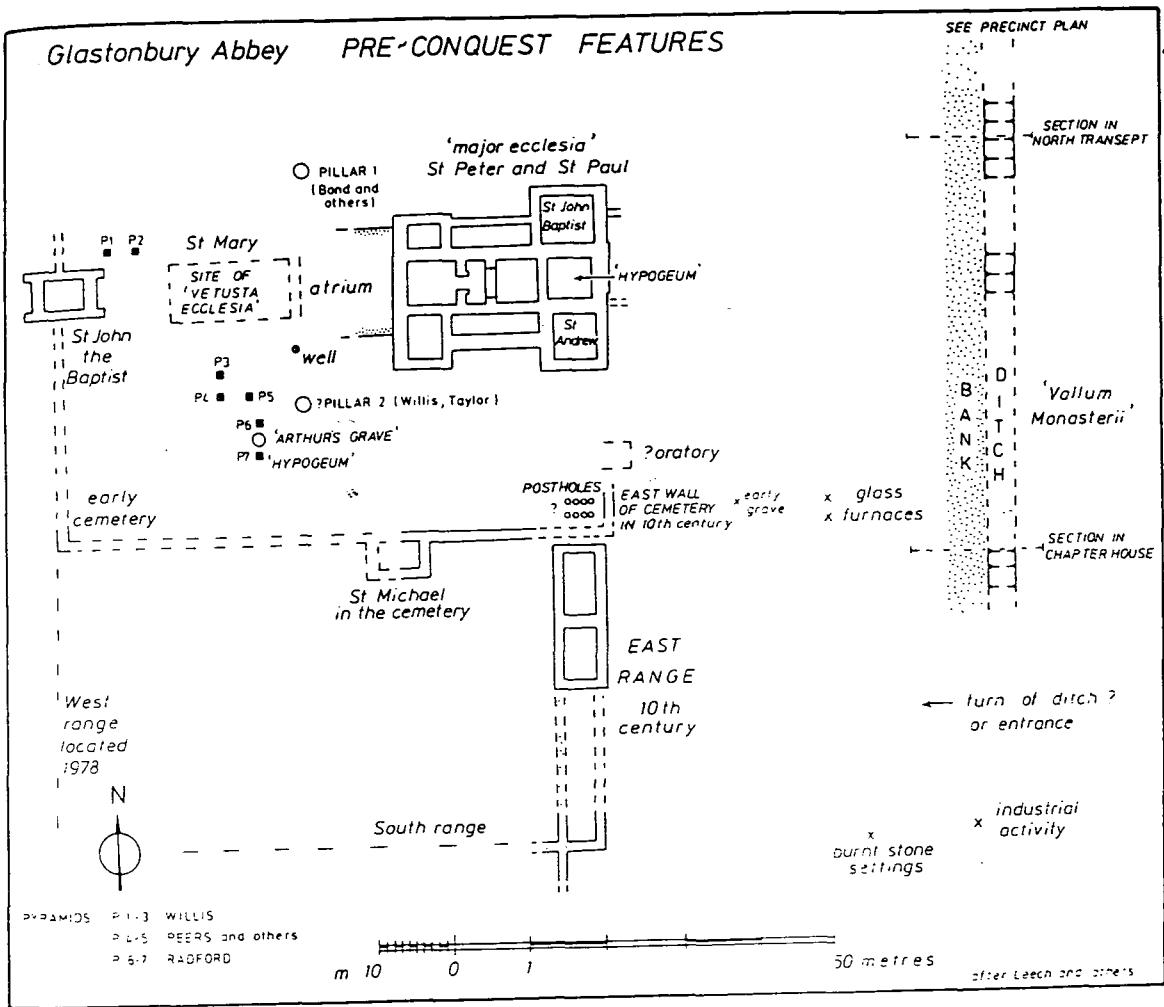

Fig 42 Glastonbury abbey: general plan of Anglo-Saxon churches
Rahtz 1993

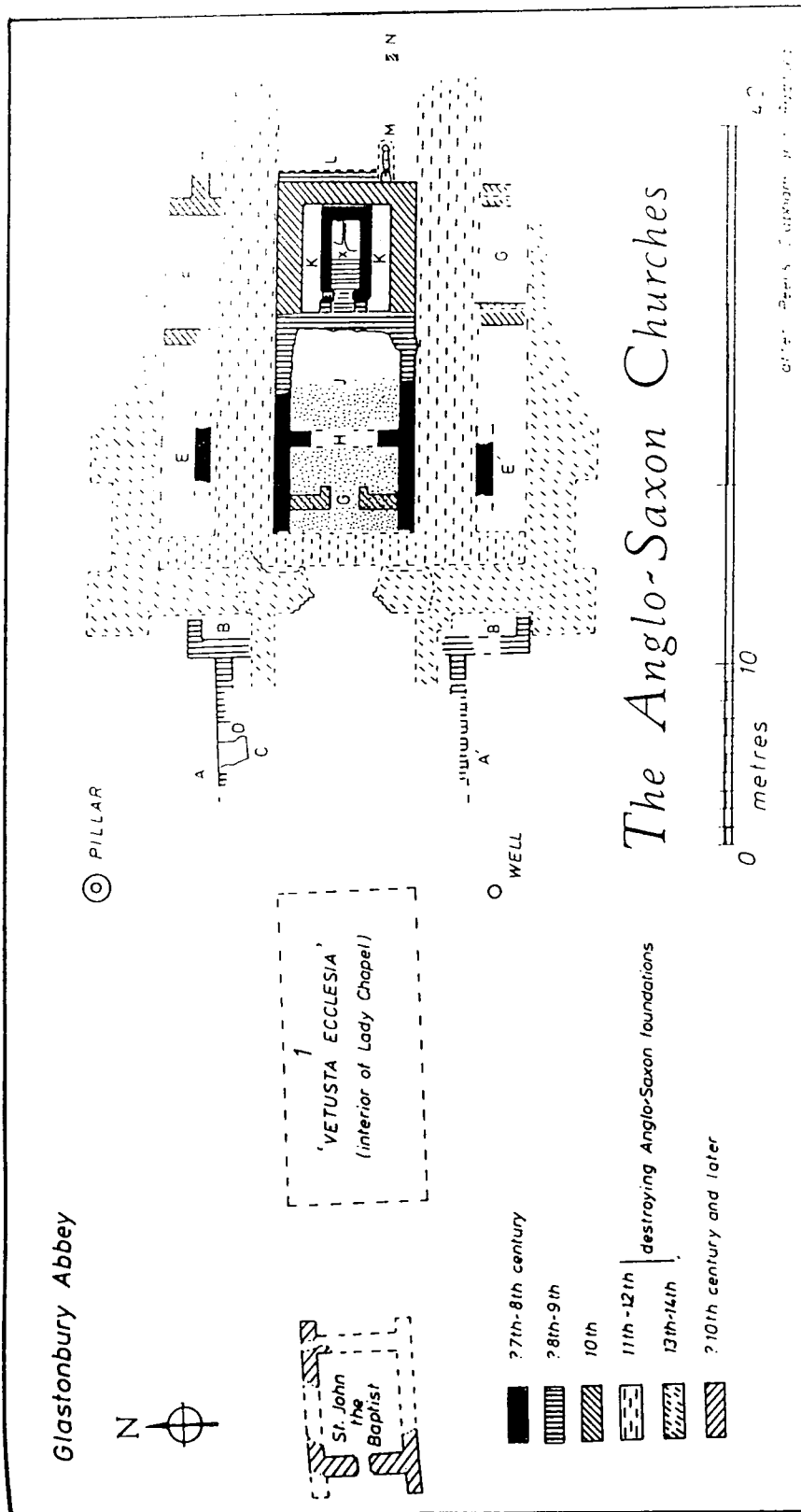

Fig 43 Glastonbury abbey: phase plans of the Anglo-Saxon churches
Rahtz 1993

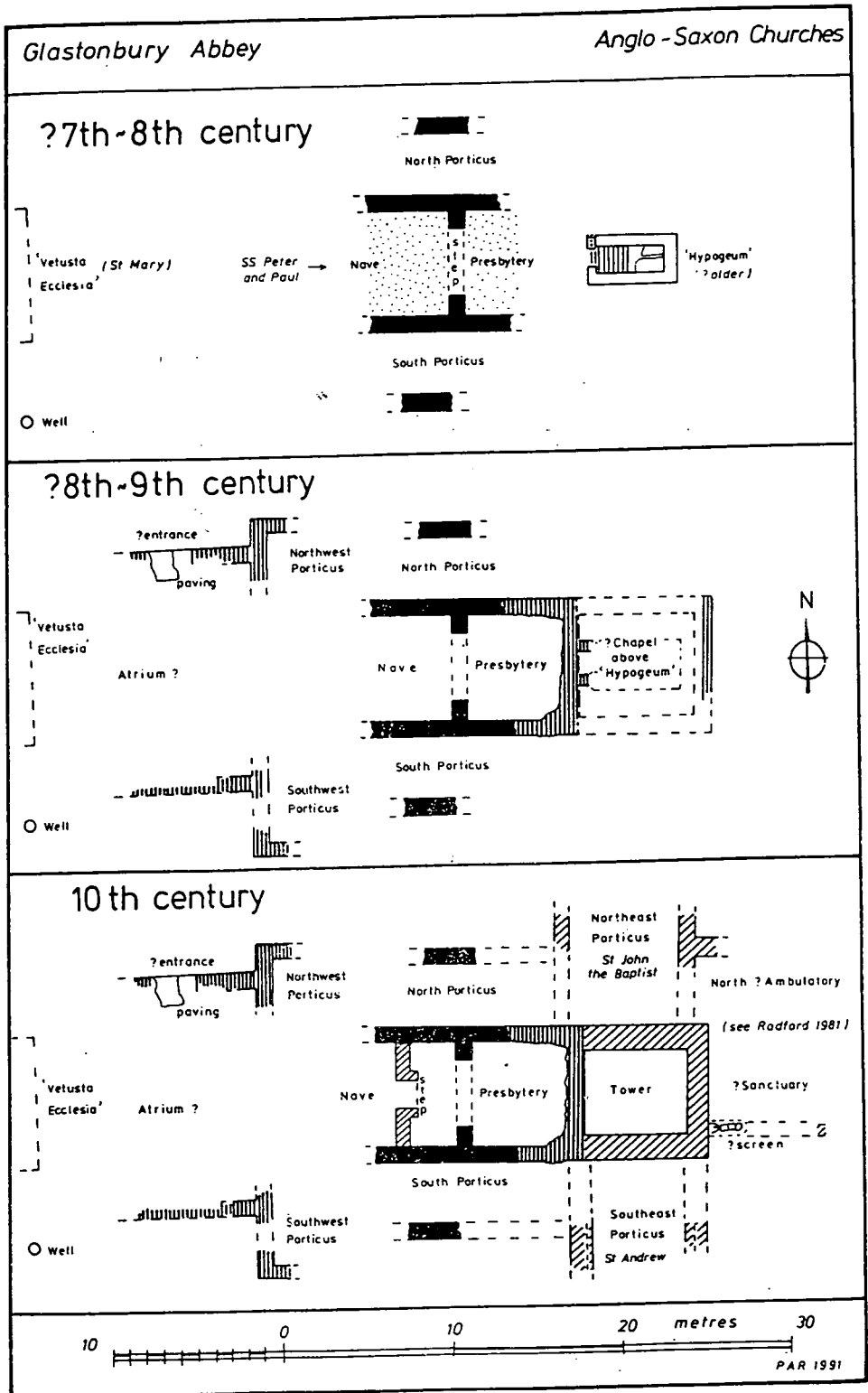

Fig 44 Glastonbury abbey: interpretation plans of the Anglo-Saxon churches
Rahtz 1993

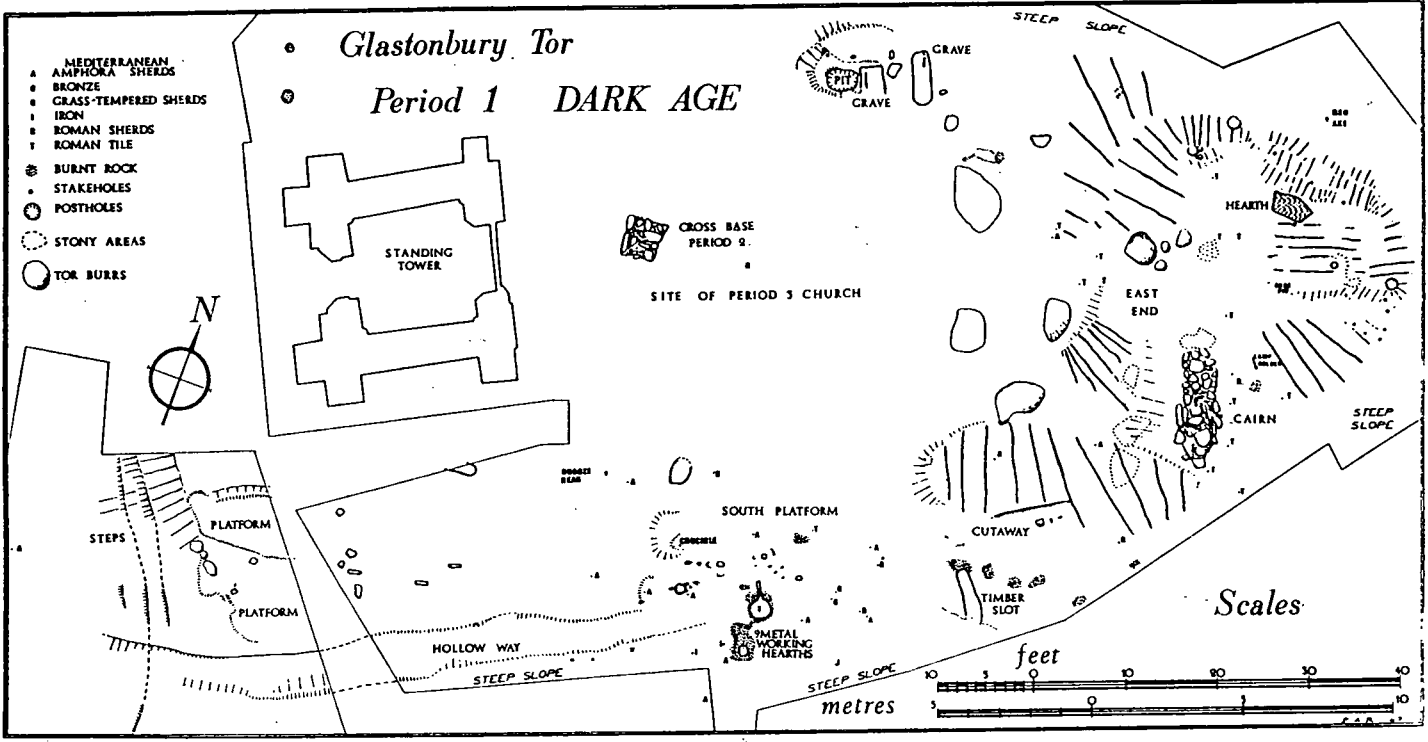

Fig 45 Glastonbury Tor: detailed plan of main area excavation
 Rahtz 1970

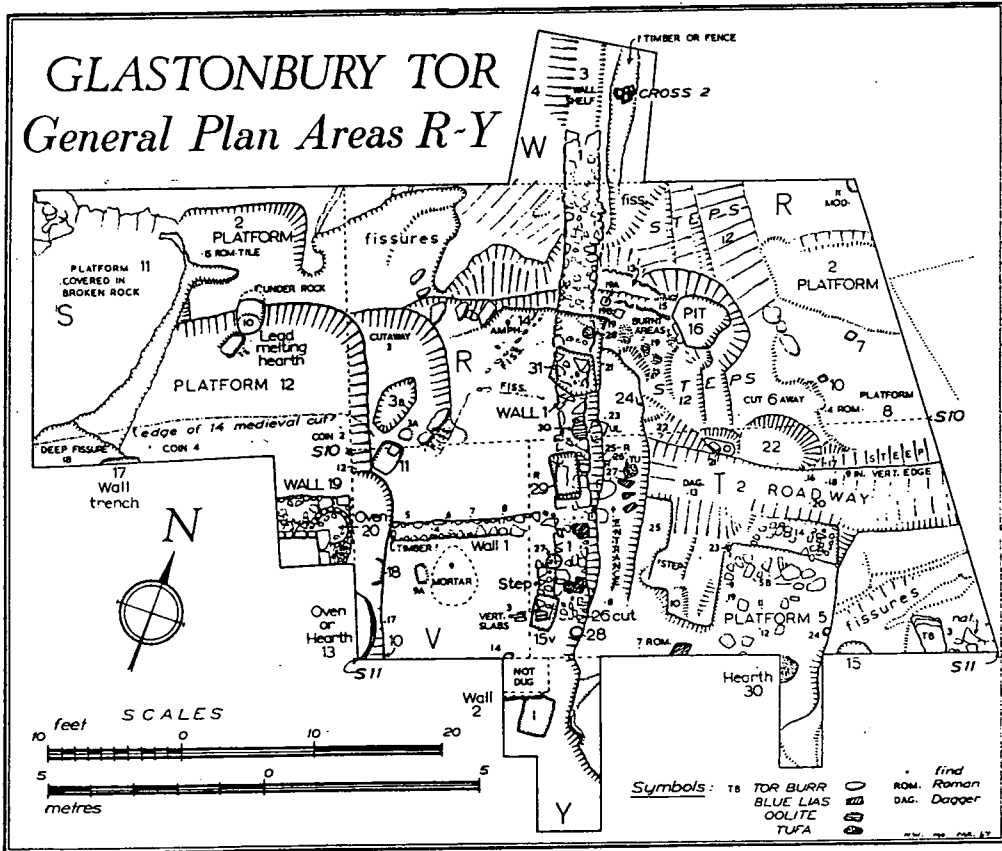

Fig 46 Glastonbury Tor: detailed plan of Anglo-Saxon features in Areas R-Y
Rahtz 1970



Fig 47 Hartlepool: general plan of Anglo-Saxon features, Period 1
Daniels 1988

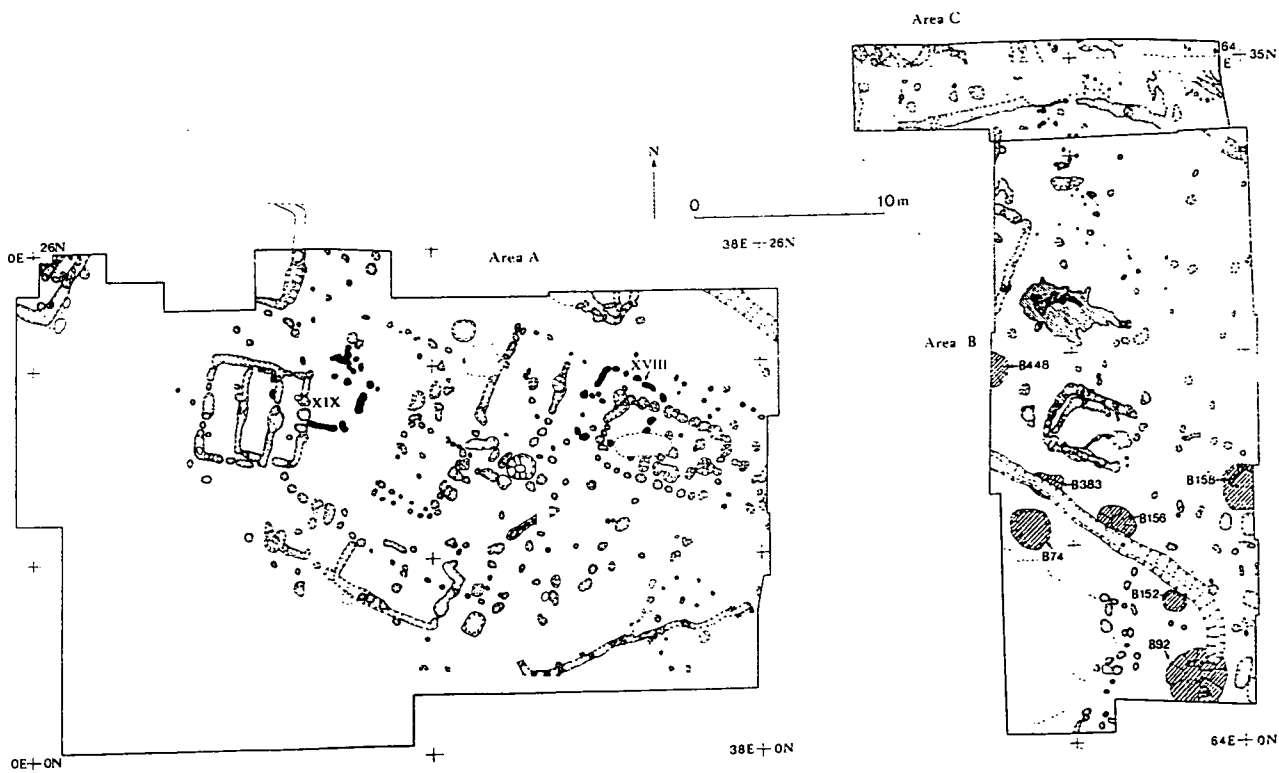

Fig 48 Hartlepool: plan of Anglo-Saxon features of Phase 1, Period 1
Daniels 1988

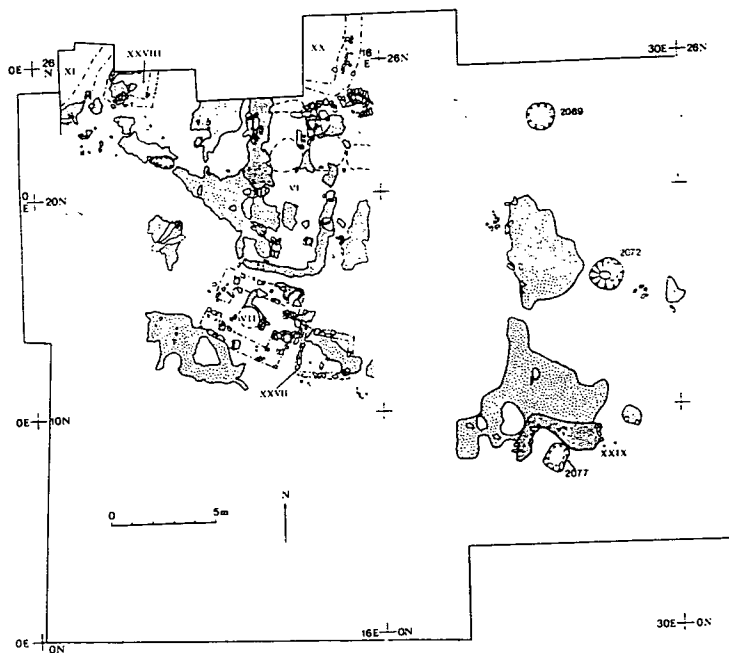

Fig 49 Hartlepool: plan of Anglo-Saxon features in Area A
Daniels 1988

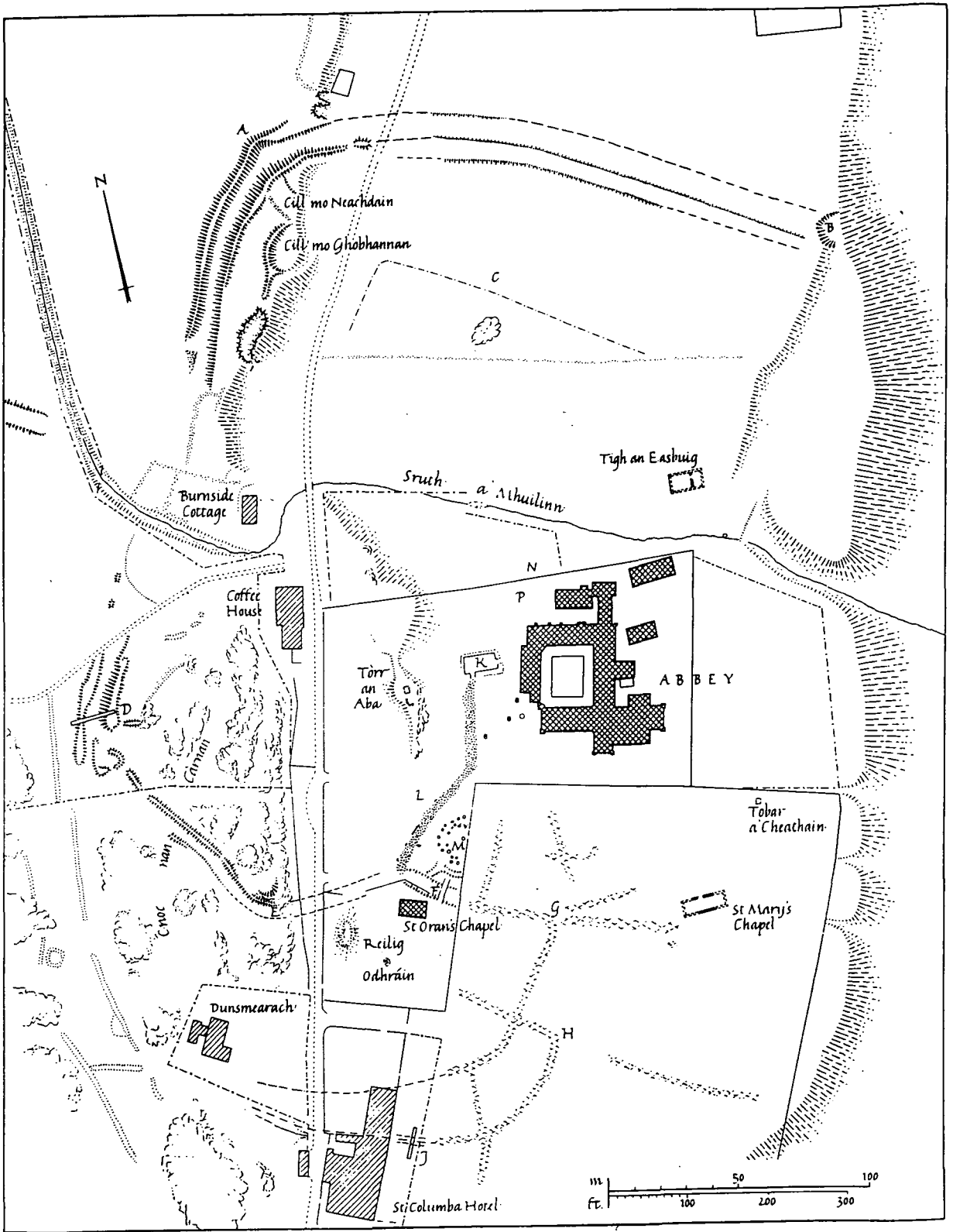

Fig 50 Iona: general plan of monastic enclosure
Ritchie 1997

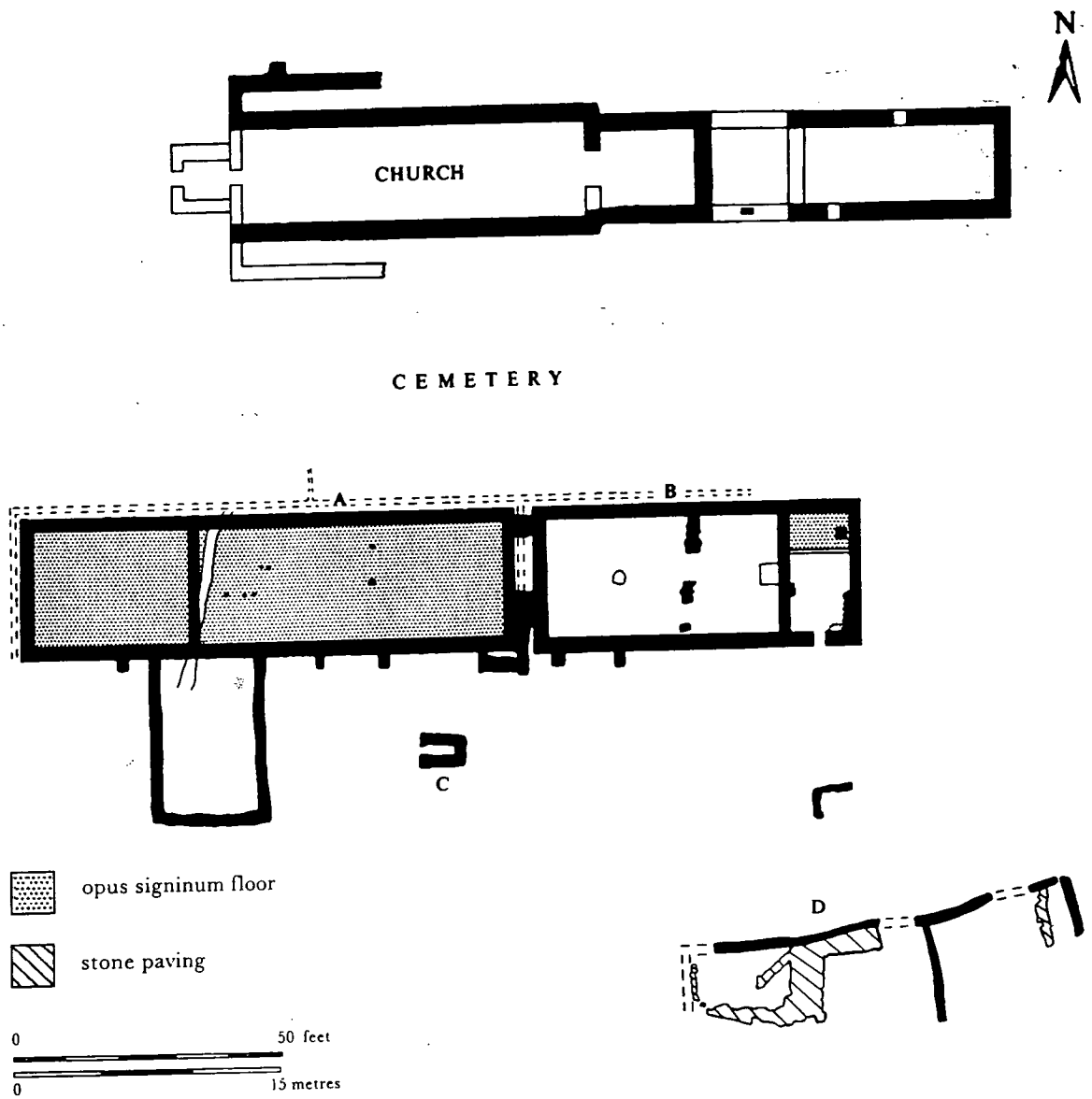

Fig 51 Jarrow: general plan of Anglo-Saxon foundations
Cramp 1994

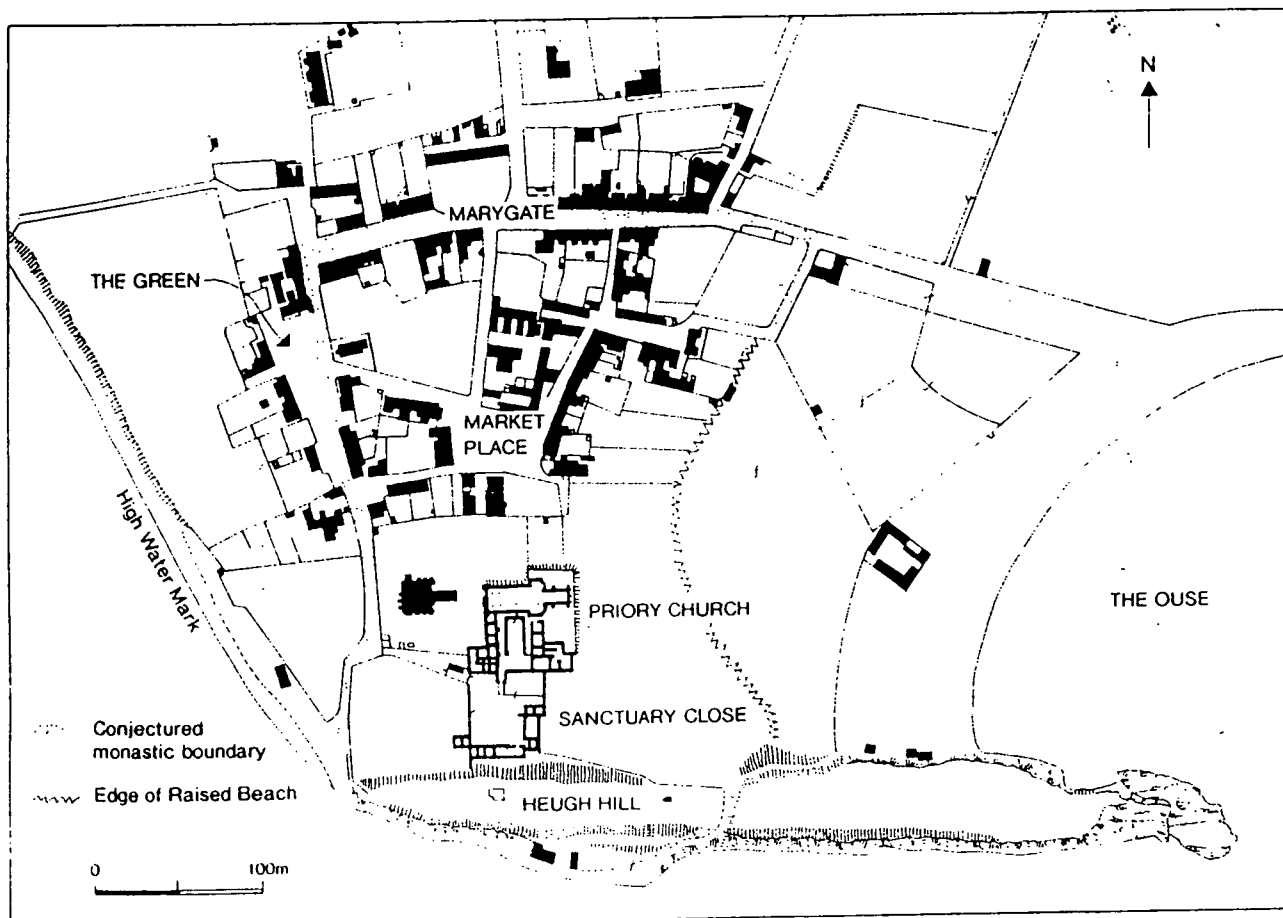

Fig 52 Lindisfarne: plan of possible Anglo-Saxon monastic enclosure
O'Sullivan & Young 1995

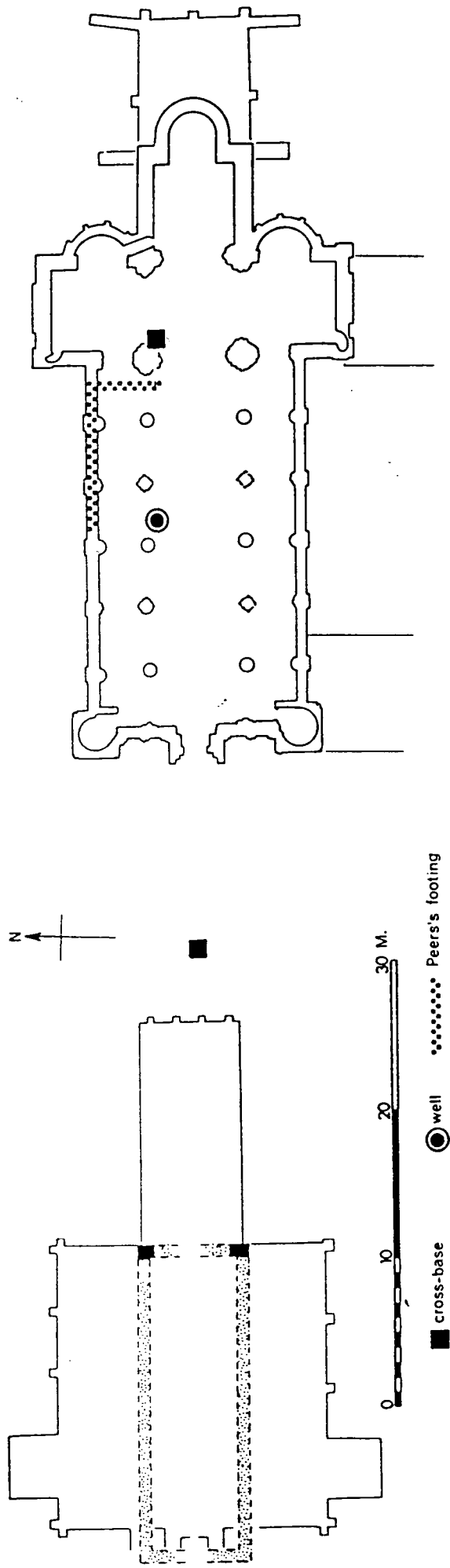

Fig 53 Lindisfame: general plan of possible timber churches
Blair 1991

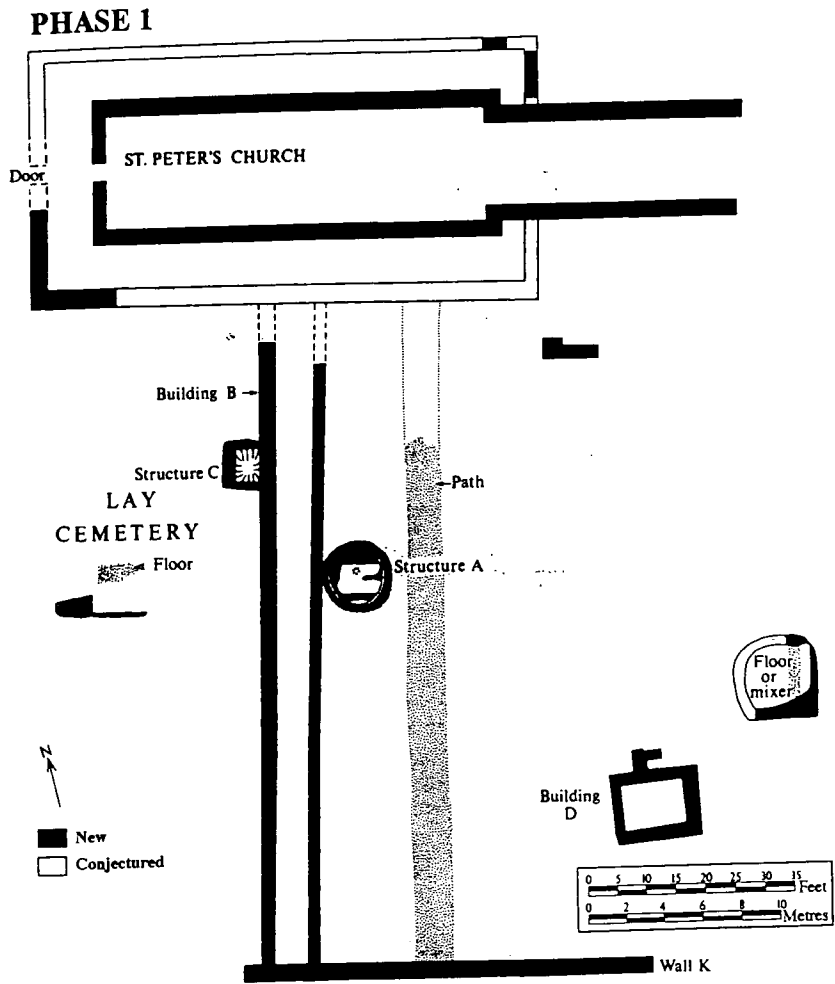

Fig 54 Monkwearmouth: plan of Anglo-Saxon foundations, Phase 1
Cramp 1994

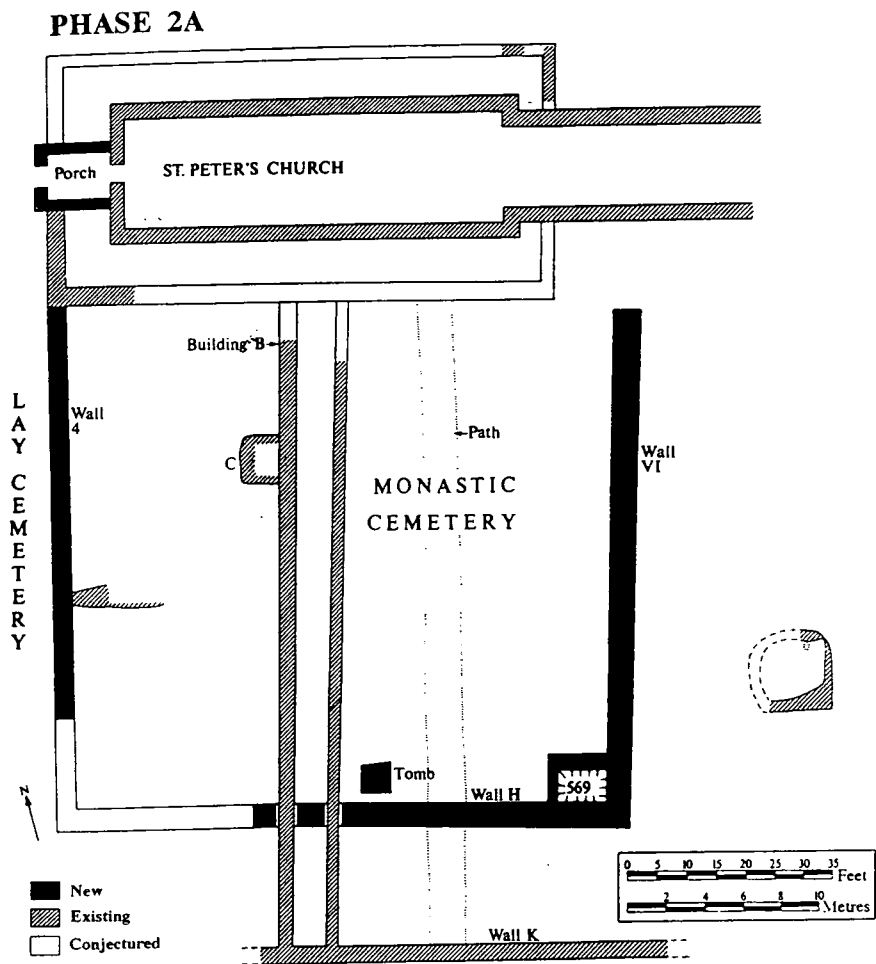

Fig 55 Monkwearmouth: plan of Anglo-Saxon foundations, Phase 2A
Cramp 1994

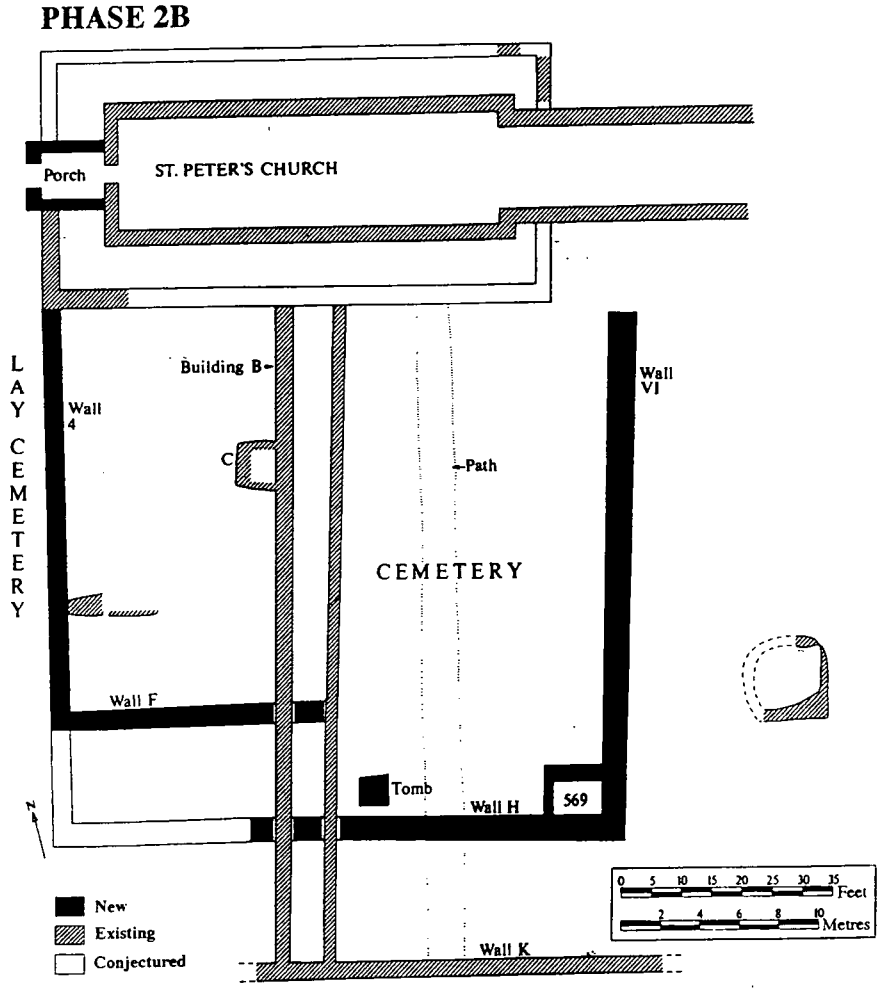

Fig 56 Monkwearmouth: plan of Anglo-Saxon foundations, Phase 2B
Cramp 1994

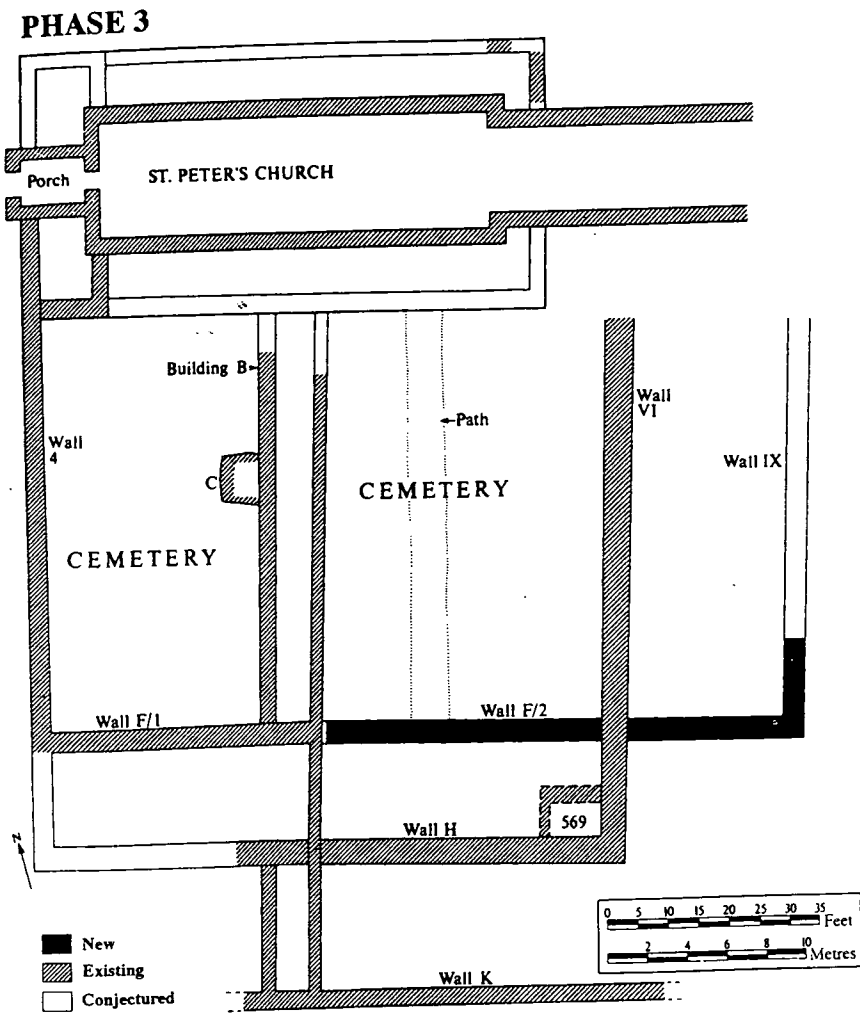
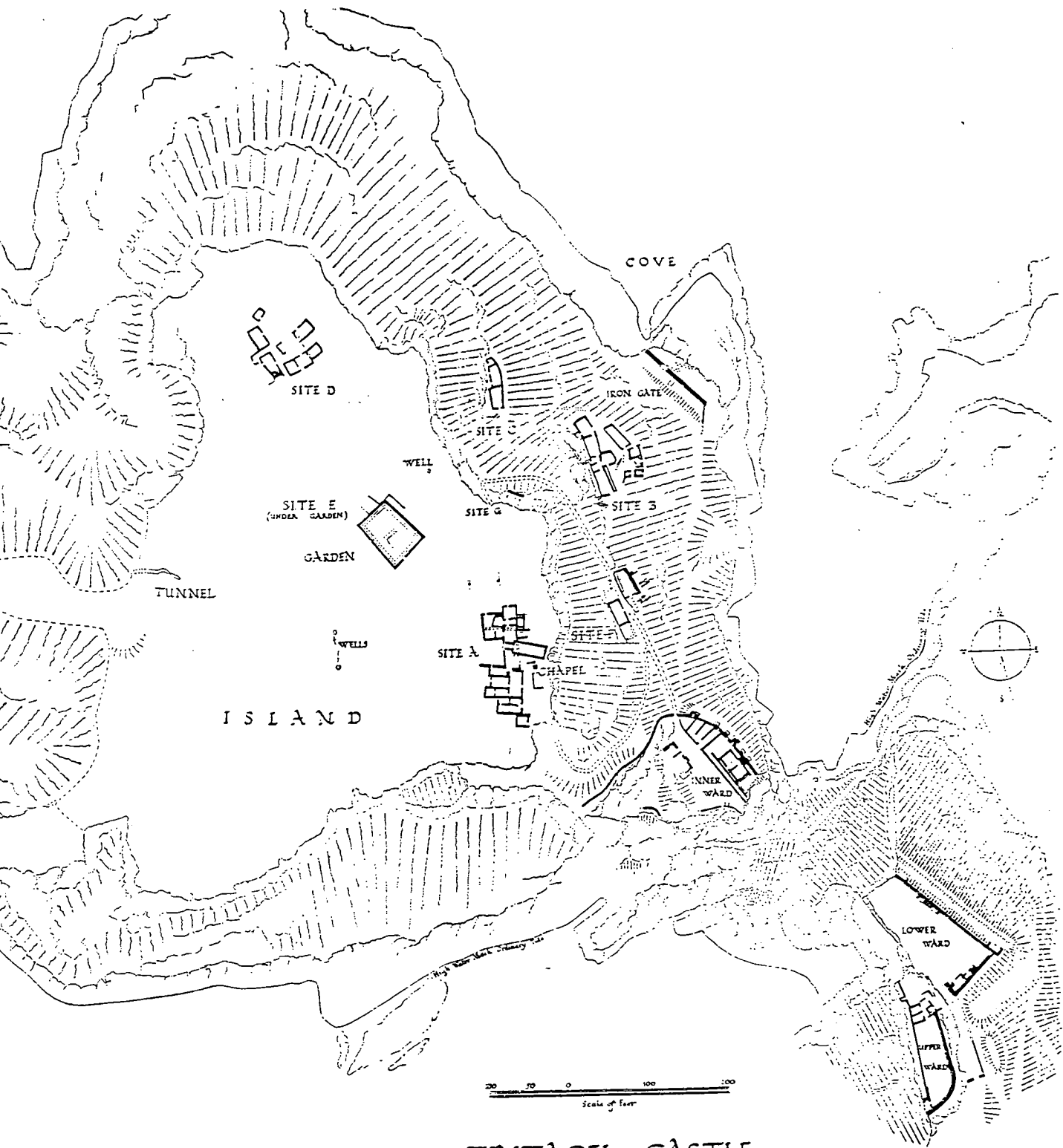

Fig 57 Monkwearmouth: plan of Anglo-Saxon foundations, Phase 3
Cramp 1994



TINTAGEL CASTLE

Fig 58 Tintagel: general plan of the island
Radford 1935

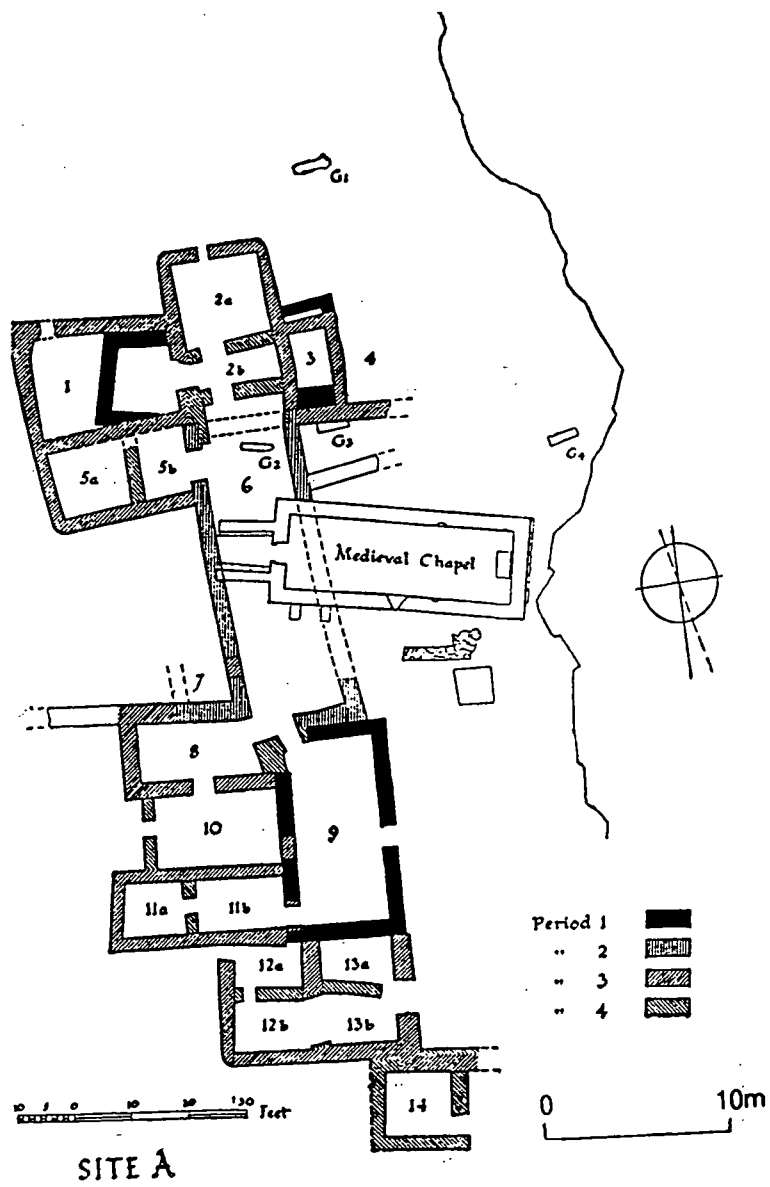
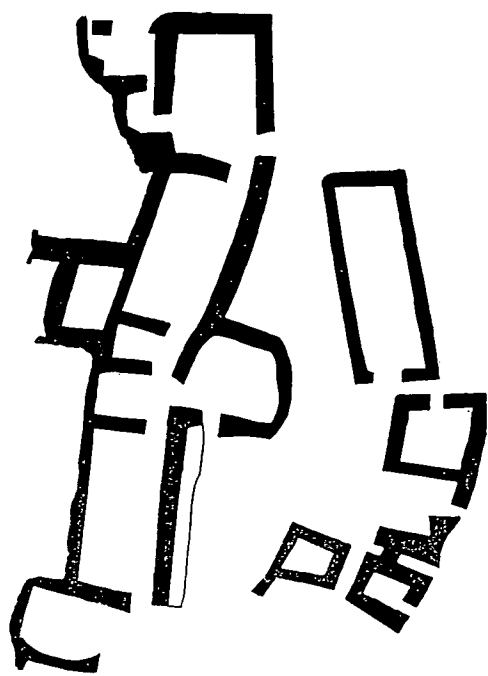
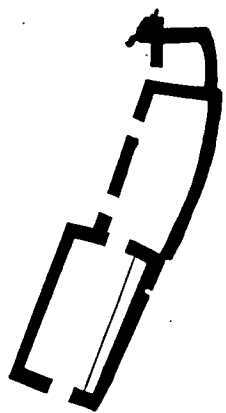

Fig 59 Tintagel: plan of Site A
Radford 1962



0 10m

Fig 60 Tintagel: plan of Site B and C
Radford 1962

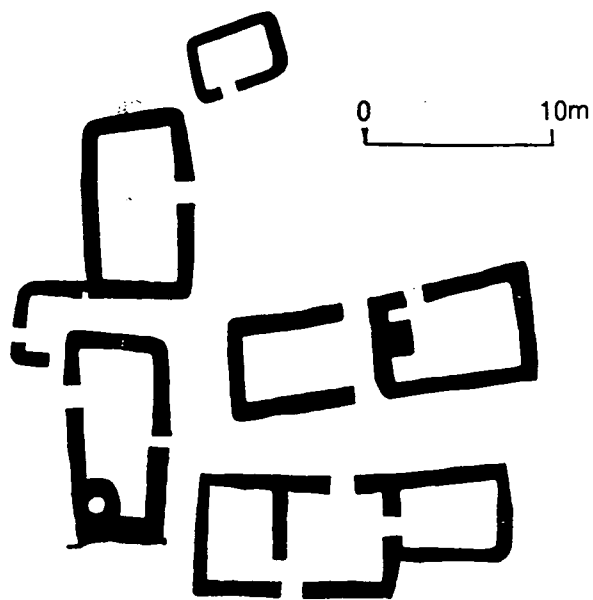

Fig 61 Tintagel: plan of Site D
Radford 1962

TYNEMOUTH TIMBER BUILDINGS

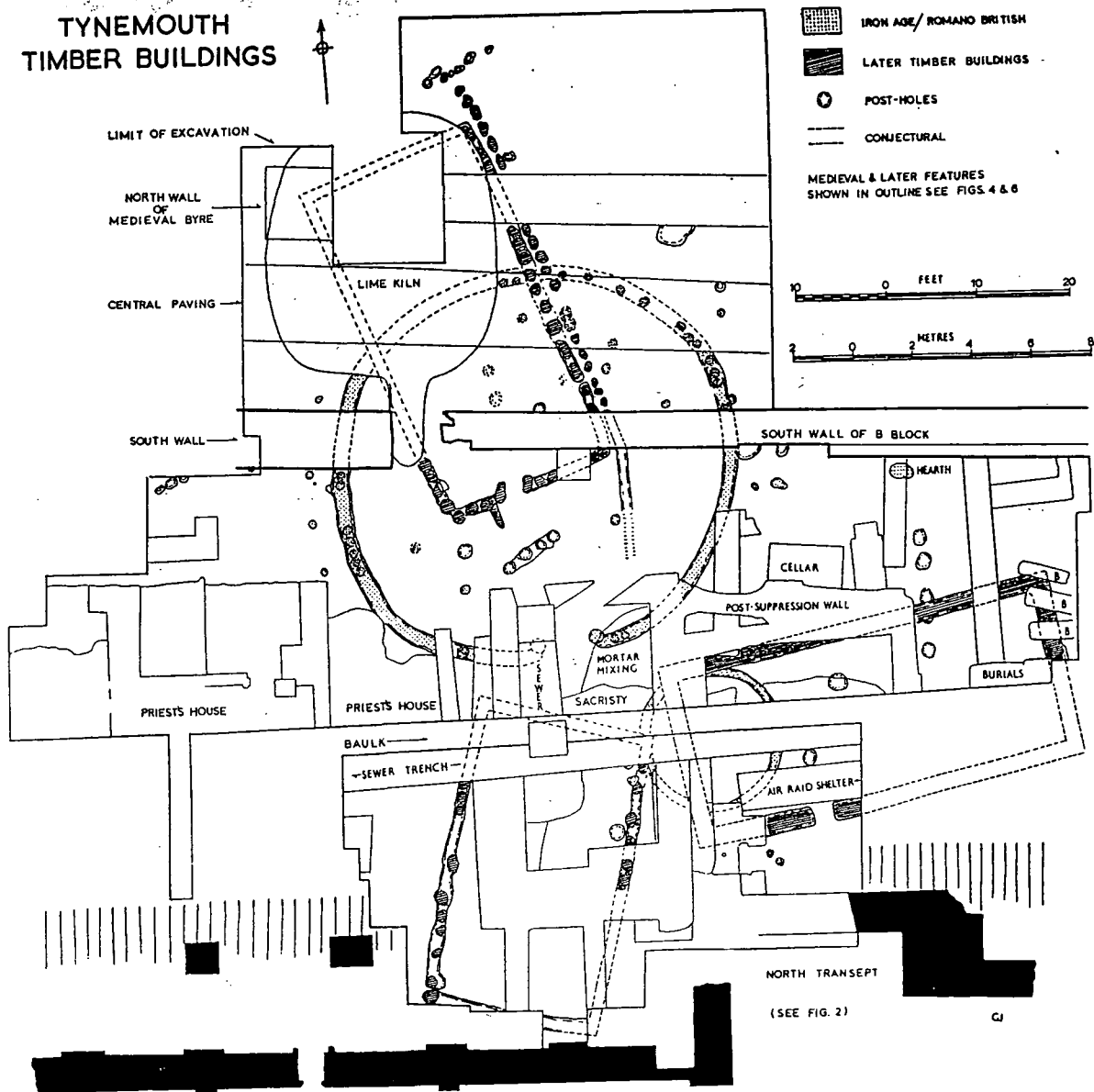

Fig 62 Tynemouth: plan of features north of the church
Jobey 1967

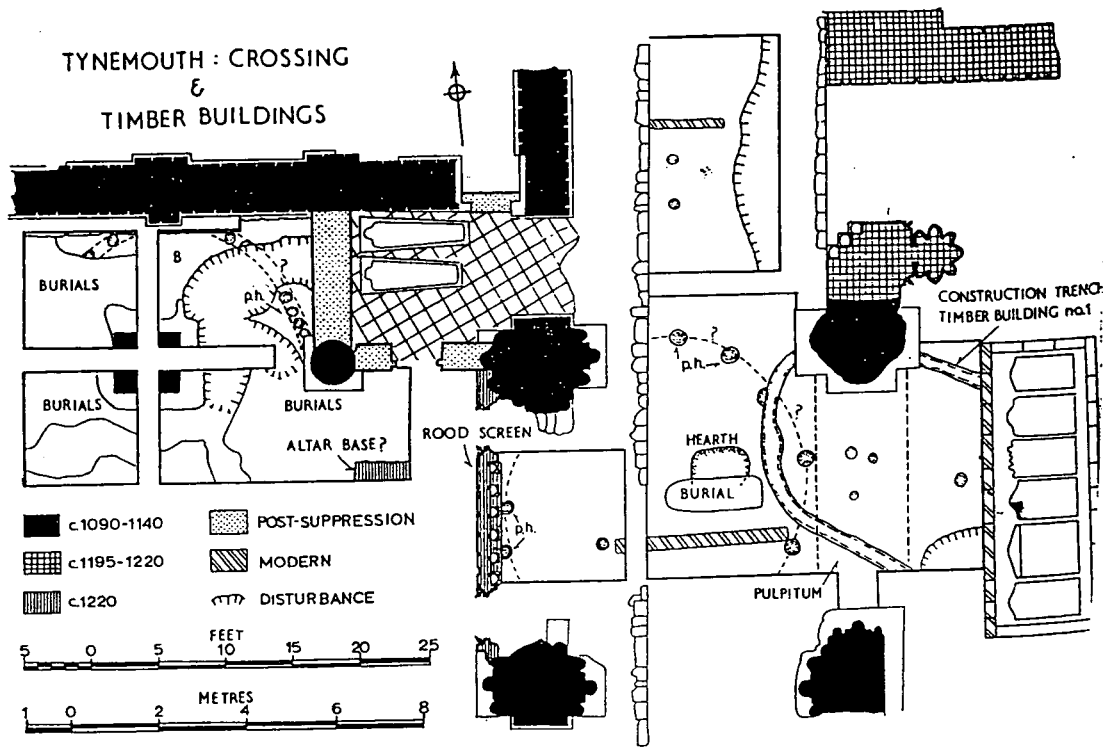
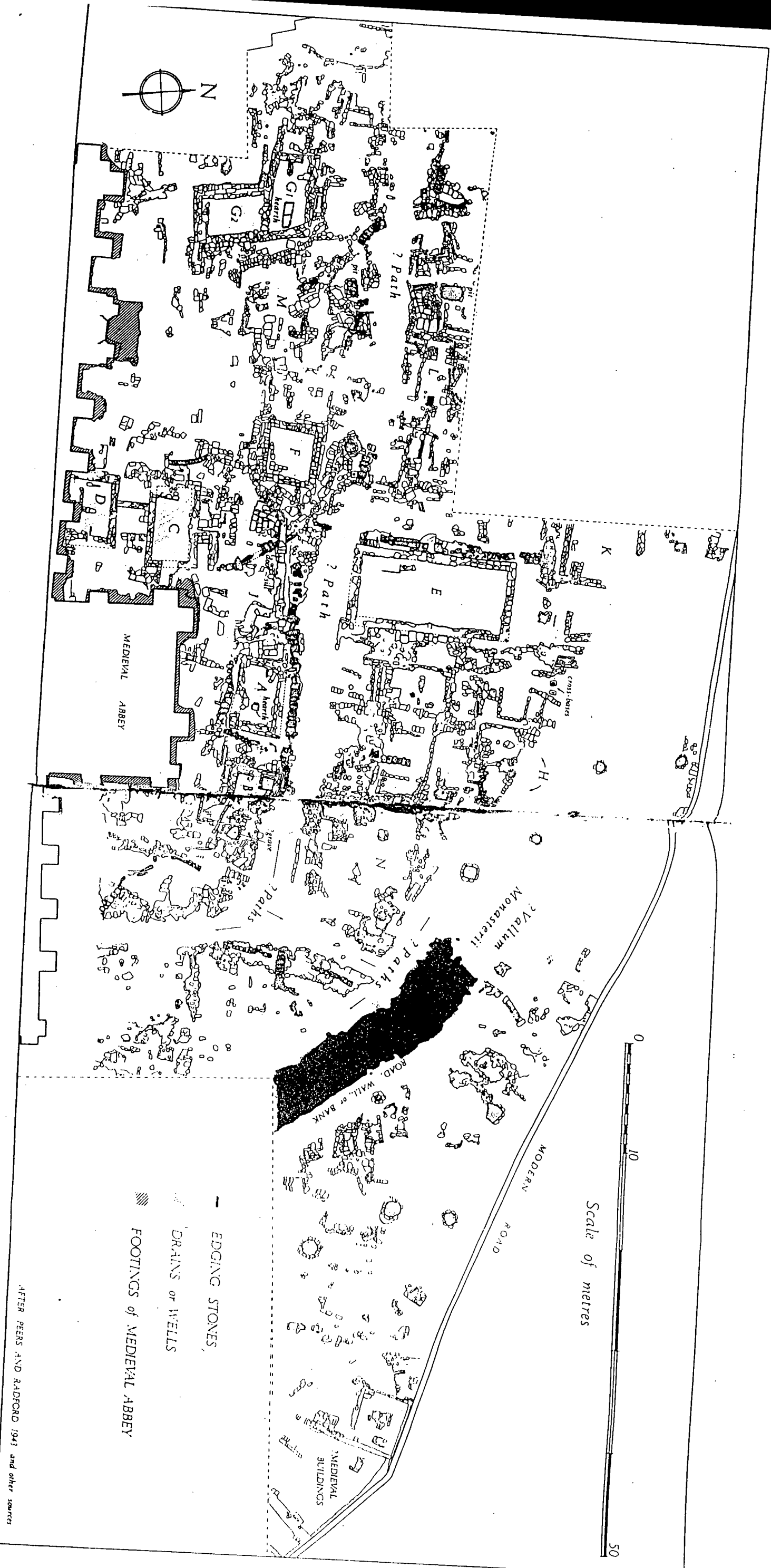

Fig 63 Tynemouth: plan of features below the church
Jobey 1967



AFTER PEERS AND RADFORD 1943 and other sources

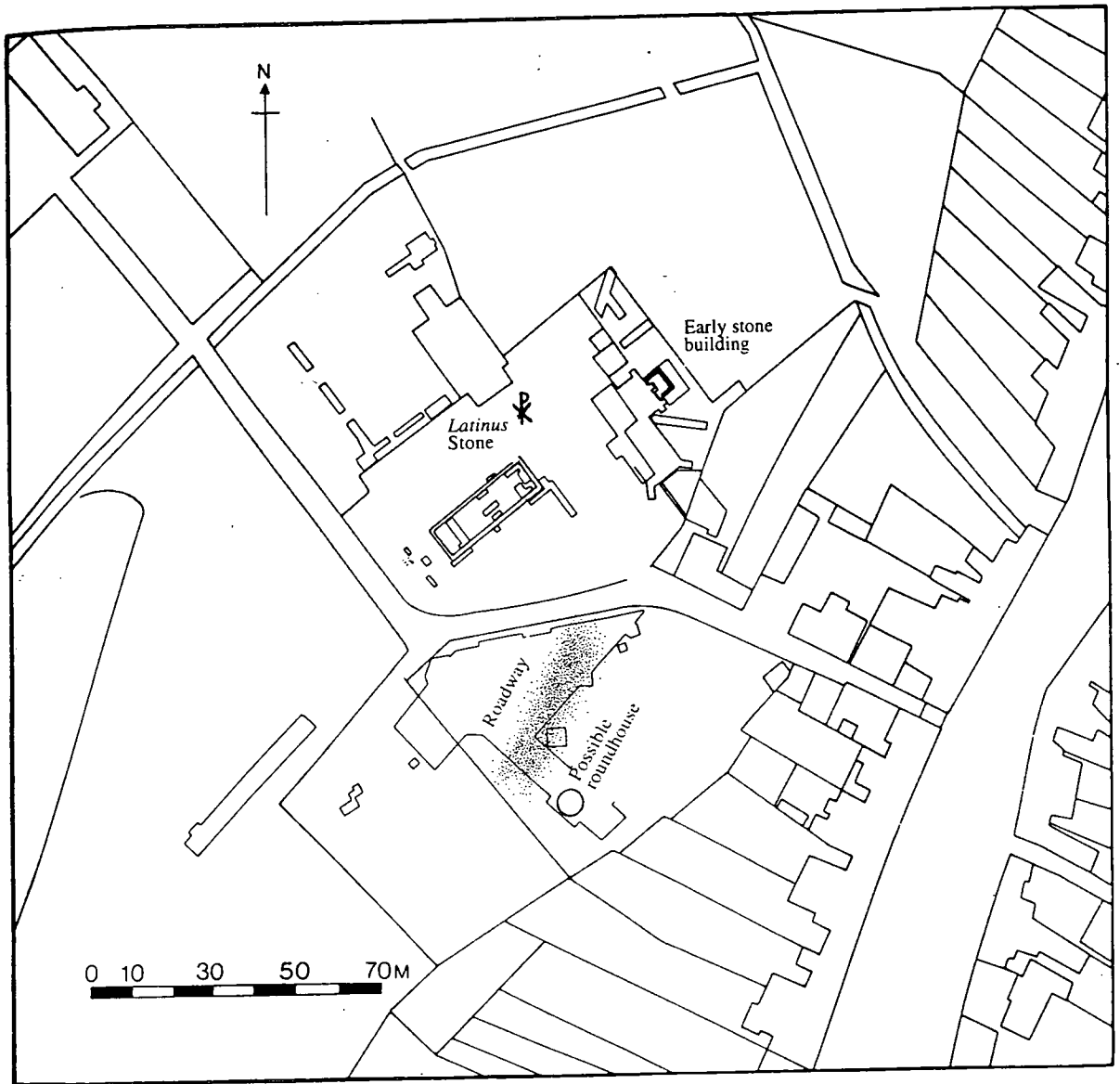

Fig 65 Whithorn: plan of settlement, Period I/O
Hill 1997

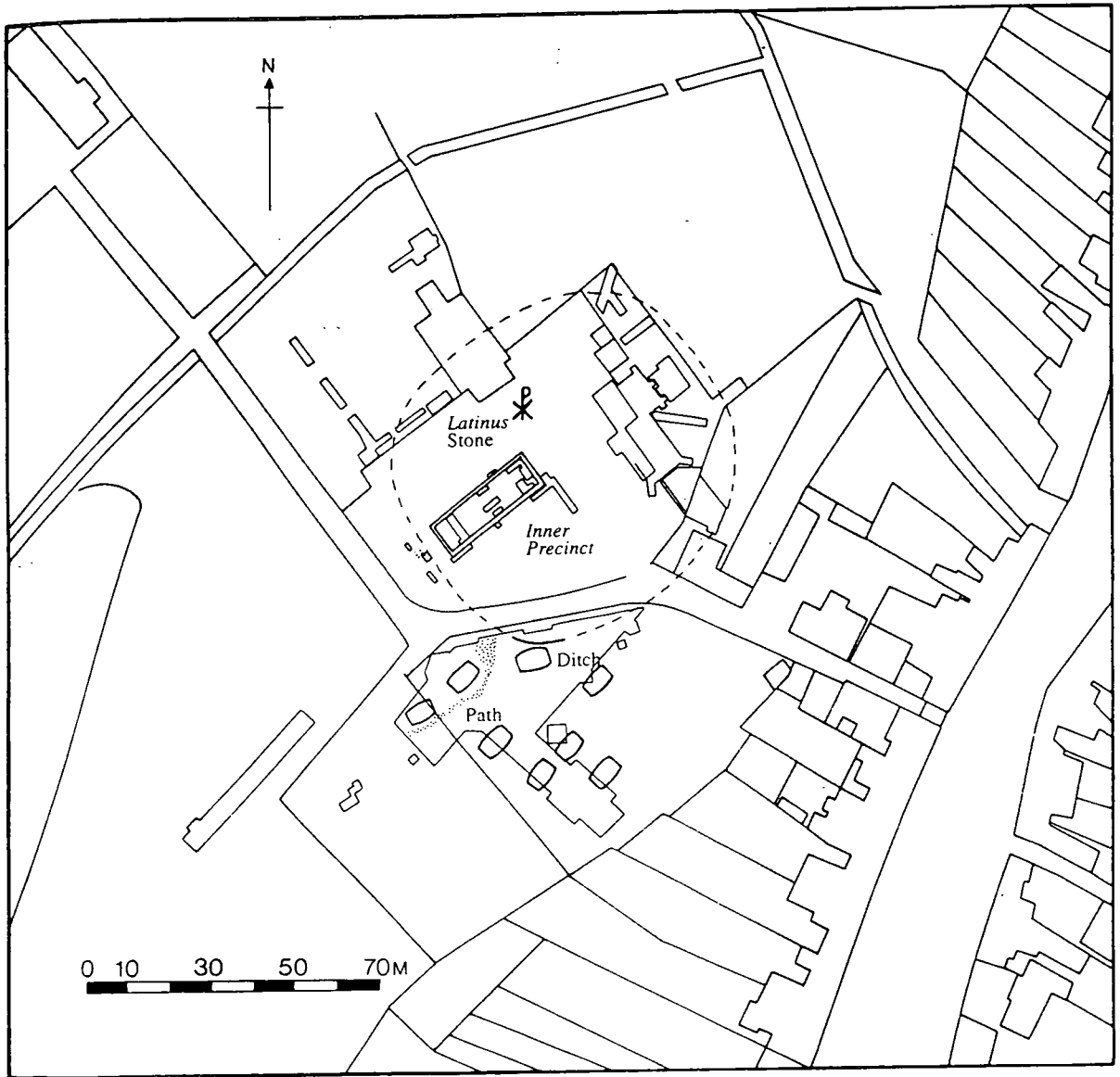

Fig 66 Whithorn: plan of settlement, Period I/1
Hill 1997

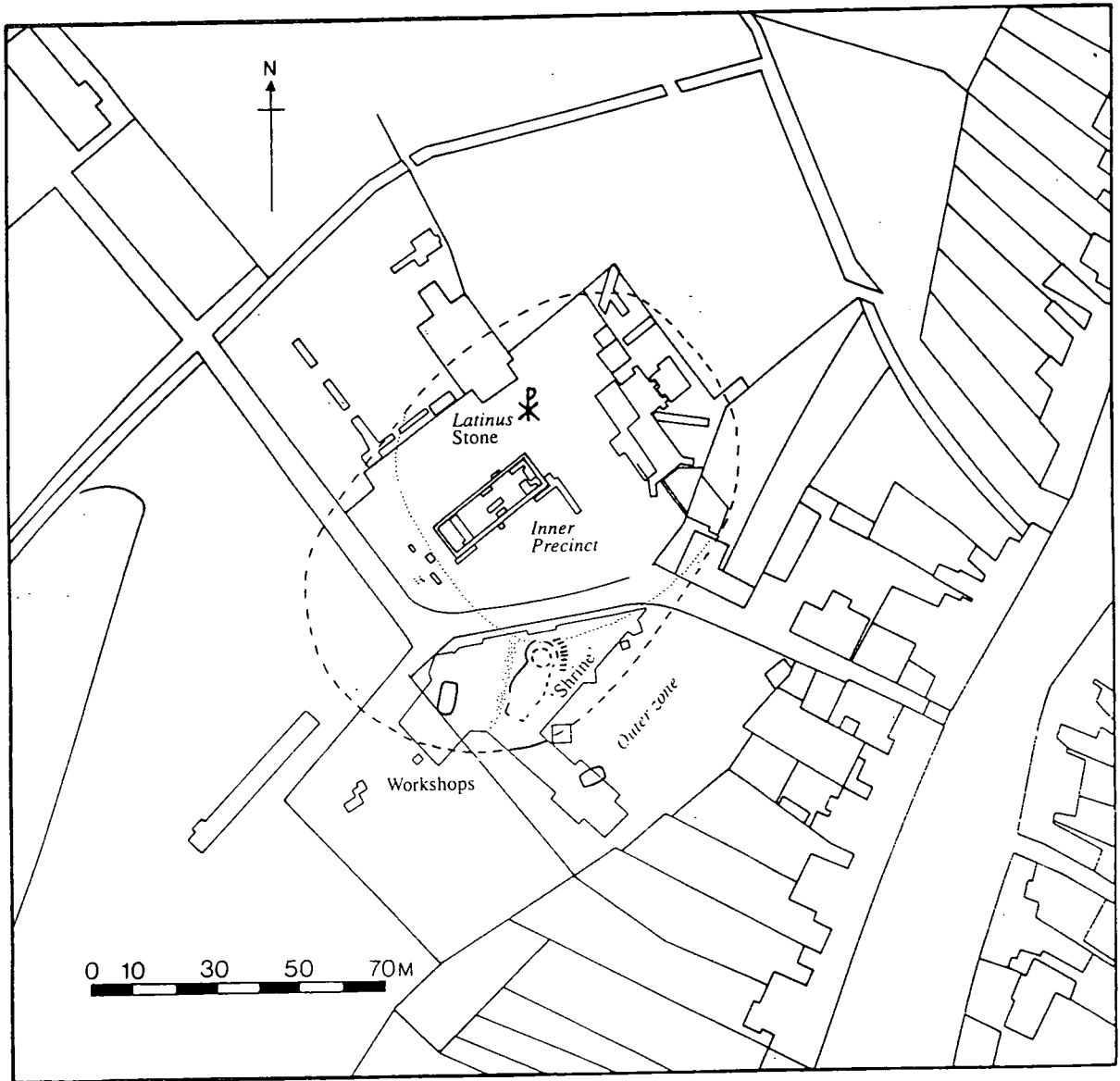

Fig 67 Whithorn: plan of settlement, Period I/2
Hill 1997

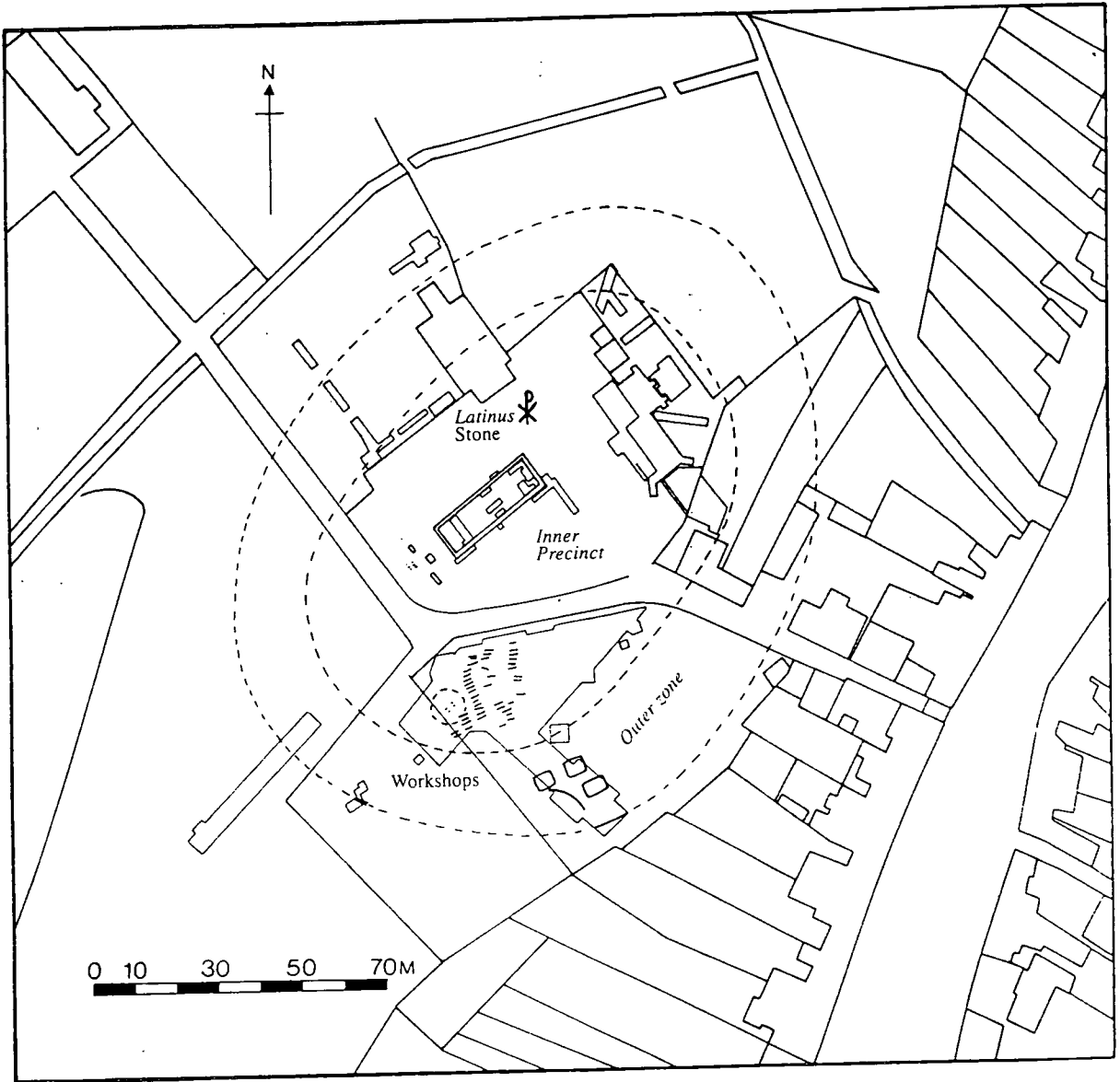

Fig 68 Whithorn: plan of settlement, Period I/4
Hill 1997

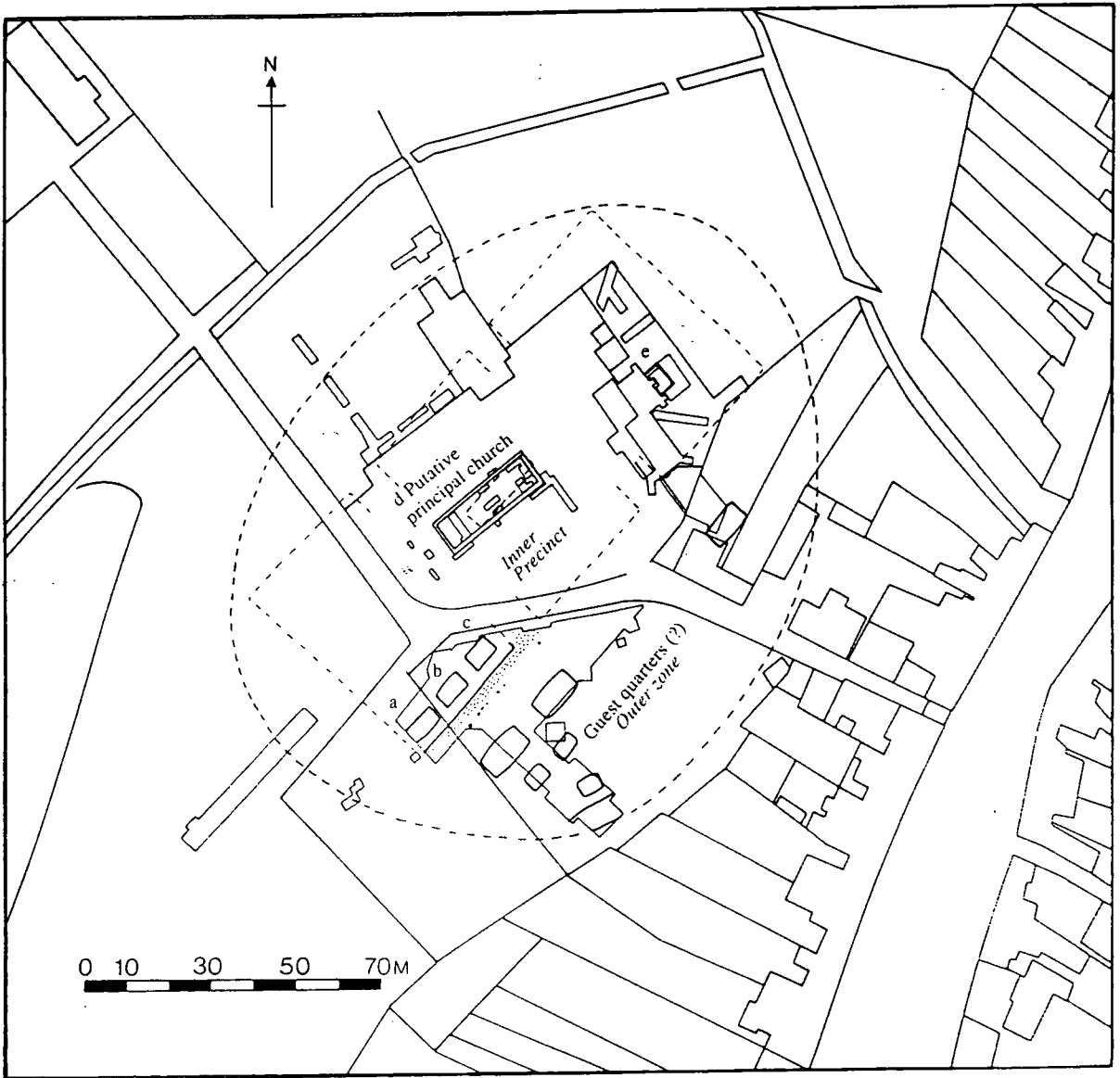

Fig 69 Whithorn: plan of settlement, Period II/2
Hill 1997

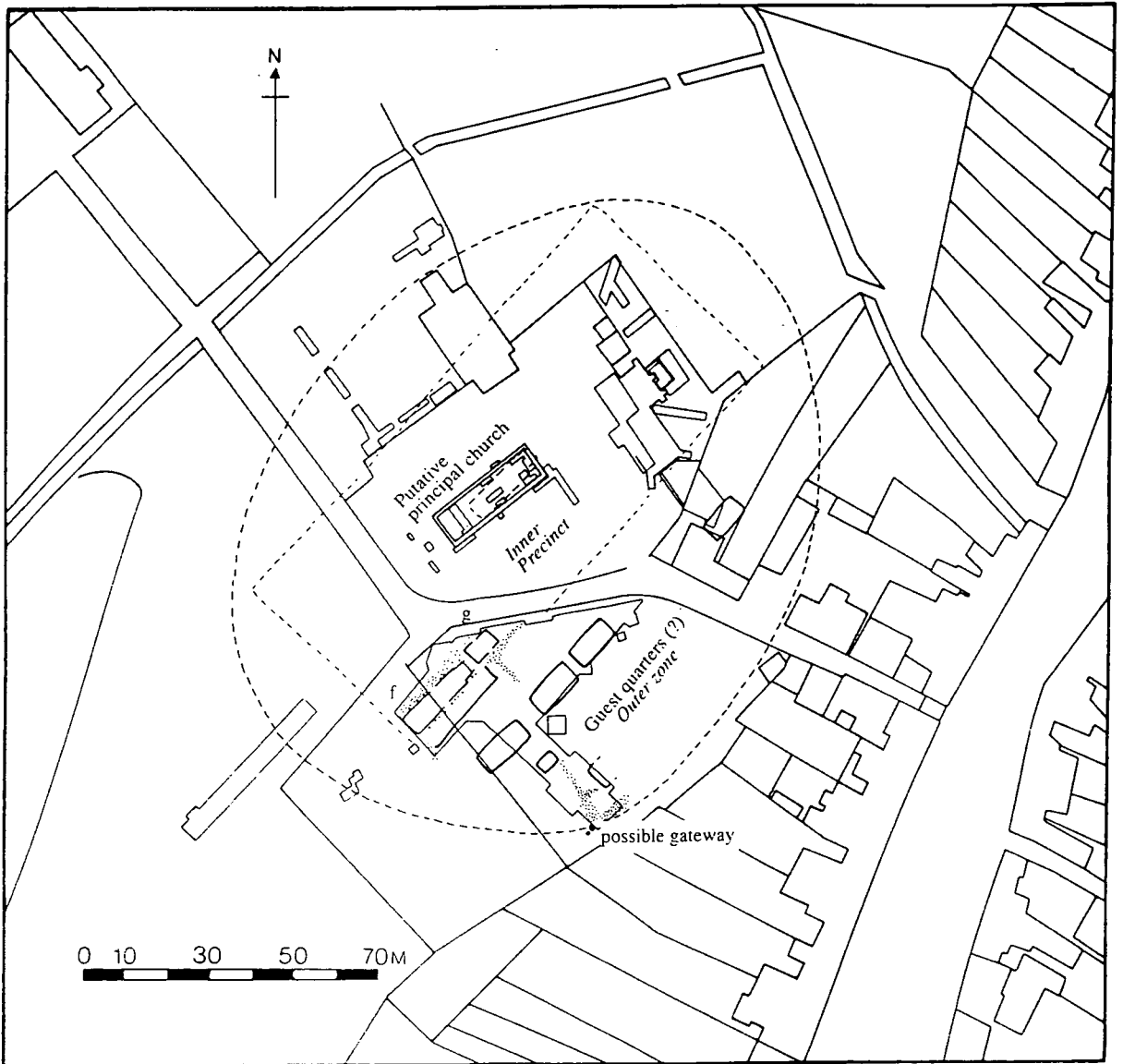

Fig 70 Whithorn: plan of settlement, Period II/4
Hill 1997

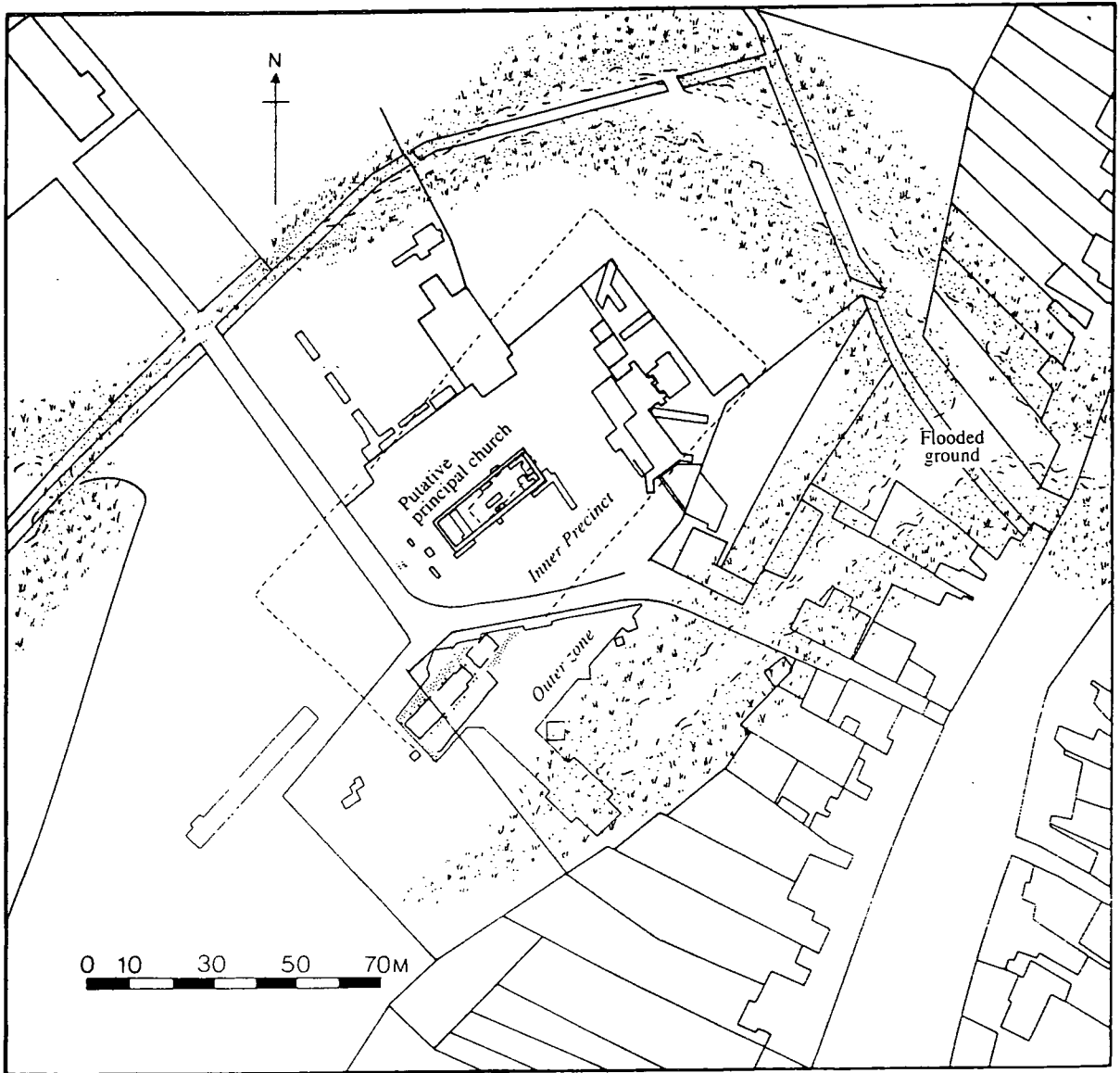

Fig 71 Whithorn: plan of settlement, Period II/7
Hill 1997

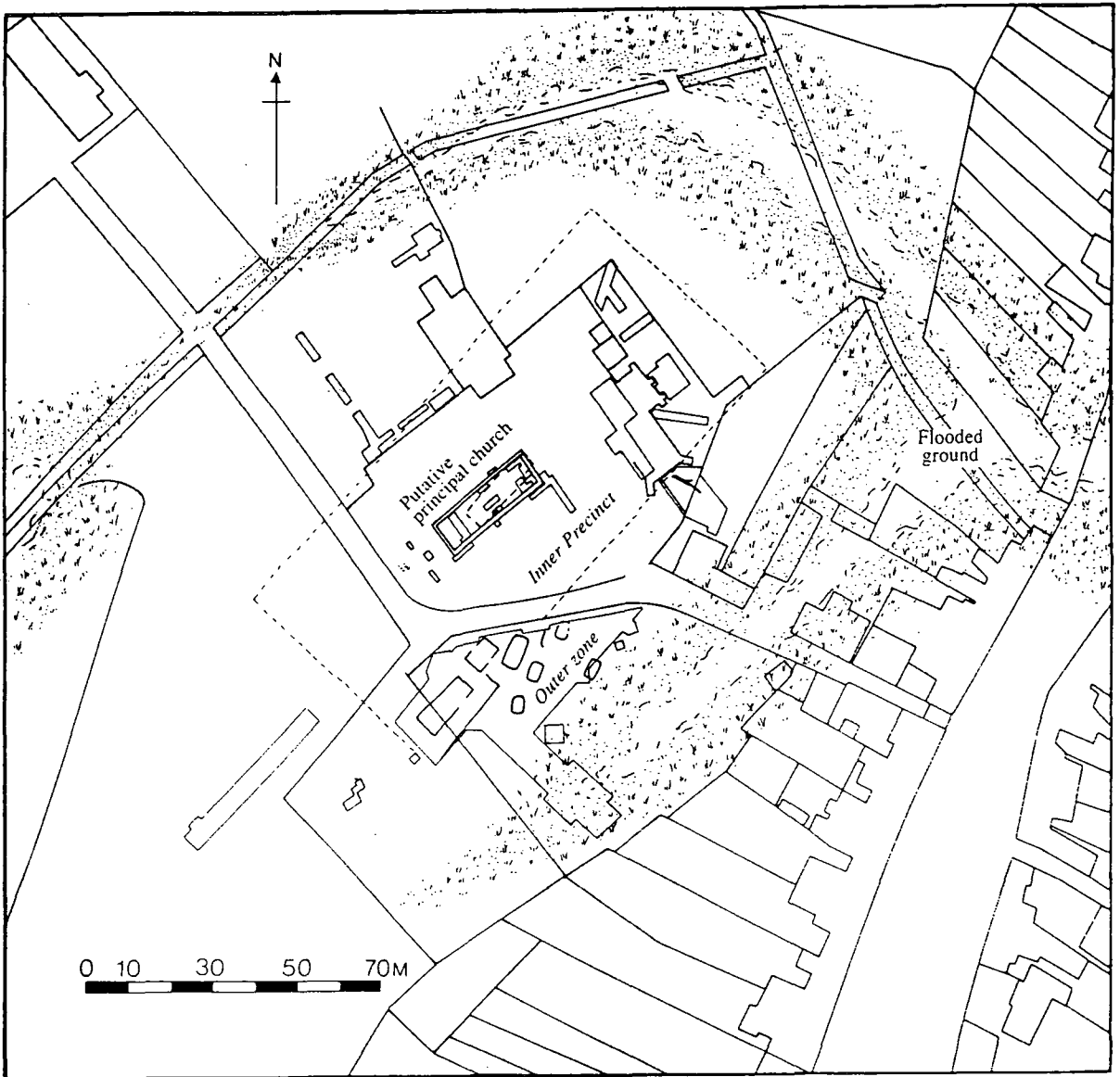

Fig 72 Whithorn: plan of settlement, Period III/1
Hill 1997

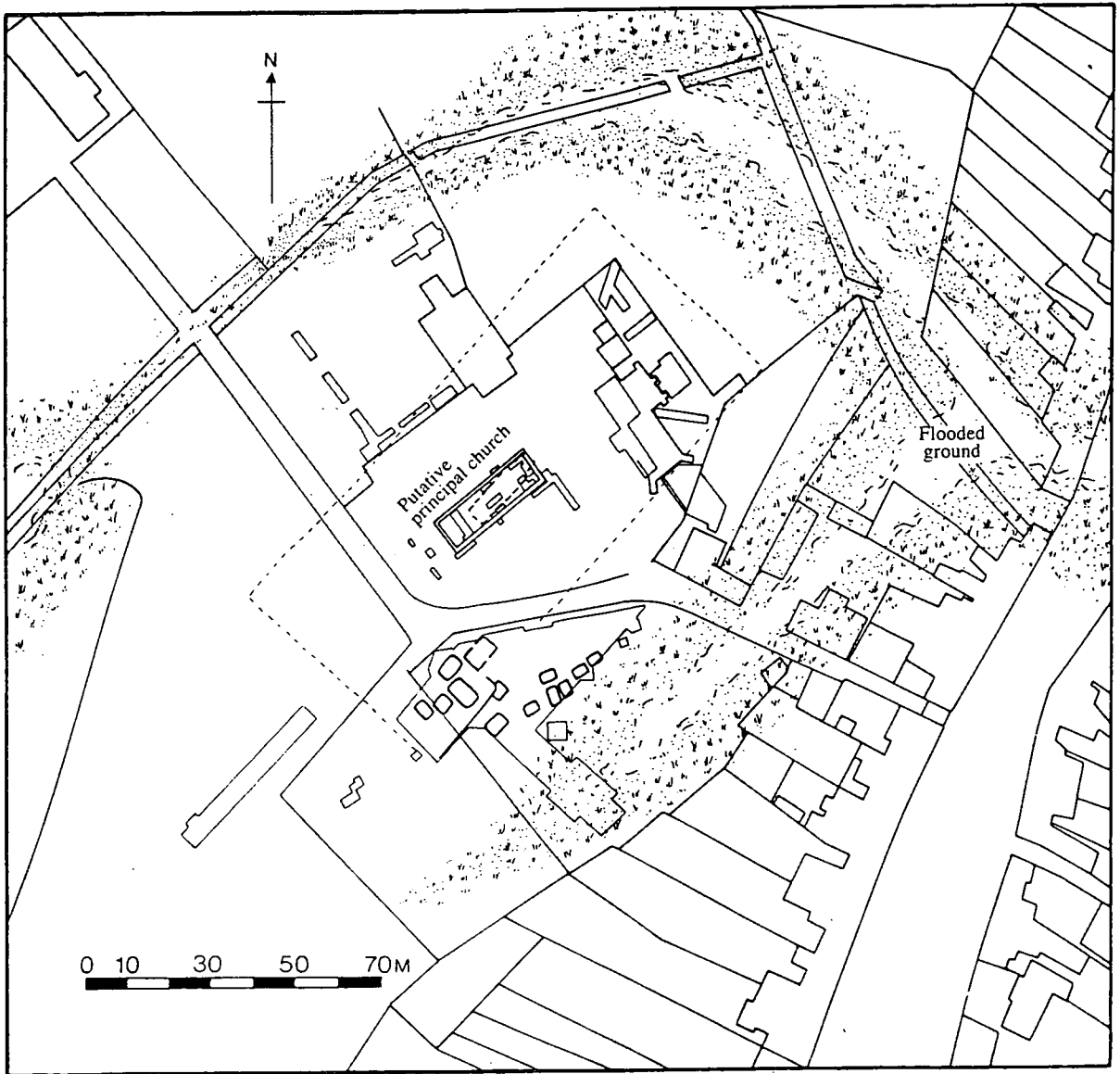

Fig 73 Whithorn: plan of settlement, Period III/2
Hill 1997

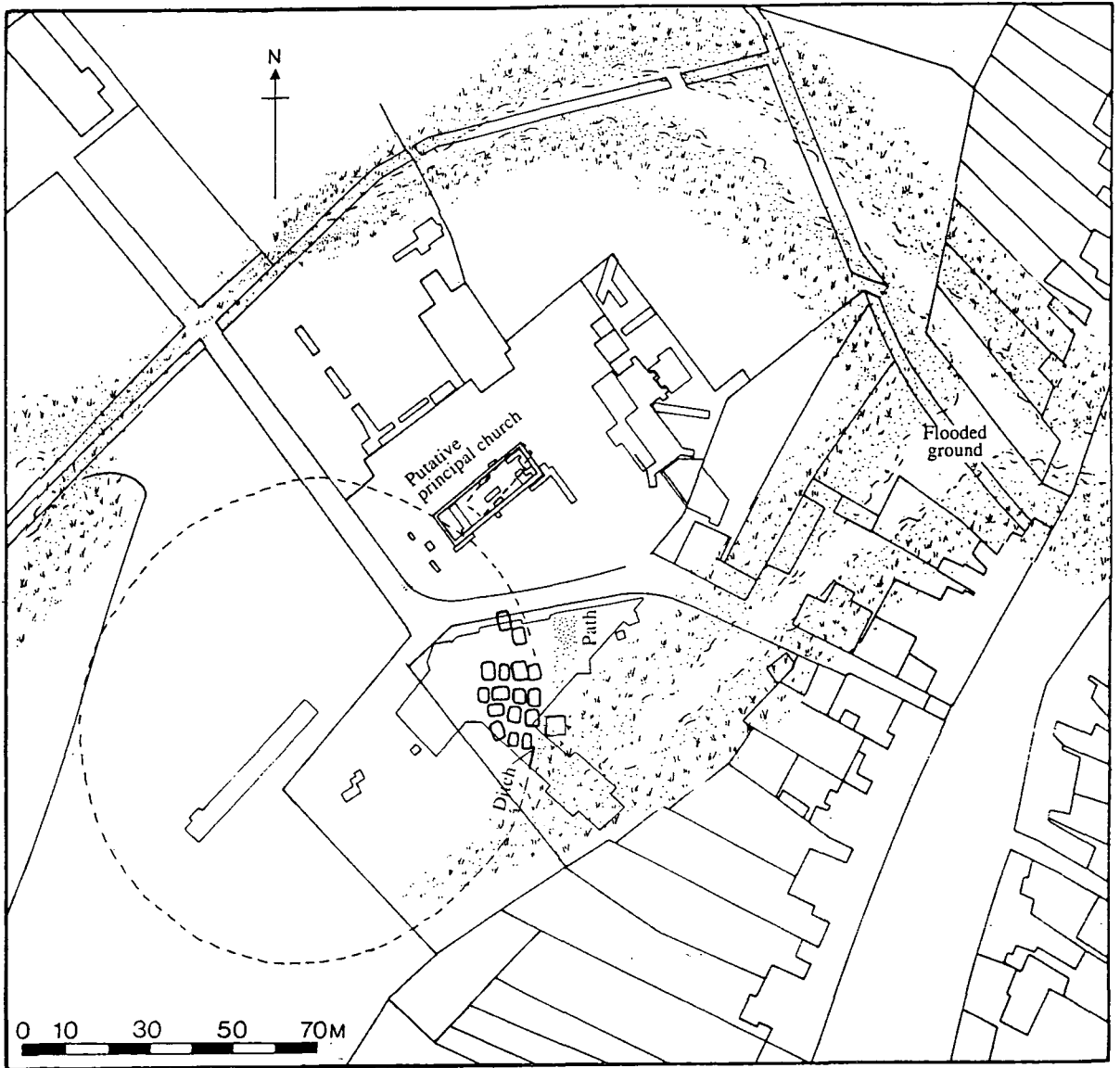

Fig 74 Whithorn: plan of settlement, Period III/3
Hill 1997

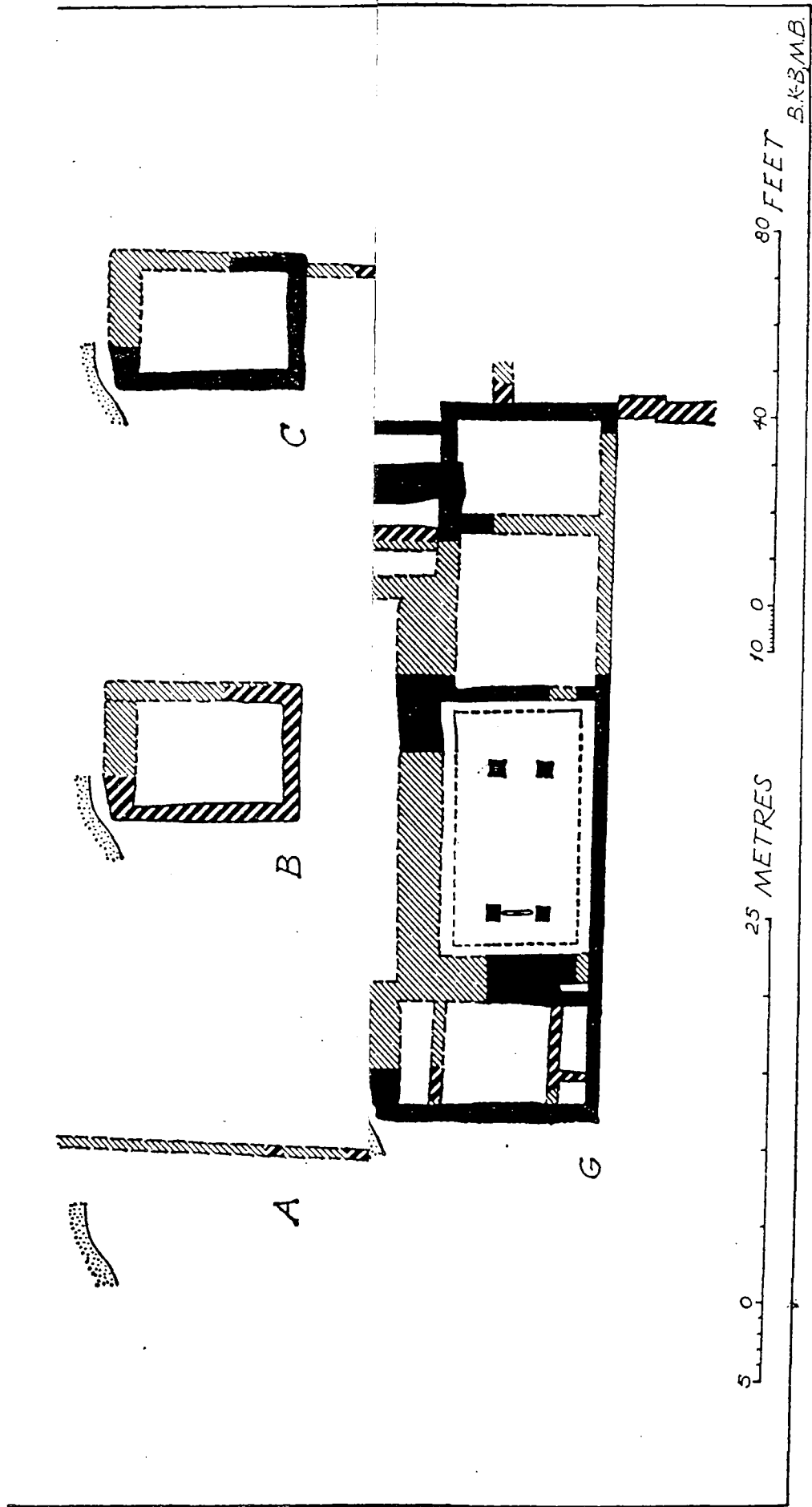

Fig 75 Winchester: New Minster, plan of Building E
Biddle 1972

- A. Rome, St. Peter's
- B. Rome, St. John's in the Lateran
- C. Rome, St. Paul's

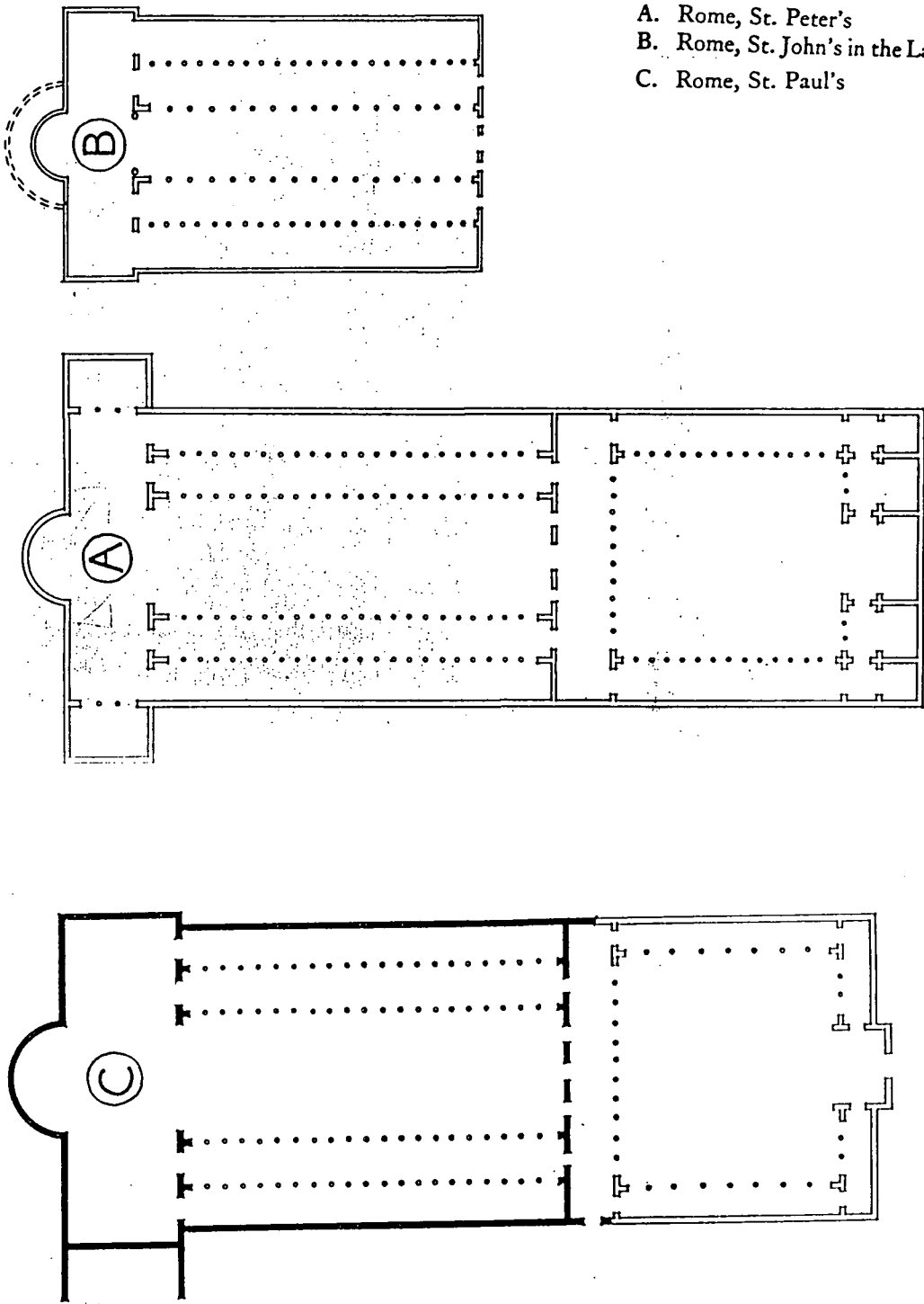

Fig 76 St Peter's, St John's in the Lateran, and St Paul's, Rome
Krautheimer 1942

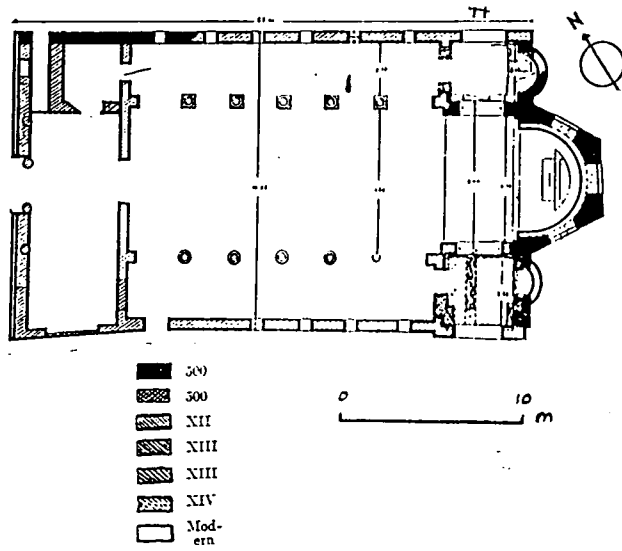

Fig 77 St Giovanni a Porta Latina, Rome
Krautheimer 1936

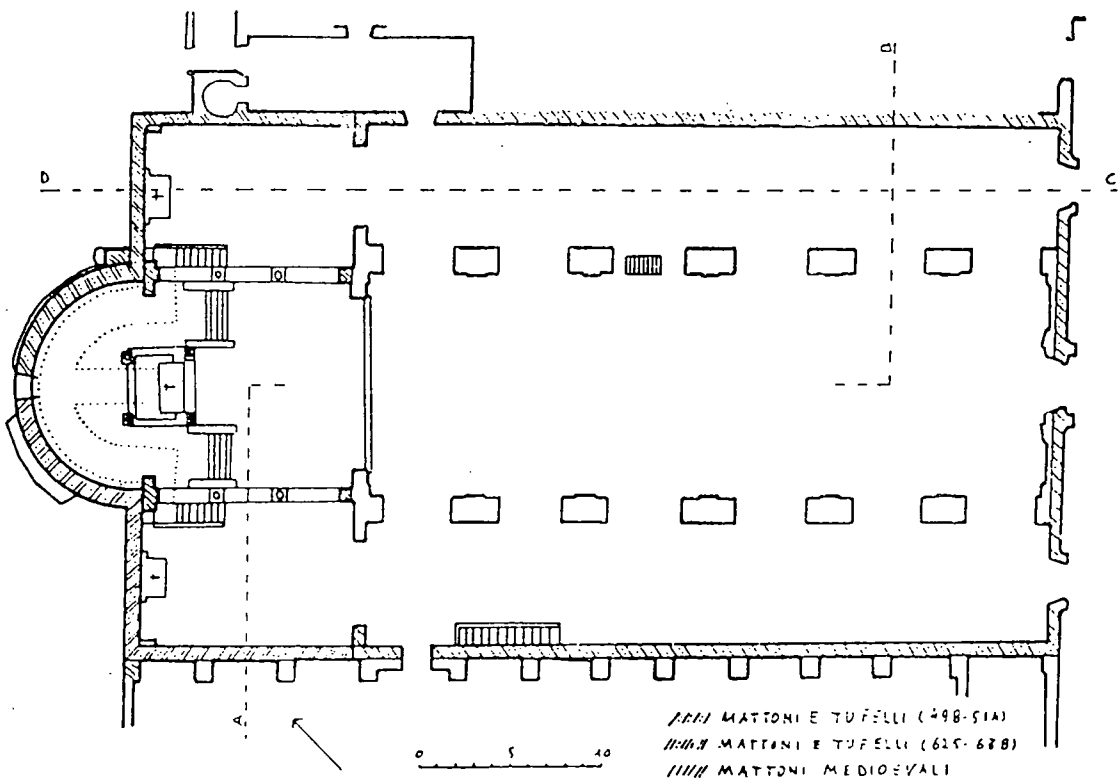

Fig 78 St Pancrazio, Rome
Nestori 1960

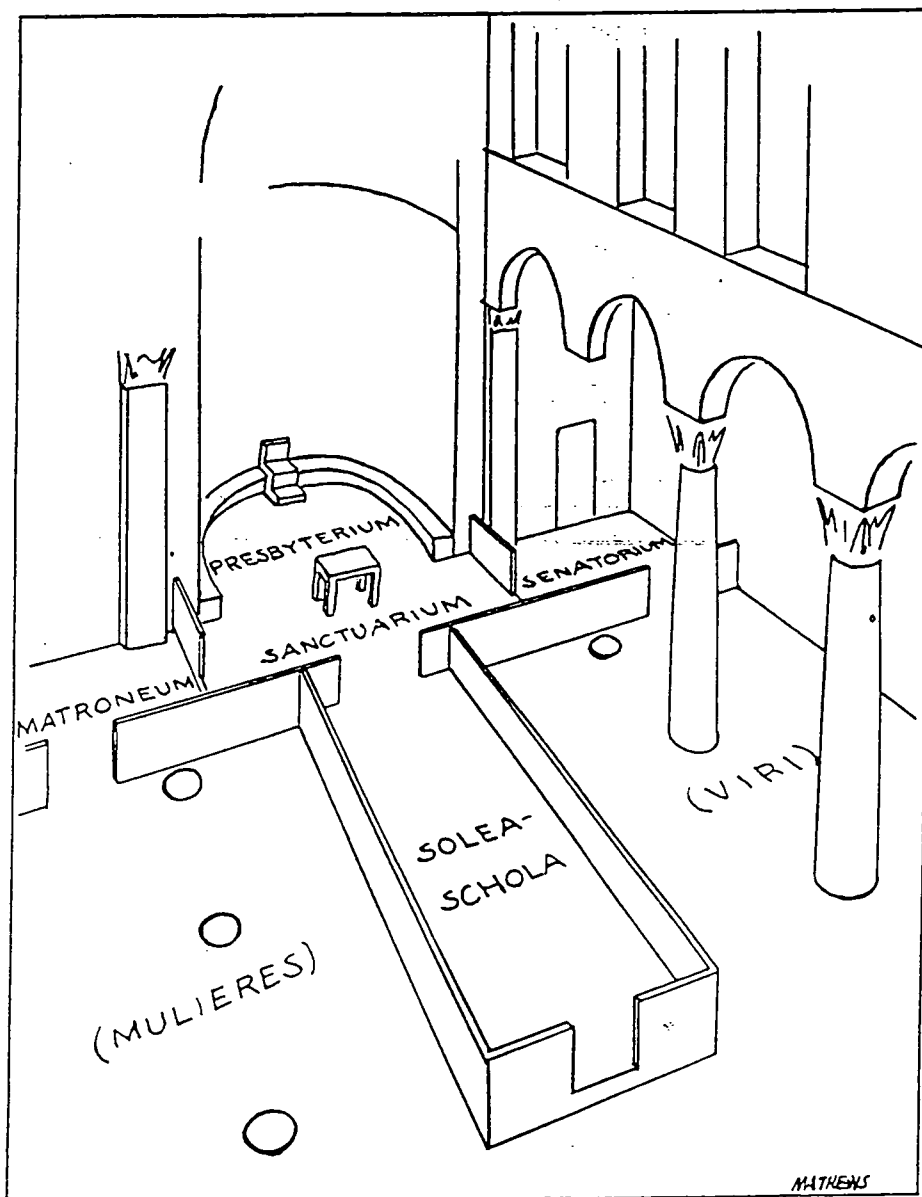

Fig 79 Reconstruction of the eastern chancel arrangement in Rome
Mathews 1962

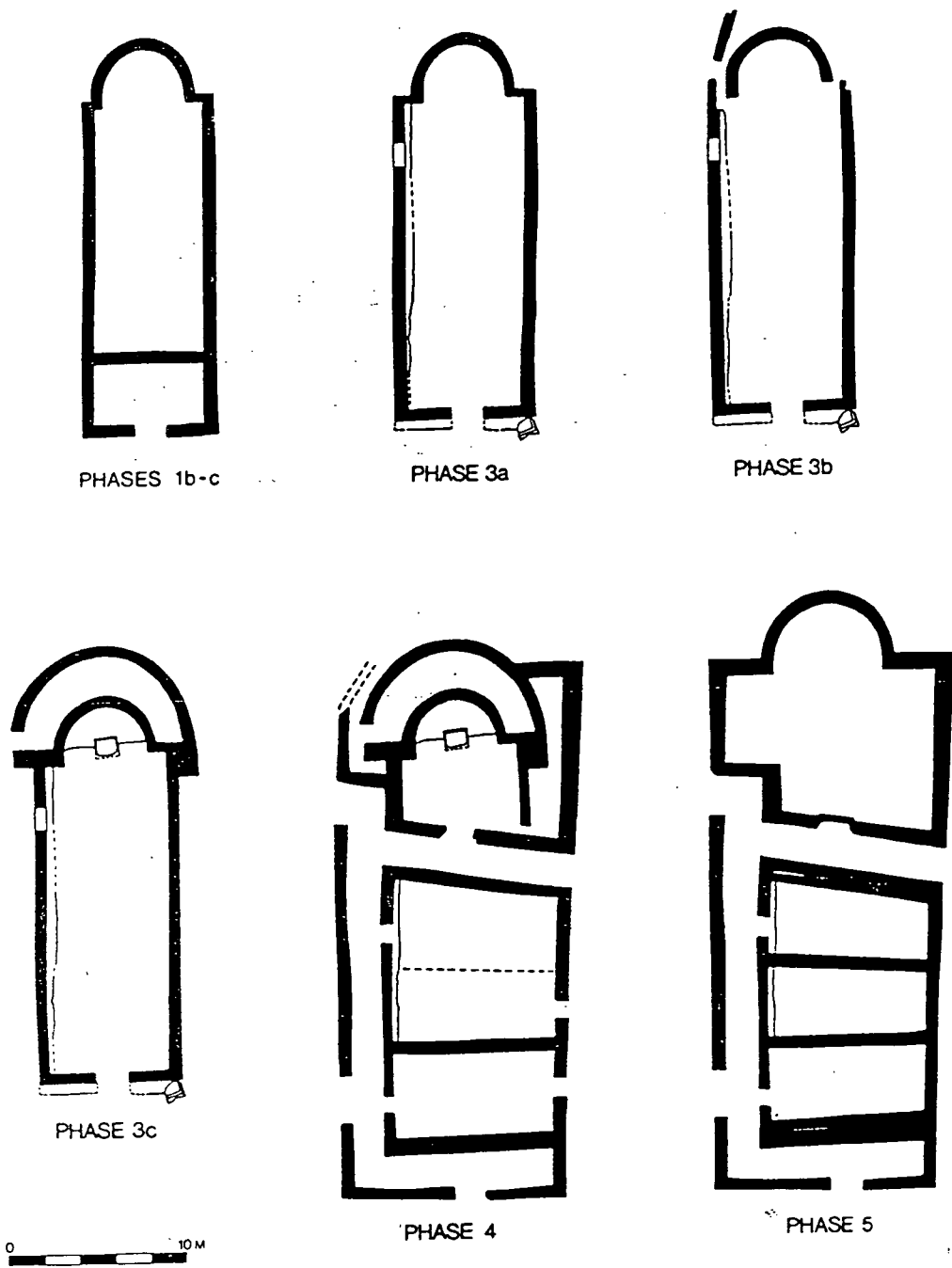

Fig 80 San Vincenzo al Voltuno, phase plans. Italy
Hodges 1993

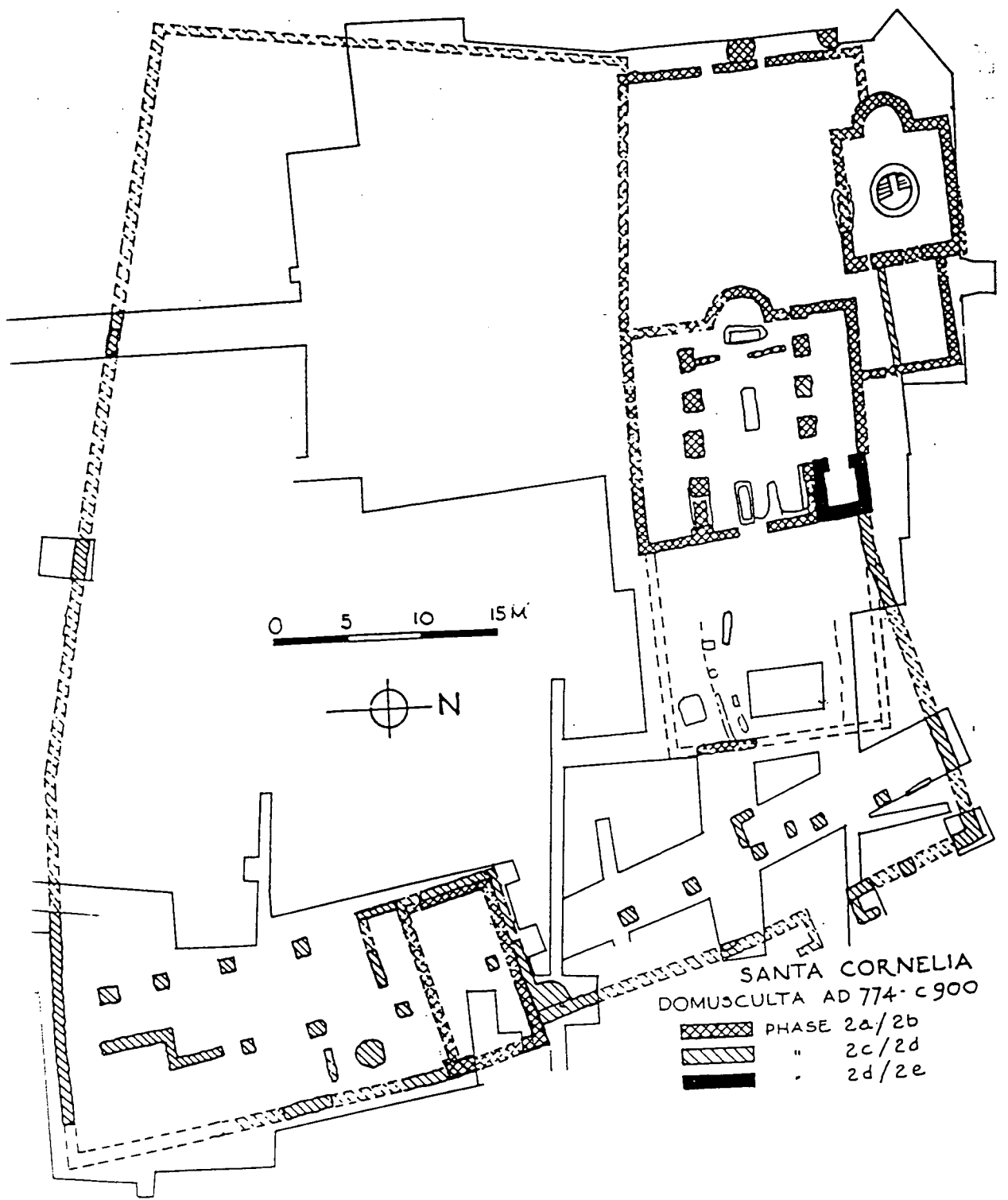

Fig 81 San Cornelia, Phase 2. Italy
Christie 1991

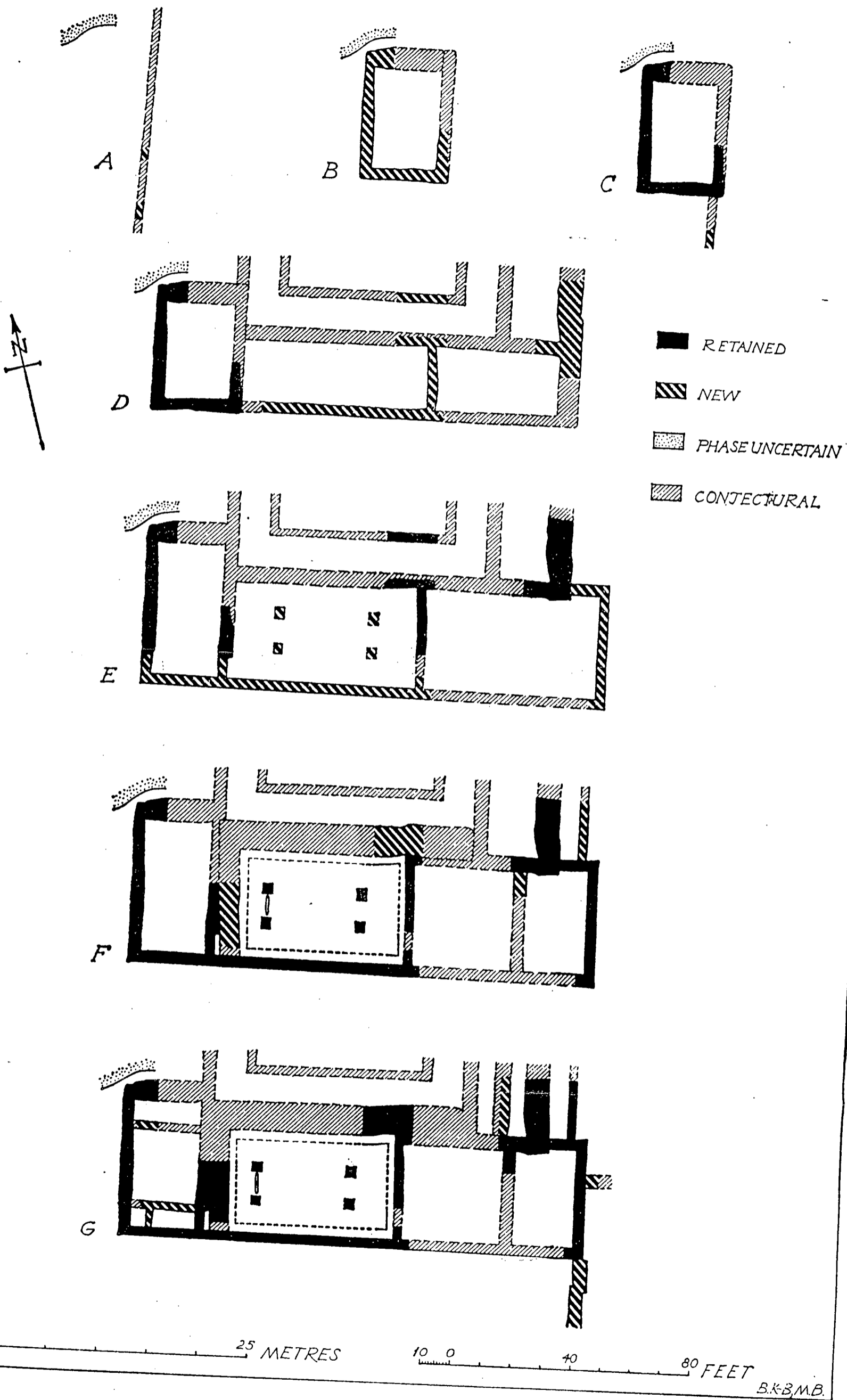

Fig 75 Winchester: New Minster, plan of Building E
Biddle 1972

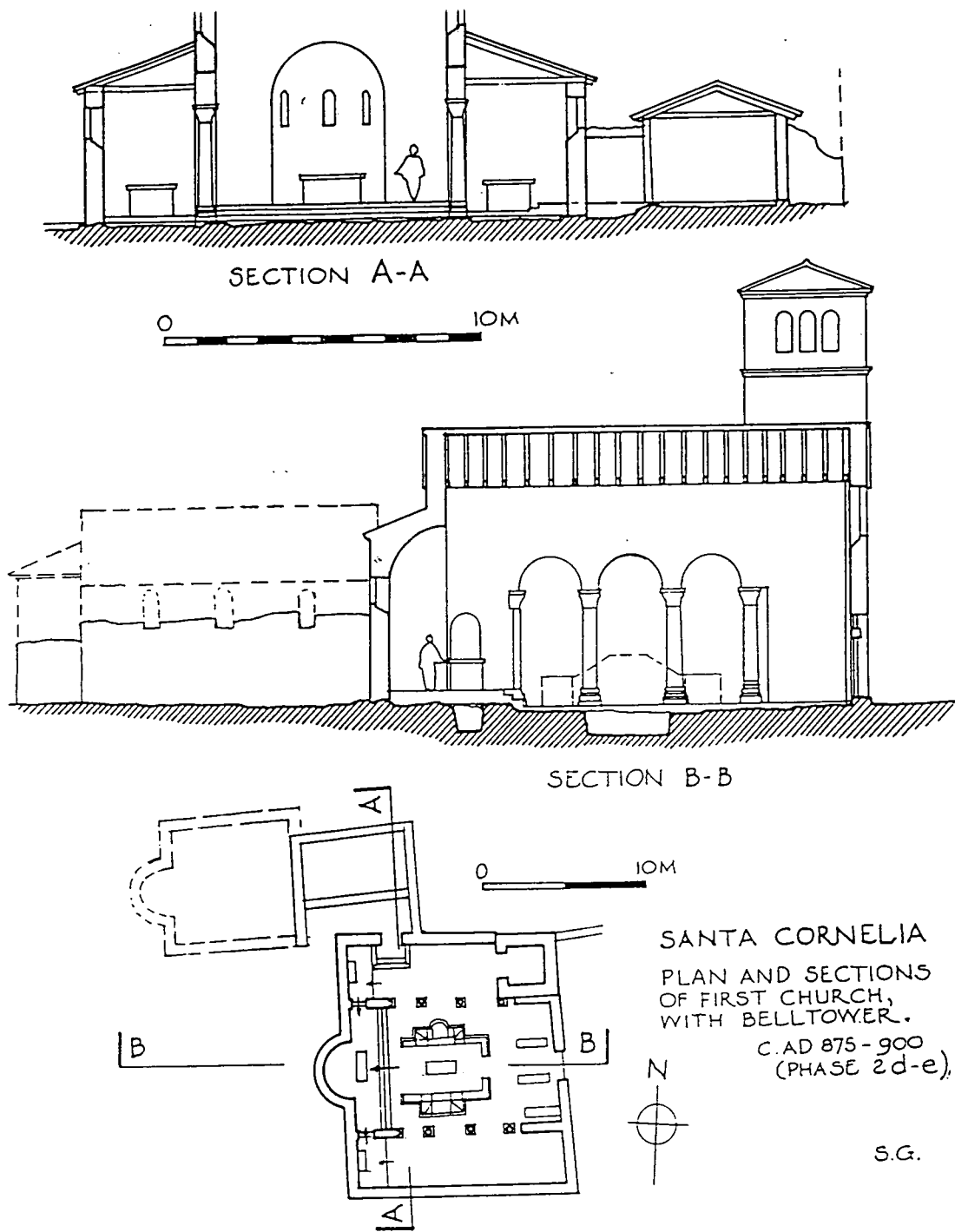

Fig 82 San Cornelia, plan and sections. Italy
 Christie 1991

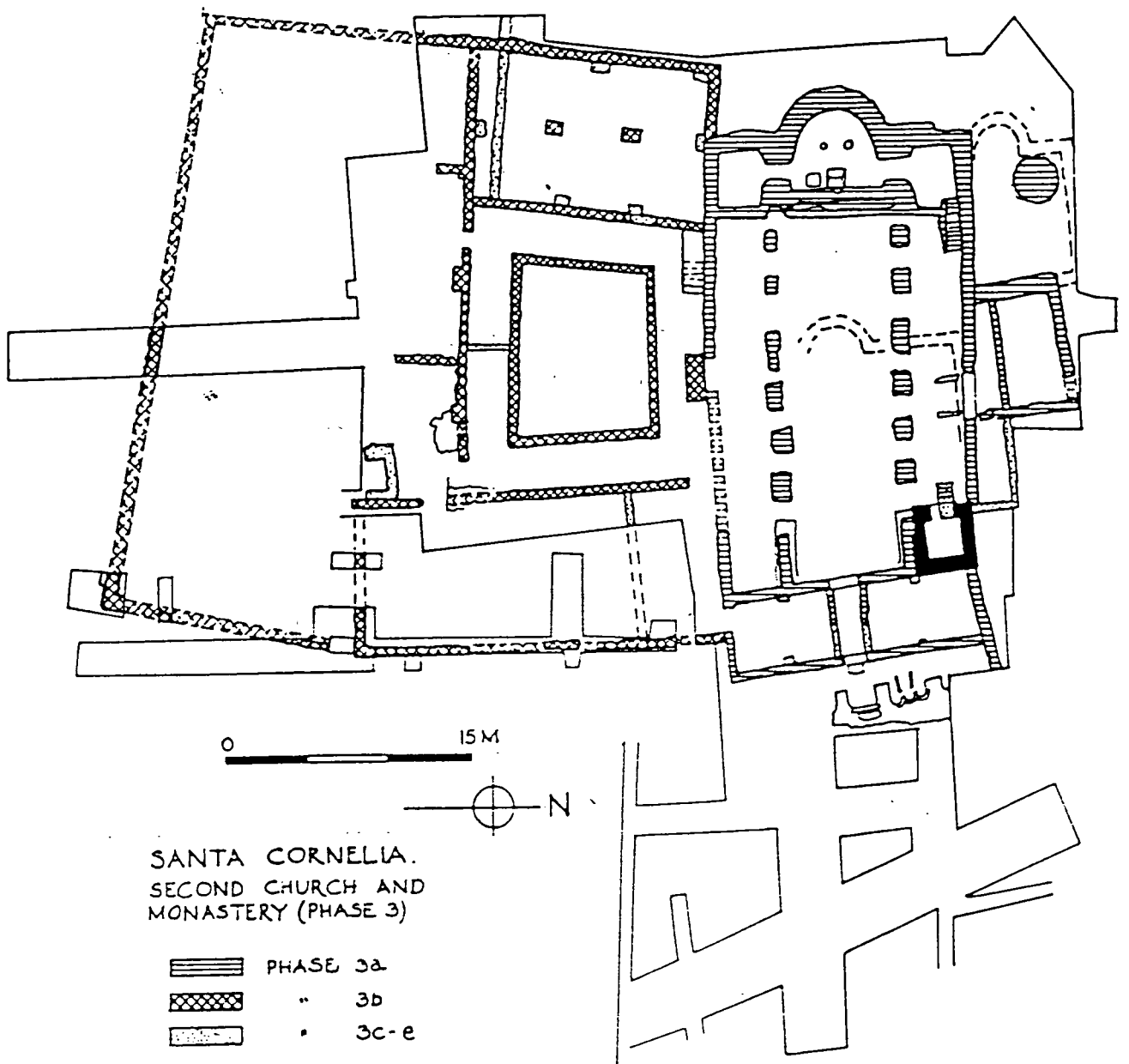



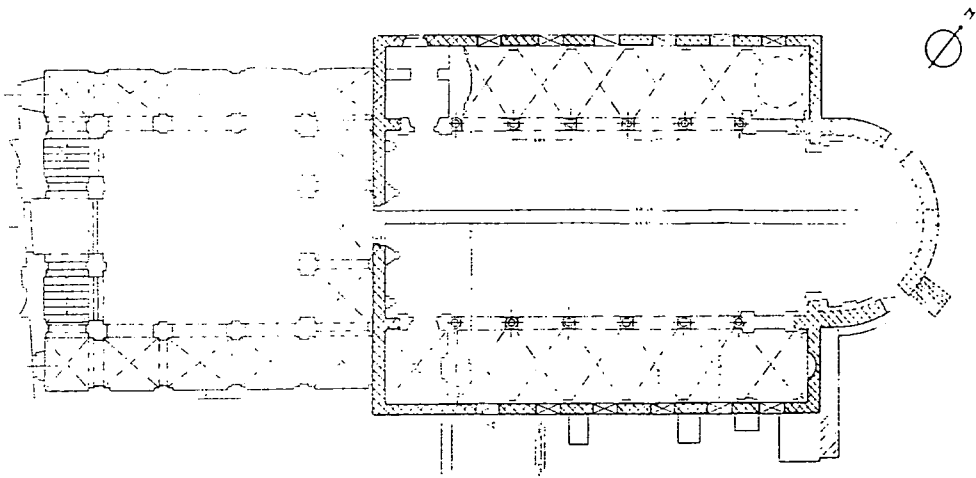

Fig 83 San Cornelia, Phase 3. Italy
Christie 1991

-  Remains V cent
- opus incertum VI cent
- Medieval masonry
- XVIII cent masonry

1. GROUNDPLAN



2. GROUNDPLAN RECONSTRUCTION

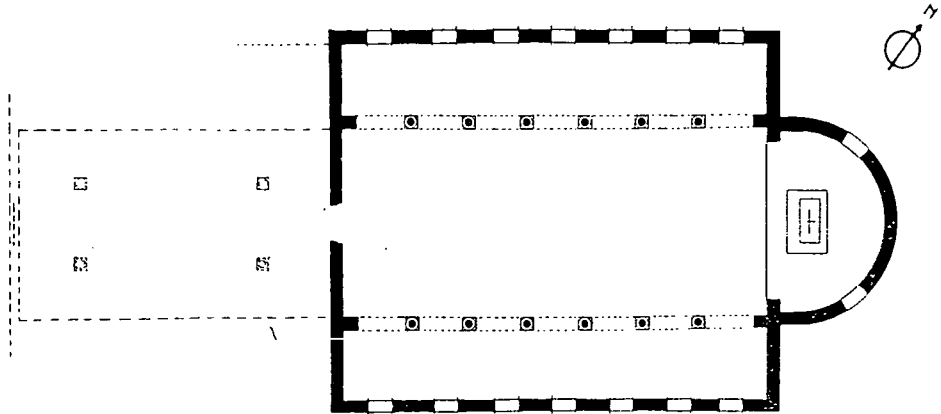

0 10m

Fig 84 St Agata dei Goti, Rome
Krautheimer 1937

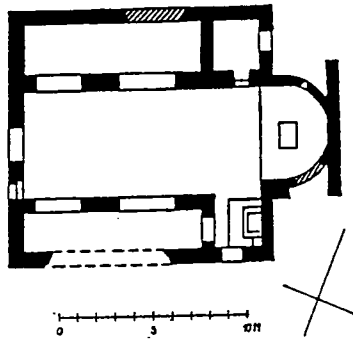

Fig 85 St Peter's, Altenburg, Italy
Oswald et al 1966

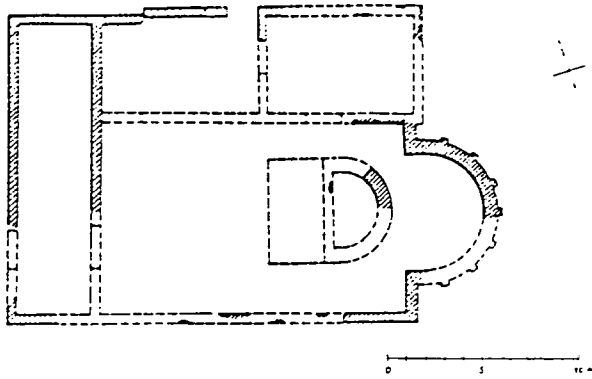

Fig 86 Ulrichsberg, Austria
Oswald et al 1966

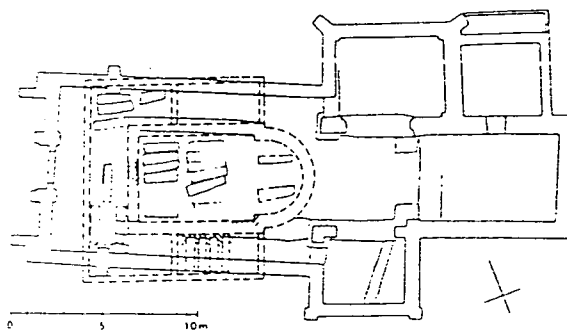
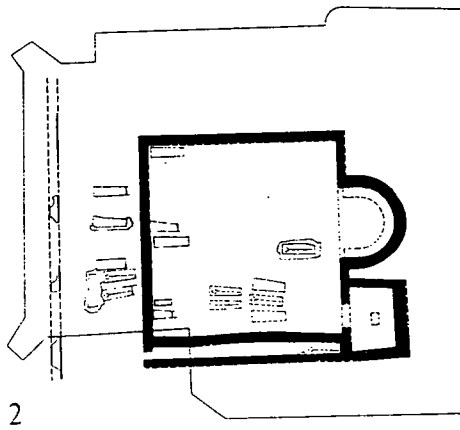
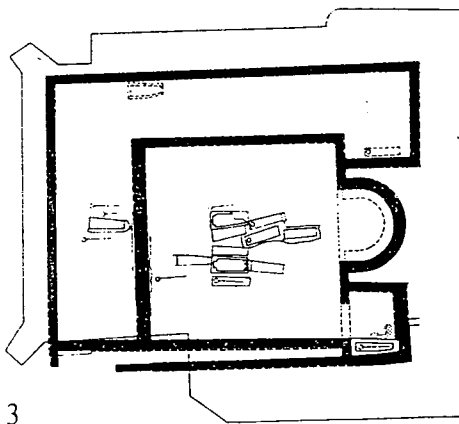

Fig 87 Grand-Saconnex, Geneva, Switzerland
Jacobsen 1991



2



3

0 10m

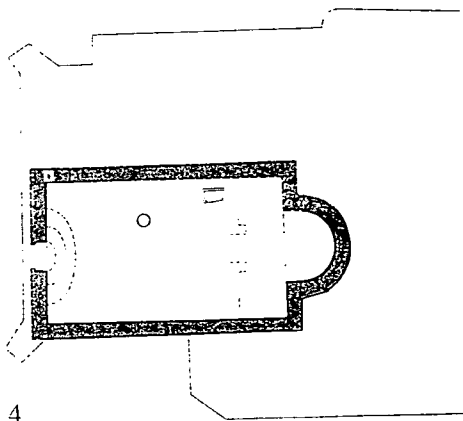

4

Fig 88 La Madeleine, Geneva, Switzerland
2. First church, 6th century
3. Second church, 6th-7th century
4. Third church 9th century
Bonnet 1986

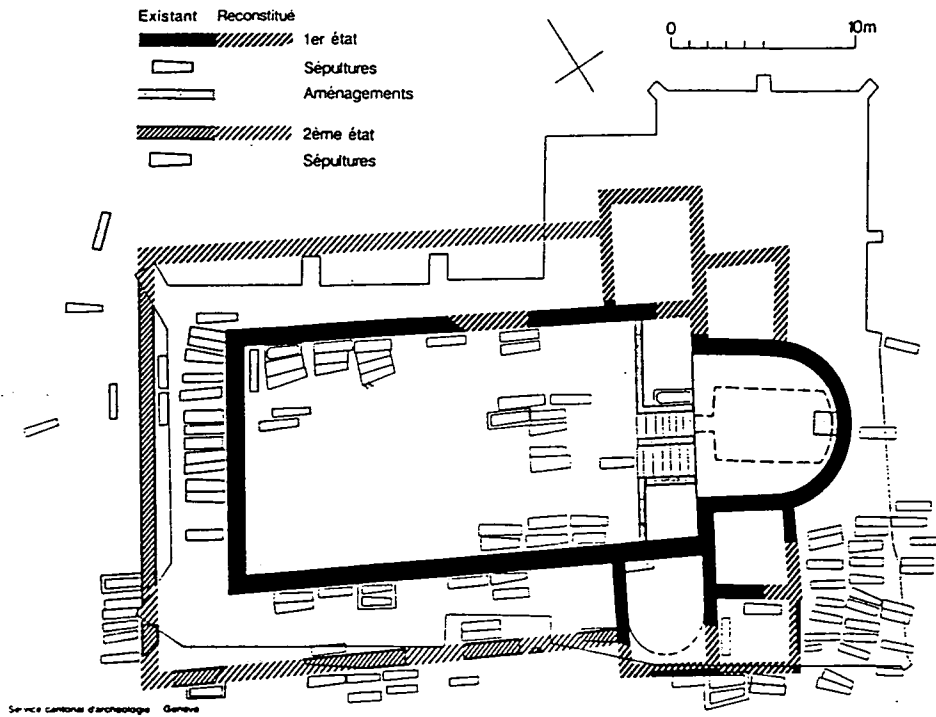

Fig 89 Saint-Gervais, Genva, Switzerland
Sapin 1994

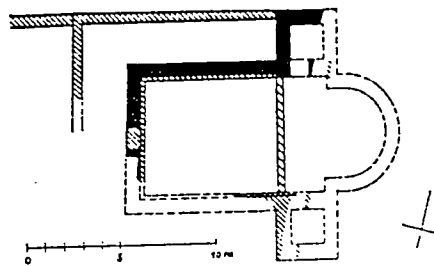

Fig 90 Notre-Dame, St-Maurice, Switzerland
Oswald et al 1966

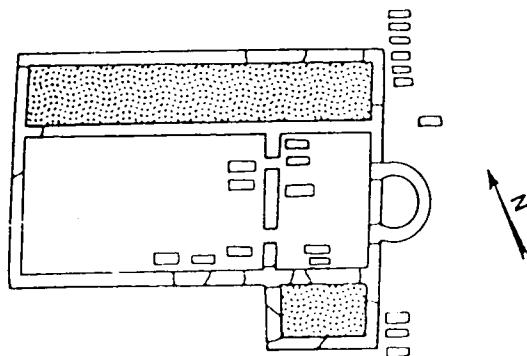

Fig 91 Saint-Martin d'Angers, France
Reynaud 1998

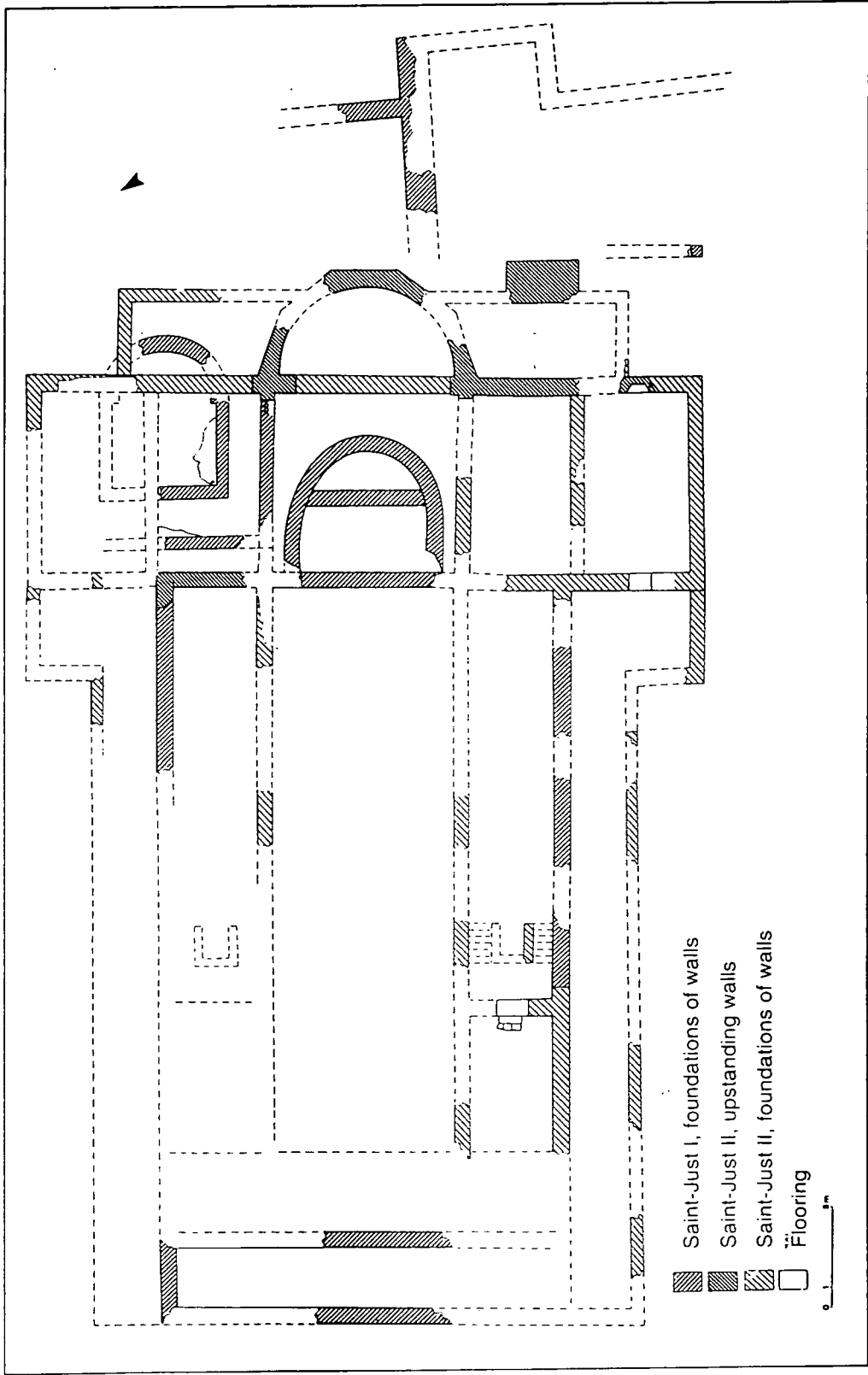

Fig 92 St Justus, Lyon, France
Gem 1997

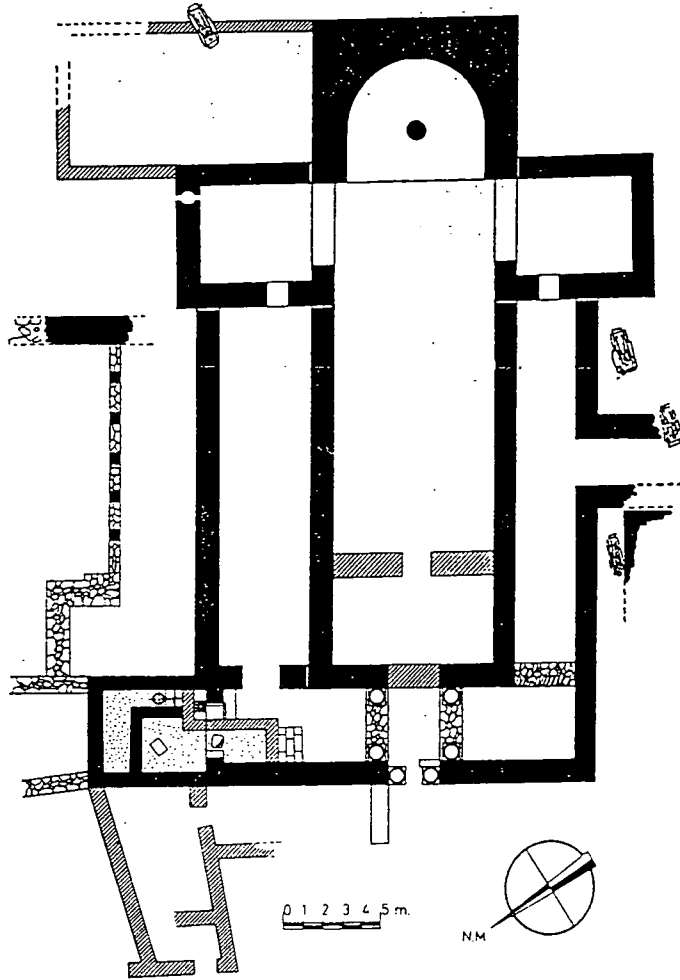

Fig 93 Basilica de Zarita de los Canes, Guadalajara, Spain
Palol 1967

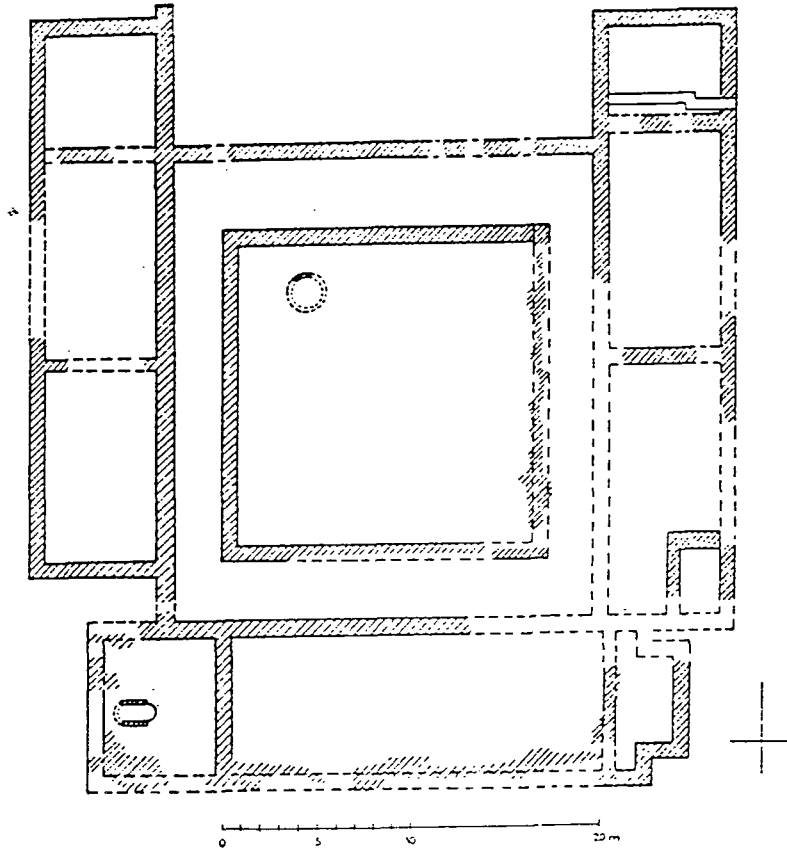
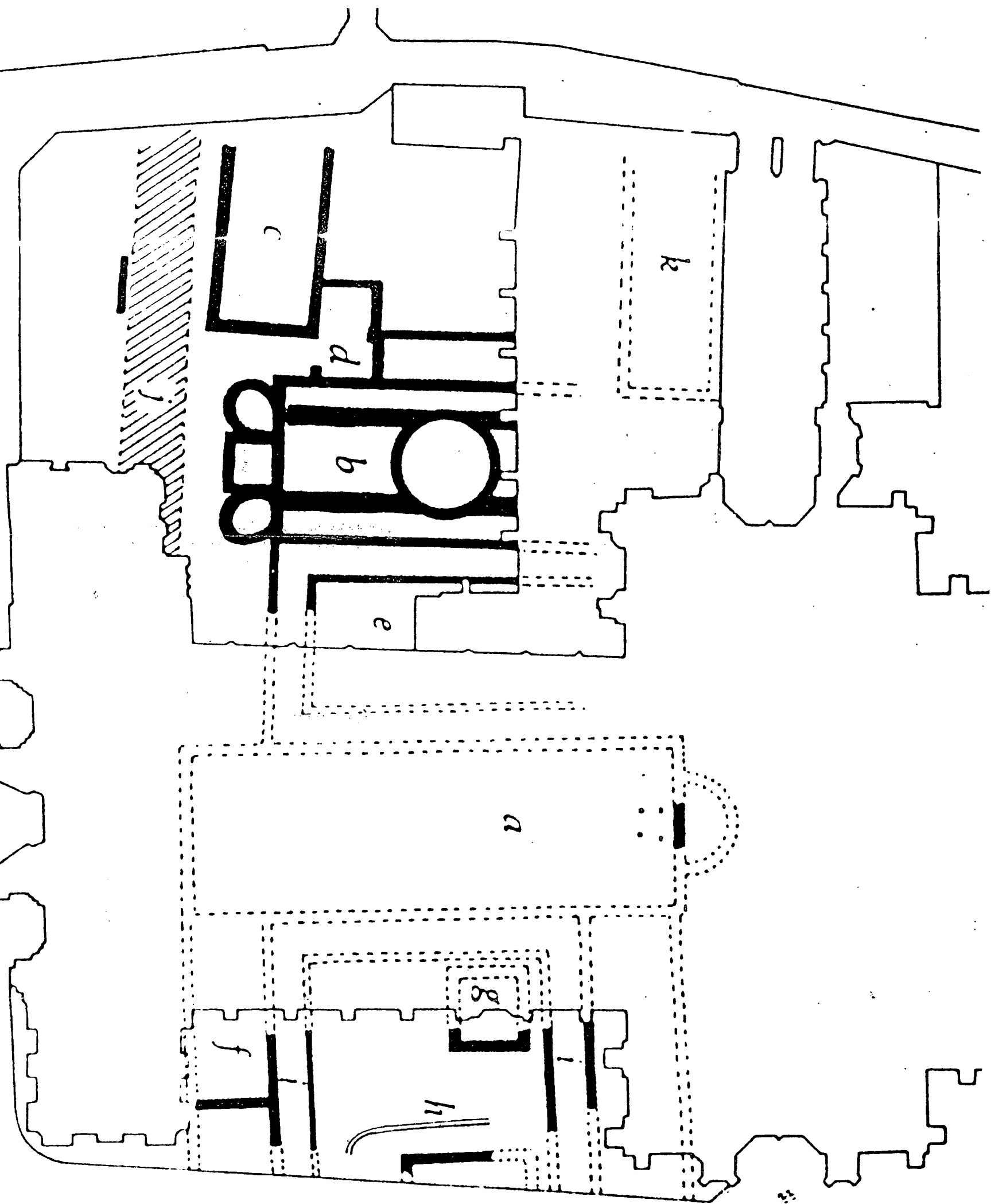
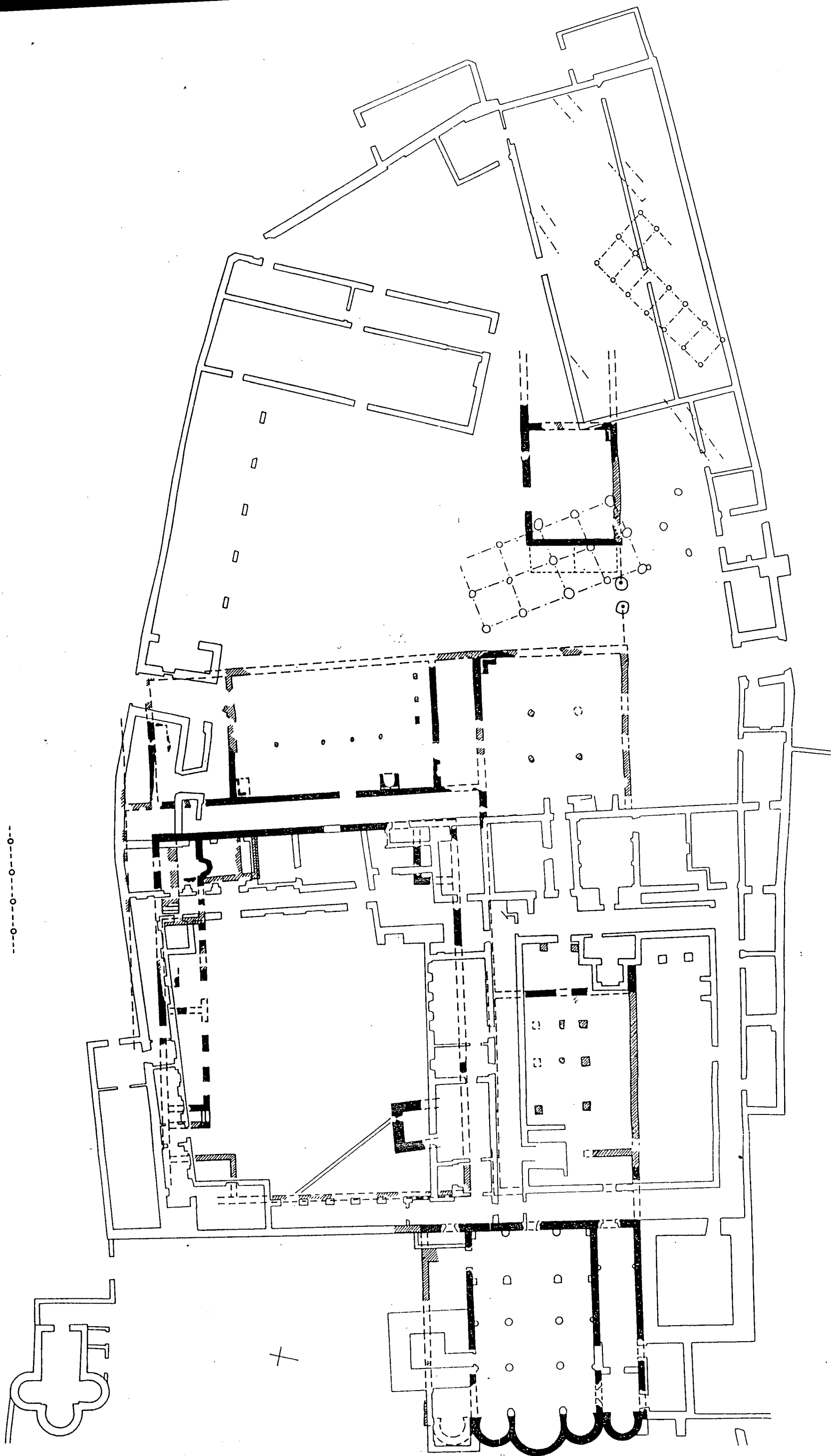

Fig 94 Lorsche, Hessen, Germany
Oswald et al 1966





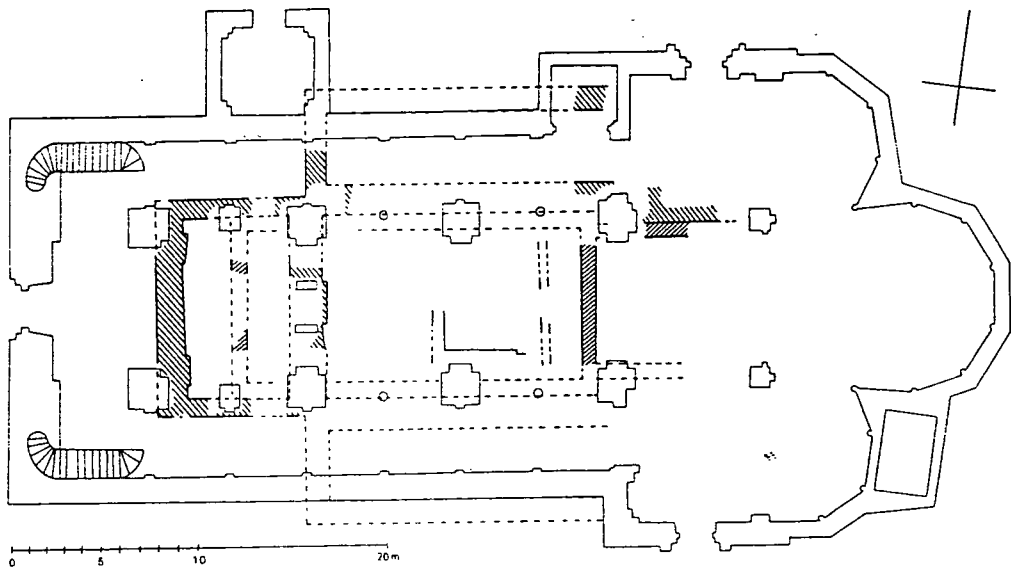

Fig 97 St Peter's, Soest, Germany
Jacobsen et al 1991

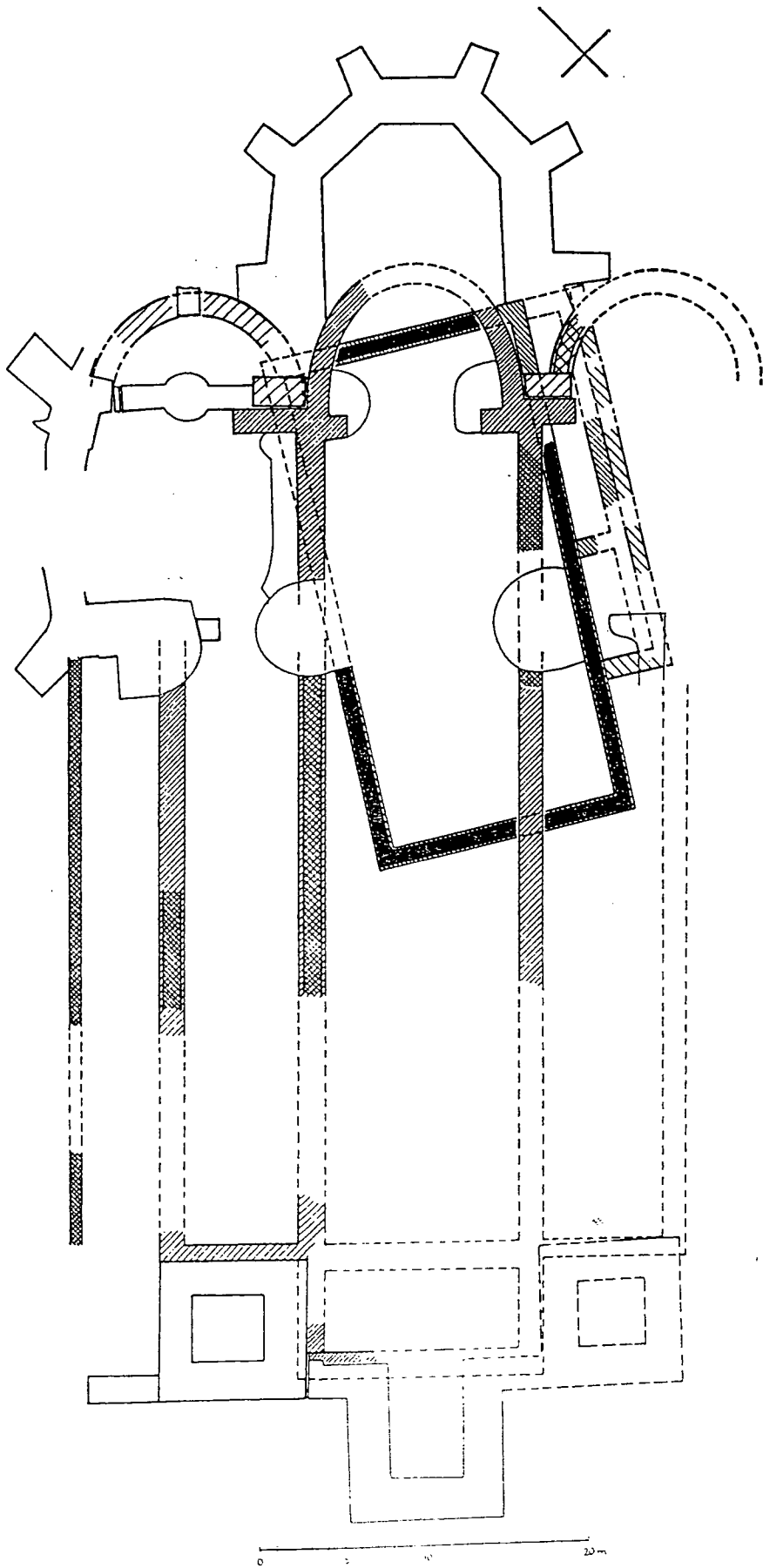

Fig 98 Manze abbey, Germany
Oswald et al 1966

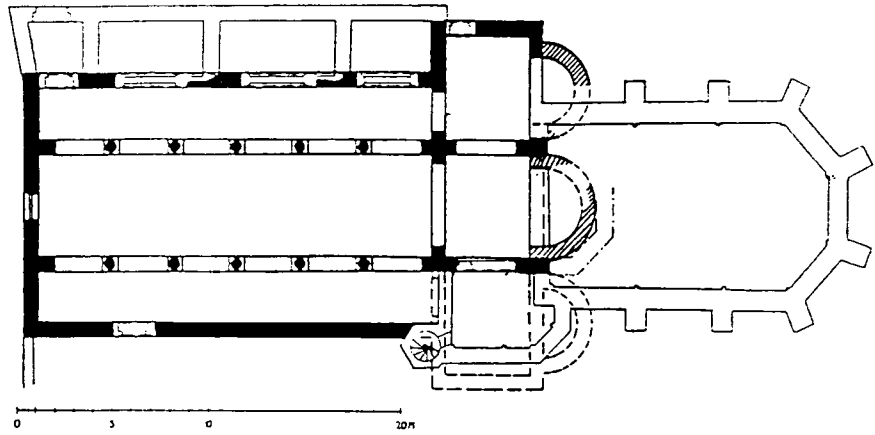

Fig 99 St Justinus, Höchst, Germany
Oswald et al 1966

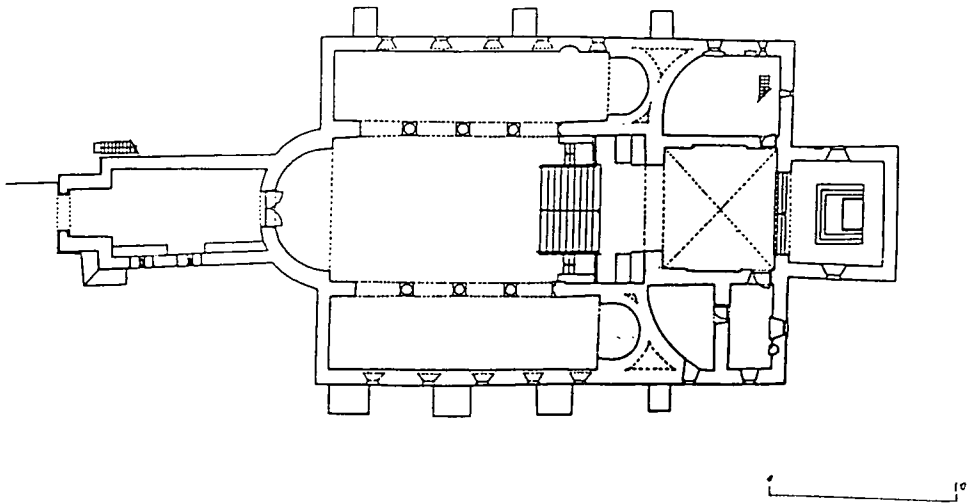

Fig 100 Reichenau-Oberzell, Switzerland
Koshi 1994

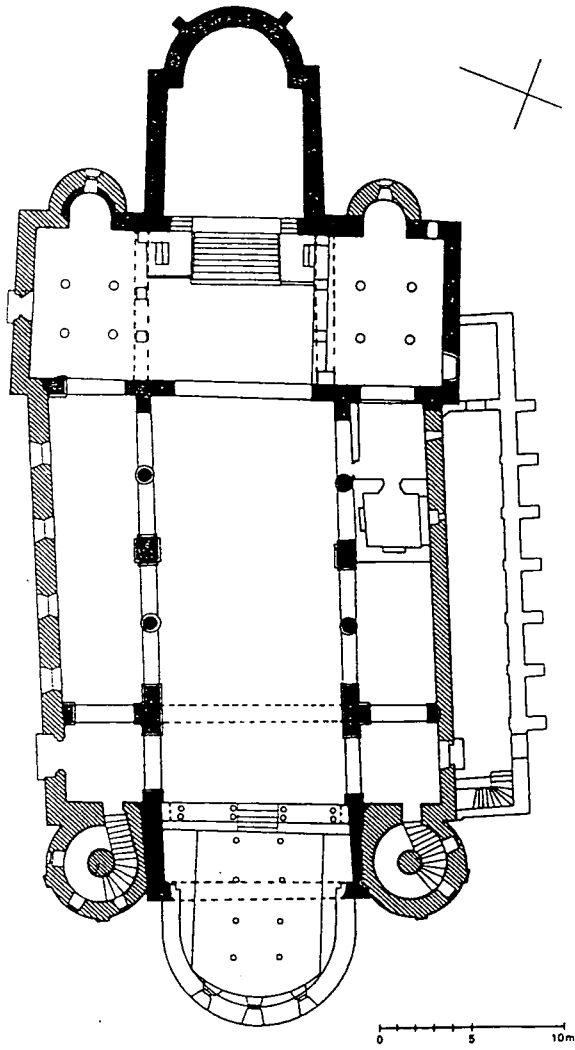

Fig 101 St Cyriakus, Gernrode, Germany
Jacobsen et al 1991

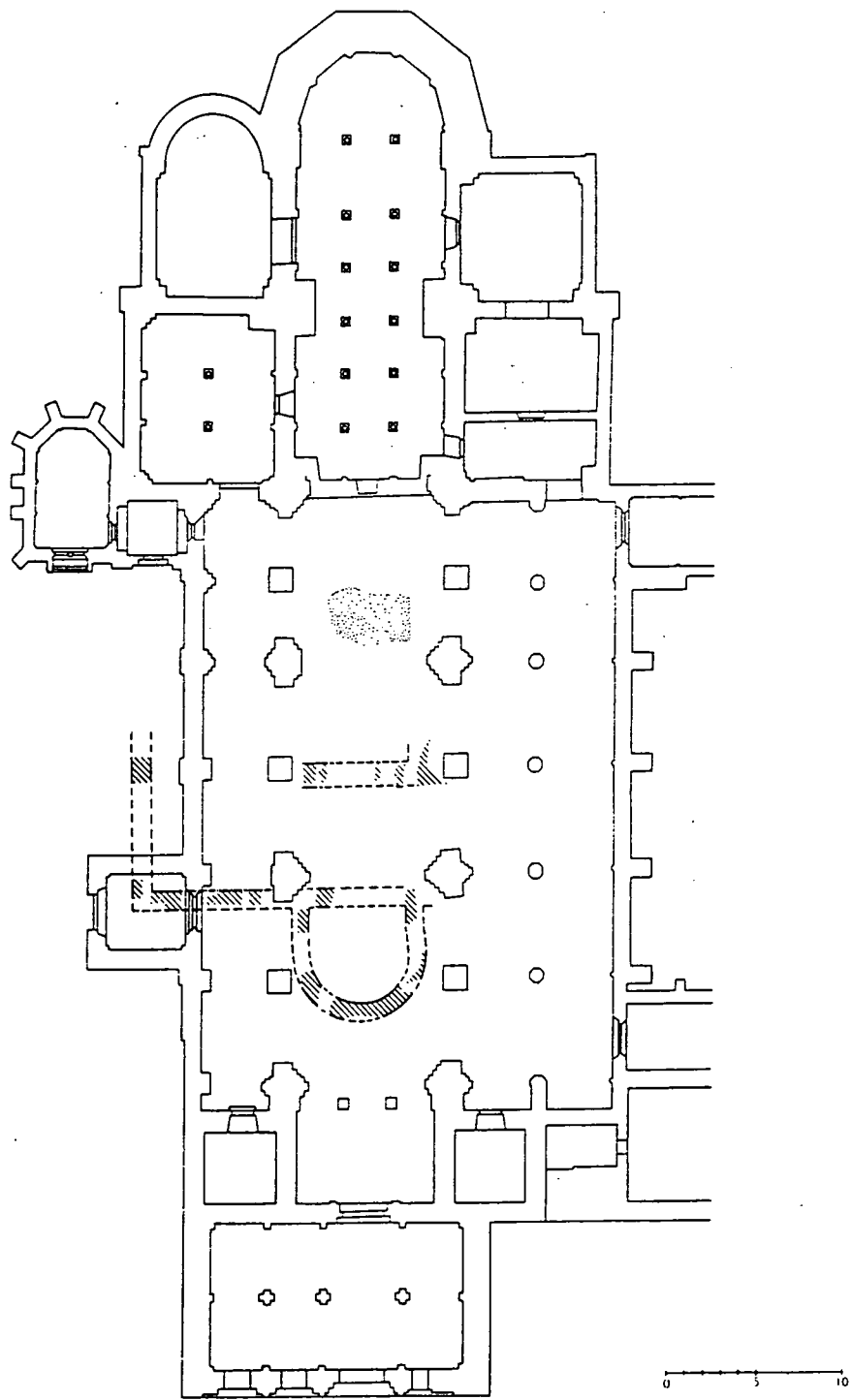
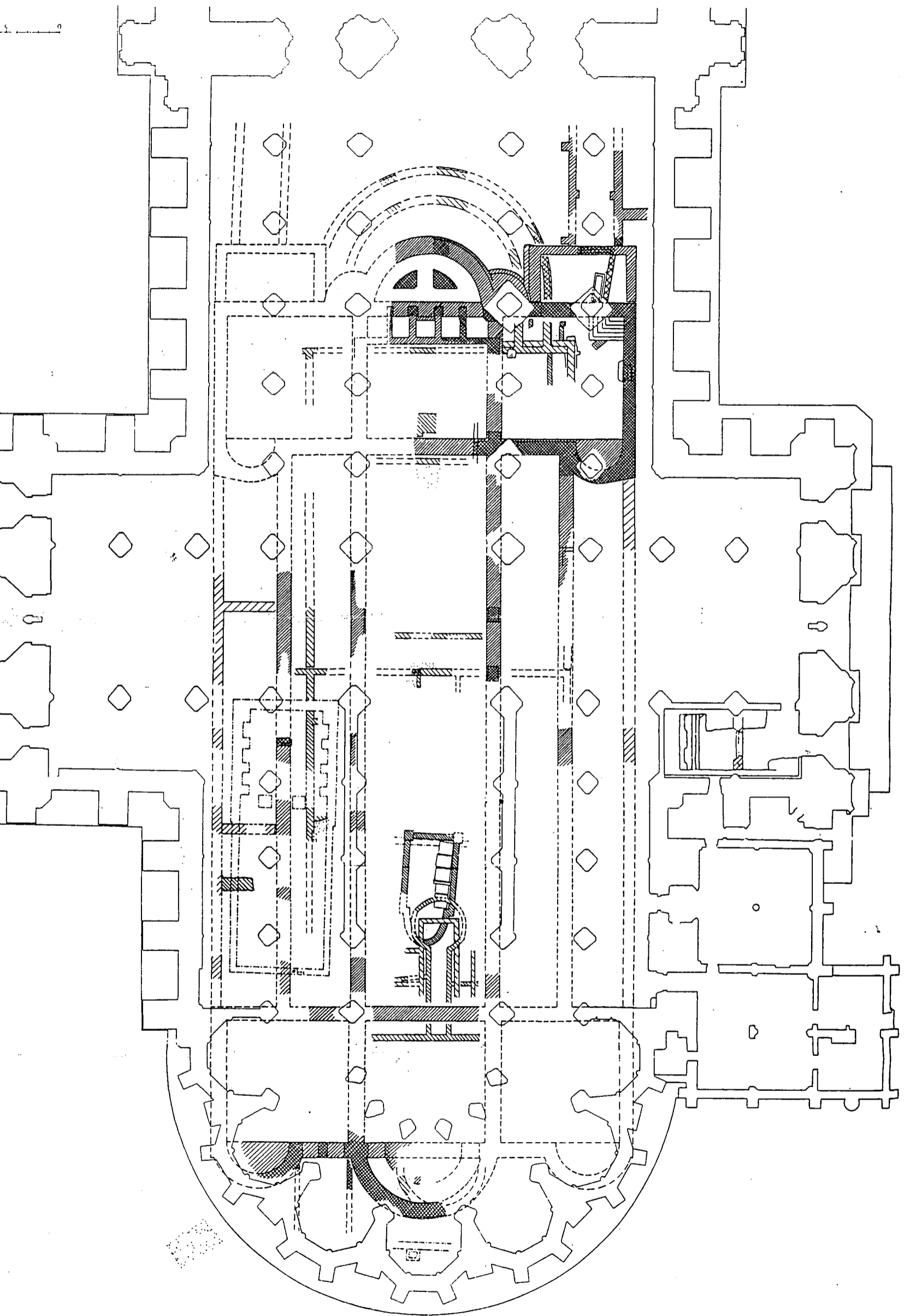
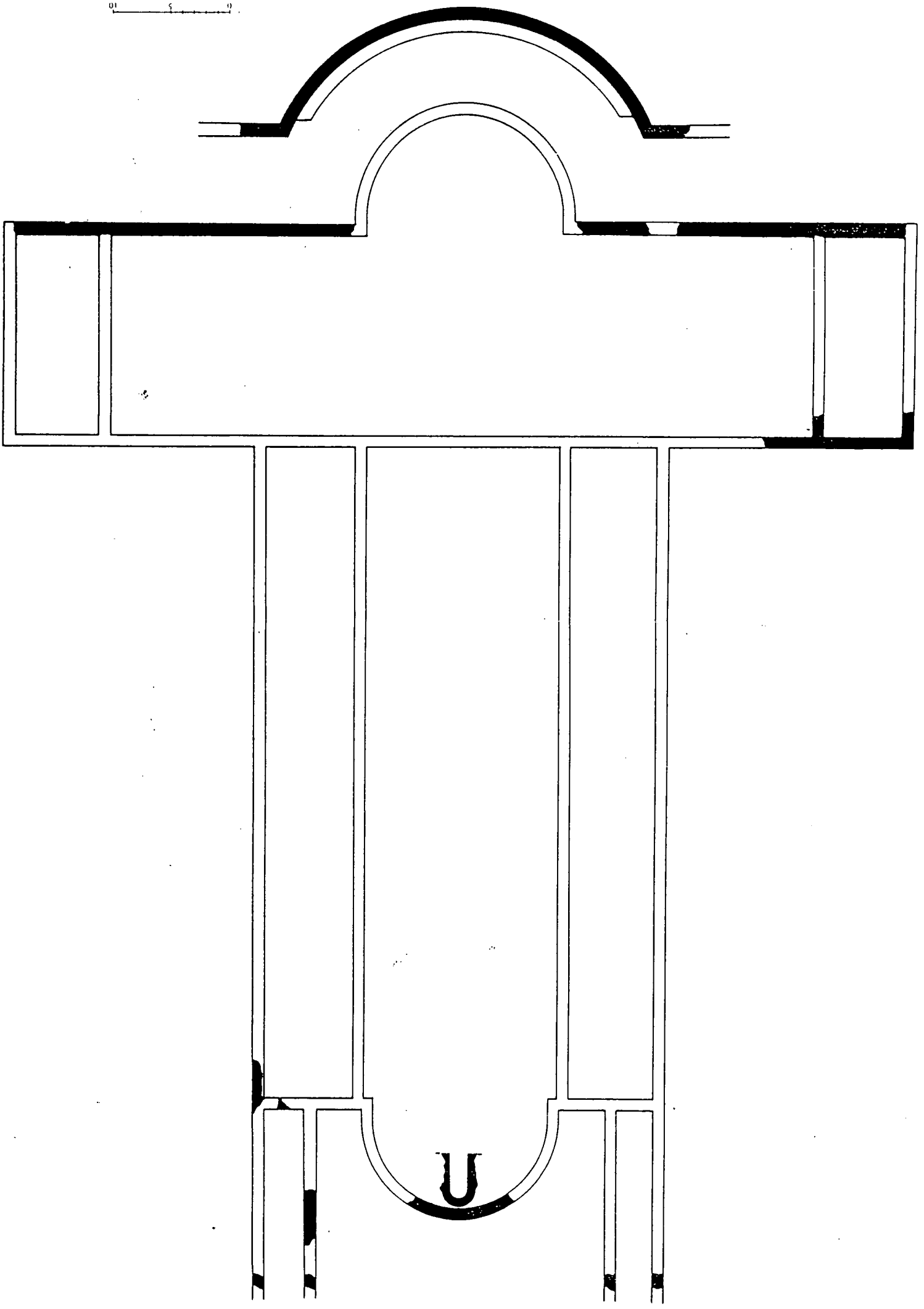

Fig 102 Fritzlar cathedral, Germany
Jacobsen 1992



01 5 0



0 5 10

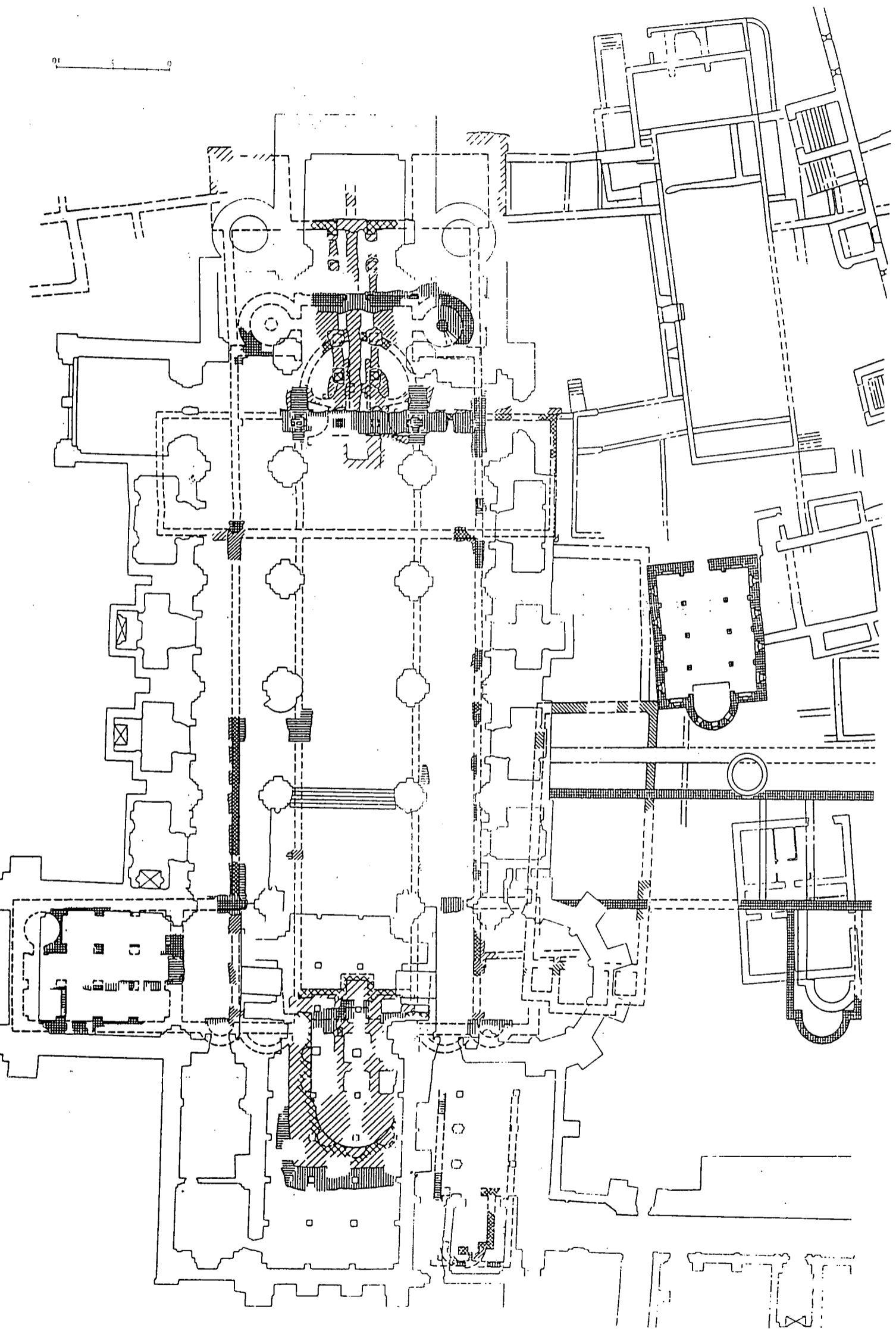

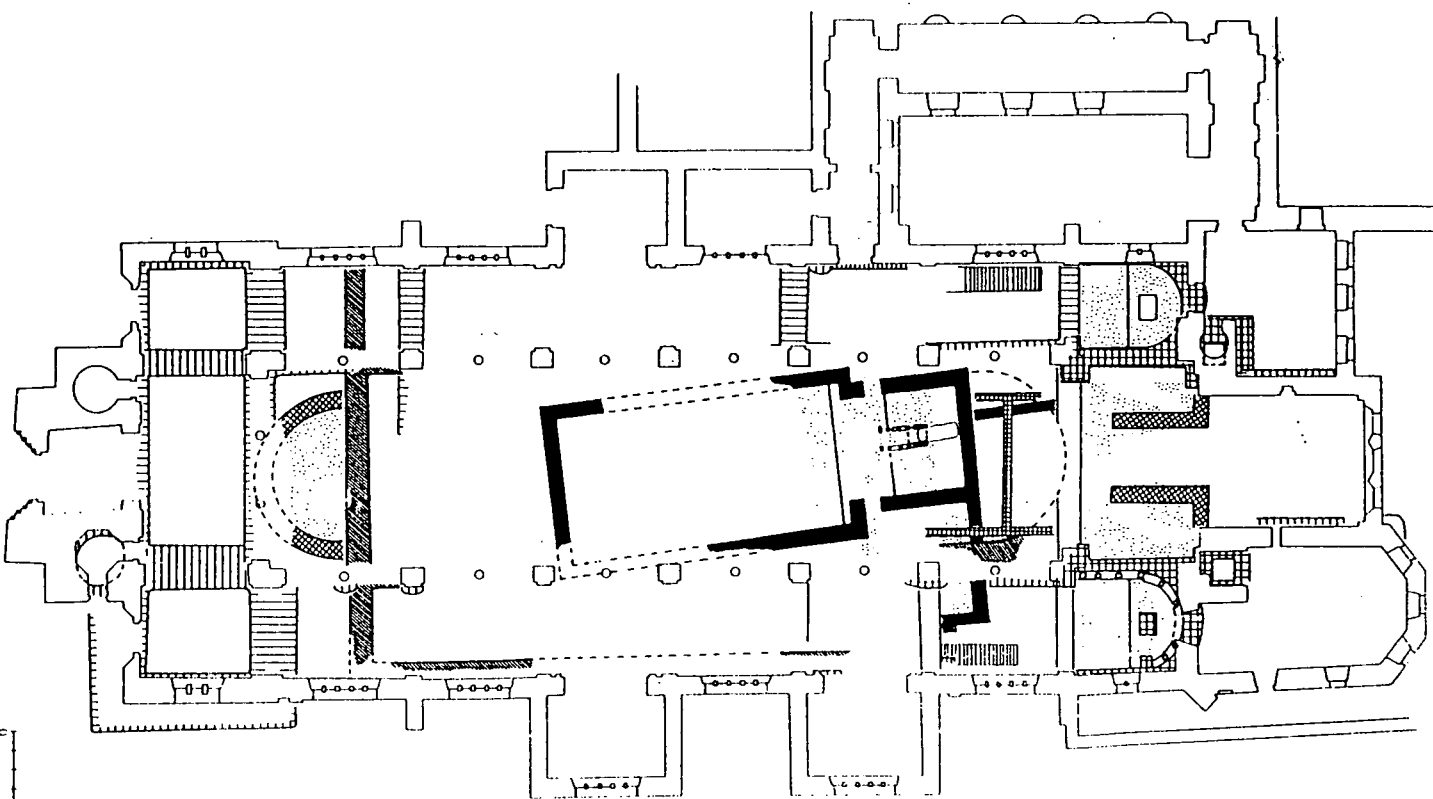

Fig 106 Echtenach abbey, Luxembourg
Jacobsen 1992

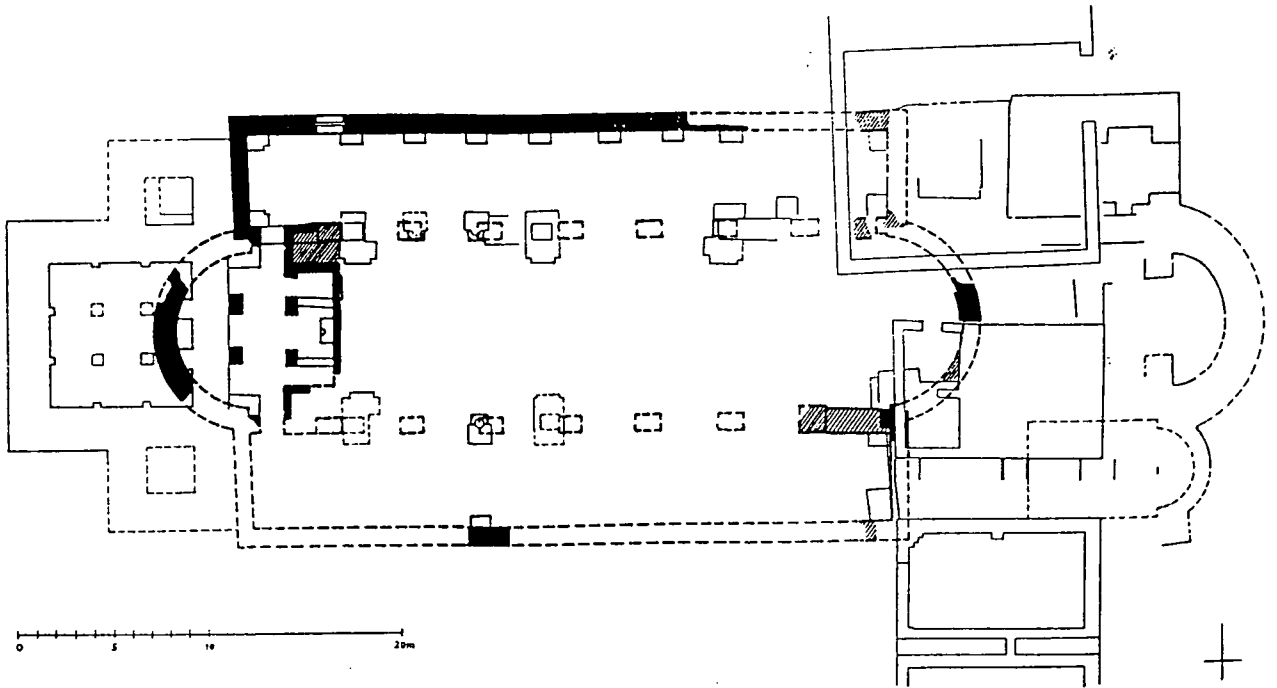

Fig 107 Helmarshausen abbey, Germany
Oswald et al 1966



Fig 108 Location of British sites mentioned in the thesis



Fig 109 Location of Continental churches mentioned in the thesis