



Durham E-Theses

Stereoselective synthesis of furofurans

Dalençon, Anne Jacqueline

How to cite:

Dalençon, Anne Jacqueline (2003) *Stereoselective synthesis of furofurans*, Durham theses, Durham University. Available at Durham E-Theses Online: <http://etheses.dur.ac.uk/3999/>

Use policy

The full-text may be used and/or reproduced, and given to third parties in any format or medium, without prior permission or charge, for personal research or study, educational, or not-for-profit purposes provided that:

- a full bibliographic reference is made to the original source
- a [link](#) is made to the metadata record in Durham E-Theses
- the full-text is not changed in any way

The full-text must not be sold in any format or medium without the formal permission of the copyright holders.

Please consult the [full Durham E-Theses policy](#) for further details.

STEREOSELECTIVE SYNTHESIS OF FUROFURANS

The copyright of this thesis rests with the author.
No quotation from it should be published without
his prior written consent and information derived
from it should be acknowledged.

ANNE JACQUELINE DALENÇON

Ph.D. Thesis

University of Durham

Department of Chemistry

March 2003

14 APR 2003



Copyright

The copyright of this thesis rests with the author. No quotation from it should be published without prior consent and information derived from it should be acknowledged.

Declaration

This work was conducted in the Department of Chemistry at the University of Durham between October 1999 and September 2002. The work has not been submitted for a degree in this, or any other university. It is my own work, unless otherwise indicated.

Acknowledgements

I would like to thank Dr Patrick Steel and David Aldous for their supervision, all my friendly co-workers (Darren, Davide, Ganesh, Dan, Ishmael, Wendy, Amel, Chris, Pete, Andy,...) for their support and specially Dr Simon de Sousa and Les Oates for their help and advice during all my PhD.

Many thanks to: Dr Alan Kenwright, Ian and Catherine (NMR), Dr Mike Jones and Lara (MS), Leny (GC and LC), Dr Andrei Batsanov (X-ray), Gordon, Ray, Malcom and Peter (Glassblowers), Elisabeth, Joe, Jim and Tony (store)...

... but also all my friends: Elodie, Stephanie, Darren, Lorna, Alison, all my flatmates and people from 'the french connection', the volleyball club and the salsa class. I have a special thought for Dr Laurent Fosset, Julien Doyon and Humsha Hariprakasha who trusted me and pushed me to do this PhD.

I also wish to thank EPSRC and Aventis for their financial support.

At last but not least, I would like to thank my family, in French for their convenience!

Je voudrais remercier ma famille tout particulièrement mes parents, mes grands-parents et ma sœur pour tout l'amour qu'ils m'ont donné et leur soutien aussi bien moral que financier qu'ils m'ont apporté; c'est pourquoi cette thèse vous est dédiée.

STEREOSELECTIVE SYNTHESIS OF FUROFURANS**ANNE JACQUELINE DALENÇON****Ph.D. - December 2002**

The 2,6–diaryl-3,7–dioxabicyclo[3,3,0]octanes (or furofurans) belong to the lignan family of natural products. Lignans represent very attractive synthetic targets owing to their large range of biological properties including anticancer, antiviral and immunosuppressant activities. There is considerable structural variation in this series in both the nature and the stereochemistry of the aryl substituents. Since activity is dependent on stereochemistry, synthetic routes, which can provide controlled but tuneable access to one particular class, are very attractive. In this respect, we have been interested in developing efficient ways to synthesise the furofuran skeleton.

Based on previous work in our group, the first synthesis of a natural *endo-endo* furofuran, Epiasarinin, has been achieved *via* a five step strategy. It included a Darzens condensation followed by a thermal rearrangement of vinyl epoxide to *cis* dihydrofuran, a Lewis acid promoted cyclisation of a dihydrofuryl alcohol and a reduction of a glycosidic bond.

Variations of this methodology afforded the selective synthesis of all the possible stereochemical combinations. An asymmetric version of the thermal rearrangement has been explored and improvement of this step *via* different activation methods considered.

Another aim of this thesis was to extend this existing method to generate aza analogues. Two strategies have been explored. Generation of furopyrroles can be achieved *via* the thermal rearrangement of vinyl aziridines or *via* the acid catalysed cyclisation of dihydrofuryl amines.

In conclusion, this short and selective synthetic route leads to a large range of natural or unnatural furofurans and the extension to their aza analogues was also explored.

Chapter 1 - General introduction

| | |
|--|-----------|
| 1.1. Origins of lignans | 2 |
| 1.1.1. Isolation of lignans | 3 |
| 1.1.2. Structures | 3 |
| 1.1.3. Biosynthesis | 5 |
| 1.2. Biological properties of natural furofurans | 7 |
| 1.3. Previous synthesis of furofurans | 8 |
| 1.3.1. Introduction | 8 |
| 1.3.2. Double cyclisation | 9 |
| 1.3.2.1. <i>Symmetrical approaches</i> | 9 |
| 1.3.2.2. <i>Unsymmetrical approaches</i> | 13 |
| 1.3.3. Heterocyclic key intermediates | 17 |
| 1.3.3.1. <i>From functionalised γ-butyrolactones</i> | 17 |
| 1.3.3.2. <i>From functionalised tetrahydrofurans</i> | 19 |
| 1.3.3.3. <i>From functionalised dihydrofurans</i> | 24 |
| 1.4. Aims of the project | 25 |
| 1.5. References | 25 |

Chapter 2 – Synthesis of Epiasarinin

| | |
|-----------------------------------|-----------|
| 2.1. Introduction | 28 |
| 2.1.1. Previous work in our group | 28 |
| 2.1.2. Synthetic challenge | 29 |

| | |
|---|-----------|
| 2.2. Vinyl epoxide synthesis | 30 |
| 2.2.1. Introduction | 30 |
| 2.2.2. Extension to Epiasarinin and limitations of the first route | 31 |
| 2.2.3. Direct synthesis of vinyl epoxide <i>via</i> Darzens condensation | 38 |
| 2.3. Thermal rearrangement | 40 |
| 2.3.1. Introduction | 40 |
| 2.3.2. Thermal rearrangement of vinyl epoxide in the synthesis of lignans | 42 |
| 2.3.3. Flash vacuum pyrolysis | 44 |
| 2.4. Reduction of the ester to the alcohol | 48 |
| 2.5. Lewis acid catalysed cyclisation | 49 |
| 2.5.1. Introduction | 49 |
| 2.5.2. Results for Epiasarinin | 52 |
| 2.5.2.1. <i>Synthesis of piperonal acetals</i> | 53 |
| 2.5.2.2. <i>Cyclisation</i> | 54 |
| 2.6. Acetal reduction | 56 |
| 2.6.1. Introduction | 56 |
| 2.6.2. Adaptation to Epiasarinin | 56 |
| 2.6.3. Rationalisation of epimerisation | 59 |
| 2.7. Conclusions | 61 |
| 2.8. References | 62 |
| Chapter 3 – Extension to all the furofuryl diastereoisomers | |
| 3.1. Introduction | 65 |
| 3.2. Synthesis of <i>trans</i> dihydrofuryl ester | 66 |

| | |
|---|-----------|
| 3.3. Lewis acid catalysed cyclisation | 70 |
| 3.3.1. Introduction | 70 |
| 3.3.2. Reduction of the <i>trans</i> dihydrofuryl ester | 70 |
| 3.3.3. Kinetic cyclisation | 71 |
| 3.3.4. Thermodynamic cyclisation | 72 |
| 3.3.5. Summary | 73 |
| 3.4. Reduction of glycosidic bond | 74 |
| 3.4.1. Attempt of reduction | 74 |
| 3.4.2. Epimerisation during the reduction | 78 |
| 3.4.3. New strategy to the <i>endo-endo</i> furofurans | 80 |
| 3.4.4. Summary on the reduction step | 83 |
| 3.5. Conclusion | 83 |
| 3.6. References | 86 |

Chapter 4 – Improvement of the thermal rearrangement

| | |
|--|-----------|
| 4.1. Introduction | 88 |
| 4.2. Asymmetric rearrangement by flash vacuum pyrolysis | 90 |
| 4.3. Activation of the rearrangement by Lewis acid | 92 |
| 4.3.1. Introduction | 92 |
| 4.3.2. Preparation of vinyl epoxide substrates | 94 |
| 4.3.3. Strategy | 95 |
| 4.3.4. Rearrangements | 97 |
| 4.3.5. Activation by the aryl group | 97 |
| 4.3.6. Conclusions | 99 |

| | |
|---|-----------|
| 4.4. Activation by microwave irradiation | 99 |
| 4.4.1. Introduction | 99 |
| 4.4.2. Application to the vinyl epoxide - dihydrofuran rearrangement | 100 |
| 4.4.3. Conclusion on microwave irradiation study | 102 |
| 4.5. Conclusions on the improvement of the thermal rearrangement | 83 |
| 4.6. References | 86 |

Chapter 5 – Synthesis of furopyrrroles

| | |
|---|------------|
| 5.1. Introduction | 105 |
| 5.2. Strategies | 105 |
| 5.3. Vinyl aziridine – 2-pyrrolidine rearrangement | 106 |
| 5.3.1. Introduction | 106 |
| 5.3.2. Aza Darzens condensation | 110 |
| 5.3.2.1. <i>Introduction</i> | 110 |
| 5.3.2.2. <i>Preparation of the imine</i> | 111 |
| 5.3.2.3. <i>Aza Darzens condensation</i> | 112 |
| 5.3.3. Conclusion | 116 |
| 5.4. Cyclisation of the dihydrofuryl amine | 116 |
| 5.4.1. Introduction | 116 |
| 5.4.2. Generation of dihydrofuryl amines | 117 |
| 5.4.2.1. <i>Amidation from the ester</i> | 117 |
| 5.4.2.2. <i>Hydrolysis of the ester</i> | 119 |
| 5.4.2.3. <i>Amidation from the acid</i> | 119 |
| 5.4.2.4. <i>Reduction of the dihydrofurylamides to the amines</i> | 125 |
| 5.4.3. Attempts of direct cyclisation | 126 |
| 5.4.4. Activation of the amine | 129 |

| | |
|-------------------------|------------|
| 5.5. Conclusions | 131 |
| 5.6. References | 133 |

Chapter 6 – Experimental

| | |
|--|------------|
| 6.1. Introduction | 136 |
| 6.2. Synthesis of vinyl –epoxide and –aziridine | 137 |
| 6.2.1. Multistep strategies | 137 |
| 6.2.2. Darzens condensation | 141 |
| 6.2.3. Aza Darzens condensation | 143 |
| 6.2.3.1. <i>Preparation of the imines</i> | 143 |
| 6.2.3.2. <i>Condensation</i> | 145 |
| 6.2.4. Functional group interconversion | 146 |
| 6.2.4.1. <i>Hydrolysis of the ester</i> | 146 |
| 6.2.4.2. <i>Coupling reactions</i> | 148 |
| 6.3. Synthesis of dihydrofuryl –ester and amide | 152 |
| 6.3.1. Sealed tube | 152 |
| 6.3.2. Flash vacuum pyrolysis | 153 |
| 6.3.3. Lewis acid activation | 158 |
| 6.3.4. Microwave irradiation | 160 |
| 6.3.5. Epimerisation | 160 |
| 6.3.6. Functional group interconversion | 163 |
| 6.3.6.1. <i>Hydrolysis of the ester</i> | 163 |
| 6.3.6.2. <i>Amidation</i> | 163 |
| 6.4. Synthesis of dihydrofuryl –alcohol and –amines | 167 |
| 6.4.1. Reductions of esters | 167 |
| 6.4.2. Reduction of amides | 169 |
| 6.4.3. Deprotection of allyl amine | 171 |

| | |
|---|------------|
| 6.5. Synthesis of furo-furan and – pyrrole | 172 |
| 6.5.1. Preparation of acetals | 172 |
| 6.5.2. Lewis acid promoted cyclisation from alcohol | 173 |
| 6.5.3. Cyclisation from amine | 178 |
| 6.5.4. Activation of the amine | 180 |
| 6.6. Glycosidic bond reduction | 182 |

Chapter 7– Appendix

| | |
|---|------------|
| 7.1. Crystalline structure of Epiasarinin (1) | 187 |
| 7.2. Crystalline structure of pyrrolidine (197) | 194 |
| 7.3. Crystalline structure of ethyl dihydrofuryl amide (208) | 201 |
| 7.4. Crystalline structure of butyl dihydrofuryl amide (204) | 208 |

| | |
|------------|--|
| Ac | acetyl |
| acac | acetylacetonate |
| Ar | aryl |
| Bn | benzyl |
| Bu | butyl |
| Bz | benzoyl |
| CI | chemical ionisation |
| Cp | cyclopentadienyl |
| d | doublet |
| DBU | 1,8-diazabicyclo-[5,4,0]-undec-7-ene |
| DCM | dichloromethane |
| de | diastereomeric excess |
| DIBAL-H | diisobutylaluminium hydride |
| DMAP | dimethylaminopyridine |
| DMF | N,N-dimethylformamide |
| DMSO | dimethylsulfoxide |
| ee | enantiomeric excess |
| EI | electronic impact |
| ES | electrospray |
| Et | ethyl |
| FVP | flash vacuum pyrolysis |
| GC | gas chromatography |
| HMDS | hexamethyldisilylamide |
| HMPA | hexamethylphosphoric triamide |
| HPLC | high performance liquid chromatography |
| <i>i</i> - | <i>iso</i> - |
| Im | imidazole |
| IR | infra red |
| LAH | lithium aluminium hydride |
| LC | liquid chromatography |
| LDA | lithium diisopropylamide |

| | |
|----------------|--|
| m | multiplet |
| <i>m-</i> | <i>meta-</i> |
| <i>m</i> -CPBA | <i>meta</i> -chloroperoxybenzoic acid |
| Me | methyl |
| MMPP | magnesium monoperoxyphthalate hexahydrate |
| mp | melting point |
| Ms | mesyl or methylsulfonyl |
| MS | mass spectroscopy |
| NMR | nuclear magnetic resonance |
| <i>o-</i> | <i>ortho-</i> |
| Ph | phenyl |
| PPTS | pyridinium <i>para</i> -toluenesulfonate |
| Pr | propyl |
| Py | pyridine |
| q | quartet |
| rt | room temperature |
| s | singlet |
| sat. | saturated |
| t | triplet |
| <i>t-</i> | <i>tertio-</i> |
| TBABr | tetrabutylammonium bromide |
| TBAF | tetrabutylammonium fluoride |
| TBS | <i>tertio</i> -butyldimethylsilyl |
| Tf | trifluoromethanesulfonyl |
| th | theory |
| THF | tetrahydrofuran |
| TLC | thin layer chromatography |
| TMS | trimethylsilyl |
| tol | tolyl |
| Ts | tosyl or toluenesulfonyl |
| y | yield |

CHAPTER ONE

General Introduction

2,6-Diaryl 3,7-dioxabicyclo[3,3,0]octanes, more often called furofurans belong to the lignan family of natural products. They are extracted from a diverse range of plants and present a wide range of biological activities. Therefore, they have become main synthetic targets for several research groups. Previous work in our group has explored strategies for the construction of the furofuran skeleton.

This first chapter will introduce the lignans, their isolation and biological properties. Previous syntheses of the most common natural furofurans will be also reported in the same chapter. Then, it will focus on the work done during this PhD project. The first goal of these studies was to use the existing method for the synthesis of natural furofurans such as Epiasarinin (**1**) and to improve it to produce the lignan skeleton, Figure 1.1; this work is described respectively in Chapter 2 and 3. Attempts to improve this methodology by different activation methods and by asymmetric induction with chiral auxiliaries are presented in Chapter 4. Chapter 5 of this thesis will discuss the extension of this methodology to generate unnatural aza analogues (fuopyrroles), Figure 1.1. Finally, all the experimental procedures and data of the synthesised products is given in Chapter 6.

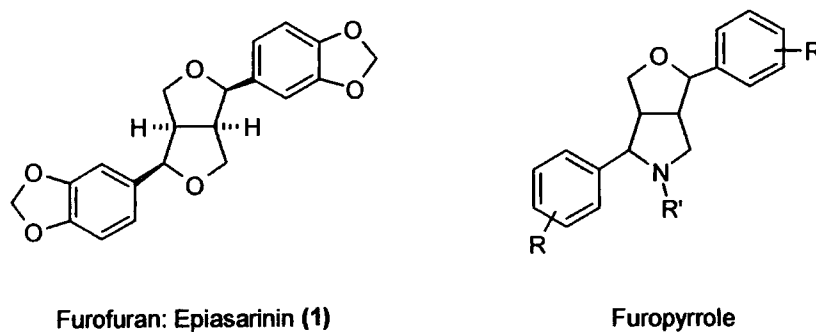

Figure 1.1

1.1. Origins of lignans

In this section, our interest will be on lignans in general, describing their isolation from natural sources and the classification in the family. Then the focus will be on the furofuran species and their diversity.

1.1.1. Isolation of lignans

Lignans are widespread in nature. They have been detected in over seventy different families of plants from the gymnosperme coniferales to the angiosperme magnoliales and myrtales.¹ They have been extracted from roots, rhizomes, resin, woods, barks, leaves, flowers, fruits or seeds.

1.1.2. Structures

The term 'lignan' has been used to describe two kinds of skeleton: the lignans (**3**, **4**), which have a β - β link generating during the phenolic oxidative coupling of derivated cinnamyl alcohol (**2**) (see Section 1.2. and 1.3.2) and the neolignans (**5**, **6**), which don't contain this β - β bond, Scheme 1.1.^{2,3}

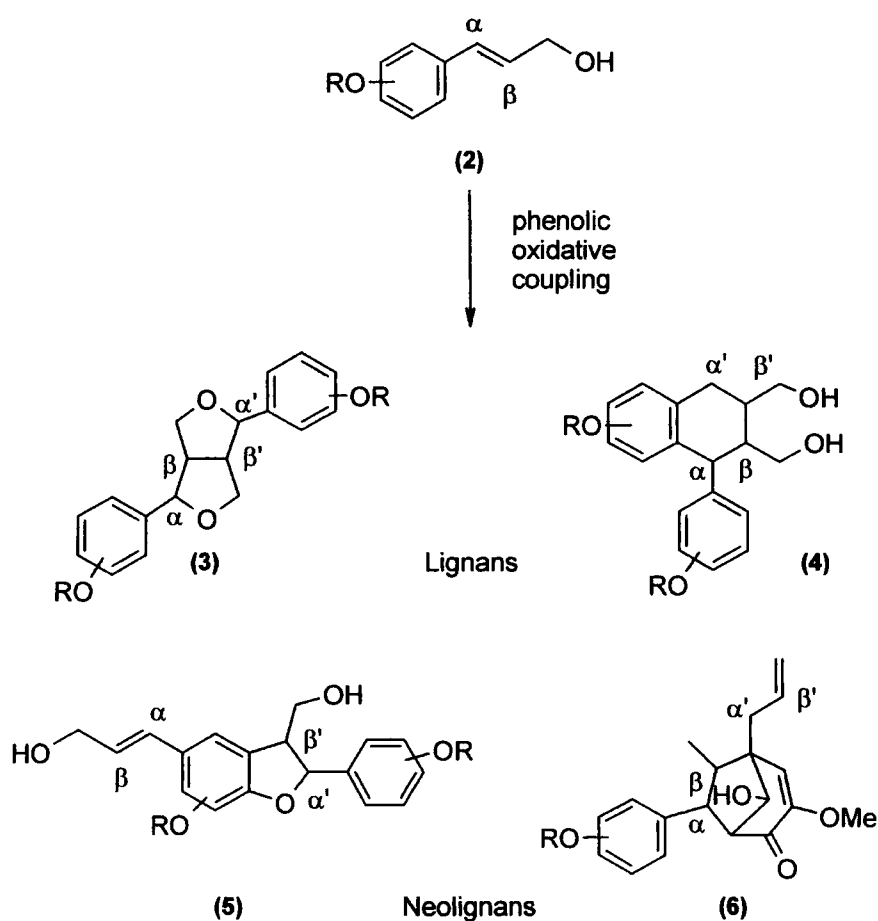

Scheme 1.1

Within the lignan family, members can be classified into different groups according to their structure, Figure 1.2. They can be substituted linear chains such as the dibenzylbutanes or –butanediols, monocyclic (for example, the tetrahydrofurans or dibenzyl butyrolactones), bicyclic, including the furofurans with their exocyclic aromatic rings or with the aromatic group inserted such as the tetralins, naphthalenes and dibenzocyclooctadienes, Figure 1.2.^{4-6,3} As furofurans are one of the main subdivision of the lignans, this thesis will concentrate solely on this class from now on.

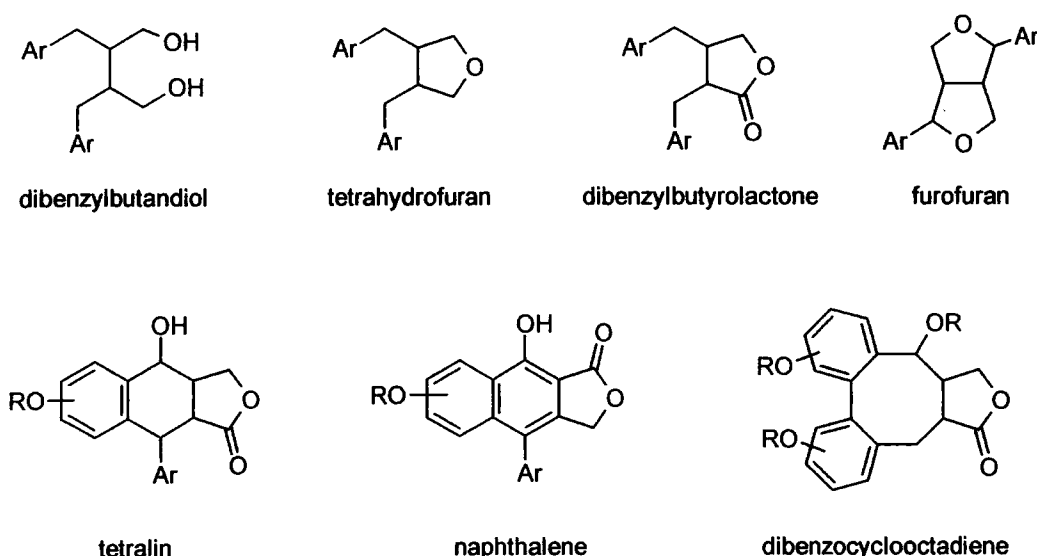

Figure 1.2

Furofurans, 2,6-diaryl-3,7-dioxabicyclo[3,3,0]octanes in systematic nomenclature, represent one of the main groups of lignans. Structurally, the bicyclic skeleton is always *cis*-fused with two aromatic substituents at the 2 and 6 positions. These aromatic groups can be mono-, di- or tri-substituted with hydroxy (phenol), methoxy, 3-4-methylenedioxy (sesamyl) groups or glucose at all positions.

The two aryl groups can be identical which leads to a symmetrical structure such as Epiasarinin or different to give a unsymmetrical compound such as Praderin (**7**) or Kobusin (**8**), Figure 1.3. Also, each aryl group can be *endo* or *exo* relative to the hydrogens at the *cis* fused ring junction. Consequently, three kinds of skeleton are observed: the *endo-endo* (Epiasarinin) which is the least thermodynamically stable, the *endo-exo* (Praderin) and the *exo-exo* (Kobusin), thermodynamically the most favoured.

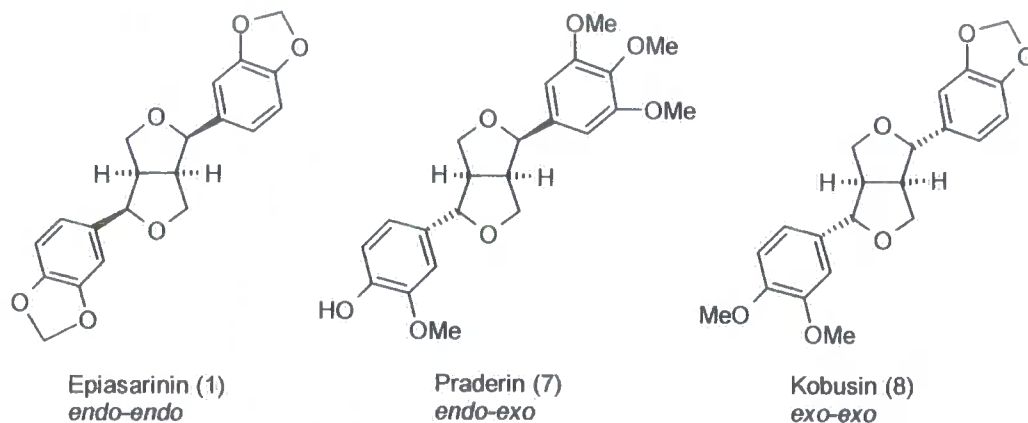
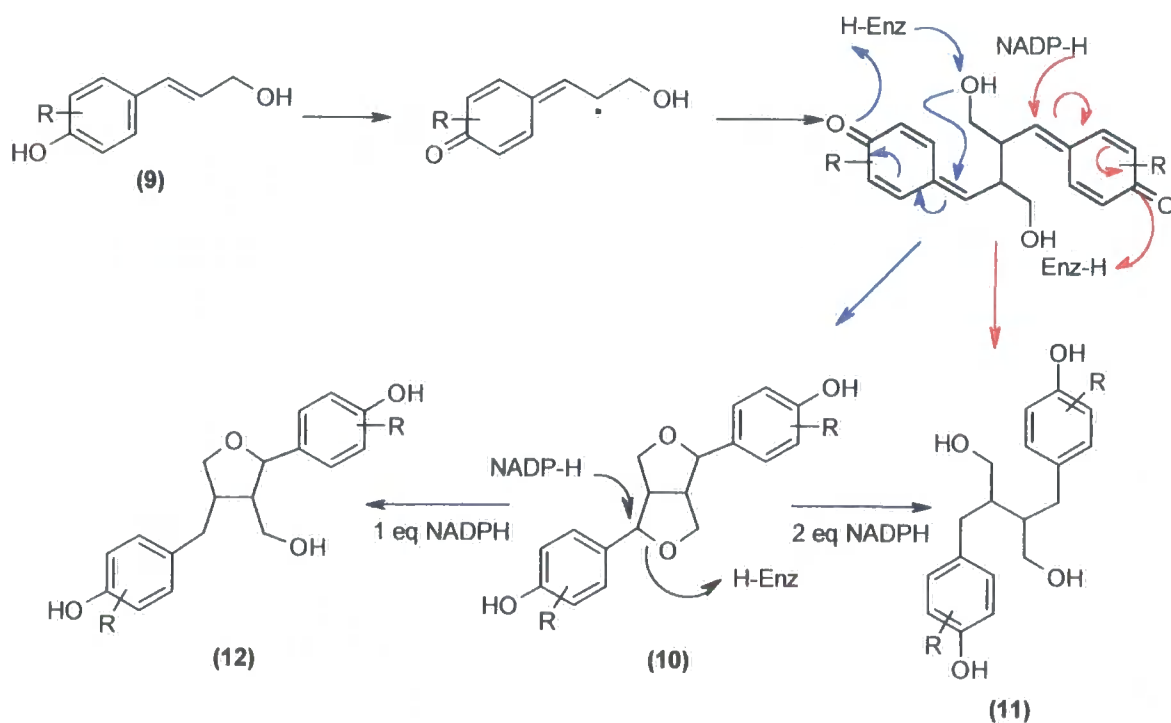

Figure 1.3

1.1.3. Biosynthesis

The biosynthesis of the furofurans has been extensively investigated and is presumed to involve an oxidative coupling between two molecules of substituted cinnamyl alcohol **(9)**. An enzymatic reduction with NADPH leads to the furofuran **(10)**, diarylbutanediol **(11)** and tetrahydrofuran **(12)** skeletons, Scheme 1.2.^{5,6} The enzyme active site in the oxidation would define the product stereochemistry. An auxiliary oxidant or oxidase are required to afford this coupling.



Scheme 1.2

Evidence for this mechanism was obtained from biomimetic oxidations. Phenolic oxidations have been reported using either isolated enzymes or inorganic reagents. For instance, chloroperoxidase oxidises coniferyl alcohol (**13**) to a mixture of furofuran, pinoresinol (**14**) and neolignan, dehydrodiconiferyl alcohol (**15**), Scheme 1.3.

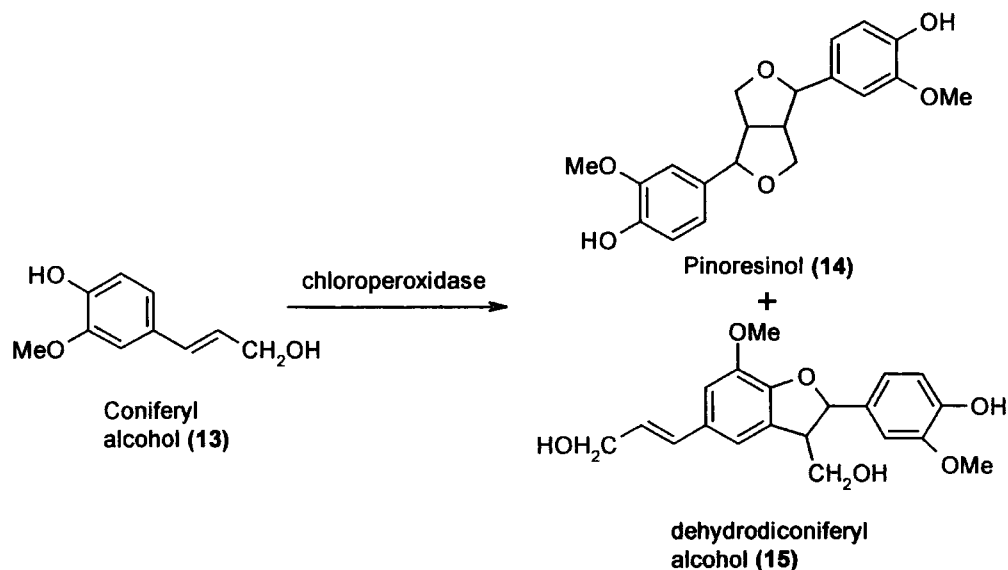

Scheme 1.3

In a similar fashion, the phenolic coupling of synapyl alcohol (**16**) in presence of laccase leads to syringaresinol (**17**), Scheme 1.4.²

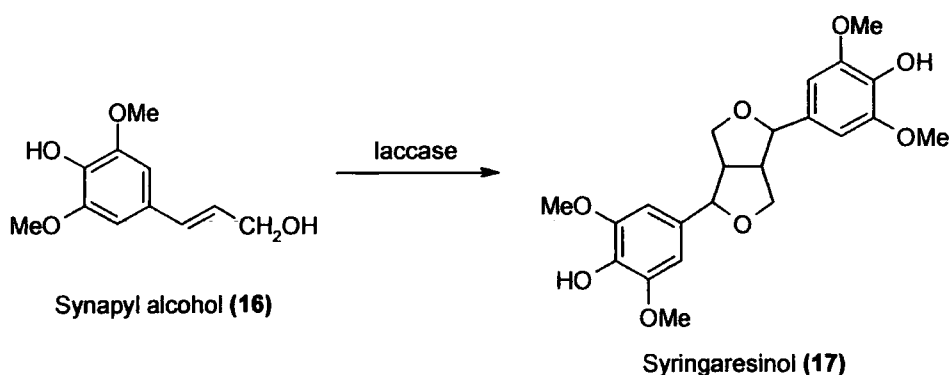

Scheme 1.4

Evidence for the radical process was obtained by using inorganic initiators; for example, iron chloride in oxygen atmosphere was able to couple ferulic acid (**18**) to give the dilactone (**19**). This can then be converted to generate the main lignan structures, Scheme 1.5.²

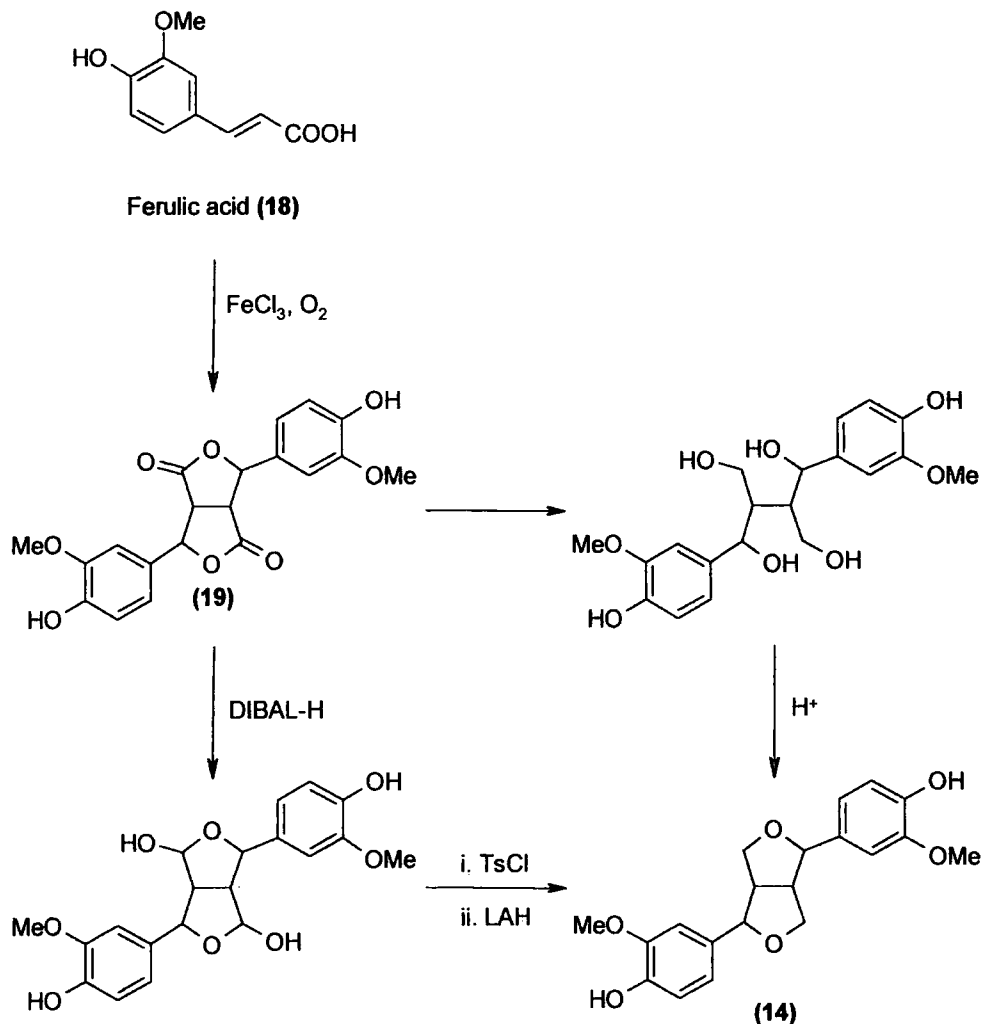

Scheme 1.5

1.2. Biological properties of natural furofurans

Lignans have been extracted from various plants which have been used in traditional medicines. The biological activity of these plants can be attributed to the presence of lignans. These can include anti-tumor, anti-viral, anti-oxidant activities.¹

As this project focuses on furofurans, more details of the activities of this class will be discussed. For example, Syringaresinol (17), Pinoresinol (14) and their analogues are reported to be cyclic adenosine monophosphate phosphodiesterase (AMP) inhibitors, Figure 1.4.¹ Kobusin (8), Fargesin (20), Sesamin (21) and Asarinin (22) inhibit the insect larval growth and can therefore enhance the toxicity of insecticides. Fargesin was reported to be a platelet activating factor (PAF) antagonist.¹

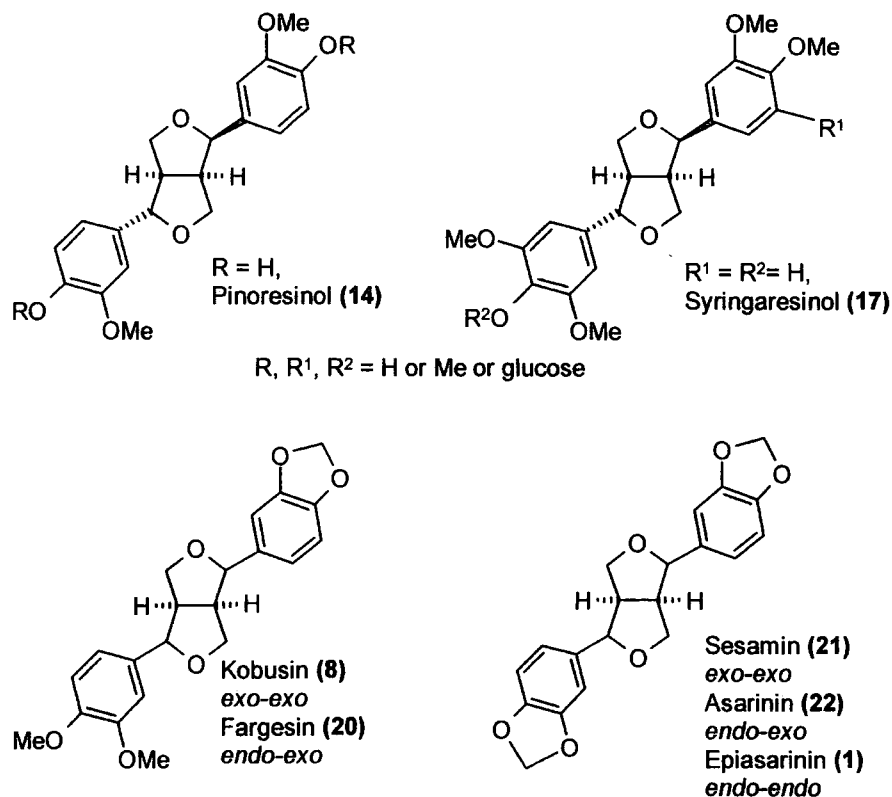
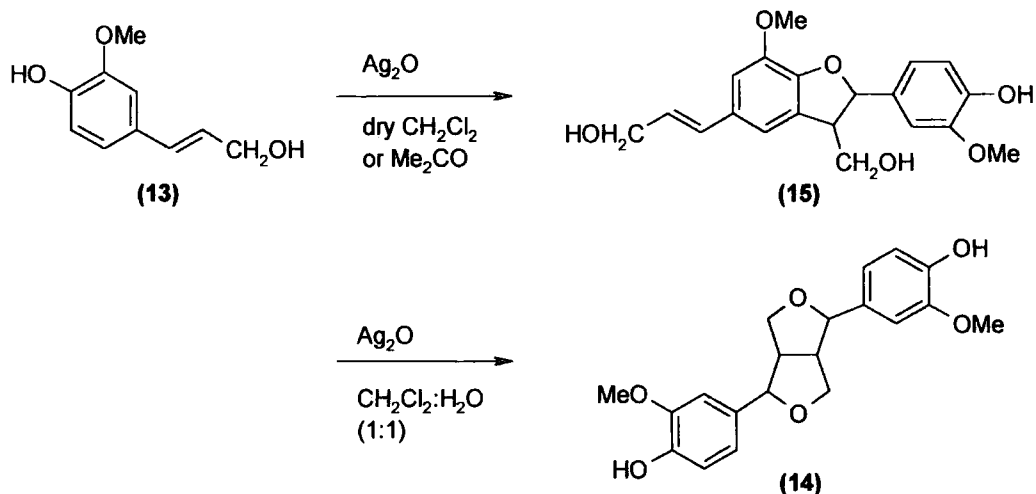

Figure 1.4

1.3. Previous syntheses of furofurans

1.3.1. Introduction

Furofurans possess a wide range of biological properties and therefore represent attractive synthetic targets. There have been a number of synthetic approaches; this section will review the published strategies using as a classification, the ring-disconnection of the retrosyntheses of the lignan. Two key stereochemical issues are involved in the furofuran synthesis namely establishment of the 1,5-ring junction stereochemistry and the 2,6-diaryl configuration. Four kinds of disconnection have been reported, Scheme 1.6. Some syntheses first generate acyclic precursors (**23**) and reach the furofuran core by a double cyclisation. Others build the stereochemistry in the preparation of monocyclic intermediates such as butyrolactones (**26**), tetrahydrofurans (**25**) or dihydrofurans (**24**) and finally generate the second furan ring. Throughout this review, comments on the selectivity and the control of the aryl groups configuration will be made.



Scheme 1.7

In a related approach, β ketoesters (27) were homocoupled using various inorganic oxidants such as iodine, bromine or potassium persulfate, to give diketodiester (28), Scheme 1.8.^{7,8} Reduction of these followed by an acid treatment led to two different diaryl furofurans depending on the stereochemistry of the starting diketodiester. From the *meso* material, only the 2,4-diaryl furofuran was isolated; whilst with the DL-compound, the 2,6-diaryl furofuran was generated as the only product.

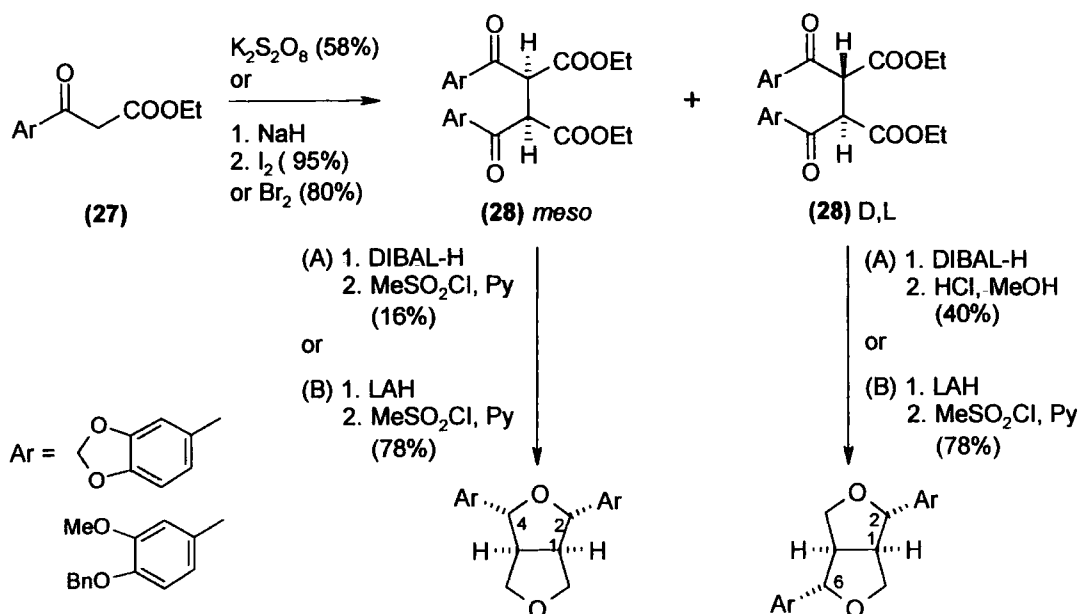

Scheme 1.8

The β -ketoester homocoupling example shows the importance of controlling the stereochemistry of the precursor. The *meso* compound will favourably *cis*-ring fuse to afford the 2,4 diaryl furofuran, instead of generating a *trans*-fused lignan which requires more energy due to the strain of this type of 5,5 bicyclic system.

In an alternative symmetrical approach to symmetrical furofurans reported by Suginome, *et al.*, the key step involved the photolysis of a hypoiodide intermediate, Scheme 1.9.⁹ Starting from the *cis* fused bicyclic *bis* β -ketoester (**29**), readily prepared from condensation of β ketoglutarate with glyoxal,¹⁰ followed by introduction of the aryl substituents using pyridine and aryl lead triacetate, conversion to the key lactol (**30**) was achieved by successive decarboxylation, Baeyer Villiger oxidation and lactone reduction. Treatment of the lactol (**30**) with mercury (I) oxide and iodine gave the expected hypoiodite intermediate which on irradiation underwent ring fragmentation to give the acyclic iodoformate (**31**). Reduction with NaBH_4 was accompanied by cyclisation to synthesise the desired furofuran (**21**).

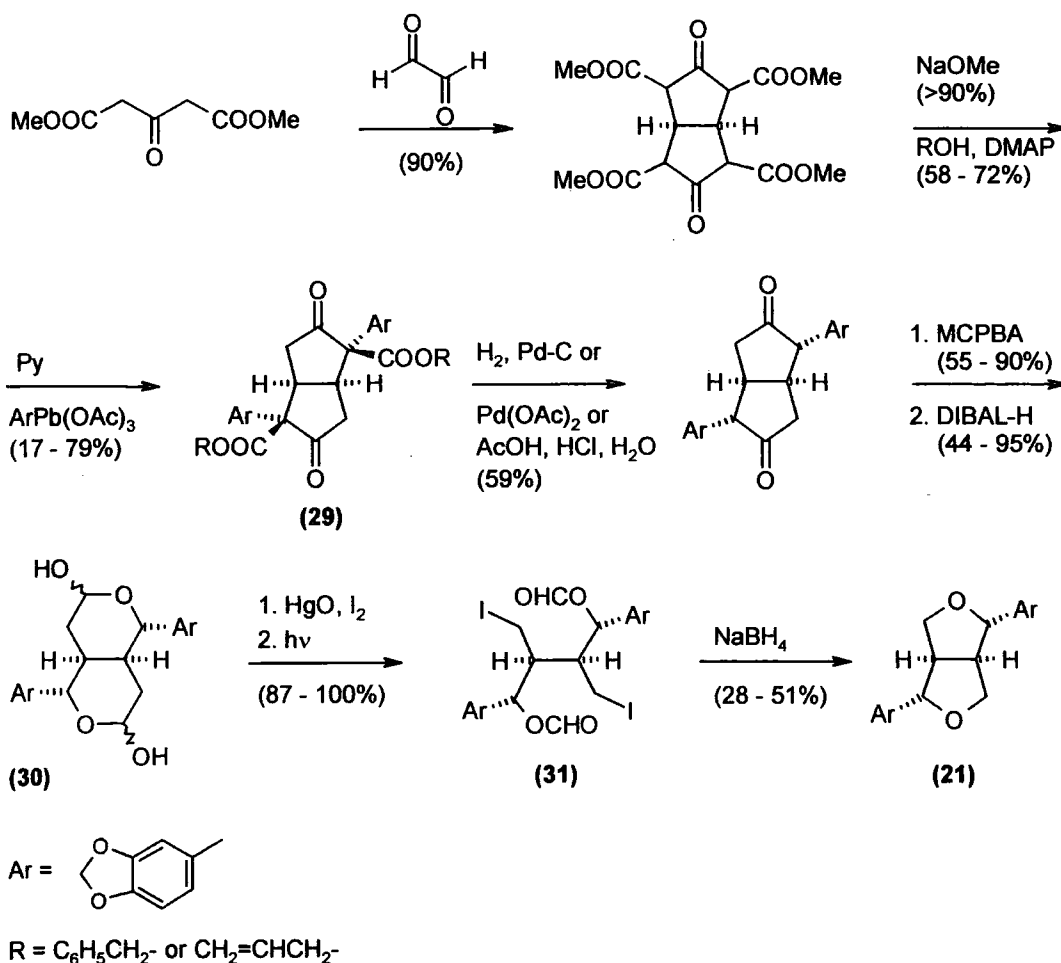

Scheme 1.9

The stereochemistry of the obtained furofuran is set by the condensation of ketoglutarate with glyoxal which leads only to a *cis* fused bicyclic system. Also, the aryl substitution occurs only on the *exo* face. The stereochemistry of the ester is not important as it is lost by the generation of an enolate in basic conditions. An interesting extension of this work would have been to use an optically pure *bis* β -ketoester, as this should lead to a single enantiomer of the furofuran.

As the furofurans have some interesting biological properties, an enantioselective route is of interest. Corey, *et al.* recently published the total synthesis of (-)-Wodeshiol (**35**).¹¹ The asymmetric induction was achieved through the use of a proline derived chiral catalyst during the reduction of the ketone (**32**) to the corresponding alcohol (**33**), Scheme 1.10. After palladium mediated homocoupling reaction, the directed *bis* epoxidation of the two *exo* methylene groups occurred with high diastereoselectivity (*dr* = 14:1). The diepoxydialcohol (**34**) was then treated with pyridinium *p*-toluenesulfonate to give (-)-Wodeshiol (**35**).

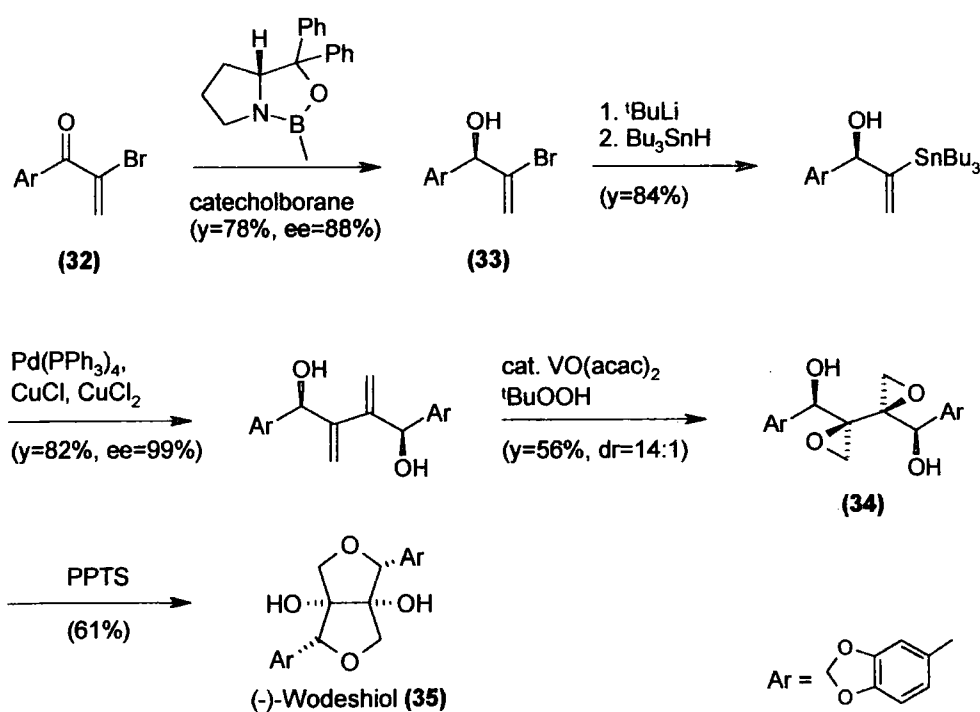

Scheme 1.10

This short synthesis of (-)-Wodeshiol was achieved with an excellent stereocontrol. However, owing to the acid mediated nature of the final cyclisation, such an approach is limited to producing only the *exo-exo* symmetrical skeleton.

By definition, all these dimerisation approaches to acyclic precursors lead to symmetrical lignans. Others strategies have been developed to generate unsymmetrical acyclic intermediates and will be discussed in the next section.

1.3.2.2. Unsymmetrical approaches

Ohmizu and Iwasaki, *et al.* reported a method, which allows the syntheses of natural and unnatural lignans using substituted succinic anhydrides and γ -butyrolactones as key intermediates, Scheme 1.11.¹²⁻¹⁵ The succinic anhydride derivatives were generated through the Michael addition of a trimethylsilyl cyanohydrin to dimethyl maleate, followed by the selective reduction of the resultant ketone (**36**) formed after cleavage of the silyl protecting group. Hydrogenation of the ketone (**36**) catalysed by Pd/C produced the *trans* alcohol (**37**) whereas the reduction with zinc borohydride generated the *cis* alcohol (**38**). Alcohol protection, ester hydrolysis and dehydration afforded the desired anhydrides (**39**) and (**40**) respectively.

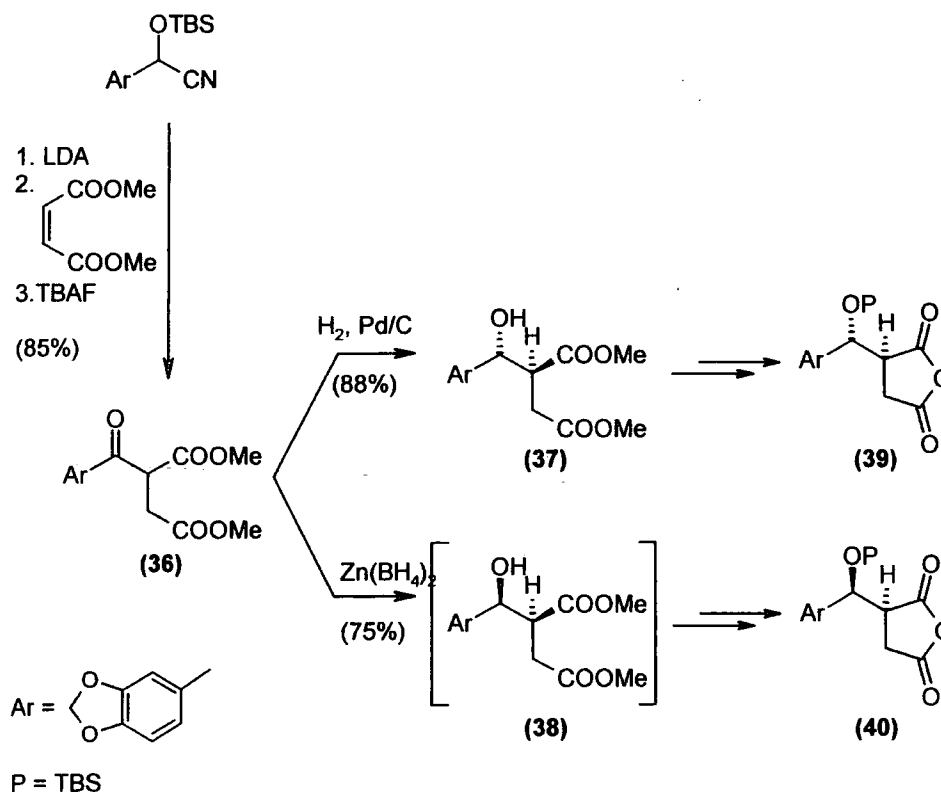

Scheme 1.11

The key lactone was obtained by aldol condensation of an aldehyde with the cyclic anhydride (**39**) or (**40**), Scheme 1.12. When the aldol reaction was carried out with LDA, no selectivity was observed. Starting either with the *cis* or the *trans* protected alcohols (**39** and **40**), KHMDS led selectively to the *syn* adducts (respectively **41** and **42**), which after rearrangement, gave the *trans* aryl lactones (respectively **44** and **45**) and the *anti* adduct (**43**) was obtained by using NaHMDS in THF at $-100\text{ }^{\circ}\text{C}$ and rearranged to the *cis* aryl lactone (**46**). The difference of selectivity was attributed to a potassium chelated twist boat transition state stabilising the *syn* adduct when KHMDS was used.

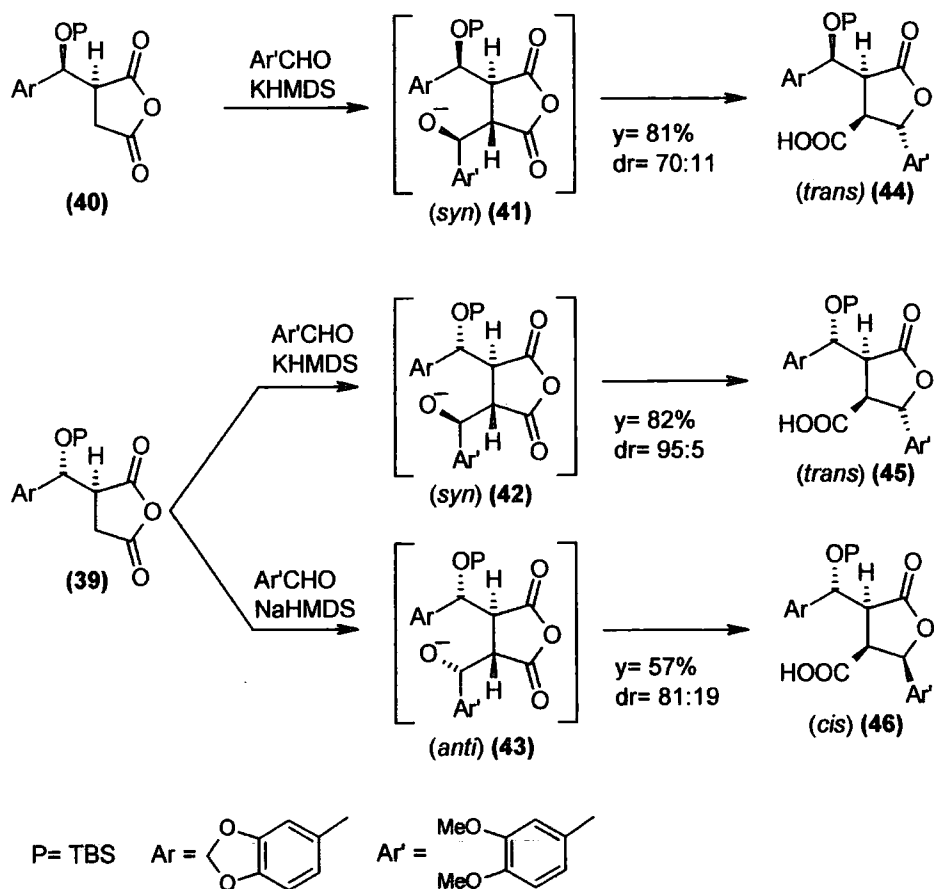

Scheme 1.12

After deprotection of the alcohol, the lactonisation led to the bislactone furofuran, Scheme 1.13a. For the *exo-exo* and *exo-endo* bislactone (respectively **47** and **48**), the cyclisation was realised in acetic acid in respectively 84% and 80% yields. Carbodiimide activation was required to achieve the cyclisation of the *endo-endo* skeleton (**49**) whilst avoiding the epimerisation which occurs on attempted acid catalysed lactonisation.

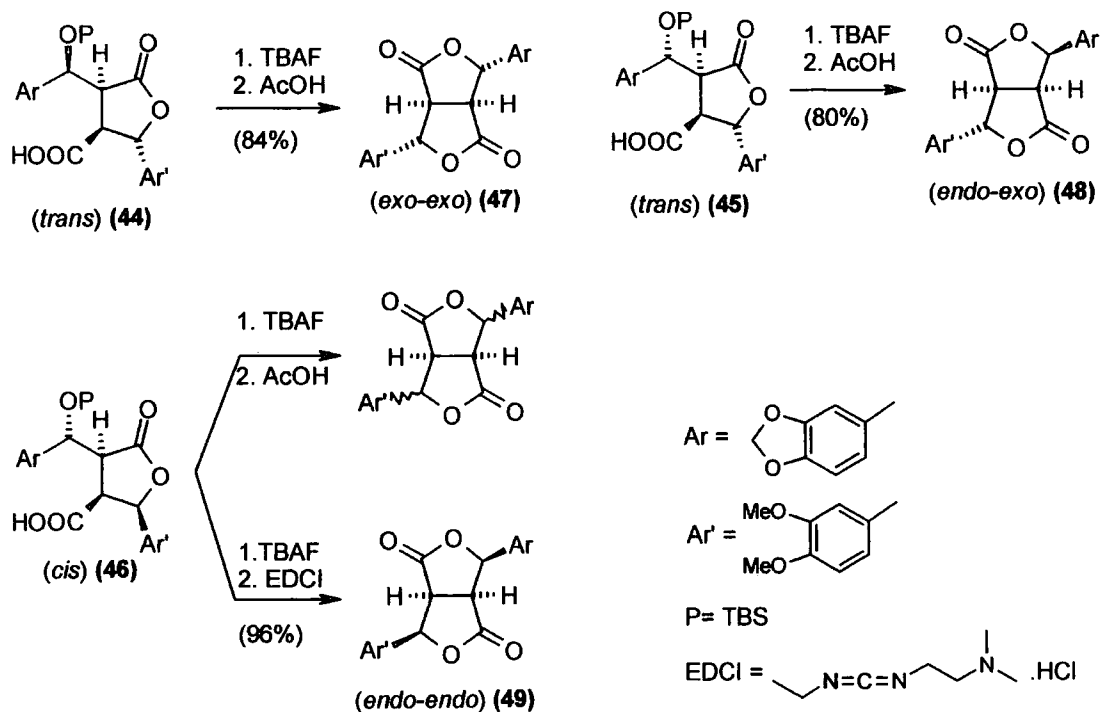

Scheme 1.13a

With this method, Ohmizu and Iwasaki could generate all the stereochemical combinations of bislactone furofurans, symmetrical and unsymmetrical. They have reported the synthesis of Fargesin (**20**).¹⁶ Starting from the unsymmetrical *endo-exo* skeleton (**48**) by reduction of the lactone to the tetraol (**50**), selective mesylation in basic conditions promoted the cyclisation, Scheme 1.13b. Although, the stereochemistry was retained during these two steps, the yields were only moderate. Surprisingly, no attempts to generate an *endo-endo* furofuran, the less thermodynamically stable system have been reported using this methodology.

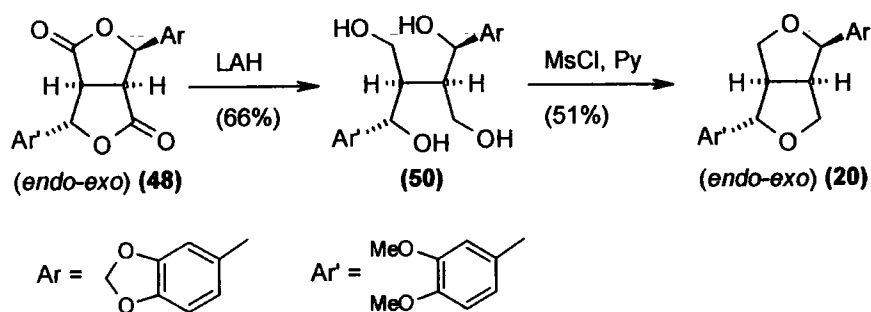

Scheme 1.13b

Ohmizu and Iwasaki have subsequently improved their strategy and achieved the total synthesis of (+)-Fargesin.¹³ Michael addition using the chiral unsaturated ester (**51**) occurred with a high diastereoselectivity ($y=94\%$, $de=93\%$). The aldol reaction led only to the *anti* adduct with the methoxy group presumed to be playing an important role in stabilising a chair transition state. After functional group interconversion, treatment as before gave (+)-Fargesin (**20**) as a single enantiomer in an overall yield of 26%.

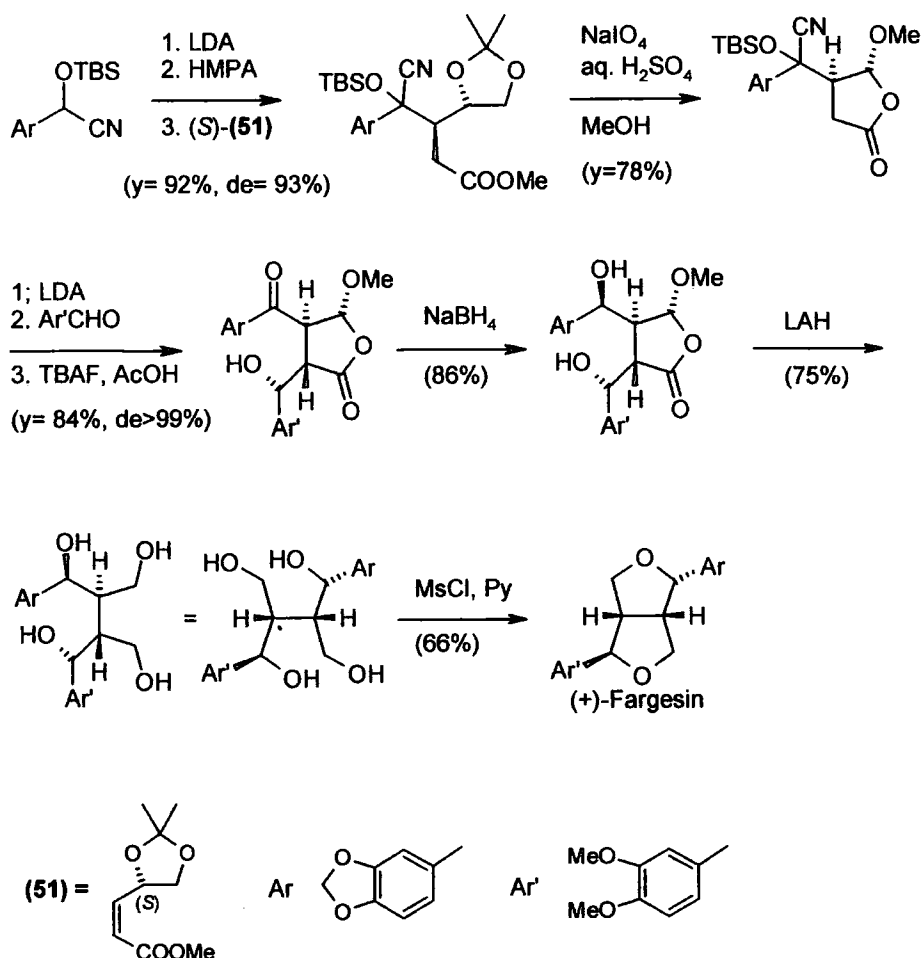

Scheme 1.14

The (+)-Fargesin synthesis illustrates the versatility of the Ohmizu and Iwasaki process. The method is diverse enough to synthesise all the stereochemical combinations of bislactone furofurans and generate *endo-exo* and *exo-exo* furofurans with good diastereocontrol at each stage. Application to the production of an *endo-endo* system remains to be demonstrated.

Most of the strategies using acyclic precursors lead to *exo-exo* bicycles; this is mainly due to the formation of the two rings simultaneously in acidic conditions and thermodynamically controlled. Some other groups worked on different approaches, producing first functionalised heterocycles and then inducing the second cyclisation. With this method, the stereochemistry set during the formation of the first heterocycle can influence the second ring formation and therefore give access to all the diastereoisomers of the furofurans. The next sections will describe attempts to use this approach by a number of different research groups; some basing their strategy on γ -butyrolactones as in the following section, others on tetrahydrofurans or dihydrofurans.

1.3.3. Heterocyclic key intermediates

1.3.3.1. From functionalised γ -butyrolactones

γ -Butyrolactones have been used as key intermediates to synthesise furofurans. As will be shown in the following examples, these intermediates can control the stereochemistry in the formation of the second ring. These furofuranones may then be converted to the target furofuran.

In a similar fashion to Ohmizu and Iwasaki,¹²⁻¹⁶ Whiting, *et al.* generated aryl butyrolactone *trans*-(**52**) through the condensation of an aldehyde with succinic anhydride in presence of zinc chloride and followed by an *in situ* rearrangement, Scheme 1.15.^{17,18} In this approach, the acid was then reduced to the alcohol (**53**), and then transformed into the mixed acetal (**54**). Treatment of this lactone-acetal (**54**) with TMSOTf and triethylamine induced to an intramolecular aldol reaction. The cyclisation afforded an *exo* (**55**) and *endo* (**56**) mixture with a (1:1.4) *ratio* of only *cis* ring-fused products. The *endo-exo* furofuranone (**56**) was then treated with LAH to give the diol (**57**) which was transformed into furofuran (Asarinin **22**) by treatment with acid.

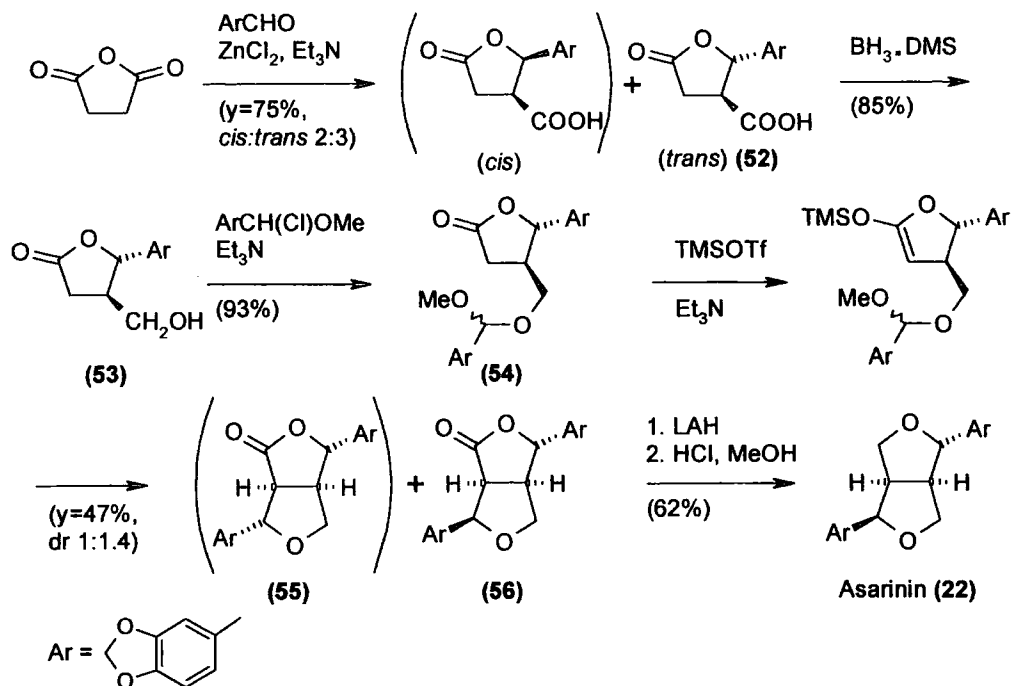

Scheme 1.15

The key step in Whiting's methodology is the intramolecular aldol reaction which sets the ring in a *cis*-fused configuration albeit with only moderate diastereoselectivity at the C⁶ position thus leading to a mixture of *endo* and *exo* aryl substituents. In contrast to other procedures in which epimerisation of the C² and C⁶ stereocentres occurs in acidic treatment, in this case, the configuration was retained during the cyclisation to yield the *endo*-*exo* furofuran in moderate yield (62%).

In an alternative approach, Brown, *et al.* based his synthesis on an intramolecular CH insertion of a diazolactone catalysed by rhodium acetate to produce a furofuranone, Scheme 1.16.^{19,20} The *trans* lactone (**58**) was prepared by a Baeyer Villiger oxidation of a cyclobutanone (**57**) obtained by a [2+2] olefin keteneiminium salt cycloaddition (ds 1:12), followed by isomer separation by flash chromatography. Direct diazo transfer failed and led instead to the *trans* azide and consequently, the diazolactone (**59**) was prepared by condensation with trifluoroethyl trifluoroacetate followed by decarbonyl diazo transfer with *p*-nitrobenzene sulphonyl azide. The CH insertion led to a furofuranone (**60**) with a *cis* fused ring junction and an *endo* stereoconfiguration of the aryl group. The conversion of the furofuranone to the furofuran (Fargesin **20**) was carried out with a LAH reduction followed by mesylation with *in situ* cyclisation as previously described by Ohmizu and Iwasaki.

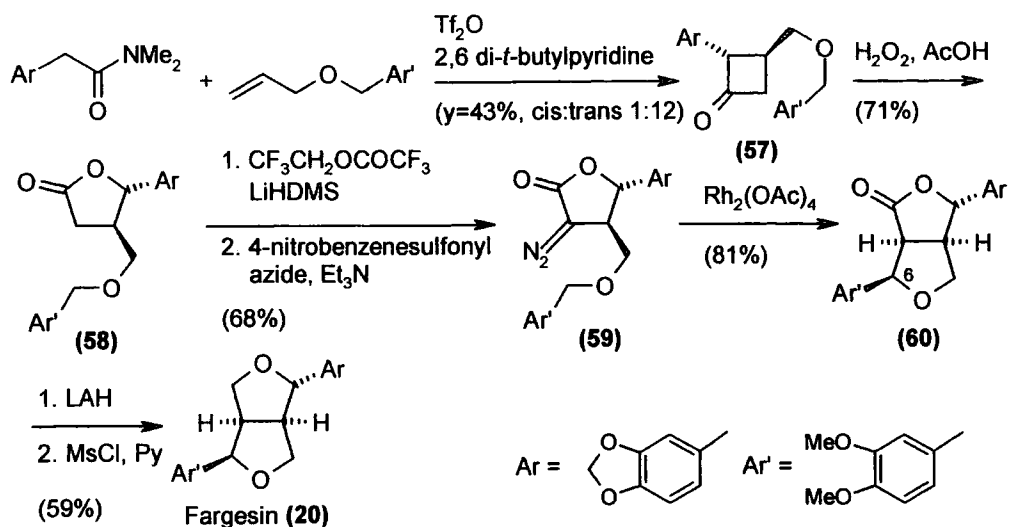

Scheme 1.16

The key step in Brown's method is the intramolecular CH insertion. During this step, the stereochemistry of the ring junction is controlled by the configuration of the C⁴ substituent of the lactone as the insertion will only lead to a *cis* fused system. Although both rhodium acetate and thermal initiator were viable methods for the CH insertion, the catalytic process afforded a cleaner reaction. Interestingly, in both cases, the *endo* configuration at the C⁶ position was detected. No comments on this selectivity have been done.

1.3.3.2. From functionalised tetrahydrofurans (THF)

Functionalised tetrahydrofurans (THFs) already have the first ring of the lignan set up so the challenge is more to synthesise these precursors with the appropriate substituents, than to cyclise them into the furofuran.

For example, THF systems can be generated by radical cyclisation as suggested by Roy, *et al.*^{21,22} After isolating bromoester (**61**), the cyclisation was induced by a radical initiator (AIBN). The *trans* substituted *exo* methylene THF (**62**) was produced exclusively in 80% yield, Scheme 1.17. This *trans* configuration is attributed to an envelope like transition state and sets the first aryl group in an *exo* position in the final furofuran.²³ Functional group interconversion led to the monoprotected diol (**63**). Swern oxidation then afforded the mixture of diastereomeric aldehydes with the *trans* product (**64**) being epimerised into *cis*-(**65**) under basic conditions. After deprotection of the alcohol, the *cis* THF (**65**) cyclised to give the hemiacetal (**66**) precursor of the furofurans.

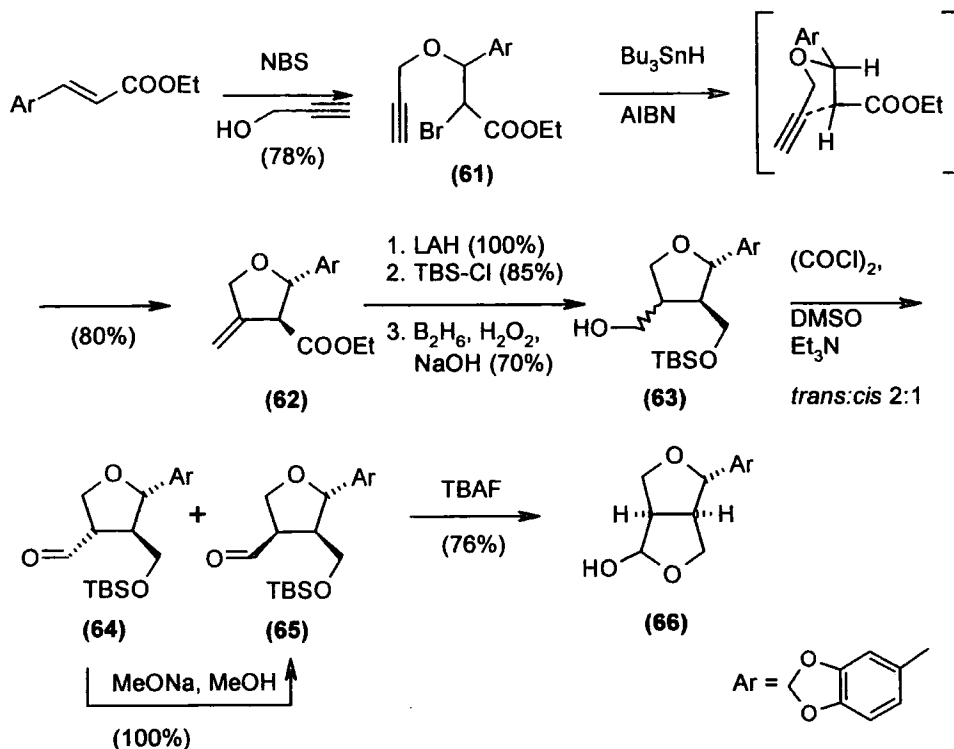

Scheme 1.17

The radical cyclisation is a key step in the building of the stereochemistry of the future furofuran. This strategy was the basis of Roy's subsequent works on the radical cyclisation of the epoxide (**69**) using titanium (III) as initiator, Scheme 1.18.^{24,25} The key intermediate was prepared by alkylation of the alcohol (**67**) with the bromide (**68**). Radical cyclisation of the epoxide (**69**) afforded Sesamin (**21**) in 93% yield. With this cyclisation process, only the most thermodynamically stable furofuran (*exo-exo*) was generated. As the aryl group in the previous THF intermediate (**65**) is in a *trans* configuration to the silyl ether, the first aryl group (at C⁶) is once again set in the *exo* position in the final furofuran. Concerning the second aryl substituent (at C²), it can theoretically adopt both configurations but only the *exo* one was detected. This strategy is an elegant and short route to unsymmetrical *exo-exo* furofurans.

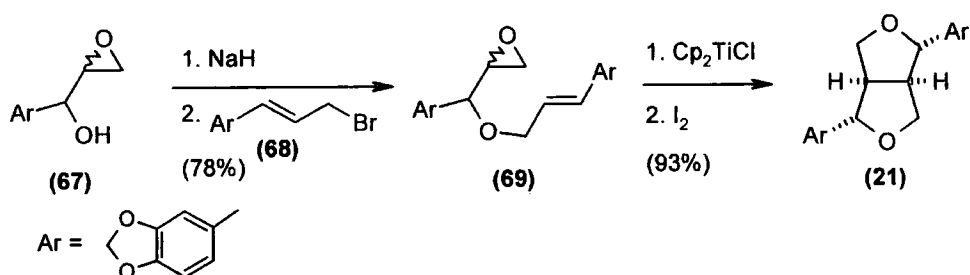

Scheme 1.18

In a different approach, Knight, *et al.* generated highly functionalised THFs (**71**) via an Ireland Claisen rearrangement of macrolactone (**70**), Scheme 1.19.²⁶ This rearrangement sets the stereochemistry of the furofuran through the configuration of the transition state (chair like with aryl group in equatorial position) so the two substituents used to generate the second ring are in a *syn* relationship thus directing the ring to a *cis*-fused configuration. Also, the aryl group is in a *trans* position, which results in an *exo* substitution pattern in the final product. The intramolecular alkylation led only to the thermodynamic product, the *exo-exo* furofuran (Sesamin **21**). No *endo-exo* lignan was presumably generated due to the acid treatment during the last cyclisation. Starting this synthesis with a chiral propargylic alcohol should give only one enantiomer of the furofuran.

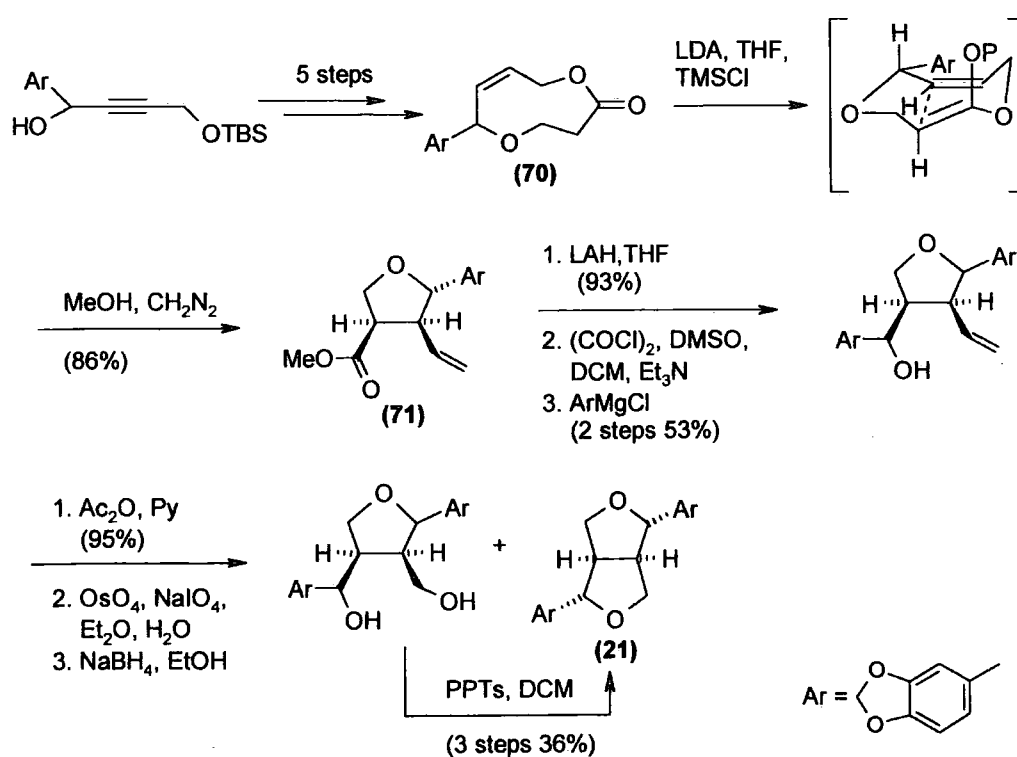

Scheme 1.19

An alternative route to substituted THFs is by hydrogenation of functionalised furans, and this strategy has been developed by Ye and Chen, *et al.*²⁷ The Diels Alder reaction between oxazole and butynediacetate afforded a trisubstituted furan (**72**) in excellent yield, Scheme 1.20. Subsequent conversion to the diaryldiol (**74**) allowed the direct intramolecular alkylation after the key hydrogenation of the furan (**73**). Due to the hydrogenolation process, this route only affords a *cis*-fused ring and once again, the intramolecular alkylation under acidic conditions gives only the *exo-exo* diastereoisomer.

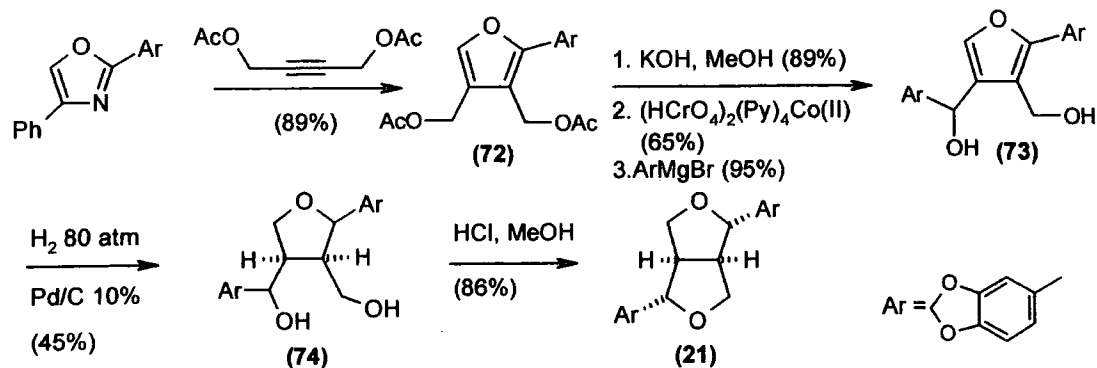

Scheme 1.20

A chiral approach involving THF intermediates has been reported by Ogasawara.²⁸ The strategy was based on a selective Heck reaction between dioxepin and a chiral *Z*-iodoalkene leading to an inseparable mixture of alkene isomers of *trans* substituted dioxepins (**75**), Scheme 1.21. Selective acid treatment led to different trisubstituted THFs (**76**, **77**). The titanium complex affords the synthesis of 2-3 *anti* 3-4 *syn* THFs (**76**) whereas the TBSOTf generates the 2-3 *syn* 3-4 *anti* THFs (**77**). This can be rationalised by the chelation of the titanium and the non-chelation of the silyl triflate generating different transition intermediates during the rearrangement. Then the aldehydes (**76** and **77**) were reduced with sodium borohydride to the corresponding alcohols (**78** and **79**).

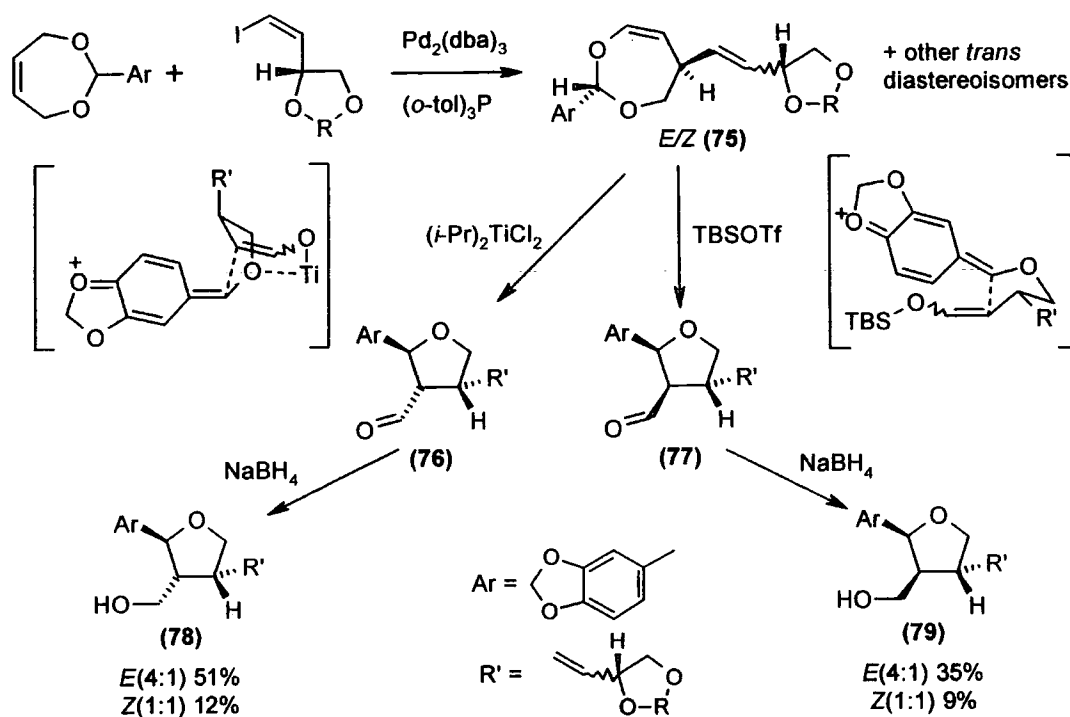

Scheme 1.21

Finally, oxidation with osmium tetroxide converted the alkenes (**78**) and (**79**) to the corresponding aldehydes (**80**) and (**82**), Scheme 1.22. In the case of the 3,4 *syn* THF (**80**), the cyclic hemiacetal (**81**) was formed directly. Treatment of the hemiacetal (**81**) with the aryl Grignard reagent followed by acidic treatment afforded the aryl substitution in an *exo* position and achieved the synthesis of (+)-Sesamin (**21**).²⁹ Concerning the 3,4 *anti* THF (**82**), the epimerisation of the C⁴ was realised in basic conditions to reach the acetal intermediate (**83**). Its treatment with trimethylsilyl chloride and imidazole followed by the aryl Grignard reagent afforded (-)-Asarinin (**22**).

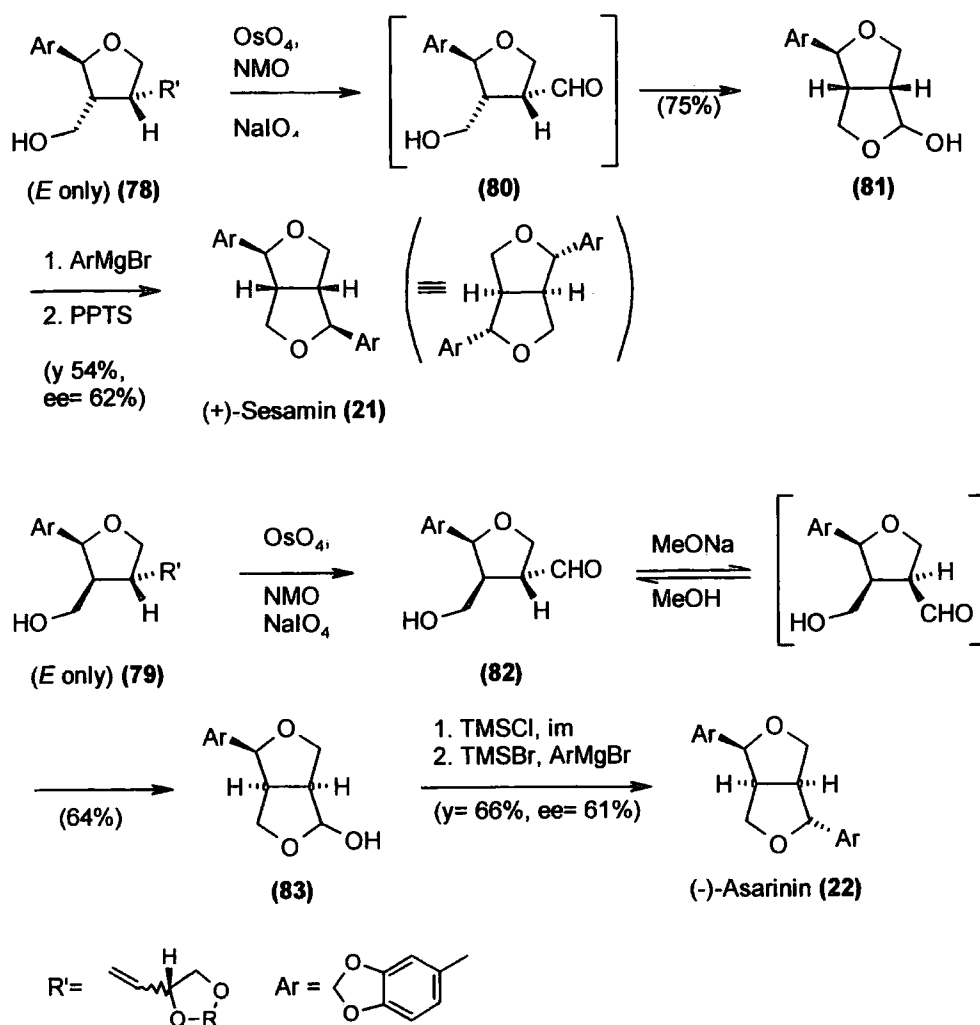

Scheme 1.22

The Heck reaction is the key step of this strategy, as the double bond is oxidised later, the configuration of the alkene is not important. However, a good selectivity in forming dioxepin (only the *trans* one) was determined. If (*E*)-iodoalkene was used in place of (*Z*)-iodoalkene, a complex mixture of *cis/trans* dioxepin and *E/Z* alkene was obtained.

1.3.3.3. From functionalised dihydrofurans

In a related strategy to that employed by Whiting,^{17,18} dihydrofurans, structurally close to THFs and butyrolactones have also been used as key intermediates in the syntheses of furofurans by the Steel group.³⁰ The *cis* dihydrofuran precursor (**85**) was generated by a selective thermal rearrangement of a vinyl epoxide (**84**), Scheme 1.23. After reduction of the ester (**85**) to the corresponding alcohol (**86**), the *in situ* preparation of the mixed acetal in the presence of a Lewis acid led to the furofurans (**87** and **88**) skeleton by cyclisation of the second furan ring.

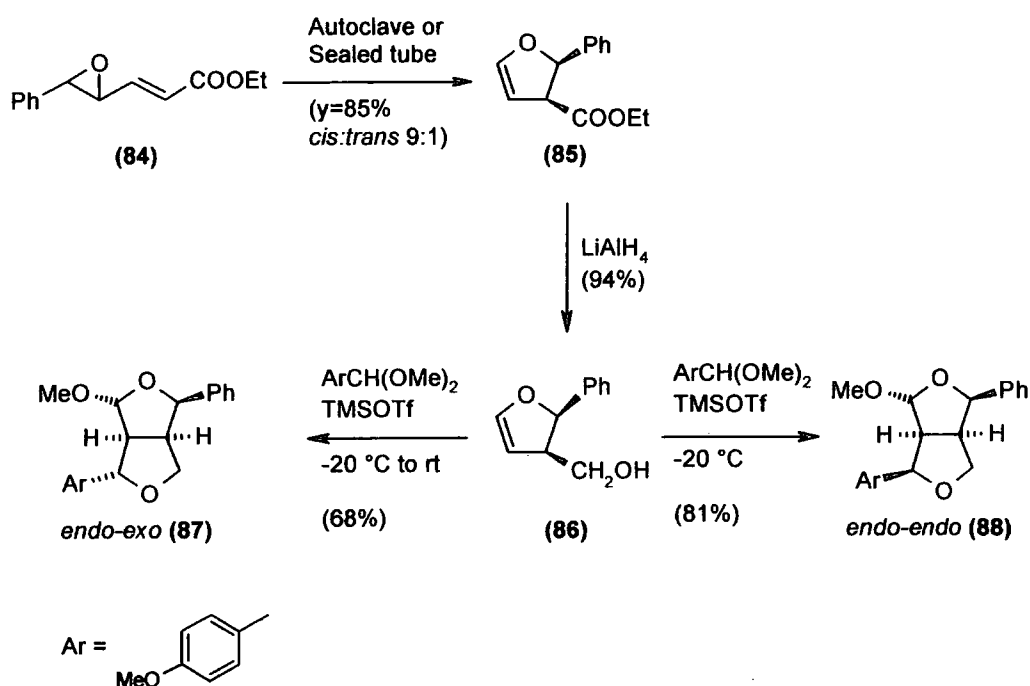

Scheme 1.23

The *cis* dihydrofuran sets the *endo* configuration of the first aryl group. Only a *cis* fused ring can be generated so the configuration of the C⁵ is set by the C¹ one. During the Lewis acid catalysed cyclisation, both the *exo* and *endo* configurations of the second aryl group could be obtained by controlling the temperature of the reaction. This strategy was demonstrated to be viable for a variety of C⁶ substituents although only moderate yields were recorded for some of them. More details on this strategy will be given further on in this thesis.

1.4. Aims of the project

This project was based on previous work within the Steel group (see previous section). The first targets were to adapt the existing methodology to the stereoselective synthesis of a natural *endo-endo* furofuran, Epiasarinin (**1**) and all the stereocombinations of furofurans. This work will be described respectively in Chapter 2 and 3. Chapter 4 will discuss attempts to enhance this methodology through the activation of the thermal rearrangement by Lewis acid catalysis and approach to an asymmetric version. To extend this strategy to unnatural aza analogues, the studies on furopyrroles are described in Chapter 5. Finally, all the experimental procedures and data of the synthesised products will be given in Chapter 6.

1.5. References

1. MacRae, W. D.; Towers, G. H. N. *Phytochemistry* **1984**, *23*, 1207.
2. Ward, R. S. *Chem. Soc. Rev.* **1982**, *11*, 75.
3. Whiting, D. A. *Nat. Prod. Rep.* **1985**, *2*, 191.
4. Enders, D.; Lausberg, V.; Del Signore, G.; Berner, O. M. *Synthesis* **2002**, 515.
5. Ward, R. S. *Nat. Prod. Rep.* **1999**, *16*, 75.
6. Ward, R. S. *Nat. Prod. Rep.* **1997**, *14*, 43.
7. Pelter, A.; Ward, R. S.; Watson, D. J.; Collins, P.; Kay, I. T. *J. Chem. Soc.-Perkin Trans. 1* **1982**, 175.
8. Maruyama, J.; Kobayashi, M.; Miyashita, M.; Kouno, I.; Irie, H. *Heterocycles* **1994**, *37*, 839.
9. Sugimoto, H.; Orito, K.; Yorita, K.; Ishikawa, M.; Shimoyama, N.; Sasaki, T. *J. Org. Chem.* **1995**, *60*, 3052.
10. Bhatnagar, S. P.; Weiss, U. *J. Org. Chem* **1977**, *42*, 3089.
11. Han, X. J.; Corey, E. J. *Org. Lett.* **1999**, *1*, 1871.
12. Yoshida, S.; Ogiku, T.; Ohmizu, H.; Iwasaki, T. *Tetrahedron Lett.* **1995**, *36*, 1455-1459.
13. Yoshida, S.; Ohmizu, H.; Iwasaki, T. *Tetrahedron Lett.* **1995**, *36*, 8225.

14. Yoshida, S.; Ogiku, T.; Ohmizu, H.; Iwasaki, T. *Synthesis* **1997**, 1475.
15. Ohmizu, H.; Ogiku, T.; Iwasaki, T. *Heterocycles* **2000**, *52*, 1399.
16. Yoshida, S.; Yamanaka, T.; Miyake, T.; Moritani, Y.; Ohmizu, H.; Iwasaki, T. *Tetrahedron Lett.* **1995**, *36*, 7271.
17. Stevens, D. R.; Whiting, D. A. *Tetrahedron Lett.* **1986**, *27*, 4629.
18. Stevens, D. R.; Till, C. P.; Whiting, D. A. *J. Chem. Soc., Perkin Trans. 1* **1992**, 185.
19. Brown, R. C. D.; Hinks, J. D. *J. Chem. Soc., Chem. Commun.* **1998**, 1895.
20. Brown, R. C. D.; Bataille, C. J.; Bataille, C. J. R.; Bruton, G.; Hinks, J. D.; Swain, N. A. *J. Org. Chem.* **2001**, *66*, 6719.
21. Adhikari, S.; Roy, S. *Tetrahedron Lett.* **1992**, *33*, 6025.
22. Maiti, G.; Adhikari, S.; Roy, S. C. *Tetrahedron Lett.* **1994**, *35*, 6731.
23. Mandal, P. K.; Maiti, G.; Roy, S. C. *J. Org. Chem.* **1998**, *63*, 2829.
24. Rana, K. K.; Guin, C.; Roy, S. C. *Tetrahedron Lett.* **2000**, *41*, 9337.
25. Rana, K. K.; Guin, C.; Roy, S. C. *Synlett* **2001**, 1249.
26. Hull, H. M.; Jones, R. G.; Knight, D. W. *J. Chem. Soc., Perkin Trans. 1* **1998**, 1779.
27. Chen, B. Z.; Ye, X. L.; Chen, Q. Q. *Synth. Commun.* **1998**, *28*, 2831.
28. Samizu, K.; Ogasawara, K. *Chem. Lett.* **1995**, 543.
29. Takano, S.; Ohkawa, T.; Tamori, S.; Satoh, S.; Ogasawara, K. *J. Chem. Soc., Chem. Commun.* **1988**, 189.
30. Aldous, D. J.; Dutton, W. M.; Steel, P. G. *Synlett* **1999**, 474.

CHAPTER TWO

Synthesis of Epiasarinin

2.1 Introduction

Since the biological activities of lignans have been reported, natural furofurans have become synthetic targets for many groups. As discussed in the previous chapter, the two main challenges in the synthesis of furofurans are the control of the stereochemistry at the ring junction and the configuration of the aryl substituents. The aim of this project was to develop simple methodology which generated selectively all the combinations of stereocentres, allowing access to all the lignans. The principal aim is to synthesise the natural furofuran, Epiasarinin (**1**).

Our research group has been working on the synthesis of furofurans for a number of years, using a thermal rearrangement as a key step. The results obtained previously will be presented in the next section, then the aims of this thesis will be described.

2.1.1. Previous work in our group

As reported previously, our group had developed a strategy for the synthesis of furofurans based on two key reactions. The first consisted of the thermal rearrangement of a vinyl epoxide (**84**) to a *cis* dihydrofuran ester which is reduced to the corresponding alcohol (**86**). The second was the Lewis acid mediated cyclisation of the *cis* dihydrofuryl alcohol (**86**) to give either furofuran (**88**) or (**89**), Scheme 2.1.³¹ The thermal rearrangement selectively leads to the *cis* dihydrofuran (**85**) and sets the aryl group at the C² position in an *endo* configuration. In the Lewis acid cyclisation, the selectivity has been shown to be temperature dependant and can selectively give either *endo* or *exo* aryl substitution at the C⁶ position, with *cis* fused rings in each case. These two key steps will be described with more detail in the appropriate sections.

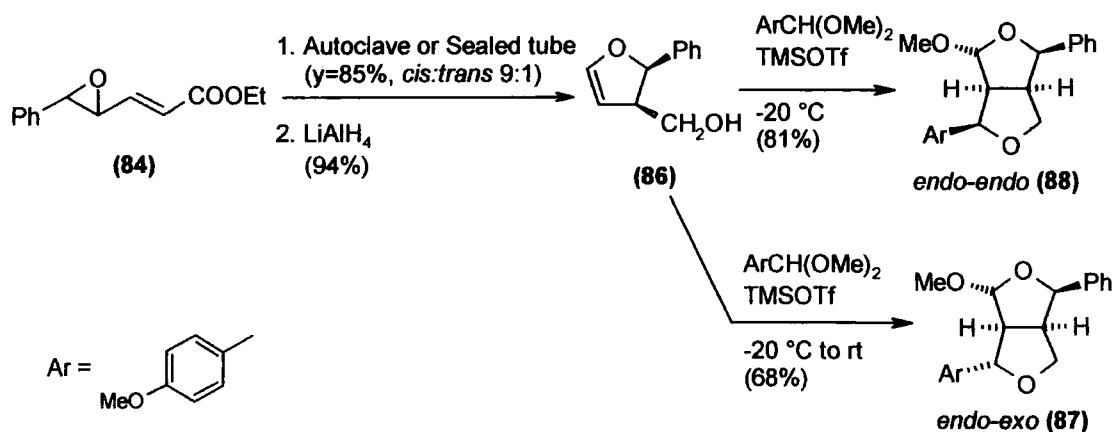

Scheme 2.1

To synthesise natural lignans, the reduction of the glycosidic bond is required. In a limited approach, the reduction was studied on a model system, the *endo-endo*-diphenyl furofuryl acetal (**89**). Attempts with triethylsilane and boron trifluoride diethyl ether complex led to the corresponding diphenyl furofuran (**90**) with retention of stereochemistry, in 61% yield, Scheme 2.2.

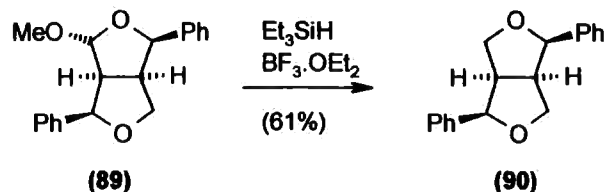

Scheme 2.2

2.1.2. Synthetic challenge

As the established methodology leads to *endo-endo* furofurans and no synthesis of a natural *endo-endo* lignan has been reported, the first aim was to synthesise a natural lignan using this approach. Syntheses of Sesamin (**21**) (*exo-exo*) and Asarinin (**22**) (*endo-exo*) have been largely explored (see section 1.3), so Epiasarinin (**1**), the *endo-endo* diastereoisomer of Sesamin and Asarinin seemed an appropriate target, Figure 2.1. Biological activities have been found for these diastereoisomers: Asarinin, Sesamin and the target molecule Epiasarinin were extracted from the plant *Asiasarum heterotropoides var. mandshuricum* which has been used in traditional Chinese medicine as an anti-tussive, expectorant and anodyne. These three diastereoisomers are also reported to inhibit Δ^5 desaturase, which catalyses the transformation of dihomono- γ -linolenic acid to arachidonic acid.³² Asarinin has also anti-tumour promotion and anti-allergic activity.³³

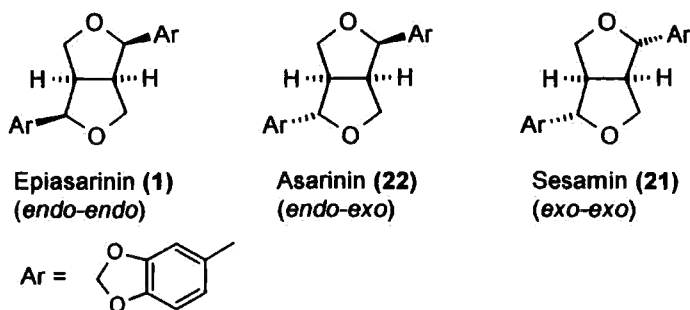
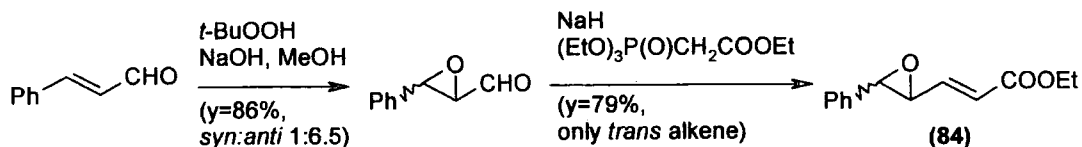

Figure 2.1



Scheme 2.4

2.2.2. Extension to Epiasarinin synthesis and limitations of the first route

The two step route described previously seemed a good approach to the required ethyl 4,5-epoxy-5-sesamyl-pent-2-enoate (**94**). As the sesamyl analogue of cinnamaldehyde is not commercially available, it needed to be synthesised. A Wittig reaction with formylmethylene triphenylphosphorane ($\text{Ph}_3\text{P}=\text{CHCHO}$) and piperonal would give the desired aldehyde (**95**) directly, Scheme 2.5. Since piperonal should be more reactive than the conjugated aldehyde product, the formation of side-products by polymerisation should be limited.

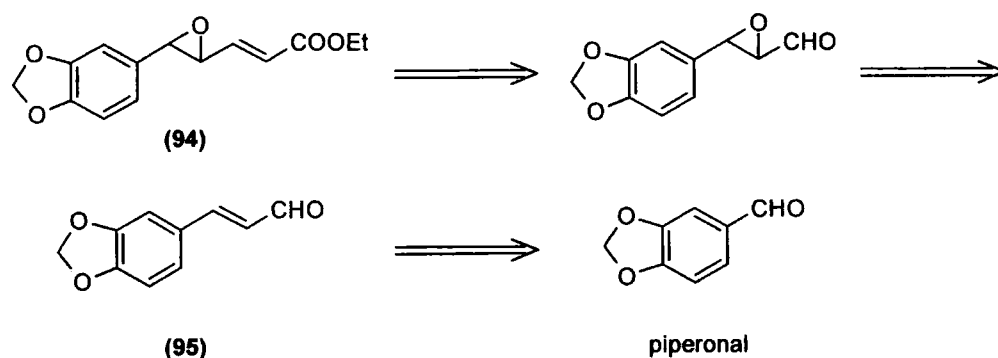

Scheme 2.5

Attempts to perform the Wittig reaction with piperonal in refluxing toluene led to a mixture of three compounds. Analysis of the ^1H NMR spectrum showed three singlets around 6 ppm, an area characteristic of the CH_2 of the sesamyl group, and one singlet and two doublets between 9 and 10 ppm confirming that the crude mixture contained three aldehydes. GC-MS analysis established that the obtained products were piperonal (m/z 150), the desired monoadduct of the Wittig (**95**) (m/z 176) and the diadduct (**96**) (m/z 202) in a ratio 5:4:1, Scheme 2.6. Other attempts of this reaction in benzene at reflux gave a mixture of the same three products in a 1:2.7:1.3 ratio. As the conversion and the selectivity of this reaction were not good, this route was abandoned.

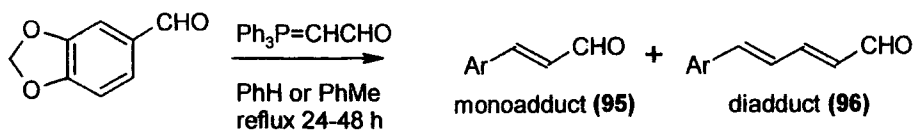

Scheme 2.6

As the selectivity of the Wittig reaction was low, a more efficient synthesis consists of a Wittig reaction with carbethoxy triphenyl phosphorane ($\text{Ph}_3\text{P}=\text{CHCOOEt}$) and piperonal followed by a reduction of the ester to the corresponding aldehyde, Scheme 2.7.

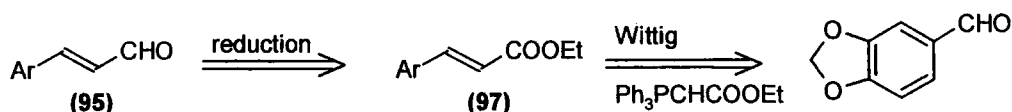

Scheme 2.7

The Wittig reaction of piperonal with carboethoxy triphenyl phosphorane afforded a single stereoisomer (97) in a good yield (88%), Scheme 2.8. The product was identified as the *trans* alkene from the coupling constant between the two ethylenic protons (7.59 and 6.26 ppm, $J=15.9$ Hz). The reduction of the ester (97) with DIBAL-H (1 equivalent) was expected to generate the corresponding aldehyde (96) directly. Unfortunately, treatment of the ester (97) gave a mixture of starting material (97) and alcohol (98) in a 1:1 ratio, and no trace of aldehyde (96) was detected. As it is frequently easier to selectively oxidise an alcohol to an aldehyde, than to selectively reduce the corresponding ester, a two step method based on reduction of the ester (97) to the alcohol (98) followed by its oxidation was considered. Therefore, the use of 2.5 equivalents of DIBAL-H led to the alcohol (98) in 80% yield, which was then oxidised with MnO_2 to give the desired aldehyde (96) in 95% yield. The structure was confirmed by a characteristic aldehyde signal at 9.64 ppm in the ^1H NMR spectrum.

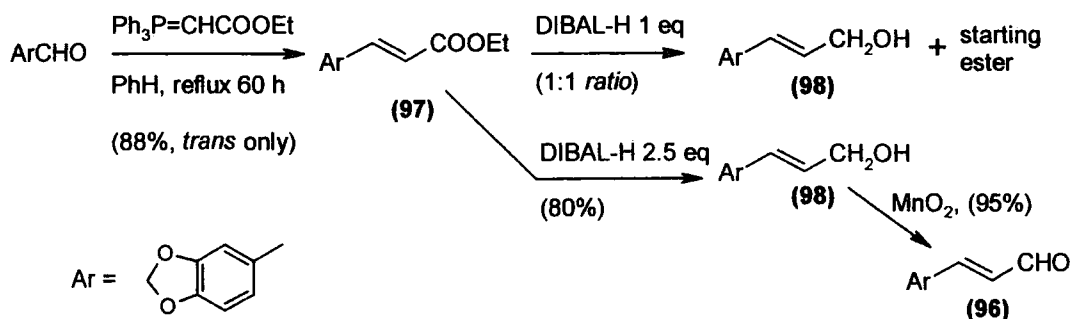

Scheme 2.8

Following the procedure previously established in the group, the epoxidation of the unsaturated aldehyde (**96**) was attempted with *t*-butyl hydroperoxide by the addition of NaOH (1M) to buffer the reaction at pH 10.5.^{34,35} No desired epoxide (**99**) was detected; however, GC-MS of the crude mixture was showed a molecular ion at 224 indicative of the opening of the epoxide by methanol, the reaction solvent, Scheme 2.9.

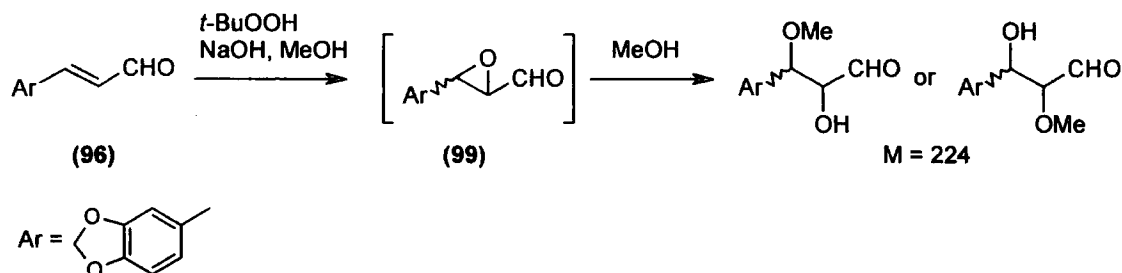

Scheme 2.9

An alternative strategy would involve the epoxidation of the allylic alcohol (**98**) followed by oxidation to the corresponding aldehyde, Scheme 2.10.

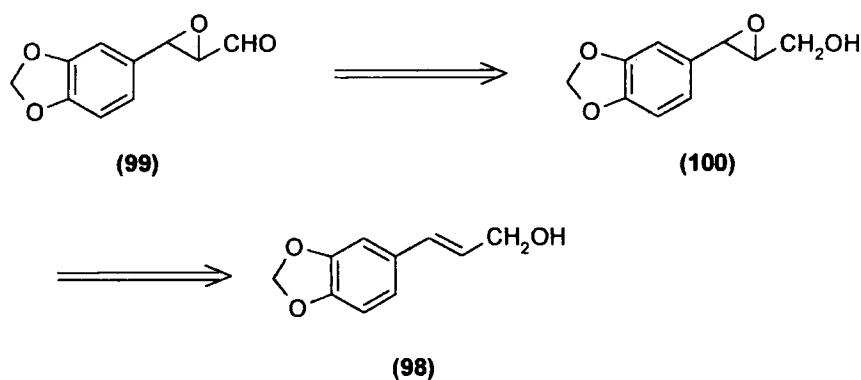

Scheme 2.10

Initial epoxidations of allylic alcohol (**98**) were attempted with *m*-CPBA, Scheme 2.11. At first, *m*-CPBA was used in DCM but no epoxide was obtained. GC-MS of the crude product showed for many GC peaks fragmentation in MS with the typical chlorine isotope pattern (³⁵Cl:³⁷Cl in 3:1 ratio) and the characteristic peaks of *m*-chlorobenzoyl cation ClC₆H₄CO⁺ at 139 and 141. Presumably, the epoxide underwent ring-opening via a nucleophilic attack of *m*-chlorobenzoic acid.

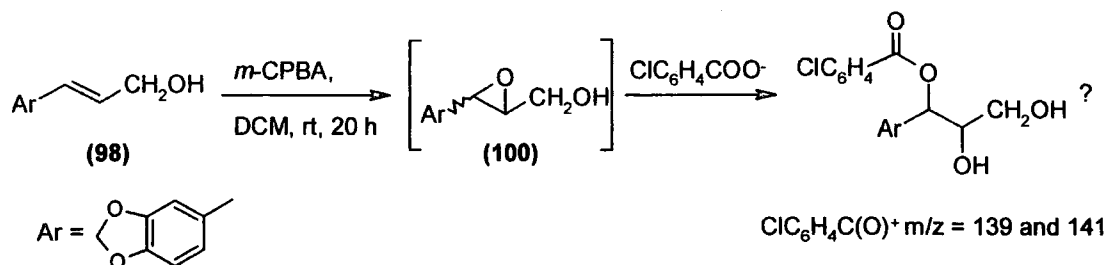

Scheme 2.11

To avoid this problem, the acid needs to be trapped, one way of isolating it from the generated epoxide is by keeping it in the aqueous layer of a biphasic reaction. Fringuelli, *et al.* reported a series of epoxidation of allylic alcohol using *m*-CPBA, aqueous sodium bicarbonate and a phase transfer catalyst, Scheme 2.12.³⁶

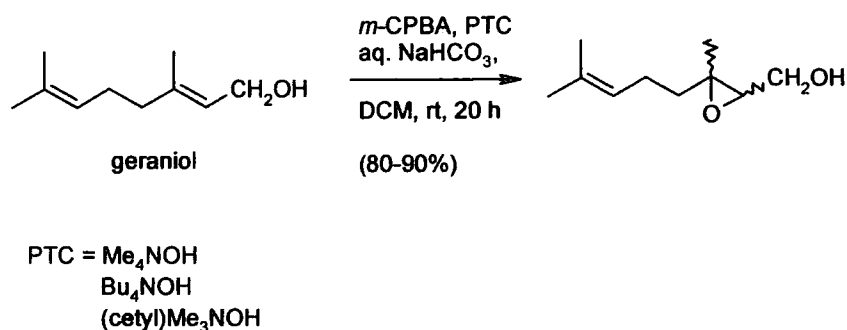

Scheme 2.12

Following Fringuelli procedure, a solution of aqueous sodium bicarbonate and a phase transfer catalyst, tetrabutylammonium bromide, were added to the reaction mixture containing the allylic alcohol (98). However, no epoxide (100) was generated under these conditions.

Assuming that the epoxide ring-opened in presence of acid, neutral epoxidising reagents such as dioxiranes were then attempted. Dioxiranes are largely used for epoxidation and are prepared from ketones and Oxone®, a commercially available triple salt containing KHSO_5 , the oxidant. As the isolation of the dioxirane is difficult, it is more convenient to prepare it *in-situ*. Yang, *et al.* reported the efficient epoxidation of olefins with methyl trifluoromethyl dioxirane, generated *in-situ*, and significant examples are shown in Scheme 2.13.³⁷

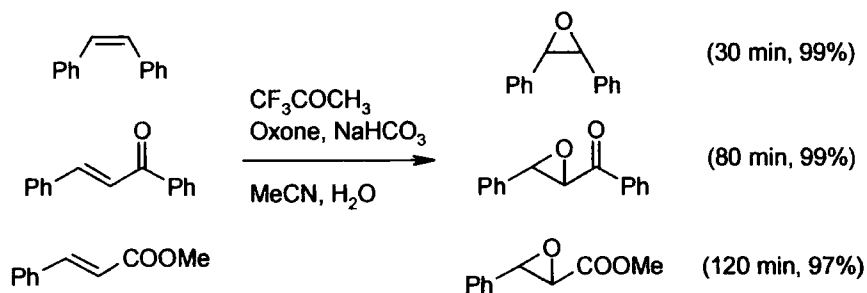

Scheme 2.13

Using Yang's procedure to generate dioxiranes,³⁷ no epoxide (**100**) was isolated. GC-MS data of the crude product mixture showed a molecular ion at 306. Therefore, the epoxide was suspected to be opened by water (solvent system) during the reaction to give a triol which then reacted with trifluoroacetone to give the trifluoroacetals (**101**, **102**, **103**) ($m/z=306$), Scheme 2.14.

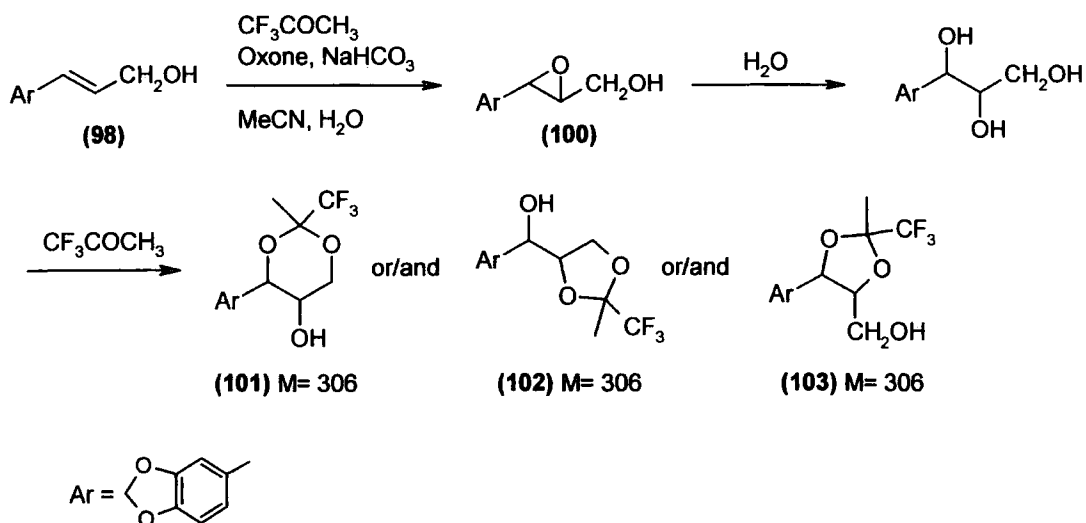

Scheme 2.14

Magnesium monoperoxyphthalate (MMPP), a neutral oxidant has been used by Brougham, *et al.* with a phase transfer catalyst in the epoxidation of cyclohexene, limonene and cholesterol with yields of 80 to 90%, Scheme 2.15.³⁸ Following this procedure initially at room temperature, no reaction with the allylic alcohol (**98**) was observed and after heating at 50 °C, only decomposition products were detected.

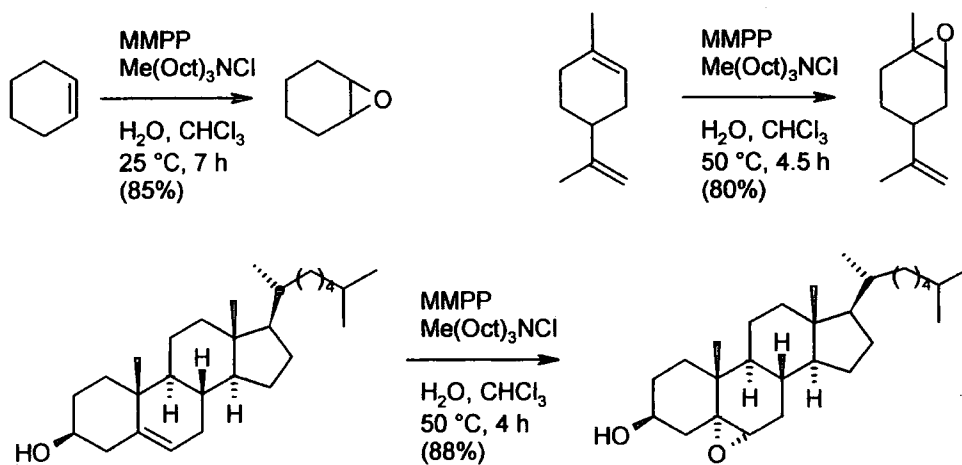

Scheme 2.15

Considering our system, the allylic alcohol should be an easy material to epoxidise, but all the attempts were unsuccessful. Presumably, the sesamyl group was involved in the opening of the epoxide. The electron rich substituents on the aryl ring may help the breaking of the carbon-oxygen bond of the epoxide, Scheme 2.16.

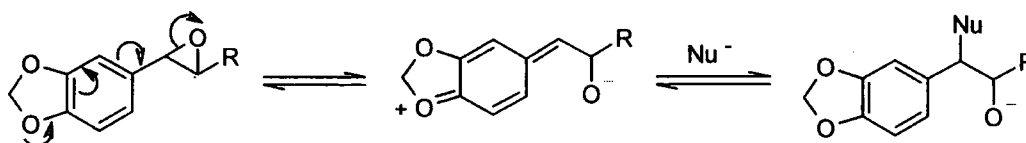

Scheme 2.16

Having experienced difficulties in epoxidising the unsaturated aldehyde and alcohol, other routes were then sought. One possibility was the epoxidation of an aryl diene. To investigate this strategy, ethyl *p*-methoxyphenyl propan-2,4-dienoate (**104**) was chosen as a model system (product already synthesised in our group). Precedents of selective epoxidations of dienes have been reported.^{39,40} For instance, Nemoto, *et al.* reported the epoxidation of different substituted hex-2,4-dienes with *m*-CPBA, Scheme 2.17.

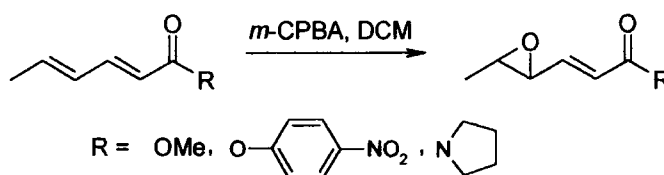

Scheme 2.17

Following Nemoto's procedure, a mixture of products was obtained with *m*-CPBA but no monoepoxide (**105**) was isolated. By GC-MS of the crude material, it was observed that some of the products contained chlorine (characteristic isotopic pattern in a *ratio* of 3:1 and characteristic peaks at 139 and 141 of *m*-chlorobenzoyl) which implied that the *m*-chlorobenzoic acid reacted with the generated epoxide (**105**), Scheme 2.18. To avoid this attack, attempts to scavenge the acid with solid potassium carbonate resulted in a complete inhibition of the reaction.

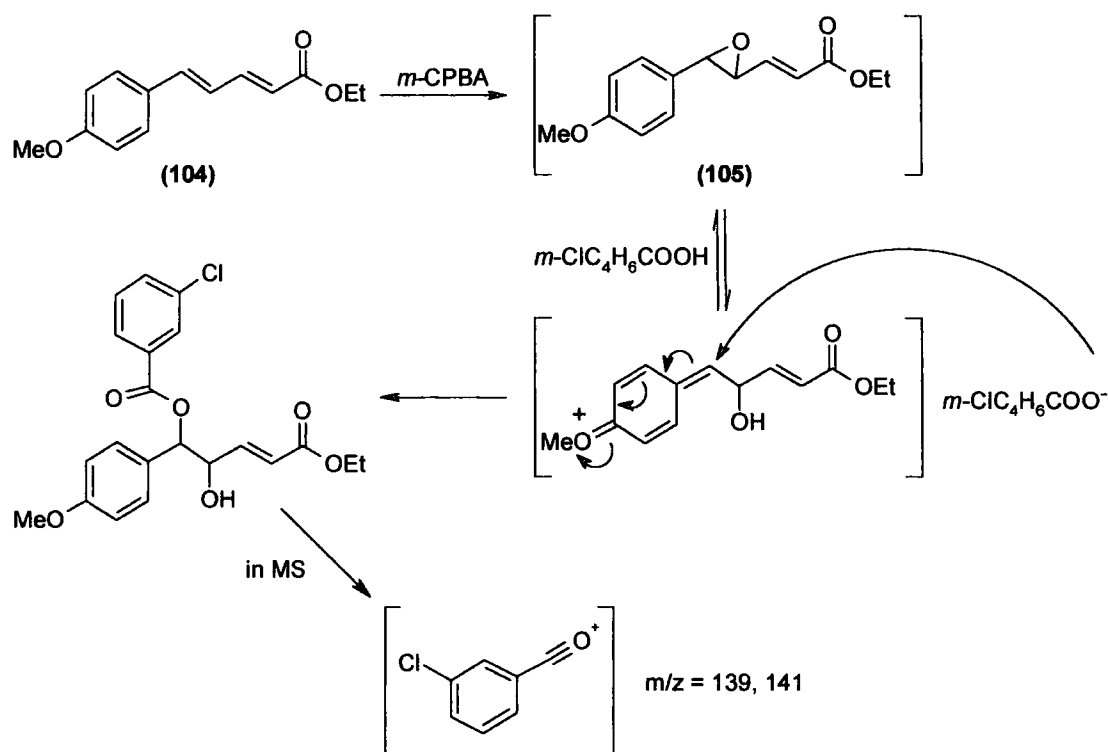

Scheme 2.18

Neutral epoxidising reagents were also used in selective epoxidations of dienes. Ley, *et al.* succeeded in the epoxidation of several hex-2,4-dieneones with DMDO (dimethyldioxirane), Scheme 2.19.^{41,42}

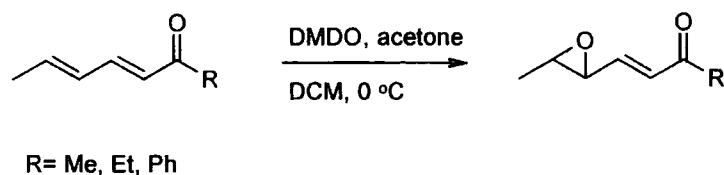

Scheme 2.19

However, no reaction was observed when DMDO prepared *in-situ* with Oxone® and acetone was used on the model system (**104**). Direct epoxidation of alkenes was abandoned after these failures and an alternative procedure was then developed to bypass these problems affording the target vinyl epoxide in a single step.

2.2.3. Direct synthesis of vinyl epoxides via Darzens condensation

An alternative route to synthesise vinyl epoxides was required. Koppel, *et al.* published the synthesis of phenyl vinyl epoxide (**107**) via a Darzens condensation of an aldehyde with bromocrotonate (**106**).⁴³ Starting with benzaldehyde, methyl bromocrotonate and potassium *t*-butoxide in *t*-butanol, phenyl vinyl epoxide (**107**) was obtained as a mixture of *syn:anti* isomers in a 3:7 ratio in 70% yield, Scheme 2.20.

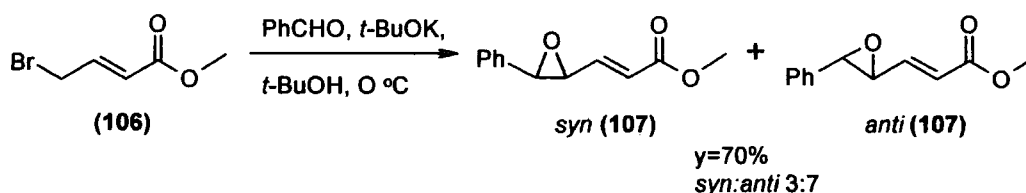

Scheme 2.20

As the Darzens condensation seemed to be a promising strategy, reaction with piperonal was attempted, Scheme 2.21. The ¹H NMR spectrum showed a large amount of starting materials but also showed a small amount of expected vinyl epoxide (**108**), approximately 15% (several singlets for the sesamyl CH₂ at 6 ppm and two doublet of doublets for the C³ ethylenic protons between 6 and 7 ppm). The very low conversion was attributed to the insolubility of potassium *t*-butoxide and the viscosity of *t*-butanol at room temperature. Also, to be sure that the sesamyl group wasn't responsible for this low reactivity, the following study of this reaction was performed on a model system, using benzaldehyde instead of piperonal. Although, increasing the temperature of the reaction improved the homogeneity of the mixture, no significant change in the conversion rate was observed. These results suggested that Koppel used a cosolvent to perform this reaction. With this in mind, different base and solvent systems were then explored.

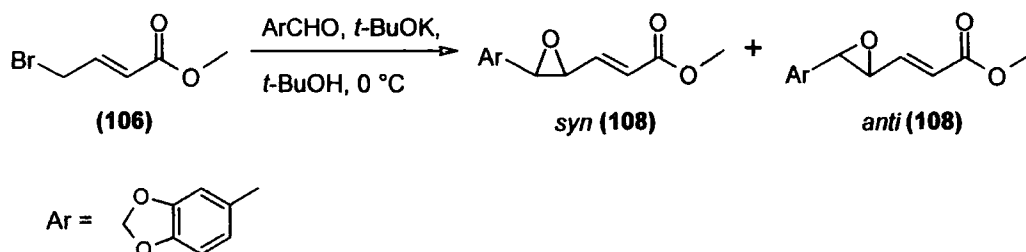

Scheme 2.21

By choosing a stronger base, LDA and carrying out the reaction in THF at -78°C , the conversion was improved to 23%. However, the product (**107**) couldn't be isolated from the large amount of residual starting materials, so the composition of the mixtures was determined by ^1H NMR of the crude product with particular attention being paid to the peaks of the ethylenic protons (C^3) of the bromocrotonate and the vinyl epoxide. As some by-products were detected during this reaction and a competitive process could be a Cannizzaro reaction generating benzyl alcohol and benzoic acid, the order of the addition of the starting materials could be crucial. It was found that adding the base to a mixture of aldehyde and bromocrotonate reduced the amount of by-products. Also, increasing the number of equivalents of base improved the conversion. Attributing the low conversion to a problem of reaction kinetics, the reaction was performed at higher temperatures -40 , -20 and 0°C . Finally, a complete conversion was observed when 2 equivalents of LDA were added to a mixture of 1.2 equivalent of benzaldehyde and 1 equivalent of bromocrotonate at 0°C and phenyl vinyl epoxide (**107**) could be obtained in 50% yield after flash chromatography, Scheme 2.22.

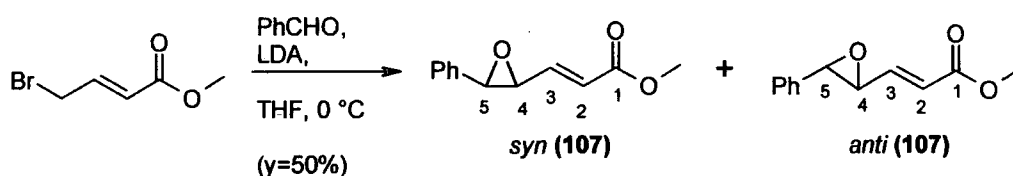

Scheme 2.22

Subsequently, this method was extrapolated to piperonal and worked well on small scale (1.5 mmol of bromocrotonate), Scheme 2.23. However, when the reaction was scaled up (6 mmol), the bromocrotonate wasn't entirely consumed and mainly decomposition products were obtained. The Darzens condensation on piperonal was successfully realised by modification of the conditions, at -20°C with 4 equivalents of piperonal ensuring all the bromocrotonate (17 mmol) reacted. During the aqueous work up, the excess piperonal was removed by treating with sodium bisulphite to give the

corresponding water soluble salt. Finally, the desired epoxide (**108**) was obtained after purification by flash chromatography in 70% yield in a *syn:anti* mixture of 3:4. Only the *trans* configuration was observed for the alkene ($J_{2-3 \text{ syn}}=15.8 \text{ Hz}$ and $J_{2-3 \text{ anti}}=15.6 \text{ Hz}$). The two isomers couldn't be separated by flash chromatography but were isolated by preparative HPLC to be fully characterised. The *syn* and *anti* compounds were distinguished by the coupling constant between the two protons at the C⁴ and C⁵ positions ($J_{4-5 \text{ syn}}=4 \text{ Hz}$, $J_{4-5 \text{ anti}}=1.5 \text{ Hz}$).

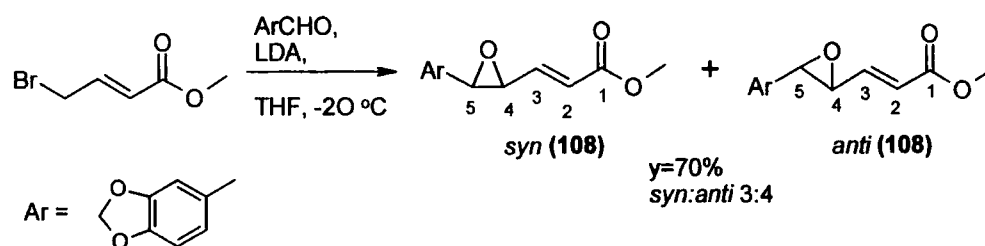

Scheme 2.23

With the vinyl epoxide (**108**) in hand, we could now try to convert it into the corresponding dihydrofuran by a thermal rearrangement, the first key step of our strategy.

2.3. Thermal rearrangement

2.3.1. Introduction

Small rings are frequently used as precursors of bigger cyclic systems. Thermal rearrangements of vinyl-cyclopropanes ($Z=\text{CH}_2$), -epoxides ($Z=\text{O}$) and -aziridines ($Z=\text{NH}$) to the corresponding five-membered rings have been widely studied in the last two decades. Three mechanisms have been proposed for the conversion of the three- to the five-membered ring systems, Scheme 2.24.⁴⁴ The first mechanism (A) is a concerted $2\sigma-2\pi$ reorganisation into the five-membered ring. In the second (B), a heterolytic fission of the three-membered ring gives an ylid type intermediate (**109**), which cyclises to the five-membered ring. In the third mechanism (C), homolytic fission and the subsequent recombination of the diradical (**110**) leads to the five-membered ring. In all these mechanisms, the driving force is the release of the strain from a three- to a five-membered ring. The precise pathway followed depends on the atom (Z) and on the configuration and the chemical properties of the substituents R and R'.

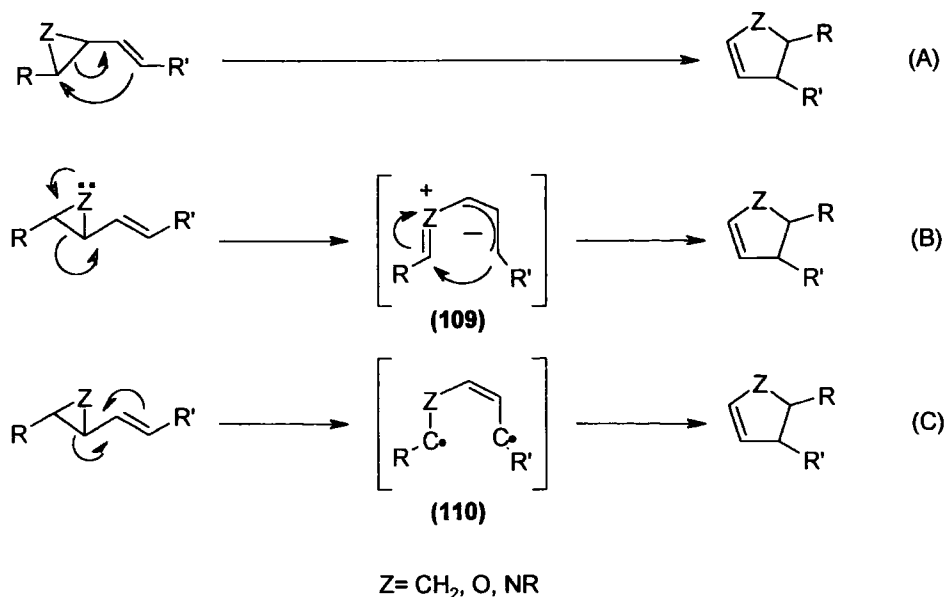

Scheme 2.24

The vinyl epoxide rearrangement is generally believed to involve a 4π electron conrotatory opening of the epoxide to afford an ylid species followed by a 6π electron disrotatory closure.⁴⁵ The thermal rearrangement shows some diastereoselectivity and leads preferentially to the *cis* dihydrofuran. Eberbach, *et al.* presumed that the ylid transition state (111) of the *trans* dihydrofuran is less favoured due to more steric hindrance than the one (112) which leads to the *cis* structure, Scheme 2.25.^{46,47}

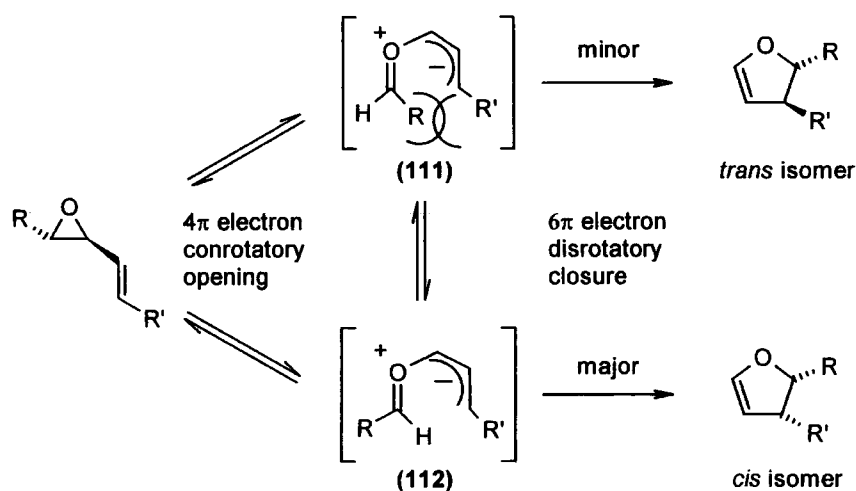

Scheme 2.25

In the process of the thermal rearrangement, racemisation of the epoxide occurs reflecting the planar geometry of the ylid transition state.^{46,47} In support of this mechanism, Crawford, *et al.* reported that racemisation of the chiral deuterium vinyl epoxide (**113**) occurs six times faster than the disrotatory ring closure, Scheme 2.26.⁴⁸ Therefore, the stereochemistry of the epoxide doesn't need to be controlled so all our experiments would start with a mixture of *syn* and *anti* epoxides.

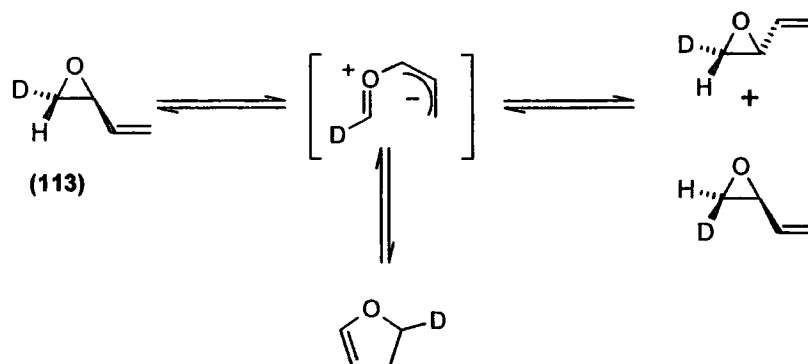

Scheme 2.26

2.3.2. Thermal rearrangement of vinyl epoxide in the synthesis of lignans

The vinyl epoxide-dihydrofuran rearrangement is a key step in Steel's strategy to generate the furofuran skeleton.³¹ Starting with a solution of the phenyl vinyl epoxide (**84**) in toluene, the rearrangement was carried out either in sealed tubes at 200 °C for 18 hours, or in autoclave at 205 °C for 8 hours (at a measured pressure of 30 bar). The thermal rearrangement yielded a mixture of *cis* and *trans* dihydrofurans (**85**) in a 9:1 ratio in a 70 to 85% yield, Scheme 2.27.

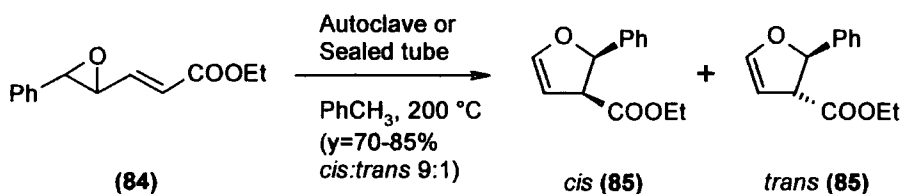

Scheme 2.27

To utilise this strategy to synthesise Epiasarinin, the rearrangement of sesamyl vinyl epoxide (**108**) was required. Initial attempts under the same conditions as described for the phenyl vinyl epoxide (**84**) (Scheme 2.27) led only to decomposition. Given that the electron-donating group on the aryl substituent can help the reaction by stabilising the benzylic carbocation of the ylid intermediate (**115**), Scheme 2.28, lower temperatures might be sufficient and reduce decomposition patterns.

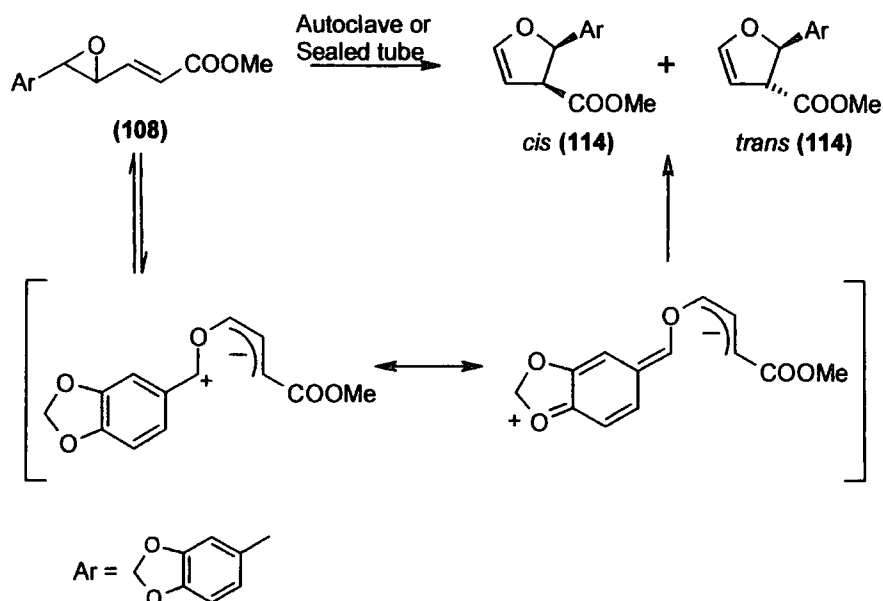

Scheme 2.28

Following this idea, the reaction was then attempted at lower temperatures and followed by ^1H NMR in sealed NMR tubes, using D_8 -toluene as solvent. Starting at 120°C , the temperature was increased with no reaction being observed until 180°C . At this temperature, consumption of the vinyl epoxide (**108**) was complete after 18 hours. However, the ^1H NMR spectrum of the crude mixture was too complicated to allow identification of the dihydrofuryl esters (**114**) peaks. Suspecting that the problem could have been an acid-catalysed decomposition of the starting materials or products on the surface of the reaction vessels, the tube was then treated with base (sodium bicarbonate) or silylated (mixture of *bis*-(trimethylsilyl)-acetamide and pyridine). Unfortunately, no improvement was noticed. In all cases, the crude products were complex mixtures which proved to be inseparable by a variety of chromatography techniques (flash chromatography, preparative TLC, preparative LC).

To avoid decomposition, the reaction was then repeated for a shorter time (12 hours) at 180 °C in an untreated tube. After purification by flash chromatography, a mixture of two products was collected in a 65% yield. The GC-MS (CI, NH₃) showed for both products, a molecular peak at 266 (=M, NH₄⁺). These could correspond to the molecular peak plus ammonium of starting epoxides (**108**) or generated dihydrofurans (**114**). As the fragmentation pattern was different to the one of starting vinyl epoxides (**108**), it was proposed that the two compounds were the expected dihydrofurans (**114**).

In order to provide sufficient material to permit isolation and characterisation of the products, the reaction was repeated in a normal sealed tube (50 mL). After several attempts, the crude mixture was successfully purified by flash chromatography to afford two fractions. One contained a pure dihydrofuryl isomer (**114**) (10% yield) and the ¹H NMR indicated a *trans* configuration (C⁴H, 5.74 ppm, doublet, J₃₋₄ *trans*=7.4 Hz). The other fraction was a mixture of the *cis* dihydrofuryl isomer (**114**) (C⁴H, 5.57 ppm, doublet, J₃₋₄ *cis*=11.2 Hz) and some starting material (estimated yield by ¹H NMR of dihydrofuran 35%), Figure 2.2. Even if this method gave the expected compounds, it was not reproducible so other conditions were attempted.

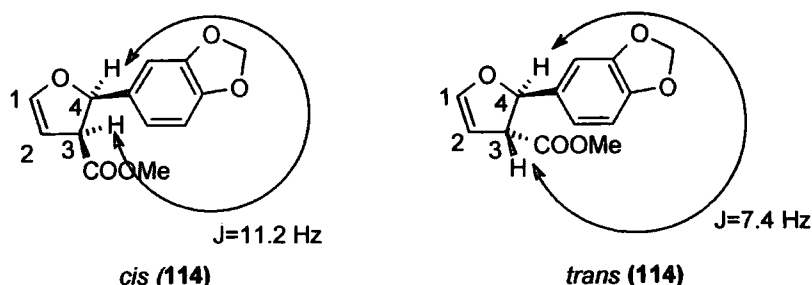
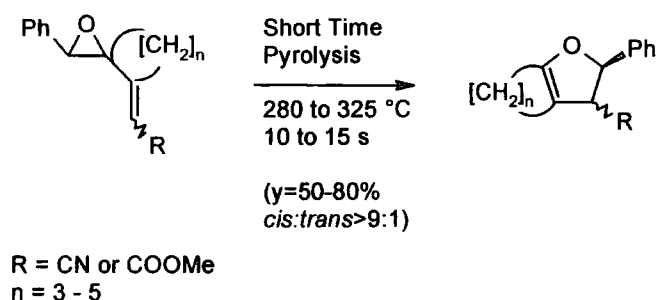

Figure 2.2

2.3.3. Flash Vacuum Pyrolysis

As the vinyl epoxide-dihydrofuran rearrangement in a sealed tube was not reproducible and the yields were low, another method needed to be developed. Thermal rearrangements have also been carried out using flash vacuum pyrolysis (FVP), Scheme 2.29. This method allows higher temperatures but for a much shorter time so it avoids decomposition of either the starting materials or products. Eberbach, *et al.* reported results with short-time pyrolysis but does not give comprehensive experimental description.^{47,49} A solution of starting material in benzene seemed to be introduced under a nitrogen flow in a glass tube which was heated at around 300 °C. The product was trapped in a flask cooled to -20 °C.



Scheme 2.29

As our apparatus was different to the one used by Eberbach, the method was first attempted on a model system, the phenyl vinyl epoxide (**84**), which was easily converted to the corresponding dihydrofuran under sealed tube conditions.

The starting material needs to be volatilised into the reaction column through the FVP oven under vacuum and the use of a Kügelrohr oven (KR) seemed a good idea to have an horizontal set-up, Figure 2.3. Finally, the product is collected in the flasks cooled in a dry ice bath. There are several parameters which effect the efficiency of the FVP reaction:

- the temperature T1 of the Kügelrohr oven
- the temperature T2 of FVP oven
- the pressure P
- the mass w of packing with glass wool.

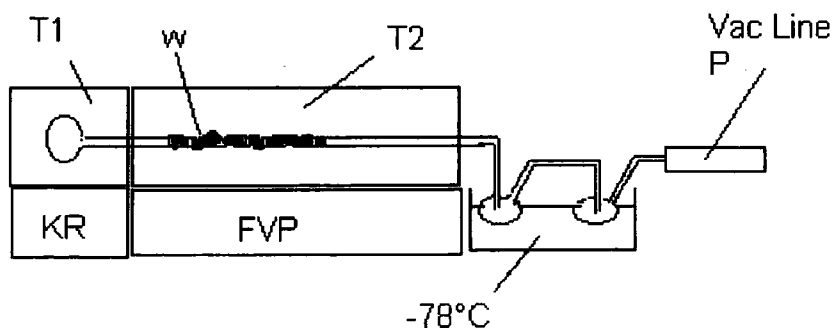

Figure 2.3

Initially, to better understand the importance of these various factors, experiments were undertaken using integration of the ^1H NMR signals to calculate different ratios:

- $trans/cis$ ratio = $H_{a\ trans}/H_{a\ cis}$
- conversion rate = $(H_{a\ trans}+H_{a\ cis}) / (H_{a\ trans}+H_{a\ cis}+H_{\alpha})$
- degradation rate = $H_{deg} / (H_b+H_{deg})$

It was easy to calculate the conversion rate and the ratio $cis:trans$ from the integration of characteristic peaks (H_{α} and H_a) of the spectra, Table 2.1. It was harder to estimate the amount of decomposition as the degradation products were not identified and the integration not attributed to a definite number of protons. Therefore, it was decided to use the integration of the area 9.6-9.4 ppm as a reference.

Table 2.1

| proton | chemical shift in ppm (300 MHz) |
|----------------|------------------------------------|
| H_{deg} | 9.6-9.4 |
| H_{α} | 6.82 |
| $H_{a\ cis}$ | 6.72 |
| $H_{a\ trans}$ | 6.57 |
| H_b | 5.06 |

On the basis that it was more easily reproducible, the initial study was conducted without column packing and the pressure used being the lowest obtainable. Using 55 mg of starting phenyl vinyl epoxide (**84**) (0.25 mmol), the effect of the temperatures T1 and T2 was explored, Table 2.2.

Table 2.2

| P (mbar) | T1 (°C) | T2 (°C) | n_{SM} (mmol) | $trans:cis$ (85) | conversion (%) | degradation (%) |
|-------------|------------|------------|--------------------|------------------------------|-------------------|--------------------|
| 0.02 | 87.5 | 400 | 0.25 | 1:8 | 54 | 5 |
| 0.04 | 100 | 400 | 0.25 | 1:10 | 50 | 1 |
| 0.02 | 100 | 450 | 0.25 | 1:7 | 88 | 6 |
| 0.02 | 100 | 475 | 0.25 | 1:6 | 88 | 8 |
| 0.01 | 100 | 475 | 1 | 1:6 | 97 | 12 |
| 0.04 | 100 | 500 | 0.25 | 1:4 | 100 | 30 |
| 0.04 | >250* | 500 | 1.5 | 1:9 | 50 | 5 |

* Use of a heat gun instead of Kugelrohr oven, Figure 2.4

By increasing the FVP oven temperature (T2), the conversion improved up to 100%. However, the percentage of degradation also increased and the *cis:trans* selectivity was slightly reduced. As it is harder to remove the starting vinyl epoxides from the generated dihydrofurans than to purify the product from the degradation compounds, high temperature (475 °C) was preferred. When the reaction was scaled up, the conversion and the degradation both increased but the selectivity was maintained. A slow evaporation of the starting epoxide with the KR oven at 100 °C led to a better conversion than a fast introduction with the heat gun. This is probably due to the concentration of material in the FVP column and the reduction of the collisions with the column walls which induce the rearrangement.

Having identified the optimum conditions for the rearrangement of phenyl vinyl epoxide (**84**), extrapolation to the sesamyl analogue (**108**) was then attempted. However, the sesamyl vinyl epoxide required significantly higher temperature to be volatilised from the K ugelrohr oven to the FVP. The temperature of the KR oven (T1) was increased to 150 °C to compensate for this and hence; decomposition of the starting material was observed. In order to minimise the contact time at high temperature, a heat gun was used to volatilise the starting vinyl epoxide (**108**) rapidly into the FVP column. A K ugelrohr rotor was used to homogenise the heat which limited the initial decomposition, Figure 2.4. Due to the use of the rotation, the product was trapped by cooling the column with dry ice. As the apparatus was under vacuum, silicone grease was used at each glass joint except the one heated at high temperature for which a special high temperature grease (Rocol anti-seize compound J166®) was utilised.

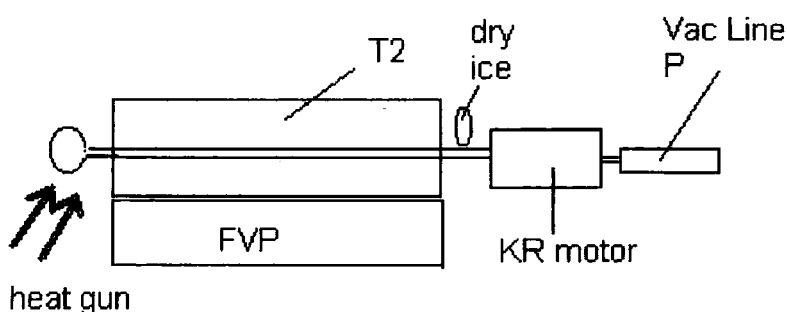
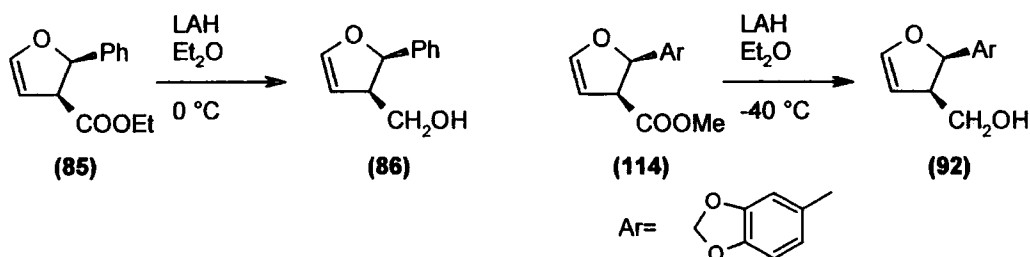

Figure 2.4

Ultimately, the optimum conditions for this rearrangement were found to be an FVP oven temperature of 500 °C and a pressure of approximately 0.04 mbar. The maximum loading of the sesamyl vinyl epoxide (**108**) permissible without significant decomposition during the volatilisation was 550 mg. Following this procedure, the rearrangement afforded a crude mixture of *cis:trans* sesamyl dihydrofurans (**114**) in an 8:1 *ratio* which were separated by flash chromatography to give the pure *cis* dihydrofuryl ester in 66% yield, and the corresponding pure *trans* dihydrofuran in 8% yield. The NMR spectra were identical to the previous ones obtained with sealed tubes. With a robust method to generate the *cis* sesamyl dihydrofuran (**114**), the focus returned to the total synthesis of Epiasarinin.

2.4. Reduction of the ester to the alcohol

In order to perform the Lewis acid catalysed cyclisation, it was necessary to reduce the ester to the corresponding alcohol. The phenyl analogue (**85**) has previously been reduced with lithium aluminium hydride in ether at 0 °C with complete conversion, Scheme 2.30.³¹ The resulting product (**86**) was not stable enough to allow a complete characterisation and was used immediately without further purification.



Scheme 2.30

An attempt to repeat the reduction of the sesamyl ester (**114**) under the same conditions was unsuccessful and led to decomposition products. After some optimisation, reduction of the sesamyl methyl ester (**114**) led to the corresponding alcohol (**92**) with quantitative conversion; in order to avoid decomposition of the product, it was achieved at a lower temperature (-40 °C). The disappearance of the methyl peak (3.30 ppm) in the ¹H NMR spectra confirmed the total consumption of the ester. The alcohol could only be stored for a couple of hours at -20 °C under argon without significant decomposition. Because of this low stability, the sesamyl dihydrofuryl alcohol (**92**) could not be fully characterised.

2.5. Lewis acid catalysed cyclisation

2.5.1. Introduction

The second key step in the strategy to synthesise furofurans is a Lewis acid mediated cyclisation. The principles behind this strategy involve the generation of the silyl ether (**116**) generated from the dihydrofuryl alcohol and the methyl oxonium (**117**). Similar methyl oxonium intermediates have been produced by treatment of dimethyl acetal with FSO_3H .⁵⁰ In theory, this oxonium intermediate (**117**) could also be formed *in-situ* from the aldehyde dimethyl acetal and trimethylsilyl triflate (TMSOTf) and liberating trimethylsilyl methoxide, Scheme 2.31. After adding the silyl ether, the mixed acetal (**118**) would be generated. Loss of trimethylsilyl methoxide would give the acyclic oxonium cation (**119**), which would cyclise to the cyclic oxonium intermediate (**120**). The *cis*-ring fusion should be favoured over the *trans* as it is less strain. The final oxonium cation would be then quenched with a nucleophile.

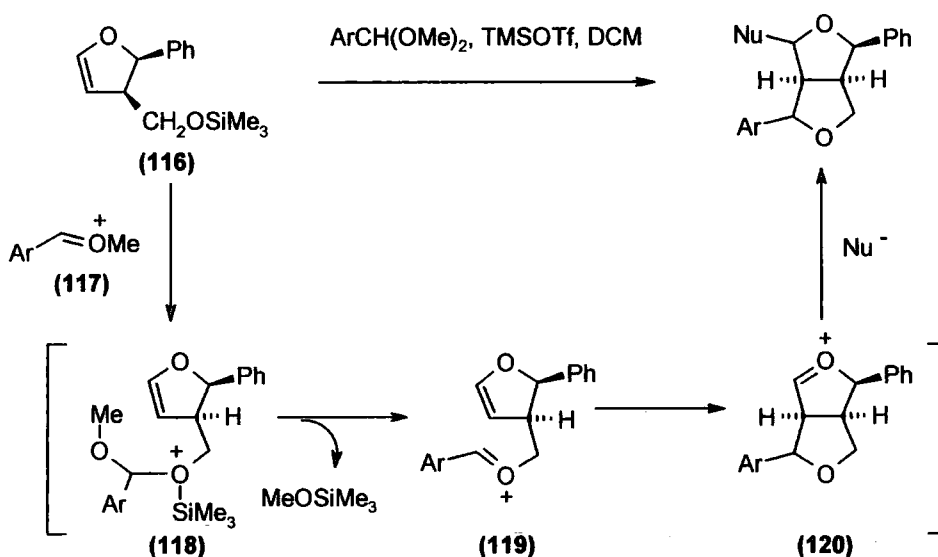

Scheme 2.31

As in the previous chapter, the furofuryl skeletons will be labelled by their configuration at the C^2 , and C^6 positions using 'endo' and 'exo' relating to the bridgehead protons at the ring fusion, Figure 2.5. The stereochemistry at the C^4 position will be specified individually and will not be part of the nomenclature.

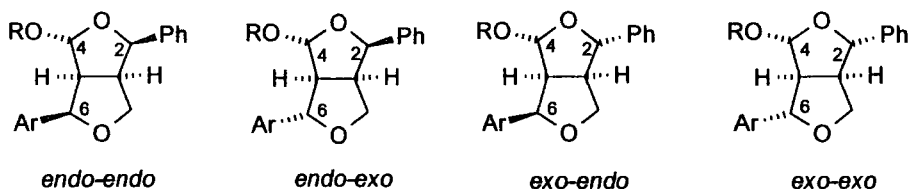
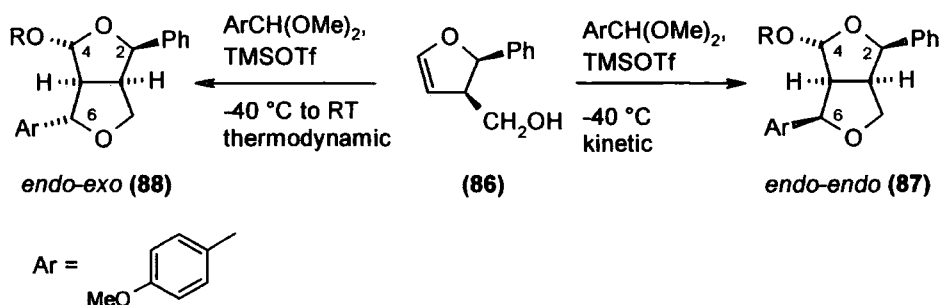

Figure 2.5

Previous studies in the group have attempted to isolate the silyl ether (**116**) but it appeared to be unsuccessful. It was then tried to generate it *in-situ* from the dihydrofuryl alcohol (**86**) and 1.1 equivalents of TMSOTf and make it react with carbonyle species, Scheme 2.32.³⁵ The study revealed that the aldehyde needs to be activated as the dimethyl acetal for any reaction to occur. As expected, the cyclisation led only to *cis* ring fusion. The methanol liberated from the dimethyl acetal acted as a nucleophile and quenched the oxonium intermediate on the less hindered face, setting the glycosidic bond at the C⁴ position in an *exo* configuration. Control of the reaction temperature leads selectively to either the *endo-endo* or *endo-exo* furofuran.



Scheme 2.32

A mechanism was proposed to explain this selectivity, Scheme 2.33. It consists of a chain of equilibrium which leads selectively to either one or the other diastereoisomer depending on the temperature employed. It was assumed that the oxonium intermediate (**119**) would adopt preferably an *E* configuration. The *endo* oxonium intermediate (**121**) is presumed be more favoured than the *exo* one (**123**), due to steric hindrance. The second oxonium intermediate (**120**) would have the bicyclic structure and the *exo* configuration of the intermediate (**124**) would be more favoured than the corresponding *endo* structure (**122**).

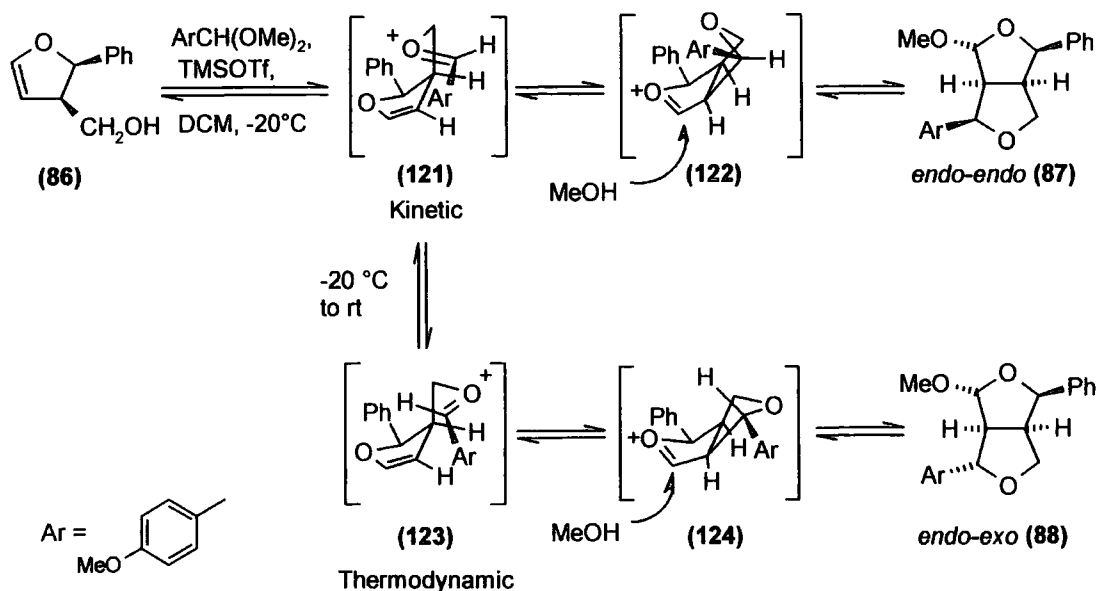

Scheme 2.33

It was subsequently observed that only the intermediates with electron-donating aryl groups (*p*-methoxyphenyl, sesamyl) were able to form the *exo* configuration, other aryl groups (phenyl, *p*-bromophenyl and methyl) led to the *endo-endo* structure even at room temperature, Scheme 2.34.³⁵

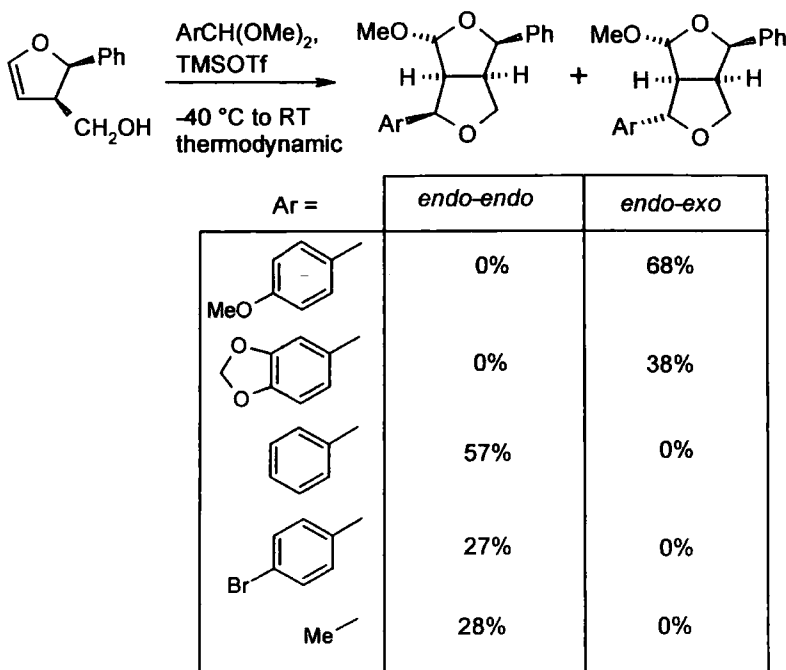

Scheme 2.34

These results imply that the *endo-exo* intermediate derives from the *endo-endo* furofuryl structure and that the *endo-exo* compound needs an activated substituent on the aryl group to reopen the furofuran skeleton and epimerise. Different mechanisms are suggested for this epimerisation to occur, Scheme 2.35. The opening can occur at the oxonium (120) stage (A) or with the furofuryl acetal (87) by the liberation of the methoxide (B1) or by breaking the carbon C⁶ – oxygen bond (B2). These results also indicate that there is no equilibrium between species (121) and (123).

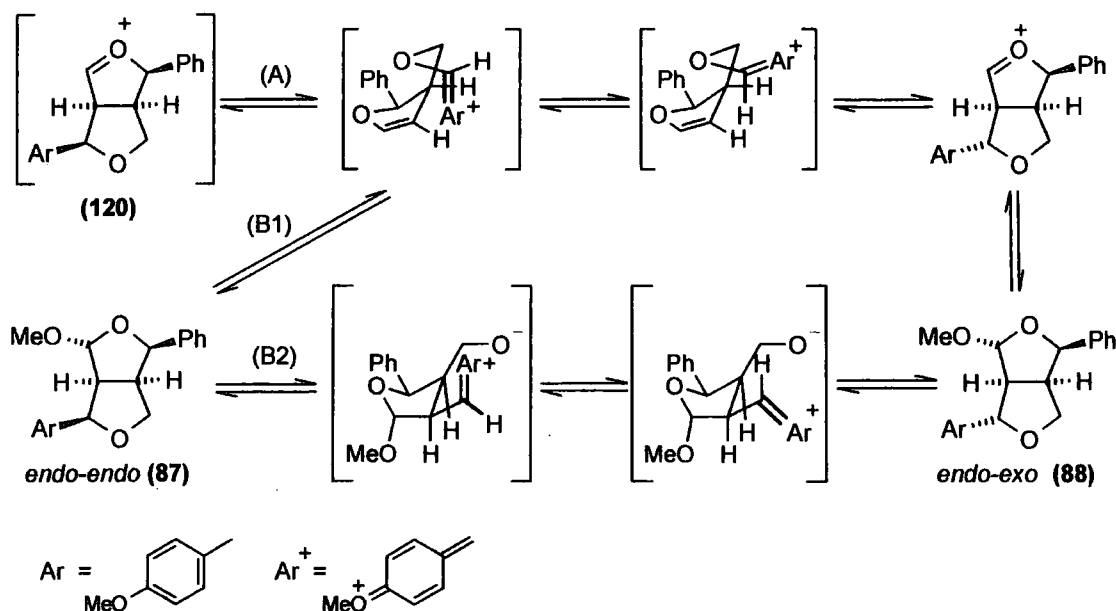

Scheme 2.35

2.5.2. Results for Epiasarinin

As Epiasarinin is an *endo-endo* furofuran substituted with electron-donating aryl groups, the cyclisation needs to be performed under kinetic conditions at low temperature, Scheme 2.36. The appropriate acetal for the synthesis of Epiasarinin is the piperonal dimethyl acetal which is not commercially available. The preparation of this acetal (121) and the Lewis acid promoted cyclisation will be discussed in the next section.

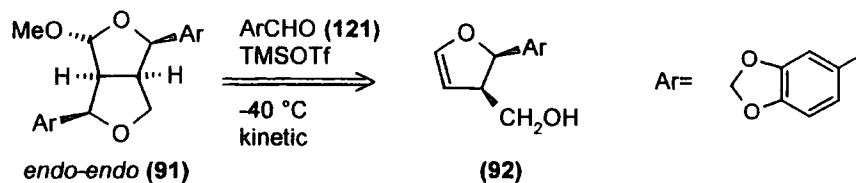

Scheme 2.36

2.5.2.1. Synthesis of piperonal acetals

Based on Dutton's work, the dimethyl acetal was first selected. Piperonal dimethyl acetal (121) was previously obtained from piperonal, methanol and trimethyl orthoformate in the presence of cerium trichloride heptahydrate, Scheme 2.37.^{51,52} In this protocol, the cerium salt is an acid catalyst and trimethyl orthoformate acts as a dehydrating agent. After following this procedure, the TLC of the crude reaction mixture showed a complete conversion. Surprisingly, the crude mixture after aqueous work-up contained a lot of piperonal. The reaction was also attempted with *p*-toluenesulfonic acid (*p*-TsOH) as acid catalyst but the conversion was only 30% after work-up.

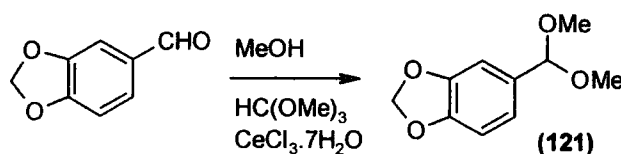

Scheme 2.37

In all the cases the reaction seemed complete by TLC before the aqueous work-up, this suggests that the problem might have been the low stability of the acetal in water. Consequently, a non aqueous treatment was needed which also removed residual aldehyde. As the piperonal-bisulfite complex has a low solubility in organic solvents, the aldehyde can be scavenged by the sodium bisulfite. Therefore, a solution of piperonal in methanol was stirred with *p*-TsOH and trimethyl orthoformate overnight at room temperature under argon then solid sodium bisulfite was added. The mixture was filtered through a Celite® plug and ether was used to rinse through. After concentration of the washings, the piperonal dimethyl acetal (121) containing less than 1% of aldehyde was obtained in a 94% yield and stored under argon in the dark. The structure of the acetal was confirmed by the singlet at 5.28 ppm corresponding to the $\text{CH}(\text{OMe})_2$ in the ¹H NMR spectra.

In view of the initial problem with the dimethyl acetal (**121**), the synthesis of a more stable acetal was then sought. As the cyclic acetals are usually more stable than the corresponding acyclic ones, the preparation of the piperonyl acetal derived from ethylene glycol was attempted. This acetal (**122**) was obtained by mixing piperonal and ethylene glycol with *p*-TsOH and trimethylorthoformate in DCM. After flash chromatography, the piperonal acetal (**122**) was obtained in 56% yield and 99% purity by GC and stored under argon in the dark. The ^1H NMR confirmed the presence of the acetal by the singlet at 5.71 ppm.

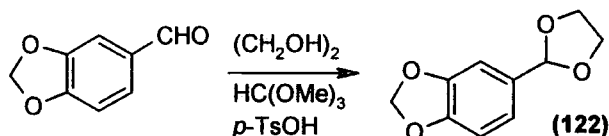

Scheme 2.38

2.5.2.2. Cyclisation

With the required acetals in hand, attention could then be focused on the Lewis acid promoted cyclisation. As a model study, the cyclisation was first attempted with commercially available *p*-methoxybenzaldehyde dimethyl acetal (**123**), Scheme 2.39. Considering that the sesamyl alcohol (**92**) was less stable than the phenyl analogue, the cyclisation was performed at lower temperature $-40\text{ }^\circ\text{C}$. The excess acetal hydrolysed during aqueous work-up to aldehyde was scavenged with sodium bisulfite. The ^1H NMR of the purified product showed only one singlet for each methyl group (3.83 and 3.15 ppm) and by GC-MS, the molecular peak corresponds to the mass of the expected compound (m/z 370). The furofuryl acetal (**124**) was obtained as a single diastereoisomer in a 53% yield after purification by flash chromatography. The *endo-endo* configuration was assumed by comparison with the phenyl furofuryl analogues (**87** and **88**) as ^1H NMR spectrum showed the characteristic pattern of two doublets and a singlet for respectively the C^2 , C^6 and C^4 hydrogens.

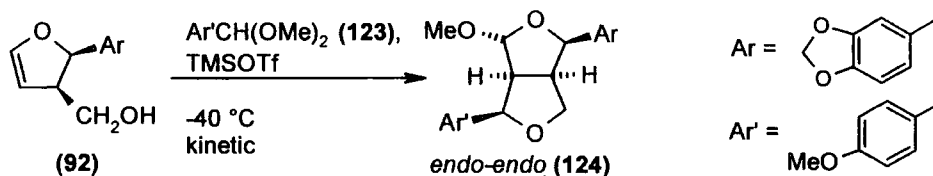

Scheme 2.39

Having established that the sesamyl dihydrofuryl alcohol (**92**) was a valid substrate for the cyclisation, the more stable cyclic piperonal acetal (**122**) was the first tested on a model system, the phenyl dihydrofuryl alcohol (**86**), Scheme 2.40. Following the same procedure, the reaction was quenched with methanol and after aqueous treatment, the 2-phenyl-6-sesamyl furofuryl acetal was collected. The crude mixture ^1H NMR spectrum confirmed that the *endo-endo* furofuran (**125**) was formed as it contained the characteristic pattern of two doublets and a singlet for the C^2 , C^6 and C^4 hydrogens. The GC-MS analysis indicated that the furofuran was the 2-hydroxyethyl acetal (m/z 370) instead of the methyl acetal (m/z 340), which was found to be one of the minor products. Purification of the mixture was unsuccessful affording only decomposition products. As the 2-hydroxyethyl furofuryl acetal (**125**) appeared harder to purify, attention was then turned to the use of the dimethyl acetal. Nevertheless, this result confirmed that the bicyclic oxonium intermediate (**120**) was quenched *in-situ* by the alcohol released from the acetal. Therefore, it was decided to always quench the reaction with the same alcohol from which the acetal was formed to avoid mixtures of acetals.

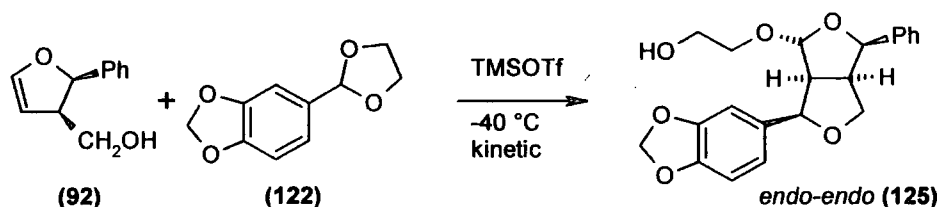

Scheme 2.40

With the piperonal dimethyl acetal, following an identical procedure to above, the cyclisation was attempted with the sesamyl dihydrofuryl alcohol (**92**), Scheme 2.41 affording after flash chromatography purification, the disesamyl furofuryl methyl acetal (**91**) in 55% yield. As expected the furofuryl acetal (**91**) was obtained as a single diastereoisomer (one singlet for the methoxy signal by ^1H NMR); the *endo-endo* stereochemistry was attributed by the two doublets, one singlet pattern of the C^2 , C^6 and C^4 hydrogens.

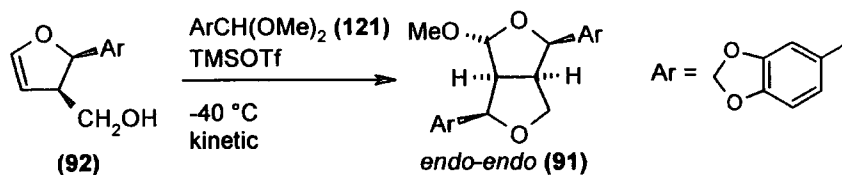

Scheme 2.41

2.6. Acetal reduction

2.6.1. Introduction

Completion of the synthesis of Epiasarinin required the reduction of the furofuryl methyl acetal to the furofuran. The glycosidic bond has already been reduced on a diphenyl furofuryl model system. In this protocol, triethylsilane and boron trifluoride diethylether complex were added to a solution of the *endo-endo* methyl acetal (**89**) in DCM at 0 °C then the mixture was warmed to room temperature and stirred for two days, Scheme 2.42.³⁵ The corresponding furofuran (**90**) was obtained in 61% yield after flash chromatography. ¹³C NMR analysis of the product showed only 7 different peaks, confirming a symmetrical structure and that the stereochemistry of the 2,6-diphenyl substitution was retained during the reduction process.

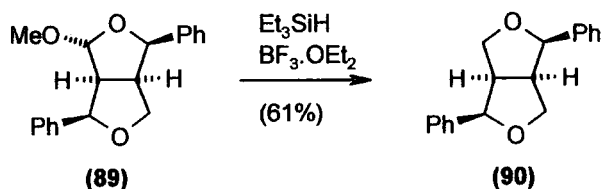

Scheme 2.42

2.6.2. Adaptation to Epiasarinin

Following the Dutton procedure, the reduction was attempted on the disesamyl methyl acetal (**91**) with the addition of the reagents at 0 °C then stirring at room temperature for two days. Disappointingly, only decomposition was observed. To reduce the degradation, the reduction was then attempted for a shorter time (4 hours). Two furofuryl diastereoisomers were obtained. The ¹H NMR revealed four main signals between 2.5 and 5.5 ppm indicating that a symmetrical furofuran was produced and six signals in the same area for a product which seemed corresponding to an unsymmetrical furofuran. Comparison of spectra of these two compounds with the reported data for Asarinin (**22**)^{53,33} and Sesamin (**21**)^{54,55} confirmed that these two diastereoisomers of Epiasarinin (**1**) has been obtained in a 1:3 *ratio*, Scheme 2.43. This meant that epimerisation at C² and/or C⁵ had occurred during the reduction.

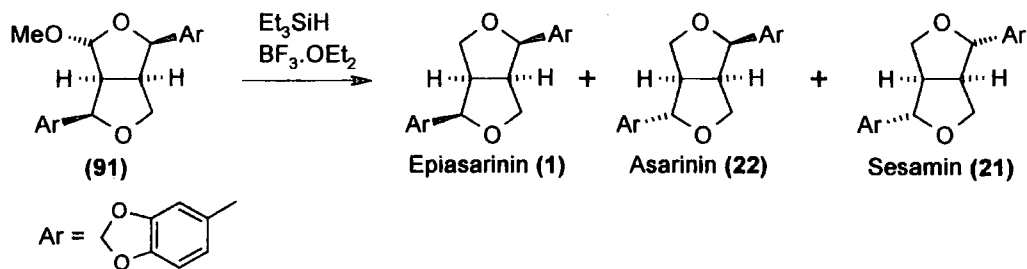

Scheme 2.43

To improve this reduction and minimise the epimerisation, different variables can be modified:

- the reaction temperature
- the reaction time
- the Lewis acid
- the reducing reagent

Therefore, the reduction was tried with triethylsilane at different temperatures and for different lengths of time, Table 2.3. All the *ratios* of the obtained mixtures were determined by ^1H NMR, by integration of the C^4H singlet of the acetal and the $\text{C}^2\text{H}/\text{C}^6\text{H}$ doublets of the furofurans. It appeared that with triethylsilane and $\text{BF}_3 \cdot \text{OEt}_2$ mixtures were always obtained. The best conditions with this pair of reagents are either $-40\text{ }^\circ\text{C}$ for 15h or $-20\text{ }^\circ\text{C}$ for 4h as the results are very similar. The furofuryl diastereoisomers (1, 22, 21) are acid sensitive so to avoid decomposition, triethylamine was required in the column eluent. Following this protocol, careful flash chromatography afforded the recovery of starting acetal and the isolation of pure samples of (\pm)-Epiasarinin (1) and (\pm)-Asarinin (22). Analytical data for (\pm)-Asarinin (22) were identical to those reported in literature.^{53,33} As expected, the ^{13}C NMR spectra of (\pm)-Epiasarinin (1) contained ten signals proving the symmetrical structure and the X-ray crystal structure confirmed the *endo-endo* configuration of the disesamyl furofuran, Figure 2.6.

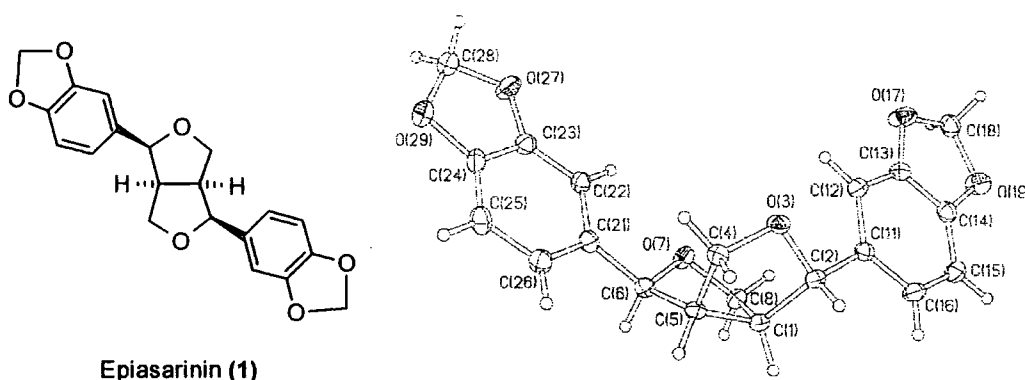

Figure 2.6

As the reduction with triethyl silane and $\text{BF}_3 \cdot \text{OEt}_2$ always led to mixtures, other conditions were sought to improve this reduction step. Consequently, reactions with different Lewis acid (e.g. titanium tetrachloride and scandium triflate) were attempted. A dark coloration suggested that the oxonium ions were formed but the use of these Lewis acids led only to decomposition or recovery of starting material, Table 2.3.

DIBAL-H is both a reducing reagent and a Lewis acid and has been explored in the reductive cleavage of acetal.⁵⁶ Consequently, DIBAL-H was studied in this transformation. However addition of DIBAL-H to the solution of acetal procured a dark pink coloration, but no reduction was observed, Table 2.3.

An alternative method to compete against the epimerisation would involve the use of a faster reducing reagent. Therefore trichlorosilane and $\text{BF}_3 \cdot \text{OEt}_2$ were used to reduce the methyl acetal. No epimerisation was observed with this pair of reagents but decomposition also occurred. The separation of some of these degradation products from Epiasarinin by flash chromatography proved not to be possible and this method was explored no further.

Table 2.3

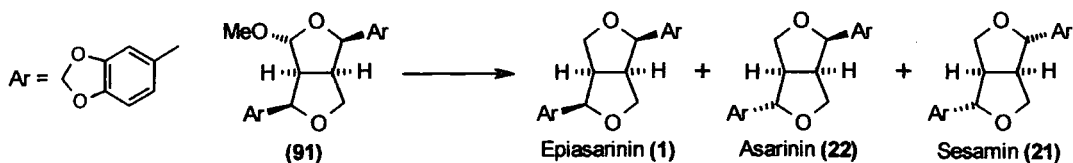

| | temperature | time | % (91) | % (1) | % (22) | % (21) | % decomp |
|--|--------------|------|--------|-------|--------|--------|----------|
| Et_3SiH $\text{BF}_3 \cdot \text{Et}_2\text{O}$ | 0 to 20 °C | 48h | 0 | 0 | 0 | 0 | 100 |
| | -78 to 20 °C | 4h | 0 | 0 | 20 | 60 | 20 |
| | -78 °C | 4h | 100 | 0 | 0 | 0 | 0 |
| | -40 °C | 4h | 90 | 10 | 0 | 0 | 0 |
| | -40 °C | 15h | 10 | 67 | 23 | 0 | 0 |
| | -20 °C | 4h | 11 | 68 | 21 | 0 | 0 |
| | -10 °C | 5h | 0 | 3 | 25 | 47 | 25 |
| 0 °C | 5h | 0 | 0 | 3 | 6 | 91 | |
| Et_3SiH TiCl_4 | -40 °C | 5h | 0 | 0 | 0 | 0 | 100 |
| | -78 °C | 5h | 0 | 0 | 0 | 0 | 100 |
| Et_3SiH $\text{Sc}(\text{OTf})_4$ | -40 °C | 5h | 100 | 0 | 0 | 0 | 0 |
| | -20 °C | 5h | 100 | 0 | 0 | 0 | 0 |
| DIBAL-H | -40 °C | 5h | 100 | 0 | 0 | 0 | 0 |
| | -20 °C | 5h | 100 | 0 | 0 | 0 | 0 |
| Cl_3SiH $\text{BF}_3 \cdot \text{Et}_2\text{O}$ | -40 °C | 4h | 0 | 25 | 0 | 0 | 75 |
| | -40 °C | 1h | 0 | 50 | 0 | 0 | 50 |
| | -78 °C | 4h | 0 | 50 | 0 | 0 | 50 |
| | -78 °C | 1h | 25 | 40 | 0 | 0 | 35 |

In conclusion, changing either the Lewis acid or the reducing reagent did not improve the reduction process. Therefore, reduction with triethylsilane (10 equivalents) and $\text{BF}_3 \cdot \text{OEt}_2$ (1.1 equivalent) gave the optimum results in term of purification and yield. The loss of the stereochemistry in this process will be explained in the next section.

2.6.3. Rationalisation of the epimerisation

The difficulty with the reduction of the acetal was the competitive epimerisation and decomposition reaction. The reduction needed to be faster than the epimerisation. Epimerisation did not happen with the diphenyl furofuran (**90**) but was observed for the disesamyl furofuran (**1**). The main difference between these two compounds is the electron donating substituent on the aryl groups of the Epiasarinin precursor. The oxygen at the *para* position can donate electrons through the aromatic group which leads to the opening of the bicycle and the loss of stereochemistry, Scheme 2.44. Two structures can be subject to the epimerisation: the oxonium intermediate (**125**) and the final product (**1**).

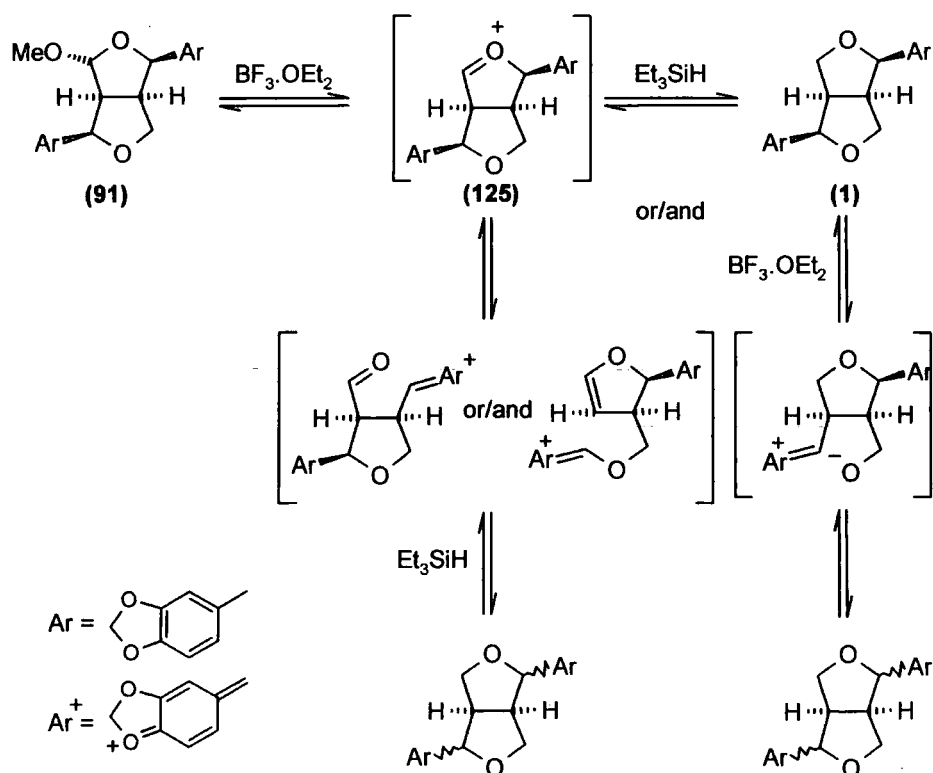

Scheme 2.44

Pelter and Ward reported a degree of epimerisation and rearrangement of some furofurans when treated with triethyl silane and $\text{BF}_3 \cdot \text{OEt}_2$.^{57,58} For example, the *exo-exo* diacetal (**126**) was reduced with this system and led to a mixture of three diastereoisomers, the *exo-exo* (**127**) and the two *exo-endo* (**128** and **129**), Scheme 2.45. The authors presumed that the epimerisation happened during the reduction at the oxonium stage.^{57,58}

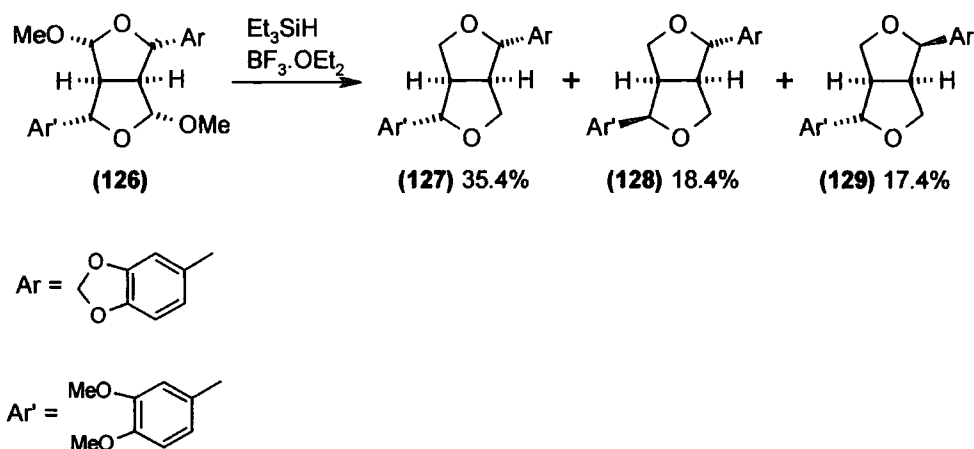

Scheme 2.45

To check that the final product was not also a substrate for the epimerisation, pure Epiasarinin (**1**) was exposed to $\text{BF}_3 \cdot \text{OEt}_2$ at $-20\text{ }^\circ\text{C}$ for three hours. The ^1H NMR showed a mixture of the three diastereoisomers, Epiasarinin (**1**), Asarinin (**22**) and Sesamin (**21**) in respectively 3%, 40% and 57%. This result proved that epimerisation can occur due to the instability of these furofurans to acidic conditions. Therefore, this reduction needs to be performed with careful control of the conditions and the purification by flash chromatography requires basic eluents to neutralise acidic residues on the silica.

2.7. Conclusions

Epiasarinin (**1**) was obtained *via* a five step route in an overall yield of 20%, Scheme 2.46. This synthesis is the first reported of a natural *endo-endo* furofuran.⁵⁹ Starting with the Darzens condensation of methyl bromocrotonate (**106**) and piperonal, the sesamyl vinyl epoxide (**108**) was then thermally rearranged to the sesamyl dihydrofuryl ester (**114**) by flash vacuum pyrolysis. After reduction of the ester, the alcohol (**92**) was combined with piperonal dimethyl acetal (**121**) at low temperature in the Lewis acid mediated cyclisation. This selectively generated the *endo-endo* disesamyl furofuryl methyl acetal (**91**). Finally, reduction of the methyl acetal gave Epiasarinin (**1**).

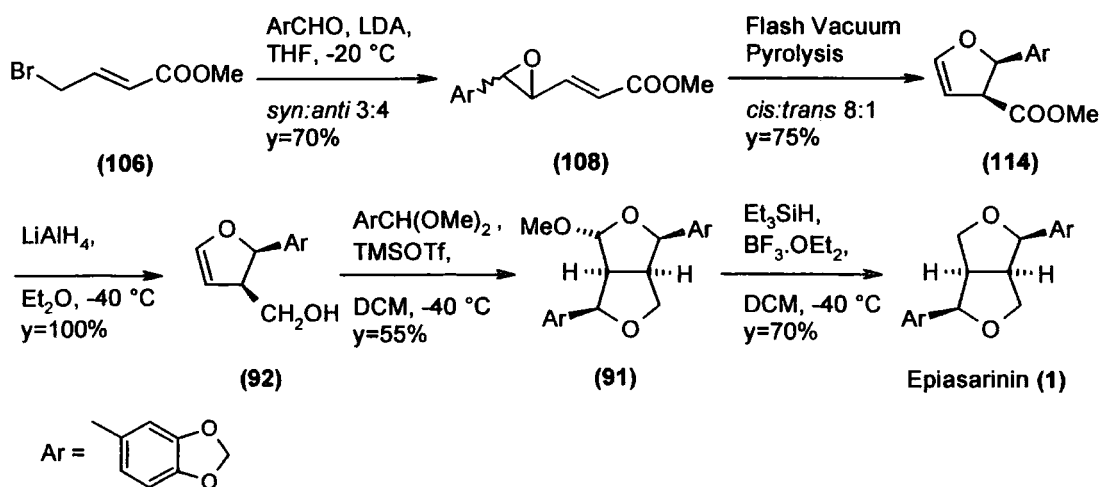

Scheme 2.46

Although the electron-donating group on Epiasarinin represented a significant challenge, the synthesis is a reproducible method, which is applicable to a range of different aryl groups.

2.8. References

31. Aldous, D. J.; Dutton, W. M.; Steel, P. G. *Synlett* **1999**, 474.
32. Shimizu, S.; Kawashima, H.; Akimoto, K.; Shinmen, Y.; Sugano, H.; Yamada, H. *Phytochemistry* **1992**, *31*, 757.
33. Brown, R. C. D.; Bataille, C. J.; Bataille, C. J. R.; Bruton, G.; Hinks, J. D.; Swain, N. *A. J. Org. Chem.* **2001**, *66*, 6719.
34. Batsanov, A. S.; Byerley, A. L. J.; Howard, J. A. K.; Steel, P. G. *Synlett* **1996**, 401.
35. Dutton, W. M. *Development and Application of the vinyl epoxide - Dihydrofuran Rearrangement*, University of Durham, UK 2000.
36. Fringuelli, F.; Germani, R.; Pizzo, F.; Santinelli, F.; Savelli, G. *J. Org. Chem.* **1992**, *57*, 1198.
37. Yang, D.; Wong, M. K.; Yip, Y. C. *J. Org. Chem.* **1995**, *60*, 3887.
38. Brougham, P.; Cooper, M. S.; Cummerson, D. A.; Heaney, H.; Thompson, N. *Synthesis* **1987**, 1015.
39. Nemoto, H.; Ibaragi, T.; Bando, M.; Kido, M.; Shibuya, M. *Tetrahedron Lett.* **1999**, *40*, 1319.
40. Harama, M.; Shigemoto, T.; Yamazari, Y.; Ito, S. *Tetrahedron Lett.* **1985**, *26*, 4133.
41. Ley, S. V.; Cox, L. R.; Meek, G.; Metten, K. H.; Pique, C.; Worrall, J. M. *J. Chem. Soc., Perkin Trans. 1* **1997**, 3299.
42. Bloch, R.; Abecassis, J.; Hassan, D. *J. Org. Chem.* **1985**, *50*, 1544.
43. Koppel, G. A. *Tetrahedron Lett.* **1972**, *15*, 1507.
44. Wong, H. N. C.; Hon, M. Y.; Tse, C. W.; Yip, Y. C.; Tanko, J.; Hudlicky, T. *Chem. Rev.* **1989**, *89*, 165.
45. Borel, D.; Gelas-Mialhe, Y.; Vessiere, R. *Can. J. Chem.* **1976**, *54*, 1590.
46. Eberbach, W.; Burchard, B. *Chem. Ber.* **1978**, *111*, 3665.
47. Eberbach, W.; Seiler, W.; Fritz, H. *Chem. Ber.* **1980**, *113*, 875.
48. Crawford, R. J.; Lutener, S. B.; Cockcroft, R. D. *Can. J. Chem.* **1976**, *54*, 3364.
49. Roser, J.; Eberbach, W. *Tetrahedron Lett.* **1984**, *25*, 2455.

50. Forsyth, D. A.; Osterman, V. M.; Demember, J. R. *J. Am. Chem. Soc.* **1985**, *107*, 818.
51. Luche, J. L.; Gemal, A. L. *J. Chem. Soc., Chem. Commun.* **1978**, 976.
52. Luche, J. L.; Gemal, A. L. *J. Org. Chem.* **1979**, *44*, 4189.
53. Pelter, A.; Ward, R. S. *Tetrahedron* **1976**, *32*, 2783.
54. Suginome, H.; Orito, K.; Yorita, K.; Ishikawa, M.; Shimoyama, N.; Sasaki, T. *J. Org. Chem.* **1995**, *60*, 3052.
55. Hull, H. M.; Jones, R. G.; Knight, D. W. *J. Chem. Soc., Perkin Trans. 1* **1998**, 1779.
56. Oikawa, M.; Oikawa, H.; Ichihara, A. *Tetrahedron* **1995**, *51*, 6237.
57. Pelter, A.; Ward, R. S.; Venkateswarlu, R.; Kamakshi, C. *Tetrahedron* **1992**, *48*, 7209.
58. Pelter, A.; Ward, R. S. *Heterocycles* **1994**, *37*, 137.
59. Aldous, D. J.; Dalencon, A. J.; Steel, P. G. *Org. Lett.* **2002**, *4*, 1159.

CHAPTER THREE

Extension to all the Furofuryl diastereoisomers

3.1. Introduction

Having demonstrated that the strategy involving a Lewis acid promoted cyclisation provides efficient access to both *endo-endo* and *endo-exo* furofurans, Scheme 3.1, the second aim of this project was to synthesise all the diastereoisomers of the lignans.^{60,61}

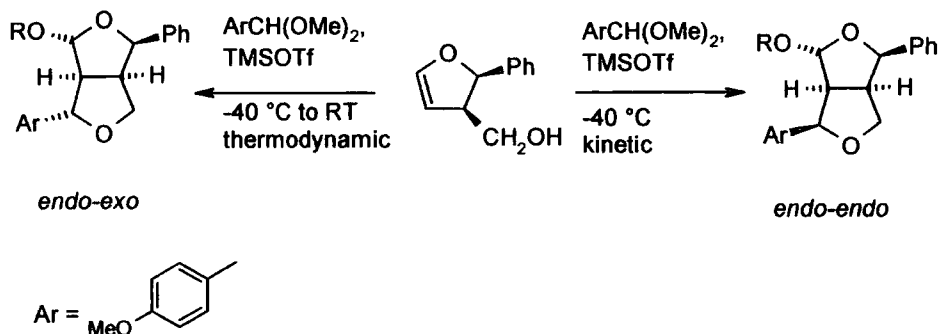

Scheme 3.1

As in the previous chapters, furofurans will be described with *exo* and *endo* relating to the bridgehead hydrogens at the ring fusion, Figure 3.1. The first configuration always refers to the aryl group at the C² position, originating from the dihydrofuran structure and the second corresponds to the C⁶ substitution, derived from the aldehyde acetal. Throughout the chapter, all structures correspond to racemic mixtures and have been drawn with the hydrogens at the ring fusion in an α position even when this represents enantiomeric series.

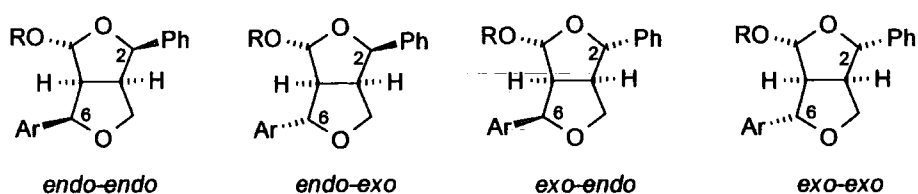
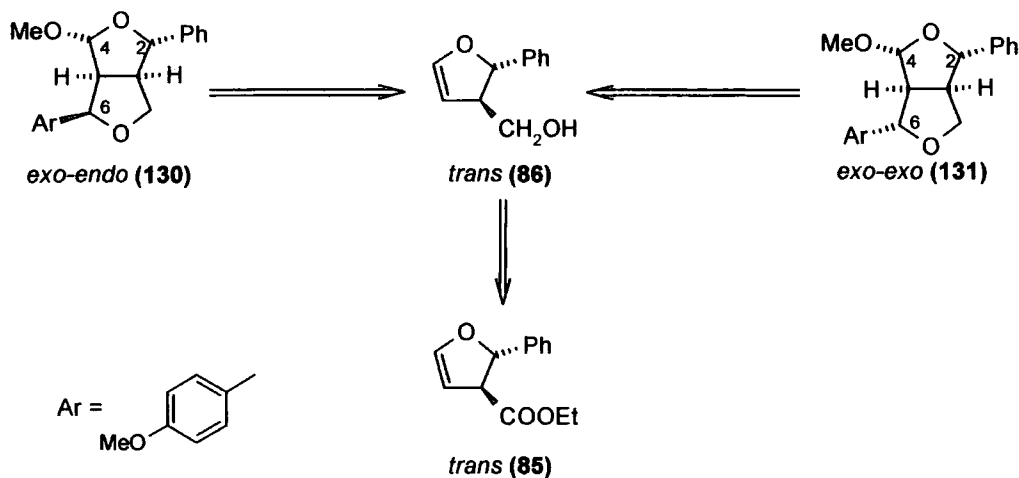

Figure 3.1

Based upon the assumption that the Lewis acid mediated cyclisation will occur with the same selectivity with all dihydrofuryl alcohol isomers, the 2-*exo* furofurans require the first aryl group (C²) to be in an *exo* position, that is derived from a *trans* dihydrofuryl template, Scheme 3.2. Therefore synthesis of 2-*exo* furofurans required an efficient access to this latter isomeric series and this is described in the next section.



Scheme 3.2

3.2. Synthesis of the *trans* dihydrofuryl ester

As the *trans* dihydrofuryl ester (**85**) is the minor product of the thermal rearrangement (maximum yield 10%), a more efficient route needed to be developed. During the studies of direct amidation of the *cis* ester (**85**) with an amine in refluxing toluene (see section 5.4.2.1), it was observed that a slow epimerisation of the *cis* dihydrofuryl ester occurs, Scheme 3.3. By ^1H NMR analysis, the two isomers can be distinguished by the coupling constant between the two hydrogens at the C³ and C⁴ position (C⁴H *cis*: 5.76 ppm, d, J=11 Hz; C⁴H *trans*: 5.84 ppm, d, J=7.5 Hz)

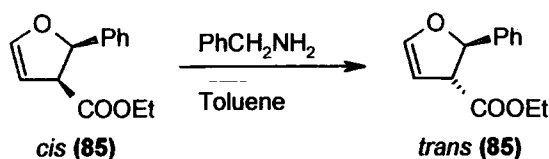

Scheme 3.3

Exploiting this observation, a range of different bases were tried including triethylamine, diisopropylethylamine, sodium ethoxide and 1,8-diazabicyclo[5.4.0]undec-7-ene (DBU) (4 equivalents). It appeared that the reaction with these amines was very slow even in refluxing toluene and needed two to four weeks to convert all the *cis* ester into the *trans* isomer. With prolonged reaction time, decomposition products were observed and alternative conditions were sought, Table 3.1.

Table 3.1

| base | T (°C) | time (day) | yield (%) | <i>cis:trans</i> | degrad (%) |
|-------------------------------|--------|------------|-----------|------------------|------------|
| NEt ₃ | 85 | 14 | 65 | 1:6.2 | 18 |
| <i>i</i> -Pr ₂ NEt | 110 | 28 | 48 | 1:4.5 | 36 |
| DBU | 80 | 10 | 55 | 1:4.2 | 28 |
| DBU cat | 110 | 0.5 | 91 | 1:19 | <5 |
| EtONa | 20 | 1 | 80 | 1:9 | 5 |

Since the process is a simple equilibration, catalytic amounts of the base should be enough for this transformation. Consequently, the epimerisation was attempted with 20 mol% DBU in refluxing toluene. Pleasantly, after 15 hours, the *cis* ester had been converted into the *trans* ester (crude ratio *cis:trans* 1:19) without any significant degradation. After flash chromatography, the *trans* ester (**85**) was obtained in a 91% yield. A similar rate of epimerisation could be obtained with sodium ethoxide (4 equivalents in ethanol) but it required freshly prepared reagent and gave a lower *cis:trans* selectivity.

A mechanism for this epimerisation was proposed to proceed via the corresponding enolate with reprotonation giving the less hindered *trans* isomer, Scheme 3.4. To confirm this supposition, attempts to trap the enolate (**132**) were considered. The first reaction tried was between the enolate (**132**) and an alkyl iodide. This alkylation, if successful, would also be interesting as a means to add a substituent at the C¹ bridgehead of the bicyclic skeleton after reduction of the ester (**133**) and cyclisation. However, a complication due to competing γ alkylation, which would lead to the formation of the esters (**134**) could lead to the potential formation of four alkylated products, Scheme 3.4. The enolate was generated at -78 °C with LDA, an alkyl iodide (methyl or butyl) was added and the mixture then stirred at -20 °C. The crude mixtures for both butyl and methyl iodide reactions were analysed by GC-MS, and found to contain at least twelve products, none of which had a mass matching with the expected isomers.

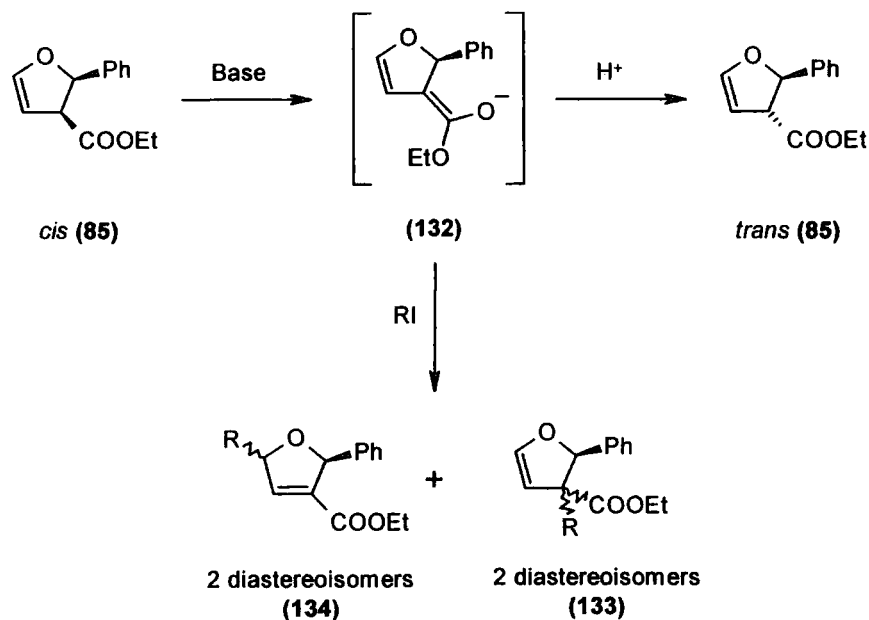

Scheme 3.4

To check that the deprotonation had occurred, the *cis* ester **(85)** was treated with LDA at $-78\text{ }^\circ\text{C}$ and quenched after one hour with acetic acid. This reaction should lead to only three possible isomers, the *cis* and *trans* ester **(85)** and the conjugated ester **(135)**, Scheme 3.5. Unfortunately, it also gave an intractable mixture of compounds and no definitive conclusions could be made.

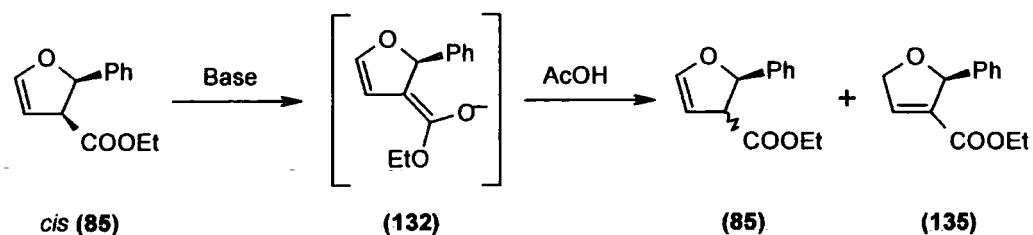

Scheme 3.5

Attempts to trap the enolate as the ketene silyl acetal were then explored.⁶² The order of the addition of the reagents is important as a Claisen condensation can compete with the trapping of the enolate, Scheme 3.6. LDA was prepared at $-60\text{ }^\circ\text{C}$ then trimethylsilyl chloride was added followed by the *cis* ester **(85)**. This gave a complex mixture which did not contain any product with the expected mass by GC-MS.

Subsequently, a mixture of trimethylsilyl chloride and the *cis* este (**85**) was added to LDA at $-78\text{ }^{\circ}\text{C}$. After one hour, the TLC analysis showed a new product and only a trace of starting material. The reaction mixture was then quenched with aqueous ammonium chloride. In the ^1H NMR spectrum of the crude product, the peak of C^3H disappeared, but the splitting patterns of C^1H , C^2H and C^4H remained unchanged. As the NMR could not precisely confirm that the silyl enolate (**136**) was present, the crude mixture was subjected to a GC analysis, which revealed a multitude of compounds. These results could be due to the instability of the product or decomposition in the GC. No further analysis was obtained on this mixture.

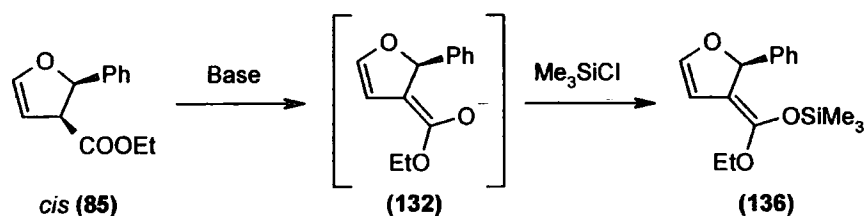

Scheme 3.6

In conclusion, trapping the enolate (**132**) proved to be harder than it was initially expected. In addition to reactions such as the Claisen condensation, fragmentation of the dihydrofuryl ester (**85**) can occur, Scheme 3.7. A way to trap the ketene silyl acetal (**136**) would involve the evaporation of the reaction solvent without aqueous work-up but this has not been tried.⁶² Alternative attempts with weaker bases than LDA such as a tertiary amine would perhaps avoid competitive processes but no more time was spent on this study.

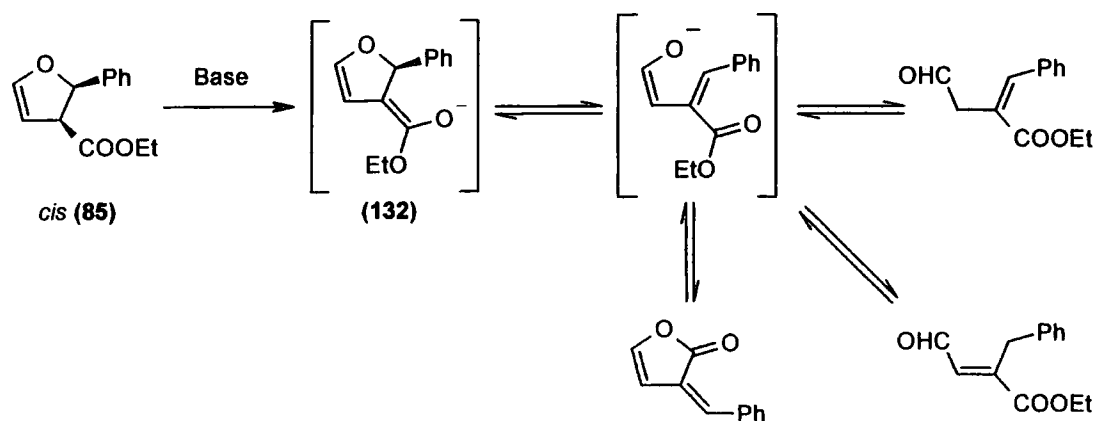

Scheme 3.7

3.3. Lewis Acid catalysed cyclisation

3.3.1. Introduction

With the *trans* isomer readily prepared, attention was turned to the cyclisation. As has been discussed in section 2.5., the stereochemistry of the furofuran is established during the cyclisation, Scheme 3.8.⁶³ The bicyclic ring structure requires a *cis*-ring fusion, so the C⁵ configuration is controlled by the C¹ stereochemistry. When an electron donating aryl acetal was used during the acid mediated cyclisation, the C⁶ substituent can be, depending on the temperature, selectively *endo* or *exo* compared to the proton at the *cis* ring junction. The nucleophilic attack of methanol at C⁴ appears to occur on the less hindered face of the bicyclic oxonium ion, leading to the *exo* configuration at the C⁴ position.

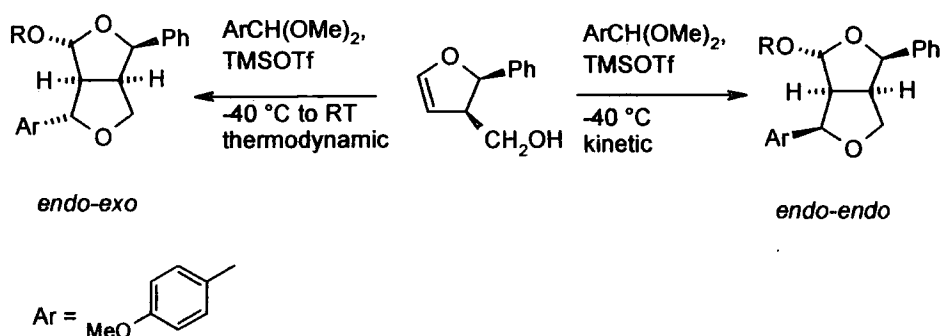

Scheme 3.8

3.3.2. Reduction of the *trans* dihydrofuryl ester

To accomplish the cyclisation, the *trans* dihydrofuryl alcohol (**86**) needs to be generated. Previously, the reductions of the *cis* esters were performed with lithium aluminium hydride (LAH) at 0 °C for the phenyl dihydrofuryl ester (**85**) and at -40 °C for the sesamyl analogue (**92**), Scheme 3.9.^{60,61,63} The two generated alcohols were not stable enough to be purified and were used immediately in the next step.

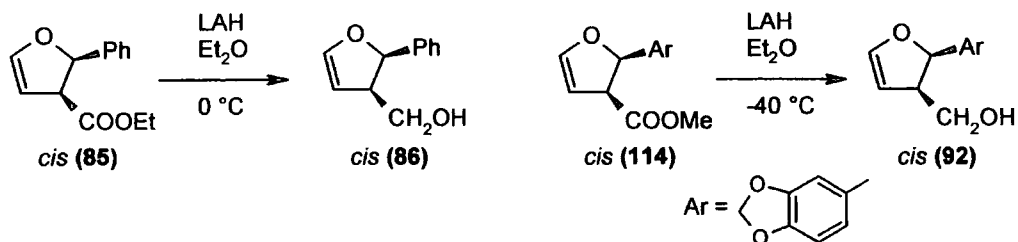

Scheme 3.9

Following this protocol, the reduction of the *trans* dihydrofuryl ester (**86**) was undertaken at $-40\text{ }^\circ\text{C}$ and afforded the corresponding alcohol in 75% yield, Scheme 3.10. The ^1H NMR spectrum did not show the signals of the ethyl ester (quartet at 4.22 ppm and triplet at 1.29 ppm) and the broad peak of an alcohol could be observed in the multiplet at 3.70 ppm. Once again the alcohol was not stable enough to be fully characterised and was used without further purification in the Lewis acid cyclisation.

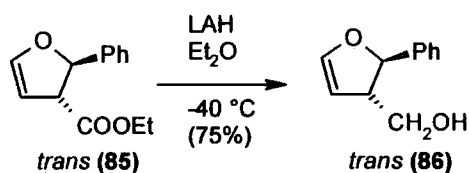

Scheme 3.10

3.3.3. Kinetic cyclisation

With the *trans*-dihydrofuryl alcohol (**86**) available, the cyclisation was immediately attempted under the kinetic conditions, at low temperature. Addition of the *trans* dihydrofuryl alcohol (**86**) to a mixture of *p*-methoxybenzaldehyde dimethyl acetal (**123**) and trimethylsilyl triflate at $-40\text{ }^\circ\text{C}$ gave the kinetic product, the *exo-endo* furofuryl acetal (**130**) as a single diastereoisomer. After purification, the furofuryl acetal (**130**) was obtained in 53% yield. It was fully characterised, with a NOESY experiment confirming the *exo-endo* stereochemistry, Scheme 2.11. As expected, the C⁴ methoxy substituent was found in an *exo* configuration.

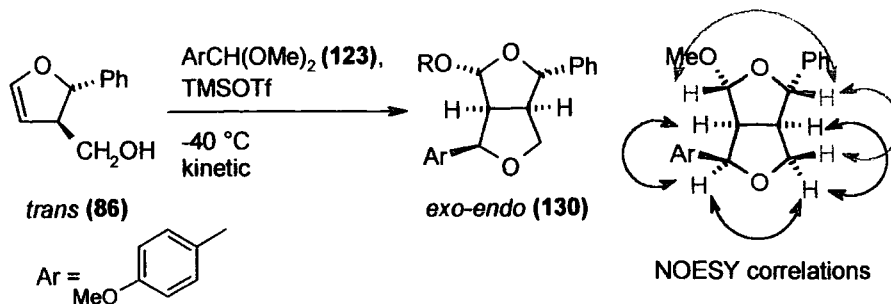

Scheme 2.11

3.3.4. Thermodynamic cyclisation

The cyclisation was then attempted with *p*-methoxybenzaldehyde dimethyl acetal (123) and trimethyl silyl triflate under the thermodynamic conditions described by Dutton.^{60,61} The reaction mixture was stirred at -20°C overnight then warmed to room temperature for one hour and quenched with methanol (30 minutes at RT). It resulted in a mixture of three diastereoisomers in a *ratio* of 5:4:1 in a 65% yield after flash chromatography. The major compound was identified as the *exo-endo* isomer (130) by comparison with the ^1H NMR spectra of the kinetic product (130) previously obtained. A second purification allowed isolation of the two other diastereoisomers which were then fully characterised. The NOESY experiments revealed that both of the diastereoisomers have the *exo-exo* configuration and were different in their stereochemistry at the C^4 position, Scheme 3.12. The *ratio* *exo:endo* acetal (131:137) (4:1) could then be determined by the integration of the signals of the C^2 and C^6 hydrogens (131 C^2 5.07 ppm, C^6 4.86 ppm; 137 C^2 4.90, C^6 5.44).

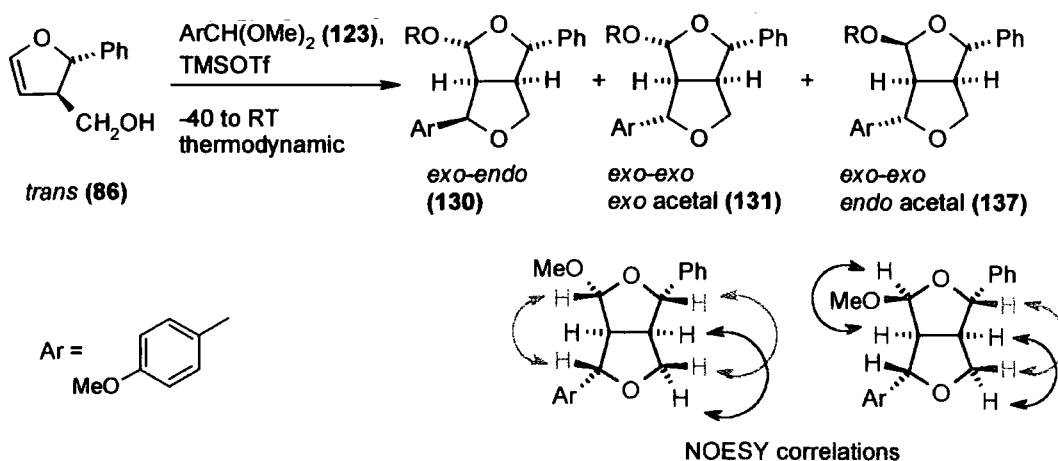

Scheme 3.12

The cyclisation to lead to the thermodynamic furofuran was then attempted under differing conditions, Table 3.2. Prolonged time at -20 °C led to similar isomeric mixtures. When the reaction was stirred for a longer time at room temperature, less of the kinetic product (**130**) was found. This suggests that the epimerisation is much slower with the *trans* dihydrofuryl system than with the *cis*. This can be explained by the fact that the *cis* system goes from a very unfavourable skeleton to a much more stable one. The difference in energy between the *exo-endo* and *exo-exo* is less important than that between *endo-endo* and *endo-exo* so the epimerisation is slower. The *ratio* between the *exo* and *endo* acetal (**131:137**) seems to be similar whatever the conditions (4:1). This mixture can be explained as the *exo* face contains the two aryl groups, more hindered and the selectivity between the two faces is reduced. Finally, using the conditions of entry 4 in Table 3.2, the *exo-exo* furofurans were obtained as a mixture of 2:1 *exo:endo* acetal in a 45% yield after purification.

Table 3.2

| entry | time at -20 °C | time at 20 °C | time in MeOH | kinetic (%) | thermo <i>exo</i> (%) | thermo <i>endo</i> (%) |
|-------|-------------------|------------------|-----------------|----------------|--------------------------|---------------------------|
| 1 | 15 h | 1 h | 0.5 h | 47.2 | 42 | 10.8 |
| 2 | 1 h | 1 h | 0.5 h | 46.1 | 43.5 | 10.4 |
| 3 | 15 h | 2 h | 0.1 h | 49.3 | 35.5 | 11.2 |
| 4 | 16 h | 3 h | 3h | 19.2 | 64.3 | 16.5 |

3.3.5. Summary

In summary, a *cis* dihydrofuryl ester (**85**), after reduction and Lewis acid mediated cyclisation with an electron donating aryl acetal, affords either the *endo-endo* and *endo-exo* furofuryl acetals (**87** and **88**), Scheme 3.13.^{60,61} The *cis* dihydrofuryl ester (**85**) can also be epimerised under basic conditions to the *trans* template. This isomer can be reduced, then used in the Lewis acid promoted cyclisation to generate the *exo-endo* furofuryl acetal (**130**) under kinetic conditions and the *exo-exo* skeleton (**131** and **137**) under the thermodynamic conditions.

The initial aim to synthesise all the diastereomeric furofuryl skeletons was achieved and the reduction of the glycosidic bond to give the furofurans was then considered and is described in the next section.

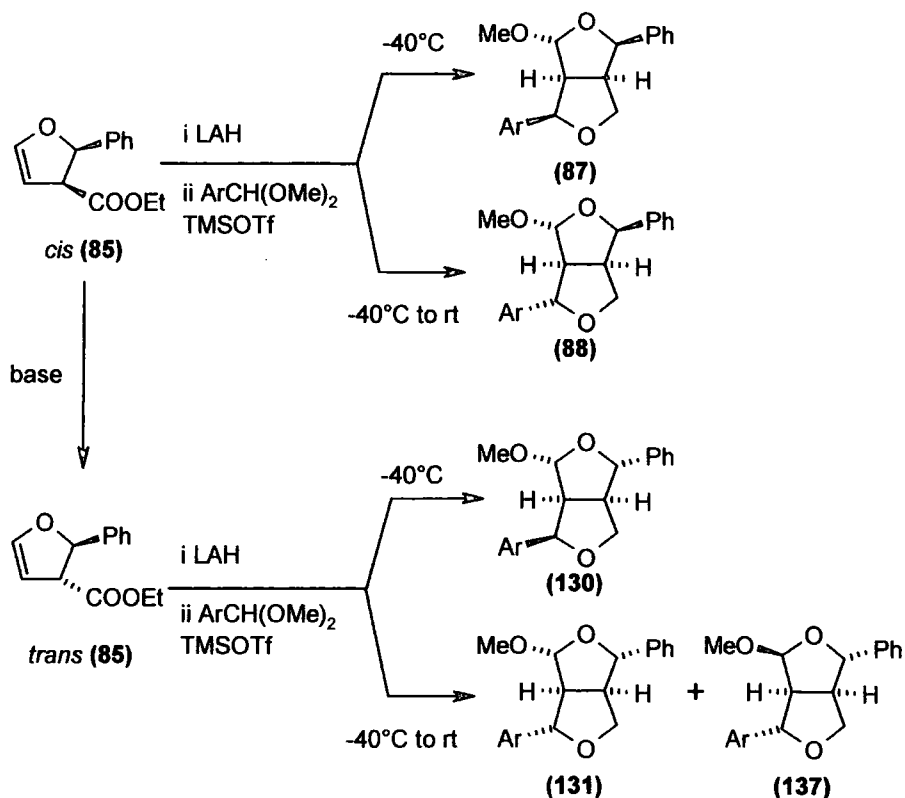

Scheme 3.13

3.4. Reduction of glycosidic bond

3.4.1. Attempt of reduction

Following the procedure optimised for the synthesis of Epiasarinin (Section 2.6.2.), the *endo-endo* furofuryl acetal **(87)** was reduced with triethyl silane and $\text{BF}_3 \cdot \text{OEt}_2$ at -40°C , Scheme 3.14. After four hours, TLC analysis indicated that the reaction was complete. After quenching the reaction with aqueous sodium bicarbonate, ^1H NMR analysis of the resulting crude mixture confirmed the absence of the methyl peak of the acetal and GC-MS indicated that the crude product contained a single furofuryl diastereoisomer (m/z 296). However, NOESY experiments revealed that the aryl and the phenyl groups were not on the same face of the skeleton, indicating that epimerisation had occurred during the reduction. As previously discussed in Section 2.6.3., electron donating aryl groups such as *p*-methoxyphenyl can help the epimerisation process. The NOESY correlations indicated that the aryl group was *exo* and the phenyl *endo* compared to the hydrogens at bridgehead confirming that it was the C⁶ stereocentre that had epimerised during the reaction leading, thus to the *endo-exo* furofuran **(139)**.

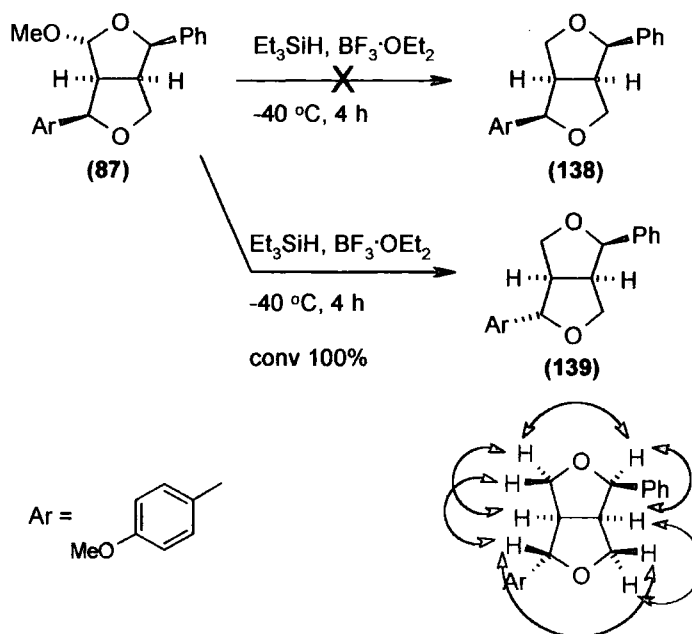

Scheme 3.14

The reduction of the *endo-exo* furofuryl acetal (88) was then considered. As the *p*-methoxyphenyl group is already in an *exo* position, even if epimerisation occurs, this reaction should still afford the *endo-exo* furofuran (139). Following the same procedure as previously, a single diastereoisomer was obtained, Scheme 3.15. The NMR data of this product fitted with that of the product (139) obtained previously starting with the *endo-endo* skeleton. This confirmed that epimerisation in the first case occurred through the *p*-methoxyphenyl assistance, at the C⁶ position.

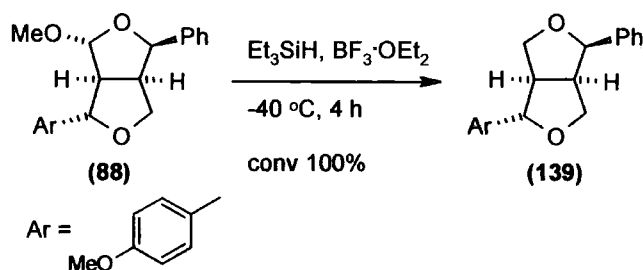

Scheme 3.15

Using the same conditions as previously, the reduction of the *exo-endo* and *exo-exo* furofuryl acetals (130, 131 and 137) was then performed, Scheme 3.16. Surprisingly, the results were similar with both starting materials, leading to a mixture of two diastereoisomers. This reduction was repeated at different temperatures (0, -20 , -40°C) for a reaction time between 1 and 16 hours with either the *exo-endo* starting

material (**130**) or the *exo-exo* acetals (**131** and **137**). In all cases, a mixture of the two diastereoisomers was obtained. The two products were separated by flash chromatography and pure samples characterised. The NOESY experiments distinguished the *exo-endo* furofuran (**140**) from the *exo-exo* diastereoisomer (**141**).

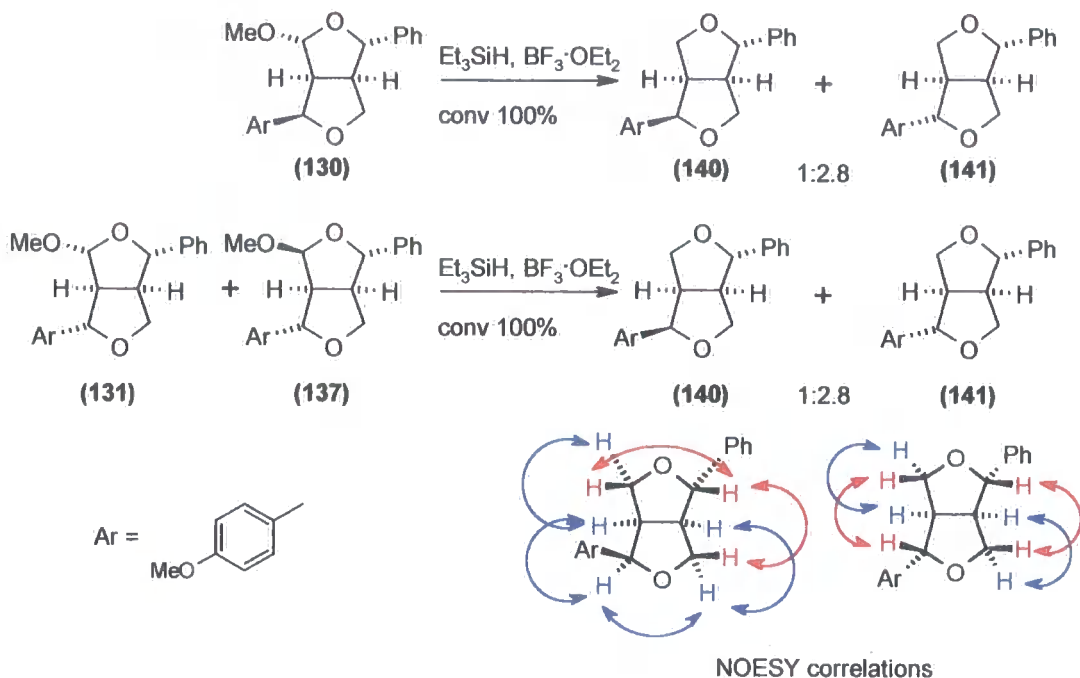

Scheme 3.16

The *ratio* of the two products was determined by ^1H NMR analysis, with the integrations of two *exo-endo* doublets for C^6H and C^2H at 4.81 and 4.45 ppm and two *exo-exo* signals, a doublet for (C^6H) at 4.70 ppm and a multiplet relating to the two *exo* protons in C^4 and C^6 position between 4.25 and 4.15 ppm (300 MHz NMR). Even under different conditions, the *ratio* was constant within the error limits of integration, at 1:2.8 *exo-endo* (**140**):*exo-exo* (**141**). This indicated that the reaction led to a thermodynamic mixture in all the cases.

If epimerisation occurs after reduction of the acetal bond, a reaction at a low temperature and for a short time should afford only kinetics products. A low conversion of material was expected under these conditions. As previously, a basic inverse quench would be used to minimise epimerisation during the work-up. Consequently, the reduction was attempted at $-78\text{ }^\circ\text{C}$ for one minute and rapidly poured at $-78\text{ }^\circ\text{C}$ into aqueous sodium bicarbonate. Under these conditions, reduction of the *exo-endo*

furofuryl acetal (**130**) gave solely the *exo-endo* furofuran (**140**) albeit with some recovered starting material (86% conversion), Scheme 3.17.

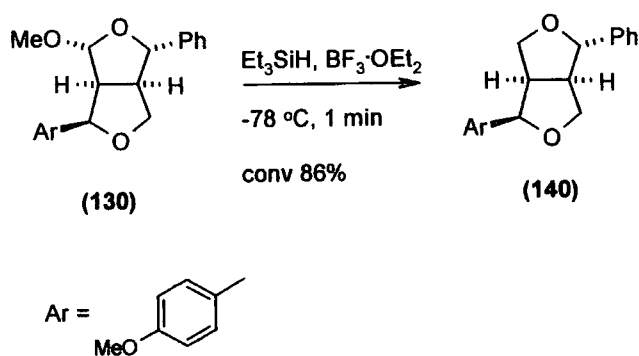

Scheme 3.17

Following the successful procedure described in the previous section, the reduction of the *exo-exo* acetals (**131** and **137**) in a similar fashion, quenched after 1.25 minutes afforded complete conversion. However, some epimerisation took place affording a mixture of *exo-exo* and *exo-endo* acetals (**141**:**140**) in 82:18 ratio, Scheme 3.18.

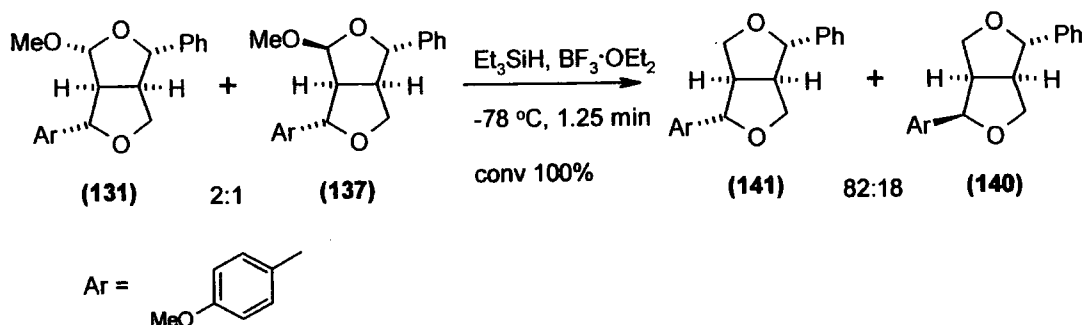

Scheme 3.18

The reduction was then attempted with the *endo-endo* furofuryl acetal (**87**), Scheme 3.19. It gave a 40:60 mixture of two diastereoisomers, one of which could be identified as the *endo-exo* furofuran (**139**) by comparison with pure samples isolated before. After separation by flash chromatography, the second compound was analysed and confirmed as the *endo-endo* furofuran (**138**) by a NOESY experiment.

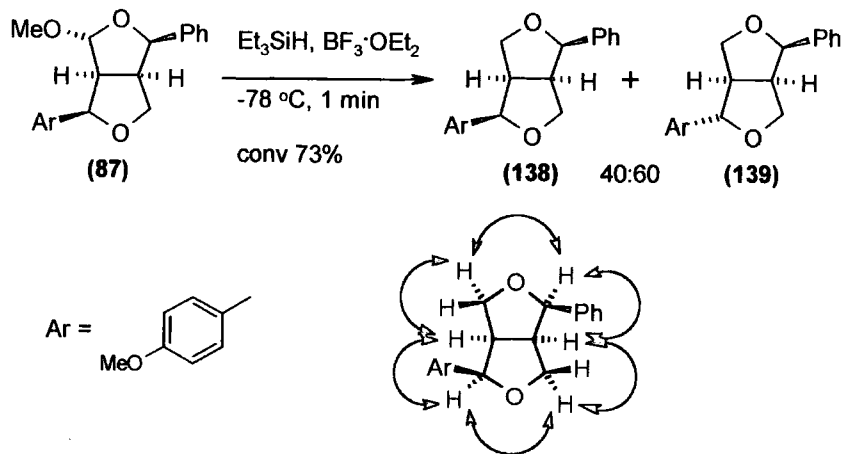

Scheme 3.19

Finally, when the *endo-exo* furofuryl acetal **(88)** was reduced at -78°C for one minute, Scheme 3.20. A lower conversion was observed (36%) and the reduction products were obtained in a mixture of *endo-exo* and *endo-endo* diastereoisomers **(139)** and **(138)** in a ratio of 92:8.

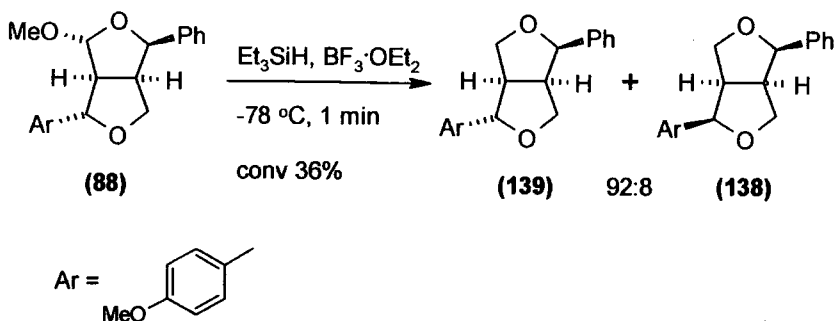

Scheme 3.20

3.4.2. Epimerisation during the reduction

Although all the 6-*p*-methoxyphenyl-2-phenyl-furofuran diastereoisomers could be synthesised, epimerisation was a major competitive reaction during the reduction step. Different mechanisms can be proposed to explain the epimerisation which can occur before and/or after the reduction of the acetal bond, Scheme 3.21. The *p*-methoxyphenyl group can participate in the loss of methoxide to generate the oxonium intermediate **(143)**. The loss of the methoxide can also be promoted by the oxygen of the furofuryl skeleton, forming the bicyclic intermediate **(142)**. This oxonium ion can then undergo reversible fragmentation promoted by the electron donating group

providing a second route to the intermediate **(143)**. On forming this intermediate **(143)**, the stereochemistry at the C⁶ position is lost. Alternatively, epimerisation can occur after reduction, catalysed by the Lewis acid, as was demonstrated with Epiasarinin, Section 2.6.3. Again, this is promoted by electron donating aryl groups promoting fragmentation and forming the monocyclic intermediate **(145)**, with the loss of the stereochemistry at the C⁶ position. As evidence supporting this proposed mechanism, the kinetic crude product of the *endo-exo* acetal reduction contained trace amounts of *endo-endo* furofuran, which would come from a kinetically controlled cyclisation of the intermediate **(143)**. Since similar intermediates were involved in the Lewis acid promoted cyclisation, it is believed that this provides evidence that epimerisation processes *via* the intermediate **(143)**.

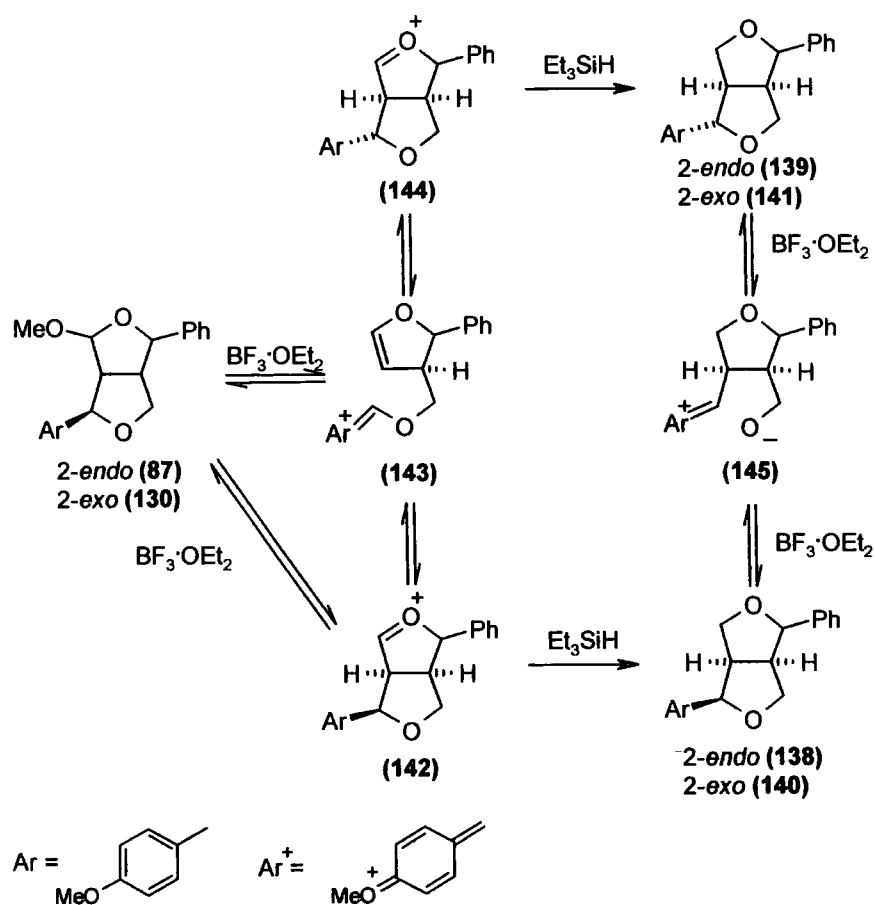

Scheme 3.21

All the furofuryl diastereomers were synthesised but the selectivity and the yield of the reduction step were moderate. To improve the strategy, a new route was attempted and the results are presented in the next section.

3.4.3. New strategy to the *endo-endo* furofurans

As the reduction of the *endo-endo* furofuryl acetal (**87**) was not efficient (73% conversion, *endo-endo:endo-exo* 2:3), a new strategy was sought. Previous studies in the group had showed that no *endo-exo* product was obtained during the Lewis acid mediated cyclisation at room temperature when the aryl groups were not substituted with an electron donating group, Scheme 3.22.⁶¹

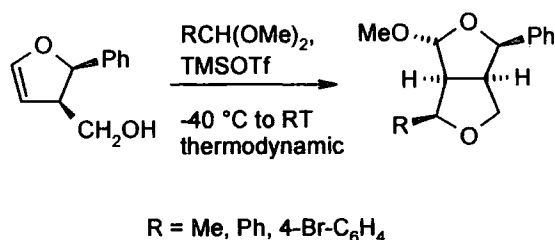

Scheme 3.22

These results also support the idea that the *endo-exo* products resulted from epimerisation during the cyclisation promoted by the electron donating aryl group. Therefore, if the furofuryl acetal is built with the electron donating aryl group at the C² position and the phenyl at the C⁶ position, selectivity during the reduction step might be improved. Consequently, the studies were then focused on the synthesis of this alternative starting material. Logically, the retrosynthesis of this was inspired by the Epiasarinin synthesis and consisted of a Darzens condensation followed by thermal rearrangement and Lewis acid promoted cyclisation, Scheme 3.23.⁶³

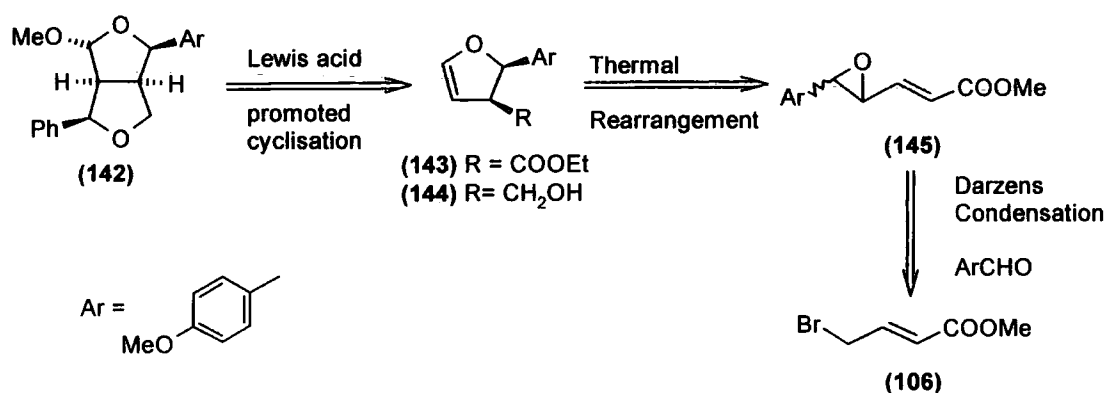

Scheme 3.23

Following the protocol optimised for the synthesis of Epiasarinin, the Darzens condensation was performed with the *p*-methoxybenzaldehyde to generate the corresponding vinyl epoxide (**145**) in 56% yield, Scheme 3.24. Thermal rearrangement of this compound by flash vacuum pyrolysis afforded the *cis* dihydrofuryl ester (**143**) in 67% yield. The reduction of the ester was carried out with lithium aluminium hydride and gave the corresponding alcohol (**144**) in 83% yield. However, in contrast to the Epiasarinin synthesis, the Lewis acid cyclisation at $-40\text{ }^{\circ}\text{C}$ with benzaldehyde dimethyl acetal and trimethylsilyl triflate led to a mixture of diastereoisomers. Subsequently, the reaction was repeated at $-80\text{ }^{\circ}\text{C}$ for one hour. Although conversion was low, the selectivity was good and a small amount of expected furofuryl acetal (**142**) was collected after flash chromatography (23% yield). The *endo-endo* stereochemistry was confirmed by NOESY experiment.

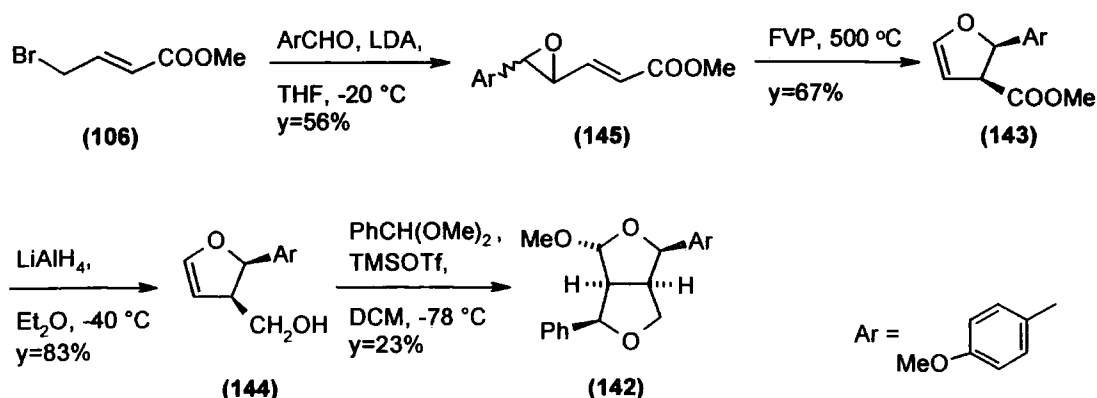

Scheme 3.24

Epimerisation also occurred during the Lewis acid promoted cyclisation of the alcohol (**144**). This indicates that the electron donating group at the C² position can also activate the opening of the skeleton and therefore induce epimerisation. Different mechanisms can explain this epimerisation, Scheme 3.25. After the formation of the oxonium (**146**), cyclisation can afford the cyclic intermediate (**147**). In each case, the *p*-methoxyphenyl group can stabilise these oxonium intermediates (**146** and **147**) leading to the cation (**148**) and loss of the stereochemical information at the C² position. Three products can be obtained after methanol quenching, the two furofuryl acetals (**142** and **151**) but also aldehyde (**150**). Alternatively, epimerisation can occur after generating the acetal. Again, this is promoted by electron donating aryl group promoting fragmentation and forming carboxylate intermediate (**152**) and thus losing the stereochemistry at the C² position.

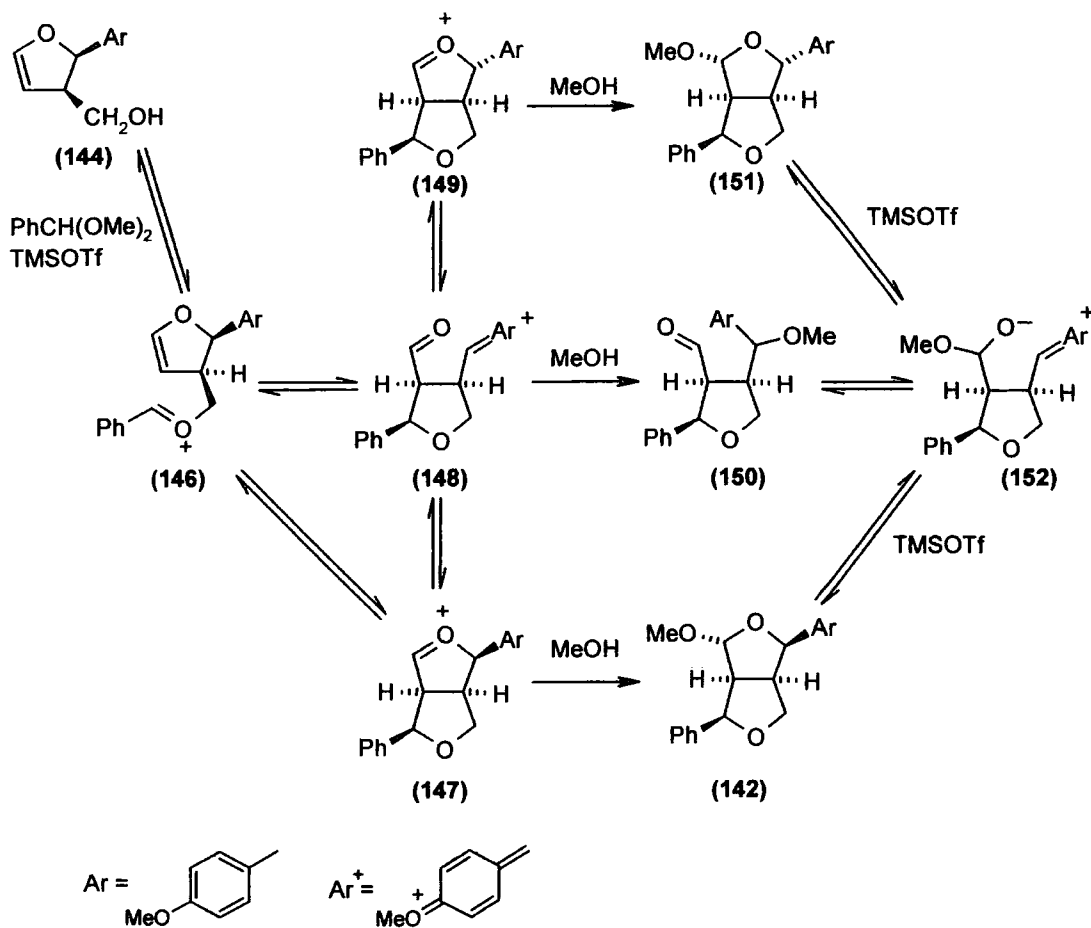

Scheme 3.25

During the cyclisation of Epiasarinin's precursor (**92**) at $-40\text{ }^{\circ}\text{C}$, the only diastereoisomer detected was *endo-endo* furofuryl acetal (**91**). In contrast, the cyclisation of the *p*-methoxyphenyl dihydrofuryl alcohol (**144**) led to a mixture of diastereoisomers. Epimerisation could be limited by working at $-78\text{ }^{\circ}\text{C}$ but the mass balance was low. This might be due to the formation of the aldehyde (**150**), which was then scavenged by sodium bisulfite during the work-up. No attempt was performed without this treatment to prove this hypothesis.

The amount of the collected *endo-endo* furofuryl acetal (**142**) was not sufficient to attempt the reduction step. Due to a lack of time, no other material could be synthesised for this studies.

3.4.4. Summary on the reduction step

The target of synthesising the four diastereoisomeric furofurans was achieved even though the reduction step was more challenging than expected. In previous studies, the diphenyl furofuran was obtained without any epimerisation as it did not contain an electron donating substituent to activate this process. With the disesamyl analogue, the reduction was slower and more selective than the reaction with the *p*-methoxyphenyl-phenyl furofuryl acetal allowing the synthesis of Epiasarinin. By comparison with the sesamyl system, the *p*-methoxyphenyl substituent increased the rate of epimerisation both in the formation of the furofuryl acetal and the reduction of the acetal bond. Although the sesamyl group contains two electron donating groups, the cyclic acetal locks the structure. Therefore, the oxygen lone pairs of the acetal are at an angle to the aromatic ring. In comparison, the *p*-methoxy group can adopt a conformation such that a lone pair is optimally aligned for overlap with the aromatic π system. This favours the resonance with the intermediates which facilitate the epimerisation.

3.5. Conclusion

With the optimised strategy, the four diastereoisomeric furofurans could be synthesised in five or six steps. The Darzens condensation afforded the vinyl epoxide (**84**) which was thermally rearranged into the *cis* dihydrofuryl ester (**85**), Scheme 3.26. After reduction of the ester to the corresponding alcohol (**86**), the Lewis acid mediated cyclisation can lead selectively to the *endo-endo* or *endo-exo* furofuryl acetal (respectively **87** and **88**). Epimerisation of the *cis* dihydrofuryl ester (**85**) to the *trans* template was performed under basic conditions and reduction of the ester and Lewis acid promoted cyclisation afford the *exo-endo* or *exo-exo* furofuryl acetal (respectively **130** and **131+137**). Reduction of the glycosidic bond under appropriate conditions for each acetal leads to the corresponding furofuran, Scheme 3.26.

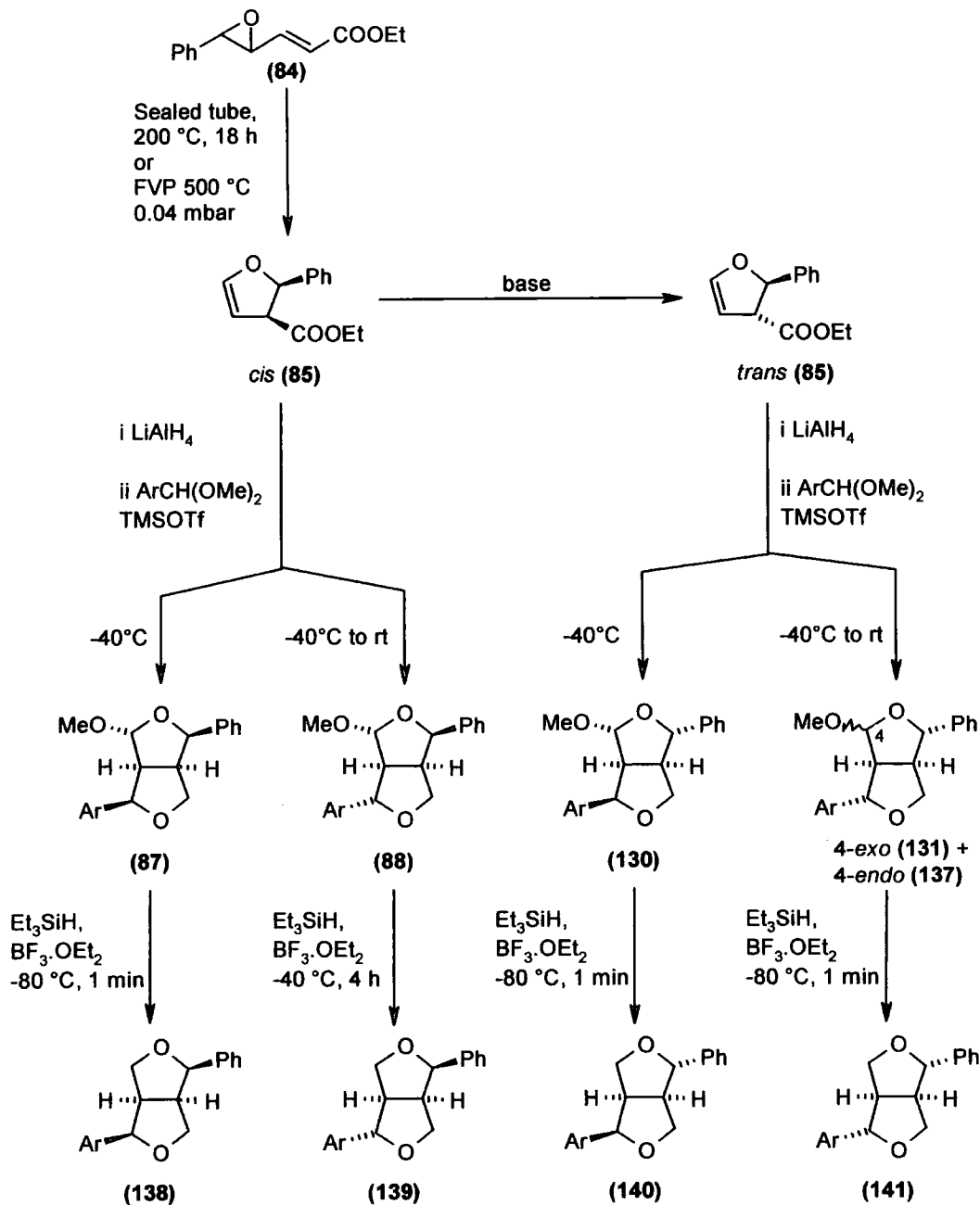

Scheme 3.26

As electron donating groups favour epimerisation, modification of the aryl groups can be an efficient way to synthesise a target molecule with the appropriate stereochemistry. If no electron donating group is required on the final product and an *exo* configuration is required an electron donating aryl group can be used during the sequence and converted to the desired group later. For example, an *exo* configuration can be obtained with a 4-hydroxybenzaldehyde dimethyl acetal (**152**); the phenol (**153**) can be then transformed into a phenyl group by reduction of the phosphorus intermediate (**154**)⁶⁴ or alkyl substituted by transmetalation from the triflate equivalent (**155**), Scheme 3.27.

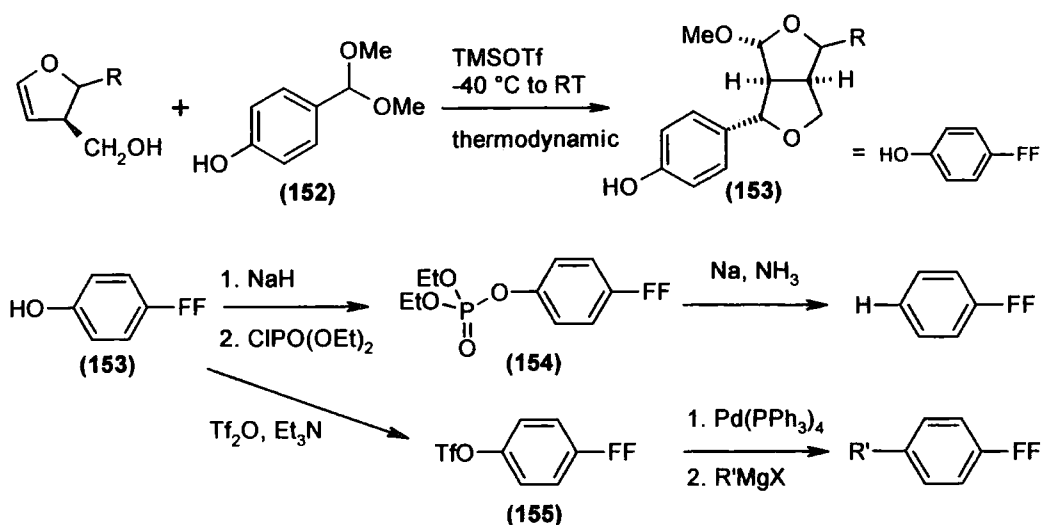

Scheme 3.27

Alternatively, if the target molecule contains an electron donating group in the *endo* position, the synthesis can be realised with an aryl group which would not favour the epimerisation and would be amenable to the target substitution easily. For example, an acetate or silyl substituted aryl group should limit the epimerisation and can be transformed to the phenol (158) by hydrolysis of the acetate (156) or oxidation on the silyl group (157), Scheme 3.28.^{65,66}

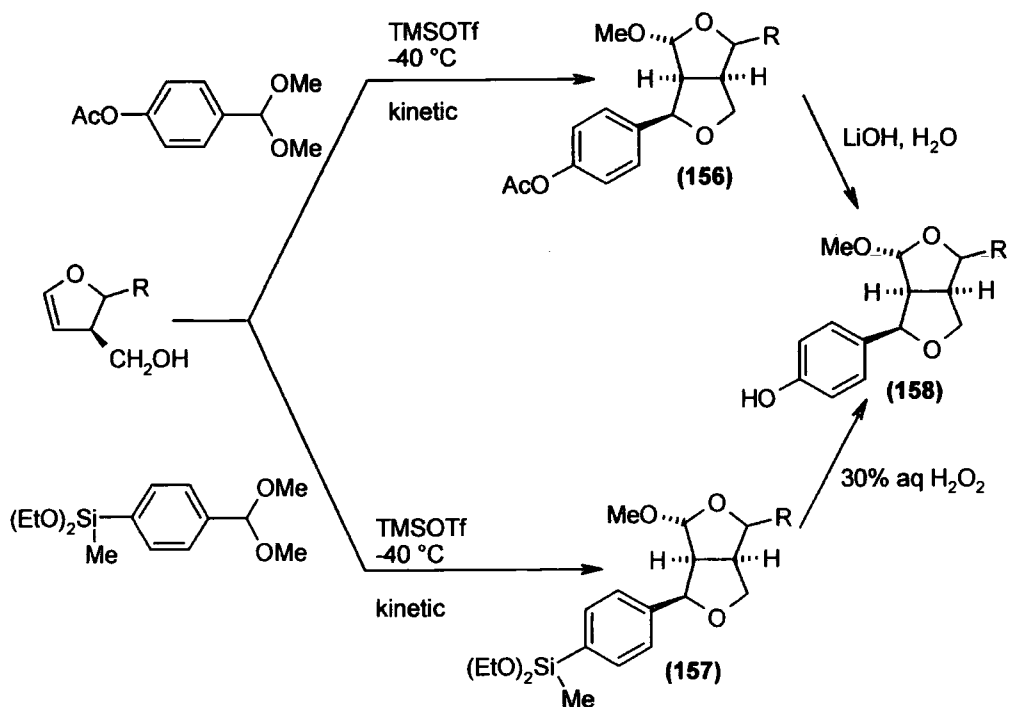

Scheme 3.28

By controlling the epimerisation process, the two previous strategies can be the future tools to synthesise any furofurans selectively. Considering the potential of these methodologies, optimisation of these steps should be considered for a future project.

3.6. References

60. Aldous, D. J.; Dutton, W. M.; Steel, P. G. *Synlett* **1999**, 474.
61. Dutton, W. M. *Development and Application of the vinyl epoxide - Dihydrofuran Rearrangement*, University of Durham, UK 2000.
62. Fleming, I.; Iqbal, J.; Krebs, E. P. *Tetrahedron* **1983**, *39*, 841.
63. Aldous, D. J.; Dalencon, A. J.; Steel, P. G. *Org. Lett.* **2002**, *4*, 1159.
64. Dominianni, C. J.; Ryan, C. W.; DeArmitt, C. W. *J. Org. Chem.* **1977**, *42*, 344.
65. Tamao, K.; Ishida, N.; Tanaka, T.; Kumada, M. *Organometallics* **1983**, *2*, 1694.
66. Tamao, K.; Kakui, T.; Akita, M.; Iwahara, T.; Kanatani, R.; Yoshida, J.; Kumada, M. *Tetrahedron* **1983**, *39*, 983.

CHAPTER FOUR

Improvement of the Thermal Rearrangement

4.1. Introduction

One of the main steps in the strategy to synthesise furofurans is the thermal rearrangement of the vinyl epoxide to the corresponding dihydrofuran. This reaction has been one of the interests of our research group for some years. To date all work has focussed on chemical efficiency and been carried out with racemic mixtures. Development of an asymmetric version was one of the goals of the project, as this would allow the synthesis of enantiopure furofurans. As mentioned previously, Section 2.3.1., loss of the epoxide stereochemistry occurs during this rearrangement, Scheme 4.1. Therefore, enantioselectivity cannot be introduced *via* a chiral epoxide and requires an external chiral source.

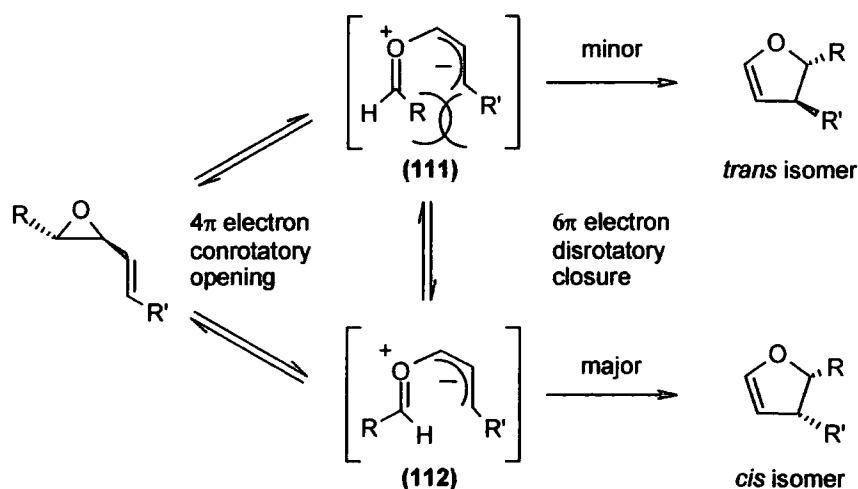

Scheme 4.1

To induce asymmetry during the rearrangement, the group's strategy was to use the carboxylate functionality of readily prepared vinyl epoxide ester (**84**) to generate chiral vinyl epoxide amides. The first studies were performed with chiral oxazolidinones using sealed tube method. For example, the thermal rearrangement was realised with the phenyl oxazolidinone (**159**) leading to four dihydrofuryl diastereoisomers (**160**, **161**, **162** and **163**), Scheme 4.2.⁶⁷ It was found that the overall *ratio cis:trans* was unchanged (9:1) and the diastereomeric excess was 20% and 27% in the *trans* and the *cis* series respectively. When the rearrangement was undertaken with the other enantiomer of the oxazolidinone, the *ratio* between dihydrofuryl diastereoisomers was unchanged. This result indicates that the diastereoselectivity is due only to the chiral auxiliary and is independent of the epoxide configuration.

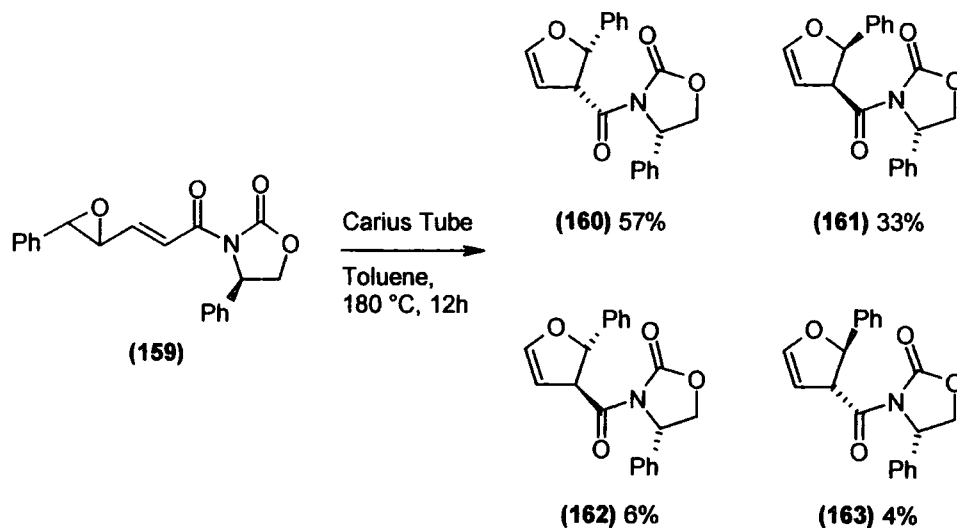

Scheme 4.2

As the diastereoselectivity is low with the oxazolidinines, alternative chiral auxiliaries were explored. Chiral pyrrolidines readily synthesised in our group⁶⁸ seemed appropriate as they lock the rotation of the carbon-nitrogen bond. In a similar fashion to the reaction with the oxazolidinone species, the rearrangement was performed in sealed tubes with these asymmetric vinyl epoxides (164), but afforded only decomposed material, Scheme 4.3.⁶⁹

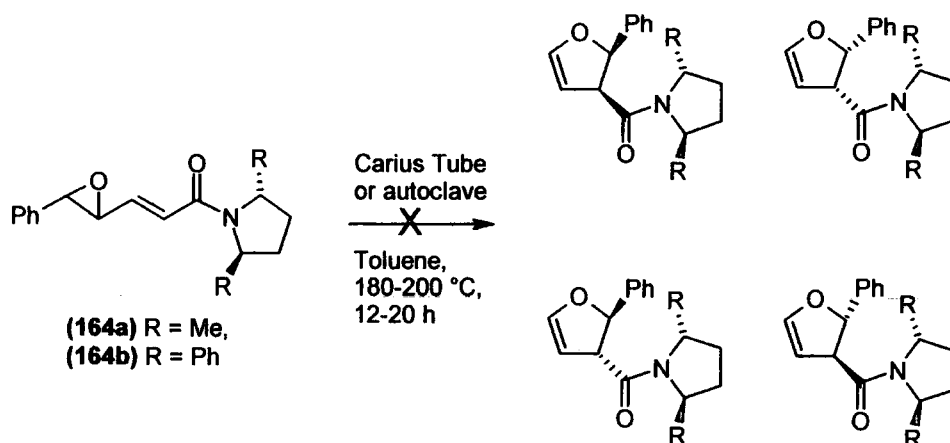

Scheme 4.3

4.2. Asymmetric rearrangement by flash vacuum pyrolysis

As the preparation of enantiomerically pure dihydrofuran would be interesting in the synthesis of furofurans, an asymmetric version of the rearrangement was one of our aims. When the rearrangement of the sesamyl vinyl epoxide (**108**) had been optimised by flash vacuum pyrolysis (FVP), this method was considered to perform the asymmetric version of the thermal rearrangement as it reduced the amount of decomposition, compared to sealed tubes.

As a model study and given that the oxazolidinone route was fully characterised, the first attempt was with this substrate. Using an FVP oven at a temperature of 500 °C and a pressure of 0.04 mbar, the chiral epoxide (**159**) was volatilised with a heat gun, however the mass balance was only 67% as the heat gun is inefficient to volatilise all the starting material. By comparison with the ¹H NMR data of the diastereoisomerically pure dihydrofurans, it was confirmed that the crude mixture contained the four diastereoisomers. The *ratio* was calculated by the integration of the signals of the proton at the C⁴ position (6.07, 6.00, 5.98, 5.84 ppm). The *ratio* of the different diastereoisomers (**160:161:162:163**) was 50:36:8:6, giving a diastereomeric excess of 16% and 14% for the *cis* and the *trans* series respectively, Scheme 4.4.

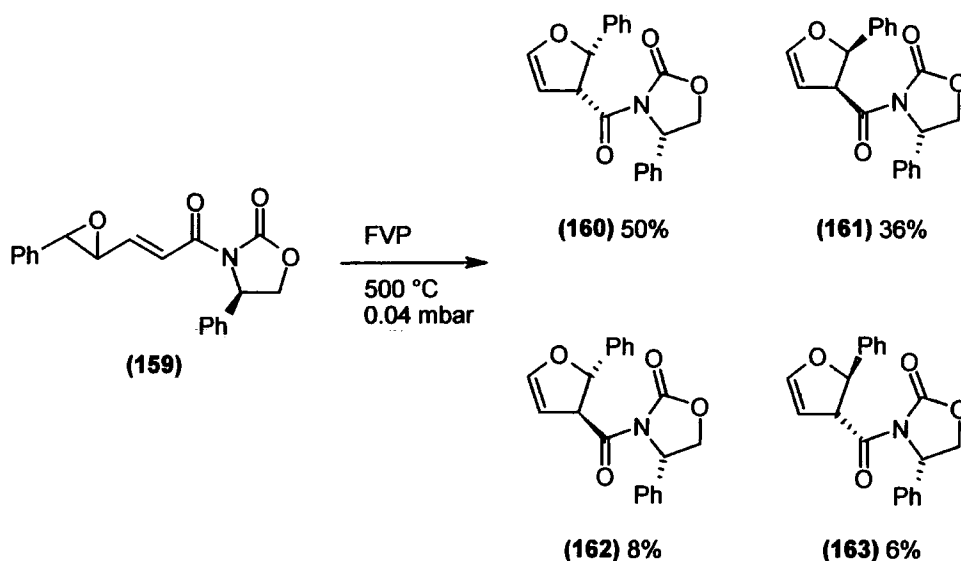

Scheme 4.4

Despite the failure to enhance the diastereoselectivity using FVP, the rearrangement of the chiral pyrolidine (**164b**) was considered. Therefore, a sample of this vinyl epoxide was rearranged by FVP using the same conditions described above. The ^1H NMR spectra of the crude mixture indicated that all the starting material was consumed but a low mass balance was obtained due to a low volatility of the starting epoxide (43%). Characteristic signals of the dihydrofuran template were detected (6.53 and 6.67 ppm, t, C^1H ; 5.54 and 5.31 ppm, d, C^4H ; 5.02 and 4.74 ppm, t, C^2H) and confirmed that the rearrangement had occurred. The two major signals corresponded to the *cis* isomers (**165**), this was shown by the coupling constant which was 10.5 Hz. The two minor compounds were the *trans* isomers (**165**) considering the lower value of the coupling constant ($J=7.2$ Hz). The *ratio* couldn't be determined directly by NMR or GC because the peaks are overlapping. HPLC analysis (Hypersil ODS, 5 μm , 25 cm, gradient for 25 min from MeCN:H₂O (10:90) to MeCN:H₂O (90:10) then for 5 min to MeCN (100), 1 mL/min) was then used to calculate the *ratio* between the four diastereoisomers: 54:34:7:5, giving a diastereomeric excess of 23% and 16% for the *cis* and the *trans* series respectively, Scheme 4.5. Unfortunately, diastereoisomerically pure products were not obtained and due to a matter of time, no further characterisation could be done.

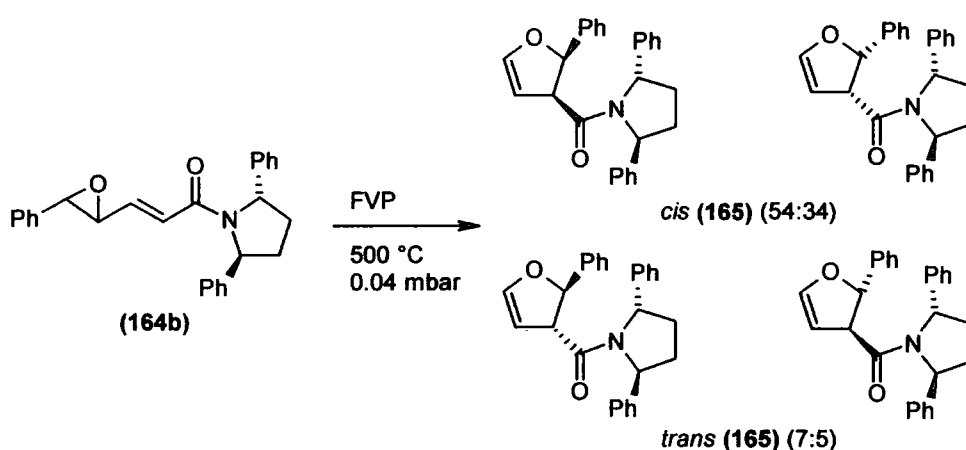

Scheme 4.5

In conclusion, the thermal rearrangement can be realised in an asymmetric fashion. The FVP was a mild method to undertake this reaction as for both of the chiral systems it was successful. The diastereoselectivity is relatively low but improvement may be achieved by changing the substitution on the chiral auxiliary (*t*-butyl is bigger than phenyl). The chiral pyrolidine derivative is promising. Syntheses of each diastereoisomeric product need to be performed to be able to identify the products obtained with the rearrangement with the FVP.

Improvement of diastereoselectivity might be obtained by changing the shape of the auxiliary. Suppressing the C-N bond rotation of the oxazolidinone intermediates by using a chiral pyrrolidine was the first attempt to improve the selectivity of the rearrangement, Figure 4.1. If the rotation of the C¹-C² bond is also limited, the diastereoselectivity should be improved. Chiral oxazolines should reduce this rotation as nitrogen and oxygen have similar volume and electronic effects, Figure 4.1. By their electron withdrawing effect oxazolines should activate the rearrangement as an amide. This strategy can be explored in future.

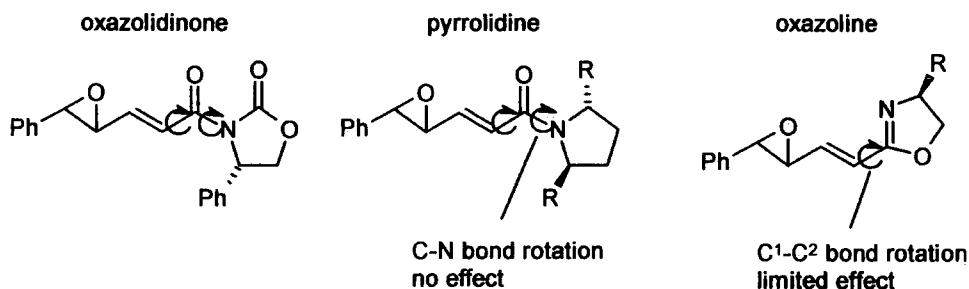
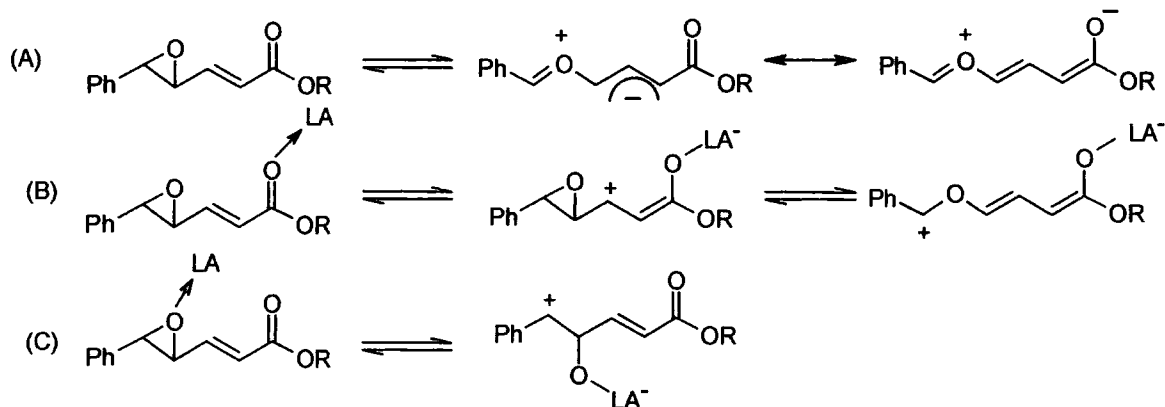

Figure 4.1

4.3. Activation of the rearrangement by Lewis acids

4.3.1. Introduction

Although the thermal rearrangement of the vinyl epoxides to dihydrofurans proceed efficiently using either FVP or an autoclave system, considering the difficulty of scaling up under these conditions, other ways to realise this reaction were considered. The hypothetical mechanism for the rearrangement involves formation of the oxonium cation followed by a carbon-carbon bond cleavage to lead to a stabilised carbanion, Equation A Scheme 4.6. Consequently, to facilitate the rearrangement, electron density needs to be withdrawn towards the ester. Therefore, a Lewis acid chelated to the ester could activate the process and permit the vinyl epoxide to rearrange at temperatures which would only require traditional equipment, Route B Scheme 4.6. However, a competitive reaction can also occur in these conditions as the Lewis acid can coordinate to the epoxide favouring its opening, Equation C Scheme 4.6.



Scheme 4.6

To favour coordination to the carbonyl over the epoxide, a bidentate Lewis acid should be used with additional chelation by the ester functionality. Similar approaches have been reported, for example, an oxazolidinone amide coordinates a Lewis acid between the two carbonyls generating a six membered ring. By this method, Evans activated Diels-Alder reactions, Synthesis A Scheme 4.7.⁷⁰ With a similar concept, Shipman used an ethylene glycol ester forming a seven membered ring when the Lewis acid was bound to the carbonyl and the free alcohol, Synthesis B Scheme 4.7.^{71,72}

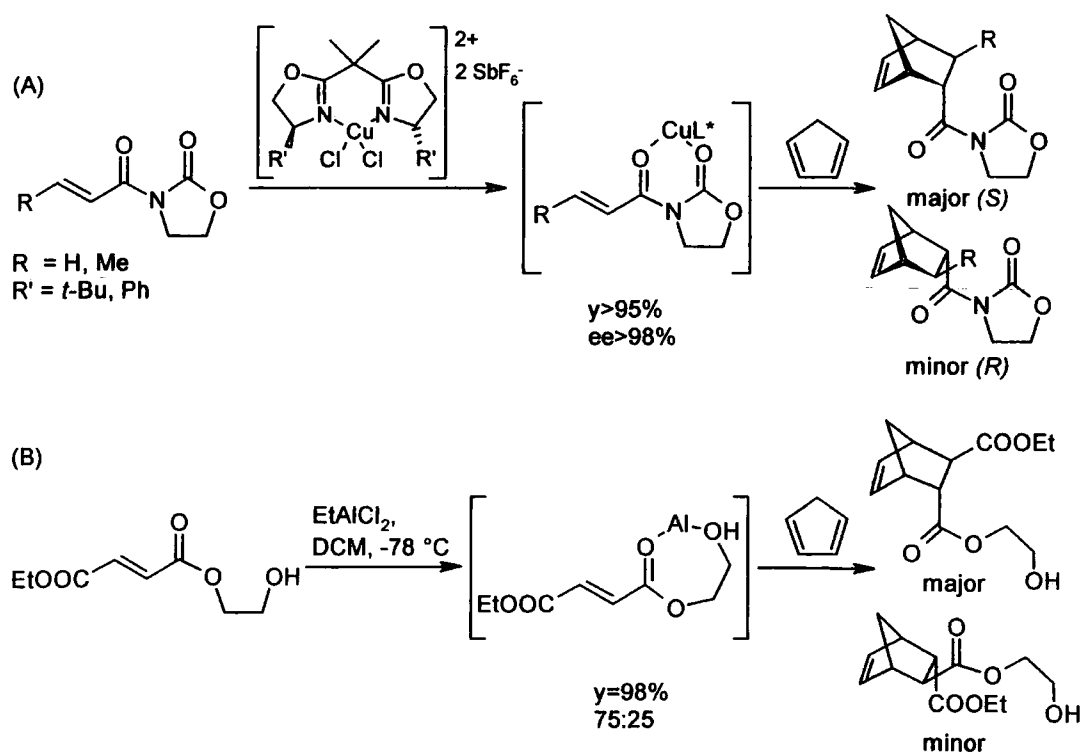

Scheme 4.7

Inspired by these two methods, the generation of the oxazolidinone amide, 2-hydroxyethyl-ester and -amide vinyl epoxide derivatives (R=H **166**, **167** and **168**) was undertaken, Figure 4.2. The choice of these compounds was also based on the potential of inducing asymmetry if the rearrangement is successful as chiral oxazolidinones and amino alcohol are commercially available (R≠H), Figure 4.2.

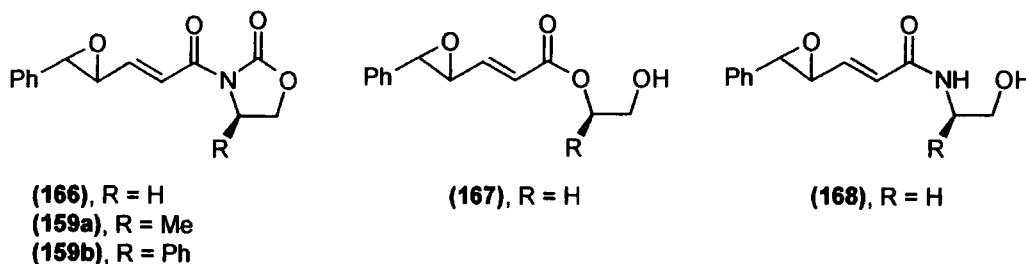
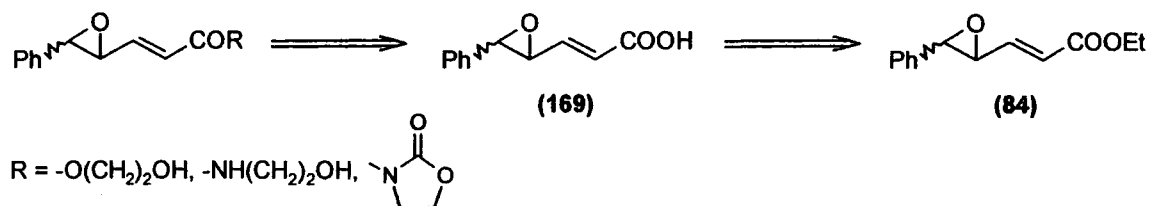

Figure 4.2

4.3.2. Preparation of the vinyl epoxide substrates

As the vinyl epoxide ester (**84**) was easily generated, this was the starting material for all the activated vinyl epoxides. Based on previous results in the group, hydrolysis of the ester to the acid (**169**) followed by esterification or amidation seemed an appropriate route, Scheme 4.8.



Scheme 4.8

Following Dutton's procedure, the hydrolysis of the ester (**84**) was performed with lithium hydroxide in methanol:water (3:1) at room temperature.⁶⁹ After aqueous work-up, the acid (**169**) was obtained in 83% yield, Scheme 4.9. Comparison with the previous data confirmed the acid structure.

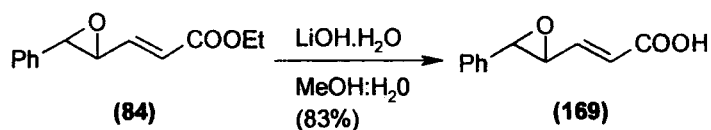

Scheme 4.9

The amidation and esterification reaction were undertaken under similar conditions. To activate the acid, treatment with pivaloyl chloride and triethylamine at $-20\text{ }^\circ\text{C}$ afforded *in-situ* the mixed anhydride (170), Scheme 4.10. Then either oxazolidinone, ethylene glycol or ethanolamine was added to the mixture with lithium chloride and led to the corresponding vinyl epoxides (166, 167 or 168). All of these compounds showed the characteristic pattern of a vinyl epoxide by ^1H NMR, the doublet and doublet of doublet for the protons respectively at C^5 and C^4 position between 3 and 4 ppm and the doublet of doublet of C^3H between 6 and 7 ppm. Yields for the coupling reaction were between 34 and 47%.

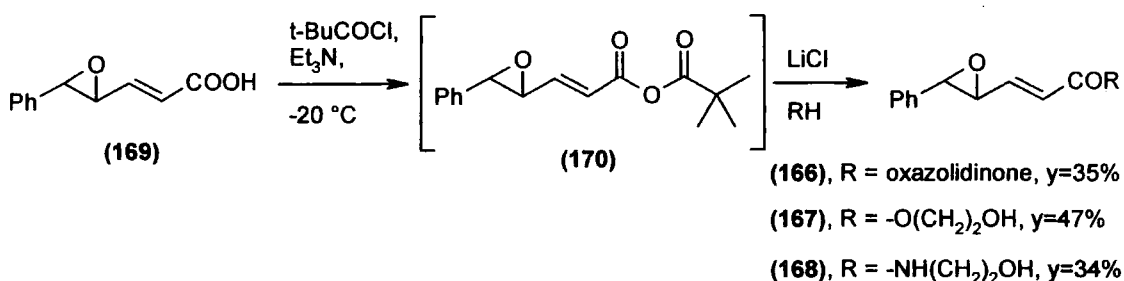

Scheme 4.10

4.3.3. Strategy

To screen several Lewis acids with the chosen substrates, a combinatorial approach seemed appropriate. The use of a GreenHouse parallel synthesiserTM allowed 24 different reactions to be carried out at the same time, but for an efficient process, a reliable analytical method was also required. Therefore, both starting materials and products needed to be synthesised and analysed before starting the combinatorial approach. For convenience, the analyses should allow rapid throughput of samples, so GC, HPLC and NMR were investigated as all these instruments have an autosampler.

To generate products, standard flash vacuum pyrolysis seemed to be the obvious method. Consequently, the freshly prepared oxazolidinone amide and 2-hydroxyethyl ester vinyl epoxide (**166** and **167**) were volatilised and rearranged in the FVP oven. In both cases, the *cis* dihydrofuran was obtained as the major compound, Scheme 4.11. *Cis:trans* ratio for oxazolidinone derivative (**171**) (*ratio*=11:1) was calculated from the integration of the signal of the proton at C⁴ position in the ¹H NMR spectra (6.11 ppm, $J_{3-4 \text{ trans}}$ =6.6 Hz and 5.82 ppm, $J_{3-4 \text{ cis}}$ =11.7 Hz). Similarly, for 2-hydroxyethyl derivative (**172**), *cis:trans* ratio (8.8:1) was calculated from the integration of the signal of the proton at C⁴ position in the ¹H NMR spectra (5.85 ppm, $J_{3-4 \text{ trans}}$ =7.34 Hz and 5.78 ppm, $J_{3-4 \text{ cis}}$ =11.1 Hz).

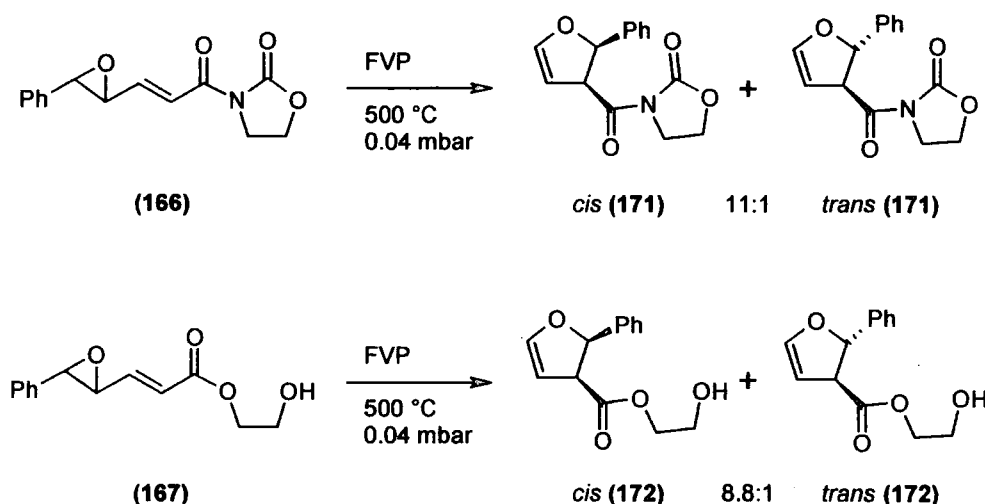

Scheme 4.11

With both the starting material and the products in hand, a general analytical method was sought. By GC, the hydroxyethyl ester had broad peaks for both starting material and product and they were overlapping. However, HPLC analyses using an RP18 reverse phase column could separate starting material from product, these were not used as the hydroxyethyl derivatives required a different method than the oxazolidinone compounds. In ¹H NMR, the distinction between starting material and product was clear in each case and did not require any change of set-up between the two different species. Therefore, analyses of the reaction mixtures were performed by ¹H NMR.

4.3.4. Rearrangements

Having synthesised the starting materials and developed an analytical method, the combinatorial screening was followed. As a triflate counter ion should be less reactive towards the epoxide than halide ions, triflate derivatives were chosen where possible. Twelve Lewis acids were selected and used in catalytic amounts (10 mol%), Table 4.1. The first attempt was realised at room temperature with the oxazolidinone and ethylene glycol derivatives in CDCl_3 to allow samples to be submitted directly for ^1H NMR analysis. The reactions were stirred for 15 hours before being treated with aqueous sodium bicarbonate and filtered through a hydrophobic frit directly into NMR tubes. For most of the reactions with both epoxides, the starting material was recovered, although some contained a small amount of degradation products and a few were completely decomposed. In none of the reactions was any evidence of the derived dihydrofuran observed.

Table 4.1

| | | | | | |
|---------------------------|---------------------------|---------------------------|------------------------------------|--------------------------|---|
| $\text{Cu}(\text{OTf})_2$ | $\text{Zn}(\text{OTf})_2$ | $\text{Sc}(\text{OTf})_3$ | $\text{Sm}(\text{OTf})_3$ | Bu_2BOTf | $\text{BF}_3 \cdot \text{OEt}_2$ |
| SnCl_4 | ZnCl_2 | MgBr_2 | $\text{Ti}(\text{O}i\text{-Pr})_4$ | TiCl_4 | $\text{Ti}(\text{O}i\text{-Pr})_2\text{Cl}_2$ |

As most of the reactions left the starting material unchanged, higher temperatures were then considered. Therefore, the next set of reactions was carried out in refluxing acetonitrile as it afforded a homogeneous system. Three Lewis acids were not used again, Bu_2BOTf and $\text{BF}_3 \cdot \text{OEt}_2$ decomposed the materials at room temperature already and SnCl_4 precipitated during the preparation. After 16 hours of heating, the mixtures were treated with aqueous sodium bicarbonate and concentrated in a Genevac® vacuum centrifuge. After adding water and D chloroform, the solutions were filtered through a hydrophobic frit into NMR tubes. Once again, only starting materials and/or degradation products were detected.

4.3.5. Activation by the aryl group

As the phenyl vinyl epoxide did not rearrange under the previous conditions, it was thought that an electron donating aryl group might help the rearrangement by a better stabilisation of the carbocation, Scheme 4.12. This aryl group can also activate the opening of the epoxide, but attempts were still made to undertake the vinyl epoxide-dihydrofuran rearrangement.

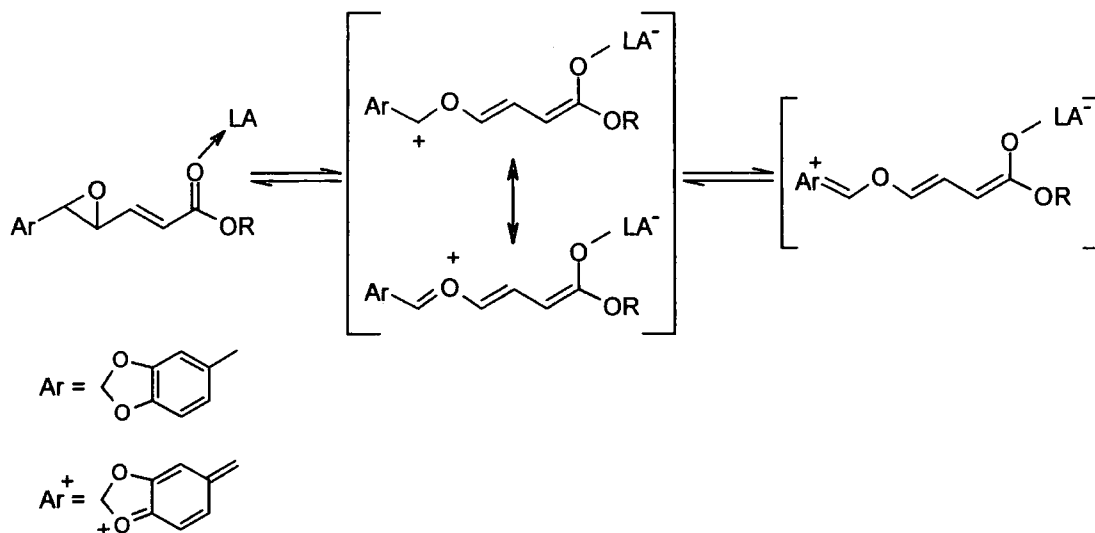

Scheme 4.12

The chosen electron donating group was sesamyl as the vinyl epoxide ester (**108**) has been synthesised previously. To prepare the corresponding oxazolidinone amide and 2-hydroxyethyl ester, hydrolysis of the methyl ester (**108**) then coupling reaction activated by pivaloyl chloride seemed the appropriate strategy as it was successful with the phenyl analogues, Scheme 4.13.

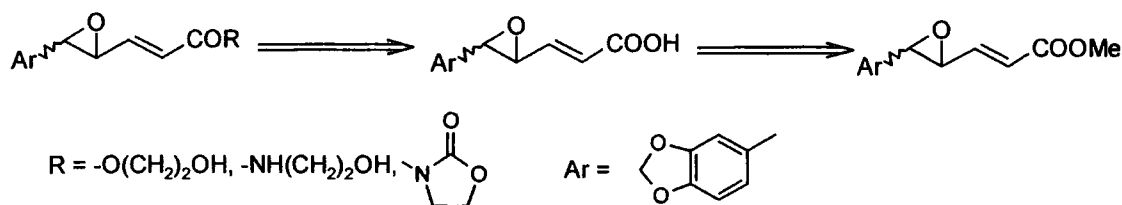

Scheme 4.13

Following the previous procedure, hydrolysis of the methyl ester (**108**) was attempted with lithium hydroxide but only decomposition was observed, Scheme 4.14. To avoid degradation during the work up, the acid (**173**) was extracted continuously during the acidification at 0 °C, but this was not successful. Other conditions (LiOH/H₂O₂,⁷³ TMSOK⁷⁴, NaI/TMSCl^{75,76}) were attempted but the results were similar.

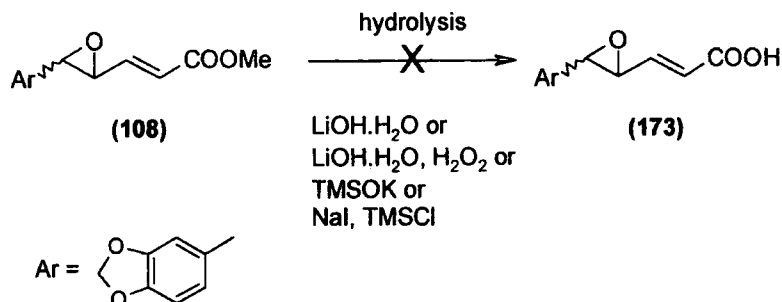

Scheme 4.14

This hydrolysis was certainly difficult because of the electron donating effect of the sesamyl group, which probably favoured a nucleophilic attack on the epoxide. This has already been discussed in the synthesis of epoxide, section 2.2.2.. Milder conditions are required and one possibility is the use of enzymes, for example PLE, even though no enzymatic hydrolysis was attempted.

4.3.6. Conclusions

The Lewis acid activation seemed a good method to generate the dihydrofuran with more convenient equipment. Unfortunately, no evidence of the rearrangement occurring was detected. Other Lewis acids can be used, e.g. cationic *bis*oxazoline copper chloride used by Evans in the previous example, Scheme 4.7 and higher boiling solvents can be explored (toluene, xylene).

With this modified method, the mixture would be stirred for a long time at reflux. As it is mentioned for the sesamyl vinyl epoxide–dihydrofuryl rearrangement (Section 2.3.3.), some starting material and/or products are not stable at high temperature, so this method might not be appropriate, therefore other activating methods were sought.

4.4. Activation by microwave irradiation

4.4.1. Introduction

For the last decade, microwave irradiation has often been used to perform thermal rearrangements. The substrate is heated directly as opposed to the reaction vessel, which implies that the temperature is homogeneous and less decomposition occurs.

To cause heat by microwave irradiation, the mixture needs to contain dipolar molecules which are sensitive to an external electric field. The microwave frequency needs to be low enough so the molecule has time to respond to the electric field but high enough to make it desynchronised with the external field. Therefore, the phase difference causes energy by molecular frictions and collisions. This phenomenon is helped when the mixture contains ions which will move under the influence of the electric field and will increase the collision rate.⁷⁷

By increasing the temperature, sealed vessels can be pressurised. This helps thermal reactions such as Diels Alder or dipolar cycloadditions. For example, an intramolecular hetero-Diels Alder reaction was performed both in a sealed tube at 110 °C for 24 hours ($y=94\%$ selectivity 1:4) and in a microwave oven, power 650 W for 14 minutes ($y=70\%$, selectivity 1:2.2), Scheme 4.15.^{78,79}

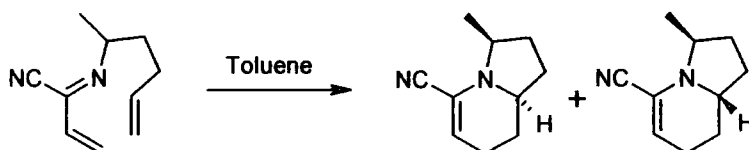

Sealed Tube, 110 °C, 24 h, $y = 94\%$ selectivity 1:4

Microwave, 650W, 6+8 min, $y = 70\%$ selectivity 1:2.2

Scheme 4.15

4.4.2. Application to the vinylepoxyde-dihydrofuryl rearrangement

As microwave irradiation gives good results in the activation of thermal reactions like cycloadditions, this process was considered for the activation of the thermal rearrangement of the vinyl epoxide (**84**) to the dihydrofuran (**85**), Scheme 4.16. The microwave apparatus used measured simultaneously the temperature and the pressure as the reaction vessels are sealed. These two parameters are the key factors of the thermal rearrangement.

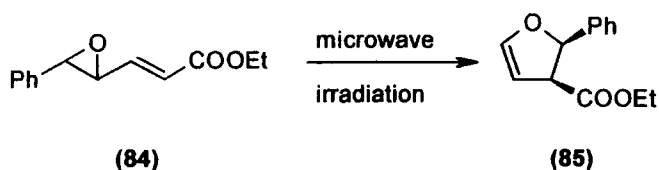

Scheme 4.16

In a first attempt, a mixture of the vinyl epoxide (**84**) in toluene was irradiated in the microwave at a power of 300 W and a maximal temperature of 200 °C. The GC of the crude mixture just showed the starting material. As it took over 7 minutes to reach the maximum temperature and the generated pressure was only 45 psi, toluene was not thought to be the best solvent.

Choosing a solvent with a higher dipolar moment, reaction in DMSO was consequently attempted. In this case, a temperature of 200 °C was reached after three minutes and the pressure increased to 150 psi. The crude mixture was black and the GC analysis confirmed total decomposition.

Since the reaction did not work in DMSO, another solvent system was required. Ionic liquids have been reported to increase the rate of collisions and so the heat. A catalytic amount of these is often added to traditional solvent in microwave experiments. For example, the Diels Alder reaction between the ethyl acrylate and the 2,3-dimethylbutadiene, traditionally needs to be in refluxing toluene or xylene for 18 to 24 hours to generate the cycloadduct (**175**) in a yield between 9 and 90%, Scheme 4.17. If the reaction is activated by a Lewis acid such as aluminium chloride, it yields in 5 hours to the cycloadduct in 73% yield. Using a catalytic amount of ionic liquid (**174**) in toluene, the reaction was performed in 5 minutes (P=100 W and T=200 °C) in 80% yield.⁸⁰

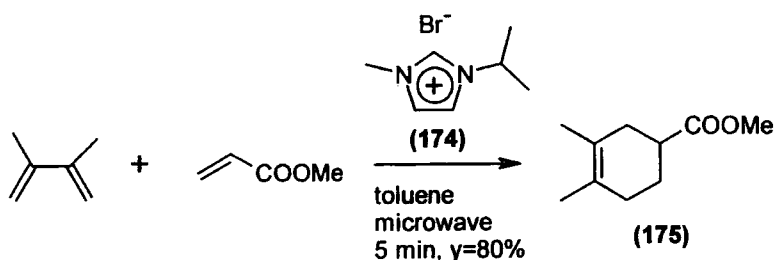

To compare:
reflux, 18-24 h, y=9-90%
AlCl₃ cat, 5 h, y=73%

Scheme 4.17



Therefore, a mixture of toluene and ionic liquid was then considered to carry out the studied thermal rearrangement. As 1-butyl-3-methyl-imidazolium hexafluorophosphate was available from another research group, this was used as ionic liquid and added in a catalytic amount in toluene. Using this system, the reaction mixture was heated between 190 and 230 °C at a pressure between 70 and 130 psi for ten minutes. The crude mixture contained mainly starting material with trace of decomposition. When the reaction was attempted with the same mixture for 5 minutes with a maximum temperature set at 250 °C, the pressure was between 160 and 230 psi and the temperature reached 265 °C. Despite these harsh conditions, starting material was collected and no product was detected by GC analysis. As the microwave equipment was available only for a week-trial, no further attempts were made to achieve the rearrangement with microwave activation.

4.4.3. Conclusion on the microwave irradiation study

Disappointingly, even when the microwave irradiation generated a high temperature and pressure, no rearrangement occurred. As all the parameters were not explored, further investigation of this methodology may yet prove fruitful. The concentration of the solution, the amount of solution in the vessel and the power of the microwave oven were unchanged during the few experiments attempted and these might be good factors to look at in future.

4.5. Conclusions on the improvement of the thermal rearrangement

In general, the activation of the rearrangement of the vinyl epoxide was not successful. The electron-donating aryl group on the vinyl epoxides can help the rearrangement activated with Lewis acids. The preparation of these starting materials needs to be improved perhaps by performing the ester hydrolysis *via* an enzymatic way. Concerning the microwave irradiation, only few experiments have been realised and there are still different parameters not yet explored such as the concentration and the power of the oven.

Similarly, the studies on the rearrangement of chiral vinyl epoxides have not been finished but results seem promising when it is undertaken by flash vacuum pyrolysis. Final dihydrofurans need to be synthesised to identify the products generated during the thermal rearrangement.

4.6. References

67. Batsanov, A. S.; Byerley, A. L. J.; Howard, J. A. K.; Steel, P. G. *Synlett* **1996**, 401.
68. Aldous, D. J.; Dutton, W. M.; Steel, P. G. *Tetrahedron: Asymmetry* **2000**, *11*, 2455.
69. Dutton, W. M. *Development and Application of the vinyl epoxide - Dihydrofuran Rearrangement*, University of Durham, UK 2000.
70. Evans, D. A.; Kozlowski, M. C.; Tedrow, J. S. *Tetrahedron Lett.* **1996**, *37*, 7481.
71. Clapham, G.; Shipman, M. *Tetrahedron Lett.* **1999**, *40*, 5639.
72. Clapham, G.; Shipman, M. *Tetrahedron* **2000**, *56*, 1127.
73. Evans, D. A.; Britton, T. C.; Ellman, J. A. *Tetrahedron Lett.* **1987**, *28*, 6141.
74. Laganis, E. D.; Chenard, B. L. *Tetrahedron Lett.* **1984**, *25*, 5831.
75. Olah, G. A.; Narang, S. C.; Balaram Gupta, B. G.; Ripudam, M. *J. Org. Chem.* **1979**, *44*, 1247.
76. Olah, G. A.; Husain, A.; Singh, B. P.; Mehrotra, A. K. *J. Org. Chem.* **1983**, *48*, 3667.
77. Lidstrom, P.; Tierney, J.; Wathey, B.; Westman, J. *Tetrahedron* **2001**, *57*, 9225.
78. Sisti, N. J.; Zeller, E.; Grierson, D. S.; Fowler, F. W. *J. Org. Chem.* **1997**, *62*, 2093.
79. Motorina, I. A.; Fowler, F. W.; Grierson, D. S. *J. Org. Chem.* **1997**, *62*, 2098.
80. Leadbeater, N. E.; Torenus, H. M. *J. Org. Chem.* **2002**, *67*, 3145.

CHAPTER FIVE

Synthesis of Fuopyrroles

5.1. Introduction

The strategy used to generate furofurans provides a short route which leads to all possible diastereoisomers. It would be interesting to extend this method to the synthesis of aza analogues, furopyrroles, Figure 5.1. No naturally occurring furopyrroles are known. Only oxidised furopyrroles such as B or C have been synthesised, but no preparation of furopyrrole with minimal oxidation as A have been reported. Considering that biological properties have been reported for most furofuran lignans and that a large number of biologically active compounds contains nitrogen heterocycles, it would be of interest to produce furopyrroles and test their biological activities.

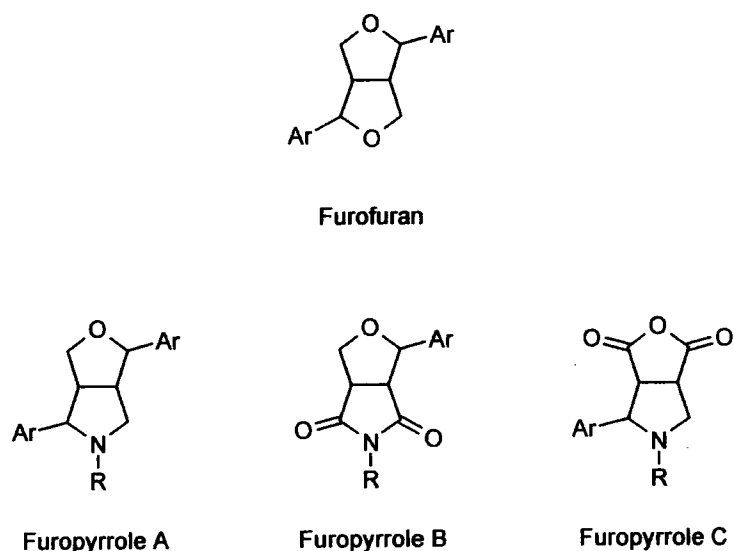
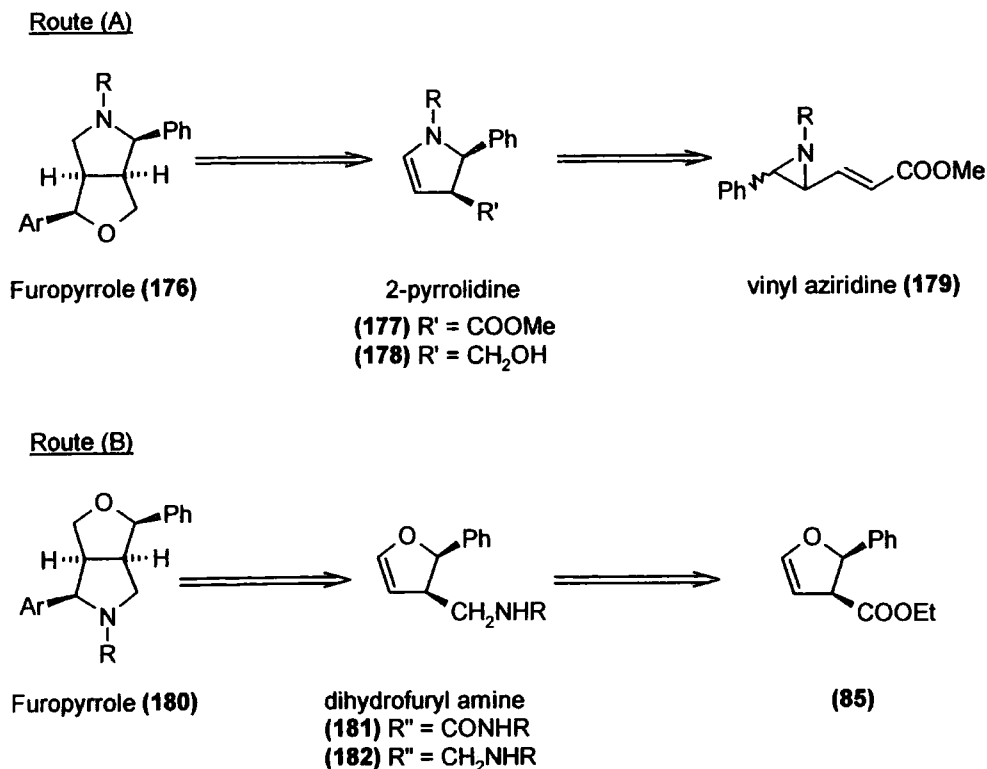

Figure 5.1

5.2. Strategies

Using the furofuran strategy, the nitrogen of the furopyrrole can be introduced into the bicyclic compound in two ways, Scheme 5.1. This may be achieved by a thermal rearrangement of a vinyl aziridine (**179**) to give a 2-pyrrolidine (**177**), (Route A) or by the acid mediated cyclisation of a dihydrofuryl amine (**182**) and an aldehyde (Route B). The amine (**182**) can be obtained from the dihydrofuryl ester (**85**) by amidation followed by reduction of the amide (**181**).



Scheme 5.1

5.3. Vinyl aziridine - 2-pyrrolidine rearrangement

5.3.1. Introduction

Only a few examples of the rearrangement of vinyl aziridines to 2-pyrrolidines are reported in the literature. The mechanism has been studied by two different groups and is assumed to be similar to the rearrangement of vinyl epoxides to dihydrofurans described in section 2.3.^{81,82} It is generally believed to involve a 4π electron conrotatory opening of the aziridine affording an iminium ion, followed by a 6π electron disrotatory closure, Scheme 5.2. The thermal rearrangement shows some diastereoselectivity and leads preferentially to the *cis* 2-pyrrolidine. It is presumed that the transition state leading to the *trans* 2-pyrrolidine is less favoured due to more steric hindrance than the one which leads to the *cis* structure.

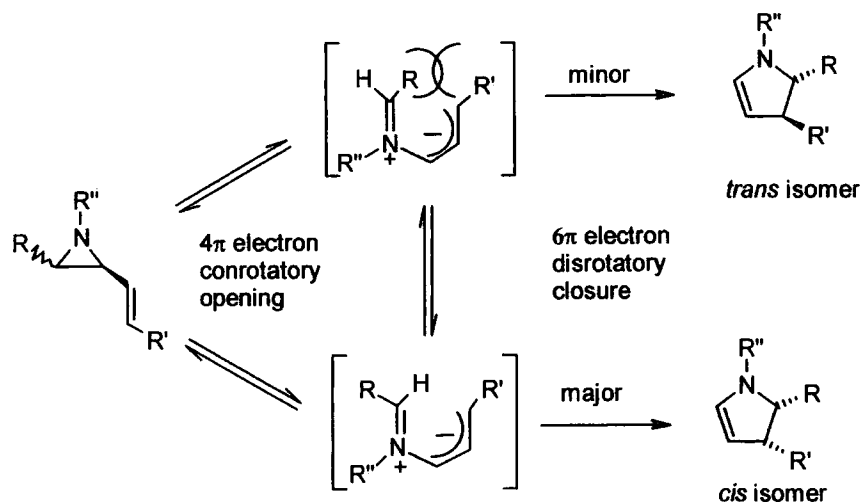

Scheme 5.2

Hudlicky used this rearrangement in the synthesis of natural products, Scheme 5.3.^{83,84} This thermal reaction was the key step in the synthesis of Platinecine, Dihydroxyheliotridane, Retronecine and Heliotridicine, Scheme 5.3.

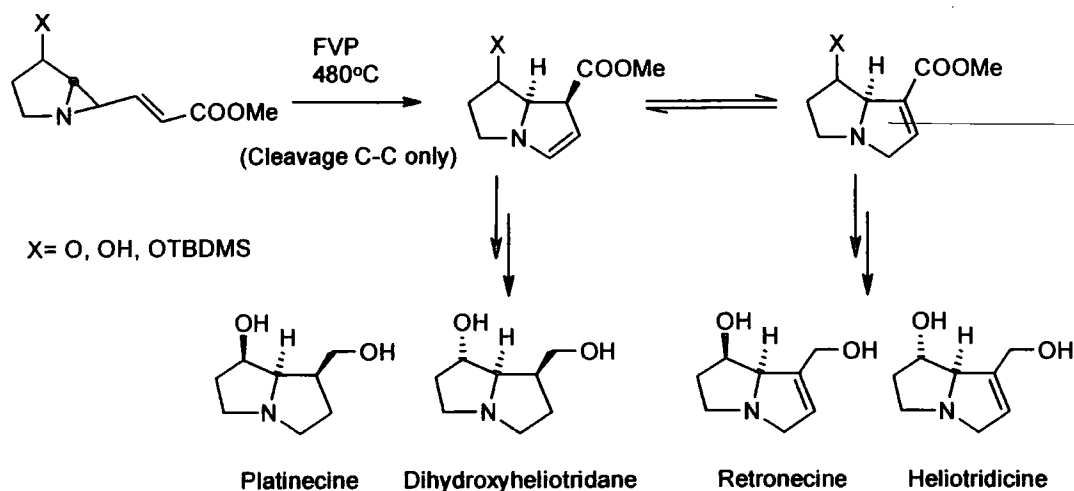

Scheme 5.3

During these studies, Hudlicky also observed some by-products (**184** and **185**); These were attributed to the competitive cleavage of the carbon-nitrogen bond, Scheme 5.4. The bicyclic product (**184**) was obtained directly by attack of the carbanion on the nitrogen and the second compound (**185**) was obtained by deprotonation α to the nitrogen.

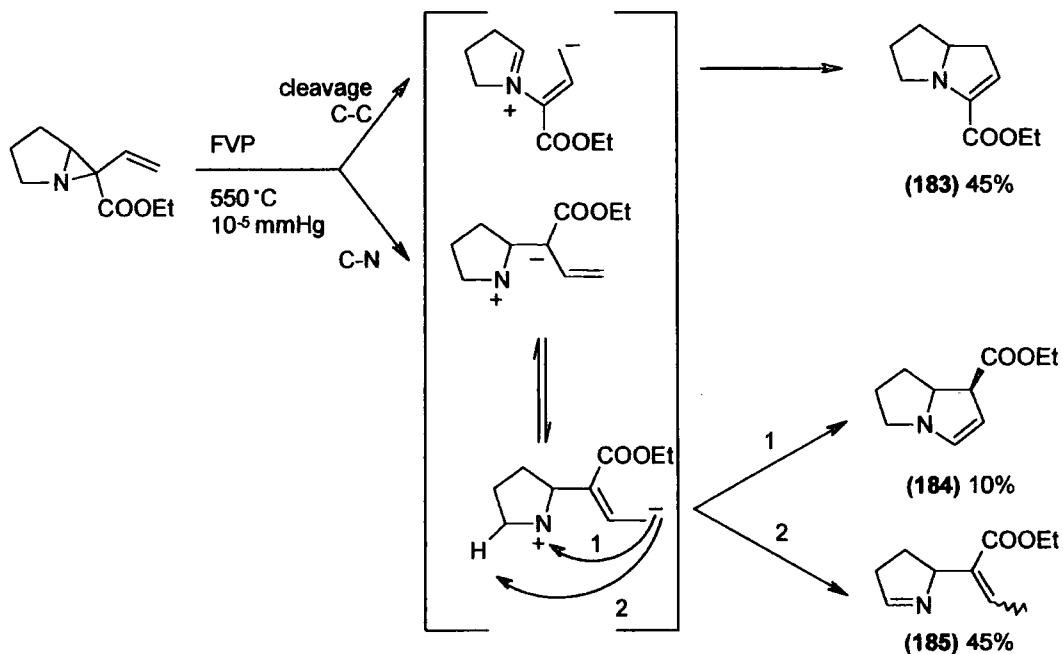

To avoid the carbon-nitrogen cleavage, Borel implied that the cation **(186)** obtained by the conrotatory opening needs to be stabilised and so favour the cleavage of the carbon-carbon bond. For this reason, Borel used a phenyl group at the C¹ position so that a benzylic carbocation **(187)** was generated, Scheme 5.5.⁸²

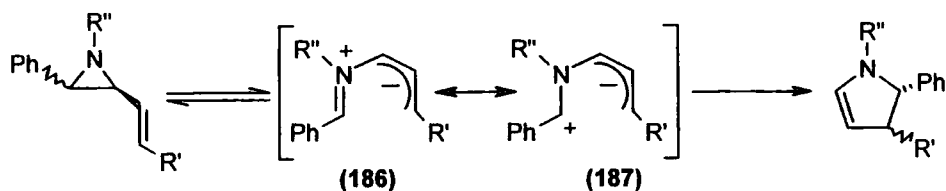

Preliminary studies in the group had explored the rearrangement of the vinyl aziridine **(190)**, Scheme 5.6.⁸⁵ The aziridine was generated *via* the opening of the corresponding epoxide with sodium azide followed by *in-situ* reduction and aziridine formation with triphenylphosphine and acetic acid, and protection with a benzoyl group, Scheme 5.6. The protection of the aziridine with a benzyl chloride was unsuccessful.

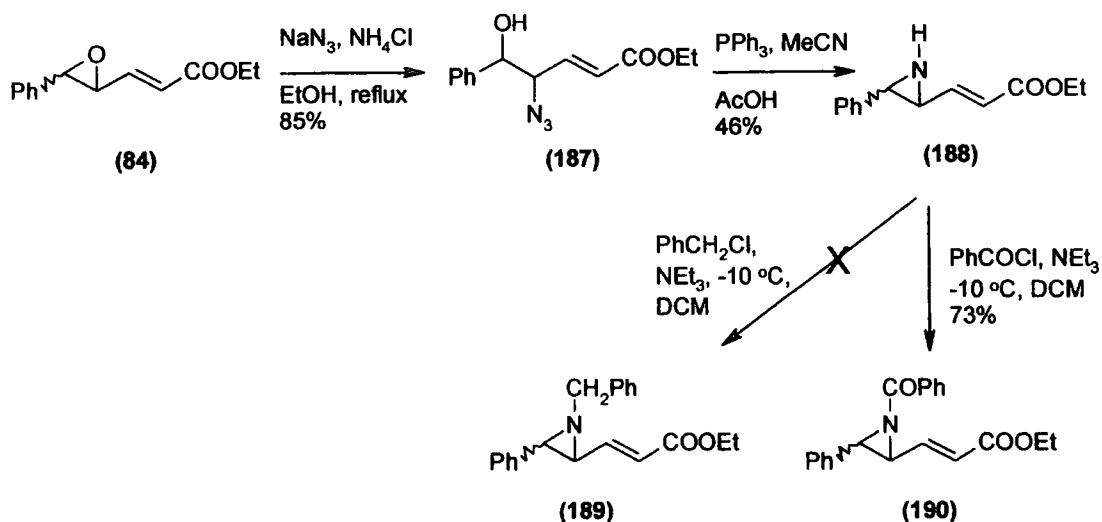

Scheme 5.6

In this previous study, the vinyl aziridine-pyrrolidine rearrangement was attempted with the protected aziridine (190) under different conditions, such as refluxing benzene or heating in toluene in a sealed tube, both with silylated or untreated glass tubes, but never by flash vacuum pyrolysis (FVP).⁸⁵ Either the starting material was partly recovered or it just resulted in decomposition, Scheme 5.7. This might be due to amide tautomerisation which would reduce the reactivity of the aziridine and the participation of the nitrogen in the carbon-carbon cleavage. As mentioned previously, it is important to stabilise the carbanion generated by the iminium intermediate which was not possible in this case.

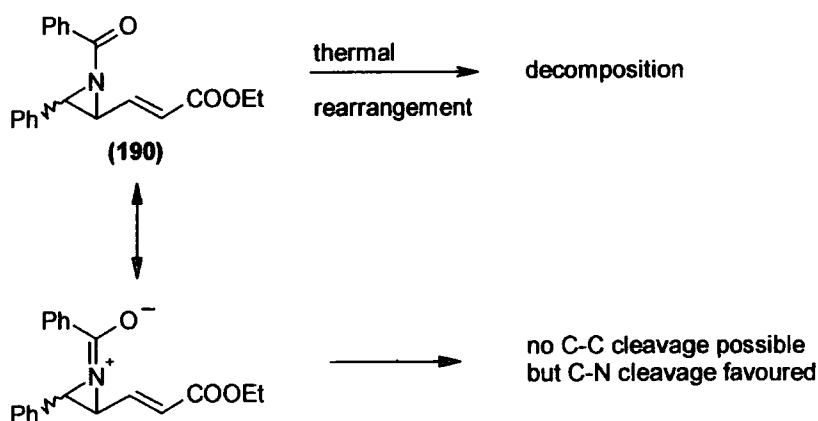

Scheme 5.7

5.3.2.2. Preparation of the imine

Two imines were selected for the aza Darzens reaction, *N*-benzyl benzylimine and *N*-tosyl benzylimine (**192**). The Darzens condensation should be easier with the *N*-tosyl imine than with the *N*-benzyl one, since the sulfone (**193**) stabilises the anion generated by the nucleophilic attack of the bromocrotonate anion, Scheme 5.10. However, the tosyl amide might reduce the reactivity of the aziridine during the thermal rearrangement as observed previously with benzoyl aziridine (**190**). It would be interesting to study these two systems.

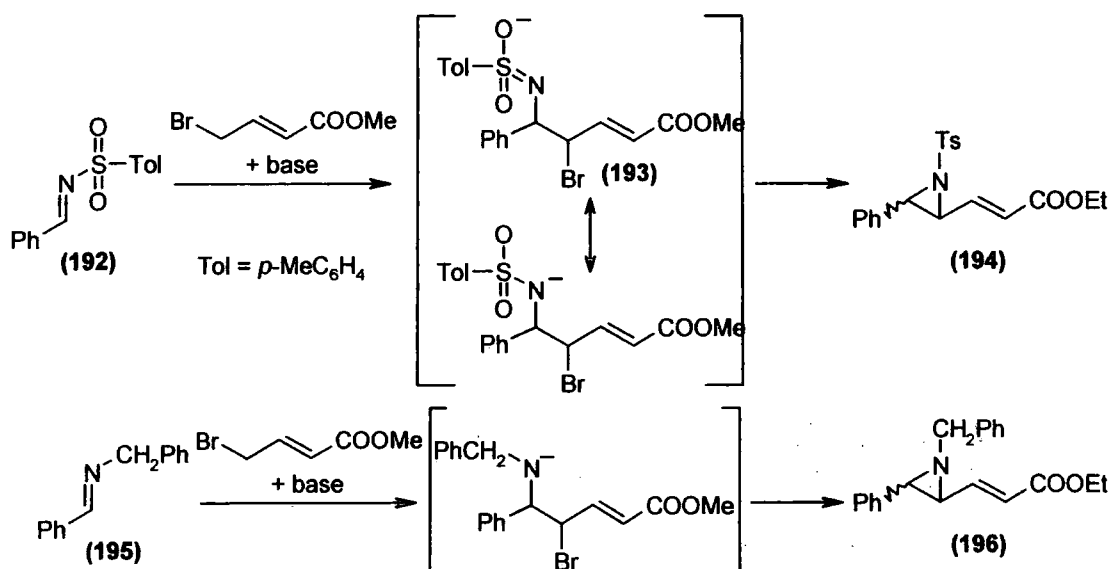

Scheme 5.10

The *N*-benzyl benzylimine (**195**) should have the opposite behaviour to the tosyl as it is an electron donating group. The advantage of the *N*-benzyl substitution is that cleavage of this protecting group is facile (e.g. hydrogenation). The *N*-benzyl benzylimine was prepared from benzaldehyde and benzylamine in chloroform, Scheme 5.11. After concentration of the chloroform, the imine (**195**) was obtained in 95% yield. The ¹H NMR spectrum showed a peak at 8.42 ppm for the CH=N and the IR spectrum had a band at 1643 cm⁻¹ characteristic of the C=N bond.

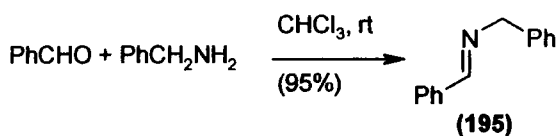

Scheme 5.11

N-tosyl benzylimine (**192**) was prepared following Jennings' procedure.⁸⁸ This involved adding a solution of titanium tetrachloride in DCM to a mixture of benzaldehyde, triethylamine and *p*-toluene sulfonamide at 0 °C, Scheme 5.13. The crude product was recrystallised from petrol:toluene (4:1) and pure *N*-tosyl imine (**192**) was obtained in 78% yield. As previously for the *N*-benzyl imine (**195**), the ¹H NMR (singlet at 9.03 ppm) and IR (band 1597 cm⁻¹) confirmed the imine functionality. The electron withdrawing tosyl group influenced the spectra as it shifted the proton to higher field and decreased the IR stretching frequency value.

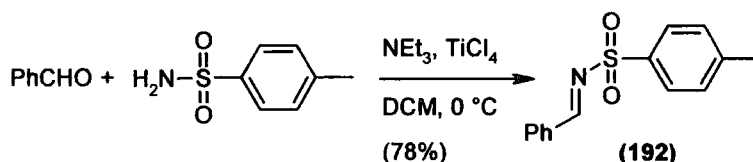

Scheme 5.13

5.3.2.3. Aza Darzens condensation

Following the procedure established to obtain the sesamyl vinyl epoxide, LDA was added to a solution of *N*-benzyl benzylimine (**195**) and bromocrotonate (**106**) in THF at -20 °C. No reaction was observed at this temperature so the mixture was warmed to room temperature. The colour of the solution changed indicating that the deprotonation of the bromocrotonate occurred, however no vinyl aziridine (**196**) was formed and the starting materials were recovered. The carbon of the imine is less electrophilic than that of the aldehyde, hence the reaction requires more forcing conditions (e.g. higher temperature). Alternatively to increase the electrophilicity of the carbon, electron density needs to be withdrawn from the nitrogen. One way to do this is by adding a Lewis acid to the reaction mixture, Figure 5.2.

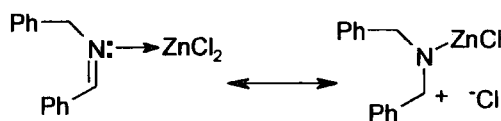
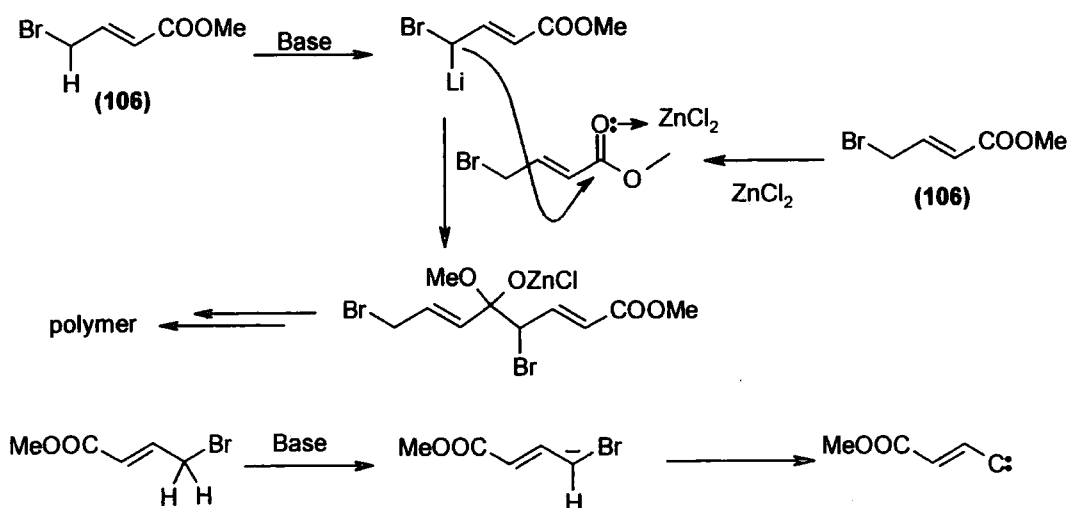

Figure 5.2

No reaction was observed after two days when LDA was added to a mixture of *N*-benzyl benzylimine (**195**), bromocrotonate (**106**) and zinc chloride. No change of colour was observed suggesting that deprotonation had not occurred. Thinking that the zinc chloride may have inhibited the deprotonation, the order of addition was reversed. Addition of LDA afforded the expected colour change indicative of deprotonation and then the Lewis acid was added. However, this attempt led only to an insoluble polymeric material. The polymerisation could be due to incomplete deprotonation which could then lead to different type of condensation, Scheme 5.14. The bromocrotonate carbanion might also be instable generating a reactive carbene. Even though different bases or Lewis acids could be explored, no further attempt was made.



Scheme 5.14

As mentioned in Section 5.3.2.2, the *N*-tosyl benzylimine (**192**) should react faster with the crotonate ion than the *N*-benzyl benzylimine (**195**) because of the electron withdrawing effect of the sulfone group increases the electrophilicity of the imine. The aza Darzens condensation was attempted by addition of LDA to a solution of imine (**192**) and crotonate (**106**) at room temperature. After purification by flash chromatography, a pure product was obtained in a 17% yield; elemental analysis was consistent with the molecular formula (C₁₉H₁₉NO₄S) but the DEPT analysis showed the presence of a CH₂ (54.9 ppm) in the molecule which did not fit with the expected aziridine (**194**) structure. Ultimately, an X-ray crystal structure determination revealed that this 'aza Darzens' reaction led to the 3-pyrrolidine (**197**), Scheme 5.15.

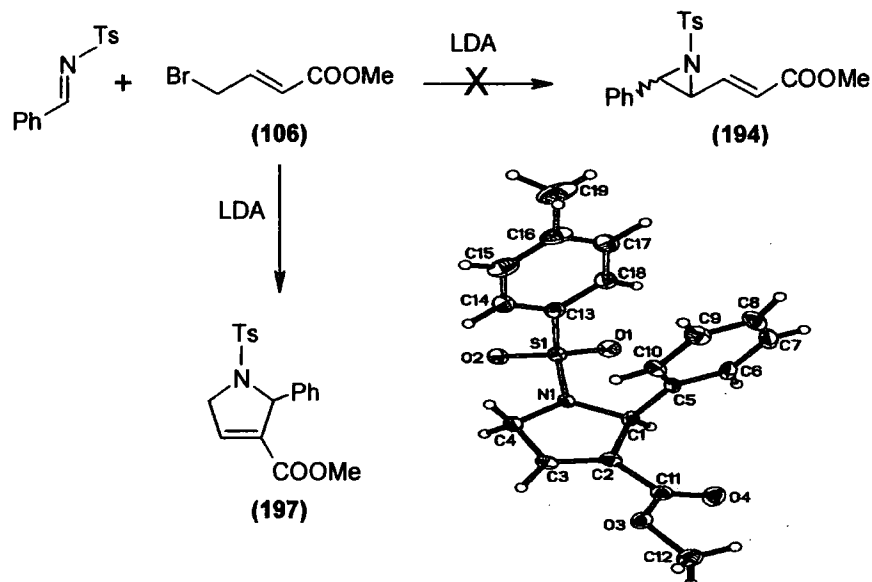

Scheme 5.15

One of the proposed mechanisms which leads to this pyrrolidine involves the attack of the carbanion followed by a hydrogen shift and cyclisation with the loss of bromide, Scheme 5.16. Another proposed mechanism is the formation of the expected vinylaziridine (194), its rearrangement to the 2-pyrrolidine (198) and the hydrogen shift to the 3-pyrrolidine (197).

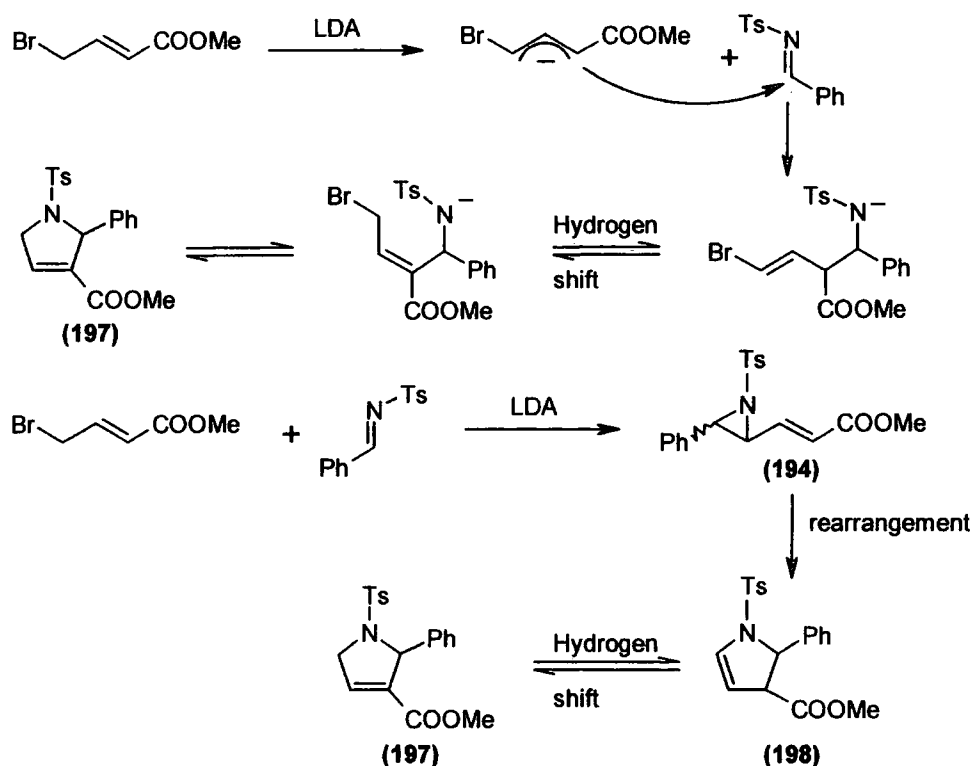

Scheme 5.16

Synthesis of vinyl aziridine (**194**) has been reported by Dai starting with tosyl benzylimine (**192**) and the 4-bromodimethylsulfonium crotonate (**191**).⁸⁶ As the sulfonium carries a positive charge, it might stabilise the carbanion at the C⁴ position and avoid the generation of 3-pyrrolidine, Scheme 5.17.

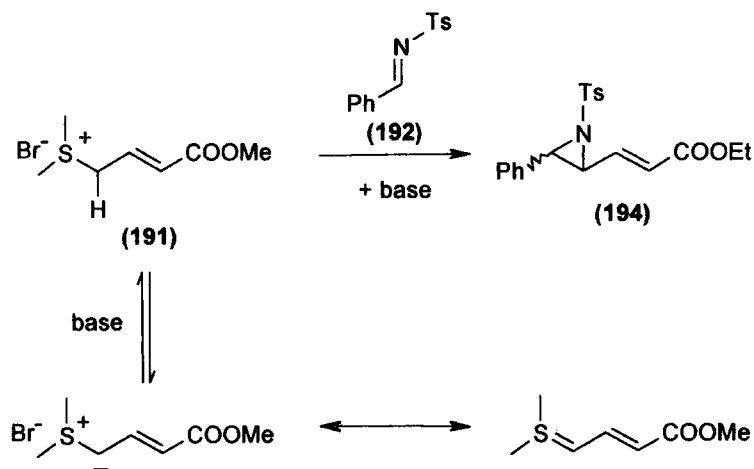

Scheme 5.17

To synthesise the vinyl aziridine, the sulfide analogue of the bromocrotonate was first prepared following Nordlander's procedure⁸⁹ and the aza Darzens reaction was then attempted under Dai's conditions, Scheme 5.18. Once again, 3-pyrrolidine (**197**) was generated in a 25% yield.

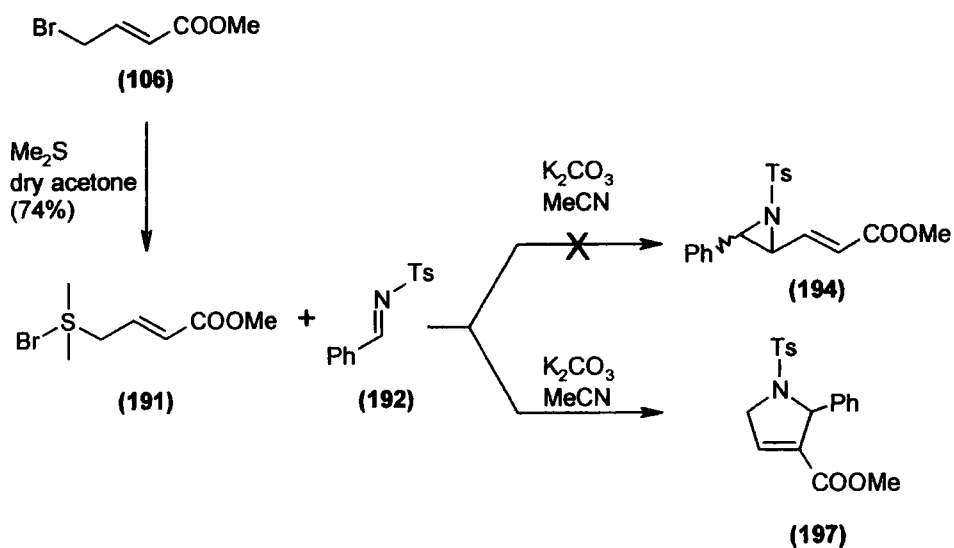

Scheme 5.18

5.3.3. Conclusion

In our hands, the aza Darzens condensation did not provide a viable route to vinyl aziridines (**194** and **196**) but instead led to the formation of an isomeric 3-pyrrolidine (**197**). Other methods can be used to obtain the expected vinyl aziridine, for instance *via* the amino alcohols (**199** and **200**) which can be prepared from the corresponding epoxide (**84**), Route A Scheme 5.19. Another way to prepare a vinyl aziridine can be by a Wittig reaction on aldehyde (**201**).⁹⁰ This can result from the attack on an imine by a carbene generated from a diazoester followed by ester reduction to the corresponding aldehyde (**201**), Route B Scheme 5.19.⁹¹⁻⁹³ The aziridine method was not pursued any further and the focus was turned to the acid mediated cyclisation of the dihydrofuryl amine. The results on this route are presented in the next section.

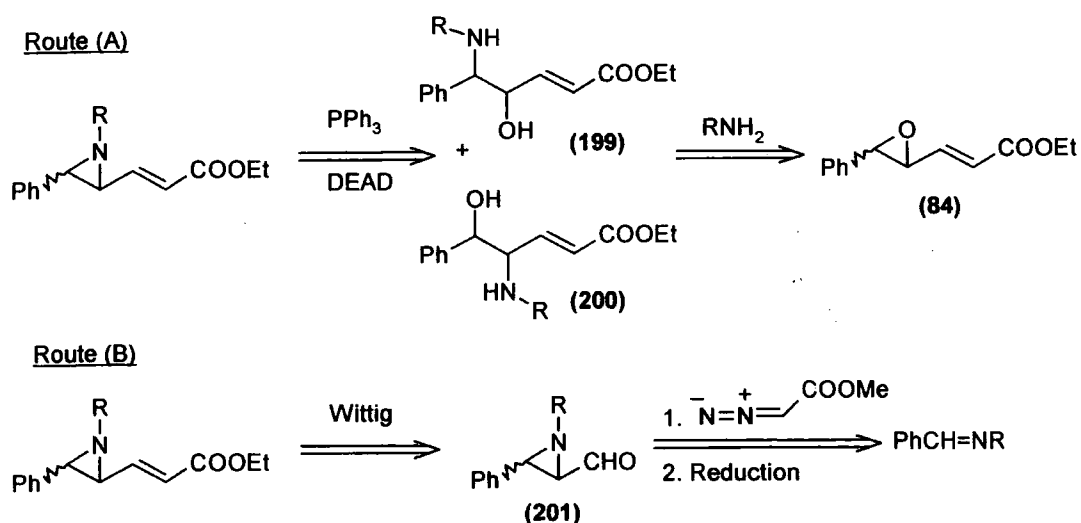

Scheme 5.19

5.4. Cyclisation of the dihydrofuryl amine

5.4.1. Introduction

The second strategy consisted of the acid catalysed cyclisation of a dihydrofuryl amine to lead to the furopyrrole (**180**) skeleton. As the dihydrofuryl ester (**85**) synthesis was previously studied, this compound seemed a good starting point for the generation of the corresponding amine. The retrosynthesis consists of the amidation of the ester (**85**) followed by the reduction of the amide (**181**) to the corresponding amine (**182**).

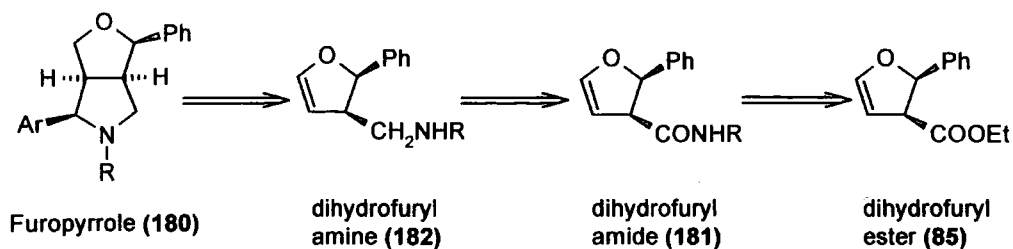

Scheme 5.20

5.4.2. Generation of dihydrofuryl amines

5.4.2.1. Amidation from the ester

The synthesis of the dihydrofuryl amides (181) was first attempted directly from the ester. As the amides are more stable than their corresponding esters, an equilibrium between the two species should thermodynamically lead to the amide. Therefore, the first conditions used were stirring the dihydrofuryl ester (85) with benzylamine in refluxing toluene, Scheme 5.21. It was observed by ^1H NMR that a new product was obtained and after purification by flash chromatography, it was determined to be the *trans* dihydrofuryl ester (85). The GC-MS showed two peaks with the same molecular weight, the ^1H NMR revealed that the two compounds had the same pattern but the coupling constants between the two hydrogen at the C³ and C⁴ positions were different ($J_{3-4 \text{ cis}} = 11 \text{ Hz}$ and $J_{3-4 \text{ trans}} = 7.5 \text{ Hz}$). To increase the nucleophilicity of the ethoxide, Scandium(III) triflate was added and 4 Å molecular sieves were used to trap the generated ethanol. Unfortunately, only a slow epimerisation at the C³ position of the starting *cis* ester (85) was observed.

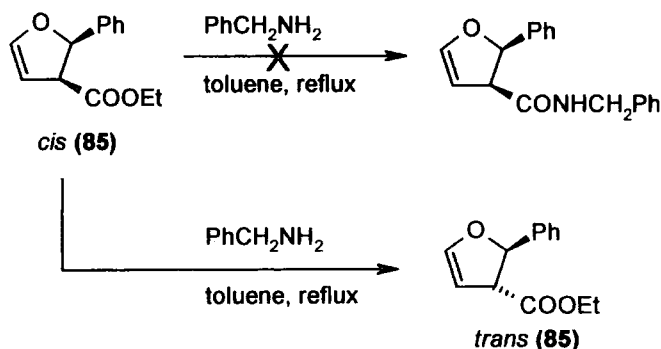

Scheme 5.21

Another reported approach is the generation of the lithium aluminium amide (**202**) from lithium aluminium hydride and the amine, followed by the addition of the ester to produce the expected amide, Scheme 5.22.^{94,95} Solladié-Cavallo used this approach in the synthesis of hydroxyamides, example A Scheme 5.22. Preparation of the lithium aluminium amide (**202**) was performed in anhydrous ether or THF at room temperature with four to five equivalents of various amines (Pr, *i*-Pr, *t*-Bu, PhCH₂) for one equivalent of LiAlH₄. Then, the ethyl 2-hydroxy-propanoate was added slowly to the generated complex (**202**). The yields of the amidation were excellent (81-100%). In some cases, reduction of the ester was observed as a minor competitive reaction. Following the same protocol, Leduc, converted the 16 ethyl esters of a dendrimer to the corresponding *n*-butyl amides, example B Scheme 5.22.

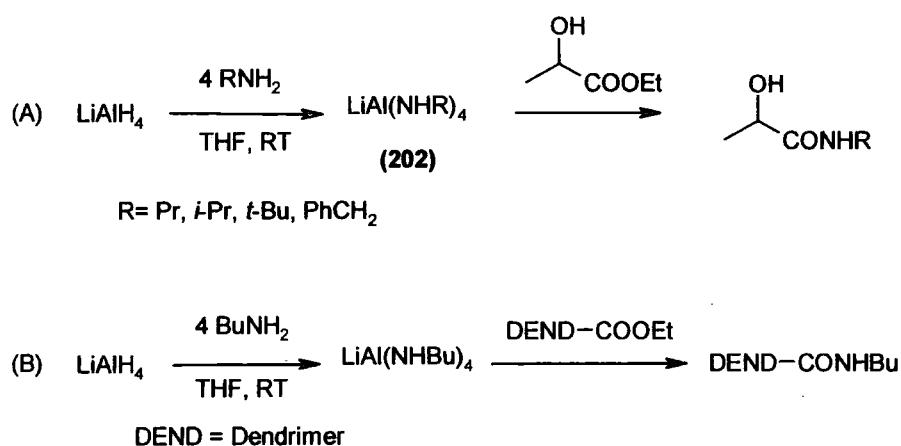

Scheme 5.22

Following this procedure, use of benzylamine and the *cis* dihydrofuryl ester (**85**) led to an intractable mixture of products, Scheme 5.23. Consequently, this method was also abandoned and attention was turned to a multistep strategy described in the next section.

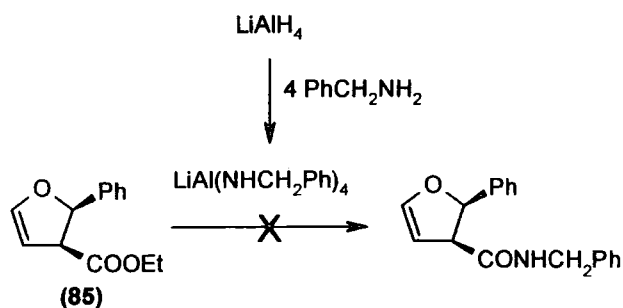

Scheme 5.23

5.4.2.2. Hydrolysis of the ester

With the failure of methods to achieve direct conversion of the ester to the amide, a multistep approach was then followed *via* hydrolysis to the acid and subsequent amide bond formation. The hydrolysis of the dihydrofuryl ester (**85**) was achieved with lithium hydroxide in methanol:water (3:1) according to the method of Yamaguchi, Scheme 5.24.⁹⁶ The addition of the base was done at 0 °C and, after allowing to warm to room temperature, the reaction mixture was stirred for three hours. The methanol was removed *in vacuo* and the unreacted ester was extracted into ether. After an acid-base extraction, the dihydrofuryl acid (**203**) was collected in 90% yield. The acid functionality was confirmed by the characteristic bands in IR spectrum (3450 cm⁻¹ (OH), 1736 cm⁻¹ (C=O)). Epimerisation at the C³ centre occurred during the basic hydrolysis as the coupling constant between the protons at the C³ and C⁴ corresponded to a *trans* configuration ($J_{3-4} = 7.2$ Hz). The generated acid (**203**) was not stable and could not be fully characterised. Consequently, it was subsequently used in the next step without further purification.

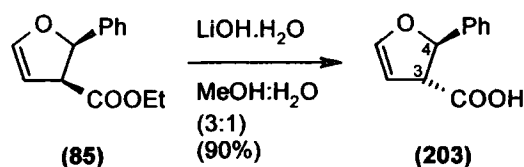

Scheme 5.24

5.4.2.3. Amidation from the acid

Different methods can be used to transform an acid to an amide, for example the acid can be activated with coupling reagents or as the acid chloride or mixed anhydride. The first methods attempted with the dihydrofuran system were through the formation of the corresponding acid chloride. Both thionyl and oxalyl chlorides were tried but only decomposition was observed, Scheme 5.25.

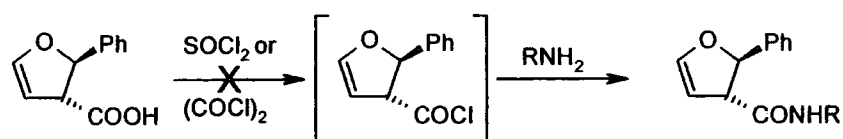

Scheme 5.25

Similar to the chloride acid strategy, carbonyldiimidazole (Imid_2CO) has been also utilised to generate amides, Scheme 5.26.⁹⁷ When this method was applied to the dihydrofuryl acid, only decomposition was observed.

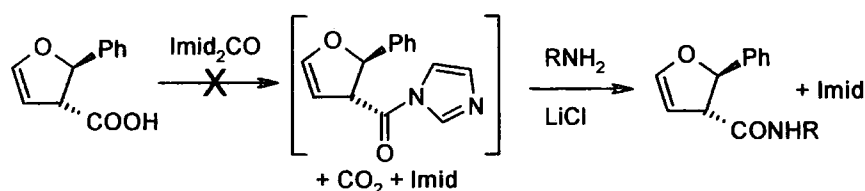

Scheme 5.26

There are many peptide coupling strategies available in literature and a large number of these were explored. The amidation was tried with various coupling reagents, Figure 5.3. With dicyclohexylcarbodiimide (DCC) and dimethylaminopyridine (DMAP), no reaction occurred. PyBOP⁹⁸ and HATU⁹⁹ in the presence of diisopropylethylamine (DIPEA) were then attempted following respectively Coste and Albericio's procedures but it resulted in a complete decomposition of the material.

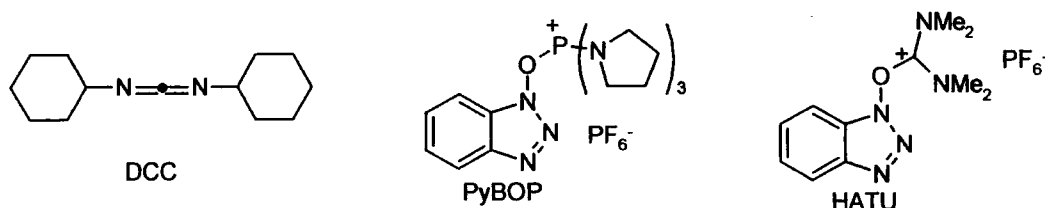
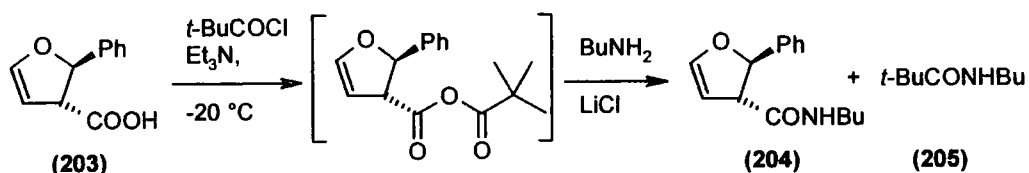

Figure 5.3

Another way to activate an acid is by forming a mixed anhydride. Therefore, the acid (**203**) was combined with triethylamine and trimethylacetyl chloride (pivaloyl chloride, *t*-BuCOCl) at $-20\text{ }^\circ\text{C}$ under argon, Scheme 5.27. After two hours, *n*-butylamine and one equivalent of lithium chloride were added and the resulting mixture was warmed to room temperature and stirred overnight. After aqueous work-up, the crude product contained both the expected butyl amide (**204**) and some pivalamide (**205**). The pivalamide by-product (**205**) was removed by Kügelrohr distillation ($T=125\text{ }^\circ\text{C}$ and $P=0.2\text{ mbar}$) and the residual product was purified by flash chromatography giving the required dihydrofuryl amide (**204**) in 64% yield. Elemental analysis was consistent with the molecular formula and the IR spectrum contained the expected characteristic bands of an amide (3291 cm^{-1} (NH); 1645 cm^{-1} , 1553 cm^{-1} (CONH)).



Scheme 5.27

As the activation method seemed successful but led also to the pivalamide (205) and therefore reduced yield, other mixed anhydrides were tried. As the selectivity was not good with pivaloyl chloride, the larger diphenylacetyl anhydride was formed under the same conditions with diphenylacetyl chloride, Scheme 5.28. The selectivity was worse with only 35% yield and the diphenylacetamide (206) was harder to remove from the mixture.

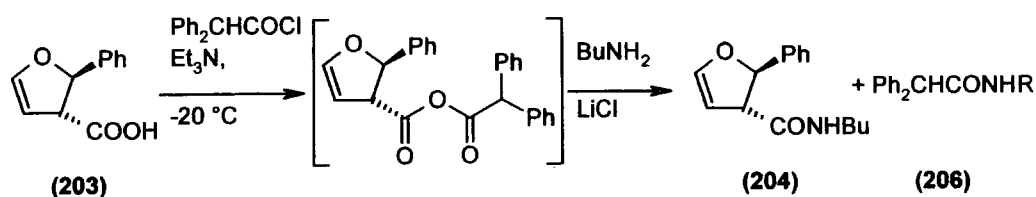

Scheme 5.28

Then, ethyl chloroformate (ClCOOEt) and triethylamine were used at room temperature, Scheme 5.29. With this activation, the amine attack should be more favoured on the ester than on the carbonate. The conversion was not complete (approximately 70%) and only a small amount of product was collected after purification by flash chromatography (yield 20%). This method was not further optimised.

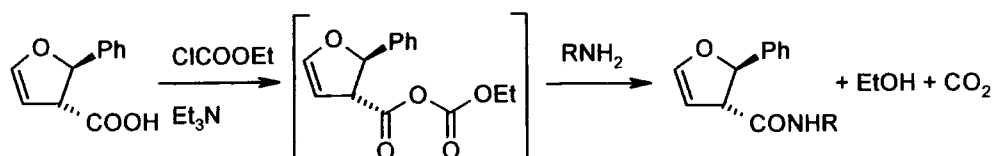

Scheme 5.29

Similarly, dimethylsulfamoyl chloride ($\text{Me}_2\text{NSO}_2\text{Cl}$) was reported to activate carboxylic acids for the preparation of esters and amides, Scheme 5.30.¹⁰⁰ Different amines (*t*-butylamine, piperidine) were coupled with various acids (cyclohexylcarboxylic acid, benzoic acid, crotonic acid, 3-phenyl propanoic acid) in excellent yield (92-97%).

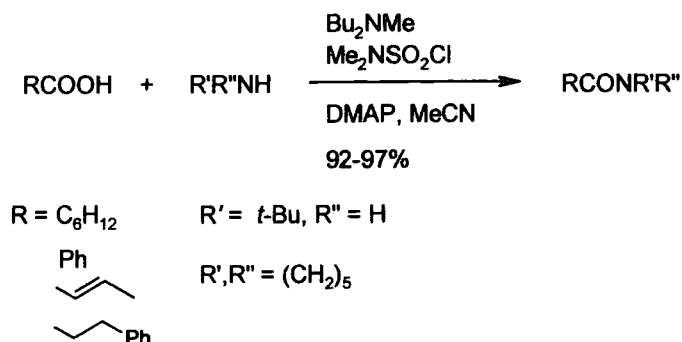

Scheme 5.30

Following this precedent, a solution of *n*-butylamine, *N,N*-dimethylethylamine and DMAP in acetonitrile was added to a solution of dihydrofuryl acid (**203**) and dimethylsulfamoyl chloride in acetonitrile at 45 °C, Scheme 5.31. The resulting mixture was stirred for three hours at this temperature before being quenched with water. The ¹H NMR spectrum of the crude product did not show any amide (**204**) and this route was also abandoned.

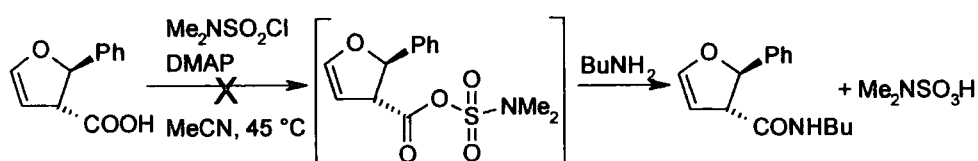

Scheme 5.31

At this stage, it was accepted that pivaloyl chloride represented the optimum coupling reagent and no further modifications were explored. Under the same conditions used previously, different amides were synthesised from ammonia (gas), ethylamine, isopropylamine, butylamine, benzylamine and allylamine, Scheme 5.32.

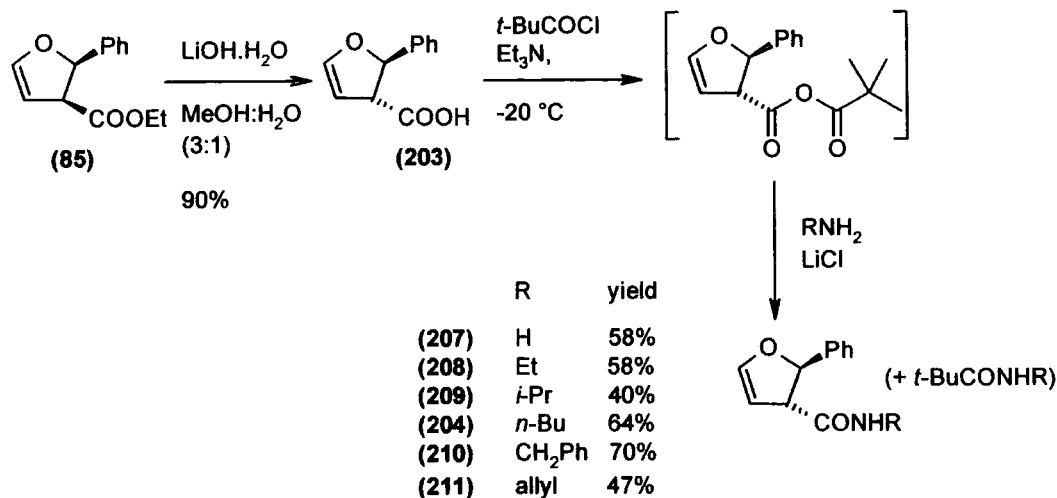

Scheme 5.32

In all cases, the *trans* configuration of the amide was obtained and confirmed by the X-ray crystal structures of the *N*-ethyl and *N*-butyl dihydrofuryl amide, Figure 5.4.

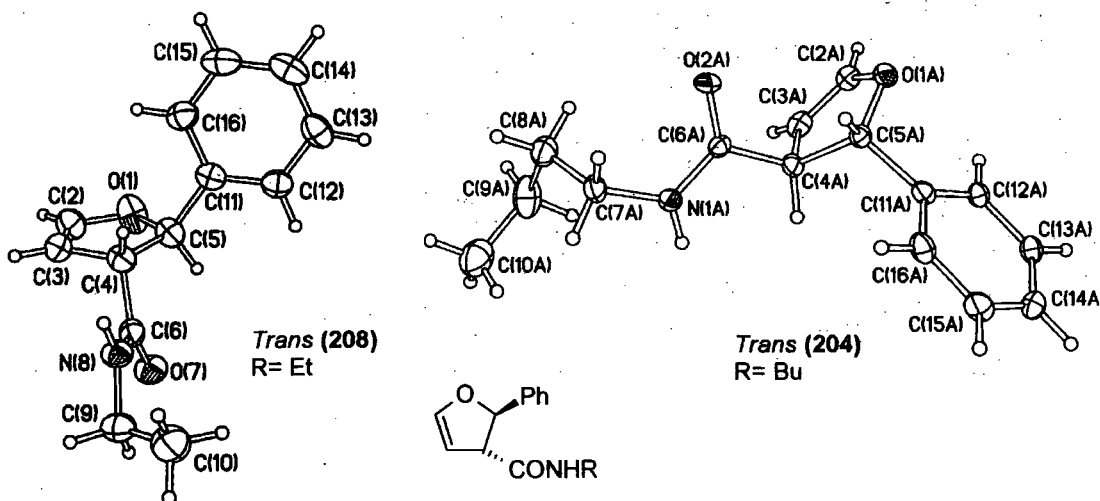
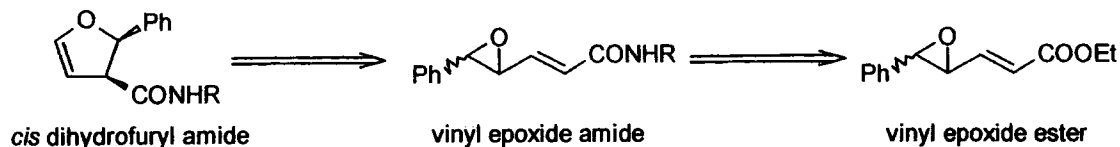

Figure 5.4

Given the very rapid epimerisation that occurs during the hydrolysis of the *cis* dihydrofuryl ester (**85**), only *trans* amides can be synthesised with this route. Therefore, another method was needed to generate the *cis* amide. Logically, it was thought that this could be achieved through thermal rearrangement of a vinyl epoxide containing an amide instead of an ester, Scheme 5.33. The desired vinyl epoxide amide could be prepared from the ester (**84**) by a similar sequence to that described above, via hydrolysis with lithium hydroxide followed by amidation activated by pivaloyl chloride.



Scheme 5.33

The hydrolysis of the ester (**84**) was performed with lithium hydroxide in methanol and water at room temperature, Scheme 5.34. This procedure led to the expected acid (**169**) in 83% yield identified by comparison with the data already reported in the group.⁸⁵ The acid was not further purified and was used immediately in the next step.

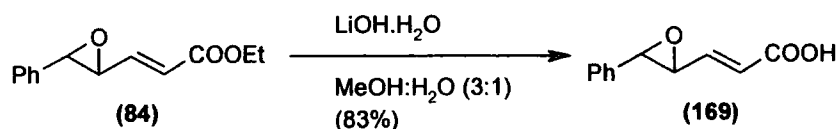

Scheme 5.34

The amidation with butyl and allyl amines was then achieved by activation with the pivaloyl chloride to form the mixed anhydride *in situ*, Scheme 5.35. After purification by flash chromatography, the *N*-butyl and *N*-allyl vinyl epoxide amides (**212** and **213**) were obtained in 78% and 65% yields respectively. The structures were confirmed by the IR spectra showing characteristic peaks of an amide at 1661 cm^{-1} for the butyl amide (**212**) and 1669 cm^{-1} for the allyl amide (**213**).

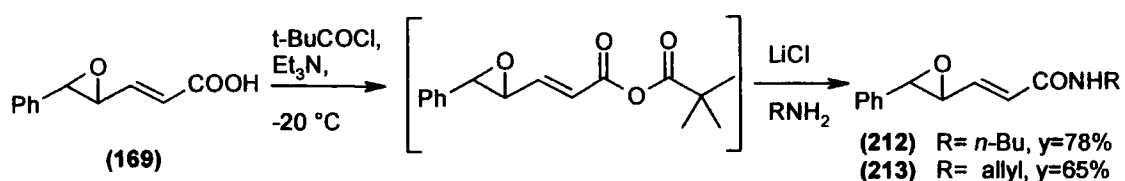

Scheme 5.35

With these amides in hand, the rearrangement of the vinyl epoxide amides (**212** and **213**) was carried out in the FVP apparatus at 500 $^\circ\text{C}$ (*cf.* reaction with esters), Scheme 5.36. After purification by flash chromatography, the corresponding *N*-butyl and *N*-allyl *cis* dihydrofuryl amides (**204** and **211**) were obtained in 71% and 63% yields respectively. The *cis* configuration was confirmed by the coupling constant (J_{3-4} = 11.1 Hz for both compounds) calculated with the C^4H doublet (5.82 ppm for butyl amide (**204**) 5.77 ppm for allyl amide (**211**)) in the ^1H NMR spectra.

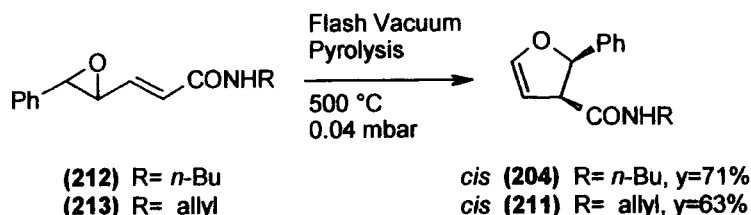

Scheme 5.36

5.4.2.4. Reduction of the dihydrofuryl amides to the amines

Following the precedents established in the ester series, the reduction of the *trans* *N*-butyl dihydrofuryl amide (**204**) to the corresponding amine (**216**) was attempted with lithium aluminium hydride (LAH) in ether at $-20\text{ }^{\circ}\text{C}$. The reaction was followed by TLC and by NMR of small quenched samples. No reduction was noticed at this temperature so the reaction was warmed to room temperature. The reaction also seemed slow at $20\text{ }^{\circ}\text{C}$ and was then heated to reflux. The speed of the reaction increased but was not complete even after five days. The reduction was then achieved with LAH in refluxing THF and was completed after two days, Scheme 5.37. The *trans* *N*-butyl dihydrofuryl amine (**216**) was obtained in a 92% yield after purification by flash chromatography. The IR spectra showed a broad peak at 3328 cm^{-1} of the NH and no peaks at 1645 and 1553 cm^{-1} confirming the reduction of the carbonyl group.

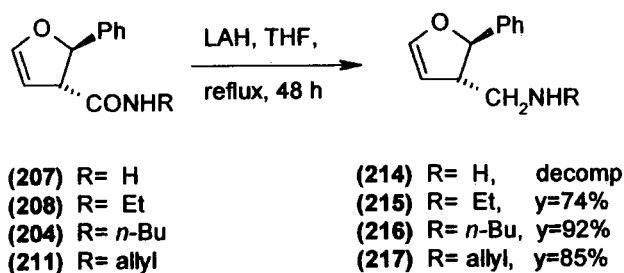

Scheme 5.37

Following the optimised procedure, the reduction of the *trans* *N*-ethyl and *N*-allyl dihydrofuryl amide (**208** and **211**) gave the *trans* *N*-ethyl amine (**215**) in 85% yield and the *trans* *N*-allyl amine (**217**) in a 74% yield. Surprisingly, the reduction of the primary amide (**207**) led only to decomposed material. The temperature was then decreased to avoid this degradation but decomposition still occurred. An alternative strategy for the primary amine could involve the deprotection of the corresponding *N*-allyl amine (**217**) with Wilkinson's catalyst, Scheme 5.38.

Following a successful procedure used previously in our group, the deprotection was attempted but only starting material was detected by ^1H NMR. Attempts to distil off the generated allyl alcohol which is thought to poison the rhodium catalyst failed to give the expected primary amine (**214**) and only the starting allyl amine (**217**) was recovered.

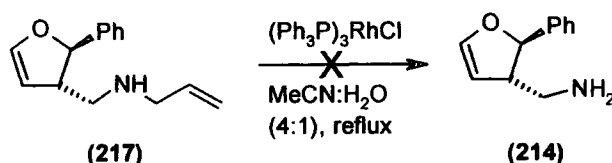

Scheme 5.38

5.4.3. Attempts of direct cyclisation

With different *trans* secondary dihydrofuryl amines in hand, attention was turned to the cyclisation which should lead to the furopyrrole skeleton (**218**). In a similar fashion to the furofuran, the furopyrrole can be obtained by the formation of the iminium salt (**220**) followed by the cyclisation and quenching of the oxonium ion (**219**), Scheme 5.39.

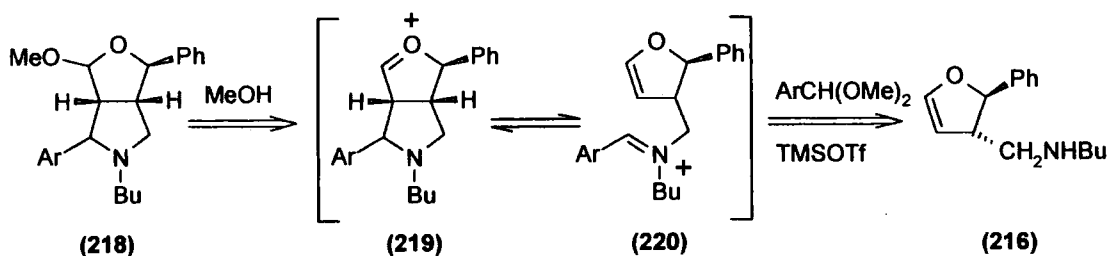

Scheme 5.39

In the optimised cyclisation to the furofuran, the dihydrofuryl alcohol was added to a mixture of dimethyl acetal and trimethylsilyl triflate (TMSOTf). Following the same procedure, the dihydrofuryl amine (**216**) was added to *p*-methoxybenzaldehyde dimethyl acetal and TMSOTf at $-20\text{ }^\circ\text{C}$ and stirred overnight, Scheme 5.40. Like the reaction with the alcohol, changes of colour during the process were noticed. However, after methanol quench and aqueous treatment, the crude mixture was analysed by ^1H NMR from which no conclusions could be made. Consequently the mixture was analysed by GC-MS, but no signals showed a mass matching the molecular ion for the expected product. Under these conditions, only decomposition products were obtained.

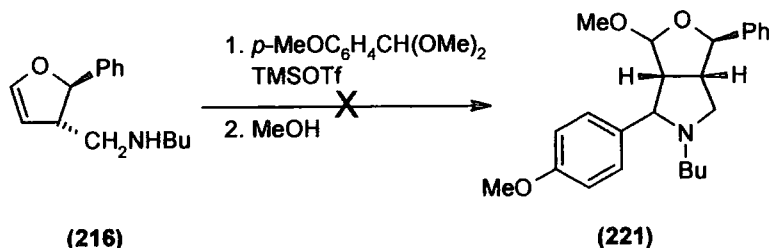

Scheme 5.40

As degradation occurred, milder conditions were then explored. The first system considered was the use of p -methoxybenzaldehyde and acetic acid. The acetic acid should catalyse the formation of the iminium salt and help in the cyclisation. With this protocol, only starting material (216) and some degradation products were recovered, Scheme 5.41. Thinking that the acetic acid used was perhaps not appropriate in this reaction as it may have contained some water which would quench the reaction, other anhydrous acids such as pyridinium p -toluene sulfonate (PPTS) and (-)-camphor sulphonic acid (CSA) were then explored. Disappointingly, no improvement was observed with these acids and only starting material was recovered.

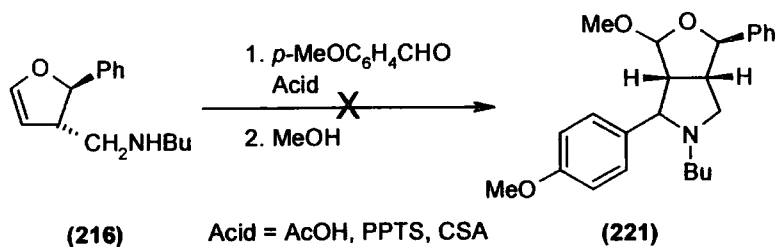

Scheme 5.41

The problem seemed to be the formation of the iminium salt (220), to check this hypothesis, a simple reductive amination was attempted. This reaction was followed by ^1H NMR and so was performed in CDCl_3 with p -bromobenzaldehyde, which has characteristic aromatic peaks in an area removed from the rest of the peaks. Following a successful procedure in the group, bromobenzaldehyde followed by acetic acid was added to the butyl dihydrofuryl amine at room temperature, Scheme 5.42. As no reaction seemed to occur after a few hours, the reaction was then heated at $50\text{ }^\circ\text{C}$.

After 35 hours, a solid appeared in the reaction mixture and the ^1H NMR analysis of the solution showed new peaks, in particular, a multiplet at 7.5 ppm which could correspond to new aromatics and two doublets between 6.5 and 6.3 ppm. Thinking the iminium salt (220) was formed, sodium borohydride was added to generate the tertiary amine (222). Unfortunately, sodium borohydride reduced the excess aldehyde but did not give the expected amine (222). This was determined by the GC-MS analysis as no product had the required mass.

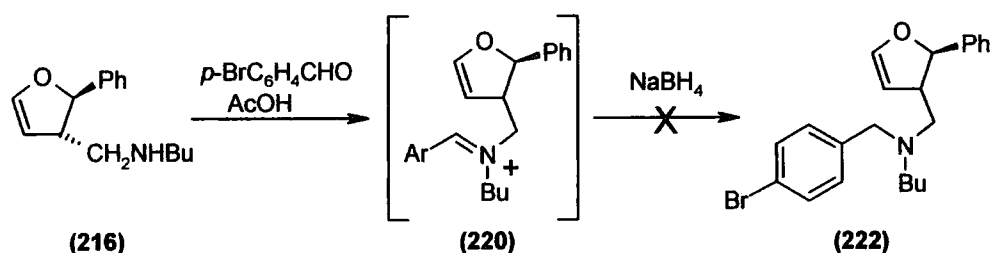

Scheme 5.42

The formation of the iminium intermediate seemed to be the problem in this reaction. In the furofuran series, the aldehyde needed to be activated as an acetal for the cyclisation to occur. By analogy, Eschenmöser salts which are aza analogues of acetals, might be more efficient than aldehydes. Consequently, butyl dihydrofuryl amine (216) was stirred with the Eschenmöser salt (223) in CDCl_3 to allow the reaction to be followed by ^1H NMR, Scheme 5.43. After two hours, the characteristic signals of the ethylenic protons of the dihydrofuran disappeared whereas new peaks appeared in the 3-5.5 ppm area. After a methanol quench and an aqueous treatment, the crude mixture contained three main compounds by GC. Unfortunately, GC-MS analysis revealed that the expected furopyrrole was not present in the crude mixture as none of the components had the required mass of the furopyrrole quenched either with methanol (224) (m/z 275) or with dimethylamine (225) from the Eschenmöser salt (m/z 288). The three main compounds were not identified (m/z 239, 311, 329).

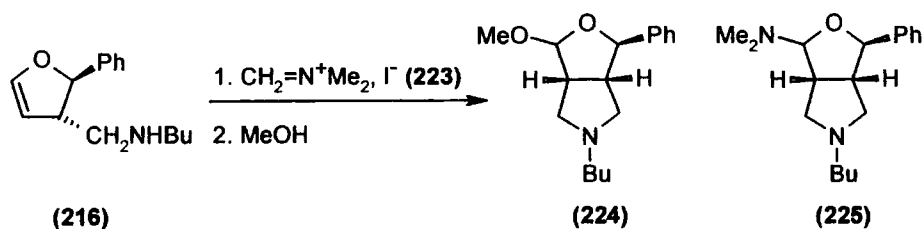

Scheme 5.43

5.4.4. Activation of the amine

As all the attempts of direct cyclisation to fuopyrrole skeleton failed, an alternative method was sought. In the previous cases, the problem seemed to be the formation of the iminium salt (**220**). To avoid this difficulty, the generation of amide (**227**) from the dihydrofuryl amine (**216**) was considered, Scheme 5.44. This amide would then be reduced by DIBAL-H to form *in situ* the intermediate (**226**) and subsequently the cyclisation should occur.

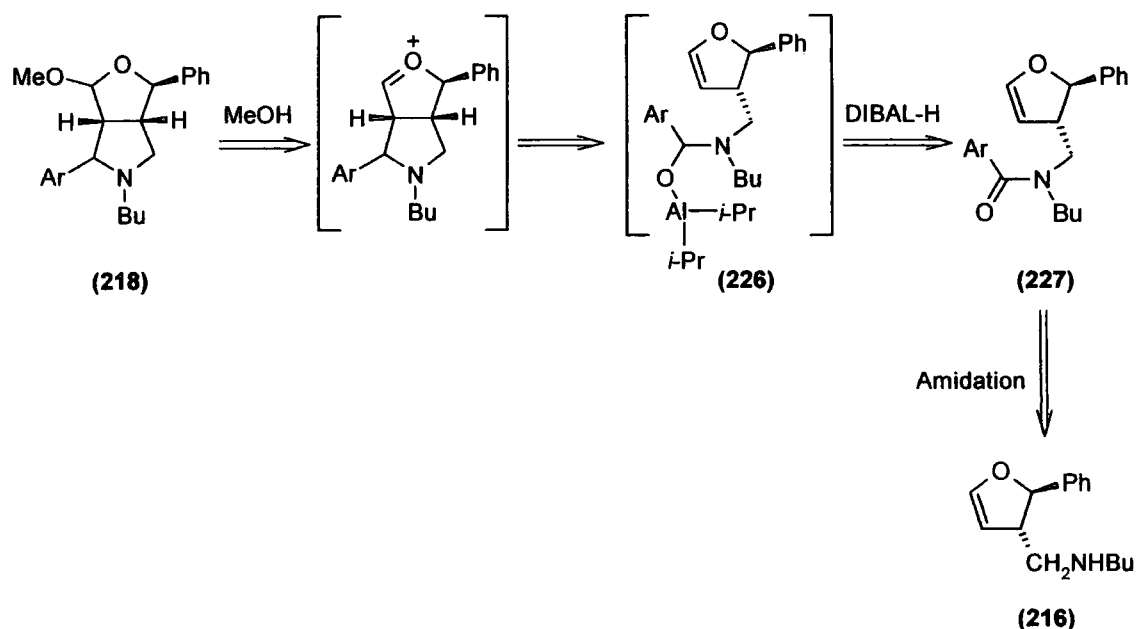

Scheme 5.44

Amide (**227**) was generated from the corresponding dihydrofuryl amine (**216**) and *p*-methoxybenzoyl chloride in the presence of triethylamine and dimethylaminopyridine (DMAP), Scheme 5.45. The reaction mixture was stirred overnight at room temperature and after aqueous work-up and purification by flash chromatography, this led to the expected amide (**227**) in 69 % yield. The GC-MS confirmed the formation of the amide (m/z 365) but the ¹H NMR showed only broad peaks at room temperature. When the sample was warmed to 55 °C the peaks were still broad. A simplified spectrum of the two rotamers was obtained at -55 °C and the characterisation of the amide could then be achieved.

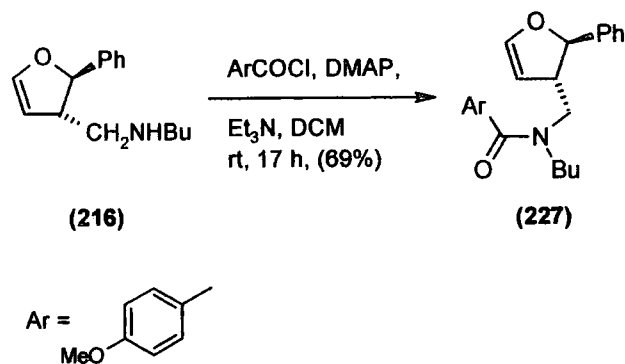

Scheme 5.45

The next step of this strategy was the reduction of the amide **(227)** with DIBAL-H, Scheme 5.46. This was performed by the addition of DIBAL-H to the amide at $-40\text{ }^\circ\text{C}$, then the mixture was warmed to room temperature and stirred overnight. By TLC analysis, the starting amide **(227)** seemed to be completely consumed and new products appeared. Consequently, the reaction was quenched with methanol and worked-up. This reduction led to a complex mixture of products in which only one minor compound could be identified. This was the tertiary amine **(228)** (m/z 351), confirming that the reduction to the tertiary amine **(227)** had occurred.

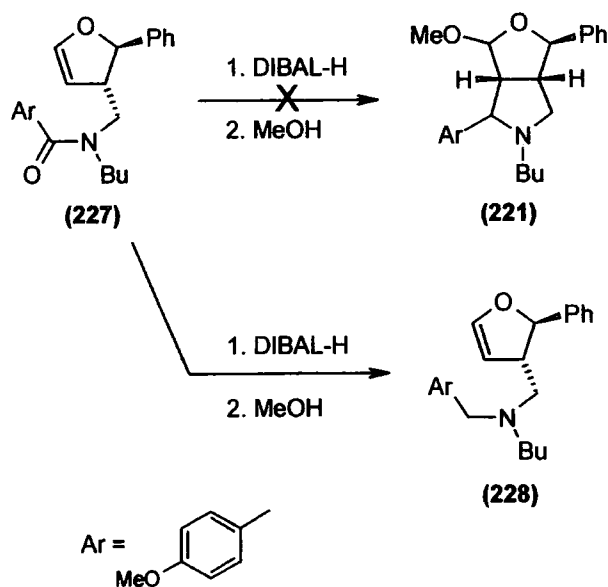

Scheme 5.46

5.5. Conclusions

The synthesis of fuopyrroles proved more difficult than their analogues, the furofurans. The nitrogen changed the reactivity of some products which led to unsuccessful steps. Even though the aza Darzens condensation generated an interesting product, the 3-pyrrolidine (**197**) which can be exploited later, it did not give access to the expected vinyl aziridines (**194** and **196**), Scheme 5.47. In future, if these compounds could be synthesised by a different route, they can then be subject to the thermal rearrangement to hopefully lead to the 2-pyrrolidines. Then after the reduction of the ester, the cyclisation from the pyrrolidine alcohol, could be attempted.

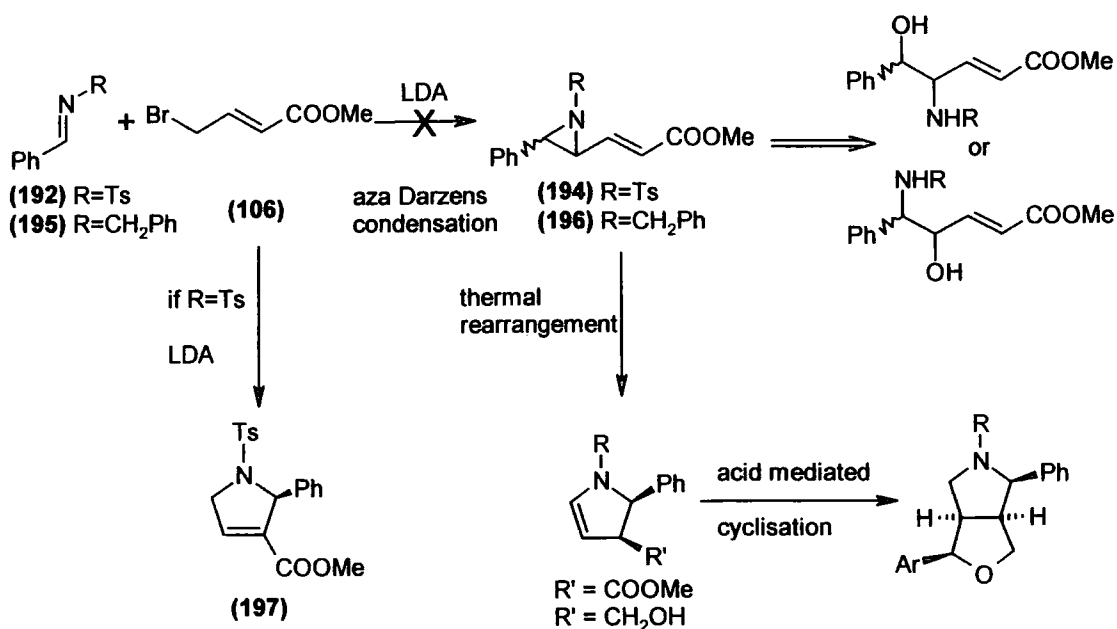

Scheme 5.47

In the second strategy to fuopyrrole studied, various dihydrofuryl amines were successfully synthesised by hydrolysis of the ester (**85**), amidation of the acid and reduction of the amide, Scheme 5.48. Epimerisation of the *cis* ester occurred during the hydrolysis step affording only *trans* amides. Therefore, to avoid this problem step, the *cis* amides were synthesised *via* thermal rearrangement of vinyl epoxide amides generated from the corresponding ester (**84**). Reduction of the amide was successfully achieved with LAH with the exception of the primary amide. Attempts to perform the acid mediated cyclisation directly proved to be unsuccessful in all cases.

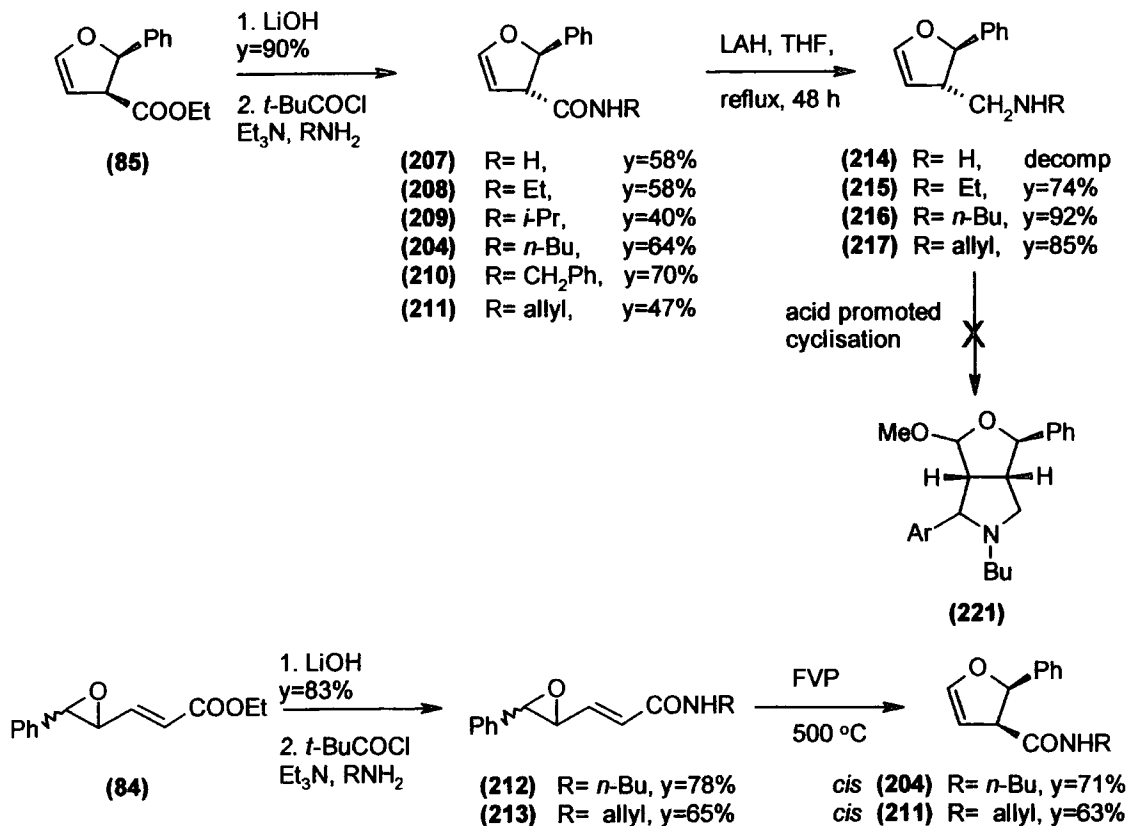

Scheme 5.48

During the acid promoted cyclisation of the amine to the fuopyrrole, the iminium intermediate (220) formation was presumed to be the difficult step (Scheme 5.42). As the imine should be easier to form, attempts to generate the primary amine (214) were performed. Even though the reduction of the primary amide and the deprotection of the allyl group with Wilkinson's catalyst did not give the expected amine, other attempts should be considered in future. As the deprotection of the allyl group was attempted on small scale only, the distillation of the allyl alcohol during the reaction was inefficient so a bigger scale deprotection should work better. The primary amine can also be obtained by reduction of the benzyl amide and deprotection by hydrogenation, Scheme 5.49.

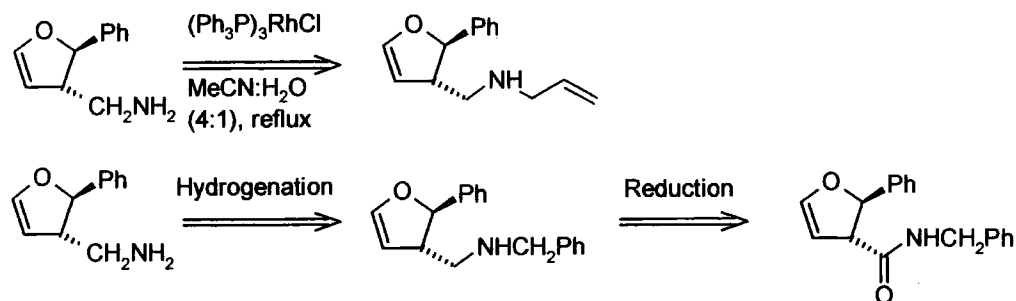

Scheme 5.49

The strategy using the activation by the amide seemed promising as the tertiary amine (**228**) was detected confirming that the reduction occurred, Scheme 5.50. Optimisation needs to be realised by varying the temperature, the reaction time and trying different reducing reagents such as lithium aluminium hydride.

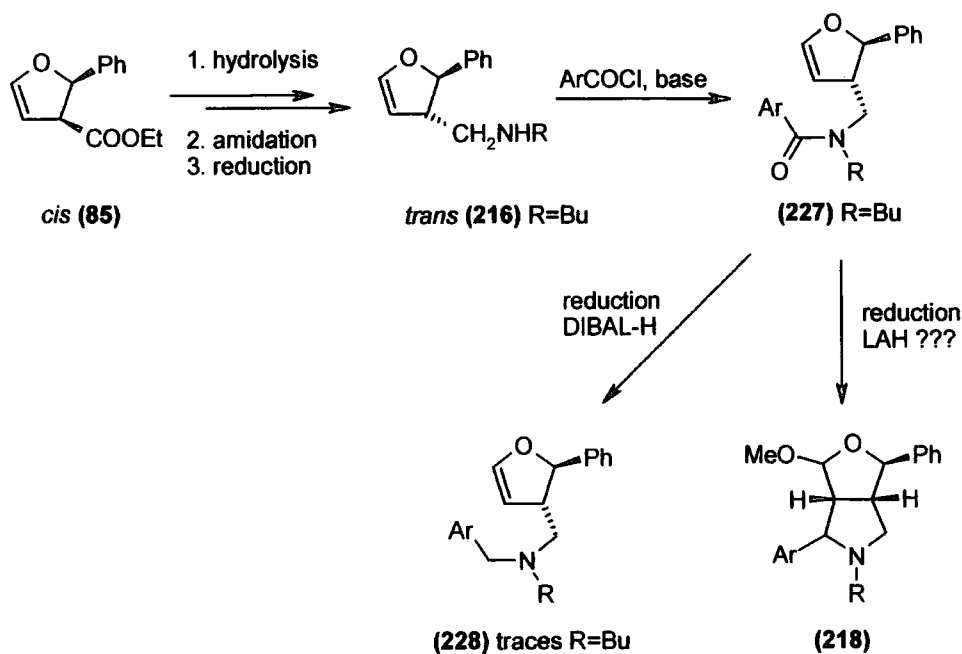

Scheme 5.50

5.6. References

81. Pommelet, J. C.; Chucho, J. *Can. J. Chem.* **1976**, *54*, 1571.
82. Borel, D.; Gelas-Mialhe, Y.; Vessiere, R. *Can. J. Chem.* **1976**, *54*, 1590.
83. Hudlicky, T.; Frazier, J. O.; Seoane, G.; Tiedje, M.; Seoane, A.; Kwart, L. D.; Beal, C. *J. Am. Chem. Soc.* **1986**, *108*, 3755.
84. Hudlicky, T.; Seoane, G.; Lovelace, T. C. *J. Org. Chem.* **1988**, *53*, 2094.
85. Dutton, W. M. *Development and Application of the vinyl epoxide - Dihydrofuran Rearrangement*, University of Durham, UK 2000.
86. Li, A. H.; Dai, L. X.; Hou, X. L. *J. Chem. Soc., Perkin Trans. 1* **1996**, 2725.
87. Li, A. H.; Dai, L. X.; Hou, X. L.; Chen, M. B. *J. Org. Chem.* **1996**, *61*, 4641.
88. Jennings, W. B.; Lovely, C. J. *Tetrahedron Lett.* **1988**, *29*, 3725.
89. Neff, J. R.; Gruetzmacher, R. R.; Nordlander, J. E. *J. Org. Chem.* **1974**, *39*, 3814.

90. Borel, D.; Gelas-Mialhe, Y.; Vessiere, R. *Can. J. Chem.* **1976**, *54*, 1582.
91. Casarrubios, L.; Perez, J. A.; Brookhart, M.; Templeton, J. L. *J. Org. Chem.* **1996**, *61*, 8358.
92. Dai, L. X.; Lin, Y. R.; Hou, X. L.; Zhou, Y. G. *Pure Appl. Chem.* **1999**, *71*, 1033.
93. Doyle, M. P.; Hu, W. H.; Timmons, D. J. *Org. Lett.* **2001**, *3*, 933.
94. Solladiecavallo, A.; Bencheqroun, M. *J. Org. Chem.* **1992**, *57*, 5831.
95. Leduc, M. R.; Hayes, W.; Frechet, J. M. J. *J. Polym. Sci. Pol. Chem.* **1998**, *36*, 1.
96. Yamaguchi, T.; Harada, N.; Ozaki, K.; Hayashi, M.; Arakawa, H.; Hashiyama, T. *Tetrahedron* **1999**, *55*, 1005.
97. Paul, R.; Anderson, G. W. *J. Org. Chem.* **1962**, *27*, 2097.
98. Coste, J.; Lenguyen, D.; Castro, B. *Tetrahedron Lett.* **1990**, *31*, 205.
99. Carpino, L. A.; Elfaham, A.; Albericio, F. *Tetrahedron Lett.* **1994**, *35*, 2279.
100. Wakasugi, K.; Nakamura, A.; Tanabe, Y. *Tetrahedron Lett.* **2001**, *42*, 7427.

CHAPTER SIX

Experimental

6.1. Introduction

All the used solvents were dry and stored under nitrogen. Petrol was distilled and the collected fractions corresponded to a boiling point of 40-60 °C. THF and ether were distilled over sodium and benzophenone; benzene and dichloromethane over calcium hydride; toluene over sodium; methanol and ethanol over magnesium alkoxide. All the sensitive reactions were flushed with nitrogen or argon and performed in dried glassware. The amines (diisopropylamine, triethylamine...) were distilled over potassium hydroxide under nitrogen. *m*-CPBA was purified by washing in DCM with a solution of phosphate buffer at pH 7.5, the organic phase dried over MgSO₄ and concentrated at RT.

Degassing Carius' tubes and sealed NMR tubes consisted of freezing, evacuating, sealing and warming up at room temperature. This cycle was repeated 3 or 4 times and the pressure checked with a manometer.

The reactions were followed by GC (Perkin Elmer 8410) or TLC (normal phase) which were revealed by UV (254 nm) and dipped in solution of phosphomolybdic acid (PMA) or KMnO₄. Flash chromatography was performed with normal phase silica (Kieselger 300-400 mesh silica). HPLC analyses were performed with a Varian 9010.

The NMR solvent was CDCl₃ unless otherwise stated. As tetramethylsilane was not used, residual CHCl₃ was taken as reference for ¹H NMR δ(¹H)=7.26 ppm and ¹³C NMR δ(¹³C)=77.0 ppm; all the chemical shifts were recorded in ppm and the coupling constant in Hz. NMR spectra were obtained on a Varian Oxford 200 (¹H at 199.975 MHz; ¹³C at 50.289 MHz), Varian Oxford 300 (¹H at 299.908 MHz; ¹³C at 75.412 MHz), Varian VXR 400 (¹H at 399.968 MHz; ¹³C at 100.572 MHz), Varian Inova 500 (¹H at 499.907 MHz; ¹³C at 125.701 MHz) or Bruker AMX 250 (¹H at 250.133 MHz; ¹³C at 62.896 MHz).

Low resolution mass spectra were recorded by GC-MS using a Hewlett Packard 5890 serie II gas chromatograph connected to a VG mass trio 1000. Electrospray analyses were performed with Micromass LCT

Melting points were determined using Gallenkamp melting point apparatus and were uncorrected. IR spectra were recorded on a Perkin Elmer FT-IR 1720X spectrometer using KBr discs.

6.2. Synthesis of vinyl-epoxide and –aziridine

6.2.1. Multistep strategies

Ethyl 3-(3',4'methylenedioxyphenyl)-prop-2-enoate (97)

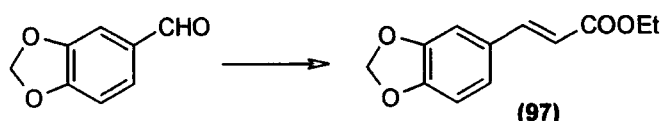

A solution of carbethoxy triphenyl phosphorane (30 g, 84 mmol) in benzene (5 mL) was added to a solution of piperonal (7.2 g, 48 mmol) under N_2 . The reaction mixture was then heated under reflux for 60 hours. The mixture was then concentrated and the residue suspended in ether:petrol (1:1). Filtration through a bed of silica and Celite removed the insoluble phosphorus by-products and afforded the title ester (**97**) (9.3 g, $y=88\%$).

$C_{12}H_{12}O_4$; %C 65.35, %H 5.49 (th 65.45, 5.49); mp 68-70 °C (lit 63-69 °C); ν_{max} (cm^{-1}) 1709 (CO), 1603 (CH=CH), 1174; δ_H (300 MHz) 7.59 (1 H, d, $J=15.9$ Hz, Ar-CH); 7.03 (1 H, s, aromatic); 7.00 (1 H, d, $J=7.8$ Hz, aromatic); 6.80 (1 H, d, $J=7.8$ Hz, aromatic); 6.26 (1 H, d, $J=15.9$ Hz, CHCOOEt); 6.00 (2 H, s, H acetal); 4.25 (2 H, q, $J=7.2$ Hz, COOCH₂CH₃); 1.32 (3 H, t, $J=7.2$ Hz, COOCH₂CH₃); δ_C (63 MHz) 167.2 (CO); 149.5, 148.3, 144.2, 128.9, 124.3, 116.2 (aromatics); 108.5 (CHCOOEt); 106.4 (ArCH); 101.5 (OCH₂O); 60.3 (COOCH₂CH₃); 14.3 (COOCH₂CH₃); MS (EI) m/z 220 (100%) (M^+), 175 (90%), 148 (55%), 145 (70%), 89 (57%)

3-(3',4'methylenedioxyphenyl)-prop-2-en-1-ol (98)

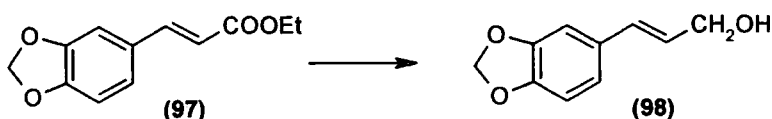

A solution of DIBAL-H 1M in hexanes (106 mL, 106 mmol) was added slowly to a solution of the ester (**97**) (9 g, 41 mmol) in THF (150 mL) under argon and the resultant mixture was stirred at -80 °C for 4 hours. The reaction was quenched with MeOH (30 mL) at -80 °C, stirred for 1 hour then water (14 mL) was added. Celite was added and the resulting granular solid was washed through a celite plug with ethyl acetate. The solvent was then removed und reduced pressure to yield the alcohol (**98**) (5.80g, $y=80\%$).

$C_{10}H_{10}O_3$; %C 67.44, %H 5.69 (th 67.41, 5.66); Mp=77 -79 °C (lit 75-79 °C); ν_{\max} (cm^{-1}) 3400-3300 (OH); δ_H (300 MHz) 6.93 (1 H, s, aromatic); 6.82 (1 H, d, J= 6.9 Hz, aromatic); 6.75 (1 H, d, J= 6.9 Hz, aromatic); 6.52 (1 H; d, J= 15.6 Hz, ArCH); 6.20 (1 H, dt, J= 5.7, 15.6 Hz, $\underline{CH}CH_2OH$); 5.95 (2 H, s, H acetal); 4.29 (2 H, d, J= 5.7 Hz, \underline{CH}_2OH); 1.46 (1 H, broad s, \underline{CH}_2OH); δ_C (63 MHz) 148.0, 147.3, 131.1, 130.9, 126.7, 121.1 (aromatics); 108.3 ($\underline{CH}CH_2OH$), 105.7 (ArCH); 101.4 (OCH_2O); 63.7 (\underline{CH}_2OH); MS (EI) m/z 178 (100%) (M^+), 135 (95%), 122 (78%), 91 (88%), 77 (65%)

3-(3',4'methylenedioxyphenyl)-prop-2-enal (96)

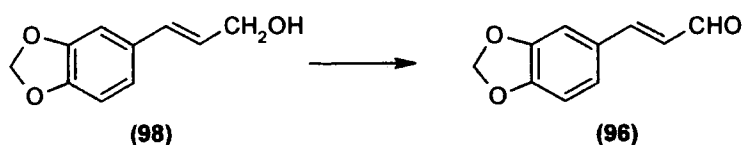

Manganese dioxide 90% (325 mg, 3.4 mmol) was added slowly to the solution of the vinylic alcohol (**98**) (100 mg, 0.56 mmol) in DCM (7.5 mL). The reaction mixture was stirred for 24 hours at rt, filtered through a celite plug and washed with DCM. The solvent was removed under reduced pressure to yield the aldehyde (**96**) (94 mg, y=95%).

$C_{10}H_8O_3$; %C 68.20, %H 4.59 (th 68.18, 4.58); Mp=84.7-85.8 °C (lit 83-86.5 °C); ν_{\max} (cm^{-1}) 1666 (CO); 1600 (CH=); δ_H (200 MHz): 9.64 (1 H, d, J= 7.6 Hz, CHO); 7.38 (1 H, d, J= 15.6 Hz, ArCH); 7.2-6.8 (3 H, m, aromatics); 6.56 (1 H, dd, J= 7.5, 15.6 Hz, $\underline{CH}CHO$); 6.05 (2 H, s, OCH_2O); δ_C (63 MHz):193.5 (CO); 152.5, 150.5, 148.5, 128.5, 126.8, 125.2 (aromatics); 108.7 (ArCH); 106.7 ($\underline{CH}CHO$); 101.8 (OCH_2O); MS (EI) m/z 176 (100%) (M^+), 147 (60%), 89 (60%), 63 (41%).

3-(3',4'methylenedioxyphenyl)-2,4-epoxy-propanal (99)

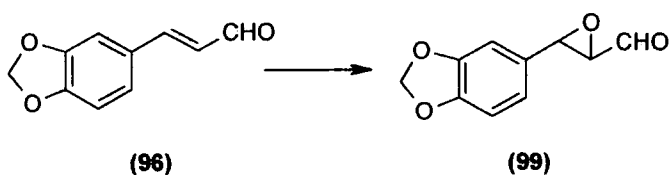

A solution of the α, β unsaturated aldehyde (**96**) (85 mg, 0.5 mmol) in methanol (3 mL) was added dropwise to a solution of *t*-BuOOH 70% aq (80 μ L, 0.6 mmol) in methanol (4 mL) and the pH was maintained at 10.5 by the addition of 1N NaOH solution. The reaction

mixture was stirred at rt for 7 hours and the pH was kept at pH 10.5 in adding NaOH. The reaction was quenched with sat. Na₂SO₃ solution (2 mL) and DCM (5 mL) was added. The layers were separated, the aqueous layer was extracted with DCM (3 x 5 mL) and the combined organic layers washed with sat. NaHCO₃ solution (5 mL) and brine (2 x 5 mL), dried (MgSO₄) and concentrated. No epoxide (**99**) was recovered.

3-(3',4'methylenedioxyphenyl)-2,3-epoxy-propan-1-ol (**100**)



Attempted method 1: With *m*-CPBA:

m-CPBA (205 mg, 1.19 mmol) was added slowly to a solution of the alcohol (**98**) (70.5 mg, 0.4 mmol) in DCM (8 mL) under argon and the resultant mixture was stirred at rt for 20 hours. The reaction was quenched with sat. Na₂SO₃ solution (5 mL) and the layers were separated. The aqueous layer was extracted with DCM (3 x 5 mL) and the combined organic layers washed with sat. NaHCO₃ solution (5 mL) and brine (2 x 5 mL), dried (MgSO₄) and concentrated. No epoxide (**100**) was recovered.

Attempted method 2: with *m*-CPBA in biphasic conditions:

m-CPBA (200 mg, 1.1 mmol) was added slowly to a solution of the alcohol (**98**) (100 mg, 0.56 mmol), TBABr (18 mg, 0.056 mmol) in DCM (3 mL) and sat. NaHCO₃ solution (5 mL) and the resultant mixture was stirred at rt for 20 hours. The reaction was quenched with sat. Na₂SO₃ solution (5 mL) and the layers were separated. The aqueous layer was extracted with DCM (3 x 5 mL) and the combined organic layers washed with sat. NaHCO₃ solution (5 mL) and brine (2 x 5 mL), dried (MgSO₄) and concentrated. No epoxide (**100**) was recovered.

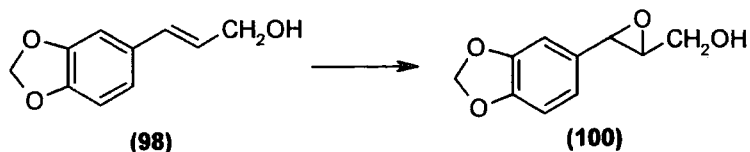

Attempted method 3: with methyl trifluoromethyl dioxirane:

A mixture of oxone (1.23 g, 2.1 mmol) and NaHCO_3 (260 mg, 3.1 mmol) was added slowly to a solution of alcohol **(98)** (75 mg, 0.42 mmol), trifluoroacetone (0.4 mL) and a 4.10^{-4} M solution of Na_2EDTA in water (2 mL) in CH_3CN (3 mL) and the resultant mixture was stirred at rt for 24 hours. The reaction was quenched with water (5 mL) and the layers were separated. The aqueous layer was extracted with ether (3 x 5 mL) and the combined organic layers washed with brine (3 x 5 mL), dried (MgSO_4) and concentrated. No epoxide **(100)** was recovered.

Attempted method 4: with MMPP:

A solution of MMPP (166 mg, 0.34 mmol) and TBABr (11 mg, 0.034 mmol) in water (3 mL) was added slowly to a solution of the alcohol **(98)** (60 mg, 0.34 mmol) in chloroform (4 mL) and the resultant mixture was stirred at 50 °C for 16 hours. The reaction was quenched with a 5% aqueous solution of NaOH and the layers are separated. The aqueous layer was extracted with chloroform (3 x 5 mL) and the combined organic layers washed with sat. aq. NaHCO_3 (5 mL) and brine (2 x 5 mL), dried (MgSO_4) and concentrated. No epoxide **(100)** was recovered.

Ethyl 5-(para-methoxyphenyl)-4,5-epoxy-pent-2-enoate (105)

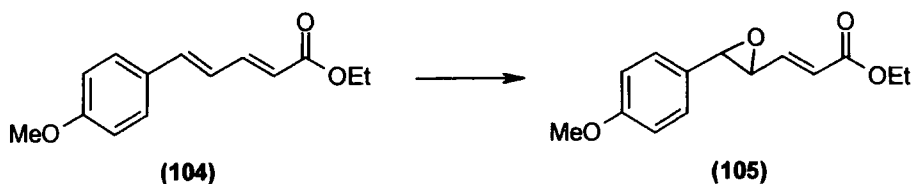

Attempted method 1: *m*-CPBA.

m-CPBA (90-370 mg, 0.5-2.1 mmol) was added slowly to a solution of the diene **(104)** (100 mg, 0.43 mmol) in DCM (5 mL) under argon and the resultant mixture was stirred at rt, 0 or -20 °C for 4 hours or 3 days depending on the temperature. The reaction was

quenched with sat. Na_2SO_3 solution (5 mL) and the layers were separated. The aqueous layer was extracted with DCM (3 x 5 mL) and the combined organic layers washed with sat. NaHCO_3 solution (5 mL) and brine (2 x 5 mL), dried (MgSO_4) and concentrated. A mixture of starting material, monoepoxide and diepoxide was obtained.

Attempted method 2: DMDO.

A solution of NaHCO_3 (160 mg, 1.9 mmol) in water (3 mL) followed by a solution of DMDO (240 mg, 0.77 mmol) in Na_2EDTA ($4 \cdot 10^{-4}$ M aq, 6 mL) was added slowly to a solution of the diene (**104**) (100 mg, 0.43 mmol) in acetone (3 mL) and the resultant mixture was stirred at RT for 60 hours. The reaction was quenched with concentrated HCl until pH=2 and after adding 5 mL of ethyl acetate the layers were separated. The aqueous layer was extracted with DCM (3 x 5 mL) and the combined organic layers washed with sat. NaHCO_3 solution (10 mL) and brine (2 x 10 mL), dried (MgSO_4) and concentrated. A mixture of starting material, monoepoxide and diepoxide was obtained.

6.2.2. Darzens condensation

General procedure A

LDA (34 mmol, 2 eq) {generated by the addition of a 1.6M solution of *n*-BuLi in hexanes (23.4 mL, 37.4 mmol, 2.2 eq) to a solution of diisopropylamine (4.75 mL, 34 mmol, 2eq) in THF (40 mL) at -20 °C under N_2 } was added dropwise to a stirred solution of aldehyde (68 mmol) and methyl 4-bromocrotonate (**106**) (2 mL, 17 mmol) in THF (60 mL) under N_2 at -20 °C. Typically, the transfer lasted 1 hour for 20 mmol of crotonate. The reaction was stirred for 2 hours at -20 °C and then quenched with sat. NH_4Cl solution (40 mL). The layers were separated and the aqueous layer extracted with ether (3 x 20 mL). The combined organic layers were then washed with sat. NaHSO_3 solution (prepared from 40 g of NaHSO_3 solid), sat. NaHCO_3 solution (20 mL) and brine (3 x 30 mL), dried (MgSO_4) and concentrated.

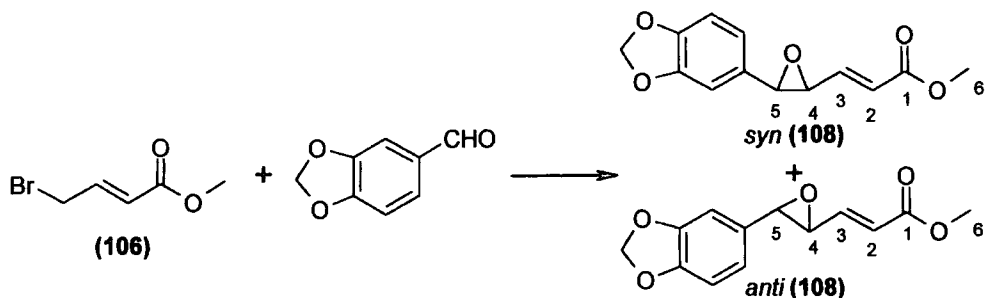
Methyl 5-(3',4'methylenedioxyphenyl)-4,5-epoxy-pent-2-enoate (108)

Following general procedure A, LDA (34 mmol) {generated from *n*-BuLi 1.6M (23.4 mL, 37.4 mmol) and diisopropylamine (4.75 mL, 34 mmol) in THF (40 mL) } was added dropwise to a stirred solution of piperonal (10.2 g, 68 mmol) and methyl 4-bromocrotonate (106) (2 mL, 17 mmol) in THF (60 mL) under N₂ at -20 °C. After treatment, purification by flash chromatography (ether:petrol 1:3) afforded the title ester (108) as a 3:4 mixture of *syn* and *anti* epoxides (2.95 g, *y*=70%). The *syn* and the *anti* epoxide were separated by prep. HPLC (hypersil semi-prep., 21.4 mm; 70% MeOH, 30% H₂O; 30 mg/mL)

Syn epoxide (108): ν_{\max} (cm⁻¹) 2992 (epoxide), 2781 (OCH₂O); 1719 (α,β unsaturated COOR); 1179 (COOCH₃); δ_{H} (500 MHz): 6.80-6.73 (3 H, m, aromatics); 6.47 (1 H, dd, *J*= 8, 15.8 Hz, C³H); 6.19 (1 H, d, *J*= 15.8 Hz, C²H); 5.97 (2 H, s, OCH₂O); 4.26 (1 H, d, *J*= 4 Hz, C⁵H); 3.71 (1 H, dd, *J*= 4.0, 8.0 Hz, C⁴H); 3.69 (3 H, s, C⁶H); δ_{C} (125 MHz): 165.6 (C¹); 147.8, 147.5 (aromatics); 141.4 (C³); 127.6 (aromatic); 126.3 (C²); 119.9, 108.3, 106.7 (aromatics); 101.2 (OCH₂O); 59.4 (C⁵); 58.0 (C⁴); 51.7 (OCH₃); *m/z* (EI) 248 (12%) (M⁺); 135 (100%); *m/z* (CI, NH₃) 266 (20%) (MNH₄⁺); 252 (80%); 233 (100%); HRMS (ES) found (MNa⁺) 271.0593 (calc. 271.0582)

Anti epoxide (108): ν_{\max} (cm⁻¹) 2992 (epoxide), 2781 (OCH₂O); 1719 (α,β unsaturated COOR); 1179 (COOCH₃); δ_{H} (500 MHz): 6.82-6.71 (3 H - 2 H, broad s, aromatics + 1 H, dd, *J*= 6.7, 15.6 Hz, C³H); 6.70 (1 H, s, aromatics); 6.17 (1 H, d, *J*= 15.6 Hz, C²H); 5.96 (2 H, s, OCH₂O); 3.76 (3 H, s, C⁶H); 3.75 (1 H, d, *J*= 1.8 Hz, C⁵H); 3.35 (1 H, dd, *J*= 1.8, 6.7 Hz, C⁴H); δ_{C} (125 MHz): 166.0 (C¹); 148.1, 147.9 (aromatics); 143.8 (C³); 129.8 (aromatic); 123.4 (C²); 119.7, 108.4, 105.3 (aromatics); 101.2 (OCH₂O); 61.1 (C⁵); 60.4 (C⁴); 51.8 (OCH₃); *m/z* (EI) 248 (12%) (M⁺); 135 (100%); *m/z* (CI, NH₃) 266 (20%) (MNH₄⁺); 252 (80%); 233 (100%); HRMS (ES) found (MNa⁺) 271.0593 (calc. 271.0582)

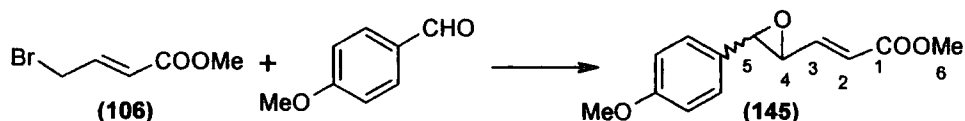
Methyl 5-(p-methoxyphenyl)-4,5-epoxy-pent-2-enoate (145)

Following general procedure A, LDA (34 mmol) {generated by *n*-BuLi 1.6M (23.4 mL, 37.4 mmol) and diisopropylamine (4.75 mL, 34 mmol) in THF (40 mL) } was added to a solution of p-methoxybenzaldehyde (8.26 mL, 68 mmol) and methyl 4-bromocrotonate (**106**) (2 mL, 17 mmol) in THF (60 mL) under N₂ at -20 °C. After treatment, purification by flash chromatography (ether:petrol 1:3) afforded the title ester as 1:2 *ratio* mixture of *syn* and *anti* epoxides (**145**) (2.21 g, *y*=56%). The *syn* and the *anti* epoxide (**145**) were separated by prep. HPLC (hypersil semi-prep., 21.4 mm; 70% MeOH, 30% H₂O; 30 mg/mL). The *trans* epoxide (**145**) decomposed during this purification.

syn epoxide (**145**): ν_{\max} 2999, 2953, 2837 (CH aromatics); 1723 (CO); δ_{H} (500 MHz): 7.25 (2H, d, 8.5 Hz, aromatics); 6.89 (2H, d, 8.5 Hz, aromatics); 6.47 (1H, dd, 8.0, 15.8 Hz, C³H); 6.19 (1H, d, 15.8 Hz, C²H); 4.29 (1H, d, 4.2 Hz, C⁵H); 3.81 (3H, s, OCH₃ ar); 3.73 (1H, dd, 4.2, 8.0, C⁴); 3.67 (3H, s, COOCH₃); δ_{C} (125 MHz): 165.6 (C¹); 159.5 (aromatics); 141.6 (C³); 127.6 (aromatics); 126.1 (C²); 125.8, 113.8 (aromatics); 59.3 (C⁵); 58.0 (C⁴); 55.3 (OCH₃ Ar); 51.7 (COOCH₃); *m/z* (ES) 257.1 (MNa⁺), 491.2 (2MNa⁺); HRMS (ES) found (MNa⁺) 257.0808 (calc. 257.0790)

6.2.3. Aza-Darzens condensation

6.2.3.1. Preparation of the imines

N-benzyl benzylimine (195)

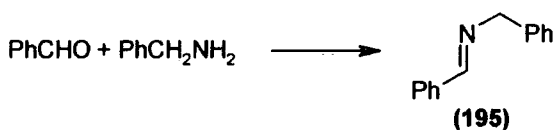

Benzylamine (6.6 mL, 60.4 mmol) was added dropwise to a solution of distilled benzaldehyde (5 mL, 57 mmol) in chloroform (50 mL). The addition was exothermic so it was done in a water bath at RT. The reaction mixture was stirred for 3 hours at rt. Then MgSO₄ was added, after filtration and concentration, a white solid was obtained and was analysed as the imine (**195**) (10.6 g, *y*=95%).

ν_{\max} 1643 (CH=N); δ_{H} (300 MHz) 8.42 (1H, s, CH=N); 8.0-7.0 (10H, m, aromatics); 4.86 (2H, s, N-CH₂); δ_{C} (75 MHz) 161.8 (CH=N); 139.2, 136.0, 130.6, 128.5, 128.4, 128.1, 127.8, 126.9 (aromatics); 64.9 (PhCH₂N); m/z (EI) 195 (55%) (M^+); 118 (7%) (PhCHNCH₂⁺); 104 (6%) (PhCHN⁺); 91 (100%) (C₇H₇⁺); 77 (10%) (C₆H₅⁺); 65 (41%) (C₅H₅⁺); 51 (14%); (C₄H₃⁺); 39 (7%) (C₃H₃⁺); m/z (CI, NH₃): 196 (100%) MH⁺

N-tosyl benzylimine (192)

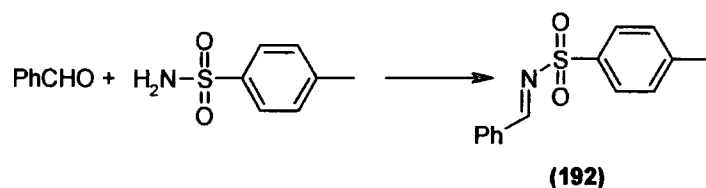

A solution of titanium tetrachloride (0.7 mL, 6.3 mmol) in DCM was added dropwise at 0 °C under N₂ to a solution of benzaldehyde (1.2 mL, 11.4 mmol), *p*-toluene sulfonamide (1.95 g, 11.4 mmol) and distilled triethylamine (0.73 mL, 35 mmol) in DCM. The reaction mixture was stirred for 30 min at 0 °C under N₂ and filtered through a celite plug then washed with DCM. The DCM removed, the residue was diluted in ether, refluxed for 5 min and filtered. The filtrate was kept and the solid was again diluted in ether, refluxed for 5 min and filtered. The 2 etherate filtrates were then concentrated to give a yellow solid. Recrystallisation in petrol:toluene (4:1) afforded the imine **(192)** (2.03 g, $y=78\%$).

mp= 95 °C (lit 91-93); ν_{\max} 1597 (CH=N); 1157 (SO₂); δ_{H} (200 MHz): 9.03 (1H, s, CH=N); 8.0-7.2 (10H, M, aromatics); 2.44 (3H, s, PhCH₃); δ_{C} (63 MHz): 170.1 (CH=N); 144.6, 134.9, 132.3, 131.3, 129.8, 129.1, 128.1 (aromatics); 21.6 (CH₃); m/z (EI) 259 (17%) (M^+); 155 (43%) (CH₃·C₆H₄SO₂⁺); 91 (100%) (C₇H₇⁺); 77 (19%) (C₆H₅⁺); 65 (28%) (C₅H₅⁺); 51 (16%) (C₄H₃⁺)

6.2.3.2. Condensation

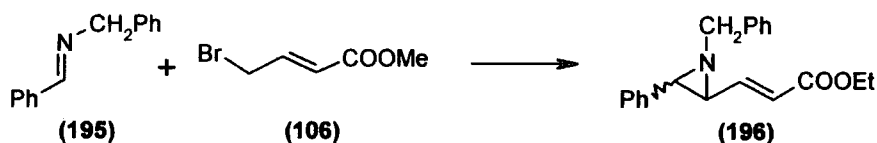
5-phenyl-4,5-benzylaziridine-pent-2-enoate (196)

Attempted method:

LDA was prepared by adding *n*-BuLi 1.6M (1.38 mL, 2.2 mmol) to a solution of diisopropylamine (280 μ L, 2.0 mmol) in THF (8 mL) at $-20\text{ }^{\circ}\text{C}$ under N_2 and stirring this mixture for 20 min. LDA was transferred dropwise to a solution of imine (195) (390 mg, 2.0 mmol) and methyl-4-bromocrotonate (106) (120 μ L, 1 mmol) in THF (8 mL) under N_2 at $-20\text{ }^{\circ}\text{C}$. The reaction was stirred for 1 hour at $-20\text{ }^{\circ}\text{C}$ then 2 hours at rt, was quenched with sat. NH_4Cl solution (10 mL) and layers were separated. The aqueous layer was extracted with ether (3 x 10 mL) and the combined organic layers washed with sat. NaHCO_3 solution (10 mL) and brine (3 x 10 mL), dried (MgSO_4) and concentrated. No expected aziridine (196) was obtained.

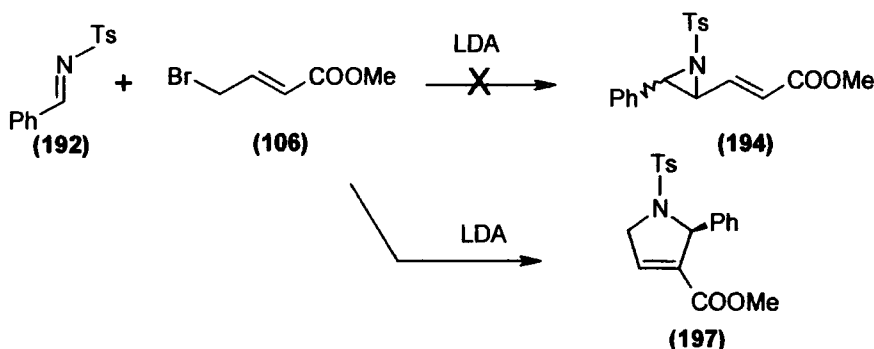
5-phenyl-4,5-tosylaziridine-pent-2-enoate (194)

Attempted method:

LDA was prepared by adding *n*-BuLi 1.6M (1.38 mL, 2.2 mmol) to a solution of diisopropylamine (280 μ L, 2.0 mmol) in THF (8 mL) at $-20\text{ }^{\circ}\text{C}$ under N_2 and stirring this mixture for 20 min. LDA was transferred dropwise to a solution of tosyl imine (192) (518 mg, 2.0 mmol) and methyl-4-bromocrotonate (106) (120 μ L, 1 mmol) in THF (12 mL) under N_2 at $-20\text{ }^{\circ}\text{C}$. The reaction was stirred for 1 hour at $-20\text{ }^{\circ}\text{C}$ then 2 hours at rt,

was quenched with sat. NH_4Cl solution (10 mL) and layers were separated. The aqueous layer was extracted with ether (3 x 10 mL) and the combined organic layers washed with sat. NaHCO_3 solution (10 mL) and brine (3 x 10 mL), dried (MgSO_4) and concentrated. Flash chromatography were performed twice (petrol:ethylacetate 4:1 to 1:1 and petrol:ether 2:3) to afford the 3-pyrrolidine (**197**) (57 mg, $y=17\%$) but no vinyl aziridine (**194**).

$\text{C}_{19}\text{H}_{19}\text{NO}_4\text{S}$; %C 63.71, %H 5.54, %N 3.92 (th 63.85, 5.36, 3.92); ν_{max} (cm^{-1}) 1723 (α,β unsaturated COOR); 1340 (SO_2N); 1163 (SO_2); δ_{H} (200 MHz) 7.5-7 (9 H, m, aromatics); 6.81 (1 H, ddd, $J= 1.8, 2.1, 2.4$ Hz, $\text{C}=\text{CH}$); 5.76 (1 H, ddd, $J= 1.8, 2.4, 5.7$ Hz, CHPh); 4.50 (1 H, dt, $J= 2.4, 17.1$ Hz, CH_2); 4.35 (1 H, ddd, $J= 2.1, 5.7, 17.1$ Hz; CH_2); 3.61 (3 H, s, COOCH_3); 2.40 (3 H, s, PhCH_3); δ_{C} (63 MHz) 162.2 (COOCH_3); 135.5 ($\text{CH}=\text{C}$); 143.3, 139.3, 135.7, 129.4, 128.3, 128.0, 127.7, 127.1 (aromatics); 68.9 (PhCH); 54.9 (CH_2); 51.8 (COOCH_3); 21.4 (PhCH_3); m/z (EI) 357 (7%) (M^+); 280 (56%) ($\text{M}-\text{C}_6\text{H}_5$); 202 (100%) ($\text{M}-\text{CH}_3\text{C}_6\text{H}_4\text{SO}_2$); 170 (51%); 155 (41%) ($\text{CH}_3\text{C}_6\text{H}_4\text{SO}_2^+$); 91 (78%) (C_7H_7^+)

6.2.4. Functional group interconversion

6.2.4.1. Hydrolysis of the ester

5-phenyl-4,5-epoxy-pent-2-enoic acid (169)



A solution of $\text{LiOH}\cdot\text{H}_2\text{O}$ (250 mg, 6 mmol) in water (3 mL) was added at 0 °C to a solution of methyl ester (**84**) (800 mg, 3.67 mmol) in methanol (10 mL). The reaction mixture was stirred at rt for 2 hours. The methanol was removed and the residue was treated with a saturated solution of citric acid in water until pH 3 at 0 °C then extracted with ether. The combined organic layers were washed with brine, dried (MgSO_4) and concentrated. The residue was purified by flash chromatography (ether:petrol 1:1) to give the acid (**169**) (580 mg, $y=83\%$).

$\text{mp}=84.5\text{-}89$ °C; ν_{max} (cm^{-1}) 3100 (OH); 1701 (α,β unsaturated COOH); 1655 ($\text{CH}=\text{CH}$ conjugated to CO); 1286 (epoxide); δ_{H} (200 MHz) 7.45-7.20 (5 H, m, aromatics); 6.95 (1 H, dd, $J= 6.8, 15.8$ Hz, C^3H); 6.20 (1 H, d, $J= 15.8$ Hz, C^2H); 3.86 (1 H, d, 1.6Hz, C^5H); 3.51 (1 H, dd, $J= 1.6, 6.8$ Hz, C^4H); δ_{C} (63 MHz) 171.0 (C^1); 146.4 (C^2); 135.8, 128.7, 128.6, 125.5 (aromatics); 123.1 (C^3); 61.2 (C^5); 60.3 (C^4)

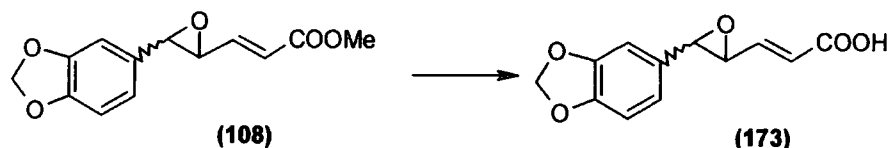
5-(3',4'methylenedioxyphenyl)-4,5-epoxy-pent-2-enoic acid

Attempted method 1:

A solution of LiOH.H₂O (17 mg, 0.4 mmol) in water (2.5 mL) was added slowly at 0 °C to a solution of the ester **(108)** (80 mg, 0.32 mmol) in methanol (5 mL) and the resultant mixture was stirred at rt for 2 hours. The methanol was removed and the residue was treated with a saturated solution of citric acid in water until pH 3 at 0 °C then extracted with ether. The combined organic layers were washed with brine, dried (MgSO₄) and concentrated. No acid was collected.

Attempted method 2:

A solution of LiOH.H₂O (22 mg, 0.52 mmol) in THF:H₂O (5:1) (5 mL) was added slowly at 0 °C to a solution of the ester **(108)** (100 mg, 0.40 mmol) in THF:H₂O (5:1) (4 mL) and the resultant mixture was stirred at rt for 20 hours. The reaction was quenched with a solution of HCl and acidified to pH 3 at 0 °C, the layers separated and the aqueous layer extracted with ether continuously. The combined organic layers (~20 mL) were washed with sat. aq. NaHCO₃ (10 mL) and brine (2 x 10 mL), dried (MgSO₄) and concentrated. No acid was collected.

Attempted method 3:

A solution of LiOH.H₂O (33.6 mg, 0.8 mmol) in THF:H₂O (3:1) (5 mL) was added slowly at 0 °C to a solution of the ester **(108)** (100 mg, 0.4 mmol) and H₂O₂ 27% (200 mg, 1.6 mmol) in THF:H₂O (3:1) (5 mL) and the resultant mixture was stirred at rt for 20 hours. The reaction was quenched with Na₂SO₃ 1.5M (1 ml) and the layers separated. The organic layer was washed with sat. NaHCO₃ solution (5 mL) and brine (2 x 5 mL), dried (MgSO₄) and concentrated to give back the starting material. The aqueous layer was acidified with 1N HCl to pH 2, was extracted with ether (3 x 5 mL) and the combined organic layers washed with sat. aq. NaHCO₃ (5 mL) and brine (2 x 5 mL), dried (MgSO₄) and concentrated. No acid was collected.

Attempted method 4:

TMSCl (95.5 mg, 0.9 mmol) was added slowly to a well-stirred solution of ester (**108**) (110 mg, 0.45 mmol) and NaI (132 mg, 0.9 mmol) in CH₃CN (5 mL) and the resultant mixture was heated under reflux for 40 hours. The reaction was quenched with water and the layers separated. The aqueous layer was extracted with ether (3 x 5 mL) and the combined organic layers washed with sat. aq. sodium thiosulphate (5 mL) and brine (2 x 5 mL), dried (MgSO₄) and concentrated. No acid was collected.

Attempted method 5:

TMSOK 90% (56.44 mg, 0.4 mmol) was added at rt under N₂ to a solution of methyl ester (**108**) (100mg, 0.4 mmol) in ether (5 mL) and the resultant mixture was stirred at rt for 48 hours. The reaction was acidified with HCl to pH 3, the layers separated and the aqueous layer continuously extracted with ether. The combined organic layers (~15 mL) were washed with sat. aq. NaHCO₃ (5 mL) and brine (2 x 5 mL), dried (MgSO₄) and concentrated. No acid was collected.

6.2.4.2. Coupling reactions

General procedure B:

Triethylamine (300 μ L, 2 mmol, 4 eq) was slowly added to a solution of acid (95 mg, 0.5 mmol, 1 eq) in THF (5 mL) at -30 °C under argon. Then, pivaloyl chloride (62 μ L, 0.5 mmol, 1 eq) was added dropwise to the mixture at -30 °C under argon. The reaction mixture was stirred for 3 hours under argon, and warmed up to -20 °C before adding lithium chloride (21 mg, 0.5 mmol, 1 eq) and the amine or alcohol (0.6 mmol, 1.2 eq). The reaction mixture was then warmed up to rt and stirred for 12 hours. Then, it was quenched with sat. NaHCO₃ solution (3 mL), water (5 mL) and ether (5 mL) were added before separation of the layers. The aqueous layer was extracted with ether (3 x 5 mL) and the combined organic layers washed with brine (3 x 5 mL), dried (MgSO₄) and concentrated. The residue was purified by K \ddot{u} gelrohr distillation (typically P=0.2-1 mbar; T=100-180 °C, the distillate contained the pivalamide) or by flash chromatography (typically ether:petrol 2:1) to afford the expected product in a yield between 30 and 80%.

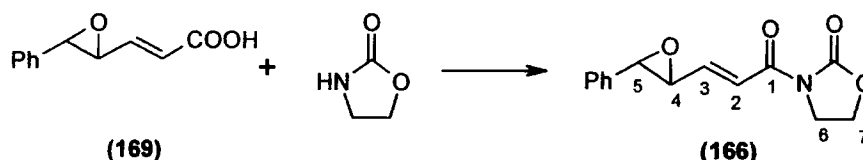
N-oxazolidinone 5-phenyl-4,5-epoxy-pent-2-enamide

Following general procedure B, from a solution of vinyl epoxide acid (**169**) (475 mg, 2.5 mmol) in THF (25 mL) and pivalyl chloride (307 μ L, 2.5 mmol), triethylamine (1.4 mL, 10 mmol), lithium chloride (106 mg, 2.5 mmol) and oxazolidinone (220 mg, 2.5 mmol) yielded after recrystallisation in ethyl acetate the desired amide (**166**) (229 mg, 35%). mp=139-141 $^{\circ}$ C; ν_{\max} (cm^{-1}) 1773 (CO); 1683 (α,β unsaturated CO); 1635 (CH=CH conjugated to CO); 1362 (COOR from a lactone); δ_{H} (300 MHz) 7.53 (1 H, d, J = 15.5 Hz, C²H); 7.35-7.10 (5 H, m, aromatics); 6.84 (1 H, dd, J = 7.5, 15.5, C³H); 4.36 (2 H, t, J = 7.5 Hz, C⁶H); 4.00 (2 H, t, J = 7.5 Hz, C⁷H); 3.80 (1 H, s, C⁵H); 3.49 (1 H, d, J = 7.5 Hz, C⁴H); δ_{C} (100 MHz) 164.1 (C⁸); 153.3 (C¹); 145.6 (C²); 135.9, 128.7, 128.6, 125.5 (aromatics); 122.8 (C³); 62.1 (C⁵); 61.0 (C⁴); 60.9 (C⁷); 42.6 (C⁶); m/z (EI) 259 (0.4%) (M^+); 172 (16%) (*M*-oxazolidinone); 153 (100%); 77 (44%) (C_6H_5^+)

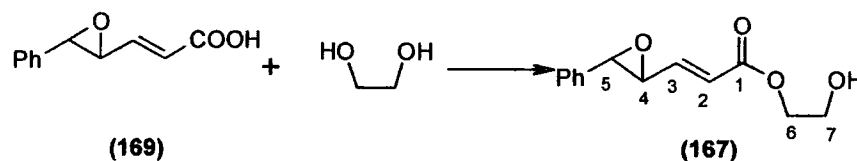
2-hydroxyethyl 5-phenyl-4,5-epoxy-pent-2-enoate (167)

Following general procedure B, from a solution of *anti* vinyl epoxide acid (**169**) (950 mg, 5 mmol) in THF (20 mL), triethylamine (2.8 mL, 20 mmol), pivaloyl chloride (610 μ L, 5 mmol), lithium chloride (215 mg, 5 mmol, 1 eq) and ethylene glycol (1.4 mL, 25 mmol, 5 eq) yielded after flash chromatography (ether:petrol 2:1) the expected 2-hydroxyethyl ester (**167**) (550 mg, y =47%).

ν_{\max} (cm^{-1}) 3083 (OH); 1719 (C=O); δ_{H} (300 MHz) 7.38-7.28 (5 H, m, aromatics); 6.87 (1 H, dd, J = 6.9, 15.9 Hz, C³H); 6.23 (1 H, d, J = 15.9 Hz, C²H); 4.33-4.30 (2 H, m, CH_2CH_2); 3.90-3.86 (2 H, m, CH_2CH_2); 3.84 (1 H, d, J = 1.8 Hz, C⁵H); 3.48 (1 H, dd, J = 1.8, 6.9 Hz, C⁴H); m/z (ES) 235.1 (MH^+); 257.1 (MNa^+); 491.2 (2MNa^+)

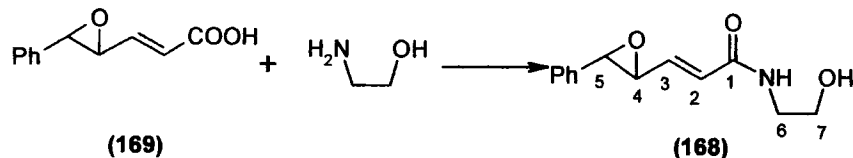
N-2-hydroxyethyl 5-phenyl-4,5-epoxy-pent-2-enamide (168)

Following general procedure B, from a solution of *anti* vinyl epoxide acid (**169**) (500 mg, 2.63 mmol) in THF (15 mL), triethylamine (1.4 mL, 10 mmol), pivaloyl chloride (340 μ L, 2.74 mmol), lithium chloride (110 mg, 2.62 mmol) and ethanolamine (530 μ L, 12.5 mmol, 4.7 eq) yielded after distillation with a K \ddot{u} gelrohr (P=0.6 mbar, T=125 $^{\circ}$ C) the expected *N*-(2-hydroxyethyl) amide (**168**) (211 mg, y=34%).

mp=98-101 $^{\circ}$ C; ν_{\max} (cm^{-1}) 3296 (NH); 3061 (OH); 2934, 2875 (CH, aromatics); 1665 (C=O); 1629 (CH=CH conjugated to CO); δ_{H} (500 MHz) 7.28-7.18 (5 H, m, aromatics); 6.70 (1 H, dd, J= 6.3, 15.3 Hz, C³H); 6.41 (1 H, broad t, J= 5.1 Hz, NH); 6.12 (1 H, d, J= 15.3, C²H); 3.72 (1 H, d, J= 1.7 Hz, C⁵H); 3.66 (2 H, t, J= 4.8 Hz, C⁶H); 3.43-3.37 (3 H, m, C⁴H, C⁷H); δ_{C} (125 MHz) 165.8 (C¹); 140.0 (C²); 136.1, 128.6 (aromatics); 125.6 (C³); 125.5 (aromatic); 61.9 (C⁶); 61.3 (C⁵); 60.7 (C⁴); 42.4 (C⁷); *m/z* (ES) 234.1 (MH⁺); 256.1 (MNa⁺); 489.2 (2MNa⁺); HRMS (ES) found (MNa⁺) 256.0967 (calc 256.0950)

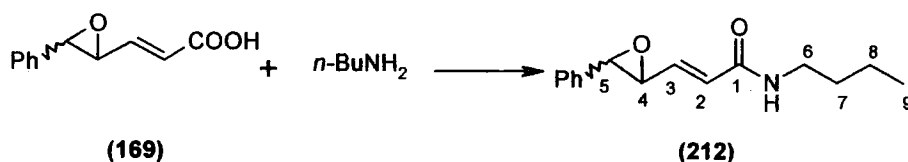
N-n-butyl 5-phenyl-4,5-epoxy-pent-2-enamide (212)

Following general procedure B, from a solution of vinyl epoxide acid (**169**) (440 mg, 2.31 mmol, 1 eq) in THF (20 mL), triethylamine (1.4 mL, 9.2 mmol, 4 eq), pivaloyl chloride (300 μ L, 2.31 mmol, 1 eq), lithium chloride (100 mg, 2.31 mmol, 1 eq) and *n*-butylamine (270 μ L, 2.77 mmol, 1.2 eq) yielded after flash chromatography (ether:petrol 3:1) the expected *N*-butyl amide (**212**) (441 mg, y=78%). Pure samples of the *syn* and *anti* epoxides could be obtained by a second chromatography (ether:petrol 2:1).

Syn epoxide (**212**): mp=107-110 $^{\circ}$ C; ν_{\max} 3286, 3086 (NH); 2958, 2931, 2871 (CH, aromatics), 1667, 1629 (CONH); δ_{H} (400 MHz): 7.35-7.28 (5H, m, aromatics); 6.36 (1H, dd, 7.9, 15.3 Hz, C³H); 6.12(1H, dd, 0.7, 15.3 Hz, C²H); 5.42 (1H, broad s, NH); 4.32 (1H, d, 4.3 Hz, C⁵H); 3.76 (1H, ddd, 0.7, 4.7, 7.9 Hz, C⁴H); 3.28-3.22 (2H, m, C⁶H);

1.50-1.42 (2H, m, C⁷H); 1.36-1.26 (2H, m, C⁸H); 0.90 (3H, t, 7.3 Hz, C⁹H); δ_c (100 MHz): 164.2 (C¹O); 136.4 (C²); 134.0 (aromatic); 129.3 (C³); 128.3, 128.1, 126.4 (aromatics); 59.5 (C⁵); 58.1 (C⁴); 39.3 (C⁶); 31.5 (C⁷); 20.0 (C⁸); 13.7 (C⁹); m/z (ES) 268.2 (MNa⁺); 513.3 (2MNa⁺); HRMS (ES) found (MNa⁺) 268.1319 (calc. 268.1313)

Anti epoxide (**212**): C₁₅H₁₉NO₂; %C 73.39, %H 7.83, %N 5.67 (th 73.44, 7.81, 5.71); mp=121-122 °C; ν_{\max} 3230, 3060 (NH); 2955, 2930, 2872 (CH, aromatics), 1661, 1627 (CONH); δ_H (400 MHz): 7.36-7.25 (5H, m, aromatics); 6.76 (1 H, dd, J= 6.5, 15.2 Hz, C³H); 6.14 (1 H, d, J= 15.2 Hz, C²H); 5.71 (1 H, broad s, NH); 3.79 (1 H, d, J= 1.8 Hz, C⁵H); 3.46 (1 H, dd, J=1.8, 6.6 Hz, C⁴H); 3.36-3.31 (2 H, m, C⁶H); 1.58-1.48 (2 H, m, C⁷H); 1.41-1.31 (2 H, m, C⁸H); 0.93 (3 H, t, J= 7.3 Hz, C⁹H); δ_c (100 MHz): 164.6 (C¹); 139.3 (C²); 136.2, 128.6, 128.5 (aromatics); 126.0 (C³); 125.4 (aromatics); 61.2 (C⁵); 60.7 (C⁴); 39.4 (C⁶); 31.6 (C⁷); 20.0 (C⁸); 13.7 (C⁹); m/z (ES) 268.2 (MNa⁺); 513.3 (2MNa⁺)

N-allyl 5-phenyl-4,5-epoxy-pent-2-enamide (**213**)

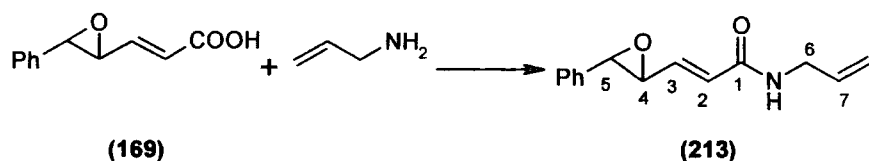

Following general procedure B, from a solution of *anti* vinyl epoxide acid (**169**) (623 mg, 3.28 mmol) in THF (25 mL), triethylamine (2.2 mL, 14.5 mmol), pivaloyl chloride (430 μ L, 3.31 mmol), lithium chloride (143 mg, 2.30 mmol) and allylamine in THF (300 μ L, 4.0 mmol, 1.2 eq) yielded after distillation with a K \ddot{u} gelrohr (P=1 mbar, T=110 °C) and flash chromatography (ether:petrol 2:1) the expected *anti N*-allyl amide (**213**) (488 mg, y=65%).

C₁₄H₁₅NO₂; %C 73.50, %H 6.64, %N 6.04 (th 73.34, 6.59, 6.11); mp= 105-106 °C; ν_{\max} (cm⁻¹) 3226 (NH); 2953, 2923, 2853 (CH, aromatics); 1663, 1560 (CONH); δ_H (300 MHz): 7.36-7.28 (5 H, m, aromatics); 6.80 (1 H, dd, J= 6.6, 15.3 Hz, C³H); 6.17 (1 H, dd, J= 0.6, 15.3 Hz, C²H); 5.94-5.78 (1 H, m, C⁷H); 5.78-5.66 (1 H, s broad, NH); 5.25-5.13 (2 H, m, C⁸H); 4.00-3.94 (2 H, m, C⁶H); 3.80 (1 H, d, J= 1.8 Hz, C⁵H); 3.47 (1 H, ddd, J= 0.6, 1.8, 6.6 Hz, C⁴H); δ_c (50 MHz): 164.5 (C¹); 139.8 (C³); 136.2 (C⁷); 133.8 (C³); 128.6, 125.6, 125.5, 116.7 (aromatics); 101.8 (C⁸); 61.3 (C⁵); 60.7 (C⁴); 42.05 (C⁶); m/z (ES) 284.1 (MNa⁺), 481.2 (2MNa⁺)

6.3. Synthesis of dihydrofuryl-ester and –amide

6.3.1. Sealed Tube

4-(3',4'methylenedioxyphenyl)-3-carbomethoxy-3,4-dihydrofuran (114)

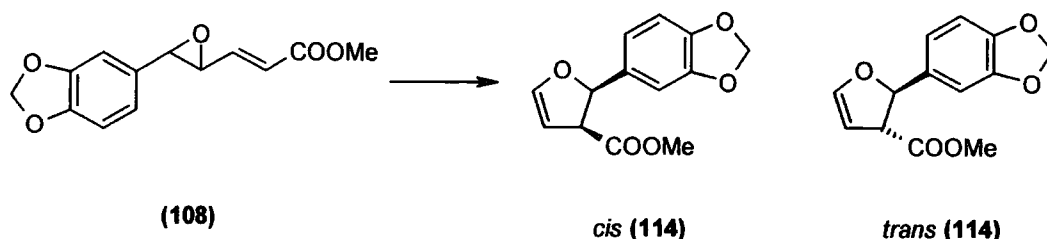

Method 1: NMR tube

A solution of α,β unsaturated epoxide (108) (28.7 mg, 0.115mmol) in D_8 -toluene (0.7 mL) was introduced into a strong NMR tube. After degassing the solution, the tube was sealed under vacuum and heated at the chosen temperature until the starting material was no more detected by NMR. The toluene was removed and the residue was purified by flash chromatography (petrol:ether 2:1) to obtain a mixture of the *trans* and *cis* dihydrofuran (114) (18 mg, $y=65\%$). Characterisation is given in Section 6.3.2.

Method 2: Carius' tube

A solution of the α,β unsaturated epoxide (108) (880 mg) in toluene (21.5 mL) (concentration 40 mg/mL # 16.1 M) were introduced in a 50 mL Carius' tube. After degassing the solution, the tube was sealed under vacuum and heated at 180 °C. After 12 hours, the solvent was removed and the residue purified by flash chromatography (petrol:ether 2:1) to give the *cis* isomer (114) (pure, 86 mg, $y=10\%$) and the *trans* isomer (74) (308 mg, in mixture with some starting material, estimated to 35% of dihydrofuran by 1H NMR). Characterisation is given in Section 6.3.2.

6.3.2. Flash vacuum pyrolysis

4-phenyl-3-carboethoxy-3,4-dihydrofuran (85)

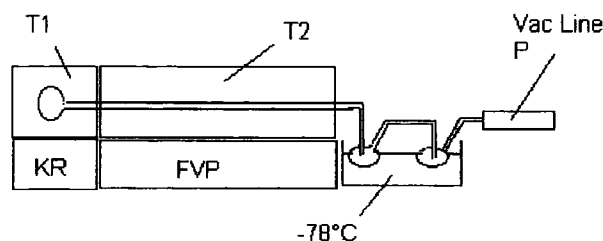

A sample of the vinyl epoxide (~200 mg) was placed in a 10 mL flask and attached to the flash vacuum pyrolysis apparatus (FVP) as indicated in the schematic above. Silicone grease was used at each glass joint as the apparatus was under vacuum ($P \leq 0.04$ mbar) and the oven heated to 475 °C. When the apparatus had stabilised at these conditions the sample was heated in a Kügelrohr oven (KR) at 100 °C. The crude material collected in the cold trap was then analysed, indicating 12% of degradation, 97% of conversion and a *cis:trans* ratio of 6:1. These products were not isolated.

General procedure C

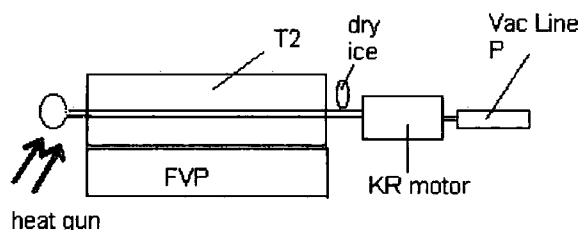

A sample of the vinyl epoxide was placed in a 10 mL rb flask and attached to the FVP apparatus as indicated in the schematic above. Silicone grease was used at each glass joint except the one heated at high temperature for which a special high temperature grease (Rocol anti-seize compound J166®) was utilised. The apparatus was then evacuated to ≤ 0.04 mbar and the oven heated to 500 °C in average. When the apparatus had stabilised at these conditions the sample was heated directly with a heat gun. The crude material collected in the cold trap was then purified by flash chromatography.

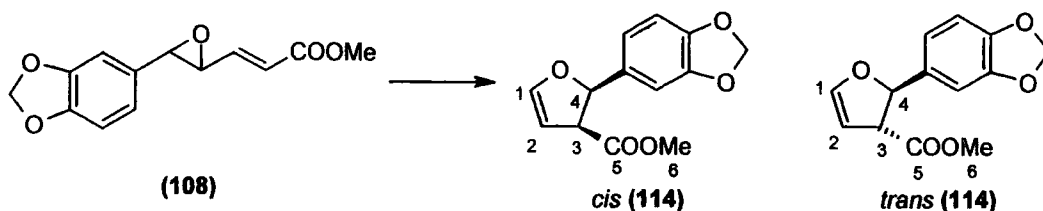
4-(3',4'-methylenedioxyphenyl)-3-carbomethoxy-3,4-dihydrofuran (114)

Method 3: FVP

Following general procedure C, the vinyl epoxide (**108**) was rearranged at 500 °C, 0.04 mbar in 500 mg batches affording a crude mixture of *cis* and *trans* dihydrofurans in a 8:1 *ratio*. After flash chromatography (ether:petrol 3:7), the pure *cis* dihydrofuran (**114**) (66%) and a small amount of the *trans* isomer (**114**) (~8%) were obtained.

Cis dihydrofuran (**114**): C₁₃H₁₂O₅; %C 62.80, %H 4.85 (th 62.90%, 4.87%); ν_{\max} (cm⁻¹) 1733 (COOR); 1250; δ_{H} (300 MHz): 6.82-6.76 (3 H, m, aromatics); 6.68 (1 H, t, 2.25 Hz, C¹H); 5.94 (2 H, s, OCH₂O); 5.67 (1 H, d, J = 11.1 Hz, C⁴H); 5.04 (1 H, t, J = 2.25 Hz, C²H); 4.06 (1 H, dt, J = 2.25, 11.1 Hz, C³H); 3.30 (3 H, s, C⁶H); δ_{C} (125 MHz): 171.5 (C⁵); 148.8 (C¹); 147.4, 147.3, 131.0, 120.0, 107.8, 106.9 5 (aromatics); 101.0 (OCH₂O); 99.3 (C²); 84.3 (C⁴); 53.4 (C³); 51.6 (C⁶); *m/z* (EI) 248 (28.6%) (M⁺); 159 (100%); *m/z* (CI, NH₃) 266 (40%) (MNH₄⁺); 249 (100%) (MH⁺).

Trans isomer (**114**): δ_{H} (300 MHz) 6.86-6.62 (3 H, m, aromatics); 6.52 (1 H, t, J = 2.2 Hz, C¹H); 5.94 (2 H, s, OCH₂O); 5.72 (1 H, d, J = 7.5 Hz, C⁴H); 5.03 (1 H, t, J = 2.2 Hz, C²H); 3.80 (3 H, s, C⁶H); 3.42 (1 H, dt, J = 2.2, 7.5 Hz, C³H); *m/z* (EI) 248 (43%) (M⁺); 159 (100%); *m/z* (CI, NH₃) 266 (40%) (MNH₄⁺); 249 (100%) (MH⁺)

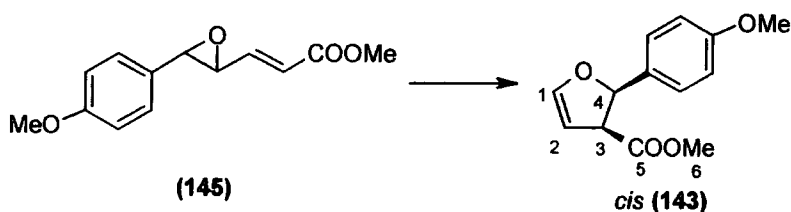
Cis 4-(*p*-methoxyphenyl)-3-carbomethoxy-3,4-dihydrofuran (143)

Following general procedure C, the vinyl epoxide (**145**) (1.31 g) was rearranged at 500 °C, 0.04 mbar in 200 mg batches affording a crude mixture of *cis* and *trans*

dihydrofurans in a 8:1 *ratio*. After flash chromatography (ether:petrol 3:7), the *cis* template (**143**) (883 mg, $y=67\%$) was obtained.

cis dihydrofuryl ester (**143**): ν_{\max} (cm^{-1}) 3001, 2951, 2838 (CH aromatics); 1731 (CO); δ_{H} (300 MHz): 7.24 (2 H, d, $J=8.6$ Hz, aromatics); 6.85 (2 H, d, $J=8.6$ Hz, aromatics); 6.75 (1 H, t, $J=2.0$ Hz, C^1H); 5.72 (1 H, d, $J=11.2$ Hz, C^4H); 5.03 (1 H, t, $J=2.5$ Hz, C^2H); 4.06 (1 H, dt, $J=2.2, 11.2$ Hz, C^3H); 3.79 (3 H, s, OCH_3); 3.21 (3 H, s, C^6H); δ_{C} (75 MHz): 171.7 (C^5); 159.3 (aromatics); 148.9 (C^1); 129.2, 127.6, 113.3 (aromatics); 99.1 (C^2); 84.2 (C^4); 55.2 (C^3); 53.4 (OCH_3); 51.5 (C^6); m/z (ES) 257.1; HRMS (ES) found (MNa^+) 257.0774 (calc. 257.0790)

4-phenyl-3-N-(5'-(S)-phenyl-oxazolidinone)-carboxamide-3,4-dihydrofuran

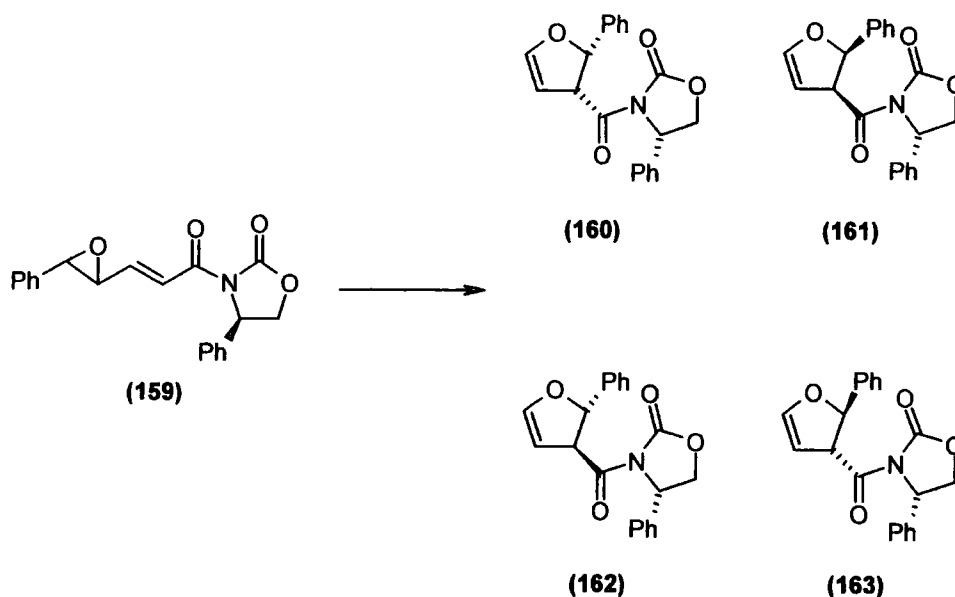

Following general procedure C, the vinyl epoxide amide (**159**) (15 mg) was rearranged at 500 °C, 0.04 mbar affording a crude mixture of dihydrofurans ($m=10$ mg, conversion 67%). The *ratio* between the diastereoisomers was determined by ^1H NMR (**160:161:162:163** (50:36:8:6))

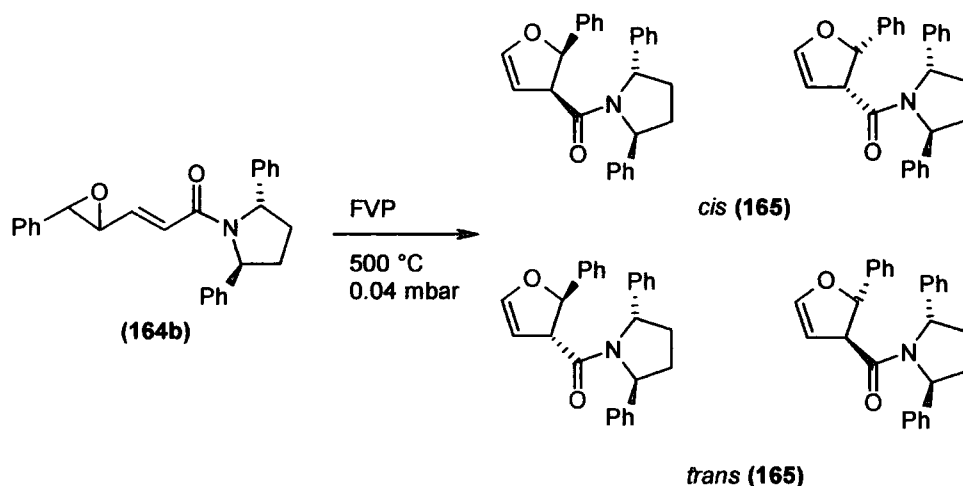
4-phenyl-3-N-(2',5'-diphenyl-pyrrolidine)-carboxamide-3,4-dihydrofuran

Following general procedure C, the vinyl epoxide amide (**164b**) (35 mg) was rearranged at 500 °C, 0.04 mbar affording a crude mixture of dihydrofurans ($m=15$ mg, conversion 43%). The *ratio* between the diastereoisomers (**165 cis** (54:34); **165 trans** (7:5)) was determined by HPLC (Hypersil ODS, 5 μm , 25 cm, gradient for 25 min from MeCN:H₂O (10:90) to MeCN:H₂O (90:10) then for 5 min to MeCN (100), 1 mL/min).

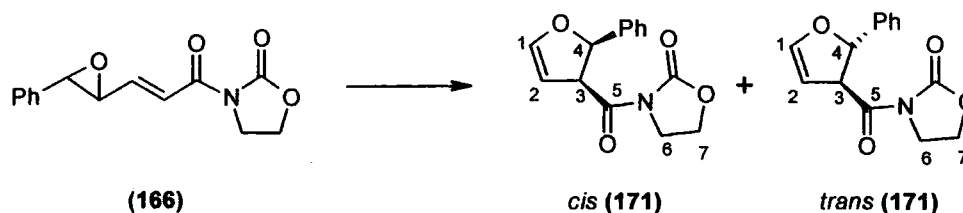
4-phenyl-3-N-oxazolidinone-carboxamide-3,4-dihydrofuran

Following general procedure C, oxazolidinone vinyl epoxide amide (**166**) (20 mg) was rearranged at 500 °C and 0.05 mbar. The *cis:trans ratio* of the crude product was 11:1. Filtration on silica afforded the *cis* dihydrofuran (**171**) (14 mg, $y=70\%$).

δ_{H} (300 MHz): 7.32-7.22 (5 H, m, aromatics); 6.68 (1 H, t, $J=2.4$ Hz, C¹H); 5.82 (1 H, d, $J=11.7$ Hz, C⁴H); 5.28 (1 H, dt, $J=2.4, 11.7$ Hz, C³H); 5.00 (1 H, t, $J=2.4$ Hz, C²H); 4.14-4.02 (1 H, m, CH₂CH₂); 3.63-3.57 (2 H, m, CH₂CH₂); 3.05-2.95 (1 H, m, CH₂CH₂); m/z (EI) 259.1 (8%) (M⁺); 172 (100%) (M-oxazolidinone); 144 (31%); 115 (94%) (M-(oxazolidinone+CO)); 77 (10%) (C₆H₅⁺)

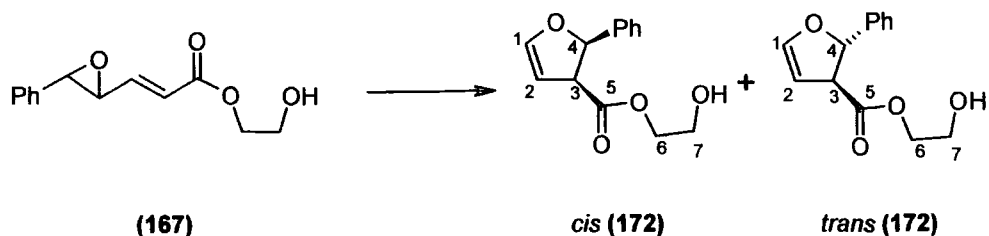
4-phenyl-3-(2-hydroxy-carboethoxy)-3,4-dihydrofuran (172)

Following general procedure C, 2-hydroxyethyl vinyl epoxide ester (**167**) (20 mg) was rearranged at 500 °C and 0.04 mbar. The *cis:trans* ratio of the crude product was 8.8:1. Filtration on silica afforded the *cis* dihydrofuran (**172**) (12 mg, *y*=60%).

δ_{H} (300 MHz): 7.37-7.34 (5 H, m, aromatics); 6.72 (1 H, t, *J* = 2.1 Hz, C¹H); 5.77 (1 H, d, *J* = 11.1 Hz, C⁴H); 5.08 (1 H, t, *J* = 2.1 Hz, C²H); 4.13 (1 H, dt, *J* = 2.1, 11.1 Hz, C³H); 3.75-3.71 (2 H, m, CH₂CH₂); 3.37-3.17 (2 H, m, CH₂CH₂)

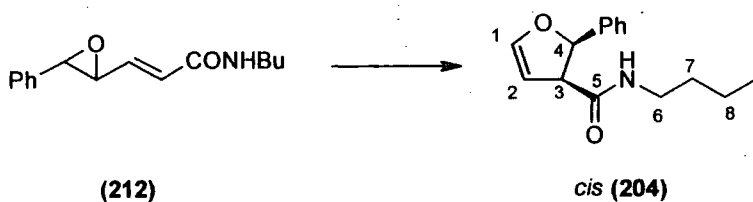
Cis 4-phenyl-3-N-n-butyl-carboxamide-3,4-dihydrofuran

Following general procedure C, *N*-(*n*-butyl) vinyl epoxide amide (**212**) (550 mg) was rearranged at 500 °C and 0.04 mbar in 100-150 mg batches. The *cis:trans* ratio of the crude product was 8.6:1 and after flash chromatography, *cis N*-(*n*-butyl) dihydrofuryl amide (**204**) (250 mg, *y*=45%) was obtained.

ν_{max} (cm⁻¹) 3301 (NH); 3075, 2984 (CH, aromatics); 1652 (CONH); δ_{H} (300 MHz): 7.32-7.28 (5 H, m, aromatics); 6.79 (1 H, t, *J* = 2.3 Hz, C¹H); 5.82 (1 H, d, *J* = 11.1 Hz, C⁴H); 5.50 (1 H, broad s, NH); 5.06 (1 H, t, *J* = 2.7 Hz, C²H); 3.96 (1 H, dt, *J* = 2.1, 11.1 Hz, C³H); 2.85-2.75 (2 H, m, C⁸H); 1.20-1.00 (4 H, m, C⁷H, C⁸H); 0.79 (3 H, t, 6.7 Hz, C⁹H);

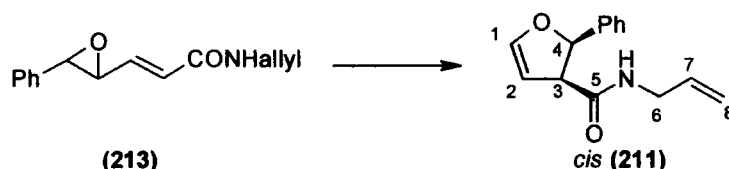
Cis 4-phenyl-3-N-n-allyl-carboxamide-3,4-dihydrofuran

Following general procedure C, *N*-allyl vinyl epoxide amide (488 mg) was rearranged at 500 °C and 0.05 mbar. Due to difficulty to volatilise the starting material, only 370 mg of product was collected and the crude product contained a mixture of *cis* and *trans* product in a 9:1 ratio. After flash chromatography, starting vinyl epoxide (90 mg) was recovered and *cis* *N*-allyl dihydrofuryl amide (190 mg, $y=47.5\%$) were obtained.

mp= 78-81 °C (lit); ν_{\max} (cm⁻¹) 3303 (NH); 2927 (CH, aromatics) 1643 (CONH); δ_{H} (300 MHz): 7.28-7.20 (5 H, m, aromatics); 6.75 (1 H, dd, $J= 1.8, 2.7$ Hz, C¹H); 5.77 (1 H, d, $J= 11.1$ Hz, C⁴H); 5.55 (1 H, broad s, NH); 5.35-5.22 (2 H, m, C⁷H); 5.02 (1 H, t, $J= 2.7$ Hz, C²H); 4.92-4.81 (2 H, m, C⁸H); 3.93 (1 H, dt, $J= 1.8, 11.1$ Hz, C³H); 3.44 (2 H, t, $J= 5.7$ Hz, C⁶H); δ_{C} (75 MHz): 169.5 (C⁵); 149.9 (C¹); 136.6 (aromatic); 133.7 (C⁷); 128.0, 127.9, 126.0 (aromatics); 116.4 (C⁸); 100.1 (C²); 85.2 (C⁴); 55.0 (C³); 41.8 (C⁶); m/z (ES) 252.0 (MNa⁺), 481.1 (2MNa⁺); HRMS (ES) found 252.0997 (calc 252.1000)

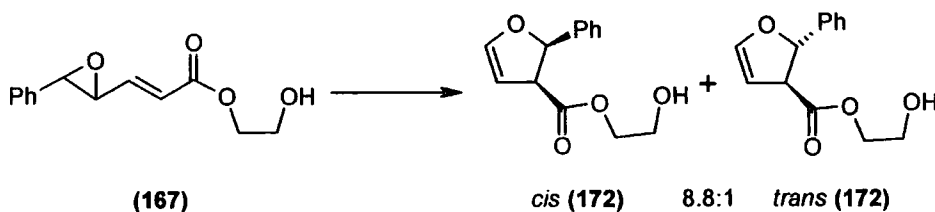
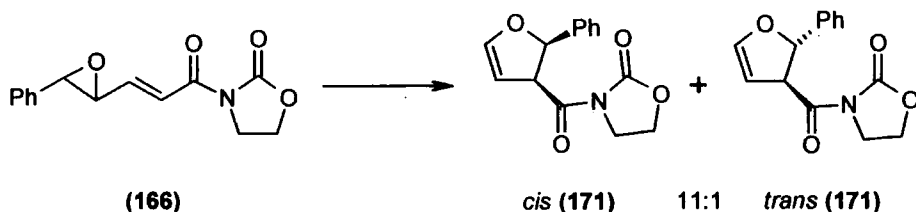
6.3.3. Lewis acid activation

All the solutions were prepared in the appropriate solvent (CDCl₃ or MeCN) under nitrogen. When the product was not completely soluble, the solution was left 1 min in a ultrasound bath. If it was still not soluble, a drop of THF or MeCN or CDCl₃ was added.

Preparation of vinyl epoxide solutions

| | | | solvent |
|----|--------------------------------|-------------------|---------|
| SA | oxazolidinone (166) | 143 mg, 0.55 mmol | 11 mL |
| SB | ethylene glycol (172) | 130 mg, 0.55 mmol | 11 mL |

Preparation of Lewis acid solutions

| | | | solvent |
|-----|--|----------------------------------|---------|
| S1 | Cu(OTf) ₂ | 18 mg, 0.05 mmol | 1 mL |
| S2 | Zn(OTf) ₂ | 18 mg, 0.05 mmol | 1 mL |
| S3 | Sc(OTf) ₃ | 25 mg, 0.05 mmol | 1 mL |
| S4 | Sm(OTf) ₃ | 30 mg, 0.05 mmol | 1 mL |
| S5 | Bu ₂ BOTf (1 M) | 50 µL, 0.05 mmol | 1 mL |
| S6 | BF ₃ ·OEt ₂ | 13 µL, 0.1 mmol | 2 mL |
| S7 | SnCl ₄ | 12 µL, 0.1 mmol | 2 mL |
| S8 | ZnCl ₂ (1 M) | 50 µL, 0.05 mmol | 1 mL |
| S9 | MgBr ₂ | 9 mg, 0.05 mmol | 1 mL |
| S10 | Ti(Oi-Pr) ₄ | 22 µL, 0.075 mmol | 1.5 mL |
| S11 | TiCl ₄ | 8 µL, 0.075 mmol | 1.5 mL |
| S12 | Ti(Oi-Pr) ₂ Cl ₂ | 0.5 mL of S10 + 0.5 mL of S11 | 0 mL |

Using a GreenHouse parallel synthesiser™, in each of the 24 reaction vials, was added 1 mL of the vinyl epoxide solution (SA or SB) and 0.1 mL of Lewis acid solution (S1 or S2 or ... S12). The reaction was stirred for 15 hours at room temperature for CDCl₃ or at reflux for acetonitrile before being quenched with aqueous sodium bicarbonate. When CDCl₃ was the solvent, the solutions were filtered through a hydrophobic frit directly into NMR tubes. Only starting material and decomposition were recovered. When acetonitrile was the solvent, the solutions were concentrated in a Genevac® vacuum centrifuge. After adding water and CDCl₃, the solutions were filtered through a hydrophobic frit into NMR tubes. Only starting material and decomposition were recovered.

6.3.4. Microwave irradiation

4-phenyl-3-carboethoxy-3,4-dihydrofuran (85)

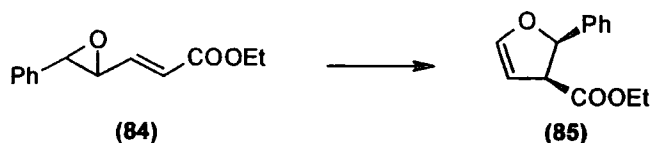

In the appropriate vessel, was poured a solution of vinyl epoxide (109 mg, 0.50 mmol) in toluene or DMSO (4 mL). When ionic liquid (approximately 0.1 M) was used, 1-butyl-3-methyl-imidazolium hexafluorophosphate (96 mg, 0.34 mmol) was added to the solution in toluene). The vessel was then sealed and irradiated. No expected dihydrofuran was obtained.

6.3.5. Epimerisation

Trans 4-phenyl-3-carboethoxy-3,4-dihydrofuran (85)



DBU (80 μ L, 0.53 mmol) was added to a solution of *cis* dihydrofuryl ester (85) (560 mg, 2.57 mmol) in toluene (10 mL) under nitrogen at room temperature. The resulting mixture was heated under reflux for 15 hours. After allowing to cool to room temperature, HCl 1M was added, causing an emulsion. The solution was filtered through a celite plug. The organic layer was washed with brine, dried over MgSO_4 and concentrated. After purification by flash chromatography (ether:petrol 1:3), was obtained the *trans* dihydrofuryl ester (85) (510 mg, $y=91\%$)

δ_{H} (300 MHz): 7.41-7.34 (5 H, m, aromatics); 6.55 (1 H, t, $J=2.4$ Hz, C^1H); 5.84 (1 H, d, $J=7.5$ Hz, C^4H); 5.05 (1 H, t, $J=2.7$ Hz, C^2H); 4.22 (2 H, q, $J=7.2$ Hz, C^5H); 3.73 (1 H, dt, $J=2.4, 7.5$ Hz, C^3H); 1.29 (3 H, t, $J=7.2$ Hz, C^6H)

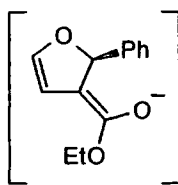
Attempts to trap the enolate (132):

(132)

Method 1: with butyl iodide

LDA {generated by the addition of *n*-BuLi 1.6M (0.7 mL, 1.1 mmol) to a solution of diisopropylamine (140 μ L, 1 mmol) in THF (3 mL) at -78 $^{\circ}$ C} was added to a solution of dihydrofuryl ester (**85**) (109 mg, 0.5 mmol) in THF (1 mL) at -78 $^{\circ}$ C. The mixture was stirred for 30 min before warming to -20 $^{\circ}$ C. Then a solution of *n*-BuI (85 μ L, 0.75 mmol) in THF (1 mL) was slowly added and the reaction mixture was stirred for 18 hours before being quenched with sat. NH_4Cl solution (3 mL). After separation, the aqueous layer was extracted with ether (3 x 2 mL) and the combined organic layers washed with brine (3 x 3 mL), dried over MgSO_4 and concentrated. BuI excess was removed by K \ddot{u} gelrohr distillation. The crude product contained only decomposition.

Method 2: with methyl iodide

LDA {generated by the addition of *n*-BuLi 1.6M (0.7 mL, 1.1 mmol) to a solution of diisopropylamine (140 μ L, 1 mmol) in THF (3 mL) at -78 $^{\circ}$ C} was added to a solution of dihydrofuryl ester (**85**) (109 mg, 0.5 mmol) in THF (1 mL) at -78 $^{\circ}$ C. The mixture was stirred for 30 min before warming to -20 $^{\circ}$ C. Then a solution of MeI (85 μ L, 0.75 mmol) in THF (1 mL) was slowly added and the reaction mixture was stirred for 18 hours before being quenched with sat. NH_4Cl solution (3 mL). After separation, the aqueous layer was extracted with ether (3 x 2 mL) and the combined organic layers washed with brine (3 x 3 mL), dried over MgSO_4 and concentrated. The crude product contained only decomposition.

Method 3: with acetic acid

LDA {generated by the addition of *n*-BuLi 1.6M (0.7 mL, 1.1 mmol) to a solution of diisopropylamine (140 μ L, 1 mmol) in THF (3 mL) at -78 °C} was added to a solution of dihydrofuryl ester (**85**) (109 mg, 0.5 mmol) in THF (1 mL) at -78 °C. The mixture was stirred for 1 hour before being quenched with acetic acid (0.5 mL) and then water (3 mL). After separation, the aqueous layer was extracted with ether (3 x 2 mL) and the combined organic layers washed with brine (3 x 3 mL), dried over MgSO₄ and concentrated. The crude product contained only decomposition.

Method 4: with trimethylsilyl chloride (TMSCl)

TMSCl (280 μ L, 2.19 mmol) was added to a solution of LDA {generated by the addition of *n*-BuLi 1.6M (1.6 mL, 2.42 mmol) to a solution of diisopropylamine (320 μ L, 2.19 mmol) in THF (3 mL) at -60 °C}. Then, a solution of dihydrofuryl ester (**85**) (160 mg, 0.74 mmol) in THF (1 mL) was added at -60 °C. The mixture was stirred for 1 hour before being quenched with sat. NH₄Cl solution (3 mL). After separation, the aqueous layer was extracted with ether (3 x 2 mL) and the combined organic layers washed with brine (3 x 3 mL), dried over MgSO₄ and concentrated. The crude product contained only decomposition.

Method 5: with TMSCl (different order)

A solution of dihydrofuryl ester (**85**) (100 mg, 0.46 mmol) and TMSCl (140 μ L, 1.09 mmol) in THF (5 mL) was added at -78 °C to a solution of LDA {generated by the addition of *n*-BuLi 1.6M (0.8 mL, 1.21 mmol) to a solution of diisopropylamine (150 μ L, 1.02 mmol) in THF (3 mL) at -78 °C}. The mixture was stirred for 1 hour and a new product was observed on TLC plate and in NMR spectra. The reaction was then quenched with sat. NH₄Cl solution (5 mL). After separation, the aqueous layer was extracted with ether (3 x 5 mL) and the combined organic layers washed with brine (3 x 7 mL), dried over MgSO₄ and concentrated. The crude product contained only decomposition.

6.3.6. Functional group interconversion

6.3.6.1. Hydrolysis of the ester

Trans 4-phenyl-3-carboxy-3,4-dihydrofuran (85)

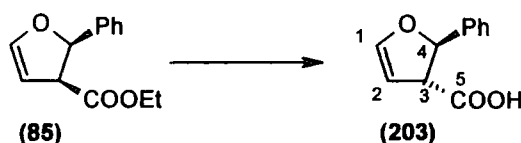

A solution of LiOH.H₂O (225 mg, 5.36 mmol) in water (3 mL) was added at 0 °C to a solution of methyl ester (58) (505 mg, 2.32 mmol) in methanol (10 mL). The reaction mixture was stirred at RT for 2 hours. The methanol was removed *in vacuo* and ether and water were added. After separation, the organic layer was kept to recycle the ester and the aqueous layer was acidified with HCl (1M) to pH 2 at 0 °C then extracted with ether. The combined organic layers were washed with brine, dried (MgSO₄) and concentrated. The *trans* dihydrofuryl acid (430 mg, y=98%) was too unstable to obtain all the analytical data and was used in the next step without further purification.

ν_{\max} (cm⁻¹) 3032 (OH); 1731 (COOH); δ_{H} (300 MHz): 7.40-7.30 (5 H, m, aromatics); 6.58 (1 H, t, J= 2.7 Hz, C¹H); 5.84 (1 H, d, J= 7.2 Hz, C⁴H); 5.08 (1 H, t, J= 2.7 Hz, C²H); 3.79 (1 H, dt, J= 2.7, 7.2 Hz, C³H); δ_{C} (75 MHz): 178.5 (C⁵O); 147.6 (C¹); 141.1, 128.7, 128.2, 125.3 (aromatics); 97.7 (C²); 83.8 (C⁴); 55.9 (C³)

6.3.6.2. Amidation

General procedure D:

Triethylamine (300 μ L, 2 mmol, 4 eq) was slowly added to a solution of acid (95 mg, 0.5 mmol, 1 eq) in THF (5 mL) at -30 °C under argon. Then, pivaloyl chloride (62 μ L, 0.5 mmol, 1 eq) was added dropwise to the mixture at -30 °C under argon. The reaction mixture was stirred for 3 hours under argon, and warmed up to -20 °C before adding lithium chloride (21 mg, 0.5 mmol, 1 eq) and the amine (0.6 mmol, 1.2 eq). The reaction mixture was then warmed up to rt and stirred for 12 hours. Then, it was quenched with sat. NaHCO₃ solution (3 mL), water (5 mL) and ether (5 mL) were added before separation of the layers. The aqueous layer was extracted with ether (3 x 5 mL) and the combined organic layers washed with brine (3 x 5 mL), dried (MgSO₄)

and concentrated. The residue was distilled with a Kügelrohr (P=0.2-0.8 mbar; T=100-180 °C), the distillate contained the pivalamide and the residue was the expected amide (yield 30-80%).

Trans 4-phenyl-3-carboxamide-3,4-dihydrofuran (207)

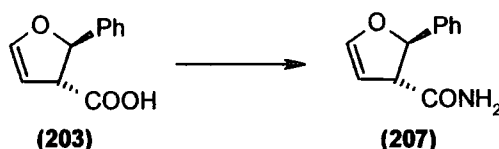

Following general procedure D, from a solution of dihydrofuryl acid **(203)** (171 mg, 0.9 mmol) in THF (5 mL), triethylamine (540 μ L, 3.6 mmol), pivaloyl chloride (150 μ L, 1.2 mmol), lithium chloride (40 mg, 0.9 mmol) and ammonia gas (approximately 5 mL) yielded after distillation with a Kügelrohr (P=0.04 mbar, T=100 °C) the expected primary amide **(207)** (99 mg, y=58%).

mp= 147-149 °C; ν_{\max} (cm⁻¹) 3331, 3157 (NH); 2921, 2853 (CH, aromatics) 1659, 1633 (CONH), 1461; δ_{H} (300 MHz): 7.39-7.30 (5 H, m, aromatics); 6.69 (1 H, dd, J= 2.2, 2.6 Hz, C¹H); 5.73 (1 H, d, J= 6.6 Hz, C⁴H); 5.7 (2 H, broad s, NH); 5.02 (1 H, t, J= 2.6 Hz, C²H); 3.60 (1 H, dt, J= 2.2, 6.6 Hz, C³H); δ_{C} (100 MHz): 177.6 (C⁵); 141.6 (C¹); 128.8, 128.1, 126.6, 125.4 (aromatics); 99.5 (C²); 83.6 (C⁴); 52.5 (C³); m/z (ES) 212.1 (MNa⁺), 401.1 (2MNa⁺); HRMS (ES) found 212.0706 (calc. 212.0682)

Trans 4-phenyl-3-N-n-ethyl-carboxamide-3,4-dihydrofuran (208)

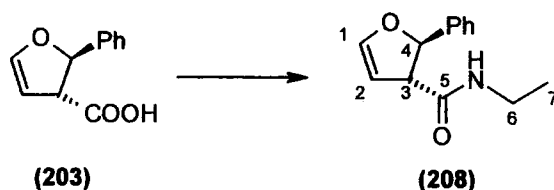

Following general procedure D, from a solution of *trans* dihydrofuryl acid **(203)** (95 mg, 0.5 mmol) in THF (5 mL), triethylamine (300 μ L, 2 mmol), pivaloyl chloride (62 μ L, 0.5 mmol), lithium chloride (21 mg, 0.5 mmol) and ethylamine 2M in THF (300 μ L, 0.6 mmol) yielded after distillation with a Kügelrohr (P=0.2 mbar, T=100 °C) the expected *trans* N-ethyl amide **(208)** (63 mg, y=58%).

mp= 87-89 °C; ν_{\max} (cm⁻¹) 3272 (NH); 3083, 2975, 2923 (CH aromatics), 1641 (CONH); δ_{H} (300 MHz): 7.39-7.36 (5 H, m, aromatics); 6.68 (1 H, t, J= 2.4 Hz, C¹H); 5.72 (1 H, s broad, NH); 5.68 (1 H, d, J= 6.4 Hz, C⁴H); 4.97 (1 H, t, J= 2.4 Hz, C²H); 3.55 (1 H, dt, J= 2.4, 6.4 Hz, C³H); 3.38-3.30 (2 H, m, C⁶H); 1.16 (3 H, t, J= 7.6 Hz, C⁷H); δ_{C} (100 MHz): 172.5 (C⁵); 149.2 (C¹); 136.1, 128.9, 128.2, 125.4 (aromatics); 98.3 (C²); 86.1 (C⁴); 58.3 (C³); 34.8 (C⁶); 15.1 (C⁷); m/z (EI) 217 (30%) (M⁺); 172 (97%) (M-EtNH₂⁺); 145 (100%); m/z (CI, NH₃): 218 (100%) (MH⁺); m/z (ES) 240.1 (MNa⁺); 457.2 (2MNa⁺); HRMS (ES) found (MNa⁺) 240.0993 (calc. 240.1000).

Trans 4-phenyl-3-N-n-isopropyl-carboxamide-3,4-dihydrofuran (209)

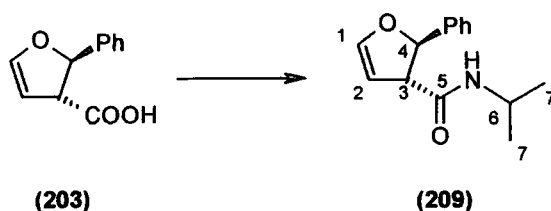

Following general procedure D, from a solution of dihydrofuryl acid (**203**) (250 mg, 1.3 mmol) in THF (10 mL), triethylamine (780 μ L, 5.2 mmol), pivaloyl chloride (165 μ L, 1.3 mmol), lithium chloride (70 mg, 1.3 mmol) and *i*-propylamine (137 μ L, 1.56 mmol) yielded after distillation with a K \ddot{u} gelrohr (P=0.2 mbar, T=125 °C) the expected *trans* *N*-isopropyl amide (**209**) (120 mg, $y=40\%$).

ν_{\max} (cm⁻¹) 3296 (NH); 1647, 1542 (CONH); δ_{H} (300 MHz): 7.4-7.3 (5 H, m, aromatics); 6.65 (1 H, t, J= 2.4 Hz, C¹H); 5.59 (2 H, s broad, NH + d, J= 6.3 Hz, C⁴H); 4.87 (1 H, t, J= 2.4 Hz, C²H); 4.02 (1 H, pseudo octuplet, J= 6.6 Hz, C⁶H); 3.44 (1 H, dt, J= 2.4, 6.6 Hz, C³H); 1.06 (6 H, d, J= 6.6 Hz, C⁷H); δ_{C} (50 MHz): 172.4 (C⁵); 148.8 (C¹); 128.6, 128.0, 127.9, 125.2 (aromatics); 98.1 (C²); 85.9 (C⁴); 58.1 (C³); 41.6 (C⁶); 22.7 (C⁷); m/z (EI) 231 (13%) (M⁺); 172 (24%) (M-*i*-PrNH₂⁺); 145 (100%); m/z (CI, NH₃): 232 (100%) (MH⁺); (ES) 254.1 (MNa⁺), 485.1 (2MNa⁺); HRMS (ES) found (MNa⁺) 254.1153 (calc. 254.1157).

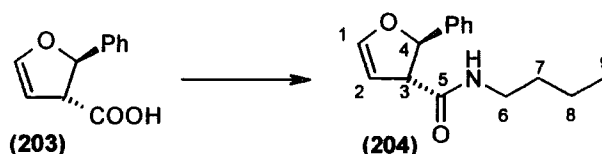
Trans 4-phenyl-3-N-n-butyl-carboxamide-3,4-dihydrofuran (204)

Following general procedure D, from a solution of dihydrofuryl acid (950 mg, 5 mmol) in THF (40 mL), triethylamine (3 mL, 20 mmol), pivaloyl chloride (0.62 mL, 5 mmol), lithium chloride (210 mg, 5 mmol) and *n*-butylamine (0.55 mL, 6 mmol, 1.2 eq) yielded after distillation with a Kügelrohr (P=0.2 mbar, T=125 °C) the expected *trans N*-(*n*-butyl) amide (760 mg, $y=64\%$).

$C_{15}H_{19}NO_2$; %C 73.15, %H 7.67, %N 5.67 (th 73.44, 7.81, 5.71); mp= 57-60 °C; ν_{\max} (cm^{-1}) 3291 (NH); 1645, 1553 (CONH); δ_H (300 MHz): 7.4-7.3 (5 H, m, aromatics); 6.68 (1 H, t, J= 2.4 Hz, C¹H); 5.72 (1 H, s broad, NH); 5.68 (1 H, d, J= 6.6 Hz, C⁴H); 4.97 (1 H, t, J= 2.4 Hz, C²H); 3.55 (1 H, dt, J= 2.4, 6.6 Hz, C³H); 3.30 (2 H, q, J= 7.2 Hz, C⁶H); 1.51 (2 H, quint, J= 7.2 Hz, C⁷H); 1.35 (2 H, hex, J= 7.2 Hz, C⁸H); 0.93 (3 H, t, J= 7.2 Hz, C⁹H); δ_C (62.5 MHz): 172.3 (C⁵); 148.9 (C¹); 141.7, 128.6, 127.9, 125.2 (aromatics); 98.1 (C²); 85.9 (C⁴); 58.0 (C³); 39.4 (C⁶); 31.6 (C⁷); 20.0 (C⁸); 13.7(C⁹); m/z (EI) 245 (12%) (M⁺); 172 (33%) (M-*n*-BuNH₂⁺); 145 (100%); m/z (CI, NH₃): 246 (71%) (MH⁺); HRMS (ES) found (MNa⁺) 268.1308 (calc. 268.1313).

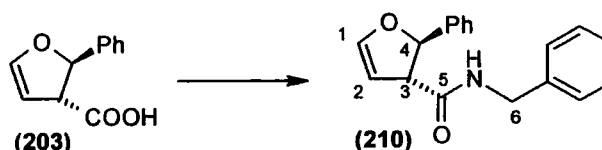
Trans 4-phenyl-3-N-benzyl-carboxamide-3,4-dihydrofuran (210)

Following general procedure D, from a solution of dihydrofuryl acid (203) (185 mg, 0.97 mmol) in THF (10 mL), triethylamine (600 μ L, 4 mmol), pivaloyl chloride (124 μ L, 1 mmol), lithium chloride (42 mg, 1 mmol) and benzylamine (131 μ L, 1.2 mmol) yielded after distillation with a Kügelrohr (P=0.8 mbar, T=180 °C) the expected *trans N*-benzyl amide (210) (196 mg, $y=70\%$).

ν_{\max} (cm^{-1}) 3297 (NH); 1650, 1537 (CONH); δ_H (200 MHz): 7.4-7.3 (10 H, m, aromatics); 6.68 (1 H, t, J= 2.4 Hz, C¹H); 6.05 (1 H, broad s, NH); 5.74 (1 H, d, J= 6.4 Hz, C⁴H); 4.98 (1 H, t, J= 2.4 Hz, C²H); 4.49 (2 H, d, J= 5.6 Hz, C⁶H); 3.62 (1 H, dt, J= 2.4, 6.4 Hz, C³H); δ_C (62.5 MHz): 172.3 (C⁵); 149.1 (C¹); 141.6, 137.9, 128.8, 128.7,

128.0, 127.8, 127.7, 125.2 (aromatics); 97.9 (C²); 85.9 (C⁴); 58.0 (C³); 43.8 (C⁶); *m/z* (ES) 302.1 (MNa⁺), 581.2 (2MNa⁺) (%); HRMS (ES) found 302.1173 (calc. 302.1157).

Trans 4-phenyl-3-N-allyl-carboxamide-3,4-dihydrofuran (211)

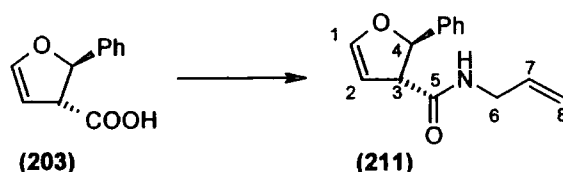

Following general procedure D, from a solution of dihydrofuryl acid (**203**) (209 mg, 1.1 mmol) in THF (10 mL), triethylamine (660 μ L, 4.4 mmol), pivaloyl chloride (140 μ L, 1.1 mmol), lithium chloride (46 mg, 1.1 mmol) and allylamine (100 μ L, 1.32 mmol) was obtained after distillation with a K \ddot{u} gelrohr (P=0.4 mbar, T=125 $^{\circ}$ C) the expected *trans* N-allyl amide (**211**) (117 mg, y=47%).

ν_{\max} (cm⁻¹) 3297 (NH); 1643, 1547 (CONH); δ_{H} (200 MHz): 7.4-7.3 (5 H, m, aromatics); 6.68 (1 H, t, J= 2.4 Hz, C¹H); 6.0-5.75 (2 H, m, C⁷H, NH); 5.71 (1 H, d, J= 6.4 Hz, C⁴H); 5.23-5.12 (2 H, m, C⁸H); 4.98 (1 H, t, J= 2.4 Hz, C²H_b); 3.92 (2 H, dt, J= 1.4, 5.8 Hz, C⁶H); 3.59 (1 H, dt, J= 2.4, 6.4 Hz, C³H); δ_{C} (62.5 MHz): 172.2 (C⁵); 148.9 (C¹); 141.6 (aromatic); 133.9 (C⁷); 128.6, 128.0, 125.1 (aromatics); 116.6 (C⁸); 97.9 (C²); 85.8 (C⁴); 57.9 (C³); 42.0 (C⁶); *m/z* (EI) 229 (38%) (M⁺); 172 (94%) (M-allylNH₂⁺); 145 (100%); 77 (42%) (C₆H₅⁺)

6.4. Synthesis of dihydrofuryl alcohols and amines

6.4.1. Reduction of esters

General procedure E

A solution of ester (1 eq) in ether was introduced slowly to a suspension of LiAlH₄ (2.5 eq) in ether at -40 $^{\circ}$ C under argon. The reaction mixture was stirred 3 hours at -40 $^{\circ}$ C under argon and quenched with distilled water (38 μ L/mmol of LiAlH₄), NaOH 3N (38 μ L/mmol of LiAlH₄) and finally water (114 μ L/mmol of LiAlH₄) before being filtered through a celite plug and concentrated. The generated alcohol was unstable and was used without further purification (storage at -20 $^{\circ}$ C under argon for a couple of hours only).

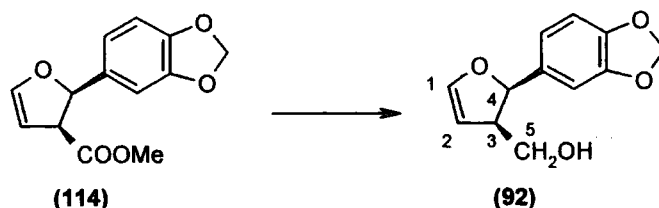
3-hydroxymethyl-4-(3',4'-methylenedioxyphenyl)-3,4-dihydrofuran (92)

Following procedure E, ester **(114)** (400 mg, 1.61 mmol) in ether (10 mL) was reduced by LiAlH_4 (150 mg, 3.95 mmol) in ether (10 mL) at -40°C under argon. After treatment, the title alcohol **(92)** (347 mg, $y=98\%$) was unstable and was used without further purification (storage at -20°C under argon for a couple of hours only).

Cis alcohol: δ_{H} (300 MHz): 6.9–6.8 (3 H; m; aromatics); 6.57 (1 H, dd, $J=1.5, 2.7$ Hz, C^1H); 5.97 (2 H, s, OCH_2O); 5.54 (1 H, d, $J=9.45$ Hz, C^4H); 4.99 (1 H, t, $J=2.7$ Hz, C^2H); 3.40–3.18 (3 H, m, $\text{C}^3\text{H}+\text{C}^5\text{H}$); δ_{C} (62.5 MHz): 147.9 (C^1); 147.2, 147.0, 131.1, 119.6, 108.2, 106.9 (aromatics); 101.5 (C^2); 101.1 (OCH_2O); 84.6 (C^4); 62.6 (C^3), 48.7 (C^5)

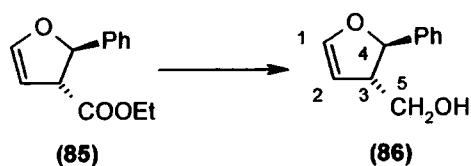
Trans 3-hydroxymethyl-4-phenyl-3,4-dihydrofuran (92)

Following general procedure E, a solution of *trans* dihydrofuryl ester **(85)** (250 mg, 1.15 mmol) in ether (10 mL) was reduced by LiAlH_4 (112.5 mg, 3 mmol) in ether (10 mL) at -40°C under argon. After treatment, the title alcohol **(86)** (151 mg, $y=75\%$) was unstable and was used without further purification.

δ_{H} (250 MHz): 7.37–7.32 (5 H, m, aromatics); 6.59 (1 H, t, $J=2.6$ Hz, C^1H); 5.37 (1 H, d, $J=6.1$ Hz, C^4H); 4.87 (1 H, t, $J=2.6$ Hz, C^2H); 3.73–3.70 (3 H, m, $\text{C}^5\text{H} + \text{OH}$); 3.15–3.07 (1 H, m, C^3H); δ_{C} (62.5 MHz): 147.5 (C^1); 142.6, 128.6, 127.8, 125.3 (aromatics); 99.0 (C^2); 85.0 (C^4); 64.9 (C^5); 54.1 (C^3)

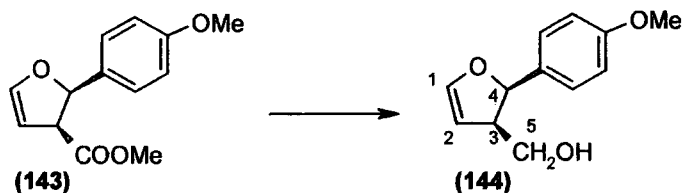
Trans 3-hydroxymethyl-4-p-methoxyphenyl-3,4-dihydrofuran (143)

Following general procedure E, a solution of *cis* dihydrofuryl ester (**143**) (290 mg, 1.24 mmol) in ether (15 mL) was reduced by LiAlH_4 (186 mg, 5 mmol) in ether (15 mL) at $-40\text{ }^\circ\text{C}$ under argon. After treatment, the title alcohol (**144**) (212 mg, $y=83\%$) was unstable and was used without further purification.

δ_{H} (300 MHz): 7.32-7.29 (2 H, m, aromatics); 6.92-6.90 (2 H, m, aromatics); 6.58 (1 H, dd, $J= 1.5, 3.0\text{ Hz}$, C^1H); 5.58 (1 H, d, $J= 9.3\text{ Hz}$, C^4H); 4.98 (1 H, t, $J= 2.4\text{ Hz}$, C^2H); 3.80 (3 H, s, OCH_3); 3.35-3.14 (3 H, m, $\text{C}^3\text{H} + \text{C}^5\text{H}$); δ_{C} (75 MHz): 158.9 (aromatics); 146.8 (C^1); 128.4, 127.3, 113.6 (aromatics); 101.5 (C^2); 84.2 (C^4); 62.6 (C^5); 55.1 (OCH_3); 48.3 (C^3)

6.4.2. Reduction of amidesGeneral procedure F

A solution of amide (1 eq) in THF was slowly added to a suspension of LiAlH_4 (3 eq) in THF at $-40\text{ }^\circ\text{C}$ under argon. The resulting mixture was then warmed at reflux for 48 hours before being quenched with water (38 $\mu\text{L}/\text{mmol}$ of LiAlH_4), NaOH 3M (38 $\mu\text{L}/\text{mmol}$ of LiAlH_4) and water (114 $\mu\text{L}/\text{mmol}$ of LiAlH_4) at $0\text{ }^\circ\text{C}$. The solution was then filtered on a celite bed, which was rinsed by ether before being concentrated.

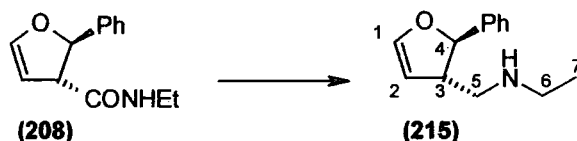
Trans 3-N-ethylaminomethyl-4-phenyl-3,4-dihydrofuran (215)

Following general procedure F, to a suspension of LiAlH_4 (7 mg, 0.19 mmol) in THF (2 mL) was added the *trans* *N*-ethylamide (**208**) (14 mg, 0.06 mmol). After flash chromatography (ether:petrol 2:1), was obtained the corresponding amine (**215**) (11 mg, $y=85\%$).

ν_{\max} (cm⁻¹) 3387 (NH); 2963, 2928, 2809 (CH, aromatics); δ_{H} (200 MHz): 7.36-7.32 (5 H, m, aromatics); 6.52 (1 H, t, J = 2.2 Hz, C¹H); 5.24 (1 H, d, J = 6.2 Hz, C⁴H); 4.95 (1 H, t, J = 2.2 Hz, C²H); 3.10-3.00 (1 H, m, C³H); 2.76 (2 H, d, J = 6.4 Hz, C⁵H); 2.67 (2 H, q, J = 7.2 Hz, C⁶H); 1.11 (3 H, t, J = 7.2 Hz, C⁷H); δ_{C} (50 MHz): 146.2 (C¹); 128.3, 127.6, 126.8, 125.4 (aromatics); 101.6 (C²); 86.2 (C⁴); 54.1 (C⁵); 51.9 (C³); 44.2 (C⁶); 15.3 (C⁷)

Trans 3-N-butylaminomethyl-4-phenyl-3,4-dihydrofuran (216)

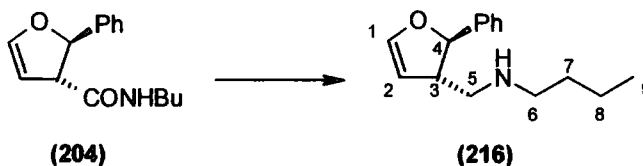

Following general procedure F, to a suspension of LiAlH₄ (185 mg, 4.9 mmol) in THF (15 mL) was added the *trans* *N*-(*n*-butyl) amide (**204**) (400 mg, 1.63 mmol). After flash chromatography (ether:petrol 2:1), was obtained the corresponding amine (**216**) (350 mg, y=93%).

ν_{\max} (cm⁻¹) 3328 (NH); 2956, 2929, 2871 (CH, aromatics), 1453; δ_{H} (300 MHz): 7.43-7.29 (5 H, m, aromatics); 6.51 (1 H, t, J = 2.4 Hz, C¹H); 5.24 (1 H, d, J = 6.3 Hz, C⁴H); 4.94 (1 H, t, J = 2.4 Hz, C²H); 3.04 (1 H, qt, J = 2.4; 6.3 Hz, C³H); 2.75 (2 H, d, J = 6.0 Hz, C⁵H); 2.61 (2 H, t, J = 6.9 Hz, C⁶H); 1.5-1.2 (4 H, m, C⁷H, C⁸H); 0.91 (3 H, t, J = 7.5 Hz, C⁹H); δ_{C} (62.5 MHz): 146.2 (C¹); 142.6, 128.5, 127.7, 125.4 (aromatics); 101.4 (C²); 86.2 (C⁴); 54.1 (C⁵); 51.6 (C³); 49.5 (C⁶); 31.8 (C⁷); 20.3 (C⁸); 13.9 (C⁹); *m/z* (GCMS EI): 231 (0.13%) (M⁺); 86 (100%) (BuNHCH₂⁺); 77 (7.4%) (C₆H₅⁺)

Trans 3-N-allylaminomethyl-4-phenyl-3,4-dihydrofuran (217)

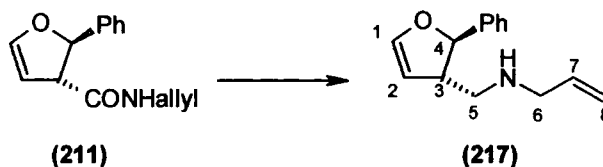

Following general procedure F, to a suspension of LiAlH₄ (28 mg, 0.75 mmol) in THF (2 mL) was added the *trans* *N*-allylamide (**211**) (57 mg, 0.25 mmol). After flash chromatography (ether:petrol 2:1), was obtained the corresponding amine (**217**) (40 mg, y=74%).

ν_{\max} (cm^{-1}) 3378 (NH); 2924 (CH, aromatics); δ_{H} (300 MHz): 7.36-7.27 (5 H, m, aromatics); 6.52 (1 H, t, $J=2.4$ Hz, C^1H); 5.97-5.82 (1 H, m, C^7H); 5.27 (1 H, d, $J=6.3$ Hz, C^4H); 5.21-5.08 (2 H, m, C^8H); 4.93 (1 H, t, $J=2.4$ Hz, C^2H); 3.27 (2 H, dd, $J=1.2, 6$ Hz, C^6H); 3.1-3.0 (1 H, m, C^3H); 2.76 (2 H, d, $J=6$ Hz, C^5H); δ_{C} (100 MHz): 146.2 (C^1); 142.8 (aromatic); 136.8 (C^7); 128.5, 127.6, 125.4 (aromatics); 115.9 (C^8); 101.4 (C^2); 86.2 (C^4); 53.5 (C^5); 52.4 (C^6); 51.9 (C^3); m/z (ES) 216.1 (MH^+), 431.3 (2MH^+); HRMS (ES) found (MH^+) 216.1389 (calc. 216.1388)

Trans 3-aminomethyl-4-phenyl-3,4-dihydrofuran (214)

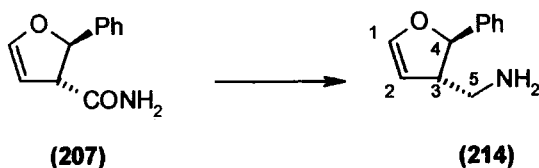

Following general procedure F, to a suspension of LiAlH_4 (105 mg, 2.76 mmol) in THF (4 mL) was added the *trans* primary amide **(207)** (169 mg, 0.73 mmol). Only decomposition material was recovered.

6.4.3. Deprotection of allyl amine

Trans 3-aminomethyl-4-phenyl-3,4-dihydrofuran (214)

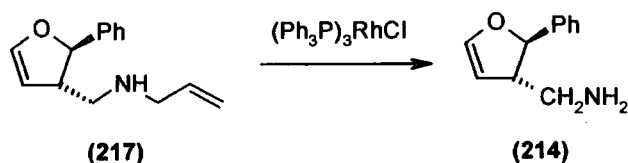

Wilkinson's catalyst ($(\text{Ph}_3\text{P})_3\text{RhCl}$, 0.5 mg, 0.5%) was added to a solution of allyl amine **(217)** (23 mg, 0.11 mmol) in acetonitrile:water 4:1 (0.8 mL:0.2 mL). The resulting mixture was heated at reflux and some solvent was added in continuous for 8 hours. Water and ether were then added. The organic layer was washed with brine, dried (MgSO_4) and concentrated. Only starting material (21 mg) was recovered.

6.5. Synthesis of furo-furan or -pyrrole

6.5.1. Preparation of acetals

Piperonal dimethyl acetal (121)

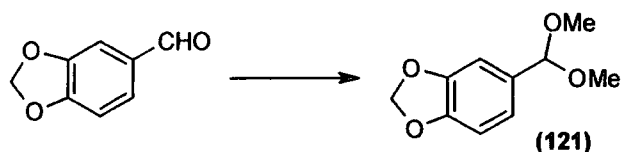

Trimethyl orthoformate (4 mL, 80.0 mmol) was added to a solution of piperonal (4 g, 26.67 mmol), *p*-toluene sulfonic acid (500 mg, 2.63 mmol) and methanol (3 mL, 74.15 mmol) at room temperature under argon. The mixture was stirred for 15 hours before adding solid sodium bisulfite (12 g, 115.38 mmol). The mixture was stirred for 45 min and filtered on a celite bed which was washed with ether. After concentration *in vacuo*, was obtained the expected acetal (**121**) (4.93 g, $y=94\%$).

δ_{H} (300 MHz): 6.95–6.77 (3 H, m, aromatics); 5.95 (2 H, s, OCH₂O); 5.28 (1 H, s, ArCH); 3.31 (6 H, m, OCH₃)

Piperonal 1,2-ethyl acetal (122)

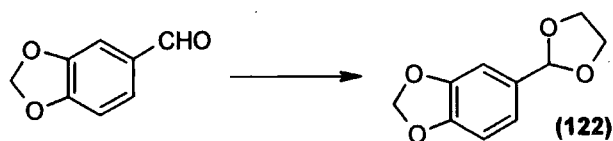

Trimethyl orthoformate (2.8 mL, 56.0 mmol) was added to a solution of piperonal (4 g, 26.67 mmol), *p*-toluene sulfonic acid (500 mg, 2.63 mmol) and ethylene glycol (1.5 mL, 27.27 mmol) at room temperature under argon. The mixture was stirred for 5 hours. After Kügelrohr distillation (125 °C, 0.1 mbar), was obtained the expected acetal (**122**) (2.91 g, $y=56\%$).

δ_{H} (300 MHz): 6.97–6.93 (2 H, m, aromatics); 6.80 (1 H, d, $J=8.1$ Hz, aromatic); 5.96 (2 H, s, OCH₂O); 5.71 (1 H, s, ArCH); 4.12–4.00 (4 H, m, CH₂CH₂); δ_{C} (62.5 MHz): 148.3, 147.7, 131.8, 120.5, 107.9, 106.7 (aromatics); 103.6 (ArCH); 101.1 (OCH₂O); 65.2 (CH₂CH₂)

6.5.2. Lewis acid promoted cyclisation from alcohol

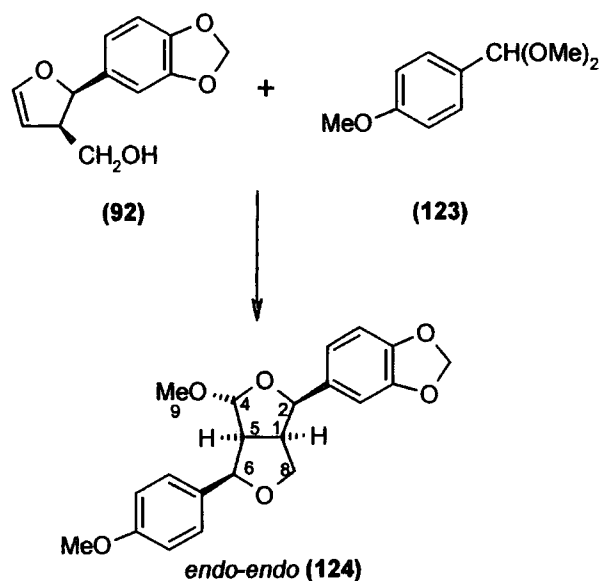
4-exo-methoxy-2-endo-(3',4'-methylenedioxyphenyl)-6-endo-p-methoxyphenyl-3,7-dioxo-bicyclo[3.3.0]octane (91)

A solution of alcohol **(92)** (81 mg, 0.37 mmol) in DCM (5 mL) was slowly added to a solution of acetal **(123)** (137 μ L, 0.55 mmol) and TMSOTf (425 μ L, 0.41 mmol) in DCM (10 mL) at -40 $^{\circ}$ C under argon. The resulting solution (dark purple) was stirred for 17 hours at -40 $^{\circ}$ C, under argon, before being quenched with methanol (2 mL) and then sat. NaHCO_3 solution (15 mL). The aqueous layer was extracted with ether (3 x 10 mL). The combined organic layers were washed with sat. NaHSO_3 solution (5 x 15 mL), to scavenge any piperonal, and with brine (3 x 15 mL), dried over MgSO_4 and concentrated. The pure *endo* methyl furofuran **(124)** (73 mg, 53%) was obtained after flash chromatography (petrol:ether 7:3).

ν_{max} (cm^{-1}) 2928, 1513, 1489, 1248. δ_{H} (500 MHz): 7.31 (2 H, d, $J = 8.5$ Hz, aromatics); 6.94-6.92 (3 H, m, aromatics); 8.84 (2 H, broad s, aromatics); 5.97 (2 H, s, OCH_2O); 5.25 (1 H, d, $J = 6$ Hz, C^2H); 4.87 (1 H, d, $J = 6.5$ Hz, C^6H); 4.49 (1 H, s, C^4H); 3.83 (3 H, s, OCH_3 Ar); 3.73 (1 H, dd, $J = 1.5, 6.5$ Hz, $\text{C}^8\text{H}_{\text{endo}}$); 3.51-3.48 (1 H, m, $\text{C}^8\text{H}_{\text{exo}}$); 3.15 (3 H, s, C^9H), 3.14-2.95 (2 H, m, $\text{C}^1\text{H}, \text{C}^5\text{H}$). δ_{C} (125 MHz): 158.8, 147.7, 146.8, 132.2, 130.6, 127.3, 119.8, 113.7, 108.2, 107.3 (aromatics); 105.3 (C^4); 101.0 (OCH_2O); 82.7 (C^6); 81.5 (C^2); 68.7 (C^8); 56.0 (C^5); 55.2 (OCH_3 Ar); 54.3 (OCH_3); 48.1 (C^1). m/z (EI) 370 (27%) (M^+)

4-exo-methoxy-2-endo,6-endo-bis(3',4'-methylenedioxyphenyl)-3,7-dioxabicyclo[3.3.0]octane (91)

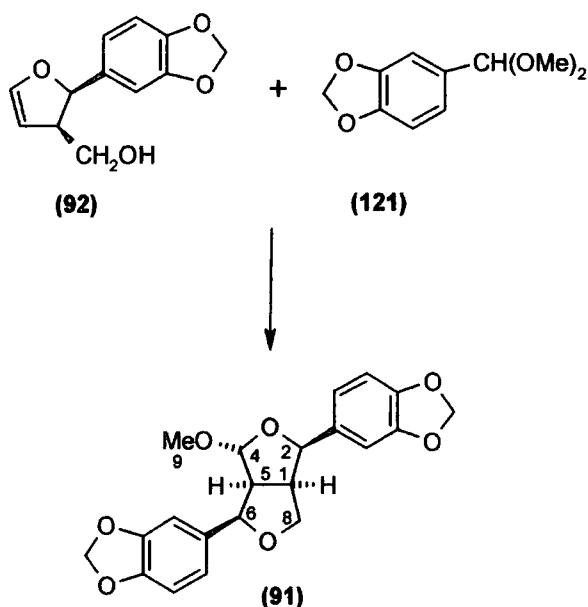

A solution of alcohol **(92)** (347 mg, 1.58 mmol) in DCM (10 mL) was slowly added to a solution of acetal **(121)** (800 mg, 4.08 mmol) and TMSOTf (425 μ L, 2.38 mmol) in DCM (20 mL) at -40 $^{\circ}$ C under argon. The resulting solution (dark purple) was stirred for 17 hours at -40 $^{\circ}$ C, under argon, before being quenched with methanol (2 mL) and then sat. NaHCO_3 solution (15 mL). The aqueous layer was extracted with ether (3 x 15 mL). The combined organic layers were washed with sat. NaHSO_3 solution (5 x 15 mL), to scavenge any piperonal, and with brine (3 x 15 mL), dried over MgSO_4 and concentrated. The pure *endo* methyl furofuran **(91)** (333.7 mg, 55%) was obtained after flash chromatography (petrol:ether 7:3).

ν_{max} (cm^{-1}) 2894, 1503, 1489, 1444, 1239, 1098, 1063, 1037; δ_{H} (300 MHz): 6.91-6.82 (6 H, m, aromatics); 5.98 (2 H, s, OCH_2O); 5.97 (2 H, s, OCH_2O); 5.25 (1 H, d, $J=6$ Hz, C^2H); 4.82 (1 H, d, $J=5.7$ Hz, C^6H); 4.53 (1 H, s, C^4H); 3.71 (1 H, d, $J=8.4$ Hz, $\text{C}^8\text{H}_{\text{endo}}$); 3.50-3.44 (1 H, m, $\text{C}^8\text{H}_{\text{exo}}$); 3.17 (3 H, s, C^9H), 3.15-3.09 (2 H, m, C^1H , C^5H). δ_{C} (125 MHz): 147.7, 147.6, 146.8, 146.7, 132.7, 132.4, 120.0, 119.5, 108.5, 108.4, 107.6, 107.1 (aromatics); 105.5 (C^4); 101.2 (OCH_2O); 82.9 (C^6); 81.7 (C^2); 68.9 (C^8); 56.3 (C^5); 54.6 (C^9); 48.3 (C^1); m/z (EI) 384 (32%) (M^+); 203 (42%); 178 (99%); 84 (100%); m/z (CI, CH_4) 385 (MH^+); 353; 307; 135; 57 (100%); HRMS (ES): found (MNa^+) 407.1139 (calc. 407.1107)

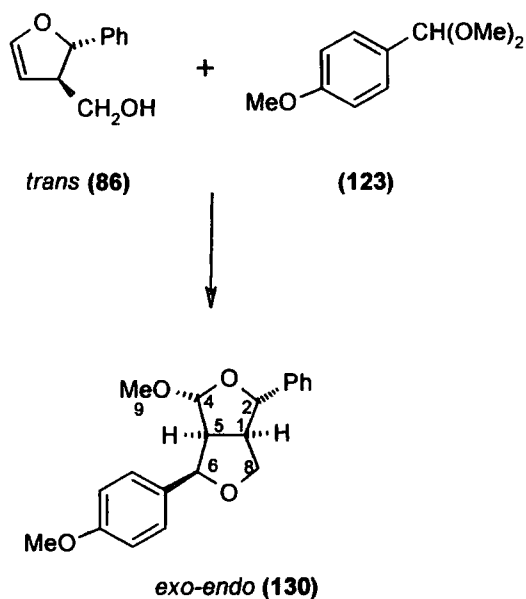
4-exo-methoxy-2-exo-phenyl-6-endo-p-methoxyphenyl-3,7-dioxabicyclo[3.3.0]octane**(130)**

A solution of *trans* alcohol (86) (96 mg, 0.51 mmol) in DCM (7 mL) was added to a mixture of *p*-methoxybenzaldehyde dimethyl acetal (123) (220 μ L, 1.30 mmol) and TMSOTf (110 μ L, 0.60 mmol) in DCM (13 mL) at -40 $^{\circ}$ C. The resulting mixture was stirred for 4 hours at -40 $^{\circ}$ C before being quenched with methanol and then sat. NaHCO_3 solution (15 mL). The aqueous layer was extracted with ether (3 x 15 mL). The combined organic layers were washed with sat. NaHSO_3 solution (5 x 15 mL), to scavenge any anisaldehyde and with brine (3 x 15 mL), dried over MgSO_4 and concentrated. Purification by flash chromatography (ether:petrol:triethylamine 25:75:1), afforded the expected *exo-endo* furofuryl acetal (130) (88 mg, $y=53\%$).

ν_{max} (cm^{-1}) 2955, 2927, 2854 (CH aromatics); δ_{H} (500 MHz): 7.43-7.32 (7 H, m, aromatics); 6.93 (2 H, d, $J=9$ Hz, aromatics); 4.95 (1 H, d, $J=7.3$ Hz, C^6H); 4.90 (1 H, d, $J=5.6$ Hz, C^2H); 4.37 (1 H, d, $J=1.8$, C^4H); 4.16 (1 H, d, $J=9.2$ Hz, $\text{C}^8\text{H}_{\text{endo}}$); 3.86-3.82 (4 H, m, OCH_3 Ar + $\text{C}^8\text{H}_{\text{exo}}$); 3.17-3.08 (5 H, m, $\text{C}^9\text{H} + \text{C}^1\text{H} + \text{C}^5\text{H}$); δ_{C} (500 MHz): 158.9, 142.5, 130.2, 128.5, 127.6, 127.5, 126.4, 113.7 (aromatics); 108.0 (C^4); 88.1 (C^2); 82.0 (C^6); 71.6 (C^8); 56.3 (C^5); 55.4 (C^9); 55.2 (OCH_3 Ar); 52.6 (C^1); m/z (EI)= 326 (8%) (M^+), 192 (100%); m/z (ES)= 348.9 (MNa^+), 674.9 (2MNa^+); HRMS (ES) found (MNa^+) 349.1397 (calc. 349.1416)

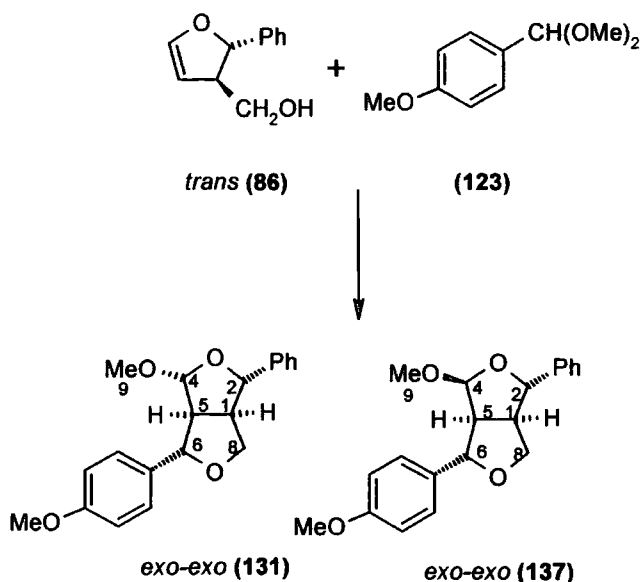
4-methoxy-2-exo-phenyl-6-exo-p-methoxyphenyl-3,7-dioxabicyclo[3.3.0]octane

A solution of *trans* alcohol (105, 0.60 mmol) in DCM (7 mL) was added to a mixture of *p*-methoxybenzaldehyde dimethyl acetal (240 μL , 1.42 mmol) and TMSOTf (120 μL , 0.65 mmol) in DCM (13 mL). The resulting mixture was stirred for 16 hours at $-20\text{ }^{\circ}\text{C}$ then for 3 hours at room temperature before being quenched by methanol, stirred for 3 more hours and then treated with sat. NaHCO_3 solution (15 mL). The aqueous layer was extracted with ether (3 x 15 mL). The combined organic layers were washed with sat. NaHSO_3 solution (5 x 15 mL), to scavenge any anisaldehyde and with brine (3 x 15 mL), dried over MgSO_4 and concentrated. Purification by flash chromatography (ether:petrol:triethylamine 25:75:1) afforded a mixture of *exo:endo* acetal in a 2:1 ratio (88 mg, $y=45\%$).

4-exo-methoxy-2-exo-phenyl-6-exo-p-methoxyphenyl-3,7-dioxabicyclo[3.3.0]octane

(131): ν_{max} (cm^{-1}) 2955, 2835 (CH aromatics); δ_{H} (500 MHz): 7.42-7.29 (7 H, m, aromatics); 6.91 (2 H, d, $J=8.5$ Hz, aromatics); 5.09 (1 H, s, C^4H); 5.07 (1 H, d, $J=6.4$ Hz, C^2H); 4.86 (1 H, d, $J=7.5$, C^6H); 4.27 (1 H, dd, $J=6.0, 9.0$, $\text{C}^8\text{H}_{\text{exo}}$); 4.05 (1 H, dd, $J=2.6, 9.1$ Hz, $\text{C}^8\text{H}_{\text{endo}}$); 3.81 (3 H, s, OCH_3 Ar); 3.40 (3 H, s, C^9H); 3.26-3.20 (1 H, m, C^1H); 2.99 (1 H, t, $J=6.0$ Hz, C^5H); δ_{C} (500 MHz): 159.3, 142.4, 133.4, 128.56, 127.7, 127.2, 126.5, 114.0 (aromatics); 108.3 (C^4); 88.4 (C^2); 83.2 (C^6); 72.6 (C^8); 61.2 (C^1); 55.3 (OCH_3 Ar); 55.2 (C^9); 53.0 (C^1); m/z (ES) = 348.9 (MNa^+), 674.9 (2MNa^+); HRMS (ES) found (MNa^+) 349.1407 (calc. 349.1416)

4-endo-methoxy-2-exo-phenyl-6-exo-p-methoxyphenyl-3,7-dioxabicyclo[3.3.0]octane

(137): ν_{\max} (cm^{-1}) 2955, 2835 (CH aromatics); δ_{H} (500 MHz): 7.38-7.26 (7 H, m, aromatics); 6.89 (2 H, d, $J = 8.5$ Hz, aromatics); 5.44 (1 H, d, $J = 4$ Hz, C^6H); 5.30 (1 H, d, $J = 5.8$ Hz, C^4H); 4.90 (1 H, d, $J = 7.3$, C^2H); 4.06 (1 H, dd, $J = 6.7, 8.9$ Hz, $\text{C}^8\text{H}_{\text{exo}}$); 3.95 (1 H, dd, $J = 4.3, 8.9$ Hz, $\text{C}^8\text{H}_{\text{exo}}$); 3.80 (3 H, s, OCH_3 Ar); 3.51 (3 H, s, C^9H); 3.41-3.39 (1 H, m, C^5H); 3.15-3.00 (1 H, m, C^1H); δ_{C} (500 MHz): 158.8, 137.7, 134.4, 129.3, 128.6, 128.0, 127.2, 126.1 (aromatics); 104.7 (C^4); 83.1 (C^2); 79.0 (C^6); 70.2 (C^8); 58.1 (C^5); 55.7 (C^9); 55.3 (OCH_3 Ar); 55.1 (C^1); m/z (ES) = 348.9 (MNa^+), 674.9 (2MNa^+); HRMS (ES) found (MNa^+) 349.1449 (calc. 349.1416)

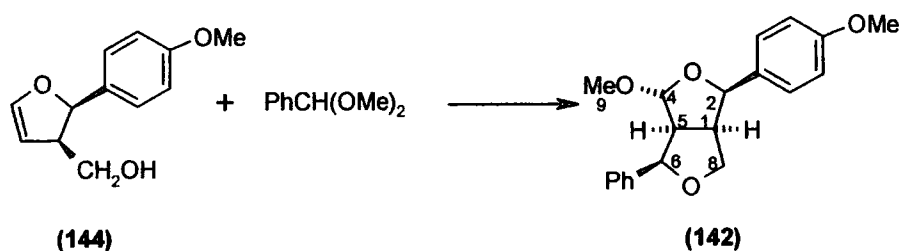
4-exo-methoxy-2-endo-p-methoxyphenyl-6-endo-phenyl-3,7-dioxabicyclo[3.3.0]octane**(142)**

A solution of *cis* alcohol (144) (24 mg, 0.12 mmol) in DCM (1.5 mL) was added to a mixture of benzaldehyde dimethyl acetal (45 μL , 0.30 mmol) and TMSOTf (35 μL , 0.19 mmol) in DCM (1.5 mL). The resulting mixture was stirred for 1 hour at -78 °C before being quenched with methanol and then sat. NaHCO_3 solution (5 mL). The aqueous layer was extracted with ether (3 x 5 mL). The combined organic layers were washed with sat. NaHSO_3 solution (5 x 5 mL), to scavenge any benzaldehyde and with brine (3 x 5 mL), dried over MgSO_4 and concentrated. Purification by flash chromatography (ether:petrol:triethylamine 25:75:1) afforded the expected furofuryl acetal (142) (9 mg, $y=23\%$).

ν_{\max} (cm^{-1}) 2927 (CH aromatics); δ_{H} (500 MHz): 7.41-7.23 (7 H, m, aromatics); 6.94 (2 H, d, $J = 8.7$, aromatics); 5.31 (1 H, d, $J = 5.4$ Hz, C^2H); 4.93 (1 H, d, $J = 5.8$ Hz, C^6H); 4.48 (1 H, s, C^4H); 3.83 (3 H, s, OCH_3 Ar); 3.72 (1 H, d, $J = 10.0$ Hz, $\text{C}^8\text{H}_{\text{endo}}$); 3.51-3.46 (1 H, m, $\text{C}^8\text{H}_{\text{exo}}$); 3.19-3.06 (5 H, m, C^1H , C^5H , C^9H); δ_{C} (125 MHz): 158.9, 138.6, 130.3, 128.3, 127.8, 127.3, 126.0, 113.8 (aromatics); 105.3 (C^4); 82.9 (C^6); 81.4 (C^2); 68.8 (C^8); 56.1 (C^9); 55.3 (OCH_3 Ar); 54.3 (C^1); 48.1 (C^5); m/z (ES) 349.1; HRMS (ES) found (MNa^+) 349.1407 (calc. 349.1416)

6.5.3. Cyclisation from amine

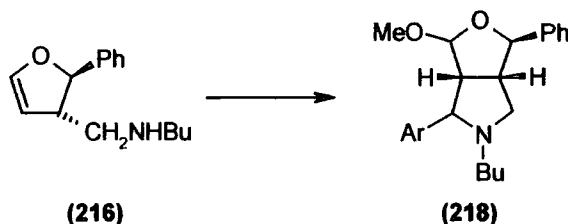
4-methoxy-2-exo-phenyl-6-aryl-3,oxa-7-aza-bicyclo[3.3.0]octane (218)Method 1: *p*-methoxybenzaldehyde dimethyl acetal + TMSOTf

A solution of *trans* butyl amine (**(216)**) (80 mg, 0.35 mmol) in DCM (1.5 mL) was added to a mixture of *p*-methoxybenzaldehyde dimethyl acetal (135 μL , 0.70 mmol) and TMSOTf (70 μL , 0.38 mmol) in DCM (1.5 mL). The resulting mixture was stirred for 16 hours at $-20\text{ }^\circ\text{C}$ before being quenched with methanol (1 mL) and then sat. NaHCO_3 solution (5 mL). The aqueous layer was extracted with ether (3 x 5 mL). The combined organic layers were washed with sat. NaHSO_3 solution (5 x 5 mL), to scavenge any anisaldehyde and with brine (3 x 5 mL), dried over MgSO_4 and concentrated. The crude mixture did not contain the expected furopyrrole.

Method 2: *p*-methoxybenzaldehyde + acetic acid

p-Methoxybenzaldehyde (175 μL , 1.42 mmol) was added to a solution of *trans* butyl amine (**(216)**) (165 mg, 0.71 mmol) in DCM (5 mL) at room temperature, under argon. After 2 hours, acetic acid (10 μL) was added and the resulting mixture was stirred for 15 hours before being quenched with methanol and then sat. NaHCO_3 solution (5 mL). The aqueous layer was extracted with ether (3 x 5 mL). The combined organic layers were washed with sat. NaHSO_3 solution (5 x 5 mL), to scavenge any anisaldehyde and with brine (3 x 15 mL), dried over MgSO_4 and concentrated. Only starting materials and decomposition products were recovered.

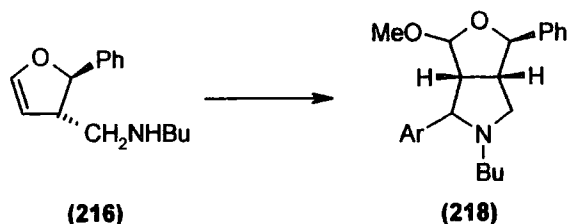

Method 3: benzaldehyde + PPTS

Benzaldehyde (140 μL , 1.34 mmol) was added to a solution of *trans* butyl amine (**216**) (155 mg, 0.67 mmol) and pyridinium p-toluene sulphonate (PPTS) (17 mg, 0.07 mmol) in CDCl_3 (2.5 mL) at room temperature, under argon. The resulting mixture was stirred for 15 hours before being quenched with methanol and then sat. NaHCO_3 solution (5 mL). The aqueous layer was extracted with ether (3 x 5 mL). The combined organic layers were washed with sat. NaHSO_3 solution (5 x 5 mL), to scavenge any benzaldehyde and with brine (3 x 15 mL), dried over MgSO_4 and concentrated. Only starting materials and decomposition products were recovered.

Method 4: benzaldehyde + CSA

Benzaldehyde (140 μL , 1.34 mmol) was added to a solution of *trans* butyl amine (**216**) (155 mg, 0.67 mmol) and (-)-camphor sulphonic acid (CSA) (16 mg, 0.07 mmol) in CDCl_3 (2.5 mL) at room temperature, under argon. The resulting mixture was stirred for 15 hours before being quenched with methanol and then sat. NaHCO_3 solution (5 mL). The aqueous layer was extracted with ether (3 x 5 mL). The combined organic layers were washed with sat. NaHSO_3 solution (5 x 5 mL), to scavenge any benzaldehyde and with brine (3 x 15 mL), dried over MgSO_4 and concentrated. Only starting materials and decomposition products were recovered.

Method 5: reductive amination *p*-bromobenzaldehyde + NaBH_4

Acetic acid (14 μL , 0.5 mmol) was added to a solution of *trans* butyl amine (**216**) (58 mg, 0.25 mmol) and *p*-bromobenzaldehyde (93 μL , 0.50 mmol) in CDCl_3 (2.5 mL) at room temperature, under argon. The resulting mixture was stirred for 35 hours at 50 $^\circ\text{C}$. Then a solution of NaBH_4 (35 mg, 1 mmol) in CDCl_3 (0.5 mL) was added. The resulting mixture was stirred for 2 hours at room temperature before being quenched. After aqueous treatment, *p*-bromobenzyl alcohol was recovered but no tertiary amine.

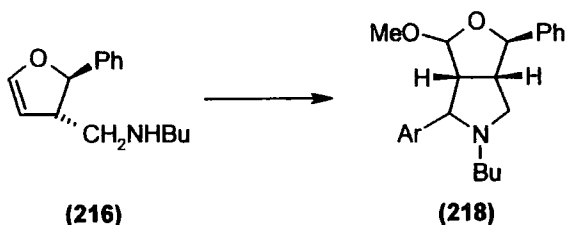

Method 6: with Eschenmöser salt

A solution of *trans* butyl amine (**(216)**) (40 mg, 0.17 mmol) in CDCl₃ (1 mL) was added to a suspension of Eschenmöser salt (CH₂NMe₂, 34 mg, 0.18 mmol) in CDCl₃ (2 mL) at room temperature under argon. The resulting mixture was stirred for 30 min before being quenched by methanol. After aqueous work-up, the crude mixture (48 mg) contained mainly 3 major compounds, none of which were not the expected furopyrrrole.

6.5.4. Activation of the amine

4-phenyl-3-N-butyl,N-p-methoxybenzoyl-aminomethyl-3,4-dihydrofuran (**(227)**)

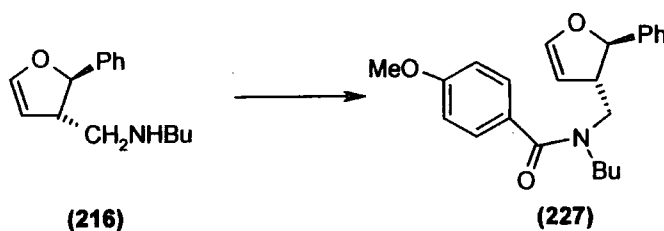

A solution of *p*-methoxybenzoyl chloride (60 mg, 0.34 mmol) and DMAP (3 mg, 0.03 mmol) in DCM (2 mL) was slowly added to a mixture of butyl amine (60 mg, 0.26 mmol) and triethylamine (180 μ L, 1.2 mmol) in DCM (3 mL) under argon at room temperature. The resulting mixture was stirred for 18 hours before being treated with HCl (1M) (3 mL). The aqueous layer was extracted with ether (3 x 3 mL). The combined organic layer washed with sat. NaHCO₃ solution (2 x 3 mL) and brine (2x3 mL) dried (MgSO₄) and concentrated. After flash chromatography (ether:petrol 1:2), was obtained the expected amide (65 mg, γ =69%). At -55 °C, the NMR spectra corresponded to the two rotamers called A and B in the interpretation.

ν_{\max} (cm^{-1}) 2957, 2931 (CH, aromatic); 1627, 1608 (CON); 1251; δ_{H} (500 MHz, $-55\text{ }^{\circ}\text{C}$): Rotamer A: 7.27-7.15 (5 H, m, aromatic); 7.14 (2 H, d, $J=8.5\text{ Hz}$, aromatics); 6.78 (2 H, d, $J=8.5\text{ Hz}$, aromatics); 6.46 (1 H, broad s, C^1H); 5.29 (1 H, broad d, $J=6.4\text{ Hz}$, C^4H); 4.90-4.76 (1 H, m, C^2H); 3.73 (3 H, s, OCH_3); 3.7-3.0 (5 H, m, C^3H , C^5H and C^6H); 1.52-1.08 (2 H, m, C^7H); 0.96-0.92 (2 H, m, C^8H); 0.66-0.64 (3 H, m, C^9H); Rotamer B: 7.27-7.15 (5 H, m, aromatics); 7.05 (2 H, d, $J=7.5\text{ Hz}$, aromatics); 6.84 (2 H, d, $J=7.5\text{ Hz}$, aromatics); 6.36 (1 H, broad s, C^1H); 5.29 (1 H, broad d, $J=6.4\text{ Hz}$, C^4H); 4.90-4.76 (1 H, m, C^2H); 3.77 (3 H, s, OCH_3); 3.7-3.0 (5 H, m, C^3H , C^5H and C^6H); 1.52-1.08 (2 H, m, C^7H); 0.82-0.77 (3 H, m, C^9H); 0.74-0.70 (2 H, m, C^8H); δ_{C} (125 MHz, $-55\text{ }^{\circ}\text{C}$): 172.4(CO A); 171.8 (CO B); 159.8 ($\text{C}^1\text{ A+B}$); 146.6, 146.2, 141.6, 141.3, 132.0, 128.7, 128.6, 128.5, 128.3, 128.1, 128.0, 127.8, 125.4, 124.6, 113.4, 113.3 (aromatics A+B); 101.3 ($\text{C}^2\text{ A}$); 100.2 ($\text{C}^2\text{ B}$); 85.9 ($\text{C}^4\text{ A}$); 84.8 ($\text{C}^4\text{ B}$); 55.5 ($\text{OCH}_3\text{ B}$); 55.3 ($\text{OCH}_3\text{ A}$); 53.1, 50.4, 50.0, 49.4, 48.4, 44.4 ($\text{C}^3, \text{C}^5, \text{C}^6\text{ A+B}$); 30.3 ($\text{C}^7\text{ A}$); 29.1 ($\text{C}^7\text{ B}$); 20.0 ($\text{C}^8\text{ B}$), 19.4 ($\text{C}^8\text{ A}$); 14.1 ($\text{C}^9\text{ B}$); 13.8 ($\text{C}^9\text{ A}$); m/z (ES) 388.2 (MNa^+), 753.4 (2MNa^+); HRMS (ES) found (MNa^+) 388.1890 (calc. 388.1889)

4-methoxy-2-exo-phenyl-6-p-methoxyphenyl-3,oxa-7-aza-bicyclo[3.3.0]octane (221)

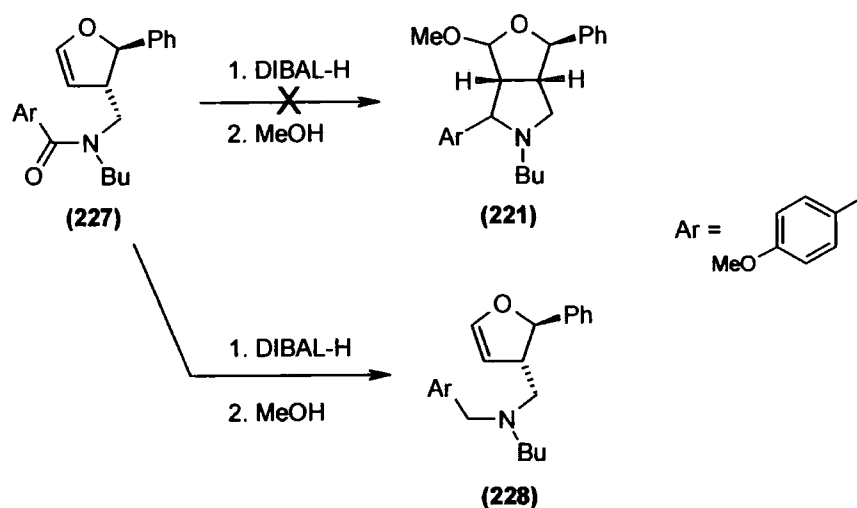

DIBAL-H (1M) (120 μL , 0.12 mmol) was slowly added to a solution of tertiary amide (227) (10 mg, 0.03 mmol) in THF (1 mL) under argon. The mixture was stirred at rt for 3 hours before being quenched by methanol. After aqueous treatment (NaHCO_3 and brine), the crude product did not contain any furopyrrrole (221) but a trace of tertiary amine (228) was detected.

6.6. Glycosidic bond reduction

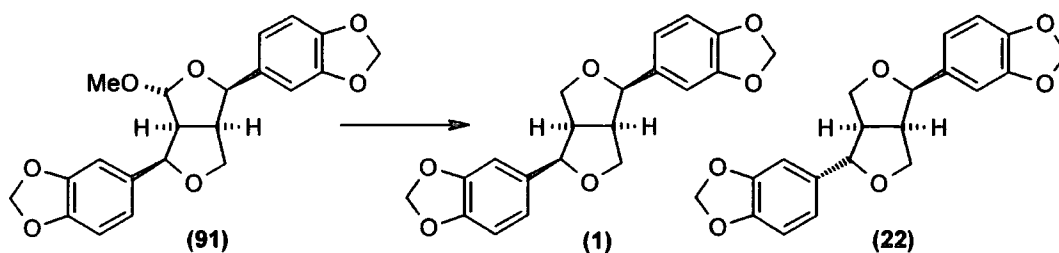
2-endo,6-endo-bis(3',4'-methylenedioxyphenyl) 3,7-dioxabicyclo[3.3.0]octane (1)

Triethylsilane (220 μL , 2.6 mmol) was slowly added to a solution of acetal (91) (100 mg, 0.26 mmol), in DCM (6 mL) at $-40\text{ }^\circ\text{C}$ under argon. $\text{BF}_3\cdot\text{OEt}_2$ (50 μL , 0.275 mmol), was then added under the same conditions and the colour of the solution turned to dark red. The resulting solution was stirred for 15 hours at $-40\text{ }^\circ\text{C}$ under argon before being poured into a saturated solution of sodium bicarbonate. The aqueous layer was extracted with ether (3 x 5 mL) and the combined organic layers were washed with brine (3 x 5 mL), dried (MgSO_4) and concentrated. The residue was purified by flash chromatography (ether:petrol:triethylamine 25:75:1) to afford Epiasarinin (25 mg, $y=27\%$) and Asarinin (3 mg, $y=3.3\%$) and a mixture of the two diastereoisomers and starting material (37 mg, 40%) which could be recycled.

Epiasarinin (1) mp = $140\text{--}142\text{ }^\circ\text{C}$; $\text{C}_{20}\text{H}_{18}\text{O}_6$; %C 67.60, %H 5.13 (th 67.79, 5.12%) ν_{max} (cm^{-1}) 2922, 1460, 1376, 1253; δ_{H} (500 MHz): 6.89 (2 H, s, aromatics); 6.82 (4 H, s, aromatics); 5.97 (4 H, s, OCH_2O); 4.87 (2 H, d, $J=5.04\text{ Hz}$, C^2H , C^6H); 3.72 (2 H, d, $J=9.7\text{ Hz}$, $\text{C}^4\text{H}_{\text{endo}}$, $\text{C}^8\text{H}_{\text{endo}}$); 3.52 (2 H, pseudo dd, $J=6.85, 9.45\text{ Hz}$, $\text{C}^4\text{H}_{\text{exo}}$, $\text{C}^8\text{H}_{\text{exo}}$); 3.13 (2 H, m, C^1H , C^5H); δ_{C} (125 MHz): 147.6, 146.7, 132.1, 119.5, 108.1, 107.1 (aromatics); 100.9 (OCH_2O); 84.1 (C^2 , C^6); 68.7 (C^4 , C^8); 49.5 (C^1 , C^5); m/z (ES^+): 377.1 (MNa^+); 731 (M_2Na^+)

Asarinin (22) ν_{max} (cm^{-1}) 2922, 1460, 1376, 1253; δ_{H} (500 MHz): 6.86–6.78 (6 H, m, aromatics); 5.96 (2 H, s, OCH_2O); 5.95 (2 H, s, OCH_2O); 4.83 (1 H, d, $J=5.15\text{ Hz}$, C^2H); 4.39 (1 H, d, $J=6.86\text{ Hz}$, C^6H); 4.09 (1 H, d, $J=9.3\text{ Hz}$, $\text{C}^4\text{H}_{\text{endo}}$); 3.83–3.80 (2 H, m, $\text{C}^4\text{H}_{\text{exo}}$, $\text{C}^8\text{H}_{\text{endo}}$); 3.31–3.29 (2 H, m, C^1H , $\text{C}^8\text{H}_{\text{exo}}$); 2.88–2.83 (1 H, m, C^5H); δ_{C} (125 MHz): 147.9, 147.6, 147.2, 146.5, 135.0, 132.2, 119.6, 118.7, 108.5, 106.5, 106.4 (aromatics); 101.0, 100.9 (OCH_2O); 87.6 (C^6); 82.0 (C^2); 70.9 (C^4); 69.7 (C^8); 54.6 (C^5); 50.1 (C^1)

Method G

Triethylsilane (10 eq) was slowly added to a solution of acetal (1 eq), in DCM at $-78\text{ }^{\circ}\text{C}$ under argon. $\text{BF}_3\cdot\text{OEt}_2$ (1.7 eq) was then added at $-78\text{ }^{\circ}\text{C}$ and the colour of the solution turned to dark red. The resulting solution was stirred for 1 min at $-78\text{ }^{\circ}\text{C}$ under argon before being poured into a saturated solution of sodium bicarbonate. The resulting mixture was filtered through a hydrophobic frit and concentrated.

Method H

Triethylsilane (10 eq) was slowly added to a solution of acetal (1 eq), in DCM at $-20\text{ }^{\circ}\text{C}$ under argon. $\text{BF}_3\cdot\text{OEt}_2$ (1.7 eq) was then added at $-20\text{ }^{\circ}\text{C}$ and the resulting solution was stirred for 4 hours at $-20\text{ }^{\circ}\text{C}$ under argon before being poured into a saturated solution of sodium bicarbonate. The resulting mixture was filtered through a hydrophobic frit and concentrated.

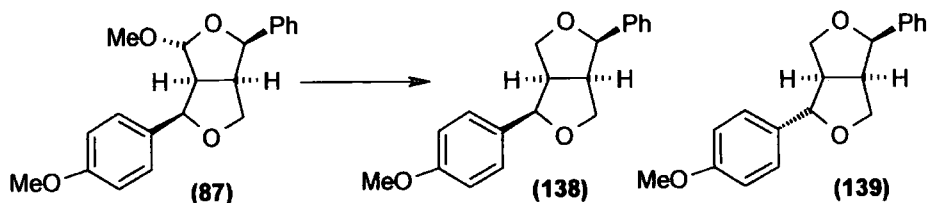
2-endo-phenyl-6-endo-p-methoxyphenyl-3,7-dioxa-bicyclo[3.3.0]octane (138)

Following method G, from *endo-endo* acetal (87) (22 mg, 0.07 mmol), Et_3SiH (60 μL , 0.70 mmol) and $\text{BF}_3\cdot\text{OEt}_2$ (20 μL , 0.12 mmol), was a mixture of furofuran (138):(139) (40:60) and was purified by flash chromatography (ether:petrol:triethylamine 25:75:1) to afford the expected *endo-endo* furofuran (138) (5 mg, 24%).

(138): ν_{max} (cm^{-1}) 2958, 2931, 2855, 1513, 1248; δ_{H} (500 MHz): 7.40-7.29 (7 H, m, aromatics); 6.92 (2 H, d, $J = 9\text{ Hz}$, aromatics); 4.97 (1 H, d, $J = 5.7\text{ Hz}$, C^2H); 4.93 (1 H, d, $J = 5.9\text{ Hz}$, C^6H); 3.83 (3 H, s, OCH_3 Ar); 3.13 (1 H, dd, $J = 2.3, 9.6\text{ Hz}$, $\text{C}^4\text{H}_{\text{endo}}$); 3.67 (1 H, dd, $J = 2.2, 9.4\text{ Hz}$, $\text{C}^8\text{H}_{\text{endo}}$); 3.55 (1 H, dd, $J = 7.3, 9.6\text{ Hz}$, $\text{C}^4\text{H}_{\text{exo}}$); 3.53 (1 H, dd, $J = 7.3, 9.4\text{ Hz}$, $\text{C}^8\text{H}_{\text{exo}}$); 3.29-3.08 (2 H, m, C^1H , C^5H); δ_{C} (125 MHz): 138.9, 130.6, 128.6, 128.3, 127.6, 126.3, 113.7 (aromatics); 84.3 (C^2); 84.0 (C^6); 68.85 (C^4); 68.75 (C^8); 55.3 (OCH_3); 49.6 (C^5); 49.5 (C^1); m/z (ES^+): 319.1 (MNa^+); 731 (2MNa^+); HRMS (ES) found (MNa^+) 319.1317 (calc. 319.1310)

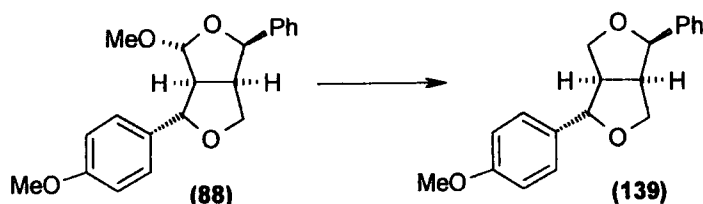
2-endo-phenyl-6-exo-p-methoxyphenyl-3,7-dioxabicyclo[3.3.0]octane (139)

Following method H, from *endo-exo* acetal (**88**) (12 mg, 0.04 mmol), Et₃SiH (30 μ L, 0.35 mmol) and BF₃•OEt₂ (10 μ L, 0.06 mmol) afforded after purification by flash chromatography (ether:petrol:triethylamine 25:75:1) the expected *endo-exo* furofuran (**139**) (9 mg, 83%).

(**139**): ν_{\max} (cm⁻¹) 2957, 2871, 2835, 1513, 1248, 1055; δ_{H} (500 MHz): 7.38-7.29 (7 H, m, aromatics); 6.90 (2 H, d, J = 9 Hz, aromatics); 4.93 (1 H, d, J = 5.9 Hz, C²H); 4.44 (1 H, d, J = 7.25 Hz, C⁶H); 4.13 (1 H, d, J = 9.5 Hz, C⁴H_{endo}); 3.88-3.80 (2 H, m, C⁸H_{exo}, C⁴H_{exo}); 3.81 (3 H, s, OCH₃ Ar); 3.42-3.38 (1 H, m, C¹H); 3.26 (1 H, d, J = 9 Hz, C⁸H_{endo}); 2.95-2.90 (1 H, m, C⁵H); δ_{C} (125 MHz): 158.3, 138.4, 133.1, 128.6, 127.5, 127.1, 125.6, 113.9 (aromatics); 87.5 (C⁶); 82.2 (C²); 70.9 (C⁴); 69.7 (C⁸); 55.3 (OCH₃); 54.5 (C⁵); 50.1 (C¹); *m/z* (ES⁺): 319.1 (MNa⁺); 731 (2MNa⁺); HRMS (ES) found (MNa⁺) 319.1296 (calc. 319.1310)

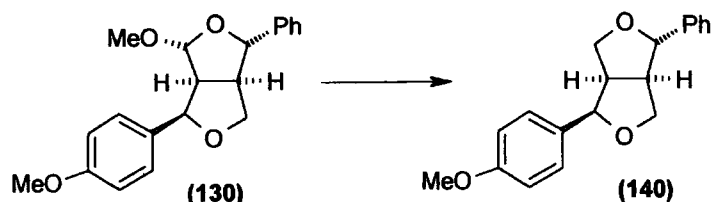
2-exo-phenyl-6-endo-p-methoxyphenyl-3,7-dioxabicyclo[3.3.0]octane (140)

Following method G, from *exo-endo* acetal (**130**) (6 mg, 0.02 mmol), Et₃SiH (15 μ L, 0.18 mmol) and BF₃•OEt₂ (5 μ L, 0.03 mmol), was obtained a mixture of starting material and *exo-endo* furofuran (**140**) (conversion 86%)

Following method H, from *exo-endo* acetal (**130**) (25 mg, 0.08 mmol), Et₃SiH (65 μ L, 0.77 mmol) and BF₃•OEt₂ (15 μ L, 0.08 mmol), was obtained a mixture of *exo-endo*:*exo-exo* furofurans (**140**:**141**) (1:2.8).

(140): ν_{\max} (cm^{-1}) 2961, 2928, 2872, 1455, 1190; δ_{H} (500 MHz $\text{CDCl}_3 + \text{C}_6\text{D}_6$): 7.32-7.19 (7 H, m, aromatics); 6.83 (2 H, d, $J = 8.7$ Hz, aromatics); 4.67 (1 H, d, $J = 5.9$ Hz, C^6H); 4.44 (1 H, d, $J = 6.8$ Hz, C^2H); 4.03 (1 H, d, $J = 9.4$ Hz, $\text{C}^8\text{H}_{\text{endo}}$); 3.78 (1 H, t, $J = 8.8$ Hz, $\text{C}^4\text{H}_{\text{exo}}$); 3.64 (1 H, dd, $J = 6.2, 9.4$ Hz, $\text{C}^8\text{H}_{\text{exo}}$); 3.57 (3 H, s, OCH_3 Ar); 3.38-3.30 (1 H, m, $\text{C}^4\text{H}_{\text{endo}}$); 3.10-3.03 (2 H, m, C^5H); 2.73-2.68 (1 H, m, C^1H); δ_{C} (125 MHz): 158.6, 141.3, 130.4, 128.6, 127.8, 126.7, 126.0, 113.7 (aromatics); 87.7 (C^6); 82.0 (C^2); 71.1, 69.8 (C^4, C^8); 55.2 (OCH_3); 54.7 (C^1); 50.2 (C^5); m/z (ES^+): 319.1 (MNa^+); 731 (2MNa^+); HRMS (ES) found (MNa^+) 319.1322 (calc. 319.1310)

2-*exo*-phenyl-6-*exo*-*p*-methoxyphenyl-3,7-dioxo-bicyclo[3.3.0]octane (141)

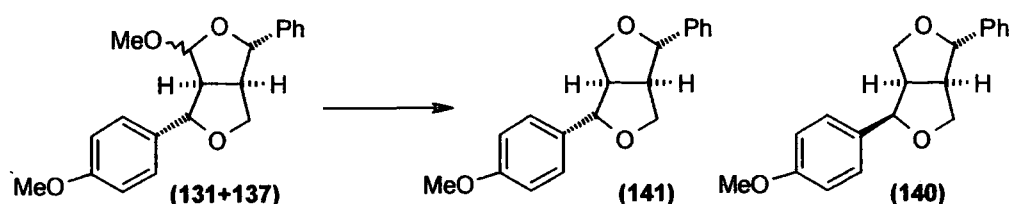

Following method G, from *exo-exo* acetal (131+137) (3 mg, 0.01 mmol), Et_3SiH (10 μL , 0.11 mmol) and $\text{BF}_3 \cdot \text{OEt}_2$ (5 μL , 0.03 mmol), was obtained a mixture of *exo-endo*:*exo-exo* furofurans (140:141) (18:82). (conversion 100%)

Following method H, from *exo-exo* acetal (131+137) (76 mg, 0.23 mmol), Et_3SiH (200 μL , 2.37 mmol) and $\text{BF}_3 \cdot \text{OEt}_2$ (75 μL , 0.41 mmol), was obtained a mixture of *exo-endo*:*exo-exo* furofurans (140:141) (1:2.8).

(141): ν_{\max} (cm^{-1}) 2957, 2929, 2855, 1512, 1247, 1033; δ_{H} (500 MHz): 7.37-7.27 (7 H, m, aromatics); 6.89 (2 H, d, 8.8 Hz, aromatics); 4.83 (1 H, d, $J = 4.9$ Hz, C^2H); 4.77 (1 H, d, $J = 4.9$ Hz, C^6H); 3.80 (3 H, s, OCH_3 Ar); 4.29-4.24 (2 H, m, $\text{C}^4\text{H}_{\text{endo}}, \text{C}^8\text{H}_{\text{endo}}$); 3.93-3.89 (2 H, m, $\text{C}^4\text{H}_{\text{exo}}, \text{C}^8\text{H}_{\text{exo}}$); 3.16-3.07 (2 H, m, $\text{C}^1\text{H}, \text{C}^5\text{H}$); δ_{C} (125 MHz): 159.2, 141.2, 133.0, 128.6, 127.6, 127.4, 125.9, 113.9 (aromatics); 85.9 (C^2); 85.6 (C^6); 71.85, 71.80 (C^4, C^8); 55.3 (OCH_3); 54.4, 54.2 (C^5, C^1); m/z (ES^+): 319.1 (MNa^+); 731 (2MNa^+); HRMS (ES) found (MNa^+) 319.1306 (calc. 319.1310)

CHAPTER SEVEN

Appendix

Appendix 1

Crystalline structure of the Epiasarinin (1)

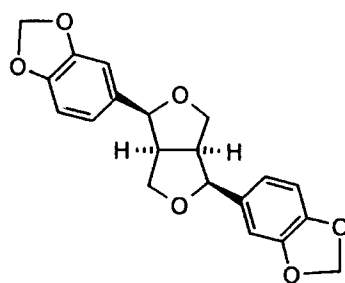
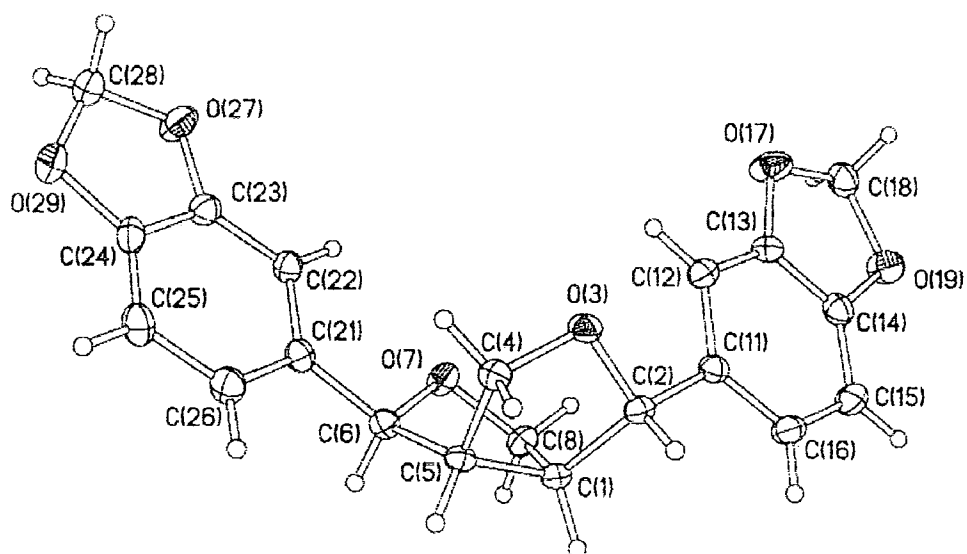

Epiasarinin (1)

Table 1. Crystal data and structure refinement for Epiasarinin (1).

| | | |
|---------------------------------------|--|----------------------------|
| Identification code | 02srv003 | |
| Empirical formula | $C_{20}H_{18}O_6$ | |
| Formula weight | 354.34 | |
| Temperature | 120(2) K | |
| Wavelength | 0.71073 Å | |
| Crystal system | Monoclinic | |
| Space group | P2(1)/n | |
| Unit cell dimensions | $a = 8.214(3)$ Å | $\alpha = 90^\circ$. |
| | $b = 7.461(2)$ Å | $\beta = 97.00(1)^\circ$. |
| | $c = 26.311(6)$ Å | $\gamma = 90^\circ$. |
| Volume | $1600.4(8)$ Å ³ | |
| Z | 4 | |
| Density (calculated) | 1.471 mg/m ³ | |
| Absorption coefficient | 0.109 mm ⁻¹ | |
| F(000) | 744 | |
| Crystal size | $0.14 \times 0.28 \times 0.38$ mm ³ | |
| Theta range for data collection | 1.56 to 28.99° . | |
| Index ranges | $-10 \leq h \leq 11$, $-10 \leq k \leq 10$, $-35 \leq l \leq 35$ | |
| Reflections collected | 18666 | |
| Independent reflections | 4228 [R(int) = 0.0341] | |
| Completeness to theta = 28.99° | 99.6 % | |
| Absorption correction | None | |
| Refinement method | Full-matrix least-squares on F ² | |
| Data / restraints / parameters | 4228 / 0 / 307 | |
| Goodness-of-fit on F ² | 1.097 | |
| Final R indices [I > 2sigma(I)] | R1 = 0.0448, wR2 = 0.1129 | |
| R indices (all data) | R1 = 0.0540, wR2 = 0.1196 | |
| Largest diff. peak and hole | 0.399 and -0.259 e.Å ⁻³ | |

Table 2. Atomic coordinates ($\times 10^4$) and equivalent isotropic displacement parameters ($\text{\AA}^2 \times 10^3$) for Epiasarinin (1). $U(\text{eq})$ is defined as one third of the trace of the orthogonalized U^{ij} tensor.

| | x | y | z | U(eq) |
|-------|---------|---------|---------|-------|
| C(1) | 4605(1) | 9749(2) | 2737(1) | 16(1) |
| C(2) | 5879(1) | 8989(2) | 3168(1) | 16(1) |
| O(3) | 6905(1) | 7828(1) | 2914(1) | 19(1) |
| C(4) | 7167(2) | 8744(2) | 2451(1) | 18(1) |
| C(5) | 5537(1) | 9672(2) | 2254(1) | 16(1) |
| C(6) | 4351(1) | 8579(2) | 1869(1) | 17(1) |
| O(7) | 3492(1) | 7430(1) | 2179(1) | 20(1) |
| C(8) | 3089(2) | 8564(2) | 2585(1) | 18(1) |
| C(11) | 5175(1) | 7992(2) | 3590(1) | 17(1) |
| C(12) | 5111(2) | 6104(2) | 3591(1) | 20(1) |
| C(13) | 4382(2) | 5313(2) | 3980(1) | 20(1) |
| C(14) | 3722(2) | 6294(2) | 4352(1) | 21(1) |
| C(15) | 3771(2) | 8139(2) | 4360(1) | 24(1) |
| C(16) | 4525(2) | 8971(2) | 3971(1) | 22(1) |
| O(17) | 4170(1) | 3508(1) | 4062(1) | 32(1) |
| C(18) | 3301(2) | 3381(2) | 4501(1) | 25(1) |
| O(19) | 3072(1) | 5159(1) | 4691(1) | 31(1) |
| C(21) | 5088(2) | 7497(2) | 1468(1) | 18(1) |
| C(22) | 4776(2) | 5648(2) | 1414(1) | 19(1) |
| C(23) | 5418(2) | 4783(2) | 1019(1) | 20(1) |
| C(24) | 6326(2) | 5672(2) | 685(1) | 21(1) |
| C(25) | 6672(2) | 7469(2) | 735(1) | 25(1) |
| C(26) | 6027(2) | 8374(2) | 1135(1) | 23(1) |
| O(27) | 5268(1) | 3001(1) | 887(1) | 30(1) |
| C(28) | 6236(2) | 2762(2) | 473(1) | 27(1) |
| O(29) | 6764(1) | 4492(1) | 319(1) | 27(1) |

Table 3. Bond lengths [Å] and angles [°] for Epiasarinin (1).

| | | | |
|--------------|------------|------------------|------------|
| C(1)-C(8) | 1.5395(17) | C(21)-C(26) | 1.3993(17) |
| C(1)-C(2) | 1.5543(16) | C(21)-C(22) | 1.4075(18) |
| C(1)-C(5) | 1.5622(17) | C(22)-C(23) | 1.3802(17) |
| C(1)-H(1) | 1.007(15) | C(22)-H(22) | 0.949(18) |
| C(2)-O(3) | 1.4302(14) | C(23)-O(27) | 1.3760(16) |
| C(2)-C(11) | 1.5094(16) | C(23)-C(24) | 1.3885(18) |
| C(2)-H(2) | 0.964(16) | C(24)-C(25) | 1.374(2) |
| O(3)-C(4) | 1.4359(15) | C(24)-O(29) | 1.3838(15) |
| C(4)-C(5) | 1.5402(17) | C(25)-C(26) | 1.4074(19) |
| C(4)-H(41) | 0.978(17) | C(25)-H(25) | 0.957(17) |
| C(4)-H(42) | 0.967(17) | C(26)-H(26) | 0.92(2) |
| C(5)-C(6) | 1.5488(16) | O(27)-C(28) | 1.4349(17) |
| C(5)-H(5) | 0.995(17) | C(28)-O(29) | 1.4357(18) |
| C(6)-O(7) | 1.4273(14) | C(28)-H(281) | 0.990(18) |
| C(6)-C(21) | 1.5118(17) | C(28)-H(282) | 0.970(18) |
| C(6)-H(6) | 0.982(16) | C(8)-C(1)-C(2) | 115.53(10) |
| O(7)-C(8) | 1.4334(14) | C(8)-C(1)-C(5) | 103.26(9) |
| C(8)-H(81) | 0.974(16) | C(2)-C(1)-C(5) | 103.16(9) |
| C(8)-H(82) | 0.991(17) | C(8)-C(1)-H(1) | 110.5(8) |
| C(11)-C(16) | 1.3967(17) | C(2)-C(1)-H(1) | 111.2(8) |
| C(11)-C(12) | 1.4100(17) | C(5)-C(1)-H(1) | 112.8(8) |
| C(12)-C(13) | 1.3796(17) | O(3)-C(2)-C(11) | 110.23(10) |
| C(12)-H(12) | 0.969(17) | O(3)-C(2)-C(1) | 105.18(9) |
| C(13)-O(17) | 1.3781(16) | C(11)-C(2)-C(1) | 115.67(10) |
| C(13)-C(14) | 1.3846(18) | O(3)-C(2)-H(2) | 107.8(9) |
| C(14)-C(15) | 1.3770(19) | C(11)-C(2)-H(2) | 109.7(9) |
| C(14)-O(19) | 1.3830(16) | C(1)-C(2)-H(2) | 107.9(9) |
| C(15)-C(16) | 1.4053(18) | C(2)-O(3)-C(4) | 105.43(9) |
| C(15)-H(15) | 0.935(17) | O(3)-C(4)-C(5) | 106.61(9) |
| C(16)-H(16) | 0.926(17) | O(3)-C(4)-H(41) | 110.6(10) |
| O(17)-C(18) | 1.4333(17) | C(5)-C(4)-H(41) | 109.6(10) |
| C(18)-O(19) | 1.4384(18) | O(3)-C(4)-H(42) | 106.8(10) |
| C(18)-H(181) | 1.000(19) | C(5)-C(4)-H(42) | 114.5(10) |
| C(18)-H(182) | 0.937(18) | H(41)-C(4)-H(42) | 108.6(13) |

| | | | |
|-------------------|------------|---------------------|------------|
| C(4)-C(5)-C(6) | 115.78(10) | | |
| C(4)-C(5)-C(1) | 103.56(9) | C(15)-C(16)-H(16) | 119.9(10) |
| C(6)-C(5)-C(1) | 102.67(9) | C(13)-O(17)-C(18) | 106.00(10) |
| C(4)-C(5)-H(5) | 110.6(9) | O(17)-C(18)-O(19) | 108.54(11) |
| C(6)-C(5)-H(5) | 110.8(9) | O(17)-C(18)-H(181) | 107.9(10) |
| C(1)-C(5)-H(5) | 113.0(9) | O(19)-C(18)-H(181) | 109.7(10) |
| O(7)-C(6)-C(21) | 110.20(10) | O(17)-C(18)-H(182) | 110.1(11) |
| O(7)-C(6)-C(5) | 104.98(9) | O(19)-C(18)-H(182) | 108.7(11) |
| C(21)-C(6)-C(5) | 117.64(10) | H(181)-C(18)-H(182) | 111.8(15) |
| O(7)-C(6)-H(6) | 108.4(9) | C(14)-O(19)-C(18) | 105.29(10) |
| C(21)-C(6)-H(6) | 107.6(9) | C(26)-C(21)-C(22) | 120.11(12) |
| C(5)-C(6)-H(6) | 107.7(9) | C(26)-C(21)-C(6) | 119.07(11) |
| C(6)-O(7)-C(8) | 104.27(9) | C(22)-C(21)-C(6) | 120.75(11) |
| O(7)-C(8)-C(1) | 106.21(9) | C(23)-C(22)-C(21) | 116.97(11) |
| O(7)-C(8)-H(81) | 109.7(9) | C(23)-C(22)-H(22) | 121.6(11) |
| C(1)-C(8)-H(81) | 110.6(9) | C(21)-C(22)-H(22) | 121.5(11) |
| O(7)-C(8)-H(82) | 107.4(10) | O(27)-C(23)-C(22) | 127.66(12) |
| C(1)-C(8)-H(82) | 114.5(10) | O(27)-C(23)-C(24) | 109.87(11) |
| H(81)-C(8)-H(82) | 108.3(13) | C(22)-C(23)-C(24) | 122.46(12) |
| C(16)-C(11)-C(12) | 120.30(11) | C(25)-C(24)-O(29) | 128.21(12) |
| C(16)-C(11)-C(2) | 118.93(11) | C(25)-C(24)-C(23) | 121.80(12) |
| C(12)-C(11)-C(2) | 120.72(11) | O(29)-C(24)-C(23) | 109.99(12) |
| C(13)-C(12)-C(11) | 116.57(11) | C(24)-C(25)-C(26) | 116.53(12) |
| C(13)-C(12)-H(12) | 121.3(10) | C(24)-C(25)-H(25) | 122.0(11) |
| C(11)-C(12)-H(12) | 122.2(10) | C(26)-C(25)-H(25) | 121.5(11) |
| O(17)-C(13)-C(12) | 127.44(11) | C(21)-C(26)-C(25) | 122.10(13) |
| O(17)-C(13)-C(14) | 109.77(11) | C(21)-C(26)-H(26) | 119.0(11) |
| C(12)-C(13)-C(14) | 122.79(12) | C(25)-C(26)-H(26) | 118.9(11) |
| C(15)-C(14)-O(19) | 127.92(12) | C(23)-O(27)-C(28) | 105.71(10) |
| C(15)-C(14)-C(13) | 121.76(12) | O(27)-C(28)-O(29) | 108.48(11) |
| O(19)-C(14)-C(13) | 110.32(12) | O(27)-C(28)-H(281) | 106.8(10) |
| C(14)-C(15)-C(16) | 116.40(12) | O(29)-C(28)-H(281) | 110.1(10) |
| C(14)-C(15)-H(15) | 122.2(11) | O(27)-C(28)-H(282) | 108.5(11) |
| C(16)-C(15)-H(15) | 121.4(11) | O(29)-C(28)-H(282) | 110.9(11) |
| C(11)-C(16)-C(15) | 122.17(12) | H(281)-C(28)-H(282) | 112.0(15) |
| C(11)-C(16)-H(16) | 117.9(10) | C(24)-O(29)-C(28) | 105.20(10) |

Table 4. Anisotropic displacement parameters ($\text{\AA}^2 \times 10^3$) for Epiasarinin (**1**). The anisotropic displacement factor exponent takes the form: $-2p^2[h^2 a^{*2} U^{11} + \dots + 2hka^* b^* U^{12}]$

| | U^{11} | U^{22} | U^{33} | U^{23} | U^{13} | U^{12} |
|-------|----------|----------|----------|----------|----------|----------|
| C(1) | 15(1) | 13(1) | 19(1) | -1(1) | 2(1) | 1(1) |
| C(2) | 16(1) | 14(1) | 18(1) | -1(1) | 2(1) | 2(1) |
| O(3) | 20(1) | 19(1) | 20(1) | 3(1) | 6(1) | 7(1) |
| C(4) | 17(1) | 18(1) | 19(1) | 2(1) | 3(1) | 1(1) |
| C(5) | 16(1) | 12(1) | 19(1) | 1(1) | 1(1) | -1(1) |
| C(6) | 17(1) | 16(1) | 18(1) | 1(1) | 2(1) | -3(1) |
| O(7) | 21(1) | 19(1) | 22(1) | -4(1) | 8(1) | -7(1) |
| C(8) | 16(1) | 19(1) | 20(1) | -3(1) | 3(1) | -1(1) |
| C(11) | 17(1) | 17(1) | 18(1) | 1(1) | 2(1) | 2(1) |
| C(12) | 22(1) | 18(1) | 20(1) | -1(1) | 4(1) | 2(1) |
| C(13) | 22(1) | 15(1) | 22(1) | 1(1) | 2(1) | 1(1) |
| C(14) | 22(1) | 24(1) | 19(1) | 3(1) | 4(1) | 2(1) |
| C(15) | 30(1) | 23(1) | 21(1) | -3(1) | 9(1) | 4(1) |
| C(16) | 26(1) | 16(1) | 23(1) | -1(1) | 6(1) | 2(1) |
| O(17) | 47(1) | 16(1) | 38(1) | 3(1) | 21(1) | 0(1) |
| C(18) | 31(1) | 24(1) | 21(1) | 4(1) | 3(1) | -3(1) |
| O(19) | 43(1) | 25(1) | 29(1) | 5(1) | 19(1) | 2(1) |
| C(21) | 17(1) | 20(1) | 17(1) | 1(1) | 0(1) | -2(1) |
| C(22) | 19(1) | 19(1) | 18(1) | 1(1) | 4(1) | -2(1) |
| C(23) | 21(1) | 19(1) | 20(1) | -2(1) | 1(1) | 1(1) |
| C(24) | 20(1) | 28(1) | 14(1) | 0(1) | 2(1) | 3(1) |
| C(25) | 27(1) | 29(1) | 21(1) | 3(1) | 7(1) | -4(1) |
| C(26) | 27(1) | 21(1) | 22(1) | 1(1) | 5(1) | -5(1) |
| O(27) | 39(1) | 21(1) | 33(1) | -6(1) | 15(1) | -1(1) |
| C(28) | 33(1) | 28(1) | 20(1) | -4(1) | 4(1) | 5(1) |
| O(29) | 32(1) | 31(1) | 21(1) | -3(1) | 8(1) | 3(1) |

Table 5. Hydrogen coordinates ($\times 10^4$) and isotropic displacement parameters ($\text{\AA}^2 \times 10^3$) for Epiasarinin (1).

| | x | y | z | U(eq) |
|--------|----------|-----------|---------|-------|
| H(1) | 4261(17) | 11000(20) | 2819(5) | 14(3) |
| H(2) | 6544(18) | 9970(20) | 3311(6) | 15(3) |
| H(41) | 8030(20) | 9640(20) | 2519(6) | 23(4) |
| H(42) | 7520(20) | 7850(20) | 2221(6) | 24(4) |
| H(5) | 5743(19) | 10880(20) | 2113(6) | 22(4) |
| H(6) | 3560(18) | 9420(20) | 1689(6) | 16(4) |
| H(81) | 2140(19) | 9300(20) | 2464(6) | 18(4) |
| H(82) | 2790(20) | 7780(20) | 2863(6) | 26(4) |
| H(12) | 5580(20) | 5390(20) | 3338(6) | 24(4) |
| H(15) | 3350(20) | 8810(20) | 4614(7) | 29(4) |
| H(16) | 4600(20) | 10210(20) | 3960(6) | 22(4) |
| H(181) | 2210(20) | 2820(20) | 4389(7) | 31(4) |
| H(182) | 3910(20) | 2710(20) | 4758(7) | 30(4) |
| H(22) | 4150(20) | 5030(20) | 1636(7) | 30(4) |
| H(25) | 7300(20) | 8080(20) | 506(7) | 29(4) |
| H(26) | 6220(20) | 9590(30) | 1175(7) | 36(5) |
| H(281) | 7200(20) | 2030(20) | 608(7) | 32(5) |
| H(282) | 5570(20) | 2170(20) | 193(7) | 33(5) |

Appendix 2

Crystalline structure of the pyrrolidine (197)

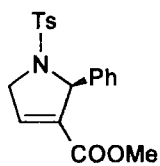
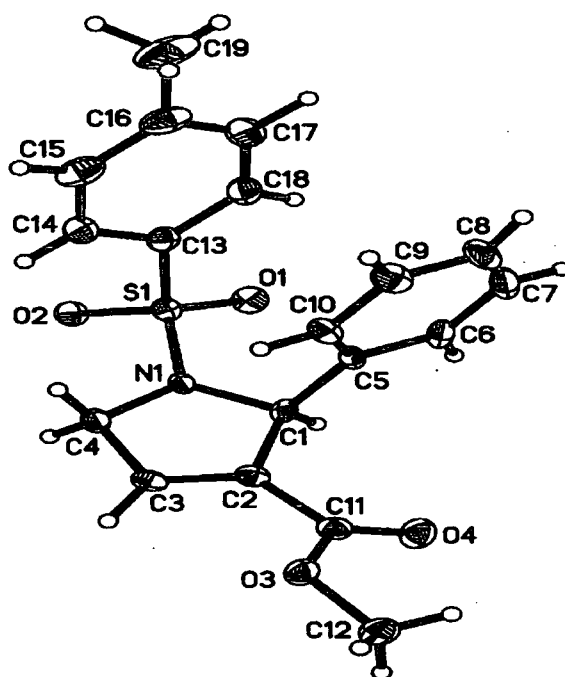

Pyrrolidine (197)

Table 1. Crystal data and structure refinement for Pyrrolidine (197).

| | | |
|-----------------------------------|---|-----------------|
| Identification code | 00srv344 | |
| Empirical formula | C ₁₉ H ₁₉ NO ₄ S | |
| Formula weight | 357.41 | |
| Temperature | 110.0(2) K | |
| Wavelength | 0.71073 Å | |
| Crystal system | Triclinic | |
| Space group | P-1 | |
| Unit cell dimensions | a = 5.8932(4) Å | α = 87.502(3)°. |
| | b = 9.2189(7) Å | β = 89.201(3)°. |
| | c = 16.199(1) Å | γ = 77.553(3)°. |
| Volume | 858.57(11) Å ³ | |
| Z | 2 | |
| Density (calculated) | 1.383 mg/m ³ | |
| Absorption coefficient | 0.212 mm ⁻¹ | |
| F(000) | 376 | |
| Crystal size | 0.38 x 0.16 x 0.08 mm ³ | |
| Theta range for data collection | 2.26 to 26.00°. | |
| Index ranges | -6 ≤ h ≤ 7, -11 ≤ k ≤ 11, -19 ≤ l ≤ 19 | |
| Reflections collected | 8583 | |
| Independent reflections | 3371 [R(int) = 0.0839] | |
| Completeness to theta = 26.00° | 99.9 % | |
| Absorption correction | None | |
| Max. and min. transmission | 0.9832 and 0.9236 | |
| Refinement method | Full-matrix least-squares on F ² | |
| Data / restraints / parameters | 3371 / 0 / 302 | |
| Goodness-of-fit on F ² | 1.005 | |
| Final R indices [I > 2σ(I)] | R1 = 0.0563, wR2 = 0.1170 | |
| R indices (all data) | R1 = 0.1054, wR2 = 0.1323 | |
| Largest diff. peak and hole | 0.297 and -0.374 e.Å ⁻³ | |

Table 2. Atomic coordinates ($\times 10^4$) and equivalent isotropic displacement parameters ($\text{\AA}^2 \times 10^3$) for pyrrolidine (197). $U(\text{eq})$ is defined as one third of the trace of the orthogonalized U^{ij} tensor.

| Atom | x | y | z | $U(\text{eq})$ |
|-------|----------|----------|---------|----------------|
| S(1) | 12439(1) | 5079(1) | 2436(1) | 17(1) |
| O(1) | 14254(4) | 5859(2) | 2558(1) | 24(1) |
| O(2) | 12985(4) | 3504(2) | 2322(1) | 23(1) |
| O(3) | 5262(4) | 7404(2) | 5145(1) | 22(1) |
| O(4) | 8511(4) | 8320(2) | 5194(1) | 28(1) |
| N(1) | 10770(4) | 5321(3) | 3240(2) | 15(1) |
| C(1) | 10303(5) | 6720(3) | 3710(2) | 16(1) |
| C(2) | 8336(5) | 6435(3) | 4263(2) | 17(1) |
| C(3) | 7633(6) | 5210(3) | 4090(2) | 18(1) |
| C(4) | 9041(6) | 4394(4) | 3411(2) | 19(1) |
| C(5) | 9637(5) | 8145(3) | 3181(2) | 16(1) |
| C(6) | 11040(6) | 9175(3) | 3145(2) | 22(1) |
| C(7) | 10422(7) | 10477(4) | 2653(2) | 28(1) |
| C(8) | 8387(6) | 10765(4) | 2210(2) | 29(1) |
| C(9) | 6954(6) | 9760(4) | 2249(2) | 26(1) |
| C(10) | 7559(6) | 8448(4) | 2734(2) | 20(1) |
| C(11) | 7424(5) | 7496(3) | 4909(2) | 19(1) |
| C(12) | 4264(7) | 8353(4) | 5804(2) | 27(1) |
| C(13) | 10839(6) | 5914(3) | 1562(2) | 20(1) |
| C(14) | 9063(6) | 5329(4) | 1257(2) | 25(1) |
| C(15) | 7733(7) | 6050(5) | 603(2) | 32(1) |
| C(16) | 8195(7) | 7344(4) | 232(2) | 34(1) |
| C(17) | 10025(7) | 7877(4) | 525(2) | 34(1) |
| C(18) | 11339(7) | 7200(4) | 1190(2) | 27(1) |
| C(19) | 6717(10) | 8128(6) | -478(3) | 51(1) |

Table 3. Bond lengths [Å] and angles [°] for pyrrolidine (197).

| | | | | | |
|------------|----------|------------|----------|-------------|----------|
| S(1)-O(1) | 1.432(2) | C(1)-C(2) | 1.515(4) | C(8)-C(9) | 1.381(5) |
| S(1)-O(2) | 1.437(2) | C(1)-C(5) | 1.517(4) | C(9)-C(10) | 1.394(4) |
| S(1)-N(1) | 1.615(2) | C(2)-C(3) | 1.326(4) | C(13)-C(14) | 1.383(5) |
| S(1)-C(13) | 1.766(3) | C(2)-C(11) | 1.479(4) | C(13)-C(18) | 1.392(5) |
| O(3)-C(11) | 1.344(4) | C(3)-C(4) | 1.497(4) | C(14)-C(15) | 1.383(5) |
| O(3)-C(12) | 1.447(4) | C(5)-C(6) | 1.386(4) | C(15)-C(16) | 1.390(6) |
| O(4)-C(11) | 1.204(4) | C(5)-C(10) | 1.401(4) | C(16)-C(17) | 1.376(5) |
| N(1)-C(4) | 1.480(4) | C(6)-C(7) | 1.394(5) | C(16)-C(19) | 1.513(5) |
| N(1)-C(1) | 1.498(4) | C(7)-C(8) | 1.377(5) | C(17)-C(18) | 1.382(5) |

| | | | |
|------------------|------------|-------------------|----------|
| O(1)-S(1)-O(2) | 120.39(13) | C(10)-C(5)-C(1) | 120.1(3) |
| O(1)-S(1)-N(1) | 107.00(13) | C(5)-C(6)-C(7) | 120.5(3) |
| O(2)-S(1)-N(1) | 105.84(13) | C(8)-C(7)-C(6) | 120.2(3) |
| O(1)-S(1)-C(13) | 107.57(15) | C(7)-C(8)-C(9) | 120.0(3) |
| O(2)-S(1)-C(13) | 106.80(14) | C(8)-C(9)-C(10) | 120.4(3) |
| N(1)-S(1)-C(13) | 108.86(14) | C(9)-C(10)-C(5) | 119.8(3) |
| C(11)-O(3)-C(12) | 115.7(3) | O(4)-C(11)-O(3) | 124.6(3) |
| C(4)-N(1)-C(1) | 113.0(2) | O(4)-C(11)-C(2) | 123.8(3) |
| C(4)-N(1)-S(1) | 121.1(2) | O(3)-C(11)-C(2) | 111.7(3) |
| C(1)-N(1)-S(1) | 123.28(19) | C(14)-C(13)-C(18) | 119.8(3) |
| N(1)-C(1)-C(2) | 99.6(2) | C(14)-C(13)-S(1) | 120.8(3) |
| N(1)-C(1)-C(5) | 115.0(2) | C(18)-C(13)-S(1) | 119.3(3) |
| C(2)-C(1)-C(5) | 112.9(2) | C(13)-C(14)-C(15) | 120.0(4) |
| C(3)-C(2)-C(11) | 127.7(3) | C(14)-C(15)-C(16) | 120.8(4) |
| C(3)-C(2)-C(1) | 113.2(3) | C(17)-C(16)-C(15) | 118.2(3) |
| C(11)-C(2)-C(1) | 119.1(3) | C(17)-C(16)-C(19) | 121.5(4) |
| C(2)-C(3)-C(4) | 112.0(3) | C(15)-C(16)-C(19) | 120.3(4) |
| N(1)-C(4)-C(3) | 101.6(2) | C(16)-C(17)-C(18) | 122.0(4) |
| C(6)-C(5)-C(10) | 119.1(3) | C(17)-C(18)-C(13) | 119.0(4) |
| C(6)-C(5)-C(1) | 120.9(3) | | |

Table 4. Anisotropic displacement parameters ($\text{\AA}^2 \times 10^3$) for pyrrolidine (197). The anisotropic displacement factor exponent takes the form: $-2\pi^2 [h^2 a^{*2} U^{11} + \dots + 2hka^*b^*U^{12}]$

| Atom | U^{11} | U^{22} | U^{33} | U^{23} | U^{13} | U^{12} |
|-------|----------|----------|----------|----------|----------|----------|
| S(1) | 15(1) | 15(1) | 21(1) | 0(1) | 0(1) | -2(1) |
| O(1) | 15(1) | 30(1) | 27(1) | -3(1) | 1(1) | -6(1) |
| O(2) | 28(1) | 14(1) | 24(1) | 1(1) | 2(1) | 3(1) |
| O(3) | 23(1) | 22(1) | 23(1) | -7(1) | 7(1) | -6(1) |
| O(4) | 26(1) | 30(1) | 29(1) | -8(1) | 0(1) | -11(1) |
| N(1) | 16(1) | 13(1) | 17(1) | 0(1) | 1(1) | -5(1) |
| C(1) | 15(2) | 17(2) | 17(2) | -2(1) | -7(1) | -5(1) |
| C(2) | 15(2) | 16(2) | 17(2) | 3(1) | 1(1) | 1(1) |
| C(3) | 19(2) | 18(2) | 16(2) | 5(1) | -1(1) | -3(1) |
| C(4) | 21(2) | 17(2) | 20(2) | 0(1) | -2(1) | -6(1) |
| C(5) | 17(2) | 13(2) | 19(2) | -2(1) | 3(1) | -4(1) |
| C(6) | 21(2) | 19(2) | 27(2) | -8(1) | 3(2) | -7(1) |
| C(7) | 32(2) | 18(2) | 38(2) | -7(2) | 13(2) | -11(2) |
| C(8) | 35(2) | 14(2) | 33(2) | 4(2) | 10(2) | 2(2) |
| C(9) | 25(2) | 22(2) | 30(2) | 2(2) | 2(2) | 0(2) |
| C(10) | 19(2) | 17(2) | 23(2) | 3(1) | 2(1) | -5(1) |
| C(11) | 20(2) | 21(2) | 15(2) | 2(1) | -3(1) | -5(1) |
| C(12) | 32(2) | 22(2) | 25(2) | -4(2) | 8(2) | 0(2) |
| C(13) | 23(2) | 15(2) | 20(2) | -4(1) | 2(1) | 2(1) |
| C(14) | 26(2) | 26(2) | 25(2) | -3(2) | 3(2) | -11(2) |
| C(15) | 26(2) | 46(2) | 23(2) | -7(2) | -5(2) | -5(2) |
| C(16) | 43(2) | 29(2) | 19(2) | -4(2) | -2(2) | 14(2) |
| C(17) | 52(3) | 17(2) | 28(2) | 3(2) | -5(2) | 1(2) |
| C(18) | 34(2) | 22(2) | 25(2) | 0(2) | -6(2) | -7(2) |
| C(19) | 67(4) | 47(3) | 24(2) | -5(2) | -21(2) | 20(3) |

Table 5. Hydrogen coordinates ($\times 10^4$) and isotropic displacement parameters ($\text{\AA}^2 \times 10^3$) for pyrrolidine (**197**).

| Atom | x | y | z | U(eq) |
|--------|-----------|-----------|----------|---------|
| H(1) | 11610(50) | 6760(30) | 4000(19) | 17(8) |
| H(3) | 6310(60) | 4820(40) | 4370(20) | 39(10) |
| H(41) | 8090(60) | 4360(30) | 2950(20) | 24(9) |
| H(42) | 9850(50) | 3390(30) | 3557(18) | 15(8) |
| H(6) | 12520(50) | 8920(30) | 3491(18) | 12(7) |
| H(7) | 11410(50) | 11120(30) | 2630(18) | 12(8) |
| H(8) | 7990(60) | 11570(40) | 1860(20) | 35(10) |
| H(9) | 5520(50) | 9900(30) | 1943(18) | 10(8) |
| H(10) | 6570(50) | 7750(30) | 2772(17) | 9(7) |
| H(121) | 4650(60) | 9280(40) | 5760(20) | 34(10) |
| H(122) | 2590(70) | 8470(40) | 5780(20) | 40(11) |
| H(123) | 5010(70) | 7950(40) | 6340(20) | 49(12) |
| H(14) | 8710(60) | 4460(40) | 1490(20) | 33(10) |
| H(15) | 6700(60) | 5570(40) | 440(20) | 28(10) |
| H(17) | 10340(70) | 8850(50) | 280(30) | 69(14) |
| H(18) | 12450(60) | 7570(40) | 1410(20) | 34(11) |
| H(191) | 6540(80) | 7400(50) | -890(30) | 76(16) |
| H(192) | 4870(80) | 8530(50) | -290(30) | 70(14) |
| H(193) | 7070(120) | 8880(80) | -680(40) | 140(30) |

Table 6. Torsion angles [°] for pyrrolidine (197).

| | | | |
|----------------------|------------|-------------------------|-----------|
| O(1)-S(1)-N(1)-C(4) | -165.8(2) | C(7)-C(8)-C(9)-C(10) | -0.3(5) |
| O(2)-S(1)-N(1)-C(4) | -36.2(3) | C(8)-C(9)-C(10)-C(5) | -0.2(5) |
| C(13)-S(1)-N(1)-C(4) | 78.3(3) | C(6)-C(5)-C(10)-C(9) | 1.2(5) |
| O(1)-S(1)-N(1)-C(1) | 33.7(3) | C(1)-C(5)-C(10)-C(9) | 179.9(3) |
| O(2)-S(1)-N(1)-C(1) | 163.2(2) | C(12)-O(3)-C(11)-O(4) | -1.8(4) |
| C(13)-S(1)-N(1)-C(1) | -82.3(3) | C(12)-O(3)-C(11)-C(2) | 177.2(3) |
| C(4)-N(1)-C(1)-C(2) | 7.5(3) | C(3)-C(2)-C(11)-O(4) | 157.6(3) |
| S(1)-N(1)-C(1)-C(2) | 169.44(19) | C(1)-C(2)-C(11)-O(4) | -22.5(4) |
| C(4)-N(1)-C(1)-C(5) | -113.5(3) | C(3)-C(2)-C(11)-O(3) | -21.3(4) |
| S(1)-N(1)-C(1)-C(5) | 48.5(3) | C(1)-C(2)-C(11)-O(3) | 158.5(2) |
| N(1)-C(1)-C(2)-C(3) | -5.8(3) | O(1)-S(1)-C(13)-C(14) | 175.4(2) |
| C(5)-C(1)-C(2)-C(3) | 116.6(3) | O(2)-S(1)-C(13)-C(14) | 44.9(3) |
| N(1)-C(1)-C(2)-C(11) | 174.3(2) | N(1)-S(1)-C(13)-C(14) | -69.0(3) |
| C(5)-C(1)-C(2)-C(11) | -63.2(3) | O(1)-S(1)-C(13)-C(18) | -6.2(3) |
| C(11)-C(2)-C(3)-C(4) | -177.9(3) | O(2)-S(1)-C(13)-C(18) | -136.7(3) |
| C(1)-C(2)-C(3)-C(4) | 2.3(4) | N(1)-S(1)-C(13)-C(18) | 109.4(3) |
| C(1)-N(1)-C(4)-C(3) | -6.4(3) | C(18)-C(13)-C(14)-C(15) | -2.4(5) |
| S(1)-N(1)-C(4)-C(3) | -168.9(2) | S(1)-C(13)-C(14)-C(15) | 176.0(3) |
| C(2)-C(3)-C(4)-N(1) | 2.5(3) | C(13)-C(14)-C(15)-C(16) | 1.7(5) |
| N(1)-C(1)-C(5)-C(6) | -116.2(3) | C(14)-C(15)-C(16)-C(17) | 0.8(5) |
| C(2)-C(1)-C(5)-C(6) | 130.4(3) | C(14)-C(15)-C(16)-C(19) | -179.6(3) |
| N(1)-C(1)-C(5)-C(10) | 65.0(4) | C(15)-C(16)-C(17)-C(18) | -2.5(5) |
| C(2)-C(1)-C(5)-C(10) | -48.4(4) | C(19)-C(16)-C(17)-C(18) | 177.8(4) |
| C(10)-C(5)-C(6)-C(7) | -1.7(5) | C(16)-C(17)-C(18)-C(13) | 1.8(5) |
| C(1)-C(5)-C(6)-C(7) | 179.5(3) | C(14)-C(13)-C(18)-C(17) | 0.7(5) |
| C(5)-C(6)-C(7)-C(8) | 1.2(5) | S(1)-C(13)-C(18)-C(17) | -177.7(3) |
| C(6)-C(7)-C(8)-C(9) | -0.2(5) | | |

Appendix 3

Crystalline structure of the ethyl dihydrofuryl amide (208)

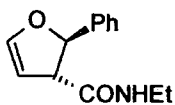
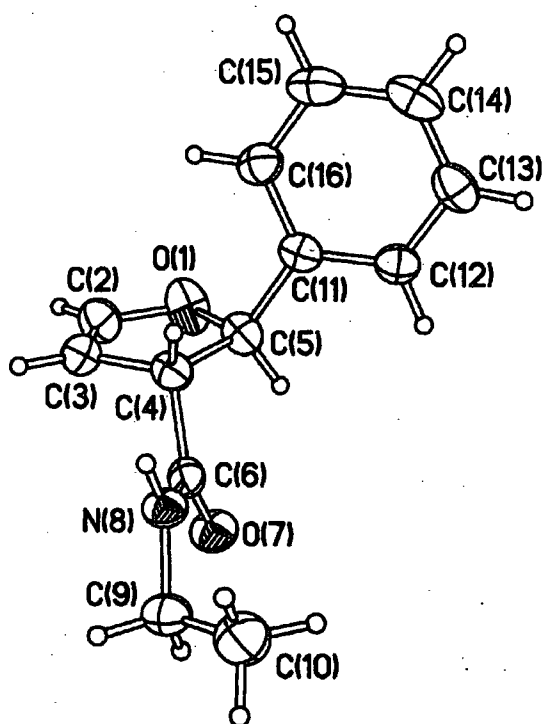

amide (208)

Table 1. Crystal data and structure refinement for ethyl amide (208).

| | | |
|-----------------------------------|---|----------|
| Identification code | 02srv004 | |
| Empirical formula | C ₁₃ H ₁₅ NO ₂ | |
| Formula weight | 217.26 | |
| Temperature | 120(2) K | |
| Wavelength | 0.71073 Å | |
| Crystal system | Orthorhombic | |
| Space group | P2(1)2(1)2(1) | |
| Unit cell dimensions | a = 4.9108(5) Å | α = 90°. |
| | b = 11.4042(13) Å | β = 90°. |
| | c = 20.862(3) Å | γ = 90°. |
| Volume | 1168.4(2) Å ³ | |
| Z | 4 | |
| Density (calculated) | 1.235 mg/m ³ | |
| Absorption coefficient | 0.083 mm ⁻¹ | |
| F(000) | 464 | |
| Crystal size | 0.53 x 0.12 x 0.11 mm ³ | |
| Theta range for data collection | 1.95 to 30.00°. | |
| Index ranges | -6 ≤ h ≤ 6, -16 ≤ k ≤ 16, -29 ≤ l ≤ 29 | |
| Reflections collected | 16386 | |
| Independent reflections | 1993 [R(int) = 0.0447] | |
| Completeness to theta = 30.00° | 100.0 % | |
| Absorption correction | None | |
| Refinement method | Full-matrix least-squares on F ² | |
| Data / restraints / parameters | 1993 / 0 / 205 | |
| Goodness-of-fit on F ² | 1.035 | |
| Final R indices [I > 2σ(I)] | R1 = 0.0344, wR2 = 0.0891 | |
| R indices (all data) | R1 = 0.0462, wR2 = 0.0945 | |
| Largest diff. peak and hole | 0.182 and -0.173 e.Å ⁻³ | |

Table 2. Atomic coordinates ($\times 10^4$) and equivalent isotropic displacement parameters ($\text{\AA}^2 \times 10^3$) for ethyl amide (208). $U(\text{eq})$ is defined as one third of the trace of the orthogonalized U^{ij} tensor.

| | x | y | z | $U(\text{eq})$ |
|-------|---------|---------|---------|----------------|
| O(1) | 447(3) | 3357(1) | 3372(1) | 49(1) |
| C(2) | 1638(4) | 2469(2) | 3029(1) | 45(1) |
| C(3) | 3126(4) | 2800(2) | 2539(1) | 41(1) |
| C(4) | 3064(3) | 4117(1) | 2486(1) | 32(1) |
| C(5) | 1259(3) | 4460(1) | 3069(1) | 34(1) |
| C(6) | 1851(3) | 4510(1) | 1849(1) | 31(1) |
| O(7) | -638(2) | 4535(1) | 1759(1) | 41(1) |
| N(8) | 3665(3) | 4800(1) | 1402(1) | 33(1) |
| C(9) | 2953(4) | 5110(2) | 743(1) | 40(1) |
| C(10) | 3840(6) | 6327(2) | 567(1) | 57(1) |
| C(11) | 2682(3) | 5218(1) | 3551(1) | 31(1) |
| C(12) | 1967(4) | 6390(1) | 3616(1) | 35(1) |
| C(13) | 3341(4) | 7107(2) | 4045(1) | 41(1) |
| C(14) | 5442(4) | 6663(2) | 4407(1) | 46(1) |
| C(15) | 6178(4) | 5500(2) | 4343(1) | 47(1) |
| C(16) | 4813(3) | 4774(2) | 3917(1) | 38(1) |

Table 3. Bond lengths [Å] and angles [°] for ethyl amide (208).

| | | | |
|----------------|------------|---------------------|------------|
| O(1)-C(2) | 1.371(2) | C(3)-C(2)-H(2) | 129.8(13) |
| O(1)-C(5) | 1.463(2) | O(1)-C(2)-H(2) | 114.7(13) |
| C(2)-C(3) | 1.311(3) | C(2)-C(3)-C(4) | 109.47(15) |
| C(2)-H(2) | 0.98(2) | C(2)-C(3)-H(3) | 126.1(12) |
| C(3)-C(4) | 1.507(2) | C(4)-C(3)-H(3) | 124.3(13) |
| C(3)-H(3) | 0.96(2) | C(3)-C(4)-C(6) | 111.46(13) |
| C(4)-C(6) | 1.523(2) | C(3)-C(4)-C(5) | 101.80(14) |
| C(4)-C(5) | 1.555(2) | C(6)-C(4)-C(5) | 112.68(13) |
| C(4)-H(4) | 1.00(2) | C(3)-C(4)-H(4) | 110.4(10) |
| C(5)-C(11) | 1.499(2) | C(6)-C(4)-H(4) | 108.3(11) |
| C(5)-H(5) | 1.00(2) | C(5)-C(4)-H(4) | 112.1(11) |
| C(6)-O(7) | 1.2372(18) | O(1)-C(5)-C(11) | 109.49(13) |
| C(6)-N(8) | 1.332(2) | O(1)-C(5)-C(4) | 106.07(13) |
| N(8)-C(9) | 1.461(2) | C(11)-C(5)-C(4) | 113.85(13) |
| N(8)-H(8) | 0.86(2) | O(1)-C(5)-H(5) | 105.3(11) |
| C(9)-C(10) | 1.500(3) | C(11)-C(5)-H(5) | 111.8(11) |
| C(9)-H(91) | 0.95(2) | C(4)-C(5)-H(5) | 109.8(11) |
| C(9)-H(92) | 0.976(19) | O(7)-C(6)-N(8) | 123.27(15) |
| C(10)-H(101) | 1.01(3) | O(7)-C(6)-C(4) | 121.73(15) |
| C(10)-H(102) | 0.99(2) | N(8)-C(6)-C(4) | 114.99(13) |
| C(10)-H(103) | 0.99(3) | C(6)-N(8)-C(9) | 123.98(13) |
| C(11)-C(12) | 1.388(2) | C(6)-N(8)-H(8) | 118.8(13) |
| C(11)-C(16) | 1.391(2) | C(9)-N(8)-H(8) | 117.2(13) |
| C(12)-C(13) | 1.388(2) | N(8)-C(9)-C(10) | 112.65(16) |
| C(12)-H(12) | 0.960(19) | N(8)-C(9)-H(91) | 107.2(13) |
| C(13)-C(14) | 1.375(3) | C(10)-C(9)-H(91) | 112.3(13) |
| C(13)-H(13) | 0.95(2) | N(8)-C(9)-H(92) | 108.1(11) |
| C(14)-C(15) | 1.381(3) | C(10)-C(9)-H(92) | 111.6(11) |
| C(14)-H(14) | 0.95(2) | H(91)-C(9)-H(92) | 104.5(18) |
| C(15)-C(16) | 1.387(3) | C(9)-C(10)-H(101) | 110.8(14) |
| C(15)-H(15) | 0.95(2) | C(9)-C(10)-H(102) | 110.4(13) |
| C(16)-H(16) | 0.98(2) | H(101)-C(10)-H(102) | 107.1(18) |
| C(2)-O(1)-C(5) | 107.09(13) | C(9)-C(10)-H(103) | 109.5(14) |
| C(3)-C(2)-O(1) | 115.55(16) | H(101)-C(10)-H(103) | 112(2) |

| | | | |
|---------------------|------------|-------------------|------------|
| H(102)-C(10)-H(103) | 107(2) | C(13)-C(14)-C(15) | 119.83(17) |
| C(12)-C(11)-C(16) | 119.13(15) | C(13)-C(14)-H(14) | 118.9(15) |
| C(12)-C(11)-C(5) | 120.20(14) | C(15)-C(14)-H(14) | 121.3(15) |
| C(16)-C(11)-C(5) | 120.60(15) | C(14)-C(15)-C(16) | 120.57(17) |
| C(13)-C(12)-C(11) | 120.49(16) | C(14)-C(15)-H(15) | 120.9(13) |
| C(13)-C(12)-H(12) | 121.4(11) | C(16)-C(15)-H(15) | 118.5(13) |
| C(11)-C(12)-H(12) | 118.1(11) | C(15)-C(16)-C(11) | 119.87(17) |
| C(14)-C(13)-C(12) | 120.12(17) | C(15)-C(16)-H(16) | 119.8(12) |
| C(14)-C(13)-H(13) | 124.2(13) | C(11)-C(16)-H(16) | 120.3(12) |
| C(12)-C(13)-H(13) | 115.7(14) | | |

Table 4. Anisotropic displacement parameters ($\text{\AA}^2 \times 10^3$) for ethyl amide (**208**). The anisotropic displacement factor exponent takes the form: $-2p^2[h^2 a^{*2} U^{11} + \dots + 2hka^* b^* U^{12}]$

| | U^{11} | U^{22} | U^{33} | U^{23} | U^{13} | U^{12} |
|-------|----------|----------|----------|----------|----------|----------|
| O(1) | 47(1) | 43(1) | 57(1) | -8(1) | 19(1) | -16(1) |
| C(2) | 47(1) | 39(1) | 48(1) | -6(1) | -4(1) | -3(1) |
| C(3) | 41(1) | 42(1) | 39(1) | -5(1) | -5(1) | 11(1) |
| C(4) | 23(1) | 42(1) | 32(1) | -6(1) | 1(1) | -1(1) |
| C(5) | 27(1) | 40(1) | 36(1) | -6(1) | 4(1) | -4(1) |
| C(6) | 24(1) | 32(1) | 37(1) | -6(1) | -3(1) | 2(1) |
| O(7) | 23(1) | 54(1) | 46(1) | -2(1) | -4(1) | 2(1) |
| N(8) | 23(1) | 42(1) | 35(1) | -1(1) | -5(1) | 0(1) |
| C(9) | 34(1) | 49(1) | 36(1) | 1(1) | -6(1) | -1(1) |
| C(10) | 78(2) | 46(1) | 47(1) | 5(1) | -4(1) | -1(1) |
| C(11) | 27(1) | 40(1) | 26(1) | 0(1) | 4(1) | -5(1) |
| C(12) | 36(1) | 39(1) | 29(1) | 3(1) | 1(1) | -3(1) |
| C(13) | 51(1) | 40(1) | 33(1) | -4(1) | 9(1) | -10(1) |
| C(14) | 45(1) | 63(1) | 31(1) | -10(1) | 3(1) | -15(1) |
| C(15) | 35(1) | 76(1) | 30(1) | 1(1) | -3(1) | 1(1) |
| C(16) | 34(1) | 48(1) | 34(1) | 2(1) | 2(1) | 5(1) |

Table 5. Hydrogen coordinates ($\times 10^4$) and isotropic displacement parameters ($\text{\AA}^2 \times 10^3$) for ethyl amide (208).

| | x | y | z | U(eq) |
|--------|----------|----------|----------|-------|
| H(2) | 1200(50) | 1678(19) | 3180(9) | 54(6) |
| H(3) | 4180(50) | 2296(18) | 2267(10) | 50(5) |
| H(4) | 4950(40) | 4445(15) | 2520(9) | 36(5) |
| H(5) | -470(40) | 4825(16) | 2915(9) | 38(5) |
| H(8) | 5370(50) | 4784(17) | 1498(9) | 41(5) |
| H(91) | 1040(50) | 5005(18) | 699(10) | 54(6) |
| H(92) | 3750(40) | 4524(17) | 458(9) | 44(5) |
| H(101) | 2840(60) | 6930(20) | 832(11) | 71(7) |
| H(102) | 3420(50) | 6491(19) | 111(10) | 58(6) |
| H(103) | 5830(60) | 6390(20) | 617(11) | 71(8) |
| H(12) | 500(40) | 6684(16) | 3358(8) | 39(5) |
| H(13) | 2690(50) | 7890(20) | 4077(9) | 50(5) |
| H(14) | 6390(50) | 7170(20) | 4689(10) | 64(7) |
| H(15) | 7690(50) | 5191(17) | 4571(9) | 46(5) |
| H(16) | 5290(50) | 3945(19) | 3891(9) | 49(5) |

Table 6. Torsion angles [°] for ethyl amide (208).

| | |
|-----------------------|-------------|
| C(12)-C(11)-C(5)-C(4) | 109.15(16) |
| C(11)-C(5)-C(4)-C(6) | -121.55(15) |
| C(5)-C(4)-C(6)-N(8) | 147.34(14) |
| C(4)-C(6)-N(8)-C(9) | 174.97(15) |
| C(6)-N(8)-C(9)-C(10) | 119.8(2) |

Table 7. Hydrogen bonds for ethyl amide (208) [Å and °].

| D-H...A | d(D-H) | d(H...A) | d(D...A) | <(DHA) |
|--------------------|---------|----------|------------|-----------|
| N(8)-H(8)...O(7)#1 | 0.86(2) | 2.05(2) | 2.9106(18) | 173.0(19) |

Symmetry transformations used to generate equivalent atoms: #1 x+1,y,z

Appendix 4

Crystalline structure of the butyl dihydrofuryl amide (**204**)amide (**204**)

Table 1. Crystal data and structure refinement for butyl amide (204).

| | | |
|-----------------------------------|---|----------------------------|
| Identification code | 01srv037 | |
| Empirical formula | $C_{15}H_{19}NO_2$ | |
| Formula weight | 245.31 | |
| Temperature | 100(2) K | |
| Wavelength | 0.71073 Å | |
| Crystal system | Monoclinic | |
| Space group | P2(1) | |
| Unit cell dimensions | a = 9.754(1) Å | $\alpha = 90^\circ$. |
| | b = 11.486(1) Å | $\beta = 90.73(1)^\circ$. |
| | c = 24.184(5) Å | $\gamma = 90^\circ$. |
| Volume | 2709.2(7) Å ³ | |
| Z | 8 | |
| Density (calculated) | 1.203 mg/m ³ | |
| Absorption coefficient | 0.079 mm ⁻¹ | |
| F(000) | 1056 | |
| Crystal size | 0.41 x 0.33 x 0.15 mm ³ | |
| Theta range for data collection | 0.84 to 28.99°. | |
| Index ranges | -13 ≤ h ≤ 12, -15 ≤ k ≤ 15, -32 ≤ l ≤ 32 | |
| Reflections collected | 21518 | |
| Independent reflections | 7508 [R(int) = 0.0616] | |
| Completeness to theta = 29.00° | 99.4 % | |
| Absorption correction | None | |
| Max. and min. transmission | . and . | |
| Refinement method | Full-matrix least-squares on F ² | |
| Data / restraints / parameters | 7508 / 1 / 649 | |
| Goodness-of-fit on F ² | 1.099 | |
| Final R indices [I > 2σ(I)] | R1 = 0.0617, wR2 = 0.1459 | |
| R indices (all data) | R1 = 0.0821, wR2 = 0.1605 | |
| Extinction coefficient | 0 | |
| Largest diff. peak and hole | 0.469 and -0.275 e.Å ⁻³ | |

Table 2. Atomic coordinates ($\times 10^4$) and equivalent isotropic displacement parameters ($\text{\AA}^2 \times 10^3$) for butyl amide (204). $U(\text{eq})$ is defined as one third of the trace of the orthogonalized U^{ij} tensor.

| | x | y | z | $U(\text{eq})$ |
|--------|----------|---------|---------|----------------|
| O(1A) | 10573(3) | 1177(3) | 5321(1) | 22(1) |
| O(2A) | 9952(2) | 3215(3) | 4324(1) | 23(1) |
| N(1A) | 7653(3) | 3283(3) | 4167(1) | 21(1) |
| C(2A) | 10350(4) | 462(3) | 4874(2) | 21(1) |
| C(3A) | 9263(4) | 704(4) | 4565(2) | 24(1) |
| C(4A) | 8570(4) | 1791(3) | 4792(1) | 19(1) |
| C(5A) | 9398(4) | 1965(3) | 5346(1) | 18(1) |
| C(6A) | 8784(4) | 2825(3) | 4404(1) | 18(1) |
| C(7A) | 7736(4) | 4291(4) | 3795(2) | 23(1) |
| C(8A) | 8159(4) | 3969(4) | 3215(2) | 32(1) |
| C(9A) | 7080(6) | 3268(4) | 2892(2) | 43(1) |
| C(10A) | 5824(5) | 3961(6) | 2718(2) | 50(1) |
| C(11A) | 8553(4) | 1698(3) | 5854(1) | 19(1) |
| C(12A) | 8581(4) | 603(3) | 6106(1) | 19(1) |
| C(13A) | 7732(4) | 391(3) | 6557(2) | 21(1) |
| C(14A) | 6868(4) | 1243(4) | 6753(2) | 23(1) |
| C(15A) | 6834(4) | 2340(4) | 6506(2) | 27(1) |
| C(16A) | 7684(4) | 2559(4) | 6057(2) | 24(1) |
| O(1B) | 4443(3) | 8796(2) | -336(1) | 20(1) |
| O(2B) | 4990(2) | 6844(2) | 687(1) | 19(1) |
| N(1B) | 7267(3) | 6766(3) | 875(1) | 17(1) |
| C(2B) | 4721(4) | 9558(3) | 89(2) | 21(1) |
| C(3B) | 5837(4) | 9319(3) | 391(1) | 20(1) |
| C(4B) | 6441(4) | 8183(3) | 190(1) | 18(1) |
| C(5B) | 5599(4) | 7991(3) | -359(1) | 17(1) |
| C(6B) | 6178(3) | 7205(3) | 609(1) | 15(1) |
| C(7B) | 7122(4) | 5829(3) | 1287(2) | 19(1) |
| C(8B) | 8430(3) | 5686(3) | 1634(1) | 19(1) |
| C(9B) | 8772(3) | 6719(3) | 2008(1) | 21(1) |

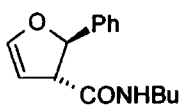
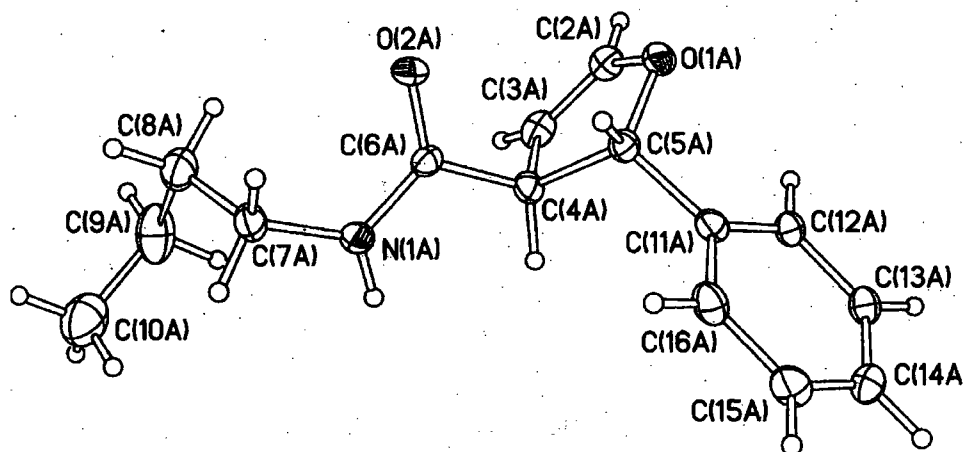
| | | | | |
|--------|----------|---------|----------|-------|
| C(10B) | 10152(4) | 6575(4) | 2311(2) | 28(1) |
| C(11B) | 6431(4) | 8217(3) | -873(2) | 18(1) |
| C(12B) | 7366(4) | 7364(4) | -1041(2) | 25(1) |
| C(13B) | 8188(4) | 7548(4) | -1498(2) | 29(1) |
| C(14B) | 8081(4) | 8577(4) | -1801(2) | 26(1) |
| C(15B) | 7151(4) | 9422(4) | -1642(2) | 25(1) |
| C(16B) | 6331(4) | 9253(3) | -1172(2) | 19(1) |
| O(1C) | -654(2) | 5676(2) | -323(1) | 18(1) |
| O(2C) | -22(2) | 7623(2) | 729(1) | 18(1) |
| N(1C) | 2271(3) | 7699(3) | 859(1) | 17(1) |
| C(2C) | -419(4) | 4910(3) | 105(2) | 20(1) |
| C(3C) | 676(4) | 5134(3) | 422(2) | 20(1) |
| C(4C) | 1346(3) | 6250(3) | 218(1) | 16(1) |
| C(5C) | 511(3) | 6466(3) | -332(1) | 16(1) |
| C(6C) | 1152(3) | 7251(3) | 625(1) | 15(1) |
| C(7C) | 2189(4) | 8678(3) | 1249(2) | 19(1) |
| C(8C) | 3521(3) | 8838(3) | 1571(1) | 19(1) |
| C(9C) | 3865(3) | 7859(3) | 1971(1) | 20(1) |
| C(10C) | 5230(4) | 8054(4) | 2273(2) | 27(1) |
| C(11C) | 1345(4) | 6286(3) | -846(1) | 17(1) |
| C(12C) | 2317(4) | 7126(4) | -985(2) | 23(1) |
| C(13C) | 3154(4) | 6989(4) | -1442(2) | 28(1) |
| C(14C) | 3030(4) | 5995(4) | -1765(2) | 26(1) |
| C(15C) | 2073(4) | 5148(4) | -1631(2) | 24(1) |
| C(16C) | 1238(4) | 5284(3) | -1170(2) | 19(1) |
| O(1D) | 5728(3) | 4382(2) | 5382(1) | 22(1) |
| O(2D) | 4966(3) | 2442(3) | 4264(1) | 23(1) |
| N(1D) | 2642(3) | 2424(3) | 4212(1) | 19(1) |
| C(2D) | 5574(4) | 5124(3) | 4941(2) | 20(1) |
| C(3D) | 4521(4) | 4925(3) | 4612(2) | 21(1) |
| C(4D) | 3753(4) | 3861(3) | 4810(1) | 18(1) |
| C(5D) | 4566(4) | 3576(3) | 5358(1) | 18(1) |
| C(6D) | 3843(3) | 2858(3) | 4399(1) | 17(1) |
| C(7D) | 2580(4) | 1481(3) | 3809(1) | 20(1) |
| C(8D) | 2822(4) | 1887(3) | 3221(2) | 28(1) |
| C(9D) | 2808(4) | 880(4) | 2802(2) | 31(1) |

| | | | | |
|--------|---------|---------|---------|-------|
| C(10D) | 1420(5) | 286(5) | 2747(2) | 43(1) |
| C(11D) | 3692(3) | 3712(3) | 5872(1) | 19(1) |
| C(12D) | 3718(4) | 4721(4) | 6190(2) | 23(1) |
| C(13D) | 2848(4) | 4816(4) | 6645(2) | 28(1) |
| C(14D) | 1959(4) | 3906(4) | 6781(2) | 28(1) |
| C(15D) | 1940(4) | 2896(4) | 6459(2) | 31(1) |
| C(16D) | 2806(4) | 2812(4) | 6010(2) | 26(1) |

Table 3. Bond lengths [Å] and angles [°] for butyl amide (**204**).

| | | | |
|---------------|----------|---------------|----------|
| O(1A)-C(2A) | 1.373(5) | N(1B)-C(7B) | 1.475(5) |
| O(1A)-C(5A) | 1.462(4) | C(2B)-C(3B) | 1.332(5) |
| O(2A)-C(6A) | 1.241(4) | C(3B)-C(4B) | 1.515(6) |
| N(1A)-C(6A) | 1.343(4) | C(4B)-C(6B) | 1.536(5) |
| N(1A)-C(7A) | 1.470(5) | C(4B)-C(5B) | 1.567(5) |
| C(2A)-C(3A) | 1.319(5) | C(5B)-C(11B) | 1.516(5) |
| C(3A)-C(4A) | 1.526(6) | C(7B)-C(8B) | 1.527(5) |
| C(4A)-C(6A) | 1.531(5) | C(8B)-C(9B) | 1.526(5) |
| C(4A)-C(5A) | 1.568(5) | C(9B)-C(10B) | 1.533(5) |
| C(5A)-C(11A) | 1.520(5) | C(11B)-C(16B) | 1.396(5) |
| C(7A)-C(8A) | 1.513(5) | C(11B)-C(12B) | 1.403(5) |
| C(8A)-C(9A) | 1.530(6) | C(12B)-C(13B) | 1.390(6) |
| C(9A)-C(10A) | 1.516(7) | C(13B)-C(14B) | 1.394(6) |
| C(11A)-C(16A) | 1.396(5) | C(14B)-C(15B) | 1.386(6) |
| C(11A)-C(12A) | 1.398(5) | C(15B)-C(16B) | 1.412(5) |
| C(12A)-C(13A) | 1.398(5) | O(1C)-C(2C) | 1.375(5) |
| C(13A)-C(14A) | 1.379(6) | O(1C)-C(5C) | 1.454(4) |
| C(14A)-C(15A) | 1.394(6) | O(2C)-C(6C) | 1.251(4) |
| C(15A)-C(16A) | 1.399(6) | N(1C)-C(6C) | 1.327(4) |
| O(1B)-C(2B) | 1.374(5) | N(1C)-C(7C) | 1.469(5) |
| O(1B)-C(5B) | 1.460(4) | C(2C)-C(3C) | 1.331(5) |
| O(2B)-C(6B) | 1.247(4) | C(3C)-C(4C) | 1.523(5) |
| N(1B)-C(6B) | 1.334(4) | C(4C)-C(6C) | 1.526(5) |

| | | | |
|-------------------|----------|----------------------|----------|
| C(4C)-C(5C) | 1.570(5) | C(6A)-C(4A)-C(5A) | 110.6(3) |
| C(5C)-C(11C) | 1.508(5) | O(1A)-C(5A)-C(11A) | 110.0(3) |
| C(7C)-C(8C) | 1.518(4) | O(1A)-C(5A)-C(4A) | 106.3(3) |
| C(8C)-C(9C) | 1.518(5) | C(11A)-C(5A)-C(4A) | 112.6(3) |
| C(9C)-C(10C) | 1.526(5) | O(2A)-C(6A)-N(1A) | 122.9(3) |
| C(11C)-C(16C) | 1.396(5) | O(2A)-C(6A)-C(4A) | 120.5(3) |
| C(11C)-C(12C) | 1.396(5) | N(1A)-C(6A)-C(4A) | 116.6(3) |
| C(12C)-C(13C) | 1.392(6) | N(1A)-C(7A)-C(8A) | 113.2(4) |
| C(13C)-C(14C) | 1.388(6) | C(7A)-C(8A)-C(9A) | 114.0(4) |
| C(14C)-C(15C) | 1.389(6) | C(10A)-C(9A)-C(8A) | 114.4(4) |
| C(15C)-C(16C) | 1.398(5) | C(16A)-C(11A)-C(12A) | 119.6(3) |
| O(1D)-C(2D) | 1.373(4) | C(16A)-C(11A)-C(5A) | 118.6(3) |
| O(1D)-C(5D) | 1.464(4) | C(12A)-C(11A)-C(5A) | 121.8(3) |
| O(2D)-C(6D) | 1.242(4) | C(13A)-C(12A)-C(11A) | 119.2(3) |
| N(1D)-C(6D) | 1.346(4) | C(14A)-C(13A)-C(12A) | 121.0(4) |
| N(1D)-C(7D) | 1.457(5) | C(13A)-C(14A)-C(15A) | 120.3(4) |
| C(2D)-C(3D) | 1.310(5) | C(14A)-C(15A)-C(16A) | 119.0(4) |
| C(3D)-C(4D) | 1.514(5) | C(11A)-C(16A)-C(15A) | 120.9(4) |
| C(4D)-C(6D) | 1.527(5) | C(2B)-O(1B)-C(5B) | 106.7(3) |
| C(4D)-C(5D) | 1.570(5) | C(6B)-N(1B)-C(7B) | 121.3(3) |
| C(5D)-C(11D) | 1.524(5) | C(3B)-C(2B)-O(1B) | 115.5(4) |
| C(7D)-C(8D) | 1.518(5) | C(2B)-C(3B)-C(4B) | 108.7(3) |
| C(8D)-C(9D) | 1.538(5) | C(3B)-C(4B)-C(6B) | 110.5(3) |
| C(9D)-C(10D) | 1.520(6) | C(3B)-C(4B)-C(5B) | 101.0(3) |
| C(11D)-C(16D) | 1.390(5) | C(6B)-C(4B)-C(5B) | 111.4(3) |
| C(11D)-C(12D) | 1.392(5) | O(1B)-C(5B)-C(11B) | 110.2(3) |
| C(12D)-C(13D) | 1.403(6) | O(1B)-C(5B)-C(4B) | 106.0(3) |
| C(13D)-C(14D) | 1.399(6) | C(11B)-C(5B)-C(4B) | 113.0(3) |
| C(14D)-C(15D) | 1.396(6) | O(2B)-C(6B)-N(1B) | 122.5(3) |
| C(15D)-C(16D) | 1.388(6) | O(2B)-C(6B)-C(4B) | 120.4(3) |
| C(2A)-O(1A)-C(5A) | 106.7(3) | N(1B)-C(6B)-C(4B) | 117.1(3) |
| C(6A)-N(1A)-C(7A) | 121.2(3) | N(1B)-C(7B)-C(8B) | 111.3(3) |
| C(3A)-C(2A)-O(1A) | 116.0(4) | C(9B)-C(8B)-C(7B) | 114.7(3) |
| C(2A)-C(3A)-C(4A) | 109.0(3) | C(8B)-C(9B)-C(10B) | 112.6(3) |
| C(3A)-C(4A)-C(6A) | 110.4(3) | C(16B)-C(11B)-C(12B) | 119.1(3) |
| C(3A)-C(4A)-C(5A) | 100.7(3) | C(16B)-C(11B)-C(5B) | 122.5(3) |

| | | | |
|----------------------|----------|----------------------|----------|
| C(12B)-C(11B)-C(5B) | 118.4(3) | C(13C)-C(14C)-C(15C) | 119.9(4) |
| C(13B)-C(12B)-C(11B) | 120.6(4) | C(14C)-C(15C)-C(16C) | 120.5(4) |
| C(12B)-C(13B)-C(14B) | 120.4(4) | C(11C)-C(16C)-C(15C) | 120.0(4) |
| C(15B)-C(14B)-C(13B) | 119.6(4) | C(2D)-O(1D)-C(5D) | 106.5(3) |
| C(14B)-C(15B)-C(16B) | 120.4(4) | C(6D)-N(1D)-C(7D) | 121.9(3) |
| C(11B)-C(16B)-C(15B) | 119.9(4) | C(3D)-C(2D)-O(1D) | 116.2(3) |
| C(2C)-O(1C)-C(5C) | 106.7(3) | C(2D)-C(3D)-C(4D) | 109.6(3) |
| C(6C)-N(1C)-C(7C) | 121.3(3) | C(3D)-C(4D)-C(6D) | 111.8(3) |
| C(3C)-C(2C)-O(1C) | 115.8(3) | C(3D)-C(4D)-C(5D) | 100.9(3) |
| C(2C)-C(3C)-C(4C) | 108.7(3) | C(6D)-C(4D)-C(5D) | 111.1(3) |
| C(3C)-C(4C)-C(6C) | 111.6(3) | O(1D)-C(5D)-C(11D) | 110.1(3) |
| C(3C)-C(4C)-C(5C) | 100.8(3) | O(1D)-C(5D)-C(4D) | 106.5(3) |
| C(6C)-C(4C)-C(5C) | 111.1(3) | C(11D)-C(5D)-C(4D) | 112.7(3) |
| O(1C)-C(5C)-C(11C) | 110.9(3) | O(2D)-C(6D)-N(1D) | 122.4(3) |
| O(1C)-C(5C)-C(4C) | 106.6(3) | O(2D)-C(6D)-C(4D) | 121.3(3) |
| C(11C)-C(5C)-C(4C) | 113.4(3) | N(1D)-C(6D)-C(4D) | 116.2(3) |
| O(2C)-C(6C)-N(1C) | 122.1(3) | N(1D)-C(7D)-C(8D) | 113.1(3) |
| O(2C)-C(6C)-C(4C) | 120.5(3) | C(7D)-C(8D)-C(9D) | 112.8(3) |
| N(1C)-C(6C)-C(4C) | 117.4(3) | C(10D)-C(9D)-C(8D) | 113.2(4) |
| N(1C)-C(7C)-C(8C) | 111.6(3) | C(16D)-C(11D)-C(12D) | 119.6(3) |
| C(9C)-C(8C)-C(7C) | 114.7(3) | C(16D)-C(11D)-C(5D) | 118.4(3) |
| C(8C)-C(9C)-C(10C) | 112.4(3) | C(12D)-C(11D)-C(5D) | 122.0(3) |
| C(16C)-C(11C)-C(12C) | 118.7(3) | C(11D)-C(12D)-C(13D) | 119.4(4) |
| C(16C)-C(11C)-C(5C) | 122.6(3) | C(14D)-C(13D)-C(12D) | 120.6(4) |
| C(12C)-C(11C)-C(5C) | 118.6(3) | C(15D)-C(14D)-C(13D) | 119.6(4) |
| C(13C)-C(12C)-C(11C) | 121.3(4) | C(16D)-C(15D)-C(14D) | 119.3(4) |
| C(14C)-C(13C)-C(12C) | 119.5(4) | C(15D)-C(16D)-C(11D) | 121.5(4) |

Table 4. Anisotropic displacement parameters ($\text{\AA}^2 \times 10^3$) for butyl amide (204). The anisotropic displacement factor exponent takes the form: $-2p^2[h^2 a^{*2} U^{11} + \dots + 2hka^* b^* U^{12}]$

| | U^{11} | U^{22} | U^{33} | U^{23} | U^{13} | U^{12} |
|--------|----------|----------|----------|----------|----------|----------|
| O(1A) | 19(1) | 28(2) | 18(1) | -2(1) | -2(1) | 0(1) |
| O(2A) | 13(1) | 28(2) | 29(1) | 5(1) | 0(1) | -3(1) |
| N(1A) | 16(1) | 29(2) | 19(1) | 2(1) | -2(1) | -3(1) |
| C(2A) | 24(2) | 17(2) | 23(2) | 0(1) | 2(1) | 1(1) |
| C(3A) | 30(2) | 22(2) | 20(2) | -2(2) | 2(2) | -8(2) |
| C(4A) | 17(2) | 22(2) | 17(2) | 2(1) | -4(1) | -3(1) |
| C(5A) | 18(2) | 20(2) | 15(2) | -1(1) | -1(1) | -2(1) |
| C(6A) | 18(2) | 20(2) | 15(2) | -1(1) | 3(1) | -1(1) |
| C(7A) | 23(2) | 26(2) | 20(2) | 4(2) | -4(1) | -1(2) |
| C(8A) | 35(2) | 35(2) | 26(2) | 5(2) | 5(2) | 5(2) |
| C(9A) | 70(3) | 36(2) | 23(2) | -4(2) | -6(2) | 1(2) |
| C(10A) | 49(3) | 64(4) | 38(2) | 5(2) | -3(2) | -14(3) |
| C(11A) | 18(2) | 21(2) | 17(2) | -3(1) | -2(1) | 3(1) |
| C(12A) | 21(2) | 19(2) | 16(2) | -2(1) | -2(1) | 0(1) |
| C(13A) | 25(2) | 19(2) | 18(2) | -1(1) | -4(1) | -1(1) |
| C(14A) | 27(2) | 25(2) | 18(2) | -1(2) | 1(1) | -1(2) |
| C(15A) | 30(2) | 26(2) | 24(2) | -8(2) | -1(2) | 12(2) |
| C(16A) | 30(2) | 20(2) | 23(2) | 1(2) | -4(2) | 6(2) |
| O(1B) | 18(1) | 20(1) | 23(1) | -1(1) | -5(1) | 0(1) |
| O(2B) | 15(1) | 15(1) | 25(1) | 2(1) | -1(1) | 0(1) |
| N(1B) | 14(1) | 19(2) | 18(1) | 4(1) | -1(1) | -4(1) |
| C(2B) | 30(2) | 15(2) | 18(2) | -1(1) | 4(1) | -4(2) |
| C(3B) | 31(2) | 16(2) | 14(2) | 0(1) | 0(1) | -9(2) |
| C(4B) | 17(2) | 20(2) | 17(2) | 1(1) | 0(1) | -4(1) |
| C(5B) | 18(2) | 13(2) | 19(2) | 2(1) | -5(1) | -1(1) |
| C(6B) | 16(2) | 15(2) | 15(2) | -1(1) | -2(1) | -1(1) |
| C(7B) | 19(2) | 16(2) | 21(2) | 4(1) | -4(1) | -2(1) |
| C(8B) | 17(1) | 19(2) | 19(2) | 0(1) | -3(1) | 1(1) |
| C(9B) | 19(2) | 25(2) | 18(2) | -2(1) | -3(1) | 6(1) |
| C(10B) | 21(2) | 38(2) | 25(2) | 0(2) | -8(1) | -1(2) |

| | | | | | | |
|--------|-------|-------|-------|--------|-------|--------|
| C(11B) | 19(2) | 16(2) | 19(2) | 0(1) | -7(1) | -3(1) |
| C(12B) | 33(2) | 17(2) | 24(2) | -2(2) | -4(2) | 8(2) |
| C(13B) | 34(2) | 27(2) | 25(2) | -6(2) | -1(2) | 8(2) |
| C(14B) | 25(2) | 33(2) | 18(2) | -2(2) | 0(1) | 6(2) |
| C(15B) | 28(2) | 24(2) | 21(2) | 4(2) | -6(1) | -1(2) |
| C(16B) | 18(2) | 16(2) | 24(2) | 1(1) | -4(1) | -1(1) |
| O(1C) | 17(1) | 20(1) | 18(1) | 0(1) | -4(1) | -4(1) |
| O(2C) | 14(1) | 18(1) | 23(1) | -5(1) | 1(1) | 1(1) |
| N(1C) | 13(1) | 19(2) | 19(1) | -4(1) | -2(1) | 0(1) |
| C(2C) | 24(2) | 15(2) | 21(2) | 0(1) | 3(1) | 1(1) |
| C(3C) | 23(2) | 15(2) | 21(2) | -1(1) | -2(1) | 6(1) |
| C(4C) | 13(1) | 20(2) | 14(1) | -1(1) | -4(1) | 1(1) |
| C(5C) | 13(1) | 17(2) | 18(2) | 0(1) | -1(1) | -2(1) |
| C(6C) | 17(2) | 14(2) | 14(1) | -1(1) | 0(1) | -1(1) |
| C(7C) | 20(2) | 16(2) | 19(2) | -4(1) | -3(1) | 0(1) |
| C(8C) | 22(2) | 17(2) | 17(2) | -1(1) | -3(1) | -5(1) |
| C(9C) | 22(2) | 22(2) | 17(2) | 1(1) | -4(1) | -5(1) |
| C(10C) | 20(2) | 38(2) | 22(2) | 3(2) | -4(1) | -1(2) |
| C(11C) | 18(2) | 19(2) | 15(2) | 3(1) | -4(1) | -1(1) |
| C(12C) | 28(2) | 22(2) | 19(2) | -2(2) | -3(1) | -9(2) |
| C(13C) | 29(2) | 33(2) | 21(2) | 2(2) | 1(2) | -11(2) |
| C(14C) | 30(2) | 33(2) | 14(2) | 1(2) | 2(2) | -1(2) |
| C(15C) | 30(2) | 20(2) | 22(2) | -5(2) | 2(2) | 1(2) |
| C(16C) | 22(2) | 17(2) | 20(2) | 1(1) | -1(1) | -2(1) |
| O(1D) | 16(1) | 25(1) | 24(1) | 2(1) | -4(1) | -4(1) |
| O(2D) | 15(1) | 26(1) | 28(1) | -7(1) | 2(1) | -1(1) |
| N(1D) | 16(1) | 23(2) | 18(1) | -4(1) | 0(1) | -2(1) |
| C(2D) | 22(2) | 17(2) | 22(2) | 1(1) | 2(1) | 0(1) |
| C(3D) | 27(2) | 18(2) | 18(2) | -1(1) | 0(1) | 3(1) |
| C(4D) | 17(2) | 21(2) | 16(2) | -4(1) | -2(1) | 2(1) |
| C(5D) | 18(2) | 18(2) | 18(2) | 0(1) | -2(1) | -1(1) |
| C(6D) | 16(2) | 19(2) | 16(2) | 1(1) | -1(1) | -1(1) |
| C(7D) | 20(2) | 21(2) | 19(2) | -1(1) | -2(1) | 0(1) |
| C(8D) | 42(2) | 23(2) | 18(2) | -2(1) | 1(2) | -5(2) |
| C(9D) | 42(2) | 29(2) | 23(2) | -7(2) | 5(2) | -5(2) |
| C(10D) | 49(3) | 46(3) | 33(2) | -13(2) | 4(2) | -11(2) |

| | | | | | | |
|--------|-------|-------|-------|-------|-------|--------|
| C(11D) | 16(2) | 24(2) | 17(2) | 0(1) | -3(1) | 0(1) |
| C(12D) | 22(2) | 23(2) | 23(2) | -1(2) | -4(1) | -1(2) |
| C(13D) | 33(2) | 30(2) | 19(2) | -4(2) | -7(2) | 4(2) |
| C(14D) | 27(2) | 40(2) | 17(2) | 2(2) | 2(2) | 2(2) |
| C(15D) | 31(2) | 37(2) | 23(2) | -2(2) | 4(2) | -13(2) |
| C(16D) | 33(2) | 24(2) | 21(2) | -4(2) | 2(2) | -7(2) |

Table 5. Hydrogen coordinates ($\times 10^4$) and isotropic displacement parameters ($\text{\AA}^2 \times 10^3$) for butyl amide (**204**).

| | x | y | z | U(eq) |
|--------|-------|------|------|-------|
| H(1A) | 6848 | 2975 | 4237 | 25 |
| H(2A) | 10942 | -170 | 4792 | 26 |
| H(3A) | 8962 | 274 | 4251 | 28 |
| H(4A) | 7575 | 1651 | 4862 | 24 |
| H(5A) | 9736 | 2786 | 5367 | 23 |
| H(7A1) | 8398 | 4859 | 3951 | 30 |
| H(7A2) | 6827 | 4674 | 3775 | 30 |
| H(8A1) | 9013 | 3505 | 3238 | 42 |
| H(8A2) | 8363 | 4691 | 3007 | 42 |
| H(9A1) | 7504 | 2939 | 2557 | 56 |
| H(9A2) | 6782 | 2609 | 3126 | 56 |
| H(10A) | 5180 | 3455 | 2517 | 75 |
| H(10B) | 6103 | 4604 | 2478 | 75 |
| H(10C) | 5380 | 4275 | 3047 | 75 |
| H(12A) | 9174 | 11 | 5975 | 22 |
| H(13A) | 7748 | -352 | 6729 | 25 |
| H(14A) | 6291 | 1080 | 7057 | 28 |
| H(15A) | 6245 | 2929 | 6644 | 32 |
| H(16A) | 7668 | 3305 | 5887 | 29 |
| H(1B) | 8088 | 7041 | 803 | 21 |

| | | | | |
|--------|-------|-------|-------|----|
| H(2B) | 4154 | 10212 | 162 | 25 |
| H(3B) | 6197 | 9785 | 683 | 24 |
| H(4B) | 7442 | 8263 | 114 | 23 |
| H(5B) | 5245 | 7174 | -369 | 22 |
| H(7B1) | 6911 | 5088 | 1096 | 25 |
| H(7B2) | 6346 | 6014 | 1532 | 25 |
| H(8B1) | 8332 | 4983 | 1867 | 24 |
| H(8B2) | 9209 | 5552 | 1384 | 24 |
| H(9B1) | 8041 | 6808 | 2286 | 27 |
| H(9B2) | 8791 | 7437 | 1782 | 27 |
| H(10D) | 10325 | 7258 | 2544 | 42 |
| H(10E) | 10883 | 6504 | 2038 | 42 |
| H(10F) | 10133 | 5875 | 2542 | 42 |
| H(12B) | 7439 | 6657 | -839 | 30 |
| H(13B) | 8829 | 6969 | -1604 | 34 |
| H(14B) | 8635 | 8696 | -2116 | 31 |
| H(15B) | 7073 | 10123 | -1848 | 29 |
| H(16B) | 5707 | 9841 | -1062 | 23 |
| H(1C) | 3078 | 7407 | 778 | 20 |
| H(2C) | -1002 | 4264 | 171 | 24 |
| H(3C) | 989 | 4672 | 724 | 24 |
| H(4C) | 2339 | 6124 | 140 | 20 |
| H(5C) | 161 | 7284 | -330 | 20 |
| H(7C1) | 1432 | 8537 | 1510 | 24 |
| H(7C2) | 1978 | 9401 | 1042 | 24 |
| H(8C1) | 3469 | 9575 | 1782 | 24 |
| H(8C2) | 4279 | 8916 | 1305 | 24 |
| H(9C1) | 3908 | 7117 | 1764 | 27 |
| H(9C2) | 3126 | 7791 | 2246 | 27 |
| H(10G) | 5408 | 7403 | 2525 | 40 |
| H(10H) | 5188 | 8781 | 2484 | 40 |
| H(10I) | 5969 | 8104 | 2003 | 40 |
| H(12C) | 2407 | 7805 | -763 | 27 |
| H(13C) | 3802 | 7573 | -1533 | 33 |
| H(14C) | 3604 | 5891 | -2076 | 31 |
| H(15C) | 1983 | 4473 | -1856 | 28 |

| | | | | |
|--------|------|------|-------|----|
| H(16C) | 596 | 4695 | -1078 | 23 |
| H(1D) | 1872 | 2717 | 4337 | 22 |
| H(2D) | 6196 | 5745 | 4877 | 24 |
| H(3D) | 4278 | 5381 | 4298 | 25 |
| H(4D) | 2776 | 4056 | 4890 | 23 |
| H(5D) | 4919 | 2760 | 5340 | 23 |
| H(7D1) | 1666 | 1109 | 3827 | 26 |
| H(7D2) | 3275 | 886 | 3909 | 26 |
| H(8D1) | 3719 | 2288 | 3206 | 36 |
| H(8D2) | 2104 | 2457 | 3115 | 36 |
| H(9D1) | 3066 | 1187 | 2435 | 41 |
| H(9D2) | 3508 | 300 | 2914 | 41 |
| H(10J) | 1480 | -348 | 2477 | 64 |
| H(10K) | 725 | 848 | 2624 | 64 |
| H(10L) | 1163 | -33 | 3107 | 64 |
| H(12D) | 4324 | 5339 | 6100 | 27 |
| H(13D) | 2858 | 5507 | 6861 | 33 |
| H(14D) | 1379 | 3972 | 7092 | 33 |
| H(15D) | 1337 | 2275 | 6547 | 37 |
| H(16D) | 2790 | 2126 | 5791 | 31 |

Table 6. Torsion angles [$^{\circ}$] for butyl amide (**204**).

| | |
|--------------------------|-----------|
| C(3A)-C(4A)-C(6A)-N(1A) | 116.7(4) |
| C(4A)-C(6A)-N(1A)-C(7A) | 178.9(3) |
| C(6A)-N(1A)-C(7A)-C(8A) | 79.9(4) |
| N(1A)-C(7A)-C(8A)-C(9A) | 68.7(4) |
| C(7A)-C(8A)-C(9A)-C(10A) | 71.2(5) |
| C(3B)-C(4B)-C(6B)-N(1B) | -112.7(4) |
| C(4B)-C(6B)-N(1B)-C(7B) | 179.6(3) |
| C(6B)-N(1B)-C(7B)-C(8B) | -165.7(3) |
| N(1B)-C(7B)-C(8B)-C(9B) | 66.3(4) |
| C(7B)-C(8B)-C(9B)-C(10B) | -175.2(3) |
| C(3C)-C(4C)-C(6C)-N(1C) | 116.9(3) |
| C(4C)-C(6C)-N(1C)-C(7C) | 178.9(3) |
| C(6C)-N(1C)-C(7C)-C(8C) | 165.4(3) |
| N(1C)-C(7C)-C(8C)-C(9C) | -67.3(4) |
| C(7C)-C(8C)-C(9C)-C(10C) | 178.6(3) |
| C(3D)-C(4D)-C(6D)-N(1D) | -123.6(3) |
| C(4D)-C(6D)-N(1D)-C(7D) | 178.7(3) |
| C(6D)-N(1D)-C(7D)-C(8D) | -78.8(4) |
| N(1D)-C(7D)-C(8D)-C(9D) | 177.9(3) |
| C(7D)-C(8D)-C(9D)-C(10D) | 65.0(5) |

Table 7. Hydrogen bonds for butyl amide (**204**) [\AA and $^{\circ}$].

| D-H...A | d(D-H) | d(H...A) | d(D...A) | $\angle(\text{DHA})$ |
|-----------------------|--------|----------|----------|----------------------|
| N(1A)-H(1A)...O(2D) | 0.88 | 1.94 | 2.806(4) | 169.2 |
| N(1B)-H(1B)...O(2C)#1 | 0.88 | 1.97 | 2.848(4) | 173.6 |
| N(1C)-H(1C)...O(2B) | 0.88 | 1.99 | 2.864(4) | 172.5 |
| N(1D)-H(1D)...O(2A)#2 | 0.88 | 1.96 | 2.793(4) | 157.9 |

Symmetry transformations used to generate equivalent atoms: #1 $x+1, y, z$ #2 $x-1, y, z$ 