

Discussion on Preconditions for reproducible measurements on power conversion harmonics between 2 and 150 kHz

Jos KNOCKAERT  
Ghent University Lemcko - Belgium  
jos.knockaert@ugent.be

Bram VANSEVEREN  
Ghent University Lemcko - Belgium  
b.vanseveren@ugent.be

Jan DESMET  
Ghent University Lemcko - Belgium  
janj.desmet@ugent.be

## ABSTRACT

*Reproducible emission measurements between 2 and 150 kHz are a challenge, as several parameters have their influence. A discussion on the influence of these parameters is presented, reaching highly accurate measurements for the case of power conversion harmonics.*

## INTRODUCTION

As most household appliances and renewable energy sources are connected to the grid by power electronic devices, the power conversion harmonics between 2 and 150 kHz have an influence on the high frequency power quality of the grid. Examples of devices are modern lighting, grid connected renewable energy sources and all electronic devices, which contain an internal switched-mode power supply. Although measurements of the high frequency harmonics (> 2 kHz) are quite common, making reproducible measurements seems to be difficult, as at current state no emission standard is available. When searching for an accurate emission measurement method, several parameters have a smaller or larger influence. In this paper, the main influencers are discussed. When taking into account these parameters, highly accurate measurements can be reached.

## BASIC MEASUREMENT SETUP

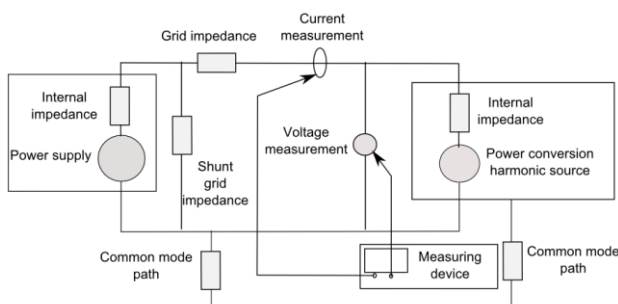

Fig. 1 Measurement setup and influencing parameters

Consider the diagram of the basic measurement setup (fig. 1). The device-under-test at the right is symbolised as a source with an internal impedance. The power supply is symbolised at the left. Additionally, the grid impedance and a shunt grid impedance are taken into account.

The measurement is done by a voltage and current probe, connected to a measurement device. As can be noticed, only the differential voltage is measured, while the current probe measures a combination of differential mode and

common mode current. The latter is similar to conducted emission measuring methods based on an artificial mains V-network (AMN). Finally, the setup contains parasitic paths and external interferences, symbolized by the common mode path.

In practical setups, the power supply and impedances can consist of an AMN and/or passive filters, defining the impedance seen by the emitting source. The measurement device will normally consist of a DAQ (data-acquisition system), combined with digital filtering.

In theory all components will have an influence on the accuracy and the reproducibility of the measurements. In practice, some parameters will have a larger influence and should be more strictly defined than others. The following section discusses the different parameters.

## PARAMETERS

### Emitting Source

In the described research, the influence of each parameter, separately, is investigated. As emitting source, at first compact fluorescent lamps (CFL) were used, but as the emitted current was very low and not stable, and in order to have all parameters under control, the used emitting source is no off-the-shelf device. For the measurement, a power electronic device is used, generating switching harmonics. The switching harmonics are fully programmable by a dSpace controller. In this way, the harmonics can be kept very stable, or if necessary just the opposite. The PWM-signal is provided to the used IGBT with an optical fiber in order to have no interference from the dSpace-system.

In this research, a stable emitting source is very important, as the influence of other parameters had to be seen. Real sources can have a different behaviour, which can be classified as:

- Constant
- Varying
- Transient

It is obvious that the measuring window, averaging and digital filtering afterwards will have a large influence on the measurement results of the second and third type of signals.

### Power Supply Voltage

The power supply voltage can be considered as the first main influencer of the measuring accuracy. Both amplitude and spectral content determine the high frequency emission.

### Low Frequency Spectral Content

As already shown in [1], a small harmonic distortion in the voltage can result in a large distortion in the current emission. Additionally, this current can cause an additional voltage drop on the grid impedance, resulting in an increase of the current emission (amplification effect).

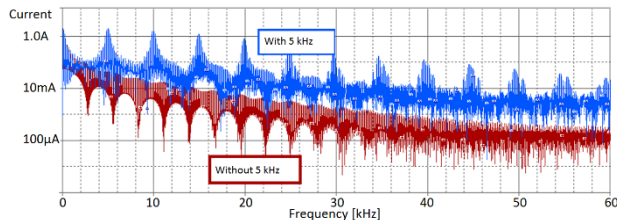

Fig. 2 Influence on current spectrum with 4% of 5 kHz harmonic distortion in supply voltage (red: without distortion, blue: with distortion)

Fig. 2 shows the measured spectrum of the current at a rectifier input when a single 5 kHz distortion in the voltage is applied. The result is modulation at all multiples of 5 kHz. It means that low frequency harmonics will have an influence on the high frequency harmonics. For this reason, the spectral content of the source needs to be strictly defined. As example, the requirements of IEC61000-3-2 [2] can be used.

### High Frequency Spectral Content

Besides the low frequency spectral content, it is obvious that the high frequency distortion should be low. This is further referred as a “clean source”. As test device, a CFL was used, as power supply, an IEC61000-3-2 full-compliant power source. On fig. 3, the frequencies, generated by the CFL, are around 40 and 80 kHz. The other frequencies (especially the high 32 and 51 kHz) are inherent to the source. Also two other sources were tested, with similar results, but with other disturbing frequencies.

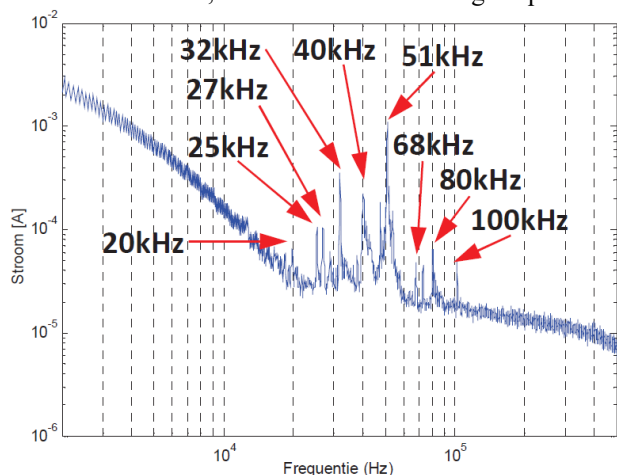

Fig. 3 Measurement on CFL fed by power source

Practical measurements show that the spectral content between 2 and 150 kHz should be below 60 dB $\mu$ V.

### Constant amplitude and RMS value

Besides a clean spectrum, the power supply voltage should be constant. When considering a perfect sinusoidal voltage, this means that the amplitude or RMS value should be kept constant, as those are related. The influence of the voltage on the high frequency harmonics is very dependent on the application. The DUT (device under test) can be controlled in constant power mode or constant current mode. The switching frequency will be voltage dependent. Also heating of elements can have an influence on the emission. Fig. 4 shows the measurement of an CFL, connected to the grid. It is known that the spectrum varies largely during the warm-up time. But on the figure it can also be seen that the frequencies keep on varying, due to the voltage variation. This variation is dependent on the control algorithm in the device. For CFL variations of 0,1%/V were found.

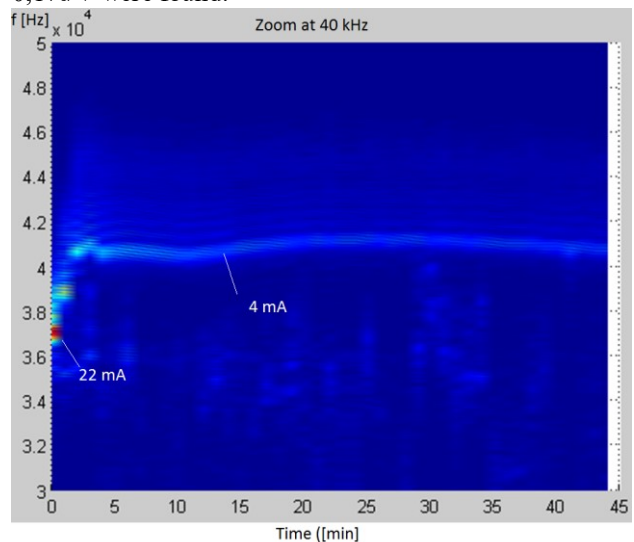

Fig. 4 Influence of heating (left) and RMS value on the spectrum of the CFL

It becomes more difficult if the voltage contains harmonics. Adding harmonics will change the RMS value. Additionally, the phase of the harmonic will influence the peak value of the waveform [3]. The influence on the high frequency harmonics is very application dependent. Much more research on this will be needed. For accurate and reproducible measurements, a definition of the harmonics, both in amplitude and phase, is required.

Finally, the defined voltage should be measured at the terminals of the DUT. This approach is similar to IEC61000-3-2 and excludes the need for a calibrated power source, as the voltage is verified at the moment of measurement by the measurement device.

### Practical measurements

For highly accurate measurements with a controllable source, the authors used a synchronous generator (fig. 5). The generator has the advantages to be a clean source and to have a controllable voltage. The disadvantage is that the

voltage contains a low frequency (but constant) distortion. For even more accuracy for testing the measurement method, the most perfect clean source was used, meaning a 12 V battery. As DUT a dSpace-controlled DCDC-converter was used. Measurements on this show that a small drop in voltage (0,8%) result in a larger drop in current (1,5%), as both voltage and source impedance of the battery change. In the end, for stable voltages, a large 80 Ah lead-acid battery was used.

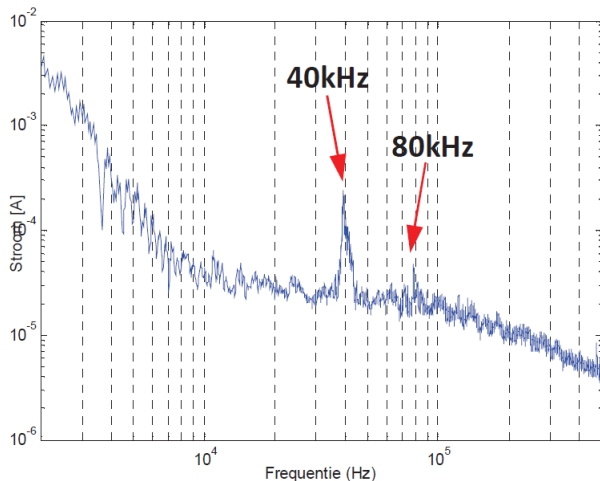

Fig. 5 Current spectrum of CFL measured with synchronous generator as source

### Grid Impedance and Shunt Impedance

This section can be started with a trivial question: do we measure voltage or current? Although the question is trivial, the answer is not. In the following section, a difference between research and compliance measurements is made.

Consider first research measurements. In this case, nothing is certain, so both current and voltage are normally measured.

Consider compliance measurements. Consider that for a good standard, the grid and source impedance are perfectly defined. In this case the voltage and current are perfectly related and both can be used as metric for compliance. This method is used for compliance measurements above 150 kHz, where an AMN and measuring receiver is used, representing a 50Ω impedance.

The problem is, that for lower frequencies (below 150 kHz), it is much more difficult to define the impedance and keep the impedance constant. Although AMN are defined below 150 kHz (CISPR16 [4] and EN50065 [5]), when connected to the grid, the impedance seen by the DUT is largely dependent on the grid impedance at the supply side than for AMN defined above 150 kHz.

Another problem that occurs here is that the grid impedance is in fact frequency dependent and is rapidly changing the last years. It means that the impedance must be accurately defined in the full frequency range from 2 to 150 kHz and that this definition should consider the future grid, not the current grid. Fig. 6 [6] shows the measured grid impedance when different loads are connected. The

impedance of the TV is very low due to capacitive behaviour. Most devices contain nowadays capacitors at the terminals filtering electromagnetic interference (EMI). As a conclusion, where the impedance varies from some Ohms to tens of Ohms, the future grid should be considered as some Ohms or lower in the full frequency range from 2 to 150 kHz.

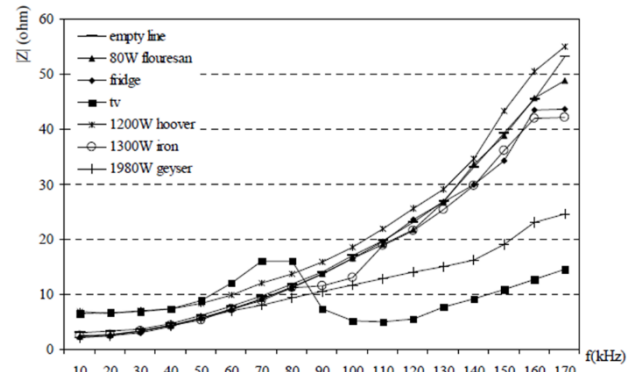

Fig. 6 Measured grid impedance with different loads [6]

The driving source of the power conversion harmonics (internal source of the DUT) can be classified as:

- the ESR (equivalent series resistance) of the internal capacitor
- the current change through a real or parasitic inductance for differential mode currents
- the common mode voltage source for common mode currents

It means that the internal source can be seen as a voltage source. This voltage source can have a high or low internal impedance. Combining this voltage source with a low impedance grid, will give a large current (the lower the impedance, the larger the current), but a low (when the internal impedance is high) or rather constant voltage (when the internal impedance is low) at the terminals of the DUT. It means that the current measurement is highly influenced by the impedance, the voltage measured much less. In practice, the current measurement is used for research, as much more information can be found in the measurement. For compliance measurements, a voltage measurement can be sufficient, if the grid impedance is well defined.

As a conclusion, the impedance, seen by the DUT, is the second main influencer of the measuring accuracy. This impedance is defined by the internal impedance of the power supply and the grid impedance (both series and shunt elements). Both magnitude and nature of the impedance will have a large influence on the measurement results. For compliance testing purposes, the impedance should be chosen as worst-case. For research purposes, the impedance should be representative and stable.

### Measuring Probes

The voltage and/or current are measured in the setup. One of the problems to find the probe, is that a large dynamic range is required. The fundamental waveform (50 Hz) of

the current and voltage may not saturate the measurement, while on the other hand mA and mV values should be measured.

For compliance measurements, an AMN can be used. Different types are described in CISPR16 and EN50065. For research purposes, highly accurate probes are necessary, with sufficient bandwidth.

A discussion on different current probes can be found in [7]. When referring to CISPR16, high frequency current probes with high current capability are rather common. The reason is that due to the setup (the probe encloses both wires) only the common mode current is measured, while the differential mode current compensates itself. For the power conversion harmonics, only one conductor is measured, in order to see both common and differential mode current. This means that the current probe needs a high dynamic range and a large bandwidth. Hall-sensor based current probes from DC to 100 MHz are used. The maximum current for the used probes is 30 A.

A differential voltage probe with a high dynamic range is necessary. Problem is that this is not commercially available. The solution that is used, is based on fig. 7. The capacitors block the fundamental of the supply voltage. The receiving part is galvanic isolated by the high-frequency transformer. The high frequency noise on the live voltage grid can be measured accurately with this probe, without an additional amplifier. The practical probe contains an additional surge protection and damping resistance.

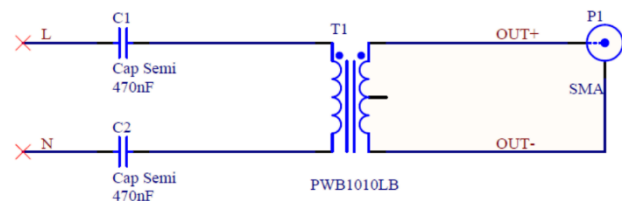

Fig. 7 High frequency differential voltage probe

### DUT Setup

For EMC measurements, according to CISPR22 [8] and similar, the setup of the DUT and the cables have a large influence on the measurement. In the considered frequency range of 2 to 150 kHz, the influence of parasitic paths is much less. In this range, the dominant current mode is the differential mode. As most systems contains cables, the differential mode path is relatively constant and hardly influenced by the position of the cables. The cable length itself should be defined for compliance measurements. Nevertheless, with large systems, the common mode path can regain dominance. At that moment, the setup is important.

Additionally, depending on the type of device, the settling time and typical (dummy) load should be defined.

### Measurement Device

As measurement device, a spectrum analyser, oscilloscope

or DAQ can be used. The largest problem to tackle is the parameters or settings from the measurement device, as the measured switching harmonics are not always stable and influenced by the power supply. It is obvious that the measurement device settings will seriously influence the results of transient harmonics and jittering phenomena. The following explains how the authors chose the averaging method. Take into account that this research focused on continuous signals, to gain knowledge on the influence of the different parameters.

Consider a measurement of  $t = 2$  seconds (Fig. 8), sampled at 1 Ms/s. The sample time is:

$$dt = 1\mu s$$

This measurement is performed at three different moments. The DUT has a stable switching pattern. The measured data is partitioned in  $x$  slices. Each partial dataset is transformed by a Fast Fourier Transform (FFT) and the mean value is calculated.

Due to the slicing, the frequency resolution in the spectrum is:

$$df = \frac{x}{dt \cdot t}$$

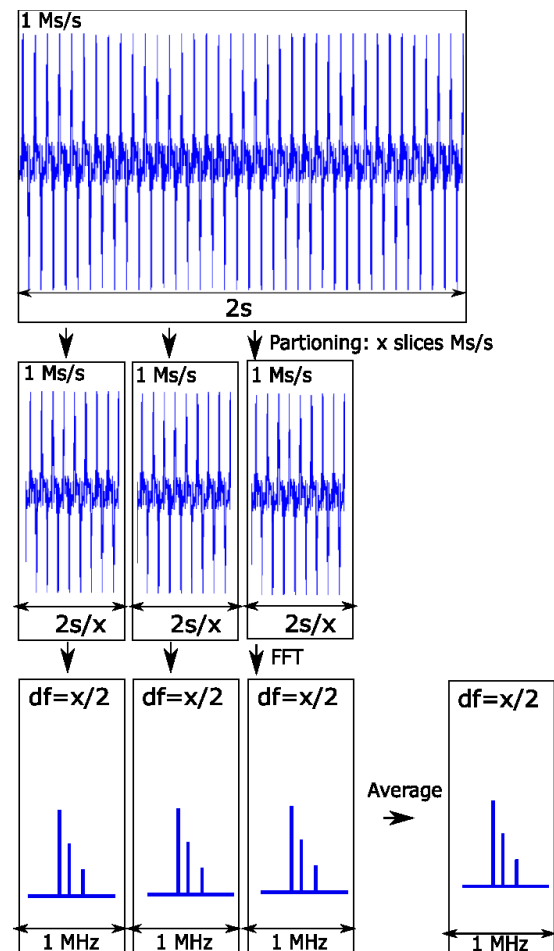

Fig. 8 Partitioning measurement (2s full sample length, 1Ms/s)

Fig. 9 shows the result of three different measurements on the same setup. As can be seen, the measurements are



reaching a similar result, when an average of 4 slices or more is taken. The reason for the bad result when no averaging is done, is due to the frequency resolution. When  $x=1$ , the resolution is 0,5 Hz. When  $x=50$ , the resolution is 25 Hz. Due to the very small frequency bands when  $x=1$ , the smallest jitter in the switching frequency, will have a large influence on the result. For this reason, for the measurements, a sufficiently wide frequency bin should be used.

Other settings that are important are the chosen sample time, the memory depth, the used window.

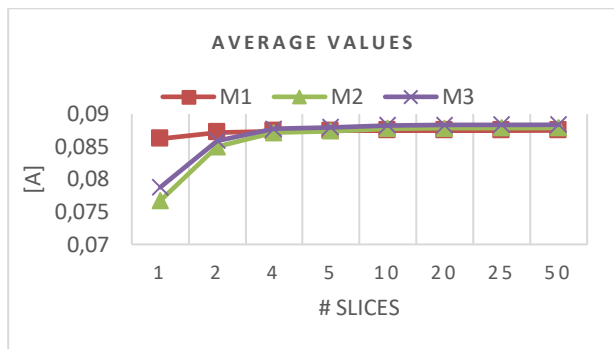

Fig. 9. Influence of partitioning

To conclude, the necessary observation time and the averaging method will be very dependent on the power supply and behaviour of the switching harmonics. For compliance measurements, research is still necessary, as settings can lead to different results.

## CONCLUSION

The engineer or researcher that wants to perform accurate measurements on power conversion harmonics needs to take several parameters into account. The above statements should give the reader an idea of what precautions are necessary for his setup. Depending on the purpose of the measurement (highly accurate measurements for research or compliance measurements for commercial devices) another accuracy range is necessary.

From the research, the following parameters should be taken into account:

The grid voltage has a large influence. For research, the voltage must be clean (both in low frequencies as in high frequencies) and stable. For compliance measurements, the voltage must have a defined frequency harmonic content for the lower frequencies ( $\leq 2$  kHz), which is similar to the grid voltage. The high frequency content ( $> 2$  kHz) should be limited. The RMS value and peak value should be kept constant during the measurements, depending on the behaviour of the device.

Besides the grid voltage, the source and grid impedance will have a very high influence.

Accurate measuring probes are necessary. The settings of the measurement device are rather decisive. For compliance measurements, this should be profoundly

described. The setup of the DUT and cables are of less importance, except for larger systems. The operation mode of the power electronics and the settling time have a large influence on the measurement.

The first measurements were executed on a non-filtered public voltage grid. Besides a full spectrum of non-explainable peaks, the variation on the measured values was more than 100%. With the precautions described in the paper, values down to 0,5 mA up to 150 kHz could be measured.

When comparing to the adjacent frequency areas, the values reached according to IEC61000-3-2 (up to 2 kHz) are typically above 1mA. For CISPR22 (and similar above 150 kHz), an accuracy of 3 dB is considered as a good measurement, meaning 30%.

## Acknowledgments

This research is partially funded by the Flemish Government (Tetra project HFPQ) and by the EU, through the Interreg V 2 Seas Project INCASE ([www.incasetoseas.eu](http://www.incasetoseas.eu)).

## REFERENCES

- [1] J. Meyer et al., 2011, "Power quality challenges in future distribution networks," in *IEEE PES Innovative Smart Grid Technologies Europe Conference*, pp.5.
- [2] EN61000-3-2 Ed.4, "Electromagnetic compatibility (EMC) – Part 3-2: Limits – Limits for harmonic current emissions (equipment input current  $\leq 16$ A per phase)", 2014.
- [3] J. Desmet, G. Vanalme, R. Belmans, "Evaluation, practice and remarks on the IEC 61000-3-2 standard", *EMC Europe*, Sorrento Italy, Sept. 2002
- [4] CISPR 16 -1 Ed. 2.1, "Specification for radio disturbance and immunity measuring apparatus and methods – Part 1: Radio disturbance and immunity measuring apparatus", 2002.
- [5] EN50065-1, "Signalling on low-voltage electrical installations in the frequency range 3kHz to 148,5kHz – Part 1: General requirements, frequency bands and electromagnetic disturbances", 2011.
- [6] E. Karadeniz, I.H. Cavdar, "Measurements of impedance and attenuation at CENELEC bands for power line communications systems", *Sensors*, pp. 8027-8036, Dec. 2008.
- [7] P. Verzele, J. Knockaert, J. Desmet 2013, "Appropriate methods to analyse power conversion harmonics", *International Conference on Renewable Energies and Power Quality (ICREPO 13)*, Renewable Energy and Power Quality Journal, no. 11, 6 p.
- [8] CISPR 22 Ed. 6, "Information technology equipment – Radio disturbance characteristics – Limits and methods of measurement", 2008.