

# **Selective improvement of rainbow trout: assessment of potential in UK strains.**

**Thesis submitted for the degree of  
Doctor in Philosophy**



by

**Jose Pedro Ureta Schmidt**

**Institute of Aquaculture  
University of Stirling, Stirling, Scotland  
January 2009**

## Declaration

I hereby declare that this thesis was composed by myself and is the result of my own investigations. It has neither been accepted nor submitted for any other degree. All sources of information have been duly acknowledged.



Signature of Candidate

---



Signature of Supervisor

---

Signature of Supervisor

---

Date

23/05/2009

## **Acknowledgments**

My main recognition is to my principal supervisor, Professor Brendan McAndrew, for giving me the opportunity to participate in his project “Selective improvement of the rainbow trout in the United Kingdom”, whilst also giving me his kind help, overall guidance, and economic support.

I am very grateful to Professor John Woolliams, for his Quantitative Genetic contribution in the present project, for his kind help, guidance, and economic support.

I am especially grateful to Doctor John Taggart, for his dedication when teaching me Biotechnology, and also for his guidance in Genetic Diversity.

I am grateful also to Ann Gilmour, Stephen Powell and Anu Frank-Lawale for their help in laboratory, and field work.

It is impossible for me to remember the name of all the people that helped me during the field work, for this reason I am giving the name of the companies where they were working. For their kind help in artificial reproduction I am grateful to Glenwyllin trout farm Isle of Man, Houghton Spring, and Trafalgar Fisheries. For their kind help in general management of the trout to Test Valley Trout. For their kind help in harvest and processing to Skretting UK.

Finally I would like to say thank you, for their company and friendship to Janina Costa, Astrid Holzer, Matteo Minghetti, Carlos Yañes, Jorge Fonseca, Adrian Hartley, Adriana Garcia, Carlos Martinez, Vasileios Karalazar, Antonio Campos, Marine Herlin, Martin van Brakel, Catherine Lecouffe, Craig MacIntyre, Una McCarthy, Charles McGurk, Jack Morales, Ben North, Matthew Sprague, John Taylor, Nick Taylor, and Pierre Buray. Sorry if I forgot to mention someone.

## Abstract

The research assessed the potential of developing a selective breeding programme for the UK rainbow trout industry. Levels of genetic variation at 12 microsatellite loci were first compared in seven different commercial strains. The Observed heterozygosity ranged from  $H_o = 48.1\%$  in a gold rainbow trout strain (GTR) to  $H_o = 66.4\%$  in a newly derived broodstock population constructed from a number of different sources (GIT). The Expected Heterozygosity ( $H_e$ ) was highest in GIM1 ( $H_e = 79.5\%$ ) and lowest in the GTR strain ( $H_e = 56.9\%$ ). The Effective number of alleles ( $M_{ae}$ ) showed that the GIM1, GIM2, GIM3, and GIT strain (5.4; 5.2; 4.8; 4.2) were significantly more variable than the other strains and that GTR strain had the lowest value (2.5). There appears to be substantial genetic variability within the commercial United Kingdom rainbow trout strains surveyed in this study. This appears to be the case despite very different management histories and levels of record keeping. The strains appear to be genetically distinct (based on population genetic analyses), though the reasons for this remain unclear (and possibly unanswerable given the poor records kept by the different companies).

The Glenwyllin farm strains (GIM) were chosen to form the base population for the project because of their high genetic variability, disease free status and because the farm produced around 20 million ova per year, so any genetic gains would have a widespread impact. The farm has an early (Strain A) and a late spawning (Strain B) and these were mated in a partial factorial design, 20 females and 20 neomales per strain (A & B) were chosen on the basis of maturity and gamete quality in November 2002 so that each male was crossed to 4 females (2 in the same strain and 2 in the other), a total of 160 families were created. All broodstock were biopsied to enable them to be genotyped. The families were reared separately up to the eyed stage at which point the eggs from each family were divided into three to generate three communal replicate populations. One of these was sent to a fingerling producer (Iwerne Spring) for on-growing to fingerling size and formed the basis of a commercial production trial at Test Valley Trout farm (TVT) in Hampshire.

When the fish reached an average weight of 5 g they were transferred from Iwerne Spring to TVT and 1500 were randomly selected, PIT tagged and biopsied to enable them to be assigned to their family using 11 multiplexed microsatellite loci. Parental assignment was based on exclusion (FAP) but the results were compared with another parental assignment based on likelihood (PAPA). Of the 1500 offspring (OIM) PIT tagged 1242 82.8% could be assigned to a single family utilizing different combinations of more than 6 loci (6 to 11).

The growth of the 1500 OIM fish was tracked throughout the grow out period before they were finally harvested and fully processed. The results of OIM strain at the end of the trial period were mean weight of 415.5 g, and a mean length of 314.5 mm. The visual measurement of colour gave a mean flesh colour values of 26.01 on the 20-34 scale (SalmoFan™), and 11.0 with the colorimetry evaluation of colour ( $a^*$ ). The heritability results for the OIM strain were  $43 \pm 9\%$  for weight,  $42 \pm 9\%$  for gutted, and  $28 \pm 8\%$  for length. The heritability estimates for the visual colour variables were  $19 \pm 7\%$  and when using the colorimeter, the red chromaticity ( $a^*$ ) heritability was  $14 \pm 6\%$ . Therefore, the heritability results of the OIM strain indicate that there are opportunities of substantial and rapid improvement of the growth rate and flesh colour

traits. Also no line effects were observed or indications of non-additive genetic variation. In contrast to these last results, the overall survival of the GIM strain from the time of the physical tagging with PIT until harvest was 52.8%, and survival heritability was extremely low,  $3 \pm 2\%$ , hardly significant.

### Abbreviation list

AFI	Line A, Female, Glenwyllin Isle of Man, Base Population
AFLP	Amplified Fragment Length Polymorphism
AFT	Line A, Female, Trafalgar
AMT	Allele Mismatch Tolerance
ANI	Line A, Neomale, Glenwyllin Isle of Man, Base Population
ANT	Line A, Neomale, Trafalgar
AST	Allele Size Tolerance
ATU	Accumulated Thermal Units
BFI	Line B, Female, Glenwyllin Isle of Man, Base Population
BFT	Line B, Female, Trafalgar
BLUP	Best Linear Unbiased Prediction
BNI	Line B, Neomale, Glenwyllin Isle of Man, Base Population
BNT	Line B, Neomale, Trafalgar
BTA	British Trout Association
BTFRA	British Trout Farmers and Restockers Association
CFA	Cat Fanciers' Association
CI	Confidence Interval
CIE	International Commission on Illumination
DC	District of Columbia
Defra	Department for Environment, Food and Rural Affairs
DNA	Deoxyribonucleic acid
dNTP	Nucleotide Triphosphates
EBV	Estimated Breeding Values
EDTA	Ethylendiaminetetra Acetic Acid

EUROSTAT	Statistical Office of the European Communities
FAN	Salmofan colour cabinet
FAO	Food and Agriculture Organization of the United Nations
FAP	Family Analysis Program
FAs	Fatty Acids
FEAP	Federation of European Aquaculture Producers
FF	Fish Flour
FHS	Female, Houghton Spring
FO	Fish Oil
FSAP	Federation of Scottish Aquaculture Production
FTE	Full Time Equivalency
GIM1	Glenwyllin 1, Isle of Man, Founding Population
GIM2	Glenwyllin 2, Isle of Man, Founding Population
GIM3	Glenwyllin 3, Isle of Man, Founding Population
GIT	Glenwyllin Trafalgar
GTR	Golden Trout Trafalgar, Wiltshire
H7S	Seven Spring Hatchery, Larne, North Ireland
Ho	Observed Heterozygosity
HS	Houghton Springs
HWE	Hardy-Weinberg Equilibrium
ICES	International Council for the Exploration of the Sea
IFFO	International Fishmeal and Fish Oil Organisation
ILO	International Labour Organization
IOM	Isle of Man
IPN	Infectious Pancreatic Necrosis

ISA	Infectious Salmon Anaemia
KCl	Potassium Chloride
MAS	Marker Assisted Selection
MgCl <sub>2</sub>	Magnesium Chloride
MP1	Multiplex 1
MP2	Multiplex 2
MSC	Marine Stewardship Council
MT	Metric Tonnes
mtDNA	mitochondrial DNA
nDNA	nuclear DNA
NHS	Neomale, Houghton Spring
OHS	Offspring Houghton Spring
OIM	Offspring Glenwyllin Isle of Man, First Generation (F1)
PAPA	Package for the Analysis of Parental Allocation
PBV	Predicted Breeding Values
PCR	Polymerase Chain Reaction
PHS	Parent Houghton Springs
PIT	Passive Integrated Transponders
PKD	Proliferative Kidney Disease
PTR	PIT Tag Reader
QTL	Quantitative Trait Loci
R&D	Research and Development
RAPD	Random Amplification of Polymorphic DNAs
REML	Restriction maximum likelihood
RFLP	Restriction Fragment Length Polymorphisms



RNA	Ribonucleic acid
RNAase	Ribonucleic Acid polymerase
SARF	Scottish Aquaculture Research Forum
SCAR	Sequence Characterized Amplified Regions
SNP	Single Nucleotide Polymorphisms
SSR	Single Sequence Repeat
STR	Simple Tandem Repeats
TDT	Transmission Disequilibrium Test
TE	Tris EDTA
TRT	Trafalgar Rainbow Trout, Wiltshire
TVT	Test Valley Trout
UK	United Kingdom
UPGMA	Unweighted Pair Group Method using Arithmetic Average
US	United States
VNTRs	Variable Number Tandem Repeats
WTO	World Trade Organization
WWF US	World Wildlife Fund United State

## Table of contents

Acknowledgments	
Abstract	
Abbreviation list	
Chapter 1 GENERAL INTRODUCTION .....	22
1.1. Rainbow trout.....	22
1.1.1 History of culture: the development of rainbow trout hatcheries .....	23
1.1.2 Present distribution and adaptability.....	24
1.1.3 What is a strain?.....	24
1.1.4 Domestication: Identified strain differences .....	27
1.2. Rainbow trout as a farm resource in the United Kingdom .....	28
1.2.1 Role and Function of British Trout Association (BTA) .....	28
1.2.2 Socio Economic Model of the UK Trout Industry.....	29
1.3. Quantitative Genetics.....	33
1.3.1 Inheritance of economic interest traits in animal production are explained by quantitative genetics theory .....	33
1.3.2 Main systems of improvement for animal production.....	39
1.3.3 Managing an improvement program.....	43
1.3.4 Organization systems that have been used in this kind of programs .....	50
1.3.5 Information management.....	52
1.3.6 Rationale that must be used before initiating a genetic improvement program.....	55
1.3.7 Statistical data of global fish farming production justify increased future development of fish breeding programs .....	56
1.3.8 Comparison of genetic improvement of different salmonid and rationale for a program with rainbow trout .....	57

1.4. Molecular Genetics .....	59
1.4.1 Molecular markers based on probe hybridization.....	62
1.4.2 Molecular markers based on Polymerase Chain Reaction (PCR) technology .....	64
1.4.3 Molecular markers based on DNA chips .....	71
1.4.4 Comparing different types of genetic markers.....	73
1.4.5 Application of genetic markers in aquaculture .....	74
1.5. Aim of the project .....	83
1.5.1 Main objective .....	83
1.5.2 Specific objectives .....	83
Chapter 2 GENERAL MATERIALS AND METHODS .....	84
2.1. Fish breeding general procedure .....	90
2.1.1 Fish strains and mating design.....	91
2.1.2 Measurement data collection .....	98
2.2. Sample collection: Tissue sampling, preservation, and PIT tagging procedure .....	100
2.2.1 Different Strain Tissue Sample Collection and Preservation .....	100
2.2.2 Broodstock tissue sampling, preservation and PIT tagging.....	101
2.2.3 Preparation for fingerling PIT tagging and tissue sampling in the laboratory .....	102
2.2.4 PIT tagging and fin clipping in the field.....	103
2.3. DNA extraction from the different Rainbow trout samples.....	104
2.3.1 Phenol-chloroform DNA extraction .....	104
2.3.2 Chelex DNA extraction.....	106
2.4. PCR techniques .....	109

2.4.1 Reactions and sequencer availability .....	109
2.4.2 Multiplex reactions .....	109
2.4.3 PCR program .....	112
2.4.4 PCR product results analysis .....	113
2.5. Assigning paternity to the offspring from the different crosses .....	116
2.5.1 How does Family Assignment Program (FAP) work? .....	116
2.5.2 How can we utilize the Package for the Analysis of Parental Allocation (PAPA) software? .....	119
Chapter 3 GENETIC VARIATION BETWEEN AND WITHIN SOME SELECTED RAINBOW TROUT STRAINS CULTIVATED IN THE UK .....	121
3.1. Introduction.....	121
3.2. Materials and methods .....	124
3.2.1 Fish samples collection .....	124
3.2.2 Statistical analysis .....	126
3.3. Results.....	128
3.3.1 Comparison of basic genetic variability measures.....	133
3.3.2 Genetic differentiation among strains .....	136
3.4. Discussion .....	138
3.4.1 Genetic variation within the different UK strains.....	138
3.4.2 Genetic variation among the different UK strains .....	141
3.4.3 General Comments on Genetic Variability in Rainbow Trout Hatchery Stocks.....	142
3.5 Conclusions.....	145
Chapter 4 PARENTAL ASSIGNMENT IN RAINBOW TROUT.....	146
4.1. Introduction.....	146

4.2. Materials and methods .....	149
4.2.1 Fish samples collection .....	149
4.2.2 Parental analysis.....	151
4.3. Results.....	155
4.3.1 Glenwyllin strain parental genotyping.....	155
4.3.2 Glenwyllin offspring genotyping.....	157
4.3.3 Parental assignment of offspring using different combinations and numbers of loci. ....	161
4.3.4 Comparison of the offspring that have multiple family assignments with the different methodologies .....	164
4.4. Discussion .....	166
Chapter 5 PHENOTYPIC AND GENETIC PARAMETERS.....	174
5.1. Introduction.....	174
5.1.1 Traits to be studied in the present project .....	176
5.2. Materials and methods .....	179
5.2.1 Fish samples: PIT tagging, tissue collection and preservation .....	180
5.2.2 IOM crossing design .....	180
5.2.3 Communal rearing .....	182
5.2.4 Harvest and processing plant .....	182
5.2.5 Statistical analysis .....	188
5.3. Results.....	193
5.3.1 OHS and OIM phenotypic parameters.....	193
5.3.2 Glenwyllin Isle of Man strain quantitative genetics .....	201
5.4. Discussion .....	209
5.4.1 Glenwyllin Isle of Man and Houghton Spring- growth traits .....	209

5.4.2 Glenwyllin Isle of Man strain growth traits genetic parameters.....	212
5.4.3 Glenwyllin Isle of Man strain flesh colour phenotype.....	214
5.4.4 Glenwyllin Isle of Man strain flesh colour genetic parameter.....	216
5.4.5 Glenwyllin Isle of Man strain survival phenotype and genetic parameter	219
5.4.6 Additive, heterosis, and maternal effects between the IOM strain lines A and B .....	222
Chapter 6 GENERAL DISCUSSION.....	224
6.1. Genetic variation between and within some selected rainbow trout strains cultivated in the UK. ....	224
6.2. Parentage assignment.....	227
6.2.1 Identification system of the individuals versus breeding method in the farm .....	229
6.3. Phenotype and quantitative genetics.....	230
6.4. Finding QTLs.....	233
6.4.1 Anonymous molecular markers .....	234
6.4.2 Work that has been done to find markers associated with resistance to diseases and flesh colour.....	235
6.5. Marker Assisted Selection (MAS).....	241
6.5.1 Limitations to the application of genetic and reproductive technologies in genetic improvement programs.....	242
6.6. Considerations of a dialogue with the salmon aquaculture industry .....	244
6.6.1 Sustainability of reduction fisheries and criteria used: What can we expect for aquaculture food product? .....	250

Reference List

## List of Tables

Table 1-1. Top 10 rainbow trout producer countries in Europe, production and value during 2003 .....	32
Table 1-2. Estimate of age heritability until sexual maturity based on half siblings family data. ....	38
Table 1-3 Calculation of different Ne index according to different proportions of males and females .....	48
Table 1-4. Response to selection for faster growth rate in different salmon and trout species taken from recent publications .....	58
Table 1-5 Advantages and disadvantages of protein and DNA variants as genetic markers (after Ferguson et al. (1995)).....	61
Table 1-6 Comparison of certain distinctive features of genetic markers (Diaz 2005)	73
Table 2-1 Measurement of Base Population weight and length .....	84
Table 2-2 Weight and length recording time from OHS and OIM trout since the stripping time. ....	88
Table 2-3 Neomales that produced less than the planed 8 families in breeding design .....	95
Table 2-4 Description of the quantity of sires, dams, and families utilized in the crossing design and the relation that were created.....	96
Table 2-5 Advantages / disadvantages of the two DNA extraction methods .....	108
Table 2-6 List of MP1 forward & reverse concentrations for a single PCR reaction and their sequence.....	110
Table 2-7 List of MP2 forward & reverse concentrations for a single PCR reaction and their sequence.....	111
Table 2-8 PCR program for the MP1 reaction.....	112
Table 2-9 PCR program for the MP2 reaction.....	113

Table 3-1 Code name description, number of samples, and date of collection for the 7 different commercial strains in UK.....	124
Table 3-2 Allelic variability at 12 loci in the first survey rainbow trout strains.....	129
Table 3-3 Exact P-value for Hardy Weinberg Equilibrium (HWE) estimation for the 7 different rainbow trout samples .....	134
Table 3-4 Differentiation probability using allele (above diagonal) and genotype (below diagonal) frequency by Fisher’s methodology .....	136
Table 3-5 Locus comparison between Fishback et al. (1999) strain and the seven strain from the first survey in the present study.....	140
Table 4-1 Code name description, number of samples, and date of collection for the 4 different groups of Glenwyllin IOM Base Population and Offspring First Generation .....	151
Table 4-2 Allele sizes and NA observed in 11 loci for the different Glenwyllin IOM parental groups.....	156
Table 4-3 Mean number of alleles, expected and observed heterozygosity over all different groups of parents. ....	156
Table 4-4 Simulation results over different combinations of loci and two uniform errors indicating in each case the mean allocating results and the mean correctness for each combinatory group.....	159
Table 4-5 Parental analysis of all 1500 offspring utilizing FAP software, first using the dataset allowing 0 mismatches and then the same dataset allowing 10 mismatches .....	160
Table 4-6 Comparison of parental assignment results using FAP software with the 1242 offspring with a single family between a database without correction and another one with correction .....	161



Table 4-7 Comparison of the results of parental assignment using PAPA software with the 1242 offspring previously selected between the dataset without correction and with correction. ....	162
Table 4-8 Comparison of the results of parental assignment between FAP and PAPA with the 1242 offspring previously selected using the dataset with correction. ....	163
Table 4-9 Comparison of the results of parental assignment between the 22 offspring with multiple families using FAP software with the results obtained using PAPA software.....	164
Table 4-10 Comparison of the results of parental assignment between the 93 offspring with multiple families using FAP software with the results obtained using PAPA software.....	165
Table 5-1 Code name description, number of samples, and date of collection for the 4 different groups of Glenwyllin IOM Base Population and Offspring First Generation .....	180
Table 5-2 Weight and length recording times post fertilisation of the OHS and OIM trout.....	184
Table 5-3 Index as described by Falconer. ....	190
Table 5-4 Weight comparisons over the different measurement times for the Offspring Houghton Spring (OHS) and Offspring Isle of Man (OIM) strains.....	197
Table 5-5 Length comparisons over the different measurement times for the Offspring Houghton Spring (OHS) and Offspring Isle of Man (OIM) strains.....	200
Table 5-6 Offspring Glenwyllin IOM weight, gutted weight, and length descriptive statistics.....	201
Table 5-7 Sire, dam and combined growth traits heritabilities for Glenwyllin IOM strain.....	202

Table 5-8 Traits predictions values between the four different days of work at the processing plant .....	202
Table 5-9 Traits predictions values between the pure bred (AxA & BxB) and hybrid crosses (AxB & BxA) .....	203
Table 5-10 Top 20 highest and lowest family values (mean) for the variables weight and length.....	204
Table 5-11 Offspring Glenwyllin IOM Roche and Chroma meter (L*,a*,b*,C*,and h*) descriptive statistics .....	205
Table 5-12 Sire, dam and combined flesh colour heritability for the Glenwyllin IOM strain, estimated using the Roche Salmofan™ and Minolta Chroma Meter (L, a, & b) methodologies .....	205
Table 5-13 Trait predictions values between the different days in the processing plant using the Roche Salmofan™ and Minolta Chroma Meter (L, a, & b) methodologies .....	206
Table 5-14 Trait prediction values between pure bred (AxA & BxB) and hybrid crosses (AxB & BxA) using the Roche Salmofan™ and Minolta Chroma Meter (L, a, & b) methodologies.....	206
Table 5-15 Top 20 highest and lowest individual values for the variables Roche and a* .....	207
Table 5-16 Sire, dam, and combined survival heritability for the Glenwyllin IOM strain.....	208
Table 5-17 Prediction of survival between pure bred (AxA & BxB) and hybrid crosses (AxB & BxA).....	208
Table 5-18 Published rainbow trout body weight heritability over the last decades.	213

## List of Figures

Figure 1-1. World rainbow trout production and relation value / production during the period 1993 – 2004 (Source Fishstat Plus). .....	33
Figure 2-1 Design of the breeding programme and the relationships between the hatcheries, fingerling producers and growers .....	86
Figure 2-2 Distribution of the work at the processing plant: <b>a.</b> - Recording data in the laptop. <b>b.</b> - Measure weight, length and identification through PIT tags (PTR = Pit Tag Reader) <b>c &amp; e.</b> - Filleting the trout. <b>d.</b> - Flesh colour Chroma meter. <b>f.</b> - Flesh colour Roche Fan (both lines). .....	89
Figure 2-3 Information layout and people (a, b, d and f) involved in collecting data on the fish.....	90
Figure 2-4 Isle of Man (IOM) breeding design indicating the pure bred crosses with the yellow & white colours (AFI x ANI & BFI x BNI) and the hybrid crosses with the pink & orange colours (AFI x BNI & BFI x ANI). The grey squares means allowed crosses. ....	94
Figure 2-5 Houghton Spring cross design indicating in grey colour the allowed crosses and in white the not allowed crosses. ....	97
Figure 2-6 Detail of the PIT tagging procedure after the female was striped.....	102
Figure 2-7 Work distribution at TVT fish farm during PIT tagging time: a) Fish handler b), c), & d) PIT taggers e) Data imputer. ....	103
Figure 2-8 Example output for assignment with allele mismatch tolerance set at two .....	118
Figure 3-1 Rainbow trout sampling collections sites around the United Kingdom...	126
Figure 3-2 Mean Observed Heterozygosity (Ho) and Mean Expected Heterozygosity (He) comparison, Bars represent standard error. ....	133

Figure 3-3 Mean number of alleles per loci ( $M_{na}$ ) and Mean effective number of alleles per loci ( $M_{ae}$ ) comparison. Bars represent the Standard Error.....	135
Figure 3-4 <b>A</b> UPGMA dendrogram based on Nei's genetic distance <b>B</b> UPGMA dendrogram based on Cavalli-Sforza's chord distance. <b>C</b> UPGMA dendrogram based on Reynold's genetic distance .....	137
Figure 4-1 Detail of the performance of the offspring Glenwyllin IOM genotype procedure. Offspring with 6 or more loci successfully genotyped are shown (n = 1490). .....	157
Figure 4-2 Detail of the total offspring genotype performance. The total number of missing genotypes is presented for every locus for the whole population (n = 1500). .....	158
Figure 4-3 Allocation efficiency according to PAPA software utilizing different values of correctness .....	166
Figure 5-1 Distribution of the work at the processing plant: <b>a.</b> - Recording data in the laptop. <b>b.</b> - Measure weight, length and identification through PIT tags (PTR = Pit Tag Reader) <b>c &amp; e.</b> - Filleting the trout. <b>d.</b> - Flesh colour Chroma meter. <b>f.</b> - Flesh colour Roche Fan (both lines).....	184
Figure 5-2 Information layout and people (a, b, d and f) involved in collecting data on the fish.....	185
Figure 5-3 CIELab plane representing the 3 dimensions that explain colour estimation in the Chroma meter.....	187
Figure 5-4 Colour cabinet (above) where the Roche Salmofan™ colour assessment chart (below) was placed in order to estimate the colour of the flesh in the rainbow trout.....	188

Figure 5-5 Exponential correlation comparison of weight versus length for the Offspring Houghton Spring and Offspring Isle of Man strains at the initial measurement time (PIT tagging) ..... 193

Figure 5-6 Exponential correlation comparison between weight and length for the Offspring Houghton Spring and Offspring Isle of Man strains at the intermediate measurement time ..... 194

Figure 5-7 Exponential correlation comparison of weight versus length for the Offspring Houghton Spring and Offspring Isle of Man strains at harvest..... 195

Figure 5-8 Quadratic regression comparison of weight versus time for the Offspring Houghton Spring (OHS) and Offspring Isle of Man (OIM) strains over the whole trial. .... 196

Figure 5-9 Growth rate over time comparison between the Offspring Isle of Man (OIM) and Offspring Houghton Spring (OHS) strains. .... 198

Figure 5-10 Quadratic regression comparison of length versus time for the Offspring Houghton Spring and Offspring Isle of Man (Glenwyllin) strains over the trial at Test Valley Trout ..... 199

Figure 5-11 Growth rate over time comparison for the Offspring Isle of Man (OIM) and Offspring Houghton Spring (OHS) strains. .... 200

## Chapter 1 GENERAL INTRODUCTION

### 1.1. Rainbow trout

Since naturalists became interested in the rainbow trout, the taxonomic classification of this fish has been an area of confusion. At one time or another there have been more than 30 supposed species described due to the large amount of phenotypic variation observed in natural populations. In 1988, the American Fisheries Society Names of Fishes Committee adopted the use of the generic name of *Oncorhynchus* for all Pacific trout and salmon to distinguish them from the Atlantic trout and salmon, *Salmo*. So the name was changed from *Salmo gairdneri* to the now internationally accepted *Oncorhynchus mykiss*, therefore the name *Oncorhynchus mykiss* is now used to refer to the rainbow trout, in all its forms (Gold, 1977; Smith and Stearly, 1989; Gall and Crandell, 1992; Hershberger, 1992).

The rainbow trout is originally from the coastal drainage of North America from Alaska to Mexico, and lakes and streams west of the continental divide in North America (Behnke, 1979). It has been proposed that the rainbow trout natural populations included two major genetic subdivisions, those inhabiting coastal water systems and those inhabiting inland water systems. Genetic variability analyses carried out with allozyme markers indicated that the majority (92%) of the variability was expressed within populations and the remainder (8%) accounted for by the genetic separation between inland and coastal forms (Utter and Allendorf, 1977; Allendorf and Utter, 1979; Allendorf and Phelps, 1981).

### **1.1.1 History of culture: the development of rainbow trout hatcheries**

The history, recorded by Wales (1939) and others, start with Mr. J.B. Campbell who settled near the McCloud River in about 1855. Mr. Campbell and other settlers shared the land with the Wyntoon tribe, aboriginal California people who got along well with the new residents.

At that time, the US commissioner of Fish and Fisheries in Washington, DC sent Mr. Livingston Stone to California. The main objective of Mr. Stone's work was to find where the Pacific salmon bred, to create a hatchery, and then to ship out eggs to different places around the US and to other countries. When Mr. Stone arrived in California and was told that the Wyntoon had been catching ripe fish in a specific place on the McCloud River. Then the history tells that near the end of 1872 he managed to ship out about 30,000 Chinook eggs.

Mr. Campbell used to live just some kilometres upriver from where Mr. Stone sent the first salmon eggs. According to historical records, it seems that Mr. Campbell was the first person that managed to ship rainbow trout eggs out of its native range, specifically to Caledonia, New York.

After Mr. Stone managed his objective with the Chinook salmon he received an order to develop a Station for rainbow trout, and then in 1879 the McCloud River Trout Ponds became the centre for rainbow trout collection and distribution, until 1888 when the ponds closed.

The small quantity of eggs produced at the ponds supports the idea that many of the eggs shipped around the world, although descendants of McCloud River fish, were produced at other hatcheries such as the Federal hatcheries located at Wytheville, Virginia and Northville, Michigan (Gall and Crandell, 1992).

### **1.1.2 Present distribution and adaptability**

MacCrimmon (1971), who reviewed the world distribution of rainbow trout in their native and present-day range, reported that the native range consisted of the western coastal drainages of North America, including Alaska, British Columbia, Washington, Oregon, Idaho, California and Mexico. Between 1874 and 1955, fish and eggs were shipped from this region to every coterminous state in the United States, except Florida; every province in Canada, except Northwest Territories; and to many countries throughout the world. Thus, it can be said that nowadays populations of this species can be found in waters on almost all continents.

Thus, it could be said that the rainbow trout is highly adaptable to new aquatic environments like hatcheries (Gall and Crandell, 1992; Hershberger, 1992). It is not fully understood what fraction of this adaptive potential is due to genetic factors. However, the maintenance of relatively high levels of genetic variability within introduced populations that have undergone several generations of fairly strong selection suggests that intrapopulation genetic variability is a very important factor (Busack et al., 1979; Guyomard, 1981; Thompson, 1985; Hershberger, 1992).

### **1.1.3 What is a strain?**

In order to be able to talk about strain, a key concept used in this Thesis, it will be necessary first to define strain and also genetic line. Woolliams & Toro (2007) in a recently published book discussed: What is a strain? Some of their selected definitions were:



- (i) Animals that, through selection and breeding, have come to resemble one another and pass those traits uniformly to their offspring.
- (ii) A breed is a group of domestic cats (subspecies *Felis catus*) that the governing body of CFA has agreed to recognize as such. A breed must have distinguishing features that set it apart from all other breeds.
- (iii) A race or variety of men or other animals, perpetuating its special or distinctive characteristics by inheritance.
- (iv) Race, stock; strain; a line of descendants perpetuating particular hereditary qualities.
- (v) Either a sub-specific group of domestic livestock with definable and identifiable external characteristics that enable it to be separated by visual appraisal from other similarly defined groups within the same species, or a group for which geographical and/or cultural separation from phenotypically separate groups has led to acceptance of its separate identity.
- (vi) A breed is a group of domestic animals, termed such by common consent of the breeders, a term which arose among breeders of livestock, created one might say, for their own use, and no one is warranted in assigning to this word a scientific definition and in calling the breeders wrong when they deviate from the formulated definition. It is their word and the breeders' common usage is what we must accept as the correct definition.
- (vii) A breed is a breed if enough people say it is.

Continuing definition (v), FAO argue that breed is very often a cultural term and should be respected as such, a perspective clearly articulated in definition (vi), and

succinctly summarised in (vii). This is acknowledged, but if the nature and use of diversity is being explored, the concept of resemblance through common hereditary descent is a useful addition to the definition of a breed (Woolliams, pers. com).

According to Magofke (2007, pers. com.), strains are subpopulations that belong to the same species that have been differentiated as a consequence of sampling effect and the inbreeding caused by genetic drift and which populations have been adapted to specific environmental conditions because of natural selection. In the domesticated species the participation of humans through artificial selection and inbreeding has made it possible to fix traits that are influenced by a few genes as well as to increase differences in productive trait and the behaviour. The genetic lines are subpopulations of individuals belonging to the same strain that have been differentiated by the isolation and for the selection criteria used artificially or in a natural way.

Kincaid (1980) writing about fish concepts, defined strain as a fish population that exhibits reproducible physiological, morphological or cultural performance characteristics that is significantly different from other fish populations of the same species or a broodstock derived from such a population and maintained thereafter as a pure breeding population. Differences in population characteristics may result from either evolutionary processes (effects of mutation, migration, natural selection, and random drift) or artificial selection by man. Strains are recognized as different after the total gene pool of two populations has changed enough to produce performance differences that are significant and reproducible. The specific time period required to produce new strains would vary widely, from two to several hundred generations, depending on the evolutionary or selection pressures involved.

#### **1.1.4 Domestication: Identified strain differences**

Kincaid (1980) defines a domestic broodstock as a population of fish maintained by man in a hatchery environment (tank, raceways, or ponds) for at least two generations. The record of egg shipment is incomplete, but available records show that the McCloud strain (derived from the McCloud River in northern California) was distributed throughout the United State between 1874 and 1900 and is undoubtedly an ancestor to many present-day broodstocks. Starting in 1895, steelhead, McCloud, and other rainbow trout were transferred between hatcheries and planted together in the same waters from 1874 to present; the specific identities of the original strains have generally been lost (MacCrimmon, 1971; Dollar and Katz, 1964).

Kincaid (1980) also said “Matching the fish type to a specific environment or management use has been a problem faced by fishery managers for many years. Field biologists, hatchery workers, and fishermen have long observed that one strain outperforms another under certain conditions”. The US Fish and Wildlife Service, recognizing the broad application of strain selection to fishery management, initiated a programme in 1974 to characterize rainbow trout populations at the Fish Genetics Laboratory, Beulah, Wyoming. Each strain was evaluated for a wide variety of cultural and non-cultural traits. The primary objective of this program was to develop information on strain characteristics for use by fishery resource managers as an aid in choosing specific strains best adapted to particular management situations.

The results of this evaluation suggested that fishery managers can enhance overall production by matching fish strains to rearing environments and management objectives. They said that “in the future, individual hatcheries may need to rear

several different strains for stocking in specific waters. As additional information on strains of rainbow trout and other species become available, strain selection can be widely practiced as management tool” (Kincaid, 1980).

## **1.2. Rainbow trout as a farm resource in the United Kingdom**

### **1.2.1 Role and Function of British Trout Association (BTA)**

Nick Read (2006), Chairman of the BTA, reviewed the role and function of BTA. He said that BTA represents 80% of the UK trout production. It liaises with European Union and United Kingdom legislative & regulatory bodies, co-ordinates and funds Research & Development, manages the Quality Trout UK quality assurance scheme and handles issues management. It is also a member of FSAP, FEAP and administers the British Trout Farmers and Restockers Association (BTFRA). Funds for the BTA are raised from fish food manufacturers, members’ levy and subscriptions, and through Quality Trout UK. The BTA recognizes the challenges of the future and undertakes to:

- Work with regulators to ensure the industry is represented in decision making while promoting and safeguarding the industry.
- Meet the current and future production challenges, including a selective breeding programme and cryopreservation of trout milt.
- Improve fish health and welfare
- Develop best practice

The BTA supported the scientific rationale and the funding of this project by DEFRA and establishing and encouraging the links between the farms and the

project. The outputs of the project were regularly presented at the annual BTA meeting held at Sparsholt College.

### **1.2.2 Socio Economic Model of the UK Trout Industry**

According to Nautilus Consultants the core trout farming industry can be divided into three sectors (Winnard, 2003).

#### **Core industry**

1. Hatchery producing ova / fry / fingerling. The whole British rainbow trout industry needs approximately 100 million eggs per year. Ova imported from outside mainland Britain meet most of the requirements. The ova come mainly from the Isle of Man, Denmark, South Africa and Northern Ireland. Several of the ova / fry / fingerling producers keep some or all production for their own use. Around half of the fingerling demand is met through sales between farms and the rest is met by the farms own production. The sales of ova / fry / fingerling contribute only 5% of the total farm income. Other activities such as table and restocking are more important source of income.
2. Table trout producer. The table trout production is approximately 14,000 tonnes. This is the most important sector for the largest farms; those producing more than 200 tonnes per year and represent over 88% of the total income. The most important way of selling the majority is from farmer to processors, and then the processors supply the supermarkets.

3. Restocking trout producers. The restocking production is approximately 2,000 tonnes. These farms are generally smaller than table farms but can obtain up to twice the farm gate price of table fish. Sales are more localised and product volumes lower. Production of restocking trout is most important for small farms producing less than 50 tonnes trout per year, representing over 70% of the total income. Several of these farms producing trout have their own recreational fisheries, income from which is also important.

#### **Wider industry: upstream and downstream industry**

The upstream industries support the core trout farming industry by supplying goods and services, including feed manufacture, research and development and pharmaceuticals.

- Feed manufacture. This is the largest sector and on average accounts for 35% of total operational cost. Food production employs around 40 people and generates turnover of £9.71 million per year.
- Research and development. Six research projects were specifically connected to the industry running partially or wholly between 2000 and 2005 and costing over £1.1 million.
- Pharmaceuticals. On average the trout farms expenditure during 2000/2001 was £4,704. Fish health cost is greatest for fry and/or fingerlings because they are more susceptible to disease than ova or larger fish.

The downstream industries are the part of the industry supplied by the core trout farming industry. They include processors, retailers and recreational trout fisheries.

- The table trout market. Trout processing employs over 250 people, generating an income of over £ 23 million and added value of over £ 6.7 million per year. Five processing companies produce approximately 95% of all trout processing in the UK. Four of the five processors supply all the major UK supermarkets, which sell approximately 60% of the trout produced for the table while two of the five supply a large proportion of the commercial catering industry.
- Angling. Recreational anglers are the consumers of farmed trout sold for restocking purposes. They pay for the opportunity to catch such fish through fees to angling clubs and fisheries. There are about 474,000 trout anglers in the UK spending approximately £ 99 million per year. The activity employs over 700 people.

The United Kingdom has been a moderate size rainbow trout producing country for many years. Nick Read (2006) said also that there are approximately 300 registered farms in the UK, which are mainly owner operated. Most are specialized, producing fry and fingerling, fish for restocking, or table fish. There is approximately 17,000 tonnes of rainbow trout produced annually on farms each producing between 10 and 1000 tonnes. The industry employs approximately 600 full time staff and upstream and downstream activities employ another 1,300 full time employees. Ex-farm sales amount to approximately £32 million with the industry as a whole, including processing and angling, having an estimated turnover of £150 million.

As the Table 1-1 shows, the UK industry has a relative small size, occupying the seventh production place in Europe during 2003, representing almost 5.0% of the total production and 5.4% of the total value.

Table 1-1. Top 10 rainbow trout producer countries in Europe, production and value during 2003

<b>Country</b>	<b>Production (t) *</b>	<b>Value (K US\$)</b>	<b>% Production</b>	<b>% Value</b>
Norway	69,128	171,681	23.0	21.0
France	39,365	94,848	13.1	11.6
Italy	38,000	128,957	12.7	15.7
Spain	33,113	72,849	11.0	8.9
Denmark	29,867	68,133	9.9	8.3
Germany	23,275	78,986	7.7	9.6
UK	14,820	44,460	4.9	5.4
Finland	12,978	44,336	4.3	5.4
Poland	11,696	21,963	3.9	2.7
Faeroe Islands	9,199	25,573	3.1	3.1
Others	18,927	67,230	6.3	8.2
<b>Total</b>	<b>300,368</b>	<b>819,016</b>	<b>100.0</b>	<b>100.0</b>

Source Fishstat Plus

Figure 1-1 shows that there is a global trend to increase production and to decrease the value per unit of production over time, a good example of supply and demand. As Britain is an open economy, the rainbow trout industry has been affected by globalization. This is translated to financial pressure on the local UK industry that wants to remain competitive, cutting cost in all their operations. McAndrew (2002) said “ In the UK, and the world generally, rainbow trout eggs have become a cheap commodity, as producers continue to try to reduce cost, so removing any incentive for the hatcheries to improve the quality and add value to the seed being produced. The whole industry would benefit if the few hatcheries supplying eggs could recoup the cost of improvement by charging a small premium for eggs that would more than be covered by their subsequent enhanced commercial performance. A feedback loop between ongrower and hatchery would ensure that the improvement was in the traits chosen by their customers so they could see the direct benefit of this activity”.



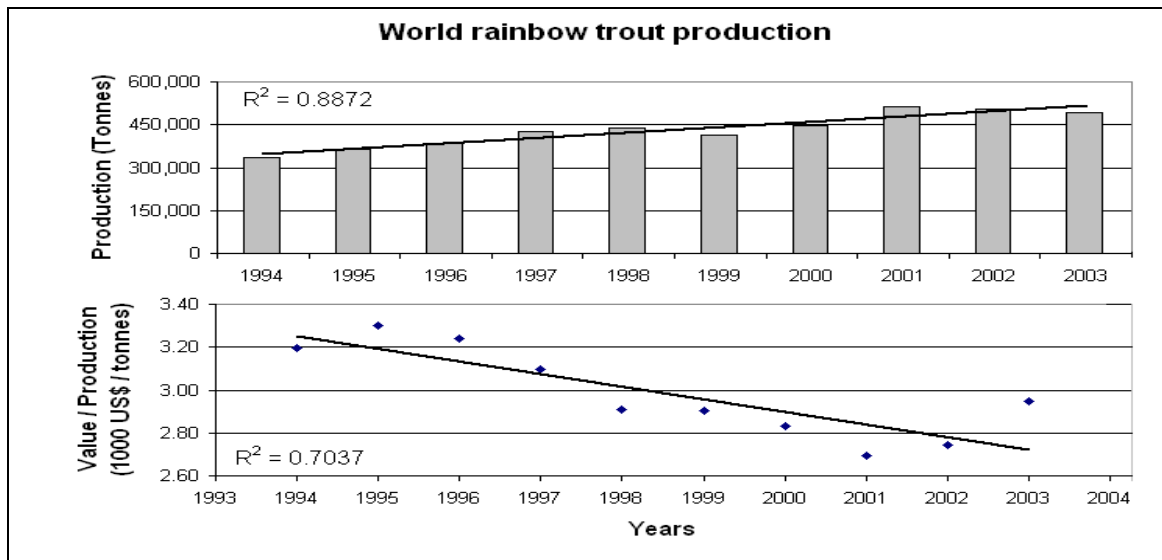

Figure 1-1. World rainbow trout production and relation value / production during the period 1993 – 2004 (Source Fishstat Plus).

### 1.3. Quantitative Genetics

#### 1.3.1 Inheritance of economic interest traits in animal production are explained by quantitative genetics theory

Most economically important traits in fish, the same as in other domestic animals and cultivated plants, are quantitative traits. This means that as it is not possible to establish discrete categories when measuring a certain phenotypic trait in a population: individual values comprise a continuous series. These quantitative traits show a hereditary variation in the population due to the segregation of several loci, not necessarily many, each one of which behaves in a Mendelian manner. The expression of these traits may be modified by the action of the environment. As each gene adds a small effect to the phenotype, this explains the continuous variation of these traits in the population (López-Fanjul and Toro, 1989; Neira et al, 1999).

Some of the economically interesting traits in fish can be, broadly speaking, the time needed to achieve commercial weight and the amount (or price) of the food consumed

to reach said weight. The first one is replaced by the weight or length at a set age, usually market size and the second one by the weight increase per time unit until said age, both of which are easy to assess. Besides the already mentioned traits, it may be interesting to take into account the following ones:

1. Mortality during ongrowing; the low economic value of the eggs and fry usually mean these stages are not considered.
2. Resistance to diseases, a complex trait due to the diversity of potential pathogens, and which must be more precisely defined stating the specific pathogens/life stages involved.
3. Quality of the fillet, particularly important in species where the value of each piece is high.
4. Age at sexual maturity, particularly in those species that are marketed with high weights, delaying maturity to obtain the weight, fillet quality and the efficiency of food conversion before maturation diminishes flesh quality and mortality increases (López-Fanjul and Toro, 1989).

The description of quantitative traits is usually done according to the so-called “infinitesimal model” proposed by Fisher in 1918, which is based on the variance analysis techniques developed by this author. The model assumes that the deviation or variance of the Phenotypic Value (PV) of a certain trait in an individual is the addition of two components, a genetic and an environmental one, which will express itself in a Genetic Variance (GV) and an Environmental Variance (EV). The GV, in its turn, is composed of an Additive Genetic Variance (AV) and a non-additive one (DV +IV dominance effects and interactions respectively):

$$PV = GV + EV$$

$$PV = AV + (DV + IV) + EV$$

AV is the variance of the additive genetic values of the individuals, which stems basically from the value of the genes that affect a trait, and which an individual may transmit to its offspring. The value stemming from allelic combinations (dominant effect) is not transmitted, as said combinations are “dismantled” by recombination as the gametes re formed (López-Fanjul and Toro, 1989; Neira et al, 1999).

Phenotypic averages and variances are the information we may obtain from the population, but obviously the phenotypic expression of the trait will not only depend on its genetic determination, but as has already been mentioned, on environmental effects. In order to genetically improve a trait we must distinguish and quantify genetic and environmental effects on the expression of the traits (Neira et al, 1999).

Quantitative phenotypes such as length, weight, viability, fat content and fecundity are measured in millimetres, grams, inches, pounds, percentages, etc. That is to say, an important consequence of the features described for quantitative traits is that they must be studied through biometric methods which characterize quantitative genetics. Quantitative traits are described in terms of phenotypic averages and variances at population level (Tave, 1993; Neira et al, 1999)

### **Heritability of economically interesting traits in populations**

To be able to know the variation fraction that is transmitted to offspring, one must know the relation between AV and PV, known as the heritability concept ( $h^2$ ). Heritability is a statistical measurement of the degree to which the observed

phenotype of a trait is genetically influenced and transmitted to offspring of the next generation:

$$h^2 = AV / PV$$

Heritability specifically measures the variability of a trait stemming from the hereditary fraction. Heritability is mainly used to determine the probability that a trait may be modified through selective breeding and in the prediction of the range of progress that may be expected from a particular population and environment (Kincaid, 1980, Neira et al, 1999).

The heritability of a production character is a property of the population and therefore, estimates vary around an expected value. It is important to know the heritability value because it permits us to know whether the phenotypic value of an individual is a good estimator of its genetic value which may help us to take decisions with respect to the best selection method to be applied and allows us to estimate the expected genetic response (Neira et al, 1999). Heritability is a population concept that is only theoretically valid for a specifically assessed population and in the assessed generation because values change over time. However, as a general rule, heritability estimated in a generation remains relatively unchanged during two or three generations.

As heritability is the fraction of the phenotypic variance due to additive genetic components, heritability values belong within the range 0 to 1. Heritability estimates may be classified according to three general categories: low (0 to 0.14), intermediate (0.15 to 0.49), and high (0.5 to 1). Selection programs are generally effective when

based on intermediate and high heritability traits but are less effective when based on low heritability traits (Kincaid, 1980).

All methods for estimating heritability are based on the relationship between related individuals. If the resemblance between relatives is close, there will be a higher probability that the trait will be heritable. If the members of a family are raised together, they share a common environment. When the environment changes from one family to the other, such as the water temperature or the culture density, the changes may induce differences between family members or create differences between families. Therefore, it is assumed in heritability estimation methods that the environmental relationship between relatives is zero or near zero. If this assumption is not fulfilled, techniques must be used to remove the environmental relationship or else the resulting estimate will be unrealistic (Kincaid, 1980).

There are many methods to estimate heritability but the six more common ones are: (1) relationship between parents and offspring, (2) parent-offspring regression, (3) response to the selection, (4) synthetic selection, (5) relationship between full-sib, and (6) relationship between half-sib. Normally, methods of parent-offspring regression or relationship between half-sib are preferred because they imply fewer assumptions about population and provide clear estimates of additive genetic effects. Estimates based on the selection response are very useful in describing the selection results, but are less useful for predicting the response to selection because the results will not be available until after the selection program has gone through a selection cycle. The method chosen in a given situation will depend on the kind of relatives available,

unless studies are designed to provide relationships that will allow for a specific method for estimating heritability (Kincaid, 1980).

Table 1-2 shows heritability values for sexual maturity in rainbow trout (*O. mykiss*) and Atlantic salmon (*S. salar*), data selected by Gjerde (1986). It must be remembered that heritability is a property both of the trait as well as the population in which it is assessed, and its value is not necessarily applicable to other populations of the same species or the same trait in other species (López-Fanjul and Toro, 1989).

Table 1-2. Estimate of age heritability until sexual maturity based on half siblings family data.

	$h^2(O. mykiss)$	$h^2(S. salar)$
Average early maturity	0.05	0.15
Average late maturity	0.26	0.37

Gjerde (1986) with modifications

### **Assessment of the breeding value of an individual with respect to its population**

From the analysis of the previous concepts and bearing in mind the work under development phenotypic assessment of traits in individuals will be important Phenotypic value (P) is the assessment of an individual's value at a given point. This value is influenced by a genotypic value (G) and an environmental deviation (E).

Therefore:

$$P = G + E.$$

Genotypic value (G) is the total genetic capacity of an individual with respect of its population. It is influenced by the additive genetic value (A), also called breeding value and by dominance effects (D) and interactions (I). Therefore:

$$G = A + D + I$$

$$P = A + D + I + E$$

Breeding value (A) is the value of an animal as a breeder, i.e., it is related with the possible average value of its offspring as deviation from the population average (Neira et al, 1999).

### **1.3.2 Main systems of improvement for animal production**

The main purpose of genetic improvement is to modify in a desired direction the relevant economically important traits in the individuals of a population. For this purpose, Simm (1998) pointed out the principal strategies that have been used to induce genetic improvement in populations.

- Selection between strains: replacing one strain with another that is known to have a better performance under local conditions, also known as migration.
- Selection within the strain: choosing the best parents from a particular strain to improve performance.
- Crossbreeding: crossing parents from two or more complementary strains or the same species that will provide an improvement of performance through hybrid vigour.

### **Selection between strains (Migration)**

Migration consists basically of introducing breeders or gametes from other stocks. When there are genetically superior stocks available this is the fastest strategy to perform an improvement. It has the disadvantage of creating dependence on obtaining germplasm from the leading producers. An example of this practice could be to import ova from fish farms where genetic improvement is done and later on crossing the breeders obtained from these ova with the local population. As fish farming is a recent activity, there are no genetically improved stocks for the majority of farmed fish species.

### **Selection within the strain**

Basically selection is the differentiated reproduction of those individuals (breeders) that show genetic superiority for the selected trait in a population. These changes are slow but accumulative through time. In simple terms, the assessment of the genetic value of an individual is based on the trait differences observed between the individuals and the average population. Due to this, the existence of phenotypic differences or variation of a certain trait in a population is essential for performing selection of a trait.

### **Selection methods within the strain**

The phenotypic value of an individual, measured as a deviation with respect of the average ( $P = X_i - \bar{X}$ ) of a population comprised of several families, may be divided



into two main parts: the deviation of the family average with respect of the population average ( $P_f$ ) and the individual deviation with respect to the family average ( $P_i$ ), where:

$$P = P_f + P_i$$

The selection methods that are applied define themselves according to the importance one gives to these two components and to the kind of information used to assess the genetic value of the individual for that trait. In working in a genetic program, one usually must do it with populations whose fish family structure is known. In these conditions there exist different sources of phenotypic information about the trait that may be used as criterion to estimate the genetic value ( $A$ ) and define the selection method. Selection methods are:

1. Individual or mass selection:

Selection is only made for the individual phenotypic value, expressed as a deviance with respect to the average population, regardless of the family to which it belongs. As regards the equation  $P = P_f + P_i$ , the same consideration is given to the family ( $P_f$ ) as to individual components ( $P_i$ ).

2. Family selection:

All individuals are selected (or in an equal number, random sample) from the best families of a population based on the family average for the trait.

### 3. Intra-family selection:

The best individuals of each family are chosen as breeders, i.e., those individuals that have the greatest phenotypic deviances with respect to the average of their respective families.

### 4. Combined selection:

This selection method uses more than one available source of information to estimate the genetic value (A) of an individual. In other words, it takes into account the individual phenotype, the full-sib or half-sibs' averages, and individual deviances between families, among other things. Usually an index is made estimating the genetic value of an individual (A) which comprises the available information sources considered according to their importance (Neira et al, 1999).

## **Crossbreeding**

The term crossbreeding is understood as the mating of individuals of different genetic origin. The most common crosses performed on traditional domestic species (cattle, sheep, chicken and pigs) are between breeds, lines and varieties, although they have also been possible between similar fish species. The use of crossbreeding in animal production seeks to exploit heterosis, complementarity and replacement of populations.

It is a common practice in fish farming to use a combination of at least two methods for genetic improvement. Usually, the selection between strains is prior to the selection within the strain or crossbreeding. Due to the amount of variation existing

between captive strains and wild populations of many species, all improvement programs should start with the collection, comparison and selection of the best material available (Refstie, 1990; Dunham and Liu, 2003).

Due to the high fecundity of aquatic species, the methods used are individual selection (mass selection), family selection or a combination of both (combined selection) (Gjerde and Rye, 1998). When the heritability of the trait is approximately 0.5, both the family and individual selection are equally efficient. Family selection is more efficient when there is less heritability, and individual selection is a more efficient selection method when there is a higher heritability. For binary traits such as the age of sexual maturity and survival, one should choose family selection (Gjedrem, 2000).

### **1.3.3 Managing an improvement program**

#### **Considerations about the base population at the start of the improvement program**

There is no single recipe with respect on how to build a base population for a selection program as this will depend on the circumstances surrounding each particular case. It is well-known that a good base population for a selection program must have the greatest possible genetic variability because the genetic profit obtained through selection is directly proportional. However, one has to bear in mind that said variability must have the attributes desired as principal product and, as far as possible it must lack those factors that are considered as undesirable from an economic point of view.

Thus, if there is more than one genetic line available, an evaluation of the stocks is usually advisable and in some cases, together with that of their reciprocal crosses. The importance of having sufficient genetic variability for the base population is generally recognised and most programmes begin by carrying out preliminary studies verifying the existence and quantifying the magnitude of the variation in the available strains. There is often sufficient evidence from the phenotypic variation to predict the results of direct breeding methods, without the need to know in detail the structure of the genome and its relation with the phenotype (Neira et al, 1999).

Where and under what environmental conditions must the stock under genetic improvement be handled? There are several theories to answer this question before the varied circumstances that are usually present. We will presently mention a series of recommendations that are generally applicable in established selection programs (Neira et al, 1999). As far as possible, stock management must be done by staff with specific training for it, as the management of stock under selection is different from normal management for production. This applies to all stages of the productive cycle. The fish of the program must be managed under the best possible environmental conditions, unless there exists evidence of the existence of important genetic-environmental interactions. The physical location of the program, during the different phases of the cycle, must be decided exclusively according to the environmental conditions. These may coincide with the location of fish for production, although normally the infrastructure for their management must be necessarily different. The most important consideration to be taken into account related to the environmental conditions is that they must be the same for all individuals being tested. What is most important is that at the time of comparatively assessing the behaviour of the potential

breeders, the observed phenotypic advantages should be a consequence of their genetic merits and not of advantageous environmental conditions (Neira et al, 1999).

### **Constitution and management of families**

In culture fish, what is known as a family in a genetic improvement program is generally the full-sib offspring ensuing from the spawning of a single female and single male. Once the stock or stocks that will be subjected to improvement are defined, three important aspects must be decided: the way of choosing the females and males that will commence the program, the size (number of families) the program must have and the cross system to be used (Neira et al, 1999).

### **Breeders that will commence the program**

If one does not have previous averages, variances, phenotypic and genetic correlations, heritability estimates, etc. of the production traits that will have more economic importance for the chosen stock, the best thing is to choose the breeders that will commence the program from a random sample of the population. This will produce a progeny population that will enable a good estimate to be calculated of these important phenotypic and genetic parameters, essential to take the appropriate decisions for the selection program.

The efficiency of an improvement program will depend on these early decisions and need to be based on a good dataset. It is important to be able to predict how direct changes produced by the selection will produce modification in other correlated traits. As an improvement program is a long-term activity, these parameters should be

known for all current and potential future economically important traits. One must take into account that these parameters are little known in fish and that they are furthermore a property of the population where they are assessed.

If one decides to choose the breeders that will initiate the program, it is advisable to make said selection between individuals that have lived under common environmental conditions up to the moment when the most important traits under study are assessed. The fish should also come from the largest possible number of unrelated families. The consequences of starting the programme with a small number of closely related individuals will have permanent impact on the success of the selection programme and the inbreeding estimates performed on the base population will be underestimated (Neira et al, 1999).

### **Number of families needed to build an improvement program**

One of the main considerations with respect to the scale of an improvement program will relate to the number of broodstock needed to maintain an adequate  $N_e$  to minimise the level of inbreeding and genetic drift within the population. This is a species specific problem and more likely to be an issue with highly fecund species in which few broodstock are needed to generate the requirements of a substantial industry. In less fecund species the process might require a multiplying stage to ensure that there are enough offspring coming from the improvement programme to meet the demand.

There is more than one way to estimate the number of broodstock needed for a selection program, Both the management of inbreeding levels as well maximizing the

possible genetic gain need to be considered. The latter will naturally depend on the principal trait(s) being selected, its variation and heritability. In the case of selecting for weight increase in salmon, in the genetic improvement program for Coho salmon from Coyhaique (Neira, 1997), an effective size of no less than 84 has been defined, easily obtained with its hierarchical cross design in which 100 females participate with 30-35 males in each generation. With this number of males and females an  $N_e$  of 90-100 was obtained which produces an inbreeding increase (F) between 0.5 - 0.6% per generation (Neira et al, 1999).

### **Breeders mating design**

Once the scale of the program has been defined and the breeders that will start it have been chosen, a mating (or cross) design must be established. The objective is to form families with known genealogical data, i.e. we will know who are the father and mother of each individual. There are a number of ways in which this can be achieved but there are two commonly used possibilities. The first one is to cross a male with a female, in which case we need an equal number of breeders from each sex. The second one is to cross a male with several females, in which case we need fewer males than females. In saying the number of females needed to cross with a male, one has to bear in mind that that influences the effective size ( $N_e$ ) of the population. If one wishes, for instance, an  $N_e$  of 100, it may be obtained with the following combinations of numbers of males and females (Table 1-3).

Table 1-3 Calculation of different Ne index according to different proportions of males and females

<b>Number of Males</b>	50	34	29	30
<b>Number of Females</b>	50	100	200	150
<b>Effective size (Ne)</b>	100	101	101	100

As a practical recipe while designing a program, one can note that an effective size (Ne) equal to the number of females used, for instance 90 or 150, is obtained with a number of males equal to a third part of the number of females: 30 and 50 respectively, in this case (Neira et al, 1999).

#### **Identification of the individuals to used in the improvement program**

Unless a mass selection system has been chosen, some fish identification system will be necessary. Fish can be identified using a number of marking systems which permit an adequate genealogical control, essential in a genetic improvement program. It is useful to know the father and mother of each individual (the family to which it belongs), both to genetically evaluate the individuals and families as for an adequate control of inbreeding.

Two methods that have proved to be very efficient as identification systems may be used in salmon and trout: family tanks and electronic markers (Neira et al, 1999) and molecular markers (microsatellites). Recent use of genetic markers for family identification purposes is a milestone in aquatic species improvement programs. This technique allows family groups to be bred in a common post-fertilization environment, and the number of families included in the test may be considerably increased (Gjoen and Bentsen, 1997).



### **Electronic markers for each individual**

The most commonly used electronic markers system is the “Passive Integrated Transponders” (PIT), that are housed in glass cylinders one millimetre in diameter and approximately one centimetre long. These are introduced into the fish and may be read from the outside by readers with different levels of sophistication. They provide a code of 8-13 digits.

They have the disadvantage of being expensive though they may be permanently reused. The advantage is that identification is individual, that they read without error and that the information may be directly transferred to the computer through an interface. If one has more sophisticated readers, these may be programmed to receive, together with the fish identification, the information obtained on each occasion, such as its weight, length, cage, date, destination, etc., building a file that is directly transferred to the computer or database (Neira et al, 1999).

### **Population inbreeding**

The offspring from matings between individuals that have a closer relationship between them than the average random couples of the population from which they proceed are called consanguineous. Two individuals are relatives when they have one or more common ancestors (collateral relatives), or one is ancestor of the other one (direct relatives). Inbreeding in a large survey population is a consequence of deliberate mating between relatives, but it also occurs as the inevitable product of random mating if the population under study is a small.

Inbreeding is usually a matter of concern for a producer on account of the consequences it has when it increases excessively in a population. An average inbreeding increase generally entails an effect called endogamic depression which lowers the performance of reproductive and production traits. In general terms it may be said that:

- The possibilities of crosses between related individuals of a population are in accordance with the population size.
- The main consequence of inbreeding is an increase in homozygosity.
- There exists a higher probability that an individual receives identical alleles from both parents through common descent.
- Said increase may be measured through the inbreeding rate (F) (López-Fanjul and Toro, 1989; Neira et al, 1999).

### **1.3.4 Organization systems that have been used in this kind of programs**

#### **Organization models**

The genetic improvement of a stock may be organized within a firm, at regional level, with the participation of several firms and with different degrees of participation of State or international organizations. These plans, or combinations of plans, are being used by the fish production industry in several countries, according to the local needs. In Chile, for example, there coexist programs of domestic firms specialized in ova and smolt production, programs that multiply in Chile stocks of fish improved in other centres, vertically integrated firms that produce for their own consumption and a program jointly organized by a State organization and the University, with participation of private firms (Neira, 1997).

**An effective dissemination of the genetic improvement program could be done through multipliers**

Whatever the plan to be used, it will always be advisable to manage the stock subjected to genetic improvement in an independent way from the animals destined for production. This stock subjected to improvement is known as the nucleus of a fish breeding company. Usually a part of the individuals generated by the nucleus will be needed in order to perpetuate it with a genetic selection plan. In practically all production stages, surplus individuals from each family that will not continue as breeders must be discarded.

These individuals may be directly destined to be sold as improved stock or as breeders for stock multiplication. This is one of the most important stages in terms of the economic viability of a genetic improvement program which consists in distributing the genetic material of superior animals to the industry, because improvement is only valuable if it benefits both the producer and the consumer. High fecundity in salmon and trout species will guarantee the genetic profit achieved in the breeding nucleus will have an extensive and immediate impact on the industry. With large family sizes there is no need to multiply the genetic material for the industry and in this way genetic improvement is available to producers with a minimum delay (Neira et al, 1999; Gjerde et al., 2002).

### **Test stations for assessing the stocks produced**

The infrastructure of a genetic improvement program for maintaining and carrying out performance tests, permitting their genetic evaluation for selection purposes, may not be representative of the fattening centres to which the individuals that are the product of the program will be finally destined. Several programs from different countries have implemented test stations which allow fish produced by the program to be assessed in different environments and to check whether the families' ranking is the same in all of them. If the ranking is basically the same, i.e. if there are no important genotype-environmental interactions, it means that the individuals selected as breeders in the program are those that produce the best fish handled under production conditions (Neira et al, 1999).

### **1.3.5 Information management**

When starting out with an improvement program one must clearly define the traits that will be improved which must be measured and recorded on an annual basis within the production cycle. As improvement methods are essentially based on the statistical analysis of said traits, an important part of the answers obtained will depend among other things on the quality or precision of the data produced. It is necessary to design a registration system which meets certain basic requirements:

1. The traits to be assessed must be chosen carefully. To be able to do this one must have previously defined the most relevant traits for the program. Among them we can name, besides the selection criteria, those that will provide levels

of productive efficiency, thus permitting to classify the information in a better way and avoiding unnecessary additional costs.

2. Measurements must be precise and reliable. This will require specially trained staff using good instrumentation and working under conditions that will minimize assessment errors.
3. Records must be kept in a standard way, with both the name of the variables and their form and dimensions throughout time.
4. The information must be stored in a safe and orderly way so as to facilitate the access and efficient management of the data for its subsequent analysis. It is advisable to keep logbooks for each one of the traits assessed and to later on incorporate them into a database, specially built for the improvement program, and permanently updated.
5. The measurements taken must be recorded together with the handling or environmental conditions of the individuals. An appropriate record will allow the identification and elimination of environmental effects that may affect the expression of the trait (for instance, the cage, date of spawning or sampling, sex, tank, date of sampling, etc.). Thus one will avoid, for instance, choosing individuals that have enjoyed more favourable environmental conditions instead of choosing them on their genetic merits (Neira et al, 1999).

#### **Database of the information obtained**

Generally, improvement programs are long-term projects. If one also takes into account the great amount of information obtained at each stage of the production cycle, there is a huge amount of data recorded each year and therefore, one needs computer tools that will allow the efficient management of the information, both to

improve fish handling and data analysis. An adequate database must be particularly designed for an improvement program according to its data schedule, management and production.

- It must permit receiving information for the system in a standardized way, both as regards the name of the variables as well as their form and dimension throughout generations.
- It must have the possibility of easily receiving the information taken from fish that are electronically identified.
- It must allow establishing interrelations between the different files contained or built into the database.
- It must be able to produce work files for genetic and productive analyses, retrieving information from any file input.
- It must be able to produce a pedigree file of all the individuals contained in the database.
- It must facilitate building useful user-designed reports for an efficient information use.
- It must be easy to use, with data entries designed according to the number of samplings carried out during the year with an identical format to that of the spreadsheets used on site.
- It must permit an easy access to the database of the historic information collected prior to building the database.
- It must have a User Manual easily accessible to the user (Neira et al., 1999).

### **1.3.6 Rationale that must be used before initiating a genetic improvement program**

After all the quantitative theory we have reviewed, philosophy makes its appearance; there are five key questions that need to be asked if genetic improvement seeks to improve productive efficiency:

1. What are the traits that need to be improved and what is the breeding goal?  
Generally, the main goal in applying any improvement method is to change or improve all the traits that are economically important for the producer or the industry. At the beginning it is not convenient to include many traits as the genetic progress obtained from each one of them will be smaller. Furthermore, the heritability of any trait must be significantly greater than zero if it is to be improved.
2. What are the best measurements and selective criteria for these traits? The cost of measuring or recording the trait must be taken into account. Food conversion efficiency, for instance, is not usually included in fish goals because it is difficult and expensive to measure.
3. What are the best selection methods to improve the traits of the breeding goals?
4. What are the research priorities?
5. How can we make sure that genetic improvement programs are implemented by the fish farming industry? (Neira et al, 1999; Lymbery et al., 2000; Gjedrem, 2000).

### **1.3.7 Statistical data of global fish farming production justify increased future development of fish breeding programs**

Fish farming production during 1948 was approximately 19.6 million Metric Tons (mMT) and it increased to a preliminary estimate of 132.2 mMT in 2003, i.e., in 55 years global production increased 6.7 times. During 2003 captive fish production accounted for 41.9 MT. Since 1990 continental fish farming production increased from 11 mMT to a preliminary estimate of 25.2 mMT in 2003. China continues being by far the largest fish farming producer, with a reported production of 27.7m MT during 2001. These figures confirm that fish farming has been the food industry that has had the largest growth at a global level (FAO, 2001, 2004).

Wild capture fisheries have attained their maximum sustainable production; therefore, a greater development of global fish farming industry is expected in the future, as happened with the evolution of agricultural development. Given this growth of fish farming development, domestication of different fish species will continue, becoming in time increasingly efficient and competitive with traditional agriculture industry. Fish and shellfish species will generally become more important as a more efficient use of food resources will be necessary to provide a sufficient amount of high quality food for the increasing world population. Domestication and application of the theory of animal breeding to the genetic improvement of breeds was the principal method used to increase production of traditional farm animal populations. Farm poultry productivity is often 3 to 5 times that of its wild progenitors. Genetic improvement has been widely demonstrated in traditional farm species. However, despite this great development of modern farming, until now aquatic species have hardly benefited



from this progress (Harris and Newman, 1994; Bentsen and Gjerde, 1994; Knibb, 2000; Lymbery et al., 2000; Gjedrem, 2000).

### **1.3.8 Comparison of genetic improvement of different salmonid and rationale for a program with rainbow trout**

Genetic improvement is the process of selecting animals with greater genetic advantages than average animals to become parents of the next generation so that the average genetic advantage of its offspring will be greater than the average one of the parent's generation. Ova or fry producers are mainly in the business to obtain profits, the same as their customers who buy their fish to produce food products. The profits of producers are influenced by the customers' demand for their products. The acquisition of an improved stock implies a cost but may be a positive influence for the system's operation by reducing other expenses or an income growth due to production or both. Genetic improvement programs may entail several benefits, most of them associated with the economic return (Harris and Newman, 1994; Cameron, 1997; Knibb, 2000).

Until a few years ago selective breeding had been rarely used in fish farming; in 1997 it was estimated that only 2% of fish and shellfish were genetically improved. This delay in the development of genetic improvement programs of aquatic species may be due to the lack of response to selection in some early studies and created a school of thought about there being little or no additive genetic variation in fish (Lopez-Fanjul and Toro, 1990; Gjedrem, 1997; 1998). However, more recent experiments that show good results have been obtained from different genetic improvement programs performed on different salmon species (Table 1-4).

Table 1-4. Response to selection for faster growth rate in different salmon and trout species taken from recent publications

Species	Mean	Gain per generation (%)	No. generations	Reference
Coho salmon	250 g	10.1	4	Hershberger et al., (1990)
Rainbow trout	3.3 g	10.0	3	Kincaid et al. (1977)
Rainbow trout	4.0 Kg	13.0	2	Gjerde (1986)
Atlantic salmon	4.5 Kg	14.4	1	Gjerde (1986)
Atlantic salmon	6.3 Kg	14.0	6	Gjerde & Korsvoll (1999)
Atlantic salmon	3.5 Kg	12.5	1	O'Flynn et al., (1999)

Besides these more recent favourable results, salmon and trout species have several advantages for geneticists over traditional agricultural species, mainly due to their reproductive biology. It is easier to perform quantitative genetic analyses on them on account of their high fecundity and external fertilization. This provides tremendous flexibility in cross designs because the eggs of a single female may be separated into many different groups, each one of them fertilized by a different male. Similarly, the semen of a single male may be used to fertilize many different females. The combination of high fecundity with external fertilization permits using an optimal combination of family size with number of families, which minimizes standard errors of estimate of genetic variance (Lynch and Walsh, 1998). If we compare different salmonid species, more is known about the physiology and biology of rainbow trout than of any other fish species. Rainbow trout is the most experimentally manageable salmon species and therefore they may become a substitute for the research needed of the economically important Atlantic salmon and other Pacific salmon species and char (Thorgaard et al., 2002).

A pioneer genetic improvement program for Atlantic salmon and Rainbow trout was commenced more than 28 years ago (Gjedrem, 1983) and it was adopted on a national level by the Norwegian salmon industry and carried out by AquaGen AS since 1992.

The Norwegian program focused itself on improving growth rate, age of sexual maturity and later on, resistance to diseases and quality traits. Similar breeding programs are being carried out in Canada (Friars, 1993), Iceland (Stofnfiskur H/F), Chile (Gentec SA and Landcatch Chile) and Scotland (Landcatch). If we analyze the general history of breeding programs, most of them started with growth rate improvement, defined as the harvest weight as selection criterion (Knibb, 2000; Refstie, 1990) and later on other traits were included in subsequent generations. The cost-benefit rate of the Norwegian genetic improvement program of Atlantic salmon and Rainbow trout is 1:15 (Gjedrem, 1997), an estimate similar to the ones obtained from genetic programs of traditional farm animals.

#### **1.4. Molecular Genetics**

Molecular markers are molecular, protein or DNA phenotypes originated by a gene. They receive this name when they behave according to Mendelian inheritance laws (Díaz N, 2005).

##### **Comparison between protein and DNA markers**

Protein markers have been used since the '60's, but more recently use has been made of variants at mitochondrial and nuclear DNA level, all of them revealed through electrophoretic analyses. Using proteins or DNA as markers has its advantages and disadvantages, a key aspect being the level of genetic resolution obtained with one or the other analysis. The difference between both approaches is that protein electrophoresis detects variations in regions of the genome only if they codify for functional biochemical products, which is a small fraction of it, and is therefore, less

representative. Instead, DNA analyses will detect genetic variations in their origins: DNA base sequences. These analyses permit us to examine all the nucleotide sequences of the genome, even those that do not codify protein products or that have no known function. Due to this larger coverage of the genome, these analyses have greater possibilities of detecting a large part of the genome's variation (Díaz N, 2005).

#### Description of DNA markers

There are two classes of DNA analyses, one of them is the kind performed with mitochondrial DNA (mtDNA), while the other one uses nuclear DNA (nDNA).

Mitochondrial DNA is a small molecule located within the mitochondria, which has a rapid rate of evolution, is haploid and of maternal inheritance. It is mainly composed of codifying sequences, which cannot be recombined and are easily isolated. The small size of mitochondrial genome and its inheritance does not permit developing many markers.

Nuclear DNA is a larger molecule arranged into chromosomes and contains a greater variation in its type of sequences, among which are coding and non-coding sequences. Non-coding sequences contain repeat sequences of different lengths and many of them can be used as markers. Nuclear DNA changes due to the replication during cell division and also to the recombination during meiosis, generating new variant combinations. Recently a great variety of molecular markers have been obtained by studying both classes of DNA (Díaz N, 2005). Ferguson et al. (1995) published a comparison between protein genetic markers and DNA markers (Table 1-5).

Table 1-5 Advantages and disadvantages of protein and DNA variants as genetic markers (after Ferguson et al. (1995))

<b>Advantages of proteins</b>	<b>Disadvantages of proteins</b>
<ul style="list-style-type: none"> <li>* Samples can be analysed quickly</li> <li>* Relatively low cost of chemicals and equipment</li> <li>* Easy -to- learn technique</li> <li>* Proteins with known function</li> <li>* Some loci subject to selection</li> </ul>	<ul style="list-style-type: none"> <li>* Tissue collection and fresh or freshly frozen storage required</li> <li>* Several tissues, and relatively large amount required / killing of specimen</li> <li>* Low number of alleles per locus</li> <li>* Only proteins detectable through histochemical stain can be examined</li> <li>* Some loci subject to significant selection</li> <li>* Analysis of patterns can be difficult especially in polyploids</li> </ul>
<b>Advantages of DNA</b>	<b>Disadvantages of DNA</b>
<ul style="list-style-type: none"> <li>* Only single tissue and relatively small amount required</li> <li>* PCR amplification allows minute amount of tissue to be used and allows examination of scales and museum specimens</li> <li>* Tissue preservation in ethanol or by drying simplifies collection and storage</li> <li>* Many thousands of potential markers available</li> <li>* Some loci are multi-allelic</li> <li>* Some loci are non-coding and not subject to direct selection</li> <li>* Mutations not resulting in protein electrophoretic mobility changes are detectable</li> </ul>	<ul style="list-style-type: none"> <li>* More difficult to learn</li> <li>* Little comparative information available</li> <li>* Relatively high cost of chemicals and equipment</li> </ul>

### **Classification and characteristics of several types of nuclear DNA markers**

Molecular genetic markers can be divided into type I and type II markers. The first ones are located in coding gene sequences while the second type are based on anonymous sequences. A second classification criterion would be the method used for detecting polymorphism, according to which we classify DNA markers into three types: based on probe hybridization, PCR-based and the ones based on DNA chips (Díaz N, 2005).

## **1.4.1 Molecular markers based on probe hybridization**

### **Restriction Fragment Length Polymorphisms (RFLP)**

To detect DNA polymorphisms one can use clones from the genic targeted regions as probes for Southern blot after digesting the target DNA with restriction endonucleases. Thus, the genomic DNA is isolated and cut by restriction enzymes; subsequently, the fragments are separated by size by electrophoresis, transferred to a membrane and hybridized with radioactive probes from the genomic targeted region (Southern blot). Most RFLP studies use restriction endonucleases which recognize sequences of six nucleotides; these enzymes cut as an average once each 4096 pb, producing DNA fragments that are easily resolved by electrophoresis in agarose gel. To reveal polymorphisms on a finer scale, the DNA must be cut by restriction enzymes that recognize sequences of four nucleotides. At present this type of marker is less commonly used than in the past because of the time required and the complexity of technique compared with PCR based markers (Araneda, 2007).

### **Variable Number Tandem Repeats (VNTRs)**

There are two types of VNTRs, called minisatellites and microsatellites which differ in the size of the motif that repeats itself (between 15 and 100 pb in minisatellites and 1 and 4 pb in microsatellites). They are present in all genomes of animals and plants and are less frequent in microorganisms (Araneda, 2007). In the following section there is a description of minisatellites, and further on, in the section about PCR markers will be a full description about microsatellites.

## **Minisatellites**

These markers were the first VNTRs to be studied. The repeated motif is not always identical and they were initially used in paternity tests. This is a multilocus method, i.e. many loci which have the minisatellites are detected at the same time, but one does not know in what region of the genome they are. The genomic DNA sample of each individual is digested with restriction enzymes, then the fragments are once more separated by size in an electrophoresis, transferred to a membrane and hybridised with a probe which in this case corresponds to the minisatellite pattern (Southern blot). The final product is a barcode pattern which is specific for an individual. The barcodes revealed by this technique have a Mendelian inheritance pattern, as on average half of the bands are inherited from each parent. The same as with RFLP, minisatellites have lost their popularity with respect to microsatellites due to the technical difficulties in developing them (Araneda, 2007).

Initial studies using nuclear markers focused on multilocus DNA fingerprinting. Interpretation and gel comparison difficulties led to use instead of single locus VNTR markers. J.B. Taggart and colleagues (Queen's University, Belfast, UK) and workers from the Marine Gene Probe Laboratory (Dalhousie University, Halifax, Canada) were the first ones to develop this technology (single locus minisatellites) for fishery uses (Taggart and Ferguson, 1990; Bentzen *et al.*, 1991; Prodohl *et al.*, 1994; Ferguson *et al.*, 1995).

### **1.4.2 Molecular markers based on Polymerase Chain Reaction (PCR) technology**

Great technological innovations were made possible by the development of PCR. PCR is a method which basically consists in making an *in vitro* replica of DNA so as to obtain multiple copies of a specific segment of this molecule, which can be used as a molecular genetic marker.

The advantage of markers based on polymerase chain reaction is that this method permits generating great amounts of DNA from specific segments of the genome of an individual quickly (Araneda, 2005).

#### **Random Amplification of Polymorphic DNAs (RAPD)**

RAPD was an innovative application of the PCR which permits rapid, low-cost generation of a battery of molecular genetic markers without any prior knowledge of the genome where they will be used. The development of this method started during the 1990's (Welsh and McClelland, 1990; Williams et al., 1990) reaching its highest application between 1999 and 2003. It is at present used in species for which there is an insufficient number of other more informative molecular markers, such as microsatellites or SSR (Liu and Cordes, 2004).

In a RAPD test a single primer of arbitrary sequence is used to perform a PCR. The primers are designed to contain 50 to 70 % guanine-cytosine. Another important variation with respect to standard PCR is that the temperature for annealing of the primers to the template genomic DNA can be as low as 35°C. Under these conditions, the primers are hybridised, but not 100%, to complementary sites present in genomic



DNA under study to generate the greatest amount of possible amplified fragments. When two primers join in sites present in the DNA in opposed and antiparallel form, within an amplifiable distance, one obtains a copy of a discrete fragment of DNA. This may happen in many sites, an average number of 5 to 6 fragments per RAPD primer are amplified, which can then be separated and visualized in an agarose gel. (Araneda, 2005).

When a fragment is amplified in an individual, one is not able to tell at first if the analyzed individual is homozygote or heterozygote for the fragment, i.e., if the individual has in its genome one or two copies of the binding sites of the primers that amplify the said fragment. Thus, the RAPD markers behave as dominant markers (Araneda, 2005).

The molecular base of polymorphism detected by RAPD is due to mutations in the markers' binding site to the target DNA, and/or insertions and losses of segments of several nucleotides in the region between both binding sites of the primers (Williams et al., 1990). Due to its nature, the RAPD is a multilocus technique, i.e., several sites in the genome are amplified at the same time in the same PCR reaction. However, each one of them can be treated as a separate locus and one can even follow the Mendelian segregation of each marker in families where the fragment shows polymorphism (Araneda, 2005).

Another important feature of the dominant markers in general and of the RAPD in particular is that each marker of this type can be converted into a SCAR (Sequence Characterized Amplified Regions) single locus marker. SCAR markers are also PCR-

based and only amplify a genomic fragment (see further on) unlike the RAPD which amplifies several fragments at the same time. SCAR markers have more interesting biotechnological applications when they derive from RAPD markers associated with loci that control quantitative traits of economic importance (Araneda, 2005).

### **Amplified Fragment Length Polymorphism (AFLP)**

This is a method that has been recently developed and permits obtaining a great number of molecular markers, i.e., multiloci, and the inheritance pattern of the developed markers are dominant. This approach basically combines the specificity and resolution of restriction enzymes with the ease and speed to detect polymorphisms of PCR (Vos et al., 1995). As with RAPDs one does not need prior knowledge about the DNA sequence of the genome of the species to develop AFLP markers (Ferreira and Grattapaglia, 1998).

The essential advantages of a AFLP test with respect to a RAPD is the great amount of amplified fragments, but with a much higher replicability, because of the high stringency of the PCR conditions used for AFLP markers. However, both techniques are quite similar, not only in their main features but with respect to the kind of problems that they can be used to study. When applying this method, one has to bear in mind that the development of AFLP markers is technically more expensive, difficult and complex with respect to RAPD; it also requires well-trained personnel. However, this difficulty is considered as a minor one if one considers the great amount of information one can obtain in a single operation.

The polymorphism detected through the AFLP markers are of two general types:

- a) Resulting from specific mutations, insertions or loss of nucleotides which produce the loss or gain of a splicing site with restriction enzymes recognized by the enzymes used; and
- b) Resulting from the alteration of the sequences recognized by the selective primers used in the PCR reaction.

Once again, the same as happens with RAPD markers, AFLP markers may be converted into a single locus SCAR PCR-based marker (Araneda, 2005).

### **Sequence Characterized Amplified Regions (SCAR)**

Polymorphic fragments previously identified through RAPD or AFLP tests may be isolated from the gel, purified, cloned and sequenced to design primers to perform a PCR that will permit the specific amplification of the targeted fragment. If this is successfully achieved, the specific sequence fragment amplified by PCR turns into a SCAR marker. As one knows the total nucleotide sequence of this marker, it is possible on many occasions to identify the nature of the polymorphism previously detected by the dominant marker (Param and Michelmore, 1993). These SCAR markers have the advantage of being species-specific and, besides, a part of them may present a co-dominant inheritance pattern, i.e. one is able to distinguish heterozygous individuals from homozygotes (Araneda, 2005).

To build a SCAR marker one must know the whole sequence of the RAPD or AFLP marker one wants to study and therefore, one has to obtain through molecular cloning

multiple copies of the dominant marker that will permit its subsequent sequencing. Thus, the basic method for building SCAR markers comprises the following steps: isolation and purification, cloning, recovery of recombinant colonies and plasma purification, sequencing, analysis of the sequences and primer design, marker amplification (Araneda, 2005).

### **Microsatellites**

Microsatellites are also known as Simple Sequence Repeats or Simple Tandem Repeats (SSR or STR). These are repeats in the sequence of the genome, from tens to hundreds of base pairs of DNA, made up of di-, tri- or tetranucleotide repeats, e.g. CA, CAC, or CATA, ordered in tandem, i.e., one after the other (Wright, 1993; Wright and Bentzen, 1994; Park and Moran, 1994). Microsatellites can also be composed of different types of repeats or exhibit cryptic simplicity in which the organization of the nucleotide sequence is mixed. These loci seem to be highly abundant throughout the genome, considering that they are to be found approximately once every 10 kbp in fish species (Jeffreys *et al.*, 1987, 1991; Wright, 1993; O'Connell and Wright, 1997).

These sequences may turn into a kind of co-dominant PCR-based marker which is highly polymorphic, i.e., these SSR may present many alleles (Araneda, 2005). In the PCR amplification of microsatellites, the primers are situated in the genomic regions that flank the tandem repeat sequences and, therefore, these markers are species-specific as these flanking sequences vary from one species to the other (Hancock, 1999).

The polymorphism detected through a SSR marker is due to variations in the number of repeats of the central motif of the microsatellite, which can be revealed after its PCR amplification by electrophoresis in denaturing polyacrylamide gels. To be able to visualize the fragments through autoradiography, one of the primers is labelled with  $^{32}\text{P}$  (Shimizu et al., 2002) although they can be made visible with silver staining, without necessarily having to use radioisotopes (Araneda, pers. com.). According to Shimizu et al. (2002), radioactive labelling has many disadvantages such as: the amount of time needed to obtain results, the expense of restriction enzymes and isotopes, possible ambiguous results and safety issues associated with the use of isotopes.

The reliability and accuracy with which the microsatellite alleles can be routinely separated has enabled the automation of detection and labelling (Edwards et al., 1991). There are two kinds of available systems for microsatellite tests: automated DNA sequencers (gel and capillary), and fluorescent image apparatus (ABI, Molecular Dynamic's FluorImager<sup>TM</sup>, and Hitachi's FMBIO<sup>TM</sup>) (O'Reilly and Wright, 1995). For this, one has to chemically modified primers with a coloured fluorochrome (red, green, blue or yellow) which together with programs like Genescan<sup>MR</sup> will serve to analyze the resulting fragments (Araneda, 2005).

According to O'Reilly and Wright (1995), all of these systems offer the following benefits over conventional methods: display of alleles without using radioisotopes, better performance, labour and laboratory cost reduction, possibility to use wavelengths in dual or multiple form and of internally running standard sizes,

increased possibility to use multiple loci and automatically labelling the size of the allele.

Multiplex PCR reactions are PCR variants in which two or more loci are simultaneously amplified in the same reaction (Henegariu et al., 1997). When more than one primer is used per reaction, the total number of reactions in an experiment is reduced. This has significant benefits in terms of costs and labour.

The inheritance pattern of microsatellite markers is co-dominant (homozygotes can be distinguished from heterozygotes) and it shows in general a large number of alleles per locus, as the tandem repeat sequences have mutation rates two to three orders of magnitude larger than single sequences ( $10^{-3}$  per gametes per generation v's  $10^{-6}$ , Ellegren 2004).

#### **Disadvantages and limitations of microsatellites**

- Development and costs

The isolation and development of microsatellites can be technically very complex and difficult, when compared with other techniques such as alloenzymes. However, several loci of polymorphic microsatellites loci can be developed in a short time (months), or else microsatellites developed by other researchers for the species may be tested. In the event that there are no specific microsatellites available for the species, one may use heterologous primers isolated from closely related species and transfer them to the one that is being studied. Microsatellites developed for an application (e.g., kinship assignment) may prove to be useful for other applications (e.g. genetic mapping) (O' Reilly and Wright, 1995). Many microsatellite loci are

now available for different salmonid species and their amount is constantly increasing in other species (GenBank).

- Stutter bands

Most alleles from dinucleotide microsatellites are visible as stutter bands instead of a single discrete product and this may cause problems when labelling certain alleles. Often the stuttering pattern is constant among individuals, and therefore well separated alleles may be unequivocally identified (O' Reilly and Wright, 1995).

- Null alleles

Null alleles are defined as alleles that may not be observed using standard tests. Non-identified polymorphism, base substitution or elimination of bases in the primer sites may cause some microsatellite alleles to amplify poorly or simply not amplify. Sometimes the presence of null alleles may be detected as divergences from classic Mendelian inheritance rules, or heterozygote deficiency predicted by the Hardy-Weinberg rules (O' Reilly and Wright, 1995).

### **1.4.3 Molecular markers based on DNA chips**

A DNA chip is a thin and flat piece of silicone or glass, of a 2 cm<sup>2</sup> or smaller area, which carries a large number of different oligonucleotides, ordered in defined positions on its surface. The DNA to be studied is marked with a fluorescent compound and pipetted onto the chip's surface. Hybridization is detected by examining the chip with a microarray scanner (laser scanners that detect fluorescence through adequate filters or confocal microscope). In low intensity one may use radioactive marking which is electronically detected with a phosphor imaging

equipment. The position from which the fluorescent signal is detected indicates the oligonucleotide that has hybridized with the DNA under study (Díaz N, 2005). A large number of Single Nucleotide Polymorphisms (SNP) can be studied with this technology in a single experiment (Brown, 1999).

### **Single Nucleotide Polymorphism (SNP)**

There are a great number of specific mutations in the genome, some of which give rise to RFLP markers, but many of these mutations may be in DNA sequences which are not recognized by restriction endonucleases. A SNP corresponds to a position in a DNA sequence in which there exist two alternative nucleotide bases (two alleles), in a significant polymorphism (>1% for the less common allele in a population (Wang et al., 1998).

To detect SNPs, oligonucleotides (generally less than 50 bases long) are used as probes. In the appropriate positions, the nucleotide will hybridize with another DNA molecule only if the oligonucleotide joins in a strictly complementary form with the target DNA molecule. Hybridization conditions are very strict; therefore, the formation of a stable hybrid molecule is only achieved if the complementation is complete. If there is only one base that is not complementary in a position, the oligonucleotide may discriminate between two SNP alleles (Díaz N, 2005).

DNA chips, besides searching for SNP, are used for comparing RNA populations from different cells and will potentially be of use in the new sequence methods that are being developed. The density of the oligonucleotides or DNA probes on the chips has been increased from about 6400 in an order of 80x80 in 18 mm<sup>2</sup>, which will



permit identifying half a million SNPs at a time, supposing there are oligonucleotides for both alleles of each SNP. The aforesaid has been achieved by developing sophisticated technologies of oligonucleotide synthesis on the chips (Brown, 1999). At this time large numbers of SNPs are not available in most farmed fish species.

#### 1.4.4 Comparing different types of genetic markers

Due to the intrinsic nature of each kind of marker, there are differential characteristics in each one of them which one needs to know before eventually using them. On Table 1-6 these features are compared, giving preference to markers using PCR (Díaz N, 2005).

Table 1-6 Comparison of certain distinctive features of genetic markers (Diaz 2005)

	<b>RFLP-PCR</b>	<b>RAPD</b>	<b>SCAR</b>	<b>MICROSATELLITE</b>	<b>AFLP</b>
<b>Principle</b>	Single locus PCR and digestion with restriction enzymes	PCR with arbitrary primers	PCR with specific primers	PCR with single repeat sequences (1-6pb)	Enzyme digestion and PCR fragment with selected primers
<b>Type of Polymorphism</b>	Change of bases in restriction sites, insertions and deletions.	Change of bases in primer joining sites, insertions and deletions	Change of bases in primer joining sites, insertions and deletions	Length differences due to number of units that repeat 10-50 times in tandem.	Differences due to specific mutations in primer joining sites
<b>Polymorphism</b>	Low	Medium	Low	High	High
<b>N° loci detected</b>	1	1 to 10	1	1	Many
<b>Mode of Inheritance</b>	Codominant	Dominant	Dominant / codominant	Codominant	Dominant
<b>Genome knowledge</b>	Yes	No	Yes	Yes	No
<b>Technical difficulty</b>	Low	Intermediate	Low	Low	Intermediate
<b>Development cost</b>	High	Low	High	High	Medium
<b>Replicability</b>	High	Medium	High	High	Medium

### **1.4.5 Application of genetic markers in aquaculture**

During recent years the development of potentially useful DNA molecular markers for aquaculture has increased, due to the funding of genomic projects in several cultivated species, initiated at the end of the '90's and that are currently furnishing a great amount of information about genes, DNA sequences and new molecular markers that are deposited in public genomic data banks (GeneBank and EMBL).

Great efforts have been focused on developing microsatellite markers and AFLPs, although other markers such as RFLPs, mitochondrial DNA and RAPD have also been usefully applied in aquaculture. This is mainly because genomic research in these species has been focused in building genetic maps of molecular markers, in which microsatellites and AFLPs have provided a lot of information (Iturra, 2005).

Thus, there are at present a significant number of microsatellite loci markers for several salmonids such as rainbow trout, Chinook salmon, brown trout and other cultivated species such as catfish, prawn and oysters.

Among molecular marker applications in aquaculture we can mention comparison of wild and cultivated stock, genetic identification and culture stock discrimination, monitoring of endogamy and other changes in genetic variation, assignation of progeny to their parents, linkage mapping, Quantitative Trait Loci (QTL) identification and their use in selection programs (Marker-Assisted Selection MAS), verification of the success of genetic manipulations such as polyploidy and gynogenesis, among others (Iturra, 2005).

### **Characterization of genetic variability within and between stocks**

Genetic markers have been used for defining the structure of the underlying stock of several wild fish species (O'Connell and Wright, 1997). As regards aquaculture, the most frequent genetic analyses are those performed to compare the genetic structure of cultivated strains with that of native wild population, as also the genetic variability within and between culture strains or stock. Loss of genetic variability has been demonstrated in cultured stock as a result of different factors, including the use of a small effective number of parents or the cross design. Therefore, cultivated strains must be monitored to detect genetic changes that may affect these populations and to avoid or minimize undesired genetic changes in the future.

Microsatellites with high polymorphism and codominant inheritance allow us to make estimates of reliable genetic population parameters. The analysis of the allele frequencies in a set of microsatellite loci has been useful for the genetic characterization of cultivated fish strains. The different strains may possess alleles that have a different frequency, becoming characteristic markers for each strain (Iturra, 2005).

There are several reports in which the genetic variation of native wild fish populations and farmed strains have been compared. The genetic difference within and between different cultures of Japanese flounder (*Paralichthys olivaceus*) was assessed and compared with native populations using 11 microsatellite loci and mitochondrial markers. The results show that these markers are very useful tools which revealed a significant genetic differentiation between wild and cultivated populations. The reduction of the number of alleles per locus of the microsatellite markers was also

detected and the variation of the mitochondrial marker in cultivated stock, probably due to the small number of parents used. This analysis suggested permitted restocking strategies so as to avoid a negative genetic impact on native populations.

Microsatellite markers have shown to be very informative in these kinds of studies. However, the problem is that they must be developed for each species, which is a relatively expensive and very laborious process and cannot be applied in species with little known genomes. In some cases, it is possible to use heterospecific microsatellites as the sequences flanking the repeat motif of the microsatellite, which correspond to the primer joining sites for PCR amplification, are generally kept in phylogenetically related species (Iturra, 2005).

#### **Monitoring of genetic changes in stocks**

Cultivated populations may be exposed to endogamy and loss of genetic variability due to the population's reduced size. Endogamy may even be induced in large populations by breeding behaviour, physiological factors and other causes. The loss of variability may be due to the use of related individuals in stock renewal or to the fact that few individuals provide the gametes that participate in reproduction when breeding is done with spermatozoid or ova pools during selection.

Alloenzyme tests have been successful in detecting the genetic impact of culture, revealing retention of high levels of heterozygosity in cultivated rainbow trout, although in other cases a loss of heterozygosity has been detected in this same species. Microsatellites are also useful for these purposes as the high number of alleles per locus in the population and, therefore, the lost of alleles is easily detected.

One example is the recent work on Atlantic salmon strains used by the industry in British Columbia, Canada. The amount and distribution of genetic variation was assessed using 11 microsatellite loci in 20 groups of breeders of major Atlantic salmon industries of this country. The strains that were studied were Mowi of Norwegian origin, McConnell from Scotland and an American one, including specimens of this latter strain that have grown wild. The variability of alleles was almost 50% less in cultivated strains (10.9 alleles per locus) than in the population grown wild with 20.3 alleles per locus. Somewhat surprising was the fact that in some of the domesticated populations there was an excess of heterozygote individuals and this result may be due to the kinship existing between the parents of the sample under study and in other cases, to hybridization phenomena between strains of different allelic frequencies, which reflect the techniques being used in the different industries. The potential use of microsatellites as a tool to assign individuals to their respective strain or stock was also established. More than 90% success was achieved in classifying each individual according to its original strain and breeder (Iturra, 2005).

#### **Parentage assignment**

The highly variable nature of the microsatellite loci makes these markers particularly convenient for investigating kinship (O'Connell and Wright, 1997). In a program of genetic improvement it is essential to know the kinship relationship (parents and offspring). Fish farmers may use microsatellites to establish the pedigree of mixed family groups cultivated in communal environments. It is generally not possible to discover mixed family groups cultivated in communal environments without molecular markers because a physical tag cannot be applied to newborn fish. In the past, progeny groups had to be bred in different tanks until physical tagging was

possible. Selection experiments were restricted to laboratories with specialized culture infrastructure with no commercial conditions (O'Connell and Wright, 1997).

Microsatellite loci are the markers that are most used for establishing kinship in various cultivated species supported by statistical analysis tools. The analysis of a set of microsatellite loci practically provides a specific alleles pattern for each individual. Simulation studies aimed at proving the power of kinship assignation have proved that it is necessary to use a minimum of four informative microsatellite loci to assign at least 99% of the progeny to their parents, considering a cross of 100 couples. The number of loci studied will also depend on the allelic variability they present in the population under study. When there exists sufficient variability in the microsatellite loci, family and parent identification is possible, even if there is no genetic information about the parents. The assumptions implied in simulation studies suggest that they must be ratified with empirical data, with real pedigree and variability data to confirm the practical power of these estimators (Iturra, 2005).

Several studies have proven the usefulness of this kind of markers in the reconstruction of pedigrees in fish populations such as salmon, trout, turbot, Japanese flounder and tilapia, among others. Microsatellites (15) were used in Atlantic salmon to determine the genotype of 200 specimens, and crosses were also performed in which parents and progeny from 10 families were genotyped for control. The feasibility of correctly assigning kinship in 98% of the progeny was shown by this study and with a larger number of families this percentage is slightly lower. It has to be pointed out that only 8 microsatellites were used for these calculations. From a practical point of view, a balance must be reached between the acceptable percentage

of non-assigned individuals and the cost and time implied in establishing the progenies' genotype with these markers. It is also important to estimate the minimum number of informative microsatellites needed to assign kinship in each production plan before routinely applying this method in improvement programs, particularly when the linkage map of the loci to be evaluated in a specific species is not known (Iturra, 2005).

### **Genetic manipulation assessment**

The success of genetic manipulation methods applied in aquaculture, such as polyploidy or gynogenesis production may be assessed using molecular markers.

Microsatellite markers are a useful tool due to their polymorphism, i.e., the high number of allelic variations present in each microsatellite locus. For instance, triploid individuals may be identified through the presence of three alleles of certain microsatellite loci in their genome and in gynogenetic progeny the presence of only maternal alleles may be detected in microsatellite markers.

Identification of turbot gynogenetic progeny was performed using a set of microsatellite loci to ensure the offspring only expressed maternal alleles. The genetic variability shown by these markers permitted a high confidence level for the paternity test, the exclusion probability being 99.897% when only the progeny genotype is known and reaching 99.999% if the genotype of one of the parents is known (Iturra, 2005).

The identification of genetic sex in monosex progeny produced is possible using sex-specific molecular markers. These markers are available for some species such as

Chinook salmon and Coho salmon. In the first species a Y chromosome-specific repeat sequence has been characterized which permits identifying sex using PCR, as an amplification of this sequence is only observed in genetically male specimens. Several sex-linked microsatellite loci have been described in the different sex related salmonid species, which may also become useful markers for identifying genetic sex in this species (Iturra, 2005). The availability of sex-linked markers in a species can dramatically reduce the time taken to develop single sex lines as it removes the need to progeny test all of the putative (e.g. homogametic XX) broodstock to assess their ability to generate the required sex-ratio in the offspring.

#### **QTLs Association: Genetic maps, mapping and QTLs detection**

One of the most important uses of molecular marker techniques is the possibility of building genetic maps of a species, i.e., establishing the chromosome order and location of DNA sequences, genes or molecular markers. There are several kinds of maps that provide different information, built with different techniques. It is important and interesting to point out that the genetic information that each one of them provides can be integrated to constitute the basis for the knowledge of the architecture and functioning of the genome of a species. Knowledge about the location and order of the genes or genetic markers in the chromosomes of a species permits mapping new genes or target markers, and also identifying gene related groups in a chromosome in homologous chromosome regions of other species (synteny). Genetic maps of major aquaculture species, such as Atlantic salmon, rainbow trout, brown trout, catfish and oysters, are in different stages of development, all of them begun with the development of molecular markers such as AFLPs and microsatellites, in particular. To these we can add RAPDs and Type I markers or protein-coding genes.



Microsatellite loci are the most used markers because they are codominant, hypervariable and are distributed in a relatively uniform way along chromosomes. Despite the efforts of several research groups, these maps are in a partial state of development, a higher level of coverage or saturation with markers in the chromosomes of different species is still needed (Iturra, 2005).

Young et al. (1998) published the first genetic linkage map of rainbow trout, mainly using AFLP markers. Sakamoto et al. (2000) made known a map of this same species using microsatellites. Nichols et al. (2003) recently presented a consolidated map which included Type I markers, and alloenzymes in rainbow trout in which markers are mapped in all the chromosomes of this species. A smaller number of markers have been mapped in the chromosomes of Atlantic salmon (Gilbey et al., 2004; Moen et al., 2004). Despite these efforts, the number of developed markers is far behind that of other model fish such as zebrafish and medaka. A genetic map of high density and complete sequence of the genome would be an extremely useful resource for genetic improvement programs (Iturra, 2005).

Many traits of economic importance have a continuous distribution in an observed scale. These traits (quantitative traits) are generally modelled as being controlled by many genes of small additive effects (Falconer, 1981). Genetic markers may be used to identify specific regions of chromosomes where genes affecting quantitative traits are located, known as Quantitative Trait Loci (QTL). QTL have been detected in experimental and commercial populations of cattle, pigs and sheep. We can find a number of QTL examples detected in cattle populations in literature (Davis and DeNise, 1998).

That is the reason why a great part of the efforts in rainbow trout have been targeted to QTL loci mapping using markers of genetic linkage maps (Sakamoto et al., 1999, Ozaki et al., 2001; Perry et al., 2001; Robinson et al., 2001). A detailed linkage map is required for mapping a QTL, with variable markers distributed throughout the genome. The linkage between a molecular marker and a QTL segregator allele may only be reliably detected at a distance equal or lower than 20 centimorgans (cM) (Soller et al., 1976).

There are several processes that may be used for detecting the genes that control a quantitative trait, assess its effects and determine its chromosome location. The basis of the use of molecular markers for this purpose is to presume that said marker is located near to the QTL in the chromosome. An important feature is that this marker must present variability. That is why the use of a set of microsatellites has proved successful on many occasions. The cosegregation of the alleles of each locus or the combined form of several loci is assessed with the productive target traits. The correct definition of the trait or phenotype under study is very important, i.e. its measurement, if it is necessary, or the unambiguous identification of the trait. Among the traits which deserve to be studied are those that are difficult or expensive to measure, or which can only be noticed once the fish is dead or are of low heritability. Knowledge of associations between molecular markers and QTLs may be included in a genetic improvement program. This information may be useful for increasing the genetic response which affects the selection intensity and its effectiveness (Iturra, 2005).

## **1.5. Aim of the project**

### **1.5.1 Main objective**

- To estimate the potential for a breeding program for the UK rainbow trout industry.

### **1.5.2 Specific objectives**

- To assess the molecular genetic variation present in a number of different rainbow trout strains utilized by the UK industry to identify suitable candidate strains to establish a breeding programme.
- In the absence of a large scale family unit. to utilize published microsatellite markers and semi automated (ABI 377 sequencer) genotyping protocols to show the feasibility of using this technology to perform parentage assignment in fish held under commercial conditions.
- To establish a breeding design to enable the calculation of genetic parameters from fish grown under commercial conditions.
- To manage the experimental offspring rainbow trout communally, in the same environments over the production cycle.
- To measure the progeny for a range of commercially relevant traits including growth, flesh colour and survival.
- To obtain estimates of heritability for growth rate, flesh colour and survival under commercial conditions.

## Chapter 2 / GENERAL MATERIALS AND METHODS

### The link aquaculture program

The LINK Aquaculture project on the genetic improvement of the UK rainbow trout was a collaborative project between the British Trout Association and some of its member farms, the Institute of Aquaculture (University of Stirling), and the Roslin Institute (Edinburgh).

### Broodstock over the reproduction season became the base population

The artificial reproduction at the 3 different hatcheries (Isle of Man, Houghton Spring, and Trafalgar) were done over 3 different dates during their reproductive season. A total of 130 neomales and 175 females were selected according to their maturity availability at those days when the artificial reproduction took place. Table 2-1 shows weight and length data of the broodstock selected for the study on the spawning date when they were selected. The Trafalgar information is included as background but none of the data was eventually utilised.

Table 2-1 Measurement of Base Population weight and length

Hatchery	Spawning date	Neomale N°	Female N°	Neomale weight (g)	Neomale length (cm)	Female weight (cm)	Female length (cm)
Isle of Man	13 Nov 2002	40	40	1731 (763)	50 (7)	2853 (618)	58 (4)
Houghton Spring	5 Dec 2002	50	95	1640 (498)	50 (5)	1189 (193)	46 (3)
Trafalgar	6 Dec 2002	40	40	757 (183)	38 (3)	3064 (905)	56 (4)
<b>Overall</b>		130	175	1396 (682)	46 (8)	1998 (1037)	51 (6)

\* parenthesis shows the standard deviation.

My role in the project was to undertake all breeding experiments previously designed in conjunction with the Roslin Institute in Glenwyllin Trout Farm in the Isle of Man, Houghton Spring Fish Farm in Dorset, and Trafalgar Fisheries in Wiltshire. After the breeding and on-growing a single component of this large trial, the Glenwyllin Isle of Man (IOM) / Test Valley Trout (TVT) fish were used as the data set for my PhD project (Figure 2-1).

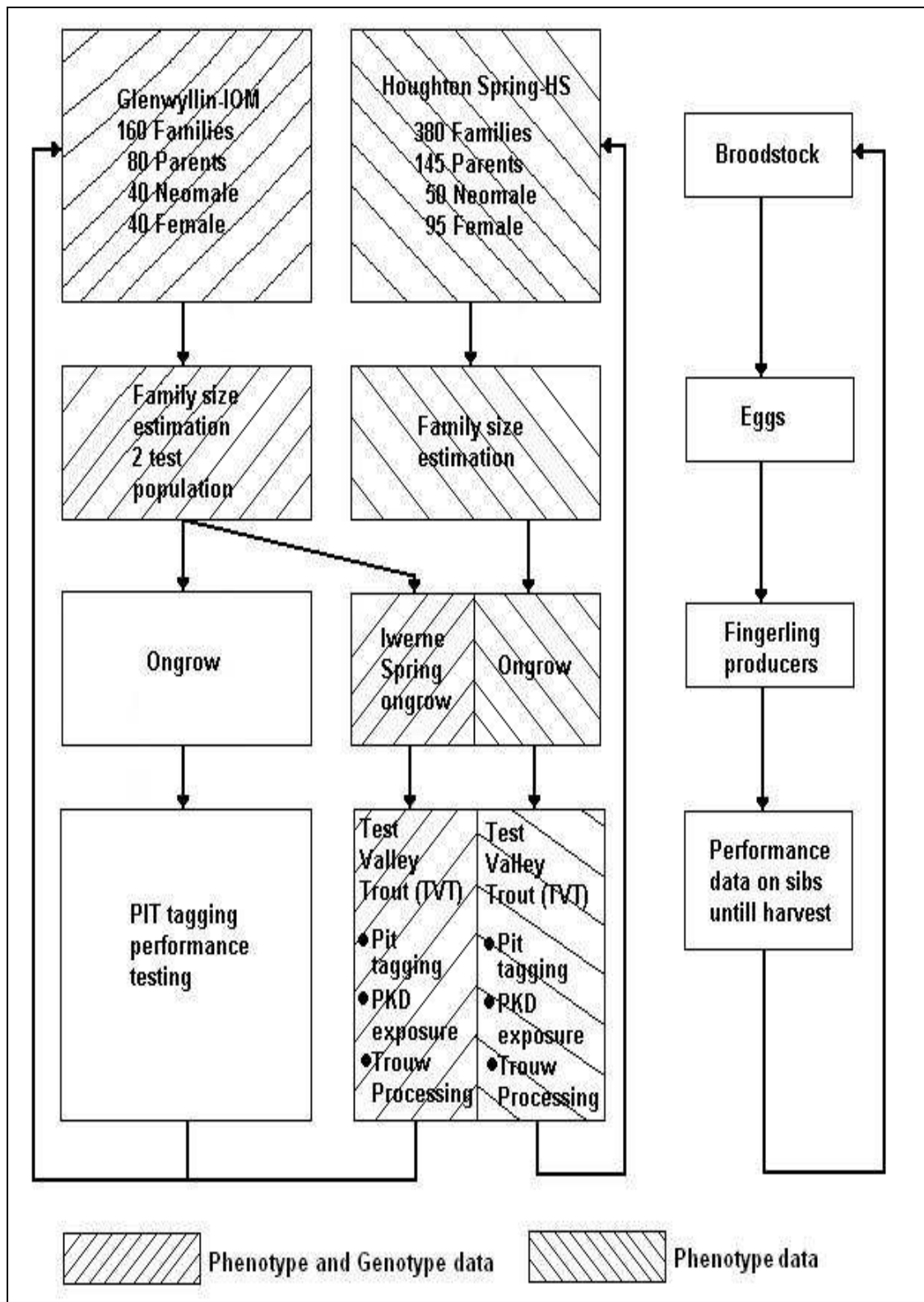

Figure 2-1 Design of the breeding programme and the relationships between the hatcheries, fingerling producers and growers

### **Offspring over the main trial at TVT**

Eyed eggs and fingerling were transported to the main trial at Test Valley Trout as described in Figure 2-1. The main growth trial was to be carried out using the facilities of Test Valley Trout (TVT).

TVT is a production unit that buys in 5 g fingerlings for ongrowing. The Glenwyllin eyed eggs were supplied to Iwerne Spring fingerling producers, and all the eggs from the communal batch were grown under normal Iwerne Spring conditions.

The Houghton Spring farm is one of the preferred fingerling producers for TVT. The families at Houghton Spring were combined and grown communally using standard fingerling production.

The Iwerne Spring fingerlings from Glenwyllin, and Houghton Spring fingerlings, were supplied to TVT. Then, the strains were held separately, into circular tanks prior to PIT tagging for identification in the communal ongrowing at TVT Great Bridge site.

On the 4<sup>th</sup> of June of 2003 in TVT, 3000 fingerling were PIT tagged; 1500 from Houghton Spring and 1500 from the Isle of Man.

The growth rate calculation of these fish was necessary, as this was one of the objectives of the study. In order to achieve this objective, it was necessary to record the weight and lengths over their production life cycle over 3 times, this data were taken as shown in Table 2-2. The initial measurement is done at the PIT tagging time and the final measurement is done at the harvest time.

Table 2-2 Weight and length recording time from OHS and OIM trout since the stripping time.

	INITIAL TIME		INTERMEDIAL TIME		FINAL TIME	
	OHS	OIM	OHS	OIM	OHS	OIM
<b>Weeks from stripping</b>	26	29	52	55	64	67

**Silver Trout processing plant: processing route and data gathering**

Before transferring the fish they may be anaesthetized with CO<sub>2</sub>, then the trout may be sacrificed in the water centres or else arrive alive to the storage centres to then enter the slaughter centres. Next they are transferred to the processing plant, in this case Silver Trout; only the sacrificed trout are processed and not those who have died of a natural death. If the fish are transported dead it is generally done inside isothermal bins with ice flakes at a temperature below 4° C. The most important factor to consider is that the least time possible must elapse between the fish’s death and its processing.

At the plant two processing lines were set up, each manned by a team of five people, plus another person working for both lines. Expert workers filleted the fish using knives specially designed for this work and experienced personnel took the quality measurement. The room temperature at the plant was below 10° C. Figure 2-2 represents an aerial view of the lines and the distribution of work in order to get all the processing data.



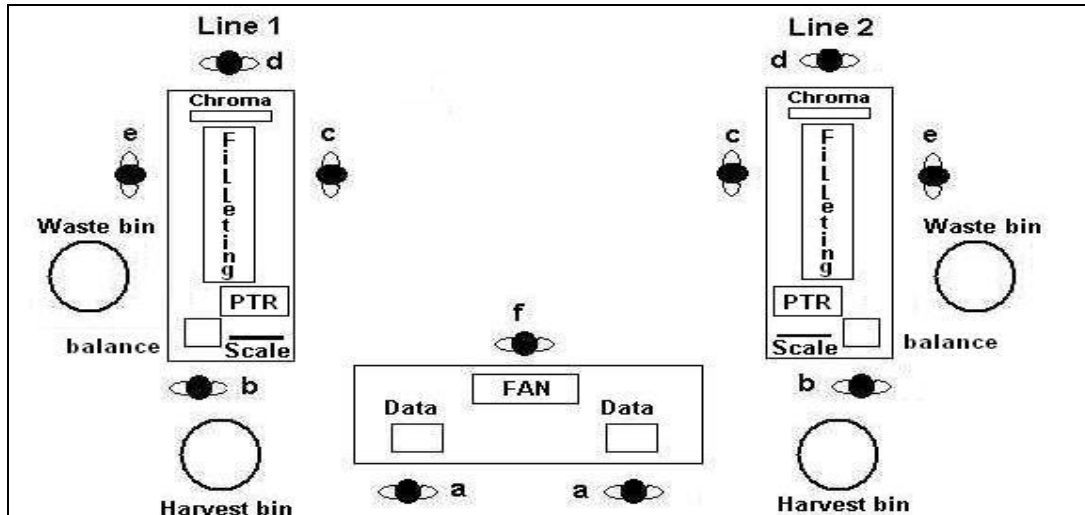

Figure 2-2 Distribution of the work at the processing plant: **a.** - Recording data in the laptop. **b.** - Measure weight, length and identification through PIT tags (PTR = Pit Tag Reader) **c & e.** - Filleting the trout. **d.** - Flesh colour Chroma meter. **f.** - Flesh colour Roche Fan (both lines).

In general terms, trout processing begins by receiving the raw material in the plant. The dead trout arrived from the farm in two large harvest bins and in less than an hour they were taken out of the water.

After having been received in the plant, they entered the processing line and were processed in ordered batches of 10 and the PIT tag numbers were directly read into the laptop next to person b. Length and weight were verbally given for each fish to the data logger a. The fish was then gutted and reweighed and this weight was given verbally to the data logger a. The fish was then filleted and a single fillet was laid on a tray in ordered batches of 10. The ordered fillets were cleaned with tissue, then read by the Minolta Chroma Meter and this data was directly printed onto a till roll and was later manually transferred to the laptop. Also Figure 2-3 explains the layout of the information gathering in the two processing lines.

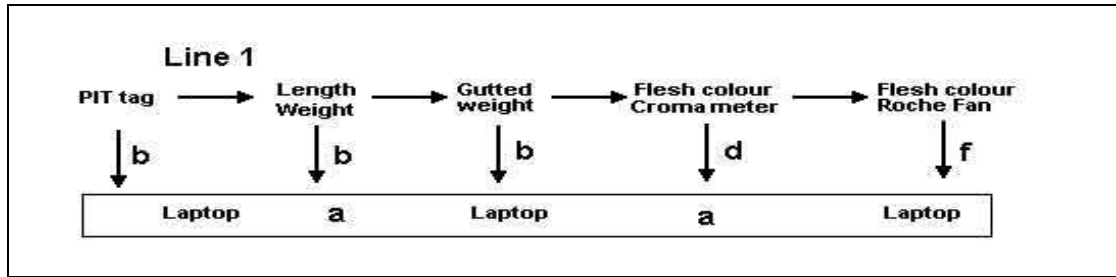

Figure 2-3 Information layout and people (a, b, d and f) involved in collecting data on the fish

The ordered tray of fillets was then passed to the Roche fan reader and the fan score called to the respective data logger, depending on whether the tray was from Line 1 or Line 2. The trout processing lasted 4 days, therefore the following data was recorded for every day of work and every fish: day of processing, PIT tag number, ungutted weight and length, gutted weight, Minolta Chroma meter ( $L^*$ ,  $a^*$  and  $b^*$ ), and Roche fan score.

## 2.1. Fish breeding general procedure

### Artificial reproduction: production of high quality ova and fry

The method of ova production has been described in several works by different authors. The breeding work was undertaken on large commercial farms and utilised standard procedures and does not need to be discussed in detail. If more details are required the broodstock management and maturity assessment is based on the works of Springate and Bromage (1984), and Ureta (2000). The spawning and stripping process has been described by Stevenson (1980), and the embryonic development and ova handling by Estay et al. (1994; 1995); finally, the eclosion and fry rearing have been described by Edwards (1978) and Stickney (1991). Only areas unique to this project will be described in more detail in the following sections. The UK industry is

now almost totally based on the production of all-female rainbow trout. This requires the production of sex-reversed females called neo-males. Neomale rainbow trout usually have incomplete sperm ducts and need to be killed and the testes removed before the milt can be extracted and used for fertilising eggs.

### **2.1.1 Fish strains and mating design**

The LINK trial at Test Valley Trout (TVT) was designed to compare two fish strains, under identical commercial conditions. The rainbow trout strains were from two different hatchery origins. The first came from Glenwyllin hatchery in the Isle of Man (IOM) and the other from Houghton Springs (HS) hatchery in Dorset.

The Glenwyllin rainbow trout stock has been genetically isolated without introductions for over 26 years. The hatchery is a major eyed egg producer, approximately 20 million eggs all female per reproductive season, supplying United Kingdom and European trout industry. In the farm there were two nominal lines, A and B, being both originally from the same strain. Spawning selection over generations has resulted in Line A spawning earlier than Line B but at this stage there is still some overlap between the groups enabling fish from both lines to be bred and assessed at the same time. This resulted in the selection of four groups of parents:

1. AFI = Line A, Female, Isle of Man.
2. ANI = Line A, Neomale, Isle of Man.
3. BFI = Line B, Female, Isle of Man.
4. BNI = Line B, Neomale, Isle of Man.

Houghton Springs Fish Farm is situated in Dorset and is borehole supplied from the aquifer supplying the Winterbourne at Winterbourne Houghton. No water is

abstracted from the Winterbourne and as such the supply is protected. The farm has evolved on a site originally developed for Watercress cultivation. Originally established as a mixed farm for restocking of both rainbows and brown trout, it is now producing 12.500/day, 6.5 g all female rainbow trout fingerlings for ongrowing at other farms and destined for the processor and ultimately the supermarkets.

The supply of ova is from their own stock, some of which are held under photoperiod conditions, offering an out of season supply. The hatching and early rearing is carried out on borehole water. For faster growth and to optimize the water usage, the ongrowing takes place in 90% recirculated water, employing two fluid bed bioreactors, after the removal of suspended solids in a conveyer belt filter. A final adjustment to the oxygen content is made by a specially designed computer controlled oxygen injection unit.

The Parent Houghton Springs (PHS) strain, there were selected two different groups of parents:

1. NHS = Neomale, Houghton Spring.
2. FHS = Female, Houghton Spring.

The offspring from the crosses of IOM parents will be called OIM (Offspring Isle of Man) and the offspring from HS parents will be called OHS (Offspring Houghton Spring). The following design was created using artificial stripping reproductive methods.

### **The Isle of Man crosses**

The crosses are a partial factorial mating designs. On the 13<sup>th</sup> of November 2002, 20 neomales and 20 females from both Lines A & B were chosen, 80 fish in total. The design required each neomale to be crossed to four different females, two of the same line and two of the other line. Similarly each female would be crossed to four different males, two of the same Line and two from the other (Figure 2-4). The complete design would result in a total of 160 different families.

To achieve this design each egg batch was divided equally into four different bowls and 1 ml of milt from the appropriate neomale was added from a syringe in line with the design.

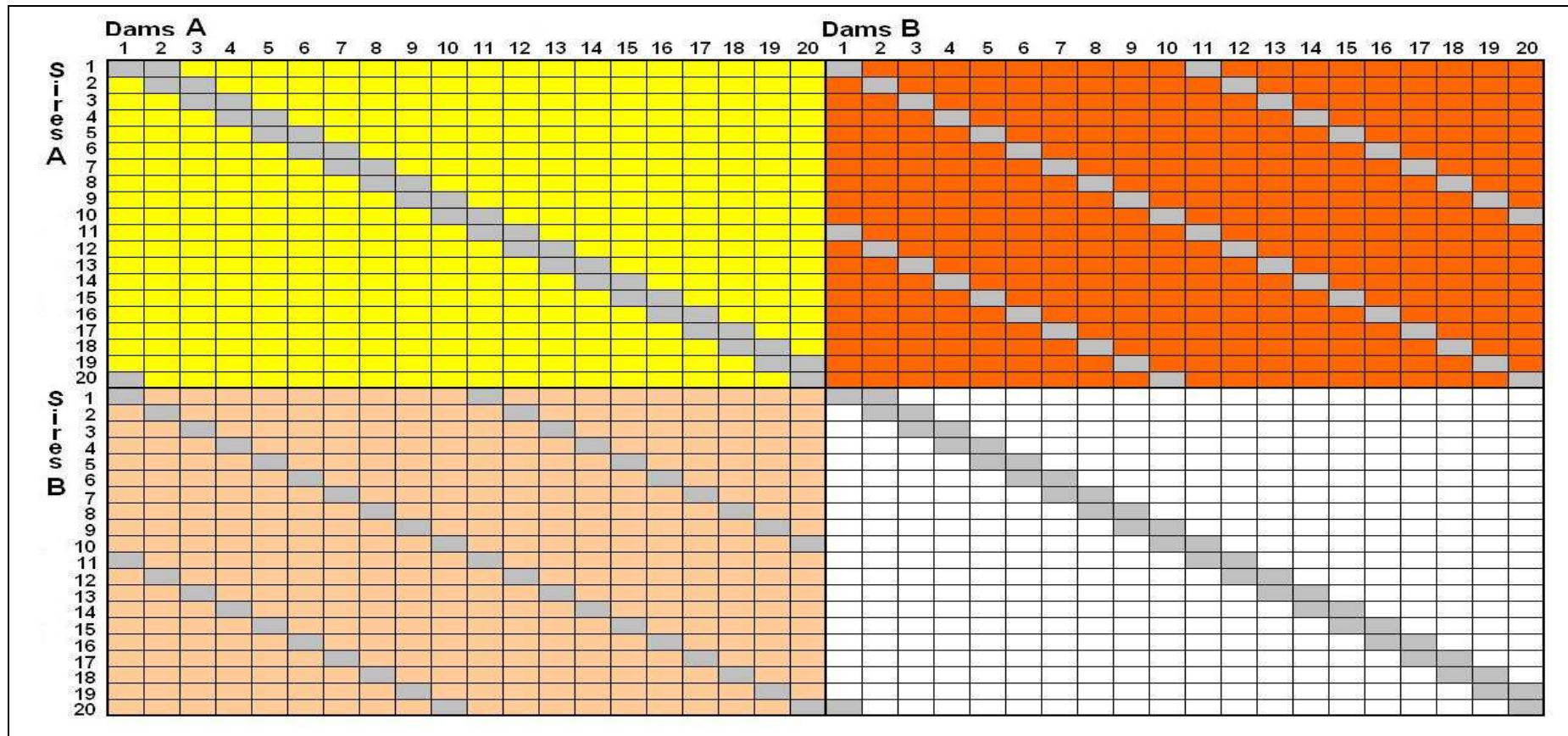

Figure 2-4 Isle of Man (IOM) breeding design indicating the pure bred crosses with the yellow & white colours (AFI x ANI & BFI x BNI) and the hybrid crosses with the pink & orange colours (AFI x BNI & BFI x ANI). The grey squares means allowed crosses.

Each egg batch was then rinsed and water hardened before being transferred to an individual egg tray. Each family was reared separately up to the eyed stage at which point the eggs were mechanically shocked, in order to separate the mortality, and then counted, as it was explained above.

The eggs from each family were then split into two equal batches and assigned to the two communal test groups. The first Glenwyllin (IOM) for broodstock replacement and the second was sent to Iwerne Spring a specialized fingerling production farm to supply TVT. At this point we knew the relative number of eggs in each family in each of the communal groups.

#### **The Houghton spring crosses**

On the 5<sup>th</sup> of December 2002, 50 neomales and 100 females were chosen from a single strain within the Houghton Spring hatchery. The design required each neomale to be crossed to eight different females (2 years old fish) and each female would be crossed to four different neomales. Problems with female size and egg numbers and quality resulted in a number of exceptions, thus it was impossible to undertake all possible eight neomale crosses. Table 2-3 shows all the neomales with less than 8 crosses, eggs from two females were pooled before being divided and fertilized.

Table 2-3 Neomales that produced less than the planed 8 families in breeding design

<b>Neomale</b>	<b>NHS 01</b>	<b>NHS 16</b>	<b>NHS 17</b>	<b>NHS 18</b>	<b>NHS 32</b>	<b>NHS 33</b>	<b>NHS 34</b>	<b>NHS 48</b>	<b>NHS 49</b>	<b>NHS 50</b>
<b>Families</b>	6	7	6	6	7	6	6	7	5	4

The design is shown in Figure 2-5. The eventual design resulted in a total of 380 different families (Table 2-4). To achieve this design each egg batch was divided equally into 4 different bowls and 1 ml of milt from the appropriate neomale was added from a syringe in line with the design; at least 4 ml of milt from each neomale was required. Each egg batch was then rinsed and water hardened before being transferred to an individual egg tray. Each family was reared separately up to eyed stage at which point the eggs were shocked and counted.

Table 2-4 Description of the quantity of sires, dams, and families utilized in the crossing design and the relation that were created

<b>Crosses</b>	<b>Sires</b>	<b>Dams</b>	<b>Families</b>	<b>Relations</b>
FHS X NHS	50	95	380	* Full sibs * Paternal Half sibs * Maternal Half sibs



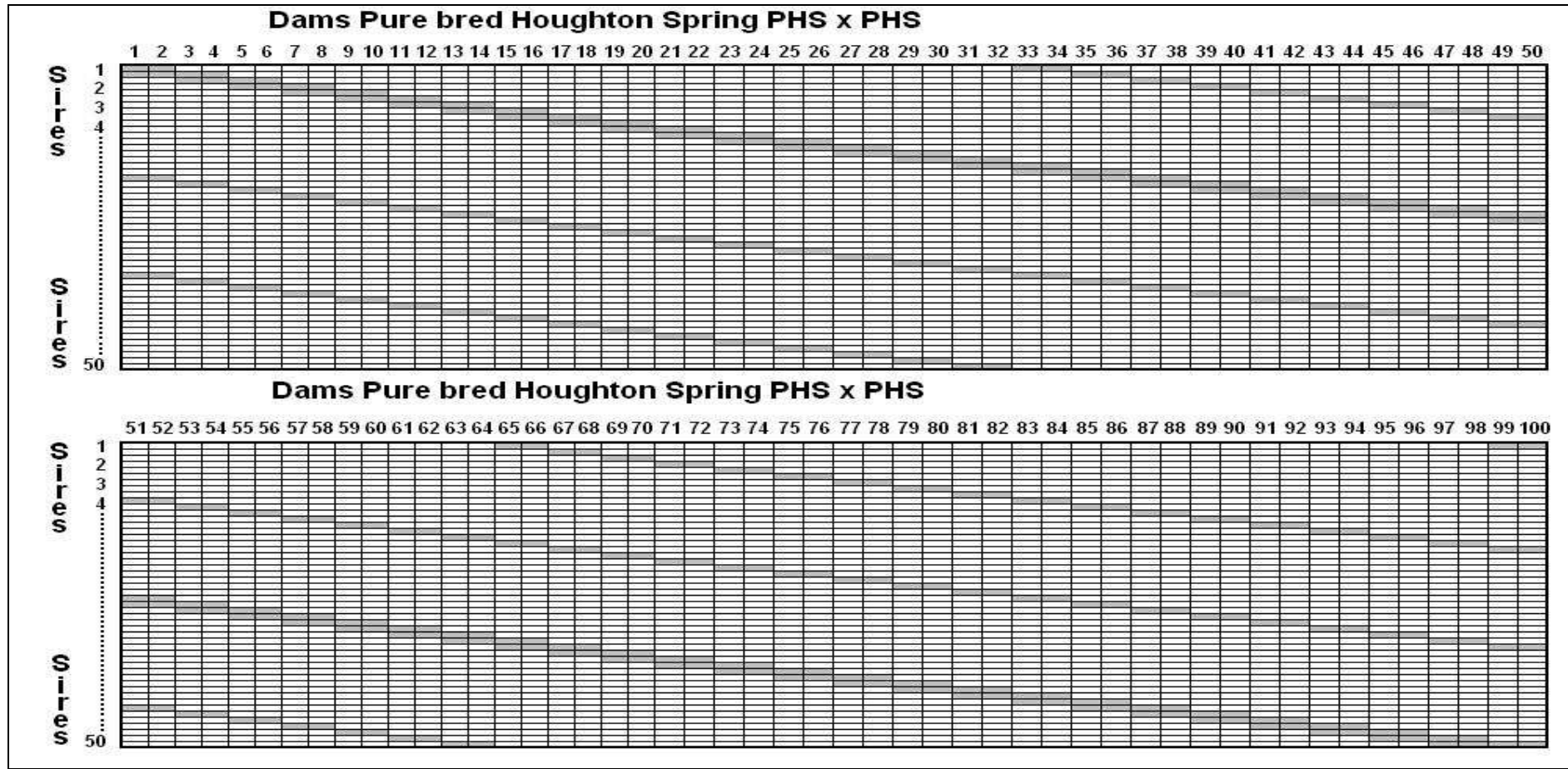

Figure 2-5 Houghton Spring cross design indicating in grey colour the allowed crosses and in white the not allowed crosses.

## **2.1.2 Measurement data collection**

### **Statistical analysis**

#### **Statistical methods and software (programs)**

Details of the different methodologies are described in detail in every Chapter. Nevertheless, the analyses of the Genetic Diversity study (Chapter 3) used the programs: GENEPOP (Raymond, M. and Rousset, F. , 1995), FSTAT version 1.2 (Goudet, 1995), GENETIX (Belkhir et al., 1996), Excel add-in Microsatellite Toolkit (Park S., 2001), PHYLIP (Felsenstein, 1993). The parental assignment (Chapter 4) was analysed utilising Family Analysis Program (FAP) version 3.5 (Taggart, 2007) and Package for the Analysis of Parental Allocation (PAPA) (Duchesne et al., 2002). Finally, the Phenotypic and Genetic parameters Chapter was analysed utilising the Minitab and GENSTAT version 5.0 software (Numerical Algorithms group, Wilkinson House, Jordan Hill road, Oxford).

### **Correlation analysis**

In certain occasions in biology is possible to find very often situations that are apparently associated or that are interdependent. For example we could have a situation in which an increase of the X variable is accompanied with a correspondent increase in the Y variable, or a decrease of the X variable is accompanied with a correspondent decrease in the Y variable. When is possible to demonstrate that the variable is in some degree associated with the variation of another, then it could be said that both variables are correlated.

This correlation is expressed by a coefficient (R) that can take values from -1 to +1. A coefficient of 1, being positive or negative, indicates a perfect correlation between two variables. By contrast, a coefficient of 0 suggests a complete lack of relation. If the researcher hopes to show a strong association, then an R value close to 1 will be considered optimum.

The determination coefficient ( $R^2$ ) could be used as an estimation of association intensity between the two variables that seems to be related. Specifically, the determination coefficient estimates the percentage of X variation that is associated with the Y variation, or vice versa. For example, if the sample correlation between two variables such as a chlorophyll and biomass is  $R = 0.5$ , the square of this coefficient gives a determination coefficient of 0.25. This suggests that the 25% of the variation of one of the two variables is associated with, or is the variation of the other.

### **Regression analysis**

The regression analysis consist in the measure of dependence degree of a Y dependent variable over an X independent variable, the researcher is able to manipulate the independent variable. In other words, the researcher decides which values will take the independent variable, while the values of the dependent variable are determined by the relation that exists, if there are, between the dependent and independent variable. For example, if a researcher measures the degree of dependence of the cardiac rhythm in alligator, subjecting them to specific temperatures, such as 10°, 15°, 20°, 25°, etc., while measuring the cardiac rhythm to those specific temperatures, the situation requires a regression analysis. In this case, the temperature it is not a random variable because the defined values of temperature were established by the

researcher. The cardiac rhythm, on the other hand, it is indeed a random variable, and it is not under the researcher control. The regression analysis could be used to predict the Y value that will result from the application of a specific X value.

### **REML analyses**

Restriction maximum likelihood (REML) has the ability to attribute variance components to individual sources. This ability could be used in a situation when there are confounding variables or the design of the experiment is unbalanced. REML is based on the general lineal model with both fixed and random effects. The fixed effects are related to the treatment being tested and random effects to the sources of random error in the data. If the data is unbalanced, a Wald statistic is used to assess the fixed effects; this statistic is based on the Chi-square distribution (Harville, 1977). In this study REML analysis was used to analyse the quantitative genetic results such as the heritability estimation of different commercial production traits (Chapter 5).

## **2.2. Sample collection: Tissue sampling, preservation, and PIT tagging procedure**

The study utilized Rainbow trout tissue samples from different strains, broodstock (base population) and offspring. The broodstock and the offspring were PIT tagged.

### **2.2.1 Different Strain Tissue Sample Collection and Preservation**

Fingerling rainbow trout samples were collected from three different culture facilities around the United Kingdom. The facilities were Glenwyllin Trout Farm in the Isle of Man, Seven Springs Trout in Larne (Northern Ireland), and Trafalgar Fisheries in

Wiltshire. At each site, fingerlings samples were collected from a number of tanks to maximize the chance of sampling from the widest number of families in each putative strain. Three strains were collected from Trafalgar Fisheries. One of them, specifically the Glenwyllin Trafalgar, GIT, was imported from the Isle of Man a number of years earlier. There are three different groups directly from the Isle of Man, the Glenwyllin strain; GIM1, GIM2, and GIM3.

All those whole fingerling samples were immediately preserved and stored in several 45 ml screw cap tubes containing 100% ethanol and transported back to the laboratory, at the Institute of Aquaculture.

### **2.2.2 Broodstock tissue sampling, preservation and PIT tagging.**

A tissue sample from the different broodstock caudal fin was collected using a scalpel, after been anaesthetised, stripped, and eggs quality checked. The females were kept alive at the trout farms. Thus, in order to being able to recover the females in the future at the farms they were PIT tagged before the anaesthetic recovery. The PIT tag used was a 10 mm glass-coated alphanumeric tags supplied by Trovan (<http://www.trovan.com>) and inserted by injection next to the pelvic fin (Figure 2-6).



Figure 2-6 Detail of the PIT tagging procedure after the female was striped.

This has been followed by the neomale broodstock caudal fin clips sample collection, after been anaesthetised, sacrificed, and milt quality checked.

All the base population (broodstock) samples were stored and preserved in individual screw-cap microcentrifuge tubes containing about 0.5 ml 100% ethanol.

### **2.2.3 Preparation for fingerling PIT tagging and tissue sampling in the laboratory**

The PIT tags (Trovan) are recorded in sequence with the PIT tag reader and placed into the ordered and numbered microfuge tubes. Then the microfuge tubes were stored in a polystyrene storage insert, which has the capacity of 50 tubes each. When completed, the PIT tag codes recorded with the PIT tag reader were downloaded into a laptop utilizing the Trovan Toolbox software. The tag codes were transferred into an Excel spreadsheet and the column containing the codes was laser printed onto paper. Each printed code was cut out and placed in the tube containing the correct PIT tag.

Laser print is stable in alcohol, so the label can still be read after a long time. Then, the lid of each Eppendorf tube was also labelled with a permanent marker with a running 1-50 number to ensure the correct usage of tags during sampling. 3000 PIT tags were prepared in batches of 50 in this way in advance of the field sampling.

#### 2.2.4 PIT tagging and fin clipping in the field

Fingerlings rainbow trout were kept in a tank (0.5 m<sup>3</sup>), near the working facility. The facility has a big table allowing several workers to work at the same time. Before the animal handling the table was fully disinfected. Batches of 10 rainbow trout were added to a 20 L bucket containing benzocaine (4:10,000). The number of fish added could be varied depending on the number of people tagging. Fish were anaesthetized to a point where they lost equilibrium and were calm when handled but had not stopped breathing. Figure 2-7 represent an aerial view of the PIT tagging procedure.

After that, the fish handler measure the weight and length and communicate the information to the data imputer, he record the data directly into a spreadsheet against the appropriate tag number. The trout were passed to one or other of the tagging operators.

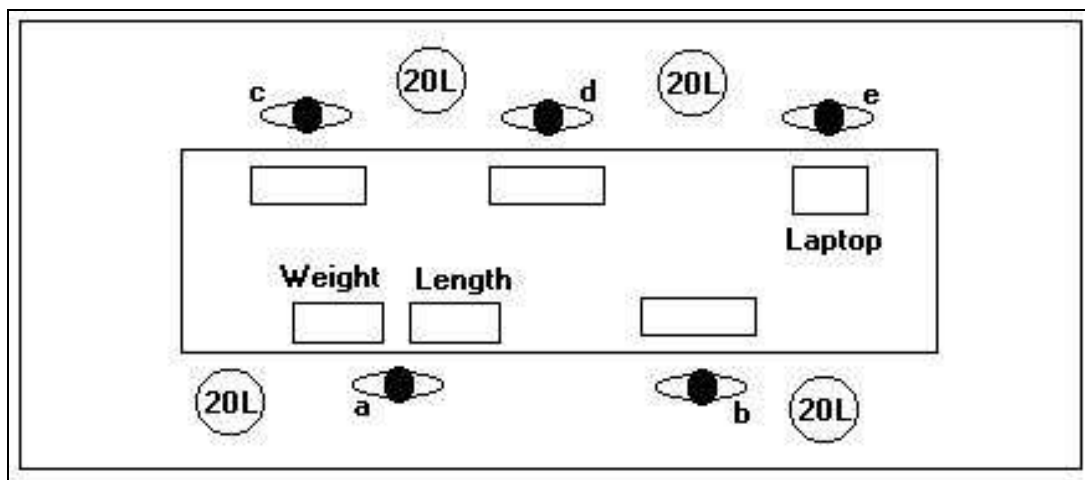

Figure 2-7 Work distribution at TVT fish farm during PIT tagging time: a) Fish handler b), c), & d) PIT taggers e) Data imputer.

Then, the PIT tag was implanted with the injector inside the abdomen, a scalpel was utilized to cut a small piece of the caudal fin tissue (10 mm<sup>2</sup>), the trout was then placed into a 20 L aerated tank containing clean water for recovery. The tissue sample was placed inside the appropriate microfuge tube with 100% ethanol. The microfuge tube was sealed and placed back into the polystyrene insert, when full the insert was sealed, marked and packed in a self-sealing plastic bag for a subsequent laboratory DNA extraction.

If an operator had a problem or was worried about the order of the fish being measured they could call a “stop” and the tags in use could be checked using the Trovan reader and any problem solved against the printed tag order.

The PIT tagging would take several days on each site, the fin clips were stored in a cool place before being returned to the laboratory for DNA extraction. A team of 5 people; 3 tagging, 1 data inputer, and 1 fish handler as the representation in Figure 2-7 could tag between 700-800 fingerlings in an 8 hours day.

## **2.3. DNA extraction from the different Rainbow trout samples**

### **2.3.1 Phenol-chloroform DNA extraction**

The protocol utilized was a modification from Taggart et al. (1992). This protocol was devised to enable the rapid extraction of salmonid DNA from fresh, frozen or ethanol preserved tissue samples. The main difference with the previous protocol was the use of Proteinase K instead of Pronase, different incubation temperatures and times.



A piece of the finclip is cut 5mm<sup>2</sup> (50 mg) and the rest is kept in the same Eppendorf tube with ethanol as a backup, in the case the procedure fails. The tissue is squeezed between two layers of paper towel to remove excess ethanol, and then each sample is placed into a sterile microcentrifuge tube (Thermo Life Sciences). To the tube is added 375 µl of 0.2M EDTA (ethylenediamine-tetraacetic acid), 0.5% SDS (Sodium Dodecyl Sulfate), and 10 µl Proteinase K (ABgene, 20mg/ml). The tube is then mixed briefly and after overnight incubation (15 hours) in a rotating oven at 55°C (the rotation helps the digestion by constant mixing of the sample) 10 µl RNAase (RNAase free; 2mg/ml) is added to the solution and again incubated in the rotating oven at 37°C for 60 minutes. Then 400 µl of phenol is added into the solution, shaken vigorously for 10 seconds by hand, followed by a more gentle mixing on a slowly revolving rotary mixer for 20 minutes. After that 400 µl of chloroform : isoamylalcohol (24:1) is added to each tube, and again shaken vigorously for 10 seconds, followed by mix in the rotary mixer for 20 minutes, before spinning the tubes in a microcentrifuge (10,000 g) for 5 minutes. After this step, the final solution is separated into different layers and 300 µl of the top aqueous layer (transparent) is removed to a new sterile microcentrifuge tube, using a wide bore pipette tip, being carefully not to disturb tissue debris at the interface. Followed by the addition of 900 µl (3 volumes) 92% ethanol, and then mixed by rapid and abrupt inversion of the tubes six times. The DNA should precipitate out immediately, carefully decant off most of the ethanol. Then add 1ml 70% ethanol, followed by gentle overend mixing turning for at least 30 minutes, preferably overnight at room temperature, after that decant off most of the ethanol wash, removing any remaining ethanol (50-100 µl) with a micropipette. The DNA pellet is allowed to partially dry at room temperature for 10 minutes (not over dry), then the pellet is

resuspended in 100  $\mu$ l TE buffer (10mM Tris, 1mM EDTA; pH 8.0), allowing the DNA at least 48 hours to dissolve fully. Quantification of DNA was achieved in all the samples by using spectrophotometry (GENEQUANT, Pharmacia Biotech), most of the time the yield resulted in a wide variation. Thus, all the samples were standardized to a final 100  $\mu$ g/ml stock concentration with the addition of TE buffer (0.25X), and then they could be stored at minus 20°C for long-term storage. Finally a sub sample of each DNA tube was used to create the 50  $\mu$ g/ml working concentration.

### **2.3.2 Chelex DNA extraction**

The protocol was modified from Estoup et al. (1996); the main differences are the first incubation temperature and the fact that the Proteinase K in this protocol was added in the second step.

A 10% Chelex solution was prepared (20g Chelex 100 resin/100-200 mesh (Biorad), in 20 ml TE buffer (10mM Tris, 1mM EDTA pH 8.0; 0.1% SDS)) prepared in sterile deionized water; The Chelex beads do not dissolve completely. Prior to use the Chelex solution is warmed to 60°C while mixing it up with a stir bar in a beaker, to aid the even suspension of beads in the solution. This procedure was done in a 'Duran' bottle with a cap to avoid evaporation. A large wide bore 1000  $\mu$ l tip was used to pipette 100  $\mu$ l 10% Chelex (warm) solution into a 96-well microtitre plates, already containing 3 $\mu$ l of Proteinase K (10 mg/ml) added to each well. After that, a biopsy tissue punch (3 mm diameter) is used to give an identical sized piece of fin tissue sample to each well respectively, and the plate sealed with an adhesive film (Hybaid tape) before being centrifuged at 2000 g for 1 minute. The plate was then incubated at 55°C in a rotating oven for at least 3 hours or overnight digestion (The

tissue should be fully digested before proceeding with the next step). After that, the plate has to be centrifuged at 3000 g for 1 minute and then incubated at 95°C for 15 minutes, in order to denature the protease enzyme (this procedure is best done in a thermocycler using a heated lid). The plate is then centrifuged again at 2000g for 1 minute.

The Chelex extractions will yield the best results (amplification) if used soon after extraction, ideally within one or two weeks. Samples may be stored at -20°C if to be used after this time, but PCR success may be reduced.

### **Comparison of the different DNA extraction methodologies**

The two different DNA extraction methodologies utilized in this study, the Phenol-Chloroform DNA extraction and the Chelex DNA extraction, were both successful in obtaining DNA suitable for use in PCR reaction (amplification). Nevertheless, both methodologies have difference in their result and process, Table 2-5 highlights the advantages and disadvantages of each technique.

The most significant difference between the two methodologies is the time spent and labour needed in the laboratory. In these terms, the Chelex was by far the most useful technique; being potentially easy to automate. The costs per reaction are reasonably similar to Phenol-Chloroform which requires much more hazardous chemicals.

While DNA extracted by the Chelex method cannot be reliably quantified, if an instrument like the puncher is utilized it is possible to standardize the amount of tissue use for each PCR reaction and thus reduce potential variability in DNA yield.

In this study all the parental rainbow trout DNA was extracted utilizing both Phenol-Chloroform and Chelex DNA extraction protocols with genotypes being determined

from both types of samples. This ensured particularly robust scoring for the parental samples. The offspring rainbow trout DNA was extracted utilizing the Chelex DNA extraction protocol. The reason of utilize this technique was the better PCR amplification resolution, and the ease and speed of DNA extraction for the large number of offspring samples used.

Table 2-5 Advantages / disadvantages of the two DNA extraction methods

<b><u>Phenol-Chloroform advantages</u></b>	<b><u>Chelex advantages</u></b>
DNA very stable (long term storage / years) DNA quantifiable by spectrophotometer	DNA extraction requires less than 5 hours Higher PCR amplification resolution
<b><u>Phenol-Chloroform disadvantages</u></b>	<b><u>Chelex disadvantages</u></b>
DNA extraction requires 2 days work Lower PCR amplification resolution Uses hazardous chemicals	Poor long term storage (weeks/months) DNA not quantifiable by spectrophotometer Requires the cost of Chelex beads

## **2.4. PCR techniques**

Genotypic data collection has become efficient through the development of automated DNA sizing technology using fluorescently labelled DNA and co-amplification of multiple loci (multiplexing) in a single polymerase chain reaction (PCR).

### **2.4.1 Reactions and sequencer availability**

The multiplex reactions utilized in this study were modified from Fishback *et al.* (1999), the researchers developed two multiplex reactions, hexaplex and octaplex, containing 14 loci in total. Their work was designed for the ABI 377 sequencer and also for rainbow trout. The modifications led to two different reactions, multiplex1 (MP1) and multiplex2 (MP2), both hexaplex (6 loci each) reactions, containing 12 loci in total. The loci Ssa20.19UCG and OmyFGT10TUF were eliminated because Fishback *et al.* (1999) had found null alleles.

### **2.4.2 Multiplex reactions**

The PCR amplification was performed in a volume of 15 µl containing 100 ng of genomic DNA template if it was Phenol-Chloroform extracted DNA or 1µl of Chelex DNA extraction solution, 280 µM of each dNTP (dGTP, dTTP, dATP, dCTP), 2X reaction buffer (20 mM Tris, 100 mM KCl; ABgene), 2 mM MgCl<sub>2</sub> (ABgene), 2 units Taq polymerase (ABgene), forward and reverse primers concentrations are specified in Table 2-6 & 2-7

Table 2-6 List of MP1 forward & reverse concentrations for a single PCR reaction and their sequence

<b>Locus</b>	<b>T<sub>m</sub></b> (°C)	<b>Dye</b> <b>label</b>	<b>Number</b> <b>of alleles</b>	<b>Allele size</b> <b>range (bp)</b>	<b>Ho</b>	<b>Sequence (5'-3')</b>	<b>PC (µM)</b>
OmyFGT14TUF	F-70		4	204-210	0.66	TGA GAC TCA ACA GTG ACC GC	0.016
OmyFGT14TUF	R-70	R-Tet				AGA GGG TTA CAC ATG CAC CC	0.016
Omy325UoG	F-70		9	122-152	0.75	GAA CTT TGA CTC CTC ATT GTG AG	0.059
Omy325UoG	R-72	R-Hex				CGG AGT CCG TAT CCT TCC C	0.059
Ssa439NCVM	F-68	F-Fam	8	114-142	0.78	AGT CAG GGG GGA GTG TAA AGG TT	0.101
Ssa439NCVM	R-68					TGC TGC TGG CAC TAA GTG GAG AT	0.101
One18ASC	F-65		5	168-184	0.64	ATG GCT GCA TCT AAT GGA GAG TAA	0.059
One18ASC	R-67	R-Hex				AAA CCA CAC ACA CTG TAC GCC AA	0.059
Omy27DU	F-63		5	99-111	0.69	TTT ATG TCA TGT CAG CCA GTG	0.146
Omy27DU	R-65	R-Hex				TTT ATG GCT GGC AAC TAA TGT	0.146
OmyFGT23TUF	F-68		6	99-121	0.78	ATT CGT GCG TGT GTA CGT GT	0.325
OmyFGT23TUF	R-69	R-Tet				CTA TTG GGG GTT GTG TTC TCA	0.325

F: Forward R: Reverse PC: Primer Concentration

Number of alleles, allele size ranges, and observed heterozygosity (Ho) were determined using genotypic data derived from 180 rainbow trout sampled from a local commercial hatchery (Fishback et al, 1999).

Table 2-7 List of MP2 forward & reverse concentrations for a single PCR reaction and their sequence

<b>Locus</b>	<b>T<sub>m</sub></b> (°C)	<b>Dye</b> <b>label</b>	<b>Number</b> <b>of alleles</b>	<b>Allele size</b> <b>range (bp)</b>	<b>Ho</b>	<b>Sequence (5'-3')</b>	<b>PC (µM)</b>
OmyFGT5TUF	F-66		4	164-184	0.66	TCC AGC CAG ACA CAC ACG	0.033
OmyFGT5TUF	R-63	R-Tet				TCC TTT TCT TCC CTT TCT TTC C	0.033
OmyFGT15TUF	F-68		4	161-167	0.61	ATA GTT TCC ACT GCC GAT GC	0.033
OmyFGT15TUF	R-69	R-Hex				GGT ACA CAC AGC TTG ATT GCA	0.033
Omy77DU	F-62		7	98-142	0.88	CGT TCT CTA CTG AGT CAT	0.033
Omy77DU	R-58	R-Tet				GTC TTT AAG GCT TCA CTG CA	0.033
Omy207UoG	F-70	F-Fam	6	105-127	0.69	ACC CTA GTC ATT CAG TCA GG	0.057
Omy207UoG	R-66					GAT CAC TGT GAT AGA CAT CG	0.057
Ots1BML	F-61	F-Fam	10	161-247	0.95	GGA AAG AGC AGA TGT TGT T	0.061
Ots1BML	R-61					TGA AGC AGC AGA TAA AGC A	0.061
Omy301UoG	F-63		11	75-123	0.85	ACT TAA GAC TGG CAA CCT T	0.114
Omy301UoG	R-68	H-Hex				CTA CAC GGC CTT CGG GTG AGA	0.114

F: Forward R: Reverse PC: Primer Concentration

Number of alleles, allele size ranges, and observed heterozygosity (Ho) were determined using genotypic data derived from 180 rainbow trout sampled from a local commercial hatchery (Fishback et al, 1999).

### 2.4.3 PCR program

Samples were amplified in a Whatman Biometra® T-Gradient PCR using touchdown reactions cycling protocols. The PCR program for the MP1 reaction is shown in Table 2-8.

Table 2-8 PCR program for the MP1 reaction

Step	Time (Sec)	Temperature (°C)	PCR step	Number of cycles
1	180	95	Denature	1
2	30	95	Denature	10
3	60	65 (-0.5 per cycle)	Annealing	10
4	240	72	Extension	10
5	30	95	Denature	30
6	60	60	Annealing	30
7	240	72	Extension	30
8	1200	72	Extension	1

The step 3 corresponds to the touchdown, this allowed loci of varying optimal annealing temperature to be amplified simultaneously while suppressing the production of artifact bands. In this step the annealing temperature will decrease 0.5°C in every cycle, thus starting at a temperature of 65°C and finishing at 60°C at the end of all the 10th cycle. The different annealing temperatures ( $T_a$ ) can be calculated from Table 2-8, using the formula  $T_a = T_m - 0.5^\circ\text{C}$ ; the annealing temperatures of those primers are in the range 65-60°C.

Step 8 is a final extension at 72°C for 20 minutes to promote non-templated adenylation 3' end of the amplified sequence by Taq polymerase. The final PCR reaction will take 4 hours 23 minutes. Table 2-9 shows the PCR programs for the MP2 reaction.



Table 2-9 PCR program for the MP2 reaction

Step	Time (Sec)	Temperature (°C)	PCR step	Number of cycle
1	180	95	Denature	1
2	30	95	Denature	12
3	60	60 (-0.5 per cycle)	Annealing	12
4	240	72	Extension	12
5	30	95	Denature	28
6	60	54	Annealing	28
7	240	72	Extension	28
8	1200	72	Extension	1

Again step 3 corresponds to the touchdown. In this step the annealing temperature will decrease 0.5°C in every cycle, thus starting at a temperature of 60°C and finishing at 54°C at the end of all the 12 cycle. The different annealing temperatures ( $T_a$ ) can be calculated from Table 2-9, using the formula  $T_a = T_m - 0.5^\circ\text{C}$ ; the annealing temperatures of those primers are in the range 60-54°C.

Step 8 is a final extension at 72°C for 20 minutes that promotes non-templated adenylation 3' end of the amplified sequence by Taq polymerase. The final PCR reaction will take 4 hours 27 minutes.

#### 2.4.4 PCR product results analysis

The PCR products were sized by electrophoresis using the ABI PRISM® 377 DNA sequencer utilising the proprietary Genescan® and Genotyper® software to extract all the information from the gel image.

Samples were separated through a standard 4.8% denaturizing polyacrylamide gel. Gel plates were washed thoroughly in hot water, ensuring that all the remaining acrylamide from the last gel was removed completely and then rinsed 3 × under running deionised water. After drying the plates were assembled into the ABI gel cassette. First the plain back plate was loaded into the cassette and the two spacer

strips (0.2 mm, notched ends to the top of the cassette), slightly dampened with deionised water were carefully laid along the long edges of the back plate. Finally the top 'rabbit-eared' plate was laid on top and the plates aligned to ensure the bottom edges were flush. The eight clamp screws were then applied. Finally the gel injection device was clamped to the bottom of the assembled cassette.

The gel mix was prepared by adding 14.4 g Urea, 4.8 ml (Page-plus Amresco Inc.), 23 ml dH<sub>2</sub>O, 1 g mixed bed resin to a 250 ml beaker containing a magnetic stirrer, and leaving the solution to stir at slow speed for about 30 minutes in order to deionise the gel solution. This solution was then put through a 0.22 µm filter (Whatman) into a 250 mL side arm flask and 4 mL of similarly filtered 10x TBE added. The solution was then de-gassed for 4 minutes (with occasional swirling of the mixture). The next step is to filter and de-gas the gel mix. To start polymerisation 200 µl of freshly made APS (Ammonium Persulfate solution; 0.1 g in 1 ml dH<sub>2</sub>O) and 25 µl TEMED were added and the solution gently swirled to mix. The solution was immediately taken up in a 50 ml syringe and the polymerising solution carefully injected between the gel plates. Tapping the upper plate along the leading edge of the injected solution while slowly injecting the remaining solution helped to prevent air bubble formation. When completely filled the reverse edge of the comb was carefully inserted along the top edge of the plates, again ensuring no airbubbles were present, and the system left for two hours at room temperature to allow gel polymerization to complete.

After the gel is set, the injector block can be carefully removed and the bottom of the plate carefully wiped clean of leaked polyacrylamide. It is particularly important to ensure that the part of the glass plate that is scanned by the lasers free of debris. The laser shield on the cassette is then folded down into place. The spacer comb is then removed from the top edge of the gel and any leaked gel cleaned away. An

appropriate shark tooth comb is then carefully inserted, the points of the teeth being pressed no more than 0.5 mm into the gel surface.

The gel rig can then be secured in place into the ABI377 and secured by the four corner clamps. The check plate module of the software is run to confirm that the read region is free from there are scratches on the glass and gel residues, as this would influence the results of the run. If necessary remove and reclean the scan area. When satisfactory, the top two clamps are released to allow the upper buffer chamber to be installed, and the clamps reapplied. Make up 1300 mL of 1x TBE. Filler the top buffer chamber with buffer to just above the printed lane numbers on the comb. Pour the remaining buffer into the lower chamber. Release the 6 middle clamps on cassette, install the hotplate into the cassette, and re-apply the clamps. Plug in hotplate inlet and outlet hoses, place lid on top buffer tank, and close the main apparatus door. Start the pre run module of the software and run for about 10 minutes, until the gel reach the working temperature of 42°C. The program is then paused. Before and after the pre-run of the ABI machine, the 48 well comb is flushed with buffer solution using a 5 ml pipette, in order to remove excess fluid, air bubbles and crystals of urea from the wells. During the pre-run the samples to be analysed are denatured for 3 minutes at 90°C and after kept on ice until the samples are loaded using a multi-channel pipette, with loaded every second lane. Loading of the gel is done in two stages. First lanes 1, 3, 5 etc are loaded, a one minute of pre-run activated (by realing the pause) the program paused again and the alternate lanes (2, 4, 6 etc.) loaded. The sample mixture consisted of 1 µl PCR product (dilution from Phenol-Chloroform DNA extraction 1/5 or without dilution from Chelex DNA extraction), 1.55 µl 100% de-ionised formamide (Amresco), 0.30 µl Perkin-Elmer / Applied Biosystems (PE / ABI) 350 Tamra internal lane standard and 0.35 µl blue Dextran loading dye. From

this mixture 1.2  $\mu$ l is taken by the 8 multi-channel pipette and the loaded into the wells. Finally, the gel is run (run module) for two hours at 3000 volts, 50 mA, with a gel temperature of 51°C and 1200 laser scans per hour using filter set C.

## **2.5. Assigning paternity to the offspring from the different crosses**

### **2.5.1 How does Family Assignment Program (FAP) work?**

The resolving power of a DNA profiling method is difficult to forecast when more than a few families and / or a few loci are involved. For example, in a single family up to four progeny genotypes are possible at any locus: i.e.  $AB \times CD = AC, AD, BC, BD$ . At six loci 4096 ( $4^6$ ) and for ten loci 1,048,576 ( $4^{10}$ ) progeny combination genotypes are possible. Comparing potential genotypes between several different families soon becomes a logistical dilemma best carried out by computer.

The Family Assignment Program (FAP) version 3.5 Taggart (2007), was utilized to perform the parental assignment. Parentage is determined by simply comparing alleles at a given locus from each offspring, with alleles from each of the potential parental crosses; using the exclusion principle.

The FAP programme was designed to perform two related tasks:

Predict the resolving power of specific parental genotype data sets for unambiguously discriminating among families / groups of families and assign progeny to the family of origin from genotypic data.

The predictive analysis assumes that all individuals are the progeny of known parental combinations for which full genotypic data is available, in others words the analyses assumes a closed environment. Two levels of hierarchy are supported; the first involves resolution to individual family and the second involves resolution to groups of families. The assignment mode also assumes a closed environment and was designed to answer the question; Which possible family(s) does this individual belong to?

The latter mode also allows two further variables to be explored: allele size tolerance and allele mismatch tolerance. The first, allele size tolerance, compensates for allele measurement error, this variable was not utilized in the present study. The second variable, allele mismatch tolerance, allows imperfect matches to be identified in cases where 'no match' is found for the full selected locus data set, e.g. to allow for scoring error / mutation among progeny genotypes, where full progeny genotypic data are not available, to identify possible null alleles or to identify possible mistyping of parental samples.

As an example, say an analysis consists of six nuclear loci and an allele mismatch tolerance of 2 is entered. For each progeny an attempt is made to assign family of origin from the full six loci (12 alleles) data set, and if successful the program records match (es) to file and moves on to the next progeny. However, if 'no match' is found then the progeny genotype data are reanalyzed looking for a match at any 11 of the 12 alleles. If a match or matches are found the family(s) of origin are printed to file - followed by the locus number where the mismatched allele was found within square brackets [ ]. A reduced tolerance match is also flagged '1' in the allele mismatch

column of output file. Having found a match the program then moves on to the next progeny (starting the search with zero allele tolerance). However, if no match is found at 11 alleles then the progeny genotypes are reanalysed again, this time looking for a match at any 10 of the 12 alleles. If match (es) are found the families are printed together with the number(s) of the loci where the two mismatch alleles were found in [ ] square brackets and flagged '2' in the allele mismatch column (Figure 2-8). If no match is found the program outputs a 'No match' flag for that progeny and moves on to the next progeny (starting the search with zero locus tolerance).

	A	B	C	D	E	F
14	Allele size tolerance = 0 bp					
15						
16	Maximum no. of mismatch alleles tolerated = 2					
17						
18	Record	Composite	Mismatch	Families sharing		
19	I.D.	genotype	Alleles	composite genotype		
20	Sample-09	107109 107107 103103 105107 103103 103103	0	Family-12	Family-22	
21	Sample-10	000000 101102 103105 103108 101104 102104	2	Family-26	[1 1]	
22	Sample-11	107109 102107 103103 107108 103103 103103	0	Family-14	Family-25	
23	Sample-12	102109 107107 103107 102108 101101 103105	0	Family-16		
24	Sample-16	107109 102107 103107 103104 101103 103103	0	Family-03	Family-06	Family-47
25	Sample-17	109109 102109 106107 108108 103103 103104	0	Family-08		
26	Sample-24	109112 102102 103103 104107 103103 103104	1	Family-55	[2]	
27	Sample-31	101103 101102 103105 103108 101104 000102	1	Family-26	[6]	
28	Sample-32	109113 102109 106107 108108 103103 103104	0	Family-08		
29	Sample-32	109113 102109 124124 108108 103103 103104	2	Family-08	[3 3]	
30	Sample-32	109113 102109 124124 108108 124124 103104	NO MATCH			

Figure 2-8 Example output for assignment with allele mismatch tolerance set at two

Prediction analyses showed that it was probable to assign a trout to a single family using less than eleven loci; seven or eight loci were usually enough. In the present study, where occasional mistyping is likely, allele mismatch tolerance was set to a high value (10) to force an assignment for each offspring and thus indicate where problematic/misassignments occurred

## **2.5.2 How can we utilize the Package for the Analysis of Parental Allocation (PAPA) software?**

The Package for the Analysis of Parental Allocation (PAPA) (Duchesne et al., 2002) is a computer program that performs parental allocation based on breeding likelihood methods and also contains simulators that allow statistical assessments of allocation accuracy. The parental allocation method used in PAPA is based on breeding likelihood (Sancristobal & Chevalet 1997). Given an offspring genotype, the likelihood of a parental pair of genotypes is defined as the probability of this pair breeding the offspring genotype among all of its possible descents. Contrary to exclusion methods, likelihood based parental allocation methods allow for some degree of transmission errors due to genotype misreading or mutation (e.g. Sancristobal & Chevalet 1997; Marshall et al. 1998). The relaxed nature of the latter condition means that likelihood methods generally call for much less extensive genetic information than exclusion-based ones.

PAPA provides a Monte-Carlo simulator that may be used to obtain empirical distributions of many relevant random variables such as rates of successful allocations and allocation failures. The embedded simulator allows modelling of all allocation conditions (allele transmission error, missing parents, etc.). Parental simulations, which involve already known parental genotypes, produce empirical distributions from which the accuracy of the allocation of real offspring may be assessed.

Allocation method: To allocate an offspring, its breeding likelihood is computed for each potential parental pair, the one with the highest likelihood is assigned parental. Offspring are not allocated when either all parents show zero likelihood ('null

likelihood') or where two or more parental-pairs share the highest positive likelihood (an 'ambiguity'). In the advent of a null-likelihood or an ambiguity, the offspring is not allocated and the procedure is said to have failed. The allocation parameters are (i) choice of loci; (ii) global level of transmission error; and (iii) distribution of transmission error over alleles.

Simulation conditions: Simulations may be run under two distinct conditions: (i) preparental; and (ii) parental. The parental simulation procedure uses real collected parental genotypes. This study uses the sexed parental simulations mode, its main purpose is to build empirical distributions of random variables, given the real collected parental genotypes. Such distributions were used to assess the accuracy level of a specific allocation process. The program requests information such as: estimated number of uncollected parents, name of loci, male genotype dataset, female genotype dataset, number of iterations, number of pseudo offspring generated at each iteration, uniform error, and number of subset of loci.

In both cases simulation and the allocation modes, a degree of transmission error (i.e. allele mistyping and/or genetic mutation) can be accommodated. This transmission error rate can be either uniform (all errors assumed to be equally likely), or non-uniform (to reflect greater mis-scoring between alleles of similar mobility). Simulations run using the chosen error model/value can be used to evaluate the likely power of the allocation and provides a computed measure of 'correctness', i.e. the level of confidence/accuracy that can be expected from actual assignments.



## **Chapter 3 / GENETIC VARIATION BETWEEN AND WITHIN SOME SELECTED RAINBOW TROUT STRAINS CULTIVATED IN THE UK**

### **3.1. Introduction**

Kincaid (1980) emphasized that genetic variability of traits between individuals, families, broodstock, and strains existed and that this should be the primary population characteristic to be used in applied management programs. In deciding how a specific broodstock or fishery is to be managed, the fishery manager also determines how the genetic variability will be managed (Kincaid, 1980).

To a large extent, fishery management is the management of genetic variability, balancing the need for immediate specific performance characteristics and long-term ability to adapt to a broad range of environmental conditions. Genetic variability arises in a population because of the diversity of alleles and allele combinations carried by individuals making up that population; it provides a population with the plasticity to adapt to changing environmental conditions and is the basis for both natural and artificial selection. Low values or lack of genetic variation is a primary cause for population or species extinction and might compromise the capacity of a population to adapt to new or changing environments, or to more immediate challenge like diseases (Kincaid, 1980; Soulé 1980; Reed et al., 2003). It could be said that the views of authors like Kincaid, Soulé, and Reed et al. is a bit radical, as they are conservationist and are dealing with natural environment. Loss of genetic variability in farmed fishes will generally result in loss of adaptive potential, but the impact on commercial culture is not known (Allendorf and Ryman, 1987; Perez et al., 2001).

Changes in genetic variability in captive salmonid broodstock populations have been shown in a number of different studies when these fish were compared to their wild progenitor populations (Ryman and Stahl, 1980; Cross and King, 1983; Stahl, 1983; Verspoor, 1988; Koljonen, 1989; Jones et al., 1997; Hansen et al., 2000). Such changes have been associated with domestication processes (Kallio-Nyberg and Koljonen, 1997).

Waples (1999) differentiates between domestication and domestication selection; defining the former as “a state or condition of a population” and can be contrasted with the term domestication selection, which refers to a process that leads to domestication. He defines domestication selection as “any change in the selection regime of a cultured population relative to that experienced by the natural population”. When working with a natural population it might be possible to eliminate intentional selection from hatchery programs, but genetic change in cultured populations can not be avoided entirely because such factors as selections resulting from non-random sampling of broodstock and temporary relaxation during the culture phase that otherwise would occur in the wild (Waples, 1999).

Different examples could be mentioned that might potentially change or result in a lost of genetic variability. In salmonid farming, it is not always necessary to have a large number of parents due to the fact that the females have a high fecundity. This increases the possibility of allele frequency changes by genetic drift and also the reduction of genetic variability by inbreeding; the potential founder effect (Gjedrem, 1979; Allendorf and Phelps, 1980; Ryman and Stahl, 1980; Doyle, 1983). On fish farms, some selective breeding programs breed from a small number of “superior”

families that may be related and others operate a mass selection approach with high selection intensity. Thus, unless there is pedigree information, there is potential for inbreeding depression (Norris et al., 1999). Experiments in Atlantic salmon from the fourth generation of the national Norwegian breeding program compared to a wild stock showed that growth of the selected fish to smolting time was twice that of the wild fish, suggesting that the genetic improvement program has contributed to the efficiency of fish farming, and thereby the genetic make up of the original wild population (Gjoen and Bentsen, 1997). Furthermore, there is the possibility of inadvertent selection e.g. Higher growth hormone levels in selected fish farm escapees changing the behaviour of a species (Fleming et al., 2002). Improved freshwater growth of a domesticated Atlantic salmon strain relative to its principal wild founder population is associated with decreased antipredator response, including behaviour and heart rate (Fleming and Einum, 1997; Johnsson et al., 2001).

In a selectively bred population, one objective is to improve performance by culling poor performers. By restricting the phenotypes of breeders, genetic diversity should decline (Falconer and Mackay, 1996). Norris et al. (1999) working with Atlantic salmon demonstrated that artificial breeding practice both family and mass selection, resulted in a decrease in genetic variability. The study of genetic diversity in selectively bred captive populations has different goals than in natural populations or conservation hatcheries.

Rainbow trout have been farmed for much longer than Atlantic salmon in many different and often much smaller units. Thus, the potential for deleterious genetic

change is likely to be greater. UK farms have had to utilize stocks that have been isolated for a long time and undergone a wide range of different management regimes (Thompson, 1985). In this chapter assaying microsatellite variability within key UK rainbow trout strains was undertaken to provide a snapshot of the level of genetic variation that exists and to provide baseline data for future tracking of directed changes over generations.

## 3.2. Materials and methods

### 3.2.1 Fish samples collection

Samples were collected from three different culture facilities around the United Kingdom, encompassing seven presumed different populations / 'strains' of rainbow trout (Table 3-1). The facilities were Glenwyllin Trout Farm in the Isle of Man, Seven Springs Trout in Larne (Northern Ireland), and Trafalgar Fisheries in Wiltshire (Figure 3-1). All sites are major egg suppliers for the industry or for their own production.

Table 3-1 Code name description, number of samples, and date of collection for the 7 different commercial strains in UK

Code name	Code name description	Number of samples	Collection date (dd/mm/yyyy)
H7S	Seven Spring Hatchery, Larne, North Ireland.	70	08-10-2001
TRT	Trafalgar Rainbow Trout, Wiltshire.	55	19-02-2002
GIT	Glenwyllin Isle of Man Trafalgar, Wiltshire (import).	27	19-02-2002
GTR	Golden Trout Trafalgar, Wiltshire.	49	19-02-2002
GIM1	Glenwyllin 1, Isle of Man, (Strain A?)	50	22-02-2002
GIM2	Glenwyllin 2, Isle of Man, (Strain B?)	50	22-02-2002
GIM3	Glenwyllin 3, Isle of Man, (Strain AxB?)	49	22-02-2002
$\Sigma$		350	

At each site, fingerlings samples were collected from a number of tanks to maximize the chance of sampling from the widest number of families in each putative strain. Samples were immediately stored in 45 ml screw cap tubes and preserved in 100% ethanol. Three strains (GIM1, GIM2, and GIM3) were collected from Glenwyllin (nominally A, B and a mixture between these) and Trafalgar Fisheries (Glenwyllin Trafalgar, GIT, was supposedly imported from the Isle of Man a number of years earlier, a golden trout strain and their commercial wild-type strain. Although not known at the time of sample collection the Glenwyllin strains were used for the Breeding Program described later in this thesis.

DNA extraction and genotyping methodology is described in detail in Chapter 2

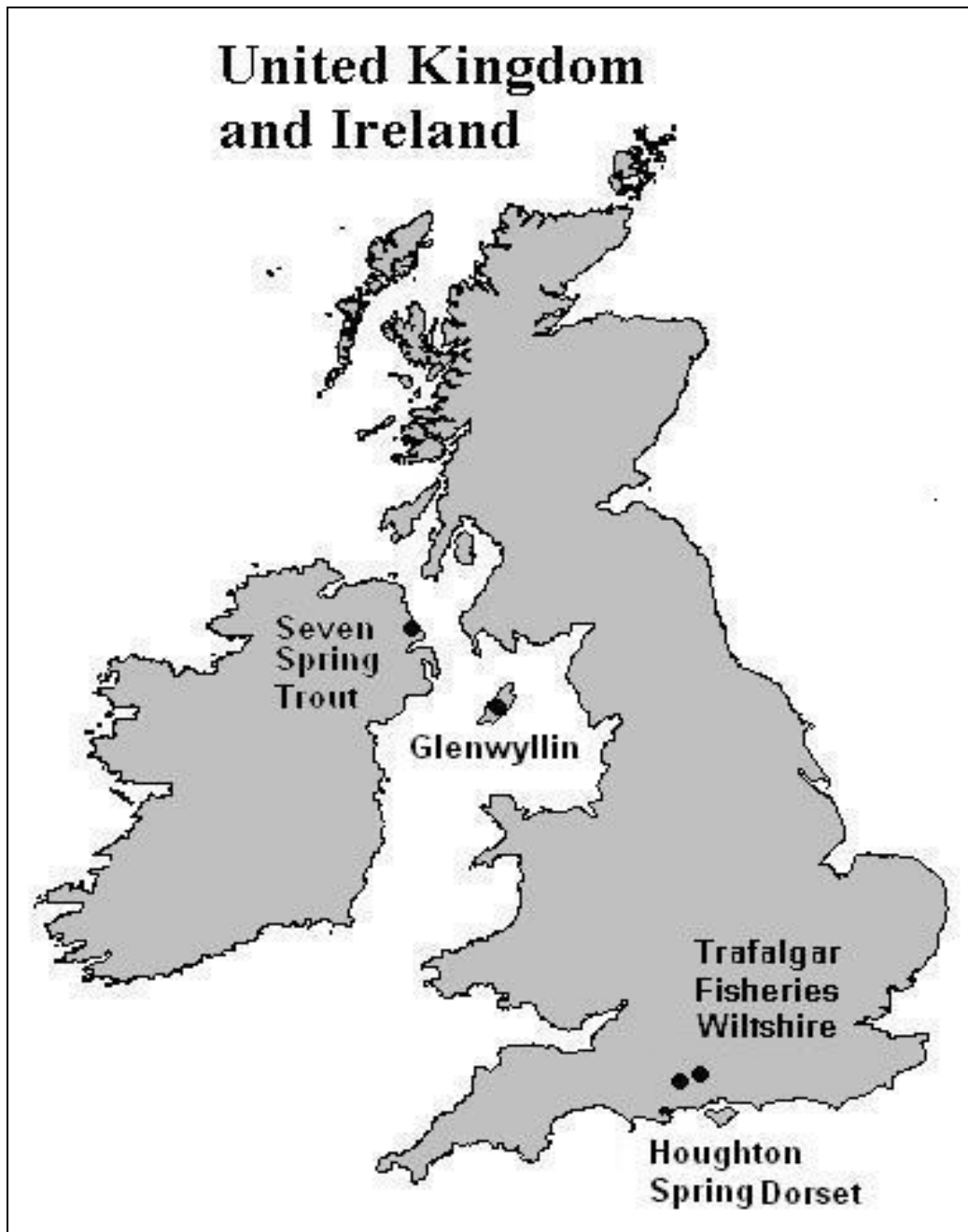

Figure 3-1 Rainbow trout sampling collections sites around the United Kingdom

### 3.2.2 Statistical analysis

Excel add-in Microsatellite Toolkit (Park S., 2001) were utilized to organize data and to produce input file formats for the various analysis programs. Basic genetic statistics, i.e. number of alleles per loci ( $N_a$ ), number of unique alleles ( $U$ ), allele size

range (R), size (S), frequencies (Fmax & Fmin) of the most and less common allele, were determined for each strain (population) at each locus using Excel and GENEPOP (Raymond and Rousset, 1995). Hardy-Weinberg exact tests and genic & genetic differentiation were calculated using the programme GENEPOP. A Markov chain method was used to estimate without bias the exact *P*-value of this test. Default analysis values were used in all cases i.e. Dememorization number (1000); Number of batches (100); Number of iterations per batch (1000). A global test (Fisher's method) across loci or across sample was also utilized.

Expected heterozygosity unbiased ( $H_e$ , Nei 1978) and observed heterozygosity ( $H_o$ ), were calculated using the program GENETIX (Belkhir et al., 1996). Effective number of alleles ( $a_e$ ) allows the comparison of allele counts across samples of different sizes. It was calculated using the formula from Ferguson (1980). Where values were computed with SEMs, comparisons were considered to be significantly different if 95% Confidence Interval (CI) did not overlap.  $95\% \text{ CI} = \pm t_{0.05} \times \text{SEM}$ .

Three different genetic distance measures were computed for each farm sample using PHYLIP (Felsenstein, 1993): i) Cavalli-Sforza chord distance, a geometric distance measure with no underlying biological assumptions; ii) Reynolds distance, which assumes a primary role for drift and is an infinite-alleles model; iii) Nei's distance, again an infinite-allele model, in which it is assumed that all loci have the same rate of neutral mutation, genetic variability is at equilibrium between mutation and genetic drift, and the effective population size of each population remains constant. The unweighted pair group method using arithmetic average (UPGMA) was used (as implemented in PHYLIP) to generate trees, and to provide confidence estimates on

the nodes bootstrap values were obtained from 100 replicates (Felsenstein, 1993). Tree files generated were visualized in TreeView (Page, 1996).

### **3.3. Results**

The total number of individuals over all samples was 350, but not all the loci were successfully amplified in all individuals. As shown in Table 3-2 the locus Ots1BML had the highest number of samples amplified (349) while Omy77DU had the lowest value (293). Considering the number of alleles per loci over all strain, Ots1BML had the highest number of alleles (29) over all loci while OmyFGT14TUF had the lowest number of alleles (7). Furthermore, the loci Ots1BML (100 bp range) presents the highest allele range over all strains while OmyFGT14TUF (14 bp range) presents the lowest allele range value.



Table 3-2 Allelic variability at 12 loci in the first survey rainbow trout strains

	Variable	GIM1	GIM2	GIM3	H7S	TRT	GIT	GTR
<b>Locus</b>								
<b>Omy207UoG</b>	<b>n</b>	49	47	45	69	40	27	26
	<b>Na</b>	9	11	12	8	11	9	7
	<b>a<sub>e</sub></b>	4.67	4.69	6.09	2.19	3.08	6.10	2.11
	<b>R</b>	107-135	103-135	103-135	103-133	103-135	103-131	105-131
	<b>U (S)</b>	0	0	0	0	0	0	1(131)
	<b>Fmax (S)</b>	0.357(117)	0.319(117)	0.256(107)	0.652(115)	0.525(115)	0.241(115)	0.673(115)
	<b>Fmin (S)</b>	0.010(131;135)	0.011(103;135)	0.011(113;127)	0.007(103;125;133)	0.013(111;131;133;135)	0.019(103;113)	0.019(107)
	<b>He</b>	0.794	0.795	0.845	0.547	0.684	0.852	0.536
	<b>Ho</b>	0.510	0.532	0.400	0.377	0.650	0.704	0.308
	<b>Omy27DU</b>	<b>n</b>	49	49	49	69	55	27
<b>Na</b>		7	6	5	4	5	5	4
<b>a<sub>e</sub></b>		3.77	2.57	2.88	2.98	3.04	2.85	3.03
<b>R</b>		98-110	100-110	100-108	102-108	92-110	98-110	104-110
<b>U (S)</b>		0	0	0	0	1(92)	0	0
<b>Fmax (S)</b>		0.398(106)	0.541(106)	0.469(106)	0.420(104)	0.491(106)	0.481(106)	0.357(106)
<b>Fmin (S)</b>		0.010(102)	0.010(100;102)	0.010(100)	0.101(102)	0.055(108)	0.019(98)	0.010(110)
<b>He</b>		0.742	0.617	0.660	0.670	0.677	0.661	0.677
<b>Ho</b>		0.653	0.612	0.571	0.754	0.491	0.741	0.714
<b>Omy301UoG</b>		<b>n</b>	47	43	47	66	55	25
	<b>Na</b>	11	11	13	11	16	8	8
	<b>a<sub>e</sub></b>	4.56	4.98	5.97	6.91	8.27	4.28	2.92
	<b>R</b>	60-122	72-124	64-124	66-122	70-120	72-106	72-114
	<b>U (S)</b>	1(60)	0	1(64)	1(66)	3(94;98;108)	1(90)	0
	<b>Fmax (S)</b>	0.309(74)	0.314(88)	0.266(84)	0.242(84)	0.200(84)	0.340(74)	0.541(74)
	<b>Fmin (S)</b>	0.011(60;110;114;120;122)	0.012(102;110;124)	0.011(104;110;124)	0.015(76;122)	0.009(70;76;102;108)	0.020(88;90)	0.020(106;114)
	<b>He</b>	0.789	0.809	0.842	0.862	0.887	0.782	0.665
	<b>Ho</b>	0.340	0.395	0.340	0.318	0.473	0.360	0.163

(continued)

	<b>Variable</b>	<b>GIM1</b>	<b>GIM2</b>	<b>GIM3</b>	<b>H7S</b>	<b>TRT</b>	<b>GIT</b>	<b>GTR</b>
<b>Locus</b>								
<b>Omy325UoG</b>	<b>n</b>	48	33	38	64	54	27	48
	<b>Na</b>	18	14	13	12	12	8	6
	<b>a<sub>e</sub></b>	8.03	9.64	5.44	5.78	2.84	4.15	1.68
	<b>R</b>	113-153	115-151	117-149	113-151	113-143	117-143	117-143
	<b>U (S)</b>	1(153)	0	0	1(125)	0	0	0
	<b>Fmax (S)</b>	0.260(121)	0.182(141)	0.329(121)	0.305(121)	0.565(121)	0.407(121)	0.740(121)
	<b>Fmin (S)</b>	0.010(127;133;149)	0.015(115;137)	0.013(117;127;139;145)	0.008(113;125)	0.009(113;119;137;139)	0.019(135)	0.010(117;127;141;143)
	<b>He</b>	0.885	0.910	0.827	0.833	0.654	0.774	0.409
	<b>Ho</b>	0.792	0.788	0.816	0.797	0.426	0.741	0.396
<b>Omy77DU</b>	<b>n</b>	46	45	46	61	31	16	48
	<b>Na</b>	9	7	12	7	7	5	7
	<b>a<sub>e</sub></b>	2.15	2.44	3.08	2.97	2.89	3.85	2.69
	<b>R</b>	99-131	99-131	97-129	97-129	97-129	97-129	91-121
	<b>U (S)</b>	0	0	2(119;127)	0	0	0	2(91;121)
	<b>Fmax (S)</b>	0.663(101)	0.611(101)	0.543(101)	0.524(99)	0.532(99)	0.406(99)	0.521(99)
	<b>Fmin (S)</b>	0.011(107;117)	0.011(131)	0.011(109;127)	0.008(109;115)	0.016(109)	0.094(103)	0.010(91;109;121)
	<b>He</b>	0.541	0.597	0.682	0.669	0.665	0.764	0.634
	<b>Ho</b>	0.283	0.267	0.326	0.393	0.516	0.438	0.542
<b>OmyFGT14TUF</b>	<b>n</b>	49	48	49	62	41	27	49
	<b>Na</b>	7	7	5	4	4	4	3
	<b>a<sub>e</sub></b>	5.29	2.97	2.87	2.23	1.95	2.24	1.73
	<b>R</b>	200-214	200-214	204-212	204-210	204-210	204-210	204-210
	<b>U (S)</b>	0	0	0	0	0	0	0
	<b>Fmax (S)</b>	0.245(208)	0.500(204)	0.418(208)	0.532(204)	0.671(204)	0.574(204)	0.704(208)
	<b>Fmin (S)</b>	0.020(214)	0.010(200;214)	0.020(212)	0.008(206)	0.024(210)	0.019(210)	0.010(210)
	<b>He</b>	0.820	0.670	0.659	0.555	0.492	0.564	0.427
	<b>Ho</b>	0.571	0.542	0.531	0.645	0.585	0.704	0.449

(continued)

	<b>Variable</b>	<b>GIM1</b>	<b>GIM2</b>	<b>GIM3</b>	<b>H7S</b>	<b>TRT</b>	<b>GIT</b>	<b>GTR</b>
<b>Locus</b>								
<b>OmyFGT15TUF</b>	<b>n</b>	45	40	45	70	41	26	49
	<b>Na</b>	9	9	8	4	6	6	7
	<b>a<sub>e</sub></b>	3.87	5.79	3.92	2.15	2.28	3.19	1.55
	<b>R</b>	158-174	158-174	160-174	160-166	160-170	158-170	160-174
	<b>U (S)</b>	0	0	0	0	0	0	0
	<b>Fmax (S)</b>	0.367(164)	0.225(166)	0.411(164)	0.621(160)	0.634(160)	0.442(160)	0.796(160)
	<b>Fmin (S)</b>	0.011(158;172)	0.013(158)	0.011(162;174)	0.043(164)	0.024(168)	0.019(158;170)	0.010(166;168)
	<b>He</b>	0.750	0.838	0.753	0.538	0.569	0.700	0.359
	<b>Ho</b>	0.622	0.675	0.489	0.429	0.342	0.346	0.204
	<b>OmyFGT23TUF</b>	<b>n</b>	48	45	49	67	45	23
<b>Na</b>		14	13	10	8	13	8	7
<b>a<sub>e</sub></b>		7.63	6.48	6.03	3.96	6.93	5.63	2.53
<b>R</b>		94-126	98-124	96-122	98-120	98-128	98-120	98-120
<b>U (S)</b>		1(94)	0	0	0	1(128)	0	0
<b>Fmax (S)</b>		0.208(116)	0.289(116)	0.224(114)	0.403(116)	0.222(98)	0.239(116)	0.576(116)
<b>Fmin (S)</b>		0.010(96;108;120;126)	0.011(98;104;120)	0.020(96;110;112)	0.015(104)	0.011(104;122;124;128)	0.022(104;118)	0.011(112;120)
<b>He</b>		0.878	0.855	0.843	0.753	0.865	0.841	0.611
<b>Ho</b>		0.729	0.800	0.592	0.702	0.800	0.870	0.478
<b>OmyFGT5TUF</b>		<b>n</b>	36	45	45	69	43	24
	<b>Na</b>	11	10	11	4	10	5	9
	<b>a<sub>e</sub></b>	4.10	4.52	5.96	1.63	3.60	2.39	4.72
	<b>R</b>	162-188	164-188	164-188	164-184	160-188	158-184	160-184
	<b>U (S)</b>	1(162)	0	0	0	0	1(158)	0
	<b>Fmax (S)</b>	0.403(174)	0.411(174)	0.278(178)	0.768(174)	0.465(174)	0.604(174)	0.344(174)
	<b>Fmin (S)</b>	0.014(164;180)	0.022(168;188)	0.011(164)	0.014(182)	0.012(188)	0.021(158)	0.010(160;164)
	<b>He</b>	0.767	0.787	0.842	0.388	0.731	0.594	0.797
	<b>Ho</b>	0.556	0.600	0.689	0.449	0.535	0.625	0.938

(continued)

	Variable	GIM1	GIM2	GIM3	H7S	TRT	GIT	GTR
<b>Locus</b>								
<b>One18ASC</b>	<b>N</b>	49	49	49	68	52	27	47
	<b>Na</b>	9	8	8	7	9	6	5
	<b>a<sub>e</sub></b>	5.12	3.33	3.48	2.88	4.25	3.61	3.15
	<b>R</b>	169-187	171-187	171-185	163-187	157-183	163-183	163-183
	<b>U (S)</b>	1(169)	0	0	0	3(157;159;167)	0	0
	<b>Fmax (S)</b>	0.296(177)	0.490(173)	0.469(173)	0.522(173)	0.385(173)	0.389(173)	0.415(177)
	<b>Fmin (S)</b>	0.020(175;185)	0.010(171)	0.010(181;185)	0.007(187)	0.010(157;171)	0.019(171)	0.021(183)
	<b>He</b>	0.813	0.707	0.720	0.657	0.772	0.737	0.690
	<b>Ho</b>	0.735	0.551	0.776	0.647	0.635	0.815	0.702
	<b>Ots1BML</b>	<b>N</b>	50	50	48	70	55	27
<b>Na</b>		14	13	11	9	20	8	8
<b>a<sub>e</sub></b>		7.23	6.13	4.81	4.90	6.44	5.72	2.46
<b>R</b>		160-256	160-254	160-254	160-250	156-250	158-172	160-250
<b>U (S)</b>		1(256)	0	0	0	11(156-228)**	1(158)	1(190)
<b>Fmax (S)</b>		0.280(170)	0.300(170)	0.323(170)	0.336(170)	0.282(160)	0.259(160)	0.582(170)
<b>Fmin (S)</b>		0.010(182;256)	0.010(162;182;184)	0.010(160;178;184)	0.007(160)	0.009(156;174;200;206;226;250)	0.019(158)	0.010(168;250)
<b>He</b>		0.870	0.845	0.800	0.802	0.852	0.841	0.600
<b>Ho</b>		0.740	0.640	0.563	0.771	0.800	0.926	0.674
<b>Ssa439NCVM</b>		<b>N</b>	49	49	49	70	53	27
	<b>Na</b>	15	12	12	13	12	9	7
	<b>a<sub>e</sub></b>	8.38	9.29	7.73	9.00	8.15	6.69	1.71
	<b>R</b>	106-144	112-140	114-142	112-146	114-146	114-140	120-140
	<b>U (S)</b>	3(106;108;144)	0	0	0	0	0	0
	<b>Fmax (S)</b>	0.214(116)	0.184(134)	0.153(114;118;120)	0.186(122)	0.217(130)	0.204(124)	0.755(130)
	<b>Fmin (S)</b>	0.010(140)	0.020(112)	0.010(130;140;142)	0.007(136)	0.028(138;146)	0.019(114)	0.010(122)
	<b>He</b>	0.890	0.902	0.880	0.895	0.886	0.867	0.421
	<b>Ho</b>	0.347	0.408	0.490	0.486	0.585	0.704	0.204

For each strain and locus: Number of samples used (n), Number of alleles per loci (Na), Effective number of alleles per loci (a<sub>e</sub>), Allelic size range in bp (R), Number of unique alleles [U (S= size in bp)], Frequency of the most common allele [Fmax (S= size in bp)], Frequency of the less common allele [Fmin (S= size in bp)], Expected heterozygosity (Nei, 1978), and Observed heterozygosity.

\*\* (156;200;202;206;210;214;216;218;222;226;228)

### 3.3.1 Comparison of basic genetic variability measures.

Comparisons of mean observed heterozygosity ( $H_o$ ) and expected heterozygosity ( $H_e$ ) for each of the seven samples are depicted in Figure 3-2. In all cases  $H_o$  was significantly lower than  $H_e$  for each sample. The GTR sample had both the lowest  $H_o$  &  $H_e$  of all samples.

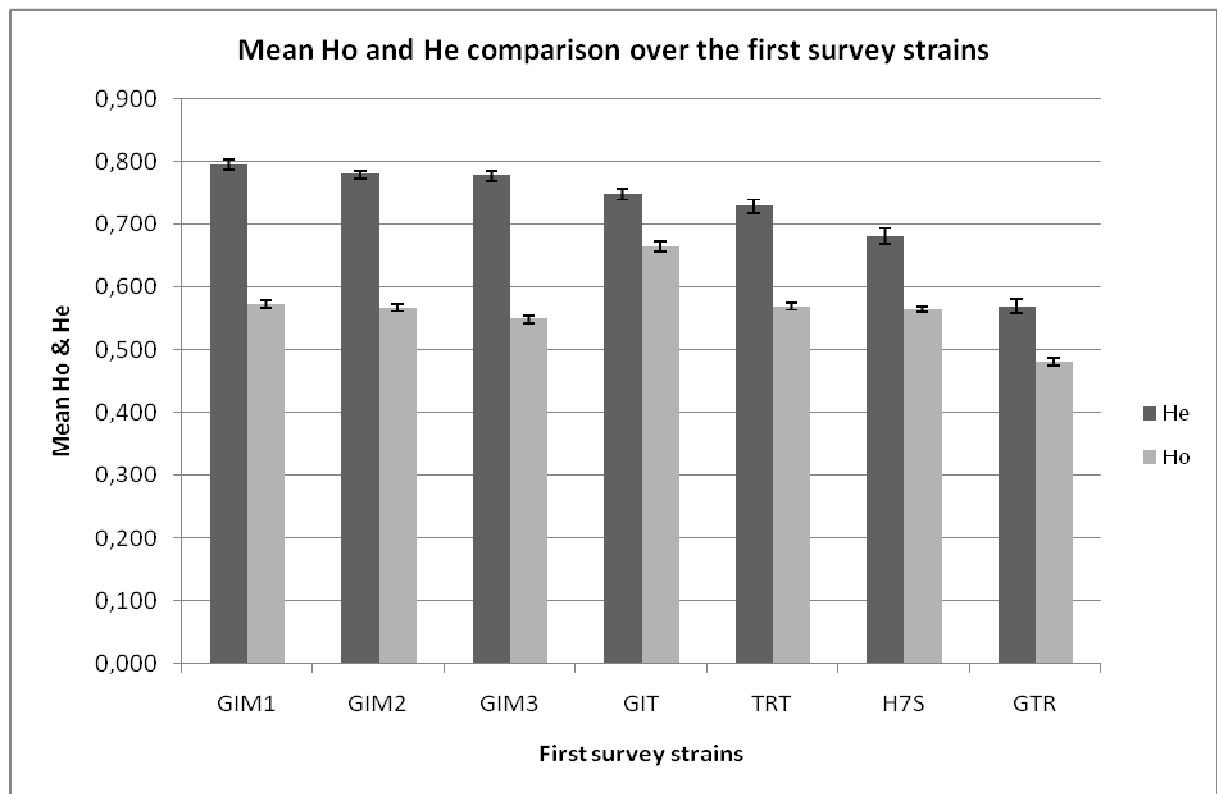

Figure 3-2 Mean Observed Heterozygosity ( $H_o$ ) and Mean Expected Heterozygosity ( $H_e$ ) comparison, Bars represent standard error.

Individual tests for HWE equilibrium at each locus in each sample are presented in Table 3-3. Most loci in most populations showed highly significant departure from HWE. Individual  $F_{is}$  values in all these cases were positive, indicating an excess of homozygotes (deficit of heterozygotes) which confirmed the results from pooled loci depicted in Fig 3-2.

Table 3-3 Exact P-value for Hardy Weinberg Equilibrium (HWE) estimation for the 7 different rainbow trout samples

	GIM1	GIM2	GIM3	H7S	TRT	GIT	GTR
<b>Omy207UoG</b>	<0.0005 (<0.0005)*	<0.0005 (<0.0005)*	<0.0005 (<0.0005)*	<0.0005 (<0.0005)*	0.299 (0.013)	<0.0005 (<0.0005)*	<0.0005 (<0.0005)*
<b>Omy301UoG</b>	<0.0005 (<0.0005)*	<0.0005 (<0.0005)*	<0.0005 (<0.0005)*	<0.0005 (<0.0005)*	<0.0005 (<0.0005)*	<0.0005 (<0.0005)*	<0.0005 (<0.0005)*
<b>Omy77DU</b>	<0.0005 (<0.0005)*	<0.0005 (<0.0005)*	<0.0005 (<0.0005)*	<0.0005 (<0.0005)*	<b>0.047 (0.003)*</b>	<b>0.029 (0.001)*</b>	<b>0.008 (0.002)*</b>
<b>OmyFGT15TUF</b>	0.227 (0.008)	<b>0.006 (0.001)*</b>	<0.0005 (<0.0005)*	0.112 (0.002)	<0.0005 (<0.0005)*	<0.0005 (<0.0005)*	<0.0005 (<0.0005)*
<b>OmyFGT5TUF</b>	<0.0005 (<0.0005)*	<0.0005 (<0.0005)*	<0.0005 (<0.0005)*	0.796 (0.000)	<0.0005 (<0.0005)*	0.205 (0.009)	0.436 (0.021)
<b>Ots1BML</b>	<b>0.014 (0.002)*</b>	<b>0.001 (0.001)*</b>	<b>0.001 (&lt;0.0005)*</b>	0.088 (0.004)	<0.0005 (<0.0005)*	0.160 (0.005)	<b>0.004 (0.001)*</b>
<b>Omy27DU</b>	<b>0.005 (0.001)*</b>	0.157 (0.005)	0.130 (0.003)	0.217 (0.003)	<0.0005 (<0.0005)*	0.759 (0.003)	0.701 (0.003)
<b>Omy325UoG</b>	<b>0.001 (&lt;0.0005)*</b>	<0.0005 (<0.0005)*	<b>0.002 (0.001)*</b>	<b>0.004 (0.001)*</b>	<0.0005 (<0.0005)*	0.469 (0.008)	<b>0.034 (0.003)*</b>
<b>OmyFGT14TUF</b>	<0.0005 (<0.0005)*	<0.0005 (<0.0005)*	<b>0.001 (0.000)*</b>	0.431 (0.004)	0.414 (0.004)	0.427 (0.003)	0.334 (0.003)
<b>OmyFGT23TUF</b>	<b>0.012 (0.008)*</b>	<b>0.013 (0.005)*</b>	<0.0005 (<0.0005)*	<b>0.021 (0.004)*</b>	<b>0.002 (0.002)*</b>	0.642 (0.013)	<0.0005 (<0.0005)*
<b>One18ASC</b>	<b>0.001 (&lt;0.0005)*</b>	<0.0005 (<0.0005)*	<b>0.014 (0.002)*</b>	0.937 (0.003)	<0.0005 (<0.0005)*	0.695 (0.005)	0.668 (0.004)
<b>Ssa439NCV</b>	<0.0005 (<0.0005)*	<0.0005 (<0.0005)*	<0.0005 (<0.0005)*	<0.0005 (<0.0005)*	<0.0005 (<0.0005)*	<0.0005 (<0.0005)*	<0.0005 (<0.0005)*

\*and **bolded** means significant deviations from HWE ( $P < 0.05$ ), standard error are in parenthesis.

Comparison of mean number of alleles per locus and mean effective number of alleles (Figure 3-3) shows that the GTR sample also has the lowest values for these metrics. The Glenwyllin and Trafalgar samples have higher numbers of alleles compared to the rest, though these are not statistically significant (based on Confidence Interval analysis).

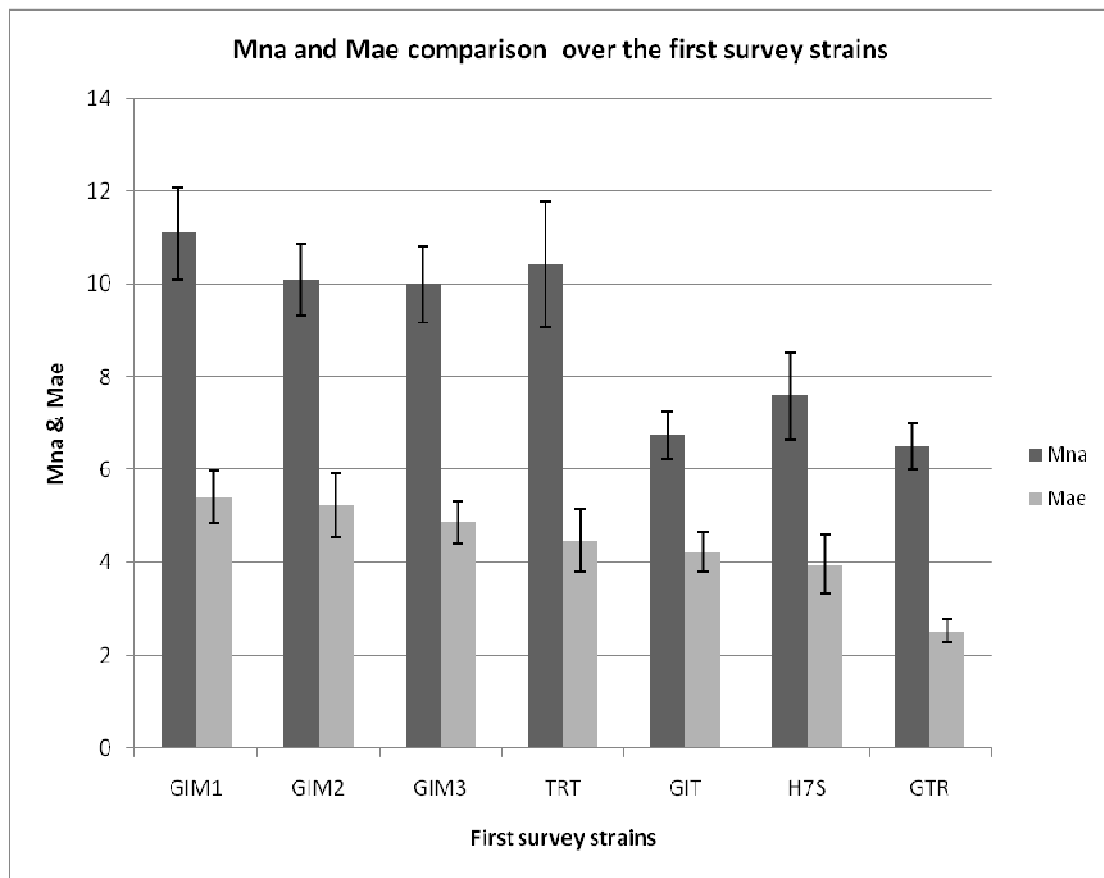

Figure 3-3 Mean number of alleles per loci ( $M_{na}$ ) and Mean effective number of alleles per loci ( $M_{ae}$ ) comparison. Bars represent the Standard Error.

### 3.3.2 Genetic differentiation among strains

Two related tests were performed, allelic (genic) and genotypic differentiation. Table 3-4 shows the pairwise results using both methodologies over all 12 loci. All comparisons (even among the three GIM samples) are significant at both allelic and genotype levels for all strains.

Table 3-4 Differentiation probability using allele (above diagonal) and genotype (below diagonal) frequency by Fisher's methodology

	<b>GIM1</b>	<b>GIM2</b>	<b>GIM3</b>	<b>H7S</b>	<b>TRT</b>	<b>GIT</b>	<b>GTR</b>
<b>GIM1</b>	--	HS	HS	HS	HS	HS	HS
<b>GIM2</b>	< 0.0005	--	< 0.0005	HS	HS	HS	HS
<b>GIM3</b>	HS	HS	--	HS	HS	HS	HS
<b>H7S</b>	HS	HS	HS	--	HS	HS	HS
<b>TRT</b>	HS	HS	HS	HS	--	HS	HS
<b>GIT</b>	HS	HS	HS	HS	< 0.0005	--	HS
<b>GTR</b>	HS	HS	HS	HS	HS	HS	--

HS = Highly Significant < 0.001

In order to more clearly resolve the pattern of genetic differentiation among the seven samples three different genetic distance measures were computed and graphically clustered (UPGMA, Fig.3-4). Included in the analysis were allele data from a further two samples (PIMAA & PIMBB; Parent Isle of Man Line A & Parent Isle of Man Line B) from Glenwyllin Isle of Man that were used in the breeding program described in Chapter 4. The analysis was based on the six loci (Omy77DU, OmyFGT15TUF, Omy27DU, Omy325UoG, OmyFGT14TUF and One18ASC) that gave consistently robust amplification across all samples. The three different genetic distance measures gave very similar / consistent results. All showed the same major branching point; one branch containing the Glenwyllin Isle of Man IOM initial samples and the parents Glenwyllin Isle of Man IOM (PIMAA & PIMBB) used in the breeding programme. The other branch includes GTR, TRT, GIT, and H7S; and



showed consistency with the Golden Trout Trafalgar (GTR) being most different among the four samples in this branch. It is interesting to note that the Glenwyllin isolate at Trafalgar (GIT) consistently grouped with H7S and not with Glenwyllin Isle of Man samples.

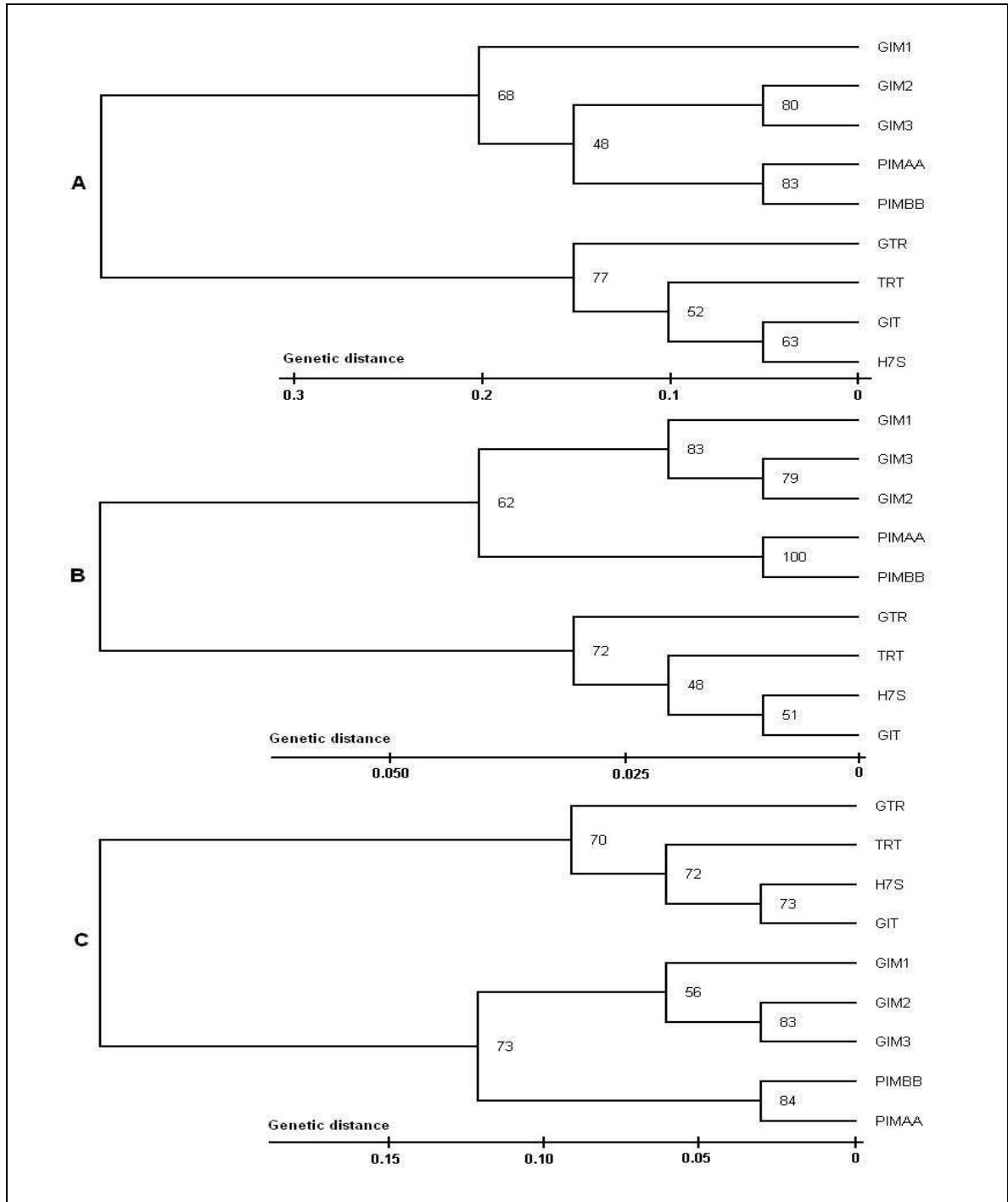

Figure 3-4 **A** UPGMA dendrogram based on Nei's genetic distance **B** UPGMA dendrogram based on Cavalli-Sforza's chord distance. **C** UPGMA dendrogram based on Reynold's genetic distance

### **3.4. Discussion**

This population genetic survey of different strains of rainbow trout was undertaken to give a general overview of the extent of variation present within the UK aquaculture industry. The different statistics computed did indicate different levels of variability within and between farm samples with highly statistically significant differentiation being apparent between samples.

#### **3.4.1 Genetic variation within the different UK strains**

It must be recognized that the population analyses undertaken were primarily devised for describing genetic variation in wild populations and not in highly managed aquaculture stocks, so results must be interpreted carefully. This particularly evident from the Hardy-Weinberg analyses undertaken. The law makes several assumption such as: the organism is diploid, reproduction is sexual, generations are non overlapping, the alleles frequencies are identical in males and female, mating is random, population size is very large, migration is negligible, mutation can be ignored, and natural selection does not affect the alleles under consideration (Hartl and Clark, 1997). Clearly many of these assumptions do not apply in this case as the rainbow trout strains will have been exposed to different management and replacement regimes. The major reason that more than half the loci in all stocks showed highly significant deviations from HWE expectations is that many of the HWE were not met in these farm population. In most cases there was an excess of homozygous individuals (heterozygote deficiency), which is a general indicator of inbreeding and / or population subdivision / mixing – either of which is likely to have occurred on all farms sampled. Possible genotyping errors cannot be excluded from

contributing in part to the observed results. One main source of genotyping error is the wrong scoring of heterozygotes as homozygotes due to the presence of null alleles and large allele dropout.

While the data are clearly not appropriate for a detailed analysis of population / stock structure, they do provide useful information for management purposes. Expected heterozygosities were relatively high and similar (0.68 – 0.79) among six of the seven samples (Fig. 3-2). Only one sample (GTR, Golden Trout Trafalgar) was noticeably lower (0.56), suggesting reduced variability. With highly variable loci, heterozygosity can be an insensitive indicator of extent of variability especially where founder effects or bottlenecks are being investigated (Chakraborty & Nei, 1977). In many cases a better indicator is the number of alleles present in a stock. Looking at these data (Fig 3-3) there appears to be two distinct groups with different mean number of alleles per loci; i.e GIM1-3 & TRT (10-11 alleles) and GIT, H7S & GTR (6.5-7.5 alleles). However, as this index of diversity is strongly dependant on sample size it is better to consider the effective number of alleles ( $M_{a_e}$ ). In this case there was less dramatic differences between samples. The three GIM samples had the highest values, with the only anomalous result being GTR, which was significantly lower (2.5) compared to the other samples (5.4 – 3.9). In general the above suggest that six of the seven samples have similar levels of variation, with GTR being lower. This observation is likely explained by founder effect bottlenecking. In comparison to the other strains the Golden Trout were founded from a relatively small number of fish that possessed the unique phenotype, and it remains necessary to mate close relatives in order to maintain the phenotype.

It is difficult to perform meaningful comparisons of levels of variability between other strains of rainbow trout unless the same panel of genetic markers is used. This is particularly the case for microsatellites, where the extent of polymorphism at different loci can vary widely. With numerous loci available for use it is not common for different researchers to use the same loci sets. It is possible however to compare the data generated in this study with those of Fishback et al. (1999) who used the same loci to characterize rainbow trout from one single strain sampled from a commercial hatchery in Canada (n = 180). Table 3-5 shows the comparison between Fishback et al (1999) strain and the 7 different strains detailed in this thesis. Note that the total number of samples was 350 but there is a range from 27 to 70 samples over the 7 strains in the present study.

Table 3-5 Locus comparison between Fishback et al. (1999) strain and the seven strain from the first survey in the present study

Locus	Allele range size		No. of alleles		Ho	
	Fishback et al.	Present study	Fishback et al.	Present study	Fishback et al.	Present study
<b>OmyFGT14TUF</b>	204-210	200-214	4	3-7	0.66	0.45-0.70
<b>One18ASC</b>	168-184	157-187	5	5-9	0.64	0.55-0.81
<b>Omy325UoG</b>	122-152	113-157	9	6-18	0.75	0.40-0.82
<b>Ssa439NCVM</b>	114-142	106-150	8	7-15	0.78	0.20-0.70
<b>Omy27DU</b>	099-111	092-110	5	4-7	0.69	0.49-0.75
<b>OmyFGT15TUF</b>	161-167	144-180	4	4-9	0.61	0.20-0.68
<b>Omy77DU</b>	098-142	091-141	7	5-12	0.88	0.27-0.54
<b>Omy207UoG</b>	105-127	101-157	6	7-12	0.69	0.31-0.70
<b>OmyFGT23TUF</b>	99-121	94-128	6	7-14	0.78	0.48-0.87
<b>OmyFGT5TUF</b>	164-184	158-188	4	4-11	0.66	0.45-0.94
<b>Ots1BML</b>	161-247	156-256	10	8-20	0.95	0.56-0.93
<b>Omy301UoG</b>	075-123	060-126	11	8-16	0.85	0.16-0.47

The mean allele range size per loci utilized by Fishback et al. (1999) was 28.3 bp, compared to 43.5 bp in the present study, a 65% increase. This most likely reflects the larger number of strains examined in the present study. The number of alleles at each locus reported by Fishback et al. (1999) for the Canadian strain were within the

range seen for the UK strains. However, despite screening a much larger sample the values for the Canadian strain were generally at the lower end of the UK range. However, surprisingly, the observed heterozygosity for each locus reported by Fishback et al. (1999) was generally at the higher end of the range observed in the current UK study, and sometimes in excess (e.g. Omy301UoG). Two possible explanations for this may be 1) a greater number of null alleles detected in UK samples and / or 2) non representative sampling of UK strains. While effort was made to try to get representative samples by taking fish from different tanks, this may not have happened in some cases, as stock movements within farms were not recorded in detail. Simply in terms of numbers the much larger sample screened by Fishback et al. (1999) (n = 180 vs 27-70 for UK ) is likely to be more representative, all other factors being considered equal.

### **3.4.2 Genetic variation among the different UK strains**

The pairwise genetic differentiation analyses suggest that there is highly significant allelic and genotypic differentiation between the different strains / samples (Table 3-4). While statistically significant and showing clear differences between samples, it is difficult to assess the extent of biological or management significance of these results. The performance of these indices can be unevenly affected by both the high number of alleles present among loci and the occurrence of many unique alleles, even if at low frequency. As noted earlier the different strains /samples were characterised by possession of a number of unique alleles. These were generally found at low frequency. While they are likely to be indicative of different imported stocks, it could be argued that the observed distribution could have arisen from founder effects of subdivision of a single strain originally imported into the UK. As details regarding the

origins and subsequent management of most strains reared in the UK are sparse or do not exist it is not possible to comment with confidence. Nevertheless the phylogenetic representations (dendrograms) do show two major branches, suggesting two different groups within the seven samples, i.e. samples from the Isle of Man and all others. Surprisingly the supposed Glenwyllin isolate at Trafalgar (GIT) did not group with any samples taken from Isle of Man. It may be that this stock has been misassigned and has not actually been derived from Glenwyllin, Isle of Man. A number of strains (including Seven Springs and Glenwyllin) were imported onto the Trafalgar site to replace broodstock that had been culled because of a disease outbreak and it is possible that these had been mixed.

### **3.4.3 General Comments on Genetic Variability in Rainbow Trout Hatchery Stocks**

With the obvious exception of the Golden Trout (GTR) sample there is no indication that any of the UK strains examined were showing indications of reduced levels of genetic variability. However this remains a potential concern. Genetic deterioration effects like inbreeding can be prevented by the conservation of large number of broodstock (large  $N_e$ ) and no selection procedures. While hatchery practice is widely thought to lead to the reduction of genetic variability, this may not be the case. Busack et al (1979) and Guyomard (1981) have found high or even higher levels of genetic variability in farmed rainbow trout stock compared to natural populations. Busack et al (1979) suggested that the conservation of higher levels of genetic variation in domestic rainbow trout was the result of historical mixing of strains or due to balancing selection following population bottleneck and artificial selection; Guyomard (1981) suggested that it was due to the mixing of different natural

populations to form or supplement the strain or possibly that the hatchery fish examined were descendents of a particularly highly polymorphic natural strain. Thompson (1985) also found high levels of genetic variability in various domesticated rainbow trout strains in the UK; he believes that the simplest explanation for this was that the strains originated from different natural populations, each with different genetic characteristics.

There used to be a wide genetic and environmental variation in wild rainbow trout spawning season. In many cases these large wild variations have been lost by the past practice of hatchery managers that tend to select for early spawners. Since then, for commercial reasons linked to year round production goals, there is now impetus to expand the spawning period in farmed strains. Due to the high spawning date heritability for this salmonid species, it has been possible to create new artificial strains from the natural populations. As an extreme example, it is possible to mention the Rainbow Spring Hatchery (Thamesford, Ontario, Canada) created in 1975 with just 25 pairs of parent founders. The constant use of artificial phenotypic selection over spawning date led to the expansion of the spawning season from initially 2 weeks to 8 months, from August to April. This expansion has resulted in four overlapping spawning seasons: summer, fall, winter, and spring (Fishback et al., 2000).

The farms are not in an environment where the conditions are changing constantly, and as Meffe (1987) argued, “low amount of genetic variation are not necessarily deleterious in an aquaculture operation if strains have the combination of genes suited to the farm environment”. However it may well be that if the sampling for

replacement parents is poor then there is a risk of missing genes not only fitting the fish to the farm environment but also conferring performance benefits. Losing some genetic variation during the founding development of stocks cannot be avoided, but the extent of loss can be minimised by appropriate modifications to applied breeding designs.

One practical methodology that might help to conserve genetic variability is to collect enough milt from the males or neomales chosen at different time intervals during the entire reproductive season of the particular strain, check the quality parameters and freeze suitable samples in liquid nitrogen. Crosses in the subsequent season should be done with female induced to spawn utilizing photoperiod manipulation. The Glenwyllin IOM farm has the facility for the photoperiod technique, thus it would be wise to utilize this methodology as an alternative of hormonal or water temperature inductions. This procedure is also increasing genetic variability by utilizing the advantages of sexual reproduction i.e. segregation and recombination (Guillespie, 1998).



### 3.5 Conclusions

- The panel of 10 loci screened was highly polymorphic in all samples screened. DNA profiling for parentage analysis could be readily applied to any of these stocks with a high expectation of success.
- There appears to be substantial genetic variability within the commercial United Kingdom rainbow trout strains surveyed in this study. This appears to be the case despite very different management histories and levels of record keeping.
- The strains appear to be genetically distinct (based on population genetic analyses), though the reasons for this remain unclear (and possibly unanswerable given the poor records kept by the different companies).
- Possibly, the Glenwyllin stock maintained by Trafalgar is misidentified. It did not show genetic similarity with samples taken directly from the Isle of Man farm.
- A set of baseline data for commercial UK rainbow trout strains has been established.

## **Chapter 4 / PARENTAL ASSIGNMENT IN RAINBOW TROUT**

### **4.1. Introduction**

In the past, the only way to be able to develop a family based genetic improvement program in fish was to keep fry populations from the same family for a time in separate compartments until the fish reached a minimum size which allowed them to be marked or tagged. In developed countries, breeding families in separate tanks has a high cost because it requires a complex infrastructure and specialized intensive labour. Besides, if the families are kept separate, the selection efficiency could be reduced and it could raise heritability estimates under some designs but will frequently reduce heritabilities due to the introduction of environmental effects with genetic effects. Genetic markers called microsatellites are highly polymorphic markers. This technology could be used for assessing the parental relation, for instance, assessing parent-offspring relationship at some time of their life cycle. Using this method allows different families to be kept together in a common environment, such as raising fry in a single tank or raceway, avoiding the confusion of environmental with genetic effects. Mixing families inside the same tanks also maximizes the number of families available for assessment and it is not necessary to have a large and complex infrastructure, as it may be done in a normal commercial hatchery without modifying it (Gjoen and Bentsen, 1997; Estoup et al, 1998; Ferguson and Danzmann, 1998; Cunningham, 1999; Norris et al, 2000; Hara and Sekino, 2003; Sekino et al, 2003).

Recently a number of questions have arisen with respect to parental analysis, the number of microsatellite loci required, the optimum level of variability in each locus and dealing with genotyping errors (Castro et al., 2004; Pompanon et al., 2005).

A genotyping error occurs when the scored genotype of an individual does not correspond to the true genotype. An error can be spotted if the experimental genotype is incompatible with other reliable independent evidence, such as pedigree data. Thompson (1976) was one of the first to note that mismatches in pedigree data could result from laboratory errors. A bibliographic survey indicates that an increasing number of researchers are aware of this difficulty but that the effect of genotyping errors still remains neglected (Pompanon et al., 2005).

Pompanon et al. (2005) proposed to group the genotype error into four categories: errors that are linked to the DNA sequence itself, errors that are due to the low quality or quantity of the DNA, biochemical artefacts and human factors. Genotyping errors have an effect on parental analysis, as they can generate incorrect paternity or maternity exclusion. Therefore, it is important to take into account the possibility of genotyping errors when designing an experimental protocol. Control procedures are costly and time consuming. Therefore, the effort for reducing the error rate must be adapted to the predictable effect of the genotyping errors. Because genotyping errors can be generated even with high-quality standards, and because they cannot all be detected, efforts must be directed towards limiting both their production and their subsequent effect. Theoretical studies and simulations are needed to quantify the robustness to genotyping error of population genetics estimates such as  $F_{st}$ , migration rate, linkage disequilibrium, probability of identity, and effective population size.

A further possibility is to use tests that, because of their statistical power, are robust to the occurrence of genotyping error. Errors can also be dealt with by allowing a certain number of inconsistencies to occur between genotypes. It is also valuable to use methods that calculate the likelihood of obtained genotypes or pedigrees using a model of error occurrence, such as a uniform or empirical distribution of errors (Pompanon et al., 2005).

The main parental analysis methods are those based on exclusion and likelihood approaches (Jones and Ardren, 2003). The exclusion principle solely depends on Mendelian genotype incompatibilities between the potential parents and offspring. In many cases, experimental designs allow all the parents to be sampled, maximizing the power of assignment. In this situation, assignment based on simple exclusion compared with likelihood approaches may be often successfully used. Furthermore, when more than one non-excluded set of parents remains, likelihood approaches may be used to choose the most probable parent (e.g. Meager and Thompson, 1986; Sancristobal and Chevalet, 1997; Vandeputte et al. 2005).

The use of a number of different programs with different strengths and weaknesses may probably enhance an assignment project (Herlin et al., 2007). Assignments based on exclusion within close-related family groups may provide a powerful method for identifying and possibly quantifying errors/mutations for a given set of loci and condition. This type of information is considered essential for analysis reports based on likelihood methods (Morrissey & Wilson 2005). In this study, the parental assignment generated by two programmes, PAPA (Duchesne et al., 2002) and FAP

free software (Taggart, 2007) are compared using the genotypes derived from eleven microsatellite loci.

## **4.2. Materials and methods**

### **4.2.1 Fish samples collection**

The study used Rainbow trout tissue samples from 80 broodstock parents and 1500 of their offspring. The broodstock (20 females and 20 neomales each from Strain A and Strain B) came from Glenwyllin trout farm on the Isle of Man farm. The 1500 offspring came from 160 potential families; the breeding design (Fig. 2-4 in the materials and methods), within and between the two different lines.

At the Glenwyllin Isle of Man Trout farm, the broodstock (parents) who became the Base Population were selected according to their availability, which means that the female and neomales selected were mature and ready for stripping or gamete extraction the day before fertilization. A fin tissue sample was taken from all broodstock used in the breeding design. Finclip samples were stored inside a 1.5 ml microfuge tube and preserved in 100% ethanol. This procedure was followed by gamete fertilization, in this way, females and neomales from two different lines (A & B) were crossed according to a programmed design (Figure 2-4), producing two pure breed lines and one hybrid cross; a total of 160 potential families.

The eggs were incubated and at the eyed stage the number of eggs in each family were counted and the families were split into four different groups. All families in each group were combined and sent to different ongrowers. The fish used in the

commercial performance testing in this project were sent to the specialist fingerling producer Company Iwerne Spring; all the families were ongrow in a communal environment. When the fingerlings had reached an average weight of 5 g they were transported to the ongrowing farm at Itchen Abbass owned by the Test Valley Trout Company (TVT), where the final communal ongrowing took place. In TVT, the Glenwyllin strain was combined with the Houghton Spring strain for communal ongrowing. Before being combined, the strains were held separately, in circular tanks prior to PIT tagging. On the 4<sup>th</sup> of June 2003, 3000 fingerling were PIT tagged and fin clipped; 1500 from Houghton Spring and 1500 from Glenwyllin were randomly selected for the communal rearing trial. Nevertheless, this study only used the samples from the Glenwyllin strain.

The sampling procedure used was first to anaesthetize the fingerlings, then a PIT tag was implanted with an injector into the abdominal cavity. A clean scalpel blade was used to cut a 5mm finclip, from the lower part of the caudal fin. Then the finclip samples were placed in a previously labelled (laser printed PIT tag number on a slip of paper inside the tube) 1.5 ml microfuge tube and preserved in 100% ethanol. Table 4-1 shows all the families produced and the codification for each family group. All the samples were transported back to the laboratory for processing at the Institute of Aquaculture.

Table 4-1 Code name description, number of samples, and date of collection for the 4 different groups of Glenwyllin IOM Base Population and Offspring First Generation

<b>Code name</b>	<b>Code name description</b>	<b>Number of samples</b>	<b>Collection date (dd/mm/yyyy)</b>
AFI	Line A, Female, Glenwyllin Isle of Man, Base Population	20	13-11-2002
ANI	Line A, Neomale, Glenwyllin Isle of Man, Base Population	20	13-11-2002
BFI	Line B, Female, Glenwyllin Isle of Man, Base Population	20	13-11-2002
BNI	Line B, Neomale, Glenwyllin Isle of Man, Base Population	20	13-11-2002
OIM	Offspring Glenwyllin Isle of Man, First Generation (F1).	1500	04-06-2003
$\Sigma$		1580	

The DNA extraction, multiplex PCR reactions, and gel preparation are explained in more detail in the General Material and Methods (Chapter 2).

## 4.2.2 Parental analysis

### **Family Analysis Program (FAP) (Taggart, 2007)**

The package specifically addresses the issue of predictive assignment at family level, while also providing useful aids to identify problematic loci/miss-scoring during actual assignment. Based on exclusion principles, and assuming all parental genotypes are known, FAP (current version 3.5) performs two related tasks — predictive and actual assignment. In this current study, the assignment mode will be used.

Assignment mode: The family database can be queried with specific progeny genotypes for family assignment. This mode may be run with or without computing predictive statistics. Progeny genotypes are read in from a tab-delimited text file and the resultant output file gives each progeny an ID, its composite genotype and lists all potential matching families. Two tolerance aids are incorporated to explore potential genotyping problems ‘Allele Mismatch Tolerance’ (AMT) and ‘Allele Size Tolerance’ (AST). In this study, the AMT aid will be explored.

AMT allows imperfect matches to be identified in cases where no match is found for the full selected locus data set (i.e. to allow for scoring error/mutation among progeny or parental samples). If AMT is enabled and no match is found for the full locus data set, the progeny genotype is reanalysed with sequentially increasing tolerance (n-1, n-2, etc. alleles matching) until a match is found or the entered AMT value is exceeded. Reduced tolerance matches are flagged and the implicated locus (or loci) is identified in the output file.

Three classes of assignment are possible: 'single-match' — where the offspring is assigned to a single family; 'multi-match' — where the offspring is assigned to more than one family (all are listed); and 'no-match' — where all potential parental-pairs are excluded, thus the offspring is not matched to any family.

#### **Package for the Analysis of Parental Allocation (PAPA) (Duchesne et al., 2002)**

PAPA is a computer program that performs parental allocation based on breeding likelihood methods (San Cristobal & Chevalet 1997), and also comprises simulators that allow statistical assessments of allocation accuracy. Given an offspring genotype, the likelihood of a parental pair of genotypes is defined as the probability of this pair producing the offspring genotype among all of their possible descendents. Contrary to exclusion methods, likelihood based parental allocation methods allow for some degree of transmission errors due to genotype misreading or mutation (e.g. San Cristobal & Chevalet 1997; Marshall et al. 1998). The relaxed nature of the latter condition means that likelihood methods generally call for much less extensive genetic information than exclusion-based ones.



PAPA provides a Monte-Carlo simulator that may be used to obtain empirical distributions of many relevant random variables such as rates of successful allocations and allocation failures. The embodied simulator allows modelling of all allocation conditions (allele transmission error, missing parents, etc.). Parental simulations, which involve already known parental genotypes, produce empirical distributions from which the accuracy of the allocation of real offspring may be assessed.

Simulation conditions: Simulations may be run under two distinct conditions: (i) preparental; and (ii) parental. The parental simulation procedure use real collected parental genotypes. This study uses the sexed parental simulations mode, its main purpose is to build empirical distributions of random variables, given the real collected parental genotypes. Such distributions were used to assess the accuracy level of a specific allocation process. The program requested to provide information such as: estimated number of uncollected parents, name of loci, male genotype dataset, female genotype dataset, number of iteration, number of pseudo offspring generated at each iteration, uniform error, and number of subset of loci.

Allocation method: To assign an offspring to a single family (parental-pair), its breeding likelihood is computed for each potential family, the one with the highest likelihood is assigned as family. Offspring are not assigned to a single family when either two or more families share the highest positive likelihood, in this case the program said there is an 'ambiguous' or all families show zero likelihood, in this case the program said there is a 'null' likelihood. The allocation parameters are (i) choice

of loci; (ii) global level of transmission error; and (iii) distribution of transmission error over alleles.

In both cases simulation and the allocation modes, a degree of transmission error (i.e. allele mistyping and/or genetic mutation) can be accommodated. This transmission error rate can be either uniform (all errors assumed to be equally likely), or non-uniform (to reflect greater miss-scoring between alleles of similar mobility). This study utilizes the uniform transmission error. Simulations run using the chosen error model/value can be used to evaluate the likely power of the allocation and provides a computed measure of 'correctness', i.e. the level of confidence/accuracy that can be expected from actual assignments.

### **Strategy**

In order to assess assigned correctness with PAPA software it was necessary to run simulation studies using the following condition: all the male and female genotypes were known, thus the uncollected parents variable were set to 0. In this particular case the use of structured parental files was used because of the crossing design. The uniform error variable was explored using two values 0.02 and 0. Furthermore, values of 300 iterations and 1500 pseudo-offspring per iteration were used. The simulation determines a critical value of minimum loci with which offspring may be analysed.

Then all the offspring are analysed with FAP to assess the effectiveness of the exclusion method: first, using 0 mismatch and then 10 mismatch to force the assignment, revealing those loci with problems. Then, the offspring with a single family may be separated from those with multiple families.

Mismatches may be eliminated from single family offspring and reanalysed to see whether the same family assignment results are obtained, comparing them then with the PAPA results. The families should be the same when using both programs. Finally, the resulting offspring with multiple families from FAP software are analysed with PAPA, which will determine a single family. This last identified family should be within the multiple families identified using FAP.

### **4.3. Results**

#### **4.3.1 Glenwyllin strain parental genotyping**

All the Glenwyllin parents and offspring genotyping was done using 12 loci (Table 4-2). However, the locus OmyFGT5TUF was eliminated because of its poor PCR amplification so subsequent analysis was based on 11 loci. All the Glenwyllin parental groups AFI, ANI, BFI and BNI, 80 adult rainbow trout in total, were successfully genotyped at 11 loci. In order to get good genotype dataset at all loci it was necessary to repeat PCR reactions and extract fresh DNA from the original tissue samples. Table 4-2 is a detailed description of overall alleles involved in the genotype of the four different Glenwyllin parental groups.

Table 4-2 Allele sizes and NA observed in 11 loci for the different Glenwyllin IOM parental groups.

Loci microsatellite	Group	Allele size range	NA	Loci microsatellite	Group	Allele size range	NA
<b>Omy207UoG</b>	AFI	107-157	11	<b>OmyFGT14TUF</b>	BFI	204-210	3
	ANI	107-157	10		BNI	204-210	4
	BFI	107-157	10	<b>OmyFGT15TUF</b>	AFI	154-166	5
	BNI	107-157	10		ANI	154-166	5
<b>Omy27DU</b>	AFI	104-108	3	<b>OmyFGT23</b>	BFI	154-166	5
	ANI	104-108	3		BNI	144-166	6
	BFI	104-108	3		AFI	099-121	7
	BNI	104-108	3		ANI	099-121	8
<b>Omy301UoG</b>	AFI	064-100	6	<b>One18ASC</b>	BFI	099-121	8
	ANI	064-122	12		BNI	099-121	7
	BFI	064-122	9		AFI	167-183	5
	BNI	070-122	10		ANI	163-183	5
<b>Omy325UoG</b>	AFI	117-143	6	<b>Ots1BML</b>	BFI	167-183	5
	ANI	117-151	7		BNI	173-183	4
	BFI	117-143	7		AFI	160-250	7
	BNI	117-143	6		ANI	160-250	8
<b>Omy77DU</b>	AFI	099-129	6	<b>Ssa439NCVM</b>	BFI	160-250	7
	ANI	099-125	6		BNI	160-178	7
	BFI	099-129	5		AFI	114-140	10
	BNI	099-129	6		ANI	114-146	10
<b>OmyFGT14TUF</b>	AFI	204-210	3	BFI	114-150	10	
	ANI	204-210	4	BNI	114-140	9	

NA = Number of alleles

Table 4-3 shows the results obtained for the variables mean number of alleles MNA, and expected and observed heterozygosity in the different Glenwyllin parental groups.

Table 4-3 Mean number of alleles, expected and observed heterozygosity over all different groups of parents.

Group	N	# Loci	MNA	MNA SD	He	He SD	Ho	Ho SD
AFI	20	11	6.27	2.49	0.738	0.035	0.650	0.032
BFI	20	11	6.55	2.54	0.731	0.039	0.705	0.031
ANI	20	11	7.09	2.81	0.731	0.039	0.682	0.031
BNI	20	11	6.55	2.38	0.731	0.032	0.695	0.031

N = number of samples    MNA = Mean number of alleles    He = expected heterozygosity  
Ho = observed heterozygosity

The results in Table 4-3 show that there is no difference in the mean number of alleles and also the expected heterozygosity and that the observed heterozygosity in the BFI group is significantly higher than that in the other female group AFI.

### 4.3.2 Glenwyllin offspring genotyping

1500 offspring rainbow trout PIT tagged at TVT were genotyped at 11 loci. However, not all the individuals were successfully genotyped at all 11 loci because of imperfect amplification due to different factors. Furthermore, the offspring were genotyped without replication. Figure 4-1 shows all the offspring genotyped with different combinations of more than 6 loci amplified altogether.

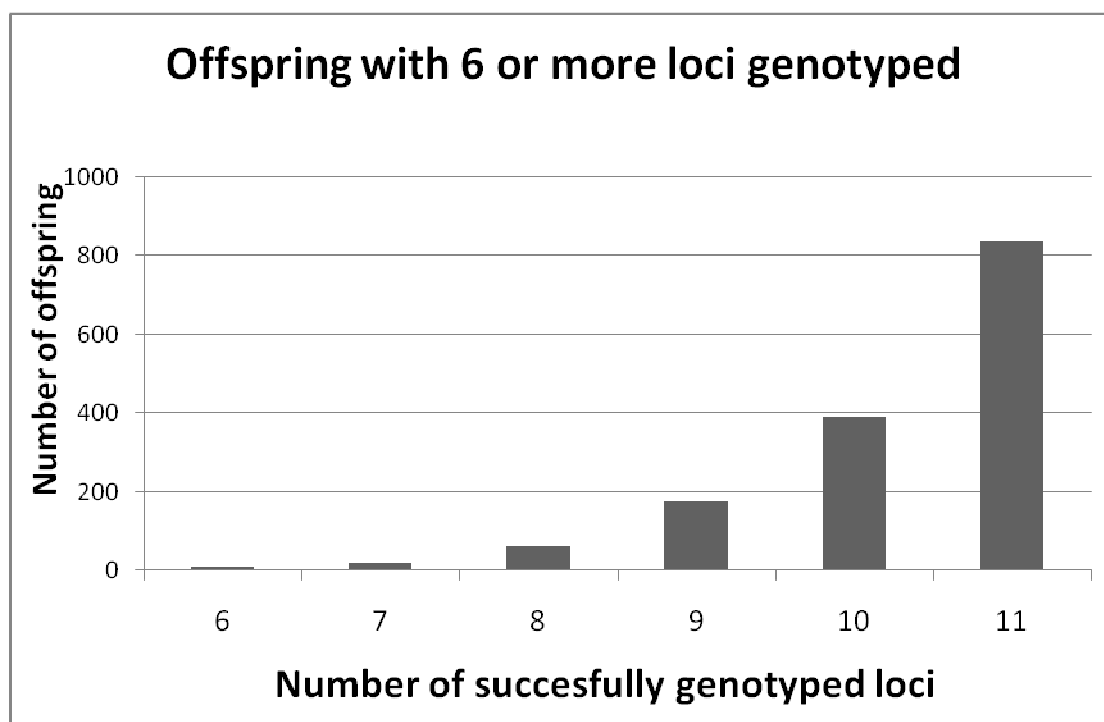

Figure 4-1 Detail of the performance of the offspring Glenwyllin IOM genotype procedure. Offspring with 6 or more loci successfully genotyped are shown (n = 1490).

Figure 4-1 shows the performance of the offspring genotype procedure. The raw genotype dataset shows that 834 (55.6%) offspring were successfully genotyped with 11 loci, then decreasing the values; 390 (26.6%) offspring with 10 loci, 175 (11.6%) offspring with 9 loci, 62 (4.1%) offspring with 8 loci, 20 (1.3%) offspring with 7 loci,

and finally 9 offspring with 6 loci. The final summation is 1490 (99.3%) offspring with more than 6 genotyped loci.

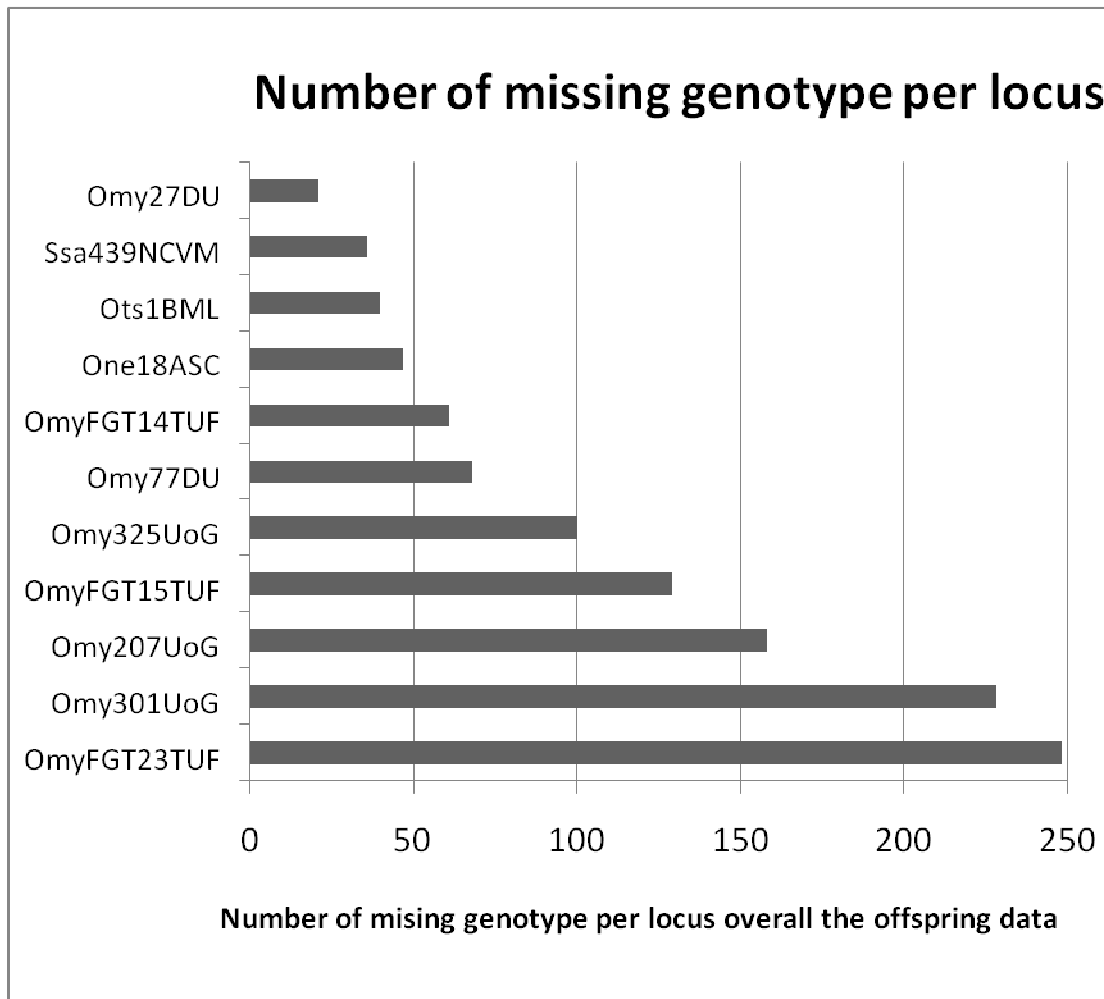

Figure 4-2 Detail of the total offspring genotype performance. The total number of missing genotypes is presented for every locus for the whole population (n = 1500).

From Figure 4-2 it is possible to appreciate the total number of missing genotypes per locus over all the offspring dataset. Thus, it is possible to appreciate that locus OmyFGT23TUF has the highest amount of missing data (248), followed by Omy301UoG (228), then Omy207UoG (158), and finally OmyFGT15TUF (129). The summation of these 4 loci resulted in 763 missing genotypes data (67.1%). Thus, there are a total of 1,136 missing genotypes data out of the 16,500 potential genotype data from all the 1500 offspring.

The next step was to proceed with the predictions using PAPA software simulation mode, the procedure used 300 iterations and 1500 pseudo offspring. Table 4-4 shows the simulation results over different numbers and combinations of loci and two different uniform transmission errors. The different combinatory analysis started with [11, 6] loci and finished with [11, 11] loci, i.e. 11 loci were used for the parents and the offspring are going to be analysed with different loci combinations: starting with different combination of 6 loci, then 7 loci, following by 8 loci, 9 loci, 10 loci, and finishing with all 11 loci. The different uniform transmission errors utilized were 0.02 and 0.

Table 4-4 Simulation results over different combinations of loci and two uniform errors indicating in each case the mean allocating results and the mean correctness for each combinatory group

Uniform error	Combinatory	Type of decisions			Mean correctness among allocated pseudo-offspring		
		Mean Allocation	Mean Ambiguous	Mean Nulls	Pair	Male	Female
0.02	[11,11]= 1	0.999	0.001	0	0.999	0.999	0.999
0	[11,11]= 1	0.999	0.001	0	0.999	0.999	0.999
0.02	[11,10]= 11	0.999	0.001	0	0.999	0.999	0.999
0	[11,10]= 11	0.999	0.001	0	0.999	0.999	0.999
0.02	[11, 9]= 55	0.999	0.001	0	0.999	0.999	0.999
0	[11, 9]= 55	0.999	0.001	0	0.999	0.999	0.999
0.02	[11, 8]= 165	0.999	0.001	0	0.996	0.996	0.996
0	[11, 8]= 165	0.999	0.001	0	0.998	0.998	0.998
0.02	[11, 7]= 330	0.997	0.003	0	0.991	0.991	0.991
0	[11, 7]= 330	0.996	0.004	0	0.996	0.996	0.996
0.02	[11, 6]= 462	0.990	0.010	0	0.977	0.977	0.977
0	[11, 6]= 462	0.988	0.012	0	0.987	0.987	0.987

Table 4-4 shows that the best simulation results, in terms of mean correctness, were obtained using a uniform transmission error of 0 over all the different combinations of loci, i.e. without error. Using this procedure there are no null assignments and just a minimal amount of ambiguity assignment. From this simulation it was decided that all

further analyses from PAPA were going to be analyzed without error when possible, because the errors could be eliminated but it is not possible to do it in the case of multiple family assignments per offspring.

Table 4-5 shows the analysis using FAP software. The analysis utilize all 11 loci and all the 1500 offspring, first allowing 0 allele mismatches, and then compared with another analysis allowing up to 10 allele mismatches. The reason for this approach was to force an assignment for each of the offspring.

Table 4-5 Parental analysis of all 1500 offspring utilizing FAP software, first using the dataset allowing 0 mismatches and then the same dataset allowing 10 mismatches

	<b>Dataset allowing 0 mismatch</b>	<b>Dataset allowing 10 mismatch</b>
<b>Total number of offspring used (%)</b>	1500 (100)	1500 (100)
<b>Number (%) of offspring assigned to a single family.</b>	104 (6.9)	1290 (86)
<b>Number (%) of offspring assigned to more than one family</b>	5 (0.3)	210 (14)
<b>Number (%) of offspring not matched to a family</b>	1391 (92.7)	0 (0)

The new parental allocation dataset, allowing up to 10 mismatches, was corrected utilizing FAP software and afterwards reanalyzed utilizing FAP software again and then PAPA software. The results of the assigned families from both programs were compared, to see whether the assigned families were the same. The simulation showed that when there is no transmission error (0 error) the parental assignment based on 6 loci gives a probability of assignment of 0.987.



### 4.3.3 Parental assignment of offspring using different combinations and numbers of loci.

Using the group of offspring assigned to a single family (n = 1290: 86 %) from the dataset of offspring allowing up to 10 mismatches (Table 4-5), it is possible to identify and quantify all the errors and then eliminate them, i.e. the mismatches are changed to zero, after this procedure the error will be considered as missing loci. This resulted again in the identification of a group of fish with subsets of less than 6 loci. In order to follow the initial simulation from PAPA software, those offspring need to be removed from the dataset. So, from the 1290 offspring, 1242 offspring have a minimum of 6 loci and 48 offspring have less than 6 loci, these last ones are discarded. In this way, a new dataset without mismatches is created. Table 4-6 shows the comparison of the family assignment results using FAP software of these 1242 offspring, between the old dataset without mismatch correction (allowing up to 10 mismatches) and the new dataset with mismatch correction (allowing 0 mismatches).

Table 4-6 Comparison of parental assignment results using FAP software with the 1242 offspring with a single family between a database without correction and another one with correction

	<b>Without Correction (10 mismatch)</b>	<b>With Correction (0 mismatch)</b>
<b>Total number of offspring used (%)</b>	1242 (100)	1242 (100)
<b>Number (%) of offspring assigned to a single family.</b>	1242 (100)	1220 (98.2)
<b>Number (%) of offspring assigned to more than one family</b>	0 (0)	22 (1.8)
<b>Number (%) of offspring not matched to a family</b>	0 (0)	0 (0)
<b>Ratio (%) of families that concur between the dataset Without Correction &amp; With Correction</b>		1220/1242 (98.2)

When the 22 offspring assigned to multiple families from the dataset group with correction were compared with the same 22 offspring with a single family from the dataset group without correction, it was possible to observe that the single families of the offspring were always included within the multiple families. The 22 offspring with multiple families have on average 2.3 families each, with a minimum of 2 and a maximum of 6 families. Table 4-6 shows the efficiency of concurrence of this method as there exists 98.2% consistency of results between the databases with and without correction. To be able to assess the efficiency of concurrence between FAP and PAPA software, the same procedure has to be done with PAPA. Following this idea, Table 4-7 shows the comparison of the family assignment results using PAPA software of these 1242 offspring, between the old dataset without mismatch correction (allowing up to 10 mismatches) and the new dataset with mismatch correction (allowing 0 mismatches). On this occasion PAPA analysis utilizing a transmission error 0.

Table 4-7 Comparison of the results of parental assignment using PAPA software with the 1242 offspring previously selected between the dataset without correction and with correction.

	<b>Without Correction (10 mismatch)</b>	<b>With Correction (0 mismatch)</b>
<b>Total number of offspring used (%)</b>	1242 (100)	1242 (100)
<b>Number (%) of offspring assigned to a single family.</b>	103 (8.3)	1236 (99.5)
<b>Number (%) of offspring assigned to more than one family</b>	0 (0)	6 (0.5)
<b>Number (%) of offspring not matched to a family</b>	1139 (91.7)	0 (0)
<b>Ratio (%) of families that concur between the dataset Without Correction &amp; With Correction.</b>		103/1242 (8.3)

These family assignments that concur between the two different dataset are significantly lower (8.3%) than the results obtained using FAP software (98.2%)

(Table 4-6). The reason of these results is because the dataset that contained error (10 mismatches) was analysed with transmission error 0. In the case of assignment to multiple families, PAPA software does not indicate which ones are the multiple families; meaning that the results are ambiguous.

A comparison of their respective parental assignment results was performed in order to be able to quantify the efficacy of using both FAP and PAPA software. Table 4-8 shows the comparison of the parental assignment results when utilizing the database with correction (0 mismatches).

Table 4-8 Comparison of the results of parental assignment between FAP and PAPA with the 1242 offspring previously selected using the dataset with correction.

	<b>FAP With Correction (0 mismatch)</b>	<b>PAPA With Correction (0 mismatch)</b>
<b>Total number of offspring used (%)</b>	1242 (100)	1242 (100)
<b>Number (%) of offspring assigned to a single family.</b>	1220 (98.2)	1236 (99.5)
<b>Number (%) of offspring assigned to more than one family</b>	22 (1.8)	6 (0.5)
<b>Number (%) of offspring not matched to a family</b>	0 (0)	0 (0)
<b>Ratio (%) of families that concur between the different software</b>	1220/1236 (98.7)	

The number of families that concur between FAP and PAPA software are 1220 (98.7%).

#### 4.3.4 Comparison of the offspring that have multiple family assignments with the different methodologies

It is possible to differentiate between two different groups of offspring with multiple families, one that has a dataset without mismatches and another with mismatches. The dataset with mismatches cannot be fixed using FAP software. The dataset are going to be analyzed separately, first the one with corrections (Table 4-9) and then the one without corrections (Table 4-10).

Table 4-9 Comparison of the results of parental assignment between the 22 offspring with multiple families using FAP software with the results obtained using PAPA software.

	<b>FAP With Correction (0 mismatch)</b>	<b>PAPA With Correction (0 mismatch)</b>
<b>Total number of offspring used (%)</b>	22 (100)	22 (100)
<b>Number (%) of offspring assigned to a single family.</b>	0 (0)	16 (72.7)
<b>Number (%) of offspring assigned to more than one family</b>	22 (100)	6 (27.3)
<b>Number (%) of offspring not matched to a family</b>	0 (0)	0 (0)
<b>Ratio (%) of families that concur between the multiples family assignment with FAP and single assignment from PAPA</b>		16/22 (72.7)

When one observe Table 4-9 it is possible to realize that the effectiveness of PAPA software in assigning to just one family is in this case 72.7%. From the 210 offspring assigned to multiple families from the dataset without correction utilizing FAP (Table 4-5), there are 93 offspring with more than 6 loci. 117 offspring assigned to multiple families were discarded for not having the minimum number of loci (6). Thus, in order to be able to determine the real parental assignment of these 93 offspring, Table 4-10 compares the multiple family assignment from the dataset without correction obtained with FAP software and the results obtained from the dataset without

correction with PAPA software. When using PAPA, the uniform transmission error was set up at 0.02, because the errors could not be eliminated.

Table 4-10 Comparison of the results of parental assignment between the 93 offspring with multiple families using FAP software with the results obtained using PAPA software.

	<b>FAP Without Correction (10 mismatch)</b>	<b>PAPA Without Correction (10 mismatch)</b>
<b>Total number of offspring used (%)</b>	93 (100)	93 (100)
<b>Number (%) of offspring assigned to a single family.</b>	0 (0)	92 (98.9)
<b>Number (%) of offspring assigned to more than one family</b>	93 (100)	1 (1.1)
<b>Number (%) of offspring not matched to a family</b>	0 (0)	0 (0)
<b>Ratio (%) of families that concur between the multiples family assignment with FAP and single assignment from PAPA</b>		92/93 (98.9)

From the results obtained with FAP it can be noticed that the 93 offspring have an average number of 2.6 families each, with an offspring with a minimum of 2 families and another offspring with a maximum of 9 families. The efficiency of PAPA software to discriminate between different families could be seen from Table 4-10, as there are 98.9% families that concur between FAP and PAPA software, i.e. only one offspring's family could not be identified.

Thus, from the different tables it can be appreciated that the total number of offspring with a single family would be 1220 from Table 4-8, plus 16 from Table 4-9 and finally plus the 92 offspring from Table 4-10, which gave us a total of 1328, with an efficiency of parental assignment of 88.5%. Nevertheless, there is a range of correctness between 0.91 and 0.99. If we look at the Figure 4-3 is possible to appreciate the efficiency of allocation with different values of correctness.

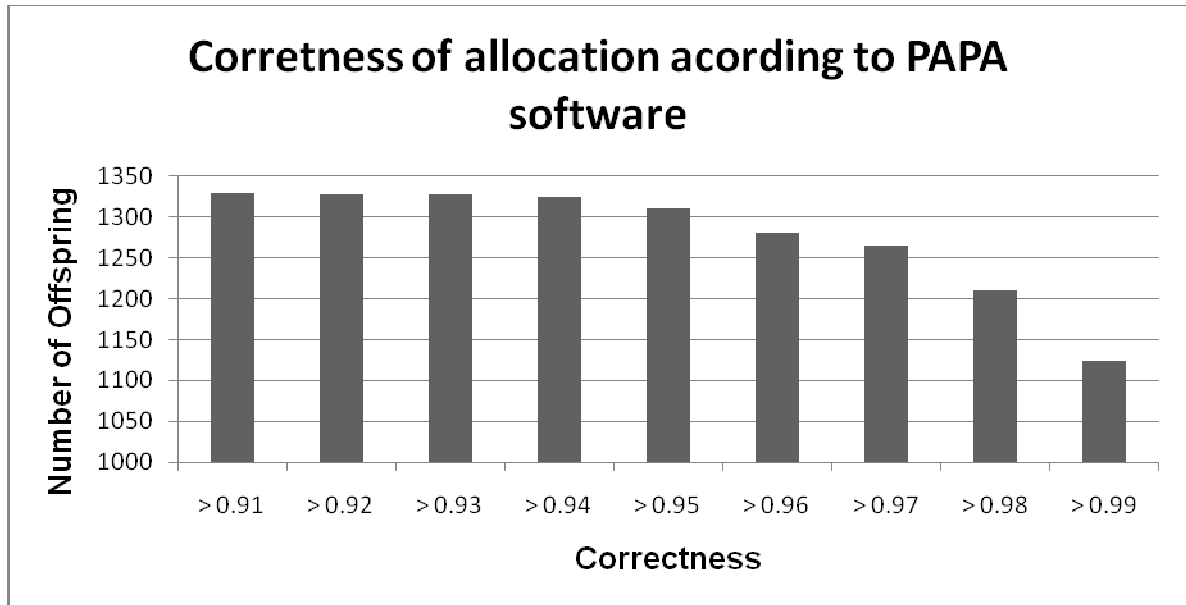

Figure 4-3 Allocation efficiency according to PAPA software utilizing different values of correctness

From the Figure 4-3 is possible to appreciate that with correctness higher than 0.95 there is an allocation efficiency of 87.3%, also with correctness higher than 0.98 there is an allocation efficiency of 80.7%, and finally with correctness higher than 0.99 there is an allocation efficiency of 74.9%.

#### 4.4. Discussion

The fact of having genotyped the 4 different groups of Glenwyllin Isle of Man parents several times each to determine their complete match genotype provides great certainty about the exactness of the results. However, due to the large number of fish used and small budget, it was decided that the offspring would be genotyped without replication. The offspring genotyping had an allelic production efficiency of 93.2% on overall 1500 offspring, 1490 (99.3%) offspring genotype have amplified more than 6 loci. The results show that the loci mainly involved in this lack of amplification were Omy207UoG, Omy301UoG, OmyFGT23TUF, and OmyFGT15TUF. These four loci

accounted for 67.1% of the missing genotypes. The loci Omy301UoG, OmyFGT23TUF, and OmyFGT15TUF had a particularly bad PCR amplification when comparing the graphic image of the ABI software with all the other different loci. When one observes the number of missing loci in the population of 1500 offspring one may feel that these results do not provide a good dataset for parental assignment. However, this is not true, as 1490 offspring, i.e., 99.3%, had more than 6 loci, and the simulation of parental assignment carried out with the PAPA software shows that with a uniform transmission error of 0 a mean correctness of 0.987 may be obtained with a mean allocation power of 0.988.

FAP is based in exclusion methodology and the program has the possibility to use the mismatches tolerance mode to get a family assignment. In the present study, this mode was used allowing up to 10 allele mismatches, as an analytical tool to identify problematic loci that did not amplify and also to find out the alleles (loci) that had a mismatch. It was therefore possible to recognize the offspring with problematic alleles (loci). Thus, 1290 offspring with parental assignment to a single family and 210 offspring with parental assignment to multiple families could be separated. In both cases, the new dataset obtained specifies in each case the offspring with the details of the mismatches and the missing data in each corresponding loci. In this way, a subgroup of 1242 from the 1290 offspring, with a minimum of 6 amplified loci were separated. However, the group (database) contained mismatches. To be able to analyse the dataset, it was decided to create a new dataset, but on this occasion without mismatches and then compare the results. To correct the errors of the dataset, one has to change the mismatching loci, both alleles, to zero. As an example, let's suppose that in the offspring OIM1022 there is 1 mismatch in the alleles "122 124"

that belongs to the locus Omy27DU. Thus, in order to correct the error, the mismatching alleles “122 124” are changed to “000 000”. Then the program may be re-run, getting a new family assignment without mismatches. Non compatible loci were eliminated. Thus, the 1242 offspring dataset with more than 6 loci amplified had an initial locus amplification production of 95% and finished with 79.1% after eliminating the problematic loci. The efficiency of this method may be seen in Table 4-6, where the comparisons of the parental assignment results between the databases, with and without correction, were analysed with FAP were 98.2%. This result suggests that the elimination of mismatches (loci) would be a good method for parental assignment, provided there are a sufficient number of loci (information) permitting this operation, as in this case.

Apart from that, Table 4-10 shows the results of these two joint FAP and PAPA programs methodology, i.e., when they use the same corrected database. The consistencies of the results in terms of the parental assignment of the offspring with this corrected database were 98.7%, suggesting a great compatibility and efficiency using these two programs together.

O'Reilly et al (1998) in a study of parental assignment analysis, performed a specific analysis with replicas to be able to study the type and rate of errors of microsatellite marker genotyping. Their results varied considerably between dinucleotide and tetranucleotide microsatellites. However, the dinucleotide microsatellite was the one that generated a larger number of errors, specifically errors in assessing the size of the allele and the stutter band. Overall, approximately 14% of their offspring surveyed during preliminary analyses were incorrectly typed at one or more alleles. Of the approximately 5400 alleles typed in their analysis, 2-3% were scored incorrectly,



based on subsequent typing and re-analysis. The impact of mutations on the accuracy of parental assignment in their study was minimal. First, mutation rates at the loci they used were quite low, between  $10^{-3}$  and  $10^{-4}$ . Second, approximately 90% of mutations should be detected using compatibility analyses, and hence, accommodated. Third, of those that were not detected, few (0.1-0.4%) could lead to incorrect determinations of parentage (O'Reilly et al, 1998).

The fact of not having performed replicate genotyping among the progeny did not allow us to make an analysis of the kind with rate of errors. However, the experience developed over the GIM sample genotyping, gave us a view of the possible kind of errors produced during the procedure. The results show that two of the most polymorphic loci (Table 4-2), Omy207UoG and Omy301UoG, are also the loci with the higher numbers of not amplified or missing alleles, suggesting that highly polymorphic dinucleotide loci (all the microsatellite used in the present study were dinucleotide) with many closely spaced alleles are not good markers for parental assignment. Maybe this was due to the large quantity of stutter band, or it could be also the difficulty of separating between alleles size (binning). In most cases alleles need to be binned, with fragment assigned to allele categories according to their lengths. These binning processes include fitting observed alleles lengths to bins defined by the repeat unit of the locus being considered by simply rounding fragment lengths to the nearest base. Binning errors may arise in many ways, but the most important and often overlooked problem is that DNA fragment mobility depends both on length and on the sequence (Rosenblum et al. 1997; Wenz et al. 1998; Amos et al. 2007). According to Pompanon et al. (2005), scoring errors might also be an important issue in the automated and semi-automated scoring of fluorescence profiles.

For example, human subjectivity during manual scoring represented the main source of discrepancy between AFLP data sets that were generated by independent scorers who were using the same electropherograms.

The locus Omy207UoG had an overlapping allele range with the locus Ots1BML in the range 155-160 bp causing confusion in the alleles within the size range at the two loci. This problem could be solved by changing the dye of one of the loci involved. Fishback et al. (1999) did not have this problem because their strain did not have alleles in the range 155-160 bp. Finally, the locus Ssa439NCVM had allele differential amplification, meaning a preferential amplification of smaller alleles over the larger alleles in heterozygotes. This problem was recognized by Fishback et al. (1999).

Pompanon et al. (2005) in an extensive survey of the literature and their own experience explained that genotyping errors resulted from diverse, complex and sometimes cryptic origins. They grouped the genotyped errors into four categories. (1) *Variation in DNA sequence*: An error that is linked to the DNA sequence can be generated by a mutation close to a marker, if this flanking sequence is involved in the marker-detection process. In microsatellite studies the most common error of this type is the occurrence of null alleles. (2) *Low quantity or quality of DNA*: A low number of target DNA molecules in an extract results from either extreme dilution of the DNA or from degradation, which leaves only a few intact molecules. Both these conditions favour allelic dropouts and false alleles. (3) *Biochemical artefact*: At the end of the elongation step of a PCR, the Taq polymerase has a tendency to add a non-templated nucleotide to the 3' end of the newly synthesized strand. (4) *Human error*:

Unexpectedly, in the few studies designed to analyze the precise cause of genotyping error, the main cause was related to human factors. In a parental exclusion study of Antarctic fur seal, Hoffman and Amos (2005) attributed 80%, 10.7%, and 6.7% of the errors to scoring, data input and allelic drop out respectively. This means that human factors were responsible for about 93% of the errors in their study.

To be able to limit errors during genotyping, it has been suggested that the best solution would be to try to minimize human error, as this variable represents the higher error percentage. To achieve this, one would have to use only highly qualified staff, with only validated procedures and a maximise automation in the process. Besides, one must always use positive and negative controls. Replicas for real-time error detection and error rate estimation should also be made. In this study, the samples were not sent to a specialized laboratory, but were instead the result of applying a protocol developed by other researchers with certain modifications done for us. The quality of the results improved toward the end of the laboratory process. Also, the process was automated as far as possible, using multiple channel pipettes and programs and systems that helped us to automate the handling of the samples. Positive controls were also used and no replicas were done, due to the additional associated cost. Pompanon et al. (2005) suggest that due to the associated cost of the systematic use of replicas, which is significant, many efforts have been made to reduce this amount using a *Maximum Likelihood Approach*, or even discarding replicas if the error rate is sufficiently low to be monitored with alternative approaches. Other researchers have stated that a common trend appears to be recommending the screening of a minimum number of markers, in order to limit cost (Castro et al., 2004; Pompanon et al., 2005; Herlin et al. 2007). However, when Herlin

et al. (2007) discussed their results, they realized that by using just 5 loci for their parental analysis, they obtained different results for parent determination when comparing the results with different software for parental analysis such as FAP, PAPA, and CERVUS. They reached the conclusion that when more DNA microsatellite marker types were developed for the species in which they were working, the process should improve. This situation would increase the cost due to the expense of the markers, but it would improve the results and processes. Besides, science tends to reduce costs of technological processes in time.

One of the purposes of the preset investigation was been to create a *Maximum Likelihood Approach* combining FAP and PAPA and skipping replicas. The results in Tables 4-9 and 4-10 show the efficiency of the PAPA software in discriminating multiple families when its results are compared with the results of multiple families identified with FAP using the database with and without correction, as Herlin et al. (2007), found in their study of parental assignment. The family matches in this study were 72.3% with dataset correction and 98.9% with the dataset without correction, suggesting that likelihood and exclusion combined are both a good methods for parentage assignment.

The present study gave 88.5% single family assignment utilizing different combination of more than 6 loci (6 to 11) with a range of correctness between 0.91 and 0.99. Thus, the allocation results varies with the level of correctness; with correctness higher than 0.95 there is an allocation efficiency of 87.3%, and with correctness higher than 0.99 there is an allocation efficiency of 74.9%. The crossing design applied in this study involved the production of 160 families. These results are

similar to those found by Ferguson and Danzmann (1998), where they obtained a 90% correct assignment rate to 135 possible families using 14 microsatellite loci. O' Reilly et al (1998), observed 99.5% correct assignment rate to 12 full sib groups [12 (1 x 1)] using 4 loci microsatellite, but then this rate decreased to 81.6% single family assignments when the number of crosses increased to 144 families (12 x 12). Finally, Villanueva et al (2002), in a simulation study obtained 99% single family assignment using nine 5-allele loci or six 10-allele loci in a 10 x 10 crossing design.

One may conclude that using DNA microsatellite markers with multiplex PCR reactions systems, combined with parental assignment software based on exclusion and likelihood are essential for obtaining good parental assignment results. In view of these advantages, the use of these systems in parental problems is particularly useful and they prove to be a versatile and reliable tool in parental assignment. Greater efforts should be made to develop multiple reactions with tetranucleotide microsatellites as these can overcome the problems of stutter and mismatching of alleles with small 1-2 base size differences.

## **Chapter 5 / PHENOTYPIC AND GENETIC PARAMETERS**

### **5.1. Introduction**

To develop a breeding program it is necessary first to understand the sources of variations within and between the rainbow trout strains or lines involved in the project. The majority of economically important traits in fish, as also in other organisms, are quantitative traits; this implies that as it is not possible to establish discrete categories when measuring a certain phenotypic trait of a population, individual values form a continuous series (Neira et al, 1999).

These quantitative traits are determined by many genes (loci), each one of which behaves in a Mendelian manner, and their effect is cumulative, which implies a quantitative inheritance. As each gene adds a small effect to the genotype, and environmental factors also contribute to phenotypic variance this explains the continuous variation of these traits in the population (Neira et al, 1999).

The value observed when the trait is measured on an individual is the phenotypic value of that individual, e.g. weight or length. To analyse the genetic properties, it is necessary to divide the phenotype into its component parts attributable to different causes. The first division is into components attributable to the influence of genotype and environment. The amount of variation in the population is measured and expressed as the variance. The total variance is the phenotypic variance ( $V_p$ ) is the sum of separate components; the genotypic ( $V_g$ ) and environmental variance ( $V_e$ ). This genotypic variance ( $V_g$ ) could be defined as the sum of additive ( $V_a$ ), dominance ( $V_d$ ), interaction ( $V_i$ ), thus:

- $V_p = V_g + V_e$
- $V_p = V_a + V_d + V_i + V_e$

This partitioning allows us to estimate the relative importance of each determinant in the phenotype, in particular heredity versus environment. The ratio  $V_a / V_p$  value which expresses the extent to which the phenotype is determined by the genes transmitted from the parents, is called the *heritability in the narrow sense* or just *heritability*. The *heritability* ( $h^2$ ) determines the degree of resemblance between relatives (Falconer, 1981). Environmental effects include a variety of different factors including climatic (e.g. temperature, salinity, etc.), nutritional, maternal effects and others such as age.

Thus, in order to optimise a breeding programme and predict selection response, components of phenotypic variance must be partitioned into additive genetic, non-additive genetic, maternal, common environment and random residual effects. The additive genetic effects are the most important components of the phenotypic variation, since it is the main cause of resemblance between relatives, therefore the determinant of the observable genetic properties and the response to selection of the strain. In the absence of additive genetic variation there can be no selection progress (Falconer, 1981).

In order to determine the resemblance between the relatives it was necessary to assign each of the offspring produced to a single parental pair. The background molecular analysis of genetic variation in the various UK trout strains showed that there was enough variation present in most strains, particularly the Glenwyllin strain, to assign individual offspring to a single strain using between 6-12 microsatellite loci. The

protocols used and the analysis of the offspring genotype data are described in detail in Chapters 2, 3 and 4. The genotyping study assigned 1242 Glenwyllin offspring to single families and it is these fish that were used to estimate the genetic parameters for this strain. Although the Houghton Spring fish were treated in the same way as those of the Glenwyllin strain it was only possible to undertake the genotyping of the Glenwyllin fish as part of my PhD because of time constraints. The production data collected during the processing of both strains is presented for comparison but only genetic parameters are presented for the Glenwyllin.

### **5.1.1 Traits to be studied in the present project**

#### **Growth rate**

Commercial farmers are paid differentially depending on individual characteristics of their products, in the present case the whole rainbow trout or the fillets. Body weight and length can be recorded easily and directly and so selection for these traits at a specific age is the most commonly used method to improve growth rate. Therefore, improvement in growth-related traits is likely to be a selection goal common to all breeding programmes.

The growth rate improvement could involve the change of two variables: time and size, e.g. improving growth rate means that it will be possible to produce the same sized fish in a shorter time, or produce a larger fish in the same production period (Gjedrem, 1997). The trout market size is well established, were produced between 400 to 500 g.; therefore the target of reducing harvest time would be the desired



outcome from selection. The reduction of time to harvest will result in a decrease in maintenance cost that will be translated into higher profits.

The growth rate and variables affecting the trait have been studied in rainbow trout by different authors like Gall and Gross (1978a); Gall and Huang (1988); Crandell and Gall (1993a, 1993b); Elvinson and Johansson (1993); Fishback et al. (2002); and Kause et al. (2002). These authors have found significant heritabilities for the growth rate traits, and their results will be utilized in the discussion in order to compare the present study results.

### **Flesh colour**

Salmon prices reached a high commercial value during the last decades (Broussard, 1991). In particular the red colour in salmon fillets gives an immediate indication of product quality in some markets, particularly the UK and Japan. Therefore these characteristics determine the marketing decisions and price of these fish (Schmidt & Idler, 1958; Schmidt & Cuthbert, 1969; Nickell and Bromage, 1998). This colour is the principal trait which makes of salmon an elite food product, and has a positive influence on its acceptance by the consumer (Hardy, 1988; Skrede & Storebakken, 1986a). This trait is also of importance due to the high cost to the industry of supplying these pigments (between 15 to 20% of the total feeding cost; Torrissen et al., 1990) and the low level of retention of dietary carotenoids in fish (Smith et al., 1992).

In biology any substance that can impart colour to organic matter is called a pigment. The majority of pigments in nature are synthesised via the photosynthetic pathway

and are then stored in leaves, algae and zooplankton. One large group of pigments are known as carotenoids, the name comes from the carrot's Latin name *Daucus carota*, and over 600 carotenoids have been characterised to date. One particular carotenoid is astaxanthine, which is found naturally in crustacea, yeast and algae. This carotenoid is the predominant pigment that gives the distinctive pink-red colour to wild salmonid flesh (Shahidi et al., 1998). However, higher organisms like salmon and trout are not able to synthesise these pigments, therefore they can only be obtained through the fish dietary intake.

The pigmentation of the flesh is influenced by a variety of exogenous and endogenous factors. The exogenous factors are dietary pigment concentration (Smith et al., 1992), dietary lipid (Einen and Roem, 1997; Einen and Skrede, 1998), carotenoid type (Choubert and Storebakken, 1989; Bjerkeng et al., 1990) and feeding period (Storebakken et al., 1986; Torrissen et al., 1989). The endogenous factors include digestibility (Foss et al., 1987; Choubert et al., 1995), absorption from the intestine (Choubert et al., 1987; Torrissen et al., 1990; Hardy et al., 1990), transport in the blood by lipoprotein (Ando et al., 1985; Choubert et al., 1994a), metabolism (Kitahara, 1984; Schiedt et al., 1985) and attachment to the muscle fibre (Henmi et al., 1987). These exogenous and endogenous variables must be standardised in a genetic study in order to estimate the variability due to pure genetics. This trait began to be studied in the 90's from a quantitative genetic point of view with the purpose of achieving genetic improvement for the flesh colour (Iwamoto et al., 1990; King, 1996). The heritability of the meat colour had been studied by some authors like Gjerde and Gjedrem (1984); Iwamoto et al. (1990); Withler and Beachham (1994); Kause et al. (2002) and Norris and Cunningham (2004).

## **Survival**

A breeding objective defined for commercial production of portion-sized rainbow trout demonstrated that production efficiency would be maximized by the development of fish with high survival among other traits (Henryon et al., 2002).

In the field, the fish has to take care of bacteria, viral, fungi and parasites, organisms with different reproductive cycles in the host. It is no wonder that the immune system has to be complex to handle the different invaders. Low levels of additive genetic variation have been found for survival under normal commercial conditions ( $h^2=0-0.15$ ), while higher levels have generally been found for resistance to specific pathogens ( $h^2=0.10-0.30$ ) (reviews by Gjedrem, 1997; Chevassus and Dorson, 1990; Fjalestad et al. 1993). Genetic variation in survival of Atlantic salmon affected by various bacterial diseases has been reasonably well documented, both during natural outbreaks and during challenge test (Gjedrem and Aulstad; 1974, Bailey, 1986; Standal and Gjerde, 1987; Gjedrem et al., 1991; Gjedrem and Gjoen, 1995).

The objective of this Chapter was to estimate the heritability for growth rate, flesh colour, and overall survival under commercial conditions.

## **5.2. Materials and methods**

The trial at Test Valley Trout (TVT) was designed to compare the performance of two strains, Glenwyllin Isle of Man (IOM) and Houghton Springs (HS) strain, communally reared under identical commercial conditions. The rainbow trout strains

were from two different hatchery origins. The first came from Glenwyllin hatchery in the Isle of Man and the other from Houghton Springs hatchery in Dorset.

### 5.2.1 Fish samples: PIT tagging, tissue collection and preservation

The study utilized Rainbow trout tissue samples from parents and offspring from the Glenwyllin IOM. The samples were separated in two different groups. The Broodstock (parents) utilized became the Base Population of an eventual Breeding Programme. The offspring are the result of a special cross breeding design, between lines A & B (Figure 2-4) that generated 160 full-sib families. The PIT tagging, tissue collection and preservation of the finclips used to assign parentage are described in the Materials and Methods chapter.

Table 5-1 Code name description, number of samples, and date of collection for the 4 different groups of Glenwyllin IOM Base Population and Offspring First Generation

<b>Code name</b>	<b>Code name description</b>	<b>Number of samples</b>	<b>Collection date (dd/mm/yyyy)</b>
AFI	Line A, Female, Glenwyllin Isle of Man, Base Population	20	13-11-2002
ANI	Line A, Neomale, Glenwyllin Isle of Man, Base Population	20	13-11-2002
BFI	Line B, Female, Glenwyllin Isle of Man, Base Population	20	13-11-2002
BNI	Line B, Neomale, Glenwyllin Isle of Man, Base Population	20	13-11-2002
OIM	Offspring Glenwyllin Isle of Man, First Generation (F1).	1500	04-06-2003
		1580	

### 5.2.2 IOM crossing design

The crosses were produced following partial factorial mating designs. On the 13<sup>th</sup> of November 2002, 20 neomales and 20 females from both Lines A & B were chosen, 80 fish in total. The design required each neomale to be crossed to four different females, two of the same line and two of the other line. Similarly each female would be crossed to four different males, two of the same line and two from the other (Figure 2-4). The complete design would result in a total of 160 different families. The details of the

breeding and subsequent stocking of these fish into the TVT facilities are described in detail in Chapter 2.

### **5.2.3 Communal rearing**

In this study the two different strains to be tested were reared communally after they had been PIT tagged soon after they arrived at TVT from the fingerling ongrowers. The 3000 PIT tagged fish were held communally from this point in a single commercial tank up to the point they were killed and were transported to the processing plant.

If the strains are living in a communal rearing environment, the mean environmental deviation in the population as a whole is taken to be zero. So the mean phenotypic value is equal to the mean genotypic value. For this reason, with the aim to eliminate or reduce the possible environmental variations, the eggs, fry, and adult trout have to be produced in a communal rearing manner, meaning that all the management, like cleaning, feeding, etc. and also environmental variables, such as water temperature and oxygen are standardized, always keeping all the individuals within the population in the same tank, moving all the group to a new bigger tank if the density is too high. Thus, in this way, all the fish have the same opportunities to grow and express freely their genetic information.

### **5.2.4 Harvest and processing plant**

The processing plant is the place where several industrial operations take place with the purpose of transforming, adapting or treating any particular raw material to obtain products with a higher added value. In this case, the raw material is the rainbow trout.

In our experiment we used the Silver Trout processing plant to obtain the quantitative and qualitative phenotypical data related to the harvest.

Quality is usually defined by general terms of appearance, taste, smell, firmness, juiciness and processing features. The desired features of the meat for a particular species vary according to the markets and may differ significantly for raw and processed products (e.g. cooked, salted, smoked or dehydrated) (Johnston, 1999).

The meat quality of fish has a complex group of features influenced by intrinsic factors such as texture, composition, chemistry, colour, fat content (Fauconneau et al., 1995) which have a genetic influence; and by extrinsic factors which strongly affect the trout quality, such as the pre- and post-killing processes, the fish handling processes such as its food diet, composition of the diet and environment which affect the fish condition and the metabolic characteristics of the muscular tissue (Gjedrem, 1997).

#### **Offspring over the main trial at TVT**

Between the 4<sup>th</sup> and 8<sup>th</sup> of June of 2003 in TVT, 3000 fingerling were PIT tagged; 1500 from Houghton Spring and 1500 from the Isle of Man. One of the objectives of this study was to measure the growth rate. Thus, in order to achieve this objective, it was necessary to record the weight and lengths over their production life cycle. It was decided to take measurements three times over the production cycle. This data were taken as is shown in Table 5-2. The initial measurement was done at the PIT tagging and the final measurement at harvest time. It has to be considered that there was an age difference between the two strains of 3 weeks due to the different spawning times.

Table 5-2 Weight and length recording times post fertilisation of the OHS and OIM trout

	INITIAL TIME		INTERMEDIAL TIME		FINAL TIME	
	OHS	OIM	OHS	OIM	OHS	OIM
Weeks post fertilisation	26	29	52	55	64	67

**Silver Trout processing plant: processing route and data gathering**

The surviving trout were transferred to the Silver Trout processing plant over a four day period. The most important factor to consider is that the least time possible must elapse between the fish's death and its processing.

At the plant two processing lines were set up, each manned by a team of five people, plus another person working for both lines. Expert workers filleted the fish using knives and experienced personnel took the qualitative and quantitative measurements.

The room temperature at the plant was below 10° C. Figure 5-1 represents an aerial view of the lines and the distribution of work in order to get all the processing data.

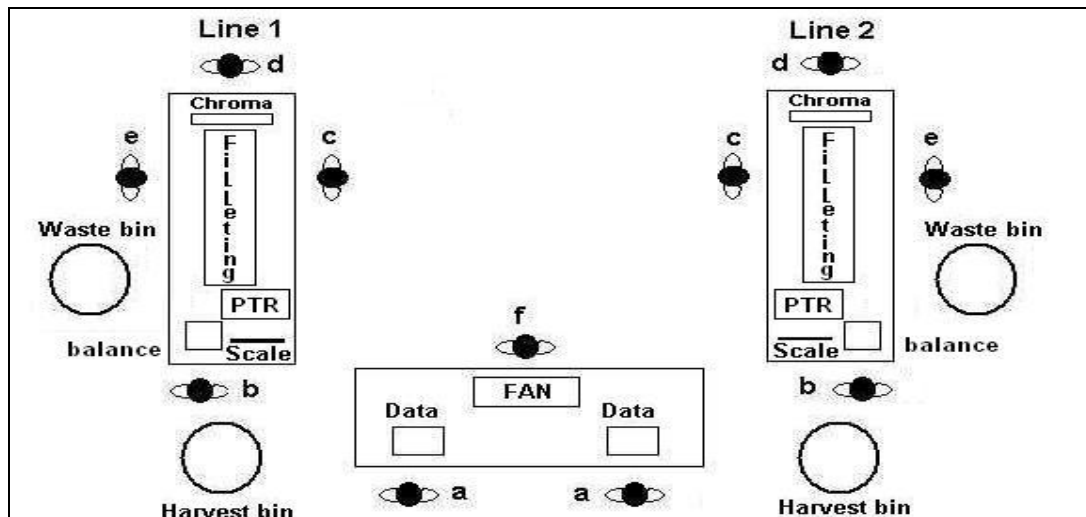

Figure 5-1 Distribution of the work at the processing plant: a. - Recording data in the laptop. b. - Measure weight, length and identification through PIT tags (PTR = Pit Tag Reader) c & e. - Filleting the trout. d. - Flesh colour Chroma meter. f. - Flesh colour Roche Fan (both lines).



In general terms, trout processing begins by receiving the raw material in the plant. The dead trout arrived from the farm in two large harvest bins less than an hour after slaughter.

They entered the processing line and were processed in ordered batches of 10 and the PIT tag numbers were directly read into the laptop next to person b. Length and weight were verbally given for each fish to the data logger a. The fish was then gutted and reweighed and this weight was given verbally to the data logger a. The fish was then filleted and a single fillet was laid on a tray in ordered batches of 10. The ordered fillets were cleaned with tissue, then read by the Minolta Chroma Meter and this data was directly printed onto a till roll and was later manually transferred to the laptop. Also Figure 5-2 also explains the layout of the information gathering in the two processing lines.

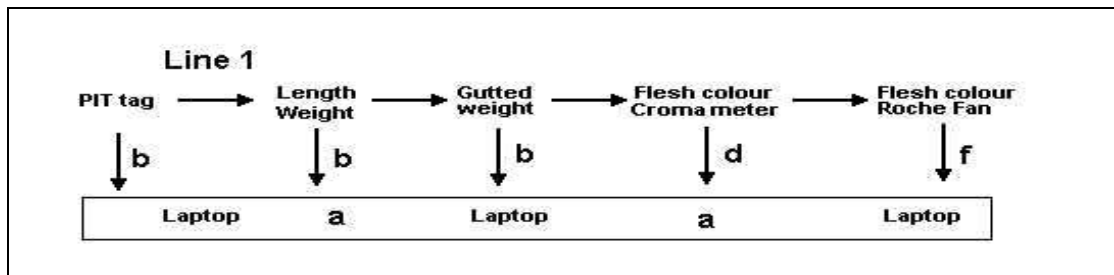

Figure 5-2 Information layout and people (a, b, d and f) involved in collecting data on the fish

The ordered tray of fillets was then passed to the Roche fan reader and the fan score called to the respective data logger, depending on whether the tray was from Line 1 or Line 2. The trout processing lasted 4 days, therefore the following data was recorded for every day of work and every fish: day of processing, PIT tag number, ungutted

weight and length, gutted weight, Minolta Chroma meter ( $L^*$ ,  $a^*$  and  $b^*$ ), and Roche fan score.

#### **Quantitative description: Minolta Chroma Meter CR-400**

The instrumental evaluation of colour was performed using a tristimulus photocolourimeter Chroma Meter, model CR-400 (MinoltaMR). This instrument measures the light reflected by the muscle sample and compares it with a white calibration standard, which permits the colour to be represented by three axes or chromaticity components known as  $L^*a^*b^*$  colour space (Smith et al., 1992). In this space, the  $a^*$  component represents the red-green axes,  $b^*$  the blue-yellow axes, and  $L^*$  the light-darkness component. In a salmon muscle sample, positive values for  $a^*$  and  $b^*$  represent the red and yellow components of the meat of these fish, respectively. Although the  $L^*a^*b^*$  space has been the one most frequently used for evaluating muscle colour in salmon, the  $L^*C^*h^*$  space (Lightness, Chrome and hue) is also being used nowadays and it is the representation in polar coordinates of the  $L^*a^*b^*$  space which allows a better comparison of the evaluated colour with that perceived by the human eye (Bjerkeng, 2000). This “hue” space ( $h^*$ ) represents the angle between the  $a^*$  and  $b^*$  [ $h^* = \tan^{-1} (b^*/a^*)$ ] chromaticity axes, and therefore, the orange hue or tone of the sample. The saturation or chrome ( $C^*$ ) is the hypotenuse of the triangle formed by axes  $a^*$  and  $b^*$  [ $C^* = [(a^*)^2 + (b^*)^2]^{1/2}$ ] and informs the purity of the colour or the intensity of the tone (Figure 5-3).

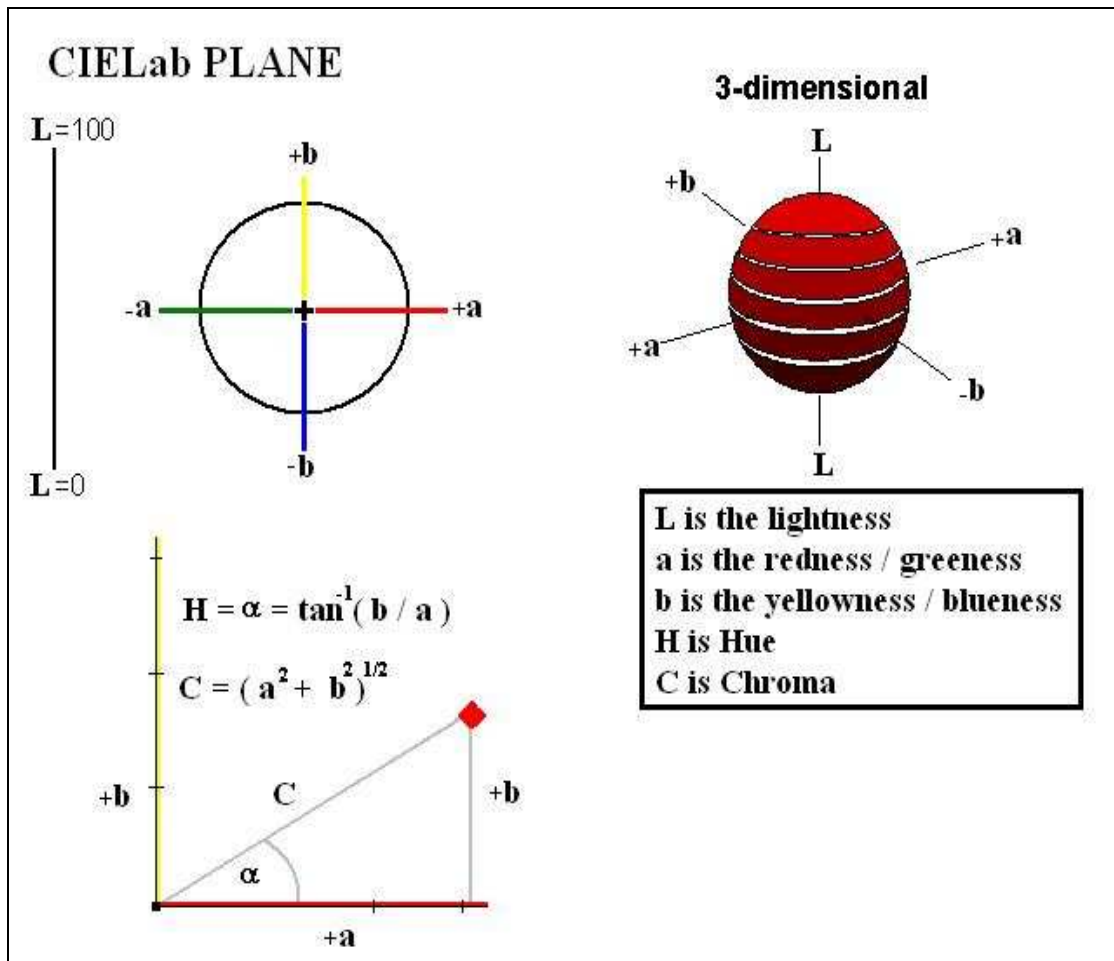

Figure 5-3 CIELab plane representing the 3 dimensions that explain colour estimation in the Chroma meter

### Qualitative description: Roche Salmofan™ colour cabinet

The visual evaluation of colour was performed in a controlled lighting cabinet, using as a standard the scale 20-34, from the Roche Salmofan™ colour card (Hoffmann-La Roche, Basel, Switzerland) (Figure 5-4). All measurements were taken by the same person, who measured the colour in the fillet at a position adjacent to the dorsal fin and level with the lateral line. In order to evaluate the colour, the observer had to compare each colour standard with the colour of the flesh sample and select the standard which matched best with the trout colour. The same worker assessed the colour over the whole process.

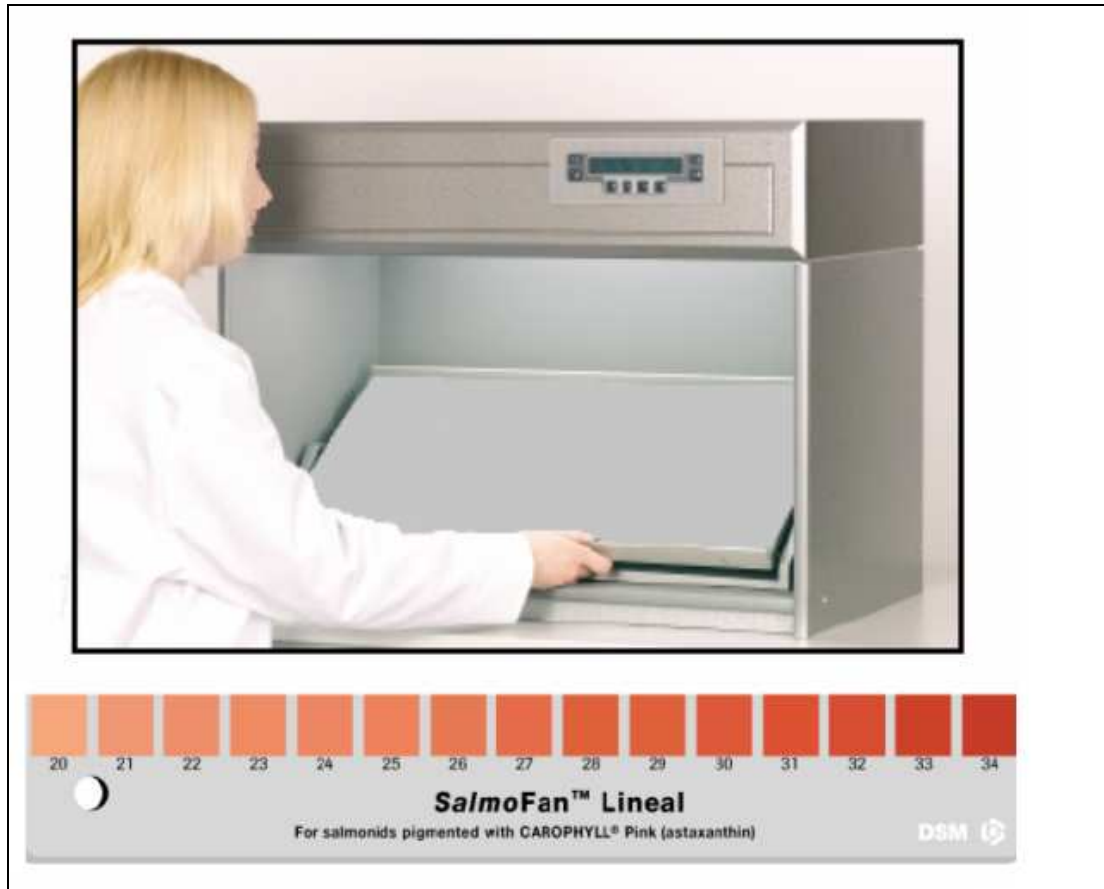

Figure 5-4 Colour cabinet (above) where the Roche Salmofan™ colour assessment chart (below) was placed in order to estimate the colour of the flesh in the rainbow trout

## 5.2.5 Statistical analysis

### Statistical methods and software

The parental assignment was analysed using Family Analysis Program (FAP) version 3.5 (Taggart, 2007), and also Package for the Analysis of Parental Allocation (PAPA) (Duchesne et al., 2002) see Chapter 4 for a detailed description of the procedures adopted to generate the 1242 assigned offspring with more than 6 loci.

The Phenotypic and Genetic parameters were analysed using GENSTAT version 5.0 software (Numerical Algorithms group, Wilkinson House, Jordan Hill Road, Oxford).

#### **Change of weight and length over time.**

The relation weight and length versus time was analysed using a quadratic regression function from Excel. The regression gives an equation in the form:

$$W = \alpha + \beta T + \gamma T^2 \quad \text{and} \quad L = \alpha + \beta T + \gamma T^2$$

If we derive both equations with respect to time, it is possible to obtain the change of weight and length over time in a linear equation, giving the possibility to estimate the change of the variables at different times, thus:

$$dW/dt = + \beta + 2\gamma T \quad \text{and} \quad dL/dt = + \beta + 2\gamma T$$

#### **Heritability estimation**

##### **REML analyses**

Restriction maximum likelihood (REML) has the ability to attribute variance components to individual sources. This ability could be used in a situation when there are confounding variables or the design of the experiment is unbalanced. REML is based on the general lineal model with both fixed and random effects. The fixed effects are related to the treatment being tested and random effects to the sources of random error in the data. If the data is unbalanced, a Wald statistic is used to assess the fixed effects; this statistic is based on the Chi-square distribution (Harville, 1977). In this study REML analysis was used to analyse the quantitative genetic parameters such as the heritability estimation of different economic production traits.

Mixed linear models were fitted to the data obtained on survival and at processing for the IOM strain using GENSTAT statistical analysis software. The processing traits analysed were length and body weight at processing, gutted weight, Roche score, and the trio of Minolta scores (L\*, a\* and b\*). The basic linear model was:

$$Y_{ijkl} = \mu + D_i + \beta_1 faA_{ijkl} + \beta_2 fdA_{ijkl} + \beta_3 fmA_{ijkl} + F_j + N_k + e_{ijkl}$$

where:  $Y_{ijkl}$  was the observed trait for the 1<sup>st</sup> fish on day  $i$  from female  $j$  and neomale  $k$ ;  $\mu$  represents an overall mean;  $D_i$  is the effect of day  $i$  ( $i=1, \dots, 4$ );  $faA_{ijkl}$ ,  $fdA_{ijkl}$  and  $fmA_{ijkl}$  are regression covariates, with coefficients  $\beta_1$ ,  $\beta_2$  and  $\beta_3$  respectively, describing the additive, heterosis and maternal effects of lines A and B as shown in Table 5-3;  $F_j$  and  $N_k$  represent the effects of the  $j^{\text{th}}$  female and  $k^{\text{th}}$  neomale respectively; and  $e_{ijkl}$  was the residual error term with variance  $\sigma_E^2$ . Of these, the effects of day and the regression covariates were treated as fixed whilst the effects  $F_j$  and  $N_k$  were treated as random and assumed to be normally distributed with mean 0 and variances  $\sigma_F^2$  and  $\sigma_N^2$  respectively.

Table 5-3 Index as described by Falconer.

Female	Neomale	Additive	Heterosis	Maternal	Female	Neomale	Additive	Heterosis	Maternal
A	A	1	0	1	B	A	0	1	-1
A	B	0	1	1	B	B	-1	0	-1

The results obtained from applying the model were used to estimate the heritabilities, and the GENSTAT VFUNCTION command was utilized to estimate the standard error. Using the three formulae below gave us the heritability based on sire, dam and combined components.

$$a. h^2_N = 4\sigma_N^2 / (\sigma_N^2 + \sigma_F^2 + \sigma_E^2)$$

$$b. h^2_F = 4\sigma^2_F / (\sigma^2_N + \sigma^2_F + \sigma^2_E)$$

$$c. h^2_{\text{combined}} = (2\sigma^2_N + 2\sigma^2_F) / (\sigma^2_N + \sigma^2_F + \sigma^2_E)$$

Data for survival were analysed by an unbiased estimate of the Fisher exact test using the program GENEPOP (Raymond and Rousset, 1995).

In addition the survival data was also analysed using the mixed linear models described above with  $Y_{ijkl} = 0$  if the fish died prior to processing and 1 if it survived. However in these models the term for day of processing was dropped from the model.

### Difference between sires and dams

The combined calculations of heritability are based on the hypothesis that variance components, sires and dams, are equal. To prove the statement that both additive genetic components are equivalent, the combined estimate of heritability ( $h^2_{cf}$ ) is calculated. In order to calculate the  $h^2_{cf}$ , it is necessary to fix the sires and dams variance in relation to the residual variance ( $\sigma^2_e$ ), thus:

$$\gamma_S = 2\sigma_S / 2\sigma_e$$

$$\gamma_D = 2\sigma_D / 2\sigma_e$$

$$\gamma_S = \gamma_D = \gamma$$

Then replacing these assumptions in the combining heritability formula it is possible to obtain the combined estimate of heritability ( $h^2_{cf}$ ):

$$h^2_c = \frac{2(\sigma^2_S) + 2(\sigma^2_D)}{\sigma^2_S + \sigma^2_D + \sigma^2_e}$$

$$h^2_{cf} = \frac{2\gamma_S + 2\gamma_D}{\gamma_S + \gamma_D + 1}$$

$$h^2_{cf} = \frac{4\gamma}{2\gamma + 1}$$

The  $h^2_{cf}$  was calculated by iteration, changing the  $\gamma$  values, choosing the value that minimised the deviance. The 95% confidence interval for  $h^2_{cf}$  is defined as the lowest value needed to refute the null hypothesis. Comparing critical value of  $\chi^2$  at the 95% confidence interval was utilized to check the significance.



### 5.3. Results

#### 5.3.1 OHS and OIM phenotypic parameters

##### Weight and length at 3 different measurement times

After processing the individual fish could be assigned to a single strain. Of the 1500 fish initially PIT tagged in each strain only 767 of the OHS and 791 of the OIM survived to harvest. Only the individuals surviving to harvest have been analysed in the earlier sampling periods.

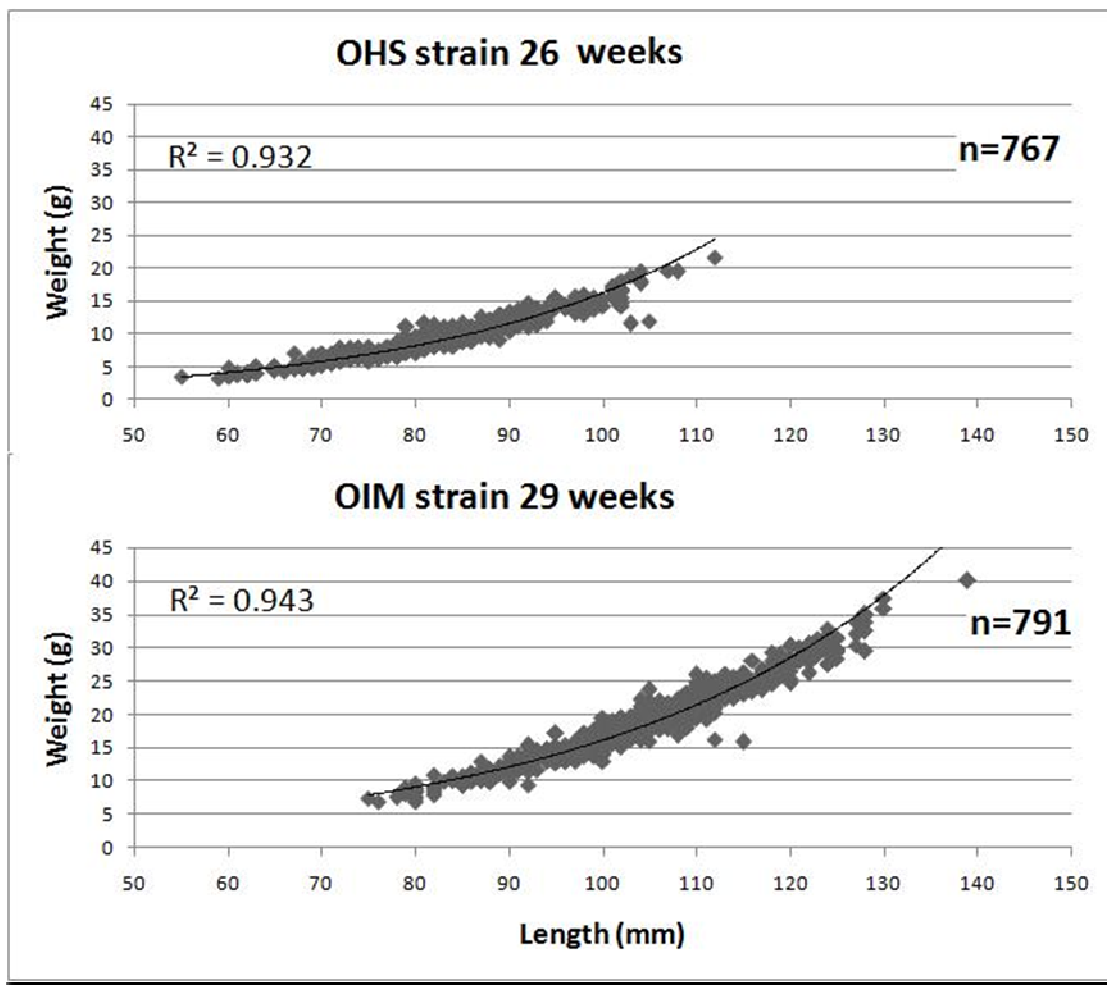

Figure 5-5 Exponential correlation comparison of weight versus length for the Offspring Houghton Spring and Offspring Isle of Man strains at the initial measurement time (PIT tagging)

Figure 5-5 shows the measurement at the initial time, during the PIT tagging. The results from the measurement show that the trout from OIM strain are bigger, in terms of mean weight and length, than the trout from OHS strain. Nevertheless, it has to be considered that there is a period of 3 weeks difference between the strains, due to the different spawning time, and also due to the fact that in the beginning the strains were reared under different temperatures (environment), because the trout came from different facilities before PIT tagging. The determination coefficient ( $R^2$ ) is high and similar for both OIM strain (0.943) and OHS strain (0.932), suggesting a stronger association between these variables.

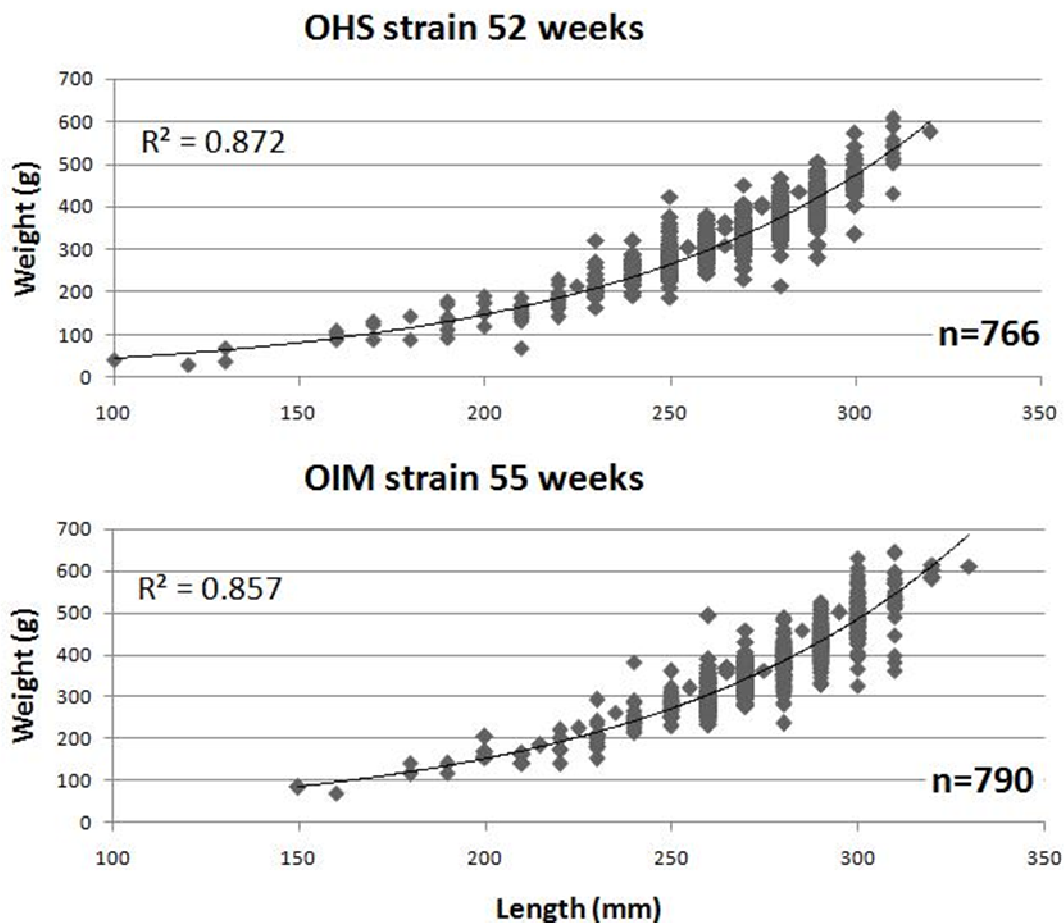

Figure 5-6 Exponential correlation comparison between weight and length for the Offspring Houghton Spring and Offspring Isle of Man strains at the intermediate measurement time

Figure 5-6 illustrates that the variables weight and length for the OHS strain (0.872) are more intensively associated than the OIM strain (0.857). The differences between the strains are not as obvious as the initial measurement; the differences are decreasing over time. Also, in both cases there is a decrease in the level of association between variables at the different measurement time.

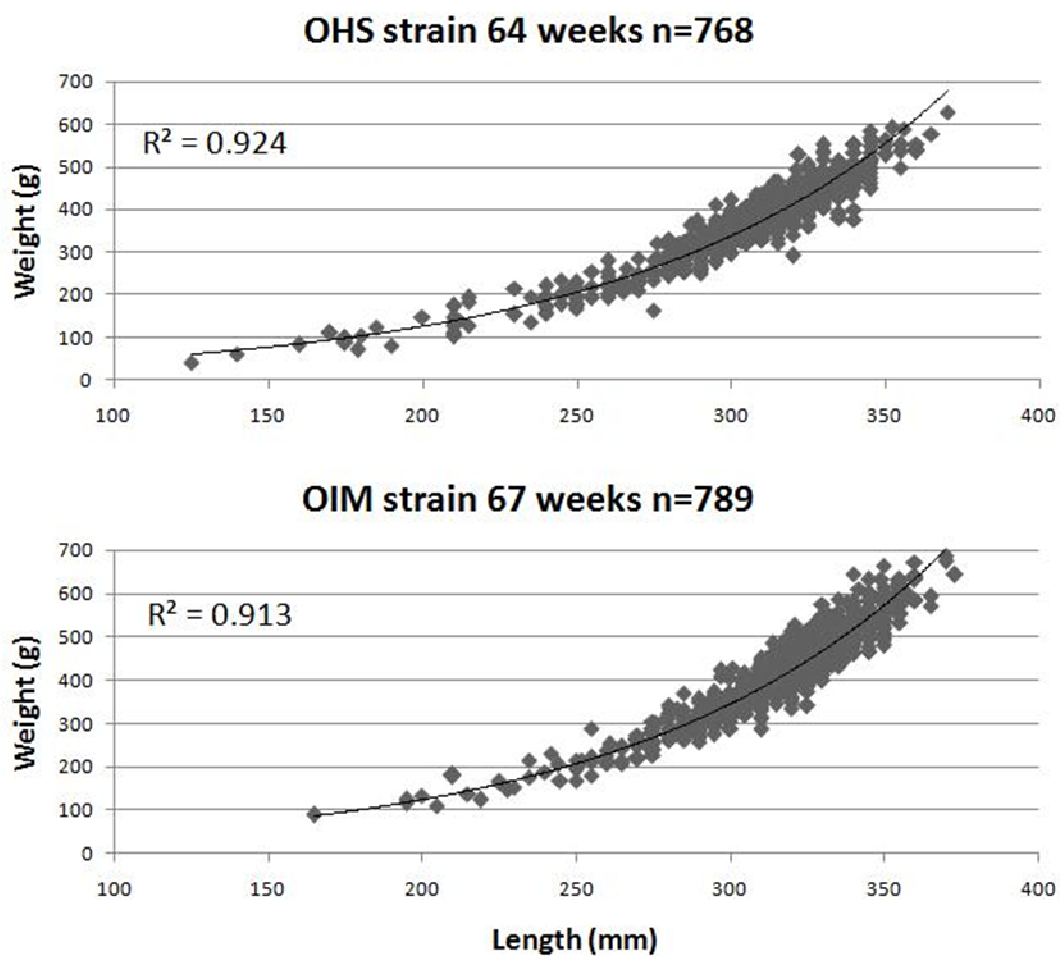

Figure 5-7 Exponential correlation comparison of weight versus length for the Offspring Houghton Spring and Offspring Isle of Man strains at harvest

Figure 5-7 shows the final measurement data at the processing plant. The exponential correlation between the variables weight and length shows that the determination

coefficient ( $R^2$ ) for the OHS strain (0.924) and the OIM strain (0.913) are similar. The initial difference in length and weight between the strains caused by the different spawning times and environmental conditions have disappeared in final measurement.

### Weight and length related to time

#### Quadratic regression model of weight versus time

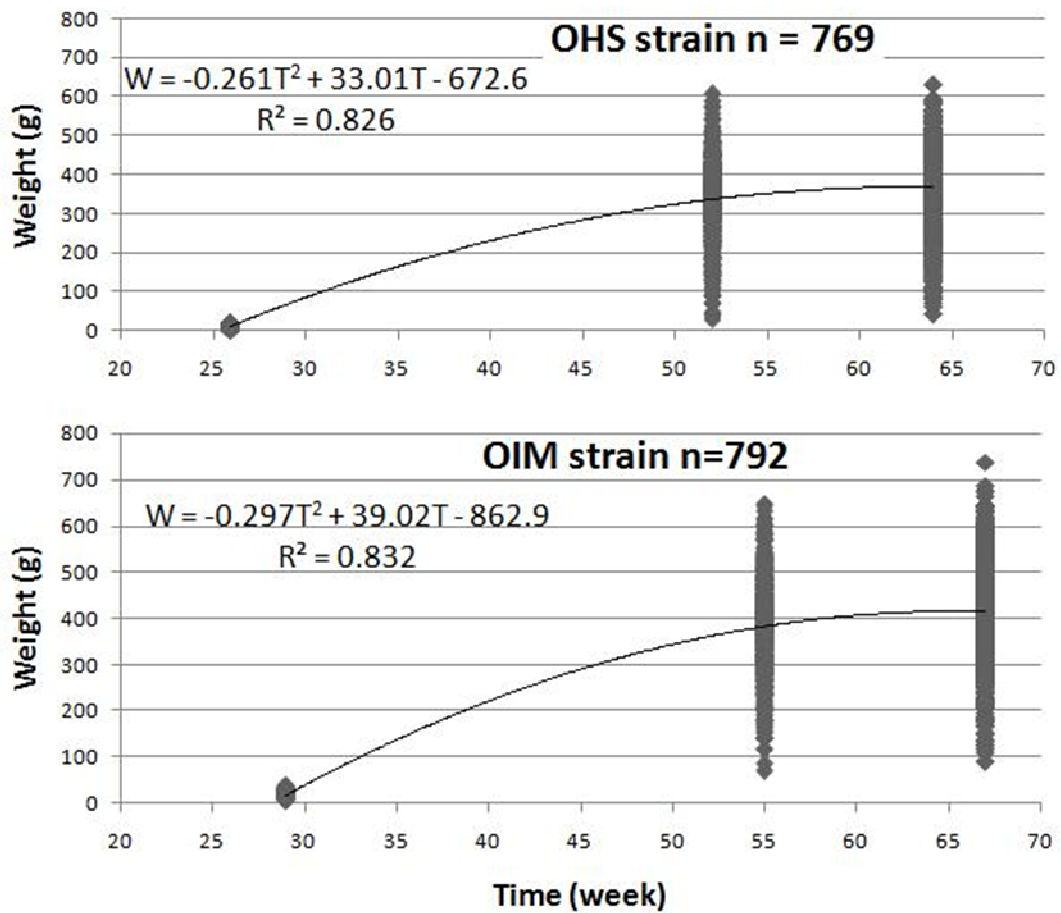

Figure 5-8 Quadratic regression comparison of weight versus time for the Offspring Houghton Spring (OHS) and Offspring Isle of Man (OIM) strains over the whole trial.

Figure 5-8 shows that the slope in both strains gradually slows from tagging to harvest time, and also that the determination coefficients ( $R^2$ ) in both strains are very similar. The quadratic regression models will be used below to compare the growth at the same time.

Table 5-4 shows weight comparison at 3 different measurement times. The result shows that there were significant differences ( $P < 0.001$ ) in weight between the strains at all the 3 different measurement times. The OIM strain was significantly bigger than the OHS strain at all times.

Table 5-4 Weight comparisons over the different measurement times for the Offspring Houghton Spring (OHS) and Offspring Isle of Man (OIM) strains

	Initial		Intermediary		Final	
	OHS	OIM	OHS	OIM	OHS	OIM
<b>N</b>	767	791	766	790	768	789
<b>Mean (g)</b>	9.23 a	18.46 b	338.2 a	383.5 b	370.6 a	415.5 b
<b>SE</b>	0.10	0.19	3.2	3.4	3.4	3.6
<b>%CV</b>	30.4	29.3	26.1	24.9	25.3	24.5

Different letters in the mean weight row (at each stage) means significant difference between OHS and OIM strains ( $P < 0.001$ ).

Figure 5-9 shows the derivation of the quadratic regression of weight versus time for both strains. After the derivation, two lineal equations are created which serve to determine the growth rate at different times.

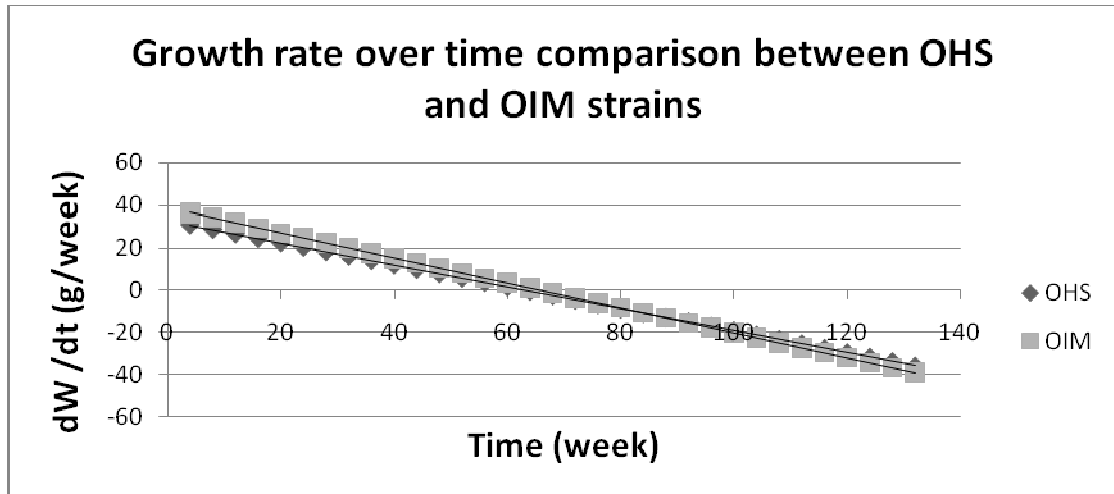

Figure 5-9 Growth rate over time comparison between the Offspring Isle of Man (OIM) and Offspring Houghton Spring (OHS) strains.

It is possible to verify what was previously seen in Figure 5-8, that the growth rates at the beginning of the trial showed the highest weight change over time values and this value decreases over the grow out time. The difference between the growth rate decreased in the two strains over the growout time but never crossed, nevertheless extrapolating the quadratic models values to the future it is possible to observe that the curves cross at the 83<sup>rd</sup> week and 3 days.

## Quadratic regression model of length versus time

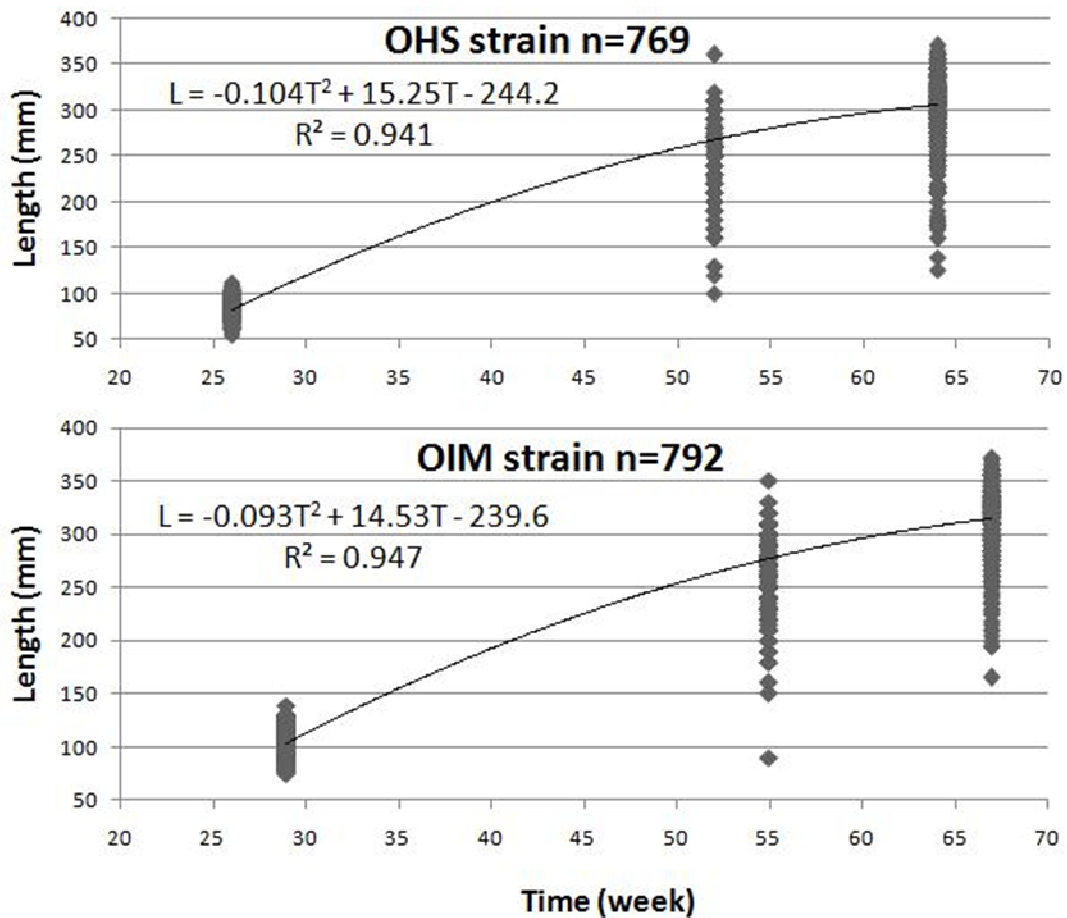

Figure 5-10 Quadratic regression comparison of length versus time for the Offspring Houghton Spring and Offspring Isle of Man (Glenwyllin) strains over the trial at Test Valley Trout

Figure 5-10 illustrates that the result of the coefficient of determination ( $R^2$ ) was somewhat higher in OIM strain (0.947) than in OHS strain (0.941). However, it can be noticed that these coefficients were significantly higher than those obtained in the quadratic correlations of weight/time.

The results in Table 5-5 show that the OIM strain was significantly bigger than the OHS strain at all the 3 different measurements times. Also, the difference in %CV over the initial and final time diminished less in the OHS strain than in the OIM strain (0.3 v/s 1.5).

Table 5-5 Length comparisons over the different measurement times for the Offspring Houghton Spring (OHS) and Offspring Isle of Man (OIM) strains

	Initial		Intermediary		Final	
	OHS	OIM	OHS	OIM	OHS	OIM
N	767	791	766	790	768	789
Mean (mm)	81.9 a	103.2 b	266.9 a	277.1 b	305.3 a	314.6 b
SE	0.3	0.4	1.0	0.8	1.1	0.9
%CV	10.5	9.9	10.1	8.2	10.2	8.4

Different letters in the mean length row (at each stage) means significant difference between OHS and OIM strains ( $P < 0.001$ ).

Figure 5-11 shows the growth rate over time, estimated from the quadratic regression model between length and time. It is possible to observe the slowing of growth rate at the end of the period (at the harvest measurement time). According to the Figure 5-11, at the beginning, the OHS strain grew faster than the OIM strain and after 32 weeks and 5 days the growth rates reverse.

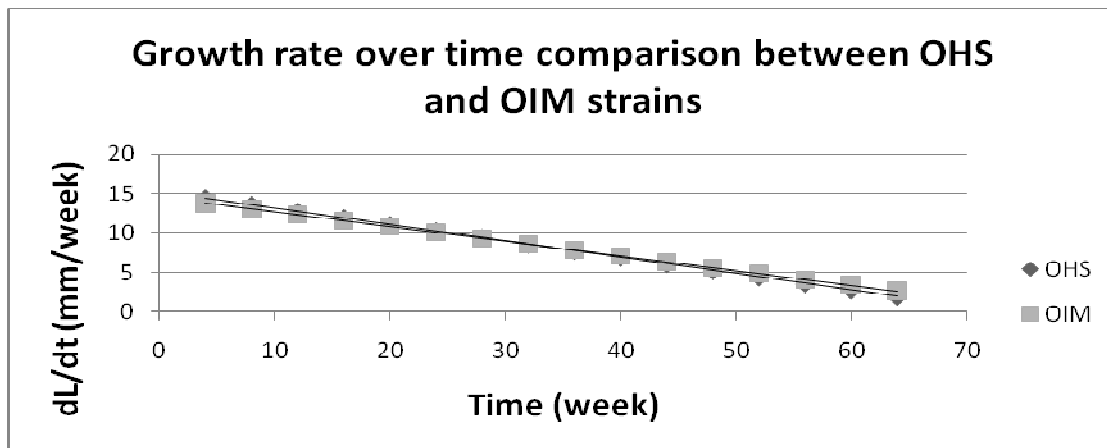

Figure 5-11 Growth rate over time comparison for the Offspring Isle of Man (OIM) and Offspring Houghton Spring (OHS) strains.

It is possible to appreciate from Figure 5-10 and 5-11 that when the rainbow trout are young the growth rate changes faster in the length variable. This is a change in one



dimension. Then, later, when they are older and the change in length decreases, they increase the change in weight (mass), a change in three dimensions.

### 5.3.2 Glenwyllin Isle of Man strain quantitative genetics

Although all the OHS and OIM rainbow trout were processed, only the surviving fish from the 1242 individuals assigned to the OIM fish were included in this analysis.

#### Growth traits

This section contains the growth traits weight, gutted weight and length. The results were recorded at the age of 67 weeks, when all the trout were harvested and transported to the processing plant. Table 5-6 shows the results of the trout that survived and were also identified in the parental assignment.

Table 5-6 Offspring Glenwyllin IOM weight, gutted weight, and length descriptive statistics

	Weight (g)	Gutted (g)	Length (mm)		Weight (g)	Gutted (g)	Length (mm)
<b>N°</b>	792	784	792	<b>%CV</b>	24.5	24.4	8.6
<b>Mean</b>	415.7	351.7	314.5	<b>Max.</b>	736	627	430
<b>SE</b>	3.6	3.1	1.0	<b>Min.</b>	89	74	165

The results show that the trout OIM strain loses on average 15.4% of body mass when comparing the results between average weight and gutted weight. It also shows that, the Coefficient of Variation (%CV) is the same between weight and gutted weight. The combined (sire and dam) heritability results are weight 0.43, gutted 0.42 and length 0.28 respectively (Table 5-7); again there is no significant difference between the weight and gutted weight for sire, dam, and combined heritabilities. The

differences between sire and dam components were tested but were not significantly different.

Table 5-7 Sire, dam and combined growth traits heritabilities for Glenwyllin IOM strain

	<b>Sire <math>\sigma</math></b>	<b>Sire <math>h^2</math></b>	<b>Dam <math>\sigma</math></b>	<b>Dam <math>h^2</math></b>	<b>Combined <math>h^2</math></b>
<b>Weight</b>	1084 (424)	0.40 (0.15) a	1202 (462)	0.45 (0.16) a	0.43 (0.09)
<b>Gutted</b>	738 (298)	0.39 (0.15) a	873 (335)	0.46 (0.16) a	0.42 (0.09)
<b>Length</b>	54.3 (25.7)	0.29 (0.13) a	52.5 (25.5)	0.28 (0.13) a	0.28 (0.08)

Same letters in the rows indicate no significant difference between sires and dams. Parenthesis indicates the standard error.

In order to estimate any day to day variation induced within the processing plant, the mean and standard error for each day of work were predicted for the different growth traits (Table 5-8).

Table 5-8 Traits predictions values between the four different days of work at the processing plant

	<b>Weight (g)</b>	<b>Gutted (g)</b>	<b>Length (mm)</b>		<b>Weight (g)</b>	<b>Gutted (g)</b>	<b>Length (mm)</b>
<b>Day 1</b>	404.6 (10.13)	340.7 (08.52)	313.7 (2.47)	<b>Day 3</b>	414.3 (10.63)	352.2 (08.94)	312.2 (2.62)
<b>Day 2</b>	405.1 (09.67)	342.8 (08.14)	314.1 (2.33)	<b>Day 4</b>	401.7 (12.44)	340.1 (10.76)	310.6 (3.17)

The model does not show any significant difference between the 4 different days at the processing plant, according to the Wald statistics test; therefore there is no evidence of differences in the predictions (Table 5-8). The fish were delivered into harvest bins from the fish farm to the processing plant and then passed through the processing line. This suggests that the methodologies being used were consistent across the 4 days of work.

Table 5-9 Traits predictions values between the pure bred (AxA & BxB) and hybrid crosses (AxB & BxA)

<b>P. Bred</b>	<b>Weight (g)</b>	<b>Gutted (g)</b>	<b>Length (mm)</b>	<b>Hybrid</b>	<b>Weight (g)</b>	<b>Gutted (g)</b>	<b>Length (mm)</b>
<b>AxA</b>	407.8 (14.16)	344.8 (11.93)	312.7 (3.41)	<b>BxA</b>	408.4 (13.34)	346.5 (11.25)	313.6 (3.18)
<b>BxB</b>	403.8 (13.08)	341.7 (11.06)	312.6 (3.09)	<b>AxB</b>	406.8 (13.41)	343.6 (11.30)	311.6 (3.20)

Also the model does not show any additive, heterosis or maternal effect of the Glenwyllin A or B strains according to Wald statistics significance, therefore there is no evidence of differences in the prediction between the pure bred and hybrid crosses over the growth traits weight, gutted weight and length (Table 5-9).

Table 5-10 Top 20 highest and lowest family values (mean) for the variables weight and length

Ranking	Category	Family	Weight (g)	Family	Length (mm)
1	Higher	BFI 09xBNI 08	576	BFI 14xANI 04	358
2	Higher	BFI 02xANI 02	570	AFI 18xANI 18	350
3	Higher	BFI 12xANI 12	565	BFI 09xBNI 08	350
4	Higher	AFI 02xANI 02	556	BFI 12xANI 12	345
5	Higher	BFI 14xANI 04	545	BFI 02xANI 02	344
6	Higher	BFI 12xBNI 11	537	BFI 08xANI 08	344
7	Higher	BFI 12xANI 02	532	AFI 02xANI 02	343
8	Higher	AFI 13xBNI 13	528	BFI 12xANI 02	343
9	Higher	BFI 13xANI 03	524	AFI 01xBNI 01	340
10	Higher	BFI 08xBNI 07	522	BFI 04xANI 14	339
11	Higher	BFI 13xBNI 13	514	BFI 08xBNI 07	336
12	Higher	AFI 08xBNI 18	514	AFI 01xANI 20	335
13	Higher	AFI 08xANI 08	514	AFI 02xANI 01	335
14	Higher	AFI 08xANI 07	507	AFI 20xBNI 20	335
15	Higher	AFI 18xANI 18	504	AFI 05xANI 04	333
16	Higher	AFI 01xBNI 01	504	BFI 13xANI 03	333
17	Higher	BFI 04xANI 14	502	AFI 08xBNI 18	331
18	Higher	BFI 13xBNI 12	492	AFI 20xANI 20	331
19	Higher	AFI 20xBNI 20	492	BFI 13xBNI 12	331
20	Higher	AFI 02xANI 01	487	BFI 12xBNI 11	331
1	Lower	BFI 07xANI 07	247	BFI 07xANI 07	256
2	Lower	AFI 11xBNI 11	250	AFI 07xANI 07	267
3	Lower	AFI 07xANI 07	267	AFI 11xBNI 11	273
4	Lower	AFI 17xBNI 17	281	AFI 16xANI 16	276
5	Lower	BFI 18xANI 18	287	AFI 18xBNI 08	280
6	Lower	AFI 12xANI 11	288	AFI 11xBNI 01	285
7	Lower	AFI 18xBNI 08	288	BFI 18xANI 18	286
8	Lower	AFI 16xANI 16	288	AFI 06xANI 05	287
9	Lower	BFI 07xANI 17	290	AFI 17xBNI 17	288
10	Lower	BFI 14xANI 14	303	AFI 12xANI 11	290
11	Lower	AFI 11xBNI 01	305	BFI 14xANI 14	290
12	Lower	BFI 05xBNI 04	312	BFI 17xANI 07	290
13	Lower	AFI 06xANI 05	316	BFI 17xANI 17	291
14	Lower	AFI 19xBNI 09	317	AFI 19xBNI 09	293
15	Lower	AFI 14xBNI 14	317	BFI 05xBNI 04	293
16	Lower	AFI 09xBNI 19	330	BFI 15xBNI 15	293
17	Lower	BFI 09xBNI 09	330	AFI 10xANI 10	294
18	Lower	BFI 17xANI 17	331	AFI 14xBNI 14	295
19	Lower	BFI 15xANI 05	338	AFI 07xANI 06	295
20	Lower	BFI 01xBNI 01	340	BFI 06xBNI 05	296

It can be noticed from Table 5-10 that in 31/40 cases there is a coincidences between the weight and length ranking.

### Flesh colour

The flesh colour measures Roche and Chroma meter are shown in Table 5-11, including the Chroma and Hue calculation for the OIM strain.

Table 5-11 Offspring Glenwyllin IOM Roche and Chroma meter (L\*,a\*,b\*,C\*,and h\*) descriptive statistics

	Roche	L*	a*	b*	C*	h*
<b>N</b>	788	765	766	755	773	748
<b>Mean</b>	26.05	35.92	11.00	12.42	16.47	48.44
<b>SE</b>	0.07	0.09	0.07	0.08	0.10	0.15
<b>%CV</b>	7.29	6.59	16.89	17.00	16.22	8.67
<b>Maximum</b>	31	47.92	19.67	19.49	24.12	64.57
<b>Minimum</b>	20	22.83	4.69	5.12	7.97	26.86

There were no significant differences between the two different methodologies used to measure the heritability of the trait; Minolta Chroma Meter CR-400 and Roche Salmofan™ colour (Table 5-12). But the estimation of the heritability of lightness (L\*) with the Minolta is not significantly different from 0 in the sire. There are no significant differences between sires and dams

Table 5-12 Sire, dam and combined flesh colour heritability for the Glenwyllin IOM strain, estimated using the Roche Salmofan™ and Minolta Chroma Meter (L, a, & b) methodologies

	Sire $\sigma$	Sire $h^2$	Dam $\sigma$	Dam $h^2$	Combined $h^2$
<b>Roche</b>	0.13 (0.09)	0.14 (0.10) a	0.22 (0.11)	0.25 (0.11) a	0.19 (0.07)
<b>L*</b>	0.01 (0.01)	0.01 (0.01) a	0.19 (0.12)	0.14 (0.09) a	0.07 (0.05)
<b>a*</b>	0.06 (0.07)	0.07 (0.08) a	0.18 (0.10)	0.21 (0.11) a	0.14 (0.06)
<b>b*</b>	0.21 (0.13)	0.20 (0.11) a	0.26 (0.13)	0.24 (0.11) a	0.22 (0.07)

Same letters in the rows indicate no significant difference between sires and dams. Parenthesis indicates the standard error.

Wald statistics in the model do not show significant differences between the different days in the processing plant with the Roche methodology (Table 5-13). Nevertheless, the same statistic show a significant difference between the different days at the processing plant with the parameters L\*, a\*, and b\*. This is probably related to the technical need to recalibrate the Chroma meter every day.

Table 5-13 Trait predictions values between the different days in the processing plant using the Roche Salmofan™ and Minolta Chroma Meter (L, a, & b) methodologies

	Roche	L*	a*	b*
<b>Day 1</b>	25.87 (0.16)	36.28 (0.20)	10.73 (0.15)	12.22 (0.17)
<b>Day 2</b>	26.06 (0.15)	35.21 (0.18)	10.93 (0.14)	11.82 (0.17)
<b>Day 3</b>	25.92 (0.17)	36.80 (0.23)	11.20 (0.16)	13.11 (0.19)
<b>Day 4</b>	25.84 (0.21)	33.82 (0.32)	11.71 (0.21)	13.02 (0.24)

Table 5-14 shows that the model does not show any additive, heterosis or maternal effect of the Glenwyllin in A or B strains according to Wald statistics significance, therefore there is no evidence of differences in the prediction between the pure bred and hybrid crosses over the Roche & L\*, a\*, b\* traits.

Table 5-14 Trait prediction values between pure bred (AxA & BxB) and hybrid crosses (AxB & BxA) using the Roche Salmofan™ and Minolta Chroma Meter (L, a, & b) methodologies

	Roche	L*	a*	b*
<b>AxA</b>	25.90 (0.22)	35.70 (0.25)	11.01 (0.20)	12.36 (0.24)
<b>BxB</b>	25.86 (0.19)	35.34 (0.22)	11.19 (0.18)	12.67 (0.22)
<b>AxB</b>	26.01 (0.20)	35.27 (0.25)	11.24 (0.19)	12.52 (0.23)
<b>BxA</b>	25.96 (0.20)	35.84 (0.24)	11.14 (0.19)	12.59 (0.23)

Table 5-15 Top 20 highest and lowest individual values for the variables Roche and a\*

Ranking	Category	ID	PIT tag	Roche	ID	PIT tag	a*
1	Higher	OIM0201	0006334713	31	OIM0008	0006332D1B	19.67
2	Higher	OIM0397	00063320FB	31	OIM0152	0006333786	18.59
3	Higher	OIM0403	0006335810	31	OIM0059	00063348A8	17.71
4	Higher	OIM0330	000633F329	30	OIM0932	00063335ED	17.39
5	Higher	OIM0409	000634001A	30	OIM0547	000633F803	16.42
6	Higher	OIM0801	00063351BD	30	OIM0994	000633523D	15.98
7	Higher	OIM0013	00063334F6	29	OIM0827	0006332F17	15.70
8	Higher	OIM0035	00063334846	29	OIM0392	0006333CC5	15.50
9	Higher	OIM0127	000633378C	29	OIM1249	000633482A	15.46
10	Higher	OIM0218	0006333E72	29	OIM1147	000633E174	15.29
11	Higher	OIM0457	0006332799	29	OIM0398	0006332545	15.24
12	Higher	OIM0532	0006334AF9	29	OIM0715	00063351CF	15.22
13	Higher	OIM0578	000633481D	29	OIM1380	000633472F	15.09
14	Higher	OIM0707	00063357BF	29	OIM0836	0006334476	15.07
15	Higher	OIM0715	00063351CF	29	OIM0887	0006334E74	15.03
16	Higher	OIM0730	000633FAC8	29	OIM1269	0006333340	15.02
17	Higher	OIM0759	00063332CF	29	OIM1116	0006333578	15.00
18	Higher	OIM0791	0006340D1C	29	OIM0816	0006334DD8	14.97
19	Higher	OIM1098	00063401A4	29	OIM0371	000633E013	14.86
20	Higher	OIM1113	000633450D	29	OIM0449	0006332A50	14.74
1	Lower	OIM0039	000633FF8E	20	OIM0387	000633E6F9	4.69
2	Lower	OIM0109	000633FC6C	20	OIM0948	000633FC60	5.45
3	Lower	OIM0237	000633F4B4	20	OIM0307	0006332830	5.60
4	Lower	OIM0327	0006334E56	20	OIM0603	0006334CE2	5.73
5	Lower	OIM0387	000633E6F9	20	OIM0630	0006333F84	5.83
6	Lower	OIM0533	000633FF91	20	OIM0683	000633EAB0	6.21
7	Lower	OIM0603	0006334CE2	20	OIM1031	0006340626	6.32
8	Lower	OIM0630	0006333F84	20	OIM1237	000633EF6B	6.53
9	Lower	OIM0793	000633EC43	20	OIM0859	000633FE84	6.80
10	Lower	OIM0914	000633E583	20	OIM1081	000633540C	6.88
11	Lower	OIM0948	000633FC60	20	OIM1376	0006334E5E	6.97
12	Lower	OIM0998	000633D9C0	20	OIM0617	0006334C68	7.12
13	Lower	OIM1026	0006334923	20	OIM0717	00063339AF	7.15
14	Lower	OIM1222	00063342BA	20	OIM1026	0006334923	7.25
15	Lower	OIM1237	000633EF6B	20	OIM0017	000633EE6F	7.32
16	Lower	OIM1246	0006333F74	20	OIM1239	00063331D0	7.33
17	Lower	OIM1280	000633F700	20	OIM1035	000633574E	7.33
18	Lower	OIM0114	0006335395	21	OIM0924	0006334F5E	7.36
19	Lower	OIM0461	0006335229	21	OIM0109	000633FC6C	7.47
20	Lower	OIM0548	00063341B4	21	OIM0457	0006332799	7.47

As is possible to appreciate from Table 5-12 the heritability for flesh colour trait is quite low, and it also was estimated in a test population, the broodstock remaining at Glenwyllin Isle of Man farm. Thus, in order to have a better result with the selection process maybe is possible to utilize MAS, to achieve this is necessary to utilize the individuals selected in Table 5-15. This technique will be explained in the final discussion.

## Survival

From a total of 1500 Glenwyllin IOM offspring selected during the PIT tagging, 792 survived to processing plant. It can therefore be said that the overall survival rate was 52.8%. The parental assignment analysis gave 1242 offspring assigned to a single pair of parents, with correctness higher or equal to 0.98. From those 1242 offspring with a single pair of parents, 635 (51.1%) survived to the age of 67 weeks (harvest time).

Table 5-16 Sire, dam, and combined survival heritability for the Glenwyllin IOM strain

	<b>Sire <math>\sigma</math></b>	<b>Sire <math>h^2</math></b>	<b>Dam <math>\sigma</math></b>	<b>Dam <math>h^2</math></b>	<b>Combined <math>h^2</math></b>
<b>Survival</b>	0.001 (0.002)	0.02 (0.04) a	0.003 (0.003)	0.05 (0.04) a	0.03 (0.02)

Same letters in the row indicate no significant difference between sires and dams. Parenthesis indicates the standard error.

As Table 5-16 shows, there was a heritability of 0.03 (0.02) for survival, this being a significant result. There was no significant difference between the sire and dam heritability estimates.

Table 5-17 Prediction of survival between pure bred (AxA & BxB) and hybrid crosses (AxB & BxA)

<b>Pure bred</b>	<b>Survival</b>	<b>Hybrid</b>	<b>Survival</b>
<b>AxA</b>	0.519 (0.03)	<b>BxA</b>	0.517 (0.03)
<b>BxB</b>	0.536 (0.03)	<b>AxB</b>	0.557 (0.03)

The model does not show any additive, heterosis or maternal effects of the Glenwyllin A or B strain according to Wald statistical significance; therefore there is no evidence of significant differences in survival between the different crosses (Table 5-17).



## 5.4. Discussion

### 5.4.1 Glenwyllin Isle of Man and Houghton Spring- growth traits

When one observes Figure 5-5, one can notice that the exponential correlation of weight/length of the OIM strain at PIT tagging is displaced to the right when compared to that of the OHS strain. This is due to the difference in weight and length measurements between the strains, possibly a result of the 22 days difference in age and early rearing on the different farms. However, from PIT tagging, both fish strains were communally reared in Test Valley Trout facilities, conditions for strains were identical as they were kept together in the same tank, fed the same food, kept under the same water temperature, etc. The determination coefficient ( $R^2$ ) value at this time is higher in the OIM than OHS strain, although the value is extremely high in both strains. The difference in mean weight between the strains is highly significant, the OHS strain being approximately half of the OIM (9.23 g OHS; 18.46 g OIM).

The intermediate measurement, Figure 5-6, shows that the exponential correlation of the OIM strain is no longer as biased as the differences between the strains decrease. This can be verified in a more quantitative manner by analysing the proportion of the mean weights at this time, which was 0.88 (338.2 g OHS; 383.5 g OIM), still a significant difference although it has been reduced. However, the coefficient of determination had diminished significantly when compared with the results of the initial measurement, 0.857 in the OIM strain and 0.872 in the OHS strain, suggesting a loss of association between the weight and length variables.

By the third measurement at harvest, there was hardly any difference between the curves. The proportion of mean weight between the strains is 0.89 (370.6 g OHS; 415.5 g OIM) which is still significant and did not vary much with respect to the intermediate measurement. However, the coefficient of determination increased considerably with respect to the intermediate measurement, on this occasion OHS strain (0.924) showing a higher value than OIM strain (0.913).

When analysing the weight/time relation of both strains, Figure 5-8, the quadratic regressions in both strains were similar. A time difference could also be seen between the strains. The coefficient of determination was likewise similar. However, it was higher in the OIM strain (0.832) than in the OHS strain (0.826). As has been previously mentioned, Table 5-4 shows that the weight differences diminish over time, although they continued to be significant right up to harvest. The coefficient of variation within each strain likewise diminished over time, although there was little variation in the last two measurements, and it seemed to come to a standstill at around 25%.

As there was a temporal difference between the strains, and so as to be able to assess the growth rate in a more efficient manner, the equations of the quadratic regressions were derived with respect to time. Figure 5-9 shows the comparison of these straight lines obtained from both strains. The figure shows that at the beginning the OIM strain grew at a higher rate, and the rates became equal over time. When we extrapolate the equations it can be seen that the rates would have been the same at the end of 83 weeks and 3 days, and in that case, the growth rate would be higher in the OHS strain.

The length/time relation for both strains showed that there was a much larger coefficient of determination than in the weight/time relation. The coefficients of determination of the length/time relation had values of 0.941 in the OHS strain and 0.947 in the OIM strain, whilst the coefficients of determination of the weight/time relation were both close to values of 0.82. This higher association between the length/time variables implies a higher certainty in the determination of the growth rate. This may be due to the fact that the length variable has 1 dimension and the weight variable has 3 dimensions (change of volume), and it may also be due to the fact that the weight measurements were not standardised for gut contents. When analyzing the proportion of mean length between the strains over the three sampling times, it can be seen that the length differences diminish towards the harvest. At the beginning there was a proportion of 0.79 (81.9 g OHS / 103.2 g OIM), and then, in the second measurement it was 0.96 (266.9 g OHS / 277.1 g OIM), showing a reduction of the differences, and finally towards harvest time, the proportion was 0.97 (305.3 g OHS / 314.6 g OIM), indicating that the differences between both strains were maintained towards the end. The coefficient of variation (%CV) indicated that the OHS strain does not vary much over time, maintained at about 10%, but with the strain OIM it started at approximately 10% and ended at 8.4%. The Figure 5-11 indicates that in the beginning the OHS strain had a higher growth rate, which then reverted and finally, the OIM strain had a higher growth towards the end of the period. This might be due to an external factor (environmental), as it is not normal that the length %CV remained constant in OHS strain and diminished in OIM strain.

#### **5.4.2 Glenwyllin Isle of Man strain growth traits genetic parameters**

The results for the IOM strain revealed that there was significant additive genetic variation for growth related traits. The heritabilities were 0.43 (0.09) for weight, 0.42 (0.09) for gutted weight, and 0.28 (0.08) for length. It was observed in the analysis that there were no significant differences between the heritability estimates from sires and dams. In consequence, it will be possible to improve the growth rate in a breeding programme.

It must be pointed out that the heritability of weight and gutted weight are the same, therefore, I will just refer to the heritability of weight, probably historically the most studied of any trait. Furthermore, the weight trait is highly phenotypically and genetically correlated with length, as could be noticed in the different figures of this work. It is due to the aforesaid reason that not much attention was dedicated to this trait because when selecting for weight, one is indirectly also selecting for length.

Heritability estimates in fish farming usually have large standard errors (Gjerde et al. 1997; Henryon et al., 2002; Gjerde et al., 2004). In order to avoid this problem, a partial factorial cross design was applied in the present work where a total amount of 160 families were represented. Temperature, water flow and oxygen levels generate changes in the rainbow trout growth rate. Elvingson and Johansson (1993) demonstrated variations in growth results with different fish density in different experimental tanks. Experiments similar to these have more variables, so will have more complex statistical models, making the results more difficult to assess. One of the advantages of utilizing the parental assignment methodology in the present study meant that all the trout could be kept together in the same experimental environment

at all times from PIT tagging until the harvest, so there was less environmental variation. In the past, families were kept separate, and this probably inflated heritability estimates as environmental effects could be confused with genetic effects. Furthermore, to be able to obtain a good representation from each family, equal volumes of ova from each family were jointly incubated.

Table 5-18 Published rainbow trout body weight heritability over the last decades.

Time (week)	Mean weight (g)	N	$h^2$	Offspring Sex	Temp. (°C)	Authors
65	439.9	na	0.66	na	Na	Gall and Gross (1978)
87	757.1	na	0.74	na	Na	Gall and Gross (1978)
33	5.44	474	0.72 (0.07)	Female	8.5	Fishback <i>et al.</i> (2002)
46	49.76	487	0.55 (0.03)	Female	8.5	Fishback <i>et al.</i> (2002)
46	56.94	492	0.61 (0.05)	Female	15	Fishback <i>et al.</i> (2002)
23	32.5	714	0.54 (0.14)	Not sexed	Na	Crandell & Gall (1993)
23	32.5	714	0.53 (0.14)	Sexed	Na	Crandell & Gall (1993)
65	882.5	692	0.22 (0.13)	Not sexed	Na	Crandell & Gall (1993)
65	886.1	692	0.40 (0.13)	Sexed	Na	Crandell & Gall (1993)
128	2666	451	0.20 (0.06)	Not sexed	Na	Kause <i>et al.</i> (2002)
67	415.7	792	0.43 (0.09)	Female	Na	Present study

As was previously mentioned, heritability is a property of the population or strain. However, the attempts to analyse whether there are factors that equally affect the different populations, i.e. sex and age, have not been altogether consistent. In an early study Crandell and Gall (1993), demonstrated (Table 5-18) that it is necessary to make a correction in the growth model for the variable sex and sexual maturity in trout, although this correction is dependant upon the age at which the heritability is estimated and the amount of sexual precocity of the fish. The rainbow trout in the present study were all females, and there were no signs of gonadal maturity during the slaughter at the processing plant. Thus, these variables are not included in the present

study. In some studies it has been demonstrated that at a younger age the heritability is low and increases with age (Gall and Gross, 1978a; Elvinson and Johansson, 1993), however Crandell and Gall (1993a and 1993b) and Fishback et al (2002) found that the growth rate heritability decreased with age.

Considering all the families selected for their higher performance in Table 5-10, one may select the breeding families that will constitute the following generation in the Glenwillyn Isle of Man farm. It would be interesting to have the information of the performance of the broodstock for the same traits in the IOM because any difference in the ranking might suggest a genotype x environmental interaction. If the magnitude of a GxE was large then this would suggest that performance traits should be assessed under commercial conditions and this information used to identify future breeding candidates.

### **5.4.3 Glenwillyn Isle of Man strain flesh colour phenotype**

The cost of pigmentation in the salmon and trout industry is approximately 20% of the total feeding cost (Torrissen et al., 1990). It is important for commercial reasons that the industry should choose individuals that efficiently absorb and deposit these pigments in their flesh. The expression of this trait in salmonids is complex and is difficult to estimate. It is necessary to slaughter the individual to be evaluated for colour (Bjerkeng, 2000), as up to now no technique has been developed to make an estimate with live animals.

There are few similar studies for rainbow trout. Therefore, I will discuss my results with information obtained from other salmonids, surmising that generally in

salmonids the mechanisms underlying muscle pigmentation are basically similar (Torrissen et al., 1989).

#### **Visual evaluation of colour**

A mean SalmoFan™ colour value of 26.01 was obtained (20-34 scale) for the rainbow trout in this study. Araneda (2003) obtained 29.20 when investigating Coho salmon, higher than the results obtained in the present study. However, our results are within the limit of the 25 to 26 range observed in Atlantic salmon (Smith et al., 1992; Kause et al., 2002; Robb et al., 2000).

It must be taken into account that a part of the interspecific differences observed in colour are related to the different amounts of carotenoid pigments which the different salmon species are able to deposit in their muscles (March & MacMillan, 1996). However, it has been established that any colour value above 26 points is considered as a colour which complies with the minimum industrial requirements to be marketed (Smith et al., 1992). Therefore, the data obtained in this work suggest that the pigmentation level met the standard required by the industry using normal commercial diets and feeding levels.

#### **Instrumental evaluation of colour**

Colour evaluations performed with instruments such as the Minolta Chroma Meter are harder to interpret, as they express the colour perceived by the human eye in coordinates of a colour space, so that the real colour perceived by an observer is a mixture of all of these components or coordinates (CIE, 1986). The colour of salmon

muscle has been described as having an orange-red hue, and that is why research has tended to quantify the red component of the colour space ( $a^*$ ), which would represent the red colour of the muscle. A mean value of 11.00 points was estimated in this thesis for the red chromaticity, with a much broader coefficient of variability (%CV) than that observed in the SalmoFan™ Roche visual methodology (16.89 versus 7.29). The value of the red chromaticity, both for rainbow trout as for Atlantic salmon, fluctuates between 8.3 to 13.4 points (No & Storebakken, 1991; Skrede & Storebakken; 1986<sup>a</sup> y 1986b). Araneda (2003) when investigating Coho salmon, obtained a mean value of 17.06 points for red chromaticity, higher than the values obtained for rainbow trout and Atlantic salmon. As has been already mentioned, these interspecific differences in the instrumental measurements of colour are related with the different ability to deposit carotenoids of each particular salmon species (March & MacMillan, 1996).

It has to be said at this point that the equipment used for evaluating colour is more sensitive than the human eye to detect colour differences (CIE, 1986). This is shown by the %CV between both methods, which is significantly higher in the instrument measurement.

#### **5.4.4 Glenwyllin Isle of Man strain flesh colour genetic parameter**

The heritability estimates for sire, dam, and combined obtained for the visual colour variables were from low to moderate magnitude (Table 5-12). The results indicate that  $19 \pm 7\%$  of the phenotypic variability observed in rainbow trout of the IOM strain is due to additive genetics. No differences were found between sire and dam. Araneda (2003) estimated that heritability by means of a visual method, indicate that in Coho



salmon, between  $12 \pm 5\%$  to  $26 \pm 7\%$  are due to transmissible genetic differences. Previously published heritability values for Atlantic salmon have been respectively  $16 \pm 8\%$ ,  $17 \pm 4\%$ , and  $12 \pm 3\%$  (Gjerde & Gjedrem, 1984; Rye & Gjerde, 1996, Norris and Cunningham, 2004) and from  $19 \pm 6\%$  up to  $28 \pm 9\%$  in rainbow trout (Gjerde & Gjedrem, 1984; Gjerde & Schaeffer, 1989; Kause et al., 2002). It may be said that the values found in the IOM strain are within the range obtained for rainbow trout and other salmonids found by other investigators.

The heritabilities estimated using an instrumental evaluation for colour was smaller than those obtained through visual measurements (Table 5-12). Heritability for red chromaticity in rainbow trout was  $14 \pm 6\%$ . No differences were found between sire and dam. The measurement is within the range estimated by Withler & Beacham (1994) for Coho salmon of  $19 \pm 12\%$ , but slightly less than that estimated by Norris and Cunningham (2004) in Atlantic salmon of  $20 \pm 2\%$ .

The heritability result obtained for variable  $L^*$  in the present study was  $7 \pm 5\%$ , Norris and Cunningham (2004) estimated  $5 \pm 3\%$  in Atlantic salmon and Araneda (2003) estimated  $1 \pm 3\%$  in Coho salmon. There was apparently an error in the method, which could be due to light-water reflection on the flesh surface. Also, the results of this study suggest that another possible problem in utilizing the colorimeter (Minolta) is the recalibration of the instruments. The Salmofan™ although standardizing light is very operator-dependent. In this study a single experienced operator did all the assessment. Our results show that there were no significant differences in the different measurements made during the 4 days of work in the processing plant.

When utilizing the Salmofan™ methodology, it is possible to introduce some modification to improve the system. For example, if the colour assessment cabinet (which has an internal, continual and standard source of light) could incorporate a digital camera, it would be possible to eliminate the reflection and then solve the problem. Modern digital camera and computer technology should help to reduce the error and subjective nature of this analysis, and it could be automated, and would be open to more detailed analysis such as distribution of pigment in the fillet. This new technology would help the plant processing line optimisation, rendering the objective of selecting trout that absorbs more pigment easier, under commercial farm conditions.

The heritability values for flesh colour presented in this thesis permit would permit an adequate response to selection, although the scope of the results are within the low to moderate range. The response to selection would be much higher if we could perform the selection directly on the parents rather than their sibs (Falconer & Mackay, 1986). The best method for performing genetic improvement would be a selection method to improve absorption and retention of pigments which could be used at any development stage, independent of environmental variations. An approach towards this development is to use molecular tools which permit identifying genetic markers associated with the muscle colour in rainbow trout. Table 5-15 shows a ranking with the Top 20 highest and lowest individual values for meat colour, over all the 1500 different individuals in the GIM offspring population. These individuals may be used for directly selecting parents in the IOM and/or to use them to find molecular markers with a method which will be explained at length in the final discussion. The diet in

this trial was commercially available and presumably aimed at masking more subtle differences in individual variation in order ensure the maximum number of fish achieved the necessary colour score. In the future trials using a range of diets with lower levels of pigment incorporation might enable us to discriminate individuals and families with the ability to better retain pigments supplied in lower concentrations, and possibly improve the heritability of the trait, and so move towards a strain with lower pigment requirements.

#### **5.4.5 Glenwyllin Isle of Man strain survival phenotype and genetic parameter**

The overall survival from PIT tagging to harvest time was 52.8% for the Glenwyllin IOM strain and 51.1% for the Houghton Spring strain, with no significant difference between the strains. The results would appear to be relatively low, although it is necessary to consider the different factors that contributed to the overall mortality.

The first would be the PIT tagging process. At that time the mean weight of the Glenwyllin IOM strain fish was 18.2g (6.7g SD) and the Houghton Spring strain fish was 9.1g (2.9g SD), 25 (1.6%) fingerlings from IOM died during the process. K Das Mahapatra et al. (2001) found that fingerlings of rohu (*Labeo rohita*) weighing between 8 and 15 g. were the most suitable and the best size range for tagging with a PIT tag, so it is possible to say that in the present study trout weights at tagging were within the optimal range. They also describe that as an effective management practice, the percentage of survival increased up to 94.46%. Tag rejection was observed to be 0.05% at the end of the experimental period. Thus, this cause does not look very important in the overall survival.

The second and most important was a naturally annual reoccurring infection with the myxozoa *Tetracapsuloides bryosalmonae*. This myxozoarian produces high mortality rate in the farm during the summers (Oliver Robinson, personal communication). During the experiment the trout were exposed to this natural infection. The parasite does not cause high mortality but it has been demonstrated that subclinical PKD infections suppress key elements of the innate immune response, resulting in immune suppression that produces an increased susceptibility to secondary infections like bacteria, viruses, fungi, protozoa and metazoan (Alderman and Feist, 1985; Holland et al., 2003 and Klontz et al., 1986). All the present study experimentation was done at commercial fish farms, therefore all the trout were environmentally exposed to PKD with a high probability of developing a secondary disease.

The very low but significant survival heritability 0.03(0.02) suggests a small adaptation of the trout to the farm environment that might be related to the survival due to a parasitizing infection. Rye et al. (1990) had assessed field survival heritability of 0.16 (0.03) and 0.01 (0.02) in the rainbow trout and the Atlantic salmon respectively; these results illustrate the lower heritability expected in field conditions. Therefore it is possible to sustain the hypothesis of an improved trout adaptation due to the host-parasite system interaction. Challenge tests are usually performed to measure the resistance to a specific pathogen. Different approaches have been developed in challenge tests, either measuring the time to death or measuring the immune response after the infection with the pathogen (Gjedrem et al., 1991 and Fjalestad et al., 1996). Gjoen et al. (1997) said “an animal may be resistant to a disease because it has high tolerance, i.e., it can be infected but is clinically unaffected

when infected; or it might be resistant because it is less susceptible to the disease, i.e., it is not infected when challenged”, therefore this kind of selection will potentially produce two different types of individuals or outcomes. Thus, challenge survival test results with the host-parasite system and field survival test must be genetically correlated in order to prove that it is possible to improve the overall survival. Henryon et al. (2002) argued that it may be unrealistic to hope to achieve resistance to all forms of disease. They also argued that during selection of fish resistant to a pathogen, the host-parasite system, the pathogen has the potential to evolve to survive in the host. This possible increased resistance in the pathogen may offset at least some of the progress made in the resistance of the fish. These will make selecting breeding for resistance challenging.

Gjoen et al (1997) said that high genetic correlation between survival in the environments indicate that genetic improvement of resistance to furunculosis may be obtained based on survival data recorded in the environment. However, the factors which influence survival under farming conditions will be multiform. Thus, they argue that challenge tests are the most accurate and proper measures. They also argued that in the field it is important to quantify the mortality causes by the different disease agents. Their research confirmed positive genetic correlations between resistance to different bacterial disease, but there were unfavourable genetic correlations between resistance to ISA and resistance to two different bacterial diseases. Thus, it may or may not be possible to find a positive correlation to the parasite *Tetracapsuloides bryosalmonae* and a secondary disease.

The final discussion (Chapter 6) will expand on this trait and how other researchers have approached this matter in order to have a positive result.

#### **5.4.6 Additive, heterosis, and maternal effects between the IOM strain lines A and B**

In the present study, it was not possible to find any additive, heterosis or maternal effects on any of the traits between lines A and B. The lack of heterosis may suggest that there is no inbreeding depression in Line A and B, and/or also that both lines are not that different. The molecular studies (Chapter 3) showed that the genetic differentiation between the strains A and B was quite low and that the isolation of the lines based on spawning time had little influence on the levels of variation. Or maybe this is because we chose our breeding population on the same spawning date from the two lines, which may have reduced the overall differences between fish at the extremes of the spawning period..

Van Raden et al. (1992) and Miztal et al. (1995) discussed that poultry and fish have a much higher fecundity rate than cattle; therefore they can provide more accurate values for detecting non-additive genetic effects. Maternal effects on juvenile weight have been found shortly after first feeding in rainbow trout (McKay et al., 1986; Crandell and Gall 1993) and coho salmon (Withler and Beacham, 1994), but these effects decrease as the juvenile grows. None of these authors separate maternal genetic and maternal environmental values. G. S. Su et al. (1996) stated that maternal effects should not be large for salmonids because the offspring are not nurtured, like in mammals. The most likely source of maternal effect would be differences in egg

size and egg quality and in situations such as family units in which families are raised separately.

It is common to exploit the heterosis effect in some fish species like carp, tilapia and catfish. In salmonids this practice is less prevalent, although some traits have been shown to exhibit heterosis. Bryden et al. (2004) did not find any useful heterosis in Chinook salmon for the various traits they studied. Quinton et al. (2004) found just a small difference in spawning dates and suggested that this may be influenced by another maternal factor in the rainbow trout, also Miller et al. (2004) did not find any heterosis in survival in the rainbow trout.

## **Chapter 6 / GENERAL DISCUSSION**

### **6.1. Genetic variation between and within some selected rainbow trout strains cultivated in the UK.**

It is clear that there were significant differences between the various rainbow trout strains bred in the UK, there were significant allele frequency differences and numbers of unique alleles observed in the different strains. These results indicate that commercial United Kingdom rainbow trout strains have had very different management histories and /or different origins as well, that allowed them to be significantly different from each other.

Different genetic variability measurement suggests that the Glenwyllin Isle of Man GIM Founding Population strain and Glenwyllin Isle of Man Trafalgar GIT strain are the most genetically variable strains. One explanation for the high variability of the Glenwyllin Isle of Man Trafalgar GIT strain is that this is a mixture of strains from a variety of different hatchery sources. The farm had to rebuild its broodstock population after the earlier stock was culled to remove a notifiable disease. According to the dendrogram, the possible mix of the Glenwyllin Isle of Man (GIM) strain is with the Hatchery Seven Spring (H7S) strain, producing a strain (GIT) with superior observed heterozygosity. In contrast the Golden Trout GTR strain is the least variable, having gone through a bottleneck in order to fix the golden colour in his strain. The genotypic characterization of the strains implies that all the strains could potentially be joined in a single breeding trial and then, at the end of the experiment, chooses the best families who present the best evaluations of a certain trait or traits and in this way, create a single new synthetic strain, the base population of a breeding program.



But, as we are going to explain in the following paragraph, the Glenwyllin Isle of Man farm has a special feature which limits this possibility.

The Glenwyllin Isle of Man strain appears to be highly variable when compared to the other tested strains. Thus, it was a good candidate strain for a Breeding Program. The strain has the advantage of a long standing disease free status, due to its geographical isolation and a strict policy of no new introductions. The strain has therefore also been genetically isolated for the last 26 years. The farm supplies 30 million eyed eggs and maintains a large breeding population of 16000 mature females. This will have helped to conserve the higher genetic variation and resulted in a large but unknown effective population size. Broodstock replacement is managed, controlled half-sib mating, to maximise the potential  $N_e$  (David Beard pers comm.).

The stock management on the Glenwyllin IOM farm is focused on egg production in order to supply the UK and European industry and for its own broodstock replacement. The farm does not undertake any rigorous selection of its replacement broodstock for growth, other than the removal of obvious problem animals, but has been trying to extend the spawning season by selecting for earlier and later spawning in two separate lines. It is a constant goal of rainbow trout hatcheries to try and supply eggs all year round, and develop strains with different breeding seasons. This was the objective of the Glenwyllin IOM farm, and it started to select for early and late spawning, developing two lines (A & B respectively) with separate temporal breeding seasons, although this was done without any pedigree information. In our methodology of the cross breeding design for the eventual breeding program, as we were trying to cross both lines, we had to collect from late spawning in one and early

spawning in the other to enable the crosses to be made in one day. It can be seen from the results of the breeding experiments that the two lines appear to have almost identical performance characteristics. The gradual selection for spawning time appears to have been achieved without any significant change in the overall levels of variation and with no reduction in the overall performance of the strains.

It was also possible to do comparisons of variation levels over the different year classes, and evaluate the conservation of genetic variability over the GIM Founding Population, GIM Base Population, and OIM First Generation. F statistics showed that when comparing the GIM founding population with the OIM first generation there was a heterozygosity deficit in the GIM founding population, suggesting a risk of genetic deterioration due to the management of the artificial reproduction without pedigree information, artificial selection for spawning date, in the rainbow trout broodstock. Nevertheless, it is possible to say that this potential inbreeding depression could be completely overcome by the next generation, due to the methodology of the cross breeding design applied in this study. Furthermore, the methodology could improve even more inducing more genetic variability throughout the management of the sexual reproduction. As has been previously mentioned, the families that were created in the GIM first generation, show genetic variability as high as the GIM Base population.

## 6.2. Parentage assignment

The results showed that of the 11 loci used for parentage assignment, the least efficient ones were Omy207UoG, Omy301UoG, OmyFGT23TUF, and OmyFGT15TUF loci. The results show that two of the most polymorphic loci, Omy207UoG and Omy301UoG, are also the loci with the highest numbers of not amplified or missing alleles, suggesting that highly polymorphic dinucleotide loci with many closely spaced alleles are not good markers for parental assignment.

If this work is to continue using multiplexed microsatellite loci reactions we need to continuously improve the technique to make it more robust and reliable. Any new multiplex reactions should include more tetranucleotide loci and dinucleotide loci with a reduced product size (< 120 bp) as suggested by O'Connell and Wright (1997). The tetranucleotide loci are easier to score because of the greater distance between alleles and reduced stutter bands. The dinucleotide loci with reduced product size tend to stutter less and their smaller size makes them physically easier to separate during electrophoresis. There is no doubt that the adaptation to the new capillary sequencer technology would encourage even more the use of microsatellite for parental assignment determination. Compared to the old acrylamide gel technology (the technology that has been used in this study) the use of capillary offers a highly significant advance in terms of time spent in laboratory, and increasing productivity in laboratory work. It also offers a higher optical sensitivity, allowing a higher quality data production, which would finally translate in an improvement in the percentage of family assignment.

Pompanon et al (2005) in an extensive bibliographical review on genotyping error suggested separating errors into 4 different general groups. One of them was human error, and they explained that in a few studies where the specific causes of error have been analyzed, the principal cause was attributed to human error. Therefore, one could consider using a robot for the preparation of the mix for the multiplex reactions and also for the DNA extraction as a way of maximum automation of the process, minimizing human error. As an example of some of these modifications in the general genotyping method, one could quote Johnson et al. (2007), who developed a single-step method of co-amplifying twelve microsatellites in two hexaplex reactions for rainbow trout. The majority (or all) of the microsatellites they chose were tetranucleotides and their method used an ABI 3730 sequencer, which uses capillary technology. The parentage analysis performed by these researchers had a result of 98% single family assignment.

The Family Analysis Program (FAP) and also the Package for the Analysis of Parental Allocation (PAPA) seem to be both particularly useful programs dealing with the eventualities of the PCR and genotype methodologies, in terms of deleting genotyping errors and producing simulations of parentage assignment. Both programs, plus Access software (Microsoft) combined well, with their different functions enabling us to deal with the not scored and mismatched alleles. The technique of using more loci than the ones recommended by the simulation is a good strategy to deal with the problems produced by the not amplified and mismatched alleles and with a successful parental assignment. As has been said, no replicas of the samples were used in this experiment. The Maximum Likelihood Approach method, proposed

by Pompanon et al (2005) was used for the analysis of the samples to obtain a parentage assignment.

### **6.2.1 Identification system of the individuals versus breeding method in the farm**

As was mentioned in the introduction, in order to carry out a genetic improvement program one has to identify the individuals involved in the program. Mass selection systems are not adequate when the heritability of the traits is very low, therefore I discarded this method. It was also mentioned that there exist generally two methods which have proved to be efficient as identification systems: electronic tags and molecular markers, in this case, microsatellites (Neira et al, 1999).

The use of these two systems makes a significant difference in the breeding method. The use of electronic tags of the PIT kind is a technique which requires “family tanks”. This is the classical option of recording the pedigree of aquatic animals which are hard to mark. In this case, the full-sib families of fish are kept in separate tanks, until they have reached a size which permits them to be marked with these electronic tags (PIT). The numbers of families is limited due to the size of the infrastructure, and generally between 50 and 500 families are used each year. After the families have been marked, they may be ongrown jointly to avoid environmental effects.

A newer methodology is the use of a combination of molecular markers with electronic tags, which is the one we use in this Thesis. With this technique, the fish may be mixed at any time, even as just fertilized ova, so family tanks or a large

infrastructure is not required. This early mix-in avoids confusion of genetic family merits with environmental effects (tank), which may be considerable, especially for measurements based on family information such as resistance to diseases and carcass traits. It furthermore permits the breeding to be carried out in a commercial environment, which is the usual environment of hatcheries for fish in an improvement program, and the measurements are therefore more realistic and useful. Finally, a classified cross breeding means that a much larger number of families may be generated. With 100 parents of each sex, up to 10,000 families may be generated. This provides a much richer pedigree design producing more precise EBV estimates and larger profits. The larger number of families also provides more information of nonadditive effects and more power to estimate parameters such as heritability from data of the resulting offspring. However, the additional costs of the tissue samples and offspring genotyping will limit the number of families that can effectively be analysed. However, there are some intelligent designs, such as the one used in this Thesis, which reduce costs, but at the same time produce a good response. On the whole, it is possible to obtain a considerably better response to the selection by using the joint method of molecular markers and electronic PIT tags. Ongoing costs for DNA pedigreeing are assumed to decrease in real terms in the future. This technology is being used in a series of aquaculture farms (Kinghorn, 2006).

### **6.3. Phenotype and quantitative genetics**

The OIM strain at the end of the trial (harvest) is significantly heavier and longer than the OHS strain. Mean weights were 415.5 g and 370.6 g while mean lengths were 314.6 mm and 305.3 mm. However, the 3 week age difference and the different early rearing would account for much of this difference. The growth simulation actually

shows that the OHS strain was still growing faster than the OIM strain towards the end of the trial and may have actually overtaken it at the same age. The OHS strain kept reducing differences over time.

In the IOM strain, the visual measurement of colour gave a mean flesh colour values of 26.01 points on the 20-34 scale (SalmoFan™) scale. Any colour value above 26 points is considered as a colour which complies with the minimum industrial requirements to be marketed (Smith et al., 1992). The use of an instrumental measurement of colour may be more precise than the human eye, as the human eye is incapable of detecting small colour changes which are detected by instruments. However the human eye is able to integrate the overall colour of the fillet that would require several different measurements on different parts of the fillet using the present instruments. Therefore, one might say that colorimeter measurements are not presently better in respect to visual measurements. However, a combination of these technologies with a computer analysis of photographs could be useful in automation and permit working with less human error.

The heritability results for the IOM strain were  $43\% \pm 9\%$  for weight,  $42\% \pm 9\%$  for gutted, and  $28 \pm 8\%$  for length. The heritability estimates for the visual colour variables were  $19\% \pm 7\%$  and when using the instrumental evaluation, the red chromaticity heritability was  $14\% \pm 6\%$ . Therefore, the heritability results of the IOM strain indicate that there are opportunities for substantial and rapid improvement of the growth rate and flesh colour traits in this strain. Also no line effects were observed or indications of non-additive genetic variation.

The overall survival of the GIM strain from the time of the physical tagging with PIT until harvest was 52.8%, and survival heritability was extremely low,  $3\% \pm 2\%$ , hardly significant. According to the information of the people in charge on site, this great mortality was mainly due to an infection with the myxozoa *Tetracapsuloides bryosalmonae* (PKD). However, there were no further data records about this mortality one of the downsides of working on a commercial farm. According to different researchers, the parasite does not cause large mortalities, but it has been proven that infections with PKD suppress the immunological response, exposing the fish to secondary infections.

If this were so, one could say that the result of survival heritability obtained in this study would not really be related to surviving PKD but possibly any exist secondary diseases. Gjoen et al. (1997) say that daily mortality must be recorded on site together with the cause of death to establish a correlation later on. These investigators obtained a genetic correlation of 0.95 between the survival in the challenge test and on site. Later on, Odegard et al. (2006) evaluated different statistical models of survival for the challenge test of Pacific salmon with furunculosis. The different models were ranked according to their ability to predict the rate of family survival to an on site epizootic. The high correlation between the prediction of the family effect based on the challenge test and the rate of family survival on site for all of its models indicated the existence of a close relation between survival on site and the challenge test. All the models included in the analysis had good results regarding the ability of predicting survival. However, the lineal longitudinal test-day model for survival was the one which obtained the best prediction result.



The following year, the same team of investigators (Odegard et al. 2007) reestimated the variance components for survival in challenge test with resistance to the ISA virus. To attain this objective, they compared different statistical models with respect to their ability to predict in a precise way the rate of survival of the following generation. The models of this study are similar to the models studied by the same authors when they made test with furunculosis (Odegard et al., 2006). The greatest difference lies in that on this occasion no site data are taken into account, but only the challenge tests. The survival heritabilities for ISA using the cross-sectional models were significantly higher than those obtained with the test-day models. The LINT model (test-day), for instance, obtained a heritability of 0.01. However, with the LOGT model (test-day) a substantially larger heritability of 0.16 was estimated. The same as with Dinh (2005), Gitterle et al. (2006), and Odegard et al. (2006), the predictive ability of the test-day models was comparatively better than the cross-sectional ones. The test-day models consider time until death from the inoculation of the individuals in the challenge test. Based on the correlation between the survival rate of the EBV offspring and parents, the test-day models have an opportunity to improve their genetic gain up to 12% compared to the traditionally used LIN model. The relative gain by using test-day models versus cross-sectional models found in their study is somewhat higher than the corresponding results for furunculosis in Atlantic salmon (7%) (Odegard et al., 2006).

#### **6.4. Finding QTLs**

QTLs may be identified by scanning the genome in which the segregation of a large number of markers, distributed throughout the complete genome, is tested for its association with the recorded phenotype. Ideally, the markers must be codominant and

with high heterozygosity. Microsatellite markers meet all these criteria and are considered by many as the most adequate markers to investigate QTL. However, as has been mentioned in the introduction of this Thesis, despite the efforts of important research groups, the maps of aquatic species are in a partial state of development and a higher level of coverage or saturation with markers in the chromosomes of the different species is still needed (Jackson et al. 1998; Ozaqui et al. 2001; Iturra, 2005).

#### **6.4.1 Anonymous molecular markers**

Due to this low development of genetic maps in fish farming, an alternative strategy for scanning the genome consists of using markers which may be developed with or without previous knowledge of the DNA sequence of the marked region (Dodgson & col., 1997). Anonymous markers are any non coding molecular phenotype which shows polymorphism and segregates in a Mendelian manner (Ferreira & Grattapaglia, 1995). Two anonymous markers which have been used in fish species may be mentioned: RAPD and AFLP.

The RAPD technique has been successful in detecting high levels of genetic variation in a great number of animal and plant species (Carlson et al., 1991; Klein-Lankhorst et al.,1991; Garcia & Benzie, 1995). These RAPD polymorphisms have been used to build single sequence genetic markers or SCAR (Sequence Characterized Amplified Region; Param & Michelmore, 1993), which have been associated with various complex phenotypes, such as resistance to diseases (Michelmore et al. 1991; Horvath et al., 1995; Deng et al.,1997; Marczewski et al., 2001) or with productive traits (Yang & Quiros, 1993) in animals and plants. Moreover, the RAPD is a quick, cheap and easy method for its application on a large number of individuals (Hoelzel &

Green, 1992; Cushwa & Medrano, 1996) Markers called AFLP are the ones most commonly used. They are known for their high replicability and several markers may be genotyped at the same time.

#### **6.4.2 Work that has been done to find markers associated with resistance to diseases and flesh colour**

There is at present a great amount of information about molecular genetic methods which permit identifying loci which affect quantitative traits. The theoretical studies and statistical methods developed for this purpose largely exceed the experimental work carried out in this area (Taylor & Rocha, 1997). There are two types of goals in the search for molecular markers linked or associated with loci which affect quantitative traits.

The first method consists in identifying the relative position of quantitative genetic loci or chromosome region by saturating that chromosome region with molecular markers. To achieve this, segregation analysis on F<sub>2</sub> generations and back crosses have been used derived from crosses performed between inbred lines which differ in quantitative phenotypes, or of crosses between populations artificially selected in a divergent manner for the trait being studied for a large number of generations (Corva & Medrano, 2001). The procedure is based on the statistical simultaneous analysis of several molecular markers to determine the position of the locus which affects the quantitative trait. The methods are those of least squares or maximum likelihood (Tanskley, 1993). This approach requires a genetic map saturated with molecular markers in the regions where the presumed interest locus is situated.

As an example of this method, one could mention the recent work of Houston et al. (2008), whose purpose was to use the large amount of available data and samples from the challenge tests to the on site IPN disease outbreak, combining with a specific strategy the salmons for a genome-wide scan with molecular markers to detect QTL which affect the resistance to IPN in a marine stage in a commercial population of Atlantic salmon. The heritability of resistance in the marine stage of the disease has been estimated from on site challenges to be approximately 0.4, which is a higher heritability than that typically associated with a trait of resistance to disease (Guy et al. 2006). For this purpose, dead fish were selected from the water between 5-12 weeks after their transfer and a veterinary inspection confirmed that the deaths during this period were due to IPN. A random selection of live fish was also done. 10 families of full siblings were chosen. A total amount of 584 sons were chosen with an equally approximate number of mortality and survivors. Then a genome-wide scan for QTL was performed by them of the 10 families of full siblings who received a natural seawater IPN challenge. Their method consisted in using the great difference of genetic recombination between the male and female Atlantic salmon, a two-stage mapping strategy. Initially, a QTL based on the sire was used to detect groups linked with significant effect in resistance to IPN, using from two to three microsatellites per linked group. Then an analysis based on the dam was performed with additional markers to confirm and position any QTL detected. Finally, they concluded that two significant QTLs of the genome-wide scan and a suggestive QTL had been detected in the scan. The most significant QTL was mapped to the linked group 21, and was significant at a genome-wide level in the analysis based both on the sire and dam. Unfortunately, the number of currently available markers limits the possibility of a more precise mapping of QTL in Atlantic salmon, therefore the development of

additional markers in the QTL region should be an important future aim. Comparative mapping and extrapolation of the available genetic physical map (Ng et al. 2005) could facilitate the identification of future markers or candidate genes in the QTL regions of Atlantic salmon. These additional markers, together with the analysis of population challenges to IPN, will be crucial for improving QTL mapping (Houston et al. 2008).

The second method is tracing a molecular marker which co-segregates with a phenotype of interest and which it is possible to use for discriminating between individuals of contrasting phenotypes. The strategy consists in identifying in a population two subgroups of individuals which represent the most extreme phenotypes for the trait being studied, limiting the search of markers in these individuals (Lander & Botstein, 1989). This “selective genotyping” approach presumes that extreme phenotypical individuals are genetically more “informative” than individuals situated in the mean population, as there is a higher probability that they are carriers of a larger proportion of “alleles which increase or reduce the value” of a quantitative trait (Darvasi & Soller, 1992). A way of applying the strategy with a large number of molecular markers is to perform the analyses using joint DNA samples (DNA pools) of several individuals belonging to each extreme phenotype (“selective DNA pooling”; Darvasi & Soller, 1994). The conceptual basis of the use of pool samples is that the polymorphisms correlated with the genetic determinants of a phenotype are more frequently present in the joint DNA samples of the individuals which express this phenotype, when compared with a pool obtained from individuals who do not express said trait (Arnheim et al., 1985). Simulation studies indicate that

when the size of the population is of more than 1,000 individuals, the probability of finding extreme phenotypical individuals is very high (Van Gested et al., 2000).

Therefore, the strategy of “selective DNA pooling” (Darvasi & Soller, 1994) is adequate for identifying association between RAPD markers and different traits in salmon species. Another approach to this method is the one which Araneda et al. (2005) propose in their study “Identification of a dominant SCAR marker associated with colour traits in Coho salmon (*Oncorhynchus kisutch*)”. They used an approach to identify RAPD markers (Welsh and McClelland, 1990; Williams et al., 1990) associated with the genetic determinants of flesh colour in Coho salmon (*Oncorhynchus kisutch*). The experimental method combined the use of predicted breeding values (PBV) in a strategy of selective DNA pooling (sensu Darvasi and Soller, 1992, 1994). Finally, they converted the RAPD marker that showed a significant association with colour traits into a dominant single locus SCAR marker (Paran and Michelmore, 1993), which has potential applications in breeding programs for genetic improvement. This approach is novel in the use of the PBV for colour instead of the individual phenotype to associate it with a particular DNA marker, as is usually done. The phenotype is used assuming that phenotypic differences between individuals are good predictors of genotypic differences, which is indeed true for quantitative traits of high heritabilities. For a low heritability trait such as flesh colour, their proposition is that if one is searching for DNA marker associated with this trait it will be more efficient to use a PVB as a BLUP estimate, instead of the individual phenotype. As a conclusion they infer that Oki206 co-segregates with one or more loci with an important contribution to breeding values for flesh colour. Nevertheless, the amplification of Oki206 was not always positive in individuals from the high

breeding value group; a small proportion of salmon did not amplify this SCAR. This result is not unexpected, due to the nature of the polygenic architecture of quantitative traits. In this way, it is possible that some individuals may have a high flesh colour score due to alleles at other loci influencing this trait and it does not present co-segregation with the marker, as has been shown in some individuals. However, their data suggest the presence of a QTL co-segregating with Oki206, although the evidence of this association needs to be confirmed with a linkage study or with a co-selection study in other hatchery populations.

Another method is the one proposed by Moen et al (2004). These investigators proposed a strategy for finding a QTL which affects the resistance to ISA, using markers of the AFLP type. It is based on two statistical methods, the Transmission Disequilibrium Test (TDT) and the survival analysis.

The first method, the TDT test, was proposed by Spielman et al. (1993) as an association test based on family data to verify the presence of genetic linkage between a genetic marker and a trait. For this end, one compares the number of times an allelic marker is transmitted or not transmitted from a heterozygous parent to an affected offspring, and therefore, only the affected offspring are taken into consideration. The specificity of the TDT test is that it detects genetic linkage only in the presence of genetic association. While the genetic association may be caused by the structure of the population, the genetic linkage will not be affected, making the TDT test robust to the presence of population structure.

The second method, the survival analysis (Altman 1991), has been amply used in human medicine to perform medical treatment tests. A data which could be of clinic or scientific importance is the time, measured from an appropriate origin, which elapses before the event occurs. It is this amount which is known as survival time, or in some contexts, fault time. Said time is either a continuous variable or it may be treated as continuous for all practical purposes. However, special methods are needed to analyze these data on account of two reasons: the first one, an empirical reason and the second, a structural reason. Survival analysis are expected to be more powerful than TDT tests, since the variables used are the time of survival of each animal instead of the characteristic “susceptibility/resistance”. As we have already mentioned, quantitative genetics is also considering the time of survival variable as better predictions can be obtained with it.

The test stages of this study were the following ones: (1) the dead fish from the challenge test were genotyped with AFLP markers and the data analyzed with the TDT analysis; (2) the resistant fish were genotyped with the significant markers of the first stage, and then a Mendelian segregation test was performed; (3) all the significant markers to the TDT test with a Mendelian segregation were analyzed using a survival analysis. The strategy enables one to perform a genome scan in a faster and cost-effective way. The need to perform a multiple test is a general problem in a genome-wide test for QTL. The proposed strategy alleviates the problem by greatly reducing the number of tests performed in the survival analysis. Finally, with the method proposed, two putative QTLs were found which affected the resistance to ISA. A first crude analysis of the QTL segregation shows that they were linked. The general conclusion of this study is that the QTL which affects resistance to diseases



may be detected in species with non-available genetic maps. This means a shorter path compared with the QTL mapping strategy that is being used in land animals. Finally, the strategy of multiple stages QTL is potentially more powerful than genome-wide conventional scans where very high thresholds must be placed for testing a great number of genetic markers. (Moen et al, 2004).

## **6.5. Marker Assisted Selection (MAS)**

According to Nguyen et al (2006), based on linked markers published for aquaculture species in the literature, there are two possible uses of Marker Assisted Selection (MAS): in cross populations between inbred lines, and within strains (Dekkers 2004). For each of these methods, three strategies can be employed, namely: 1) Selection on Estimated Breeding Values (EBV) derived from markers alone (MAS), 2) Selection on markers-based EBV first and then on polygenic EBV, and 3) Index selection combining both QTL-EBV and polygenic- EBV (COMB).

*MAS for crosses between inbred lines:* For aquaculture species, inbred lines are seldom available and when they are, they have very low fitness. Hence, at present, this approach is not of practical value in aquatic animal improvement programs.

*MAS within strains:* This method has potential of selection for traits that are measured on slaughtered animals (flesh quality) or traits that are recorded in only one sex (sexual maturity in female). The efficiency of MAS within strain is largely dependent on heritability of the interested traits, size of QTL effects and recombination rate, increasing for lowly heritable traits and with the proportion of the variance explained by the QTL (Meuwissen and Goddard 1996). The advantage of MAS selection, however, decreases over generations due to fixation of QTL and loss in polygenic response. Despite high efficiency expected from theoretical prediction (2 to 60%), this

method of selection requires extensive recording of both phenotypic and genotypic data for several generations prior to selection in order to accurately estimate QTL effects. In addition, prior knowledge of QTL regions that segregate within the population limits its application to the currently existing breeding programs in tilapia or carps because QTL mapping studies need to be conducted prior to implementation of MAS (Nguyen et al, 2006).

### **6.5.1 Limitations to the application of genetic and reproductive technologies in genetic improvement programs**

At this stage of development in molecular genetics, two major issues that limit application of genetic markers are as follows:

*Technical issues:* There has been a lack of high resolution linkage maps in most of the aquaculture species. The efficiency of MAS is low if markers are located far from the target gene. Even when molecular markers are closely mapped, false positive detection of marker and gene association also results in low efficiency of MAS. The technology should be used only when there is a tight linkage between markers and the gene of interest. Experiences in both plant and animals indicate that MAS is successful with traits controlled by single gene with major effects, but little progress has been made with traits controlled by multiple genes. This creates a need to develop new generation markers (e.g. SNP), physical and comparative maps, and to integrate them into linkage maps to increase the ability to identify functional mutations or candidate genes in aquaculture species (Nguyen et al, 2006).

*Costs of MAS:* Although there are currently various molecular markers of the microsatellite kind associated with loci that affect complex phenotypes in salmon as

resistance/susceptibility to viral diseases (Ozaki et al., 2001) or spawning season in rainbow trout (Sakamoto et al., 1999), no programs of “Marker Assisted Selection” (MAS) have been implemented, mainly due to the increase in cost and complications in the animal handling the incorporation of these markers would imply. At various stages of MAS development, areas that represent large costs include laboratory equipment, consumables, infrastructure, marker development, genotyping, data recording and labour. The question of whether these costs can be compensated by economic returns from genetic gain using MAS still remains open (Nguyen et al, 2006). When using molecular markers in selection programs, it is expected that they may accelerate the response to the selection in a short term, a progress which can also be obtained in the long-term with traditional selection methods without using markers (Kuhn et al., 1997). From this point of view, MAS use is only justified in traits which are hard to assess, heritability of medium to low magnitude and for those that have not been previously selected (Smith & Simpson, 1986).

In addition, several constraints and limitations for the application of molecular genetic information include intellectual property rights, joint research collaborations among international institutions, the lack of manpower, and research funding (Nguyen et al, 2006).

From the aforesaid, we may infer that it is possible to find a QTL which affects the resistance to the previously mentioned parasite (agent causing the PKD) and its later use in the MAS method. For this purpose, I consider that the best method would be to perform a challenge test with this parasite and consider the time of death. One should take care that said parasite does not coevolve due to the resistance of the trout, thus

reducing its virulence level. Then the analysis to find the QTL should be done in the most cost-efficient way which apparently would be by using anonymous markers. To perform this, tissue samples from the contrasting phenotypes would be needed.

## **6.6. Considerations of a dialogue with the salmon aquaculture industry**

In the context of the dialogue initiated in February 2004 by the WWF US with the Salmon Aquaculture Industry, Tacon (2008) submitted a report called “State of information on Salmon Aquaculture feed and the environment”. The goal of the Dialogue is to engage stakeholders in a constructive dialogue to define environmentally, socially, and economically sustainable salmon farming, develop performance-based and verifiable standards, and foster their implementation. One of the main points of this report was:

- Trends in volume of feed produced and used in salmon aquaculture: An Overview of total global use of fishmeal & fish oil

Total world production of farmed salmon and marine-brackish water reared rainbow trout in 2003 was 1,464,289 tonnes (FAO, 2005a), including Atlantic salmon 76.1%, rainbow trout 13.3%, Coho salmon 7.2%, and Chinook salmon 1.5%. In global terms, salmon feeds represent only 8.4% of total compound aquafeed production by weight in 2003, with aquaculture in turn representing about 3% of total global industrial animal feed production in 2004.

At present over two thirds of salmon feeds by weight are composed of two marine feed ingredients, namely fishmeal and fish oil. The latest global estimate from the International Fishmeal and Fish Oil Organisation (IFFO), shows that the use of fishmeal and fish oil within aquaculture and animal feeds currently stands at 46% in the case of fishmeal usage and 81% in the case of fish oil. As is seen from this data, the aquaculture sector is currently heavily dependent upon the use of fishmeal and fish oil within compound aquafeeds. In particular the dependency upon fishmeal and fish oil is particularly strong for those higher value species feeding high on the aquatic food chain, including all carnivorous finfish species, and to a lesser extent, most omnivorous/scavenging crustacean species.

Since between 50 and 75% of commercial salmon feeds are currently composed of fishmeal and fish oil it follows that any price increases in these finite commodities will have a significant effect on feed price and farm profitability; salmon feeds and feeding representing between 60 to 70% of total farm production costs. The above is particularly critical in view of the general trend toward decreasing farm salmon prices (due to increased farmed salmon production and market supply) and increases in feed ingredient prices due to increased market demand and competition (Tacon, 2008).

- Fish landings destined for reduction and status of exploitation of major reduction fisheries

The quantities of landed fish and shellfish from capture fisheries destined for reduction into meals and oils and other non-food purposes has increased over seven-fold from 3 million tonnes in 1950 (representing 16.1% total capture fisheries landings) to 21.37 million tonnes in 2003 or 23.4% total capture fisheries

landings (FAO, 2005a). With the exception of the El Nino year of 1998, the proportion of the fisheries catch (whole fish) destined for reduction into fishmeal and fish oil has fluctuated between 20 and 30 million tonnes.

Information concerning the global state of exploitation of wild fish stocks is only currently available for about 80% of total capture fisheries landings (FAO, 2005b). According to the review, an estimated over 52% of the world fish stocks are considered as being fully exploited, and as such, are producing catches that are already at, or very close to, their maximum sustainable production limit, with no room for further expansion, and with some risk of decline if not properly managed. From the remaining, approximately 17% are over-exploited, 7% depleted and 1% recovering, and thus offer no room for further expansion. In the case of the major pelagic reduction fisheries, a combination of heavy fishing pressure and severe adverse environmental conditions associated with changes in the El Nino Southern Oscillation have recently led to a sharp decline in the three most abundant pelagic species in the southeast Pacific, the Peruvian anchoveta, the South American pilchard and the Chilean jack mackerel. In the northwest Pacific large changes in the abundance of Japanese pilchard, Japanese anchovy and Alaska Pollock have also occurred in response to heavy fishing and to natural decadal oscillations. This alternation of stocks follows a pattern also observed in other regions of the world that seem to be mainly governed by climatic regimes affecting stock distribution and overall fish abundance (Tacon, 2008).

Ewos S.A. (2006), in a technical report about the conversion rate in the salmon farming industry at the same meeting, explained that the limited availability of this

Fish Flour (FF) and Fish Oil (FO) resource, its high price and the principle of economic and environmental sustainability of the industry, have led that replacement of FF in salmon diets by other alternative protein ingredients have been accelerated in the last years. As an example, in 2000, the FF level used in the salmon diets was on average over 50% of the portion. Therefore, reduction in the levels of FF in the last 5 years has been substantial, which has been obtained thanks to a maintained effort on resources for investigation from food producing companies and research centres both in the main salmonids producing countries.

One of the goals of EWOS company, in a two to three year term is to reduce FF levels to 10% of the diet and in a 6 year term, to lower them to about 0%. Nevertheless, the level and depth of the investigation required to reduce FF in the fish diets to these levels will demand an even greater economic effort in scientific research. This is because these changes in the diet formulas must be made without harming the productive efficiency, the well-being, and nutritional and sanitary quality of fish. For this, important resources in areas such as nutrition, biotechnology, new technological processes for food production, nutritional and vegetal genomics, among others, are being invested to allow the inclusion of a greater level of protein sources from vegetal and land animal origin in the fish diets.

Among ingredients that have been used in the last years to replace FF and those that will become more relevant in the years ahead, soybean, lupine, canola, peas, sunflowers, corn gluten and wheat gluten, proteins from poultry, bioproteins, etc. are included. Among vegetables, some protein concentrates with high digestibility, as well as value added flours of animal origin will acquire greater importance. The future

incorporation level of this type of inputs will be increased, taking advantage of the carnivorous nature of salmonids.

With respect to the replacement of Fish Oil (FO), the investigation available nowadays allows to conclude that this input can be replaced by 50% by vegetal oils without affecting the productive fish performance, their well-being or nutritional quality. Some vegetal oils rich in vegetal Omega-3 Fatty Acids (FAs) allow to replace part of FO, but not the totality.

Unfortunately, there are no other abundant and commercially available sources of these FAs nowadays, apart from fish oil. Nevertheless, we count on very encouraging scientific advances in the development of vegetal seeds, yeasts and other FAs being able to generate and to turn themselves into EPA and DHA, which will allow in the future a lower dependence from FAs in the salmonids diets.

In relation to conversion rates, the main reasons for the improvement in the conversion efficiency is the development of technological processes for salmonid food production, that allowed the transition from a pelletized to extruded food in the last decade. This development has had a tremendous environmental and economic impact when reducing food losses significantly. It is also possible to mention that if we compare the conversion rate of food into salmon flesh (1.35) with other productive species such as poultry (1.85), pigs (2.7) and bovine (> 7.0), one can conclude that salmons are far more efficient in this process. In conclusion, sustainability of the fishing resources and the salmon industry from the feeding view point are being



addressed by food producers and the scientific world in a serious and responsible way (Ewos, 2006).

Thus one of the main conclusions which concerns us in Tacon's (2008) report are:

- Current dependence of the salmonid aquaculture and salmonid feeds upon fishmeal and fish oil and the need to reduce this dependency for the long term sustainability of the salmonid aquaculture sector;
- Current ability of the feed manufacturing sector to reduce up to 70% and 50% of the fishmeal and fish oil content of salmon feeds with alternative more sustainable dietary protein and lipid sources, respectively;
- Absence of agreed standards and criteria for assessing the sustainability of reduction fisheries.

Thus, a vertical and horizontal integration of the project should be considered, meaning a joint venture with different innovative companies that develop, for example, new food products and new vaccine development. As was mentioned in the dialogue "State of information on Salmon Aquaculture feed and the environment", food production companies have to develop new feeding products for salmonids reducing the amount of fishmeal, changing them for other animal and vegetal proteins, and they also need to change fish oil for vegetal oil, or yeast oil, or microalgae oil. All this must be done in a progressive way until these ingredients are reduced to a minimum without affecting the health and quality of the fish. This assessment of food change could be carried out within the context of a genetic improvement program similar to the one of the present study, as it would only require making comparisons between the growth rates with the different foods. Likewise, the

sanitary part would have to be reviewed to assess whether there is no reduction of the immunological system and that is the reason why another company which develops vaccines would have to be included.

The vaccine development companies should make challenge tests to quantify the quality of their vaccine. The genetic improvement programme could provide the rainbow trout that the companies need for their challenge test. Thus, giving pathogen resistant data that could be genetically correlated to the fish farm commercial production and also giving the possibility to find more QTLs. Generally, the vaccines do not protect 100 % of the population. Let's suppose a vaccine that protects 80 % of the population and the company decides not to further improve the vaccine because it is not economically viable. Then the vaccine and the genetic resistant selected rainbow trout could be combined, and improve up to a total protection of the population. This strategic merge could significantly increase the sales of the vaccine development company.

#### **6.6.1 Sustainability of reduction fisheries and criteria used: What can we expect for aquaculture food product?**

To date the criteria used by fisheries biologists, fisheries economists and fishery policy makers to determine the sustainability of specific reduction fisheries has been mainly based upon variations in reported landed stock biomass (usually on a traditional single species basis), fishing capacity and effort, and concerning the existence and implementation of adequate fisheries management regimes so as to ensure that the landings of the target species are kept within agreed safe biological limits (Bjørndal et al. 2004; FIN, 2005; SEAFEEDS, 2003; Yndestad & Stene, 2002).

However, at present little or no consideration is usually given within the sustainability criteria used toward the consideration of wider ecosystem implications such as trophic interactions, habitat destruction, and potential social, economic and environmental benefits and risks (Bogstad & Gjosaeter, 2001; Carscadden et al. 2001; Dalsgaard et al. 1995; FAO, 1999; Folke et al. 1998; Furness, 2002; Huntington, 2004; Huntington et al. 2004; Jeroen et al. 1999; Lankester, 2005; Murawski, 2000; Pimentala, 2001; Royal Commission on Environmental Pollution, 2004; Tuominen & Esmark, 2003; University of Newcastle upon Tyne/Poseidon Aquatic Resource Management Ltd, 2004).

Is there sufficient research on the sustainability of reduction fisheries to certify them? As mentioned previously, this will depend upon the definition of sustainability employed and criteria and indicators used for the certification of the reduction fishery. For example, Huntington (2004a) was unable to ascertain the sustainability of selected reduction fisheries based upon the modified 'Sustainable Fishing' principles and criteria of the Marine Stewardship Council (MSC). At present there are no 'certified' wild reduction fisheries available for sourcing fish for fishmeal and fish oil manufacture. The leading role of FAO, the International Council for the Exploration of the Sea (ICES) and non-government organizations such as MSC in the future development of internationally recognized and accepted criteria for ascertaining the sustainability of reduction fisheries is paramount (Tacon, 2008).

Clearly, it follows from the above discussion that if wider ecosystem and socio-economic factors are to be taken into consideration into revised and more broader ecologically-based sustainability assessments of reduction fisheries, then new revised

definitions, principles and criteria will have to be developed (Huntington, 2004; Huntington et al. 2004; Lankester, 2005; SEAFEEDS, 2003). However, such principles and criteria will have to be crafted and implementable under real world conditions (with the participation of all major fishery stake holders) and due consideration given toward the special needs, requirements and capabilities of developing countries when ever possible (Tacon, 2008).

Therefore, according to this rationale, how will we be able to certify that our fish proceeding from fish farms are produced in a sustainable manner if our main input, fishmeal and fish oil, do not have a sustainability certification? There is undoubtedly some progress which could be done for a start, as for instance, quantifying the socioeconomic impact of fish farming, so that other countries which are less developed than the United Kingdom, such as Chile, may have a reference.

## REFERENCE LIST

- Alderman, D. and Feist, S. (1985). Exophiala infection of kidney of rainbow trout recovering from proliferative kidney disease. *Transactions of the British Mycology Society* , 84, 157-185.
- Allendorf, F. and Phelps, S. (1981). Isozymes and the preservation of genetic variation in salmonid fishes. *Ecol. Bull. (Stockholm)* , 34, 37-52.
- Allendorf, F. and Utter, R. (1979). Population genetics. En D. R. W.S. Hoar, *Fish Physiology* (pages. pp. 407-454). NY: Vol. 8. Academic Press, New York.
- Allendorf, F. and Phelps, S. (1980). Loss of genetic variation in a hatchery stock of cutthroat trout. *Trans. Am. Fish. Soc.* , 109, 537-543.
- Allendorf, F. and Ryman, F. (1987). Genetic Management of Hatchery stocks. En N. a. Ryman, *Population genetic and fishery management* (pages. 141-143). Seattle: University of Washington Press.
- Altman, D. (1991). *Practical Statistics for Medical Research*. London: Chapman & Hall.
- Amos, W. Hoffman, I. Frodsham, A. Zhang, L. Best, S. Hill, V. (2007). Automated binning of microsatellite alleles: problems and solutions. *Molecular Ecology Notes.* , 7, 10-14.
- Ando, S. Takeyama, T. Hatano, M. and Zama, K. (1985). Carotenoid-carrying lipoproteins in the serum of chum salmon (*Oncorhynchus keta*) associated with migration. *Agricultural Biological Chemistry* , 49, 2185-2187.
- Araneda, C. (2003). Variacion fenotipica, genetica y molecular asociada a la pigmentacion de la carne en salmon coho. *PhD. Thesis* .
- Araneda, C. (2005). Marcadores geneticos basados en PCR. En N. A. Díaz, *El uso de marcadores geneticos moleculares en el mejoramiento genetico de peces* (pages. 13-32). Santiago, Chile: Serie Publicaciones para la Acuicultura N° 4.
- Araneda, C. ( 2007). Apunte de marcadores moleculares. *Circular Departamento Producción Animal* . Santiago, Región Metropolitana, Chile: Universidad de Chile.
- Araneda, C. Neira, R. Iturra, P. (2005). Identification of a dominant SCAR marker associated with colour traits in Coho salmon (*Oncorhynchus kisutch*). *Aquaculture* , 247: 67-73.
- Arnheim, N. Strange, C. & H. Eirlich. (1985). Use of pooled DNA samples to detect linkage disequilibrium of polymorphic restriction fragments and human disease: studies of the HLA class II loci. *Proceedings of National Academy of Science USA* , 82:6970-6974.
- Bailey, J. (1986). Differential survival among full-sib Atlantic salmon (*Salmo salar*) families exposed to furunculosis. *Salmon Genetics Research Programme, Report Series No. 58* .
- Barnes, W. (1992). The fidelity of Taq polymerase catalyzing PCR is improved by an N-terminal deletion. *Gene* , 112, 29-35.
- Baynes, S. (1999). Fertilization procedures for use in all-female brood production. *Trout News* , 28, 23-25.

Behnke, R. (1979). *The native trouts of the genus Salmo of western North America. Monograph for U.S.D.A., Forest Service, Fish and Wildlife Service, and Bureau of Land Management.* Lakewood, CO.

Belkhir, K. Borsa, P. Chikhi, L. Raufaste, N. and Bonhomme, F. (1996). GENETIX 4.04, Logiciel sous Windows TM pour la genetique des populations. Laboratoire Genome, Populations, Interactions, CNRS UMR 5000,.

Bentzen, H. and Gjerde, B. (1994). Design of fish breeding programs. *Proceeding of the 5th World Congress on Genetics Applied to Livestock Production.*, (pages. 19, 353-359). Guelph, Canada.

Bentzen, P. Harris, A. and Wright, J. (1991). Cloning of hypervariable minisatellite and simple sequence microsatellite repeats for DNA fingerprinting of important aquacultural species of salmonids and tilapia. En T. D. Burke, *DNA Fingerprinting Approaches and Applications.* (pages. 243-262.). Basel, Switzerland: Birkhauser Verlag.

Bjerkeng, B. (2000). Carotenoid pigmentation of salmonid fishes - recent progress. En R.-M. D.-S.-N.-C. SCruz- Suarez L., *Avances en Nutrición Acuícola V.* Mérida, Yucatán.: Memorias del V Simposium Internacional de Nutrición Acuícola. 19-22 Noviembre, 2000.

Bjerkeng, B. Storebakken, T. and Liaaen-Jensen, S. (1990). Response to carotenoids by rainbow trout in the sea: reabsorption and metabolism of dietary astaxanthin and canthaxanthin. *Aquaculture* , 108, 333-346.

Bjørndal, T. Gordon, D. Kaitala, V. & M. Lindroos. (2004). International Management Strategies for a Straddling Fish Stock: A Bio-Economic Simulation Model of the Norwegian Spring-Spawning Herring Fishery. *Environmental and Resource Economics* , 29(4):435-457.

Bogstad, B. & H. Gjosaeter. (2001). Predation of cod (*Gadus morhua*) on capelin (*Mallotus villosus*) in the Barents Sea: implications for capelin stock assessment. *Fisheries Research* , 53(2):197-209.

Brannon, E. and Klontz, G. (1989). The Idaho aquaculture industry. *Northwest Environ. J.* , 5, 23-35.

Broussard, M. C. (1991). Aquaculture: Opportunities for the nineties. *Journal of Animal Science* , 69:4221-4228.

Brown, T. (1999). *Genomes.* USA: John Wiley & Sons Inc.

Bryden, C. Heath, J. and Heath, D. (2004). Performance and heterosis in farmed and wild Chinook salmon (*Oncorhynchus tshawytscha*) hybrid and purebred crosses. *Aquaculture* , 235, 249-261.

Busack, C. and Gall, G. (1980). Ancestry of artificially propagated California rainbow trout strains. *Calif. Fish Game* , 66, 17-24.

Busack, C. Halliburton, R. and Gall, G. (1979). Electrophoretic variation and differentiation in four strains of domesticated trout (*Salmo gairdneri*). *Can. J. Genet. Cytol.* , 21, 81-94.

Bye, V. and Lincoln, R. (1986). Commercial methods for the control of sexual maturation in rainbow trout (*Salmo gairdneri* R.). *Aquaculture* , 57, 299-309.

Byers, S. (1999).

[http://www.wto.int/spanish/thewto\\_s/minist\\_s/min99\\_s/spanish/state\\_s/d5187s.doc](http://www.wto.int/spanish/thewto_s/minist_s/min99_s/spanish/state_s/d5187s.doc).

Cameron, N. (1997). *Selection Indices and Prediction of Genetic Merit in Animal Breeding*. Oxon, UK.: CAB INTERNATIONAL.

Carlson, J. Tulsieram, L. Glaubitz, J. Luk, V. Kauffeldt, C. & R. Rutledge. (1991). Segregation of random amplified DNA markers in F1 progeny of conifers. . *Theoretical and Applied Genetics* , 83:194-200.

Carscadden, J Frank, K.T. & W.C. Leggett. (2001). Ecosystem changes and the effects on capelin (*Mallotus villosus*), a major forage species. . *Canadian Journal of Fisheries and Aquatic Sciences* , 58(1):73-85.

Castro, J. Bouza, C. Presa, P. Pino-Querido, A. Riaza, A. Ferreiro, L. Sanchez, L. Martinez, P. (2004). Potential sources of error in parentage assessment of turbot (*Scophthalmus maximus*) using microsatellite loci. *Aquaculture* , 242, 119-135.

Chakraborty, R. and Nei, M. 1977 Bottleneck effects on average heterozygosity and genetic distance with stepwise mutation models. *Evolution* 31: 347-356

Chevassus, B. and Dorson, M. (1990). Genetics of resistance to diseases in fish. *Aquaculture* , 85, 83-107.

Choubert, G. and Storebakken, T. (1989.). Dose response to astaxanthin and canthaxanthin pigmentation of rainbow trout fed various dietary carotenoid concentrations. . *Aquaculture* , 81, 69-77.

Choubert, G. Guillou, A. and Fauconneau, B. (1987). Absorption and fate of labeled canthaxanthin 15, 15<sup>3</sup>H<sub>2</sub> in rainbow trout (*Salmo gairdneri* Rich.). *Comparative Biochemistry and Physiology* , 87A, 717-720.

Choubert, G. Milicua, J. and Gomez, R. (1994a). The transport of astaxanthin in immature rainbow trout *Oncorhynchus mykiss* serum. . *Comparative Biochemistry and Physiology* , 108A, 245-248.

Choubert, G. Milicua, J. Gomez, R. Sance, S. Petit, H. Negre-Sadargues, G. Castillo, R. and Trilles, J. (1995). Utilization of carotenoids from various sources by rainbow trout: muscle colour, carotenoid digestibility and retention. *Aquaculture International* , 3, 205-216.

CIE. (1986). Colorimetry. Commission Internationale de l'Eclairage, publicación.

Corva, P. & J. Medrano. (2001). Quantitative trait loci(QTLs) mapping for growth traits in themouse: a review. *Genetics Selection Evolution* , 33:105-32.

Crandell, P. and Gall, G. (1993a.). The effect of sex on heritability estimates of body weight determined from data on individually tagged rainbow trout (*Oncorhynchus mykiss*). *Aquaculture* , 113, 47-55.

Crandell, P. and Gall, G. (1993b). The genetics of body weight and its effect on early maturity based on individually tagged rainbow trout (*Oncorhynchus mykiss*). *Aquaculture* , 117, 77-93.

- Cross, T. and King, J. (1983). Genetic effects of hatchery rearing in Atlantic salmon. *Aquaculture* , 33, 33-40.
- Cunningham, E. (1999). The application of biotechnologies to enhance animal production in different farming systems. *Livestock Production Science* , 58, 1-24.
- Cushwa, W. & J. Medrano. (1996). Applications of the random amplified polymorphic DNA (RAPD) assay for genetic analysis of livestock species. *Animal Biotechnology* , 7:11-31.
- Dalsgaard, J. Lightfoot, C. & V. Christensen. (1995). Towards quantification of ecological sustainability in farming systems analysis. *Ecological engineering* , 4:181-189.
- Danzmann, R. Ferguson, M. and Allendorf, F. (1989). Genetic variability and components of fitness in hatchery strains of rainbow trout. *J. Fish Biol.* , 35 (Suppl. A), 313-319.
- Danzmann, R. Ferguson, M. and Heculuck, D. (1994). Heterogeneity in the Distribution of Mitochondrial DNA Haplotypes in Female Rainbow Trout Spawning in Different Seasons. . *Can. J. Aquat. Sci.* , 51 (Suppl. 1), 284-289.
- Darvasi, A. & M. Soller. (1992). Selective genotyping for determination of linkage between a marker locus and quantitative trait locus. *Theoretical and Applied Genetics* , 85: 353-359.
- Darvasi, A. & M. Soller. (1994). Selective DNA pooling for determination of linkage between a molecular marker and a quantitative trait locus. *Genetics* , 138:1365-1373.
- Davis, G. and DeNise, S. (1998). The impact of Genetic Markers on Selection. *J. Anim. Sci.* , 76, 2331-2339.
- Dekkers, J. (2004). Commercial application of marker- and gene- assisted selection in livestock: strategies and lessons. *Jour. of Animal Science* , 82:313-328.
- Deng, Z. Huang, S. Xiao, S. & F. Gmitter. (1997). Development and characterization of SCAR marker linked to the citrus tristeza virus resistance gene *Poncirus trifoliata*. *Genome* , 40:697-704.
- Díaz, N. (2005). Marcadores genéticos moleculares. En N. A. Díaz, *El uso de Marcadores genético moleculares en el mejoramiento genético de peces* (pages. 4-12). Santiago, Chile.: Serie Publicaciones para la acuicultura N° 4.
- Dinh, H. (2005). *Genetic analysis of survival to furunculosis and ISA challenge test in Atlantic salmon*. Ås, Norway.: University of Life Sciences Master thesis.
- Dodgson J. Cheng, H. & Okimoto, R. (1997). DNA marker technology: A revolution in animal genetics. . *Poultry Science* , 76:1108-1114.
- Dollar, A. and Katz, M. . (1964). Rainbow trout brood stocks and strains in American hatcheries as factors in the occurrence of hepatoma. *Prog. Fish-Cult.* , 26, 167-174.
- Doyle, R. (1983). An approach to the quantitative analysis of domestication selection in aquaculture. *Aquaculture* , 33, 167-185.
- Duchesne, P. Godbout, M. Bernatchez, L. (2002). PAPA (package for the analysis of parental allocation): a computer program for simulated and real allocation. *Molecular Ecology Notes* , 2, 191-193.



- Dunham, R. and Liu, Z. (2003). Gene mapping, isolation and genetic improvement in catfish. En N. e. Shimizu, *Aquatic genomics: steps toward a great future*. (pages. 45-60). Tokyo: Springer-Verlag.
- Edwards, A. Civitello, A. Hammond, H. and Caskey, C. (1991). DNA typing and genetic mapping with trimeric and tetrameric tandem repeats. *American Journal of Human Genetics* , 49, 746-756.
- Edwards, D. (1978). *Salmon and Trout Farming in Norway*. Farnham, Surrey, England: Fishing News Books Limited.
- Einen, O. and Roem, A. . (1997). Dietary protein / energy ratios for Atlantic salmon in relation to fish size: growth, feed utilization and slaughter quality. *Aquaculture Nutrition* , 3, 115-126.
- Einen, O. and Skrede, G. (1998). Quality characteristics in raw and smoked fillets of Atlantic salmon, *Salmo salar*, fed high-energy diets. *Aquaculture Nutrition* , 4, 99-108.
- Ellegren, H. (2004). Microsatellites: simple sequences with complex evolution. *Nature Reviews Genetics* , 5, 435-445.
- Elvingson, P. and Johansson, K. (1993). Genetic and environmental components of variation in body traits of rainbow trout (*Oncorhynchus mykiss*) in relation to age. *Aquaculture* . , 118, 191-204.
- Estay, F. Cerisola, H. and Téllez, V. (1994). *Biología del desarrollo y reproducción artificial en la trucha arcoiris*. Santiago, Chile.: Serie Publicaciones para la Acuicultura N° 1.
- Estay, F. Diaz, N. Neira, R. and Fernandez, X. (1994). Analysis of reproductive performance in a rainbow trout hatchery in Chile. *Prog. Fish-Cult.* , 56, 244-249.
- Estay, C. Díaz, N. Valladares, B. Dazarola, M. (1995). *Manejo Reproductivo de Salmonidos*. Santiago, Chile.: Serie Publicaciones para la acuicultura N° 2.
- Estoup, A. Gharbi, K. SanCristobal, M. Chevalet, C. Haffray, P. and Guomard, R. (1998). Parentage assignment using microsatellites in turbot (*Scophthalmus maximus*) and rainbow trout (*Oncorhynchus mykiss*) hatchery populations. *Canadian journal of Fisheries and Aquatic Sciences* , 55, 715-725.
- Estoup, A. Largiader, C. Perrot, E. and Chourrout, D. . (1996). Rapid one-tube DNA extraction for reliable PCR detection of fish polymorphic markers and transgenes. *Molecular Marine Biology and Biotechnology* , 5 (4), 295-298.
- EWOS, S. A. (2006). TECHNICAL REPORT: CONVERSION RATE IN THE SALMON FARMING INDUSTRY. *Aquaculture Dialogue with the Industry* , 2.
- Falconer, D. (1981). *Introduction to Quantitative genetics*. NY and London: Longman Inc., New York.
- Falconer, D. and Mackay T. (1996). *Introduction to Quantitative Genetics*. Essex, UK: Prentice-Hall.
- Fauconneau, B. Alami-Durante, H. Laroche, M. Marcel, J. Vallot, D. (1995). Growth and meat quality relations in carp. *Aquaculture* , 129: 265-297.

FAO. (1999). Indicators for sustainable development. *FAO Technical Guidelines for Responsible Fisheries.* , No.8. Rome, FAO. 1999. 68p.

FAO. (2005a). *FAO Fisheries Department, Fishery Information, Data and Statistics Unit. Fishstat Plus: Universal software for fishery statistical time series. Aquaculture production: quantities 1950-2003, Aquaculture production: values 1984-2003;*. Capture production: 1950-2003; Commodities production and trade: 1950-2003; Total production: 1970-2003, Vers. 2.30.

FAO. (2005b). Review of the state of world marine fishery resources. *FAO Technical Paper* , 457. Rome, FAO. 235p

Felsenstein, J. (1993). PHYLIP (Phylogeny Inference Package) version 3.5c. Distributed by the author. *Department of Genetics, University of Washington, Seattle.*

Ferguson, A. (1980). *Biochemical Systematics and Evolution.* Glasgow: Blackie & Son Limited.

Ferguson, A. Taggart, J. Prodohl, P. McMeel, O. Thompson, C. Stone, C. McGinnity, P. and Hynes, R. (1995). The application of molecular markers to the study and conservation of fish populations, with special reference to *Salmo*. *J. Fish Biol.* , 47 (Suppl. A), 103-126.

Ferguson, M. Danzmann, R. and Arndt, S. (1993). Mitochondrial DNA and allozyme variation in Ontario cultured rainbow trout spawning in different seasons. *Aquaculture* , 117, 237-259.

Ferguson, M. and Danzmann, R. (1998). Role of genetic markers in fisheries and aquaculture: useful tools or stamp collecting? *Canadian Journal of Fisheries and Aquatic Sciences* , 55, 1553-1563.

Ferreira, M. & Grattapaglia, D. (1995). *Introdução ao uso de marcadores moleculares em análise genética.* EMBRAPA/CENARGEN: 220 pp.

Ferreira, M. and Grattapaglia, D. (1998). *Introducción al uso de marcadores moleculares en análisis genético.* Brasilia, Brasil: Documento 20.

FIN. (2005). Annual review of the feed grade fish stocks used to produce fishmeal and fish oil for the UK market. *March 2005.* (<http://www.gafta.com/fin/finnews.html>) .

Fishback, A. Danzmann, R. Sakamoto, T. and Ferguson, M. (1999). Optimization of semi-automated microsatellite multiplex polymerase chain reaction systems for rainbow trout (*Oncorhynchus mykiss*). *Aquaculture* , 172, 247-254.

Fishback, A. Danzmann, R. and Ferguson, M. (2000). Microsatellite allelic heterogeneity among hatchery rainbow trout maturing in different seasons. *Journal of Fish Biology* , 57, 1367-1380.

Fishback, A. Danzmann, R. Ferguson, M. and Gibson, J. (2002). Estimates of genetic parameters and genotype by environment interactions for growth traits of rainbow trout (*Oncorhynchus mykiss*) as inferred using molecular pedigrees. *Aquaculture* , 206, 137-150.

Fjalestad, K. T. Gjedrem, T. Gjerde, B. (1993). Genetic improvement of disease resistance in fish: an overview. *Aquaculture* , 111, 65-74.

- Fjalestad, T. Jorgen, H. and Roed, K. (1996). Antibody response in Atlantic salmon (*Salmo salar*) against *Vibrio anguillarum* and *Vibrio salmonicida* O-antigens: Heritabilities, genetic correlations and correlations with survival. *Aquaculture* , 145, 77-89.
- Fleming, I. Agustsson, T. Finstad, B. Johnsson, J. and Bjornsson, B. (2002). Effects of domestication on growth physiology and endocrinology of Atlantic salmon (*Salmo salar*). . *Can. J. Fish. Aquat. Sci.* , 59, 1323-1330.
- Fleming, I. and Einum, S. (1997). Experimental tests of genetic divergence of farmed from wild Atlantic salmon due to domestication. *ICES J. Mar. Sci.* , 54, 1051-1063.
- Folke, C., Kautsky, N., Berg, H. , Jansson, A. & M. Troell. (1998). The ecological foot print concept for sustainable seafood production: a review. *Ecological applications* , 8(1):S63-S70.
- Foss, P. Storebakken, T. Austreng, E. and Liaaen-Jensen, H. (1987). Carotenoids in diets for salmonids. V. Pigmentation of rainbow trout and sea trout with astaxanthin and astaxanthin dipalmitate in comparison with canthaxanthin. *Aquaculture* , 65, 293-305.
- Friars, G. (1993). *Breeding Atlantic salmon*: . St Andrews, NB: A primer. ASF.
- Furness, R. (2002). Management implications of interactions between fisheries and sandeel-dependent seabirds and seals in the North Sea. *ICES Journal of Marine Science* , 59(2):261-269.
- Gall, G. and Crandell, P. (1992). The rainbow trout. *Aquaculture* , 100, 1-10.
- Gall, G. and Gross, S. (1978). Genetic studies of growth in domesticated rainbow trout. *Aquaculture* , 13, 225-234.
- Gall, G. and Huang, N. (1988). Heritability and Selection Schemes for Rainbow Trout: Body Weight. *Aquaculture* , 73, 43-56.
- Garcia, D. & J. Benzie. (1995). RAPD markers of potential use in panaeid prawn (*Penaeus monodon*) breeding programs. . *Aquaculture* , 130:137-444.
- Gitterle, T. Ødegård, J. Gjerde, B. Rye, M. Salte, R. (2006). Genetic parameters and accuracy of selection for resistance to White Spot Syndrome Virus (WSSV) in *Penaeus* (*Litopenaeus*) *vannamei* using different statistical models. *Aquaculture* , 251, 210–218.
- Gilbey, J. Verspoor, E. McLay, A. and Houlihan, D. (2004). A microsatellite linkage map for atlantic salmon (*Salmo salar*). *Animal genetics* , 35, 98-105.
- Gjedrem, T. (1975). Possibilities of genetic gains in salmonids. *Aquaculture* , 6, 23-29.
- Gjedrem, T. (1979). Selection for growth rate and domestication in Atlantic salmon. *Z. Tierz. Zuchtungsbiol* , 96 (1), 56-59.
- Gjedrem, T. (1983). Genetic variation in quantitative traits and selective breeding in fish and shellfish. *Aquaculture* , 33, 51-72.
- Gjedrem, T. (1997). Flesh quality improvement in fish through breeding. *Aquacult. Int.* , 5; 197 – 206.
- Gjedrem, T. (1997). Breeding to raise resistance. En E. M. Bernoth, *Furunculosis. Multidisciplinary Fish Disease Research*. San Diego: Academic Press.

- Gjedrem, T. (1997). *Selective breeding to improve aquaculture production*. Louisiana, USA: World Aquaculture Society
- Gjedrem, T. (1998). Developments in fish breeding and genetics. *Acta Agricultura Scandinavica Section A-animal Science* , 8, 19-26.
- Gjedrem, T. (2000). Genetic improvement of cold-water fish species. *Aquaculture research* , 31, 25-33.
- Gjedrem, T. and Aulstad, D. (1974). Selection experiments with salmon: I. Differences in resistance to vibrio disease of salmon parr (*Salmo salar*). *Aquaculture* , 3, 51-59.
- Gjedrem, T. Gjoen, H. (1995). Genetic variation in susceptibility of Atlantic salmon, *Salmo salar* L., to furunculosis, BKD and cold water vibriosis. *Aquaculture Research* , 26, 129-134.
- Gjedrem, T. Salte, R. Gjoen, H.M. (1991). Genetic variation in susceptibility of Atlantic salmon to furunculosis. *Aquaculture* , 97, 1-6.
- Gjerde, B. (1986). Growth to reproduction in fish and shellfish. *Aquaculture* , 57, 37-55.
- Gjerde, B. and Gjedrem, T. (1984). Estimates of phenotypic and genetic parameters for carcass traits in Atlantic salmon and rainbow trout. *Aquaculture* , 36, 97-110.
- Gjerde, B. and Korsvoll, S. (1999). Realized selection differentials for growth rate and early sexual maturity in Atlantic salmon. En L. L. Reinertsen, *Aquaculture Europe 99* (pages. 27, 73-74). Trondheim, Norway: Special publication.
- Gjerde, B. Roer, J. Lein, I. Stoss, J. and Refstie, T. (1997). Heritability for body weight in farmed turbot. *Aquaculture International* . , 5, 175-178.
- Gjerde, B. and Rye, M. (1998). Design of breeding Programmes in aquaculture species: Possibilities and constrains. *Proceeding of the Seminar of the CIHEAM Network on Technology of Aquaculture in the Mediterranean (TECAM)* (pages. Vol. 34, 181-192). Zaragoza, Spain: jointly organized by CIHEAM and FAO.
- Gjerde, B. & Schaeffer, R. (1989). Body traits in rainbow trout II. Estimates of heritabilities and of phenotypic and genetic correlations. *Aquaculture* , 80:25-44.
- Gjerde, B. Terjesen, B. Barr, Y. Lein, I. and Thorland, I. (2004). Genetic variation for juvenile growth and survival in Atlantic cod (*Gadus morhua*). *Aquaculture* , 236, 167-177.
- Gjerde, B. Villanueva, B. and Bentsen, H. (2002). Opportunities and challenges in designin sustainable fish breeding programs. *Proceedings of the 7th World congress of Genetics Applied to Livestock Production.*, (pages. 06-01). Montpellier, France.
- Gjoen, H. and Bentsen, H. (1997). Past, present, and future of genetic improvement in salmon aquaculture. ICES. *Journal of Marine Sciences* , 54, 1009-1014.
- Gjoen, H. Refstie, T. Ulla, O. and Gjerde, B. (1997). Genetic correlations between survival of Atlantic salmon in challenge and field test. *Aquaculture* , 158, 277-288.

- Gold, J. (1977). Systematics of western North American trout (*Salmo*), with notes on the redband trout of Sheephaven Creek, California. *Can. J. Zool.* , 55, 1858-1873.
- Goudet, J. (1995). FSTAT v1.2 a computer program to calculate F-statistics. *Journal of Heredity* , 86, 485-486.
- Guillespie, J. (1998). *Population Genetics: A concise guide*. Baltimore and London: The Johns Hopkins University Press.
- Guy, D. Bishop, S. Brotherstone, S. Hamilton, A. Roberts, R. McAndrew, B. and J. Woolliams. (2006). Analysis of the incidence of infectious pancreatic necrosis mortality in pedigreed Atlantic salmon, *Salmo salar* L., populations. *J Fish Dis.* , 29: 637-647.
- Guyomard, R. (1981). Electrophoretic variation in four French populations of domesticated rainbow trout (*Salmo gairdneri*). *Can. J. Genet. Cytol.* , 23, 33-47.
- Hancock, H. (1999). Microsatellites and other simple sequences: genomic context and mutational mechanisms. En D. a. Goldstein, *Microsatellites evolution and applications* (pages. 1-6). New York: Oxford University Press.
- Hansen, M. Nielsen, E. Ruzzante, D. Bouza, C. and Mensberg, K. (2000). Genetic monitoring of supportive breeding in brown trout (*Salmo trutta* L.) using microsatellite DNA markers. *Canadian Journal of Fisheries and Aquatic Sciences* , 57, 2130-2139.
- Hara, M. and Sekino, M. . (2003). Efficient detection of parentage in a cultured Japanese flounder *Paralichthys olivaceus* using microsatellite DNA marker. *Aquaculture* , 217, 107-114.
- Hardy, R. (1988). Carotenoid pigmentation of salmonids. National Marine Fisheries Service. Washington: NOAA Northwest and Alaska Fisheries Center, Utilization Research Division. .
- Hardy, R. Torrissen, O. and Scott, T. (1990). Absorption and distribution of 14 C-labelled canthaxanthin in rainbow trout (*Oncorhynchus mykiss*). *Aquaculture* , 87, 331-340.
- Harris, D. and Newman, S. (1994). Breeding for Profit: Synergism Between Genetic Improvement and Livestock Production (A Review). *J. Anim. Sci.* , 72, 2178-2200.
- Hartl, D. and Clark, A. (1997). *Principles of Population Genetics*. Sunderland, Massachusetts.: 3 ed. Sinauer Associates, .
- Henegariu, O. Heerema, N. and Dlouhy, S. (1997). Multiplex PCR: critical parameters and step-by-step protocol. *Biotechniques* , 23 (3), 504-511.
- Henmi, H. Iwata, T. and Hata, M. (1987). Studies of the carotenoids in the muscle of salmon. I. Intracellular distribution of carotenoids in the muscle. *Tohoku Journal Agricultural Research* , 37, 101-111.
- Henryon, M. Jokumsen, A. Berg, P. Lund, I. Pedersen, P. Olesen, N. and Slierendrecht, W. (2002). Genetic variation for growth rate, feed conversion efficiency, and disease resistance exists within a farmed population of rainbow trout. *Aquaculture* , 209, 59-76.
- Herlin, M. Taggart, J. McAndrew, B. Penman, D. (2007). Parentage allocation in a complex situation: a large commercial Atlantic cod (*Gadus morhua*) mass spawning tank. *Aquaculture* , x, xxxx-xxxx.

- Hershberger, W. (1992). Genetic variability in rainbow trout populations. *Aquaculture* , 100, 51-71.
- Hershberger, W. Meyers, J. McAuley, W. and Saxton, A. (1990). Genetic changes in growth of coho salmon (*Oncorhynchus kisutch*) in marine netpens, produced by ten years of selection. *Aquaculture* , 85, 187-197.
- Hines, N. (1976). *Fish of Rare breeding*. Washington, DC: Smithsonian Institute Press.
- Hoelzel, A. & A. Green. (1992). Molecular genetic analysis of populations, A practical approach. En *Analysis of population-level variation by sequencing PCR-amplified DNA*. (pages. 159-186 pp.). Oxford: IRL Press, Oxford University Press.
- Hoffman, J. Amos, W. (2005). Microsatellite genotyping errors: detection approaches, common sources and consequences for paternal exclusion. *Molecular Ecology* , 14, 599-612.
- Holland, J. Gould, C. Jones, C. Noble, L. and Secombes, C. (2003). The expression of immune-regulatory genes in rainbow trout, *Oncorhynchus mykiss*, during a natural outbreak of proliferative kidney disease (PKD). *Parasitology* , 126, S95 - S102.
- Horvath, D. Dahlehn, L. Stebbing, J. & G. Penner. (1995). A co-dominant PCR-based marker for assisted selection of durable stem rust resistance in barley. *Crop Science* , 35:1445-1450.
- Houston, R. Haley, C. Hamilton, A. Guy, D. Tinch, A. Taggart, J. McAndrew, B. & S. Bishop. (2008). Major QTL affect resistance to Infection Pancreatic Necrosis in Atlantic Salmon (*Salmo salar*). *Genetics* , xxxx.
- Huntington, T. (2004). Feeding the fish: sustainable fish feed and Scottish aquaculture. . *Report to the Joint Marine Programme (Scottish Wildlife Trust and WWF Scotland) and RSPB Scotland. Poseidon Aquatic Resource Management Ltd* , Lymington, Hampshire, UK. August 2004.(<http://www.wwf.org.uk/filelibrary/pdf/feedingthefish.pdf>).
- Huntington, T., C. Frid, R. Banks, C. Scott & O. Paramor. (2004). Assessment of the sustainability of industrial fisheries producing fish meal and fish oil. *Report to the Royal Society for the Protection of Birds (RSPB). Poseidon Aquatic Resource Management Ltd, Lymington, Hampshire, UK.* , June 2004. ([http://www.rspb.org.uk/Images/fishmeal\\_tcm5-58613.pdf](http://www.rspb.org.uk/Images/fishmeal_tcm5-58613.pdf)).
- Iturra, P. (2005). Aplicaciones de marcadores geneticos en Acuicultura. En N. A. Díaz, *El uso de marcadores genetico moleculares en el mejoramiento genetico de peces* (pages. 33-41). Santiago, Chile: Serie Publicaciones para la Acuicultura N° 4.
- Iwamoto, R. Myers, J. and Hershberger, W. (1990). Heritability and genetic correlations for flesh coloration in Pen-Reared Coho Salmon. *Aquaculture* , 86, 181-190.
- Jackson, T. Ferguson, R. Danzmann, A. Fishback, A. Ihssen, E. et al. (1998). Identification of two QTL influencing upper temperature tolerance in three rainbow trout (*Oncorhynchus mykiss*) half-sib families. *Heredity* , 80: 143–151.
- James, M. (2006). Grass Roots Aquaculture R&D and importante notes for bean counters. *Finfish News* , 1, 29-34.
- James, M. (2005). Technology transfer- fact or fiction? *Trout News* , 39, 27-29.

- Jeffreys, A. Royle, N. Patel, I. Armour, J. MacCleod, A. Collick, A. Gray, I. Neumann, R. Gibbs, M. Crossier, M. Hill, M. Signer, E. and Monckton, D. (1991). Principles and recent advances in human DNA fingerprinting. En T. D. Burke, *DNA Fingerprinting Approaches and Application*. (pages. 1-19.). Basel, Switzerland: Birkhauser Verlag.
- Jeffreys, A. Wilson, V. Kelly, R. Taylor, B. and Bulfield, G. (1987). Mouse DNA "fingerprint" analysis of chromosome localization and germ-line stability of hypervariable loci in recombinant inbred strains. *Nucleic Acids Res.* , 15, 2823-2837.
- Jeroen, C.J.M., Bergh, van den & H. Verbruggen. (1999). Spatial sustainability, trade and indicators: an evaluation of the 'ecological footprint'. *Ecological economics*, , 29:61-72.
- Johnsson, J. Hojesjo, J. and Fleming, I. (2001). Behavioural and heart rate responses to predation risk in wild and domesticated Atlantic salmon. *Can. J. Fish. Aquat. Sci.* , 58, 788-794.
- Johnston, I. A. (1999). Muscle development and growth: potential implications for quality in fish. *Aquaculture* , 177:99-115.
- Jones, M. Danzmann, R. and Clay, D. (1997). Genetic relationships among populations of wild resident, and wild and hatchery anadromous brook charr. *Journal of Fish Biology* , 51, 29-40.
- Jones, A. Ardren, W. (2003). Methods of parentage analysis in natural populations. *Mol. Ecol.*, 12, 2511-2523.
- Johnson, N. Rexroad III, C. Hallerman, E. Vallejo, R. Palti, Y. (2007). Development and evaluation of a new microsatellite multiplex system for parental allocation and management of rainbow trout (*Oncorhynchus mykiss*) broodstocks. *Aquaculture* , 266, 53-62.
- Kallio-Nyberg, I. and Koljonen, M. (1997). The genetic consequence of hatchery-rearing on life-history traits of Atlantic salmon. *Aquaculture* , 153, 207-224.
- Kause, A. Ritola, O. Paananen, T. Mäntysaari, E. and Eskelinen, U. (2002). Coupling body weight and its composition: a quantitative genetic analysis in rainbow trout. *Aquaculture* , 211, 65-79.
- Kincaid, H. , Bridges, W. and Von Limbach, B. (1977). Three generations of selection for growth rate in fall spawning rainbow trout. *Transactions of the American Fish Society* , 106, 621-629.
- Kincaid, H. (1980). *Fish Breeding Manual*. Kearneysville: U.S. Fish and Wildlife Service National Fisheries Center.
- Kincaid, H. (1981). *Trout strain registry*. Kearneysville, WV: National Fisheries Center - Leetown, U.S. Fish and Wildlife Service.
- King, L. (1996). Use of colorimetric analysis to estimate salmonid flesh carotenoid content. *The Progressive Fish-Culturist* , 58:215-218.
- Kinghorn, B. (2006). Lessons from established breeding programs: terrestrial and aquatic animals. En R. B. Ponzoni, *Development of aquatic animal genetic improvement and dissemination programs: current status and action plans* (pág. 120p.). Malaysia: WorldFish Center Conference 73.

- Kinunen, W. and Moring, J. (1978). Origin and use of rainbow trout brood stocks. *Prog. Fish. Cult.* , 40, 87-89.
- Kitahara, T. (1984). Behavior of carotenoids in the chum salmon (*Oncorhynchus keta*) during anadromous migration. . *Comp. Biochem. Physiol.* ,76B, 97-101.
- Klein-Lankhost, R. Vermunt, A. Weide, R. Liharska, T. & Zabel, P. (1991). Isolation of molecular markers for tomato (*L. esculentum*) using random amplified polymorphic ADN (RAPD). *Theoretical and Applied Genetics* , 83:108-114.
- Klontz, G. Rourke, A. and Eckblad, W. (1986). The immune response during proliferative kidney disease in rainbow trout: a case history. *Veterinary Immunology and Immunopathology* , 12, 387-393.
- Klontz, G. (1978). *The Kamloops trout in commercial aquaculture*. Moscow, ID: Department of Fishery Resources, Wildlife and Range Science, University of Idaho, .
- Knibb, W. (2000). Genetic improvement of marine fish - which method for industry? *Aquac Res.* , 31 (1), 11-23.
- Kohler, H. Moore, M. and Wolfensohn, J. (16 de Mayo de 2002). [http://www.wto.org/spanish/news\\_s/news02\\_s/joint\\_note\\_oecd\\_16may02\\_s.htm](http://www.wto.org/spanish/news_s/news02_s/joint_note_oecd_16may02_s.htm).
- Koljonen, M. L. (1989). Electrophoretically detectable genetic variation in natural and hatchery stocks of Atlantic salmon in Finland. *Hereditas* , 110, 23-35.
- Kuhn, M. Fernando, R. & A. Freeman. . (1997). Response to mass versus quantitative trait locus selection under a infinite loci model. . *Journal of Dairy Science* , 80(Supplement 1):228.
- Lander, E. & D. Botstein. (1989). Mapping mendelian factors underlying quantitative traits using RFLP linkage maps. *Genetics* , 121: 185-199.
- Lankester, K. (2005). *Sustainability in the anchoveta fisheries in Peru: descriptive background document*. . Amsterdam, The Netherlands, 24p. (in press): Report to the Netherlands Committee for IUCN.
- Leary, R. Allendorf, F. and Knudsen, K. (1989). Genetic Differences among Rainbow Trout Spawn on Different Days within a Single Season. . *The Progressive Fish-Culturist* , 51, 10-19.
- Liu, Z. and Cordes, J. (2004). DNA marker technologies and their applications in aquaculture genetics. *Aquaculture* , 238, 1-37.
- Lopez-Fanjul, C. and Toro, M. (1989). *Mejora genética de peces y moluscos*. Madrid: Ediciones Mundi-Prensa.
- Lymbery, A. , Doupe, R. , Jenkins, G. and Thorne, T. (2000). Genetics in the aquaculture industry. *Aquaculture research* , 31, 1-2.
- Lynch, M. and Walsh, B. (1998). *Genetics and Analysis of Quantitative Traits*. . Sunderland, MA.: Sinauer Associates Inc.
- MacCrimmon, H. R. (1971). World distribution of rainbow trout (*Salmo gairdneri*). *J. Fish. Res. Board Can.* , 28, 663-704.



- Mahapatra, K., Gjerde, B., Reddy, P., Sahoo, M., Jana, R., Saha, J. and Rye, M. (2001). Tagging: on the use of passive integrated transponder (PIT) tags for the identification of fish. *Aquaculture Research* , 32, 47-50.
- March, B. & MacMillan, C. (1996). Muscle pigmentation and plasma concentrations of astaxanthin in rainbow trout, chinook salmon, and Atlantic salmon in response to different dietary levels of astaxanthin. *The Progressive Fish-Culturist* , 58:178-186.
- Marczewski, W. Flis, B. Syller, J. Schafer-Pregl, R. & C. Gebhardt. (2001). A major quantitative trait locus for resistance to Potato leafroll virus is located in a resistance hotspot on potato chromosome XI and is tightly linked to N-gene-like markers. *Mol. Plant. Microbe Interact* , 14:1420-15255.
- Marshall, T. Slate, J. Kruuk, L. Pemberton, J. (1998). Statistical confidence for likelihood-based paternity inference in natural populations. *Molecular Ecology* , 7, 639-655.
- McAndrew, B. (2002). Selective improvement of rainbow trout. *Trout News* , 33, 33-34.
- McKay, L.R. Ihssen, P.E. and Friars, G.W. (1986). Genetic parameters of growth in rainbow trout, *Salmo gairdneri*, prior to maturation. . *Canadian Journal of Genetics and cytology* , 28, 306-312.
- Meager, T. Thompson, E. (1986). The relationship between single and parent pair genetic likelihoods in genealogy reconstruction. *Theor. Popul. Biol.* , 29, 87-106.
- Meffe, G. (1987). Conserving fish genomes: philosophies and practices. . *Environ. Biol. Fishes.* , 18, 3-9.
- Meuwissen, T. and M. Goddard. (1996). The use of marker haplotypes in animal breeding schemes. . *Genet. Sel. Evol.* , 28:161-176.
- Michelmore, R. Param, I. & R. Kesseli. (1991). Identification of markers linked to disease-resistance genes by bulked segregant analysis: A rapid method to detect markers in specific genomic regions by using segregating populations. *Proceedings of National Academy of Science USA* , 88:9828-9832.
- Miller, L. Close, T. and Kapuscinski, R. (2004). Lower fitness of hatchery and hybrid rainbow trout compared to naturalized populations in Lake Superior tributaries. *Molecular Ecology* , 13, 3379-3388.
- Moen, T. Fjalestad, K. Munck, H. Gomez-Raya, L. (2004). A multistage testing strategy for detection of quantitative trait loci affecting disease resistance in Atlantic Salmon. *Genetics* , 167: 851-858.
- Moen, T. Hoyheim, B. Munk, H. and Gomez-Raya, L. (2004). A linkage map of Atlantic salmon (*Salmo salar*) reveals an uncommonly large difference in recombination rate between the sexes. *Animal Genetics* , 35, 81-92.
- Morrissey, M. Wilson, A. . (2005). The potential cost of accounting for genotypic errors in molecular parentage analyses. *Mol. Ecol.* , 14, 4111-4121.
- Murawski, S. (2000). Definitions of overfishing from an ecosystem perspective. *ICES. Journal of Marine Science* , 57:649-658.

- Needham, P. R. and Behnke, R. J. (1962). The origin of hatchery rainbow trout. *Prog. Fish - Cult.* , 24, 156-158.
- Neira, R. (1997). Centro de Mejoramiento Genético de Salmón Coho. *Aquanoticias Internacional.* , 34, 48-55.
- Neira, R. Lhorente, C. Diaz, N. Dazarola G. Yany, G. (1999). *Alternativas para el Mejoramiento genético de Salmonidos.* Valparaiso, Chile: Serie Manuales de Innovación Tecnológica para la Acuicultura.
- Neyts-Uyttebroeck, A. (10 de Noviembre de 2001).  
[http://www.wto.org/spanish/thewto\\_s/minist\\_s/min01\\_s/statements\\_s/st5.doc](http://www.wto.org/spanish/thewto_s/minist_s/min01_s/statements_s/st5.doc).
- Ng, S. Artieri, C. Bosdet, I. Chiu, R. Danzmann, R. G. et al. (2005). A physical map of the genome of Atlantic salmon, *Salmo salar*. *Genomics* , 86: 396-404.
- Nguyen, N. Ponniah, A. and R. W. Ponzoni. (2006). Potential applications of reproductive and molecular genetic technologies in the selective breeding of aquaculture species. En R. A. Ponzoni, *Development of aquaculture animal genetic improvement and dissemination programs: current status and action plans.* (page. 120). Penang, Malaysia: WorldFish Center Conference Proceedings 73.
- Nichols, K. Young, W. Danzmann, R. Robison, B. Rexroad, C. et al. (2003). A consolidated linkage map for rainbow trout (*O mykiss*). *Animal Genetics* , 34, 102-115.
- Nickell, D.C. and Bromage, N.R. . (1998a). The effect of dietary lipid level on variation of flesh pigmentation in rainbow trout (*Oncorhynchus mykiss*). *Aquaculture* , 161, 237-251.
- No, H. & Storebakken, T. (1992). Pigmentation of rainbow trout with astaxanthin and canthaxanthin in freshwater and saltwater. *Aquaculture* , 101:123-134.
- Norris, A. , Bradley, E. and Cunningham, E. (1999). Microsatellite genetic variation between and within farmed and wild Atlantic salmon (*Salmo salar*) populations. *Aquaculture* , 180, 247-264.
- Norris A. , Bradley D. and Cunningham E. (2000). Parentage and relatedness determination in farmed Atlantic salmon (*Salmo salar*) using microsatellite markers. *Aquaculture* , 182, 73-83.
- Norris, A.T. and Cunningham, E.P. (2004). Estimates of phenotypic and genetic parameters for flesh colour traits in farmed Atlantic salmon based on multiple trait animal model. *Livestock Production Science* , 89, 209-222.
- O' Connell, M. and Wright, J. (1997). Microsatellite DNA in fishes. . *Reviews in Fish Biology and Fisheries* , 7, 331-363.
- Odegard, J. Olesen, I Gjerde, B. Klemetsdal, G. (2006). Evaluation of statistical models for genetic analysis of challenge test data on furunculosis resistance in Atlantic salmon (*Salmo salar*): Prediction of field survival. *Aquaculture* , 116-123.
- Odegard, J. Olesen, I. Gjerde, B. Klemetsdal, G. (2007). Evaluation of statistical models for genetic analysis of challenge-test data on ISA resistance in Atlantic salmon (*Salmo salar*): Prediction of progeny survival. *Aquaculture* , 266, 70-76.

- O'Flynn, F. , Bailey, J. and Friars, G. (1999). Responses to two generations of index selection in Atlantic salmon. *Aquaculture* , 173, 143-147.
- O'Reilly, P. and Wright, M. (1995). The evolving technology of DNA fingerprinting and its application to fisheries and aquaculture. *Journal of Fish Biology* , 47 (Suppl. A), 29-55.
- O'Reilly, Herbinger, C. Wright, J. (1998). Analysis of parentage determination in Atlantic salmon (*Salmo salar*) using microsatellites. *Animal Genetics* . , 29, 363-370.
- Ozaki, A. Sakamoto, T. Khoo, S. and et al. (2001). Quantitative trait loci (QTLs) associated with resistance / susceptibility to infectious pancreatic necrosis virus (IPNV) in rainbow trout (*Oncorhynchus mykiss*). *Mol. Genet. Genomics* , 265, 23-31.
- Page, R. (1996). TREEVIEW: An application to display phylogenetic trees on personal computers. *Computer Applications in the Biosciences* , 12, 357-358.
- Param, I. & R.W. Michelmore. (1993). Development of reliable PCR-based markers linked to downy mildew resistance genes in lettuce. *Theoretical and Applied Genetics* , 85:985-993.
- Park, S. (2001). Trypanotolerance in West African Cattle and the population genetics effects of selection. *PhD. Thesis* , University of Dublin.
- Park, L. K. and Moran, P. (1994). Developments in molecular-genetic techniques in fisheries. *Rev. Fish Biol. Fisher.* , 4 (3), 272-299.
- Pérez, L. Winkler, F. Díaz, N. Cárcamo, C. Silva, N. (2001). Genetic variability in four hatchery strains of coho salmon, *Oncorhynchus kisutch* (Walbaum), in Chile. *Aquaculture Research* , 32, 41-46.
- Perry, G. Danzmann, R. Ferguson, M. and Gibson, J. (2001). Quantitative trait loci for upper thermal tolerance in outbred strains of rainbow trout (*Oncorhynchus mykiss*). *Heredity* , 86, 333-341.
- Pimentel, D. (2001). Pricing biodiversity and ecosystem services. . *BioScience* , 51(4):270-271.
- Pollution, R. C. (2004). *Turning the tide: addressing the impact of fisheries on the marine environment*. London, UK.: Twenty-fifth Report Cm 6392, December 2004.
- Pompanon, F. Bonin, A. Bellemain, E. Taberlet, P. (2005). Genotyping errors: causes, consequences and solutions. *Nature Reviews* , 6, 847-859.
- Prodohl, P. A. Taggart, J. B. and Ferguson, A. (1994). Single locus inheritance and joint segregation analysis of minisatellite (VNTR) DNA loci in brown trout (*Salmo trutta* L.). *Heredity* , 73, 556-566.
- Quinton, C.D. McKay, L.R. and Mcmillan, I. (2004). Strain and maturation effects on female spawning time in diallel crosses of three strains of rainbow trout (*Oncorhynchus mykiss*). *Aquaculture* , 234, 99-110.
- Raymond, M. and Rousset, F. (1995). GENEPOP (version 1.2): population genetics software for exact tests and ecumenicism. *Journal Heredity* , 86, 248-249.
- Read, N. (2006). Role and Function of British Trout Association. *Finfish magazine* , 2,25-26.

- Reed D., Lowe E., Briscoe D. and Frankham, R. (2003). Fitness and adaptation in a novel environment: effect of inbreeding, prior environment, and lineage. *Evolution* , 57, 1822-1828.
- Refstie, R. (1990). Application of Breeding Schemes. *Aquaculture* , 85, 163-169.
- Reinitz, G. Orme, L. and Hitzel, F. (1979). Variations in body composition and growth among strains of rainbow trout. *Trans. Am. Fish. Soc.* , 108, 204-207.
- Robb, D. Kestin, S. & Warris, P. (2000). Muscle activity at slaughter: I. Changes in flesh colour and gapping in rainbow trout. *Aquaculture* , 182:261-269.
- Robinson, B. Wheeler, P. Sundin, K. Sikka, P. and Thorgaard, G. (2001). Composite interval mapping reveals a major locus influencing embryonic development rate in rainbow trout (*Oncorhynchus mykiss*). *J. Hered.* , 92, 16-22.
- Rodzen, J. Famula, T. May B. (2004). Estimation of parentage and relatedness in the polyploid white sturgeon (*Acipenser transmontanus*) using a dominant marker approach for duplicated microsatellite loci. *Aquaculture* , 232, 165-182.
- Rosenblum, B. Oaks, F. Menchen, S. Johnson, B. (1997). Improved single-stranded DNA sizing accuracy in capillary electrophoresis. *Nucleic Acids Research* , 25, 3925-3929.
- Rye, M. & Gjerde, B. (1996). Phenotypic and genetic parameters of body compositional traits and flesh colour in Atlantic salmon, *Salmo salar* L. *Aquaculture Research* , 27:121-133.
- Rye, M. Lillevik, K.M. and Gjerde, B. (1990). Survival in early life of Atlantic salmon and rainbow trout: estimates of heritabilities and genetic correlations. *Aquaculture* , 89, 209-216.
- Ryman, N. and Stahl, G. (1980). Genetic changes in hatchery stocks of brown trout (*Salmo trutta*). *Canadian Journal of Fisheries and Aquatic Sciences* , 37, 82-87.
- Sakamoto, T. Danzmann, R. Okamoto, N. Ferguson, M. and Ihssen, P. (1999). Linkage analysis of quantitative traits loci associated with spawning time in rainbow trout (*Oncorhynchus mykiss*). *Aquaculture* , 173, 33-43.
- Sakamoto, T. Danzmann, R. Gharbi, K. Howard, P. Ozaki, A. Khoo, S. Woram, R. Okamoto, N. Ferguson, M. Holm, L. Guyomard, R. and Hoyheim, B. (2000). A microsatellite linkage map of rainbow trout (*O. mykiss*) characterized by large sex-specific differences in recombination rates. *Genetics* , 155, 1331-1345.
- Sancristobal, M. Chevalet, C. (1997). Error tolerant parent identification from a finite set of individuals. *Genet. Res.* , 70, 53-62.
- Schiedt, K. Leuenberger, F. Vecchi, M. and Glinz, E. (1985). Absorption, retention and metabolic transformations of carotenoids in rainbow trout, salmon and chicken. *Pure and Applied Chemistry* , 57, 685-692.
- Schmidt, P. & Cuthbert, R. (1969). Colour sorting of raw salmon. *Food Technology* , 23:232-234.
- Schmidt, P. & Idler, D. (1958). Predicting the color of canned sockeye salmon from the color of the raw flesh. *Food Technology* , 12:44-48.

SEAFEEDS. (2003). Final report of the Seafeeds Workshop organized and chaired by Nautilus Consultants in association with the Stirling University Institute of Aquaculture, Stirling 8th – 9th. April 2003.  
([www.nautilus-consultants.co.uk/seafeeds/Files/Final%20Report.pdf](http://www.nautilus-consultants.co.uk/seafeeds/Files/Final%20Report.pdf)).

Sedgwick, S. (1973). *Trout Farming Handbook*. Osney Mead, England: Fishing News Books.

Sekino M. , Saito K. , Yamada T. , Kumagai A. , Hara M. and Yamashita Y. (2003). Microsatellite-based pedigree tracking in the Japanese flounder *Paralichthys olivaceus* hatchery strain: implications of hatchery management related to stock enhancement program. *Aquaculture* , 221, 255-263.

Shahidi, F. M. (1998). Carotenoid pigments in seafoods and aquaculture. *Reviews in food science* , 38 (1), 1-67.

Shimizu, M. Kosaka, N. Shimada, T. Nagahata, T. Iwasaki, H. Nagai, H. Shiba, T. and Emi, M. (2002). Universal fluorescent labeling (UFL) method for automated microsatellite analysis. *DNA Research* , 9 (5), 173-178.

Siitonen, L. and Gall, G. (1997). Response to selection for early spawn date in rainbow trout, *Salmo gairdneri*. *Aquaculture* , 154, 115-124.

Silverstein, J. Rexroad III, C King, T. (2004). Genetic variation measured by microsatellites among three strains of domesticated rainbow trout (*Oncorhynchus mykiss*, Walbaum). *Aquaculture Research* , 35, 40-48.

Simm, G. (1998). *Genetic improvement of Cattle and Sheep*. United Kingdom: Farming Press.

Skrede, G. & Storebakken, T. (1986a. ). Characteristics of color in raw, baked and smoked wild a pen-reared Atlantic salmon. *Journal of Food Science* , 51:804-808.

Skrede, G. & Storebakken, T. (1986b). Instrumental colour analysis of farmed and wild Atlantic salmon when raw, baked and smoked. *Aquaculture* , 53:279-286.

Smith, B. Hardy, R. & Torrissen, O. (1992). Synthetic astaxanthin deposition in pan-size coho salmon (*Oncorhynchus kisutch*). *Aquaculture* , 104:105-119.

Smith, G. R. and Stearley, R. F. (1989). The classification and scientific names of rainbow trout and cutthroat trouts. *Fisheries* , 14, 4-10.

Smith, C. & S. Simpson. (1986). The use of genetic polymorphism in livestock improvement. *Journal of Animal Breeding and Genetics* , 103.205-217.

Soller, M. Brody, T. and Genizi, A. (1976). On the power of experimental designs for the detection of linkage between marker loci and quantitative trait loci in crosses between inbred lines. . *Theor. Appl. Genetic* , 47, 35-39.

Soulé, M. (1980). Thresholds for survival: maintaining fitness and evolutionary potential. En M. S. (eds.), *Conservation Biology, an Evolutionary-Ecological Perspective* (pages. 151-171). Sinauer, Sunderland, MA.

Spielman, R. McGinnis, R. and W. Ewens. (1993). Transmission test for linkage disequilibrium: the insulin gene region and insulin-dependent diabetes mellitus (IDDM). *Am. J. Hum. Genet.* , 52: 506–516.

- Springate, J. and Bromage, N. (1984). Husbandry and the ripening of eggs. *Fish Farmer* , 22-23.
- Stahl, G. (1983). Differences in the amount and distribution of genetic variation between natural populations and hatchery stocks of Atlantic salmon. *Aquaculture* , 33, 23-32.
- Standal, M. Gjerde, B. (1987). Genetic variation in survival of Atlantic salmon during sea rearing period. *Aquaculture* , 66, 197-207.
- Storebakken, T. Foss, P. Huse, I. Wandsvik, A. and Lea, T. (1986). Carotenoids in diets for salmonids. III. Utilisation of canthaxanthin from dry and wet diets by Atlantic salmon, rainbow trout, and sea trout . *Aquaculture* , 51, 245-255.
- Stevenson, J. (1980). *Trout Farming Manual*. Farnham, Surrey, England: Fishing News Books Limited.
- Stickney, R. (1991). *Culture of Salmonid Fishes*. Seattle, Washington: Boca Raton Ann Arbor Boston London
- Stickney, R. (1996). *Aquaculture in the United States, A Historical Survey* Wiley. New York.
- Su, G.S. Liljedahl, L.E. and Gall, G.A.E. (1996). Genetic and environmental variation of body weight in rainbow trout (*Oncorhynchus mykiss*). *Aquaculture* , 144, 71-80.
- Su, G. Liljedahl, L. and Gall, G. (1997). Genetic and environmental variation of female reproductive traits in rainbow trout (*Oncorhynchus mykiss*). *Aquaculture* , 154, 115-124.
- .
- Tacon, A. (2008). *State of information on Salmon Aquaculture feed and the environment*. Santiago, Chile: Salmon Aquaculture dialogue.
- Taggart, J. (2007). FAP: an exclusion-based parental assignment program with enhanced predictive functions. *Molecular Ecology Notes* , 7 (3), 412-415.
- Taggart, J. B. and Ferguson, A. . (1990). Hypervariable minisatellite DNA single locus probes for Atlantic salmon, *Salmo salar* L. *J. Fish. Biol.* , 37, 991-993.
- Taggart, J. Hynes, R. Prodohl, P. and Ferguson, A. (1992). A simplified protocol for routine total DNA isolation from salmonid fishes. *Journal of fish biology* , 40 (6), 963-965.
- Tave, D. (1993). *Genetics for Fish Hatchery Managers*. New York: Van Nostrand Reinhold.
- Tanskley, S. (1993). Mapping polygenes. *Annual Review of Genetics* , 27:205-233.
- Taylor, JF. & JL Rocha. (1997). QTL analysis under linkage equilibrium. En P. A. Editor, *Molecular dissection of complex traits* (pages. 103-118.). Boca Raton: CRC Press .
- Thompson, D. (1985). Genetic identification of trout strains. . *Aquaculture* , 46, 341-351.
- Thorgaard, G. , Bailey, G. , Williams, D. and Buhler, D. et al. (2002). Status and opportunities for genomics research with rainbow trout. . *Comparative Biochemistry and Physiology.* , 133 (B), 609-646.

- Torrissen, O. Hardy, R. and Shearer, K. . (1989). Pigmentation of salmonids -carotenoids deposition and metabolism. *Review of Aquatic sciences* . , 1, 209-225.
- Torrissen, O. Hardy, R. Shearer, K. Scott, T. & Stone, F. (1990). Effects of dietary canthaxanthin level and lipid level on apparent digestibility coefficients for canthaxanthin in rainbow trout (*Oncorhynchus mykiss*). *Aquaculture* , 88:351-362.
- Tuominen, T-R. & M. Esmark. (2003). *Food for thought: the use of marine resources in fish feed* . Report 2/03, WWF-Norway, February 2003.  
(<http://www.panda.org/downloads/marine/foodforthoug.pdf>).
- University of Newcastle Upon Tyne (UK), Poseidon Aquatic Resource Management Ltd (UK). (2004). *The fishmeal & fish oil industry: its role in the common fisheries policy. Directorate-General for research, Working Paper. European Parliament. Fisheries Series, FISH 113 EN* ([www.europarl.eu.int/studies](http://www.europarl.eu.int/studies)).
- Ureta, J. (2000). *Optimisation of methodologies for the artificial reproductive management of the brown trout (Salmo trutta) to obtain high quality eyed eggs*. (Vol. I). Santiago, Chile.: Universidad Andres Bello (Thesis).
- Utter F. M. and Allendorf F. W. (1977). Determination of the breeding structure of steelhead populations through gene frequency analysis. En C. C. 77-1, *Genetic Implications of Steelhead Management*. (pages. pp. 10-15). California: T.J. Hassler and R.R. VanKirk.
- Vandeputte, M. Mauger, S. Dupont-Nivet, M. (2005). An evaluation of allowing for mismatches as a way to manage genotyping errors in parentage assignment by exclusion. *Molecular Ecology Notes* , 6, 265-267.
- Van Gested, S. Houwing-Duistermaat, J. Adolfsson, R. Van Duijn, C. & C. Van Broeckhoven. (2000). Power of selective genotyping in genetic association analyses of quantitative traits. . *Behavior Genetics* , 30: 141-146.
- Verspoor, E. (1988). Reduced genetic variability in first generation populations of Atlantic salmon (*Salmo salar*). *Canadian Journal of Fisheries and Aquatic Science* , 45, 1686-1690.
- Villanueva, B. Verspoor, E. and Visscher, P. (2002). Parental assignment in fish using microsatellite genetic markers with finite numbers of parents and offspring. *Animal Genetics*, 33, 33-41.
- Vollmann-Schipper, F. (1975). *Transport Lebender Fische*. Hamburg and Berlin: Paul Parey.
- Vos, P. Hogers, R. Bleeker, M. Reijans, M. van de Lee, T. Hornes, M. Frijters, A. Pot, J. Peleman, J. and Kuiper, M. (1995). AFLP- a new technique for DNA fingerprinting. *Nucleic Acids Research* , 23, 4407-4414.
- Wales, J. (1939). General report of investigations on the McCloud River drainage in 1938. *Calif. Fish Game* , 25, 272-309.
- Wang, D. Fan J. Siao, C. Berno, A. Young, P. et al. (1998). Large scale identification, mapping, genotyping of single-nucleotide polymorphisms in the human genome. *Science* , 280, 1077-1082.
- Waples, R. (1999). Dispelling some myths about hatcheries. *Fisheries* , 24, 12-21.

- Welsh, J. and McClelland, M. (1990). Fingerprinting genomes using PCR with arbitrary primers. *Nucleic Acids Res.* , 18, 7213-7218.
- Wenz, H. Robertson, J. Menchen, S. et al. (1998). High-precision genotyping by denaturing capillary electrophoresis. *Genome Research* , 8, 69-80.
- Williams, J. Kubelic, A. Livak, K. Rafalski, L. and Tingey, S. (1990). DNA polymorphism amplified by arbitrary primers are useful as genetic markers. *Nuclei Acids Res.* , 18, 6531-6535.
- Winnard, K. (2003). Socio-Economic model of the UK trout Industry. *Trout News* , 35, 20-24.
- Withler, R.E. and Beacham, T.D. (1994). Genetic variation in body weight and flesh colour of the coho salmon (*Oncorhynchus kisutch*) in British Columbia. . *Aquaculture* , 119, 135-148.
- Woolliams, J. & M. Toro. (2007). What is genetic diversity? En K. O. (Ed), *Utilisation and Conservation of Farm Animal Genetic Resources*. Wageningen Academic Publishers.
- Wright, J. and Bentzen, P. (1994). Microsatellites: genetic markers for the future. *Rev. Fish. Biol. Fish.* , 4, 384-388.
- Wright, J. M. (1993). DNA fingerprinting in fishes. En P. W. Hochachka, *Biochemistry and Molecular Biology of Fishes* (pages. 2, 58-91.). Amsterdam: Elsevier.
- Yang, X. & C. Quiros. (1993). Identification and classification of celery cultivars with RAPD markers. *Theoretical and Applied Genetics* , 86:205- 212.
- Young, W. Wheeler, P. Coryell, V. Keim, P. and Thorgaard, G. (1998). A detailed linkage map of rainbow trout produced using doubled haploids. *Genetics* , 148, 839-850.
- Yndestad, H. & A. Stene. (2002). System dynamics of the Barents Sea capelin. ICES. *Journal of Marine Science* , 59(6):1155-1166.