

Thesis
2949

**Aspects of the Reproductive Biology and Endocrinology of the
Substrate-Spawning Cichlid *Tilapia zillii*.**

A thesis submitted for the degree of Doctor of Philosophy

by

Kevin Coward

Institute of Aquaculture, University of Stirling, Stirling, Scotland.

September 1997

DECLARATION.

The work presented in this thesis was carried out between 1991 and 1994 at the Institute of Aquaculture, University of Stirling. Except where specifically acknowledged, the work presented herein has been conducted independently and has neither been accepted nor submitted for any other degree.

CANDIDATE.....

SUPERVISOR.....

DATE.....

Abstract.

This study investigated several, previously little-known, aspects of reproductive physiology and endocrinology in the substrate-spawning cichlid *Tilapia zillii*; a tilapia that is becoming increasingly popular in world aquaculture. Studies were undertaken in controlled laboratory aquaria, thereby reducing the potential influence of environmental variation evident in many previous field studies of this species. Analysis involved two strains of *T. zillii*: strain 'A' (*T. zillii*) and strain 'B' (formerly known as *Tilapia tholloni*).

Spawning periodicity and total fecundity generally increased with fish size. Egg size varied within a narrow window and did not generally increase with fish size though fish weighing 100 - 200g tended to produce the largest eggs. The best estimate of spawning periodicity was considered to be 'mean days elapsed/spawn' as this figure was based upon both spawning and non-spawning fish in an experimental group. Mean days elapsed/spawn increased with increasing fish size and averaged 61.4 days and 37.5 days in strains 'A' and 'B' respectively. The shortest reproductive cycles observed were just 7 days and 6 days for strains 'A' and 'B' respectively. Total fecundity ranged from 461 - 11640 eggs/clutch. Mean total fecundity was 3606 ± 280 in strain 'A' and 3560 ± 243 in strain 'B'. Mean egg diameter was 1.5 ± 0.04 mm and 1.4 ± 0.08 mm in strains 'A' and 'B' respectively. Fecundity and egg size also varied over successive spawns in serial-spawning females but these variations did not appear to be related to spawning periodicity.

Regression analysis revealed strong relationships between fish size (weight and length) and total fecundity, relative fecundity and total egg volume. Relationships between fish size and egg size were generally much weaker. Fecundity and egg size were related to the length of the preceding inter-spawn-interval (ISI) in fish of certain weight categories but not others, providing limited evidence that length of ISI may in part, control fecundity and egg size in this species.

Ovarian recrudescence was classified into ten distinct developmental stages based upon oocyte size, biochemical properties and structure. This classification

scheme was comparable to classification schemes developed for other teleosts but represents the first detailed description of oocyte growth in a substrate-spawning tilapia.

Radioimmunoassay and stereological analysis provided valuable and novel data concerning the dynamics of ovarian development in this species. Levels of 17 β -oestradiol (E₂) and testosterone (T) peaked within 6 days of spawning, suggesting that vitellogenesis began as early as day 2 or 3 post-spawning. By day 8, ovaries were dominated by large late-vitellogenic/maturing oocytes (stages 6 & 7) occupying 60 - 70% of the ovary. Gonadosomatic index (GSI) reached maximal levels by day 14. Since the proportion of stage 6/7 oocytes exhibited little change from day 8 onwards, it is suggested that pre-vitellogenic oocytes are recruited into vitellogenic growth immediately after spawning and complete vitellogenesis as early as day 8 post-spawning. Analysis of serial-spawning fish found that initial post-spawn E₂ and T peaks (on days 2 - 6) were much lower after the second spawning.

Sex steroid levels were also found to be suppressed in confined *T. zillii* (i.e. where stocking densities were > 10kg/m³). Confined females failed to spawn but displayed a marked tendency to do so after transfer to individual aquaria. Serum E₂ and T were suppressed during confinement but increased rapidly following transfer to individual aquaria (coincident with resumed spawning activity). It is suggested that levels of E₂ and T under confinement are not sufficient to allow completion of vitellogenic growth and are most probably suppressed via a pheromonal mechanism.

Finally, the present study investigated the effect of prolonged food restriction on various aspects of reproduction. *T. zillii* were rationed from first feeding and throughout the following 17 months. Despite very large differences in fish size, no significant differences were detected in total fecundity, egg diameter nor total egg volume once data had been adjusted for differences in fish size. These data suggest that despite very large differences in food availability throughout the periods of sexual differentiation and on-growing, investment in reproduction remained relatively

consistent. It appeared that during food restriction, *T. zillii* sacrificed body weight and growth so as to maintain reproductive investment.

In summary, this study provides valuable and novel information regarding the reproductive physiology and endocrinology of female *T. zillii* and suggests that this species may be a suitable 'model' species for future work on fecundity and ovarian development.

KEYWORDS: Tilapia, *T. zillii*, fecundity, spawning periodicity, ovarian development, food restriction, confinement.

Acknowledgements.

I wish to extend my sincere gratitude to Professor Niall Bromage for his invaluable help and guidance throughout the duration of this project. Particular thanks are also extended to Dr. Brendan McAndrew, Dr. Krishen Rana, Dr. James Myers, Dr. Sirawut Klingbunga, Dr. Mark Porter, Anne Gilmour, Iain McEwan and Steve Powell for their help and guidance with a wide range of topics and problems.

Special thanks are extended to Dr. Clive Randall, Dr. Mark Thrush, Dr. Briony Campbell and Dr. Penpun Srisakultiew for their guidance, time and advice concerning the techniques of radioimmunoassay, atomic absorption spectrophotometry, histology and stereology. Thanks also to Professor Mauro Mattioli of the University of Bologna, Italy who helped in the early stages of the hormonal work presented in Chapter 5 (and also with preliminary spawning induction work not presented here). Thanks also to Dr. David Little of the Asian Institute of Technology, Thailand for his enthusiasm and comments concerning Chapter 6.

My sincere gratitude is extended to all other members of the Institute of Aquaculture who helped with this project, particularly Keith Ranson and Willie Hamilton for aquarium system maintenance, fish feeding and general fish husbandry, to Mairi Thrush and Debbie Wright for their help in the Histopathology Laboratory and to Billy Struthers for his help with the spectrophotometer.

Finally, thanks to Dr. Charles Tyler and Dr. Francisco Prat of Brunel University for their help during the final few months of the compilation of this thesis and to the Natural Environment Research Council for provision of a Research Studentship.

Last, but certainly not least, thanks to Helen for her encouragement and consideration whilst this thesis was being written and for proof-reading the final manuscript.

This thesis is dedicated to my parents for their continued love and support.

List of contents.

Title page.....	i
Declaration.....	ii
Abstract.....	iii
Acknowledgements.....	vi
List of contents.....	vii
List of figures, tables and plates.....	xiv
Glossary of latin and common names of fish.....	xxi
Glossary of commonly-used abbreviations.....	xxiii

Chapter 1: General introduction, literature overview & aims of research.

1.1. Current taxonomic position of tilapia.....	4
1.2. Modes of reproduction in <i>Oreochromis</i> , <i>Sarotherodon</i> and <i>Tilapia</i> ..	5
1.3. Culture systems and tilapia fry production.....	8
1.4. Fecundity in tilapias.....	10
1.5. Spawning cycles and seasonality in tilapias.....	14
1.6. Ovarian recrudescence in teleost fish.....	19
1.7. Exogenous and endogenous control of spawning patterns in teleost fish.	
1.7.1. Exogenous factors.....	25
1.7.2. Endogenous factors.....	40
1.8. Aims of this thesis.....	52

Chapter 2: General materials & methods.

2.1. Fish, aquaria design and fish maintenance.....	54
2.1.1. Fish.....	54
2.1.2. Aquaria design.....	54
2.1.3. Fish maintenance.....	57

2.2. Fish handling, anaesthesia, identification, stripping & fertilisation...	57
2.2.1. Fish handling and anaesthesia.....	57
2.2.2. Fish identification.....	57
2.2.3. Stripping of eggs/milt and fertilisation.....	58
2.3. Blood serum collection, ovarian biopsy and ovary/liver sampling....	60
2.3.1. Blood serum collection.....	60
2.3.2. Ovarian biopsy.....	61
2.3.3. Ovary and liver sampling from sacrificed fish.....	61
2.4. Determination of total fecundity, egg size and estimation of spawning periodicity.....	62
2.4.1. Determination of total fecundity.....	62
2.4.2. Determination of mean egg size, mean egg diameter and validation egg measurement procedure.....	67
2.4.3. Determination of mean individual egg volume, mean individual egg dry weight, relative fecundity, total egg volume and egg weight to body weight ratio (EW:BW).....	68
2.5. Analysis of ovarian morphology and histology.....	71
2.5.1. Plastic resin embedding.....	72
2.5.2. Staining protocols for histological slides.....	75
2.5.3. Photomicroscopy.....	77
2.5.4. Analysis of ovarian histology by stereology and estimation of ovarian volume fractions and ovarian numerical densities.....	77
2.6. Determination of total serum calcium.....	88
2.6.1. Analysis equipment, dilution of serum samples and preparation of calcium standards.....	88
2.6.2. Calculation of total serum calcium and expression of results..	91
2.6.3. Quality control.....	91

2.7. Determination of serum sex steroid levels by radioimmunoassay.....	91
2.7.1. Preparation of assay constituents.....	91
2.7.2. Radioimmunoassay protocol.....	94
2.7.3. Calculation of results.....	96
2.7.4. Assay quality control.....	98
2.7.5. Validation of radioimmunoassay technique.....	98
2.8. Statistical methods.....	98
2.8.1. Estimation of the population mean and calculation of the standard error of the mean.....	102
2.8.2. Calculation of the coefficient of variation.....	102
2.8.3. Chi-squared analysis for comparison of two data sets.....	103
2.8.4. Testing variance for homogeneity.....	103
2.8.5. ARCsine transformation.....	104

Chapter 3: Spawning periodicity, fecundity and egg size in laboratory stocks of *T. zillii* held under controlled environmental conditions.

3.1. General introduction.....	106
3.2. Experiment 1: Spawning periodicity in <i>T. zillii</i> (strains 'A' and 'B')..	115
3.2.1. Materials and methods.....	115
3.2.2. Results.....	116
3.2.3. Summary.....	125
3.3. Experiment 2: Fecundity & egg size in <i>T. zillii</i> (strains 'A' & 'B')...	127
3.3.1. Materials and methods.....	127
3.3.2. Results.....	129
3.3.3. Summary.....	149

3.4. Experiment 3: Variation of fecundity and egg size over consecutive spawns in serial spawning <i>T. zillii</i>	153
3.4.1. Results.....	153
3.4.2. Summary.....	157
3.5. Discussion.....	157

Chapter 4: Histological classification and size distribution of oocyte developmental stages in *T. zillii*.

4.1. Introduction.....	175
4.1.1. Primary growth phase.....	180
4.1.2. Secondary growth phase.....	184
4.1.3. Post-ovulatory follicles.....	191
4.1.4. Atresia (oocyte degeneration and resorption).....	192
4.2. Materials and methods.....	195
4.3. Results.....	196
4.3.1. Primary growth phase.....	196
4.3.2. Secondary growth phase.....	200
4.3.3. Post-ovulatory follicles.....	210
4.3.4. Atresia.....	210
4.4. Discussion.....	210

Chapter 5: The dynamics of ovarian recrudescence and associated reproductive endocrinology in *T. zillii*.

5.1. General introduction.....	229
5.2. Experiment 1: Profiles of E ₂ , T and total calcium during ovarian recrudescence in individually maintained <i>T. zillii</i> (strains 'A' & 'B').....	236
5.2.1. Materials and methods.....	236
5.2.2. Results.....	237

5.2.3. Summary.....	243
5.3. Experiment 2: Profiles of E ₂ , T and total calcium and concurrent ovarian recrudescence as monitored by serial ovarian biopsy in individually maintained post- spawned <i>T. zillii</i> (strain 'A').....	244
5.3.1. Materials and methods.....	244
5.3.2. Results.....	247
5.3.3. Summary.....	258
5.4. Experiment 3: Ovarian recrudescence in different regions of the <i>T. zillii</i> ovary as monitored by sacrifice of fish at periodic intervals after spawning.....	261
5.4.1. Materials and methods.....	261
5.4.2. Results.....	263
5.4.3. Summary.....	272
5.5. Discussion.....	278

Chapter 6: Studies on the effect of confinement and transfer to individually-partitioned aquaria on spawning incidence, ovarian development and circulating sex steroid level in *T. zillii*.

6.1. General introduction.....	296
6.2. Experiment 1: Preliminary investigation of the effect of confinement and transfer to individually-partitioned aquaria upon spawning incidence and ovarian condition (as assessed by endoscopy) in female <i>T. zillii</i> (strain 'B').....	306
6.2.1. Materials and methods.....	306
6.2.2. Results.....	308
6.2.3. Summary.....	314
6.3. Experiment 2: Effect of confinement and transfer to individually-partitioned aquaria on circulating levels of sex steroids, ovarian development and spawning incidence in <i>T. zillii</i> (strain 'B').....	316
6.3.1. Materials and methods.....	317
6.3.2. Results.....	318

6.3.3. Summary.....	327
6.4. Experiment 3: The effect of visual contact with conspecifics and presence of spawning substrate on levels of circulating sex steroids and spawning incidence in previously confined female <i>T. zillii</i> (strain 'A') being transferred into individually-partitioned aquaria.....	329
6.4.1. Materials and methods.....	330
6.4.2. Results.....	331
6.4.3. Summary.....	343
6.5. Discussion.....	344

Chapter 7: Studies on the effect of reduced food ration on the reproductive physiology and endocrinology of female *T. zillii*.

7.1. General introduction.....	354
7.2. Experiment 1: The effect of two food ration levels on the growth and early survival of laboratory-held <i>T. zillii</i> stocks.....	363
7.2.1. Materials and methods.....	363
7.2.3. Results.....	366
7.2.4. Summary.....	369
7.3. Experiment 2: Effect of two long-term ration levels on sex steroid level in on-growing <i>T. zillii</i> (male and female).....	371
7.3.1. Materials and methods.....	371
7.3.2. Results.....	371
7.3.3. Summary.....	378
7.4. Experiment 3: Effect of two long-term ration levels on spawning performance, fecundity and egg size.....	379
7.4.1. Materials and methods.....	379
7.4.2. Results.....	380
7.4.3. Summary.....	393

7.5. Experiment 4: Effect of two long-term ration levels on ovarian histology..	393
7.5.1. Materials and methods.....	394
7.5.2. Results.....	395
7.5.3. Summary.....	399
7.6. Discussion.....	401
Chapter 8: General conclusions and discussion.....	415
Chapter 9: References.....	435
Appendix 1.1: Main features of recirculating aquaria (system 1).....	506
Appendix 1.2: Main features of recirculating aquaria (system 2).....	507
Appendix 1.3a: Main features of recirculating aquaria (system 3)...	508
Appendix 1.3b: Main features of recirculating aquaria (system 3)...	509
Appendix 1.4: Specifications of pelleted fish food.....	510
Appendix 1.5: Research Publications.....	511

List of Figures, Tables and Plates.

Figure 2.1	Gravity-fed recirculating aquaria used for housing individual broodstock.....	56
Table 2.1	Evaluation of fecundity determination method through direct enumeration by tally counter.....	64
Table 2.2.	Evaluation of fecundity determination method through estimation by wet weight.....	66
Table 2.3.	Evaluation of fecundity determination method through estimation by dry weight.....	66
Table 2.4.	Validation of egg measuring technique.....	69
Table 2.5.	Staining protocol for haematoxylin and eosin.....	76
Table 2.6.	Staining protocol for polychrome.....	78
Figure 2.2.	A model illustrating the Delesse principle.....	82
Figure 2.3	Demonstration of the estimation of volume fraction from histological sections.....	85
Table 2.5.	Cross reactivity of E ₂ and T antisera.....	93
Figure 2.4.	Examples of E ₂ and T standard curves.....	97
Table 2.8	Radioimmunoassay correction factors.....	99
Table 2.9.	Radioimmunoassay correction factors.....	99
Figure 2.5.	Parallelism of E ₂ standard curve and inhibition curve.....	100
Figure 2.6.	Parallelism of T standard curve and inhibition curve.....	101
Table 3.1.	Spawning frequencies and repeat spawning in <i>T. zillii</i> (strains 'A' and 'B') held individually for up to 195 days.....	118
Table 3.2.	Spawning frequencies in individually held <i>T. zillii</i> ('A') held individually for up to 195 days.....	119
Figure 3.1.	Mean ISI and mean days elapsed/spawn in <i>T. zillii</i> ('A') held individually for up to 195 days.....	121
Table 3.3.	Spawning frequencies in individually-held <i>T. zillii</i> ('B') held individually for up to 131 days.....	122

Figure 3.2.	Mean ISI and mean days elapsed/spawn in <i>T. zillii</i> ('B') held individually for up to 131 days.....	124
Table 3.4.	Comparison of spawning data for <i>T. zillii</i> (strains 'A' and 'B').....	126
Table 3.5.	Fecundity and egg size data for <i>T. zillii</i> (strain 'A').....	130
Figure 3.3.	Fecundity and egg size data for <i>T. zillii</i> (strain 'A').....	131
Table 3.5.	Fecundity and egg size data for <i>T. zillii</i> (strain 'B').....	134
Figure 3.4.	Fecundity and egg size data for <i>T. zillii</i> (strain 'B').....	135
Table 3.7.	Inter-strain comparison of fecundity and egg size data.....	137
Table 3.8.	Inter-strain ANCOVA of fish weight and fecundity, egg diameter and total egg volume.....	139
Table 3.9.	Correlation and regression analysis of fecundity and egg size parameters to fish weight/length in <i>T. zillii</i> (strain 'A').....	140
Table 3.10.	Correlation and regression analysis of fecundity and egg size parameters to fish weight/length in <i>T. zillii</i> (strain 'B').....	141
Figure 3.5.	Regression analysis of fish size and total fecundity in <i>T. zillii</i> (strain 'A').....	143
Figure 3.6.	Regression analysis of fish size and total egg volume in <i>T. zillii</i> (strain 'A').....	144
Figure 3.7.	Regression analysis of fish size and total fecundity in <i>T. zillii</i> (strain 'B').....	146
Figure 3.8.	Regression analysis of fish size and total egg volume in <i>T. zillii</i> (strain 'B').....	147
Table 3.11.	Regression analysis of ISI and total fecundity.....	148
Figure 3.9.	Regression analysis of ISI and total fecundity.....	150
Table 3.12.	Regression analysis of ISI and mean egg volume.....	151
Figure 3.10.	Regression analysis of ISI and mean egg volume.....	152
Figure 3.11.	Variation of relative fecundity and mean egg volume over successive spawns in serial-spawning <i>T. zillii</i> (strain 'A').....	155

Table 3.13.	Variation of fish weight, total fecundity and egg size over successive spawns in serial-spawning <i>T. zillii</i> (strain 'A').....	156
Figure 4.1.	Variation of oocyte shape with developmental stage.....	197
Figure 4.2.	Variation of oocyte diameter with developmental stage.....	197
Plate 4.1.	Transverse section of ovary showing oogonia and stage 1 oocytes.....	199
Plate 4.2.	Transverse section of ovary showing stage 2 oocytes.....	199
Plate 4.3.	Transverse section of ovary showing stage 2 oocytes.....	202
Plate 4.4.	Transverse section of ovary showing stage 2 oocytes.....	202
Plate 4.5.	Transverse section of ovary showing stage 3 oocytes.....	204
Plate 4.6.	Transverse section of ovary showing a stage 4 oocyte.....	204
Plate 4.7.	Transverse section of ovary showing an early stage 5 oocyte.....	207
Plate 4.8.	Transverse section of ovary showing a late stage 5 oocyte.....	207
Plate 4.9.	Transverse section of ovary showing a stage 6 oocyte.....	209
Plate 4.10.	Transverse section of ovary showing a stage 7 oocyte.....	209
Plate 4.11.	Transverse section of ovary showing follicular layer of a stage 6/7 oocyte.....	212
Plate 4.12.	Transverse section of ovary showing a post-ovulatory follicle.....	212
Plate 4.13.	Transverse section of ovary showing numerous post- ovulatory follicles.....	214
Plate 4.14.	Transverse section of ovary showing α -stage atresia.....	214
Plate 4.15.	Transverse section of ovary showing α - and β -atresia.....	216
Plate 4.16.	Transverse section of ovary showing λ -atresia.....	216
Table 4.1.	Summary of classification scheme used to identify stages of oocyte growth.....	217
Figure 5.1.	Comparison of E ₂ , T, total calcium and E ₂ /T ratio in individual <i>T. zillii</i> (strains 'A' and 'B') over a 42 day period.....	239
Figure 5.2.	Profiles of T in eight individual <i>T. zillii</i> (strain 'A') over 42 days.....	241

Figure 5.3.	Profiles of T in eight individual <i>T. zillii</i> (strain 'B') over 42 days.....	242
Table 5.1.	Validation of ovarian biopsy method.....	248
Figure 5.4.	Profiles of E ₂ , T and E ₂ /T ratio in two experimental groups of <i>T. zillii</i> over a period of 82 days.	250
Figure 5.5.	Volume fraction analysis of oocyte developmental stages in two experimental groups of <i>T. zillii</i> over a 82 day period.....	253
Figure 5.6.	Profiles of E ₂ , T and E ₂ /T ratio in an individual repeat- spawning fish.....	257
Figure 5.7.	Volume fraction analysis of oocyte developmental stages in an individual repeat-spawning fish.....	259
Table 5.2.	Oocyte size and shape data necessary for numerical density stereology.....	264
Figure 5.8.	Profiles of GSI, HSI, E ₂ , T, total serum calcium and E ₂ /T ratio in <i>T. zillii</i> (strain 'A') over a 26 day period following spawning.....	265
Figure 5.9.	Volume fraction analysis of oocyte developmental stages in <i>T. zillii</i> over a 26 day period following spawning.....	268
Figure 5.10.	Numerical density analysis of oocyte developmental stages in <i>T. zillii</i> over a 26 day period following spawning.....	271
Plate 5.1.	Transverse section of ovary soon after spawning.....	275
Plate 5.2.	Transverse section of ovary one day after spawning.....	275
Plate 5.3.	Transverse section of ovary two days after spawning.....	277
Plate 5.4.	Transverse section of ovary three days after spawning.....	277
Plate 5.5.	Transverse section of ovary four days after spawning.....	280
Plate 5.6.	Transverse section of ovary four days after spawning.....	280
Plate 5.7.	Transverse section of ovary six days after spawning.....	282
Plate 5.8.	Transverse section of ovary twenty six days after spawning.....	282

Figure 6.1.	Flow diagram representing sampling protocol used in Experiment 1b (Chap. 6).....	309
Plate 6.1.	Superficial view of <i>T. zillii</i> (strain 'B') ovary.....	312
Table 6.1.	Comparison of endoscopic appearance of ovary in three groups of <i>T. zillii</i> (strain 'B').....	313
Table 6.2.	Incidence of spawning activity in three experimental groups of <i>T. zillii</i> (strain 'B').....	315
Figure 6.2.	Profiles of E ₂ and T in confined and individual <i>T. zillii</i> (strain 'B') over a 65 day period.	320
Figure 6.3.	Profiles of E ₂ and T in confined and individual <i>T. zillii</i> ('B'); individual fish subdivided into spawning and non-spawning fish.....	321
Figure 6.4.	Volume fraction analysis of confined and individual <i>T. zillii</i> (strain 'B') over a 65 day period.....	324
Figure 6.5.	Volume fraction analysis in confined and individual <i>T. zillii</i> (strain 'B'); individual fish subdivided into spawning and non-spawning fish.....	326
Figure 6.6.	Flow diagram indicating the sampling protocol used in Experiment 3 (Chap. 6).....	332
Figure 6.7.	Profiles of E ₂ and T in confined and individual <i>T. zillii</i> (strain 'A') over a 95 day period.....	334
Figure 6.8.	Profiles of E ₂ and T in confined and individual <i>T. zillii</i> (strain 'A'); individual fish subdivided into spawning and non-spawning fish.....	336
Figure 6.9.	Profiles of E ₂ and T in confined and individual <i>T. zillii</i> (strain 'A'); individual fish subdivided into 4 sub-groups based upon whether provided with spawning substrate and/or visual contact with male conspecifics.....	340

Table 6.3.	Incidence of spawning activity in 4 sub-groups of fish experiencing differing regimes of spawning substrate and/or visual contact with male conspecifics.....	342
Figure 7.1.	Growth of 4 groups of <i>T. zillii</i> fry from first feeding to day 290 maintained on either high or low ration sizes.....	367
Figure 7.2.	Cumulative mortality in 4 groups of <i>T. zillii</i> maintained on either high or low ration sizes over 290 days.....	368
Table 7.1.	Ration allocation during Experiment 1 (Chap. 7).....	370
Table 7.2.	Comparison of SGR over Experiment 1(Chap. 7).....	370
Table 7.3.	Comparison of FCR over Experiment 1(Chap. 7).....	370
Figure 7.3.	Mean weight and length of 3 groups of rationed <i>T. zillii</i> (males and females treated separately) over a 90 day period.....	372
Figure 7.4.	Mean weight and length of 3 groups of rationed <i>T. zillii</i> (males and females compared) over a 90 day period.....	374
Table 7.4.	Comparison of SGR in 3 groups of rationed <i>T. zillii</i> over Experiment 2 (Chap. 7).....	376
Table 7.5.	Comparison of FCR in 3 groups of rationed <i>T. zillii</i> over Experiment 2 (Chap. 7).....	376
Figure 7.5.	Comparison of E ₂ and T in rationed groups of <i>T. zillii</i> (male and female).....	377
Figure 7.6.	Variation of mean weight and length in groups of individual <i>T. zillii</i> maintained on differing rations over a 60 day period.....	382
Table 7.6.	Spawning performance of 4 groups of individual <i>T. zillii</i> maintained on differing rations over a 60 day period.....	383
Table 7.7.	Mean fecundity, egg size and other spawning parameters in two groups of rationed <i>T. zillii</i> over a 60 day period.....	385
Figure 7.7.	Cumulative total egg volume in three groups of <i>T. zillii</i> maintained on different rations over a 60 day period.....	385

Table 7.8.	Correlation and regression analysis of fecundity and egg size data with fish size for <i>T. zillii</i> fed upon high ration.....	387
Figure 7.8.	Regression analysis of fecundity and fish weight in high and low ration <i>T. zillii</i>	388
Table 7.9.	Correlation and regression analysis of fecundity and egg size data with fish size for <i>T. zillii</i> fed upon low ration.....	389
Table 7.10.	Correlation and regression analysis of fecundity and egg size data for <i>T. zillii</i> (high and low ration pooled).....	390
Figure 7.9.	Regression analysis of fecundity, mean egg diameter and total egg volume with fish weight (data from high and low rations pooled).....	391
Table 7.11.	ANCOVA of total fecundity, mean egg diameter and total egg volume with fish weight in two groups of <i>T. zillii</i> fed differing ration sizes.....	392
Figure 7.12.	Comparison of mean length, weight, GSI and HSI in groups of <i>T. zillii</i> fed high and low ration sizes.	396
Figure 7.13.	Comparison of mean E ₂ and T in groups of <i>T. zillii</i> fed high and low ration size.....	398
Figure 7.14.	Volume fraction analysis of oocyte developmental stages in three groups of <i>T. zillii</i> fed upon differing feeding regimes.....	400
Plate 7.1.	Transverse section of ovary from a fish fed upon high ration.....	403
Plate 7.2.	Transverse section of ovary from a fish fed upon low ration.....	403
Plate 7.3.	Transverse section of ovary from a fish fed <i>ad libitum</i>	405

Glossary of scientific and common names of fish mentioned in this thesis.

Note: some species of fish (especially tilapia) do not have widely recognised common names. These species are indicated here by a dash (-) in place of the common name.

<u>SCIENTIFIC NAME.</u>	<u>COMMON NAME.</u>
<i>Acanthobrama terrae-sanctae</i>	-
<i>Acipenser transmontanus</i>	White sturgeon
<i>Anguilla anguilla</i>	European eel
<i>Brachydanio rerio</i>	Zebrafish
<i>Carassius auratus</i>	Goldfish
<i>Carassius carassius</i>	Crucian carp
<i>Chelidonichtys kumu</i>	Red gurnard
<i>Chromis dispilus</i>	Damselfish
<i>Cichlasoma citrinellum</i>	Midas cichlid
<i>Cichlasoma nigrofasciatus</i>	Convict cichlid
<i>Clarias gariepinus</i>	African catfish
<i>Clupea harengus</i>	Atlantic herring
<i>Clupea harengus pallasii</i>	Pacific herring
<i>Colisa lalia</i>	Dwarf gourami
<i>Cottomephorus grewingi</i>	Yellowfish Baikal sculpin
<i>Cymatogaster aggregata</i>	Sea perch
<i>Cynoscion nebulosus</i>	Spotted sea trout
<i>Cyprinus carpio</i>	Common carp
<i>Dicentrachus labrax</i>	Sea bass
<i>Esox lucius</i>	Pike
<i>Etroplus suratensis</i>	Pearlspot
<i>Engraulis japonica</i>	Japanese anchovy
<i>Fundulus confluentus</i>	Marsh killifish
<i>Fundulus heteroclitus</i>	Killifish
<i>Gadus morhua</i>	Cod
<i>Gasterosteus aculeatus</i>	Three-spined stickleback
<i>Gobius jazo</i>	Black goby
<i>Haplochromis 'argens'</i>	-
<i>Heteropneustes fossilis</i>	Indian catfish
<i>Hippoglossus hippoglossus</i>	Atlantic halibut
<i>Lates niloticus</i>	Nile perch
<i>Leuciscus leuciscus</i>	Dace
<i>Lepomis gibbosus</i>	Pumpkinseed sunfish
<i>Leptocottus armatus</i>	Staghorn sculpin
<i>Limanda limanda</i>	Dab
<i>Lutjanus campechanus</i>	Red snapper
<i>Maccullochella macquariensis</i>	Australian freshwater trout cod
<i>Melanogrammus aeglefinus</i>	Haddock
<i>Merlangus merlangus</i>	Whiting
<i>Micropogonias undulatus</i>	Atlantic croaker
<i>Micropterus salmoides floridanus</i>	Largemouth bass
<i>Mugil cephalus</i>	Grey mullet
<i>Mycteroperca olfax</i>	Galapagos bacalao
<i>Oncorhynchus keta</i>	Chum salmon
<i>Oncorhynchus kisutch</i>	Coho salmon
<i>Oncorhynchus mykiss</i>	Rainbow trout
<i>Oncorhynchus nerka</i>	Kokanee salmon
<i>Oncorhynchus rhodurus</i>	Amago salmon
<i>Oncorhynchus tshawytscha</i>	Chinook salmon
<i>Oreochromis aureus</i>	Blue tilapia

<i>Oreochromis esculenta</i>	-
<i>Oreochromis leucosticta</i>	-
<i>Oreochromis macrocephala</i>	-
<i>Oreochromis mossambicus</i>	Mozambique mouthbrooder
<i>Oreochromis niloticus</i>	Nile tilapia
<i>Oreochromis spilurus niger</i>	-
<i>Oryzias latipes</i>	Medaka
<i>Pagrus auratus</i>	Snapper
<i>Pagrus major</i>	Red sea bream
<i>Perca flavescens</i>	Yellow perch
<i>Petromyzon marinus</i>	Sea lamprey
<i>Pimophales promelas</i>	Fathead minnow
<i>Pleuronectes platessa</i>	Plaice
<i>Pseudopleuronectes americanus</i>	Winter flounder
<i>Poecilia monacha</i>	Top minnow
<i>Poecilia reticulata</i>	Guppy
<i>Pterophyllum scalare</i>	Angelfish
<i>Rutilus rutilus</i>	Roach
<i>Salmo salar</i>	Atlantic salmon
<i>Salmo trutta</i>	Brown trout
<i>Salvelinus alpinus</i>	Arctic charr
<i>Salvelinus fontinalis</i>	Brook trout
<i>Sardinops melanostictus</i>	-
<i>Sarotherodon galileus</i>	-
<i>Sarotherodon leucostictus</i>	-
<i>Sarotherodon melanotheron</i>	Black-chinned tilapia
<i>Scomber scombrus</i>	Atlantic mackerel
<i>Scophthalmus maximus</i>	Turbot
<i>Seriola dumerilii</i>	Mediterranean yellowtail
<i>Solea solea</i>	Dover sole
<i>Sparus auratus</i>	Gilthead sea bream
<i>Symphysodon aequi fasciata axelrodi</i>	-
<i>Thunnus albacares</i>	Yellowfin tuna
<i>Tilapia guineensis</i>	-
<i>Tilapia macrocephala</i>	-
<i>Tilapia mariae</i>	-
<i>Tilapia rendalli</i>	-
<i>Tilapia tholloni</i>	-
<i>Tilapia zillii</i>	Redbelly tilapia
<i>Trichogoita trichopterus</i>	Blue gourami

Glossary of commonly-used abbreviations.

<u>ABBREVIATION</u>	<u>FULL TERM</u>
ANOVA	Analysis of variance
ANCOVA	Analysis of covariance
E ₁	Oestrone
E ₂	17 β -oestradiol
E ₃	Oestriol
FSH	Follicle stimulating hormone
GnRH	Gonadotropin releasing hormone
GnRIH	Gonadotropin release inhibitory factor
GSI	Gonadosomatic index
GTH	Gonadotropin
hCG	Human chorionic gonadotropin
HSI	Hepatosomatic index
LH	Luteinizing hormone
MIS	Maturation-inducing steroid
ND	Numerical density
POF	Post-ovulatory follicle
PRL	Prolactin
SE	Standard error
T	Testosterone
VF	Volume fraction
VTG	Vitellogenin
3 β -HSD	3 β -hydroxysteroid dehydrogenase
11-KT	11-ketotestosterone
17 α -OH-P	17 α -hydroxy-progesterone
17 α -20 β -P	17 α -20 β -dihydroxy-pregnen-3-one

Chapter 1

General introduction, literature overview and aims of research.

(1) General introduction, literature overview & aims of research.

Over recent years, tilapiine fish (Family: Cichlidae) have steadily grown to become one of the most commercially important groups of freshwater fish species in tropical aquaculture and represent a major protein source in many developing countries. Whilst tilapia are indigenous to African countries, their distribution has been widened through artificial introduction to over 100 tropical and sub-tropical countries including the Americas, the Middle East and Asia (Balarin & Hatton, 1979; Pullin & Lowe-McConnell, 1982; Pullin, 1983).

Tilapias offer immense potential to aquaculture due to several beneficial physiological attributes. Firstly, tilapias tolerate a variety of environmental conditions and can adapt to wide ranges of salinity, oxygen tension and overcrowding. Growth rates are swift even when maintained on various natural or cheap artificial foods. Tilapias have relatively short reproductive cycles, breed prolifically under culture conditions, are strongly resistant to disease and infection and are relatively amenable to handling. Most importantly, tilapias are valued by humans for their palatability as a food source (Pullin & Lowe-McConnell, 1982). An excellent example of the tilapias suitability to aquaculture was provided by Edwards *et al.* (1988), who claimed yields of 5 - 6 tonnes/hectare/year of the Nile tilapia *Oreochromis niloticus* (L.) raised in ponds solely fertilized with sewage over a period of 5 to 7 months.

Despite the current widespread distribution and development of tilapia culture, world production of tilapia from aquaculture totalled just 391,000 tonnes in 1990 (Source: Food and Agricultural Organization, 1992; cited by Macintosh & Little (1995)). This production figure forms just over 5% of the annual total freshwater fish production for 1990.

Over 70 species of fish are referred to by the common name 'tilapia'. Of these, Huet (1971) listed 16 species that had been subject to either experimental or commercial culture; a more recent study by Balarin and Hatton (1979) quoted a total of 23 separate species. Realistically, just eight or nine species of tilapia remain of significance in terms of aquaculture (Schoenen, 1982; Pullin, 1983).

Culture of tilapia has progressed swiftly over recent years, particularly in certain parts of Asia, e.g. Thailand, Taiwan, the Phillipines and notably as part of integrated culture schemes in China (Chen, 1990). Culture has remained relatively poorly developed in African and other regions.

The potential for future expansion of commercial tilapia culture is extremely high. An estimated shortfall of approximately 20 million tonnes is expected between market demand and expected marine fisheries production (100 million tonnes) by the year 2000. In order to address this shortfall, output by inland fisheries will need to rise proportionally (Manzi, 1989; Haight, 1992; cited by Macintosh & Little, 1994). Clearly then, the further development of tilapia culture operations not only shows huge potential but will become a necessity within the next decade.

As consumer demand for tilapias increases it becomes vital that culture operations strive to meet such market demand. Optimisation of hatchery efficiency is of paramount importance if production is to be maximised and maintained. Mass production of high quality fry remains the most important prerequisite in the expansion and intensification of tilapia culture. Broodfish productivity remains one of the most significant constraints on commercial production costs and thus knowledge of the factors affecting broodstock productivity is of great importance to the futher development of tilapia culture.

Sexually mature Cichlidae are generally able to undergo successive reproductive cycles at intervals of 4 - 6 weeks. Theoretically, this should lead to an almost continous production of fry assuming that seasonal environmental variation remained minimal (Moreau, 1979). Under intensive farming conditions however, the asynchronous nature of the reproductive cycles of individual broodstock may lead to spasmodic fry production to the detriment of total farm output (Jalabert & Zohar, 1982). Low fecundity and asynchronous spawning patterns by female broodstock inevitably lead to the need for extensive fish holding facilities to even approach satisfactory output and often requires careful, time-consuming management of very large numbers of fish.

Broodfish productivity remains one of the most significant constraints on commercial production costs and a knowledge of the factors affecting broodstock production is of immense importance if tilapia culture is to be developed effectively. This is particularly emphasised in the case of substrate-spawning tilapia, which have received far less attention than mouth-brooding genera.

The general aim of this thesis was to investigate several, previously little known aspects of reproductive physiology and endocrinology (e.g. fecundity, spawning periodicity, dynamics of ovarian recrudescence and associated hormonal profiles) in a substrate-spawning tilapia *Tilapia zillii* (Gervais), a tilapia that is becoming increasingly popular in world aquaculture.

(1.1) Current taxonomic position of tilapia.

Taxonomic classification of tilapias has been subject to several revisions over recent years. Initially, most commercially viable tilapia species were originally classified into one genus, *Tilapia* (eg. Trewavas, 1966). Subsequent studies separated the individual species belonging to the *Tilapia* genus based upon differences in reproductive mode. Those species that had evolved as substrate-spawner/guarders were retained in the *Tilapia* genus whilst those species found to rear their young orally were grouped into a new genus (*Sarotherodon*) (Lowe-McConnell, 1959; Trewavas, 1982). The most recent re-classification of tilapia taxonomy was reported by Trewavas (1983); this proposed the adoption of three generic groupings; *Tilapia*, *Sarotherodon*, and *Oreochromis*. These groupings were based upon differences in terms of feeding habits, biogeographical distribution but principally mode of reproduction.

The reader should be aware that the commonly used term 'tilapia' is often used to collectively refer to members of all three genera within the tribe tilapiini. Considering the frequent changes in tilapia taxonomy, it should also be noted that existing literature obviously adopts the classification system in use at the time of publication, thus whilst the Nile tilapia is referred to as *Oreochromis niloticus* in present day literature, the same species is found to be referred to as *Tilapia nilotica* in older

publications. In such cases and to avoid unnecessary confusion, it is the intention of this thesis to refer to such cases in the text of this thesis by the most recent classification scheme whilst the actual corresponding reference given in the reference section of this thesis will use the classification scheme adopted at the time of publication.

Furthermore, it should be noted that throughout this thesis, species of tilapia will be referred to by their scientific names since few have widely recognised common names (see Glossary, page xxi).

(1.2) Modes of reproduction in *Oreochromis*, *Sarotherodon* and *Tilapia*.

The majority of tilapias featuring significantly in aquaculture belong to the *Oreochromis* genus, e.g. *Oreochromis niloticus* and *Oreochromis mossambicus* (Peters). Members of this genus adopt a maternal mouthbrooding mode of reproduction. Communal breeding results in male fish building and defending territories within a defined spawning area (referred to as a 'lek'). Courtship between resident males and females visiting the 'lek' is relatively short, lasting just a few hours (Rana, 1988) and results in batches of eggs being spawned into shallow nests. Eggs fertilised by the male are picked up by the female and incubated in her mouth. Directly after spawning the female leaves the nest and rears her clutch until the fry are free-swimming (Rana, 1988). This is followed by a period of extended maternal care in which free-swimming fry may seek shelter in the females mouth.

Species belonging to the *Sarotherodon* genus, e.g. *Sarotherodon galileus* (L.) and *Sarotherodon melanotheron* (Rüppel) also exhibit mouthbrooding behaviour though brooding may be undertaken by either the male or female. Courtship lasting several hours to several days precedes the release of eggs into a shallow nest defended by both sexes of the courting pair (Rana, 1988). After egg-laying and fertilisation is complete, both sexes or the male may pick up the egg batch for oral incubation. In contrast to *Oreochromis* species, parent fish belonging to the *Sarotherodon* genus remain together after spawning until fry are released from the buccal cavity. Once released, fry may not be collected by the parents (Rana, 1988).

Species of the *Tilapia* genus, for example *T. zillii* and *Tilapia rendalli* (Boulenger), spawn in territories established and defended by both sexes after a long period of courtship (several days). Adhesive eggs are laid into a pre-cleaned nest and are guarded by both parents which often involves the removal of the developing clutch to further nest sites (Rana, 1988).

Unlike many other species of teleost, tilapias exhibit high levels of parental care (Lowe-McConnell, 1955, 1975, 1982; Fryer & Iles, 1972; Trewavas, 1983). It is thought that members of the Tribe Tilapiini were originally substrate-spawners and that the mouthbrooding *Sarotherodon* and *Oreochromis* forms evolved from differing species of ancestral substrate-spawner. However, as Rana (1988) highlighted, the polyphyletic pathways from guarders to maternal oral rearing remains largely unresolved and a much debated topic (Noakes & Balon, 1982). Two main hypotheses have been argued. Trewavas (1982) claimed that a mouthbrooding ancestor diverged from ancestral substrate-spawners and formed the origin of the group *Sarotherodon* and then *Oreochromis* (i.e. all mouth-brooders have a common origin). Peters & Berns (1978) however, claimed that present mouthbrooders have different ancestors and that there was numerous divergences from substrate-spawning groups (i.e. multiple speciation). The authenticity of these hypotheses has been examined on numerous occasions using allozyme studies (e.g. Kornfield *et al.*, 1979; McAndrew & Majumdar, 1983; Sodsuk & McAndrew, 1991). Whilst confirming the existence of the 3 groups of tilapia proposed by Trewavas (1983), an indisputable phylogeny could not be identified. More recently, through comparative studies of enzyme loci, Pouyard & Agnès (1995) found evidence to support the hypothesis that mouthbrooders have a single origin and thus negated the hypothesis of multiple speciation (Peter & Berns, 1978). Confusion still exists however, over the phylogeny of *S. melanotheron* since it was found to be genetically closer to the *Oreochromis* genus than *Sarotherodon* (Pouyard & Agnès, 1995).

The present study investigates the dynamic basis of reproductive physiology and endocrinology within the substrate-spawning *Tilapia* genus, concentrating

predominantly on *T. zillii*. This species can tolerate wide ranges of temperature, is one of the most salinity tolerant of all tilapias (El-Zarka, 1956; Bayoumi, 1969) and can readily utilise aquatic vegetation as its main food source (Siddiqui, 1979). Furthermore, *T.zillii* is one of the nine tilapias featuring significantly in world aquaculture (Pullin, 1983). Consequently, this species is extensively cultured in Africa and has been progressively introduced into several different regions of Africa and the Middle East. More recently, *T. zillii* has been introduced into the irrigation canals of southern California (U.S.A.) as an effective biological control agent against aquatic weed and has subsequently proven successful in the biological control of aquatic weed and concurrent control of mosquito and chironomid midge populations. Moreover, *T. zillii* is becoming a highly valued sporting fish amongst game fishermen (see Legner, 1983).

Whilst several studies have investigated the reproductive biology of the tilapias, much of the previous work has concentrated on the more widespread and widely cultured mouthbrooding genera (e.g. Aronson, 1949; Shaw & Aronson, 1954; Lowe-McConnell, 1955; Welcomme, 1967; Iles & Holden, 1969; Fryer & Iles, 1972; Marshall, 1979; Babiker & Ibrahim, 1979a; Payne & Collinson, 1983; Rana, 1986; Srisakultiew, 1993; Tacon *et al.*, 1996). Comparatively little research has been directed towards substrate-spawning species. Since the distribution and culture of *T. zillii* is gaining in momentum, a knowledge of the underlying reproductive physiology and endocrinology of this species is highly desirable. Moreover, the beneficial attributes of such a species described earlier, particularly the general hardiness and relatively short reproductive cycle of the tilapia, renders this species particularly appropriate for detailed studies of the dynamics of ovarian and endocrine change throughout reproductive cycles. This is of particular interest since *T. zillii* is a multiple-spawning fish with relatively short reproductive cycles.

(1.3) Culture systems and tilapia fry production.

Tilapias are cultured using various methodologies ranging from traditional pen, hapa (nylon net enclosures), cage and pond culture to more intensive tank and raceway culture systems.

Pen and cage culture of tilapias is thought to be the most appropriate for developing countries whilst pond culture systems, requiring a greater level of management, may be better suited to developed countries (Henderson, 1982). Henderson further noted that the major technical and managerial complexities involved in tilapia culture lie in the production of fry rather than on-growing, particularly in the case of hybrid seed which is thought to be best suited to temperate climates.

Polyculture of tilapias (pond culture of tilapias integrated with pig, chicken or duck farming) is also widely practised, particularly in developing countries. Organic manures and fertilisers used in such an operation serve well to stimulate heterotrophic food chains in culture ponds and are considered to be much better than inorganic fertilisers for microphagous tilapia stocks (Hepher & Pruginin, 1982).

Tilapias, though a much valued fish, pose particular problems when grown in ponds irrespective of whether polyculture or monoculture methodology are adopted. A major drawback lies in the early maturation of tilapiine species; tilapias may spawn as young as 4 - 5 months of age (Wohlfarth & Hulata, 1983) at a size of just 6 - 15 cm (Babiker & Ibrahim, 1979a; Dadzie & Wangila, 1980). Such early maturation can quickly result in prolific spawning activity resulting in very large numbers of small fry, thus effectively "stunting" the entire pond population and often other species present. Consequently, the proportion of market size fish (200 - 250g) and the yield at each harvest becomes progressively smaller with the passage of time. Hepher & Pruginin (1982) reported that such sequential harvesting undertaken on an intensive commercial farm striving to supply consistently large quantities of market-sized fish becomes increasingly impractical and reduces profitability. A further, potentially more serious implication of such a practice was documented by Silliman (1975) who claimed that post-harvest fish, remaining in the pond and from which fry are usually taken for future

rearing, will inadvertently be selected-for in terms of slower growth, a trait most likely inherited by their offspring. There is little doubt that early and prolific breeding under tropical pond aquaculture remains the most serious disadvantage in the culture of indigenous cichlids (Pillay, 1979).

Various methodologies have been investigated in an attempt to control unwanted reproduction in tilapias. Huet (1971) recommended that culture of tilapias only be carried out over defined periods interspersed with the complete draining of culture ponds in between successive cycles. The polyculture of tilapias with natural predators has also been attempted using predator species such as Nile perch *Lates niloticus* (L.) (Ofari, 1988). Culture at high stocking densities in the order of 30 fish/m² has also been attempted (Henderson, 1982). However, the two most commonly practised ways of overcoming unwanted reproduction remains the culture of a mixed sex population coupled with harvesting before the attainment of sexual maturity (Hepher & Pruginin, 1982) or the culture of monosex populations (i.e. the faster growing male) (e.g. Mires, 1977). Of these methodologies, monosex culture remains the most favoured technique (Mires, 1977; Guerrero, 1982).

Populations of all male tilapia can be obtained via various means including hand or mechanical size grading (Guerrero, 1982), by hand sexing (Mires, 1977; Guerrero, 1982), by hybridisation (e.g. Mires, 1977) or by sex-reversal techniques using male steroid hormones such as methyl-testosterone (e.g. Gale *et al.*, 1995).

For successful production of consistently large numbers of fry however, all the above techniques would require large numbers of fry of a similar age and size. Furthermore mass production of tilapia fry is often complicated by unpredictable and asynchronous spawning patterns and the requirement for large numbers of broodstock.

Despite the tendency for prolific breeding, tilapia fry production from traditional pond systems have been reported to be as low as 10 fry/female/month (Coche, 1982). This low productivity is thought to be a consequence of low fecundity per spawn, use of inappropriate sex ratios, incompatibility between both sex and species and through

frequent disturbance of broodfish during harvesting (Rana, 1986). Generally, fry quality and quantity remain largely dependent upon the managerial practice adopted.

Unlike salmonid and carp species, tilapias are asynchronous spawners and have inherently low fecundity. As a consequence, large scale production of tilapia fry requires large numbers of broodstock. For example, the production of 100 tonnes of tilapia averaging 250g each would involve an estimated production of 1,000,000 fry/year and require at least 100 spawnings per month (Rana, 1986).

The development of large scale intensive hatcheries is now thought to be critical to offset the shortfall in seed production by more traditional methods (Pullin & Lowe-McConnell, 1982). However, intensive tilapia production from hatcheries based upon spawning arena, tank and hapa methodology remains problematical due to inherent variation between individual fecundities and through the differences and asynchrony of spawning periodicity between broodstock individuals. Nevertheless, as reported by Rana (1986), such intensive methodologies have shown a pronounced increase in fry production from less than 100 fry/female/month to over 500 - 600 fry/female/month.

(1.4) Fecundity in tilapias.

Fish fecundity has been studied extensively in teleost fish and is often defined as the number of eggs spawned. However, considering the wide ranges of reproductive habits adopted by fish (Breder & Rosen, 1966), a precise definition of fecundity that is applicable under all circumstances remains difficult to devise (Bagenal, 1978).

The precise definition of fecundity in tilapia has been the subject of considerable debate in previous studies and will be discussed in length in Chapter 3. The present study however, adopts the definition suggested by Rana (1988) who proposed that ideally, total fecundity of tilapias should be defined as the number of eggs found in a freshly spawned egg clutch.

Evolution of the high degree of parental care exhibited by the tribe tilapiini (particularly those species belonging to the mouthbrooding *Oreochromis* and *Sarotherodon* genera) has led to a resultant increase in egg size and a corresponding

reduction in the number of eggs laid per clutch (Svardson, 1949; Lowe-McConnell, 1959; Fryer & Iles, 1972; Noakes & Balon, 1982; Peters, 1983; Trewavas, 1983). Since tilapias are multiple-spawners, their fecundity represents only a fraction of their reproductive potential (Rana, 1988).

It is generally accepted in teleost fish that total fecundity increases and relative fecundity (number of eggs/unit body weight) decreases in accordance with increasing female age, length and weight (e.g. Bagenal & Tesch, 1978; Wootton, 1979; Mann & Mills, 1979; Hislop, 1984; Rana, 1986). These relationships have also been reported for tilapias (e.g. Lowe-McConnell, 1955; Riedel, 1965; Welcomme, 1967; Botros, 1969; Dadzie, 1970; Marshall, 1979; Siraj *et al.*, 1983). Rana (1986), however, found that total fecundity of *O. niloticus* was more closely related to maternal size than age and that fecundity of similar aged fish increased with body size. Mouthbrooding tilapias have generally been associated with low fecundities e.g. 324 - 1672 eggs/spawn in *Oreochromis esculenta* (Graham) (Lowe-McConnell, 1955), 56 - 498 eggs/spawn in *Oreochromis leucosticta* (Trewavas) (Welcomme, 1967) and 325 - 4392 in *Oreochromis aureus* (Steindachner) (Dadzie, 1970).

The fecundity of *T. zillii* has received relatively scant attention. Moreover, few of the reported studies have attempted to relate fecundity to egg size or to spawning periodicity. Lowe-McConnell (1955) reported that *T. zillii* produced many more eggs than any of the mouthbrooding species. Several studies of *T. zillii* have provided fecundity estimates based upon actual counts (either directly or by estimation) of spawned egg clutches. For example El-Zarka (1956) found fecundity to average 4600 eggs/spawn in laboratory stocks held at ambient temperature. Further laboratory studies by Fishelson (1966) and Rothbard (1979) recorded values of 600 - 1500 eggs/spawn and 1000 eggs/spawn (for a 30g fish) respectively. Loiselle (1977) recorded fecundities ranging from 3500 - 5000 eggs/spawn in Lake Volta (Ghana). A further study reported a mean fecundity of 6000 eggs/spawn in Lake Mariut (for a 300g fish) (Botros, 1969) but also found considerable variation of fecundity between fish of the same body length. Peters (1983) found the fecundity of *Tilapia tholloni*

(Sauvage) to increase with maternal weight to approximately 3000 eggs/spawn (in a fish of approx. 60g). A more recent study by Dadzie & Wangila (1980) on pond-raised *T. zillii* found fecundity to range from 674 eggs/spawn (in a fish 6.6cm in length) to 7009 eggs/spawn (in a fish 14.1cm in length) (mean = 2359 eggs/spawn). Fecundity was found to increase with maternal weight, length and depth. No correlation was found between fecundity and egg size. Egg size in tilapias is reported to be species-specific (Lowe-McConnell, 1955; Trewevas, 1983) though there is considerable evidence to suggest that larger eggs are produced by bigger fish (see Trewevas, 1983). Rana (1988) maintained that the factors governing egg size in tilapias remain unclear though there is considerable evidence to suggest that maternal age may be the predominant factor influencing egg size.

Little is known about the determination of fecundity in tilapias though Lowe-McConnell (1955) stated that fecundity could be influenced by the length of breeding season, the frequency of spawning during a breeding season, the number of eggs laid per spawn and the care taken of eggs before and after hatching. Peters (1983) stated that the high level of oocyte resorption seen in tilapias is likely to play a critical role in fecundity determination. A more recent study by Srisakultiew (1993) found that spawning history affected both quality and quantity of eggs in *O. niloticus*. Fecundity of each non-mouthbrooding female appeared to depend upon the spawning history of that female. Individual females that had spawned for the second or third time were found to ovulate more eggs than those which had spawned for the first time.

Little is known of how fecundity varies with progressive spawns in tilapias. Studies on *O. esculenta* and other species suggested that the gonads may be larger and produce more eggs per spawn at the start of the spawning period than towards the end (Lowe-McConnell, 1955). Siraj *et al.* (1983) studied fecundity in three year classes of *O. niloticus* over 3 spawning periods and found relative fecundity (number of eggs/kg maternal weight) to decrease with successive spawning periods. More recently, Srisakultiew (1993) found that spawning history heavily influenced the number of eggs ovulated in *O. niloticus*. Non-mouthbrooding females which had spawned previously

tended to release more eggs than those that had just spawned for the first time. There is no record of how fecundity varies with progressive spawns in substrate-spawning tilapias.

Macintosh & Little (1995) noted that consideration of fecundity alone is probably not the best expression of reproductive capacity in a multiple spawning fish such as the tilapia and that factors governing spawning periodicity should also be taken into consideration alongside size-related fecundity when determining reproductive capacity.

Inherent low fecundity coupled with the asynchronous nature of spawning cycles (Mires, 1982; Rana, 1986) necessitates the upkeep of large numbers of broodstock for adequate seed production (Rana, 1988). Rana (1988) further claimed that the need to maintain large numbers of broodstock could be reduced by selecting broodstock which exhibit optimal reproductive traits such as egg size, egg clutch weight and clutch size. Cisse (1988) reported that whilst the culture of *S. melanotheron* has great potential for both subsistence and production scale farming, successful culture has been limited due to the relatively low fecundity of the species despite its early maturation and multiple-spawning. Cisse continued to report that enhancement of fry production in various tilapiine fishes has been attempted by hormonal treatment, manipulation of temperature and photoperiod to induce spawning (Cridland, 1961, 1962), removal of eggs from the buccal cavity of mouthbrooding species (Dadzie, 1970; Lee, 1979) and also by varying nutrient supply (Cisse, 1988).

Mass fry production remains a major constraint in the intensive culture of tilapia (Mires, 1982) and several studies have attempted to induce spawning in the females of several tilapiine species. These studies have had only limited success. They have involved temperature manipulation (Behrends & Smitherman, 1983; Srisakultiew & Wee, 1988), hypophysation with carp pituitary (CP) preparations (Dadzie, 1970; Srisakultiew & Wee, 1988) and treatment with hormonal preparations such as human chorionic gonadotrophin (hCG) (Dadzie, 1970; Babiker & Ibrahim, 1979b; Srisakultiew & Wee, 1988) or luteinizing hormone (LH) (Dadzie, 1970). Gissis *et al.*, (1988) reported promising results using combined injections of GnRH α and the

dopamine antagonist metaclopramide with 9 out of 13 treated females stripped within 48 hours of injection. In a more recent study Srisakultiew (1993) reported that neither injections of D-ALA⁶-GLY¹⁰-LHRH+pimozide nor implantations (fast or slow release pellets containing LHRH) were effective in inducing spawning in selected *O. niloticus* females. However, females held in isolation and allowed only visual but not physical contact with males were successfully induced to spawn by injection of LHRH+pimozide (Srisakultiew, 1993).

In summary, very little is known about fecundity and egg size in substrate-spawning tilapias such as *T. zillii*, particularly under controlled environmental conditions. Furthermore, little is known of how these factors relate to maternal body size. Moreover, few studies have successfully related fecundity to spawning periodicity in tilapias. Little is also known of how fecundity is determined or how fecundity and egg size vary over successive spawns in serial-spawning fish. A knowledge of the factors involved in the determination of fecundity and spawning frequency in the multiple-spawning tilapias and the controlling mechanisms involved would be of immense benefit to practical culture and continued successful fry production. This is becoming increasingly important as the application of conventional spawning induction protocols to tilapia culture continue to report only limited success. These factors will be addressed further in Chapter 3 using large numbers of *T. zillii* broodstock maintained in environmentally-controlled laboratory aquaria.

(1.5) Spawning cycles and seasonality in tilapiine fish.

de Vlaming (1974) noted that in most cases, the spawning cycles of teleost fish are adjusted by interaction of a series of environmental factors including photoperiod, temperature, rainfall and salinity such that fry are produced only during those environmental conditions favouring fry survival. In temperate fish, reproduction is affected by the fluctuations in temperature and photoperiod found to occur with increasing distance from the equatorial zone. Moreover, reproduction often occurs only

during a limited season in the year and in most cases is restricted to a single occasion (Jalabert & Zohar, 1982).

In equatorial regions, variations in temperature and photoperiod are much less marked than in more temperate regions and thus play less of a regulatory role in the control of reproduction. Several other environmental changes do however, occur in equatorial regions that may affect fry survival such as changes in cloud cover, rainfall and salinity and it is these factors that play more of a regulatory role in the reproduction of equatorial fish stocks.

Many species of tilapia are commonly found in equatorial, sub-tropical and Mediterranean locations either through natural distribution or through artificial introduction. Moreau (1979) observed that in the case of lake populations of tilapia located at high altitude in Madagascar, low temperatures appeared to exert control on spawning periodicity. Moreover, Jalabert & Zohar (1982) noted that tilapias generally tend to extend their spawning seasons for as long as environmental temperatures remain favourable and further observed that although all developmental stages can be found in the testes, the process of spermatogenesis becomes severely retarded during times of low environmental temperature. Furthermore, total inhibition of exogenous vitellogenesis in the female ovary was recorded at low ambient temperature, ultimately resulting in the virtual disappearance of yolky oocytes. Mironova (1977) also reported that reproduction in the tilapia was stimulated by increasing temperature.

Generally, equatorial populations of tilapia exhibit tendencies to breed all year round e.g. *O. niloticus* (Lowe-McConnell, 1958). With increasing distance from the equator however, an element of seasonality begins to appear with stocks of *O. niloticus* exhibiting a well defined breeding season in coincidence with warm, sunny seasons (Lowe-McConnell, 1958). Similarly, whilst equatorial populations of *T. zillii* show no evidence of seasonality (Siddiqui, 1979), the same species in more northern areas possess a well defined spawning period coinciding with times of maximum water temperature and daylength (Ben Tuvia, 1959; Fishelson, 1966; Siddiqui, 1977).

Stocks of tilapia at high altitudes are reported to possess only a 3 - 4 month spawning period during which only 3 spawning cycles can be expected (Mires, 1982; Rothbard *et al.*, 1983). In tropical coastal areas, however, spawning cycles may occur monthly (Philippart & Ruwet, 1982). However, as Jalabert & Zohar (1982) point out, it remains unwise to assume the non-existence of reproductive seasonality in equatorial zones and quote the contradictory results of two studies involving the same equatorial population of *O. leucosticta*. In the first, Hyder (1970) demonstrated a definite seasonal variation in reproduction in this fish whilst Siddiqui (1977) concluded that breeding in the same population was non-seasonal. Studies undertaken by Lowe-McConnell (1959) and Fishelson (1966) using captive tilapias maintained under constant environmental conditions, however, found no evidence of seasonality.

More recently McKaye (1984) and Hussein (1984) reported that under natural conditions tilapiine fish adopt a multiple-spawning strategy and generally display a breeding season of about 6 months timed so as to provide optimum conditions for food availability and fry survival. A study undertaken by Peters (1983) claimed that wild tilapias spawned at least twice a year. Behrends *et al.* (1993) further reported that in *O. aureus* stocked in small hapas, removal of the pre-maxillary bone from females significantly reduced frequency of spawning and clutch size.

Whilst the process of ovarian development is similar amongst most species of teleost (described later in this Chapter), the time taken to undergo each spawning cycle remains largely species dependent. Tilapias have evolved complex courtship behaviour, spawning patterns and varying degrees of parental care. Such traits obviously have a significant bearing on spawning cycles and thus cycles are often found to vary with fish size, species and with the degree of parental care (Srisakultiew, 1993).

It has become well accepted in tilapia reproductive biology that removal or 'robbing' of eggs from mouthbrooding females can effectively reduce the inter-spawn-interval (ISI) by approximately the period of time normally allocated to oral incubation (Dadzie, 1970; Lee, 1979; Siraj *et al.*, 1983; Rana, 1986) and as reported by Rana (1986), can result in reproductive cycles of only 12 - 16 days in length. Rana further

noted that whilst such a practice remains a useful technique for manipulation of breeding cycles, the removal of eggs from females under certain farming conditions may not necessarily reduce the females ISI and quotes the example of fish stocks held in crowded aquaria where the ISI may be as long as those of natural breeding cycles in ponds. Fishelson (1966) reported the production of 11 egg clutches over a 12 month period from a single individual *O. niloticus* from which the eggs were regularly robbed. Contrastingly, the same species was found to spawn just 2 - 7 times per year with average cycles of 23 - 50 days (Mires, 1982) when maintained under the same conditions as those used by Fishelson (1966).

Studies by Uchida & King (1962) and Hughes & Behrends (1983) both suggested that the stocking density and sex ratio of broodfish may exert particular influences on breeding intensity. This will be discussed later in this thesis but as a general rule, the selected sex ratio should be sufficient for a female in the appropriate physiological condition to easily find a male with which to spawn (Little, 1989). Since male tilapia are highly polygynous, stocking of high ratios of females to males has become normal tilapia farming practice (Lowe-McConnell, 1955, 1959; Fryer & Iles, 1972). Moreover, total fry output has been found to decrease with increasing female to male stocking ratios (Mires, 1982; Hughes & Behrends, 1983).

The size of food ration and dietary protein level have also been implicated in the length of spawning cycles in tilapias. For example, Mironova (1977) reported increased fecundity and increased allocation of total mean daily energy production to egg growth in *O. mossambicus* experiencing a shortage of food. Wee & Tuan (1988) found that fish fed diets containing low and medium levels of protein (20, 27.5 and 35%) had higher fecundity than those fed on higher protein levels (42.5 and 50%). Moreover, low protein fish had smaller eggs than the high protein fish and spawned much more frequently.

Very few studies have investigated spawning periodicity in *T. zillii*. Of these, several concern spawning periodicity of wild stocks in isolated lakes and few have investigated spawning periodicity under controlled laboratory conditions. In Lake

Quarun (Egypt), *T. zillii* were found to spawn several times within a spawning period from May - September; highest activity occurred from July - August. A period of approximately one month was recorded between successive spawns. Spawning periodicity was suggested to be controlled by water temperature (El-Zarka, 1956; El-Bolock & Koura, 1960). In Nigerian waters, Welman (1941) observed that *T. zillii* spawned all year round with a climax in Spring. This prolonged breeding period was attributed to the effect of an equatorial climate. An unpublished study by Hamed & Ezzat (quoted by Botros, 1969) found 2 peaks in gonadosomatic index (GSI) in *T. zillii* in Lake Maruit (Egypt) during one breeding season and suggested that this indicated only two spawns within the same season. In studying stocks of *T. zillii* held in experimental tanks at ambient temperature, El-Zarka (1956) found that 30 days after spawning, breeding pairs were able to re-spawn. Three consecutive spawns were recorded, though spawning stopped after the 3rd spawn (this was attributed to a drop in water temperature). El-Zarka continued to suggest that there was a regularity in the breeding cycle of *T. zillii*, the length of the cycle reflecting the time required for fry to become independent from the parents. A further laboratory study involving constant environmental conditions found that from 7 breeding pairs, 35 broods were recorded over 19 months. The shortest interval between broods of any one pair was 15 days and the longest 106 days (Cridland, 1962).

Little is known of the factors governing spawning periodicity in *T. zillii* though environmental factors such as water temperature have been suggested to play crucial roles (El-Zarka, 1956, 1962). In *Oreochromis macrocephala* (Bleeker) spawning capacity was found to decrease with age of fish. Such a tendency for spawning frequency to decrease with age may well hold true for other tilapias (Lowe-McConnell, 1955). Srisakultiew (1993) claimed that the duration of spawning cycles may depend upon absolute peak levels of testosterone (T) and 17 β -oestradiol (E₂) during ovarian recrudescence of that cycle. When mean levels of these hormones were considered high throughout the cycle, 87% of females spawned at a median time of 13 days, whereas females with lower absolute peaks exhibited longer cycles.

In summary, spawning frequencies of multiple-spawning individual tilapia broodstock exhibit great variability according to several variables including fish size, temperature, latitude, degree of parental care, stocking density, sex ratio, food ration and dietary protein level. The mechanisms controlling such variability in spawning frequency in tilapias remains unclear (Mires, 1982) and need to be investigated more thoroughly, preferably in controlled environmental conditions. Existing knowledge of the spawning frequency of substrate-spawning species of tilapia such as *T. zillii* remains sparse. Similarly, little is known of how spawning frequency relates to maternal body size in this species. These factors will be addressed in Chapter 3 of this thesis using large numbers of broodstock maintained in environmentally-controlled laboratory aquaria.

(1.6) Ovarian recrudescence in teleost fish.

In teleosts, ovarian development and the ultimate production of mature eggs is a highly complex process, timed and modulated by various environmental and endocrine pathways such that young are produced only at times when fry survival is optimal; usually when food availability is at its highest.

Gross gonadal and histological changes accompanying development of the teleost ovary has been described in numerous species (e.g. Dadzie, 1970; Takahashi, 1974; Wallace and Selman, 1981; Guraya, 1986; Wallace *et al.*, 1987; Bromage & Cumaranatunga, 1988 and Selman & Wallace, 1989; Selman *et al.*, 1993; Macchi *et al.*, 1995). Ovarian development in tilapias has received fairly limited attention (especially those of the substrate-spawning genus) but detailed macroscopic/microscopic analysis of ovarian cycles are to be found in Aravindan & Padmanabhan (1972) (*O. mossambicus*), Latif & Saady (1973) (*O. niloticus*), Dadzie (1974) (*O. mossambicus*), Siddiqui (1979) (*T. zillii*), Babiker & Ibrahim (1979a,b) (*O. niloticus*), Dadzie & Wangila (1980) (*T. zillii*), Hussein (1984) (*O. niloticus*) and Srisakultiew (1993) (*O. niloticus*).

Ovarian development in teleost fish can be broadly divided into distinct stages largely dependent upon the biochemical properties and histological morphology of the nucleus, cytoplasm and follicular layer (Dadzie, 1970; Selman & Wallace, 1983, 1989; Wallace *et al.*, 1987; Bromage & Cumaranatunga, 1988; Tyler & Sumpter, 1996). Considering such criteria, oocyte growth can be broadly divided into several distinct stages; oogonial proliferation, oogenesis, folliculogenesis, cortical alveolar formation, vitellogenesis, final maturation and ovulation (Khoo, 1979; Kagawa *et al.*, 1981; Wallace & Selman, 1981). Only a brief description of this series of events is given here, a full review will be given later in this thesis (Chapter 4).

Oogonial proliferation, oogenesis and folliculogenesis together constitute the primary growth phase (PGP) and are often referred to as 'pre-vitellogenesis'. This stage is initiated when oogonia proliferate through extensive mitotic division to ultimately form secondary oogonia. The precise period during which this phase of ovarian development occurs remains unclear, though in the case of most teleosts exhibiting well defined breeding cycles, oogonial proliferation has been observed immediately before, during or after the main spawning period (Franchi *et al.*, 1962).

Subsequent meiotic division results in the transformation of secondary oogonia into primary oocytes. Chromosomes continue to replicate and proceed through leptotene, zygotene and pachytene of meiotic prophase. It is now well accepted that replicating chromosomes become arrested at the diplotene stage of this first meiotic prophase (Wallace & Selman, 1981).

Oocyte growth during the meiotic prophase can be further subdivided into three sub-stages: chromatin nucleolar stage, early perinucleolar stage and late perinucleolar stage. Growth during these stages is largely due to increased growth and an increase in electron dense cytoplasm (Lambert, 1970; Wallace & Selman, 1981; Forberg, 1982). The increasing presence of aggregates of ribonucleoprotein particles results in oocytes losing their basophilic nature (Wallace & Selman, 1981; Forberg, 1982). These aggregates later become surrounded by less densely stained cytoplasmic material to form complexes known as 'yolk nuclei' or 'Balbiani bodies', the precise function of

which remains unclear. Balbiani bodies migrate to the periphery of the cytoplasm at the end of PGP (van den Hurke & Peute, 1979; Bruslè, 1980; Wallace & Selman, 1981) and dissolve as oocyte size enlarges (Wallace & Selman, 1981; Bromage & Cumaranatunga, 1988).

Folliculogenesis begins during the meiotic transformation of oogonia into oocytes and results in primary oocytes being drawn away from oogonial nests and their close association with pre-follicular cells (Moser, 1967) and the oocyte becomes increasingly surrounded by follicular cells and later several follicular layers. The inner-most follicular layer surrounding the ooplasm is the zona radiata (sometimes known as the zona pellucida, vitelline membrane or chorion). Surrounding this is the granulosa (a single layer of squamous cells), the theca and a surface epithelium covered by connective tissue. The structure and function of the follicular layers will be discussed in detail in Chapter 4.

Following the formation of the follicular layers and under the stimulus of various hormonal and environmental conditions, a number of the larger oocytes completing PGP are recruited into the secondary growth phase.

The cortical alveolar stage marks the beginning of the oocytes secondary growth phase (SGP). During this stage a number of vesicles (cortical alveoli) appear in the periphery of the ooplasm. Cortical alveoli are thought to contain a glycoprotein termed intravesicular yolk (Korfsmeir, 1966) of endogenous origin and have been referred to by several names including yolk vacuoles (Yamamoto, 1956; Bisht & Joshi, 1975) and primary yolk globules (Beach, 1959). These names suggest a presumed relationship with the 'true' or exogenous yolk produced by the liver and sequestered by growing oocytes during vitellogenesis. Presently however, there is little evidence to suggest that these vesicles are involved with either incorporation or processing of hepatically derived yolk (Bromage & Cumaranatunga, 1988). Moreover, Selman *et al.* (1987) stipulated that the term 'yolk' is inappropriate when referring to these vesicles since they do not serve as a nutrient source for the embryo. Whilst such vesicles grow in both size and number eventually filling the oocyte cytoplasm (Wallace *et al.*, 1987),

they are ultimately displaced by developing exogenously derived yolk granules and migrate to the periphery of the ooplasm to lie adjacent to the oolemma (Khoo, 1979; Wallace & Selman, 1981). The precise role of cortical alveoli in oocyte development remains unclear but present understanding will be discussed later in Chapter 4.

The bulk of oocyte growth occurs during a phase of exogenous vitellogenesis. In the rainbow trout for example, exogenously synthesized yolk proteins account for over 98% of final egg volume (Tyler *et al.*, 1990; Tyler & Sumpter, 1996). This phase of growth involves uptake by the oocyte of large amounts of an extraovarian proteinaceous material (vitellogenin, a high molecular weight lipoglycophosphoprotein) of hepatic origin under the stimulus of ovary derived oestrogen. Vitellogenin accumulates in the blood and is subsequently sequestered by developing oocytes (Wallace, 1978; Tyler *et al.*, 1987) by endocytosis mediated by receptors on the oocyte surface (Tyler *et al.*, 1988). Once sequestered by oocytes, vitellogenin (VTG) is enzymatically cleaved to form the yolk proteins lipovitellin (a lipid rich protein) and phosphovitin (a phosphate rich protein) (Tyler *et al.*, 1988). Exogenous vitellogenesis is characterised by the appearance of yolk granules in the periphery of the ooplasm. These granules grow in size and number as more VTG is sequestered until they completely fill the ooplasm (Bromage & Cumaranatunga, 1988).

After completion of exogenous vitellogenesis and under appropriate hormonal stimulation, oocytes mature and enlarge to reach their full size. During this phase of maturation the germinal vesicle positioned thus far in the centre of the ooplasm migrates and ultimately breaks down (germinal vesicle breakdown - GVBD) at the oocyte periphery to adopt a position adjacent to the micropyle through which sperm can enter and cause fertilization. Concomitant with GVBD, the chromosomes previously arrested in meiotic diplotene condense and enter the first meiotic metaphase resulting in the elimination of the first polar body. Remaining chromosomes subsequently enter the second meiotic metaphase whereupon meiosis is arrested once more. At this stage the oocyte is deemed mature and is capable of being fertilised by male sperm cells.

Mature oocytes (eggs) are generally ovulated soon after final maturation resulting in the release of eggs from their respective follicular layers into the body cavity or ovarian lumen ready for oviposition.

At any stage of development, oocytes may undergo degeneration (known as atresia) (Ryan, 1981), a process common to all vertebrate groups (Brambell, 1956; Byskov, 1978; Saidapur, 1978; Bromage & Cumaranatunga, 1988). Incidence of atresia is believed to be influenced by age, the relative stage of oocyte development, dietary status and hormonal status (Bromage & Cumaranatunga, 1988), though Tyler and Sumpter (1996) claimed that atresia is likely to be an uncommon occurrence in physiologically healthy individuals. The precise function of atresia and the factors controlling its occurrence remain unclear though the process is believed to be involved in the initiation of follicular growth and in the selection of follicles for ovulation (Tyler, 1988), steroidogenesis (Saidapur, 1978) and is thought to be an important determinant of fecundity (Vladykov, 1956; Springate *et al.*, 1985; Bromage *et al.*, 1992).

The granulosa and theca of ovulated follicles remain in the ovary and are known as post-ovulatory corpora lutea (Hoar, 1969) or more commonly as post-ovulatory follicles (POFs). The granulosa of each POF becomes hypertrophied, collapses into the follicular lumen (Kagawa *et al.*, 1981) and subsequently undergoes various stages of degeneration and autophagocytosis (Kagawa *et al.*, 1981; van den Hurk & Peute, 1979). A steroidogenic function has been suggested and indeed demonstrated by several authors (e.g. Bara, 1965; Nagahama *et al.*, 1976; Lam *et al.*, 1978; van den Hurk & Peute, 1979; Kagawa *et al.*, 1981; Lang, 1981; Nagahama *et al.*, 1995), but it remains unclear as to the precise role and significance of POFs in ensuing ovarian cycles.

The macroscopic and microscopic ovarian structure of tilapiines has been investigated on several occasions, initially in wild stocks but more recently in captive laboratory stocks. Much of the existing literature relates to mouthbrooding genera such as *O. niloticus* (Latif & Saady, 1973; Babiker & Ibrahim, 1979a; Hussein, 1984; Srisakultiew, 1993), *O. mossambicus* (Aravindan & Padmanabhan, 1972; Dadzie,

1974), *O. aureus* (Garcia & Phillip, 1986; Rashid & Umar, 1990) and *S. melanotheron* (Eyeson, 1979). The ovarian development of substrate-spawning species has received much less attention. Studies by El-Zarka (1962), Siddiqui (1979) and Dadzie & Wangila (1980), on *T. zillii* and Peters (1983) on both *T. zillii* and *T. tholloni*, form the basis of knowledge of ovarian recrudescence in substrate-spawners. Until recently histological classification of ovarian development in tilapias remained rather arbitrary and classification of discrete periods of oocyte growth varied according to different authors. For example, studies by Siddiqui (1979) and Rashid & Umar (1990) classified developing oocytes as immature, maturing and mature. Eyeson (1979) defined stages of development in *S. melanotheron* according to oocyte size (i.e. small oocytes, medium sized yolky oocytes and large or mature yolky oocytes). Other studies have involved classification into a long series of stages such as the 9 stages reported by Aravindan & Padmanabhan (1972). Moreover, few of these early studies have included atresia or post-ovulatory follicles. More recently studies by Srisakultiew (1993) on *O. niloticus* have attempted to define ovarian development according to those criteria used by Bromage & Cumaranatunga (1988) in the rainbow trout. Classification of oocyte growth in substrate-spawning tilapias remains similarly arbitrary. For example, stages of oocyte development in *T. zillii* were classified as immature, maturing or mature by Siddiqui (1979) or as immature, maturing, ripening, ripe or spent (El-Zarka, 1962; Dadzie & Wangila, 1980). Peters (1983) further described 3 phases of development in *T. zillii* and *T. tholloni* based upon oocyte size. A comprehensive classification scheme comparable to other teleosts has yet to be devised for any substrate-spawning tilapia. Similarly little is known of the dynamics of ovarian development in any tilapiine species though Srisakultiew (1993) reported the dynamic changes of development throughout a 10 day period immediately following spawning, but only involving three sampling points.

To summarise, the ovarian development of substrate-spawning tilapias has received scant attention. Existing classification schemes for histological development of the ovary describing discrete developmental stages of ovarian growth remain basic and

often omit important phases such as atresia or post-ovulatory follicles. Moreover, nothing is known of the dynamics of ovarian development in such species or how the timing of ovarian development relates to spawning periodicity or fecundity. A knowledge of the timing involved with ovarian recrudescence would undoubtedly aid with the development of more effective spawning induction protocols and will be considered further in Chapters 4 and 5.

(1.7) Exogenous and endogenous control of spawning patterns in teleost fish.

Those stages of ovarian development detailed in the previous section are synchronised by an interrelated series of internal (endogenous) and external (exogenous) stimuli. Exogenous factors such as temperature, photoperiod, food availability, water quality and a variety of social factors are perceived by the brain and translated into neural impulses serving to stimulate the endocrine pathways of the hypothalamo-pituitary-gonadal-axis to respond in an appropriate fashion such that reproduction only occurs during those times of the year when optimal survival of fry can be expected. Different species of fish react to different exogenous and endogenous cues.

(1.7.1) Exogenous factors.

The role of the environment in teleost reproduction has been reviewed extensively elsewhere (e.g. Hokanson *et al.*, 1973; Scott, 1979; Wootton, 1979; 1982; Baggerman, 1980; Gerking, 1980; Billard *et al.*, 1981; Bromage *et al.*, 1982a,b; Scott, 1990) and thus will be mentioned only briefly here.

(1.7.1.1) Photoperiod and temperature.

The photoperiodic control of reproduction has been the subject of extensive study, particularly in birds and mammals. Indeed, most organisms indigenous to

middle and higher latitudes have been shown to have evolved some degree of ability to utilise daylength to time reproduction.

Photoperiod and its control of reproduction has been extensively studied in salmonids and has been of immense benefit to the aquaculture industry particularly in the case of the rainbow trout *Oncorhynchus mykiss* (Walbaum) by making possible the production of trout seed (fry and eggs) outside of the natural breeding season. Experiments with rainbow trout exposed to either advanced or compressed seasonal light cycles have induced gonadal development (Elliot *et al.*, 1984; Duston & Bromage, 1987). Ovarian maturation is triggered by constant short daylength (Whitehead *et al.*, 1978a,b; Billard *et al.*, 1978; Bromage & Cumaranatunga, 1988). However, advances in spawning time generally produce smaller eggs (Bromage & Cumaranatunga, 1988; Bon *et al.*, 1997).

Whilst photoperiod is thought to be the main exogenous factor regulating reproduction in salmonids, temperature has also been found to act upon gametogenesis particularly at the end of the reproductive cycle (Billard, 1985). Northern stocks of salmonids for example, often show a delay in spawning time due to low temperature and ice cover earlier in the year. Goryczko (1972) also reported that spring-summer strains of salmonids sometimes fail to complete gonadal development in the autumn when temperature exceeds 5°C.

Further temperature dependent effects of photoperiod have been demonstrated in several other fish species. In the pumpkinseed sunfish *Lepomis gibbosus* (L.) a long photoperiod (16L:8D) induced nest building at 25°C but not at 11-13°C (Smith, 1970). Similarly in the medaka *Oryzias latipes* (Temminck & Schlegel) long photoperiods fail to stimulate gonadal recrudescence at temperatures below 10°C (Yoshioka, 1970). However, long photoperiods are found to be stimulatory in some species at both warm and cold temperatures. For example, the processes of maturation in the three-spined stickleback *Gasterosteus aculeatus* (L.) (Baggerman, 1957; 1980; Schneider, 1969) and ovarian development in the goldfish *Carassius auratus* (L.) (Gillet *et al.*, 1978).

Temperature exerts influences on the reproduction of many teleost species. Low temperatures promote early oocyte growth in the marsh killifish *Fundulus confluentus* (Goode) for example, whilst high temperatures are required in the latter phases of oocyte growth (Harrington, 1959). In contrast, the formation and primary growth phase of oocytes in the sea perch *Cymatogaster aggregata* (Gibbons) are stimulated by warm temperatures and the latter phases of ovarian growth by low temperature (Wiebe, 1968).

Whilst gonadal development and spawning is modulated by both temperature and photoperiod in cyprinid species; low water temperature tends to inhibit final ovulation (Bye, 1984). For example, the ovaries of goldfish were found to be arrested at the end of exogenous vitellogenesis when maintained under natural photoperiod and at a temperature below 14°C but were shown to ovulate at any time when the temperature exceeds 20°C (Yammamoto, 1969).

Despite the relatively small variation in photoperiod and temperature in sub-tropical and tropical regions, several species of fish exhibit physiological responses to such changes. For example, photoperiod and temperature were both found to affect gonadal recrudescence in the summer-spawning Indian catfish *Heteropneustes fossilis* (Bloch) though temperature was thought to be of greater importance (Sundararaj & Vasal, 1976). Whilst exposure of this fish to a long photoperiod (14L:10D) during February - April stimulated vitellogenesis, the response was temperature dependent (greater response at higher temperatures). In winter spawning sub-tropical fish such as the grey mullet *Mugil cephalus* (L.) a short photoperiod (6L:18D) was found to induce vitellogenesis but also in a temperature-dependent fashion (greater response, lower temperature).

In tropical areas, variations in photoperiod are much less pronounced and in equatorial regions show very little variation at all. Temperature however, may exhibit some degree of variation in accordance with wet/dry seasons. Tropical fish generally tend to exhibit either continuous breeding or extended breeding (see also Section 1.5), though peaks of spawning activity have been reported, usually associated with or

following heavy rainfall and flooding (e.g. de Vlaming, 1974; Lowe-McConnell, 1975). Typical species adopting this behaviour include the African catfish *Clarias gariepinus* (Gunther) (Bruton, 1979), the Indian catfish (Sundararaj & Vasal, 1976) and the Indian major carps (Sinha *et al.*, 1974). Indeed, some species fail to spawn at all in the absence of rainfall or floods (e.g. Lowe-McConnell, 1975; Bruton, 1979; Sinha *et al.*, 1974).

Temperature and light intensity were found to be important cues for peaks of gonadal activity in equatorial stocks of *O. leucosticta* (Hyder, 1970); however Cridland (1962) found that high light intensities delayed sexual maturity in both developing male and female *T. zillii*. Temperature is considered to be the factor most likely to control tilapia reproduction. Ovarian development in tilapiine species was reported to be stimulated when water temperatures exceeded 22°C (Wohlfarth & Hulata, 1983) with optimum spawning performance occurring within the temperature range 25 - 29°C (Rothbard & Pruginin, 1975). Spawning frequency in *O. mossambicus* for example, increased with increasing temperature up to 28 - 31°C (Mironova, 1977).

Rapid changes in temperature often trigger endocrine secretion (Stacey, 1984) and have been shown to stimulate ovarian development and spawning in tilapias. Female *O. aureus* for example, transferred to 28°C showed marked ovarian development in only two weeks when moved from 17°C conditions (Terkatin-Shimony *et al.*, 1980). Similarly, a group of *O. niloticus* moved from a holding temperature of 29 - 32°C to 22 - 25°C for 6 hours and then back to 29 - 32°C exhibited an increase of 10 - 25% in the proportion of cold treated females spawning (Srisakultiew & Wee, 1988).

Only one study has observed any influence of lunar periodicity on the reproduction of tilapias. In a clear-water Nigerian stream, *Tilapia mariae* (Boulenger) demonstrated lunar periodicity in breeding activity with most (85%) of egg clutches being laid during the last quarter of the lunar cycle (Schwank, 1987). Interestingly, these fish appeared to maintain this rhythm under a constant L:D cycle in aquaria but with semi-lunar periodicity.

In summary, little is known of how important exogenous factors such as temperature and photoperiod/light intensity are in the control of reproduction in tilapias. Whilst temperature appears to exert some degree of control over the timing of ovarian development, the precise mechanisms involved remain unclear and have not been thoroughly investigated. Although factors such as temperature and photoperiod are not addressed directly in this thesis, it is important to realise that such factors can exert powerful modifying influences over those factors that are addressed, e.g. spawning frequency and dynamics of ovarian development.

(1.7.1.2) Broodstock nutrition and food availability.

Besides photoperiod and temperature, another factor thought to influence reproduction in teleosts is nutrition. This topic has received much attention (e.g. Woodhead, 1960, 1978; Wootton, 1973a; 1977; 1979; 1982, 1985; Townshend & Wootton, 1984, 1985; Jones & Bromage, 1987; Bromage & Jones, 1991; Fletcher & Wootton, 1995) and will be discussed in greater detail later in this thesis (Chapter 7).

Restrictions in diet may result in delayed maturation and spawning (e.g. Scott, 1962; McFadden *et al.*, 1965; McKay & Mann, 1969), reduced fecundity (e.g. Scott, 1962; McFadden *et al.*, 1965; McKay & Mann, 1969; Townshend & Wootton, 1984) and reduced egg size (e.g. Townshend & Wootton, 1984; Springate *et al.*, 1985). However several studies involving restricted feeding have demonstrated no effect on fecundity (Kato, 1975; Ridelman *et al.*, 1984). Numerous studies have shown increased fecundity when fish are fed high energy diets or larger daily rations (Phillips *et al.*, 1964; Harris & Griess, 1978; Smith *et al.*, 1979; Springate *et al.*, 1985). Reduced food supply has been reported to retard or inhibit gonadal development in several species including salmonids (e.g. Scott, 1962; Bagenal, 1969), the guppy *Poecilia reticulata* (Peters) (Hester, 1964; Dahlgren, 1979) and the roach *Rutilus rutilus* (L.) (Kuznetsov & Khalitov, 1978). Moreover, under food restriction, female salmonids may remain in a stage of sexual stasis during the summer and miss one reproductive cycle (Wydoski & Cooper, 1966). In the three-spined stickleback,

restriction of food availability during the breeding season was found to reduce the number and frequency of spawning females and moreover, total food deprivation led to a cessation of spawning activity (Wooton, 1973a, 1977). In investigating the influence of food ration size on the reproductive performance of rainbow trout Jones & Bromage (1987) found that higher rations induced a greater number of fish to spawn and that the magnitude of ration had no effect on egg size. Furthermore, ration size was found to have a significant effect on fecundity and egg volume above that solely due to the size of the parent fish.

Nutrition has been suggested to play an important regulatory role in terms of seasonal changes in abundance and nutritive quality of food. For example, it is commonly known that plankton undergo seasonal changes in abundance and composition (even in tropical regions). Billard (1985) suggested that this may have a profound effect further up the foodchain especially in low productivity tropical regions. It has been suggested that such a fluctuation in food supply may be an important controlling factor in the timing and frequency of reproduction in tropical fish (Lowe-McConnell, 1975). The effect of seasonal alterations in food ration was investigated by Jones & Bromage (unpublished) (see Bromage *et al.*, 1992). Significant changes in fecundity and total egg volume were found to result from changes from high to low rations at different times of the year. Reducing the ration over the final 3 months prior to spawning had no adverse effect on fecundity.

Relatively few studies have examined the effects of differing food ration sizes and/or diet composition on the reproductive performance of tilapias. Existing studies have focused on the mouthbrooding genera of tilapia particularly *O. niloticus* and *O. mossambicus*. Mironova (1977) examined the reproductive intensity of *O. mossambicus* at 4 - 9 months of age at different temperatures and with abundant or insufficient food. With abundant feed, the weight increment of females was greater than with restricted feeding. However, females experiencing a shortage of food produced more eggs. Energy allocation to egg production was found to be considerably higher in females with unfavourable feeding conditions. Santiago & Reyes (1993) supplied

groups of *O. niloticus* with varying diets containing various lipid sources: cod liver oil, corn oil, soybean oil, coconut oil-based cooking oil, corn oil/cod liver oil (1:1) and a control diet (with no lipid supplement). Fish fed the soybean diet had the best overall reproductive performance over a 24 week period. Fish fed the cod liver oil diet exhibited the highest weight gain but the poorest reproductive performance.

Several studies have examined the effects of protein level on reproduction in tilapias. Santiago *et al.* (1983) fed *O. niloticus* with pellets containing 20 - 50% crude protein. Spawning frequency and total growth (body weight and total weight of eggs collected) of females had a tendency to increase as the dietary crude protein level increased. A further study by Santiago *et al.* (1985) involved feeding *O. niloticus* pelleted feed containing supplements of 20 or 40% crude protein. The diet containing 40% protein consistently produced the highest fry production and growth. The 20% diet produced variable results; in some trials growth and fry production were similar to those of fish fed the 40% protein diet but were significantly lower in other trials. Breeders without supplemental protein had the lowest body weight and produced the least number of fry. In contrast, Wee & Tuan (1988) found that fish fed diets containing low and medium levels of protein (20, 27.5 and 35%) had higher fecundities than those fed on high protein diets (42.5 and 50%). Moreover, fish fed on low protein diets had smaller eggs than those on higher protein diets and spawned much more frequently. Cisse (1988) found no significant differences amongst mean spawning frequencies and mean numbers of eggs produced per spawning amongst groups of *S. melanotheron* fed diets varying in protein content from 20 - 50%. Whilst growth was better in the higher protein diets, there was no significant correlation between fish weight and the number of eggs spawned. More recently Vasudevan & Jayaprakas (1992) fed *O. mossambicus* with diet containing 20, 30, 40 and 50% protein. Fish fed 30 and 40% protein attained early maturity and spawned earlier whilst fish fed 20 and 50% spawned later. Fish fed 30% protein produced most eggs per spawn which were smaller in size. Fish fed the 40 and 50% protein diets produced

fewer and larger eggs per spawn. Spawning frequency was found to vary with dietary protein level.

Whilst the effects of dietary ration size and protein content have been shown to influence spawning frequency, fecundity and egg size in tilapias, little is known of how these factors affect ovarian physiology and endocrinology. Only one study has investigated this area. Cumaranatunga & Thabrew (1990) examined the effects of legume (*Vigna catianga*) substituted diets on the histological ovarian development of *O. niloticus*. In this study, groups of fish were fed either a control diet (30% fish meal) or one of two test diets (10 or 20% fish meal). Each diet contained 25% protein. The two test diets contained 18 or 42% legume. Fish fed the control diet showed better ovarian growth than the fish fed the two test diets. Vitellogenic oocytes of control fish were significantly larger than those of either test diet. Fish meal was found to have an enhanced effect on the growth and maturation of vitellogenic oocytes when compared to legume substituted diets. This was attributed to the presence of higher levels of proteins and/or lipids in fish meal.

There is no record of how food ration size (or dietary protein content) may affect ovarian physiology, fecundity or spawning frequency in *T. zillii* or any other substrate-spawning tilapia. It would also be useful to know how and if food ration size or content may influence levels of circulating sex steroid levels as this would almost certainly manifest in other aspects of reproductive physiology. These factors are addressed in Chapter 7 of this thesis.

(1.7.1.3) Spawning substrate, social interaction, crowding and other factors.

Several species of fish require the presence of appropriate substrate or vegetative matter before spawning can occur. In the absence of such substrate, final ovulation may fail to occur even though exogenous vitellogenesis is complete. The importance of spawning substrate in the regulation of ovulation is likely to be influenced by substrate

requirements, spatio-temporal distribution of substrate and the length of time ovulated eggs can remain within the ovarian or body cavity (Stacey, 1984).

Ovulation for example, fails to occur in goldfish unless suitable aquatic vegetation is present (Stacey *et al.*, 1979). Similarly, the Australian freshwater trout cod *Maccullochella macquariensis* (Cuvier) requires the presence of a nesting substrate (e.g. hollow logs) to complete its reproductive cycle (Lake, 1967). Three-spined sticklebacks also appear to demonstrate a preference for spawning substrate; experiments demonstrated that males started to build nests quicker if aquarium tanks contained a sandy substrate than bare glass or if the sand had been covered with glass (Schulz, 1980). It has also been suggested that in British Columbia, male three-spine sticklebacks select different spawning substrates according to whether the fish is a low or completely-plated morph (Hagen, 1967). Whilst laboratory tests have further shown that male sticklebacks can show clear preferences to where they build nests, males in natural conditions appear quite versatile in their selection of nest-site depending upon the habitats available (Wootton, 1984a).

In some fish, for example the red snapper *Lutjanus campechanus* (Poey) and the gilthead sea bream *Sparus aurata* (L.), ovulation can occur spontaneously into aquaria regardless of substrate conditions (Stacey, 1984). Under natural conditions, tilapias often construct circular depressions/nests on substrate materials on which to spawn (McKaye, 1984). However, since most captive species of tilapia are able to spawn successfully in the absence of nesting substrates (Lowe-McConnell, 1959), Stacey (1984) suggested that the spawning mechanisms of tilapias are probably insensitive to spawning substrate. Bruton & Gophen (1992) observed that in Lake Kinneret (Israel), *T. zillii* prefer fine sediments and muds for use as spawning substrates and in the absence of such materials utilised stones and boulders. Nest site distribution was found to be determined by exposure to wave action, substrate type, water depth and macrophyte cover. In most mouthbrooding species, sexually active males aggregate into large groups ('leks') and are visited by ripe females. Similar aggregations have rarely been reported in substrate-spawning species (Loiselle, 1977). The chief factor

limiting the practice of such colonial spawning in substrate-spawners is the availability of an adequate number of spawning sites in a restricted area (Loiselle, 1977). If a suitable area is located, colonial breeding may occur (Daget, 1952) otherwise spawning pairs will be obliged to breed solitarily wherever they can find a suitable site (Loiselle, 1977).

Visual and chemical (pheromonal) stimulation from conspecifics have been found to be of great significance for the reproduction of several fish species. Silverman (1978a) reported the importance of visual stimuli in the spawning of *O. mossambicus* since first spawning in isolated females was delayed if deprived of visual contact with a conspecific of similar age in adjacent aquaria. This was interpreted as a delay in ovarian development rather than ovulation or oviposition since visually isolated fish exhibited improved growth suggesting a lower energy drain for ovarian development. A further study of *O. mossambicus* by Marshall (1972) reported the importance of audible signals. Recorded sounds produced by the male hastened spawning of isolated females by approximately 10 days suggesting an acceleration in ovarian development and/or ovulation or oviposition. Reisman (1968) reported that the presence of conspecifics stimulated the development of androgen-dependent sexual characteristics in male sticklebacks. Although it is clear that visual and chemical stimuli from conspecifics can increase spawning frequency in females of some species, for the most part, these factors appear to act by stimulating ovarian development and not by triggering ovulation (Liley, 1982).

Sexually active goldfish males are reported to induce ovulation in females (Yamazaki, 1965). Kyle *et al.* (1979, 1982), however, claimed that the enhanced gonadotropin secretion and milt production observed in males during contact with a pair of spawning goldfish was probably not mediated by either visual or chemical cues. Oviposition itself is thought to be triggered by attracted males 'pushing' against the ovulated female (Partridge *et al.*, 1976).

Pheromones form a group of chemical substances secreted by an organism into the surrounding environment to serve as a signal to others (usually the same species).

Such a method is common amongst teleost fish during reproduction utilising 'sex pheromones' to mediate spawning behaviour and endocrine pathways. Pheromones have evolved in seven orders of freshwater fish and are widely distributed in at least two of these (Cypriniformes & Characiformes). Pheromonal systems in fish are diverse; electro-olfactograms have detected species responsive to combinations of free, glucuronidated and sulphated C21, C19 and C18 steroids as well as prostaglandins (Stacey & Cardwell, 1995). Several species of fish have been found in which released hormones and their metabolites function as sex pheromones: zebrafish *Brachydanio rerio* (Hamilton-Buchanan) (Chen & Martinich, 1975), angelfish *Pterophyllum scalare* (Scalare) (Chien, 1973), Pacific herring *Clupea harengus pallasii* (L.) (Stacey & Hourston, 1982), black goby *Gobius joso* (L.) (Colombo *et al.*, 1982), African catfish (van den Hurk & Resink, 1992), Atlantic salmon *Salmo salar* (L.) (Moore & Scott, 1992), goldfish (Stacey *et al.*, 1994) and crucian carp *Carassius carassius* (L.) (Bjerselius *et al.*, 1995).

The presence of sex pheromones originating from the ovary and causing excitation in conspecific males has been reported in several species (Liley, 1982). Chemical cues originating from males and causing excitation of females is less well understood though male African catfish produce sex pheromones to attract females (Van Weerd *et al.* 1991). Pheromones have also been reported to influence oocyte maturation and ovulation in females by elevating levels of circulating gonadotropin (Stacey *et al.*, 1989) and have been reported to stimulate post-ovulatory ovarian development in *O. mossambicus* (Silverman, 1978a,b).

Studies have shown that urine forms the major source of sex pheromones in numerous species of fish. Urine from the ovulated female black goby for example, was found to contain a pheromone stimulating courtship behaviour in males (Colombo *et al.*, 1982). Similarly, the urine of both the male sea lamprey *Petromyzon marinus* (L.) and the male yellowfin Baikal sculpin *Cottocomephorus grewingki* (Dyb) contained pheromones attracting and stimulating respective female conspecifics (Adams *et al.*, 1987; Dmitrieva *et al.*, 1988). Scott *et al.* (1994) recently showed that

the urine of sexually-mature rainbow trout contained a priming pheromone which induced an increase in 17α -hydroxy- 20β -dihydroxy-pregnen-3-one (17α - 20β -P), testosterone (T) and GTH II (see Section 1.7.2) in the blood of sexually mature male trout. 17α - 20β -P was also found to be released by female goldfish and common carp *Cyprinus carpio* (L.) a few hours before ovulation causing an increase in male GTH II and milt volume (Dulka & Stacey, 1991; Stacey *et al.*, 1994, respectively).

Fecundity and spawning frequency in tilapias are known to be influenced by various types of social interaction (Jalabert & Zohar, 1982). For example the spawning frequency of cichlids can be increased by various sensory stimuli from conspecifics e.g. visual, audible and chemical stimuli (Aronson, 1945; Marshall, 1972; Chien, 1973). Studies by Aronson (1945), Marshall (1972) and Silverman (1978a, 1979b) found that females of the *Sarotherodon* genus were able to spawn regularly even when isolated, but showing increased inter-spawn intervals compared to non-isolated females. Extensive studies by Silverman (1978a, b) in *O. mossambicus* dissociated the effects of different levels of social stimulus on the inter-spawn interval. Contact was defined as either unlimited (several fish in the same aquarium), medium (adjacent aquaria each containing one fish so that each fish can see into the other fish) and low contact (visually isolated fish in different aquaria). Results showed that visual stimulus may hasten ovulation but had little influence on oogenesis. Non-visual stimuli (e.g. tactile/chemical) in unlimited contact females were able to advance vitellogenesis by seven days. Silverman suggested that his results may be related to the gregarious nature of *O. mossambicus*. Similar experiments are yet to be published for other tilapias. Sriskultiew (1993) investigated the effect of social contact (limited or unlimited) on the effectiveness of spawning induction (by LHRH) in *O. niloticus*. Females held in isolation spawned within 2 - 6 days of inducement. In contrast, hormone-treated fish held in communal spawning tanks in which fish had unlimited contact, showed similar spawning cycles to that of the controls. Thus Srisakultiew (1993) postulated that the degree of contact between males and females may be one of the most important factors for successful spawning in tilapias. If peak levels of

circulating testosterone in females are low, it is believed that males will attack or even kill females rather than stimulating spawning (Fishelson, 1966; Rothbard, 1979; Mires, 1982). Srisakultiew (1993) found that when protected by plastic partitions, males were able to stimulate females via visual and chemical stimulus. Similar results were reported by Chien (1973) in the angel fish. Fish exposed to visual and chemical stimulus had a higher spawning frequency than those maintained with either visual or chemical stimulus alone.

Several teleosts are reported to release steroid hormones with pheromone-like properties suggested to aid regulation of behavioural or physiological processes pertaining to reproduction. Hines *et al.* (1995) investigated gonadal steroidogenesis by *O. niloticus* under different social environments in an attempt to examine whether endocrine correlates of the social environment are involved in the reproductive behaviour and physiology of this species. Mature male and female *O. niloticus* were maintained under three social regimes: isolated individuals, same-sex groups and mixed-sex groups. Sex-specific differences in gonadal steroidogenesis were more apparent than differences due to social environment. The authors thus stated that extra-gonadal steroid biosynthesis may contribute significantly to the overall changes in behaviour and physiology associated with social environment. Watts *et al.* (1995) investigated androgen and oestrogen synthesis in the kidneys and gonads of *O. niloticus* exposed to several social environments (single males or females, grouped males or females or individually paired males and females). Male kidneys, regardless of social group produced high quantities of oestrone (not observed in female kidneys or male testes). Female kidneys, regardless of social group produced high quantities of an unknown steroid. This steroid was normally produced in high quantity by male testes and minimally by female ovaries. The authors suggest that the production of steroids in the kidneys may be related to either an undefined endocrine function and/or a pheromonal function.

In contrast to mouthbrooding tilapias, little is known of the effect of the social environment on spawning in substrate-spawning tilapias, though parental behaviour,

mate selection and aggressive behaviour were investigated in *T. mariae* in both field and aquaria-based populations by Schwank (1987). Parental behaviour was found to differ in aquaria from that in nature. Males stayed with the eggs less but attacked intruders more. Intra-pair aggression was greater in aquaria particularly in females. Cridland (1962) also reported extensive aggression in aquaria stocks of *T. zillii*. Pairs of *T. zillii* were kept separated in aquaria by nylon mesh until ripe upon which time the female was introduced into the males compartment. If females were introduced before they were fully ripe, they were attacked and killed by the male. Indeed, territorialism reaches its extreme under aquarium conditions (Rothbard, 1979), since territory is limited. Consequently, fish inhabiting an aquaria form a special hierarchy. Rothbard (1979) found that in an aquarium stocked with 5 male and 5 female *T. zillii*, 2 permanent couples were formed on opposite sides of the tank. The remainder of the fish were pushed to the center of the tank and attacked by the 2 pairs to such an extent that within a week only the two pairs were left. A week later, one pair killed the other pair and only then did the remaining pair commence spawning.

To summarize, it is not clear how the presence or absence of spawning substrate and/or conspecifics affects spawning or ovulation in *T. zillii*. Moreover, there is no record of whether the presence of suitable substrate material and/or conspecific stimulation can influence spawning periodicity, the timing of ovarian development or whether levels of circulating sex hormones are affected. Though not addressed in detail, spawning substrate and visual contact with male conspecifics and the effect that these factors may exert on various aspects of reproductive physiology and endocrinology in *T. zillii* are investigated briefly in Chapters 5 and 6.

High population density has been shown to have a strong influence on spawning and endocrine status in several species of fish. Crowding has been reported to inhibit spawning in various species of fish through several factors including pheromones, competition for food and space, stress, water quality *etc.* and will be discussed in detail in Chapter 6. Inhibition of spawning during crowding has been reported in several species, for example zebrafish, blue gourami *Trichogaster trichopterus* (Pallas)

(Yu & Perlmutter, 1970), largemouth bass *Micropterus salmoides floridanus* (Lacepede) (Chew, 1972) and the convict cichlid *Cichlasoma nigrofasciatus* (Gunther) (Fitzgerald & Keenleyside, 1978). Population density influences hormonal status of fish. For example, territory-holding male damselfish *Chromis dispilus* (Poey) from areas of high population density have higher levels of gonadal steroids than fish from lower population density (Pankhurst & Barnett, 1993) though in this case higher steroid levels in fish at high density were associated with higher spawning frequency. High stocking densities elevate secretion of cortisol in the brook trout *Salvelinus fontinalis* (Mitchill) (Vijayan & Leatherland, 1990). Cortisol suppresses secretion of 17 β -oestradiol (E₂) and T from rainbow trout follicles cultured *in vitro* (Carragher & Sumpter, 1990). Moreover, chronic confinement for 1 month caused significant elevation in plasma cortisol but suppressed levels of plasma T and 11-ketotestosterone (11-KT) in male brown trout *Salmo trutta*. (L.) (Pickering *et al.*, 1987). Recent evidence however, suggests that the inhibitory effect of stress on reproduction is not mediated by the action of cortisol on ovarian steroidogenesis (Pankhurst *et al.*, 1995).

Crowding has been implicated in reduced production from tilapia culture. Studies by Uchida & King (1962) and Hughes & Behrends (1983) suggest that stocking density and sex ratio of broodfish during spawning both exert influences over breeding intensity. As a general rule, the selected sex ratio should be sufficient for a female in the appropriate physiological condition to easily find a male with which to spawn (McConnell, 1955, 1959; Fryer & Iles, 1972). Hughes & Behrends (1983) recorded a reduction in seed production with increased stocking densities in small *O. niloticus* hapas. Increased stocking densities are likely to result in an increased frequency of interruption during spawning by other broodfish (Little, 1989) which may ultimately result in total inhibition of spawning (Coche, 1982; Rana, 1986). To date, only one study has investigated the mechanism of spawning inhibition in densely stocked tilapias. Falter & Debacker (1988) observed a density-dependent behavioural shift in *O. niloticus*. Frequency of aggressive acts in a 200 litre tank was increased in groups comprising of 4 males and reduced drastically in groups comprised of 16 males. These

authors concluded that both the aggressive and sexual behaviour of *O. niloticus* may have derived from low density groups and reverts to schooling behaviour under high density conditions. This shift to schooling behaviour was thought to be the most likely reason for the disappearance of both sexual and aggressive behaviour in high production systems.

To date, there has been no attempt to link such density-dependent shifts in behaviour in tilapia to physiological correlates such as the dynamics of ovarian development or to possible associated changes in circulating sex hormones. This will be investigated further in Chapter 6 by studying the effect of confinement and subsequent transfer to individually-partitioned aquaria (and *vice versa*) on various aspects of reproductive physiology and endocrinology in *T. zillii*.

(1.7.2) Endogenous factors.

It is now widely accepted (see Fontaine, 1976; Dodd and Sumpter, 1984; Scott, 1990) that the reproductive cycles of teleost fish are modulated by changing levels of circulating hormones from the 'hypothalamo-pituitary-gonadal-axis', these changes are timed by exogenous cues from the external environment (see Section 1.7.1). Basically, levels of gonadotropin(s) and sex steroids rise in the plasma during gonadal maturation and fall following ovulation (e.g. Wingfield & Grim, 1977). Major hormones involved include hypothalamic gonadotropin-releasing-hormone (GnRH), gonadotropin release inhibitory factor (GnRIH), pituitary gonadotropin(s) (GTH), sex steroids and prostaglandins. Studies of such hormones and their inter-related cycles serve as sensitive indicators in the determination of gonadal development.

Arguably, the most important phases of ovarian development are modulated by GTH(s) produced by the gonadotrophic cells located within the adenohypophysis of the pituitary gland (Campbell and Idler, 1976; Peute *et al.*, 1978; Suzuki, 1988a,b; Kawauchi *et al.*, 1989), in turn under the control of hypothalamic GnRH. Fang & Wang (1983) demonstrated the presence of only one type of gonadotroph in the pituitary of *O. mossambicus*. These gonadotroph cells contained two secretory granules

(termed large & small). These cells form the target cells for the hypothalamic (releasing) hormones.

Structurally, teleost GnRH was found to be a peptide similar to GnRH in reptiles and birds (King and Millar, 1990). Moreover, similarity has been established in terms of structure and action with mammalian luteinizing hormone releasing hormone (LHRH). Two forms of GnRH have been detected in the brain of chum salmon *Oncorhynchus keta* (Walbaum): a decapeptide homologous to mammalian LHRH termed salmon-I-GnRH (s-GnRH-I) (Sherwood *et al.*, 1983) and salmon-II-GnRH (s-GnRH-II), thought to be identical to chicken-II-GnRH (c-GnRH-II) (Sherwood *et al.*, 1984). At least seven other teleosts have also been reported to possess 2 forms of GnRH exhibiting the same chromatographic and immunological profiles as s-GnRH-I and s-GnRH-II (Sherwood *et al.*, 1984; Sherwood, 1987). Furthermore, 2 forms of GnRH have been isolated from the sea lamprey (lamprey I and II GnRH (see Sherwood, 1987)). A series of brain lesion experiments have suggested that the nucleus lateralis tuberis (NLT) of the hypothalamus is most likely the site of GnRH production (see Peter, 1982).

Two forms of GnRH have also been found in the brain of African catfish (Schulz *et al.*, 1993); these were localised in the same peptidergic nerve fibres, often within the same secretory granules in the vicinity of the gonadotrophs. Similarly, two forms of GnRH have been found in the eel *Anguilla anguilla* (L.): mGnRH and cGnRH. Higher levels of mGnRH were found in the pituitary, olfactory lobes, telencephalon, diencephalon and mesencephalon. During sexual maturation, increased mGnRH levels were found in the pituitary and anterior parts of the brain. The differential distribution and control of the two hormones suggested that they had different physiological roles (Dufour *et al.*, 1993). Studies by Pati & Habibi (1992) in the goldfish found that GnRH receptors are not restricted to the pituitary and that goldfish possess a family of GnRH receptors that can be classified into four groups: (1) high affinity - pituitary, ovary, testis, (2) super high affinity - brain, (3) intermediate affinity - liver and kidney and (4) low affinity - all other tissues containing specific GnRH binding sites except for

liver and kidney. Recent studies have also found that sex steroids can increase pituitary sensitivity to GnRH peptides (Trudeau *et al.*, 1993) and that GnRH antagonists inhibit GnRH-stimulated GTH II release by competitively binding to pituitary binding sites (Murthy *et al.*, 1994). Most recently, GnRH binding sites have been characterised in the gilthead sea bream ovary and suggesting that GnRH or compounds with GnRH-like activity play an important function in the ovary (Nabissi *et al.*, 1997).

Brain lesion studies in goldfish have suggested the existence of a gonadotropin-release-inhibitory-factor (GRIF, now known as GnRIH) (Peter & Paulencu, 1980), produced by the hypothalamic nucleus preopticus region (NPO) (Peter *et al.*, 1982; Ball, 1981). The catecholamine dopamine is widely thought to function as GRIF both in the goldfish (Peter, 1980, 1982) and the rainbow trout (Crim, 1982). Intra-peritoneal injections of dopamine and apomorphine (a dopamine agonist) in the goldfish resulted in a marked reduction in circulating GTH whereas administration of pimozide (a dopamine antagonist) led to a marked increase in GTH (Chang and Peter, 1983). Similarly, levels of blood GTH in rainbow trout were found to increase markedly following administration of either 6-hydroxydopamine (a catecholaminergic neurotoxin) or pimozide (Crim, 1982). Pimozide injections followed 12 hours later by LHRH injections were found to induce virtually 100% ovulation in goldfish concomitant with extremely high plasma GTH levels (Peter, 1980). These findings were consistent with an *in vitro* study reported by Crim (1982) showing dopamine inhibition of GTH release in the rainbow trout. In studying the GnRH α stimulation of GTH release from the tilapia pituitary (even at temperatures below that required for reproduction), Gissis *et al.* (1988) found that a dopamine-like catecholamine was involved in GRIF activity in the tilapia. In addition, there are other possible controls of GnRH, for example, GABA, Neuropeptide Y and neuroexcitatory amino acids (see Kah, *et al.*, 1993).

Levani-Zermonsky & Yaron (1987) found that GTH secretion from the tilapia pituitary was stimulated by GnRH α in a dose-dependent manner. At high doses the response was found to be biphasic. The authors further claimed that in contrast to

mammals, tilapia pituitary gonadotrophs were not desensitised by prolonged exposure to hypothalamic hormones; constant exposure of tilapia pituitary to GnRH α resulted in a continuous high rate of secretion of GTH for 20 hours. The biphasic response was also reported by Gissis *et al.* (1988) and was suggested to reflect two different actions of the gonadotroph cells; perhaps release and synthesis of GTH. A further study by Levavi Sivan *et al.* (1995) reported that GTH secretion from perfused fragments of tilapia pituitary was also stimulated in a dose-dependent manner by GnRH. Results showed that stimulation of GTH secretion in tilapias is dependent, as in mammals, on extracellular Ca^{2+} and probably protein-kinase-C.

GTH has several functions; it has been shown to stimulate ovarian production of oestrogen thus stimulating exogenous vitellogenin (VTG) production (Crim & Idler, 1978; Fostier *et al.*, 1979); to stimulate follicular uptake of VTG (Campbell, 1978; Upahayday *et al.*, 1978; Abraham *et al.*, 1984) and to stimulate synthesis of hormones necessary for maturation (see Nagahama, 1987; Nagahama *et al.*, 1995).

The precise number and nature of teleost GTH(s) has been the source of considerable debate in research literature, largely due to differing purification protocols and assay procedures. Up until recently, two main theories existed. Firstly, the hypothesis of Burzawa-Gerard (1974) claimed that a single carbohydrate rich GTH was responsible for inducing both maturation and ovulation. Campbell & Idler (1976) and Ng *et al.* (1980) however, claimed the existence of two distinct GTH's, a carbohydrate poor GTH stimulating follicular VTG uptake and a second carbohydrate rich GTH inducing ovulation.

Affinity chromatography aided the isolation of 2 chemically distinct GTH's from the pituitaries of chum salmon and chinook salmon *Oncorhynchus tshawytscha* (Walbaum), a carbohydrate poor fraction termed Con AI and a carbohydrate rich fraction termed Con AII (Idler, 1982; Idler & Ng, 1983; Ng & Idler, 1983) originating from a single gonadotroph (van Oordt & Peute, 1983). Con AI was thought to stimulate VTG sequestration by developing oocytes (Campbell, 1978; Idler, 1982; Ng & Idler, 1983; Idler & So, 1987) whilst Con AII was found to principally stimulate

oestrogen and VTG synthesis, maturation and ovulation (Idler, 1982; Idler & Ng, 1983; Ng & Idler, 1983; Nagahama, 1987).

The existence of 2 GTH's is now commonly accepted. This followed the purification of 2 distinct GTH's (GTH I and GTH II) from chum salmon that were homologous to mammalian luteinizing hormone (LH) and follicle stimulating hormone (FSH) (Kawauchi *et al.*, 1987; Itoh *et al.*, 1988; Suzuki *et al.*, 1988a,b; Kawauchi *et al.*, 1989). GTH I and GTH II were found to be equipotent in the stimulation of gonadal growth in rainbow trout (Suzuki *et al.*, 1988a) and the *in vitro* synthesis of E₂ from vitellogenic follicles of Amago salmon *Oncorhynchus rhodurus* (Jordan & McGregor) (Suzuki *et al.*, 1987; Suzuki *et al.*, 1988a,c). GTH II however, was much more effective in the release of 17 α -hydroxy-20 β -dihydroprogesterone (17 α 20 β -P) from post-vitellogenic ovarian follicles (Suzuki *et al.*, 1987; Suzuki *et al.*, 1988c). This work, and that of Slater *et al.* (1994) suggested that GTH I predominated during early vitellogenesis whilst GTH II became dominant during maturational stages. Similarly, a combination of *in vitro* and *in vivo* work in the rainbow trout clearly showed that GTH I stimulated ovarian growth whilst GTH II remained responsible for ovarian maturation (Tyler *et al.*, 1991).

GTH I and GTH II have now been identified in coho salmon (Swanson *et al.*, 1991), rainbow trout (Campbell, 1995), common carp (Van der Kraak *et al.*, 1992), red sea bream *Pagrus major* (Temminck & Schlegel) (Tanaka *et al.*, 1993), Atlantic croaker *Micropogonias undulatus* (L.) (Copeland & Thomas, 1993) and Mediterranean yellowtail *Seriola dumerilii* (Risso) (García Hernández *et al.*, 1995). The duality of teleost GTH is therefore well established in several taxa but may not apply to teleosts in general (Schulz *et al.*, 1995).

Several studies have attempted to purify and characterise pituitary gonadotropins in cichlids. Two preparations obtained from *O. mossambicus* (Farmer & Papkoff, 1977) exhibited some biochemical characteristics similar to higher vertebrate LH and FSH. More recently Bogomolnaya & Yaron (1987) isolated and purified a steroidogenic gonadotropin of tilapia (taGTH) from *O. niloticus/O. aureus* hybrids. A

radioimmunoassay was later developed for qualitative determination of taGTH levels (Bogomolnaya & Yaron, 1988; Bogomolnaya *et al.*, 1989). This taGTH was shown to be potent in the stimulation of E₂ synthesis from tilapiine ovaries (Bogomolnaya *et al.*, 1989). Hyder *et al.* (1981) further isolated two active fractions from the pituitary of *O. niloticus*; both fractions could stimulate steroidogenesis though the fraction resembling FSH of higher vertebrates was much more potent than that resembling LH. Studies by Levavi Sivan & Yaron (1992) have further shown that cyclic adenosine monophosphate (cAMP) acts as a mediator in the transduction of GnRH-stimulated GTH release in the tilapia.

Various salmonid studies have shown differences between the rate of synthesis and secretion of GTH I and GTH II. For example, Kawauchi *et al.* (1987) and Swanson *et al.* (1987) found the pituitaries of rainbow trout in early vitellogenesis to release significant amounts of GTH I but not GTH II in response to a GnRH analogue (GnRH-a). Mature pituitaries however, released GTH II but not GTH I. Such studies lead to the 'maturational surge hypothesis' which proposed that all aspects of reproductive development up to the time of spawning remained under GTH I regulation, as is the production of steroids causing accumulation of GTH II in the pituitary (Dickhoff & Swanson, 1990). A surge in blood GTH II at spawning subsequently results in ovulation. More recently, Prat *et al.* (1996) found that levels of GTH II remained undetectable in the rainbow trout throughout most of the reproductive cycle until shortly preceding ovulation. Plasma levels of GTH I were elevated during early vitellogenesis, fell to a basal level shortly before ovulation and rose again at ovulation. It was concluded that in rainbow trout, plasma profiles of GTH I and II mimic cycles of plasma FSH and LH respectively, in the ovulatory cycle of higher vertebrates.

Recent evidence has also shown that stimulatory long-short photoperiods can increase levels of GTH I during vitellogenesis in the rainbow trout compared to fish exposed to an ambient photoperiod (Davies *et al.*, 1995).

GnRH and dopamine (DA) producing neurons are the principal stimulatory and inhibitory systems controlling GTH II release. Recent evidence suggests that amino acid neurotransmitters are important for GTH II release (e.g. γ -aminobutyric acid - GABA). Amino acids such as glutamate and taurine have been found in large amounts in the teleost pituitary and have been shown to stimulate GTH II release *in vitro* (See Trudeau & Peter, 1995). Neuropeptides (NPY) and cholecystokinin (CCK) can also stimulate GTH II release *in vitro*; as can mammalian inhibin-A and activin-A (growth factors).

Developing teleost ovaries secrete several sex steroids, e.g. 17β -oestradiol (E₂) and oestrone (E₁) (oestrogens) and testosterone (T) and androstenedione (androgens). Ovarian androgens form obligatory precursors for oestrogens (T for E₂ and androstenedione for E₁) (Scott, 1990). An enzyme complex termed aromatase (Kagawa *et al.*, 1982; Nagahama *et al.*, 1995) converts androgens to oestrogens and is most active during vitellogenesis. Studies by Kagawa *et al.* (1981, 1982; Nagahama *et al.*, 1995) found the thecal and granulosa layers to be steroidogenic. Scott (1990) suggested that whilst the theca is the most likely site of androgen synthesis, these androgens are later aromatised by aromatase in the granulosa to E₂. This pathway is known as the "2 cell type model" (Kagawa *et al.*, 1982; Nagahama *et al.*, 1982; Nagahama *et al.*, 1995). Aromatase has also been located in the brain and pituitary (Callard, 1982) and it is at these sites that ovarian androgens found in the serum are most likely aromatised. Aromatase was found to be concentrated in the proximal pars distalis in *O. mossambicus* (Callard *et al.*, 1988).

A large number of paracrine factors including steroids and proteins (e.g. activin, inhibin and growth factors such as IGF-I) are synthesised by the granulosa and theca of mammals and are thought to be involved in oocyte growth and maturation (see Tyler & Sumpter, 1996). Since these factors are only synthesised at specific times, it is likely that they have specific roles in oocyte growth and development. Initial work on teleosts appears to suggest that these factors have similar roles in teleost fish (see Tyler & Sumpter, 1996).

Both androgens and oestrogens are capable of stimulating GTH synthesis and pituitary accumulation through both negative (Billard, 1978) and positive (Crim *et al.*, 1981) feedback. However GTH release was not promoted. Indeed, a study by Brommalaer *et al.* (1981) suggested an inhibitory role of ovarian steroids in terms of GTH release (castration of female rainbow trout during vitellogenesis led to increased serum GTH levels). Female androgens are also thought to stimulate behavioural responses (Lambert *et al.*, 1986).

Generally, serum levels of E₂, E₁, T and VTG rise markedly during the early stages of ovarian development (e.g. Whitehead *et al.*, 1978a,b; Scott *et al.*, 1980; Bromage & Cumaranatunga, 1988) with steroid levels in migratory Atlantic salmon and winter flounder *Pseudopleuronectes americanus* (Walbaum) and rainbow trout for example reaching a peak at spawning followed by a rapid decline (Whitehead *et al.*, 1978a,b; Scott *et al.*, 1980; Campbell & Idler, 1977).

Oocytes undergoing vitellogenic growth produce oestrogens (particularly E₂) in response to GTH I stimulation in turn inducing hepatic VTG production, its release into circulation and its subsequent sequestration by developing follicles (Wallace *et al.*, 1987). E₁, present in the bloodstream before E₂, is also capable of inducing VTG synthesis but is far less potent (van Bohemen *et al.*, 1982). The precise function of E₁ remains unclear although one opinion is that it may serve to sensitise liver hepatocytes to E₂ (van Bohemen *et al.*, 1982). Elliott *et al.* (1984) and Bromage & Cumaranatunga (1988) claimed that since E₁ secretion precedes that of E₂, its presence may simply be a function of its position in the stepwise synthesis of ovarian oestrogens.

Circulating levels of T also rise during vitellogenesis (e.g. Wingfield & Grim, 1977; Whitehead *et al.*, 1978a,b) although its precise function also remains unclear. The presence of greater concentrations of T in females than males (Scott *et al.*, 1980) is thought to suggest that T may have a precise functional role rather than simply as a precursor to E₂. GTH synthesis in response to T stimulation was later reported by Crim & Evans (1979), Crim *et al.* (1981b), Gielen & Goos (1984) and Gur *et al.* (1995). Further possible functions of T will be discussed in Chapter 5.

Yaron *et al.* (1977) found a positive correlation between levels of E₂ and ovarian weight in *O. aureus*. The ovary was also found to be the main source of E₂ and that circulating levels of this hormone depended upon the maturity of the ovary. E₂ was also found to stimulate the synthesis and release of VTG indicating that E₂ is the major oestrogenic hormone in tilapias. Similar results were reported by (Bogomolnaya & Yaron, 1984), who found that stimulation of E₂ secretion in *O. aureus* was found to be mediated, as in other vertebrates, by cyclic-AMP as a secondary messenger. These authors also reported a dose-dependent increase in E₂ synthesis with increasing GTH stimulation; the response being dependent upon incubation temperature and the stage of ovarian development. Terkatin-Shimony *et al.* (1980) monitored levels of serum E₂ in breeding and non-breeding female *O. aureus*. E₂ in non-breeding females was found to be 10% of that seen in breeding females. Oestriol (E₃) was found to have a greater vitellogenic potency than E₂, which was in turn more potent than E₁.

Oocyte maturation remains largely under the control of GTH II. Stimulation of the ovary by GTH II results in ovarian steroid synthesis ultimately stimulating oocyte maturation. As oocyte maturation proceeds, androgen and particularly oestrogen production declines and there is a surge of circulating GTH(s) (e.g. Billard *et al.*, 1978; Bromage *et al.*, 1982a; Breton *et al.*, 1983; Scott & Sumpter, 1983; Scott *et al.* 1983; Whitehead *et al.*, 1983; Zohar *et al.*, 1986; Sumpter & Scott, 1987; Scott, 1990; Nagahama *et al.*, 1995). Evidence suggests that levels of E₂ are negatively correlated to GTH levels suggesting that the observed surge in GTH occurs in response to a reduction in E₂ (Scott *et al.*, 1983; Whitehead *et al.*, 1983). Concurrent with increased GTH levels is the secretion of 2 further ovarian steroids: 17 α -hydroxyprogesterone (17 α OH-P) and 17 α -hydroxy-20 β -dihydroprogesterone (17 α 20 β -P) which control final maturation and ovulation (Scott & Baynes, 1982; Scott *et al.*, 1982; Goetz, 1983; Scott *et al.*, 1983). In marine teleosts corticosteroids such as 11-deoxycortisol and 11-deoxycortisone are also produced by the ovaries during maturation (Colombo *et al.*, 1978).

17α 20 β -P has been identified in many teleosts eg. rainbow trout, goldfish, pike *Esox lucius* (L.) (Jalabert, 1976) and yellow perch *Perca flavescens* (Mitchill) (Goetz and Theofan, 1979) and is often referred to as maturation inducing steroid (MIS). Goetz (1983) for example, reported that injection of MIS resulted in germinal vesicle migration and breakdown. Other hormones such as 17α -20 β ,21-trihydroxy-4-pregnen-3-one (17α 20 β ,21-triOH-progesterone) have been implicated as being the MIS in marine fish such as the Atlantic croaker and the spotted sea trout *Cynoscion nebulosus* (Cuvier) (Thomas & Trant, 1989; Patino & Thomas, 1990). That receptors to 17α 20 β -P were found on oocyte membranes suggests that there was a cytoplasmic factor that mediated the action of 17α 20 β -P; this factor was named maturation promoting factor (MPF) and was first demonstrated in amphibian oocytes (Nagahama *et al.*, 1995). Existence of MPF in fish oocytes was demonstrated by microinjection of cytoplasm from mature unfertilised goldfish oocytes into starfish *Asterina pectinifera* (Muller & Troschel) oocytes causing germinal vesicle breakdown (Kishimoto, 1988). Fish MPF, like that of clawed toad *Xenopus laevis* (Daudin) and starfish, consists of two components: cdc2 kinase and cyclin B (Nagahama *et al.*, 1995). 17α 20 β -P appears to induce oocytes to synthesise cyclin B, which in turn, activates pre-existing cdc2 kinase producing an active version of cdc2 kinase.

The principle function of 17α OH-P appears to be as a precursor to 17α 20 β -P. The theca produces 17α OH-P which is converted to 17α 20 β -P by the granulosa in a process that has become known as the 'two-cell model' (Nagahama *et al.*, 1985; Nagahama and Yamashita, 1989; Nagahama *et al.*, 1995). In *O. mossambicus* 17α OH-P concentrations remain low throughout the reproductive cycle, with a single peak at 7 days after spawning in non-mouthbrooding females and at 40 days post-spawning in mouthbrooding females (Smith & Haley, 1988).

Once oocyte maturation is complete, eggs are ovulated (expelled from the follicle). This process is known to be controlled by prostaglandins acting upon the smooth muscle of both the follicular thecal layers and the ovarian lammellae (Scott, 1990). The involvement of prostaglandins was demonstrated when it was found that follicular

rupture was blocked in goldfish administered with indomethacin, a prostaglandin synthesis inhibitor (see Stacey, 1984).

Finally, once ovulated, eggs are released from the body (oviposition) into the environment. This generally requires the presence/courtship of a conspecific male, suitable substrate and pheromonal stimulus (see Section 1.7.1.3) accompanied by suitable environmental conditions (see Section 1.7.1.1).

The endocrine control of reproduction in tilapias has received relatively scant attention. Previous studies have suggested that hormonal profiles of multiple-spawning fish such as tilapias are not as well defined as other teleosts. Profiles of E₂ and T remain unclear and unlike salmonids can exhibit several peaks prior to spawning (Smith & Haley, 1988). Few studies have investigated the changes in taGTH and sex steroid levels throughout ovarian cycles in tilapias. Moreover, all existing literature relate to mouthbrooding genera particularly *O. niloticus*, *O. mossambicus* and *O. aureus*.

Few studies have related hormonal profiles to oocyte development in tilapias, though studies by Rothbard *et al.* (1991), Kishida *et al.* (1995) and Tacon *et al.* (1996) have investigated hormonal profiles associated with mouthbrooding behaviour. Rothbard *et al.* (1991) monitored taGTH, T and E₂ throughout 7 phases of breeding behaviour in *O. niloticus*. taGTH was low at all phases except during actual spawning (when a 5-fold increase was observed). T and especially E₂ increased gradually during acquisition of nuptial colouration and pairing and receded during spawning and mouthbrooding. More recently Kishida *et al.* (1995) and Tacon *et al.* (1996) investigated levels of steroids in relation to mouthbrooding behaviour in *O. mossambicus* and *O. niloticus* respectively. These studies suggested an involvement of steroids with mouthbrooding behaviour.

Only two studies have attempted to relate hormonal rhythms with concurrent ovarian growth: Smith & Haley (1988) and Srisakultiew (1993). Smith & Haley (1988) found that initial peaks of T, E₂ and progesterone (P) occurred later in the cycle of mouthbrooding than non-mouthbrooding *O. mossambicus*. An initial peak of T and E₂ occurred on day 15 after spawning. Whilst E₂ stayed high, T fell at 25 days post-

spawning and rose again just prior to spawning. During the latter phases of mouthbrooding (15 - 25 days post-spawn) intra-ovarian oocytes did not increase in size. During this time E₂ was suggested to play a role in parental behaviour or to protect oocytes from atresia. Levels of P did not rise until 25 days after spawning, then decreased and peaked again towards the end of the cycle. A further study of *O. niloticus* monitored levels of total calcium (as an indicator of vitellogenin), E₂ and T over 2 - 3 spawning cycles and correlated these with the histological development of the ovary. With each spawning cycle volume fraction of stage 6 (maturing) oocytes increased from 0 - 15% (day 1 post-spawning) to 65 - 72 (day 10) coinciding with peak levels of total calcium and T. E₂ was found to peak at day 5 and then fall by day 10. By day 10 vitellogenesis was found to be complete (Srisakultiew, 1993). Unfortunately, sampling was only undertaken on days 1, 5 and 10 after spawning in this study and may therefore have missed changes that had occurred quickly in the developing ovary.

In summary, much of the present knowledge concerning the endocrine control of spawning and ovarian development in tilapia is based upon studies of mouthbrooding species. Very little is known of the hormonal control of spawning and ovarian development in substrate-spawning species of tilapia. Furthermore, only two previous studies have correlated hormonal cycles in tilapia with dynamic aspects of ovarian development. Both of these studies were in mouthbrooding species. There is no comparable study in substrate-spawning tilapia. The investigation described in Chapter 5 of this thesis therefore aims to redress this imbalance and describes the histological and endocrine changes associated with a developing *T. zillii* ovary. A knowledge of these changes (and particularly the timing associated with them) would be of considerable benefit to broodstock management and to the further enhancement of artificial spawning induction protocols.

(1.8) Aims of this thesis:

(1) To investigate and compare spawning periodicity, fecundity and egg size in various maternal weight classes of individually-maintained female *T. zillii* held under controlled laboratory conditions and to investigate changes in fecundity and egg size over successive reproductive cycles in repeat-spawning fish.

(2) To investigate the histology of, and determine a classification scheme for, the different stages of oocyte development in the recrudescence *T.zillii* ovary.

(3) To analyse the quantitative dynamics of ovarian development in *T. zillii* via various means throughout the reproductive cycle and attempt to relate such changes to concurrent dynamic changes in sex steroid levels. This will also be investigated using experimental fish experiencing changes in social environment (by way of the presence/absence of spawning-substrate and visual contact/no contact with conspecifics).

(4) To examine whether confinement influences spawning in *T. zillii* (as observed in other tilapias) and thereafter investigate the concurrent ovarian physiology and endocrinology associated with such inhibition.

(5) To investigate the effect of food ration size on circulating sex steroids, ovarian histology, fecundity, egg size and spawning periodicity in *T. zillii*.

Chapter 2

General materials and methods.

(2) General materials and methods.

Only details of those general materials and methods commonly utilised throughout this study are given in this Chapter. Details of materials and methods specific to particular sections of the thesis are given in the relevant chapters.

(2.1) Fish, aquaria design and fish maintenance.

(2.1.1) Fish.

The work presented in this thesis was conducted on the substrate-spawning cichlid *Tilapia zillii* (Gervais, 1848) of Egyptian origin and to a lesser extent, the closely related *Tilapia tholloni* (Sauvage, 1884) of West African origin. Whilst these fish are taxonomically classed as distinct species, recent genetic evidence suggests that the two species held at the Institute of Aquaculture, University of Stirling may, indeed, not be separate species at all (B. McAndrew, personal communication) and are more likely to be descended from two isolated biogeographical populations of *T. zillii*. Nothing however has been published to this effect. Thus, the Institute of Aquaculture, University of Stirling has adopted the interim classification of *T. zillii* (strain 'A') and *T. zillii* (strain 'B') referring to Institute stocks of *T. zillii* and *T. tholloni* respectively. During this study both strains of fish were used to maximize the total fish stocks available and to serve as a comparative investigation of reproductive physiology and endocrinology.

All fish were obtained or derived from genetically pure broodstock (i.e. free from hybridisation with other species/genuses) held at the Tropical Aquarium Suite at the Institute of Aquaculture, Stirling University. Further details of age, strain and size of fish are given in the methods section of relevant experiments.

(2.1.2) Aquaria design.

All fish were maintained in gravity-fed recirculating aquaria incorporating various types and sizes of covered fish holding tanks linked to several settling tanks, faecal traps and filtration units appropriate to system size and capacity. Settling tanks

incorporated filter brushes (Black Knight Company, U.K.) and bio-rings (Dryden Aquaculture, U.K.) to aid particulate filtration and maximise biofiltration. Water was pumped from system settling tanks to respective header tanks via various types of water pump appropriate to system capacity (Beresford Pumps Ltd., U.K.).

Broodstock were maintained in either of two aquarium systems, arbitrarily termed System 1 and System 2. System 1 (Appendix 1.1) incorporated several 114 x 114 x 42cm fibreglass holding tanks containing male and female fish in a ratio of 2 males: 1 female. Inflowing water entered each holding tank at a rate of 400 litres/hour.

System 2 (Appendix 1.2) incorporated several different sizes of holding tank with fish from the present study being housed in 'bucket' tanks (top diameter = 50cm, base diameter = 38cm, vertical height = 41cm) at similar sex ratios as those described above. Water inflow was maintained at a rate of 190 litres/hour.

In addition to on-going broodstock maintenance, the holding tanks of Systems 1 and 2 were also utilised in several experimental protocols. This is noted in the relevant experimental methods sections.

Experiments involving the maintenance of individual fish utilised a further design of aquarium system, arbitrarily termed System 3 (see Figure 2.1 and Appendix 1.3) and System 4 (similar to System 3). As Systems 3 and 4 were so similar, only System 3 will be described in detail here. System 3 incorporated eight 122.0 x 47.0 x 47.5cm glass tanks. Each glass tank incorporated two, three or four (depending on fish size) vertical dividers constructed from translucent perspex (0.5cm thick), thus respectively creating three, four or five separately partitioned 'holding spaces' within each tank into which female broodstock could be introduced and maintained individually.

Those experiments involving fecundity determination were performed whilst such glass tanks were fitted with removeable false bases constructed from perspex (0.2cm thick) and fitted to each 'holding space'. The aggressive and active nature of the fish necessitated the use of plastic netting (mesh size : 2.0 x 2.0cm) to cover experimental



Figure 2.1. Gravity-fed recirculating aquarium system (System 3) used throughout this study for maintenance of individual experimental fish. Note the use of perspex dividers to create discrete 'holding spaces' within each glass tank into which individual fish could be introduced and maintained (see also Appendix 1.3a and 1.3b).

glass tanks and thus minimize risk of escape. Inflowing water entered each glass tank at a rate of 327 litres/hour.

(2.1.3) Fish Maintenance.

All aquaria experienced a constant daily photoperiod regime of 12L:12D and a water temperature of $27\pm 1^{\circ}\text{C}$. Broodstock holding tanks were oxygenated via airstones coupled to a low pressure blower unit. Unless otherwise stated fish were fed *ad libitum* twice daily with a commercial pelleted trout feed (Trouw Aquaculture Ltd./Ewos Ltd., U.K.). Pellet size varied according to fish size. Protein content of feeds was dependent upon pellet type and size (see Appendix 1.4). Water quality was monitored in each aquarium system by measuring pH bi-weekly and testing nitrate, nitrite and ammonia levels (C-Test kits, New Aquarium Systems, U.K.) monthly. The pH of aquarium water averaged 6.5. System settling tanks and filters were cleaned every two weeks concurrent with a 10-20% water change.

(2.2) Fish handling, anaesthesia, identification, stripping and fertilisation.

(2.2.1) Fish handling and anaesthesia.

All procedures requiring fish handling e.g. stripping, tagging, weighing, blood sampling *etc.* were performed under anaesthesia to minimise stress and scale damage. Selected fish were anaesthetised by immersion in a 1:20,000 (v/v) dilution of 2-phenoxyethanol (Sigma Chemicals, U.K.). Anaesthesia was generally induced within 1 - 2 minutes. After the sampling procedure had been undertaken anaesthetised fish were placed into clean, aerated water until recovery. Full recovery usually occurred within 1 - 2 minutes. Post-anaesthesia mortalities were rarely observed.

(2.2.2) Fish identification.

Individual fish were tagged with passive subcutaneous electronic transponding-PIT tags (AVID, Labtrac Ltd., U.K.). Tags were implanted through small incisions

made into either the dorsal musculature or the peritoneal cavity (dependant upon fish size). Incision sites were sterilised prior to implantation with 70% ethanol and sealed post-implantation with a commercial dental tissue glue 'Orahesive Protective Powder' (Allardyce Health Group, U.K.) in combination with 'Cicatrín' (Wellcome Trust, U.K.), a mild topical antibiotic available from most pharmaceutical outlets (3 parts Orahesive : 1 part Cicatrín antibiotic).

(2.2.3) Stripping of eggs/milt and fertilisation.

Ordinarily, female broodfish were allowed to spawn unhindered on aquarium tank bases. However, when extra stocks of fry were required or when an assessment of egg quality was required, broodfish were stripped and the resultant pool of eggs fertilised manually. Stripping was not possible until selected female fish had fully ovulated.

As spawning approaches in *T. zillii*, territories are first established and are rigorously defended thus signalling the onset of nest excavation (Bruton and Gophen, 1992). In breeding pairs, the male usually establishes suitable territory and begins to excavate a nest which is then cleaned by both fish (Bruton and Gophen, 1992). Due to the lack of suitable nesting substrate in the aquaria utilised in the present study, lone females were found to simply clean a discrete area on the horizontal tank base. As gonads ripen and ovulation approaches, both fish (or the lone female in the present study) adopt vivid colour patterns; the ventral region takes on a vivid red colouration coupled with the appearance of several black stripes running vertically along each flank as described in Voss (1969) and Fryer and Iles (1972). In the present study this was found to be coincident with a swelling of the genital papilla, a decrease in nest building and an increased level of display behaviour which, in a breeding pair, would tend to initiate spawning and fertilization (Fischelson, 1966). Despite the absence of conspecific males in the present study, females proceeded to undergo ovulation and oviposition. Two to three hours prior to oviposition, the genital papilla was found to undergo considerable swelling and extension. Fish observed to be in this physiological

condition were monitored at regular 20 - 30 minute intervals for signs of egg release. Once ovulation was complete, females released numerous olive-green coloured ovoid-shaped eggs which were laid in long strings. Such strings were found to adhere to the selected substrate due to adhesive glutinous threads located on the outer surface of each egg chorion (Rana, 1988). After laying one string of eggs, the female immediately lays a further string perpendicular to that laid previously (Fishelson, 1966). This behaviour results in a roughly circular-shaped dense network of eggs adherent to the substrate. Such egg masses would subsequently be rigorously guarded and defended by the female fish. Furthermore, egg masses are 'fanned' by spasmodic movement of the parent's pelvic fins to aid oxygenation. Whilst guarding, defending and fanning were observed to be undertaken by lone females in the present study, it should be noted that in breeding pairs these tasks are usually shared equally between male and female parents (Bruton and Gophen, 1992).

In the present study, once experimental fish had begun to oviposit eggs directly on to the tank base, ovulation was deemed to be complete and only then was stripping attempted. The genital papillae of anaesthetised females were blot-dried with absorbent tissue paper and the fish held dorsal side uppermost with the left hand holding the fish and the right hand carefully massaging the fish's abdomen in such a manner that eggs were extruded from the ovary and collected into a clean plastic petri-dish (B.D.H./Merck Ltd., U.K.). Care must be taken to avoid water contamination which would otherwise initiate water hardening and thus precocious closure of egg micropyles. Once egg extrusion had ceased or at the first sign of blood in the egg pool, stripping was stopped and the petri-dish covered. During stripping extreme care must be taken not to apply too much pressure to the abdomen of the fish as internal body organs are easily damaged.

Once eggs had been obtained, sperm was collected and pooled from 2 - 3 anaesthetised males by applying the same stripping technique as detailed above after first emptying the fish's bladder. Sperm released from the testes was collected directly

from the genital papillae with the aid of a disposable glass haematocrit tube (Camlab, U.K.).

Eggs were fertilised by adding pooled sperm to the petri-dish containing eggs. Gametes were carefully but thoroughly mixed with a fine brush and a tiny amount of water (100 - 200 μ l). The mixture was then allowed to stand at ambient aquarium temperature for 4 - 5 minutes. Fertilised eggs were then placed onto clean perspex sheets (10.0 x 10.0 x 0.3cm) and spread evenly. Water was poured over the top of the eggs with a 1ml syringe (Terumo Europe N.V., Belgium) taking care not to disturb the even distribution of eggs. After a further standing period of 4 - 5 minutes, water hardening occurred and eggs adhered to the perspex sheets. Perspex sheets were then placed into round-bottomed plastic containers (see Rana, 1986) supplied with clean, U.V. sterilised water and left until hatching (approximately 2 days post-fertilisation) and absorption of yolk sac (a further period of approximately 5 days). At this stage fry were transferred into 25 litre tanks in a recirculating fry system for on-growing.

(2.3) Blood serum collection, ovarian biopsy and ovary/liver sampling.

(2.3.1) Blood serum collection procedure.

Blood samples were taken from the caudal dorsal aorta by using either 19 G, 23 G or 25 G sterile hypodermic needles (dependent upon fish size) and sterilised 1ml syringes (Terumo Europe N.V., Belgium). Where possible, 200 - 300 μ l of blood was removed from fish (unless otherwise stated in the individual experimental protocols). Immediately after sampling, the needle was removed from the syringe and the blood sample expelled into a clean eppendorf microcentrifuge tube (Fisons Scientific Equipment, U.K.) and placed on ice until sampling was completed. Blood samples were then transferred to a refrigerator and allowed to clot for 2 - 3 hours, whereupon samples were centrifuged at 13,000 rpm for 10 minutes in a biofuge (Heraeus Sepatech, Germany). Resultant serum samples (supernatant) were removed and transferred to clean eppendorf tubes and stored at -25°C for future analysis.

(2.3.2) Ovarian biopsy.

The technique of ovarian biopsy was employed in situations where representative partial samples of intra-ovarian tissue were required from live fish. Samples of ovarian tissue were obtained from anaesthetised fish through a small bore (1.9mm diameter) polyethylene cannula (pre-sterilised with absolute ethanol and allowed to dry) carefully inserted through the gonopore, up the oviduct and directly into the ovary. Cannulae were renewed every 5 biopsies to reduce the risk of infection. To standardise the technique, each biopsy was taken with the cannula positioned mid-way along the left ovary. A validative study undertaken by Shehadeh *et al.* (1973) indicated that, in the case of the synchronously developing grey mullet ovary, an intra-ovarian biopsy taken from any of seven different ovarian locations would be representative of the entire ovary.

In the present study, small samples of tissue were removed from the ovary through connection of the cannula to a 20 ml syringe (also pre-sterilised in 70% ethanol) and application of gentle suction. Ovarian tissue was transferred to Bouin's fluid (see Section 2.5.1.1) for fixation immediately after removal.

Stereological validation of the biopsy method for obtaining a representative sample of the true histological appearance of the asynchronous tilapia ovary is given in Chapter 5.

(2.3.3) Ovary and liver sampling from sacrificed fish.

Fish were sacrificed by an overdose of anaesthetic followed by spinal transection performed immediately posterior to the opercula. Sacrificed fish were weighed to the nearest 0.1g on a Mettler 400 balance (Fisons Scientific Equipment, U.K.) and the ovaries and liver removed by dissection. Liver and ovaries (left + right) were weighed individually to the nearest 0.0001g on a Mettler AE100 balance (Fisons Scientific Equipment, U.K.). Gonadosomatic (GSI) and hepatosomatic (HSI) indices were determined as shown overleaf.

(a) $GSI (\%) = \text{gonad weight} / (\text{body weight} - \text{gonad weight}) \times 100$

(b) $HSI (\%) = \text{liver weight} / \text{body weight} \times 100$

(2.4) Determination of total fecundity, egg size and estimation of spawning periodicity.

(2.4.1) Determination of total fecundity.

Considerable debate exists in research literature over the precise definition of fecundity in the multiple-spawning tilapiine family of fish and this will be discussed in more detail later in this thesis. The present study adopts the definition of Rana (1986) who stated that total fecundity of tilapias should only be defined as the number of discrete eggs found in a freshly spawned egg clutch.

Spawning activity in substrate-spawning tilapias results in the oviposition of many small interlinked chains of eggs with each egg possessing numerous glutinous threads on the outer layer of the chorion facilitating the adhesion of eggs to a suitable substrate pre-cleaned by a pair of spawning fish (Rana, 1988). In this study the majority of egg batches were oviposited directly on to the aquarium base, though in rare isolated cases egg batches were laid onto the aquarium walls instead.

All measurements of fecundity and egg size in this study were made on water hardened eggs (unless otherwise stated) laid by individually-held female fish. Spawning females were left undisturbed until oviposition was complete.

Soon after the cessation of oviposition (no longer than 30 minutes), spawning females were removed from their respective aquaria and anaesthetised in 2-phenoxyethanol as detailed in Section 2.2.1. Fish were blot dried on absorbent tissue paper and weighed (to the nearest 0.1g) on a Mettler 400 balance (Fisons Scientific Equipment, U.K.) and total length determined (to the nearest mm). Total length was defined as the distance between the snout-tip and the most posterior part of the caudal fin and was determined using a scaled ruler fitted to a wooden frame. The aggressive and territorial nature of tilapiine fish often leads to fighting and inevitably split and damaged fins. Thus total length was the only length measurement deemed appropriate.

Whilst the anaesthetised fish was undergoing recovery in a recovery bath, the false base was removed from the aquarium 'holding space' allowing the egg mass to be carefully removed by scraping with a spatula. Egg masses were then gently teased apart with forceps allowing enumeration of total fecundity.

A preliminary trial was performed to assess and compare direct counts of total fecundity in freshly spawned egg clutches with two indirect methods based on egg biomass. These three methods of egg enumeration were evaluated as follows :

(a) Determination of total fecundity in a freshly spawned egg clutch through direct enumeration by manual tally counter.

Egg masses were removed from experimental aquaria as detailed above and individual eggs counted manually with the aid of a tally counter (B.D.H./Merck Ltd., U.K.). An egg mass containing approximately 1000 eggs could usually be counted within 10 minutes. To evaluate consistency and accuracy of this technique, the total fecundity of one discrete egg mass was successively determined a total of ten times allowing calculation of a coefficient of variation (C.V. - see Section 2.8.2). Coefficient of variation was found to be 0.21% (refer to Table 2.1).

(b) Estimation of total fecundity through calculation based upon wet weight of egg clutch.

Ten freshly spawned egg clutches were removed from experimental aquaria as described earlier. Each egg clutch was blot dried on absorbent tissue paper and weighed to the nearest 0.0001g on a Mettler AE100 balance (Fisons Scientific Equipment, U.K.). A random sub-sample of 200 eggs was then removed from the egg mass and weighed (also to the nearest 0.0001g). Total egg number could then be calculated using the results of the two weighings. To allow statistical analysis of the accuracy of this method, each egg clutch was then counted directly using a tally counter in the same fashion as in (a) above. Estimated egg counts and concurrent direct egg counts were then compared using chi-squared (χ^2) statistical analysis (see Section

Table 2.1. Evaluation of total fecundity determination through direct enumeration by manual tally counter.

Count Replicate (one discrete egg mass counted a total of ten times)	Egg Count
1	1367
2	1362
3	1363
4	1367
5	1359
6	1361
7	1365
8	1365
9	1362
10	1367
Coefficient of Variation (%) (See Section 2.8.2)	0.21 %

2.8.3). Results are presented in Table 2.2. A considerable proportion of the estimated egg counts were found to be significantly ($p < 0.05$ or $p < 0.01$) different than respective direct counts performed using a tally counter.

(c) Estimation of total fecundity through calculation based upon dry weight of egg clutch.

A further nine freshly spawned egg clutches were removed from experimental aquaria as described earlier. Each egg mass was first enumerated directly using a tally counter as detailed in (a) above. A sub-sample of 200 randomly chosen eggs was then removed from each egg mass and placed on a aluminium foil weighing boat (pre-weighed to the nearest 0.0001g). The remaining egg mass was then placed onto a further weighing boat (also pre-weighed to the nearest 0.0001g). The two foil boats were then placed into a 60°C drying oven. Foil boats were removed 48-60 hours later and placed into a dessicator containing silica gel (BDH/Merck Ltd., U.K.) to cool to room temperature for at least one hour prior to reweighing. Boats and eggs were reweighed to constant weight after similar periods of drying. Total egg number of the original egg mass could then be computed by knowledge of the resultant two dry weights. Estimated egg counts and concurrent direct egg counts were compared using chi-squared (χ^2) statistical analysis (see Section 2.8.3). Results are presented in Table 2.3. Results showed that most (8 out of 9) estimated counts did not vary significantly ($p \geq 0.05$) from counts performed directly using a tally counter. One replicate however, yielded an estimate significantly ($p < 0.01$) different than the direct count.

Previous studies of fecundity determination in *T. zillii* have predominantly utilised direct manual counting methods (El-Zarka, 1956; Lowe-McConnell, 1955; Peters, 1983). Isolated studies have also employed gravimetric estimation (Siddiqui, 1977, 1979) and estimations on the basis of wet weight (Botros, 1969). A more recent study undertaken by Dadzie and Wangila (1980) however, claimed that direct counting remained the most accurate means of fecundity determination since it avoids the technical variations of calculated egg numbers; a problem noted by several previous

Table 2.2. Evaluation of total fecundity through estimation on a wet weight basis. Estimates are compared with concurrent direct egg counts by chi-squared (χ^2) statistical analysis.

Count Replicate	Direct Egg Count	Estimated Egg Count	χ^2 statistic	Test Result
1	3641	4285	52.32	p<0.01
2	5918	6657	43.42	p<0.01
3	9281	9348	0.24	p \geq 0.05
4	1377	1408	0.34	p \geq 0.05
5	4881	5032	2.30	p \geq 0.05
6	4308	4526	5.38	p<0.05
7	2871	3023	3.92	p<0.05
8	2583	2848	12.92	p<0.01
9	3582	3681	1.35	p \geq 0.05
10	2647	2087	66.24	p<0.01

Table 2.3. Evaluation of total fecundity through estimation on a dry weight basis. Estimates are compared with concurrent direct egg counts by chi-squared (χ^2) statistical analysis.

Count Replicate	Direct Egg Count	Estimated Egg Count	χ^2 statistic	Test Result
1	1970	1938	0.26	p \geq 0.05
2	2471	2433	0.29	p \geq 0.05
3	3241	3230	0.10	p \geq 0.05
4	1714	1753	0.44	p \geq 0.05
5	2204	2174	0.21	p \geq 0.05
6	2123	2006	3.31	p \geq 0.05
7	726	605	11.00	p<0.01
8	1759	1726	0.31	p \geq 0.05
9	2099	2223	3.55	p \geq 0.05

studies involving other teleost species (Burrows, 1951; Vladykov, 1956; Siddiqui, 1977).

The preliminary trial undertaken in the present study showed that whilst direct enumeration can be the most time consuming of the fecundity determination methods tested, it is also the most accurate and consistent (C.V. = 0.21%). Estimation of total fecundity on the basis of wet weight and dry weight, whilst being easier and much less time consuming, proved inaccurate when compared to concurrent direct counts.

Inconsistencies in the wet weight method were thought to be due to the incomplete removal of excess water contained within the confines of the egg mass. Pockets of water, although small, would lead to overestimated fecundity values. Whilst estimation on basis of dry weight proved much more accurate than on a wet weight basis, the long periods of time taken for an egg mass (particularly a large egg mass) to attain a steady dry weight rendered this technique impractical. As a result, fecundity was determined in the present study by tally counter.

(2.4.2) Determination of mean egg size, mean egg diameter and validation of egg measurement procedure.

Since the eggs of substrate-spawning tilapias are ovoid-shaped, two parameters were measured in calculating mean egg size; egg long axis and egg short axis. Egg long axis refers to the length of the longest axis of the egg, whereas egg short axis refers to the maximum length of the axis perpendicular to the main longest axis. These two parameters can subsequently be used to calculate egg diameter.

(2.4.2.1) Determination of mean egg size and mean egg diameter.

Maximum lengths of the long and short axes of a sub-sample of 50 randomly chosen eggs from each spawned egg mass were measured to the nearest 0.001mm with a binocular microscope (Olympus Optical Co. Ltd., U.K.), incorporating a calibrated eyepiece graticule. Mean egg diameter was calculated using the equation overleaf :

$$d = \frac{l + s}{2}$$

where :

d = egg diameter (mm)

l = mean length of egg long axis (mm)

s = mean length of egg short axis (mm)

(2.4.2.2) Validation of egg measurement procedure.

Maximum lengths of both long and short axes of a sub-sample of 50 randomly chosen eggs from a water-hardened egg clutch were measured to the nearest 0.001mm as described in Section 2.4.2.1 above. This same subsample was re-measured a further four times allowing calculation of a coefficient of variation (See section 2.8.2). Results are presented in Table 2.4. Coefficients of variation (C.V.) were found to be 0.89% and 0.31% for long and short axis measurement respectively.

(2.4.3) Determination of mean individual egg volume, mean individual egg dry weight, relative fecundity, total egg volume and egg weight to body weight ratio (EW:BW).

(2.4.3.1) Determination of mean individual egg volume.

Mean volume of individual eggs was calculated using the following equation :

$$v = \frac{\pi}{6} \cdot l \cdot h^2$$

where :

v = volume of egg (mm³)

l = mean length of egg long axis (mm)

h = mean length of egg short axis (mm)

Table 2.4. Validation of egg measurement technique. A subsample of 50 randomly chosen eggs from a water-hardened egg clutch were measured in terms of long and short axis length. This procedure was repeated a further four times to allow calculation of a coefficient of variation for measurement of each axis.

Count Replicate	Mean long axis length (mm±SE)	Mean short axis length (mm±SE)
1	1.847±0.0091	1.461±0.0081
2	1.843±0.0077	1.466±0.0070
3	1.846±0.0085	1.461±0.0090
4	1.876±0.0082	1.469±0.0080
5	1.875±0.0088	1.471±0.0081
Mean of 5 replicates	1.857±0.0074	1.466±0.0020
Standard Deviation	0.0166	0.0046
Coefficient of Variation	0.89 %	0.31 %

(2.4.3.2) Determination of mean individual egg dry weight.

A sub-sample of 100 eggs was randomly removed from the spawned egg mass and dried on a pre-weighed aluminium foil weighing boat (weighed to the nearest 0.0001g on a Mettler AE100 balance (Fisons Scientific Equipment, U.K.)) in a 60°C drying oven. Foil boats were removed 48-60 hours later and placed into a dessicator containing silica gel (B.D.H./Merck Ltd., U.K.) to cool to room temperature for at least one hour prior to reweighing. Boats and eggs were reweighed to constant weight after similar periods of drying.

(2.4.3.3) Determination of relative fecundity.

Relative fecundity (expressed as eggs/g) was calculated using the following equation :

$$RF = \frac{TF}{W}$$

where:

RF = relative fecundity (eggs/g)

TF = total fecundity

W = weight of fish (g)

(2.4.3.4) Determination of total egg volume.

Total egg volume (expressed as mm³) was calculated using the following equation :

$$TEV = TF * MEV$$

where:

TEV = total egg volume (mm³)

TF = total fecundity

MEV = mean egg volume (mm³)

(2.4.3.5) Determination of EW:BW ratio.

Egg weight to body weight ratio (EW:BW, expressed as %) was calculated using the equation given overleaf :

$$EW:BW = (EDW * TF/W) * 100$$

where:

EW:BW = egg weight to body weight ratio (%)

EDW = egg dry weight (mg)

TF = total fecundity

W = weight of fish (g)

(2.4.4) Estimates of spawning periodicity.

Estimates of spawning periodicity throughout this thesis were based upon the following two parameters:

(1) ISI (inter-spawn-interval): based upon completed reproductive cycles of repeat spawning fish, i.e. the time elapsed from one spawn to the next.

(2) Overall mean days elapsed per spawn: based upon all fish (non-spawning and spawning) within an experimental group.

Calculation: total days observed / total spawns observed.

(2.5) ANALYSIS OF OVARIAN MORPHOLOGY AND HISTOLOGY.

Several previous studies involving the histology of fish ovaries and oocytes have indicated that established paraffin wax embedding techniques fail to successfully infiltrate advanced yolky oocytes, thus resulting in poor quality incomplete sections (Cumaranatunga, 1985; Brook, 1988; Coello, 1989; Tyler, 1988; Srisakultiew, 1993). Thus, the present study solely utilised plastic embedding techniques to create histological sections from ovarian tissue, a technique used successfully in previous studies of tilapia (*O. niloticus*) by Srisakultiew (1993).

(2.5.1) Plastic resin embedding.

Historesin embedding kits and accessories (Reichert-Jung, Cambridge Instruments GmbH, Germany) were utilised throughout this study.

(2.5.1.1) Tissue fixation.

Samples of ovarian tissue were cut to an appropriate size (i.e. no greater than 5mm in thickness) to allow adequate fixative penetration. Samples were then immersed in at least ten times the individual sample volume of Bouin's fluid for 24 hours as recommended by Drury & Wallington (1980). Bouin's fluid was prepared as follows:

40% formaldehyde	25ml
saturated aqueous picric acid	75ml
glacial acetic acid	5ml

Extreme care must be taken when handling picric acid as the powdered component is explosive if allowed to dry out. All the above chemicals were purchased from BDH/Merck Ltd. (U.K.) and were all of AnalR grade.

Following fixation in Bouin's fluid, samples were washed thoroughly with several changes of 70% ethanol to remove picric acid and stored indefinitely in 70% ethanol until required for infiltration. The importance of thorough washing after fixation in Bouin's fluid cannot be over-emphasised. Residual picric acid can damage tissues resulting in poor quality sections.

(2.5.1.2) Preparation of infiltration solution.

Infiltration solution was prepared by dissolving 0.5g of Historesin activator (containing 50% benzoyl peroxide) in 50 ml of Historesin basic resin (containing hydroxyethylmethacrylate) with the aid of a magnetic stirrer. Once prepared, the infiltration solution was kept in a light-proof container at 4°C.

(2.5.1.3) Preparation of embedding medium.

Plastic embedding medium was prepared by adding 1ml of hardener to 15 ml of pre-prepared infiltration solution in a 50ml glass beaker surrounded by crushed ice to retard polymerization upon mixing. The prepared solution must be mixed thoroughly and used immediately; despite the use of crushed ice, polymerization can be extremely rapid.

(2.5.1.4) Preparation of mounting medium.

Mounting medium was only made up immediately prior to use. Powdered (polymethylmethacrylate) and liquid (methylmethacrylate and 5% methanol) components of the mounting media were mixed together in a ratio of 2 parts powder to one part liquid (assuming that 1ml of the liquid component weighed approximately 1g). Mounting media was only prepared in small batches as hardening could be very rapid.

(2.5.1.5) Infiltration, embedding and mounting of ovarian tissue.

Ovarian samples, previously fixed in Bouin's fluid and subsequently stored in 70% ethanol, were first transferred to 20ml glass vials and dehydrated in a series of ethanol solutions (80% and 95% ethanol) at 4°C. The hydrophilic nature of the infiltration solution ensured that complete dehydration of tissue was not necessary. Samples were then slowly infiltrated at 4°C through a series of infiltration solutions of increasing strength in accordance with the protocol given below:

(a) 70% ethanol	1 day
(b) 80% ethanol	1 day
(c) 90% ethanol	1 day
(d) 95% ethanol	1 day
(e) 50:50 (infiltration solution : 95% ethanol)	3 - 7 days*
(f) 75:25 (infiltration solution : 95% ethanol)	3 - 7 days*
(g) 100% (infiltration solution)	7 - 14 days*

Infiltration is more effective if tissue is left for longer periods of time at each of the steps marked (*). Successful tissue infiltration was marked by the samples appearing slightly translucent and were found to sink to the bottom of the vials. Once successfully infiltrated, tissue could then be embedded in resin.

Samples were individually placed into separate compartments of appropriately-sized historesin mould trays (Reichert-Jung, Cambridge Instruments GmbH, Germany) and covered with freshly prepared embedding medium. Once covered with embedding medium, samples were moved slightly and positioning checked with fine-nosed forceps to eliminate any trapped air bubbles that would otherwise prove harmful to successful sectioning. Samples were allowed to polymerise at room temperature overnight, whereupon, they could be mounted.

Excess embedding medium was removed from mould trays using absorbent tissue paper. Freshly prepared mounting media was then carefully poured into each mould and a 2.5 - 3cm section of a cylindrical wooden block (diameter 2.5 cm) pressed into the medium and onto the hardened embedding resin. Mounting media was allowed to harden at room temperature for 15 - 20 minutes.

(2.5.1.6) Sectioning of prepared sample blocks.

Results of the present study suggested that optimum sectioning success is achieved if resin blocks are placed in a dessicator containing self-indicating silica-gel for 3 - 4 days prior to sectioning.

Blocks were sectioned at a thickness of 2 - 5 μ m with a glass knife and a 2050 Supercut automatic retracting microtome (Reichert-Jung, Cambridge Instruments GmbH, Germany). Knife glass (Ultramicrotome Glass; 40.6 x 2.5 x 0.6 cm) was precleaned overnight in a solution of 5% Decon (Decon Laboratories Ltd., U.K.), rinsed in distilled water and dried thoroughly before being placed into a Reichert-Jung histo-knifemaker. Knife incidence onto blocks was found to be most effective at an angle of 5°. Particularly difficult blocks were sectioned using a tungsten carbide blade.

Microscope slides were also pre-soaked in 5% Decon and rinsed thoroughly in distilled water prior to use. To aid section adhesion, clean slides were carefully coated with a very thin film of 'section adhesive' comprising 50% glycerol (B.D.H./Merck Ltd., U.K.) and 50% egg albumin, a modification of 'Mayers egg albumen section adhesive' described by Luna (1968) and successfully employed in a previous study involving plastic embedded sections by Srisakultiew (1993). After cutting, sections were floated in a water bath (Raymond A. Lamb, U.K.) at 35°C, transferred to precoated slides and allowed to dry on a hotplate (Raymond A. Lamb, U.K.) set at 40°C for 1-2 hours. Sample details were etched onto appropriate slides with a diamond-tipped pen and slides dried overnight in a 60°C oven (Windsor Incubator, U.K.) prior to staining.

(2.5.2) Staining protocols for histological slides.

The present study routinely utilised the haematoxylin and eosin staining technique but also, to a lesser extent, a polychrome method.

(2.5.2.1) Haematoxylin and Eosin stain.

Haematoxylin has become one of the most widely utilised stains in histological analysis, highlighting most cellular structures and is commonly used as a nuclear stain preceding staining of cytoplasm and connective tissue by eosin (see Drury and Wallington, 1980).

Where general visualisation of internal ovarian structure was required, batches of 25 slides at a time were placed into a slide rack and stained in accordance to a slightly modified version of the haematoxylin and eosin staining schedule used routinely in the histopathology laboratory at the Institute of Aquaculture, University of Stirling as detailed in Table 2.5.

Table 2.5 Staining protocol for Haematoxylin and Eosin.

CHEMICAL/SOLUTION	IMMERSION TIME (Minutes)
Alcohol I	2.0
Methylated Spirits	1.5
WASH - running tap water	1.0
Haematoxylin	5.0
WASH - running tap water	1.0
Acid Alcohol	4 swift dips
WASH WELL - running tap water	1.0
Scott's tap water	1.0
EXAMINE SLIDES UNDER MICROSCOPE	
WASH - running tap water	1.0
Eosin	5.0
WASH - running tap water	20 seconds
Alcohol II	2.0
Alcohol I	2.0

The above staining protocol has been modified from one used routinely in the Histopathology Laboratory, Institute of Aquaculture, University of Stirling for paraffin wax embedded tissues to suit the plastic embedded tissues used in the present study. The only main modification is the omission of xylene baths before and after the first and second alcohol I baths respectively.

After the final alcohol I bath, slides were removed from the slide rack, carefully wiped clean with tissue paper and coverslips mounted using Pertex. Slides were allowed to dry at room temperature overnight before examination.

(2.5.2.2) Polychrome stain.

The polychrome staining schedule has been increasingly utilised in histological studies of fish ovaries in recent years and has been used successfully to visualise stages of oocyte development in the Atlantic mackerel *Scomber scombrus* (L.) and yellowfin tuna *Thunnus albacares* (Cuvier) (Coello, 1989). Moreover, the stain has been shown to be effective in oocyte classification in recent studies on the tilapia *O. niloticus* (Srisakultiew, 1993).

Staining of ovarian tissue by the polychrome stain offers the versatility of not only discrimination of gross yolk composition from a single histological section but also all other main ovarian components including atretic oocytes, post-ovulatory follicles and particularly oocytes undergoing very early vitellogenesis (Coello, 1989).

The particular staining schedule utilised in the present study (given in Table 2.6) was initially used in an earlier study of tilapiine ovaries by Srisakultiew (1993), originally adapted from that given by Coello (1989).

(2.5.3) Photomicroscopy.

Selected histological sections were photographed using primarily a Zeiss Photomicroscope II (Carl Zeiss, U.K.) and a 100 speed colour film. Where low magnification photographs were required, an Olympus OM-4 Ti Black SLR camera was used in conjunction with an Olympus BH-2 binocular microscope (Olympus Optical Co. Ltd., U.K.), again using a 100 speed colour film. Macrophotographs of gross ovarian morphology were taken using the same Olympus OM-4 Ti Black SLR camera linked to stage-lit auto-bellows.

(2.5.4) Analysis of ovarian histology by stereology and estimation of ovarian volume fractions and ovarian numerical densities.

(2.5.4.1) An introduction to the technique of stereology.

Stereology has been a recognised scientific technique since its conceptual acceptance at an international conference of scientists in 1961 (see Elias, 1963) and

Table 2.6 Staining schedule for polychrome stain modified from Coello (1989) by Srisakultiew (1993).

CHEMICAL/SOLUTION	IMMERSION TIME (Minutes)
1% Periodic acid	10
WASH - running tap water	5
Schiff's Reagent	30
WASH - running tap water	5
0.1% Bromophenol Blue(in 95% ethanol)	25
0.5% Acetic acid	20
WASH - running tap water	5
Haematoxylin	40
Phosphate Buffer pH 7.4 - 8.0*	2 washes (renew buffer after each wash)

Slides were transferred from phosphate buffer, carefully wiped clean with tissue paper and coverslips mounted with Pertex. Slides were allowed to dry at room temperature overnight before examination.

* Preparation of phosphate buffer used in polychrome stain.

Constituents :

- (1) 0.2M Disodium hydrogen orthophosphate 12 Hydrate GPR (BDH/Merck Ltd.)
- (2) 0.1M Sodium dihydrogen orthophosphate GPR (BDH/Merck Ltd.)

Preparation :

Add 217.5ml of (1) to 32.5ml of (2) and make up to 500cm³ in a volumetric flask and ensure that pH is within the range 7.4 - 8.0 (adjust if necessary).

describes a body of mathematics that relates 3-dimensional structures to measurements taken from 2-dimensional sections of that structure. Subsequently stereology has become a widely used quantitative morphometric technique successfully utilised by many disciplines of science including mineralogy, metallurgy, mathematics and over recent years has become heavily employed in biological morphometry.

Moreover, the science of stereology has successfully been demonstrated to be particularly applicable to the quantitative analysis of ovarian histo-morphometry in fish (Kestemont, 1990; Srisakultiew, 1993; Macchi *et al.*, 1995) and in the estimation of fish fecundity (Emerson *et al.*, 1990). Emerson *et al.* (1990) successfully described the application and evaluation of stereological methods for counting fish oocytes in the herring *Clupea harengus* (L.), Dover sole *Solea solea* (L.) and Atlantic mackerel. Previous studies involving oocyte counts in fish species possessing a wide size range of oocytes of differing degrees of maturity have tended to employ the digestion of ovaries in a mercury-based fixative (Gilson's fluid) with subsequent sub-sampling of the digested tissue sample by either 'gravimetric' methods (Burd & Howlett, 1974) (based upon weight), 'volumetric' methods (Simpson, 1951)(based upon volume) or by use of automated particle counters (Witthames and Greer Walker, 1987). Such techniques have been fraught with difficulty. Gilson's fluid is highly toxic due to its high mercury content and successful digestion of ovarian samples can take several months. Moreover, automatic particle counters such as the one described by Witthames and Greer Walker (1987) can only accurately count oocytes over a pre-specified size threshold. The development of dependable techniques that do not utilise Gilson's fluid is therefore very important.

Application of stereology by Emerson *et al.* (1990) found that in both the sole and the herring, there was no significant differences in fecundity estimates derived from either volumetric sampling, automated particle counting or stereology. In the case of the mackerel however, the stereological method applied yielded significantly higher fecundity estimates than volumetric techniques. This discrepancy was attributed by the authors to a fault with the volumetric technique used within their own laboratory.

More recently, Srisakultiew (1993) validated the technique of stereology for quantification of different oocyte development stages in the ovaries of the mouthbrooding tilapia *O. niloticus* by comparing numerical density stereological techniques with the traditional digestion of ovarian samples in Gilson's fluid. Results showed that there was no statistical difference between oocyte numbers derived from either Gilson's fluid or stereological techniques and that consequently, stereology employing the use of numerical density equations could be used as an accurate alternative to the more traditional Gilson's fluid technique in *O. niloticus*.

Thus, quantitative stereology has been demonstrated to be an accurate method of quantifying oocyte developmental stages in the ovaries of several fish species and avoids exposure of laboratory workers to the mercury-based Gilson's fluid. Moreover, stereology classifies oocyte stages from histological sections and thus offers more accurate levels of quantification since oocyte classification is based upon changes in visible oocyte structure rather than differences in oocyte diameter (West, 1990). This observation was further clarified by Srisakultiew (1993) who found that estimates of oocyte numbers found in varying developmental stages could be heavily influenced by the criteria used to classify the oocytes. The present study thus utilises stereological analysis of histological sections for quantification of oocyte developmental stages in the ovaries of experimental animals.

(2.5.4.2) Theoretical stereology.

Weibel (1979) defined stereology as 'a body of mathematics that relates three-dimensional parameters defining the structure to two dimensional measurements obtainable from sections of the structure'. All stereological methods are based upon a principle known as the 'Delesse Principle' first derived by Delesse (1847). This theory forms one of the fundamental bases of stereology and successfully demonstrated that a random section can be quantitatively representative of the total composition of the original material from which the section was derived.

The fundamentals of the Delesse Principle can be easily demonstrated. A cuboid structure is placed into an x, y, z coordinate system and sliced parallel to the x, z plane into thin slices of thickness dy (refer to Figure 2.2). Total sectional area (A_{st}) of each histological slide and sectional object area (A_{so}) of interest thus contain a certain volume of sectional object (V_{so}) and the total volume of section (V_{st}) which must be equal to the profile area multiplied with the slice thickness as demonstrated in equations (1) and (2) below:

$$V_{so} = A_{so} \cdot dy \quad (1)$$

$$V_{st} = A_{st} \cdot dy \quad (2)$$

Now, take the summation of total sectional volumes (V_{st}) and total sectional object volumes (V_{so}) to obtain the total volumes of the cuboid and the object. Total object volume ($\sum V_{so}$) is then divided by total sectional volume ($\sum V_{st}$) (see equation 3) to calculate volume density.

$$\frac{\sum V_{so}}{\sum V_{st}} = \frac{V_{so}}{V_{st}} = V_{vo} \quad (3)$$

Now, replace V_{so} and V_{st} by the products of area times thickness (equations (1) and (2)) and perform the following calculation :

$$\frac{\sum(A_{so} \cdot dy)}{\sum(A_{st} \cdot dy)} = \frac{(dy \sum A_{so})}{(dy \sum A_{st})} = \frac{A_{so}}{A_{st}} = A_{ao} \quad (4)$$

Since slice thickness is constant it can be cancelled from the calculations. The ratio of the sum of profile areas is evidently the areal density of profiles on the section, A_{ao} . It is also apparent that equations (3) and (4) are equal to each other, thus it has been proved that :

$$V_{vo} = A_{ao} \quad (5)$$

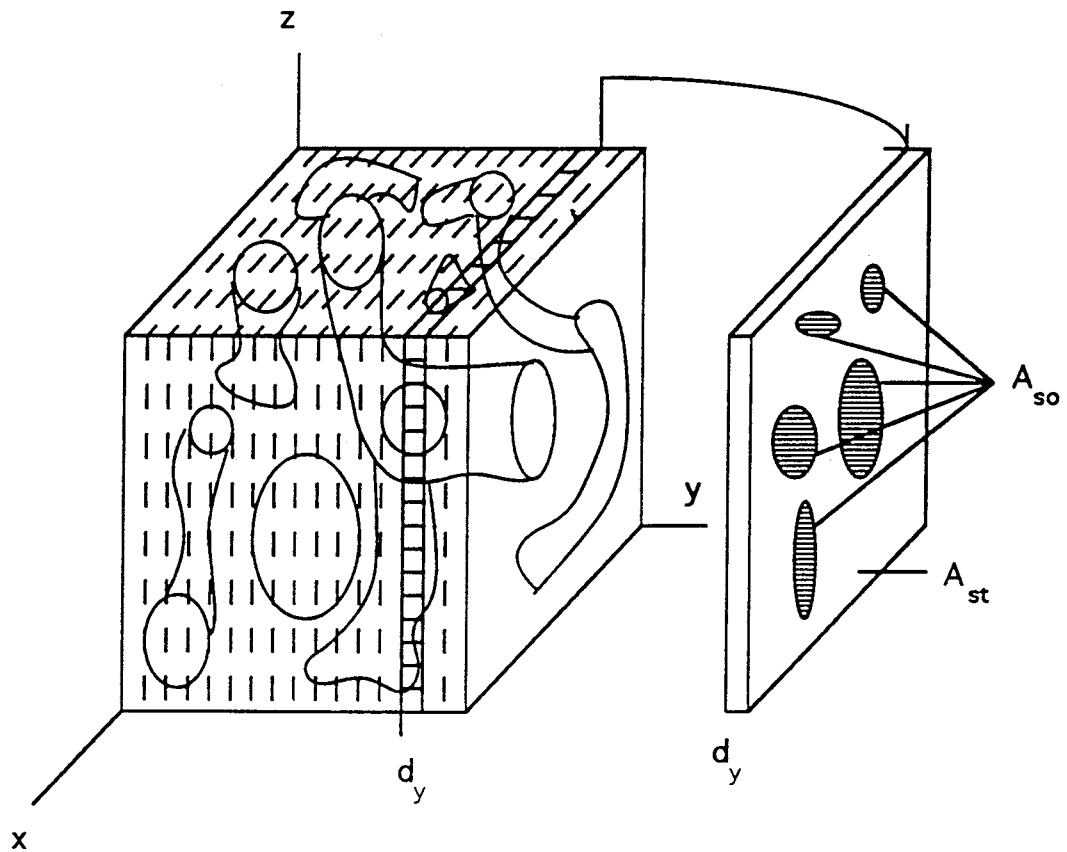

Figure 2.2. A model illustrating the fundamental basis of stereological analysis; the Delesse Principle. A cuboid is placed into an x, y, z coordinate system and sliced parallel to the x, z plane at a thickness of d_y . (A_{so} represents the sectional object area and A_{st} represents the total sectional area). Area fraction (A_{ao}) and volume fraction (V_{vo}) of the object can be calculated by $A_{ao} = V_{vo} = A_{so}/A_{st}$. (Taken from Srisakultiew (1993), originally modified from Weibel (1979)).

Thus, if A_{ao} is measured by a point counting technique (P_{po}) utilising a random grid point procedure (see Weibel, (1979)) to measure area fraction of an object (P_{so}) within a total area (P_{st}) of the histological section then :

$$P_{po} = \frac{P_{so}}{P_{st}} \quad (6)$$

Finally, it can thus be concluded that :

$$V_{vo} = A_{ao} = P_{po} \quad (7)$$

Stereology can therefore be successfully applied to quantify the area or volume fraction occupied by specified objects of interest on histological slides eg. cell nuclei, mitochondria and liver cells. Moreover, in the discipline of fish physiology, such a method can be further applied to quantify the numbers or proportions of different oocyte developmental stages from histological slides prepared from experimental fish ovaries.

The present study uses stereology to derive two quantitative parameters from histologically prepared ovarian tissue: ovarian volume fraction and ovarian numerical density.

(2.5.4.3) Calculation of ovarian volume fractions from histologically prepared ovarian tissue.

A stereological technique incorporating point counting methodology was used to measure the oocyte area occupied by stage 'x' oocytes (A_{sx}) on histological preparations of the ovaries from experimental animals where stage 'x' is classified as stage 2, 3, 4, 5, 6/7, atretic or post-ovulatory according to the oocyte stage classification scheme given in Chapter 4 of this thesis.

Histological sections were prepared as detailed in Section 2.5. Four sections were cut from each ovarian sample and stained in either haematoxylin and eosin or polychrome stains (also detailed in Section 2.5). Slides were examined under an Olympus BH-2 binocular microscope (Olympus Optical Co. Ltd, U.K.) connected to a Panasonic F10 CCD videocamera (Panasonic, Matsushita Communications, Japan) and

via a Sony LV-474UB VHS video recorder (Sony, Japan) to a Sony trinitron PVM-1440QM (13 inch screen) colour monitor. Slides were viewed using a x4 objective lens on the binocular microscope with a x2.5 lens fitted to the neck piece connecting the microscope to the video camera. A Weibel-2 stereology graticule (Type: GW3; Graticules Ltd, U.K.) was fitted inside the x2.5 connecting lens so as to project the image of the graticule onto the monitor and thus overlay the image of any slide placed on the microscope stage. Total number of graticule grid points visible on the monitor screen was recorded (42 points) and the system set-up prior to use in such a way that this number of grid points remained standard throughout analysis.

The area fraction (volume fraction) of stage 'x' oocytes ($A_{ax}=V_{vx}$) on each of four histological sections was calculated as detailed below:

- (a) Initialise system equipment as above.
- (b) Record total number of graticule grid points visible on the monitor (classed as one field; total grid points = 42)
- (c) Place first tissue section on microscope stage such that image is projected onto the monitor overlapped by the graticule.
- (d) Identify which of the 42 gridpoints overlap oocytes and total the number of these points found overlying each oocyte development stage. (Grid points found not to directly overlap oocytes were ignored) (see Figure 2.3).
- (e) Repeat the above procedure on at least ten randomly chosen fields on each of the four histological sections (thus forty fields analysed per tissue allowing calculation of mean \pm S.E.
- (f) Area fraction occupied by each stage of ovarian development was computed as detailed in equation (8):

$$A_{axp} = \frac{A_{sx}}{A_{ts}} \quad (8)$$

where :

- A_{axp} = area fraction of stage 'x' oocytes
- A_{sx} = number of points occupied by stage 'x' oocytes in the field.

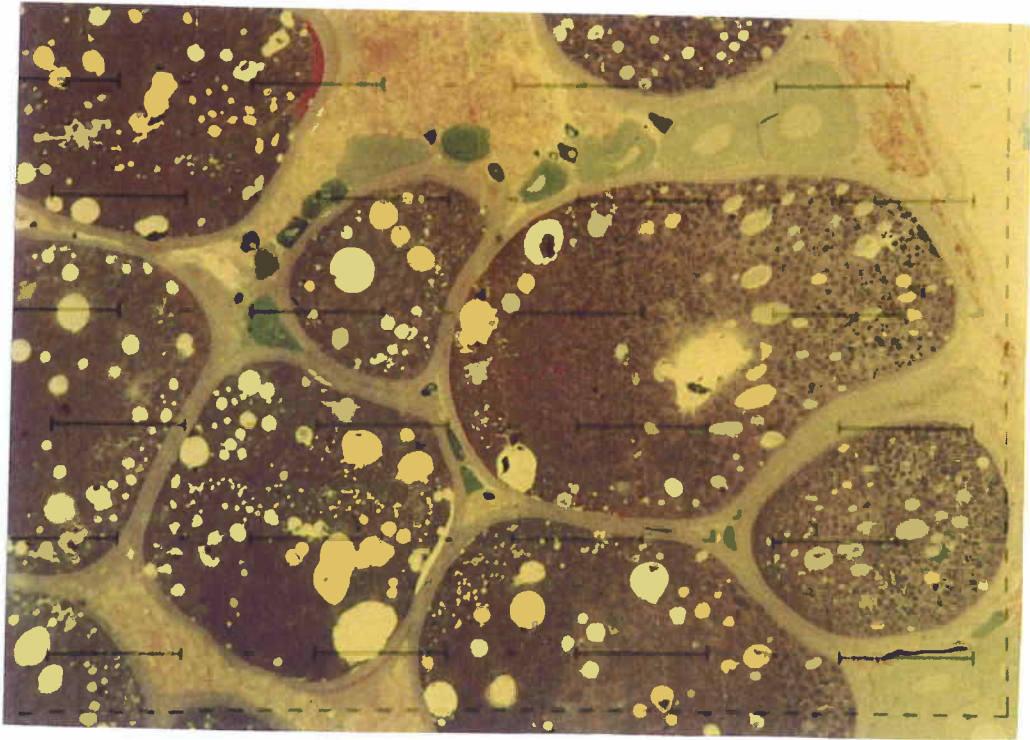

Total number of grid points on field = 45

Ovary volume fractions (V_{VX}) calculated as follows:

$$V_V \text{ stage 2 oocytes} = 3/45 = 6.66\%$$

$$V_V \text{ stage 3 oocytes} = 2/45 = 4.44\%$$

$$V_V \text{ stage 4 oocytes} = 0/45 = 0\%$$

$$V_V \text{ stage 5 oocytes} = 0/45 = 0\%$$

$$V_V \text{ stage 6/7 oocytes} = 32/45 = 71.11\%$$

$$V_V \text{ atretic oocytes} = 0/45 = 0\%$$

$$V_V \text{ post ovulatory follicles} = 0/45 = 0\%$$

Figure 2.3. Demonstration of the estimation of volume fraction (V_{VX}) of various oocyte developmental stages in a unit volume of *T. zillii* ovary. Note that for demonstrative purposes only, the total number of grid points per field in the above Figure is 45. All of the volume fraction analyses reported hereafter involve 42 grid points per field. For more information of the oocyte developmental stage classification scheme used above - refer to Chapter 4.

A_{ts} = total number of points on the field (ie. the monitor).

(g) Oocyte volume fractions were finally transformed using an ARCSine transformation prior to statistical analysis.

(2.5.4.4) Calculation of ovarian numerical densities from histologically prepared ovarian tissue.

A numerical density equation developed by Weibel and Gomez (1962) was used to quantify the numbers of stage 'x' oocytes in a unit volume (N_{ax}) from the area fraction (volume fraction) of the given oocyte stage (A_{ax} or V_{vx}) calculated from histological preparations of ovarian tissue.

Stereological analysis equipment was assembled as detailed in Section 2.5.4.3 above. The graticule was not necessary for numerical density analysis and was thus removed from the lens connecting the microscope to the video camera. Total area of a single field was calculated using calibrated graticules (one field on monitor represents a total area of 4.727 mm^2 on each histological section using the microscope lens combination detailed in Section 2.5.4.3 above (x4 objective lens and x2.5 connecting lens)).

Total numbers of each oocyte developmental stage that fell within the boundary imposed by the field (ie. the monitor) were counted in each of ten randomly chosen fields on four different histological sections. To standardise the procedure, any oocyte found crossing the left or the top of the field were included in the count whilst those oocytes overlapping the right or bottom field boundaries were excluded.

Oocyte numerical density was thus computed from knowledge of the oocyte shape (herein defined as β_x) and oocyte diameter distribution (herein defined as K_x) of each stage of oocyte development. The number of stage 'x' oocytes in a unit volume (N_{ax}) can also be multiplied with the total volume of the whole ovary. This procedure is given in the following series of equations.

Firstly, the shape of each oocyte development stage is calculated (equation 9):

$$\beta_x = \frac{l_x}{s_x} \quad (9)$$

where :
 β_x = oocyte shape in developmental stage 'x'
 l_x = length of long axis of oocyte stage 'x' (mm)
 s_x = length of short axis of oocyte stage 'x' (mm)

Then, the oocyte diameter distribution of stage 'x' oocytes were calculated according to equation 10:

$$K_x = \left[\frac{M_3}{M_1} \right]^{3/2} \quad (10)$$

where : K_x = oocyte diameter distribution of stage 'x'

$$M_1 = \frac{(D_{x1} + D_{x2} + D_{x3} + \dots + D_{xn})}{n}$$

$$M_{x3} = \left[\frac{(D_{x1})^3 + (D_{x2})^3 + (D_{x3})^3 + \dots + (D_{xn})^3}{n} \right]^{1/3}$$

n_x = number of oocytes counted

D_x = mean diameter of stage 'x' oocytes (see equation 11)

$$D_x = \frac{(l_x + s_x)}{2} \quad (11)$$

Finally, numbers of each oocyte development stage per unit volume are computed as given in equation (12):

$$N_{vx} = \frac{K_x}{\beta_x} \cdot \frac{N_{ax}^{3/2}}{V_{ix}^{1/2}} \quad (12)$$

Where : N_{VX} = numbers of stage 'x' oocytes per unit volume
 N_{AX} = numbers of stage 'x' per unit area
 V_{IX} = volume fraction occupied by the oocyte stage 'x' = A_{IXP}

Oocyte numerical densities (N_{VX}) were averaged and log₁₀ transformed prior to statistical analysis. To obtain the number of each oocyte developmental stage in the entire ovary, N_{VX} could be multiplied by the total volume of the ovary if required.

(2.6) DETERMINATION OF TOTAL SERUM CALCIUM.

Calcium ions have been found to be incorporated into the post-translational modification of the vitellogenin molecule prior to its release from the liver (Tata, 1978). Moreover, studies have shown serum calcium levels to rise during exogenous vitellogenesis (Elliott *et al.*, 1979; de Vlaming *et al.*, 1980); a rise shown to be directly correlated to blood vitellogenin concentration (eg. Elliott *et al.*, 1982). Thus, determination of total serum calcium levels offer a reliable, albeit indirect means of measuring blood vitellogenin level.

(2.6.1) Analysis equipment, dilution of serum samples and preparation of calcium standards.

The present study utilised an atomic absorption spectrophotometer (AAS; Perkin-Elmer 2280, U.K.) to measure total calcium levels in selected serum samples.

Serum samples were mixed with a whirlimixer and diluted (1:150 fold) with calcium diluting solution (see Section 2.6.1.1) in conical based 13.5ml polyethylene tubes (Sterelin, B.D.H./Merck Ltd., U.K.) and were tightly stoppered. Tubes were thoroughly mixed and stored at 4°C overnight prior to analysis.

Calcium standards (2mg/l and 4mg/l), used to calibrate the atomic absorption spectrophotometer during use were prepared immediately before use by diluting

calcium standard (Spectrosol, B.D.H./Merck Ltd., U.K.) in an appropriate amount of calcium diluting solution (see Section 2.6.1.1).

The atomic absorption spectrophotometer was prepared and calibrated in accordance with the schedule given in Section 2.6.1.2. Total serum calcium levels in diluted samples were then analysed. Calibration of the spectrophotometer was verified every 10 samples and adjusted with pre-prepared standards if necessary.

(2.6.1.1) Calcium diluting solution.

- (1) 6 litres of a 1% solution of nitric acid (B.D.H./Merck Ltd., U.K.) was prepared.
- (2) 3 litres of 1% nitric acid was decanted into a suitable container.
- (3) 30g of lanthanum chloride (Fisons Scientific Equipment, U.K.) were added.
- (4) Resulting solution was stored at 4°C until required.

(2.6.1.2) Set-up/shut-down procedure for atomic absorption spectrophotometer.

(a) Preliminary set-up.

- (1) Check drain vessel. Empty if necessary.
- (2) Ensure that calcium bulb is fitted to spectrophotometer.
- (3) Ensure that GAIN and LAMP1 settings are turned to zero.
- (4) Switch on power. Allow bulb to warm-up for 15-30 minutes.
- (5) Reset the machine as follows :
 - (a) BGKD to AA
 - (b) SLIT to 0.7 (normal)
 - (c) WAVELENGTH to 423nm
 - (d) SIGNAL to lamp1
 - (e) MODE to CONT
- (6) Adjust lamp/energy to 20 with LAMP1.
- (7) Set SIGNAL to ABS.
- (8) Adjust lamp/energy to 50 with GAIN.

- (9) Maximise lamp/energy by moving calcium bulb within its mounting and by adjusting the two position knobs.
- (10) Set lamp/energy to 75.
- (11) Return burner head to lowest setting with horizontal alignment knob.
- (12) Clear absorption reading with AZ.
- (13) Raise burner head until a reading is obtained on absorption display, then lower burner until display reads zero.

(b) Ignition of flame and warm-up procedure.

- (1) Open Acetylene bottle, switch on extractor-fan and air compressor.
- (2) Place sample tube in de-ionized water.
- (3) Turn on air, fuel and ignite flame. Ensure that fuel flow = 20 and air flow = 50.
- (4) Allow to warm-up for 10- 15 minutes.
- (5) Maximise flame position with flame orientation knob and vertical burner alignment knob.
- (6) Maximise aspiration rate of sample tube.

(c) Calibration and sample measurement.

- (1) Place sample tube in de-ionized water and ensure that lamp energy is still set at 75.
- (2) Set SIGNAL to CONC and MODE to HOLD.
- (3) Key in: 2.0 S1, 4.00 S2, 2.0 t
- (4) Calibrate machine by aspirating prepared standards (lowest first) and keying S1/S2 then set MODE to CONT.
- (5) Re-check each standard and measure samples (ensure lamp/energy remains at 75 and recheck standards often).

(d) Shutdown procedure.

- (1) Place sample tube in deionized water for several seconds.
- (2) Turn off fuel, air, compressor and extractor fan.

(3) Turn GAIN and LAMP1 to zero.

(4) Close acetlylene bottle.

(2.6.2) Calculation of total serum calcium and expression of results.

Serum calcium levels recorded from the atomic absorption spectrophotometer were multiplied by the dilution used (1:150) and divided by 10 to obtain the total serum calcium concentration (expressed as mg%).

(2.6.3) Quality control.

Serum samples from 10 - 15 mature male and female *T. zillii* (100 - 400g in weight) were pooled and aliquots of the serum pool diluted as detailed in Section (2.6.1) to act as line standards during analysis. Line standards were measured at the beginning and at the end of sample analysis and after every 30-40 samples during analysis. Intra- and inter-assay coefficients of variation (see Section 2.8.2) were calculated from these line standards. Intra-assay coefficient was found to be 7.30% and the inter-assay coefficient of variation was 10.10%.

(2.7) DETERMINATION OF SERUM SEX STEROID LEVELS BY RADIOIMMUNOASSAY.

Levels of the sex steroid hormones 17 β -oestradiol (E₂) and testosterone (T) were determined in selected serum samples according to the established radioimmunoassay method described by Duston and Bromage (1987).

(2.7.1) Preparation of assay constituents.

(2.7.1.1) Assay phosphate buffer.

The following assay buffer constituents were dissolved in freshly deionized water in a 500ml volumetric flask on a magnetic stirrer/hotplate and made up to a final volume of 500ml:

Sodium dihydrogen orthophosphate-1-hydrate	8.88g
--	-------

Disodium hydrogen orthophosphate (anhydrous)	5.82g
Sodium chloride	4.50g
Gelatine powder	0.50g

All constituent chemicals (AnalR grade where available) were supplied by B.D.H./Merck Ltd., U.K. Buffer pH was checked and adjusted to 7.0 if necessary. Prepared buffer could then be stored at 4°C for periods of up to seven days.

(2.7.1.2) Antisera.

(a) 17 β -oestradiol.

Rabbit anti-17 β -oestradiol obtained from Steranti Research Ltd. (U.K.) was raised against 17 β -oestradiol-6-(CMO)-BSA through o-carboxy-methyl-oxime formation at the steroid '6' position and coupling to BSA (bovine serum albumin).

(b) Testosterone.

Rabbit anti-testosterone was raised against testosterone-3-(CMO)-BSA through a similar process of o-carboxy-methyl-oxime formation (steroid '3' position) and coupling to BSA. Stock testosterone antisera was obtained from Prof. J. Sumpter (Brunel University, U.K.).

(c) Antisera cross reaction data.

Cross reaction data (i.e. specificity) for both E₂ and T antisera with a number of structurally similar steroid hormones are presented in Table 2.5.

(d) Antisera reconstitution.

Freeze-dried antisera was reconstituted with 1ml of freshly prepared assay phosphate buffer and transferred in aliquots of 100 μ l to polystyrene tubes (LP3; Luckhams Ltd.). Aliquots were stored at -20°C until required. The assay working solution was prepared by diluting one 100 μ l aliquot of antiserum to 10ml with assay buffer, providing enough antisera for 100 assay tubes (dilution = 1: 25,000).

Table 2.5. Cross reactivity (expressed as %) of 17 β -oestradiol and testosterone antisera with a number of structurally similar steroid hormones. Cross reactivity is expressed as the reduction in the proportion of bound radiolabel produced by 100 pg of steroid hormone relative to that produced by either 17 β -oestradiol or testosterone. Taken from Duston and Bromage (1987).

STEROID	% CROSS REACTION	
	17 β Oestradiol	Testosterone
17 β -oestradiol	Taken as 100	5.8
Testosterone	1.6	Taken as 100
Oestrone	7.5	2.9
Oestriol	12.2	1.0
11-ketotestosterone	1.0	34.5
Androstenedione	1.8	1.0
17 α -hydroxyprogesterone	1.0	1.66
17 α -hydroxy-20 β - dihydroprogesterone	1.0	1.0
Pregnenolone	1.0	3.3
Cortisol	1.0	1.0

(2.7.1.3) Radiolabels.

[2,4,6,7-³H] oestradiol (specific activity 85 - 110Ci/mmol) and [1,2,6,7-³H] testosterone (specific activity 85-105Ci/mmol) were purchased from Amersham International Ltd. (U.K) in 250 μ Ci quantities in a solution of toluene and ethanol (9:1 respectively). An intermediate solution (stock 'A') was prepared by diluting 10 μ l of stock label to 2ml with absolute ethanol (AnalR grade, B.D.H./Merck Ltd., U.K.). Stock 'A' solutions were stored at -20°C until required. For assays, an aliquot of 45 μ l of stock 'A' solution was diluted in 10ml of assay phosphate buffer to prepare a working solution of approximately 20,000 dpm/100 μ l.

(2.7.1.4) Assay standards.

Stock standards of E₂ and T were prepared by dissolving 1 μ g of dry 17 β -oestradiol or testosterone (Steranti Research Ltd., U.K.) in 10ml of absolute ethanol (AnalR, B.D.H./Merck Ltd., U.K.) and stored at -20°C until required. A working solution of 10ng/ml was prepared fresh for each assay by diluting 100 μ l of stock standard to 1ml with absolute ethanol (AnalR grade, B.D.H./Merck Ltd., U.K.). Standard curves for each assay were prepared by serial dilution of 100 μ l aliquots of the working standard solution to provide standards in the range 7.8 - 1000 pg/tube.

(2.7.1.5) Dextran-coated charcoal preparation.

For each assay, one 'Separex' dextran-coated charcoal tablet (obtained from Steranti Research Ltd., U.K.) was dissolved in 50 ml of assay phosphate buffer. This solution was stirred on crushed ice for 30 minutes before use.

(2.7.2) Radioimmunoassay protocol.

Duplicate standards and samples were assayed for E₂ and T according to the following protocol.

(2.7.2.1) Steroid extraction.

- (1) 100µl of each serum sample was placed into a separate polypropylene tube (LP4; Luckhams Ltd., U.K.).
- (2) 2ml of ethyl acetate (AnalR; B.D.H./Merck Ltd., U.K.) was added to each tube and tightly stoppered.
- (3) Tubes were mixed thoroughly for 1 hour on a rotary mixer (Blood Cell Suspension Mixer; Matburn Ltd., U.K.).
- (4) Tubes were centrifuged (MSE Chilspin, Fisons Scientific Equipment, U.K.) at 1500 rpm for 10 minutes at 4°C.
- (5) Steroid extracts were then stored at 4°C until required for assay.

(2.7.2.2) Assay.

- (1) 400µl (E₂ assay) or 50µl (T assay) of each steroid extract was placed into polypropylene assay tubes (LP3; Luckhams Ltd., U.K.). Smaller volumes of steroid extract were generally used for the T assay due to the relatively high concentration of circulating T in tilapia. Similarly, a large volume of extract was employed in the E₂ assay due to relatively small concentrations of circulating E₂.
- (2) A series of standards of the desired hormone were prepared by serial dilution with absolute ethanol (see earlier) covering the range 0 - 1000 pg/100µl.
- (3) Extracts and standards were dried down in a vacuum oven (Size 2; Gallenkamp, U.K.) connected to a vacuum pump (Edwards High Vacuum, U.K.) at less than 35°C.
- (4) Tubes were cool dried to 4°C in a refrigerator for 30 - 60 minutes.
- (5) 100µl of anti-E₂ or anti-T antiserum was added to each tube.
- (6) 100µl of tritiated E₂ or tritiated T was also added to each tube.
- (7) Two extra tubes were added at this stage each containing 100µl of tritiated hormone but with 100µl of assay phosphate buffer replacing the relevant antisera. These tubes were included to aid estimation of non-specific binding activity within each assay.

(8) All tubes were thoroughly vortexed for 10 seconds and were incubated at 4°C overnight.

(9) 500µl of dextran-coated charcoal was added to each tube (stirring stock charcoal throughout addition), after which tubes were vortexed and incubated for 10 minutes at 4°C.

(10) Tubes were centrifuged at 2000 rpm (4°C) for 10 minutes (Jouan CT422 centrifuge, Jouan Ltd, U.K.).

(11) 400µl of the supernatant of each tube (total volume 700µl) was transferred to 6 ml plastic 'Pony' scintillation vials (Canberra Packard, U.K.) containing 4 ml of scintillation fluid (Optima Gold, Canberra Packard, U.K.).

(12) Scintillation vials were mixed thoroughly on a whirlimixer (Fisons Scientific Equipment, U.K.) for 10 seconds and radioactivity counted for 5 minutes in a liquid scintillation analyser (Tri-Carb 1900TR; Canberra Packard, U.K.). Three extra vials were included at this stage, two containing 100µl of tritiated hormone and 4ml of scintillation fluid for estimation of total radioactivity added to each tube and one vial containing only scintillation fluid for automatic subtraction of background counts.

(2.7.3) Calculation of results.

Standard curves (see Figure 2.4) and results were calculated from the raw radioactivity data from the liquid scintillation analyser by use of a computer program ('Assayzap Universal Assay Calculator'; Biosoft, U.K.) running on an Apple Macintosh personal computer (Ensuring that counts of total radioactivity were corrected for the difference between the total reagent volume per assay tube and the volume of the supernatant counted).

Results were then multiplied by 0.0525 (E₂ assay) or 0.42 (T assay) to correct samples for volume of extract assayed (400 or 50µl from a total of 2.1ml; x 21 or x42), and volume of serum extracted (100µl; x10) and finally were converted to ng/ml (x 1/1000). In some cases insufficient serum was available to allow addition of 100µl of serum to 2ml of ethyl acetate in the steroid extraction protocol. In these cases final

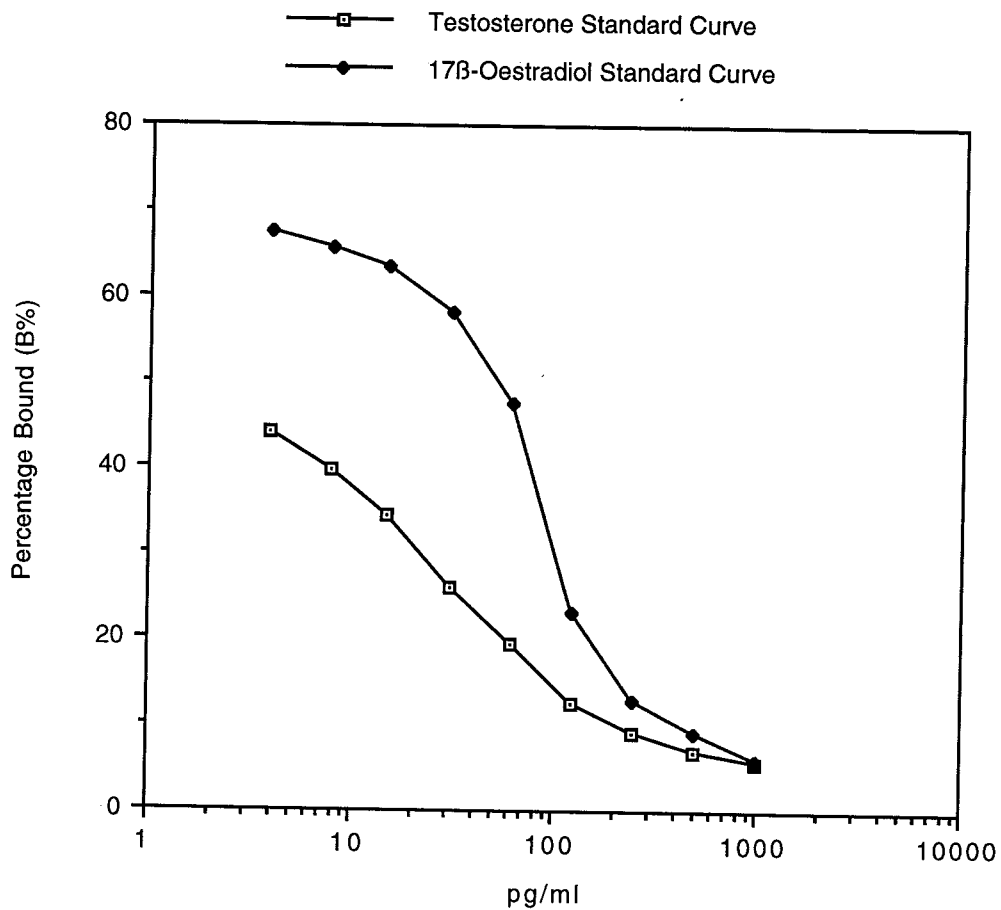

Figure 2.4. Examples of the standard curves obtained for testosterone and 17 β -oestradiol using the radioimmunoassay method developed by Duston and Bromage (1987). Concentration of the specified hormone is obtained by intersection of the appropriate standard curve at the point corresponding to the percentage of the radiolabel bound to antibody (% bound) in each sample. Note that each point represents the mean of duplicate standard preparations.

results were adjusted accordingly with appropriate variations of the above correction calculation (shown in Tables 2.8 and 2.9).

(2.7.4) Assay quality control.

Serum samples from 10 - 15 mature male and female *T. zillii* (100 - 400g in weight) were pooled and aliquots of the serum pool subjected to steroid extraction as detailed in Section 2.7.2.1 to act as line standards during analysis. Line standards were measured at the beginning and at the end of sample assay. Aliquots of such pooled serum contained approximately 0.98 ng/ml and 4.87 ng/ml of E₂ and T respectively and were used throughout this study for assay quality control. The intra-assay coefficient of variation (see Section 2.8.2) was 10.45% for E₂ and 9.21% for T assays. The inter-assay coefficient of variation was 11.20% for E₂ and 10.9% for T assays.

(2.7.5) Validation of radioimmunoassay technique.

Inhibition curves obtained from serial dilution of steroid extracts found to contain a relatively high concentration of E₂ or T were found to be parallel to respective standard curves (Figures 2.5 and 2.6). For both steroid hormones, analysis of covariance ANCOVA (calculated using an in-house computer program developed by Dr. M.A.Thrush, Institute of Aquaculture, University of Stirling) revealed no significant difference for either E₂ or T ($p \geq 0.05$) between the slopes of the standard curve and the inhibition curve. This indicates that the 'E₂' and 'T' detected in steroid extracts prepared from tilapia blood samples were immunologically similar to the standard steroid hormone.

(2.8) STATISTICAL METHODS.

Only those statistical techniques used commonly throughout this thesis are discussed here. Those techniques employed with specific experimental data sets are described in the methods section of the relevant experiments. Statistics were, unless

Tables 2.8 and 2.9 Radioimmunoassay correction factors.

Table 2.8 Testosterone Assays (assuming 50 μ l of steroid extract used in assay).

Vol. Serum extracted (μ l)	Tot. Extract vol./amount extract used in assay	Conversion to ng/ml	CORRECTION FACTOR
30 μ l = 1000/30 = x33.30	2030/50 = x 40.6	x 0.001	x 1.352
40 μ l = 1000/40 = x25.00	2040/50 = x 40.8	x 0.001	x 1.020
50 μ l = 1000/50 = x20.00	2050/50 = x 41.0	x 0.001	x 0.820
60 μ l = 1000/60 = x16.67	2060/50 = x 41.2	x 0.001	x 0.686
70 μ l = 1000/70 = x14.28	2070/50 = x 41.4	x 0.001	x 0.591
80 μ l = 1000/80 = x12.50	2080/50 = x 41.6	x 0.001	x 0.520
90 μ l = 1000/90 = x11.11	2090/50 = x 41.8	x 0.001	x 0.464
100 μ l = 1000/100 = x10.00	2100/50 = x 42.0	x 0.001	x 0.420

Table 2.9 17 β -oestradiol Assays (Assuming 400 μ l of steroid extract in assay).

Vol. Serum extracted (μ l)	Vol. Extract vol./amount extract used in assay	Conversion to ng/ml	CORRECTION FACTOR
30 μ l = 1000/30 = x33.30	2030/400 = x 5.075	x 0.001	x 0.1680
40 μ l = 1000/40 = x25.00	2040/400 = x 5.100	x 0.001	x 0.1270
50 μ l = 1000/50 = x20.00	2050/400 = x 5.125	x 0.001	x 0.1025
60 μ l = 1000/60 = x16.67	2060/400 = x 5.150	x 0.001	x 0.0858
70 μ l = 1000/70 = x14.28	2070/400 = x 5.175	x 0.001	x 0.0739
80 μ l = 1000/80 = x12.50	2080/400 = x 5.200	x 0.001	x 0.0650
90 μ l = 1000/90 = x11.11	2090/400 = x 5.225	x 0.001	x 0.0580
100 μ l = 1000/100 = x10.00	2100/400 = x 5.250	x 0.001	x 0.0525

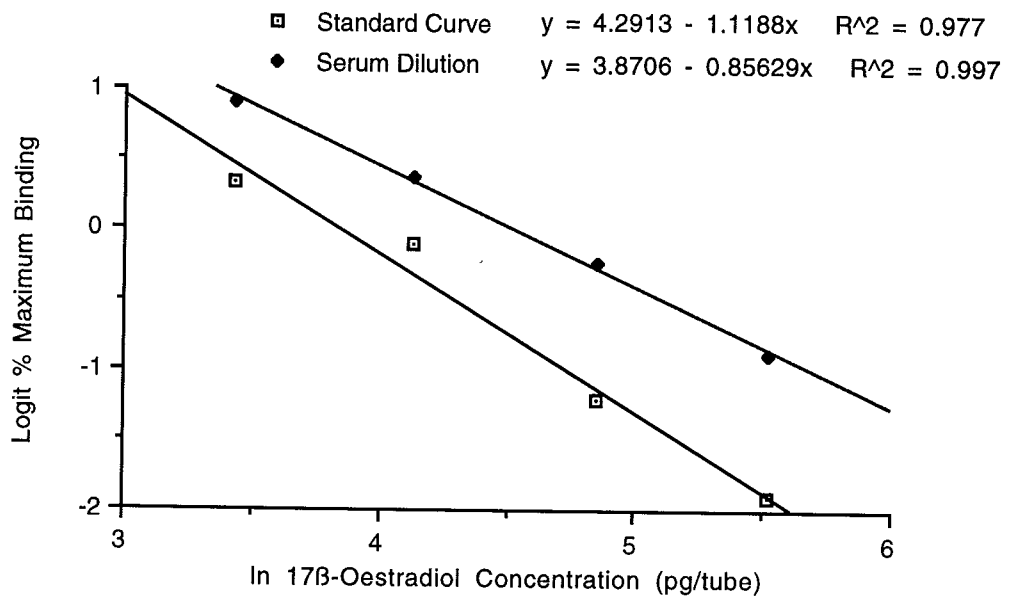

Figure 2.5. Parallelism of a 17β-Oestradiol standard curve and an inhibition curve prepared by serial dilution (1:2 fold) of a steroid extract found to contain a relatively large concentration of 17β-oestradiol. The two curves have been linearised by logit transformation (see Rodbard and Lewald, 1970): $\text{logit } b = \ln (b/100-b)$ where b represents the proportion of tritiated hormone bound to antibody expressed as a percentage of that in the zero standard (% maximum binding). Each individual point on the linearised curves represents the mean of duplicate samples and the x-axis represents the natural log (ln) of the 17β-oestradiol content in the standard preparations. Regression equations for both the linearised standard curve and the linearised serum dilution curve are also given.

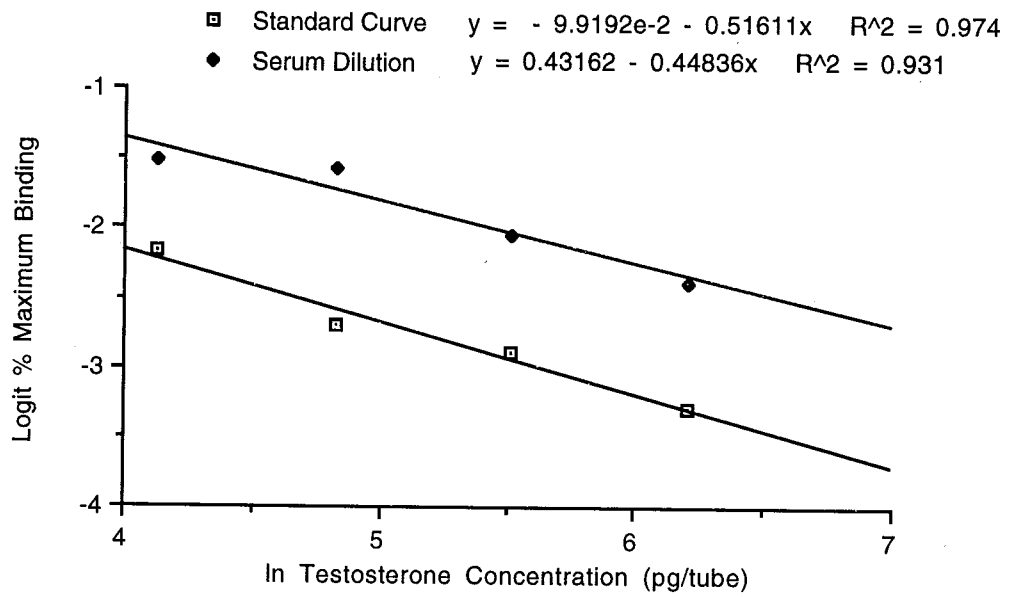

Figure 2.6. Parallelism of a testosterone standard curve and an inhibition curve prepared by serial dilution (1:2 fold) of a steroid extract found to contain a relatively high concentration of testosterone. The two curves have been linearised by logit transformation (see Rodbard and Lewald, 1970): $\text{logit } b = \ln (b/100-b)$ where b represents the proportion of tritiated hormone bound to antibody expressed as a percentage of that in the zero standard (% maximum binding). Each individual point on the linearised curves represents the mean of duplicate samples and the x-axis represents the natural log (ln) of the testosterone content in the standard preparations. Regression equations for both the linearised standard curve and the linearised serum dilution curve are also given.

stated to the contrary, analysed in accordance to those guidelines detailed by Sokal and Rohlf (1981) using the 'Statview' statistical package (Version 4.1, Abacus Concepts, U.S.A) running on an Apple Macintosh personal computer.

(2.8.1) Estimation of the population mean and calculation of the standard error of the mean.

The calculated arithmetic mean (or sample mean (\bar{X})), forms the best estimate of the overall population mean (μ) and is calculated as shown below :

$$\bar{x} = \Sigma x / n$$

where n = total number of individual observations and

Σx = summation of the individual observations

Sample means are presented in this thesis (unless otherwise stated) \pm one standard error of the mean (i.e. \pm S.E.), where the standard error of the mean is calculated as follows :

$$S.E. = s/\sqrt{n}$$

where n = total number of observations and

$$s = \text{sample standard deviation} = \sqrt{\frac{\Sigma x^2 - (\Sigma x)^2 / n}{n - 1}}$$

(2.8.2) Calculation of the coefficient of variation.

The coefficient of variation (C.V.) forms a measure of variability and was thus used in this study to compare variation in populations with differing means. The coefficient of variation is derived as follows :

$$\%C.V. = (s.100) / \bar{x}$$

where s = standard deviation of the data being tested and

\bar{x} = sample mean of the data being tested.

(2.8.3) Chi-squared (χ^2) analysis for comparison of two data sets.

Chi-squared analysis involves the non-parametric investigation of possible association between nominal categories of data. The null hypothesis adopted was that no association exists between the two sets of data. This involves calculation of the frequency that would be expected should the null hypothesis be true. The 'expected' frequency is then compared to the 'observed' frequency to produce a test statistic (χ^2).

χ^2 is calculated as follows :

$$\chi^2 = \sum \frac{(O - E)^2}{E}$$

where

O = 'observed' frequencies and

E = 'expected' frequencies.

If the value of χ^2 is found to be higher than that tabulated at the 5% level, then the null hypothesis is rejected and it is concluded that the observed association between the two data sets is statistically significant.

(2.8.4) Testing variances for homogeneity.

The variances of any data sets to be analysed statistically were first assessed for homogeneity of variance, i.e. whether the sample variances are similar to each other. This was assessed using the F-test which assumes that if the difference between the largest and smallest variances within each sample are not significantly different then the other variances cannot be significantly different either. The F-test was performed as follows :

$$F_s = \text{greater variance } (S_1^2) / \text{lesser variance } (S_2^2)$$

(degrees of freedom (v_1, v_2) = $n_1 - 1$ and $n_2 - 2$ respectively)

If F_s was found to be less than the tabulated value of F at the 5% level then it could be concluded that the variances were homogeneous. If F_s was greater than the tabulated

value of F, then the variances were deemed to be heterogeneous. Heterogeneous data were transformed logarithmically prior to further analysis.

(2.8.5) Statistical transformation of percentage data.

All data (e.g. volume fraction, GSI, HSI) initially expressed as a percentage was transformed prior to statistical analysis using an ARCSine transformation. Percentages were first converted to proportions. The squareroot of the proportion was then taken and was ARCSine transformed using the 'Statview' statistical package (Version 4.1, Abacus Concepts, U.S.A.).

Chapter 3

Spawning periodicity, fecundity and egg size in laboratory stocks of *T. zillii* held under controlled environmental conditions.

(3) Spawning periodicity, fecundity and egg size in laboratory stocks of *T. zillii* held under controlled environmental conditions.

(3.1) General introduction.

This Chapter investigates spawning periodicity, fecundity and egg size in stocks of female *T. zillii* held under controlled laboratory conditions. These topics have received very little attention in substrate-spawning tilapias; previous work has tended to concentrate upon mouthbrooding genera. Furthermore, existing studies of substrate-spawning tilapias mostly concern isolated populations of fish in lakes or ponds from differing biogeographical regions and are thus subject to differing environmental conditions. Few studies have investigated reproductive performance under environmentally-controlled conditions. Cichlidae have been shown to produce many more broods in a year in aquaria or culture ponds than under natural conditions in lakes or rivers. The reasons for this are not clear and may vary from species to species (Lowe-McConnell, 1982). The present analysis involved both strains of *T. zillii* held at the Institute of Aquaculture, Stirling: *T. zillii* (strain 'A') and *T. zillii* (strain 'B' - formerly known as *T. tholloni*). Analysis of each strain was undertaken separately. However, since a comparative study of reproductive traits has yet to be undertaken between the two strains, data arising from this investigation were also compared.

As consumer demand for tilapia rises it becomes essential that culture operations continue to meet increased market demand. It is essential that hatchery efficiency is optimised and maintained. Mass production of high quality tilapia fry remains the most important prerequisite in the intensification of tilapia culture. Productivity of broodfish, however, remains one of the most important constraints upon commercial production and thus knowledge of the factors affecting broodstock productivity is of prime importance to the further development of tilapia culture.

Sexually-mature cichlids are generally able to undergo successive reproductive cycles at intervals of approximately 4 - 6 weeks. Assuming that environmental conditions remained reasonably constant this would, theoretically, lead to continuous fry

production (Moreau, 1979). However, reproductive cycles of individual tilapia broodstock under intensive farming conditions tend to be asynchronous (Jalabert & Zohar, 1982), leading inevitably to episodic fry production. Evolution of parental care in tilapias has led to an increase in egg size and a corresponding reduction in the number of eggs per clutch (Noakes & Balon, 1982). The low number of eggs per spawn in combination with the asynchronous nature of spawning behaviour in tilapias under hatchery conditions would thus necessitate the use of extensive fish-holding facilities and time-consuming management of extremely large numbers of fish to maintain a continual supply of sufficient high-quality fry. These requirements may be reduced in part by selecting and utilising broodstock exhibiting optimal reproductive traits such as egg size, fecundity (i.e. number of eggs produced per spawn), clutch weight and egg to body weight ratio (Rana, 1986). Reproductive capacity of broodstock however, not only concerns fecundity and egg size but also factors such as nutritional status (Wootton, 1979; Townshend & Wootton, 1984; Watanabe *et al.*, 1984) and spawning frequency.

To minimize the number of broodstock needed to attain target production, factors such as broodstock size that have previously been shown to influence reproductive capability (e.g. Nikolskii, 1969; Wootton, 1979; Hislop, 1984) need to be investigated. Consequently, the present study investigates reproductive traits such as spawning periodicity, fecundity, egg size and egg to body weight ratio in a range of differently sized broodstock *T. zillii*.

Since tilapias are multiple spawners, their fecundity represents only a fraction of their reproductive potential (Rana, 1988). Spawning frequency in tilapias is generally governed by environmental temperature and therefore also by latitude & altitude (e.g. Lowe-McConnell, 1955; Ben-Tuvia, 1959; El-Zarka, 1962; Uchida & King, 1962; Marshall, 1979; Phillipart & Ruwet, 1982) and rainfall (Riedel, 1965; Marshall, 1979; Siddiqui, 1979; Chandrasoma & De Silva, 1981; Lowe-McConnell, 1982). Generally, equatorial populations of tilapia breed all year round, for example *O. niloticus* (Lowe-McConnell, 1958). With increasing distance from the equator an element of seasonality

appears and *O. niloticus* were found to exhibit a well defined breeding period coinciding with warm sunny seasons (Lowe-McConnell, 1958). Similarly, whilst equatorial stocks of *T. zillii* show no evidence of seasonality (Siddiqui, 1979), the same species in more northern areas exhibit a well defined spawning period coinciding with maximum water temperature and daylength (Ben-Tuvia, 1959; Fishelson, 1966; Siddiqui, 1977). Stocks of tilapia at high altitude are reported to possess only a 3 - 4 month spawning period in which only 3 spawning cycles are likely to occur (Mires, 1982; Rothbard *et al.*, 1983). Both McKaye (1984) and Hussein (1984) report that under natural conditions, tilapia adopt a multiple-spawning strategy and exhibit a breeding season of about 6 months timed so as to provide optimum conditions in terms of food availability and fry survival.

It is well known that parental care can influence spawning frequency. Increased levels of parental care are known for example, to result in longer inter-spawn-intervals in both tilapia (e.g. Smith & Haley, 1987; Tacon *et al.*, 1996) and *Haplochromis 'argens'* (Smith & Wootton, 1994).

Spawning frequency may also be influenced by various manipulative techniques. For example, removal (or 'robbing') of eggs from mouthbrooding females can effectively reduce inter-spawn intervals by approximately the period of time normally allocated to oral incubation (Dadzie, 1970; Lee, 1979; Siraj *et al.*, 1983; Rana, 1986). Under ideal conditions females may spawn every 12 - 16 days when robbed of their eggs (Rana, 1986). In *T. zillii*, removal of eggs from guarding females does not affect spawning interval (Cridland, 1962). Stocking density and sex ratio are also reported to influence breeding intensity in tilapias (discussed further in Chapter 6), as have food ration size (Mironova, 1977) and dietary protein level (Wee & Tuan, 1988). Little *et al.* (1993) described a means of improving spawning synchrony and frequency in *O. niloticus* by 'conditioning' intended broodstock in high density hapas suspended in pond water rich with natural food. 'Conditioning' periods such as this are often used in conjunction with broodfish exchange policies. Broodstock management in most tilapia hatcheries generally relies upon continual use of the same fish throughout a

production period. Fry production often declines over time under such conditions and thus broodstock are often replaced, usually after a change in fry-production is observed (Little, 1989).

Very little information is readily available concerning the spawning frequency of *T. zillii* and in the case of *T. tholloni* (strain 'B' in the present study) none at all. Most studies of spawning periodicity in *T. zillii* concern stocks of wild fish in isolated lakes or ponds from various biogeographical regions. For example, Lake Quarun *T. zillii* spawn several times between May - September with peak activity during July-August. Inter-spawn-intervals were said to be approximately 1 month in length and were governed predominantly by water temperature (El-Zarka, 1956; El-Bolock & Koura, 1960). In Lakes Huleh & Tiberias (Israel), *T. zillii* were found to spawn only during May - July (Ben-Tuvia, 1959). Spawning frequency during this period however, was not given. In equatorial Nigerian waters, *T. zillii* spawned all year round with a climax in Spring (Welman, 1941) but again, no estimate of spawning frequency was given. Similarly, Siddiqui (1979) found that *T. zillii* breed all year round in equatorial Lake Naivasha (Kenya) though with higher breeding intensity during wet months, but again did not provide any indication of spawning frequency during these periods. In Lake Mariut, *T. zillii* exhibited 2 peaks in GSI during one breeding season and were thus thought to spawn only twice during one season (Hamed & Ezzat cited by Botros, 1969). The authors did not give any indication of the length of breeding season.

Studies undertaken by Lowe-McConnell (1959) and Fishelson (1966) have suggested that when maintained under constant environmental conditions, captive tilapias show no evidence of seasonality and may spawn throughout the year. Only studies by El-Zarka (1956) and Cridland (1962) have investigated spawning frequency in *T. zillii* under environmentally controlled conditions. El-Zarka (1956) studied *T. zillii* in experimental tanks but supplied with water at ambient temperature. After spawning, breeding pairs were able to re-spawn just 30 days later. He further suggested that there was a regularity in the breeding cycle that seemed to reflect the length of time required

for fry to become independent from parents. A further study involving constant environmental conditions found that from 7 breeding pairs of *T. zillii*, 35 broods were recorded over a period lasting 19 months. The shortest interval between broods of any one pair was 15 days and the longest 106 days (Cridland, 1962). None of these studies however, compared spawning periodicity amongst a range of fish sizes.

As yet, there has been no large scale investigation of spawning frequency, fecundity and egg size in either *T. zillii* or *T. tholloni* held under constant environmental conditions. Available data concern populations of fish in isolated lakes or ponds from various biogeographical regions. Moreover, little is known of how these factors relate to maternal size in these species. These questions are considered in Experiments 1 and 2 of this Chapter.

In teleosts, fecundity has been defined in many different ways but is generally defined as the number of ripening oocytes or mature eggs in the ovary immediately prior to spawning (Bagenal, 1978). This however, assumes that few mature eggs are retained in the ovary after spawning and seriously under-estimates the fecundity of multiple-spawning teleosts where recruitment of oocytes into a maturing batch can be very rapid (Wootton, 1979).

The fecundity of tilapia has been defined in several ways. Many previous studies of fecundity in tilapia have adopted the 'classical' definition of fecundity as being the number of maturing oocytes in the ovaries prior to spawning (Riedel, 1965; Welcomme, 1967; Botros, 1969; Siddiqui, 1977; Marshall, 1979; Payne & Collinson, 1983; De Silva, 1986). Whilst this definition is valid for determining the reproductive potential of fish exhibiting a well-defined annual breeding season it was deemed inappropriate for use with multiple-spawning fish such as tilapias (Rana, 1988). The mature ovaries of annual breeders possess only two classes of oocytes; mature oocytes for the current year and a stock of undifferentiated oocytes for the following year. In tilapias, recruitment of oocytes into maturational stages is more complex. Histological analysis of 'ripening' ovaries revealed a multi-modal distribution of maturing oocytes (Siddiqui, 1977; Peters, 1983). Only in very 'ripe' ovaries was the distribution of

oocytes distinctly bimodal. Considering the uncertainty of the origin of oocytes for the next wave of gonadal activity (Jalabert & Zohar, 1982) and the presence of atretic eggs in the ovary (Peters, 1983; Rana, 1986), Rana (1988) observed that overestimation of total fecundity and its relationship with body size may result. This observation was particularly important considering that histological examination of ovaries after spawning revealed the presence of many unovulated vitellogenic oocytes (Rana, 1988). This phenomenon was also observed in the present study of *T. zillii* (see Chapter 5).

Lowe-McConnell (1955) defined fecundity as the number of fry produced by an individual in its own lifetime. This definition was later deemed inappropriate under culture conditions, since broodstock would normally only be used during their optimum reproductive period (Rana, 1988). As a result both Mires (1982) and Macintosh (1985) suggested that the definition should be restricted to the number of fry produced over a 12 month period. Rana (1988) dismissed the measurement of fecundity over a fixed time period since (a) the number of spawns is dependent upon temperature and thus altitude & latitude (b) the number of fry successfully reared is often less than values suggested by ovarian or direct egg counts, thereby underestimating reproductive potential and (c) the relationship between egg numbers and fry released may not be strongly correlated. The work described in this thesis thus adopts the definition of fecundity suggested by Rana (1988), i.e. total fecundity is defined as the number of eggs in a freshly spawned egg clutch.

In teleosts, the relationship between fecundity (F) and fish length (L) is usually curvilinear: $F = aL^b$ (Bagenal, 1967, 1973; Wootton, 1979; Wootton, 1990; Wootton, 1994). The relationship between fecundity and weight (W) is usually close to linear ($F = cW^d$) (Wootton, 1979); if linear, $d = 1$. In the rainbow trout, both fecundity and egg size are significantly related to fish size and increase as fish get larger (Bromage & Cumaranatunga, 1988; Bromage *et al.*, 1990, 1992). In the three-spined stickleback, fecundity is highly correlated with fish size (length and weight) but no significant relationship exists between fish size and egg size (Wootton, 1973b). Positive relationships also exist between fish size and egg size in Atlantic salmon (Pope *et al.*,

1961) and dace *Leuciscus leuciscus* (L.) (Mann & Mills, 1985), but not in cod *Gadus morhua* (L.) (Oosthuizen & Daan, 1974). Relationships have also been observed between egg size and fecundity. In herring for example, late winter and spring spawners are less fecund but produce larger eggs than fish spawning later in the year (Messieh, 1976). Relationships may also exist between fecundity and age, though the effect of fish size must be eliminated by appropriate statistical techniques before any relationship between fecundity and age can be detected (Wootton, 1979). Nevertheless, the relationship between age and fecundity (even after fish size has been eliminated from analyses) is usually fairly small or even non-existent (see Wootton, 1979).

As in many other species of fish, the fecundity of tilapia is generally found to increase with age, length and weight of female broodfish (Lowe-McConnell, 1955; Riedel, 1965; Welcomme, 1967; Botros, 1969; Dadzie, 1970; Marshall, 1979; Siraj *et al.*, 1988). However, much of this work was based upon ovarian counts and is thus of only limited value for accurate prediction of egg production. Rana (1986) for example, measured fecundity in *O. niloticus* using egg counts from freshly laid spawns and found that fecundity increased with fish length at rate of $L^{1.74}$. By contrast, ovarian counts by Payne & Collinson (1983) in the same species observed a rate of $L^{2.25}$.

Fecundity is defined in the present study as the number of eggs in a freshly spawned egg clutch as suggested by Rana (1988). Thus, the fecundity of individual females may then be expressed as either total number of eggs spawned (i.e. as total fecundity) or expressed as number of eggs spawned per unit body weight (i.e. as relative fecundity). The merit of using relative fecundity has been the source of considerable debate. This is because the number of eggs produced for each unit increase in weight exhibits significant linear variation (refer to Bagenal, 1973; 1978; Wootton, 1979; Bromage *et al.*, 1990; Bromage *et al.*, 1992). Moreover, attempts to correlate weight with relative fecundity are also subject to autocorrelation. Bromage *et al.* (1992) observed however, that relative fecundity remains a useful working index for the farm manager since it allows egg production capability to be directly related to stocking levels, feeding rates and the age and number of broodfish. On this basis

therefore, relative fecundity has been included in the present analysis. Relative fecundity usually decreases as fish get larger (Bagenal, 1978). In rainbow trout for example, relative fecundity decreases with increasing fish size as a consequence of increasing egg size and a diminishing rate of fecundity increase (Bromage *et al.*, 1992).

Egg size data (sometimes egg diameter or egg weight but more commonly egg volume) is usually presented concurrent with any fecundity study since egg size is sometimes thought to be a determinant of egg quality (see Bromage *et al.*, 1992 for review). Since *T. zillii* eggs are ellipsoid in shape, both long and short axes need to be considered when providing an index of egg size. Mean egg volume is thus suggested to be the best estimate of egg size under these circumstances since it is derived from a mathematical equation and takes into account both long and short axes of ellipsoids. Whilst egg volume is considered in the present study to be the superior index of egg size, two further measures; mean egg dry weight and mean egg diameter are also given. This is to allow comparison of egg size with those earlier studies not using egg volume as an index.

A further index of egg production included in the present study is total egg volume. Whilst not normally used by farmers, this index is considered to be a far superior index of egg production in fish (Bromage *et al.*, 1992) since it considers the aggregate of egg number and egg size. It also shows a much better correlation with fish size than fecundity or egg size alone (Wootton, 1984; Bromage *et al.*, 1992).

Evolution of parental care in the tilapias has led to an increase in egg size and a corresponding reduction in the number of eggs per clutch (Noakes & Balon, 1982). Substrate spawners may lay thousands of small (1.0 - 1.5mm) eggs per spawning, whereas mouthbrooding species that protect their eggs and fry from predators by oral incubation may lay only a few hundred larger (up to 5mm) eggs per spawning (Trewavas, 1983).

Only one study, that of Peters (1983), has reported data concerning fecundity and egg size in *T. tholloni*. Moreover, most of the available information regarding fecundity and egg size in *T. zillii* is based upon studies of isolated lakes or ponds in

several different biogeographical regions. Furthermore, much of these data are derived from ovarian counts of 'mature' ovaries (e.g. Ben-Tuvia, 1959; Botros, 1969; Siddiqui, 1979; Peters, 1983) and not direct counts from freshly-spawned egg clutches and thus may over-estimate fecundity. Only those studies by El-Zarka (1956), Cridland (1962) and Dadzie & Wangila (1980) used direct counts to estimate fecundity. Of these, only El-Zarka (1956) and Cridland (1962) investigated fecundity in laboratory-held *T. zillii*. In the study by El-Zarka (1956) water temperature was not controlled and remained ambient; mean egg size was 1.6 x 1.3mm and mean number of eggs/spawn was 4600 though no mention was made of the size of fish upon which these estimates were based upon. The study by Cridland (1962) found that the number of eggs laid by *T. zillii* was clearly a function of maternal size though the relationship was not found to be proportional. Number of eggs/spawn varied from 2218 (in a fish measuring 11.0cm) to 6702 (in a fish measuring 18.4cm). Mean number of eggs/g body weight was found to be 65.5. Mean egg size varied from 1.53 x 1.10mm to 1.56 x 1.12mm.

In addition to a lack of general data concerning fecundity and egg size in stocks of *T. zillii* and *T. tholloni* held under controlled environmental conditions, nothing is known of how these reproductive traits vary with consecutive spawns, under natural conditions or otherwise. Considerable data exists for other teleost species though causal mechanisms still remain relatively unclear. In killifish *Fundulus heteroclitus* (L.) for example, eggs ovulated in early spawns are usually larger than in later spawns; this is generally associated with diminishing resources of the female (Hsiao *et al.*, 1994). Egg size also decreases during the breeding season in gobies (Miller, 1984). In the convict cichlid, increasing egg size was found to relate to the increase in length of the inter-spawn-interval (ISI) with successive spawnings (Townshend & Wootton, 1984). In the three-spined stickleback, clutch size has not only being found to vary amongst individuals within a population but also between clutches produced by the same female during a breeding season. The causes of such variation are not known (Wootton, 1994). Very little data exist for tilapia. El-Zarka (1956) followed *T. zillii* over 3 consecutive broods but did not record corresponding fecundity or egg size. Cridland

(1962) observed a general increase in brood size with successive broods in *Oreochromis spilurus niger* (Gunther) whilst Dadzie (1970) reported that egg size from the same female increased with successive spawns in *O. aureus*.

The present chapter therefore aimed to provide further information on the spawning periodicity, fecundity and egg size in laboratory-held stocks of *T. zillii* (strain 'A') and (strain 'B' - previously known as *T. tholloni*) subject to constant environmental conditions. Fecundity was estimated from counts of freshly-laid egg clutches so as to avoid the risk of overestimation present in many previous studies where fecundity was estimated using ovarian counts. Owing to the confusion over the taxonomic position of these two strains, data for each strain was initially treated separately. However, since no comparative study of egg production between the two strains is readily available, data for each strain were compared as appropriate. A direct statistical comparison however, may not be appropriate. In order to compare fecundity and egg size between the two strains, it was first necessary to compare spawning periodicity. It would obviously have been unwise to compare fecundity and egg size if spawning periodicity proved to differ between the two strains.

The present study also planned to undertake a preliminary investigation into how reproductive traits such as fecundity and egg size vary over consecutive spawns in serial spawning *T. zillii* and to examine the influence of spawning periodicity on these traits.

(3.2) Experiment 1: Spawning periodicity in *T. zillii* (strain 'A' & 'B').

The following investigations were designed to study spawning periodicity in *T. zillii* (strains 'A' & 'B') held in controlled laboratory aquaria. Particular emphasis was placed on the effect of maternal size.

(3.2.1) Materials and methods.

Broodfish used in this investigation were maintained in two 114 x 114 x 42cm holding tanks (System 1, see Section 2.1.2 and Appendix 1.1) holding stocks of *T.*

zillii (strain 'A') and *T. zillii* (strain 'B') respectively. Broodfish of unknown spawning history were selected at random from each holding tank (12 at a time) and placed into glass aquaria partitioned with perspex dividers such that each individual had its own 'holding space' (System 3, see Section 2.1.2 and Appendix 1.3) for periods of 80 days or longer whereupon, the 12 fish were replaced. To increase sample size, extra fish were stocked into partitioned aquaria (for periods not less than 20 days) as and when space became available between the experiments described elsewhere in this thesis. Each 'holding space' was fitted with a removeable false base to aid egg collection (see Section 2.1.2). Prior to stocking into individual aquaria each female was anaesthetised (Section 2.2.1), weighed (to the nearest 0.1g) and measured (to the nearest mm)(Section 2.4.1) and implanted with a PIT tag (Section 2.2.2). Each 'holding' space was checked daily (at approximate 3 hourly intervals during daylight hours) for evidence of spawning (clutches of eggs adhered to tank base or sides). Spawn dates were recorded for each individual fish. Estimates of spawning periodicity (inter-spawn-interval & mean days elapsed/spawn) were determined as described in Section 2.4.4. Feeding regime, photoperiod and temperature were maintained as described in Section 2.1.3.

Data were grouped according to maternal body weight and analysed where appropriate by one-way ANOVA followed by multiple comparison analysis using the Bonferroni/Dunn test if necessary. Regression analysis was used to analyse untransformed and transformed (\log_{10}) data for relationships between fish size (weight and length) and ISI.

(3.2.2) Results.

Fish recovered well following anaesthesia and no mortalities were observed. Several mortalities were observed throughout the investigations described in this Chapter through the occasional collapse of perspex-partitions held within glass aquaria. This allowed 2 previously segregated fish access to one another and usually lead to the

more dominant of the two fish killing the other. In total, 7 *T. zillii* (strain 'A') and 4 *T. zillii* (strain 'B') were lost in this way.

In total, 101 *T. zillii* (strain 'A') and 22 *T. zillii* (strain 'B') were observed for varying periods of time up to 195 days and 131 days respectively. Unfortunately, stocks of sexually-mature strain 'B' females were limited and thus resulted in a smaller sample size than that of strain 'A'.

33.6% and 40.9% of strain 'A' and 'B' respectively failed to spawn during discrete periods of observation (see Table 3.1) whereas 35.6% and 22.7% spawned just once. A total of 18.8% (strain 'A') and 27.2% (strain 'B') spawned twice or more during the period of observation (Table 3.1). Maximum number of spawns observed in a single observation period was 8 spawns in 137 days in the case of strain 'A' and 5 spawns in just 62 days in the case of strain 'B'.

(a) Strain 'A' (refer to Table 3.2).

101 strain 'A' females (weight range: 28.9g - 651.9g) were observed for periods of time varying from 22 - 195 days. Of these, 66.3% spawned at least once during the discrete observation period. Only 30.7% spawned more than once. When data were grouped according to fish weight, it was observed that the proportion of each weight group which spawned at least once during their respective observation period, fell as weight increased (i.e. 100% of 0 - 49g weight group spawned at least once compared to just 30.8% of the 350g+ group).

Mean time interval until the first spawn was observed following transfer to individual aquaria varied from 8.8 ± 1.9 days (in the 150 - 199g group) to 22.3 ± 2.3 days (in the 50 - 99g group). No trend was observed in relation to weight groupings. Indeed, no significant differences ($p \geq 0.05$) were found between any of the weight groupings. Overall, the mean time interval until first spawn was found to be 18.1 ± 2.0 days.

Mean number of spawns produced per observation period tended to fall with increasing fish weight and varied from 0.38 ± 0.2 (in the 350g+ group) to 1.85 ± 0.67 (in the 150 - 199g group). Overall mean was 1.35 ± 0.2 spawns/observation period.

Table 3.1 : Breakdown of spawning frequencies and incidence of repeat-spawning in 101 female *T. zillii* (strain 'A') and 22 female *T. zillii* (strain 'B') held in individually-partitioned aquaria for known lengths of time (strain 'A': 22 - 195 days, strain 'B': 20 - 131 days).

Number of spawns observed during period of individual fish observation.	% of study group (n = 101 <i>T. zillii</i> strain 'A')	% of study group (n = 22 <i>T. zillii</i> strain 'B')
0	33.6%	40.9%
1	35.6%	22.7%
2	11.9%	9.1%
3	7.9%	9.1%
4	5.9%	4.5%
5	3.0%	13.6%
6+	2.0%	0%

Table 3.2. Spawning frequencies of 101 female *T. zillii* (strain 'A') maintained in individually-partitioned glass aquaria for varying periods of time. Data grouped according to maternal weight.

Weight range of fish (g)	Number of fish monitored	Wt. range of fish monitored (g)	Mean wt. of fish (g±S.E.)	Range of observation duration (days)	Mean duration of observation period (days±S.E.)	No. of fish spawning at least once during observation (% of group)	No. of fish spawning more than once during observation (% of group)	Mean time interval until first spawn (days±S.E.)*	Mean no. of spawns per individual fish during observation period (±S.E.)	Mean ISI (days±S.E.)	Range of ISI's observed within group (days)	Overall mean days elapsed per spawn
0 - 49	7	28.9-49.9	39.3±2.6	23 - 57	36.4±5.6 a	7 (100%)	1 (14.3%)	14.7±4.6 a	1.4±4.6 ab	18.5±7.5 a	11 - 26	19.8
50 - 99	25	52.1-97.3	72.0±2.8	22 - 168	87.1±8.8 b	23 (92%)	12 (48%)	22.3±3.4 a	1.8±0.3 a	30.7±5.2 a	8 - 74	47.3
100 - 149	22	102.6-148.9	127.2±3.7	22 - 137	85.4±9.9 bc	15 (68.2%)	7 (31.8%)	16.9±4.9 a	1.7±0.4 a	25.7±4.5 a	7 - 85	50.8
150 - 199	7	167.7-195.6	177.7±4.9	26 - 137	73.4±14.0 ab	5 (71.4%)	4 (57.1%)	8.8±1.9 a	1.9±0.67 a	19.2±5.8 a	7 - 40	39.5
200 - 249	13	203.1-245.2	227.3±4.8	22 - 195	92.0±13.7 ab	5 (38.5%)	2 (15.4%)	16.6±5.0 a	0.8±0.4 ac	17.5±2.4 a	19 - 23	118.9
250 - 299	8	251.7-299.2	267.0±5.8	26 - 129	82.7±13.6 ad	5 (62.5%)	2 (25%)	21.6±11.3 a	1.1±0.5 ac	10.5±0.9 a	9 - 12	64.7
300 - 349	6	316.5-339.4	329.0±4.0	25 - 191	71.2±29.1 ab	3 (50%)	2 (33.3%)	5.7±1.7 a	1.0±0.5 a	38.7±13.6 a	12 - 57	71.2
350+	13	353.7-651.9	432.5±28.0	55 - 114	80.1±6.2 ad	4 (30.8%)	1 (7.7%)	18.2±11.4 a	0.4±0.2 bc	56 ‡ a	56 ‡	208.2
OVERALL	101	28.9-651.9	184.2±12.8	22 - 195	80.2±4.3	67 (66.3%)	31 (30.7%)	18.1±2.0 a	1.4±0.2	25.9±2.4	7 - 85	61.4

Note : Within a column, values annotated with the same letter are not significantly different (p≥0.05).

Significant differences (p<0.05) are indicated by annotation with different letters.

* after transfer of fish from holding conditions into individually-partitioned aquaria.

‡ denotes single observation.

Significant differences ($p < 0.05$) were found between some, but not all of the weight groups.

Mean ISI (inter-spawn-interval), based upon completed reproductive cycles varied from 10.5 ± 0.9 days (in the 250 - 299g group) to 56 days (in the 350g+ group, though this latter figure was based upon just one fish)(see Figure 3.1a). No obvious trend was observed in relation to weight grouping, though the largest fish exhibited the largest ISIs. No significant differences ($p \geq 0.05$) were found in terms of mean ISI between the eight weight groupings. Overall, mean ISI was found to be 25.9 ± 2.4 days. The shortest ISI observed during the study was just 7 days and was observed in both the 100 - 149g group and the 150 - 199g group. Regression analysis failed to detect any significant relationships between fish size (weight or length) and ISI (in terms of either untransformed or \log_{10} transformed data).

Results from all fish (both spawning & non-spawning) in each weight grouping were considered together and used to calculate the overall mean days elapsed per spawn (i.e. total days observed/total spawns observed). This figure was found to vary from 19.8 days (in the 0 - 49g group) to 208.20 days (in the 350g+ group) and tended to rise as fish weight increased (see Figure 3.1b). The overall mean was found to be 61.4 days.

(b) Strain 'B' (refer to Table 3.3).

22 strain 'B' females (weight range: 47.5g - 270.7g) were observed for periods of time varying from 20 - 131 days. To allow comparison with the results obtained from strain 'A', strain 'B' data were grouped into identical weight categories as strain 'A'. Since the largest strain 'B' fish encountered was only 270.7g, no direct comparisons to strain 'A' were possible in either the 300 - 349g or 350g+ group.

Of the 22 strain 'B' fish observed, 59.1% spawned at least once during their respective observation period. Only 36.4% spawned more than once. These proportions were very similar to those found with strain 'A' (i.e. 66.3% and 30.7% respectively). In contrast to strain 'A' data, the proportion of each weight group

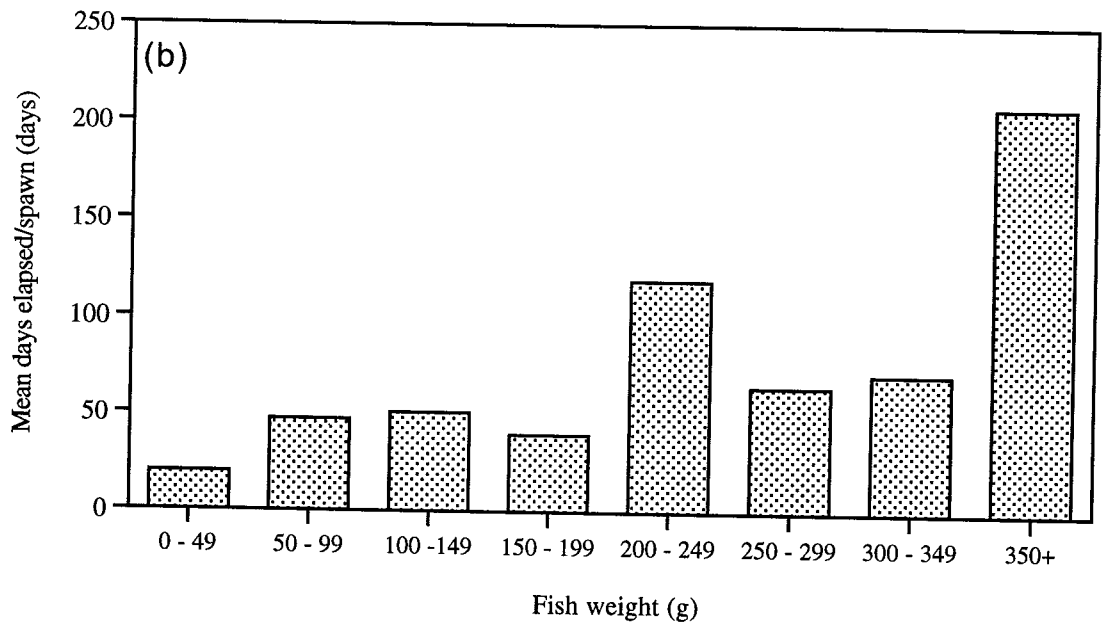
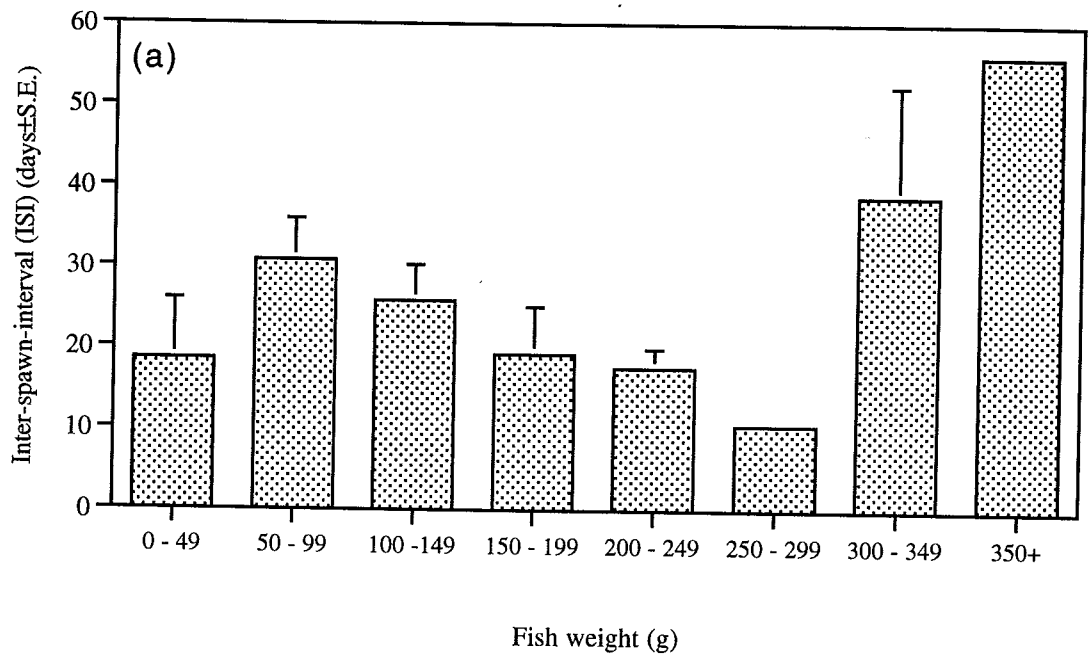

Figure 3.1. (a) Mean inter-spawn-interval (ISI±S.E.) and (b) mean days elapsed/spawn in different sizes of broodstock *T. zillii* (strain 'A'). Note - no S.E. is shown in Fig. 3.1b owing to the way in which mean days elapsed/spawn was calculated (see Section 2.4.4).

Table 3.3. Spawning frequencies of 22 female *T. zillii* (strain 'B') maintained in individually-partitioned glass aquaria for varying periods of time. Data grouped according to maternal weight.

Weight range of fish (g)	Number of fish monitored	Wt. range of fish monitored (g)	Mean wt. of fish (g±S.E.)	Range of observation duration (days)	Mean duration of observation period (days±S.E.)	No. of fish spawning at least once during observation (% of group)	No. of fish spawning more than once during observation (% of group)	Mean time interval until first spawn (days±S.E.) *	Mean no. of spawns per individual fish during observation period (±S.E.)	Mean ISI (days±S.E.)	Range of ISI's observed within group (days)	Overall mean days elapsed per spawn
0 - 49	1	47.5‡	47.5‡	26‡	26‡	1 (100%)	0 (0%)	14‡	1‡	-	-	26‡
50 - 99	3	77.1-91.0	85.5±4.2	34 - 131	87.3±28.4	2 (66.6%)	2 (66.6%)	2.5±0.5	2.7±1.4	11.2±2.0	6 - 20	32.7
100 - 149	4	112.7-139.2	128.5±6.1	34 - 71	56.5±79.2	4 (100%)	2 (50%)	8.7±2.9	2.2±0.9	14.8±2.8	11 - 24	25.1
150 - 199	8	154.6-198.7	174.8±6.3	20 - 98	51.6±0.8	3 (37.5%)	3 (37.5%)	8.0±5.0	1.4±0.7	17.0±4.3	8 - 46	37.5
200 - 249	4	202.3-222.0	211.0±4.2	48 - 78	64.7±6.5	3 (75%)	1 (25%)	9.7±6.7	1.2±0.6	18.5±8.5	10 - 27	64.7
250 - 299	2	262.0-270.7	266.3±4.4	26 - 62	44.0±18.0	0 (0%)	0 (0%)	-	-	-	-	-
300 - 349	0	-	-	-	-	-	-	-	-	-	-	-
350+	0	-	-	-	-	-	-	-	-	-	-	-
OVERALL	22	47.5-270.7	163.3±12.4	20 - 131	57.9±6.0	13 (59.1%)	8 (36.4%)	8.2±2.0	1.54±0.4	14.9±2.0	6 - 46	37.5

Note : Within a column, values annotated with the same letter are not significantly different ($p \geq 0.05$).

Significant differences ($p < 0.05$) are indicated by annotation with different letters.

* after transfer of fish from holding conditions into individually-partitioned aquaria.

‡ denotes single observation.

spawning at least once during their observation periods did not fall steadily with increasing weight, but varied from one weight grouping to another with no obvious trend.

Mean time interval until first spawn was observed following transfer to individual aquaria varied from 2.5 ± 0.5 days (in the 50 - 99g group) to 14 days (in the 0 - 49g group, though this was based upon just one fish). Overall mean was 8.2 ± 2.0 days. No trend was observed in relation to weight groupings and as with strain 'A', no significant differences ($p \geq 0.05$) were detected between any of the weight groupings.

Mean number of spawns/observation period tended to fall with increasing fish size (as in strain 'A') and varied from 1 (in the 0 - 49g group, though this was based upon just one fish) to 2.7 ± 1.4 (in the 50 - 99g group). Overall mean was found to be 1.54 ± 0.4 spawns/observation period. No significant differences however, were found between any of the weight groupings ($p \geq 0.05$), unlike strain 'A' where several significant differences ($p < 0.05$) were found, particularly when comparing the largest weight group (350g+) with those groups weighing less than 200g.

Mean ISI varied from 11.2 ± 2.0 days (in the 50 - 99g group) to 18.5 ± 8.5 days (in the 200 - 249g group)(see Figure 3.2a). Unlike strain 'A', mean ISI steadily increased as fish weight increased, though as with strain 'A' data, no significant differences were detected between weight groups ($p \geq 0.05$). Overall mean ISI was found to be 14.9 ± 2.0 days. The shortest ISI observed during the study of strain 'B' was just 6 days and was observed in the 50 - 99g group. As with strain 'A', regression analysis failed to detect any significant relationships between fish size (weight or length) and ISI (in terms of either untransformed or \log_{10} transformed data).

As with strain 'A', mean days elapsed per spawn tended to rise steadily with increasing fish weight and varied from 25.1 days (in the 0 - 49g group) to 88.0 days (in the 250 - 299 group)(see Figure 3.2b). Overall mean was found to be 37.5 days.

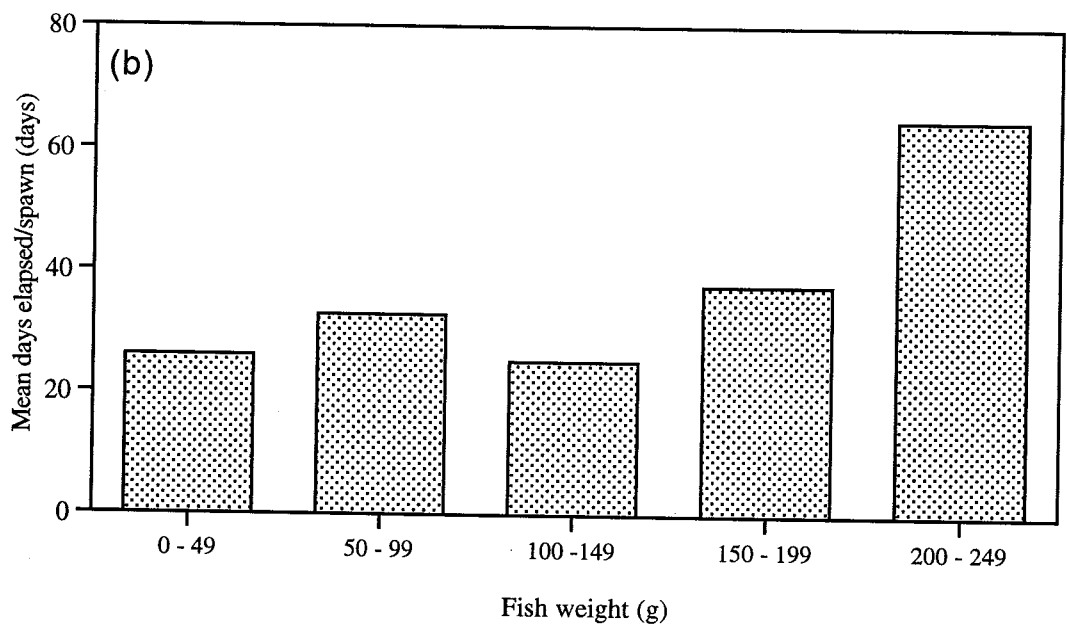
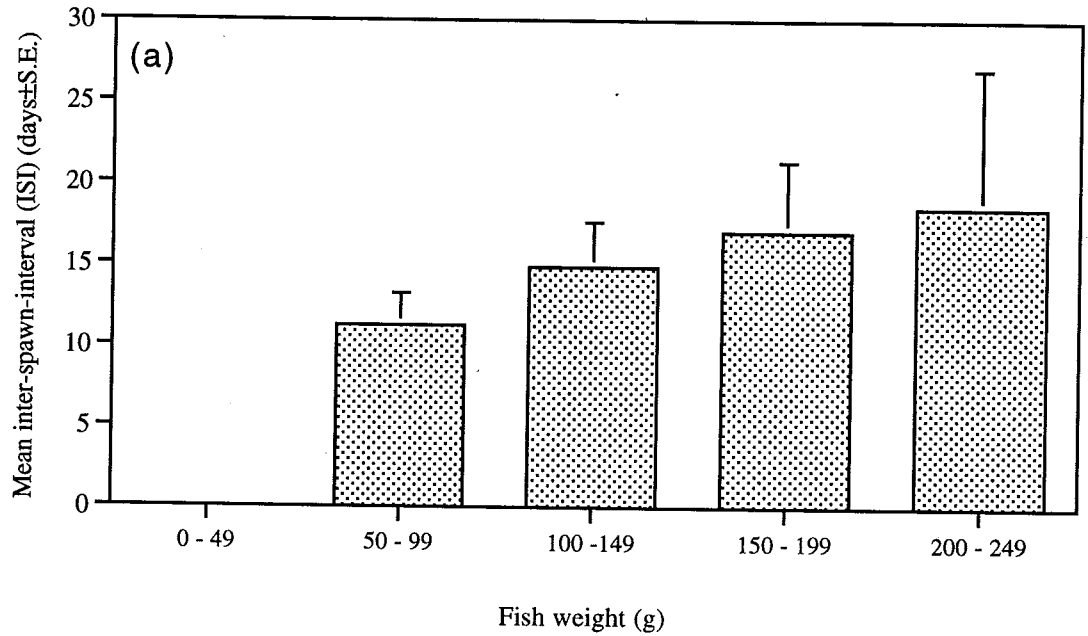

Figure 3.2. (a) Mean inter-spawn-interval (ISI±S.E.) and (b) mean days elapsed/spawn in different sizes of *T. zillii* broodstock (strain 'B'). There were no spawning fish >250g in weight. Only one fish in the 0 - 49g category spawned but did not spawn again; as a result, an ISI could not be determined. Note - No S.E. is given in Fig. 3.2b owing to the way in which mean days elapsed/spawn was calculated (see Section 2.4.4).

(c) Statistical comparison of strain 'A' and strain 'B' (refer to Table 3.4)

Direct statistical comparisons (using oneway ANOVA) between strain 'A' and 'B' data, both for each weight grouping and overall are given in Table 3.4. Although many more strain 'A' fish were studied than strain 'B' and although a much greater variation in weight was evident amongst strain 'A', there was no significant difference ($p \geq 0.05$) between the overall mean weights of those strain 'A' and strain 'B' fish studied. Similarly there was no significant difference ($p \geq 0.05$) in terms of overall mean duration of observation period between the two strains. When spawning characteristics were considered it was found that whilst there was no significant difference between the overall mean number of spawns produced per fish per observation period ($p \geq 0.05$) between the two strains, both overall mean time interval until first spawn and overall mean ISI were significantly shorter ($p < 0.05$) in strain 'B' than strain 'A'. Moreover, overall mean days elapsed per spawn was much shorter (by approx. 40%) in strain 'B' than in strain 'A' though the statistical significance of this could not be tested.

(3.2.3.) Summary.

Mean time interval until first spawning following transfer to individual aquaria was significantly shorter ($p < 0.05$) in strain 'B' (~8 days) than strain 'A' (~18 days). Overall mean ISI was also significantly shorter ($p < 0.05$) in strain 'B' (~15 days) than strain 'A' (~26 days). ISI exhibited a complex relationship to fish size though the largest fish tended to exhibit the longest ISI's. Shortest ISI was 7 days in strain 'A' and 6 days in strain 'B'. No significant relationships were found between ISI and fish size in either strain. Mean days elapsed/spawn (considering all fish - both spawning and non-spawning) varied in strain 'A' from ~20 days to ~208 days and tended to increase as fish weight increased (overall mean was ~61 days). In strain 'B', mean days elapsed/spawn also rose steadily with increasing fish weight and varied from ~25 days to ~88 days (overall mean was 37.5 days, approximately 40% shorter than that of strain 'A').

Table 3.4. Comparison of spawning data obtained from *T. zillii* strains 'A' & 'B'.

Weight range (g)	(1) Mean weight of fish studied (g±S.E.)		(2) Mean duration of observation period (days±S.E.)		(3) Mean time interval until first spawn (days±S.E.) *	
	strain 'A'	strain 'B'	strain 'A'	strain 'B'	strain 'A'	strain 'B'
0 - 49	39.3±2.6 a	47.5‡ a	36.4±5.6 a	26‡ a	14.7±4.6 a	14‡ a
50 - 99	72.0±2.8 a	85.5±4.2 b	87.1±8.8 a	87.3±28.4 a	22.3±3.4 a	2.5±0.5 a
100 - 149	127.2±3.7 a	128.5±6.1 a	85.4±9.9 a	56.5±79.2 a	16.9±4.9 a	8.7±2.9 a
150 - 199	177.7±4.9 a	174.8±6.3 a	73.4±14.0 a	51.6±0.8 a	8.8±1.9 a	8.0±5.0 a
200 - 249	227.3±4.8 a	211.0±4.2 a	92.0±13.7 a	64.7±6.5 a	16.6±5.0 a	9.7±6.7 a
250 - 299	267.0±5.8 a	266.3±4.4 a	82.7±13.6 a	44.0±18.0 a	21.6±11.3 a	-
300 - 349	329.0±4.0	-	71.2±29.1	-	5.7±1.7	-
350+	432.5±28.0	-	80.1±6.2	-	18.2±11.4	-
OVERALL	184.2±12.8a	163.3±12.4a	80.2±4.3a	57.9±6.0a	18.1±2.0a	8.2±2.0b

Weight range (g)	(4) Mean no. of spawns per individual fish during observation period (±S.E.)		(5) Mean ISI (days±S.E.)		(6) Overall mean days elapsed per spawn	
	strain 'A'	strain 'B'	strain 'A'	strain 'B'	strain 'A'	strain 'B'
0 - 49	1.4±4.6 a	1‡ a	18.5±7.5 a	-	19.8	26‡
50 - 99	1.8±0.3 a	2.7±1.4 a	30.7±5.2 a	11.2±2.0 a	47.3	32.7
100 - 149	1.68±0.4 a	2.2±0.9 a	25.7±4.5 a	14.8±2.8 a	50.8	25.1
150 - 199	1.85±0.67 a	1.4±0.7 a	19.2±5.8 a	17.0±4.3 a	39.5	37.5
200 - 249	0.76±0.4 a	1.2±0.6 a	17.5±2.4 a	18.5±8.5 a	118.9	64.7
250 - 299	1.12±0.5	-	10.5±0.9	-	64.7	88.0
300 - 349	1.0±0.5	-	38.7±13.6	-	71.2	-
350+	0.38±0.2	-	56‡	-	208.2	-
OVERALL	1.35±0.2a	1.54±0.4a	25.9±2.4a	14.9±2.0b	61.4	37.5

Note : Significant differences ($p < 0.05$) between strains 'A' & 'B' for each parameter measured (1 - 6) are indicated by annotation with different letters. Non significant differences ($p \geq 0.05$) between strains 'A' & 'B' are indicated by annotation with the same letter.

* after transfer of fish from holding conditions into individually-partitioned aquaria.

‡ denotes single observation.

(3.3) Experiment 2: Fecundity & egg size in *T.zillii* (strain 'A' & 'B').

This investigation ran concurrently with Experiment 1 above. Where possible, egg clutches spawned by fish monitored in Experiment 1 were removed from individual aquaria and analysed to determine fecundity and egg size characteristics.

(3.3.1) Materials & methods.

Individual fish utilised in Experiment 1 (above) were assessed for indications of possible spawning activity at approximately 3 hourly intervals during daylight hours. Spawning fish were monitored closely and were allowed to spawn without interruption.

As soon as possible after the cessation of oviposition, post-spawned females were removed from their respective aquaria, anaesthetised (Section 2.2.1), weighed (to the nearest 0.1g) and measured (to the nearest mm)(Section 2.4.1). Fish were allowed to recover fully before being returned to their respective aquaria. The perspex false base was removed from the appropriate 'holding space' within the partitioned aquaria allowing the attached egg mass to be carefully removed with a spatula. Egg masses were teased apart and individual eggs counted directly using the method described in Section 2.4.1 to determine total fecundity. Mean lengths of egg long and short axes, mean egg diameter, mean individual egg volume, mean individual dry weight, mean relative fecundity, mean total egg volume and egg weight to body weight ratio (EW:BW ratio) were calculated as described in Section 2.4.

Data were grouped according to maternal weight and analysed where appropriate using one-way ANOVA followed by multiple comparison analysis using the Bonferroni/Dunn test. EW:BW ratios were transformed prior to statistical analysis by ARCSine transformation. Relationships between fish weight and fish length with total fecundity, relative fecundity, egg dry weight, egg diameter, egg volume, total egg volume and EW:BW were investigated using correlation and regression analysis. Regression analysis was also used to analyse untransformed and log₁₀ transformed

data for relationships between ISI and fecundity and between ISI and mean egg volume in each strain of fish.

One-way ANOVA was initially used to compare spawning data between the two strains of *T. zillii*, though this was followed by more rigorous analysis using one-factor analysis of covariance (ANCOVA). This technique combines the statistical techniques of regression and ANOVA and tests a dependent variable 'y' for homogeneity among group means similar to ANOVA. Before means are tested they are adjusted for group differences in the independent variable 'x' (the covariate), thus attempting to simulate the results that would have been obtained had a constant value for the independent variable been used (Snedecor & Cochran, 1980). The main significance test involved in ANCOVA is a test of homogeneity of the 'y' intercepts (elevation). For this test to be accurate the regression lines being tested should first be tested for homogeneity in both residual variances and then slope. If slopes are heterogeneous then the treatment effects are not the same at different levels of the covariate; thus the adjusted means can be misleading (Snedecor & Cochran, 1980).

In this study ANCOVA was used to compare the two strains of *T. zillii* in terms of three main spawning parameters (total fecundity, mean egg diameter and total egg volume). These factors were used individually as dependent 'y' variables and were tested against post-spawned fish weight as the independent 'x' variable. Weight was chosen as the 'x' variable in preference to total length since weight appears to be a more commonly used and accepted index of tilapia size. For each spawning parameter ('y' variable), a F_{\max} (variance-ratio) test was first used to test for homogeneity of residual variances. Statistical comparison of common slope and intercept (elevation) between the two strains were then analysed using ANCOVA as described by Snedecor & Cochran (1980) and performed using the SUPERANOVA (version 1.11) statistical package (Abacus Concepts, USA) running on an Apple Macintosh computer.

(3.3.2) Results.

In total, 91 spawns were recorded from 101 individually-maintained *T. zillii* (strain 'A') and 34 spawns recorded from 22 individually-maintained *T. zillii* (strain 'B'). In both strains, spawning always occurred between 9am and 2pm. Generally, oviposition occurred directly on to the base of the aquaria, though on very rare occasions fish were seen to oviposit on to the side-wall of the aquaria instead. Fish approaching spawning displayed intense colouration. The lower half of each flank and the entire ventral side of fish adopted a vivid red colour and a series of 3 - 5 vertical black bands appeared upon each flank. This was observed in conjunction with increased levels of activity particularly in terms of 'cleaning' the chosen area of spawning substrate and aggression towards fish in neighbouring partitions. Colouration and activity levels intensified as the gonopore extended. Usually fish spawned within 1 - 2 hours after full extension of the gonopore (approx. 1cm). Cessation of oviposition was marked by a gradual loss of the previously intense colouration and by regression of the gonopore. Eggs were olive coloured and were ellipsoid in shape.

Freshly-laid spawns were removed from aquaria as soon as possible after completion of oviposition. On two separate occasions spawns were left in aquaria for more than 3 hours. In both cases, the female was observed to eat a small proportion of the eggs she had just previously laid. These two spawns were omitted from subsequent analysis.

(a) Strain 'A' (refer to Table 3.5 and Figure 3.3).

Mean total fecundity increased steadily as fish weight (& total length) increased. Mean total fecundity varied from 2079.2 ± 255.9 eggs (in the 0 - 49g group) to 9066.3 ± 1316.5 eggs (in the 350g+ weight group). Significant differences ($p < 0.05$) were found between some, but not all weight groups. Overall mean fecundity was found to be 3605.5 ± 279.6 . Smallest total fecundity was just 461 eggs (in a fish weighing 85.4g) whilst the highest fecundity was 11640 eggs (in a fish weighing

Table 3.5. Fecundity, egg dry weight, egg size and egg volume data recorded over 91 spawns by 101 individually-maintained *T. zillii* (strain 'A')
Data grouped according to maternal weight.

Weight range (g)	n	Mean weight of spawning fish (g±S.E.)	Mean length of spawning fish (mm±S.E.)	Mean total fecundity (±S.E.)	Mean relative fecundity (eggs/g±S.E.)	Mean egg dry weight (mg±S.E.)	Mean length of egg long axis (mm±S.E.)	Mean length of egg short axis (mm±S.E.)	Mean egg diameter (mm±S.E.)	Mean egg volume (mm ³ ±S.E.)	Mean total egg volume (x1000 mm ³ ±S.E.)	EW:BW (%) *
0 - 49	14	41.0±1.5 _a	133.5±2.4 _a	2079.2±255.9 _a	50.1±5.2 _a	0.42±0.03 _a	1.56±0.05 _{bc}	1.24±0.03 _a	1.39±0.04 _{bc}	1.27±0.09 _a	2.86±0.57 _a	2.16±0.31 _c
50 - 99	28	74.8±2.9 _b	155.7±2.0 _b	2314.8±174.1 _a	31.3±2.1 _b	0.45±0.02 _a	1.54±0.03 _c	1.31±0.04 _{ab}	1.43±0.03 _c	1.45±0.10 _{ab}	3.63±0.40 _a	1.44±0.15 _{ab}
100 - 149	18	120.95±3.6 _c	181.3±1.8 _c	3794.4±344.7 _b	32.4±3.5 _b	0.57±0.04 _b	1.67±0.04 _{abc}	1.36±0.02 _{bc}	1.52±0.03 _{abc}	1.62±0.08 _{bc}	6.49±0.52 _b	1.91±0.31 _{bc}
150 - 199	13	178.6±3.7 _d	205.0±2.3 _d	4404.5±352.6 _{bc}	24.9±2.1 _b	0.59±0.03 _b	1.68±0.03 _{abc}	1.37±0.03 _b	1.53±0.03 _{abc}	1.72±0.10 _b	7.73±0.69 _b	1.48±0.14 _{abc}
200 - 249	5	210.2±1.7 _e	211.6±1.8 _{de}	5178.5±413.7 _{bc}	24.7±1.9 _b	0.49±0.10 _{ab}	1.54±0.08 _{ab}	1.28±0.08 _{ab}	1.41±0.08 _{ab}	1.37±0.23 _{ab}	7.07±1.59 _b	1.14±0.25 _{abc}
250 - 299	5	269.1±2.9 _f	235.8±2.1 _f	5530.2±1425.1 _{cd}	20.7±5.4 _b	0.52±0.08 _{ab}	1.46±0.11 _a	1.26±0.03 _{ab}	1.36±0.07 _a	1.25±0.15 _{ab}	6.92±2.12 _b	1.01±0.35 _a
300 - 349	5	334.7±6.3 _g	239.0±3.7 _{fg}	7282.8±1022.2 _{de}	21.6±2.8 _b	0.49±0.10 _{ab}	1.64±0.01 _{abc}	1.35±0.01 _{ab}	1.49±0.02 _{abc}	1.56±0.04 _{ab}	11.26±2.16 _c	1.20±0.16 _{ab}
350+	3	390.9±19.3 _h	262.7±7.8 _h	9066.3±1316.5 _e	23.6±4.6 _b	0.52±0.05 _{ab}	1.65±0.05 _a	1.35±0.03 _{ab}	1.49±0.04 _a	1.57±0.11 _{ab}	13.99±0.95 _c	1.22±0.20 _{abc}
OVERALL	91	136.35±9.8	180.0±3.8	3605.5±279.6	31.8±1.6	0.51±0.02	1.60±0.02	1.32±0.02	1.46±0.04	1.49±0.05	5.91±0.41	1.60±0.10
[RANGE OF RAW DATA]		[28.9 - 419.0]	[115 - 271]	[461 - 11640]	[4.9 - 84.3]	[0.18 - 1.10]	[1.05 - 1.80]	[1.06 - 1.81]	[1.14 - 1.71]	[0.77 - 2.50]	[0.69 - 15.83]	[0.30 - 4.64]

Within a column, values annotated with the same letter are not significantly different ($p \geq 0.05$)
Significant differences ($p < 0.05$) are indicated by annotation with different letters.

* EW:BW data transformed using ARCSine transformation prior to statistical analysis

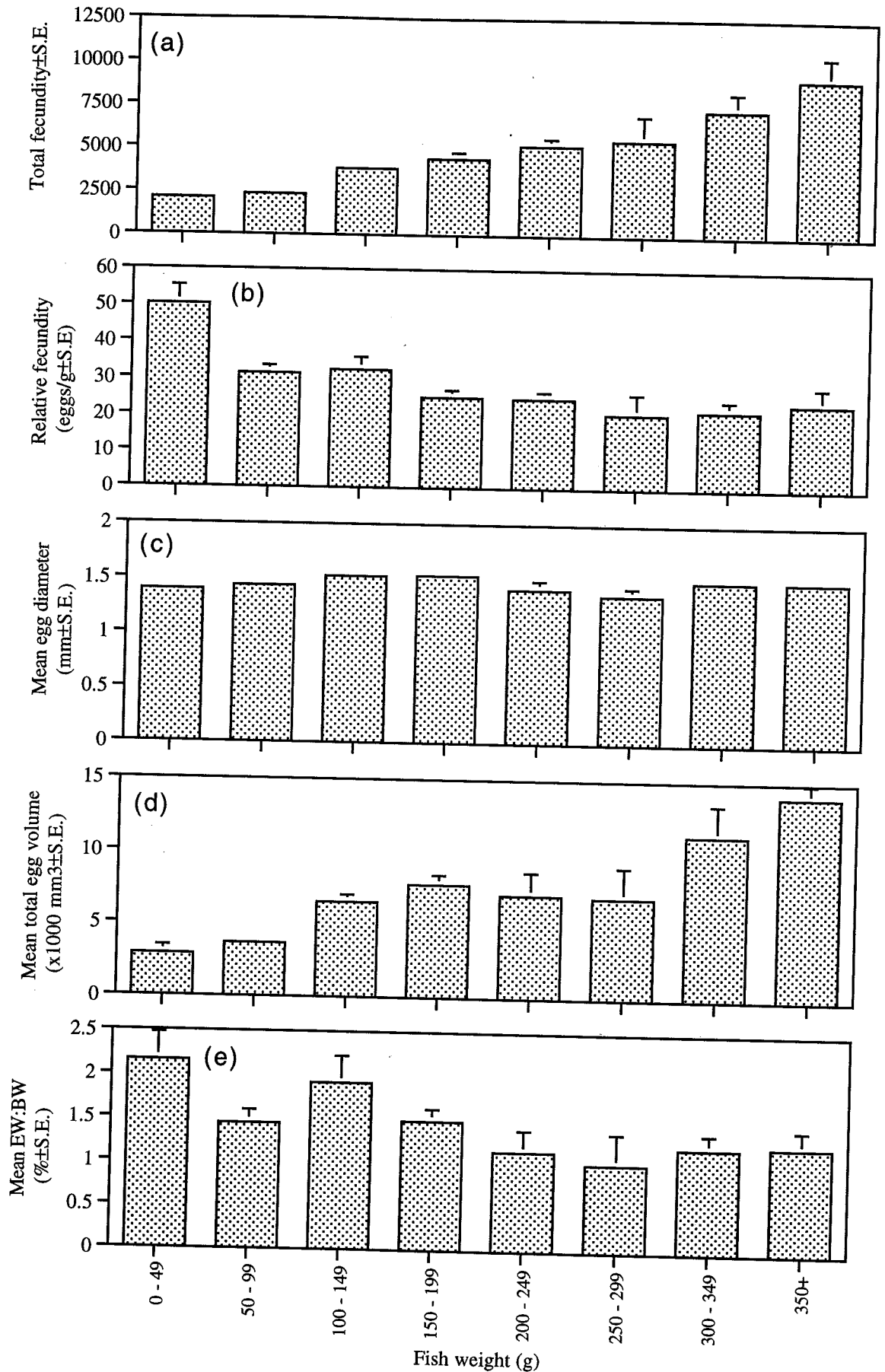

Figure 3.3. Variation of mean (a) total fecundity, (b) relative fecundity, (c) egg diameter, (d) total egg volume and (e) EW:BW ratio with fish weight in *T. zillii* (strain 'A'). Where the S.E. is not shown, it lies within the confines of the histogram.

353.7g). Interestingly, there was a tendency for increased variation in total fecundity as fish weight (and length) increased.

Mean relative fecundity (expressed as eggs/g) fell steadily with increasing fish weight (& length) from 50.1 ± 5.2 eggs/g (in the 0 - 49g group) to 23.6 eggs/g (in the 350g+ group). Overall relative fecundity was found to be 31.8 ± 1.6 eggs/g.

Mean egg dry weight varied from 0.42 ± 0.03 mg to 0.59 ± 0.03 mg. There was no obvious relationship between egg dry weight and fish weight (or fish length) although fish weighing between 100 and 200g tended to produce eggs with the greatest dry weight. With the exception of the 0 - 49g and 50 - 99g weight groups (which had significantly lower ($p < 0.01$) egg dry weights than either the 100 - 149g group or the 150 - 199g group), no significant differences ($p \geq 0.05$) were found between weight groupings. Overall egg dry weight was found to be 0.51 ± 0.02 mg.

Mean egg diameter varied only within a narrow range (1.39 ± 0.04 mm - 1.53 ± 0.03 mm). There was no obvious relationship to fish size, though again, fish weighing 100 - 200g tended to produce eggs with the largest diameter. Significant differences ($p < 0.05$) were found between some, but not all weight groupings. Overall mean egg diameter was found to be 1.46 ± 0.04 mm.

Mean individual egg volume varied from 1.25 ± 0.15 mm³ to 1.72 ± 0.10 mm³. Again, no obvious relationship was seen in relation to either fish weight or length, though (as with egg dry weight) fish weighing between 100 and 200g produced eggs with the greatest volume. Significant differences ($p < 0.05$) were found between some, but not all of the weight groupings. Overall mean egg volume was found to be 1.49 ± 0.05 mm³.

Mean total egg volume generally increased with increasing fish weight and length and varied from 2.86 ± 0.57 (x1000 mm³) in the 0 - 49g weight group to 13.99 ± 0.95 (x1000 mm³) in the 350g+ group. Significant differences ($p < 0.05$) were found between some, but not all weight groupings. As with total fecundity, there was a tendency for increased variation in mean total egg volume as fish weight (and length) increased. Overall mean egg volume was found to be 5.91 ± 0.41 (x1000 mm³).

Finally, EW:BW ratio generally fell with increasing fish weight and length and varied from $2.16 \pm 0.31\%$ (in the 0 - 49g weight group) to $1.01 \pm 0.35\%$ (in the 250 - 299 weight group). Significant differences ($p < 0.05$) were found between some, but not all weight groupings and overall EW:BW ratio as found to be $1.60 \pm 0.10\%$.

(b) Strain 'B' (refer to Table 3.6 and Figure 3.4).

Since the available stocks of mature strain 'B' females fell within a more restricted weight range than strain 'A' and since the one strain 'B' female weighing $< 50\text{g}$ failed to spawn, data presented in this section only concern weight groupings from 50g - 250g.

As with strain 'A', mean total fecundity increased as fish weight (& total length) increased. Mean total fecundity varied from 2607.2 ± 225.6 eggs (in the 0 - 49g group) to 4431.3 ± 1142.8 eggs (in the 200 - 249g weight group). Significant differences ($p < 0.05$) were found between some, but not all weight groups. Overall mean fecundity was found to be 3560.3 ± 242.8 . Smallest total fecundity was just 1810 eggs (in a fish weighing 77.5g) whilst the highest fecundity was 9733 eggs (in a fish weighing 210.0g). As with strain 'A', there was also a tendency for increased variation in total fecundity as fish weight (and length) increased.

Again, as with strain 'A', mean relative fecundity (expressed as eggs/g) fell steadily with increasing fish weight (& length) from 38.0 ± 4.1 eggs/g (in the 50 - 99g group) to 20.3 ± 5.5 eggs/g (in the 200 - 249g group). Significant differences ($p < 0.05$) were found between some but not all weight groups. Overall relative fecundity was found to be 32.8 ± 1.6 eggs/g.

Mean egg dry weight varied from $0.47 \pm 0.03\text{mg}$ to $0.50 \pm 0.04\text{mg}$. There was no obvious relationship between egg dry weight and fish weight (or fish length). No

Table 3.6. Fecundity, egg dry weight, egg size and egg volume data recorded over 34 spawns by 22 individually-maintained *T. zillii* (strain 'B')
Data grouped according to maternal weight.

Weight range (g)	n	Mean weight of spawning fish (g±S.E.)	Mean length of spawning fish (mm±S.E.)	Mean total fecundity (±S.E.)	Mean relative fecundity (eggs/g ±S.E.)	Mean egg dry weight (mg±S.E.)	Mean length of egg long axis (mm±S.E.)	Mean length of egg short axis (mm±S.E.)	Mean egg diameter (mm±S.E.)	Mean egg volume (mm ³ ±S.E.)	Mean total egg volume (x1000 mm ³ ±S.E.)	EW:BW (%) *
0 - 49	0	-	-	-	-	-	-	-	-	-	-	-
50 - 99	6	70.5±6.0 a	153.5±2.5 a	2607.2±225.6 a	38.0±4.1 a	0.47±0.03 a	1.52±0.05 a	1.17±0.04 a	1.34±0.04 a	1.11±0.11 a	2.87±0.34 a	1.75±0.20 a
100 - 149	14	123.0±4.0 b	178.4±2.4 b	3765.3±194.6 ab	30.6±1.2 a	0.49±0.01 a	1.57±0.03 a	1.25±0.03 a	1.41±0.02 a	1.23±0.08 a	4.84±0.36 ab	1.53±0.08 a
150 - 199	8	168.4±2.4 c	200.0±2.0 c	3266.3±362.2 ab	19.4±2.2 b	0.48±0.01 a	1.59±0.02 a	1.28±0.02 a	1.43±0.02 a	1.37±0.05 a	4.49±0.56 ab	0.95±0.11 b
200 - 249	6	221.5±6.0 d	212.0±1.7 d	4431.3±2.5 b	20.3±5.5 b	0.50±0.04 a	1.55±0.06 a	1.31±0.06 a	1.43±0.04 a	1.42±0.15 a	6.74±2.41 a	1.11±0.43 b
250 - 299	0	-	-	-	-	-	-	-	-	-	-	-
300 - 349	0	-	-	-	-	-	-	-	-	-	-	-
350+	0	-	-	-	-	-	-	-	-	-	-	-
OVERALL		141.8±8.7	185.0±3.6	3560.3±242.8	32.8±1.6	0.49±0.01	1.56±0.02	1.25±0.02	1.41±0.08	1.31±0.05	4.76±0.49	1.36±0.10
[RANGE OF RAW DATA]	34	[53.2 - 240.8]	[143.0 - 216.0]	[1962 - 9733]	[9.8 - 54.4]	[0.33 - 0.69]	[1.32 - 1.77]	[1.03 - 1.53]	[1.22 - 1.59]	[0.81 - 1.89]	[1.84 - 18.38]	[0.62 - 2.38]

Within a column, values annotated with the same letter are not significantly different ($p \geq 0.05$)
Significant differences ($p < 0.05$) are indicated by annotation with different letters.

* EW:BW data transformed using ARCSine transformation prior to statistical analysis.

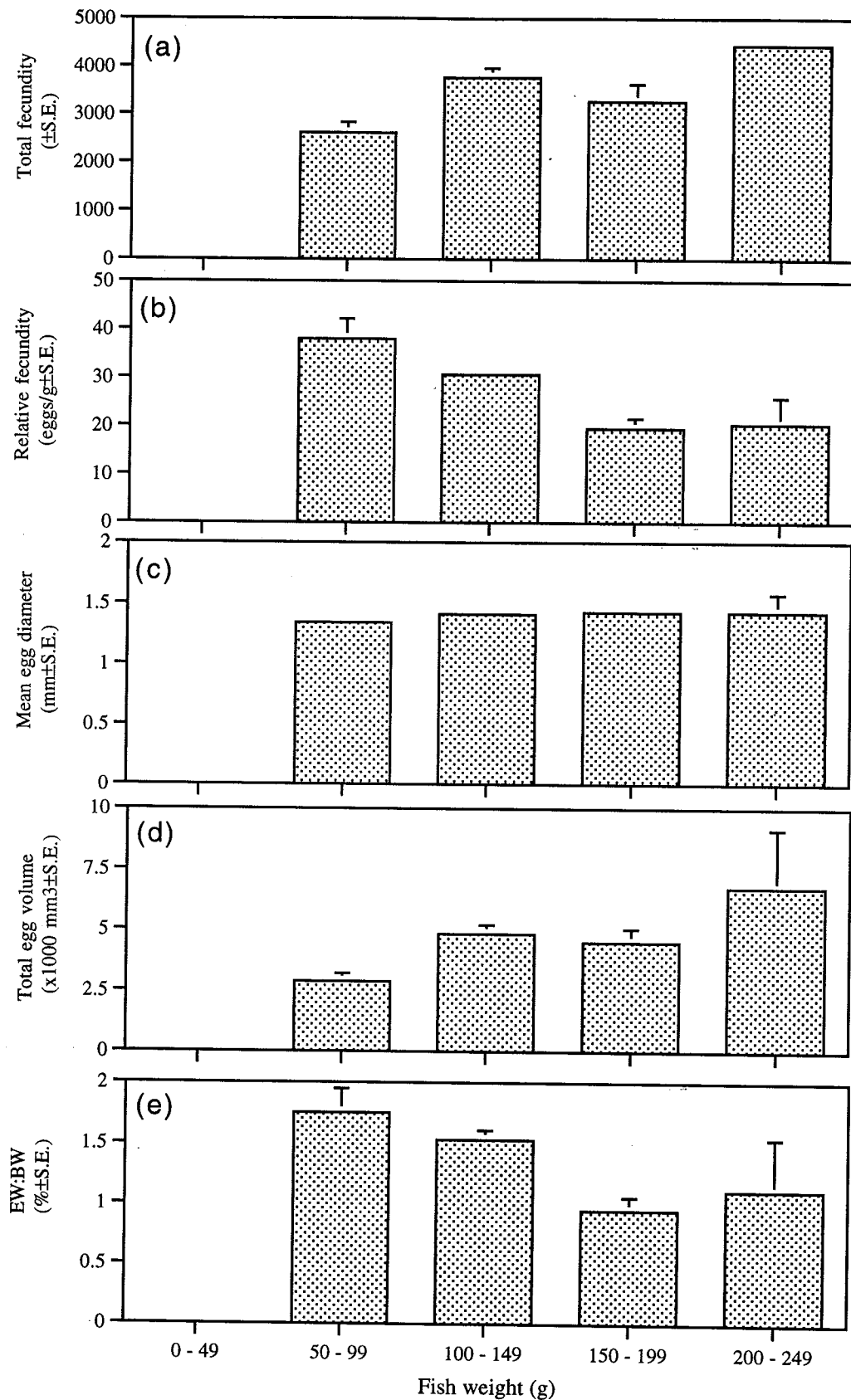

Figure 3.4. Variation of mean (a) total fecundity, (b) relative fecundity, (c) egg diameter, (d) total egg volume and (e) EW:BW ratio with fish size in *T. zillii* (strain 'B'). Where the S.E. is not shown it lies within the confines of the histogram. There were no spawning fish <50g or >250g in weight.

significant differences ($p \geq 0.05$) were found between any weight groupings. Overall egg dry weight was found to be 0.49 ± 0.01 mg.

Mean egg diameter varied only within a very narrow range (1.34 ± 0.04 mm - 1.43 ± 0.04 mm). As with strain 'A', there was no obvious relationship to fish size. Unlike strain 'A' however, no significant differences ($p \geq 0.05$) were detected between any of the weight groups. Overall mean egg diameter was found to be 1.41 ± 0.08 mm.

Mean individual egg volume varied from 1.11 ± 0.11 mm³ to 1.42 ± 0.15 mm³, and was observed to rise with increasing fish weight and length (unlike strain 'A' data where no obvious relationship was seen). No significant differences ($p \geq 0.05$) were found however between weight groupings. Overall mean egg volume was 1.31 ± 0.05 mm³.

As seen in strain 'A', mean total egg volume generally increased with increasing fish weight and length and varied from 2.87 ± 0.34 (x1000 mm³) in the 50 - 99g group to 6.74 ± 2.41 (x1000 mm³) in the 200 - 249g group. Significant differences ($p < 0.05$) were found between some, but not all weight groupings. As with total fecundity, there was a tendency for increased variation in mean total egg volume as fish weight (and length) increased. Overall mean egg volume was 4.76 ± 0.49 (x1000 mm³).

Finally, EW:BW ratio generally fell with increasing fish weight and length (as seen in strain 'A') and varied from $1.75 \pm 0.20\%$ to $0.95 \pm 0.11\%$. Significant differences ($p < 0.05$) were found between some, but not all weight groupings and overall EW:BW ratio was found to be $1.36 \pm 0.10\%$.

(c) Statistical comparison of strain 'A' and strain 'B' (refer to Table 3.7).

Comparative results presented earlier in Table 3.4 demonstrated that strains 'A' and 'B' differed significantly in terms of spawning periodicity. On this basis, direct comparisons of fecundity, egg size, egg weight and egg volume between two strains of multiple-spawning fish such as these would not be appropriate since spawning periodicity could theoretically influence such parameters. The results presented in

Table 3.7. Comparison of total fecundity, egg weight, egg size and egg volume data obtained from 91 spawning *T. zillii* (strain 'A') and 34 spawning *T. zillii* (strain 'B'). Data grouped by maternal weight.

Weight (g)	Mean weight (g±S.E.)		Mean length (mm±S.E.)		Mean total fecundity		Mean relative fecundity (eggs/g±S.E.)		Mean egg dry weight (mg±S.E.)	
	strain 'A'	strain 'B'	strain 'A'	strain 'B'	strain 'A'	strain 'B'	strain 'A'	strain 'B'	strain 'A'	strain 'B'
0 - 49	41.0±1.5	-	133.5±2.4	-	2079.2±255.9	-	50.1±5.2	-	0.42±0.03	-
50 - 99	74.8±2.9a	70.5±6.0a	155.7±2.0a	153.5±2.5a	2314.8±174.1a	2607.2±225.6a	31.3±2.1a	38.0±4.1a	0.45±0.02a	0.47±0.03a
100 - 149	120.95±3.6a	123.0±4.0a	181.3±1.8a	178.4±2.4a	3794.4±344.7a	3765.3±194.6a	32.4±3.5a	30.6±1.2a	0.57±0.04a	0.49±0.01a
150 - 199	178.6±3.7a	168.4±2.4a	205.0±2.3a	200.0±2.0a	4404.5±352.6a	3266.3±362.2b	24.9±2.1a	19.4±2.2a	0.59±0.03a	0.48±0.01b
200 - 249	210.2±1.7a	221.5±6.0a	211.6±1.8a	212.0±1.7a	5178.5±413.7a	4431.3±2.5a	24.7±1.9a	20.3±5.5a	0.49±0.10a	0.50±0.04a
250 - 299	269.1±2.9	-	235.8±2.1	-	5530.2±1425.1	-	20.7±5.4	-	0.52±0.08	-
300 - 349	334.7±6.3	-	239.0±3.7	-	7282.8±1022.2	-	21.6±2.8	-	0.49±0.10	-
350+	390.9±19.3	-	262.7±7.8	-	9066.3±1316.5	-	23.6±4.6	-	0.52±0.05	-
OVERALL	136.35±9.8a	141.8±8.7a	180.0±3.8a	185.0±3.6a	3605.5±279.6a	3560.3±242.8a	31.8±1.6a	32.8±1.6a	0.51±0.02a	0.49±0.01a

Weight (g)	Mean egg diameter (mm±S.E.)		Mean egg volume (mm ³ ±S.E.)		Mean total egg volume (mm ³ x 1000±S.E.)		Mean egg weight:body ratio (EW:BW) (%±S.E.)	
	strain 'A'	strain 'B'	strain 'A'	strain 'B'	strain 'A'	strain 'B'	strain 'A'	strain 'B'
0 - 49	1.39±0.04	-	1.27±0.09	-	2.86±0.57	-	2.16±0.31	-
50 - 99	1.43±0.03a	1.34±0.04a	1.45±0.10a	1.11±0.11a	3.63±0.40a	2.87±0.20a	1.44±0.15a	1.75±0.20a
100 - 149	1.52±0.03a	1.41±0.02b	1.62±0.08a	1.23±0.08b	6.49±0.52a	4.88±0.36b	1.91±0.31a	1.53±0.08a
150 - 199	1.53±0.03a	1.43±0.02b	1.72±0.10a	1.37±0.05b	7.73±0.69a	4.49±0.56b	1.48±0.14a	0.95±0.11b*
200 - 249	1.41±0.08a	1.43±0.04a	1.37±0.23a	1.42±0.15a	7.07±1.59a	6.74±2.41a	1.14±0.25a	1.11±0.43a
250 - 299	1.36±0.07	-	1.25±0.15	-	6.92±2.12	-	1.01±0.35	-
300 - 349	1.49±0.02	-	1.56±0.04	-	11.26±2.16	-	1.20±0.16	-
350+	1.49±0.04	-	1.57±0.11	-	13.99±0.95	-	1.22±0.20	-
OVERALL	1.46±0.02a	1.41±0.08a	1.49±0.05a	1.31±0.05b	5.91±0.41a	4.76±0.49a	1.60±0.10a	1.36±0.10a

Note : Significant differences (p<0.05) between strains 'A' & 'B' for each parameter measured are indicated by annotation with different letters. Significant differences where p<0.01 are indicated by an asterisk (*). Non significant differences (p≥0.05) between strains 'A' & 'B' are indicated by annotation with the same letter.

Section 3.4 (to follow) however, suggest that (at least in a sample of 6 strain 'A' fish) total fecundity, egg weight, egg size and egg volume vary widely over consecutive spawns and do not appear to follow any definite pattern or relationship with underlying spawning periodicity. On this basis, direct comparisons of these reproductive traits between strains 'A' and 'B' have been included here.

Despite many more spawns being recorded by strain 'A' fish than strain 'B' fish and despite a much greater variation in fish weight (and length) amongst strain 'A', there was no significant difference ($p \geq 0.05$) between the two strains in either overall mean weight or overall mean length of spawning fish (see Table 3.7). Similarly, there was no significant difference in terms of overall mean total fecundity, overall mean relative fecundity, overall mean egg dry weight, overall mean egg diameter, overall mean total egg volume or overall mean egg weight to body weight ratio (EW:BW) ($p \geq 0.05$). However, significant differences were found between the two strains in terms of overall mean egg volume (significantly ($p < 0.05$) greater in strain 'A' than strain 'B').

One-factor ANCOVA was used to further compare the two strains in terms of total fecundity, mean egg diameter and total egg volume after adjustment to a common post-spawned fish weight. ANCOVA found no significant ($p \geq 0.05$) difference between the two strains of fish in terms of either total fecundity, mean egg diameter or total egg volume (see Tables 3.8a,b,c respectively). The ANCOVA may not have been as robust, however, since in each test both residual variances and slopes were found to be heterogeneous (except in the case of total fecundity where residual variances were found to be homogeneous - see Table 3.8a).

(d) Correlation and regression analysis.

Correlation and regression analyses between fish size (length & weight) and a variety of egg production traits (total fecundity, relative fecundity, egg dry weight, egg diameter, egg volume and total egg volume) are presented for strain 'A' and strain 'B' in Tables 3.9 and 3.10 respectively.

Table 3.8a. Analyses of covariance (ANCOVA) of log₁₀ total fecundity and log₁₀ post-spawned fish weight (g) for *T. zillii* strains 'A' & 'B'. (* where $F < F_{crit}$ data are homogeneous, where $F > F_{crit}$ data are heterogeneous)

Homogeneity of residual variances			Slope			Intercept (Elevation)		
F	df	Result *	F	df	Result	F	df	Result
1.3	89, 33	Homog.	5.86	1, 120	p<0.05	3.05	1, 123	p≥0.05

Table 3.8b. Analyses of covariance (ANCOVA) of log₁₀ mean egg diameter (mm) and log₁₀ post-spawned fish weight (g) for *T. zillii* strains 'A' & 'B'. (* where $F < F_{crit}$ data are homogeneous, where $F > F_{crit}$ data are heterogeneous)

Homogeneity of residual variances			Slope			Intercept (Elevation)		
F	df	Result *	F	df	Result	F	df	Result
2	79, 33	Heterog.	5.63	1, 110	p<0.05	0.61	1, 123	p≥0.05

Table 3.8c Analyses of covariance (ANCOVA) of log₁₀ total egg volume (x1000 mm³) and log₁₀ post-spawned fish weight (g) for *T. zillii* strains 'A' & 'B'. (* where $F < F_{crit}$ data are homogeneous, where $F > F_{crit}$ data are heterogeneous)

Homogeneity of residual variances			Slope			Intercept (Elevation)		
F	df	Result *	F	df	Result	F	df	Result
4.02	78, 33	Heterog.	12.4	1, 109	p<0.01	0.44	1, 123	p≥0.05

Table 3.9. Summary of correlation and regression analysis of fecundity, egg dry weight, egg size and egg volume data recorded over 91 spawns by 101 individually-maintained *T. zillii* (strain 'A').

VARIABLES TESTED		UNTRANSFORMED DATA				FOLLOWING LOGARITHMIC TRANSFORMATION OF BOTH DEPENDENT & INDEPENDENT VARIABLES			
Dependent Variable	Independent Variable	Correlation Coefficient (r)	Regression equation (x = independent variable, y = dependent variable)	Coefficient of determination (r ²)	Correlation Coefficient (r)	Regression equation (x = independent variable, y = dependent variable)	Coefficient of determination (r ²)		
Total fecundity	fish weight (g)	0.77 ***	y = 18.30x + 1203.54 ***	0.60	0.69 ***	log y = 0.65logx + 2.17 ***	0.48		
Relative fecundity (eggs/g)	fish length (mm)	0.73 ***	y = 44.46x + 4300.30 ***	0.54	0.67 ***	log y = 2.11logx + 1.26 ***	0.46		
	fish weight (g)	-	-	-	-0.46 ***	log y = -0.35logx + 2.17 ***	0.22		
Egg dry weight (mg)	fish length (mm)	-	-	-	-0.47 ***	log y = -1.20logx + 4.14 ***	0.22		
	fish weight (g)	0.25 *	y = 4.1x10 ⁻⁴ x + 0.45 *	0.06	0.32 **	log y = 0.16logx - 0.63 **	0.10		
Egg diameter (mm)	fish length (mm)	0.32 **	y = 0.0001x + 0.27 **	0.10	0.33 **	log y = 0.54logx - 1.53 **	0.10		
	fish weight (g)	0.15 ns	y = 2.23x10 ⁻⁴ + 1.43 ns	0.02	0.24 *	log y = 0.04logx + 0.09 *	0.06		
Egg volume (mm ³)	fish length (mm)	0.21 ns	y = 0.001x + 1.31 ns	0.05	0.24 *	log y = 0.12logx - 0.10 *	0.06		
	fish weight (g)	0.12 ns	y = 0.0001x + 1.42 ns	0.02	0.24 *	log y = 0.11logx - 0.06 *	0.01		
	fish length (mm)	0.18 ns	y = 0.002x + 1.13 ns	0.03	0.24 *	log y = 0.35logx - 0.06 *	0.01		
Total fecundity	Egg volume (mm ³)	0.14 ns	y = 732.80x + 2758.59 ns	0.02	0.28 *	log y = 0.57logx + 3.43 *	0.08		
EW:BW ratio	fish weight (g)	-0.26 *	y = -1.10x10 ⁻⁴ x + 0.35 *	0.07	-0.22 *	log y = -0.10logx - 0.74 *	0.05		
	fish length (mm)	-0.23 *	y = -2.23x10 ⁻⁴ x + 0.16 *	0.06	-0.22 *	log y = -0.31logx - 0.23 *	0.05		
Total egg volume (mm ³)	fish weight (g)	0.71 ***	y = 27.69x + 2010.56 ***	0.50	0.67 ***	log y = 0.73logx + 2.16 ***	0.44		
	fish length (mm)	0.70 ***	y = 69.67x + 6805.47 ***	0.49	0.65 ***	log y = 2.38logx - 1.67 ***	0.42		

N.B. (1) Levels of significance: * = p<0.05, ** = p<0.01, *** = p<0.001

(2) EW:BW ratio was ARCSine transformed prior to statistical analysis.

Table 3.10. Summary of correlation and regression analysis of fecundity, egg dry weight, egg size and egg volume data recorded over 34 spawns by 22 individually-maintained *T. zillii* (strain 'B').

VARIABLES TESTED		UNTRANSFORMED DATA				FOLLOWING LOGARITHMIC TRANSFORMATION OF BOTH DEPENDENT & INDEPENDENT VARIABLES			
Dependent Variable	Independent Variable	Correlation Coefficient (r)	Regression equation (x = independent variable, y = dependent variable)	Coefficient of determination (r ²)	Correlation Coefficient (r)	Regression equation (x = independent variable, y = dependent variable)	Coefficient of determination (r ²)		
Total fecundity	fish weight (g)	0.32 ns	y = 8.95x + 2292.59 ns	0.10	0.33 ns	log y = 0.29logx + 2.92 ns	0.11		
Relative fecundity (eggs/g)	fish length (mm)	0.37 *	y = 24.83x - 1032.55 *	0.13	0.34 *	log y = 1.02logx + 1.23 *	0.12		
	fish weight (g)	-	-	-	-0.66 ***	log y = -0.71logx + 2.92 ***	0.43		
Egg dry weight (mg)	fish length (mm)	-	-	-	-0.62 ***	log y = -2.30logx + 6.61 ***	0.39		
	fish weight (g)	0.14 ns	y = 1.87x10 ⁻⁴ x + 0.47 ns	0.02	0.16 ns	log y = 0.10logx - 0.43 ns	0.03		
Egg diameter (mm)	fish length (mm)	0.19 ns	y = 0.0001x + 0.38 ns	0.04	0.19 ns	log y = 0.23logx - 0.83 ns	0.04		
	fish weight (g)	0.31 ns	y = 0.001x + 1.32 ns	0.10	0.33 ns	log y = 0.06logx + 0.02 ns	0.11		
Egg volume (mm ³)	fish length (mm)	0.30 ns	y = 0.001x + 1.14 ns	0.10	0.30 ns	log y = 0.18logx - 0.27 ns	0.10		
	fish weight (g)	0.38 *	y = 0.002x + 1.01 *	0.15	0.38 **	log y = 0.22logx - 0.36 *	0.15		
	fish length (mm)	0.37 *	y = 0.01x + 0.38 *	0.14	0.36 ns	log y = 0.70logx - 1.49 *	0.13		
Total fecundity	Egg volume (mm ³)	0.30 ns	y = 1503.95x + 1596.87 ns	0.09	0.19 ns	log y = 0.29logx + 3.50 ns	0.04		
EW:BW ratio	fish weight (g)	-0.53 *	y = -2.69x10 ⁻⁴ x + 0.15 **	0.28	-0.56 **	log y = -0.33logx - 0.25 **	0.31		
	fish length (mm)	-0.48 **	y = -0.001x + 0.22 **	0.23	-0.52 *	log y = -1.05logx + 1.43 *	0.27		
Total egg volume (mm ³)	fish weight (g)	0.37 *	y = 20.86x + 1807.80 *	0.14	0.45 **	log y = 0.51logx + 2.56 **	0.20		
	fish length (mm)	0.41 *	y = 55.40x - 5484.09 *	0.17	0.45 **	log y = 1.72logx - 0.26 **	0.20		

N.B. (1) Levels of significance: * = p<0.05, ** = p<0.01, *** = p<0.001

(2) EW:BW ratio was ARCSine transformed prior to statistical analysis.

Correlation and regression analysis was performed using both untransformed (raw) and transformed (\log_{10}) data. Whilst untransformed data have the advantage of being immediately comprehensible, the recommended procedure for this type of data analysis involves logarithmic transformation (Sokal & Rohlf, 1981).

In general, transformation did not tend to improve the strength of the relationship being tested when compared to corresponding analyses of raw untransformed data (refer to coefficients of determination, Tables 3.9 and 3.10). In several cases however, relationships found not to be significant by analysis of raw data were found to be significant following transformation. For this reason, only the results of those analyses involving transformed data are described here. Both transformed and untransformed regressions are included however, in the accompanying figures.

Examination of transformed data demonstrate strong relationships with total fecundity (and fish length or weight), with total egg volume (and fish length or weight) and with relative fecundity (and fish length or weight). In these cases coefficients of determination range from 0.22 - 0.48 (in strain 'A') and from 0.11 - 0.43 (in strain 'B'). All other analyses (i.e. those involving egg size) tended to exhibit far smaller coefficients of determination indicating much weaker relationships, despite several of these relationships proving to be significant.

(1) Total fecundity. Significant positive relationships were found between total fecundity and fish length in both strain 'A' ($r^2 = 0.46$, $p < 0.001$, Figure 3.5d - see Figure 3.5c for untransformed data) and strain 'B' ($r^2 = 0.12$, $p < 0.05$, Figure 3.6d - see Figure 3.6c for untransformed data). The relationship was much weaker in strain 'B' however with only 12% of the data points being covered by the line of regression compared to 46% in strain 'A'. A very significant positive relationship was also found between total fecundity and fish weight in strain 'A' ($r^2 = 0.48$ $p < 0.001$, Figure 3.5b - see Figure 3.5a for untransformed data) but interestingly not in strain 'B' ($r^2 = 0.11$, relationship not significant, Figure 3.6b - see Figure 3.6a for untransformed data).

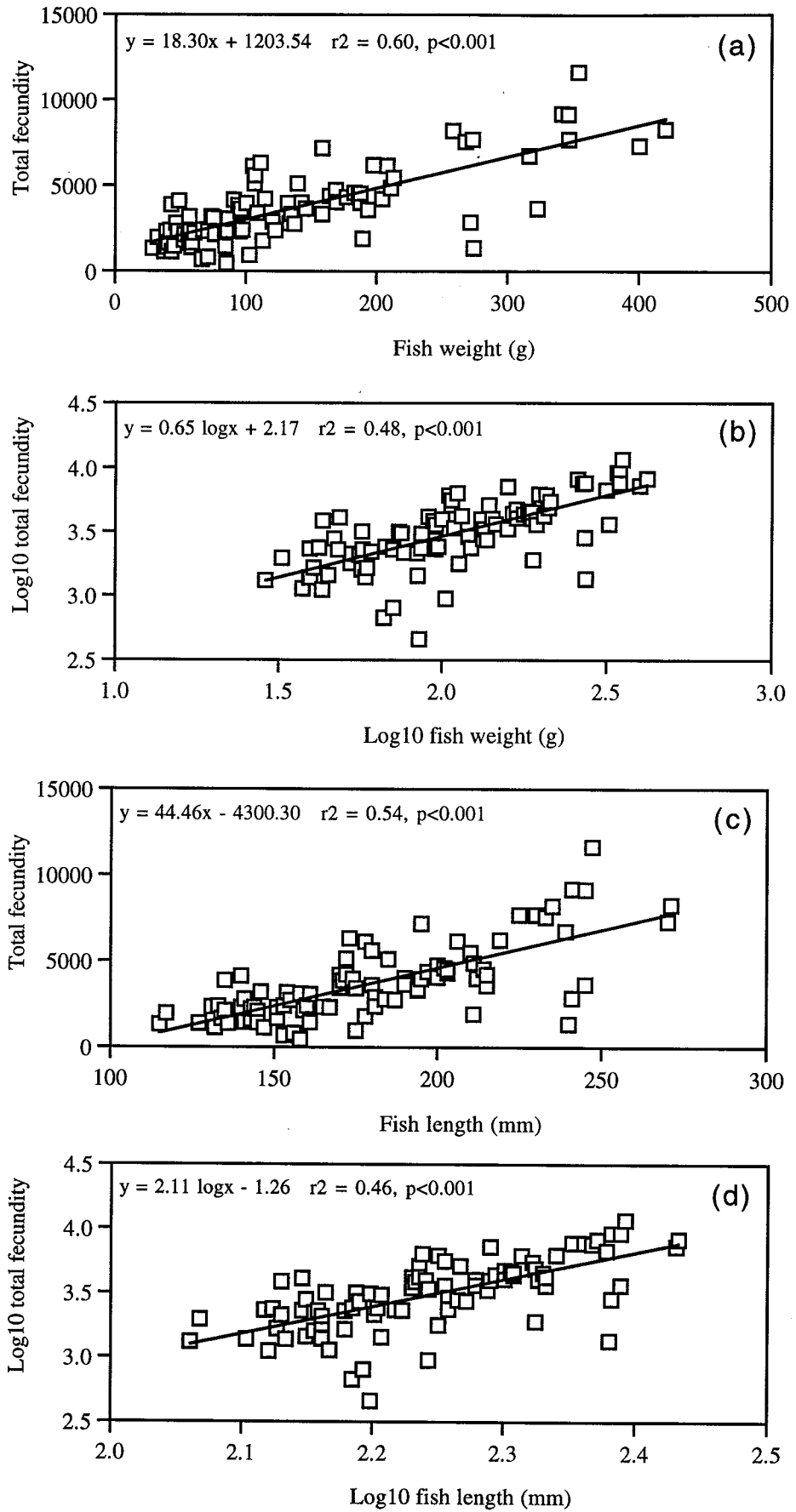

Figure 3.5. Relationships between total fecundity and fish size in *T. zillii* (strain 'A'): (a) total fecundity and fish weight, (b) total fecundity and fish weight (log10 transformed), (c) total fecundity and fish length and (d) total fecundity and fish length (log10 transformed).

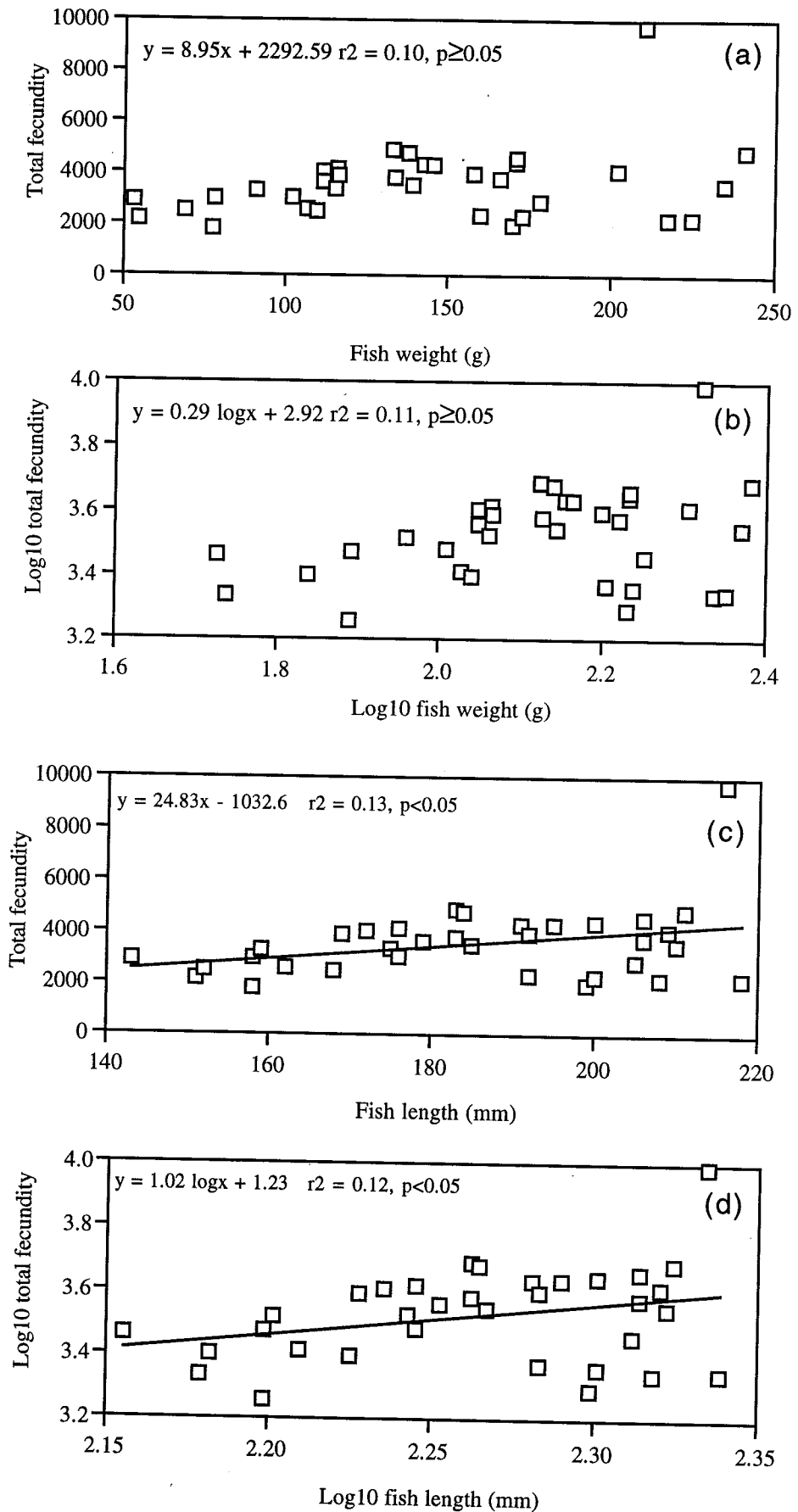

Figure 3.6. Relationships between total fecundity and fish size in *T. zillii* (strain 'B'): (a) total fecundity and fish weight, (b) total fecundity and fish weight (log₁₀ transformed), (c) total fecundity and fish length and (d) total fecundity and fish length (log₁₀ transformed).

(2) Relative fecundity. Very significant negative relationships (where $p < 0.001$) were observed between relative fecundity and both fish weight and length in both strains of fish.

(3) Egg dry weight. Analysis also found significant positive relationships between egg dry weight and both fish weight ($r^2 = 0.10$, $p < 0.01$) and fish length ($r^2 = 0.10$, $p < 0.01$) in strain 'A' but found these variables to be unrelated in strain 'B'.

(4) Egg diameter. Significant positive relationships were found between egg diameter and both fish weight ($r^2 = 0.06$, $p < 0.05$) and fish length ($r^2 = 0.06$, $p < 0.05$) in strain 'A' but (as with egg dry weight) found these parameters to be unrelated in strain 'B'.

(5) Egg volume. Significant positive relationships were found between egg volume and fish weight (where $p < 0.05$) and fish length (where $p < 0.05$) in both strains of fish, though coefficients of determination were low.

(6) Total fecundity. A positive significant relationship was found between total fecundity and egg volume in strain 'A' ($p < 0.05$) though the coefficient of determination was low ($r^2 = 0.08$). No relationship was detected in strain 'B'.

(7) EW:BW ratio. Significant negative relationships were detected between EW:BW ratio and fish length (where $p < 0.05$ for both strain 'A' & 'B') and between EW:BW ratio and fish weight (where $p < 0.05$ for strain 'A' and $p < 0.01$ for strain 'B').

(6) Total egg volume. Significant positive relationships were found to both fish length and weight in strain 'A' (where $p < 0.001$, see Figures 3.7b and 3.7d - see Figures 3.7a and 3.7c for untransformed data) and in strain 'B' (where $p < 0.01$, see Figures 3.8b and 3.8d - see Figures 3.8a and 3.8c for untransformed data).

(7) Relationships between ISI and fecundity.

Regression analysis failed to detect significant relationships between ISI and fecundity ($p \geq 0.05$) amongst data from either strain 'A' or strain 'B' or when data for the two strains were pooled. Efforts to remove the possible influence of fish size by analysing data that had been categorised according to fish weight also generally failed

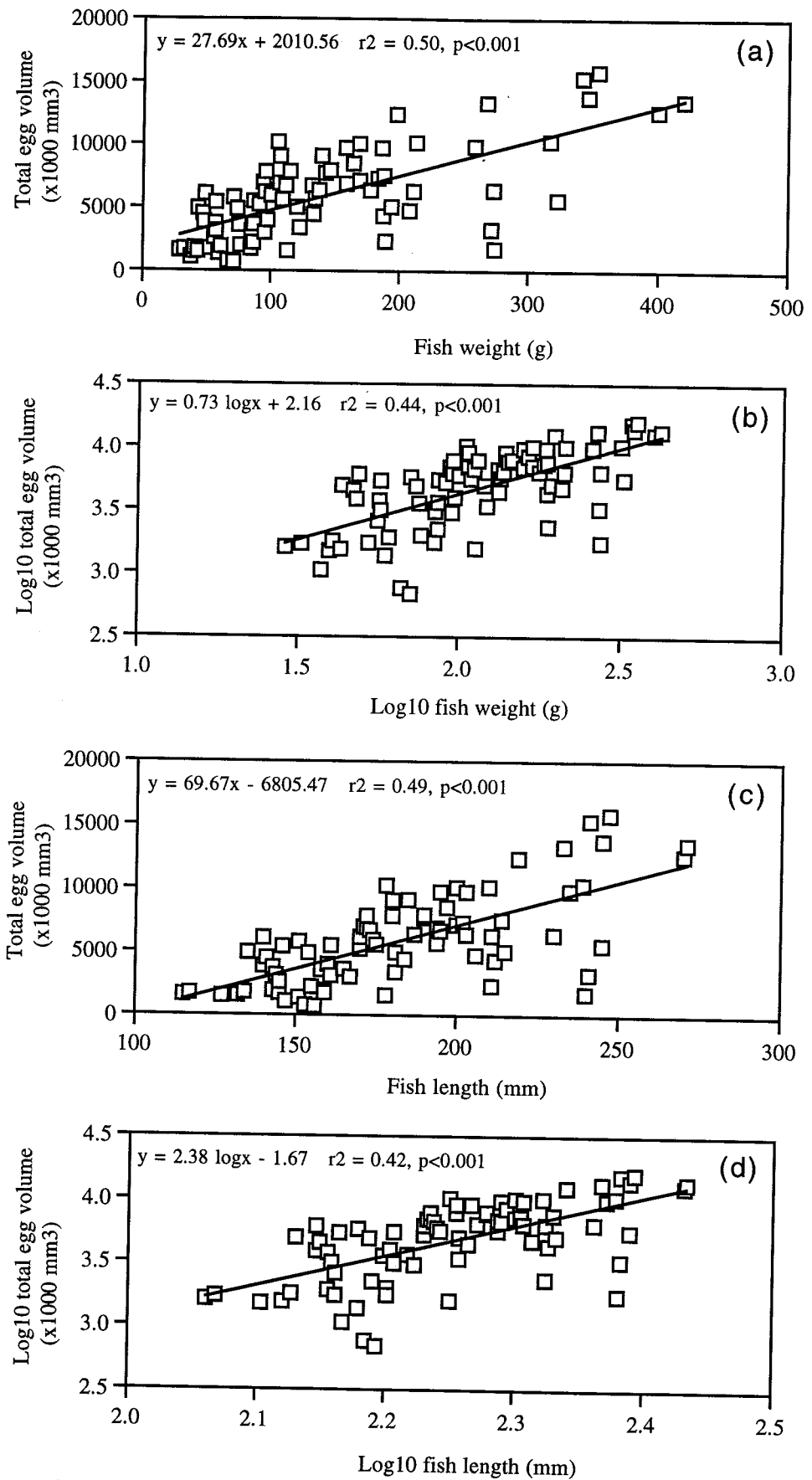

Figure 3.7. Relationships between total egg volume and fish size in *T. zillii* (strain 'A'): (a) total egg volume and fish weight, (b) total egg volume and fish weight (log₁₀ transformed), (c) total egg volume and fish length and (d) total egg volume and fish length (log₁₀ transformed).

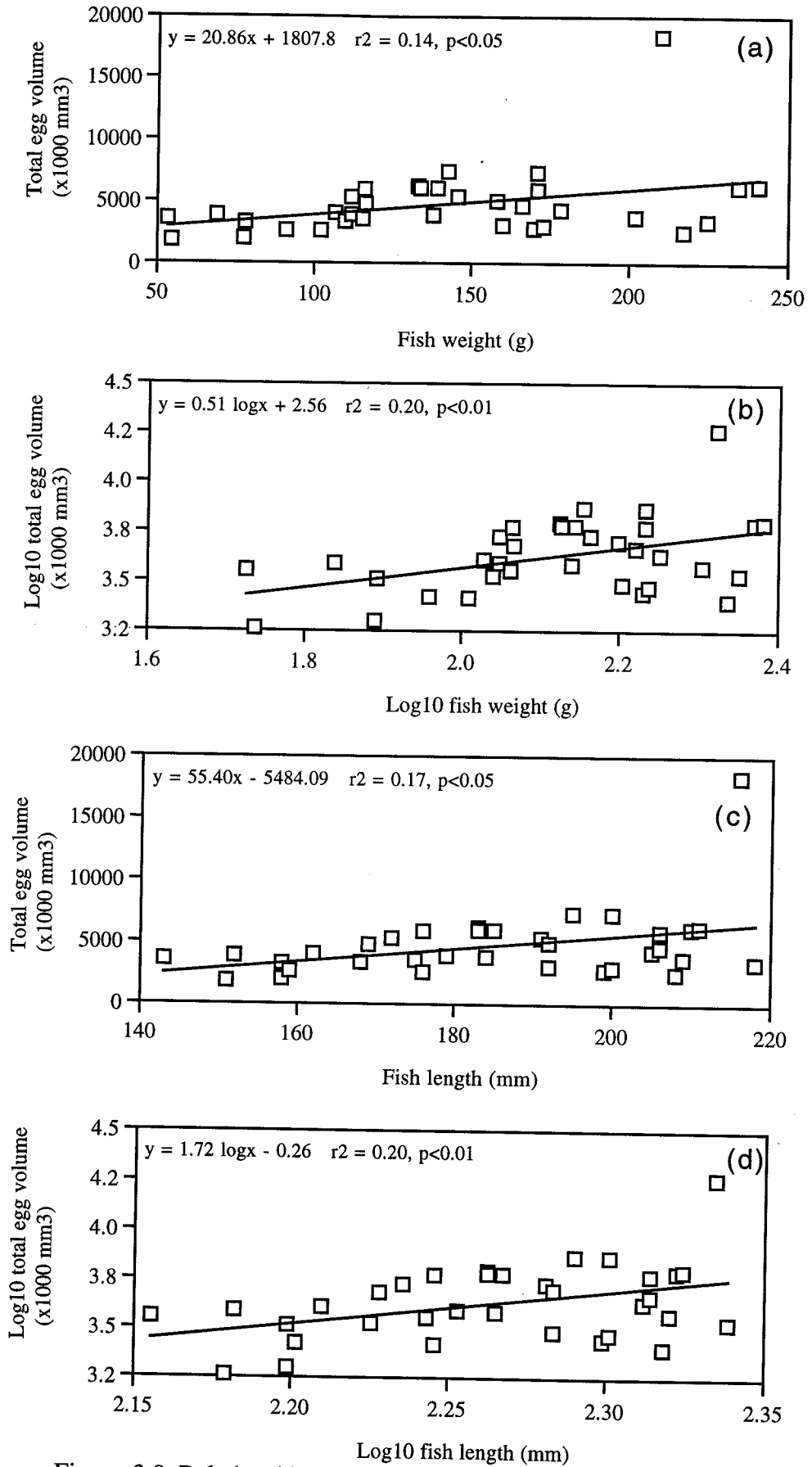

Figure 3.8. Relationships between total egg volume and fish size in *T. zillii* (strain 'B'): (a) total egg volume and fish weight, (b) total egg volume and fish weight (log₁₀ transformed), (c) total egg volume and fish length and (d) total egg volume and fish length (log₁₀ transformed).

Table 3.11a. Regression analysis of ISI and fecundity for strain 'A' data.

Fish weight (g)	Independent variable (x)	Dependent variable (y)	Test result
0 - 49g (n = 4)	(1) ISI	(1) Total fecundity	ns ($p \geq 0.05$)
	(2) Log ₁₀ ISI	(2) Log ₁₀ total fecundity	ns ($p \geq 0.05$)
50 - 99g (n = 10)	(1) ISI	(1) Total fecundity	ns ($p \geq 0.05$)
	(2) Log ₁₀ ISI	(2) Log ₁₀ total fecundity	ns ($p \geq 0.05$)
100 - 149g (n = 7)	(1) ISI	(1) Total fecundity	ns ($p \geq 0.05$)
	(2) Log ₁₀ ISI	(2) Log ₁₀ total fecundity	Significant ($p < 0.05$) *
150g+ (n = 6)	(1) ISI	(1) Total fecundity	ns ($p \geq 0.05$)
	(2) Log ₁₀ ISI	(2) Log ₁₀ total fecundity	ns ($p \geq 0.05$)

* see Figure 3.9a for regression equation.

Table 3.11b. Regression analysis of ISI and fecundity for strain 'B' data.

Fish weight (g)	Independent variable (x)	Dependent variable (y)	Test result
50 - 99g (n = 3)	(1) ISI	(1) Total fecundity	ns ($p \geq 0.05$)
	(2) Log ₁₀ ISI	(2) Log ₁₀ total fecundity	ns ($p \geq 0.05$)
100 - 149g (n = 4)	(1) ISI	(1) Total fecundity	ns ($p \geq 0.05$)
	(2) Log ₁₀ ISI	(2) Log ₁₀ total fecundity	ns ($p \geq 0.05$)
150g+ (n = 6)	(1) ISI	(1) Total fecundity	ns ($p \geq 0.05$)
	(2) Log ₁₀ ISI	(2) Log ₁₀ total fecundity	ns ($p \geq 0.05$)

Table 3.11c. Regression analysis of ISI and fecundity for pooled strain 'A' & 'B' data.

Fish weight (g)	Independent variable (x)	Dependent variable (y)	Test result
0 - 49g (n = 4)	(1) ISI	(1) Total fecundity	ns ($p \geq 0.05$)
	(2) Log ₁₀ ISI	(2) Log ₁₀ total fecundity	ns ($p \geq 0.05$)
50 - 99g (n = 13)	(1) ISI	(1) Total fecundity	ns ($p \geq 0.05$)
	(2) Log ₁₀ ISI	(2) Log ₁₀ total fecundity	ns ($p \geq 0.05$)
100 - 149g (n = 11)	(1) ISI	(1) Total fecundity	ns ($p \geq 0.05$)
	(2) Log ₁₀ ISI	(2) Log ₁₀ total fecundity	Significant ($p < 0.05$)*
150g+ (n = 12)	(1) ISI	(1) Total fecundity	ns ($p \geq 0.05$)
	(2) Log ₁₀ ISI	(2) Log ₁₀ total fecundity	ns ($p \geq 0.05$)

* see Figure 3.9b for regression equation.

to reveal significant relationships between ISI and fecundity (see Tables 3.11a,b,c). A significant relationship ($p < 0.05$) was, however, detected between ISI and fecundity in strain 'A' fish weighing 100 - 150g (see Table 3.11a and Figure 3.9a) but only in the case of \log_{10} transformed data. This relationship was also detected when data for strain 'A' and strain 'B' were pooled (Table 3.11c and Figure 3.9b).

(8) Relationships between ISI and mean egg volume.

Regression analysis failed to detect significant relationships between ISI and mean egg volume ($p \geq 0.05$) amongst data from either strain 'A' or strain 'B' or when data for the two strains were pooled. As with total fecundity (above), analysis of data that had been categorised according to weight also generally failed to reveal significant relationships between ISI and mean egg volume (see Tables 3.12a,b,c). Significant relationships were, however, detected between ISI and mean egg volume in strain 'A' fish weighing $< 49\text{g}$ (see Table 3.12a and Figures 3.10a and 3.10b).

(3.3.3) Summary.

Mean total fecundities did not differ significantly between strains 'A' and 'B' and were ~ 3605 and ~ 3560 respectively. In both strains, mean total fecundity increased with increasing fish weight. The highest fecundity was 11640 in a strain 'A' fish weighing $\sim 354\text{g}$. There was also a tendency (in both strains) for increased variation in fecundity as fish size increased. Mean relative fecundity fell steadily with increasing fish size (in both strains); no significant difference was found between the two strains when comparing mean overall relative fecundity. A significant relationship ($p < 0.05$) was detected between ISI and fecundity in strain 'A' fish weighing 100 - 150g (also detected when data for the two strains were pooled) but was not found in other weight categories.

Mean egg volume generally increased with increasing fish size (in both strains) and was significantly ($p < 0.05$) larger in strain 'A' than strain 'B'. Mean egg dry weight and mean egg diameter did not appear to relate to fish size and were not significantly different between the two strains; fish weighing 100 - 200g generally produced the

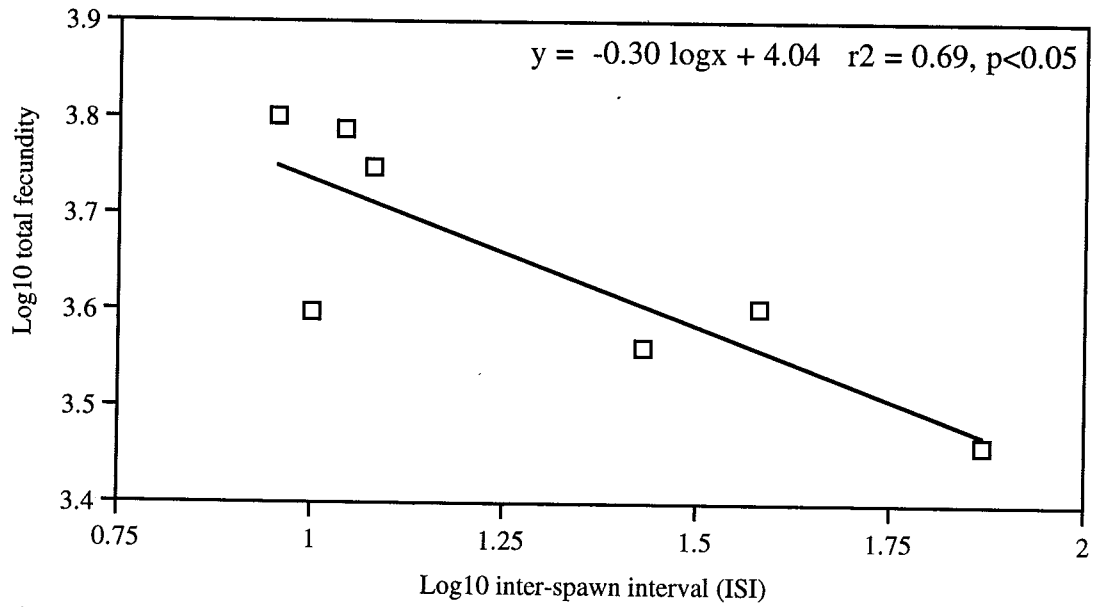

Figure 3.9a. Regression analysis of log10 inter-spawn-interval (ISI) and log10 total fecundity in seven *T. zillii* (strain 'A') weighing 100 - 149g.

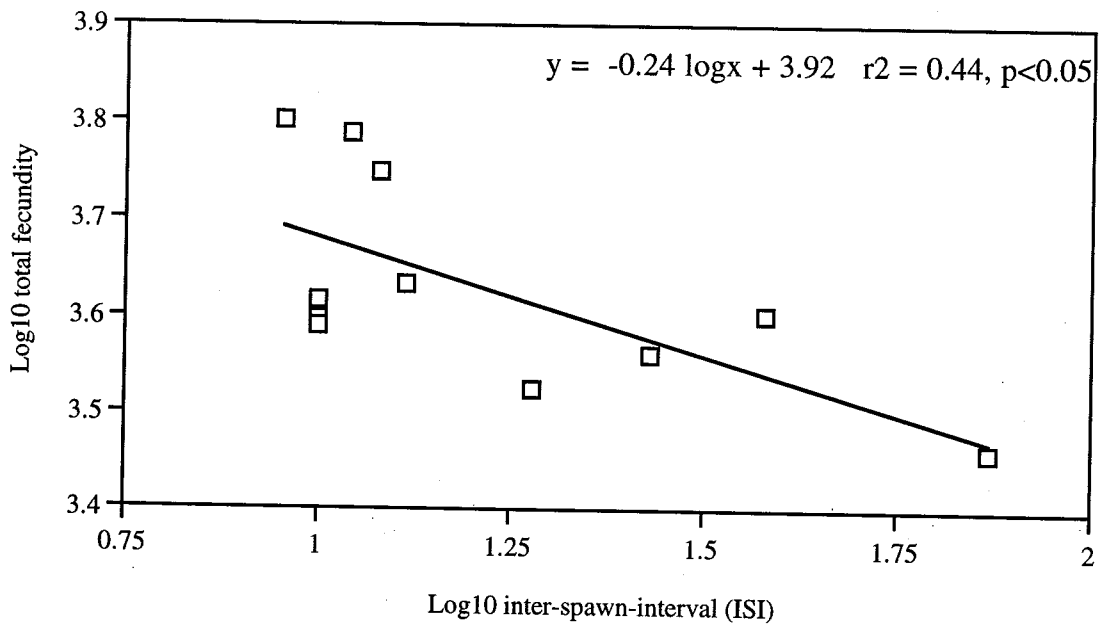

Figure 3.9b. Regression analysis of log10 inter-spawn-interval (ISI) and log10 total fecundity in *T. zillii* weighing 100 - 149g (data pooled from strain 'A' & strain 'B', n = 11).

Table 3.12a. Regression analysis of ISI and mean egg volume for strain 'A' data.

Fish weight (g)	Independent variable (x)	Dependent variable (y)	Test result
0 - 49g (n = 4)	(1) ISI	(1) Total fecundity	Significant (p<0.05)*
	(2) Log ₁₀ ISI	(2) Log ₁₀ total fecundity	Significant (p<0.05)**
50 - 99g (n = 10)	(1) ISI	(1) Total fecundity	ns (p≥0.05)
	(2) Log ₁₀ ISI	(2) Log ₁₀ total fecundity	ns (p≥0.05)
100 - 149g (n = 7)	(1) ISI	(1) Total fecundity	ns (p≥0.05)
	(2) Log ₁₀ ISI	(2) Log ₁₀ total fecundity	ns (p≥0.05)
150g+ (n = 6)	(1) ISI	(1) Total fecundity	ns (p≥0.05)
	(2) Log ₁₀ ISI	(2) Log ₁₀ total fecundity	ns (p≥0.05)

* see Figure 3.10a for regression equation.

** see Figure 3.10b for regression equation.

Table 3.12b. Regression analysis of ISI and mean egg volume for strain 'B' data.

Fish weight (g)	Independent variable (x)	Dependent variable (y)	Test result
50 - 99g (n = 3)	(1) ISI	(1) Total fecundity	ns (p≥0.05)
	(2) Log ₁₀ ISI	(2) Log ₁₀ total fecundity	ns (p≥0.05)
100 - 149g (n = 4)	(1) ISI	(1) Total fecundity	ns (p≥0.05)
	(2) Log ₁₀ ISI	(2) Log ₁₀ total fecundity	ns (p≥0.05)
150g+ (n = 6)	(1) ISI	(1) Total fecundity	ns (p≥0.05)
	(2) Log ₁₀ ISI	(2) Log ₁₀ total fecundity	ns (p≥0.05)

Table 3.12c. Regression analysis of ISI and mean egg volume for pooled strain 'A' & 'B' data.

Fish weight (g)	Independent variable (x)	Dependent variable (y)	Test result
0 - 49g (n = 4)	(1) ISI	(1) Total fecundity	Significant (p<0.05)*
	(2) Log ₁₀ ISI	(2) Log ₁₀ total fecundity	Significant (p<0.05)**
50 - 99g (n = 13)	(1) ISI	(1) Total fecundity	ns (p≥0.05)
	(2) Log ₁₀ ISI	(2) Log ₁₀ total fecundity	ns (p≥0.05)
100 - 149g (n = 11)	(1) ISI	(1) Total fecundity	ns (p≥0.05)
	(2) Log ₁₀ ISI	(2) Log ₁₀ total fecundity	ns (p≥0.05)
150g+ (n = 12)	(1) ISI	(1) Total fecundity	ns (p≥0.05)
	(2) Log ₁₀ ISI	(2) Log ₁₀ total fecundity	ns (p≥0.05)

* see Figure 3.10a for regression equation.

** see Figure 3.10b for regression equation.

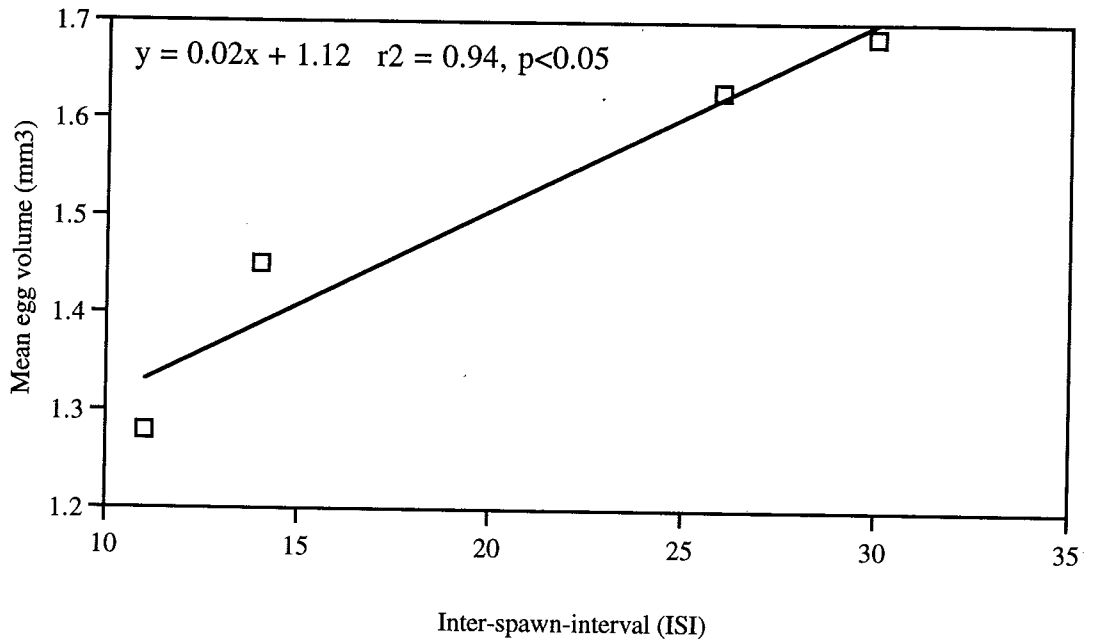

Figure 3.10a. Regression analysis of inter-spawn interval (ISI) and mean egg volume in four *T. zillii* (strain 'A') weighing <49g.

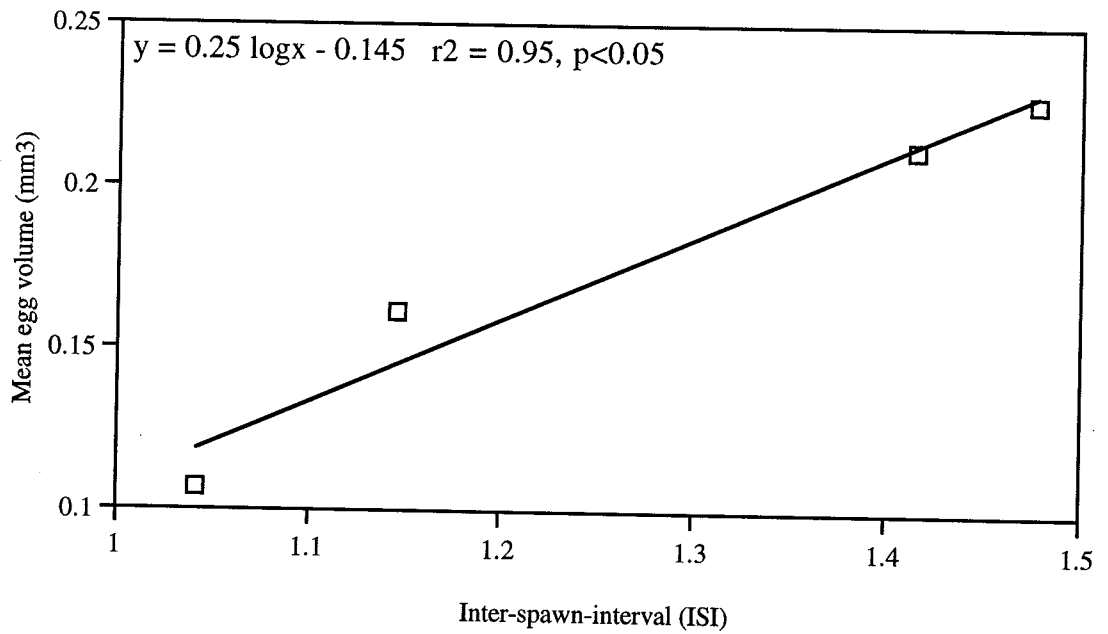

Figure 3.10b. Regression analysis of log₁₀ inter-spawn interval (ISI) and log₁₀ mean egg volume in four *T. zillii* (strain 'A') weighing <49g.

largest eggs however. No significant differences were found between the two strains in terms of either total egg volume (which increased with increasing fish size) or EW:BW ratio (which decreased with increasing fish size). A significant relationship was detected between ISI and mean egg volume in strain 'A' fish weighing <49g but was not observed amongst fish weighing >50g.

Regression analysis of log₁₀ transformed data revealed strong relationships between fish size and total fecundity, between fish size and total egg volume and between fish size and relative fecundity. All other analyses (i.e. those involving egg size) tended to indicate much weaker relationships despite several proving to be significant.

ANCOVA failed to detect significant differences between strain 'A' and strain 'B' in terms of either total fecundity, mean egg diameter or total egg volume, though the ANCOVA may not have been as robust since in each test residual variances and slopes were heterogeneous (except in the case of total fecundity where residual variance was homogeneous).

(3.4) Experiment 3: Variation of fecundity and egg size over consecutive spawns in serial spawning *T.zillii*.

This investigation analysed data from serial-spawning females utilised in Experiments 1 and 2 that spawned four or more times in succession during one observation period. Total fecundity, relative fecundity (eggs/g), mean egg diameter, mean egg volume and mean egg dry weight were calculated as described in Experiment 2 (above).

(3.4.1) Results.

Fecundity and egg size data from repeat-spawning strain 'B' fish were unfortunately limited since (a) sample size was low (n=34 spawns recorded) and (b) only 4.5% of strain 'B' fish spawned 4 times or more in succession during the period of study. Similarly, only 5.9% of strain 'A' fish spawned 4 times or more in

succession but since the sample size was much larger ($n=91$), it was possible to compile a full dataset of reproductive traits from a reasonable number of fish (6) spawning between 4 and 8 times in succession.

Since the 6 fish varied markedly in weight (39.6g - 158.4g) it was considered unwise to group data according to fish weight but rather to treat each fish separately. As a result, statistical analysis was limited to the use of coefficients of variation (CV, see Section 2.8.2). Since variation in body weight was evident, only relative fecundity (eggs/g) and egg volume (mm^3) are presented diagrammatically in Figure 3.11. This is because relative fecundity is probably the best index of egg production to use under these circumstances since it normalises fecundity data for body weight. It should be noted however, that relative fecundity data are subject to autocorrelation when related to fish weight (see Section 3.1). Egg volume is also presented in Figure 3.11 since it is considered the best index of egg size. Further data (fish weight, total fecundity, egg diameter, egg dry weight and total egg volume) are given for each repeat spawn by each of the six fish in Table 3.13.

Definite trends over successive spawns were only observed in terms of body weight. Body weight was found to increase steadily with each successive spawn in each of the six fish (Table 3.13). Relative fecundity exhibited quite marked variation with successive spawns in each fish (CV ranged from 10.37% over 5 spawns in fish 5 to 46.65% over 5 spawns in fish 4, Figure 3.11). Mean egg volume was also found to exhibit variation with successive spawns but to a lesser extent than relative fecundity (CV ranged from 3.29% over 5 spawns in fish 4 to 17.44% in fish 6). There was no obvious trend common to all 6 fish in terms of such variation in relative fecundity and egg volume. That is to say, neither relative fecundity nor egg volume followed a set trend over successive spawns (i.e. a tendency to increase or decrease with successive spawns) that was common to all 6 fish. Upon examination of the dataset for each individual fish it became apparent that the variation observed in relative fecundity and egg volume over successive spawns were surprisingly not related to the length of the respective spawning cycles. For example in any one fish, a longer spawning cycle

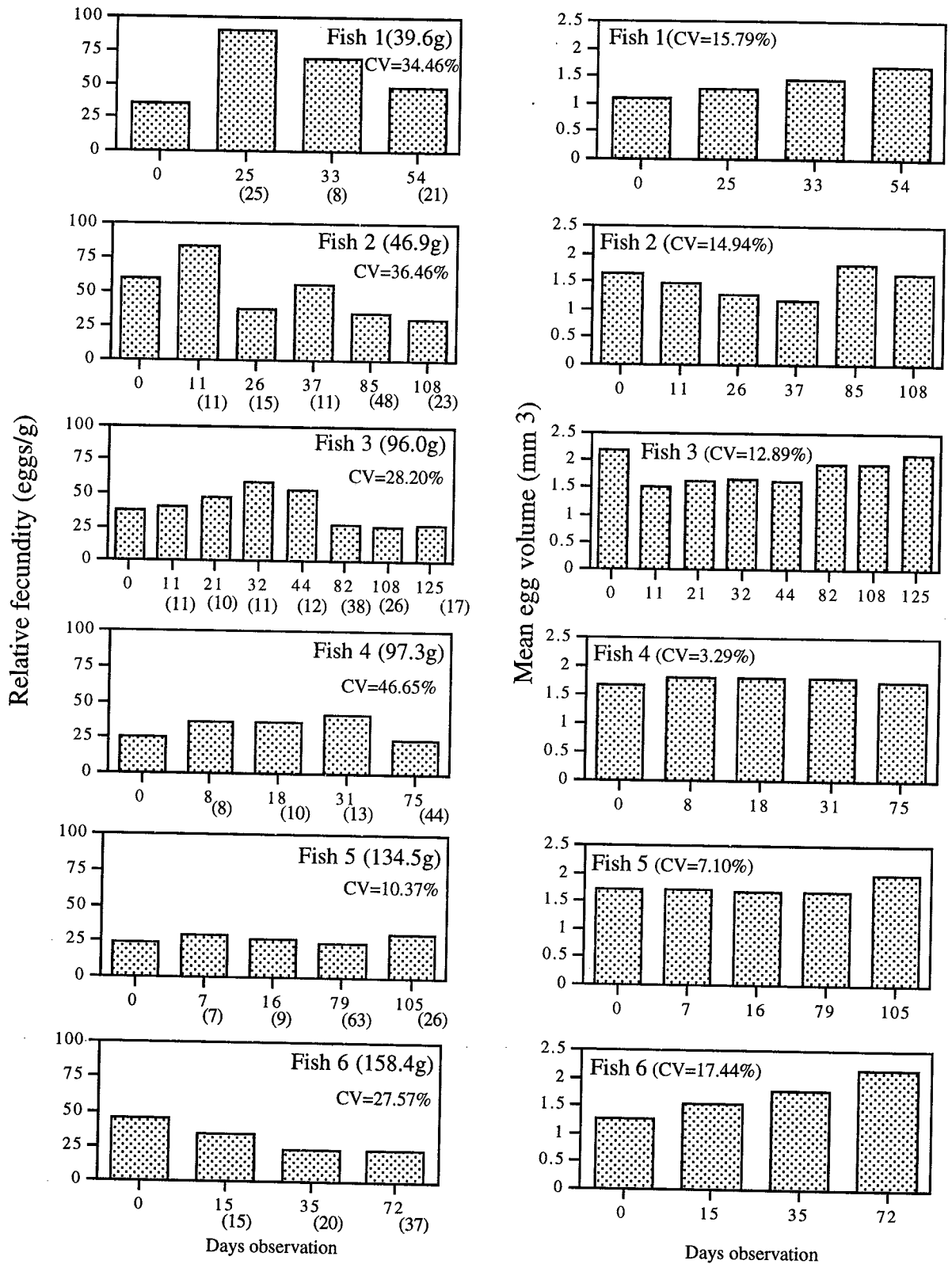

Figure 3.11. Variation of relative fecundity (eggs/g) and mean egg volume (mm³) over successive spawns in six serial-spawning *T. zillii* (Strain 'A'). Weights given are those noted at the time of the first spawn. The number of days elapsed since last spawn is given in brackets on the x-axis. CV = coefficient of variation (see Section 2.8.2).

Table 3.13. Variation of fish weight, total fecundity, egg diameter, egg dry weight and total egg volume over successive spawns in six serial spawning *T. zillii* (strain 'A').

Spawn No.	FISH 1				FISH 2				FISH 3						
	Weight (g)	Total fecundity	Mean egg diameter (mm)	Mean egg dry weight (mg)	Total egg volume (x1000 mm ³)	Weight (g)	Total fecundity	Mean egg diameter (mm)	Mean egg dry weight (mg)	Total egg volume (x1000 mm ³)	Weight (g)	Total fecundity	Mean egg diameter (mm)	Mean egg dry weight (mg)	Total egg volume (x1000 mm ³)
1	39.6	1377	1.35	0.43	1.51	46.9	2779	1.53	0.60	4.53	96.0	3603	1.66	0.61	7.82
2	43.2	3856	1.42	0.52	4.93	48.7	4103	1.47	0.48	6.08	100.1	3957	1.46	0.55	5.96
3	45.0	3100	1.42	0.47	4.50	55.9	2073	1.38	0.70	2.59	102.1	4830	1.46	0.55	7.87
4	48.1	2295	1.17	0.43	3.87	57.0	3181	1.53	0.64	5.41	105.3	6132	1.51	1.10	10.21
5	-	-	-	-	-	86.6	3053	1.58	0.67	5.50	107.1	5597	1.51	0.60	9.07
6	-	-	-	-	-	108.83	3402	1.51	0.56	5.60	142.4	4009	1.61	0.80	7.73
7	-	-	-	-	-	-	-	-	-	-	164.1	4374	1.60	0.74	8.52
8	-	-	-	-	-	-	-	-	-	-	168.8	4737	1.64	0.72	10.08
C.V.(%)*	6.99	34.71	8.81	8.00	41.23	33.74	19.82	4.58	12.02	25.46	22.99	17.31	5.17	24.16	16.56

Spawn No.	FISH 4				FISH 5				FISH 6						
	Weight (g)	Total fecundity	Mean egg diameter (mm)	Mean egg dry weight (mg)	Total egg volume (x1000 mm ³)	Weight (g)	Total fecundity	Mean egg diameter (mm)	Mean egg dry weight (mg)	Total egg volume (x1000 mm ³)	Weight (g)	Total fecundity	Mean egg diameter (mm)	Mean egg dry weight (mg)	Total egg volume (x1000 mm ³)
1	97.3	2400	1.52	0.53	4.00	134.5	3320	1.56	0.61	5.71	158.4	7167	1.41	0.50	9.74
2	95.6	3445	1.56	0.48	6.20	132.1	3952	1.56	0.47	6.71	164.0	5700	1.41	0.55	8.84
3	95.0	3600	1.56	0.50	6.52	135.2	4201	1.56	0.50	7.06	169.3	4038	1.54	0.62	7.16
4	93.9	3844	1.56	0.53	6.97	187.8	4523	1.57	0.68	7.53	186.4	4503	1.66	0.68	9.73
5	120.2	2894	1.55	0.54	5.00	197.6	6201	1.63	0.66	12.39	-	-	-	-	-
6	-	-	-	-	-	-	-	-	-	-	-	-	-	-	-
7	-	-	-	-	-	-	-	-	-	-	-	-	-	-	-
8	-	-	-	-	-	-	-	-	-	-	-	-	-	-	-
C.V.(%)*	9.96	16.29	1.11	4.35	21.19	42.80	44.78	1.93	14.47	33.12	6.18	22.62	7.98	11.63	13.72

* Coefficient of variation (see Section 2.8.2)

(relative to the previous cycle) did not appear to result in either more eggs of similar size or fewer eggs of greater size (as one might expect). Similarly, there was no clear relationship between spawning periodicity and observed variation over successive spawns in total fecundity, egg dry weight and total egg volume.

(3.4.2) Summary.

Data from six fish spawning four or more times in succession were analysed to investigate how reproductive traits such as fecundity and egg size vary over successive spawns. In each fish, body weight increased steadily with each spawn. Relative fecundity exhibited quite marked variation with successive spawns (CV ranged from 10.37% to 46.65% over 5 spawns). Mean egg volume also exhibited variation but to a lesser extent. There was no obvious trend common to all six fish in terms of these parameters. Moreover, variation did not appear to be related to spawning periodicity. Similarly, there was no clear relationship between spawning periodicity and variation in total fecundity, egg dry weight and total egg volume over successive spawns.

(3.5) Discussion.

Currently, intensive tilapia hatcheries are constrained through fecundity variation amongst individuals, variation in spawning interval and asynchronous spawning cycles. Inherently low fecundity and the asynchronous nature of spawning in tilapia under hatchery conditions necessitates the use of extensive facilities and time consuming (and costly) management of large numbers of fish in order to maintain a consistent supply of quality fry. Such requirements may however, be reduced in part by selecting and utilising broodstock exhibiting optimal reproductive traits such as egg size, fecundity and egg to body weight ratio (Rana, 1986). Data already exist to suggest that genetic inheritance for qualities such as colour, body shape, growth rate and fecundity are indeed measurable and may be selected-for (see Macintosh & Little, 1995). It has become evident that heritability in tilapiines is complex and is often obscured by their well developed environmental adaptability (Behrends *et al.*, 1988).

By breeding tilapia and incubating fry under controlled conditions, selection for desirable traits can proceed rapidly. This is aided further by the short generation time of tilapias and their ability to spawn at frequent intervals (Macintosh & Little, 1995).

The present study aimed to investigate spawning periodicity and various reproductive traits such as fecundity and egg size in the substrate spawning tilapia *T. zillii*. In contrast to earlier studies of this species, this work involved broodstock held in environmentally controlled aquaria thus attempting to control for variations in food availability/quality, photoperiod and water temperature/quality that may be experienced under natural conditions. Attempts were made to relate reproductive traits such as fecundity and egg size to fish size (length and weight) in order that such relationships may be used to predict reproductive potential of a given broodstock. The possible influence of maternal age over such traits was not investigated since available broodstock were of largely unknown age structure. Broodstock length and weight are however, generally indicative of age. Many of the limited existing publications of spawning periodicity in *T. zillii* originate from studies of wild stocks in isolated ponds and lakes and do not generally consider spawning periodicity together with fecundity or egg size. The most detailed study of reproduction in *T. zillii*, that by Dadzie & Wangila (1980), analysed fecundity and egg size in a stunted population of *T. zillii* but did not determine spawning periodicity in these fish. Since tilapias are multiple spawners, fecundity alone does not represent the best estimate of reproductive output, spawning periodicity should be also considered.

That females in the present study were not subject to conspecific male contact may perhaps explain why approximately 34% and 41% of strain 'A' & 'B' respectively failed to spawn during average observation periods of 80 and 58 days respectively. Nevertheless, approximately 66% and 59% of strains 'A' & 'B' respectively were observed to spawn at least once, concurring with those studies made by Aronson (1945), Marshall (1972) and Silverman (1978a, 1979b) who reported that tilapias are able to spawn regularly even when isolated. Studies by Srisakultiew (1993) found that male *O. niloticus* separated from females by plastic partitions through which water

supply was circulated were capable of stimulating adjacent females via both chemical and visual stimuli. The results of an experiment presented in Chapter 6 (Section 6.4) however found that visual and chemical stimulus from adjacent males did not significantly alter spawning rates in *T. zillii* when compared to females deprived of male contact. Larger scale investigations into the effect of conspecific males on spawning periodicity in *T. zillii* are required both under natural conditions and in aquaria.

In both strains of *T. zillii*, mean ISI exhibited a complex relationship to fish size though the smallest fish exhibited the shortest ISI's and the largest fish exhibited the longest ISI's. These results are contrary to those reported for the three-spined stickleback; providing food supply was sufficient, larger females spawned more often during the spawning season, produced more eggs/spawn and exhibited shorter ISIs than smaller fish (Wootton, 1973a). In the present study, overall mean ISI was found to be approximately 26 days in strain 'A', similar to that reported for Lake Quarun *T. zillii* by El-Zarka (1956) and indeed several mouthbrooding species (see Rana (1988)). The mean ISI observed in strain 'B' was much shorter at 15 days. In the present study, mean ISI was based solely on completed reproductive cycles and therefore underestimates true spawning periodicity. The best index of spawning periodicity is considered to be 'mean days elapsed/spawn' (thus taking into account both spawning and non-spawning fish). As with ISI, mean days elapsed/spawn increased in both strains of *T. zillii* with increasing fish size and averaged 61.4 days and 37.5 days in strain 'A' and 'B' respectively. Interestingly though, for a given weight class, considerable variation in spawning interval was evident. The shortest spawning cycles observed were just 7 days and 6 days for strain 'A' and 'B' respectively, considerably shorter than the shortest cycle (15 days) observed by Cridland (1962).

Little is known of the factors governing spawning periodicity in *T. zillii* though environmental factors such as water temperature have been suggested to play crucial roles (El-Zarka, 1956, 1962). Since water temperature was controlled in the present study, it is unlikely that changes in water temperature could account for the observed variability in spawning periodicity. Mean ISI and mean days elapsed/spawn were both

found to increase in both strains of *T. zillii* with increasing fish size. In studying *O. macrocephala*, Lowe-McConnell (1982) observed that spawning capacity decreased with age and postulated that the same may well hold true in other tilapias. Since body size is largely indicative of age it seems possible that the reason larger *T. zillii* exhibit longer spawning cycles is because of senescence. This is discussed in further detail later in this section. Tacon *et al.* (1996) suggested that observed variability in ISI in aquaria-held *O. niloticus* was probably due to genetic differences between females and also from the physiological response of individuals to a variety of factors such as social status and conspecific stimulation. Tacon *et al.* (1996) further suggested that since several batches of small early vitellogenic oocytes were present at the time of spawning in *O. niloticus* (also witnessed in *T. zillii*, see Chapter 5), such variability in ISI may in part be related to the number of oocytes in such developing batches and the time taken to complete vitellogenesis. It is conceivable that this may also hold true for *T. zillii* and will be discussed further in Chapter 5.

Number of spawnings per breeding season in the three-spined stickleback and the convict cichlid is related to food ration size (Wootton, 1990). This is unlikely to be the case in the present study since fish were fed *ad libitum*.

Srisakultiew (1993) further suggested that spawning periodicity in *O. niloticus* may also depend upon absolute peaks of testosterone (T) during the reproductive cycle. Females with lower absolute peaks of T exhibited longer reproductive cycles than those with higher peaks. The relationship between sex steroids, ovarian development and length of spawning cycles in *T. zillii* will be investigated and discussed further in Chapter 5.

When spawning data were compared in the two strains of *T. zillii* it was found that mean ISI was significantly shorter (by approximately 10 days) in strain 'B' than strain 'A'. Furthermore, mean number of days elapsed/spawn was approximately 24 days shorter in strain 'B'. Whilst many more strain 'A' fish were observed than strain 'B', the fact that the mean weight of fish did not differ significantly between the two strains suggests that this difference in spawning periodicity is real and not due to

differential sample size. The reason for this difference is unknown but since both strains had been maintained under identical environmental conditions prior to and during the experiment, such differences are more likely due to genetic factors rather than physiological response to variation within the culture environment.

A further curious difference between strain 'A' and 'B' was that on average strain 'B' fish spawned significantly sooner (by approx. 10 days) when transferred from stock conditions into partitioned aquaria. It is also unclear as to why this is so but may be linked to differences in egg size between the two strains. Egg volume was found to be significantly smaller in strain 'B'. Studies described in Chapter 6 found that female *T. zillii* held in confined stock conditions (identical to those conditions from which broodstock were taken for the present study) failed to spawn but displayed a tendency to spawn soon after transfer to individually-partitioned aquaria. The ovaries of confined fish appeared to change very little during such periods of confinement and appeared to possess large proportions of vitellogenic oocytes coincident with suppressed levels of circulating sex steroids. It is possible that low steroid levels are not sufficient to allow completion of oocyte growth and that the length of time taken for the first spawn to occur after transfer to individual aquaria is simply a reflection of the time needed for renewed oocyte growth (which coincides with rising sex steroid levels) to reach completion, thus taking longer in strain 'A' since egg volume was larger.

The smallest spawning fish observed in the present study were 28.9g (115mm) and 53.2g (143mm) in strain 'A' and 'B' respectively. This compares to 120mm *T. zillii* in Lake Naivasha (Siddiqui, 1979), 130mm in Lake Victoria (Welcomme, 1967) and just 70mm and 66cm in overcrowded ponds (Lowe-McConnell, 1955; Dadzie & Wangila, 1980 respectively). Tilapias have the ability to alter the age and size at which they attain maturity in response to the environment (Rana, 1988). Maturation is often delayed in stable environments such as lakes but is often found to occur much earlier in unstable environments such as rivers and under culture conditions (Lowe-McConnell, 1958, 1975; 1982; Fryer & Iles, 1972; Noakes & Balon, 1982; Phillipart & Ruwet, 1982). The evolutionary significance of this tactic is still unresolved (Rana, 1988) but

since ancestral tilapias probably evolved in unstable riverine & fluvial habitats, early maturation is thought to be an adaptation for the rapid colonisation of newly formed but temporary water bodies. Peters (1983) observed however, that the time at which tilapias first spawn is not necessarily an index of the attainment of first maturity since several spawns may have been produced and resorbed before first oviposition occurs.

In determining total fecundity in *T. zillii*, it became highly apparent that to avoid underestimation, egg clutches needed to be removed from aquaria soon after spawning had occurred. On two separate occasions, post-spawned females were seen to eat (or at least take into their mouths) a proportion of their eggs. Similar observations were made by Bruton & Gophen (1992) who claimed that *T. zillii* preyed on unfertilized eggs and Peters (1983) who found that 40% of post-spawned *T. tholloni* (*T. zillii* strain 'B' in the present study) had eggs in their stomachs. The extent of this behaviour was highlighted by Schwank (1986) who found that 41% of broods from the substrate-spawner *T. mariae* were eaten before the free-swimming stage was reached. Eyeson (1983) also reported that 67% of *T. zillii* had swallowed large numbers of eggs and fry. Eyeson attributed the egg swallowing habit to emotional disturbance. The substrate-spawning convict cichlid has also been observed to 'mouth' eggs. A study by Townshend & Wootton (1985) in the convict cichlid found that 'mouthing' frequency was not related to either food ration clutch size nor female weight; 'mouthing' was defined as the parent enclosing one or more eggs within its mouth, thereby removing opaque and fungus-covered eggs but leaving healthy eggs unharmed (see Smith-Grayton & Keenleyside, 1978).

Previous estimates of fecundity in *T. zillii* range from 1000 - 7061 in Lake Victoria (Lowe-McConnell, 1955) where mean length of fish was 82mm, 2218 - 6702 in experimental tanks where fish length varied from 110mm - 184mm (Cridland, 1962), 1700 - 4100 in fish 140 - 180mm in length (Ben-Tuvia, 1959), 2990 - 12344 in Lake Naivasha (Siddiqui, 1979) with a mean of 6606 where fish ranged from 119 - 238mm (32.1 - 276.3g), 674 - 7009 in stunted pond stocks (Dadzie & Wangila, 1980) where fish ranged from 66 - 141mm (approx. 20 - 120g) and mean fecundity was 2359 eggs.

The only available estimate of fecundity in *T. tholloni* (*T. zillii* strain 'B') was given by Peters (1983) where fecundity ranged from approximately 600 - 2900 in fish of 7 - 60g. A mean fecundity of 4600 in Lake Qarun fish was also given by El-Zarka (1956) though the size of spawning fish was not given. Most of these estimates are based upon ovarian counts of 'mature' ovaries and are therefore prone to overestimation. Only those studies by El-Zarka (1956), Cridland (1962) and Dadzie & Wangila (1980) used direct counts of freshly-spawned clutches to estimate fecundity.

In the present study, total fecundity ranged from 461 - 11640 with a mean of 3606 in strain 'A' (115 - 271mm, 28.9 - 419.0g) and from 1962 - 9733 with a mean of 3560 in strain 'B' (143 - 216mm, 53.2 - 240.8g). Despite encompassing a wider range of fish size in the analysis, these figures generally compare favourably with earlier studies, particularly with that of Siddiqui (1979). However, overall mean total fecundity (3606 and 3560 in strains 'A' & 'B' respectively) was much lower than the estimate of 6606 given for fish in Lake Naivasha by Siddiqui (1979) though this estimate was based upon ovarian counts and may be overestimated; it is also lower than the estimate of 4600 given for Lake Qarun fish by El-Zarka (1956). Present estimates were understandably much larger than that given by Dadzie & Wangila (1980) whose analysis involved a stock of 'stunted' *T. zillii*. As expected, present estimates of fecundity in substrate-spawning *T. zillii* (strains 'A' & 'B') were much greater than those given for mouthbrooding species, e.g. 324 - 1672 in *O. esculentus* (Lowe-McConnell, 1955), 56 - 498 in *O. leucostictus* (Welcomme, 1967) and 309 - 1158 in *O. niloticus* (Rana, 1986).

Generally, fish that produce large eggs tend to be less fecund than those producing smaller eggs. Rainbow trout for example, produce eggs that are approximately 4.5mm in diameter and spawn 1000 - 3000 eggs/kg (Tyler *et al.*, 1990; Bromage *et al.*, 1992). Egg diameter in the three-spined stickleback varies between 1.1 and 1.7mm and mean clutch size is approximately 80 - 100 eggs (Wootton, 1973b, Selman & Wallace, 1979); this translates to a relative fecundity of approximately 5000 eggs/kg (Tyler & Sumpter, 1996). Under favourable conditions, sticklebacks may

spawn many times during a breeding season (at intervals of just a few days) (Wootton, 1982) and can thus have a total fecundity considerably greater than that of salmonid species; this would also be the case in other multiple spawners such as *T. zillii* where relative fecundity in strain 'A' is approximately 32000 eggs/kg. Marine species such as cod and Atlantic halibut *Hippoglossus hippoglossus* (L.) produce small pelagic eggs but tend to exhibit incredibly high fecundities; several million eggs can be produced per season (Norberg *et al.*, 1991).

In both strains of *T. zillii*, fecundity increased with increasing fish size (length and weight) as also observed by Lowe-McConnell (1955), Cridland (1962), Botros (1969), Siddiqui (1979) and Dadzie & Wangila (1980). None of these previous studies described whether fecundity is significantly related to body size. In the present study total fecundity was found to be significantly related to fish length (in both strains) and body weight (in strain 'A'). That a significant relationship was not found with fish weight in strain 'B' is confusing though on the whole, relationships between various reproductive traits and body size were weaker in strain 'B' than in strain 'A'. However, it is possible that this difference was more a result of the smaller sample size of strain 'B' fish. In finding that fecundity was highly correlated to fish size (at least in strain 'A'), the present study concurs well with those studies by Wootton (1973b), Rana (1986) and Bromage *et al.* (1992) in the three-spined stickleback, *O. niloticus* and the rainbow trout respectively. Rana (1986) also observed a closer association of total fecundity to maternal size than age. It was not possible to investigate the effects of age in the present study since broodstock were of largely unknown age structure. Rana (1986) however, found that total fecundity and relative fecundity increased and decreased significantly (respectively) with maternal age class.

A wide variation in total fecundity was observed in both strain 'A' & 'B' within narrow size classes, particularly within the larger size classes. This was also observed in *T. zillii* by Dadzie & Wangila (1980). Several teleosts are known to exhibit wide variation in fecundity even amongst individuals of the same species, size and age (Bagenal, 1957). Bagenal (1966, 1969) suggested that variation in fecundity may be

due to differential abundance of food. Indeed, wide fluctuations in fecundity of the mouthbrooding tilapia *S. galileus* in Ilta lake (Nigeria) were attributed to differential feeding success by Fagade *et al.* (1984). Wootton (1979) observed that plots of fecundity against fish size can often exhibit marked variation about a fitted curve. This was attributed partly to the effects of age and egg size and partly to the effects of genetic and environmental factors upon fecundity. While inheritance plays a vital role in determining fecundity in an individual tilapia (Fagade *et al.*, 1984; Macintosh & Little, 1995), environmental factors are also of considerable importance. In the present study individual fish showed variations in fecundity over consecutive spawns (discussed further later in this section). Moreover, these variations did not appear to be related to concurrent changes in spawning periodicity. It is unclear as to why such variation occurred and it requires further study. However, since fish in the present study experienced constant environmental conditions it seems likely that the variation of fecundity observed in the present study was not due to changes in environmental factors such as water temperature, water quality or food ration/quality.

The rate (b) at which mean total fecundity increased with female length differed between the two strains of *T. zillii* and was greater in strain 'A'. In strain 'A' total fecundity increased at a rate proportional to length (L) to the power 2.11 compared to $L^{1.02}$ in strain 'B'. The rate observed in strain 'A' was similar to earlier findings by both Botros (1969) and Dadzie & Wangila (1980) where fecundity was found to increase in *T. zillii* at a rate proportional to the square of fish length. Rate of increase in fecundity has been found to be proportional to body length in many other species. Simpson (1951) argued that (b) should be restricted by geometric constraints to particular values and that fecundity should increase as the cube of body length. In analysing data from 62 teleosts, Wootton (1979) observed that although values of (b) did cluster around 3.0, they varied from 1 to 7 (with a modal value of 3.25 - 3.75). Earlier estimates of (b) in respect of length in tilapias have tended to approximate to the square of length e.g. Babiker & Ibrahim (1979a) in *O. leucostictus*; Blay (1981) in *S. galileus*, Payne & Collinson (1983) in *O. niloticus* and *O. aureus*, Fagade *et al.* (1984)

in *S. galileus* and both Botros (1969) and Dadzie & Wangila (1980) in *T. zillii*. In *O. niloticus* and *O. mossambicus* however, Rana (1986) found that (b) increased at a rate proportional to $L^{1.74}$ and $L^{1.10}$ respectively and attributed these lower rates to the estimation of fecundity based upon the number of eggs shed per spawn. Marine species usually exhibit higher values of (b) than freshwater species (Wootton, 1979; Wootton, 1990). There is also a tendency for short-lived species with poor post-spawning survival to have lower values of (b) than longer-lived species with good post-spawning survival (Wootton, 1979). It is interesting to note the difference in (b) between strains 'A' and 'B' in the present study and unclear as to why this is so. However, limited sample size may have contributed to the much poorer rate of increase in strain 'B'.

Egg size in tilapias is generally species-specific (Lowe-McConnell, 1955). Within each species however, egg size is generally larger in larger fish (Rana, 1988). Peters (1983) claimed that with increasing body size in *O. niloticus* and *S. galileus*, egg size ceased to increase as rapidly as with smaller fish and that as a consequence, egg size initially increased with increasing body weight and then stabilised. In both strains of *T. zillii*, mean egg size (indicated by egg dry weight, egg diameter and egg volume) only varied within a relatively narrow window. Fish weighing 100 - 200g tended however, to produce the largest eggs.

Mean egg diameter was found to be approximately 1.5mm and 1.4mm in strains 'A' and 'B' respectively. Substrate-spawning fish generally produce large yolky eggs relative to maternal size (Tyler & Sumpter, 1996). For example, a rainbow trout weighing about 1kg would produce eggs approximately 5mm in diameter whilst a 10kg chinook salmon would produce eggs measuring 1cm or more (Tyler & Sumpter, 1996). The three-spined stickleback also produces large eggs relative to its' body size; whilst this fish generally weighs less than 10g, eggs measure 1.1 - 1.7mm (Wootton, 1976). Egg size is much smaller in those fish that produce pelagic eggs. For example, sea bass *Dicentrarchus labrax* (L.) and cod produce eggs that are little more than 1mm in diameter (see Tyler & Sumpter, 1996).

In strain 'A', regression analysis found egg dry weight, egg diameter and egg volume to be significantly related to both body length and weight but with extremely low coefficients of determination (1 - 10%). Egg size was also found to be correlated to fish size in the rainbow trout (Bromage & Cumaranatunga, 1988; Bromage *et al.*, 1990, 1992); though the relationship was far stronger than seen here. Wootton (1973b) found no evidence of a relationship between fish size and egg size in the three-spined stickleback. In strain 'B', significant relationships were only found between fish size (length & weight) and egg volume (again with very low coefficients of determination) not egg dry weight nor egg diameter. Previous studies of *T. zillii* by Dadzie & Wangila (1980) found no correlation between fish size (length or weight) and egg size in females varying from 20 - 120g in size. Peters (1983) similarly found no relationship between fish size and egg size in 10 - 80g *T. tholloni* and *T. zillii* nor between 10 - 40g *S. melanotheron*. Moreover, egg size was not significantly correlated to maternal weight or length within a narrow age class in either *O. niloticus* nor *O. mossambicus* (Rana, 1988).

In tilapias it is unclear as to whether maternal age or size is the predominant factor influencing egg size though mounting evidence appears to suggest that maternal age may be an important contributory factor (Rana, 1988). It is also important to remember that egg size can be influenced/modulated by the nutritional status of the female (e.g. Wootton, 1973a; 1977; 1979; 1982; 1985; Townshend & Wootton, 1984; Bromage & Jones, 1991; Bromage *et al.*, 1992; see Chapter 7 for more details).

Most studies of reproduction tend to consider fecundity and egg size as separate indicators of reproductive performance. It is generally accepted however, that there is an inverse relationship between fecundity and egg size; fish produce either more eggs of a smaller size or fewer eggs of a larger size (Springate *et al.*, 1985; Bromage & Cumaranatunga, 1988; Bromage *et al.*, 1990; Bromage *et al.*, 1992). As a result of this 'trade-off', it was suggested that total egg volume was a more appropriate index of egg production (Wootton, 1984b; Bromage *et al.*, 1990, 1992), since it considers the aggregate of both egg number and size. Relationships of either fecundity or egg size on

weight in the rainbow trout were found to be strengthened by their combination as a single resource (total egg volume), thus strongly supporting the 'trade-off' hypothesis (Springate *et al.*, 1985; Bromage & Cumaranatunga, 1988; Bromage *et al.*, 1990; Bromage *et al.*, 1992). Similar levels of correlation were reported by Wootton (1984) in a study of total egg volume on fish length in a selection of Canadian freshwater fish.

In the present study, the combination of fecundity and egg size as total egg volume also strengthened relationships to fish size but only in strain 'B'. Coefficients of determination were, however, rather low; just 14 - 20% of the variance in total egg volume could be accounted for by body size. The relationship between total egg volume and body size was stronger in strain 'A', where 42 - 50% of the variation in total egg volume could be accounted for by body size. However, the relationship between fecundity and body size was slightly stronger than when fecundity and egg size were combined as total egg volume. The weaker correlation between total egg volume and body size in strain 'B' perhaps indicates that there is greater scope for independent variation of fecundity and egg size than in strain 'A'. Clearly, fish size, fecundity and egg size are interrelated parameters; if one parameter is changed then compensatory changes occur in the others (Bromage *et al.*, 1992).

Relative fecundity was found to be negatively related to fish size in both strains of *T. zillii* and fell with increasing fish size. This was also observed in *O. niloticus* and *O. mossambicus* (Rana, 1986). Relative fecundity also decreased with increasing fish size in rainbow trout (Bromage & Cumaranatunga, 1988; Bromage *et al.*, 1990; Bromage *et al.*, 1992). This was attributed to an increase in egg size and the gradually diminishing rate of increase in fecundity with increasing fish size. This provides further support for the 'trade-off hypothesis' between egg size and fecundity. It should be noted that relative fecundity data are, however, subject to autocorrelation when related to fish weight (see Section 3.1).

These negative relationships indicate a reduction in reproductive efficiency with increasing growth. This was also the case in terms of spawning periodicity; smaller fish exhibited shorter reproductive cycles than larger fish suggesting that smaller

(younger) fish make better broodstock than larger (older) fish. Over time, the reproductive capacity of females becomes increasingly affected by both spawning frequency and ovarian senescence (Woodhead, 1979). In guppies for example, numbers of ripening ovarian eggs and atretic eggs were found to decrease and increase respectively coincident with ageing and spawning (Woodhead & Ellet, 1969). Furthermore as ageing progresses, the ovary becomes infiltrated by connective tissue accompanied by a thickening of the ovary wall and a consequential reduction in germinal tissue (Woodhead, 1978).

In individually-held strain 'A', optimal egg production was observed in 150 - 199g fish. Fish of this size exhibited a mean total fecundity of 4404 eggs/clutch and a spawning interval of 39.5 days in aquaria. This suggests that on average each fish spawned 7 times per year producing approximately 39636 eggs/year. Assuming that hatching rates in aquaria are 59.6% (K. Coward, personal observation), 23623 fry/fish/year are expected. In strain 'B', optimal production was observed in 100 -149g fish where total fecundity and spawning interval averaged 3765 eggs/clutch and 32.7 days respectively suggesting that on average 14 spawnings/fish/year could be achieved producing approximately 52710 eggs/fish/year (or 31415 fry), substantially more than the optimal production observed in strain 'A' fish. Whether fish held in aquaria could sustain such short spawning cycles for long periods of time is questionable however. In ponds, fry production has been found to decline with time (Little, 1989), this being largely attributed to a lack of synchrony in spawning cycles and lower spawning frequency of older broodstock (Lovshin cited by Mires, 1982). To counteract this, broodstock are usually replaced soon after a decline in fry production is observed (Little, 1989). It is known that with increasing time the reproductive capacity of female fish becomes increasingly affected by both spawning frequency and ovarian senescence (Woodhead, 1978). Indeed, depletion of the soma is often associated with spawning and ovarian development (e.g. Woodhead, 1960; Love, 1970). In Egyptian *T. zillii* for example, lipid from the liver was mobilised during ovarian maturation prior to first spawning in June, whilst a second spawn in September was associated

with a depletion of both liver and muscles (El-Maghraby *et al.*, 1972). Although tilapias have the potential to spawn regularly throughout the year under constant conditions (Lowe-McConnell, 1959; Fishelson, 1966) it is generally observed that spawning does not tend to occur continually. Rather, fish spawn several times, pause for varying periods of time then continue spawning (Peters, 1983). It seems likely then that although fish in the present study were capable of producing up to 14 clutches of eggs/year on average under aquaria conditions, such spawning rates might not be sustained for long periods of time. Consequently, it may be wise to replace broodfish periodically.

In both strains of *T. zillii* regression analysis revealed strong and significant relationships (where coefficients of determination were reasonably high) between fish size (length & weight) and (a) total fecundity (b) relative fecundity and (c) total egg volume. These parameters are therefore suggested as better predictors of reproductive capability than relationships of fish size to egg size (egg dry weight, egg diameter and egg volume) which were generally far weaker.

When reproductive traits were compared between strains 'A' and 'B' by one-way ANOVA it was found that overall mean total fecundity, mean relative fecundity, mean egg dry weight, mean egg diameter, mean total egg volume and mean EW:BW ratio did not differ significantly. However, mean egg volume was found to be significantly smaller in strain 'B'. This difference may be due to the fact that strain 'A' fish encompassed a much wider size range than strain 'B', though this is unlikely since mean weight did not differ significantly between the two strains. Inter-spawn-interval was also found to be significantly shorter in strain 'B' and it is likely that this is linked to the smaller egg size observed in this strain. More rigorous analysis involving one-factor ANCOVA also failed to detect significant differences in total fecundity, mean egg diameter and total egg volume between the two strains of fish after adjustment to a common post-spawn weight. ANCOVA may not have been as robust as it could have been since residual variances and slope were mostly heterogeneous. Where heterogeneity of slope is evident then the treatment effects are not the same at different

levels of the covariate; thus the adjusted means can be misleading (Snedecor & Cochran, 1980).

Little is known of how (and why) reproductive traits such as fecundity and egg size vary with consecutive spawns in tilapias particularly in substrate-spawners. In the present study it was found that both relative fecundity and egg volume varied widely over consecutive spawns in six repeat-spawning *T. zillii* (strain 'A'). No definite trends (i.e. tendencies to increase or decrease with successive spawns) were observed in these fish. Similar variations were also observed in terms of total fecundity, egg dry weight and total egg volume. Moreover these variations did not appear to relate to changes in the length of spawning cycle. Lowe-McConnell (1982) claimed that the number of eggs from individual tilapia in equatorial lakes or ponds diminishes with each spawning, though several studies in both substrate-spawners and mouthbrooders have found the converse. For example, in laboratory-held fish, Cridland (1962) found brood size and egg size to increase and decrease respectively in successive broods in both *T. zillii* and *O. nigra*. In his study of *T. zillii*, Cridland also found that survival at hatching did not differ from early to late broods. Lee (1979) also found that there was a tendency for clutch size to increase with successive spawns in some individual *O. aureus*, *O. urolepis hornorum* and *O. niloticus* but found this not to be uniform. A trend for the number of eggs/clutch to increase with successive spawns was also observed in individual *O. niloticus* by Siraj *et al.* (1983) and Mires (1982), though this was found not to be consistent amongst all fish and in the case of Siraj *et al.* (1983) was seen coincident with increasing egg size. In aquaria-held *O. aureus*, Dadzie (1970) observed a general increase in egg size with successive spawns and a tendency for fecundity to vary. Most of the fish used by Dadzie however had been induced to spawn and it is therefore not appropriate to compare such results with non-induced fish. Rana (1986) also found that fecundity varied with consecutive spawns in aquaria-held *O. niloticus*. In Ebrié lagoon (Ivory Coast), both *S. melanotheron* and *T. guineensis* were found to reproduce throughout the year and relative fecundity was found to be higher during the dry season than the rainy season (Legendre & Ecoutin, 1989).

Changes in relative fecundity and egg size throughout a season or spawning period have been reported in several other multiple and batch-spawning fish species, though causal mechanisms still remain unclear. For example, egg size in sole generally decreases with successive spawns (Houghton *et al.*, 1985). In Atlantic mackerel, fecundity was found to decrease with successive spawns (Watson *et al.*, 1992), a trend also observed in cod (Kjesbu & Kryvi, 1989), whiting *Merlangus merlangus* (L.) (Hislop, 1975) and sea bass (Mayer *et al.*, 1990). In the goby, relative fecundity was found to vary (initially increase then remain constant) with successive spawns within a breeding season (Rogers, 1989); egg size decreased throughout the season (Miller, 1984). These observations in the goby were partially attributed to food availability (Rogers, 1989; Miller, 1984).

Several other studies implicate food availability in the observed variation of fecundity and egg size. For example, changes of relative fecundity observed in whiting were partially attributed to variations in food supply during oocyte maturation (Hislop, 1975). In the three-spined stickleback, fecundity varies between clutches produced by the same female during a single breeding season (Wootton, 1994). The precise reasons for this are not known. Depending upon feeding conditions during the breeding season however, a female stickleback is physiologically capable of a 10 - 20 fold variation in fecundity (Wootton, 1985). In killifish, eggs ovulated in early spawns are usually larger than in later spawns; this is generally associated with diminishing resources of the female (Hsiao *et al.*, 1994).

Egg size has been found to decrease during the breeding season in several commercially important marine species, e.g. whiting (Hislop, 1975), haddock *Melanogrammus aeglefinus* (L.) (Hislop *et al.*, 1978), cod (Kjesbu, 1989) and turbot *Scophthalmus maximus* (L.) (McEvoy & McEvoy, 1991). Kjesbu *et al.* (1990) claimed that the seasonal decline in egg size observed in cod was attributable to depletion of liver reserves; species such as cod, halibut and turbot have been found to fast or reduce food intake during the breeding season. McEvoy & McEvoy (1991) further claimed that in turbot at least, the seasonal decline in egg size was genetically controlled.

The fecundity of partial or serial spawners may be modified by environmental factors (Wootton, 1982). Variations in food supply may also alter propagule size in guppies (see Reznick & Yang 1983; Reznick *et al.*, 1996). Variations in food supply may well account for the variations in egg size and fecundity observed over successive spawns in several studies of tilapia held under natural conditions (Lowe-McConnell, 1987; Ecoutin & Legendre, 1989). However, it is unlikely that variations in food supply were responsible for the observed variations in fecundity and egg size in laboratory/aquaria-based studies such as the present study and those of Cridland (1962), Dadzie (1970), Lee (1979), Siraj *et al.* (1983) and Rana (1986) since food supply was controlled and remained constant. It should be further noted that some factors such as pollution or abrupt changes in water level may stress female fish and thereby reduce fecundity (see Gerking, 1980). In guppies, the social environment may also influence fecundity (e.g. Dahlgren, 1979).

It remains unclear as to why fecundity and egg size varied with successive spawns and surprising that such variations did not appear to relate to spawning periodicity. One possible explanation is partial spawning. Some researchers claim that tilapias may spawn mature oocytes from one lobe of the ovary leaving a batch of mature oocytes in the remaining lobe to be spawned at a later date (Don Macintosh, personal communication). However, no evidence of this phenomenon was found throughout the studies described in this thesis; both lobes of the ovary were consistently found to be alike, even in immediately post-spawned fish. It is likely therefore, that variation of fecundity and egg size is controlled by complex inter-related mechanisms involving not only spawning periodicity but also oocyte recruitment, growth and maturation and also reproductive endocrinology. The possible involvement of atresia, found to be common in the ovarian cycle of both wild and captive tilapias (Peters, 1983), should also be investigated.

Chapter 4

Histological classification and size distribution of oocyte developmental stages in *T. zillii*.

(4) Histological classification and size distribution of oocyte developmental stages in *T. zillii*.

Previous attempts at the classification of ovarian development in substrate-spawning tilapia remains very superficial. For example, stages of ovarian development in *T. zillii* were classified as immature, mature, nearly ripe, ripe and spent by El-Zarka (1962) based upon macroscopic appearance. A further study classified oocyte growth according to oocyte diameter as immature, maturing (0.4 - 1.0mm), or mature (0.9 - 1.55mm) Siddiqui (1979). The most comprehensive study of oocyte growth in *T. zillii* was undertaken by Dadzie & Wangila (1980) who defined ovaries as immature, maturing, ripening, ripe or spent based upon both macroscopic appearance and degree of yolk accumulation. A comprehensive classification comparable to other teleosts has yet to be devised for any substrate-spawning tilapia. It is the intention of this Chapter to devise a scheme that classifies ovarian recrudescence in *T. zillii* into several distinct developmental stages. This will form the basis for further investigations concerning ovarian growth that are described later in this thesis and would also be invaluable in assessing 'ovarian maturity' in spawning induction studies.

(4.1) Introduction.

It is the intention here to briefly review current knowledge of ovarian growth in fish and the histological classification schemes devised thus far.

As in other vertebrates, the teleost ovary develops as an attachment to the dorso-lateral lining of the peritoneal cavity. Developing ovaries are paired, elongate hollow organs positioned immediately ventral to the swim bladder and consisting of numerous partial transverse septa projecting into the ovarian lumen (Scott, 1962; van den Hurk & Peute, 1979). It is on these septa that developing oocytes grow. Two forms of ovarian structure have been recognised: cystovarian (closed) and gymnovarian (naked) (Hoar, 1969). The cystovarian ovary (e.g. the tilapiine ovary) remains fully enclosed by the peritoneum (or mesovarium) and following maturation, oocytes are released into a central ovarian lumen leading to the posterior oviduct (Mullerian duct). The

gynovarian ovary, however, is only partially covered by the peritoneum and releases mature oocytes directly into the body (peritoneal) cavity (e.g. salmonidae). Oocytes are subsequently released into the external environment through the oviduct. The oviduct is a posterior continuation of the peritoneum and opens into a urogenital sinus (Scott, 1962; van den Hurk & Peute, 1979).

The highly vascular outer wall of the teleost ovary is known as the tunica albuginea (Matthews, 1938) and is rich in smooth muscle, collagen and elastic fibres. Folding of the internal ovary lining has been observed in several teleosts and is referred to as ovigerous lamellae (Braekevelt & McMillan, 1967; Hoar, 1969; Brummett *et al.*, 1982). Primary oogonia and ovarian follicles are known to develop in close association with the inner epithelium of the lamellae (known as the germinal epithelium) (Hoar, 1969; van den Hurk & Peute, 1979). The cells of this tissue are reported to contain numerous Golgi complexes, endoplasmic reticulum, endocytotic pits and cytoplasmic vesicles (Brummett *et al.*, 1982). Between the ovigerous lamellae and the tunica albuginea lies a highly vascular stroma in which developing oocytes are found. Extending into the stroma from the tunica albuginea are loosely bound strands of collagen, elastic and reticulate fibres known as trabeculae. Trabeculae contain numerous desmosomes and are thought to provide structural support for the developing ovaries (Braekevelt & McMillan, 1967; Brummett *et al.*, 1982).

The ovary of *O. mossambicus* is an unpaired structure, bilobed towards the anterior with a mid-ventral groove separating the organ into left and right halves (Aravindan & Padmanabhan, 1972). The ovary wall is composed of three layers; the peritoneal layer (outermost), the tunica albuginea (comprised of connective tissue, muscle fibres and blood vessels) and the germinal epithelium (innermost). Numerous lamellae varying in size and shape throughout ovarian development were found to protrude from the germinal epithelium into the ovarian cavity. As in other teleosts, oocytes originate from clusters of cells within the ovigerous lamellae (Aravindan & Padmanabhan, 1972). These authors also found irregular strands of cells proliferating from the germinal epithelium and extending into the ovocoel. Follicular and oogonial

cells were found to originate from these strands. It should be noted, however, that teleost ovaries may exhibit structural differences according to species, the nature of their respective reproductive cycles and also during different phases of oocyte development (see Nagahama, 1983).

Three major patterns of oocyte development have been described: synchronous, group-synchronous and asynchronous (Wallace & Selman, 1981, 1987; de Vlaming, 1983). The oocytes of synchronous ovaries mature at the same time and are ovulated in unison. Usually, this condition is found in those anadromous and catadromous teleosts spawning only once during their lifetime (e.g. eels - anguillidae, Pacific salmon). Group synchronous ovaries are those simultaneously containing at least two cohorts of oocytes in different development phases. Fish possessing synchronous ovaries commonly spawn just once a year (e.g. rainbow trout), shedding the larger cohort of oocytes, leaving the smaller cohort to develop and mature for the next spawning. In asynchronous fish, ovaries contain oocytes at all stages of development; oocyte recruitment occurs continually and is seen typically in killifish and tilapiine species. It should be noted however, that modifications of asynchronous/synchronous patterns exist both in the three-spined stickleback (Wallace & Selman, 1979) and pipefish (syngnathidae) (Moser, 1967; Barr, 1963; Braekevelt & McMillan, 1967; Matthews, 1938; Wallace & Selman, 1989). Sticklebacks are batch spawners; they ovulate a number of times during a breeding season. At any one time the ovary contains only three distinct cohorts of oocytes: a primordial cohort, a vitellogenic cohort and a cohort undergoing hydration and preparing for oviposition (Wallace & Selman, 1979).

Sexual differentiation occurs in teleosts soon after oocytes enter the first meiotic prophase (leptotene) (Franchi *et al.*, 1962). Prior to this, distinction between spermatogonia, oogonia and primary oocytes remains arbitrary (Reinboth, 1972). First meiotic division is usually utilised as the main criteria for differentiation (e.g. Takahashi, 1974) though some studies have used the structural formation of the ovarian cavity or testicular lumen as criteria (e.g. Nakamura & Takahashi, 1973). Onset of

sexual differentiation largely depends upon species and temperature (Conover & Kynard, 1981).

Three main patterns of sexual differentiation are thought to exist in teleosts (D'Ancona, 1956). The first pattern involves the gonadal presence of mixed male and female cells with one or the other predominating during subsequent development. The second pattern is characterised by the presence of distinct male and female zones within the gonad. Usually one phase precedes the other leading to either protandrous or protogynous development, though both male and female zones may ripen occasionally to produce a hermaphrodite condition. The third pattern involves the establishment of sexuality early in development although traces of hermaphroditism may exist (Dodd & Sumpter, 1984).

Sex differentiation in rainbow trout begins 45 - 50 days after fertilization (Takashima *et al.*, 1980; van den Hurk & Slof, 1981), soon after yolk-sac resorption. In *O. mossambicus*, differentiation was found to occur earlier in females than males (Takahashi, 1974) and results in the formation of the ovarian cavity and meiotic germ cells approximately 20 days after hatching (at 20°C) (Nakamura & Takahashi, 1973). Testicular development occurred within the same timescale though meiotic division of sperm cells did not occur until 50 - 60 days after hatching (Nakamura & Takahashi, 1973). Sexual differentiation in *O. niloticus* occurs 30 - 33 days post-hatching (at 25 - 26°C) (Alvendiá-Casauay & Carino, 1988). A more recent study found differentiation in *O. niloticus* to be influenced by stocking density. At stocking densities of 10 and 20 fry/litre, 30 and 45% of fry respectively, were found to be sexually differentiated 11 days post-hatch whilst fry held at much lower stocking densities (2 fry/litre) were not (Srisakultiew, 1993). In *T. zillii*, two types of gonad were distinguishable fifteen days after hatching, one containing many germ cells (some in meiotic prophase), the other containing few germ cells and no meiotic prophase (Yoshikawa & Oguri, 1978). During the course of further development the former differentiated into ovary and the latter into testis.

The macroscopic and microscopic ovarian structure of tilapia has been examined on numerous occasions, mostly in wild populations. Most existing literature describes ovarian growth in mouthbrooding tilapias such as *O. niloticus* (Latif & Saady, 1973; Babiker & Ibrahim, 1979a; Jalabert & Zohar, 1982; Hussein, 1984; Srisakultiew, 1993; Tacon *et al.*, 1996), *O. mossambicus* (Aravindan & Padmanabhan, 1972; Dadzie, 1974), *O. aureus* (Garcia & Phillip, 1986; Rashid & Umar, 1990) and *S. melanotheron* (Eyeson, 1979). Classification of ovarian growth in most of these studies was somewhat basic and tended to vary according to different authors. Two of these studies relied upon oocyte diameter criteria rather than histological appearance. Peters (1983) for example, described 3 phases of oocyte development in *O. macrocephala*, *O. mossambicus* and *S. galileus* said to be common to a further 4 species of tilapia based upon oocyte size without referring to histological appearance. Similarly, ovarian growth in *S. melanotheron* was classified into 3 stages based upon oocyte size and degree of yolk incorporation; small (< 1.0 x 1.0mm), medium yolky oocytes (1.0 x 1.0mm - < 2.1 x 1.9mm) and large yolky oocytes (2.1 x 1.9mm - 3.0 x 2.0mm). Jalabert & Zohar (1982) described oocyte growth in *O. niloticus* in a similar manner; previtellogenic and vitellogenic, also based upon oocyte size and degree of yolk incorporation. Further studies by Aravindan & Padmanabhan (1972), Latif & Saady (1973), Babiker & Ibrahim (1973a), Dadzie (1974) and Hussein (1984) classified stages of ovarian development according to histological appearance. Classification schemes proposed in these studies varied according to author and ranged from the 4 stages adopted by Latif & Saady (1973) to the 9 stages of Aravindan & Padmanabhan (1972).

Only recent studies by Srisakultiew (1993) in *O. niloticus* have attempted to relate histological development of oocytes in the tilapia to the comprehensive classification schemes developed for other teleosts such as the rainbow trout (Bromage & Cumaranatunga, 1988). Aravindan & Padmanabhan (1972), however, described ovarian development in *O. mossambicus*, referring to several stages of development

comparable to those of later studies by Wallace & Selman (1981, 1987) and Bromage & Cumaranatunga (1988).

The present study therefore aims to develop a detailed classification scheme that would allow designation of developing oocytes in *T. zillii* into distinct developmental stages. In order to do this, the following sections review the general physiology of ovarian development in teleosts.

(4.1.1) Primary growth phase (PGP).

Ovarian growth is a complex process whereby immature oocytes proceed through several distinguishable phases of development into mature oocytes (or ova). The process of oogenesis is timed and modulated by a series of exogenous and endogenous factors such that young are produced only at times when fry survival is optimal (see Section 1.7). The following account aims to briefly describe the distinct phases involved in this process.

Stages of ovarian development can be broadly divided into several distinct phases dependent upon the biochemical properties and histological morphology of the nucleus, cytoplasm and follicular layer. Based upon these criteria, ovarian development is generally divided into several distinct stages: oogonial proliferation, oogenesis, folliculogenesis (together constituting primary growth phase or PGP) and cortical alveolar (or vesicular) formation, vitellogenesis and final maturation (constituting secondary growth phase or SGP) (e.g. Dadzie, 1970; Khoo, 1979; Kagawa *et al.*, 1981; Wallace & Selman, 1981; Selman & Wallace, 1983, 1989; Nagahama, 1983; Wallace *et al.*, 1987; Bromage & Cumaranatunga, 1988; Selman *et al.*, 1993).

(a) Oogonia.

Oogonia consist of a large nucleus containing a single large nucleolus enclosed within a narrow rim of cytoplasm (Braekevelt & McMillan, 1967) and are generally found singularly or more often in small oogonial nests often in association with small pre-follicle cells (Tokaz, 1978; Bruslé, 1980; Bromage & Cumaranatunga, 1988)

derived from the germinal epithelium (Moser, 1967) from which the follicular layer later develops. Pre-follicle cells contain desmosome-like junctions, ribosomes, mitochondria, endoplasmic reticulum and Golgi complexes (Bruslé, 1980). Following periodic mitotic division, oogonia are transformed into primary and secondary oogonia (Franchi *et al.*, 1962; Khoo, 1979). In teleosts possessing well defined breeding cycles, oogonial proliferation has been observed immediately before, during or after the main spawning period (Franchi *et al.*, 1962). Bromage & Cumaranatunga (1988) reported that whilst oogonia predominate immediately post-ovulation, they are also present in all stages of ovarian growth and all age groups thus suggesting that pools of oogonia are available for recruitment throughout. In some species however, limited numbers of oogonia are determined early in development and undergo no further proliferation (e.g. eels). Recent studies in rainbow trout however, have confirmed that windows for oogonial proliferation extend over wider periods of ovarian development, such that any losses from pools of maturing follicles may be balanced accordingly (Tyler *et al.*, 1994).

The oogonia of *O. niloticus* are reported to be irregularly shaped, containing very little cytoplasm and are 2 - 5 μm in diameter (Srisakultiew, 1993).

(b) Stage 1 oocytes: chromatin nucleolar stage.

Secondary oogonia are transformed by meiosis into stage 1 or primary oocytes (chromatin nucleolar stage). During the first meiotic prophase chromosomal DNA first replicates (leptotene), followed by pairing and condensation of homologous chromosomes (zygotene). Chromosomes then shorten and thicken to form synaptonemal complexes (pachytene) and eventually assume a "lamp-brush" configuration (diplotene) whereupon they become arrested (Wallace & Selman, 1981). Chromatin nucleolar oocytes are characterised by the presence of a conspicuous central nucleolus and associated threads of chromatin surrounded by a weakly basophilic cytoplasm. These oocytes can be subdivided further into synaptic and post-synaptic stages according to the current phase of meiosis (Yamamoto, 1956). In rainbow trout, stage 1

oocytes are less commonly found thus suggesting a rapid turnover of oogonia through stage 1 to stage 2 (Bromage & Cumarantunga, 1988). The chromatin nucleolar stage defined by Srisakultiew (1993) in *O. niloticus* varied from 5 - 52 μm in size and contained a nucleus containing a single nucleolus and several strands of chromatin. Cytoplasm was observed in an indistinct narrow band around the nucleus.

Folliculogenesis begins during the meiotic transformation of oogonia into oocytes and results in primary oocytes being drawn away from oogonial nests to become closely associated with the pre-follicle cells (Moser, 1967).

(c) Stage 2 oocytes: early perinucleolar stage.

Following meiotic prophase, oocytes enter a growth phase during which the central nucleolus disappears and as ribosomal genes amplify, several smaller peripheral nucleoli begin to appear (Anderson & Smith, 1978). Basophilic nature of the nucleus decreases whilst cytoplasmic basophilia reaches a maximum (e.g. Wallace & Selman, 1981; Forberg, 1982; Nagahama, 1983). Shallow undulations of the nuclear envelope are observed and RNA and mRNA are transported from the nucleus to the oocyte cytoplasm appearing as an aggregation of basophilic electron-dense material. These are referred to as 'yolk nuclei' or 'Balbiani bodies'. These bodies are composed of RNA, mitochondria, endoplasmic reticulum, Golgi bodies and vesicular bodies (Guraya, 1986; Selman & Wallace, 1989) and whilst forming initially in the juxtannuclear region, subsequently migrate to the oocyte periphery and disperse (Guraya, 1986). Kessel (1985) reported the presence of annulate lamellae (closely associated with rough endoplasmic reticulum) in the vicinity of Balbiani bodies. Whilst Balbiani bodies have been observed in many teleosts (Guraya, 1986) their precise function is poorly understood. Common opinion is that they are involved in the synthesis of cellular organelles during oocyte growth (Guraya, 1979; 1986; Selman & Wallace, 1989; Wallace *et al.*, 1987), as indeed are annulate lamellae (Kessel, 1985). Stage 2 oocytes can be further subdivided according to the degree of basophilia and the relative

positioning of the Balbiani bodies into stage 2a, 2b and 2c (Bromage & Cumaranatunga, 1988).

In *O. niloticus* stage 2 oocytes varied from 50 - 205 μm , contained several nucleoli and were subdivided into 3 stages according to the position of their Balbiani bodies (Srisakultiew, 1993). Balbiani bodies were initially seen close to the nuclear envelope (stage 2a), later distributed over the cytoplasm (2b) and finally found to migrate to the periphery of the cytoplasm (stage 2c).

(d) Stage 3 oocytes: late perinucleolar stage.

This stage is distinguished by the presence of numerous small spherical nucleoli lying close to the nuclear membrane. Ooplasmic basophilia decreases and remaining Balbiani bodies migrate to the periphery of the ooplasm and disperse (Guraya, 1986). By the end of this phase, a definitive follicle has formed, consisting of a zona radiata, a single layer of squamous granulosa cells an outer thecal layer and a surface epithelial layer (Wallace & Selman, 1981). As oocytes grow, these cells become flattened (Tokaz, 1978; Bruslé, 1980) and additional cells become attached as a result of mitotic division or by attachment of neighbouring pre-follicle cells. By stage 3 the follicular layer consists of a single granulosa and 2 thecal layers (Bromage & Cumaranatunga, 1988) and microvillii are observed between the developing oocyte and granulosa cells (Tokano, 1964) though are not found in more developed oocytes.

Stage 3 oocytes in *O. niloticus* were found to vary from 110 - 340 μm and were seen to contain numerous small vacuoles initially close to the nucleus but later found at the periphery of the ooplasm (Srisakultiew, 1993). A developing follicle layer consisting of a cuboidal granulosa layer and a single thecal layer was apparent. The relationship between the thecal layer and developing oocytes however, differs in pipefish from other teleosts by way of two oocytes sharing the same theca and surface epithelium (Selman *et al.*, 1987).

(4.1.2) Secondary growth phase (SGP).

(a) Stage 4 oocytes: cortical alveolar stage.

This stage of oocyte growth is distinguished by the appearance of numerous peripheral vesicles and in previous literature was known as the stage of endogenous vitellogenesis. These vesicles have been given several names: yolk vacuoles, primary yolk globules, lipid vesicles, oil vesicles, primary yolk vesicles or granules and cortical alveoli for example. Most of these terms suggest a presumed relationship of peripherally-located vesicles to yolk. This was deemed unsound since the vesicles do not contain yolk to be directly utilised for nutrition by developing embryos (Selman *et al.*, 1986; Wallace *et al.*, 1987; Selman & Wallace, 1989). Thus, the terms cortical vesicles (Bromage & Cumaranatunga, 1988) and cortical alveoli (Wallace *et al.*, 1987; Selman & Wallace, 1989) have become generally accepted. Presently, there is little evidence to suggest that cortical alveoli/vesicles are involved in the incorporation or processing of hepatic derived yolk (Bromage & Cumaranatunga, 1988).

Oocytes classified as being stage 4 can be further sub-divided into stage 4a and 4b according to the relative number and location of vesicles present (Bromage & Cumaranatunga, 1988). In *O. niloticus*, stage 4 oocytes varied from 172 - 683 μm in diameter and were much larger than stage 3 oocytes due to accumulation of endogenous and trophoplasmic substances (Srisakultiew, 1993). Numerous alveoli/vesicles were also observed close to the oocyte periphery.

The alveoli/vesicles of stage 4 oocytes have been suggested to contain intravesicular yolk (Marza *et al.*, 1937), glycosaminoglycans (Yamamoto, 1956) or polysaccharides (e.g. Khoo, 1979). Korfsmeier (1966) concluded that the composition of vesicles in the zebrafish was an endogenously derived glycoprotein. Several recent reports have demonstrated that cortical alveoli (vesicles) contain lectins possessing specific-sugar binding properties (Krajhanzl *et al.*, 1984a; 1984b; Nosek, 1984). Further studies showed cortical alveoli in zebrafish to be a glycoprotein of endogenous origin (te Heesen & Engels, 1973; te Heesen, 1977). Khoo (1979) further reported that vesicular intrusions were PAS-positive. More recent studies by Selman *et al.* (1986)

detected the presence of a large glycoconjugated protein (>200 kDa) within the cortical alveoli. Antibodies raised against a glyconjugate derived from the cortical alveoli of *Fundulus heteroclitus* (L.) (Selman *et al.*, 1987) successfully demonstrated the similarity between the structures referred to as cortical alveoli and the structures known as yolk vesicles in earlier studies. As a result, the presence of cortical alveoli in oocytes is usually assessed by staining for proteins with either alcian blue, toluidine blue or periodic acid/shiff reagents. Wallace *et al.* (1987) noted that the cortical alveoli remain difficult to preserve and often lose their staining characteristics (especially as they increase in size) and thus assume a vacuolar appearance.

During stage 4, the zona radiata (also known as the zona pellucida, vitelline envelope or chorion) develops between the granulosa and the ooplasm. The zona radiata may consist of two to four major proteins synthesised by either the oocyte itself (e.g. Begovac & Wallace, 1989) or the liver (e.g. Hyllner *et al.*, 1991). Granulosa cells are separated from a vast capillary plexus and the thecal cells by a thick glycoprotein layer containing collagen fibres (the basal lamina) (Anderson, 1967). Pore canals are found within the zona radiata from which microvillii arising from the granulosa and ooplasm extend (Bromage & Cumaranatunga, 1988). Stage 4 oocytes in *O. niloticus* were seen associated with a developing zona radiata (Srisakultiew, 1993).

(b) Stage 5 oocytes: exogenous vitellogenesis.

The bulk of oocyte growth is found to occur during a prolonged phase of exogenous vitellogenesis. Oocytes have to reach a certain minimum size before they enter vitellogenesis and sequester VTG. This minimum size is species specific (Tyler, 1988). The duration of the vitellogenic growth phase depends largely on the pattern of ovarian development adopted. In rainbow trout and other salmonids, vitellogenesis extends over a period of approximately 9 months (Tyler *et al.*, 1990). In batch spawners, vitellogenesis lasts for a considerably shorter period of time, e.g. 5 - 7 weeks in the Atlantic halibut (Norberg *et al.*, 1991). In the three-spined stickleback, vitellogenesis can last just 5 days (Selman & Wallace, 1979).

Exogenously derived proteins form over 80 - 90% of final egg dry weight (Wallace *et al.*, 1987) and over 98% of final egg volume in rainbow trout (Tyler *et al.*, 1990) thus representing arguably the most important phase of oocyte growth. Under the stimulus of ovarian oestrogens and pituitary gonadotropins, the liver produces large amounts of a proteinaceous material (vitellogenin, a high molecular weight lipoglycophosphoprotein). Vitellogenin (VTG) is transported to the ovaries by the bloodstream and is sequestered by growing oocytes (Wallace, 1978; Tyler *et al.*, 1987) by endocytosis mediated by receptors at the oocyte surface (Tyler *et al.*, 1988). Studies by Chan *et al.* (1991) in *O. mossambicus* showed that membrane binding sites for VTG are a specific single class of receptors. Numbers of receptors were found to increase from previtellogenesis to vitellogenesis and remained unchanged throughout the pre-ovulatory period. Factors regulating the VTG receptor system are likely to be key determinants affecting vitellogenic growth (Tyler & Sumpter, 1996).

Once inside the oocyte, VTG forms yolk bodies by micropinocytosis and is enzymatically cleaved to form the yolk proteins lipovitellin (lipid rich) and phosphovitin (phosphate rich) (Tyler *et al.*, 1988). Specker *et al.* (1991), through immunoelectron localization studies in *O. mossambicus* and *O. niloticus*, demonstrated specific reactions in endocytotic vesicles (50 - 100nm in size), yolk granules (200 - 400nm in size) and in yolk globules but not in yolk vesicles (cortical alveoli) nor oil droplets.

Exogenous VTG production is stimulated by oestrogens (particularly E₂) secreted by the ovary in response to elevated GTH. Follicular uptake of VTG remains predominantly under the regulation of GTH (Crim & Idler, 1978; Fostier *et al.*, 1979). The stage of exogenous vitellogenesis is characterised by the first appearance in the ooplasm of peripheral eosinophilic yolk granules (van den Hurk and Peute, 1979), growing in size and number as more VTG is sequestered. As development progresses, peripheral yolk granules coalesce to form yolk globules (Bromage & Cumaranatunga, 1988).

Other plasma lipoproteins are present in the circulation during vitellogenesis (Babin, 1987) but there is little evidence that they are sequestered in significant amounts

by oocytes. Nagler & Idler (1990) however, found that very high lipoprotein II (VHDL II) gave rise to yolk proteins in winter flounder. Also a yolk protein termed 'β-component' has been isolated from a number of *Oncorhynchus* species (Makert & Vanstone, 1978) which has neither the characteristics of lipovitellins nor of phosvitins. It is believed to be originally derived from a plasma protein distinct from VTG but has been found to have an immunological relationship with plasma VTG (Campbell & Idler, 1980). It remains likely that several components vital for production of viable eggs are selectively sequestered during the vitellogenic growth period though these are not thought to contribute significantly to physical oocyte growth (Tyler & Sumpter, 1996).

Stage 5 oocytes classified in *O. niloticus* by Srisakultiew (1993) were 214 - 970 μm in diameter and contained numerous yolk granules, subsequently accumulating into yolk globules throughout the ooplasm. Yolk globules increased in size due to further fusion with yolk granules. Numerous vacuoles were found in the periphery of the ooplasm.

The zona radiata thickens during early stage 5 concomitant with an increasing proportion of rough endoplasmic reticulum in the theca and granulosa (Bromage & Cumaranatunga, 1988). Squamous granulosa cells originally found during primary growth as a single layer become cuboidal in shape with further development as a result of mitotic division and later become flattened due to extensive oocyte growth (Braekevelt & McMillan, 1967; Kagawa *et al.*, 1981; Forberg, 1982). Intracellular spaces are often seen amongst the developing granulosa cells filled with an amorphous material forming a net-like structure at all points except those with specialised attachments (Kagawa *et al.*, 1981). These spaces are suggested to assist in the passage of VTG from the blood into the oocyte (Anderson, 1967; Selman & Wallace, 1982). In addition granulosa cells possess numerous cellular organelles such as endoplasmic reticulum and mitochondria (with lamellar cristae) (Hoar & Nagahama, 1978; Kagawa *et al.*, 1981) suggesting that these cells are responsible for the production of proteins incorporated during growth of the zona radiata and deposited between the oolemma and

the granulosa (Wourms, 1976; Wourms & Sheldon, 1976; Hoar & Nagahama, 1978). Golgi complexes, lysosomes and electron dense membrane-bound secretory granules are found within the 'Golgi-field' close to the cellular membrane (Kagawa *et al.*, 1981). This finding suggests that the granulosa has a role in the handling or formation of phospholipid transport into the oocyte during SGP (Wourms, 1976; Wourms & Sheldon, 1976).

Granulosa cells have been suggested to be steroidogenic. In the cyprinid *Acanthobrama terrae-sanctae*, for example, 3 β -hydroxy-dehydrogenase (steroid converting enzyme, 3 β -HSD) was demonstrated within the granulosa cells and in both granulosa and theca of *O. niloticus* prior to ovulation (Yaron, 1971). Livni (1971) also found activity of this enzyme in the granulosa of *O. aureus*. Yaron (1971) also found PAS+ve yolk particles in the apical cytoplasm of the granulosa cells and in the chorion canaliculi of *Acanthobrama terrae-sanctae* together demonstrating alkaline phosphatase activity in the granulosa. Yaron (1971) suggested that this may imply that the granulosa is involved in the transport of yolk proteins to the developing oocyte.

Further studies by Kagawa *et al.* (1981, 1982) also found the thecal and granulosa layers to be steroidogenic. Scott *et al.* (1982) suggested that whilst the theca is the most likely site of androgen synthesis, these androgens are later aromatised by the enzyme aromatase in the granulosa to E₂. This pathway is known as the "2 cell type model" (Kagawa *et al.*, 1982; Nagahama *et al.*, 1982). Yaron (1971) however claimed that such a model was based upon studies in a species (Amago salmon) where the 2 non-germinal components of the follicle could be separated mechanically. Yaron (1971) continued to argue that whilst such a clear-cut separation of steroidogenic steps is possible in a fish with synchronous ovaries containing a mainly uniform population of follicles, care must be taken when considering the case of asynchronous ovaries as found in tilapias.

The radial striations observed in the developing zona radiata (Forberg, 1982) are most likely to be the pores through which cytoplasmic microvillii penetrate for oocyte/follicle metabolic exchange (Flügal, 1967).

(c) Stage 6 oocytes : germinal vesicle migration.

Stage 6 marks the onset of oocyte maturation and involves continued VTG sequestration such that yolk globules eventually fill the entire ooplasm (Bromage & Cumaranatunga, 1988). The nucleus (germinal vesicle) later migrates to the oocyte periphery (known as germinal vesicle migration, GVM) towards the animal pole of the ooplasm close to the micropyle. *In vitro* studies of GVM in rainbow trout have shown oocytes to possess increased sensitivity to both maturational GTH and to the maturational steroid 17α - 20β -P (Jalabert & Fostier, 1984). During maturation, the theca produces 17α OH-P which is subsequently converted to 17α - 20β -P by the granulosa (the 'two-cell' model: Nagahama *et al.*, 1985; Nagahama & Yamashita, 1989).

(d) Stage 7 oocytes: Final maturation and germinal vesicle breakdown.

As oocytes mature, the recently migrated germinal vesicle of stage 7 oocytes breaks down at its peripheral position (germinal vesicle breakdown, GVBD) concomitant with the dissociation of the nucleoplasm releasing nucleoli into the ooplasm amongst yolk globules (Wasserman & Smith, 1978). At this point in time, the chromosomes previously arrested in meiotic diplotene condense and enter first meiotic metaphase resulting in the extrusion of the first polar body. Chromosomes remaining enter second meiotic metaphase and are arrested once more. In some teleosts this is accompanied by a further enlargement due to hydration (Wallace & Selman, 1981). This is particularly important in the case of pelagic eggs produced by many marine teleosts in which oocyte volume increases dramatically due to rapid water uptake by the maturing oocyte (e.g. Hirose & Ishida, 1974; Hirose *et al.*, 1976). Oocyte maturation largely remains under the control of GTH II. As maturation proceeds, androgen and oestrogen production declines and GTH(s) rises rapidly, leading to the synthesis of maturation steroids such as 17α -OH-P and 17α - 20β -P resulting in final maturation and ovulation (Scott & Baynes, 1982; Scott *et al.*, 1982; Goetz, 1983; Scott *et al.*, 1983).

In the classification of ovarian development in *O. niloticus* reported by Srisakultiew (1993) stage 6 and stage 7 oocytes were grouped as one stage. This was due to a difficulty (due to the small size of the nucleus relative to the oocyte) in determining the relative position of the nucleus within the ooplasm. Stage 6/7 oocytes (422 - 1965 μm in size) were found to contain numerous vacuoles (cortical alveoli or oil droplets) located close to the follicular layers. Some yolk granules were found to have fused to form yolk platelets, platelets being larger in size at the animal pole of the oocyte than the vegetal pole. The zona radiata was observed to be well developed and clearly distinguishable into two layers; the zona interna and the zona externa.

Cytochemical studies have revealed high enzyme activity in certain thecal cells known as specialised thecal cells and are thought to be involved in steroidogenesis (Hoar & Nagahama, 1978; van den Hurk & Peute, 1979; Kagawa *et al.*, 1982). In most teleosts these are found in the theca interna (Dodd & Sumpter, 1984) but in the rainbow trout they are found in the theca externa (van den Hurk & Peute, 1979). These cells have been shown to be similar to the steroidogenic leydig cells in testes (Dodd & Sumpter, 1984) and possess numerous ultrastructural features common to steroidogenic cells (e.g. van den Hurk & Peute, 1979; Kagawa *et al.*, 1981). van den Hurk & Peute (1979) further claimed that steroidogenesis in rainbow trout peaks during maturation and ovulation coincident with the appearance of special thecal cells within the follicle and thus suggested a major role of these cells in ovarian steroidogenesis.

Mature oocytes (eggs) are generally ovulated soon after final maturation resulting in the extrusion of eggs from their respective follicular layers into the body cavity or ovarian lumen ready for release into the external environment (oviposition). Ovulation is thought to be controlled by catecholamines and prostaglandins (Jalabert, 1976). Prostaglandins act upon the smooth muscle of the theca and ovarian lamellae (Scott, 1990) to aid expulsion of the mature oocyte.

Penetration of male sperm through the micropyle (see Nagahama, 1983 and Wallace & Selman, 1981) leads to fertilization and the resumption of second meiotic division followed by the chromosomal combination of both sexes. During fertilization,

the peripherally-located cortical alveoli release their contents into the peri-vitelline space resulting in the uptake of water and subsequent 'water-hardening' (Bromage & Cumaranatunga, 1988).

(4.1.3) Post ovulatory follicles.

Following ovulation, the granulosa and theca remain in the ovary known as post-ovulatory corpora lutea (Hoar, 1967) or more commonly as post-ovulatory follicles (POFs). The granulosa undergoes degeneration and autophagocytosis (Kagawa *et al.*, 1981; van den Hurk and Peute, 1985) resulting in hypertrophication and collapse into the follicular lumen (Kagawa *et al.*, 1981). Few studies of ovarian development report the presence of POFs in tilapias. Only those studies by Dadzie (1974) and Aravindan & Padmanabhan (1972) in *O. mossambicus*, Dadzie & Wangila (1980) in *T. zillii*, and by Srisakultiew (1993) in *O. niloticus* observe 'ruptured follicles' or POFs.

A steroidogenic function has been suggested and demonstrated in both the granulosa and theca of POFs (Bara, 1965; Nagahama *et al.*, 1976; Lam *et al.*, 1978; van den Hurk & Peute, 1979; Kagawa *et al.*, 1981; Lang, 1981). A link with oogonial proliferation has also been suggested (van den Hurk & Peute, 1979; Kagawa *et al.*, 1981) though Lam *et al.* (1978) claimed that POFs may help maintain ovulated eggs whilst still within the ovarian lumen by producing steroids, in turn, stimulating the ovarian epithelium to produce fluid used to bathe ovulated eggs. Hoar (1969) suggested that although teleost POFs may be homologous to mammalian corpora lutea, teleost POFs secrete oestrogens rather than progesterones. In a more recent study Nagahama (1983) suggested that since the theca and granulosa have extensively been reported to possess 3 β -HSD activity, a functional resemblance to the mammalian corpus luteum seems likely though secreting oestrogens rather than progesterones. Bromage & Cumaranatunga (1988) reported the presence of many oogonial nests amongst the connective tissue and ovigerous lamellae surrounding POFs and further suggested that

it is from these that pre-vitellogenic oocytes later develop. The precise role and function of POFs remains unclear.

(4.1.4) Atresia (oocyte degeneration and resorption).

Arguably, one of the most important processes occurring within the teleost ovary is the degeneration and resorption (or atresia) of oocytes and represents a common process in the ovaries of all vertebrate animals (e.g. Brambell, 1956; Byskov, 1978; Saidapur, 1978; Bromage & Cumaranatunga, 1988). Oocyte resorption is commonly divided into four successive stages (α , β , γ and δ) (Bretschneider & Duyvene de Wit, 1947), though an additional fifth stage (Σ) was described by Khoo (1975). The following account draws largely upon the work of Bretschneider & Duyvene de Wit (1947).

During α -stage atresia, oocytes lose water and shrink concomitant with phagocytosis of the oolemma and oocyte contents by the granulosa cells. Rupture of the nucleus results in the release of nuclear material into the degenerating ooplasm. Yolk liquifies, losing its acidophilic nature to form basophilic granules. β -stage involves the invasion of the degenerating oocyte by follicle cells and their subsequent multiplication. Interspersed amongst these follicle cells are numerous blood vessels. Leucocytes produced from these blood vessels and from the thecal cells of the multiplying follicles were initially thought to be responsible for oocyte degeneration (e.g. Barr, 1963; Braekevelt & McMillan, 1967; Rastogi, 1966) though Lang (1981) concluded that leucocytes do not make a significant contribution to atresia. Completion of follicular disintegration and an accumulation of lutein pigment (thought to originate from follicle cells) marks the onset of γ -stage atresia. Atretic follicles then regress due to migration of cells into surrounding tissue and through further resorption. Finally, regressing follicles develop residual bodies either black or brown in colour. These bodies are commonly known as "brown bodies" (Chan *et al.*, 1967) and are thought to differentiate into irregular bundles of connective tissue and cells (Bretschneider & Duyvene de Wit, 1947). The Σ -stage defined by Khoo (1975) in the goldfish was

thought to be involved in oogenesis since large numbers of oogonia were often seen in ovaries containing Σ -stage atresia.

The precise functional role of atresia remains largely unclear. Early work suggested a possible secretory function (Scott, 1962). Hoar (1969) later suggested a steroidogenic role. Khoo (1975) reported active 17 β -hydroxysteroid-dehydrogenase in goldfish oocytes undergoing γ -stage atresia, suggesting functional homology to the corpora lutea of other vertebrates. Studies of other teleosts have shown limited 3 β -hydroxysteroid-dehydrogenase activity in atretic tissue (e.g. Saidapur & Nadkarni, 1976; Lang, 1981). Since smooth endoplasmic reticulum, mitochondria and other such organelles usually associated with steroid biosynthesis are absent from atretic follicles, the steroidogenic properties observed in atretic tissue may simply be due to metabolism of cholesterol and lipid originating from the degenerating follicle (Cumaranatunga, 1985). Lang (1981) however, claimed that atretic follicles are merely degenerative structures exhibiting histological change due to phagocytosis and lysosomes. Yaron (1971) observed activity of 3 β -HSD in both the theca and the granulosa of *O. niloticus*. Following invasion of atretic oocytes by the granulosa however, activity of this enzyme was not found. The presence of steroid converting enzyme before but not after oocyte invasion suggested a shift in function of the granulosa cells from glandular and nutritive to phagocytic roles (Yaron, 1971).

Subsequent studies have also shown scepticism towards a precise functional role. van den Hurk and Peute (1979) stated that atresia did not contribute significantly to ovarian physiology. This statement was supported by several other studies (e.g. Rastogi, 1966; Wallace & Selman, 1979, 1981). These authors claimed that atresia is simply a means of "mopping-up" at the end of a breeding cycle especially in asynchronous or multiple spawning fish. Further study has suggested that atresia is involved in the initiation of follicular growth and in the selection of follicles for ovulation (Tyler, 1988) and an important determinant of fecundity (Vladykov, 1956; Springate *et al.*, 1985; Springate, 1985; Bromage *et al.*, 1992). Rastogi (1966) claimed that atresia could occur at any stage of ovarian development although it is most

commonly encountered during vitellogenesis or post-ovulation (Bromage & Cumaranatunga, 1988). In rainbow trout, atresia was shown to clearly affect stages 4, 5, 6 and 7 (Bromage & Cumaranatunga, 1988). The occurrence of atresia in pre-vitellogenic oocytes has not yet been clearly demonstrated though it remains likely that resorption of such small oocytes would be extremely rapid. Incidence of atresia is relatively poorly understood though is believed to be influenced by age, stage of reproductive cycle, dietary status and hormonal status (Bromage & Cumaranatunga, 1988) and also by captivity, light, temperature and crowding (Guraya, 1973; 1979). Any stage of oocyte can be affected by atresia (Rastogi, 1966), though Nagahama (1983) and Guraya (1979) claimed that it is the vitellogenic oocytes and unshed ova that are mostly affected. Many authors however, claim that atresia is an uncommon event in well-fed physiologically healthy individuals (Henderson, 1963; Wallace & Selman, 1981; Tyler & Sumpter, 1996).

Several studies of ovarian development in tilapia report atresia (Aravindan & Padmanabhan, 1972; Babiker & Ibrahim, 1979a; Peters, 1983; Hussein, 1984; Srisakultiew, 1993). Srisakultiew (1993) reported three stages of atresia in *O. niloticus*; α , β , and γ . α -stage atresia involved the collapse and release of nuclear contents into the cytoplasm and the hypertrophy of the granulosa. β - and γ -stage atresia involved the advanced liquification of yolk and the advanced invasion of the oocyte by follicular layers. By the end of β - and γ -stage, follicles had completely disintegrated.

It should be stressed that although the above account of ovarian development describes a sequence of oocyte growth with successive developmental phases replacing each other, several phases often occur simultaneously in different oocytes (Wallace & Selman, 1981). Similarly, although a large population of oocytes undergo development, only a species-specific number of oocytes are actually ovulated (Saidapur, 1978). Even within an oocyte, it is likely that periods exist where a number of the growth phases described above may overlap (Wallace & Selman, 1979). Consequently, it remains difficult to ascribe distinct stage boundaries to different growth phases. Moreover, the size of an oocyte at which a particular developmental

stage/process begins is species specific. Relatively large proportions of oocytes may be effectively lost from the ovary via atresia (Ingram, 1962). Furthermore, the rate of respective developmental phases may be influenced by both endocrine events and/or by atresia (Wallace & Selman, 1981; Wallace *et al.*, 1987; Selman & Wallace, 1989).

The present study aims to provide a classification scheme for ovarian development in *T. zillii* based upon those described by Selman & Wallace (1983, 1989), Selman *et al.* (1993), Wallace *et al.* (1987), Bromage & Cumaranatunga (1988) and Srisakultiew (1993). This will form the first detailed classification of oocyte development in any substrate-spawning tilapia and will be referred to in subsequent investigations throughout this thesis.

(4.2) Materials and methods.

Fish utilised in this study were taken from genetically pure stocks of *T. zillii* (strain 'A') held at the Institute of Aquaculture and maintained under those conditions of temperature, photoperiod and diet detailed in Section 2.1.3. In order to build up a representative picture of ovarian condition throughout the reproductive cycle, at least 10 sexually mature female *T. zillii* of various sizes and ages were sacrificed at different timepoints from each of the following conditions:

- (a) stock conditions (Systems 1 and 2, Section 2.1.2), held with males.
- (b) individual conditions (Systems 3 and 4, Section 2.1.2).

Selected fish were anaesthetised, weighed and total length determined as detailed in Sections 2.2.1. and 2.4.1. Fish were then sacrificed by an anaesthetic overdose followed by spinal transection. Ovaries were then removed, fixed in Bouin's fluid and embedded in Historesin as detailed in Section 2.5. Tissues were sectioned at thicknesses of 2 - 5 μm (Section 2.5.2.6) and stained in either haematoxylin and eosin or with polychrome (see Section 2.5.2). Slides were examined microscopically and oocytes in which the nucleus was clearly visible classified according to criteria given in Selman & Wallace (1983, 1989), Selman *et al.* (1993), Wallace *et al.* (1987), Bromage

& Cumaranatunga (1988) and Srisakultiew (1993). Representative stages of oocyte development were photographed according to Section 2.5.3.

Discrete stages of oocyte development were then measured using a binocular microscope (Olympus Optical Co. Ltd., London, U.K.) fitted with a calibrated eyepiece graticule. At least 30 oocytes from each classified stage were measured. Since most oocyte stages were ovoid shaped, both long and short axes were measured. Only those oocytes sectioned directly through the nucleus were used for measurement.

(4.3) Results.

Oocyte development in *T. zillii* was classified into several distinct stages based upon criteria given by Selman & Wallace (1983, 1989), Wallace *et al.* (1987), Bromage & Cumuranatunga (1988) and Srisakultiew (1993).

Since all developmental stages (except oogonia) were non-spherical (Figure 4.1) and since it was not known where upon the longitudinal axis oocytes had been sectioned, the best representation of oocyte size was thought to be the mean of both long and short axes (see equation given in Section 2.4.2.1).

(4.3.1) Primary growth phase (PGP).

(a) Oogonia.

Oogonia were found either singularly or more commonly in oogonial nests in the germinal tissue. Oogonia were approximately spherical, contained little cytoplasm and ranged from 4 - 6 μm in diameter with a mean of $5\pm 0.1 \mu\text{m}$ (Figure 4.2, Plate 4.1).

(b) Stage 1 (chromatin nucleolar stage).

Stage 1 oocytes (chromatin nucleolar stage) were often observed close to oogonia and were very similar to oogonia in appearance. Stage 1 oocytes ranged from 7 μm to 12 μm in diameter (mean = $9\pm 0.3 \mu\text{m}$). The nucleus contained a large

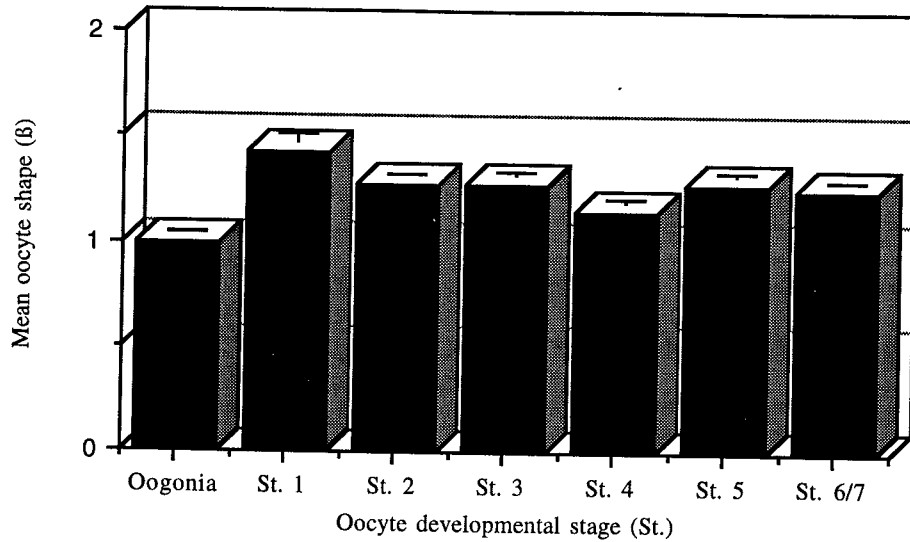

Figure 4.1 Variation of mean oocyte shape (β) with developmental stage in *T. zillii*. Measurements taken from 2 - 5 μ m histological sections prepared from the ovaries of 30 - 333g *T. zillii*. Mean oocyte shape was calculated using equation 9 (Section 2.5.4.4). An oocyte shape of 1.0 indicates a spherical shape. An oocyte shape >1 indicates a progressively ellipsoid nature.

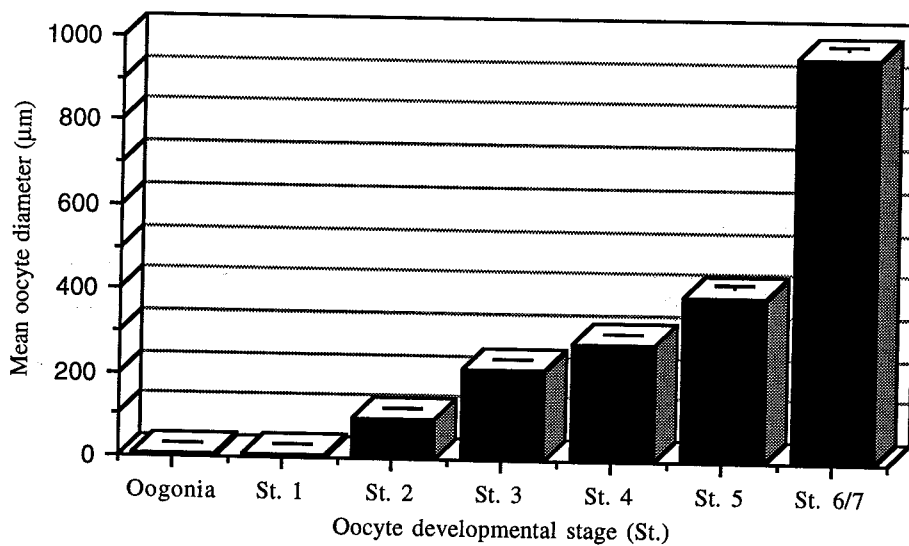

Figure 4.2 Variation of oocyte diameter (μ m) with developmental stage in *T. zillii*. Measurements taken from 2 - 5 μ m histological sections prepared from the ovaries of 30 - 333g *T. zillii*. Mean oocyte diameter was calculated using the equation given in Section 2.4.2.1.

Plate 4.1 Transverse section (4.5µm thick) of *T. zillii* (120.8g in weight) ovary showing oogonia and stage 1 (chromatin nucleolar stage) oocytes. Stained with haematoxylin & eosin (Mag. x250). Scale: 10 µm.

C - chromatin strands

N - nucleus

NU - nucleolus

OG - oogonia

S1 - stage 1 oocyte

S6/7 - stage 6 or 7 oocyte

A.

Plate 4.2 Transverse section (4.5µm thick) of *T. zillii* (120.8g in weight) ovary showing various sizes of stage 2 oocytes (early perinucleolar stage). Stained with polychrome (Mag. x40). Photographed on black & white film. Note areas of particularly basophilic material (Balbiani-like). Scale: 100 µm.

BM - Balbiani-like basophilic material

S3 - stage 3 oocyte

N - nucleus

S6/7 - stage 6 or 7 oocyte

NU - nucleoli

OP - ooplasm

S2 - stage 2 oocyte

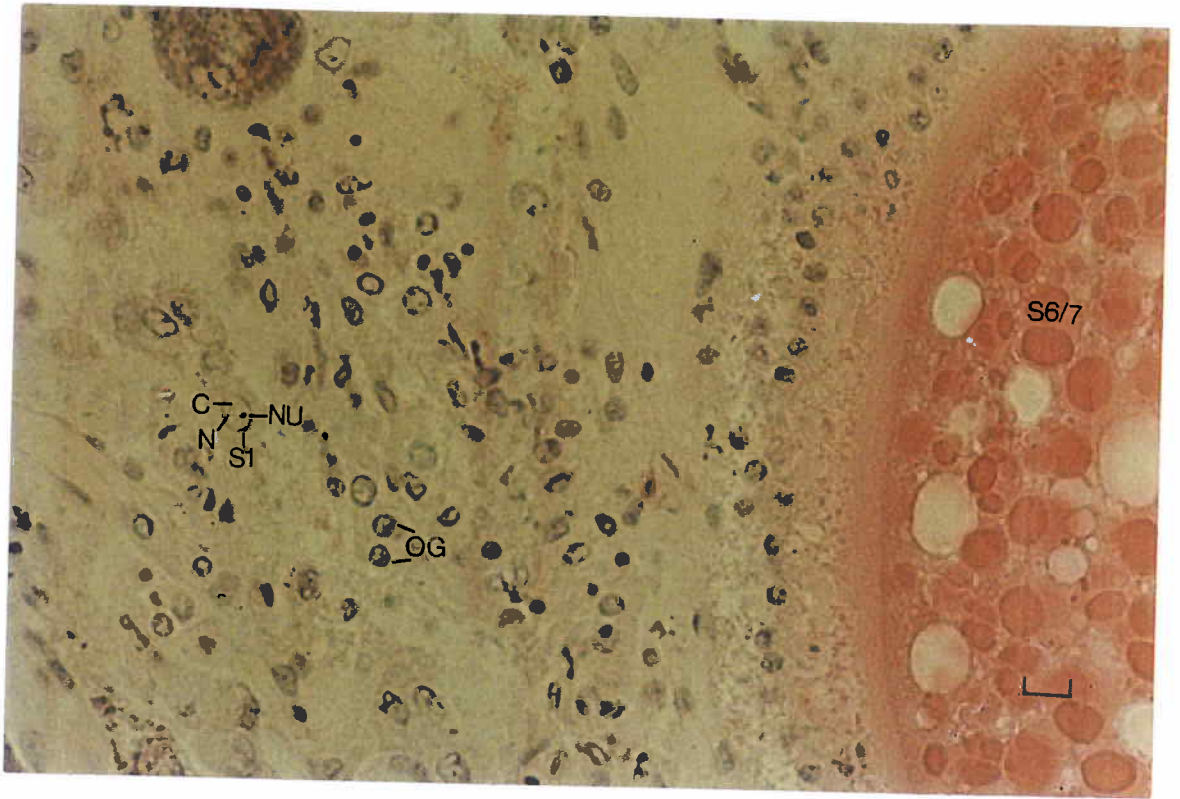

Plate 4.1.

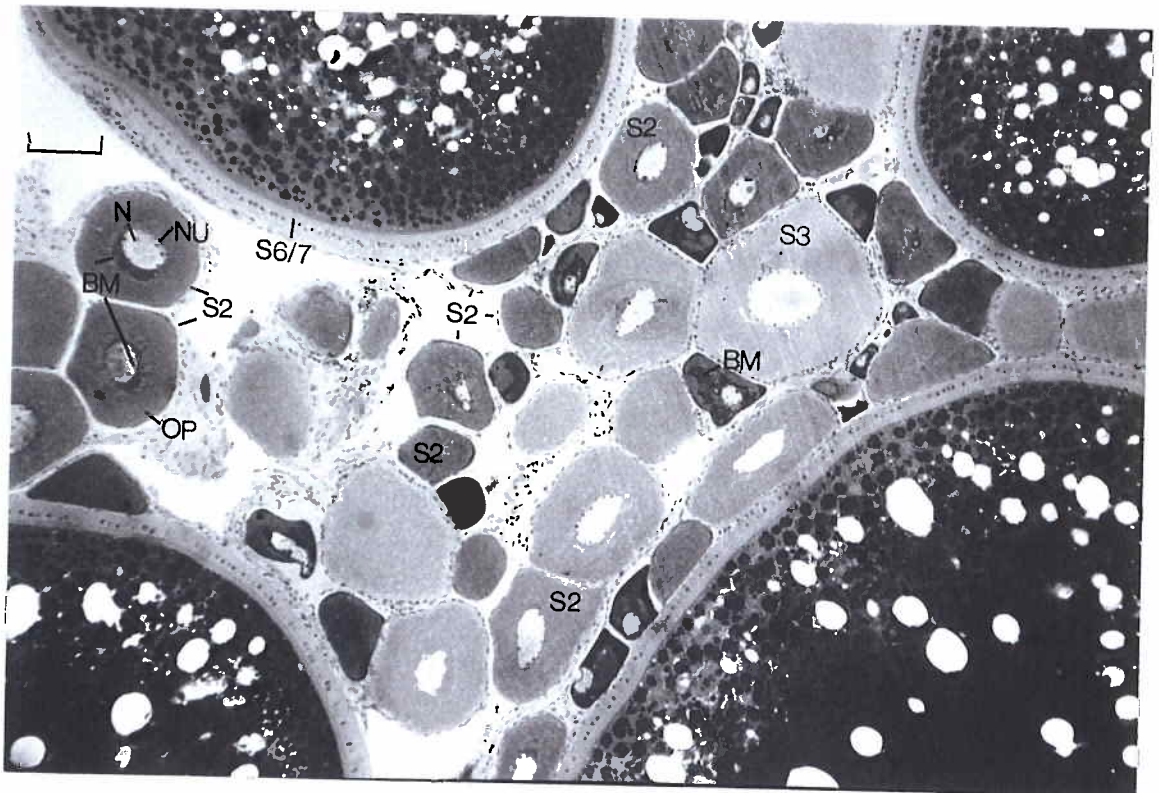

Plate 4.2.

conspicuous nucleolus and several strands of chromatin surrounded by a thin layer of cytoplasm. (Figure 4.2, Plate 4.1).

(c) Stage 2 oocytes (early perinucleolar stage).

Stage 2 oocytes (early perinucleolar stage) ranged from 36 μm to 240 μm in diameter (mean = $97 \pm 1.1 \mu\text{m}$) (Figure 4.2). Highly basophilic cytoplasm stained either dark purple/black (in polychrome stain) or dark red/purple (in haematoxylin & eosin) (See Plates 4.2 - 4.10 and 4.12 - 4.16).

Structures resembling the Balbiani bodies reported by Bromage & Cumarantunga (1988) in the rainbow trout and by Srisakultiew (1993) in *O. niloticus* were not seen in the present study. Localised areas of particularly basophilic material ('Balbiani body-like') were however observed in many stage 2 oocytes. The positioning of these areas varied but were most commonly found either close to the nucleus or the oocyte periphery (Plates 4.2, 4.3, 4.4).

(d) Stage 3 oocytes (late perinucleolar stage).

Stage 3 oocytes (late perinucleolar stage) ranged from 122 μm to 342 μm in diameter (mean = $214 \pm 1.4 \mu\text{m}$) (Figure 4.2). The nucleus contained several small nucleoli close to the nuclear envelope and numerous strands of chromatin (Plate 4.5). Due to the decreasing degree of basophilia, the oocyte cytoplasm stained much lighter than stage 2 oocytes (light grey/blue in polychrome or pale pink in haematoxylin and eosin). A developing follicular layer was observed consisting of a granulosa and thecal layer (Plate 4.5, see also Plates 4.2, 4.3, 4.8, 4.13 and 4.15).

(4.3.2) Secondary growth phase (SGP).

(a) Stage 4 (cortical alveolar stage).

The diameter of stage 4 (cortical alveolar stage) oocytes ranged from 219 μm to 326 μm (mean = $280 \pm 3.2 \mu\text{m}$) (Figure 4.2). Several small nucleoli and chromatin strands were still present within the nucleus close to the undulated nuclear envelope.

Plate 4.3 Transverse section (3.0µm thick) of *T. zillii* (150.6g in weight) ovary showing a cluster of stage 2 oocytes. Stained with haematoxylin & eosin (Mag. x250).

Scale: 10 µm.

BM - Balbiani-like basophilic material	RC - red blood cells
C - chromatin strands	S2 - stage 2 oocyte
N - nucleus	S3 - stage 3 oocyte
NU - nucleoli	
OP - ooplasm	

Plate 4.4 Transverse section (4.5µm thick) of *T. zillii* (333.0g in weight) ovary showing stage 2 oocytes. Stained with haematoxylin & eosin (Mag. x250).

Scale: 10 µm.

BM - Balbiani-like basophilic material	S2 - stage 2 oocyte
C - chromatin strands	S6/7 - stage 6 or 7 oocyte
N - nucleus	
NU - nucleoli	
OP - ooplasm	

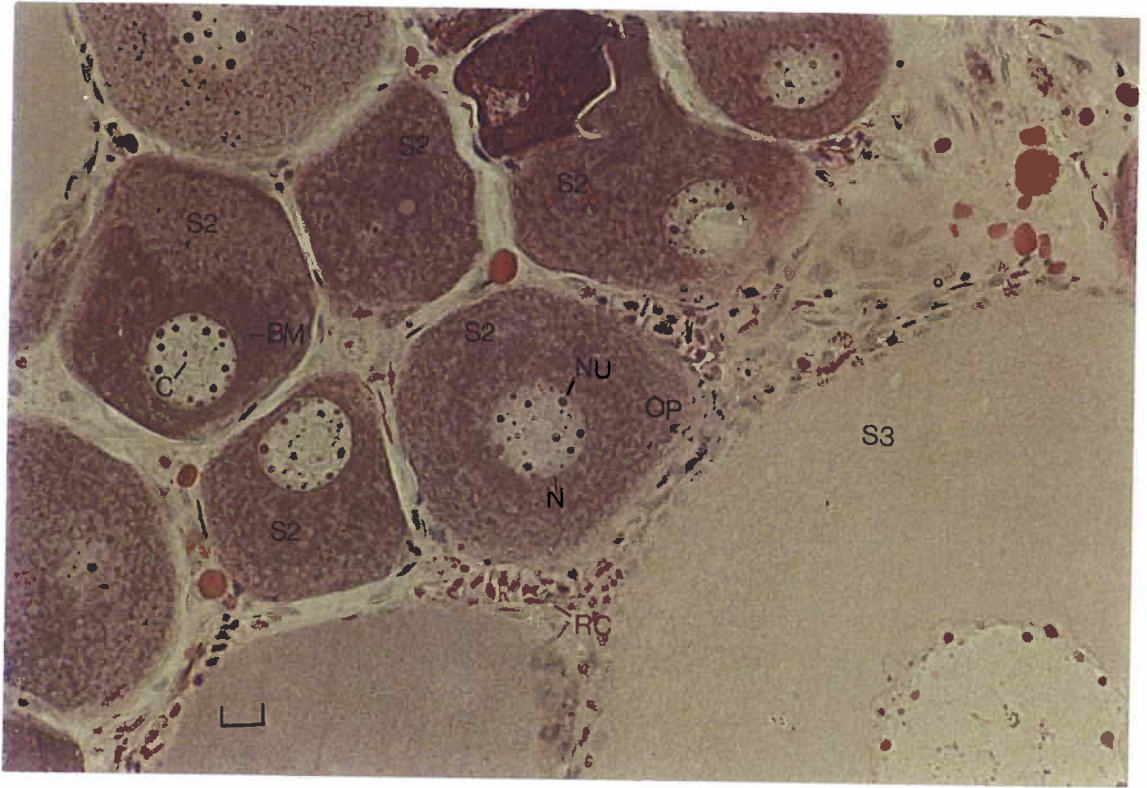

Plate 4.3.

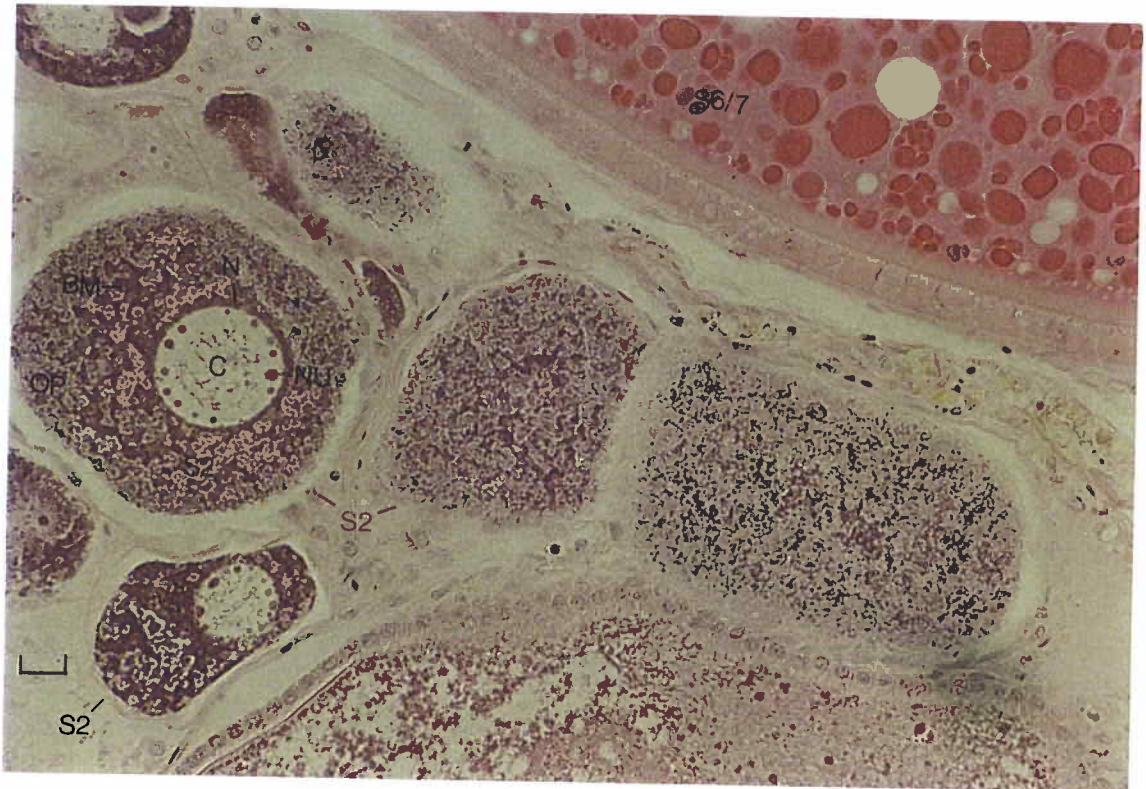

Plate 4.4.

Plate 4.5 Transverse section (4.5µm thick) of *T. zillii* (333.00g in weight) ovary showing stage 3 oocytes (late perinucleolar stage). Stained with haematoxylin & eosin (Mag. x250). Scale: 10 µm.

BM - Balbiani-like basophilic material	S2 - stage 2 oocyte
C - chromatin strands	S3 - stage 3 oocyte
G - granulosa	S6/7 - stage 6/7 oocyte
N - nucleus	T- theca
NU - nucleoli	
OP - ooplasm	
RC- red blood cells	

Plate 4.6 Transverse section (4.5µm thick) of *T. zillii* (138.81g in weight) ovary showing a stage 4 oocyte (cortical alveolar stage). Stained in haematoxylin & eosin (Mag. x40). Scale: 100 µm.

C - chromatin	S2 - stage 2 oocyte
CA - cortical alveoli	S4 - stage 4 oocyte
G - granulosa	S6/7 - stage 6 or 7 oocyte
N - nucleus	T - theca
NE - nuclear envelope	ZR - zona radiata
NU - nucleoli	V - vacuoles

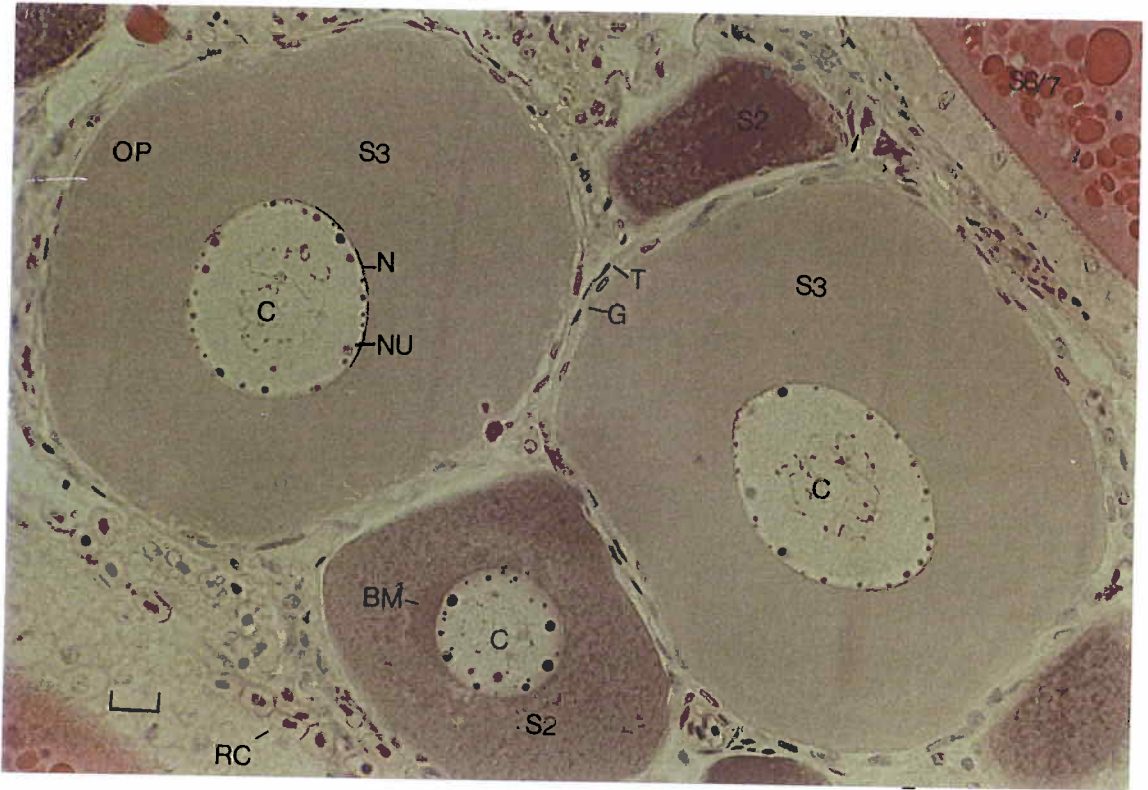

Plate 4.5.

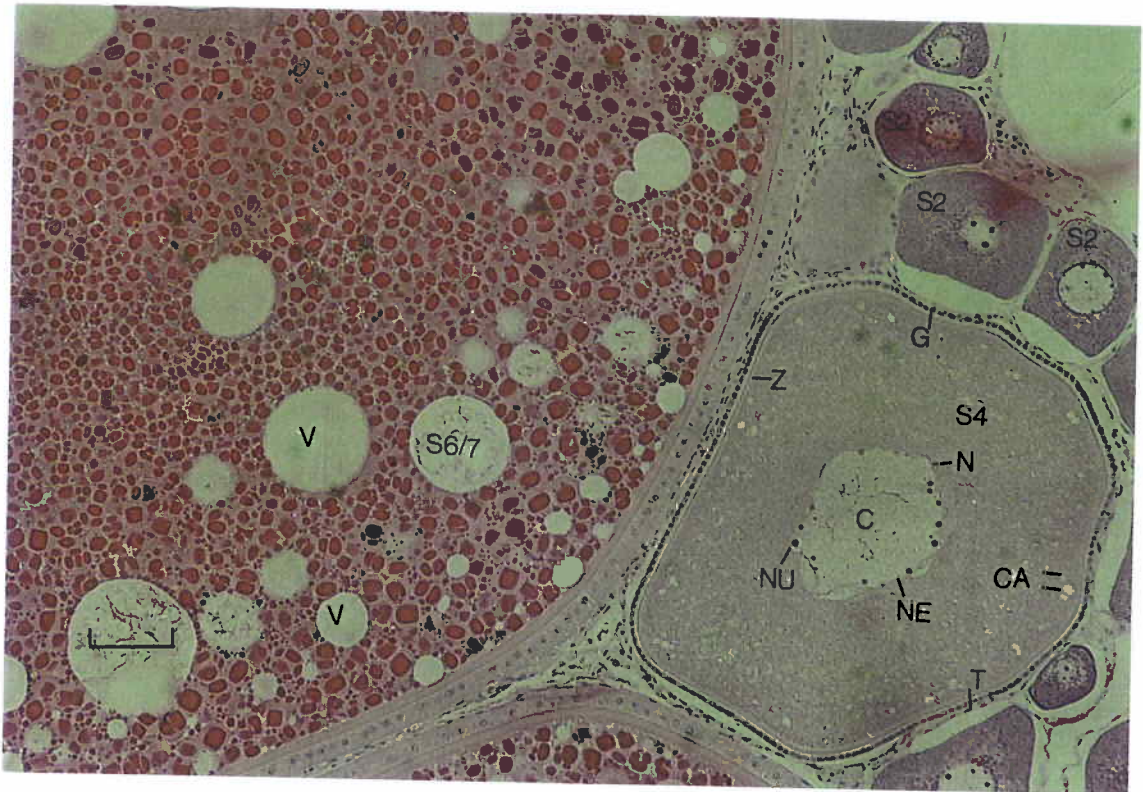

Plate 4.6.

Oocyte cytoplasm was highly acidophilic and stained light blue in polychrome or light pink in haematoxylin and eosin). Numerous vesicles (cortical alveoli) were observed close to the oocyte periphery. The developing follicular layer was found to be composed of a developing zona radiata, a cuboidal granulosa and a thin thecal layer (Plate 4.6).

(b) Stage 5 oocytes.

Stage 5 oocytes ranged from 224 μm to 658 μm in diameter (mean = 395 ± 3.9 μm) (Figure 4.2). Early stage 5 oocytes were characterised by the appearance of small yolk granules in the oocyte periphery (Plate 4.7). Numerous vesicles/vacuoles were found dispersed throughout the ooplasm (Plate 4.7). As vitellogenesis progressed throughout stage 5, yolk granules (staining mauve blue in polychrome or dark pink in haematoxylin and eosin) accumulated into yolk particles (or globules). Towards the end of stage 5, yolk particles (globules) were found distributed throughout the ooplasm (Plate 4.8) and stained much more intensely than earlier in stage 5. Numerous vacuoles/vesicles were observed located close to the oocyte periphery. The zona radiata became much more developed by late stage 5 and was seen in association with a developed cuboidal granulosa and thicker thecal layer (Plates 4.7 and 4.8).

(c) Stage 6 and 7 oocytes (maturation and germinal vesicle migration).

Stage 6 and 7 oocytes ranged from 428 μm to 1416 μm in diameter (mean = 964 ± 6.9 μm) (Figure 4.2). Many apparently empty vacuoles were found throughout the oocyte but especially in areas close to the oocyte periphery. Large yolk globules were found distributed throughout the entire ooplasm. The nucleus of stage 6 oocytes was still centrally positioned (Plate 4.9). The nucleus of stage 7 oocytes was observed to have migrated to the oocyte periphery (at the animal pole) (Plate 4.10). See also Plates 4.1, 4.2, 4.4 - 4.6, 4.8, 4.10, 4.12 and 4.14 - 4.16 for stage 6/7 oocytes. A well developed follicular layer of zona radiata (consisting of a zona interna and zona

Plate 4.7 Transverse section (4.5µm thick) of *T. zillii* (150.1g in weight) ovary showing an early stage 5 oocyte. Stained with haematoxylin & eosin (Mag. x100).

Scale: 100 µm.

C - chromatin	S5 - stage 5 oocyte
G - granulosa	T - theca
N - nucleus	VE - vesicles
NE - nuclear envelope	YG - yolk granules
NU - nucleoli	ZR - zona radiata
S2 - stage 2 oocyte	

Plate 4.8 Transverse section (4.0µm thick) of *T. zillii* (114.55g in weight) ovary showing a late stage 5 oocyte. Stained with haematoxylin & eosin (Mag. x100). Scale:

100 µm.

G - granulosa	T - theca
S2 - stage 2 oocyte	VA - vacuoles
S3 - stage 3 oocyte	VE - vesicles
S5 - stage 5 oocyte	YG - yolk globules
S6/7 - stage 6 or 7 oocyte	ZR - zona radiata

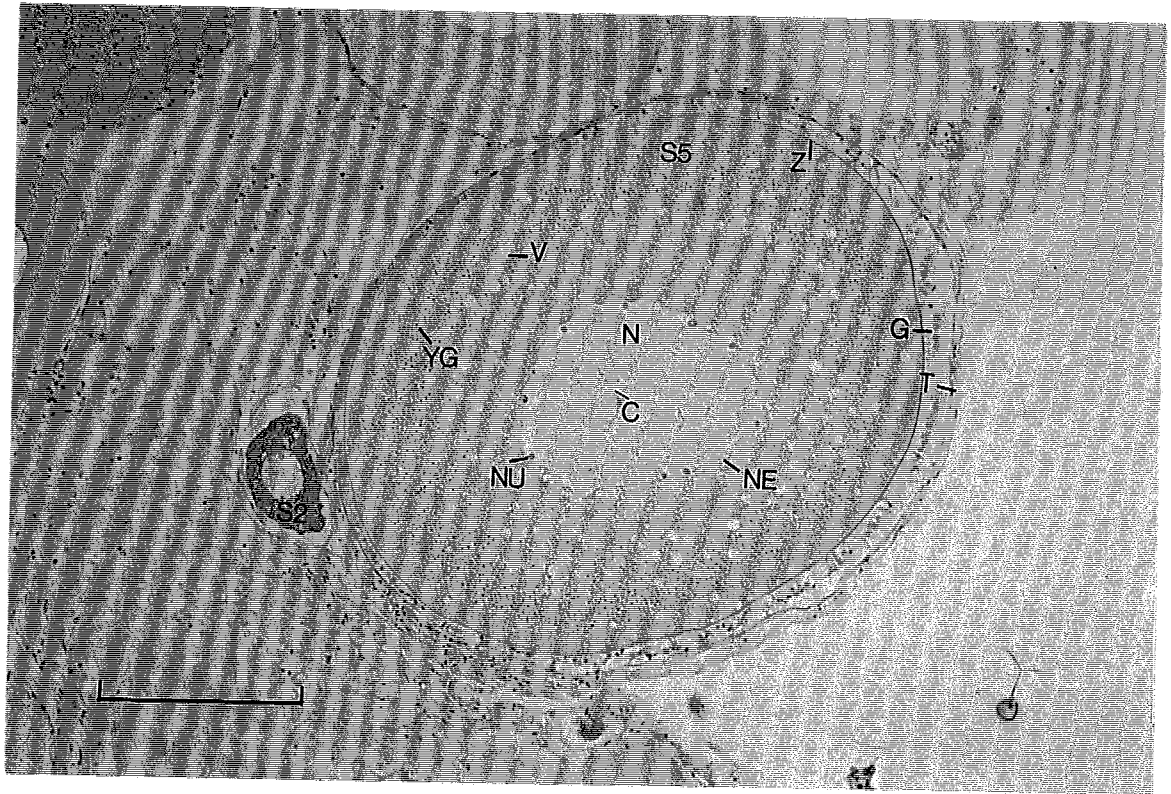

Plate 4.7.

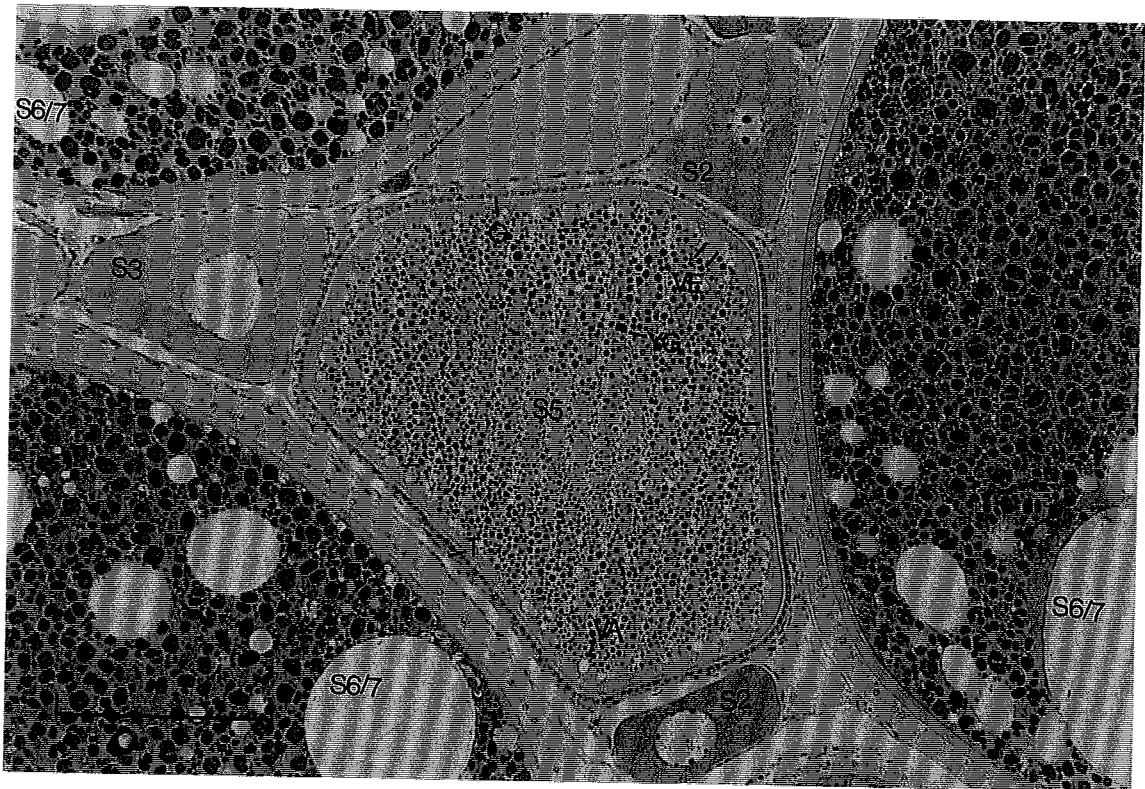

Plate 4.8.

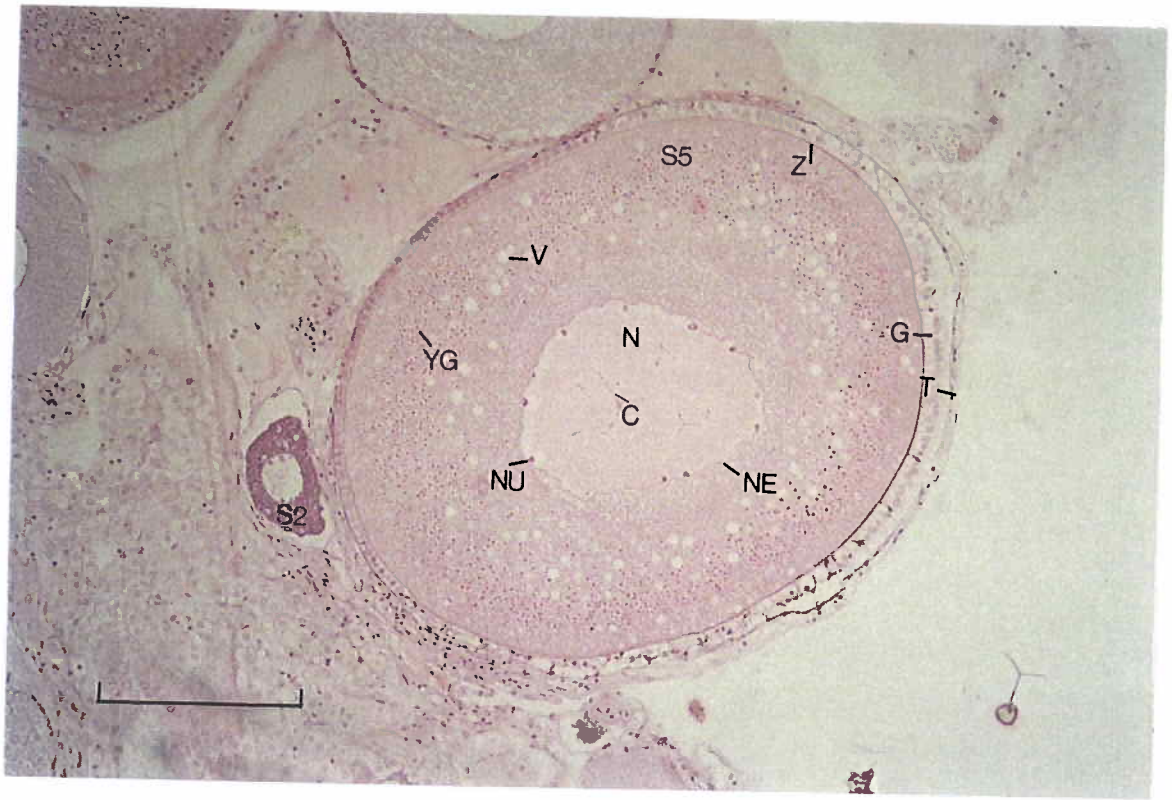

Plate 4.7.

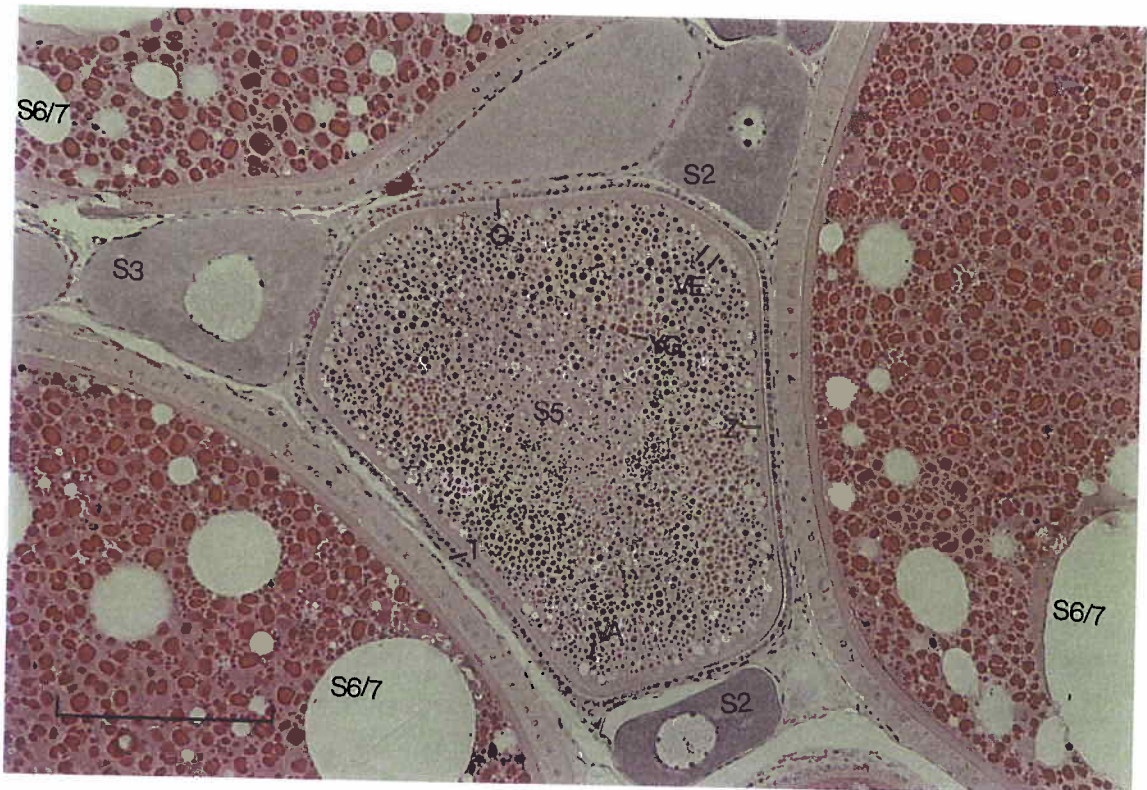

Plate 4.8.

Plate 4.9 Transverse section (4.5µm) of *T. zillii* (333.0g in weight) ovary showing a stage 6 oocyte with centrally positioned nucleus (germinal vesicle). Stained with haematoxylin & eosin (Mag. x40). Scale: 100 µm.

N - nucleus (germinal vesicle)

VA - vacuoles

S2 - stage 2 oocyte

YG - yolk globule

S6 - stage 6 oocyte

S6/S7 - stage 6 or 7 oocyte

Plate 4.10 Transverse section (4.5µm thick) of *T. zillii* (200.1g in weight) ovary showing a stage 7 oocyte undergoing germinal vesicle migration (GVM). Stained with haematoxylin & eosin (Mag. x40). Scale: 100 µm.

N - nucleus (germinal vesicle)

VA - vacuoles

S2 - stage 2 oocyte

YG - yolk globule

S6/7 - stage 6 or 7 oocyte

S7 - stage 7 oocyte

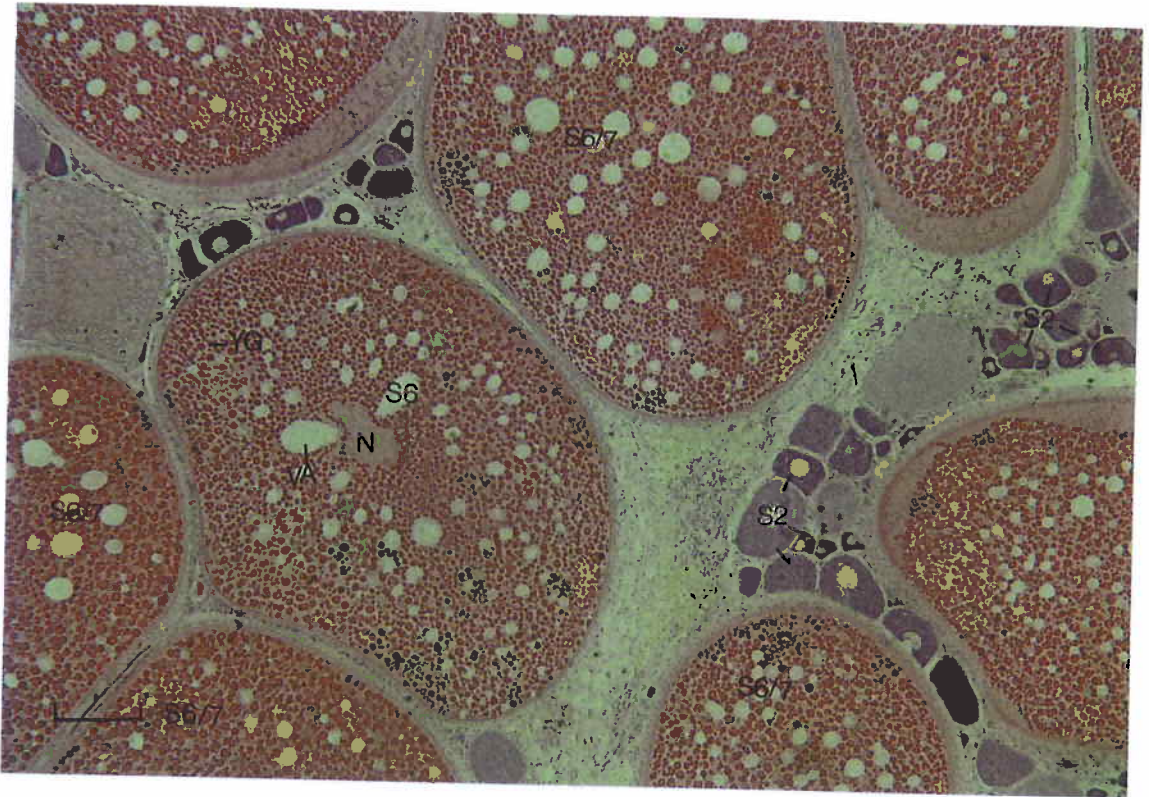

Plate 4.9.

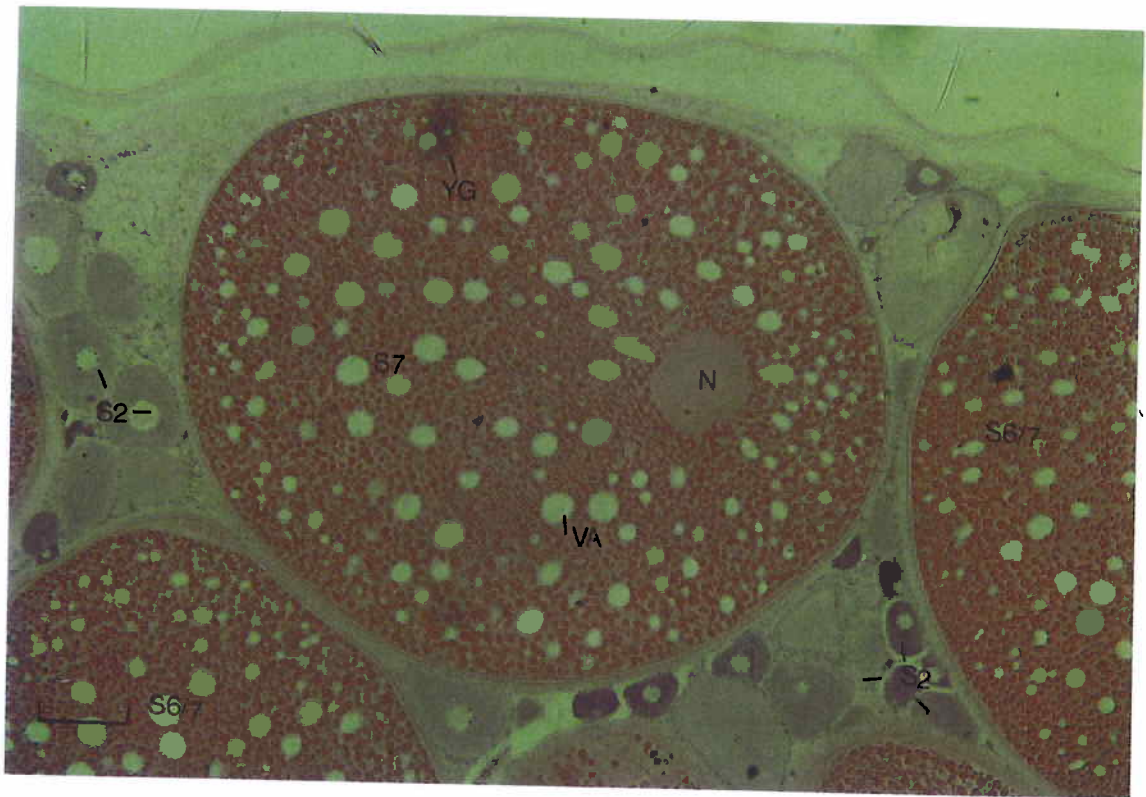

Plate 4.10.

externa), granulosa and theca was observed in both stage 6 and stage 7 oocytes (Plate 4.12).

Since it was impossible to distinguish between stages 6 and 7 unless the oocyte had been sectioned directly through the nucleus (which was fairly uncommon), stages 6 and 7 were grouped in all subsequent investigations in this thesis as one common stage - stage 6/7.

(4.3.3) Post-ovulatory follicles.

Post-ovulatory follicles (POFs) were highly irregular structures consisting of theca and granulosa follicular layers. The granulosa was found to be hypertrophied and along with the theca had collapsed into the follicular lumen (Plates 4.12 and 4.13). Due to the wide variation in shape of POFs it was not possible to accurately quantify their size.

(4.3.4) Atresia.

Atresia was assigned to one of three stages (α , β , or γ) depending upon the extent of degeneration and phagocytosis. Early atresia (α -stage) was characterised by the oocyte shrinking and separating from the hypertrophied granulosa layer (Figure 4.14). Yolk granules and globules of atretic oocytes lost their basophilic nature and become progressively acidophilic. As atresia progressed through β -stage (Plate 4.15) and into γ -stage (advanced atresia), liquified yolk became more acidophilic with increased invasion by in-folding follicular layers and phagocytosis by the hypertrophied granulosa layer (Plate 4.16).

A summary of the above classification scheme for use with both haematoxylin and eosin and polychrome stains are given in Table 4.1.

(4.4) Discussion.

Oocyte growth in *T. zillii* was classified into several discrete stages of development based upon criteria described by Selman & Wallace (1983, 1989), Selman

Plate 4.11 Transverse section (2.5µm thick) of *T. zillii* (120.78 in weight) ovary showing the fine structure of the follicular layer of a stage 6/7 oocyte. Stained with haematoxylin & eosin (Mag. x250). Note the difference in follicular development between the stage 6/7 oocyte and the stage 5 oocyte lying adjacent. Scale: 10 µm.

G - granulosa

YG - yolk globules

S5 - stage 5 oocyte (early)

ZI - zona interna

S6/7 - stage 6 or 7 oocyte

ZE - zona externa

T - theca

Plate 4.12 Transverse section (2.5µm thick) of *T. zillii* (208.1g in weight) ovary one day after spawning showing a post-ovulatory follicle (POF). Stained with polychrome and photographed with black and white film (Mag. x100). Scale: 100 µm.

G - hypertrophied granulosa layer

T - theca

RC - red blood cells

POF - post-ovulatory follicle

S2 - stage 2 oocyte

S6/7 - stage 6 or 7 oocyte

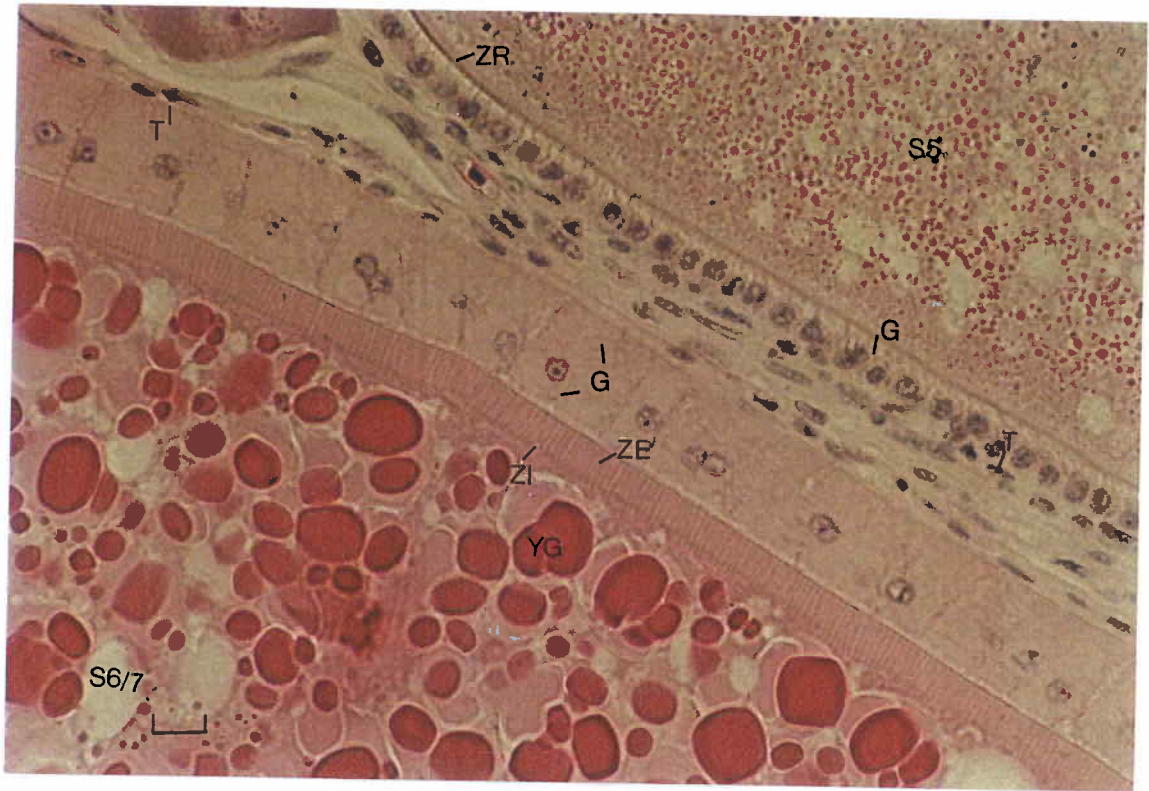

Plate 4.11.

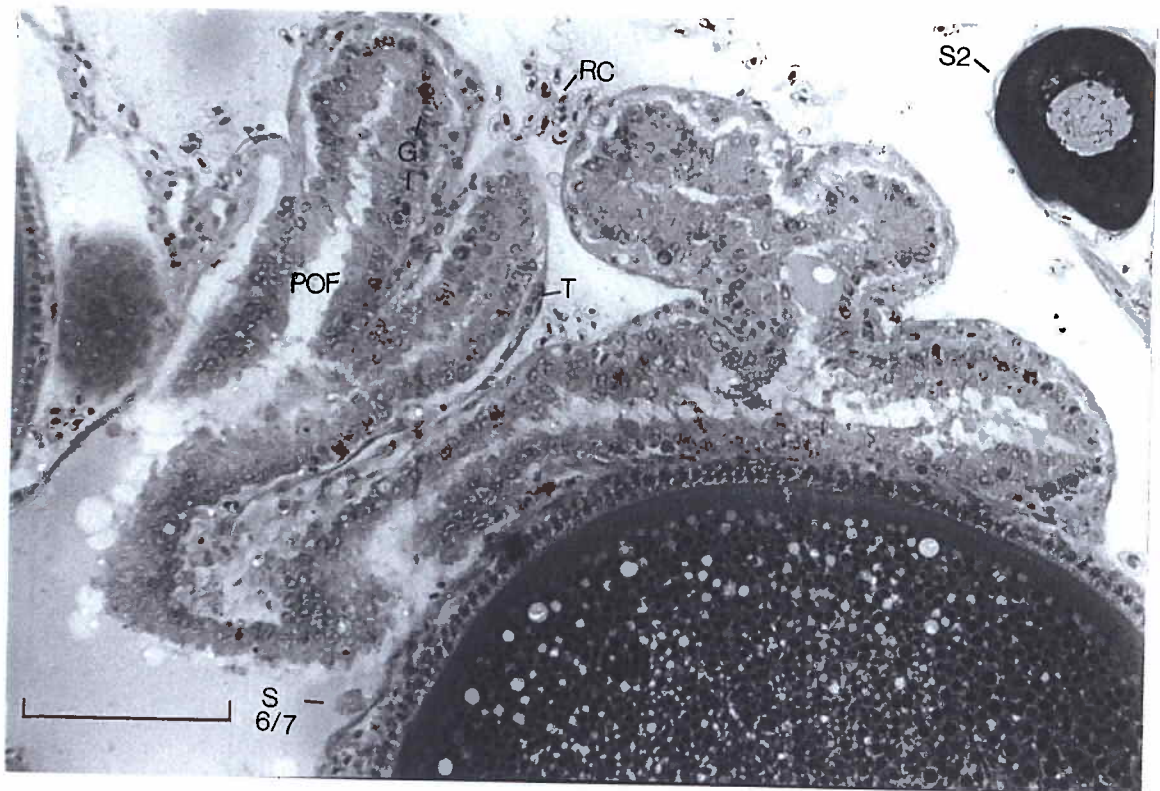

Plate 4.12.

Plate 4.13 Transverse section (2.5µm thick) of *T. zillii* (78.4g in weight) ovary immediately after spawning showing numerous post-ovulatory follicles. Stained with polychrome (Mag. x40). Scale: 100 µm.

S2 - stage 2 oocyte

S3 - stage 3 oocyte

POF - post-ovulatory follicle

Plate 4.14 Transverse section (4.5µm thick) of *T. zillii* (333.0g in weight) ovary showing stage 6/7 oocytes in early stages of atresia (α -stage). Stained with haematoxylin & eosin (Mag. x40). Scale: 100 µm.

AT - atretic oocyte

S2- stage 2 oocyte

AY - acidophilic yolk

S6 - stage 6 oocyte

G - hypertrophied granulosa

S6/7 - stage 6 or 7 oocyte

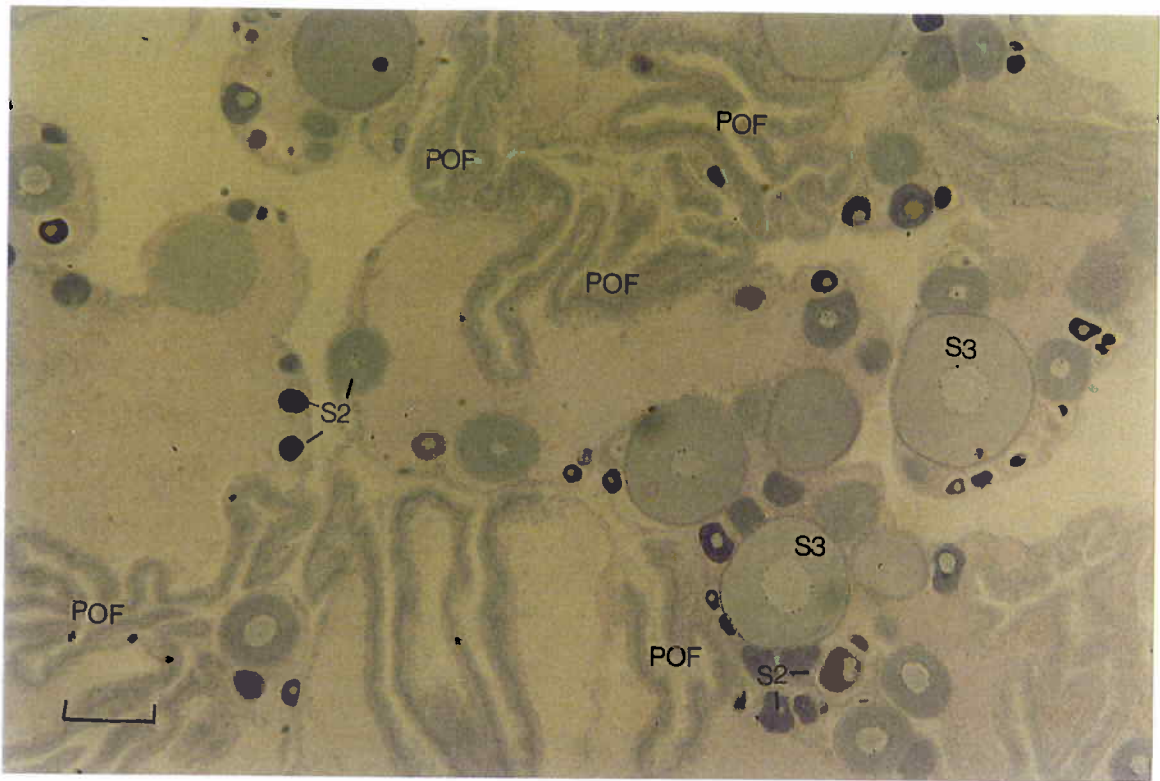

Plate 4.13.

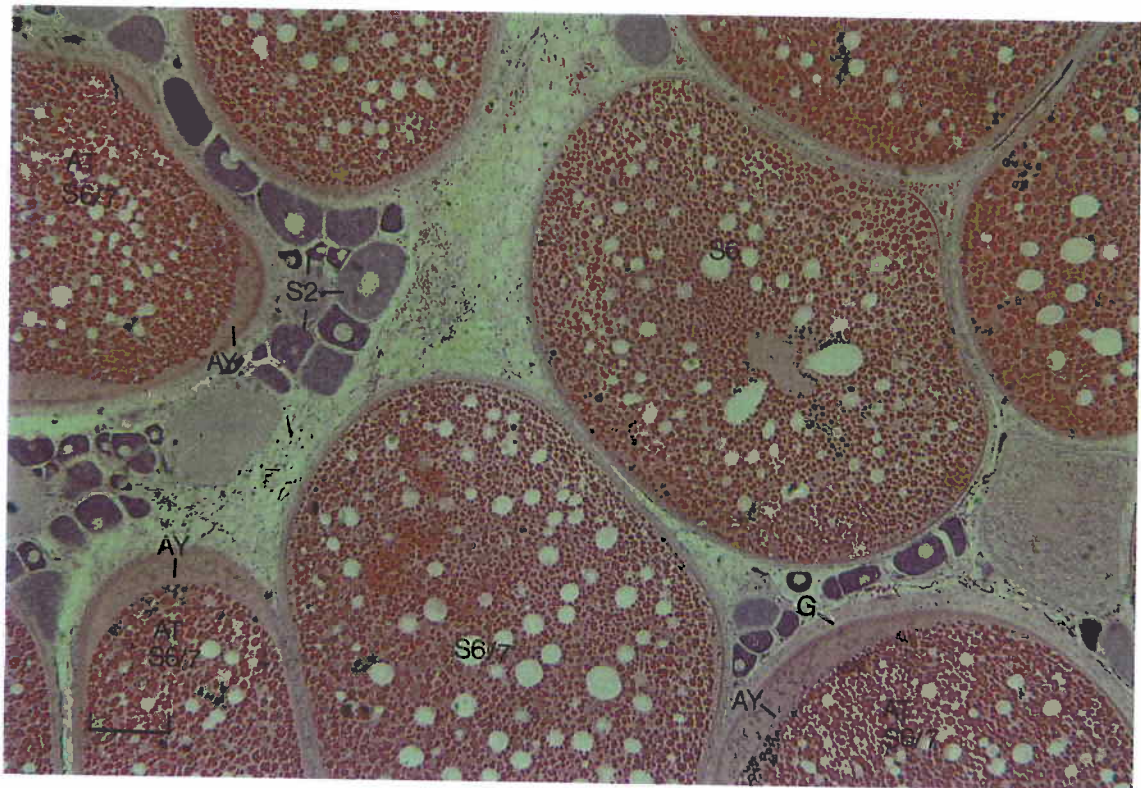

Plate 4.14.

Plate 4.15 Transverse section (4.5µm thick) of *T. zillii* (110.3g in weight) ovary showing (a) α-stage and (b) β-stage atresia in stage 6/7 oocytes. Stained with haematoxylin & eosin (Mag. x100). Scale: 100 µm.

AT - atretic oocyte

S3 - stage 3 oocyte

AY - acidophilic yolk

S6/7 - stage 6 or 7 oocyte

G - hypertrophied granulosa

LP - yolk globules

S2- stage 2 oocyte

LY - liquified yolk

Plate 4.16 Transverse section (4.5µm thick) of *T. zillii* (140.1g in weight) ovary showing advanced γ-stage atresia in a stage 6/7 oocyte. Stained with haematoxylin & eosin (Mag. x40). Scale: 100 µm.

AT - atretic oocyte

S6/7 - stage 6 or 7 oocyte

G - hypertrophied granulosa

FYG - free yolk globules

S2- stage 2 oocyte

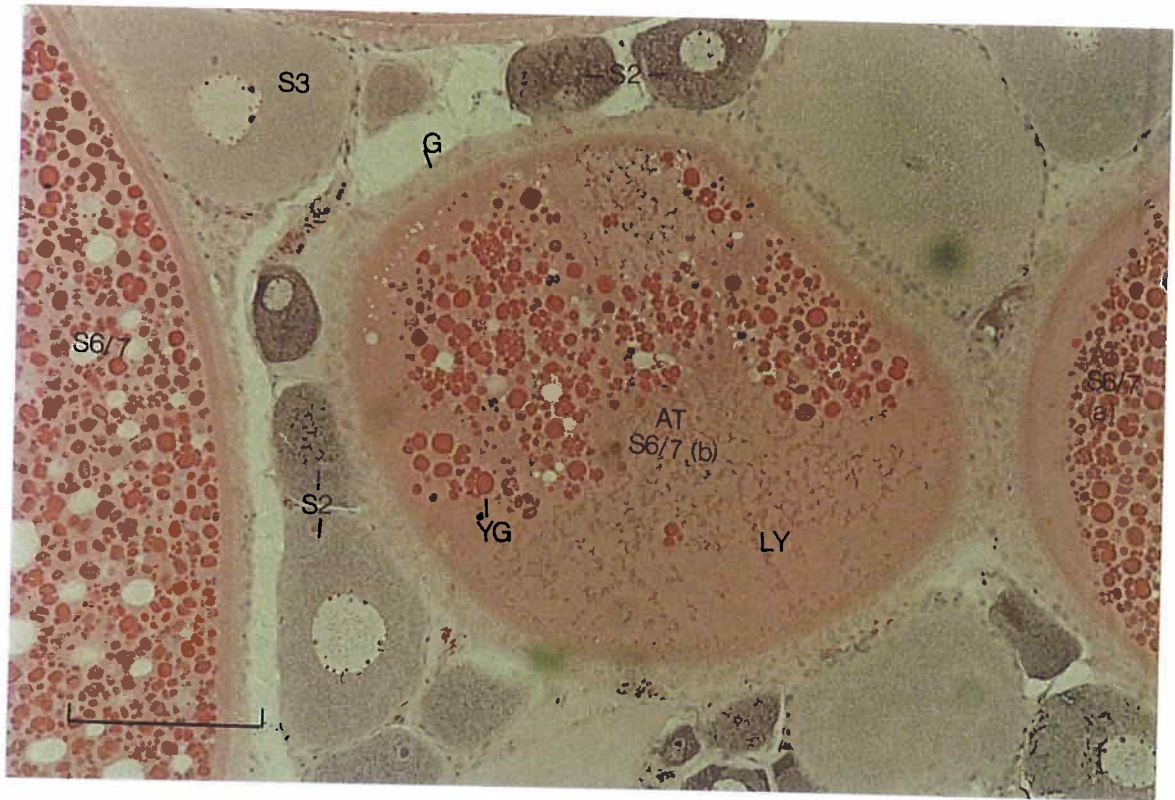

Plate 4.15.



Plate 4.16.

Table 4.1 Summary of classification scheme used to identify discrete stages of oocyte development from tissue stained with either haematoxylin & eosin (H & E) or polychrome.

Oocyte Stage	Size range (µm)	Appearance with haematoxylin & eosin	Appearance with polychrome stain
Oogonia	4 - 6	Approx. Spherical. Contain little cytoplasm. Often found in nests in germinal tissue.	As with H & E
Stage 1 (Chromatin Nucleolar St.)	7 - 11	Often close to oogonia. Similar to oogonia in appearance. Conspicuous nucleus containing chromatin strands.	As with H & E
Stage 2 (Early Perinucleolar St.)	36 - 240	Highly basophilic cytoplasm staining dark red/purple. Localised areas of intense basophilia often close to nucleus or oocyte periphery.	Highly basophilic cytoplasm staining dark purple/black. Localised areas of intense basophilia often close to nucleus or oocyte periphery.
Stage 3 (Late Perinucleolar St.)	122 - 342	Less basophilic than stage 2 - therefore stains lighter (pale pink). Central nucleus contains several nucleoli and chromatin strands. Developing follicular layer.	Less basophilic than stage 2 - therefore stains lighter (light grey/blue). Central nucleus contains several nucleoli and chromatin strands. Developing follicular layer.
Stage 4 (Cortical Alveolar St.)	219 - 326	Ooplasm highly acidophilic - stains light pink. Numerous vesicles close to oocyte periphery. Nucleoli and chromatin persist in central nucleus.	Ooplasm highly acidophilic - stains light blue. Numerous vesicles close to oocyte periphery. Nucleoli and chromatin persist in central nucleus.
Stage 5 (Exogenous Vitello-genesis)	224 - 658	Appearance of small yolk granules at oocyte periphery. Numerous vesicles/vacuoles dispersed throughout oocyte. Yolk granules stain dark pink. Follicular layer becomes much more developed. Nucleus still central.	Appearance of small yolk granules at oocyte periphery. Numerous vesicles/vacuoles dispersed throughout oocyte. Yolk granules stain mauve. Follicular layer becomes much more developed. Nucleus still central.
Stage 6 (Maturation)	428 - 1416	Yolk granules accumulate into large yolk globules. Many apparently empty large vacuoles found especially towards oocyte periphery. Yolk globules distributed throughout oocyte. Nucleus remains central. Particularly prominent follicular layer.	As with H & E.
Stage 7 (GVM) Atretic	428 - 1416	As stage 6 but germinal vesicle seen to migrate towards periphery of oocyte (animal pole)	As stage 6 but germinal vesicle seen to migrate towards periphery of oocyte (animal pole)
Post-ovulatory follicle	840 - 1400 Too variable to measure	Breakdown of nuclear membrane. Liquefied yolk mass. Yolk progressively acidophilic. Increased invasion of in-folding follicular layers and phagocytosis of granulosa. Highly irregular structure consisting of theca and granulosa. Granulosa hypertrophied & theca collapsed into follicular lumen.	Breakdown of nuclear membrane. Liquefied yolk mass. Yolk progressively acidophilic. Increased invasion of in-folding follicular layers and phagocytosis of granulosa. As with H & E.

et al., 1993), Wallace *et al.* (1987), Bromage & Cumaranatunga (1988) and Srisakultiew (1993). As in other teleosts, oogonia were found to enter a period of primary growth (pre-vitellogenesis) during which oocytes increased in diameter from 5 μm to 214 μm due to incorporation of endogenously derived carbohydrate. This was followed by a secondary growth period (vitellogenesis) during which oocytes underwent significant enlargement (214 μm to 964 μm in diameter) largely due to the rapid incorporation of large amounts of exogenous hepatically derived VTG.

Oocytes of each classified developmental stage (both pre-vitellogenic and post-vitellogenic) were all found throughout the reproductive cycle, thus indicating that *T. zillii* possesses 'asynchronous' ovaries (Wallace *et al.*, 1987).

Ten discrete stages were identified: oogonia, stage 1 (chromatin nucleolar stage), stage 2 (early perinucleolar stage), stage 3 (late perinucleolar stage), stage 4 (cortical vesicle stage), stage 5 and stage 6 (exogenous vitellogenic growth periods) and stage 7 (germinal vesicle migration and breakdown, GVM and GVBD). Atretic oocytes and post-ovulatory follicles (POFs) were also found.

Oogonia and stage 1 (chromatin nucleolar stage) oocytes were similar structures to those observed in the rainbow trout (Bromage & Cumaranatunga, 1988) and *O. niloticus* (Srisakultiew, 1993). Whilst oogonia were found to be of a similar size to those seen in *O. niloticus*, stage 1 oocytes were somewhat smaller. Oogonia (and to a lesser extent, stage 1 oocytes) were found to be present in all tissue sections examined throughout the reproductive cycle. This concurs with the findings of Bromage & Cumaranatunga (1988) who reported that whilst oogonia predominate immediately post-ovulation, they remain present in all stages of oocyte growth, thus suggesting that pools of oogonia are available for recruitment throughout. This would be of particular importance in a multiple-spawning fish such as *T. zillii* with both short and variable reproductive cycles. This was also noted by Babiker & Ibrahim (1979a) who claimed that in spite of the periodicity of oviposition and spawning, the generation and development of oocytes proceed in *O. niloticus* without interruption. This was indicated by the high frequency of occurrence of primary oocytes in all stages of

maturation. Tyler *et al.* (1994) further stated that windows for oogonial proliferation extend over wide periods of ovarian development in the rainbow trout such that any losses from pools of maturing follicles may be balanced accordingly. In the rainbow trout, stage 1 oocytes were less commonly found in ovaries than oogonia suggesting that the transformation of oogonia to stage 1 and then to stage 2 was a relatively rapid process (Bromage & Cumaranatunga, 1988).

Folliculogenesis begins during the meiotic transformation of oogonia into oocytes and results in primary oocytes been drawn away from oogonial nests to become closely associated with pre-follicle cells (Moser, 1967) containing desmosome-like junctions, ribosomes, mitochondria, endoplasmic reticulum and Golgi complexes (Bruslé, 1980). Structures accurately resembling pre-follicle cells described in earlier studies were not observed in the present study.

Earlier studies (e.g. Bromage & Cumaranatunga, 1988; Srisakultiew, 1993) subdivided stage 2 oocytes (early perinucleolar stage) into 3 sub-stages depending upon the relative positioning of Balbiani-bodies (or 'yolk nuclei') within the ooplasm. In the present study, stage 2 oocytes were not sub-divided. This was due to a failure to find definitive structures resembling Balbiani-bodies in the stage 2 oocytes of *T. zillii* despite the use of similar staining protocols as the earlier studies. Localised areas of strongly basophilic material were however commonly found and designated 'Balbiani-like material'. Similarly, Balbiani-bodies were not observed in *O. mossambicus* (Aravindan & Padmanabhan, 1972) but were described by Dadzie (1974) in the same species. Balbiani-bodies were also reported in *O. niloticus* by both Latif & Saady (1973) and Hussein (1984). Balbiani bodies have been observed in many species but their precise functional role remains poorly understood (Guraya, 1986). Balbiani bodies generally form in the juxtannuclear region of the oocyte and generally migrate to the oocyte periphery where components undergo dispersal (Wallace & Selman, 1987).

The results of the present study found that stage 3 oocytes were of similar structure and size of those observed in *O. niloticus* (Srisakultiew, 1993). Numerous vacuoles were however, reported in *O. niloticus* (Srisakultiew, 1993) close to the

nucleus and migrating to the oocyte periphery. No mention however, was made of the possible functional significance of these vacuoles. Dadzie (1974) reported frequent sightings of cytoplasmic vacuoles in protoplasmic phase oocytes (equivalent of stage 3 in the present classification). These vacuoles were found to contain fat and disappear towards the end of this stage of development. It is possible that the vacuoles found by Srisakultiew (1993) in stage 3 oocytes were similar to the fat vacuoles described by Dadzie (1974). Such vacuoles were not seen in the stage 3 oocytes of *T. zillii* in the present study nor were they mentioned in the classification of stage 3 oocytes in rainbow trout (Bromage & Cumaranatunga, 1988). During this stage of development the follicular layer became much more apparent and consisted of a thin granulosa layer and thecal layer. This concurred with the findings of Srisakultiew (1993) in *O. niloticus*. In the rainbow trout, stage 3 oocytes were found to possess a single granulosa layer and two thecal layers (Bromage & Cumaranatunga, 1988). In the present study it was only possible to detect a very thin single thecal layer.

Transformation of stage 3 oocytes into stage 4 was characterised by the appearance of small vesicles (cortical alveoli) close to the oocyte periphery. This observation was in accordance to those of Bromage & Cumuranatunga (1988) in the rainbow trout and Srisakultiew (1993) in *O. niloticus*. A similar vesicle stage was also reported in *O. mossambicus* by both Aravindan & Padmanabhan (1972) and Dadzie (1974).

The function of cortical alveoli has been the subject of considerable debate (see Section 4.1.2). At present there is little evidence to suggest that the alveoli found in stage 4 oocytes are involved in any way with the incorporation and/or processing of VTG. In the rainbow trout cortical alveoli arise in close association with golgi apparatus and endoplasmic reticulum (Bromage & Cumaranatunga, 1988) and during stage 5 are displaced further towards the cytoplasmic membrane or oolemma of the oocyte. Upon fertilisation, cortical alveoli fuse with the oolemma and release their contents into the perivitelline space (the 'cortical reaction').

A further event found to occur in stage 4 oocytes is the formation of lipid inclusions or droplets, initially found in the perinuclear cytoplasm. This process is reported to vary greatly amongst different species and not all species are found to possess such inclusions (Wallace *et al.*, 1987). These inclusions have been found to coincide with the appearance of an orange-colour characteristic of carotenoid pigments associated with the lipid component of VTG (Selman *et al.*, 1987). This suggests that lipid bodies may be derived from VTG that has begun to 'leak' into the oocyte prior to actual vitellogenesis (Tyler, personal communication). Lipid inclusions were not observed in any of the stage 4 oocytes examined in the present study, though fat deposition was observed in a similar stage of development by Latif & Saady (1973) in *O. niloticus*.

Stage 4 oocytes in *T. zillii* were found to be markedly smaller in diameter than those of *O. niloticus*. In the present study stage 4 oocytes were also less commonly found than other developmental stages perhaps suggesting a rapid transformation from stage 3 to 4 and from stage 4 to 5.

Aside from the increase in size and the appearance of cortical vesicles, a further development characteristic of stage 4 is the formation of a zona radiata in the follicular layer (Bromage & Cumarantunga, 1988). A developing zona radiata was indeed observed during stage 4 in the present study, concurring with the observations of Srisakultiew (1993) in *O. niloticus*.

The appearance of small yolk particles in the oocyte periphery characterised the onset of exogenous vitellogenesis and was designated stage 5. This concurred with the observations of Bromage & Cumarantunga (1988) and Srisakultiew (1993). As vitellogenesis progressed these particles began to accumulate into yolk globules. During the latter part of stage 5, large yolk globules were found dispersed throughout the entire ooplasm. Numerous seemingly empty vesicles/vacuoles were found dispersed throughout the stage 5 ooplasm. Srisakultiew (1993) claimed that these structures may be the cortical alveoli of the previous stage that had been displaced from the oocyte periphery by increased yolk incorporation. It is difficult to assign a precise origin to the

vacuoles/vesicles seen in the stage 5 oocytes of *T. zillii* though their large size and abundance suggests that they are unlikely to be displaced cortical alveoli. Similar empty vacuoles were reported in *O. niloticus* by Latif & Saady (1973) and Hussein (1984), as a single layer surrounding the oocyte beneath the zona radiata. No mention was made however, of the functional role of these vacuoles.

Arguably stage 5 is the most important phase of oocyte development, as it is during this stage that huge increases in cytoplasmic size occur (Bromage & Cumaranatunga, 1988). In the present study, oocytes increased in diameter considerably during stage 5, thus indicating significant growth due to uptake of VTG. Under the stimulus of ovarian oestrogens and pituitary gonadotropins, the liver produces large amounts of VTG which is transported to the ovaries by the bloodstream and sequestered by growing oocytes by an endocytotic process involving specific receptors at the oocyte surface (Wallace *et al.*, 1987; Tyler *et al.* 1987). Once inside the oocyte, VTG forms yolk bodies by micropinocytosis and is enzymatically cleaved to form the yolk proteins lipovitellin (lipid rich) and phosphovitin (phosphate rich) (Tyler *et al.*, 1988). In *O. mossambicus*, two biochemically distinct and possibly differentially regulated, forms of VTG have been isolated; tVTG-200 and tVTG-130, indicating the molecular mass (kDa) of their monomeric forms (Kishida & Specker, 1993). These tVTGs were also found in the surface mucus of the *O. mossambicus* (Kishida & Specker, 1994); the possible uptake by free-swimming embryos was suggested.

In accordance with Bromage & Cumaranatunga (1988), little change was observed in the follicular layer between stage 4 and stage 5 apart from further development of the zona radiata and a more cuboidal appearance to the granulosa. Bromage & Cumaranatunga (1988) however, also found enhanced development of rough endoplasmic reticulum within both granulosa and theca.

Exogenous yolk incorporation continues actively during stage 6 and probably during stage 7 though this has not been clearly demonstrated (Bromage & Cumaranatunga, 1988). As a consequence oocytes continue to grow in size quite

markedly (stage 6 and 7 oocytes ranged from 428.00 μm to 1416.00 μm in diameter in *T. zillii*). Srisakultiew (1993) noted that yolk globules fused to form yolk platelets in *O. niloticus*. Yolk platelets were also described in *O. mossambicus* by Aravindan & Padmanabhan (1972) in addition to structures described as yolk spherules. These structures were not found in the present study. This agrees with the observations of Bromage & Cumaranatunga (1988) in the rainbow trout who stated that although fluid yolk may take on a polygonal appearance, yolk platelets were not formed. Yolk has been found to be stored in most amphibians and cyclostome fish in the form of a crystalline platelet (Lange, 1985), but in most teleosts as fluid filled globules or spheres (Wallace & Selman, 1981). These globules may either retain their integrity throughout development or fuse to form a continuous mass of fluid yolk as seen in three-spined sticklebacks (Wallace & Selman, 1981). Bromage & Cumaranatunga (1988) and Srisakultiew (1993) also found that yolk globules/platelets at the animal pole were of a smaller size than those at the vegetal pole. No obvious relationship was detected in the present study between yolk globules and their relative position within the oocyte.

In accordance with Srisakultiew (1993), numerous vacuoles were found within the ooplasm of stage 6 and 7 oocytes particularly close to the oocyte periphery. The functional significance of these structures is not known but they may be cortical alveoli or more likely oil/lipid droplets.

During stage 6 and 7, the follicular layers were well developed and consisted of a zona radiata (consisting of two layers; the zona interna and the zona externa), a cuboidal granulosa and a single thecal layer. These findings concurred with those of Bromage & Cumaranatunga (1988) and Srisakultiew (1993). The advanced development of the follicular layer during these stages reflects the increased steroidogenic function of the granulosa and theca during active vitellogenesis. Both the theca and granulosa have been found to be steroidogenic (e.g. Kagawa *et al.*, 1981, 1982). It is believed that the theca most likely synthesises androgens which are later aromatised by the enzyme aromatase (Scott *et al.*, 1982) in the granulosa layer. In *O. niloticus*, 3 β -HSD was demonstrated in both the granulosa and theca (Yaron, 1971), indicating a steroidogenic

role. Livni (1971) also found activity of this enzyme in the granulosa of *O. aureus*. Yaron (1971) also claimed that the granulosa may be involved in the transport of yolk proteins to the developing oocyte.

The nuclei of stage 6 oocytes are smaller than those of stage 5 and have less prominent nucleoli and a more highly folded nuclear envelope (Bromage & Cumaranatunga, 1988). This was found to be the case in *T. zillii*, though nucleoli were no longer apparent in the nucleus of either stage 6 or stage 7. Similarly, a reduction in nucleus size and increased irregularity in shape was also reported by Aravindan & Padmanabhan (1972) in *O. mossambicus* and by Hussein (1984) in *O. niloticus*. Empty vacuoles were also found throughout the ooplasm of both stage 6 and stage 7 oocytes (as in stage 5). Similar structures were reported by Bromage & Cumaranatunga (1988) in the rainbow trout though in this case they were found close to the germinal vesicle. No mention was made of the possible functional significance of these structures.

During late stage 6, the nucleus (germinal vesicle) began to migrate towards the animal pole of the oocyte to a position close to the micropyle. At this point oocytes are designated stage 7 (Bromage & Cumaranatunga, 1988). The germinal vesicle breaks down (GVBD) once it has adopted a position close to the micropyle. At ovulation, ripe stage 7 oocytes are forced out of the follicles leaving behind the granulosa and thecal layers. The zona radiata becomes the chorion of the egg (Bromage & Cumaranatunga, 1988). During fertilisation, the cortical alveoli are found between the zona radiata and the egg cytoplasm (bounded by the oolemma). It is into this volume, the peri-vitelline space, that water is taken during water-hardening making the chorion impervious to water or any other materials (Bromage & Cumaranatunga, 1988).

Following ovulation, the granulosa and theca remain in the ovary and are known as post-ovulatory lutea (Hoar, 1967) or more commonly as post-ovulatory follicles (POFs). The granulosa then degenerates and undergoes autophagocytosis (Kagawa *et al.*, 1981; van den Hurk & Peute, 1985) resulting in hypertrophication and collapse into the follicular lumen.

The precise functional role of POFs is not known though both the granulosa and theca of POFs have been demonstrated to be steroidogenic (Bara, 1965; Nagahama *et al.*, 1976; Lam *et al.*, 1978; van den Hurk & Peute, 1979; Kagawa *et al.*, 1981; Lang, 1981). Since the theca and granulosa have been reported to possess 3 β -HSD activity, a functional resemblance to the mammalian corpus luteum was suggested (Nagahama, 1983), though secreting oestrogens rather than progestagens. Lam *et al.* (1978) claimed that POFs may help to maintain ovulated eggs whilst still within the ovarian lumen by producing steroids that in turn stimulate the ovarian epithelium to produce fluid used to bathe ovulated eggs. A possible link with oogonial proliferation has been suggested (van den Hurk & Peute, 1979, 1985; Kagawa *et al.*, 1981). Indeed, Bromage & Cumaranatunga (1988) reported the presence of many oogonial nests amongst the connective tissue and ovigerous lamellae surrounding POFs and further suggested that it is from these that pre-vitellogenic oocytes later develop. In a study of *O. niloticus*, Aravindan & Padmanabhan (1972) noted that after spawning a fresh crop of oocytes was found to arise from oogonial nests in the germinal epithelium and from ramifying strands of epithelium. No evidence however, was found to suggest that degenerating follicle cells form a source of a new crop of oocytes. Latif & Saady (1973) however, could not trace dividing cells or primary oocytes in the germinal epithelium of *O. niloticus* and concluded that new generations of oocytes may arise from existing oocytes. This implies that the formation of primary oocytes from oogonia occurs over a finite period in early gonadal development. There is however, little supporting evidence to support this hypothesis in *O. niloticus* and in the majority of teleosts oogenesis proceeds continually or cyclically throughout reproductive life (see Babiker & Ibrahim, 1973a).

Few studies of ovarian development have reported the presence of POFs in tilapias. Only studies by Aravindan & Padmanabhan (1972) in *O. mossambicus*, Dadzie & Wangila (1980) in *T. zillii* and by Srisakultiew (1993) in *O. niloticus* have reported 'ruptured follicles' or POFs. In the present study POFs were found to be common soon after spawning but were not seen at any other timepoint within the

reproductive cycle. As in other species, POFs were highly irregular structures consisting of a theca and granulosa. The granulosa was found to be highly hypertrophied and along with the theca, had collapsed into the follicular lumen.

A further structure found in the ovary are atretic oocytes. Atresia is a process in which oocytes are resorbed. Atresia may occur during any stage of development (Rastogi, 1966) but is most commonly found during vitellogenic and post-ovulatory phases. In the present study atresia was observed only in stages 5, 6 or 7 (vitellogenic phases) and especially in those residual stage 6 or 7 oocytes remaining in the ovary after ovulation. Residual eggs (both ovulated and unovulated) are found in the ovaries of tilapia after spawning and are later resorbed (Peters, 1983). Atresia was not found in pre-vitellogenic developmental stages. This concurs with the findings of Srisakultiew (1993) in *O. niloticus*. Peters (1983) noted that egg resorption in tilapias was a common occurrence both in captive and wild stocks but also suggested that atresia only occurred in yolk laden oocytes. Bromage & Cumarantunga (1988) noted that the occurrence of atresia on pre-vitellogenic oocytes has not yet been clearly demonstrated though it remains likely that resorption of such small oocytes would be very rapid.

Atresia in the present study was assigned into 3 stages (α , β , or γ) depending upon the extent of degeneration and phagocytosis (as in Srisakultiew, 1993). Oocytes in early stages of atresia (α -stage) were found to shrink and separate from the hypertrophied granulosa layer. As atresia progressed through β -stage and γ -stage liquified yolk became more acidophilic with increased invasion by follicular layers and phagocytosis by the hypertrophied granulosa layer. Comparable stages were found in *O. niloticus* (Srisakultiew, 1993). Terminal stages of atresia are known as 'brown bodies' (Chan *et al.*, 1967); these were not seen in the observations described in this Chapter but were observed macroscopically (Chapter 6).

The precise functional role of atresia remains unclear and the source of much debate, though a steroidogenic role seems likely (Khoo, 1975; Saidapur & Nadkarni, 1976; Lang, 1981). Several authors have claimed that atresia does not contribute significantly to ovarian physiology (Rastogi, 1966; van den Hurk & Peute, 1979;

Wallace & Selman, 1979, 1981) and suggested that atresia serves to 'mop-up' at the end of the breeding cycle. Further studies have claimed that atresia may be involved in the initiation of follicular growth and in the selection of follicles for ovulation (Tyler, 1988) and as an important determinant of fecundity (Vladykov, 1956; Peters, 1983; Springate *et al.*, 1985; Bromage *et al.*, 1992).

The incidence of atresia is poorly understood but is thought to be influenced by many factors e.g. age, stage of reproductive cycle, dietary status, hormonal status (Bromage & Cumaranatunga, 1988) and also captivity, light, temperature and crowding (Guraya, 1973; 1986). Atresia has been said to be a relatively uncommon event in well-fed healthy individuals (Henderson, 1963; Wallace & Selman, 1981; Tyler & Sumpter, 1996), though this remains the source of much debate. Peters (1983) claimed that atresia occurred throughout the reproductive cycle in tilapias but noted that the tendency of tilapia spawns to be resorbed is related to the fact that 'spawn-readiness' can only be maintained for a short time (approximately 1 week). If no suitable male is found during this time, the entire spawn was said to be resorbed. Such a phenomenon is obviously very likely to influence spawning periodicity and lead to a longer inter-spawning-interval. In the present study atresia was found quite commonly but particularly in those residual stage 6 or 7 oocytes remaining in the ovary after ovulation.

To summarize, the present study classifies ovarian developmental in *T. zillii* into several discrete stages based upon oocyte size, biochemical properties and oocyte structure. This classification scheme is comparable to those developed by other authors (Wallace & Selman, 1981, 1987; Bromage & Cumaranatunga, 1988 & Srisakultiew, 1993) and will be referred to in several investigations throughout this thesis.

Chapter 5

The dynamics of ovarian recrudescence and associated reproductive endocrinology in *T. zillii*.

(5) The dynamics of ovarian recrudescence and associated reproductive endocrinology in female *T. zillii*.

(5.1) General introduction.

This chapter aimed to investigate the dynamics of ovarian development and concurrent reproductive endocrinology in *T. zillii* maintained individually in glass aquaria. Little is known of the reproductive endocrinology (nor its association with ovarian growth) in substrate-spawning tilapia. As in most areas of tilapia reproductive biology, most research in this particular field (although also somewhat limited) has been undertaken using mouthbrooding species (e.g. Bogomolnaya *et al.*, 1984; Cornish & Smit, 1987; Smith & Haley 1988; Rothbard *et al.*, 1991; Srisakultiew, 1993; Tacon *et al.*, 1996).

Under natural conditions (with the exception of equatorial stocks) tilapias are seasonal breeders (e.g. McKaye, 1984; Hussein, 1984); breeding seasons are timed so as to coincide with optimal food availability for developing fry. In contrast, captive tilapia may spawn throughout the year (Lowe-McConnell, 1959; Fishelson, 1966) as long as environmental conditions remain suitable. Spawning frequency may vary considerably in tilapia (even within individuals) and the factors that control such variability remains unclear (Mires, 1982). As a consequence, broodstock spawning patterns often exhibit asynchrony; a significant problem to farm managers (Jalabert & Zohar, 1982).

Although the process of ovarian development is relatively similar amongst teleosts, the duration required for each reproductive cycle remains species dependent. Since tilapias have evolved complex courtship and spawning behaviour, it seems likely that the length of spawning cycle would not only reflect fish species and fish size but also the degree of parental care (Srisakultiew, 1993). Mechanisms underlying such variability remain unclear and highlights the need for a greater understanding of the dynamics of ovarian growth (and its endocrine control) in such species. This is particularly important in the case of substrate-spawning tilapias such as *T. zillii*, where

not only is research into ovarian growth lacking but where spawning cycles also exhibit great variability (see Chapter 3). Furthermore, a detailed knowledge of the hormonal factors involved in the control of ovarian development and of their secretion during different phases of ovarian growth may allow artificial manipulation of spawning cycles (for example, via the administration of exogenous hormones) and in turn, improvements in management of farm stocks.

Ovarian development in *T. zillii* was classified earlier in this thesis (see Chapter 4) into eight discrete stages; oogonia, stage 1 (chromatin nucleolar stage), stage 2 (early perinucleolar stage), stage 3 (late perinucleolar stage), stage 4 (cortical vesicle stage), stages 5 and 6 (vitellogenic stages) and stage 7 (germinal vesicle migration and breakdown). Atretic oocytes and post-ovulatory follicles (or POFs) were also observed. This classification system was similar to that described by Wallace & Selman (1981), Selman & Wallace (1989), Wallace *et al.* (1987), Bromage & Cumaranatunga (1988) and Srisakultiew (1993).

Three main patterns of oocyte development have been described in teleosts: synchronous (e.g. eels, anadromous *Oncorhynchus* species), group-synchronous (e.g. rainbow trout) and asynchronous (e.g. tilapia) (Wallace & Selman, 1981, 1987; de Vlaming, 1983; Billard, 1992). Modifications of both asynchronous and synchronous patterns exist however, in fish such as the three-spined stickleback and pipefish (see Chapter 4 for further details).

Discrete stages of ovarian development are synchronised by an inter-related series of internal (endogenous) and external (exogenous) stimuli; exogenous factors such as photoperiod or food availability are perceived by the brain and stimulate various endocrine pathways to respond in an appropriate fashion. It is now well accepted (see Fontaine, 1976; Dodd & Sumpter, 1984; Scott, 1990; Nagahama *et al.*, 1995) that modulation of spawning cycles in teleosts occurs via changing levels of hormones from the 'hypothalamo-pituitary-gonadal-axis' timed by exogenous cues from the environment. In brief, major hormones involved include hypothalamic gonadotropin releasing hormone (GnRH), gonadotropin release inhibitory factor

(GnRIH), pituitary gonadotropin(s) (GTH I & GTH II), sex steroids (e.g. 17 β oestradiol (E₂), oestrone (E₁) and testosterone (T)), progestagens and prostaglandins (see Chapter 1 for review). Studies of such hormones and their inter-related cycles serve as sensitive indicators in the determination of gonadal development.

Most studies of ovarian development and associated endocrine control have been undertaken in salmonid species (e.g. Breton *et al.*, 1972; Crim *et al.*, 1973; Breton *et al.*, 1975; Sumpter *et al.*, 1984; Bromage & Cumaranatunga, 1988), in carp (Billard *et al.*, 1978; Santos *et al.*, 1986) or goldfish (Kobayashi *et al.*, 1986, 1988, 1989). Relatively few (Bogomolnaya *et al.*, 1984; Cornish & Smit, 1987; Smith & Haley 1988; Rothbard *et al.*, 1991; Srisakultiew, 1993; Tacon *et al.*, 1996) have considered the tilapia; all concerning mouthbrooding species.

Studies of carp, goldfish and various salmonids have shown that in general, levels of E₂ and E₁ increase during the early part of the reproductive cycle, peak during the most active period of vitellogenesis and then fall, remaining at low levels until the next spawning phase (Whitehead *et al.*, 1978a, b; Bromage *et al.*, 1982a, b; Elliot *et al.*, 1984; Fostier *et al.*, 1978; 1983; Scott *et al.*, 1980; Scott & Sumpter, 1983; Kobayashi *et al.*, 1986, 1988; Bromage & Cumaranatunga, 1988; Rothbard & Yaron, 1992). Although the primary role of oestrogens (E₁ and E₂) is in the stimulation of VTG from the liver, possible roles in the metabolism of fat have been suggested (see Bromage & Cumaranatunga, 1988).

Testosterone (T) also increases during the early part of the cycle (along with E₁ and E₂) but peaks after the oestrogens. The function of T in ovarian growth and maturation remains unclear although it is well accepted (Nagahama *et al.*, 1985, 1995) that T (produced by granulosa cells under GTH stimulation) is converted to E₂ in the thecal cells via the enzyme aromatase. Other possible functions of T are discussed later in this Chapter. In goldfish, T peaks at ovulation (Kobayashi *et al.*, 1986, 1988, 1989) and in rainbow trout peaks approximately 8 days prior to ovulation and falls thereafter (Scott *et al.*, 1983).

In terms of multiple-spawning fish; plasma E₂ was found to be relatively high during vitellogenesis in the Japanese sardine *Sardinops melanostictus* (Temminck & Schlegel) but decreased during final oocyte maturation. E₂ however, rose immediately after spawning (Matsuyama *et al.*, 1994). E₂ was also found at high levels during vitellogenesis in another multiple-spawner, sea bass; plasma VTG and the number of vitellogenic oocytes both peaked during December at a time when E₂ levels attained high values. During the spawning period (Jan - Mar), the number of vitellogenic oocytes and plasma E₂ remained elevated though plasma VTG level fell by approximately one half (Prat *et al.*, 1990). A similar scenario was observed in the spotted sea trout which begins spawning in late spring with each individual spawning several times during a two month period. Prior to the spawning period, levels of plasma E₂, T and VTG were elevated but declined during spawning. As with sea bass, levels of plasma VTG fell by one half as spawning began but was consistently maintained at this level throughout the spawning period (Thomas *et al.*, 1992).

In rainbow trout, GTH I (or fish FSH) was shown to increase during early vitellogenesis, fall to a basal level shortly before ovulation then rise once again at ovulation. GTH II (or fish LH) however remained undetectable throughout most of the reproductive cycle, but rose sharply immediately preceding ovulation (Prat *et al.*, 1996). Final maturation and ovulation are also initiated in the spotted sea trout by a surge in GTH II (Thomas *et al.*, 1992). GTH II appeared to prime follicle-enclosed oocytes so that they became competent and underwent final maturation in response to the maturation-inducing steroid (MIS).

Several other sex steroids known as progestagens increase just before ovulation; of these 17 α -hydroxyprogesterone (17 α OH-P) and 17 α -hydroxy-20 β -dihydroprogesterone (17 α 20 β -P also known as 17 α -20 β -dihydroxy-4-pregnen-3-one) are thought to be the most important. In rainbow trout, levels of 17 α 20 β -P are found at low levels during vitellogenesis but then dramatically increase to peak sharply just prior to ovulation (Scott *et al.*, 1983). In the Japanese sardine, 17 α 20 β -P remained at a consistently low level during vitellogenesis but increased dramatically during oocyte

maturation. Levels fell rapidly just after spawning (Matsuyama *et al.*, 1994). $17\alpha 20\beta$ -P was found at very low levels throughout ovarian growth in carp (Rothbard & Yaron, 1992); levels only rose following spawning induction. In sea bass, $17\alpha 20\beta$ -P has been found in high levels in mature females but in a conjugated form rather than a free form; suggesting that the former is the mediator of oocyte maturation (see Carrillo *et al.*, 1992). It is likely that other steroids may act as the MIS in this species.

Profiles of reproductive hormones in multiple-spawning tilapia are not as well defined as those seen in salmonid species such as rainbow trout. Profiles of E₂ and T during the spawning cycle of tilapia remain unclear and unlike salmonids can show several peaks prior to spawning (Smith & Haley, 1988).

Early work in *O. mossambicus* found increasing levels of E₂ coincided with an increasing GSI. As E₂ fell, progesterone levels rose (Cornish & Smit, 1987). In *O. niloticus*, Rothbard *et al.* (1991) monitored hormonal profiles throughout 7 phases of the breeding cycle (from quiescence through courtship and eventually to mouthbrooding). GTH (known as taGTH and measured using the RIA developed by Bogomolnaya *et al.*, 1989) was low in all phases but increased 5-fold during actual spawning. T and especially E₂ increased gradually during acquisition of nuptial colouring and pairing but decreased during spawning and mouthbrooding. That peaks of taGTH were found to occur after peaks of E₂ and T had receded suggests an association of taGTH with final oocyte maturation (as with GTH II in other fish species).

In individually cycling *O. niloticus*, levels of E₂ were found to increase from day 1 after spawning, peak on day 5 and fall by day 10 suggesting that vitellogenesis occurred at day 5 but was completed by day 10 (Srisakultiew, 1993); trends of T and total serum calcium (as an indicator of serum vitellogenin) during ovarian recrudescence were found to be similar but peaked on day 10 post-spawning concomitant with maximum proportions of stage 6 (late vitellogenic) oocytes. On the basis of these observations Srisakultiew (1993) suggested that the *O. niloticus* ovary is fully mature just 10 days after spawning.

In terms of oocyte maturation, previous studies in tilapia have failed to show a clear increase in $17\alpha20\beta$ -P during the breeding cycle of tilapia (Yaron *et al.*, 1983; Bogomolnaya *et al.*, 1984; Rothbard *et al.*, 1991). Studies by Katz & Eckstein (1974), however, claimed that deoxycortisone may function as a maturation-inducing steroid (MIS) in *O. niloticus*. In mouthbrooding *O. mossambicus*, progesterone levels did not increase until day 25, fell, then peaked again towards the end of the cycle. $17\alpha20\beta$ -P peaked at approximately day 40 (Smith & Haley, 1988). In non-mouthbrooding fish, however, $17\alpha20\beta$ -P levels were low with a single peak recorded 7 days after spawning.

A major disparity between the life history strategies of salmonid and tilapia species is the extent of parental behaviour extended to eggs and young. Tilapias expend considerable amounts of energy in parental care, especially in the case of mouthbrooding species.

It has been suggested that oestrogens and the pituitary hormone prolactin (PRL) are both necessary for successful mouthbrooding in cichlid species and to prevent parent fish from preying on eggs or young (see Blüm, 1985). In the cichlid, *Symphysodon aequi fasciata axelrodi* (L.) for example, PRL was found to induce both behavioural and histiotropic effects. Behavioural effects included fanning movements of pectoral fins and suppression of feeding/fighting; histiotropic effects included increased body surface mucous production which normally serves to nourish young (Blüm & Fiedler, 1965). Similar effects have been found in other cichlids. More recently, Tacon (1996) observed an erratic diurnal profile of PRL in *O. niloticus* but could not demonstrate any relationships between such fluctuations and parental care. Moreover, mouthbrooding was not induced by injection of ovine PRL. The cDNA for prolactin has recently been sequenced in the tilapia (Poncelet *et al.*, 1996); specific probes designed to this sequence will be invaluable in future physiological investigations of PRL function.

Parental care strategies have also been shown to influence levels of sex steroids in tilapia. In a study of *O. mossambicus*, Smith & Haley (1988) found differences in

the hormonal profiles of mouthbrooding and non-mouthbrooding fish. In non-mouthbrooding females levels of T, E₂ and progesterone peaked initially at 10 days post-spawn and fell by day 15. T and E₂ rose again at the end of the cycle. In mouthbrooding females the first peak of T and E₂ occurred later at 15 days post-spawn. Although E₂ remained high, T fell by day 25 but rose once more immediately prior to spawning. Smith & Haley continued to suggest that the high levels of T in mouthbrooding females may serve to retard oocyte growth until brooding ceases and that high E₂ levels may serve in the protection of oocytes from atresia. Generally though, the participation of steroid hormones in parental behaviour has received only scant attention in only a few fish (see Liley & Stacey, 1983).

It is well known that parental care in mouthbrooding tilapias after spawning may affect the dynamics of ovarian development in the ensuing reproductive cycle. Smith & Haley (1987) for example found that ovarian development occurred at greater rates in non-mouthbrooding *O. mossambicus* than in mouthbrooders. Little *et al.* (1993) further reported that parental care plays an inhibitory role on ovarian development in *O. niloticus*. In a mouthbrooding haplochromid, mouthbrooding (over a period of sixteen days) females took 33% longer to re-spawn than non-mouthbrooding females (Smith & Wootton, 1994). Most recently Tacon *et al.* (1996), working with *O. niloticus*, also found retardation of vitellogenesis during parental phases resulting in an elongation of the inter-spawn-interval. Interestingly, a much earlier study by Blüm & Fiedler (1965) reported antagonism between PRL (released during the parental phases) and levels of circulating gonadotropins. Further influences of parental care on the length of spawning cycles are discussed in Smith & Wootton (1995a, b, c).

It is clear therefore that the pattern of ovarian development in tilapias and its associated endocrine control is not as well defined as in other teleosts such as the rainbow trout or carp. Levels of circulating reproductive hormones not only depend upon the phase of ovarian development but also certain behavioural phases such as courtship or parental care. Nothing is known of the dynamics of ovarian growth and

associated hormonal profiles in substrate-spawning tilapia, despite their prominence in world aquaculture. A detailed knowledge of this area of physiology may allow artificial manipulation of the spawning cycle in these fish, e.g. via the administration of exogenous hormones. This is of particular importance considering the wide variability observed in the spawning periodicity of *T. zillii* (see Chapter 3) and the asynchronous nature of spawning cycles in tilapia generally (Jalabert & Zohar, 1982).

The present chapter therefore aimed to investigate the dynamics of ovarian growth and associated hormonal profiles in reproductively cycling *T. zillii* maintained in individual aquaria. Analysis of the endocrine control of ovarian growth consisted of measurement of the sex steroids E₂ and T (arguably two of the most important hormones involved in the control of ovarian development). Total serum calcium levels were also measured. Serum calcium analysis has been widely adopted as an indicator of serum VTG secretion (Elliot *et al.*, 1984). This is primarily due to the strong correlation between serum calcium levels and serum VTG levels and the ease with which the former can be measured.

(5.2) Experiment 1: Profiles of E₂, T and total calcium during ovarian recrudescence in individually-maintained *T. zillii* (strains 'A' & 'B').

This experiment aimed to monitor levels of the circulating sex steroids E₂ and T in female *T. zillii* at discrete points throughout the cycle of ovarian development. Total serum calcium was also measured as an indicator of vitellogenin concentration. Analyses involved both strain 'A' and strain 'B' fish. Results are presented for each strain separately and then as an inter-strain comparison.

(5.2.1) Materials and methods.

Twenty female *T. zillii* (strain 'A') were removed at random from 114 x 114 x 42cm holding tanks (system 1, see Section 2.1.2 and Appendix 1.1) and transferred to glass aquaria partitioned with perspex dividers such that each fish could be maintained individually (System 3, see Section 2.1.2 and Appendix 1.3). At the time of transfer,

each female was anaesthetized (Section 2.2.1), weighed (to the nearest 0.1g) and measured (to the nearest mm) (Section 2.4.1). Fish were stocked into glass aquaria such that none had visual contact with male conspecifics.

Fish were left uninterrupted until spawning activity was seen to occur. Spawning was allowed to proceed until oviposition (i.e. egg clutches seen adhered to tank base or sides). Immediately after completion of oviposition and concomitant with gonopore regression, post-spawned fish were removed from their respective aquaria, anaesthetised, weighed, measured and blood sampled (Section 2.3.1). Serum was obtained by allowing blood samples to clot at 4°C followed by centrifugation (Section 2.3.1). Blood samples taken from fish immediately after spawning were referred to as the 0-day sample. Further blood samples were then taken from each post-spawned fish on days 2, 4, 6 and every subsequent 4 days until day 42. The experiment continued until blood had been taken from 8 post-spawned fish over this time period.

Serum E₂ and T levels were measured by radioimmunoassay as detailed in Section 2.7. Total serum calcium was measured as detailed in Section 2.6. Feeding regime, photoperiod and water temperature were maintained as described in Section 2.1.3.

The same procedure was then used to profile E₂, T and total calcium in 8 strain 'B' *T. zillii* females.

Data were analysed by one-way or two-way ANOVA followed by Bonferroni/Dunn multiple comparison tests where appropriate. Data were logarithmically transformed if necessary. Total serum calcium data were ARCSine transformed prior to analysis.

(5.2.2) Results.

No mortalities were observed during the course of this experiment. All fish recovered well from anaesthesia and blood sampling.

In total, 8 strain 'A' and 8 strain 'B' females were monitored in this study. Weights of strain 'A' fish ranged from 193.7 - 232.0g (mean = 201.8±5.0g); lengths

ranged from 205 - 225mm (mean = 213.3 ± 3.1 mm). Weights of strain 'B' fish ranged from 111.7 - 211.1g (mean = 162.9 ± 12.0); lengths ranged from 172 - 216mm (mean = 197.0 ± 6.9 mm). There was no significant difference ($p \geq 0.05$) between the two strains in terms of either mean weight or mean length.

(5.2.2.1) Spawning incidence.

None of the fish involved in this experiment were observed to spawn during the course of the study. As a result it was unfortunately not possible to compile data throughout a completed reproductive cycle.

(5.2.2.2) Profiles of E₂, T, total calcium and E₂/T ratio.

(a) E₂ profile (refer to Figure 5.1a): One-way ANOVA found significant ($p < 0.001$) differences in E₂ levels over time, both in strain 'A' and in strain 'B'. Immediately after spawning mean levels of circulating E₂ were low (2.5 ± 1.2 ng/ml and 1.8 ± 0.2 ng/ml for strains 'A' and 'B' respectively). Levels then rose significantly ($p < 0.001$) to peak just two days after spawning (11.5 ± 2.1 ng/ml and 21.8 ± 5.5 ng/ml for strains 'A' and 'B' respectively) but had fallen steadily to ~ 3 ng/ml by day 10 (post-spawn). Throughout the remainder of the 42 days, levels remained relatively low and fluctuated only slightly, though levels appeared to become elevated around days 14 - 16 and around days 34 - 38.

No significant differences ($p \geq 0.05$) were found between the E₂ profiles of strain 'A' and strain 'B' *T. zillii* over the 42 day period (two-way ANOVA).

(b) T profile (refer to Figure 5.1b): Significant differences were observed in levels of T over time (one-way ANOVA) in both strain 'A' ($p < 0.05$) and strain 'B' ($p < 0.001$). Immediately after spawning, levels of T (as with E₂) were found to be low (9.6 ± 4.3 ng/ml and 7.6 ± 1.4 ng/ml for strains 'A' and 'B' respectively). A significant

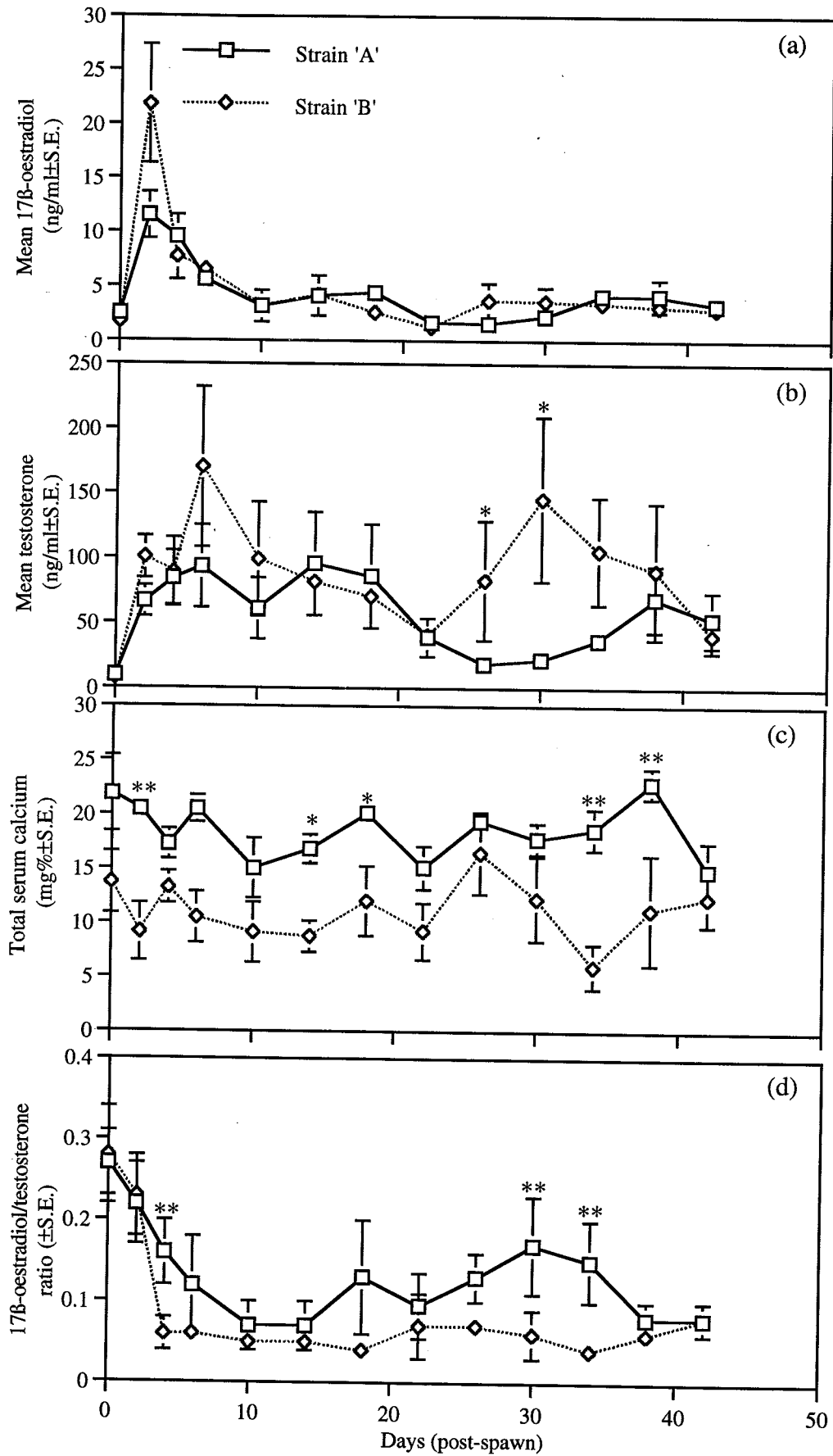

Figure 5.1. Comparison of mean \pm S.E. (a) 17 β -oestradiol, (b) testosterone, (c) total serum calcium and (d) 17 β -oestradiol/testosterone ratio between *T. zillii* strains 'A' and 'B' over a 42 day period after spawning (day 0 = day of spawn). Statistical differences between the two strains at any particular timepoint are indicated by * ($p < 0.05$) or ** ($p < 0.01$).

increase in T was found to occur between days 0 and 2 in strain 'A' (to $66.3 \pm 11.9 \text{ ng/ml}$, $p < 0.01$) and in strain 'B' (to $100.3 \pm 16.3 \text{ ng/ml}$, $p < 0.001$). This rise occurred coincident with significant increases in E₂. Levels of T continued to rise and appeared to peak in both strains on day 6, 2 days after peak levels of E₂. Throughout the rest of the experimental period, interpretation of the profile (in either strain) was made difficult by marked variation amongst individuals at the same timepoint (note large standard error bars). Profiles of T in individual fish are given in Figures 5.2 and 5.3 for strains 'A' and 'B' respectively. In strain 'A' most variation was found to occur in the early part of the cycle (days 4 - 18). In contrast, variation in strain 'B' was particularly marked within the latter part (days 26 - 38) of the cycle.

Two-way ANOVA detected significant ($p < 0.01$) differences in the profile of T over the 42 day period between the two strains.

(c) Total serum calcium profile (refer to Figure 5.1c): Total serum calcium was observed to fluctuate between $14.9 \pm 2.6 \text{ mg\%}$ and $22.9 \pm 1.4 \text{ mg\%}$ in strain 'A' and between $6.0 \pm 2.1 \text{ mg\%}$ and $16.5 \pm 3.8 \text{ mg\%}$ in strain 'B' over the timecourse of this experiment; no obvious trends were detectable. Moreover, one-way ANOVA found no significant ($p \geq 0.05$) changes in serum calcium levels over the 42 day period in either strain 'A' or strain 'B'.

Curiously though, mean total serum calcium was found to be significantly higher ($p < 0.001$) when compared over the entire 42 day period in strain 'A' than in strain 'B' (two-way ANOVA).

(d) E₂/T profile (refer to Figure 5.1d): Significant differences were detected in E₂/T ratio over time (one-way ANOVA) in both strain 'A' ($p < 0.05$) and strain 'B' ($p < 0.01$). In both strains mean ratio of E₂ to T was found to be highest immediately after spawning (day 0) and fell steadily thereafter until day 14. The ratio then remained low over the remainder of the 42 day period with only slight fluctuation, though the ratio did appear to become elevated around days 28 - 32.

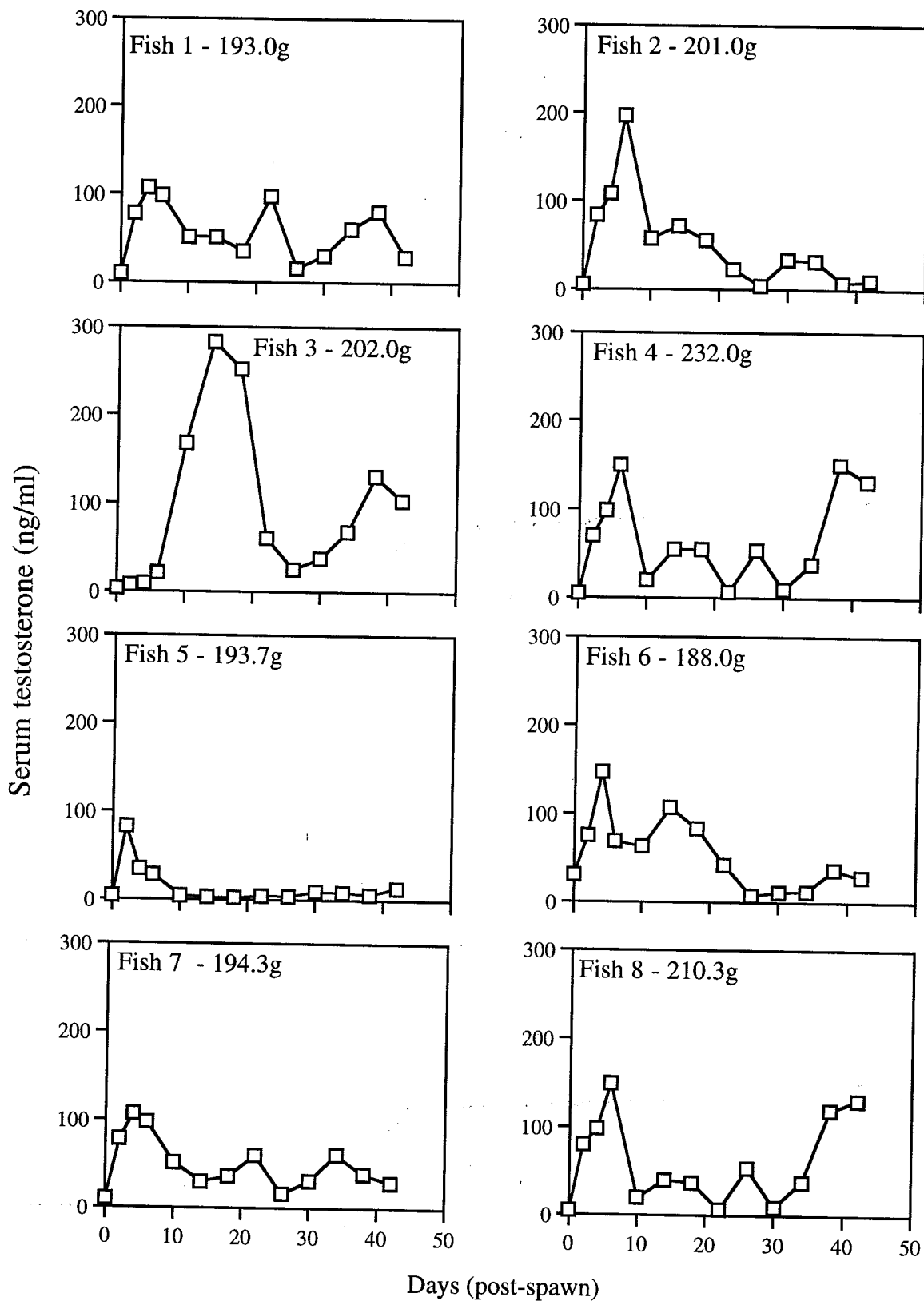

Figure 5.2. Profiles of serum testosterone in eight individual *T. zillii* (strain 'A') females over a period of 42 days (day 0 = day of spawn).

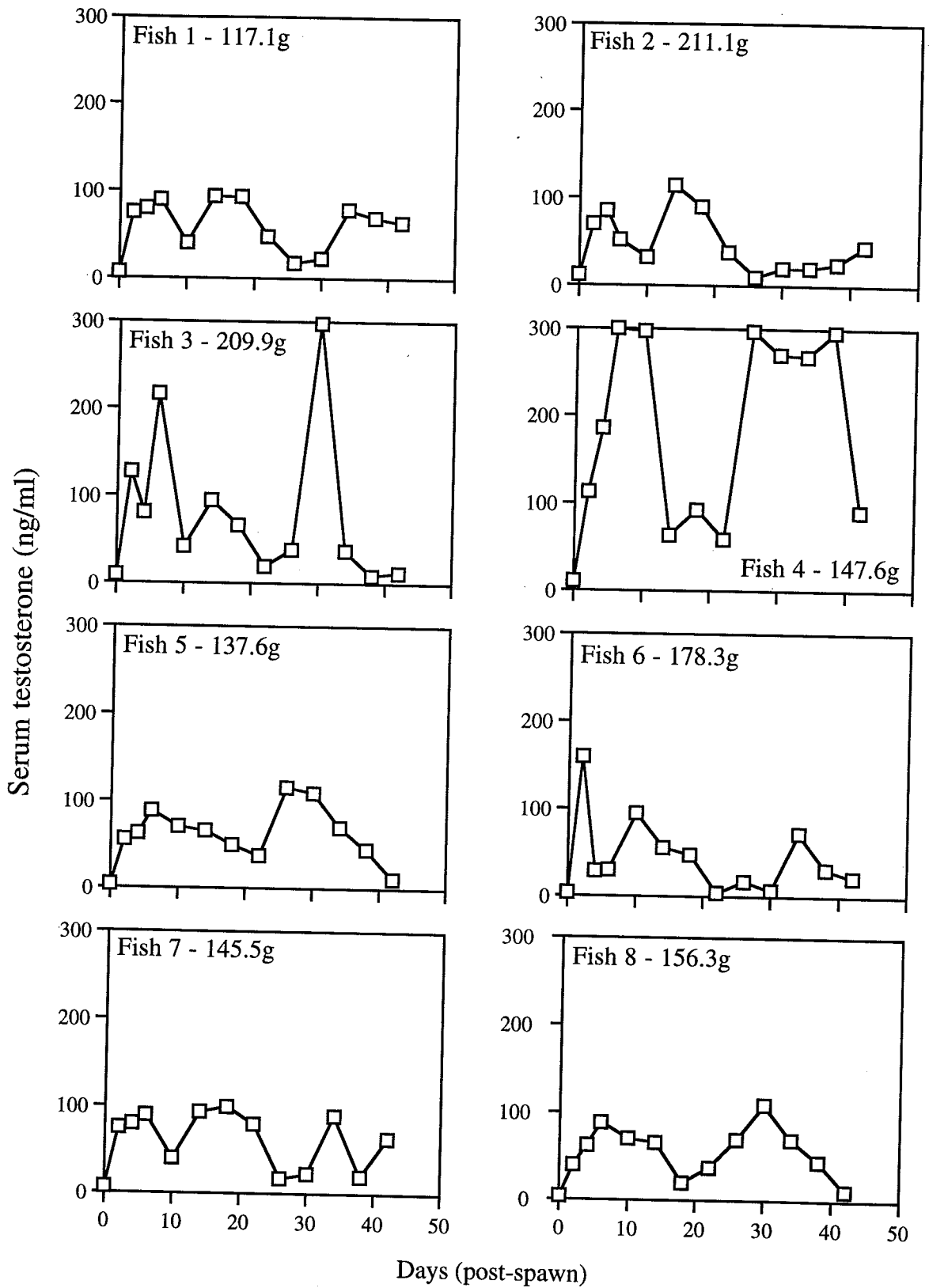

Figure 5.3. Profiles of testosterone (ng/ml) in eight individual female *T. zillii* (strain 'B') over a 42 day period (day 0 = day of spawn).

Mean E₂/T was found to be significantly higher ($p < 0.01$) when compared over the 42 day period in strain 'A' than strain 'B' (two-way ANOVA).

(5.2.3) General summary (Experiment 1).

This experiment monitored levels of E₂, T, total serum calcium and E₂/T ratio in 8 female *T. zillii* (strain 'A') and 8 *T. zillii* (strain 'B') over a 42 day period following spawning. No significant differences were found between the two strains in terms of E₂; levels rising from ~2.5ng/ml immediately after spawning to reach a peak of 11.5 - 21.8 ng/ml on day 4, falling to and remaining at ~3ng/ml thereafter. Immediately after spawning T was low (7.6 - 9.6ng/ml), rising to a peak of 90 - 180ng/ml by day 6. Throughout the remainder of the experimental period, interpretation of the T profile was difficult due to marked variation amongst individuals at the same timepoint. Significant differences ($p < 0.01$) were however detected between 'A' and 'B' strains in terms of T.

Total serum calcium was not found to differ significantly ($p \geq 0.05$) over the course of the 42 day period in either strain of fish and varied from $14.9 \pm 2.6\text{mg}\%$ to $22.9 \pm 1.4\text{mg}\%$ in strain 'A' and from $6.0 \pm 2.1\text{mg}\%$ to $16.5 \pm 3.8\text{mg}\%$ in strain 'B'.

In both strains of fish, ratio of E₂/T was found to be highest immediately after spawning (day 0), falling steadily thereafter until day 14. Ratio then remained relatively constant. Mean E₂/T ratio was found to be significantly higher ($p < 0.01$) between the two strains over the 42 day period.

Unfortunately, none of the fish in this experiment spawned during the course of this study, thereby preventing compilation of a completed cycle. To assess ovarian condition, four fish from each strain were sacrificed at the end of the experiment. Each fish possessed well-developed ovaries containing late-vitellogenic oocytes, suggesting that these fish were indeed capable of spawning. Moreover, data given in Chapter 3 suggest that *T. zillii* weighing <50g are very capable of spawning. The weight range of fish used in the present study was 111.7 - 232.0g. Data presented in Chapter 3 demonstrate that *T. zillii* within this size range have the potential to spawn profusely.

(5.3) Experiment 2: Profiles of E₂, T and total calcium and concurrent ovarian recrudescence as monitored by serial ovarian biopsy in individually-maintained post-spawned *T. zillii* (strain 'A').

This experiment aimed to further analyse profiles of E₂, T and total serum calcium (as an indicator of serum vitellogenin concentration) in individually maintained *T. zillii* (immediately post-spawned) females and to attempt to monitor concurrent ovarian recrudescence in such females via the process of serial ovarian biopsy, thereby avoiding the need for sacrifice. An attempt was also made to assess whether visual contact with male conspecifics could influence sex steroid levels and/or ovarian growth in this species.

The results of Experiment 1 (Section 5.2) found that levels of total serum calcium did not change significantly ($p \geq 0.05$) over a period of 42 days in either *T. zillii* strain 'A' or strain 'B'. This suggests that measurement of total serum calcium is of little use as an indicator of serum vitellogenin levels in this species. This will be discussed fully later in this Chapter (Section 5.5). As a further check however, serum calcium levels were also measured and analysed during the present experiment. Furthermore, none of the fish monitored in Experiment 1 (Section 5.2) spawned during the experiment and therefore prevented measurements being taken throughout a completed cycle. For this reason, fish used here in experiment 2 were monitored for a longer period of time (82 days).

(5.3.1) Materials & methods.

(a) Validation of biopsy technique.

To ensure that histological sections prepared from ovarian biopsies were accurate representations of true intra-ovarian histology, the following validation was undertaken. Four female *T. zillii* not involved in the present study, were anaesthetised (Section 2.2.1) and an ovarian biopsy taken (as detailed in Section 2.3.2). Each fish was then sacrificed and a small transverse section of ovary removed (see Section

2.3.3). Both biopsy and transverse sections were taken from the same region, mid-way along the ovary. Biopsies and transverse sections were fixed in Bouin's fluid, embedded in 'Histo-resin', sectioned at 3 μ m and stained in haematoxylin & eosin as detailed in Sections 2.5.1 and 2.5.2. Volume fraction of each stage of oocyte (categorised according to the classification scheme given in Chapter 4) were determined using stereology (Section 2.5.4). One-way ANOVA was then used to compare the volume fractions calculated for each oocyte stage between the biopsied tissue and the transverse section. Volume fraction data were ARCSine transformed prior to analysis.

(b) Main experiment.

Twenty female *T.zillii* (strain 'A') were removed at random from holding tanks and transferred into glass aquaria partitioned with perspex dividers such that each fish could be maintained individually (as in Experiment 1 - Section 5.2.1). Fish were stocked into glass aquaria such that none had visual contact with male conspecifics.

Fish were left uninterrupted until spawning activity was seen to occur (as in Experiment 1). Spawning was allowed to proceed until oviposition had occurred (i.e. egg clutches seen adhered to tank base or sides). Immediately after completion of oviposition and concomitant with gonopore regression, post-spawned fish were removed from their respective aquaria and were anaesthetised, weighed, measured (Section 2.4.1) and blood sampled (Section 2.3.1). Serum was obtained by allowing blood samples to clot at 4°C followed by centrifugation (Section 2.3.1). A small sample of ovarian tissue was also taken by ovarian biopsy as detailed in Section 2.3.2. Ovarian tissue samples were fixed in Bouin's fluid (Section 2.5.1), embedded in 'Histo-resin' and sectioned at 3 μ m (Section 2.5.1), and stained in haematoxylin and eosin (Section 2.5.2).

Blood and ovarian biopsy samples taken from fish immediately after spawning were referred to as the 0-day sample. Further samples were then taken from each post-spawned fish on days 2, 4, 6 and every subsequent 4 days until day 42. The

experiment continued until samples were being taken from 8 individually cycling fish. On day 42, 4 fish were allowed visual contact with male conspecifics (i.e males stocked in adjacent aquaria partitions; hereafter referred to as group 1). The remaining 4 fish continued to be deprived of visual contact with males (group 2). Blood and ovary sampling continued in each fish at 4 day intervals until day 82.

Serum E₂ and T levels were measured by radioimmunoassay as detailed in Section 2.7. Total serum calcium was measured as detailed in Section 2.6. Stages of oocyte growth were categorised according to the classification scheme given in Chapter 4. Volume fractions of each oocyte stage were determined using stereology (Section 2.5.4). Although three stages of atresia were identified in Chapter 4, volume fraction analysis presented herein involves merely 'atretic oocytes' and represents pooled data from each of the three stages of atresia (α -stage & β -atresia were by far the most commonly found phases of atresia; λ -stage was found only rarely).

At the end of the experiment, fish were weighed again (Section 2.4.1) to assess whether fish gained or lost weight during the experimental procedure and thereby provide an indication of whether the experimental conditions were detrimental to fish.

Feeding regime, photoperiod and water temperature were maintained as described in Section 2.1.3.

Data were analysed by one-way or two-way ANOVA followed by Bonferroni/Dunn multiple comparison tests where appropriate. Data were logarithmically transformed if necessary. Total serum calcium and volume fraction data were ARCSine transformed prior to analysis.

(5.3.2) Results.

(5.3.2.1) Validation of biopsy technique.

Validation data are presented in Table 5.1. No significant differences ($p \geq 0.05$) were observed when comparing volume fractions determined via ovarian biopsy and those determined from the ovaries of sacrificed fish. On this basis it was considered that ovarian biopsy could indeed provide an accurate representation of true intra-ovarian histology in live experimental fish.

(5.3.2.2) Main experiment.

No mortalities were observed during the course of this experiment. All fish recovered well from anaesthesia and blood sampling.

In total, eight *T. zillii* females (strain 'A') were monitored in this study. Weights of group 1 fish ranged from 183.8 - 415.4g (mean = 288.4 ± 67.8 g); lengths ranged from 215 - 270mm (mean = 240.0 ± 16.1 mm). Weights of group 2 fish ranged from 267.7 - 363.6g (mean = 322.0 ± 28.4 g); lengths ranged from 234 - 255mm (mean = 243.0 ± 6.3 mm). There was no significant difference ($p \geq 0.05$) between the two groups in terms of either mean weight or mean length (one-way ANOVA) at the start of the experiment or at the end of the experiment. By the end of the experiment mean fish weight had increased only slightly in group 1 (288.4 ± 67.8 g to 289.1 ± 68.5 g) but had fallen in group 2 (322.01 ± 28.4 g - 319.4 ± 24.3 g). These changes were not, however, significant ($p \geq 0.05$).

(5.3.2.3) Spawning incidence.

Only one fish (belonging to group 1) was observed to spawn during this experiment. Spawning occurred on day 58 (16 days after provision of visual contact with conspecific). Data obtained from this fish after day 58 have not therefore, been included in the following analyses. Data from this fish are however, presented separately so that dynamic changes over a completed reproductive cycle may be depicted.

Table 5.1. Comparison of the volume fractions of various oocyte developmental stages determined from histological slides taken from (a) intra-ovarian tissue removed via ovarian biopsy and (b) transverse ovarian sections taken from sacrificed fish. Volume fractions represent mean±S.E. and were calculated from 4 fish. Data were ARCSine transformed prior to analysis and were compared using one-way ANOVA.

Oocyte developmental stage	Volume fraction (%±S.E.) determined using stereological analysis		Result of one-way ANOVA
	Biopsy method	Sacrifice method	
Stage 2	8.9±3.2	8.0±1.2	p≥0.05 (ns)
Stage 3	6.3±2.2	5.2±0.7	p≥0.05 (ns)
Stage 4	1.9±1.0	1.8±1.4	p≥0.05 (ns)
Stage 5	19.7±10.4	23.2±12.7	p≥0.05 (ns)
Stage 6/7	36.5±16.9	38.3±22.0	p≥0.05 (ns)
Atretic oocytes	3.2±2.1	2.8±0.09	p≥0.05 (ns)

(5.3.2.4) Profiles of E₂, T, total calcium and E₂/T ratio.

(a) E₂ profile (refer to Figure 5.4a): Over the initial 42 day period, profiles of E₂ in each group were very similar and mirrored those trends observed in Experiment 1 (see Section 5.2.2.2). E₂ peaked in both groups 2 days after spawning (at ~16ng/ml and ~8ng/ml respectively) but had fallen to ~1.5ng/ml by day 10. Over the remainder of the initial 42 day period, E₂ fluctuated only slightly with slight elevations around days 14 - 16 and days 34 - 42 (as also seen in Experiment 1). During this period, two-way ANOVA found no significant differences ($p \geq 0.05$) between the two groups but significant ($p < 0.01$) differences between timepoints irrespective of group.

From day 42 onwards (i.e group 1 with visual contact with males, group 2 with no visual contact), levels of E₂ (in both groups) appeared to continue to fluctuate only slightly and generally remained < 5 ng/ml. No significant difference was found between the two groups ($p \geq 0.05$, two-way ANOVA) from day 42 onwards. Moreover, no significant difference ($p \geq 0.05$) in E₂ was found amongst different timepoints from day 42 onwards irrespective of group (two-way ANOVA).

(b) T profile (refer to Figure 5.4b): As in Experiment 1 (see Section 5.2.3.2), levels of T rose from day 0, concurrent with rising E₂, to peak on day 6 at ~70 - 90ng/ml (2 days after maximal E₂ levels). Levels began to fall thereafter. Wide variation in T was observed amongst individuals in both groups during the early part of the cycle (up to day 14), as also seen in strain 'A' fish in Experiment 1 (Section 5.2.2.2), though levels appeared to rise in both groups 1 and 2 from day 10 - 20. From days 22 - 30, levels of T remained relatively low (< 10 ng/ml), rising from day 34 - 46 concurrent with a slight elevation in E₂. Two-way ANOVA detected no significant differences ($p \geq 0.05$) between the two groups irrespective of time during the initial 42 day period but significant ($p < 0.05$) differences between timepoints irrespective of group.

From day 42 onwards, levels of T continued to fluctuate in each group though generally remaining < 50 ng/ml with more fluctuation in group 1 (+ males) than group 2

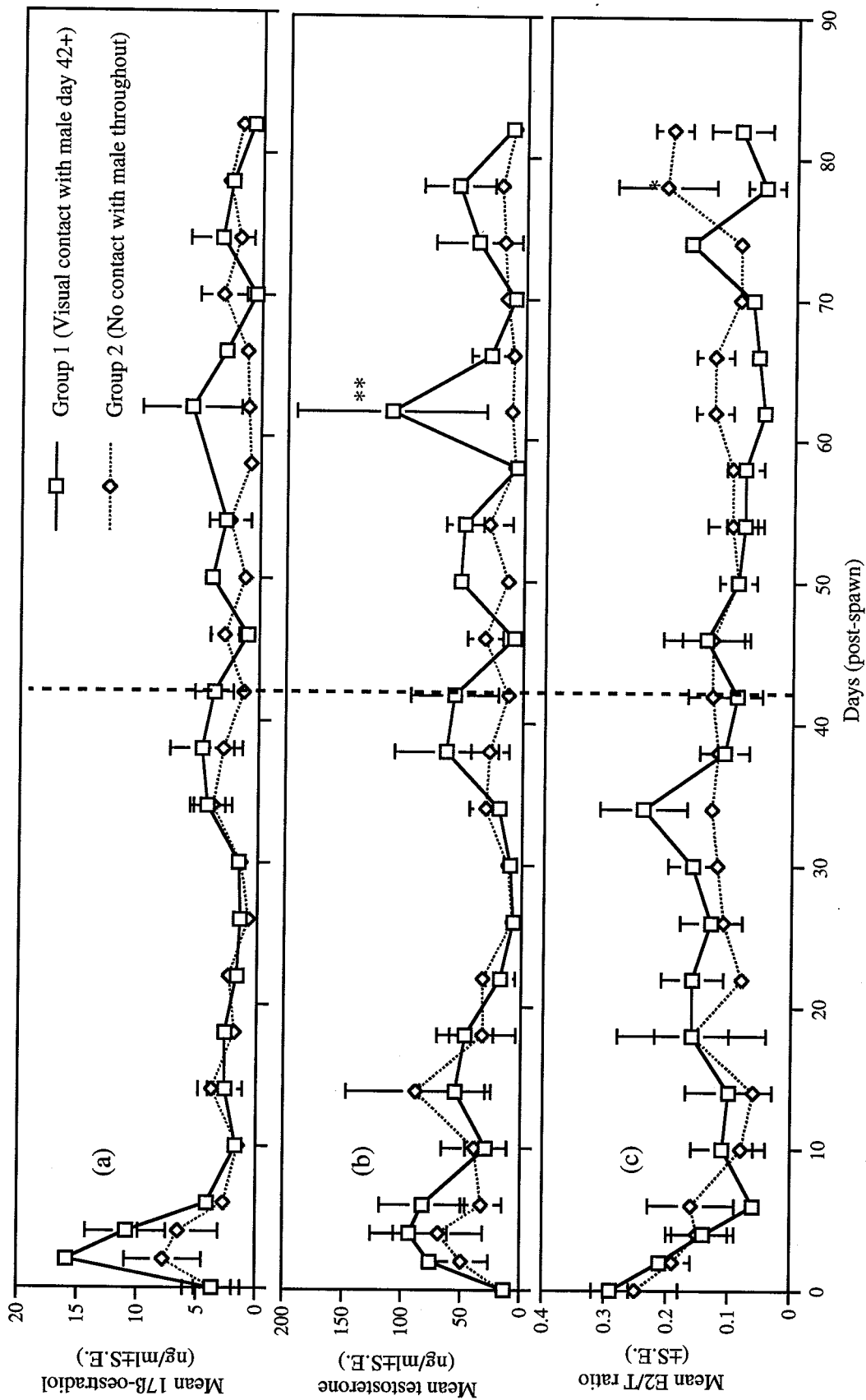

Figure 5.4. Profiles of mean (a) 17β-oestradiol, (b) testosterone and (c) 17β-oestradiol/testosterone ratio in two groups of individually-held female *T. zilli* (strain 'A'). Between days 0 and 42 both groups were deprived of visual contact with males. Group 1 however, were allowed visual contact with males from day 42 onwards. Day 42 is identified by the broken line. Statistically significant differences between the two groups at any one timepoint are indicated by * ($p < 0.05$) or ** ($p < 0.01$). Otherwise differences between groups are not significant.

(- males). Group 1 also appeared to exhibit more variation amongst individuals than group 2. Significant differences ($p < 0.05$) were found between groups during this period (two-way ANOVA) but no significant differences between timepoints irrespective of group ($p \geq 0.05$). It remains likely however, that the significant difference observed between groups during this period was due to one group 1 fish on day 66 exhibiting a T level of 192.4ng/ml, far in excess of other group 1 fish at the same timepoint (~30ng/ml).

(c) Total serum calcium profile: Levels of total serum calcium varied from $8.4 \pm 1.9\text{mg}\%$ to $24.2 \pm 5.7\text{mg}\%$ in group 1 and from $6.8 \pm 2.3\text{mg}\%$ to $27.6 \pm 8.1\text{mg}\%$ in group 2. As with Experiment 1 (see Section 5.2) however, no obvious trends were detected. Furthermore, one-way ANOVA found no significant ($p \geq 0.05$) changes in serum calcium levels over the 82 day period in either group 1 or group 2. Further analysis using two-way ANOVA further found that there was no significant difference ($p \geq 0.05$) in terms of total calcium levels between the two groups when compared over the entire experimental period. For this reason total serum calcium data collected from this experiment are not presented in the form of a figure.

(d) E₂/T profile (refer to Figure 5.4c): As observed in Experiment 1 (see Section 5.2.2.2), mean E₂/T ratio (in both groups) was highest on day 0 immediately after spawning, falling thereafter to day 10 and fluctuating only slightly thereafter. E₂/T appeared to increase around days 30 - 34 (as also seen in experiment 1 - see Section 5.2.2.2). Two-way ANOVA found no significant differences ($p \geq 0.05$) between groups 1 and 2 during the first 42 days of the experiment but found significant differences ($p < 0.05$) between timepoints irrespective of group.

From day 42 onwards E₂/T continued to fluctuate at low levels rising in group 1 from day 70 and in group 2 from day 74. Significant ($p < 0.05$) differences were found between groups during this period (two-way ANOVA) but not between timepoints irrespective of groups ($p \geq 0.05$, two-way ANOVA).

(5.3.2.5) Volume fractions (VF) of oocyte developmental stages.

Biopsied ovarian tissue was found to contain the following oocyte developmental stages: stage 2, stage 3, stage 4, stage 5, stage 6/7 and atresia (see Chapter 4 for full description/classification). Post-ovulatory follicles (POFs) were not found in any of the biopsies, even those taken soon after spawning (days 0, 2 and 4). Biopsies taken on day 0 (immediately after spawning) were only found to contain stage 5, stage 6/7 and atretic oocytes and did not contain stages 2, 3 or 4. Thereafter stages 2, 3, 5 and 6 were common and found in most biopsies throughout the experimental period. Atresia also appeared to be a phenomenon common to most biopsies. Stage 4 oocytes were only found during the early part of ovarian recrudescence (i.e. days 2 - 6), though some were observed in group 1 fish (i.e. those with visual contact with males) in several biopsies taken after day 42.

(a) Stage 2 oocytes (refer to Figure 5.5a): Mean VF of stage 2 oocytes fluctuated between 0 and $5.4 \pm 3.1\%$ throughout the first 42 day period and between 0.2 ± 0.03 and 10.1 ± 2.3 from days 42 - 82. Higher VF's were generally found earlier in the cycle (days 2 - 18) but were found to be particularly high on the day of the final biopsy (day 82). No significant differences ($p \geq 0.05$) were found between group 1 and group 2 during the initial period 42 day period, nor between days 42 and 82 (whilst group 1 were allowed visual contact with male conspecifics). No significant differences were found between different timepoints irrespective of grouping during days 0 - 42. Significant differences ($p < 0.01$) were however found (two-way ANOVA) between timepoints irrespective of grouping from day 42 onwards.

(b) Stage 3 oocytes (refer to Figure 5.5b): Mean VF of stage 3 oocytes appeared to remain relatively constant throughout the initial 42 day period and generally remained $< 1\%$. Despite this, significant differences ($p < 0.05$) were found between timepoints during this period irrespective of grouping (two-way ANOVA). No significant differences were found between the two groups however ($p \geq 0.05$). From day 42 - 82, mean stage 2 VF appeared much more variable ($0.2 \pm 0.1\% - 3.0 \pm 2.7$).

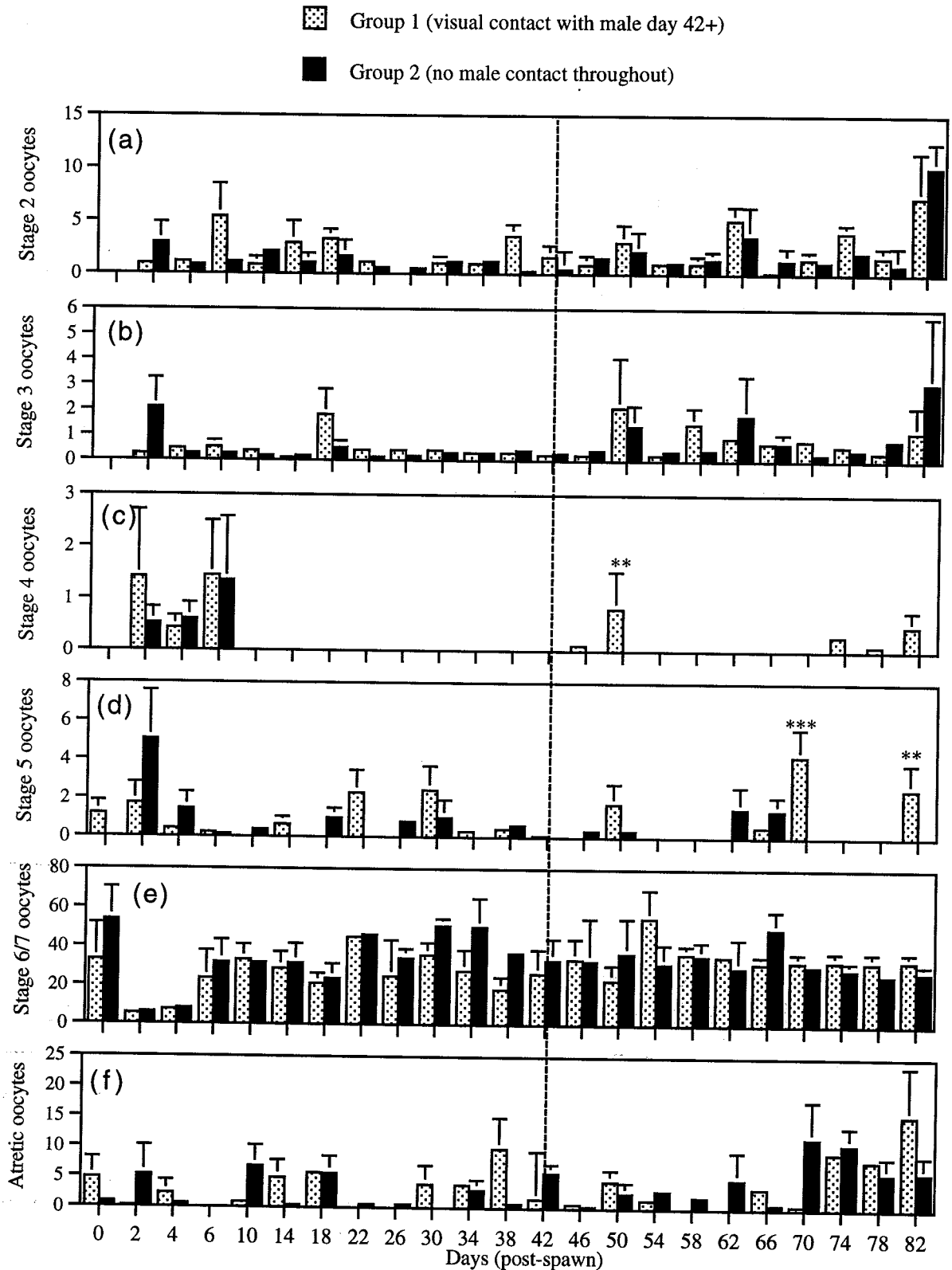

Figure 5.5. Mean volume fraction (% \pm S.E.) of oocyte developmental stages in ovarian tissue biopsied from *T. zillii* at various timepoints following spawning. Day 0 represents the day of spawning. Group 1 ($n = 4$) were provided with visual contact with male conspecifics from day 42 onwards. Group 2 ($n = 4$) were denied visual contact with males throughout the entire experimental period. Where no S.E. is visible, the S.E. lies within the confines of the symbol. Statistical differences between group 1 and group 2 at any particular timepoint are indicated by * ($p < 0.05$), ** ($p < 0.01$) or *** ($p < 0.001$), otherwise differences are not significant. Day 42 is indicated by the broken line.

During this period no significant differences ($p \geq 0.05$) were found between groups or between different timepoints irrespective of grouping.

(c) Stage 4 oocytes (refer to Figure 5.5c): Stage 4 oocytes were rarely found in biopsies and were observed predominantly in early ovarian recrudescence (days 2, 4 and 6). There was no significant difference ($p \geq 0.05$) between group 1 and group 2 during the first 42 days of the experiment, though significant differences ($p < 0.05$) were found between timepoints irrespective of grouping. From day 42 - 82, stage 4 oocytes were only found in group 1 (i.e. those experiencing visual contact with males). Whilst significant ($p < 0.05$) differences were found between the two groups during this period, no significant differences were observed between different timepoints irrespective of group (two-way ANOVA).

(d) Stage 5 oocytes (refer to Figure 5.5d): Stage 5 oocytes were commonly found during the first 34 days but infrequently found thereafter. During the first 42 days mean VF in group 1 varied from 0 - $2.4 \pm 1.2\%$ and in group 2 from 0 - $5.0 \pm 2.5\%$. No significant differences ($p \geq 0.05$) were found between groups during this period although significant ($p < 0.01$) differences were found between timepoints irrespective of group. From day 42 onwards, significantly more ($p < 0.05$) stage 5 oocytes were found in the biopsies from group 1 than group 2 (two-way ANOVA). Significant differences ($p < 0.01$) were also found between different timepoints irrespective of grouping during this period.

(e) Stage 6/7 oocytes (refer to Figure 5.5e): Stage 6/7 oocytes were found in every ovarian biopsy taken. Immediately after spawning (day 0), mean VF of stage 6/7 oocytes in biopsied tissue was high ($32.9 \pm 19.0\%$ in group 1 and $53.8 \pm 16.6\%$ in group 2). By day 2 however, mean VF was $< 10\%$ (in both groups). Mean VF then increased steadily to reach $33.2 \pm 7.8\%$ and $31.8 \pm 2.2\%$ (in groups 1 and 2 respectively) by day 10. Thereafter mean VF fluctuated between $21.1 \pm 5.2\%$ and $54.9 \pm 14.6\%$. There was no significant difference ($p \geq 0.05$) between the two groups of fish either between days 0 and 42 or between days 42 and 82. Significant differences ($p < 0.05$) were found

between timepoints irrespective of group during the first 42 days but not ($p \geq 0.05$) from days 42 - 82.

(f) Atresia (refer to Figure 5.5f): Atretic oocytes were found at most timepoints throughout the experiment, though mostly at low levels (<5%). There was no significant ($p < 0.05$) difference between the two groups during either days 0 - 42 or 42 - 82 ($p \geq 0.05$). During the first 42 days, mean VF fluctuated between 0 and $9.8 \pm 5.1\%$. No significant difference ($p \geq 0.05$) was observed between different timepoints irrespective of grouping during this period. From day 42 onwards, mean VF continued to fluctuate but mostly remained <5%, levels of atresia were however elevated during the last 12 days of the experiment (days 70 - 82). This elevation occurred in both groups and resulted in mean VF reaching levels of 10% or more. From day 42 onwards, significant ($p < 0.05$) differences were found between different timepoints irrespective of group.

(5.3.2.6) Regression analysis.

No significant relationships ($p \geq 0.05$) were found between serum T and the VF of any oocyte developmental stage (2, 3, 4, 5, 6/7, atresia) in either group 1 or group 2. A significant relationship ($p < 0.05$) was however found between serum E₂ and stage 6/7 VF (see regression equation 1 below) in group 1 (but not group 2, $p \geq 0.05$). Serum E₂ was also found to be significantly related ($p < 0.05$) to stage 4 VF in group 2 females (see regression equation 2 below). A similar correlation was not found in group 1 females.

(1) Log E₂ (x) and stage 6/7 (y) (group 1): $y = -0.11 \log x + 0.63$ ($r^2 = 0.2$, $p < 0.05$)

(2) Log E₂ (x) and stage 4 (y) (group 2): $y = -0.05 \log x + 0.003$ ($r^2 = 0.2$, $p < 0.05$)

Note that in both equations, VF values represent ARCSine transformed data.

(5.3.2.7) Complete profile of repeat-spawning fish.

As explained earlier, only one fish (belonging to group 1) spawned during this experiment. It spawned on day 58 (16 days after provision of visual contact with

conspecific). Data obtained from this fish after day 58 have not been included in the previous analyses but are presented separately here so that dynamic changes over a completed reproductive cycle may be depicted.

(a) E₂ profile (refer to Figure 5.6a): Prior to the second spawn, the individual's E₂ profile appeared very similar to those E₂ profiles observed earlier in this Chapter. Immediately after spawning (day 0) serum E₂ was low (~2ng/ml), rose to a peak of ~18ng/ml by day 4 and fell to 2 - 3 ng/ml by day 10. Small elevations in E₂ level were observed between days 14 - 22 and between days 22 - 30. A second major peak of E₂ was found to occur between days 30 and 46 (peak E₂ = ~10ng/ml), concurrent with a major T peak. The second spawn occurred on day 58 just twelve days after these peaks of E₂ and T. Immediately after the second spawn E₂ rose again, peaking on day 2, though this peak in E₂ was much less (at ~4ng/ml) than the peak observed immediately after the first spawn (~18ng/ml, days 2 - 4).

(b) T profile (refer to Figure 5.6b): As with E₂, the profile of T appeared very similar to those observed earlier in this Chapter. Immediately after the first spawn, T rose to peak on day 6 at ~150ng/ml (slightly after peak E₂ levels) falling to ~20ng/ml by day 10. Small elevations of T were also seen between days 10 - 22 and days 22 - 30 (as also witnessed with E₂). A second major peak of T was observed between days 34 - 46 (peak T = ~150ng/ml) concurrent with a major peak of E₂, and a third peak between days 46 and 50 (reaching ~70ng/ml on day 50). The second spawn occurred directly after this third peak of T on day 58. Immediately after the second spawn, T rose again, peaking on day 2 - 4 though this peak was much less (at ~20ng/ml) than the peak observed immediately after the first spawn (~150 ng/ml, day 6).

(c) E₂/T ratio (refer to Figure 5.6c): As seen earlier, E₂/T ratio was highest at the time of spawning. This was evident both with the first spawn (on day 0) and the second spawn (day 58). In both cases E₂/T ratio fell steadily over a period of 4 - 6 days after each spawn but fluctuated thereafter. E₂/T ratio appeared to elevate slightly between days 18 - 26, 26 - 42 and 42 - 54.

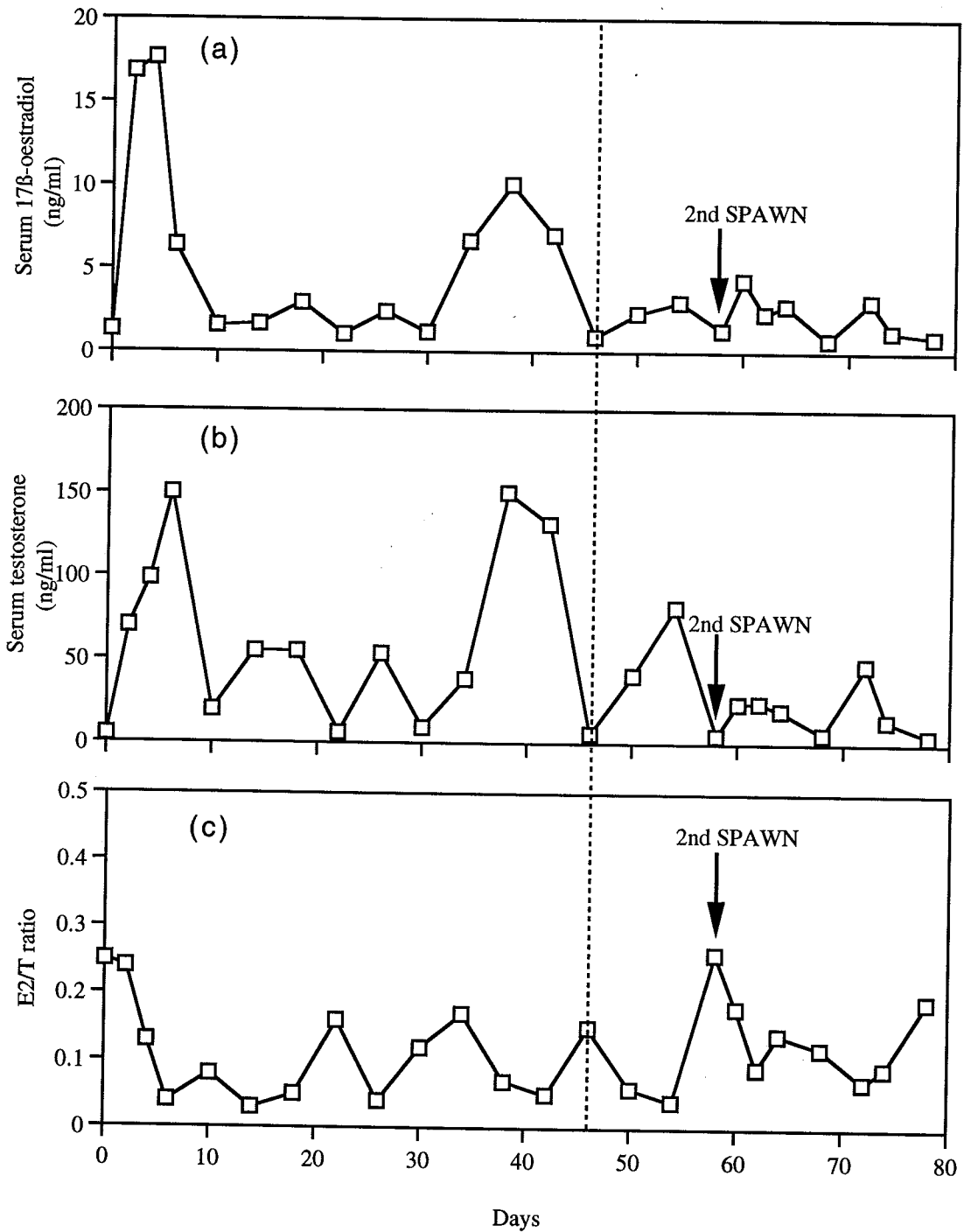

Figure 5.6. Profiles of (a) 17 β -oestradiol, (b) testosterone and (c) 17 β -oestradiol/testosterone ratio in an individual repeat-spawning fish. First spawning occurred on day 0 and the second spawn on day 58 (indicated by arrow). Visual contact with male conspecifics was provided from day 42 onwards (indicated by broken line).

(d) Ovarian volume fraction analysis (refer to Figure 5.7a -f): In the case of this particular fish, very few ovarian biopsies were found to contain stage 2, 3, 4 or 5 oocytes; biopsies containing these oocyte developmental stages were generally taken between days 38 and 62. VF of stage 6/7 oocytes appeared to remain relatively steady between days 10 and 42 (at ~30 - 40%) but rose steadily from day 42 (coincident with provision of visual contact with male conspecifics and also coincident with rising E₂ and particularly T) to peak on day 54 at ~70%; spawning occurring on day 58. Following this second spawn VF of stage 6/7 oocytes rose from 0% (on day 0) to ~55% (on day 72, just 14 days after the second spawn). Atresia was particularly found at the beginning of the reproductive cycle (in the case of both observed spawns) and towards the end of the first cycle (i.e. prior to the second spawn).

No significant relationships were found ($p \geq 0.05$) between either serum T or E₂ and the VF of any oocyte developmental stage (2, 3, 4, 5, 6/7, atresia) in this particular individual.

(5.3.3) General Summary (Experiment 2).

This experiment aimed to further analyse levels of E₂, T, total serum calcium and E₂/T ratio over a longer time period (82 days) than Experiment (1) and attempted to investigate concurrent changes in ovarian histology via the use of ovarian biopsy. Attempts were also made to assess whether visual contact with male conspecifics could influence sex steroid level and/or ovarian growth.

Over the first 42 day period, the profiles of E₂ and T generally mirrored those observed in Experiment (1). Again, a wide variation in T was observed amongst individuals. After the first initial peak (days 2 - 4), E₂ generally remained low (<5ng), though a slight elevation was observed between days 30 and 42 (also evidence of this in Experiment 1). Provision of visual contact with males from day 42 onwards did not influence levels of E₂ but resulted in a significant increase in serum T ($p < 0.05$).

As with Experiment 1, no significant differences were detected between the levels of total serum calcium over time suggesting that this method was of little use as a

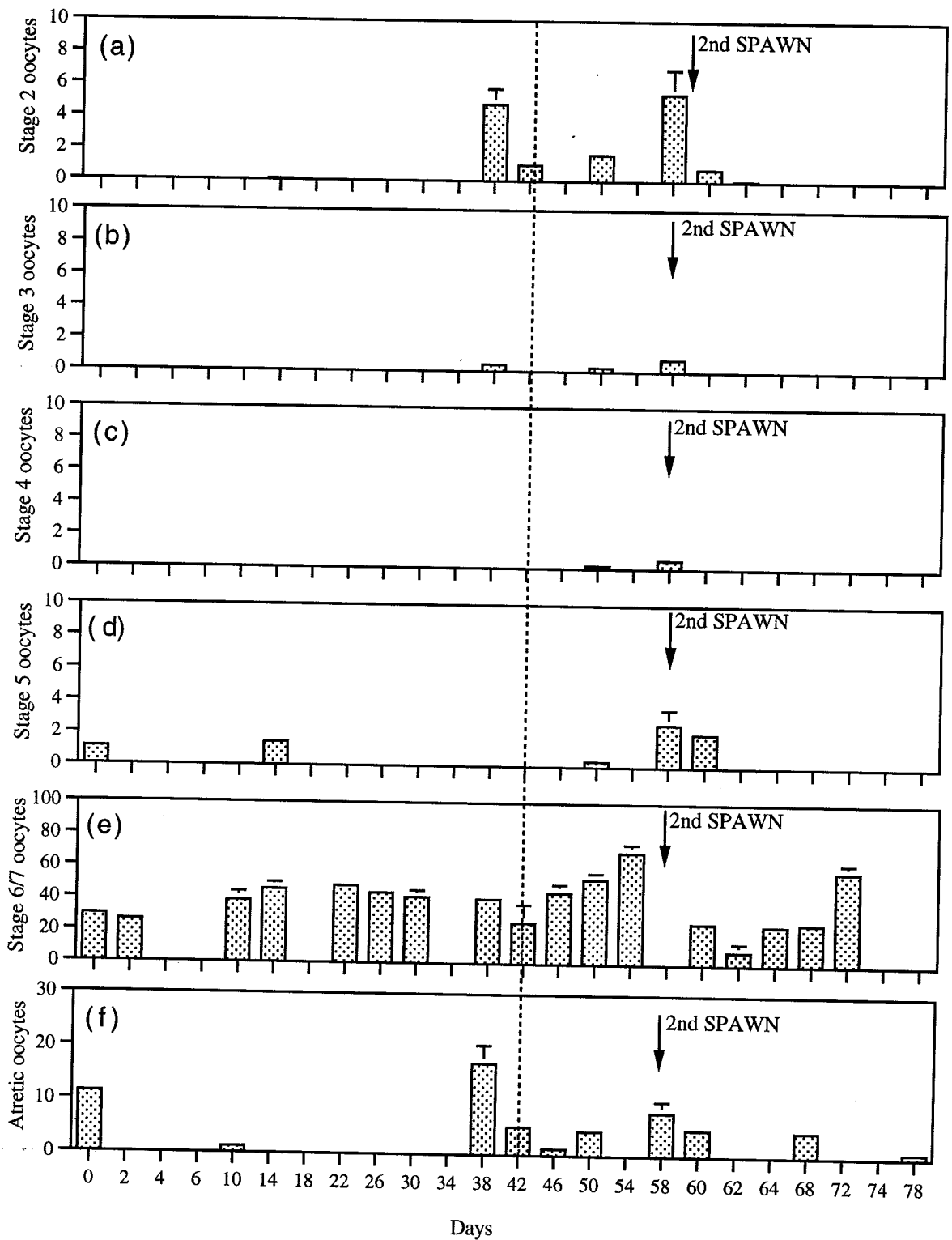

Figure 5.7. Mean volume fractions ($\% \pm \text{S.E.}$) of oocyte developmental stages in ovarian tissue biopsied from a repeat-spawning *T. zillii* female at various timepoints following spawning. First spawning occurred on day 0 and the second spawn on day 58 (indicated by arrow). Visual contact with male conspecifics was provided from day 42 onwards (indicated by broken line). Where the S.E. is not visible, it lies within the confines of the histogram.

means of monitoring changes in serum vitellogenin concentration in this particular species. As also observed in Experiment (1), ratio of E₂/T was highest immediately after spawning.

No significant ($p < 0.05$) differences were observed when comparing ovarian histology assessed via biopsy or assessed using dissected tissue from sacrificed animals, suggesting that biopsy was a suitable technique for the investigation of ovarian histology but without the need for sacrifice.

In terms of ovarian histology, stages 2, 3, 5 and 6 were common and found in most biopsies throughout the experimental period. Atresia also appeared to be a phenomenon common to most biopsies. Levels of atresia remained relatively low throughout much of the experiment but were elevated during the last 12 days of experimentation. Stage 4 oocytes were generally only found during the early part of ovarian recrudescence (days 2 - 6). VFs of stage 6/7 oocytes appeared to have reached maximal levels just 6 - 10 days after spawning and fluctuated only slightly thereafter. Providing females with visual contact with male conspecifics from day 42 onwards did not affect stages 2, 3, 6/7 or the VF of atretic oocytes. Provision of male contact did, however, affect VF's of both stage 4 and stage 5 oocytes; groups of females given male contact exhibited significantly greater VFs of stage 4 and stage 5 oocytes.

Unfortunately only one fish spawned during this investigation, data being presented separately. Prior to the second spawn, the individuals E₂ and T profile appeared similar to those described earlier. In addition to the peak of E₂ on day 4 however, a second smaller peak was evident between days 30 and 46 concurrent with a major T peak. The second spawn occurred on day 58 just twelve days after these peaks. After the second spawn, E₂ rose again to peak on day 2. This peak was however much smaller (by a factor of four) than the peak observed immediately after the first spawn. As described earlier, E₂/T ratio was highest immediately after spawning (i.e. on day 0 - first spawn and on day 58 - second spawn). In terms of ovarian histology, very few ovarian biopsies were found to contain stage 2, 3, 4 or 5 oocytes; biopsies containing these oocyte stages were generally taken between days 38 and 62. VF of stage 6/7

oocytes remained reasonably steady between days 10 and 42 but rose steadily from day 42 (coincident with provision of visual contact with males) and also coincident with rising levels of E₂ and T. Atretic oocytes were most commonly found at the beginning of the cycle (i.e. after spawning) and towards the end of the cycle.

(5.4) Experiment 3: Ovarian recrudescence in different regions of the *T. zillii* ovary as monitored by sacrifice of fish at periodic intervals after spawning.

This experiment aimed to monitor ovarian recrudescence in different parts of the the *T. zillii* ovary following spawning and to attempt to correlate this information to other data e.g. gonadosomatic index (GSI), hepatosomatic index (HSI), serum E₂ level and serum T level. In order to do this, fish were sacrificed at discrete timepoints following spawning activity. This experiment aimed to expand on the information obtained in Experiment 1 (Section 5.2) and Experiment 2 (Section 5.3) but eliminates the potential detrimental effect of on-going stress that may be associated with serial blood (and ovarian biopsy) sampling. None of the fish involved in Experiment 1 and only one fish from Experiment 2 spawned over the experimental periods. Moreover, one group of fish involved in Experiment 2 lost weight during the experimental period; the other group exhibited only a very slight weight increase. This suggests that growth and spawning activity may have been affected by the stress involved with serial-sampling protocols.

Moreover, although the results of Experiment 2 demonstrated that ovarian biopsy provided an accurate representation of true intra-ovarian histology, it is not known as to whether this relationship would hold true over a long period of time with repeated serial-sampling.

(5.4.1) Materials & methods.

Twenty female *T. zillii* (strain 'A') of similar age and size were removed at random from holding tanks and were transferred into glass aquaria partitioned with

perspex dividers (as in Experiment 1 - Section 2.2.1). Fish were left uninterrupted until spawning activity was seen to occur. Spawning was allowed to proceed until oviposition had occurred (i.e. egg clutches seen adhered to tank base or sides). Immediately after completion of oviposition and concomitant with gonopore regression, post-spawned fish were removed from their respective aquaria and were anaesthetized, weighed, measured (Section 2.4.1) and blood sampled (Section 2.3.1). Fish were then sacrificed by anaesthetic overdose followed by spinal transection. Ovaries and liver were removed and weighed separately to the nearest 0.0001g. GSI and HSI were then determined as detailed in Section 2.3.3. Transverse sections were taken from the anterior, mid and posterior regions of the right ovary and were fixed in Bouin's fluid (Section 2.5.1), embedded in 'Historesin' and sectioned at 3 μ m (section 2.5.1). For each tissue sample, at least 8 sections were stained in haematoxylin & eosin and at least 8 sections stained in polychrome (Section 2.5.2).

Serum was obtained from blood samples by clotting at 4°C followed by centrifugation (Section 2.3.1). Levels of serum E₂ and T were determined by radioimmunoassay as detailed in Section 2.7. Total serum calcium was also determined as detailed in Section 2.6.

Volume fraction and numerical density of each oocyte developmental stage was determined from histological sections using stereology (Section 2.5.4). Numerical densities of oocytes/unit area (volume) were calculated using the series of equations given in Section 2.7 and using the data presented here in Table 5.2 (derived from Chapter 4 analyses). It was only possible to determine an accurate oocyte size or shape for the first stage of atresia (α -stage) since oocyte size and shape varied widely in later stages of atresia. The numerical density data presented herein therefore, is based solely on α -stage atresia (also the most commonly found atretic phase). As in Experiment 2, volume fraction analysis considers all three stages of atresia (α , β & λ -atresia) together. Similarly, numerical density analysis could not be performed on post-ovulatory follicles (POF's) due to extremely wide variation in size and shape.

Oocyte developmental stages were classified according to the classification scheme developed in Chapter 4.

This process was repeated until four fish had been sampled. An identical protocol was used to sacrifice 4 more fish at each of the following time intervals: 1, 2, 3, 4, 5, 6, 8, 10, 14, 22 and 26 days post-spawning. Each fish removed from individual aquaria for sacrifice was replaced with a further individual from the holding tank. Feeding regime, photoperiod and water temperature were maintained as described in Section 2.1.3.

Data were analysed by one-way ANOVA followed by Bonferroni/Dunn multiple comparisons if necessary. Data were logarithmically transformed if necessary. Volume fraction and HSI/GSI data were ARCSine transformed prior to analysis. Numerical density data were logarithmically transformed prior to statistical analysis. Weibel (1979) reported that the diameter distribution (K) of the particles being counted are normally distributed if K lies within the range 1.0 - 1.07. In the present study K was found to vary between 1.01 and 1.18 (Table 5.2) and it was thus decided to logarithmically transform data prior to analysis.

(5.4.2) Results.

(5.4.2.1) Weight and length of fish sacrificed.

(a) Weight: Mean weight of fish sacrificed in this Experiment was 69.2 ± 4.5 g (range = 32.8 - 203.1g). No significant difference ($p \geq 0.05$) was found in terms of mean weight of sacrificed fish amongst different timepoints (one-way ANOVA).

(b) Length: Mean length of fish sacrificed in this Experiment was 152 ± 3 mm (range = 117 - 213mm). No significant difference ($p \geq 0.05$) was found in terms of mean length amongst different timepoints (one-way ANOVA).

(5.4.2.2) GSI and HSI (refer to Figure 5.8a).

(a) GSI: Immediately after spawning, GSI was $1.85 \pm 0.4\%$ and rose steadily up to $2.79 \pm 0.5\%$ by day 8. GSI increased significantly ($p < 0.05$) between days 8 and 10

Table 5.2. Oocyte size and shape data necessary for numerical density stereology. Data are derived from analyses used in the development of an oocyte stage classification scheme given in Chapter 4. Refer to Section 2.5.4.4. for further explanation of equations/data given.

Oocyte stage	No. oocytes analysed.	Mean oocyte shape (β) *1	M1 - Mean oocyte diameter (mm) *2	M3 *3	K - Oocyte diameter distribution *4	K/ β (constant used in numerical density calculation)
2	801	1.268	0.0968	0.1079	1.18	0.93
3	691	1.275	0.2141	0.2212	1.05	0.82
4	59	1.144	0.2795	0.2818	1.01	0.88
5	410	1.272	0.3951	0.4113	1.06	0.83
6/7	825	1.249	0.9639	0.9659	1.00	0.80
Atretic (α)	870	1.200	0.9100	0.9432	1.05	0.88

$$*1: \beta_x = \frac{l_x}{s_x}$$

Where x = oocyte developmental stage, l = long axis length (mm) and s = short axis length (mm).

$$*2: M_1 = \frac{(D_{x1} + D_{x2} + D_{x3} + \dots + D_{xn})}{n}$$

Where D = oocyte diameter, i.e. D = length of long axis (mm) + length of short axis (mm)/2). x = oocyte developmental stage.

$$*3: M_{x3} = \left[\frac{(D_{x1})^3 + (D_{x2})^3 + (D_{x3})^3 + \dots + (D_{xn})^3}{n} \right]^{1/3}$$

Where D = oocyte diameter (as in *2 above) and x = oocyte developmental stage.

$$*4: K_x = \left[\frac{M_3}{M_1} \right]^{3/2}$$

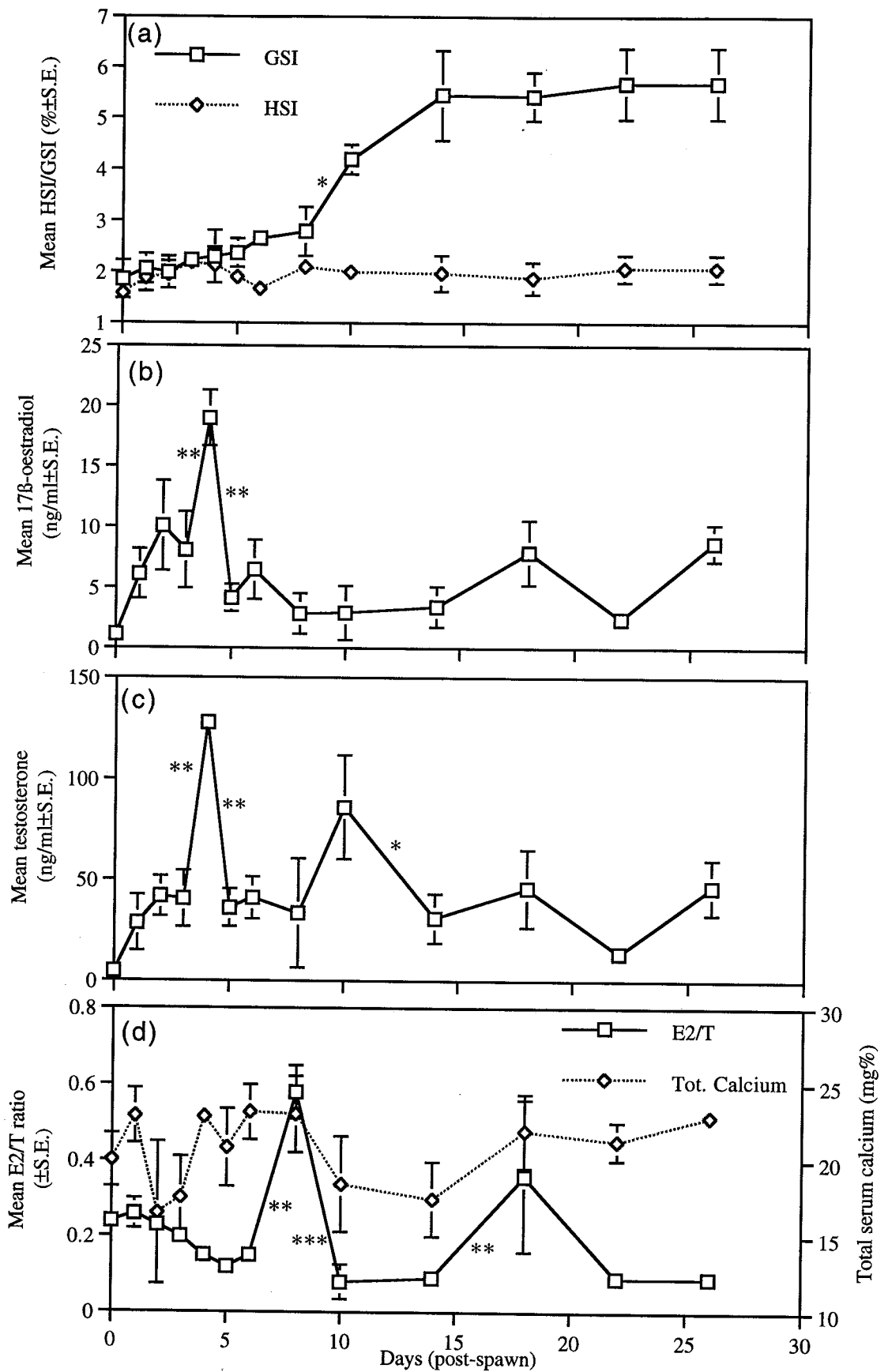

Figure 5.8. Profiles of mean (a) HSI and GSI, (b) serum 17 β -oestradiol, (c) serum testosterone and (d) 17 β -oestradiol/testosterone ratio over a 26 day period following spawning activity in female *T. zillii*. Total serum calcium data are also given in Figure 5.8d. Where the S.E. is not visible, it lies within the confines of the symbol. Significant differences from one timepoint to the next are indicated by * ($p < 0.05$), ** ($p < 0.01$) or *** ($p < 0.001$). Otherwise differences are not significant ($p > 0.05$).

(post-spawn) and had reached $4.19 \pm 0.3\%$ by day 10. Little change was observed in GSI after day 10 and by the end of the observation period (26 days post-spawn) had reached $5.68 \pm 0.7\%$. Very significant differences were detected in GSI over the 26 day period ($p < 0.001$, one-way ANOVA).

(b) HSI: Immediately after spawning, HSI was 1.58% and rose thereafter to reach a maximum of $2.19 \pm 0.15\%$ on day 4. By day 6 HSI had fallen to $1.68 \pm 0.18\%$ and fluctuated only slightly over the remainder of the period of observation. One-way ANOVA revealed no significant ($p \geq 0.05$) differences in HSI over the observation period.

(5.4.2.3) Serum E₂ and T.

(a) E₂ (refer to Figure 5.8b): E₂ levels rose from 1.1 ± 0.3 ng/ml after spawning to 10.1 ± 3.7 ng/ml on day 3. E₂ rose significantly ($p < 0.01$) to 19.0 ± 2.3 ng/ml on day 4 and subsequently fell significantly ($p < 0.01$) to 4.1 ± 1.1 ng/ml on day 5. Thereafter E₂ fluctuated only slightly (2.4 ± 0.9 ng/ml - 7.9 ± 2.7 ng/ml), though a slight elevation was observed between days 14 and 22. Significant differences ($p < 0.01$) were detected in E₂ level over the observation period (one-way ANOVA).

(b) T (refer to Figure 5.8c): T levels rose from 4.70 ± 1.3 ng/ml after spawning to 44.58 ± 15.5 ng/ml on day 3. T then rose significantly ($p < 0.01$) to peak at 133.0 ± 2.2 ng/ml on day 4 concurrent with maximal E₂ levels and subsequently fell significantly ($p < 0.01$) to 36.2 ± 9.3 ng/ml on day 5. A further smaller elevation in T was observed between days 8 and 14 where T levels reached 86.0 ± 25.7 ng/ml. Significant differences ($p < 0.01$) were detected in T level over the observation period (one-way ANOVA).

(c) E₂/T ratio and total calcium (refer to Figure 5.8d): In contrast to the findings of Experiment 1 (Section 5.2.) and Experiment 2 (Section 5.3), E₂/T ratio was highest on day 8 (not immediately after spawning as observed earlier in this Chapter). Immediately after spawning E₂/T ratio was 0.24 ± 0.03 and fell gradually to 0.12 ± 0.03 by day 5. The ratio increased significantly ($p < 0.01$) from day 6 to reach 0.58 ± 0.07 on

day 8 and subsequently fell significantly ($p < 0.001$) to 0.08 ± 0.05 by day 10. A further significant rise ($p < 0.01$) occurred between days 14 and 18. Significant differences ($p < 0.01$) were detected in mean E₂/T ratio over the observation period (one-way ANOVA).

Mean total serum calcium varied between $16.5 \pm 4.7 \text{ mg\%}$ to $23.1 \pm 2.5 \text{ mg\%}$ and did not differ significantly over the course of the 26 day period ($p \geq 0.05$).

(5.4.2.4) Volume fractions (VF) of oocyte stages.

No significant differences ($p \geq 0.05$) were found when comparing mean volume fraction determined from either anterior, mid or posterior regions of the ovary at any experimental timepoint (0 - 26 days). This was the case with each oocyte developmental stage. For clarity the following analyses are therefore based solely on data from histological sections taken from the mid region of the ovary.

(a) Stage 2 oocytes (refer to Figure 5.9a): Over a 26 day period immediately following spawning, mean ovarian volume fraction (VF) of stage 2 oocytes varied between $3.64 \pm 0.67\%$ and $16.68 \pm 8.31\%$. No significant differences ($p \geq 0.05$) were detected over this period of time (one-way ANOVA), although VF appeared to be generally higher towards the beginning of the reproductive cycle (days 0 - 4 post-spawning).

(b) Stage 3 oocytes (refer to Figure 5.9b): As with stage 2 oocytes, no significant differences ($p \geq 0.05$, one-way ANOVA) were detected in mean VF of stage 3 oocytes over the 26 day period following spawning. VF also appeared to be generally higher towards the beginning of the cycle (as with stage 2) and varied between $0.44 \pm 0.05\%$ and $3.70 \pm 2.09\%$.

(c) Stage 4 oocytes (refer to Figure 5.9c): Again, no significant differences ($p \geq 0.05$, one-way ANOVA) were detected in mean VF of stage 4 oocytes over the observation period. As with both stage 2 and stage 3 oocytes though, mean VF of stage 4 oocytes appeared to be generally higher at the beginning of the cycle (days 0 - 2).

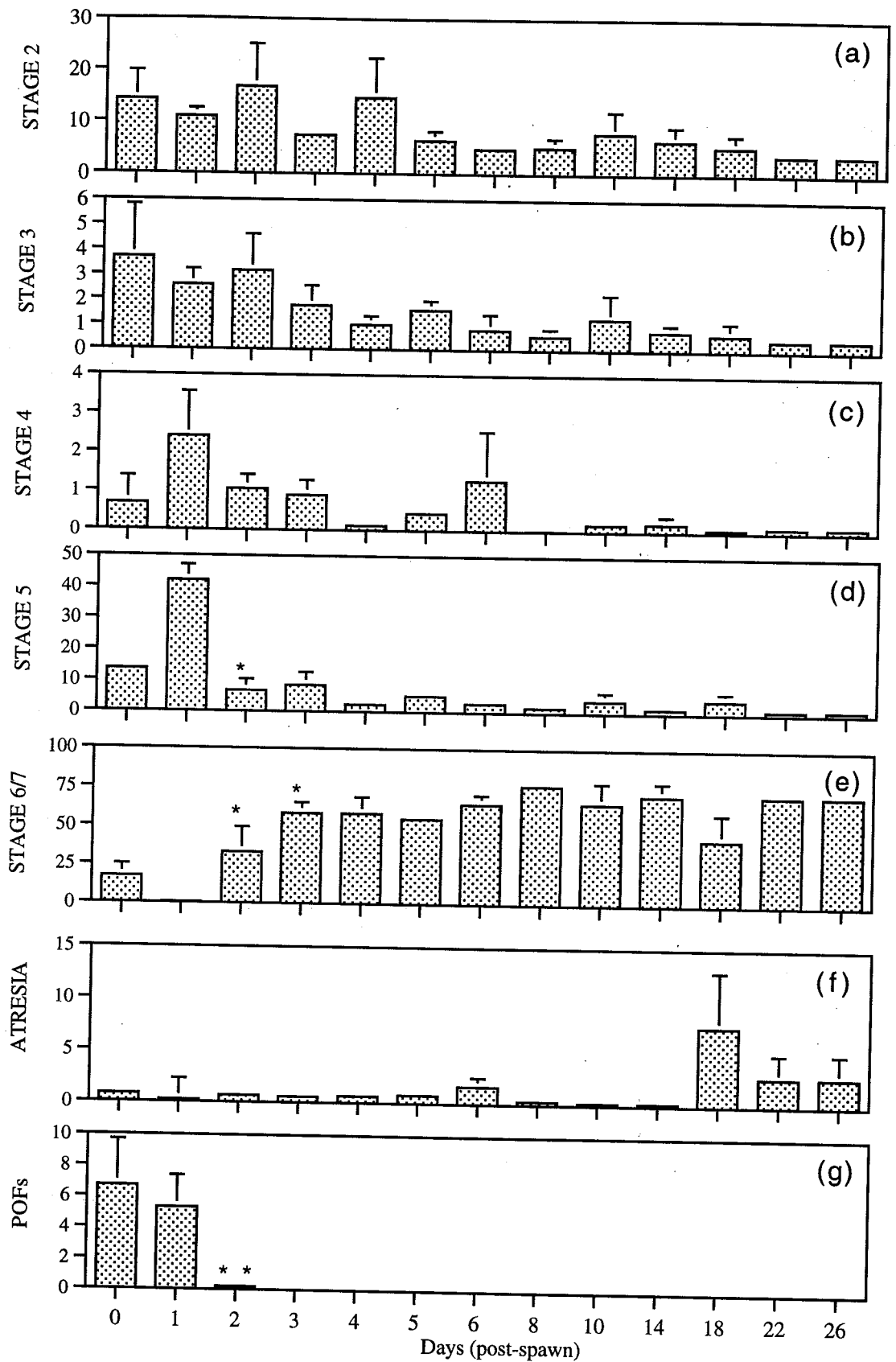

Figure 5.9 (a-g). Mean volume fraction (%±S.E.) of various oocyte developmental stages over a 26 day period following spawning. Instances where the S.E. is not visible represent cases where the S.E. is very small. POFs = post ovulatory follicle. Volume fractions of atresia represent α , β and λ atresia pooled. Bars marked with * or ** are significantly ($p < 0.05$ or $p < 0.01$ respectively) higher/lower than the preceding bar (one-way ANOVA).

Throughout the 26 day period, mean VF of stage 4 oocytes varied between $0.57 \pm 0.24\%$ and $2.40 \pm 1.16\%$.

(d) Stage 5 oocytes (refer to Figure 5.9d): Significant differences ($p < 0.01$) were detected over the period of observation in terms of mean VF of stage 5 oocytes. Immediately after spawning (day 0), stage 5 oocytes occupied $13.53 \pm 1.4\%$ of the ovary, rising to $42.01 \pm 5.09\%$ by day 1. A significant ($p < 0.05$) decrease was observed between days 1 and 2 as mean VF fell from to $6.67 \pm 3.69\%$. Throughout the remainder of the 26 day period, mean VF varied very little and generally remained $< 8\%$. As with stages 2, 3 & 4 however, VF of stage 5 was highest soon after spawning and appeared to fall with time.

(e) Stage 6/7 oocytes (refer to Figure 5.9e): Very significant ($p < 0.001$, one-way ANOVA) changes were detected in terms of stage 6/7 oocytes over the 26 day period. Immediately after spawning (day 0), $17.00 \pm 8.02\%$ of the ovary was occupied by stage 6/7 oocytes. By day 1 post-spawn however, no stage 6/7 oocytes were present at all. VF then rose significantly ($p < 0.05$) between days 1 and 2 to reach $33.07 \pm 16.47\%$ and again ($p < 0.05$) between days 2 and 3 to reach $58.34 \pm 6.97\%$. Mean VF then continued to increase reaching a maximum of $76.88 \pm 3.86\%$ just 8 days after spawning, remaining at similar levels thereafter.

(f) Atresia (refer to Figure 5.9f): No significant changes were observed in terms of mean VF of atretic oocytes over the 26 day period following spawning ($p \geq 0.05$, one-way ANOVA). Levels of atresia remained low (generally $< 2\%$) throughout days 0 - 14 (but was found at every timepoint sampled). Level of atresia appeared to become elevated between days 18 and 26 ($2.73 \pm 2.26\%$ - $7.54 \pm 5.28\%$).

(g) Post-ovulatory follicles (POFs) (refer to Figure 5.9g): Very significant changes were found in terms of mean VF of POFs ($p < 0.01$, one-way ANOVA). POFs were only found on days 0, 1 and 2 after spawning. Immediately after spawning, POFs occupied $6.72 \pm 2.96\%$ of the ovary, falling to $5.3 \pm 2.08\%$ by day 1 post-spawning. Mean VF then fell significantly ($p < 0.01$) from day 1 to 2 to $0.21 \pm 0.11\%$ and finally fell to 0 by day 3.

(5.4.2.5) Numerical densities (ND) of oocyte stages.

As with volume fraction data, no significant differences ($p \geq 0.05$) were found when comparing mean numerical density (per unit area/volume) determined from either anterior, mid or posterior regions of the ovary at any experimental timepoint (0 - 26 days). This was the case with each oocyte developmental stage. For clarity the following analyses are therefore based solely on data from histological sections taken from the mid region of the ovary.

(a) Stage 2 oocytes (refer to Figure 5.10a): Mean ND (number of oocytes per unit area/volume - i.e. number of oocytes per 4.7mm^2 of ovary - see Section 2.5.4.4.) remained relatively consistent during the 26 day period of observation and varied between 21.91 ± 8.63 and 134.56 ± 115.92 . No significant changes ($p \geq 0.05$, one-way ANOVA) were detected over the 26 day period.

(b) Stage 3 oocytes (refer to Figure 5.10b): As with stage 2, no significant changes ($p \geq 0.05$, one-way ANOVA) were detected in mean ND over the 26 days following spawning. Mean ND varied between 0.48 ± 0.37 and 4.37 ± 0.61 .

(c) Stage 4 oocytes (refer to Figure 5.10c): Again, no significant changes ($p \geq 0.05$, one-way ANOVA) were observed in mean ND of stage 4 oocytes. ND remained low fluctuating between 0.01 and 5.31 ± 5.23 .

(d) Stage 5 oocytes (refer to Figure 5.10d): Significant changes ($p < 0.01$, one-way ANOVA) were however detected in terms of stage 5 ND. Mean ND was highest early in the reproductive cycle (day 0 - 4) at ~ 4 oocytes/unit area. From day 4 onwards, mean ND fell and largely remained < 1 oocytes/unit area thereafter. A small but significant elevation in stage 5 ND occurred between days 8 and 10.

(e) Stage 6/7 oocytes (refer to Figure 5.10e): Very significant changes ($p < 0.001$, one-way ANOVA) were observed in mean ND of stage 6/7 oocytes over the

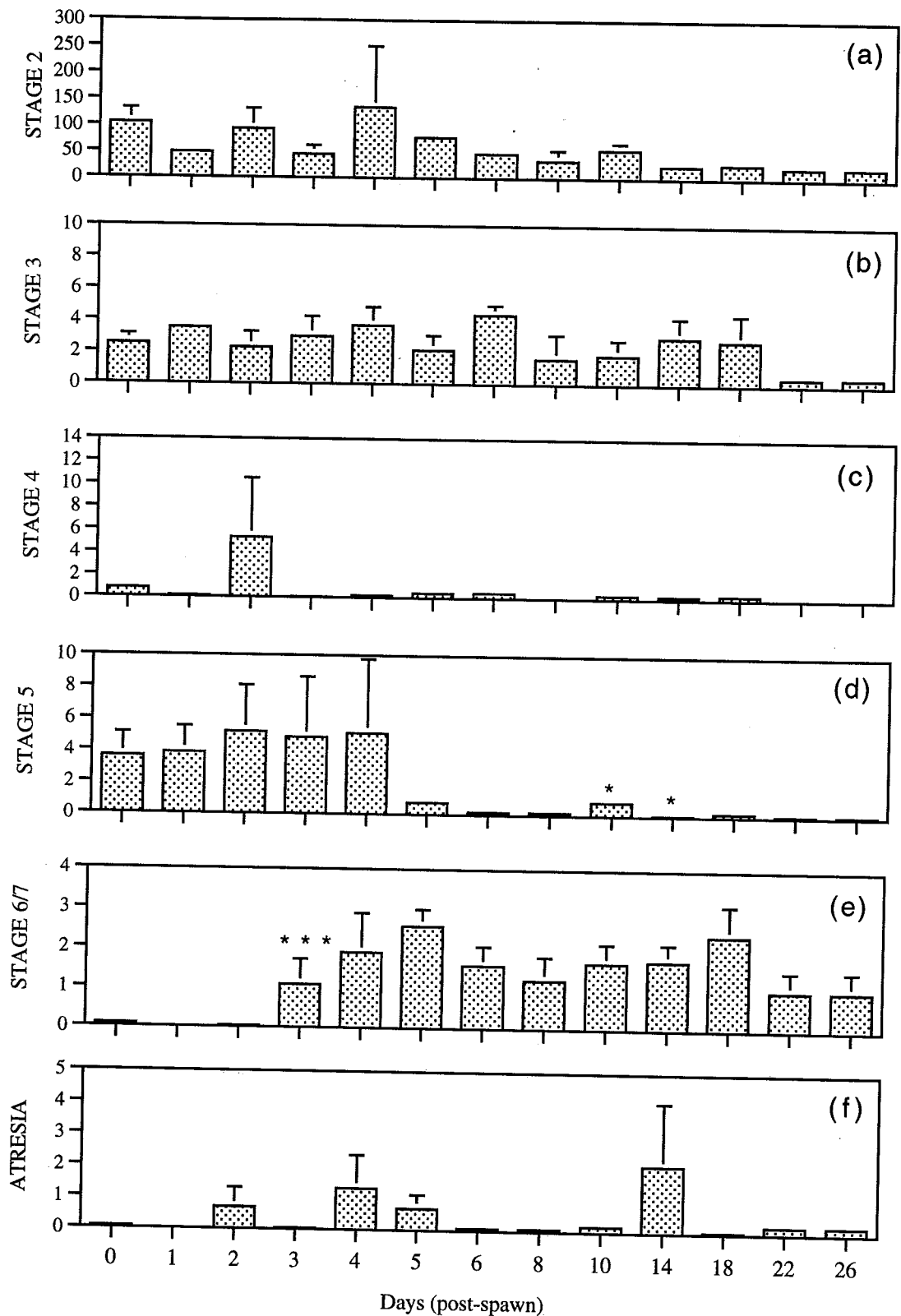

Figure 5.10 (a-f). Mean numerical density (number of oocytes unit area/volume ± S.E.) of various oocyte developmental stages over a 26 day period following spawning. Instances where no S.E. is visible, represent cases where the S.E. was very small. Numerical densities of atretic oocytes include α -stage atresia only. Bars annotated with * or *** are significantly ($p < 0.05$ or $p < 0.001$ respectively) higher/lower than the preceding bar (one-way ANOVA).

26 day period. Immediately after spawning, mean ND was low (0.07 oocytes/unit volume) and fell to 0 by day 2. Mean ND then rose significantly ($p < 0.001$) from 0.02 on day 2 to 1.08 ± 0.04 on day 3, rising to a maximum of 2.56 ± 0.43 on day 5. Stage 6 ND remained largely between 1 and 2 thereafter.

(f) Atresia (refer to Figure 5.10f): No significant changes ($p \geq 0.05$, one-way ANOVA) were detected over time in terms of the ND of atresia (α -stage only) which remained low throughout the 26 day period (0.05 - 2.10 oocytes/unit area).

(5.4.2.6) Regression analysis.

No significant relationships were found between serum E₂ and T and the VF of any oocyte developmental stage ($p \geq 0.05$). Similarly, no significant relationships ($p \geq 0.05$) were found between serum E₂ and the ND of any oocyte developmental stage. A significant relationship was found however between levels of serum T and the ND of stage 6/7 oocytes (regression equation (1) given below). A significant relationship was also found between GSI and the VF of stage 6/7 oocytes, but not ND of stage 6/7 oocytes (see equation 2). No significant relationships were found between the HSI and levels of either E₂ or T. A significant relationship was also found between the VF of POFs and level of serum T (but not with E₂) - see equation (3).

(1) Log T (x) and log stage 6/7 ND (y): $y = 0.405 \log x - 0.463$ ($r^2 = 0.2$, $p < 0.05$)

(2) VF stage 6/7 (x) and GSI (y): $y = 0.06 x + 0.12$ ($r^2 = 0.2$, $p < 0.05$)

(3) Log T (x) and POF VF (y): $y = -0.08 \log x + 0.15$ ($r^2 = 0.20$, $p < 0.01$)

Note that in equation (2) values given for VF stage 6/7 and GSI represent ARCSine transformed data (as also in the case of VF of POFs in equation (3)).

(5.4.3) General summary (Experiment 3).

To summarise, stereological analysis revealed that oocyte developmental stages 2, 3, 4 and 5 were present at all timepoints sampled during a 26 day period following spawning (although in varying proportions). Atretic oocytes were also present at all

timepoints though mostly remaining at a low level. Atresia did however, appear to become more prevalent from day 18 onwards. Neither VF or ND of stages 2, 3 or 4 oocytes (i.e. pre-vitellogenic phases) were found to vary significantly throughout the 26 day period, suggesting that these stages were present throughout the reproductive cycle in relatively consistent proportions. Furthermore, levels of atresia remained relatively consistent (VF was generally < 2%) and did not differ significantly over the 26 day period (though levels of atresia did appear to become elevated from day 18 onwards). Significant ($p < 0.01$ or $p < 0.001$) changes were, however, observed in the VF and ND of vitellogenic oocytes (stage 5 and stage 6/7). Significant changes ($p < 0.01$) were also observed in terms of POFs which were only found in days 0, 1 and 2 following spawning.

Stage 2 oocytes were by far the most numerous (up to ~100 oocytes/unit area, though only occupying up to 25% of the ovary) whilst stage 6/7 and atretic oocytes were the least numerous. From day 3 post-spawn onwards however, stage 6/7 oocytes generally occupied >60% of the ovary. Stage 4 oocytes were particularly scarce, generally ND was <1 stage 4 oocyte/unit area (occupying <1% of the ovary) and although the ND of stage 4 oocytes did not appear to change over days 0 - 3 post-spawn, VF was found to increase, suggesting an increase in size of these oocytes.

Immediately after spawning, ovaries of *T. zillii* generally contained varying proportions of all oocyte developmental stages classified (stages 2, 3, 4, 5, 6/7, atresia and POFs - see Plate 5.1). Stages 2 and 3 (pre-vitellogenic) remained at a relatively consistent level throughout the period of observation. Stage 4 oocytes (cortical alveolar stage) also exhibited only small fluctuation but appeared to be generally higher between days 0 and 3 post-spawn. Stage 5 oocytes (early vitellogenic) were also most common during this early period and were found at maximal levels on day 1 post-spawning (see Plate 5.2). Stage 5 oocytes were seen to possess a developing follicular layer (zona radiata, granulosa and theca).

A small proportion (VF = ~20%) of stage 6/7 oocytes were present immediately after spawning (day 0) but were not found on day 1. As the VF of both stage 4 and 5

Plate 5.1. Transverse section (3.5 μ m) of *T. zillii* ovary (strain 'A') soon after spawning (day 0) exhibiting a predominance of pre-vitellogenic oocytes and post-ovulatory follicles (POFs). Stained with polychrome (Mag. x40). Scale: 100 μ m.

S2 - stage 2 oocytes

S3 - stage 3 oocytes

POF - post-ovulatory follicles (POFs)

Plate 5.2. Transverse section (3.5 μ m) of *T. zillii* ovary (strain 'A') soon after spawning (day 1) exhibiting a predominance of pre-vitellogenic oocytes, early vitellogenic oocytes and POFs. Stained in polychrome (Mag. x40). Scale: 100 μ m.

S2 - stage 2 oocytes

V - vacuoles/vesicles

S3 - stage 3 oocytes

N - nucleus (germinal vesicle)

YG -yolk globules

Nu - nucleoli

POF - post-ovulatory follicles (POFs)

S5 - stage 5 oocytes

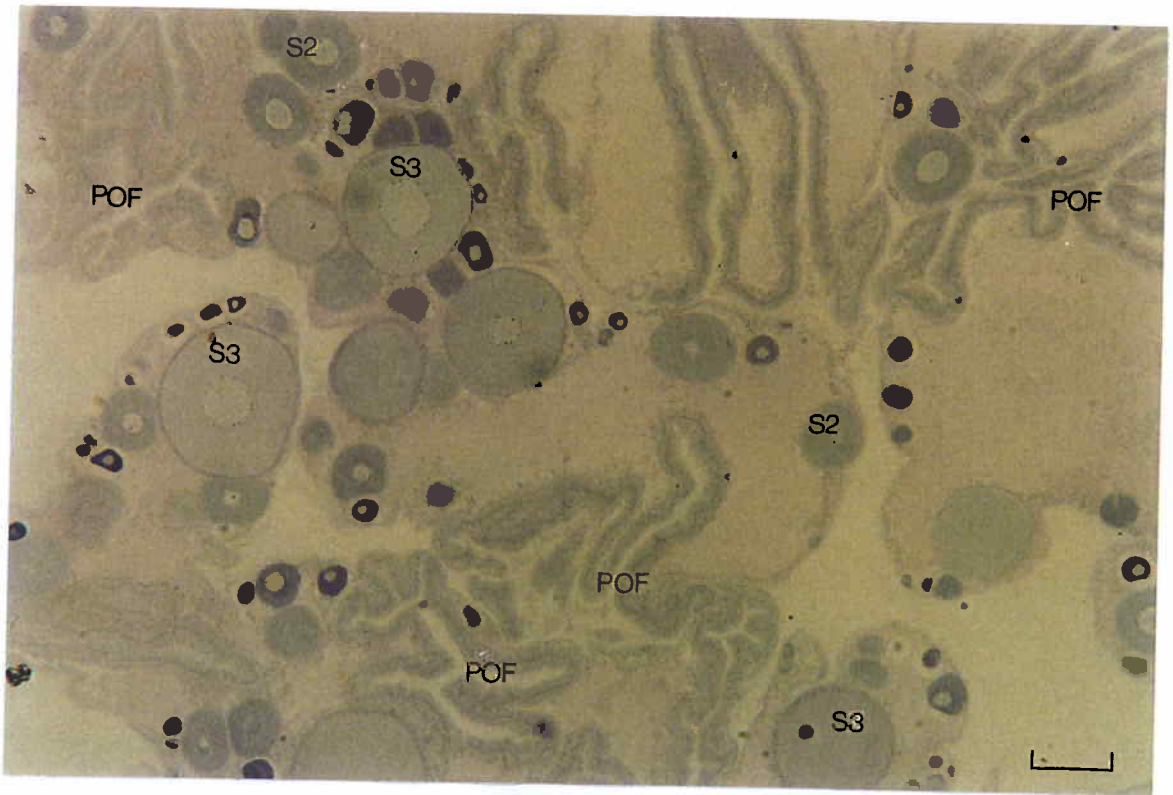

Plate 5.1.

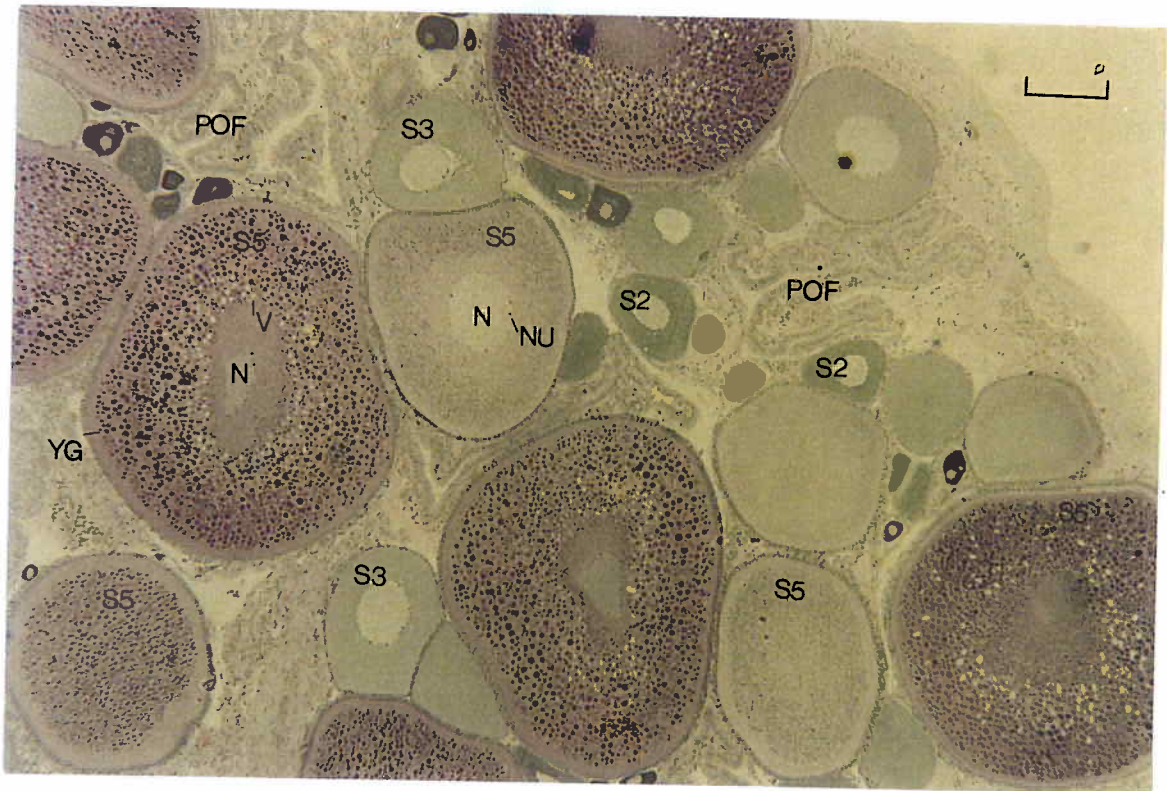

Plate 5.2.

Plate 5.3. Transverse section (3.5 μ m) of *T. zillii* ovary (strain 'A') two days after spawning exhibiting POFs and early stage 6 (vitellogenic) oocytes. Stained in polychrome (Mag. x40). Scale: 100 μ m.

S2 - stage 2 oocytes

S3 - stage 3 oocytes

S6 - stage 6 oocytes

POF - post-ovulatory follicles (POFs)

Plate 5.4. Transverse section (3.5 μ m) of *T. zillii* ovary (strain 'A') three days after spawning showing pre-vitellogenic oocytes, stage 5 oocytes (early vitellogenic) and stage 6/7 oocytes (vitellogenic). Stained in polychrome (Mag. x40). Scale: 100 μ m.

S2 - stage 2 oocytes

N - nucleus (GV)

S3 - stage 3 oocytes

AT - atresia

S5 - stage 5 oocytes

S6/7 - stage 6/7 oocytes

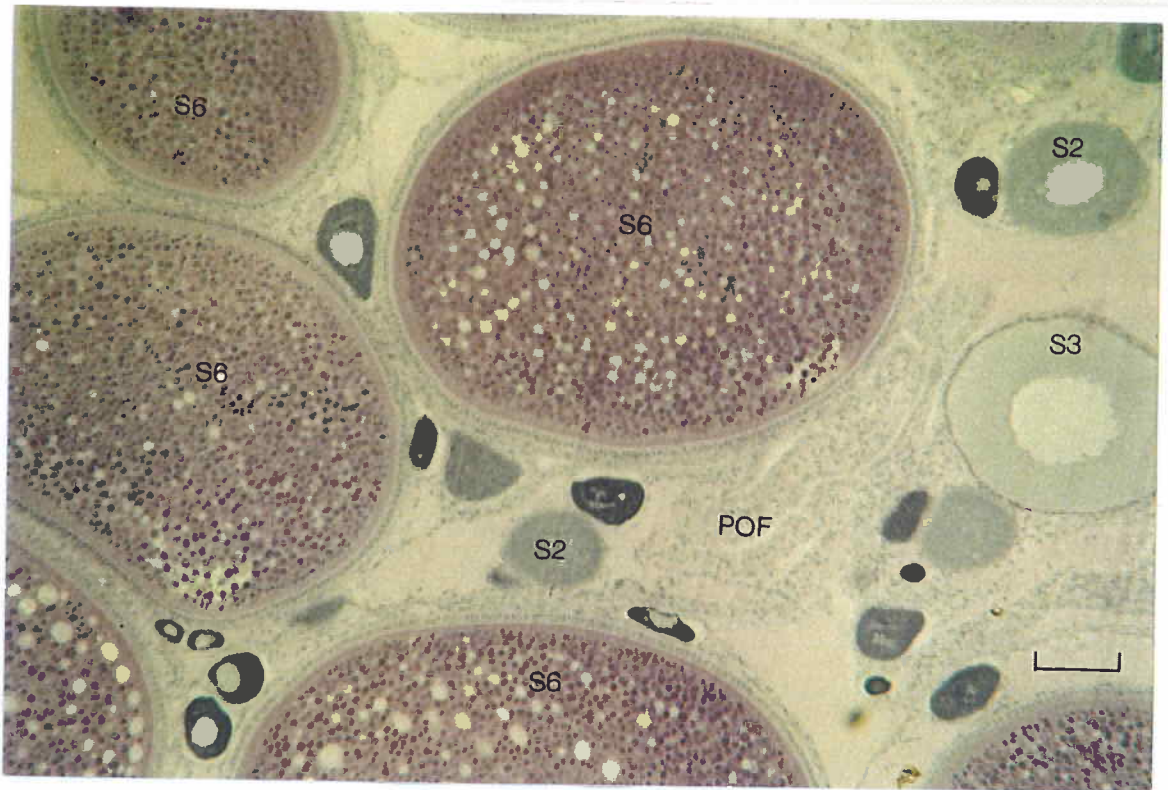

Plate 5.3.



Plate 5.4.

oocytes dropped (by day 3) and coincident with large increases in both E₂ and T, stage 6/7 VF began to increase (see Plates 5.3 & 5.4, see p. 277). Significant increases ($p < 0.05$) were observed between days 1 and 2 and between days 2 and 3, these changes being reflected in GSI. GSI was found to increase slowly from day 0 to day 8 post-spawning but increased significantly ($p < 0.05$) between days 8 and 10 and reached a plateau from day 14 onwards. Furthermore, developing stage 6/7 oocytes were observed to possess extremely well developed follicular layers as early as 4 days post-spawn (see Plates 5.5 & 5.6). As early as 6 days post-spawning, the ovary was dominated by stage 6/7 oocytes (VF = ~60 - 70%) with only very small proportions of stages 2, 3, 4 or 5 oocytes being present (VF of stages 3, 4 and 5 largely remained <1% and VF of stage 2 was ~5%) (see Plate 5.7). Atresia was also present at this timepoint but also at a very low incidence (VF = ~1%).

By 26 days post-spawning, little change had occurred in the ovary (see Plate 5.8). Stage 6/7 oocytes still dominated (VF = ~70%); stages 2, 3, 4 and 5 were still present in very similar proportions to that seen on day 8 post-spawn. Incidence of atresia had however, increased to ~7% (though the S.E. was large suggesting a wide variation amongst individuals).

The failure to detect a significant change in total serum calcium levels over the course of this experiment also confirms the observations of Experiments 1 and 2, i.e. that measurement of total serum calcium is of little value for monitoring serum vitellogenin concentration in this particular species of fish.

(5.5) Discussion.

The general aims of this Chapter were to examine the dynamics of ovarian recrudescence and associated changes in sex steroid levels in the substrate-spawning *T. zillii*. Little is known about this area of reproductive physiology despite the prominence of substrate-spawning tilapias in world aquaculture. Detailed knowledge of this area would also aid the future development of techniques that may be used to artificially manipulate the spawning cycle of this species. This is of particular concern considering

Plate 5.5. Transverse section (3.5µm) of *T. zillii* ovary (strain 'A') four days after spawning showing well developed stage 6/7 oocytes with well developed follicular layers. Stained in polychrome (Mag. x40). Scale: 100 µm.

S2 - stage 2 oocytes

S6/7 - stage 6/7 oocytes

G - granulosa

ZR - zona radiata

T - theca

V - vacuoles

Plate 5.6. Transverse section (3.5µm) of *T. zillii* ovary (strain 'A') 4 days after spawning showing the extent of follicular layer development. Stained in polychrome (Mag. x250). Scale: 10 µm.

S2 - stage 2 oocytes

S6/7 - stage 6/7 oocytes

YG - yolk globules

ZR - zona radiata

ZI - zona interna

ZE - zona externa

G - granulosa

T - theca

V - vacuoles

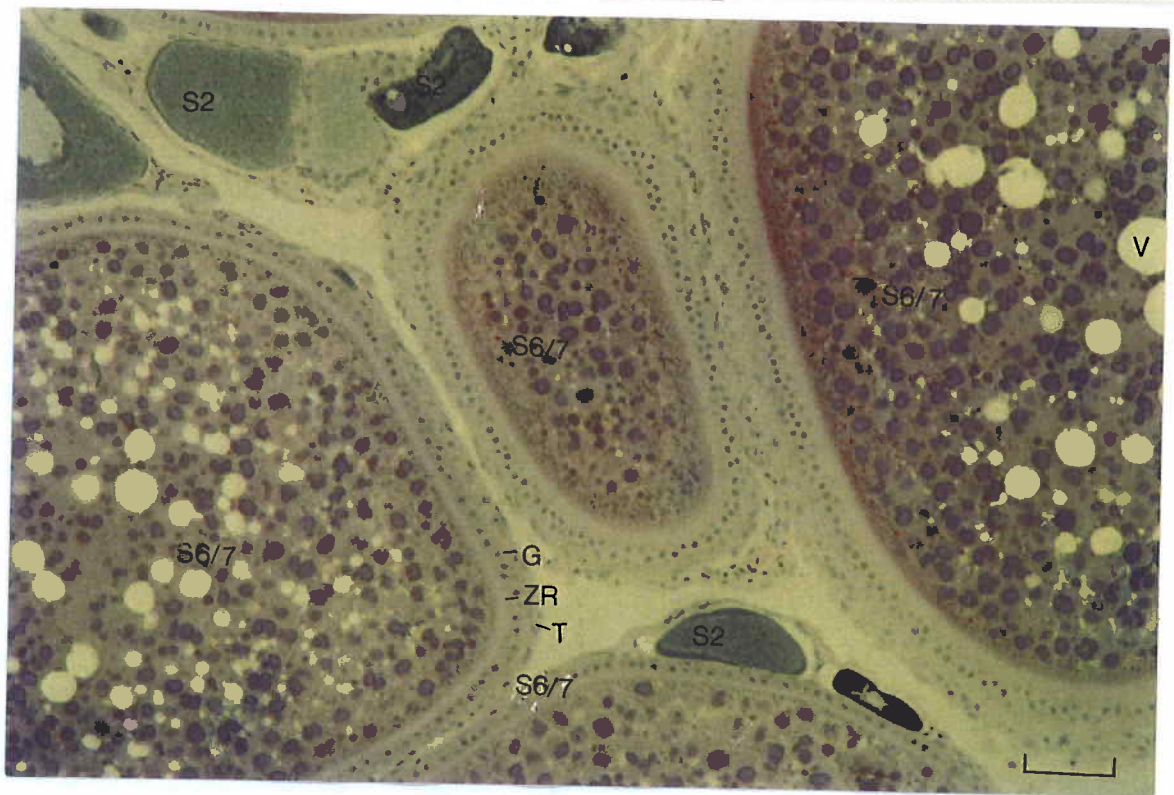

Plate 5.5.



Plate 5.6.

Plate 5.7. Transverse section (3.5 μ m) of *T. zillii* ovary (strain 'A') just six days after spawning demonstrating a predominance of stage 6/7 oocytes. Stained in polychrome (Mag. x40). Scale: 100 μ m.

S2 - stage 2 oocytes

S4 - stage 4 oocytes

S6/7 - stage 6/7 oocytes

V - vacuoles

Plate 5.8. Transverse section (3.5 μ m) of *T. zillii* ovary (strain 'A') twenty six days after spawning demonstrating a predominance of stage 6/7 oocytes. Stained in polychrome (Mag. x40). Scale: 100 μ m.

S2 - stage 2 oocytes

S3 - stage 3 oocytes

S6/7 - stage 6/7 oocytes

N - nucleus (germinal vesicle).

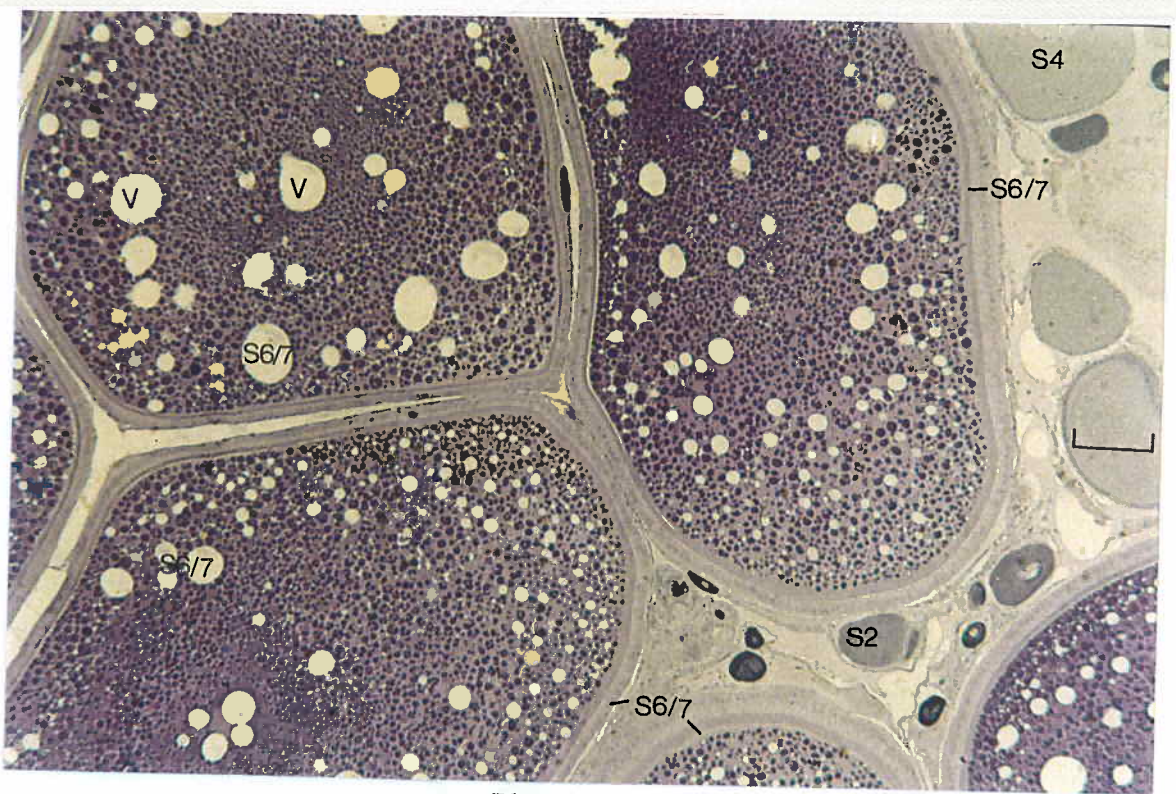

Plate 5.7.

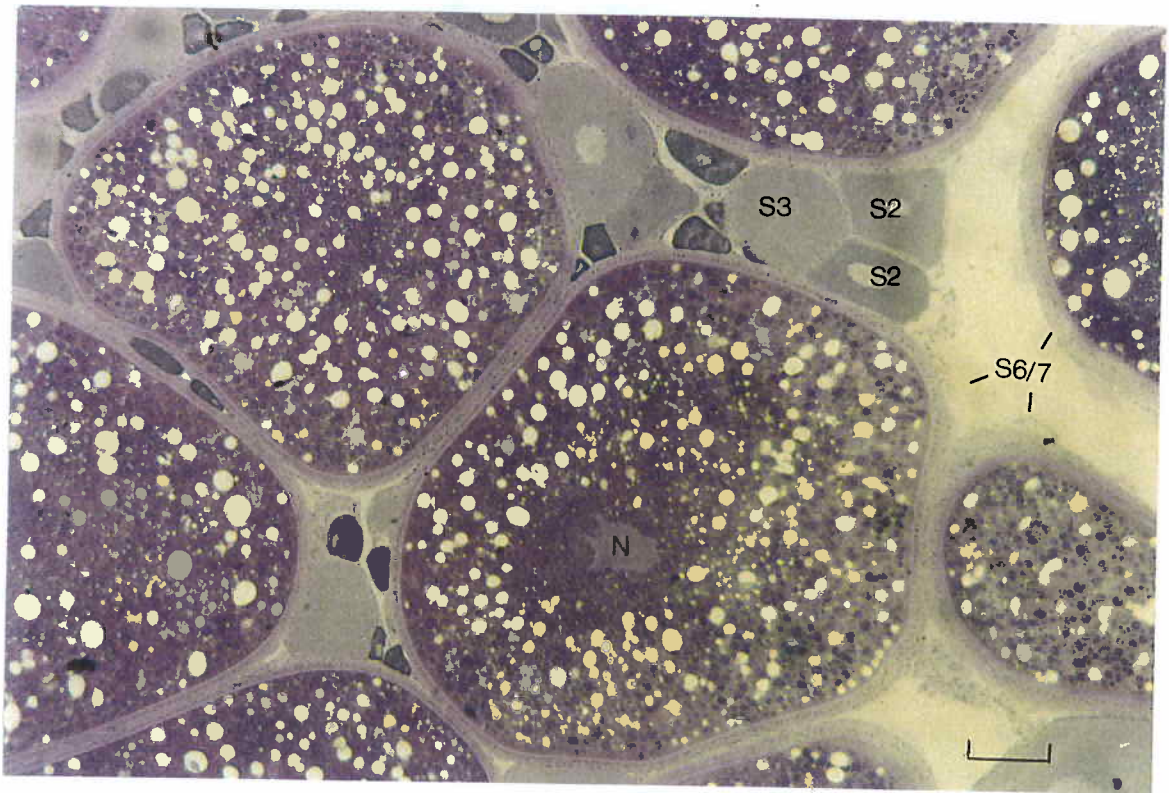

Plate 5.8.

the wide variability observed in spawning periodicity (see Chapter 3) and the asynchronous nature of spawning cycles in tilapia (Jalabert & Zohar, 1982). In the past, changing levels of total serum calcium have been used as an indicator of VTG secretion into the serum; calcium is used in the post-translational modification of VTG (Elliot *et al.*, 1984). This method has often been used to indirectly measure changes in VTG concentration in preference to a specific radioimmunoassay, largely due to the high correlation between serum calcium levels and serum VTG concentration and the ease with which calcium levels can be determined. This technique has been shown to be effective both in salmonids (e.g. Whitehead *et al.*, 1978a,b; Elliot *et al.*, 1984) and in *Oreochromis* species (Srisakultiew, 1993; Hussain *et al.*, 1995) but has not previously been used in substrate-spawning species of tilapia. In the present study levels of total serum calcium did not exceed $27.6 \pm 8.1 \text{ mg\%}$ (mg/100 ml) in either strain of *T. zillii* ('A' or 'B'). Furthermore, over periods of either 26, 42 or 82 days following spawning, levels of total serum calcium did not change significantly, implying that this technique was not sensitive enough to use in this particular species of fish. The problem may be a function of small egg size. During vitellogenesis in rainbow trout for example, eggs can reach 5.4mm in diameter and plasma VTG concentrations rise from 1.5mg/l - 25mg/l (Tyler *et al.*, 1990). In *O. niloticus*, where egg size can reach 2.8 - 4.3mm (Lowe-McConnell, 1955), levels of total serum calcium were found to reach only 48.6mg/100ml (Srisakultiew, 1993). Substrate-spawning tilapias have much smaller eggs than mouthbrooders. Maximum diameter of *T. zillii* eggs was found to be just ~1.52 mm in the present study (see Chapter 3). It is therefore likely that levels of VTG secretion during vitellogenic growth are also reduced in this species and that fluctuations of serum calcium accompanying VTG secretion occur only within a narrow range. Low levels of circulating VTG have also been found in a variety of cyprinid fish even throughout active vitellogenesis; in the European minnow and fathead minnow *Pimephales promelas* (L.) for example, levels of plasma VTG do not exceed 20µg/ml (Tyler *et al.*, 1995a). However, levels of circulating calcium would not only depend upon egg size but also the total amount of yolk being transported. In conclusion, it was

unfortunately not possible to monitor changes in VTG concentration by measuring serum calcium levels. A better approach would have been to utilise a specific radioimmunoassay for VTG. A radioimmunoassay for tilapia VTG has yet to be developed.

The results of the present study demonstrate that the E₂ profiles of *T. zillii* undergoing ovarian recrudescence consistently exhibited an initial peak on either day 2 or day 4 coincident with, or slightly before, an initial peak of T. Subsequent to this, T was found to vary quite widely amongst individuals at the same timepoint. Levels of E₂ had generally fallen by day 10 and remained low thereafter, though a slight elevation appeared to occur (in both E₂ and T) between days 30 and 42. Since hepatic VTG production is under the control of E₂, and to a lesser extent E₁ (e.g. van Bohemen *et al.*, 1982; Wallace *et al.*, 1987), this suggests that developing oocytes were recruited into vitellogenesis as early as 2 days post-spawn and that the phase of vitellogenic growth had been largely completed by 10 days post-spawn. This concurs with the findings of Srisakultiew (1993) in *O. niloticus* that had been robbed of eggs (i.e. non-brooding) in which E₂ peaked 5 days after spawning but fell by day 10; T and total serum calcium also peaked by day 10. Yaron *et al.* (1983) also found E₂ peaked soon after spawning (day 4 post-spawn) in *O. niloticus*. The profiles of E₂ observed in the present study and by Srisakultiew (1993) are generally similar to those reported for annual spawners such as rainbow trout (e.g. Scott *et al.*, 1983; Bromage & Cumaranatunga, 1988), goldfish (Kobayashi *et al.*, 1986, 1988, 1989) and Japanese sardine (Matsuyama *et al.*, 1994). In these cases E₂ is elevated during vitellogenesis, but remains at low levels thereafter until the next spawning phase.

These observations also conform to the findings of Smith & Haley (1988) in non-brooding *O. mossambicus*; E₂, T and progesterone all exhibited post-spawning peaks (though somewhat later at day 10) that fell by day 15 but increased again towards the end of the cycle. The case of actively mouthbrooding *O. mossambicus* was somewhat different however; two early-cycle peaks of E₂ were observed. It was claimed that the first peak (day 10) 'protected' oocytes from atresia during

mouthbrooding behaviour (see Sundararaj & Goswari, 1968) and that the second peak (day 25) corresponded to the period of vitellogenic growth (Smith & Haley, 1988). That parental care can influence levels of reproductive hormones is well appreciated (see Introduction to this Chapter); Rothbard *et al.* (1991) for example, found maximal levels of E₂ to occur in *O. niloticus* during pair-bonding behaviour.

As explained earlier, the precise role of T in ovarian recrudescence is unclear. T has been used as an indicator of spawning in some fish (Fitzpatrick *et al.*, 1987). T of thecal origin is known to be converted to E₂ in the granulosa via the "two cell type model" (Kagawa *et al.*, 1982; Nagahama *et al.*, 1982; Nagahama *et al.*, 1995). The presence of greater concentrations of T in females than males (Scott *et al.*, 1980) is thought to suggest that T may have a precise functional role rather than as an obligatory precursor to E₂. It is now commonly known that T can stimulate GTH synthesis (Crim & Evans, 1979; Crim *et al.*, 1981; Gielen & Goos, 1984). T is also reported to stimulate yolk globule formation (Crim & Evans, 1979). In the present study, the ratio of E₂/T was highest (in both Experiments 1 and 2) on day 0 (immediately after spawning) suggesting that conversion of T to E₂ was greatest at this timepoint. Interestingly, a significant peak of E₂/T ratio was found on day 8 and a further significant increase between day 14 and day 18 in Experiment 3 (and not seen in either Experiments 1 or 2). The reason for this difference is not known. A study by Yaron *et al.* (1983) however, found E₂/T to be maximal in *O. niloticus* on day 4 post-spawn. A significant correlation was found between T and the numerical density (ND) of stage 6/7 (vitellogenic/maturing) oocytes in Experiment 3 of the present study.

Smith & Haley (1988) recorded high levels of T in *O. mossambicus* during mouthbrooding but found levels to drop when brooding behaviour ceased and suggested that T may have retarded oocyte growth until parental care had ceased. Similarly Bogomolnaya *et al.* (1984) reported high levels of T during mouthbrooding in *O. aureus*. A direct involvement of T in mouthbrooding behaviour has yet to be proved however, although Kramer (1972) observed that female blue gourami treated with

methytestosterone adopted a role in parental behaviour that is normally fulfilled by the male.

Unfortunately only one fish re-spawned during blood sampling experiments. Data from this one fish, however, suggests that although E₂ remained at a relatively low level following the initial post-spawn peak, a second slightly smaller peak occurred between days 30 and 46 coincident with a second peak of T. This second T peak was followed immediately by a third, slightly smaller peak, ovulation occurring immediately after this third peak (on day 58). It is likely that the second peak of E₂ observed between days 30 and 46 corresponds to the second elevation of E₂, T and progesterone observed in *O. mossambicus* by Smith & Haley (1988) and is probably associated with final oocyte maturation. It is widely thought that T is involved in ovulation. Peak levels of T were found in the goldfish for example at ovulation (Kobayashi *et al.*, 1986, 1988, 1989). In rainbow trout, T was found to peak just 8 days prior to ovulation (Scott *et al.*, 1983). It is likely therefore that the second and particularly third peak of T observed in the present study were involved with impending ovulation. Similar rises in T immediately prior to spawning were also reported by Katz & Eckstein (1974) in *O. aureus*. A further possibility is that the second peak of T is associated with the GTH surge often seen to occur prior to oocyte maturation and ovulation (Stacey *et al.*, 1979). This involves a surge in GTH production that elicits production of a maturation-inducing steroid (MIS) that initiates oocyte maturation. This surge is also thought to recruit a clutch of oocytes into the cortical alveolar stage in the staghorn sculpin *Leptocottus armatus* (Girard) (de Vlaming *et al.*, 1984).

It remains unclear as to why only one fish re-spawned during the course of the experiments reported here. That stress induced via serial blood sampling may have prevented fish from spawning cannot be ignored, though Srisakultiew (1993) found that blood-sampling *O. niloticus* every 3 days did not significantly affect spawning periodicity. Srisakultiew (1993) also reported that the relationship between spawning and peak levels of E₂, T and total serum calcium varied amongst individual female *O. niloticus* and that although some fish spawned sometime (11 - 29 days) after initial

hormonal peaks, some did not, despite possessing ovaries that had completed vitellogenesis. It remains likely that peak levels of T in some females in the present study and that of Srisakultiew (1993) were not sufficient enough for ovulation to occur, despite the completion of vitellogenic growth. Low levels of T were found to delay spawning in coho salmon *Onchorhynchus kisutch* (Walbaum) for example (Fitzpatrick *et al.*, 1987). Similarly unovulated mature common carp were found to exhibit low peaks of T and GTH (Santos *et al.*, 1986).

Interestingly, in the one fish that did re-spawn during the present study, initial post-spawn peaks (on days 2 - 6) of E₂ and T were found to be much smaller after the second spawning when compared to the first. Similar observations were found in serial spawning *O. niloticus*, where initial peaks of T, E₂ and total serum calcium fell steadily over the course of three spawns (Srisakultew, 1993). Since peak E₂ levels had also been linked to fertilisation rates (and hence 'egg quality'), as E₂ fell over the three spawns, so did egg quality.

Unfortunately it was not possible to measure levels of GTH or 17 α -20 β -P in the present study (no radioimmunoassays were available within the Institute of Aquaculture). A knowledge of the dynamic changes of these hormones (particularly GTH) would certainly improve the understanding of the *T. zillii* reproductive cycle. In other tilapias, GTH was found to remain low in all phases of spawning behaviour except during spawning; peak levels of GTH occurred after levels of E₂ and T had receded (Rothbard *et al.*, 1991). It was also suggested however that a further gonadotropic agent may act during earlier phases. Cornish & Smit (1987) also found that progesterone peaked only after E₂ receded. 17 α -20 β -P is widely thought of as being the MIS and is usually found to rise during maturation and ovulation in other species of fish (Scott *et al.*, 1982, 1983; Hirose *et al.*, 1985). Smith & Haley (1988) however reported that the scenario in *O. mossambicus* was not so clear. 17 α -20 β -P was found to peak in the early cycle of non-brooding fish and towards the end of the cycle in brooding fish. Similarly, low levels of 17 α -20 β -P during latter stages of the reproductive cycle were also reported in the sea bass (Prat *et al.*, 1990) and in the

snapper *Pagrus auratus* (Bloch & Schneider) (Carragher & Pankhurst, 1993). Peaks of this hormone, however, can be very rapid and occur within a very short time frame and can therefore be easily missed if the sampling protocol is inadequate (Smith & Haley, 1988; Rinchard *et al.*, 1997).

The results of the present study also suggest that ovarian biopsy can be a particularly useful and accurate technique for assessing intra-ovarian histology without the need for sacrifice. Such a technique would therefore be of great benefit for assessing ovarian maturity prior to selecting suitable broodfish for spawning inducement programs.

Numerical density analysis revealed that the shape coefficient (β) of *T. zillii* oocytes varied between a fairly broad range (1.144 - 1.275), suggesting *T. zillii* oocytes are far more elliptical than those of *O. niloticus* where β was found to vary within only a very narrow range (1.08 - 1.10) (Srisakultiew, 1993).

Stereological analysis revealed that the ovaries of *T. zillii* immediately after spawning contained a mixture of all oocyte developmental stages (from stage 2 - stage 6/7, atresia and post-ovulatory follicles). Srisakultiew (1993) reported similar findings in *O. niloticus* but also found that composition varied according to spawning history. For example, volume fraction (VF) of atretic oocytes after spawning was found to be far less on day 1 in the second spawning cycle than on day 1 in the first spawning cycle. Stage 2 oocytes were found to be the most numerous oocyte developmental stage in the present study but along with stages 3 and 4 generally occupied less than 10% of the ovary. These observations broadly agree with those of Srisakultiew (1993) in *O. niloticus*. In *T. zillii*, proportions of stage 4 and stage 5 oocytes remained relatively constant over time except during the first three or four days after spawning, where proportions were elevated. As the proportion of stage 4 and 5 oocytes declined (by day 3) and coincident with dramatic increases in both E₂ and T, the proportion of stage 6/7 oocytes began to increase. Significant increases in the VF of stage 6/7 were observed between days 1 and 2 and days 2 and 3, these changes being reflected in GSI. GSI increased slowly from day 0 to day 8 post-spawning but increased significantly

between days 8 and 10, appearing to reach maximal levels from day 14 onwards. This suggests that very soon after spawning a batch of pre-vitellogenic oocytes enter stages 4 and 5, progressing into stage 6/7 extremely quickly. As early as 8 days post-spawning, the ovary was dominated by stage 6/7 oocytes occupying up to 70% of the ovary. In *O. niloticus*, VF of stage 6/7 oocytes can reach up to 70% within 10 days of spawning (Srisakultiew, 1993). Dadzie & Wangila (1980) also observed that vitellogenic oocytes appear in the *T. zillii* ovary soon after spawning. A new batch of vitellogenic oocytes were found to be already present in the ovary at the time of spawning in *O. niloticus* (Tacon *et al.*, 1996) as also reported by Hyder (1970) and Peters (1983). Tacon *et al.* (1996) however, also reported wide variability amongst individuals in this respect and claimed that this was due to genetic differences and due to individual responses to a variety of factors.

GSI in *T. zillii* was reached maximal values (~5.5%) by day 14 post-spawn and was highly correlated to the VF of stage 6/7 oocytes. In pond-raised *T. zillii*, GSI reached 6.2%, though Peters (1983) reported that the GSI of *T. zillii* can reach 14.3%. Estimates of GSI in mouthbrooding tilapia include 4.6 - 10.2% (Peters, 1983), 7.0 - 8.2% (Srisakultiew, 1993) and $\leq 6\%$ (Tacon *et al.*, 1996). GSI is often used as an indicator of the state of maturity in many teleost species and can reach up to 30% in some salmonid species (e.g. rainbow trout; Tyler *et al.*, 1990). In the case of serial spawners however, GSI greatly underestimates reproductive investment (Wootton, 1979).

Up to 20% of the immediately post-spawned *T. zillii* ovary (i.e day 0) was occupied by stage 6/7 oocytes that for one reason or another had not been ovulated. Residual eggs were also spotted in the post-spawned ovary of *O. niloticus* by Avarindan & Padmanabhan (1972) but not by Srisakultiew (1993) in the same species. Peters (1983) also noted the presence of residual eggs and claimed that residual eggs swiftly progress into atresia; 'mechanical' effects were said to determine whether eggs are ovulated or not; though the precise meaning of this statement was not clarified. In *Oreochromis* species, Peters (1983) found that the number of residual eggs remaining

in the ovary after spawning remained relatively constant (generally <10) as the number of eggs ovulated (i.e fecundity) increased. In *T. tholloni* (*T. zillii* strain 'B') however, greater variation was observed; number of residual eggs generally remained <10 but several cases were reported where up to 60 eggs remained.

Atretic oocytes were found throughout the time period monitored in the present study but appeared to be particularly prevalent towards the end of the spawning cycle. In *O. niloticus*, Srisakultiew (1993) found that up to 40% of the ovary 1-day after spawning could be occupied by atretic oocytes; in the present study, atretic oocytes occupied <4% of the ovary at this timepoint. That atresia appeared to be more prevalent towards the end of the spawning cycle suggests that the longer the spawning cycle, the greater potential impact of atresia. This may effectively reduce the expected fecundity for a given fish size and also influence egg quality. The relative importance of atresia in ovarian recrudescence has been the source of much debate. The process of atresia is known to affect any stage of oocyte development and occurs in all vertebrate groups (Brambell, 1956; Byskov, 1978; Saidapur, 1978; Bromage & Cumaranatunga, 1988). Incidence of atresia is believed to be influenced by age, oocyte developmental stage, dietary status and hormonal status (Bromage & Cumaranatunga, 1988). Bromage & Cumaranatunga (1988) reported that atresia plays an important role in ovarian development, particularly in the determination of fecundity. Other studies have claimed that atresia is a fairly uncommon event in fish held under optimum conditions that are largely free from stress (Tyler *et al.*, 1990; Tyler *et al.*, 1994; Tyler & Sumpter, 1996). It is, however, well established that the incidence of atresia is increased under sub-optimal holding conditions and that starvation can result in the resorption of all maturing oocytes (Bromage & Cumaranatunga, 1988). It has also been suggested that atresia is more common in fish where recruitment into vitellogenesis occurs continually, for example in the case of indeterminate spawners (Tyler & Sumpter, 1996). Peters (1983) reported that both captive and wild tilapias exhibit a marked tendency to resorb ripe eggs, as did Hussein (1984) who additionally reported that atresia could affect final fecundity and could affect oocytes undergoing both protoplasmic (pre-vitellogenic) and

trophoplasmic (vitellogenic) growth. Peters (1983) claimed that the tendency of tilapias to resorb ripe eggs was due to the fact that readiness to spawn could be maintained only for a short time period. If after this time, conditions were not suitable for spawning, then the spawn was resorbed.

The precise function of atresia in fish and the factors regulating its occurrence remain unclear though it is believed to be involved in the initiation of follicular growth and the selection of follicles for ovulation (Tyler, 1988), steroidogenesis (e.g. Saidapur, 1978) and is thought to be an important determinant of fecundity (Vladykov, 1956; Springate *et al.*, 1985; Bromage *et al.*, 1992).

Post-ovulatory follicles (POFs) were only found in the *T. zillii* ovary on days 0 - 2 post-spawn (occupying ~6.6% on day 0 falling to <0.5% by day 2). In *O. niloticus*, Srisakultiew (1993) observed that POFs occupied up to 23% of the ovary on day 1 falling to ~10% and 0% by days 5 and 10 respectively. POFs therefore persisted in the ovary at least 3 days longer in *O. niloticus* than *T. zillii*. Smith & Haley (1988) reported that POFs persisted up to day 25 in actively mouthbrooding *O. mossambicus* and up to day 10 in non-brooding fish. Several authors have claimed that POFs exhibit a steroidogenic function (Bara, 1965; Nagahama *et al.*, 1976; Lam *et al.*, 1978; van den Hurk & Peute, 1979; Kagawa *et al.*, 1981; Lang, 1981; Smith & Haley, 1987), but the precise role and potential significance to ensuing spawning cycles remains unclear. Atretic oocytes may also exhibit steroidogenic activity (e.g. Saidapur, 1978). The presence of atretic oocytes and POFs during the ovarian cycle of *T. zillii* may therefore contribute to ovarian steroidogenesis, particularly during key periods. For example, in the first 6 days following spawning, during which pre-vitellogenic oocytes are rapidly recruited into active vitellogenesis coincident with dramatic increases in circulating E₂ and T. A strong correlation was indeed found in *T. zillii* between the VF of POFs and the circulating level of T (but not E₂).

There are numerous sites within the ovary where steroids have been shown (via histochemistry and immuno-cytochemistry) to be produced, e.g. granulosa cells, special thecal cells (STCs), POFs, atretic oocytes, interstitial gland cells (e.g. Yaron,

1971; Lam *et al.*, 1978; van den Hurk & Peute, 1979; Lang, 1981; Nagahama *et al.*, 1982) and more recently steroid producing cells (SPCs) (Nakamura *et al.*, 1993; Nakamura *et al.*, 1996). SPCs were found to appear coincident with gonadal differentiation and later invaded the thecal layer as oocytes began production of E₂ and became vitellogenic (Nakamura *et al.*, 1993). Cell types associated with a steroidogenic function usually contain large amounts of smooth endoplasmic reticulum (SER) or mitochondria with tubular cristae (van den Hurk & Peute, 1979). In the rainbow trout ovary, van den Hurk & Peute (1979) demonstrated that young POFs did indeed exhibit steroidogenic activity, though only weak. The same authors could not however demonstrate the presence of 3 α - or 3 β -hydroxysteroid dehydrogenase (3 α -HSD or 3 β -HSD) in atretic follicles, as Lambert (1970) and Khoo (1975) had done previously in guppy and goldfish, and therefore concluded that atretic follicles in rainbow trout do not have a steroidogenic function. Lang (1981) further found that the atretic follicles of yellow perch did not contain SER or mitochondria with tubular cristae and could not demonstrate 3 β -HSD activity. Similar results were reported in *O. niloticus* (Yaron, 1971) and medaka (Iwasaki, 1973).

3 α -HSD and 3 β -HSD are key enzymes involved in the oxidation of steroid hormones (van den Hurk & Peute, 1979) and have been found in the stromal cells, interstitial cells, special thecal cells and granulosa cells in the ovaries of several species of fish, demonstrating the importance of these structures in ovarian steroidogenesis. In *O. mossambicus*, SER, Golgi complex vesicles, micro-villi and micro-filaments were found in granulosa cells whilst active 3 β -HSD was located in the thecal cells of 5 - 7 day post-spawned fish (Smith & Haley, 1987). Activity of 3 β -HSD was at its most intense on day 10 post-spawning. Ultra-structural studies of post-spawned *O. niloticus* ovaries demonstrated that the follicular layer of early vitellogenic oocytes on day 1 post-spawn consisted of a flat thecal layer, granulosa cells containing large nucleoli with well developed mitochondria and a well developed zona radiata (Srisakultiew, 1993). Morphology of the follicular layer was also found to change as the ovary developed; theca, granulosa and zona radiata were all found to increase in size between day 1 and

day 5 post-spawning. Furthermore, microvilli (involved with the pinocytosis of cellular products) extending between the granulosa and the ooplasm increased in length between days 1 and 5 after spawning (Srisakultiew, 1993). Although ultra-structural observations were not taken in the present study, the follicular layer of developing stage 6/7 oocytes in *T. zillii* was extremely well developed as early as day 4 post-spawning coincident with peak levels of E₂ and T.

Synthesis of steroids by granulosa cells has been found to occur coincident with several major intra-cellular changes. In killifish for example, oocyte maturation was accompanied by proliferation of Golgi bodies and an increase in the number of cisternae of endoplasmic reticulum (ER) and of free ribosomes (Selman & Wallace, 1983; Selman *et al.*, 1986). Such activity during oocyte maturation provides further evidence that the granulosa is involved in the production of the maturation inducing steroid (MIS). It is widely accepted that T is produced in the theca and is converted to E₂ in the granulosa via an enzyme known as aromatase (Kagawa *et al.*, 1982; Nagahama *et al.*, 1982; Scott *et al.*, 1982). Further evidence supports the hypothesis that during ovarian maturation, 17 α -OH-P is also produced by the theca and converted into 17 α -20 β -P (widely believed to be the MIS) in the granulosa (Nagahama *et al.*, 1985; Nagahama & Yamashita, 1989; Nagahama *et al.*, 1995).

In the present study, provision of visual contact with male conspecifics (after 42 days of deprivation) was found not to influence circulating levels of E₂ significantly but resulted in a significant increase in T, perhaps attributable to aggression or courtship. Elevated levels of T were found throughout courtship, acquisition of nuptial colouring and pair-bonding in *O. niloticus* (Rothbard *et al.*, 1991). Provision of male contact also resulted in a significant increase in the proportion of stage 4 and stage 5 oocytes suggesting perhaps that male contact induced a recruitment of a batch of pre-vitellogenic oocytes into vitellogenic growth.

In summary, levels of E₂ and T peaked and fell in *T. zillii* within 6 days of spawning suggesting that vitellogenesis began as early as day 2 or 3. By day 8, the ovary was dominated by stage 6/7 oocytes (occupying 60 - 70% of the ovary) and GSI

was ~4%. From day 8 onwards, little change was observed in the proportion of stage 6/7 oocytes in the ovary though GSI was observed to increase (as oocytes matured) to reach maximal levels (~5.0 - 5.5%) from day 14 onwards. This suggests that pre-vitellogenic oocytes are recruited into the vitellogenic growth phase immediately after spawning and complete vitellogenesis as early as day 8 post-spawning. Knowledge of this timing is likely to contribute immensely to the development of spawning induction programs in this species. As *T. zillii* exhibit wide variations in spawning periodicity even under controlled laboratory conditions (see Chapter 3), the future success of culture operations may depend upon the development of techniques to allow artificial manipulation of spawning cycles.

Chapter 6

Studies on the effect of confinement and transfer to individually-partitioned aquaria on spawning incidence, ovarian development and circulating sex steroid level in *T. zillii*.

(6) Studies on the effect of confinement and transfer to individually-partitioned aquaria on spawning incidence, ovarian development and circulating sex steroid level in *T. zillii*.

(6.1) General introduction.

This Chapter concerns the effects of confinement (or 'crowding') on the reproduction of substrate-spawning tilapias. Several studies have reported that reproduction in tilapias can be inhibited under high population density (Coche, 1982; Paessum & Allison, 1984; Balarin *et al.*, 1986; Rana, 1986; Falter & Debacker, 1988; Turner *et al.*, 1989). Unfortunately, little is known of the physiological mechanisms responsible for such inhibition.

Increased stocking densities are likely to result in an increased frequency of interruption during spawning from other broodfish (Little, 1989), which may ultimately result in total inhibition of spawning (Coche, 1982; Rana, 1986). Current data suggest that inhibition of spawning in densely stocked tilapias is due to a density dependent shift in behaviour resulting in adoption of schooling behaviour at times of high density (Balarin *et al.*, 1986; Falter & Debacker, 1988). This shift in behaviour appears coincident with a complete cessation of spawning activity. Nothing however, is known of the physiological correlates or mechanisms of such shifts in behaviour.

Observations of several species of tilapia have provided evidence that dominance hierarchies play an important role in adult behaviour (Fishelson, 1983). The establishment of hierarchies however, has been shown to be markedly affected by stocking density. Behrends *et al.* (1993) for example, found that removal of the pre-maxillary bone in female *O. aureus* significantly reduced frequency of repeat spawning and clutch size whilst also causing weight gain through subsequent breakdown of dominance hierarchies.

Lee (1979) investigated hierarchical and agonistic behaviour between female tilapia held in aquaria. Competition resulted in a vertical hierarchy; weaker subordinate females were displaced into upper water levels above dominant females. Several

authors have observed that hierarchy between spawning groups in aquaria can cause dominant females to spawn more than others (Fishelson, 1966; Mires, 1973; Rothbard & Pruginin, 1975). If a hierarchy is established such that a few individual males and females dominate spawning behaviour in the limited area of a densely stocked spawning unit, then the sexual activity of the remaining subordinate fish would inevitably be reduced (Little, 1989).

Hierarchies are established and maintained by mainly visual contact and agonistic behaviour (Aronson, 1949; Heiligenberg, 1965; Turner, 1986). Since sound (Marshall, 1972; Lanzing, 1974; Silverman, 1978c) and chemical stimulation (Silverman, 1978c) have been found to play a role in mate identification and spawning; a role in the establishment and stability of hierarchies also seems likely (Little, 1989). That Hulata *et al.* (1985) observed reduced levels of incompatibility between species during hybrid production using green water rather than clear water may suggest that visual cues are particularly important in hierarchy formation/stability. The use of visual cues would be more difficult in turbid water, making reproductive behaviour less discriminatory (Little, 1989). Turner (1986) also noted that activities such as catching and measuring fish from a breeding colony of *O. mossambicus* was very stressful and entirely disrupted the structure of territories and possible social relationships. Little (1989) suggested that at a critical density, the hierarchy becomes more unstable and territory establishment, courtship and spawning take longer.

In a study of Atlantic salmon, Kjartansson *et al.* (1988) found that although fish did not experience a high level of chronic stress even at high density, social and size hierarchies were apparently not established at high stocking densities. Joergensen *et al.* (1993) further observed that although dominance hierarchies were established at low densities of Arctic charr *Salvelinus alpinus* (L.), schooling behaviour was predominant at both medium and high stocking densities.

Population density has been found to affect the reproduction of several species of fish, for example carp (Yoshihara, 1952), guppy (Rose, 1959; Dahlgren 1979, 1980; Borowsky & Diffley, 1981; Weeks & Quattro, 1991; Nishibori & Kawutu,

1983), three-spined stickleback (Schneider, 1969; Wootton, 1976, 1985; Stanley & Wootton, 1986), Japanese anchovy *Engraulis japonica* (Houttuyn) (Tsurata, 1992), killifish (Kneib, 1981), medaka (Kawazari, 1950) and various species of tilapia (e.g. Sanchez *et al.*, 1981; Ita *et al.*, 1989; Maluwa, 1991). In some species, spawning is totally inhibited during crowding, for example, in the zebrafish, and blue gourami (Yu & Perlmutter, 1970), largemouth bass (Chew, 1972), convict cichlid (Fitzgerald & Keenleyside, 1978) and tilapia (Paessum & Allison, 1984; Balarin *et al.*, 1986; Falter & Debacker, 1988).

The effects of increased population density on reproduction in fish are numerous. In the Japanese anchovy for example, Tsurata (1992) found that the number of eggs spawned per female was reduced at high stocking densities, while growth was better than at low density. Sea water taken from high density tanks and discharged into low density tanks was found to also reduce the fecundity per female in the low density tank.

Poeciliidae have been the object of many investigations of the effects of stocking density on reproductive rate. Borowsky & Diffley (1981) for example, found that laboratory crowding stress in a species of Xiphoridae caused a suspension of breeding whilst a return to uncrowded conditions permitted its resumption. Interestingly, females released simultaneously from crowding tended to be synchronised in subsequent broods, although this synchrony deteriorated with time. Weeks & Quattro (1991) examined reproductive investment in the topminnow *Poeciliopsis monacha* (Peters) under varying dietary and density treatments. Growth and fecundity decreased with both increasing density and food stress. Furthermore, age at first spawning increased with increasing density. Similarly, Nishibori & Kawata (1993) also reported that fecundity in the guppy decreases as population density increased and suggested that guppies are able to visually recognise surrounding densities and alter their own fecundity in response to changes in density. Fecundity is also found to exhibit a negative response to high density in the killifish (Kneib, 1981). Dahlgren (1979) also found that increased population density of guppies resulted in

decreased fecundity (number of eggs produced by the female) and fertility (number of intra-follicular embryos produced by the female), despite an equal amount of food available for each fish. Results indicated that the best reproductive strategy of females at low density (and thus reduced competition) was to maximize the rate of natural increase ('r-selection'). At high population levels, competition was greater and thus the best strategy would be to reduce the number of ova and to produce fewer but larger progeny with superior competitive abilities ('k'-selection). Guppy populations are self-regulating and also self-thinning and at high population levels, cannibalism by parents on their own progeny becomes prevalent (see Dahlgren, 1979). Aggression also becomes more prevalent (Farr & Herrnkind, 1974) and reproductive displays become suppressed (Warran, 1973).

There have been numerous attempts to study the effect of stocking density on reproduction in tilapia. Most of these studies have however, involved mouthbrooding species. Little is known of how stocking density may affect the reproduction of substrate-spawning tilapia.

Studies by Uchida & King (1962) and Hughes & Behrends (1983) both suggested that stocking density and the sex ratio of broodfish may influence breeding intensity in tilapia. As a general rule, sex ratio should be sufficient for a female in the appropriate physiological condition to easily find a male with which to spawn (Lowe-McConnell, 1955, 1959; Fryer & Iles, 1972). Several studies have shown that sex-ratio may influence fry production in tilapia (Mires, 1982; Hughes & Behrends, 1983; Bautista *et al.*, 1988; Ita *et al.* 1989). Generally, fry output decreases with increasing female to male stocking ratios (Mires, 1982; Hughes & Behrends, 1983). Studies by Delgado-Ardiles (1985) and Madu & Ita (1988) on *O. niloticus* however, suggested that sex-ratio did not have a significant affect on production or spawning frequencies.

Optimum stocking density of tilapia broodfish per unit area for seed production is very system specific (Little, 1989). Thereotically, stocking density may be increased until courtship behaviour is inhibited and/or spawning becomes less successful. A wide range of broodfish stocking densities have been reported; 0.24 kg/m² (Snow *et al.*,

1983), 2.52 kg/m² (Balarin & Haller, 1982), 0.4 - 0.64 kg/m² (Rothbard & Pruginin, 1975; Mires, 1977; Hulata *et al.*, 1985) for example. These densities are however, much lower than those used for grow-out systems (>100 kg/m²) (Little, 1989).

Ita *et al.* (1989) found that the highest mean monthly fry production in *O. niloticus* came from ponds with the lowest water level (30cm) and the least stocking density. Similarly, Sanchez *et al.* (1981) observed that the number of post-larvae per female *O. aureus* and the post-larvae mean weight was significantly higher when breeder density was lowest. Hughes & Behrends (1983) also recorded a reduction in seed production from *O. niloticus* with increased stocking density in small hapas. Allison *et al.* (1976) also observed that fry production was inversely related to stocking density of tilapia in concrete ponds over the range 4 - 20 fish/m². Little (1989) found no significant differences in mean seed production by *O. niloticus* using three high density treatments and suggested that spawning was relatively insensitive to densities between 1.5 and 3.0 fish/m² in a hapa environment. Guerrero (1985) further observed that intensive pond production was optimised when ponds received flow-through underground water and were heavily stocked with small (50 - 100g) broodfish. Similarly, high stocking densities were shown to be effective in the production of swim-up fry in earthen ponds in Israel but only if water quality was maintained by completely draining the system after each harvest; refilling with high quality well water afterwards (Rothbard *et al.*, 1983). However as Little (1989) highlighted, stocking densities are highly system specific and comparisons between stocking densities should be treated carefully if system design varies. In aquaculture, stocking densities have generally been defined by humans according to the physical carrying capacity of the tank/pond and not according to the social 'needs' of the species concerned. Care must be taken to remember that the social structure of a particular species has evolved during its phylogeny and thus 'low', 'medium' or 'high' stocking densities should be defined by the species itself using ethological methods rather than by physiological measurement by humans (Dr. Ursula Falter, personal communication).

The only recorded studies of the effects of stocking density on reproduction in substrate-spawning species were reported by Legner (1978) and Turner *et al.* (1989). Legner (1978) studied breeding in *T. zillii* at 3 different stocking densities in ponds of varying size and depth. Nest and brooding tube construction was found to be variably influenced by both pond depth and stocking density. Turner *et al.* (1989) investigated courtship behaviour in *T. mariae* in the confines of a small tank with no other subordinate conspecifics present and found a total absence of courtship.

There is evidence to suggest that spawning during times of high stocking density reduces mean clutch size via increased interference during spawning and/or stress during fry incubation (Balarin & Haller, 1982; Rana, 1986). There is also evidence that in spawning ponds that become overcrowded with broodfish and recruitment, spawning becomes inhibited (Mires, 1982). This presents considerable difficulty since in both experimental and commercial systems, there is a tendency to adopt higher broodfish densities to compensate for the inherent low fecundity of tilapias (Little, 1989). These studies suggest that at a critical density, hierarchies weaken such that dominant males cannot effectively control their territories resulting in increased aggression and interruption of spawning.

Increased stocking densities are also likely to result in an increased frequency of interruption during spawning by other broodfish (Little, 1989) which may ultimately result in total inhibition of spawning (Balarin & Haller, 1982; Coche, 1982; Mires, 1982; Rana, 1986). Paessum & Allison (1984) maximized production of *O. niloticus* and *O. aureus* by sequential rearing, grading and restocking at high densities. Under high density however, no reproductive activity was recorded. At densities in excess of 100 individuals/m³, territorial behaviour of intensively cultured tilapia disappeared, the social hierarchy collapsed and breeding was abandoned (Balarin *et al.*, 1986).

Literature suggests that changes in reproductive behaviour of fish maintained under crowded conditions may be achieved predominantly through either alterations in the available food supply or through the action of water-borne pheromones or other secretions. Investigations by Brown (1946) on the brown trout and Rose (1959) on the

guppy both revealed the existence of water-borne pheromones serving to inhibit reproductive cycles during times of high population density. Similar mechanisms were also found in goldfish and carp (Swingle, 1953). Pheromones have also been reported to stimulate ovarian maturation and ovulation through the elevation of GTH levels in the goldfish (Stacey *et al.*, 1989) and to stimulate ovarian development in *O. mossambicus* (Silverman, 1978a, b). The maturational steroid 17α - 20β -dihydroxy-pregnen-3-one (17α - 20β -P) of the goldfish was found to significantly increase milt volume and GTH level in common carp and to function as a potent and specific olfactory stimulant with pheromonal actions in the goldfish (Stacey *et al.*, 1994; Stacey *et al.*, 1995). Urine is known to be the major source of sex pheromones in the males of several teleosts, e.g. sea lamprey (Adams *et al.*, 1987) and yellowfin Baikal sculpin (Dmitrieva *et al.*, 1989). The urine of mature rainbow trout has been shown to induce increased levels of 17α - 20β -P, T and GTH II in the blood of conspecifics (Scott *et al.*, 1994). For a detailed review of pheromones in fish see Stacey & Sorensen (1991).

In addition to stocking density, hierarchy formation and pheromones, other factors that may influence spawning is the presence of suitable spawning substrate and/or contact with male conspecifics. Several fish require a suitable spawning substrate before spawning can occur successfully. Goldfish for example, generally fail to spawn should suitable vegetation not be available (Stacey *et al.*, 1979). The Australian freshwater trout cod also requires a substrate on which to nest (e.g. hollow logs) in order to spawn successfully. Under natural conditions, tilapias often construct depressions or nests on substrate prior to spawning (McKaye, 1984). However, since captive species of tilapia are able to spawn successfully in the absence of substrate (Lowe-McConnell, 1959), Stacey (1984) suggested that spawning mechanisms of tilapias may be insensistive to spawning substrate. Little is known of how reproduction in substrate-spawning tilapias may be influenced by the presence or absence of suitable substrate, although Bruton & Gophen (1992) found that *T. zillii* preferred fine sediments and muds for use as spawning substrates in Lake Kinneret but in the absence of these, spawned directly on to stones and boulders. In Chapter 3, it

was found that female *T. zillii* spawned directly on to the base of glass aquaria despite the absence of conspecifics and spawning substrate. Nothing is known however, of how presence or absence of substrate may affect reproductive endocrinology or spawning performance.

Visual, chemical (pheromonal) and audible stimulation from conspecifics has also been found to be of significance to the reproduction of several teleost species. These are reviewed in Section 1.7.1.3. and thus will only be mentioned briefly here. Marshall (1972) found that audible sounds produced by male *O. mossambicus* hastened spawning in females. Studies by Silverman (1978a, b) also with *O. mossambicus*. showed that visual stimulus may hasten ovulation but had little effect on ovarian development whilst non-visual stimuli (e.g. tactile, chemical) resulted in advancement of vitellogenesis by 7 days. Srisakultiew (1993) examined the effect of social contact in conjunction with spawning induction trials in *O. niloticus*. Isolated females spawned within 2 - 6 days of inducement whereas hormonal treatment of fish held in communal spawning tanks failed to have any significant effect. Srisakultiew (1993) suggested that the degree of contact between male and female tilapia may be one of the most important factors governing successful spawning. Male *O. niloticus* separated from females by plastic partitions were however, capable of stimulating adjacent females via both chemical and visual stimuli (Srisakultiew, 1993). Studies by Chien (1973) further showed that angelfish exposed to visual and chemical stimuli were found to have a higher spawning frequency than those maintained with either visual or chemical stimuli alone. Whilst predominantly investigating the effect of confinement and transfer to individual aquaria upon spawning and reproductive physiology of *T. zillii*, the present study also aims to incorporate a preliminary investigation into the influence of spawning substrate and visual contact with male conspecifics.

Several authors have suggested that population density acts upon reproductive activity via alterations in the available food supply. Bagenal (1967) for example, noted that overcrowding leads inevitably to a shortage of food. Wootton (1979) also reported that aggressive behaviour by several female sticklebacks under crowded conditions

frequently prevented access of other females to food, resulting in cessation of egg production in poorly nourished individuals. Studies on the effects of male density and food availability on territoriality and nest-building in male three-spined sticklebacks are described by Stanley & Wootton (1986). Number of territories and nests at a given density were higher at higher rations, as was the proportion of males that established territories and built nests. Whilst the number of territories and nests increased with density at a given ration, the proportion of males that established territories and built nests actually decreased. The number of nests being destroyed also increased with increasing density (Stanley & Wootton, 1986). In the guppy, both fecundity and fertility were found to be related to population density when fed a constant amount of food (Dahlgren, 1979). However, when fed to excess, no density-dependent effects on fecundity or fertility were apparent (Dahlgren, 1980). Furthermore, variations of fecundity reported by Bagenal (1957), Raitt (1968) and Hodder (1963) were all attributed to alterations in food supply through population density effects.

Nothing is known of how population density may influence ovarian development in tilapia though effects upon egg retention rates (Semko, 1954; Beall & Marty, 1987) and fecundity (e.g. Dahlgren, 1979; Tsurata, 1992) have been observed in other teleost species.

Similarly, nothing is known of how population density may affect circulating levels of sex steroids in tilapias. That population density is able to exert influence over sex steroid levels has however, been demonstrated in several other species of fish. For example, plasma levels of T, 11-ketotestosterone (11 KT) and 17α - 20β -P were found to be higher in male demoiselles from highly populated areas during spawning than males from areas of lower density. This was correlated with higher spawning frequency and frequency of interaction at high densities (Pankhurst & Barnett, 1993). Confinement in brown trout and rainbow trout was found to result in elevated levels of plasma cortisol, a corticosteroid released into the bloodstream during stress. This has also been observed in rainbow trout and Atlantic salmon (Davis & Parker, 1983), brook trout (Vijayan & Leatherland, 1990), chinook salmon (Mazur & Iwama, 1992)

and *O. mossambicus* (Foo & Lam, 1993a). Furthermore, whilst chronic confinement for 1 month caused significant elevation of plasma cortisol in male brown trout, levels of plasma T and 11 KT were suppressed (Pickering *et al.*, 1987).

Whilst several studies have reported inhibition of spawning in confined or densely stocked tilapia (Coche, 1982; Paessum & Allison, 1984; Balarin *et al.*, 1986; Rana, 1986; Falter & Debacker, 1988; Turner *et al.*, 1989), little is known of the possible mechanisms or factors regulating such inhibition. Only one study has investigated the mechanism of spawning inhibition in densely stocked tilapias. Falter & Debacker (1988) observed a density-dependent behavioural shift in *O. niloticus*. Frequency of aggressive acts in a 200 litre tank was increased in groups comprising of 4 males and reduced drastically in groups comprised of 16 males. These authors concluded that both the aggressive and sexual behaviour of *O. niloticus* may have derived from low density groups and reverts to schooling behaviour under high density conditions. This shift to schooling behaviour was thought to be the most appropriate reason for the disappearance of both sexual and aggressive nature in high production systems. To date, there has been no attempt to link such density-dependent shifts in behaviour in tilapia to concurrent physiological correlates such as ovarian histology or to possible associated changes in reproductive physiology.

This Chapter concerns earlier unpublished observations taken in the Tropical Aquarium Suite (Institute of Aquaculture, University of Stirling) suggesting that substrate-spawning species such as *T. zillii* and *T. rendalli* fail to spawn when maintained under confined hatchery conditions. Nothing is known of the effect of confinement on the reproductive physiology of substrate-spawning tilapias. The aim of this Chapter was thus, to investigate the effect of confinement on incidence of spawning, ovarian physiology and reproductive endocrinology in *T. zillii* (strains 'A' & 'B'). This was performed by comparing spawning incidence, ovarian histology and serum sex steroid levels in groups of confined fish and individually-maintained fish. Particular attention was given to the effect of transfer from confined conditions to individually-maintained conditions and *vice versa*.

(6.2) Experiment 1: Preliminary investigation of the effect of confinement and transfer to individually-partitioned aquaria upon spawning incidence and ovarian condition (as assessed by endoscopy) in female *T. zillii* (strain 'B').

This experiment aimed to investigate and compare spawning incidence and ovarian condition in groups of *T. zillii* (strain 'B') maintained under two regimes: under confined holding conditions and in individually-partitioned aquaria. Particular attention was paid to the effect of transfer from confined conditions to individual aquaria. Ovarian condition was assessed using fibre-lit endoscopy so that after examination, fish could be returned to aquaria and spawning performance monitored.

(6.2.1) Materials & methods.

Experiment 1a - Evaluation of endoscopy for use in classification of oocyte developmental stages.

To aid the interpretation of oocyte developmental stages by internal endoscopy, the ovaries of 3 female *T. zillii* (strain 'B') were assessed internally by *in vivo* endoscopy. This was then followed by histological examination. Fish were anaesthetized (see Section 2.2.1) and ovarian condition in each of the fish assessed using a fibre-lit small bore (4mm diameter) endoscope powered by a 150 watt cold light source (Edward Fletcher & Partners, U.K.). The endoscope was inserted into the peritoneal cavity through a small incision (approximately 1cm in length) in the left lower flank of the fish slightly anterior to the gonopore. The endoscope was sterilised immediately before and after use by swabbing with 70% ethanol (B.D.H./Merck Ltd., U.K.) and allowing to air-dry. Subsequent to internal examination, the wound was sealed with powdered dental tissue glue/antibiotic as detailed in Section 2.2.2. Fish

were then sacrificed by anaesthetic overdose followed by spinal transection. Following removal of the ovaries, a small section of ovary from each fish (approx. 1 cm²) was again examined endoscopically. These sections of ovary were then fixed in Bouin's fluid and then embedded in Histo-resin as detailed in Section 2.5.1. for light microscopy. Sections of 4 - 5µm were cut from the embedded tissue and stained in haematoxylin & eosin as detailed in Section 2.5.2.1. Oocytes were then staged histologically using the classification scheme developed in Chapter 4. These observations were then compared to those taken with the endoscope to aid identification of distinct developmental stages by use of the endoscope alone.

Experiment 1b - Transfer of previously confined *T. zillii* (strain 'B') into individually-partitioned aquaria: effects upon spawning incidence and ovarian condition (as assessed by endoscopy).

Six female *T. zillii* (strain 'B') (group 1) were randomly removed from a 114 x 114 x 42cm holding tank (System 1, see Section 2.1.2. and Appendix 1.1) originally containing 22 females and 26 males of similar age and size. These fish were anaesthetized (see Section 2.2.1), weighed (to the nearest 0.1g), measured (to the nearest mm) (see Section 2.4.1) and were replaced into glass aquaria partitioned with perspex dividers such that each fish could be maintained individually (System 3, see Section 2.1.2 and Appendix 1.3).

Twenty days later, a further group of 6 females (group 2) were removed from the original holding tank. These fish were also anaesthetised, weighed and measured. Ovarian condition in each of the fish in group 2 was then assessed by endoscopy (as detailed in Experiment 1a above). For comparison, the ovaries of group 1 fish removed from the same holding tank 20 days previously and maintained individually thereafter, were also examined endoscopically concurrent with group 2. The 10 females remaining in the confined holding tank (along with 26 males) formed group 3 and were also examined endoscopically.

Following endoscopy, group 2 were also replaced into partitioned glass aquaria such that each fish was maintained individually for a total period of 26 days. Group 3 were returned to the holding tank. A flow-diagram indicating the sampling protocol employed in this experiment is given in Figure 6.1.

Throughout a total of 46 days of observation, both the holding tank (containing group 3) and the individually-partitioned aquaria (containing both group 1 and group 2) were assessed daily for evidence of spawning (i.e. egg clutches adhered to tank base or sides).

Weight and total length data were analysed using one-way ANOVA. Spawning data was also analysed using one-way ANOVA.

Feeding regime, photoperiod and temperature were maintained as described in Section 2.1.3.

(6.2.2) Results.

All fish recovered well after anaesthesia and *in vivo* endoscopic examination. No mortalities were observed during the course of the experiment. Mean weights of groups 1, 2 and 3 were $174.4 \pm 23.9\text{g}$, $187.8 \pm 9.6\text{g}$ and $175.3 \pm 17.8\text{g}$ respectively. Mean total lengths of groups 1, 2 and 3 were $216 \pm 14\text{mm}$, $226 \pm 5\text{mm}$ and $217 \pm 11\text{mm}$ respectively. There was no significant difference in either weight or total length between groups 1, 2 or 3 ($p \geq 0.05$).

(6.2.2.1) Endoscopic appearance of ovary.

It was not possible to accurately quantify different oocyte developmental stages in those ovaries examined endoscopically in the present study. It was however,

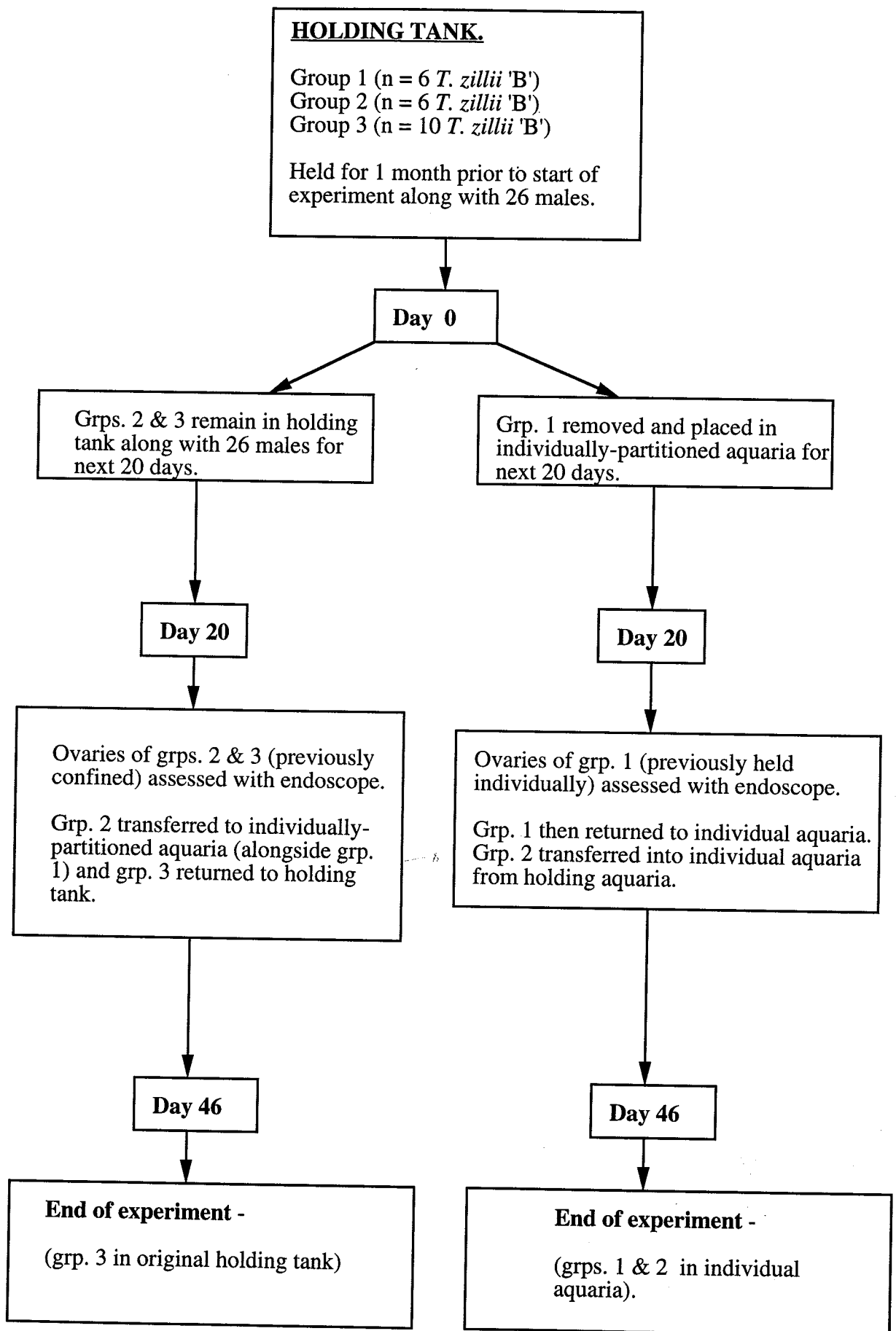

Figure 6.1. Flow-diagram representing sampling protocol employed in Experiment 1b (Section 6.2.1).

possible to identify pre-vitellogenic, vitellogenic and atretic oocytes based upon relative oocyte size, colouration and shape. Principle features identified during endoscopic examination of ovarian tissue *in vivo* included small white oocytes (roughly spherical), larger yellow/green oocytes (slightly ellipsoid in shape) and large olive-green ellipsoid oocytes. Endoscopic examination followed by histological analysis of discrete sections of ovarian tissue demonstrated that the small white oocytes are previtellogenic stages of oocyte development (stages 2 & 3 in the classification scheme given in Chapter 4), the larger yellow/green oocytes represent early vitellogenesis (stage 4 and early stage 5) and the large olive-green ellipsoid oocytes are late vitellogenic oocytes (late stage 5 and stage 6). Localised areas of brown tissue also visible endoscopically were found to be areas of atretic tissue.

Plate 6.1 presents a superficial view of the ovary of *T. zillii* (strain 'B') similar to how the ovary appeared during endoscopy and indicates the areas of brown (atretic) tissue mentioned earlier.

(6.2.2.2) Ovarian condition.

Descriptions of the endoscopic appearance of ovarian condition observed in groups 2 and 3 (immediately after removal from a confined holding tank) and group 1 (removed from same confined tank 20 days previously but maintained individually thereafter) are given in Table 6.1. Ovaries of all group 2 and group 3 fish exhibited a marked similarity in condition and all appeared to be dominated by large olive-green oocytes in late-vitellogenesis. Also present but to a much lesser extent were smaller yellow/green oocytes in early stages of vitellogenesis. Interspersed amongst these vitellogenic oocytes were infrequent clusters of small white pre-vitellogenic oocytes and small infrequent localised patches of brown atretic tissue. There appeared to be much more variation in ovarian condition amongst group 1 fish (i.e. those that had been maintained individually). Fish numbers 1, 2 and 4 were similar in condition to those of group 2, dominated by numerous late-vitellogenic oocytes. However fish numbers 3, 5 and 6 showed pronounced differences in relative proportions of pre-vitellogenic, early-

Plate 6.1. Superficial view of the outer-wall of an ovary removed from *T. zillii* (strain 'B') indicating general tissues/structures identifiable using endoscopy.

BV - blood vessels.

AT - atretic tissue.

PV - pre-vitellogenic oocytes.

EV - early-vitellogenic oocytes.

LV - late-vitellogenic oocytes.

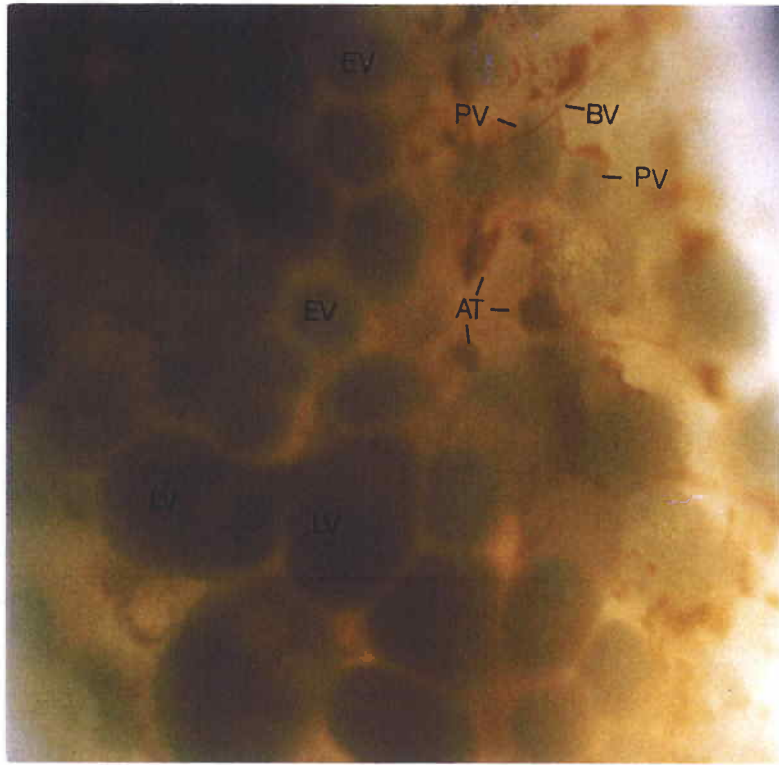

Plate 6.1

Table 6.1. Comparison of endoscopic appearance of ovarian condition in 3 groups of *T. zillii* (strain 'B'). Groups 2 and 3 had just been removed from a confined holding tank. Group 1 had been removed from the same confined tank 20 days previously but had been maintained individually thereafter.

Group 1 (removed from confined holding tank 20 days previously and held individually thereafter)		Group 2 (immediately after removal from confined holding tank)		Group 3 (immediately after removal from confined holding tank)	
Fish No.	Endoscopic appearance of ovary	Fish No.	Endoscopic appearance of ovary	Fish No.	Endoscopic appearance of ovary
1	Dominated by large olive-green late-vitellogenic oocytes interspersed with smaller yellow/green oocytes in early vitellogenesis. Infrequent clusters of white pre-vitellogenic oocytes present and small localised patches of brown atretic tissue.	1	Large distended ovary dominated by large olive-green oocytes in late vitellogenesis. Also present but to a much lesser extent were several much smaller yellow/green early-vitellogenic oocytes. Interspersed with these were infrequent clusters of small white pre-vitellogenic oocytes and small infrequent patches of brown atretic tissue.	1	Large distended ovary dominated by large olive-green oocytes in late vitellogenesis. Also present but to a much lesser extent were several much smaller yellow/green early-vitellogenic oocytes. Interspersed with these were infrequent clusters of small white pre-vitellogenic oocytes and small infrequent patches of brown atretic tissue.
2	Largely as Fish No. 1 above.	2	Largely as Fish No. 1 above.	2	Largely as Fish No. 1 above.
3	Dominated by small yellow/green early-vitellogenic oocytes interspersed with many clusters of small white pre-vitellogenic oocytes. No large olive-green oocytes. Many localised patches of atresia.	3	Largely as Fish No. 1 above.	3	Largely as Fish No. 1 above.
4	Largely as Fish No. 1 above.	4	Largely as Fish No. 1 above.	4	Largely as Fish No. 1 above.
5	Dominated by small yellow/green early-vitellogenic oocytes interspersed with many clusters of small white pre-vitellogenic oocytes. Several large olive-green late-vitellogenic oocytes. Few patches of atresia.	5	Largely as Fish No. 1 above.	5	Largely as Fish No. 1 above.
6	Dominated by a mixture of yellow/green early-vitellogenic oocytes and olive-green vitellogenic oocytes interspersed with infrequent clusters of white pre-vitellogenic oocytes. Few patches of atresia.	6	Largely as Fish No. 1 above.	6 - 10	All largely as Fish No. 1 above.

vitellogenic, late-vitellogenic and atretic oocytes suggesting that they were at differing points within their respective reproductive cycles.

(6.2.2.3) Spawning incidence.

During 46 days of observation, no egg clutches were found in the holding tank, indicating a total absence of oviposition by fish experiencing these conditions (i.e. group 2 during the first 20 days of the experiment or group 3 throughout the entire 46 days). On separate occasions however, 2 females were seen to exhibit vivid colouration and possess extended gonopores (usually associated with pre-spawning activity). These females were both observed attempting to defend territories (usually in a small depression in the tank base surrounding the stand-pipe). After 2 - 3 days, the colouration of these females returned to normal, the territorial behaviour diminished and the gonopore seemed to regress.

Those fish initially removed from the confined tank and replaced into individually-partitioned aquaria for a total of 46 days (group 1) did however exhibit spawning activity (Table 6.2). Of the 6 fish in group 1, 3 fish (50%) spawned. Two of these (fish 3 and 5) went on to re-spawn within the 46 days of observation (mean number of spawns/fish during 46 days observation = 0.83). Group 2 fish exhibited pronounced spawning activity after transfer into individual conditions on day 20. Four of the 6 fish (67%) spawned within 4 days of transfer. Two of these (fish 2 and 3) re-spawned within the 26 days of observation (mean number of spawns/fish during 26 days observation = 1.0). There was no significant difference between groups 1 and 2 in terms of mean number of spawns/fish/observation period ($p \geq 0.05$).

(6.2.3) Summary of results.

(1) *T. zillii* (strain 'B') failed to spawn whilst maintained in a confined holding tank. Two females however, were seen to possess a 'biological urge' to spawn as indicated by their vivid colouration, extended gonopores and territorial behaviour. Final oviposition however, did not occur.

Table 6.2 Incidence of spawning activity observed in 3 groups of *T. zillii* (strain 'B'). Group 1 (n=6) and group 2 (n=6) were removed from holding conditions and were maintained in individually-partitioned aquaria for periods of 46 and 26 days respectively. Group 3 (n=10) remaining in a confined holding tank throughout.

Group 1 - during 46 days observation			Group 2 - during 26 days observation			Group 3 - during 46 days observation		
Fish no.	No. of spawns seen during period of observation (46 days)	Time of spawn (days after transfer to individual aquaria)	Fish no.	No. of spawns seen during period of observation (26 days)	Time of spawn (days after transfer to individual aquaria)	Fish no.	No. of spawns seen during period of observation (46 days)	Time of spawn (days after transfer to individual aquaria)
1	0	-	1	1	2	1 - 10	0	-
2	0	-	2	2	4, 14	-	-	-
3	2	18, 31	3	2	4, 23	-	-	-
4	0	-	4	1	4	-	-	-
5	2	16, 40	5	0	-	-	-	-
6	1	14	5	0	-	-	-	-
Mean spawns/fish	*****	0.83	Mean spawns/fish	*****	1.0	Mean spawns/fish	*****	0

(2) Endoscopy proved effective in identifying pre-vitellogenic, early-vitellogenic, late-vitellogenic and atretic oocytes in live *T. zillii* (strain 'B'). The technique was disadvantaged however, by the inability to obtain quantifiable data suitable for further analysis.

(3) Endoscopic examination revealed that the ovaries of confined *T. zillii* (strain 'B', groups 2 and 3) appeared to be dominated by numerous late-vitellogenic oocytes. Moreover, ovaries exhibited a marked similarity in condition amongst fish removed from confinement (groups 2 and 3) suggesting that such fish possessed ovaries at similar stages of development. In contrast, the ovaries of a second group of females removed from the same confined tank 20 days previously and maintained individually thereafter (group 1) exhibited much more variation in ovarian condition suggesting that individual fish were at differing timepoints within their reproductive cycles.

(4) Previously confined *T. zillii* (strain 'B') exhibited a marked tendency to spawn soon after transfer to individually-partitioned aquaria. Four out of the 6 females in group 2 (67%) spawned within 4 days of transfer.

(6.3) Experiment 2: Effect of confinement and transfer to individually-partitioned aquaria on circulating levels of sex steroids, ovarian development and spawning incidence in *T. zillii* (strain 'B').

The previous experiment (Experiment 1, Section 6.2) demonstrated that *T. zillii* (strain 'B') failed to spawn under confined holding conditions despite possessing seemingly 'ripe' ovaries. Moreover, previously confined females exhibited a marked tendency to spawn soon after transfer to individually-partitioned aquaria. The present experiment aimed to investigate the dynamics of ovarian development and concurrent levels of the circulating sex steroids E₂ and T in two groups of *T. zillii* (strain 'B') held under confined conditions. Particular emphasis was placed upon the effect of transferring one of these groups into individually-partitioned aquaria. The effect of replacing individually-held fish back into confined conditions was also examined.

(6.3.1) Materials & methods.

Fourteen female *T. zillii* (Strain 'B') previously held under confined holding conditions for at least 1 month) were placed into a 114 x 114 x 42cm holding tank (System 1, see Section 2.1.2. and Appendix 1.1) along with 20 males of similar age and size (stocking density = $\sim 10 \text{ kg/m}^3$). Each female was surgically implanted with a passive electronic transponding tag as detailed in Section 2.2.2. At the time of stocking (day 0) each female was anaesthetized (Section 2.2.1), weighed (to the nearest 0.1g) and measured (to the nearest mm) (Section 2.4.1). Each fish was then blood sampled (Section 2.3.1). Serum was obtained by allowing blood samples to clot at 4°C followed by centrifugation (Section 2.3.1). A small piece of intra-ovarian tissue was also removed by ovarian biopsy (Section 2.3.2), fixed in Bouin's fluid and embedded in Histo-resin for light microscopy (Section 2.5.1). Sections of 4 - 5µm were cut from embedded tissue (Section 2.5.1.6) and stained with haematoxylin & eosin as detailed in Section 2.5.2.1. Following full recovery, fish were returned to the holding tank.

Fish were weighed, measured, blood sampled and biopsied at approximate 5 day intervals thereafter for a total of 30 days. Immediately after the 30 day samples were taken, fish were randomly divided into 2 groups; group 1 (n = 7) and group 2 (n = 7). Group 1 were returned to the holding tank whilst group 2 were transferred into glass aquaria partitioned with perspex dividers such that each fish could be maintained individually (System 3, see Section 2.1.2 and Appendix 1.3).

Sampling continued at approximate 5 day intervals for a further 30 day period. Immediately after the 60 day samples were taken, group 2 were returned to the original holding tank alongside group 1. Final blood samples and ovarian biopsies were taken after a further 5 days under confinement (total experimental duration 65 days).

Serum T and E₂ were measured by radioimmunoassay as detailed in Section 2.7. Total serum calcium was also measured as detailed in Section 2.6 but data are not presented here owing to the findings of Chapter 5 (profiles of total serum calcium over either 26, 42 or 82 days did not vary significantly suggesting that measurement of total

serum calcium was of little use for monitoring changes in serum vitellogenin in this particular species of fish).

Ovarian histology was analyzed using stereological analysis of volume fractions (Section 2.5.4). Oocyte developmental stages were identified using the classification scheme developed in Chapter 4. Volume fractions were estimated for each oocyte developmental stage as described in Section 2.5.4.3. Although three stages of atresia were identified in Chapter 4, volume fraction analysis presented herein involves merely 'atretic oocytes' and represents pooled data from each of the three stages of atresia (α -stage & β -atresia were by far the most commonly found phases of atresia; λ -stage was found only rarely).

Throughout the experimental period, both the holding tank and the individually-partitioned glass aquaria were assessed daily for evidence of spawning (i.e. egg clutches adhered to tank base or sides). Total fecundity was determined from any observed spawn using the method described in Section 2.4.1.

Feeding regime, photoperiod and temperature were maintained as described in Section 2.1.3.

Weight and total length data were analysed using two-way ANOVA followed by multiple comparisons using the Bonferroni/Dunn test. E₂ and T data were analysed using two-way ANOVA as were volume fraction data resulting from stereology (volume fractions were ARCSine transformed as described in Section 2.8.7 prior to analysis). In both cases multiple comparison was performed using the Bonferroni/Dunn test. Relationships between mean levels of E₂ and T and individual oocyte developmental stages were assessed using linear regression analysis.

(6.3.2) Results.

All fish recovered well after anaesthesia, blood sampling and ovarian biopsy and no mortalities were observed during the course of the experiment.

(6.3.2.1) Fish weight and total length.

There was no significant difference in total length or weight between groups 1 and 2 at any timepoint throughout the experimental period ($p \geq 0.05$). During confinement, mean fish weight tended to slowly decrease. Once transferred to individual aquaria however, mean weight increased. Such weight losses/gains were not, however, statistically significant ($p \geq 0.05$).

(6.3.2.2) Profiles of serum E2 and T.

(a) E2 (refer to Figure 6.2a).

Throughout the entire 65 day period that group 1 remained crowded in the holding tank, mean E2 levels remained consistently low with little variation (0.38 ± 0.01 - 1.76 ± 0.72 ng/ml). Group 2 however, exhibited large fluctuations in E2 (1.00 ± 0.10 - 6.03 ± 1.63 ng/ml).

During the first 23 days of the initial confinement period both groups exhibited consistently low levels of E2 (0.69 ± 0.12 - 1.61 ± 0.46 ng/ml). No significant differences were observed between the 2 groups at any sampling timepoint ($p \geq 0.05$). On the day of transfer to individual conditions (day 30), 1 fish from group 2 showed a much higher E2 level (13.90 ng/ml) than other members of the same group (~ 1.50 ng/ml); T remained similar to other members of the group.

Just 4 days after transfer of group 2 to individual conditions, E2 levels had risen to levels significantly higher ($p < 0.05$) to those seen in group 1 fish which remained crowded. E2 levels continued to rise (remaining significantly higher ($p < 0.05$) than group 1) to a maximum of 6.03 ± 1.63 ng/ml on day 44 (14 days after transfer). This level was also significantly higher ($p < 0.001$) than group 1. Throughout the remainder of the period in individual conditions (day 44 to day 60), E2 fell steadily to levels not significantly different than those of group 1 ($p \geq 0.05$).

When group 2 was sub-divided into spawning and non-spawning fish (see Figure 6.3a) during the period of time held individually (days 30 - 60), it was found that mean E2 was significantly higher in both group 2 non-spawners ($p < 0.01$) and

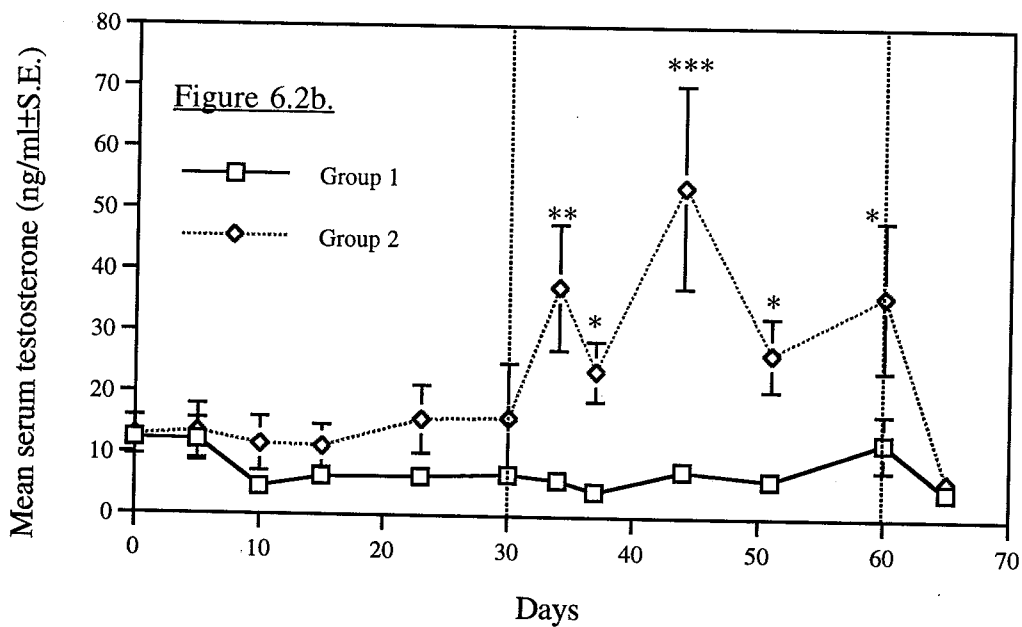
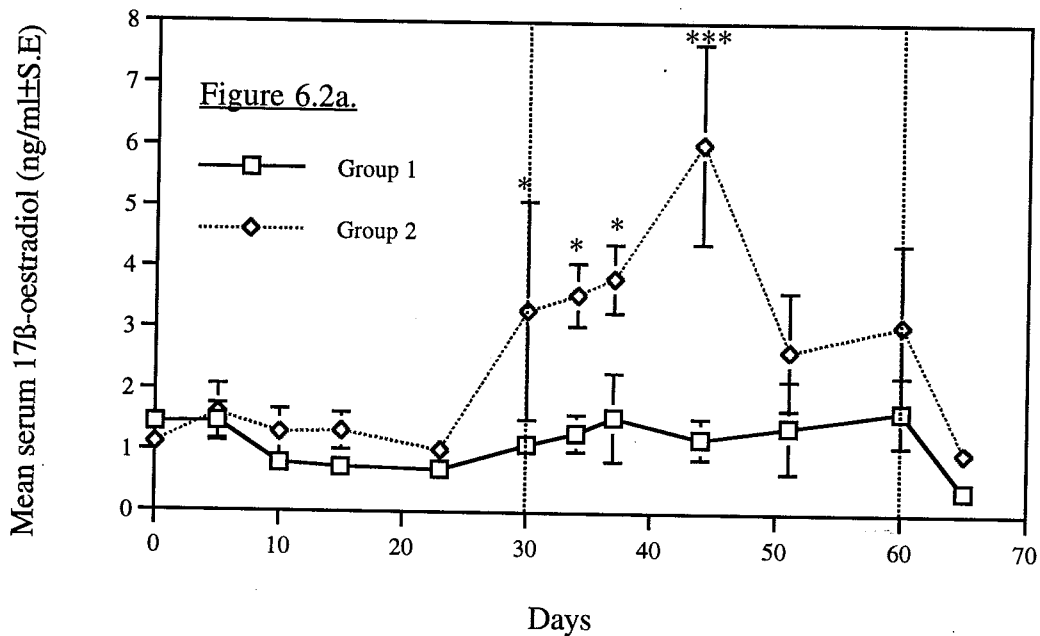

Figure 6.2. Profiles of (a) mean 17β-oestradiol and (b) mean testosterone (ng/ml±S.E.) in 2 groups of *T. zillii* (strain 'B'). Group 1 were maintained in confined conditions throughout a 65 day period. Group 2 were initially confined (along with group 1) for a 30 day period, then transferred into individually-partitioned aquaria for a further 30 day period then returned to confinement for a final 5 day period. Broken lines represent times of transfer. Differences between the two groups at a particular timepoint are not significant unless indicated by * ($p < 0.05$), ** ($p < 0.01$) or *** ($p < 0.001$). Datapoints not showing S.E. bars represent instances where the S.E. lies within the confines of the symbol.

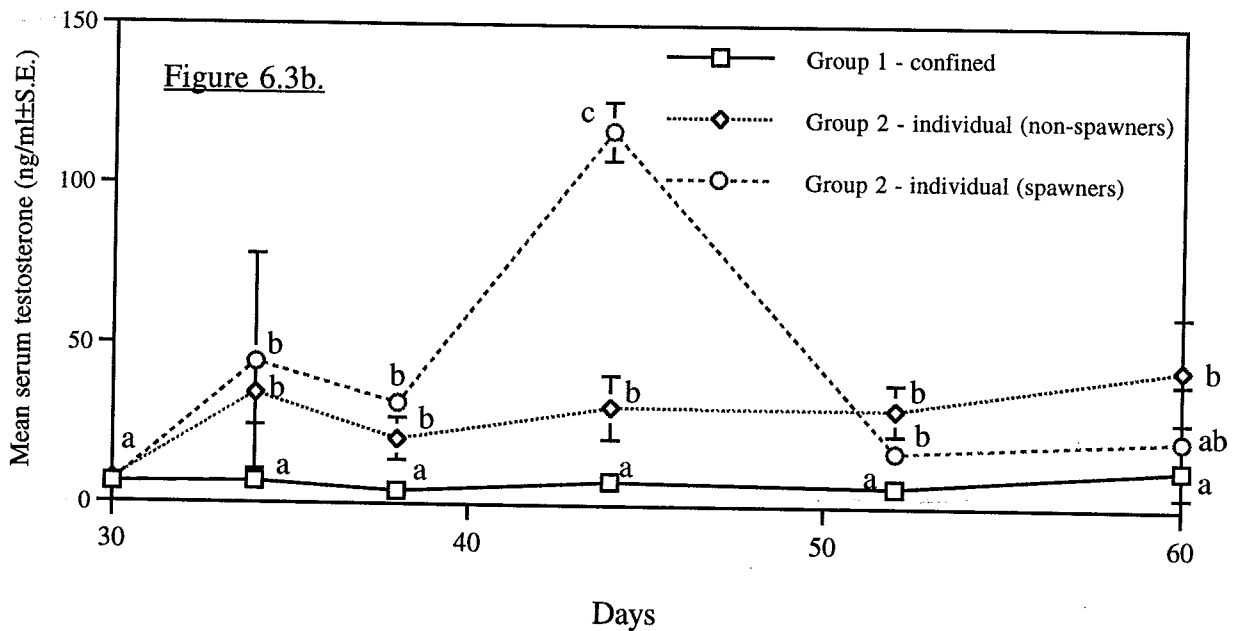
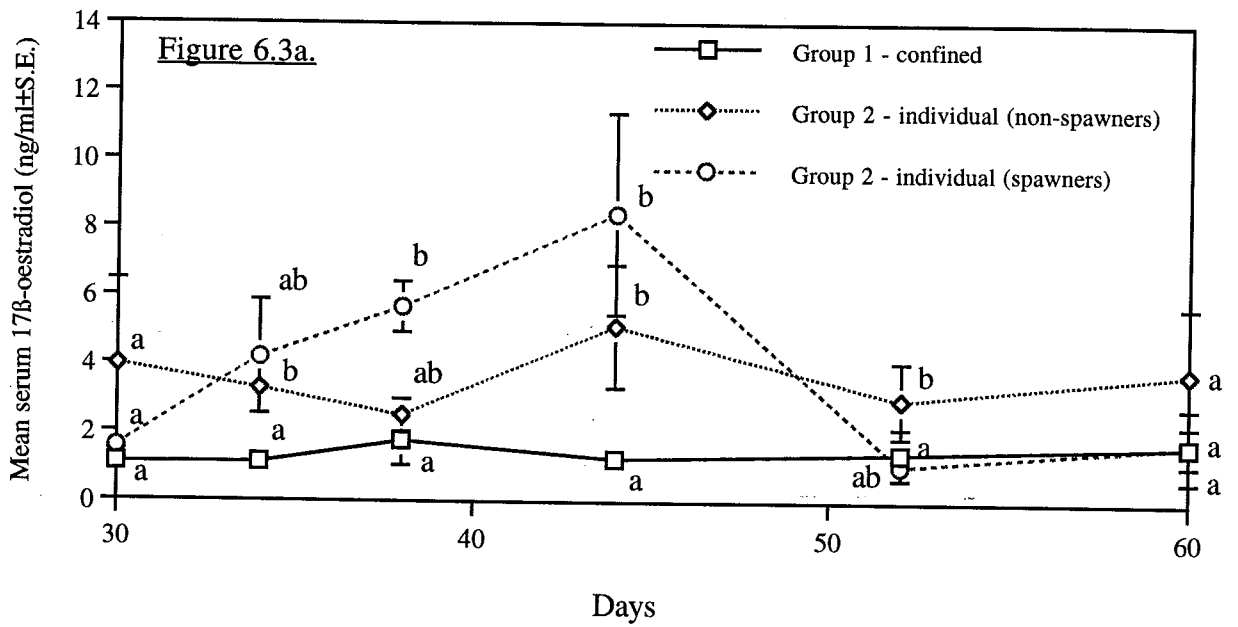

Figure 6.3. Profiles of (a) mean 17β-oestradiol and (b) mean testosterone (ng/ml±S.E.) in groups of *T. zillii* (strain 'B') between days 30 and 60 of Experiment 2. Group 1 (n = 7) remained confined throughout. Group 2 were transferred into individual aquaria on day 30 and in this Figure have been sub-divided into non-spawning fish (n = 5) and spawning fish (n = 2). Significant differences ($p < 0.05$) between groups at any particular timepoint are indicated by annotation with different letters. Annotation with the same letter indicates no significant difference ($p \geq 0.05$). Where no S.E. is visible, it lies within the confines of the symbol.

group 2 spawners ($p < 0.01$) than in group 1 which remained confined. There was no significant difference ($p \geq 0.05$) between the non-spawning and spawning fish of group 2 though mean E₂ appeared generally higher in spawning fish.

Replacement of group 2 into crowded conditions on day 60 resulted just 5 days later in a significant ($p < 0.05$) drop in E₂ level to 1.0 ± 0.10 ng/ml. This level was not significantly different ($p \geq 0.05$) to that of group 1 on day 65. Removal of group 2 on day 30 (and replacement on day 60) did not cause any significant ($p \geq 0.05$) change in the E₂ levels of group 1 remaining in the holding tank.

(b) T (refer to Figure 6.2b, page 320).

Levels of mean serum T in groups 1 & 2 followed a similar pattern to that of E₂. Group 1 fish, confined in the holding tank throughout the 65 day experimental period exhibited consistently low levels of T with little variation ($4.20 \pm 0.63 - 12.40 \pm 4.62$ ng/ml). Group 2 however, exhibited large fluctuations ($6.14 \pm 0.59 - 53.87 \pm 16.52$ ng/ml).

During the first 30 days of the initial period of crowding both groups exhibited consistently low levels of T ($< 16.06 \pm 8.80$ ng/ml). No significant differences ($p \geq 0.05$) were found between the two groups at any timepoint.

Transfer of group 2 to individual conditions on day 30 however, resulted in a significant ($p < 0.05$) rise in T to a level significantly greater than that of group 1 ($p < 0.01$). Throughout the remainder of the period under individual conditions (up to and including day 60) T levels of group 2 were consistently significantly higher ($p < 0.05$ or $p < 0.001$) than those of group 1 which remained crowded. As with E₂, T levels of group 2 peaked on day 44 (14 days after transfer to individual aquaria) at 53.87 ± 16.52 . This level was significantly higher ($p < 0.001$) than that of group 1.

When group 2 was sub-divided into spawning and non-spawning fish (see Figure 6.3b, page 321) during the period of time held individually (days 30 - 60), it was found that mean T was significantly higher in both group 2 non-spawners ($p < 0.001$) and group 2 spawners ($p < 0.001$) than group 1 which remained confined.

There was no significant difference ($p \geq 0.05$) between group 2 non-spawners and group 2 spawners though mean T was generally higher in spawning fish (as with E₂).

Replacement of group 2 back into confined conditions on day 60 resulted just five days later in a highly significant drop in T ($p < 0.01$) to 6.14 ± 0.59 ng/ml. This level was not significantly different than that of group 1 ($p \geq 0.05$). Removal of group 2 on day 30 (and replacement on day 60) did not cause any significant ($p \geq 0.05$) change in the T level of group 1 remaining in the holding tank.

(6.3.2.3) Incidence of spawning.

During 65 days of observation, no egg clutches were found in the holding tank indicating a total absence of oviposition from both group 1 and 2 fish subjected to these conditions. Spawning was, however, observed in 2 of the 7 group 2 fish (29%) following their transfer to individually-partitioned aquaria. Egg clutches were released by 1 female just 4 days (on day 34) after transfer to individual conditions (coincident with rising levels of mean E₂ and T). The second spawn was witnessed 30 days after transfer to individual aquaria (day 60) as mean E₂ and T rose again (between days 51 and 60). Together, these 2 spawns produced a total of 5267 eggs.

(6.3.2.4) Stereological analysis of ovarian condition.

Volume fraction data are presented in Figure 6.4. Ovarian tissue sections were usually found to contain varying proportions of each oocyte developmental stage as classified in Chapter 4. Post-ovulatory follicles were not observed in any of the ovarian tissue sections analysed during this experiment.

(a) Stage 2 oocytes - Mean volume fraction of stage 2 oocytes varied throughout the 65 day period from 0.57 ± 0.25 - $11.93 \pm 4.89\%$ (Figure 6.4). There were no significant differences throughout the entire experimental period between group 1 and 2 irrespective of timepoint ($p \geq 0.05$) or between timepoints irrespective of group ($p \geq 0.05$). Two-way ANOVA over the period that group 2 was held in individual

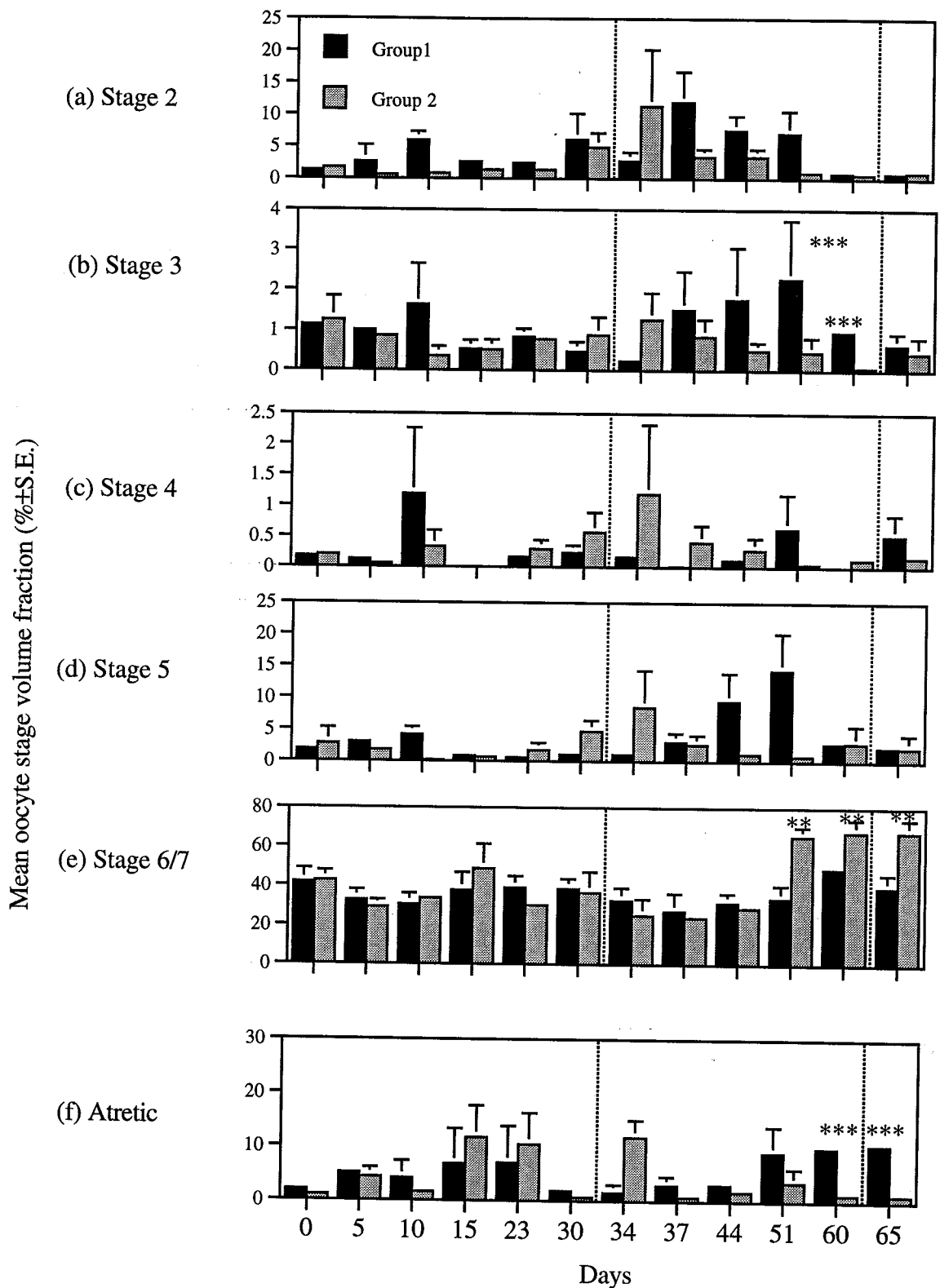

Figure 6.4. Mean volume fraction (%±S.E.) of different oocyte stages in 2 groups of *T. zillii* (strain 'B'). Group 1 were maintained in confined conditions throughout a 65 day period. Group 2 were initially maintained in confined conditions (along with group 1) then transferred into individually-partitioned aquaria for a further 30 day period then returned to confinement for a final 5 day period. Broken lines represent times of transfer. Bars not showing an S.E. bar represent instances where the S.E. lies within the confines of the histogram. Differences between bars of each oocyte stage at each timepoint are not significant unless designated * (p<0.05), ** (p<0.01) or *** (p<0.001).

aquaria (days 30 - 60) however, detected significant differences ($p < 0.05$) between spawning and non-spawning fish in group 2 (though these were not reflected in multiple comparison tests - see Figure 6.5).

(b) Stage 3 oocytes - Mean volume fraction of stage 3 oocytes varied from $0.23 \pm 0.10\%$ - $2.27 \pm 1.47\%$. Throughout days 0 - 44 there was no significant difference in stage 3 volume fraction between the 2 groups (Figure 6.4). However, volume fraction of stage 3 oocytes in group 1 fish (remaining confined) was significantly higher ($p < 0.001$) than that of group 2 fish (in individual conditions) on both day 51 and day 60. There was no significant difference between groups 1 and 2 however, on day 65, following return of group 2 to the crowded holding tank. No significant differences ($p < 0.05$) were detected between spawning and non-spawning group 2 fish between days 30 and 60 (see Figure 6.5).

(c) Stage 4 oocytes - Mean volume fraction of stage 4 oocytes ranged from $0 - 1.19 \pm 1.07\%$ (Figure 6.4). There were no significant differences throughout the entire experimental period between group 1 and 2 irrespective of timepoint ($p \geq 0.05$) or between timepoints irrespective of group ($p \geq 0.05$). Significant differences ($p < 0.05$) were detected however, between spawning and non-spawning fish from group 2 (see Figure 6.5) between days 30 and 60.

(d) Stage 5 oocytes - Mean volume fraction of stage 5 oocytes ranged from $0.15 \pm 0.09\%$ - $14.36 \pm 5.76\%$ (Figure 6.4). There were no significant differences throughout the entire experimental period between group 1 and 2 irrespective of timepoint ($p \geq 0.05$) or between timepoints irrespective of group ($p \geq 0.05$). Significant differences ($p < 0.05$) were detected however, between spawning and non-spawning fish from group 2 between days 30 and 60 (see Figure 6.5).

(e) Stage 6/7 oocytes - Mean volume fraction of stage 6/7 oocytes varied from $24.11 \pm 3.09 - 67.63 \pm 6.35\%$. Throughout days 0 - 44 there was no significant difference in stage 6/7 volume fraction ($p \geq 0.05$) between the 2 groups (see Figure 6.4). However, volume fraction of stage 6/7 oocytes in group 2 fish (in individual conditions) was significantly higher ($p < 0.01$) than that of group 1 fish (remaining

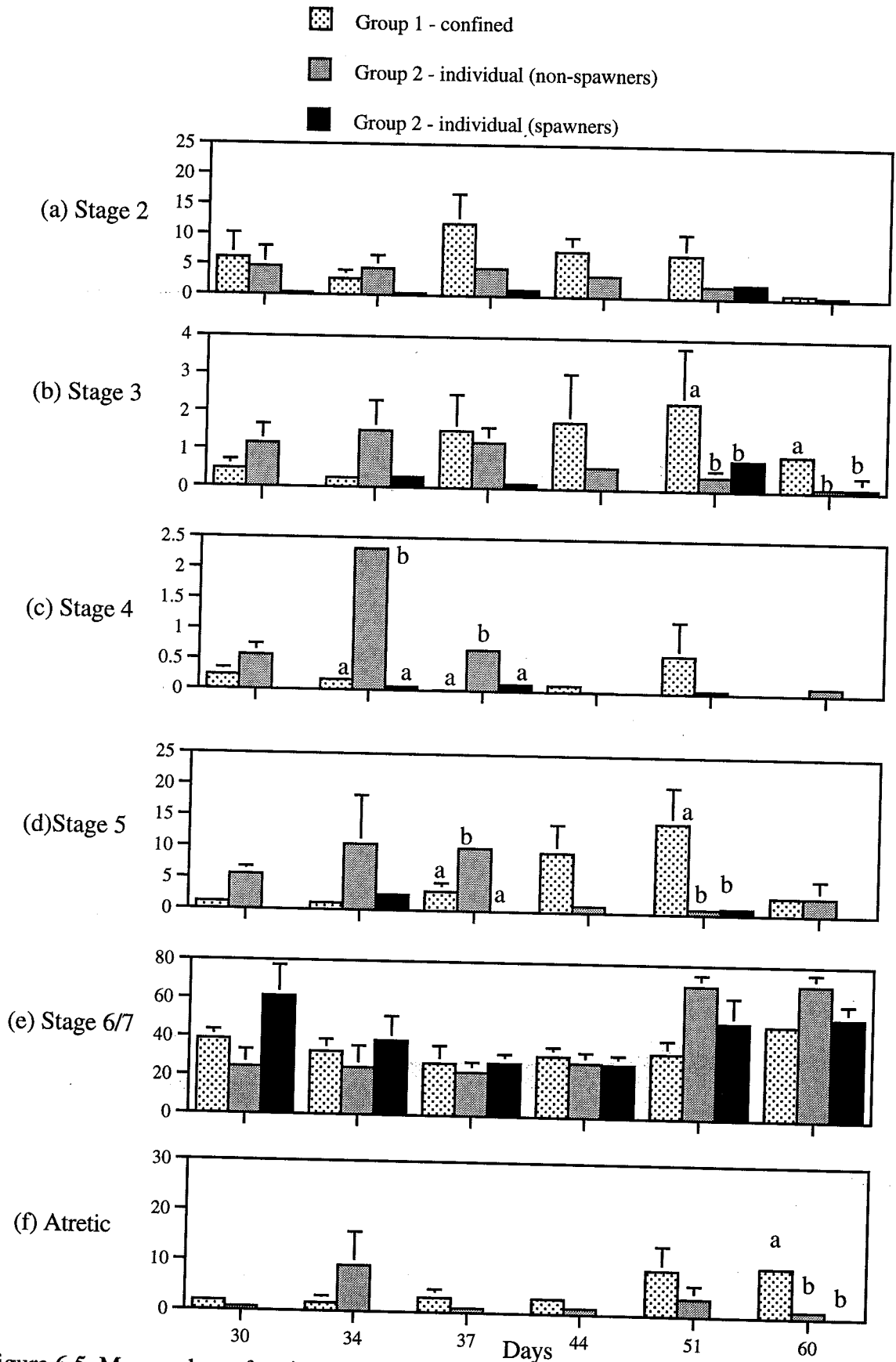

Figure 6.5. Mean volume fraction ($\% \pm \text{S.E.}$) of different oocyte stages in groups of *T. zillii* (strain 'B') between days 30 and 60 of Experiment 2. Group 1 ($n = 7$) remained confined throughout. Group 2 were transferred into individually-partitioned aquaria on day 30 and in this Figure have been sub-divided into non-spawning fish ($n = 5$) and spawning fish ($n = 2$). Significant differences ($p < 0.05$) between groups at a particular timepoint are indicated by annotation with different letters; otherwise differences are not significant ($p \geq 0.05$). Where the S.E. is not visible, it lies within the confines of the histogram.

crowded) on days 51, 60 and 65. No significant differences ($p \geq 0.05$) were detected however, between spawning and non-spawning fish from group 2 between days 30 and 60 (see Figure 6.5).

(f) Atretic oocytes - Atresia was only observed in late vitellogenic oocytes (i.e. stage 6/7 oocytes). Volume fraction of atretic oocytes varied from $0.68 \pm 0.21\%$ to $12.56 \pm 6.81\%$ (Figure 6.4). Throughout days 0 - 51 there was no significant difference in volume fraction of atretic oocytes ($p \geq 0.05$) between the 2 groups. However, the volume fraction in the group 1 fish (remaining crowded) was significantly higher ($p < 0.001$) than that of group 2 fish (in individual conditions) on day 60 and on day 65 (after return of group 2 to confinement). Significant differences ($p < 0.05$) were detected between spawning and non-spawning fish from group 2 between days 30 and 60 (see Figure 6.5); spawning fish either had extremely low proportions of atresia or none at all throughout this period.

(6.3.2.5) Regression analysis of steroid levels and oocyte stages.

Linear regression analysis revealed that the volume fraction of stage 5 oocytes was significantly related ($p < 0.05$) to circulating levels of both E_2 and T (equations 1 and 2 below), though r^2 was rather low. Volume fractions of other oocyte developmental stages were not found to be significantly related to the levels of either sex steroid ($p \geq 0.05$).

$$(1) \text{ Stage 5 (y) \& log}_{10}E_2 \text{ (x)} : y = 7.61 \log x + 0.68 \quad (r^2 = 0.27, p < 0.05)$$

$$(2) \text{ Stage 5 (y) \& log}_{10}T \text{ (x)} : y = 6.49 \log x - 4.72 \quad (r^2 = 0.32, p < 0.05)$$

(6.3.3) Summary of results.

(1) Whilst no significant differences were detected between mean weight of the two groups of fish throughout the entire 65 day experimental period, both groups appeared to lose weight during their respective periods in the confined holding tank. Mean weight of group 1 (remaining in the confined holding tank throughout), fell

steadily throughout the 65 day period. During the initial 30 day period of confinement (along with group 1), mean weight of group 2 also fell steadily but increased immediately after these fish were transferred into individually-partitioned aquaria. However, replacement back into the original confined holding tank (alongside group 1) on day 60 resulted in a further decrease in mean weight in this group.

(2) Confined conditions appeared to cause a suppression in mean circulating levels of both E₂ and T. During the initial 30 day period under confinement, fish in both group 1 and group 2 exhibited consistently low levels of mean circulating serum E₂ and T. No significant differences were detected between the 2 groups of fish during this period in terms of either E₂ or T. Both steroids rose sharply in group 2 however, following transfer into individually-partitioned aquaria on day 30. Just 4 days after transfer, mean levels of both E₂ and T were significantly higher than those of group 1 remaining under confinement. Levels of both steroids continued to rise, remaining significantly higher than group 1 to peak on day 44 (14 days after transfer). Throughout the remainder of the period in individual conditions E₂ fell steadily to levels that were consistently higher but not significantly different than group 1. Mean T however, was maintained at levels that were consistently and significantly higher than those of group 1. Return of group 2 to the confined holding tank (alongside group 1) was marked by a significant decrease in E₂ and a highly significant decrease in T to levels not significantly different than those of group 1.

(3) Stereological analysis of biopsied tissue failed to detect any significant differences ($p \geq 0.05$) between individual or confined groups in terms of the relative proportions of stage 2, stage 4 or stage 5 oocytes. Significantly higher ($p < 0.001$) proportions of stage 3 oocytes were found in individual fish 21 - 30 days after transfer coinciding with significantly higher ($p < 0.01$) proportions of stage 6/7 oocytes. Evidence also appears to suggest that confined fish suffered from a greater incidence of atresia as the period of confinement increased.

(4) Spawning was not observed by fish of either group experiencing confined conditions whilst spawning was observed in the group transferred into individually-

partitioned aquaria. During 65 days of observation no egg clutches were found in the holding tank indicating a total absence of oviposition from group 1 (throughout the 65 day period) and group 2 (from days 0 - 30 and days 60 - 65). Spawning was however observed in 2 of the 7 fish (28.6%) in group 2 upon transfer to individual conditions. Spawning occurred in 1 female just 4 days after transfer and in a second female 30 days after transfer.

(5) Significant relationships were found between the serum levels of both E₂ and T and the volume fraction of stage 5 oocytes (though r² was low).

(6.4) Experiment 3: The effect of visible contact with conspecifics and presence of spawning substrate on levels of circulating sex steroids and spawning incidence in previously confined female *T. zillii* (strain 'B') being transferred into individually-partitioned aquaria.

This study aimed to investigate the effect of spawning substrate and the effect of visual contact with conspecific males on circulating E₂ and T in previously-confined fish or being transferred into individually-partitioned aquaria. The previous experiment (Section 6.3) demonstrated that as confined fish are transferred into individual conditions both E₂ and T rise sharply, reaching a peak soon after transfer. There was a marked tendency for such fish to spawn within this period of time concurrent with rising levels of E₂ and T. The present experiment aims to confirm these previous findings using a larger number of fish and to investigate whether provision of a suitable spawning substrate or visual contact with males (or a combination of both) can in any way influence rising levels of E₂ and T and spawning performance of fish transferred to individual conditions. In order to increase sample size, stocks of *T. zillii* (strain 'A') were utilised in this study as stocks of *T. zillii* (strain 'B') were limited.

(6.4.1) Materials & methods.

Forty female *T. zillii* (strain 'A') (previously held under confined holding conditions for at least 1 month) were placed into a 114 x 114 x 42cm holding tank (System 1, see Section 2.1.2. and Appendix 1.1) along with 20 males of similar age and size (stocking density = ~20 kg/m³). Each female was surgically implanted with a passive electronic transponding tag as detailed in Section 2.2.2. At the time of stocking (day 0) each female was anaesthetized (Section 2.2.1), weighed (to the nearest 0.1g) and measured (to the nearest mm) (Section 2.4.1). Each female was then blood sampled (Section 2.3.1). Serum was obtained by allowing blood samples to clot at 4°C followed by centrifugation (Section 2.3.1). At this point females were randomly divided into 2 groups; group 1 (n = 20) and group 2 (n= 20). Following full recovery, fish were returned to the holding tank.

Each female was re-weighed, re-measured and a further blood sample taken at approximate 5 day intervals thereafter for a total of 35 days. Immediately after the day 35 samples were taken, group 1 was returned to the holding tank and group 2 randomly divided into 4 sub-groups; group 2a (n = 5), group 2b (n = 5) , group 2c (n = 5) and group 2d (n = 5). The 4 sub-groups of group 2 were then transferred into individually-partitioned glass aquaria (System 3, see Section 2.1.2. and Appendix 1.3.) arranged such that each sub-group experienced a differing regime in terms of provision of spawning substrate and/or visual contact with conspecific males (see guide below).

Sub-group	Spawning substrate ? (yes/no)	Visual contact with males ? (yes/no)
2a	yes	no
2b	yes	yes
2c	no	yes
2d	no	no

Where provision of a spawning substrate was required, the base of the glass aquaria was covered with 3 - 4cm of pre-washed inert coarse aquarium gravel. Aquaria

were individually-partitioned using opaque perspex dividers in order to prevent visual contact between adjacent females. In the case of groups 2b and 2c in which provision is made for visual contact with conspecific males, clear perspex dividers were used to partition tanks. In these instances conspecific males were removed from a separate holding tank not part of the present experiment and stocked in adjacent partitions either side of each female.

Sampling of both group 1 and group 2 continued at approximate 5 day intervals for a further 30 day period. Immediately after samples were taken on day 65, group 2 sub-groups were returned to the holding tank where group 1 had remained throughout. Sampling continued at approximate 5 day intervals for a further period of 30 days (total duration of experiment 95 days). A flow diagram of the sampling protocol and arrangement of sampling groups is given in Figure 6.6.

Serum T and E₂ were measured by radioimmunoassay as detailed in Section 2.7. Total serum calcium was also measured as detailed in Section 2.6 but data are not presented here owing to the findings of Chapter 5 (see brief explanation earlier in Experiment 2).

Throughout the experimental period, both the holding tank and the individually-partitioned aquaria were assessed daily for evidence of spawning (i.e. egg clutches adhered to tank base or sides). Total fecundity was determined from any observed spawn using the method described in Section 2.4.1. Feeding regime, photoperiod and temperature were maintained as described in Section 2.1.3.

Weight, length, E₂ and T data were statistically analysed using two-way ANOVA followed by multiple comparisons using the Bonferroni/Dunn test. Spawning data was analysed using one-way ANOVA.

(6.4.2.) Results.

All fish recovered well after anaesthesia and blood sampling and no mortalities were observed during the course of the experiment.

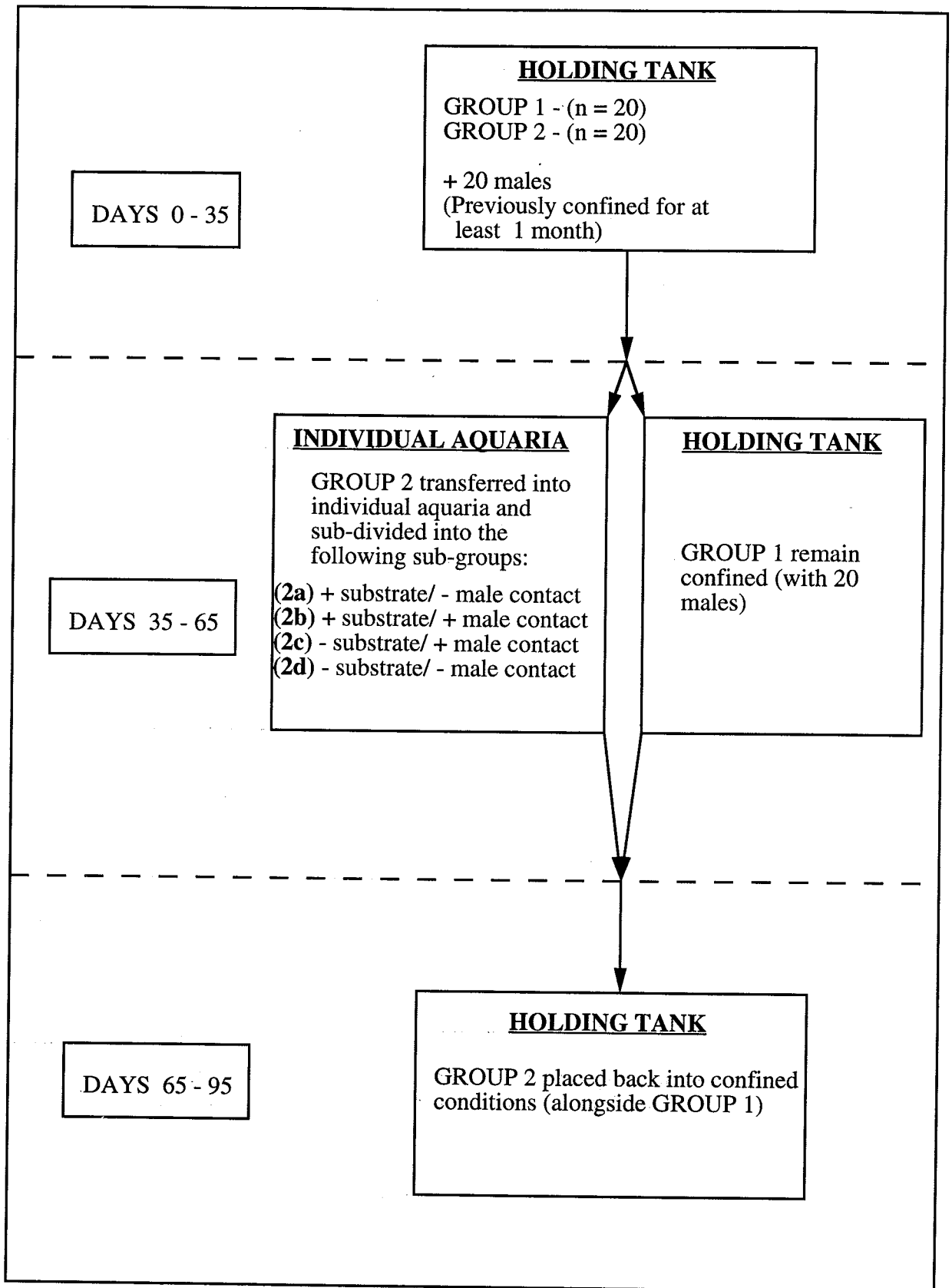

Figure 6.6. Flow diagram indicating the sampling protocol (and division of sampling groups) used in Experiment 3. Fish from each group were weighed, measured and blood sampled at approximate intervals of 5 days throughout the experiment.

(6.4.2.1) Weight and total length.

There was no significant difference in total length or weight between groups 1 and 2 at any timepoint throughout the experimental duration ($p \geq 0.05$). During confinement, mean fish weight tended to slowly decrease. Once transferred to individual aquaria however, mean weight increased. Such weight losses/gains were not, however, statistically significant ($p \geq 0.05$).

(6.4.2.2) Profiles of circulating E₂ and T levels.

(A) Comparison between groups 1 & 2 (pooled from sub-groups 2a - 2d) throughout entire 95 day period.

Profiles of mean circulating E₂ and T of group 1 and groups 2a - 2d (pooled) are given in Figure 6.7a and Figure 6.7b respectively.

(a) E₂ (refer to Figure 6.7a).

Throughout the entire 95 day period that group 1 remained under confinement in the holding tank, mean E₂ levels remained consistently low with only slight fluctuation ($0.73 \pm 0.10 - 2.48 \pm 0.25 \text{ ng/ml}$). Group 2 (data pooled from sub-groups 2a - 2d) however, exhibited quite large fluctuations ($0.72 \pm 0.20 - 5.67 \pm 0.90 \text{ ng/ml}$). During the first 35 days of the initial confinement period both groups exhibited consistently low but fluctuating levels of E₂ ($0.84 \pm 0.10 - 2.33 \pm 0.56 \text{ ng/ml}$). Small peaks of mean E₂ were observed in both groups on day 5 and then on day 25. No significant differences were however, observed between the 2 groups at any sampling timepoint ($p \geq 0.05$), though there were significant differences between different timepoints ($p < 0.001$) irrespective of grouping.

Transfer of group 2 fish into individually-partitioned aquaria on day 35 resulted in a significant rise ($p < 0.001$) in mean E₂ to a level (on day 40) that was significantly higher ($p < 0.001$) than that of group 1 remaining confined. Mean E₂ in group 2 fish then began to slowly fall, though remaining significantly higher than group 1 on day 45 ($p < 0.001$) and day 50 ($p < 0.05$). By day 55 E₂ levels in group 2 had fallen to levels

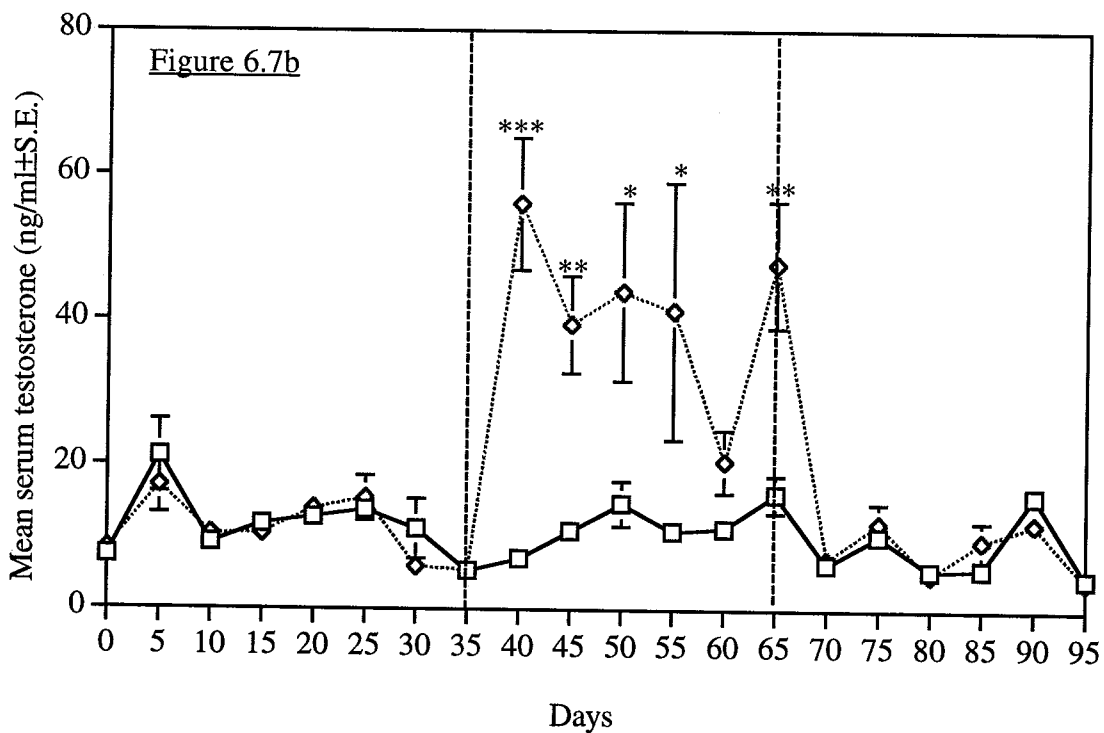
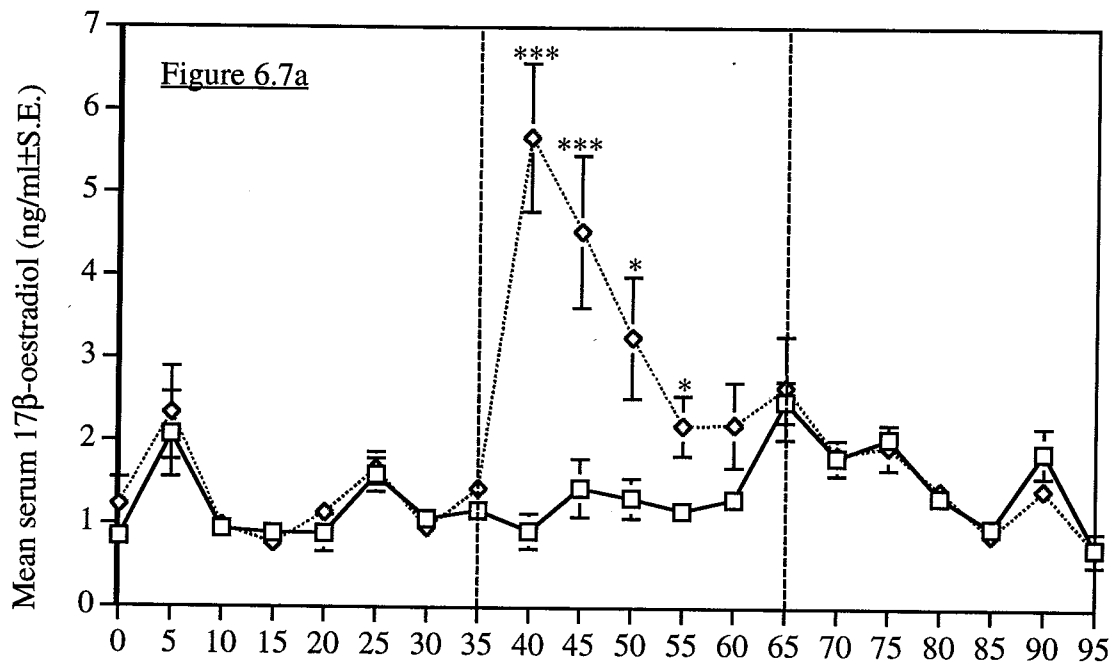

Figure 6.7. Profiles of mean (a) 17β-oestradiol and (b) testosterone (ng/ml±S.E.) in 2 groups of female *T. zillii* (strain 'A'). From day 0 - 35 both groups were confined in a holding tank containing 20 males. From day 35 - 65 group 1 remained confined whilst group 2 was transferred into individually-partitioned aquaria. Group 2 was returned to confinement (alongside group 1) on day 65 and maintained for a further period of 30 days (total experimental duration = 95 days). Differences between the two groups are not significant at any particular timepoint unless indicated by * ($p < 0.05$), ** ($p < 0.01$) or *** ($p < 0.001$). Where the S.E. bars are not visible, they lie within the confines of the symbol. Broken lines represent times of group 2 transfer.

that were not significantly different than those of group 1. There were no significant differences between the 2 groups over the remainder of the period in which group 2 were held individually (days 55 - 65).

When group 2 was divided into spawning and non-spawning fish (see Figure 6.8a) during the period of time held individually (days 35 - 65), it was found that mean E₂ was significantly higher in both group 2 non-spawners ($p < 0.001$) and group 2 spawners ($p < 0.001$) than group 1 which remained confined. Spawning fish from group 2 also exhibited higher ($p < 0.001$) E₂ levels than non-spawning fish during this period.

Following replacement of group 2 into the holding tank (alongside group 1) on day 65, mean levels of E₂ appeared to gradually fall in group 2 until day 85. E₂ then rose to a small peak (in both groups) on day 90. No significant differences ($p \geq 0.05$) were found between group 1 and group 2 at any of the timepoints during this period (days 65 - 95). Significant differences, however, were observed during this period between different timepoints irrespective of grouping ($p < 0.001$).

Removal of group 2 on day 35 (and replacement on day 65) did not cause any significant ($p \geq 0.05$) change in the E₂ levels of group 1 remaining in the holding tank.

(b) T (refer to Figure 6.7b, page 334).

Throughout the entire 95 day period that group 1 remained confined, mean T levels remained low with little variation ($4.52 \pm 0.47 - 16.02 \pm 2.56 \text{ ng/ml}$). Group 2 (data pooled from sub-groups 2a - 2d) however, exhibited quite marked fluctuations ($4.95 \pm 0.70 - 50.00 \pm 9.10 \text{ ng/ml}$).

During the first 35 days of initial confinement both groups exhibited consistently low levels of T with only small fluctuation ($5.45 \pm 1.01 - 21.22 \pm 5.01 \text{ ng/ml}$). A small peak of T was observed in both groups on day 5 (as with E₂). No significant differences were however, observed between the 2 groups at any timepoint during this period ($p \geq 0.05$), though significant differences were found between different timepoints ($p < 0.001$) irrespective of grouping.

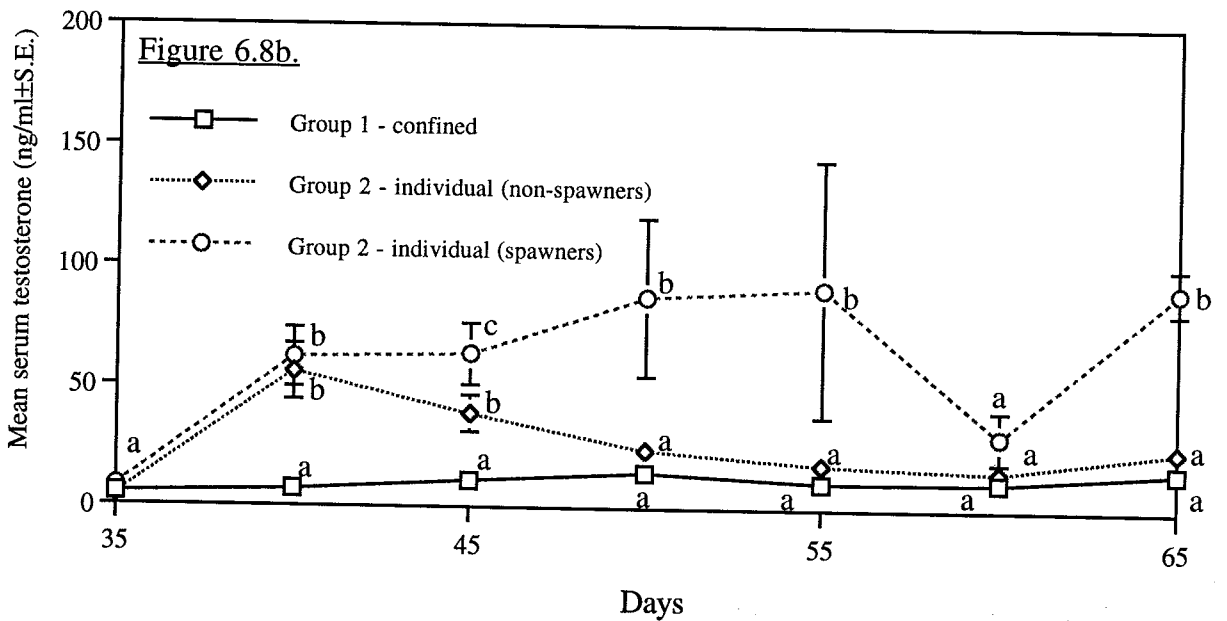
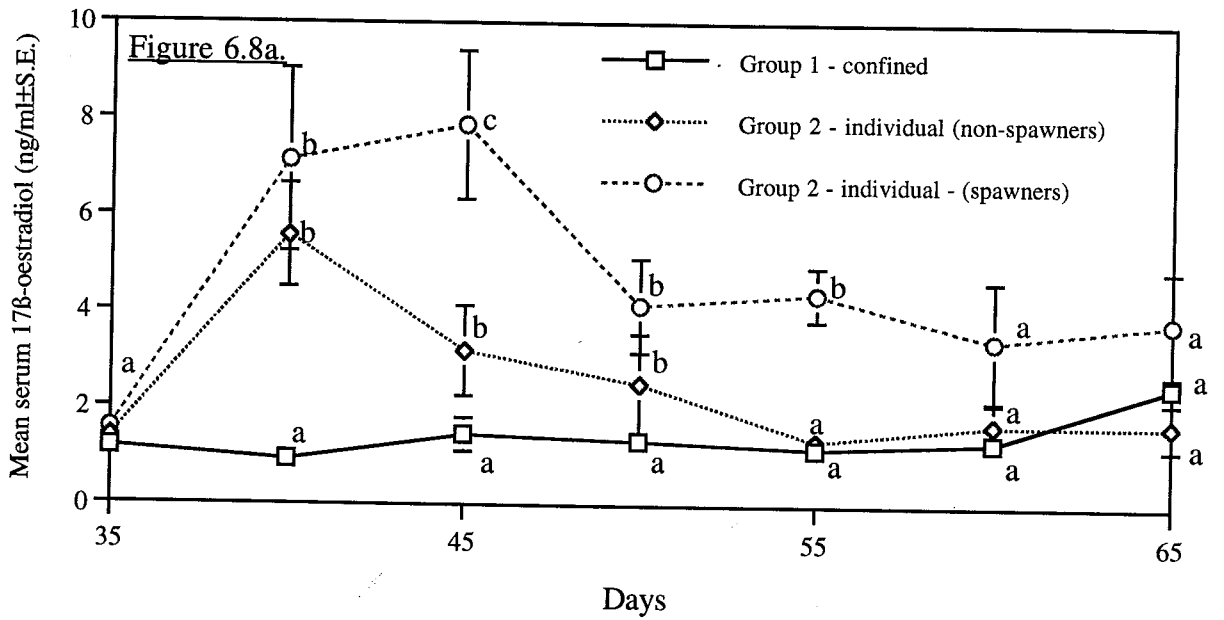

Figure 6.8. Profiles of mean (a) 17β -oestradiol and (b) testosterone (ng/ml±S.E.) in groups of *T. zillii* ('strain 'A') between days 36 and 65 of Experiment 3. Group 1 ($n = 20$) remained confined throughout. Group 2 were transferred into individual aquaria on day 35 and in this figure have been sub-divided into non-spawning fish ($n = 14$) and spawning fish ($n = 6$). Significant differences ($p < 0.05$) between groups at any given timepoint are indicated by annotation with different letters. Annotation with the same letter indicates no significant difference. Where no S.E. is visible, it lies within the confines of the symbol.

Transfer of group 2 fish into individually-partitioned aquaria on day 35 resulted in a significant rise ($p < 0.001$) in mean T to a level (on day 40) that was significantly higher ($p < 0.001$) than that of group 1 remaining confined. As with E₂, mean T in group 2 then gradually fell, though remaining significantly higher than group 1 on day 45 ($p < 0.01$), day 50 ($p < 0.05$) and day 55 ($p < 0.05$). By day 60 levels of T in group 2 had fallen to a level not significantly different than those of group 1 ($p \geq 0.05$), though T in group 2 then increased rapidly to a level (on day 65) significantly different than group 1 ($p < 0.01$).

When group 2 was sub-divided into spawning and non-spawning fish (see Figure 6.8b, page 336) during the period of time held individually (days 35 - 65), it was found that mean T was significantly higher in both group 2 non-spawners ($p < 0.001$) and group 2 spawners ($p < 0.001$) than group 1 which remained confined. Spawning fish from group 2 also exhibited significantly higher ($p < 0.001$) T levels than non-spawning fish during this period.

Replacement of group 2 into the holding tank on day 65 was accompanied by a significant ($p < 0.001$) fall in T to a level (on day 70) not significantly different than group 1 ($p \geq 0.05$). Throughout the remainder of this period (days 70 - 95) T remained consistently low in both groups with little variation though a small peak was observed in both groups on day 90 (as seen in E₂). There was however, no significant differences between group 1 or 2 ($p \geq 0.05$) at any timepoint during this period. Significant differences were observed however, during this period between different timepoints irrespective of grouping ($p < 0.001$).

Removal of group 2 on day 35 (and replacement on day 65) did not cause any significant ($p \geq 0.05$) change in the T levels of group 1 remaining in the holding tank.

(B) Effect of spawning substrate and visual contact with male conspecifics on serum levels of E₂ and T - comparison of group 2 sub-groups (2a - 2d) during days 35 - 65.

The effect of differing regimes of spawning substrate and/or visual contact with conspecific males on circulating levels of E₂ and T in group 2 sub-groups (2a - 2d)

during the period that group 2 were held individually (days 35 - 65) are shown in Figures 6.9a and 6.9b respectively. Since group 1 was compared with pooled group 2 data in (A) above, statistical analysis in this section relates to sub-groups 2a - 2d and does not involve group 1.

(a) E₂ (refer to Figure 6.9a).

ANOVA revealed no significant difference between the profiles of E₂ from sub-groups 2a - 2d ($p \geq 0.05$), though significant differences were detected between timepoints irrespective of grouping ($p < 0.01$).

Transfer into individual aquaria on day 35 was marked by a rapid increase in mean E₂ in each sub-group (2a - 2d). The largest increase was seen in sub-group 2c (no gravel but visual contact with males), where mean E₂ rose from 1.29 ± 0.01 ng/ml on day 35 (prior to transfer) to a peak of 10.84 ± 1.75 ng/ml by day 40 (5 days after transfer to individual conditions) that was significantly ($p < 0.05$) higher than that of sub-groups 2a (gravel but no visual contact with males) and 2d (no gravel, no visual contact with males) but not significantly different ($p \geq 0.05$) than sub-group 2b (gravel and visual contact with males). Whilst sub-groups 2a and 2b also exhibited peak levels of E₂ on day 40, E₂ was found to peak in sub-group 2d on day 45 (10 days after transfer to individual aquaria) at 6.87 ± 2.88 ng/ml, significantly higher than sub-group 2a, but not significantly different from sub-groups 2b or 2c. By day 50 there was no significant difference in E₂ between the sub-groups ($p \geq 0.05$), this trend continued throughout the remainder of the period in individual aquaria.

(b) T (refer to Figure 6.9b).

ANOVA revealed no significant difference between the profiles of T from sub-groups 2a - 2d ($p \geq 0.05$) or between timepoints irrespective of grouping ($p \geq 0.05$).

Figure 6.9. Profiles of mean (a) 17β -oestradiol and (b) testosterone (ng/ml \pm S.E.) in group 1 and sub-groups 2a - 2d from day 35 - 65 only. Group 1 remained confined throughout, whilst sub-groups 2a - 2d were transferred on day 35 to individually-partitioned aquaria such that each sub-group experienced differing regimes in terms of provision of spawning substrate and/or visual contact with male conspecifics. Sub-groups 2a - 2d were replaced back into confinement (alongside group 1) on day 65. Where S.E. bars are not visible, they lie within the confines of the symbol. (ns) indicates no significant difference between groups at a given timepoint. Data points annotated with the same letter are not significantly different from one another at that particular timepoint. Significant differences at a given timepoint are indicated by annotation with different letters.

Group 1 (n = 20): confined (□)

Group 2a (n = 5): + substrate/ - male (◇)

Group 2b (n = 5): + substrate/ + male (○)

Group 2c (n = 5): - substrate/ + male (△)

Group 2d (n = 5): - substrate/ - male (⊠)

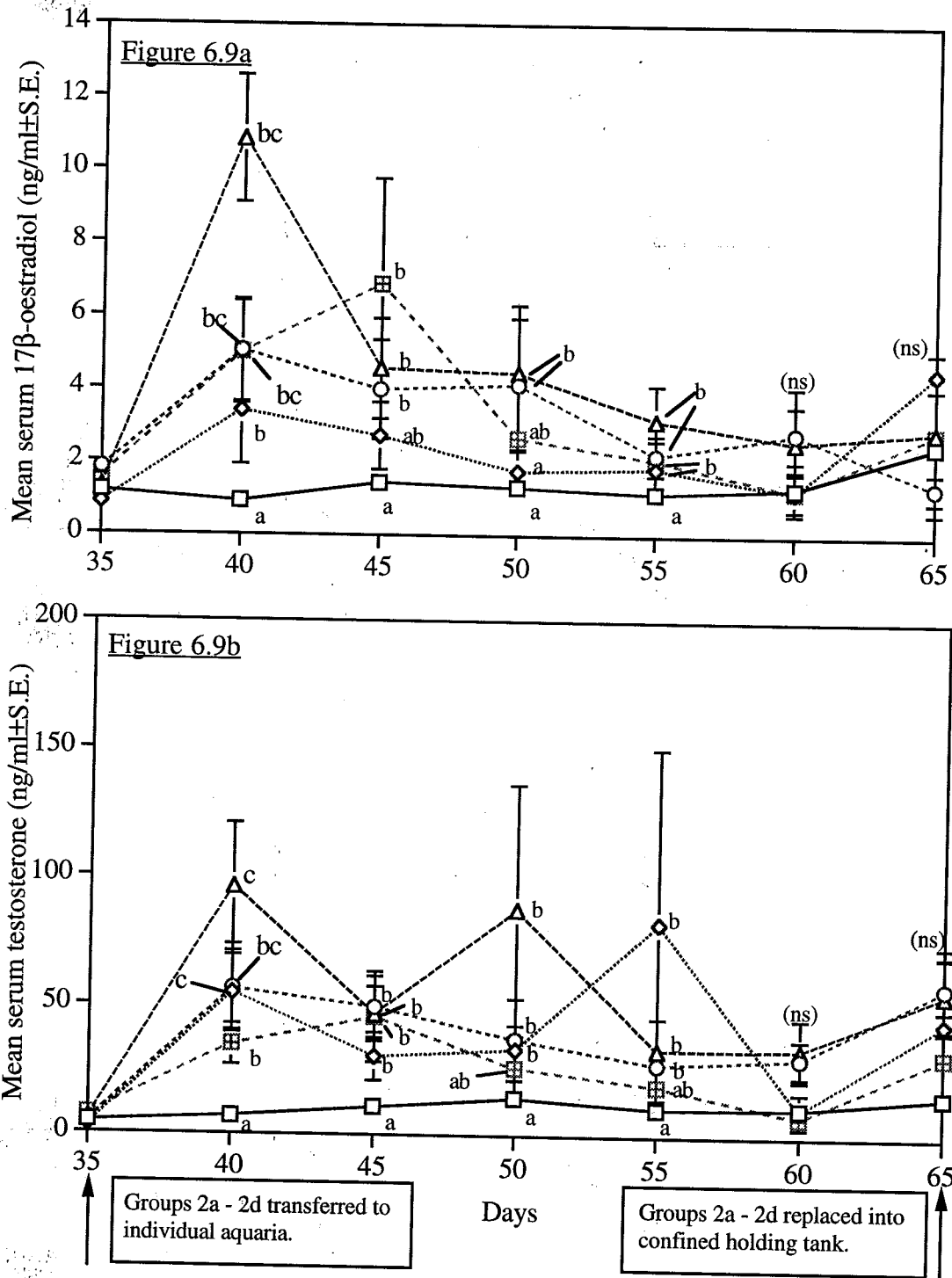

Figure 6.9. For legend see opposing page.

As with E₂, transfer to individual aquaria on day 35 was marked by an increase of mean T in each sub-group. The largest increase was seen in sub-group 2c (as with E₂) where T rose from 5.87±0.91ng/ml on day 35 (prior to transfer) to 95.97±24.98ng/ml on day 40 (5 days after transfer), though this level was not significantly different from those levels in sub-groups 2a, 2b or 2d. As in the case of E₂, levels of T in sub-group 2d peaked on day 45. Throughout the remainder of the period in individual aquaria, T fluctuated in each sub-group such that there was no significant difference between the sub-groups ($p \geq 0.05$) at any timepoint except on day 55 where sub-group 2a was significantly higher ($p < 0.05$) than 2d but not 2b or 2c ($p \geq 0.05$).

(6.4.2.3) Spawning incidence.

During 95 days of observation, no egg clutches were found in the holding tank indicating a total absence of oviposition from both group 1 (throughout the experiment) and group 2 (when held in holding tank, i.e. days 0 - 35 and days 65 - 95). Spawning was, however, observed in 6 of the 20 group 2 fish (30%) following their transfer to individually-partitioned aquaria. Four of these fish (67%) continued to re-spawn either once or twice during the period held individually. A total of 11 spawns were recorded by the 6 fish spawning during the 30 day period in individually-partitioned aquaria. Six of these spawns (55%) occurred within 10 days of transfer coincident with peak levels of E₂ and T. Spawning data for individual sub-groups (2a - 2d) are given in Table 6.3. Maximum number of spawns/group was observed in the sub-group 2c provided with visual contact with adjacent males but not spawning substrate. However, whilst there was no significant difference ($p \geq 0.05$) between sub-groups 2a - 2d in terms of mean number of spawns/fish during the period held individually, sub-group 2c (no substrate but visual contact with males) produced over twice the number of eggs as sub-group 2b

Table 6.3 Incidence of spawning activity in 4 sub-groups of *T. zillii* (strain 'A') (2a - 2d) whilst maintained individually for a period of 30 days. Each sub-group experienced a differing regime in terms of provision of spawning substrate and/or visual contact with male conspecifics.

Sub-group	Provision of suitable spawning substrate? (y/n)	Provision of visual contact with males? (y/n)	Fish Number	Spawns/fish	Time of spawn (no. days after transfer to individual tanks)	Cumulative total fecundity of spawns/sub-group
2a (n = 5)	yes	no	1	2	10, 21	4794 eggs
			2	0	-	
			3	0	-	
			4	0 (Mean=0.4)	-	
			5	0 (Total = 2)	-	
2b (n = 5)	yes	yes	1	2	3, 15	8407 eggs
			2	1	8	
			3	0	-	
			4	0 (Mean=0.6)	-	
			5	0 (Total = 3)	-	
2c (n = 5)	no	yes	1	3	8, 19, 29	16955 eggs
			2	1	8	
			3	0	-	
			4	0 (Mean=0.8)	-	
			5	0 (Total = 4)	-	
2d (n = 5)	no	no	1	2	6, 26	5250 eggs
			2	0	-	
			3	0	-	
			4	0 (Mean=0.4)	-	
			5	0 (Total = 2)	-	

and over 3 times the number of eggs produced by either sub-group 2a or sub-group 2b.

(6.4.3) Summary of results.

(1) During confinement, mean fish weight tended to slowly decrease. Once transferred into individual aquaria however, mean weight increased. Such weight losses/gains were not statistically significant.

(2) Confinement suppressed circulating levels of E₂ and T in female *T. zillii* (strain 'A') (as shown in strain 'B' in Experiment 2 earlier). During confinement, mean levels of E₂ and T remained low with little fluctuation. No significant differences were detected between the 2 experimental groups at any timepoint during periods of confinement. Transfer of group 2 into individually-partitioned aquaria on day 35 resulted in a significant rise in both steroids to peak levels that were significantly higher (on day 40, 5 days after transfer) than those of group 1 remaining confined in the holding tank. Both steroids in group 2 then fell steadily with time, though remaining significantly higher than group 1 levels until day 60 whereupon levels were not significantly different from group 1. No significant difference was detected in E₂ level between the 2 groups throughout the remainder of the period held individually. Replacement of group 2 back into the confined holding tank (alongside group 1) on day 65 was marked by a significant decrease in T to levels not significantly different than group 1. During the subsequent 30 day period of observation, both groups 1 and 2 exhibited a gradual decline in E₂ followed by a small peak on day 90. Levels of T during this period remained low with little variation though a small peak was seen in both groups on day 90 (as with E₂). No significant difference was detected between groups 1 and 2 with either steroid during this final 30 day period.

(3) Provision of spawning substrate or visual contact with male conspecifics (or a combination of both) had no significant effect on mean levels of E₂ and T in group 2 fish (sub-groups 2a - 2d) during a period of 30 days in individual-aquaria. E₂ rose immediately in each sub-group following transfer to individual aquaria on day 35

to reach a peak on either day 40 (sub-groups 2a, 2b and 2c) or on day 45 (sub-group 2d).

Initial peaks of E₂ were greatest in sub-group 2c (provided with visual contact with males but no spawning substrate). T also rose rapidly in each sub-group following transfer into individually-partitioned aquaria. Levels of mean T peaked in sub-groups 2b and 2c on day 40 (5 days after transfer) but did not peak until day 45 in sub-group 2d (as also observed with E₂) or day 55 in sub-group 2a.

(4) Spawning was only observed in the group transferred into individually-partitioned aquaria. Spawning occurred in 6 of the 20 (30%) fish in group 2 following transfer to individual aquaria on day 35. Four of these fish (67%) re-spawned either once or twice during the 30 day period held individually. A total of 11 spawns were recorded, 6 of these (55%) occurring within 10 days of transfer (coincident with initial peaks of E₂ and T). Provision of spawning substrate or visual contact with conspecific males (or a combination of both) did not significantly alter spawning performance during the 30 day period held individually though most spawns were recorded by the group provided with visual contact with males but no spawning substrate (also exhibiting higher levels of E₂ and T). Over the 30 day period held individually this group produced far more eggs than either of the other groups.

(6.5) Discussion.

The present study aimed to investigate the failure of substrate-spawning *T. zillii* (strains 'A' & 'B') to spawn when held in crowded holding tanks and the marked spawning activity (and improved spawning synchrony) evident when previously crowded fish were transferred into individual aquaria (Coward, unpublished). In observing similar results in a species of Xiphoridae, Borrowsky & Diffley (1981) concluded that stress may have resulted in an inhibition of spawning during crowding whilst a return to uncrowded conditions permitted its resumption. Relevant physiological mechanisms that may have accompanied these observations were however, neither investigated nor discussed.

In the present study, individually-held female *T. zillii* spawned successfully even in the absence of males, concurring with the observations of Aronson (1949), Marshall (1979) and Silverman (1978a) in other tilapiine species. It is thought that in the absence of male conspecifics, female tilapia may stimulate each other visually (Silverman, 1978a, b). Lee (1979) further reported that female tilapia in the same aquarium typically spawn at similar times and that this was attributable to mutual stimulation and inducement. In the present study, spawning females did appear to stimulate females in adjacent aquaria but only by making body colouration more intense. Spawning females did not typically induce adjacent females to spawn soon afterwards.

Neither presence of spawning-substrate nor visual contact with adjacent males (or a combination of both) significantly affected spawning incidence or circulating levels of T and E₂ in *T. zillii* following transfer from confinement to individual aquaria. Initial increases in E₂ and T seen during the first 15 days after transfer to individual aquaria from confinement were highest in fish allowed visual contact with a male but not provided with spawning substrate. This group of fish also produced far more eggs than any other group, although no significant difference was observed between the various groups in terms of mean spawns/fish during the observation period.

Under natural conditions, tilapias are known to construct nests or depressions in substrate prior to spawning (McKaye, 1984). However, since captive species of tilapia are mostly known to spawn successfully in the absence of substrate (Lowe-McConnell, 1959), Stacey (1984) suggested that spawning mechanisms of tilapia may be insensitive to substrate. Studies by Silverman (1978a) also proved that *O. mossambicus* can attain and maintain breeding condition in the absence of males such that ovulation and oviposition still occurs. In agreeing with these earlier observations, the present study also provides further evidence that neither the provision of substrate or visual contact with male conspecifics (or a combination of both) can significantly

alter spawning performance or circulating levels of E₂ or T in *T. zillii*, at least over the timespan investigated here.

Endoscopy proved to be an effective means of discriminating between different oocyte developmental stages without sacrifice of the fish and allowed the reproductive cycle of individual females to be followed closely *in vivo*. This technique was disadvantaged however, since quantification of data was not possible and oocyte size could not be accurately measured. Endoscopy did, however, allow discrimination between pre-vitellogenic, early and late-vitellogenic and atretic oocytes. Atretic oocytes appeared in the ovary as irregular-shaped brown patches. This agreed with the observations of Peters (1983) in *T. tholloni*, though Peters (1983) did not confirm his findings by histological analysis. These findings also agreed with those of Bromage & Cumaranatunga (1988) in rainbow trout. Endoscopic analysis revealed a marked similarity in ovarian condition amongst confined *T. zillii*. Ovaries of different fish appeared to contain similar proportions of different oocyte developmental stages. The reproductive cycles of confined fish thus appeared to be synchronised.

Sudden environmental change may improve spawning synchrony in tilapiines. Srisakultiew & Wee (1988) for example, reported improved spawning synchrony in *O. niloticus* that had been cold-shocked prior to stocking in spawning hapas. The basis of cold shocking is that oocyte maturation can be synchronised; cold shocking has been found to improve synchrony of spawning in *O. niloticus* in Israel though the level of synchrony and intensity of breeding breaks down as the breeding season progresses (Mires, 1982). Improved spawning synchrony (and frequency) in *O. niloticus* was also found to result from 'conditioning' broodstock prior to stocking in spawning tanks (Macintosh & Little, 1995). Fish were 'conditioned' in high density hapas suspended in pond water rich in natural food. During this period, fish fed intensively but did not reproduce since hierarchy formation was prevented due to the high stocking density and turbid conditions (Little, 1989). Similar conditioning periods were used by Guerrero & Guerrero (1985) to improve spawning synchrony in *O. niloticus*. Besides the improvement of spawning synchrony, conditioning *O. niloticus* prior to stocking in

spawning tanks also appeared to increase spawning frequency (Little *et al.*, 1993). *T. zillii*, confined in the present study, may have also been 'conditioned'. Feeding to satiation and the failure of fish to successfully defend sufficient territory may have prevented spawning and allowed ovarian cycles to become more synchronous. Transfer to individual aquaria would have allowed a resumption of territoriality and thus re-initiated spawning.

During thirty days of crowding (Experiment 2), stereological analysis of ovarian biopsies did not reveal any significant differences between the volume fractions of oocyte developmental stages of two groups of *T. zillii* (strain 'B'). Moreover, irrespective of grouping, volume fractions of developmental stages were not found to differ significantly from one sampling point to another, suggesting little change in ovarian development during this period. No significant differences were detected between either of the two groups at any point within the experiment in terms of stage 2, 4 or 5 oocytes. Significantly lower volume fractions of stage 3 oocytes were, however, detected in individual fish on days 51 and 60. This coincided with significantly higher volume fractions of stage 6/7 oocytes in these fish, which remained significantly higher than crowded fish thereafter. This appears to suggest that fish were preparing one batch of oocytes for spawning (stage 6/7 oocytes) whilst preparing a pool of pre-vitellogenic oocytes (stage 3) for recruitment into the ensuing spawning cycle.

By the end of the experiment, fish that had been crowded throughout were found to exhibit significantly higher volume fractions of atretic oocytes. This may imply that over-ripe or poor quality oocytes were being 'mopped-up' in large numbers due to the failure to spawn for some time or due to the failure to complete maturation. After long periods of conditioning at high density, the ovaries of *O. niloticus* have also been found to contain high proportions of atretic eggs (Little, personal communication); GSI was much greater than normal and ovaries were found to be very distended. Increased levels of follicular atresia (also in vitellogenic oocytes) were also found in the ovaries of wild-caught red gurnard *Chelidonichthys kumu* (Lesson & Garnot) confined

for up to 96 hours (Clearwater & Pankhurst, 1997). It has been suggested that levels of atresia in fish are linked to levels of GTH (gonadotropin) and E₂ (Anand & Sundararaj, 1974; Guraya, 1986). Perhaps then, the apparent prolonged suppression of E₂ in *T. zillii* may have contributed to the observed increase in atresia over the last ten days of prolonged crowding. Levels of GTH were not determined in the present study. Increasing levels of gonadal atresia have also been linked to stress (Billard *et al.*, 1981; Matsuyama *et al.*, 1988; Barton & Iwama, 1991).

Under crowded holding conditions, serum levels of E₂ and T showed little variation and appeared to be suppressed with levels of both steroids remaining consistently lower during crowding than those found in individually-cycling fish. Both steroids were found to increase dramatically after transfer to individual aquaria, peaking 5 or 14 days after transfer (in strain 'A' and strain 'B' respectively). Once fish were returned to crowded holding tanks, both steroids fell rapidly. Spawning was inhibited whilst fish were confined but occurred upon transfer to individual aquaria. Only 27% and 30% of fish transferred to individual aquaria in Experiments 2 and 3 respectively, spawned however, though it is possible that stress resulting from serial ovarian biopsy/blood sampling may have hindered spawning in others.

Sex steroids such as E₂ and T have several functions in the control of ovarian development. E₂ is particularly important in inducing hepatic production of vitellogenin (VTG), its release into circulation and its subsequent sequestration by developing oocytes (e.g. Selman & Wallace, 1989). T is believed to serve several functions, the most important being as an obligatory precursor to E₂. It is possible that during crowding, levels of these two steroids were suppressed and as a consequence prevented completion of vitellogenic growth. Transfer of crowded fish to individual aquaria coincided with rapidly increasing levels of both steroids, perhaps allowing resumption and completion of ovarian growth. Indeed, most spawns witnessed in Experiments (1) and (2) occurred within 10 days of transfer to individual aquaria coincident with high levels of E₂ and T.

The precise reason for the apparent suppression of E₂ and T in crowded *T. zillii* remains unclear. It is well known that stress can suppress reproduction in a variety of vertebrates. For example, humans (Collu *et al.*, 1984), the rat *Rattus rattus* (L.) (Hulse & Coleman, 1983), the Mongolian gerbil *Meriones unguiculatus* (L.) (Fenske, 1986), in birds such as the domestic chicken *Gallus domesticus* (L.) (Pettite & Etches, 1991), in reptiles such as the American alligator *Alligator mississippiensis* (Daudin) (Elsey *et al.*, 1990, 1991), in amphibians such as the bullfrog *Rana catesbiana* (Shaw) (Licht *et al.*, 1983) and in fish such as the brown trout (Pickering *et al.*, 1987) and rainbow trout (Carragher *et al.*, 1989; Pottinger & Pickering, 1990). It is also known that capture, handling and confinement can induce a stress response in several species of fish that involves elevation of plasma cortisol levels concomitant with a reduction of plasma oestrogens and androgens (Pickering *et al.*, 1987; Sumpter *et al.*, 1987; Carragher & Pankhurst, 1991; Safford & Thomas, 1991; Pankhurst & Dedual, 1994). In *O. mossambicus*, Foo & Lam (1993a, b) found that capture and confinement resulted in a significant rise in serum cortisol and that cortisol implants could retard ovarian growth. Recently, periods of confinement of up to 96 hours in duration (following capture from the wild) were found to significantly reduce plasma E₂ and T in red gurnard to levels comparable to post-spawning levels (Clearwater & Pankhurst, 1997). The physiological mechanisms underlying these suppressive effects remain unclear. It is now widely believed that corticosteroids such as cortisol, act at various levels of the hypothalamo-pituitary-gonadal axis (see Campbell *et al.*, 1992) and mediate inhibitory effects of stress upon reproduction through alterations in either the level of gonadotropin releasing hormones and/or gonadotropin levels and/or changes in gonadal steroidogenesis. A study by Pankhurst *et al.* (1995), however, claimed that the inhibitory effects of stress in teleosts are not necessarily mediated by cortisol or that they arise higher in the endocrine pathway than at the level of ovarian steroidogenesis.

It is unclear as to how much of an impact stress may have had in the experiments presented here. Serial blood sampling and ovarian biopsy are however, potentially stressful procedures and therefore a suppression of E₂ and T via a stress

mechanism cannot be ignored. That fish appeared to lose weight under crowded conditions does indeed suggest that fish may have been suffering from appetite loss, perhaps as a result of crowding stress. However, it is also conceivable that because of increased competition for food during crowding, stronger more competitive individuals fared better than less-dominant individuals. That variability in weight change appeared to be greater under confined conditions appears to support the fact that certain dominant fish exhibited a competitive advantage of more subordinate fish. However, the gain in weight of fish following transfer to individual aquaria despite experiencing identical feeding protocols to those fish remaining under confinement suggest that the weight-loss seen in crowded fish was not due to any stress from sampling techniques. High stocking densities for example, were found to promote mobilisation of triglyceride stores in brook char (Vijayan *et al.*, 1990) and both liver and muscle glycogenolysis in Indian catfish (Bloch) (Srivasta & Sahai, 1987). In a study of *T. zillii*, Schulze-Wiehenbrauk (1978) observed aerobic metabolism in water loaded with fish excreta. This concurred with the authors earlier work in which crowded fish were found to exhibit increased metabolism but decreased energy utilization. That several fish were observed to spawn in the present study (and exhibit rapidly increasing steroid levels) after transfer from crowded to individual conditions, suggests that stress *per se* is not likely to be the cause of sex steroid suppression.

A further explanation for the suppression of sex steroids and cessation of spawning activity in confined *T. zillii* is through a pheromonal mechanism. Pheromones have been reported to stimulate ovarian maturation and ovulation through the elevation of GTH levels in the goldfish (Stacey *et al.*, 1989) and to stimulate ovarian development in *O. mossambicus* (Silverman, 1978a, b). The maturational steroid 17α -hydroxy- 20β -dihydroxy-pregnen-3-one (17α - 20β -P) of the goldfish was found to significantly increase milt volume and GTH level in common carp and to function as a potent and specific olfactory stimulant with pheromonal actions in the goldfish (Stacey *et al.*, 1994; Sorensen *et al.*, 1995). The urine of sexually mature rainbow trout has also been shown to induce an increase of 17α - 20β -P, T and GTH II

in the blood of conspecifics (Scott *et al.*, 1994). Pheromones in fish are reviewed in detail in Stacey & Sorensen (1991). Conversely, pheromones may serve to repress reproduction during times of high population density as revealed for the brown trout (Brown, 1946), goldfish and common carp (Swingle, 1953) and the guppy (Rose, 1959). The potential impact of water-borne pheromones on broodstock within a closed recirculating system would also depend upon the design and carrying-capacity of the system concerned. It is not presently known whether tilapia utilise pheromones to control spawning. A recent study by Rocha & ReisHenriques (1996) however, detected high levels of conjugated steroids (including 17α - 20β -P) in the urine of *O. mossambicus* and suggested a possible pheromonal role in reproduction.

Recent improvements in the broodstock management of *O. niloticus* have focussed upon the conditioning of broodfish at high stocking densities prior to their stocking in spawning ponds, the removal of eggs from the mouths of brooding females and the exchange of broodfish (or spawned females only) with rested and conditioned fish (Macintosh & Little, 1995). The present study suggests that levels of serum sex steroids are important during the conditioning phase.

In summary, the present study has demonstrated that *T. zillii* fail to spawn when held in crowded holding tanks but spawn soon after transfer to individual aquaria. Serum levels of E₂ and T were suppressed during crowding but increased rapidly following transfer of fish to individual aquaria coincident with resumed spawning activity. Reduced levels of E₂ and T during crowding may not be sufficient to allow completion of vitellogenic growth. The mechanism resulting in suppression of E₂ and T is not known but a shift from sexual to schooling behaviour known to occur in tilapias during crowding (Balarin *et al.*, 1986; Falter & Debacker, 1988) coincides with reduced stimulation of the hypothalamo-pituitary-gonadal axis thereby influencing levels of gonadal sex steroids in the serum. That levels of serum GTH are also affected is likely but would require further study. It would also be interesting to investigate whether the level of suppression during confinement is strictly related to stocking density. The present study suggests that at least for the two densities tested here, that it

is not density dependent, as the levels of E₂ and T during confinement were similar in Experiments 2 and 3.

Chapter 7

Studies on the effect of reduced food ration on the reproductive physiology and endocrinology of female *T. zillii*.

(7) Studies on the effect of reduced food ration on the reproductive physiology and endocrinology of female *T. zillii*.

(7.1) General introduction.

This chapter investigates the effect of long term food restriction on various aspects of reproductive physiology and endocrinology in laboratory-held stocks of female *T. zillii* (strain 'A'). Most of the previous studies into tilapia nutrition have concentrated upon ration size, feeding frequency, diet formulation and diet supplementation and their respective effects upon growth and survival. Very few have investigated effects upon reproduction, particularly amongst the substrate-spawning genus. To date, nutritional studies of substrate-spawning tilapia such as *T. zillii* have been confined to general feeding ecology (e.g. Spataru, 1978; Khallaf & Alne-na-ei, 1987), feeding rates (e.g. Hauser, 1975; Legner & Murray, 1981) and diet formulation (Teshima *et al.*, 1978; Mazid *et al.*, 1979) and their respective effects upon growth and survival not reproduction. Moreover, many existing studies of nutrition and its interaction with reproduction upon tilapia were undertaken in outdoor tanks or ponds where dietary influences are difficult to quantify and separate from other environmental variables.

Fry supply can become a limiting factor in semi-intensive culture operations due to the inherent low fecundity of tilapias (Mires, 1982). As a result there is increasing emphasis to reduce maintenance costs (particularly feed costs) by adoption of appropriate husbandry practices such as (for example) restricted ration, by development of practical diets incorporating plant ingredients or by the evaluation of alternative protein sources other than fishmeal which over recent years has suffered from uncertain supply and rising costs. The influence of such practices on tilapia culture, particularly in terms of reproductive performance is not clearly understood.

Many existing studies of nutrition and its effect upon reproduction involve temperate fish such as the salmonids, particularly rainbow trout (e.g. Scott, 1962; Phillips *et al.*, 1964; Springate *et al.*, 1985; Bromage *et al.*, 1992) and the three-spined

stickleback (Wootton, 1973a, 1977; Wootton & Evans, 1976; Fletcher & Wootton, 1995). Studies of tropical species are less common and tend to be restricted to the convict cichlid (Townshend & Wootton, 1984, 1985; Smith & Wootton, 1995a) or the mouthbrooding genera of tilapia (e.g. Mironova, 1977; Santiago *et al.*, 1983, 1985; Wee & Tuan, 1988; Gunasekera *et al.*, 1995). Surprisingly, despite the continued increase in distribution and development of commercial tilapia culture to over 100 countries, available data concerning the effect of dietary quality and quantity on reproductive physiology remains sparse and exclusive to mouthbrooding genera. Moreover, much of the existing information was derived from field studies and not controlled laboratory investigations. Existing studies mostly concern the effect of feeding frequency and ration size (e.g. Natarajan & Jameson, 1984; Papoutsoglou & Voutsinos, 1988; Siraj *et al.*, 1988), diet formulation (Davis & Stickney, 1978; Wang *et al.*, 1985) or diet supplementation (e.g. Viola & Arieli, 1982; Santiago & Reyes, 1993; Shiau & Liang, 1994; Yousef *et al.*, 1994) upon growth rate, survival and food conversion ratio (FCR).

Results from these studies have shown that growth performance of tilapia fry is better if fish are fed frequently throughout the day so that they can browse on food over a prolonged period. This is because the tilapia gut is adapted to receive food in small amounts and to digest it slowly (Jauncey & Ross, 1982). For example, *Oreochromis spilurus* (Gunther) fry grew significantly better if the same daily ration was fed over 5 rather than 3 feeds (New *et al.*, 1984). The most commonly reported daily ration sizes for tilapia broodstock lie between 1% body weight/day (bw/day) (e.g. Santiago *et al.*, 1985) and 5% bw/day (e.g. Legendre & Ecoutin (1989). Macintosh & Little (1995) however, concluded that tilapia broodstock should be fed 2 - 3% bw/day or to appetite, the ration being provided over at least 3 feeds. In terms of dietary protein level, 25 - 30% crude protein is suggested as being optimum for tilapia broodfish (Macintosh & Little, 1995) whilst levels of 27 - 35% and 25% are required for growth of fry and juvenile tilapia respectively (Jauncey & Ross, 1982; Wee & Tuan, 1988; Luquet, 1991). Commercially-produced pelleted feeds are now used

routinely in tilapia culture, though little is known of the underlying nutrition of broodstock, particularly the relative importance of lipid, essential amino acid (EAA), vitamin or mineral requirements (Macintosh & Little, 1995).

There have been several investigations into the influence of diet formulation (i.e. protein and lipid content) on the reproduction of teleost fish, most notably in the case of temperate species. The relative influences of such factors on the reproduction of tilapia however, is less clear. Since the effect of diet formulation was not investigated in the present study, only a brief synopsis is given here. Increased dietary protein levels increased ovarian weight in the dwarf gourami *Colisa lalia* (Hamilton & Buchanan) (Landesman *et al.*, 1986). Phillips *et al.* (1964) investigated the influence of 3 diets comprising differing protein and calorie levels in the brown trout and found that fecundity was slightly higher amongst fish fed high protein/high calorie diets. Egg size and survival to hatching were inversely related to dietary protein/calorie level. The importance of these findings was however, difficult to interpret, since the diets differed also in other ingredients. Smith *et al.* (1979) also investigated the effect of protein/energy levels but in rainbow trout. Fish maintained upon high protein/high energy diets weighed more and produced a greater number of eggs/spawn. As with the study of Phillips *et al.* (1964) however, the test diets used by Smith *et al.* (1979) also varied in other ingredients. Subsequent studies found that a reduction in protein level to 28% resulted in decreased growth and a reduction in egg size & egg hatchability (Watanabe *et al.*, 1984). Roley (1985) observed that rainbow trout fed diets containing 27 & 37% protein weighed significantly less at spawning than fish fed diets containing 47% and 56% protein. Total fecundity and egg diameter were highest in fish fed a 47% protein diet but relationships were not significant. More recently Washburn *et al.* (1990) investigated the effect of dietary treatment (protein/carbohydrate level) upon rainbow trout and observed that although egg composition did not differ amongst treatments, eggs from fish fed low protein/intermediate diets had significantly higher relative fecundity and survival to eyed-stage. From these studies upon rainbow trout it

appears that dietary protein and energy levels in broodstock diets do influence reproduction and do so primarily through the effects on fish weight at first spawning.

By far the most extensively studied aspect of tilapia broodstock nutrition is the influence of protein level. Santiago *et al.* (1983) and Cisse (1988) found spawning frequency in *O. niloticus* and *S. melanotheron* to increase as crude protein level increased from 20 - 50%; fecundity was unaffected. Better growth was observed at the higher protein levels. In *O. mossambicus*, levels of 30% and 40% protein resulted in earlier maturity and spawning compared to diets containing 20% and 50%. Diets containing 30% protein yielded the most number of eggs/spawn (though of a smaller size) whilst diets containing higher protein levels (40% and 50%) produced fewer but larger eggs (Vasudevan & Jayaprakas, 1992). More recently, *O. niloticus* fed high protein levels were found to reach puberty earlier with oocytes growing and maturing faster than fish fed diets containing lower levels of protein. When onset of puberty and oocyte maturation rate were evaluated in relation to fish size though, there were no significant differences amongst test diets indicating that dietary protein may have influenced oocyte growth and puberty merely through its effect upon growth. The chemical composition of eggs did not differ between diets (Gunasekera *et al.*, 1995).

Interest in the influence of dietary lipid content on reproduction is growing. Yu *et al.* (1979) investigated the effect of feeding rainbow trout purified diets over 34 months containing 1% ethyl linolenate plus 1% ethyl linoleate or 1.5% ethyl linoleate. Egg size and fecundity were similar between the two groups suggesting that n-3 fatty acids support normal reproduction and that n-6 fatty acids are unnecessary. Hardy (1985) and Watanabe *et al.* (1984) claimed that liposoluble vitamins and fatty acids are indeed necessary for normal reproduction but n-6 fatty acids play more of an important role in juvenile fish. Watanabe *et al.* (1985) further claimed that rainbow trout broodstock may well have some requirement for n-6 fatty acids and that large chain fatty acids may contribute towards egg quality. Studies on rainbow trout showed that fecundity and the costs of egg production were optimised by the use of diets containing 7 - 12% gross fat (Jones & Bromage, unpublished, cited in Bromage *et al.*, 1992).

Little is known of lipid nutrition and its influence on tilapia reproduction. A study by (Santiago & Reyes, 1993) however, found that the number of females spawning, spawning frequency, total fry production and number of fry/spawn were increased by supplementation of diets with various lipid sources (soybean oil, corn oil, coconut oil) with the exception of cod liver oil. Fish fed soybean oil diets gave the best overall reproductive performance.

The effect of dietary vitamins and minerals upon tilapia reproduction remains unclear though addition of dietary ascorbic acid was found to improve hatchability and fry quality in *O. mossambicus* (Soliman *et al.*, 1986). In rainbow trout, α -tocopherol (King *et al.*, 1985) and ascorbic acid (Sandnes *et al.*, 1984; Soliman *et al.*, 1986; Dabrowski & Blom, 1994; Dabrowski *et al.*, 1995; Blom & Dabrowski, 1996) have been shown to be particularly important in terms of reproduction. Ascorbic acid deficiency in diets given over several months prior to spawning considerably depleted ascorbic acid reserves of rainbow trout eggs (Dabrowski & Blom, 1994). Ascorbic acid also appeared to influence production of steroids such as testosterone in the rainbow trout (Dabrowski *et al.*, 1995) and to protect hatched fry against mortality (Blom & Dabrowski, 1996). Hardy (1985) concluded that increasing dietary vitamins and trace elements from deficient to adequate dietary levels can influence the composition of eggs and thus egg quality but further dietary supplementation did not offer any additional advantage and may indeed reduce egg survival (particularly in the case of fat soluble vitamins).

Most studies investigating the influence of food ration size and reproduction in teleosts concern rainbow trout (e.g. Scott, 1962; Phillips *et al.*, 1964; Springate *et al.*, 1985; Jones & Bromage, 1987; Bromage *et al.*, 1992) and the three-spined stickleback (Wootton, 1973a, 1977; Wootton & Evans, 1976; Fletcher & Wootton, 1995). Other species that have received more limited attention include the viviparous guppy (Hester, 1964), winter flounder (Tyler & Dunn, 1976), haddock *Melanogrammus aeglefinus* (L.) (Hislop *et al.*, 1978) and plaice *Pleuronectes platessa* (L.) (Horwood *et al.*, 1989).

Scott (1962) found that when rainbow trout experienced a shortage of food then fecundity and the percentage of females spawning decreased although there were no differences between wet weights of intra-ovarian eggs of fish on different diets. Similarly, in brown trout Bagenal (1969) also found that a reduction in food supply resulted in a corresponding reduction in fecundity and the percentage of females spawning but also found that the dry weights of intra-ovarian eggs of low ration fish were significantly higher than high ration fish. Kato (1975, 1978) further reported similar results to those of Scott (1962) and Bagenal (1969) in the kokanee salmon *Oncorhynchus nerka* (Walbaum). In studying the effect of ration size on rainbow trout, Cumaranatunga (1985) observed that a reduction in food intake increased the numbers of atretic oocytes, delayed oocyte recruitment into vitellogenesis, decreased fecundity and reduced the sizes of both developing oocytes and ovulated eggs. Springate *et al.* (1985) also found that ration size had an effect upon the timing of reproduction in rainbow trout and the number, size and quality of eggs; a 22% drop in fecundity was observed in low ration fish. Jones & Bromage (1987) investigated the effects of feeding rainbow trout at 0.4 - 1.5% bw/day and found that at 0.4% and 0.75% bw/day broodfish produced significantly fewer eggs than those fed at higher levels even after statistical allowance for large differences in fish size. Total egg volume also showed parallel reductions on the 2 lower rations. Mean egg size was found to be generally larger for fish on higher rations.

In the three-spined stickleback, the percentage of spawning fish and the number of eggs produced increased with increasing ration size (Wootton, 1973a) but a relationship between food intake and egg dry weight was not detected. Fish fed on the highest food level spawned at shorter intervals than fish at lower levels. In a further study of sticklebacks, Wootton (1977) found that the number of spawns and total egg production were a function of ration level and that egg production/spawn was not a function of ration level but positively related to female weight. Inter-spawn-interval however was negatively related to ration level. More recently Fletcher & Wootton (1995) found that ration variation in sticklebacks did not alter the protein and lipid

content of eggs and that egg size increased with increasing ration size but not directly proportional to the increase in ration. Rate of spawning, total breeding season fecundity and total weight of eggs spawned over a breeding season were sensitive to ration with fecundity and weight increasing proportional to ration. In haddock, feeding level and egg production were found to be positively correlated; egg dry weight was lower and fewer fish spawned amongst low ration fish (Hislop *et al.*, 1978). In plaice, Horwood *et al.* (1989) found that whilst all high ration fish produced granular oocytes, only 39% of low ration fish did so. In the guppy, food limitation affected the number of offspring produced during three gestation cycles. A restriction in food supply during a cycle reduced the number of young born in both that cycle and the next. Food limitation appeared to restrict oocyte recruitment into a stage at which they could be fertilised but did not reduce the size of newborn fish nor alter the period separating successive births (Hester, 1964). Variation in food quantity can also influence propagule size in guppies (Reznick & Yang, 1983).

The mechanisms through which food limitation may affect fecundity has been the source of much debate. Field observations by Vladykov (1956) and Wydoski & Cooper (1966) on brook trout led these authors to believe that low fecundity was linked to low food supply via increased oocyte resorption (atresia). Henderson (1963), however, argued that the levels of atresia in this species were too low to account for any change in fecundity. Bagenal (1969) and de Vlaming (1971), working with brown trout and an estuarine goby respectively, also concluded that atresia plays little part in reducing fecundity at low ration levels. Rather, results suggested that the controlling mechanism was a reduction in oocyte recruitment. Robb (1982) also claimed that reduced fecundity in low rationed haddock was the result of modification in the recruitment of oocytes into vitellogenesis. Townshend & Wootton (1984) also suggested that low ration levels affected not only the rate of recruitment of vitellogenic oocytes but also the rate of atresia in the convict cichlid. Literature suggests that there are several ways in which fecundity in fish may be influenced; firstly through the extent of oogonial proliferation, through modification of the rate of recruitment of pre-

vitellogenic oocytes (stages 1, 2, 3) and in turn cortical alveolar oocytes (stage 4) into vitellogenesis or through atresia (Springate *et al.*, 1985; Bromage & Cumaranatunga, 1988; Bromage *et al.*, 1992). Following food limitation, up to 22% of the total number of vitellogenic oocytes may become atretic (Springate *et al.*, 1985) and during starvation, 100% of vitellogenic oocytes may undergo atresia (Bromage & Cumaranatunga, 1988).

Little is known of how ration size may affect the reproductive performance of tilapia broodstock, though the results of a study on *O. mossambicus* by Mironova (1977) yielded results that suggested that reproduction was apparently stimulated by a restriction in food ration size. This is of immense interest considering the current need to reduce maintenance costs of tilapia broodstock. Although a restriction in ration resulted in growth limitation (as would be expected) and whilst fecundity (number of eggs/spawn) was reduced, frequency of spawning, the total number of eggs produced and the proportion of energy allocated for egg production was increased. Whether a restriction in food ration would have similar effects on substrate-spawning tilapia is unknown and has yet to be investigated. The relationship between food supply and reproduction in another substrate-spawning cichlid, the convict cichlid has, however been investigated by Townshend & Wootton (1984, 1985). Reductions of fecundity were found to occur in this species on low and medium ration levels. Egg size and inter-spawn-interval (ISI) were found to be positively and inversely related to ration size respectively. A reduction in the proportion of oocytes that became vitellogenic was also observed in low ration groups (Townshend & Wootton, 1984). Ration level was also found to influence parental behaviour in this species, suggesting that the allocation of time and effort between parental and maintenance activities are related to the supply of food (Townshend & Wootton, 1985). Time spent fanning egg clutches by females was positively related to ration whilst males on high ration spent slightly more time fanning than those on lower rations. No significant effect of ration levels were observed on the frequency of 'mouthing' eggs and young or on intra-pair aggression. Moreover the eggs of low ration fish hatched earlier than those on other rations though

no differences were observed in terms of post-hatch survival (Townshend & Wootton, 1985). Similarly, food ration has been found to affect the parental behaviour of male sticklebacks (Stanley & Wootton, 1986). Territorial and nest-building behaviour and time spent fanning eggs were all affected by food ration.

It is important to remember that the nutritional requirements of female tilapia may be affected by their mode of reproduction. This is particularly emphasised in the case of the mouthbrooding genera *Oreochromis* & *Sarotherodon* spp. where females deprive themselves of food throughout oral incubation of fry. This can often lead to short feeding periods between broods resulting in the necessity for females to feed voraciously to regain body composition and energy for the ensuing reproductive cycle. Similar periods of non-feeding during the incubation phase are found in other cichlids such as the midas cichlid *Cichlasoma citrinellum* (Gunther) (McKaye, 1984) and the pearlspot *Etroplus suratensis* (Bloch) (Ward & Samarakoon, 1981). Female *O. mossambicus* consume up to 40% of their body weight in pelleted feed within a 48 hour period following release of previously incubated fry (Macintosh, unpublished, cited in Macintosh & Little, 1995).

Data concerning the effect of food ration and its effect upon ovarian histology and reproductive endocrinology is also very limited in both tilapia and other teleosts. In rainbow trout, Washburn *et al.* (1990) suggested the existence of a possible relationship between oestrogens, carbohydrate metabolism and reproductive performance; a general inverse relationship between glucose & vitellogenin level was observed. In largemouth bass, Roseblum *et al.* (1991) raised fish on either forage or pelleted diets. Pellet fed fish were found to have a significantly higher GSI and whilst no differences were found in terms of testosterone (T) level, differences were found between forage and pellet fed fish in terms of 17 β -oestradiol (E₂) levels. *In vitro* work suggested that although ovaries from pellet fed fish had lower basal T and E₂ secretion, they were more responsive to gonadotropin (GTH) stimulation and produced more E₂ than forage-fed tissues. A further study by Springate *et al.* (1985) found significantly lower serum levels of vitellogenin and T in low ration rainbow trout and that alteration

may be related to reduction in the size and the number of eggs produced. Nothing is known of whether alterations in food supply could influence endocrinology in tilapias.

Only Cumaranatunga & Thabrew (1990) have investigated possible links between food supply and ovarian histology in tilapia. In investigating the effect of substituting fish meal in *O. niloticus* broodstock diets for a legume *Vigna catiang* it was found that fish meal had an enhanced effect upon the growth and maturation of vitellogenic oocytes when compared to legume diets. Studies into the effects of nutrition on ovarian histology in other species appear to be confined to rainbow trout (Cumaranatunga, 1985; Springate *et al.*, 1985), winter flounder (Tyler & Dunn, 1976), plaice (Horwood *et al.*, 1989) and the convict cichlid (Townshend & Wootton, 1984).

The aim of this chapter was to investigate the effects of long-term food restriction on the reproductive physiology and endocrinology of female *T. zillii*. Previous studies on nutrition and reproduction in tilapia have been conducted over only short time periods. The present study aimed to particularly investigate the effect of long term food rationing on ovarian histology and associated sex steroid levels.

(7.2) Experiment 1: The effect of two food ration levels on the growth and early survival of laboratory-held *T. zillii* stocks.

This experiment aimed to produce stocks of male and female *T. zillii* that had been subject to long-term food rationing that could be used as a stock of high and low rationed fish for use in subsequent experiments. Fish were rationed from first feeding (end of yolk sac - EYS) for several months until they could be used in subsequent physiological experiments. Owing to a lack of tank space, only two ration levels (high and low) could be provided, with 2 duplicate tanks of each rationed stock.

(7.2.1) Materials & methods.

Five female *T. zillii* (strain 'A') were induced to spawn by an intramuscular injection (750 I.U./kg) of hCG (human chorionic gonadotropin, Sigma Chemicals, U.K.) given at approximately 2pm. Three females spawned at approximately 11am the

next morning. Each female was stripped as detailed in Section 2.2.3 and the eggs pooled in a large petri-dish. Eggs were fertilised with milt pooled from 3 males and were allowed to adhere to perspex sheets as detailed in Section 2.2.3. Plates were then placed into recirculating incubators (see Rana, 1986) supplied with U.V. sterilised water until fry were at first feeding stage (end of yolk-sac stage). This took approximately 4 - 5 days. Fry were then randomly divided into 4 groups (~190 fry/group); group 1 & 2 (duplicate high ration) and group 3 & 4 (duplicate low ration). Each group was placed into a pre-cleaned 42 x 26 x 30 cm (20 litre capacity, inflow = 0.5 - 1 litre/min) perspex tank forming part of a recirculating fry system. Outflow pipes were protected with fine mesh to avoid loss of fry. Fry were allowed to acclimatise for 24 hours prior to any further interference.

Two groups of 10 fry from each tank were sacrificed and weighed to the nearest 0.0001g. This data was used to calculate the average initial weight of fry per treatment tank. Initial high ration was set at 40% bw/day and initial low ration at 10% bw/day (Macintosh, personal communication). These ration levels were similar to those used by Macintosh & De Silva (1984) in a similar study of early growth and survival in *O. mossambicus* and *O. niloticus* x *O. aureus* hybrids. Ration levels were altered as necessary over the course of fry development. Alterations to rations were made when large amounts of excess (uneaten) food was observed in treatment tanks. On these occasions, fish in the high-ration tanks were fed to satiation 3 times during a 24 hour period; this providing an indication of the new high ration size to be allocated. Low ration groups were fed no more than 50% of the ration given to high ration groups.

Food rations for each treatment tank were weighed out in advance in 10 day quantities. Rations were initially provided by grinding commercial pelleted trout feed ('Fry 02 granules' - see Appendix 1.4) to a suitable particle size (initially 250 - 500µm). Particle and pellet size were gradually increased as fish grew. Daily rations were provided to each treatment group 3 times daily. Faeces and excess food were siphoned from each tank twice daily. Any mortalities were removed as soon as discovered and rations altered accordingly. Every 10 days, 2 groups of at least 10 fry

from each treatment group were re-weighed and the daily ration altered. To minimize damage/stress to young fry, batches of 10 fry were weighed in a pre-weighed beaker of water. Once fish in each group had grown to a weight of approximately 5g, the 10 day weighings were made by weighing fish individually to the nearest 0.01g. Due to the fragility of young fry, measurements of length were not taken.

Every 30 days, the true number of fish remaining in each treatment tank was ascertained by counting manually. This was to avoid relying merely upon the presence of carcasses as an indicator of mortality. It was assumed that a degree of cannibalism may occur and would thus lead to over-estimations of population size in each tank. Once deemed large enough, fry were transferred into a second recirculating aquarium system (System 2 incorporating 50 x 38 x 41 cm 'bucket' type tanks - see Section 2.1.2) and finally into a third recirculating system (System 1, incorporating 114 x 114 x 42 cm tanks - see Section 2.1.2). Water temperature and photoperiod in all maintenance aquaria were as detailed in Section 2.1.3. Rationing was maintained for a total of 290 days whereupon a series of physiological experiments were commenced. Thus growth data are only provided up to day 290 here. Rationing of the 4 treatment groups was, however, continued so as to provide a stock of rationed fish for Experiments 2, 3, and 4. Growth data of rationed fish used in each subsequent experiment are provided with the relevant experiment. Specific growth rate (SGR), the instantaneous rate of growth per unit weight over a defined period of time and food conversion ratio (FCR) were calculated using equations (1) and (2) respectively (see below):

$$(1) SGR = \frac{\text{LOG}_E W_2 - \text{LOG}_E W_1}{T} \cdot 100$$

Where W_1 = initial weight (g), W_2 = final weight (g) and T = duration (days).

$$(2) FCR = \frac{TFI}{B_F - B_I}$$

Where TFI = total food intake, BF = final wet biomass and BI = initial wet biomass.

(7.2.2) Results.

(1) Fish growth (Figure 7.1).

Fish weights for each ration-level were pooled from the two respective duplicate tanks. This was because, at each ration-level, duplicate tanks were not significantly different ($p \geq 0.05$) from one another in terms of mean fish weight.

Mean fry weight was significantly ($p < 0.001$) higher in the high ration group when compared to the low ration group. Fish on high ration grew from 0.0022 ± 0.0002 g (on day 0) to $72.6 \text{g} \pm 7.2$ (by day 290) whilst fish on low ration grew from 0.0023 ± 0.0002 g (on day 0) to 16.7 ± 2.5 g. Differences in mean individual fish weight were not significant ($p \geq 0.05$) between the two ration levels until day 180. Thereafter however, fish maintained upon high ration size were consistently larger ($p < 0.05$ or $p < 0.01$ or $p < 0.001$) than fish on low ration levels.

(2) Mortality (Figure 7.2).

Generally, mortality was lower in fish maintained on higher ration levels with approximately 60% mortality observed in group 1 over the course of 290 days compared to approximately 86% and 88% in low ration groups 3 and 4 respectively. Owing to a aquarium fault, all fish in group 2 (high ration) were lost on day 170. Mortality in both high and low ration groups was most pronounced during the first 90 days of the experiment (particularly during the first 30 days) but much reduced thereafter. Losses during the first 30 days were particularly high in the case of both low ration groups. During the first 30 days, observed mortality (recovery of carcasses from experimental tanks) appeared to closely match actual mortality (calculated from counts of remaining live fish). Thereafter, actual mortality (in both high and low rationed groups) consistently exceeded observed mortality. Actual mortality was approximately

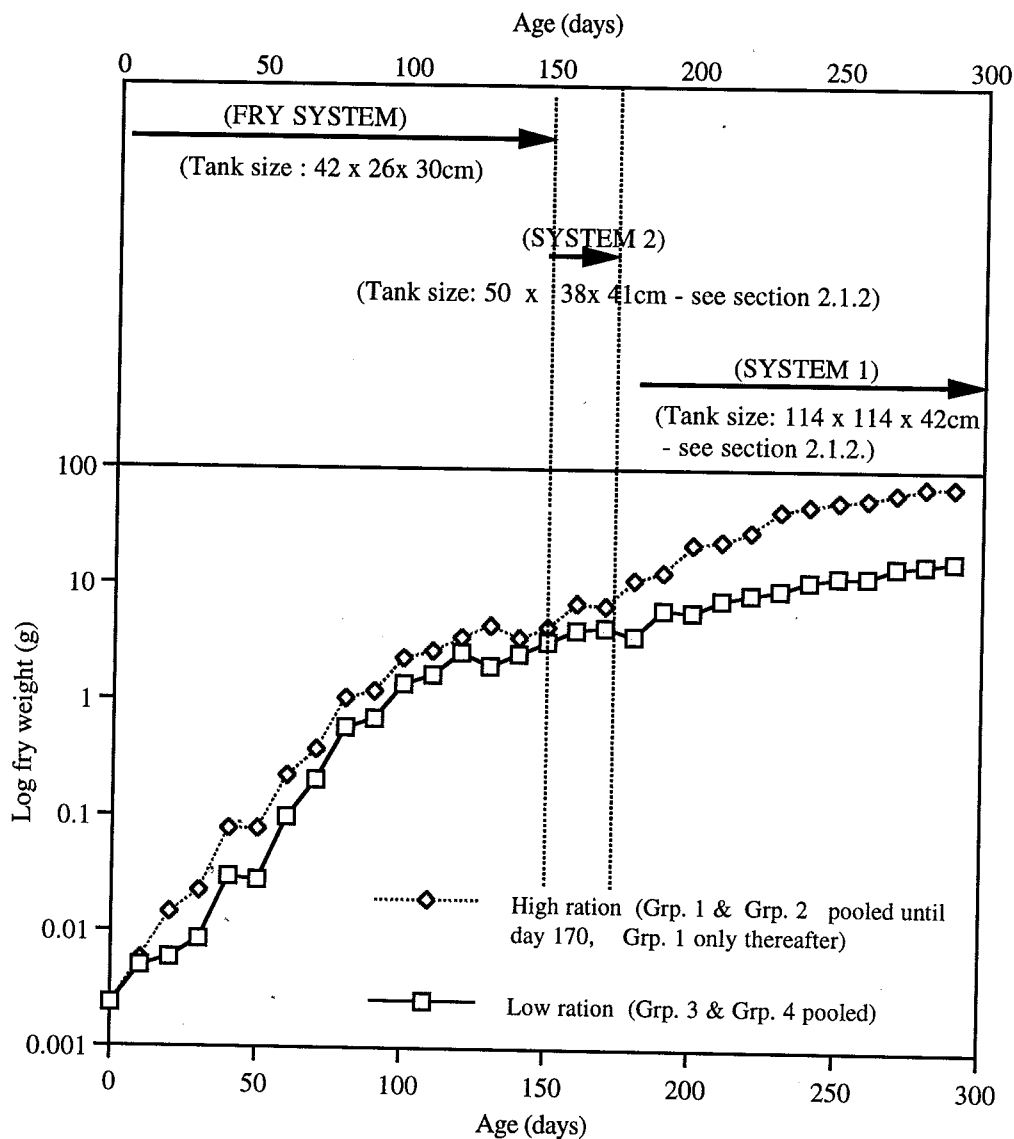

Figure 7.1. Growth of 4 groups of *T. zillii* fry from day 0 (EYS - end of yolk sac stage) to day 290 maintained on either high ration (grp. 1 & 2) or low ration (grp. 3 & 4). Data are presented as the mean of each treatment group (high or low ration size, data pooled from duplicate groups at each ration level). Mean weight was significantly higher ($p < 0.05$ or $p < 0.01$ or $p < 0.001$) in the high ration group from day 180 onwards. Three aquarium systems were used to maintain fish during the course of development. Fish were initially held in a fry system (days 0 - 150), then moved into a system incorporating 'bucket' type tanks (system 2, see section 2.1.2). Following an aquarium system fault on day 170 resulting in the deaths of all Grp. 2 (high ration) fish, all fish from remaining groups were moved into system 1 (see Section 2.1.2) on day 180.

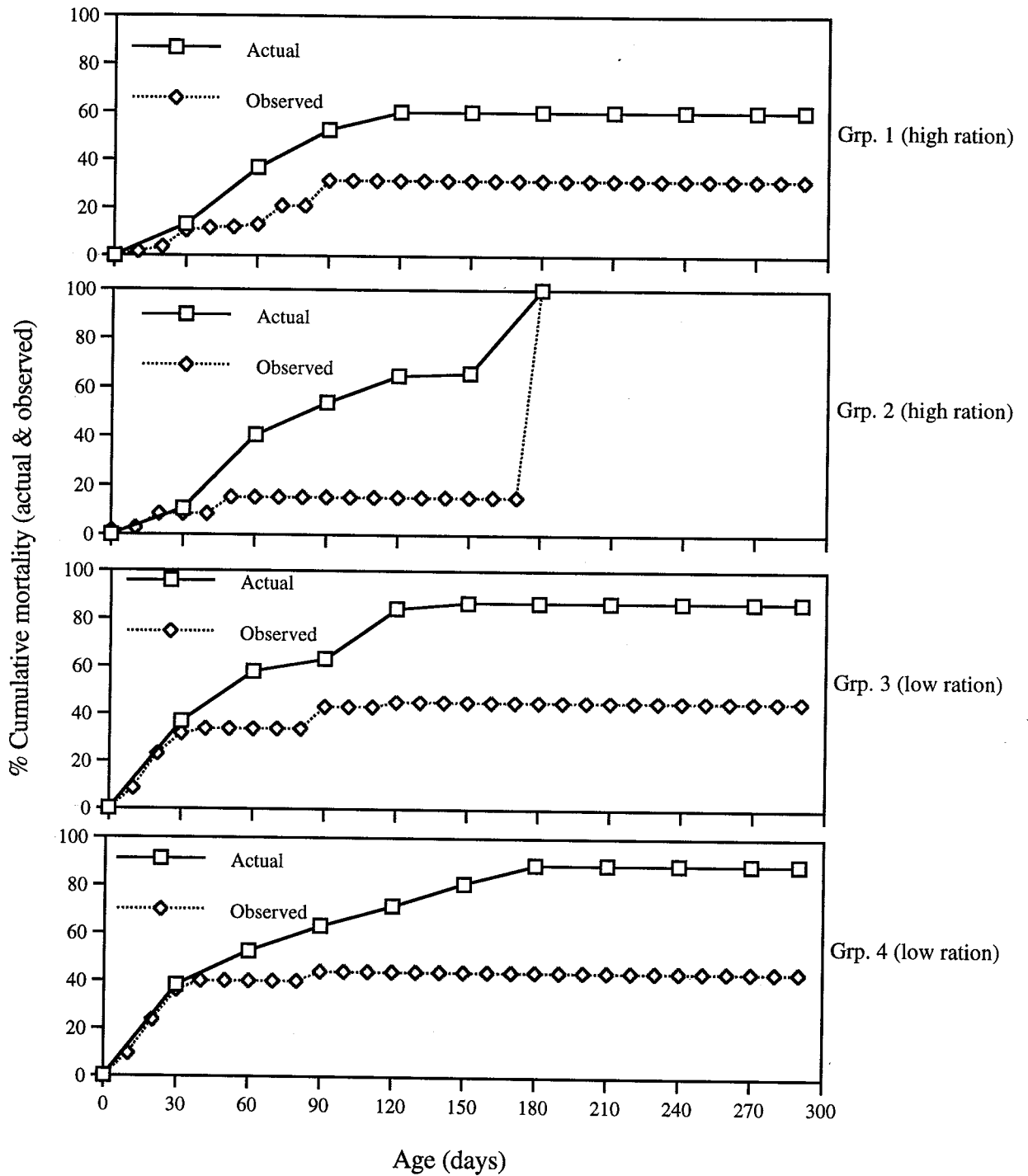

Figure 7.2. % cumulative mortality (expressed as 'actual' and 'observed' mortality) in 4 groups of *T. zillii* maintained on either high (grp. 1 & grp. 2) or low (grp. 3 & grp. 4) ration sizes. 'Observed' figures represent physical mortalities removed from tanks during the course of the experiment. 'Actual' data represent the true mortality found in each treatment group and was determined by counting the number of fish remaining in each treatment tank at 30 day intervals.

29 - 45% and 41 - 44% higher than observed mortality in high rationed groups and low ration groups respectively.

(3) Ration allocation, SGR and FCR.

Initially, ration size was 40% and 10% bw/day for high and low ration groups. Ration size was altered as fry developed and by the end of the 290 day period had reached 1.5 and 0.8% bw/day (Table 7.1).

Overall SGR and FCR (expressed over the entire 290 day period) were both higher in high ration groups than in low ration groups (see Tables 7.2 and 7.3 respectively).

(7.2.3) Summary.

A pool of *T. zillii* (strain 'A') EYS fry were divided into 4 groups (~190 fry/group) and were maintained on different ration sizes; groups 1 and 2 (duplicate high ration) and groups 3 and 4 (duplicate low ration). High ration size was initially 40% bw/day (low ration = 10% bw/day) but by the end of the experiment had been reduced to 1.5% bw/day (low ration = 0.8% bw/day). Rationing was maintained for 290 days. At the end of the experiment, high ration fish weighed 72.6 ± 7.2 g and low ration fish weighed 16.7 ± 2.5 g. Differences in mean individual fish weight were not significant until day 180. Thereafter, high ration fish were significantly larger at each timepoint. Generally, mortality was lower in high ration fish. Mortality in both high and low ration groups was most pronounced during the first 90 days of the experiment (particularly during the first 30 days). Losses during the first 30 days were particularly high in low ration groups. Both SGR and FCR (expressed over the entire 290 day period) were greater in high ration fish.

Table 7.1. Ration allocation during Experiment 1 (up to day 290).

Age (days)	Ration allocation (% of body weight/day)	
	High ration (Grps. 1 & 2)	Low ration (Grps. 3 & 4)
0 - 60	40	10
60 - 80	30	10
80 - 100	10	5
100 - 130	8	4
130 - 160	5	2
160 - 190	3	1
190 - 270	2	1
270 - 290	1.5	0.8

Table 7.2 Comparison of SGR over entire 290 day experimental period (Experiment 1).

Ration	Mean initial weight (g)	Mean final weight (g)	Mean SGR (%/day)
HIGH	0.002315	72.55	3.57
LOW	0.002345	16.67	3.06

Table 7.3 Comparison of FCR over entire 290 day experimental period (Experiment 1).

RATION	Total initial biomass (g)	Total final biomass (g)	Total food given (g)	FCR
HIGH	0.86	5513.87	10777	1.95
LOW	0.84	766.82	822.73	1.07

(7.3) Experiment 2: Effect of two long-term ration levels on sex steroid levels in on-growing *T. zillii* (male and female).

This experiment aimed to examine the reproductive endocrinology of on-growing *T. zillii* experiencing two differing ration sizes and utilised stocks of rationed fish (groups 1, 3 & 4) produced during Experiment 1 (Section 7.2).

(7.3.1) Materials & methods.

Group 1 (high ration, n = 76), group 3 (low ration, n = 25) and group 4 (low ration, n = 21) remaining from Experiment 1 (i.e. on day 290) were maintained in their respective holding aquaria (System 1, see Section 2.1.2). Ration manipulation was maintained as detailed in Experiment 1 (see also Table 7.1) with group 1 (high ration) being provided with 1.5% bw/day and groups 3 & 4 (low ration) being allocated 0.8% bw/day. These ration levels were maintained throughout the following 100 days.

On day 300, at least 6 females and 6 males were removed at random from each treatment tank. Fish were anaesthetized as detailed in Section 2.2.1, weighed (to the nearest 0.1g) and measured (to the nearest mm) as detailed in Section 2.4.1. Blood samples (no more than 200µl) were taken from each fish as detailed in Section 2.3.1. Blood samples from females were assayed for both E₂ and T and blood samples from males assayed for T as detailed in Section 2.7. Total serum calcium analysis was not undertaken owing to the results described in Chapter 5. Ration size for each treatment tank was calculated according to mean individual fish weight and rations weighed out in advance for the next 10 day period. This procedure was subsequently repeated at 10 day intervals for a total period of 90 days. Temperature and photoperiod were as detailed in Section 2.1.3.

(7.3.2) RESULTS.

(1) Fish growth

(a) Females. (Figures 7.3a & 7.3c): There was no significant difference between the two low ration groups (groups 3 & 4) in terms of either weight or length

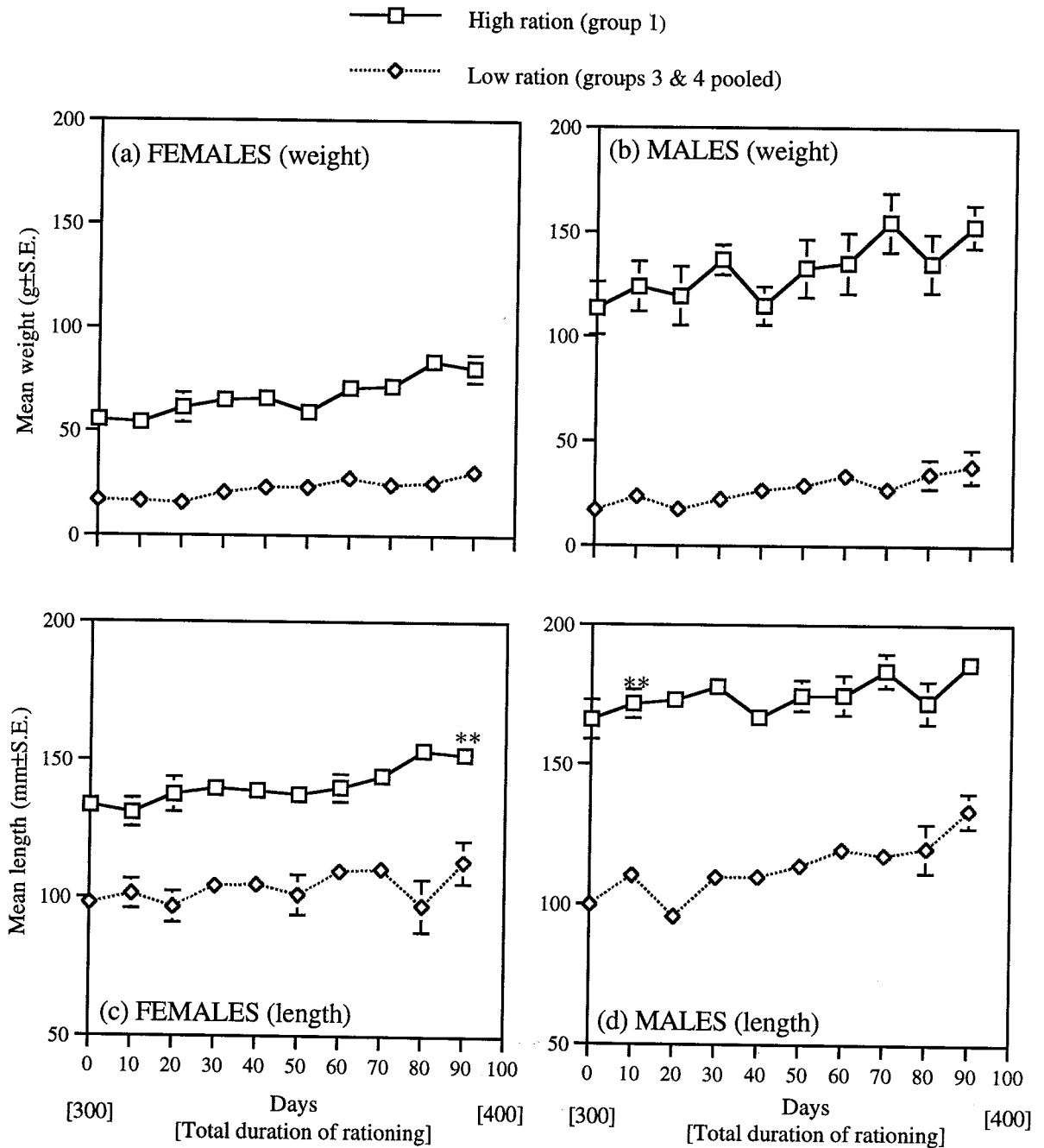

Figure 7.3. Mean weight ($g \pm S.E.$) and length ($mm \pm S.E.$) of 3 groups of *T. zillii* during a period of 90 days fed on either high ration (group 1) or low ration (groups 3 & 4). Low ration groups (3 & 4) have been pooled together since no statistical difference was found between the two groups in terms of mean fish weight or length. Where no S.E. is visible, the error lies within the confines of the symbol. Mean weight and mean length (in both males and females) are significantly higher at each of the ten timepoints in high rationed fish than low rationed fish. Level of significance is $p < 0.001$ unless otherwise indicated (* = $p < 0.05$, ** = $p < 0.01$).

($p \geq 0.05$). Consequently, low ration groups 3 & 4 were pooled together for analysis. Females in the high ration group grew from 55.4 ± 3.7 g (length = 133.4 ± 3.2 mm) on day 0 of the experiment (i.e. 300 days since rationing began at EYS) to 80.6 ± 6.7 g (length = 152.0 ± 3.27 mm) by day 90. Low rationed females grew from 16.8 ± 1.2 g (length = 97.8 ± 2.3 mm) to 30.8 ± 4.0 g (length = 113.1 ± 7.8 mm). Throughout the experiment, females fed low rations were consistently smaller (by approx. 60 - 70%) than those on high ration. Weight and length of high ration females were significantly larger (ANOVA-repeated measures, $p < 0.001$) than those on low ration. One-way ANOVA further revealed that high ration females were significantly larger ($p < 0.01$ or $p < 0.001$) than low rationed females at each of the 10 timepoints (0 - 90 days).

(b) Males (Figures 7.3b & 7.3d): There was no significant difference between the 2 low ration groups (groups 3 & 4) in terms of either weight or length ($p \geq 0.05$), groups 3 & 4 were pooled together for analysis. High ration males grew from 113.5 ± 12.6 g (length = 166.1 ± 7.1 mm) on day 0 to 152.9 ± 10.3 g (length = 186.2 ± 4.4 mm) by day 90. Males on low ration grew from 16.9 ± 3.3 g (length = 99.8 ± 3.3 mm) to 38.1 ± 8.0 g (length = 133.7 ± 6.2 mm). Throughout the experiment low ration males were consistently smaller (by approx. 75 - 85%) than those on high ration. Weight and length of high ration males were significantly larger (two-way ANOVA, $p < 0.001$) than those on low ration. One-way ANOVA further revealed that high ration males were significantly larger ($p < 0.01$ or $p < 0.001$) than low rationed males at each of the 10 timepoints (0 - 90 days).

(c) Males vs females: High ration males were significantly larger (in terms of both weight and length) than high ration females (two-way ANOVA, $p < 0.001$) (Figures 7.4a & 7.4c).

As in the case of the high ration group, low ration females were consistently smaller than low ration males. The difference between males and females was not as

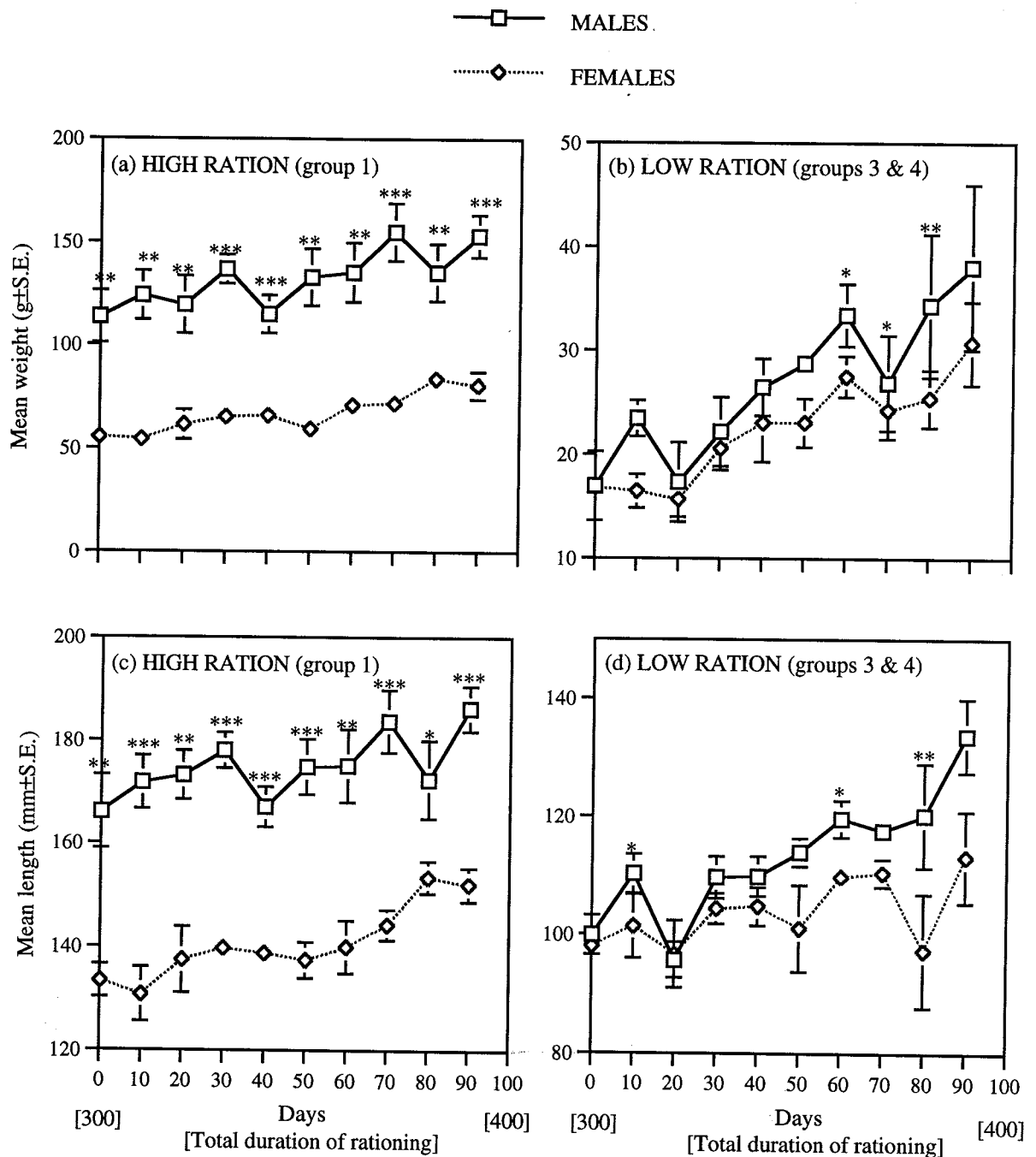

Figure 7.4. Comparison of mean weight (g±S.E.) and length (mm±S.E.) between male and female *T. zillii* maintained on two ration levels; high ration (group 1, see Figure 7.4a & 7.4c) and low ration (groups 3 & 4, see Figure 7.4b & 7.4d). Low ration groups (3 & 4) have been pooled together. Where no S.E. is visible, the error bars lie within the confines of the symbol. Statistical differences between males and females at any given timepoint are indicated by * ($p < 0.05$), ** ($p < 0.01$) or *** ($p < 0.001$).

marked as at high ration however; low ration females were just 1 - 19% smaller than low ration males. Despite this, low ration males were significantly larger than low ration females (two-way ANOVA, weight: $p < 0.001$; length: $p < 0.05$). Multiple comparison tests, however, only revealed significant differences in weight or length ($p < 0.05$ or $p < 0.001$) between low ration males and low ration females on just 3 of the 10 timepoints (Figures 7.4b & 7.4d).

(2) Mortality.

No mortalities were observed in any of the treatment groups during this experiment. All fish recovered well from anaesthesia. No spawnings were observed during the experiment.

(3) SGR & FCR.

SGR (expressed over the entire experimental period) was greatest at low ration size (in both males & females). SGR of high ration males and high ration females were very similar. Likewise, SGR of low ration males and low ration females were similar (see Table 7.4).

FCR (expressed over the entire experimental period) was far greater in high ration fish than low ration fish (see Table 7.5).

(4) Sex steroid levels.

Since there was no significant difference ($p \geq 0.05$) between the 2 low ration groups (groups 3 & 4) in terms of serum levels of female E₂, female T or male T over the entire experimental period, groups 3 & 4 were pooled in the following analyses.

(a) Females: Levels of serum E₂ in high ration females rose from 1.9 ± 0.2 ng/ml on day 0 to 5.9 ± 2.1 ng/ml on day 10 and then fluctuated between 0.9 ± 0.1 - 2.6 ± 1.0 ng/ml. This fluctuation exhibited no obvious trend. Similarly, no obvious trend was evident in terms of E₂ in low ration fish with fluctuating levels between 1.0 ± 0.1 ng/ml and 2.5 ± 0.6 ng/ml (see Figure 7.5a). There were no significant

Table 7.4. Comparison of SGR over duration of Experiment 2.

Ration	SEX	Mean initial weight (g)	Mean final weight (g)	Mean SGR (%/day)
HIGH	M	113.48	152.89	0.30
LOW	M	16.94	38.09	0.81
HIGH	F	54.37	80.60	0.39
LOW	F	16.46	30.76	0.63

Table 7.5. Comparison of FCR over duration of Experiment 2.

RATION	Total initial biomass (g)	Total final biomass (g)	Total food given (g)	FCR
HIGH	6324.72	8320.10	9548.4	4.79
LOW	788.81	1403.92	869.6	1.41

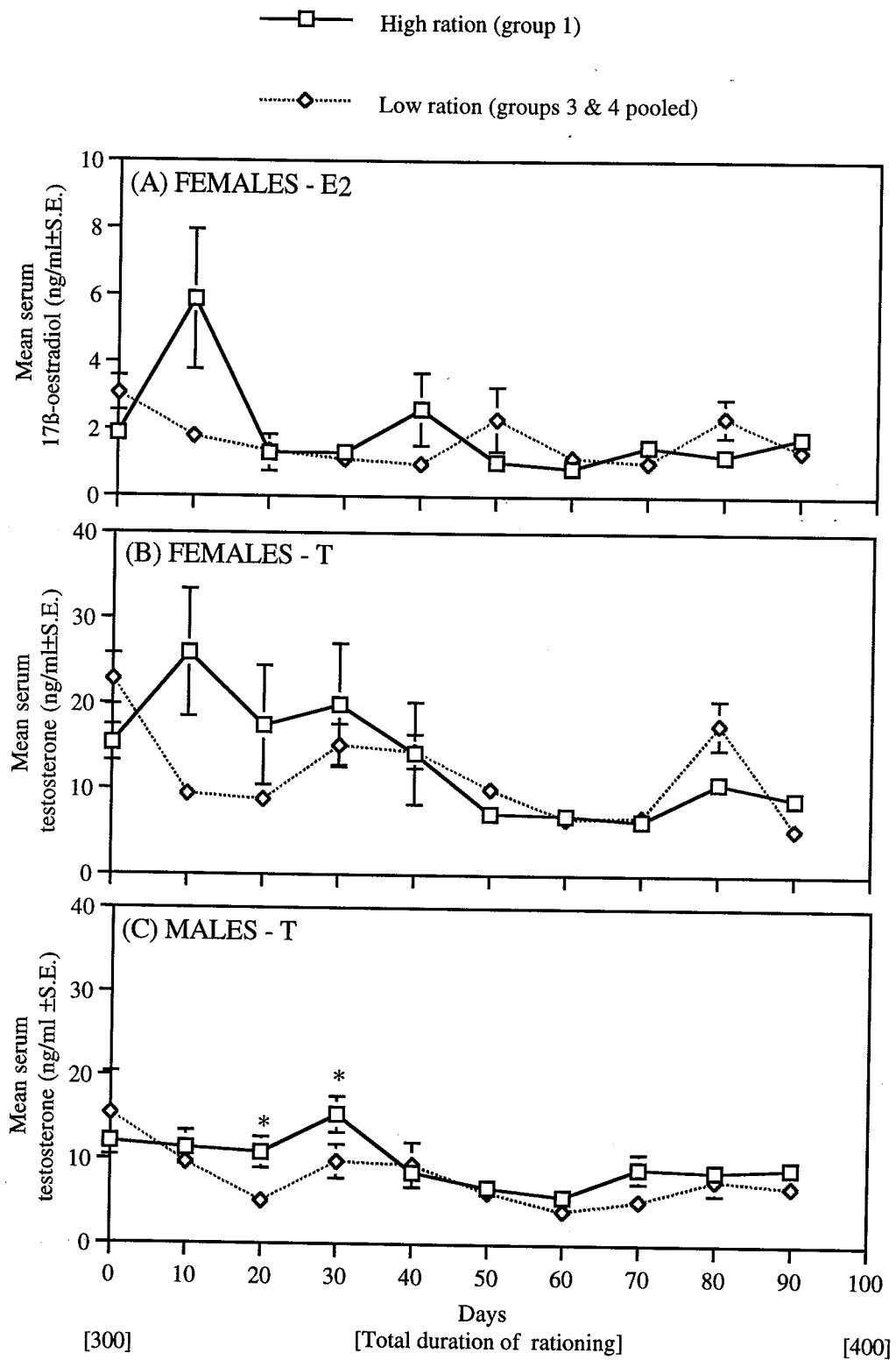

Figure 7.5. Levels (ng/ml±S.E.) of mean serum 17β-oestradiol (E₂) and testosterone (T) in female (E₂ and T) and male (T only) *T. zillii* maintained on different food rations; high ration (group 1) and low ration (groups 3 & 4 pooled). Statistical differences between mean steroid levels in high or low rationed groups at any given timepoint are indicated by * (p<0.05).

differences ($p \geq 0.05$) in terms of E₂ level between females fed upon high or low ration size.

Levels of serum T in both high and low ration females also showed considerable fluctuation throughout the 100 day period (Figure 7.5b) and varied from 6.3 ± 0.7 - 25.9 ± 0.6 ng/ml in high ration females and from 5.4 ± 0.4 - 22.9 ± 3.0 ng/ml in low ration females. No obvious trend was observed in either high ration or low ration fish. There were no significant differences ($p \geq 0.05$) in terms of T level between females fed upon high or low ration.

(b) Males: Serum T in high ration males varied between 5.7 ± 0.6 ng/ml and 15.4 ± 2.1 ng/ml whilst fluctuating between 4.0 ± 0.8 - 15.4 ± 5.0 ng/ml in low ration males (see Figure 7.5c). No obvious trend was evident in either group of fish. Profiles of T in males fed upon low and high ration were significantly different (two-way ANOVA, $p < 0.01$). One-way ANOVA performed at each 10 day sampling timepoint found that serum T was significantly higher ($p < 0.05$) in high ration males than low ration males on both day 20 and day 30 (see Figure 7.5c).

(7.3.3) Summary.

Groups of rationed fish produced during Experiment 1 were blood sampled at 10 day intervals for a period of 90 days. Throughout the experiment, low ration females were significantly ($p < 0.001$) smaller than high ration females. Similarly, low ration males were significantly ($p < 0.001$) smaller than high ration males. Males were found to be significantly larger ($p < 0.001$) than females at each of the ration sizes. Serum E₂ fluctuated between 0.9 ± 0.1 ng/ml and 5.9 ± 2.1 ng/ml in high ration females with no obvious trend. Similarly, no obvious trend was seen in low ration females where E₂ varied between 1.0 ± 0.1 ng/ml and 2.5 ± 0.6 ng/ml. No significant difference ($p \geq 0.05$) was observed when the profiles of E₂ in high and low ration fish were compared. Serum T fluctuated considerably in both low and high ration females. Again, no obvious trend was observed and no significant difference was found

between the 2 ration sizes. High ration males, however, were found to have significantly higher ($p < 0.001$) serum T than low ration males.

(7.4) Experiment 3: Effect of two long-term ration levels on spawning performance, fecundity and egg size.

This experiment was designed to investigate the effect of two long-term food rations (low and high) on the spawning performance (fecundity, egg size, inter-spawn-interval *etc.*) on rationed female *T. zillii* produced during Experiment 1 (Section 7.2). Spawning trials commenced on day 450 of total rationing (i.e. at approximately 15 months of age). An extra batch of *T. zillii* of similar age but not involved in any of the previous food rationing experiments were also assessed for spawning performance to serve as a comparison to the two food rationed groups.

(7.4.1) Materials & methods.

Broodstock were selected at random from each of the 3 holding tanks of rationed fish produced during Experiment 1 (Section 7.2) and consistently rationed thereafter. Six females from each of the rationed groups (group 1, group 3 and group 4) were utilised in this experiment. An additional 6 females (group A) of similar age as the rationed fish but having being fed *ad libitum* since first feeding were also included. Each treatment group were held in separate glass tanks. Females were removed from their respective holding tanks and placed into individual glass aquaria (System 3, see Section 2.1.2 & Appendix 1.3). Partitions were fitted tightly to glass aquaria such that food provided to one holding space could not inadvertently travel into the next. Immediately prior to transfer to individual aquaria, selected fish were anaesthetized, weighed (to the nearest 0.1g) and total length determined (to the nearest mm) as detailed in Sections 2.2.1 and 2.4.1. Fish were also tagged individually with PIT tags as detailed in Section 2.2.2.

Broodfish were maintained individually for a period of 60 days. Ration manipulation was maintained as detailed earlier in Experiments 1 & 2. High ration was

0.8% bw/day and low ration was 0.4% bw/day. Group A were fed *ad libitum*. Daily rations were provided to each treatment group 3 times daily. Faeces and excess food were siphoned from each tank twice daily. Food rations for each fish were weighed out in advance in 10 day quantities using 'standard expanded 4 pellet' (see Appendix 1.4). Fish were reweighed and ration size adjusted accordingly every 10 days. Water temperature and photoperiod were as detailed in Section 2.1.3. Each 'holding space' was assessed daily (at approximately 3 hourly intervals during daylight hours) for evidence of spawning. As soon as possible after oviposition, post-spawned females were anaesthetized (Section 2.2.1), weighed and total length determined (Section 2.4.1). Total fecundity, mean length of long and short egg axes, mean egg volume, mean egg dry weight, mean relative fecundity, mean total egg volume and egg weight to body weight ratio (EW:BW) were determined according to Section 2.4.

Relationships between fish size and total fecundity, relative fecundity, egg dry weight, egg diameter, egg volume and total egg volume were investigated using linear regression analysis. Correlation and regression analysis was performed using both untransformed (raw) and transformed (\log_{10}) data. Spawning characteristics such as total fecundity, mean egg diameter *etc.* were initially compared between the two rationed groups using one-way ANOVA of group means. Such analysis however fails to take into account differences in fish size between rationed groups. One-factor analysis of covariance (ANCOVA) was thus used to adjust data to a common fish size and therefore provide a more rigorous comparison of the two rationed groups (see Section 3.2.2 for more details on this technique). Three main spawning parameters (total fecundity, mean egg diameter and total egg volume) were compared in such fashion.

(7.4.2) Results.

(1) Fish weight and length.

There was no significant difference between groups 3 & 4 (both low ration) over the 60 day experimental period (two-way ANOVA, $p \geq 0.05$) in terms of either

mean weight or length. On this basis, groups 3 & 4 were pooled together in the following analyses.

(a) Fish weight (Figure 7.6a). Mean weight of group A rose from 142.1 ± 13.3 g on day 0 of the experiment (day 450 of total rationing) to 157.5 ± 10.8 g by day 60 (day 500 of total rationing). Group 1 (high ration) grew from 100.2 ± 10.7 g to 119.9 ± 9.3 g, whilst mean weight of groups 3 & 4 (data pooled) rose from 30.6 ± 3.7 g to 39.8 ± 5.4 g. There were significant differences ($p < 0.001$) between the 3 groups irrespective of time but no significant differences between timepoints irrespective of group ($p \geq 0.05$).

(b) Fish length (Figure 7.6b). Mean length of group A rose from 181.3 ± 7.2 mm on day 0 of the experiment to 197.0 ± 5.3 mm by day 60. Group 1 (high ration) grew from 147.0 ± 19.6 mm in length to 175.2 ± 4.4 mm and groups 3 & 4 (data pooled) grew from 115.4 ± 3.8 mm to 126.1 ± 4.4 mm. There were significant differences ($p < 0.001$) between the 3 groups irrespective of time and significant differences between timepoints irrespective of group ($p < 0.05$).

(2) Spawning performance (Table 7.6).

None of the fish fed *ad libitum* (group A) spawned. Conversely, several spawns were witnessed in both the high (group 1) and low (groups 3 & 4) rationed groups. Spawning occurred in 3 fish from group 1 (high ration), 3 fish from group 3 (low ration), and 4 fish from group 4 (also low ration); 1 fish from each group spawning twice during the experimental period. There was no significant difference in terms of either mean weight or length between spawning and non-spawning fish at each ration. In fish exhibiting spawning activity, there was no significant difference ($p \geq 0.05$) between groups 1, 3 or 4 in terms of the mean number of days elapsed prior to the first observed spawn. Furthermore, overall mean days elapsed/spawn (see Section 2.4.4) was identical between group 1 (high ration) and group 3 (low ration) and was found to be the least in group 4 (low ration). Spawns occurred between

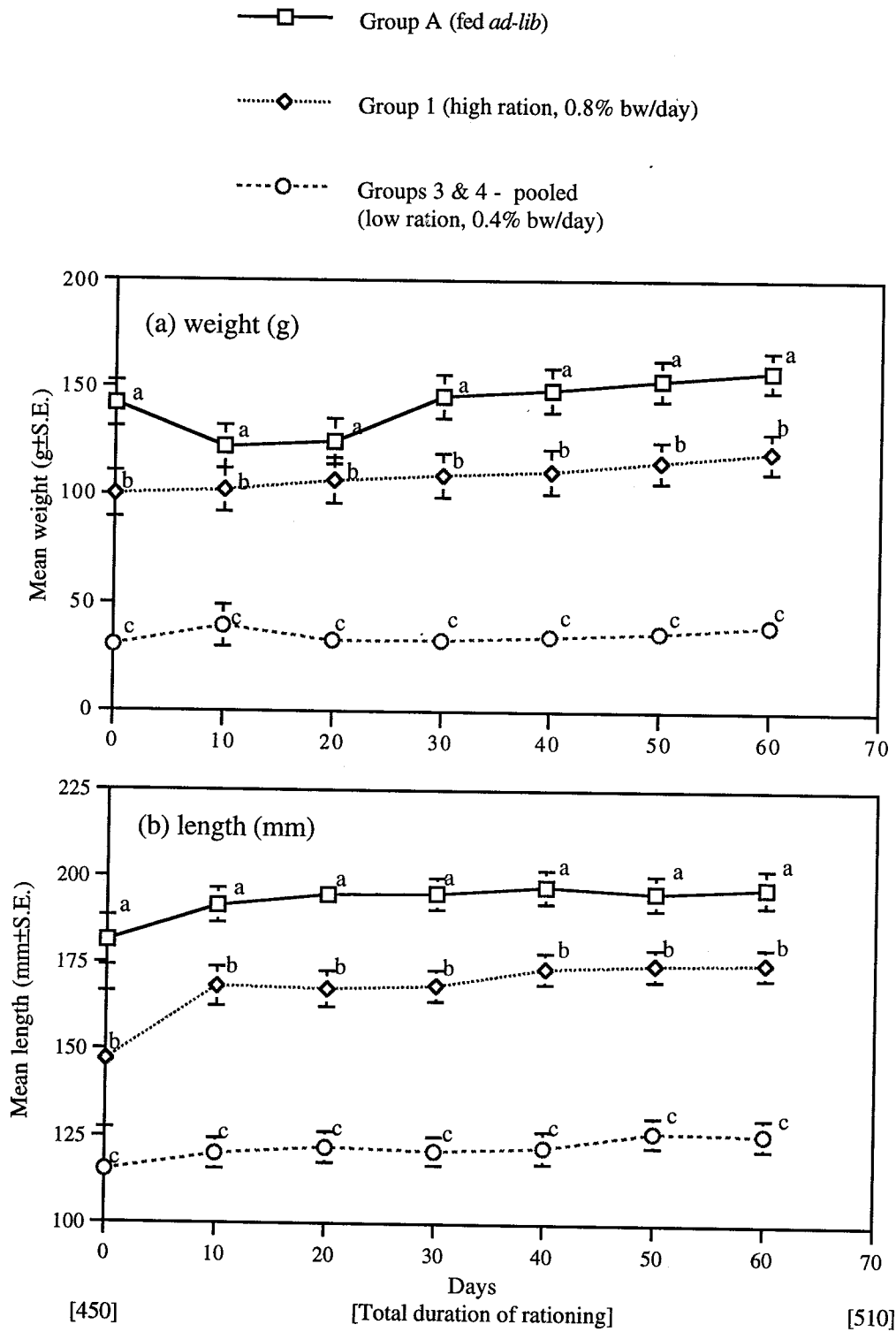

Figure 7.6. Variation of (a) mean weight and (b) mean length in groups of *T. zillii* maintained on differing rations over a 60 day period; group A (fed *ad libitum*), group 1 (high ration, fed 0.8% bw/day) and groups 3 & 4 (pooled, low ration, fed 0.4% bw/day). Values expressed as mean \pm S.E. Where no S.E. is visible, the error bars lie within the confines of the symbol. Significant differences between groups at each timepoint are indicated by annotation with different letters ($p < 0.05$).

Table 7.6. Spawning performance of 4 groups of female *T. zillii* maintained on differing rations over a 60 day period; group A (fed *ad libitum*), group 1 (high ration, fed 0.8% bw/day) and groups 3 & 4 (low ration, fed 0.4% bw/day).

Treatment group	No. fish in treatment group	No. Spawns *	Mean spawns/fish	No. fish spawning [as %]	No. fish repeat-spawning [as %]	Mean days to first spawn (of those spawning) *	Mean days elapsed/spawn **
Group A (<i>ad libitum</i>)	6	0	0	0 [0%]	0 [0%]	0	-
Group 1 (0.8% bw/day)	6	4	0.7	3 [50%]	1 [16.7%]	8.7±4.2 a	15
Group 3 (0.4% bw/day)	6	4	0.7	3 [50%]	1 [16.7%]	5.3±1.2 a	15
Group 4 (0.4% bw/day)	6	5	0.8	4 [66.7%]	1 [16.7%]	9.0±2.4 a	12

* Differences between groups tested by one-way ANOVA. Values annotated with the same letter are not significantly different ($p \geq 0.05$).

** Mean days elapsed/spawn: figure based upon all fish within group (spawning & non-spawning). Calculation: total days observed/total spawns observed (see Section 2.4.4).

9am and 2pm (aquaria were illuminated from 8am - 8pm). Low ration fish however displayed a tendency to spawn much earlier than those maintained on high ration and usually spawned before 9am (i.e. within 1 hour of 'daybreak').

At least 1 low ration fish displayed a tendency to eat her own eggs (or at least take eggs into her mouth) very soon (within 1 hour) after laying an egg clutch. For this reason it was considered extremely important to monitor spawning fish closely and remove egg clutches as soon as spawning had ceased.

(3) Fecundity and other egg characteristics.

Since there was no significant difference between the 2 low ration groups (3 & 4) in terms of mean weight or length (two-way ANOVA, $p \geq 0.05$) nor the number of spawns produced by either group (one-way ANOVA, $p \geq 0.05$), it was considered appropriate to analyse fecundity and other egg characteristics from the 2 low ration groups collectively except in (b) below where cumulative total egg production is compared.

(a) Comparisons of spawning data using one-way ANOVA (refer to Table 7.7).

Mean length and weight of high ration fish were significantly ($p < 0.001$) larger than those fed upon low ration as were mean total fecundity ($p < 0.01$) and mean total egg volume ($p < 0.01$). Mean relative fecundity was found to significantly smaller ($p < 0.05$) in high ration fish. No significant differences ($p \geq 0.05$) were found between the two ration sizes in terms of EW:BW, mean egg diameter, mean egg dry weight or mean egg volume.

(b) Comparison of cumulative total egg volume production (refer to Figure 7.7).

Cumulative total egg volume production by each of the rationed groups over the 60 day experimental period are compared in Figure 7.7. At the end of the experiment cumulative total egg volume by the high ration group was approximately twice that of each low ration group. During the first 15 days of the experiment however, cumulative egg volume appeared very similar amongst high and low ration groups.

Table 7.7. Mean fecundity, egg size and other spawning characteristics in two groups of rationed *T. zillii*; group 1 (high ration), groups 3 & 4 (low ration, data pooled). Data from spawns recorded over a 60 day experimental period in individual aquaria.

Characteristic	Group 1 (high ration)	Groups 3 & 4 (low ration, data pooled)
Total number of spawns	4	8
Mean spawns/fish (over 60 days)	0.7	0.75
Mean weight of spawning fish (g±S.E.)	89.3±13.9 a**	28.7±3.2 b**
Mean length of spawning fish (mm±S.E.)	162.0±7.7 a*	117.5±3.7 b*
Mean total fecundity (±S.E.)	2608.2±338.2 a*	1190.6±94.6 b*
Mean relative fecundity (eggs/g±S.E.)	29.9±3.5 a	43.1±3.6 b
Mean egg diameter (mm±S.E.)	1.44±0.03 a	1.53±0.03 a
Mean egg dry weight (mg±S.E.)	0.53±0.03 a	0.48±0.03 a
Mean egg volume (mm ³ ±S.E.)	1.40±0.1 a	1.66±0.1 a
Mean tot. egg volume (x1000 mm ³ ±S.E.)	3.69±0.6 a*	2.05±0.2 b*
Mean EW:BW ratio (%±S.E.)	1.58±0.3 a	2.12±0.3 a

Note: Significant differences ($p < 0.05$, one-way ANOVA) between the two groups are indicated by annotation with different letters. Differences where $p < 0.01$ and $p < 0.0001$ are also annotated with '*' or '**' respectively. Non significant differences ($p \geq 0.05$) between the two groups are indicated by annotation with the same letter.

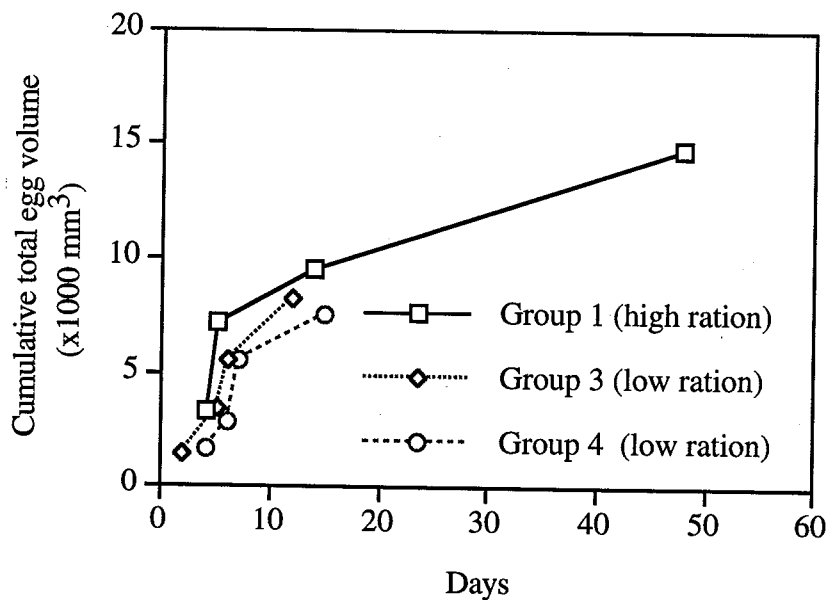

Figure 7.7. Cumulative total egg volume (x1000mm³) in 3 groups of *T. zillii* maintained on differing rations; group 1 (high ration) and groups 3 & 4 (low ration) over a 60 day experimental period in individual aquaria.

(c) Regression analysis of spawning data.

(1) High ration fish (refer to Table 7.8): Correlation and regression analysis (using either raw or log₁₀ transformed data) failed to reveal any significant relationships between fish size and any of the dependent variables tested. In the case of raw data, coefficients of determination (r^2) ranged from 0.02 - 0.78. Logarithmic transformation of data did not generally improve the strength of relationship being tested (range of r^2 : 0.03 - 0.77). Regressions of total fecundity, mean egg diameter and total egg volume on post-spawned weight are given in Figures 7.8 a - f (raw and log₁₀ transformed).

(2) Low ration fish (refer to Table 7.9): As in the case of the high ration fish, correlation and regression analysis (using raw and log₁₀ transformed data) failed to reveal any significant relationships between fish size and any of the dependent variables tested. In the case of raw data, r^2 ranged from 0.002 to 0.47. Logarithmic transformation failed to improve the strength of these relationships (range of r^2 : 0.001 - 0.42). Regressions of total fecundity, mean egg diameter and total egg volume on post-spawned weight are given in Figures 7.8 a - f (raw and log₁₀ transformed data).

(3) High and low ration fish pooled (refer to Table 7.10): Once spawning data arising from high and low rationed fish were pooled, several significant relationships were revealed. Significant relationships were found between fish size and (1) total fecundity ($p < 0.001$), (2) relative fecundity ($p < 0.01$) and (3) total egg volume ($p < 0.01$). In the case of raw data, r^2 varied from 0.001 - 0.85 and in the case of transformed data 0.00003 - 0.84. Regressions of total fecundity, mean egg diameter and total egg volume on post-spawned weight are given in Figures 7.9 a - f (raw and log₁₀ transformed data).

(d) Comparison of spawning data using ANCOVA (refer to Table 7.11 a - c)

One-factor ANCOVA found no significant ($p \geq 0.05$) difference between the 2 ration levels in terms of either total fecundity, mean egg diameter or total egg volume. Only in the case of total fecundity, however, were all criteria for ANCOVA fully satisfied (i.e. homogeneity of both residual variances and slope). Although tests

Table 7.8. Summary of correlation and regression analysis of fecundity, egg dry weight, egg size and egg volume data recorded over 4 spawns by 6 individually-maintained *T. zillii* maintained upon high ration (see Figure 7.8).

VARIABLES TESTED		RAW DATA				FOLLOWING LOGARITHMIC TRANSFORMATION OF BOTH DEPENDENT & INDEPENDENT VARIABLES			
Dependent Variable	Independent Variable	Correlation Coefficient (r)	Regression equation (x = independent variable, y = dependent variable)	Coefficient of determination (r ²)	Correlation Coefficient (r)	Regression equation	Coefficient of determination (r ²)		
Total fecundity	fish weight (g)	0.69 ns	y = 16.81x + 1.107.56 ns	0.48	0.68 ns	y = 0.65logx + 2.14 ns	0.46		
Relative fecundity (eggs/g)	fish length (mm)	0.65 ns	y = 28.60x - 2021.83 ns	0.42	0.62 ns	y = 1.83logx - 0.63 ns	0.35		
	fish weight (g)	-	-	-	-0.44 ns	y = -0.35logx + 2.14 ns	0.20		
Egg dry weight (mg)	fish length (mm)	-	-	-	-0.50 ns	y = -1.20logx + 4.12 ns	0.25		
	fish weight (g)	0.23 ns	y = 0.0005x + 0.48 ns	0.06	0.28 ns	y = 0.12logx - 0.50 ns	0.08		
Egg diameter (mm)	fish length (mm)	0.15 ns	y = 0.01x + 0.43 ns	0.02	0.17 ns	y = 0.21logx - 0.75 ns	0.03		
	fish weight (g)	0.87 ns	y = 0.002x + 1.26 ns	0.76	0.88 ns	y = 0.14logx - 0.12 ns	0.77		
Egg volume (mm ³)	fish length (mm)	0.83 ns	y = 0.003x + 0.87 ns	0.69	0.82 ns	y = 0.41logx - 0.74 ns	0.68		
	fish weight (g)	0.77 ns	y = 0.05x + 0.96 ns	0.60	0.77 ns	y = 0.36logx - 0.55 ns	0.60		
EW:BW ratio	fish length (mm)	0.72 ns	y = 0.08x + 0.04 ns	0.52	0.70 ns	y = 0.99logx - 2.05 ns	0.50		
	fish weight (g)	-0.26 ns	y = -0.05x + 2.03 ns	0.07	-0.70 ns	y = -0.48logx - 0.06 ns	0.48		
Total egg volume (mm ³)	fish length (mm)	-0.31 ns	y = -0.11x + 3.37 ns	0.10	-0.61 ns	y = -1.26logx + 1.93 ns	0.37		
	fish weight (g)	0.89 ns	y = 0.04x + 0.22 ns	0.78	0.84 ns	y = 1.01logx - 1.41 ns	0.70		
	fish length (mm)	0.84 ns	y = 0.07x - 7.13 ns	0.71	0.76 ns	y = 2.83logx - 5.69 ns	0.58		

N.B. (1) Correlation coefficients (r) significance tests: ns = no significant difference

(2) Regressions tested for significance using ANOVA (ns = no significant difference)

(3) EW:BW ratio was ARCSine transformed prior to statistical analysis.

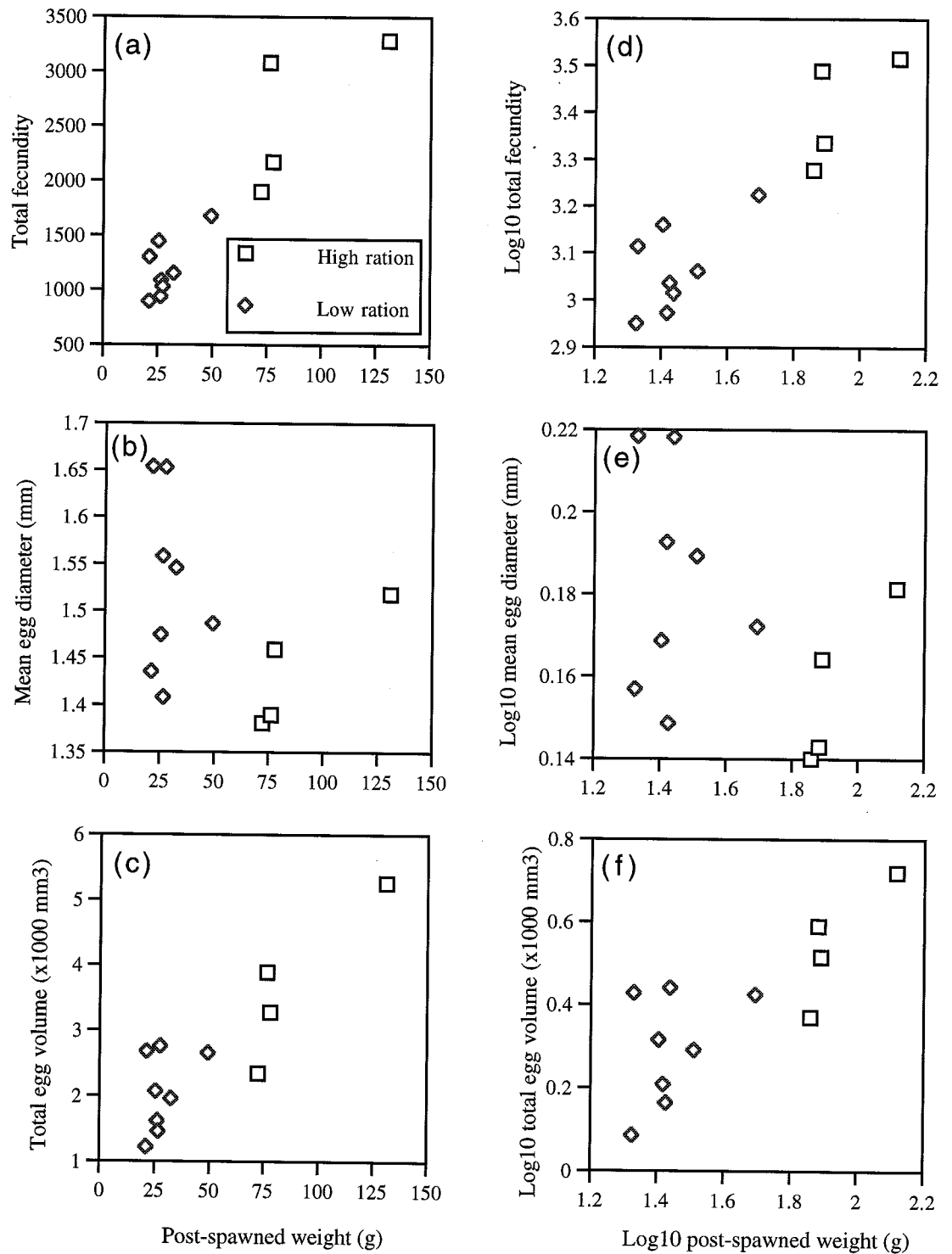

Figure 7.8. Relationships of total fecundity, mean egg diameter (mm) and total egg volume (mm³) with post-spawned fish weight (g) in fish maintained on either high or low food rations. Figures 7.8 (a - c) represent raw data whilst figures 7.8 (d - f) represent log₁₀ transformed data. None of the above relationships were found to be significant (see regression analysis in Tables 7.8 and 7.9 for high ration and low ration fish respectively)

Table 7.9. Summary of correlation and regression analysis of fecundity, egg dry weight, egg size and egg volume data recorded over 8 spawns by 12 individually-maintained *T. zillii* maintained upon low ration (see Figure 7.8).

VARIABLES TESTED		RAW DATA				FOLLOWING LOGARITHMIC TRANSFORMATION OF BOTH DEPENDENT & INDEPENDENT VARIABLES		
Dependent Variable	Independent Variable	Correlation Coefficient (r)	Regression equation (x = independent variable, y = dependent variable)	Coefficient of determination (r ²)	Correlation Coefficient (r)	Regression equation	Coefficient of determination (r ²)	
Total fecundity	fish weight (g)	0.68 ns	y = 20.16x + 612.02 ns	0.46	0.61 ns	y = 0.49logx + 2.36 ns	0.37	
Relative fecundity (eggs/g)	fish length (mm)	0.68 ns	y = 17.50x - 865.9 ns	0.47	0.65 ns	y = 1.65logx - 0.36 ns	0.42	
	fish weight (g)	-	-	-	-0.64 ns	y = -0.52logx + 2.38 ns	0.41	
Egg dry weight (mg)	fish length (mm)	-	-	-	-0.57 ns	y = -1.47logx + 4.67 ns	0.32	
	fish weight (g)	-0.04 ns	y = 0.0004x + 0.47 ns	0.002	-0.05 ns	y = -0.03logx - 0.28 ns	0.002	
Egg diameter (mm)	fish length (mm)	-0.04 ns	y = -0.0003x + 0.52 ns	0.002	-0.08 ns	y = -0.16logx + 0.004 ns	0.01	
	fish weight (g)	-0.14 ns	y = -0.001x + 1.57 ns	0.02	-0.12 ns	y = -0.03logx + 0.22 ns	0.01	
Egg volume (mm ³)	fish length (mm)	-0.13 ns	y = -0.001x + 1.67 ns	0.02	-0.12 ns	y = -0.09logx + 0.36 ns	0.02	
	fish weight (g)	-0.08 ns	y = -0.03x + 1.74 ns	0.01	-0.04 ns	y = -0.02logx + 0.25 ns	0.001	
EW:BW ratio	fish length (mm)	-0.07 ns	y = -0.002x + 1.88 ns	0.01	-0.04 ns	y = -0.07logx + 0.36 ns	0.001	
	fish weight (g)	-0.35 ns	y = -0.003x - 0.76 ns	0.12	-0.43 ns	y = -0.27logx - 0.45 ns	0.18	
Total egg volume (mm ³)	fish length (mm)	-0.38 ns	y = -0.003x - 0.53 ns	0.14	-0.40 ns	y = -8.10logx - 0.82 ns	0.16	
	fish weight (g)	0.40 ns	y = -0.03x + 1.29 ns	0.16	0.41 ns	y = 0.46logx - 0.37 ns	0.17	
	fish length (mm)	0.44 ns	y = 0.03x - 0.91 ns	0.19	0.45 ns	y = -0.81logx + 0.82 ns	0.16	

N.B. (1) Correlation coefficients (r) significance tests: ns = no significant difference

(2) Regressions tested for significance using ANOVA (ns = no significant difference)

(3) EW:BW ratio was ARCSINE transformed prior to statistical analysis.

Table 7.10. Summary of correlation and regression analysis of fecundity, egg dry weight, egg size and egg volume data recorded over 12 spawns by 18 individually-maintained *T. zillii* (low + high ration females pooled, see Figure 7.9).

VARIABLES TESTED		RAW DATA				FOLLOWING LOGARITHMIC TRANSFORMATION OF BOTH DEPENDENT & INDEPENDENT VARIABLES		
Dependent Variable	Independent Variable	Correlation Coefficient (r)	Regression equation (x = independent variable, y = dependent variable)	Coefficient of determination (r ²)	Correlation Coefficient (r)	Regression equation	Coefficient of determination (r ²)	
Total fecundity	fish weight (g)	0.92 ***	y = 22.05x + 85.22 ***	0.85	0.92 ***	y = 0.66logx + 2.12 ***	0.84	
Relative fecundity (eggs/g)	fish length (mm)	0.91 ***	y = 29.89x - 2292.22 ***	0.83	0.92 ***	y = 2.27logx - 1.63 ***	0.84	
	fish weight (g)	-	-	-	-0.77 **	y = -0.34logx + 2.13 **	0.60	
Egg dry weight (mg)	fish length (mm)	-	-	-	-0.77 **	y = -1.18logx + 4.07 **	0.59	
	fish weight (g)	0.28 ns	y = 0.001x + 0.47 ns	0.08	0.27 ns	y = 0.07logx - 0.42 ns	0.07	
Egg diameter (mm)	fish length (mm)	0.24 ns	y = 0.001x + 0.40 ns	0.06	0.24 ns	y = 0.22logx - 0.77 ns	0.06	
	fish weight (g)	-0.03 ns	y = -0.001x + 1.78 ns	0.001	0.02 ns	y = 0.01logx + 0.19 ns	0.001	
Egg volume (mm ³)	fish length (mm)	0.06 ns	y = 0.002x + 1.47 ns	0.003	0.05 ns	y = 0.10logx + 0.01 ns	0.003	
	fish weight (g)	-0.30 ns	y = -0.002x + 1.70 ns	0.09	-0.36 ns	y = -1.00logx + 0.35 ns	0.13	
EW:BW ratio	fish length (mm)	-0.34 ns	y = -0.004x + 2.09 ns	0.12	-0.35 ns	y = -0.34logx + 0.90 ns	0.12	
	fish weight (g)	-0.11 ns	y = -0.0001x + 0.14 ns	0.012	-0.02 ns	y = -0.01logx - 0.86 ns	0.0003	
Total egg volume (mm ³)	fish length (mm)	-0.05 ns	y = -0.0001x + 0.14 ns	0.002	0.01 ns	y = 0.01logx - 0.88 ns	0.00003	
	fish weight (g)	0.77 **	y = 0.03x + 1.18 **	0.59	0.60 **	y = 0.45logx - 0.36 *	0.36	
	fish length (mm)	0.72 **	y = 0.04x - 2.12 **	0.52	0.60 **	y = 1.55logx - 2.92 *	0.36	

N.B. (1) Correlation coefficients (r) significance tests: ns = no significant difference, * = p<0.05, ** = p<0.01, *** = p<0.001

(2) Regressions tested for significance using ANOVA (ns = no significant difference, * = p<0.05, ** = p<0.01, *** = p<0.001)

(3) EW:BW ratio was ARCSine transformed prior to statistical analysis.

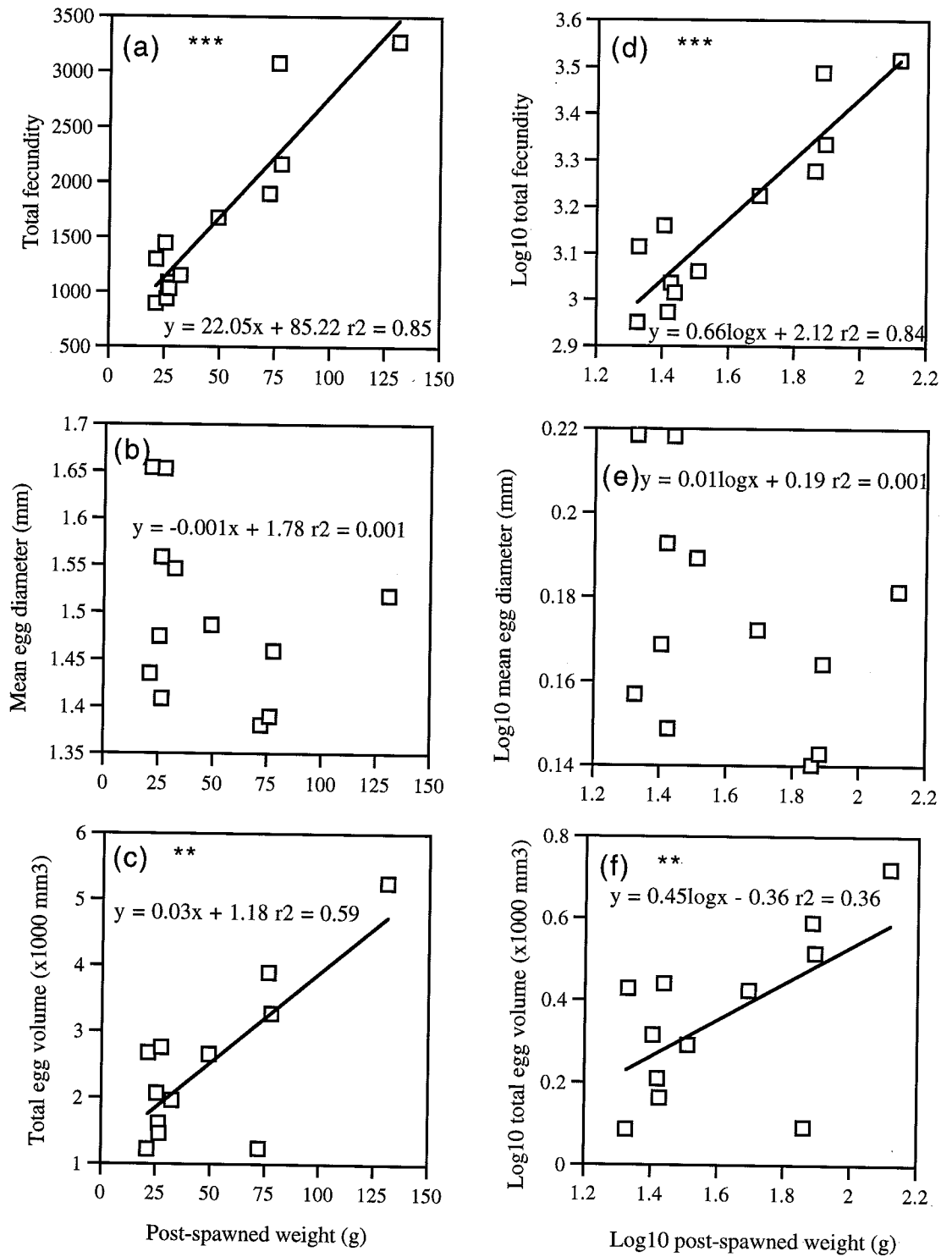

Figure 7.9. Relationships of total fecundity, mean egg diameter (mm) and total egg volume (mm³) with post-spawned fish weight (g) in fish maintained on either high or low rations (here data for the 2 rations are pooled). Figures 7.9 (a - c) represent raw data whilst Figures 7.9 (d - f) represent log₁₀ transformed data. Significant relationships are indicated by * (p<0.05), ** (p<0.01) or *** (p<0.001). Regression equations are given in Table 7.10.

Table 7.11a Analyses of covariance (ANCOVA) of log₁₀ total fecundity and log₁₀ post-spawned fish weight (g) for *T. zillii* maintained upon high (group 1) and low (groups 3 & 4 pooled) ration.

* where $F < F_{crit}$ data are homogeneous, where $F \geq F_{crit}$ data are heterogeneous)

Homogeneity of residual variances			Slope			Intercept (Elevation)		
<i>F</i>	df	Result *	<i>F</i>	df	Result	<i>F</i>	df	Result
1.83	2, 6	Homog.	0.53	1, 8	p \geq 0.05	0.06	1, 11	p \geq 0.05

Table 7.11b Analyses of covariance (ANCOVA) of log₁₀ mean egg diameter (mm³) and log₁₀ post-spawned fish weight (g) for *T. zillii* maintained upon high (group 1) and low (groups 3 & 4 pooled) ration.

* where $F < F_{crit}$ data are homogeneous, where $F \geq F_{crit}$ data are heterogeneous)

Homogeneity of residual variances			Slope			Intercept (Elevation)		
<i>F</i>	df	Result *	<i>F</i>	df	Result	<i>F</i>	df	Result
7.56	6, 2	Homog.	320.21	1, 8	p $<$ 0.01	1.68	1, 11	p \geq 0.05

Table 7.11c Analyses of covariance (ANCOVA) of log₁₀ total egg volume (x1000 mm³) and log₁₀ post-spawned fish weight (g) for *T. zillii* maintained upon high (group 1) and low (groups 3 & 4 pooled) ration.

* where $F < F_{crit}$ data are homogeneous, where $F \geq F_{crit}$ data are heterogeneous)

Homogeneity of residual variances			Slope			Intercept (Elevation)		
<i>F</i>	df	Result *	<i>F</i>	df	Result	<i>F</i>	df	Result
1.7	6, 2	Homog.	10.07	1, 8	p $<$ 0.05	0.65	1, 11	p \geq 0.05

involving mean egg diameter and total egg volume demonstrated homogeneity of residual variance, both tests were compromised by heterogeneity of slope (see Tables 7.11b, 7.11c). In view of this, tests were not considered to be as robust.

(7.4.3) Summary.

This experiment further utilised rationed fish produced during Experiment 1. Six females from each group were placed into individual aquaria and maintained for a period of 60 days. An additional 6 females (group A) of similar age as rationed fish but having being fed *ad libitum* since first feeding were also included. Spawning occurred only in high and low ration groups. Overall mean days elapsed/spawn was identical between groups 1 and 3 and was found to be the least in group 4. ANOVA revealed that mean total fecundity and mean total egg volume were significantly larger ($p < 0.01$) in high ration fish when compared to low ration fish, though relative fecundity was significantly smaller ($p < 0.05$). No significant difference was found between the 2 rations in terms of EW:BW or egg size. Regression analysis failed (for both high ration and low ration fish) to detect any significant relationships between fish size and either total fecundity, relative fecundity, egg dry weight, egg diameter, egg volume, EW:BW or total egg volume. Several significant relationships were detected when spawning data for both ration levels were pooled. Significant relationships were found between fish size and (1) total fecundity ($p < 0.001$), (2) relative fecundity ($p < 0.01$) and (3) total egg volume ($p < 0.01$). Further analysis using ANCOVA failed to find any significant difference between the 2 ration levels in terms of total fecundity, egg diameter or total egg volume, though ANCOVA may not have been as robust due to heterogeneity of slopes.

(7.5) Experiment 4: Effect of two long-term ration levels on ovarian histology.

This experiment aimed to study the effect of long term food rationing on ovarian histology in rationed female *T. zillii* produced during Experiment 1 (Section 7.2) and

rationed thereafter in holding aquaria. It was thought necessary to undertake such comparison at a 'standardised' point within the reproductive cycle and thus fish used in this experiment were removed from holding aquaria (where *T. zillii* fail to spawn - see Chapter 6) and not from individual aquaria where spawning cycles of individual fish may have been very asynchronous. It was ensured that all fish used had not been involved in Experiment 3 and had therefore not spawned previously. An extra batch of *T. zillii* of similar age (~17 months) but not involved in any of the previous rationing experiments were also assessed for ovarian histology to serve as a comparison to the 2 food rationed groups. This group had previously been held in holding aquaria for 1 month and had therefore not spawned for at least 1 month.

7.5.1 Materials & methods.

Five females from each rationed group (group 1 - high ration, groups 3 & 4 - low ration) were removed from their respective holding aquaria along with five further females (group A) that had not formed part of the food rationing and were of an age that was as close as possible to the experimental fish.

Fish were anaesthetized as detailed in Section 2.2.1, weighed (to the nearest 0.1g) and measured (to the nearest mm) as detailed in Section 2.4.1. Blood samples (~500 μ l) were taken from each fish as detailed in Section 2.3.1. Fish were then sacrificed. Liver and ovaries were removed and weighed (see Section 2.3.3). Gonadosomatic index (GSI) and hepatosomatic index (HSI) were then calculated as also detailed in Section 2.3.3. Transverse sections of the right ovary were taken from the anterior, mid and posterior areas of the ovary. Sections were fixed in Bouin's fluid and embedded in 'Historesin' (see Section 2.5.1). Histological sections of 3 μ m thickness were cut from each block of tissue and stained with haematoxylin and eosin as detailed in Sections 2.5.1 and 2.5.2. Volume fraction was determined from ovarian histology using stereology as detailed in Section 2.5.4. Oocyte developmental stages were classified according to Chapter 4. Although atresia was classified into 3 distinct stages in Chapter 4 (α , β , and λ), the analysis here relates merely to 'atresia', i.e. (α ,

β , and λ -atresia data pooled). Blood samples were analysed for both E₂ and T as detailed in Section 2.7. Total serum calcium was not measured owing to the findings of Chapter 5. Prior to sacrifice, ration levels had been set at 0.8% bw/day (high) and 0.4% bw/day (low) for at least 2 months.

Statistical comparison was made using one-way ANOVA. Multiple comparison tests, if necessary, were performed using the Dunn/Bonferroni test. Volume fraction, GSI and HSI data were ARCSine transformed (see Section 2.8.5) prior to statistical analysis.

(7.5.2) Results.

One-way ANOVA found no significant ($p \geq 0.05$) differences between the 2 low ration groups (groups 3 & 4) in terms of either mean weight, length, HSI, GSI, E₂ level or T level and have therefore being pooled together in the following analyses.

(1) Fish size (Figure 7.12a & 7.12b).

Owing to poor availability of suitably aged fish, fish previously fed *ad libitum* throughout their life and included here as a comparison (grp. A) were approximately 4 - 5 months older than the 2 rationed groups. Mean length (Figure 7.12a) ranged from 116mm (low ration, grps. 3 & 4) to 199mm (grp. A - fed *ad libitum*). Mean weight (Figure 7.12b) ranged from 25.6g (low ration fish) to 161.9g (grp. A fish - fed *ad libitum*). One-way ANOVA found that all 3 groups of fish were significantly different from one another in terms of both mean length ($p < 0.001$) and mean weight ($p < 0.001$) with fish fed *ad libitum* exhibiting significantly larger mean weight ($p < 0.001$) and mean length ($p < 0.001$) than either of the rationed groups.

(2) GSI and HSI (Figures 7.12c & 7.12d).

Mean HSI (Figure 7.12c) exhibited wide variation and ranged from 1.33% - 2.22%. There was no significant difference ($p \geq 0.05$) in mean HSI between low ration fish (grps. 3 & 4) and those fish fed *ad-libitum* (grp. A) where mean HSI was

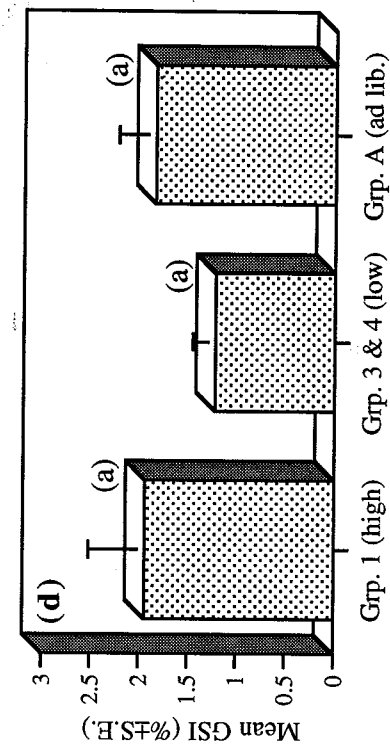
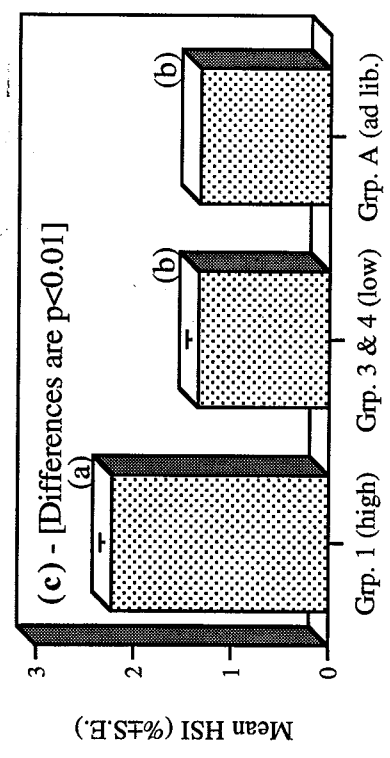
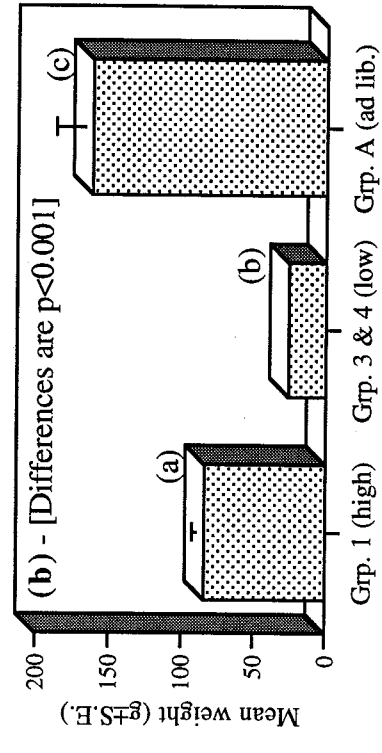
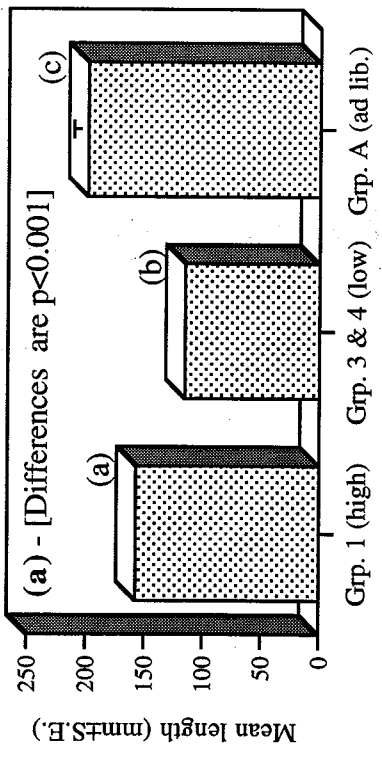

Figures 7.12. Comparison of (a) mean length (b) mean weight, (c) mean HSI and (d) mean GSI between three groups of female *T. zillii*; group 1 (high ration), groups 3 & 4 (low ration, data pooled) and group A (previously fed *ad libitum* and not involved in food rationing). Significant differences between groups are indicated by annotation of the figure with different letters. Non significant differences are indicated by annotation with the same letter. Level of significance (where appropriate) is given within the figure.

approximately 1.33% in each case. Mean HSI in high ration fish (grp. 1), however, was found to be significantly ($p < 0.01$) larger (at 2.22%) than either low ration fish or fish fed *ad libitum* (grp. A). Mean GSI (Figure 7.12d) varied from 1.22 - 1.94%. No significant differences ($p \geq 0.05$) were found between the 3 groups in terms of mean GSI.

(3) Steroid level (Figures 7.13a & 7.13b).

Mean circulating level of E₂ (Figure 7.13a) ranged from 0.8 ng/ml in fish fed *ad libitum* (grp. A) to 1.3 ng/ml in high ration fish (grp. 1); no significant differences ($p \geq 0.05$) were observed between the 3 groups. Mean circulating level of T (Figure 7.13b) ranged from 3.4 ng/ml in low ration fish (grps. 3 & 4) to 8.1 ng/ml in high ration fish (grp. 1). T was significantly ($p < 0.05$) higher in high ration fish (grp. 1) than low ration fish (grps 3 & 4) but not fish fed *ad libitum* (grp. A)

(4) Ovarian histology

All ovaries were found to contain a mixture of all oocyte developmental stages previously classified in Chapter 4 (i.e. stages 2, 3, 4, 5, 6/7 and atresia). No post-ovulatory follicles (POFs) were observed in any ovary. No significant differences ($p \geq 0.05$) were found between the 2 low ration groups (grps. 3 & 4) in terms of the mean volume fraction (V.F.) of any oocyte developmental stage from either anterior, mid and posterior regions of the ovary. For this reason, V.F. data from these two groups are pooled in the following analyses.

(a) Comparison between different regions of the ovary at each ration level.

Within each rationed group, one-way ANOVA revealed no significant difference ($p \geq 0.05$) between the 3 regions of the ovary tested (anterior, middle and posterior) in terms of mean V.F. of any oocyte developmental stage. For this reason and to maintain clarity, although statistical comparisons between rationed groups were undertaken within each of the 3 ovary regions, the results described in (2) overleaf reflect only those comparisons made in the mid-region of the ovary.

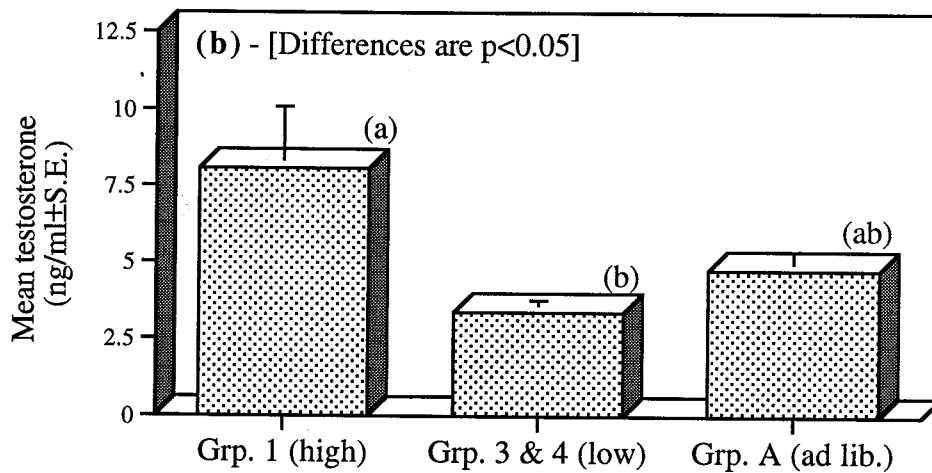
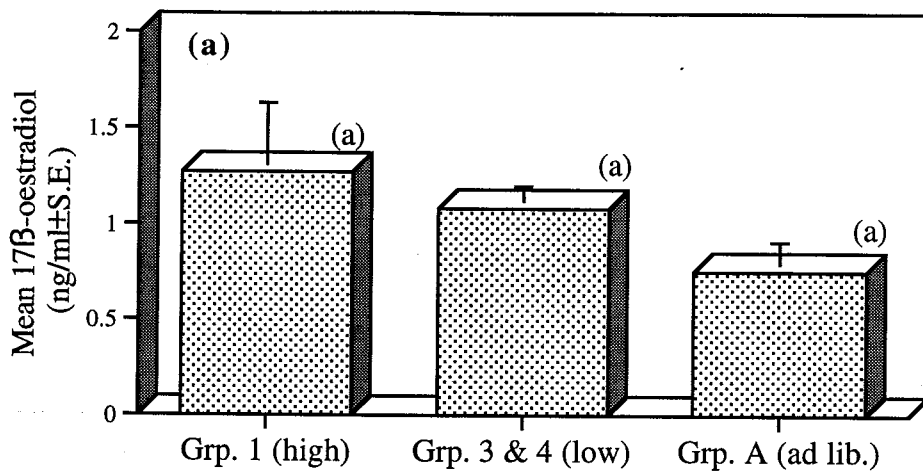

Figure 7.13. Comparison of (a) mean circulating 17β -oestradiol level and (b) mean circulating testosterone level between three groups of female *T. zillii*; group 1 (high ration), groups 3 & 4 (low ration, data pooled) and group A (previously fed *ad libitum* and not involved in food rationing). Significant differences between groups are indicated by annotation of the figure with different letters. Non significant differences are indicated by annotation with the same letter. Level of significance (where appropriate) is given within the figure.

(b) Comparison between rationed groups (Figure 7.14).

(b.1) Stage 2 oocytes: Mean V.F. varied from ~4.5% in fish fed *ad libitum* to ~29.4% in low ration fish. The ovaries of low ration fish exhibited a significantly greater ($p < 0.05$) mean VF of stage 2 oocytes than fish fed *ad libitum* but not those of high ration fish ($p \geq 0.05$).

(b.2) Stage 3 oocytes: Mean V.F. varied from ~1.3% in fish fed *ad libitum* to ~5.7% in low ration fish. Mean V.F. was significantly ($p < 0.05$) greater in low rationed fish than either of the other 2 groups. No difference ($p \geq 0.05$) was found however between fish fed *ad libitum* and those fed high ration.

(b.3) Stage 4 oocytes: No significant difference ($p \geq 0.05$) was found between any of the 3 groups with mean V.F. ranging from ~0.3% in fish fed *ad libitum* to ~3.2% in low ration fish.

(b.4) Stage 5 oocytes: No significant difference ($p \geq 0.05$) was found between any of the 3 groups with mean V.F. ranging from ~0.8% in fish fed *ad libitum* to ~17.6% in low ration fish.

(b.5) Stage 6/7 oocytes: Mean V.F. varied from ~7.8% in low ration fish to ~59.0% in high ration fish. Ovaries of low rationed fish were found to exhibit a significantly lower ($p < 0.05$) V.F. of stage 6 oocytes than fish fed *ad libitum* but not significantly different ($p \geq 0.05$) from the ovaries of high ration fish. No significant difference ($p \geq 0.05$) was observed between fish fed *ad libitum* and those fed high ration.

(b.6) Atretic oocytes : Mean VF varied from ~0.4% in low ration fish to ~2.0% in fish fed *ad libitum*. No significant difference ($p \geq 0.05$) was found between low ration fish and high ration fish (or between high ration fish and fish fed *ad libitum*). The V.F. of low ration fish however was significantly lower ($p < 0.05$) than fish fed *ad libitum*.

(7.5.3) Summary.

Unfortunately it was not possible to obtain fish of a similar age as the rationed fish. As a result group A (fed *ad libitum*) were unfortunately 4 - 5 months older than

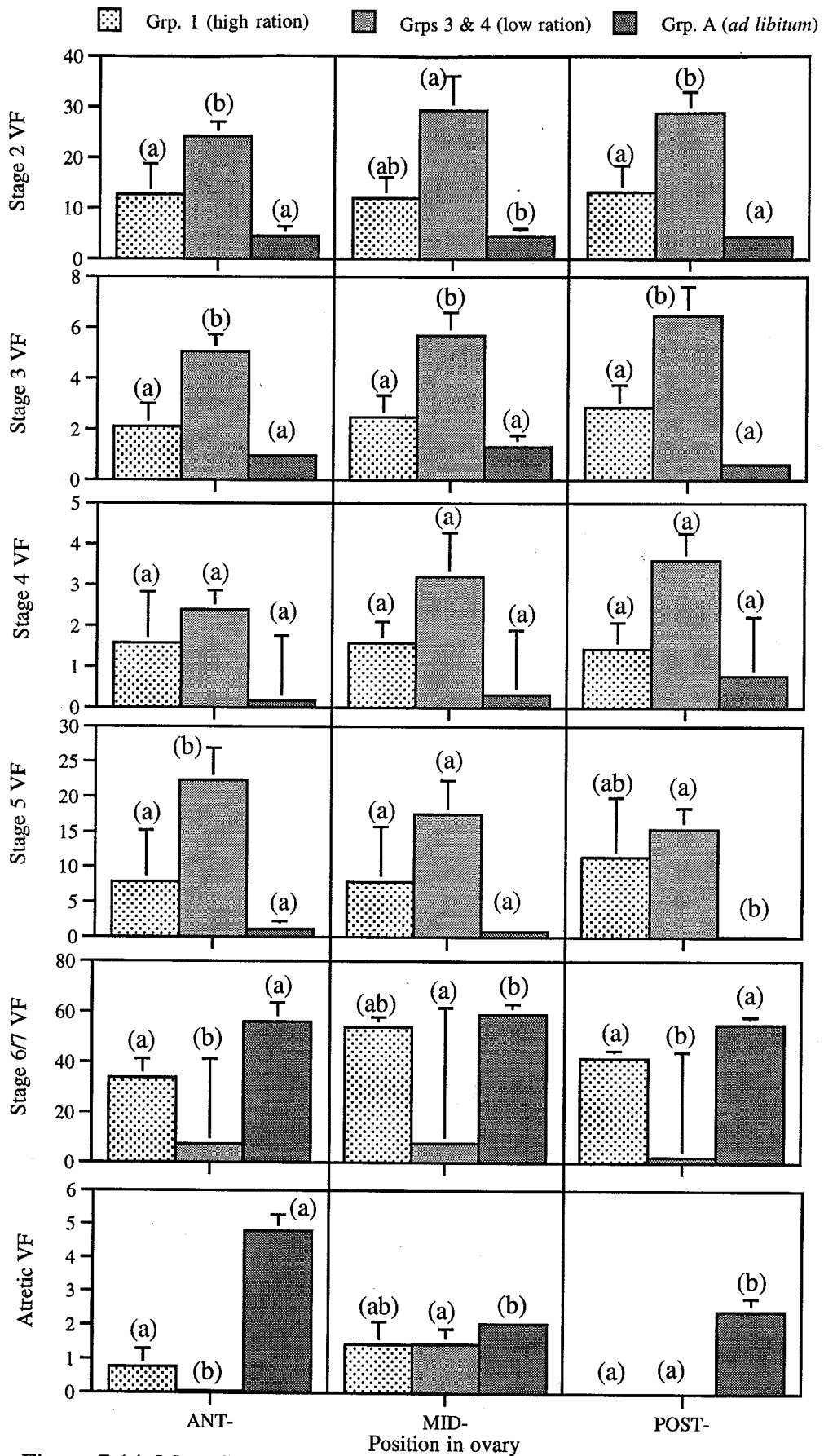

Figure 7.14. Mean VF (%±S.E.) of oocyte stages in 3 groups of *T. zillii*; gp. 1 (high ration), gps. 3 & 4 (low ration, data pooled) and gp. A (normal, fed *ad libitum*). Comparison between groups is made within 3 regions of the ovary; anterior (ANT-), middle (MID-) and posterior (POST-). Comparison for each oocyte stage is made within and not between each region of the ovary. Statistical differences ($p < 0.05$) are indicated by annotation of columns with different letters. Annotation with the same letter indicates no significant difference ($p \geq 0.05$).

the 2 rationed groups. ANOVA revealed that all 3 groups were significantly different from each other in terms of both length ($p < 0.001$) and weight ($p < 0.001$) with group A being significantly larger than either of the two rationed groups. No significant differences were found in terms of HSI between low ration fish and group A (*ad libitum*) though HSI in high ration fish was significantly larger ($p < 0.01$) than either low ration fish or group A. No significant difference was observed between the 3 groups in terms of GSI or E₂ level. Serum T was, however, significantly higher ($p < 0.05$) in high ration fish than low ration fish but not fish fed *ad libitum*. Low ration fish consistently exhibited the highest mean V.F.'s in terms of oocyte developmental stages 2, 3, 4 and 5 (i.e. pre-vitellogenic and early vitellogenic phases) whilst fish fed *ad libitum* consistently exhibited the lowest. Fish fed *ad libitum* did however exhibit the greatest V.F. of stage 6/7 (late vitellogenic/maturing/mature) oocytes; low ration fish exhibiting the least. No significant difference was found in terms of stage 6/7 oocytes between high ration fish and group A. Atresia was much more prevalent in the largest/eldest fish (i.e. those fed *ad libitum*) and was found to be least in the fish fed low ration (i.e. the smallest). No significant difference was detected between high and low ration groups in terms of atresia. A visual comparison of typical histological sections from each group of fish are provided in Plates 7.1 - 7.3.

(7.6) General discussion.

This Chapter forms the first detailed attempt to investigate the effect of restricted food supply on the reproductive physiology and endocrinology of the substrate-spawning tilapia *T. zillii*. Unlike many previous studies of mouthbrooding tilapia, the present investigation took place under controlled laboratory conditions (where temperature, photoperiod, flow rate and water quality were strictly controlled). Previous studies were mostly undertaken in outdoor tanks/ponds where dietary influences were inherently difficult to quantify and separate from other environmental variables. Earlier studies have also failed to utilise appropriate statistical techniques such as ANCOVA to adjust reproductive data for differences in fish size. Since aquaria

Plate 7.1. Transverse section (3µm thick) of ovary (mid-region) from *T. zillii* fed upon high ration (group 1). Note predominance of large late vitellogenic stage 6/7 oocytes. Stained with haematoxylin & eosin (Mag: x40). Scale : 100µm.

S2 - stage 2 oocyte

AT - atretic oocyte

S3 - stage 3 oocyte

VA - yolk vacuoles

S6/7 - stage 6/7 oocyte

YG - yolk globules

Plate 7.2. Transverse section (3µm thick) of ovary (mid-region) from *T. zillii* fed upon low ration (groups 3 & 4). Note predominance of pre-vitellogenic oocytes and early vitellogenic stage 5 oocytes. Stained with haematoxylin & eosin (Mag: x40). Scale : 100µm.

S2 - stage 2 oocyte

AT - atretic oocyte

VA - yolk vacuoles

N - nucleus (germinal vesicle)

YG - yolk globules

S5 - stage 5 oocyte

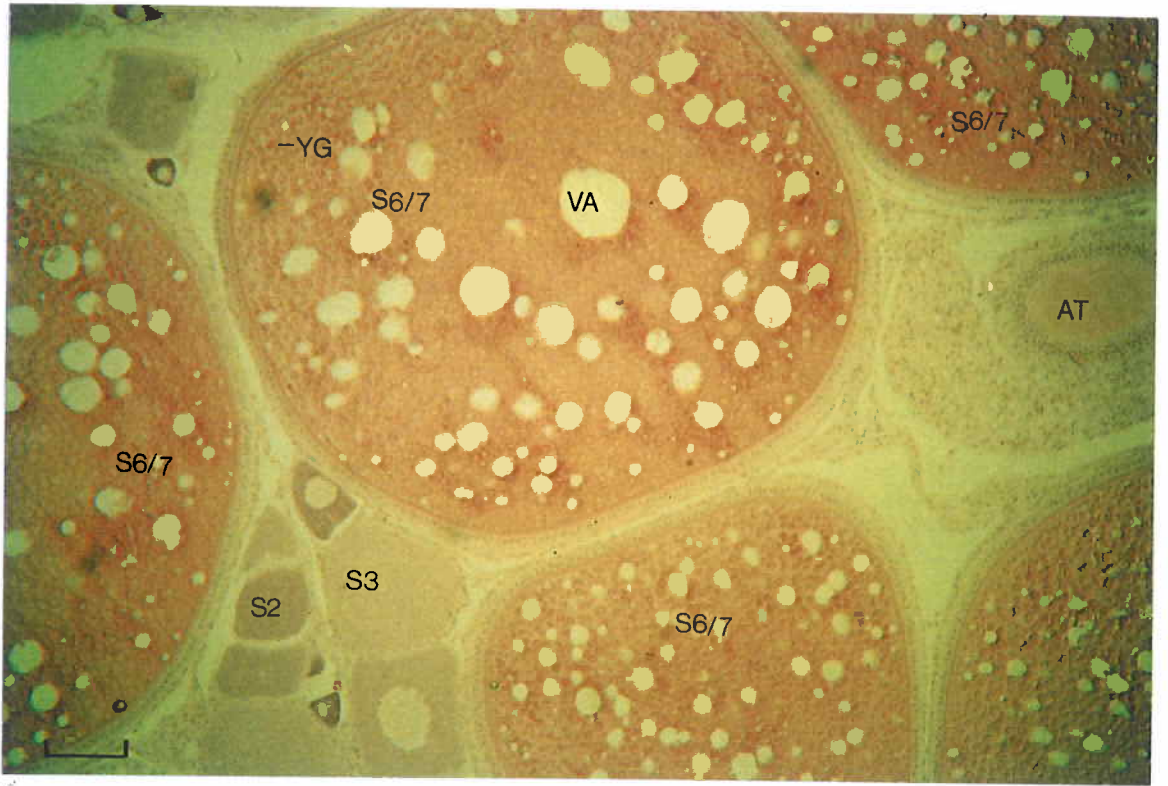

Plate 7.1

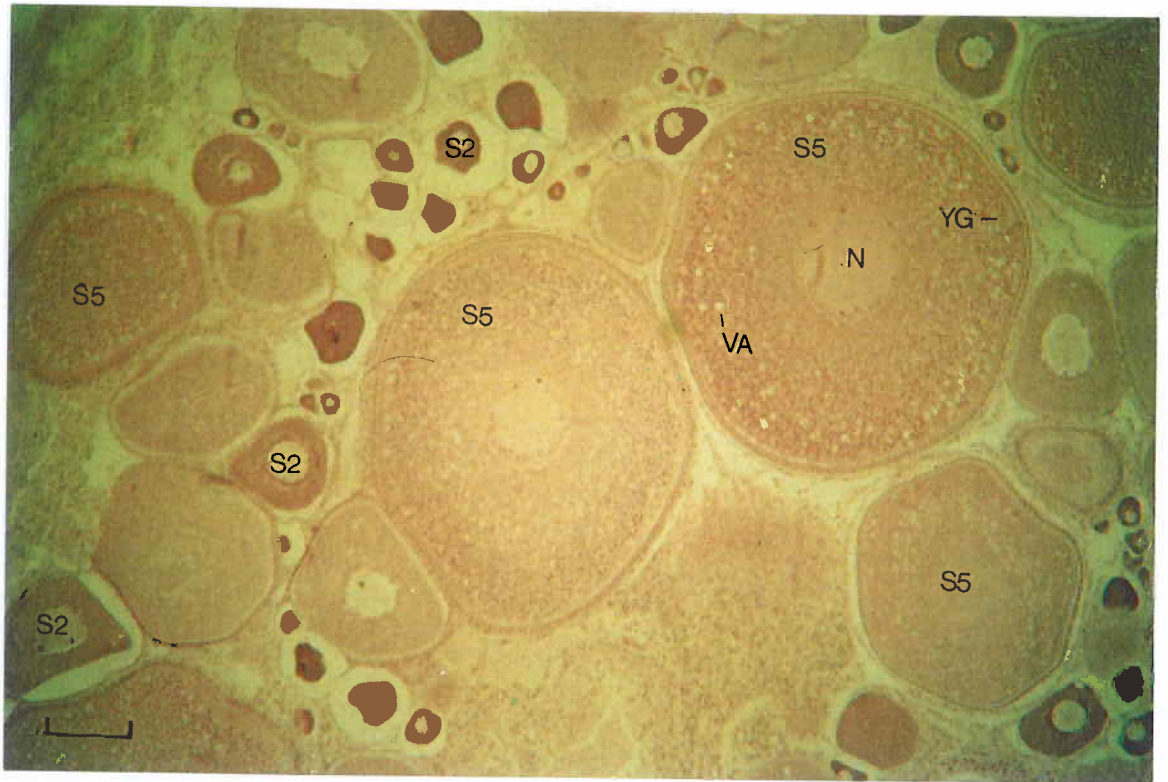

Plate 7.2

Plate 7.3. Transverse section (3µm thick) of ovary (mid-region) from *T. zillii* fed *ad libitum* (group A). Note predominance of large late vitellogenic stage 6/7 oocytes and large atretic oocytes. Stained with haematoxylin & eosin (Mag: x40). Scale : 100µm.

S2 - stage 2 oocyte

AT - atretic oocyte

S3 - stage 3 oocyte

VA - yolk vacuoles

S6/7 - stage 6/7 oocyte

YG - yolk globules

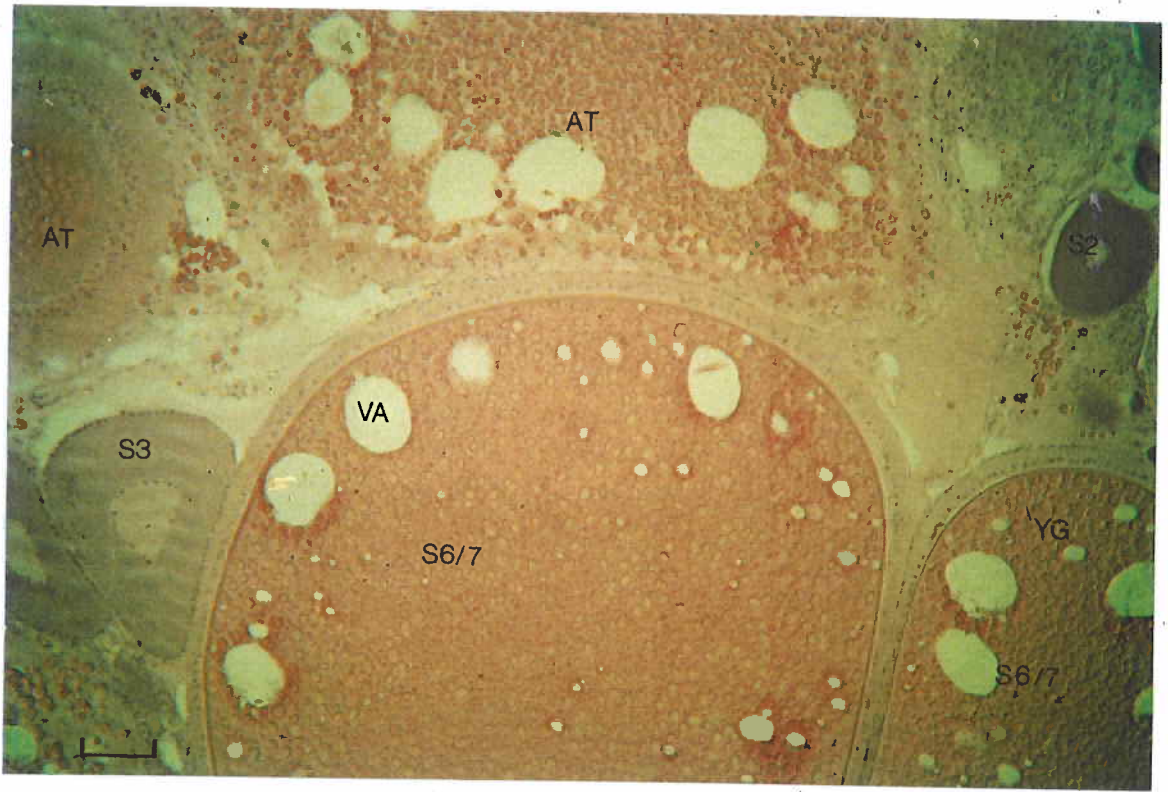

Plate 7.3

used in the present study were identical, it was assumed that differences in results between groups of experimental fish would be solely attributable to the controlled variable (ration size). The possibility that effects may be due to behavioural differences (or population density differences) cannot however be disregarded and will be discussed further later.

T. zillii were maintained upon two ration sizes (high and restricted) from the time of first feeding, beginning at approximately 4 - 5 days post-hatch and continuing for some 17 months. The commencement of rationing at EYS was planned so as to coincide with the process of sexual differentiation. Onset of sexual differentiation (movement of primordial germ cells from the mesoderm and endoderm to the presumptive gonadal sites to form the ovarian cavity or ovocoel) in tilapia appears to depend upon species, rearing temperature and rearing density. Sexual differentiation in *O. mossambicus* reared at 20° C for example occurred by 20 days post-hatch (Alvendi-Casavay & Carino, 1988). In the case of *T. zillii* (at 30° C), an ovarian cavity was formed by 20 days post-hatch (Yoshikawa & Oguri, 1978). Since rationing was undertaken in the present study from first-feeding onwards it seems likely that most, if not all, of the process of sexual differentiation occurred during manipulation of ration size, thus testing whether food restriction during sexual differentiation could affect reproductive performance upon attainment of sexual maturity.

Ration sizes were initially set at 40% and 10% bw/day (for high & low ration respectively) and were altered as necessary during the course of development. Once fish were approximately 15 months of age and being used as broodfish for comparison of reproductive indices, ration levels were 0.8% bw/day (high) and 0.4% bw/day (low). These levels seem rather low when compared to other estimates of ration size recommended for tilapia broodfish where ration size varies from 1 - 5% bw/day (Santiago *et al.*, 1985; Legendre & Ecoutin, 1989). Macintosh & Little (1995), however, recommended a ration size of 3% bw/day. That the high ration provided to *T. zillii* during the last few weeks of experimentation was much lower at 0.8% bw/day

may be a reflection of culture conditions. Jackson *et al.*, (1982) for example found feeding rates to be particularly low in a recirculating system housing *O. mossambicus*.

Not surprisingly, food restriction resulted in dramatic limitations of fish growth and by the end of rationing (approximately 17 months) had resulted in high ration females being approximately 3.5x larger than low ration females. Similar studies involving *O. niloticus* (Eguia & Eguia, 1993), *O. mossambicus* and *O. niloticus* x *O. aureus* hybrids (Macintosh & De Silva, 1984) have also reported growth retardation as a result of food restriction. In the present study, although visible differences in fish size were detectable by approximately day 80 of rationing, such differences did not become statistically significant until day 180. During Experiment 2 (day 290 - day 390), it was found that females were significantly smaller than males. This occurred at both ration levels but the size difference between sexes was far greater at high ration. That tilapias exhibit significant degrees of sexual dimorphism resulting in males often being larger than females of equivalent age is well known (Macintosh & Little, 1995). It is this male size advantage that has led to such strong interest in the production of all-male fry stocks via hormonal treatments or hybridisation (e.g. Macintosh *et al.*, 1985; McAndrew, 1993).

Over the first 290 day period, mortality was higher in fish receiving low rations (at ~87%) than at high rations (where mortality rate was ~60%) and was particularly high during the first 30 days of experimentation perhaps reflecting the stressful transfer of fry from incubators. Macintosh & De Silva (1984) also found that higher food ration levels improved survival rate. That mortality was higher in low ration groups may reflect poorer nutrition, increased levels of stress, increased competition or increased levels of cannibalism. In their study of *O. mossambicus* and *O. niloticus* x *O. aureus* hybrids, Macintosh & De Silva (1984) found that although cannibalism occurred in all experimental groups (and accounted for 10 - 35% of fry mortality), the incidence was reduced at higher ration sizes. In the present study, cannibalism accounted for 29 - 45% and 41 - 44 % of total mortality in high and low ration groups respectively. Cannibalism amongst fry of the same age is a significant problem for tilapia producers

because of the appearance of individuals or 'shooters' that are much larger than the rest of the stock (see Macintosh & Little, 1995).

During the first 290 days of study, specific growth rate (SGR) and food conversion ratio (FCR) were both greatest in high ration groups suggesting that growth was better and food conversion more efficient at higher ration levels. These findings agree with Macintosh & De Silva (1984) who found that SGR in mouthbrooding tilapias also increased with food ration. SGR also increases with increasing food ration in the white sturgeon *Acipenser transmontanus* (Richardson) (Cui *et al.*, 1996) and the three-spined stickleback (Wootton, 1994). FCR in the white sturgeon was also found to increase with increasing ration size (Cui *et al.*, 1996), though studies with mouthbrooding tilapia have failed to detect a consistent relationship between FCR and ration size (Macintosh & De Silva, 1984). Curiously, during Experiment 2 (from days 290 - 390), SGR was greatest in low ration fish. Reduced SGR in high ration fish during this period may be attributable to the fish in this group undergoing sexual maturation. Sexual maturation reduces growth rate in tilapias (Lowe-McConnell, 1982; Honer, 1987) resulting in a reduction in appetite, decreased SGR and often decreased FCR (not seen in the present study).

Food ration has been found to influence parental behaviour in another substrate-spawning cichlid, the convict cichlid (Townshend & Wootton, 1985). Amongst other effects, time spent by females fanning eggs was positively related to ration. Although the present study did not monitor parental behaviour *per se*, it was observed that at least one low ration fish appeared to 'eat' or 'mouth' her own eggs very soon after laying an egg clutch. Such behaviour was not observed in high ration fish. Whether such behaviour was the result of the parent preying on her own eggs (i.e. due to poor food supply) is not known, though other studies of tilapia (including substrate-spawners) have found eggs in the stomachs of up to 67% of the population of fish examined (Eyeson, 1983; Schwank, 1986). In their study of the convict cichlid, Townshend & Wootton (1985) found that both male and female fish 'mouthed' eggs. Mouthing

frequency however, did not appear to be affected by ration nor was it related to the number of eggs per spawn nor to female weight.

It should also be noted that differences in mortality between the two food rations employed in the present study inevitably resulted in differences in fish density between the two groups. It is known that in salmonid species, dominance status is inversely related to a chronic state of stress (Ejike & Shreck, 1980) and it has been demonstrated that increasing densities lead to reduced growth (e.g. Fagerlund *et al.*, 1981). High densities of tilapia prevent the establishment of stable territories and dominance ranks change more often. This would facilitate avoidance of confrontation and aggression and although fighting occurs more often, its effect on individual fish and on population growth is reduced (Honer *et al.*, 1987). Thus the increased growth seen in the high ration group in the present study may not simply be a result of increased food ration but a combination of increased food ration and increased density.

During on-growing (from day 290 - 390) no significant differences were found in terms of circulating E₂ or T level in females maintained on either high or low ration size. This was initially surprising since in other species, such as the rainbow trout, diet restriction was found to result in significant reductions in serum E₂, T and total calcium (i.e. as an indicator of vitellogenin) (Springate *et al.* 1985).

The effect of diet on reproductive physiology has been extensively studied in mammals. For example, food restriction and fasting have been found to influence both the pulsatile release of luteinizing hormone (LH) and the expression of the gonadotropin releasing hormone (GnRH) gene (Rutter & Manns, 1987; Grunewald & Matsumoto, 1993). Quite extensive work has been undertaken in this area in porcine biology; it is well known for example, that steroid synthesis in the boar is sensitive to transient reductions in nutrient uptake (Brown, 1994). A clear impact of nutrition on reproductive endocrinology has also been found in female pigs, via its influence upon various points of the hypothalamo-pituitary-gonadal axis (Cosgrove & Foxcroft, 1996); effects may be upon short term modulation of pulsatile luteinising hormone (LH) and in circulating steroid concentrations. Recent data from sheep suggest that nutrition may

also alter the balance between pituitary FSH secretion and gonadal feedback by changing responsiveness to the inhibitory effects of oestradiol and inhibin (Boukhliq *et al.*, 1996). It is also likely that ovarian steroidogenesis could be influenced by the concentration of circulating cholesterol (which is highly dependent upon the lipid composition of the diet); steroidogenesis is known to be dependent upon supply of sufficient cholesterol to the gonads (Nagahama *et al.*, 1993). Recent work in the sea bass involving alterations of dietary lipid composition appears to suggest that dietary deficiency may account for dysfunctional GTH II release (Navas *et al.*, 1995).

That no significant differences were found in terms of inter-group E₂ and T levels amongst females in the present study is probably attributable to the physiological mechanisms associated with confinement discussed in Chapter 6 (and not known at the time experimental work for Chapter 7 was undertaken). In brief, circulating levels of E₂ and T were suppressed during confinement in holding tanks (even at very low stocking densities) and increased rapidly following transfer to individual aquaria. Since food rationed stocks of fish were also held in similar recirculating holding tanks as those used in Chapter 6, it is likely that the failure to detect differences in E₂ and T amongst rationed fish was attributable to suppression of sex steroids in each rationed group to a common 'maintenance' level. Differences in T level (but not in E₂) were however detected in females at sacrifice at the age of ~15 months. That differences were found in T level between rationed females (T was largest in high ration fish) implies, however, that levels (at least in the case of T) were not being suppressed and that the differences may indeed have been attributable to ration. A better strategy (and retrospectively, a more informative one) would have been to compare circulating levels of steroids between rationed fish held individually at set time-points throughout the reproductive cycle (e.g. 0 days, 2 days, 4 days etc.) Interestingly, T was found to be significantly higher in high ration males than low ration males. A recent study by Toguyeni *et al.* (1996) also found that male *O. niloticus* fed higher rations tended to exhibit higher 11-ketotestosterone (11-KT) levels. These observations may be attributable to differences in growth and/or perhaps aggression.

During trials in individual aquaria over a period of 60 days, it was found that the mean number of spawns/fish and the mean number of days elapsed/spawn was remarkably consistent across rationed groups despite very large and significant differences in fish size. Previous studies on the three-spined stickleback (Wootton, 1977) and the convict cichlid (Townshend & Wootton, 1984) have observed a positive relationship between the number of spawns and ration size, though the underlying physiological mechanism is not known. In *O. mossambicus* however, ration restriction resulted in increased spawning frequency (Mironova, 1977). Why group A (fed *ad libitum*) failed to spawn during this period is not known but may be a function of size and age. Although attempts were made to utilise fish of an age similar to that of rationed fish, group A were unavoidably older than rationed fish by approximately 4 months and were significantly larger than either low or high rationed fish. The results of Chapter 3 suggested that spawning performance declines as *T. zillii* get larger (older). Nevertheless, *T. zillii* weighing ~150g should spawn (under individual conditions) at intervals of ~40 days (see Chapter 3). Moreover, histological analysis found that the ovaries of group A fish (discussed further later) were dominated by late vitellogenic/maturing oocytes. Atresia, however, was most prevalent in this group.

Regression analysis of spawning data from either high or low ration fish failed to detect significant relationships between fish size and reproductive parameters tested (total fecundity, relative fecundity, egg dry weight, egg diameter, egg volume, EW:BW ratio or total egg volume). It is suggested that the failure to detect significant relationships was probably due to a combination of low sample size and the quite large variation in such parameters (even within a discrete size class) seen in this species (see Chapter 3). When high and low data were pooled, significant relationships were found between fish size and total fecundity, relative fecundity and total egg volume (as also found in Chapter 3). In contrast to the stocks of fish used in Chapter 3 however, relationships were not found with egg dry weight nor EW:BW.

Studies involving other species of fish have generally found that food restriction results in a decline in fecundity, eg. rainbow trout (Scott, 1962; Cumaranatunga, 1985;

Bromage *et al.*, 1992), brown trout (Bagenal, 1969), guppy (Hester, 1964), winter flounder (Tyler & Dunn, 1976), three-spined stickleback (Wootton, 1973a), convict cichlid (Townshend & Wootton, 1984, 1985) and *O. mossambicus* (Mironova, 1977). The present study also observed significantly reduced total fecundity at low ration levels. This was attributable however to size differences between high and low ration fish; significant relationships existing between fecundity and fish size (see Chapter 3). After adjustment to a common body size using ANCOVA, no significant difference was found between rationed fish in terms of either fecundity or total egg volume. This is especially interesting since rationing occurred throughout sexual differentiation. The pre-requisites of ANCOVA, however, were only fully satisfied in the case of total fecundity. In the case of total egg volume, the test may not have been as robust.

Neither ANOVA nor ANCOVA, found significant differences between the two rationed groups of fish in terms of any index of egg size (egg diameter, egg dry weight or egg volume). Although some previous studies have found changes in egg size attributable to ration (e.g. Scott, 1962; Springate *et al.*, 1985; Bromage *et al.*, 1992; all in the rainbow trout), several report that food rationing had no effect upon egg size (e.g. Hester, 1964; Wootton, 1973a; Baiz, 1978; Kuznetsov & Khalitov, 1978). Moreover, Fletcher & Wootton (1995) found no relationship between egg protein or lipid content (nor DNA or RNA content) and food ration in the three-spined stickleback. Similarly, ration size was found to have no effect on rainbow trout eggs in terms of total fat, protein or amino acid profile (Springate *et al.*, 1985). Conservation of egg composition has also been observed in several marine species (see Kjorsvik *et al.*, 1990). Such results suggest (as detailed in Fletcher & Wootton, 1995) that female fish appear to ensure consistent egg composition (as diet quality and body reserves allow).

Sacrifice of fish at the age of ~17 months for histology found that GSI did not differ significantly between high or low ration groups or fish not part of the experiment and having being fed normally throughout development (group A). The HSI of high ration fish was significantly larger than either of the other groups, perhaps reflecting

greater loading on the liver in terms of protein and fat regulation or perhaps increased VTG production (though this is unlikely since no differences were found in concurrent E₂ levels amongst groups). Links between liver size and food ration were also found by Tyler & Dunn (1976) in the winter flounder and by Allen & Wootton (1982) in the three-spined stickleback.

Differences in ovarian histology were evident between rationed groups in the present study. Low ration fish possessed ovaries containing predominantly pre-vitellogenic and early vitellogenic oocytes whilst high ration fish (and fish fed *ad libitum*) contained predominantly late-vitellogenic/maturing oocytes. These findings concur well with those of Tyler & Dunn (1976) in the winter flounder and Townshend & Wootton (1984) in the convict cichlid; i.e. that the proportion of vitellogenic oocytes present in the ovary was related to food supply. Reductions in ration were suggested to have such effect via reducing recruitment of vitellogenic oocytes. Atresia in the present study was more prevalent in the larger sized fish (i.e. groups fed high ration and *ad libitum*). This was contrary to the findings of Springate *et al.* (1985) in the rainbow trout where atresia was found to be far more common in low ration fish. In the convict cichlid, atresia was only observed in females that had not spawned for long periods (Townshend & Wootton, 1984). Atresia has been suggested as a mechanism that could reduce fecundity during food restriction. Inter-ration differences in ovarian histology were not however manifested in terms of spawning performance in the present study; in spawning trials, mean number of spawns/fish and mean days elapsed/spawn did not differ between the two groups of rationed fish. This is perhaps a reflection of the relationship between spawning periodicity and fish size (see Chapter 3); spawning interval appears to increase with fish size. In multiple-spawning fish (such as *T. zillii*) several mechanisms may exist by which food supply could affect production of eggs; a reduction in egg production may reflect the result of one or more of these mechanisms. A model describing typical effects of such mechanisms is given in Wootton (1973a).

In summary, despite very large (and significant) differences in fish size, ANCOVA found no difference in size-adjusted total fecundity, egg diameter nor total egg volume in groups of *T. zillii* that had been fed either a high or low food ration size from EYS. That no differences were found in terms of GSI or EW:BW or in serum levels of E₂ further suggests that despite large differences in supplied ration throughout sexual differentiation and on-growing, investment in reproduction remained remarkably consistent. Low ration fish appeared to sacrifice growth to maintain reproductive capacity. Bekker (1959) postulated that under poor feeding conditions some fish mobilise all internal possibilities to safeguard reproduction; usually at the expense of somatic tissue. Nikolskii (1969) further noted the existence of dwarf forms of fish under conditions of poor food supply but with early maturation and high reproductive ability. Chimits (1957) also observed intensive spawning and population increase in pond stocks of *O. mossambicus* coincident with growth retardation. Moreover, inadequate food supply has been recognised as one factor that causes 'stunting' and precocious breeding in tilapias (Lowe-McConnell, 1982).

Under conditions of restricted food supply, an animal can invest limited energy into either somatic maintenance and growth (thereby increasing life expectancy and ensuring that a large ovary could be supported should food supply improve) or shunt energy into egg production at the expense of body weight (Wootton, 1977). Under food restriction, the winter flounder maintained body weight at the expense of egg production (Tyler & Dunn, 1976); the proportion of fish with yolk bearing ovaries was reduced at low ration due to increased atresia and a reduction of recruitment into vitellogenesis. Since low ration females were significantly smaller than high ration females in the present study, that GSI and EW:BW did not differ according to ration size and that ANCOVA found no differences in terms of total fecundity, egg diameter or total egg volume, it is suggested that female *T. zillii* adopt a contrasting approach to food restriction as winter flounder and instead, sacrifice body weight so that reproductive investment can be maintained. A similar scenario occurs in the three-spined stickleback (Wootton, 1977).

Chapter 8

General conclusions and discussion.

(8) General conclusions and discussion.

The present study aimed to investigate several, previously little-known, aspects of reproductive physiology and endocrinology in *T. zillii*; a tilapia that is becoming increasingly popular in world aquaculture.

Spawning periodicity and total fecundity tended to increase with fish size. Egg size only varied within a narrow size window and did not generally increase with fish size. Fish weighing 100 - 200g, however, appeared to produce the largest eggs. Analysis revealed strong relationships between body size and total fecundity, relative fecundity and total egg volume; relationships between fish size and egg size were much weaker. Fecundity and egg size were related to the length of the preceding inter-spawn-interval (ISI) in fish of certain weight categories but not others. Despite very large differences in fish size, no differences were found in terms of size-adjusted total fecundity, egg size or total egg volume between groups of *T. zillii* that had been fed either a high or low ration since first feeding, suggesting that investment in reproduction had remained remarkably consistent despite very large differences in food availability throughout sexual differentiation and on-growing.

Radioimmunoassay and stereological analysis provided valuable and unique data concerning the dynamics of ovarian development in this species. Levels of E₂ and T peaked within 6 days of spawning, suggesting that vitellogenesis began as early as day 2 or 3 post-spawn. By day 8, ovaries were dominated by stage 6/7 oocytes occupying 60 - 70% of the ovary. GSI reached maximal levels by day 14. Since proportions of stage 6/7 oocytes exhibited little change from day 8 onwards it is suggested that pre-vitellogenic oocytes are recruited into vitellogenic growth immediately after spawning and complete vitellogenesis as early as day 8 post-spawn.

Probably the most important finding was that sex steroid levels were suppressed in confined tilapia. Confined *T. zillii* (i.e. where stocking density was > 10 kg/m³) failed to spawn but spawned soon after transfer to individual aquaria. Serum E₂ and T were suppressed during confinement but increased rapidly following transfer to individual aquaria (coincident with resumed spawning activity). It is suggested that

levels of E₂ and T under confinement are not sufficient to allow completion of vitellogenic growth and are most probably suppressed via a pheromonal mechanism.

Collectively, these findings are of particular interest to managers of tilapia broodstock farms and hatcheries as asynchronous spawning and low fecundity compared to other fish complicate the production of consistent and sufficient numbers of fry.

The red-belly tilapia, *T. zillii* is extensively cultured in Africa and has been introduced into several different regions of Africa and the Middle East. It has been introduced into the irrigation canals of southern California (U.S.A.) where it has proved successful in the biological control of aquatic weed and thus mosquito and chironomid midge populations (Legner, 1983). *T. zillii* is also becoming a highly valued sporting quarry amongst game fishermen (Legner, 1978). Not surprisingly, *T. zillii* is one of the nine tilapias featuring significantly in World aquaculture (Pullin, 1983). The success of this species undoubtedly reflects the plasticity of its physiology; it is one of the most adaptive tilapias and can accommodate wide ranges in temperature, salinity and diet (El-Zarka, 1956; Bayoumi, 1969).

Potential for the future expansion of tilapia fisheries is high; an estimated shortfall of ~20 million tonnes is expected to occur between market demand (120 million tonnes) and expected marine fisheries production (100 million tonnes) by the year 2000. As a result, global production from inland fisheries will need to rise to 20 million tonnes by the year 2000 to meet the expected shortfall (Manzi; 1989; Haight, 1992; cited in Macintosh & Little, 1995). Production figures given by Macintosh & Little (1995) state that in 1990, annual tilapia production was only 391, 000 tonnes (a mere 5% of total freshwater fish production). Clearly then, the further development and intensification of tilapia culture not only shows great promise but will become a necessity within the next decade. It is vital that culture operations strive to meet increasing consumer demand. Optimisation of hatchery efficiency is of paramount importance if production is to be maximised and maintained. Broodfish productivity remains one of the most significant constraints on commercial production costs and a

knowledge of the factors affecting broodstock productivity is of immense importance if tilapia culture is to be developed effectively. This is particularly emphasized in the case of substrate-spawning tilapias, which have received far less research attention than mouthbrooding genera.

Individually-held *T. zillii* spawned successfully even in the absence of males. This concurs with the observations of Aronson (1949), Silverman (1978a) and Marshall (1979) in other species of tilapia. It is thought that in the absence of males, female tilapia may stimulate each other visually resulting in a shorter ISI (Aronson, 1949; Silverman, 1978a; Marshall, 1979). The results of a small trial reported in Chapter 6 however, found that the provision of male contact did not alter spawning incidence in adjacent females when compared to females deprived from male contact. Further trials found that visual contact with males did not influence levels of E₂ but resulted in a significant increase in T; perhaps associated with aggression or courtship. Provision of male contact also resulted in a significant increase in the proportion of early vitellogenic oocytes suggesting that provision of male contact may induce recruitment in females previously isolated from males.

Lee (1979) found that female tilapia housed in the same aquarium typically stimulate each other and consequently spawn at similar times. In the present study, spawning females appeared to stimulate adjacent females but only in terms of making body colouration more intense. Typically, spawning females did not induce adjacent females to spawn soon afterwards. Unfortunately, present data did not allow an investigation of how a spawning female may influence ovarian development and endocrinology in an adjacent fish. However, since body colouration changes dramatically throughout normal courtship and spawning behaviour in this species, it seems likely that a spawning female may well influence the hormonal status of an adjacent female which may, in turn, affect the ovaries.

During the present study no significant differences were found between the two strains in terms of either overall mean fecundity, mean egg dry weight, mean total egg volume, mean EW:BW (egg weight to body weight ratio) or in terms of circulating E₂

profile during ovarian recrudescence. Spawning interval was however, found to be shorter in strain 'B' than strain 'A'. Furthermore, strain 'B' fish spawned significantly sooner (by approximately 10 days) when transferred from stock conditions to individually-partitioned aquaria. It is unclear why this occurred although it may be linked to egg size. Mean egg volume was significantly smaller in Strain 'B'. Studies described in Chapter 6 found that *T. zillii* held in confined stock conditions failed to spawn but displayed a marked tendency to do so after transfer to individual aquaria. The ovaries of confined fish appeared to possess large proportions of vitellogenic oocytes coincident with suppressed levels of circulating sex steroids (to be discussed more fully later). It is possible that low steroid levels are not sufficient to allow completion of oocyte growth and that the length of time taken for the first spawn to occur after transfer to individual aquaria is simply a reflection of the time needed for renewed oocyte growth (seen coincident with dramatic rises in serum E₂ and T) to reach completion, thus taking longer in strain 'A' since egg size was larger. Curiously, peak levels of E₂ and T, following transfer from confined stock conditions into individual aquaria, occurred nine days later in strain 'B' (day 14 post-transfer) than strain 'A' (day 5). Further significant inter-strain differences were detected in the serum profiles of T and total calcium during ovarian recrudescence; serum T was found to be significantly higher in strain 'B' and total calcium was found to be significantly higher in strain 'A'.

The results of the present study therefore suggest the existence of possible inter-strain differences in several reproductive parameters. It remains unclear as to why these differences were observed. Perhaps, since stocks of the Tilapia Reference Collection are subject to constant aquarium conditions (environment, feeding regime *etc.*), the observed differences, particularly those related to endocrine status, may be attributable to behavioural differences and not to environmental conditions. It may be wise therefore to conduct further comparative studies on the two strains involving much larger sample sizes and perhaps addressing behavioural traits.

One of the most important features of tilapia reproductive biology is the plasticity of age and size at first sexual maturity (Rana, 1988). This was particularly evident with *T. zillii* in the present study where the smallest spawning fish were 28.9g (115mm) and 53.2g (143mm) in strains 'A' and 'B' respectively (at approximately 4 - 5 months of age). Fish of this size were found to exhibit mean total fecundities of 2079.2 ± 256 and relative fecundities of 50.1 ± 5 eggs/g.

Mean inter-spawn-interval (ISI) was found to increase in both strains of *T. zillii* with increasing fish size, though not significantly. Overall mean ISI was found to be approximately 26 days in strain 'A', similar to that reported for Lake Quarun *T. zillii* by El-Zarka (1956) and several mouthbrooding species (Rana, 1988). Mean ISI in Strain 'B' however, was much shorter at 15 days. In the present study, mean ISI was based solely on completed reproductive cycles and therefore underestimates true spawning periodicity. The best index of spawning periodicity was considered to be 'mean days elapsed per spawn' (thus taking into account both spawning and non-spawning fish - see Chapter 3). As with ISI, mean days elapsed per spawn increased with increasing fish size and averaged 61.4 days and 37.5 days in strains 'A' and 'B' respectively. The shortest spawning cycles observed in the present study were just 7 days and 6 days for strains 'A' and 'B' respectively, considerably shorter than previous reports (e.g. 15 days - Cridland (1962)). Interestingly and of great significance to the hatchery manager, is the fact that considerable variation in spawning interval was observed within a given maternal size class, despite aquarium conditions in the present study (temperature, photoperiod, water quality and feeding regime) being strictly controlled.

Factors governing spawning periodicity in *T. zillii* remain unclear and obviously require further study. It is unlikely that the variation observed in the present study was due to fluctuation in temperature as previously claimed by El-Zarka (1956, 1962), since water temperature was controlled. Tacon *et al.* (1996) also observed variability in ISI in aquaria-held *O. niloticus* and suggested that this was probably due to genetic differences between females and from individual responses to a variety of factors including social status and conspecific stimulation. Indeed, in the present study

visual contact with male conspecifics resulted in an overall significant elevation of serum T levels (though the response was extremely variable amongst individuals) which may have an important bearing on several other factors including GTH level (see Chapter 5). The observed variability is unlikely to be due to differential response to male conspecifics in the present study since spawning periodicity trials were undertaken in the absence of males. Tacon *et al.* (1996) also observed that several batches of early vitellogenic oocytes were found in the *O. niloticus* ovary immediately after spawning (also observed in *T. zillii*) and suggested that variability in ISI may be in part related to the number of oocytes in these developing batches and the time taken for them to complete vitellogenesis. Srisakultiew (1993) further found that spawning periodicity in *O. niloticus* depended upon absolute peaks of T during the reproductive cycle; females with low peaks of T exhibited longer reproductive cycles. Similarly, low levels of T were found to delay spawning in coho salmon and common carp (Fitzpatrick *et al.*, 1987; Santos *et al.*, 1986). Although peak levels of T occurred in *T. zillii* soon after spawning (days 4 - 6), marked variation was observed amongst individuals throughout the remainder of the cycle. It is likely then that this wide variation in T is in part responsible for the observed variation in ISI. The reason for such variation in T is unclear but is probably related to social factors, aggression to neighbouring females *etc.*

Total fecundity of laboratory-held *T. zillii* was found to range from 461 - 11640 (mean = 3606 ± 280) in strain 'A' (115 - 271mm, 28.9 - 419.0g) and from 1962 - 9733 (mean = 3560 ± 243) in strain 'B' (143 - 216mm, 53.2 - 240.8g). Sample size was far greater in the present study than many previous studies. Overall, mean total fecundity was much lower (at ~3600) than that given (~6600) by Siddiqui (1979). Siddiqui (1979) may however have overestimated fecundity as his data were based upon intra-ovarian egg counts. Present estimates were understandably greater than that given by Dadzie & Wangila (1980) whose analysis involved a stock of stunted *T. zillii*. As expected, present estimates of total fecundity were much greater than those given for mouthbrooding species, e.g. 324 - 1672 in *O. esculentus* (Lowe-McConnell, 1955),

56 - 498 in *O. leucostictus* (Welcomme, 1967) and 309 - 1158 in *O. niloticus* (Rana, 1986).

Fecundity was found to increase with increasing fish size as also observed by Lowe-McConnell (1955), Cridland (1962), Botros (1969), Siddiqui (1979) and Dadzie & Wangila (1980). None of these studies however, described whether a statistically significant relationship existed between fecundity and fish size. In the present study, significant relationships were consistently found between fish size (length and weight) and total fecundity, relative fecundity and total egg volume. Relationships were generally weaker in strain 'B' perhaps reflecting a smaller sample size. Relationships between egg size and fish size were weak. It is suggested that total fecundity, relative fecundity and total egg volume are the best predictors of reproductive capability in *T. zillii*.

The combination of fecundity and egg size as total egg volume strengthened the relationships to fish size but only in strain 'B'; 14 - 20% of the variance in total egg volume could be accounted for by body size. In Strain 'A', 42 - 50% of the variation could be accounted for by body size. The weaker correlation between total egg volume and body size in strain 'B' suggests that there is greater scope for independent variation of fecundity and egg size than in strain 'A'. That relationships were generally strengthened by the combination of egg size and fecundity as a single resource (total egg volume) suggests that *T. zillii* may conform to the 'trade-off' hypothesis reported in a variety of other species (see Wootton, 1984; Springate *et al.*, 1985; Bromage & Cumaranatunga, 1988; Bromage *et al.*, 1990; Bromage *et al.*, 1992). Further evidence for this 'trade-off' was provided by the significant decline of relative fecundity with increasing body size. That the present data appear to conform to the 'trade-off' hypothesis suggests that *T. zillii* may be an appropriate model for future work investigating the control of fecundity in teleosts. The many beneficial attributes of tilapia, e.g. resilience, amenability to handling, short reproductive cycles *etc.*, would further aid the use of *T. zillii* as a model research species.

Optimal egg production in strain 'A' was observed in 150 - 199g fish. Fish of this size range exhibited a mean fecundity of 4404 eggs/clutch and a spawning cycle lasting 39.5 days in aquaria. This suggests that on average, each fish spawns seven times per year producing 39636 eggs/year. Assuming that hatching rates in aquaria are approximately 60% (K. Coward, personal observation), 23782 yolk-sac fry/fish/year would be expected.

As with spawning periodicity, total fecundity was observed to vary markedly within a narrow maternal size class, particularly within larger size classes (as also observed by Dadzie & Wangila (1980)). Several species of fish are known to exhibit wide variation in fecundity, even amongst individuals of the same size and age (Bagenal, 1957; Wootton, 1979; Bromage *et al.*, 1992). Food abundance has been linked to such variations in fecundity (e.g. Bagenal, 1966, 1969). Indeed, wide fluctuations in fecundity were attributed to differential feeding success of *S. galileus* in Iita lake, Nigeria (Fagade *et al.*, 1984). Since fish in the present study experienced constant environmental conditions it seems likely that the variation was not due to changes in environmental factors such as water temperature, water quality or food ration/quality. Wootton (1979) observed that plots of fecundity and fish size often exhibit marked variation around a fitted curve and attributed this partly to the effects of age and egg size and partly to the effects of genetic and environmental factors on fecundity.

In the present study it was found that both relative fecundity and egg volume varied markedly over consecutive spawns in six serial-spawning females. No definite trends (i.e. tendencies to increase or decrease with successive spawns) were observed. Similar variations were observed in terms of fecundity, egg dry weight and total egg volume. These variations did not appear to relate to changes in ISI. Changes in fecundity and egg size have been reported in many other species of fish (see Hislop, 1975; Houghton *et al.*, 1985; Kjesbu & Kryvi, 1989; Mayer *et al.*, 1990; Watson *et al.*, 1992; Wootton, 1994; Hsiao *et al.*, 1994). Such changes have generally been attributed to food availability or depletion of the females resources (Hislop, 1975; Kjesbu *et al.*,

1990; Hsiao *et al.*, 1994). Other studies report a genetic involvement (McEvoy & McEvoy, 1991). Variations in food supply may well account for those variations in fecundity and egg size observed in studies of tilapia under natural conditions but are unlikely to have contributed to the present results since fish were fed *ad libitum*. It remains unclear why fecundity and egg size varied with successive spawns and surprising that such variations did not appear to relate to spawning periodicity. It is likely that the mechanism responsible involves more complex inter-relations between spawning periodicity, ovarian recruitment/growth/maturation, atresia and hormonal status.

Relatively little is known of how fecundity is determined in any fish though available evidence appears to suggest that genetic inheritance, nutritional status and the incidence of ovarian atresia play key roles. Vladykov (1956) stated that food deprivation reduced oocyte numbers in the brook trout by inducing atresia. Henderson (1963) however, reported that levels of atresia in this particular species were too low to account for any significant change in fecundity. In rainbow trout, atresia was said to play an important role in ovarian development particularly in the determination of fecundity (Bromage & Cumarantunga, 1988); when feeding levels were reduced, for example, all vitellogenic oocytes present in the ovary underwent atresia. Other studies such as those of Wallace & Selman (1979), Tyler *et al.* (1990) and Tyler & Sumpter (1996) claim that atresia is a fairly uncommon event in captive fish maintained under optimal conditions. In *T. zillii*, atresia was found at relatively consistent proportions throughout the reproductive cycle, but was particularly prevalent at the beginning and towards the end of reproductive cycles. Peters (1983) also observed high incidences of atresia in tilapia and claimed that this reflected the fact that a tilapia's 'readiness to spawn' could only be maintained for a short period. An involvement of atresia in the determination of fecundity in this species thus seems very likely.

In plaice, Simpson (1951) suggested two critical periods in which fecundity could be influenced. Firstly, during the period when the germinal epithelium was laid down during the first year of life and secondly, either the time at which new primary

oocytes are formed each year or when the eggs to be laid each year are separated from the mass of developing ova. The former period may fix the general level of fecundity for the duration of the fish's life whilst the latter periods would be expected to influence the number of eggs to be laid year by year and that food balance may well determine such periods (Simpson, 1951). Several studies have found that fecundity may be modified by nutrition (e.g. Bagenal, 1969; Allen & Wootton, 1982; Townshend & Wootton, 1984; Wootton, 1985; Bromage & Jones, 1991; Bromage *et al.*, 1991; Bromage *et al.*, 1992). Fecundity in rainbow trout for example, is reduced significantly in females maintained upon half ration during the early part of ovarian recrudescence but fed upon a full ration thereafter (Bromage & Jones, 1991; Bromage *et al.*, 1991), suggesting that fecundity is determined early in the reproductive cycle. Bromage *et al.* (1992) further claimed that there were three main methods by which fecundity could be determined: atresia, recruitment of pre-vitellogenic oocytes into vitellogenesis (also suggested by Robb (1982)) and finally the extent of oogonial proliferation. Tyler & Sumpter (1996) further reported that an individual's genetic and nutritional condition most probably act as absolute determinants of fecundity and that the actual number of eggs produced at spawning involves a combination of oocyte recruitment into vitellogenesis and the incidence of atresia.

Genetic inheritance is said to play an important role in the determination of fecundity in fish (Fagade *et al.*, 1994; Macintosh & Little, 1995; Tyler & Sumpter, 1996) though conclusive evidence has yet to be revealed. Mammalian studies however have revealed the existence of a specific gene in the Booroola sheep that has been found to determine fecundity (e.g. McNatty *et al.*, 1994).

In *O. niloticus*, Srisakultiew (1993) observed that the number of eggs produced at each spawning may relate to the proportions of oocyte developmental stages present after the previous spawn (and thus depend upon spawning history). For example, immediately after the first spawn, ovaries contained a higher proportion of atretic oocytes than after the second or third spawn whilst proportions of post-ovulatory follicles (POFs) increased (Srisakultiew, 1993). This suggests that those fish that had

already spawned may successfully ovulate more eggs than those that had never spawned. Results from the present study found that the length of the preceding ISI was significantly related to fecundity and egg volume in certain maternal weight categories but not all. This provides limited evidence that length of ISI may in part, control fecundity and egg size in *T. zillii*.

There are therefore, a number of interrelated factors that may be involved in the determination of fecundity in the multiple-spawning tilapia family and offer many opportunities for exciting future research. One technique that holds great promise for the detailed analysis of ovarian growth and recruitment and may be employed effectively in studies concerning fecundity determination is unilateral ovariectomy. Recently employed in the rainbow trout, this technique involves surgical removal of one ovary. The remaining ovary undergoes compensatory hypertrophy, thereby inducing oocyte recruitment (Tyler *et al.*, 1994, 1996; Tyler & Sumpter, 1996). Partial or unilateral ovariectomies therefore offer effective means of inducing recruitment and could be used to examine the roles of several endocrine factors such as GTH I, insulin or IGFs in early oocyte growth. The ease with which tilapia can be maintained and their prolific spawning behaviour suggest that this species would be highly suitable for such work.

Obviously there is great need for further research into the control of spawning periodicity and the determination of fecundity in tilapias. In the interim period, current culture problems associated with low fecundity may be alleviated in part by selecting and using broodstock exhibiting optimal reproductive traits such as total fecundity, egg size and EW:BW ratio (as also suggested by Rana, 1988). Research findings remain limited but do suggest that genetic inheritance for desirable traits such as colour, growth rate and fecundity are measurable (Macintosh & Little, 1995). The process is not an easy one to understand; heritability in tilapias is complex and can be obscured by their environmental adaptability (Behrends, 1988).

Oocyte growth was classified in the present study into several distinct developmental stages based upon oocyte size, biochemical properties and structure;

oogonia, stage 1 (chromatin nucleolar stage), stage 2 (early perinucleolar stage), stage 3 (late perinucleolar stage), stage 4 (cortical alveolar stage), stage 5 (vitellogenesis), stage 6 and 7 (maturation and germinal vesicle breakdown), atresia and post-ovulatory follicles (POFs). This classification scheme was comparable to other classification schemes developed by Wallace *et al.* (1987), Bromage & Cumaranatunga (1988), Selman & Wallace (1989) and Srisakultiew (1993), but represents the first detailed description of oocyte growth in any substrate-spawning tilapia.

Stereological analysis of ovarian histology and radioimmunoassay of sex steroid levels provided unique information concerning ovarian recrudescence in this species. Briefly, levels of E₂ and T peaked and fell within 6 days of spawning suggesting that vitellogenic growth began as early as day 2 or 3 post-spawning. As early as day 8 the ovary was dominated by stage 6/7 oocytes occupying 60 - 70% of the ovary. From day 8 onwards little change was seen in the proportion of stage 6/7 oocytes though GSI was observed to increase (as oocytes matured) to reach maximal levels of 5.0 - 5.5% from day 14 onwards. GSI was significantly correlated to the volume fraction (VF) of stage 6/7 oocytes, as also found by Srisakultiew (1993) in *O. niloticus*. These data suggest that pre-vitellogenic oocytes are recruited into vitellogenic growth very soon after spawning and complete vitellogenesis as early as day 8 post-spawning.

Profiles of E₂ consistently exhibited an initial peak on either day 2 or day 4, coincident with, or slightly before, an initial peak of T. Subsequent to this, T varied quite widely amongst different individuals at the same timepoint; a factor that may have contributed to variations in spawning periodicity (see earlier). Levels of E₂ had fallen by day 10 and generally remained low thereafter, though slight elevations were observed between days 30 and 42. The role of T in ovarian recrudescence is unclear (see Chapters 1 and 5); analysis in Chapter 5 however, found that serum T was significantly correlated to the VF of POF's and to the ND of stage 6/7 oocytes (but only after logarithmic transformation). These findings suggest that T may indeed play an important role in the tilapiine ovary. Serum E₂ was significantly correlated to the VF of stage 6/7 oocytes, an observation also made by Srisakultiew (1993) in *O. niloticus*.

A further experiment in Chapter 6 however, detected significant relationships between the VF of stage 5 (early vitellogenic) oocytes and serum levels of E₂ and T; relationships to stage 6/7 oocytes were not significant. The reason for this difference is not clear.

Unfortunately, only one fish re-spawned during blood sampling experiments. Data from this fish suggest that although E₂ remained relatively low following the initial post-spawn peak, a second slightly smaller peak occurred between days 30 and 46 coincident with a second T peak. The second T peak was followed immediately by a third, slightly smaller peak. Ovulation occurred immediately after the third T peak. It is suggested that the second peak of E₂ occurring between days 30 and 46 corresponds to the second elevation of E₂, T and progesterone reported by Smith & Haley (1988) in *O. mossambicus* and is probably associated with oocyte maturation. It is possible that the second peak of T was involved in a GTH surge (see Stacey, 1979) and that the third peak involved impending ovulation (see Kobayashi *et al.*, 1986, 1988, 1989). Interestingly, initial post-spawn E₂ and T peaks (on days 2 - 6) were much smaller after the second spawning than the first concurring with those observations of Srisakultiew (1993) in *O. niloticus*. Since Srisakultiew (1993) detected a link between E₂ levels and fertilisation rates (and hence 'egg quality'), it appears that in both *O. niloticus* and *T. zillii*, egg quality may deteriorate over successive spawnings.

That only one fish re-spawned during blood-sampling experiments re-emphasises a problem common to studies of reproduction in multiple-spawners; i.e. low sample size. When investigating reproductive cycles in multiple-spawners it is obviously necessary to commence studies at a 'standardised point'. This is usually immediately after spawning and thus represents the beginning of the next cycle. As a result, it is often necessary to wait for broodfish to spawn naturally prior to beginning experimental work. It can therefore take some time to build-up an appropriate sample size.

Atresia was particularly prevalent at the beginning and towards the end of the spawning cycle; this suggests that the longer the spawning cycle, the greater potential

impact of atresia. Indeed, analysis reported in Chapter 3 found that fecundity was related to length of the preceding ISI in some but not all maternal weight categories and that fecundity decreased with increasing ISI. Perhaps this was attributable to atresia becoming more prevalent in longer spawning cycles. It may also be attributable to the fact that a tilapia's 'readiness to spawn' can only be maintained for a relatively short period (Peters, 1983). One day after spawning, atretic oocytes occupied <4% in *T. zillii*, far less than levels reported in mouthbrooding species at the same timepoint (~40%, Srisakultiew, 1993).

Vitellogenesis is arguably the most important phase of oocyte growth and in rainbow trout for example, accounts for up to 95% of egg volume (Tyler *et al.*, 1990). In teleosts, as in other oviparous vertebrates, VTG is sequestered by receptor-mediated endocytosis involving a specific VTG receptor located on the oocyte membrane (Chan *et al.*, 1991; Tyler & Lancaster, 1993; Lancaster & Tyler, 1994). Hormones and growth factors regulating the VTG receptor are therefore likely to play critical roles in oocyte growth. A greater understanding of vitellogenesis and oocyte growth in fish is likely to come from studies involving the developmental expression of the VTG receptor using specific probes designed to the receptor cDNA sequence. Such studies are already well underway in the rainbow trout (Tyler *et al.*, 1995b) but as yet have not been addressed in tilapiine species.

Probably the most interesting findings of the present study (and the most applicable to commercial culture) are described in Chapter 6. Briefly, the present study showed that *T. zillii* fail to spawn when held in confined holding tanks. Moreover, there is a marked tendency for previously confined fish to spawn soon after transfer to individually-partitioned aquaria. Similar results were observed in the platyfish (Borowsky & Diffley, 1981). In the case of the platyfish it was concluded that stress may have resulted in an inhibition of spawning during crowding whilst a return to uncrowded conditions permitted its resumption. However, relevant physiological mechanisms that may have accompanied these observations were neither investigated nor discussed. In the case of tilapias, it is widely believed that spawning synchrony

can be improved through exposure of broodstock to sudden environmental change. Srisakultiew & Wee (1988) for example, reported improved spawning synchrony in broodstock *O. niloticus* (L.) that had been cold-shocked prior to stocking in spawning hapas. Improved spawning synchrony (and frequency) in *O. niloticus* was also found to result from 'conditioning' broodstock prior to stocking in spawning tanks (Macintosh & Little, 1995). Fish were 'conditioned' in high density hapas suspended in pond water rich in natural food. During this period, fish fed intensively but did not reproduce since hierarchy formation was prevented due to the high stocking density and turbid conditions (Little, 1989). Again, physiological correlates such as ovarian histology and endocrine profiles were absent from these studies.

In *T. zillii*, circulating levels of E₂ and T were suppressed during crowding but increased rapidly following transfer of fish to individual aquaria coincident with resumed spawning activity. It is suggested that the reduced levels of E₂ and T during crowding were not sufficient to allow completion of vitellogenic growth. The mechanism resulting in suppression of E₂ and T is not known but is most probably pheromonal (see Chapter 6 for full discussion). The shift from sexual to schooling behaviour known to occur in tilapias during crowding (Balarin *et al.*, 1986; Falter & Debacker, 1988) therefore appears to coincide with changing stimulation of the hypothalamo-pituitary-gonadal axis thereby influencing circulating levels of gonadal sex steroids. Levels of circulating GTH are probably also affected but would require further study. These particular findings initiated collaborative work with the Asian Institute of Technology (Bangkok, Thailand) and the design of a field experiment under realistic commercial conditions investigating the sex steroid levels of *O. niloticus* throughout 'conditioning' (as described by Little, 1989; Little *et al.*, 1993; Macintosh & Little, 1995) in high density hapas and after transfer to spawning tanks. In brief, results of the field trial suggested that there was a high degree of correlation between levels of T, E₂, total calcium and seed production by females conditioned for varying periods of time. Unspawned fish removed from spawning hapas had higher steroid and calcium

levels than fish conditioned for 7 days (Little, Coward, Pham, Bhujel & Bromage, unpublished).

Fry supply can become a limiting factor in semi-intensive culture operations due to the inherent low fecundity of tilapias (Mires, 1982) and the asynchronous nature of their spawning cycles (Jalabert & Zohar, 1982). This results in the need for very large numbers of broodfish requiring time-consuming (and expensive) management. As a direct result there is increasing pressure to reduce running costs. This is particularly so in the case of feed costs and has been addressed through the development of practical diets incorporating plant ingredients (e.g. De Silva & Radampola, 1989), by the evaluation of alternative protein sources other than fishmeal (which is rising in price) (Santiago *et al.*, 1983, 1985; Wee & Tuan, 1988; Gunasakera *et al.*, 1995) or by restriction of ration size (Mironova, 1977; Macintosh & De Silva, 1984).

The present study investigated the effect on various aspects of reproduction of a prolonged restriction in ration size; *T. zillii* were rationed from first-feeding and throughout the following 17 months. Despite very large (and significant) differences in fish size, no significant differences were detected in total fecundity, egg diameter nor total egg volume once differences in fish size had been partitioned using ANCOVA. That no differences were found in terms of GSI, EW:BW or in circulating levels of E₂ further suggests that despite large differences in ration size throughout the periods of sexual differentiation and on-growing, investment in reproduction remained relatively consistent. Under conditions of restricted food supply, an animal can invest its limited income into either somatic growth and maintenance or shunt energy into egg production at the expense of body weight (Wootton, 1977). It appears therefore, that during food restriction, *T. zillii* sacrifice body weight and growth so as to maintain reproductive investment, even over prolonged periods of time. This implies that in restricting ration size (and thereby cutting maintenance costs), farm managers would only observe a change in reproductive output that reflected a resultant modification in fish size (i.e. total fecundity, relative fecundity, spawning periodicity, egg size and EW:BW ratio are related to fish size).

The unpredictable and asynchronous nature of spawning cycles in tilapia suggest that the development of artificial techniques that may be used to manipulate and control cycles would be of immense benefit to culture. This is particularly so in the case of *T. zillii*. Several studies have attempted to develop methods aimed at inducing spawning on demand. Such studies have met with only very limited success and have involved temperature manipulation (Behrends *et al.*, 1983; Srisakultiew & Wee, 1988) and treatment with exogenous hormones such as human chorionic gonadotropin (hCG) (Dadzie, 1970; Babiker & Ibrahim, 1979b; Srisakultiew & Wee, 1988), luteinizing hormone (LH) (Dadzie, 1970) or implantations of luteinizing hormone releasing hormone (LHRH) (Srisakultiew, 1993).

It is likely that the application of exogenous hormones may be effective as early as eight days after spawning in *T. zillii*; by this time vitellogenesis was largely complete and the ovary was dominated by stage 6/7 oocytes (occupying 60 - 70% of the ovary). Intra-ovarian biopsy was found to be an extremely effective means of assessing the histological condition of the *T. zillii* ovary and could therefore be invaluable in the screening of broodstock for suitable fish to induce. Although not reported in this thesis, a preliminary study was carried out investigating the potential of spawning inducement in selected *T. zillii* broodstock. Intra-muscular injections of hCG at doses of 100, 500, 750 and 1500 IU/kg resulted in limited success; the most encouraging results were obtained at dose rates of 750 IU/kg. Of particular interest was the finding that intramuscular injections of pregnant mares serum gonadotropin (PMSG) on day 3 post-spawn followed by hCG (500 IU/kg) on day 5 invariably initiated spawning on day 6. This was repeated in five individual fish up to five times in succession. The implications of this finding and its potential benefit to tilapia culture show great promise and should receive further attention. Of most concern is the fact that egg quality (as indicated by hatching rates) varied markedly in these fish.

In summary, the present study provides valuable and novel information regarding fecundity, egg size, spawning periodicity, ovarian dynamics and reproductive endocrinology in *T. zillii*; a tilapia that is becoming increasingly popular in aquaculture.

These studies suggest that *T. zillii* could play an important role in the future expansion of tilapia culture and could represent a valuable 'model species' for future work on fecundity and ovarian development. The most notable finding was that sex steroid levels were suppressed in confined tilapia but increased rapidly following transfer to individual aquaria. Suppressed levels of E₂ and T were thought to be insufficient to allow completion of vitellogenic growth and thereby prevented oviposition. This finding is likely to be of great importance to commercial tilapia culture.

Chapter 9

References.

(9). References.

- Abraham, M., Hilge, V., Lison, S. & Tibika, H. (1984). The cellular envelope of oocytes in teleosts. *Cell and Tissue Research* **235**, 403 - 420.
- Adams, M.A., Teeter, J.H., Katz, Y. & Johnsen, P.B. (1987). Sex pheromones of the sea lamprey (*Petromyzon marinus*): steroid studies. *Journal of Chemical Ecology* **13**, 386 - 395.
- Allen, J.P.M. & Wootton, R.J. (1982). Effect of food on the growth of carcass, liver and ovary in female *Gasterosteus aculeatus* L. *Journal of Fish Biology* **21**, 537 - 547.
- Allison, R., Smitherman, R.O. & Cabrero, J. (1979). Effects of high density culture on reproduction and yield of *Tilapia aurea*. In *Advances in Aquaculture*. FAO Technical Conference, Kyoto, Japan. pp. 168 - 170.
- Alvendia-Casavay, A. & Carino, V.S. (1988). Gonadal sex differentiation in *Oreochromis niloticus*. In *The Second International Symposium on Tilapia in Aquaculture* (Pullin, R.S.V., Bhukaswan, T., Tonguthai, K. & Maclean, J.L., eds.), pp. 121 - 124. Department of Fisheries, Bangkok, Thailand and International Center for Living Aquatic Resources Management, Manila, Phillipines.
- Anderson, E. (1967). The formation of primary envelope during oocyte differentiation in teleosts. *Journal of Cell Biology* **35**, 195 - 212.
- Anderson, D.M. & Smith, L.D. (1978). Patterns of synthesis and accumulation of heterogeneous RNA in lampbrush stage oocytes of *Xenopus laevis* (Daudlin). *Developmental Biology* **67**, 274 - 279.
- Aronson, L.R. (1945). Influence of the stimuli provided by the male cichlid fish, *Tilapia macrocephala*, on the spawning frequency of the female. *Physiology and Zoology* **18**, 403 - 415.
- Aronson, L.R. (1949). An analysis of reproductive behaviour in the mouthbreeding cichlid fish, *Tilapia macrocephala* (Bleeker). *Zoologica N.Y.*, **34**, 133 - 158.

- Avarindan, C.M. & Padmanabhan, K.G. (1972). Source of a new crop of oocytes in *Tilapia mossambica*. *Helgoländer wiss Meeresunters* **23**, 184 - 192.
- Babiker, M.M. & Ibrahim, H. (1979a). Studies on the biology of reproduction in the cichlid *Tilapia nilotica* (L.): gonadal maturation and fecundity. *Journal of Fish Biology* **14**, 437 - 448.
- Babiker, M.M. & Ibrahim, H. (1979b). Studies on the biology of reproduction in the cichlid *Tilapia nilotica* (L.): effects of steroid and trophic hormones on ovulation and ovarian hydration. *Journal of Fish Biology* **15**, 21 - 30.
- Babin, P.J. (1987). Apolipoproteins and the association of egg yolk proteins with plasma high density lipoproteins after ovulation and follicular atresia in the rainbow trout (*Salmo gairdneri*). *Journal of Biological Chemistry* **262**, 4290 - 4296.
- Bagenal, T.B. (1957). The breeding and fecundity of the Long Rough Dab (Fabr.) and the associated cycle in condition. *Journal of the Marine Biological Association of the U.K.* **36**, 339 - 375.
- Bagenal, T.B. (1966). The ecological and geographical aspects of the fecundity of the plaice. *Journal of the Marine Biological Association of the U.K.* **46**, 161 - 186.
- Bagenal, T.B. (1967). A short review of fish fecundity. In *The Biological Basis of Freshwater Fish Production* (Gerking, S.D., ed.), pp. 89 - 111. Blackwell Scientific Publications: Oxford, U.K.
- Bagenal, T.B. (1969). The relationship between food supply and fecundity in brown trout *Salmo trutta*. *Journal of Fish Biology* **1**, 167 - 182.
- Bagenal, T.B. (1973). Fish fecundity and its relations with stock and recruitment. *Rapp. P. -v. Réun. Conseil International pour l'Exploration de la Mer* **164**, 186 - 198.
- Bagenal, T.B. (1978). Aspects of fish fecundity. In *Ecology of Freshwater Fish Production* (Gerking, S.D., ed.), pp. 75 - 101. Blackwell Scientific Publications: Oxford.

- Bagenal, T.B. & Tesch, F.W. (1978). Age and growth. In *Methods for the Assessment of Fish Production in Freshwaters 3rd Edition* (Bagenal, T.B., ed.), pp. 101 - 136. IBP Handbook No. 3. Blackwell Scientific: Oxford, U.K.
- Baggerman, B. (1957). An experimental study of the timing of breeding and migration in the three-spined stickleback (*Gasterosteus aculeatus* L.). *Archives of Netherlands Zoology* **12**, 105 - 318.
- Baggerman, B. (1980). Photoperiodic and endogenous control of the annual reproductive cycle in the teleost fishes. In *Environmental Physiology of Fishes* (Ali, M.A., ed.), pp. 533 - 567. Plenum Press: New York, U.S.A.
- Baiz, M. (1978). Fecundity of reared rainbow trout *Salmo gairdneri*. *Ecologia* **3**, 57 - 64.
- Balarin, J.D. & Hatton, J.P. (1979). *Tilapia: A Guide to Their Biology and Culture in Africa*. University of Stirling, Stirling, Scotland., U.K.
- Balarin, J.D. & Haller, R.D. (1982). The intensive culture of tilapias in tanks, raceways and cages. In *Recent Advances in Aquaculture* (Muir, J.F. & Roberts, R.J., eds.), pp. 267 - 335. Westview Press: Boulder, CO, USA.
- Balarin, J.D., Haller, R.D. & Armitage, A.T.C. (1986). Research on intensive culture of tilapia in tanks. In *Proceedings of the African Seminar on Aquaculture Organised By the International Foundation For Science (IFS)*, (Huisman, E.A., ed.), pp. 206 - 216. Sweden.
- Ball, J.N. (1981). Hypothalamic control of the pars distalis in fishes, amphibians and reptiles. *General and Comparative Endocrinology* **44**, 135 - 170.
- Bara, G. (1965). Histochemical localization of $\Delta 5-3\beta$ -hydroxysteroid dehydrogenase in the ovaries of a teleost fish, *Scomber scomber* (L.). *General and Comparative Endocrinology* **5**, 284 - 296.
- Barr, W.A. (1963). The endocrine control of the sexual cycle in the plaice, *Pleuronectes platessa* (L.). I - Cyclical changes in the normal ovary. *General and Comparative Endocrinology* **3**, 197 - 204.

- Barton, B. A. & Iwama, G.K. (1991). Physiological changes in fish from stress in aquaculture with emphasis on the response and effects of corticosteroids. *Annual Review of Fish Diseases* **1**, 3 - 26.
- Bautista, A. Ma., Carlos, M.H. & San Antonio, A.I. (1988). Hatchery production of *Oreochromis niloticus* L. at different sex ratios and stocking densities. *Aquaculture* **73** (1 - 4), 85 - 95.
- Bayoumi, A.R. (1969). Notes on the occurrence of *Tilapia zillii* (Pisces) in Suez Bay. *Marine Biology* **4**, 255 - 256.
- Beach, A.W. (1959). Seasonal changes in the cytology of the ovary and the pituitary gland of the goldfish. *Canadian Journal of Zoology* **37**, 615 - 625.
- Beall, E. & Marty, C. (1987). Optimization of the natural reproduction of Atlantic salmon in a spawning channel: effect of female density. In *Restoration of Salmon rivers* (Thibault, M., Billard, R., eds). Institute de la Recherche Agronomique. Jouy en Josas, France.
- Begovac, P.C. & Wallace, R.A. (1989). The major envelope proteins in pipefish oocytes originate within the follicle and are associated with the Z3 layer. *Journal of Experimental Zoology* **251**, 56 - 73.
- Behrends, L.L. & Smitherman, R. O'Neal. (1983). Use of warm water effluents to induce winter spawning of Tilapia in a temperate climate. In *International Symposium of Tilapia in Aquaculture* (Fishelson, L. and Yaron, Z., eds.), p. 446 - 454. Tel Aviv University, Israel.
- Behrends, L.L., Kingsley, J.B. & Price III, A.H. (1993). Hatchery production of blue tilapia, *Oreochromis aureus* (Steindachner) in small suspended hapa nets. *Aquaculture and Fisheries Management* **24** (2), 237 - 243.
- Bekker, V.E. (1959). The influence of the density of fish on their growth and reproductive capacity (as exemplified by Crucian carp). *Tr. Mosk. tekhn. in-ta rybn prom-sti i kh-va*, No. 10.
- Bell, J.G., Castell, J.D., Tocher, D.R., MacDonald, F.M. & Sargent, J.R. (1995). Effects of different aracidonic acid:docosahexaenoic acid ratios on phospholipid

- fatty acid compositions and prostaglandin production in juvenile turbot (*Scophthalmus maximus*). *Fish Physiology and Biochemistry* **14**, 139 - 151.
- Bell, J.G., Farndale, B.M., Bruce, M.P., Carillo, M. (1997). Effects of broodstock dietary lipid on fatty acid compositions of eggs from sea bass (*Dicentrarchus labrax*). *Aquaculture* **149** (1 - 2), 107 - 119.
- Ben-Tuvia, A. (1959). The biology of the cichlid fishes of Lakes Tiberias and Huleh. *Bulletin of the Research Council of Israel, Sect. B: Zool.*, **8B**, 152 - 188.
- Billard, R. (1978). Testicular feedback on the hypothalamo-pituitary axis in the rainbow trout (*Salmo gairdneri*). *Annales de Biologie, Biochimie et Biophysique* **18**, 813 - 818.
- Billard, R. (1985). Environmental factors in salmonid culture and the control of reproduction. In *Salmonid Reproduction, an International Symposium* (Iwamoto, R.N. & Sower, S., eds.), pp. 70 - 87. Washington Sea Grant Program, University of Washington, Seattle, Wa.
- Billard, R. (1992). Reproduction in rainbow trout. Sex differentiation, dynamics of gametogenesis, biology and preservation of gametes. *Aquaculture* **100** (1-3), 263 - 298.
- Billard, R., Breton, B., Fostier, A., Jalabert, B. & Weil, C. (1978). Endocrine control of the teleost reproductive cycle and its relation to external factors: salmonid and cyprinid models. In *Comparative Endocrinology* (Gaillard, P.J. & Boer, H.H., eds.), pp. 37 - 48. Elsevier: Amsterdam, The Netherlands.
- Billard, R., Bry, C. & Gillet, C. (1981). Stress, environment and reproduction in teleost fish. In *Stress and Fish* (Pickering, A.D., ed.), pp. 185 - 208. Academic Press: London.
- Bisht, J.S. & Joshi, M.L. (1975). Seasonal histological changes in the ovaries of a mountain stream teleost, *Schizothorax richardsonii* (Gray and Hard). *Acta Anatomical* **93**, 512 - 525.
- Bjerselius, R., Olsen, K.H. & Zheng, W. (1995). Behavioural and endocrinological responses of mature male goldfish to the sex pheromone 17 α -20 β -dihydroxy-pregnen-3-one in the water. *Journal of Experimental Biology* **198**, 747 - 754.

- Blay, J. (1981). Fecundity and spawning frequency of *Sarotherodon galilaeus* in a concrete pond. *Aquaculture* **25**, 95 - 99.
- Blüm, V. (1985). Reproductive behaviour. In *Vertebrate Reproduction*, pp. 219. Springer-Verlag: Berlin, Heidelberg, New York, Tokyo.
- Blüm, V. & Fiedler, K. (1965). Hormonal control of reproductive behaviour in some cichlid fish. *General and Comparative Endocrinology* **5**, 186 - 196.
- Bogomolnaya, A. & Yaron, Z. (1984). Stimulation *in vitro* of estradiol secretion by the ovary of a cichlid fish, *Sarotherodon aureus*. *General and Comparative Endocrinology* **53**, 187 - 196.
- Bogomolnaya, A. & Yaron, Z. (1987). The steroidogenic gonadotropin of tilapia: isolation and radioimmunoassay. In *Reproductive Physiology of Fish* (Idler, D.R., Crim, L.W. & Walsh, J.M., eds.), p. 67. Memorial Univ. of Newfoundland, St. Jones, Canada.
- Bogomolnaya, A. & Yaron, Z. (1988). Tilapia gonadotropin: isolation and radioimmunoassay for its quantitative determination. In *Reproduction in Fish - Basic and Applied Aspects in Endocrinology and Genetics* (Zohar, Y. & Breton, B., eds.), pp. 109 - 113. INRA: Paris, France.
- Bogomolonaya, A., Rothbard, S. & Yaron, S. (1984). Sex steroids at various phases of the breeding cycle: preliminary *in vivo* and *in vitro* studies. *General and Comparative Endocrinology* **53**, 452 - 453.
- Bogomolnaya, A., Yaron, Z., Hilge, V., Graesslin, D., Lichtenberg, V. & Abraham, M. (1989). Isolation and radioimmunoassay of a steroidogenic gonadotropin of tilapia. *Bamidgeh* **41**, 123 - 136.
- van Bohemen, Ch.G., Lambert, J.G.D., Goos, H.J.Th. & Van Oordt, P.G.W.J. (1982). Estrone and estradiol participation during exogenous vitellogenesis in the female rainbow trout, *Salmo gairdneri*. *General and Comparative Endocrinology* **46**, 81 - 92.
- Bon, E., Corraze, G., Kaushik, S. & Le Menn, F. (1997). Effects of accelerated photoperiod regimes on the reproductive cycle of the female rainbow trout: I -

Seasonal variations of plasma lipids correlated with vitellogenesis. *Comparative Biochemistry and Physiology*, in press.

- Borrowsky, R. & Diffley, J. (1981). Synchronised maturation and breeding in natural populations of *Xiphophorus variatus* (Poeciliidae). *Environmental Biology of Fish* **6**, 49 - 58.
- Botros, G.A. (1969). A comparative study on the fecundity of *Tilapia nilotica* L. and *T. zillii* Gerv. from Lake Mariut (Egypt). *Revue de Zoologie et Botanique Africaine* **79**, 280 - 308.
- Boukhliq, R., Adams, N.R. & Martin, G.B. (1996). Effect of nutrition on the balance of production of ovarian and pituitary hormones in ewes. *Animal Reproduction Science* **45** (1 - 2), 59 - 70.
- Braekevelt, C.R. & McMillan, D.B. (1967). Cyclic changes in the ovary of the brook stickleback *Eucalia inconstans* (Kirtland). *Journal of Morphology* **134** (4), 273 - 295.
- Brambell, F.W.R. (1956). Ovarian changes. In *Marshall's Physiology of Reproduction - 3rd edition* (Parkes, A.S., ed.), pp. 397 - 542. Longmans, Green & Co.: London, U.K.
- Breder, C.M. & Rosen, D.E. (1966). *Modes of Reproduction in Fishes*. T.F.H. Publications, Jersey City, N.J., U.S.A.
- Bretschneider, L.H. & Duyvene de Wit, J.J. (1947). Sexual endocrinology of non-mammalian vertebrates. *Monographs on the progress of research in Holland* **11**, 77 - 116. Elsevier: Amsterdam, The Netherlands.
- Breton, B., Billard, R., Jalabert, B. & Kann, G. (1972). Dosage radioimmunologiques des gonadotropines plasmatiques chez *Carassius auratus*, au cours du nycthemere et pendant l'ovulation. *General and Comparative Endocrinology* **18**, 463 - 468.
- Breton, B., Jalabert, B., Fostier, A. & Billard, R. (1975). Etude sur le cycle reproducteur de la truite arc-en-ciel et de la tanche. Effect de variations experimentales de la temperature. *Journal of Physiology (Paris)* **30**, 561 - 564.

- Breton, B., Fostier, A., Zohar, Y., Le Bail, P.Y. & Billard, R. (1983). Gonadotropine glycoproteique maturante et oestradiol-17 β pendant le cycle reproducteur chez la truite fario (*Salmo trutta*) femelle. *General and Comparative Endocrinology* **49**, 220 - 231.
- Blom, J.H. & Dabrowski, K. (1996). Ascorbic acid metabolism in fish: is there a maternal effect on the progeny ? *Aquaculture* **147** (3 - 4), 215 - 224.
- Bromage, N.R. & Cumaranatunga, P.R.T. (1988). Egg production in the rainbow trout. In *Recent Advances in Aquaculture* (Muir, J.F. and Roberts, R.J. eds.), pp. 65 - 138. Croom Helm: London and Sydney.
- Bromage, N.R. & Jones, J. (1991). The effects of seasonal alterations in ration on fecundity and maturation in rainbow trout (*Oncorhynchus mykiss*). In *Proceedings of the Fourth International Symposium of Reproductive Physiology of Fish* (Scott, A.P., Sumpter, J.P., Kime, D.E. & Rolfe, J., eds.), p. 162. Sheffield University Press: Sheffield, U.K.
- Bromage, N.R., Whitehead, C. & Breton, B. (1982a). Relationships between serum levels of gonadotropin, oestradiol-17 β and vitellogenin in the control of ovarian development in the rainbow trout. II. Effects of alterations in environmental photoperiod. *General and Comparative Endocrinology* **47**, 366 - 376.
- Bromage, N.R., Whitehead, C., Elliot, J., Breton, B. & Matty, A.J. (1982b). Investigations into the importance of daylength on the photoperiodic control of reproduction in the female rainbow trout. In *Reproductive Physiology of Fish* (Richter, C.J. & Goos, H. Th., comps.), pp. 233 - 236. Purdoc Press: Wageningen., The Netherlands.
- Bromage, N.R., Hardiman, P., Jones, J., Springate, J. & Bye, V. (1990). Fecundity, egg size and total egg volume differences in 12 stocks of rainbow trout, *Oncorhynchus mykiss* Richardson. *Aquaculture and Fisheries Management* **21**, 269 - 284.
- Bromage, N.R., Jones, J., Randall, C., Thrush, M., Davies, B., Springate, J., Duston, J. & Barker, G. (1992). Broodstock management, fecundity, egg quality and the timing of egg production in the rainbow trout (*Oncorhynchus mykiss*). *Aquaculture* **100**, 141 - 166.

- Brommalaer, M.C., Billard, R. & Breton, B. (1981). Changes in plasma gonadotropin after ovariectomy and oestradiol supplementation at different stages at the end of the reproductive cycle in the rainbow trout, *Salmo gairdneri*. *Reproduction Nutrition Development* **21**, 989 - 997.
- Brown, B.W. (1994). A review of nutritional influences on reproduction in boars, bulls and rams. *Reproduction Nutrition Development* **34**, 89 - 114.
- Brown, M.E. (1946). The growth of brown trout (*Salmo trutta* Linn.) I. Factors influencing the growth of trout fry. *Journal of Experimental Biology* **22**, 118 - 129.
- Brook, A.J. (1989). *The environmental control of reproduction in the female dace, Leuciscus leuciscus*. Ph.D. thesis, Aston University in Birmingham, Birmingham, U.K.
- Brummet, A.R., Dumont, J.N. & Larkin, J.R. (1982). The ovary of *Fundulus heteroclitus*. *Journal of Morphology* **173**, 1 - 16.
- Bruslé, S. (1980). Fine structure of early previtellogenic oocytes in *Mugil (Liza) anratus* Risso, 1810 (Teleostei, Mugilidae). *Cell and Tissue Research* **207**, 123 - 134.
- Bruton, M.N. (1979). The breeding biology and early development of *Clarias gariepinus* (Pisces: Clariidae) in Lake Sibaya, South Africa, with a review of breeding in species of the subgenus *Clarias* (Clarias). *Transactions of the Zoological Society of London* **35**, 1 - 45.
- Bruton, M.N. & Gophen, M. (1992). The effect of environmental factors on the nesting and courtship behaviour of *Tilapia zillii* in Lake Kinneret (Israel). *Hydrobiology* **239**, 171 - 178.
- Burd, A.C. & Howlett, G.J. (1974). Fecundity studies on North Sea herring. *Journal du Conseil International pour l'Exploration de la mer* **35**, 107 - 120.
- Burrows, R.E. (1951). An evaluation of methods of egg enumeration. *Progressive Fish Culturist* **13**, 79 - 85.

- Burzawa-Gerard, E. (1974). Etude biologie et biochemique de l'hormone gonadotrope d'un poisson teleosteen, la carpe (*Cyprinus carpio*). *Memoires of the Museum of Natural History Series A. Zoology* **86**, 1 - 77.
- Bye, V. (1984). The role of environmental factors in the timing of reproductive cycles. In *Fish Reproduction: Strategies and Tactics* (Potts, G.W. & Wootton, R.J., eds.). Academic Press: London, U.K.
- Byskov, A.G. (1978). Follicular atresia. In *The Vertebrate Ovary* (Jones, R.E., ed.), pp. 533 - 562. Plenum Press: New York & London.
- Callard, G.V. (1982). Aromatase in the teleost brain and pituitary: role in hormone action. In *Reproductive Physiology of Fish* (Richter, C.J.J. & Goos, H.J.Th. Goos, comps), p. 40 - 43. Purdoc Press: Wageningen.
- Callard, G.V., Specker, J.L., Knapp, J., Nishioka, R.S. Bern, H.A. (1988). Aromatase is concentrated in the proximal pars-distalis of tilapia pituitary. *General and Comparative Endocrinology* **71** (1), 70 - 79.
- Campbell, B. (1995). Environmental and hormonal control of reproduction in the female rainbow trout, *Oncorhynchus mykiss*. Ph.D. thesis. University of Stirling, Stirling, Scotland, U.K.
- Campbell, C.M. (1978). *In-vitro* stimulation of vitellogenin incorporation into trout oocytes by salmon pituitary extracts. *Annales de Biologie, Biochimie et biophysique* **18**, 1013 - 1018.
- Campbell, C.M. & Idler, D.R. (1976). Hormonal control of vitellogenesis in hypophysectomized winter flounder (*Pseudopleuronectes americanus*, Walbaum). *General and Comparative Endocrinology* **28**, 143 - 150.
- Campbell, C.M. & Idler, D.R. (1977). Oocyte maturation and ovulation induced in hypophysectomized winter flounder (*Pseudopleuronectes americanus*). *Journal of the Fisheries Research Board of Canada* **34**, 2125 - 2155.
- Campbell, P.M., Pottinger, T.G. and Sumpter, J.P. (1992). Stress reduces the quality of gametes produced by rainbow trout. *Biology of Reproduction* **47**, 1140 - 1150.

- Carragher, J.F. & Sumpter, J.P. (1990). The effect of cortisol on the secretion of sex steroids from cultured ovarian follicles of rainbow trout. *General and Comparative Endocrinology* **77** (3), 403 - 407.
- Carragher, J.F. & Pankhurst, N.W. (1991). Stress and reproduction in a commercially important fish, *Pagrus auratus* (Sparidae). In *Proceedings of the Fourth International Symposium of Reproductive Physiology of Fish* (Scott, A.P., Sumpter, J.F., Kime, D.E. & Rolfe, M.S., eds.), pp. 253 - 255. University of Sheffield: Sheffield, U.K.
- Carragher, J.F. & Pankhurst, N.W. (1993). Plasma levels of sex steroids during sexual maturation of snapper, *Pagrus auratus* (Sparidae), caught from the wild. *Aquaculture* **109** (3-4), 375 - 388.
- Carragher, J.F., Sumpter, J.P., Pottinger, T.G. and Pickering, A.D. (1989). The deleterious effects of cortisol implantation on reproductive function in two species of trout *Salmo trutta* L. and *Salmo gairdneri* Richardson. *General and Comparative Endocrinology* **76**, pp 31 - 321.
- Carrillo, M., Zanuy, S., Prat, F., Cerda, J., Ramos, J., Mananos, E. & Bromage, N. (1995). Sea bass (*Dicentrarchus labrax*). In *Broodstock Management and Egg and Larval Quality* (Bromage, N.R. & Roberts, R.J., eds.), pp. 138 - 168. Blackwell Science: Oxford, U.K.
- Chan, S.T.H., Wright, A. & Phillips, J.G. (1967). The atretic structures in the gonads of the rice-field eel (*Monopterus albus*) during natural sex reversal. *Journal of Zoology (London)* **153**, 527 - 539.
- Chan, S.L., Tan, C.H., Pang, M.K. and Lam, T.J. (1991). Vitellogenin purification and development of an assay for vitellogenin receptor in oocyte membranes of the tilapia (*Oreochromis niloticus*, Linnaeus 1766). *Journal of Experimental Zoology* **257**, 96 - 109.
- Chandrasoma, J. & De Silva, S.S. (1981). Reproductive biology of *Puntius sarana*, an indigenous species, and *Tilapia rendalli*, an exotic, in an ancient man-made lake in Sri Lanka. *Fisheries Management* **12** (1), 17 - 28.
- Chang, J.P. & Peter, R.E. (1983). Effects of pimozide and des Gly¹⁰, [D-Ala⁶] luteinizing hormone-releasing hormone ethylamide on serum gonadotropin

- concentrations, germinal vesicle migration and ovulation in female goldfish, *Carassius auratus*. *General and Comparative Endocrinology* **52**, 30 - 37.
- Chen, L. -C. (1990). *Aquaculture in Taiwan*. Fishing News Books, Blackwell Scientific Publications Ltd: Oxford, U.K. 273pp.
- Chen, L. -C. & Martinich, R.L. (1975). Pheromonal stimulation and metabolite inhibition of ovulation in the zebrafish, *Brachydanio rerio*. *Fishery Bulletin* **73**, 889 - 894.
- Chew, R.L. (1972). The failure of largemouth bass *Micropterus salmoides floridanus* (Le Sneur) to spawn - eutrophic, over-crowded environments. *Proceedings of the Conference of the South Association of Game and Fisheries* **26**, 1 - 28.
- Chien, A.K. (1973). Reproductive behaviour of the angelfish *Pterophyllum scalare* (Pisces: Cichlidae). II. Influence of male stimulation on the spawning rate of females. *Animal Behaviour* **21**, 457 - 463.
- Chimits, P. (1957). *The Tilapias and their Culture*. A second review and bibliography. FAO Fish. Bull., **20**, No. 1
- Cisse, A. (1988). Effects of varying protein levels on spawning frequency and growth of *Sarotherodon melanotheron*. In *The Second International Symposium of Tilapia in Aquaculture* (Pullin, R.S.V., Bhukaswan, T., Tonguthai, K. & Maclean, J.L., eds.), pp. 329 - 333. Department of Fisheries, Bangkok, Thailand and International Center for Living Aquatic Resources Management, Manila, Phillipines.
- Clearwater, S.J. & Pankhurst, N.W. (1997). The response to capture and confinement stress of plasma cortisol, plasma sex steroids and vitellogenic oocytes in the marine teleost, red gurnard. *Journal of Fish Biology* **50**, 429 - 441.
- Coche, A.G. (1982). Cage culture of tilapias. In *The Biology and Culture of Tilapias, ICLARM Conference Proceedings 7* (Pullin, R.S.V. & Lowe-McConnell, R.H., eds.), pp 205 - 246. International Center for Living Aquatic Resources Management, Manila, Phillipines.

- Coello, S. (1989). A new staining schedule for formalin-fixed, glycol methacrylate-embedded fish ovaries. *Journal of Fish Biology* **34**, 329 - 330.
- Collu, R., Gibb, W. & Ducharme, J.R. (1984). Effects of stress on gonadal function. *Journal of Endocrinological Investigation* **7**, 529 - 537.
- Colombo, L., Belvedere, P.C. & Arcarese, G. (1978). Emergence of ovarian 11-deoxycorticosteroid biosynthesis at ovulation time in the sea bass, *Dicentrarchus labrax* L. *Annales de Biologie, Biochimie et Biophysique* **18**, 937 - 941.
- Colombo, L., Belvedere, P.C., Marconata, A. & Bentivegna, F. (1982). Pheromones in teleost fish. In *Reproductive Physiology of Fish* (Richter, C.J.J. & Goos, H. J. Th., comps.), pp. 84 - 94. Purdoc Press: Wageningen, The Netherlands.
- Conover, D.O. & Kynard, B.E. (1981). Environmental sex determination: Interaction of temperature and genotype in a fish. *Science* **213**, 577 - 579.
- Copeland, P.A. & Thomas, P. (1993). Isolation of gonadotropin subunits and evidence for distinct gonadotropins in Atlantic croaker (*Micropogonias undulatus*). *General and Comparative Endocrinology* **91**, 115 - 125.
- Cornish, D.A. & Smit, G.L. (1987). Seasonal reproductive steroid hormone profiles in *Oreochromis niloticus*. In *Proceedings of the Third International Symposium of Reproductive Physiology of Fish* (Idler, D.R., Crim, L.W. & Walsh, J.M., eds.), p. 165. Memorial University of St. John's, Newfoundland, Canada.
- Cosgrove, J.R. & Foxcroft, G.R. (1996). Nutrition and reproduction in the pig - ovarian ethiology. *Animal Reproduction Science* **42** (1-4), 131 -141.
- Cridland, C.C. (1962). Breeding studies on *Tilapia zillii* and *Tilapia nigra*. *Report of the East African Freshwater Fisheries Research Organisation for 1961*, pp. 29 - 32.
- Crim, L.W. (1982). Environmental modulation of annual and daily rhythms associated with reproduction in teleost fishes. *Canadian Journal of Fish and Aquatic Science* **39**, 17 - 21.
- Crim, L.W. & Idler, D.R. (1978). Plasma gonadotropin, oestradiol and vitellogenin and gonad phosphitin levels in relation to the seasonal reproductive cycle of

- female brown trout. *Annales de Biologie, Biochimie et Biophysique* **18**, 1001 - 1005.
- Crim, L.W. & Evans, D.M. (1979). Stimulation of pituitary gonadotropin by testosterone in juvenile rainbow trout (*Salmo gairdneri*). *General and Comparative Endocrinology* **37**, 192 - 196.
- Crim, L.W., Meyer, R.K. & Donaldson, E.M. (1973). Radioimmunoassay estimates of plasma gonadotropin levels in spawning pink salmon. *General and Comparative Endocrinology* **21**, 69 - 76.
- Crim, L.W., Peter, R.E. & Billard, R. (1981). Onset of gonadotropic hormone accumulation in the immature trout pituitary gland in response to estrogen or aromatizable androgen steroid hormones. *General and Comparative Endocrinology* **44**, 374 - 381.
- Cui, Y., Hung, S.S.O. & Zhu, X. (1996). Effects of ration and body size on the energy budget of juvenile white sturgeon. *Journal of Fish Biology* **49**, 863 - 876.
- Cumaranatunga, P.R.T. (1985). *The ovarian cycle of rainbow trout with special reference to atresia*. Ph.D. thesis, Aston University, U.K.
- Cumaranatunga, P.R.T. & Thabew, H. (1990). Effects of a legume (*Vigna catieng*) substituted diets on the ovarian development of *Oreochromis niloticus* (L.). In *The Current Status of Fish Nutrition in Aquaculture. Proceedings of the Third International Symposium on Feeding and Nutrition in Fish* (Takeda, M. & Watanabe, T., eds.), pp. 333 - 344.
- Dabrowski, K. & Blom, J.H. (1994). Ascorbic acid deposition in rainbow trout (*Oncorhynchus mykiss*) eggs and survival of embryos. *Comparative Biochemistry and Physiology A*, **108**, 1, 129 - 135.
- Dabrowski, K., Ciereszko, R.E., Blom, J.H. & Ottobre, J.S. (1995). Relationship between vitamin-C and plasma concentrations of testosterone in female rainbow trout, *Oncorhynchus mykiss*. *Fish Physiology and Biochemistry* **14** (5), 409 - 414.

- Dadzie, S. (1970). *Growth, maturation and pituitary activity in Tilapia species*. Ph.D. thesis, University of Stirling, Scotland, U.K.
- Dadzie, S. (1974). Oogenesis and the stages of maturation in the female cichlid fish, *Tilapia mossambica*. *Ghana Journal of Science* **14** (1), 23 - 31.
- Dadzie, S. & Wangila, B.C.C. (1980). Reproductive biology, length-weight relationship and relative condition of pond-raised *Tilapia zillii* (Gervais). *Journal of Fish Biology* **17**, 243 - 253.
- Daget, J. (1952). Observations sur la ponte de *Tilapia zillii* (Gervais), poissons de la famille des Cichlidae. *Annual Magazine of Natural History* **5** (12), 309 - 310.
- Dahlgren, B.T. (1979). The effects of population density on fecundity and fertility in the guppy, *Poecilia reticulata* (Peters). *Journal of Fish Biology* **15**, 71 - 91.
- Dahlgren, B.T. (1980). The effects of three different dietary protein levels on the fecundity in the guppy, *Poecilia reticulata* (Peters). *Journal of Fish Biology* **16** (1), 83 - 97.
- D'Ancona, U. (1956). Morphogénèse et différenciation du sexe chez les poissons teleosteens. *Bulletin of the Society of Zoology (France)* **81**, 219 - 229.
- Das, P., Mukhopadhyah, M.K., Das, K.M. & Pandit, P.K. (1987). Gonadal sex manipulation of *Oreochromis mossambicus* (Peters). In *Proceedings of the World Symposium on Selection, Hybridization and Genetic Engineering in Aquaculture* Vol. II (Tiews, E., ed.), pp. 74 - 78. Bordeaux: France.
- Davies, B., Swanson, P. & Bromage, N. (1995). The effects of photoperiod and temperature on serum GTH I and GTH II and the timing of maturation in the female rainbow trout. In *The Fifth International Symposium of Reproductive Physiology of Fish* (Goetz, F.W. & Thomas, P., eds.), p. 185. University of Texas, Texas.
- Davis, A.T. & Stickney, R.R. (1978). Growth responses of *Tilapia aurea* to dietary protein quality and quantity. *Transactions of the American Fisheries Society* **107** (3), 479 - 483.

- Davis, K.B. & Parker, N.C. (1983). Plasma corticosteroid and chloride dynamics in rainbow trout, Atlantic salmon, and lake trout during and after stress. *Aquaculture* **32** (1 - 2), 189 - 194.
- Delesse, M.A. (1847). Procédé mécanique pour déterminer la composition des roches. *C.R. Academy of Science (Paris)* **25**, 544.
- Delgado-Ardiles, S. (1985). Efecto de la proporción sexual, densidad y edad de los reproductores en la producción de semilla de *Tilapia nilotica* (Pisces, Cichlidae). *Bol. Inst. Mar. Peru.*, **9** (1), 3 - 27.
- De Silva, S.S. (1986). Reproductive biology of *Oreochromis mossambicus* populations of man-made lakes in Sri Lanka: a comparative study. *Aquaculture and Fisheries Management* **17**, 31 - 47.
- Dickhoff, W.W. & Swanson, P. (1990). Functions of salmon pituitary glycoprotein hormones: The maturational surge hypothesis. In *Progress in Comparative Endocrinology (Progress in Clinical and Biological Research, Volume 342)* (Epple, A., Scanes, C.G. & Stetson, M.H., eds.), pp. 349 - 356. Wiley-Liss Inc.: New York, U.S.A.
- Dmitrieva, T.M., Katsel, P.L., Valeev, R.B., Ostroumov, V.A. & Kozlov, Y.P. (1988). Isolation of sex pheromone of the male yellowfin Baikal sculpin (*Cottomephorus grewingki* Dyb.). *Biologicheskie Nauki* **6**, 39 - 44 (Text in Russian).
- Dodd, J.M. & Sumpter, J.P. (1984) Fishes. In *Marshall's Physiology of Reproduction, Vol. 1, Reproductive Cycles of Vertebrates* (Lamming, G.E., ed.), pp. 1 - 126. Churchill Livingstone: Edinburgh, U.K.
- Drury, R.A.B. & Wallington, E.A. (1980). *Carleton's Histological Technique Fifth Edition* (Drury, R.A.B. & Wallington, E.A., eds.). Oxford University Press: Oxford, New York & Toronto.
- Dufour, S., Montero, M., Lebel, N., Bassompierre, M., King, J.A., Millar, R.P., Peter, R.E. & Fontaine, Y. (1993). Differential distribution and response to experimental sexual maturation of 2 forms of brain gonadotropin releasing hormone (GnRH) in the European eel, *Anguilla anguilla*. *Fish Physiology and Biochemistry* **11** (1-6), 99 - 106.

- Dulka, J.G. & Stacey, N.E. (1991). Effects of olfactory tract lesions on gonadotropin and milt responses to the female sex pheromone 17 α -20 β -dihydroxy-4-pregnen-3-one in male goldfish. *Journal of Experimental Zoology* **257** (2), 223 - 229.
- Duston, J. & Bromage, N.R. (1987). Constant photoperiod regimes and the entrainment of the annual cycle of reproduction in the female rainbow trout (*Salmo Gairdneri*). *General and Comparative Endocrinology* **65**, 373 - 384.
- Edwards, P., Pullin, R.S.V. & Gartber, J.A. (1988). *Research and Education for the Development of Intergrated Crop-Livestock-Fish Farming Systems in the Tropics, ICLARM Studies and Reviews* **16**. International Center for Living Aquatic Resources Management, Manila, Philippines.
- Eguia, M.R.R. & Eguia, R.V. (1993). Growth response of three *Oreochromis niloticus* strains to feed restriction. *Bamidgeh* **45** (1), 8 - 17.
- Ejike, C. & Schreck, C.B. (1980). Stress and social hierachy rank in coho salmon. *Transactions of the American Fisheries Society* **109**, 423 - 426.
- El Bolock, A. & Koura, R. (1960). Age, growth and breeding season of *Tilapia zillii* (Gerv.) in Egyptian experimental fish pond. *Notes & Memoires of the Alexandria Institute of Hydrobiology* **49**, 1 - 36.
- Elias, H. (1963). Address of the President. In *Proceedings of the First International Conference for Stereology*. (Haug, H., ed.), p. 2. Congressprint: Wien.
- Elliot, J., Bromage, N.R. & Springate, J. (1984). Changes in reproductive function of three strains of rainbow trout exposed to constant and seasonally-changing light cycles. *Aquaculture* **43**, 23 - 34.
- El-Maghraby, A.M., Ezzat, A. & Saleh, H.H. (1972). Fat metabolism in *Tilapia zillii* Gerv. *Bulletin of the Institute of Oceanography and Fisheries (Egypt)* **2**, 297 - 332.
- Elsay, R.M., Joanen, T., McNease, L. & Vance, V. (1990). Stress and plasma corticosterone levels in the American alligator - relationships with stocking

- density and nesting success. *Comparative Biochemistry and Physiology* **95**, 55 - 63.
- Elsley, R.M., Lance, V.A., Joanen, T., McNease, L. (1991). Acute stress suppresses plasma estradiol levels in female alligators (*Alligator mississippiensis*). *Comparative Biochemistry and Physiology Series A. Comparative Physiology* **100**, 649 - 652.
- El-Zarka, S. (1956). Breeding behaviour of the Egyptian cichlid fish, *Tilapia zillii*. *Copeia*, 112 - 113.
- El-Zarka, S. (1962). *Tilapia Fisheries Investigation in Egyptian Lakes III. Maturity, spawning and sex ratio of Tilapia zillii (Gerv.) in Lake Quarun*. United Arab Republic Ministry of Agriculture Notes and Memoirs 67. General Organisation for Government Printing Offices: Cairo. 24 pp.
- Emerson, L.S., Greer Walker, M. & Witthames, P.R. (1990). A stereological method for estimating fecundity. *Journal of Fish Biology* **36**, 721 - 730.
- Eyeson, K.N. (1979). Studies on egg production, spawning and fry development in *Tilapia melanotheron*. *Ghana Journal of Science* **17** (1), 25 - 34.
- Eyeson, K.N. (1983). Egg and fry swallowing habits of tilapia. *Aquaculture* **32**, 415 - 418.
- Fagade, S.O., Adebisi, A.A. & Atanda, A.N. (1984). The breeding cycle of *Sarotherodon galilaeus* in the IITA lake, Ibadan, Nigeria. *Archives of Hydrobiology* **100**, 493 - 500.
- Fagerlund, U.H.M., McBride, J.R. & Stone, E.T. (1981). Stress related effects of hatchery rearing density on coho salmon. *Transactions of the American Society of Fisheries* **110**, 644 - 649.
- Falter, U. & Debacker, L. (1988). Density-dependent behavioural shift in *Oreochromis niloticus*. In *The Second International Symposium on Tilapia in Aquaculture*, ICLARM Conference Proceedings (Pullin, R.S.V., Bhukaswan, T., Toguthai, K. & Maclean, J.L., eds.), p. 599. Department of Fisheries, Bangkok, Thailand and International Center for Living Aquatic Resources Management, Manila, Phillipines.

- Fang, Y.C. & Wang, M. (1983). On the mechanism of the action of hypothalamic luteinizing-hormone-releasing-hormone analog (LHRH-A). 3. Its effect on the ultrastructure of the gonadotropic cells of the pituitary gland of *Tilapia mossambica*. *Acta Zoologica Sinica* **29** (2), p. 124.
- Farmer, S.W. & Papkoff, H. (1977). A teleost (*Tilapia mossambica*) gonadotropin that resembles luteinizing hormone. *Life Sciences* **20** 1227 - 1232.
- Farr, J.A. & Herrnkind, W.F. (1974). A quantitative analysis of social interaction of the guppy, *Poecilia reticulata* (Pisces: Poeciliidae) as a function of population density. *Animal Behaviour* **22**, 582 - 591.
- Fenske, M. (1986). Adrenal function in the Mongolian gerbil (*Meriones unguiculatus*): influence of confinement stress upon glucocorticosteroid, progesterone, dehydroepiandrosterone, testosterone and androstenedione plasma levels, adrenal content and *in vitro*-secretion. *Experimental Clinical Endocrinology* **87**, 15 - 25.
- Fishelson, L. (1966). Cichlidae of the genus *Tilapia* in Israel. *Bamidgeh* **18**, 67 - 80.
- Fishelson, L. (1983). Social behaviour of adult fish in nature and captivity. In *International Symposium of Tilapia in Aquaculture* (Fishelson, L. & Yaron, Z., eds.), pp. 48 - 58, Tel Aviv University, Tel Aviv, Israel.
- Fitzgerald, G.J. & Keenleyside, M.H.A. (1978). The effects of numerical density of adult fish in reproduction and parental behaviour in the convict cichlid *Cichlasoma nigrofasciatum* (Günther). *Canadian Journal of Zoology* **56**, 1367 - 1371.
- Fitzpatrick, M.S., Redding, J.M., Ratti, F.D. & Schreck, C.B. (1987). Plasma testosterone concentration predicts the ovulatory response of coho salmon (*Oncorhynchus kisutch*) to gonadotropin-releasing hormone analog. *Canadian Journal of Fisheries and Aquatic Science* **44**, 1351 - 1357.
- Fletcher, D.A. & Wootton, R.J. (1995). A hierarchical response to differences in ration size in the reproductive performance of female three-spined sticklebacks. *Journal of Fish Biology* **46**, 657 - 668.

- Flügel, H. (1967). Elektronenmikroskopische untersuchungen and den Hüller der oozyten and eier des flussbarsches *Perca fluviatilis*. *Zeitschrift Zellforsch.*, **77**, 244 - 256.
- Forberg, K.G. (1982). A histological study of development of oocytes in capelin, *Mallotus villosus* (Müller). *Journal of Fish Biology* **20**, 143 - 154.
- Fontaine, M. (1976). Hormones and the control of reproduction in aquaculture. *Journal of the Fisheries Research Board of Canada* **33**, 922 - 939.
- Foo, J.T.W. & Lam, T.J. (1993a). Serum cortisol response to handling stress and the effect of cortisol implantation on testosterone level in the tilapia, *Oreochromis mossambicus*. *Aquaculture* **115** (1-2), 145 - 158.
- Foo, J.T.W. & Lam, T.J. (1993b). Retardation of ovarian growth and depression of serum steroid levels in the tilapia, *Oreochromis mossambicus* by cortisol implantation. *Aquaculture* **115** (1-2), 135 - 143.
- Fostier, A., Weil, C., Terqui, M., Breton, B. & Jalabert, B. (1978). Plasma estradiol-17 β and gonadotropin during ovulation in rainbow trout (*Salmo gairdneri* Richardson). *Annales de Biologie, Biochimie et Biophysique* **18**, 929 - 936.
- Fostier, A., Breton, B. & Jalabert, B. (1979). Stimulation hypophysaire de la secretion doestradiol-17 β chez la Carpe commune (*Cyprinus carpio*). *Annales de Endocrinologie* , **40**, 83 - 84.
- Fostier, A., Jalabert, B., Billard, R., Breton, B. & Zohar, Y. (1983). The gonadal steroids. In *Fish Physiology* (Hoar, W.S. & Randall, D.J., eds), Vol. IX. *Reproduction. Part. A. Endocrine Tissues and Hormones*, pp. 277 - 372. Academic Press: London, U.K.
- Franchi, L.L., Mandle, A.M. & Zuckerman, S. (1962). The development of the ovary and the process of oogenesis. In *The Ovary* Vol. 1 (Zuckerman, S., ed.), pp. 1 - 88. Academic Press: New York, U.S.A.
- Fryer, G. & Iles, T.D. (1972). *The Cichlid Fishes of the Great Lakes of Africa*. 641 pp. Oliver & Boyd: London, U.K.

- Gale, W.L., Fitzpatrick, M.S. & Schreck, C.B. (1995). Immersion of Nile tilapia (*Oreochromis niloticus*) in 17α -methyltestosterone and mestanolone for the production of all-male populations. In *The Fifth International Symposium of Reproductive Physiology of Fish* (Goetz, F.W. & Thomas, P., eds.), p. 117. University of Austin, Texas, U.S.A.
- García, T. & Phillip, P. (1986). Oocyte development in *Oreochromis aureus*. *Reviews in Marine Investigation* 7 (2), 63 - 70.
- García Hernández, M.P., Koide, Y., García Gomez, A. & Kawauchi, H. (1995). Isolation and characterization of 2 distinct gonadotropins from Mediterranean yellowtail (*Seriola dumerilii*, Risso 1810) pituitary granules. In *The Fifth International Symposium of Reproductive Physiology of Fish* (Goetz, F.W. & Thomas, P., eds.), p. 30. University of Austin, Texas, U.S.A.
- Gerking, S.D. (1980). Fish reproduction and stress. In *Environmental Physiology of Fishes* (Ali, M.A., ed.), p. 569 - 587. Plenum Press: New York, U.S.A.
- Gielen, J.Th. & Goos, H.J.Th. (1984). The brain-pituitary-gonadal-axis in the rainbow trout, *Salmo gairdneri*. III. Absence of an inhibiting action of testosterone on gonadotropin release in juveniles. *General and Comparative Endocrinology* 56, 457 - 465.
- Gillet, C., Breton, B. & Billard, R. (1978). Seasonal effects of exposure to temperature and photoperiod regimes on gonadal growth and plasma gonadotropin in goldfish (*Carassius auratus*). *Annales de Biologie, Biochimie et Biophysique* 18, 1045 - 1049.
- Gissis, A., Levavi-Zermonsky, B., Bogomolnaya-Bass, A. & Yaron, Z. (1988). Gonadotropin levels in the female tilapia treated with GnRH analog, and reserpine or pimozide. In *Reproduction in Fish - Basic and Applied Aspects of Endocrinology and Genetics* (Zohar, Y. & Breton, B., eds.), pp. 63 - 67.
- Goetz, F.W. (1983). Hormonal control of oocyte final maturation and ovulation in fishes. In *Fish Physiology Vol. IX, Reproduction, Part B, Behaviour and Fecundity* (Hoar, W.S., Randall, D.J. & Donaldson, E.M., eds.), pp. 117 - 170. Academic Press: New York, U.S.A.

- Goetz, F.W. & Theofan, G. (1979). *In-vitro* stimulation of germinal vesicle breakdown and ovulation of yellow perch, (*Perca flavescens*) oocytes. Effects of 17α -hydroxy- 20β -dihydroxyprogesterone and prostaglandins. *General and Comparative Endocrinology* **37**, 273 - 285.
- Goryczko, K. (1972). A change in the spawning season in rainbow trout (*Salmo gairdneri* Richardson). *Roc nauk Roln Ser. H.* **94**, 57 - 68.
- Grunewald, D.A. & Matsumoto, A.M. (1993). Reduced gonadotropin-releasing hormone gene expression with fasting in the male rat brain. *Endocrinology* **132**, 480 - 482.
- Guerrerro III, R.D. (1982). Control of Tilapia Reproduction. In *The Biology and Culture of Tilapias* (Pullin, R.S.V. & Lowe-McConnell, R.H., eds.), pp. 15 - 60. ICLARM conference proceedings 7. International Center for Living Aquatic Resources Management, Manila, Phillipines.
- Guerrerro III, R.D. (1985). Tilapia farming in the Phillipines: practices, problems and prospects. In *The Biology and Culture of Tilapias*. ICLARM Conf. Proc. 12 (Smith, I.R., Tonnes, E.B. & Tan, E.O., eds.), pp. 3 - 14. Phillipine council for Agric. and Res. and Dev., Los Banos, Laguna & International Center for Aquatic Resources Management, Manila, Phillipines.
- Gunasekera, R.M., Shim, K.F. & Lam, T.J. (1995). Effect of dietary protein level on puberty, oocyte growth and egg chemical composition in the tilapia, *Oreochromis niloticus* (L.). *Aquaculture* **134** (1-2), 169 - 183.
- Gur, G., Melamed, P., Levavi Sivan, B., Holland, C., Gissis, A., Bayer, D., Elizir, A., Zohar, Y. & Yaron, Z. (1995). Long term testosterone treatment stimulates GTH II synthesis and release in the pituitary of the black carp *Mycopharyngodon piceus*. In *The Fifth International Symposium of Reproductive Physiology of Fish* (Goetz, F.W. & Thomas, P., eds.), p. 32. University of Austin, Texas, U.S.A.
- Guraya, S.S. (1973). Follicular atresia. *Proceedings of the Indian National Science Academy* **39B** (3), 311 - 332.

- Guraya, S.S. (1979). Recent advances in the morphology, cytochemistry and functions of Balbiani's vitelline body in animal oocytes. *International Review of Cytology* **59**, 249 - 321.
- Guraya, S.S. (1986). Follicular (or oocyte) atresia. In *The Cell and Molecular Biology of Fish Oogenesis* (Sauer, H.W., ed.), pp. 169 - 180. Basel: Karger.
- Habibi, H.R. & Pati, D. (1993). Extrapituitary gonadotropin releasing hormone (GnRH) binding sites in the goldfish. *Fish Physiology and Biochemistry* **11** (1-6), 43 - 49.
- Hagen, D.W. (1967). Isolating mechanisms in three-spined sticklebacks (*Gasterosteus*). *Journal of the Fisheries Research Board of Canada* **24**, 1637 - 1692.
- Haight, B.A. (1992). Growing towards the 21st Century: World Aquaculture Conference in the USA. *ALCOM News* **7**, pp 4 - 6. Aquaculture for Local Community Development Programme, FAO, Harare, Zimbabwe.
- Hardy, R.W. (1985). Salmonid broodstock nutrition. In *Salmonid Reproduction*. An International Symposium (Iwamoto, R.N. & Sower, S., eds.) pp. 98 - 108. Washington Sea Grant Program. Univ. Washington, Seattle, Wa., U.S.A.
- Harrington, R. W. Jr. (1959). Photoperiodism in fishes in relation to the annual sexual cycle. In *Photoperiodism and Related Phenomena in Plants and Animals* (Withrow, R.B., ed.), pp. 651 - 657. Washington D.C., U.S.A.
- Harris, L. & Griess, L. (1978). *Trout nutrition and diseases*. Progress Report Dept., National Res. Colorado Division Wildlife F-28-R-14, 45 pp.
- Hauser, W.J. (1975). An unusually fast growth rate for *Tilapia zillii*. *California Fish and Game* **61**, 54 - 56.
- Heesen, D. Te (1977). Immunologische Untersuchungen an exo-und endogenen Dotterproteinen von *Brachydanio rerio* (*Teleostei Cyprinidae*) und verwandten Arten. *Zool. Jb. Aanal. Bd.*, **97**, 566 - 582.

- Heesen, D. Te & Engles, W. (1973). Electrophoretic studies on vitellogenesis in *Brachydanio rerio*. *Wilhelm Roux. Arch. Entwicklungsmech Org.*, **173**, 45 - 59.
- Hepher, B. & Pruginin, Y. (1982). Tilapia culture in ponds under controlled conditions. In *The Biology and Culture of Tilapias*, ICLARM Conference Proceedings (Pullin, R.S.V. & Lowe-McConnell, R.H., eds.), pp. 185 - 203. ICLARM conference proceedings 7, International Center for Living Aquatic Resources Management, Manila, Philippines.
- Heiligenberg, W. (1965). The effect of external stimuli on the attack readiness of a cichlid fish. *Zeitschrift vergl. Physiology* **49**, 459 - 464.
- Henderson, H.F. (1982). Culture - Chairmans Overview. In *The Biology and Culture of Tilapia* (Pullin, R.S.V. & Lowe-McConnell, R.H., eds.), pp. 181 - 185. ICLARM conference proceedings 7, International Center for Living Aquatic Resources Management, Manila, Philippines.
- Henderson, N.E. (1963). Extent of atresia in maturing ovaries of the eastern brook trout *Salvelinus fontinalis* (Mitchill). *Journal of the Fisheries Research Board of Canada* **20**, 859 - 897.
- Hester, F.J. (1964). Effects of food supply on fecundity in the female guppy *Lebistes reticulatus* (Peters). *Journal of the Fisheries Research Board of Canada* **21**, 757 - 764.
- Hines, G.A., Wasson, K.M. & Watts, S.A. (1995). Testicular steroidogenesis in relation to social interaction in the Nile tilapia *Oreochromis niloticus*. In *Proceedings of the Fifth International Symposium of Reproductive Physiology of Fish* (Goetz, F.W. & Thomas, P., eds.), p. 232. University of Austin, Texas, U.S.A.
- Hirose, K. & Ishida, R. (1974). Effect of cortisol and human chorionic gonadotropin (HCG) on ovulation in ayu, *Plecoglossus altivelis*, (Temminck & Schlegel) with special respect to water and on ion balance. *Journal of Fish Biology* **6**, 557 - 564.
- Hirose, K., Machida, Y. & Donaldson, E.M. (1976). Induction of ovulation in the Japanese flounder (*Limanda yokohamae*) with human chorionic gonadotropin

- and salmon gonadotropin. *Bulletin of the Japanese Society of Science and Fisheries* **42**, 13 - 20.
- Hirose, K., Adachi, S. & Nagahama, Y. (1985). Changes in plasma steroid hormone levels during sexual maturation in the Ayu *Plecoglossus altivelis*. *Bulletin of the Japanese Society of Science and Fisheries* **51**, 399 - 403.
- Hislop, J.R.G. (1975). The breeding and growth of whiting, *Merlangus merlangus* in captivity. *Journal du Conseil International pour l'Exploration de la Mer* **36**, 119 - 127.
- Hislop, J.R.G. (1984). A comparison of the reproductive tactics and strategies of cod, haddock, whiting and Norway pout in the North Sea. In *Fish Reproduction: Strategies and Tactics* (Potts, G.W. & Wootton, R.J., eds.), pp. 311 - 329. Academic Press: London, U.K.
- Hislop, J.R.G., Robb, A.P. & Gauld, J.A. (1978). Observations on effects of feeding level on growth and reproduction in haddock (*Melanogrammus aeglefinus* L.) in captivity. *Journal of Fish Biology* **13**, 85 - 98.
- Hoar, W.S. (1969). Reproduction. In *Fish Physiology* Vol. III (Hoar, W.S. & Randall, D.J., eds.), pp. 1 - 72. Academic Press: New York, U.S.A.
- Hoar, W.S. & Nagahama, Y. (1978). The cellular sources of sex steroids in teleost gonads. *Annales de Biologie, Biochimie et Biophysique* **18**, 893 - 898.
- Hodder, V.M. (1963). Fecundity of Grand Bank haddock. *Journal of the Fisheries Research Board of Canada* **20**, 1465 - 1487.
- Hokanson, K.E.F., McCormick, J.H., Jones, B.R. & Tucker, J.H. (1973). Thermal requirements for maturation, spawning and embryo survival of the brook trout, *Salvelinus fontinalis*. *Journal of the Fisheries Research Board of Canada* **30**, 975 - 984.
- Höner, G., Rosenthal, H. & Krüner, G. (1987). Growth of juvenile *Sarotherodon galilaeus* in laboratory aquaria. *Journal of Aquaculture in the Tropics* **2**, 59 - 71.

- Horwood, J.W., Greer Walker, M. & Witthames, P. (1989). The effect of feeding levels of plaice (*Pleuronectes platessa*). *Journal of the Marine Biological Association, U.K.* **69**, 81 - 92.
- Houghton, R.G., Last, J.M. & Bromley, P.J. (1985). Fecundity and egg size of sole (*Solea solea* (L.)) spawning in captivity. *Journal du Conseil International pour l'Exploration de la Mer.*, **42**, 162 - 165.
- Hsiao, S-M., Greeley, M.S. Jr. & Wallace, R.A. (1994). Reproductive cycling in female *Fundulus heteroclitus*. *Biological Bulletin* **186**, 271 - 284.
- Huet, M. (1971). *Textbook of Fish Culture: Breeding and Cultivation of Fish*. Fishing News Books Ltd., Surrey England, U.K. (Translated from French by H. Kahn.)
- Hughes, D.G. & Behrends, L.L. (1983). Mass production of *Tilapia nilotica* seed in suspended net enclosures. In *International Symposium of Tilapia in Aquaculture* (Fishelson, L. & Yaron, Z., eds.), pp. 394 - 401. Tel Aviv University, Tel Aviv, Israel.
- Hulata, G., Rothbard, S., Itzkovich, J., Wohlfarth, G. & Halevy, A. (1985). Differences in hybrid fry production between two strains of the Nile tilapia. *Progressive Fish Culturist* **47**, 81 - 85.
- Hulse, G.K. & Coleman, G.J. (1983). The role of endogenous opioids in the blockade of reproductive function in the rat following exposure to acute stress. *Pharmacology and Biochemical Behaviour* **19**, 795 - 799.
- Hurk, R. van den & Peute, J. (1979). Cyclic changes in the ovary of the rainbow trout, *Salmo gairdneri* with special reference to sites of steroidogenesis. *Cell and Tissue Research* **199**, 289 - 306.
- Hurk, R. van den & Slof, G.A. (1981). A morphological and experimental study of gonadal sex differentiation in the rainbow trout, *Salmo gairdneri*. *Cell and Tissue Research* **218**, 487 - 497.
- Hurk, R. van den & Resink, J.W. (1992). Male reproductive system as pheromone producer in teleost fish. *Journal of Experimental Zoology* **261**, 204 - 213.

- Hussain, M.G., Rao, G.P.S., Humayun, N.M., Randall, C.F., Penman, D.J., Kime, D., Bromage, N.R., Myers, J.M. and McAndrew, B.J. (1995). Comparative performance of growth, biochemical composition and endocrine profiles in diploid and triploid tilapia *Oreochromis niloticus* (L.). *Aquaculture* **138**, 87 - 97.
- Hussein, Kh. A. (1984). Gonadal maturation and fecundity of a fish with partial spawning (*Tilapia nilotica* L.). *Arabian Gulf Journal of Science and Research* **2**, 683 - 699.
- Hyder, M. (1970). Gonadal and reproductive patterns in *Tilapia leucosticta* (Teleostei, Cichlidae) in an equatorial lake: Lake Naivaisha (Kenya). *Journal of Zoology* **162**, 179 - 195.
- Hyder, M., Shah, A.V. & Stockwell-Hartree, A. (1981) Methallibure studies on *Tilapia* III. Effects of tilapian partially purified pituitary gonadotropic fractions on the testes of methallibure-treated *Sarotherodon spirulus* (= *Tilapia nigra*). *General and Comparative Endocrinology* **39**, 475 - 480.
- Hyllner, S.J., Oppen-Bernstein, D.O., Helvik, J.V., Walther, B.T. & Haux, C. (1991). Oestradiol-17 β induces the major envelope proteins in both sexes in teleosts. *Journal of Endocrinology* **131**, 229 - 236.
- Idler, D.R. (1982). Some perspectives on fish gonadotropins. In *Reproductive Physiology of Fish* (Richter, C.J.J. & Goos, H.Th., comps.), pp. 4 - 13. Purdoc Press: Wageningen, The Netherlands.
- Idler, D.R. & Ng, T. Bun. (1983). Teleost gonadotropins: isolation, biochemistry and function. In *Fish Physiology Vol. IX, Reproduction - Endocrine tissues and hormones* (Hoar, W.S., Randall, D.J. & Donaldson, E.M., eds.). Academic Press: New York, U.S.A.
- Idler, D.R. & So, Y.P. (1987). Carbohydrate-poor gonadotropins. In *Proceedings of the Third International Symposium on Reproductive Physiology of Fish* (Idler, D.R., Crim, L.W. & Walsh, J.M., eds.), pp. 57 - 60. Memorial University of Newfoundland, St. Johns, Canada.
- Iles, T.D. & Holden, M.J. (1969). Bi-parental mouth brooding in *Tilapia galilaea* (Pisces: Cichlidae). *Journal of Zoology (London)* **158**, 327 - 333.

- Ingram, D.L. (1962). In *The Ovary* (Zuckerman, S., ed.), pp. 247 - 273. Academic Press: New York, U.S.A.
- Ita, E.O., Omorinkoba, W.S. & Termaaku, F.T. (1989). Observations on the effects of sex combination ratios, stocking density and water depth on fry production in *Oreochromis niloticus* (tilapia) in outdoor concrete ponds. *Annual Report of the National Institute of Freshwater Research (Nigeria)* 71 - 81.
- Itoh, H., Suzuki, K. & Kawauchi, H. (1988). The complete amino acid sequences of β -subunits of two distinct chum salmon GTHs. *General and Comparative Endocrinology* 71, 438 - 451.
- Iwasaki, Y. (1973). Histochemical detection of Δ^5 -3 β -hydroxysteroid dehydrogenase in the ovary of medaka, *Oryzias latipes*, during annual reproductive cycle. *Bulletin of the Faculty of Fisheries, Hokkaido University* 23, 177 - 184.
- Jackson, A.J., Capper, B.S. & Matty, A. J. (1982). Evaluation of some plant proteins in complete diets for the Tilapia, *Sarotherodon mossambicus*. *Aquaculture* 27 (2), 97 - 109.
- Jalabert, B. (1976). *In vitro* oocyte maturation and ovulation in rainbow trout (*Salmo gairdneri*), Northern Pike (*Esox lucius*) and goldfish (*Carassius auratus*). *Journal of the Fisheries Research Board of Canada* 33, 974 - 988.
- Jalabert, B. & Zohar, Y. (1982). Reproductive physiology in cichlid fishes, with particular reference to *Tilapia* and *Sarotherodon*. In *The Biology and Culture of tilapias* (Pullin, R.S.V. and Lowe-McConnell, R.H., eds.), pp. 129 - 140. ICLARM conference proceedings 7, International Center for Living Aquatic Resources Management, Manila, Philippines.
- Jalabert, B. & Fostier, A. (1984). The follicular sensitivity *in vitro* to maturation-inducing hormones in rainbow trout, *Salmo gairneri*: Role of oestradiol-17 β . *Aquaculture* 43, 1 - 11.
- Jauncey, K. & Ross, B. (1982). *A Guide to Tilapia Feeds and Feeding*. Institute of Aquaculture, University of Stirling, Stirling, U.K. 111 pp.

- Joergensen, E.H., Christiansen, J.S. & Jobling, M. (1993). Effects of stocking density on food intake, growth performance and oxygen consumption in Arctic charr (*Salvelinus alpinus*). *Aquaculture* **110** (2), 191 - 204.
- Jones, J. & Bromage, N.R. (1987). The influence of ration size on the reproductive performance of female rainbow trout (*Salmo gairdneri*). In *Proceedings of the Third International Symposium of Reproductive Physiology of Fish* (Idler, D.R, Crim, L.W. & Walsh, J.M., eds.), p. 202. Memorial University of Newfoundland, St. Johns, Canada.
- Kagawa, H., Takano, K. & Nagahama, Y. (1981). Correlation of plasma oestradiol-17 β and progesterone levels with ultrastructure and histochemistry of ovarian follicles in the white spotted char, *Salvelinus leucomaenis*. *Cell and Tissue Research* **218**, 315 - 329.
- Kagawa, H., Young, G., Adachi, A. & Nagahama, Y. (1982). Estradiol-17 β production in amago salmon (*Oncorhynchus rhodurus*) ovarian follicles: roles of the thecal and granulosa cells. *General and Comparative Endocrinology* **47**, 440 - 448.
- Kah, O., Anglade, I., Lepretre, E., Dubourg, P. & Demonbrison, D. (1993). The reproductive brain of fish. *Fish Physiology and Biochemistry* **11** (1-6), 85 - 98.
- Kato, T. (1975). The relationship between the growth and reproductive characters of rainbow trout, *Salmo gairdneri*. *Bulletin of the Freshwater Fisheries Research Laboratory* **25**, 83 - 115.
- Kato, T. (1978). Relation of growth to age maturity and egg characteristics in kokanee salmon (*Oncorhynchus nerka*). *Bulletin of the Freshwater Fisheries Research Laboratory* **28**, 61 - 75.
- Katz, Y. & Eckstein, B. (1974). Changes in steroid concentration in the blood of female *Tilapia aurea* (Teleostei, Cichlidae) during initiation of spawning. *Endocrinology* **95**, 963 - 967.
- Kawauchi, H., Suzuki, K., Itoh, H., Swanson, P. & Nagahama, Y. (1987). Duality of salmon pituitary gonadotropins. *Proceedings of the First Congress of the*

Asia and Oceania Society for Comparative Endocrinology (AOSCE), p. 15 - 18.

Kawauchi, H., Suzuki, K., Itoh, H., Swanson, P., Naito, N., Nagahama, Y., Nozaki, M., Nakai, Y. & Itoh, S. (1989). The duality of teleost gonadotropins. *Fish Physiology and Biochemistry* **7**, 29 - 38.

Kawaziri, M. (1950). Influence of population density on reproduction on killi-fish. *Report of the Central Fisheries Station of Japan* **104**, 166 - 172.

Kessel, R.G. (1985). Annulate lamellae (porous cytomembranes): with particular emphasis on their possible role in differentiation of the female gamete. In *Developmental Biology: A Comprehensive Synthesis* (Browder, L., ed.). Plenum Press: New York, U.S.A.

Kestemont, P. (1990). Dynamic aspects of ovogenesis in an asynchronous fish, the gudgeon, *Gobio gobio* (L.) (Teleostei, Cyprinidae), under controlled temperature and photoperiod conditions. *Aquatic Living Resources* **3**, 61 - 74.

Khallaf, E.A. & Alne-na-ei, A.A. (1987). Feeding ecology of *Oreochromis niloticus* (Linnaeus) & *Tilapia zillii* (Gervais) in a Nile Canal. *Hydrobiology* **146**, 57 - 62.

Khoo, K.H. (1975). The corpus luteum of goldfish (*Carassius auratus* L.) and its functions. *Canadian Journal of Zoology* **53**, 1306 - 1323.

Khoo, K.H. (1979). The histochemistry and endocrine control of vitellogenesis in goldfish ovaries. *Canadian Journal of Zoology* **57** (3), 617 - 626.

King, I., Hardy, R.W. & Halver, J.E. (1985). The effect of dietary vitamin E on the distribution of α -tocopherol in rainbow trout (*Salmo gairdneri*) during ovarian maturation. In *International Symposium of Salmonid Reproduction* (Iwamoto, R.N. & Sower, S., eds.), pp. 111 - 112. Washington Sea Grant Program, Washington, Seattle, WA., U.S.A.

King, J.A. & Millar, R.P. (1990). Genealogy of the GnRH family. In *Progress in Comparative Endocrinology. Proceedings of the Eleventh International Symposium on Comparative Endocrinology* (Epple, A, Scanes, C.G. & Stetson, M.H., eds.), pp. 54 - 59. Malaga, Spain

- Kishida, M. & Specker, J.L. (1993). Vitellogenin in tilapia (*Oreochromis mossambicus*): induction of two forms by oestradiol, quantification and characterisation in oocyte extract. *Fish Physiology and Biochemistry* **12** (3), 171 - 182.
- Kishida, M. & Specker, J.L. (1994). Vitellogenin in the surface mucus of tilapia (*Oreochromis mossambicus*): possibility for uptake by the free-swimming embryos. *Journal of Experimental Zoology* **268**, 259 - 268.
- Kishida, M., Tyler III, W.A. & Specker, J.L. (1995). Changes in plasma estradiol and testosterone concentration during a brooding cycle of female mouthbrooding tilapia, *Oreochromis mossambicus* and male mouthbrooding tilapia, *Sarotherodon melanotheron*. In *Proceedings of the Fifth International Symposium of Reproductive Physiology of Fish* (Goetz, F.W. & Thomas, P., eds.), p. 236. University of Austin, Texas, U.S.A.
- Kishimoto, T. (1988). Regulation of metaphase by a maturation promoting factor. *Development and Growth Differentiation* **30**, 105 - 115.
- Kjartansson, H., Fivelstad, S., Thomassen, J.M. & Smith, M.J. (1988). Effects of different stocking densities on physiological parameters and growth of adult Atlantic salmon (*Salmo salar* L.) reared in circular tanks. *Aquaculture* **73** (1-4), 261 - 274.
- Kjesbu, O.S. (1989). The spawning activity of cod (*Gadus morhua* L.). *Journal of Fish Biology* **34**, 195 - 206.
- Kjesbu, O., Whittames, P.R., Solemdal, P. & Greer Walker, M. (1990). Ovulatory rhythm and a method to determine the stage of spawning in Atlantic cod (*Gadus morhua*). *Canadian Journal of Fisheries and Aquatic Science* **47**, 1185 - 1193.
- Kjesbu, O. & Kryvi, H. (1989). Oogenesis in Cod, *Gadus morhua* L., studied by light and electron microscopy. *Journal of Fish Biology* **34**, 735 - 746.
- Kjorsvik, E., Mangor-Jensen, A. & Holmefjord, I. (1990). Egg quality in fishes. *Advances in Marine Biology* **26**, 71 - 113.

- Kneib, R.T. (1981). Size-specific effects on the growth, fecundity and mortality of the fish *Fundulus heteroclitus* in an intertidal salt marsh. *Marine Ecology Progress Series* **6** (2), 203 - 212.
- Kobayashi, M., Aida, K. & Hanyu, I. (1986). Annual changes in plasma levels of gonadotropin and steroid hormones in goldfish. *Bulletin of the Japanese Society for Science and Fisheries* **52**, 1153 - 1158.
- Kobayashi, M., Katsumi, A. & Hanyu, I. (1988). Hormone changes during the ovary cycle in goldfish. *General and Comparative Endocrinology* **69**, 301 - 307.
- Kobayashi, M., Aida, K. & Hanyu, I. (1989). Involvement of steroid hormones in the pre-ovulation gonadotropin surge in female goldfish. *Fish Physiology and Biochemistry* **7**, 141 - 146.
- Konopacka, B. (1935). Recherches histochemiques sur la developpment des poissons. I. La vitellogenese chez le Goujon (*Gobio fluviatilis*) et la carpe (*Cyprinus carpio*). *Bulletin of the International Academy of Polish Science Letters Series B.*, 163 - 182.
- Korfsmeir, K.H. (1966). Zur geness de dottersystmes in der oocyte von *Brachydanio rerio*. *Autoradiographische untersuchungen Zell Forsch* **71**, 283 - 296.
- Kornfield, I.L., Ritte, C., Richler, C. & Wahrman, J. (1979). Biochemical and cytological differentiation amongst cichlid fishes of the sea Galilee. *Evolution* **33**, 1 - 14.
- Krajhanzl, A., Nosek, J., Monsigny, M. & Kocourek, J. (1984a). Direct visualization of endogenous lectins in fish by glycosylated flourescent cytochemical markers. *Histochemistry Journal* **16**, 426 - 428.
- Krajhanzl, A., Nosek, J., Habrova, V. & Kocourek, J. (1984b). An immunoflourescence study on the occurence of endogenous lectins in the differentiating oocytes of silver carp (*Hypothalmichthys molithrix* Valenc.) and tench (*Tinca tinca* L.). *Histochemistry Journal* **16**, 432 - 434.
- Kramer, D.L. (1972). The role of androgens in the parental behaviour of the blue gourami, *Trichogaster trichopterus* (Pisces, Belontiidae). *Animal Behaviour* **20**, 798 - 807.

- Kuznetsov, V.A. & Khalitov, N. Kh. (1978). Alterations in the fecundity and egg quality of the roach, *Rutilus rutilus* in connection with different feeding conditions. *Journal of Ichthyology* **18** (1), 63 - 70.
- Kyle, A. L., Stacey, N.E., Billard, R. & Peter, R.E. (1979). Sexual stimuli rapidly increase milt and gonadotropin levels in goldfish. *American Zoologist* **19**, Abst. 19.
- Kyle, A.L., Stacey, N.E. & Peter, R.E. (1982). Sexual stimuli associated with increased gonadotropin and milt levels in goldfish. In *Reproductive Physiology of Fish* (Richter, C.J.J. & Goos, H.J.Th., comps.), p. 240. Purdoc Press: Wageningen, The Netherlands.
- Lake, J.S. (1967). Rearing experiments with five species of Australian freshwater fishes I. Inducement of spawning. *Australian Journal of Freshwater and Marine Research* **18**, 137 - 153.
- Latif, A.F.A. & Saady, B.E. (1973). Oogenesis in the Nile boliti, *Tilapia nilotica* L. *Bulletin of the Institute of Oceanography (Cairo)* **3**, 183 - 202.
- Lam, T.J., Nagahama, Y., Chan, K. & Hoar, W.S. (1978). Overripe eggs and post-ovulatory corpora lutea in the three-spined stickleback, *Gasterosteus aculeatus* L., from trachurus. *Canadian Journal of Zoology* **56**, 2029 - 2036.
- Lambert, J.G.D. (1970). The ovary of the guppy, *Poecilia reticulata*. The granulosa cells as sites of steroid bio-synthesis. *General and Comparative Endocrinology* **15**, 464 - 476.
- Lambert, J.G.D., Van den Hurk, R., Schoonen, W.G.E.J., Resink, J.W. & Van Oordt, P.G.W.J. (1986). Gonadal steroids and the possible role of steroid glucuronides as sex pheromones in 2 species of teleosts. *Fish Physiology and Biochemistry* **2**, 101 - 107.
- Lancaster, P.M. & Tyler, C.R. (1994). Developmental expression and modulation of the vitellogenin receptor in ovarian follicles of the rainbow trout, *Oncorhynchus mykiss*. *Journal of Experimental Zoology* **269**, 458 - 466.

- Landesman, L., Shim, K.F. & Lam, T.J. (1986). Effect of dietary protein levels on protein maintenance and reproductive performance of the adult dwarf gourami. *The First Asian Fisheries Forum Proceedings* (Maclean, J.L., Dizon, L.B., Hosillos, L.V., eds.), pp. 585 - 588. Manila, Philippines.
- Lang, I. (1981). Electron microscopic and histochemical investigations of the atretic oocytes of *Perca fluviatilis* (Teleostei). *Cell and Tissue Research* **220**, 201 - 212.
- Lange, R. (1985). The vertebrate yolk-platelet crystal: comparative analysis of an *in vivo* crystalline aggregate. *International Review of Cytology* **97**, 133 - 181.
- Lanzing, W.J.R. (1973). Sound production in the cichlid *Tilapia mossambicus* Peters. *Journal of Fish Biology* **6**, 341 - 347.
- Lee, J.C. (1979). *Reproduction and hybridization of three cichlid fishes, Tilapia aurea (Steindachner), T. hornorum (Trewavas) and T. nilotica (Linnaeus) in aquaria and in plastic pools*. Ph. D. thesis, Auburn University, Alabama, U.S.A.
- Legendre, M. & Ecoutin, J.M. (1989). Suitability of brackish water tilapia species from the Ivory coast for lagoon aquaculture. 1. Reproduction. *Aquatic Living Resources* **2** (2), 71 - 79.
- Legner, E.F. (1978). Mass culture of *Tilapia zillii* (Cichlidae) in pond ecosystems. *Entomorphia* **23** (1), 51 - 55.
- Legner, E.F. (1983). Imported cichlid behaviour in California. In *The Second International Symposium on Tilapia in Aquaculture*, ICLARM Conference Proceedings **15** (Pullin, R.S.V., Bhukaswan, T., Toguthai, K. & Maclean, J.L., eds.), pp. 59 - 63. Department of Fisheries, Bangkok, Thailand and International Center for Living Aquatic Resources Management, Manila, Phillipines.
- Legner, E.F. & Murray, C.A. (1981). Feeding rates and growth of the fish *Tilapia zillii* (Cichlidae) on *Hydrilla verticillata*, *Potamogeton percinatus* and *Myriophyllum spicatum* var. *exalbescens* and interactions in irrigation canals of southeastern California. *Journal of the American Mosquito Control Association* **41** (2), 241 - 250.

- Levavi Sivan, B. & Yaron, Z. (1992). Involvement of cyclic adenosine monophosphate in the stimulation of gonadotropin stimulation from the pituitary of the teleost fish, Tilapia. *Molecular and Cell Endocrinology* **85** (3), 175 - 182.
- Levavi Sivan, B., Ofir, M. & Yaron, Z. (1995). Possible sites of dopaminergic inhibition of gonadotropin release from the pituitary of a teleost fish, Tilapia. *Molecular and Cell Endocrinology* **109** (1), 87 - 95.
- Levavi-Zermonsky, B. & Yaron, Z. (1987). Gonadotropin secretion from the pituitary of Tilapia: stimulation by GnRH and possible mode of Action. In *Reproduction in Fish - Basic and Applied Aspects in Endocrinology and Genetics* (Zohar, Y. & Breton, B., eds.). INRA, Paris, France.
- Licht, P., McCreery, B.R., Barnes, R. and Pang, R. (1983). Seasonal and stress related changes in plasma gonadotropins, sex steroids and corticosterone in the bullfrog, *Rana catesbeiana*. *General and Comparative Endocrinology* **50**, 124 - 145.
- Little, D.C. (1989). *A evaluation of strategies for production of Nile tilapia (Oreochromis niloticus L.) fry suitable for hormonal treatment*. Ph.D. thesis, Institute of Aquaculture, University of Stirling, Stirling, Scotland, U.K.
- Little, D.C., Macintosh, D.J. & Edwards, P. (1993). Improving spawning synchrony in the Nile Tilapia, *Oreochromis niloticus* (L.). *Aquatic Living Resources* **24**, 399 - 405.
- Liley, N.R. (1982). Chemical communication in fish. *Canadian Journal of Fisheries and Aquatic Science* **38**, 334 - 347.
- Liley, N.R. & Stacey, N.E. (1983). Hormones, pheromones, and reproductive behaviour in fish. In *Fish Physiology* (Hoar, W.S. & Randall, D.J., eds.), Vol. **9B**, pp. 1 - 63. Academic Press: New York, U.S.A.
- Livni, N. (1971). Ovarian histochemistry of the fishes *Cyprinus carpio*, *Mugil capito* and *Tilapia aurea* (Teleostei). *Histochemistry Journal* **3**, 405 - 414.
- Loiselle, P. (1977). Colonial breeding by an African substratum-spawning cichlid fish, *Tilapia zillii* (Gervais). *Biology of Behaviour* **2**, 129 - 142.

- Love, R.M. (1970). *The Chemical Biology of Fishes*. Academic Press: London, U.K. 547 pp.
- Lowe-McConnell, R.H. (1955). The fecundity of *Tilapia* species. *East African Agricultural Journal* **21**, 45 - 52.
- Lowe-McConnell, R.H. (1958). Observations on the biology of *Tilapia nilotica* Linn (Pisces: Cichlidae) in East African waters. *Revue de Zoologie et Botanique Africaine* **57**, 129 - 170.
- Lowe-McConnell, R.H. (1959). Breeding behaviour patterns and ecological differences between *Tilapia* species and their significance for evolution within the genus *Tilapia* (Pisces: Cichlidae). *Proceedings of the Zoological Society (London)* **132**, 1 - 30.
- Lowe-McConnell, R.H. (1975). *Fish Communities in Tropical Freshwaters, their Distribution, Ecology and Evolution*. Longman: London, U.K.
- Lowe-McConnell, R.H. (1982). Tilapias in fish communities. In *The Biology and Culture of Tilapias* (Pullin, R.S.V. & Lowe-McConnell, R.H., eds.), pp. 83 - 113. ICLARM Conference Proceedings 7, International Center for Living Aquatic Resources Management, Manila, Philippines.
- Luna, L.G. (1968). *Manual of Histologic Staining Methods of the Armed Forces Institute of Pathology*. Third edition. McGraw-Hill: New York, Sydney, Toronto, London. 258 pp.
- Luquet, P. (1991). *Tilapia, Oreochromis* spp. In *Handbook of Nutrient Requirements of Finfish* (Wilson, R.P., ed.), pp. 169 - 179. CRC Press: New York, U.S.A.
- Macchi, G.J., Elias, I. & Burgos, G.E. (1995). Histological observations on the reproductive cycle of the Argentinian sandperch, *Pseudoperca semifasciata* (Osteichthyes, Pinguipedidae). *Scientia Marina* **59** (2), 119 - 127.
- Macintosh, D.J. (1985). *Tilapia Culture: Hatchery Methods for Oreochromis mossambicus and O. niloticus with Special Reference to All-Male Fry Production*. Institute of Aquaculture, University of Stirling, Stirling, U.K. 154 pp.

- Macintosh, D.J. & De Silva, S.S. (1984). The influence of stocking density and food ration on fry survival and growth in *Oreochromis mossambicus* and *O. niloticus* female x *O. aureus* male hybrids reared in a closed circulated system. *Aquaculture* **41**, 345 - 358.
- Macintosh, D.J. & Little, D.C. (1995). Nile Tilapia (*Oreochromis niloticus*). In *Broodstock Management and Egg and Larval Quality* (Bromage, N.R. and Roberts, R.J., eds.), pp 227 - 320. Blackwell Science Ltd: Oxford, U.K.
- Macintosh, D.J., Varghese, T.J. & Rao, G.P.S. (1985). Hormonal sex reversal of wild-spawned tilapia in India. *Journal of Fish Biology* **26**, 87 - 94.
- Madu, C.T. & Ita, E.O. (1988). The effects of sex ratio of breeders on spawning frequency and fry production in indoor hatchery management of the tilapia *Oreochromis niloticus* (L.). *Nigerian Journal of Applied Fisheries and Hydrobiology* **3**, 25 - 28.
- Maluwa, A.O. (1991). Fry production of *Oreochromis shiranus* in hapas. *Aqua. Res. and Dev. in Rural Africa*. (Costa-Pierce, B.A., Lightfoot, C., Ruddle, K., Pullin, R.S.V., eds.). Summary Report on the ICLARM GTZ Malawi Fisheries Dept. Univ. of Malawi Conf., Malawi. **27**, p. 26.
- Mann, R.H.K. & Mills, C.A. (1979). Demographic aspects of fish fecundity. In *Fish Phenology: Anabolic Adaptiveness in Teleosts* (Hart, P.J., ed.), pp. 161 - 177. *Symp. Zool. Soc. Lond.*, No. 44. Academic Press: London, U.K.
- Mann, R.H.K. & Mills, C.A. (1985). Variations in the sizes of gonads, egg and larvae of the dace, *Leuciscus leuciscus*. *Environmental Biology of Fish* **13**, 277 - 287.
- Manzi, J.J. (1989). Aquaculture Research Priorities for the 1990s. *World Aquaculture* **20**, pp. 29 - 32.
- Markert, J.P. & Vanstone, W.E. (1968). Egg proteins of Pacific salmon, genus *Oncorhynchus*: proteins in the soluble fraction. *Canadian Journal of Biochemistry* **46**, 1334 - 1337.

- Marshall, B.E. (1979). Observations on the breeding biology of *Sarotherodon macrochir* (Boulenger) in Lake McIlwaine, Rhodesia. *Journal of Fish Biology* **14**, 419 - 424.
- Marshall, J.A. (1972). Influence of male sound production on oviposition in female *Tilapia mossambica* (Pisces:Cichlidae). *Bulletin of the Ecology Society of America* **53**, p. 29.
- Marza, V.D., Marza, E.V. & Guthrie, M. J. (1937). Histochemistry of the ovary of *Fundulus heteroclitus* with special reference to the differentiating oocytes. *Biology Bulletin* **73**, 67 - 92.
- Matsuyama, M., Adachi, S., Nagahama, Y. & Matsuura, S. (1988). Diurnal rhythm of oocyte development and plasma steroid hormone levels in the female red sea bream, *Pagrus major* during the spawning season. *Aquaculture* **73**, 357 - 372.
- Matsuyama, M., Fukuda, T., Ikeura, S., Nagahama, Y. & Matsuura, S. (1994). Spawning characteristics and steroid hormone profiles in the wild female Japanese sardine, *Sardinops melanostictus*. *Fishery Science* **60** (6), 703 - 706.
- Matthews, A. (1938). The seasonal cycle in th gonads of *Fundulus*. *Biology Bulletin* **75**, 66 - 74.
- Mayer, I., Shackley, S.E. & Witthames, P.R. (1990). Aspects of the reproductive biology of the bass *Dicentrarchus labrax* L. II. Fecundity and pattern of oocyte development. *Journal of Fish Biology* **36**, 141 - 148.
- Mazid, M.A., Tanaka, Y., Katayama, T., Rahman, M.A., Simpson, K.L. & Chichester, C.O. (1979). Growth response of *Tilapia zillii* fingerlings fed isocaloric diets with variable protein levels. *Aquaculture* **18** (2), 115 - 122.
- Mazur, C.F. & Iwama, G.K. (1992). Effect of stocking density on wild and hatchery-reared chinook salmon (*Oncorhynchus tshawytscha*). *Northwest Science* **66** (2), p.140.
- McAndrew, B.J. (1993). Sex control in tilapiines. In *Recent Advances on Aquaculture IV* (Muir, J.F. & Roberts, R.J., eds.), pp. 87 - 98. Blackwell Science: Oxford, U.K.

- McAndrew, B.J. & Majumdar, K.C. (1983). Tilapia stock identification using electrophoretic markers. *Aquaculture* **30**, 249 - 261.
- McEvoy, L.A. & McEvoy, J. (1991). Size fluctuation in the eggs and newly hatched larvae of captive turbot (*Scophthalmus maximus*). *Journal of the Marine Biology Association U.K.* **71**, 679 - 690.
- McFadden, J.T., Cooper, E.L. & Anderson, J.K. (1965). Some effects of environment on egg production in brown trout (*Salmo trutta*). *Limnology and Oceanography* **10**, 88 - 95.
- McKay, I. & Mann, K.H. (1969). Fecundity of two cyprinid fishes in the River Thames, Reading, England. *Journal of the Fisheries Research Board of Canada* **26**, 2795 - 2805.
- McKaye, K.R. (1984). Behavioural aspects of cichlid reproductive strategies: Patterns of territoriality and brood defence in Central American Mouthbrooders. In *Fish Reproduction: Strategies & Tactics* (Potts, G.W. & Wootton, R.J., eds.), 245 - 273. Academic Press: London, U.K.
- McNatty, K.P., Hudson, N.L., Shaw, L. & Moore, L. (1994). Plasma concentrations of FSH, LH, thyroid stimulating hormone and growth hormone after exogenous stimulation with GnRH, TRH and GHRH in Booroola ewes that are homozygous carriers or non-carriers of the Fec B gene. *Journal of Reproduction and Fertility* **102**, 177 - 183.
- Messieh, S. (1976). Fecundity studies in Atlantic herring from the Southern Gulf of St. Lawrence and along the Nova Scotia coast. *Transactions of the American Fisheries Society* **105**, 384 - 394.
- Miller, P.J. (1984). The tokology of gobioid fishes. In *Fish Reproduction: Strategies and Tactics* (Potts, G.W. & Wootton, R.J., eds.), 119 - 153. Academic Press: London, U.K.
- Mires, D. (1973). A hatchery for forced spawning at Kibbutz Ein Hamifrats. *Bamidgeh* **25**, 72 - 84.
- Mires, D. (1977). Theoretical and practical aspects of the production of all-male Tilapia hybrids. *Bamidgeh* **29**, 94 - 101.

- Mires, D. (1982). Study of the problems of the mass production of hybrid tilapia fry. In *The Biology and Culture of Tilapias* (Pullin, R.S.V. & Lowe-McConnell, R.H., eds.), pp. 317 - 329. ICLARM conference proceedings 7, International Center for Living Aquatic Resources Management, Manila, Philippines.
- Mironova, N.V. (1977). Energy expenditure on egg production in young *Tilapia mossambica* and the influence of maintenance conditions on their reproductive intensity. *Journal of Ichthyology* **17**, 727 - 633.
- Moore, M.C., Thompson, C.W. & Marler, C.A. (1991). Reciprocal changes in corticosterone and testosterone levels following acute and chronic handling stress in the tree lizard *Urosaurus ornatus*. *General and Comparative Endocrinology* **81**, 217 - 226.
- Moreau, J. (1979) Les introduction d'espèces étrangères dans les eaux continentales Africaines. Interêt et limites. In *The African Fishes, Their Biology, Recent Trends*. (Levêque, C., Bruton, M. & Ssontongo, G.W., eds.). Nairobi SIL UNEP Symp., Dec. 1979.
- Moser, H.G. (1967), Seasonal histological changes in the gonads of *Sebastodes paucipinus* A., an oviparous teleost. *Journal of Morphology* **123**, 329 - 354.
- Murthy, C.K., Wong, A.O.L., Habibi, H.R., Rivier, J.E. & Peter, R.E. (1994). Receptor binding of gonadotropin releasing hormone antagonists that inhibit release of gonadotropin II and growth hormone in goldfish, *Carassius auratus*. *Biology of Reproduction* **51** (3), 349 - 357.
- Nabissi, M., Pati, D., Polzonettimagni, A.M. & Habibi, H.R. (1997). Presence and activity of compounds with GnRH-like activity in the ovary of sea bream *Sparus aurata*. *Comparative Physiology* **41** (1), R111 - R117.
- Nagahama, Y. (1983). The functional morphology of teleost gonads. In *Fish Physiology. Vol. IX. Reproduction Part A, Endocrine tissues and hormones* (Hoar., W.S., Randall, D.J. & Donaldson, E.M., eds.), pp. 223 - 276. Academic Press: New York, U.S.A.
- Nagahama, Y. (1987). Gonadotropin action on gametogenesis and steroidogenesis in teleost gonads. *Zoological Science* **4**, 209 - 222.

- Nagahama, Y. & Yamashita, M. (1989). Mechanisms of synthesis of 17α - 20β -dihydroxy-4-pregnen-3-one, a teleost maturation-inducing substance. *Fish Physiology and Biochemistry* **7**, 193 - 200.
- Nagahama, Y., Chan, K. & Hoar, W.S. (1976). Histochemistry and ultrastructure of pre- and post-ovulatory follicles in the ovary of the goldfish, *C. auratus*. *Canadian Journal of Zoology* **54**, 1128 - 1139.
- Nagahama, Y., Young, G. & Kagawa, H. (1982). Cellular sources of sex steroids in teleost gonads. *Canadian Journal of Fisheries and Aquatic Science* **39**, 56 - 64.
- Nagahama, Y., Young, G., Veda, H., Kagawa, H. & Adachi, S. (1985). Endocrine control of final gamete maturation in salmonids. In *Salmonid reproduction Review papers* (Iwamoto, R.N. & Sower, S., eds.), pp. 8 - 19. Washington Sea Grant Program. University of Washington, U.S.A.
- Nagahama, Y., Yoshikuni, M., Yamashita, M., Sakai, N. & Tanaka, M. (1993). Molecular endocrinology of oocyte growth and maturation in fish. *Fish Physiology and Biochemistry* **11**, 3 - 14.
- Nagahama, Y., Yoshkuri, M., Yamashita, M., Tokumoto, T. & Katsu, Y. (1995). Regulation of oocyte growth and maturation in fish. *Current Trends in Developmental Biology* **30**, 103 - 145.
- Nagler, J.J. & Idler, D.R. (1990). Ovarian uptake of vitellogenin and another high density lipoprotein in winter flounder (*Pseudopleuronectes americanus*) and their relationship to yolk proteins. *Biochemistry and Cell Biology* **68**, 330 - 335.
- Nakamura, M. & Takahashi, H. (1973). Gonadal sex differentiation in *Tilapia mossambica*, with special regard to the time of estrogen treatment effective in inducing complete feminization of genetic males. *Bulletin of the Faculty of Fisheries, Hokkaido University* **24** (1), 1 - 13.
- Nakamura, M., Specker, J.L. & Nagahama, Y. (1993). Ultrastructural analysis of the developing follicle during early vitellogenesis in tilapia, *Oreochromis niloticus*,

- with special reference to the steroid-producing cells. *Cell and Tissue Research* **272**, 33 - 39.
- Nakamura, M., Specker, J.L. & Nagahama, Y. (1996). Innervation of steroid-producing cells in the ovary of tilapia *Oreochromis niloticus*. *Zoological Science* **13**, 603 - 608.
- Nataranjan, P. & Jameson, J.D. (1984). Effects of food ration on growth and dietary protein conversion in three species of fish fingerlings. *Comparative Physiology and Ecology* **9**, 348 - 351.
- Navas, J.M., Mananos, E., Thrush, M., Ramos, J., Zanuy, S., Carillo, M., Zohar, Y. & Bromage, N.R. (1995). Effect of the lipid composition of the diet on hormonal levels and spawning performance of sea bass (*Dicentrarchus labrax*). In *The Fifth International Symposium of Reproductive Physiology of Fish* (Goetz, F.W. & Thomas, P., eds.), p. 131. University of Austin, Texas, U.S.A.
- New, M.B., Hopkins, K.D. & El Dakour, S. (1984). Effects of feeding frequency on survival and growth of tilapia fry. *Kuwait Institute for Scientific Research*, Safat, KISR Publication 1287.
- Nikolskii, G.V. (1969). *Theory of Fish Population Dynamics as the Biological Background for Rational Exploitation and Management of Fishery Resources* (Translated by Bradley, J.E.S.). Oliver & Boyd: Edinburgh, U.K.
- Nisibori, M. & Kawata, M. (1993). The effect of visual density on the fecundity of the guppy, *Poecilia reticulata*. *Environmental Biology of Fish* **37** (2), 213 - 217.
- Ng, T.B., Campbell, C.M. & Idler, D.R. (1980). Antibody inhibition of vitellogenesis on oocyte maturation in salmon and flounder. *General and Comparative Endocrinology* **41**, 233 - 239.
- Ng, T.B. & Idler, D.R. (1983). Yolk formation and differentiation in teleost fishes. In *Fish Physiology Vol IX. Reproduction-Part A, Endocrine tissue and hormones* (Hoar, W.S., Randall, D.J. & Donaldson, E.A., eds.), pp. 373 - 404. Academic Press: New York, U.S.A.

- Noakes, D.L.G. & Balon, E.K. (1982). Life histories of tilapias: an evolutionary perspective. In *The Biology and Culture of Tilapias* (Pullin, R.S.V. & Lowe-McConnell, R.H., eds.), pp. 61 - 82. ICLARM conference Proceedings 7, International Center for Living Aquatic Resources Management, Manila, Philippines.
- Norberg, B., Valkner, V., Huse, J., Karlsen, I & Grung, G.L. (1991). Ovulatory rhythms and egg variability in Atlantic halibut *Hippoglossus hippoglossus*. *Aquaculture* **97**, 365 - 371.
- Nosek, J. (1984). Biogenesis of the cortical granules in fish oocytes. *Histochemistry Journal* **16**, 435 - 437.
- Ofari, J.K. (1988). The effect of predation by *Lates niloticus* on overpopulation and stunting in mixed sex culture of tilapia species in ponds. In *The Second International Symposium on Tilapia in Aquaculture* (Pullin, R.S.V., Bhukaswan, Tonguthai, & Maclean, J.L., eds.), pp. 69 - 73. International Center for Living Aquatic Resources Management, Manila, Philippines.
- van Oordt, P.G.W.J. & Peute, J. (1983). The cellular origin of pituitary gonadotropins in teleosts. In *Fish Physiology Vol. IX, Reproduction - Endocrine tissues and hormones* (Hoar, W.S., Randall, D.J. & Donaldson, E.M., eds.). Academic Press: New York, U.S.A.
- Ooshuizen, E. & Daan, N. (1974). Egg fecundity and maturity of North Sea cod *Gadus morhua* (L.). *Netherlands Journal of Sea Research* **8**, 378 - 397.
- Paessum, M.A. & Allison, R. (1984). Maximizing Tilapia production in recirculating systems by sequential rearing. *Aquaculture* **42**, 185 - 189.
- Pankhurst, N.W. & Barnett, C.W. (1993). Relationship of population density, territorial interaction and plasma levels of gonadal steroids in spawning male demoiselles *Chromis dispilus* (Pisces: Pomacentridae). *General and Comparative Endocrinology* **90** (2), 168 - 176.
- Pankhurst, N.W. & Dedual, M. (1994). Effects of capture and recovery on plasma levels of cortisol, lactate and gonadal steroids in a natural population of rainbow trout. *Journal of Fish Biology* **45**, 1013 - 1025.

- Pankhurst, N.W., Van Der Kraak, G., Peter, R.E. (1995). Evidence that the inhibitory effect of stress on reproduction in teleost fish are not mediated by the action of cortisol on ovarian steroidogenesis. *General and Comparative Endocrinology* **99** (3), 249 - 257.
- Papoutsoglou, S.E. & Voutsinos, G.A. (1988). Influence on growth rate of *Tilapia aureus* (Steindachner) reared in a closed circulated system. *Aquaculture and Fisheries Management* **19** (3), 291 - 298.
- Partridge, B.L., Liley, N.R. & Stacey, N.E. (1976). The role of pheromones in the sexual behaviour of the goldfish. *Animal Behaviour* **24**, 291 - 299.
- Pati, D. & Habibi, H.R. (1992). Characterization of gonadotropin releasing hormone (GnRH) receptors in the ovary of common carp (*Cyprinus carpio*). *Canadian Journal of Physiology and Pharmacology* **70** (2), 268 - 274.
- Patino, R. & Thomas, P. (1990). Induction of maturation of Atlantic croaker oocytes by $17\alpha,20\beta,21\text{trihydroxy-4-pregnen-3-one}$ *in vitro* consideration of some biological and experimental variables. *Journal of Experimental Zoology* **255**, 97 - 109.
- Payne, A.I. & Collinson, R.I. (1983). A comparison of the biological characteristics of *Sarotherodon aureus* (Steindacher) with those of *S. niloticus* (L.) and other tilapia of the delta and lower Nile. *Aquaculture* **30**, 335 - 351.
- Peter, R.E. (1980). Serum gonadotropin levels in mature male goldfish in response to leutenizing hormone-releasing hormone (LHRH) and des-Gly¹⁰-[D-Ala⁶]-LHRH ethylamide. *Canadian Journal of Zoology* **58**, 1100 - 1104.
- Peter, R.E. (1982). Neuroendocrine control of reproduction in teleosts. *Canadian Journal of Fisheries and Aquatic Science* **39**, 48 - 55.
- Peter, R.E. & Paulencu, C.R. (1980). Involvement of the preoptic region in gonadotropin release-inhibition in goldfish, *Carassius auratus*. *Neuroendocrinology* **31**, 133 - 141.
- Peter, R.E., Chang, J.P., Cook, A.F. & Nahorniak, C.S. (1982). Neuroendocrine regulation of gonadotropin and growth hormone secretion in goldfish. In

Proceedings of the Ninth International Symposium on Comparative Endocrinology (Lofts, B., ed.). University of Hong Kong Press: Hong Kong.

- Peters, H.M. (1983). Fecundity, egg weight and oocyte development in tilapias (Cichlidae, Teleostei). *ICLARM Translations 2*, International Center for Living Aquatic Resources Management, Manila, Philippines, 28pp.
- Peters, H.M. & Berns, S. (1978). Über die vorgeschichte der maulbrütenden Cichlidae. *Aquarien Magasine* **5**, 211 - 217.
- Pettite, J.N. & Etches, R.J. (1991). Daily infusion of corticosterone and reproductive function in the domestic hen (*Gallus domesticus*). *General and Comparative Endocrinology* **83**, 397 - 405.
- Peute, J., Goos, H.J.Th., de Bruyn, M.G.A. & Van Oordt, P.G.W.J. (1978). Gonadotropic cells of the rainbow trout pituitary during the annual cycle. Ultrastructure and hormone content. *Annales de Biologie, Biochimie et Biophysique* **18**, 905 - 910.
- Phillipart, J-Cl. & Ruwet, J-Cl. (1982). Ecology and distribution of tilapias. In *The Biology and Culture of Tilapias* (Pullin, R.S.V. & Lowe-McConnell, R.H., eds.), pp. 15 - 59. ICLARM Conference Proceedings 7, International Center for Living Aquatic Resources Management, Manila, Philippines.
- Phillips, A.M. Jr., Podoliak, H.A., Poston, H.A., Booke, H.E., Pyle, E.A. and Hammer, G.L. (1964). The Nutrition of Trout. Cortland Hatchery Rep. No. 32, *Fisheries Research Bulletin* (New York).
- Pickering, A.D., Pottinger, T.G., Carragher, J.F. and Sumpter, J.P. (1987). The effects of acute and chronic stress on the levels of reproductive hormones in the plasma of mature brown trout *Salmo trutta* L. *General and Comparative Endocrinology* **68**, 249 - 259.
- Pillay, T.V.R. (1979). The state of aquaculture 1976. In *Advances in Aquaculture* (Pillay, T.V.R. & Dill, W.A., eds.), pp. 1 - 10. Fishing News Books Ltd., Surrey, England.
- Poncelet, A.C., Levavi Sivan, B., Muller, M., Yaron, Z., Martial, J.A. & Belayew, A. (1996). The prolactin-I gene. Evolutionary conservation of the regulatory

- elements affecting pituitary specific expression. *DNA and Cell Biology* **15** (8), 679 - 692.
- Pope, J.A., Mills, D.H. & Shearer, W.M. (1961). The fecundity of the Atlantic Salmon *Salmo salar* (L.). *Freshwater Salmon Fisheries Research* **26**, 1 - 12.
- Pottinger, T.G. & Pickering, A.D. (1990). The affect of cortisol administration on hepatic and plasma estradiol-binding capacity in immature female rainbow trout (*Oncorhynchus mykiss*). *General and Comparative Endocrinology* **80**, 264 - 273.
- Pouyard, L. & Agnès, J.-F. (1995). Phylogenetic relationships between 21 species of three tilapiine genera *Tilapia*, *Sarotherodon* and *Oreochromis* using allozyme data. *Journal of Fish Biology* **47**, 26 - 38.
- Prat, F., Zanuy, S., Carillo, M., De Mones, A. & Fostier, A. (1990). Seasonal changes in the plasma levels of gonadal steroids of sea bass *Dicentrarchus labrax* L. *General and Comparative Endocrinology* **70**, 361 - 373.
- Prat, F., Sumpter, J.P. & Tyler, C.R. (1996). Validation of radioimmunoassays for two salmon gonadotropins (GtH I and GtH II) and their plasma concentrations throughout the reproductive cycle in male and female rainbow trout (*Oncorhynchus mykiss*). *Biology of Reproduction* **54**, 1375 - 1382.
- Pullin, R.S.V. & Lowe-McConnell, R.H. (1982). *The Biology and Culture of Tilapias. ICLARM Conference Proceedings 7*, International Center for living Aquatic Resources Management, Manila, Phillipines.
- Pullin, R.S.V. (1983). Choice of tilapia species for aquaculture. In *International Symposium on Tilapia in Aquaculture*. (Fishelson, L. & Yaron, Z., eds.) Tel Aviv University Press, Tel Aviv.
- Raitt, D.F.S. (1968). The population dynamics of the Norway pout in the North Sea. Department of Agriculture and Fisheries (Scotland), *Marine Research* **5**.
- Rana, K. J. (1986). *Parental influences on egg quality, fry production and fry performance in Oreochromis niloticus (Linnaeus) and O. mossambicus (Peters)*. Ph.D. thesis, Institute of Aquaculture, University of Stirling, Scotland, U.K.

- Rana, K. J. (1988). Reproductive biology and the hatchery rearing of tilapia eggs and fry. In *Recent Advances in Aquaculture* (Muir, J.F. & Roberts, R.J., eds.), vol. 3, pp. 343 - 406. Croom Helm: London & Sydney.
- Rashid, M.H. & Umar, T. (1990). Effect of hCG on histological changes in the ovaries of *Tilapia aurea*. *Proceedings of the Pakistan Congress on Zoology* **10**, 1 - 9.
- Rastogi, R.K. (1966). A study of the follicular atresia and evacuated follicles of the viviparous Indian teleost *Xenentodon cancila* (Ham.). *Acta Biologica Academiae Scientiarum Hungaricae* **17**, 51 - 63.
- Reznick, D. & Yang, A.P. (1993). The influence of fluctuating resources on life history patterns of allocation and plasticity in female guppies. *Ecology* **74** (7), 2011 - 2019.
- Reznick, D., Callahan, H. & Llauredo, R. (1996). Maternal effects on offspring quality in poeciliid fishes. *American Zoologist* **36** (2), 147 - 156.
- Riedel, D. (1965). Some remarks on the fecundity of Tilapia (*T. mossambica* Peters) and its introduction into Middle Central America (Nicaragua) together with a first contribution towards the limnology of Nicaragua. *Hydrobiologia* **25**, 357 - 388.
- Reinboth, R. (1972). Hormonal control of the teleost ovary. *American Zoologist* **12**, 307 - 248.
- Reisman, H.M. (1968). Effects of social stimuli on the secondary sex characteristics of male three spined sticklebacks *Gasterosteus aculeatus*. *Copeia* **4**, 816 - 826.
- Ridelman, J.M., Hardy, R.W. & Brannon, E.L. (1984). The effects of short-term starvation on ovarian development and egg viability in rainbow trout (*Salmo gairdneri*). *Aquaculture* **37**, 133 - 140.
- Rinchard, J., Kestemont, P. & Heine, R. (1997). Comparative study of reproductive biology in multiple-spawner cyprinid fish. II. Sex steroid and plasma protein phosphorous concentrations. *Journal of Fish Biology* **50**, 169 - 180.

- Robb, A.P. (1982). Histological observations on the reproductive biology of the haddock *Melanogrammus aeglefinus* (L.). *Journal of Fish Biology* **20**, 397 - 408.
- Rocha, M.J. and ReisHenriques, M.A. (1996). Plasma and urine levels of C-18, C-19 and C-21 steroids in an asynchronous fish, the tilapia *Oreochromis mossambicus* (Teleostei, cichlidae). *Comparative Biochemistry and Physiology* **155**, 257 - 264.
- Rodbard, D. & Lewald, J.E. (1970). Computer analysis of radioligand assay and radioligand data. *Acta Endocrinology (Kbh.) Supplement* **147**, p. 79.
- Rogers, S. I. (1989). Seasonal variations in fecundity and egg size of the common goby, *Pomatoschistus microps*. *Journal of the Marine Biological Association of the U.K.* **69**, 535 - 543.
- Roley, D.D. (1985). The effect of diet protein level, feeding level and the holding water temperature for rainbow trout broodstock on their growth and reproductive performance. In *Salmonid Reproduction*. An International Symposium (Iwamoto, R.N. & Sower, S., eds.) p. 112. Washington Sea Grant Program. Univ. Washington, Seattle, Wa.
- Rose, S.M. (1959). Population control in guppies. *American Naturalist* **62**, 474 - 481.
- Roseblum, P.M., Horne, H., Chatterjee, N. & Brandt, T.M. (1991). Influence of diet on ovarian growth and steroidogenesis in largemouth bass. In *Proceedings of the Fourth International Symposium of Reproductive Physiology of Fish* (Scott, A.P., Sumpter, J.P., Kime, D.E. & Rolfe, M.S., eds.), pp. 265 - 267. University of Sheffield Press : Sheffield, U.K.
- Rothbard, S. (1979). Observation on the reproductive behaviour of *Tilapia zillii* and several *Sarotherodon* spp. under aquarium conditions. *Bamidgeh* **31**, 35 - 43.
- Rothbard, S.M. & Pruginin, Y. (1975). Induced spawning and artificial incubation of *Tilapia*. *Aquaculture* **5**, 315 - 321.

- Rothbard, S. & Yaron, Z. (1995). Carps (Cyprinidae). In *Broodstock Management and Egg and Larval Quality* (Bromage, N.R. & Roberts, R.J., eds.), 231 - 352. Blackwell Science: Oxford, U.K.
- Rothbard, S., Solnik, E., Shabbath, S., Amado, R. & Grabie, I. (1983). The technology of mass production of hormonally sex-inversed all-male tilapias. In *Proceedings of International Symposium on Tilapia in Aquaculture* (Fishelson, L., & Yaron, Z., eds.), Tel Aviv University, Tel Aviv, Israel.
- Rothbard, S., Ofir, M., Levavi-Sivan, B. & Yaron, Z. (1991). Hormonal profile associated with breeding behaviour in *Oreochromis niloticus*. In *Proceedings of the Fourth International Symposium of Reproductive Physiology of Fish* (Scott, A.P., Sumpter, J.P., Kime, D.E. & Rolfe, M.S., eds.), p. 206. University of Sheffield Press: Sheffield, U.K.
- Rutter, L.M. & Manns, J.G. (1987). Hypoglycaemia alters pulsatile luteinizing hormone secretion in the postpartum beef cow. *Journal of Animal Science* **64**, 479 - 488.
- Safford, S.E. & Thomas, P. (1987). Effects of capture and handling on circulating levels of gonadal steroids and cortisol in the spotted seatrout, *Cynoscion nebulosus*. In *Proceedings of the Third International Symposium of Reproductive Physiology of Fish* (Idler, D.R., Crim, L.W. & Walsh, J.M., eds.), p. 312. Memorial University of Newfoundland, St. Johns, Canada.
- Saidapur, S.K. (1978). Follicular atresia in the ovaries of non mammalian vertebrates. *International Review of Cytology* **54**, 225 - 244.
- Saidapur, S.K. & Nadkarni, V.B. (1976). Steroid synthesizing cellular sites in the ovary of the catfish, *Mystes carrassius*, a histochemical study. *General and Comparative Endocrinology* **30**, 437 - 461.
- Sanchez, T., Vazquez, J. & Bencomo, I. (1981). Effects of 2 fertilization systems and 2 breeder densities on the production of tilapia *Oreochromis aureus* larvae. *Reviews of Cuban Investigations in Fisheries* **6** (1), 44 - 54.
- Sandnes, K., Ulgenes, Y., Braekkan, O.R. & Utre, F. (1984). The effect of ascorbic acid supplementation in broodstock feed for reproduction of rainbow trout (*Salmo gairdneri*). *Aquaculture* **43**, 167 - 178.

- Santiago, C.B. & Reyes, O.S. (1993). Effects of dietary lipid source on reproductive performance and tissue lipid levels of Nile tilapia *Oreochromis niloticus* (L.) broodstock. *Journal of Applied Ichthyology* **9** (1), 33 - 40.
- Santiago, C.B., Aldaba, M.B. & Laron, M.A. (1983). Effects of varying dietary crude protein levels on spawning frequency and growth of *Sarotherodon niloticus* breeders. *Fisheries Research Journal of the Phillipines* **8** (2), 9 - 18.
- Santiago, C.B., Aldaba, M.B., Abuan, E.F. & Laron, M.A. (1985). The effects of artificial diets on fry production and growth of *Oreochromis niloticus* breeders. *Aquaculture* **47** (2-3), 193 - 202.
- Santos, A.J.G., Furukawa, K., Kobayashi, M., Bando, K., Aida, K. & Hanyu, I. (1986). Plasma gonadotropin and steroid hormone profiles during ovulation in the carp *Cyprinus carpio*. *Bulletin of the Japanese Society of Science and Fisheries* **52**, 1159 - 1166.
- Sargeant, J.R. (1995). Origins and functions of lipids in fish eggs: nutritional implications. In *Broodstock Management and Egg and Larval Quality* (Bromage, N.R. & Roberts, R.J., eds.), pp. 353 - 372. Blackwell Science: Oxford, U.K.
- Sargent, J.R., Henderson, R.J. & Tocher, D.R. (1989). The Lipids. In *Fish Nutrition 2nd Edition* (Halver, J.E., eds.), 153 - 218. Academic Press: San Diego, U.S.A.
- Schneider, L. (1969). Experimentelle untersuchungen über den einfluss van Tageslänge un temperatur auf die gonadeneifung bein dreinstachligen stichling (*Gasterosteus aculeatus*). *Oecologia* **3**, 249 - 265.
- Schulz. E. (1980). Die wirkung van untergrund und nestmaterial auf das nestbauverhalten des dreistachligen stichings (*Gasterosteus aculeatus*). *Behaviour* **72**, 242 - 317.
- Schulz, R., Bosma, P.T., Zandbergen, M.A., Vandersanden, M.C.A., Vandijk, W., Peute, J., Bogerd, J. & Goos, H.J.Th. (1993). Gonadotropin releasing hormones in the African catfish, *Clarias gariepinus* - localization, pituitary

receptor binding and gonadotropin release activity. *Endocrinology* **133** (4), 1569 - 1577.

Schulz, R., Bogerd, J., Bosma, P.T., Peute, J., Rebers, F.E.M., Zandbergen, M.A. & Goos, H.J.Th. (1995). Physiology, morphological and molecular aspects of gonadotropins in fish with special reference to the African catfish, *Clarias gariepinus*. In *The Fifth International Symposium of Reproductive Physiology of Fish* (Goetz, F.W. & Thomas, P., eds.), 2 - 6. University of Austin, Texas, U.S.A.

Schoenen, P. (1982). *A Bibliography of Important Tilapias* (Pisces: Cichlidae) for Aquaculture. ICLARM Bibliographies, **3**. International Center for Living Aquatic Resources Management, Phillipines.

Schwank, E. (1986). Filial cannibalism in *Tilapia mariae*. *Journal of Applied Ichthyology* **2**, 65 - 74.

Schwank, E. (1987). Lunar periodicity in the spawning of *Tilapia mariae* in the Ethiop River, Nigeria. *Journal of Fish Biology* **30**, 533 - 537.

Scott, A.P. (1990). Salmonids. In *Reproductive Seasonality in Teleosts* (Munro, A.D., Scott, A.P. & Lam, T.J., eds.), pp. 33 - 51. CRC Press Inc: Boca Raton, Florida, U.S.A.

Scott, A.P. & Baynes, S.M. (1982). Plasma levels of sex steroids in relation to ovulation and spermiation in rainbow trout. In *Reproductive Physiology of Fish* (Richter, C.J. & Goos, H. Th., comps.), pp. 103 - 106. Purdoc Press: Wageningen, The Netherlands.

Scott, A.P. & Sumpter, J.P. (1983). The control of trout reproduction: basic and applied research on hormones. In *Control Processes in Fish Physiology* (Rankin, J., Pticher, T. & Duggan, R., eds.), pp. 201 - 220. Croom Helm: London, U.K.

Scott, A.P., Bye, V.L. & Baynes, S.M. (1980). Seasonal variations in sex steroids of female rainbow trout (*Salmo gairdneri* Richardson). *Journal of Fish Biology* **17**, 587 - 592.

- Scott, A.P., Sheldrick, E.L. & Flint, A.P.F. (1982). Measurement of 17α - 20β -dihydroxy-4-pregnen-3-one in plasma of trout (*Salmo gairdneri* Richardson): Seasonal changes and response to salmon pituitary extract. *General and Comparative Endocrinology* **46**, 444 - 451.
- Scott, A.P., Sumpter, J.P. & Hardiman, P.A. (1983). Hormone changes during ovulation in the rainbow trout (*Salmo gairdneri* Richardson). *General and Comparative Endocrinology* **49**, 444 - 451.
- Scott, A.P., Liley, N.R. & Vermeirssen, E.L.M (1994). Urine of reproductively mature female rainbow trout *Oncorhynchus mykiss* (Walbaum), contains a priming pheromone which enhances plasma levels of sex steroids and gonadotrophin II in males. *Journal of Fish Biology* **44**, 131 - 147.
- Scott, D.P. (1962). Effect of food quantity on fecundity of rainbow trout, *Salmo gairdneri*. *Journal of the Fisheries Research Board of Canada* **19**, 715 - 731.
- Scott, D.P. (1979). Environmental timing and the control of reproduction in teleost fish. *Symposium of the Zoological Society (London)* **44**, 105 - 132.
- Selman, K. & Wallace, R.A. (1982). Oocyte growth in the sheepshead minnow: uptake of exogenous protein by vitellogenic oocytes. *Cell and Tissue Research* **14** (3), 555 - 571.
- Selman, K. & Wallace, R.A. (1983). Oogenesis in *Fundulus heteroclitus*. III. Vitellogenesis. *Journal of Experimental Zoology* **226**, 441 - 457.
- Selman, K. & Wallace, R.A. (1989). Cellular aspects of oocyte growth in teleosts. *Zoological Science* **6**, 211 - 231.
- Selman, K., Wallace, R.A. & Barr, V. (1986). Oogenesis in *Fundulus heteroclitus* IV. yolk-vesicle formation. *Journal of Experimental Zoology* **239**, 277 - 288.
- Selman, K., Barr, V. & Wallace, R.A. (1987). The relationship between yolk vesicles and cortical alveoli in teleost oocytes and eggs. In *Proceedings of the Third International Symposium of Reproductive Physiology of Fish* (Idler, D.R., Crim, L.W. & Walsh, J.M., eds.), p. 216. Memorial University of Newfoundland, St. Johns, Canada.

- Selman, K., Wallace, R.A., Sarka, A. & Xiaoping, Q. (1993). Stages of oocyte development in the zebrafish, *Brachydanio rerio*. *Journal of Morphology* **218**, 203 - 224.
- Semko, R.S. (1954). Stocks of west Kamchatka salmon and their commercial utilization. *Izv. tikhookean. nauch. no-issled. Inst ryb. Khoz. Fisheries Research Board of Canada Translation Series* **288**, 1 - 131 (1960).
- Shaw, E.S. & Aronson, L.R. (1954). Oral incubation in *Tilapia macrocephala*. *Bulletin of the American Museum of Natural History* **103**, 379 - 415.
- Shehadeh, Z.H., Kuo, C.M. & Milisen, K.K. (1973). Validation of an *in vivo* method for monitoring ovarian development in the grey mullet (*Mugil cephalus* L.). *Journal of Fish Biology* **5**, 489 - 496.
- Sherwood, N.M. (1987). The GnRH family of neuropeptides. *Trends in Neuroscience* **10**, 129 - 132.
- Sherwood, N.M., Eider, L., Brownstein, M., Spiess, J., Rivier, J. & Vale, W. (1983). Characterisation of a teleost gonadotropin releasing hormone. *Proceedings of the National Academy of Science (USA)* **80**, 2794 - 2798.
- Sherwood, N.M., Harvey, B., Brownstein, M.J. & Eider, L.E. (1984). Gonadotropin releasing hormone (Gn-RH) in striped mullet (*Mugil cephalus*), milkfish (*Chanos chanos*) and rainbow trout (*Salmo gairdneri*): comparison with salmon Gn-RH. *General and Comparative Endocrinology* **55**, 174 - 181.
- Shiau, S.Y. & Liang, H.S. (1994). Nutrient digestibility and growth of hybrid tilapia, *Oreochromis niloticus* x *Oreochromis aureus*, as influenced by agar supplementation. *Aquaculture* **127** (1), 41 - 48.
- Siddiqui, A.Q. (1977). Reproductive biology, length-weight relationship and relative condition of *Tilapia leucosticta* (Trewavas) in Lake Naivasha, Kenya. *Journal of Fish Biology* **10**, 251 - 260.
- Siddiqui, A.Q. (1979). Reproductive biology of *Tilapia zillii* (Gervais) in Lake Naivasha, Kenya. *Environmental Biology of Fish* **4**, 257 - 262.

- Silliman, R.P. (1975). Selective and unselective exploitation of experimental populations of *Tilapia mossambicus*. *Fishery Bulletin* **62**, 21 - 52.
- Silverman, H.I. (1978a). The effects of visual social stimulation upon age at first spawning in the mouth-brooding Cichlid fish *Sarotherodon (Tilapia) mossambicus* (Peters). *Animal Behaviour* **26**, 1120 - 1125.
- Silverman, H.I. (1978b). Effects of different levels of sensory contact upon reproductive activity of adult male and female *Sarotherodon (Tilapia) mossambicus* (Peters); Pisces; Cichlidae. *Animal Behaviour* **26**, 1081 - 1090.
- Silverman, H.I. (1978c). Changes in male courting frequency in pairs of the cichlid fish (*Tilapia mossambicus*), with unlimited or with only visual contact. *Behavioural Biology* **23** (2), 189 - 196.
- Simpson, A.C. (1951). The fecundity of the Plaice. *Fisheries Investigations*, Series 2, **17** (5), 27 pp.
- Sinha, V.R.P., Jhingran, V.G. & Ganapati, S.V. (1974). A view on spawning of the Indian major carps. *Archives of Hydrobiology* **73**, 518 - 536.
- Siraj, S.S., Smitherman, R.O., Castillo-Gallusser, S. & Durham, R.A. (1983). Reproductive traits for three year classes of *Tilapia nilotica* and maternal effects on their progeny. In *International Symposium of Tilapia in Aquaculture* (Fishelson, L. and Yaron, Z., eds.), pp. 210 - 218. Tel Aviv University, Israel.
- Siraj, S.S., Kamaruddin, Z., Satar, M.K.A. & Kamaruddin, M.S. (1988). Effects of feeding frequency on growth, food conversion and survival of red tilapia (*Oreochromis mossambicus/O. niloticus*) hybrid fry. *The Second International Symposium of Tilapia in Aquaculture* (Pullin, R.S.V., Bhukaswan, T., Tonguthai, K. & Maclean, J.L., eds.), pp. 383 - 386. Department of Fisheries, Bangkok, Thailand and International Center for Living Aquatic Resources Management, Manila, Philippines.
- Slater, C.H., Shreck, C.B. & Swanson, P. (1994). Plasma profiles of the sex steroids and gonadotropin in maturing female spring chinook salmon (*Oncorhynchus tshawytscha*). *Comparative Biochemistry and Physiology* **109A** (1), 167 - 175.

- Smith, C. & Wootton, R.J. (1994). The cost of parental care in *Haplochromis 'argens'* (Cichlidae). *Environmental Biology of Fish* **40**, 99 - 104.
- Smith, C. & Wootton, R.J. (1995a). Experimental analysis of some factors affecting parental expenditure and investment in *Cichlasoma nigrofasciatum* (Cichlidae). *Environmental Biology of Fish* **42**, 289 - 302.
- Smith, C. & Wootton, R.J. (1995b). Experimental analysis of some factors affecting parental expenditure and investment in *Gasterosteus aculeatus* (Gasterosteidae). *Environmental Biology of Fish* **43**, 63 - 76.
- Smith, C. & Wootton, R.J. (1995c). The costs of parental care in teleost fishes. *Reviews in Fish Biology and Fisheries* **5**, 7 - 22.
- Smith, C.E., Osborne, M.D., Piper, R.G. & Dwyer, W.P. (1979). Effect of diet composition on performance of rainbow trout broodstock during a three year period. *Progressive Fish Culturist* **41**, 185 - 188.
- Smith, C.J. & Haley, S. (1987). Evidence of steroidogenesis in post-ovulatory follicles of the tilapia, *Oreochromis mossambicus*. *Cell and Tissue Research* **247**, 675 - 687.
- Smith, C.J. & Haley, S. (1988). Steroid profiles of the female tilapia, *Oreochromis mossambicus*, and correlation with oocyte growth and mouthbrooding behaviour. *General and Comparative Endocrinology* **69**, 88 - 98.
- Smith, R.J.F. (1970). Control of prespawning behaviour of sunfish (*Lepomis gibbosus* and *Lepomis megalotis*). II. Environmental factors. *Animal Behaviour* **18**, 575 - 587.
- Smith-Grayton, P.K. & Keenleyside, M.H.A. (1978). Male-female parental roles in *Herotilapia multispinosa* (Pisces:Cichlidae). *Animal Behaviour* **26**, 520 - 526.
- Snedecor, G.W. & Cochran, W.G. (1980). *Statistical Methods, 7th Edition*. Iowa State University Press: Ames, Iowa, U.S.A.
- Snow, J.R., Berrios-Hernandez, J.M. & Henri, Y. Ye. (1983). A modular system for producing Tilapia seed using simple facilities. In *Proceedings of the*

- International Symposium of Tilapia in Aquaculture* (Fishelson, L. & Yaron, Z., eds.), pp. 402 - 413. Tel Aviv University, Tel Aviv, Israel.
- Sodsuk, P. & McAndrew, B.J. (1991). Molecular systematics of three tilapiine genera *Tilapia*, *Sarotherodon* and *Oreochromis* using allozyme data. *Journal of Fish Biology* **39** (Suppl. A), 301 - 308.
- Sokal, R.R. & Rohlf, F.J. (1981). *Biometry. The Principles and Practice of Statistics in Biological Research*. 2nd. Edition. W.H. Freeman & Company: San Francisco, U.S.A.
- Soliman, A.K., Jauncey, K. & Roberts, R.J. (1986). The effect of varying forms of dietary ascorbic acid on the nutrition of juvenile tilapias (*Oreochromis niloticus*). *Aquaculture* **52**, 1 - 10.
- Sorensen, P.W., Scott, A.P., Stacey, N.E. & Bowdin, I. (1995). Sulfated 17 α -20-dihydroxy-4-pregnen-3-one functions as a potent and specific olfactory stimulant with pheromonal actions in the goldfish. *General and Comparative Endocrinology* **100**, 128 - 142.
- Spataru, P. (1978). Food and feeding habits of *Tilapia zillii* (Gervais) (Cichlidae) in Lake Kinneret (Israel). *Aquaculture* **14**, 327 - 338.
- Specker, J.L., Ueda, H., Kishida, M. & Nagahama, Y. (1991). Immunoelectron microscopic localization of vitellogenin in the tilapia ovary. *Zoological Science* **8**, p. 1070.
- Springate, J.R.C., Bromage, N.R. & Cumarantunga, P.R.T. (1985). The effects of different ration on fecundity and egg quality in the rainbow trout (*Salmo gairdneri*). In *Nutrition and Feeding in Fish* (Cowey, C.B., Mackie, A.M. & Bell, J.G., eds.), pp. 371 - 391. Academic Press: London, U.K.
- Srisakultiew, P. (1993). *Studies on the reproductive biology of Oreochromis niloticus* (L.), Ph.D. thesis, Institute of Aquaculture, University of Stirling, Stirling, Scotland, U.K.
- Srisakultiew, P. & Wee, K.L. (1988). Synchronous spawning of Nile tilapia through hypophysation and temperature manipulation. In *The Second International Symposium on Tilapia in Aquaculture*, ICLARM Conference Proceedings **15**

- (Pullin, R.S.V., Bhukaswan, T., Toguthai, K. & Maclean, J.L., eds.), pp. 275 - 84. Department of Fisheries, Bangkok, Thailand and International Center for Living Aquatic Resources Management, Manila, Phillipines.
- Srivasta, A.K. & Sahai, I. (1987). Effects of loading density on carbohydrate metabolism and hematology in the Indian freshwater, *Heteropneustes fossilis*. *Aquaculture* **66**, 275 - 286.
- Stacey, N.E. (1984). Control of the timing of ovulation by exogenous and endogenous factors. In *Fish Reproduction: Strategies and Tactics* (Potts, G.W. & Wootton, R.J., eds.), pp. 207 - 222. Academic Press: London, U.K.
- Stacey, N.E. & Hourston, A.S. (1982). Spawning and feeding behaviour of captive Pacific herring *Clupea harengus Pallasi*. *Canadian Journal of Fisheries and Aquatic Science* **39**, 489 - 498.
- Stacey, N.E. & Sorensen, P.W. (1991). Function and evolution of fish hormonal pheromones. In *Biochemistry and Molecular Biology of Fishes*, Vol. 1 (Hochachka, P.L. & Mommsen, T.P., eds.), pp. 109 - 135. Elsevier: Amsterdam, The Netherlands.
- Stacey, N.E. & Cardwell, J.R. (1995). Hormones as sex pheromones in fish: widespread distribution amongst freshwater species. In *The Fifth International Symposium of Reproductive Physiology of Fish* (Goetz, F.W. & Thomas, P., eds.), 244 - 248. University of Austin, Texas, U.S.A.
- Stacey, N.E., Cook, A.F. & Peter, R.E. (1979). Ovulatory surge of gonadotropin in the goldfish, *Carassius auratus*. *General and Comparative Endocrinology* **37**, 246 - 249.
- Stacey, N.E., Sorenson, P.W., Van Der Kraak, G.J. & Dulka, J.G. (1989). Direct evidence that 17α - 20β -dihydroxy-4-pregnen-3-one functions as a goldfish primer pheromone: pre-ovulatory release is closely associated with male endocrine responses. *General and Comparative Endocrinology* **75**, 62 - 70.
- Stacey, N.E., Zheng, W.B., Carwell, J. (1994). Milt production in common carp (*Cyprinus carpio*) - stimulation by a goldfish steroid pheromone. *Aquaculture* **127** (2 - 3), 265 - 276.

- Stacey, N.E. & Cardwell, J.R. (1995). Hormones as sex pheromones in fish: widespread distribution among freshwater species. In *The Fifth International Symposium of Reproductive Physiology of Fish* (Goetz, F.W. & Thomas, P., eds.), p. 244 - 248. University of Austin, Texas, U.S.A.
- Stanley, B.V. & Wootton, R.J. (1986). Effects of ration and male density on the territoriality and nest-building of male three-spined sticklebacks (*Gasterosteus aculeatus* L.). *Animal Behaviour* **34** (No. APR), 527 - 535.
- Sumpter, J.P. & Scott, A.P. (1987). Gonadotropin levels in rainbow trout (*Salmo gairdneri*) during sexual maturation. In *Proceedings of the Third International Symposium on Reproductive Physiology of Fish* (Idler, D.R., Crim, L.W. & Walsh, J.M., eds.), p. 77. Memorial University of Newfoundland, St. John's, Canada.
- Sumpter, J.P., Scott, A.P., Baynes, S.M. & Witthames, P.R. (1984). Early stages of the reproductive cycle in virgin female rainbow trout (*Salmo gairdneri* Richardson). *Aquaculture* **43**, 235 - 242.
- Sumpter, J.P., Carragher, J.F., Pottinger, T.G. & Pickering, A.D. (1987). Interaction of stress and reproduction in trout. In *Reproductive Physiology of Fish 1987* (Idler, D.R., Crim, L.W. & Walsh, J.M., eds.), pp. 299 - 302. Memorial University of Newfoundland, St. John's, Canada.
- Sundararaj, B.I. & Goswami, S.V. (1968). Effects of estrogen, progesterone, and testosterone on the pituitary and ovary of the catfish, *Heteropneustes fossilis* (Bloch). *Journal of Experimental Zoology* **169**, 211 - 228.
- Sundararaj, B.I. & Vasal, S. (1976). Photoperiod and temperature control in the regulation of reproduction in the female catfish, *Heteropneustes fossilis*. *Journal of the Fisheries Research Board of Canada* **33**, 959 - 973.
- Suzuki, K., Kawauchi, H. & Nagahama, Y. (1987). Biological characterization of two distinct gonadotropins from chum salmon pituitaries. *Proceedings of the First Congress of the Asia and Oceania Society for Comparative Endocrinology* (AOSCE), p. 173 - 174 (Ohnishi, E., Nagahama, Y. & Ishizaki, H., eds.), pp. 93 - 94. Nagoya, University Corporation, Nagoya, Japan.

- Suzuki, K., Kawauchi, H. & Nagahama, Y. (1988a). Isolation and characterisation of two distinct gonadotropins and chum salmon pituitary glands. *General and Comparative Endocrinology* **71**, 292 - 301.
- Suzuki, K., Kawauchi, H. & Nagahama, Y. (1988b). Isolation and characterisation of subunits from two distinct salmon gonadotropins. *General and Comparative Endocrinology* **71**, 302 - 306.
- Suzuki, K., Kawauchi, H. & Nagahama, Y. (1988c). Steroidogenic activities of two distinct salmon gonadotropins. *General and Comparative Endocrinology* **71**, 452 - 458.
- Svardson, G. (1949). Natural selection and egg number in fish. *Report of the Institute of Freshwater Research Drottningholm* No. 29: 115 - 122.
- Swanson, P., Suzuki, K. & Kawauchi, H. (1987). Effects of des-Gly¹⁰[D-Ala⁶] gonadotropin-releasing hormone ethylamide (GnRH_a) on secretion of two distinct gonadotropins by salmonid pituitaries *in vitro*. In *Proceedings of the First Congress of the Asia and Oceania Society for Comparative Endocrinology (AOSCE)* (Ohnishi, E., Nagahama, Y. & Ishizaki, H., eds.), pp. 93 - 94. Nagoya, University Corporation, Nagoya, Japan.
- Swanson, P., Suzuki, K., Kawauchi, H. & Dickhoff, W.W. (1991). Isolation and characterization of 2 coho salmon gonadotropins, GTH I and GTH II. *Biology of Reproduction* **44**, 29 - 38.
- Swingle, H.S. (1953). A repressive factor controlling reproduction in fishes. *Proceedings of the Eighth Pacific Science Congress IIIA*, 865 - 871.
- Tacon, P., Indiaye, P., Cauty, C., Le Menn, F. & Jalabert, B. (1996). Relationships between the expression of maternal behaviour and ovarian development in the mouthbrooding cichlid fish *Oreochromis niloticus*. *Aquaculture* **146**, pp. 261 - 275.
- Takahashi, H. (1974). Modification of the development of female reproductive organs in the guppy, *Poecilia reticulata*, following an androgen treatment in their juvenile period. *Bulletin of the Faculty of Fisheries, Hokkaido University* **23** (3), 174 - 199.

- Takashima, F., Patino, R. & Nomura, M. (1980). Histological studies on the sex differentiation in rainbow trout. *Bulletin of the Japanese Society of Fisheries and Science* **46**, 1317 - 1322.
- Takeuchi, T., Watanabe, T., Agino, C., Saito, M., Nishimura, K. & Nose, T. (1981). Effects of low protein high calorie diets and deletion of trace elements from a fish meal diet on reproduction of rainbow trout. *Bulletin of the Japanese Society of Fisheries and Science* **47**, 645 - 654.
- Tanaka, H., Kagawa, H., Okugaw, K. & Hirose, K. (1993). Purification of gonadotropins (PmGTH I and II) from red sea bream (*Pagrus major*) and development of a homologous radioimmunoassay for PmGTH II. *Fish Physiology and Biochemistry* **10**, 409 - 418.
- Tata, J.R. (1978). Regulation of vitellogenesis by oestrogen. In *Hormones and Cell Regulation* (Dumont, J. & Numez, J., eds.). Vol. 2, pp. 37 - 54. Elsevier: North Holland Biomedical Press, The Netherlands.
- Terkatin-Shimony, A., Ilan, Z., Yaron, Z. & Johnson, D.W. (1980). Relationship between temperature, ovarian recrudescence, and plasma cortisol level in *Tilapia aurea* (Cichlidae, Teleostei). *General and Comparative Physiology* **40**, 143 - 148.
- Teshima, S., Gonzalez, G.M.O. & Kanazawa, A. (1978). Nutritional requirements of tilapia: utilization of dietary protein by *Tilapia zillii*. *Memoires of the Faculty of Fisheries, Kagoshima University* **27** (1), 49 - 57.
- Thomas, P. & Trant, J.M. (1989). Evidence that 17,20 β 21-trihydroxy-4-pregnen-3-one is a maturation inducing steroid in spotted sea trout. *Fish Physiology and Biochemistry* **7**, 185 - 191.
- Thomas, P., Arnold, C.R. & Holt, G.J. (1992). Red drum and other sciaenids. In *Broodstock Management and Egg and Larval Quality* (Bromage, N.R. & Roberts, R.J., eds.), 118 - 137. Blackwell Science: Oxford, U.K.
- Thrush, M., Navas, J., Ramos, J., Bromage, N.R., Carillo, M. & Zanuy, S. (1993). The effect of artificial diets on lipid class and total fatty acid composition of cultured sea bass (*Dicentrarchus labrax*) eggs. *Actas IV Congreso Nac. Acuicultura* pp. 37 - 42.

- Toguyeni, A., Baroiller, J.F., Fostier, A., Lebail, P.Y., Kuhn, E.R., Mol, K.A. & Fauconneau, B. (1996). Consequences of food restriction on short term growth variation and on plasma circulatory hormones in *O. niloticus* in relation to sex. *General and Comparative Endocrinology* **103** (2), 167 - 175.
- Tokano, K. (1964). On the egg formation and the follicular changes in *Lebistes reticulatus*. *Bulletin of the Faculty of Fisheries, Hokkaido University* **15**, 147 - 155.
- Tokaz, R.R. (1978). Oogonial proliferation, oogenesis and folliculogenesis in non-mammalian vertebrates. In *The Vertebrate Ovary* (Jones, R.E., ed.), pp. 145 - 180. Plenum Press: New York & London.
- Townshend, T.J. & Wootton, R.J. (1984). Effects of food supply on the reproduction of the convict cichlid, *Cichlasoma nigrofasciatum*. *Journal of Fish Biology* **24**, 91 - 104.
- Townshend, T.J. & Wootton, R.J. (1985). Adjusting parental investment to changing environmental conditions: the effect of food ration on parental behaviour of the convict cichlid, *Cichlasoma nigrofasciatum*. *Animal Behaviour* **33**, 494 - 501.
- Trewavas, E. (1966). A preliminary review of fishes of the genus *Tilapia* in the eastward-flowing rivers of Africa, with proposals for two new specific names. *Revue de Zoologie et Botanique Africaine* **74**, 394 - 424.
- Trewavas, E. (1982). Generic groupings of Tilapiini used in aquaculture. *Aquaculture* **27**, 79 - 81.
- Trewavas, E. (1983). Tilapiine fishes of the genera *Sarotherodon*, *Oreochromis* and *Danakilia*. British Museum (Natural History). London. 583pp.
- Trudeau, V.L. & Peter, R.E. (1995). Functional interactions between neuroendocrine systems regulating GTH II release. In *The Fifth International Symposium of Reproductive Physiology of Fish* (Goetz, F.W. & Thomas, P., eds.), 44 - 48. University of Austin, Texas, U.S.A.
- Trudeau, V.L., Murthy, C.K., Habibi, H.R., Sloley, B.D., Peter, R.E. (1993). Effects of sex steroid treatments on gonadotropin releasing hormone-stimulated

- gonadotropin secretion from the goldfish pituitary. *Biology of Reproduction* **48** (2), 300 - 307.
- Tsurata, Y. (1992). Reproduction in the Japanese anchovy (*Engraulis japonica*) as related to population fluctuation. *Bulletin of National Research into Fisheries and Engineering, Japan* **13**, 129 - 168.
- Turner, G.F. (1986). Sex, aggression and fear in female *Cichlasoma nigrofasciatum*. *Ann. Mus. Roy. Afr. Centr. (Zool.)*. **251**, 21 - 24.
- Turner, G.F., Phiri, M.L and Cawthraw, S. (1989). Partner attack inhibition in the sexually monomorphic biparental cichlid *Tilapia mariae*. *Behaviour* **109**, 1 - 18.
- Tyler, A.V. & Dunn, R.S. (1976). Ration, growth and measures of somatic and organ condition in relation to meal frequency in winter flounder, *Pseudopleuronectes americanus*, with hypotheses regarding population homeostasis. *Journal of the Fisheries Research Board of Canada* **33**, 63 - 75.
- Tyler, C.R. (1988). Sequestration of vitellogenin by the developing ovary of the rainbow trout, *Salmo gairdneri*. Ph.D. thesis. Aston University. Birmingham, U.K.
- Tyler, C.R. & Sumpter, J.P (1989). The development of a RIA for carp, *Cyprinus carpio*, vitellogenin. *Fish Physiology and Biochemistry* **8**, 129 - 140.
- Tyler, C.R. & Lancaster, P.M. (1993). Isolation and characterisation of the receptor for vitellogenin from follicles of the rainbow trout, *Oncorhynchus mykiss*. *Comparative Biochemistry and Physiology* **106B**, 321 - 329.
- Tyler, C.R. & Sumpter, J.P. (1996). Oocyte growth and development in teleosts. *Reviews in Fish Biology and Fisheries* **6**, 287 - 318.
- Tyler, C.R., Sumpter, J.P. & Bromage, N.R. (1987). Vitellogenin uptake by cultured oocytes of rainbow trout. *General and Comparative Endocrinology* **66**, 19 - 20.

- Tyler, C.R., Sumpter, J.P. & Bromage, N.R. (1988). Selectivity of protein sequestration by vitellogenic oocytes of the rainbow trout *Salmo gairdneri*. *Journal of Experimental Zoology* **255**, 216 - 231.
- Tyler, C., Sumpter, J.P. & Witthames, P.R. (1990). The dynamics of oocyte growth during vitellogenesis in the rainbow trout, *Salmo gairdneri*. *Biology of Reproduction* **43**, 202 - 209.
- Tyler, C.R., Sumpter, J.P., Kawauchi, H. & Swanson, P. (1991). Involvement of gonadotropin in the uptake of vitellogenin into vitellogenic follicles of the rainbow trout, *Oncorhynchus mykiss*. *General and Comparative Endocrinology* **84**, 291 - 299.
- Tyler, C.R., Nagler, J.J., Pottinger, T.G. & Turner, M. (1994). Effects of unilateral ovariectomy on recruitment and growth of follicles in the rainbow trout, *Oncorhynchus mykiss*. *Fish Physiology and Biochemistry* **13**, 309 - 316.
- Tyler, C.R., Pottinger, T.G., Santos, E., Sumpter, J.P., Prices, S.-A., Brooks, S. & Nagler, J.J. (1996). Mechanisms controlling egg size and number in the rainbow trout, *Oncorhynchus mykiss*. *Biology of Reproduction* **54**, 8 - 15.
- Tyler, C., van der Eerden, B., Jobling, S., Panter, G. & Sumpter, J.P. (1995a). Measurement of vitellogenin, a biomarker for exposure to oestrogenic chemicals, in a wide variety of cyprinid fish. *Journal of Comparative Physiology* **166**, 418 - 426.
- Tyler, C., Lubberink, K., Brooks, S. & Coward, K. (1995b). Towards the development of genetic probes to the vitellogenin receptor in the rainbow trout, *Oncorhynchus mykiss*: characterisation of ovarian receptor proteins specific for vitellogenin. In *The Fifth International Symposium of Reproductive Physiology in Fish* (Goetz, F.W. & Thomas, P., eds.), 339 - 341. University of Austin, Texas, U.S.A.
- Uchida, R.N. & King, J.E. (1962). *Tank culture of Tilapia*. U.S. Fish and Wildlife Service Fisheries Bulletin, **62**, 21 - 52.
- Upadhyay, S.N., Breton, B. & Billard, R. (1978). Ultrastructural studies on experimentally induced vitellogenesis in juvenile rainbow trout (*Salmo gairdneri*). *Annales de Biologie, Biochimie et Biophysique* **18**, 1019 - 1025.

- Van der Kraak, G., Suzuki, K., Peter, R.E., Itoh, H. & Kawauchi, H. (1992). Properties of common carp gonadotropin I and gonadotropin II. *General and Comparative Endocrinology* **85**, 217 - 299.
- Van Weerd, J.H., Sukkel, M., Bongers, A.B.J., Vanderdoes, H.M., Seynis, E. & Richter, C.J.J. (1991). Stimulation of gonadal development by sexual interaction of pubertal African catfish, *Clarias gariepinus*. *Physiology and Behaviour* **49** (2), 217 - 223.
- Vasudevan, K. & Jayaprakas, V. (1992). Impact of dietary protein on broodstock development and reproduction of *Oreochromis niloticus*. In *Broodstock Management and Egg and Larval Quality Conference Proceedings*, Institute of Aquaculture, Stirling University, Scotland, U.K.
- Vijayan, M.M. & Leatherland, J.F. (1990). High stocking density affects cortisol secretion and tissue distribution in brook charr, *Salvelinus fontinalis*. *Journal of Endocrinology* **124** (2), 311 - 318.
- Vijayan, M.M., Ballantyne, J.S. & Leatherland, J.F. (1990). High stocking density alters the energy metabolism of brook charr, *Salvelinus fontinalis*. *Aquaculture* **88**, 371 - 381.
- Viola, S. & Arieli, Y. (1982). Nutrition studies with a high protein pellet for carp and *Sarotherodon* spp. (Tilapia). *Bamidgeh* **34** (2), 39 - 46.
- Vladykov, V.D. (1956). Fecundity of wild speckled trout (*Salvelinus fontinalis*) in Quebec Lakes. *Journal of the Fisheries Research Board of Canada* **13**, 799 - 841.
- de Vlaming, V. (1971). The effects of food deprivation and salinity changes in the estuarine gobiid fish *Gillichthys mirabilis*. *Biological Bulletin of the Marine Laboratory Woods Hole* **141**, 458 - 471.
- de Vlaming, V. (1974). Environmental and endocrine control of teleost reproduction. In *Control of sex of fishes* (Schreck, C.B., ed.), pp. 13 - 83. Virginia Polytechnic Institute and State University. Blackburg, U.S.A.

- de Vlaming, V. (1979). Environmental control of teleost cycles: a brief review. *Journal of Fish Biology* **4**, 131 - 140.
- de Vlaming, V. (1983). Oocyte development patterns and hormonal involvements among teleosts. In *Control Processes in Fish Physiology* (Rankin, J.C., Pitcher, T. & Duggan, R.T., eds.), pp. 179 - 199. Croom Helm: London, U.K.
- de Vlaming, V. Wiley, H.S., Delahunty, G. & Wallace, R.A. (1980). Goldfish (*Carassius auratus*) vitellogenin: Induction, isolation, properties and relationship to yolk proteins. *Comparative Biochemistry and Physiology* **67B**, 613 - 623.
- de Vlaming, V., Fitzgerald, R., Delahunty, G., Cech, J.J.Jr., Selman, K., Barkley, M. (1984). Dynamics of oocyte development and related changes in serum estradiol-17 β , yolk precursor, and lipid levels in the teleostean fish, *Leptocottus armatus*. *Comparative Biochemistry and Physiology* **77A**, 599 - 610.
- Voss, J. (1969). Contribution à l'ethologie des poissons Cichlidae: *Tilapia zillii* (Gervais, 1848). *Revue de Zoologie et Botanique Africaine* **74**, 99 - 109.
- Wallace, R.A. (1978). Oocyte growth in non-mammalian vertebrates. In *The Vertebrate Ovary* (Jones, R.E., ed.), pp. 469 - 502. Plenum Press: New York & London.
- Wallace, R.A. & Selman, K. (1979). Physiological aspects of oogenesis in two species of sticklebacks, *Gasterosteus aculeatus* (L.) and *Apeltes quadracus* (Mitchill). *Journal of Fish Biology* **14**, 551 - 564.
- Wallace, R. A. & Selman, K. (1981). Cellular and dynamic aspects of oocyte growth in teleosts. *American Zoologist* **21**, 325 - 343.
- Wallace, R.A., Selman, K., Greeley, M.S. Jr., Begovac, P.C., Lin, Y-W. P. & McPherson, R. (1987). Current status of oocyte growth. *Proceedings of the Third International Symposium on the Reproductive Physiology of Fish* (Idler, D.R., Crim, L.W. & Walsh, J.M., eds.), pp. 167 - 177. Memorial University of Newfoundland, St. John's, Canada.

- Wang, K.-W., Takeuchi, T. & Watanabe, T. (1985). Effect of dietary protein levels on growth of *Tilapia nilotica*. *Bulletin of the Japanese Society of Fisheries and Science* **51**, 141 - 146.
- Ward, J. & Samarakoon, J. (1981). Reproductive tactics of the Asian cichlids of the genus *Etilapia* in Sri Lanka. *Environmental Biology of Fish* **6**, 95 - 103.
- Warran, E.W. (1973). The effects of relative density upon some aspects of the behaviour of the guppy - *Poecilia reticulata* (Peters). *Journal of Fish Biology* **5**, 753 - 765.
- Washburn, B.S., Frye, D.J., Hung, S.S.O., Doroshov, S.I. & Conte, F.S. (1990). Dietary effects on tissue composition, oogenesis and the reproductive performance of female rainbow trout (*Oncorhynchus mykiss*). *Aquaculture* **90** (2), 179 - 195.
- Wasserman, W.J. & Smith, L.D. (1978). Oocyte maturation in nonmammalian vertebrates. In *The Vertebrate Ovary* (Jones, R.E., ed.), pp. 443 - 468. Plenum Press: New York & London.
- Watanabe, T. (1984). Importance of broodstock nutrition study for further development of aquaculture. *Abstracts from the Congress on Fish Nutrition*, p. 27., Aberdeen, U.K.
- Watanabe, T. (1993). Importance of docosahexaenoic acid in marine larval fish. *Journal of the World Aquaculture Society* **24**, 152 - 161.
- Watanabe, T., Takeuchi, T., Saito, M. & Nishimura, K. (1984). Effect of low protein-high calorie or essential fatty acid deficiency diet on reproduction of rainbow trout. *Bulletin of the Japanese Society of Fisheries and Science* **50** (7), 1207 - 1215.
- Watanabe, T., Itoh, A., Satoh, S., Kitajima, C. & Fujita, S. (1985). Effect of dietary protein levels and feeding period before spawning on chemical components of eggs produced by red seabream broodstock. *Bulletin of the Japanese Society of Fisheries and Science* **51** (9), 1501 - 1509.

- Watson, J.J., Priede, I.G., Witthames, P.R. & Oworiwadunde, A. (1992). Batch fecundity of Atlantic mackerel, *Scomber scombrus* L. *Journal of Fish Biology* **40** (4), 591 - 598.
- Watts, S.A., Wasson, K.M. & Hines, G.A. (1995). A sexual paradox: androgen synthesis in the tilapia kidney. In *Proceedings of the Fifth International Symposium of Reproductive Physiology in Fish* (Goetz, F.W. & Thomas, P., eds.), p. 277. University of Austin, Texas, U.S.A.
- Wee, K.L. & Tuan, N.A. (1988). Effects of dietary protein level on growth and reproduction of Nile Tilapia (*Oreochromis niloticus*). In *The Second International Symposium on Tilapia in Aquaculture* (Pullin, R.S.V., Bhukaswan, T., Tonguthai, K. & Maclean, J.L., eds.), pp. 401 - 410. ICLARM Conference Proceedings 15, Department of Fisheries, Bangkok, Thailand and International Center for Living Aquatic Resources Management, Manila, Philippines.
- Weeks, S.C. & Quattro, J.M. (1991). Life-history plasticity under resource stress in a clonal fish (Poeciliidae: Poeciliopsis). *Journal of Fish Biology* **39** (4), 485 - 494.
- Weibe, J.P. (1968). The effects of temperature and daylength on reproductive physiology of the viviparous sea perch, *Cymatogaster aggregata*. *Canadian Journal of Zoology* **46**, 1207 - 1219.
- Weibel, E.R. (1979). *Stereological Methods. Vol.1 : Practical Methods for Biological Morphometry*. Academic Press: London, U.K. 415pp.
- Weibel, E.R. & Gomez, D.M. (1962). A principle for counting tissue structures on random sections. *Journal of Applied Physiology* **17**, p. 343.
- Welcomme, R.L. (1967). The relationship between fecundity and fertility in the mouthbrooding cichlid fish *Tilapia leucosticta*. *Journal of the Zoological Society (London)* **151**, 453 - 468.
- Welman, J.B. (1941). *Preliminary survey of the freshwater fisheries of Nigeria*. Government Printer: Lagos.

- West, G. (1990) Methods of assessing ovarian development in fishes: a review. *Australian Journal of Marine and Freshwater Research* **41**, 199 - 222.
- Whitehead, C., Bromage, N.R. & Forster, J.R.M. (1978a). Seasonal changes in reproductive function of the rainbow trout (*Salmo gairdneri*). *Journal of Fish Biology* **12**, 601 - 608.
- Whitehead, C., Bromage, N.R., Forster, J.R.M. and Matty, A.J. (1978b). The effects of alterations in photoperiod on ovarian development and spawning time in the rainbow trout (*Salmo gairdneri*). *Annales de Biologie, Biochimie et Biophysique* **18**, 1035 - 1043.
- Whitehead, C., Bromage, N.R. & Breton, B. (1983). Changes in serum levels of gonadotropin, oestradiol-17 β and vitellogenin during the first and subsequent reproductive cycles of female rainbow trout. *Aquaculture* **34**, 317 - 326.
- Withames, P.R. & Greer-Walker, M. (1987). An automated method for counting and sizing fish eggs. *Journal of Fish Biology* **30**, 225 - 235.
- Wingfield, J.C. & Grim, A.S. (1977). Seasonal changes in plasma cortisol, testosterone and oestradiol-17 β in the plaice, *Pleuronectes platessa* L. *General and Comparative Endocrinology* **31**, 1 - 11.
- Wohlfarth, G.W. & Hulata, G. (1983). *Applied Genetics of Tilapias*. International Center for Living Aquatic Resources Management, Manila, Philippines.
- Woodhead, A.D. (1979). Senescence in fishes. In *Fish Phenology: Anabolic Adaptiveness in Teleosts* (Miller, P.J., ed.), pp. 179 - 205. Symposium of the Zoological Society of London. No. 44. Academic Press: London, U.K.
- Woodhead, A.D. (1960). Nutrition and reproductive capacity in fish. *Proceedings of the Nutrition Society* , **19**, 23 - 28.
- Woodhead, A.D. (1978). Fish in studies of ageing. *Experimental Gerontology* **13**, 125 - 140.
- Woodhead, A.D. & Ellet, S. (1969). Aspects of ageing in the guppy, *Lebistes reticulatus* (Peters). IV. The Ovary. *Experimental Gerontology* **4**, 197 - 205.

- Wootton, R.J. (1973a). The effects of size of food ration on egg production in the female three-spined stickleback *Gasterosteus aculeatus*. *Journal of Fish Biology* **5**, 89 - 96.
- Wootton, R.J. (1973b). Fecundity of the three-spined stickleback, *Gasterosteus aculeatus* (L.). *Journal of Fish Biology* **5**, 683 - 688.
- Wootton, R.J. (1976). *The Biology of the Sticklebacks*. Academic Press: New York, U.S.A.
- Wootton, R.J. (1977). Effect of food limitation during the breeding season on the size, body components and egg production in female sticklebacks (*Gasterosteus aculeatus*). *Journal of Animal Ecology* **46**, 823 - 834.
- Wootton, R.J. (1979). Energy costs of egg production and environmental determinants of fecundity in teleost fishes. In *Fish Phenology: Anabolic Adaptiveness in Teleosts*. (Miller, P.J., ed.), pp. 133 - 159. Symposium of the Zoological Society of London. No. 44. Academic Press: London, U.K.
- Wootton, R.J. (1982). Environmental factors in fish reproduction. In *Reproductive Physiology of Fish* (Richter, C.J.J. & Goos, H.J.Th., eds.). Purdoc Press: Wageningen, The Netherlands.
- Wootton, R.J. (1984a). *A Functional Biology of the Stickleback*. Croom Helm: London & Sydney, 265 pp.
- Wootton, R.J. (1984b). Introduction: Strategies and Tactics in Fish Reproduction. In *Fish Reproduction: Strategies and Tactics*. (Potts, G.W. & Wootton, R.J., eds.), pp. 1 - 12. Academic Press: London, U.K.
- Wootton, R.J. (1985). Effects of food and density on the reproductive biology of the three-spined stickleback with a hypothesis on population limitation in stickleback. *Behaviour* **93**, 101 - 111.
- Wootton, R.J. (1990). *Ecology of Teleost Fishes*. Chapman & Hall: London & New York.
- Wootton, R.J. (1994). Energy allocation in the threespine stickleback. In *The Evolutionary Biology of the Threespine Stickleback* (Bell, M.A. & Foster,

- S.A., eds.), 114 - 143. Oxford Science Publications: Oxford, New York & Tokyo.
- Wootton, R.J. & Evans, G.W. (1976). Cost of egg production in the three-spined stickleback (*Gasterosteus aculeatus* L.). *Journal of Fish Biology* **8**, 385 - 395.
- Wourms, J.P. (1976). Annual fish oogenesis. I. Differentiation of the mature oocyte and formation of the primary envelope. *Developmental Biology* **50**, 338 - 354.
- Wourms, J.P. & Sheldon, H. (1976). Annual fish oogenesis. II. Formation of the secondary egg envelope. *Developmental Biology* **50**, 355 - 366.
- Wydoski, R. & Cooper, E. (1966). Maturation and fecundity of brook trout from infertile streams. *Journal of the Fisheries Research Board of Canada* **23**, 623 - 649.
- Yamamoto, K. (1956). Studies on the formation of fish eggs. II. changes in the nucleus of oocytes of *Liopsetta obscura*, with special reference to the activity of the nucleolus. *Journal of the Faculty of Science Hokkaido University Ser.*, **6** (12), 375 - 390.
- Yamamoto, T. (1969). Sex differentiation. In *Fish Physiology Vol. III: Reproduction and Growth, Bioluminescence, Pigments and Poison* (Hoar, W.S. & Randall, D.J., eds.), p. 117 - 159. Academic Press: New York, U.S.A.
- Yamazaki, F. (1965). Endocrinological studies on the reproduction of the female goldfish, *Carassius auratus* with special reference to the function of the pituitary gland. *Memoires of the Faculty of Fisheries Hokkaido University*, **13**, 1 - 64.
- Yaron, Z. (1971). Observations on the granulosa cells of *A. terraesanctae* and *T. nilotica* (Teleostei). *General and Comparative Endocrinology* **17**, 247 - 252.
- Yaron, Z., Terkatin-Shimony, A., Shaham, Y. & Saltzer, H. (1977). Occurrence and biological activity of estradiol-17 β in the intact and ovariectomized *Tilapia aurea* (Cichlidae: Teleostei). *General and Comparative Endocrinology* **33**, 45 - 52.
- Yaron, Z., Ilan, Z., Bogomolnaya, A., Blauer, Z. & Vermaak., J.F. (1983). Steroid hormones in two tilapia species: *Oreochromis aureus* and *O. niloticus*. In

Proceedings of the International symposium on Tilapia in Aquaculture (Fishelson, L. & Yaron, Z., eds.), pp. 153 - 164. Tel Aviv University, Israel.

Yoshihara, T. (1952). Effect of population-density and pond-area on the growth of fish. *Journal of Tokyo University of Fisheries* **39**, 47 - 61.

Yoshikawa, H. & Oguri, M (1978). Sex differentiation in a cichlid, *Tilapia zillii*. *Bulletin of the Japanese Society of Science and Fisheries* **44** (4), 313 - 318.

Yoshioka, H. (1970). On the effects of environmental factors upon the reproduction of fishes. IV. Effects of long photoperiod on the development of ovaries of adult medaka *Oryzias latipes* at low temperatures. *Journal of Hokkaido University* **21**, 14 - 20.

Yousef, O.M., Alhadhrami, G.A. & Pessaraki, M. (1994). Evaluation of dehydrated alfalfa and salt bush (*Atriplex*) leaves in diets for tilapia (*Oreochromis aureus* L.). *Aquaculture* **126** (3-4), 341 - 347.

Yu, M.L. & Perlmutter, A. (1970). Growth inhibiting factors in the zebrafish, *Brachydanio rerio* and the blue gourami, *Trichogaster trichopterus*. *Growth* **34**, 153 - 175.

Yu, T.C., Sinnhuber, R.O. & Hendricks, J.D. (1979). Reproduction and survival of rainbow trout (*Salmo gairdneri*) fed linolenic acid as the only source of essential fatty acids. *Lipids* **14**, 572 - 575.

Zerani, M., Armabili, F., Mosconi, G. & Gobbeti, A. (1991). Effects of captivity stress on plasma steroid levels in the green frog, *Rana esculenta*, during the annual reproductive cycle. *Comparative Biochemistry and Physiology A Comparative Physiology* **98**, 491 - 496.

Zohar, Y., Breton, B. & Fostier, A. (1986). Short-term profiles of plasma gonadotropin and 17 α -hydroxy-20 β -dihydroxyprogesterone levels in the female rainbow trout at the periovulatory period. *General and Comparative Endocrinology* **64**, 189 - 198.

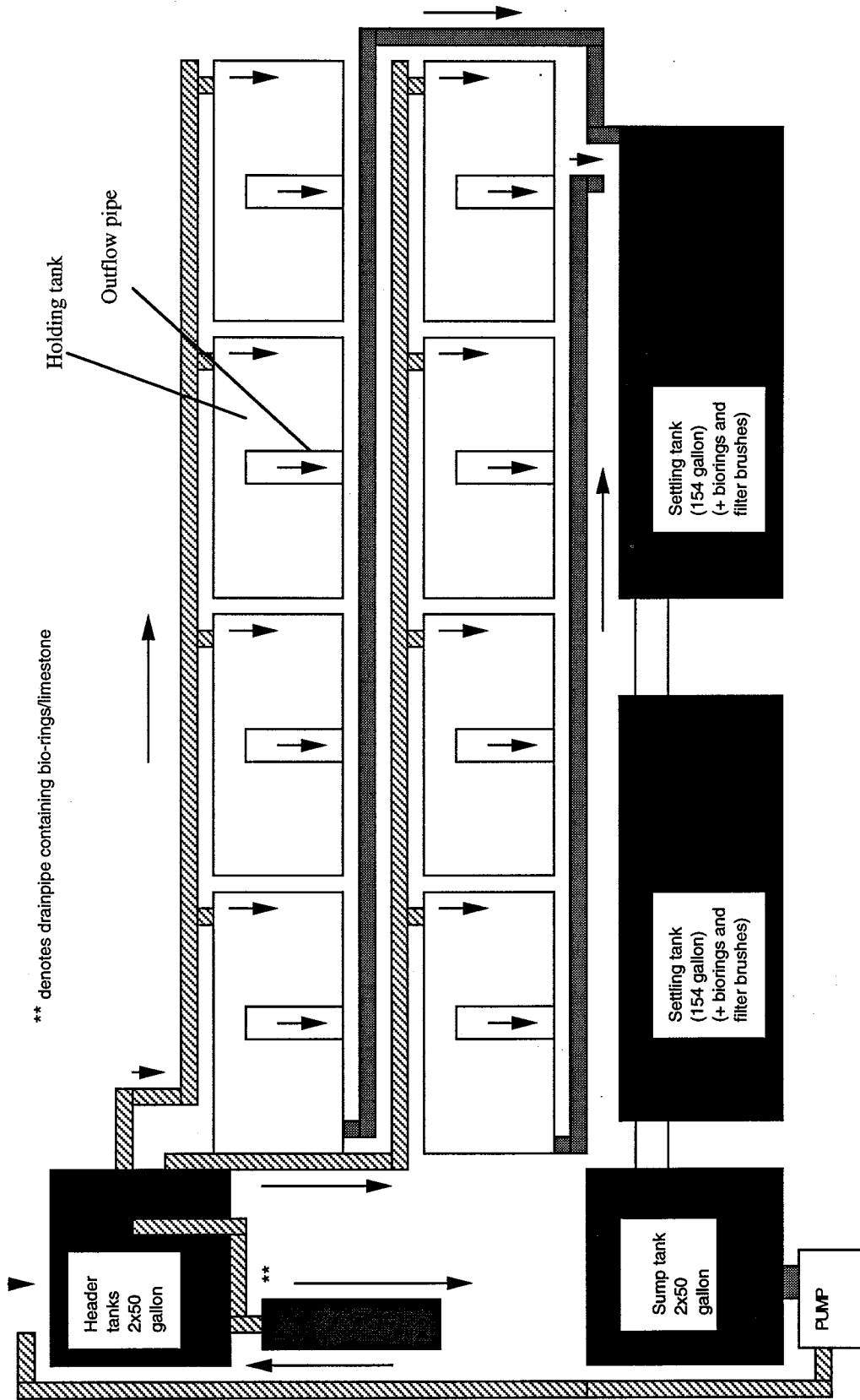

** denotes drainpipe containing bio-rings/limestone

Holding tank

Outflow pipe

Header tanks
2x50
gallon

Sump tank
2x50
gallon

Settling tank
(154 gallon)
(+ bio-rings and
filter brushes)

Settling tank
(154 gallon)
(+ bio-rings and
filter brushes)

PUMP

Appendix 1.1 Main features of gravity-fed recirculating aquaria (System 1) used for

holding broodstock . Not to scale.

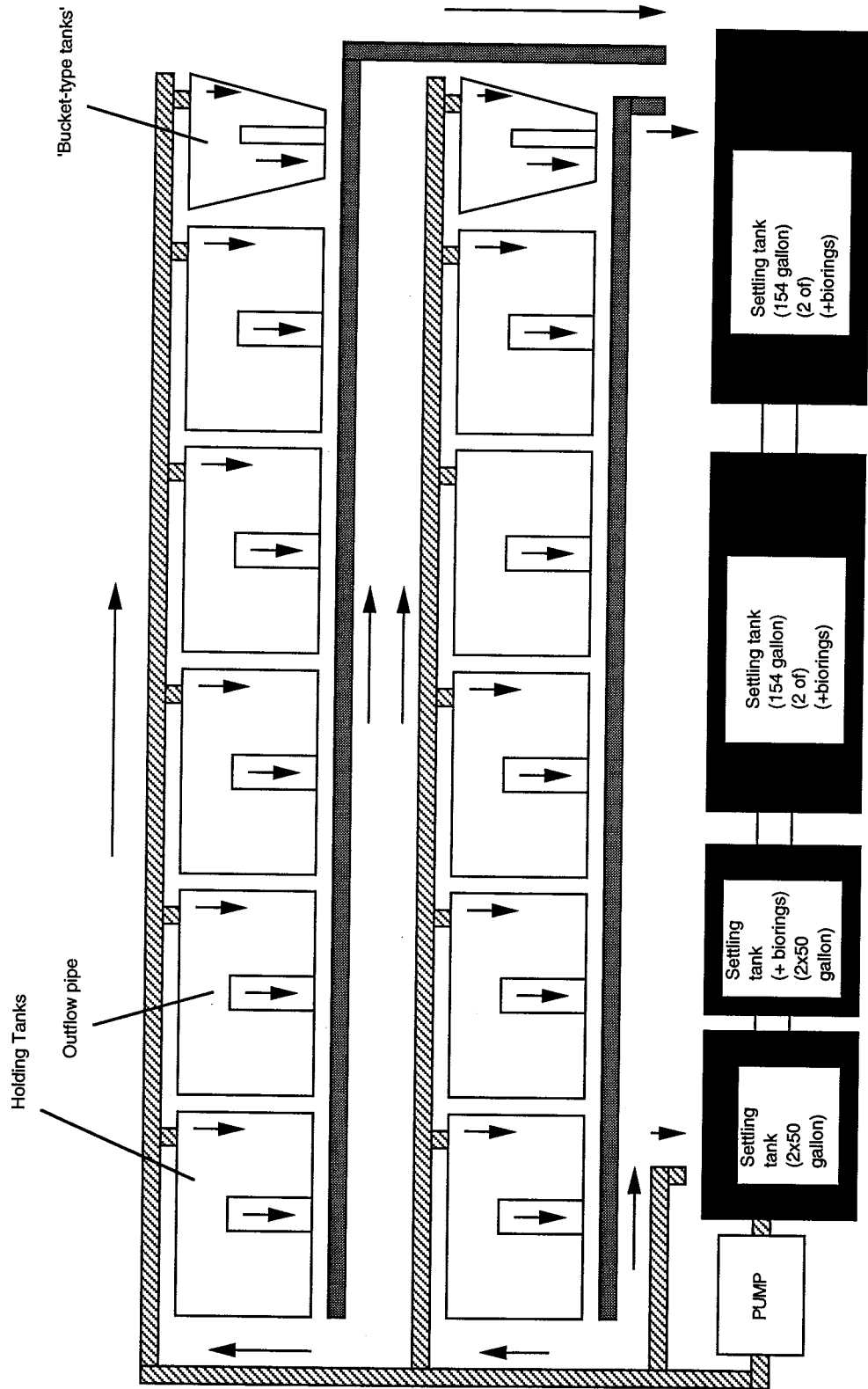

Appendix 1.2. Main features of gravity-fed recirculating aquaria (System 2) used for holding broodstock. Not to scale.

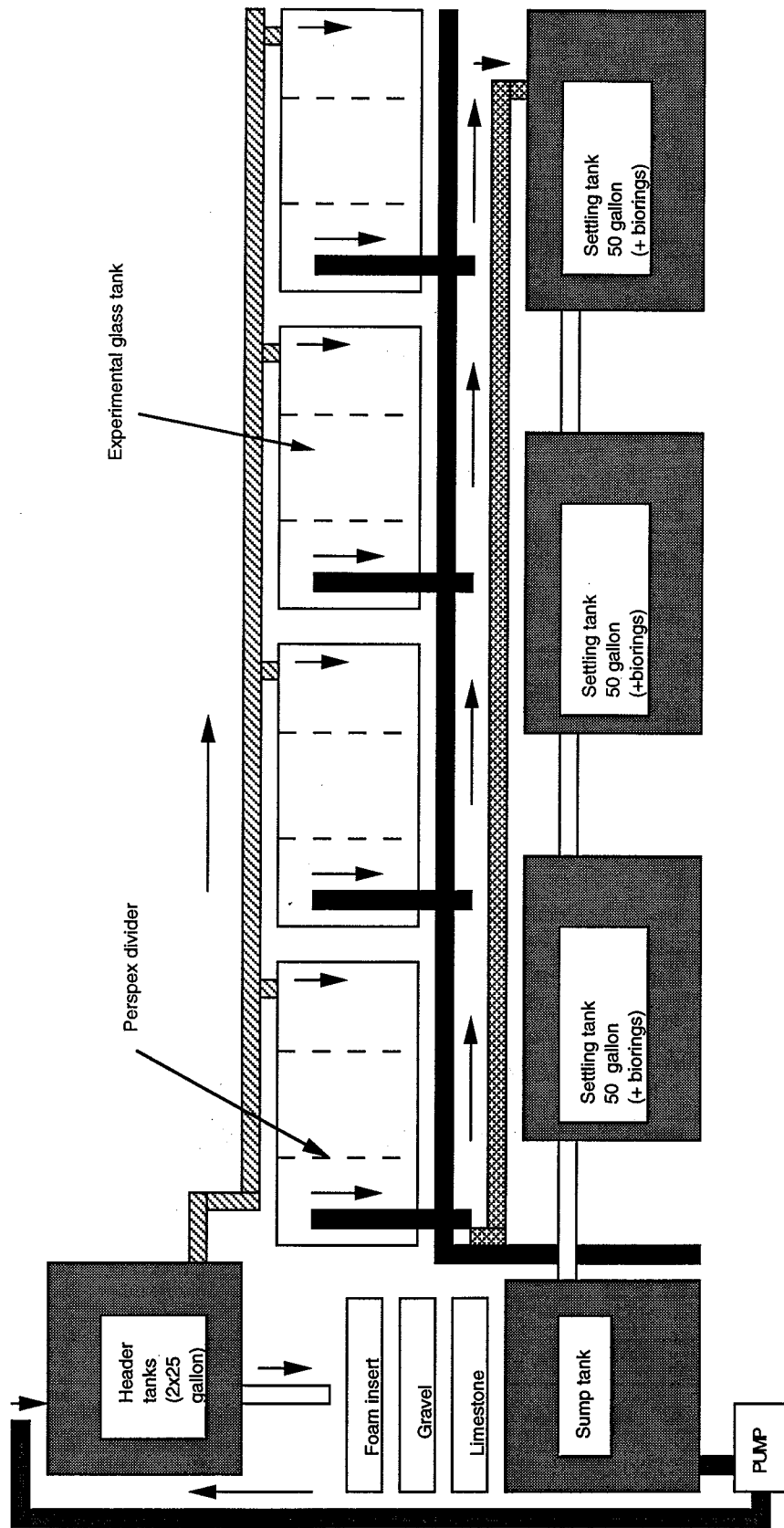

Appendix 1.3a. Main features of gravity-fed recirculating aquaria (System 3) used for holding individual experimental fish. (see also Appendix 1.3b and Figure 2.1). Not to scale.

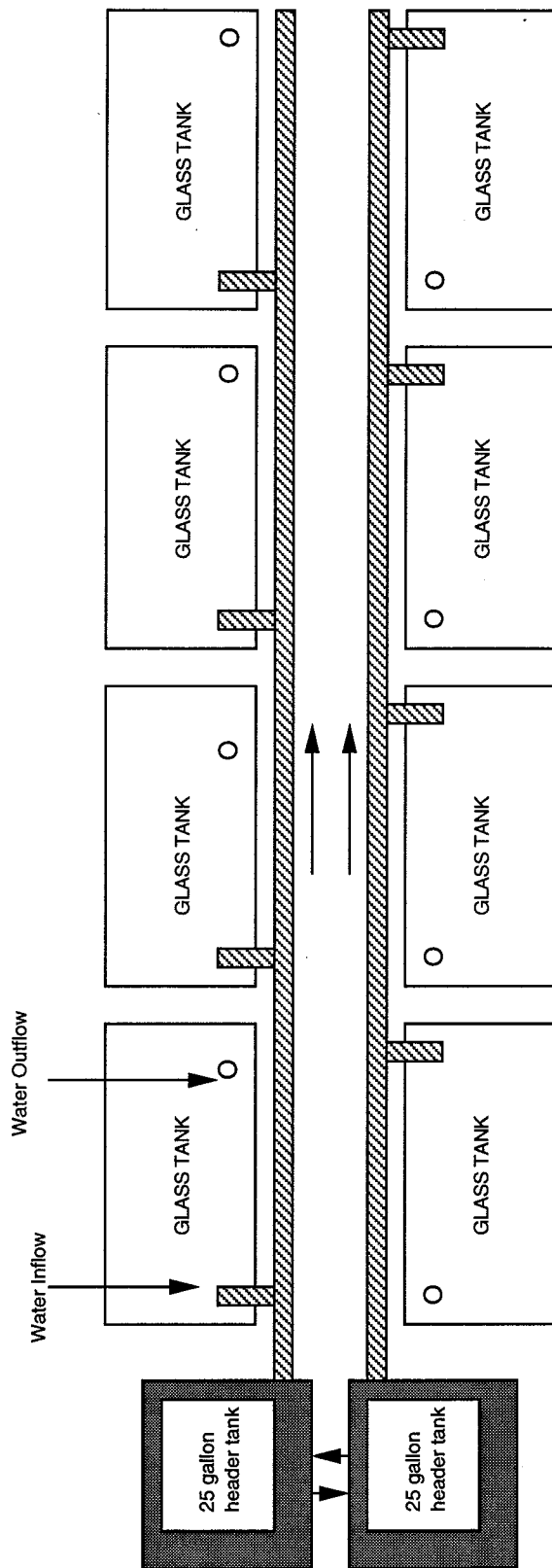

Appendix 1.3b. Aerial layout of gravity-fed recirculating aquaria (System 3) used for holding individual experimental fish (see also Appendix 1.3a and Figure 2.1). Not to scale.

APPENDIX 1.4 - Specifications of pelleted fish food.

(a) Trouw Aquaculture Ltd., U.K.

PELLET GRADE	PROTEIN CONTENT (%)
Fry 02 granules (Small pellet size)	54%
Standard expanded 3 (Medium pellet size)	40%
Standard expanded 4 (Large pellet size)	40%

(b) Ewos Ltd., U.K.

PELLET GRADE	PROTEIN CONTENT (%)
110/2 crumb (Small pellet size)	54%
Trout Hi-Energy 329/4 (Medium pellet-size)	42%
Trout Hi-Energy 329/6 (Large pellet size)	42%

Appendix 1.5 - Research publications.

Conference abstracts/posters.

K. Coward & N.R. Bromage (1992). Endoscopic examination of ovarian condition in densely stocked *Tilapia tholloni* (Sauvage) and subsequent spawning activity following transfer to individually-partitioned aquaria. In *Proceedings of the Broodstock Management and Egg and Larval Quality Conference. A Science in Aquaculture International Conference*, June 1992. University of Stirling, Scotland. U.K.

K. Coward & N.R. Bromage (1995). Density-dependent inhibition of spawning in the substrate-spawning cichlid *Tilapia tholloni* (Sauvage). In *The Fifth International Symposium of Reproductive Physiology of Fish* (Goetz, F.W. & Thomas, P., eds), p. 184. University of Texas. U.S.A.

Refereed papers.

K. Coward, N.R. Bromage & D.C. Little (1997). Inhibition of spawning and associated suppression of sex steroid levels during confinement in a substrate-spawning tilapiine *Tilapia zillii* (Gervais). *J. Fish. Biol.* In press.