



Strathprints Institutional Repository

Given, M and Mason, Ronald and Judd, Martin and Mcglone, Phillip and Timoshkin, Igor and Wilson, Mark (2011) *Comparison between RF and electrical signals from the partial discharge activity of twisted pair cables at reduced pressures*. In: 2011 IEEE Electrical Insulation and Dielectric Phenomena (CEIDP), 2011-10-16 - 2011-10-19, Cancun. (Unpublished)

Strathprints is designed to allow users to access the research output of the University of Strathclyde. Copyright © and Moral Rights for the papers on this site are retained by the individual authors and/or other copyright owners. You may not engage in further distribution of the material for any profitmaking activities or any commercial gain. You may freely distribute both the url (<http://strathprints.strath.ac.uk/>) and the content of this paper for research or study, educational, or not-for-profit purposes without prior permission or charge.

Any correspondence concerning this service should be sent to Strathprints administrator: <mailto:strathprints@strath.ac.uk>

Comparison between RF and electrical signals from the partial discharge activity of twisted pair cables at reduced pressures

M. J. Given, R. Mason, M. Judd, P. McGlone, I. V. Timoshkin, and M. P. Wilson
Department of Electrical Engineering
University of Strathclyde
Glasgow G1 1XW UK

Abstract- A pressure-controlled test facility has been set up that allows the PD behaviour of polymer insulated twisted pair samples exposed to 50 Hz AC voltages in the range of 0 to 10 kV to be characterised. Resulting PD activity is quantified using the methods defined in IEC standard 60270 and by using a simple monopole antenna to detect the RF signals excited inside the pressure vessel by the discharges. This paper gives the results of preliminary tests performed on samples of wire insulated with Ethylenetetrafluorethylene, Silicon Rubber and Polyvinylchloride in the pressure range between 10^3 and 10^5 Pa in atmospheric air. The dependence of PD inception voltage on the environmental pressure is reported. Changes in the behaviour of the PD activity; the correlations between the RF and electrical measurements and the frequency components of the RF signals as the applied voltage and pressure are varied are characterised and discussed.

I. INTRODUCTION

The reliable performance of electrical wiring systems plays an important role in aerospace power systems. Modern aircraft have extensive wiring systems and these are exposed mechanical, thermal, electrical and chemical stressing in the course of normal operation. In addition these systems are exposed to large variations of pressure [1]. The ageing induced by these stresses is considered to be a precursor to arcing between the conductors in the wiring system [2,3]. The behavior of partial discharge (p.d.) activity is strongly affected by the environmental pressure that the insulation system experiences. Work has been performed under low pressure conditions to investigate the p.d. behavior of twisted pair samples and dielectric barrier discharge geometries [4] using methods based on the IEC 60270 standard. This paper reports on the development of a test system which will allow the partial discharge behavior of twisted pair samples at reduced pressures to be monitored using both the IEC methodology and RF detection techniques.

II. Experimental System

A. Test Chamber and Sample Holder.

An aluminium high vacuum chamber was used for this project with customized high voltage connectors.

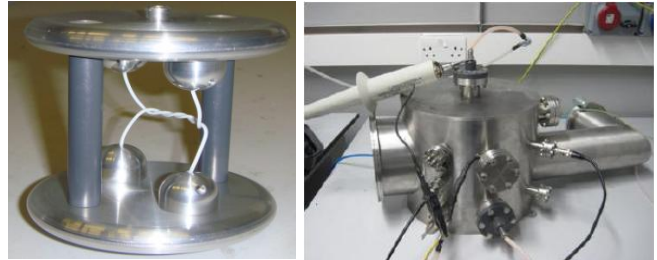

Fig. 1 Sample holder and test chamber.

The twisted pair samples were held in a custom built jig (Fig. 1). The IEC measurement system which is described below was held within the vacuum chamber. In the experimental tests that were performed a rotary pump was used to evacuate the chamber achieving a minimum pressure of -85 kPa gauge.

B. Samples Used

Three types of wire samples were used in these initial tests: An ETFE insulated wire with an outer diameter of 1.3 mm and an insulation thickness of 0.25mm; A Silicon Rubber insulated wire with an outer diameter of 1.85mm and an insulation thickness of 0.7mm and a PVC insulated wire with an outer diameter of 2.75mm and an insulation thickness of 1mm. Lengths of the wire were formed into twisted pairs with 6 twists in a 5 cm length. A force of 40 N was applied during the twisting process.

C. IEC 60270 and RF Measurement System

The IEC measurement system consisted of a 100 pF vacuum capacitor in series with a 50Ω viewing resistor. This combination was placed in parallel with the test sample. Fig. 2. The viewing resistor was connected to a 50Ω BNC vacuum lead-through. The RF antenna consisted of a 10 cm length of copper wire connected to a second BNC vacuum lead-through. The output of the two sensors were then connected through 50Ω coaxial cables to an oscilloscope an inline filter was included on the RF connection to remove the 50 Hz component of the signal. The system was stressed using a modified Foster oil test transformer capable of providing a maximum output of 25 kV in the configuration used.

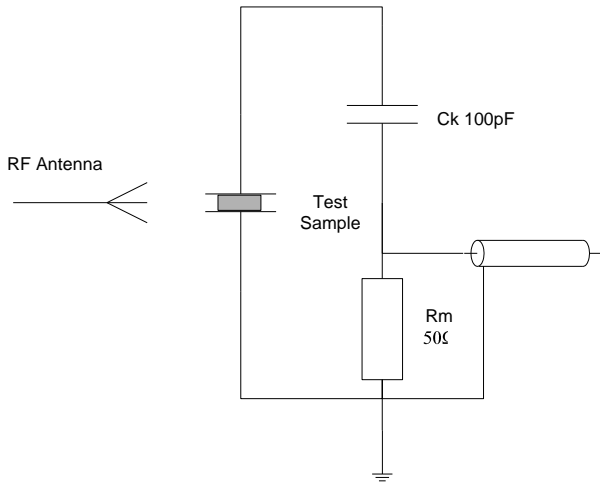

Fig. 2 Schematic of Measurement System

In initial tests, the basic IEC system used was shown to be capable of detecting partial discharges and signals of the order of 10V were observed from the system Fig. 3. The output of the antenna for the RF measurements was of the order of 200mV and could be directly observed using the oscilloscope. Fig. 3. To ensure that the p.d. signals were originating from the twisted pair and not from the sample holder or measurement system, the twisted pair sample was replaced with two loops of wire which were not in contact. No discharge activity was observed in this case for the range of voltages used.

III. EXPERIMENTAL RESULTS

A. Behaviour at Atmospheric Pressure

An example of the measured output of the IEC and RF systems for a partial discharge event are shown in Fig.3.

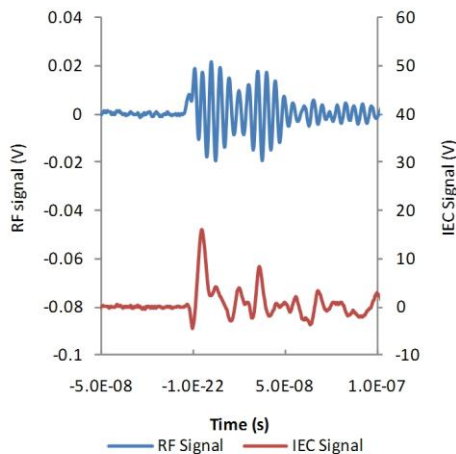

Fig 3 Output of IEC and RF detection systems to a p.d. event in ETFE sample.

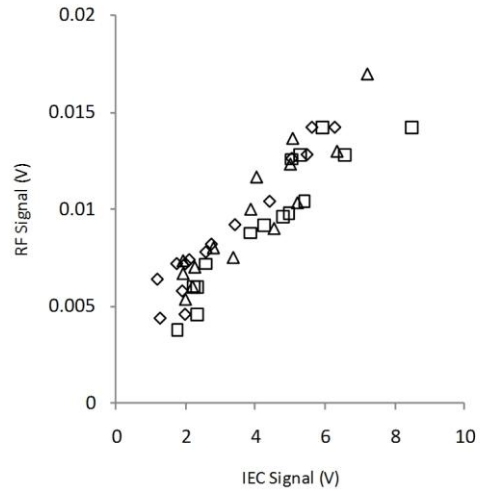

Fig. 4 Comparison of signal peak data for IEC and RF detection systems. Δ ETFE, \square SIR, \diamond PVC

Data was collected for the peak values for both signals for the three sample types over a range of voltages at atmospheric pressure. The results are shown in Fig. 4. It can be seen that there is a reasonable correlation between the peak signals produced by the two different monitoring systems.

Spectral analysis was performed on the output waveforms obtained from the measurement systems. Fig. 5a shows a frequency spectrum for a ETFE sample at atmospheric pressure at an applied voltage of 2.5 kV. It can be seen that there is a major peak at 40 MHz and smaller peaks occurring at 90, 120, 150 and 210 MHz. Fig. 5b shows the corresponding spectrum for the RF probe data. In this spectrum there is a clear peak at 210 MHz with a suggestion of a secondary peak at 225 MHz. No significant changes in the spectral content were observed as the voltage applied to the ETFE samples was changed

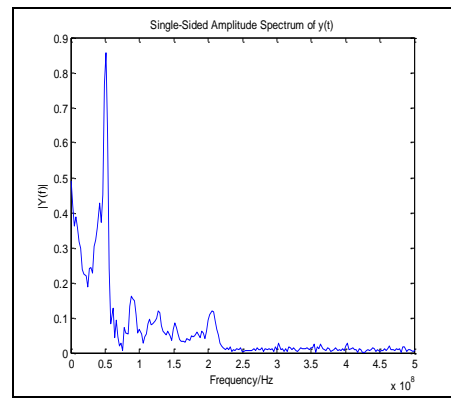

Fig. 5a spectrum from IEC measurements for EDFE at 2.5 kV

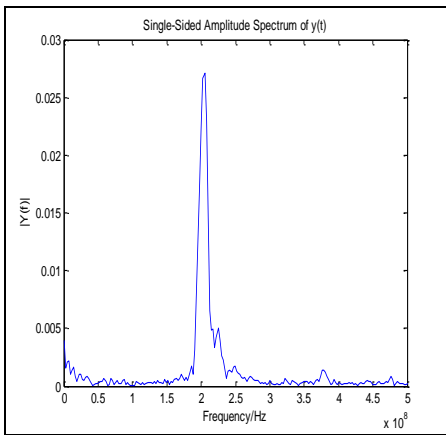

Fig. 5b spectrum from RF measurements for EDFE at 2.5 kV

Fig. 6a shows the frequency spectrum for the signal from the IEC probe for a p.d. event in a SIR sample at atmospheric pressure at a voltage of 3.2kV. Like the spectra for ETFE the spectrum contains a major peak at 40 MHz. However, above this frequency there are differences in the spectrum with an additional peak appearing at 70 MHz and the peak at 210 MHz being suppressed.

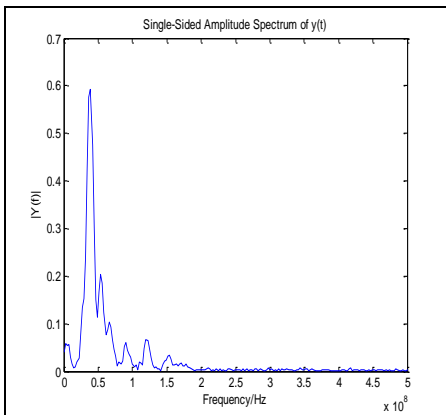

Fig. 6a spectrum from IEC measurements for SIR at 3.2 kV

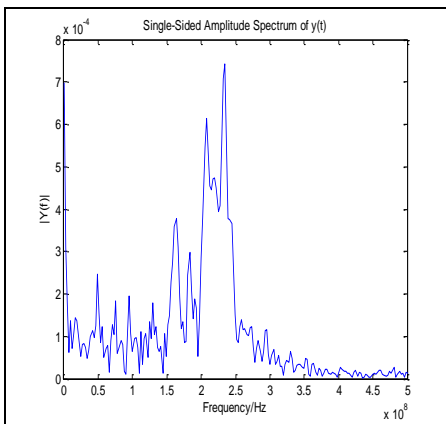

Fig. 6b spectrum from RF measurements for SIR at 3.2 kV

The corresponding RF spectrum, Fig. 6b, maintains the strong double peak structure but the intensity of the peaks below 200 MHz is strongly reduced. There is also a clear change in the frequency content of the UHF signal for SIR compared to ETFE under these conditions with a clear double peak at frequencies of 210 and 240 MHz. The most obvious difference is that rather than seeing a single peak with a shoulder at 210 MHz a clear double peak at frequencies of 210 and 240 MHz. Another smaller double peak feature appears between 150 and 200 MHz and a series of small peaks can be seen in the spectrum between 50 and 125 MHz.

At higher voltages, changes in both the IEC spectrum Fig. 6c and the RF spectrum Fig. 6d are observed. At 4.0 kV the IEC spectrum still shows a clear signal at 40 MHz but the relative magnitude of the peaks at 70, 90 and 120 MHz has increased.

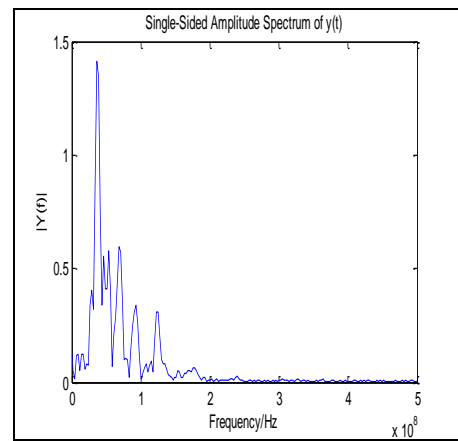

Fig. 6c spectrum from IEC measurements for SIR at 4.0 kV

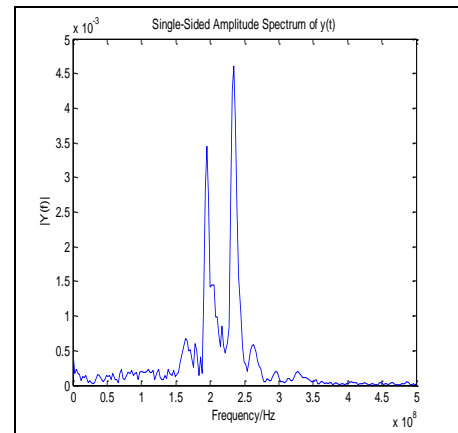

Fig. 6d spectrum from RF measurements for SIR at 4.0 kV

Fig. 7a Shows the IEC spectrum for a p.d. event in the PVC insulated system at a voltage of 3.75kV. Again a peak is observed a major peak is observed at 40 MHz. As with ETFE peaks are also observed at 90, 120 and 150 MHz. However the relative amplitude of these peaks is stronger than those

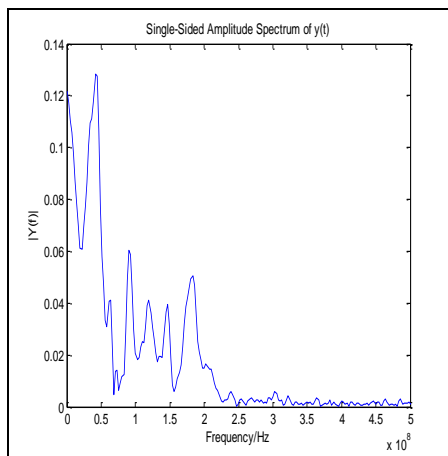

Fig. 7a spectrum from IEC measurements for PVC at 3.75 kV

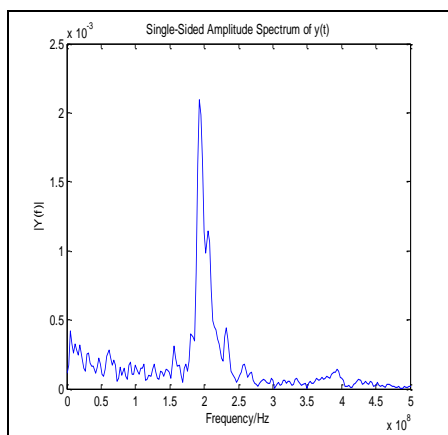

Fig. 7b spectrum from IEC measurements for PVC at 3.75 kV

observed in ETFE. The RF spectrum, Fig. 7b, shows a major peak close to 190 MHz with suggestions of a second peak at 210 MHz. No significant changes in the spectra of the discharge events were observed for the PVC samples as the applied voltage was increased.

B Behaviour at reduced pressures

The initiation voltage for p.d activity as a function of pressure was investigated and the results obtained are illustrated in Fig. 8. As has been reported in the literature [5] the initiation voltage decreases as the pressure is reduced. The measured peak values of both the IEC and RF signals was also observed to increase as the pressure was reduced.

In certain cases when measurements were performed at reduced pressure for the SIR and PVC insulation systems, the magnitude of the output of the IEC probe lead to clipping of the recorded waveforms. This made it impossible to accurately analyse the frequency content of the spectra of these signals. Preliminary evaluation of the spectral content of the p.d. signals in ETFE show no significant changes in the IEC signals as the pressure is changed.

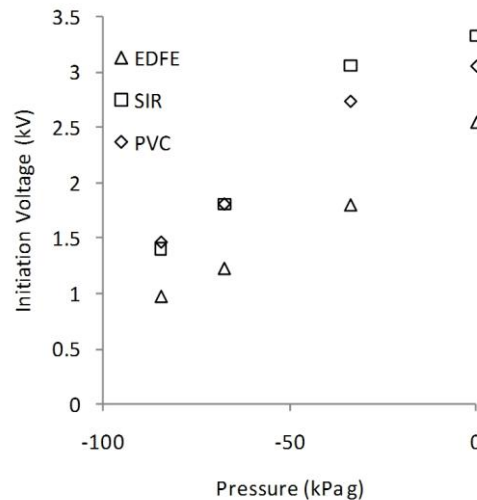

Fig. 8 Initiation voltage for p.d. activity

IV. CONCLUSIONS

A test system has been developed that allows the partial discharge activity of twisted pair samples to be investigated over a range of pressures using both an IEC 60270 and a RF measurement system. For the three insulation systems considered partial discharge activity was observed using both detection systems and correlation was possible between the IEC and RF signals.

Examining the spectral content of both the IEC and RF signals clear differences can be observed for the three insulation systems used in this initial study observed at atmospheric pressure. As expected the behavior of both the IEC signals the partial discharge activity for the three samples was dependent on the pressure minor modifications are required to the IEC measurement system to deal with the signal magnitudes generated at low pressures to allow a detailed examination to be undertaken.

ACKNOWLEDGMENT

The results presented in this paper are come are based on work performed by Mr Feng Ding and Ms. Xiaoxin Liu as part of their MSc by Instruction and B.Eng Degree project work at the University of Strathclyde.

REFERENCES

- [1] J. S. Kuzniar, G. A. Slenski, "Wire Integrity Field Survey of USAF Legacy Aircraft," *Proceedings of the RTO AVT Specialists' Meeting on Life Management Techniques for Aging Air Vehicles*, RTO-MP-079, 2001.
- [2] Y. X. Wang, E. Y. Dong, J. Y. Cong, J. Y. Zou, D. Koenig, "Arc Tracking Properties of the Aging Wires in Aircraft," *IEEE*, 1-4244-2386-6, June 2008.
- [3] F.R. Frontzek, D. Koenig, M.D. Judd, H.J. Reher, "Fault Arc Propagation on Cables for Space Applications in Vacuum, Oxygen-enriched Air and Air" *IEEE Transactions on Dielectrics and Electrical Insulation*, Vol 2 no 2, 1995, pp 190-7
- [4] X Liu "Partial Discharge Detection and Analysis in Low Pressure Environments" Ph.D. Thesis Ohio State University USA 2006