



## Strathprints Institutional Repository

Al-Hanafy, Waleed and Weiss, S. (2010) *Trade-off between complexity and BER performance of a polynomial SVD-based broadband MIMO transceiver*. In: The 27th National Radio Science Conference, NRSC 2010, 2010-03-16 - 2010-03-18, Menouf, Egypt.

Strathprints is designed to allow users to access the research output of the University of Strathclyde. Copyright © and Moral Rights for the papers on this site are retained by the individual authors and/or other copyright owners. You may not engage in further distribution of the material for any profitmaking activities or any commercial gain. You may freely distribute both the url (<http://strathprints.strath.ac.uk/>) and the content of this paper for research or study, educational, or not-for-profit purposes without prior permission or charge.

Any correspondence concerning this service should be sent to Strathprints administrator: <mailto:strathprints@strath.ac.uk>

Al-Hanafy, Waleed and Weiss, S. (2010) Trade-off between complexity and BER performance of a polynomial SVD-based broadband MIMO transceiver. In: The 27th National Radio Science Conference, NRSC 2010, 16-18 March 2010, Menouf, Egypt.

<http://strathprints.strath.ac.uk/27157/>

Strathprints is designed to allow users to access the research output of the University of Strathclyde. Copyright © and Moral Rights for the papers on this site are retained by the individual authors and/or other copyright owners. You may not engage in further distribution of the material for any profitmaking activities or any commercial gain. You may freely distribute both the url (<http://strathprints.strath.ac.uk>) and the content of this paper for research or study, educational, or not-for-profit purposes without prior permission or charge. You may freely distribute the url (<http://strathprints.strath.ac.uk>) of the Strathprints website.

Any correspondence concerning this service should be sent to The Strathprints Administrator: [eprints@cis.strath.ac.uk](mailto:eprints@cis.strath.ac.uk)

# Trade-off between Complexity and BER Performance of a Polynomial SVD-Based Broadband MIMO Transceiver

Waleed Al-Hanafy<sup>\*‡</sup> and Stephan Weiss<sup>\*</sup>

<sup>\*</sup> *Centre for Excellence in Signal & Image Processing, Dept. of EEE, Univ. of Strathclyde, Glasgow, Scotland, UK*

<sup>‡</sup> *Electronics & Comm. Eng. Dept., Faculty of Electronic Engineering, Menoufia Univ., Menouf, Egypt*

*Email: {waleed.alhanafy, stephan.weiss}@eee.strath.ac.uk*

## Abstract

In this paper we investigate non-linear precoding solutions for the problem of broadband multiple-input multiple-output (MIMO) systems. Based on a polynomial singular value decomposition (PSVD) we can decouple a broadband MIMO channel into independent dispersive spectrally majorised single-input single-output (SISO) subchannels. In this contribution, the focus of our work is to explore the influence of approximations on the PSVD, and the performance degradation that can be expected as a result.

## 1 Introduction

Multiple-input multiple-output (MIMO) technology has recently received considerable attention due to the tremendous increase in system capacity gained by the high spectral efficiency of the spacial dimension utilisation [1, 2]. This motivates the growth of high data-rate applications in the real world of the commercial wireless communication systems. The communication channel of these systems cannot be considered as frequency-flat channel, usually referred to in the literature as broadband channel, and hence incurs inter-symbol-interference (ISI) along with co-channel-interference (CCI). In order to realise the anticipated high capacity gain of MIMO broadband systems a sophisticated transceiver design [3, 4, 5, 6] that combat these interferences as well as do not admit any redundancy is of particular interest.

Therefore, we propose a non-block based approach, which is based on a generalisation of the SVD — optimal in many ways to enable communication over a narrowband MIMO channel [7] — to the broadband case. A recently proposed polynomial SVD (PSVD) [8] is applied to decouple the broadband MIMO system into frequency-selective single-input single-output (SISO) subchannels of ordered quality, similar to [9]. These broadband SISO subchannels are individually equalised using nonlinear Tomlinson-Harashima precoding (THP) [10, 11], whereby the decision delay can be independently optimised for every subchannel. The PSVD decomposition is achieved by an iterative algorithm that is required a large number of algorithmic steps in order to neatly transfer the energy of the channel matrix onto the main diagonal and eliminate the off-diagonal elements of this broadband MIMO channel.

In this work, the effect of the number of PSVD iterations on the performance is investigated aiming to estimate a reasonable cut-off number of iterations that is hardly sacrificing any performance. Furthermore, two THP methods to mitigate the ISI of the resultant dispersive SISO subsystems is presented and compared that showing a transferable property of this two methods with respect to temporal and spatial interferences.

The rest of this paper is organised as follows. In Sec. 2, the PSVD algorithm is first reviewed and used to mitigate CCI which highlights the motivation of an approximate PSVD version. ISI mitigation is also introduced with two alternate THP methods. Simulation results are presented in Sec. 3 to investigate both ISI and CCI mitigation performance, while conclude remarks are drawn in Sec. 4.

## 2 System Model

A MIMO frequency selective channel created by  $N$  transmit and  $M$  receive antennas can be described by a finite impulse response (FIR) filter  $\mathbf{H}[l]$  or its corresponding transfer function  $\mathbf{H}(z)$  given by

$$\mathbf{H}(z) = \sum_{l=0}^L z^{-l} \mathbf{H}[l] \quad . \quad (1)$$

The matrix-valued character of (1) results in the transmission system suffering from both spatial interference in terms of co-channel interference (CCI) as well as temporal interference in terms of inter-symbol interference. In (1),  $L$  is the order of the MIMO system and  $\mathbf{H}[l]$  is an  $M \times N$  matrix containing the channel impulse response coefficients at lag  $l$ , such that  $h_{mn}[l]$  is the  $l$ th complex baseband channel coefficient of the FIR filter describing the path from the  $n^{\text{th}}$  transmit antenna to the  $m^{\text{th}}$  receive antenna.

In [9, 12] the joint equalisation and precoding of this broadband MIMO system is performed in two steps. Firstly, using a polynomial SVD (PSVD) algorithm [8] the MIMO problem is reduced to decoupled, parallel dispersive spectrally majorised SISO subchannels, thereby eliminating CCI in this step. Secondly, THP [10, 11] is applied to the resulting SISO subchannels to mitigate their individual ISI. This section reviews both steps, with an emphasis on simplifying the PSVD calculation such that computational cost is reduced at the expense of a poorer approximation of the characteristics of an ideal PSVD. This reduced complexity scheme is combined with two different SISO-THP schemes, which are compared in terms of their BER performance.

### 2.1 CCI Mitigation via Polynomial SVD

The application of a broadband singular value decomposition algorithm detailed in [8] to the channel matrix  $\mathbf{H}(z)$  in (1) leads to a decomposition

$$\mathbf{H}(z) = \mathbf{U}(z)\mathbf{D}(z)\tilde{\mathbf{V}}(z) \quad (2)$$

with paraunitary matrices  $\mathbf{U}(z)$  and  $\tilde{\mathbf{V}}(z)$  and an approximately diagonalised and spectrally majorised matrix  $\mathbf{D}(z)$ . This decomposition is achieved by an iterative algorithm, which in each step eliminates the largest off-diagonal element by a delay step and a Givens rotation [8]. The algorithm has been shown to converge by transferring the energy of the channel matrix onto the main diagonal, and the approximation is due to limiting the number of algorithmic steps and the order of the resulting polynomial matrices  $\mathbf{U}(z)$ ,  $\mathbf{V}(z)$  and  $\mathbf{D}(z)$ . The iteration steps are defined such that both  $\mathbf{U}(z) \in \mathbb{C}^{M \times M}(z)$  and  $\mathbf{V}(z) \in \mathbb{C}^{N \times N}(z)$  are paraunitary (or lossless) by definition, i.e.

$$\tilde{\mathbf{U}}(z)\mathbf{U}(z) = \mathbf{U}(z)\tilde{\mathbf{U}}(z) = \mathbf{U}(z)\mathbf{U}^H(z^{-1}) = \mathbf{I} \quad (3)$$

The matrix  $\mathbf{D}(z) \in \mathbb{C}^{M \times N}(z)$  is diagonal

$$\mathbf{D}(z) = \text{diag} \{D_0(z), D_1(z), \dots, D_{K-1}(z)\}, \quad (4)$$

where  $K = \min(M, N)$ . The diagonalisation in (4) can be ambiguous and has to be tied down by an additional constraint. As an extension of the ordering of singular values in the standard SVD, the algorithm in [8] aims to spectrally majorise  $\mathbf{D}(z)$ , such that

$$D_0(e^{j\Omega}) \geq D_1(e^{j\Omega}) \geq \dots \geq D_{K-1}(e^{j\Omega}) \quad \forall \Omega \quad , \quad (5)$$

where  $D_k(e^{j\Omega}) = D_k(z)|_{z=e^{j\Omega}}$ . Note that due to the iterative nature and the finite number of steps of the algorithm in [8], (4) and (5) may only be approximately fulfilled. This is demonstrated in Fig. 1 for a normalised broadband 3x3 MIMO channel of fourth order with a coefficient profile  $|h_{mn}[l]|$  shown in Fig. 1(a). The resulting approximately diagonalised system  $\mathbf{D}(z)$  according to (4) is depicted in Fig. 1(b), whereas spectral majorisation according to (5) is highlighted in Fig. 1(c).

Referring to (2) and by defining a precoder  $\mathbf{P}(z) = \mathbf{V}(z)$  and an equaliser  $\mathbf{E}(z) = \tilde{\mathbf{U}}(z)$ , the overall MIMO broadband system  $\mathbf{H}(z)$  can be reduced to a diagonalised system  $\mathbf{D}(z)$  such that for a transmitted data streams  $\underline{\mathbf{X}}(z)$  the received data is given by

$$\underline{\mathbf{Y}}(z) = \mathbf{D}(z)\underline{\mathbf{X}}(z) + \underline{\xi}(z), \quad (6)$$

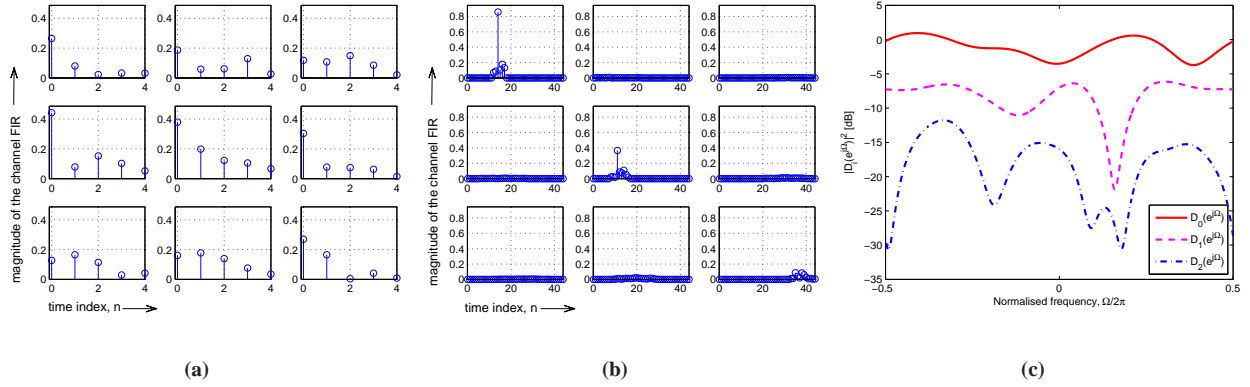

**Figure 1: (a) Sample 3x3 fourth order MIMO channel probe and its PSVD, showing (b) an approximately diagonalised system with SISO subsystems and (c) the magnitude responses along the main diagonal.**

where  $\underline{\xi}(z)$  represents additive white Gaussian noise at the receiver. Noting that the  $z$ -domain representation of a random process does not exist, (6) utilises the  $z$ -domain for notational convenience only, while all calculations would be performed in the time domain.

The ideal decoupling of the MIMO system in (6) such that CCI is eliminated requires exact diagonalisation of  $\mathbf{H}(z)$  by the PSVD algorithm. However, due to the approximate and iterative nature of the PSVD algorithm this is not necessarily fulfilled and off-diagonal elements of finite size may remain in  $\mathbf{D}(z)$ , which is likely to deteriorate the overall error performance. Therefore, the selection of the number of iteration (NoI) of the PSVD algorithm is important if good performance is to be attained. The effect of NoI on performance is twofold, as off-diagonal elements consume part of the system power, and an imperfectly diagonalised  $\mathbf{D}(z)$  will admit CCI. Therefore the idealistic approximation in (6) can be more correctly described by the time domain formulation for the  $i$ th received symbol stream  $y_i[l]$ ,  $i = 0, \dots, K - 1$ , as

$$y_i[l] = \sum_{v=0}^{L_i} d_{ii}[v] \cdot x_i[l-v] + \sum_{\substack{m=0 \\ m \neq i}}^{K-1} \sum_{v=0}^{L_{im}} d_{im}[v] \cdot x_m[l-v] + \xi_i[l] \quad . \quad (7)$$

The quantities  $L_i$  and  $L_{im}$  in (7) denote, respectively, the order of the main and off diagonal polynomials of  $\mathbf{D}(z)$ , such that the majority of system energy is preserved. In the following, we worked with a figure of 99.9%. The second term on the l.h.s. of (7) represents the residual CCI contributed by the off-diagonal terms in  $\mathbf{D}(z)$ .

## 2.2 ISI Mitigation

After mitigating CCI, ISI incurred through dispersion of individual SISO subchannels remains to be tackled. In [12] the spectral majorisation of the PSVD algorithm is exploited to maximise the overall system throughput by allocating different rates that match the individual qualities of the SISO subchannels, i.e., applying bit loading in a heuristic fashion. However in order to investigate the effect of the NoI of the PSVD algorithm on the system performance, bit loading is ignored in this paper and all SISO subchannels are loaded with the same modulation scheme. THP is used to mitigate the individual ISI of these SISO subsystems (cf. Fig. 2) and overcome the error propagation problem which a DFE scheme would experience. Two different THP methods under the Zero-Forcing (ZF) design criterion are presented, using spectral factorisation [5, 13] and block transmission [14].

### 2.2.1 Spectral Factorisation Scheme

Fig. 3(a) shows the ZF-THP system designed using the spectral factorisation method detailed in [5, 13] to mitigate ISI of the  $i$ th subchannel  $D_i(z)$  in Fig. 2. Since  $D_i(z)$  is usually non-minimum phase, the feedforward filter  $F_i(z)$  of order  $L_F^{(i)}$  is set to render the end-to-end discrete-time response  $D_i(z)F_i(z)$  a monic minimum phase system. Thereafter, the task of the  $L_B^{(i)}$  order feedback filter  $B_i(z)$  is to completely remove the remaining postcursor ISI from  $D_i(z)F_i(z)$  by

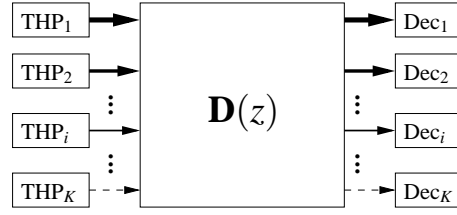

**Figure 2: THP applied to SISO subsystems resulting from the approximately diagonalised system  $D(z)$ , where  $THP_i$  and  $Dec_i$  blocks are shown in Fig. 3.**

means of an iterative feedback loop shown in Fig. 3(a). These two filters along with the decision delay are computed for each  $D_i(z)$ . The decision delay is individually optimised for each SISO subchannel and is generally equivalent to  $L_F^{(i)} - 1$ .

The importance of the spectral factorisation scheme lies in its capability of allowing serial transmission between transmitter and receiver. In the next section a second method is introduced, which is based on block transmission.

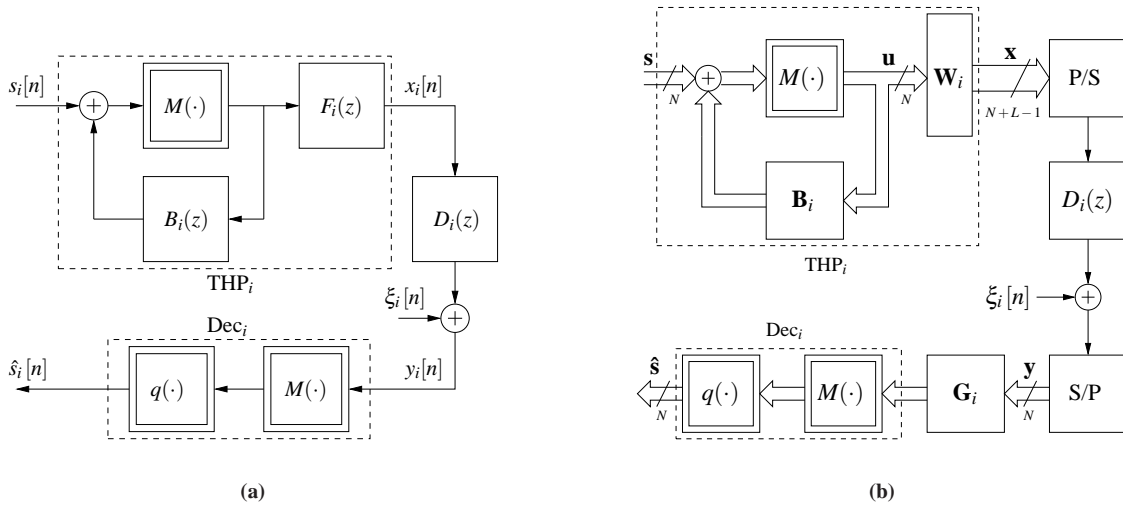

**Figure 3: SISO-THP transceivers using (a) spectral factorisation and (b) block transmission schemes.**

### 2.2.2 Block Transmission Scheme

ZF-THP can also be implemented in block transmission mode. Given the  $i$ th SISO subchannel from Sec. 2.1  $\mathbf{d} = [d_{ii}^{(0)} \ d_{ii}^{(1)} \ \dots \ d_{ii}^{(L_i)}]$  of order  $L_i$ , the block transmission scheme can be formulated following the procedures presented in [14] and with the aid of Fig. 3(b) as follows. The block input-output behaviour of the SISO subchannel is formulated as a convolutional matrix

$$\mathbf{D}_i = \begin{bmatrix} d_{ii}^{(0)} & d_{ii}^{(1)} & \dots & d_{ii}^{(L_i)} & 0 & \dots & 0 \\ 0 & d_{ii}^{(0)} & d_{ii}^{(1)} & \dots & d_{ii}^{(L_i)} & \ddots & \vdots \\ \vdots & \ddots & \ddots & \dots & \dots & \ddots & 0 \\ 0 & \dots & 0 & d_{ii}^{(0)} & d_{ii}^{(1)} & \dots & d_{ii}^{(L_i)} \end{bmatrix} \in \mathbb{C}^{N_b \times N_b + L_i}, \quad (8)$$

where  $N_b$  is the block size of the data streams  $\mathbf{s}$ , i.e.,  $\mathbf{s} = [s_{N_b} \ s_{N_b-1} \ \dots \ s_1]^T$ . This stacking can be easily performed using a serial to parallel (S/P) device as shown in Fig. 3(b). The ZF-THP solution to such a system can be obtained once the feedforward and feedback filter matrices  $\mathbf{W}_i$  and  $\mathbf{B}_i$ , respectively, have been evaluated using the QR decomposition

$$\mathbf{D}_i^H = \mathbf{Q}_i \begin{bmatrix} \mathbf{R}_i^H & \mathbf{0} \end{bmatrix}^H. \quad (9)$$

Here,  $\mathbf{Q}_i \in \mathbb{C}^{N_b+L_i \times N_b+L_i}$  is a unitary matrix and  $\mathbf{R}_i \in \mathbb{C}^{N_b \times N_b}$  is an upper triangular matrix. The feedforward filter  $\mathbf{W}_i$  is equal to the first  $N_b$  columns of  $\mathbf{Q}_i$ , while the feedback filter is given by  $\mathbf{B}_i = \mathbf{I} - \mathbf{G}_i \mathbf{R}_i^H$ , where  $\mathbf{I}$  is the identity matrix of size  $N_b$  and  $\mathbf{G}_i = \text{diag} [r_{11}^{-1}, r_{22}^{-1}, \dots, r_{N_b N_b}^{-1}]$  with  $r_{ii}$  being the  $i$ th diagonal element of  $\mathbf{R}_i$ . This translates ISI into CCI between different elements of the transmitted data block, which can be easily addressed by subspace methods. However, using block transmission is likely to sacrifice some redundancy to remove inter-block interference (IBI) between successive transmit data blocks, and hence can reduce the overall system throughput. In Sec. 3, BER performances of both methods are compared on the basis of identical transmit power.

### 3 Simulation Results

In this Section, a comparison between the spectral factorisation and block transmission schemes of the SISO-THP is investigated, prior to evaluating the influence of the NoI onto the error performance of a polynomial-SVD based transceiver.

To evaluate the non-linear precoding methods, SISO systems with 5 coefficients are drawn independently from a complex Gaussian distribution. A total of 300 channel realisations with responses obeying an exponentially decaying average power delay profile have been simulated. Fig. 4 shows the BER performance averaged over the outlined simulations. It can be noted that the block transmission scheme outperforms its spectral factorisation counterpart due to the extra redundancy incorporated in the block transmission which, in turn, reduces the system throughput by a factor of  $\frac{N_b}{N_b+L_i}$  which corresponds to a redundancy of  $\frac{L_i}{N_b}$ . Referring to Fig. 4, it is also evident that when  $N_b \gg L_i$ , the redundancy approaches zero while the throughput reduction factor  $\simeq 1$ , both block transmission and spectral factorisation BER performances converge to identical curves.

For a broadband MIMO system results, a 3x3 MIMO system with exponential power delay profile is simulated by drawing the coefficients  $h_{mn}[l]$  from a random complex Gaussian distribution. One such ensemble probe is shown in Fig. 1 which is normalised w.r.t. its Frobenius norm

$$\|\mathbf{H}(z)\|_F = \sqrt{\sum_{m=1}^M \sum_{n=1}^N \sum_{l=0}^L |h_{mn}(l)|^2} = 1 \quad . \quad (10)$$

For the  $i^{\text{th}}$  PSVD-SISO subsystem, the length of the feedforward filter in case of the spectral factorisation scheme is set to twice the channel order i.e.,  $L_F^{(i)} = 2 \times \text{order}(D_i(z))$ , while the filter length of the feedback filter is assumed as  $L_B^{(i)} = \text{order}(D_i(z))$ . Three symbol mappings are conducted using M-QAM for  $M = 4, 16$  and  $64$ , i.e. QPSK, 16-QAM, and 64-QAM, in order to investigate the performance for different transmission rates. As stated in Sec. 2.2, no bit loading is assumed in this study, therefore different subchannels' BER performances are expected as a result of the spectral majorisation property of the PSVD algorithm.

To investigate the effect of NoI within the PSVD algorithm on the BER performance of individual SISO-THP subsystems  $D_i(z)$ , three different NoI values of 20, 60 and 100 are tested. Figs. 5, 6 and 7 demonstrate this effect for the three transmission rates using QPSK, 16-QAM, and 64-QAM, respectively. This NoI determines how well both decoupling and spectral majorisation can be achieved. The following comments are motivated by the simulation results:

- For all cases and all subchannels, the BER performance is improved by increasing the NoI. Also note that for high NoI, this advantage becomes incremental. This decrease allows for a significant reduction in system complexity by choosing a moderate NoI without any degradation in performance.
- The stronger the subchannel the minor the effect of the NoI, as can be easily noted in the 1st subchannels for all cases. Spectral majorisation is a very useful instruments in practical applications as if one or more subchannels (from last subchannels) is no longer needed because of their poor performance and/or successfully achieved a required target throughput then the NoI can be decreased in this case and hence leads to further reduction in system complexity.

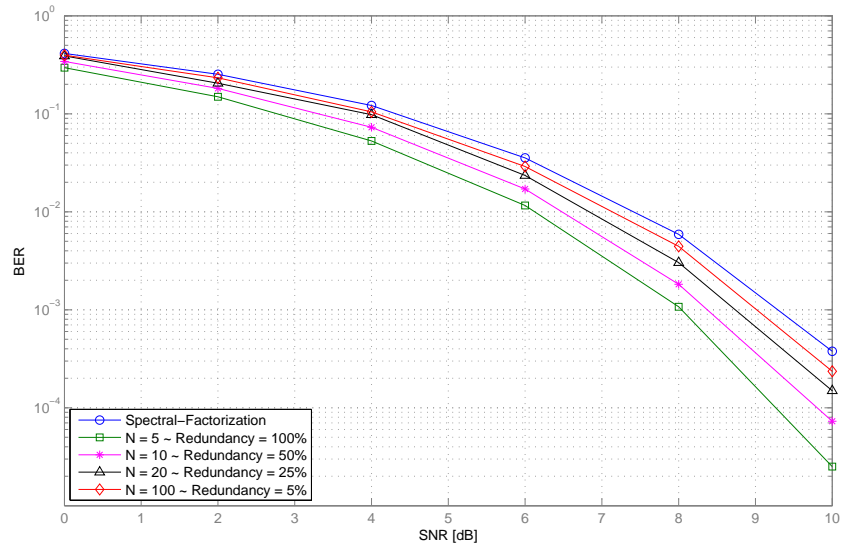

Figure 4: BER performance comparison of the spectral factorisation and block transmission schemes for SISO-THP system.

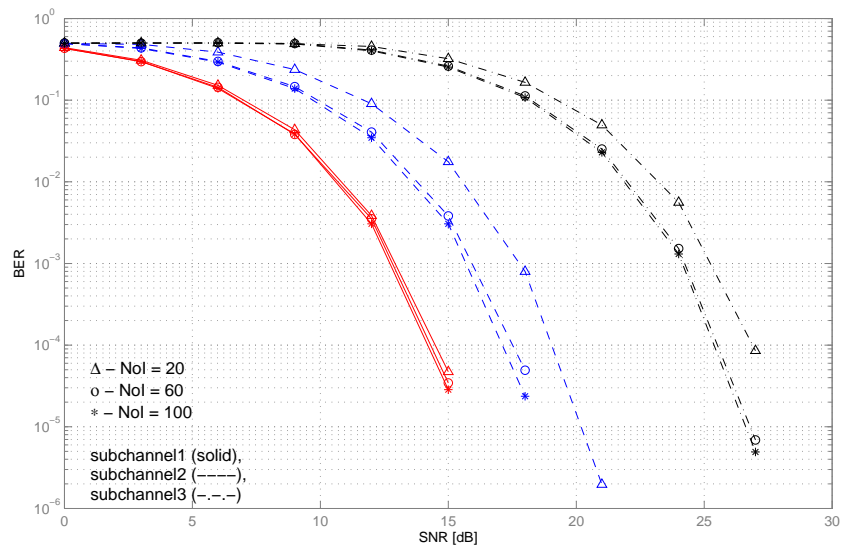

Figure 5: SISO-THP performance of the individual subchannels resulting from the application of the PSVD algorithm with varying NoI to a 3x3 MIMO system and "QPSK" transmission.



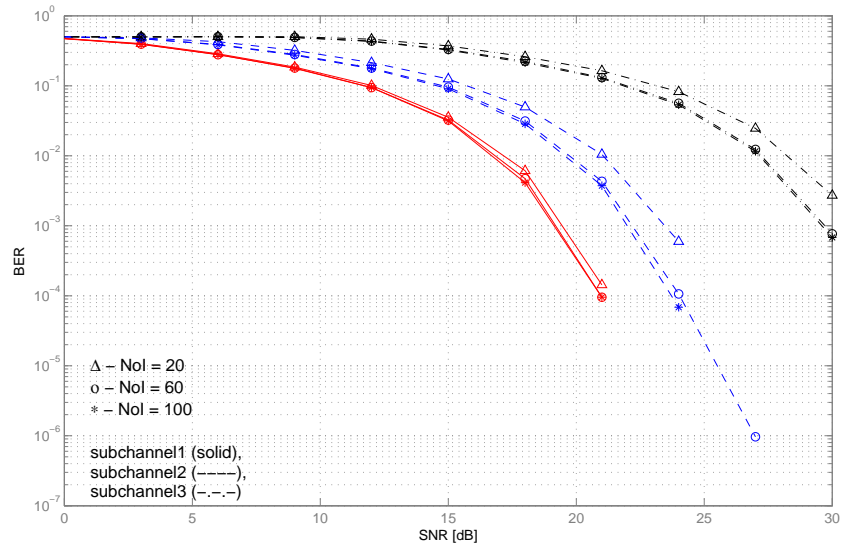

Figure 6: SISO-THP performance of the individual subchannels resulting from the application of the PSVD algorithm with varying NoI to a 3x3 MIMO system and “16-QAM” transmission.

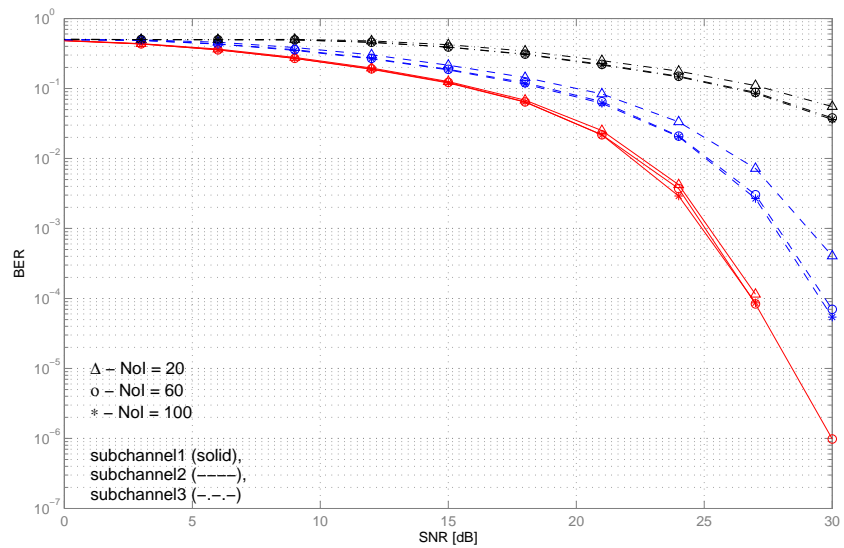

Figure 7: SISO-THP performance of the individual subchannels resulting from the application of the PSVD algorithm with varying NoI to a 3x3 MIMO system and “64-QAM” transmission.

## 4 Conclusions

A study on the approximate fulfilment of the novel polynomial SVD (PSVD) algorithm to diagonalise a broadband MIMO system into a number of independent frequency selective SISO subsystems as well as its impact on the system performance is considered. Due to the iterative nature and the finite number of the PSVD algorithm steps, a sufficient number of iteration (NoI) is investigated showing that a reasonable moderate NoI can be used to asymptotically achieve the desired performance of the individual SISO subsystems. Furthermore, two nonlinear ZF-THP precoding alternative schemes for the resultant ISI SISO subchannels are compared demonstrating that further performance improvement is attainable with extra redundancy.

## References

- [1] G. Foschini and M. Gans, "On Limits of Wireless Communications in a Fading Environment when Using Multiple Antennas," *Wireless Personal Communications*, vol. 6, no. 3, pp. 311–335, March 1998.
- [2] I. E. Telatar, "Capacity of Multi-antenna Gaussian Channels," *European Transactions on Telecommunications*, vol. 10, no. 6, pp. 585–595, December 1999.
- [3] A. Lozano and C. Papadias, "Layered Space-Time Receivers for Frequency-Selective Wireless Channels," *IEEE Transactions on Communications*, vol. 50, no. 1, pp. 65–73, January 2002.
- [4] M. Joham, D. A. Schmidt, J. Brehmer, and W. Utschick, "Finite-Length MMSE Tomlinson-Harashima Precoding for Frequency Selective Vector Channels," *IEEE Transactions on Signal Processing*, vol. 55, no. 6, pp. 3073–3088, June 2007.
- [5] R. F. Fischer and J. B. Huber, "Equalization Strategies for Transmission over Space and Time," *Elektronik und Informations-technik*, vol. 6, pp. 187–195, 2005.
- [6] L.-U. Choi and R. D. Murch, "A Pre-BLAST-DFE Technique for the Downlink of Frequency-Selective Fading MIMO Channels," *IEEE Transactions on Communications*, vol. 52, no. 5, pp. 737–743, May 2004.
- [7] M. Vu and A. Paulraj, "MIMO Wireless Linear Precoding," *IEEE Signal Processing Magazine*, vol. 24, no. 5, pp. 86–105, September 2007.
- [8] J. G. McWhirter, P. D. Baxter, T. Cooper, S. Redif, and J. Foster, "An EVD Algorithm for Para-Hermitian Polynomial Matrices," *IEEE Transactions on Signal Processing*, vol. 55, no. 5, pp. 2158–2169, May 2007.
- [9] W. Al-Hanafy, A. P. Millar, C. H. Ta, and S. Weiss, "Broadband SVD and non-linear precoding applied to broadband MIMO channels," in *42nd Asilomar Conference on Signals, Systems and Computers*, Oct. 2008, pp. 2053–2057.
- [10] M. Tomlinson, "New Automatic Equaliser Employing Modulo Arithmetic," *IEE Electronics Letters*, vol. 7, no. 5/6, pp. 138–139, March 1971.
- [11] H. Harashima and H. Miyakawa, "Matched-Transmission Technique for Channels with Intersymbol Interference," *IEEE Transactions on Communications*, vol. 20, pp. 774–780, August 1972.
- [12] W. Al-Hanafy and S. Weiss, "Comparison of precoding methods for broadband MIMO systems," in *3rd IEEE International Workshop on Computational Advances in Multi-Sensor Adaptive Processing (CAMSAP)*, Dec. 2009, pp. 388–391.
- [13] R. F. H. Fischer, "Sorted Spectral Factorization of Matrix Polynomials in MIMO Communications," *IEEE Transactions on Communications*, vol. 53, no. 6, pp. 945–951, June 2005.
- [14] F. K. Lee, S. M. Emami, O. F. Oteri, and A. J. Paulraj, "Tomlinson-Harashima Precoding for MISO Frequency-Selective Broadcast Channels," in *Conference Record of the Thirty-Ninth Asilomar Conference on Signals, Systems and Computers*, 2005, pp. 1508–1513.