



Strathprints Institutional Repository

Samuel, A.A.A. and Hand, J. (2007) *CFD assessments within strongly transient domains*. In: 10th IBPSA Conference on Building Simulation 2007, 2007-09-03 - 2007-09-06, Beijing.

Strathprints is designed to allow users to access the research output of the University of Strathclyde. Copyright © and Moral Rights for the papers on this site are retained by the individual authors and/or other copyright owners. You may not engage in further distribution of the material for any profitmaking activities or any commercial gain. You may freely distribute both the url (<http://strathprints.strath.ac.uk/>) and the content of this paper for research or study, educational, or not-for-profit purposes without prior permission or charge.

Any correspondence concerning this service should be sent to Strathprints administrator: <mailto:strathprints@strath.ac.uk>

CFD ASSESSMENTS WITHIN STRONGLY TRANSIENT DOMAINS

Aizaz Samuel, Jon Hand
 Energy Systems Research Unit
 University of Strathclyde, Glasgow, Scotland

ABSTRACT

Assessments based on CFD snapshots of stable conditions within strongly transient domains do not address many aspects of performance associated with occupant interventions, control actions or changing climate. Such domains (e.g. double skin façades) are characterised by transient flow patterns due to changing weather patterns, actuation of dampers intermittent opening of façade windows and operation of building environmental systems. Importing boundary conditions from whole building simulation is an improvement but it discounts the impact of the flow predictions on the building domain. A transient approach is suggested which is fully coupled to flow and thermal solvers for the building fabric, environmental control systems and air flow regime. The paper reviews a number of patterns of flow evolution in strongly transient domains in response to changes in ambient conditions, damper actuation, façade openings and intermittent flow from mechanical ventilation systems.

INTRODUCTION

Buildings are continually exposed to transient driving forces in terms of climate, user interaction and control permutations. Building performance can be addressed at varying resolution such as thermal simulation, flow and thermal, inclusion of detailed systems and CFD. Unfortunately, these domains are usually not solved in an integrated fashion and hence full advantage of detailed simulation is not realised. This paper aims to address this issue for the specific area of CFD assessments within transient domains. Usually such assessments are based on snapshots of the flow field and transient nature of the problem is not taken in account. An improvement to user specified boundary conditions is to use boundary conditions generated from results of a building and mass flow simulation exercise (Hand and Samuel 2006). Such an approach has the overhead of transposing CFD boundary conditions every time step. One possible way forward is the coupling of CFD with building thermal simulation and network flow.

De Gids (1989) cites combining CFD and multi-zone models as one of the most pressing research activities. Armstrong et al (2001) state that integration of CFD with building thermal and air flow simulation can yield information useful to new advances in building operation. It is therefore important that the boundary conditions imposed onto a CFD problem are physically realistic and well posed, otherwise difficulties may arise in obtaining an accurate solution.

CFD is commonly used to determine detailed air flow, temperature, relative humidity and species

concentration fields. A key problem faced by a designer when setting up a CFD model is the definition of boundary conditions because for most flow configurations, if the boundary conditions have been well specified, it is probable that the results will be correct.

INTEGRATED MODELLING APPROACH

Integration of CFD with building simulation takes place independently for network flow and thermal modelling. Thermal boundary conditions are configured at each time step using an adaptive algorithm (Beausoleil-Morrison 2000). Flow type boundary conditions are also taken dynamically from the flow network (Samuel 2005). The approach is shown schematically in figure 1 where thermally integrated mass flow predictions and results from thermal simulation are imposed on the CFD domain as boundary conditions. Thermal boundary conditions are adaptively configured and mass flow boundary conditions are configured such that both CFD and network mass flow iteratively converge to one solution. The passage of information to / from the CFD domain is shown by the arrows in Figure 1. This is described in detail in Samuel (2005) and Samuel and Strachan (2007). Two interesting applications are studied in the sections that follow. The first application is to a conference room in a naturally ventilated building and the second application is to

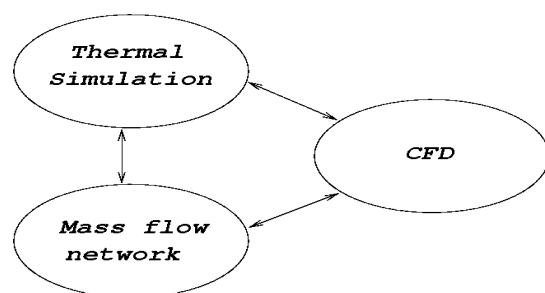

Figure 1 Schematic representation of domain integration

naturally ventilated double skin façade for a mechanically ventilated office building.

CANADIAN CONFERENCE BUILDING WITH ATRIUM

This building was originally studied by Hand and Strachan (2002): the design of the building ventilation system was novel and designed not to be energy intensive. It involved a displacement ventilation

system driven by occupant, lighting and small power gains within the building and linked to an atrium which is comfort conditioned. The idea was to naturally ventilate the conference rooms of Figure 2 from the atrium. The driving forces behind this ventilation would be stack effect enhanced by thermal gains within the rooms. Ventilation would be driven by heat gains from the rooms. In the absence of occupants the driving force would diminish and so would the ventilation rate. Such a design requires components and ducting with extremely low flow resistance.

The original study used a coupled zone and mass flow network approach with stratification assessed via the use of multiple thermal zones for each physical room. This approach assumed air flow determined from stack effects as the heat transfer mode between these multiple zones. For example, the conference rooms were represented by three stacked zones and the exhaust air ducts and stacks were also represented by thermal zones and included in the air flow network.

The study identified that extreme care was required to ensure flows with such weak driving forces. Although

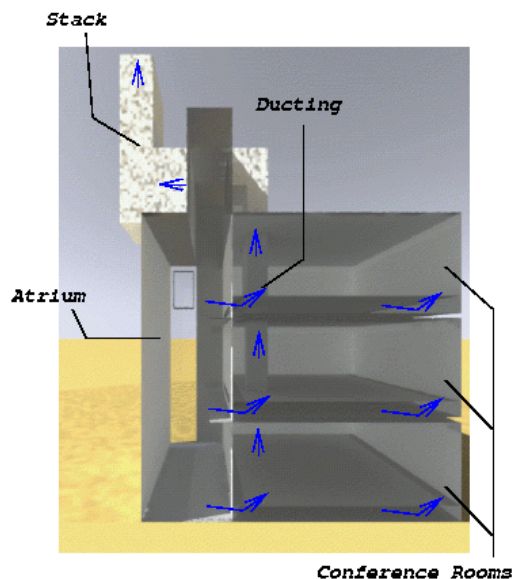

Figure 2 Canadian conference building with atrium showing designed air flow regime

they can be modelled using network approach common risers would not work because of the risk of flow reversal between levels. Adding a low grade heat source within the upper stack was found to increase flow rates.

It was not possible to answer the design teams questions about air quality and flow patterns within the rooms using a mass flow approach but the use of CFD was not considered an option at the time. The authors have revisited the project using conflation of thermally integrated mass flow network with CFD. It then became possible to assess the temporal sensitivity of the design to; placement of inlets (side vents vs floor vents), use of common vs separate risers for each occupied floor, effect of depth of room on ventilation, mixing and contaminant distribution, full conditioning of the atrium vs opportunistic use of ambient air, free floating atrium temperatures vs use of night flushing in that space, different occupancy and lighting gain levels and schedules. The dependence of air flow on internal air and surface temperature distributions, ambient

temperature, geometry and configuration of non-adventitious openings made it important that a thermally coupled mass flow network be used and greater detail obtained from dynamic boundary condition specification used for detailed fluid flow analysis.

The ground level conference room was defined to be represented by a CFD domain and the boundary conditions were defined from thermal simulation for the solid boundaries. Outside air is allowed to enter the atrium and it tempered. This air then flows into each of the conference rooms through underfloor vents on both sides of the rooms. (Due to the lack of mechanical ventilation air flow rates to each level may be quite different because of the prevalence of buoyancy effects.) Once inside the rooms, the air is heated by occupancy and equipment gains and rises. Temperature difference between stratified layers of air is typically around 4-6°C and flow rates of 0.4-0.55m³/s are obtained. Outside occupied periods temperature stratification drops to ~1°C and flow rate to ~0.2m³/s. Air from the rooms exits the building via individual risers that lead into the stack and from there on to the outside.

Detailed assessments were carried out with 10 minute time steps from an hour before the occupied period through several meetings and for an hour after the meetings.

Although the initial bulk air movement predictions suggested floor grills rather than wall diffusers to introduce air from the atrium raised floor level temperatures and provided slightly lower temperatures, this was demonstrated conclusively in the conflated CFD study (Figure 3 shows temperature distribution for underfloor air inlets). Similarly it was difficult to study the effect of displacement of air by using wall mounted grills. The CFD identified the region between the two inlets at the near and far side of the room is poorly ventilated. Consequentially local mean age of air (the time required by air to travel from the inlet to that point in space) was highest in that part of the room as shown in figure 4. Figure 3 shows results for one particular time in the morning (09:06) using floor grills to provide fresh air. The figure shows that fresh and cool air is rising from the floor into a warmer surrounding. The air temperature before this snapshot was considerably higher but this high temperature drove the ventilation system to higher mass flow which resulted in cooling of this space. Temperatures after 09:06 seemed to stabilise with a high temperature patch near equipment in the room.

Figure 4 shows CFD results for the computation of local mean age of air within the space at 10:00am and figure 5 shows the velocity of the rising air. It can be seen that the fresh air provided from the floor grills tends to accumulate towards the right wall in the image and there is some stratification between the two grills. It can now be recommended that if the grill design was changed such that the ventilation air initially flowed parallel to the floor, air freshness would be better distributed within the room.

Animations convey the transient nature of the design much better than snapshots. It is worth noting that the 60 time steps investigated with this study are a relatively crude assessment in comparison to studies based on hundreds of time steps reported on the ESP-r discussion list and one would expect studies based on

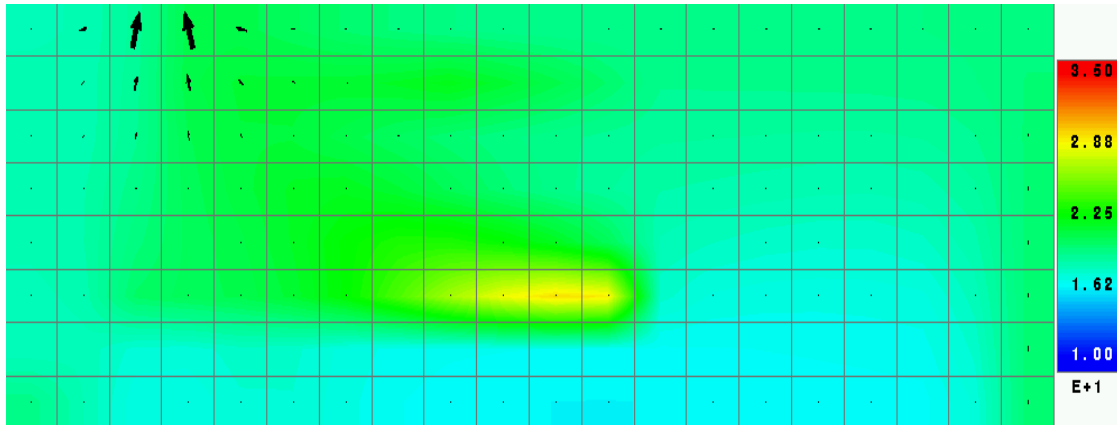

*Figure 3 Temperature distribution (measured in Celsius) in ground level room (atrium is to the left)
Figure shows a vertical cross section through the centre of the room*

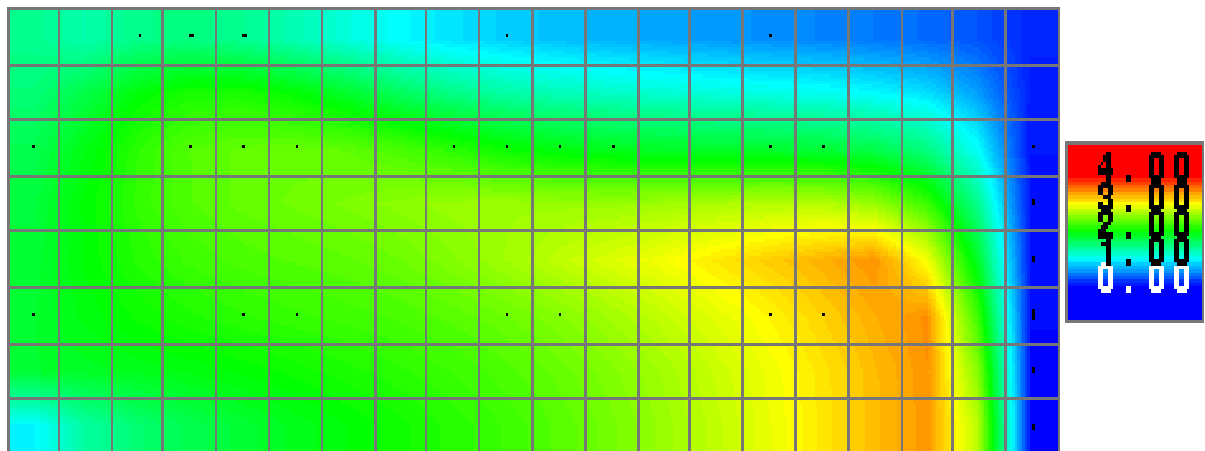

*Figure 4 Local mean age of air distribution in ground level room.
Figure shows a vertical cross section through the centre of the room*

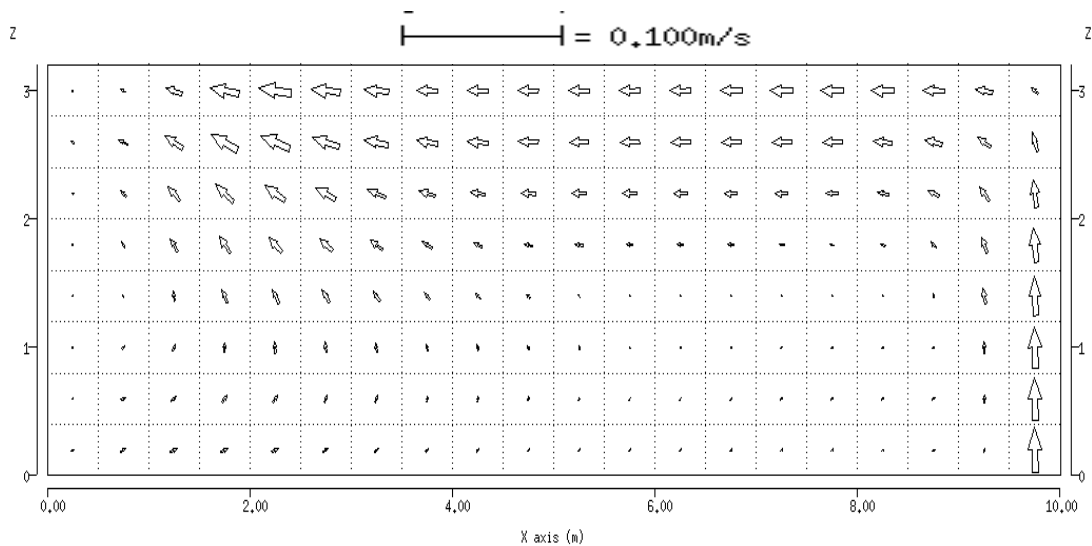

Figure 5 Air velocity distribution in ground level room

thousands of time steps to be unremarkable in the near future.

DOUBLE SKIN FACADES

Double skin façades offer a challenge for building simulation. The environment inside a double skin can

be strongly transient because of temporal conditions of weather and unpredictability of occupant interaction with the building. Double skin façades are currently the subject of a lot of research activity and this transient study addresses some of the heat and mass transfer issues that such an envelope raises.

Figure 6 shows a part of a building with a double skin façade. The model is composed of four zones: corridor, manager_a, manager_b and dbl_skn_fac. The corridor is part of a larger corridor with cellular offices similar to manager_a and manager_b. The double skin façade is represented by the zone dbl_skn_fac. Only the section of double façade in direct contact with manager_a has been taken into consideration. The model shows how the double skin façade modifies thermophysical conditions inside the zone manager_a. The results can be compared with manager_b where there is no double skin façade.

An air flow network was set up for this model, it consisted of small adventitious openings between all zones and to the outside. The principle air flow paths were through centrally hung horizontal axis windows in the manager_b office and similar openings in the double skin façade. Figure 7 shows a schematic diagram representing the air flow network overlaid on the floor plan of the office building section.

The double skin façade is linked to the flow network so that mass boundary conditions (e.g. wind driven pressures, openings to the manager_a) are included. Other configurations of the double skin façade by using coupled CFD and thermally integrated network mass flow would be straightforward to define. An alternative not explored in this paper is to include a double skin façade in front of the other office but use a mass flow network to represent flow and thus make it easier to capture differences in predictions between the two methods.

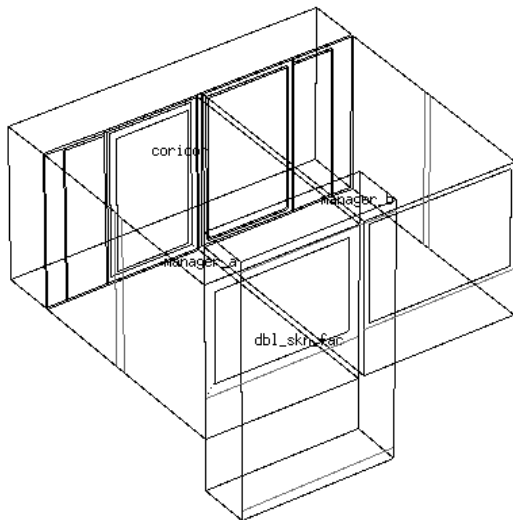

Figure 6 Perspective view of cellular offices and double skin façade

Simulation Parameters

It was assumed that the building was occupied during office hours. Internal energy gains were produced from two occupants (one in each cellular office), lighting gains were set at 10W/m². Such transient gains described within the zone domain become heat source blocks within the CFD domain. And, of course solar gains on the inner office façade influence the flow regimes at particular times of the day. The building was simulated at 20 minute time steps and this was also the frequency of CFD runs. The CFD grid was fairly coarse (around 4000 grid cells) in order to facilitate quick convergence. Environment

temperature was controlled to a heating set point of 19degC, and a cooling set point of 26degC. The façade was naturally ventilated.

The model was simulated for a summer day (6th June), a summer week (14th June to 20th June) and also for a winter week (6th February to 12th February) using typical UK climate data. Simulation periods of extreme weather conditions were chosen in order to contrast the environmental differences between the occupied space and ambient conditions. The time steps selected are useful for characterising flow patterns. On a 2.8 GHz single processor computer approximately 25 minutes were required to simulate 24 hours at 20 minute time steps. Where control actions are at a higher frequency it is still reasonable to expect an overnight turn-around for a months simulation.

For the CFD simulation, standard K-epsilon turbulence model was used along with Yuan wall functions (Yuan et. al. 1993). Hexahedral grid cells were used.

During the solution the thermally integrated mass flow network and CFD solvers ran iteratively to converge to a common estimate of flows at the boundary of the two domains. It was found that the iteration process was not a very large overhead on simulation time because only the first CFD run of the iteration took up substantial CPU time. Successive runs converged rapidly, primarily because these were initialised to the flow field of the first CFD solution. Where boundary conditions changed, solution efficiency decreased somewhat for subsequent time steps.

Results

Figure 8 shows two images from the CFD simulation for 6th June. The images show the behaviour of the double skin façade at midnight and at noon. The left of each cross section is the outside and the right is the partition with the adjacent office. It can be seen that the air velocity is higher during the midday period. This is due to higher wind speed at that time. This particular configuration is highly dependent on wind conditions and not as much on buoyancy for the period it was simulated. The flow pattern predicted by CFD suggests that during the day air is drawn through the top opening due to wind pressure and this flow cools the upper part of the surface of façade adjacent to the office wall. This is evident from the temperature plots. There seems to be separation of flow from this surface further along and this results in slightly higher temperatures for the lower part of the wall. Overall it can be seen that there is low flow nearer the outer wall of the double façade. It is easy to appreciate how this temporal change in boundary conditions affects thermal simulation and CFD solution set. Figure 9 shows temperatures within the CFD domain at midnight and at noon (note the scales are different). The temperature within the double skin follows the ambient temperature but with a buffering effect i.e. the temperature decay within the office with the double façade is more gradual than the office without it. It can be considered analogous to an increase in thermal capacitance of the office with the double façade. This can be seen from the temperature plots of Figure 10. These plots are for the summer week simulated.

It was found that the double skin façade improved thermal performance of the cellular office, in that both the heating and cooling loads for the building dropped to around 15% of the case with no double façade. The duration for which tempering was required was also

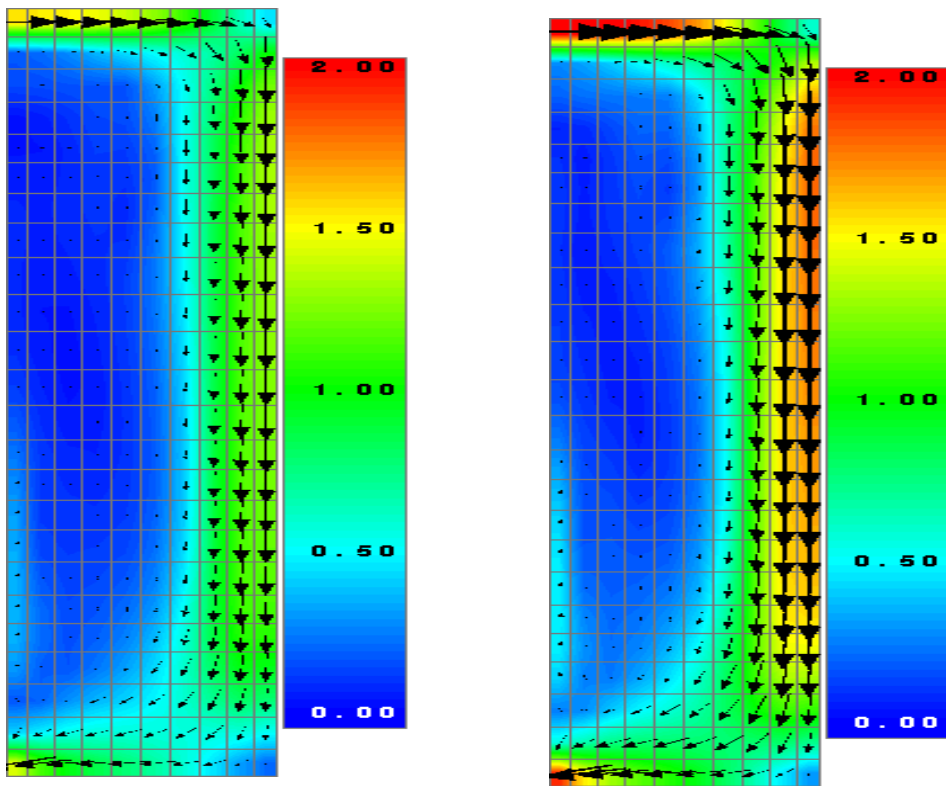
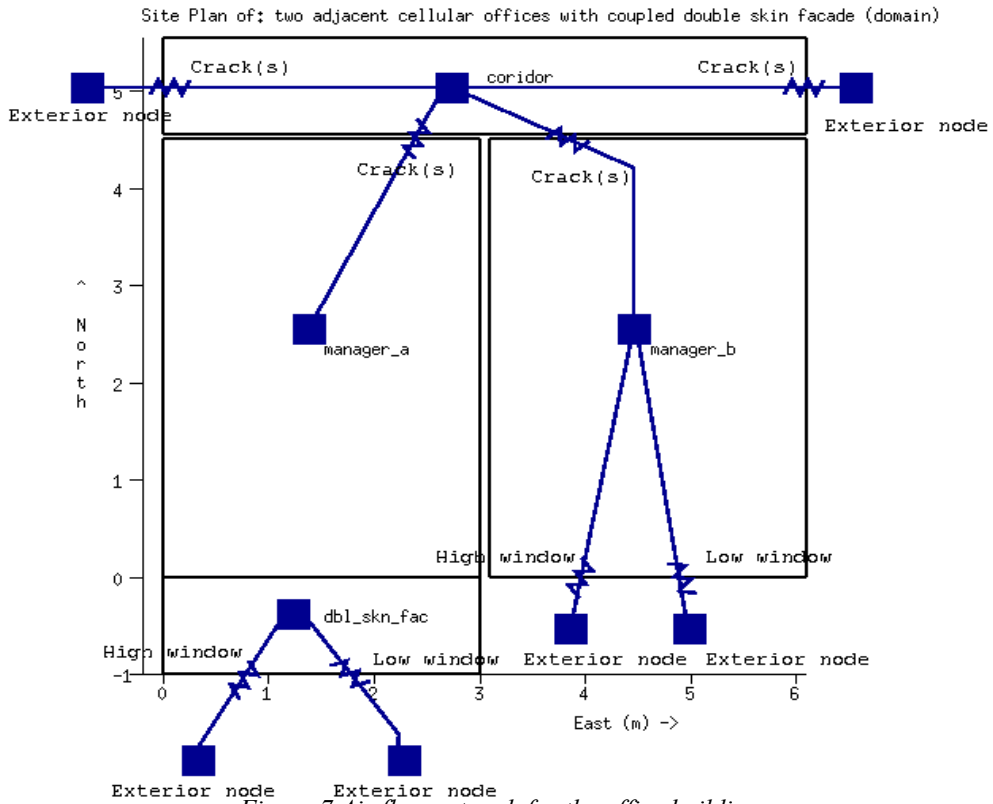

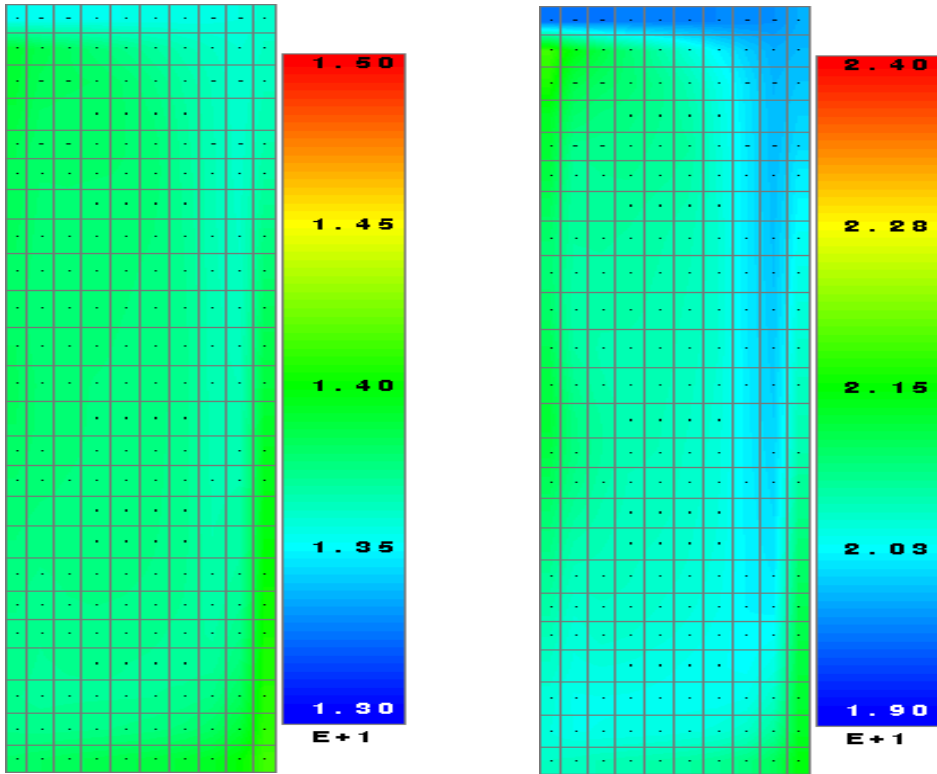

Figure 9 Temperature (deg C) in the double façade at midnight (left) and at noon (right). Please note that scales for the two figures are different, this was done in order to make the best use of available colour ranges.

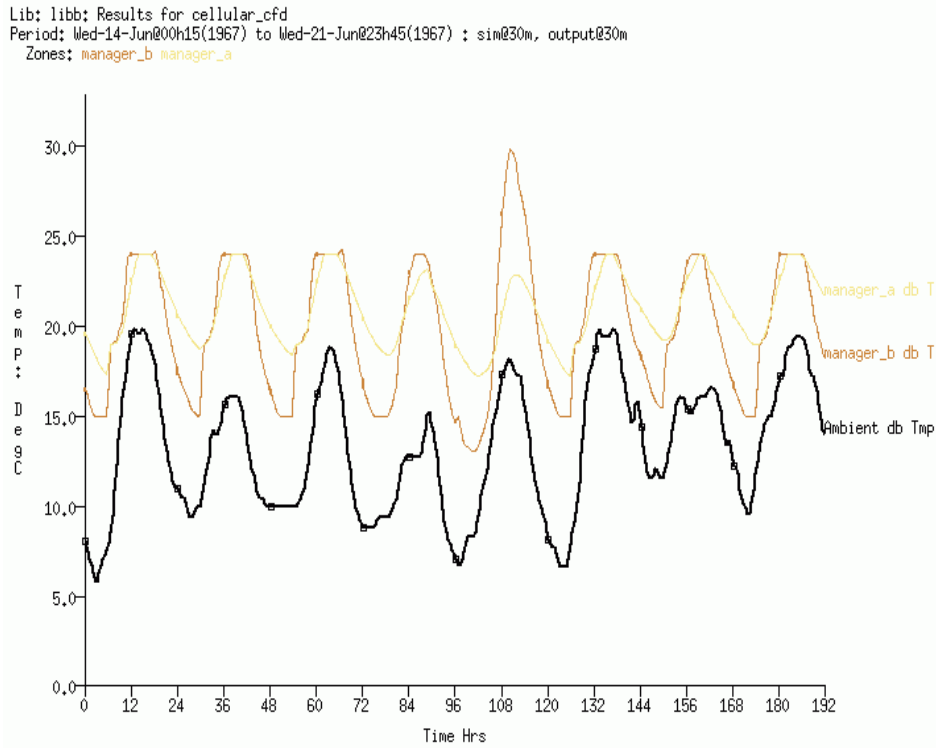

Figure 10 Temperature plots for the office with double skin façade (manager_a) and office without it (manager_b)

reduced by around 50% for both heating and cooling requirements. Improved performance is probably due to the occupied space being provided with a buffer zone that retains heat during winter and enhances heat loss during summer. For the winter period it was seen that manager_a (with double façade) temperatures followed a gentler decay and did not show the same quick variation as manager_b (without double façade). Heating loads are lower for manager_a as well with a peak of 0.6kW as compared to 1.0kW for manager_b. The total heat demand for manager_a was 19kWhr and for manager_b it was 60kWhr. Neither snapshots of CFD flow patterns or a CFD only assessment would have delivered this type of information on the energy implications of the double skin façade.

This overview did not explore issues of control actions such as adjusting the upper and lower inlets but this would be straightforward to represent by the addition of control actions to the mass flow network components representing the wind driven boundary connection for the CFD domain. Of course it would be necessary to shorten the simulation time step to be consistent with the operating cycle of such dampers and this would increase the computational demands.

CONCLUSIONS

Applications of a coupled solution approach are described. This solution approach couples thermally integrated network mass flow and building thermal simulation with CFD. Boundary conditions for CFD are taken from building thermal simulation and mass flow solution. At run time there is some iteration of these domains but subsequent calls to CFD are not resource intensive.

It is possible to put some confidence in the simulation approach because it takes advantage of the strengths of building thermal, mass flow simulation and CFD. The transient prediction capability of thermal building simulation is captured along with flow detail as predicted from CFD. The net result of this is thought to be more accurate than either of these predictive techniques alone. Problems which up to now have been difficult to solve with conventional simulation procedures can be resolved in a direct manner by the coupled solution approach. Two such applications have been described.

For designs which exhibit transient responses a coupled approach has advantages. Firstly coupled CFD boundary conditions have a higher confidence level because these are predicted from building simulation. Secondly because the final solution is arrived at by an iterative solution it is thought to be more accurate than either of building simulation or CFD. And a coupled approach makes demands on simulation teams and computing resources which are extreme and this constrains its application.

RECOMMENDATIONS

The approach is far from mature and there are a number of issues to be resolved:

- the learning curve associated with defining a CFD domain and coupling it with a mass flow network and thermal simulation building zones requires tool skills, domain knowledge and persistence,
- the recovery of predictions is somewhat tedious and it is difficult to easily compare

data between the CFD, mass flow and building domains,

- the coupling of CFD cells and boundary mass flow network connections uses iteration to ensure that both the flow network and the CFD domains converge and this logic could be improved.

In many ways the coupled approach remains more of academic interest than a commercially viable approach. And this is rapidly evolving as users push the boundaries of domain resolution and the frequency of the transient solution.

It is reasonable to think that over the course of simulating a long period of time (of the order of a few weeks or more) many time steps results may be similar to each other to a large degree. Running a CFD solution for each of these similar time steps may be unnecessary. There is potential in terms of time saving if a mechanism is incorporated that eliminates the need to run CFD simulations for similar time steps.

For the applications described in this paper the CFD domain was kept relatively simple because CFD solution was required for a large number of time steps. More useful information would have been gathered if a higher resolution CFD assessment was made of a subset of these many CFD runs. These could be the flow fields with "extreme" thermodynamic parameters.

REFERENCES

- Armstrong, P. R., Stenner, R. D., Hadley, D. L., Janus, M. C. 2001. *Whole Building Airflow Network Characterization by a Many-Pressure-States (MPS) Technique*. ASHRAE Transactions 2001, Volume 107 Part II.
- de Gids, W. F. 1989. *A perspective on the AIVC. Progress and Trends in Air Infiltration and Ventilation Research*. 10th AIVC Conference, Espoo, Finland.
- Beausoleil-Morrison, I. 2000. *The Adaptive Coupling of Heat and Air Flow Modelling within Dynamic Whole-Building Simulation*. PhD Thesis, University of Strathclyde, Glasgow, UK.
- Hand, J. W. Samuel, A. A. 2006. *Modelling Potentially Complex Airflows within Historical Buildings*. IBPSA USA Conference. Cambridge, USA.
- Hand, J., Strachan, P. 2002. *Passive Displacement Ventilation Study, ESRU Consultancy Report*. Private Communication.
- Samuel, A. A. 2005. *On the Conflation of Contaminant Behaviour Prediction within Whole Building Performance Simulation*. PhD Thesis, University of Strathclyde, Glasgow, UK.
- Samuel, A. A. Strachan, P. A. 2007. *Integration of Network Flow Modeling and Computational Fluid Dynamics to Simulate Contaminant Transport and Behavior in the Indoor Environment*. ASHRAE Transactions. (currently under review)
- Yuan, X., Moser, A., Suter, P. 1993. *Wall Functions for Numerical Simulation of Turbulent Natural Convection Along Vertical Plates*. International Journal of Heat and Mass Transfer, 36 (18).