

<b>Project</b>	AtlantOS – 633211
<b>Deliverable number</b>	3.4
<b>Deliverable title</b>	Design a buoy fitted with a low cost salinity sensor
<b>Description</b>	A number of prototypes equipped with different sensors (if more than one exists) will be tested at sea with different methods to avoid bio-fouling. CNRS will conduct evaluation of the test performed by NKE.
<b>Work Package number</b>	3
<b>Work Package title</b>	Enhancement of autonomous observing networks
<b>Lead beneficiary</b>	NKE, CNRS
<b>Lead authors</b>	Arnaud David (NKE), Gilles Reverdin (CNRS), Paul Poli (EUMETNET/Météo-France)
<b>Contributors</b>	Christophe Billon and Renan Férézou (Météo-France) for buoy testing Anja Reitz (GEOMAR) for editorial improvements
<b>Submission data</b>	
<b>Due date</b>	April 2017 (PM 24)
<b>Comments</b>	Further qualification of the demonstrator is planned in 2017 to increase the Technical Readiness Level.



This project has received funding from the European Union's Horizon 2020 research and innovation programme under grant agreement n° 633211.

Last updated: 24 March 2017

## I. Executive Summary: key points

- **A low-cost drifting buoy measuring salinity has been designed.**
- The demonstrator is the result of developments carried out by European manufacturer NKE in partnership with partners CNRS and EUMETNET/Météo-France.
- **The buoy reports sea-surface temperature at a resolution of 1 mK (1 milliKelvin) and sea-surface salinity at a resolution of 1 mPSU (1 milli-practical salinity unit)**
- **Reports are sent autonomously by the buoy at regular, selectable time intervals, *via* Iridium for satellite transmission.**
- **The accuracy of the novel salinity sensor is estimated to be around 50 mPSU.**
- **Industrial production of this demonstrator would yield cost savings around 30%** for clients (e.g., European scientists, generally working from public funds), as compared to non-European leading brands.

## II. Development timeline

27 November 2015

Meeting in Lorient (NKE hometown), with CNRS and EUMETNET/Météo-France

8 November 2016

Novel sensor ready for assembly into the buoy

19 December 2016

Demonstrator calibrated and tested by NKE

27 December 2016

Demonstrator delivered by NKE to EUMETNET/Météo-France

19-23 January 2017

Full transmission testing, via Iridium satellites, with buoy in seawater bath, at EUMETNET/Météo-France

2 February 2017

Demonstrator returned to NKE for fixing a software problem

### ***Plans***

*April 2017*

*Testing in controlled environment (water tanks) at CNRS*

*Mid-2017*

*Sea deployment and recoveries during Peacetime cruise by CNRS*

### III. Technical Readiness Level (TRL)

At time of writing, **TRL1 to TRL6 have been met:**

- **TRL1:** Basic principles of technology observed and reported; Evidence in the literature or from experiment indicates that a measurable response to the target parameter(s) is observed.
- **TRL2:** Technology concept and or application formulated; Requirements of the application / market formally recorded, concept design(s) documented.
- **TRL3:** Analytical and laboratory studies to validate analytical predictions; The analytical element (e.g. assay plus absorption cell) has been tested and performance evaluated vs design expectations.
- **TRL4:** Component and / or basic sub-system technology valid in a lab environment; Benchtop system (e.g. labview control, benchtop pumps, simple chip) performance validated in the lab.
- **TRL5:** Component and / or basic sub-system technology valid in a relevant environment; Components of the technology, or subsystems validated in a relevant environment (e.g. pressure pot, or dockside tests of elements of the system).
- **TRL6: System / sub-system technology model or PROTOTYPE demo in relevant environment; Prototype demonstrated in pressure pot or dockside.**

Pending are still:

- **TRL7:** System technology prototype demonstrated in an operational environment; Prototype demonstrated in target deployment (e.g. in a river, mooring, glider etc.).
- **TRL8:** System technology qualified through test and demonstration; Performance in final environment validated through repeated testing and deployment.
- **TRL9:** System technology qualified through successful mission operations; Technology has delivered data to science in the target environment on more than a handful of occasions.

## IV. Concept and motivations

Drifting buoys collect essential data at sea owing to their exact position at the air-sea interface. They typically measure: sea-surface currents (by monitoring drift in positions), sea-surface temperature (with a thermistor), and atmospheric surface pressure.

Owing to this location right at the interface between ocean and atmosphere, the data collected by these platforms are essential to calibrate and validate data from satellite sensors, which directly measure electromagnetic radiation, and not medium properties.

Until the AtlantOS project started, the only recognized source of reliable sea-surface salinity (SSS) data for such satellite calibration and validation work were from two well-known manufacturers, at a high price (around 5,000-6,000€ per unit, plus additional 1,200€ if the buoy also measures air pressure), and with a life-time shorter than 2 years. For comparison, a buoy alone measuring only drift and sea-surface temperature costs around 1,300€ (plus additional 1,200€ if the buoy also measures air pressure). Drifting buoys rarely exceed lifetimes of 3 years, and last typically around 400 days.

Recognizing a need to calibrate and validate SSS satellite retrievals from various missions, such as Aquarius or SMOS or other future missions, the investigators proposed to develop a low-cost solution, without compromising on precision or accuracy, but keeping into account the opportunity offered by a platform that does not have to last for long (unlike the Argo floats onto which the sensors described above are generally embarked).

## V. Developments carried out

Following initial exchanges by email, the demonstrator developments really kicked-off following a meeting at the manufacturer (NKE) premises on 27 November 2015, with partners EUMETNET/Météo-France and CNRS. During this meeting, the following points were discussed:

- Data acquisition cycle,
- Data processing onboard,
- Data transmission cycle,
- Data transmission format (via Iridium Short-Burst Data, SBD),
- Target lifetime,
- Sensor calibration,
- Remote commands,
- Batteries,
- Major pitfall: biofouling.

The expected product was an SVP buoy able to connect a new sensor designed to measure Conductivity and Temperature with high accuracy. Both parts (buoy and sensor) had to be studied.

A new probe was designed to be more accurate than basic products, including cost constraints.

Designing this novel probe was comparatively less time-consuming than improving hardware, software, calibration, and mechanical design.

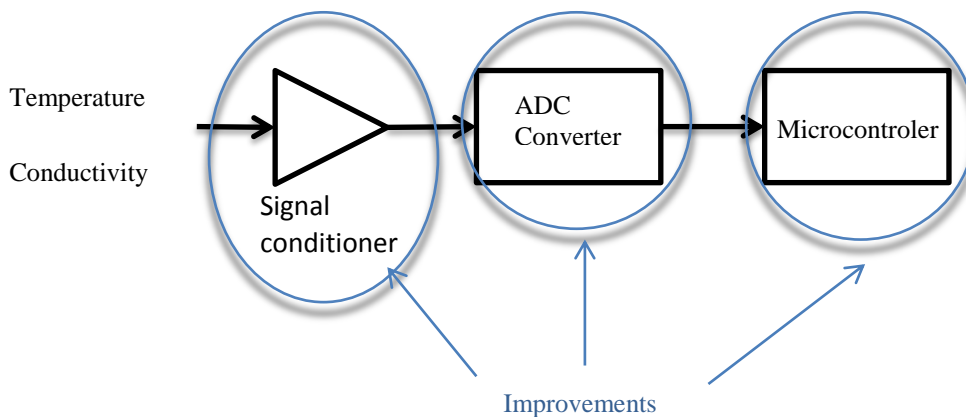

Figure 1: Outline of the improvements on the signal processing design.

For both parameters we processed some electronic modifications (see Figure 1) in signal conditioning to improve signal quality mainly signal to noise Ratio (SNR) and stability with temperature. We have also increase the dynamics range by using a 24 bits analog to digital signal converter and the use of a more powerful 32 bits microcontroller allows more signal processing.

Work was also carried out on the SVP buoy such as the development of a new message SVP

and protocol definition between buoy and sensor. Software and hardware have been updated to take into account the new parameters (conductivity and Salinity) and be compliant with the protocol selected.

Communication between buoy and CTS probe is Modbus protocol (see Figure 2). Modbus protocol is a reliable and commonly used industrial protocol. The scheme below shows the basic principle of measurements.

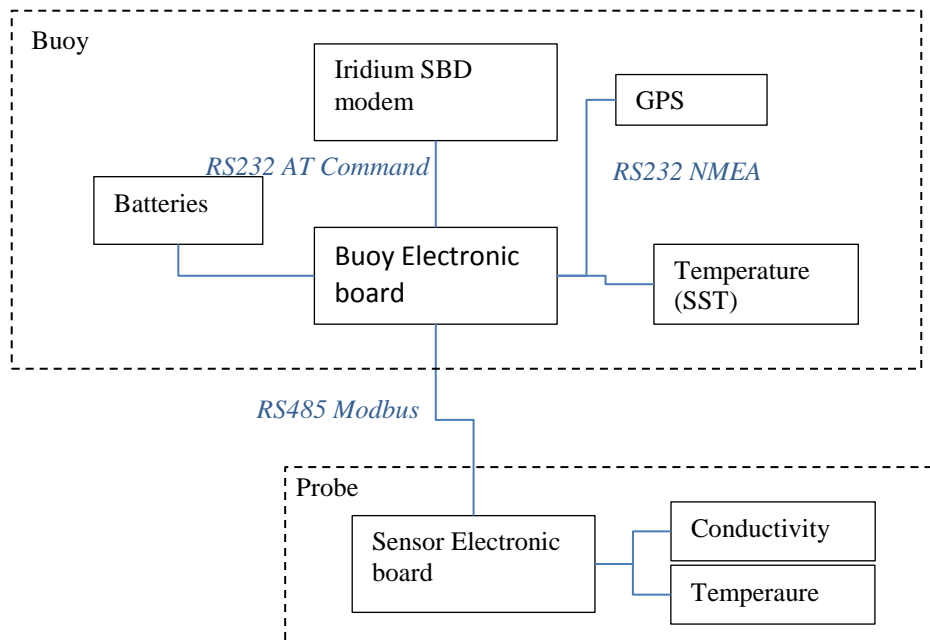

Figure 2: Outline of the improvements on the buoy electronic design

A dedicated Biofouling protection has been designed. It is a passive copper based protection to save energy. Particular attention was devoted to ensure that the protection does not influence the measurements. To verify this, successful comparisons in NKE's metrological bath have been carried out, indicating that the conductivity is not affected by this protection.

The buoy is equipped with a conductivity and temperature sensor by default. If the extended sensor is not present only (hull) sea-surface temperature is processed. The extended sensor is synchronous to measurement of sea-surface temperature. A series of measurements are collected by default at a sampling rate of 1 Hz for a period of 15 seconds. Note the sample period, as well as the duration of measurements, are adjustable. At the end of this acquisition, only the median value of each field (conductivity, temperature, and salinity) is retained, and processed into the Iridium message.

The transmission network uses Iridium SBD, as specified. This service is indeed best suited for the application (considering its cost versus the amount of data to transmit).

Technical specifications are shown in Table 1. The sensor with its encasing is shown in Figure 3.

Buoy	
Dimension	390mm Diameter
Weight	12 kg
Temperature Range (SST)	-2°C to 35°C
SST Accuracy	0,5°C
Precision	0,01°C
Transmission	Iridium SBD
Batteries	Alkaline 45Ah
Sensor	
Weight	350 g
Size	length 240mm & Diameter 40mm
Communication	RS485 Modbus
Temperature Range	-2°C to 35°C
Accuracy	0,01°C
precision	0,001°C
Conductivity Range	0 to 65 mS/cm
Accuracy	0,04 mS/cm
precision	0,001 mS/cm
Salinity Range	15 to 42 PSU (atm pressure)
Accuracy	0,05 PSU
precision	0,001 PSU

Table 1: Specifications of the novel buoy and low-cost salinity sensor.



Figure 3: Picture of the novel SSS sensor, which actually measures temperature and conductivity.

The data transmission format is described below. It is now reported in the Joint WMO-IOC Technical Commission for Oceanography and Marine Meteorology (JCOMM) Data Buoy Cooperation Panel (DBCP) documentation, under the link "Recommended Iridium SBD dataformats for buoys": <http://www.jcommops.org/dbcp/data/sharing.html>

This format is labeled as #022 and indicated in Table 2.



**Format #022 - SVP-BSC (salinity/conductivity)**  
(26 bytes)

Parameter	Bits	Pos	Offset	Max	Formula
Format identifier	8	0	0	254	Forced to 22 in present version
Year	7	8	2000	2126	Year = n + 2000
Month	4	15	0	12	Month = n
Day	6	19	0	31	Day = n
Hour	5	25	0	23	Hour = n
Minute	6	30	0	59	Minute = n
Air pressure	11	36	850.0	1054.6	AP (hPa) = n*0.1 + 850
SST	12	47	-5.00	35.94	SST (°C) = n*0.01 - 5
Pressure tendency	9	59	-25.5	25.5	dP (hPa) = n*0.1 - 25.5
CT temperature <sup>1</sup>	16	68	-5.00	60.534	CT_temp (°C) = n*0.001 - 5
CT conductivity	16	84	0	65.53	CT_cond (mS/cm) = n*0.001
Salinity	15	99	15	47.77	SSS (psu) = n*0.001 + 15
CT sensor error	1	114	0	1	Err = n
Submergence/gauge count	6	115	0	100	Subm. (%) = n*1.6129
Battery voltage	6	121	5	17.4	Vbat (V) = n*0.2 + 5
1 <sup>st</sup> Tech. parameter (Iridium)	8	127	0	254	See § 3
2 <sup>nd</sup> Tech. parameter	8	135	0	254	See § 3
GPS fix time delay	12	143	0	4094	Delay (min) = n
GPS Latitude	20	155	-90	90	Lat (deg) = n*0.0002 - 90
GPS Longitude	21	175	-180	180	Lon (deg) = n*0.0002 - 180
3 <sup>rd</sup> Tech. parameter (GPS)	7	196	0	126	See § 3
4 <sup>th</sup> Tech. parameter (GPS)	4	203	0	14	See § 3
Spare (unused)	1	207			All bits forced to « 1 »

**Table 2: Specifications of the Iridium SBD data format for the buoy reporting conductivity and salinity (as well as default SVP parameters)**

<sup>1</sup> Sea temperature measured by the conductivity sensor

## VI. Final product

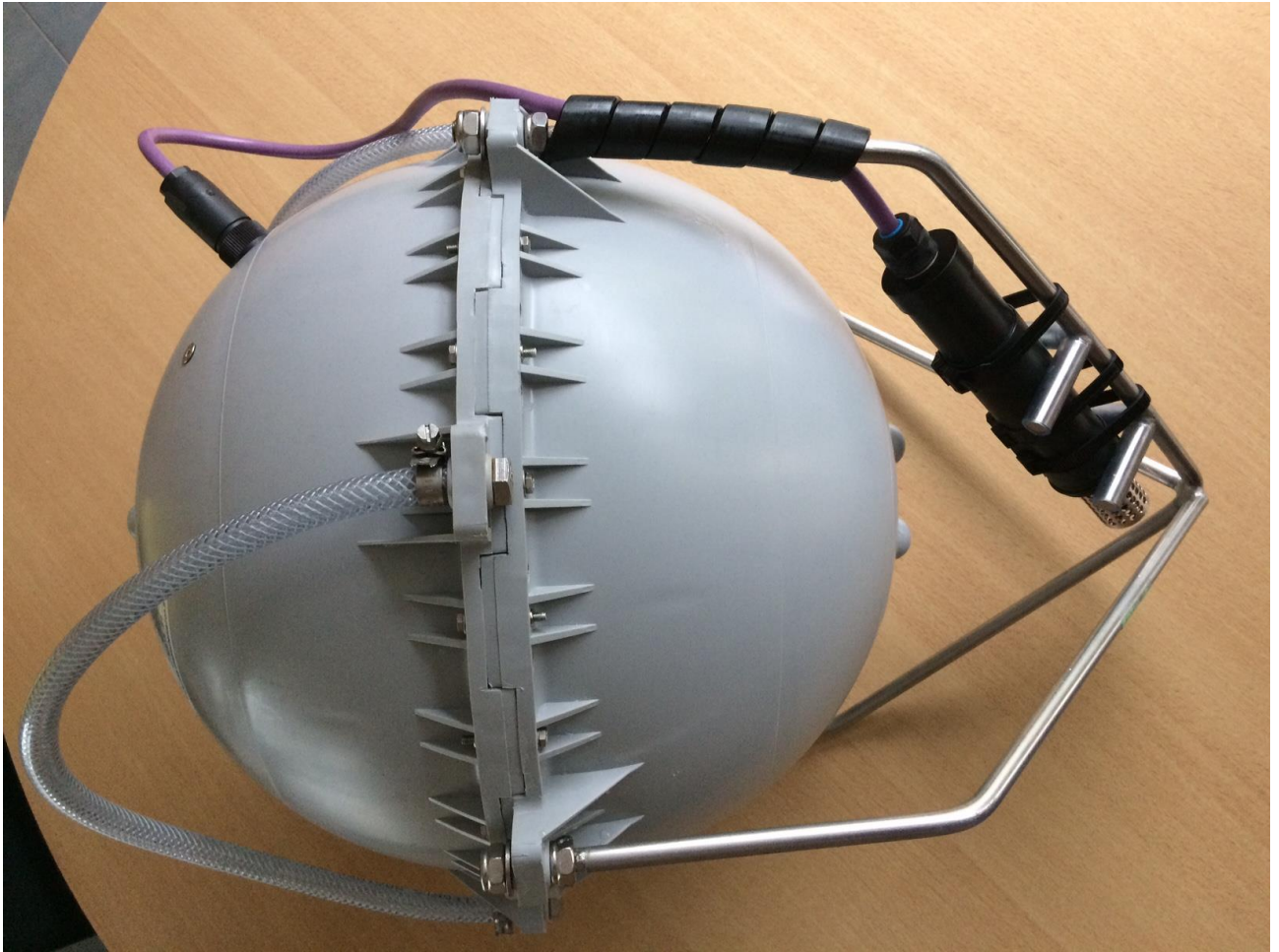



Figure 4: Picture of the demonstrator in a bench, at NKE manufacturer's premises. Note the two handles to ease recovery. The novel SSS sensor is located on the right, in a black plastic encasing.

The demonstrator shown in Figure 4 uses the data format indicated above. The IMEI number of the Iridium modem is 300234064733330. Using alkaline batteries the lifetime in operation is estimated around 600 days.

Although series have not been produced yet, the shelf price of serial repeats of the demonstrator buoy with the novel SSS sensor is estimated to be around 3,800€, which is around 30% cheaper than an equivalent from leading brand references.

## VII. Testing by manufacturer NKE

The buoy was tested by NKE using state-of-the-art laboratory facilities. The results are indicated thereafter in the calibration sheet.

Rapport d'étalonnage				
Date :	19/12/2016			
Product :	Capteur CT Atlantos			
Serial number :	0xABCD			
				
<b>Température</b>				
Exactitude :	10 m°C			
Bain Fluke 7051A				
Seabird SBE37SMP : Etalonnage Décembre 2016				
Méthode 3 points d'étalonnage et 3 points de vérification				
Comments	Std T (°C)	Raw value	Calculated T (°C)	Deviation (m°C)
Etalonnage	5,1165	90444	5,1165	0,0
Etalonnage	10,2144	71006	10,2144	0,0
Etalonnage	15,1591	56533	15,1591	0,0
Contrôle	20,0551	45396	20,0551	0,0
Contrôle	24,9493	36676	24,9491	-0,2
Contrôle	29,8902	29747	29,8880	-2,2
Steinhart Coefficient	$t(^{\circ}\text{C}) = 1 / (C \cdot \text{LN}(x)^3 + B \cdot \text{LN}(x) + A) - 273,15$			
Coefficient A	0,0008485			
Coefficient B	0,0002268			
Coefficient C	1,057E-07			
<b>Conductivité</b>				
Exactitude :	40uS/cm			
Solution standard OSIL				
Ref : Salinity 35.0 (±0,2%)				
Mesure salinomètre Portasal solution OSIL				
S	35,018			
K	1,00046			
RAW	T90 (°C)	Std C (mS/cm)	Calculated C (mS/cm)	Deviation (uS/cm)
119541	5,1654	33,6208	33,6212	-0,4
136298	10,2582	38,3521	38,3515	0,6
153190	15,1993	43,1335	43,1331	0,4
170451	20,0906	48,0322	48,0328	-0,6
188169	24,9817	53,0763	53,0765	-0,2
206445	29,9166	58,2946	58,2943	0,3
Correction polynomiale du second ordre				
<b>Contrôle Salinité sur eau de mer</b>				
Exactitude :	50mPSU			
Température	Capteur CT(PSU)	Salinomètre	Déviation (mPSU)	
20°C	36,3	36,283	17	

The results indicate temperature accuracy around 0.01 K for temperature and <20 mPSU for SSS.

## VIII. Testing by data processing center EUMETNET



Figure 5: Picture of the demonstrator at EUMETNET/Météo-France premises, on 29 December 2016. Note the magnet to turn ON/OFF the buoy.

The demonstrator was delivered by NKE to EUMETNET/Météo-France on 27 December 2016 (see Figure 5). The buoy was then put in a seawater bath and the data were received on Météo-France Iridium email address. The data, once decoded looked like this:

WMOid	TESTNKE	TESTNKE	TESTNKE	TESTNKE
Date OBS	23/01/2017 14:00	23/01/2017 14:30	23/01/2017 15:00	23/01/2017 15:30
Lat POS (deg)	48.4092	48.4092	48.4092	48.4092
Lon POS (deg)	4.5034	4.5034	4.5034	4.5034
Qualite position	3	3	3	3
P mer (Pa)	999999	999999	999999	999999
T mer (Deg K)	280.23	279.71	279.78	279.27
Tend (Pa)	9999	9999	9999	9999
Sub (%)	0	0	0	0
Tbat (Volt)	9.8	9.8	9.8	9.8
DD (Deg vrais)	999	999	999	999
FF (M/s)	999	999	999	999
12001	9999	9999	9999	9999
(conductivity)22066	26.242	26.371	26.467	26.532
Salinité (Psu)	28.911	28.896	28.900	28.902

<b>Humidite (%)</b>	999	999	999	999
<b>Td (Deg K)</b>	9999	9999	9999	9999
<b>2149</b>	1	1	1	1
<b>2034</b>	1	1	1	1
<b>2035</b>	15	15	15	15
<b>22001</b>	999	999	999	999
<b>T13 (s)</b>	999	999	999	999
<b>Hvagues (m)</b>	999	999	999	999
<b>Date POS</b>	23/01/2017 14:00	23/01/2017 14:00	23/01/2017 15:00	23/01/2017 15:00
<b>Type anemo (code)</b>	9	9	9	9
<b>Z anemo (m)</b>	999	999	999	999
<b>Lat Irid (deg)</b>	48.4603	48.3953	48.3953	48.4157
<b>Lon Irid (deg)</b>	-5.9637	-4.4899	-4.4899	-4.6559
<b>CEP radius (m)</b>	749000	3000	2000	12000
<b>Del GPS (sec)</b>	999	999	999	999
<b>Del Iridium (sec)</b>	22	22	22	22
<b>Tec2 Iridium</b>	999	999	999	999
<b>Tec2 GPS</b>	999	999	999	999
<b>MAWSbin (code)</b>	0	0	0	0
<b>Tmer1 (Deg K)</b>	275.636	275.826	275.949	276.033

As the data show, this testing allowed to detect a problem with longitudes reported as positive westwards, whereas the DBCP convention defines longitudes as positive eastwards.

Longer data series were collected for a couple of days. The results are presented below in Figure 6, Figure 7, Figure 8, and Figure 9, bearing in mind that the seawater bath was located outside and exposed to radiation and evaporation/rainfall.

## Temperature timeseries

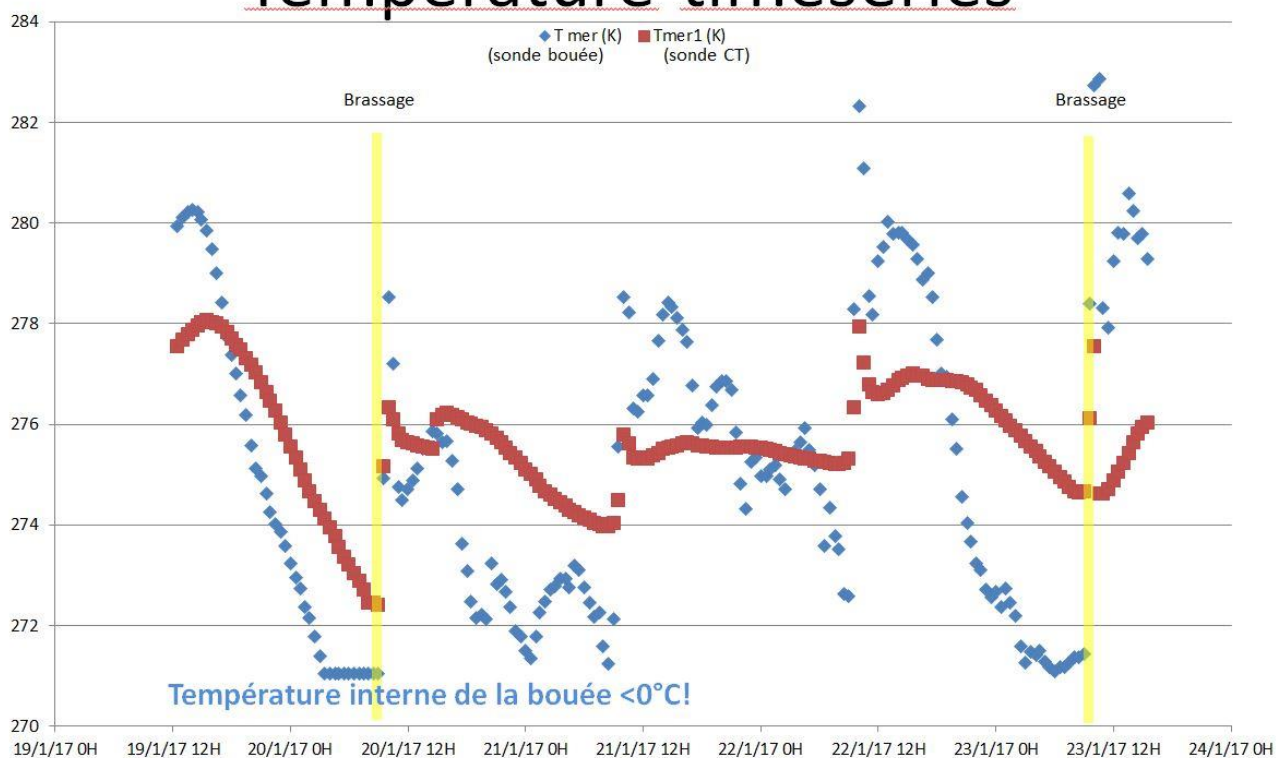

Figure 6: Timeseries of temperature measured by the hull (in blue, rather measuring the buoy internal temperature), and by the novel sensor (in red). The seawater bath was subject to mixing on several occasions.

## Salinity timeseries

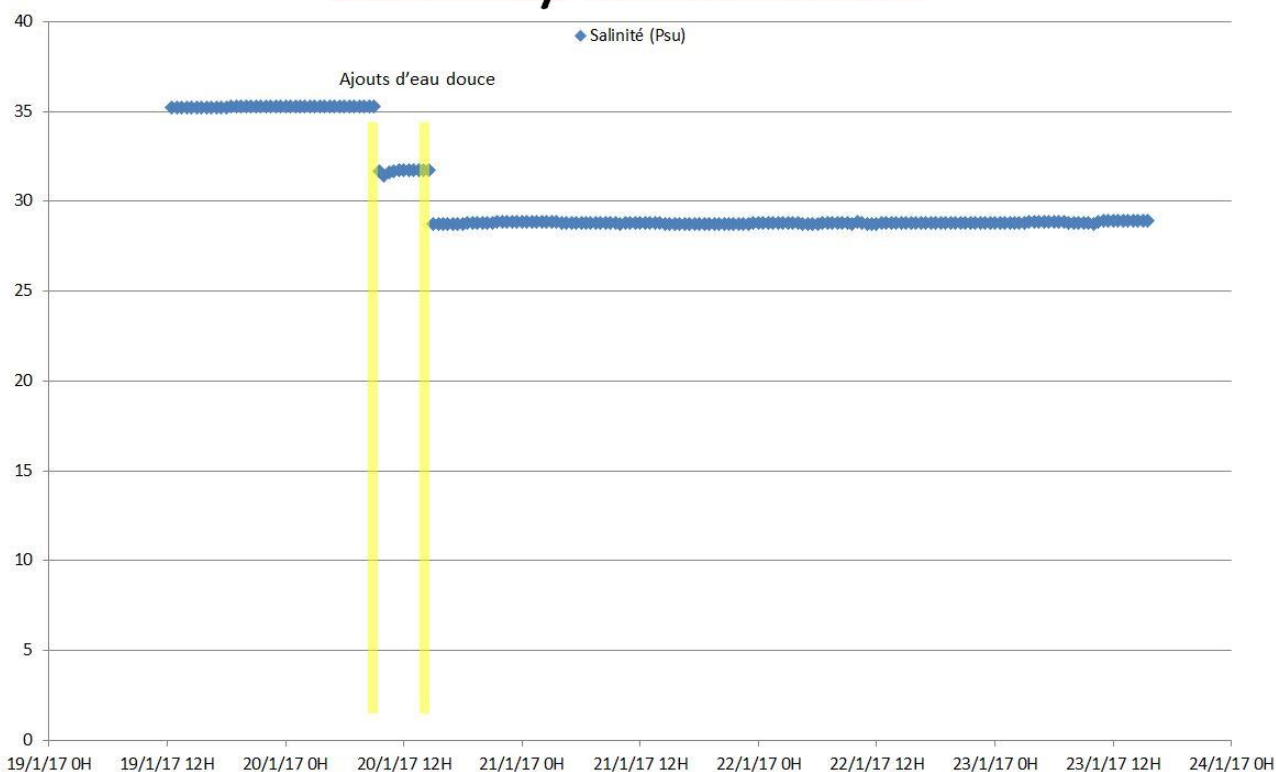

Figure 7: Timeseries of SSS measured by the novel sensor. As expected, the salinity remained constant until freshwater was added (on two occasions, marked in yellow).

# Salinity timeseries, seawater sample taken on 20/01

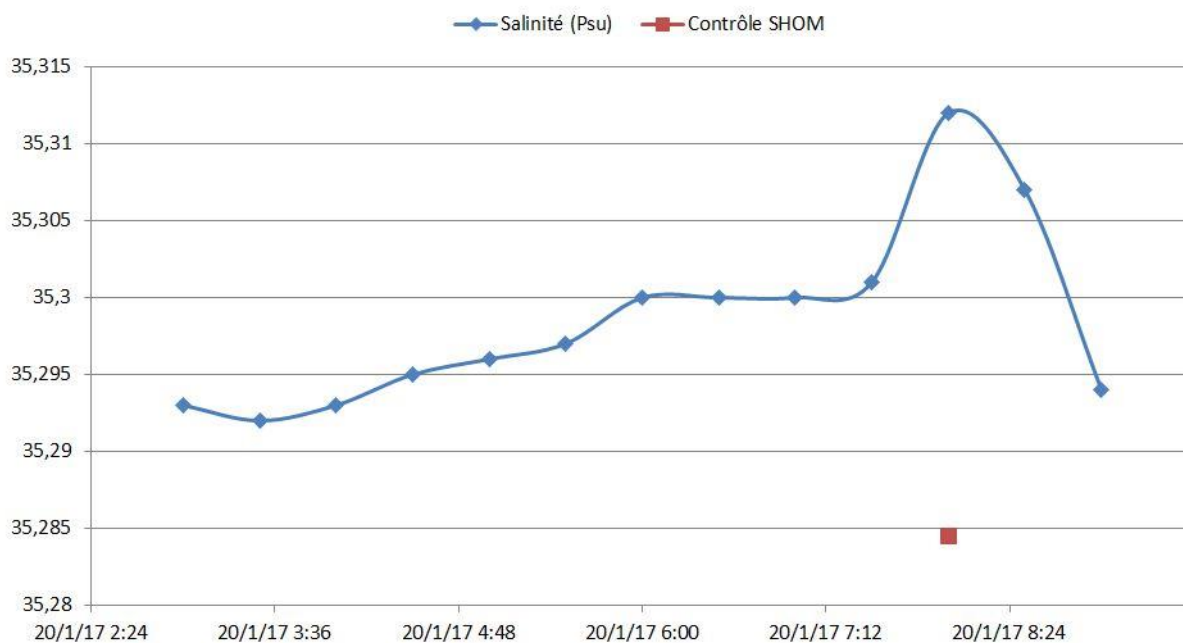

Figure 8: Zoom on SSS timeseries on 20 January 2017, when a seawater sample was taken for independent analysis by the SHOM metrology lab. Their result is shown with a red square, indicating a difference around 20 to 30 mPSU.

# Salinity timeseries, seawater sample taken on 23/01

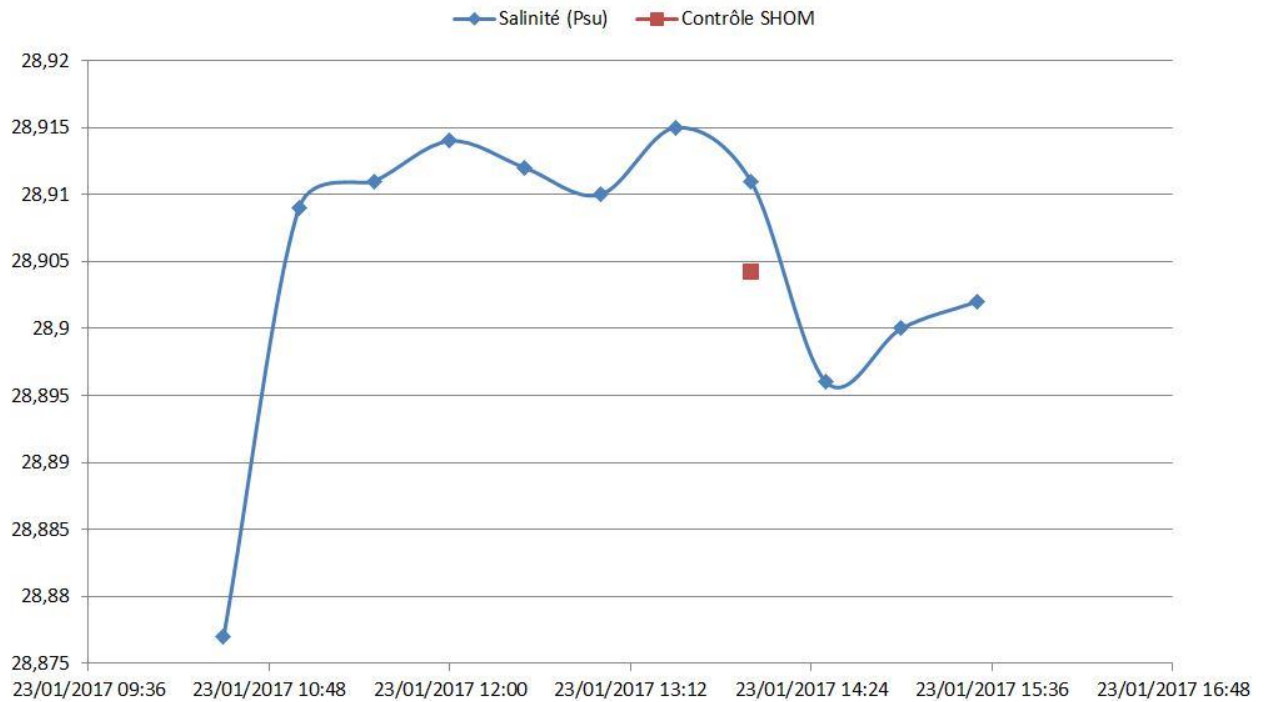

Figure 9: Zoom on SSS timeseries on 27 January 2017, when a seawater sample was taken and analysed by the SHOM metrology lab. Their result is shown in red, indicating a difference around 10 mPSU.

Based on these tests, it was concluded that:

- The buoy had to be returned to manufacturer NKE to fix the software and report properly the longitude sign (positive eastwards). This was done on 2 February 2017;
- The SSS sensor behaved satisfactorily for measuring SSS in a seawater bath with a very small negative bias under 50 mPSU for both samples, and reporting data at a resolution of 0.001 psu;
- The SSS sensor gave temperature readings far more accurate than the hull sensor to characterize the seawater temperature, reporting data at a resolution of 0.001 K.



## IX. Testing by scientific data user CNRS

At time of writing, no testing has been carried out yet by CNRS, as the prototype has not yet been returned to CNRS, but necessary steps have been taken to plan and secure future qualification tests.

Qualification is planned as follows:

1. Tests in a tank over two weeks in April 2017, to check sensor characteristics and verify calibration within 0.01°C and 0.01 psu in typical seawater characteristics.
2. Three short deployments (+recoveries) during Peacetime cruise on RV Atalante in the Mediterranean Sea. The deployments will be 1-3 days long, and will be associated with extensive CTD casts and U-CTD surveys that will be used to check data flow at sea, consistency of measurements with nearby CTD casts (and ship TSG), and to check how to deploy/recover the drifter.