



## Strathprints Institutional Repository

Kokogiannakis, G. (2009) *Support for the integration of simulation in the European Energy Performance of Buildings Directive*. PhD thesis, University Of Strathclyde.

Strathprints is designed to allow users to access the research output of the University of Strathclyde. Copyright © and Moral Rights for the papers on this site are retained by the individual authors and/or other copyright owners. You may not engage in further distribution of the material for any profitmaking activities or any commercial gain. You may freely distribute both the url (<http://strathprints.strath.ac.uk/>) and the content of this paper for research or study, educational, or not-for-profit purposes without prior permission or charge.

Any correspondence concerning this service should be sent to Strathprints administrator: <mailto:strathprints@strath.ac.uk>



Kokogiannakis, G. (2009) Support for the integration of simulation in the European Energy Performance of Buildings Directive. PhD thesis, University of Strathclyde.

<http://strathprints.strath.ac.uk/7816/>

Strathprints is designed to allow users to access the research output of the University of Strathclyde. Copyright © and Moral Rights for the papers on this site are retained by the individual authors and/or other copyright owners. You may not engage in further distribution of the material for any profitmaking activities or any commercial gain. You may freely distribute both the url (<http://strathprints.strath.ac.uk>) and the content of this paper for research or study, educational, or not-for-profit purposes without prior permission or charge. You may freely distribute the url (<http://strathprints.strath.ac.uk>) of the Strathprints website.

Any correspondence concerning this service should be sent to The Strathprints Administrator: [eprints@cis.strath.ac.uk](mailto:eprints@cis.strath.ac.uk)

**Support for the Integration of Simulation in the  
European Energy Performance of Buildings Directive**

Georgios Kokogiannakis B.Eng., M.Sc.

A thesis submitted for the  
Degree of Doctor of Philosophy

Energy Systems Research Unit  
Department of Mechanical Engineering  
University of Strathclyde

December 2008

## **COPYRIGHT DECLARATION**

The copyright of this thesis belongs to the author under the terms of the United Kingdom Copyright Acts as qualified by the University of Strathclyde Regulation 3.51. Due acknowledgement must always be made of the use of any material contained in, or derived from, this thesis.

## Table of contents

CHAPTER 1: DESIGN FOR SUSTAINABILITY .....	1
1.1 Introduction .....	1
1.2 Global and local external environmental issues .....	2
1.2.1 <i>Global warming</i> .....	2
1.2.2 <i>Acid rain</i> .....	3
1.2.3 <i>Ozone depletion</i> .....	4
1.2.4 <i>Materials and energy resources depletion</i> .....	4
1.2.5 <i>Local air pollution</i> .....	5
1.2.6 <i>The effect on the urban environment</i> .....	6
1.2.7 <i>Other global and local issues</i> .....	7
1.3 Indoor environmental performance issues .....	8
1.3.1 <i>Indoor air quality</i> .....	8
1.3.2 <i>Comfort</i> .....	9
1.3.3 <i>Humidity levels, condensation risk and mould growth</i> .....	11
1.3.4 <i>Operational Energy</i> .....	12
1.3.5 <i>Technical systems</i> .....	14
1.4 Benefits of sustainable design .....	16
1.5 Achieving sustainable design with integrated energy performance simulation programs .....	17
1.6 Research Objectives and Thesis Outline .....	18
1.7 References .....	21
CHAPTER 2: EUROPEAN ENERGY PERFORMANCE OF BUILDINGS DIRECTIVE .....	27
2.1 Introduction .....	27
2.2 Background and objectives of the Directive .....	27
2.3 Content of the Directive .....	30
2.4 Implementation of the Directive .....	33
2.5 Discussion and future evolution of the Directive .....	37
2.6 Summary .....	38
2.7 References .....	39
CHAPTER 3: CALCULATION METHODS FOR HEATING AND COOLING ENERGY REQUIREMENTS .....	42
3.1 Introduction .....	42
3.2 CEN ISO 13790 Standard simplified methods .....	44
3.2.1 <i>Quasi-steady state monthly method</i> .....	45
3.2.2 <i>Simple hourly method</i> .....	58
3.3 Detailed simulation programs .....	66
3.4 CIBSE steady state methods .....	73
3.4.1 <i>Reference Model</i> .....	73
3.4.2 <i>Basic Model</i> .....	74
3.4.3 <i>Simple Model</i> .....	74
3.5 CIBSE dynamic methods .....	75
3.6 ASHRAE simplified methods .....	76
3.6.1 <i>Radiant-time series method</i> .....	76

3.6.2 <i>Weighting-Factor method</i> .....	77
3.7 Degree-Day methods.....	77
3.8 Thermal-Network methods.....	81
3.9 Assumptions and limitations of the various calculation methods .....	82
3.10 Previous comparisons between calculation methods .....	86
3.11 Summary .....	88
3.12 References .....	90

#### CHAPTER 4: INTEGRATED MODELLING APPROACH – FUNCTIONALITY OF SIMULATION PROGRAMS..... 94

4.1 Introduction .....	94
4.2 Global and local external environmental issues: Functionality requirements for simulation programs .....	103
4.2.1 <i>Global Warming</i> .....	103
4.2.2 <i>Acid rain</i> .....	104
4.2.3 <i>Ozone depletion</i> .....	105
4.2.4 <i>Materials and energy resources depletion</i> .....	106
4.2.5 <i>Local air pollution</i> .....	107
4.2.6 <i>The effect on the urban environment</i> .....	108
4.3 Indoor environmental performance issues: Functionality requirements for simulation programs .....	110
4.3.1 <i>Indoor air quality</i> .....	110
4.3.2 <i>Thermal comfort</i> .....	113
4.3.3 <i>Visual comfort</i> .....	116
4.3.4 <i>Acoustic comfort</i> .....	117
4.3.5 <i>Humidity levels, condensation risk and mould growth</i> .....	119
4.3.6 <i>Operational energy – thermal energy requirements</i> .....	120
4.3.7 <i>Operational energy – peak thermal loads</i> .....	122
4.3.8 <i>Operational energy – electrical energy requirements</i> .....	124
4.3.9 <i>Operational energy – peak electrical loads</i> .....	125
4.3.10 <i>Operational energy – systems’ performance</i> .....	126
4.4 Summary .....	128
4.5 References .....	130

#### CHAPTER5: IMPACT OF USING DIFFERENT MODELS IN A REGULATORY CONTEXT – CASE STUDIES..... 136

5.1 Introduction .....	136
5.2 First group of cases.....	140
5.2.1 <i>Building model details and parametric analysis</i> .....	140
5.2.2 <i>Model equivalencing</i> .....	143
5.2.3 <i>Results and discussion</i> .....	147
5.2.4 <i>Optimising the monthly method of the 13790 Standard</i> .....	153
5.2.5 <i>Optimisation results</i> .....	154
5.3 Second group of cases .....	157
5.3.1 <i>Building model details and parametric analysis</i> .....	157
5.3.2 <i>Model equivalencing</i> .....	161
5.3.3 <i>Results and discussion</i> .....	161

5.3.4 <i>Optimising the monthly method of the 13790 Standard and optimisation results</i> .....	166
5.4 Discussion and closing remarks .....	169
5.6 References .....	174
 CHAPTER 6: INTEGRATED MODELLING: SELECTION AND QUALITY ASSURANCE .....	
6.1 Introduction .....	176
6.2 Embedded validation .....	179
6.2.1 <i>General framework</i> .....	179
6.2.2 <i>ANSI/ASHRAE Standard 140 Building Thermal Envelope and Fabric Load Tests</i> .....	180
6.2.3 <i>EN ISO 13791 Standard: Calculation of Internal Temperatures of a Room in Summer without Mechanical Cooling</i> .....	184
6.3 Results from implementation of ASHRAE 140 Standard .....	185
6.4 Results from implementation of EN ISO 13791 Standard .....	189
6.5 Sensitivity studies for ASHRAE 140 Standard .....	194
6.5.1 <i>Embedded validation: Sensitivity study – Sky temperature calculation</i> .....	195
6.5.2 <i>Embedded validation: Sensitivity study - External convection</i> .....	199
6.6 Discussion and closing remarks .....	204
6.9 References .....	207
 CHAPTER 7: CONCLUSIONS AND RECOMMENDATIONS FOR FUTURE WORK .....	
7.1 Conclusions .....	211
7.1.1 <i>The ability of simulation programs to respond to the required functional for a sustainable design of buildings</i> .....	212
7.1.2 <i>The application of integrated simulation programs and the simplified calculation methods of the CEN Standards in the same regulatory context</i> .....	213
7.1.3 <i>Embedded validation as an aid for program selection and code quality assurance</i> .....	217
7.2 Recommendations for future work .....	219
7.2.1 <i>Extending the comparisons between simplified methods and simulation programs in other areas of energy performance calculations</i> .....	219
7.2.2 <i>Extending the embedded validation facility</i> .....	220
7.2.3 <i>Future enhancements to the capabilities of simulation programs</i> .....	220
7.2.4 <i>Task-based interfaces for energy performance calculation methods</i> .....	221
7.3 References .....	225
 APPENDIX A: DETAILS OF CASE STUDIES .....	
A.1 Introduction .....	227
A.1.1 <i>Base case for the first group of cases – Quality Assurance report</i> .....	227
A.1.2 <i>Base case (heating) for the second group of cases – Quality Assurance report</i> .....	244
 APPENDIX B: DISCUSSION ON THE NUMERICAL OUTPUTS FROM THE CALCULATION METHODS OF THE 13790 STANDARD .....	
B.1 Introduction .....	260

B.2 First group of cases – Space heating results .....	260
B.3 First group of cases – Space cooling results .....	262
B.4 Second group of cases – Space heating results.....	264
B.5 Second group of cases – Space cooling results.....	265
APPENDIX C: BASE CASE - FIRST GROUP OF CASES: HEAT GAINS AND LOSSES ANALYSIS .....	266
C.1 Introduction.....	266
C.2 Heat gains and losses outputs .....	266
APPENDIX D: FULL SET OF RESULTS FROM THE OPTIMISATION OF MONTHLY’S METHOD NUMERICAL PARAMETERS .....	269
D.1 Introduction .....	269
D.2 Full set of optimisation results (First group of cases) .....	269
APPENDIX E: EMBEDDING THE CEN 15265 VALIDATION TESTS WITHIN ESP-r .....	277
E.1 Introduction.....	277
E.2 Results from implementation of CEN 15265 Standard .....	278
E.3 References.....	281



## **Acknowledgements**

I would first like to thank my supervisors Dr Paul Strachan and Professor Joe Clarke for their continuous help and useful guidance they gave me during the years of study for this degree. They have put a lot of effort to guide me to the right direction for completing this work and I am sincerely grateful to them.

I would also like to thank the staff and students in ESRU (past and present) for their cooperation and the interesting discussions that we had all these years. This highly skilful team gave me the chance to exchange ideas and to learn a lot from their experiences. In particular, special thanks go to Dr Jon Hand and Dr Iain Macdonald for advising me whenever I needed help for the use and coding of ESP-r.

I also wish to thank the State Scholarships Foundation (I.K.Y) of Greece for providing financial assistance during the early years of this work.

Finally parents, friends and wife have all been supportive to me and I thank them for this.

## **Abstract**

Concerns about the security of energy supply in Europe and the reduction of greenhouse gas emissions led to the introduction of the European Energy Performance of Buildings Directive (EPBD). A key requirement within the EPBD is that Member States will need to adopt a methodology for calculating the integrated energy performance of buildings. This thesis is concerned with the use of detailed energy simulation programs to address this requirement of the EPBD and its possible future evolution.

The analysis identified the functionality requirements that these programs should include in order to be able to perform the current calculations needed for the EPBD and a wider range of assessments related to sustainable building designs. It was concluded that:

- The capabilities of integrated detailed simulation programs are greater than those required by recent energy performance regulations that are implementing the EPBD.
- These programs offer a large number of capabilities with regards to assessments needed during the design of sustainable buildings and are capable of responding to additional requirements that a possible future evolution of the EPBD will introduce. However, limitations and possible future developments with respect to the capabilities of these programs were also identified.

The option of using integrated detailed simulation programs for the purposes of the EPBD, as well as prescribed simplified methods, has been included within the new set of EPBD-related CEN Standards. One of the main Standards, the 13790 Standard that provides methods for calculating space heating and cooling energy requirements, has been used in case studies to investigate the impact of applying a number of calculation methods of varying complexity in a regulatory context. Model equivalencing procedures for the inputs and boundary conditions were followed to comply with the Standard's specifications. Considerable differences in the compliance results of the various calculation methods were found in some cases, in

particular when a building with ventilated double façade was studied. The detailed simulation programs used in the study produced similar outputs with each other when their inputs and algorithms were constrained to follow the instructions in the 13790 Standard.

Validation tests can offer useful assistance for the selection of programs that are able to predict the energy performance of buildings in an accurate way and they can give confidence to practitioners that the programs they are using are able to produce reliable results. An embedded validation facility within the ESP-r program is presented in the last part of the thesis where validation tests from recent energy performance Standards are integrated within the simulation program for easy access by users. Details of the implementation of this facility and the benefits that it offers to users and developers are discussed and demonstrated.

DESIGN FOR SUSTAINABILITY

**1.1 Introduction**

Sustainable design of buildings has become a desirable goal and a popular request from society due to its increasing importance and the possible benefits that could be gained from it. A large number of architecture and engineering firms have started specialising in this way of designing buildings or they provide it as an extra service in order to increase their market by responding to the increasing demand for it, improve their reputation and promote any relevant energy, environmental and economic benefits.

Several attempts have been made to define sustainability. A common definition of this term is the one given by the World Commission on Environment and Development which defines sustainable development as the development that meets the needs of the present without compromising the ability of future generations to meet their own needs (WCED, 1987). However, all the definitions so far have been found inadequate to describe sustainability due to the different topics that could be included within this term. Sustainable design of buildings is considered as the method to design buildings that are more energy efficient, demand less resources and create a healthier indoor environment than the more traditionally designed buildings (Swan 2003). This definition is used for the purposes of this thesis to define the sustainable design of buildings and the outcome of this type of design is used for the definition of sustainability. Although this chapter does not intend to define sustainability in absolute terms, it attempts to discuss its importance together with all the challenges and the problems that make this method of design a necessary practice for the current and the future building design methodologies.

These challenges are divided in this chapter in two main sections: those related with global and local external environmental issues and those related with indoor

environmental performance issues. The complexity often associated with addressing these challenges and the interactions often encountered between them suggest that they should be studied with tools that consider them as integrated and not as separate processes, such as the integrated building energy simulation programs. Integrated building energy simulation programs have been used in various ways by building professionals in order to respond to these challenges and assist them improve the building designs towards the aim of sustainability. This has imposed functionality requirements for these programs that are further discussed in detail in chapter 4.

## **1.2 Global and local external environmental issues**

### ***1.2.1 Global warming***

Global warming is a term used to describe the overall increase in the earth's average ground and atmospheric temperatures. Although the causes of this are still debatable and not fully proved, a large number of people in the area believe that an increase in heat-trapping (greenhouse) gases in the atmosphere over recent decades has contributed to the global warming. In any case, this possible global warming topic has become popular nowadays.

Buildings are producing a large amount of greenhouse gas emissions (Commission of the European Communities, 2005) and mainly carbon dioxide (CO<sub>2</sub>) emissions which are considered as the most important regarding the overall emissions level and global warming potential (IPCC, 1996). CO<sub>2</sub> is transparent to the incoming shortwave radiation but opaque to outgoing longwave (infrared) radiation emitted by the earth's surface (Cline, 1992). This results in the trapping of longwave radiation close to the surface of the earth and it is believed that causes increased temperatures at the surface of the earth.

Buildings contribute to these emissions mainly because of the energy consumed to cover their needs for heating, cooling, hot water, lighting and auxiliary devices, which is in many cases associated with the direct consumption of fuels like natural gas and petroleum. Emissions are also produced in many cases due to the energy

needed for building materials such as brick and steel and building products such as appliances and furniture. More detailed scenarios could consider the fuel used for the transport of the construction and demolition materials or the effect of using wood intensive products that can serve as carbon sinks – reducing net CO<sub>2</sub> emissions.

Overall, sustainable design of buildings can have a positive contribution to the attempts for reducing greenhouse gas emissions and limiting the effect of global warming. The UK for example, under the Kyoto agreement, has to reduce greenhouse gas emissions to 12.5% below 1990 levels by 2010. However, the targets agreed for Kyoto Protocol were not considered by some countries as adequate to dramatically change the effect of global warming and for this reason, they have set more ambitious reduction targets. In the case of UK, by 2010 the aim is to reduce the carbon dioxide emissions by 20% below 1990 levels (DETR, 2000).

### ***1.2.2 Acid rain***

Acid rain occurs when sulphur dioxide (SO<sub>2</sub>) and nitrogen oxides (NO<sub>x</sub>) are emitted and combined with water in the upper atmosphere. The result of this is the formation of acidic compounds that are then deposited back to the earth's surface as acid rain. Acid rain is responsible for damage to plants, aquatic life and buildings (Driscoll et al., 2001; Coote et al. 1989).

High levels of SO<sub>2</sub> produced from the combustion of sulphur-containing fossil fuels, such as coal used for electricity production, are usually the major cause of acid rain in both developed and fast developing countries.

Moreover, the use of natural gas, for example in classic central heating boilers, generates NO<sub>x</sub> emissions during the combustion process which can also contribute to acid rain.

Buildings are responsible for a large part of these emissions. In the United States, for example, buildings are responsible for 36% of the country's energy demand, 68% of

the electricity production (more than half of which is generated from coal), and nearly 40% of the country's natural gas consumption (DOE 2002). As a result, buildings in the United States account for approximately 48% of the overall national SO<sub>2</sub> emissions, 20% of the NO<sub>x</sub> , and 36% of the CO<sub>2</sub> (DOE 2002).

### ***1.2.3 Ozone depletion***

The use of materials that are harmful to the environment should be minimised at every stage of buildings' life cycle. An example of this is the use of chlorofluorocarbons (CFC) in building systems. CFCs have been used, and are still in some cases being used, in buildings as the working fluid in refrigeration and air conditioning systems, and in a few cases as a blowing agent for insulation materials. The escape of CFCs into the atmosphere leads to the depletion of ozone (O<sub>3</sub>) in the upper layers of the atmosphere and causes the ozone hole that allows the harmful wavelengths of ultraviolet (UV) radiation to pass the atmosphere and reach the earth's surface (Molina and Rowland, 1974). Increased levels of ultraviolet radiation have several adverse human health and environmental effects. Health effects include increased incidence of skin cancer, increased eye cataracts, and suppression of the human immune response system (Gallagher and Lee, 2006). Environmental damages include, for example, damage to crops and to marine phytoplankton (UN, 2003). More recent technologies replace CFCs with hydrofluorocarbons (HFCs), which although they have less or negligible impact on the ozone problem, they still possess some health and environmental hazards (e.g. global warming, flammability hazard, adverse effect of exposure). A summary of these hazards is given by Tsai (2005). Minimisation of the use of systems that function with these chemicals should be achieved through sustainable design.

### ***1.2.4 Materials and energy resources depletion***

A considerable amount of physical resources such as materials, energy and water are used during the whole lifetime of buildings. This includes the use of resources at the early stages of the building's life cycle before the building is constructed, for

example the materials manufacturing stage, until its latest stages, for example at the stage where the building materials are recycled or disposed of.

Buildings through their life cycle, and including their construction stages, are responsible for the consumption of around half of all the resources humans take from nature (UNEP, 2003). Various estimates also indicate that buildings use 30% of the raw materials consumed in the United States (EPA, 2001).

The building and construction sector (i.e. including production and transport of building materials) in OECD countries consumes 25–40% of all energy used (as much as 50% in some countries) (UNEP, 2003). Production of building materials, as well as the construction, operation, renovation and the eventual decommissioning of buildings consume about 36% of primary electrical energy generated in the United States (Howard, 1993).

These figures highlight the importance of considering the materials and energy resources depletion issue during the design of sustainable buildings.

### ***1.2.5 Local air pollution***

Air pollution could be characterised by winter and summer smogs (Netcen, 2005). Winter smogs typically occur in cold, still and foggy weather. These weather conditions trap pollution produced from various sources including space heating or electricity generation plants. Winter episodes are usually characterised by elevated levels of nitrogen dioxide, PM<sub>10</sub> particles and volatile organic compounds (VOCs) such as benzene. High SO<sub>2</sub> levels can also occur in some industrial or coal burning regions.

By contrast, summer smogs occur in hot and sunny weather. Sunlight and high temperatures accelerate chemical reactions in mixtures of air pollutants that are emitted again from various sources including those from burning fuel to cover buildings' energy needs. The pollutants that cause such an episode can often travel



long distances. During the large-scale air movement, they react together to produce high levels of O<sub>3</sub>, as well as other pollutants such as nitrogen dioxide and fine particles (i.e. PM<sub>10</sub>). Unlike the ozone layer in the upper levels of the atmosphere that provides protection from the ultraviolet radiation, ground level ozone produced in this way is harmful to both human health and vegetation.

In all cases, air pollution has long been recognised as posing a significant risk to human health and the environment. It was estimated that in the year 2000, exposure to particulate matter reduced average statistical life expectancy by approximately nine months in the EU-25. This equates to approximately 3.6 million life years lost or 348,000 premature mortalities per annum. In addition to these estimations, the same year there were approximately 21,400 cases of hastened death due to ozone. (EU, 2005).

Improving the energy performance of buildings through sustainable design could limit the building related emissions and therefore the related air pollution problems.

### ***1.2.6 The effect on the urban environment***

Heat islands develop when a large fraction of the natural land cover in an area is replaced by built surfaces that absorb incoming solar radiation during the day and then re-radiate it at night (Quattrochi et al., 2000; Oke, 1982). This slows the cooling process thereby keeping nighttime air temperatures high relative to temperatures in less urbanised areas (Oke, 1982). This increase in urban air temperatures as compared to surrounding suburban and rural temperatures is referred to as the heat island effect. Additional causes of the heat island effect are the anthropogenic heat sources (e.g. waste heat from transportation, heating and excessive use of air conditioning, etc.), the reduced air flows due to tall buildings and narrow streets and the displacement of trees and vegetation (Graves et. al., 2001). Trees and vegetation usually maximise the natural cooling effects of shading and evaporation of water from soil and leaves.

Heat islands of varying extent and magnitude have been observed in most urbanised areas in the world (Landsberg, 1981). Central London for example, has been several degrees warmer than surrounding rural areas (Lee, 1992). A study for Athens has shown that city layout, pollution and high anthropogenic heat input from traffic, buildings and industry can produce daytime city temperatures that are much higher than the surrounding countryside (Santamouris, 1998; Littlefair, 2000). A positive peak heat island peak temperature difference of 7–8 °C compared with the surrounding areas has been recorded in the centre of Athens at midday, rising to 12–13 °C in specific high traffic density streets (Littlefair, 2000).

Buildings in urban environments can also affect the outdoor wind speed and the patterns of wind direction within these areas. This will have an effect on the buildings' energy usage (i.e. low wind speeds due to the sheltering effect of neighbouring buildings will result in low external convection heat transfer coefficients) and the decision for the ventilation strategy as it may change the infiltration rates and the local ambient air quality.

Finally buildings in urban environments may have an impact also on the shading and daylight availability of the surrounding buildings, which indirectly may affect the energy usage in these surrounding buildings (for example, with the regular use of artificial lighting).

### ***1.2.7 Other global and local issues***

There are also additional impacts that are usually taken into account during sustainable design studies, such as those related with water resources, land use and transport (e.g. building location with regards to roads with high traffic levels). However, a discussion for these additional challenges is not included here because this thesis is focusing only on the issues that the building's energy performance is directly or indirectly related to.

## **1.3 Indoor environmental performance issues**

### ***1.3.1 Indoor air quality***

Indoor air quality is directly related with the health of occupants and their productivity in buildings. Headaches, allergies, asthma symptoms and other diseases are often diagnosed for the occupants of buildings with poor indoor air quality being the main cause (Hanssen, 2004). Regarding the productivity of the occupants in buildings, experiments showed for example that poor indoor air quality can reduce the performance of office work by 6-9% (Wyon, 2004). Over recent decades the energy conservation regulations in buildings has led to an increase in air tightness of buildings, and therefore a reduction in the number of air changes with the external environment. In addition, the lower ventilation rates in the building spaces increased the levels of room air relative humidity and led to mould growth on insufficiently insulated parts of the building envelope, and especially, on thermal bridges in the envelope (ODPM, 2006). These changes to the indoor conditions often necessitated the installation of mechanical ventilation. Taking also into account that people now spend a lot of their time indoors, the indoor air quality issue should not be underestimated during the design of sustainable buildings.

In any case, it is necessary to ensure that an acceptable indoor air quality will be achieved by minimising the concentration of contaminants in the occupied spaces of the building and by ensuring that the required amount of fresh air is provided to them. The type of contaminants can vary depending on the specific case of building. It can, for example, vary for different uses or regions of buildings, such as buildings located next to roads with high traffic volume, or for different materials that are used during the buildings' construction and operation. Samuel (2006) summarises the main pollutants that can be found in the buildings' indoor environment. Examples of these common indoor pollutants are: carbon dioxide (CO<sub>2</sub>), nitrous oxide (N<sub>2</sub>O), carbon monoxide (CO), nitrogen dioxide (NO<sub>2</sub>), sulphur dioxide (SO<sub>2</sub>), ozone (O<sub>3</sub>).

To find ways to provide the required amount of fresh air in buildings without increasing their capital cost and the energy consumption, for example without

mechanical ventilation, is one of the big challenges that design teams typically have to face.

### ***1.3.2 Comfort***

Comfort is another aspect related with the buildings' energy performance and is considered during sustainable design. This aspect includes the thermal, visual and acoustic environment of buildings and as for the indoor air quality aspect, it affects the productivity and the general living of the occupants inside them.

In the ISO Standard 7730 thermal comfort is defined as the condition of mind which expresses thermal satisfaction with the thermal environment (ISO 1994). Studies show that thermal sensation complaints in buildings account for 75% of all environmental complaints from occupants (Federspiel, 1998). It is therefore essential that any energy saving measures should not be taken if they have a negative impact on the indoor thermal conditions and the thermal comfort of the occupants.

Poor design of buildings in relation with the local external climate conditions can cause overheating, even in temperate or cold climates where such problems traditionally never existed (Roaf et al, 2003). Sustainable building designs eliminate the creation of under-heated and over-heated spaces, especially during the occupied hours of the building.

The visual environment has also to be adapted to the visual needs of the occupants so that the visual tasks in the building spaces are performed efficiently, accurately and safely without causing undue visual fatigue and discomfort. Visual comfort is usually achieved by providing adequate levels of illuminance in the building spaces. Research also indicates that an uncomfortable level of glare may cause serious problems, for example reduced performance of the building occupants (Velds, 1999). This is especially important at specific places of interest locally inside buildings, such as desk study areas. If a bright light source occurs in the field of occupants' view, either directly or by reflection as illustrated in Figure 1.1, it is likely to cause

distraction, possibly visual discomfort or, in extreme cases, visual disability. To prevent this, it is necessary to minimise or exclude all bright sources from the normal and reflected field of occupants' view.

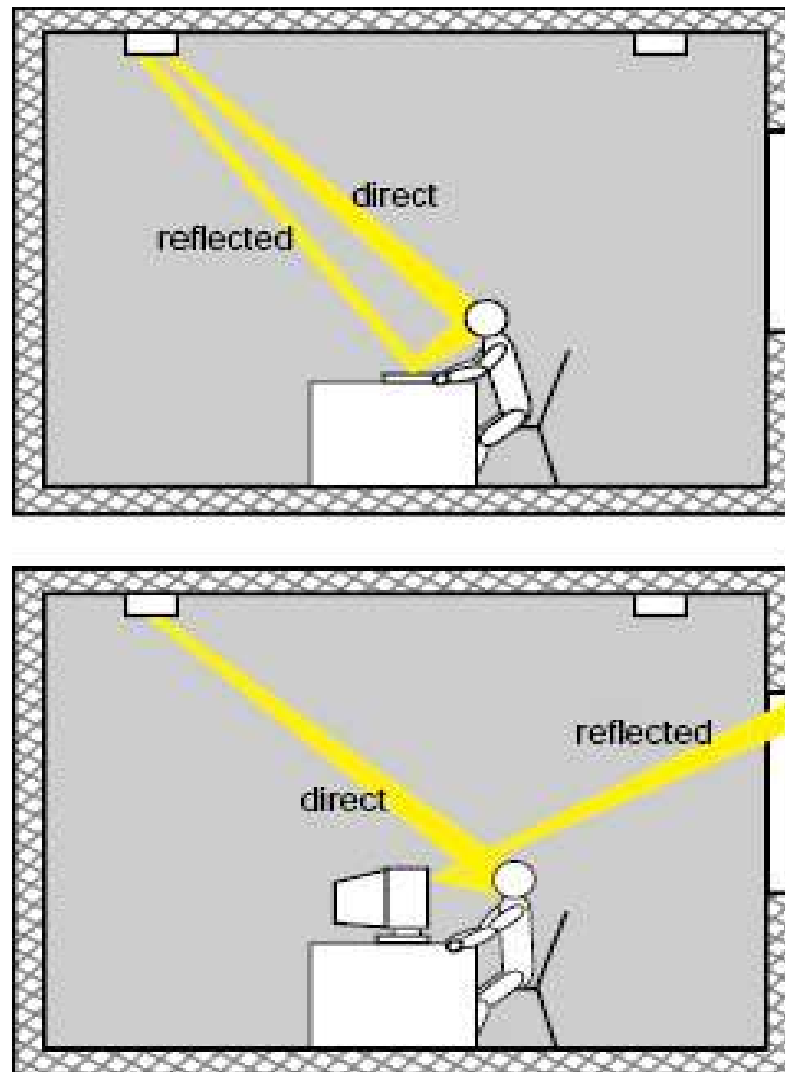

Figure 1.1 Example of direct and reflected sources of glare in a room (DETR, 1999)

Incorrect design decisions for the size and position of the glazing areas could lead to excessive glare and summer solar gains or inadequate levels of daylight and therefore increase the electricity consumption of the building. The same applies for the different lighting control strategies where it has to be ensured for example that they do not create irritation and interference to occupants.

Attention has to be paid to avoid potential conflicts between local overheating and the desire to maximise thermal and daylighting benefits of solar radiation. An overall balance between them should be achieved through sustainable design.

Acoustic comfort is another comfort factor that should not be ignored, especially for those buildings where the quality of sound is important for their function (e.g. offices, theatres, etc.).

Indoor spaces in buildings can be noisy due to unwanted noise from outside the building or even due to the inability of internal surfaces to absorb the noise produced from inside the building. The choice of the type of constructions for the walls, floors and ceilings in sustainable buildings has to be made by ensuring that any potential noise will be isolated or absorbed and at the same time there will be no adverse effects on other aspects of the building's energy performance, such as thermal comfort. For example, thermal mass might be beneficial for acoustic comfort but at the same time could also cause thermal discomfort or vice versa. In order to achieve acoustic comfort, there should be no unwanted sounds in the building spaces that could prevent the occupants from carrying out their tasks comfortably and without distraction.

The selection of building fabric materials and the appropriate consideration of the ventilation strategies can have a significant impact on the acoustic comfort inside the building spaces. In some cases for example, the use of heavyweight surfaces to provide thermal mass will reduce the acoustic absorption and lead to a reverberant space. Some natural ventilation systems or large openings associated with them in commercial buildings, such as inlets for chimney exhaust systems, might transmit noise from outside to inside the building spaces.

### ***1.3.3 Humidity levels, condensation risk and mould growth***

The levels of humidity and the risk of developing condensation have always been of a concern during the design and operation of buildings in order to avoid implications

on health and structural degradation. Cornish et al. (1986) report that, at the time of their research, surface condensation was affecting about 15 percent of the UK housing stock.

Increased humidity levels can result in indoor microbiological growth and discomfort (Bayer et al., 2002), while they may also have an effect on the preservation of artefacts in specific types of buildings (CIBSE, 2006). Camuffo and Sturaro (2000), for example, describe how condensation leads to problems for the artworks and paintings within churches. Fuller and Luther (2003) state that there are also specific types of commercial buildings (e.g. roller-skating centres) where condensation can be dangerous for their occupants. Moon (2005) summarises the findings of previous research studies on the health implications from mould growth in buildings. It was found, for example, from these studies that mould developed in buildings is linked to asthma symptoms, coughing, wheezing, and upper respiratory tract symptoms.

The risk of development of surface and interstitial condensation in buildings and as well of mould growth should be minimised through sustainable design that takes into account the potential operational characteristics of the buildings (for example, churches have mainly one day per week high occupancy). The design decisions will determine in particular the appropriate combinations of materials and systems in these buildings that could be used to ensure condensation and mould growth will not occur.

#### ***1.3.4 Operational Energy***

The operational energy of buildings is a term used to describe the energy that is required to cover their thermal and electrical needs during their years of operation. This is another important aspect that is considered for the performance of sustainable buildings not only because of the greenhouse gas emissions and any other environmental impacts produced in order to cover these needs but also because of the large potential for energy savings when the buildings' design is optimised towards this.

Building shape, shading, orientation, fabric, lighting configuration, windows, air flow paths, control systems, electrical power flows and high efficiency plant systems that match the thermal and electrical demand are examples of the different design aspects that have to be optimised, especially during the early design stages, so that the maximum potential energy savings will be achieved.

In Denmark, for example, applying cost-effective energy saving measures to residential buildings could reduce their space heating energy requirements by about 80% up to year 2050 and by about 30% up to year 2030 (Tommerup and Svendsen, 2006). Assuming a similar improvement for the energy consumption of domestic hot water, electricity consumption for heating and ventilation systems and also including non-residential buildings, the total thermal and electrical heating-related energy consumption in the Danish building stock could be reduced to 20% of the current level (Tommerup and Svendsen, 2006).

Similar conclusions could be drawn from studies done for specific types of buildings such as for example, hotels. Hotels vary greatly in size, standards, occupancy level throughout the year, etc. and they offer a large potential for energy savings. A previous study (Santamouris et al, 1996) presented several scenarios to reduce energy consumption levels for 158 already existing Hellenic hotels by using different simulations. The annual average total energy consumption of these hotels was measured as 273 kWh/m<sup>2</sup> and it was concluded that it is possible to reach an overall 20% reduction of the average energy consumption without disturbing the function of these hotels. The same study showed that savings for these buildings could even exceed 40% when using advanced energy systems (e.g. high performance lamps).

Another example is the commercial and public buildings in UK where it is estimated that it is possible to reduce their energy consumption by at least 20% using cost effective measures (CIBSE, 2004). These figures are even larger for new buildings or buildings that undergo major renovations. New low-energy buildings in UK consume around 50% less energy than similar existing buildings and 20% less than typical new buildings (CIBSE, 2004).



These figures are of high importance considering the large amount of energy used in buildings. In 2000 for example, the UK delivered energy consumption was 6695 PJ of which 3120 PJ was used in buildings (DTI, 2000). Other estimations in UK approximate the total cost of energy in buildings to £21.3 billion per annum (CIBSE, 2004). Similar figures for the proportion of energy used in buildings were obtained for other European countries, for example Sweden (SEA, 2002).

In the EU, space heating represents about 57 per cent of total consumption in residential buildings and 52 per cent in non-residential buildings. If cooling and water heating are included in the figures for residential buildings and cooling, water heating and lighting are included in the figures for non-residential buildings, they represent 89 per cent and 79 per cent of the total consumption of residential buildings and non-residential buildings respectively (Janssen, 2004).

It is therefore important to optimise all the aspects that affect the operational energy of the building and minimise the amount of energy consumed without affecting the function of the building.

### ***1.3.5 Technical systems***

Technical systems in buildings typically include their plant systems (e.g boilers, building integrated renewables, etc.) and the components associated with them (e.g. radiators, air diffusers, controls, etc.). Plant systems are used in buildings to generate heat and power in order to cover the buildings' thermal and electrical needs. Plant systems are also used for providing fresh air inside the building spaces at conditions that improve or maintain the occupants' health and comfort.

In the UK, fans and pumps are oversized by at least 15%, with the capacity of boilers and chillers often oversized more than this. It is estimated that this oversizing is typically responsible for approximately 10-15% of HVAC related energy consumption (Brittain, 1997).

An oversized plant, apart from the high capital cost, usually also results in high fuel consumption during its operation and therefore high operation cost and high emissions to the environment. However, the overall performance of a building system depends not only on the individual dynamic efficiencies of each plant item but on the combined performance of all the components within the loop of this system and in many cases from the performance of other systems. Therefore, it is important to investigate the efficiency of the whole system. An oversized damper, for example, will provide less resistance to airflow and the system will require lower capacity of the fan. In turn, an oversized fan will generate additional heat and therefore will increase the cooling loads due to the additional parasitic heat losses. Oversizing issues could also arise when building integrated renewable systems are used, such as PV-solar cells. This is because of the high capital cost of these systems and the different pricing policies between countries when exporting any excess electricity produced from these systems back to the national grid. Thus, in cases where generation and distribution systems are involved (e.g. district heating and cooling systems), it is necessary to optimise their efficiency in order to avoid, for example, unnecessary heat losses.

Overall, an oversized system will operate for large proportions of the time under part load conditions and in most cases with, consequently, lower energy efficiency (exceptions are systems such as chillers, heat pumps, radiators, etc.).

The potential benefits that different technologies can have against classic plant installations is also often underestimated or ignored during the design of buildings, for example the option of using micro-combined heat and power systems (CHP) or building-integrated renewable systems against other boiler technologies. Regarding this example, Peacock and Newborough (2005) estimated that the annual savings for UK dwellings amount to 574 kg CO<sub>2</sub> for a 1 kW CHP Stirling engine system and 892 kg CO<sub>2</sub> for a 1kW CHP fuel cell system, when compared to a non-CHP base case of employing a condensing boiler of 90% efficiency and network electricity. The same applies for the different possible ventilation strategies and especially where the use

of natural ventilation is applicable instead of mechanical ventilation systems. In these cases, natural ventilation could offer a cheaper and, if a high efficiency heat recovery system is not used, a more environmental friendly option due to the fact that there is no need to purchase HVAC plant systems and there is less energy consumed than that needed for the mechanical ventilation systems operation (e.g. no fans are used). On the other hand, the option of using a high efficiency heat recovery ventilation system could also offer energy savings and its feasibility against the other potential ventilation strategies should be considered during the building design.

#### **1.4 Benefits of sustainable design**

Socio-economic and environmental benefits from designing sustainable buildings are with no doubt many and important. There have been ample publications in the literature analysing these benefits in detail (e.g. DOE, 2003; Yates, 2001; Yates, 2003) and this section will only discuss them briefly.

Preventing the problems and the consequences already described in this chapter can be an incentive for designing sustainable buildings. Sustainable design tends to lead to lower energy and fuel consumption than the more typical designs during the whole life cycle of the buildings. This improves the air and water quality by reducing the related emissions to the environment and especially the greenhouse gases emissions. Natural resources are also managed in a better way (e.g. reduced environmental impacts from the reduced amount of materials used in buildings) and, due to the reduced energy demand, there is less need for new power plants and transmission lines. Regarding the economic benefits, sustainable design techniques usually reduce the operation and maintenance cost of the building and in many cases the initial capital cost. For example, ancient or historic buildings will require less maintenance if the outdoor air pollution is limited. Building lifetimes are in many cases longer and this could increase their asset value. Indoor conditions match the occupants' needs and their comfort, health and productivity are also improved. At a national level, it leads to the reduction of the energy demand and therefore there is less dependency on countries that control the energy market, limiting potential problems with the

security of energy supply. Especially in Europe, by 2025 to 2030 around 70% of the Union's energy requirements, compared to 50% in 2005, will be met by imported fuels – some from regions threatened by insecurity (Commission of the European Communities, 2006). In addition, the Kyoto protocol obligations make the need for sustainable design of buildings in Europe a necessary policy for the future.

The European Energy Performance of Buildings Directive (EU, 2003) is one of the latest attempts to promote through legislation the sustainable design of buildings by targeting their operational energy consumption and the emissions associated with this. A description of this Directive together with the suggested methods of implementation is given in chapter 2.

### **1.5 Achieving sustainable design with integrated energy performance simulation programs**

Achieving a sustainable design requires all the building energy performance challenges that were mentioned in this chapter to be taken into account during the design process. However, this should be done with methods and programs that treat all of them simultaneously as an integrated process without ignoring potential interactions between them that could have negative effects on the final performance of the design. This is in contrast with many traditional design approaches from different building professionals that often treat only some of these aspects on their own and with prescriptive approaches without interacting with other members of the design team (Hopfe et al., 2006). For example, architects optimised the building form and fabric, building services engineers made the decisions for the HVAC systems and electrical engineers for the electrical installations. This separate treatment of the different design appraisals has meant that the implications of decisions by one part of the design team were not considered on other areas of the building's performance. For example, optimising the position and the size of windows for better daylighting could possibly create increased heat losses in winter (e.g. higher fabric U-values) and increased unwanted solar gains in summer leading to possible overheating and therefore to the need for installing large HVAC systems.

During traditional design approaches, building professionals have relied on a range of different programs (e.g. CAD, tools for lighting systems, etc.). These programs were used to assess only one or few of the aspects needed for the final design, missing with this way the coupling and the interactions between the different design aspects that have to be taken into account during the sustainable design of buildings.

It is therefore necessary to consider the use of integrated design programs that can assess every aspect of the building's energy performance simultaneously at any time of the design process. However, this integrated approach to building design requires that each team member has a basic understanding of the underlying building physics and technologies that are related with each design aspect. Integrated energy simulation programs are suggested in this thesis as the method to be used for performing assessments with regards to sustainable design and chapter 4 discusses their capabilities and the functionality requirements that are needed for these programs to perform assessments for this purpose.

## **1.6 Research Objectives and Thesis Outline**

The above discussion has indicated that building designs can have an effect on global and local environmental issues as well as on the indoor environmental conditions. Sustainable building designs should consider the effect of buildings on all these issues and the introduction of the Energy Performance of Buildings Directive (EPBD) in Europe is certainly a step to push legislation in this direction.

This study is based on the hypothesis that the use of integrated energy simulation programs could be a method for addressing the requirement set by the EPBD for calculating the integrated energy performance of buildings but without compromising overall environmental performance. Details on the Directive are given in chapter 2. This research aims to investigate and support the integration of detailed simulation programs in the EPBD. Therefore, the following objectives are defined:

- identify the functionality requirements for the integrated energy simulation programs to respond to the EPBD and also to the overall sustainable design challenges that were described in this chapter;
- investigate the possible impacts from the use of simplified methods instead of detailed simulation methods in a regulatory context and for the purposes of the EPBD;
- investigate the impact of using different detailed simulation programs for regulations compliance purposes;
- develop and implement a technique for selection and quality assurance of the modelling programs in order to assist practitioners in their choice of program to use in the new energy performance regulations and facilitate developers in assessing the impact of new developments on their program's performance.

The structure of this thesis is as follows.

Chapter 1 discussed the challenges and the problems that practitioners try to tackle when adopting a sustainable building design approach in order to optimise the building's energy performance.

The Energy Performance of Buildings Directive (EPBD) was introduced in Europe as a measure to overcome some of these problems and improve the energy performance of buildings. Chapter 2 discusses the background, the content and the implications from the implementation of the EPBD.

Addressing the requirements of the EPBD requires the adoption of calculation methods for the integrated energy performance of buildings. Chapter 3 reviews common simplified and detailed methods that are used to perform assessments for calculating the energy requirements of buildings, and in particular those used for space heating and cooling energy requirements.

Chapter 4 focuses on the integrated energy simulation programs and investigates the functionality requirements for these programs to respond to the EPBD and the

sustainable building design challenges. It discusses the current ability of these programs to offer this functionality and the possible limitations that may exist. The discussion is then expanded to any potential future developments that would improve the use of simulation programs in the context of these studies.

The capability of integrated simulation programs to assess metrics related to EPBD is recognised in chapter 4. Chapter 5 uses case studies to investigate the implications from the practical use of integrated simulation programs to perform energy performance appraisals in a regulatory context and in comparison with relevant simplified methods that have been developed for the same purposes. The need for managing the use of all the available calculation methods is recognised and a way to achieve this is discussed in chapter 6.

Chapter 6 describes a facility that aims to respond to the users' demand for ensuring simulation programs are continuously tested and fulfil specified requirements (e.g. against tests within Standards) in order to be able to be used with confidence during the design of buildings and for energy performance regulation compliance ratings. The development can be used to assist users in their selection of the different available programs. It enables the users or developers of an integrated simulation program to easily perform automatic checks for ranges defined by tests within Standards and software accreditation processes. This process makes easier the testing of the program's performance with regards to these Standards, it assists the developers to quantify the impact of algorithmic changes on the results for these Standards and it increases the users' confidence for the program's results in practical applications. The focus is mainly on Standards set by some countries as requirements for allowing the use of integrated simulation programs in the relevant EPBD regulation compliance checks.

Finally, in chapter 7 conclusions are drawn and recommendations made for future work.

## 1.7 References

Bayer C.W., Hendry R.J., Crow S.A., Fischer J.C. 2002. The relationship between humidity and indoor air quality in schools. Proceedings Indoor Air 2002. Santa Cruz, USA.

Brittain J.R.J. 1997. *Reducing the energy consumption of oversized plant*. Final Report 78440, BSRIA. UK.

Camuffo D., Sturaro G. 2000. *Church heating: a challenge looking for solutions*. Proceedings of 4th European Commission Conference - Research for protection, conservation and enhancement of cultural heritage: opportunities for European enterprises. Strasbourg, France.

CIBSE (Chartered Institution of Building Services Engineers). 2006. *CIBSE Guide A: Environmental design (7<sup>th</sup> Edition)*. London, UK.

CIBSE (Chartered Institution of Building Services Engineers). 2004. *CIBSE Guide F: Energy efficiency in buildings (2<sup>nd</sup> edition)*. London, UK.

Cline R.W. 1992. *The economics of global warming*, ISBN 0-88132-150-8. Washington, USA.

Commission of the European Communities. 2005. *Energy efficiency - or doing more with less*. Green Paper, COM (2005) 265 final.

Commission of the European Communities. 2006. *A European strategy for sustainable, competitive and secure energy*. Green Paper, COM (2006) 105 final.

Coote A.T., Lewry A.J., Yates T.J.S., Butlin R.N. 1989. *Acid deposition and building materials*. British Library Technical Communications publication. ISBN 0-712307-65-6. BRE, Watford, UK.



Cornish J.P., Sanders C.H., Garratt J. 1986. *Surface condensation and mould*. Building Research & Information, 14 (3), pp. 148-153.

DETR (Department of the Environment Transport and the Regions). 1999. *Lighting for people, energy efficiency and architecture – an overview of lighting requirements and design*. Good Practice Guide 272. UK.

DETR (Department of the Environment Transport and the Regions). 2000. *Climate change the UK programme*. Cm 4913. London, UK.

DOE (U.S. Department of Energy). 2002. *2002 Buildings energy databook*. Washington, USA.

DOE (U.S. Department of Energy). 2003. *The Business case for sustainable design in federal facilities*. USA.

Driscoll C.T., Lawrence G.B., Bulger A.J., Butler T.J., Cronan C.S., Eagar C., Lambert K.F., Likens G.E., Stoddard J.L., Weathers K.C. 2001. *Acid rain revisited: advances in scientific understanding since the passage of the 1970 and 1990 Clean Air Act amendments*. Hubbard Brook Research Foundation. Science Links Publication. Vol.1, no.1.

DTI (Department of Trade and Industry). 2000. *Digest of UK energy statistics*. The Stationery Office. London, UK.

EPA (U.S. Environmental Protection Agency). 2001. *The greening curve: lessons learned in the design of the new EPA campus in North Carolina*. Research Triangle Park, North Carolina, USA.

EU. 2003. *Directive 2002/91/EC of the European parliament and of the council of 16 December 2002 on the energy performance of buildings*. Official Journal of the European Communities (L1), 43, pp. 65-71.

EU. 2005. *COM/2005/447/FINAL Proposal for a directive of the European parliament and of the council on ambient air quality and cleaner air for Europe*. Brussels, Belgium.

Federspiel C.C. 1998. *Statistical analysis of unsolicited thermal sensation complaints in commercial buildings*. ASHRAE Transactions, 104 (1), pp. 912-923.

Fuller R.J., Luther M.B. 2003. *Simulation of condensation problems in a roller-skating centre*. Building Research & Information, 31 (1), pp. 48-59.

Gallagher R.P., Lee T. K. 2006. *Adverse effects of ultraviolet radiation: A brief review*. Progress in Biophysics and Molecular Biology, 92, pp. 119–131.

Graves H., Watkins R., Westbury P., Littlefair P. 2001. *Cooling buildings in London – Overcoming the heat island*. BRE report BR 431. Watford, UK.

Hannsen S.O. 2004. *HVAC – The importance of clean intake section and dry air*. Indoor Air, 14 (7), pp. 195-201.

Hopfe C.J., Struck C., Hensen J., Wilde P. De. 2006. *Considerations regarding decision support tools for conceptual building design*. Proceedings of the 11<sup>th</sup> International Conference on Computing in Civil and Building Engineering (ISCCCBE). Montreal, Canada.

Howard B. 1993. *Simplified pollution avoidance calculation for builders*. Proceedings of the 1993 Conference of Energy Efficient Building Association (EEBA) and Northeast Sustainable Energy Association (NESEA) - Building Solutions, 2, pp G67-G82.

IPCC (Intergovernmental Panel on Climate Change). 1996. *Climate change 1995: The science of climate change*. Houghton J.T., Meira Filho L.G., Callander B.A.,

Harris N., Kattenberg A., Maskell K. (eds.). Cambridge University Press. Cambridge, U.K.

ISO Standard 7730. 1994. *Moderate thermal environments - Determination of the PMV and PPD indices and specification of the conditions for thermal comfort*. International Organisation for Standardisation, Geneva, Switzerland.

Janssen R. 2004. *Towards energy efficient buildings in Europe*. EuroACE, Final Report. London, UK.

Landsberg H. E. 1981. *The urban climate*. National Academy Press. New York, USA.

Littlefair P.J., Santamouris M., Alvarez S., Dupagne A., Hall D., Teller J., Coronel J.F., Papanikolaou N. 2000. *Environmental site layout planning: solar access, microclimate and passive cooling in urban areas*. BRE report BR 380. Watford, UK.

Molina, M.J., Rowland, F.S. 1974. *Stratospheric sink for chlorofluoromethanes: chlorine atom-catalysed destruction ozone*. Nature, 249, pp. 810–812.

Moon H.J. 2005. *Assessing mold risks in buildings under uncertainty*. PhD Thesis, Georgia Institute of Technology, Atlanta, USA.

Netcen (National Environmental Technology Centre). 2006. *Air pollution in the UK: 2005*. A report prepared for DEFRA, the Welsh Assembly Government, the Scottish Executive and the Department of Environment in Northern Ireland. UK.

ODPM (Office of the Deputy Prime Minister). 2006. *Asthma/Dust mite study – Final report: Sensitivity of humidity and mould growth to occupier behaviour in dwellings designed to the new air tightness requirements*. Building Research Technical Report 7/2005. London, UK.

Oke T.R. 1982. *The energetic basis of urban heat island*. Journal of the Royal Meteorological Society, 108, pp. 1-24.

Quattrochi D., Luvall J., Rickman D., Estes M., Laymon C., Howell B. 2000. *A decision support information system for urban landscape management using thermal infrared data*. Photogrammetric Engineering and Remote Sensing, 66, pp. 1195-1207.

Peacock A.D., Newborough M. 2005. *Impact of micro-CHP systems on domestic sector CO2 emissions*. Applied Thermal Engineering, 25, pp. 2653-2676.

Roaf S., Fuentes M., Thomas S. 2003. *ECOHOUSE 2: A design guide*. Architectural Press publications. ISBN 0-7506-5734-0. Oxford,UK.

Samuel A.A. 2006. *On the conflation of contaminant behaviour within whole building performance simulation*. PhD Thesis, ESRU, University of Strathclyde. Glasgow, UK.

Santamouris M., Balaras C.A., Dascalaki E., Argiriou A. Gaglia A. 1996. *Energy conservation and retrofitting potential in Hellenic hotels*. Energy and Buildings, 24 (1), pp. 65–75.

Santamouris M. 1998. *The Athens urban climate experiment*. PLEA '98, James & James Science Publishers Ltd. Lisbon, Portugal.

SEA (Swedish Energy Agency). 2002. *Energy in Sweden, facts and figures. ET 19:2002*. Eskilstuna, Sweden.

Swan M. 2003. *Sustainability – Un-definable success in a defined world*. Proceedings Building Sustainability Value and Profit, CIBSE/ASHRAE International Conference. Edinburgh, UK.

Tommerup H., Svendsen S. 2006. *Energy savings in Danish residential building stock*. Energy and Buildings, 38 (6), pp. 618-626.

Tsai W.T. 2005. *An overview of environmental hazards and exposure risk of hydrofluorocarbons (HFCs)*. Chemosphere, 61 (11), pp. 1539–1547.

UN (United Nations). 2003. *Environmental effects of ozone depletion and its interaction with climate change*. Progress Report. Nairobi, Kenya.

UNEP (United Nations Environment Programme). 2003. *Sustainable building and construction*. Industry and Environment, 26 (2).

Velds M. 1999. *Assessment of lighting quality in office rooms with daylighting systems*. Ph.D. thesis, Technical University of Delft, The Netherlands.

WCED (World Commission on Environment and Development). 1987. *Our common future*. United Nations World Commission on Environment and Development, Oxford University Press. London, UK.

Wyon D.P. 2004. *The effects of indoor air quality on performance and productivity*. Indoor Air, 14 (7), pp. 195-201.

Yates, A. 2001. *Quantifying the business benefits of sustainable buildings – summary of existing research findings*. Project Report Number 203995. Centre for Sustainable Construction, BRE. Watford, UK.

Yates, A. 2003. *Sustainable buildings: benefits for investors and developers*. BRE Information Paper 13/03 part 3. Watford, UK.

EUROPEAN ENERGY PERFORMANCE OF BUILDINGS DIRECTIVE

## **2.1 Introduction**

The previous chapter introduced the main issues and the challenges that have to be considered when trying to achieve a sustainable building design, and subsequently when using building energy performance simulation programs to perform the appraisals needed for this purpose. Although legislative measures do not yet exist in many European countries to address all of these challenges with an integrated approach, an important measure that has been put forward by the European Union, having as its main aim to improve the energy performance of buildings, was the introduction of the Energy Performance of Buildings Directive (EU, 2003). This chapter discusses the Directive in detail including its content, its objectives and the various methods suggested for addressing all of the requirements contained in it. Finally, it will also summarise the possible implications that this Directive can have for the construction industry. For the reason that this thesis is concerned with the issues arising for building energy simulation programs after the introduction of the Energy Performance of Buildings Directive (EPBD), the main research focus deals with the part of the Directive that is related to the calculation of the energy performance of buildings and the ways integrated energy simulation tools could be used in practice for this purpose.

## **2.2 Background and objectives of the Directive**

On the 4<sup>th</sup> of January 2003, the Directive 2002/91/EC of the European Parliament and Council came into force with the main objective to improve the energy performance of buildings across the Member States. Member States were required to implement the Directive no later than thirty-six months after it came into force (i.e. by 4 January 2006). There is though an additional 3-year period to allow Member States to apply the provisions of specific articles of the Directive (Articles 7, 8 & 9).

Improving the energy efficiency in buildings has been the aim of existing legal instruments that were in force before the introduction of the 2002/91/EC Energy Performance of Buildings Directive. Among the main Directives of European Community legislation in this area are the hot water Boiler Directive (EU, 1992), the Construction Products Directive (EU, 1989) and the buildings provisions in the SAVE Directive (EU, 1993). There have also been prescriptive regulations in many of the EU countries, mainly to limit the heat losses through the envelope of the building by increasing the insulation levels and reducing the maximum permissible elemental thermal transmittance (U-value). An example of how the maximum permissible U-values of exposed external walls, roofs and floors have changed over the years in England and Wales is given in Figure 2.1.

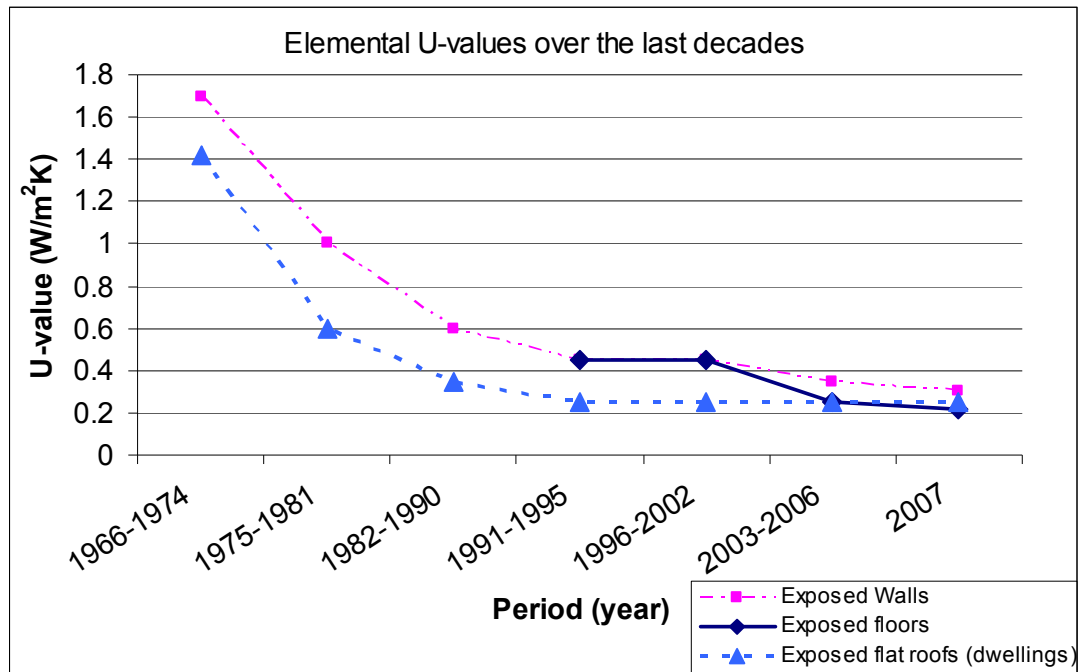

Figure 2.1: Maximum permissible U-values of exposed external walls and floors in England and Wales (source of data: SAP 2005, 2005; Doran and Carr, 2005)

Prescriptive regulations though did not encourage innovation and the use of any new or renewable technologies in buildings and they may have had limited other areas of the buildings' overall environmental performance. For example, new airtight

buildings had lower ventilation rates and the use of mechanical ventilation was necessary to cover the fresh air needs of their occupants (Reardon et al., 1990).

The Energy Performance of Buildings Directive is not as prescriptive as these regulations and has been urgently introduced for different reasons than those of the existing Directives before it.

The principal reason that led the EU to the introduction of this Directive was the security of energy supply problem according to the Green Paper (Commission of the European Communities, 2006). This can be noticed from the fact that the energy consumption and the imports of energy products in the European Union are increasing, with energy production in the EU insufficient to cover this increasing energy demand across Europe. As a result, the dependence for energy on countries outside the EU is constantly increasing (Commission of the European Communities, 2006). Moreover, the options in the EU to influence the energy supply conditions are limited. Consequently, it is and will be essential for the EU to apply measures, such as the EPBD, for controlling the energy demand mainly by promoting energy savings and energy efficiency in buildings and in the transport sector. The introduction of the EPBD is also expected to have a positive impact on limiting the increasing amount of greenhouse gases in the Member States and contribute to meeting the EU's Kyoto Protocol obligations.

Estimates for the building sector project a cost-effective energy savings potential realisable by 2010 of around 22% of 2003 buildings' energy consumption - if this potential was realised, around 20% of the EU Kyoto commitment could be met (Bowie and Jahn, 2003). Transposition of this Directive into national regulations without delays on January 2006 would allow achieving a portion of this energy savings potential by 2010 as a result of the better energy performance of buildings.



## 2.3 Content of the Directive

The Directive consists of 17 articles and an Annex. It can be summarised in four main sections that define its general requirements.

1. A common methodology has to be established, at national or regional level, for the calculation of the integrated energy performance of buildings (Article 3) on the basis of the general framework set out in the Annex of the Directive. This is a different approach to the prescriptive building regulations existing in most of the Member States before the Directive's implementation. The Annex of the Directive indicates that the proposed methodology has to include and integrate different building energy performance aspects such as building envelope, heating and air-conditioning installations, ventilation, hot water installations, lighting installations, the position and orientation of the building, passive solar systems, shading, natural ventilation and indoor climatic conditions. It also proposes that the positive influence of technologies such as active solar systems or other renewable energy systems, CHP systems, district or block heating and cooling systems and finally daylight utilisation techniques should be taken into account in the overall methodology, mainly for specific sizes of buildings. Article 3 of the Directive also states that the energy performance of a building should be expressed in a way that is easy to be understood and may include a CO<sub>2</sub> emission indicator. However, the Directive does not specify the methods that should be used in order to derive this integrated energy performance of buildings. Member States can decide about the calculation methods that they use at national or regional level.
2. Minimum standards of energy performance should be applied to new buildings and to certain existing buildings when they are renovated (Articles 4, 5 and 6). The Directive specifies that all new residential and non-residential buildings should meet the minimum energy performance standards based on the integrated methodology suggested in Article 3. Furthermore these standards should also be applied to larger existing buildings (i.e. those

of more than 1000 m<sup>2</sup>) when the buildings undergo major renovation. However, any upgrades to improve their energy performance should be undertaken to the amount that is technically, functionally and economically feasible. For new buildings with total useful area over 1000 m<sup>2</sup>, Member States shall also ensure that the feasibility of alternative technical systems such as renewable energy systems, CHP, district thermal systems and heat pumps is taken into account before the construction of the building starts. The Member States are responsible for setting the minimum standards. These standards shall be reviewed at regular intervals, which should not be longer than five years and, if necessary, updated in order to reflect technical progress in the building sector.

However, exemptions apply for specific categories of buildings such as, for example, historic buildings, religious places, temporary industrial sites and stand-alone buildings with a total useful area of less than 50 m<sup>2</sup>.

3. The Directive requires Member States to introduce certification schemes for all buildings that are constructed, sold or rented out on the basis of the above standards. In all EU countries, an energy certificate should be issued and visibly displayed for all buildings over 1,000 m<sup>2</sup> that are occupied by public authorities or provide public services to a large number of persons (Article 7). The European Commission expects that clear displayed information will influence the rent that owners can set and therefore will be an incentive for them to make investments in the energy efficiency of buildings and houses. It is normally the tenant who pays the energy bills and currently the incentive for the owner to invest in energy efficiency is low, but by making the energy performance information clear and available to prospective tenants, these investments will possibly become an attractive option. However, the Directive does not force any specific action and any decision about the energy supply options and the energy efficiency of the various components of the building is left up to the owner of the building - as long as the overall minimum performance requirements are fulfilled. The certificates,

which should not be more than ten years old, shall include reference values such as current legal standards and benchmarks in order to make it possible for consumers to make comparisons and assess the energy performance of the building and should also include accompanying advice on how to improve the energy performance of the building. Denmark is the only Member State that was issuing certificates for both new and existing buildings before the introduction of the EPBD.

4. The Directive expects Member States to take measures in order to establish a regular inspection and assessment of boilers and heating/cooling installations (Article 8). For boilers, governments can either put in place a regular inspection plan or they can “take steps to ensure the provision of advice to the users on the replacement of boilers, other modifications to the heating system or on alternative solutions which may include inspections to assess the efficiency and appropriate size of the boiler” (Article 8). The UK consultation on the Directive for example, indicates that the Government is choosing this second option for the reason that it offers greater flexibility at lower costs (BRE, 2004). However, the Directive states that in case a Member State adopts this advice plan option, the Government must submit a report every two years showing that their decision for providing advice has equivalent impact to the option of regular inspection. This section of the Directive applies only to boilers fired by non-renewable liquid or solid fuel of an effective rated output of more than 20 kW. In particular, boilers of an effective rated output of more than 100 kW are required to be inspected at least every two years. For gas boilers, this period may be extended to four years. For heating installations with boilers of an effective rated output of more than 20 kW which are older than 15 years, Member States shall introduce measures to establish a one-off inspection of the whole heating installation. This inspection shall include an assessment of the boiler efficiency and the boiler sizing compared to the heating requirements of the building.

Provision has also been made for the regular inspection of air conditioning systems with an effective rated output of more than 12 kW (Article 9). The cooling requirements of the buildings that are served by the air conditioning system will have to be quantified in order to determine the air-conditioning efficiency and sizing. Appropriate advice shall be provided to the owners of the buildings on possible improvements or replacement of the air-conditioning system.

The Member States shall ensure that the certification of buildings, the accompanying recommendation documents and the inspection of boilers and air-conditioning systems are carried out by qualified and independent personnel (Article 10).

## **2.4 Implementation of the Directive**

For the reason that this thesis is focusing on the use of energy simulation programs to meet the requirements of the Directive, the issues related in particular with the implementation of article 3 for the methodology of the calculation of the integrated energy performance of buildings are investigated in detail. This research aims to examine the issues with regard to the ability of building energy simulation programs to be used as a means for the calculation.

Every country must define a means of calculating energy performance of buildings within a common EU framework. In order to compare the performance, the calculation method must be the same at the national as at the regional level, and it must take into account all the factors described in the Annex of the Directive.

At the same time, the Commission introduced procedures to facilitate the implementation of the Directive in the EU countries. This was done by giving a mandate to the European Committee of Standardization (CEN) in order to develop standards needed for calculating the energy performance of buildings based on the EPBD requirements. The aim was to offer within a short period (2004-2006) a

consistent set of standards that can be used as a basis to facilitate the national procedures in the Member States. In particular the Member States with a very limited experience in the field of the EPBD could benefit from this. The Directive also mentions that the Commission intends further to develop standards such as EN 832 (1998) and EN ISO 13790 (2003). However, Member States have discretion in how they implement the Directive as long as they satisfy its requirements. Depending on the traditional legal procedures and building control systems together with their previous experiences and practices in the area, different countries will implement it in different ways. For example, some countries (e.g. UK) require a second calculation after the construction of the building has finished in order to confirm that the prediction (e.g. in UK it is expressed in terms of CO<sub>2</sub> emissions level) is still less than the one needed for compliance. Unless it is a requirement by national legislation, CEN standards are not going to be mandatory for the implementation of the EPBD in the Member States. In addition, the given short timescale made it difficult for the CEN technical committees to produce a set of approved and published standards to be implemented in the Member States before the national implementation of the EPBD. Consequently, Member States, in the preparation of national legislation, have to refer to either existing or new national procedures. Most Member States are taking into account in their implementation the main parts of the draft standards and they are planning to adopt them within a few years from publication. Some standards are likely to be further developed as experience in implementing the Directive is gained. Over time it is probable that the national implementation mechanisms will tend to follow the developed European Standards. Although this is a fast changing area, the “EPBD Buildings Platform” website (EPBD Buildings Platform, 2008) attempts to give an overview of the implementation of the EPBD requirements in EU countries. A useful review is also given by Goncalves (2007).

The overall structure of the main CEN standards that support the EPBD Directive is summarised with Figure 2.2. Each of these individual standards is also based on other supporting CEN standards. For example, the prEN ISO/DIS 13789 Standard (2007) for the heat transmission properties of the building elements is based on a

series of other standards, such as the EN ISO 6946 (2007) and EN ISO 10077-1 (2006). Details about the individual CEN standards (ENs) or draft CEN standards (prENs) and combined EN-ISO standards are officially published by CEN in Brussels but can only be obtained from the National Standard Bodies of each country. A summary of the most important EPBD Standards is given by Roulet and Anderson (2006); Zweifel (2007) also discusses those Standards and, in particular, those dealing with simulation-related issues. Chapter 3 provides details of the prEN ISO/DIS 13790 (2007) for the reason that it is the most important Standard related to the calculation of energy performance. As can be seen in Figure 2.2, detailed simulation is included in the methods that are allowed to be used for determining the energy use for space heating and cooling in buildings. This is the first time that the option of detailed simulation can be used within performance based energy regulations in Europe and ensures a level playing field between the different developed methods in the context of building regulations. Despite the various energy performance calculation options offered to the EU countries, there are not currently many countries that have adopted advanced energy performance calculation methods, such as detailed simulation, in their legislation. Exceptions are Portugal, UK and possibly Slovenia while Netherlands also anticipates the development of a competitive market between the calculation methods by developing tests for the acceptance of the various methods (Hitchin, 2005).

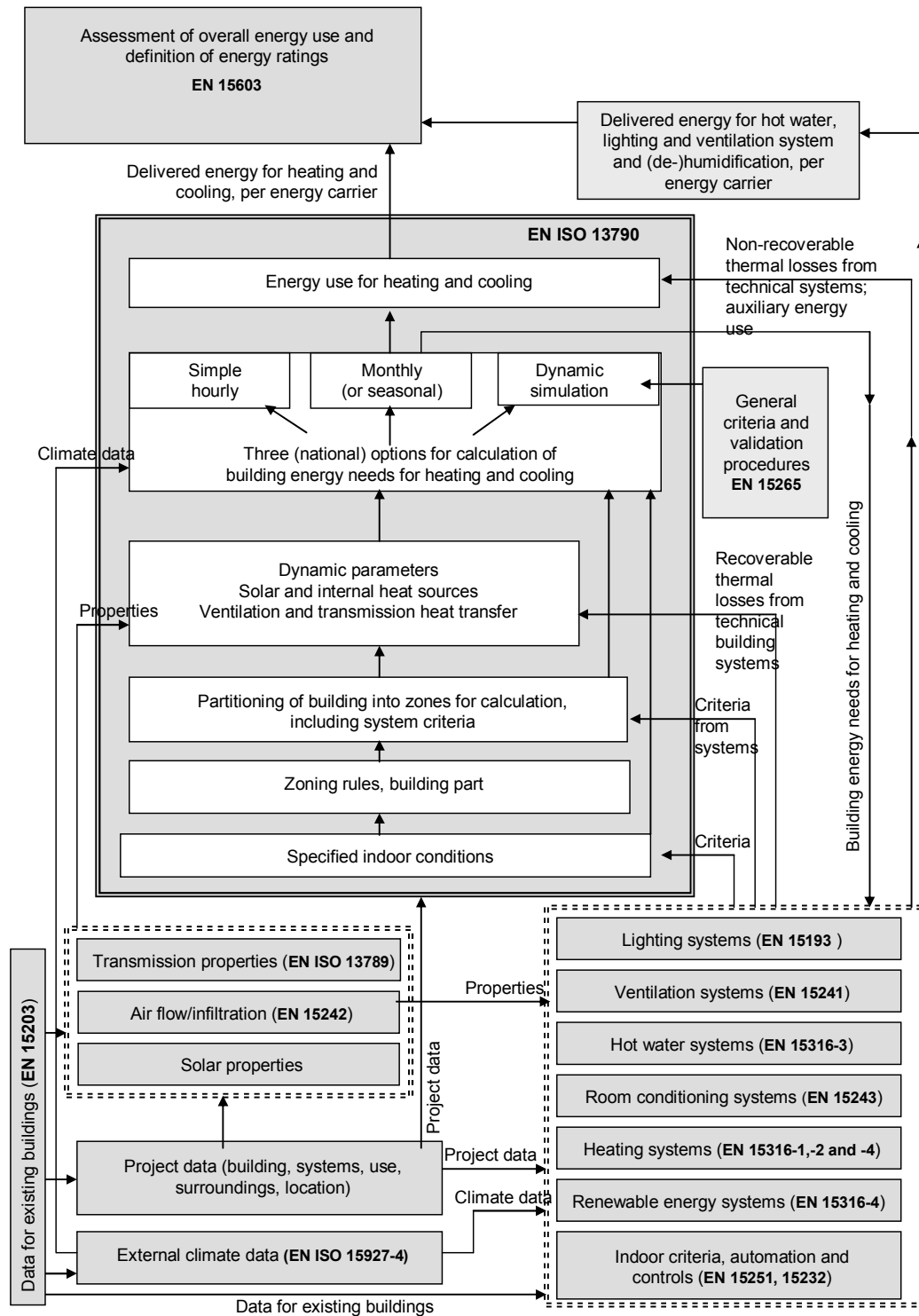

Figure 2.2: CEN standards structure supporting EPBD (source: prEN ISO/DIS 13790, 2007)

The implementation of articles 8 and 9 of the EPBD, concerning inspection of boilers and air conditioning systems, is also a major time-consuming process in terms of

procedures, number of accredited inspectors and training of inspectors. Different countries have initiated procedures to address these issues at a national or regional level. However, this section of the Directive is out of the scope of this thesis which is focusing on the calculation procedures and the practical use of integrated energy simulation programs for this purpose.

## **2.5 Discussion and future evolution of the Directive**

It is possible that the content of the Directive will be extended in the future and follow a more holistic integrated building performance approach by tackling, for example, all the aspects that can lead to more sustainable building designs that were described in chapter 1 (for example, materials and energy resources depletion indicators). Chapter 4 investigates the capabilities of the integrated modelling tools with regard to a possible upcoming evolution of the Directive towards these sustainable design aspects.

It is also necessary to monitor the progress of the Directive's implementation. The European Union consists of countries that have different regional characteristics and interests. In order to achieve progress by all Member States, it would be useful to have clear targets and a proposed timetable. The progress towards these targets could be monitored by independent European bodies. An example for how to achieve this is the European project "DATAMINE" (DATAMINE project team, 2006), which has been introduced with the aim of using the Energy Performance Certificates as a data source for monitoring different performance indicators (e.g. insulation levels) for new and existing buildings.

There are also concerns about the number of buildings that are exempted by the Directive. Introducing minimum energy performance requirements for the large number of existing buildings that are below 1000m<sup>2</sup> can lead to even larger energy savings in Europe. In this case, however, the economic implications and the extra costs for the owners of these buildings should be carefully considered beforehand. Government initiatives could possibly be introduced to support the implementation



of this additional measure. Also, feasibility studies could be carried out on the potential use of the alternative systems that are suggested in the Directive (for example, renewable energy systems and CHP) before the construction of each new building, instead of only the new buildings that are larger than 1000 m<sup>2</sup>. The same concerns apply to the special categories of buildings that are exempted from the Directive. Large religious places for example could possibly consume considerable amounts of energy and they should be exempted only when important historic reasons exist and prevent modifications to the way the energy is consumed in these kind of buildings. Likewise, the Directive could possibly be extended in the future to include boilers of an effective rated output less than 20 kW.

## **2.6 Summary**

This chapter has described the background, the content and the objectives of the Energy Performance of Buildings Directive. It has been seen that the main reasons for the introduction of this Directive were the security of energy supply problem in Europe, the Kyoto Protocol obligations and the large potential for limiting the energy demand in the building sector. The Directive sets requirements for a common methodology for an integrated energy performance of buildings calculation, minimum energy performance standards and certification schemes for certain buildings and inspection of certain size boilers and air-conditioning systems. The main focus of this thesis is on the requirement for the calculation of an integrated energy performance of buildings and the issues that this raised for integrated detailed simulation programs. Proposed calculation techniques are prepared within the CEN standards and validated integrated simulation programs are now part of these techniques. However, Member States are free to define their own procedures at national or regional level. The next chapter will summarise common available calculation methods for the most important energy demand sector in buildings: space heating and cooling. The analysis will focus in more detail on the methods included within the CEN 13790 Standard.

## 2.7 References

Bowie R., Jahn A. 2003. *European Union - The new Directive on the energy performance of buildings – Moving closer to Kyoto*. European Commission, Directorate General for Energy & Transport, Unit D1 – Regulatory Policy & Promotion of New Energies and of Demand Management, Brussels, Belgium.

BRE (Building Research Establishment). 2004. *Implementation of Article 8 of the energy performance of buildings directive*. Report prepared for Alan Christie, Sustainable Energy Policy Division - DEFRA. UK

Commission of the European Communities. 2006. *A European strategy for sustainable, competitive and secure energy*. Green Paper, COM (2006) 105 final.

DATAMINE project team. 2006. *Concepts of data collection and analysis*. Synthesis Report. ISBN-10: 3932074939 & ISBN-13: 978-3932074936. Darmstadt, Germany. Available from:

[http://www.iwu.de/fileadmin/user\\_upload/dateien/energie/datamine\\_sr\\_dec\\_2006.pdf](http://www.iwu.de/fileadmin/user_upload/dateien/energie/datamine_sr_dec_2006.pdf)

Doran S.M., Carr B.D. 2005. *On-site inspections and thermal insulation performance*. BRE Client report 15921 prepared for Energy Saving Trust. UK

EN 832. 1998. *Thermal performance of buildings - Calculation of energy use for heating - Residential buildings*. CEN. Brussels, Belgium.

EN ISO 10077-1. 2006. *Thermal performance of windows, doors and shutters – Calculation of thermal transmittance – Part 1: General*. ISO. Geneva, Switzerland.

EN ISO 13790. 2003. *Thermal performance of buildings – Calculation of energy use for space heating*. CEN. Brussels, Belgium.

EN ISO 6946. 2007. *Building components and building elements – Thermal resistance and thermal transmittance – Calculation method*. ISO. Geneva, Switzerland.

EPBD Buildings Platform. 2008. *Information papers: Country reports*. <http://www.buildingsplatform.eu>.

EU. 1989. *Directive 89/106/EEC of the European parliament and of the council of 21 December 1988 on the approximation of laws, regulations and administrative provisions of the Member States relating to construction products*. Official Journal of the European Communities (L40), pp. 12-26.

EU. 1992. *Directive 92/42/EEC of the European parliament and of the council of 21 May 1992 on efficiency requirements for new hot-water boilers fired with liquid or gaseous fuels*. Official Journal of the European Communities (L167), pp. 17-28.

EU. 1993. *Directive 93/76/EEC of the European parliament and of the council of 13 September 1993 to limit carbon dioxide emissions by improving energy efficiency (SAVE)*. Official Journal of the European Communities (L237), pp. 28-30.

EU. 2003. *Directive 2002/91/EC of the European parliament and of the council of 16 December 2002 on the energy performance of buildings*. Official Journal of the European Communities (L1), pp. 65-71.

Goncalves H. 2007. *Task 2.3 – Review of performance regulation affecting product characteristics per country / climatic zones*. EIE-05-024 GREEN-IT report. Portugal.

Hitchin R. 2005. *Implementation of EU directives on energy efficiency into the Czech Republic – Review of the EPBD in relation to Article 3: Changes needed in the Czech Republic & experiences in other EU Countries*. EU project report: [http://www.phare-epbd.org/project\\_outcomes/EU\\_experience\\_analysis/ARTICLE\\_3\\_REVIEW\\_EN.pdf](http://www.phare-epbd.org/project_outcomes/EU_experience_analysis/ARTICLE_3_REVIEW_EN.pdf)

prEN ISO/DIS 13789. 2007. *Thermal performance of buildings – Transmission and ventilation heat transfer coefficients – Calculation methods*. ISO, Geneva, Switzerland.

prEN ISO/DIS 13790. 2007. *Energy performance of buildings – Calculation of energy use for space heating and cooling*. ISO, Geneva, Switzerland.

Reardon J., Shaw C., Chown G. 1990. *Ventilation Strategies for Small Buildings*. Proceedings Building Science Insight '90, Small buildings: Technology in Transition. Ottawa, Canada.

Roulet C.A., Anderson B., 2006. *CEN Standards for implementing the European directive on energy performance of buildings*. Proceedings 23rd International Conference on Passive and Low Energy Architecture. Geneva, Switzerland.

SAP 2005. 2005. *The government's Standard Assessment Procedure for energy rating of dwellings*. BRE. Watford, UK.

Zweifel G. 2007. *New EPBD related European Standards and their relation to building and HVAC system simulation*. Proceedings Building Simulation '07. Beijing, China.

CALCULATION METHODS FOR HEATING AND COOLING ENERGY  
REQUIREMENTS

**3.1 Introduction**

The requirements of the EPBD were discussed in Chapter 2 where it was mentioned that European countries are now required to establish a methodology for the calculation of the energy performance, and therefore the energy requirements, of buildings. This chapter reviews calculation methods that are traditionally used for assessments of the space heating and cooling energy requirements in buildings. Although the calculations for the energy requirements of buildings should also consider and integrate other end use applications, such as those for lighting, domestic hot water, etc., the main focus here is on the calculations for heating and cooling energy requirements. This is, as mentioned in chapter 1, because the demand for space heating and cooling is usually the largest out of the overall energy demand in buildings and the associated CO<sub>2</sub> emissions with it are usually large compared with the other types of energy demands of buildings. There is also a significant complexity with regards to the calculations for space heating and cooling energy requirements due to the dynamic, often non-linear and interactive heat transfer phenomena that should be included in them. Finally, the large amount of inputs often needed to describe the processes associated with these calculations and the related uncertainty for determining these inputs justify the importance of reviewing the relevant calculation methods of the energy demand for space heating and cooling. The choice of the appropriate calculation method for these assessments may therefore be important for the results and the effectiveness of the EPBD.

In terms of EPBD implementation, the energy requirements for heating and cooling are in many countries quantified for annual periods. However, the methods described in this chapter might also be applicable to other heating or cooling assessments (e.g. peak thermal loads). While a number of methods with regards to these assessments

are discussed in this chapter, the analysis is more detailed for those included in the 13790 Standard due to their direct relation with the EPBD.

A variety of approaches with regards to calculation methods for quantifying space heating and cooling loads have been adopted in practice. Simple rules of thumb were initially used by practitioners for space heating and cooling energy assessments but their application has been reduced since the introduction of manual and computerised heating and cooling load calculation methods. Examples of “rules of thumb” methods are given by BSRIA (2003). The only criterion for determining heating and cooling energy requirements in these examples is the type of building (e.g. office, hotel, etc.). This is obviously a quick way to determine energy requirements but at same time, it is oversimplified and does not guarantee any accuracy. The need for ensuring better estimation of heating and cooling energy requirements led to the use of alternative calculation methods.

A simple alternative was the steady state calculation method, which can be applied with manual or computerised techniques. Steady state methods assume steady indoor and outdoor conditions for the calculation of the heat gains and losses in the building spaces and they do not take into account climate variations and any potential time lags or responses involved when heat is absorbed and released in the building spaces (e.g. due to thermal mass). Examples of the CIBSE steady state methods are briefly described in this chapter.

Finally, the need to take into account the dynamic interactions involved in the building environment increased the popularity of dynamic or transient methods. These are computer based methods that have also been used in practice and they are also briefly discussed in this chapter.

The discussion in this chapter starts with a detailed description of the methods included in the 13790 Standard and this is followed by brief description of the CIBSE steady state and dynamic methods as well as the most common methods that are described by ASHRAE. Finally, it discusses the degree-days approach as it has

also been widely adopted, with slightly different implementations, in heating and cooling energy calculations.

### **3.2 CEN ISO 13790 Standard simplified methods**

The prEN ISO/DIS 13790 Standard (2007) is one of the main CEN Standards that has been updated to support the implementation of the EPBD in European countries. It aims to suggest methods for the calculation of the energy used in buildings for space heating and cooling on an annual basis. It was mentioned in Chapter 2 that this Standard allows the use of detailed simulation programs and prescribes two simplified methods that could be used for the objectives of this Standard. This section describes briefly the simplified methods that are included in the 13790 Standard while chapter 5 discusses their practical implementation in case studies. The next section of this chapter will also introduce the detailed simulation programs that are also included within the 13790 Standard in terms of calculation techniques that they use while chapter 4 will discuss in detail their functionality.

These simplified methods in the 13790 Standard are a quasi-steady state monthly method and a simple hourly method. There is also a seasonal quasi-steady method described in this Standard but it follows similar procedures as the monthly method and it will be assumed in this chapter that the monthly method's description is adequate to describe both methods (e.g. monthly and seasonal). A complete description of these methods is given in the 13790 Standard. The review is based on the prEN ISO/DIS 13790 version of the Standard as prepared before its formal vote on March 2007. It is worth saying here that the description for the simplified methods is for single zone calculations or multi-zone calculations without thermal coupling between zones (i.e. an independent series of single zone calculations). This is also normally the way that these methods are implemented in practical or software applications. Although a description of a multi-zone calculation with thermal coupling between zones is included in the Appendices of the 13790 Standard, its use is recommended only in special situations due to the complexity associated with it and the amount of effort required for collecting the inputs and performing the

necessary calculations. Detailed simulation programs though, which are also included in this Standard, have existing structure that allows by default to consider the thermal interactions between each zone of multi-zone buildings. This is done in the simulation programs without any additional complexity and without any overhead for the users' inputs.

### 3.2.1 *Quasi-steady state monthly method*

This method attempts to calculate the heat balance of spaces over a monthly or seasonal period and uses an empirically determined gain and/or loss utilization factor to take into account the dynamic effects associated with the calculations. The annual energy needs for space heating and cooling purposes are calculated by summing up the monthly energy requirements for heating and cooling respectively. The monthly energy requirements for heating are therefore determined by equation (3.1) and similarly, for cooling by equation (3.2):

$$Q_{H,nd} = Q_{H,h(tr,v)} - \eta_{H,gn} \cdot Q_{H,gn} \quad (3.1)$$

$$Q_{C,nd} = Q_{C,gn} - \eta_{C,loss} \cdot Q_{C,h(tr,v)} \quad (3.2)$$

where,

$Q_{H,nd}$  and  $Q_{C,nd}$  are the building energy needs for heating and cooling respectively [MJ].

$Q_{H,h(tr,v)}$  and  $Q_{C,h(tr,v)}$  are the sums of the heat transfer by transmission ( $Q_{tr}$ ) (e.g. through the fabric) and ventilation ( $Q_{vent}$ ) during the heating and cooling calculation respectively (e.g. total heat losses). These are defined by equations (3.3) and (3.4) respectively [MJ].

$\eta_{H,gn}$  and  $\eta_{C,loss}$  are the dimensionless gain utilization factor for heating and the dimensionless loss utilization factor for cooling respectively. These are determined by equations (3.15) to (3.17) and (3.19) to (3.21) respectively [-].



$Q_{H,gn}$  and  $Q_{C,gn}$  are the sums of the solar ( $Q_{sol}$ ) and internal ( $Q_{int}$ ) heat gains during the heating and cooling calculation respectively (e.g. total heat gains). The calculations of the solar heat gains ( $Q_{sol}$ ) are based on equation (3.6) and the calculations of the internal heat gains ( $Q_{int}$ ) are based on user defined inputs as will be further discussed in this section [MJ].

The sum of the monthly calculated values for the above heat gains and losses gives the annual energy figures. These equations apply to continuous heating and cooling and take into account only sensible energy requirements. The methods for the calculation of humidification and dehumidification requirements of the space (e.g. latent energy) are given by other Standards, such as the prEN ISO/DIS 15243 (2007). The way intermittent heating is treated is discussed at the end of this section.

The heat transfer by transmission is calculated by:

$$Q_{tr} = H_{tr} \cdot (\theta_{setp} - \theta_e) \cdot t \cdot 10^{-6} \quad (3.3)$$

where,

$H_{tr}$  is the heat transfer coefficient by transmission [W/K].

$\theta_{setp}$  is the heating or cooling (depending on the calculation) set-point temperature of the building's thermal zone, and it is taken to be equal to the zone's operative temperature [ $^{\circ}$ C].

$\theta_e$  is the ambient air temperature (monthly average in this case) [ $^{\circ}$ C].

$t$  is the duration of the calculation period [s].

$10^{-6}$  is used for the conversion of the result in MJ.

The transmission heat transfer coefficient is defined in the prEN ISO/DIS 13789 (2007) by the sum of the transmission coefficients for the different boundary

conditions of the building surfaces (e.g. to the exterior, ground, unconditioned spaces etc.). The transmission heat transfer coefficient of every building surface includes area related thermal transmittance and thermal bridges, and as well linear and point thermal bridges.

Similarly, the heat transfer by ventilation is calculated by:

$$Q_{vent} = H_{vent} \cdot (\theta_{setp} - \theta_e) \cdot t \cdot 10^{-6} \quad (3.4)$$

where,

$\theta_e$  in this case is the air supply temperature, which can be equal to the ambient temperature if the air is supplied in the building zone at the same temperature as the ambient temperature [°C].

$H_{vent}$  is the heat transfer coefficient by ventilation [W/K].

This can be determined by:

$$H_{vent} = \rho_a \cdot c_a \cdot \left\{ \sum (b_k \cdot q_{vent,k}) \right\} \quad (3.5)$$

where,

$\rho_a$  is the density of the air, which is equal to approximately 1.2 kg/m<sup>3</sup> at 20 °C.

$c_a$  is the specific heat capacity of the air, which is equal to approximately 1000 J/kg·K at 20 °C.

$b_k$  is a dimensionless temperature adjustment factor for an air flow element  $k$  for the cases where the supply temperature  $\theta_e$  is not equal to the ambient temperature [-]. The value of this factor for various ventilation cases is further discussed in the Standard.

$q_{vent,k}$  is the time-average air flow rate of air flow element  $k$  [m<sup>3</sup>/s].

The internal heat gains (e.g. from occupants, lights, appliances, etc.) use monthly values that are determined by integrating user defined hourly heat gain schedules over the monthly periods.

Solar gains ( $Q_{sol}$ ), are determined by summing up the calculated for the considered month heat fluxes ( $\Phi_{sol,k}$ ) through building elements for which solar radiation has direct access (e.g. exterior walls and windows, internal walls of sunspaces, etc.). This is expressed by equation (3.6):

$$Q_{sol} = \left\{ \sum_k \Phi_{sol,k} \right\} \cdot t \cdot 10^{-6} \quad (3.6)$$

where,

$Q_{sol}$  are the total solar heat gains in the considered building zone for the considered month [MJ].

$\Phi_{sol,k}$  is the average monthly heat flux through building element  $k$  for which solar radiation has direct access during the considered month [W].

The above heat flux from solar sources through building element  $k$  ( $\Phi_{sol,k}$ ) is calculated from equation (3.7):

$$\Phi_{sol,k} = F_{sh,k} \cdot A_{sol,k} \cdot I_{sol,k} - F_{vf,k} \cdot \Phi_{r,k} \quad (3.7)$$

where,

$F_{sh,k}$  is the shading reduction factor for external obstacles for the area of building element  $k$  [-]. This is obtained from equation (3.8).

$A_{sol,k}$  is the effective collecting areas of the building element  $k$  [m<sup>2</sup>]. This is defined by equation (3.9) for transparent elements and by equation (3.11) for opaque elements.

$I_{sol,k}$  is the solar incidence radiation per  $m^2$  of the effective collecting area of building element  $k$  [ $W/m^2$ ]. The monthly method does not calculate this input. The calculation for every surface orientation, every location and every climate relies on other procedures (e.g. climate analysis programs) and it is not part of the monthly method. In practice, users of this method will have to use pre-calculated values provided to them, usually only for specific locations and orientations, or use a simulation program that calculates and provides these values automatically (e.g. based on building's location and surface azimuth).

$F_{vf,k}$  is the view factor between the building element and the sky [-]. This takes the value of 1 for unshaded horizontal roofs and 0.5 for unshaded vertical walls.

$\Phi_{r,k}$  is the heat flux due to thermal radiation to the sky from building element  $k$  [W]. This is described by equation (3.12).

The shading reduction factor for external obstacles in this equation takes values between 0 and 1 and is defined by equation (3.8):

$$F_{sh,k} = \frac{I_{sol,act,k}}{I_{sol,k}} \quad (3.8)$$

where,

$I_{sol,act,k}$  is the actual solar incident radiation falling on the shaded surface  $k$ .

$I_{sol,k}$  is the incident solar radiation that would fall on the surface  $k$  if it was unshaded.

Determining the shading reduction factor for external obstacles has to be done either by using the tabulated pre-calculated values for specific locations and specific obstacles that Annex G of the 13790 Standard suggests or by using a detailed

simulation program for more precise values for the specific location and type of obstacle.

To determine the effective solar collecting areas needed for equation (3.7), different calculation procedures apply for opaque and transparent elements.

The effective solar collecting areas for transparent elements are defined by equation (3.9):

$$A_{sol,k} = F_{sh,gl,k} \cdot g_k \cdot (1 - F_F) \cdot A_w \quad (3.9)$$

where,

$F_{sh,gl,k}$  is the shading reduction factor for movable shading provisions for the glazing element  $k$  [-]. This is determined by equation (3.10).

$g_k$  is the total solar energy transmittance of the transparent element  $k$  [-]. The solar energy transmittance for radiation perpendicular to the glazing is calculated according to the EN 673 Standard (1997) and then a reduction factor (usually 0.9) is applied to calculate the time-averaged value needed for this equation.

$F_F$  is the ratio of the projected frame area to the overall projected area of the glazed element (including frame area) [-].

$A_w$  is the overall area of the glazed element (including frame area) [m<sup>2</sup>].

Equation (3.10) describes the shading reduction factor ( $F_{sh,gl,k}$ ) for movable shading provisions for the glazing element  $k$ :

$$F_{sh,gl,k} = \frac{(1 - f_{sh,with,k}) \cdot g_k + f_{sh,with,k} \cdot g_{k+sh}}{g_k} \quad (3.10)$$

where,

$f_{sh,with,k}$  is the weighted fraction of the time with the solar shading in use [-]. Specific procedures to determine this are not given by the 13790 Standard. However, examples of pre-calculated values for three specific climates, locations and some orientations and tilt angles of the window are given in Annex G of this Standard. These values were produced assuming shading will be in use if incident solar radiation on the window exceeds  $300 \text{ W/m}^2$ .

$\mathcal{G}_{k+sh}$  is the total solar energy transmittance of the transparent element  $k$  when shading is in use [-]. This is determined with the same procedure as the total solar energy transmittance ( $\mathcal{G}_k$ ) of the transparent element  $k$  when shading is not in use.

The effective solar collecting area for the opaque building elements is given by equation (3.11):

$$A_{sol,k} = \alpha_k \cdot R_{se} \cdot U_k \cdot A_{op} \quad (3.11)$$

where,

$\alpha_k$  is the solar absorption coefficient of the opaque element  $k$  [-].

$R_{se}$  is the external surface resistance of the opaque element  $k$  [ $\text{m}^2\text{K/W}$ ]. This is suggested to be equal to  $0.04 \text{ m}^2\text{K/W}$ , according to the EN ISO 6946 (2007).

$U_k$  is the thermal transmittance of the opaque element  $k$ , which is calculated according to the ISO 6946 Standard [ $\text{W/m}^2\text{K}$ ].

$A_{op}$  is the overall area of the opaque element  $k$  [ $\text{m}^2$ ].

It still remains now to define in equation (3.7) the way thermal radiation heat exchange between the sky and the building elements (e.g. the roof) is calculated. This Standard uses equation (3.12) to calculate the heat flow rate to the sky:

$$\Phi_{r,k} = R_{se} \cdot U_k \cdot A_k \cdot h_r \cdot \Delta \mathcal{G}_{e-sky} \quad (3.12)$$

where,

$A_k$  is the overall area of the element  $k$  [m<sup>2</sup>]. This is equal to  $A_{op}$  for opaque elements and  $A_w$  for glazed elements.

$h_r$  is the external radiative heat transfer coefficient, which is approximated from equation (3.13) [W/m<sup>2</sup>K].

$\Delta \mathcal{G}_{e-sky}$  is the average monthly temperature difference between the external air temperature and the sky temperature [K]. Sky temperature should again be externally calculated by a climate analysis program and then provided for the purposes of this method. In the cases that this is not available, the Standard suggests that  $\Delta \mathcal{G}_{e-sky}$  could be taken as 9 K in sub-polar areas, 13 K in the tropics and 11 K in intermediate zones.

While this describes a procedure for determining time-varying thermal radiation heat losses to the sky, it contradicts the assumption of the Standard for having a fixed outside surface thermal resistance (i.e. the thermal radiation heat exchange is assumed to be constant) which is used, apart from the solar heat gains calculations, in the fabric heat loss calculations. A suggested method to approximate the external heat transfer radiative coefficient ( $h_r$ ) is given by equation (3.13):

$$h_r = 4 \cdot \varepsilon_k \cdot \sigma (\theta_{ss} + 273)^3 \quad (3.13)$$

where,

$\varepsilon_k$  is the emissivity of the external element  $k$  [-].

$\sigma$  is the Stefan-Boltzmann constant, which is equal to  $5.67 \times 10^{-8}$  W/(m<sup>2</sup>K<sup>4</sup>)

$\theta_{ss}$  is the arithmetic average of the surface temperature and the sky temperature [°C].

The sky temperature and the surface temperature needed for determining  $(\theta_{ss})$  are not calculated by the monthly method of this Standard. For this reason, an approximation is necessary and it is suggested that  $(h_r)$  can be taken equal to  $5 \epsilon_k$ , which corresponds to an average  $(\theta_{ss})$  temperature of 10 °C.

The procedures for calculating the total heat gains and heat losses needed for equations (3.1) and (3.2) have been described. It is only now required for these equations to calculate the gain utilization factor for heating and the loss utilization factor for cooling.

The gain utilization factor for heating  $(\eta_{H,gn})$  is calculated for every month by using the gain/loss ratio  $(\gamma_H)$  for the specific month and a numerical parameter  $(a_H)$  that depends on the building inertia. The equations described here were the outcome of the PASSYS research project (PASSYS-I, 1989; PASSYS-II, 1993) with regards to space heating energy assessments only (i.e. not for cooling). The proposed relationships that were developed (e.g. utilization factor equations) were based on simulation runs for a variety of buildings. Although the simulation assumptions of that time do not seem to be fully documented, the research was based on ideal heating systems that assumed perfect temperature control and infinite flexibility. The utilization factor is therefore defined in the 13790 Standard independently of the heating system characteristics and is based on all these assumptions.

Equations (3.14) to (3.17) describe this calculation:

$$\gamma_H = \frac{Q_{H,gn}}{Q_{H,h(tr,v)}} \quad (3.14)$$

$$\text{if } \gamma_H \geq 0 \text{ and } \gamma_H \neq 1: \quad \eta_{H,gn} = \frac{1 - \gamma_H^{a_H}}{1 - \gamma_H^{a_H+1}} \quad (3.15)$$



$$\text{if } \gamma_H = 1: \quad \eta_{H,gn} = \frac{a_H}{a_H + 1} \quad (3.16)$$

$$\text{if } \gamma_H < 0: \quad \eta_{H,gn} = \frac{1}{\gamma_H} \quad (3.17) \quad (\text{i.e. in this case there is no need for heating})$$

where,

$\gamma_H$  is the gain/loss ratio for heating [-].

$a_H$  is a numerical parameter that depends on the time constant of the building. This is described by equation (3.22) [-].

Similarly, the loss utilization factor for cooling ( $\eta_{C,loss}$ ) is described from equation (3.18) to (3.21) and uses the gains/losses ratio ( $\gamma_C$ ) for the specific month and also a numerical parameter ( $a_C$ ) that depends on the building inertia.

$$\gamma_C = \frac{Q_{C,gn}}{Q_{C,h(tr,v)}} \quad (3.18)$$

$$\text{if } \gamma_C > 0 \text{ and } \gamma_C \neq 1: \quad \eta_{C,loss} = \frac{1 - \gamma_C^{-a_C}}{1 - \gamma_C^{-(a_C+1)}} \quad (3.19)$$

$$\text{if } \gamma_C = 1: \quad \eta_{C,loss} = \frac{a_C}{a_C + 1} \quad (3.20)$$

$$\text{if } \gamma_C < 0: \quad \eta_{C,loss} = 1 \quad (3.21)$$

where,

$\gamma_C$  is the gain/loss ratio for cooling [-].

$a_C$  is a numerical parameter that depends on the time constant of the building. This is described by equation (3.23) [-].

The numerical parameters ( $a_H$  and  $a_C$ ) depend on the time constant ( $\tau$ ) of the building and are given by equations (3.22) and (3.23):

$$\alpha_H = \alpha_{H,0} + \frac{\tau}{\tau_{H,0}} \quad (3.22)$$

$$\alpha_C = \alpha_{C,0} + \frac{\tau}{\tau_{C,0}} \quad (3.23)$$

where,

$\alpha_{H,0}$  and  $\alpha_{C,0}$  are reference numerical parameters. The 13790 Standard suggests that these are equal to 1 for the monthly method [-].

$\tau$  is the time constant of the building zone, determined by equation (3.24) [h].

$\tau_{H,0}$  and  $\tau_{C,0}$  are defined as reference time constants [hours]. The suggested value for these parameters in the 13790 Standard is equal to 15 hours.

It should be noted here that the constant values of the numerical parameters are, according to the 13790 Standard, empirical values. These values were determined, as previously mentioned, from the PASSYS project based on simulations that were using ideal heating control systems. The only minor difference was that the reference time constant value determined at that time had a value of 16 hours instead of 15 hours that is used for the current draft of the 13790 Standard. The Standard suggests that the selection of these values can also be determined at national level.

The time constant of the building ( $\tau$ ), needed for equations (3.22) and (3.23), is determined by:

$$\tau = \frac{C_m / 3600}{H_{tr} + H_{vent}} \quad (3.24)$$

where,

$C_m$  is the internal heat capacity of the building zone, expressed in (J/K). This is described in the next paragraph and calculated by equation (3.25).

3600 is used to convert J/K to Wh/K.

The internal heat capacity of the building zone ( $C_m$ ) is calculated by summing the heat capacities of all the building elements in direct thermal contact with the internal air of the zone under consideration, as given by Equation (3.25):

$$C_m = \sum(\kappa_k \cdot A_k) \quad (3.25)$$

where,

$\kappa_k$  is the internal heat capacity of the building element  $k$ , expressed in (J/m<sup>2</sup>K). This is usually determined according to prEN ISO/DIS 13786 Standard (2007). The simplified method, described in Annex A of this Standard, is usually used for this calculation. It is based on an effective heat capacity calculation that takes into account the layers of the element up to a maximum effective thickness. The 13790 Standard suggests that the value of 0.1m should be used as maximum effective thickness for this calculation.

$A_k$  is the area of the building element  $k$  [m<sup>2</sup>].

For intermittent heating or cooling, the energy requirements are calculated as for the continuous operation and then a reduction factor is applied to these calculated values.

The energy need for heating in these cases ( $Q_{H,interm}$ ) is calculated from the equation (3.26):

$$Q_{H,interm} = a'_{H,red} \cdot Q_{H,cont} \quad (3.26)$$

where,

$Q_{H,cont}$  is the energy need for continuous heating, determined according to the previously described procedures

$a'_{H,red}$  is the reduction factor for intermittent heating. This is calculated from equation (3.27):

$$\alpha'_{H,red} = 1 - b_{H,red} \cdot (\tau_{H,0} / \tau) \cdot \gamma_H \cdot (1 - f_{H,hours}) \quad (3.27)$$

where,

$b_{H,red}$  is an empirical correlation factor, set equal to 3 [-].

$f_{H,hours}$  is the fraction of the number of hours in the week with a normal (no setback, etc.) heating set-point (e.g. “number of hours with heating/168”, where 168 is the hours of the week).

The minimum value for this reduction factor is taken to be:  $\alpha'_{H,red} = f_{H,hours}$ , and the maximum is taken to be:  $\alpha'_{H,red} = 1$ .

Similarly to the reduction factor for heating, a reduction factor for cooling ( $\alpha'_{C,red}$ ) is used with the same procedure to quantify the cooling needs when intermittent cooling is used.

The reduction factor for intermittent cooling ( $\alpha'_{C,red}$ ) is calculated with the same equation as for heating (but using the cooling terms). However, in this case the fraction ( $f_{C,day}$ ) is used instead of the fraction ( $f_{H,hours}$ ). The fraction ( $f_{C,day}$ ) is defined as the fraction of the number of days in the week with cooling operating at normal cooling set-point (e.g. excluding reduced set-point or switch-off days: “number of days with cooling/7”, where 7 is the days of the week). It is unclear from the 13790 Standard how many hours of operation each day will be needed to account that day as a day of operation in the above reduction factor.

The minimum value for this reduction factor is taken to be:  $\alpha'_{C,red} = f_{C,day}$ , and the maximum is taken to be:  $\alpha'_{C,red} = 1$ .

The procedure described in this section provides the energy needs for heating and cooling on an annual basis by summing the monthly calculated values. To determine the energy used by the systems for covering these requirements (e.g. to include system heat losses), the 13790 Standard refers to three other international Standards. These are: all parts of the prEN ISO/DIS 15316 (2007) for heating systems, the prEN ISO/DIS 15243 for cooling systems and the prEN ISO/DIS 15241 (2007) for ventilation systems.

### ***3.2.2 Simple hourly method***

Although there is no information about the background of this method in the literature, the 13790 Standard offers a fully prescribed description of it. This method is based on an equivalent resistance — capacitance (R-C) model. It uses an hourly time step for the calculations and all building and system input data can be modified each hour.

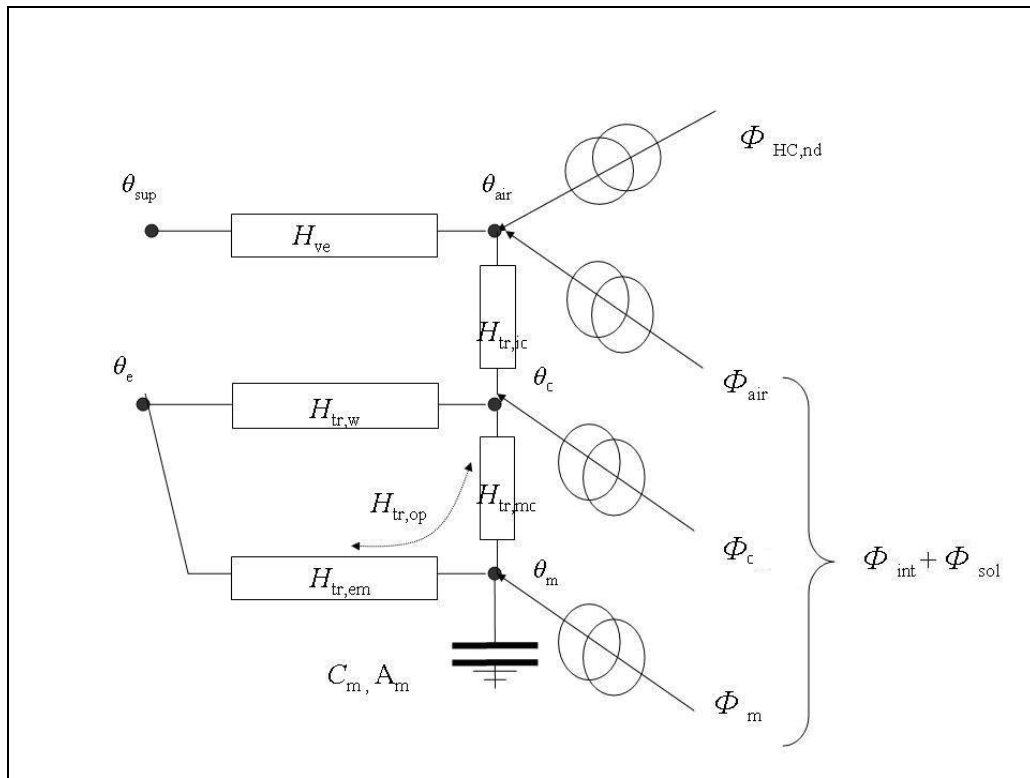

Figure 3.1: 5 Resistances – 1 Capacitance (5R1C) model (source: prEN ISO/DIS 13790, 2007)

Figure 3.1 shows the configuration of the network. Five nodes are used to represent temperature conditions with resistances (i.e. described in this method as conductances) between them to describe the heat transfer processes and the related energy flowpaths. These nodes are the internal air node ( $\theta_{air}$ ), the “central” node ( $\theta_c$ ), which is defined by the Standard as the node representing a mix of air temperature ( $\theta_{air}$ ) and mean radiant temperature ( $\theta_{r,mean}$ ), the building mass node ( $\theta_m$ ), the external air node ( $\theta_e$ ) and the supply air node ( $\theta_{sup}$ ) that can be the same as the external air node in the cases where the supply of air to the building zone is based on external air conditions. One thermal capacitance is also part of this network and it is placed on the building mass node to take into account the thermal capacity of the building mass.

In a same way as the monthly method, heat transfer coefficients are used in the hourly method to account for the heat transfer by transmission and ventilation. The same procedures as those used in the monthly method should be followed to determine these two coefficients. Heat transfer by transmission is split into the transparent surfaces (e.g. windows) part, ( $H_{tr,w}$ ), taken as having zero thermal mass, and the remainder is assigned to the opaque surfaces, which contain the thermal mass. The transmission heat transfer coefficient of the transparent surfaces, ( $H_{tr,w}$ ), is used to connect the external air temperature node with the central temperature node. The transmission heat transfer coefficient of the opaque surfaces, ( $H_{tr,op}$ ), on the other hand is split into two parts: the coupling conductance between the external air temperature node and the temperature node that represents the mass of the building, ( $H_{tr,em}$ ), and the coupling conductance that connects the temperature node that represents the mass of the building with the central temperature node, ( $H_{tr,mc}$ ). The ventilation heat transfer coefficient, ( $H_{vent}$ ), is connected directly to the internal air temperature node ( $\theta_{air}$ ), and to the node representing the supply air temperature ( $\theta_{sup}$ ). The network is completed by defining a coupling conductance between the internal air temperature node and the central node, ( $H_{tr,ic}$ ).

The two parts of the transmission heat transfer coefficient for the opaque surfaces (i.e.  $H_{tr,em}$  and  $H_{tr,mc}$ ) are calculated as follows. The coupling conductance between the temperature node that represents the mass of the building and the central temperature node, ( $H_{tr,mc}$ ), is given by equation (3.28):

$$H_{tr,mc} = h_{mc} \cdot A_m \quad (3.28)$$

where,

$h_{mc}$  is the heat transfer coefficient between the building mass node and the “central” node, expressed in W/m<sup>2</sup>K. This has a fixed value of 9.1 W/m<sup>2</sup>K.

$A_m$  is the effective mass area [m<sup>2</sup>]. This is defined as:

$$A_m = \frac{C_m^2}{\sum(A_k \cdot \kappa_k^2)} \quad (3.29)$$

where all the parameters in this equation were defined in previous equations.

The coupling conductance between the external air temperature node and the temperature node that represents the mass of the building, ( $H_{tr,em}$ ), is calculated by equation (3.30):

$$H_{tr,em} = \frac{1}{\left( \frac{1}{H_{tr,op}} - \frac{1}{H_{tr,mc}} \right)} \quad (3.30)$$

where  $H_{tr,op}$  and  $H_{tr,mc}$  were previously defined.

The ventilation heat transfer coefficient and the heat gains (i.e. solar and internal) are determined in the same way as for the monthly method. The heat gains, in terms of hourly heat fluxes, are distributed over the internal air temperature node ( $\theta_{air}$ ), the temperature node that represents the mass of the building ( $\theta_m$ ) and the central temperature node ( $\theta_c$ ). The way that the heat gains are distributed over these nodes is described by equations (3.31) to (3.33) respectively:

$$\Phi_{air} = 0.5 \cdot \Phi_{int} \quad (3.31)$$



$$\Phi_m = \frac{A_m}{A_{tot}} (0.5 \cdot \Phi_{int} + \Phi_{sol}) \quad (3.32)$$

$$\Phi_c = \left( 1 - \frac{A_m}{A_{tot}} - \frac{H_{tr,w}}{9.1 \cdot A_{tot}} \right) \cdot (0.5 \cdot \Phi_{int} + \Phi_{sol}) \quad (3.33)$$

where,

$\Phi_{air}$  is the total heat gains on the air node during the considered hour [W].

$\Phi_m$  is the total heat gains on the node that represents the mass of the building during the considered hour [W].

$\Phi_c$  is the total heat gains on the central node during the considered hour [W].

$A_{tot}$  is the area of all surfaces facing the building zone. The Standard suggests that this can be equal to:  $4.5 \cdot A_{fl}$ , where  $A_{fl}$  is the floor area of the building.

$\Phi_{sol}$  is the total heat flux from solar sources through all building elements for which solar radiation has direct access during the considered hour [W].

$\Phi_{int}$  is the total heat flux generated from internal heat sources during the considered hour [W].

The heating and/or cooling need is found by calculating for each hour the actual need for heating or cooling power ( $\Phi_{HC,nd,ac}$ ), expressed in Watts and counted positive for heating and negative for cooling, that needs to be supplied to or extracted from the internal air node ( $\theta_{air}$ ) to maintain a certain minimum or maximum set-point temperature. The heating or cooling set-point temperature ( $\theta_{H,set}$  or  $\theta_{C,set}$ ) is again based on the operative temperature ( $\theta_{op}$ , i.e. weighted mean of air and mean radiant temperature) but the air temperature can also be used with this method as set-point

temperature with slightly different equations than those described in this section. The 13790 Standard suggests that both detailed simulation programs and the simple hourly method should use the operative temperature as set-point temperature in order to ensure that equivalency between the inputs of all methods is achieved as well as to ensure that thermal comfort requirements in terms of temperature are met during the operation of heating or cooling.

It is therefore necessary to calculate the operative temperature ( $\theta_{op}$ ) and the actual heating or cooling power, ( $\Phi_{HC,nd,ac}$ ), for the current hour of the calculation period. In all cases, the value of the temperature node that represents the mass of the building ( $\theta_m$ ) is also calculated and stored, as it is used for the following hour.

The calculation procedure starts by performing a check to determine whether heating or cooling is needed. This is done by taking  $\Phi_{HC,nd} = 0$  and then applying equations (3.34) to (3.43):

$$\theta_{op} = 0.3 \cdot \theta_{air} + 0.7 \cdot \theta_c \quad (3.34)$$

$$\theta_{air} = \frac{H_{tr,ic} \cdot \theta_c + H_{vent} \cdot \theta_{sup} + \Phi_a + \Phi_{H,nd}}{H_{tr,ic} + H_{ve}} \quad (3.35)$$

$$\theta_c = \frac{\left[ H_{tr,mc} \cdot \theta_m + \Phi_c + H_{tr,w} \cdot \theta_e + \left( \theta_{sup} + \frac{\Phi_{air} + \Phi_{H,nd}}{H_{vent}} \right) \right]}{H_{tr,mc} + H_{tr,w} + H_{tr,l}} \quad (3.36)$$

$$\theta_m = \frac{\theta_{m,t} + \theta_{m,t-1}}{2} \quad (3.37)$$

$$\theta_{m,t} = \frac{\left[ \theta_{m,t-1} \left( (C_m / 3600) - 0.5 (H_{tr,3} + H_{tr,em}) \right) + \Phi_{mtot} \right]}{\left[ (C_m / 3600) - 0.5 (H_{tr,3} + H_{tr,em}) \right]} \quad (3.38)$$

where,

$$\Phi_{mtot} = H_{tr,3} \cdot \frac{\left[ \Phi_c + H_{tr,w} \cdot \theta_e + H_{tr,1} \cdot \left[ \left( \frac{\Phi_{air} + \Phi_{H,nd}}{H_{vent}} \right) + \theta_{sup} \right] \right]}{H_{tr,2}} \quad (3.39)$$

$$+ H_{tr,em} \cdot \theta_e + \Phi_m$$

$$H_{tr,1} = \frac{1}{\frac{1}{H_{vent}} + \frac{1}{H_{tr,ic}}} \quad (3.40)$$

$$H_{tr,ic} = h_{ic} \cdot A_{tot} \quad (3.41)$$

where,

$h_{ic}$  is the heat transfer coefficient between the internal air temperature node and the central node. The Standard suggests that this value is equal to 3.45 W/m<sup>2</sup>K.

$$H_{tr,2} = H_{tr,1} + H_{tr,w} \quad (3.42)$$

$$H_{tr,3} = \frac{1}{\frac{1}{H_{tr,2}} + \frac{1}{H_{tr,mc}}} \quad (3.43)$$

The resulting  $\theta_{op}$  is then named as  $\theta_{op,0}$  ( $\theta_{op,0}$  is the operative temperature in free floating conditions).

If  $\theta_{H,set} \leq \theta_{op,0} \leq \theta_{C,set}$ , no heating or cooling is required so that  $\Phi_{HC,nd,ac} = 0$  and the actual operative temperature ( $\theta_{op,ac}$ ) is equal to  $\theta_{op,0}$ . This means that no further calculations are needed for the current hour.

However, if this condition is not satisfied, the set-points are taken into account and the heating and cooling needs are calculated as follows.

If  $\theta_{op,0} < \theta_{H,set}$ , take  $\theta_{op,set} = \theta_{H,set}$

If  $\theta_{op,0} > \theta_{C,set}$ , take  $\theta_{op,set} = \theta_{C,set}$

Equations (3.34) to (3.43) should be then applied by taking:  $\Phi_{HC,nd} = \Phi_{HC,nd,10}$

where,

$\Phi_{HC,nd,10} = 10 \cdot A_f$ , and  $A_f$  is the floor area of the conditioned space.

The resulting  $\theta_{op}$  is then named as  $\theta_{op,10}$  ( $\theta_{op,10}$  is the operative temperature obtained for a heating power of 10 W/m<sup>2</sup>). The heating or cooling requirements to reach the set-point temperature, ( $\Phi_{HC,nd,set}$ ), are then calculated by equation (3.44) as:

$$\Phi_{HC,nd,set} = \Phi_{HC,nd,10} \cdot \frac{(\theta_{op,set} - \theta_{op,0})}{(\theta_{op,10} - \theta_{op,0})} \quad (3.44)$$

where,

$\Phi_{HC,nd,set}$  is positive for heating and negative for cooling [W].

A check is then performed to determine if the available cooling or heating power is sufficient.

If  $\Phi_{HC,nd,set}$  is between  $\Phi_{H,max}$  (maximum heating power) and  $\Phi_{C,max}$  (maximum cooling power), then:

$\Phi_{HC,nd,ac} = \Phi_{HC,nd,set}$  and the actual operative temperature ( $\theta_{op,ac}$ ) is equal to  $\theta_{op,set}$ .

In this case, the calculation for the specific hour has been completed.

If, however,  $\Phi_{HC,nd,set}$  is not between the maximum available heating and cooling power, then the set-point is not attained. In this case:

If  $\Phi_{HC,nd,set} > 0$ , then  $\Phi_{HC,nd,ac} = \Phi_{H,max}$ .

If  $\Phi_{HC,nd,set} < 0$ , then  $\Phi_{HC,nd,ac} = \Phi_{C,max}$ .

The actual operative temperature ( $\theta_{op,ac}$ ) is then calculated by using equations (3.35) to (3.44) and by taking  $\Phi_{HC,nd} = \Phi_{HC,nd,ac}$ .

### 3.3 Detailed simulation programs

A reference to detailed simulation methods is given in the 13790 Standard as an alternative to the two prescribed simplified methods. A particular simulation program is not suggested but the programs used for the same purpose (i.e. annual energy calculations for heating and cooling) should pass specific validation tests, such as EN 15265 (2007). For regulation compliance checks and energy rating assessments, these programs should also follow the same procedures prescribed by the Standard

for their use in terms of input data and boundary conditions. It should be noted here that although the simplified methods of the 13790 Standard do not have to demonstrate that they pass the prEN 15265 validation tests, there is an Annex in this Standard where one of these validation tests is used as an example for demonstrating the application of the two simplified methods.

An exact definition of detailed simulation programs is not given in this Standard. However, these programs should not be confused with simplified design tools. Detailed simulation programs integrate mathematical models to accurately represent all the potential energy flowpaths occurring in the building environment. It is then possible to produce a large number of results with regard to the energy performance of buildings (e.g. heating and cooling loads, surface and air temperatures, etc.). The functionality of these programs is described in chapter 4. A complete implementation of the Heat Balance approach described in this section is usually the method used by these tools.

The Heat Balance Method involves the simultaneous solution of heat balance equations for each of the outside and inside zone surfaces, along with the zone air. These heat balances consider all important energy flow paths: transmission through the fabric, longwave radiation exchange between internal and between external surfaces, solar radiation distribution on the inside surfaces, convection from the indoor air to wall and window surfaces, etc. (*see Figure 3.2*).

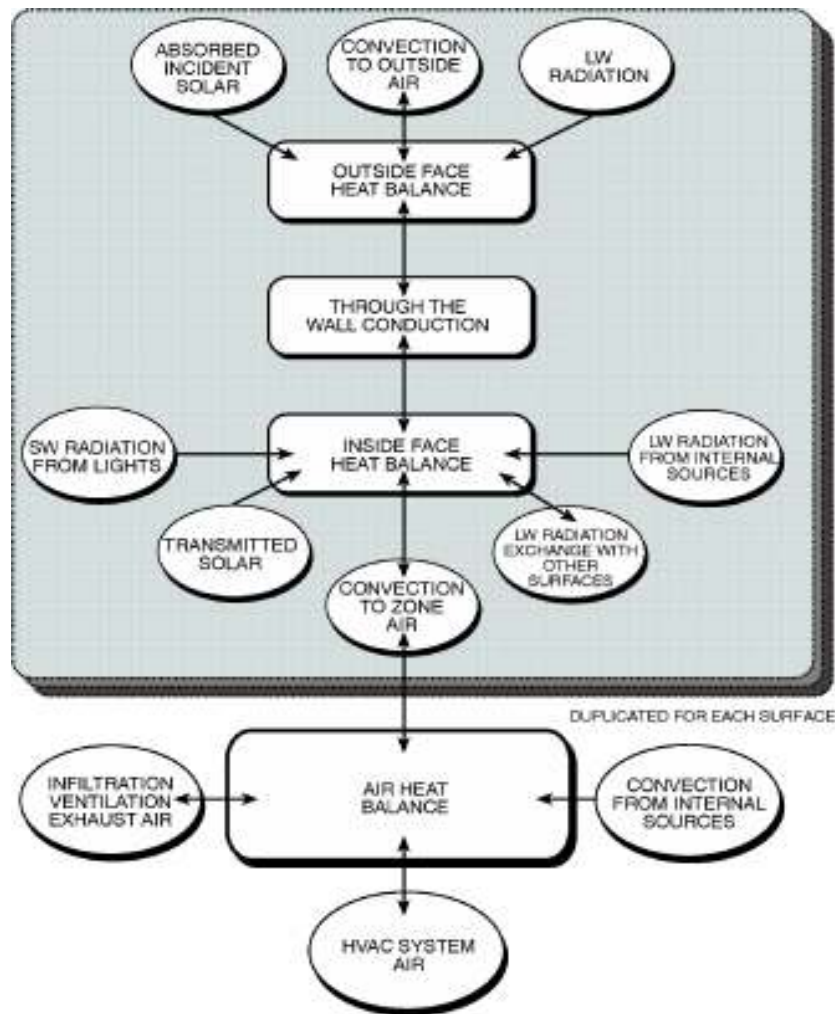

Figure 3.2: Heat Balance Method processes for a single opaque surface (source: ASHRAE, 2005)

The heat balances are formed and solved each calculation time step to estimate surface and room-air temperatures, and heat flows. This method can be viewed as four distinct processes:

1. Outside-face heat balance
2. Wall conduction process
3. Inside-face heat balance
4. Air heat balance

The first three are repeated for each surface. Figure 3.2 shows the relationship between these processes for a single opaque surface (exposed to the outside air). The

process for transparent surfaces is similar, but the absorbed solar component appears in the conduction process block instead of at the outside face, and the absorbed component splits into inward and outward flowing fractions.

The main simplification with this method is that it assumes a uniform air temperature in the building zone. It also assumes that a surface (i.e. in the building zone) has uniform temperature, uniform longwave and shortwave irradiation, and one-dimensional heat conduction within.

However, in usual descriptions of the Heat Balance method (e.g. ASHRAE, 2005), conduction through the zone fabric is dealt with by the use of conduction transfer functions (i.e. a series of temperature and flux coefficients that describe the relation of the heat fluxes at both sides of a construction with a history of previous temperatures and fluxes at both the interior and exterior surface) while some detailed simulation programs use instead numerical discretisation and simultaneous solution techniques (Clarke, 1977) for this purpose as well as for the representation of the rest of the building elements (e.g. surfaces, air spaces and plant components). The advantages and disadvantages between the two approaches are described by Clarke (2001) but the latter approach is considered as more appropriate for energy performance calculations due to its ability to deal well with non-linear processes that are associated with these calculations. These programs that use these discretisation methods could also be included in some way within the general thermal network methods category that is described in a separate section of this chapter.

For the analysis in this thesis and for the case studies in chapter 5, two building energy simulation programs are used; the ESP-r program (2007) and the EnergyPlus program (2007a).

In ESP-r, the finite volume approach is used where the model of the building is described by a number of control volumes (or nodes), to which the principles of conservation of energy, mass and momentum can be applied. This technique requires the identification of typical control volume (or node) types (Clarke 2001). There are



three general node types, for example, for the analysis of the thermal domain of a building: solid, fluid and surface (solid/fluid boundaries). Figure 3.3 summarises the various heat and mass transfer processes that may be included within the conservation equations for each of these three node types.

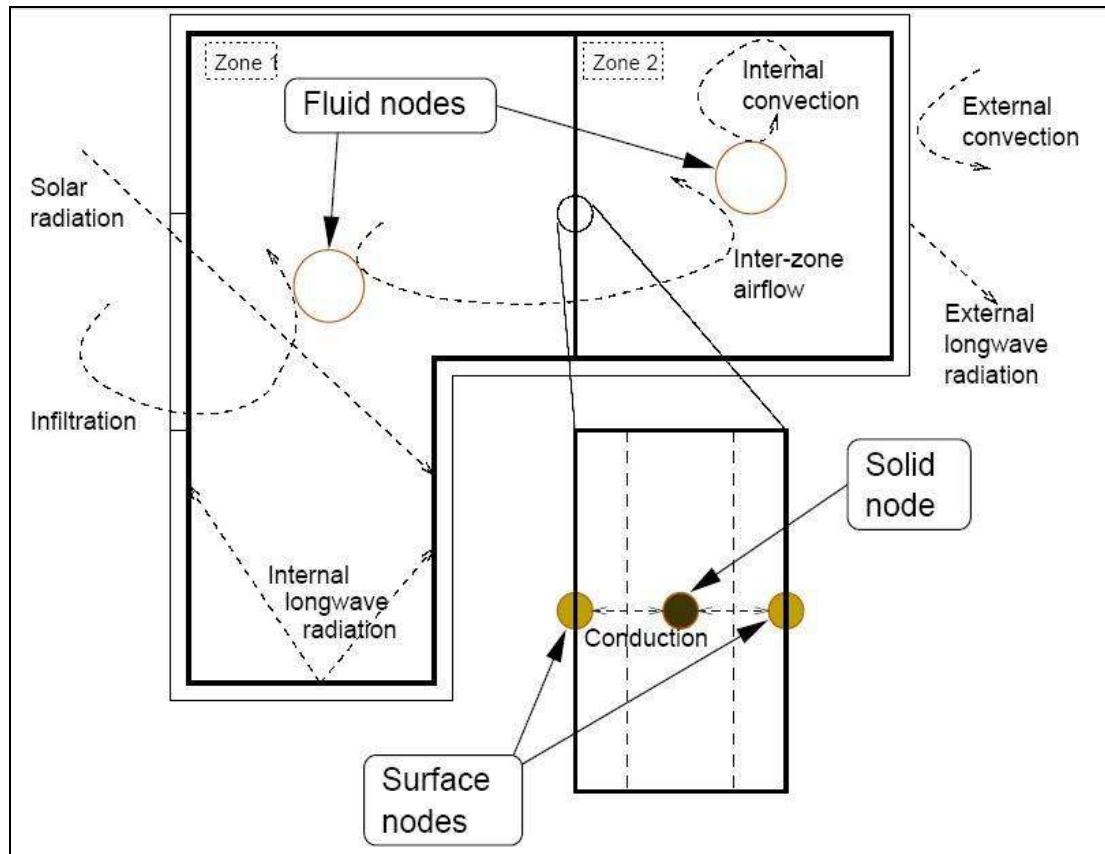

Figure 3.3: Building node types and heat flows (source: Macdonald, 2002)

The energy balance for the surface node is described as an example here:

Heat stored in volume = Net heat conducted into volume + Net heat radiated into volume + Net heat convected into volume + Heat generated in volume

The mathematical representation of these mechanisms for the surface node has been described in several publications in the literature (e.g. Macdonald, 2002; Clarke, 2001) and it is given by equation (3.45):

$$\rho \cdot C \cdot V \cdot \frac{\partial \theta}{\partial t} = k_i \cdot A_i \cdot \frac{\partial \theta}{\partial \chi} + \sum_{s=1}^m q_{s, longwave} + q_{convection} + q_{plant} + q_{solar} + q_{RadIntGains} \quad (3.45)$$

where,

$\rho$  is the average density of the node [kg/m<sup>3</sup>].

$C$  is the average specific heat capacity of the node [J/kgK].

$V$  is the volume of the surface node [m<sup>3</sup>].

$\theta$  is the average temperature of the volume [°C].

$t$  is the time [s].

$k$  is the thermal conductivity of the material the node is composed of [W/mK].

$A$  is the area normal to heat flow [m<sup>2</sup>].

$\chi$  is the distance between nodes [m].

$S$  is the receiving surface for longwave radiation.

$q_{s, longwave}$  is the longwave radiative heat flux between the surface  $S$  and the  $m$  other surfaces in the zone [W].

$q_{convection}$  is the convective heat flux [W].

$q_{plant}$  is an additional heat flux from the plant system [W].

$q_{solar}$  is the fraction of the solar flux absorbed at this node and depends on the solar transmission properties of the surrounding layers and any shading of the construction [W].

$q_{RadIntGains}$  is the heat flux from internal radiant components (e.g. from lighting) [W].

Equation 3.45 is expanded and numerical techniques are used, resulting to the final general form for a surface node (e.g. Macdonald, 2002; Clarke, 2001):

$$\begin{aligned}
& \left( 2 \cdot \rho \cdot C + \frac{2 \cdot k \cdot \delta t}{(\delta \chi)^2} + \sum_{s=1}^m \frac{h_{r,s} \cdot A_t \cdot \delta t}{V} + \frac{h_c \cdot A_t \cdot \delta t}{V} \right) \cdot \theta_{i,t+1} - \frac{2 \cdot k \cdot \delta t}{(\delta \chi)^2} \theta_{i+1,t+1} - \\
& \frac{q_{plant,t+1} \cdot \delta t}{V} - \frac{q_{solar,t+1} \cdot \delta t}{V} - \sum_{s=1}^m \frac{h_{r,s} \cdot A_t \cdot \delta t}{V} \theta_{s,t+1} - \frac{h_c \cdot A_t \cdot \delta t}{V} \theta_{fluid,t+1} = \\
& \left( 2 \cdot \rho \cdot C - \frac{2 \cdot k \cdot \delta t}{(\delta \chi)^2} - \sum_{s=1}^m \frac{h_{r,s} \cdot A_t \cdot \delta t}{V} - \frac{h_c \cdot A_t \cdot \delta t}{V} \right) \cdot \theta_{i,t} + \frac{2 \cdot k \cdot \delta t}{(\delta \chi)^2} \theta_{i+1,t} + \\
& \frac{q_{plant,t} \cdot \delta t}{V} + \frac{q_{solar,t} \cdot \delta t}{V} + \sum_{s=1}^m \frac{h_{r,s} \cdot A_t \cdot \delta t}{V} \theta_{s,t} + \frac{h_c \cdot A_t \cdot \delta t}{V} \theta_{fluid,t} \quad (3.46)^1
\end{aligned}$$

where,

$h_{r,s}$  is the radiative heat transfer coefficient for surface  $s$  [ $\text{W}/\text{m}^2\text{K}$ ].

$h_c$  is the convective heat transfer coefficient [ $\text{W}/\text{m}^2\text{K}$ ].

$\theta_i$  is the temperature of the volume  $i$  [ $^{\circ}\text{C}$ ].

$\theta_s$  is the temperature of the surface  $S$  [ $^{\circ}\text{C}$ ].

$\theta_{fluid}$  is the temperature of the fluid (e.g. air) [ $^{\circ}\text{C}$ ].

EnergyPlus is based on the same heat balance principles as ESP-r but the solution technique differs. Details of the underlying algorithms and the equations used in EnergyPlus are given in the engineering reference manual of the program (EnergyPlus, 2007b). In particular, the main difference is that wall conduction is considered with the use of Conduction Transfer Functions instead of the finite volume solution in ESP-r (however, an alternative finite difference method is used in the case of phase change materials). This relates the conduction heat flux at a surface with a series of temperature histories at both sides of this surface without needing to know temperatures and fluxes within the surface. Additional details with regards to the implementation of this method in EnergyPlus can be found in its Engineering Manual.

---

<sup>1</sup> Assumes 1-D conduction heat transfer.

### **3.4 CIBSE steady state methods**

CIBSE Guide A (CIBSE, 2006) provides guidance with methods for calculating heat losses from buildings. It describes the Full steady state calculation model from which three other steady-state heat loss models are produced. These are the Reference, the Basic and the Simple Models. The major difference between these models is the way in which longwave radiant exchange between surfaces is represented.

The Full Model is supposed to account for variable air temperatures throughout the space and complex longwave radiation transfer between room surfaces. This model was used as a basis to develop the three practicable CIBSE steady-state models that are described in this chapter. Although intended for the purpose of calculating steady-state heat losses CIBSE suggests that they could also be used as components of dynamic models.

#### ***3.4.1 Reference Model***

The Reference Model is a simplification of the Full Model mainly because it assumes a uniform air temperature throughout the space. This model also uses the control temperature, for example the operative temperature which at low air speeds is the average of the air and mean radiant temperatures. The control temperature is assigned to a control sensor. The mean radiant temperature “seen” by this sensor is considered to be the equivalent radiant temperature for radiant heat exchange between the sensor and its surroundings. The sensor is modelled as an additional room surface which should be located at a position where the proportion of longwave radiation received from each surface is directly proportional to the ratio of the area of the surface to the total room area. Furthermore, the sensor is also assumed to have an emissivity of unity (i.e. a black body).

Assuming that any radiant heat input is uniformly distributed over each surface, which is often not the case in real applications (e.g. when considering non-convex zones), the Reference Model may be represented by a set of equations that include

surface and control sensor heat balance equations and their solution provides air and surface temperatures as well as the emitter output (i.e. the sum of convective and radiant outputs). Further details about the equations involved with this model are given in CIBSE Guide A.

#### ***3.4.2 Basic Model***

The Basic Model attempts to simplify the Reference Model by treating differently the surface-to-surface radiant heat flow processes. For this purpose it uses two nodes for the air and radiant temperatures. It assumes that just as all convective heat input must first increase the air temperature, i.e. enters the ‘air temperature node’ so all radiant heat enters at the ‘radiant temperature node’. Heat then flows into each room surface by means of a heat transfer coefficient that is adjusted to take account of the multiple reflections of radiation between surfaces. The description of the method used for determining the radiant heat transfer coefficient for a six-sided space is also discussed in CIBSE Guide A but the details of this are outside the scope of this chapter. For spaces with more than six surfaces, CIBSE Guide A does not suggest alternative ways to calculate the radiant heat transfer coefficients needed for this method. The Basic Model is also represented by a set of equations that include surface and control sensor heat balance equations as well as convection and radiant heat balance. Their solution provides air and surface temperatures, the heat input and the temperature of the radiant node. Further details about the equations involved with this model are given in CIBSE Guide A.

#### ***3.4.3 Simple Model***

The Simple Model uses the same assumptions as the Basic Model but it treats the radiant heat exchange between surfaces as an individual heat transfer process (i.e. it is solved separately). It achieves this approximation by assuming that, with the exception of the surface under study, all surface temperatures are known. This assumption allows the use of constant internal radiative heat transfer coefficients. The internal convective heat transfer coefficient is also assumed to be constant. The

fixed values that are suggested and used in the CIBSE Guide A for this model are 3.0 W/m<sup>2</sup>K and 5.7 W/m<sup>2</sup>K for the convective and radiative heat transfer coefficients respectively. The Simple model also uses other simplified assumptions, such as that the surface where the calculation is applied has an area equivalent to one sixth of the overall area in the space where this surface is located.

Details of the equations involved in the steady state heat loss calculation with this method are given in CIBSE Guide A.

### **3.5 CIBSE dynamic methods**

The CIBSE Simple Dynamic Model (i.e. admittance method) is described in detail in the CIBSE Guide A while there is only a reference to the Reference (dynamic) model. This section is based on this description and summarises the Simple Dynamic Model.

This model, known as admittance method, is meant to be used for quantifying peak summertime temperatures and space cooling loads. However, it is admitted by CIBSE that its application must be treated with care due to the simplicity of this method. In the admittance method, it is assumed that the boundary conditions (e.g. outdoor climate) fluctuate sinusoidally with a period of 24 hours. Accordingly, the admittance method is a two-stage calculation procedure in which the mean and fluctuating components of the loads and temperatures are calculated separately. The mean components are calculated using the CIBSE simplified steady-state model. The admittance procedure defines how the fluctuating components of the loads and temperature differences are calculated.

The admittance method relies on the concept of the environmental temperature, which is a hypothetical temperature that is used to determine the combined radiant and convective heat exchange with the room surfaces. All the zone surfaces are linked to a common environmental temperature node at which a heat balance is calculated. The concept of the environmental temperature has been previously

criticised (Davies, 1992): it was noticed that its main disadvantage is the representation of the internal longwave radiant heat exchange between the zone's surfaces. In the admittance method, transient conductive heat transfer through the wall is based on a factor called decrement factor and a time lag, which determine the response to the external climate variations. To represent the external climate, it uses an "equivalent" temperature, known as the sol-air temperature, which is generally used to model in a simplified way exterior convection, longwave radiation, and absorbed solar radiation as one process. A single fixed combined convection and radiation coefficient must be used for this purpose, independent of the outdoor climate variations. The admittance calculation method also uses the admittance value and the surface factor, together with their associated time lags, to determine the response to variations of the internal environmental temperature and the radiant heat fluxes at the internal surfaces (i.e. from shortwave sources to the surface and then to the room space) respectively.

### **3.6 ASHRAE simplified methods**

#### ***3.6.1 Radiant-time series method***

The purpose of the radiant-time series method is for use in determining peak space cooling loads and the time of occurrence of these loads. This method assumes a single design day for the calculation. In this method, a constant air zone temperature is initially assumed and based on this, convective and radiant heat gains are calculated every hour. It then accounts for both conduction time delay (i.e. delay of conductive heat gain through opaque surfaces) and radiant time delay effects (i.e. to convert radiant loads to cooling loads) by multiplying hourly heat gains by a set of zone response factors (the so-called radiant-time series). The time series multiplication, in effect, distributes heat gains over time. The convective part of the heat gains is then summed with the calculated "delayed" part of the radiant gains to determine the cooling load for each hour of the design day.

One of the simplifications that this method adopts is that it uses the sol-air temperature to model exterior heat transfer processes as well as fixed combined

radiant/convective heat transfer coefficients. A single fixed value is also used for the inside surface heat transfer coefficient during the calculation.

### ***3.6.2 Weighting-Factor method***

This method is similar to the radiant time series method but it is usually applied for annual energy analysis, and especially for cooling load calculations. The main differences between this method and the time series method are summarised by McQuiston et al. (2005) as follows. The weighting factor method uses annual weather data instead of using only data for a single design day and the internal heat gains (e.g. occupants, lights, etc.) with this method can be scheduled and varied on an hourly and daily basis. It does not therefore assume a repeating design day for the calculation.

The same simplifications as those described previously for the radiant time series method are used within the weighting factor method and are not repeated here.

## **3.7 Degree-Day methods**

Degree-days are the summation of temperature differences between a defined reference temperature and the outdoor air temperatures over time. The reference temperature is known as the base temperature or as the balance-point temperature. The base temperature is defined as that value of the outdoor temperature at which, for the specified value of the interior temperature, the total heat loss is equal to the heat gains and therefore the heating (or cooling) systems do not need to run in order to maintain comfort conditions (ASHRAE, 2005). A detailed description of the degree-days method and some ways to determine the base temperature are given in the CIBSE Technical Manual 41 (CIBSE, 2006b).

This method has been mainly applied in heating energy assessments but the available descriptions in the literature are also for cooling applications. It is based on the assumption that heat loss from a building is directly proportional to the indoor-to-



outdoor temperature difference and therefore that the energy consumption of a heated building over a period of time should be related to the sum of these temperature differences over this period. The usual time period is 24 hours, hence the term degree-days, but it is possible to work with degree-hours. In practice the outdoor temperature may fluctuate around the base temperature. In building heating applications this happens in the warmer months or when the base temperature is particularly low. In this case calculation methods are required that capture the fact that degree-days are positive when the temperature falls below the base for part of the day, but ignore the times when it rises above the base (there can be no negative degree-day values). The opposite case where the outside temperature is above the base temperature is used for the cooling degree-days. Ideally this can be calculated from continuous (i.e. hourly or even shorter interval) temperature data if it is available. Positive temperature differences are taken and negative ones set to zero; these are summed over the day and divided by the number of readings (24 in the case of hourly data).

The energy consumption for heating or cooling is calculated based on the relationship (3.47):

$$Q_{H,C,nd} = \frac{K_{tot}}{\eta_{H,C}} \cdot DD_{H,C} \cdot 24 \quad (3.47)$$

where ,

$Q_{H,C,nd}$  is the annual energy consumption for heating or cooling [kWh].

$K_{tot}$  is the overall heat loss coefficient of the building (i.e. the sum of the ventilation and the transmission heat loss coefficients) [kW/K].

$\eta_{H,C}$  is the efficiency of the heating or cooling system

$DD_{H,C}$  is the number of heating or cooling degree-days [K·day].

24 is the number of hours per day and it is used to convert the days to hours [h/day].

The overall heat loss coefficient ( $K_{tot}$ ) is made up of two components: the transmission heat loss coefficient (i.e. fabric), and the ventilation coefficient that also includes the effect of infiltration. The transmission heat loss coefficient is the sum of the  $U \cdot A$  values for all the building components (U values are usually expressed in  $W/m^2K$  and surface areas A in  $m^2$ ). To ventilation heat loss coefficient is calculated by using average values of the air changes in the building spaces. A complete description of this calculation is not included in this chapter and can be found, for example, in CIBSE Guide A (CIBSE, 2006). While equation (3.47) has been generalised to include cooling assessments, its application for this assessments should be considered beforehand due to the highly variable internal conditions that are usually met during the cooling seasons. These conditions are assumed to be constant with the degree-days method.

The outdoor air temperature can fluctuate differently every day. It can, for example, fluctuate in a way that the maximum daily temperature ( $\theta_{max}$ ) is less than the base temperature ( $\theta_b$ ) (Figure 3.4).

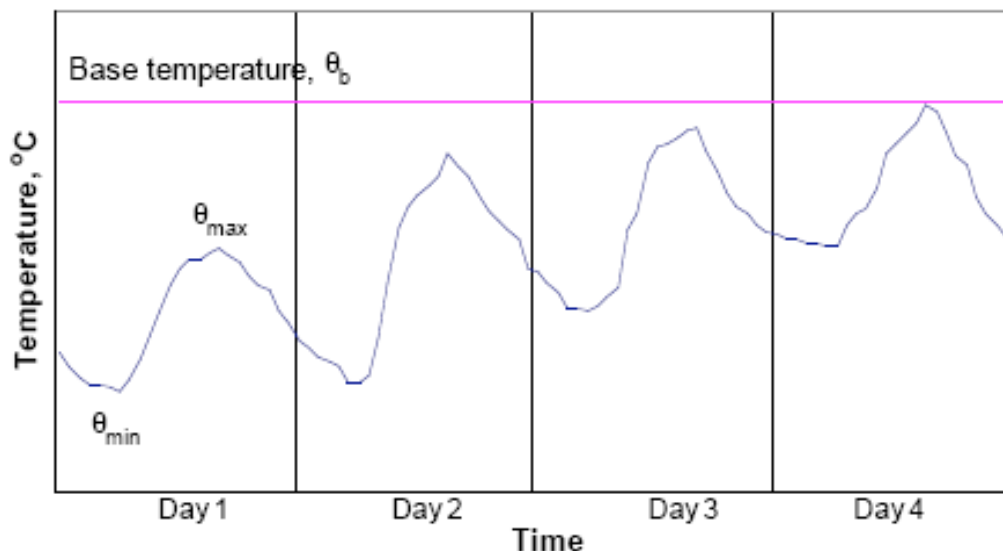

Figure 3.4: Four days of outdoor temperature variation where the maximum daily temperature is always less than the base temperature (source: CIBSE, 2006b)

In this case, the heating degree-days is the total area bounded by the two temperature curves. However, Figure 3.5 shows a different base temperature whereby the maximum daily temperature ( $\theta_{max}$ ) exceeds the base temperature ( $\theta_b$ ) on days 2, 3 and 4.

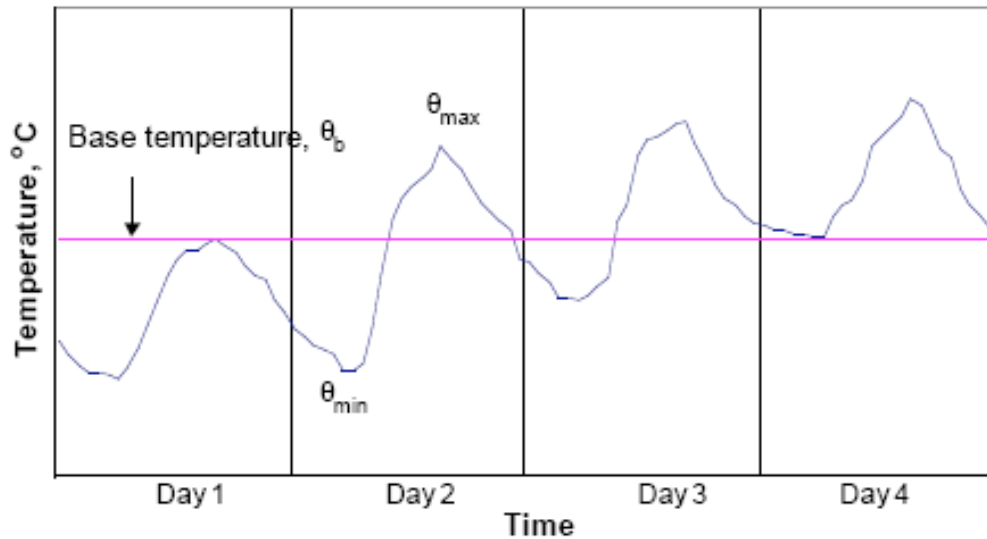

Figure 3.5: Four days of outdoor temperature that have different relative variations about the base temperature (source: CIBSE, 2006b)

The calculation of degree-days needs to be able to cope with these situations (for both heating and cooling). There are a number of ways in which this can be done and they are briefly described here:

- Mean degree-hours: The calculation of degree-days is done by summing up hourly temperature differences and then dividing by 24. Smaller time increments may also be used if the data exists. It is important that only positive differences are summed.
- Using daily maximum and minimum temperatures: In this case, simplified correlations have been developed to calculate the degree-days depending on how the values of maximum and minimum temperatures compare with the base temperature. A detailed description of all the possible cases is given in the CIBSE Technical Manual 41 (CIBSE, 2006b).

- Using mean daily temperatures: This is a simplified degree-days calculation that is based on the differences between mean daily outdoor temperatures and the base temperature. It is therefore assumed that heating systems do not operate on days where the mean daily outdoor temperature exceeds the base temperature and cooling systems do not operate on days where the mean daily outdoor temperature is less than the base temperature.
- Direct calculation of monthly degree-days from mean monthly temperature and the monthly standard deviation of the variation in outdoor temperature during the month: this is based on statistical analysis of temperature distributions and the correlation for the degree-days calculation depends on the location of the building. Location-specific standard deviation values of the variation of the outdoor temperature exist in the literature for various places around UK (Hitchin, 1983).

In any degree-day application from those presented in this section, the decision for the value of the base temperature is important in the final calculation of the heating or cooling energy requirements. It is recommended that building-specific base temperatures be used where possible but this would add extra complexity in the calculation. It would require, for example, additional procedures to calculate the casual heat gains. An example of a brief building specific base temperature calculation that uses pre-calculated inputs (e.g. for building thermal capacity, solar gains, etc.) is given in the CIBSE Technical Manual 41 (CIBSE, 2006b).

### **3.8 Thermal-Network methods**

Thermal network methods discretise the building into a network of nodes, with interconnecting paths through which energy flows. The energy flow paths may include conduction, convection and radiation. The implementation of thermal network methods can vary from simplified to very detailed. A generally simple implementation of this type of method has been demonstrated with the description of the simple-hourly method that is included in the 13790 Standard. A more detailed

implementation can be considered to be the one within the ESP-r program, which has been summarised in this chapter too.

In many respects, thermal-network models may be considered a refinement of the heat balance method. For example, the heat balance model generally uses one node for zone air while a thermal network method might use multiple nodes. In addition, heat balance models generally have a single exterior node and a single interior node while thermal network models may have additional nodes. Another possible difference is that heat balance models generally distribute radiation from lights or other building equipment in a simple manner whereas thermal network models may consider these systems explicitly (e.g. for lighting systems it may be possible to model lamp, ballast and the shell of the luminaire housing separately). Although thermal network methods offer flexibility, their detailed implementations require detailed models, high computational times and additional user effort (particularly for their inputs).

### **3.9 Assumptions and limitations of the various calculation methods**

This section attempts to summarise the main assumptions and limitations of the various methods presented in this chapter. The methods are discussed here in the same order as they are presented in this chapter.

The simplified methods within the 13790 Standard are only meant to be used for calculations of the annual space heating and cooling energy requirements. Their implementation within an interface is necessary for their practical use as they are too complex for individuals to apply them in common daily assessments.

The monthly outputs from the simplified monthly method could be of use but it is suggested by the 13790 Standard that the results for months during the transition of seasons (i.e. from months when heating is needed to months when cooling is needed, and vice versa) are not accurate. The dynamic effects of the calculation (e.g. thermal storage of the building fabric over time) are taken into account by the gains or loss

utilisation factors and intermittent heating or cooling operations are approximated with reduction factors. The consequences of all these are discussed in detail in chapter 5. As in most of the simplified methods, it uses fixed heat transfer coefficients for the calculation which implies, for example, that air flows and the amount of solar radiation absorbed or emitted on the inside and outside faces of the building surfaces do not vary with time. Finally, solar radiation data have to be prepared or pre-calculated with another method for every surface and orientation of the building under study.

The simple hourly method within the 13790 Standard is also meant to have the same applicability as the monthly method in the 13790 Standard: annual energy requirements for space heating and cooling. It is recommended by the 13790 Standard that the hourly results of this method should not be used as there has not been any previous check on them. Air temperatures are also available on an hourly basis with this method but the same limitation as for the energy values is applied here too. This method also uses fixed heat transfer coefficients and requires pre-defined solar radiation data for every orientation of the building. It also approximates the effect of thermal mass by using one node to represent the whole mass of the building instead of an explicit study for all the building elements.

The applicability and the limitations of detailed simulation programs depend on the type of program and its functionality. Their concept is based on the heat balance method or on a detailed definition of the thermal network methods and therefore their limitations are discussed in the related sections for these methods. The functionality of detailed simulation programs will be discussed in detail in chapter 4. The complexity associated with the understanding of the underlying algorithms used in these simulation programs has been overcome either with existing interfaces or data models that could be used for the development of user friendly and user specific interfaces. In this way, functionality can be offered with the same complexity as in the simplified methods (i.e. through a simple interface) without sacrificing accuracy.

CIBSE steady state methods have a limited applicability in practice as they only calculate heat loss under steady state conditions. It is suggested by CIBSE Guide A that they can be useful for sizing emitters to achieve a specified operative temperature. This is often done by assuming a steady and a conservative outside temperature (i.e. slightly low for the particular location). However, summertime temperatures and cooling loads cannot be determined by steady state methods because it is necessary, for example, to take account of the time delays associated with the storage of heat within the building fabric.

CIBSE Guide A suggests that the admittance procedure (CIBSE simple dynamic method) can be used for rapid assessments of peak summertime temperatures, space cooling loads and preheat requirement. However, due to its main assumption that steady cyclic conditions are achieved (e.g. a single day repeated for subsequent days), it cannot represent the effects of rapid load changes nor long-term storage. Therefore it is not a suitable method to use for calculating the performance of buildings with a large thermal capacity or the effects of rapid changes in load (e.g. unoccupied weekend periods). Another simplification of this method is that it uses for the calculations the environmental and the sol-air temperatures. The main disadvantages of the use of these temperatures have been discussed previously in this chapter. Moreover, in the admittance method the transmitted shortwave solar radiation is assumed to be uniformly distributed over room surfaces, whereas in an actual case it would depend on the geometry of the building. Finally, a significant simplification is that heat exchange between room surfaces follows the same heat transfer assumptions as those for the CIBSE simple steady state model (e.g. use of constant internal radiative and convective heat transfer coefficients)

The heat balance method can be applied in a large number of assessments as the solution provides results for surface and room-air temperatures, heat flows through building elements and therefore for the energy loads for heating or cooling (e.g. annual, peak, etc.). The explicit knowledge of surface and air temperatures can also be used for other energy performance assessments, such as thermal comfort. The main simplifications of the heat balance method have already been mentioned in this

chapter. They involve assumptions that building zones and surfaces have uniform air temperatures and also that surfaces have uniform longwave and shortwave irradiation, and one-dimensional heat conduction within. However, these are limitations that only complex implementations of thermal network methods can overcome and they are also applicable for the rest of the methods described in this chapter.

The radiant-time series method is only suited for calculating the peak cooling load in a defined zone on a particular design day and for a constant indoor temperature. This method also adopts similar simplifications as the admittance method, involving the use of the sol-air temperature to model exterior heat transfer processes and as well as fixed combined internal and external surface heat transfer coefficients. The radiant-time series method approximates the storage and release of energy by the building elements (walls, floors, etc.) with a predetermined zone response, which according to McQuiston et al. (2005) may result in a few cases, particularly for zones with large amounts of glass, in a significant overprediction of the cooling load.

The applicability and the simplifications of the weighting factor method are similar to those for the radiant-time series method. The only difference is that the weighting factor method uses annual weather data instead of using only data for a single design day and therefore it could be applied for the quantification of annual heating and cooling energy requirements.

The degree-day method can only be used in cases where the indoor temperature, air flows and internal gains are relatively constant and as long as the heating and cooling systems operate for a complete season. A large uncertainty with this method is the way the base temperature is determined. In practice, the base temperature of most buildings varies throughout the year. This can be explained, for example, by the fact that the internal heat gain of the building is affected by the sun (solar heat gain), the wind, and the patterns of occupancy, all of which typically vary throughout the year. The internal temperature of the building will also typically vary unless the building's heating control system is working perfectly. In addition to these factors, the degree-



days calculation becomes more complex and not appropriate for cases where there is intermittent operation of heating and cooling systems as it only covers continuous calculation periods. If for example, a building is heated only during daytime the consideration of night-time outside air temperatures in the calculation of degree-days would not be directly relevant to the energy consumption for heating as the degree-days calculation would normally assume. Intermittent operation has also an effect on the way heat is stored and released in the building spaces, which is also not taken into account with the degree-days method.

The implementations of thermal network methods can vary from simple to very detailed. The simplified approaches can, for example, have limitations as those described earlier in this chapter for the simple hourly method of the 13790 Standard, while the detailed approaches can possibly overcome the assumptions of the heat balance method that were also discussed in this chapter. A general reference of the thermal network methods is only given in this chapter without going into detail for all the different possible implementations of these methods. The main focus of this chapter is on the three types of methods included within the 13790 Standard due to the direct relation of this Standard with the EPBD.

### **3.10 Previous comparisons between calculation methods**

One significant previous comparison between some of the methods described in this chapter was done between implementations of the admittance method, the radiant-time series method and the heat balance method (Spitler and Rees, 1998; Rees et al. 1998). This study compared peak cooling loads and time of occurrence of these loads for a large number of parametric cases. The implementation used for the heat balance method was taken as the reference method in that study and the results of the two other simplified methods were compared against it. Careful consideration was taken to ensure the inputs and boundary conditions for all three methods were the same and it was concluded that although the two simplified methods were normally in good agreement with the heat balance method in terms of predictions for the time of occurrence of peak cooling loads, disagreements were often noticed between the

results of peak cooling loads. The reasons for these differences were identified in simplifications of the admittance and the radiant-time series methods, especially for their treatment of the solar and radiant internal heat gains. In general, compared with the results produced from the heat balance method, the radiant-time series method show better agreement than the admittance method. Further information on other studies between previous ASHRAE methods (i.e. methods that were replaced by the radiant-time series method and are not currently used) that are available in the literature are also given in these two publications. However, it was admitted that no large quantitative comparisons were done until the time of this publication (i.e. 1998) between simplified methods and the heat balance procedure.

A number of comparative studies between detailed simulation programs have been reported in the literature with regards to energy calculations for space heating and cooling (e.g. Judkoff and Neymark, 1995; Lomas, 1992). However, this type of study will be further analysed in chapter 5 and 6 where the option of performing energy performance assessments with different simulation programs will be discussed. This chapter is only focusing on the available methods for heating and cooling load calculations, considering detailed simulation programs as one option.

A limited number of previous publications refer to quantitative comparisons between the CEN 13790 methods, and especially between the recent updated versions of these methods. Beccali et al. (2001) compared two simplified methods similar to those described in the monthly method of the 13790 Standard with TRNSYS (2007) for cooling load assessments based on three typical Italian climates. Jokisalo and Kurnitski (2007) applied the monthly method described in a previous draft of the 13790 Standard for heating load assessments based on a typical Finnish climate against the results of IDA-ICE (2002). Corrado and Fabrizio (2007), studied the dynamic parameters of the monthly method described in a previous draft of the 13790 Standard for cooling load assessments based on typical Italian climates against the results of EnergyPlus. These three studies revealed large differences between the results of the simplified methods and the detailed programs: the calculation of the dynamic parameters was often identified as the main source of the differences. The

lack of flexibility in the inputs of the simplified methods and their inability to accurately represent a large number of building cases for a number of climates was recognised in these studies. For example, Beccali et al. concluded that the simplified methods they used were inappropriate for quantifying accurately sensible cooling energy demand in Italian climates. The study of Corrado and Fabrizio was also done for Italian climates and cooling load calculations. However, they only researched the dynamic parameters of the simplified monthly method using a detailed simulation program for this purpose (i.e. not the actual monthly method). Their conclusions suggested that the default numerical parameters used in the calculations of the utilisation factor with the monthly method were not appropriate for the cases they studied. Finally, Jokisalo and Kurnitski reported that the monthly method in their study was not suitable for heating calculations in Finnish climates and especially for studies of office buildings. They also concluded that the decision for the default dynamic parameters in the monthly method has significant impact on the results.

### **3.11 Summary**

This chapter reviewed common space heating and cooling energy calculation methods due to the importance they have on the overall energy performance assessments of buildings. The discussion included calculation methods whose concepts vary in complexity (e.g. from rules of thumb or the degree days method to the heat balance or thermal network methods). However, the main focus of the discussion was in the methods included in the CEN 13790 Standard due to their relevance with the EPBD (see Figure 2.2 in chapter 2). Previous comparative studies between some of these methods and especially between the methods that are relevant to the CEN 13790 Standard were then referenced and discussed. Although these studies each had a specific focus (e.g. only numerical comparisons for cooling load calculations, etc.) for specific climates and for specific building types, further research is needed for the application of the updated 13790 Standard, which in addition includes the simplified hourly method and rules for the inputs and the boundary conditions of detailed simulation programs. This will be particularly useful as this Standard will be used for suggesting methodologies that facilitate the

implementation of the EPBD in European countries, in terms of annual heating and cooling energy calculations.

A further investigation on these issues will be discussed with case studies in chapter 5 where the impact that the selection of appropriate methods for performing these calculations may have on regulation compliance decisions will be shown. Chapter 4 discusses the option of detailed simulation programs as a method to be used for the purposes of the EPBD and as well for addressing the common challenges that were described in chapter 1 for the sustainable design of buildings. The analysis will list the main capabilities of detailed simulation programs against the functionality required to respond to these challenges that are represented in the next chapter by a structured set of environmental performance indicators.

### 3.12 References

ASHRAE (American Society of Heating, Refrigerating and Air-Conditioning Engineers). 2005. *2005 ASHRAE Handbook – Fundamentals (SI), chapter 30 & chapter 32*. Atlanta, USA.

Becalli M., Mazzarella L., Motta M. 2001. *Simplified models for building cooling energy requirement*. Proceedings Building Simulation '01. Rio de Janeiro, Brazil.

BSRIA (Building Services Research and Information Association). 2003. *Rules of thumb (UK 4<sup>th</sup> edition)*. BSRIA BG 14/2003. Bracknell, UK.

CIBSE (Chartered Institution of Building Services Engineers). 2006. *CIBSE Guide A: Environmental design (7<sup>th</sup> Edition)*. London, UK.

CIBSE (Chartered Institution of Building Services Engineers). 2006b. *Degree-days: theory and application*. Technical Manual 41. ISBN-10: 1-903287-76-6. London, UK.

Clarke J.A. 1977. *Environmental systems performance*. PhD Thesis, University of Strathclyde, Glasgow, UK.

Clarke J.A. 2001. *Energy simulation in building design (2<sup>nd</sup> Edition)*. Butterworth-Heinemann. ISBN 0-750-65082-6. Oxford, UK.

Corrado V., Fabrizio E. 2007. *Assessment of building cooling energy need through a quasi-steady state model: Simplified correlation for gain-loss mismatch*. Energy and Buildings, 39 (5), pp. 569-579.

Davies M.G. 1992. *Flaws in the environmental temperature model*. Building Services Engineering Research Technology, 13 (4), pp. 209-215.

EN 15265. 2007. *Thermal performance of buildings – Calculation methods of energy use for space heating and cooling – General criteria and validation procedures*. European Committee for Standardization, Brussels, Belgium.

EN 673. 1997. *Glass in building: determination of thermal transmittance (U value) - Calculation method*. European Committee for Standardization, Brussels. Belgium.

EN ISO/DIS 6946. 2007. *Building components and building elements - Thermal resistance and thermal transmittance - Calculation method*. ISO, Geneva, Switzerland.

EnergyPlus 2.1.0. . 2007a. *Building energy simulation program*. US Department of Energy, USA. Available from: <http://www.energyplus.gov>.

EnergyPlus 2.1.0. 2007b. *EnergyPlus engineering reference – The reference to EnergyPlus calculations*. US Department of Energy, USA. Available from: <http://www.energyplus.gov>.

ESP-r 11.4. 2007. *Building energy simulation program*. University of Strathclyde, Glasgow, UK. Available from: <http://www.esru.strath.ac.uk>.

Hitchin E.R. 1983. *Estimating monthly degree-days*. Building Services Engineering Research & Technology, **4** (4), pp. 159-162.

IDA-ICE 3.0. 2002. *IDA Indoor Climate and Energy 3.0 Simulation Program*. Sweden.

Jokisalo J., Kurnitski J. 2007. *Performance of EN ISO 13790 utilisation factor heat demand calculation method in a cold climate*. Energy and Buildings, **39** (2), pp. 236-247.

Judkoff R., Neymark J. 1995. *International Energy Agency building energy simulation test (BESTEST) and diagnostic method*. IEA Annex 21/Task 12 Co-operative Project, Final Report, NREL/TP-472-6231. National Renewable Energy Laboratory, Colorado, USA.

Lomas K.J. 1992. *Applicability study I: executive summary*. ETSU Report S1213, De Montfort University, Leicester, UK.

Macdonald I.A. 2002. *Quantifying the effects of uncertainty in building simulation*. PhD Thesis, ESRU, University of Strathclyde. Glasgow, UK.

McQuiston F.C., Parker J.D., Spitler J.D. 2005. *Heating, ventilating, and air conditioning (6<sup>th</sup> Edition)*. ISBN 0-471-47015-5. USA.

Nielsen T.R. 2005. *Simple tool to evaluate energy demand and indoor environment in the early stages of the building design*. Solar Energy, 78 (1), pp. 73-83.

PASSYS-I. 1989. *Development of simplified design tools*. Research Report of the Simplified Design Tools Subgroup. Commission of the European Communities, Directorate General XII, EUR 12 998 EN, Brussels, Belgium.

PASSYS-II. 1993. *Final report of the simplified design tools subgroup*. Commission of the European Communities, Directorate General XII, Contract JOUE-CT90-0022, Brussels, Belgium.

prEN ISO/DIS 13786. 2007. *Thermal performance of building components – Dynamic thermal characteristics - Calculation method*. ISO, Geneva, Switzerland.

prEN ISO/DIS 13789. 2007. *Thermal performance of buildings – Transmission and ventilation heat transfer coefficients – Calculation methods*. ISO, Geneva, Switzerland.

prEN ISO/DIS 13790. 2007. *Energy performance of buildings – Calculation of energy use for space heating and cooling*. ISO, Geneva, Switzerland.

prEN ISO/DIS 15241. 2007. *Ventilation for buildings – Calculation methods for energy losses due to ventilation and infiltration in buildings*. ISO, Geneva, Switzerland.

prEN ISO/DIS 15243. 2007. *Ventilation for buildings – Calculation of room temperatures and of load and energy for buildings with room conditioning systems*. ISO, Geneva, Switzerland.

prEN ISO/DIS 15316 (all parts). 2007. *Heating systems in buildings – Method for calculation of system energy requirements and system efficiencies*. ISO, Geneva, Switzerland.

Rees S.J., Spitler J.D., Haves P. 1998. *Quantitative comparison of North American and U.K. cooling load calculation procedures – Results*. ASHRAE Transactions, 104 (2), pp. 47-61.

Spitler J.D., Rees S.J. 1998. *Quantitative comparison of North American and U.K. cooling load calculation procedures – Methodology*. ASHRAE Transactions, 104 (2), pp. 36-46.

TRNSYS 16.0. 2007. *A transient systems simulation program*. Solar Energy Lab (SEL), University of Wisconsin, Madison, USA. Available from: <http://sel.me.wisc.edu/trnsys/>.



INTEGRATED MODELLING APPROACH – FUNCTIONALITY OF  
SIMULATION PROGRAMS

**4.1 Introduction**

Common calculation methods for quantifying space heating and cooling energy requirements were described in chapter 3, with the main focus being on the methods suggested by the CEN Standards that facilitate the implementation of EPBD. Detailed energy simulation programs have been included within these Standards as a potential method to offer an integrated calculation for the energy performance of buildings. These programs, apart from quantifying space heating and cooling energy requirements, may offer a large number of capabilities that could also be used to address the issues described in chapter 1, and their use could help practitioners to design more sustainable buildings. A number of detailed energy simulation programs have been developed over the years and their capabilities vary. In some cases, the development of these programs has taken place over more than twenty years with an associated long validation history.

Existing studies discussing the general capabilities of detailed energy simulation programs are available in the literature. Of particular note, Crawley et al. (2005) listed the capabilities of twenty programs based on the existing modelling areas of these programs. However, this description was using language and terms from vendors or developers of simulation programs. These terms are not always clear to the practitioners and may not reflect the assessments that practitioners are performing during their attempts to optimise the energy performance of buildings and produce sustainable building designs. CIBSE has also published Application Manual 11 (CIBSE, 1998) which discusses the capabilities of detailed energy simulation programs and indicates the issues of importance when selecting these programs for modelling assessments. The guide describes the capabilities of these programs for the various modelling domains (thermal, air flow and lighting) and focuses on the

various methods that these programs could use to deliver these capabilities. These methods include steady state calculations, although the guide clearly defined its focus on programs that can predict the dynamics associated with the energy performance of buildings. The analysis offered in the guide is extensive in terms of referencing the number of assessments that could be performed using these programs. The capabilities of simulation programs are not, however, listed and matched against a structured set of sustainability issues and environmental performance indicators for which they could be used in practical design studies. This chapter presents the capabilities of detailed simulation programs with regards to the functionality requirements that arise from the set of issues described in chapter 1. These issues reflect on what practitioners have to consider during studies of optimising the energy performance of buildings to deliver sustainable building designs. It is expected that from the outcome of this chapter, the capabilities of simulation programs will become clearer to the practitioners and will provide them with a list of potential functionality that they should be looking for in cases where they have to select between the various available detailed simulation programs. The selection of a simulation program by practitioners in terms of calculation aspects should mainly be based on two criteria:

- The ability to offer the required functionality.
- The validation history of the program.

This chapter will focus on the former while the latter will be discussed in chapter 6 where a facility is presented within a simulation program that enables practitioners to easily check the performance of the program against the various validation tests that are included within energy performance standards.

While the ability of offering a quick description of the building model is also another requirement that is often requested in practice, the assumption in this thesis is that all programs should have flexible interfaces and data models that can be adjusted at the level of complexity that the user requires. It is not intended in this thesis to analyse the simulation programs in terms of their interfaces and the amount of data that they

need to model the various building domains since this can be a preference that varies for each user differently. However, it is expected that the programs can allow either the interface to be flexible or the data model to be available to the users so that they could define their own user-specific interfaces. Finally, the cost of buying the program and the associated cost of training could be also another issue during the selection of simulation programs. However, since advanced open source or public-domain programs are currently available, the cost of buying a program should not be an issue for practitioners. The cost of training is always considerable for most programs but this is again a user-specific issue and it will not be accounted as significant in this chapter, which focuses only on issues related to calculation capabilities.

The analysis in this chapter follows the structure of Table 4.1. This table includes all the environmental performance indicators related to the issues discussed in chapter 1 for the sustainable design of buildings and for which detailed simulation programs could provide functionality. The first section of this table summarises the metrics that are used to describe the required functionality for the study of every environmental performance indicator and the level of detail needed for the output of these metrics. The next section of Table 4.1 discusses the ability of simulation programs to provide this functionality, while the last sections present the possible limitations that may exist when delivering this functionality and, if applicable, any potential future developments in the capabilities of simulation programs with regards to these studies. It should be noted here that this table provides only a summary of the analysis and a more detailed discussion for every section of this table is given in the rest of this chapter. The discussion in this chapter uses also information from the report of Crawley et al. (2005).

	Required functionality		Ability of whole building integrated energy simulation programs to provide this functionality ( <i>Widespread or not</i> )	Limitations (to determine the metrics with whole building energy simulation programs)	Future capabilities
	Metrics	Level of detail ( <i>Spatial &amp; Temporal Resolution</i> )			
<b>Global warming</b>	- CO <sub>2</sub> and other greenhouse gas emissions (e.g. kg CO <sub>2</sub> /m <sup>2</sup> of floor area). - CO <sub>2</sub> equivalent (GrCO <sub>2</sub> eq).	- Global values for the whole building. - Annual results.	A large number of programs have CO <sub>2</sub> output results based on the calculation of building's energy consumption for the operational stage of the building but rarely for the whole life cycle of the building.	Simulation programs do not include whole life cycle analysis: There is lack of publicly available standardised databases from manufacturers of products in terms of their environmental impacts during their life span.	Incorporate Life Cycle Analysis.
<b>Acid rain</b>	- SO <sub>2</sub> and NOx emissions (e.g. kg SO <sub>2</sub> /m <sup>2</sup> of floor area, kg NOx/m <sup>2</sup> of floor area, kg SO <sub>2</sub> equivalent).	- Global values for the whole building. - Annual results.	A small number of simulation programs report these emissions.	Simulation programs do not include whole life cycle analysis: There is lack of publicly available standardised databases from manufacturers of products in terms of their environmental impacts during their life span.	Incorporate Life Cycle Analysis
<b>Ozone depletion</b>	- CFC and HCFC that could escape from old AC systems (kg CFC, kg HCFC).	- Global values for the whole building. - Annual results.	A small number of simulation programs report these emissions.	Simulation programs do not include whole life cycle analysis: There is lack of publicly available standardised databases from manufacturers of refrigerators and other chilling components in terms of their environmental impacts during their life span.	Approximations for existing buildings (e.g. inference procedures): based on the age, type and use of AC systems to indicate possible effects on ozone depletion.
<b>Materials and energy resources depletion</b>	- Amount of materials (kg) and energy (kWh or MJ) used.	- Depending on the focus of the study all levels of spatial resolution may be required (e.g. from whole building to a specific	None of the integrated simulation programs is used for these assessments. Only individual applications are available (e.g. ECO-BAT and ENVEST).	Simulation programs do not include whole life cycle analysis: There is lack of publicly available standardised databases from manufacturers	Incorporate Life Cycle Analysis

	Required functionality		Ability of whole building integrated energy simulation programs to provide this functionality ( <i>Widespread or not</i> )	Limitations (to determine the metrics with whole building energy simulation programs)	Future capabilities
	<i>Metrics</i>	<i>Level of detail (Spatial &amp; Temporal Resolution)</i>			
		<p>construction layer)</p> <ul style="list-style-type: none"> <li>- Temporal resolution may vary from analysis of the whole life cycle to analysis of only a specific detailed stage of the building's life span</li> </ul>		<p>of products in terms of their environmental impacts during their life span.</p>	
<b>Local air pollution</b>	<ul style="list-style-type: none"> <li>- SO<sub>2</sub>, NO<sub>2</sub>, PM10 and PM2.5 emissions (kg SO<sub>2</sub>, kg NO<sub>2</sub>, kg PM10 and kg PM2.5).</li> <li>- POCP indicator (kg C<sub>2</sub>H<sub>4</sub> eq.)</li> </ul>	<ul style="list-style-type: none"> <li>- Global values for the whole building.</li> <li>- Annual results.</li> </ul>	<p>A limited number of simulation programs report these emissions and only for the operational stage of buildings.</p>	<p>Lack of data and databases from different fuels and operations to take into account pollutants generated from the use of buildings.</p>	-
<b>Effect on urban environment</b>	<ul style="list-style-type: none"> <li>- Solar radiation absorbed/reflected from building surfaces (W/m<sup>2</sup>)</li> <li>- Wind channelling or recirculation around the buildings (flow images)</li> <li>- Percentage of shading on surrounding building surfaces (%) and daylight factors for their spaces (-).</li> </ul>	<ul style="list-style-type: none"> <li>- Solar radiation: Global values for the whole building. For warm/summer periods.</li> <li>- Wind: high spatial resolution – explicit for the surrounding area. High temporal resolution for short periods.</li> <li>- Shading: For critical facades and spaces of surrounding buildings. For short periods that consider both clear and overcast sky conditions.</li> </ul>	<ul style="list-style-type: none"> <li>- Solar radiation metrics: widely available within integrated energy simulation programs.</li> <li>- Wind patterns metrics: Not common for integrated simulation programs. Stand-alone CFD and wind tunnels are instead used.</li> <li>- Shading and daylight metrics: available to many but not all integrated energy simulation programs.</li> </ul>	<ul style="list-style-type: none"> <li>- Radiation heat exchange with surrounding buildings: not represented in detail.</li> <li>- Not easy or possible to define explicitly the surrounding building areas for wind flow analysis.</li> </ul>	- Community scale simulations
<b>Indoor Air Quality</b>	<ul style="list-style-type: none"> <li>- Minimum fresh air requirements per person (l/s per person).</li> <li>- Volume flow rates in</li> </ul>	<ul style="list-style-type: none"> <li>- Average room space analysis for well-mixed spaces. Otherwise, local analysis in a room space.</li> </ul>	<ul style="list-style-type: none"> <li>- A good number of programs do multi-zone airflow analysis (usually with nodal network flow models)</li> <li>- Contaminant analysis (with sinks, sources,</li> </ul>	<ul style="list-style-type: none"> <li>- Air flow/contaminants concentration modelling is not always coupled with thermal simulation: Important in a few</li> </ul>	<ul style="list-style-type: none"> <li>- Sources and sinks databases for contaminants simulation.</li> </ul>

	Required functionality		Ability of whole building integrated energy simulation programs to provide this functionality ( <i>Widespread or not</i> )	Limitations (to determine the metrics with whole building energy simulation programs)	Future capabilities
	Metrics	Level of detail ( <i>Spatial &amp; Temporal Resolution</i> )			
	<p>a space (m<sup>3</sup>/s).</p> <ul style="list-style-type: none"> <li>-Contaminant distribution levels (g of contaminant per kg of air).</li> <li>- Distribution of the mean age of air (s).</li> <li>- Perceived air quality (decipol)</li> <li>- Odour levels (odour unit)</li> </ul>	<ul style="list-style-type: none"> <li>- High temporal resolution (hourly or sub-hourly) for short periods: must account for the variations on the occupancy patterns.</li> </ul>	<p>filters, etc.) is currently provided by less simulation programs than the nodal network airflow analysis.</p> <ul style="list-style-type: none"> <li>- Local analysis is offered only by a few simulation programs: usually using stand-alone CFD – one program offers CFD coupled with thermal and inter-zone air-flow simulation.</li> <li>- None for perceived indoor air quality.</li> </ul>	<p>cases (e.g. naturally ventilated buildings).</p> <ul style="list-style-type: none"> <li>-Coupling CFD and thermal simulation for local analysis: not easily applicable.</li> <li>-Contaminants analysis: sources and sinks information is not easily available.</li> </ul>	<ul style="list-style-type: none"> <li>- Ease the application of multi-zone coupled CFD/thermal simulation analysis.</li> <li>- Incorporate perceived indoor air quality.</li> <li>- Include adaptive behaviour models.</li> </ul>
<b>Thermal Comfort</b>	<ul style="list-style-type: none"> <li>- Peak/minimum operative temperature during occupied hours (°C).</li> <li>- Frequency and time of occurrence of high operative temperatures (e.g. occupied hrs that <math>\theta_{op} &gt; 28^{\circ}\text{C}</math>).</li> <li>- Average and local perceived thermal comfort indicators (e.g. PMV, PPD).</li> <li>- Adaptive comfort temperature (°C).</li> </ul>	<ul style="list-style-type: none"> <li>- Average room space analysis unless the study is for local discomfort metrics.</li> <li>- High temporal resolution: following occupancy variations.</li> </ul>	<ul style="list-style-type: none"> <li>- A large number of programs provide results for most average thermal comfort metrics.</li> <li>- A few programs calculate local discomfort.</li> <li>- Simulation programs have started considering adaptive comfort metrics but work is at an early stage.</li> </ul>	<ul style="list-style-type: none"> <li>- Comfort indicators are based on models derived from empirical experiments that were assuming steady-state conditions and their applicability to more realistic conditions needs to be reconsidered.</li> </ul>	<ul style="list-style-type: none"> <li>- Make practical for local discomfort analysis the use of integrated CFD and thermal simulation.</li> <li>- Further integrate adaptive behaviour models.</li> </ul>
<b>Visual Comfort</b>	<ul style="list-style-type: none"> <li>- Illuminance levels (lux) or daylight factors (-).</li> <li>- Glare discomfort</li> </ul>	<ul style="list-style-type: none"> <li>- Average values for a space (illuminance/ daylight factors) and locally for specific points within a</li> </ul>	<p>A small number of integrated energy simulation programs offer illuminance/daylight factors and especially glare metrics (usually by linking to specialised software).</p>	<ul style="list-style-type: none"> <li>- High resolution required for defining the geometry of internal spaces.</li> <li>- Detailed calculation methods</li> </ul>	<ul style="list-style-type: none"> <li>- Templates for internal space layouts of different building</li> </ul>

	Required functionality		Ability of whole building integrated energy simulation programs to provide this functionality ( <i>Widespread or not</i> )	Limitations (to determine the metrics with whole building energy simulation programs) may require long calculation times.	Future capabilities
	<i>Metrics</i>	<i>Level of detail (Spatial &amp; Temporal Resolution)</i>			
	indices: Unified Glare Rating, Daylight Glare Index, BRS Glare Index, etc.	space (illuminance/ dayl. factors and glare). - For short periods that include typical sky conditions (i.e. overcast and clear). - At room space. - Temporal resolution is not important: metrics depend on room characteristics.	None of the integrated energy simulation programs (some applications exist at research level) – usually offered by specialised software.		types. - Further integrate adaptive behaviour models.
<b>Acoustic Comfort</b>	- Background sound rating curves (NR, NC, RC, etc.). - Reverberation time in different octave bands (s).	- At room space. - At surface and/or at construction layer. - Hourly timesteps to represent humidity and temperature variations. - Seasonal (mostly annual) periods.	- Some of the existing whole building energy simulation programs could be used for these studies (e.g. ESP-r) but they may incorporate simplifications. - Detailed analysis is offered by specialised programs studying only individual constructions but fixed input from an external whole building analysis is required.	- Difficult to determine the sound transmission properties through façades.	- Better integration within energy simulation programs to start considering this type of study.
<b>Humidity levels, condensation risk and mould growth</b>	- [Surface temperature-Dew point temperature] (K) and number of occasions that this is less than or equal to 0. - Accumulation of moisture (g of moisture per m <sup>2</sup> of construction area) - Mould growth thresholds defined by Relative Humidity and temperature combinations (limiting curves). - Mould growth risk as the cause of design and operational parameters: Number of risky mould	- At room space. - At surface and/or at construction layer. - Hourly timesteps to represent humidity and temperature variations. - Seasonal (mostly annual) periods.	- Some of the existing whole building energy simulation programs could be used for these studies (e.g. ESP-r) but they may incorporate simplifications. - Detailed analysis is offered by specialised programs studying only individual constructions but fixed input from an external whole building analysis is required.	- Adsorption and desorption characteristics of the construction materials are ignored by current whole building simulation programs. - The effect of moisture accumulation on the temperatures and heat transfer is ignored (i.e. not integrated). - Specialised applications for individual constructions may overcome the above limitations but some fixed pre-calculated conditions should be determined from whole building analysis programs.	- Account for adsorption/desorption hysteresis of materials (whole building analysis). - Integration/ coupling of heat, air and moisture transfer calculations (whole building analysis).

	Required functionality		Ability of whole building integrated energy simulation programs to provide this functionality ( <i>Widespread or not</i> )	Limitations (to determine the metrics with whole building energy simulation programs)	Future capabilities
	Metrics	Level of detail ( <i>Spatial &amp; Temporal Resolution</i> )			
	days (days)				
<b>Operational Energy – Thermal energy requirements</b>	-Thermal energy requirements for heating/cooling/hot water (kWh/m <sup>2</sup> of floor area).	- At room space and global values for the whole building. - Annual periods (seasonal and multi-year may also be useful).	Widespread (calculation approaches vary).	- Methods may be simplified but there is no real consensus of what level of detail is needed.	- Processes to guide users on applicability and performance against validation tests.
<b>Operational energy – Peak thermal loads</b>	- Maximum diversified (block) room space loads (kW). - Frequency of occurrence of high thermal loads (frequency distribution tables).	- At room space and global values for the whole building. - Hourly or sub-hourly calculation timesteps should be used for a representative period (e.g. design day, warm week, etc.).	- Most programs report peak thermal loads for the building overall. - No available information on the exact number of programs offering frequency distribution analysis of these loads but there are a number of known examples (e.g. ESP-r).	- Detailed internal heat gains profiles are usually unknown and are not usually considered in detail by programs (i.e. by using profiles that can vary at each timestep).	- Establish databases with detailed internal heat gains profiles and incorporate them in simulation programs. - Further integrate adaptive behaviour models.
<b>Operational energy – Electrical energy requirements</b>	- Electrical energy requirements for lighting and small power (kWh/m <sup>2</sup> of floor area). - Matching between energy demand for electricity and supply (statistical coefficients: Rank Correlation Coefficient, Inequality Coefficient, etc.).	- Global values for the whole building. - Annual results (less often: seasonal). - For studies of energy demand/ supply matching: short timesteps should be used to quantify the demand profile in detail.	- Calculations for the energy requirements of lights and small power loads are widely available. - Demand and supply match studies are not automated within integrated simulation programs. Only specialised applications are used for this purpose.	- Optimising the match between energy demand and supply requires post-processing or the use of external specialised programs.	- Incorporate demand side management controls - Further integrate adaptive behaviour models.



	Required functionality		Ability of whole building integrated energy simulation programs to provide this functionality ( <i>Widespread or not</i> )	Limitations (to determine the metrics with whole building energy simulation programs)	Future capabilities
	<i>Metrics</i>	<i>Level of detail (Spatial &amp; Temporal Resolution)</i>			
<b>Operational energy – Peak electrical loads</b>	<ul style="list-style-type: none"> <li>- Peak electrical loads for building power loads (kW).</li> <li>- Peak electrical supply for autonomous buildings (kW).</li> </ul>	<ul style="list-style-type: none"> <li>- Global values for the whole building.</li> <li>- Short periods for which worse case scenarios may occur.</li> </ul>	Widespread.	<ul style="list-style-type: none"> <li>- Optimising the match between energy demand and supply requires post-processing or the use of external specialised programs.</li> </ul>	<ul style="list-style-type: none"> <li>- Incorporate demand side management controls</li> <li>- Further integrate adaptive behaviour models.</li> </ul>
<b>Operational energy – Systems’ performance</b>	<ul style="list-style-type: none"> <li>- Maximum system output (kW).</li> <li>- Systems efficiency (e.g. %)</li> <li>- Ability of control systems to maintain set-points (-)</li> </ul>	<ul style="list-style-type: none"> <li>- Components as a whole network and individually</li> <li>- Temporal resolution depends on the systems and may vary enormously from short periods to multi-year assessments.</li> </ul>	Different programs include different range of systems and at different level of detail.	<ul style="list-style-type: none"> <li>- Electrical power flow modelling is not usually available for modelling microgeneration systems.</li> <li>- Manufacturers of components do not usually provide data on all the component’s details needed for their simulation.</li> <li>- High number of simulation timesteps is often used for some systems, which may lead to long calculation times.</li> </ul>	<ul style="list-style-type: none"> <li>- Flexible templates of predefined components and networks of components</li> </ul>

Table 4.1: Summary of environmental performance indicators and required functionality for simulation programs

## **4.2 Global and local external environmental issues: Functionality requirements for simulation programs**

### ***4.2.1 Global Warming***

The metrics used for the assessments on the effect of buildings on global warming are mainly the amounts of CO<sub>2</sub> and, to a less extent, other common greenhouse gases (CH<sub>4</sub>, N<sub>2</sub>O, etc.) that are produced from the energy consumed during the whole life cycle of buildings, and especially during their operational stage. This is usually expressed in kg of CO<sub>2</sub> or kg of CO<sub>2</sub> per m<sup>2</sup> of floor area. The CO<sub>2</sub> equivalent may also be used as a metric for these assessments to express the quantity that describes, for a given mixture and amount of greenhouse gas, the amount of CO<sub>2</sub> that would have the same global warming potential (GWP) as this greenhouse gas, when measured over a specified period. An example of a unit used for this metric is billion metric tonnes of CO<sub>2</sub> equivalent (GtCO<sub>2</sub>eq).

While it is possible to analyse the issue of this section at a detailed level where the amount of CO<sub>2</sub> could be quantified by energy end use applications in buildings (e.g. for heating, hot water, lighting, etc.), the values used in practice are usually the global values resulting from the whole building analysis as a total or from a community of buildings. An exception to this may be when the study is focused on a specific source of emissions where detailed outputs by energy end use application are required. The analysis is usually undertaken for annual periods to accumulate the possible variations of CO<sub>2</sub> emissions from buildings over the year and to allow easier comparisons between buildings. Global values of CO<sub>2</sub> emissions for the building overall during its operational stage (i.e. not complete life cycle), for example, are used in the UK building regulations (e.g. PART L2A, 2006) and are quantified for annual periods.

A large number of detailed simulation programs provide outputs for CO<sub>2</sub> emissions based on the calculation of the energy consumption of buildings during their operational stage and on standardised, usually at national level, conversion factors of energy to CO<sub>2</sub> emissions. This is usually calculated at a level where the results are also offered by energy end use application but the assessments are not extended to

account for the whole life cycle of buildings. Twelve out of twenty programs that are included in the report of Crawley et al. (2005) claim that they can report major greenhouse gas emissions.

A useful extension of the capabilities of integrated building simulation programs will be to include Life Cycle Impact Assessments (LCIA) in order to produce CO<sub>2</sub> emissions for all the stages of building's life cycle. This would require publicly available standardised databases provided from manufacturers or building contractors with details about the environmental impacts of their products during the building's life span.

#### ***4.2.2 Acid rain***

Assessing the effect of buildings on the formation of acid rain requires mainly the quantification of sulphur dioxide (SO<sub>2</sub>) and nitrogen oxides (NO<sub>x</sub>) emissions that are produced due to the energy consumed at different stages of the building's life cycle. These pollutants are especially produced from buildings when natural gas is used in central heating boilers and when the electricity consumed in buildings is produced from microgeneration units or power stations that use sulphur-containing fossil fuels. Units of mass per floor area are also used for these assessments, for example kg of SO<sub>2</sub> per m<sup>2</sup> and kg of NO<sub>x</sub> per m<sup>2</sup>. In a similar way as for the Global Warming Potential, SO<sub>2</sub> equivalent may be used to describe, for a specific amount of pollutant, the amount of SO<sub>2</sub> that would have the same Acidification Potential as this pollutant when measured over a specified period. This can be for example expressed in kg of SO<sub>2</sub> equivalent.

The analysis should provide values for the emissions of the whole building. The total value for a group of buildings could be used to draw conclusions for the effect of these buildings on the formation of acid rain. In a same way as the CO<sub>2</sub> emissions, the assessments for the pollutants discussed in this section are also usually done for annual periods.

The pollutants related to the formation of acid rain are not usually part of the reports offered by integrated detailed simulation programs and it is not therefore discussed in the report of Crawley et al. (2005). There are a few programs, however, which offer outputs of SO<sub>2</sub> and NO<sub>x</sub> (e.g. ESP-r, 2007; EnergyPlus, 2007; etc.). These outputs are only related to the energy used during the operational stage of buildings and do not include an analysis for their whole life cycle.

#### ***4.2.3 Ozone depletion***

The effect of buildings on ozone depletion will depend on the type of refrigerants used in air-conditioning systems. The refrigerants affecting the ozone depletion are mainly CFCs, and to a less degree HCFCs. CFCs have been banned and are only used in old air-conditioning systems, while plans to reduce HCFCs consumption and production have also been adopted by a vast majority of countries. The alternatives suggested for the replacement of these refrigerants, as mentioned in chapter 1, do not have an effect on ozone depletion, although they may have other environmental impacts (e.g. toxicity, Global Warming Potential, etc.) and their use in buildings should be also kept to a minimum. Assessments for the effect of buildings on ozone depletion should only be performed for the cases where CFCs and HCFCs are used. The metrics for these assessments are the amounts of these two types of refrigerants used in these buildings and especially the amounts that could be possibly escaping to the environment. These are expressed in units of mass (e.g. kg of CFCs or kg of HCFCs).

High level of detail may not be required for these assessments. The overall amount of CFCs and HCFCs that may be escaping to the environment from the whole building will give an indication for the condition and the level of maintenance of the air-conditioning systems in that building. These figures must be obtained for annual or seasonal periods during the use of these systems.

These assessments are not part of the capabilities of integrated detailed simulation programs as they are only applicable to refrigerants that are not widely used anymore

in developed countries and they are assessments related to the way air-conditioning systems are maintained (they could, however, be estimated with leakage and refrigerator data). The report of Crawley et al. does not include ozone depletion assessments in the discussion for the capabilities of detailed simulation programs. However, detailed simulation programs could possibly be used to investigate different design options for buildings in order to minimise their cooling loads and the use of air-conditioning or the heating loads in the case of heat pumps. The output of these assessments could be, for example, expressed in terms of number of hours that the air-conditioning systems operate during the period of the assessments. The capabilities of simulation programs for the calculation of cooling loads are part of the discussion in the sections related to the operational energy of the building (i.e. sections 4.3.5 to 4.3.9).

Possible effects of buildings on ozone depletion could be approximated within integrated detailed simulation programs with the future development of inference procedures that are based on the age, type and use of air-conditioning systems. This would be particularly important if integrated simulation programs are used during the operation years of buildings and not only during their design stages.

#### ***4.2.4 Materials and energy resources depletion***

The quantification of the amounts of materials and fuel used during the whole life cycle of buildings are the metrics that could be used to assess the effect of buildings on the materials and energy resources depletion. These can be expressed in units of mass (e.g. kg).

The spatial resolution needed for assessments related to these metrics may vary depending on the focus of the study. Studies may be performed for only a specific material used in the building, the materials of a specific construction of the building envelope, a technical system (e.g. a boiler), a whole building space or the whole building. In terms of temporal resolution for these studies, the whole life cycle of the building has to be analysed. In terms of spatial resolution however, studies could be

performed for specific detailed or general stages of the life cycle of buildings, such as for example the materials fabrication stage and the building's construction stage respectively. Citherlet (2001) gives a detailed explanation of these stages in the context of the built environment and describes the implementation of life cycle impact assessments within an integrated whole building simulation program.

Assessing the effect of buildings on the materials and energy resources depletion would therefore require life cycle impact assessment for the whole building which, as mentioned in the previous sections of this chapter, is not usually included within the capabilities of integrated simulation programs. Individual specialised applications have been developed only for this purpose but they are not integrated with the rest of the building domains and the procedures required for a complete calculation of the building's energy performance. Examples of these applications are ECO-BAT (2008) and Envest 2 (2003). Applications for life cycle impact assessments have also been partially implemented within the ESP-r integrated simulation program (Citherlet, 2001) but the use of these applications has been limited to research studies. This topic is not discussed in the report of Crawley et al. (2005).

The limitations with regard to the implementation of life cycle impact assessment within integrated simulation programs were briefly discussed in section 4.2.1 for global warming: the lack of publicly available standardised databases for the environmental impacts of building materials over the building's life span was considered to be the main barrier.

#### ***4.2.5 Local air pollution***

The main metrics that could be used to investigate the effect of buildings on the local air pollution are the amounts of sulphur dioxide (SO<sub>2</sub>) and nitrogen dioxide (NO<sub>2</sub>) emissions that are produced from the use of fossil fuels in buildings. In addition, emissions of PM<sub>10</sub> and PM<sub>2.5</sub> may also be generated from energy related processes in buildings and could also be included in the metrics for these assessments as they increase local air pollution. Units of mass (i.e. kg) are again used to express the metrics of this section. The Photochemical Ozone Creation Potential (POCP) is an

indicator (Heijungs, 1992) which was developed to assess the various emission scenarios for volatile organic compounds and can also be used as a metric for the fuel emissions generated by the buildings' energy consumption, particularly in cases where microgeneration units are used. This is usually expressed in kg of ethylene (C<sub>2</sub>H<sub>4</sub>) equivalent.

Integrated total values for the whole building could be a useful output from these assessments. The resulting values for a number of buildings could be then used to draw conclusions for the effect of these buildings on their area's air pollution. The pollutants discussed in this section could be quantified for annual periods, although they are not included within the requirements of current building energy performance regulations in Europe that focus only on CO<sub>2</sub> emissions.

The pollutants from buildings that are related to local air pollution are not usually part of the reports offered by detailed simulation programs, although there are a number of programs (e.g. ESP-r, EnergyPlus, etc.) that could provide results of SO<sub>2</sub>, NO<sub>2</sub> and PM for the operational stage of the building. These outputs are usually depending on what conversion factors the user defines for simply converting the energy output from these programs to mass of pollutants. Three out of the twenty programs that are included in the report of Crawley et al. can provide outputs of SO<sub>2</sub>, NO<sub>2</sub> and PM.

There are, however, specific types of buildings (e.g. chemical labs and industrial buildings) whose operation may lead to local air pollution problems. Simulation programs need to do customization to take into account the resulting pollutants from the use of these buildings. Databases with the pollutants generated from different fuels and operations could be a useful development that could be used by simulation programs for assessments focusing on the effect of building on the local air pollution.

#### ***4.2.6 The effect on the urban environment***

Assessments for the effect of buildings on the urban environment may focus on three main topics:

- Their effect on the urban heat island in cases of buildings located in urban areas where hot periods are noticed on a regular basis. The metrics for these assessments could be the total amount of solar radiation absorbed and reflected from the external building surfaces. This can be expressed, for example, in  $W/m^2$ .
- Their effect on local wind speeds by identifying any potential wind channelling or recirculation around the buildings and especially within urban canyons. This is usually expressed with output of flow images that include wind velocity magnitude (m/s).
- Their effect on the shading and daylight availability of the surrounding buildings. These could be expressed in terms of percentage of shading on the surrounding building surfaces and daylight factors in their spaces respectively.

A different level of detail, in terms of spatial and temporal resolution, is required for the analysis of these three topics. For urban heat island studies, solar radiation results should be extracted for the total number of buildings located in the urban area of the study and a representative summer period should be used for the calculations. For the cases where the effect of buildings on local wind speeds is studied, the outputs for the flow regimes are of high spatial resolution and explicit for the area around the buildings. The assessments for these cases are also of high temporal resolution and are usually performed for short periods that are adequate to understand the flow regimes around buildings. For the last of these cases of this section where the effect of a building on the shading and daylight availability on the surrounding buildings is studied, the output for the daylight factors should be given for critical spaces of the surrounding buildings that may be affected by the building of the study. The output for the shading patterns, likewise, should be given for the critical façades of the buildings that may be shaded by the building of the study. Both overcast and clear sky conditions will need to be considered for the shading and daylight calculations and the analysis should be done for short but representative periods (i.e. by researching on worse case scenarios).



The ability of simulation programs to assess the effect of buildings on urban environment is not discussed in the report of Crawley et al. (2005). While integrated simulation programs often provide results related to urban heat island studies, such as the solar radiation absorbed and reflected on the building's surfaces, they do not usually represent in detail the radiation heat exchange between the building of the study and the buildings of the area. Attempts have been made at research level to overcome this barrier with the development of the "SUNtool" model (Robinson et al., 2007) as part of a European research project. Extending the capabilities of current integrated simulation programs towards community scale simulations would be a useful future development for these programs. For the cases where the effect of buildings on the wind patterns of urban environments is analysed, the use of integrated simulation programs is not common. Stand-alone CFD programs and wind tunnel experiments are instead used for this type of studies. These methods seem to be adequate in practice and if simulation programs are extending their capabilities to include this type of study it will be necessary to embed CFD within their structure and allow with appropriate interfaces the easy definition of the area around the buildings. Finally, there are a number of integrated simulation programs that are able to report daylight factors and shading patterns with direct calculations or by integrating specialised programs for this purpose (e.g. Radiance (2008)). Six out of twenty programs in the report of Crawley et al. claim that they have this capability. This topic will be further discussed in section 4.3.3 of this chapter for the capabilities of simulation programs with regards to visual comfort assessments.

### **4.3 Indoor environmental performance issues: Functionality requirements for simulation programs**

#### ***4.3.1 Indoor air quality***

The aim for indoor air quality (IAQ) studies is to ensure that there will be no health risk for the occupants from breathing the air in the building spaces and also that the occupants will perceive the air as fresh and pleasant. The metrics used in the former case are often simply the minimum fresh air requirements per person in a space or

the actual volume flow rates in that space (expressed in l/s per person and m<sup>3</sup>/s respectively). However, in cases of uneven distribution of air inside the building spaces these metrics can not guarantee that there will be no amount of indoor pollutants concentrated in some parts of these spaces. Metrics such as the contaminant concentration and distribution levels in the building spaces can be used instead for this purpose. These can be expressed in units of mass of contaminants per kg of air (e.g. g of contaminant per kg of air). In addition, the distribution of the mean age of air in a building space, expressed in units of time (e.g. s), may also be used as a metric for indoor air quality studies, but again the amount of indoor pollutants in these cases will not be taken into account. Metrics for perceived indoor air quality have also been developed and are summarised in a report from European Concerted Action (1992). Perceived air quality may be expressed as the percentage of dissatisfied, i.e. those persons who perceive the air to be unacceptable just after entering a space. This is determined as a function of the ventilation rate per standard person (i.e. standard person: average sedentary adult office worker feeling thermally neutral). The olf unit is used in these studies to express the pollution generated by this standard person, while the decipol unit is used to express the perceived air quality in a space with pollution source strength of one olf and 10 l/s of ventilated clean air. Odour levels may also be used as metrics for perceived indoor air quality studies instead of the percentage dissatisfied. This is usually expressed with the odour unit, which relates to the odour threshold and it is described in detail in the EN 13725 Standard (2003).

The level of detail needed for the outputs of these metrics in terms of spatial resolution depends on the type of ventilation system used in the building. In the cases where the air is well mixed in the building spaces then an analysis for the whole space as a total is adequate. In all other cases, local analysis within specific places in the building spaces may be necessary for drawing conclusions about the quality of the air in these places. Temporal resolution for indoor air quality studies should be high (i.e. hourly or sub-hourly) in order to account for the variations of the occupancy in the building spaces. The assessments are usually undertaken for typical short periods that are representative of the occupancy patterns of the spaces.

It is common amongst detailed simulation programs to include functionality for proving that minimum fresh air requirements have been met in a space. However, it is currently less common for most detailed simulation programs to include contaminants distribution analysis in their capabilities. Analysis of the mean age of air in a space would require the use of CFD, which is currently available only in a few integrated energy simulation programs. Perceived indoor air quality metrics are not available in any of the current integrated simulation programs.

To quantify the metrics of indoor air quality at room space level, it may be possible to use a number of simulation programs that incorporate nodal network flow models (e.g. Walton, 1983; Maver and Clarke, 1984). However, local analysis within the specific places in a room will require the use of CFD facilities (ideally coupled with the thermal simulation) that are not widely available within the capabilities of energy simulation programs. Information about indoor air quality is not included in the report of Crawley et al. (2005), but it is reported that nine out of twenty programs include multizone air flow analysis, while there is not a lot of discussion in this report for programs that have fully implemented contaminants concentration analysis. Finally, there is no information in this report about the metrics used for perceived indoor air quality studies.

A possible limitation when performing indoor air quality studies with most simulation programs is that predicted air flows and contaminants transport are usually calculated by stand alone analysis of air flows, ignoring the thermal variations and interactions in the building spaces. This may be particularly important for specific types of ventilation strategies, such as natural ventilation strategies where air flows are affected by the calculated temperatures. In addition to this, multizone CFD analysis coupled with the thermal simulation may be required for local indoor air quality studies but has been only applied at research level and it increases considerably the resolution of the analysis. Another limitation associated with the use of integrated simulation programs for indoor air quality analysis, and more specific for contaminant distribution studies, is that while information for contaminant

sources and sinks is required as input for these studies, it is not easily available in practice.

Databases for contaminant sources and sinks should be developed and made available within simulation programs that have the ability to perform contaminant distribution studies. This would reduce the effort required to define the information needed for these studies and would possibly encourage practitioners to start applying them more often in practice. Procedures for making easier the practical use of simulation programs that integrate CFD and thermal simulation domains should also be developed in the future to allow high resolution local indoor air quality studies across the building spaces of naturally ventilated buildings. Future developments in the capabilities of integrated simulation programs could incorporate as well metrics for perceived indoor air quality studies and adaptive occupants' behaviour algorithms that are based on indoor air quality criteria.

#### ***4.3.2 Thermal comfort***

A common thermal comfort assessment is the investigation of the potential risk for overheating (and sometimes underheating) of the building spaces. One of the metrics usually used for this type of study is the peak, or minimum in the case of an underheating study, operative temperature (i.e. the mean of the air and radiant temperatures - expressed in °C) of a space during occupied hours. It may also be required to estimate the frequency of when a range of specific high operative temperatures occur in the building spaces together with their time of occurrence (to consider, for example, only the occupied hours). This is also the main metric used by UK's building regulations for assessing the risk of overheating. It is usually expressed as the number of hours that the operative temperature within a space is above a certain value during the occupied hours of that space. Additional metrics for thermal comfort studies include specific comfort indicators that are compared against thermal sensation scales in order to predict the thermal sensation and the physiological response of the occupants to their thermal environment. PMV (Predicted Mean Vote) and PPD (Percentage People Dissatisfied) are two of the most

common examples of these indicators. Details of these indicators have been well documented in the literature and they have been also included in the current EN 15251 Standard (2007). The metrics described so far in this section are the metrics used for average thermal comfort studies within a space and the comfort indicators express possible discomfort for the human body. Thermal comfort studies can also be done for specific local areas within the building spaces or for local discomfort. In these cases, the most common metrics are the percentage of people dissatisfied due to draught (i.e. based on mean air velocity, turbulence intensity and air temperature), vertical air temperature differences, contact with a warm or cool floor and radiant temperature asymmetry caused by warm or cool surfaces (e.g. warm ceilings and cool walls). The average comfort indicators described in this paragraph have also been included in the current EN 15251 Standard (2007). Another metric that has now been included within this comfort Standard and as well within other international comfort Standards (ASHRAE, 2004) for naturally ventilated office buildings or dwellings is the adaptive comfort temperature (expressed in °C). This is defined as the optimal operative temperature and is related to the running mean of the outdoor temperature with relationships described in these Standards and are not discussed in detail here. This temperature defines upper and lower limits of comfort for different building categories. The applicability of these limits, however, depends on the individuals being able to take adaptive actions when they experience discomfort.

The analysis of thermal comfort metrics is usually done at room space level. The metrics, however, for local discomfort studies could be quantified at specific places within a room space. In all cases of average and local thermal comfort metrics, temporal resolution should be high with calculations that include hourly or sub-hourly timesteps and account for the variations in the occupancy patterns of the space. It should be noted that the adaptive comfort temperature is quantified with a different method outside the heating or cooling periods than during these periods (EN 15251 Standard, 2007).

The outputs for the metrics used for quantifying average thermal comfort have been included in the capabilities of most integrated simulation programs. The metrics for

local comfort studies are in most cases more difficult to calculate than the average thermal comfort metrics of a space and are therefore calculated only by a few integrated simulation programs. This is because the studies may require, for example, a CFD analysis for the calculation of the local environmental conditions (e.g. air temperatures, air velocity, etc.) or they may require the definition of local radiant temperature sensors that represent the occupant's body in order to calculate local view factors and local radiant temperatures. Adaptive thermal comfort temperature calculations and the resulting thermal comfort criteria are required for the implementation of adaptive behavioural models in the structure of simulation programs. Initial efforts have been demonstrated that include these adaptive behavioural algorithms within simulation programs (Rijal et al., 2007), but the vast majority of programs do not currently incorporate functionality for this purpose. Half of the programs in the report of Crawley et al. include models for calculating average comfort indicators within a space. Half of the programs also in this report can calculate operative temperatures but only four of these programs can provide radiant discomfort results.

A limitation with regards to the non-adaptive thermal comfort indicators discussed in this section is the fact that there have been several criticisms and suggestions for their improvement (Hensen, 1990; Humphreys and Nicol, 2002) due to that they are based on models derived from empirical experiments that were assuming steady-state conditions.

Integrated CFD analysis with thermal simulation is not widely used in practice for thermal comfort studies although it may offer some useful results, particularly for local discomfort studies. Future developments should aim to make this type of study more easily available to the users of simulation programs. Additional developments in the capabilities of these programs should also focus on the modelling of occupants' behaviour and provide thermal comfort outputs based on adaptive criteria.

### ***4.3.3 Visual comfort***

The main metrics used for visual comfort studies are the illuminance levels and daylight factors on horizontal, vertical and tilted levels within the building spaces. Illuminance levels are expressed in lux units while daylight factors are dimensionless. Glare discomfort analysis may also define metrics for visual comfort assessments and several glare index metrics pointing to glare discomfort scales have been developed for this purpose. Examples of well-known glare indices that have been used for glare discomfort assessments are: Unified Glare Rating (UGR), Daylight Glare Index (DGI), BRS Glare Index, etc. A number of publications in the literature provide overviews of the main glare indicators (e.g. Osterhaus, 2005; Wienold and Christoffersen, 2006) and are not discussed in detail in this section.

The calculations for the illuminance levels and the daylight factors may be done either for the room space level to obtain average values for the space or, in more detail, locally within a room space using, for example, a grid of points to obtain the distribution of these metrics in the room. Glare discomfort studies, however, are only undertaken for specific points within room spaces where it is required to specify the occupant's viewpoint and the direction of their view. In terms of temporal resolution, the assessments for both illuminance levels and glare discomfort indices are usually undertaken over short periods for typical days to assess the effect of lighting sources and typical sky conditions (e.g. clear sky and overcast sky types). It may also be necessary to calculate illuminance levels at short timesteps, but this is mainly done for studying the effect of lighting switching on cooling loads and energy consumption instead for visual comfort purposes.

Visual comfort assessments are not widely integrated within the capabilities of detailed energy simulation programs. However, there are a small number of integrated simulation programs that offer outputs for illuminance values and glare discomfort indices. This is done in many cases through links to more specialized software programs such as the Radiance software (2008). Six programs out of twenty included in the report of Crawley et al. list in their capabilities the calculation of

illuminance levels and the ability of performing glare simulation (which may be through links to specialised software).

A limitation with respect to the application of visual comfort studies is mainly the fact that high resolution is required for the geometrical definition of internal spaces. The detailed and more accurate methods for this type of study (i.e. ray-tracing methods) may be also limited by long calculation times and high computational requirements (Aizlewood, 1998). Another limitation is that the application of glare discomfort indices, in some cases, is still debatable and further guidance may be needed for practitioners who plan to perform this type of study. Galasiu and Veitch (2006), for example, state that successful prediction of discomfort glare from daylighting has not yet been achieved in a form useful for widespread practical application.

A future enhancement for integrated energy simulation programs that incorporate visual comfort assessments could be the development and availability of standard templates for internal space layouts of different building types, in order to ease the definition of the space's geometrical characteristics that are needed for this type of studies. Further developments within these programs could be the inclusion of adaptive occupants' behaviour algorithms that are describing the relationships between the occupant behaviour and the visual conditions of the spaces. Examples of such applications within the ESP-r simulation program and the benefits from it have been demonstrated at research level (Bourgeois et al., 2006) but additional work is required in order to use them in practical design tasks.

#### ***4.3.4 Acoustic comfort***

It is common in practice to use some of the several background sound rating curves for assessing calculated or measured indoor noise levels and draw conclusions on the acoustic comfort in the building spaces. Typical examples of these curves are the noise rating (NR) which has been only applied in Europe, the noise criteria (NC) and the room criteria (RC). A detailed discussion for these metrics can be found in the



ASHRAE Fundamentals (2005) and the CIBSE Guide A (2006). In addition, a useful metric for this type of study could be the reverberation time of rooms in different octave-bands. This metric is expressed in seconds and it is only used for large spaces where in some cases reverberation time may be a problem.

The spatial resolution needed for this type of study is at room space level. Temporal resolution is not important for quantifying the metrics of this section. These metrics are depending on the sound absorption characteristics of the room and do not usually change with time. It may, however, be necessary in some cases to re-calculate the reverberation time, for example to account for large variations in the occupancy and therefore the sound absorption characteristics of the space.

While ensuring a comfortable acoustics environment should be part of the sustainable design of buildings as was pointed out in chapter 1 (i.e. it has an impact on the ventilation and façade designs and therefore on the energy consumption), integrated energy simulation programs do not usually offer functionality for this type of studies. Exceptions of integrated simulation programs that include metrics of acoustic comfort in their functionality may exist (Citherlet, 2001), but they are mainly at research level and other specialised programs are instead used in practice for this type of study. A summarised list of these programs can be found on the U.S. D.O.E. website (2008). The report of Crawley et al. does not discuss this topic.

The main limitation with regard to this type of study is that especially for room to room acoustics and outside to inside acoustics it is difficult to find information or determine the sound transmission properties through façades. These properties can vary and be influenced by a large number of factors, such as cracks, frames, etc. Additional research is needed in this area.

Better integration of acoustic calculations, and especially of room to room acoustics and outside to inside acoustics, within the functionality of detailed energy simulation programs could be useful for the users of these programs (e.g. it can become part of natural ventilation feasibility studies).

#### ***4.3.5 Humidity levels, condensation risk and mould growth***

Building designs should ensure that condensation and mould growth risk are minimised within the indoor environment. A metric that could be used to assess condensation is the difference between the actual temperature of the point of study (i.e. a surface or construction layer) and the dew point temperature at that point. This is expressed in Kelvin. Condensation will occur in cases where the actual temperature is less than or equal to the dew point temperature. The number of occasions when condensation happens should also be provided to give an indication if condensation is an actual problem for that point. The occurrence of condensation may not be critical if moisture is not accumulated over a specific period. The accumulation of moisture over a period could be considered as an additional metric for this type of study. This can be expressed in g of moisture per m<sup>2</sup> of construction area. Mould on the other hand can also grow in conditions where condensation does not occur. Mould growth metrics are mainly empirical or based on statistical approaches. Clarke et al. (1999) identified the minimum growth requirements in terms of relative humidity and temperature combinations for the principal mould species affecting U.K. dwellings. This has been expressed in limiting curves (2 axes: relative humidity and temperature at a localised point) for various mould growth species. Moon (2005) developed the Mold Risk Indicator (MRI) to express the mould growth risk in buildings as the causal effect of certain dominant building design and operational parameters (e.g. infiltration rate, HVAC operation, etc.). The metric in this case is the number of risky mould days.

The metrics of this section are usually quantified for room spaces and more often for specific surfaces and construction layers. Temporal resolution for these assessments should be kept at hourly timesteps to follow the hourly outdoor humidity and temperature variations that are usually available in climate datasets. An annual period for the calculation would be better suited for these studies, as it would consider a range of outdoor climate variations and provide, for example, indications for the moisture storage within constructions over a number of seasons.

Some of the existing whole building simulation programs could be used for condensation calculations (TRNSYS, 2007; ESP-r, 2007; etc.). These calculations, however, are mostly based on simplified approaches where the adsorption and desorption characteristics of the construction materials are not taken into account. In these cases, heat, air and moisture transfer are not coupled during the simulation and while the presence and movement of moisture within the constructions may affect the temperature distribution and the heat fluxes, they do not interact during the simulations. A whole building energy simulation program that includes all of the above does not currently exist. On the other hand there are advanced applications that can study individual constructions separately (i.e. not the whole building) and overcome all of the above limitations. Example of such programs are MATCH (2003) and WUFI (2008). A drawback of this approach is the lack of information that has to be calculated from a whole building analysis. For example, internal surface resistances have to be pre-calculated and fixed in these stand-alone applications. A fully coupled heat, air and moisture transfer calculations would be a considerably useful development for the capabilities of the whole building energy simulation programs. Mould growth risk analysis is also rare amongst the capabilities of these programs. While exceptions may exist (e.g. ESP-r), the implementation of such capabilities within these programs is, as well as for the condensation calculations, based on simplifications for the hygroscopic capacity of the construction materials. Future developments for whole building energy simulation programs should aim to provide mould growth analysis assessments in order to assist practitioners to consider this issue during the design of buildings. The topics of condensation and mould growth are not discussed in the report of Crawley et al. (2005).

#### ***4.3.6 Operational energy – thermal energy requirements***

Quantifying the thermal energy requirements in terms of demand for heating, cooling and hot water is the metric used for the environmental performance indicator of this section. This is often expressed in kWh or kWh/m<sup>2</sup> of floor area.

In terms of spatial resolution, the metrics are usually quantified at room space level and at building level. This is also true for the cases of district heating where thermal energy requirements are quantified per building and collected for analysis at a community level.

The studies for the thermal energy requirements of buildings are in some cases undertaken for seasonal periods (e.g. for heating and cooling seasons) and more often for annual periods due to the fact that it is a current requirement of the latest energy performance regulations in most of European countries (e.g. UK) that implement the EPBD. Multi-year assessments, although not usual in practice, may also be useful for this type of study. A multi-year assessment could be used to investigate the effects of the variability from one year to another on the requirements for heating and cooling. They could be used, for example, to explore how the ground temperature variations below the building slab affect the thermal energy requirements as they are changing over the years. Multi-year assessments could also be applied for research studies on what may happen according to climate change projections.

A large number of programs provide outputs of thermal energy requirements, with some of them adopting methods that have been discussed previously in chapter 3. The metrics discussed in this section are included in the outputs of most detailed energy simulation programs. In the report of Crawley et al. (2005), there is not an explicit reference to the thermal energy requirements issue but it is reported that seventeen out of twenty programs can provide energy demand outputs by end use.

Despite the fact that there are many programs of varying complexity that could be used for studying the topic of this section, there is no real consensus of what level of detail is needed and what impact the choice of program may have on the design of buildings and most importantly on areas such as the compliance checks for the recent EPBD-related energy performance regulations. The impact that the selection of program may have when used for energy regulations compliance purposes is further investigated in chapter 5. The large variations on the calculation methods and programs can also be seen from the large differences in the results of inter-model

validation studies in this area (e.g. Judkoff and Neymark, 1995). A useful future development for these programs would be to provide guidance on their applicability and their possible limitations and as well implement techniques that clarify their performance against well-known validation tests that are related to the topic of the study. The implementation of such a technique for demonstrating easily the program's performance against benchmarks (e.g. validation tests) is described and discussed in chapter 6.

#### ***4.3.7 Operational energy – peak thermal loads***

Peak thermal loads are quantified as maximum diversified (block) loads and are expressed in kW. In some cases, peak thermal loads occur a few times during a season and it may also be of interest to study the frequency of occurrence of the high thermal loads in the building spaces (e.g. those with values higher than the 98% of the peak thermal demand value). This could be expressed with a frequency distribution table across a range of thermal loads.

The spatial resolution needed for these metrics is at room space level. The calculations should be accompanied with the dates and time of occurrence of these loads so that the diversified (block) loads of the building in total are also calculated by adding the room (i.e. thermal zone) loads together at every calculation timestep. This is particularly useful for studies of buildings with many thermal zones when trying to size central equipment, heat pumps, etc., because quite often peak thermal load is not occurring at the same time for all zones. In terms of temporal resolution, the analysis may be done at any user specified period representative to the purposes of the study (e.g. a hot week for peak cooling loads), although the concept of “design days” is often used to represent typical daily climate conditions for which peak thermal loads are likely to occur. Hourly or sub-hourly timesteps should be used for the calculations to account for variations in occupancy, air flows, climate conditions, etc.

Outputs of peak thermal loads are offered by most detailed energy simulation programs, while there are also a number of simplified programs that perform this type of study. In the report of Crawley et al., eighteen out of twenty programs can provide outputs on peak thermal demand. Differences in the results produced from the high number of programs that can report peak thermal loads have been previously reported in the literature not only between simplified and detailed approaches (e.g. Rees et al., 1998), but also during inter-model validation studies for the simulation programs themselves (e.g. Judkoff and Neymark, 1995).

One of the limitations with regards to this type of study is that detailed internal heat gain profiles are often unknown at the time of the assessment and they are usually approximated by practitioners. Another limitation is that despite the importance internal heat gains may have on peak thermal loads and their time of occurrence, programs do not always consider them in detail by allowing, for example, the input of internal heat gains profiles that could vary at every timestep. In some cases simplified approaches are also limited by not considering the time of occurrence of peak thermal loads for every building space, and instead of calculating the maximum diversified thermal load of the building, they consider as maximum building load the sum of the peak thermal loads of every space during the calculation period. This simplification will lead in most cases to the overestimation of building's peak thermal loads and therefore to oversized building equipment.

Incorporating detailed internal heat gains profiles within the structure of simulation programs would therefore be a useful potential development for programs that do not consider these profiles in detail and would improve their accuracy on the treatment of peak thermal loads assessments. Establishing well validated databases for internal heat gain schedules in different types of buildings is also essential. The effect of occupant behaviour, as has been already mentioned in section 4.3.2 for the thermal comfort metrics, is rarely considered within integrated simulation programs. This may, however, be significant for peak thermal loads studies (e.g. it may have an effect on the time of occurrence of peak loads) and therefore the inclusion of such algorithms would be a useful addition in the capabilities of these programs.

#### ***4.3.8 Operational energy – electrical energy requirements***

In a similar way as for the thermal requirements, electrical energy requirements for both lighting and small power are also metrics that could be included within the functionality of integrated energy simulation programs. The units usually used for expressing these metrics are kWh or kWh/m<sup>2</sup> of floor area. In some cases where integrated building energy systems are used, it would be useful to consider additional metrics within detailed simulation programs in order to provide information on the possible “quality” of the match between the (electrical) energy demand and the energy supply. A number of statistical techniques have been developed and used in the literature (Born, 2001) to express the match between energy demand and supply profiles. Examples are Spearman’s Rank Correlation Coefficient (CC), the Inequality Coefficient (IC), the least-squares value (LS) and the residual of energy supply and demand profiles (r(t)).

Only a global value for the whole building is needed for the electrical energy requirements outputs. In terms of temporal resolution, the analysis may be for specific seasons, although it is more common to quantify these energy requirements on an annual basis, especially when the study is for energy performance regulations purposes in European countries where the implementation of EPBD has started (e.g. annual outputs are required in UK). In cases where the match between demand and supply is investigated, a small timestep analysis for the whole year may be required to accurately quantify the electrical energy demand and supply profiles over this period.

Calculations of the electrical energy needs for lighting and small power are widely available within the functionality of integrated energy simulation programs. Demand and supply match studies, however, have not yet been implemented within these programs. These are only available from individual stand-alone applications specialised in this type of study (e.g. HOMER, 2008; MERIT, 2008). The issue of demand and supply matching is not discussed in the report of Crawley et al. The

majority of programs in that report (fifteen out of twenty) claim support for building power loads but at the same time it is mentioned that most of these loads are simply scheduled inputs. It has been mentioned already in the section for the building's thermal energy requirements that seventeen out of twenty programs in the report of Crawley et al. have the ability to calculate energy consumption by end use, and therefore energy requirements for lighting and small power.

In terms of limitations and future developments, current integrated energy simulation programs could possibly incorporate demand side management controls to consider a better optimisation of the supply profile against the demand. Moreover, the inclusion of adaptive behaviour models (e.g. for blinds, light switching, etc.) in the detailed simulation programs would be another useful addition for this type of study.

#### ***4.3.9 Operational energy – peak electrical loads***

An additional metric, which is also related to the previous section of this chapter, is the peak electrical load for building power loads (expressed in kW). In cases of buildings where electrical supply is only from autonomous building integrated systems the metric can also be the peak electrical supply for these systems, which is also expressed in kW.

An output for the whole building is adequate for these metrics in terms of spatial resolution. For the requirements of temporal resolution, the calculations should focus only in short periods for which worse case scenarios (i.e. high electrical loads) may occur.

The discussion for the ability of simulation programs to provide functionality for the metrics of this section, their current limitations and possible future developments is the same as for the previous section (i.e. 4.3.8) for the electrical energy requirements and there is no need to repeat it here.



#### ***4.3.10 Operational energy – systems' performance***

This section discusses issues for the performance of systems that are used to deliver the energy demand in buildings. The maximum system output required for delivering the energy requirements is the main metric needed for these studies. This can be expressed in kW. Determining the efficiency of these systems individually and in combination is also another metric that assists decisions on which type of combination of systems is more appropriate to use in the specific building case. While the ways of expressing systems (i.e. individually and as a network) efficiency varies depending on the type of systems, the outputs are usually related to ratios of energy delivered to the energy consumed. For example, in the special case of a microcogeneration system, the energy utilisation factor could be used to define the ratio of useful power and heat output to fuel input. Finally, an additional metric for this section that could be used for the evaluation of control systems is the ability of these systems to maintain the set-points.

The analysis for these metrics in terms of spatial resolution is usually undertaken for the whole network of components but it may also be of interest to research on components individually. Temporal resolution can vary enormously depending on the type of system or the combination of systems used in the specific study. It may be necessary, for example, to use short periods and very short timesteps for cases where control systems are studied or perform multi-year assessments for cases where Ground Source Heat Pump (GSHP) or other long-term storage systems are used.

The representation of systems used in buildings for delivering the energy demand varies markedly across the different simulation programs. Different programs include different range of systems and at different level of detail. The network of systems is also studied differently across the programs. Hensen and Clarke (2001) give an overview of the different approaches on representing systems within detailed simulation programs. The report of Crawley et al. (2005) lists a large number of HVAC components and for each one of these components there is a different number of programs that are able to represent it. For the cases of building integrated energy systems where often advanced modelling techniques may be needed in order to

consider the interactions between the thermal and electrical domains (e.g. for façade-integrated PV, microcogeneration, etc.), out of the twenty programs in that report: eight include PV components, twelve include Trombe wall components, two include small-scale wind turbine components and three include microcogeneration integrated with thermal simulation (plus two programs which have it partially implemented).

A common limitation amongst simplified and most detailed programs is that for modelling of microcogeneration systems, electrical power flow modelling is not available and the interactions between plant, thermal and electrical domains are rarely considered. Using a detailed simulation program to perform these assessments requires the additional definition of an electrical network in order to accurately analyse the power flows (real and reactive – overall and by phase) within this network and their interactions with other building domains (e.g. thermal). A detailed description of the electrical power flow modelling, their coupling with other building domains and their integration in a detailed simulation program is given by Kelly (1998). The integration and coupling of the different building domains should be established in the future across all simulation programs that model this type of system. Another limitation with regard to the modelling of systems used to deliver the energy demand in buildings is that manufacturers of components are more likely to provide data on the component's performance instead on the component's details that are needed for their simulation (e.g. geometrical and material/fluid properties). Simulation time may also be a barrier for the simulation of some of the building systems (e.g. control systems) when short timesteps are used to account for the transient effects and the interactions between the systems themselves and the rest of building simulation domains.

The number of inputs required for the simulation of systems components and their networks is often a significant overhead for practitioners in terms of details and time needed for their definition. To assist practitioners on completing this task, templates of predefined components and networks of components should be provided within simulation programs. Despite that there have been such efforts in the past (Crawley

et al., 2002), their application is still difficult and future work should focus on the direction of further developing such facilities.

#### **4.4 Summary**

This chapter described the functionality requirements for detailed energy simulation programs based on a structured set of environmental performance indicators that have to be considered during the sustainable design of buildings. While the implementation of the calculation method for the EPBD in most European countries includes only a few of these indicators (e.g. annual thermal and electrical energy requirements), it is expected to evolve towards the set of indicators that were analysed here.

The metrics for each environmental performance indicator and the level of detail needed for their analysis were identified. The current capabilities of integrated energy simulation programs to produce the required metrics in the appropriate level of detail have been discussed together with any possible limitations and any relevant future developments with regards to these capabilities.

It has been concluded that the capabilities of integrated detailed simulation programs are greater than those required by recent energy performance regulations that came into force for the EPBD purposes. Metrics needed for EPBD purposes in European countries, such as are CO<sub>2</sub> emissions and annual energy (thermal and electrical) requirements, are easily available within integrated detailed simulation programs. Additional metrics that are also available from these programs are in particular those described in this chapter for the indoor environmental performance indicators. For example, air volume flow rates, indoor contaminants distribution, peak operative temperatures, illuminance levels, occurrence of condensation, peak thermal and electrical loads, etc. It should be stated here that in all these cases there may be uncertainties that apply in terms of inputs and algorithms used for the calculations. Simulation programs should be able to quantify the size of these uncertainties.

Some of the possible future developments that were identified in this chapter with respect to the capabilities of these programs are as follows:

- improve the integration of life cycle impact assessments within their structure,
- include adaptive occupant behaviour models for indoor air quality and comfort studies,
- predict mould growth risk for the whole building by accounting also for the simultaneous interactions between heat, air and moisture transfer,
- implement techniques that clarify their performance against well-known validation tests. Further explanation for such a development within the ESP-r detailed simulation program as part of this thesis is given in chapter 6.

Initial efforts for some of these developments within whole building integrated energy simulation programs have already been demonstrated at research level (Citherlet, 2001; Bourgeois et al., 2006, etc.) and further work is expected to establish their application in practice.

While detailed integrated simulation programs have a large number of advanced capabilities and their use for the purposes of EPBD has been considered in the energy performance regulations of European countries together with simplified methods, there are concerns raised for the implications that this may have on the resulting regulation compliance procedures. This will be further investigated in chapter 5.

## 4.5 References

Aizlewood M.E. 1998. *Interior lighting calculations: a guide to computer programs*. Information Paper IP 16/98, ISBN 1-860-81257-0, BRE, UK.

ASHRAE (American Society of Heating, Refrigerating and Air-Conditioning Engineers). 2005. *2005 ASHRAE Handbook – Fundamentals (SI), chapter 7*. Atlanta, USA.

ASHRAE (American Society of Heating Refrigerating and Air-Conditioning Engineers). 2004. *ASHRAE Standard 55-04. Thermal environmental conditions for human occupancy*, Atlanta, USA.

Born F.J. 2001. *Aiding renewable energy integration through complimentary demand-supply matching*. PhD Thesis, University of Strathclyde. Glasgow, UK.

Bourgeois D., Reinhart C.F., Macdonald I.A. 2006. *Adding advanced behavioural models in whole building energy simulation: a study on the total energy impact of manual and automated lighting control*. *Energy and Buildings*, 38 (7), pp. 814-823.

CIBSE (Chartered Institution of Building Services Engineers). 2006. *CIBSE Guide A: Environmental design (7<sup>th</sup> Edition)*. London, UK.

CIBSE (Chartered Institution of Building Services Engineers). 1998. *Building energy and environmental modelling*. Application Manual 11. ISBN-10: 0-900953-85-3. London, UK.

Citherlet S. 2001. *Towards the holistic assessment of building performance based on an integrated simulation approach*. PhD Thesis, Swiss Federal Institute of Technology (EPFL), Lausanne, Switzerland.

Clarke J.A., Johnstone C.M., Kelly N.J., McLean R.C., Anderson J.A., Rowan N.J., Smith J.E. 1999. *A technique for the prediction of the conditions leading to mould growth in buildings*. Energy and Buildings, 34 (4), pp. 515-521.

Crawley D.B., Hand J.W., Kummert M., Griffith B.T. 2005. *Contrasting the capabilities of building energy performance simulation programs*. Joint Report available from:

[http://www.eere.energy.gov/buildings/tools\\_directory/pdfs/contrasting\\_the\\_capabilities\\_of\\_building\\_energy\\_performance\\_simulation\\_programs\\_v1.0.pdf](http://www.eere.energy.gov/buildings/tools_directory/pdfs/contrasting_the_capabilities_of_building_energy_performance_simulation_programs_v1.0.pdf)

Crawley D.B., Lawrie L.K., Winkelmann F.C., Buhl W.F., Pedersen C.O., Strand R.K., Liesen R.J., Fisher D.E., Witte M.J., Henninger R.H., Glazer J., Shirey D. 2002. *EnergyPlus: New, capable, and linked*. Proceedings of the eSim 2002 conference. Montreal, Quebec, Canada.

ECO-BAT 2.43. 2008. *Life cycle impact assessment software*. Laboratory of Solar Energetics and Buildings Physics, University of Applied Sciences of Western Switzerland, Switzerland. Available from: <http://www.eco-bat.ch/>

EN 13725. 2003. *Air quality – Determination of odour concentration by dynamic olfactometry*. CEN. Brussels, Belgium.

EN 15251. 2007. *Indoor environmental parameters for design and assessment of energy performance of buildings - addressing indoor air quality, thermal environment, lighting and acoustics*. CEN. Brussels, Belgium.

Envest 2. 2003. *Environmental impact assessment software*, BRE, UK. Available from: <http://envestv2.bre.co.uk/>

EnergyPlus 2.1.0. 2007. *Building energy simulation program*. US Department of Energy, USA. Available from: <http://www.energyplus.gov>.

ESP-r 11.4. 2007. *Building energy simulation program*. University of Strathclyde, Glasgow, UK. Available from: <http://www.esru.strath.ac.uk>.

European Concerted Action. 1992. *Indoor air quality and its impact on man*. Report No. 11: Guidelines for Ventilation Requirements in Buildings. Office for Publications of the European Communities, Luxembourg.

Galasiu A.D., Veitch J.A. 2006. *Occupant preferences and satisfaction with the luminous environment and control systems in daylight offices: a literature review*. Energy and Buildings, 38 (7), pp. 728-742.

Heijungs R., Guinee J.B., Huppes G., Lankreijer R.M., Haes H.A.U.d., Sleeswijk A.W., Ansems A.M.M., Eggels P.G., Duin R.v., Goede H.P.d. 1992. *Environmental life cycle assessment of products – Guide and backgrounds*. National Reuse of Waste Research Program (NOH), Center of Environmental Science. ISBN-10: 90-5191-064-9. Leiden, The Netherlands.

Hensen J.L.M. 1990. *Literature review on thermal comfort in transient conditions*. Building and Environment, 25 (4), pp. 309-316.

Hensen J.L.M., Clarke J.A. 2001. *Integrated simulation for HVAC performance prediction: state-of-the-art illustration*. Proceedings of the International ASHRAE/CIBSE 20-20 Vision conference, Dublin, Ireland.

HOMER 2.67 beta. 2008. *Micropower systems optimization program*. National Renewable Energy Laboratory (NREL), USA. Available from: <https://analysis.nrel.gov/homer/>

Humphreys M.A., Nicol F.J. 2002. *The validity of ISO-PMV for predicting comfort votes in every-day thermal environments*. Energy and Buildings, 34 (6), pp. 667-684.

Judkoff R., Neymark J. 1995. *International Energy Agency building energy simulation test (BESTEST) and diagnostic method*. IEA Annex 21/Task 12 Co-operative Project, Final Report, NREL/TP-472-6231. National Renewable Energy Laboratory, Colorado, USA.

Kelly N.J. 1998. *Towards a design environment for building-integrated energy systems: the integration of electrical power flow modelling with building simulation*. PhD Thesis, ESRU, University of Strathclyde, Glasgow, UK.

MATCH 1.6.0.5. 2003. *Program for transient calculation of the coupled transport of heat and moisture through composite building constructions*. Thermal Insulation Laboratory, Technical University of Denmark, Lyngby, Denmark. Available from: <http://www.match-box.dk/>

Maver T.W., Clarke J.A. 1984. *Major extensions to the ESP-r system*. Final Report for Science and Engineering Research Council Grant GR/C/2283.7, University of Strathclyde, Glasgow, UK.

MERIT 3.01. 2008. *Demand/supply matching-design program for renewable and low - carbon energy systems*. University of Strathclyde, Glasgow, UK. Available from: <http://www.esru.strath.ac.uk>.

Moon H.J. 2005. *Assessing mold risks in buildings under uncertainty*. PhD Thesis, Georgia Institute of Technology, Atlanta, USA.

Osterhaus W.K.E. 2005. *Discomfort glare assessment and prevention for daylight applications in office environments*. *Solar Energy*, 79 (2), pp. 140-158.

PART L2A. 2006. *Conservation of fuel and power in new buildings other than dwellings*. ISBN-10: 1-85946-219-5. Office of the Deputy Prime Minister, UK.



Radiance 3.9. *Lighting simulation program*. 2008. Lawrence Berkeley National Laboratory, USA. Available from: <http://radsite.lbl.gov/radiance/>

Rees S.J., Spitler J.D., Haves P. 1998. *Quantitative comparison of North American and U.K. cooling load calculation procedures – Results*. ASHRAE Transactions, 104 (2), pp. 47-61.

Rijal H.B., Tuohy P., Humphreys M.A., Nicol J.F., Samuel A.A., Clarke J.A. 2007. *Using results from field surveys to predict the effect of open windows on thermal comfort and energy use in buildings*. Energy and Buildings, 39 (7), pp. 823-836.

Robinson D., Cambell N., Gaiser W., Kabel K., Le-Mouel A., Morel N., Page J., Stankovic S., Stone A. 2007. *SUNtool – A new modelling paradigm for simulating and optimising urban sustainability*. Solar Energy, 81 (9), pp. 1196-1211.

Samuel A.A. 2006. *On the conflation of contaminant behaviour within whole building performance simulation*. PhD Thesis, ESRU, University of Strathclyde. Glasgow, UK.

TRNSYS 16.0. 2007. *A transient systems simulation program*. Solar Energy Lab (SEL), University of Wisconsin, Madison, USA. Available from: <http://sel.me.wisc.edu/trnsys/>.

U.S. D.O.E. 2008. *Building energy software tools directory*. Available from: [http://www.eere.energy.gov/buildings/tools\\_directory/](http://www.eere.energy.gov/buildings/tools_directory/)

Walton G.N. 1983. *Thermal analysis research program reference manual*. NBSIR 83-2655, National Bureau of Standards. Washington, USA.

Wienold J., Christoffersen J. 2006. *Evaluation methods and development of a new glare prediction model for daylight environments with the use of CCD cameras*. Energy and Buildings, 38 (7), pp. 743-757.

WUFI Pro 4.2. 2008. *Program for calculating the coupled heat and moisture transfer in building components*. Fraunhofer Institute for Building Physics IBP, Stuttgart, Germany. Available from:

[http://www.hoki.ibp.fhg.de/wufi/wufi\\_frame\\_e.html](http://www.hoki.ibp.fhg.de/wufi/wufi_frame_e.html)

IMPACT OF USING DIFFERENT MODELS IN A REGULATORY CONTEXT –  
CASE STUDIES

## **5.1 Introduction**

The capabilities of detailed simulation programs were discussed in chapter 4, while existing calculation methods for heating and cooling energy assessments were described in chapter 3. In particular, the methods in the CEN 13790 Standard were discussed in detail in chapter 3 due to their relevance to the EPBD. The inclusion of a number of calculation methods within the 13790 Standard and the potential allowance for their use in energy performance regulations for EPBD purposes (i.e. depending on decisions at national level for each country) has offered significant advantages. The allowance of only a single method for regulation compliance would have affected design teams who would have to use this single method and developers of existing energy performance calculation programs. If design teams were not familiar with this single calculation method they would have to invest time in learning it and they would be limited to the capabilities of this single method. A compulsory single method would also have implications on the market, and therefore on the development, of existing programs that embed advanced calculation methods. This would possibly restrict building designs to the capabilities of the single method and would not encourage the development and use of innovative technologies outside these capabilities. To avoid these drawbacks, CEN Standards allow the use of a number of methods for the energy performance calculations of buildings and they suggest that particular care should be taken to ensure consistency across them in terms of compliance outputs. Despite the significant advantages that this may offer, the fact that there is a range of methods and model types that can be used to evidence compliance for building regulations may lead to substantially different compliance results. This chapter investigates this issue. The focus is on the methods included in the 13790 Standard for the calculation of space heating and cooling energy requirements. The reasons that justify focusing on these calculations were described

in chapter 3 (e.g. large percentage out of the overall energy demand, uncertainty). It has been also mentioned in chapter 3 that two simplified methods are fully prescribed within the 13790 Standard; a monthly quasi-steady state method and a 5R-1C simple hourly method. The Standard also allows the use of validated detailed simulation programs and gives details for the common procedures and descriptions, boundary conditions and input data that these programs should adopt in order to ensure consistency with the simplified methods. The aim of the 13790 Standard is not to specify the validation procedures and the performance criteria for simulation programs. It states that there are other Standards for this purpose and gives the example of EN 15265 Standard (2007) for validation tests related to the calculation of the annual energy for space heating and cooling. This chapter applies all the methods in the 13790 Standard in order to investigate the impact of allowing the use of different methods on energy performance compliance studies. Two detailed simulation programs were used in the study (ESP-r (2007) and EnergyPlus (2007)) to determine the magnitude of differences that may result from the choice of simulation program. These programs were run for compliance calculations according to the procedures prescribed by the Standard. The aim is not to quantify the magnitude of the numerical differences, which may be expected, but to determine whether these methods will lead to different compliance conclusions. It should be noted that the intention is not to assess the accuracy of the methods.

The research considered office buildings as they are a predominant building type where the CEN Standard methods are likely to be applied. The comparison of the various calculation methods when applied to a common building specification was undertaken in terms of the annual energy demand for space heating and cooling. Two groups of cases are discussed in this chapter. A common building shape without any advanced technologies and with simple operational characteristics is used for the first group of cases to investigate the use of all the methods under some typical building specifications. A more advanced technology (i.e. a ventilated double façade) is included in the second group of cases to analyse the use and the flexibility of simplified and detailed simulation methods in similar cases that include advanced building technologies. Parametric variations were applied to each one of these group

of cases to assess the implications of method choice in regulation compliance results across a range of possible design changes. Including all the possible design variations within the limits of this chapter was impossible, especially when considering the number of calculation methods used to produce the rating results. However, a wide range of variations of important determinants of building space heating and cooling energy consumption have been studied. The method used was based on single design variations of the base cases in order to offer also the possibility of assessing the sensitivity of the different calculation methods over the various design changes (i.e. against the base case). However, this will be briefly discussed in this chapter as the rating outputs between the different calculation methods are more important and a more detailed discussion of the sensitivity of the methods on the design variations will be given in Appendix B.

It is important, however, to determine at this stage the size of the differences from these comparisons that would lead practitioners to obtain different compliance results. A few existing applications classified buildings based on their energy consumption and in some cases there was an additional classification based on the building's energy requirements for space heating. An example is the Italian BESTClass software (2007) which uses different classes to categorise buildings mainly for every 20 and 30 kWh/m<sup>2</sup> per annum difference in their energy consumption (e.g. classes B, C and D use 20 kWh/m<sup>2</sup> per annum and class E uses 30 kWh/m<sup>2</sup> per annum). With the introduction of EPBD and its requirement for energy certificates, some countries started adopting software applications that place buildings in different bands based on their energy consumption or, more commonly, on their CO<sub>2</sub> emissions output. In Scotland, for example, the outputs from the SBEM program (2008) produce energy certificates that categorise buildings in different bands by directly considering their calculated annual CO<sub>2</sub> emissions output. In this case, an office building with electric heating and cooling would be placed in a different band if the calculated space heating and cooling energy requirements vary from 16 to 19 kWh/m<sup>2</sup> per annum (i.e. as a consequence of associated high CO<sub>2</sub> emissions: for example 17 kWh/m<sup>2</sup> per annum defines the range for B+ band, 19 kWh/m<sup>2</sup> per annum for B, 16 kWh/m<sup>2</sup> per annum for C+, etc.). Based on these

examples, and for the purposes of this study, 20 kWh/m<sup>2</sup> per annum has been considered a critical benchmark for the comparison of the space heating and cooling results produced from the various methods. A similar scale to the one for Scotland is used in this chapter for the presentation of the results. Letters will be used together with the “+” symbol for every letter (i.e. A+, A, B+, B, etc.); each adjacent category indicates a difference of 20 kWh/m<sup>2</sup> per annum in the space heating and cooling results (see example in Table 5.1). This decision may have implications in cases where the numerical results from the different calculation methods are close to each other but fall around a class boundary. It may be possible in these cases that different ratings are assigned between the calculation methods without the occurrence of large numerical differences. The discussion of the results does not consider these cases as critical but they are however representative of possible realistic situations that could also occur with the actual energy performance ratings that are produced from different calculations in the new European regulations. Due to the fact that a number of parametric cases in this chapter were undertaken for various climate locations, the compliance results should not be directly compared between cases but only between the various calculation methods. One way to overcome this would have been to normalise the results of the various locations based on heating or cooling degree days but this has not been considered important for the purposes of the chapter because the focus is on comparing the compliance results for the calculation methods.

<b><i>Band</i></b>	<b><i>Energy requirements (kWh)</i></b>
<i>A+</i>	<i>0 – 20</i>
<i>A</i>	<i>20 – 40</i>
<i>B+</i>	<i>40 – 60</i>
<i>B</i>	<i>60 – 80</i>
<i>C+</i>	<i>80 – 100</i>
<i>C</i>	<i>100 – 120</i>
...	...
<i>G+</i>	<i>240 – 260</i>
<i>G</i>	<i>260 – 280</i>

Table 5.1: Example of bands used for the comparison of the compliance results

Based on the trends of the results the possibility of optimising the inter-method match between all methods was also investigated for all the groups of cases that are included in this chapter.

To achieve the objective of this study, it has been considered important to ensure model equivalence for all methods in terms of boundary conditions and inputs used. Details of the case studies used for the purposes of the comparison and the way model equivalence has been achieved are given in the following sections.

## **5.2 First group of cases**

### ***5.2.1 Building model details and parametric analysis***

In this group of cases, the simplified monthly and simple hourly method of the 13790 Standard and the ESP-r and EnergyPlus detailed simulation programs were used for the analysis. A three-storey building was used that consists of 9 spaces of different geometry aligned in a way that considers different possibilities of exposure (i.e. ground/mid/top floor) and façade orientations. The total floor area of the building is 336 m<sup>2</sup>. The glazing area of the base case is 58.1 m<sup>2</sup> and it is covering 15% of the exposed wall area. An opaque external door is also included at each of the three storeys. This building can not be considered as a typical small office building for the whole of Europe as the characteristics of this type of buildings vary across the different European countries. However, if the parametric design variations that will be described in this section are considered in its definition then it will cover a large number of buildings of this type. An example of the building, as produced from the ESP-r program (and the link with Radiance), is shown in Figure 5.1. Additional details of the buildings used in all cases of this chapter are given in Appendix A.

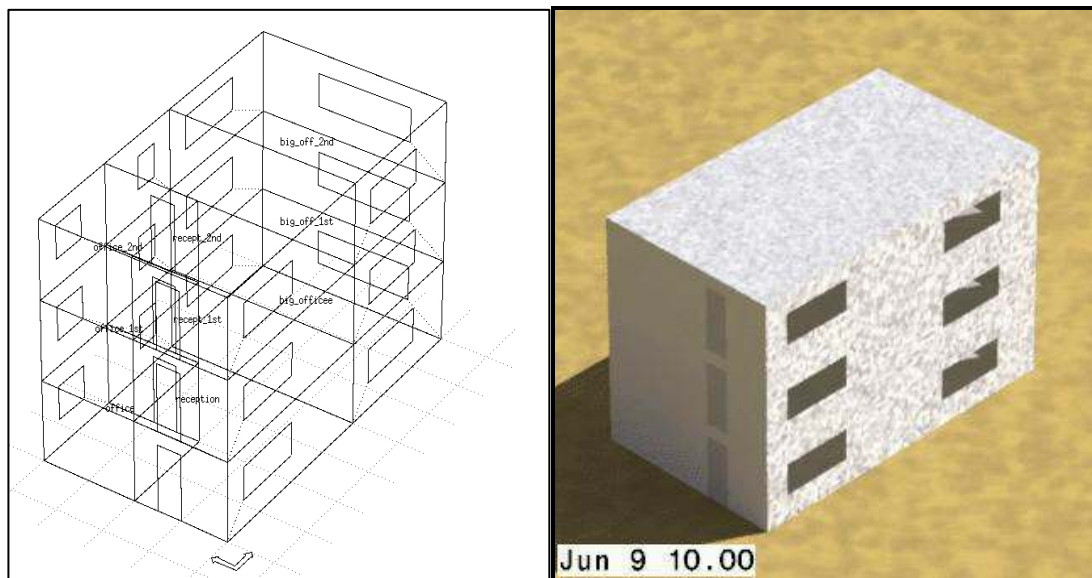

Figure 5.1: The building used for the first group of cases.

The base case for the annual heating calculation was based on a central/northern European location (Amsterdam). Cooling requirements were determined for the same location. An additional base case for a southern European location (Athens) was used to determine the sensitivity of the methods to higher cooling loads and for the different design variations described in this group of cases (see the two sections of cooling results in Table 5.3). Alternative locations were also studied for the heating and cooling calculations as part of the climate variations in the parametric study. To avoid increasing the complexity of the calculations with regards to the simplified methods, all spaces were assumed to have the same temperature set-point for heating and cooling and also the same heating, cooling, ventilation and internal heat gains schedules. This strategy has been adopted because the typical application of the simplified methods ignores the dynamic interactions between the thermal zones and a direct comparison with the dynamic simulation programs would not therefore be fully realistic. Multi-zone coupling for the simplified methods is considered as possible within the 13790 Standard but at the same time the resulting methods are complex and the Standard does not recommend its application for these methods.

The parametric studies covered design parameters that typically will have a significant effect on the building's annual heating and cooling energy requirements.



Some parameters did not affect the monthly method (e.g. changing the internal gain profiles) and these were used to assess the impact of assuming average monthly values. Results for the following parameter variations were considered for this group of cases:

- Three building locations and climates, representing a southern, a central and a northern European location.
- Five different internal heat gains schedules. The base case incorporated occupant and lighting schedule where the sensible heat gains during occupied hours were  $12 \text{ W/m}^2$  and  $10 \text{ W/m}^2$  respectively and 10% of these values during non-operational weekday hours and weekends. These values may vary significantly in practice and typical values are given in CIBSE Guide A (2006). The selected for the base case internal heat gains are slightly lower than those listed in this guide (e.g. total sensible heat gains including equipment gains:  $25 \text{ W/m}^2$  for a general office space) but alternative values were also studied in this chapter. The rest of the internal heat gains schedules that were studied for this group of cases are as follows. Two cases used the same average monthly internal heat gains values as the base case; in one, the values are hourly averages for every day of the week (i.e. the same hourly value at each hour throughout the week); in the other, values were averaged for every hour separately for weekdays and weekends (i.e. a constant hourly value during weekdays with a separate value at weekends). A third case used higher internal heat gain values (by approximately 55% compared to the base case) but with the same hourly pattern, while the last case used lower values (by approximately 60% compared to the base case), again with the same hourly pattern.
- Three glazing areas: the base case using  $58.1 \text{ m}^2$  and two other cases using half and double this amount.
- Four external wall constructions, corresponding to ultra-lightweight, lightweight and heavyweight cases with standard insulation, and a low insulation heavyweight case.

- Five ventilation schedules. The base case model assumed a constant ventilation rate of 0.72 air changes/hour throughout the year; two cases used higher (1.5 air changes/hour) and lower (0.3 air changes/hour) constant ventilation rates; and two cases used the same average monthly ventilation rates as the base case but varied the magnitude throughout each day to reflect occupancy.
- Three building orientations: the base case was rotated 90° and 180° anticlockwise.
- Six heating and cooling set-point strategies. Three of these strategies have a steady operative temperature set-point throughout the year and three have intermittent heating/cooling (i.e. continuous during the day time, continuous during the night time for the same hours as the previous case for day time and at different periods during the day time).

### ***5.2.2 Model equivalencing***

While it has not been explicitly stated in the 13790 Standard, the procedures suggested for the application of all methods in practice for a common purpose (e.g. for regulation compliance checks), may constrain detailed simulation programs to use less advanced procedures than those they normally use in order to match the inputs and boundary conditions used in the simplified methods. This section will follow these procedures in order to allow precise comparisons to be made between the results of all four methods, and represent in this way an accurate implementation of the 13790 Standard. In fact, while it is not explicitly declared in the 13790 Standard that simulation programs should behave as the simplified methods, the procedures specified for the simulation programs are based on what simplified methods are able to use for their calculations. For example, the Standard states that the overall transmission (conduction) heat transfer calculated from the simulation programs should be the same as the one in the simplified methods. The simplified methods use fixed heat transfer coefficients and the only way to succeed in this with simulation programs is by using the same fixed values. This is clearly less advanced

than what some detailed simulation programs are normally able to do and the process of making all methods equivalent is not easy as will be shown in this section.

Input data and boundary condition equivalencing between the methods was ensured as follows.

The same climate files were used for both ESP-r and EnergyPlus (Crawley *et al* 1999). Tabulated hourly temperature data were then exported and used with the simplified methods (after averaging in the case of the monthly method). With solar radiation data, the incident solar radiation on all surfaces was calculated by the simulation programs and used as inputs to the simplified methods.

The set-point temperatures, even in the cases of intermittency, were the same for all methods. In ESP-r, ideal controls were used to maintain the operative temperature in the zones at the value set in the simplified methods, while in EnergyPlus an ideal system ('Purchased Air') was employed to the same end. This approach has been adopted as it aligns with the definition of the utilisation factor in the monthly method of the 13790 Standard: "the utilisation factor is defined independently of the heating system characteristics, assuming perfect temperature control and infinite flexibility". Additional uncertainty in the results will probably be added when systems and controls are considered explicitly and calculations will have to account, for example, for the time constant of these systems (e.g. for slowly responding systems such as underfloor heating systems). However, the Standard suggests that decisions on this matter should be taken at national level by the EU countries in case the monthly method is adopted by these countries. With intermittent operation, the method described in the 13790 Standard for the simplified monthly method was used to determine the relevant reduction factors. The heat emitter's properties are not specified in the 13790 Standard and for this reason a 50% convective and 50% radiative system is used. The effect of this decision is not significant for the base case of this group of cases where the heating energy results taken from ESP-r for a fully convective system were lower by 1% than those taken for a fully radiative system. However, for the case where a poorly insulated heavyweight wall has been

used, the difference in the heating results between these two systems is in the range of 3.5%, with respect to the fully convective system's result.

In relation to fabric conduction, the same areas, materials, layers and constructions of the building were used in all methods. In order to set the same surface resistances, the pre-defined values given in EN ISO 6946 (2007) (and prEN ISO/DIS 10077-1 (2006) in the case of windows) were used. This means that for ESP-r and EnergyPlus, the inside and outside convective and radiative heat transfer coefficients were held constant throughout simulations (i.e. because the simplified methods use fixed surface resistances). Regarding the heat transmission to the ground, the method described in Annex D of the prEN ISO/DIS 13370 (2007) was used with the detailed simulation programs to model the construction of the floor and the boundary condition below it. This included a specific thickness of soil and a virtual layer with specific thermophysical properties below it. The resulting calculated monthly ground temperatures were used over the simulation period. Regarding the simplified methods, heat transfer coefficients were used in accordance with the 13790 and related Standards (i.e. 13789 Standard (2007), which points to the 13370 Standard). Thermal bridges were not accounted for in any of the methods. For the foundation, a slab on the ground was assumed with 1-D thermal conduction only.

Equivalency between the input data for all methods with regards to the losses from ventilation or infiltration was ensured by using the same air flow schedules on an hourly and monthly basis. However, ventilation heat losses or gains are based on the operative temperature in the monthly simplified method and on the air temperature in the simplified hourly and the detailed simulation programs, but because this is not an input or a boundary condition difference the equivalency between the methods is maintained. The air is assumed to be supplied from the external environment to building spaces at the ambient temperature.

The internal heat capacities of the building constructions were represented explicitly in the detailed programs and via the use of an internal heat capacity factor, ( $C_m$ ), according to the 13790 Standard in the simplified monthly and hourly methods.

For solar gains, and in addition to what has been already mentioned in the previous paragraphs (for example, for the solar radiation climate data), the surface absorptivity of every external opaque surface layer is ensured to be the same in every method. Specialised programs, WIS (2004) and WINDOW 5.2 (2005), were used to provide detailed optical properties for the detailed simulation programs and the solar energy transmittance (g-value) for the simplified methods. Window frames for this group of cases were not taken into account by any of the calculation methods and no shading devices were applied. Moreover, the view factor to the ground was ensured to be the same for all the surfaces in every method.

The external surface emissivities were set to zero as this was the only way to impose a fixed surface resistance on the detailed simulation programs. This means that the longwave radiation heat exchange with the sky was not taken into account. Detailed simulation programs solve the heat transfer by transmission and radiation to the sky simultaneously, so they cannot follow at the same time both of the ISO 13790 instructions for their treatment (for example see chapter 3, section 3.2.1, equations 3.12 and 3.13 for  $U_k$ ,  $R_{se}$  and  $h_r$ ). It is not possible, in other words, to model the transmission losses assuming a fixed radiative heat transfer coefficient and, at the same time, assume a time varying external longwave radiation heat exchange with the sky. For purposes of equivalency between all the methods, the longwave radiation heat exchange with the sky was not taken into account in any of the calculation methods. The effect of this decision in the calculated heating energy requirements was investigated in the simplified monthly method and for the base case of this section. It resulted to a small change in the monthly method's output (i.e. less than 1 kWh/m<sup>2</sup>-annum).

The internal heat gains in the spaces were also the same for every method. The same schedules were used on an hourly or monthly basis for every method. In ESP-r and EnergyPlus, 50% convective and 50% radiative fraction was assumed in accordance with the 13790 Standard instructions.

### ***5.2.3 Results and discussion***

Results are presented in terms of rating outputs from the various calculation methods. The full sets of numerical results of the different calculation methods for the building's annual heating and cooling energy requirements are also given for reference in Tables 5.2 and 5.3 respectively at the end of this section. All cases studied in this chapter are given a "case ID" number for making easier their discussion and display in graphs. This "case ID" number for the first group of cases that are included in section 5.2 of this chapter can be found in Tables 5.2 and 5.3. The methods were applied correctly and multiple checks were undertaken for the models and the calculations in order to eliminate potential user errors in these results (the results were produced by one person). For example, the inputs of each method were compared several times against the inputs of the other methods and the calculations involved in the simplified methods were checked against the instructions of the 13790 Standard. In particular the calculation procedure that was used in these case studies for the monthly method was also compared against the simple example building described in the Annexes of the 13790 Standard (Annex J in prEN ISO/DIS 13370:2007) and it was confirmed that the results were the same with those reported in the Standard.

Of the twenty-three cases for heating, six cases (Table 5.2, case ID: 3, 7, 9, 11, 16 and 19) produced results that, although they are not numerically the same for the different methods used, are within the same rating bands. Of the remaining seventeen cases the results of the four calculation methods did not differ more than one band (i.e. considering the lower limit of a band and the upper limit of the next band: less than 40 kWh/m<sup>2</sup>-annum), as is shown in Figures 5.2 and 5.3.

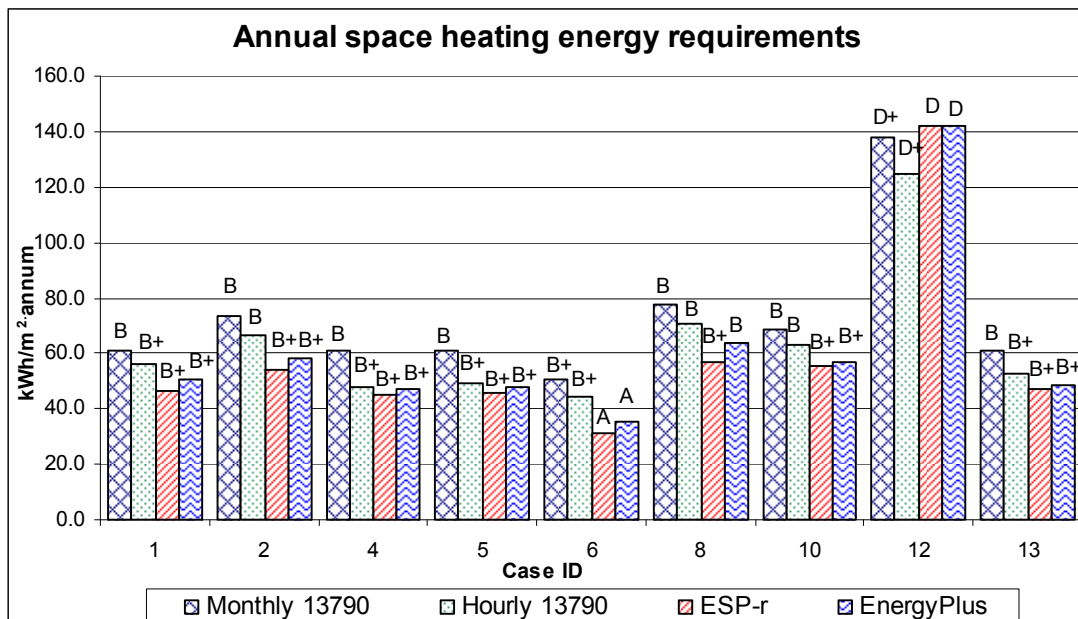

Figure 5.2. Cases between 1 and 13 where differences in the ratings for annual space heating energy requirements ( $\text{kWh/m}^2\text{-annum}$ ) were noticed

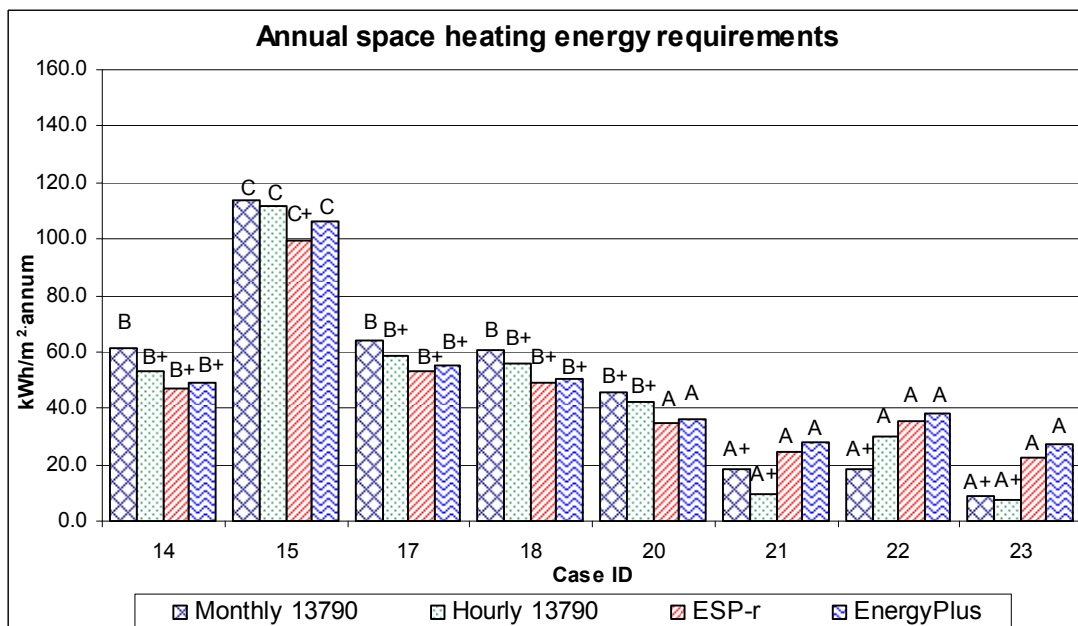

Figure 5.3. Cases between 14 and 23 where differences in the ratings for annual space heating energy requirements ( $\text{kWh/m}^2\text{-annum}$ ) were noticed

With the exception of the case where uninsulated heavyweight walls (case ID: 12) were used and the cases of intermittent heating (case ID: 21, 22 and 23), it can be seen that there is a general trend for the monthly method of the 13790 Standard to

produce results that place the building in a slightly worse rating band than the other methods. For the intermittent heating cases (i.e. Figure 5.3, case ID: 21, 22 and 23), the simplified methods seem to favour better rating bands than the simulation programs. It can also be noticed from the results of intermittent heating cases that there is a lack of sensitivity of the monthly method to the variations in the daily temperature set-point schedules (see case ID: 21 and 22).

For a small number of cooling cases, all four calculation methods produced the same rating results. For only six cases out of the forty-three cooling cases the results were placed within the same band for all calculation methods (Table 5.3, case ID: 11, 21, 30, 34, 37 and 41). Of the remaining thirty-seven cases, the results did not differ by more than one band apart from six cases for which larger differences were noticed. Details of these thirty-seven cases for cooling can be obtained from Table 5.3. The six cooling cases for which there was more than one band difference between the four calculation methods are shown in Figure 5.4. Of these six cases, three were for the Amsterdam climate: a case where the internal heat gains do not vary through the day (case ID: 4), a case where the internal heat gains vary only between weekdays and weekends (case ID: 5) and a case for which high internal gains were assumed (case ID: 6). The last of these three cases may be particularly common, considering the high use of office equipment often found in this type of building. The other three of the six cases that produced large disagreements in the cooling rating results were for the Athens climate: the case where the building was assumed to be highly glazed (i.e. case ID: 28, doubling the size of the windows for the base case) and the cases of intermittent cooling during the night (case ID: 42) and during different periods over the day (case ID: 43).



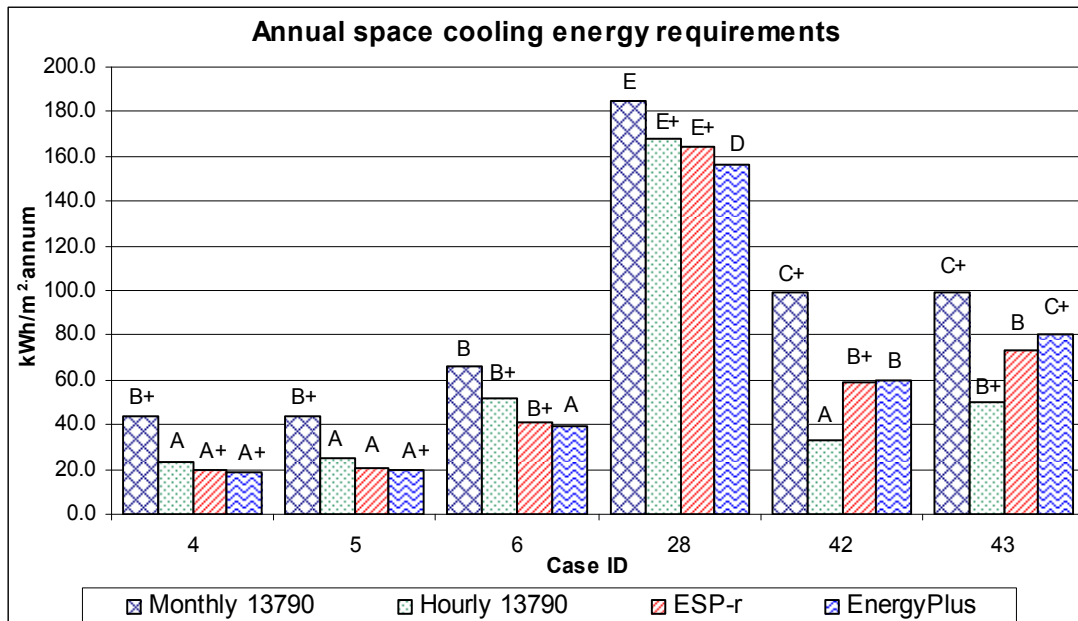

Figure 5.4. Characteristic differences in ratings for annual space cooling energy requirements (kWh/m<sup>2</sup>-annum).

It can be seen from Figure 5.4 that in all six cases the monthly method produces results that place the building at a slightly worse rating than the other methods. In the case of night cooling (i.e. Figure 5.4, case ID 42), however, the monthly method places the building in a band which is three (or almost four) ratings worse than the band given by the simplified hourly method. The results of the two simulation programs for this case differ from both of the two simplified methods; although numerically they are only slightly different from each other, the difference is close to the limits of a band and a different rating is produced from them (i.e. B+ with ESP-r and B with EnergyPlus). In general for all heating and cooling cases of this group, the simulation programs produce ratings that are either within the same band or differ by one band when the numerical results are usually close to the borders of a band.

The intermittent cooling results produced confirmed the expected lack of sensitivity of the monthly method to the variations in the daily temperature set-point schedules (in Table 5.3, see case ID: 21, 22, 23, 41, 42 and 43).

As a general conclusion from the cooling cases for which differences in the compliance results were noticed and from all the numerical results produced for the

cooling cases of this group, it can be stated that there is a trend for the monthly method to produce results that place the building at a worse rating than the other methods. The next section will investigate possible ways to overcome this inconsistency and will discuss how specific parameters in the monthly method could be optimised in order for this method to produce outputs closer to the other methods. The reasons that caused these differences can not be easily identified from this study. This is not within the main research interests of this chapter which is focusing on assessing the impact on the compliance ratings from the use of all the main EPBD calculation methods. However, a brief discussion for the causes of these differences is given in the next section with additional details in Appendix C.

Case ID	Description	Monthly 13790	Hourly 13790	EnergyPlus	ESP-r
1	Base Case (Amsterdam – 19°C set-point)	61.1	56.1	50.3	46.3
2	Climate Aberdeen	73.7	66.5	58.2	53.8
3	Climate Athens	14.0	12.0	5.2	4.6
4	Internal Gains averaged hourly (7 days/week)	61.1	48.0	47.0	44.9
5	Int. Gains averaged hourly (Weekdays/Weekends)	61.1	49.2	47.9	45.8
6	High internal gains	50.7	44.0	35.1	31.5
7	Low internal gains	76.6	74.7	71.7	67.0
8	Glazing area: double	77.9	70.8	63.9	56.5
9	Glazing area: half	53.2	49.8	44.9	42.8
10	Construction: ultra-lightweight ( $C_m = 56.9 \text{ kJ/m}^2\text{K}$ )	68.3	63.3	57.1	55.4
11	Construction: heavyweight ( $C_m = 231.6 \text{ kJ/m}^2\text{K}$ )	47.2	46.7	47.4	45.4
12	Construction: heavyweight, no insulation	138.0	125.0	141.8	142.0
13	Ventilation daily schedule	61.1	52.9	48.5	46.8
14	Ventilation Weekday/Weekends schedule	61.1	53.2	48.7	47.0
15	High ventilation rates (1.5 ac/h)	113.4	111.5	106.5	99.7
16	Low ventilation rates (0.3 ac/h)	35.3	29.8	23.8	23.9
17	Rotate 90° anticlockwise	63.9	58.7	55.1	53.0
18	Rotate 180° anticlockwise	60.8	56.1	50.6	48.8
19	Set-point @ 21°C	79.5	73.0	67.1	64.6
20	Set-point @ 17°C	45.3	42.5	35.8	34.5
21	Intermittent heating 7-17.00h	18.2	9.2	28.1	24.3
22	Intermittent heating 0-10.00h	18.2	29.9	38.0	35.6
23	Intermittent heating (different periods @ 19°C)	9.1	7.3	27.5	22.6

Table 5.2: Annual heating energy requirements ( $\text{kWh/m}^2 \text{ annum}$ ).

Case ID	Description	Monthly 13790	Hourly 13790	EnergyPlus	ESP-r
1	Base Case (Amsterdam - 24°C set-point)	43.8	32.0	22.3	24.1
2	Climate Aberdeen	34.3	18.6	9.3	10.6
3	Climate Athens	116.3	106.1	98.2	100.2
4	Internal Gains averaged hourly (7 days/week)	43.8	23.5	18.6	20.0
5	Int. Gains averaged hourly (Weekdays/Weekends)	43.8	24.6	19.2	20.6
6	High Internal Gains	66.4	52.1	39.0	41.4
7	Low Internal Gains	23.5	16.4	9.7	10.9
8	Glazing area: double	75.3	58.8	42.0	40.7
9	Glazing area: half	29.0	19.9	13.0	14.0
10	Construction: ultra-lightweight ( $C_m = 56.9 \text{ kJ/m}^2\text{K}$ )	43.9	31.8	22.1	24.0
11	Construction: heavyweight ( $C_m = 231.56 \text{ kJ/m}^2\text{K}$ )	27.0	20.9	20.5	22.1
12	Construction: heavyweight, no insulation	27.3	15.8	12.9	13.9
13	Ventilation daily schedule	43.8	30.0	22.4	24.1
14	Ventilation Weekday/Weekends schedule	43.8	29.9	26.2	23.8
15	High ventilation rates (1.5 ac/h)	35.5	22.5	13.3	14.8
16	Low ventilation rates (0.3 ac/h)	51.2	41.6	32.0	33.7
17	Rotate 90° anticlockwise	42.5	29.9	22.0	23.6
18	Rotate 180° anticlockwise	45.4	32.0	22.5	24.3
19	Set-point @ 26°C	37.8	24.2	14.3	15.9
20	Set-point @ 22°C	51.4	41.4	32.2	34.2
21	Intermittent cooling 7-17.00h	31.3	28.3	20.7	21.7
22	Intermittent cooling 0-10.00h	31.3	6.1	9.1	9.4
23	Intermittent cooling (different periods @ 24°C)	31.3	17.1	19.7	18.4
	Base Case (Athens - 24°C set-point)	116.3	106.1	98.2	100.2
24	Internal Gains averaged hourly (7 days/week)	116.3	97.4	94.6	96.1
25	Int. Gains averaged hourly (Weekdays/Weekends)	116.3	98.2	94.9	96.4
26	High Internal Gains	148.1	137.6	129.5	132.3
27	Low Internal Gains	82.3	76.3	70.3	71.7
28	Glazing area: double	184.7	167.5	155.9	164.1
29	Glazing area: half	82.8	75.2	69.6	70.5
30	Construction: ultra-lightweight ( $C_m = 56.9 \text{ kJ/m}^2\text{K}$ )	117.1	107.5	100.4	102.6
31	Construction: heavyweight ( $C_m = 231.56 \text{ kJ/m}^2\text{K}$ )	103.1	93.6	97.9	99.5
32	Construction: heavyweight, no insulation	128.5	107.3	120.9	123.2
33	Ventilation daily schedule	116.3	105.5	99.8	101.6
34	Ventilation Weekday/Weekends schedule	116.3	104.9	101.6	100.8
35	High ventilation rates (1.5 ac/h)	112.6	101.3	94.0	95.4
36	Low ventilation rates (0.3 ac/h)	120.7	112.3	106.1	108.1
37	Rotate 90° anticlockwise	117.6	104.4	101.2	102.5
38	Rotate 180° anticlockwise	118.8	104.0	96.4	98.4
39	Set-point @ 26°C	99.9	89.2	79.6	81.5
40	Set-point @ 22°C	133.7	125.6	119.1	121.2
41	Intermittent cooling 7-17.00h	99.0	80.4	84.0	84.3
42	Intermittent cooling 0-10.00h	99.0	33.1	60.1	59.3
43	Intermittent cooling (different periods @ 24°C)	99.0	50.2	80.4	73.5

Table 5.3: Annual cooling energy requirements ( $\text{kWh/m}^2$  annum).

#### ***5.2.4 Optimising the monthly method of the 13790 Standard***

This section investigates the possibility of optimising the parameters within the monthly method (equations 3.22 and 3.23 in chapter 3) in order to bring the compliance results produced from this method closer to the results of the other methods.

To identify the critical parameters that could be optimised for this method, the outputs of the calculated gains and losses from the simulation programs and the monthly method for the base case building were compared. The simplified hourly method was excluded from this comparison because there is no way to determine separately the heat losses from this method. The comparison confirmed that heat gains (solar and internal) and heat losses (ventilation and fabric conduction) were similar between the methods when the instructions of the 13790 Standard were followed. Appendix C provides details related to this comparison. This also confirmed that the equivalencing procedures described earlier in this paper were successfully applied. It was therefore concluded that the calculation of the utilisation factor used in the monthly method to account for dynamic effects had a major potential for being optimised. This possibility will be further discussed in this section.

A complete description of the monthly method has been given in chapter 3. The basic equations involved in the calculation of the utilisation factor were given in that chapter too and are not reproduced here (see equations 3.14 to 3.17 for heating and 3.18 to 3.21 for cooling). This factor uses the ratio between heat gains and heat losses and some suggested reference numerical parameters, which are named usually as  $\alpha_H$  and  $\alpha_C$  for heating and cooling respectively. These reference numerical parameters depend on the time constant of the building and are described by equation 5.1 (this is a repetition of equations 3.22 and 3.23 for heating and cooling respectively in order to assist the discussion in this section):

$$\alpha_{H,C} = \alpha_0 + \frac{\tau}{\tau_0} \quad (5.1)$$

where the symbol  $\alpha_{H,C}$  is used here to define both  $\alpha_H$  and  $\alpha_C$  reference numerical parameters for heating and cooling respectively but they are calculated separately,  $\alpha_0$  is defined in the 13790 Standard as the reference dimensionless numerical parameter with a suggested default value of 1 for both heating and cooling,  $\tau$  is the building time constant and  $\tau_0$  is defined as the reference time constant with a suggested default value of 15 hours for both heating and cooling.

The following paragraphs identify the most appropriate reference numerical parameters for improving the inter-method match of the rating results produced for this group of cases, without changing the utilisation factor main equations (in chapter 3: equations 3.14 to 3.17 for heating and 3.18 to 3.21 for cooling). The objective here is to identify the best combination of ( $\alpha_0$ ) and ( $\tau_0$ ) for all of the cases of this group (i.e. not localised specific parameters for specific cases).

The correlation developed by Corrado and Fabrizio (2007) is also used with the monthly method whereby the numerical parameter ( $\alpha_C$ ) that is used in the calculation of the utilisation factor for cooling is instead described by:

$$\alpha_C = 8.1 - 13\xi + \frac{\tau}{17} \quad (5.2)$$

where  $\xi$  is the window-to-floor area ratio. Although this correlation aims to improve the results of the monthly method for the calculation of the cooling energy requirements, its effect on the results for heating was also investigated.

### ***5.2.5 Optimisation results***

An iterative investigation revealed the best combination of the two numerical parameters to be  $\alpha_0 = 3.5$  and  $\tau_0 = 10$  hours. Imposing these values on the simplified monthly method produced results that placed the building in bands closer to the other methods and especially to results of the simulation programs. Thirteen cases out of the twenty-three heating cases and twenty-two out of the forty-three cooling cases

produced exactly the same rating when the new numerical parameters were used in the monthly method. In almost all of the remaining cases for heating and cooling, there is only one band difference in the rating results and this is often associated with small numerical differences that are close to the limit values of a band. Similar trends were noticed when the correlation of Corrado and Fabrizio was used, for which in almost all cases slightly lower numerical results were produced compared to the results of the monthly method with the optimised numerical parameters (i.e.  $\alpha_0 = 3.5$  and  $\tau_0 = 10$  hours). The largest differences for the heating results after the optimisation of the monthly method were noticed again for the cases of intermittent heating (see Figure 5.5, case ID 21, 22 and 23). The intermittent cooling cases during the night and at different periods during the day for the warm climate (i.e. Figure 5.6, case ID: 42 and 43) still generate the largest differences between the rating results of the various methods. For these two intermittent cooling cases, the correlation of Corrado and Fabrizio seems to be the best alternative for use in the monthly method. Figures 5.5 and 5.6 show some examples of the rating results after the application of the improvements in the monthly method. These examples were based on some of the cases of Figures 5.2 to 5.4 where differences in the initial rating results before the optimisation were noticed. They include the five cases for intermittent heating and cooling and some additional examples for which the improvements on the monthly method were notable. The full set of results after the optimisation is given in Appendix D.

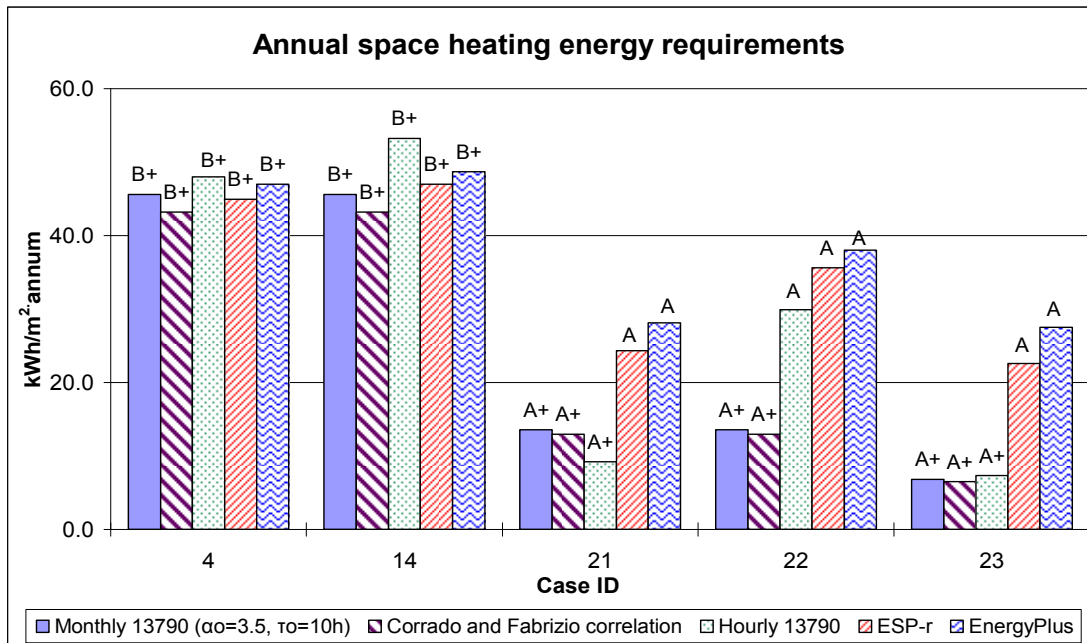

Figure 5.5. Optimisation: annual space heating energy requirements (kWh/m<sup>2</sup>-annum).

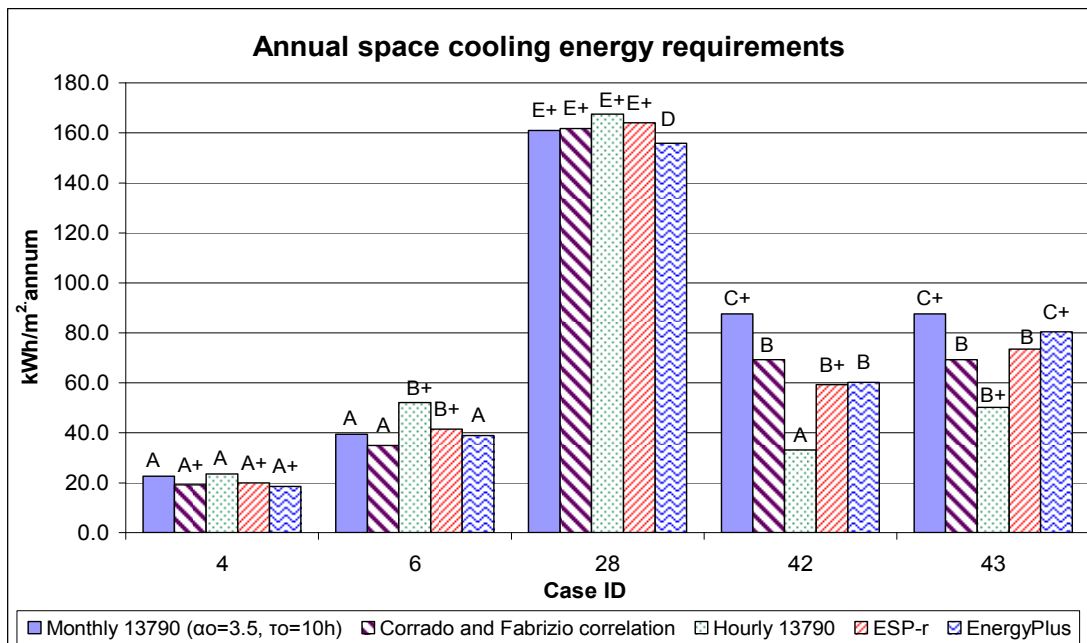

Figure 5.6. Optimisation: annual space cooling energy requirements (kWh/m<sup>2</sup>-annum).

While the optimisation process of the monthly method improved the rating results, further research is needed on the impact of the use of the various methods on different building types and especially where advanced building design techniques are used (e.g. atriums, ventilated double facades, etc.). Large differences may be produced in such cases and the choice of a calculation method may have to be based

on validation procedures and guidance from the policy makers of the countries that are adopting these methods (e.g. detailed guidance on the applicability and the limitations of the potential methods). An example of such a case where larger differences in the cooling results (compared to those for this first group of cases) is given in the next section for an office building incorporating a mechanically ventilated double façade.

### **5.3 Second group of cases**

#### ***5.3.1 Building model details and parametric analysis***

In this group of cases, the ESP-r detailed simulation program was used against the simplified monthly method of the 13790 Standard. The objective was to compare the performance in terms of compliance rating outputs for space heating and cooling of one simplified method against a detailed simulation program in a case where more advanced design technologies are used (i.e. ventilated double facades).

A three-storey building with three spaces and a ventilated double façade was used for this group of cases. The total floor area of the building is 144 m<sup>2</sup>. The external walls have a U-value of 0.245 W/m<sup>2</sup>K and are of low thermal mass. An example of the building, as produced from the ESP-r program (and the link with Radiance), is shown in Figure 5.7. Additional details of the buildings used in all cases of this chapter are given in Appendix A.



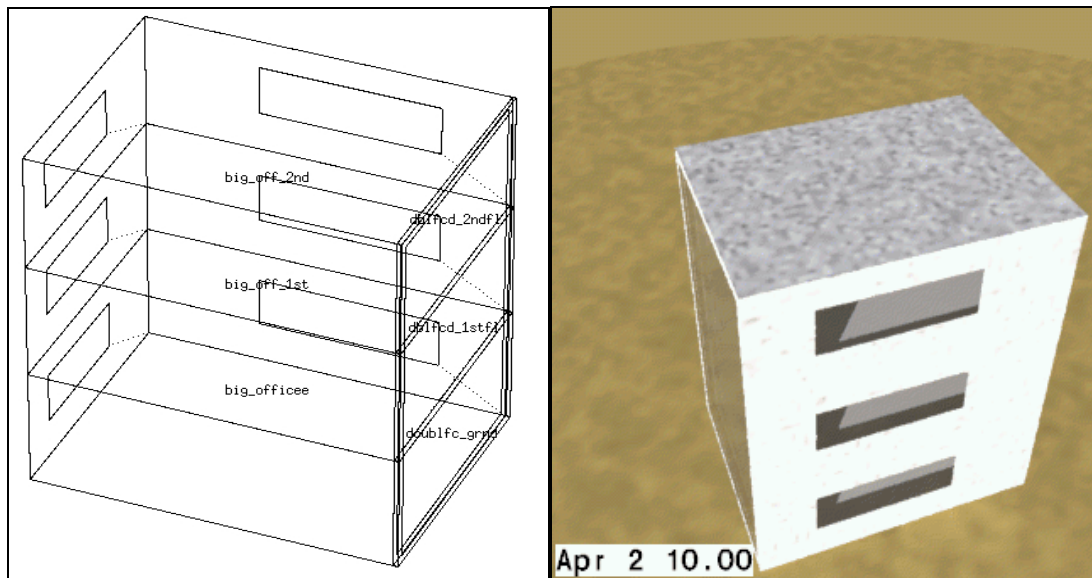

Figure 5.7: The building used for the second group of cases

The calculations for the base case were done for a northern/central European location (based on weather data for Amsterdam). The ventilated double façade was initially considered to fully cover the south façade from the bottom to the top of the building without any separation between storeys. The ventilated double façade consists of a double glazed clear inside layer and a single glazed clear outside layer. Window frames were also included and modelled explicitly. The application of the method described in the Annexes of the 13790 Standard for this type of building (i.e. with double façades) is limited to ventilated double façades with an air cavity width between 15 mm and 100 mm. For this reason, the analysis was done for a 100 mm wide ventilated double façade. The method to determine the air flow rates within the façade in the case of a natural ventilation strategy was not clear in the 13790 Standard method and for this reason a mechanical ventilation strategy was studied in this group of cases. In the cases where the calculations focused on annual heating energy requirements, the air intake is the bottom outside layer of the double façade. The air then flows through the cavity of the facade with the help of the mechanical ventilation system and at the top of the building is evenly distributed in the three storeys. For the annual cooling energy calculations and the base case, a similar configuration for the double façade was studied but this time the air at the top of the ventilated double façade exits back to the outside environment. Figure 5.8 shows an

example of the double façade configuration that is used for the base case of the second group of cases.

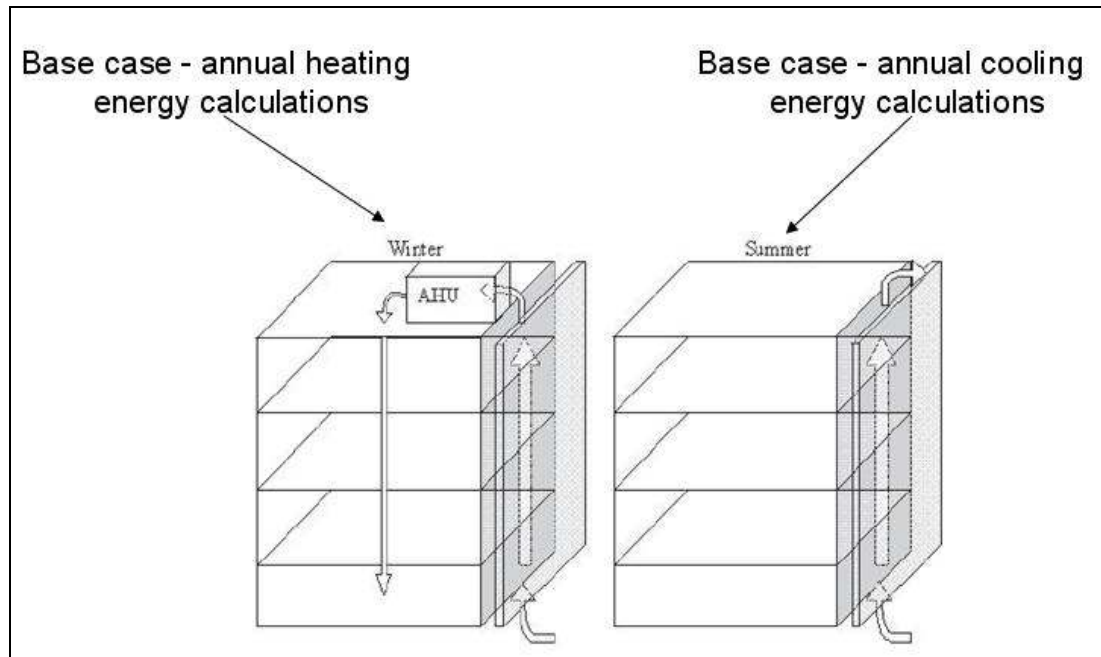

Figure 5.8: Base case configuration for the second group of cases (source: Poirazis, 2004).

As for the first group of cases and for the same reasons described in that case study (i.e. multi-zone calculations with thermal coupling between thermal zones are not recommended for the simplified method), all three spaces were assumed to have the same set-points for heating and cooling and also the same heating, cooling, ventilation and internal heat gains schedules.

The parametric studies covered a number of design variations that are likely to have an impact on the building's annual heating and cooling energy requirements. A large number of additional variations could have been added here but the number of cases presented in this section was adequate to draw conclusions on the impact of the use of a simplified method and a detailed simulation program in a regulatory context for this type of building. A larger number of design variations were presented for the previous group of cases of this chapter. Results for the following design variations

are presented for the second group of cases that incorporate the ventilated double façade:

- A case where the air enters from outside the base of the double facade and is evenly distributed in the internal spaces when it reaches the top of the façade (base case for heating) and another case where the air enters from the base of the double facade and exits to the outside from the top of the double facade (base case for cooling). The base case was also studied without the ventilated double façade. For the base case for cooling and for the case without the ventilated double façade, the air flow in the spaces was provided separately from the outside air (without preheat).
- Three different ventilation rates. The base case model (0.75 air changes/hour for all three room spaces), a case with half the base case's ventilation rate (0.375 air changes/hour) and a case with twice the base case's ventilation rate (1.5 air changes/hour).
- Three different building orientations: the base case was rotated 90° and 180° anticlockwise. In these cases, the double façade was facing east and north respectively.
- Three different internal heat gains schedules. The base case incorporated occupant and lighting schedules where the sensible heat gains during occupied hours were 12 W/m<sup>2</sup> and 10 W/m<sup>2</sup> respectively and 10% of these values during non-operational weekday hours and weekends. A second case used higher internal heat gain values but with the same hourly pattern, while the last case used lower values, again with the same hourly pattern.
- Three building locations and climates based on Southern, Central and Northern European weather data.
- Four heating and cooling strategies. The base case has a steady operative temperature set-point throughout the year and for the other three cases, different intermittent heating or cooling strategies were used (i.e. continuous during the day time, continuous during the night time for the same hours as the previous case for day time and at different periods during the day time).

### ***5.3.2 Model equivalencing***

The process of achieving equivalency between the inputs and the boundary conditions of the various methods is similar to the one for the first group of cases. For this reason, the details with regard to the way equivalency has been achieved are not repeated here. The longwave radiation heat exchange between the building surfaces and the sky is again not included in the calculations of heating and cooling energy requirements in either of the two calculation methods (i.e. to allow a fixed external surface resistance to be used in the simulation program).

The calculations in the monthly method are based on similar principles as in the previous group of cases. However, the effect of the ventilated double façade in this method is based on the description in the Annexes of the 13790 Standard for this type of application (i.e. with double façades) and it is taken into account by adjusting the ventilation heat transfer coefficient of the space under study (assuming the double façade acts as an air-to-air heat exchanger) and the amount of the double façade solar gains. The heat transfer coefficient of the double façade is also calculated in the monthly method according to the properties of the façade, i.e. the double façade was only treated as an extra construction layer with an air layer that had a fixed thermal resistance. In ESP-r, however, the ventilated façade was modelled as an additional thermal zone and the condition of the air inside it varied over the year resulting in variations in the heat losses of the adjacent building spaces. The results of the calculation are presented in the following sections.

### ***5.3.3 Results and discussion***

The results for this group of cases are also presented in terms of rating outputs from the two calculation methods. The full sets of numerical results for annual heating and cooling are also given for reference in Tables 5.4 and 5.5 respectively at the end of this section. “Case ID” numbers were used for this group of cases too for making easier their discussion and display in graphs. The “case ID” numbers for this second group of parametric variations can be found in Tables 5.4 and 5.5. In the same way

as for the previous group of cases, special care has been taken to eliminate any potential user errors in these results by undertaking multiple checks for the models and the calculations (by comparing the inputs of each method against the inputs of the other methods, by checking the calculations involved in the simplified methods against the instructions of the 13790 Standard, etc.).

Of the fourteen cases for heating, seven cases (Figure 5.9, case ID: 1, 4, 5, 6, 7, 11 and 12) produced results that are within the same rating bands. Of the remaining cases, the results between the two calculation methods for five of these cases (Figure 5.9, case ID: 3, 9, 10, 13, and 14) did not differ more than one band (i.e. considering the lower limit of a band and the upper limit of the next band: less than 40 kWh/m<sup>2</sup>-annum). For the two remaining cases the differences were in the range of two bands (Figure 5.9, case ID: 2 and 8). These were the case where the building was studied without the ventilated double façade (i.e. case ID 2) and the case where high internal heat gains were assumed (i.e. case ID 8). The results for heating are shown in Figure 5.9.

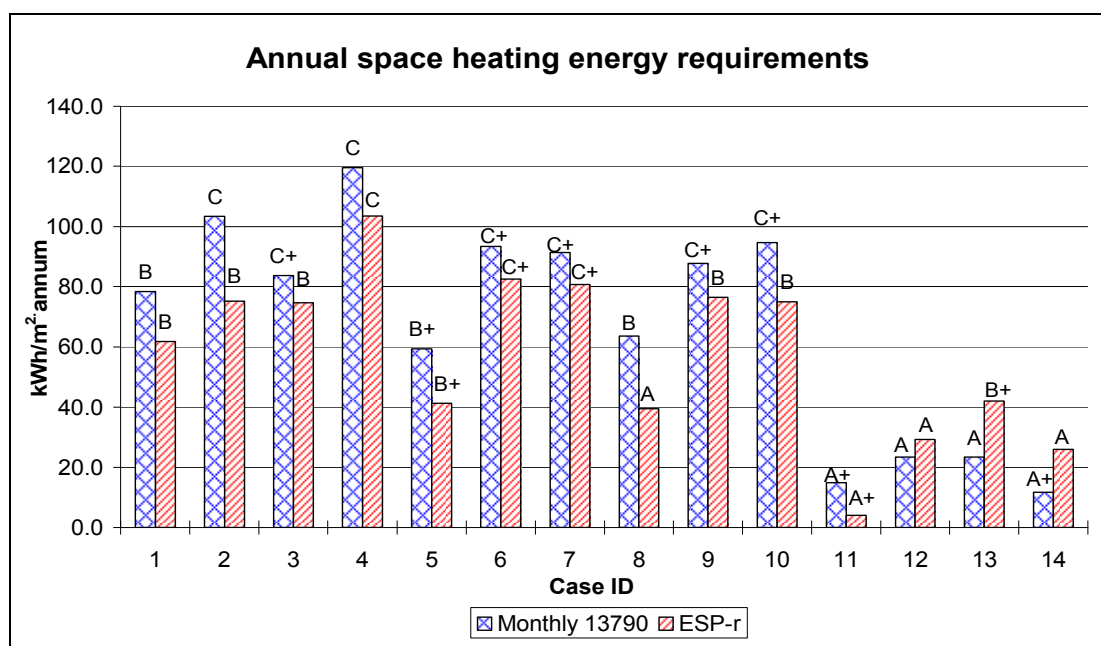

Figure 5.9. Rating outputs - Annual space heating energy requirements (kWh/m<sup>2</sup>-annum).

The same trend as for the first group of cases can be noticed for the heating cases of this group too: with the exception of the intermittent heating cases, the monthly method of the 13790 Standard often produces results that place the building at a slightly worse rating band than the ESP-r simulation program. It can also be noticed from the results of intermittent heating cases that there is a lack of sensitivity of the monthly method between the case that uses a day time temperature set-point schedule (case ID 12) and the case that uses a night time temperature set-point schedule (case ID 13).

Larger differences were noticed for the cooling cases. There was no case for which the ratings produced from the two calculation methods were the same. For a small number of cases (Figure 5.10, case ID: 11, 12 and 14) the results between the two calculation methods did not differ by more than one band and differences of two and three bands were noticed for the remaining cases. In particular, the case where the double façade was facing north (case ID: 7), the case where the climate of Aberdeen was used (case ID: 10) and the case of intermittent night cooling (case ID: 13) produced the largest rating differences. The ratings produced for the cooling cases are shown in Figure 5.10.

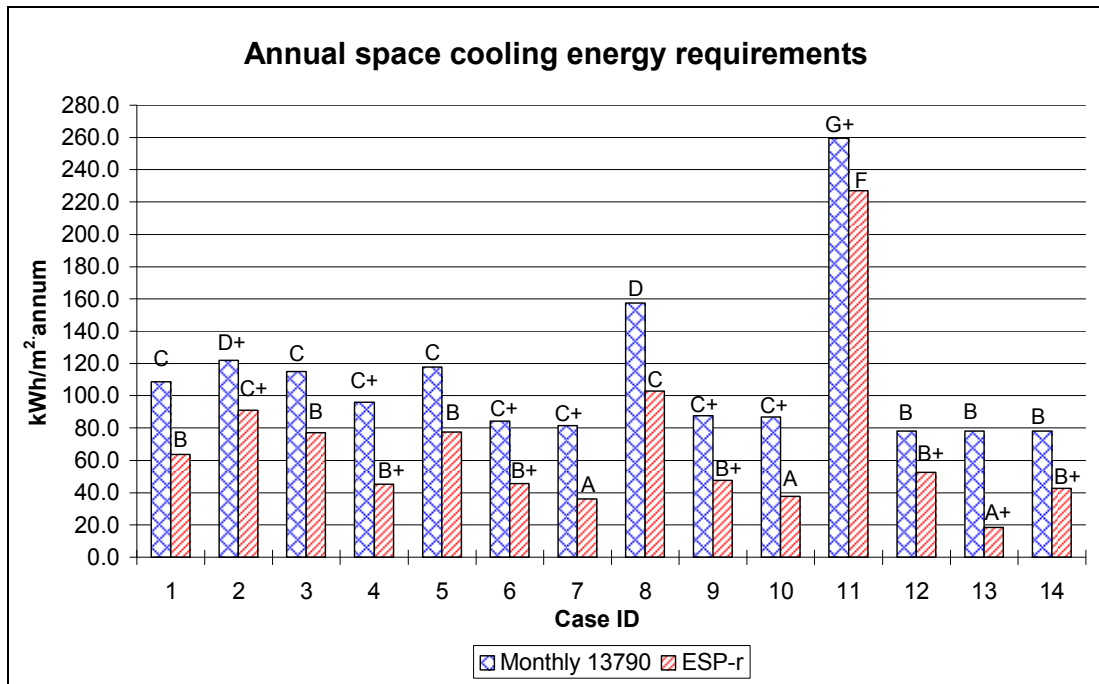

Figure 5.10. Rating outputs - Annual space cooling energy requirements (kWh/m<sup>2</sup>·annum).

It can be seen from Figure 5.10 that in all cases, the monthly method of the 13790 Standard produces results that place the building at a worse rating than the ESP-r simulation program. It has been confirmed for these cases too that for intermittent cooling, the results produced from the monthly method of the 13790 Standard are not affected by the variations in the daily temperature set-point schedules (Figure 5.10, see case ID: 12, 13 and 14).

The next section (i.e. section 5.3.4) will apply the same optimisation parameters in the monthly method as those used for the first group of cases in order to investigate if these parameters could also improve the inter-method match for the type of cases described in this section (i.e. for office buildings incorporating mechanically ventilated double facades).

The numerical results for this second group of cases of this chapter are given below. Although these are less important for the objectives of this chapter (i.e. for the impact of using multiple methods for regulation compliance purposes), interesting conclusions can be drawn for the sensitivity of the two calculation methods in the

design changes used here and the way they would have affected design decisions for the specific group of cases. In brief, two of the most notable conclusions that were drawn from the numerical results are as follows:

- Both methods highlighted the potential energy savings that the ventilated double façade could offer in terms of heating and cooling requirements when the base case was studied without the ventilated double façade.
- The monthly method indicates improved (to a large extent) heating potential from the use of double façade compared with the dynamic simulation. However, dynamic simulation indicates improved cooling potential from the use of double façade compared with the monthly method.

The application of ventilated double facades has significant cost implications and any potential energy benefits that this would offer will usually require to be accurately estimated.

Case ID	Description	Monthly 13790	ESP-r
1	Base Case – air enters the spaces from the top (Amsterdam – 19 °C set-point)	78.3	61.8
2	Base Case without ventilated double façade	103.4	75.1
3	Base Case – air exits from the outside upper layer of the double façade	83.6	74.6
4	High ventilation rates (1.5 ac/h in the building spaces)	119.5	103.5
5	Low ventilation rates (0.375 ac/h in the building spaces)	59.3	41.3
6	Rotate 90° anticlockwise (double façade is facing east)	93.3	82.5
7	Rotate 180° anticlockwise (double façade is facing north)	91.3	80.7
8	High internal heat gains	63.6	39.5
9	Low internal heat gains	87.7	76.4
10	Climate Aberdeen	94.7	74.9
11	Climate Athens	14.9	4.1
12	Intermittent heating 7-17.00h	23.3	29.2
13	Intermittent heating 0-10.00h	23.3	42.1
14	Intermittent heating (different periods during the day at 19 °C)	11.7	25.9

Table 5.4: Annual heating energy requirements (kWh/m<sup>2</sup>.annum)



Case ID	Description	Monthly 13790	ESP-r
1	Base Case - air exits to the outside from the top (Amsterdam – 24 °C set-point)	108.7	63.8
2	Base Case without ventilated double façade	122.1	91.0
3	Base Case – air enters the spaces from the top of the double façade	115.1	77.1
4	High ventilation rates (1.5 ac/h in the building spaces)	96.1	45.3
5	Low ventilation rates (0.375 ac/h in the building spaces)	117.9	77.6
6	Rotate 90° anticlockwise (double façade is facing east)	84.3	45.6
7	Rotate 180° anticlockwise (double façade is facing north)	81.5	36.2
8	High internal heat gains	157.4	103.0
9	Low internal heat gains	87.7	47.5
10	Climate Aberdeen	86.9	37.8
11	Climate Athens	259.6	227.0
12	Intermittent cooling 7-17.00h	78.1	52.6
13	Intermittent cooling 0-10.00h	78.1	18.4
14	Intermittent cooling (different periods during the day at 24 °C)	78.1	42.6

Table 5.5: Annual cooling energy requirements (kWh/m<sup>2</sup>-annum)

#### ***5.3.4 Optimising the monthly method of the 13790 Standard and optimisation results***

In this section, the same optimisation options as those described in section 5.2.4 were used for the monthly method of the 13790 Standard in order to investigate the general applicability of these parameters for the second group of building cases that are described in this chapter.

The rating results of the monthly method when using the optimised numerical parameters (i.e.  $\alpha_0 = 3.5$  and  $\tau_0 = 10$  hours) and the correlation of Corrado and Fabrizio (i.e. see equation 5.2, in section 5.2.4) are shown in Figures 5.11 and 5.12 against the outputs from the ESP-r simulation program.

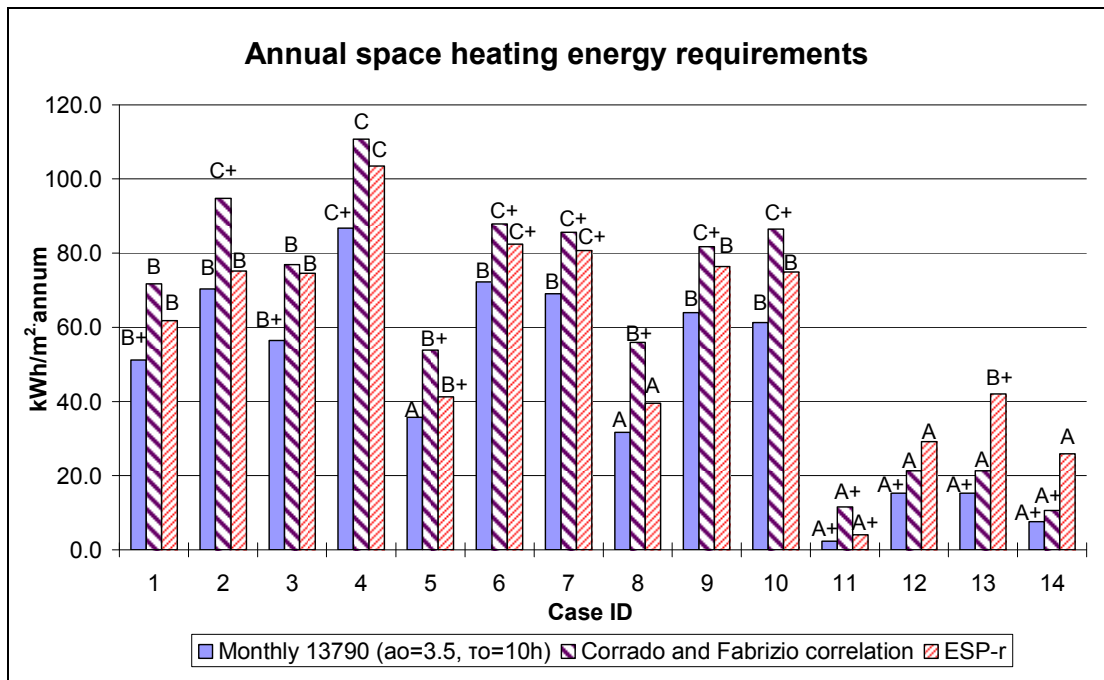

Figure 5.11. Optimisation: annual space heating energy requirements (kWh/m<sup>2</sup>-annum).

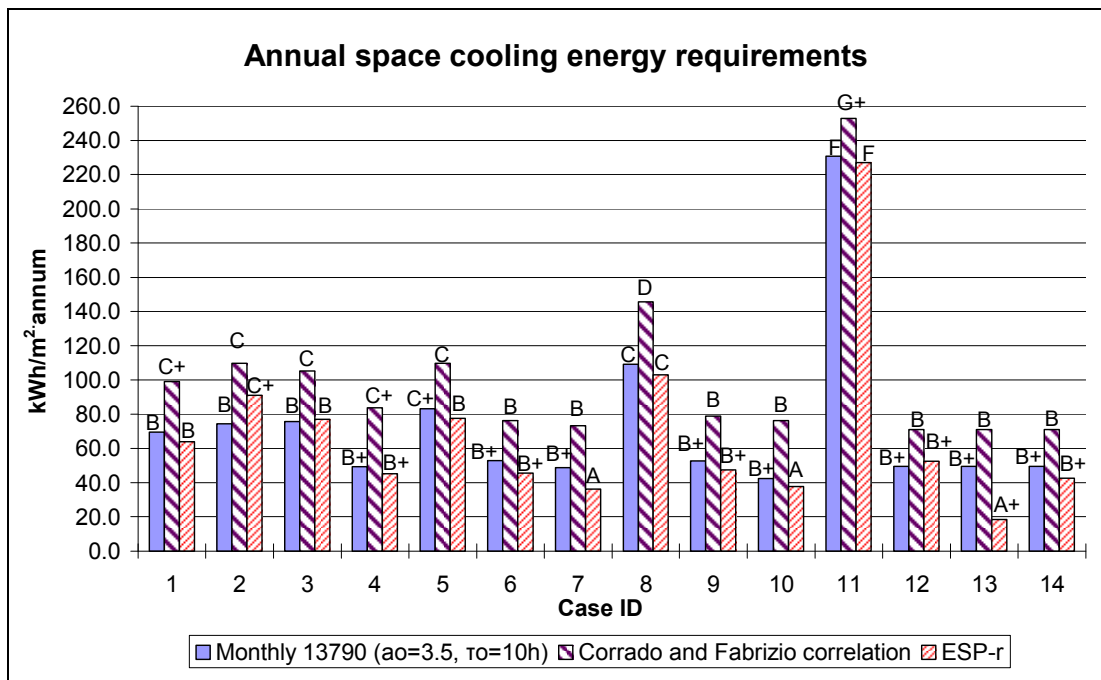

Figure 5.12. Optimisation: annual space cooling energy requirements (kWh/m<sup>2</sup>-annum).

It can be seen that by imposing the new numerical parameters on the simplified monthly method produced results that were placing the building in bands closer to the results of the ESP-r simulation program for the cooling cases but on the other

hand, it affected some of the heating cases for which the results between the two calculation methods were previously within the same band (for example in Figure 5.11, case ID: 1 and 4 for heating). The correlation of Corrado and Fabrizio also improved the results of the monthly method but the different ratings between the monthly method and the simulation program were still notable, in particular for the cooling cases of this group.

For the heating cases, none of the options described in this chapter seem to be able to perfectly optimise the inter-method match between the results of the two calculation methods. Out of the fourteen heating cases in Figure 5.11, eight cases produced results that were placing the rating of the monthly method in the same band as the rating from the simulation program when the correlation of Corrado and Fabrizio was used, instead of five cases when the optimised numerical parameters (i.e.  $\alpha_0 = 3.5$  and  $\tau_0 = 10$  hours) were used (which is worse than the default parameters for which, as was mentioned in section 5.3.3, seven cases produced the same ratings for the two calculation methods). For all three different ways that the monthly method has been applied in this group of cases, two cases of intermittent heating never produced the same rating as the simulation program. These were: the case of intermittent heating during night (Figure 5.11, case ID: 13), which is an unrealistic case for this type of building but included here to demonstrate the sensitivity of calculation methods in various intermittent heating set-point schedules, and the case of intermittent heating at different periods during the day (Figure 5.11, case ID: 14).

For the cooling cases, however, the monthly method with the optimised numerical parameters (i.e.  $\alpha_0 = 3.5$  and  $\tau_0 = 10$  hours) produced rating outputs that were in the same band as the simulation outputs for nine out of the fourteen cooling cases (see Figure 5.12). In almost all of the remaining five cases, the differences between the results of the two calculation methods were in the range of one band and the results were usually close to the borders of a band (e.g. see Figure 5.12 for case ID: 5, 7 and 10). An exception was again the case where night cooling was used and the results between the optimized monthly method and the simulation program were in the range of two bands (e.g. see Figure 5.12 for case ID: 13).

The correlation of Corrado and Fabrizio for the cooling cases reduced the differences between the monthly method and the simulation program when comparing with the differences produced from the default use of the monthly method in Figure 5.10. However, the rating results of the monthly method that uses this correlation were still in a different band to those produced from the ESP-r simulation program for all the fourteen cooling cases. In particular, amongst these cases when the correlation of Corrado and Fabrizio is used in the monthly method, the largest difference was noticed again for the case of night cooling (three bands difference between ESP-r and monthly method - see Figure 5.12 for case ID: 13).

#### **5.4 Discussion and closing remarks**

While prescribing and allowing a number of calculation methods within the EPBD offer advantages, it also raises the issue of method conformity in a regulatory context. To investigate this issue the methods described within the 13790 CEN Standard were applied to a common building specification for two groups of cases and the space heating and cooling predictions compared. The impact of this issue was assessed by considering the energy band which would be assigned for the building based on the calculation results. Building model and boundary condition equivalence was attained by adhering to instructions contained in the Standard, which necessitated assumptions that are not always consistent with those used in practice, mainly because these instructions are based on the simplified methods and are less advanced than what detailed simulation programs normally use for their calculations. EU countries should carefully consider this matter before the implementation of the 13790 Standard. In case they decide not to restrict the choice of inputs and algorithms used by the calculation methods, larger differences in the rating outputs than those presented in this chapter may be produced from the adopted methods. A detailed description of how model and boundary condition equivalence was achieved between the different calculation methods was given in this chapter and as well the main barriers during this process were identified (e.g. the treatment of the external longwave radiation).

For the first group of cases in this study, a common building design was used and the simplified monthly and simplified hourly method of the 13790 Standard were used together with two detailed simulation programs. A building that incorporates a more advanced technology (i.e. a mechanically ventilated double façade) than the first group of cases was studied with the simplified monthly method and the ESP-r detailed simulation program for the second group of cases in order to further research the impact from the use of simplified and detailed calculation methods on the compliance ratings produced for this type of building.

The results from the first group of cases show that, in terms of space heating, all methods would place the building either within the same or an adjacent band. The largest differences were noted for the case of intermittent heating.

With space cooling for the first group of cases, there were a small number of cases where the results from each method were within the same band. The majority, however, were rated differently by the methods: of these the majority were within a single band range, while six cases exhibited large differences, the most notable corresponding to night cooling in a warm climate.

Similar trends as for the first group of cases were noticed for the heating results produced for the second group of cases. In this case, while most of the ratings outputs from the two calculation methods (monthly and ESP-r) would be either within the same or an adjacent band, there were two heating cases for which the ratings produced were different by two bands: the case where high internal heat gains were assumed and the case where the building was studied without the ventilated double façade (which resulted in higher solar gains to building spaces compared with the base case, and during the heating season: higher conduction losses and lower ventilation losses compared with the base case).

Larger differences in the ratings between the two calculation methods than those noticed for the first group of cases were produced for the cooling cases of the second

group of cases. For none of these cooling cases were the rating outputs from the two calculation methods the same. For the majority of the cooling cases of this group, differences in the range of two and three bands were noticed between the rating outputs of the monthly method and the ESP-r program. The largest differences in the ratings were produced for the cases where: the double façade was facing north (which implies less solar gains), the climate of Aberdeen was used (i.e. colder climate: less solar gains and lower temperatures) and the intermittent night cooling case.

For the specific group of cases, both methods highlighted the benefits with regards to energy savings in terms of heating and cooling requirements with the use of a ventilated double façade. The monthly method indicated significant benefits in the heating potential from the use of double façade compared with the dynamic simulation. However, dynamic simulation indicated larger benefits in the cooling potential from the use of double façade than those indicated from the monthly method.

Overall the results from both groups of cases indicate that apart from the intermittent heating cases, there is a general trend concerning the monthly method, whose predictions are higher than the other methods, resulting in many cases in a different rating. Based on this trend, the improvement of the inter-method match of the ratings was investigated across all cases with the use of alternative numerical parameters in the monthly method. These alternative numerical parameters for the first group of cases were demonstrated to bring the results for this monthly method in line with the other methods, although differences for the case of night cooling in a warm climate were still significant. Unfortunately, these alternative assumptions did not fully improve the inter-method match of the ratings for the cases of the second group with the ventilated double façade. In particular, some of the intermittent heating cases of this group never produced the same rating between the two calculation methods for any of the previous optimisation options that have been tried on the first group of cases. Mostly small differences between the ratings produced from the monthly method and the ESP-r program for the cooling cases of the second group were still

evident even after applying the optimisation options on the numerical parameters of the monthly method. However, significant differences with regards to the cooling calculations for this group of cases were noticed again for the case of night cooling, i.e. minimum difference of two bands between the best optimised option of the monthly method and the simulation program. It should be stated that the whole optimisation exercise proved to be a time-consuming process, which required several iteration steps (it could also be the same when optimising against empirical results).

It can be seen from this chapter that even by considering the strict control of the inputs and boundary conditions of all the potential EPBD calculation methods, it is not possible to produce the same ratings from the various calculation methods for every building case. In some countries (e.g. England & Wales), the concept of a benchmark building (often called a notional or reference building) is used for comparing the output of the calculation methods. This building is also used in these countries as a way to eliminate the differences in the outputs of the various calculation programs. However, this actually depends on the way this benchmark building is defined. If, for example, this building uses always specific construction elements (as in England and Wales for non-domestic buildings) then it is still possible to obtain differences across the results of the various calculation methods. This can be seen for example from the numerical results of Table 5.2 in this chapter where if the results for the heavyweight building (case ID: 12) were meant to be compared always with the lightweight base case (case ID: 1 – it should be remembered that the only difference between these two cases is the wall construction) then differences across the methods would have been again noticed. The thesis did not investigate the use of a notional building since its definition may vary between countries and, at least currently, the specifications for this building are not fully prescribed and documented to the public.

The option of restricting the calculation of the regulation compliance outputs to one method, and especially to one simplified method, in order to avoid these inconsistencies on the ratings has drawbacks as discussed in the beginning of this chapter. An alternative option of using validation tests in a way to assist the selection

process for the calculation methods that could be capable of producing outputs that agree with the outputs of other calculation methods, and further evaluate these methods for their actual use in energy performance assessments, is discussed in chapter 6.



## 5.6 References

BESTClass Software, 2007. *Energy certification software*. Polytechnic of Milan and Province of Milan, Italy. Available from: <http://www.sacert.eu/bestclass.php>

CIBSE (Chartered Institution of Building Services Engineers). 2006. *CIBSE Guide A: Environmental design (7<sup>th</sup> Edition)*. London, UK.

Corrado V., Fabrizio E. 2007. *Assessment of building cooling energy need through a quasi-steady state model: Simplified correlation for gain-loss mismatch*. *Energy and Buildings*, 39 (5), pp. 569-579.

Crawley D.B., Hand J.W., Lawrie L.K. 1999. *Improving the weather information available to simulation programs*. Proceedings Building Simulation '99. Kyoto, Japan.

EN ISO 13789. 2007. *Thermal performance of buildings – Transmission and ventilation heat transfer coefficient – Calculation method*. ISO, Geneva, Switzerland.

EN 15265. 2007. *Thermal performance of buildings – Calculation methods of energy use for space heating and cooling – General criteria and validation procedures*. Brussels, Belgium.

EN ISO 6946. 2007. *Building components and building elements – Thermal resistance and thermal transmittance – Calculation method*. ISO, Geneva, Switzerland.

EnergyPlus 2.1.0. 2007. *Building energy simulation program*. US Department of Energy, USA. Available from: <http://www.energyplus.gov>.

ESP-r 10.14, 2007. *Building energy simulation program*. University of Strathclyde, Glasgow, UK. Available from: <http://www.esru.strath.ac.uk>.

Poirazis H. 2004. *Double skin facades for office buildings – Literature review*. ISBN 91-85147-02-8. Report EBD-R--04/3. Lund University, Sweden.

prEN ISO/DIS 10077-1. 2006. *Thermal performance of windows, doors and shutters – Calculation of transmittance – Part 1: General*. ISO, Geneva, Switzerland.

prEN ISO/DIS 13370. 2007. *Thermal performance of buildings – Heat transfer via the ground – Calculation methods*. ISO, Geneva, Switzerland.

SBEM v3.1, 2008. *Simplified building energy model*. BRE, UK. Available from: <http://www.ncm.bre.co.uk>

WINDOW5.2. 2005. *Window thermal and optical performance program*. Lawrence Berkeley National Laboratory, USA. Available from: <http://windows.lbl.gov/software/>

WIS, Window Information System. 2004. *Window thermal and optical performance program*. EU Thematic Network WinDat – coordinated by TNO Building and Construction Research Delft, Netherlands. Available from: <http://windat.ucd.ie/wis/html/index.html>

## **6.1 Introduction**

In chapter 5, the advantages of allowing a number of calculation methods to be used for regulation compliance purposes were described but it was shown at the same time that selecting methods which are consistent with each other in terms of regulation compliance rating outputs is not a trivial task. The value of validation studies could be considered at this stage as a way of supporting the selection process between the calculation methods and to provide confidence to building professionals in their use of the right method in their designs. This should also be combined with the ability of the method to offer the required functionality for the design as discussed previously in chapter 4. Validation studies have also been of particular importance for program developers to continuously test the performance of their program and identify the causes of potential weaknesses or the effect specific code developments will have on program's predictions. This chapter will describe the development of a facility integrated within the ESP-r simulation program that can be used by program users and developers as an aid to easily check the performance of the program against results of validation tests and for code quality assurance purposes.

In the literature, the various elements of program validation are well established (Judkoff, 1983; Jensen, 1993; Bloomfield, 1999) and comprise the following elements:

- Review of theory
- Code checking
- Analytical verification
- Interprogram comparison
- Empirical validation

The first two of these are necessary for any technical software development. To permit future development and re-use, high-quality comprehensive documentation of the theory and its implementation are an essential element for state-of-the-art programs which are too complex for individuals to develop. The advantages and disadvantages of the other three techniques are well understood, as is the fact that all techniques need to be applied on a regular basis during program development.

The ESP-r program that was used for the development described in this chapter has been the subject of numerous validation studies over the period of almost three decades. A summary of all the main validation studies is given by Strachan et al (2008). This comprises studies included as part of European projects, within several IEA Annexes/Tasks, within national studies and as part of PhD theses. It was observed that the early exercises were mostly focused on empirical validation as this is the most obvious method to test program validity. However, these early studies pointed out the difficulties with experimental studies - the need for expensive and accurate instrumentation, consideration of all heat and mass flow paths/processes, detailed test specifications and documentation, accurate control and minimisation of uncertainty. Following this, a more balanced view was taken which emphasised the complementary nature of the various validation techniques. A significantly large amount of resources in terms of time and persons involved had been invested for some of these validation studies, for example PASSYS (Jensen, 1993), IEA Annex 21/Task 12 Cooperative Project (Judkoff and Neymark, 1995; Lomas et al., 1994), etc. This highlights the amount of effort needed to undertake thorough validation. And in spite of such multiyear, multi-team projects, there are numerous areas of program functionality that have not yet been fully tested (e.g. integrated thermal and air flow modelling, integration of thermal bridges, integration of renewable energy systems, etc.).

A key observation from the large range of validation studies is that program predictions for the validation tests may change over the years. By this it is meant that, although the program may have achieved reasonable agreement with measured data in empirical studies, or other programs in comparative studies, there is no

certainty that this level of agreement is achieved several years later. For example, the original ranges obtained in the IEA Annex 21/Task 12 BESTEST qualification tests which have been adopted in ASHRAE Standard 140 (ASHRAE, 2004) were all obtained from simulations run with a number of programs in 1993. There have been numerous program developments and bug fixes in the intervening period, and as shown in a later section in this chapter, in some cases program predictions have changed. For this reason, it is considered necessary to embed the tests within the structure of the simulation program and regularly monitor them to check if there have been significant changes in predictions. There is also a clear need for regular review of published ranges.

Embedding the tests to enable their easy application, particularly those tests in approved standards, is also of benefit to program users concerned with validation and accreditation. Program developers are often asked by those who directly use the simulation program regarding the confidence that can be placed in results and whether the program has been validated or accredited against specific regulation related tests. Including the tests with the program allows users to check compliance with standards for themselves, as well as confirming that the program has been properly installed. It should increase their confidence in the use of this program. It is becoming increasingly important that programs be shown to comply with national and international standards, and embedding the tests within the simulation program allows the check to be made easily by users and possibly by those in charge of program accreditation.

This chapter sets out the facility developed within ESP-r and discusses the ASHRAE and CEN validation tests as examples that have been incorporated into the structure of the program. Results from the ASHRAE thermal envelope and fabric load tests and the EN ISO 13791 Standard (2004) summer overheating tests are presented, highlighting some modelling issues. Appendix E also provides results from the recent EN 15265 (2007) validation tests for the calculation of the annual energy for space heating and cooling that has also been embedded within ESP-r. Two sensitivity studies are then described, which involve changing the external convection algorithm

and the sky temperature calculation algorithm, to demonstrate how the embedded tests can be used to investigate the impact of code changes and to show how significant these choices are on the results of some validation tests.

## **6.2 Embedded validation**

### ***6.2.1 General framework***

Ben-Nakhi and Aasem (2002) developed a set of analytical solutions for dynamic heat transfer through opaque multi-layer constructions involving a step change in internal or external temperatures. Constructional thermophysical properties were the required input data, together with the inside and outside boundary conditions (given as either surface temperatures or air temperatures, or as adiabatic). Initial conditions, simulation period and simulation timesteps can be specified. It is then possible to compare the predictions from a thermal simulation program to the analytical solution.

What was novel about the work was that it was implemented within a simulation program (the ESP-r program). After the user specifies the input data listed above, a thermal zone is automatically created, a simulation performed and results extracted for comparison with the analytical solution. It is therefore easy to undertake these comparisons at regular intervals during program development, or to check on numerical accuracy and stability for any particular construction. Ben-Nakhi and Aasem set out the initial framework for embedding the validation checks and based on this concept a similar facility has been developed for the work reported in this chapter to include comparative and analytical validation tests, especially those related to building energy performance standards (e.g. for validating programs to use for EPBD accreditation purposes).

A significant recent development in energy simulation has been the inclusion of validation tests within standards, reflecting the increasing move towards performance-based standards instead of prescriptive standards. Of note are the adoption of the BESTEST comparative tests within ASHRAE 140 Standard,

mentioned in the previous section, and the inclusion of validation tests in CEN European Standards (until recently, those concerned with summer overheating and cooling load calculations in the 13791 Standard but additional tests such as those in the 15265 and 15255 Standards (2007) have been only lately formally published regarding annual space thermal loads and peak cooling loads respectively). These specific ASHRAE and CEN Standards have some characteristic differences in their approach. Some simulation parameters are not fully prescribed within the ASHRAE 140 Standard. The specified ranges of predictions for particular tests in this standard are sometimes quite large, reflecting the different assumptions and algorithms used by the various programs involved in the range setting. On the other hand, a more prescriptive approach has been adopted in the CEN Standards, for example by specifying the surface heat transfer coefficients that should be used, and for this reason narrower tolerance bands are specified.

To demonstrate the usefulness of embedding validation tests, comparative and analytical tests from the ASHRAE 140 Standard that focus on the building thermal envelope loads, and from the CEN ISO 13791 Standard that focus on summer overheating risk, have been included in the ESP-r program. It was intended that they were implemented so that they can be easily run by program developers and users. The development of the facility aimed to create a generalised structure that can be extended in the future for other tests or other new standards without investing a large amount of time and without any code modifications.

### ***6.2.2 ANSI/ASHRAE Standard 140 Building Thermal Envelope and Fabric Load Tests***

The ASHRAE tests are grouped into high mass and low mass cases and classed as either basic sensitivity tests or in-depth sensitivity tests. The tests are designed in a way that it is primarily the differences between pairs of tests that are of interest: for example, the difference in prediction between two models that are identical apart from a change in the external surface absorptivity. In addition, there is a group with four free float tests and one test that has a second free float thermal zone (all the

other test cases have one thermal zone). Results are also presented in the standard from all the individual models.

The basic sensitivity tests analyse the ability of software to model building envelope loads by varying the window orientation, shading devices, setback thermostat, and night ventilation. In-depth sensitivity tests 195 through 320 analyse the ability of software to model building envelope loads for a non-deadband on/off thermostat control configuration with the following variations among the cases: no windows, opaque windows, exterior infrared emittance, infiltration, internal gains, exterior shortwave absorptance, solar transmittance for south facing glazing, interior shortwave absorptance, window orientation, shading devices, and thermostat set-points. In-depth cases 395 through 440, 800, and 810 analyse the ability of software to model building envelope loads in a deadband thermostat control configuration with the following variations: no windows, opaque windows, infiltration, internal gains, exterior shortwave absorptance, solar transmittance for south facing glazing, interior shortwave absorptance, and thermal mass.

Using the validation facility in ESP-r, the user can access the tests and has the choice to run a specific group of tests, run individual tests, or run all the tests. After selecting the models to be run, simulation is automatically invoked with predefined parameters without the need for user intervention. For every simulation, analysis of results is also automatically invoked, and the specific required results for every test are recovered and saved in a file. In order to know what kind of results need to be recovered for each case (e.g. annual heating loads, peak heating loads, etc.), a result recovery data file that is provided with each of the models is read in.

Apart from the free float tests, for every case selected in the groups, the files with the recovered results are scanned and the differences in the peak and annual heating and cooling loads are extracted and are displayed on screen or sent to an external file.

In addition to the simulation results, the minimum and maximum limits listed in ASHRAE 140 Standard informative annexes are provided to the user (i.e. displayed



or saved in the same file with the current test results). A check is made automatically to determine whether the recovered results are within the specified range and an “outside” or “inside” message is included in the final results to notify the user. Another set of predictions is also provided automatically to the users. This could be for example from the previously released version of the program so that program developers can determine the impact of coding changes on these standard tests. As the tests are designed to separately stress most of the fundamental heat transfer processes, this is a useful diagnostic tool for identifying the effect of program developments on these processes. Alternatively, it is possible to provide instead the ESP-r predictions originally obtained in the IEA Annex 21 project, which are published in ASHRAE 140 Standard, so that the magnitude of changes over the last 14-15 years can be quantified. These are the values presented in this chapter.

The same approach applies to the free float and the individual tests. For the free float tests, the files with the recovered results are scanned for the minimum and maximum temperatures together with the time of occurrence of these temperatures and the annual average temperature. For all the other individual tests, the results are scanned for the peak heating and cooling loads and also for the annual heating and cooling loads. Some tests require additional more specific data to be extracted (either annual or hourly for a specific date); for example, for test 600 (base case) additional results are required for the annual incident total solar radiation on each external façade. These additional data requirements are also specified in the results recovery data files of the test, so that they can be extracted and presented to the user.

Figure 6.1 sets out the overall structure of the implemented approach.

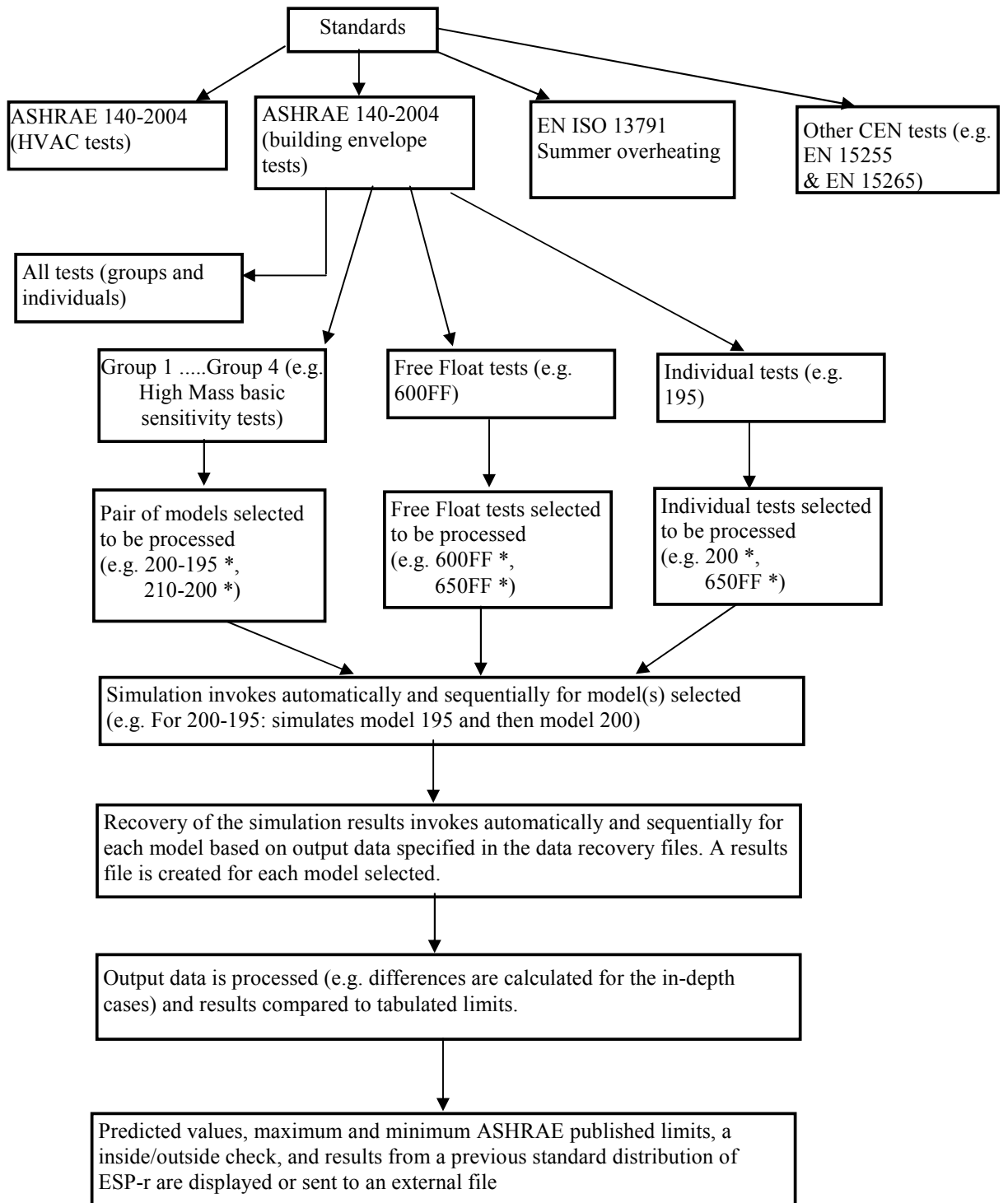

Figure 6.1: Implementation details.

### ***6.2.3 EN ISO 13791 Standard: Calculation of Internal Temperatures of a Room in Summer without Mechanical Cooling***

The process in this CEN Standard is based on defining a standard method to solve the problem and a performance-based approach to provide the required outputs. This process allows developers to either adopt the standard equations and solution process for compliance with this Standard or use their own equations to prove that they are within the acceptable range of the published data. This is the concept behind the EN ISO 13791 Standard where the recommended approach is that of solving the governing equations using an implicit finite difference approach.

There are four areas of the simulation program's performance that are examined in separate tests within the 13791 Standard. These tests are:

- Transient response in a solid opaque construction to a 10 °C change in external air temperature. This test examines the transient conduction algorithm in isolation, as all other aspects of the model are fixed (e.g. radiation and convection coefficients).
- Internal longwave radiation under steady-state conditions, given boundary temperatures and a solar gain to a specific surface.
- Solar shading to examine the ability of a program to calculate the degree of shading of direct solar radiation for six shading device configurations over a period of several hours.
- An overall whole model test to examine the combined modelling of solar processes, conduction, and internal radiation modelling for two single-zone geometries. There are no shading devices in these tests, but there are heat gains from internal sources and ventilation airflows.

The CEN 13791 Standard has a specific applicability - a single-zone model without mechanical heating or cooling for a warm period. It does not apply to spaces where solar radiation can pass through (e.g. escape back to the environment or to another adjacent space) or to spaces that are adjacent to a sunspace or atrium, for which a more robust model would be required. The tests aim to test the program's ability to

model the main thermal flow paths in buildings where there is no mechanical cooling system.

The Standard is prescriptive in specifying many aspects of the heat transfer processes. In some cases, there are differences in the way these processes are modelled in existing simulation programs. In the case of ESP-r, differences in modelling approaches were found in the handling of solar radiation distribution, convective heat transfer coefficients, and boundary condition specification. Thus, in some cases changes needed to be made at source code level to conform with the requirements of the Standard (for example, to develop a new adiabatic boundary condition with exactly the same specification as that in the Standard). This type of intervention can be done only by program developers or other experienced users. Also, some of the required outputs, such as the sunlit factors, were not available directly from the results module in ESP-r (which is needed for automatic recovery of results without user intervention for embedded tests); it was necessary to undertake (automatically) multiple simulations to obtain the required data.

These validation tests will be described in section 6.4 in more detail with results obtained. They have been also placed in ESP-r in the same structure as described in section 6.2.2 for the ASHRAE 140 Standard thermal envelope and fabric load tests. There are again tolerance bands given in the Standard against which predictions of ESP-r can be compared automatically with the use of the embedded validation facility, and it is also possible to detect whether there have been changes in predictions from a previous application of the tests.

### **6.3 Results from implementation of ASHRAE 140 Standard**

It is not intended to give a complete set of results in this chapter due to space constraints. However, to demonstrate the inclusion of the ASHRAE 140 Standard within the embedded validation facility of the ESP-r program, one typical example from each category of the cases in the Standard is given in Table 6.1. The table shows the results obtained from using the new approach with the embedded models.

A screenshot from the program is given in Figure 6.2 to show how results are presented to the user, which can also be redirected to a file. The table shows the test number, the output parameter, the predicted result, the inside/outside range check against the range given in the informative annexes of the ASHRAE standard, the range limits, and finally the results from the runs carried out in IEA Annex 21 by De Montfort University using ESP-r in 1993. The results of ESP-r in Table 6.1 are produced using the current default calculation algorithms of the program. It should be noted that while a few changes in the default algorithms of the main heat transfer processes may have been made since the IEA Annex 21 BESTEST work (e.g. default sky model – see related discussion later in this section and in section 6.5), most default algorithms remain the same as those used in that project (e.g. same internal and external convection algorithm, same sky temperature calculation algorithm). The results in Table 6.1 enable an evaluation to be made of the impact of any program changes over the last 14-15 years. It can be expanded to include all the ASHRAE 140 Standard results without any additional user effort due to the automated embedded validation facility, i.e. as long as the user selects to run all the ASHRAE 140 Standard tests.

In Table 6.1:

- 960-900 is a “high mass basic sensitivity test,” which tests mass/interzone heat transfer (the difference between models 960 and 900).
- 610-600 is a “low mass basic sensitivity test,” which tests the effect of a south overhang (the difference between models 610 and 600).
- 900-810 is a “high mass basic and in-depth sensitivity test,” which tests interior solar absorptance and mass interaction (the difference between models 900 and 810).
- 270-220 is a “low mass in-depth sensitivity test,” which tests south solar transmittance/incidence solar radiation (the difference between models 270 and 200).
- 650FF is a “free float test”, which tests venting of a free floating room.
- 410 is an “individual test,” which tests infiltration.

<b>Test</b>	<b>Output description</b>	<b>ESP-r (2007)</b>	<b>Range check</b>	<b>Min bound</b>	<b>Max bound</b>	<b>ESP-r (1993)</b>
960-900	Peak Heating Load (kW)	-0.528	inside	-1.018	-0.440	-0.440
960-900	Peak Cooling Load (kW)	-2.001	inside	-2.501	-1.935	-1.935
960-900	Annual Heating Load (kWh)	1098	inside	775	1718	1141
960-900	Annual Cooling Load (kWh)	-1859	inside	-2697	-1644	-1644
610-600	Peak Heating Load (kW)	0.001	inside	-0.011	0.001	0.000
610-600	Peak Cooling Load (kW)	-0.505	inside	-0.811	-0.116	-0.525
610-600	Annual Heating Load (kWh)	53	inside	21	98	59
610-600	Annual Cooling Load (kWh)	-1707	inside	-2227	-1272	-2222
900-810	Peak Heating Load (kW)	-0.138	inside	-0.166	-0.089	-0.129
900-810	Peak Cooling Load (kW)	1.074	inside	0.595	1.223	1.036
900-810	Annual Heating Load (kWh)	-658	outside	-1107	-669	-669
900-810	Annual Cooling Load (kWh)	1203	inside	975	1707	1080
270-220	Peak Heating Load (kW)	-0.004	inside	-0.034	0.218	-0.004
270-220	Peak Cooling Load (kW)	5.825	inside	5.475	5.894	5.796
270-220	Annual Heating Load (kWh)	-2433	inside	-2761	-1948	-2434
270-220	Annual Cooling Load (kWh)	7907	inside	7342	9515	7342
650FF	Annual Hourly Max Temp (°C)	65.6	inside	63.2	68.2	63.2
650FF	Annual Hourly Min Temp (°C)	-23.0	inside	-23.0	-21.6	-22.6
650FF	Annual Hourly Aver Temp (°C)	18.9	inside	18.0	19.6	18.2
410	Peak Heating Load (kW)	3.880	inside	3.625	4.487	3.625
410	Peak Cooling Load (kW)	0.312	inside	0.035	0.814	0.035
410	Annual Heating Load (kWh)	8626	inside	8596	10506	8596
410	Annual Cooling Load (kWh)	11	inside	0	84	0

Table 6.1: Results from selected ASHRAE 140 thermal envelope and fabric load tests.

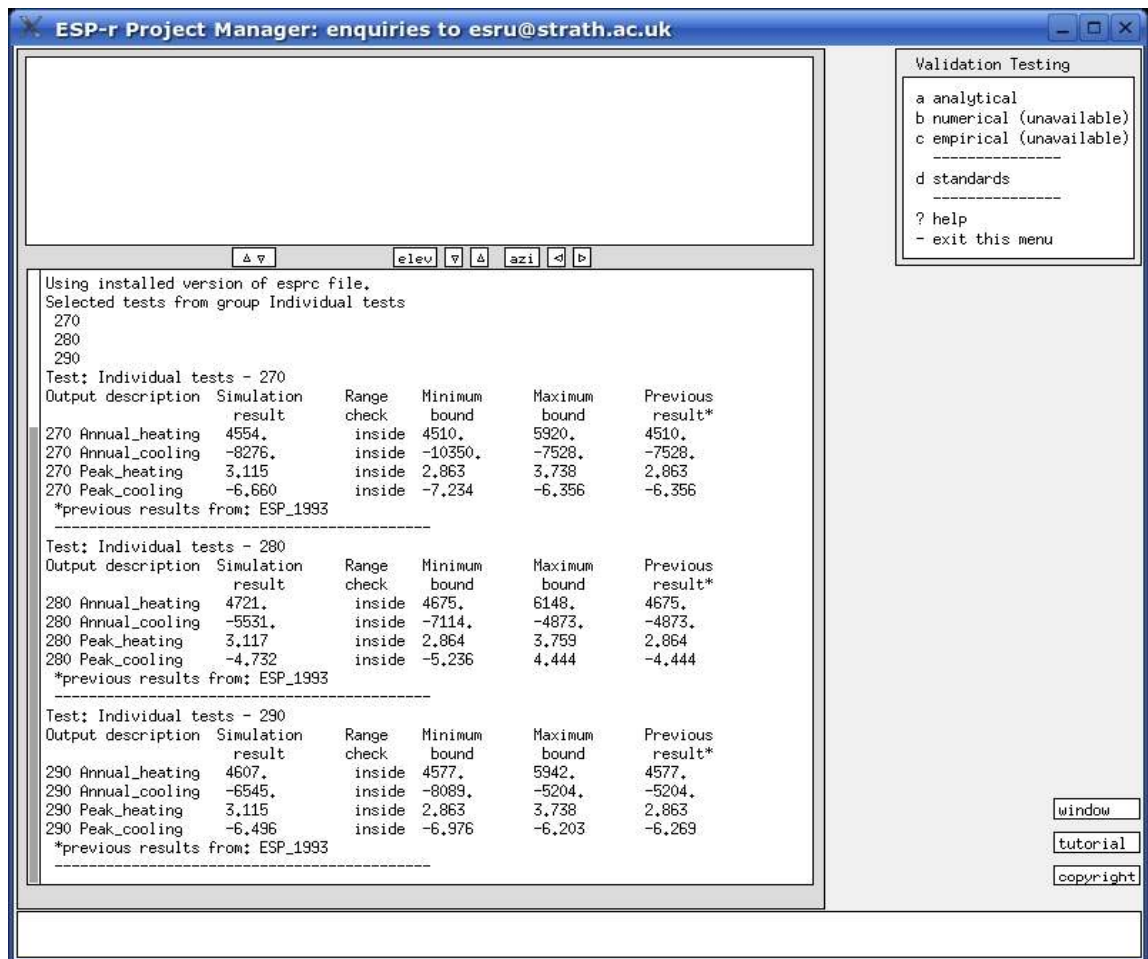

Figure 6.2: Screenshot of validation test selection and results

The following points were noticed in the results obtained:

- There are, in some cases, significant differences in the current results from predictions obtained in the IEA Annex 21 work and those from the current version of ESP-r. There have been a number of code developments, bug fixes and changes on the default algorithms in the intervening years. An example has been already mentioned in this section for the updates in the solar algorithm (e.g. updates to some of the solar equations, including a change of algorithm for the anisotropic diffuse sky, from the Klucher (1979) model to the Perez et al. (1990) model).
- The current results report now an occasional “outside”, with one example given in Table 6.1. In some cases in the range setting in the IEA Annex 21 project, ESP-r predictions formed either the lower or higher limits of the

identified range. The program's code has evolved since then, and sometimes the predictions have changed to be outside the specified range. It is usually by a small amount but, nevertheless, may be of interest because it indicates that there may be a greater degree of variability between programs for the specific test than currently indicated in the informative annex of ASHRAE 140 Standard. It also underlines the need for the regular updating of the informative annex.

#### **6.4 Results from implementation of EN ISO 13791 Standard**

Results were also extracted for the 13791 Standard using the embedded validation facility and are displayed in Tables 6.2 through 6.6. They show how simulation results for prediction of air temperatures, sunlit factors, and operative temperatures compare against the test limits in the 13791 Standard.

Table 6.2 shows the simulation predictions and the results that define the acceptable ranges in the 13791 Standard for the opaque conduction test. The test comprises four separate tests with different constructions subjected to a 10 °C change in external air temperature. For each test, the lower and upper acceptable air temperatures are given for the required times after the step change in external temperature. To set-up and run the test with ESP-r, no source code changes were necessary and the convective heat transfer coefficients had to be set to fixed values (i.e. overriding the system default). It can be seen from this table that predictions lie within the limits prescribed by the Standard for this test.

Table 6.3 shows the internal air temperature results for the longwave radiation test. There are four thermal zone configurations to be tested for this test. Again, no source code modifications were necessary for this test. The convection coefficients were changed from the default approach adopted by ESP-r to match the specifications in the Standard. It is not possible to directly set the radiative coefficients in ESP-r to a fixed value. The external radiative coefficient that had to be set to a fixed value for this test was included within a total convective coefficient that represents the total



external heat transfer coefficient when the emissivity of the outside construction layer is set to zero. The solar gain to the interior face of a single surface had to be modelled in ESP-r as an imposed controlled heat flux to that surface. This is because the test is using opaque surfaces and it is not possible to have a solar gain inside a zone with only opaque surfaces. As can be seen, predictions are within the required limits for this longwave radiation test.

Table 6.4 shows results at different times of the day for sunlit factors for a test surface using six different shading device configurations. It is interesting to mention here that test case 6 at 12 noon requires the solar shading to be calculated for a solar azimuth corresponding to due south. However, the projection of the sun rays at that time is parallel to the east-facing test surface, so it could be argued that the surface is neither in shade nor direct sunlight (although the test assumes that this is fully sunlit). The results in Table 6.4 show that ESP-r's predictions are within the published ranges for the solar shading test.

The final set of tests requires a single-zone model to be created and simulated for two geometries, three configurations of construction/boundary conditions, and three ventilation schedules. The results for these tests are reported in Table 6.5 and Table 6.6. In the "Test" column of these tables, the naming convention of the 13791 Standard is followed: the uppercase character refers to the geometry (where A has a small window and B a large window), the number to the construction/boundary conditions, and the lowercase character to the ventilation schedule. To fully implement the test it was necessary to apply some modifications to the ESP-r source code and the input data:

- A new boundary type was developed to match the (non-physically realistic) CEN definition of an adiabatic boundary. This boundary condition had to impose equal solar gains on both sides of a partition.
- In a same way as for the longwave radiation test, a total fixed external heat transfer coefficient was used to account for the fixed external radiative

coefficient (i.e. it is not possible to separately use a fixed value for the radiative coefficient in ESP-r).

As can be seen from Table 6.5 and Table 6.6, all possible combinations are tested, and predictions lie within the prescribed limits. However, there are several ambiguous definitions in the test specification:

- External longwave radiation should be considered with respect to the sky and the air (using a fixed radiative coefficient). However, the Standard does not impose an algorithm for calculating sky temperature.
- The test provides hourly averaged solar radiation data for both horizontal and vertical surfaces, but it does not specify whether the averages are centred on the start or end of the hour or on the half-hour between two sequential hours.
- There is no explicit definition for the boundary condition of the roof for the case where the third set of construction types is used (ambient conditions were assumed in the ESP-r model).
- There are numerous assumptions that are not physically realistic, for example: time invariant solar distribution factors, a solar to air factor (it defines what part of the solar gain that enters the test space is immediately transferred to the internal air), and no solar radiation lost from the zone although the Standard states that the internal surface absorptivity is only 0.6. It is therefore necessary to create models that are as close as possible to the specifications of the test, but in principle it is possible for a detailed simulation program to fail the tests because it is modelling the reality more accurately than what is required by the Standard.

Overall, predictions for geometry B will be more sensitive to the uncertainties discussed above than for geometry A, as the window is twice the area in B compared to A.

There are two approaches to resolving some of the issues highlighted in the above discussion: either increase the acceptable temperature ranges or improve the

specification of the test. Both approaches have drawbacks. In the former case models with genuine mistakes could pass the tests, and in the latter case it may make it more difficult to constrain simulation codes to conform with the new requirements in the specifications. It is possible that such prescribed tests will be part of software accreditation procedures for programs to be used for energy regulations compliance checks. However, the regulation compliance check in practice with the use of an accredited program will not be based on the same prescribed, and often non-physically realistic, inputs and algorithms as for these tests. It is therefore possible to have accredited programs that have passed these 13791 Standard tests and not to be validated for the actual settings or algorithms that users may be using for practical applications and for energy performance compliance checks.

Time (hrs)	Test 1			Test 2			Test 3			Test 4		
	Low	High	ESP-r	Low	High	ESP-r	Low	High	ESP-r	Low	High	ESP-r
2	19.56	20.56	20.04	24.59	25.59	24.64	19.50	20.50	19.99	19.50	20.50	19.99
6	20.76	21.76	21.29	29.13	30.13	29.49	19.76	20.76	20.24	19.56	20.56	20.05
12	22.98	23.98	23.46	29.50	30.50	29.98	21.17	22.17	21.63	19.75	20.75	20.24
24	25.87	26.87	26.36	29.50	30.50	30.00	24.40	25.40	24.85	20.13	21.13	20.62
120	29.50	30.50	29.96	29.50	30.50	30.00	29.45	30.45	29.94	22.67	23.67	23.16

Table 6.2: Results of CEN ISO 13791 conduction tests (air temperatures, °C)

	Test 1			Test 2			Test 3			Test 4		
	Low	High	ESP-r	Low	High	ESP-r	Low	High	ESP-r	Low	High	ESP-r
Result	33.9	34.9	34.4	29.9	30.9	30.4	38.0	39.0	38.6	25.0	26.0	25.7

Table 6.3: Results of CEN ISO 13791 internal longwave radiation tests (air temperatures, °C)

Time (hrs)	Test 1			Test 2			Test 3			Test 4			Test 5			Test 6		
	Low	High	ESP-r	Low	High	ESP-r	Low	High	ESP-r	Low	High	ESP-r	Low	High	ESP-r	Low	High	ESP-r
7	0.00	0.05	0.00	0.00	0.05	0.00	0.00	0.05	0.00	0.00	0.05	0.00	0.95	1.00	1.00	0.00	0.05	0.00
8	0.48	0.58	0.51	0.42	0.52	0.49	0.00	0.05	0.00	0.95	1.00	1.00	0.84	0.94	0.90	0.00	0.05	0.00
9	0.19	0.29	0.23	0.71	0.81	0.77	0.00	0.50	0.00	0.95	1.00	1.00	0.66	0.76	0.70	0.02	0.12	0.10
10	0.16	0.26	0.21	0.92	1.00	0.97	0.13	0.23	0.18	0.95	1.00	1.00	0.34	0.44	0.40	0.67	0.77	0.70
11	0.25	0.35	0.30	0.95	1.00	1.00	0.25	0.35	0.30	0.85	0.95	0.85	0.00	0.05	0.03	0.95	1.00	1.00
12	0.28	0.38	0.35	0.95	1.00	1.00	0.28	0.38	0.35	0.79	0.89	0.80	0.00	0.05	0.03	0.95	1.00	1.00

Table 6.4: Results of CEN ISO 13791 direct solar shading tests (sunlit factor, -)

Test	Maximum operative temperature			Average operative temperature			Minimum operative temperature		
	Low	High	ESP-r	Low	High	ESP-r	Low	High	ESP-r
A1.a	38.2	39.2	39.0	35.4	36.4	35.7	33.1	34.1	33.5
A1.b	33.6	34.6	33.9	28.9	29.9	29.2	25.0	26.0	25.5
A1.c	33.0	34.0	33.5	28.5	29.5	29.1	24.9	25.9	25.4
A2.a	37.1	38.1	37.9	35.4	36.4	35.9	33.9	34.9	34.5
A2.b	31.7	32.7	32.2	29.0	30.0	29.3	26.0	27.0	26.5
A2.c	31.9	32.9	32.4	28.6	29.6	29.2	25.9	26.9	26.5
A3.a	40.3	41.3	41.2	38.2	39.2	38.8	36.6	37.6	37.2
A3.b	34.9	35.9	35.7	31.1	32.1	31.7	27.5	28.5	28.2
A3.c	33.3	34.3	33.9	29.8	30.8	30.5	26.9	27.9	27.6

Table 6.5: Results of CEN ISO 13791 whole model tests for geometry A (operative temperature, °C)

Test	Maximum operative temperature			Average operative temperature			Minimum operative temperature		
	Low	High	ESP-r	Low	High	ESP-r	Low	High	ESP-r
B1.a	35.4	36.4	35.8	30.2	31.2	30.2	26.7	27.7	26.7
B1.b	29.4	30.4	29.5	21.6	22.6	21.7	15.9	16.9	16.5
B1.c	27.6	28.6	28.2	21.0	22.0	21.6	15.7	16.7	16.4
B2.a	33.2	34.2	34.0	30.3	31.3	30.7	28.0	29.0	28.6
B2.b	26.2	27.2	26.7	21.7	22.7	22.0	17.4	18.4	18.0
B2.c	25.9	26.9	26.6	21.2	22.2	21.8	17.2	18.2	18.0
B3.a	35.5	36.5	36.5	32.2	33.2	32.8	29.8	30.8	30.4
B3.b	29.1	30.1	30.0	23.7	24.7	24.2	18.7	19.7	19.5
B3.c	27.2	28.2	28.1	22.2	23.2	23.0	18.1	19.1	19.0

Table 6.6: Results of CEN ISO 13791 whole model tests for geometry B (operative temperature, °C)

## 6.5 Sensitivity studies for ASHRAE 140 Standard

It was mentioned in section 6.2.1 that ASHRAE 140 Standard did not fully prescribe some simulation parameters and allowed the simulation programs to use their default algorithms or any alternative algorithms for representing better these parameters in the program. This adds uncertainty in the way results for this Standard are produced, especially when considering the fact that some simulation programs have a number of different algorithms available to use depending on the user needs and the type of simulation problem they are trying to solve. The parameters that were not fixed in the ASHRAE Standard thermal envelope tests and could be studied with sensitivity analysis for the effect they have on the Standard's results were: the anisotropic diffuse radiation sky models, the internal and external convection coefficient algorithms and the sky temperature calculation. Additional sensitivity studies on these tests could be possibly done for the simulation options that are available for example in the ESP-r for the treatment of solar distribution entering the thermal zone (e.g. all solar radiation falls on the floor when entering the zone; diffuse solar radiation distribution on all surfaces; time-varying insolation analysis) or for different types of set-point temperatures (e.g. air temperature against operative temperature that is the only available option in some simplified methods). However,

for the latter, ASHRAE 140 Standard explicitly states that air temperature should be used as the set-point temperature for the validation tests.

An existing sensitivity study on the effect the decisions between different algorithms may have on the results of the ASHRAE 140 Standard has been reported for the sky models and the internal convection coefficients that are available in ESP-r (Strachan et al, 2006). It was found that the predictions for the test cases were affected to a large extent by the decision for the internal convection algorithm (i.e. in the range of 20% for the base case 600). All the algorithms that were studied (for both internal convection and sky models) were equally allowable for the purposes of the Standard. In the next sections, the embedded validation facility in ESP-r will be used to perform sensitivity studies for the effect the available in ESP-r sky temperature and external convection coefficient algorithms have on the predictions of the ASHRAE Standard tests. The current default algorithms in ESP-r will be used in these sensitivity studies for the other areas of the simulation. It has been reported already in this chapter that a notable change on the default algorithms over the years was the default sky model (from Klucher (1979) to Perez (1990)).

One benefit from embedding the tests so that they are easily available in the program (i.e. within the embedded validation structure) is that it enables program developers to rapidly check alternative algorithms and to check whether a change to the program has resulted in significant changes to predictions. In both cases, the diagnostic tests could be used to check the impact on specific program areas for which the diagnostic tests are designed or on the impact with respect to standards compliance.

#### ***6.5.1 Embedded validation: Sensitivity study – Sky temperature calculation***

To demonstrate the use of the new facility, a study of alternative sky temperature calculation models was undertaken in this section. Sky temperature is used by simulation programs for the calculation of the external longwave radiation heat exchange with the sky. There have been numerous studies of such models, but there is no definitive answer at present as to which is the most appropriate model to use. A

good review of some available sky temperature calculation models is given by Kjaersgaard et al. (2007).

It was decided to use alternative algorithms in the ESP-r simulations for two cases of the ASHRAE 140 Standard:

1. Using diagnostic cases that emphasise the differences in the treatment of solar radiation by the simulation programs. Case 250-220, which is categorised as a “low mass in-depth sensitivity” test case in the Standard, was chosen because it involved altering the external surface absorptance in the test building from 0.1 to 0.9, with no other changes.
2. Using Case 960 - a more realistic case with a sunspace - with two zones (back zone and sun zone) separated by a common wall. The back zone is of lightweight construction and the sunroom of heavyweight construction.

Running the tests with the embedded validation facility was straightforward. The tests were pre-configured in ESP-r with the alternative sky temperature calculation options enabled. The identified test cases were selected and the automated simulation and results recovery initiated. The algorithms invoked in this sensitivity study were Martin and Berdahl (1984), Clarke (2001), Cole (1976), Kasten and Czeplak (referenced in: Jensen, 1990, the original publication is in German), and two cases with Swinbank’s model (1963) using for the calculations ambient air dry bulb and wet bulb temperature respectively. These algorithms were researched and implemented in ESP-r previously but this study focuses on investigating the sensitivity of the ASHRAE 140 Standard results to the choice of these algorithms with the use of the embedded validation facility. This can be particularly useful to common users of the program that want to quickly and easily evaluate the various algorithmic options without having background knowledge of the details associated with them and without having to use advanced features of the program.

Tables 6.7 and 6.8 show the results directly obtained from the program for the two cases selected. The ranges quoted are taken again from the informative annex of

ASHRAE 140 Standard based on the results from programs in the original BESTEST simulations that were run in 1993. The column headed “Range Check” shows whether the current results (for the default Martin and Berdahl model) are inside or outside the corresponding range. The values given in the “Reference value” column are those obtained by ESP-r in the original IEA Annex 21 BESTEST study (the Martin and Berdahl sky temperature calculation model was also used at that time) and also published in the annex of ASHRAE 140 Standard. All the ranges and reference values are stored in a text file so they can be easily updated in case new ranges will be obtained. Of more practical use, the reference values can be updated with the results obtained in the previous program release so that it is easy to detect whether predictions have changed during the development of the program.

Output parameter	Simulation result						Range Check (against Martin and Berdahl)	Min (Range)	Max (Range)	Reference value
	Martin and Berdahl	Clarke	Cole	Kasten and Czeplak	Swinbank (dry bulb Temp.)	Swinbank (wet bulb Temp.)				
Peak Heating Load (kW)	-0.001	0.000	-0.001	-0.001	-0.001	-0.001	inside	-0.007	0.005	-0.001
Peak Cooling Load (kW)	2.725	2.822	2.562	2.486	2.555	2.818	inside	1.043	3.699	2.800
Annual Heating Load (kWh)	-2113	-2421	-1984	-1864	-2074	-2287	inside	-2193	-1448	-2193
Annual Cooling Load (kWh)	3195	2920	3316	3433	3240	3034	outside	1752	3027	3027

Table 6.7: Case 250-220 low mass in-depth sensitivity test



Output parameter	Simulation result						Range Check (against Martin and Berdahl)	Min (Range)	Max (Range)	Reference value
	Martin and Berdahl	Clarke	Cole	Kasten and Czeplak	Swinbank (dry bulb Temp.)	Swinbank (wet bulb Temp.)				
Peak Heating Load (kW)	2.527	2.740	2.510	2.508	2.646	2.653	inside	2.410	2.863	2.410
Peak Cooling Load (kW)	1.142	0.905	1.287	1.400	1.267	1.010	inside	0.953	1.403	0.953
Annual Heating Load (kWh)	2282	3676	2172	2046	2665	2822	outside	2.311	3.373	2.311
Annual Cooling Load (kWh)	700.1	242.3	785	986	692	444	inside	411	803	488
Annual Hourly Max Temperature (°C)	50.8	47.3	51.5	52.3	50.8	49.4	inside	48.9	55.3	48.9
Annual Hourly Min Temperature (°C)	2.0	-1.5	2.3	2.5	0.4	0.3	inside	-2.8	3.9	2.7
Annual Hourly Average Temperature (°C)	28.8	25.3	29.1	29.7	28.1	27.3	inside	26.4	29.0	27.5

Table 6.8: Case 960 high mass basic test

It can be seen from Tables 6.7 and 6.8 that there are two cases where the current results are just outside the indicative ranges when the default Martin and Berdahl model is used. These are cases where ESP-r was used to set the suggested limits based on simulations undertaken during the Annex 21 project and where subsequent code developments over the years have pushed predictions outside these limits. It can

be noticed that in some of these tests, the predictions of ESP-r may vary significantly depending on the choice of the external sky temperature model. However, in most cases the differences in these predictions are generally small compared with the range given in ASHRAE 140 Standard (assuming here that the “Clarke” correlation is excluded from this statement because its predictions seem to be in disagreement with the others produced in this study and further investigation on its implementation may be needed).

The next section will investigate the sensitivity of the ASHRAE 140 Standard results to a number of external convection algorithms that are available in ESP-r by using again the embedded validation facility.

#### ***6.5.2 Embedded validation: Sensitivity study - External convection***

In a similar way as for the previous section, the embedded validation facility is used here to examine the sensitivity of the results predicted for ASHRAE 140 Standard case 600 (i.e. the base case of the envelope and fabric load tests) upon the modelling of external surface convection. The BESTEST procedure allows the use of fixed convection coefficients (internal and external) for programs that do not calculate them. The results reported for the majority of the reference programs in BESTEST (and thus in the informative annexes of ASHRAE Standard 140) employed this technique.

There are fifteen different external convection models available in ESP-r and all of them were used for this sensitivity study. There is also the option of having fixed convection coefficients and the values suggested by the BESTEST specification were also used here. Sixteen models were preconfigured and embedded in ESP-r and automatic simulations were performed for each one of them (i.e. using the case 600) to investigate the impact of external surface convection modelling. The models used were: correlations from McAdam’s wind tunnel test (Clarke, 2001), Yazdanian and Clems (1994), Hagishima and Tanimoto (2003), three correlations from Liu (2007), two correlations from Loveday and Taki (1996) and a combined one by the same

authors published in CIBSE Guide C (2007), another equation from Jorges that is also referenced in CIBSE Guide C (2007, the original publication is in German), the EN ISO 6946 equation (2007), Nicol (1977) and Jayamaha (1996). In many cases, these correlations represent linear relationships between wind speed and convective coefficients by also taking into account the wind direction and surface orientation. Liu (2006) gives a detailed description of the equations and the background of all these external convective coefficient models.

The same process, as used previously for the sky temperature calculation models, has been followed here too. Simulations and results extraction were automatically performed for case 600 and for each one of the above external convection models. From the results produced using the embedded validation facility, it was discovered that one of Loveday's models was wrongly implemented in the code and was producing numerical inconsistencies (see Figure 6.3). The wrongly implemented code was then fixed and a simulation for this case was again invoked.

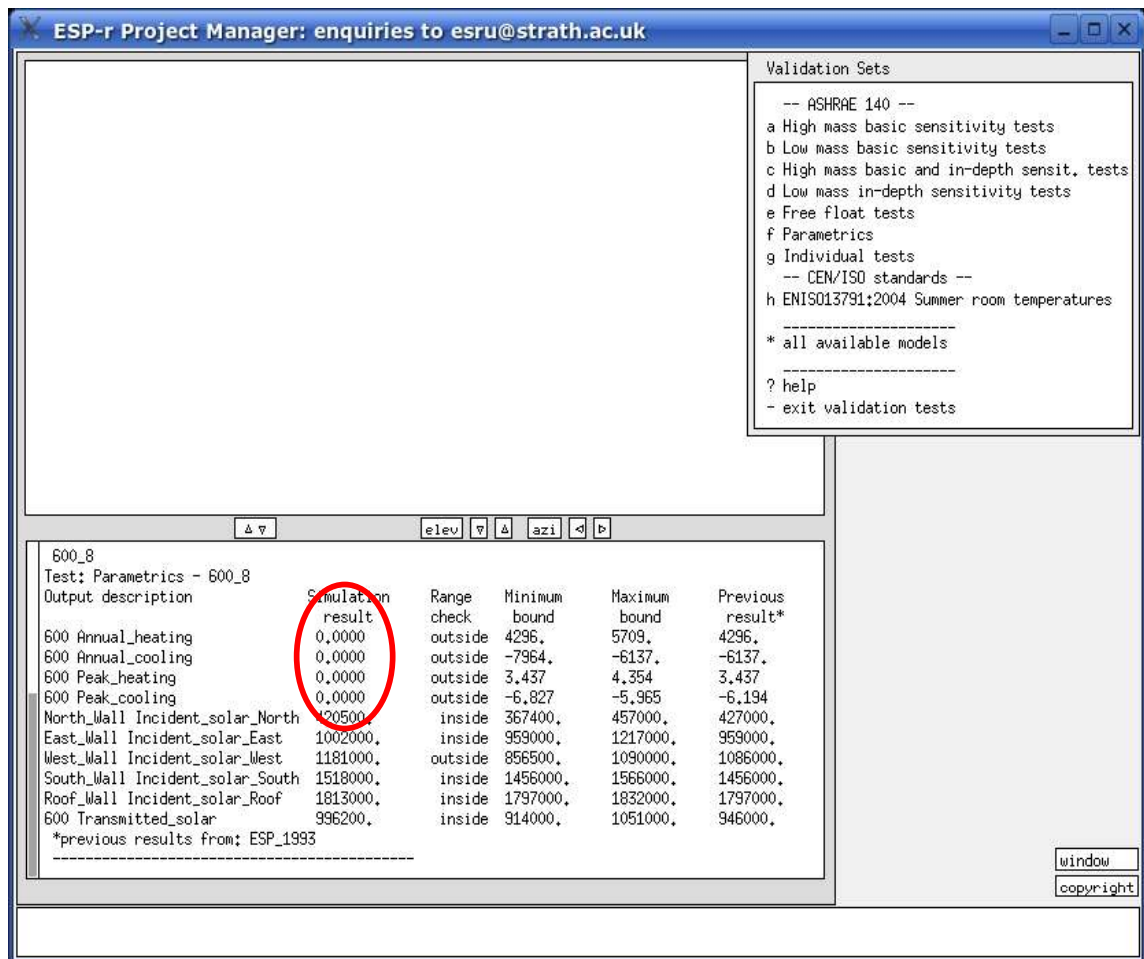

Figure 6.3: Identifying code implementation mistakes by using the embedded validation test facility.

The automatically recovered results from all these cases are presented in Figure 6.4 through Figure 6.7. Default algorithms, similar to those used in ESP-r for the original Annex 21 project, were used for the rest of the calculation areas of these simulations (e.g. internal convection, sky temperature, etc.). It should be remembered that the main change over the years is the default solar algorithms (i.e. Perez 1990, instead of Klucher).

Although a different validation case has been used (i.e. case 600) than the sensitivity study of the previous section, the spread of the results of this sensitivity study is not as wide as it is for the different sky temperature calculations. The ranges defined within the ASHRAE 140 Standard are again much larger than the range defined from the results produced for the different external convective coefficient models.

Nevertheless, from the results obtained during this sensitivity study the maximum values were greater than the minimum values by 6.2% for peak heating, 8.6% for peak cooling, 7.5% for annual heating and 21.1% for annual cooling.

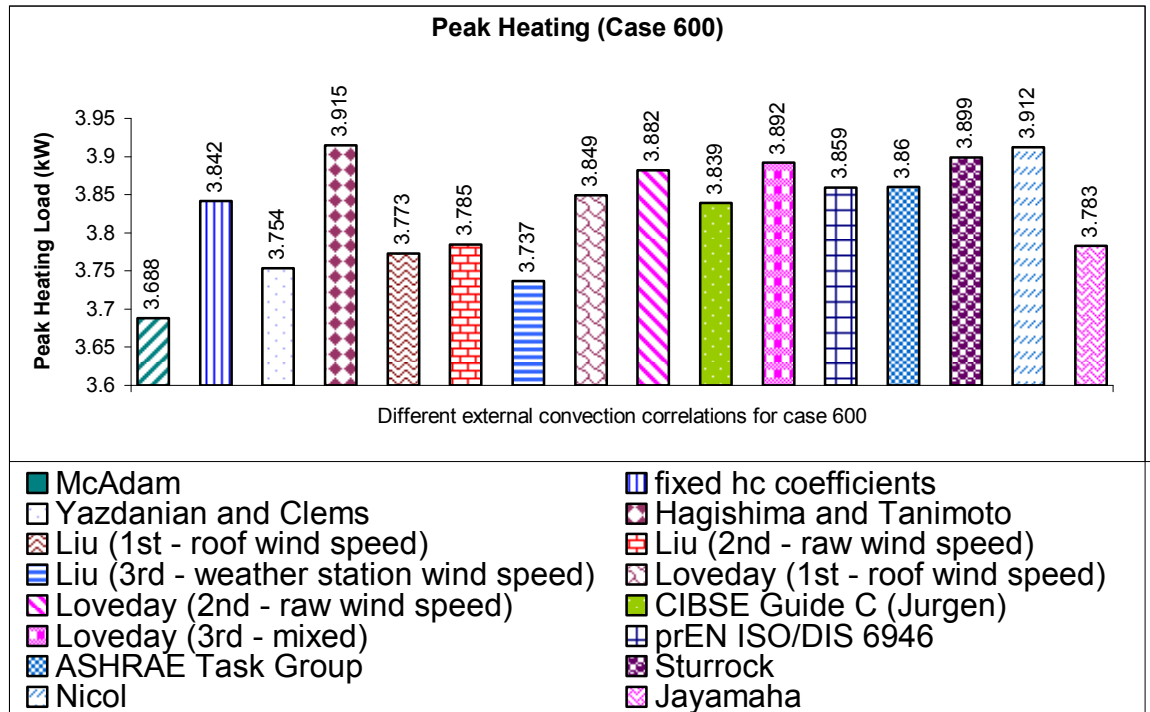

Figure 6.4: Peak heating (kW) – **Minimum/Maximum bounds: 3.437 – 4.354 kW.**

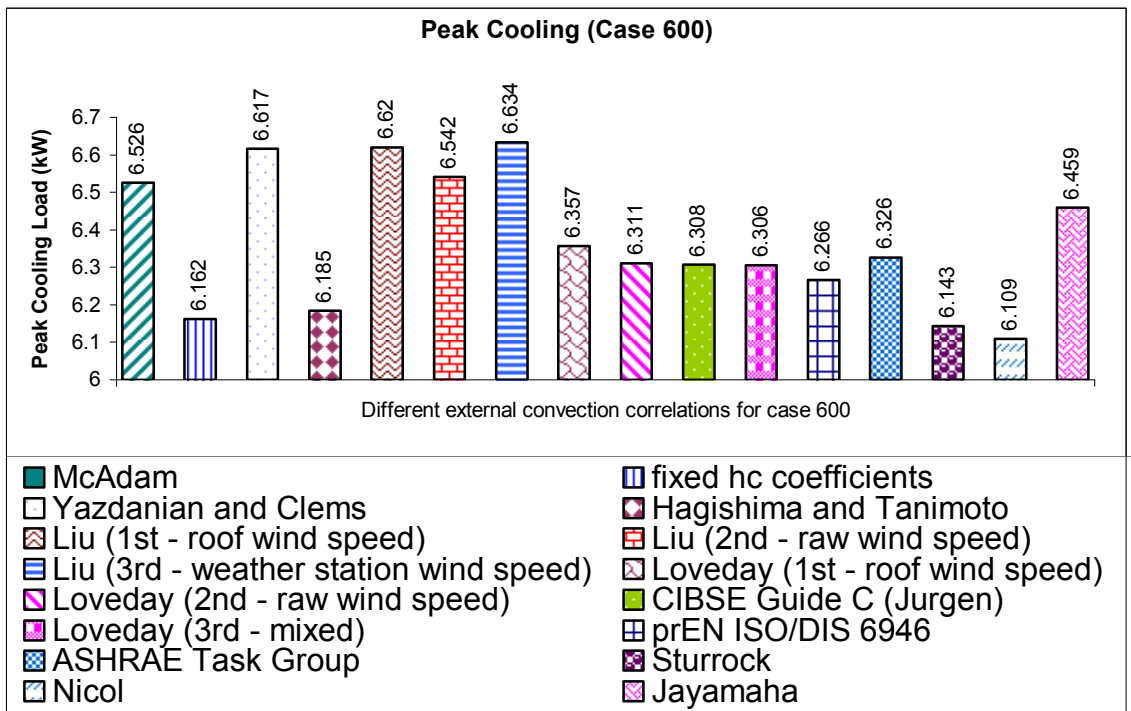

Figure 6.5: Peak cooling (kW) – **Minimum/Maximum bounds: 5.965 – 6.827 kW.**

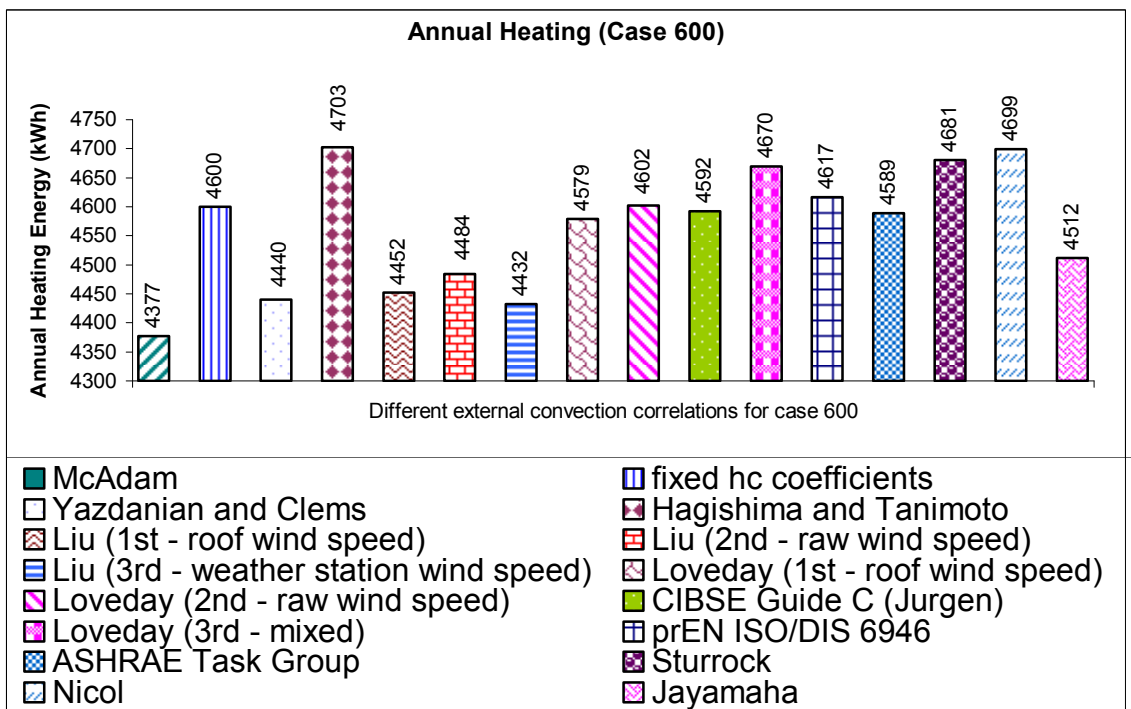

Figure 6.6: Annual heating (kWh) – **Minimum/Maximum bounds: 4296 – 5709 kWh.**

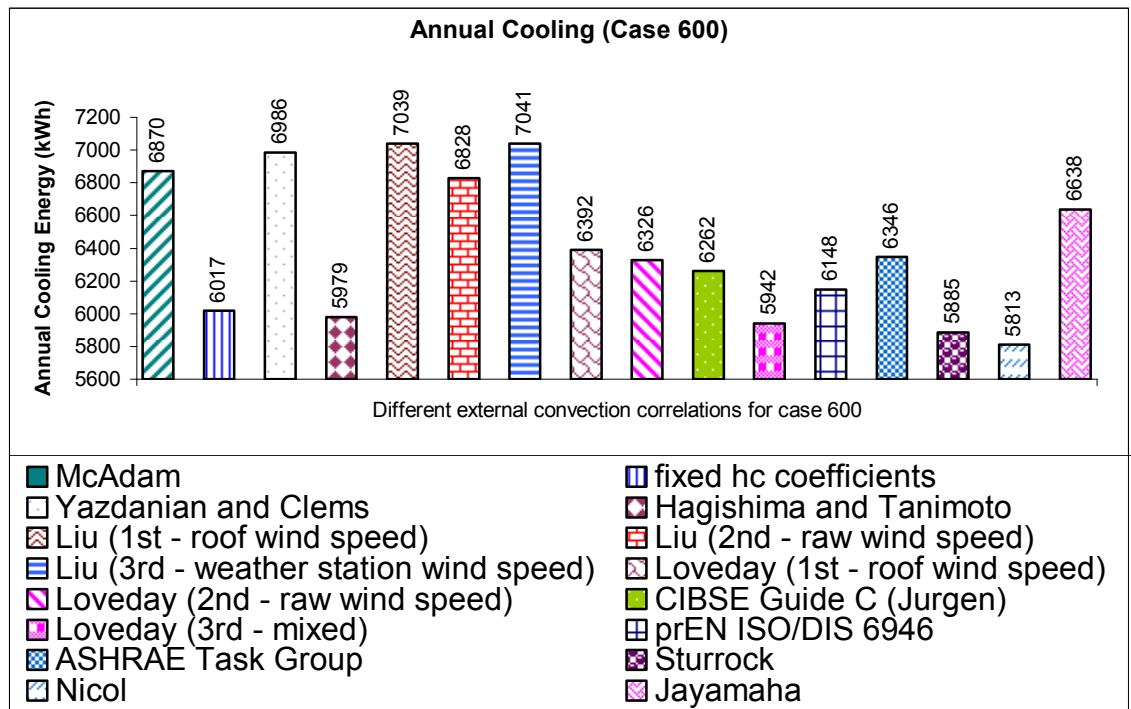

Figure 6.7: Annual cooling (kWh) – **Minimum/Maximum bounds: 6137 – 7964 kWh.**

## 6.6 Discussion and closing remarks

The need for validation tests as a means of continuously checking the programs during their development and at the same time to provide confidence to their users for their outputs has been well recognised in the simulation community. However, validation models and tests can be time consuming to set up (i.e. they may involve a large number of tests and detailed specifications) and, as a consequence, programs are only irregularly checked. In addition, program predictions may change over the years. There is a clear need for regular checking of program outputs against a whole range of standard tests and also for regular assessment of what are deemed to be acceptable ranges for predictions. This requirement is becoming more pressing as simulation-based standards are introduced within building energy performance regulations. The work discussed in this chapter shows how it is possible to embed these tests to make it easy for developers and users to apply them and test the predictions of the program against them. It described the development of the embedded validation facility within the ESP-r program for comparative and

analytical validation tests and in particular those in ASHRAE and CEN standards.

The benefits are:

- Program developers can check the impact of code modifications, algorithmic substitution, etc., and in some cases mistakes in their code can be identified.
- Developers can check compliance with requirements from standards included within energy performance regulations.
- User confidence is improved and their selection for using a program can be easily justified from the program's performance against the embedded validation tests.
- Users can confirm that their installation is correct and check standard compliance themselves.
- It avoids the repetition of constructing the models set out in the validation tests, and, therefore, it reduces the associated possibility of error. It is sometimes difficult to construct the models when unusual modelling assumptions are required.
- Frequent checking will confirm the fact that a program continues to be within the specified tolerance bands. This is important, as most state-of-the-art programs are under constant development.

While the embedded validation facility can be equally applied to any type of validation test, the tests within the ASHRAE 140 Standard and CEN 13791 Standard were described in detail as they are the first which have been considered to be included within energy performance regulations (e.g. Portugal have included ASHRAE 140, and UK have included CEN 13791). The fundamental differences in the validation approach between the two Standards have been discussed in this chapter. In general, ASHRAE 140 Standard adopts a performance based approach by allowing simulation programs to model the various heat transfer processes with their own methods while CEN 13791 is more prescriptive. In the first case, the indicative tolerance bands for the tests are wide and programs with errors could still fall within the specified bands. In the latter case, the tolerance bands are narrow and some unrealistic modelling assumptions are included within the modelling exercise.



However, in this case, it may be possible for more detailed and accurate ways of modelling to give out-of-range predictions. In either of these two approaches, if a program is used with a simplified and constrained way of modelling a particular heat transfer process in order to fall within the required tolerance bands, a decision should be taken by those who approve the use of programs in energy performance regulations for whether or not the program will always have to be used in this mode in order to claim compliance with standards and produce regulation compliance ratings equivalent to the other methods allowed for the same purpose.

It is believed the way forward is to develop guidance on the most appropriate way to model the important heat transfer processes in these tests (e.g. by defining in the specifications the heating/cooling/ventilation system types in order to assist the modelling of internal convection). In this way, it should be possible to reduce the acceptable bands for program predictions without being unnecessarily prescriptive. In addition, techniques such as embedded validation can be further used in sensitivity studies to investigate the magnitude of the predictions across a range of different algorithms. An example was given in this chapter for some of the ASHRAE 140 Standard tests and for a number of different correlations for sky temperature calculation and external convection. While differences in the predictions when using the different correlations were noticed, in most cases their magnitude was generally small compared with the wide ranges defined for the specific tests within the ASHRAE Standard.

## 6.9 References

ASHRAE (American Society of Heating, Refrigerating and Air-Conditioning Engineers). 1975. *ASHRAE task group, procedure for determining heating and cooling loads for computerising energy calculations. Algorithms for building heat transfer subroutines*. ASHRAE Publications. New York, USA.

ASHRAE (American Society of Heating, Refrigerating and Air-Conditioning Engineers). 2004. *ANSI/ASHRAE Standard 140-2004, standard method of test for the evaluation of building energy analysis computer programs*. Atlanta, USA.

Ben-Nakhi A., Aasem E.O. 2002. *Development and integration of a user-friendly validation module within whole building dynamic simulation*. Energy Conversion and Management, 44 (1), pp. 53-64.

Bloomfield D.P. 1999. *An overview of validation methods for energy and environmental software*. ASHRAE Transactions, 105 (2), pp. 685-93.

CIBSE (Chartered Institution of Building Services Engineers). 2007. *CIBSE Guide C: 2007 Edition*. London, UK.

Clarke J.A. 2001. *Energy simulation in building design (2<sup>nd</sup> Edition)*. Butterworth-Heinemann. Oxford, UK. ISBN 0-750-65082-6.

Cole R.J. 1976. *The longwave radiation incident upon the external surface of buildings*. Building Services Engineer, 44, pp.195-206.

EN ISO 13791. 2004. *Thermal performance of buildings - Calculation of internal temperatures of a room in summer without mechanical cooling - General Criteria and Validation Procedures*. ISO, Geneva.

EN 15255. 2007. *Thermal performance of buildings – Sensible room cooling load calculation - General criteria and validation procedures*. Brussels, Belgium.

EN 15265. 2007. *Thermal performance of buildings – Calculation methods of energy use for space heating and cooling – General criteria and validation procedures*. Brussels, Belgium.

EN ISO 6946. 2007. *Building components and building elements – Thermal resistance and thermal transmittance – Calculation Method*. ISO, Geneva, Switzerland.

Hagishima A., Tanimoto J. 2003. *Field measurements for estimating the convective heat transfer coefficient at building surfaces*. *Building and Environment* 38 (7), pp. 873-881.

Jayamaha S.E.G. Wijesundera N.E., Chou S.K. 1996. *Measurement of the heat transfer coefficient for walls*. *Building and Environment*, 31 (5), pp. 399-407.

Jensen S.O. (ed.). 1990. *The PASSYS project phase I. Subgroup Model Validation and Development – Final report. 1986-1989*. Commission of the European Communities, Directorate General XII for Science, Research and Development, EUR 13034E. Brussels, Belgium.

Jensen S.O. (ed.). 1993. *Validation of building energy simulation programs, Part I and II*. Research report, PASSYS Subgroup Model Validation and Development, CEC, EUR 15115 EN. Brussels, Belgium.

Judkoff R., Wortman D., O’Doherty R., Burch J. 1983. *A methodology for validating building energy analysis simulations*. Solar Energy Research Institute Report SERI/TR-254-1508. Colorado, USA.

Judkoff R., Neymark J. 1995. *International Energy Agency building energy simulation test (BESTEST) and diagnostic method*. IEA Annex 21/Task 12 Co-

operative Project, Final Report, NREL/TP-472-6231. National Renewable Energy Laboratory, Colorado, USA.

Kjaersgaard J.H., Plauborg F.L., Hansen S. 2007. *Comparison of models for calculating daytime longwave irradiance using long term data set*. Agricultural and Forest Meteorology, 143 (1-2), pp. 49-63.

Klucher T.M. 1979. *Evaluation of models to predict insolation on tilted surfaces*. Solar Energy, 23 (2), pp. 111-114.

Liu Y. 2006. *Effects of shelterbelt trees on reducing energy consumption for space heating for office buildings in Scotland*. PhD thesis, School of the Built Environment, Heriot-Watt University, UK.

Liu Y., Harris D.J. 2007. *Full-scale measurements of convective coefficient on external surface of a low-rise building in sheltered conditions*. Building and Environment, 42 (7), pp. 2718-2736.

Lomas K.J., Eppel H., Martin C., Bloomfield D. 1994. *Empirical validation of thermal building simulation programs using test room data*. IEA Annex 21/Task 12 Cooperative Project, Final Report, Volumes 1, 2, and 3.

Loveday D.L., Taki A.H. 1996. *Convective heat transfer coefficients at a plane surface on a full-scale building façade*. International Journal Heat Mass Transfer, 39 (8), pp. 1729-1742.

Martin M., Berdahl P. 1984. *Characteristics of infrared sky radiation in the United States*. Solar Energy, 33 (3-4), pp. 321-336.

Nicol K. 1977. *The energy balance of an exterior window surface*. Building and Environment, 31 (5), pp. 215-219.

Perez R., Ineichen P., Seals R., Michalsky J., Stewart R. 1990. *Modeling daylight availability and irradiance components from direct and global irradiance*. Solar Energy, 44 (5), pp. 271-289.

Strachan P.A., Kokogiannakis G., Macdonald I.A. 2008. *History and development of validation with the ESP-r simulation program*. Building and Environment, 43 (4), pp. 601-609.

Strachan P.A., Kokogiannakis G., Macdonald I.A., Beausoleil-Morrison I. 2006. *Integrated comparative validation tests as an aid for building simulation tool users and developers*. ASHRAE Transactions, 112 (2), pp. 395-408.

Sturrock N.S. 1971. *Localised boundary layer heat transfer from external building surfaces*. PhD thesis, University of Liverpool, UK.

Swinbank W.C. 1963. *Long-wave radiation from clear skies*. The Quarterly Journal of the Royal Meteorological Society, 89 (381), pp. 339–348.

Yazdanian M., Klems J.H. 1994. *Measurement of the exterior convective film coefficient for windows in low-rise buildings*. ASHRAE Transactions, 14 (4), pp. 1087-1096.

CONCLUSIONS AND RECOMMENDATIONS FOR FUTURE WORK

**7.1 Conclusions**

The main objective of this research was to investigate the impact of the application of building energy performance simulation programs to address the requirement of the EPBD for an integrated energy performance calculation method. A number of calculation methods of varying complexity, including detailed energy simulation programs, are allowed for use in European energy performance regulations. A study of the impact of this decision has also been included within the objectives of this thesis. Finally, a facility has been implemented within a simulation program that assists practitioners in their choice of program to use in the new energy performance regulations by increasing their confidence in the programs' predictions.

To achieve these objectives, it was initially essential to analyse the current ability of simulation programs to provide the required functionality for the topics discussed in EPBD. This functionality analysis was expanded to include topics that a sustainable building design (and perhaps a future evolution of this EPBD) would include. The main calculation methods that have been considered in the CEN Standards that support the EPBD were then applied in a regulatory context and were used in case studies. This allowed the examination of the impacts on the compliance results that could be caused from the decision of allowing alternative methods of varying complexity to be used. Comparative and analytical validation tests that have been included in energy performance standards were then embedded within the structure of the ESP-r simulation program and a facility was developed to assist users and developers to easily (in an automatic way) check that the program's predictions are consistent with those presented in the standards.

### ***7.1.1 The ability of simulation programs to respond to the required functional for a sustainable design of buildings***

In the first part of the research the capabilities of simulation programs were listed and matched against a structured set of sustainability issues and environmental performance indicators which could be used in studies related to EPBD or in other practical design studies. The analysis included the metrics that are used to describe the required functionality for the study of each of these environmental performance indicators and the level of detail needed for the output of these metrics. The ability of simulation programs to provide this functionality was then discussed together with the possible limitations that may exist and as well any potential future developments that would help to better deliver the required functionality.

The environmental performance indicators that have been considered were placed in two general categories:

- Indicators related to global and local external environmental issues. These include the impact of buildings on global warming, acid rain, ozone depletion, materials and energy resources depletion, local air pollution and urban environment.
- Indicators related to indoor environmental performance issues. These have been categorised as indoor air quality, comfort (thermal, visual and acoustic), indoor humidity levels (including condensation risk and mould growth) and operational energy (thermal and electrical energy requirements, peak thermal and electrical loads, and systems' performance). It is worth mentioning that some of these issues define the metrics that are currently the outcome from calculations of EPBD-related energy performance regulations across Europe (for example, some of the thermal comfort and operational energy metrics are the requirements for England and Wales Part L2A regulations (2006)).

It has been concluded that integrated energy simulation programs have the capability to report the metrics related to EPBD, which currently for most countries are CO<sub>2</sub> emissions and energy consumption based on the annual energy requirements and,

where applicable, high operative temperatures for thermal comfort purposes. These programs can also report the vast majority of the metrics related to the other identified indoor environmental performance indicators and they can also discuss a small number of metrics for the indicators related to global and local external environmental issues (i.e. emissions with regards to global warming, acid rain and local air pollution during the operational stage of the building, and some of the metrics for the effect of buildings on urban environment).

Characteristic examples of possible future developments for integrated energy simulation programs that could further enhance their capabilities for the treatment of these environmental performance indicators were identified as the incorporation of life cycle assessments, occupant behaviour models and mould growth prediction with coupled heat, air and moisture transfer calculations.

### ***7.1.2 The application of integrated simulation programs and the simplified calculation methods of the CEN Standards in the same regulatory context***

It has been shown that the benefits from the use of detailed simulation programs in terms of functionality offered at the required level of detail are significant. However, for the EPBD calculations, European countries have considered for adoption, or have already adopted, either one simplified method (usually the monthly method of the 13790 Standard for heating and cooling energy calculations) or they allow a number of calculation methods of varying complexity to be used. The disadvantages of the former case have been summarised in chapter 5 but concerns of the dangers involved in the latter case with regards to issues of model conformity in a regulatory context have been also raised. In both cases, the main argument for the choice to include or prefer simplified methods was that their simplicity will facilitate an easy adoption in practice, especially by practitioners who are not experienced with building energy performance calculation methods. However, based on the experiences of chapter 5, it is not an easy and simple procedure to practically use either of the simplified calculation methods (which are the basis for the majority of the applications adopted in Europe for the EPBD) without a user interface. In general, all methods used



(detailed and simplified) require user interfaces that could make any type of method easier to use. Detailed simulation programs could produce results with monthly input data as long as the appropriate interface for their input exists.

The potential implications from the application of more than one method in regulations compliance checks have been investigated in chapter 5 for the two simplified methods prescribed within the 13790 CEN Standard and two detailed simulation programs. Building cases with parametric design variations were used to compare the energy rating output results from all these calculation methods. All methods had to be applied according to the instructions of the 13790 Standard for their inputs and boundary conditions in order to achieve model equivalence between them. This was a necessary first step that had to be taken in order to ensure that the outcome of this comparison was going to be useful for drawing results on the potential differences between the methods. Although the 13790 Standard only requires that the inputs and boundary conditions are the same across the methods used for the calculation of space heating and cooling, in some cases it indirectly constrains detailed simulation programs to use specific algorithmic assumptions that follow those used in the simplified methods (i.e. the same transmission heat transfer gains/losses have to be calculated by all methods, which is only possible if the simulation programs use the fixed surface thermal resistances that are used in the simplified methods). It is worth mentioning here that specific countries (e.g. UK) allow all these calculation methods to be used for the purposes of the EPBD without following the exact constrained instructions described in the CEN Standards. Differences in the result outputs should be expected in these cases and potential impacts from the choice of method could be larger than those reported in chapter 5 and summarised below.

The results in chapter 5 were analysed in terms of the impact in assigning energy bands (rather than the absolute energy consumption). The energy band widths were 20 kWh/m<sup>2</sup> per annum.

From the results obtained, it was concluded that for a small office building incorporating conventional design features, differences of a maximum of one band could be produced between the calculation methods for the space heating calculations. For the same type of building and for space cooling calculations, it is common to obtain ratings between the calculation methods that differ by one band and for a few cases, differences of two bands could be noticed. The most notable differences were for the case where night cooling is used for a building that is located in a warm climate.

For buildings incorporating ventilated double façades, similar trends as for the conventional building cases were noticed for the space heating results: a maximum of one band difference between simulation and simplified methods (with an exception being the case where high internal heat gains were assumed and for which differences of two bands were produced). For the cooling results, however, larger differences on the ratings were observed between the calculation methods than those noticed for the conventional building cases. There was no cooling case for this type of building for which the outputs from the calculation methods produced the same rating. For the majority of the cooling cases, differences in the range of two and three bands were noticed between the rating outputs of the calculation methods. The largest differences in the ratings were produced for three cases: the case where the double façade was facing north (which implies less solar gains), the case where the climate of Aberdeen was used (i.e. colder climate: less solar gains and lower temperatures) and the intermittent night cooling case.

When comparing the outputs of the two simulation programs against each other, it can be seen that the ratings produced from these programs were either within the same band or differ by one band when their numerical results were usually close to the borders of a band. Overall, from the results of all cases in chapter 5 (and with the exception of the intermittent heating cases), a general trend can be observed for the monthly method, whose predictions are higher than the other methods, resulting in many cases in a different rating. Based on this trend, the optimisation of numerical parameters in the monthly method was also investigated in order to improve the

inter-method match of the ratings produced from this method with the ratings produced from the simulation programs. The 13790 Standard suggests that the selection of these parameters in the monthly method can also be determined at national level. The optimisation process improved significantly the results matching for the conventional building type, although differences for the case of night cooling in a warm climate were still significant. However, when the same optimisation procedure was applied to the building with the ventilated double façade it did not prove to be fully beneficial (i.e. in terms of improving the inter-method match of the results). Differences between the ratings of the monthly method and the simulation program were still notable, for example, for some of the cases of intermittent heating and in particular for the case of night cooling (i.e. minimum difference of two energy bands between the best optimised option of the monthly method and the simulation program).

As a general conclusion from all the results obtained in chapter 5, it can be said that there is no generic rule or procedure that would make the rating outputs produced from the different calculation methods to perfectly match each other for every building case (unless the energy bands are very wide). Localised optimisation parameters for the different methods could be further investigated for their application only to specific building cases but the effort involved with this in terms of testing and risk for the definition of their applicability is significant. The optimisation and development of the simplified methods is a time consuming process and considering that their application is not easy without interface developments, it questions the value from the inclusion of these methods in the energy performance calculations for the EPBD. Additional implications may also occur in cases where the compliance results from these methods are instead used by practitioners for design purposes too. The example of the building with the ventilated double façade in chapter 5 can highlight this issue where different design decisions can be taken when considering the outputs produced from the simplified and detailed calculation methods.

In any case, and for all types of calculation methods, validation tests could be used to further assist the selection process between the calculation methods and assess their potential applicability. However, the implementation and the application of these tests in the calculation methods is not always an easy process, especially for non-experienced users. A facility implemented within the ESP-r simulation program and described in chapter 6 could help to overcome these difficulties. The main issues with respect to the implementation of this facility and the benefits from it are summarised in the next section.

### ***7.1.3 Embedded validation as an aid for program selection and code quality assurance***

Comparative validation tests that are included in recent national and international standards, and in particular those within the ASHRAE and CEN Standards, were embedded within the ESP-r program. The implementation, which has been discussed in detail in chapter 6, allows users and developers to choose from the interface and automatically run a specific number or the whole set of validation tests. After the simulations are finished, it also invokes automatically the extraction of the results required for the specified tests and compares them against the ranges defined for these tests in the Standards. An additional set of predictions is also available automatically to the users in order to check the program's prediction against another output that can be, for example, from a previous version of the program so that it is possible to determine the impact of coding changes on the validation tests.

The benefits from this facility are significant for both users and developers. In particular, it benefits program users because their confidence in the program predictions and its accuracy against specific validation tests is improved, they can confirm that their installation is correct and they can perform standards compliance by themselves without having to re-construct the validation models needed for this (and therefore the possibility of making an error during the process of constructing the validation models is reduced, especially when the specifications of the validation cases are difficult to be followed by novice users). Program developers can also

benefit from the embedded validation facility because, as well as being able to check the performance of their program against the ranges defined in energy performance standards, they can also check the impact the various program developments (e.g. code modifications) have on the program's predictions. This is particularly important, as most state-of-the-art energy simulation programs are under constant development. This facility also allows program developers to check the sensitivity of their program's results when algorithmic substitutions, such as those demonstrated in chapter 6, are performed. In some cases, errors in the implementation of the code can also be identified with the use of the embedded validation.

While the existing validation tests that are included within Standards (such as the ASHRAE and CEN validation tests that were discussed in chapter 6) may not cover or accurately validate every aspect of building physics, they could offer a valuable benchmark for the applicability of any type of energy performance calculation method (i.e. simplified and detailed) that is meant to be used for producing the EPBD-related energy performance ratings. It has been demonstrated in chapter 6 that the choice of calculation algorithms is important in some types of validation tests, such as for example in the tests included within the ASHRAE 140 Standard. In these cases, adequate documentation and justification for the algorithms used in the programs should be provided to those interested in their predictions with regards to these validation tests (e.g. to users or to national bodies responsible for software accreditation). Ideally, a facility for having the validation tests embedded within the program should also be included to easily demonstrate the program's performance against the validation tests. This could also allow reporting predictions across a number of alternative calculation algorithms that may be available in the program or highlight the differences of any other program developments that could affect the predictions for the program's standard version. The facility can be used for example in a regulatory context to demonstrate the effect on program's predictions from the use of alternative calculation algorithms that allow the program to pass specific accreditation tests and be approved for use in energy performance regulations. This is an important issue because if a program is used with a simplified and constrained way of modelling a particular heat transfer process in order to fall within the required

by the accreditation bodies tolerance bands, a decision should be taken by those who approve the use of programs in energy performance regulations for whether or not the program will always have to be used in this mode in order to claim compliance with standards and produce regulation compliance ratings equivalent to the other methods allowed for the same purpose.

## **7.2 Recommendations for future work**

### ***7.2.1 Extending the comparisons between simplified methods and simulation programs in other areas of energy performance calculations***

A comparison between simplified methods and simulation programs has been performed for the impacts on the ratings produced for space heating and cooling energy requirements. Although the calculations for space heating and cooling have been considered as the most important assessments (and this has been justified in this thesis), further research can be focused on other energy performance assessments such as calculations for the energy needed for lighting or domestic hot water, the risk of excessive indoor temperatures, etc.

The calculations, for example, of the energy requirements for domestic hot water are often oversimplified by ignoring the dynamics of the systems involved. However, the overhead of creating the inputs to describe in detail the plant systems might be considerable. It would be worthwhile to investigate the balance between the effort needed to describe and simulate in detail these systems against the predicted differences in energy consumption from the adoption of a simplified approach. Ideally a program could provide alternative methods for hot water calculations in order to allow the users to select the level of detail they want for the calculations and as well provide adequate support for detailed calculations.

In a similar way, the risk of overheating could be considered in detail within simulation programs using nodal air flow networks. Building energy performance regulations often either ignore this issue or reference simplified approaches to approximate it (e.g. in England & Wales Part L regulations, there is a reference to the

methods described for naturally ventilated buildings in CIBSE TM37 (2006b): this suggests checking the sum of internal and tabulated solar heat gains against specific maximum values).

### ***7.2.2 Extending the embedded validation facility***

The existing embedded validation facility has been generalised so that it allows adding validation tests without any programming skills. The current implementation of this facility includes a large number of test cases (i.e. ASHRAE 140-2004 envelope and fabric load tests, CEN 13791 and CEN 15265) but it would be useful if this is extended to include additional tests in order to cover more validation areas (e.g. empirical tests). In particular it would be useful to add tests that have been also included within Standards, such as HVAC-BESTEST (Neymark and Judkoff, 2002; Neymark and Judkoff, 2004) and the cases within CEN 15255 Standard (2007). Other tests that could be added are: IEA HVAC-BESTEST fuel-fired furnace test (Purdy and Beausoleil-Morrison, 2003), IEA Annex 21 empirical test (Lomas et al. 1994), and also tests used for software accreditation purposes such as those within the CIBSE TM33 document (2006a).

### ***7.2.3 Future enhancements to the capabilities of simulation programs***

Some possible future developments that could further enhance the capabilities of simulation programs for issues related to sustainable building design were identified and discussed in chapter 4. A brief summary is given again in this section.

The quantification of the metrics needed for studying the impacts of buildings on global warming, acid rain and the depletion of materials and energy resources would be an interesting output from simulation programs when all the different stages of the whole life cycle of buildings, and not only their operational stage, are considered in the calculations. The implementation of such developments may require some standardised assumptions to be adopted for the environmental impacts associated with the buildings' life span.

The development and integration within the simulation programs of models that predict the behaviour of building occupants is also an area where simulation capabilities could be further expanded. This will allow the calculations to account and quantify the effect of this behaviour on the thermal energy requirements, the indoor air quality and as well on the thermal, visual and acoustic comfort.

Finally, additional areas of research where future developments for simulation programs could focus are: the ability to perform detailed community scale simulations, the incorporation of demand side management controls (i.e. for investigating their effect on energy savings, thermal comfort etc.) and the integration of heat, air and moisture transfer within whole building analysis simulation programs.

#### ***7.2.4 Task-based interfaces for energy performance calculation methods***

It is well recognised that programs used for the calculation of the energy performance of buildings would benefit from the development of user friendly interfaces. This is becoming particularly important with the implementation of the EPBD, which generated an increasing need for energy performance assessments and may lead a large number of practitioners who are not familiar or have little understanding of building physics to attempt to perform this type of assessment.

In particular, detailed simulation programs are often criticised for having a steep learning curve, mainly because developers have considered building physics in detail without always investing resources on program interfaces. In any case, simplified and well-planned interfaces for simulation programs would be preferred by the practitioners and would help to expand the use of these programs. For example, well-developed interfaces of commercial programs such as those for IES-VE (2008) and DesignBuilder (2008) improve the popularity of these programs amongst the practitioners and assist them to easily perform their energy assessments. However, it should be noted here that interfaces should not restrict the design of buildings and



should offer at the same time flexibility for alternative high resolution analysis on the various building design parameters.

Advanced interfaces could be, for example, task based and they could use step-by-step wizards to guide the user towards the completion of a specific calculation task. Take for example the task: “Perform an overheating risk assessment” for a proposed naturally ventilated building, which can be translated as “looking for the number of occupied hours that air temperature is above a specified temperature”. A wizard could guide the user to define first the geometry of the building based on the building plans. A practitioner would prefer, if possible, to directly input the drawings or the CAD files in the simulation program or alternatively to use a CAD interface similar to the classic CAD tools to define the geometry from scratch. The user will then be directed by the wizard to attribute every surface of the building in terms of constructions that they are made of by providing existing large scale construction databases and to define boundary conditions. This step should be as flexible as possible, by allowing for example multiple attributions at once and giving the option to “undo” previous choices. It could also be assisted by visual images, by highlighting for example the surface that is being attributed. The next step would be to guide the user to create a nodal airflow network based on visual diagrams that use icons or symbols for each component of the network. The openings of the building could be for example automatically identified at this stage and a database of typical openings should be of assistance. Easy to apply control strategies for the components of the network could also be defined here. The wizard could then ask for the rest of the basic inputs needed for the simulation (e.g. activity of spaces, location and climate) by always providing default values and the option to choose these inputs from pre-defined databases. It can then suggest to the user to initiate the simulations and automatically recover a set of results related to overheating risk. Additional outputs should always be available for other energy performance metrics in order to further investigate related design issues. Some of these processes could be optionally automated, for example by using a similar concept as the one described in chapter 6 for automating the way the embedded validation facility works. This will reduce the overall time needed for completing the energy performance assessments. The

interface should ensure that every step described here is self-explanatory to the users, so that it is possible for different members of a design team to perform specific steps of the study. The whole process of performing the specified tasks could be monitored and documented using process modelling approaches, for example the formal and graphical language of Petri-Nets (e.g. Petri and Reisig, 2008) which is often used for modelling the concurrent behaviour of distributed systems. This will enable, for example, simulation experts or the quality assurance team of the firm that performs the energy performance assessments to easily supervise the simulation exercise.

The alternative option of generating simulation models by developing plugins in existing user friendly drawing programs is also appealing. In particular, the development of plugins that integrate simulation programs within the Google SketchUp (2008) software is becoming increasingly popular. Google SketchUp is a free to use 3-D drawing program that offers the advanced visualisation capabilities of more expensive computer-aided design (CAD) packages, but with a much simpler interface that facilitates the rapid sketching of designs. It also offers a plugin development environment, which enables plugins to be written in Ruby scripting language and interpreted by SketchUp's own embedded Ruby interpreter that executes all the code for plugins. Beta versions of such plugins have already been released for public use (e.g. Ellis et al., 2008).

Such interface developments would be an invaluable contribution and would increase the popularity of detailed simulation programs among the practitioners, giving them the chance to take advantage of the capabilities offered by these programs and, consequently, to promote sustainability through their designs.

#### ***7.2.5 Development of user-accreditation procedures to ensure consistent application of calculation programs.***

The use of calculation programs has to be consistent between the different users in order to ensure that the same compliance ratings are produced when the same building is assessed by several users. It has been mentioned in this thesis that this is

also a software interface issue and appropriate interfaces should be developed for this purpose (i.e. with constraint inputs and flexible alternative detailed options). Nevertheless, future work should also focus on developing appropriate user-accreditation procedures in order to assess users for the way they are using programs and the way they understand energy performance calculations. Initial user-accreditation schemes for programs used in energy performance regulations have been recently introduced in UK. For example, BRE's Approved Certifier of Design scheme for Scotland aims to provide practitioners with the basics around the energy performance regulations and test their knowledge for the SBEM software (2008). The effectiveness of this type of schemes is still something that has to be evaluated and potential issues that will make them more effective may need to be identified and adopted. It should be ensured that there will be no differences on the energy performance calculation outputs from the different accredited users when they are assessing the same building.

### 7.3 References

CIBSE (Chartered Institution of Building Services Engineers). 2006a. *CIBSE TM33: Tests for software accreditation and verification*. London, UK.

CIBSE (Chartered Institution of Building Services Engineers). 2006b. *CIBSE TM37: Design for improved solar shading control*. London, UK.

DesignBuilder 1.8.1.001. 2008. *Building energy modelling program*. DesignBuilder Software Ltd, UK. Available from: <http://www.designbuilder.co.uk>.

Ellis P.G., Torcellini P.A., Crawley D.B. 2008. *Energy Design plugin: an EnergyPlus plugin for SketchUp*. Proceedings of the 3<sup>rd</sup> National Conference of IBPSA USA (SimBuild 2008). California, USA.

EN 15255. 2007. *Thermal performance of buildings – Sensible room cooling load calculation - General criteria and validation procedures*. Brussels, Belgium.

Google SketchUp 7. 2008. *3-D drawing and visualisation program*. Available from: <http://sketchup.google.com/>

IES-VE 5.9. 2008. *Building energy modelling program*. Integrated Environmental Solutions (IES) Ltd, UK. Available from: <http://www.iesve.com>.

Lomas K.J., Eppel H., Martin C., Bloomfield D. 1994. *Empirical validation of thermal building simulation programs using test room data*. IEA Annex 21/Task 12 Project, final report, vols 1 - 3.

Neymark J., Judkoff R. 2002. *International Energy Agency building energy simulation test and diagnostic method for heating, ventilation and air-conditioning equipment models (HVAC BESTEST), vol. 1, Cases E100-E200*. NREL/TP-550-30152. National Renewable Energy Laboratory, Colorado, USA.

Neymark J., Judkoff R. 2004. *International Energy Agency building energy simulation test and diagnostic method for heating, ventilation and air-conditioning equipment models (HVAC BESTEST), vol. 2, cases E300-E545*. NREL/TP-550-36754. National Renewable Energy Laboratory, Golden, Colorado, USA.

PART L2A. 2006. *Conservation of fuel and power in new buildings other than dwellings*. ISBN-10: 1-85946-219-5. Office of the Deputy Prime Minister, UK.

Petri C.A, Reisig W. 2008. *Petri net*. Scholarpedia, 3 (4):6477. Available from: [http://www.scholarpedia.org/article/Petri\\_net](http://www.scholarpedia.org/article/Petri_net)

Purdy J. Beausoleil-Morrison I. 2003. *HVAC BESTEST: fuel-fired furnace test cases*. IEA Task 22 Subtask C Report, NRCan, Ottawa, Canada.

SBEM v3.1, 2008. *Simplified building energy model*. BRE, UK. Available from: <http://www.ncm.bre.co.uk>

DETAILS OF CASE STUDIES

**A.1 Introduction**

The details of the base case models that were used in the two groups of cases in chapter 5 are presented here. These details are provided as an output from the ESP-r program when using its quality assurance report facility.

**A.1.1 Base case for the first group of cases – Quality Assurance report**

Synopsis

This is a synopsis of the model Basic 3 zone model, defined in bld\_basicCurtain.cfg generated on Wed Dec 19 12:31:00 2007. Notes associated with the model are in bld\_basic.log

The model is located at latitude 52.30 with a longitude difference of -0.23 from the local time meridian. The year used in simulations is 1995 and weekends occur on Saturday and Sunday. The site exposure is sky=0.50 ground=0.50 other buildings=0.00 and the ground reflectance is 0.20.

The climate used is: AMSTERDAM - NLD and is held in: ../dbs/NLD\_Amsterdam\_IWEC and uses half hour centred solar data.

There are currently 3 user defined ground temperature profiles.

Ground temperatures Jan-Dec:

4.6 2.8 3.3 5.1 6.1 9.6 11.4 13.6 14.3 12.7 7.5 5.5

Ground temperatures Jan-Dec:

16.1 16.1 16.6 17.6 19.5 21.4 22.4 22.9 22.1 20.5 18.1 16.7

Ground temperatures Jan-Dec:

5.8 5.5 6.6 8.8 11.9 13.7 15.0 15.1 13.2 10.6 7.5 6.0

Databases associated with the model:

pressure distributions : /home/georgios/esru/esp-r/databases/pressc.db1  
materials : ../dbs/chate\_school.materialdb  
constructions : ../dbs/chate\_school.constrdb  
plant components : /usr/esru/esp-r/databases/plantc.db1  
event profiles : /usr/esru/esp-r/databases/profiles.db1  
optical properties : EPlus

---

The model includes ideal controls as follows:

Control description:

basic controls for a simple building (no control used in roof space)

Zones control includes 9 functions.

The sensor for function 1 senses a mix of db T and MRT in reception.  
 The actuator for function 1 is mixed convective/radiant flux in reception.  
 There have been 1 day types defined.  
 Day type 1 is valid Sun-01-Jan to Sun-31-Dec, 1995 with 1 period.  
 Per|Start|Sensing |Actuating | Control law | Data  
 1 0.00 db temp > flux basic control 100000.0 0.0 100000.0  
 0.0 19.0 100.0 0.0  
 basic control: max heating capacity 100000.0W min heating capacity 0.0W max  
 cooling capacity 100000.0W min cooling capacity 0.0W. Heating setpoint  
 19.00C cooling setpoint 100.00C.

The sensor for function 2 senses a mix of db T and MRT in office.  
 The actuator for function 2 is mixed convective/radiant flux in office.  
 There have been 1 day types defined.  
 Day type 1 is valid Sun-01-Jan to Sun-31-Dec, 1995 with 1 periods.  
 Per|Start|Sensing |Actuating | Control law | Data  
 1 0.00 db temp > flux basic control 100000.0 0.0 100000.0  
 0.0 19.0 100.0 0.0  
 basic control: max heating capacity 100000.0W min heating capacity 0.0W max  
 cooling capacity 100000.0W min cooling capacity 0.0W. Heating setpoint  
 19.00C cooling setpoint 100.00C.

The sensor for function 3 senses a mix of db T and MRT in recept\_1st.  
 The actuator for function 3 is mixed convective/radiant flux in recept\_1st.  
 There have been 1 day types defined.  
 Day type 1 is valid Sun-01-Jan to Sun-31-Dec, 1995 with 1 periods.  
 Per|Start|Sensing |Actuating | Control law | Data  
 1 0.00 db temp > flux basic control 100000.0 0.0 100000.0  
 0.0 19.0 100.0 0.0  
 basic control: max heating capacity 100000.0W min heating capacity 0.0W max  
 cooling capacity 100000.0W min cooling capacity 0.0W. Heating setpoint  
 19.00C cooling setpoint 100.00C.

The sensor for function 4 senses a mix of db T and MRT in office\_1st.  
 The actuator for function 4 is mixed convective/radiant flux in office\_1st.  
 There have been 1 day types defined.  
 Day type 1 is valid Sun-01-Jan to Sun-31-Dec, 1995 with 1 periods.  
 Per|Start|Sensing |Actuating | Control law | Data  
 1 0.00 db temp > flux basic control 100000.0 0.0 100000.0  
 0.0 19.0 100.0 0.0  
 basic control: max heating capacity 100000.0W min heating capacity 0.0W max  
 cooling capacity 100000.0W min cooling capacity 0.0W. Heating setpoint  
 19.00C cooling setpoint 100.00C.

The sensor for function 5 senses a mix of db T and MRT in office\_2nd.  
 The actuator for function 5 is mixed convective/radiant flux in office\_2nd.  
 There have been 1 day types defined.  
 Day type 1 is valid Sun-01-Jan to Sun-31-Dec, 1995 with 1 periods.  
 Per|Start|Sensing |Actuating | Control law | Data  
 1 0.00 db temp > flux basic control 100000.0 0.0 100000.0  
 0.0 19.0 100.0 0.0  
 basic control: max heating capacity 100000.0W min heating capacity 0.0W max  
 cooling capacity 100000.0W min cooling capacity 0.0W. Heating setpoint  
 19.00C cooling setpoint 100.00C.

The sensor for function 6 senses a mix of db T and MRT in recept\_2nd.  
 The actuator for function 6 is mixed convective/radiant flux in recept\_2nd.  
 There have been 1 day types defined.  
 Day type 1 is valid Sun-01-Jan to Sun-31-Dec, 1995 with 1 periods.  
 Per|Start|Sensing |Actuating | Control law | Data  
 1 0.00 db temp > flux basic control 100000.0 0.0 100000.0  
 0.0 19.0 100.0 0.0

basic control: max heating capacity 100000.0W min heating capacity 0.0W max cooling capacity 100000.0W min cooling capacity 0.0W. Heating setpoint 19.00C cooling setpoint 100.00C.

The sensor for function 7 senses a mix of db T and MRT in big\_officee. The actuator for function 7 is mixed convective/radiant flux in big\_officee.

There have been 1 day types defined.

Day type 1 is valid Sun-01-Jan to Sun-31-Dec, 1995 with 1 periods.

Per	Start	Sensing	Actuating	Control law	Data
1	0.00	db temp	> flux	basic control	100000.0 0.0 100000.0
0.0	19.0	100.0	0.0		

basic control: max heating capacity 100000.0W min heating capacity 0.0W max cooling capacity 100000.0W min cooling capacity 0.0W. Heating setpoint 19.00C cooling setpoint 100.00C.

The sensor for function 8 senses a mix of db T and MRT in big\_off\_1st. The actuator for function 8 is mixed convective/radiant flux in big\_off\_1st.

There have been 1 day types defined.

Day type 1 is valid Sun-01-Jan to Sun-31-Dec, 1995 with 1 periods.

Per	Start	Sensing	Actuating	Control law	Data
1	0.00	db temp	> flux	basic control	100000.0 0.0 100000.0
0.0	19.0	100.0	0.0		

basic control: max heating capacity 100000.0W min heating capacity 0.0W max cooling capacity 100000.0W min cooling capacity 0.0W. Heating setpoint 19.00C cooling setpoint 100.00C.

The sensor for function 9 senses a mix of db T and MRT in big\_off\_2nd. The actuator for function 9 is mixed convective/radiant flux in big\_off\_2nd.

There have been 1 day types defined.

Day type 1 is valid Sun-01-Jan to Sun-31-Dec, 1995 with 1 periods.

Per	Start	Sensing	Actuating	Control law	Data
1	0.00	db temp	> flux	basic control	100000.0 0.0 100000.0
0.0	19.0	100.0	0.0		

basic control: max heating capacity 100000.0W min heating capacity 0.0W max cooling capacity 100000.0W min cooling capacity 0.0W. Heating setpoint 19.00C cooling setpoint 100.00C.

Zone to control loop linkages:

```

zone ( 1) reception << control 1
zone ( 2) office << control 2
zone ( 3) recept_1st << control 3
zone ( 4) office_1st << control 4
zone ( 5) office_2nd << control 5
zone ( 6) recept_2nd << control 6
zone ( 7) big_officee << control 7
zone ( 8) big_off_1st << control 8
zone ( 9) big_off_2nd << control 9

```

---

ID	Zone Name	Volume m <sup>3</sup>	No.	Opaque	Transp	~Floor	
1	reception	144.0	12	187.0	5.0	48.0	reception describes a
2	office	48.0	8	78.1	1.9	16.0	office describes a
3	recept_1st	144.0	12	187.0	5.0	48.0	recept_1st describes a
4	office_1st	48.0	8	78.1	1.9	16.0	office_1st describes a
5	office_2nd	48.0	8	78.1	1.9	16.0	office_2nd describes a
6	recept_2nd	144.0	12	187.0	5.0	48.0	recept_2nd describes a
7	big_officee	144.0	9	167.5	12.5	48.0	big_officee describes a
8	big_off_1st	144.0	9	167.5	12.5	48.0	big_off_1st describes a
9	big_off_2nd	144.0	9	167.5	12.5	48.0	big_off_2nd describes a
	all	1008.	87	1298.	58.	336.	



Zone reception ( 1) is composed of 12 surfaces and 28 vertices.  
 It encloses a volume of 144.m<sup>3</sup> of space, with a total surface area of 192.m<sup>2</sup> & approx floor area of 48.0m<sup>2</sup>  
 There is 48.000m<sup>2</sup> of exposed surface area, 48.000m<sup>2</sup> of which is vertical.  
 Outside walls are 89.583 % of floor area & avg U of 0.365 & UA of 15.681.  
 Glazing is 10.417 % of floor & 10.417 % facade with avg U of 2.841 & UA of 14.205.

A summary of the surfaces in reception( 1) follows:

Sur	Area	Azim	Elev	surface	geometry	construction	environment
	m^2	deg	deg	name	type  local	name	other side
1	20.3	180.	0.	south	OPAQUE	VERT extern_w_0em	< external
2	24.0	90.	0.	east	OPAQUE	VERT gyp_gyp_ptn	< Surf-4:
big_officee							
3	10.8	0.	0.	north	OPAQUE	VERT extern_w_0em	< external
4	9.50	270.	0.	part_a	OPAQUE	VERT gyp_gyp_ptn	< part_a:
office							
5	12.0	0.	0.	part_b	OPAQUE	VERT gyp_gyp_ptn	< part_b:
office							
6	9.50	270.	0.	west	OPAQUE	VERT extern_w_0em	< external
7	48.0	0.	90.	ceiling	OPAQUE	CEIL ceilingflr	< floor:
recept_1st							
8	48.0	0.	-90.	floor	OPAQUE	FLOR concr_floort	< user def
grnd profile 3							
9	3.75	180.	0.	glz_s	EPlus_	VERT d_glz_0em	< external
10	2.50	270.	0.	door_a	OPAQUE	VERT door	< door_a:
office							
11	1.25	0.	0.	window_nrth	EPlus_	VERT d_glz_0em	< external
12	2.50	270.	0.	ext_door_wes	OPAQUE	VERT ext_door_0em	< external

All surfaces will receive diffuse insolation (if shading not calculated).  
 No shading analysis requested.  
 No insolation analysis requested.

Number of control periods: 1  
 Number of surfaces =12

Period 1 start 0.00 finish 24.00  
 CEN convection regime:  
 CEN user edited hc coefficients  
 CEN regime based on typical floor "floor" and typical ceiling "ceiling".  
 Floor upwards flow hc is 10.000 and downwards 5.900 and external 25.000.  
 Ceiling upwards flow hc is 10.000 and downwards 5.900 and external 25.000.  
 Sloped upwards flow hc is 10.000 and downwards 5.900 and external 25.000.  
 Walls inside hc is 7.700 and other side of partitions 7.700 and external 25.000.

Control: no control of air flow

Number of Weekday Sat Sun air change periods = 1 1 1									
	Period	Infiltration	Ventilation		From Source				
	id	Hours	Rate	ac/h	Rate	ac/h	m3/s	Zone	Temp.
Wkd	1	0 - 24	0.72	0.0288	0.00	0.0000	0	0.00	
Sat	1	0 - 24	0.72	0.0288	0.00	0.0000	0	0.00	
Sun	1	0 - 24	0.72	0.0288	0.00	0.0000	0	0.00	

Number of Weekday Sat Sun casual gains= 6 2 2							
Day	Gain	Type	Period	Sensible	Latent	Radiant	Convec
	No.	labl	Hours	Magn. (W)	Magn. (W)	Frac	Frac
Wkd	1	OccuptW	0 - 7	57.6	0.0	0.50	0.50
Wkd	2	OccuptW	7 - 17	576.0	0.0	0.50	0.50
Wkd	3	OccuptW	17 - 24	57.6	0.0	0.50	0.50
Wkd	4	LightsW	0 - 7	48.0	0.0	0.50	0.50
Wkd	5	LightsW	7 - 17	480.0	0.0	0.50	0.50
Wkd	6	LightsW	17 - 24	48.0	0.0	0.50	0.50
Sat	1	OccuptW	0 - 24	57.6	0.0	0.50	0.50
Sat	2	LightsW	0 - 24	48.0	0.0	0.50	0.50
Sun	1	OccuptW	0 - 24	57.6	0.0	0.50	0.50
Sun	2	LightsW	0 - 24	48.0	0.0	0.50	0.50

Zone office ( 2 ) is composed of 8 surfaces and 16 vertices.  
It encloses a volume of 48.0m<sup>3</sup> of space, with a total surface area of 80.0m<sup>2</sup> & approx floor area of 16.0m<sup>2</sup>

There is 24.000m<sup>2</sup> of exposed surface area, 24.000m<sup>2</sup> of which is vertical.  
Outside walls are 138.28 % of floor area & avg U of 0.245 & UA of 5.4133.  
Glazing is 11.719 % of floor & 7.8125 % facade with avg U of 2.841 & UA of 5.3267.

A summary of the surfaces in office( 2 ) follows:

Sur	Area	Azim	Elev	surface	geometry	construction	environment
	m <sup>2</sup>	deg	deg	name	type	local name	other side
1	12.0	180.	0.	part_b	OPAQUE	VERT gyp_gyp_ptn	< part_b:
reception							
2	9.50	90.	0.	part_a	OPAQUE	VERT gyp_gyp_ptn	< part_a:
reception							
3	10.1	0.	0.	North_w	OPAQUE	VERT extern_w_0em	< external
4	12.0	270.	0.	West_w	OPAQUE	VERT extern_w_0em	< external
5	16.0	0.	90.	Ceiling	OPAQUE	CEIL ceilingflr	< Floor:
office 1st							
6	16.0	0.	-90.	Floor	OPAQUE	FLOR concr_floort	< user def
grnd profile 3							
7	2.50	90.	0.	door_a	OPAQUE	VERT door	< door_a:
reception							
8	1.88	0.	0.	wind_north	EPlus_	VERT d_glz_0em	< external

All surfaces will receive diffuse insolation (if shading not calculated).  
No shading analysis requested.  
No insolation analysis requested.

Number of control periods: 1  
Number of surfaces = 8

Period 1 start 0.00 finish 24.00

CEN convection regime:

User supplied hc values

CEN regime based on typical floor "Floor" and typical ceiling "Ceiling".

Floor upwards flow hc is 10.000 and downwards 5.900 and external 25.000.

Ceiling upwards flow hc is 10.000 and downwards 5.900 and external 25.000.

Sloped upwards flow hc is 10.000 and downwards 5.900 and external 25.000.

Walls inside hc is 7.700 and other side of partitions 7.700 and external 25.000.

Control: no control of air flow

Number of Weekday Sat Sun air change periods = 1 1 1  
 Period Infiltration Ventilation From Source  
 id Hours Rate ac/h m3/s Rate ac/h m3/s Zone Temp.  
 Wkd 1 0 - 24 0.72 0.0096 0.00 0.0000 0 0.00  
 Sat 1 0 - 24 0.72 0.0096 0.00 0.0000 0 0.00  
 Sun 1 0 - 24 0.72 0.0096 0.00 0.0000 0 0.00

Number of Weekday Sat Sun casual gains= 6 2 2  
 Day Gain Type Period Sensible Latent Radiant Convec  
 No. labl Hours Magn. (W) Magn. (W) Frac Frac  
 Wkd 1 OccuptW 0 - 7 19.2 0.0 0.50 0.50  
 Wkd 2 OccuptW 7 - 17 192.0 0.0 0.50 0.50  
 Wkd 3 OccuptW 17 - 24 19.2 0.0 0.50 0.50  
 Wkd 4 LightsW 0 - 7 16.0 0.0 0.50 0.50  
 Wkd 5 LightsW 7 - 17 160.0 0.0 0.50 0.50  
 Wkd 6 LightsW 17 - 24 16.0 0.0 0.50 0.50  
 Sat 1 OccuptW 0 - 24 19.2 0.0 0.50 0.50  
 Sat 2 LightsW 0 - 24 16.0 0.0 0.50 0.50  
 Sun 1 OccuptW 0 - 24 19.2 0.0 0.50 0.50  
 Sun 2 LightsW 0 - 24 16.0 0.0 0.50 0.50

Zone recept\_1st ( 3) is composed of 12 surfaces and 28 vertices.  
 It encloses a volume of 144.m^3 of space, with a total surface area of 192.m^2 & approx floor area of 48.0m^2

There is 48.000m2 of exposed surface area, 48.000m2 of which is vertical.  
 Outside walls are 89.583 % of floor area & avg U of 0.365 & UA of 15.681.  
 Glazing is 10.417 % of floor & 10.417 % facade with avg U of 2.841 & UA of 14.205.

A summary of the surfaces in recept\_1st( 3) follows:

Sur	Area	Azim	Elev	surface	geometry	construction	environment
	m^2	deg	deg	name	type  local	name	other side
1	20.3	180.	0.	south	OPAQUE VERT	extern_w_0em	< external
2	24.0	90.	0.	east	OPAQUE VERT	gyp_gyp_ptn	< Surf-4:
big_off_1st							
3	10.8	0.	0.	north	OPAQUE VERT	extern_w_0em	< external
4	9.50	270.	0.	part_a	OPAQUE VERT	gyp_gyp_ptn	< part_a:
office_1st							
5	12.0	0.	0.	part_b	OPAQUE VERT	gyp_gyp_ptn	< part_b:
office_1st							
6	9.50	270.	0.	west	OPAQUE VERT	extern_w_0em	< external
7	48.0	0.	90.	ceiling	OPAQUE CEIL	ceilingflr	<
floor:recept_2nd							
8	48.0	0.	-90.	floor	OPAQUE FLOR	floor_invert	< ceiling:
reception							
9	3.75	180.	0.	glz_s	EPlus_ VERT	d_glz_0em	< external
10	2.50	270.	0.	door_a	OPAQUE VERT	door	< door_a:
office_1st							
11	1.25	0.	0.	wind_north	EPlus_ VERT	d_glz_0em	< external
12	2.50	270.	0.	ext_door_wes	OPAQUE VERT	ext_door_0em	< external

All surfaces will receive diffuse insolation (if shading not calculated).  
 No shading analysis requested.  
 No insolation analysis requested.

Number of control periods: 1  
 Number of surfaces =12

Period 1 start 0.00 finish 24.00

CEN convection regime:

User supplied hc values

CEN regime based on typical floor "floor" and typical ceiling "ceiling".

Floor upwards flow hc is 10.000 and downwards 5.900 and external 25.000.

Ceiling upwards flow hc is 10.000 and downwards 5.900 and external 25.000.

Sloped upwards flow hc is 10.000 and downwards 5.900 and external 25.000.

Walls inside hc is 7.700 and other side of partitions 7.700 and external 25.000.

Control: no control of air flow

Number of Weekday Sat Sun air change periods = 1 1 1

	Period	Infiltration	Ventilation	From Source
id	Hours	Rate ac/h	m3/s	Rate ac/h
Wkd 1	0 - 24	0.72	0.0288	0.00 0.0000 0 0.00
Sat 1	0 - 24	0.72	0.0288	0.00 0.0000 0 0.00
Sun 1	0 - 24	0.72	0.0288	0.00 0.0000 0 0.00

Number of Weekday Sat Sun casual gains= 6 2 2

Day	Gain	Type	Period	Sensible	Latent	Radiant	Convec
No.	labl	Hours	Magn. (W)	Magn. (W)	Frac	Frac	Frac
Wkd 1	OccupW	0 - 7	57.6	0.0	0.50	0.50	
Wkd 2	OccupW	7 - 17	576.0	0.0	0.50	0.50	
Wkd 3	OccupW	17 - 24	57.6	0.0	0.50	0.50	
Wkd 4	LightsW	0 - 7	48.0	0.0	0.50	0.50	
Wkd 5	LightsW	7 - 17	480.0	0.0	0.50	0.50	
Wkd 6	LightsW	17 - 24	48.0	0.0	0.50	0.50	
Sat 1	OccupW	0 - 24	57.6	0.0	0.50	0.50	
Sat 2	LightsW	0 - 24	48.0	0.0	0.50	0.50	
Sun 1	OccupW	0 - 24	57.6	0.0	0.50	0.50	
Sun 2	LightsW	0 - 24	48.0	0.0	0.50	0.50	

Zone office\_1st ( 4) is composed of 8 surfaces and 16 vertices.  
 It encloses a volume of 48.0m<sup>3</sup> of space, with a total surface area of 80.0m<sup>2</sup> & approx floor area of 16.0m<sup>2</sup>

There is 24.000m<sup>2</sup> of exposed surface area, 24.000m<sup>2</sup> of which is vertical.  
 Outside walls are 138.28 % of floor area & avg U of 0.245 & UA of 5.4133.  
 Glazing is 11.719 % of floor & 7.8125 % facade with avg U of 2.841 & UA of 5.3267

A summary of the surfaces in office\_1st( 4) follows:

Sur	Area	Azim	Elev	surface	geometry	construction	environment
	m <sup>2</sup>	deg	deg	name	type	local name	other side
1	12.0	180.	0.	part_b	OPAQUE	VERT gyp_gyp_ptn	< part_b:
recept_1st							
2	9.50	90.	0.	part_a	OPAQUE	VERT gyp_gyp_ptn	< part_a:
recept_1st							
3	10.1	0.	0.	North_w	OPAQUE	VERT extern_w_0em	< external
4	12.0	270.	0.	West_w	OPAQUE	VERT extern_w_0em	< external
5	16.0	0.	90.	Ceiling	OPAQUE	CEIL ceilingflr	< Floor:
office_2nd							
6	16.0	0.	-90.	Floor	OPAQUE	FLOR floor_invert	< Ceiling:
office							

```

7 2.50 90. 0. door_a OPAQUE VERT door ||< door_a:
recept_1st
8 1.88 0. 0. wind_north EPlus_ VERT d_glz_0em ||< external

```

All surfaces will receive diffuse insolation (if shading not calculated).  
No shading analysis requested.  
No insolation analysis requested.

Number of control periods: 1  
Number of surfaces = 8

Period 1 start 0.00 finish 24.00  
CEN convection regime:  
CEN user edited hc coefficients  
CEN regime based on typical floor "Floor" and typical ceiling "Ceiling".  
Floor upwards flow hc is 10.000 and downwards 5.900 and external 25.000.  
Ceiling upwards flow hc is 10.000 and downwards 5.900 and external 25.000.  
Sloped upwards flow hc is 10.000 and downwards 5.900 and external 25.000.  
Walls inside hc is 7.700 and other side of partitions 7.700 and external 25.000.

Control: no control of air flow

Number of Weekday Sat Sun air change periods = 1 1 1										
		Period		Infiltration		Ventilation		From Source		
		id	Hours	Rate	ac/h	m3/s	Rate	ac/h	m3/s	Zone Temp.
Wkd	1	0 - 24		0.72	0.0096	0.00	0.0000	0	0.00	
Sat	1	0 - 24		0.72	0.0096	0.00	0.0000	0	0.00	
Sun	1	0 - 24		0.72	0.0096	0.00	0.0000	0	0.00	

Number of Weekday Sat Sun casual gains= 6 2 2							
Day Gain Type		Period	Sensible	Latent	Radiant	Convec	
No.	labl	Hours	Magn. (W)	Magn. (W)	Frac	Frac	
Wkd	1	OccuptW	0 - 7	19.2	0.0	0.50	0.50
Wkd	2	OccuptW	7 - 17	192.0	0.0	0.50	0.50
Wkd	3	OccuptW	17 - 24	19.2	0.0	0.50	0.50
Wkd	4	LightsW	0 - 7	16.0	0.0	0.50	0.50
Wkd	5	LightsW	7 - 17	160.0	0.0	0.50	0.50
Wkd	6	LightsW	17 - 24	16.0	0.0	0.50	0.50
Sat	1	OccuptW	0 - 24	19.2	0.0	0.50	0.50
Sat	2	LightsW	0 - 24	16.0	0.0	0.50	0.50
Sun	1	OccuptW	0 - 24	19.2	0.0	0.50	0.50
Sun	2	LightsW	0 - 24	16.0	0.0	0.50	0.50

---

Zone office\_2nd ( 5) is composed of 8 surfaces and 16 vertices.  
It encloses a volume of 48.0m<sup>3</sup> of space, with a total surface area of 80.0m<sup>2</sup> & approx floor area of 16.0m<sup>2</sup>

There is 40.000m<sup>2</sup> of exposed surface area, 24.000m<sup>2</sup> of which is vertical.  
Outside walls are 138.28 % of floor area & avg U of 0.245 & UA of 5.4133.  
Flat roof is 100.00 % of floor area & avg U of 0.254 & UA of 4.0591.  
Glazing is 11.719 % of floor & 7.8125 % facade with avg U of 2.841 & UA of 5.3267.

A summary of the surfaces in office\_2nd( 5) follows:

Sur	Area	Azim	Elev	surface	geometry	construction	environment
	m^2	deg	deg	name	type  local	name	other side
1	12.0	180.	0.	part_b	OPAQUE VERT	gyp_gyp_ptn	< part_b:
recept_2nd							
2	9.50	90.	0.	part_a	OPAQUE VERT	gyp_gyp_ptn	< part_a:
recept_2nd							
3	10.1	0.	0.	North_w	OPAQUE VERT	extern_w_0em	< external
4	12.0	270.	0.	West_w	OPAQUE VERT	extern_w_0em	< external
5	16.0	0.	90.	Ceiling	OPAQUE CEIL	kingspnr_f_0e	< external
6	16.0	0.	-90.	Floor	OPAQUE FLOR	floor_invert	< Ceiling:
office_1st							
7	2.50	90.	0.	door_a	OPAQUE VERT	door	< door_a:
recept_2nd							
8	1.88	0.	0.	wind_north	EPlus_ VERT	d_glz_0em	< external

All surfaces will receive diffuse insolation (if shading not calculated).  
 No shading analysis requested.  
 No insolation analysis requested.

Number of control periods: 1  
 Number of surfaces = 8

Period 1 start 0.00 finish 24.00

CEN convection regime:

User supplied hc values

CEN regime based on typical floor "Floor" and typical ceiling "Ceiling".

Floor upwards flow hc is 10.000 and downwards 5.900 and external 25.000.

Ceiling upwards flow hc is 10.000 and downwards 5.900 and external 25.000.

Sloped upwards flow hc is 10.000 and downwards 5.900 and external 25.000.

Walls inside hc is 7.700 and other side of partitions 7.700 and external 25.000.

Control: no control of air flow

Number of Weekday Sat Sun air change periods = 1 1 1									
		Period		Infiltration		Ventilation		From Source	
Wkd	id	Hours	Rate	ac/h	m3/s	Rate	ac/h	m3/s	Zone Temp.
1	1	0 - 24	0.72	0.0096	0.00	0.0000	0	0.00	
Sat	1	0 - 24	0.72	0.0096	0.00	0.0000	0	0.00	
Sun	1	0 - 24	0.72	0.0096	0.00	0.0000	0	0.00	

Number of Weekday Sat Sun casual gains= 6 2 2									
Day Gain		Type	Period	Sensible	Latent	Radiant	Convec		
No.	labl	Hours	Magn. (W)	Magn. (W)	Frac	Frac	Frac		
Wkd	1	OccupTW	0 - 7	19.2	0.0	0.50	0.50		
Wkd	2	OccupTW	7 - 17	192.0	0.0	0.50	0.50		
Wkd	3	OccupTW	17 - 24	19.2	0.0	0.50	0.50		
Wkd	4	LightsW	0 - 7	16.0	0.0	0.50	0.50		
Wkd	5	LightsW	7 - 17	160.0	0.0	0.50	0.50		
Wkd	6	LightsW	17 - 24	16.0	0.0	0.50	0.50		
Sat	1	OccupTW	0 - 24	19.2	0.0	0.50	0.50		
Sat	2	LightsW	0 - 24	16.0	0.0	0.50	0.50		
Sun	1	OccupTW	0 - 24	19.2	0.0	0.50	0.50		
Sun	2	LightsW	0 - 24	16.0	0.0	0.50	0.50		

Zone recept\_2nd ( 6) is composed of 12 surfaces and 28 vertices.  
 It encloses a volume of 144.m^3 of space, with a total surface area of 192.m^2 & approx floor area of 48.0m^2

There is 96.000m2 of exposed surface area, 48.000m2 of which is vertical.  
 Outside walls are 89.583 % of floor area & avg U of 0.365 & UA of 15.681.  
 Flat roof is 100.00 % of floor area & avg U of 0.254 & UA of 12.177.  
 Glazing is 10.417 % of floor & 10.417 % facade with avg U of 2.841 & UA of 14.205.

A summary of the surfaces in recept\_2nd( 6) follows:

Sur	Area	Azim	Elev	surface	geometry	construction	environment
	m^2	deg	deg	name	type  local	name	other side
1	20.3	180.	0.	south	OPAQUE VERT	extern_w_0em	< external
2	24.0	90.	0.	east	OPAQUE VERT	gyp_gyp_ptn	< Surf-4:
big_off_2nd							
3	10.8	0.	0.	north	OPAQUE VERT	extern_w_0em	< external
4	9.50	270.	0.	part_a	OPAQUE VERT	gyp_gyp_ptn	< part_a:
office_2nd							
5	12.0	0.	0.	part_b	OPAQUE VERT	gyp_gyp_ptn	< part_b:
office_2nd							
6	9.50	270.	0.	west	OPAQUE VERT	extern_w_0em	< external
7	48.0	0.	90.	ceiling	OPAQUE CEIL	kingspnrf_0e	< external
8	48.0	0.	-90.	floor	OPAQUE FLOR	floor_invert	< ceiling:
recept_1st							
9	3.75	180.	0.	glz_s	EPlus_ VERT	d_glz_0em	< external
10	2.50	270.	0.	door_a	OPAQUE VERT	door	< door_a:
office_2nd							
11	1.25	0.	0.	window_nrth	EPlus_ VERT	d_glz_0em	< external
12	2.50	270.	0.	ext_door	OPAQUE VERT	ext_door_0em	< external

All surfaces will receive diffuse insolation (if shading not calculated).  
 No shading analysis requested.  
 No insolation analysis requested.

Number of control periods: 1  
 Number of surfaces =12

Period 1 start 0.00 finish 24.00

CEN convection regime:

User supplied hc values

CEN regime based on typical floor "floor" and typical ceiling "ceiling".

Floor upwards flow hc is 10.000 and downwards 5.900 and external 25.000.

Ceiling upwards flow hc is 10.000 and downwards 5.900 and external 25.000.

Sloped upwards flow hc is 10.000 and downwards 5.900 and external 25.000.

Walls inside hc is 7.700 and other side of partitions 7.700 and external 25.000.

Control: no control of air flow

Number of Weekday Sat Sun air change periods = 1 1 1									
		Period	Infiltration	Ventilation		From Source			
Wkd	id	Hours	Rate	ac/h	m3/s	Rate	ac/h	m3/s	Zone Temp.
1	1	0 - 24	0.72	0.0288	0.00	0.0000	0	0.00	
Sat	1	0 - 24	0.72	0.0288	0.00	0.0000	0	0.00	
Sun	1	0 - 24	0.72	0.0288	0.00	0.0000	0	0.00	

Number of Weekday Sat Sun casual gains= 6 2 2							
Day	Gain	Type	Period	Sensible	Latent	Radiant	Convec
No.	labl		Hours	Magn. (W)	Magn. (W)	Frac	Frac
Wkd 1	Occup	W	0 - 7	57.6	0.0	0.50	0.50
Wkd 2	Occup	W	7 - 17	576.0	0.0	0.50	0.50
Wkd 3	Occup	W	17 - 24	57.6	0.0	0.50	0.50
Wkd 4	Light	W	0 - 7	48.0	0.0	0.50	0.50
Wkd 5	Light	W	7 - 17	480.0	0.0	0.50	0.50
Wkd 6	Light	W	17 - 24	48.0	0.0	0.50	0.50
Sat 1	Occup	W	0 - 24	57.6	0.0	0.50	0.50
Sat 2	Light	W	0 - 24	48.0	0.0	0.50	0.50
Sun 1	Occup	W	0 - 24	57.6	0.0	0.50	0.50
Sun 2	Light	W	0 - 24	48.0	0.0	0.50	0.50

Zone big\_officee ( 7) is composed of 9 surfaces and 20 vertices.  
 It encloses a volume of 144.m^3 of space, with a total surface area of 180.m^2 & approx floor area of 48.0m^2

There is 60.000m2 of exposed surface area, 60.000m2 of which is vertical.  
 Outside walls are 98.958 % of floor area & avg U of 0.245 & UA of 11.622.  
 Glazing is 26.042 % of floor & 20.833 % facade with avg U of 2.841 & UA of 35.511.

A summary of the surfaces in big\_officee( 7) follows:

Surf	Area	Azim	Elev	surface	geometry	construction	environment
	m^2	deg	deg	name	type	local name	other side
1	14.3	180.	0.	Surf-1	OPAQUE VERT	extern_w_0em	< external
2	19.0	90.	0.	Surf-2	OPAQUE VERT	extern_w_0em	< external
3	14.3	0.	0.	Surf-3	OPAQUE VERT	extern_w_0em	< external
4	24.0	270.	0.	Surf-4	OPAQUE VERT	gyp_gyp_ptn	< east:
reception							
5	48.0	0.	90.	Surf-5	OPAQUE CEIL	ceilingflr	< Surf-6:
big_off_1st							
6	48.0	0.	-90.	Surf-6	OPAQUE FLOR	concr_floort	< user def
grnd profile 3							
7	3.75	180.	0.	wind_south	EPlus_ VERT	d_glz_0em	< external
8	3.75	0.	0.	wind_nrth	EPlus_ VERT	d_glz_0em	< external
9	5.00	90.	0.	wind_east	EPlus_ VERT	d_glz_0em	< external

All surfaces will receive diffuse insolation (if shading not calculated).  
 No shading analysis requested.  
 No insolation analysis requested.

Number of control periods: 1  
 Number of surfaces = 9

Period 1 start 0.00 finish 24.00

CEN convection regime:

User supplied hc values

CEN regime based on typical floor Surf-6 and typical ceiling Surf-5.

Floor upwards flow hc is 10.000 and downwards 5.900 and external 25.000.

Ceiling upwards flow hc is 10.000 and downwards 5.900 and external 25.000.

Sloped upwards flow hc is 10.000 and downwards 5.900 and external 25.000.

Walls inside hc is 7.700 and other side of partitions 7.700 and external 25.000.



Control: no control of air flow

Number of Weekday Sat Sun air change periods = 1 1 1								
		Infiltration		Ventilation		From Source		
Wkd	id	Hours	Rate ac/h	m3/s	Rate ac/h	m3/s	Zone	Temp.
1	0 - 24	0.72	0.0288	0.00	0.0000	0	0.00	
2	0 - 24	0.72	0.0288	0.00	0.0000	0	0.00	
3	0 - 24	0.72	0.0288	0.00	0.0000	0	0.00	

Number of Weekday Sat Sun casual gains= 6 2 2							
Day Gain Type		Period	Sensible	Latent	Radiant	Convec	
No.	labl	Hours	Magn. (W)	Magn. (W)	Frac	Frac	
Wkd 1	OccuptW	0 - 7	57.6	0.0	0.50	0.50	
Wkd 2	OccuptW	7 - 17	576.0	0.0	0.50	0.50	
Wkd 3	OccuptW	17 - 24	57.6	0.0	0.50	0.50	
Wkd 4	LightsW	0 - 7	48.0	0.0	0.50	0.50	
Wkd 5	LightsW	7 - 17	480.0	0.0	0.50	0.50	
Wkd 6	LightsW	17 - 24	48.0	0.0	0.50	0.50	
Sat 1	OccuptW	0 - 24	57.6	0.0	0.50	0.50	
Sat 2	LightsW	0 - 24	48.0	0.0	0.50	0.50	
Sun 1	OccuptW	0 - 24	57.6	0.0	0.50	0.50	
Sun 2	LightsW	0 - 24	48.0	0.0	0.50	0.50	

Zone big\_off\_1st ( 8) is composed of 9 surfaces and 20 vertices.  
 It encloses a volume of 144.m^3 of space, with a total surface area of 180.m^2 & approx floor area of 48.0m^2

There is 60.000m2 of exposed surface area, 60.000m2 of which is vertical.  
 Outside walls are 98.958 % of floor area & avg U of 0.245 & UA of 11.622.  
 Glazing is 26.042 % of floor & 20.833 % facade with avg U of 2.841 & UA of 35.511.

A summary of the surfaces in big\_off\_1st( 8) follows:

Sur	Area	Azim	Elev	surface	geometry	construction	environment
	m^2	deg	deg	name	type	local name	other side
1	14.3	180.	0.	Surf-1	OPAQUE	VERT extern_w_0em	< external
2	19.0	90.	0.	Surf-2	OPAQUE	VERT extern_w_0em	< external
3	14.3	0.	0.	Surf-3	OPAQUE	VERT extern_w_0em	< external
4	24.0	270.	0.	Surf-4	OPAQUE	VERT gyp_gyp_ptn	< east:
recept_1st							
5	48.0	0.	90.	Surf-5	OPAQUE	CEIL ceilingflr	< Surf-6:
big_off_2nd							
6	48.0	0.	-90.	Surf-6	OPAQUE	FLOR floor_invert	< Surf-5:
big_officee							
7	3.75	180.	0.	wind_sthlst	EPlus_	VERT d_glz_0em	< external
8	3.75	0.	0.	wind_nrthlst	EPlus_	VERT d_glz_0em	< external
9	5.00	90.	0.	wind_eastlst	EPlus_	VERT d_glz_0em	< external

All surfaces will receive diffuse insolation (if shading not calculated).  
 No shading analysis requested.  
 No insolation analysis requested.

Number of control periods: 1  
 Number of surfaces = 9

Period 1 start 0.00 finish 24.00

CEN convection regime:

User supplied hc values

CEN regime based on typical floor "Surf-6" and typical ceiling "Surf-5".

Floor upwards flow hc is 10.000 and downwards 5.900 and external 25.000.

Ceiling upwards flow hc is 10.000 and downwards 5.900 and external 25.000.

Sloped upwards flow hc is 10.000 and downwards 5.900 and external 25.000.

Walls inside hc is 7.700 and other side of partitions 7.700 and external 25.000.

Control: no control of air flow

Number of Weekday Sat Sun air change periods = 1 1 1  
Period Infiltration Ventilation From Source  
id Hours Rate ac/h m3/s Rate ac/h m3/s Zone Temp.  
Wkd 1 0 - 24 0.72 0.0288 0.00 0.0000 0 0.00  
Sat 1 0 - 24 0.72 0.0288 0.00 0.0000 0 0.00  
Sun 1 0 - 24 0.72 0.0288 0.00 0.0000 0 0.00

Number of Weekday Sat Sun casual gains= 6 2 2  
Day Gain Type Period Sensible Latent Radiant Convec  
No. labl Hours Magn. (W) Magn. (W) Frac Frac  
Wkd 1 OccuptW 0 - 7 57.6 0.0 0.50 0.50  
Wkd 2 OccuptW 7 - 17 576.0 0.0 0.50 0.50  
Wkd 3 OccuptW 17 - 24 57.6 0.0 0.50 0.50  
Wkd 4 LightsW 0 - 7 48.0 0.0 0.50 0.50  
Wkd 5 LightsW 7 - 17 480.0 0.0 0.50 0.50  
Wkd 6 LightsW 17 - 24 48.0 0.0 0.50 0.50  
Sat 1 OccuptW 0 - 24 57.6 0.0 0.50 0.50  
Sat 2 LightsW 0 - 24 48.0 0.0 0.50 0.50  
Sun 1 OccuptW 0 - 24 57.6 0.0 0.50 0.50  
Sun 2 LightsW 0 - 24 48.0 0.0 0.50 0.50

Zone big\_off\_2nd ( 9) is composed of 9 surfaces and 20 vertices.  
It encloses a volume of 144.m<sup>3</sup> of space, with a total surface area of 180.m<sup>2</sup> & approx floor area of 48.0m<sup>2</sup>

There is 108.00m<sup>2</sup> of exposed surface area, 60.000m<sup>2</sup> of which is vertical.  
Outside walls are 98.958 % of floor area & avg U of 0.245 & UA of 11.622.  
Flat roof is 100.00 % of floor area & avg U of 0.254 & UA of 12.177.  
Glazing is 26.042 % of floor & 20.833 % facade with avg U of 2.841 & UA of 35.511.

A summary of the surfaces in big\_off\_2nd( 9) follows:

Sur	Area	Azim	Elev	surface	geometry	construction	environment
	m <sup>2</sup>	deg	deg	name	type	local name	other side
1	14.3	180.	0.	Surf-1	OPAQUE VERT	extern_w_0em	< external
2	19.0	90.	0.	Surf-2	OPAQUE VERT	extern_w_0em	< external
3	14.3	0.	0.	Surf-3	OPAQUE VERT	extern_w_0em	< external
4	24.0	270.	0.	Surf-4	OPAQUE VERT	gyp_gyp_ptn	< east:
recept_2nd							
5	48.0	0.	90.	Surf-5	OPAQUE CEIL	kingspnrf_0e	< external
6	48.0	0.	-90.	Surf-6	OPAQUE FLOR	floor_invert	< Surf-5:
big_off_1st							
7	3.75	180.	0.	wind_sth2nd	EPlus_ VERT	d_glz_0em	< external
8	3.75	0.	0.	wind_nrth2	EPlus_ VERT	d_glz_0em	< external
9	5.00	90.	0.	wind_east2n	EPlus_ VERT	d_glz_0em	< external

All surfaces will receive diffuse insolation (if shading not calculated).  
No shading analysis requested.  
No insolation analysis requested.

Number of control periods: 1  
 Number of surfaces = 9

Period 1 start 0.00 finish 24.00

CEN convection regime:

User supplied hc values

CEN regime based on typical floor "Surf-6" and typical ceiling "Surf-5".

Floor upwards flow hc is 10.000 and downwards 5.900 and external 25.000.

Ceiling upwards flow hc is 10.000 and downwards 5.900 and external 25.000.

Sloped upwards flow hc is 10.000 and downwards 5.900 and external 25.000.

Walls inside hc is 7.700 and other side of partitions 7.700 and external 25.000.

Control: no control of air flow

Number of Weekday Sat Sun air change periods = 1 1 1									
		Period		Infiltration		Ventilation		From Source	
Wkd	id	Hours	Rate	ac/h	m3/s	Rate	ac/h	m3/s	Zone Temp.
Wkd	1	0 - 24	0.72	0.0288	0.00	0.0000	0	0.00	
Sat	1	0 - 24	0.72	0.0288	0.00	0.0000	0	0.00	
Sun	1	0 - 24	0.72	0.0288	0.00	0.0000	0	0.00	

Number of Weekday Sat Sun casual gains= 6 2 2							
Day	Gain	Type	Period	Sensible	Latent	Radiant	Convec
	No.	labl	Hours	Magn. (W)	Magn. (W)	Frac	Frac
Wkd	1	OccuptW	0 - 7	57.6	0.0	0.50	0.50
Wkd	2	OccuptW	7 - 17	576.0	0.0	0.50	0.50
Wkd	3	OccuptW	17 - 24	57.6	0.0	0.50	0.50
Wkd	4	LightsW	0 - 7	48.0	0.0	0.50	0.50
Wkd	5	LightsW	7 - 17	480.0	0.0	0.50	0.50
Wkd	6	LightsW	17 - 24	48.0	0.0	0.50	0.50
Sat	1	OccuptW	0 - 24	57.6	0.0	0.50	0.50
Sat	2	LightsW	0 - 24	48.0	0.0	0.50	0.50
Sun	1	OccuptW	0 - 24	57.6	0.0	0.50	0.50
Sun	2	LightsW	0 - 24	48.0	0.0	0.50	0.50

---

Project floor area is 336.00m2, wall area is 337.88m2, and window area is 58.125m2.

Sloped roof area is 0.00m2, flat roof area is 112.00m2, skylight area is 0.00m2.

There is 508.00m2 of outside surface area, 396.00m2 of which is vertical.

Outside walls are 100.56 % of floor area & avg U of 0.290 & UA of 98.148.

Flat roof is 33.333 % of floor area & avg U of 0.254 & UA of 28.414.

Glazing is 17.299 % of floor & 14.678 % facade with avg U of 2.841 & UA of 165.13.

---

Multi-layer constructions used:

Details of opaque construction: door

Layer	Prim	Thick	Conduc-	Density	Specif	IR	Solr	Diffu	R	Descr
	db	(mm)	tivity		heat	emis	abs	resis	m^2K/W	
1	76	25.0	0.190	700.	2390.	0.01	0.65	12.	0.13	Oak_0emis

ISO 6946 U values (horiz/upward/downward heat flow)= 3.316 3.682 2.928  
(partition) 2.554  
Total area of door is 15.00

Details of opaque construction: gyp\_gyp\_ptn

Layer	Prim	Thick	Conduc-	Density	Specif	IR	Solr	Diffu	R	Descr
	db	(mm)	tivity		heat	emis	abs	resis	m^2K/W	
Ext	111	12.0	0.190	950.	840.	0.01	0.22	11.	0.06	White ptd Gypb_0em
2	0	50.0	0.000	0.	0.	0.99	0.99	1.	0.17	air 0.17 0.17 0.17
Int	111	12.0	0.190	950.	840.	0.01	0.22	11.	0.06	White ptd Gypb_0em

ISO 6946 U values (horiz/upward/downward heat flow)= 2.144 2.292 1.975  
(partition) 1.798  
Total area of gyp\_gyp\_ptn is 273.00

Details of opaque construction: concr\_floort

Layer	Prim	Thick	Conduc-	Density	Specif	IR	Solr	Diffu	R	Descr
	db	(mm)	tivity		heat	emis	abs	resis	m^2K/W	
Ext	301	100.0	0.044	1.	1.	0.01	0.50	10.	3.35	virtual
2	265	250.0	0.520	2050.	184.	0.01	0.85	2.	0.48	Gravel ba_0em
3	262	250.0	0.520	2050.	184.	0.90	0.85	2.	0.48	Gravel based
4	32	50.0	1.400	2100.	653.	0.90	0.65	19.	0.04	Heavy mix concrete
5	32	50.0	1.400	2100.	653.	0.90	0.65	19.	0.04	Heavy mix concrete
6	32	50.0	1.400	2100.	653.	0.90	0.65	19.	0.04	Heavy mix concrete
7	32	50.0	1.400	2100.	653.	0.90	0.65	19.	0.04	Heavy mix concrete
Int	231	7.0	0.060	186.	1360.	0.01	0.60	10.	0.12	Wilton_0em

ISO 6946 U values (horiz/upward/downward heat flow)= 0.211 0.212 0.209  
(partition) 0.207  
Total area of concr\_floort is 112.00

Details of opaque construction: ceilingflr

Layer	Prim	Thick	Conduc-	Density	Specif	IR	Solr	Diffu	R	Descr
	db	(mm)	tivity		heat	emis	abs	resis	m^2K/W	
Ext	77	5.0	0.140	600.	1210.	0.01	0.65	14.	0.04	Floori_0emi
2	0	180.0	0.000	0.	0.	0.99	0.99	1.	0.16	air 0.16
3	32	65.0	1.400	2100.	653.	0.90	0.65	19.	0.05	Heavy mix concrete
4	32	65.0	1.400	2100.	653.	0.90	0.65	19.	0.05	Heavy mix concrete
5	0	100.0	0.000	0.	0.	0.99	0.99	1.	0.17	air 0.17
Int	154	13.0	0.380	1120.	840.	0.01	0.60	12.	0.03	Ceiling (plas_0emi)
ISO 6946 U values (horiz/upward/downward heat flow)=										1.509 1.580 1.423
(partition)										1.328
Total area of ceilingflr is										224.00

Details of opaque construction: floor\_invert

Layer	Prim	Thick	Conduc-	Density	Specif	IR	Solr	Diffu	R	Descr
	db	(mm)	tivity		heat	emis	abs	resis	m^2K/W	
Ext	154	13.0	0.380	1120.	840.	0.01	0.60	12.	0.03	Ceiling (plas_0emi)
2	0	100.0	0.000	0.	0.	0.99	0.99	1.	0.17	air 0.17
3	32	65.0	1.400	2100.	653.	0.90	0.65	19.	0.05	Heavy mix concrete
4	32	65.0	1.400	2100.	653.	0.90	0.65	19.	0.05	Heavy mix concrete
5	0	180.0	0.000	0.	0.	0.99	0.99	1.	0.16	air 0.16
Int	77	5.0	0.140	600.	1210.	0.01	0.65	14.	0.04	Floori_0emi
ISO 6946 U values (horiz/upward/downward heat flow)=										1.509 1.580 1.423
(partition)										1.328
Total area of floor_invert is										224.00

Details of opaque construction: extern\_w\_0em

Layer	Prim	Thick	Conduc-	Density	Specif	IR	Solr	Diffu	R	Descr
	db	(mm)	tivity		heat	emis	abs	resis	m^2K/W	
Ext	129	20.0	1.130	1431.	1000.	0.01	0.50	19.	0.02	
Rendering_0emis										
2	36	100.0	1.060	1950.	1000.	0.90	0.40	18.	0.09	concrete block (milton keynes)
3	0	50.0	0.000	0.	0.	0.99	0.99	1.	0.17	air 0.17 0.17
4	72	10.0	0.150	700.	1420.	0.90	0.65	576.	0.07	Plywood
5	211	70.0	0.040	250.	840.	0.90	0.30	4.	1.75	Glasswool
6	211	70.0	0.040	250.	840.	0.90	0.30	4.	1.75	Glasswool
Int	110	13.0	0.190	950.	840.	0.01	0.50	11.	0.07	Gypsum plasterb_0em
ISO 6946 U values (horiz/upward/downward heat flow)= 0.245 0.246 0.242 (partition) 0.239										
Total area of extern_w_0em is 330.38										

Details of transparent construction: d\_glz\_0em with EPlus\_WINDO5 optics.

Layer	Prim	Thick	Conduc-	Density	Specif	IR	Solr	Diffu	R	Descr
	db	(mm)	tivity		heat	emis	abs	resis	m^2K/W	
Ext	247	6.0	1.000	2710.	837.	0.01	0.05	19200.	0.01	
Plate_gl_0emi										
2	0	12.0	0.000	0.	0.	0.99	0.99	1.	0.17	air 0.17 0.17
Int	247	6.0	1.000	2710.	837.	0.01	0.05	19200.	0.01	Plate_gl_0emi
ISO 6946 U values (horiz/upward/downward heat flow)= 2.841 3.106 2.551 (partition) 2.262										
eplus glazing_with WINDOW5: with id of: EPlus_WINDO5										
with 3 layers [including air gaps] and visible trn: 0.78										
Direct transmission @ 0, 40, 55, 70, 80 deg										
0.594 0.563 0.499 0.346 0.151										
Layer  absorption @ 0, 40, 55, 70, 80 deg										
1 0.170 0.185 0.200 0.219 0.217										
2 0.001 0.001 0.001 0.001 0.001										
3 0.124 0.131 0.131 0.116 0.079										
Total area of d_glz_0em is 58.12										

Details of opaque construction: kingsprnf\_0e

Layer	Prim	Thick	Conduc-	Density	Specif	IR	Solr	Diffu	R	Descr
	db	(mm)	tivity		heat	emis	abs	resis	m^2K/W	
Ext	49	1.0	210.000	2700.	880.	0.01	0.72	19200.	0.00	Grey cotd alum_0emis
	2	0	50.0	0.000	0.	0.	0.99	0.99	1.	0.17 air 0.17
	3	214	53.0	0.030	25.	1000.	0.90	0.30	67.	1.77 EPS
	4	214	53.0	0.030	25.	1000.	0.90	0.30	67.	1.77 EPS
Int	110	13.0	0.190	950.	840.	0.01	0.50	11.	0.07	Gypsum plasterb_0em

ISO 6946 U values (horiz/upward/downward heat flow)= 0.254 0.256 0.251  
(partition) 0.248  
Total area of kingsprnf\_0e is 112.00

Details of opaque construction: ext\_door\_0em

Layer	Prim	Thick	Conduc-	Density	Specif	IR	Solr	Diffu	R	Descr
	db	(mm)	tivity		heat	emis	abs	resis	m^2K/W	
	1	76	50.0	0.190	700.	2390.	0.01	0.65	12.	0.26 Oak_0emis

ISO 6946 U values (horiz/upward/downward heat flow)= 2.309 2.480 2.113  
(partition) 1.911  
Total area of ext\_door\_0em is 7.50

### ***A.1.2 Base case (heating) for the second group of cases – Quality Assurance report***

#### **Synopsis**

This is a synopsis of the model Basic 3 zone model, defined in bld\_basicCurtain.cfg generated on Wed Dec 19 12:35:27 2007. Notes associated with the model are in bld\_basic.log

The model is located at latitude 52.30 with a longitude difference of -10.23 from the local time meridian. The year used in simulations is 1995 and weekends occur on Saturday and Sunday. The site exposure is sky=0.50 ground=0.50 other buildings=0.00 and the ground reflectance is 0.20.

The climate used is: AMSTERDAM - NLD and is held in:  
../dbs/NLD\_Amsterdam\_IWEC  
and uses half hour centred solar data.

There are currently 4 user defined ground temperature profiles.

Ground temperatures Jan-Dec:  
4.6 2.8 3.3 5.1 6.1 9.6 11.4 13.6 14.3 12.7 7.5 5.5  
Ground temperatures Jan-Dec:  
16.1 16.1 16.6 17.6 19.5 21.4 22.4 22.9 22.1 20.5 18.1 16.7  
Ground temperatures Jan-Dec:  
5.8 5.5 6.6 8.8 11.9 13.7 15.0 15.1 13.2 10.6 7.5 6.0  
Ground temperatures Jan-Dec:  
5.2 4.8 6.1 8.7 12.2 14.3 15.7 15.9 13.6 10.7 7.1 5.4

```

Databases associated with the model:
pressure distributions : /home/georgios/esru/esp-r/databases/pressc.db1
materials             : ../dbs/chate_school.materialdb
constructions         : ../dbs/chate_school.constrdb
plant components     : /usr/esru/esp-r/databases/plantc.db1
event profiles       : /usr/esru/esp-r/databases/profiles.db1
optical properties   : EPlus

```

---

The model includes ideal controls as follows:  
Control description:  
basic controls for a simple building (no control used in roof space)

Zones control includes 3 functions.  
convective heating to 20C at 7h00 on weekdays and free floating on Saturday and Sunday. Ideal control used with 1kw capacity..

The sensor for function 1 senses a mix of db T and MRT in big\_officee.  
The actuator for function 1 is mixed convective/radiant flux in big\_officee.  
There have been 1 day types defined.

Day type 1 is valid Sun-01-Jan to Sun-31-Dec, 1995 with 1 periods.  
Per|Start|Sensing |Actuating | Control law | Data  
1 0.00 db temp > flux basic control 100000.0 0.0 100000.0  
0.0 19.0 100.0 0.0

basic control: max heating capacity 100000.0W min heating capacity 0.0W max cooling capacity 100000.0W min cooling capacity 0.0W. Heating setpoint 19.00C cooling setpoint 100.00C.

The sensor for function 2 senses a mix of db T and MRT in big\_off\_1st.  
The actuator for function 2 is mixed convective/radiant flux in big\_off\_1st.

There have been 1 day types defined.  
Day type 1 is valid Sun-01-Jan to Sun-31-Dec, 1995 with 1 periods.

Per|Start|Sensing |Actuating | Control law | Data  
1 0.00 db temp > flux basic control 100000.0 0.0 100000.0  
0.0 19.0 100.0 0.0

basic control: max heating capacity 100000.0W min heating capacity 0.0W max cooling capacity 100000.0W min cooling capacity 0.0W. Heating setpoint 19.00C cooling setpoint 100.00C.

The sensor for function 3 senses a mix of db T and MRT in big\_off\_2nd.  
The actuator for function 3 is mixed convective/radiant flux in big\_off\_2nd.

There have been 1 day types defined.  
Day type 1 is valid Sun-01-Jan to Sun-31-Dec, 1995 with 1 periods.

Per|Start|Sensing |Actuating | Control law | Data  
1 0.00 db temp > flux basic control 100000.0 0.0 100000.0  
0.0 19.0 100.0 0.0

basic control: max heating capacity 100000.0W min heating capacity 0.0W max cooling capacity 100000.0W min cooling capacity 0.0W. Heating setpoint 19.00C cooling setpoint 100.00C.

Zone to control loop linkages:

```

zone ( 1) big_officee << control 1
zone ( 2) big_off_1st << control 2
zone ( 3) big_off_2nd << control 3
zone ( 4) doublfc_grnd << control 0
zone ( 5) dblfcd_1stfl << control 0
zone ( 6) dblfcd_2ndfl << control 0

```

---



The model includes an air flow network.

Flow network description.

10 nodes, 2 components, 9 connections; wind reduction = 1.000

#	Node	Fluid	Node Type	Height	Temperature	Data_1	Data_2
1	1externSouth	air	Boundary & wind ind	4.5	0	Coef 1	Azim 180
2	2grndInterna	air	Internal & unknown	1.5	20	(-) 0	Vol 1.8
3	3_1stFl_Intr	air	Internal & unknown	4.5	20	(-) 0	Vol 1.8
4	4_2ndFl_Int	air	Internal & unknown	7.5	20	(-) 0	Vol 1.8
5	5Intoff2ndfl	air	Internal & unknown	7.5	20	(-) 0	Vol 144
6	6Int_of1stfl	air	Internal & unknown	4.5	20	(-) 0	Vol 144
7	7Int_ofGrndf	air	Internal & unknown	1.5	20	(-) 0	Vol 144
8	8ext_2ndflNo	air	Boundary & wind ind	7.625	0	Coef 1	Azim 0
9	9ext_1stNort	air	Boundary & wind ind	4.625	0	Coef 1	Azim 0
10	10ext_grNort	air	Boundary & wind ind	1.625	0	Coef 1	Azim 0

Component Type C+ L+ Description

opening 110 2 0 Specific air flow opening m = rho.f(A,dP)  
Fluid 1.0 opening area (m) 0.560

fan\_0.03m3\_s 30 2 0 Constant vol. flow rate component m = rho.a  
Fluid 1.0 flow rate (m^3/s) 0.30000E-01

#	+Node	dHght	-Node	dHght	Component	Z @+	Z @-
1	1externSouth	-1.500	2grndInterna	-4.500	opening	3.000	-3.000
2	2grndInterna	1.500	3_1stFl_Intr	-1.500	opening	3.000	3.000
3	3_1stFl_Intr	1.500	4_2ndFl_Int	-1.500	opening	6.000	6.000
4	4_2ndFl_Int	0.000	5Intoff2ndfl	0.000	opening	7.500	7.500
5	4_2ndFl_Int	0.000	6Int_of1stfl	-3.000	opening	7.500	1.500
6	4_2ndFl_Int	0.000	7Int_ofGrndf	-4.500	opening	7.500	-3.000
7	5Intoff2ndfl	1.000	8ext_2ndflNo	1.000	fan_0.03m3_s	8.500	8.625
8	6Int_of1stfl	1.000	9ext_1stNort	1.000	fan_0.03m3_s	5.500	5.625
9	7Int_ofGrndf	1.000	10ext_grNort	1.000	fan_0.03m3_s	2.500	2.625

thermal zone to air flow node mapping:

thermal zone -> air flow node  
big\_officee -> 7Int\_ofGrndf  
big\_off\_1st -> 6Int\_of1stfl  
big\_off\_2nd -> 5Intoff2ndfl  
doublfc\_grnd -> 2grndInterna  
dblfc\_d\_1stfl -> 3\_1stFl\_Intr  
dblfc\_d\_2ndfl -> 4\_2ndFl\_Int

ID	Zone Name	Volume m^3	No.	Surface Opaque	Transp	~Floor	
1	big_officee	144.0	9	155.6	24.4	48.0	big_officee describes a
2	big_off_1st	144.0	10	154.5	25.6	48.0	big_off_1st describes a
3	big_off_2nd	144.0	9	155.6	24.4	48.0	big_off_2nd describes a
4	doublfc_grnd	1.8	8	5.8	32.0	0.6	doublfc_grnd describes a
5	dblfc_d_1stfl	1.8	10	3.0	34.8	0.6	dblfc_d_1stfl describes a
6	dblfc_d_2ndfl	1.8	8	5.8	32.0	0.6	dblfc_d_2ndfl describes a
	all	437.	54	480.	173.	146.	

Zone big\_officee ( 1) is composed of 9 surfaces and 20 vertices.  
 It encloses a volume of 144.m<sup>3</sup> of space, with a total surface area of 180.m<sup>2</sup> & approx floor area of 48.0m<sup>2</sup>

There is 66.000m<sup>2</sup> of exposed surface area, 66.000m<sup>2</sup> of which is vertical.  
 Outside walls are 119.27 % of floor area & avg U of 0.245 & UA of 14.007.  
 Glazing is 18.229 % of floor & 13.258 % facade with avg U of 2.841 & UA of 24.858.

A summary of the surfaces in big\_officee( 1) follows:

Surf	Area	Azim	Elev	surface	geometry	construction	environment
	m <sup>2</sup>	deg	deg	name	type	local name	other side
1	19.0	90.	0.	Surf-2	OPAQUE	VERT extern_w_0em	< external
2	14.3	0.	0.	Surf-3	OPAQUE	VERT extern_w_0em	< external
3	24.0	270.	0.	Surf-4	OPAQUE	VERT extern_w_0em	< external
4	48.0	0.	90.	Surf-5	OPAQUE	CEIL ceilingflr	< Surf-6:
big_off_1st							
5	48.0	0.	-90.	Surf-6	OPAQUE	FLOR concr_floort	< user def
grnd profile 4							
6	3.75	0.	0.	wind_nrth	EPlus_	VERT d_glz_0em	< external
7	5.00	90.	0.	wind_east	EPlus_	VERT d_glz_0em	< external
8	15.7	180.	0.	glz_backFaca	EPlus_	VERT d_glz_faca_0	<
glz_backFaca: doublfc_grnd							
9	2.32	180.	0.	frame_backFa	OPAQUE	VERT frame_inv	<
frame_backFa:doublfc_grnd							

An hourly solar radiation distribution is used for this zone.  
 All surfaces will receive diffuse insolation (if shading not calculated).  
 No shading analysis requested.  
 No insolation analysis requested.

Shading patterns have been calculated for this zone.

Number of control periods: 1  
 Number of surfaces = 9

Period 1 start 0.00 finish 24.00  
 User specified convection coefficients  
 User supplied hc values

Surface		Inside	Outside
1 Surf-2	(VERT)	7.700	25.000
2 Surf-3	(VERT)	7.700	25.000
3 Surf-4	(VERT)	7.700	25.000
4 Surf-5	(CEIL)	10.000	10.000
5 Surf-6	(FLOR)	5.900	25.000
6 wind_nrth	(VERT)	7.700	25.000
7 wind_east	(VERT)	7.700	25.000
8 glz_backFaca	(VERT)	7.700	11.970
9 frame_backFa	(VERT)	7.700	11.970

Ventilation & infiltration is assessed via network analysis and the associated network node is: 7Int\_ofGrndf

Number of Weekday		Sat	Sun	casual gains=			6	2	2
Day	Gain Type	Period	Sensible	Latent	Radiant	Convec			
No.	labl	Hours	Magn. (W)	Magn. (W)	Frac	Frac			
Wkd 1	OccuptW	0 - 7	57.6	0.0	0.50	0.50			
Wkd 2	OccuptW	7 - 17	576.0	0.0	0.50	0.50			
Wkd 3	OccuptW	17 - 24	57.6	0.0	0.50	0.50			
Wkd 4	LightsW	0 - 7	48.0	0.0	0.50	0.50			
Wkd 5	LightsW	7 - 17	480.0	0.0	0.50	0.50			
Wkd 6	LightsW	17 - 24	48.0	0.0	0.50	0.50			
Sat 1	OccuptW	0 - 24	57.6	0.0	0.50	0.50			
Sat 2	LightsW	0 - 24	48.0	0.0	0.50	0.50			
Sun 1	OccuptW	0 - 24	57.6	0.0	0.50	0.50			
Sun 2	LightsW	0 - 24	48.0	0.0	0.50	0.50			

Zone big\_off\_1st ( 2) is composed of 10 surfaces and 20 vertices.  
 It encloses a volume of 144.m^3 of space, with a total surface area of 180.m^2 & approx floor area of 48.0m^2  
 There is 66.000m2 of exposed surface area, 66.000m2 of which is vertical.  
 Outside walls are 119.27 % of floor area & avg U of 0.245 & UA of 14.007.  
 Glazing is 18.229 % of floor & 13.258 % facade with avg U of 2.841 & UA of 24.858.

A summary of the surfaces in big\_off\_1st( 2) follows:

Surf	Area	Azim	Elev	surface	geometry	construction	environment
	m^2	deg	deg	name	type	local name	other side
1	19.0	90.	0.	Surf-2	OPAQUE VERT	extern_w_0em	< external
2	14.3	0.	0.	Surf-3	OPAQUE VERT	extern_w_0em	< external
3	24.0	270.	0.	Surf-4	OPAQUE VERT	extern_w_0em	< external
4	48.0	0.	90.	Surf-5	OPAQUE CEIL	ceilingflr	< Surf-6:
big_off_2nd							
5	48.0	0.	-90.	Surf-6	OPAQUE FLOR	floor_invert	< Surf-5:
big_officee							
6	3.75	0.	0.	wind_nrth1st	EPlus_ VERT	d_glz_0em	< external
7	5.00	90.	0.	wind_east1st	EPlus_ VERT	d_glz_0em	< external
8	16.8	180.	0.	glz_backFaca	EPlus_ VERT	d_glz_faca_0	<
glz_backFaca:dblfc_d_1stfl							
9	0.600	180.	0.	frame_backFa	OPAQUE VERT	frame_inv	<
frame_backFa:dblfc_d_1stfl							
10	0.600	180.	0.	frame_back2	OPAQUE VERT	frame_inv	< frame2:
dblfc_d_1stfl							

An hourly solar radiation distribution is used for this zone.  
 All surfaces will receive diffuse insolation (if shading not calculated).  
 No shading analysis requested.  
 No insolation analysis requested.

Shading patterns have been calculated for this zone.

Number of control periods: 1  
 Number of surfaces =10

Period 1 start 0.00 finish 24.00  
 User specified convection coefficients  
 User supplied hc values

Surface	Inside	Outside
1 Surf-2	(VERT)	7.700 25.000
2 Surf-3	(VERT)	7.700 25.000
3 Surf-4	(VERT)	7.700 25.000
4 Surf-5	(CEIL)	10.000 10.000
5 Surf-6	(FLOR)	10.000 10.000
6 wind_nrth1st	(VERT)	7.700 25.000
7 wind_east1st	(VERT)	7.700 25.000
8 glz_backFaca	(VERT)	7.700 11.970
9 frame_backFa	(VERT)	7.700 11.970
10 frame_back2	(VERT)	7.700 12.000

Ventilation & infiltration is assessed via network analysis and the associated network node is: 6Int\_of1stfl

Number of Weekday Sat Sun casual gains= 6 2 2

Day	Gain Type	Period	Sensible Magn. (W)	Latent Magn. (W)	Radiant Frac	Convec Frac
Wkd 1	OccupW	0 - 7	57.6	0.0	0.50	0.50
Wkd 2	OccupW	7 - 17	576.0	0.0	0.50	0.50
Wkd 3	OccupW	17 - 24	57.6	0.0	0.50	0.50
Wkd 4	LightsW	0 - 7	48.0	0.0	0.50	0.50
Wkd 5	LightsW	7 - 17	480.0	0.0	0.50	0.50
Wkd 6	LightsW	17 - 24	48.0	0.0	0.50	0.50
Sat 1	OccupW	0 - 24	57.6	0.0	0.50	0.50
Sat 2	LightsW	0 - 24	48.0	0.0	0.50	0.50
Sun 1	OccupW	0 - 24	57.6	0.0	0.50	0.50
Sun 2	LightsW	0 - 24	48.0	0.0	0.50	0.50

Zone big\_off\_2nd ( 3) is composed of 9 surfaces and 20 vertices.  
 It encloses a volume of 144.m^3 of space, with a total surface area of 180.m^2 & approx floor area of 48.0m^2

There is 114.00m2 of exposed surface area, 66.000m2 of which is vertical.  
 Outside walls are 119.27 % of floor area & avg U of 0.245 & UA of 14.007.  
 Flat roof is 100.00 % of floor area & avg U of 0.254 & UA of 12.177.  
 Glazing is 18.229 % of floor & 13.258 % facade with avg U of 2.841 & UA of 24.858.

A summary of the surfaces in big\_off\_2nd( 3) follows:

Sur	Area	Azim	Elev	surface	geometry	construction	environment
	m^2	deg	deg	name	type	local name	other side
1	19.0	90.	0.	Surf-2	OPAQUE VERT	extern_w_0em	< external
2	14.3	0.	0.	Surf-3	OPAQUE VERT	extern_w_0em	< external
3	24.0	270.	0.	Surf-4	OPAQUE VERT	extern_w_0em	< external
4	48.0	0.	90.	Surf-5	OPAQUE CEIL	kingspnrf_0e	< external
5	48.0	0.	-90.	Surf-6	OPAQUE FLOR	floor_invert	< Surf-
5:big_off_1st							
6	3.75	0.	0.	wind_nrth2	EPlus_ VERT	d_glz_0em	< external
7	5.00	90.	0.	wind_east2n	EPlus_ VERT	d_glz_0em	< external
8	15.7	180.	0.	glz_backFaca	EPlus_ VERT	d_glz_faca_0	<
glz_backFaca:dblfc_d_2ndfl							
9	2.32	180.	0.	frame_backFa	OPAQUE VERT	frame_inv	<
frame_backFa:dblfc_d_2ndfl							

An hourly solar radiation distribution is used for this zone.  
 All surfaces will receive diffuse insolation (if shading not calculated).  
 No shading analysis requested.  
 No insolation analysis requested.

Shading patterns have been calculated for this zone.

Number of control periods: 1  
 Number of surfaces = 9

Period 1 start 0.00 finish 24.00  
 User specified convection coefficients  
 User supplied hc values

Surface		Inside	Outside
1 Surf-2	(VERT)	7.700	25.000
2 Surf-3	(VERT)	7.700	25.000
3 Surf-4	(VERT)	7.700	25.000
4 Surf-5	(CEIL)	10.000	25.000
5 Surf-6	(FLOR)	10.000	10.000
6 wind_nrth2	(VERT)	7.700	25.000
7 wind_east2n	(VERT)	7.700	25.000
8 glz_backFaca	(VERT)	7.700	11.970
9 frame_backFa	(VERT)	7.700	11.970

Ventilation & infiltration is assessed via network analysis and the associated network node is: 5Intoff2ndfl

Day	Gain No.	Type labl	Period Hours	Sensible Magn. (W)	Latent Magn. (W)	Radiant Frac	Convec Frac
Wkd	1	OccuptW	0 - 7	57.6	0.0	0.50	0.50
Wkd	2	OccuptW	7 - 17	576.0	0.0	0.50	0.50
Wkd	3	OccuptW	17 - 24	57.6	0.0	0.50	0.50
Wkd	4	LightsW	0 - 7	48.0	0.0	0.50	0.50
Wkd	5	LightsW	7 - 17	480.0	0.0	0.50	0.50
Wkd	6	LightsW	17 - 24	48.0	0.0	0.50	0.50
Sat	1	OccuptW	0 - 24	57.6	0.0	0.50	0.50
Sat	2	LightsW	0 - 24	48.0	0.0	0.50	0.50
Sun	1	OccuptW	0 - 24	57.6	0.0	0.50	0.50
Sun	2	LightsW	0 - 24	48.0	0.0	0.50	0.50

Zone doublfc\_grnd ( 4) is composed of 8 surfaces and 16 vertices.  
 It encloses a volume of 1.80m<sup>3</sup> of space, with a total surface area of 37.8m<sup>2</sup> & approx floor area of 0.600m<sup>2</sup>

There is 18.600m<sup>2</sup> of exposed surface area, 18.600m<sup>2</sup> of which is vertical.  
 Outside walls are 486.67 % of floor area & avg U of 3.798 & UA of 11.089.  
 Glazing is 2613.3 % of floor & 84.301 % facade with avg U of 5.618 & UA of 88.090.

A summary of the surfaces in dblfcd\_grnd( 4) follows:

Surf	Area   m^2	Azim   deg	Elev   deg	surface   name	geometry   type	local   name	construction   name	environment   other side
1	2.32	180.	0.	frame_frontF	OPAQUE	VERT	frame	< external
2	0.300	90.	0.	Surf-2	OPAQUE	VERT	extern_wall	< external
3	2.32	0.	0.	frame_backFa	OPAQUE	VERT	frame	<
frame_backFa:big_officee								
4	0.300	270.	0.	Surf-4	OPAQUE	VERT	extern_wall	< external
5	0.600	0.	90.	Surf-5	fict	CEIL	fict	< fictitious:
dblfcd_lstfl								
6	0.600	0.	-90.	Surf-6	OPAQUE	FLOR	concr_floort	< user def
grnd profile 4								
7	15.7	180.	0.	outsGlz_faca	sg_fac	VERT	singglz_0emO	< external
8	15.7	360.	0.	glz_backFaca	EPlus_	VERT	dglzfaca0emI	<
glz_backFaca: big_officee								

An hourly solar radiation distribution is used for this zone.  
 All surfaces will receive diffuse insolation (if shading not calculated).  
 No shading analysis requested.  
 No insolation analysis requested.

Shading patterns have been calculated for this zone.

Number of control periods: 1  
 Number of surfaces = 8  
 Period 1 start 0.00 finish 24.00  
 User specified convection coefficients  
 User supplied hc values

Surface	Inside	Outside
1 frame_frontF (VERT)	11.970	25.000
2 Surf-2 (VERT)	11.970	25.000
3 frame_backFa (VERT)	11.970	7.700
4 Surf-4 (VERT)	11.970	25.000
5 Surf-5 (CEIL)	-1.000	-1.000
6 Surf-6 (FLOR)	-1.000	-1.000
7 outsGlz_faca (VERT)	11.970	25.000
8 glz_backFaca (VERT)	11.970	7.700

Ventilation & infiltration is assessed via network analysis and the associated network node is: 2grndInterna

Day	Gain	Type	Period	Sensible	Latent	Radiant	Convec
No.	labl	Hours	Magn. (W)	Magn. (W)	Frac	Frac	Frac
Wkd 1	OccuptW	0 - 24	0.0	0.0	0.50	0.50	
Wkd 2	LightsW	0 - 24	0.0	0.0	0.50	0.50	
Wkd 3	EquiptW	0 - 24	0.0	0.0	0.40	0.60	
Sat 1	OccuptW	0 - 24	0.0	0.0	0.50	0.50	
Sat 2	LightsW	0 - 24	0.0	0.0	0.50	0.50	
Sat 3	EquiptW	0 - 24	0.0	0.0	0.40	0.60	
Sun 1	OccuptW	0 - 24	0.0	0.0	0.50	0.50	
Sun 2	LightsW	0 - 24	0.0	0.0	0.50	0.50	
Sun 3	EquiptW	0 - 24	0.0	0.0	0.40	0.60	

Zone dblfcd\_1stfl ( 5) is composed of 10 surfaces and 16 vertices.  
 It encloses a volume of 1.80m<sup>3</sup> of space, with a total surface area of 37.8m<sup>2</sup> & user edited floor area of 0.600m<sup>2</sup>

There is 18.600m<sup>2</sup> of exposed surface area, 18.600m<sup>2</sup> of which is vertical.  
 Outside walls are 300.00 % of floor area & avg U of 3.187 & UA of 5.7357.  
 Glazing is 2800.0 % of floor & 90.323 % facade with avg U of 5.618 & UA of 94.382.

A summary of the surfaces in dblfcd\_1stfl( 5) follows:

Surf	Area   m <sup>2</sup>	Azim  deg	Elev  deg	surface   name	geometry  type	construction  local name	environment  other side
1	0.600	180.	0.	frame_frontF	OPAQUE VERT	frame	< external
2	0.300	90.	0.	Surf-2	OPAQUE VERT	extern_wall	< external
3	0.300	270.	0.	Surf-4	OPAQUE VERT	extern_wall	< external
4	0.600	0.	90.	Surf-5	fict CEIL	fict	< ficti:
dblfcd_2ndfl							
5	16.8	180.	0.	outsGlz_faca	sg_fac VERT	singglz_0emO	< external
6	16.8	0.	0.	glz_backFaca	EPlus_ VERT	dglzfaca0emI	<
glz_backFaca:big_off_1st							
7	0.600	0.	0.	frame_backFa	OPAQUE VERT	frame	<
frame_backFa:big_off_1st							
8	0.600	0.	0.	frame2	OPAQUE VERT	frame	<
frame_back2:big_off_1st							
9	0.600	180.	0.	front_frame2	OPAQUE VERT	frame	< external
10	0.600	0.	-90.	fictitious	fict FLOR	fict	< Surf-5:
doublfc_grnd							

An hourly solar radiation distribution is used for this zone.  
 All surfaces will receive diffuse insolation (if shading not calculated).  
 No shading analysis requested.  
 No insolation analysis requested.

Shading patterns have been calculated for this zone.

Number of control periods: 1  
 Number of surfaces =10

Period 1 start 0.00 finish 24.00  
 User specified convection coefficients  
 User supplied hc values

Surface		Inside	Outside
1 frame_frontF	(VERT)	12.000	25.000
2 Surf-2	(VERT)	12.000	25.000
3 Surf-4	(VERT)	12.000	25.000
4 Surf-5	(CEIL)	-1.000	-1.000
5 outsGlz_faca	(VERT)	12.000	25.000
6 glz_backFaca	(VERT)	11.970	7.700
7 frame_backFa	(VERT)	11.970	7.700
8 frame2	(VERT)	12.000	25.000
9 front_frame2	(VERT)	12.000	25.000
10 fictitious	(FLOR)	-1.000	-1.000

Ventilation & infiltration is assessed via network analysis and the associated network node is: 3\_1stFl\_Intr

Number of Weekday		Sat	Sun	casual gains=			
Day	Gain Type	Period	Sensible	Latent	Radiant	Convec	
No.	labl	Hours	Magn. (W)	Magn. (W)	Frac	Frac	
Wkd 1	OccuptW	0 - 24	0.0	0.0	0.50	0.50	
Wkd 2	LightsW	0 - 24	0.0	0.0	0.50	0.50	
Wkd 3	EquiptW	0 - 24	0.0	0.0	0.40	0.60	
Sat 1	OccuptW	0 - 24	0.0	0.0	0.50	0.50	
Sat 2	LightsW	0 - 24	0.0	0.0	0.50	0.50	
Sat 3	EquiptW	0 - 24	0.0	0.0	0.40	0.60	
Sun 1	OccuptW	0 - 24	0.0	0.0	0.50	0.50	
Sun 2	LightsW	0 - 24	0.0	0.0	0.50	0.50	
Sun 3	EquiptW	0 - 24	0.0	0.0	0.40	0.60	

Zone dblfcd\_2ndfl ( 6) is composed of 8 surfaces and 16 vertices.  
 It encloses a volume of 1.80m<sup>3</sup> of space, with a total surface area of 37.8m<sup>2</sup> & user edited floor area of 0.600m<sup>2</sup>

There is 19.200m<sup>2</sup> of exposed surface area, 18.600m<sup>2</sup> of which is vertical.  
 Outside walls are 486.67 % of floor area & avg U of 3.798 & UA of 11.089.  
 Flat roof is 100.00 % of floor area & avg U of 0.254 & UA of 0.15222.  
 Glazing is 2613.3 % of floor & 84.301 % facade with avg U of 5.618 & UA of 88.090.

A summary of the surfaces in dblfcd\_2ndfl( 6) follows:

Surf	Area	Azim	Elev	surface	geometry	construction	environment
	m <sup>2</sup>	deg	deg	name	type	local name	other side
1	2.32	180.	0.	frame_frontF	OPAQUE	VERT frame	< external
2	0.300	90.	0.	Surf-2	OPAQUE	VERT extern_wall	< external
3	2.32	0.	0.	frame_backFa	OPAQUE	VERT frame	<
frame_backFa:big_off_2nd							
4	0.300	270.	0.	Surf-4	OPAQUE	VERT extern_wall	< external
5	0.600	0.	90.	roof	OPAQUE	CEIL kingspnrfl_0e	< external
6	15.7	180.	0.	outsGlz_faca	sg_fac	VERT singglz_0emO	< external
7	15.7	0.	0.	glz_backFaca	EPlus_	VERT dglzfacal_0emI	<
glz_backFaca:big_off_2nd							
8	0.600	0.	-90.	ficti	fict	FLOR fict	< Surf-5:

An hourly solar radiation distribution is used for this zone.  
 All surfaces will receive diffuse insolation (if shading not calculated).  
 No shading analysis requested.  
 No insolation analysis requested.

Shading patterns have been calculated for this zone.

Number of control periods: 1  
 Number of surfaces = 8  
 Period 1 start 0.00 finish 24.00  
 User specified convection coefficients  
 User supplied hc values

Surface	Inside	Outside
1 frame_frontF (VERT)	12.000	25.000
2 Surf-2 (VERT)	12.000	25.000
3 frame_backFa (VERT)	11.970	7.700
4 Surf-4 (VERT)	12.000	25.000
5 roof (CEIL)	-1.000	25.000
6 outsGlz_faca (VERT)	12.000	25.000
7 glz_backFaca (VERT)	12.000	7.700
8 ficti (FLOR)	-1.000	-1.000



Ventilation & infiltration is assessed via network analysis and the associated network node is: 4\_2ndFl\_Int

Number of Weekday		Sat	Sun	casual gains=				
Day	Gain Type	Period	Sensible	Latent	Radiant	Convec		
No.	labl	Hours	Magn. (W)	Magn. (W)	Frac	Frac		
Wkd 1	OccuptW	0 - 24	0.0	0.0	0.50	0.50		
Wkd 2	LightsW	0 - 24	0.0	0.0	0.50	0.50		
Wkd 3	EquiptW	0 - 24	0.0	0.0	0.40	0.60		
Sat 1	OccuptW	0 - 24	0.0	0.0	0.50	0.50		
Sat 2	LightsW	0 - 24	0.0	0.0	0.50	0.50		
Sat 3	EquiptW	0 - 24	0.0	0.0	0.40	0.60		
Sun 1	OccuptW	0 - 24	0.0	0.0	0.50	0.50		
Sun 2	LightsW	0 - 24	0.0	0.0	0.50	0.50		
Sun 3	EquiptW	0 - 24	0.0	0.0	0.40	0.60		

Project floor area is 145.80m2, wall area is 179.39m2, window area is 74.410m2.  
 Sloped roof area is 0.00m2, flat roof area is 48.600m2, skylight area is 0.00m2.  
 There is 302.40m2 of outside surface area, 253.80m2 of which is vertical.

Outside walls are 123.04 % of floor area & avg U of 0.390 & UA of 69.936.  
 Flat roof is 33.333 % of floor area & avg U of 0.254 & UA of 12.330.  
 Glazing is 51.036 % of floor & 29.318 % facade with avg U of 4.638 & UA of 345.14.

Multi-layer constructions used:

Details of opaque construction: concr\_floort

Layer	Prim	Thick	Conduc-	Density	Specif	IR	Solr	Diffu	R	Descr
	db	(mm)	tivity		heat	emis	abs	resis	m^2K/W	
Ext	301	100.0	0.044	1.	1.	0.01	0.50	10.	3.35	virtual
2	265	250.0	0.520	2050.	184.	0.01	0.85	2.	0.48	Gravel
3	262	250.0	0.520	2050.	184.	0.90	0.85	2.	0.48	Gravel
4	32	50.0	1.400	2100.	653.	0.90	0.65	19.	0.04	Heavy mix concrete
5	32	50.0	1.400	2100.	653.	0.90	0.65	19.	0.04	Heavy mix concrete
6	32	50.0	1.400	2100.	653.	0.90	0.65	19.	0.04	Heavy mix concrete
7	32	50.0	1.400	2100.	653.	0.90	0.65	19.	0.04	Heavy mix concrete
Int	231	7.0	0.060	186.	1360.	0.01	0.60	10.	0.12	Wilton_0em

ISO 6946 U values (horiz/upward/downward heat flow)= 0.211 0.212 0.209  
 (partition) 0.207  
 Total area of concr\_floort is 48.60

Details of opaque construction: ceilingflr

Layer	Prim	Thick	Conduc-	Density	Specif	IR	Solr	Diffu	R	Descr
	db	(mm)	tivity		heat	emis	abs	resis	m^2K/W	
Ext	77	5.0	0.140	600.	1210.	0.01	0.65	14.	0.04	Floori_0emi
2	0	180.0	0.000	0.	0.	0.99	0.99	1.	0.16	air 0.16
3	32	65.0	1.400	2100.	653.	0.90	0.65	19.	0.05	Heavy mix concrete
4	32	65.0	1.400	2100.	653.	0.90	0.65	19.	0.05	Heavy mix concrete
5	0	100.0	0.000	0.	0.	0.99	0.99	1.	0.17	air 0.17
Int	154	13.0	0.380	1120.	840.	0.01	0.60	12.	0.03	Ceiling (plas_0emi)
ISO 6946 U values (horiz/upward/downward heat flow)=										1.509 1.580 1.423
(partition)										1.328
Total area of ceilingflr is										96.00

Details of opaque construction: floor\_invert

Layer	Prim	Thick	Conduc-	Density	Specif	IR	Solr	Diffu	R	Descr
	db	(mm)	tivity		heat	emis	abs	resis	m^2K/W	
Ext	154	13.0	0.380	1120.	840.	0.01	0.60	12.	0.03	Ceiling (plas_0emi)
2	0	100.0	0.000	0.	0.	0.99	0.99	1.	0.17	air 0.17
3	32	65.0	1.400	2100.	653.	0.90	0.65	19.	0.05	Heavy mix concrete
4	32	65.0	1.400	2100.	653.	0.90	0.65	19.	0.05	Heavy mix concrete
5	0	180.0	0.000	0.	0.	0.99	0.99	1.	0.16	air 0.16
Int	77	5.0	0.140	600.	1210.	0.01	0.65	14.	0.04	Floori_0emi
ISO 6946 U values (horiz/upward/downward heat flow)=										1.509 1.580 1.423
(partition)										1.328
Total area of floor_invert is										96.00

Details of opaque construction: extern\_w\_0em

Layer	Prim	Thick	Conduc-	Density	Specif	IR	Solr	Diffu	R	Descr
	db	(mm)	tivity		heat	emis	abs	resis	m^2K/W	
Ext	129	20.0	1.130	1431.	1000.	0.01	0.50	19.	0.02	
Rendering_0emis										
2	36	100.0	1.060	1950.	1000.	0.90	0.40	18.	0.09	concrete block (milton keynes)
3	0	50.0	0.000	0.	0.	0.99	0.99	1.	0.17	air 0.17
4	72	10.0	0.150	700.	1420.	0.90	0.65	576.	0.07	Plywood
5	211	70.0	0.040	250.	840.	0.90	0.30	4.	1.75	Glasswool
6	211	70.0	0.040	250.	840.	0.90	0.30	4.	1.75	Glasswool
Int	110	13.0	0.190	950.	840.	0.01	0.50	11.	0.07	Gypsum plasterb_0em
ISO 6946 U values (horiz/upward/downward heat flow)= 0.245 0.246 0.242 (partition) 0.239										
Total area of extern_w_0em is 171.75										

Details of transparent construction: d\_glz\_0em with EPlus\_WINDO5 optics.

Layer	Prim	Thick	Conduc-	Density	Specif	IR	Solr	Diffu	R	Descr
	db	(mm)	tivity		heat	emis	abs	resis	m^2K/W	
Ext	247	6.0	1.000	2710.	837.	0.01	0.05	19200.	0.01	
Plate_gl_0emi										
2	0	12.0	0.000	0.	0.	0.99	0.99	1.	0.17	air 0.17
Int	247	6.0	1.000	2710.	837.	0.01	0.05	19200.	0.01	
Plate_gl_0emi										
ISO 6946 U values (horiz/upward/downward heat flow)= 2.841 3.106 2.551 (partition) 2.262										
eplus glazing_with WINDOW5: with id of: EPlus_WINDO5										
with 3 layers [including air gaps] and visible trn: 0.78										
Direct transmission @ 0, 40, 55, 70, 80 deg										
0.594 0.563 0.499 0.346 0.151										
Layer  absorption @ 0, 40, 55, 70, 80 deg										
1 0.170 0.185 0.200 0.219 0.217										
2 0.001 0.001 0.001 0.001 0.001										
3 0.124 0.131 0.131 0.116 0.079										
Total area of d_glz_0em is 26.25										

Details of opaque construction: kingspnrf\_0e

Layer	Prim	Thick	Conduc-	Density	Specif	IR	Solr	Diffu	R	Descr
	db	(mm)	tivity		heat	emis	abs	resis	m^2K/W	
Ext	49	1.0	210.000	2700.	880.	0.01	0.72	19200.	0.00	Grey cotd alum_0emis
	2	0	50.0	0.000	0.	0.	0.99	0.99	1.	0.17 air 0.17
	3	214	53.0	0.030	25.	1000.	0.90	0.30	67.	1.77 EPS
	4	214	53.0	0.030	25.	1000.	0.90	0.30	67.	1.77 EPS
Int	110	13.0	0.190	950.	840.	0.01	0.50	11.	0.07	Gypsum plasterb_0em

ISO 6946 U values (horiz/upward/downward heat flow)= 0.254 0.256 0.251  
(partition) 0.248  
Total area of kingspnrf\_0e is 48.60

Details of opaque construction: frame

Layer	Prim	Thick	Conduc-	Density	Specif	IR	Solr	Diffu	R	Descr
	db	(mm)	tivity		heat	emis	abs	resis	m^2K/W	
Ext	323	30.0	1.530	2700.	880.	0.01	0.40	10.	0.02	Oem_framing_inver
Int	321	30.0	1.530	2700.	880.	0.88	0.40	10.	0.02	framing

ISO 6946 U values (horiz/upward/downward heat flow)= 4.780 5.580 4.013  
(partition) 3.342  
Total area of frame is 11.68

Details of transparent construction: fict with fict optics.

Layer	Prim	Thick	Conduc-	Density	Specif	IR	Solr	Diffu	R	Descr
	db	(mm)	tivity		heat	emis	abs	resis	m^2K/W	
1	322	2.0	200.000	100.	100.	0.99	0.01	10.	0.00	fictitious

ISO 6946 U values (horiz/upward/downward heat flow)= 5.882 7.142 4.762  
(partition) 3.846

fictitious surface: with id of: fict  
with 1 layers [including air gaps] and visible trn: 1.00  
Direct transmission @ 0, 40, 55, 70, 80 deg  
1.000 1.000 1.000 1.000 1.000  
Layer| absorption @ 0, 40, 55, 70, 80 deg  
1 0.000 0.000 0.000 0.000 0.000  
Total area of fict is 2.40

Details of opaque construction: frame\_inv

Layer	Prim	Thick	Conduc-	Density	Specif	IR	Solr	Diffu	R	Descr
	db	(mm)	tivity		heat	emis	abs	resis	m^2K/W	
Ext	321	30.0	1.530	2700.	880.	0.88	0.40	10.	0.02	framing
Int	323	30.0	1.530	2700.	880.	0.01	0.40	10.	0.02	

Oem\_framing\_inver

ISO 6946 U values (horiz/upward/downward heat flow)= 4.780 5.580 4.013  
(partition) 3.342  
Total area of frame\_inv is 5.84

Details of transparent construction: d\_glz\_faca\_0 with EPlus\_WINDO5 optics.

Layer	Prim	Thick	Conduc-	Density	Specif	IR	Solr	Diffu	R	Descr
	db	(mm)	tivity		heat	emis	abs	resis	m^2K/W	
Ext	242	6.0	1.000	2710.	837.	0.83	0.05	19200.	0.01	Plate glass
	2	0	12.0	0.000	0.	0.	0.99	0.99	1.	0.17 air 0.17
										0.17 0.17
Int	247	6.0	1.000	2710.	837.	0.01	0.05	19200.	0.01	

Plate\_gl\_0emi

ISO 6946 U values (horiz/upward/downward heat flow)= 2.841 3.106 2.551  
(partition) 2.262

eplus glazing\_with WINDOW5: with id of: EPlus\_WINDO5  
with 3 layers [including air gaps] and visible trn: 0.78  
Direct transmission @ 0, 40, 55, 70, 80 deg  
0.594 0.563 0.499 0.346 0.151  
Layer| absorption @ 0, 40, 55, 70, 80 deg  
1 0.170 0.185 0.200 0.219 0.217  
2 0.001 0.001 0.001 0.001 0.001  
3 0.124 0.131 0.131 0.116 0.079  
Total area of d\_glz\_faca\_0 is 48.16

Details of transparent construction: dglzfaca0emI with EPlus\_WINDO5 optics.

Layer	Prim	Thick	Conduc-	Density	Specif	IR	Solr	Diffu	R	Descr
	db	(mm)	tivity		heat	emis	abs	resis	m^2K/W	
Ext	247	6.0	1.000	2710.	837.	0.01	0.05	19200.	0.01	Plate_gl_0emi
	2	0	12.0	0.000	0.	0.	0.99	0.99	1.	0.17 air 0.17
										0.17 0.17
Int	242	6.0	1.000	2710.	837.	0.83	0.05	19200.	0.01	Plate glass

ISO 6946 U values (horiz/upward/downward heat flow)= 2.841 3.106 2.551  
(partition) 2.262

eplus glazing\_with WINDOW5: with id of: EPlus\_WINDO5  
with 3 layers [including air gaps] and visible trn: 0.78  
Direct transmission @ 0, 40, 55, 70, 80 deg  
0.594 0.563 0.499 0.346 0.151  
Layer| absorption @ 0, 40, 55, 70, 80 deg  
1 0.170 0.185 0.200 0.219 0.217  
2 0.001 0.001 0.001 0.001 0.001  
3 0.124 0.131 0.131 0.116 0.079  
Total area of dglzfaca0emI is 48.16

Details of transparent construction: singglz\_0emO with sg\_facade optics.

Layer	Prim	Thick	Conduc-	Density	Specif	IR	Solr	Diffu	R	Descr
	db	(mm)	tivity		heat	emis	abs	resis	m^2K/W	
Ext	247	4.0	1.000	2710.	837.	0.01	0.05	19200.	0.00	
Plate_gl_0emi										
Int	242	4.0	1.000	2710.	837.	0.83	0.05	19200.	0.00	Plate glass
ISO 6946 U values (horiz/upward/downward heat flow)= 5.618 6.757 4.587										
(partition) 3.731										
Direct transmission @ 0, 40, 55, 70, 80 deg										
0.726 0.704 0.657 0.533 0.315										
Layer  absorption @ 0, 40, 55, 70, 80 deg										
1 0.199 0.215 0.226 0.230 0.211										
Total area of singglz_0emO is 48.16										

DISCUSSION ON THE NUMERICAL OUTPUTS FROM THE CALCULATION  
METHODS OF THE 13790 STANDARD

## **B.1 Introduction**

The results from the comparison between the methods within the 13790 Standard were presented in Chapter 5 for two groups of building cases. The discussion was focused in that part of thesis on the differences between the rating outputs from the different calculation methods as this is the significant issue with respect to the EPBD. Appendix B will briefly discuss the results produced in terms of the numerical differences that help to investigate the sensitivity of the methods on the design variations. The discussion will be based on the results of Tables 5.1 to 5.4 that were included in chapter 5 and are not reproduced here.

## **B.2 First group of cases – Space heating results**

For the base case of the first group in Table 5.1, the annual heating energy requirements results vary between 46.3 kWh/m<sup>2</sup>-annum (ESP-r) and 61.1 kWh/m<sup>2</sup>-annum (monthly 13790), a 24.2% difference with respect to the simplified monthly method.

All calculation methods have a similar sensitivity to the different locations and climate that were used to investigate the annual heating energy requirements.

Averaging the internal gains on a daily or weekly basis did not seem to have a significant effect on the final annual heating energy requirements apart from the case where the simplified hourly method was using the same average hourly schedules every day instead of the original hourly varying internal gain schedule. The two schedules were equal on a weekly and monthly basis but the annual heating energy requirement results for the simplified hourly method varied from 48.0

kWh/m<sup>2</sup>-annum to 56.1 kWh/m<sup>2</sup>-annum (a 14.4% difference with respect to the base case result with the simplified hourly method). The results from the two dynamic simulation programs are slightly sensitive to this change and the results from the simplified monthly method remained the same for all these cases.

Differences were noticed between the annual heating energy results produced from the four methods for the case that investigated sensitivity to high internal heat gain loads. The numerical outputs vary from 31.5 kWh/m<sup>2</sup>-annum (ESP-r) to 50.7 kWh/m<sup>2</sup>-annum (monthly 13790), a 37.9% difference with respect to the monthly method. However, the numerical results for the low internal heat gains case were in close agreement for all methods.

The calculation methods were similarly sensitive to the changes on the glazing areas but small differences on the way these design changes have been accounted by the methods were again noticed.

Changing the construction of the external walls to a slightly 'lighter' construction (total internal heat capacity  $C_m=56.9$  kJ/m<sup>2</sup>K) than the base case leads to similar differences in the annual heating results as those for the base case. However, when using a heavyweight wall (total internal heat capacity  $C_m=231.56$  kJ/m<sup>2</sup>K) all methods produce results that are in a very good agreement with each other.

From the annual heating results produced for the different ventilation cases it can be concluded that averaging the pre-defined air flow schedules on a daily or weekly basis does not have a significant effect on the initial results of each method.

Rotating the base case had an effect on the annual heating results for all methods. The two simulation programs produced numerical results that were more sensitive to the building's orientation changes than the two simplified methods. For example, rotating the building 90° anticlockwise changed ESP-r's annual heating result from 46.3 kWh/m<sup>2</sup>-annum to 53.0 kWh/m<sup>2</sup>-annum, while the simplified hourly method result changed from 56.1 kWh/m<sup>2</sup>-annum to 58.7 kWh/m<sup>2</sup>-annum.



In the cases where a different heating set-point was used, all methods are similarly sensitive. Differences that were noticed for the base case can still be noticed for the different set-points used for this study.

The calculation methods were not the same sensitive for the intermittent heating cases. In these cases and when compared with the outputs for the base case, the numerical results of the simplified methods changed to a larger extent than for the simulation programs.

### **B.3 First group of cases – Space cooling results**

Table 5.2 in chapter 5 included the annual cooling results for the first group of cases. Large numerical differences between the calculation methods were noticed for the results produced for the base case and the cold climate case (Aberdeen). However, for the warmer climate (Athens) the numerical results for the base case were in close agreement.

For the different internal heat gains scenarios, the range between the annual cooling results produced from all methods was similar to the results for the base case.

Similar conclusions were drawn for the different glazing area cases. For the climate of Amsterdam the differences in the annual cooling results were considerable, while for the climate of Athens, the maximum differences were in the range of 15.9% with respect to the simplified monthly method.

As for annual heating numerical results, the annual cooling results for the different external wall constructions were in a close numerical agreement for all four methods in the case of the heavyweight walls. With the non-insulated heavyweight construction in the Amsterdam climate, the simplified monthly method's annual cooling output (27.3 kWh/m<sup>2</sup>-annum) was considerably higher than the outputs of the other three methods. It was also apparent that the simplified monthly method was

not as sensitive as the other three methods for this change on the construction of the walls when compared with the insulated heavyweight construction. For these two construction cases, the annual cooling decreases in the other three calculation methods. However, for the Athens climate, the simplified hourly method's numerical output (107.3 kWh/m<sup>2</sup>·annum) was lower than the outputs of the other three methods. The sensitivity of the simplified hourly method to this wall construction change does not seem to agree with all the other three methods.

For the different ventilation cases, the annual cooling results show again a large variation between the different calculation methods for the Amsterdam climate but are in closer agreement for the Athens climate.

Studying the numerical results under different orientations revealed small differences in some cases for both of the Athens and Amsterdam climates. It was also shown that the different methods had different sensitivity to these orientation changes. For example, the annual cooling result of the simplified hourly method for the Athens climate decreased when the building orientation was rotated 90° anticlockwise, while the annual cooling results of the other three methods increased (i.e. compared with the numerical outputs for the base case). A similar difference was noticed for the simplified monthly method's annual cooling result when the building was rotated 180° anticlockwise while using the Athens climate. In this case, the numerical result of the simplified monthly method was slightly increased in comparison with the base case result but the results of the other three methods decreased when comparing with the base case.

In the cases where a different cooling set-point was used, all methods seem to be similarly sensitive.

For the intermittent cooling cases, large differences were noticed between the annual cooling results of all four methods. The monthly method's annual cooling result for all three intermittent cooling cases remained the same, whereas the numerical results of the other three methods varied significantly.

## **B.4 Second group of cases – Space heating results**

Table 5.3 presented the annual heating results for these cases. It has been stated in chapter 5 that when both calculation methods studied the base case without the ventilated double façade, they highlighted the potential energy savings that the ventilated double south-oriented façade could offer in terms of heating requirements. However, the size of the improvement was different between the two calculation methods: the monthly method predicted an improvement from 103.4 kWh/m<sup>2</sup>·annum to 78.3 kWh/m<sup>2</sup>·annum, while ESP-r predicted an improvement from 75.1 kWh/m<sup>2</sup>·annum to 61.8 kWh/m<sup>2</sup>·annum.

In the case where the air in the façade is not distributed in the building spaces but exits from the outside upper layer of the double façade, the outputs of the two calculation methods are numerically close to each other. ESP-r predicted 74.6 kWh/m<sup>2</sup>·annum while the monthly method predicted 83.6 kWh/m<sup>2</sup>·annum, a 10.8% difference with respect to the monthly method. However, the result of ESP-r in this case is slightly different from its previous output for the case where the building was studied without the double façade (74.6 kWh/m<sup>2</sup>·annum and 75.1 kWh/m<sup>2</sup>·annum respectively), while the difference for these two cases in the results of the monthly method were large (83.6 kWh/m<sup>2</sup>·annum and 103.4 kWh/m<sup>2</sup>·annum respectively).

Both calculation methods have a similar sensitivity to the different ventilation rates for the annual heating energy calculations.

For the cases where two alternative building orientations were studied, both methods confirmed that orientating the building in a way that the double façade faces south would offer more energy savings in terms of heating requirements.

Numerical differences were also noticed for the variations on internal heat gain schedules and climate. However, both methods accounted with a similar way these design changes.

The differences on the sensitivity of the two calculation methods and on their numerical results were more evident in the cases of intermittent heating. The effect of intermittency had in all three cases of Table 5.3 a greater effect on the reduction of the heating load in the monthly method than in the simulation program.

### **B.5 Second group of cases – Space cooling results**

The positive effect of the ventilated double facade in terms of energy savings for cooling purposes can be noticed from the results of Table 5.4 for both calculation methods. However, ESP-r predicted that the double façade has a larger impact on the cooling energy requirements (29.9% improvement: from 91 kWh/m<sup>2</sup>·annum to 63.8 kWh/m<sup>2</sup>·annum) than that predicted by the monthly method (11% improvement: from 122.1 kWh/m<sup>2</sup>·annum to 108.7 kWh/m<sup>2</sup>·annum).

In general, the cooling numerical outputs between the calculation methods are considerably different from each other. For example, for the case where the building is orientated such that the double façade faces north, the monthly method predicted 81.5 kWh/m<sup>2</sup>·annum while ESP-r predicted 36.2 kWh/m<sup>2</sup>·annum, which is 55.6% lower than the monthly method's result.

Both calculation methods were sensitive to the design variations for all the continuous cooling cases. However, the results of the monthly method did not vary for any of the three intermittent cooling cases (i.e. always 78.1 kWh/m<sup>2</sup>·annum), while the results of ESP-r varied from 18.4 kWh/m<sup>2</sup>·annum to 42.6 kWh/m<sup>2</sup>·annum depending on what time of the day cooling was imposed to the spaces.

BASE CASE - FIRST GROUP OF CASES: HEAT GAINS AND LOSSES  
ANALYSIS

### **C.1 Introduction**

This Appendix provides details of the heat gains and losses that were extracted from the monthly method of the 13790 Standard, the ESP-r program and, where possible, the EnergyPlus program. The purpose of this is to confirm that the methods were applied correctly during the comparison of chapter 5 and that the reasons for any of the differences that were noticed in that chapter was not caused by mistakes on the calculations of heat gains and losses. However, this exercise can still not guarantee that there are no mistakes on the code of the methods. To investigate the accuracy and robustness of the methods it is necessary to perform more detailed validation studies as those described in chapter 6.

The barriers for extracting and comparing the calculated heat gains and losses are briefly discussed in this Appendix. The discussion is limited to the heating energy requirements calculations for the base case of the 1<sup>st</sup> group of cases but the same principles apply for any of the cases used in chapter 5.

### **C.2 Heat gains and losses outputs**

It has been mentioned in chapter 5 that the calculations of energy losses with the monthly method of the 13790 Standard are based on the operative temperature, while in ESP-r and EnergyPlus are based on the air temperature. In order to exclude this difference between the calculation methods, a period when these temperatures are close to each other has been selected for the comparison of the heat gains and losses. It was decided to use January month for this purpose because during this period, the air temperature in the building spaces does not often exceed the heating set-point and it is close to the operative temperature. This can be confirmed from the ESP-r and

EnergyPlus temperature results. For example, the average air temperature in the building spaces during this month has been reported from ESP-r as 19.28 °C and from EnergyPlus as 19.22 °C. Moreover, the climate data used for this case (Amsterdam location) were such that no cooling is required during this month.

The results are presented in Table C.1:

	<i>ESP-r</i>	<i>EnergyPlus</i>	<i>13790 Standard monthly method</i>
<i>Ventilation heat loss:</i>	<i>9652 MJ</i>	<i>9757 MJ</i>	<i>9590 MJ</i>
<i>Internal heat gains:</i>	<i>7249 MJ</i>	<i>7249 MJ</i>	<i>7325 MJ</i>
<i>Solar heat gains:</i>	<i>2812 MJ</i>	<i>N/A</i>	<i>2716 MJ</i>
<i>Heating requirements:</i>	<i>12553 MJ</i>	<i>12983 MJ</i>	<i>13681 MJ</i>

Table C.1: Base case - Available heat gains and losses for January period

Difficulties arose with the extraction of solar gains from the simulation programs. It was not possible to extract the solar gains from EnergyPlus and it was not either a straightforward process to obtain them from ESP-r. To achieve this with ESP-r, it was necessary to run two simulations: a first simulation with all the inputs as for the normal base case model but with controls that were set to maintain the set-point at the same fixed temperature over the year (i.e. operative temperature of 19 °C) and a second simulation similar to the first one but without processing the effect of the sun, i.e. without solar heat gains (this is possible to be set from the “simulation toggles” menu of ESP-r). The differences between the loads of the two simulations gave the solar gains that were used in the base case of the first group of cases. In conclusion, it can be seen that although the values of these heat gains and losses are close between the calculation methods, the resulted heating and cooling loads from the simulation programs were still different than the outputs of the monthly method. The resulted heating load during the January month, for example, was 13681 MJ for the monthly method, 12553 MJ for ESP-r and 12983 MJ for EnergyPlus. The differences on the heating loads for this case study become larger during the months close to the

beginning and the end of the heating and cooling season. The reason for this is that the monthly averaging of inputs and boundary conditions that is used in the simplified monthly method ignores the possible dynamic changes within months, while detailed simulation programs are accounting for these dynamics.

FULL SET OF RESULTS FROM THE OPTIMISATION OF MONTHLY'S METHOD NUMERICAL PARAMETERS

**D.1 Introduction**

Details on the optimisation of the numerical parameters that are used in the monthly method of the 13790 Standard were given in chapter 5. With regard to this optimisation, the most important outputs for the first group of cases and the whole set of outputs for the second group of cases were also shown in chapter 5. The full set of optimisation results for the first group of cases is presented in this Appendix.

**D.2 Full set of optimisation results (First group of cases)**

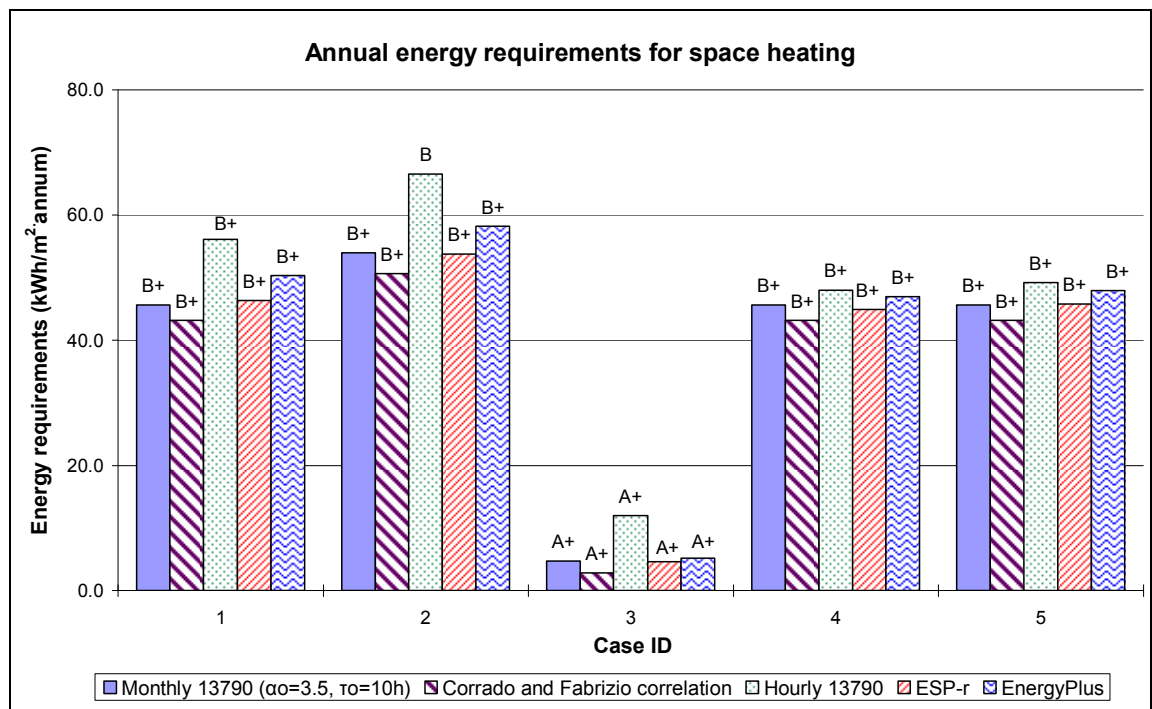

Figure D.1: Annual heating energy requirements (kWh/m<sup>2</sup>·annum), Cases 1-5 (optimisation)



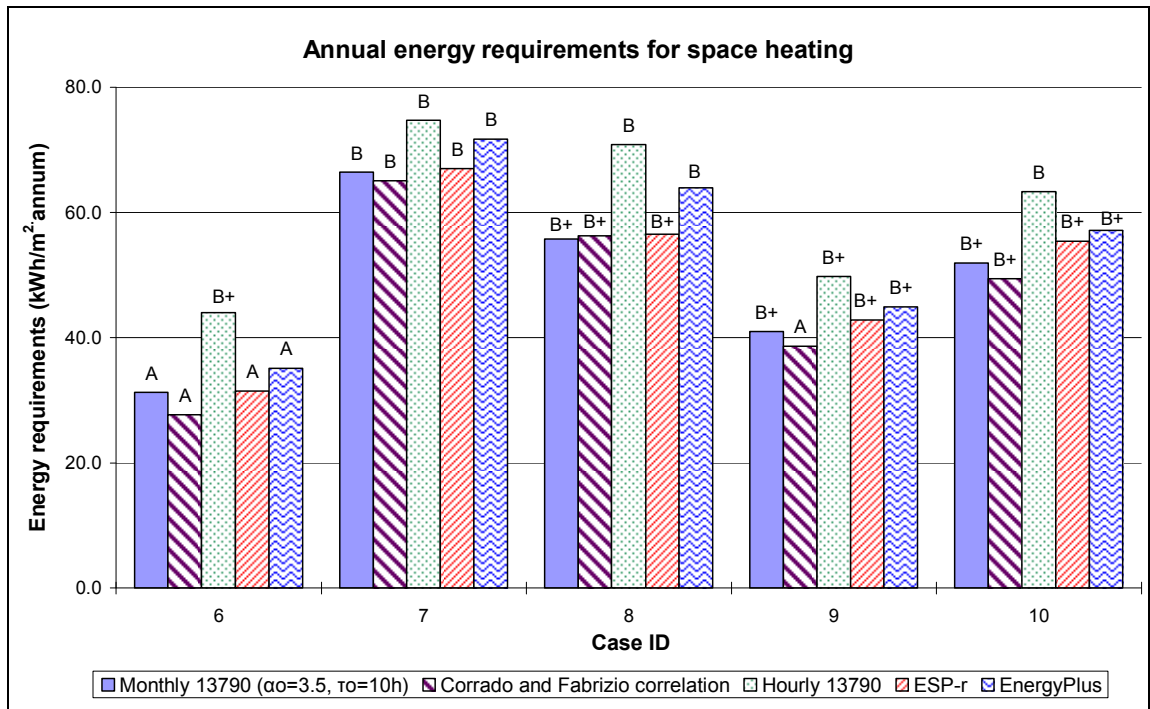

Figure D.2: Annual heating energy requirements ( $\text{kWh/m}^2\text{-annum}$ ), Cases 6-10 (optimisation)

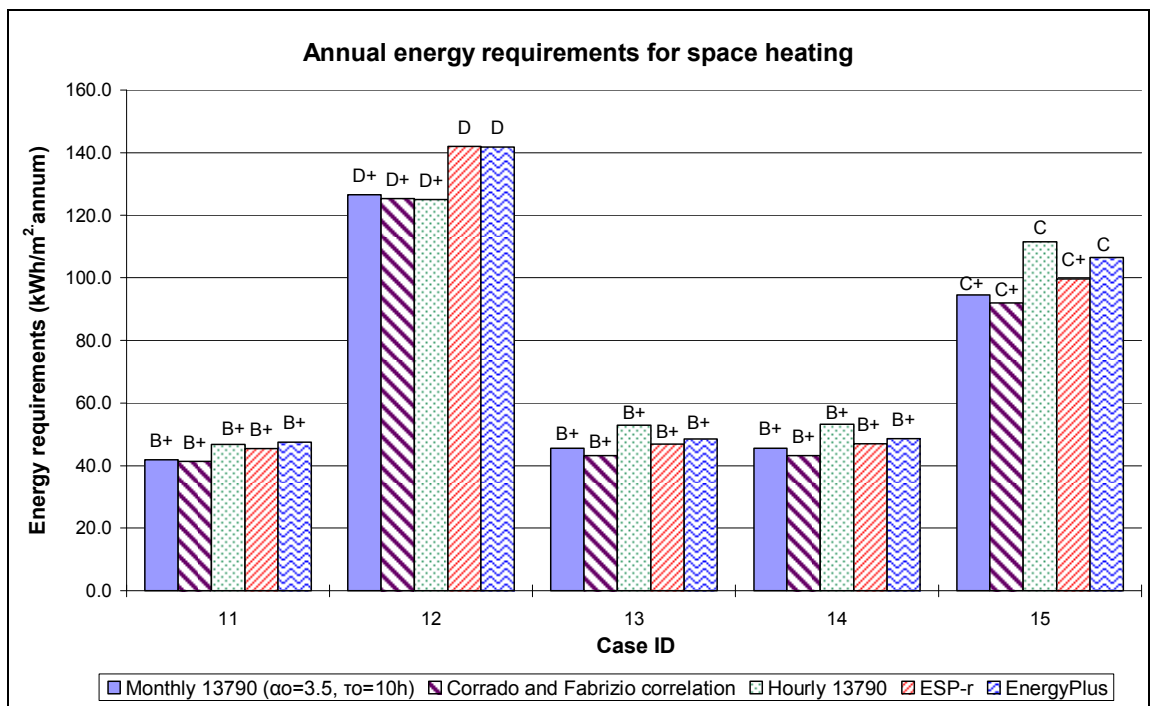

Figure D.3: Annual heating energy requirements ( $\text{kWh/m}^2\text{-annum}$ ), Cases 11-15 (optimisation)

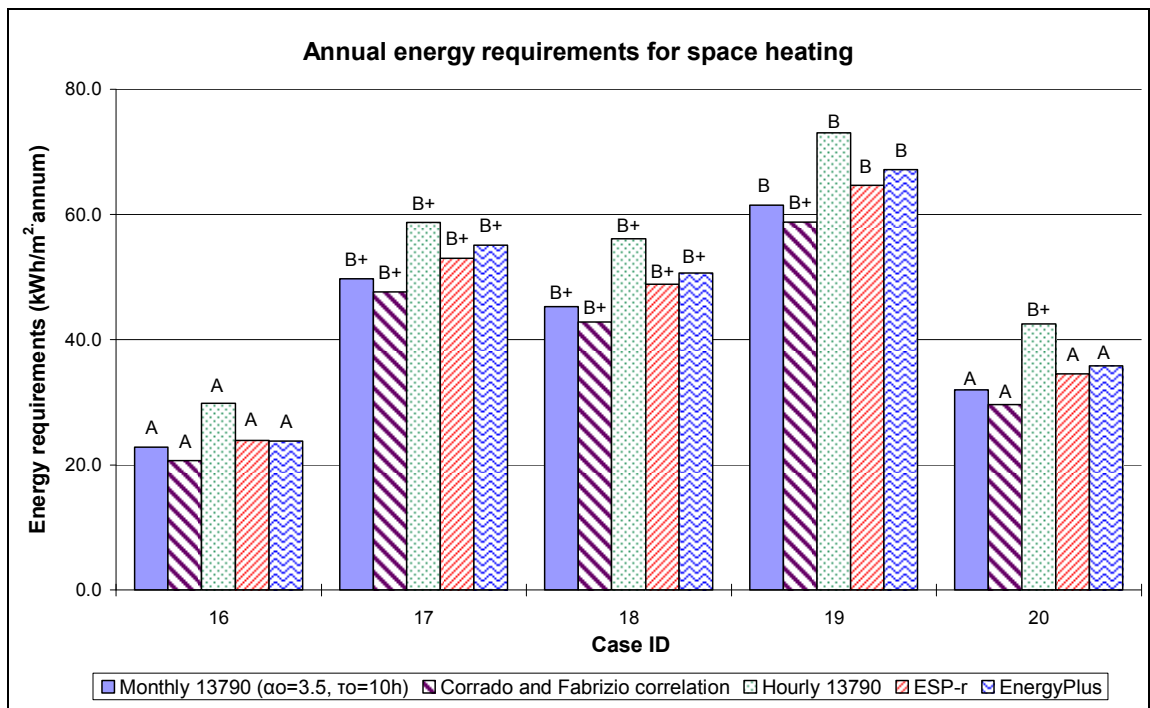

Figure D.4: Annual heating energy requirements (kWh/m<sup>2</sup>·annum), Cases 16-20 (optimisation)

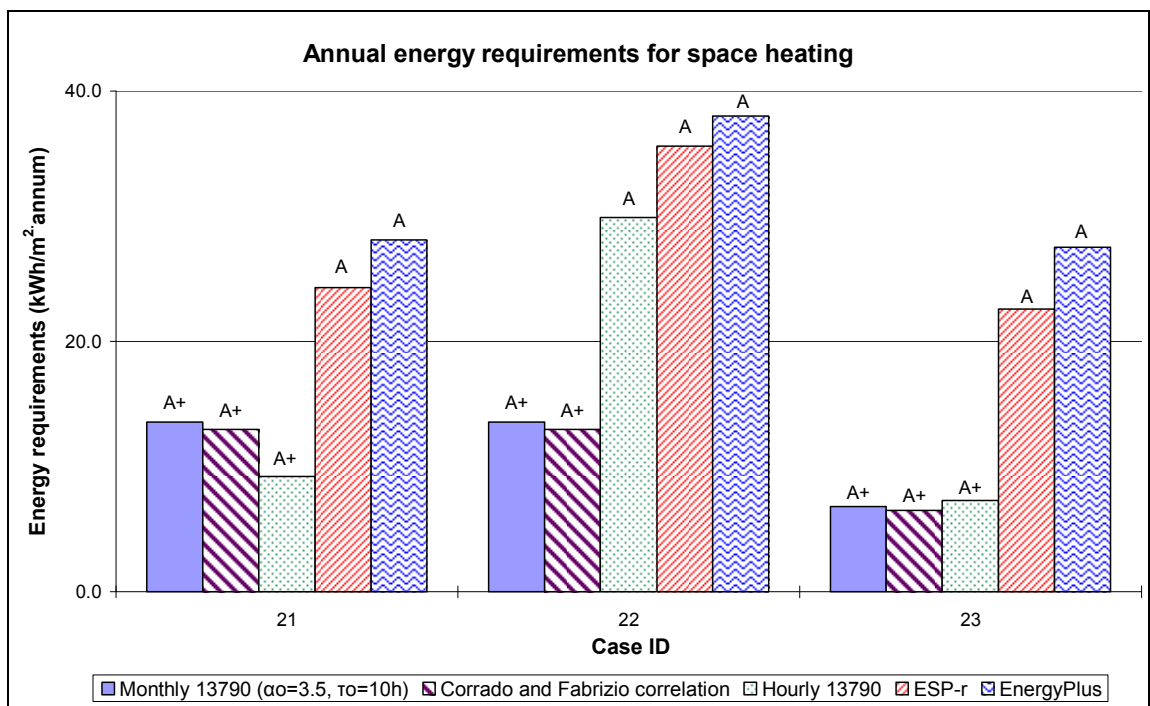

Figure D.5: Annual heating energy requirements (kWh/m<sup>2</sup>·annum), Cases 20-23 (optimisation)

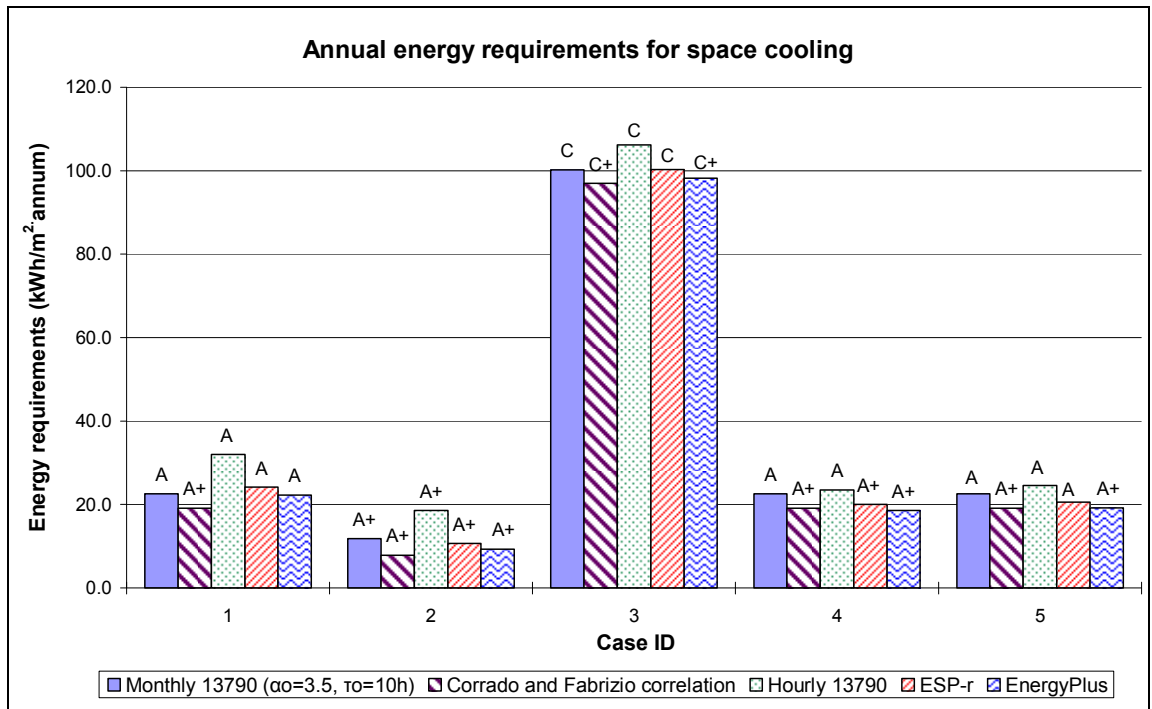

Figure D.6: Annual cooling energy requirements (kWh/m<sup>2</sup>·annum), Cases 1-5 (optimisation)

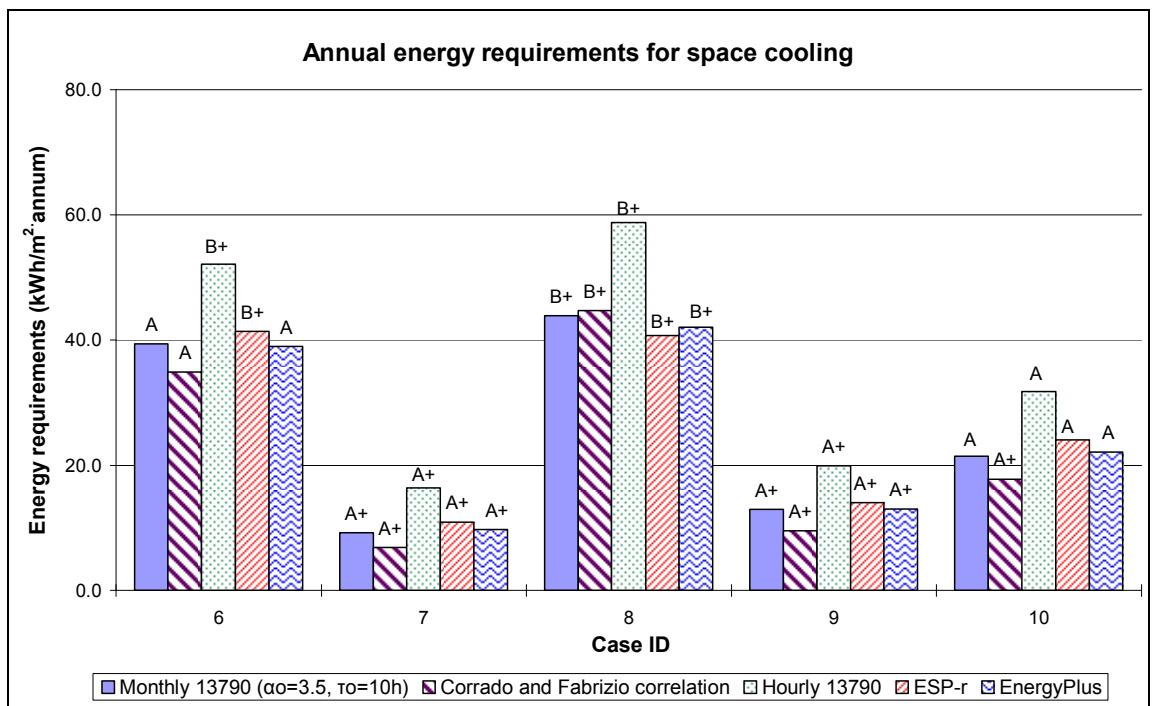

Figure D.7: Annual cooling energy requirements (kWh/m<sup>2</sup>·annum), Cases 6-10 (optimisation)

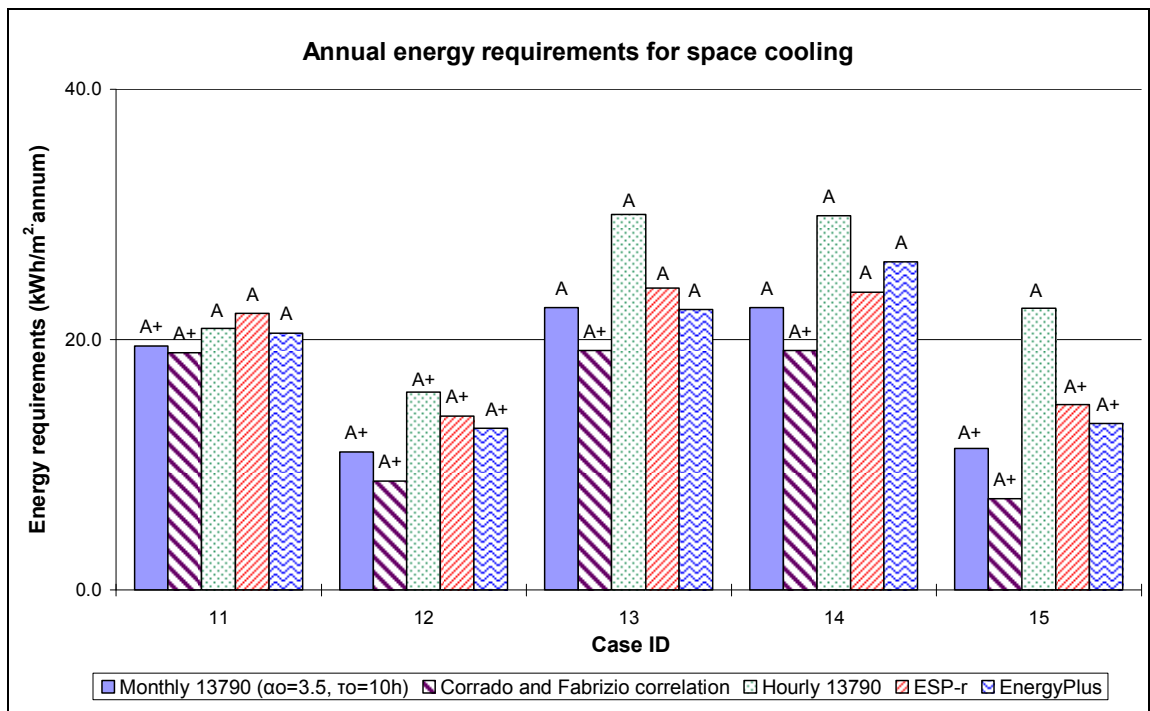

Figure D.8: Annual cooling energy requirements (kWh/m<sup>2</sup>·annum), Cases 11-15 (optimisation)

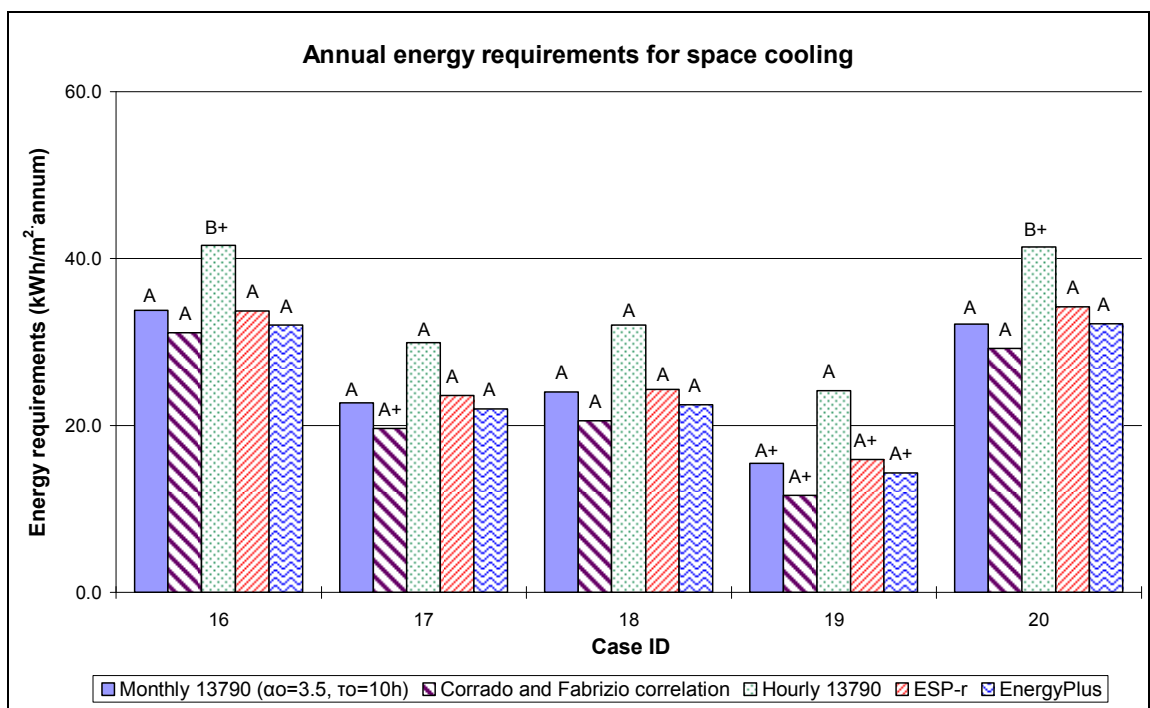

Figure D.9: Annual cooling energy requirements (kWh/m<sup>2</sup>·annum), Cases 16-20 (optimisation)

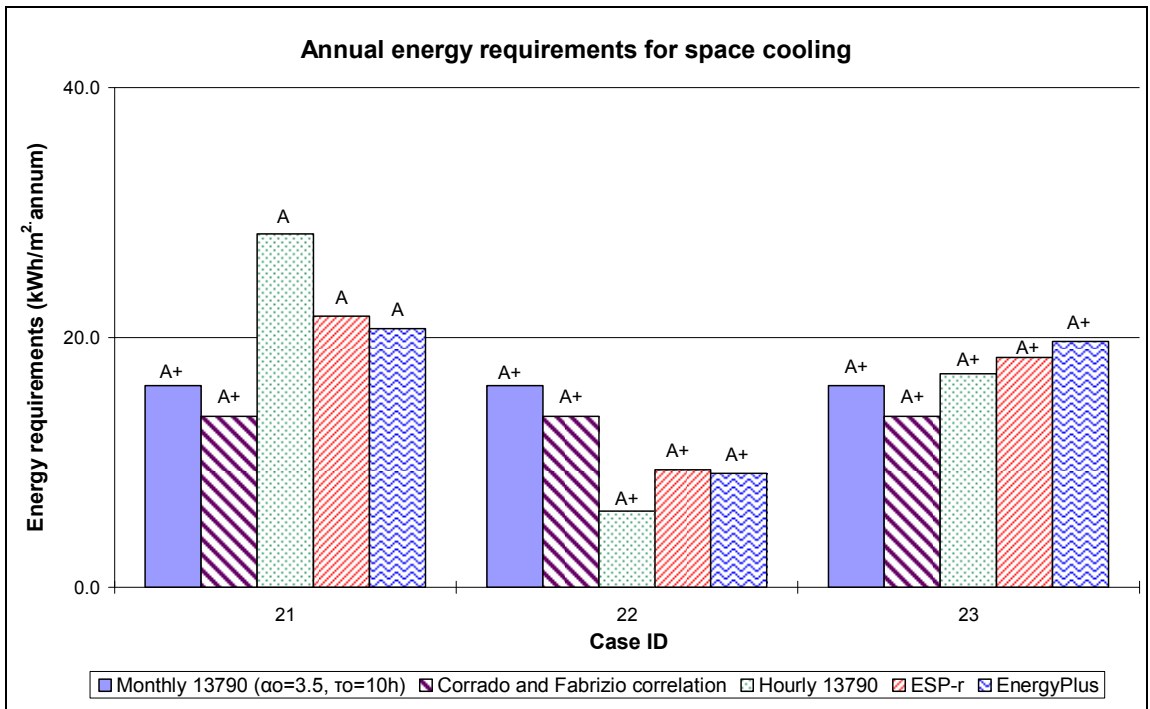

Figure D.10: Annual cooling energy requirements (kWh/m<sup>2</sup>·annum), Cases 20-23 (optimisation)

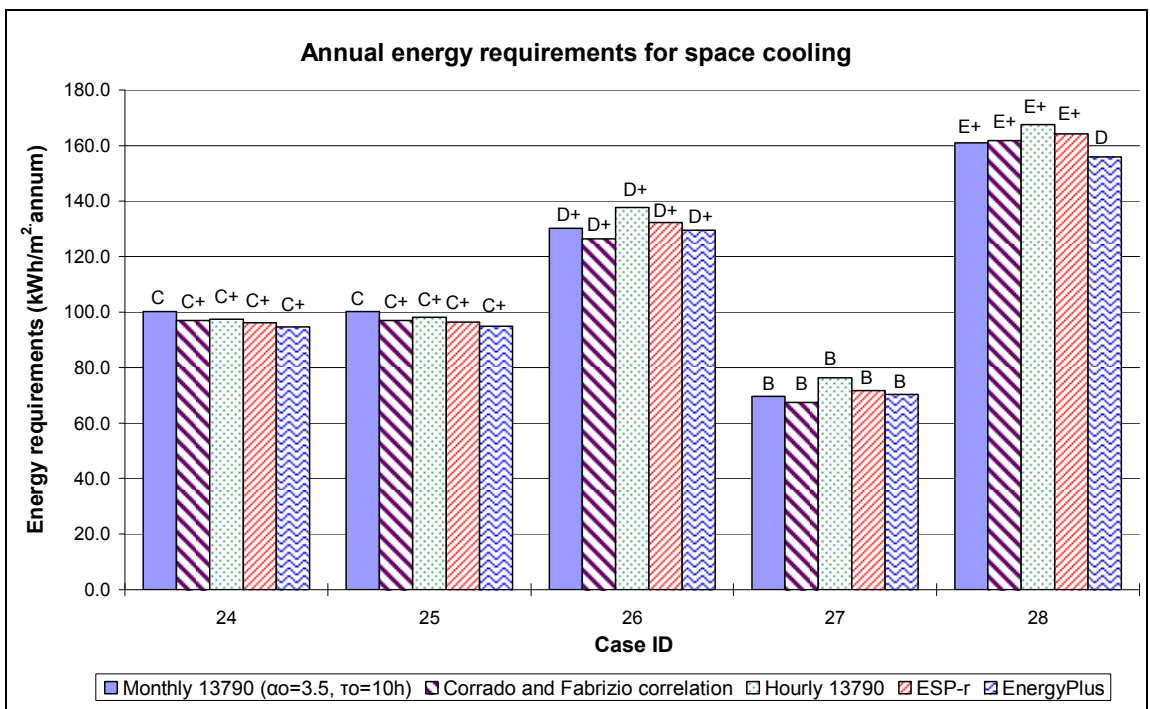

Figure D.11: Annual cooling energy requirements (kWh/m<sup>2</sup>·annum), Cases 24-28 (optimisation)

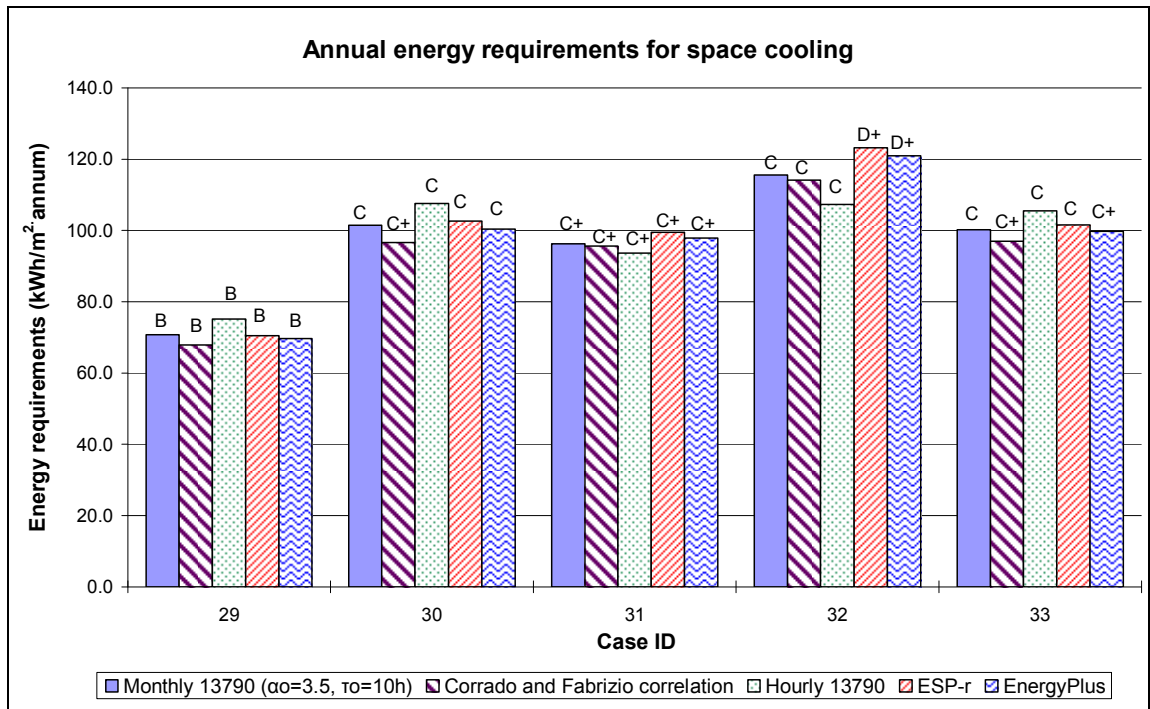

Figure D.12: Annual cooling energy requirements ( $\text{kWh/m}^2\text{-annum}$ ), Cases 29-33 (optimisation)

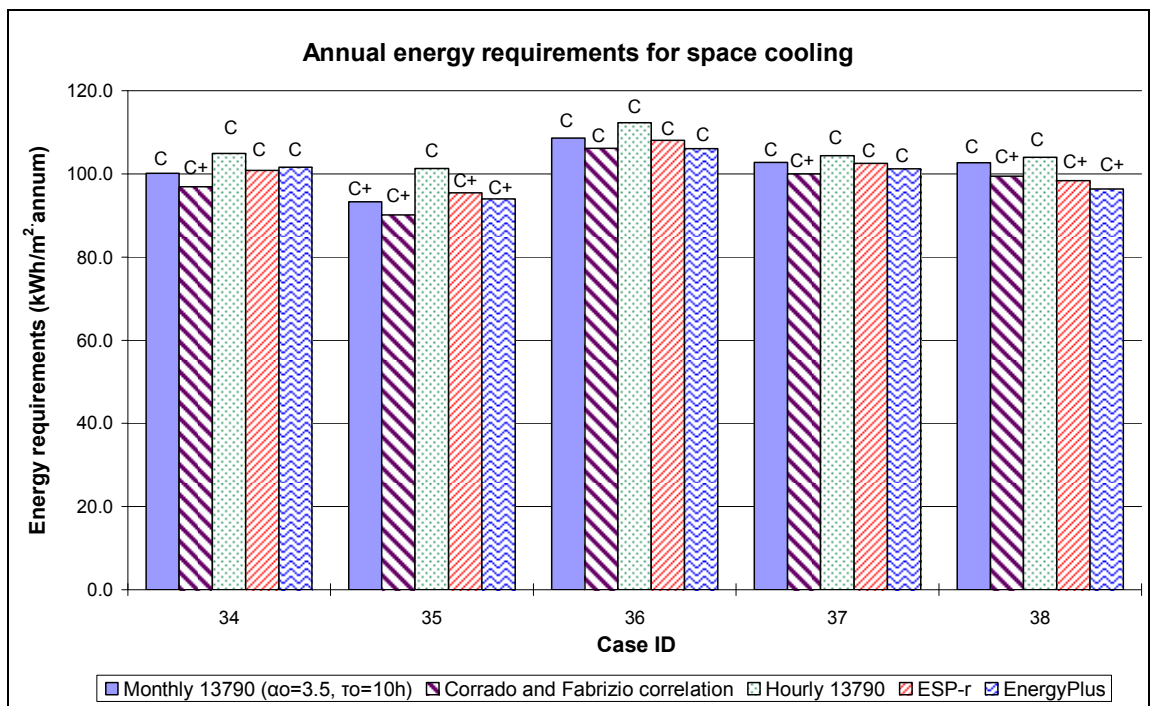

Figure D.13: Annual cooling energy requirements ( $\text{kWh/m}^2\text{-annum}$ ), Cases 34-38 (optimisation)

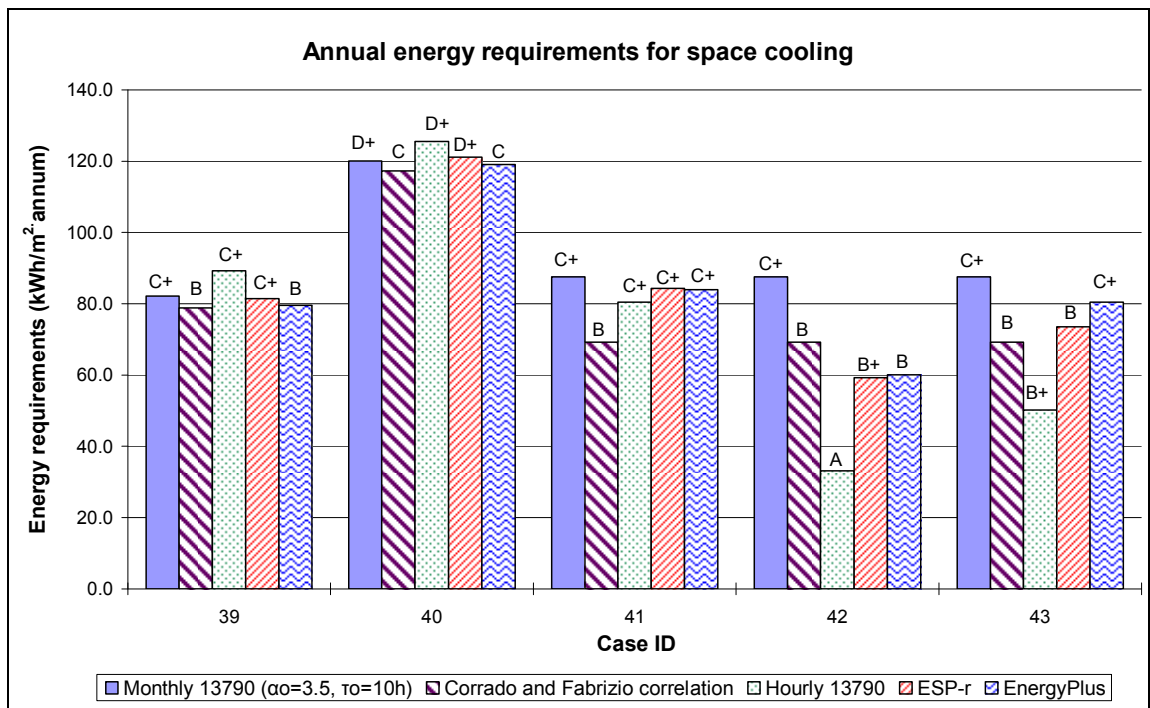

Figure D.14: Annual cooling energy requirements (kWh/m<sup>2</sup>-annum), Cases 39-43 (optimisation)

EMBEDDING THE CEN 15265 VALIDATION TESTS WITHIN ESP-r

### **E.1 Introduction**

CEN 15265 Standard (2007) includes validation tests for the calculation of energy needs for space heating and cooling. The Standard is prescriptive and it includes four informative (non-compulsory) tests and eight normative tests. Annual heating and cooling energy requirements should be calculated for all the tests that are described by a one thermal zone model of simple geometry. A complete description of the specifications is not given in this Appendix, which will only focus on the integration of the tests within the embedded validation of ESP-r and the results obtained from this exercise.

It should be stated that there is no documentation in the Standard on what was the basis for deciding the Standard's reference values that determine the accuracy of programs. In an external publication (Millet, 2007), the reference values of these programs are given and it is reported that a number of different software programs were used to produce the reference results. The publication shows then a chart with ESP-r being one of these programs. However, this does not agree with the prior to this thesis official version of ESP-r and it was not probably possible at the time this chart was produced because specific code had to be developed as part of this thesis to follow precisely the 15265 Standard's specifications. The development of the specific to this Standard code was relatively difficult for novice developers. In particular, code had to be developed for:

- imposing global solar radiation on vertical west facing surfaces in order to follow the given climate data in the Annex of the Standard
- accounting for time shifting of all schedules between summer and winter (paragraph 8.3.1 in 15265 Standard)



It is not therefore clear of how the reference values inside the 15265 Standard were determined, especially if ESP-r (without the code changes described above) was one of the programs used for determining these values. This is another case that demonstrates the importance of embedding these tests within the simulation program in order to allow users who do not have experience with code development to assess the program’s predictions.

The predictions of ESP-r for these tests as reported from the embedded validation facility are given in section E.2. The predictions of ESP-r are within the “level A” accuracy range ( $\pm 5\%$  from the reference values) for all eight normative tests. They are also within this limit for all four informative (non-compulsory) tests, with an exception being the annual cooling result of Test 4 where the program’s prediction is within the “level C” accuracy range ( $\pm 15\%$  from the reference values).

Annex J of the 13790 Standard gives the predictions of the simplified monthly and hourly methods for the validation test case 6 of the 15265 Standard. These are summarised in Table E.1 together with ESP-r’s result for the specific test.

<i>CEN 15265 - Test 6 (one thermal zone – 19.8 m<sup>2</sup> of floor area)</i>	<i>15265 “level A” reference values</i>	<i>Monthly 13790</i>	<i>Hourly 13790</i>	<i>ESP-r</i>
<i>Annual Heating (kWh)</i>	<i>509.8</i>	<i>571</i>	<i>537</i>	<i>487.1</i>
<i>Annual Cooling (kWh)</i>	<i>185.1</i>	<i>213</i>	<i>177</i>	<i>195.7</i>

Table E.1: Results for Test 6 of 15265 Standard (kWh per annum)

## **E.2 Results from implementation of CEN 15265 Standard**

This section includes the predictions of ESP-r for the 15265 Standard tests as provided by the embedded validation facility of ESP-r (using the file-output option):

Test: EN ISO15265:2007 Annual heating/cooling load - Test\_1\_Level\_A

Output description	Simulation	Range	Minimum	Maximum	Previous result*
	result	check	bound	bound	
Test_1 Annual_heating	748.0	inside	699.0	797.0	748.0
Test_1 Annual_cooling	-229.5	inside	-282.9	-184.7	-233.8

\*previous results from: 15265\_reference\_result

-----

Test: EN ISO15265:2007 Annual heating/cooling load - Test\_2\_Level\_A

Output description	Simulation	Range	Minimum	Maximum	Previous result*
	result	check	bound	bound	
Test_2 Annual_heating	726.7	inside	676.5	768.9	722.7
Test_2 Annual_cooling	-202.7	inside	-246.7	-154.3	-200.5

\*previous results from: 15265\_reference\_result

-----

Test: EN ISO15265:2007 Annual heating/cooling load - Test\_3\_Level\_A

Output description	Simulation	Range	Minimum	Maximum	Previous result*
	result	check	bound	bound	
Test_3 Annual_heating	1352.	inside	1298.	1439.	1369.
Test_3 Annual_cooling	-26.33	inside	-113.6	9999.	-43.00

\*previous results from: 15265\_reference\_result

-----

Test: EN ISO15265:2007 Annual heating/cooling load - Test\_4\_Level\_A

Output description	Simulation	Range	Minimum	Maximum	Previous result*
	result	check	bound	bound	
Test_4 Annual_heating	601.8	inside	462.4	672.4	567.4
Test_4 Annual_cooling	-1275.	outside	-1636.	-1426.	-1531.

\*previous results from: 15265\_reference\_result

-----

Test: EN ISO15265:2007 Annual heating/cooling load - Test\_4\_Level\_C

Output description	Simulation	Range	Minimum	Maximum	Previous result*
	result	check	bound	bound	
Test_4 Annual_heating	601.8	inside	252.6	882.2	567.4
Test_4 Annual_cooling	-1275.	inside	-1846.	-1216.	-1531.

\*previous results from: 15265\_reference\_result

-----

Test: EN ISO15265:2007 Annual heating/cooling load - Test\_5\_Level\_A

Output description	Simulation	Range	Minimum	Maximum	Previous result*
	result	check	bound	bound	
Test_5 Annual_heating	438.6	inside	429.8	496.4	463.1
Test_5 Annual_cooling	-214.9	inside	-235.0	-168.4	-201.7

\*previous results from: 15265\_reference\_result

-----

Test: EN ISO15265:2007 Annual heating/cooling load - Test\_6\_Level\_A

Output description	Simulation	Range	Minimum	Maximum	Previous result*
	result	check	bound	bound	
Test_6 Annual_heating	487.1	inside	475.0	544.6	509.8
Test_6 Annual_cooling	-195.7	inside	-219.9	-150.3	-185.1

\*previous results from: 15265\_reference\_result

-----

Test: EN ISO15265:2007 Annual heating/cooling load - Test\_7\_Level\_A

Output description	Simulation	Range	Minimum	Maximum	Previous result*
	result	check	bound	bound	
Test_7 Annual_heating	1035.	inside	1013.	1122.	1067.
Test_7 Annual_cooling	-15.37	inside	-73.80	9999.	-19.50

\*previous results from: 15265\_reference\_result

-----

```

Test: EN ISO15265:2007 Annual heating/cooling load - Test_8_Level_A
Output description      Simulation      Range      Minimum      Maximum      Previous
                        result        check      bound        bound        result*
Test_8 Annual_heating   319.8         inside    240.9        385.5        313.2
Test_8 Annual_cooling   -1074.        inside    -1206.        -1061.       -1133.
*previous results from: 15265_reference_result
-----

```

```

Test: EN ISO15265:2007 Annual heating/cooling load - Test_9_Level_A
Output description      Simulation      Range      Minimum      Maximum      Previous
                        result        check      bound        bound        result*
Test_9 Annual_heating   722.6         inside    701.8        792.4        747.1
Test_9 Annual_cooling   -183.8        inside    -203.6        -113.0       -158.3
*previous results from: 15265_reference_result
-----

```

```

Test: EN ISO15265:2007 Annual heating/cooling load - Test_10_Level_A
Output description      Simulation      Range      Minimum      Maximum
Previous
                        result        check      bound        bound
result*
Test_10 Annual_heating  590.6         inside    535.9        612.5        574.2
Test_10 Annual_cooling -159.1        inside    -230.7        -154.1       -192.4
*previous results from: 15265_reference_result
-----

```

```

Test: EN ISO15265:2007 Annual heating/cooling load - Test_11_Level_A
Output description      Simulation      Range      Minimum      Maximum
Previous
                        result        check      bound        bound
result*
Test_11 Annual_heating  1357.         inside    1325.         1466.        1395.
Test_11 Annual_cooling -11.64        inside    -84.50        9999.        -14.10
*previous results from: 15265_reference_result
-----

```

```

Test: EN ISO15265:2007 Annual heating/cooling load - Test_12_Level_A
Output description      Simulation      Range      Minimum      Maximum
Previous
                        result        check      bound        bound
result*
Test_12 Annual_heating  551.6         inside    460.4        606.6        533.5
Test_12 Annual_cooling -878.5        inside    -1001.        -855.2       -928.3
*previous results from: 15265_reference_result
-----

```

### **E.3 References**

EN 15265. 2007. *Thermal performance of buildings – Calculation methods of energy use for space heating and cooling – General criteria and validation procedures*. Brussels, Belgium.

Millet J.R. 2007. *The simple hourly of prEN 13790: a dynamic method for the future*. Proceeding of Clima 2007 Well Being Indoors. Helsinki, Finland.