

Advanced Experimental Medical Diagnostic System Design and Realization

M. Penhaker, M. Stankus, M. Prauzek, O. Adamec, T. Peterek, M. Cerny, V. Kasik

FEECS, Department of Measurement and Control, VSB – Technical University of Ostrava, 17. listopadu 15, Ostrava – Poruba, Czech Republic, phone: +420 597323510, e-mails: marek.penhaker@vsb.cz, martin.stankus@vsb.cz, michal.prauzek@vsb.cz, ondrej.adamec@vsb.cz, tomas.peterek@vsb.cz, martin.cerny@vsb.cz

crossref <http://dx.doi.org/10.5755/j01.eee.117.1.1060>

Introduction

The reading out of biological signals is very actual topic recently. There is wide range of biological signals to measure from and on the live organism. Live organism produces a lot of different signals, from the electrical, mechanical, magnetic, acoustic, optical and chemical ones. Especially the electrical signal called the bioelectrical signal is very important for clinicians to determine live organism's conditions. That is why the bioelectrical signals are required to measure and evaluate in most cases.

Biopotential electrodes places on live organisms and scanning the signals are active sensors – source of electrochemical half cell voltage with frequency range 0 – 0.5 Hz and source of measured biological signal with frequency range 0.5 – 1 kHz. A signal from biopotential electrodes is conducted into medical electronics for processing. Those medical electronics devices for measuring biological signal are unique concerning the requirements which are non-interchangeable with standard electronic measuring devices used in electronic industry generally.

Problem definition

The electronics used for bioelectrical signals measurement has specific requirements for experimental and practical use. These requirements concerns especially the bioelectrical signals measured from living organisms. The first main requirement on electronics is to have high input impedance (10 -100 M Ω) due to electrode-skin electrochemical connection. The second requirement is amplification ability (400 – 20000) of bioelectrical signals measured from hundreds of μ V to tens mV with low basic noise. The third important requirement is electronic device's ability for simultaneously multi-channel measuring with uniform time base for further signal processing [1].

Biomedical data acquisition device have to fulfill some specific needs. Device and bio-amplifiers have to be of modular construction allowing for easy swap of application specific analogue frontends. Another important attribute is production cost. The lower the production cost per device is, the easier the large scale deployment is. However the cost of the device has to be balanced with device quality and performance.

Data Acquisition Unit. Moreover, design of device for biomedical data acquisition is driven by some general requirements. Ability to acquire multiple signals simultaneously is definitely required. Because measured biomedical signals are inevitably correlated, input channels of data acquisition device have to be synchronized. Another way for synchronization of data acquisition is to arrange for constant inter-channel time delay. Data transport delay is not an issue as acquired data are typically not meant for purpose of real time control.

Number of input channels depends on bio-signal measurement type normally is used one to six with sampling frequency of 2 kHz and 12 bit ADC resolution per channel. Medical instruments have to be safe for measured subject. In this case, electrical circuits directly connected to measured subject have to be galvanically isolated from mains voltage. As data acquisition device can be powered from data processing workstation, device has to implement galvanical isolation of application specific analogue frontends. Connectivity of proposed device with data processing workstation should be straightforward and simple. USB technology seems to be suitable for both fast data transport and device powering. It should be noted that experimental biomedical data acquisition device is not typical in hospital measurement device. Simplicity of data acquisition and ease of use in different software development platforms is more important than full scale support of various data acquisition software interfaces most frequently. Proprietary software library implementing low

level functionality and exposing simple application programming interface to data processing application is optimal solution of required device interfacing [2].

There are wide range data acquisition units on the market. But most of them are not engineered for low signal (μV and mV) measurement or they are not galvanically isolated from mains voltage. The existing one (ADInstruments, Gtec, Biopac) fulfil of previous assumption but concerning constant signal conditioning and uniform time base in multi-channel measurement is unidentifiable. This data acquisition devices information insufficiency or un-ability to measure this bio-signals makes the further signal analysis impracticable. An example of such signal analysis is continuous noninvasive blood pressure (cNIBP) determination. In the measurement are electrocardiographycal and plethysmographycal signal measured. From both on body signal transmission time is established the value of cNIBP as far as the uniform time baseline for both signals the same.

Bio-optical Signal Amplifier of Photoplethysmography.

A photoplethysmograph (PPG) is an optically obtained plethysmograph (Fig. 1). The PPG is often obtained by using a pulse oximeter, which illuminates skin and measures changes in light absorption on specific wave length (625nm – 920nm). The conventional pulse oximeter monitors perfusion of blood to the dermis and subcutaneous tissue of the skin. With each cardiac cycle the heart pumps blood to the periphery. Even though this pressure pulse is somewhat damped by the time, it reaches the skin and it is enough to distend the arteries and arterioles in the subcutaneous tissue.

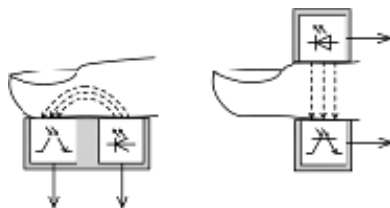

Fig. 1. Principle of reflex or transmission sensor in photoelectric plethysmograph

There are many modules (Envitec, Masimo, Technicare, etc.) with digital and analog output. These modules have the automatic correction of the signal amplitude. Changing of the signal correction automatically harm the relevant medical interpretation in some cases due to signal distortion.

Bio-electrical Signal Amplifier of Electrocardiography.

A modern Electrocardiography (ECG) use very integrated and complex circuit design. All components change some part of the ECG signal and signal is modified too. This paper explain, among others, way how to obtain raw ECG signal with basic filters without all noise factor such as complicated hardware and software filtration algorithm etc. Another serious issue is driven right leg circuit Fig. 2. Clear and no deformed ECG signals are measured by this right leg concept and then it is easy used to obtained data for next analysis.

There are many commercials modules (Corscience, Medlab, Cardex, Envitec, Biopac, ADInstrument etc.) with analog or digital outputs, but no one are brought clear and really raw signal as required concept too.

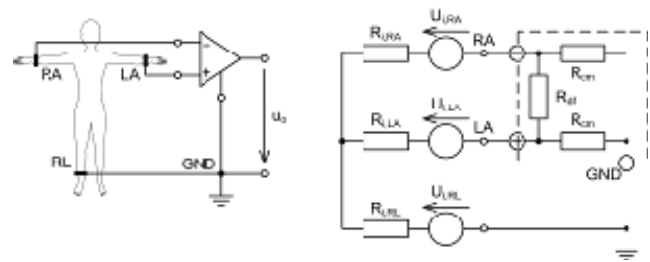

Fig. 2. Principle of bipolar three leading wire circuit with driven right leg noise elimination

This paper is aimed at design of en modular cheep and high quality balanced electronic device for multi-channel biomedical signals acquisition. This device respects the requirements for standard medical electronic devices including the electrical safety in human medicine definitely.

Advanced medical diagnostic system suggestion

The proposed modular medical diagnostics system consists of three parts Fig. 3. The first one is data acquisition unit (DAU) completed with two bio-amplifier units. The first one is bioelectrical amplifier for electrocardiography (ECG) measurement and the second one is for bio-optical signal amplification of photoplethysmography (PPG) measurement.

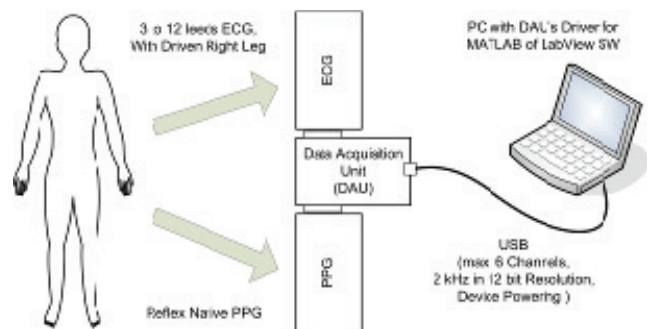

Fig. 3. Concept of advanced medical diagnostics system suggestion

Concept of advanced medical diagnostic system represents the main data acquisition unit for analog-digital conversion equipped with USB bus. This modular solution makes it possible to combine proposed PPG of ECG module or to connection by another type of bio-amplifier with multi-channel [3].

Data Acquisition Unit Suggestion. Biomedical data acquisition device is composed of several functional blocks Fig. 4. All data manipulation functionality is implemented using single microcontroller (MCU). This microcontroller reads data from analog to digital converter (ADC) via serial peripheral interface (SPI) bus.

Acquired data are formatted into data packets and sent to workstation by USB bus for subsequent processing and evaluation. Whole device is powered by USB bus sourcing voltage of 5 V. MCU and unisolated side of SPI bus isolator are powered by 3.3 V power rail provided by low dropout regulator (LDO) which is in turn powered from 5V USB power rail. Galvanical isolation is achieved by isolation of power rail and SPI bus. For this purpose, dedicated isolated DC/DC converter and SPI bus isolator

are used. Analogue front ends are connected using two inputs with three channels each. These analogue front ends and isolated side of SPI bus isolator are powered by isolated 5 V power rail providing total current of 100 mA [4].

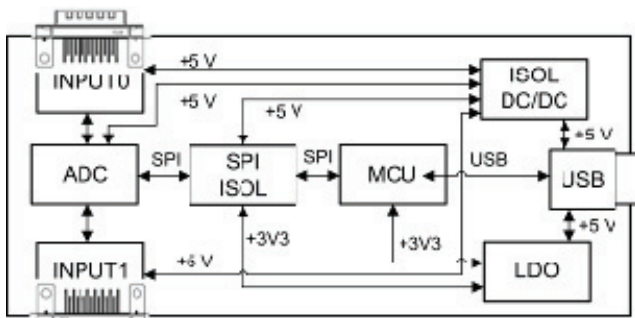

Fig. 4. Data acquisition device unit function block diagram

PPG Unit Suggestion. The new solution contains the photoplethysmography sensor as first element of the measurement chain Fig. 5. This sensor is used for linear photoplethysmograph sensing. The device uses reflex method of plethysmography. The infrared emission is reflected from finger and it is scanned by the infrared detector.

The current-voltage convector is the next step of the analog signal processing. There is signal converted from current to voltage form for next elaboration. The rest of the module is active amplifiers with exactly defined amplification and linear filters.

The high pass filter is first in the measurement chain. It has to filter direct current and sensor offset, the critical frequency is set to 0.3 Hz and the filter also contains the amplification.

Data Acquisition Unit is implemented on three layer PCB. Extra ground plane layer improves signal integrity and reduces radio frequency interference caused by DC to DC converter. As can be seen on Fig. 4 and Fig. 7, device is spatially divided into communication part containing MCU and LDO and isolated part containing ADC and analogue input connectors. Boundary between these two parts is formed of isolated DC/DC converter and SPI bus isolator. USB bus provides power for both Data Acquisition Unit and connected analogue frontends. Analogue frontends are provided with isolated 5V power rail. Total power available for both analogue frontends is 500 mW [5].

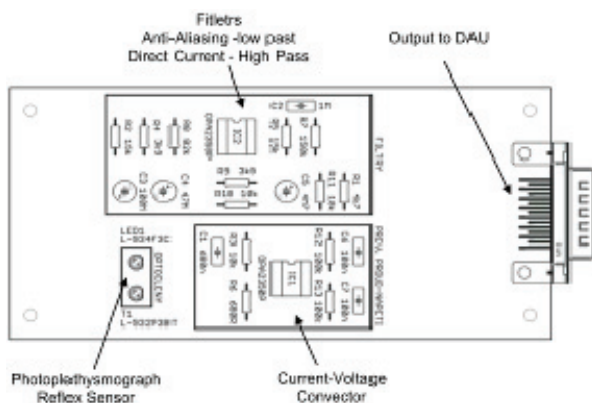

Fig. 5. PPG unit function block diagram

ECG Unit Suggestion. The design of ECG device unit is made to measure ECG signal that has specific parameters. The measured amplitude range can be between 0.5 mV and 5 mV. The frequency range standard for diagnostic purposes set up between 0.05 Hz and 150 Hz. The signal measured from the body surface is also influenced by various artifacts, such as breathing, moving, lack electrodes contact and system hum or high-frequency interference from other devices. This is why it is very important to make precise data preprocessing so that the measured bio-signals are well amplified and without mentioned artifacts.

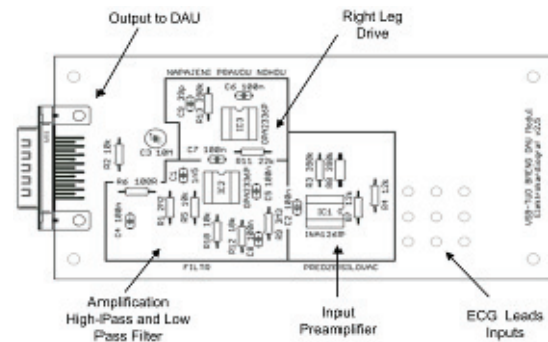

Fig. 6. ECG unit function block diagram

The proposed analog measuring chain consists of an input preamplifier, a high-pass filter, an amplifier, a right leg drive and a low-pass filter Fig. 6. Each part is designed with high respect to real signal i.e. shape of signal is minimal deformed during passage the measuring chain.

Advanced medical diagnostic system realisation

Whole device is of modular design. Data Acquisition Unit as well as analogue frontends is realized as printed circuit boards. These boards are connectable using D-SUB15 connectors. Each of these two connectors bears three analog channels and power.

Hardware Data Acquisition Unit Implementation. Data Acquisition Unit is implemented on three layer PCB. Extra ground plane layer improves signal integrity and reduces radio frequency interference caused by DC to DC converter. As can be seen on Fig. 4 and Fig. 7, device is spatially divided into communication part containing MCU and LDO and isolated part containing ADC and analogue input connectors. Boundary between these two parts is formed of isolated DC/DC converter and SPI bus isolator. USB bus provides power for both Data Acquisition Unit and connected analogue frontends. Analogue frontends are provided with isolated 5V power rail. Total power available for both analogue frontends is 500 mW [6].

Software Data Acquisition Unit Implementation. Firmware driving Data Acquisition Unit uses vendor provided USB stack. USB stack is fed with ADC data from FIFO buffer. Use of this buffer is vital as timing of USB operations and timing of finite state machine driving ADC read operations are inherently asynchronous (USB is host-centric bus). Start of ADC read cycle is triggered by hardware timer. Although sampling period provided by timer is accurate, there are other factors contributing to

slight temporal errors (see Fig. 12). These errors are discussed in following chapter.

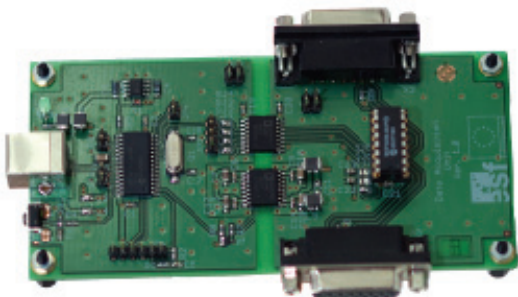

Fig. 7. Hardware realization of data acquisition unit on four layer PCB with advanced EMC protection

PPG Unit Realization. The realization of PPG unit is composed into five blocks. The input part represents the infrared LED transmitter and receiver, current-voltage converter and filters with amplification Fig. 8. The A/D converter is not included in device, because the prime application of the device is analog signal preprocessing a filtration only. The combination of the simple elements forms unique simple device for sensing of photoplethysmography record.

Infrared radiation (IR) is electromagnetic radiation with the wavelength in the range of 0.7 and 300 micrometers, which equates to the frequency range of approximately 1 and 430 THz.

The infrared LED IRL81a was used as a transmitter of emission. This device works on wavelength 870 nm, which is ideal for the plethysmography measurement. The IR LED works from 1.2 V power supply.



Fig. 8. PPG hardware realization

The NPN phototransistor LPT80a was chosen to receive IR emission from the transceiver because relative spectral sensitivity of this transistor is in the same range as the IR transmitter. The transmitter and receiver are placed on the plethysmography board and both devices are turned to the same direction. The IR emission is reflected from the finger.

The operational amplifier OPA2350 is used for active filter solution. The circuit is made by CMOS technology and it is optimized for low voltage and high speed operation. Rail-to-rail input/output makes them ideal to be used in the plethysmography device.

ECG Unit Realization. In a case of electrocardiography realization the input preamplifier is arranged by an instrumentation amplifier (INA126, Texas Instruments) that rejects common-mode noise from the electrodes and

amplifies only the differential input voltage. The amplification is set up at about 8 times to avoid the saturation of the preamplifier.

The right leg drive in the feedback is used, as well, to improve the noise rejection. It inverts the absolute value of the common-mode noise and sends it back to the patient through the electrode on the right leg.

The high-pass filter eliminates low frequency components from the ECG signal up to the frequency of 0.1 Hz. This filter is often realized by the integrating amplifier (basically low-pass) placed as the negative feedback for the instrument amplifier. In the instrument amplifier is low frequency subtracted from output signal. And then it works as high pass filter.

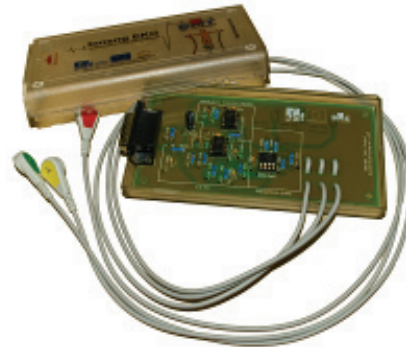

Fig. 9. ECG hardware realization with leads to electrodes

The ECG signal needs to be amplified to appropriate level 5 V maximum. The main amplification is realized by an inverting operational amplifier (OPA2335, Texas Instruments). The total amplification of the measuring chain is requested at least 1000 to render the ECG signal usable. The preamplifier amplifies the input signal 8 times so that there is need to amplify it by this operational amplifier only 130 times. But in this case is used amplifier 220 times for higher peak-peak voltage.

Using a low-pass filter is necessary to reject high frequency noises by defining the frequency spectrum of the signal to the acceptable range for displaying. Its lower critical frequency is 150 Hz and it is made again by the RC elements in the feedback of this amplifier.

Measurement and tests

With that all units were realized and completed separately the first animation were done. There were used laboratory power source, oscilloscope and ECG FLUKE 7000DP and Index 2 Pulse Oximeter Simulator tester for PPG a ECG units function verification.

The data acquisition unit was programmed (MCU) for data harvesting and USB bus transmission protocol. Then after the testing signal from signal generator (± 3.5 V, sin wave 30 Hz and rectangle 1:1) were driven on six channels at once. The software in LabView prepared for measure stored the data into file within system time for each channel. The simple discounts of each channel ratify the operation rightness.

After the particular function test the complete Advanced Medical Diagnostics System were approved on humans Fig. 10. The synchronous ECG and PPG signal were first time measured by proposed solution and verified the quality of biological signal concerning to level of noise.



Fig. 10. Complete ready to test advanced medical diagnostic system

Drivers and Software Testing. Software for testing and visualization biomedical signal has been developing in LabView 2010 because of its friendly user interface and easy possibility communication with a dynamic link library which operate with DAU. The main requirements for software have been determined as easy user interface with read and display data in real-time comprehensive possibility to store data into file for a further processing.

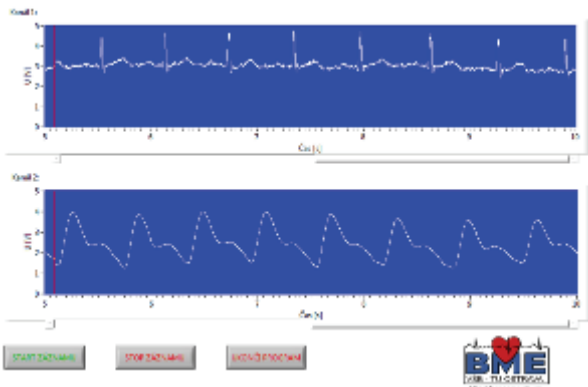

Fig. 11. Testing software screen with measured native biological signals

The communication between LabView and DAU is realized by a dynamic link library, which is a module that contains functions and data that can be used in another application. The DLL contains three inner important functions. First of all it is necessary to open the DAU interface. It is realized by calling `daufaceOpen` functions. If the opening DAU interface passes correctly the algorithm goes to another step. It is necessary delete samples which were saved in to the FIFO stack; it precludes a time axis distortion. This step is realized by calling `FlushFifos` function. Now the algorithm is ready for regular data collection. The merit of algorithm is made by never-ending loop. In the testing application The couple of samples are collected in each iteration. According to a key on a analog module the algorithm recognizes if ECG or PPG a ECG is measured. Both biological signal comes from PPG a ECG could be display in one of two separate charts. The software is on the picture (Fig. 11)

DAU data synchronization test. All data manipulation of biomedical data acquisition device is implemented using single microcontroller. This functionality includes implementation of USB stack, finite state machine driving periodical reading of input ADC channels and FIFO buffer connecting both USB stack and ADC finite state machine. Required computational performance of microcontroller is

dependent on numerous factors including number of input channels and required sampling frequency. 16 bit microcontroller with performance of 16 MIPS is adequate for device with 6 input channels, each with sampling frequency of 2 kHz and 12 bit resolution.

Time delay between sampling of individual data channels is caused by two factors. First factor is clock frequency of SPI bus connecting microcontroller and ADC. This frequency is limited mainly by transport delay of SPI bus galvanical isolator and round trip data delay inside of ADC. Second factor is time needed by microcontroller to process particular sample and issue read command for next sample. Aggregate time delay caused by these two factors (SPI bus frequency of 1 MHz and 16 bit 16 MIPS microcontroller) was measured as roughly 30 μ s with some minor random deviations.

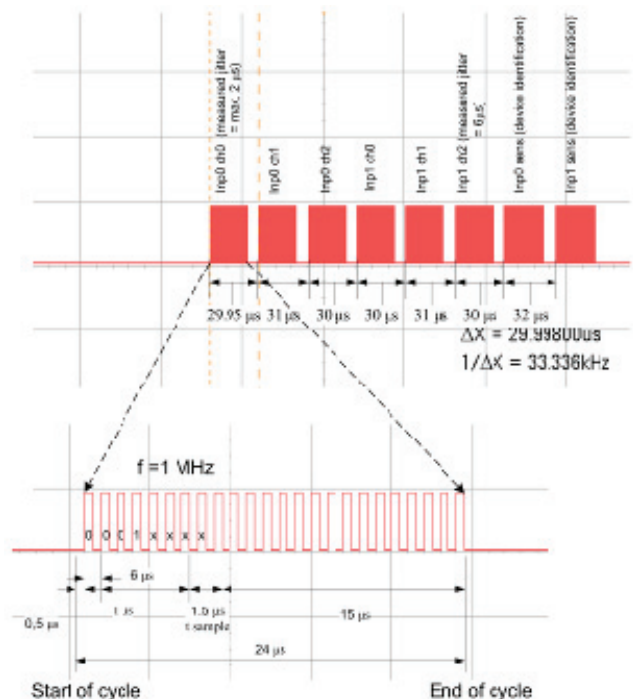

Fig. 12. SPI bus timing – inter-channel delay and sampling frequency jitter

One of the key factors affecting performance of biomedical data acquisition device is jitter of sampling period. Jitter of first sample in cycle was measured as 2 μ s, jitter of last sample in cycle was measured as 6 μ s. These jitters cause some aperture error which is deemed acceptable considering implementation of whole data manipulation using single microcontroller.

Experimental test shown the PPG unit works without any surrounding light disturbance into the measured blood volume in human finger. Advantage of this solution was cross glass test. There were placed the 2 mm glass plate from between PPG sensor and finger. The PPG record was 77 % of original amplitude. This test validates presumption of measurement eventuality for example in personal body weight installation or self checking procedure as embedded electronics in daily use in domestic consumers.

Simultaneously were discovered another application of designed PPG electronic as crossbar. The PPG sensor can be used as optical crossbar sensor for 1.7 m indoor installation too.

Conclusions

The goal of this work was design and realization of modular experimental medical diagnostic system which is up to date. There were realized three units for measuring the bio-signals with reasonable costs (in comparison with others) and appropriate quality. The laboratory and experimental tests showed that the high quality photoplethysmography and electrocardiography signals with uniform time base unit can be measured out of supplementary signal processing. This system is ready to be use as laboratory and experimental instrument for wide range of bio-signal measurement for further analysis. Along the system employment the supplementary function of photoplethysmography unit were tested. The possibility of door gap in maximum 1.7 m distance in indoor can applied.

Acknowledgements

The work and the contribution were supported by the project: Ministry of Education of the Czech Republic under Project 1M0567 "Centre of applied electronics", student grant agency SV 4501141 "Biomedical engineering systems VII" and TACR TA01010632 "SCADA system for control and measurement of process in real time". Also supported by project MSM6198910027 Consuming Computer Simulation and Optimization.

References

1. **Cerny M.** Movement Monitoring in the HomeCare System // In IFMBE proceedings. – Dossel–Schleger, Berlin:Springer, 2009. – Iss. 25.
2. **Adam K. A., Garani G., Samaras N., Srovnal V., Koziorek J., Kasik V., Kotzian J.** Design and Development of Embedded Control System for a Lime Delivery Machina // In Proceedings of the 10th Wseas International Conference Mathematical Methods and Computational Techniques (MMACTEE' 08), 2008. – P. 186–192.
3. **Skapa J., Vasinek V., Siska P.** Analysis of Optical–Power Redistribution for Hybrid Optical Fibers // Fiber Optic Sensors and Applications, 2007. – Vol. 6770. DOI: 10.1117/12.752587.
4. **Krejcar O., Janckulik D., Motalova L.** Architecture, Development and Testing of Home Care Biomedical System. // Vehicular Technology Conference Fall (VTC 2009–Fall). – IEEE Conference Publishing Services, Piscataway, NJ, USA, 2009. – P. 2108–2113. <http://dx.doi.org/10.1109/VETECF.2009.5378908>.
5. **Brida P., Machaj J., Benikovsky J., Duha J.** An Experimental Evaluation of AGA Algorithm for RSS Positioning in GSM Networks // Electronics and Electrical Engineering. – Kaunas: Technologija, 2010. – No. 8(104). – P. 113–118.

Received 2011 03 19

Accepted after revision 2011 05 02

M. Penhaker, M. Stankus, M. Prauzek, O. Adamec, T. Peterek, M. Cerny, V. Kasik. *Advanced Experimental Medical Diagnostic System Design and Realization // Electronics and Electrical Engineering.* – Kaunas: Technologija, 2012. – No. 1(117). – P. 89–94.

The aim of this work is to design and realize the experimental diagnostic instrument for biological data measurement. In the biomedical engineering daily live work is necessary to measure and analyze wide range of variables coming primary from humans or animals. There are measured mostly electrical signals from in vivo or in vitro from the subjects. Concerning these requirements we proposed the cheap and quality balanced measuring device for six channels with 2 kHz and 12 bit ADC resolution equipped with USB bus. Concerning our requirements were realized the photoplethysmography and electrocardiography module connected into measuring device to realize practical bio-signal measurements and tests. Ill. 12, bibl. 5 (in English; abstracts in English and Lithuanian).

M. Penhaker, M. Stankus, M. Prauzek, O. Adamec, T. Peterek, M. Cerny, V. Kasik. *Išplėstinės eksperimentinės medicininės diagnostinės sistemos projektavimas ir realizacija // Elektronika ir elektrotechnika.* – Kaunas: Technologija, 2012. – Nr. 1(117). – P. 89–94.

Šio darbo tikslas yra suprojektuoti ir realizuoti eksperimentinį diagnostinį instrumentą biologiniams duomenims matuoti. Biomedicininės inžinerijos kasdieniniame darbe reikia matuoti ir analizuoti didelį skaičių žmonių ar gyvūnų parametrų. Tai daugiausia elektriniai signalai iš subjektų vidaus arba išorės. Įvertinant šiuos reikalavimus pasiūlytas pigus ir gana kokybiškas įtaisas turintis šešis 2 kHz ir 12 bitų ADC kanalus su USB sąsaja. Pagal reikalavimus buvo sukurtas fotofetismografijos ir elektrokardiografijos modulis, jungiamas prie matavimo įtaiso. Il. 12, bibl. 5 (anglų kalba; santraukos anglų ir lietuvių k.).