

Motion-tracking skill assist and power assist for sinusoidal motions with a semi-active assist mechanism using energy control

著者	KUSAKA Takashi, TANAKA Takayuki, KAJIWARA Hidekazu
journal or publication title	ROBOMECH Journal
volume	4
number	2
page range	1-11
year	2017-01-03
URL	http://hdl.handle.net/10258/00009217

doi: info:doi:10.1186/s40648-016-0069-8

RESEARCH ARTICLE

Open Access



Motion-tracking skill assist and power assist for sinusoidal motions with a semi-active assist mechanism using energy control

Takashi Kusaka^{1*†}, Takayuki Tanaka^{1†} and Hidekazu Kajiwar^{2†}

Abstract

This paper describes a skill assist method for sinusoidal motions using a semi-active assist mechanism through an energy control method. In a previous study, we had developed and verified the effectiveness of a power assist device with a semi-active assist mechanism and a control method for reducing loads during periodic motion. Here, we have developed a skill assist method as an extension of our power assist device for periodic motion. The skill of performing sinusoidal motions is defined in this study as an operator's ability to track such motions. Therefore, our skill assist method attempts to improve the operator's tracking ability. The proposed skill assist method is implemented using our previous power assist device; therefore, the device provides not only a power assist effect but also a skill assist effect to correct the motion. Hence, an operator obtains both the power and the skill assist effects simultaneously.

Keywords: Power assist systems, Skill assist, Periodic input control

Background

We have developed semi-active assist mechanisms to facilitate power assist and motion correction [1, 2]. The semi-active assist mechanisms use elastic materials as the source of the assist force and as actuators for controlling the elastic force. Elastic materials such as springs retain equilibrium because their material generates a restoring force towards the natural length. This characteristic is effective in assisting movement that requires a restoration of posture, such as bending and stretching of the human limbs [3]. Moreover, the actuator of a semi-active assist mechanism can control the restoring force by adjusting its equilibrium point.

The semi-active assist mechanism consists of elastic materials and actuators, and therefore, it is a series of elastic actuators. This series of elastic actuators can use the energy of the actuators efficiently by utilizing the elastic materials for energy storage. Uemura et al. [4]

suggested an assist mechanism for sinusoidal motion that uses the stiffness control of an elastic material in a such way that the mechanism's actuator resonates with the operator's sinusoidal motions. Moreover, they stated that "in power assisting, it is important that cooperation exists among human, mechanical elastic elements, and actuators from the viewpoint of energy efficiency." Walsh et al. [5] also developed a highly energy efficient device that utilizes elastic materials to assist in human ankle extension using the energy stored when the knee is in flexion.

In this paper, we propose a new assist method for a semi-active assist mechanism by employing the concept of "skill assist" that is defined as motion correction or motion induction. "Skill" is defined as tracking ability in this study. We realize such motion assistance by impedance control of the man-machine systems. There are some studies pertaining to the adjustment of impedance in man-machine systems, such as self-impedance matching (SIM) [6], impedance training [7], and subliminal calibration [8]. SIM is an adaptive algorithm to improve the maneuverability of man-machine systems by estimation of their optimal impedance parameters. Its effectiveness in energy consumption has been confirmed by

*Correspondence: kusaka@ssc.ssi.ist.hokudai.ac.jp

[†]Takashi Kusaka, Takayuki Tanaka and Hidekazu Kajiwar contributed equally for this paper.

¹The Graduate School of Information Science and Technology, Hokkaido University, N14, W9, Sapporo, Japan

Full list of author information is available at the end of the article

experiments. Impedance training is a method of training the human hand to adjust its impedance, for rehabilitation purposes. This training needs to measure many parameters for determining the impedance of the human body, such as electromyogram (EMG), forces, and posture. Subliminal calibration allows for an impedance change in the man-machine system without the user's notice. It has two characteristics: the operator keeps the control initiative, and it does not disturb the operator learning the motion. These studies have realized impedance adjustment and have confirmed its effectiveness. However, they have not improved and corrected the motion because they have focused on controlling the maneuverability only.

Therefore, we aim to realize motion correction by using the phase difference between the forces as a method of controlling the impedance of the man-machine systems, limiting the target to periodic motion only. In periodic motion, impedance control is equivalent to motion control; moreover, many motions in daily life and work are periodic, such as walking and repeatable tasks.

Specifically, we have defined the phase difference between the operator's force and the actuator's force, and the phase difference generates the induction force automatically. The force transducing characteristic of the semi-active assist mechanism can realize such control.

In previous studies, we had developed wearable semi-active assist devices and had optimized its controls for various forms of target work. Its effectiveness pertaining to work with a bending motion that requires a restoring force, such as agricultural work [9], snow removal [10], and horse training [2], was also confirmed. This falls under the concept of *KEIROKA* (fatigue reduction) assist that we had proposed as part of a Japan Science and Technology Agency project [11]. Through these studies, we had confirmed that there were many periodic motions in those tasks. Therefore, developing an assist method for periodic tasks is beneficial and the method we have developed has the ability to assist walking, running, and other daily tasks.

Methods

Energy control for power assist and skill assist

Semi-active assist mechanism

Figure 1 displays the photograph and the schematic of our semi-active assist mechanism. We have used the simplest version of our semi-active assist mechanism in this study, namely, a serially concatenated system consisting of an actuator, a spring, and a handle. The user grasps the handle, and the force from the actuator is transferred to this handle via the spring. The combined user and actuator forces provide a driving force to a slider. The relation between the slider driving force F , the user's force F_h ,

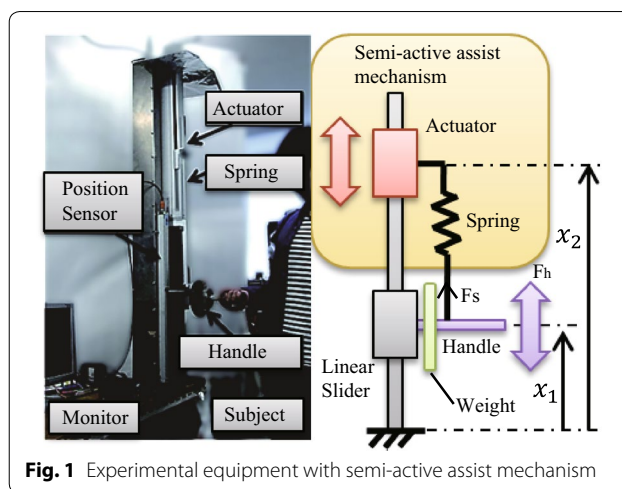

Fig. 1 Experimental equipment with semi-active assist mechanism

and the assist force F_s generated by the semi-active assist mechanism can be expressed as follows:

$$F = F_h + F_s + F_D, \quad (1)$$

$$F_s = k(x_2 - x_1 - l_0 + l_g) \quad (2)$$

$$F_D = -c\dot{x}_1. \quad (3)$$

Here, k is the spring constant, x_1 is the handle position, x_2 is the actuator position controlled by actuator, l_0 is the natural length of the spring, and l_g is the elongation of the spring by gravity. l_g is calculated as $l_g = -mg/k$, where m is the total mass of the handle and the weight and g is the gravitational constant. F_D is the friction of the handle, however we have considered $c = 0$ for easy analysis. If we need to consider friction, our control method described later, that cancels the term can be used. Because the frictional and dissipative forces are sufficiently small, we can ignore them in our analysis. We thus restrict ourselves to considering an ideal system.

To realize a power assist, the device must decrease the operator's force F_h by appropriately controlling F_s according to Eq. (1). We can control the assist force by adjusting x_2 , and if F_s is synchronized with F_h , then the user's force is decreased by the provision of a power assist.

Conversely, if $F_s = 0$ then $F = F_h$. However, F_s can also be applied to alter the user's motion. Namely, the assist force can adjust the impedance of the man-machine system, especially in a periodic motion. If the user cannot perform a desired motion, we can correct the user's motion by adding an appropriate F_s to provide a skill assist.

Therefore, not only power assist but also skill assist can also be provided by using the elastic material as a power source. The elastic element constrains motion only if it is infinitely stiff; otherwise it does not constrain motion at all, but provides forces that influence motion.

Concept of skill assisting during power assisting

Generally, applying power assist destabilizes the system. Kazerooni [12] pointed out the trade-off between stability and performance in power assist systems. Low stability, in particular, worsens maneuverability in human-machine systems.

Our proposed method realizes a balance between performance and maneuverability, as the power assist and the skill assist respectively, considering the energy of the system. First, we consider the power and skill assist effects with respect to energy. Energy control is used in the trajectory planning of bipedal robots [13, 14] and here the periodic movements can be similarly controlled, considering the energy state. The motions of the handle and actuator are assumed to be

$$x_1 = x_{10} + \tilde{x}_1 \sin(\omega t), \quad (4)$$

$$x_2 = x_{20} + \tilde{x}_2 \sin(\omega t + \varphi), \quad (5)$$

$$x_{20} - x_{10} = l_0 - l_g, \quad (6)$$

where x_{10} and x_{20} are the initial positions of the handle and the actuator respectively, \tilde{x}_1 and \tilde{x}_2 are the respective changes in the amplitude of the handle and the actuator, ω is the angular velocity, and φ is the phase difference between the assist and the user forces. Here, x_{10} and \tilde{x}_1 are measured by some position sensor because it is an input to control system. In this study, it is measured by magnetic-type absolute position sensor. On the other hand, x_{20} and \tilde{x}_2 are parameters to design the assist effect because it is related to the magnitude of assist force. In this study, we treated them as constant values. Eq. (6) indicates that the static positions x_{10} and x_{20} balance at the position of balance between the gravitational force mg , the operator's force F_h , and the assist force F_s . Therefore, the system under consideration assists a part of the load using the gravitational force.

Next, we consider changes according to the phase difference φ . We can then describe the assist force as

$$F_s = kA \sin(\omega t + \psi). \quad (7)$$

$$\begin{cases} A(\tilde{x}_1, \tilde{x}_2, \varphi) = \sqrt{\tilde{x}_1^2 + \tilde{x}_2^2 - 2\tilde{x}_1\tilde{x}_2 \cos \varphi} \\ \psi(\tilde{x}_1, \tilde{x}_2, \varphi) = \tan^{-1} \left(\frac{\tilde{x}_2 \sin \varphi}{\tilde{x}_2 \cos \varphi - \tilde{x}_1} \right) \end{cases}$$

Hence, we can control the phase difference, ψ , between the handle driving force and the assist force, by controlling φ . In addition, we can design the system such that φ takes a value prescribed by the desired value of ψ :

$$\varphi(\psi) = \sin^{-1}(\gamma) \quad (8)$$

$$\gamma = \frac{\tan \psi}{1 + \tan^2 \psi} \left(\sqrt{1 + \left(1 - \frac{\tilde{x}_1^2}{\tilde{x}_2^2}\right) \tan^2 \psi} - \frac{\tilde{x}_1}{\tilde{x}_2} \right) \quad (9)$$

We now consider the power assist and skill assist effects. The operator's force is $F_h = \tilde{F}_h \sin(\omega t)$ and the assist force is given by Eq. (7). Then, the power assist ratio η is as follows,

$$\begin{aligned} \eta &= \frac{F_s}{F_h} = \frac{kA \sin(\omega t + \psi)}{\tilde{F}_h \sin(\omega t)} \\ &= \frac{kA}{\tilde{F}_h} \left(\cos \psi + \frac{\sin \psi}{\tan \omega t} \right) \end{aligned} \quad (10)$$

To reduce $F_{hp} \cos \psi$ must be large, or ψ should be zero for the power assist, because the power assist effect is disturbed by the increase in phase difference. This effect has already been confirmed and analyzed in detail in our previous study [15].

On the other hand, we can calculate the assist energy as the work done by the assist force in changing the handle's position over a period:

$$\langle E_s \rangle = \int_0^T F_s \dot{x}_1 dt = \pi kA \tilde{x}_1 \sin \psi. \quad (11)$$

Here, the operator $\langle \cdot \rangle$ denotes the periodic average with respect to the period T . The skill assist effect is thus described by this equation, because it represents the energy that is used to change the operator's motion. The effect of changing the motion owing to the work done by the phase difference was also analyzed as the impedance adjustment effect in our previous study [16].

Finally, we can summarize the power assist effect described by $\cos \psi$ and the skill assist effect described by $\sin \psi$ through the phase difference ψ , as shown in Fig. 2. Specifically, for the phase difference ψ , the power assist effect- Eq. (10) is changed by $\cos \psi$, and the skill assist effect- Eq. (11) is changed by $\sin \psi$. In this paper, we do not discuss the direction of the radius, in order to consider the effect of the phase only. Further, the axis of the skill assist effect indicates both motion excitation ($0 < \psi < \pi/2$) and motion inhibition ($-\pi/2 < \psi < 0$). Therefore, the skill assistance effect increases with $\sin \psi$. In the $\psi > \pi/2$ and $\psi < -\pi/2$ regions, the effect can be understood as a motion disturbance through Eqs. (10) and (11). When $\psi = 0$, the controller performs solely as a power assist. Note that the controller cannot perform only as a skill assist, because it is an extension of the power assist that uses ψ . Therefore, if the operator can perform a tracking task without skill assist, the controller automatically performs strictly as a power assist.

Energy control by periodic input control

Energy control for skill assist

E_s can be controlled through the amplitude of F_s and ψ , where the assist energy is set to be positive ($E_s > 0$) to induce motion, and the assist energy is set to be negative ($E < 0$) to inhibit motion:

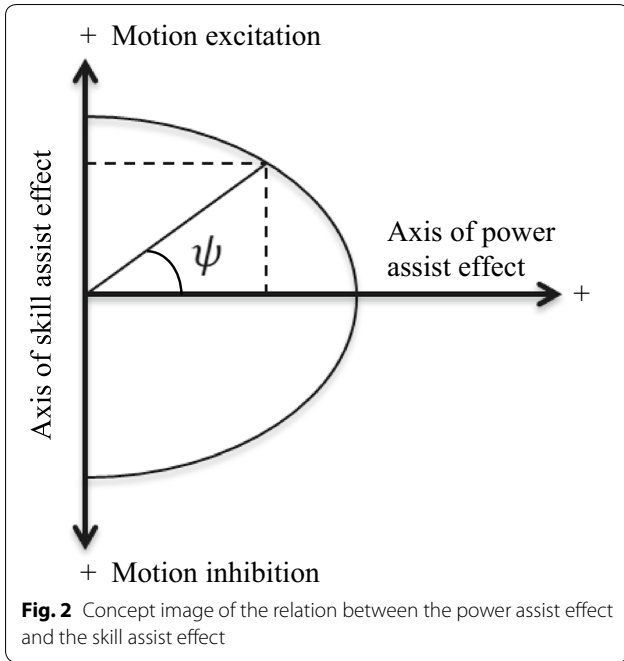

$$\psi(\Delta E) = \begin{cases} \sin^{-1} \left(\frac{\Delta E + E_D}{\pi k A x_1} \right) & (r_E; 1) \\ -\frac{\pi}{2} & (r_E; 1, \Delta E; 0) \\ \frac{\pi}{2} & (r_E; 1, \Delta E; 0) \end{cases} \quad (12)$$

Here, ΔE is the energy required for a motion state change given by

$$\Delta E = E_d - E_h, \quad (13)$$

where E_d is the desired energy state and E_h is the operator's current energy state. E_D is the dispersion energy owing to friction. If $c \neq 0$ in Eq. (3), then the friction effect can be cancelled. Here, E_d and E_h are calculated by following equations as the energy of the harmonic oscillator because we assume the target is the periodical motion.

$$E_d = \frac{M}{2} \dot{x}_{1d}^2 + \frac{K}{2} x_{1d}^2 \quad (14)$$

$$E_h = \frac{M}{2} \dot{x}_1^2 + \frac{K}{2} x_1^2 \quad (15)$$

M and K are imaginary inertia and stiffness satisfying $\omega = \sqrt{K/M}$. x_{1d} is the desired value of the human's motion and x_1 is the measured human's motion. r_E is the ratio between the energy required for a motion change and the available energy of the assist system:

$$r_E = \frac{|\Delta E|}{|E_s|}. \quad (16)$$

From Eq. (12), we can obtain the ψ value automatically determined by ΔE . To correct the operator's motion, we apply this value of ψ as the phase difference of the periodic input control. Thus, we can generate the appropriate assist force for motion correction. We refer to this method as the skill assist control.

When $r_E > 1$, however, the assist system cannot supply the total energy required for the motion state change; therefore, $|E_s|$ supplies only a portion of the energy. Hence, as described above, the control method can move the motion state closer to the desired state by using ψ .

Synchronization of sinusoidal motion using a hybrid oscillator

To employ energy control, the assist force must be synchronized with the operator's force possessing an arbitrary phase difference. Therefore, we apply the periodic input control to our system by utilizing a hybrid oscillator.

Periodic input control is a control method that can synchronize an input and an output with an arbitrary phase difference.

The method stabilizes the periodic dynamics in a limit cycle that has the desired energy state by adding an appropriate assist force [17–19]. The inclusion of this assist force is accomplished through frequency entrainment such as that of a Van der Pol oscillator, as described by a nonlinear equation. In this study, we use a hybrid oscillator that evolves in time according to the following nonlinear equation:

$$\ddot{\xi} + (\gamma + \varepsilon \xi^2 + \delta \dot{\xi}^2) \dot{\xi} + \Omega^2 \xi = 0. \quad (17)$$

Here, ξ is the displacement of an imaginary oscillator, the dots denote differentiation with respect to time, γ is a negative constant, and ε , δ , and Ω are the positive constants. The trajectories of this oscillator are a good approximation to those of the human limb movements [20]. Thus, we use this oscillator to synchronize the actuator and the operator motions naturally. In the next section, we analyze the oscillator's frequency entrainment properties.

Frequency entrainment of the hybrid oscillator

The characteristics of the van der Pol oscillator have been analyzed by many researchers. For example [21, 22], derived its conditions of frequency entrainment by the averaging method. The averaging method is one of the perturbation methods. Here, we have confirmed that the hybrid oscillator also has same conditions, by using the averaging method.

$$\ddot{\xi} - \varepsilon(1 - \xi^2 - \delta \dot{\xi}^2) \dot{\xi} + \Omega^2 \xi = \dot{u}. \quad (18)$$

Equation (18) can synchronize the solution ξ to the sinusoidal input u by the frequency entrainment phenomena.

Next, under the input condition $\dot{u} = \alpha e^{i\omega t}$, we assume that the solution of the above differential equation can be expressed as

$$\xi(t) = a(t)e^{i(\omega t + \phi(t))}, \quad (19)$$

where $a(t)$ and $\phi(t)$ are unknown functions that change slowly. Then, the differential equation can be rewritten by using Eq. (19) and its derivative:

$$\begin{aligned} [2\omega(i\dot{a} - \dot{\phi}) + a(\Omega^2 - \omega^2) - i\varepsilon(1 - a^2)a\omega] e^{i(\omega t + \phi(t))} \\ = \alpha e^{i\omega t}. \end{aligned} \quad (20)$$

Here, the second and higher-order terms are ignored because ε , \dot{a} , and $\dot{\phi}$ are considered insignificant. From the real and the imaginary parts of Eq. (20), we finally get the following equations:

$$\dot{\phi} = \frac{\omega^2 - \Omega^2}{2\omega} - \frac{\alpha \cos \phi}{2a\omega}, \quad (21)$$

$$\dot{a} = \frac{\varepsilon a(1 - \omega^2)}{2} + \frac{\alpha \sin \phi}{2\omega}. \quad (22)$$

When $\dot{a} = \dot{\phi} = 0$, the frequency entrainment is described and the conditions leading to this solution are

$$a^2 \left[\left(\frac{\omega^2 - \Omega^2}{2\omega} \right)^2 + \varepsilon(1 - \omega^2)^2 \right] = \frac{\alpha^2}{\omega^2}, \quad (23)$$

$$\left| \frac{\omega^2 - \Omega^2}{2\omega} \right| \leq \left| \frac{\alpha}{2a\omega} \right| \Rightarrow \left| \omega^2 - \Omega^2 \right| \leq \frac{\alpha}{a}. \quad (24)$$

Equation (23) determines the amplitude of the periodic solution as a function of α and ω , and Eq. (24) is the condition such that $\dot{\phi} = 0$.

Periodic input control

In the previous section, we established that the hybrid oscillator can synchronize the input and output of our system. Under the condition of Eq. (24), if u and ξ are given by simple sinusoidal motions $u = \alpha \sin \omega t$ and $\xi = a \sin \omega t$, we can obtain the synchronized output x_{pic} with a phase difference of $\varphi(\psi)$, by using ξ and its differential solution $\dot{\xi}$ as shown below:

$$\begin{aligned} x_{pic}(u, \psi) &= K_s(K_{AG1}\xi(u) \cos \varphi(\psi) \\ &\quad + K_{AG2}\dot{\xi}(u) \sin \varphi(\psi)) \\ &= K_s \sin(\omega t + \varphi(\psi)). \end{aligned} \quad (25)$$

Here, K_s is a control gain, and K_{AG1} and K_{AG2} are automatic gains to normalize ξ and $\dot{\xi}$. Specifically, both the

amplitudes become 1.0 by using the maximum value over the last half-period.

ψ in Eq. (25) is given by Eq. (12), and is utilized in the skill assist control. Therefore, we can realize power assist and skill assist simultaneously by using this periodic input control.

Figure 3 shows the controller performance. These results were obtained by a simulation under the condition $\psi = 0$ and an ideal input which has constant frequencies. The frequencies of the input are 1.0 Hz during 0–5 s, 1.2 Hz during 5–10 s, and 0.7 Hz during 10–15 s. We confirmed the ability of the frequency entrainment of the developed controller. According to the results, the controller can synchronize x_2-x_1 by adapting to the frequency change in the input. Our controller can perform without phase delay, adapting the frequency automatically to the change in the input frequency, because of frequency entrainment by the controller.

Experiment on the developed skill assist

Experimental set-up and conditions

Next, we investigate the effects of the power assist and the skill assist through a visual tracking experiment by

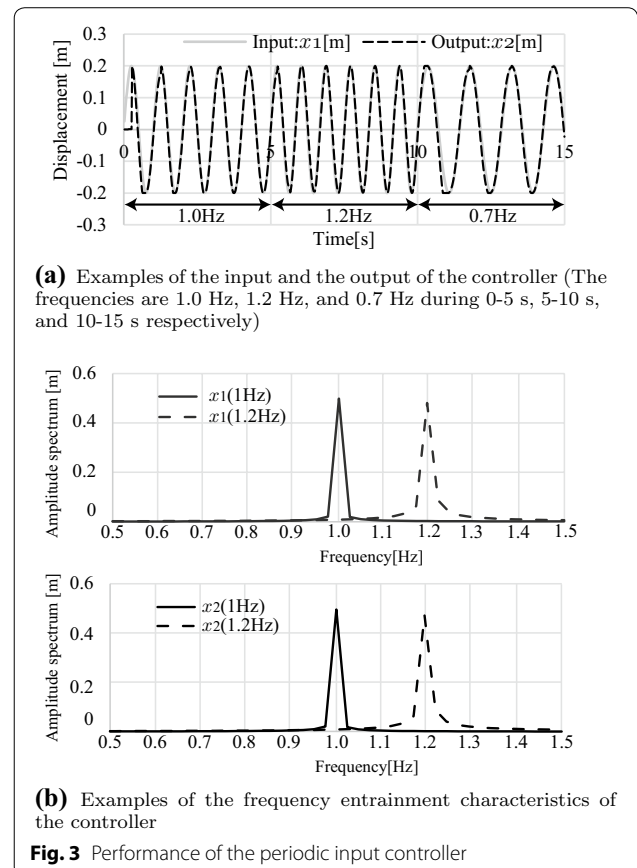

controlling the phase difference of the synchronized assist force. The effect of controller is already analyzed and confirmed by simulation with ideal input in our previous study [16]. We have confirmed that the control method can control operator's movement by adjusting the phase difference of assist force. Therefore, the assist system should be able to improve the motion of subjects in this experiment.

Figure 4 shows an overview of the experiment. Here, in order to validate the motions of subjects, we controlled the experimental conditions as much as possible. For example, the standing position and the posture of grasping handle were decided strictly like Fig. 1. The handle's height is measured by a position sensor. The operator moves the handle (the bar in Fig. 4) to follow a tracking target (the circle in Fig. 4) that is displayed on a monitor. In this experiment, the target is a periodic motion; thus, if the operator becomes accustomed to the experiment, they may fall into a natural rhythmic motion instead of visually tracking the target. To investigate the effect of visual tracking only, we use frequency modulation to prevent motion prediction. The operator performs the tracking task watching the target x_{1d} and the handle position x_1 . In this study, the graph plotting of the motion history is not displayed to the operator, to prevent predicting the next motion. Furthermore, in order to observe the motion correction effect clearly, we decided that the trial time and the resting time are 30 and 60 s, respectively, because we confirmed that the repeated trials with over 30 s trial time provide a large fatigue to the subjects and such fatigues might affect the result of the skill by preliminary experiments.

The visual tracking experiment was conducted using an apparatus incorporating the semi-active assist mechanism (Fig. 1). The experimental conditions were as follows: The desired motion, x_{1d} , is presented to the operator on the monitor. This motion is periodic and oscillates with an angular velocity ω . The operator moves the position of the handle, x_1 , to track the desired motion.

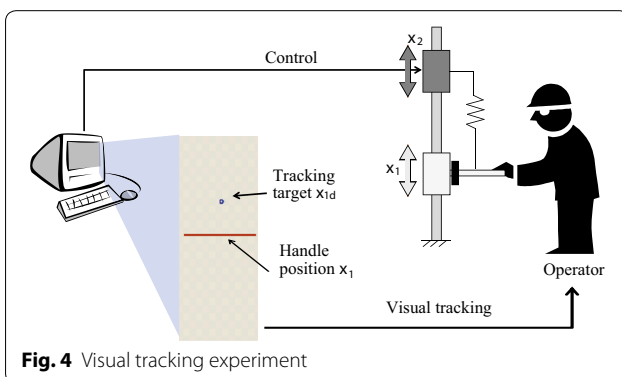

The actuator's position, x_2 , is synchronized with the operator's motion by means of a periodic input control. Moreover, the actuator has a phase difference ψ for skill assist control. The three ideal positions are thus described as

$$x_{1d} = x_{1d0} + \tilde{x}_{1d} \sin(\omega t), \quad (26)$$

$$x_1 = x_{10} + \tilde{x}_1 \sin(\omega t), \quad (27)$$

$$x_2 = x_{20} + x_{pic}(x_1, \psi), \quad (28)$$

where x_{1d0} and \tilde{x}_{1d} are the initial position and change in amplitude of the desired motion, respectively. In this experiment, we adjust the actuator's angular velocity to prevent habituation to simple oscillation. The frequency change, denoted by ω_s , is obtained by adding $\Delta\omega$ to the desired position's angular velocity ω_c through frequency modulation:

$$x_{1d} = x_{1d0} + \tilde{x}_{1d} \sin\left(\omega_c t + \frac{\Delta\omega}{\omega_s} \sin \omega_s t\right). \quad (29)$$

This equation is equivalent to Eq. (26) if we set $\omega = \omega_c + \Delta\omega \cos(\omega_s t)$. In this experiment, ω_c and $\Delta\omega$ are set to 1.0 and 0.5 Hz, respectively. Therefore, the frequency continuously varies between 0.5 and 1.5 Hz. The experimental conditions are configured as shown in Tables 1 and 2. The experiments have four conditions. The first experiment is "no assistance, without weight." To measure the operators' basic ability, this condition is without a weight on the handle and without the spring. The second experiment is "no assistance, with weight." The weight is attached in this condition. The next experiment is "power assist only." This condition uses the power assist, without the skill assist (i.e., $\psi = 0$). The final condition is "power assist with skill assist." This condition applies both the power assist and the skill assist (i.e., $\psi = \psi(\Delta E)$).

Appropriate excitation and inhibition of the motion improves the operability of the motion correction. Here we investigate the effectiveness of the motion correction through energy control of the semi-active mechanism. Energy control is performed by adjusting the phase difference as the situation demands, through Eq. (12).

Thus, to apply energy control to the actuator by periodic input control, the phase difference must always be equal to $\psi(\Delta E)$ (see Eq. (12)). To provide skill assist, the control supplies the required energy to move the energy towards the desired state. In this experiment, using the system represented in the block diagram in Fig. 5, the actuator control is made to depend upon the operator's motion.

Results of the skill assist experiment

We analyze the results of the experiments. In this analysis, we use only the latter half of the measured data for

Table 1 Experimental conditions

	Set-up conditions
Weight (handle mass)	3.2 kg
Spring constant	72.5 N/m
\dot{x}_{1d}	200 mm
ω_c	2π rad/s (1 HZ)
$\Delta\omega$	π rad/s (0.5 HZ)
Sampling time	10 ms
	Experimental conditions
Subjects	5 subjects
Trials	5 times each pattern
Trial time	30 s (60 s resting interval between trials)
Conditions	4 conditions
	1 : No assist without weight
	2 : No assist with weight
	3 : Only power assist ($\psi = 0$)
	4 : Power assist with skill assist ($\psi = \psi(\Delta E)$)

Table 2 Conditions for each case

	Attaching weight	Applying power assist	Applying skill assist
Condition 1	×	×	×
Condition 2	✓	×	×
Condition 3	✓	✓	×
Condition 4	✓	✓	✓

analysis because the target of our controller is only steady-state of periodical motions.

In the case of power assist only, the motion of the subjects was disturbed when the frequency was decelerated by frequency modulation. However, applying the skill assist improved the tracking errors.

Figure 6 and Table 3 exhibit all the experimental results. We evaluated the effects of each assist method by examining the position error between the operator’s handle and the desired value and the p value of its t test. The error e defined as the root mean square error (RMSE) is as follows:

$$e = \sqrt{\frac{1}{T} \int_{T_0}^{T_0+T} \{x_{1d}(t) - x_1(t)\}^2 dt}. \tag{30}$$

From the results it can be inferred that, applying the skill assist method decreased e compared to all the other cases (including using the power assist method only) for all the subjects.

We statistically confirmed the effects using a t test. We defined an alternative hypothesis H_1 as “applying skill will decrease the tracking error than applying only the power assist,” and a corresponding null hypothesis H_0 as “applying skill assist does not result in a motion correction.” A type-I error might therefore mean rejecting H_0 despite the skill assist increasing the error, so evaluation of a type-I error is important for the safety of the operators. On the other hand, a type-II error would mean accepting H_0 despite the tracking error under the skill assist being smaller than the error under the power assist only. So a type-II error would result in a mistaken estimation of the effect, but this would not necessarily result in an untoward effect.

According to the results, the motions of the subjects A, D, and E were improved by a statistically significant amount. The results of a t test for subjects A–E were $p = 0.012$ ($p < 0.05$, $d = 1.90$, 95% CI [1.26, 7.33]), $p = 0.121$ ($d = 0.55$, [−1.00, 4.19]), $p = 0.353$ ($d = 0.17$, [−7.00, 10.20]), $p = 0.035$ ($p < 0.05$, $d = 1.59$, [0.49, 20.70]) and $p = 0.034$ ($p < 0.05$, $d = 1.64$, [0.42, 18.17]), respectively. In general, if the statistical power ($1 - \beta$) is more than 0.8, then the statistical analysis has enough samples. Therefore, we confirmed the statistical power by the post-hoc power analysis [23]. The

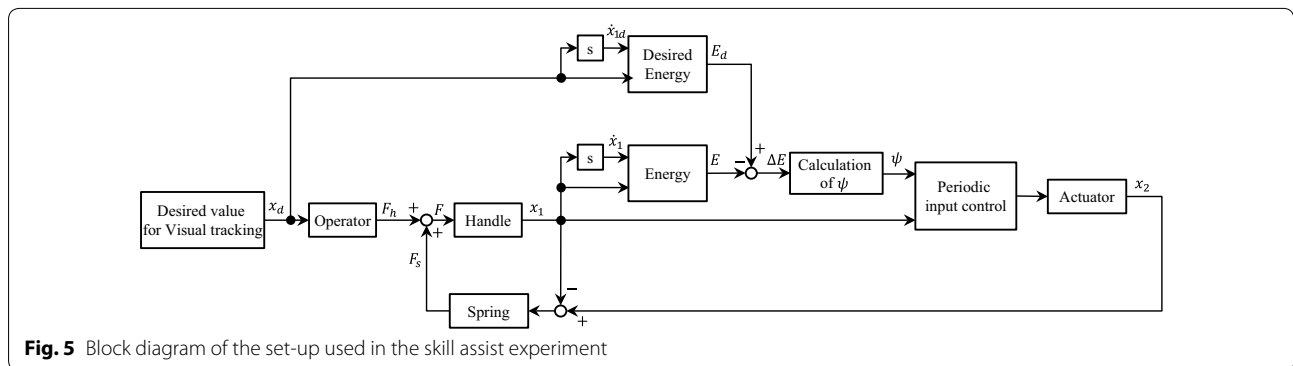
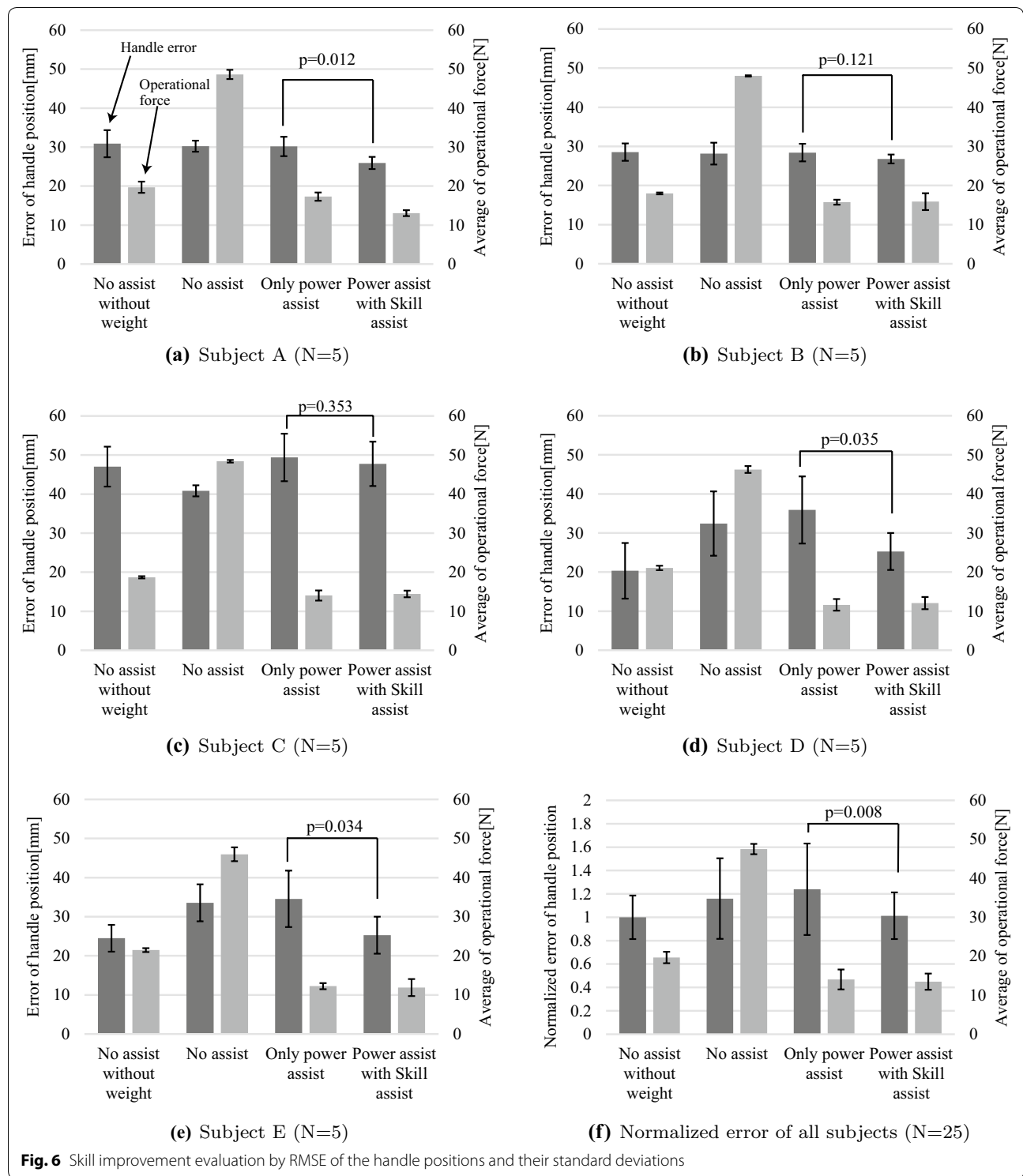

Fig. 5 Block diagram of the set-up used in the skill assist experiment



statistical powers for those tests were 86, 20, 8, 74 and 76%, respectively. The subject A is enough and the subjects D and E are almost enough statistical power for statistical analysis.

Next, we must verify that the power assist effects of our system are retained, because the skill assist method is an extension of the power assist method. Hence, the skill assist method should have a power assist effect related to Fig. 2.

Table 3 RMSEs of the position tracking ($\mu \pm SD$) and p values between the cases applying power assist only and power assist with skill assist

	Subject A	B	C	D	E	Average of the normalized error
RMSE of position tracking (mm)						
No assist without weight	30.9 ± 3.09	28.5 ± 2.21	47.0 ± 5.11	20.3 ± 7.13	24.5 ± 3.43	1.00 ± 0.186
No assist with weight	30.2 ± 1.43	28.1 ± 2.79	40.8 ± 10.0	32.4 ± 8.24	33.5 ± 4.73	1.16 ± 0.356
Only power assist	30.2 ± 2.49	28.4 ± 2.25	49.3 ± 6.08	35.9 ± 8.59	34.6 ± 7.20	1.24 ± 0.391
Power assist with skill assist	25.9 ± 1.57	26.8 ± 1.13	47.7 ± 5.72	25.3 ± 4.72	25.3 ± 4.72	1.01 ± 0.199
p value of t test	0.012	0.121	0.353	0.035	0.034	0.008
Statistical power ($\alpha = 0.05$)	0.86	0.20	0.08	0.74	0.76	0.83

The power assist effect is evaluated by measuring the operational force with a force gauge on the handle. The detailed analysis of the power assist effects will be discussed in another paper; here, we merely establish that the results of the skill assist method demonstrate a significant load reduction effect similar to the power assist method (Figs. 6, 7). The force data shown in Fig. 7 was measured in the experiment. We confirmed that the tracking error was reduced by applying phase control as a skill-assist. It can be discerned that our system also works simultaneously as a power assist system.

In the experiment, the load reduction effect can be explained as the average phase difference tending to zero at all times. Under these circumstances, our skill assist method provides a local motion correction, and provides a load reduction equal to that given by the power assist method (i.e., $\psi = 0$) globally. If the average phase difference is not zero, then we find that the power assist effect is less for the extended method than for the power assist method. This possibility may exist in cases where continuously increasing energy is needed during motion acceleration.

Finally, standard deviations of the experimental phase differences are listed in Table 4, and an example phase difference distribution is shown in Fig. 8. The value of the phase difference during periodic input control corresponds to the level of disturbance in the operator’s motions. Thus, we can

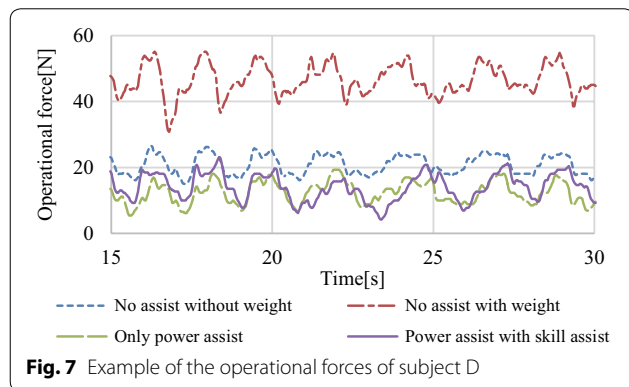

Fig. 7 Example of the operational forces of subject D

Table 4 Standard deviation of the phase difference σ_ψ

	Subject A	B	C	D	E
Standard deviation of the phase difference (rad)					
No assist without weight	0.213	0.269	0.466	0.262	0.332
No assist with weight	0.229	0.243	0.356	0.264	0.330
Only power assist	0.222	0.263	0.598	0.305	0.376
Power assist with skill assist	0.200	0.230	0.448	0.291	0.303

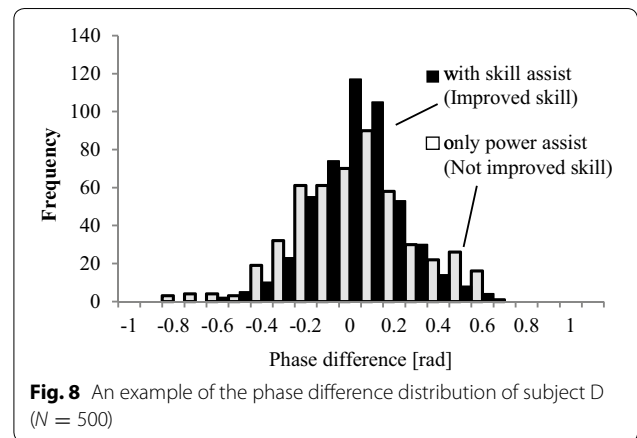

Fig. 8 An example of the phase difference distribution of subject D (N = 500)

also use the standard deviation of the phase difference to evaluate the operator’s skill quantitatively. If the operator can perform the tracking task perfectly (with $e = 0$), then the phase difference is zero at all times and the assist effect is the same as that when applying power assist only. The standard deviations of the phase differences were reduced by applying the skill assist for all subjects (Table 4). Further, subject C, who was evaluated as having poor skill in Section IV.B, also had a high standard deviation.

Discussion

By examining the results for each subject in detail, we see that a skill assist effect is clearly manifested for subject A because application of the skill assist decreased e compared to the other three cases. The value of e is

almost the same for all cases. The mean of e for subject B was decreased by the skill assist, but the decrease was not statistically significant. Comparing this outcome with the results from subject A, we can see that subject B already has sufficient ability to perform the task and is able to perform the required motion. Subject B therefore does not need a skill assist to accomplish the task. The mean of e for subject C is also not statistically significant. Moreover, e was particularly insignificant for subject C in the no assist case with a weight, as compared to the case without a weight; the weight enables the subject to slow down the motion and determine the handle position. In the case where only the power assist is applied, the motion is disturbed by the force from the assist device. The skill assist effect is significant for subject D. Subject E also clearly shows the effect. The motions of subjects D and E were disturbed by the assist device when applying the power assist alone, but were improved by simultaneously applying the skill assist.

In summary, we confirmed the applicable range of the developed system from the heterogeneity across subjects, especially our assist system has the ability to correct the operator's motion when the skill becomes worse by applying power assist.

We also investigated the total effect for all the subjects collectively, to confirm some system-wide characteristics, irrespective of the differences between the subjects. To compare the errors between the subjects, the errors were normalized by the average error of the condition "no assist without weight." Figure 6f depicts the normalized error that has been calculated using the data from all the subjects. The skill assist effect is significant at $p = 0.008$ ($p < 0.01$) with a statistical power of 83%. Therefore, we could confirm that this total analysis has enough meaning statistically. Hence, we conclude that the system we have developed improves the operators' motion, and at a minimum, does not increase the error.

Conclusion

We have proposed a skill assist method by using a semi-active assist mechanism through energy control. This method was realized using the phase difference that is a parameter of the control system (Fig. 2), and has enabled us to employ our previously developed semi-active assist device.

We have considered details of the skill assist effect based upon the phase difference resulting from periodic input control. According to experimental results, the motion correction effect of the proposed method is validated because the average tracking error has decreased by 16.1% at the 5% significance level. We have also established from Fig. 6 that the power assist effect

of the extended method remains high. The effectiveness of the proposed method is similar to the case in which only the power assist is applied, namely, the phase difference is approximately zero. We have concluded that the reason for this result was that the distribution of changes in the phase difference was around zero, in the experiment.

We have applied our skill assist method to the semi-active assist mechanism in this study, but it can be applied to any force-control system having a periodic motion. Therefore, our method can be applied to any area with periodic systems.

In future, we will develop a system that has the ability to control the assist ratio by designing x_{20} and \tilde{x}_2 , extending the skill assist to more complex periodic motions, for practical applications such as assistance for walking. Moreover, because the semi-active assist mechanism is implemented using elastic materials, the risk of harm to the human body in the case of erroneous operation of the system is lower than that for other assist systems that do not incorporate an SEA mechanism. In the design of human-robot systems such as the one proposed here, human safety is of paramount importance [24, 25], and assistive robot systems must have the autonomy to ensure the safety of the humans operating them. Therefore, we will continue the pursuit for safer and more convenient autonomous systems that can be applied to real-world tasks.

Authors' contributions

TK took the lead in experimentation, implemented our developed control method, and wrote this paper as corresponding author. TT devised the basic concept of the skill assist method for sinusoidal motions by using semi-active assist mechanisms and the periodic input control. HK improved the theoretical analysis of the effect of the periodic input control. All authors read and approved the final manuscript.

Author details

¹The Graduate School of Information Science and Technology, Hokkaido University, N14, W9, Sapporo, Japan. ²Muroran Institute of Technology, Muroran, Japan.

Acknowledgements

The authors thank Prof. Kaneko of the Graduate School of Information Science and Technology, Hokkaido University for his advice on the experimental methods and its statistical analysis. This work was supported by JSPS KAKENHI Grant Number 11J01391.

Competing interests

The authors declare that they have no competing interests.

Received: 1 January 2016 Accepted: 6 December 2016

Published online: 03 January 2017

References

1. Tanaka T, Satoh Y, Kaneko S, Suzuki Y, Sakamoto SN (2008) Seki: soft power suit with semi-active assist mechanism -prototype for supporting waist and knee joint. In: Proceedings of ICROS-SICE international joint conference ICCAS-SICE

2. Kusaka T, Tanaka T, Kaneko S, Suzuki Y, Saito M, Kajiwara H (2009) Assist force control of smart suit for horse trainer considering motion synchronization. *Int J Autom Technol* 3(6):723–730
3. Rosendo A, Tanaka T, Kaneko S (2012) A yank-based variable coefficient method for a low-powered semi-active power assist system. *J Robot Mechatron* 24(2):291–297
4. Uemura M, Kanaoka K, Kawamura S (2006) Power assist system for sinusoidal motion by passive element and impedance control. In: Proceedings of the IEEE international conference on robotics and automation, pp 3935–3940
5. Walsh CJ, Pasch K, Herr H (2006) An autonomous, underactuated exoskeleton for load carrying augmentation. In: Proceedings of the IEEE/RSJ international conference on intelligent robots and systems, pp 3935–3940
6. Morishita S, Tanaka T, Yamafuji K, Kanamori N (1999) Improvement of maneuverability of man-machine system for wearable nursing robots. *J Robot Mechatron* 11(6):461–467
7. Takeda Y, Tanaka Y, Tsuji T (2003) A virtual training sports system for measuring human hand impedance. In: Proceedings of the IEEE/ASME international conference on advanced intelligent mechatronics, pp 914–919
8. Igarashi H (2012) Subliminal calibration for machine operation. *J Adv Comput Intell Intell Inform* 16(1):108–116
9. Kusaka T, Tanaka T, Nara H (2014) Smart suit for dairy working—a wearable power assistive device based on semi-active assist mechanism. In: Proceedings of the 2nd international conference of universal village, robotics and future universal village, pp 1–5
10. Imamura Y, Tanaka T, Kaneko S, Yamanaka M, Suzuki Y, Saitoh M (2009) Design of smart suit for snow shoveling based on motion based assist method. *Proc JSME Mech Eng Congr 2009*:287–288 (in Japanese)
11. Nara H, Tanaka T, Imamura Y, Yoshinari S, Nakajima Y, Kaneko S (2011) Fundamental study on evaluation of keiroka (fatigue-reduction) technology in using ud shovel for removing snow by musculo-skeletal dynamics simulator. In: Proceedings of the IEEE international conference on robotics and biomimetics, pp 1579–1584
12. Kazarooni H (1993) Extender: a case study for human-robot interaction via transfer of power and information signals. In: Proceedings of the IEEE international workshop on robot and human communication, pp 10–20
13. Pratt JE, Pratt GA (1999) Exploiting natural dynamics in the control of 3D bipedal walking simulation. In: Proceedings of the international conference on climbing and walking robots, pp 974–981
14. Kajita S, Yamaura T, Kobayashi A (1999) Dynamic walking control of a biped robot along a potential energy conserving orbit. *IEEE Trans Robot Autom* 8(4):431–438
15. Kusaka T, Tanaka T, Kaneko S, Kajiwara H (2013) Power assist and skill assist for periodical motions by using semi-active assist mechanism—control of power assist ratio under use of skill assist. In: Proceedings of the 18th robotics symposia, pp 9–14. (in Japanese)
16. Kusaka T, Tanaka T, Kaneko S, Kajiwara H (2013) Power assist and skill assist for sinusoidal motions by using semi-active assist mechanisms—analysis of impedance adjustment effect of phase difference control-. *Proc JSME ROBOMECH 2013*:9–14 (in Japanese)
17. Kajiwara H, Hashimoto Y, Tsuchiya T (2001) Motion control of a pendulum via periodic input. *Trans Jpn Soc Mech Eng* 67(663):84–90
18. Umegae M, Kajiwara H, Tanaka T, Kaneko S (2009) A robust walk of quasi passive walking robot controlled by periodic input. *Trans Jpn Soc Mech Eng* 42(8):974–981 (in Japanese)
19. Hachiya M, Suzuki S (2009) Stabilization of a biped quasi passive walking robot via periodic input. *Trans Jpn Soc Mech Eng* 33(1):57–63 (in Japanese)
20. Huys R, Jirsa VK (2010) *Nonlinear dynamics in human behavior*. Springer, Berlin
21. Zwillinger D (1997) *Handbook of differential equations*, 3rd edn. Academic Press, Cambridge
22. Susuki Y, Yokoi Y, Hikiyama T (2007) Energy-based analysis of frequency entrainment described by van der pol and phase-locked loop equations. *CHAOS Interdiscip J Nonlinear Sci* 17:023108
23. Faul F, Erdfelder E, Buchener A, Lang A (2009) Statistical power analysis using g*power 3.1: tests correlation and regression analysis. *Behav Res Methods* 41(4):1149–1160
24. Yamada Y, Hirasawa Y, Huang S, Umetani Y, Suita K (1997) Human–robot contact in the safeguarding space. *IEEE ASME Trans Mechatron* 2(4):230–236
25. Suita K, Ikeda H (1995) A failure-to-safety “kyozon” system with simple contact detection and stop capabilities for safe human–autonomous robot coexistence. In: Proceedings of the IEEE international conference on robotics and automation, pp 3089–3096

Submit your manuscript to a SpringerOpen® journal and benefit from:

- Convenient online submission
- Rigorous peer review
- Immediate publication on acceptance
- Open access: articles freely available online
- High visibility within the field
- Retaining the copyright to your article

Submit your next manuscript at ► springeropen.com
