

DRY GAS SEAL RETROFIT

by

James F. Southcott

Product Support Manager

John Crane, Inc.

Morton Grove, Illinois

J. Michael Sweeney

Mechanical Systems Engineer

Mobil Exploration and Production Technical Center

Dallas, Texas

and

Paul L. Feltman Jr.

Design Engineer

John Crane, Inc.

Morton Grove, Illinois



James F. (Jim) Southcott is Product Support Manager, Type 28 Product Group, for John Crane, Inc. His responsibilities with John Crane include the application and marketing of the dry gas seal and its ancillary instrumentation/control systems to turbomachinery in the HPI, Chemical and Gas Transmission Segments.

Prior to joining John Crane, Mr. Southcott had over 20 years of experience in a broad range of mechanical equipment applications, design installation, and troubleshooting. This included experiences in fluid dynamics/turbomachinery.

Mr. Southcott has a B.S.M.E. degree from the University of Wisconsin.



Paul L. Feltman, Jr. is a Mechanical Engineer for the Dry Gas Seal Group at John Crane Inc., located in Morton Grove, Illinois. He has been with John Crane for seven years and has worked with gas seals exclusively. His responsibilities include product design, troubleshooting, and advanced seal applications.

Mr. Feltman studied Electrical Engineering at the University of Illinois and is coauthor of one U.S. Patent.

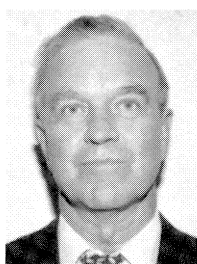

J. Michael (Mike) Sweeney is a Mechanical Systems Engineer with Mobil Exploration and Production Technical Center in Dallas, Texas. He has over 30 years experience in the design, manufacturing, installation, operation, maintenance, and failure analysis of large stationary engines, gas turbines, reciprocating, and centrifugal compressors. This experience involved work assignments in Ohio, Louisiana, Texas, Canada, Venezuela, Pakistan, Indonesia, Norway (Ekofisk), Scotland, Korea, Japan, Libya, Angola, Nigeria, and North Slope Alaska.

Mr. Sweeney has a B.A. degree (Liberal Arts) and a B.S. degree (Mechanical Engineering) from Notre Dame University (1960) (1961). He is a member of Tau Beta Pi Engineering Honor Society, ASME, and a registered Professional Engineer in the States of Ohio and Texas.

ABSTRACT

Conventionally lubricated shaft sealing systems have long been known to be unreliable, high in maintenance and in some cases hazardous in centrifugal compressors. Labyrinth sealing systems, while generally low in maintenance, are extremely high in operating costs (product loss and steam costs).

Dry gas lubricated sealing systems retrofitted into centrifugal compressors are now recognized as a cost effective means of improving equipment performance.

Step by step requirements for a successful retrofit of a centrifugal compressor with dry running gas lubricated seals is presented based upon experience and the review of numerous retrofit projects in which dry gas seals are now operating.

A description and the advantages of dry gas seals are provided, along with a feasibility study to determine whether or not a retrofit is technically, environmentally, and economically desirable.

A detailed proposal request narrative and steps suggested in awarding the contract are shown. This is followed by installation procedures for the dry gas seals along with the commissioning of the newly retrofitted machine. The significant issues presented are based on actual case histories.

INTRODUCTION

Conventional oil seal related problems have been determined as an area significantly affecting compressor reliability. As a

solution to these problems, dry gas seal retrofits have become quite common throughout the world in the last few years.

The advantages and limitations of dry gas seals are presented along with the seal principles of operation and design. A guideline for a feasibility study, proposal request, considerations for awarding the contract, installation of dry gas seals, and commissioning of the retrofitted machine will be shown.

CONSIDERATION OF COMPRESSORS FOR POSSIBLE RETROFIT OF DRY GAS SEALS

Dry gas seal retrofitting is generally considered when any one or more of the following conditions prevail in an existing centrifugal compressor system.

Safety

Oil sealing systems (though utilizing degassers) have been known to absorb gas into the oil, thereby lowering the flash point of the oil. Some explosions have been attributed to this reason. Since dry gas seals utilize no oil, they are safer, and they eliminate this hazard.

Reliability

Dry gas seals have proven themselves over the years to be much more reliable than most oil sealing systems. With fewer aborted startups and fewer failures between planned turnarounds, some dry gas seal retrofits have been economically justified on this basis alone.

Maintenance Costs

With upwards of 30 permissives in some seal oil systems due to high pressure oil pumps, coalescing filters, heaters, coolers, and redundancy, maintenance costs are considerably higher on most oil systems than dry gas seal systems on like applications.

Operating Costs

Parasitic horsepower loads required for oil seal support are significantly higher than those for dry gas seal systems. Pumps, vacuum pumps, and transfer pumps are eliminated. Horsepower required for gas shear is reduced by 95 percent that of oil shear.

Oil Usage

In general, higher to moderate pressure machines will require greater amounts of oil than low pressure machines. Chronic extraordinary oil usage where little improvement to conventional oil seals is possible, generally leads to dry gas seal retrofit considerations [1].

Process Gas Loss

Process gas loss with oil seals can run as high as 10 to 25 times that of dry gas seal leakages. This becomes a very significant factor in the economic evaluation when dealing with valuable process gas such as ethylene.

Abnormally Low Seal Life

Oil seals should last from one turnaround to the next. Excessive failure of oil seals (failure between turnarounds) have given reason to investigate dry gas seal retrofits.

Cross Coupling and Rotor Instability

In some situations the retrofitting of dry gas seals eliminates cross coupling effects and helps gain rotor stability [2]. A very detailed rotordynamic analysis including undamped critical speed calculations and stability analysis is necessary to determine adequate seals feasibility.

Environmental Consideration

The dumping or leaking of seal oil, now a hazardous waste, can cause the necessity of extremely expensive cleanup in the future. Some dry gas seal retrofits have been justified on this basis alone.

Operating Simplicity

Though it is hard to put a dollar value on ease of operation, some companies have retrofitted with dry gas seals citing this as a major benefit.

Fouling of Downstream Equipment

Dry gas seal retrofits have eliminated heat exchanger and other downstream equipment fouling thereby eliminating expensive cleaning requirements and allowing for a much more efficient process.

Reduction of Need to Vent Casing on Shutdown

Seal oil systems require low settle out pressures necessitating flaring large amounts of product during shutdown. Gas seals require no such pressure reduction requirement thereby eliminating a considerable amount of "flared" product. In one case, this resulted in a \$2 mm capital expenditure avoidance for a new dry flare drum [3].

Reducing Overall Machinery Space and Weight

The retrofitting of centrifugal compressors with dry gas seals, particularly in offshore situations, has reduced space and weight requirements enough to erect additional needed equipment on platforms.

Benefits have already resulted in the majority of new centrifugal gas compressors being ordered with dry gas seals. However, some limitations should be taken into account, the most notable of which follow:

The figures given below are typical and vary from one manufacturer to another. All of these limiting values may not be available in any one seal.

- Maximum dynamic sealing pressure 3000 psi
- Maximum static (settle out) sealing pressure 3600 psi
- Maximum temperature (with elastomers) 450°F
- Minimum temperature (with elastomers) -40°F
- Maximum temperature (with nonelastomers) 650°F
- Minimum temperature (with nonelastomers) -250°F
- Maximum surface speed 590 fps
- Maximum shaft size (diameter) 14 in
- Maximum axial movement 0.125 in
- Maximum radial movement 0.062 in
- Reduced damping of rotor shaft (due to elimination of oil bushings) may require more detailed rotordynamic analysis
 - Positive differential pressure across seal faces should be maintained
 - Possible limitation of reverse rotation
 - Filtering seal gas system is required to prevent the presence of liquid or foreign particles at the seal faces
 - Some leakage across the seal faces always occurs

DRY GAS SEAL DESIGN CONSIDERATIONS

The principle of operation of the seal is that moving and stationary radial faces are separated and lubricated by a micro-

scopically thin film of gas, which implies that some small leakage of this gas must occur across the faces of the seal. Therefore, the collection and safe disposal of this gas must be taken into account in the overall design of the seal systems. The presentation includes sections on control, measurement and routing of the leakages as well as the supply of seal gas. The necessity and use of a suitable buffer gas is also considered.

Since most dry gas seal applications are unique and often demand their own specific design, it is particularly important that the performance of the seal and its ancillary system is checked thoroughly before installation.

Seal Arrangements

Analysis of the operating conditions and process parameters must be carefully undertaken in order to determine the optimum seal arrangement requirements. Sealing pressure, temperature, speed, gas composition, and contaminants are factors governing the seal selection procedure. Since there is a small leakage from the seal, venting, flaring, or a primary leakage recovery system should be considered as part of the seal arrangement and control system design.

There are four basic arrangements that can be prescribed for a diverse group of applications. These arrangements are shown in Figure 1.

Single Seal Arrangement

Gases that are inert or nontoxic are typically sealed by this seal arrangement. The leakage from the seal is either vented or flared.

Tandem Seal Arrangement

A majority of the hydrocarbon mixtures, chemical, and petrochemical process gases, and those having toxic and corrosive contaminants such as hydrogen sulfide have to be sealed from the environment and the lubrication systems. In a tandem seal arrangement, two seal modules are oriented in the same direction. The first seal (primary) handles full pressure, while the second seal (secondary) would run as standby or backup seal with zero pressure differential. The backup seal then functions as an additional barrier between the process gas and atmosphere. The primary leakage from the first seal can be safely vented or flared. There is some leakage from the second set of faces, though it is minimal (typically of the order of liters per minute).

The preferred method of buffering the Type 28AT tandem arrangement consists of buffering with nitrogen over the pair of faces (with labyrinth over the mating ring to minimize nitrogen consumption). This eliminates any process gas from leaking through the second set of faces to the secondary vent, thereby eliminating any concerns of gas leaking to atmosphere even in minimal amounts.

Triple Seal Arrangement

In this arrangement, the sealing pressure is broken down across the primary seal and secondary seal. The seal design controls breakdown (approximately 50 percent across each seal) of pressure across the two seals, the third seal is the backup.

Double Opposed Seal Arrangement

In situations where zero process leakage to the atmosphere is the plant safety requirement and a minimal amount of nitrogen is allowable in the process, a double opposed seal arrangement with plant nitrogen buffer should be utilized. The nitrogen buffer leaks into the process at a selective rate (< 1 scfm) and also leaks (< 1 scfm) to the atmosphere. This prevents atmospheric and bearing oil contaminations.

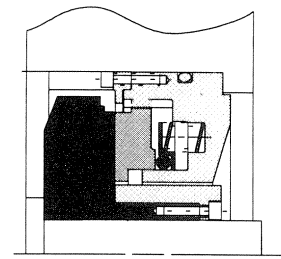

SINGLE SEAL

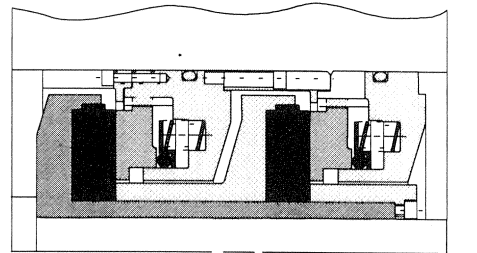

TANDEM SEAL

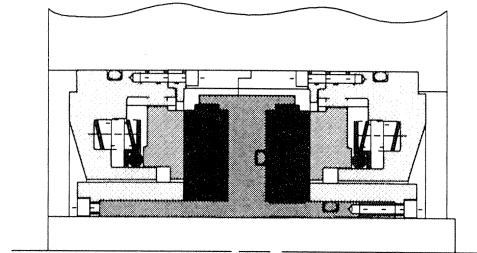

DOUBLE OPPOSED SEAL

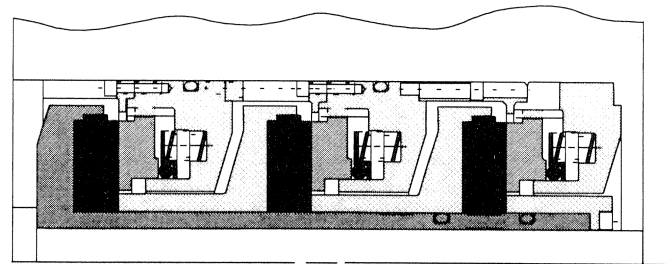

TRIPLE SEAL

Figure 1. Basic Dry Gas Seal Arrangements.

The arrangement also works in applications where compressor suction pressure has the potential or is subatmospheric.

Principles of Operation

Dry gas seals have the same basic design features as mechanical end face seals with one significant difference. A dry gas seal has shallow grooves cut in the rotating seal face part way across the face. The grooves are commonly of a spiral pattern although other patterns are used, and permit a flow of gas towards the inner diameter of the seal face where an ungrooved portion of the face forms a sealing dam. Some face patterns are shown in Figure 2.

The seal faces separate, without shaft rotation above a limiting static pressure (typically around 100 psi) or without static

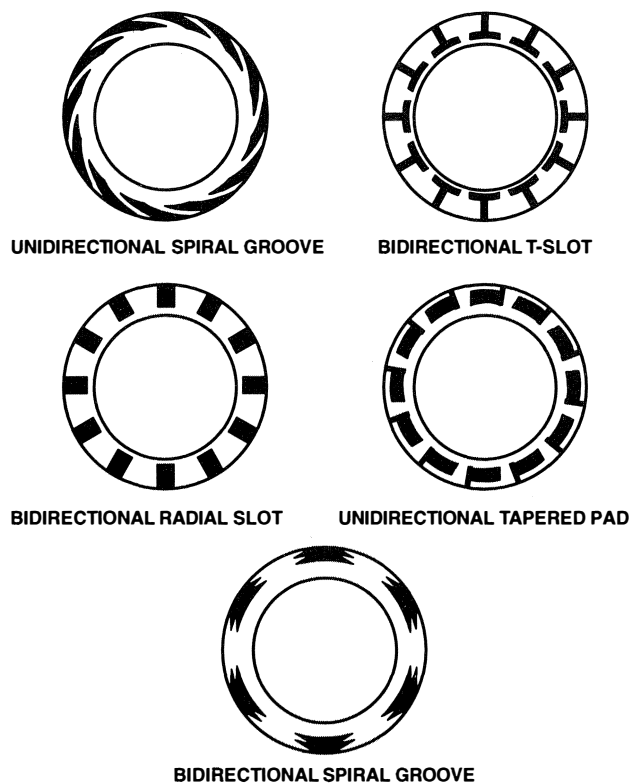

Figure 2. Some Typical Dry Gas Seal Face Patterns.

pressure at a low rotational speed. Leakage rates when pressurized at standstill are extremely low, such that a system may be left pressurized for long periods without a significant pressure loss.

When running, the grooves cause an increase in gas pressure between the seal faces and a stable running gap is achieved when the dynamic and static forces are equal. If the gap tends to close, the separation force is increased and the movement reversed. Establishing a stable running gap is achieved automatically by the inherent design features of the seal. The gap is in the order of 2.0 to 5.0 microns and, hence, the leakage is low. Dynamic leakage is dependent on speed, pressure and seal diameter and is typically less than 3.0 scfm.

Seal Cartridge

The seal unit at each end of the rotor assembly should be in a cartridge with positive location features to prevent incorrect internal installation or inadvertent installation in the wrong machine end that would allow operation in reverse rotation. Each cartridge should have a unique serial number.

The rotating element should be balanced to the same or more stringent requirements as the unit to which they are fitted. This will be normally to the API or equivalent ISO standard. The seal should be designed to contain failure of the gas seal face and so minimize consequential damage.

Any threaded devices using left hand threads should be marked with an arrow indicating the removal direction and the word "OFF."

Barrier Seal (sometimes referred to as the separation seal)

The purpose of the barrier seal is to prevent lube oil from migrating along the shaft and into the dry gas seal and to prevent gas (leaking from the backup seal) from leaking into the bearing cavity.

There are two types of barrier seals:

- *Center tapped labyrinth* for introducing separation gas into the center for keeping gas out of the bearing cavity and oil out of the dry gas seal
- *Double carbon ring*—carbon rings may be a split ring design with a garter spring around the outside of the carbon segments or they may be a one piece carbon ring

The double carbon ring seal is generally preferred to the labyrinth, because it consumes less separation gas (generally nitrogen) and it provides a more effective seal against the oil and the leakage gas.

Seal Materials

Materials of construction should be the seal manufacturer's standard for the specific operating conditions, or as required by the data sheets. The metallurgy of all major components should be stated clearly in the proposal.

- Mating rings are usually of tungsten carbide. However, silicone carbide is sometimes specified, because of its lower density for high speed application.

- O-rings must be compatible with all specific services. For high-pressure services, special consideration should be given to the selection of O-rings to ensure that they will not be damaged upon rapid depressurization or consider nonelastomer secondary seals.

After the gas seal arrangement has been selected from the guidelines shown previously, the following design considerations are suggested.

DRY GAS SEAL SYSTEM DESIGN CONSIDERATIONS

General Considerations

The seal system should be designed to serve the full range of equipment operating conditions. The design of the seal system must also recognize limitations that are inherent in the seal design. These conditions and limitations may include, but are not necessarily limited to, the following:

- *Settling Out Pressure.* This is the maximum static sealing pressure and will occur each time the machine trips when the gas at discharge pressure expands back into the casing and will be a function of the trapped volumes.

- *Reverse Rotation.* This may occur after a trip and during the gas settling out period or a leaky or "stuck open" discharge valve. It will be short term. Most gas seals are suitable for rotation in one direction only, and for these seals reverse rotation should be avoided.

- *Process Relief Valve Setting.* The seal system still functions if the process system pressure rises sufficiently to actuate the relief valves.

- *Reverse Pressurization.* Reverse differential pressure under running conditions must be avoided as it may cause damage to seal components. Reverse differential pressure under static conditions may cause the stationary seal face to move back and "hang up" on the stationary face O-ring; it should be limited to a figure agreed upon with the seal manufacturer (typically around 10 psig).

Reverse pressurization can occur under various circumstances. A further condition is on trip, where the casing is depressurized and the vent to flare is pressurized to its highest condition while handling flare gas from other parts of the plant. Provisions should be made in the system for atmospheric venting under

these circumstances by use of a three-way valve or similar arrangement.

- *Subatmospheric Compressor Inlet Pressure.* This may occur as a continuous operational parameter or as a transient condition during startup. Under this condition, atmospheric air should not be allowed to enter the process gas stream. A startup seal gas supply must be available at an adequate pressure in place of the normal supply that may be from the machine intermediate wheel or discharge when running. The use of suction throttling requires careful consideration.

- *Liquid Contamination.* While the seal should cope with small quantities of liquid droplets, prolonged contamination with liquids may prevent the formation of the dynamic gas film and result in serious damage to the seal. In view of the proximity of bearings and seals in many machines an effective method of preventing lube oil migration towards the seal is recommended. Separation gas from an external source may be required; labyrinth, wind back seals, and oil slingers may also be effective.

- *Depressurization.* Certain materials are subjected to explosive decompression damage if they are too absorbent and depressurized too quickly. On the other hand, O-rings which are less absorbent are usually harder and tend to impair movement and take a permanent set, making them less satisfactory as seals. A maximum depressurization rate should be agreed upon before the seals are manufactured. It should be noted that some dry gas seals can be supplied with spring energized contaminant polymer rings as the secondary seal thereby eliminating the concern over depressurization rate.

- *Contaminant.* The seal should be designed to contain failure of the gas seal mating ring and so minimize consequential damage.

DRY GAS SEAL CONTROL SYSTEM DESIGN CONSIDERATIONS

One of the main advantages of dry gas seals is to increase the reliability of the compressor by eliminating the complex seal oil system. Keep the control system as simple as possible. A typical dry gas seal control system is shown in Figure 3.

The system covers the arrangements for the supply of seal gas, separation gas, buffer gas (if required), and the provision for venting of gas that has leaked through the seal faces.

Seal Gas

One of the main functions of the control system is to provide clean, dry, filtered seal gas to the primary seal. The seal gas source is usually compressor discharge gas, however other sources (generally cleaner) may be used. During startup and when the machine runs down to a standstill, a small amount of unfiltered process gas, may enter the seal region from the body of the machine. This generally is not considered significant, but in cases where it is considered significant, an alternate source of seal gas should be employed when the compressor is shutdown. This will prevent the introduction of foreign material into the seal during downtime and during the time the compressor is being started and pressurized.

If an alternate seal gas supply is to be used during downtime, provide a double check valve arrangement. As a result, the compressor discharge pressure will automatically come into service when it becomes higher than the alternate supply pressure.

Seal gas should be supplied in such a volume that a velocity of approximately 15 fps across the process side labyrinth is maintained. A pressure control valve is generally used to keep the seal gas pressure from 10 to 30 psig above the compressor suction pressure.

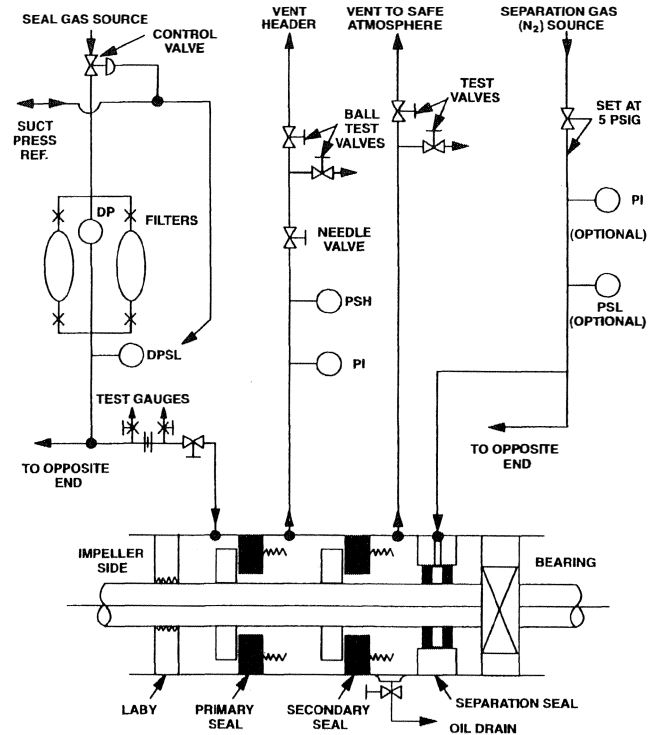

Figure 3. Typical Tandem Dry Gas Seal Control System.

Install a differential pressure switch to sound an alarm if the seal gas pressure fails below suction pressure.

Seal gas must go to both ends of the compressor. Do not assume that the seal gas will distribute equally to both ends, because different cavity pressures may cause unequal flow. Install needle valves to balance the flow to both ends. Install flow orifices with differential pressure transmitters to measure the seal gas flow to both ends. Provide test valves for connecting gauges during routine preventive maintenance procedures.

The seal gas should be filtered to a two-micron nominal rating. Use two filters with isolating valves so that one filter element can be replaced while the other is in service. The bowl of the filters should be equipped with bleed valves vented to a safe area. Install a differential pressure indicator and alarm switch on the filters.

If coalescing filters are necessary, locate them downstream of the pressure control valve to catch any liquids formed by the pressure reduction.

Primary Seal (Leakage) Vent

The end user should define the venting or flare system to which the primary seal leakage will be connected and define the normal operating, design conditions, and upset conditions for this system.

The valving/orificing/gauging and instrumentation in the primary seal leakage line should be such that the health of the primary seal can be monitored and some restriction is in the line to limit maximum flow under seal failure conditions.

Following is a suggested means of providing these controls.

Install needle valves in the primary leakage lines. Each needle valve should be set to hold a slight back pressure (approximately 5.0 psig) on the chamber between the primary and secondary seal. This will create some load against the secondary seal, allowing the secondary seal to leak slightly, and to keep it cool.

These needle valves should be refrigeration system type with a cover that can be sealed once the valve has been properly adjusted. Fixed orifices may also be used, if preferred.

Pressure Switches

Install two pressure switches upstream of the needle valve in the primary leakage lines. Set one switch to sound an alarm and one at higher level to shut down the machine if the leakage increases above normal levels.

Leakage Measurements (Rotameters)

Trend measurement of seal leakage is recommended for monitoring the health of the seal.

Measuring the leakage from dry gas seals is difficult because the leakage rates are very low, in the order of 2.0 scfm per seal. Rotameters could be suitable for this service, but some process plants prohibit rotameters because of safety concern about the glass or plastic windows. Also, rotameters do not give reliable service for long term operation, because they typically become dirty, or fouled, and give erratic readings.

It is not necessary to precisely measure the leakage on a continual basis. Pressure indicators on the leakage line upstream of the needle valve give a general indication of the leakage rate.

Once a month, or more frequently as required, a more precise measurement of the leakage can be obtained with a set of portable calibrated rotameters. Use a set of three rotameters with different flow ranges. The readings from these calibrated rotameters can then be trended for preventive maintenance.

Test Valves

- Install the valve through which the leakage can be measured periodically with calibrated rotameters. It is recommended that these valves be ball valves, because they will be fully-closed or fully-opened.

- Another function of the test valves on the primary leakage is for routine preventive maintenance. Once a month, the ball valve should be closed to transfer the full load to the secondary seal to verify that the secondary seal is still functioning properly.

Backup Seal (Secondary) Vent

The backup seal vent line should be routed to atmosphere by a line designed to give the lowest possible back pressure, so that the backup seal never operates with a reverse pressure across it. Primary and backup seal vents should not be combined. The quantity of gas which will leak past the backup seal under normal, upset, and failure conditions, and the variation of flow with back pressure on the vent system should be clearly defined.

Flow measurement through the backup seal vent is not necessary on a continual basis, because this leakage is primarily air or nitrogen from the barrier seal, mixed with a very small amount of seal gas.

Ball type test valves and vent connections should be installed in the backup seal leakage lines for preventive maintenance procedures.

A gas analyzer should be used to check the relative concentrations of seal gas to air or nitrogen on a monthly basis. If high concentrations of seal gas are detected in the back up seal leakage line, this would indicate a problem with the back up seal.

A manual drain valve from the low point in the chamber between the dry gas seal and the barrier seal should be provided. Periodically opening this valve will indicate whether lube oil is leaking past the separation seal into the dry gas seal cavity.

Barrier (Separation) Sealing

It is possible that oil or oil vapor may leak into the seal housing, contaminating the backup seal face, or that leakage of

process gas could get past the back-up seal into the bearing housing and hence into the oil reservoir. To eliminate these possibilities, a suitable method of separation, with provisions for air or nitrogen purging, should be provided.

Design the system so that the separation gas will continue to flow after shutdown to prevent post-lube or pre-lube oil from leaking into the dry seal assemblies.

Inert gas such as nitrogen is preferred for separation service. A supply can be generated with one of the small membrane units that are readily available from several manufacturers. Low grade nitrogen with up to 6.0 percent oxygen is acceptable for this service.

Many pipeline compressors in North America use compressed air for separation service, because a source of nitrogen is not available in remote locations.

If air is used, consideration should be given to using dry instrument air to avoid condensation effects. Care must be taken to ensure that the use of air does not give rise to the formation of explosive mixtures in the seal housing or backup seal vent piping. As an alternate, nitrogen may be introduced upstream of the backup seal. This should reduce the quantity of separation gas required. The location of the nitrogen injection point should be separated from the primary seal vent, e.g., by a labyrinth.

The separation gas supply can be controlled by a simple pressure regulator to hold approximately 3.0 to 5.0 psig pressure at the barriers. The consumption of separation gas is normally low if a labyrinth is used. Carbon ring-type barrier seals use significantly lower amounts (1.0 to 2.0 scfm per end).

An optional pressure indicator switch can be added to sound an alarm if the separation gas supply pressure falls below the prescribed level.

SEAL TESTING

Tests should be carried out in the seal manufacturer's facility prior to installation in the rotating machine. The objectives are:

- To ensure mechanical integrity over the operating range of speeds, pressure and temperature.
- To verify that leakage rates of the seal meet design requirements, both static and dynamic, over the complete operating envelope of speed, pressure, and temperature.
- To investigate any potential upset conditions the seal may encounter due to process or machine testing variations.
- To provide data for setting up ancillary equipment and instrumentation.

The leakage rates measured are a good indicator of the seal's condition. Unless problems are perceived, it is optional whether or not the seal is disassembled after the test. (In the event of a disassembly the seal should be statically tested.)

As a minimal, each seal should be tested to the following requirements:

Static

- Static leakage, primary seal at 25, 50, 75, and 100 percent of design pressure
- Breakaway torque at 25, 50, 75, and 100 percent of design pressure

Dynamic

- Primary leakage at design speed and 25, 50, 75, 100, and 125 percent of design pressure
- Secondary leakage at design speed and 25, 50, 75, 100, and 125 percent of design pressure
- Primary leakage at maximum continuous speed and 100 percent of design pressure

- Primary leakage (recorded at 2.0 min intervals) for a 60 min run at design speed and 100 percent of design pressure
- Secondary leakage (recorded at 2.0 min intervals) for 15 min at design speed and 100 percent of design pressure
- (Optional) Disassemble the seal cartridge and inspect faces for abnormal contact patterns, scratches or rubs
- Seal acceptance criteria is based on leakage remaining within the maximum guaranteed limits and the condition of the seal faces

RETROFIT FEASIBILITY STUDY

A successful dry gas seal retrofit is dependent on a thorough review of the service conditions, dry gas seal/systems design considerations, plant safety, reliability requirements of the end-user, and good communication channels from the end-user to the OEM and from the OEM to the seal manufacturer.

A typical time table for a dry gas seal retrofit project is shown in Table 1. It is recommended that the compressor manufacturer be contacted to submit a dry gas seal retrofit proposal. The compressor manufacturer has all of the critical dimensions and data concerning the compressor and is considered to be the best qualified to give a complete retrofit price. The data sheet (Table 2) should be partially filled out by the end-user and accompany the request for proposal. It will be completed by the compressor manufacturer and be an integral part of the proposal.

Request for Retrofit Proposal

The following list should be specifically spelled out in the proposal request as items to be provided by the OEM if he were to receive an order for the retrofit.

- Complete the information required on the data sheet
- Rotordynamic study
- Layout drawings showing the seal cartridge installed in the seal cavity, including oil separation seal and process side labyrinth
- Drawing detailing remachining (if required)
- Bill of materials specifically stating who will supply each item
- Identification of required and surplus ports and connections
- Proposed control system design (with bill of materials)
- Special tools required
- Recommended spare parts list
- Estimated downtime required to retrofit
- Itemized price of material, i.e., seals, control system, rotordynamic analysis, engineering, and any specials there may be

Table 1. Typical Dry Gas Seal Retrofit Project Schedule

Feasibility Study	1 to 2 months
Project Approval (AFE)	1 month (sometimes several months)
Detail Engineering Design and Drawing Approval	2 to 3 months
Manufacturing of Dry Gas Seals and Control Panel	4 to 5 months
Transport and Install	1 month
Total	9 - 12 months

Table 2. Dry Gas Seal Retrofit Data Sheet

Equipment Information

Manufacturer _____

Equipment Type _____

Model/Serial No. _____

Rated RPM/Max RPM/Trip Speed _____

Present Seal Type _____

Common Seal & Bearing Oil System? Yes No _____

Buffer or Inert Gas Available? Yes No _____

Describe _____

Year Installed _____

Operation Information

Application/Process Fluid _____

Describe Contaminants _____

Normal Operating Pressure:Suction/Min/Max _____

Discharge/Min/Max _____

Normal Operating Temperature/Min/Max _____

Current Gas Leakage _____

Current Oil Leakage _____

Number of Seal Failures/Total/Year to Date _____

Dimensional Information

Seal Arrangement _____

Shaft Diameter _____

Bore Diameter _____

Axial Depth (Inches) _____

Shaft Rotation _____

- Delivery schedule

Economic Evaluation

As part of the economic evaluation, the end user will need to gather maintenance and operating costs of the conventional sealing system based on three to five year costs and analyze them. The costs required are shown in Table 3. These costs were developed for a 3 1/2 in (shaft), moderate pressure, 10,7000 rpm machine and *should only be used as a guide*.

Each project will have costs unique to its specific application and due diligence should be used to obtain proper costs for that particular project. After a favorable economic evaluation resulting from the foregoing feasibility study and an authorization for expenditure has been granted, the contract for the retrofit will be awarded.

Table 3. Economic Evaluation Wet vs. Dry Gas Sealing Systems Operating & Maintenance Costs

Existing Wet Seal System

U.S. \$ per annum

1. Maintenance cost/year 100 hours @ U.S.	\$ 3200 \$32.00
2. Replacement costs of seal components Change every 3 years	\$ 6,600
3. Parasitic power loss of seal = 30 kw per seal cost of power = U.S. \$0.06 per kwh = 30 x 2 x \$0.06 x 365 x 24	\$31,536
4. Parasitic load of main seal oil pump = 40 kw = 40 x \$0.06 x 365 x 24	\$21,024
5. Degassing power loss = 15 kwh = 15 x \$0.06 x 365 x 24	\$ 7,884
6. Product loss = 3 scfm per seal @ U.S. \$1.70 per 1,000 scf = 3 x 2 x \$1.70/1,000 x 60 x 24 x 365	\$ 5,361
7. Seal oil renewal/make-up @ U.S. \$2.70 per gallon 15,330 gallons/year 2.70	\$41,391
8. Extrordinary Situations = Oil seals caused two unplanned outages between planned turnarounds within a six year period. \$275,000/outage X 2÷6 years	\$91,667
TOTAL	\$208,663

Dry Gas Seal System

U.S. \$ per annum

1. Maintenance cost/year U.S. \$5,000/seal/3 years	\$ 1,667
2. Replacement costs of seal components Change every 3 years	\$2,5000
3. Parasitic power loss of seal = 1 kw per seal cost of power = U.S. \$0.06 per kwh = 2 x \$0.06 x 365 x 24	\$ 1,051
4. Parasitic load of main seal oil pumps	\$ 0.00
5. Degassing power loss	\$ 0.00
6. Product loss = 0.32 scfm/min per seal @ U.S. \$1.70 per 1,000 scf = .32 x 2 x \$1.70 x 60 x 24 x 365	\$ 572
7. Seal oil renewal/make-up	\$ 0.00
8.	
TOTAL	\$5,790

Awarding the Dry Gas Seal Retrofit Purchase Order

Prior to awarding the purchase order, check to see that all the items shown in the request for proposal are accounted for. In addition, the dry gas seal manufacturer should be determined based on the following criteria:

- Technical considerations
- Dry gas seal engineering experience
- Users list (talk to users)
- Manufacturing capabilities
- Service/Support
- Training offered

After the purchase order has been awarded and prior to the receipt of the seals and control system, a critical path type chart is helpful.

DRY GAS SEAL INSTALLATION

Dry gas seal assemblies should be installed in the centrifugal compressor following the seal and machine manufacturers stated procedures. The installer should consider requesting technical assistance from the seal manufacturer or his representative to ensure correct installation of the seal system and to preserve warranties. *Care must be taken to avoid any damage to the seal faces during installation.*

Because of fine tolerances and surface finishes in gas seals, *cleanliness of the work area is very important*, both in the workshop and in the field. Spare seal cartridges should be stored in the manner described in the manufacturer's manuals.

Installation and instruction manuals should provide sufficient written instructions, including a cross-referenced list of all drawings, to enable the purchaser to correctly install, operate, and maintain the equipment ordered.

The manual containing operating and maintenance data should include a section, if appropriate, to cover special instructions for operations at extreme environmental conditions (such as temperature). The following should be included in this manual:

- Instructions covering start-up, normal shutdown, emergency shutdown, operating limits and routine operational procedures
- A description of dry gas seal construction features and the functioning of component parts and auxiliary systems
- Outline and sectional drawings, schematics, and illustrative sketches in sufficient detail to identify all parts and clearly show the operation of all equipment and components and the methods of inspection and repair. Standardized sectional drawings are only acceptable if they represent the actual construction of the seal system

• As-built data sheets

Prior to seal installation, machine end covers and shaft if necessary. This machining should be carried out in strict accordance with the detailed drawings from the retrofitter.

Preinstallation Checks

- Verify that the latest revision of the seal assembly cross-section drawings are available at the compressor site. Check the complete bill of materials to verify that all required parts, fasteners, O-rings, and special tools are available.

- Verify that the outside surfaces of the shaft are smooth and free of burrs and deep scratches. Verify that all required chamfers are present to prevent damage of the secondary seals. Measure the outside diameters of the shaft and compare with design dimensions.

- Check to see that the inside surface of the cavity is smooth and free of burrs, deep scratches, and sharp edges that may cut the secondary seals (O-rings and/or spring energized polymer rings). Verify that all required chamfers and radii are present.
- Verify that all internal diameters and dimensions of the seal cavities are in accordance with design tolerance.
- Remove any seal oil from internal passages with mineral spirits and/or hot steam, and blow dry with compressed air. Blow all cuttings and dirt from cavity and from the drilled passages in the end cover with compressed air.
- If a threaded lock nut is used, verify that it will fit the threads on both ends of the shaft. Pay special attention to the direction of thread used as many OEMs use l.h. threads at one end of the compressor and r.h. threads at the other.
- Check fit the seal cartridge on the shaft to verify that it will fit. The elastomers and seal rotor centering device may make installation difficult. Do not use hammers or knockers to install the seal as blows may crack the seal faces.
- Check fit the seal assembly in the cavity in the compressor end cover. Check fit the internal labyrinth seal. Verify the location and orientation of the anti-rotation mechanism for the process side laby (if applicable, as some labyrinths are secured to the seal cartridge with cap screws). Verify that the labyrinth will go all the way “home,” and will not prevent the complete installation of the seal assembly.

Seal Installation

- Install the rotor in the compressor and install the end covers. Install the seal rotor drive mechanism (pin, key, etc.) at t.d.c. to facilitate seal installation. (if applicable).
- It is recommended that the thrust end seal be installed first. Install a shaft locking fixture on the opposite end of the shaft to lock its position axially to prevent any damage to the internal seal components.
- Measure the seal installation reference dimension. If it is necessary to shift the rotor, verify that the axial float capability specified on the outline drawing is not exceeded. Grind the seal rotor spacing device (if so equipped) to the required dimension to achieve the correct seal installation reference dimension.
- Once the shaft is correctly spaced axially, lock the shaft in place with the fixture on drive end of the shaft.
- Install the process side labyrinth over the shaft and center the shaft in the housing with a shaft jack. Center the shaft within 0.1 mm (0.005 in). Use a test rod of the proper length to center the shaft, which is much faster than using micrometers.
- Select the correct seal for the thrust end of the compressor. The seal assembly should be marked accordingly. Verify that the direction of rotation is correct. Record the part number of the seal and its serial number.
- The seal capsule must be exercised prior to installation to minimize sticking during extended storage. This exercising can be accomplished as follows:
 - Place the seal cartridge on a clean surface with the installation plate(s) facing up.
 - Loosen the inner row of socket head cap screws two complete revolutions.
 - Pull up on the installation plate until uniform contact is achieved with the socket head capscrews.
 - Push down on the installation plate and release/pull up five to six times.
- Tighten the inner row of socket head cap screws. Loosen the outer row of socket head cap screws two complete revolutions.
- Carefully rotate the seal assembly upside-down with the installation plate(s) on the bottom.
- Push down on the rotor (sleeve) and release/pull up five to six times.
- Tighten all the installation plate cap screws.
- Loosen all the installation plate cap screws, one revolution to allow for slight radial, misalignment between shaft and compressor, bore.
- Clean the end of the shaft and cover the bearing journal and vibration probe areas with a teflon sleeve or wrap with masking tape. This covering will protect these surfaces from damage while the seal is being installed.
- Lightly lubricate the inside of the cavity, the outside of the shaft, and the external O-rings with O-ring lube.
- Check the orientation of the seal rotor drive mechanism and verify that it corresponds with the orientation of the slot in the seal sleeve. With a fine-line felt tip pen, mark two parallel lines from the sides of the seal rotor drive mechanism to the end of the shaft. These lines will help to align the key with the slot in the seal rotor.
- Carefully lift the seal cartridge and slide the seal assembly along the shaft until it is a 5.0 cm (2.0 in) away from engaging with the cavity.
- Verify that all the O-rings are in place, especially any small O-rings that connect to side or radial drilled ports, if possible.
- Push the seal into place by hand until it engages with the housing and/or compressor shaft.
- Slowly and evenly, draw the seal cartridge into the compressor using a pusher plate tool while checking compressor shaft/bore concentricity every several inches. **DO NOT USE KNOCKERS.**
- Push the seal cartridge in until it bottoms with metal to metal contact. Check the seal assembly drawing for details of how the seal rotor interfaces with the compressor shaft and how the seal stationary seal group interfaces with the compressor bore.
- Remove the cap screws which secure the installation plate(s) to the seal cartridge, being careful not to drop screws into the compressor housing or flow passages.
- Remove the installation plate(s) and place in the shipping container for future use.
- Secure the seal rotating group to the compressor shaft with the hardware provided. Typically, this is either a threaded locknut or split-ring and collar.
- Secure the seal stator group to the compressor with the hardware provided. Typically, this is done either with large cap screws or a shear ring assembly.
- Install bearing side separation seal (labyrinth, windback, or bushing assembly) if not integral with gas seal cartridge.
- Install thrust bearing.
- Repeat the above sequence for the opposite end of the compressor.

Seal Control System Interface

Upon completion of dry gas seal installation and remaining compressor reassembly, the seal control system may be plumbed up to the appropriate compressor ports. Typically, half inch OD

stainless steel tube will pass the required flow for most applications, although many end users specify schedule 80 pipe for structural integrity.

All plumbing should be free of welding slag or other contaminants that could damage the seal faces. It is recommended that all flow paths be blown clean with compressed air until a fine mesh screen at the exhaust end of the path will not trap any debris.

All connections should be carefully checked against the P&ID for accuracy, as an incorrect connection may damage the gas seal.

SUMMARY

Knowledge of the dry gas seal and its ancillary control system requirements along with the procedures detailed in this tutorial will result in a successful dry gas sealing system retrofit. Close attention must be paid to all of the elements brought forth in this paper. They are:

- Knowledge of dry gas sealing system design considerations are mandatory. Noting the advantages and limitations is necessary so that it can be economically / technically / environmentally justified.
- The retrofit feasibility study. Includes the homework involved to acquire current conventional seal costs, projected dry gas seal costs, and the capitol investment necessary for the retrofit.

- Retrofit proposal request
- Acquiring the AFE approval
- Retrofitter and dry gas seal manufacturer selection
- Installation
- Commissioning

REFERENCES

1. Carter, D. R., "Application of Dry Gas Seals on a High Pressure Hydrogen Recycle Compressor," *Proceedings of the Seventeenth Turbomachinery Symposium*, Turbomachinery Laboratory, Texas A&M University, College Station, Texas (1988).
2. Atkins, K. E. and Perez, R. X., "Influence of Gas Seals on Rotor Stability of a High Speed Hydrogen Recycle Compressor," *Proceedings of the Seventeenth Turbomachinery Symposium*, Turbomachinery Laboratory, Texas A&M University, College Station, Texas (1988).
3. Dugas, J. R., Jr., Tran, B. X., and Southcott, J. F., "Adaptation of a Propylene Refrigeration Compressor with Dry Gas Seals," *Proceedings of the Twentieth Turbomachinery Symposium*, Turbomachinery Laboratory, Texas A&M University, College Station, Texas (1991).