

# CHANGING AND CONTROLLING THE “FIRST CRITICAL SPEED” OF OVERHUNG CENTRIFUGAL FANS

by

**S.T. (Ted) Myrick, Jr.**

**Principal Consultant**

**E.I. DuPont**

**Wilmington, Delaware**

**W. Barry Crawford**

**Rotating Equipment Reliability Technologist**

**and**

**Gerald L. Schumpert**

**Rotating Equipment Reliability Engineer**

**E.I. DuPont**

**New Johnsonville, Tennessee**



*S.T. (Ted) Myrick, Jr., is a Principal Consultant in the Engineering Mechanics Group of E.I. DuPont, in Wilmington, Delaware. He has more than 31 years of experience in the fields of rotordynamics, vibration analysis, and maintenance of rotating machinery. With DuPont, Dr. Myrick has had assignments in Engineering R&D, Project Engineering, and the Gulf Regional Consulting Office in Beaumont, Texas, and is presently a Technology Group*

*Leader in DuPont Engineering Technologies.*

*Dr. Myrick holds BSME (1967) and MSME (1969) degrees from the University of Tennessee, and a Ph.D. degree (1973) from the University of Texas.*

---



*W. Barry Crawford is a Rotating Equipment Reliability Technologist in the Reliability Group at the DuPont Titanium Technologies plant in New Johnsonville, Tennessee. He has 36 years of service with the E.I. DuPont Company, working for the first 24 years as a maintenance mechanic on all types of machinery and for the last 12 as the lead vibration analyst in the Reliability Group. He has been called on to analyze vibration and balance difficult*

*machines at other DuPont plant sites.*

*Mr. Crawford has a Level III certification in vibration analysis from Technical Associates of Charlotte, and is especially skilled in balancing.*

---

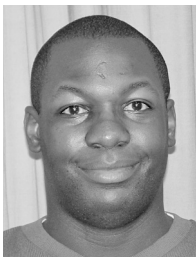

*Gerald L. Schumpert is a Rotating Equipment Reliability Engineer at the DuPont Titanium Technologies plant in New Johnsonville, Tennessee. He has six years of service with E.I. DuPont, including a previous assignment in Maintenance and Reliability for the DuPont plant in Edgemoor, Delaware.*

*Mr. Schumpert holds a BSME degree from the University of Tennessee, and MLT*

*I and Category II certifications from the International Council of Machinery Lubrication and the Vibration Institute.*

---

## ABSTRACT

Nine 150 hp centrifugal fans with overhung 40 inch diameter wheels pull hot air through the spray dryer bag houses (SDBH) in the finishing area of a titanium dioxide (TiO<sub>2</sub>) plant in New Johnsonville, Tennessee. The fans had operated for years at 1900 rpm, but in 1998, with the fan manufacturer's agreement, their operating speed was increased to 2080 rpm. Following this change, several of the fans experienced high vibration and became balance sensitive, and two fans wrecked catastrophically after bearings failed. Operation on or near the "first lateral critical speed" was suspected; however, before the speed was increased, the fan manufacturer had reported the "critical speed" of the fan as 3000 rpm. Through a combination of extensive testing and rotordynamics analysis by the end user, it was determined that the actual "first critical speed" of the nine fans varied from as low as 1700 rpm to no higher than 2405 rpm, straddling the 2080 rpm operating speed. This paper presents the results of the extensive analysis, explaining:

- Why the large discrepancy between reported and actual first critical speeds,
- How the actual first critical speeds were determined,
- What factors contributed to such a large range of critical speeds,
- What was changed to move the first critical speeds away from operating speed,
- How much did each change accomplish, and
- What control process was put in place to assure that when new fans are installed, the first critical speed will not be a problem.

The program at the New Johnsonville plant has been a success and fans that once were the number one maintenance issue have since been removed from the "constant headache" list. In fact, one mechanic commented recently: "We just don't work on those fans anymore."

## INTRODUCTION

The DuPont titanium dioxide (TiO<sub>2</sub>) plant at New Johnsonville uses spray dryers to evaporate excess water from a treated pigment (TiO<sub>2</sub>), which enters the finishing, drying, and grinding area in a cake/slurry form. Three 150 hp centrifugal fans (Figure 1) and three bag houses are used to induce a draft inside each spray dryer.

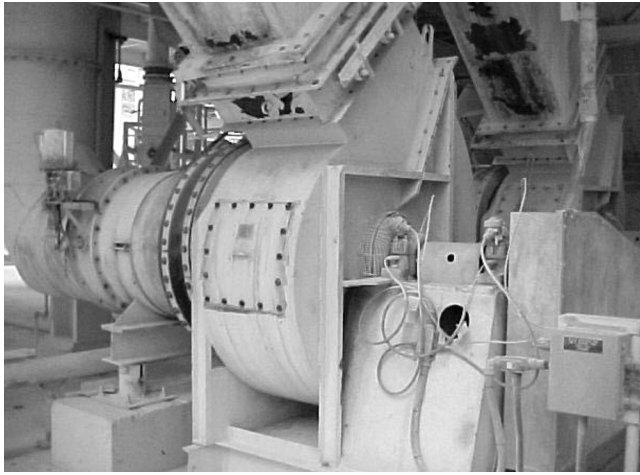

Figure 1. One of Nine 150 HP “Bag House” Fans. (Apparent “holes” in exhaust duct are just peeled paint. [Note the bearings have continuous temperature and vibration monitoring. The fan operates at 350°F.]

To meet a business need in 1998, a decision was made to increase the dryer rate, which resulted in increasing the speed of the fans by 10 percent. To accomplish this, the belts and sheaves were changed, but based on the advice of the bearing vendor, the bearings remained unchanged even though the published “limiting speed” on them was 380 rpm lower than the new operating speed. The fan manufacturer reported the “critical speed” was 3000 rpm and agreed with the new 2080 rpm speed for the fan due to the wide margin between the “critical speed” and operating speed. Reliability issues were noticed almost immediately:

- Some fans became very difficult to balance.
- Bearing temperatures increased.
- A slight pigment buildup would result in excessive vibration levels requiring a shut down and water wash.
- There was a major impact on plant uptime and maintenance cost (in the \$500,000/yr range).

Clearly something had to be done, but slowing the fans back down was not an option from the business standpoint. Nor was replacing the fans.

## MACHINE DESCRIPTION

These fans have a single, overhung 351 lb steel wheel ( $W_r^2 = 71,000 \text{ lb-in}^2$ ) on a 3.45 inch diameter straight steel shaft. The total rotor weight is 590 lb, including a 117 lb steel sheave. Total rotor length is 46 inches with an 11 inch to 13 inch overhang of the wheel and 21 inches between bearings. The rotor is supported on spherical roller bearings with tapered adapters. The base, anchored to a concrete pad at ground level, is a trapezoidal, hollow steel box with  $\frac{5}{8}$  inch thick steel bars on a  $\frac{3}{8}$  inch thick steel plate supporting the pillow-block housings. The single-speed, 1800 rpm motor drives the sheave through a timing belt.

### Nine Different Fans

But the nine fans were not identical. Seven wheels had straight cylindrical-fit hubs, while two had tapered hubs. Six wheels had “airfoil” blades, while three had “backward leaning” blades. Three trapezoidal bases were filled most of the way up with concrete, but the other six were empty. And the amount of overhang of the wheel from the “inboard” bearing varied between the fans by up to 2 inches.

## PROBLEM ANALYSIS

A simple rotordynamics analysis of the basic fan, varying combined (or “effective”) bearing and base support stiffness, showed that the “first critical speed” would be right at 2080 rpm if the effective support system stiffness was 143,000 lb/inch at each bearing. This seemed a reasonable range for bearings mounted on a skip-welded, fabricated steel support frame.

Figure 2 shows the simple rotor model and Figure 3 shows the first mode shape. Note that the first mode is a nearly rigid shaft and sensitive to the effective bearing support stiffness.

New Johnsonville Bag House Fan Critical Speed with 351-lb Wheel — 4/3/2000  
(CRTSP2 Data File)

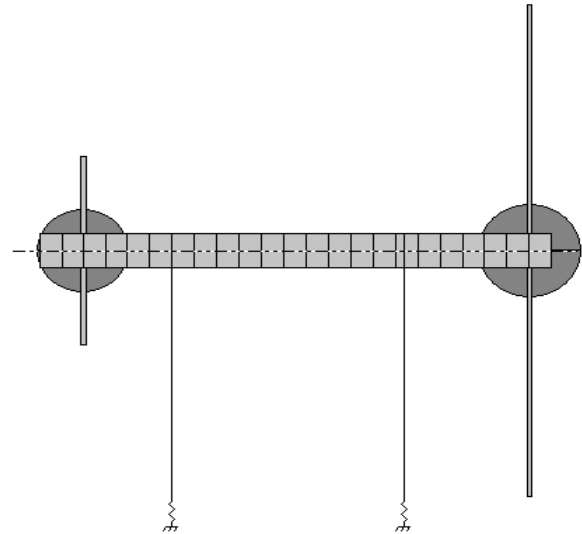

Figure 2. Simple “Critical Speed” Model of the Fan.

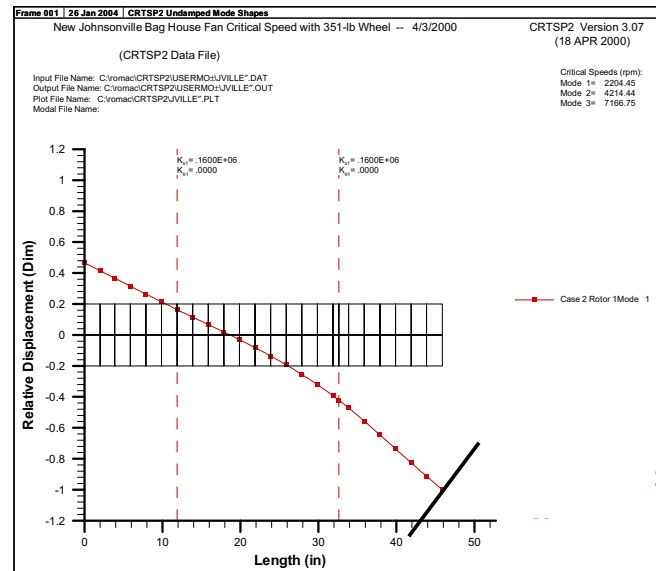

Figure 3. First Lateral Natural Frequency (“First Critical Speed”) with  $K_{eff} = 160,000 \text{ Lb/Inch}$ . (Note the large amount of motion in the bearings. The effective stiffness of the bearings is controlled by the clearances in the bearings and the stiffness of base under the pillow-block housings.)

A crude test with a force gauge and dial indicator mounted on the boom of a small crane revealed stiffness (force/deflection)

values in the 125,000 to 200,000 lb/in range for the horizontal support plate, validating the analysis. But the reported “critical speed” was “3000 rpm,” and the model showed this would require 500,000 lb/in at each bearing. How can this be explained?

*What Does “Critical Speed” Mean?*

It turns out the plant asked the right question, but used the wrong terminology. They asked: “What is the ‘critical speed’ of the fan?” The answer was: “3000 rpm.” But “critical speed” to the fan manufacturer, per the “Joint Product Specification” (JPS) in place for the fan purchase meant, by definition, on “infinitely rigid bearings.” Per the JPS, page A3:

- “Critical speed is that speed which coincides with the fundamental natural frequency in bending...supported on infinitely stiff, undamped supports at the bearing locations.”
- “Design resonant speed is that speed which coincides with the fundamental natural frequency in bending when the...stiffness of the bearing oil film, bearing housing, and bearing support is taken into account in the calculation.”

If the plant wanted the “actual critical speed,” they should have asked for the “design resonant speed.” The plant project people doing the speed upgrade were not experts in rotordynamics and were not experienced in the terminology, and as a result, they were asking one question while the fan manufacturer was answering another.

*How the “Actual Critical Speed” Was Determined*

The first step in the authors’ program to improve fan reliability was to find out what the “actual critical speed” of the fans was, but they could only test a fan when it was not running. And they knew the gyroscopic forces acting on the large overhung wheel would significantly change the static natural frequency when the fan was operating.

The process the authors developed to determine the “actual first critical speed” and to develop an understanding of what fan features controlled that speed evolved as follows. First, they would do:

- Static testing of the wheel and shaft mounted in the bearings in place on the base using an impact hammer and modal analysis software.
- Rotordynamic calculations to predict how much the static natural frequency changes with speed due to gyroscopic effects on the large, overhung wheel.

The goal at that point was to develop an “OK-Not OK” table of static natural frequencies for these fans with associated critical speeds predicted for operation at 2080 rpm. For example, if the static impact test found the first lateral mode at 1620 cpm, the first critical speed with the fan running would be 2080 rpm. This fan would be a problem. If, however, the static test found the first mode at 1740 cpm, the predicted first critical would be 2270 rpm. With a separation margin of 190 rpm, this fan would be “OK.” In this way, the static test could be used to identify a fan that would be operating near its critical speed so changes could be made before putting it in service. But it was not that simple.

The first fans tested yielded major surprises, which showed the need for a much more extensive measurement program than had been anticipated. The surprises included: a rotor with a first lateral natural frequency that changed as the rotor was turned by hand, and a rotor with two first lateral natural frequencies. The measurement program was expanded to include:

- Vibration analysis using “waterfall” spectrum displays during coastdowns from operating speed to observe running speed harmonics excite the “critical” as they passed through it. (Sometimes this worked—once spectacularly [shown later in Figure 11]—but it did not work on all the fans.)

- Changing wheels on fans and retesting, then changing bearings and retesting, and modifying the base support and retesting.

Eleven fans were tested (Fan #9 was built three times). The results continued to be surprising.

*Test Methods*

The “screening test” for static first lateral natural frequency was simple. Place an accelerometer axially on the bottom of the wheel using a magnetic base and a second accelerometer radially on the flange of the sheave (Figure 4). Use an impact hammer to excite the top of the wheel axially and, using “peak hold” averaging of the wheel accelerometer output, determine the first lateral mode with a portable frequency analyzer. The accelerometer on the sheave can be used to confirm the phase of the mode. A typical first mode response is shown in Figure 5.

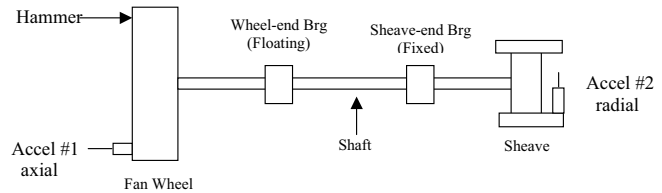

Figure 4. Setup for First Lateral Natural Frequency “Screening Test” by Impacting Wheel.

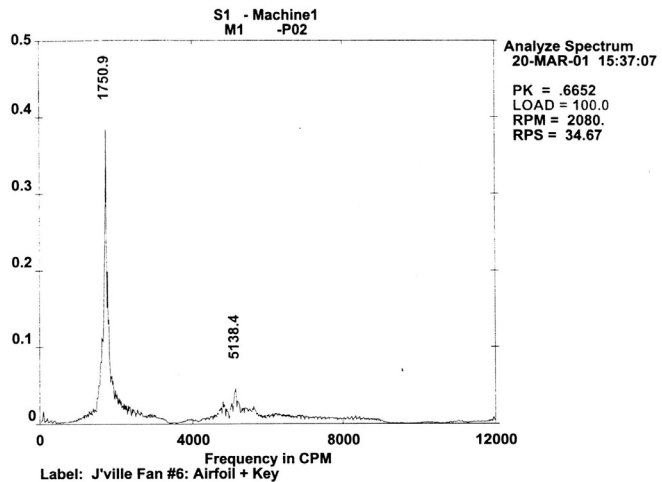

Figure 5. Single, High “Q” First Mode Response Measured Axially on the Wheel.

“Modal analysis” testing was a little more complicated involving the use of 20 accelerometers, a six-channel signal analyzer, and a modal analysis software program featuring animated display of the mode shapes. Eight accelerometers were placed axially on the wheel, two were placed radially along the shaft, one vertically on each bearing pillow-block, and eight vertically on the horizontal base supporting the bearings. The impact hammer was used to excite the wheel and the accelerometer outputs were recorded simultaneously. A typical output of the modal analysis software is shown in Figure 6. This test revealed that the horizontal plate on the bearing support frame was deflecting and needed to be stiffened to drive the “effective support stiffness” up. It also showed that the wheel natural frequencies, such as the 2D/0C, 3D/0C, and more complex wheel modes, had frequencies beginning at 12,640 cpm, and continuing higher, and were therefore not associated with the first critical speed issue.

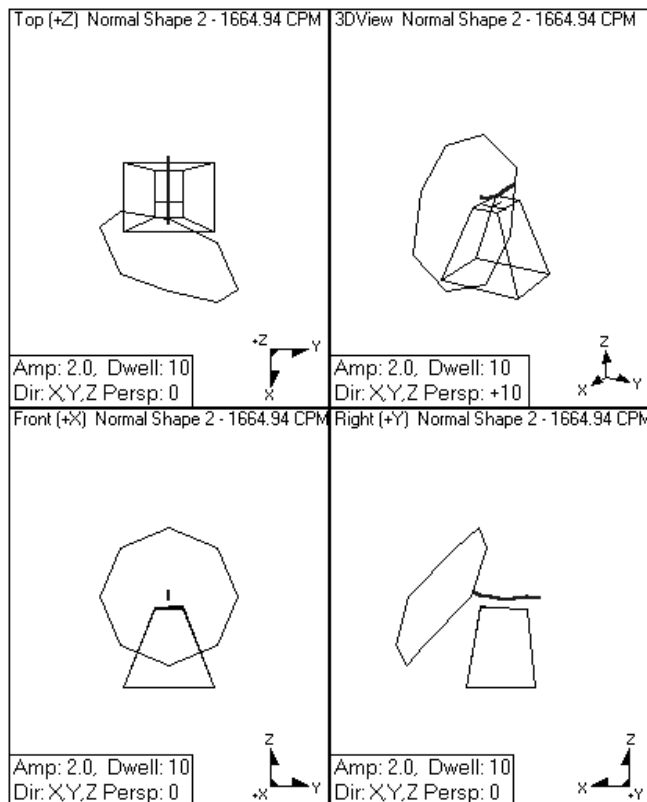

Figure 6. Freeze Frame from Animated Display of Modal Analysis of #8 Fan. Frequency Is 1665 CPM. (One of two first modes. [Note base deflection.] )

#### Single First Mode Change

The first fan tested yielded the first surprise. The authors made the first impact measurement and then broke for lunch. When they returned, the rotor had turned approximately 45 degrees. To their surprise, when they repeated the test in this new orientation, they found a significantly different frequency. The authors turned the rotor in 45 degree increments and repeated the test. Repeatability was good versus the orientation of the wheel. The highest frequency was found in the plane of the single key and the lowest frequency was in the plane at 90 degrees to the key. Since this was a cylindrical fit hub, the authors reasoned the hub was tight on the key, and therefore stiffer in that plane than in the slightly looser direction 90 degrees around the hub. Of the 11 fans tested, three wheels were found with this characteristic, and one of those three had a very low average frequency and a 400 cpm difference in frequency between the two planes (Figure 7). When this wheel was later removed from the shaft, the clearance between shaft and hub was found to be a “loose” fit.

#### Single, Clearly-Defined First Mode

Three rotors had one single, clearly defined first lateral natural frequency, which did not change as the rotor was turned (Figure 5). This sharp, high response mode had a “Q” (or “resonance amplification factor”) of 18:1. With these data, the authors determined, were the critical speed coincident with operating speed, they only needed to shift the critical speed by a maximum of  $\pm 8$  percent to decrease the vibration amplitude by 75 percent—from an “interlock” level of 0.8 ips to a “marginally acceptable” level of 0.2 ips (Figure 8). Their “defect zone” became  $\pm 8$  percent, minimum, around operating speed, but their goal was  $\pm 10$  percent or more.

#### Two Clearly-Defined First Modes

The next surprise found was—four rotors had two first lateral natural frequencies (Figure 9), with 1D/0C wheel modes oriented

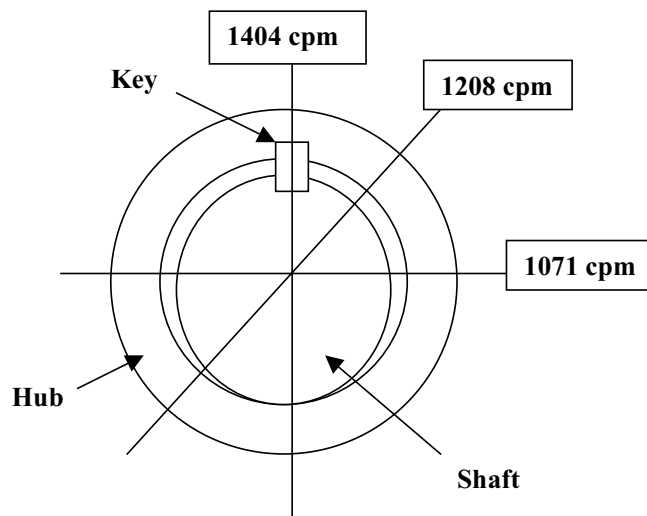

Figure 7. Large Difference Between First Mode Frequency When Tested in the Plane of the Key Versus in a Plane 90 Degrees to Key.

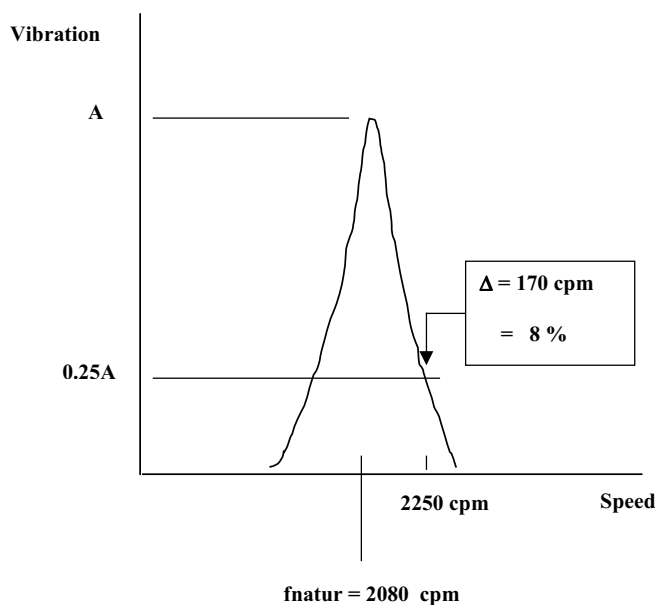

Figure 8. Determination of  $\pm 8$  Percent “Defect Range” for “Q” = 18:1 Mode.

90 degrees to the other (Figure 10)! The node line of each was oriented 45 degrees from the key.

At this point the authors were puzzled. Would the gyroscopic forces cause both first modes to increase? Had they somehow created a “two-mass” system, or a “tuned mass damper”?

The authors decided to do “waterfall” tracking of a coastdown of a fan with two first modes to see what could be learned. They knew from experience that harmonics of running speed, as the fan slows down, will pass through natural frequencies and the minor increases in vibration resulting from these coincidences could be used to track changes in the natural frequencies. In fact, a portion of a track down done early in this program had alerted them that at least one fan had a first critical speed very near 2080 rpm. The  $2\times$  component of vibration had peaked at 2080 cpm, when turning speed was 1040 rpm. Gyroscopics would have shifted the critical somewhere above operating speed when the fan was back up to 2080 rpm, but it was one of the first indications that a critical speed was very close to operating speed in these fans.

The authors tracked three fans down and had a spectacular success with one, as shown in Figure 11. Not only can the

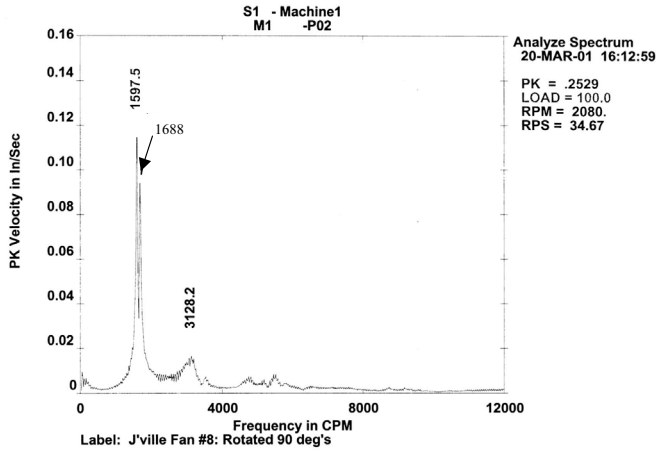
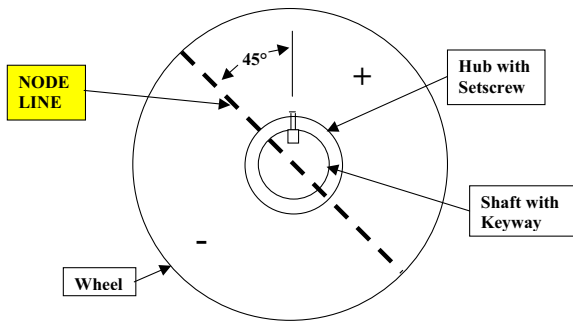

Figure 9. Fan #8 with Two First Lateral Natural Frequency Responses.

**1598 to 1611 cpm –**



**1665 to 1688 cpm –**

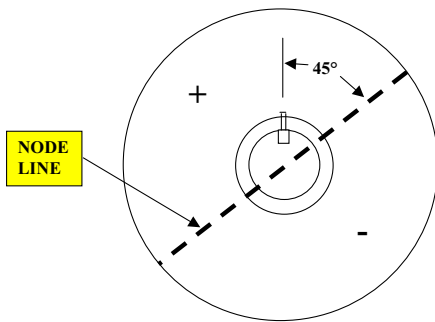

Figure 10. 1D/0C Wheel Modes Oriented 90 Degrees to the Other.

“forward-whirl first lateral natural frequency” (i.e., the “first critical speed”) be clearly identified decreasing in frequency as the fan slows and gyroscopic effects lessen, the “reverse-whirl first lateral natural frequency” can also be clearly tracked as it increases in frequency as the fan slows. By extracting each spectrum at a particular speed during coastdown and determining the forward- and reverse-whirl frequencies at that rotor speed (Table 1), first modes could be plotted versus running speed. And as shown in Figure 12, they converged on the two static first natural frequencies! In theory, they should have converged on one frequency, as has been seen with the forward- and reverse-whirl first modes of the pendulum-like 10,000 rpm spray disks in the spray dryers.

Now looking at Figure 12 in reverse, as a startup of the fan, we can exactly determine:

- Where the “forward-whirl” critical speed is (2290 rpm in this fan) when the rotor is running at 2080 rpm, and

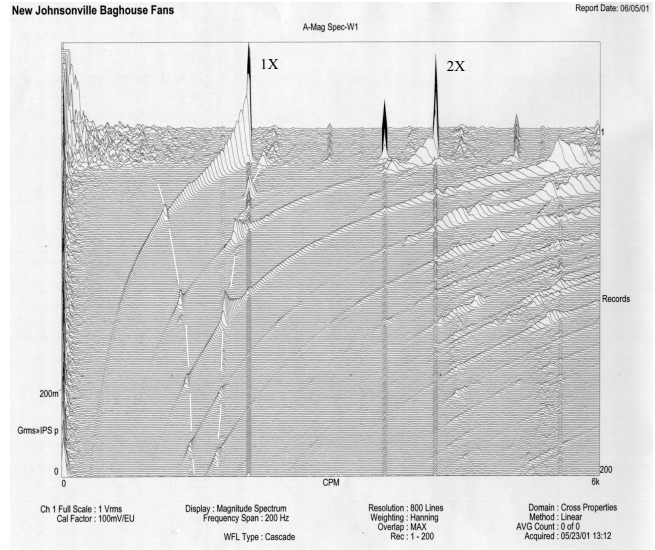

Figure 11. “Waterfall” Plot of Coastdown of #9 Fan Showing Forward- and Reverse-Whirl First Modes.

Table 1. Reverse- and Forward-Whirl First Lateral Natural Frequencies Versus Rotor Speed During Coastdown of the Fan.

Speed 1 x RPM	Reverse Whirl 1st cpm	Forward Whirl 1st cpm
2070		2280
2055		2280
2025		2265
1995		2250
1980		2250
1905		2205
1395		2085
1155	1155	2010
960		1935
660	1320	
615		1830
465	1395	
435		1770
360	1440	
315		1740
0	1611	1665

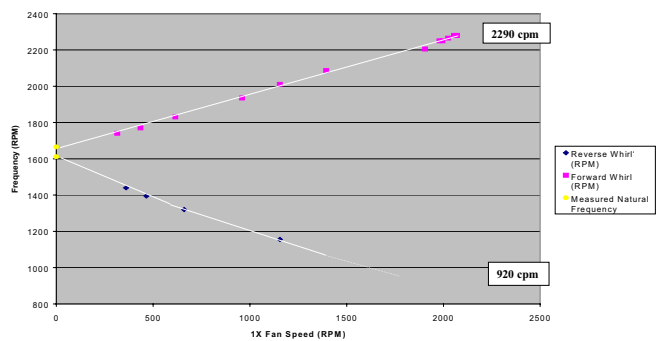

Figure 12. Forward- and Reverse-Whirl First Lateral Modes Versus Rotor Speed During Coastdown.

- How much the first natural frequency changed between zero and 2080 rpm due to gyroscopic forces.

This second “measurement”—how much the first natural frequency changed between zero and 2080 rpm—allowed the authors to make corrections to the “Go-No Go” table of “measured static first modes” and associated “predicted first critical speeds” (Table 2). For the fan in this track down, Fan #8, the first mode changed from 1668 cpm at zero speed to 2290 cpm at 2080 rpm, which is a change of 622 cpm. The rotordynamics model before the test had predicted an increase of only 505 cpm and a “critical speed” of 2173 cpm, a 117 cpm error. This 5 percent error is significant since the separation margin the authors were shooting for was only ±170 cpm (or ±8 percent). The “Go-No Go” table (Table 2) has since been corrected.

Table 2. “Go-No Go” Table for Johnsonville Fans. (Avoid fans with static “first modes” in the range from 1450 to 1635 cpm, as identified by impact testing.)

“Zero Speed” Nat. Freq. Found by “Bump” Test	Effective Stiffness, K, Of Support System At Each Bearing	Predicted “1 <sup>st</sup> Critical” With Fan Oper at 2080 rpm	Increase in Nat. Freq. Due to Rotor Speed
1450 cpm	100,000 lb/inch	1955 rpm	505 cpm
1485	110,000	2010	
1525	120,000	2065	540
1560	130,000	2120	
1595	140,000	2175	
1620	143,000	2190	570
1635	150,000	2230	
1668*	160,000	2290*	625 * Fan #8
1705	170,000	2335	
1740	180,000	2390	650
1780	190,000	2325	
1820	200,000	2380	

NOTE: We are looking for a **minimum** “separation margin” of 8% from 2080 rpm speed. (API Standard 673 requires a “separation margin” of 15% to 26%, for reference.)

Nine Fans—Nine Critical Speeds

The authors tested for static first lateral natural frequencies of all nine fans and used the corrected gyroscopic speed increase to determine where the first critical speed was for each fan. And they were not surprised to find nine different critical speeds (Table 3). The actual “first critical speed” of the nine fans varied from as low as 1700 rpm to no higher than 2405 rpm, straddling the 2080 rpm operating speed.

Table 3. Nine Fans in Eleven Configurations—First Critical Speeds Range from 1700 RPM to 2405 RPM.

Fan No.	No. of Peaks	Impact Test fn @ 0 rpm	K = Eff. Stiffness at each Brg	Estimated 1 <sup>st</sup> Critical Speed
1	2	1545 - 1575 cpm   1635 cpm	150,000 lb/in	2230 rpm
2	1	1710 - 1740	177,000	2365
3	Band	1560*, 1665, 1695, 1740, 1755	155,000	2275
4	2	1580 - 1613   1730 - 1747	180,000	2390
5	2	1568 - 1581   1691 - 1713	170,000	2335
6	1	1751 - 1761	183,750	2405
7	Band	1071, 1207, 1208, 1404	Loose fit wheel	1700
8	2	1598 - 1611   1665 - 1688	160,000	2290
9-Orig	Band	1545, 1581, 1600, 1671	143,000	2185
9-New	1	1638	148,000	2235
9-New Modified	2	1635   1740	180,000	2390

Three of the nine fans had critical speeds less than 8 percent away from operating speed when they were tested, but the test period stretched over several months and many of the fans were rebuilt during that time without being tested. (The plant is in Tennessee and the test equipment was normally in use in Delaware.) Records

indicate at least five fans were persistent “headache” fans, but it could have been more. When a fan had to be replaced for some reason, the replacement was whatever wheel and whatever shaft were available, with bearings and pillow-block housings picked from Stores. There was no process in place to select and assemble a wheel, a shaft, and a set of bearings with the goal of assuring the first critical speed was greater than 8 percent above operating speed. But a procedure would be in place when the authors were through.

How Do You Alter the Critical Speed?

The next step, then, was to identify the design factors that controlled the first critical and determine how changes in each would affect the critical. One of the problem fans was tested, Fan #9, varying one design feature at a time: first installing a wheel with an interference-fit, taper hub-to-shaft connection in place of the original wheel, which had a straight cylindrical hub-to-shaft fit with a setscrew. The authors had to have a repeatable fit, not one like was found in Fan #7 (Figure 7). To the best of their ability to hold all other factors constant, the taper-fit hub with light interference fit increased the first critical by 50 rpm (Table 3). But had they put the taper-fit hub on Fan #7, where the loose-fit cylindrical hub caused the critical to be at approximately 1700 rpm, the change would likely have been closer to 500 to 600 rpm. This based on 1700 rpm increasing to at least 2200 to 2300 rpm (typical of the other fans). Whatever the actual numbers, whether 50 rpm or 500 rpm, the rigidity of the wheel hub to shaft fit is clearly a major factor in determining the first critical of an overhung fan.

Next the spherical roller bearing fit was tested, measuring clearance between the top of the rollers and the inside surface of the outer race as the tapered adapter was tightened down with a hammer spanner. Tightening the clearance on these #22220 C3 spherical roller bearings from 0.004 inch down to 0.0012 inch to 0.002 inch increased the first critical by 55 rpm.

In addition, fitting of the outer race in the pillow-block housing is very important. The specification is discussed below under “Control Plan for Building New Fans.”

Modal analysis had shown that the 3/8 inch thick plate supporting the bearings was deflecting in two planes, parallel to and perpendicular to the shaft centerline. Since the rotordynamics analysis showed support stiffness was a major factor in controlling the first critical, a 3 inch high vertical stiffener was welded in place under the horizontal plate (Figure 13). (The authors would have preferred to cross brace under the plate, but the bearing pillow-block hold-down bolts were in the way.) The horizontal plate was also welded continuously around its perimeter. These base modifications increased the first critical by about 100 rpm.

With the tapered hub wheel/shaft connection and with tighter bearing clearances, vibration on Fan #9 was reduced from near interlock levels (0.8 ips) to the 0.15 to 0.2 ips range. And after the stiffener was added to the bearing support frame, vibration was reduced to 0.08 to 0.11 ips, a nearly 10:1 reduction from original amplitudes.

Table 4 summarizes how much each component in the tests on Fan #9 changed the first lateral critical speed. Fan #7 showed a loose cylindrical wheel-to-shaft fit could lower the critical by several hundred rpm versus a tight fit (line-to-line to 0.0005 inch interference); however, tests on Fan #9 showed probably a more typical case. The combination of tapered hub, tighter bearings, and stiffer base combined to increase the first critical by a total of 205 rpm—a shift of about 11 percent.

Control Plan for Building New Fans

Based on the results of the tests on the various fans, and with the help of several experienced mechanics, the authors wrote a detailed “Maintenance Work Procedure.” This procedure allows a maintenance team to select and assemble a wheel, a shaft, and a set of bearings with assurance that the first critical speed will be greater than 8 percent above operating speed. Key points include:

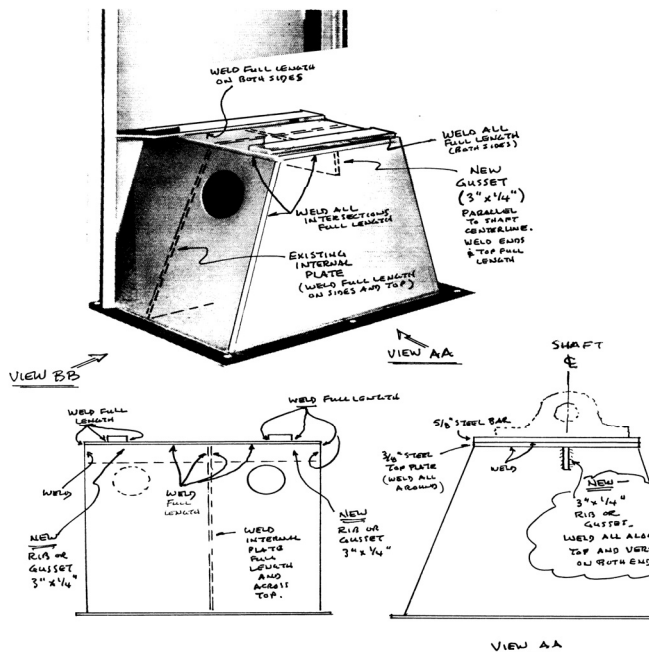

Figure 13. Modifications to Fan Base Fabricated Steel Pedestal.

Table 4. Summary of Tests Conducted on Fan #9. (Cumulative change in first critical speed was +205 rpm.)

Static Natural Frequency, cpm	Estimated 1 <sup>st</sup> Critical Speed, rpm	Delta Frequency Change, rpm	Design Change
1610	2185	Datum	Baseline condition
1640	2235	+ 50	Tapered, interference-fit hub replaced original cylindrical-fit hub
1670	2290	+ 55	Reduced bearing clearance from 0.004" to 0.0015" to 0.002"
1740	2390	+ 100	Stiffened base pedestal by welding and adding 3" centerline brace

- All new wheels and shafts purchased from the fan manufacturer are required to have tapered hubs with a light interference fit.
- Bearings and pillow-blocks are all measured and selected to fit to each other so that the outer race is “line-to-line” to no more than 0.0026 inch loose in the pillow-block.
- During installation, the tapered hub is tightened until the clearance between the top of the roller and the inside surface of the outer race of the spherical roller bearings is 0.0012 inch to 0.002 inch.
- All bases have been, or are being, modified to include the vertical stiffener under the horizontal plate, and any new bases purchased come premodified by the manufacturer.

And after the unit is assembled—

- The fan is statically impact tested by the plant Reliability Group using a portable Fourier analyzer and the method shown in Figure 4 to assure the first lateral natural frequency is outside the “defect range”; that is, it will be at least 8 percent above 2080 rpm.

In total, the “Maintenance Work Procedure” addresses:

- Removal and replacement of fan wheel and shaft.
- Installation of new bearings.
- Lubrication of new bearings.
- Installation of the sheave.
- Installing, aligning, and tensioning of a new timing belt.

- Inspection of fan housing and motor base for loose or missing bolts.
- Inspection of air flow dampers and all expansion joints.
- Inspecting and balancing the fan wheel (and checking rotor shaft for runout).
- Replacing, realigning, and/or retensioning the installed timing belt.
- Relubricating bearings.

After it was written, it was field tested and upgraded by the Maintenance Team.

CONDITION MONITORING

With the speed increase, the new operating speed was some 380 rpm above the recommended grease-lubrication speed limit. In fact, two machines suffered catastrophic failures before the correct lubrication procedure was developed. To give early warnings of problems and to prevent another major failure, continuous bearing vibration and temperature monitoring were installed on each bearing of the nine fans.

A new, small, two-wire vibration sensor was used that output a 4-20 mA signal proportional to bearing velocity. This signal was put into the distributed control system (DCS) for monitoring overall levels of vibration and for alarming, but hardwired interlocks were installed for personnel safety reasons.

Bearing temperature, using spring-loaded resistance temperature detectors (RTDs) mounted in the pillow-blocks, was also alarmed and hardwire interlocked. Temperature is one of the quickest indicators of inadequate lubrication in a bearing.

Monitoring bearing temperature with RTDs and vibration with the 4-20 mA sensors gives little diagnostic information. Their function is to either provide an early warning of slowly developing problems so the Reliability Group will have time to do a diagnostic analysis with a portable frequency analyzer, or to shut the fan down quickly in the case of severe, sudden-onset problems to prevent a catastrophic failure. This combination of continuous overall and periodic, or as-needed, diagnostic monitoring has worked well.

CONCLUSION

Fans appear to be pretty simple machines: a wheel, a hub and a shaft, two bearings and a sheave, and a timing belt and a motor. Turn it on and let it run. “Wrong.” The authors experience shows fans can be complex machines requiring the right design, precision assembly, and condition monitoring for reliable operation.

Other key points from this project:

- Ask the right questions when changing speeds on a rotating machine. In addition to “what is the critical speed,” ask questions about assumptions used in the analysis. Or, involve someone with experience in rotordynamics in the project to ask the questions.
- The rigidity of the wheel-shaft connection in overhung fans can change the first critical by a big amount—in the authors case, by as much as 25 percent in one fan.
- Bearings and steel supporting frames are nowhere near “infinitely rigid.”
- A test as simple as an impact test of a wheel, when combined with a rotordynamics analysis, can be used to predict the first critical speed of an overhung fan; however, validating the model with experimental evidence is strongly recommended.
- The adage “When you make a measurement, you almost always learn something you did not expect” is true—like finding a first mode that changes as the shaft is turned, or finding two first modes in a fan rotor.
- Gyroscopic forces and moments acting on an overhung fan wheel can increase the first lateral mode by a big amount—in the

authors' case, by 37.5 percent (by 625 cpm—to 2290 cpm at 2080 rpm from 1668 cpm at rest).

- “Waterfall” track downs of rotating machines can be one of the most useful methods for diagnosing vibration problems. Natural frequencies can often be identified by harmonics for rotors on rolling-element bearings, but the technique does not work as well with fan rotors on sleeve bearings.

- Vibration is almost always a symptom of some other problem, but relatively inexpensive continuous monitoring of overall vibration levels, with alarms and hardwired interlocks, combined with “as-needed” portable diagnostic vibration analysis, can be an effective preventive maintenance (PM) strategy for detecting and identifying those problems.

The results of this project were reviewed with the fan manufacturer, and they were in agreement with the findings.

#### APPENDIX A

An alternate method of stiffening the horizontal baseplate of a large fan is to drill four holes in the baseplate and install large-diameter anchor bolts (Figure A-1). Each anchor bolt should have a nut on both sides of the plate tightened snug enough to keep the bolt in position. Then fill the base structure with epoxy or cement grout until the lower two-thirds of the anchor bolt is covered. By having the nut below the horizontal plate snug with the bottom surface of the plate, after the grout hardens, tightening only the topside nut allows the plate to be stiffened without deflecting the plate or altering the fan alignment. This was done at a plant where a 1250 hp overhung fan on initial startup was vibrating at 3.2 ips due to a variety of problems, including operation so near the first critical that the fan could not be trim balanced. “Operating deflection shape” measurements showed the 1 $\frac{3}{8}$  inch thick support plate was flexing  $\pm 0.0011$  inch under the bearing next to the wheel (Brg. #1 in Figure A-1). Four 1.5 inch diameter anchor bolts were used to stiffen the 1 $\frac{3}{8}$  inch thick support plate. The deflection was reduced to  $\pm 0.0001$  inch. This shifted the critical speed allowing the fan to be trim balanced and eliminated an 0.18 ips vibration

component at 3 $\times$  rpm. After balancing, vibration velocity at operating speed of the fan was reduced from 0.3 ips to 0.03 ips. Overall vibration was reduced from 0.5 ips to 0.05 ips.

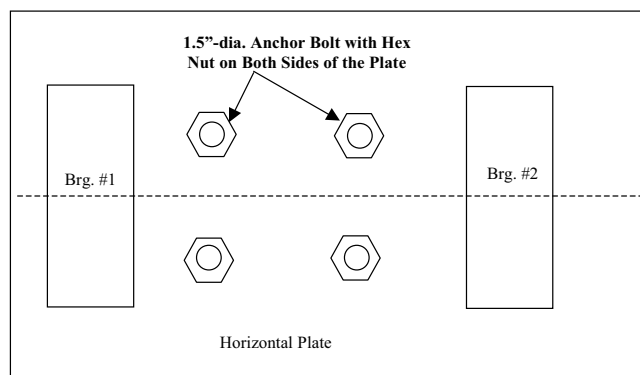

*Figure A-1. Using Four Large-Diameter Anchor Bolts (and Cement Grout) to Stiffen the Horizontal Plate of the Motor/Bearing Frame of an Overhung Centrifugal Fan to Raise First Critical. (The anchor bolts were 36 inches long and had a 5 inch diameter plate welded on the bottom to pass through the opening in the side of the frame. Two cubic yards of grout were poured in the frame covering the lower two-thirds of the anchor bolts.)*

#### ACKNOWLEDGMENT

The authors would like to thank the Maintenance Teams in the “Finishing” Area of the DuPont DTT plant at New Johnsonville, Tennessee, for all their sweat and long hours during the testing of Fan #9. And a special thanks is extended to Mr. William V. Calisesi and Mr. William J. Hollowell for their contributions to the “Bag House Fan Maintenance Work Procedure.” They also would like to thank Stacy M. Hamlet, DuPont Engineering, for conducting the modal analysis and providing the animated displays of wheel, shaft, and pedestal motion for Fan #9.