



Politecnico di Torino

Porto Institutional Repository

[Article] A New Resilience Rating System for Countries and States

Original Citation:

Kammouh, Omar; Dervishaj, Glen; Cimellaro, Gian Paolo (2017). *A New Resilience Rating System for Countries and States*. In: [PROCEDIA ENGINEERING](#), vol. 198, pp. 985-998. - ISSN 1877-7058

Availability:

This version is available at : <http://porto.polito.it/2685185/> since: October 2017

Publisher:

Elsevier Ltd

Published version:

DOI:[10.1016/j.proeng.2017.07.144](https://doi.org/10.1016/j.proeng.2017.07.144)

Terms of use:

This article is made available under terms and conditions applicable to Open Access Policy Article ("Creative Commons: Attribution-Noncommercial-No Derivative Works 3.0") , as described at http://porto.polito.it/terms_and_conditions.html

Porto, the institutional repository of the Politecnico di Torino, is provided by the University Library and the IT-Services. The aim is to enable open access to all the world. Please [share with us](#) how this access benefits you. Your story matters.

(Article begins on next page)

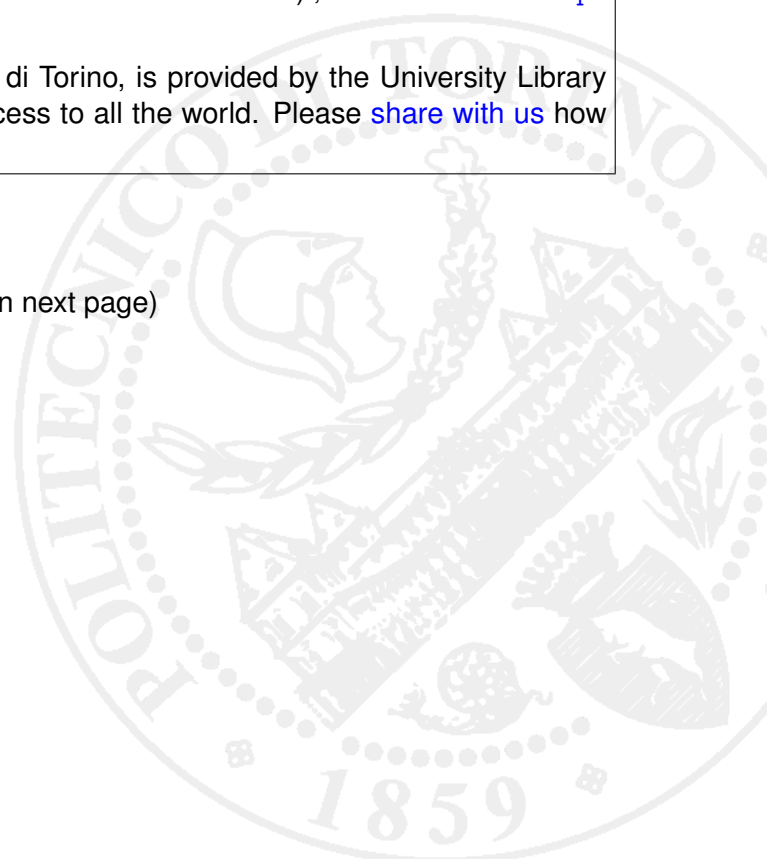



Urban Transitions Conference, Shanghai, September 2016

A new resilience rating system for Countries and States

Omar Kammouh, Glen Dervishaj, Gian Paolo Cimellaro*

Department of Structural, Building and Geotechnical Engineering, Politecnico di Torino, Corso Duca degli Abruzzi, 24, Torino 10129, Italy

Abstract

This research presents a quantitative method to assess resilience at the state level. The approach introduced in this work is an evolution of the risk assessment concept. Risk is mainly a function of vulnerability, hazard, and exposure; on the other hand, resilience focuses more on the internal characteristics of a system rather than its vulnerability. To tackle this difference, a new formulation has been introduced for the evaluation of resilience. In this formulation, resilience is a function of hazard, exposure, and intrinsic resilience. Generally, intrinsic resilience deals with the internal characteristics of a system, and it differs from the traditional resilience index that takes into account external factors in its assessment, such as the disaster intensity and the level of exposure. The paper also provides a method to compute the intrinsic resilience of countries. This method is based on the data provided by Hyogo Framework for Action (HFA), which is a work developed by the United Nations (UN). HFA evaluates the inherent resilience of countries based on a number of equally weighted indicators. However, further analysis has shown that the contribution made by each of those indicators toward the intrinsic resilience is different. This discrepancy has necessitated weighting the indicators based on their individual contribution towards the intrinsic resilience. To do that, we introduce the Dependence Tree Analysis (DTA). DTA is a method that determines the correlation between a component and its sub-components (i.e., between intrinsic resilience and its indicators), enabling us to orderly allocate new weights to the indicators to obtain a more representative output for the intrinsic resilience. Finally, a case study composed of 37 states has been conducted in order to illustrate the methodology in all details. Both intrinsic resilience and resilience indexes for each of the states were assessed. This was followed by a comparative analysis in order to test the applicability of the methodology, and the results were in line with the predictions.

© 2017 The Authors. Published by Elsevier Ltd. This is an open access article under the CC BY-NC-ND license (<http://creativecommons.org/licenses/by-nc-nd/4.0/>).

Peer-review under responsibility of the organizing committee of the Urban Transitions Conference

Keywords: Community resilience; Vulnerability; Risk management; Hyogo Framework for Action

* Corresponding author. Tel.: +39 (011) 090-4801; fax: +39 (011) 090-4899.
E-mail address: gianpaolo.cimellaro@polito.it

1. Introduction

Over the years, community resilience has attracted tremendous attention due to the increasing number of natural and man-made disasters. The concept of resilience is multi-dimensional, and therefore involves various subjects of different disciplines [1]. In engineering, resilience is the ability to “withstand stress, survive, adapt, and bounce back from a crisis or disaster and rapidly move on” [2]. The term resilience is defined by Bruneau et al. as “the ability of social units (e.g. organizations, communities) to mitigate hazards, contain the effects of disasters when they occur, and carry out recovery activities in ways to minimize social disruption and mitigate the effectors of further earthquakes” [3]. In their own part, Allenby & Fink defined resilience as “the capability of a system to stay in a functional state and to degrade gracefully in the face of internal and external changes” [4]. The concept of resilience has only recently been applicable to the engineering field, which makes it hard to determine a general accepted definition for resilience engineering [5].

The absence of a concise and methodical approach makes it extremely difficult to evaluate resilience. The immense progress in the Hyogo Framework for Action (HFA) — a work developed by the United Nations — has led to the formulation of an international blueprint that is very useful in building the intrinsic resilience of nations and communities. The methodology adopted by the HFA focuses on implementing detailed measures at the governmental and policy levels. The goal was to encourage the countries to implement the HFA in their respective laws. The lifespan for the implementation was from 2005 to 2015, after which each of the participating countries were required to submit a report on their own progress. A score was then given by the UN to each of the submitted reports on the basis of the progress each country had made.

One of the many topics discussed when referring to resilience is its relationship with vulnerability and whether they are similar enough to be considered the same. Although vulnerability is strongly linked to the concept of risk assessment [6], Richard et al. pointed out that the concept of vulnerability had long been associated with resilience under various scientific disciplines [7]. Cardon et al. [8] identified vulnerability as the lack of capacity. Under this context, the vulnerability is reduced by increasing the system’s capacity. Moreover, Klein et al. [9] indicated that some literary publications provide the same definitions for resilience and vulnerability, while Gallopin [10] identified some instances where scholars had different views for the two concepts, admitting that they may overlap in some areas. Table 1 shows a comparison between vulnerability and resilience on different scales. The contrast suggests that resilience is more concerned with the human capacity to recover from a disaster within a short time and with no outside assistance, while vulnerability is the property of resisting the stress caused by a natural hazard.

Table 1. Difference between vulnerability and resilience at different levels [11].

Vulnerability	Resilience
Resistance	Recovery
Force bound	Time bound
Safety	Bounce back
Mitigation	Adaptation
Institutional	Community-based
System	Network
Engineering	Culture
Risk assessment	Vulnerability and capacity analysis
Outcome	Process
Standards	Institution

In this paper, we are proposing an analytic formulation to assess the resilience of communities. The notion resembles the risk evaluation method in many ways. While risk is the combination of vulnerability (V), hazard (H), and exposure (E), resilience focuses more on the intrinsic characteristics of a system rather than its vulnerability. To tackle this difference, a new formulation for evaluating resilience has been introduced. In that formulation, resilience is a function of intrinsic resilience, hazard, and exposure (Fig. 1). The difference between intrinsic resilience and resilience is that the former deals with the internal characteristics of a system while the latter takes into account external factors in its assessment, such as the disaster intensity and the level of exposure. In this work, resilience's first parameter (exposure) is obtained from the World Risk Report (WRR), while the second parameter (hazard) is obtained from past data on disasters. As for the third parameter (intrinsic resilience), we are presenting a new method based on the data provided by the Hyogo Framework for Action. HFA estimates the intrinsic resilience of nations based on equally weighted indicators. However, it has been found that the contribution made by each of those indicators toward the intrinsic resilience is not equal. Therefore, it is important to realize the indicators according to their actual contribution towards intrinsic resilience. To do that, we introduce the Dependence Tree Analysis (DTA) [12]. DTA is a method that determines the correlation between a component and its sub-components (i.e., between the intrinsic resilience and its indicators), assigning weights to the sub-components accordingly. This leads to generating modified intrinsic resilience outputs for the countries. The modified outputs are subsequently used in the assessment of resilience (by combining it with exposure and hazard). To exemplify this, a complete case study composed of 37 states is presented in this paper, where the intrinsic resilience (R_i) and the resilience (R) indexes of each state are computed.

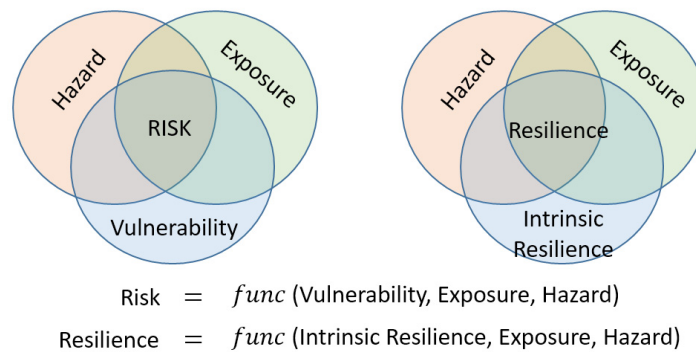

Fig. 1. The difference between the concepts of risk and resilience.

1.1. Hyogo framework for action (HFA)

Hyogo Framework for Action (HFA) was originally conceptualized in Kobe, Japan. It was eventually adopted as a global blueprint for minimizing risk associated with natural hazards by implementing national laws regarding risk management and control [13]. HFA is the product of a long initiative by an affiliate within the United Nations known as the International Strategy of Disaster Reduction (ISDR) [14]. The International Strategy of Disaster Reduction (ISDR) was developed as the result of the experience gained in the International Decade for Natural Disaster Reduction (1990-1999).

The aim of HFA was to boost awareness on disaster risk and to guide committed states in executing a master plan to avert the loss of lives and the economic impact caused by natural hazards. The HFA consists of five priorities for action. Each priority is satisfied with a number of indicators, with a total of 22 indicators for all five priorities (Table 2). The major role of the five priorities of HFA is to identify the specific sectors that every country should focus on to endorse disaster resilience. The indicators are assessed by answering a set of questions. Table 3 shows the sort of questions that are asked by the UN in order to assess a certain indicator. The answers can be either 'YES/NO' or 'description text'. The progress recorded by every government is computed on the basis of a five-point scale for

each of the indicators, where ‘one point’ indicates weak progress and poor signs of planning and actions, while ‘five points’ implies a great endeavor and commitment in that specific area [15].

Table 2. Priorities and indicators used in the assessment of Hyogo Framework for Action [16].

PRIORITY 1:	
Ensure that disaster risk reduction (DRR) is a national and a local priority with a strong institutional basis for implementation	
I 1	National policy and legal framework for disaster risk reduction exists with decentralized responsibilities and capacities at all levels.
I 2	Dedicated and adequate resources are available to implement disaster risk reduction plans and activities at all administrative levels
I 3	Community Participation and decentralization is ensured through the delegation of authority and resources to local levels
I 4	A national multi sectoral platform for disaster risk reduction is functioning.
PRIORITY 2:	
Identify, assess and monitor disaster risks and enhance early warning	
I 5	National and local risk assessments based on hazard data and vulnerability information are available and include risk assessments for key sectors.
I 6	Systems are in place to monitor, archive and disseminate data on key hazards and vulnerabilities
I 7	Early warning systems are in place for all major hazards, with outreach to communities.
I 8	National and local risk assessments take account of regional / trans boundary risks, with a view to regional cooperation on risk reduction.
PRIORITY 3:	
Use knowledge, innovation, and education to build a culture of safety and resilience at all levels	
I 9	Relevant information on disasters is available and accessible at all levels, to all stakeholders (through networks, development of information sharing systems etc.)
I 10	School curricula, education material and relevant trainings include disaster risk reduction and recovery concepts and practices.
I 11	Research methods and tools for multi-risk assessments and cost benefit analysis are developed and strengthened.
I 12	Countrywide public awareness strategy exists to stimulate a culture of disaster resilience, with outreach to urban and rural communities.
PRIORITY 4:	
Reduce the underlying risk factors	
I 13	Disaster risk reduction is an integral objective of environment related policies and plans, including for land use natural resource management and adaptation to climate change.
I 14	Social development policies and plans are being implemented to reduce the vulnerability of populations most at risk.
I 15	Economic and productive sectorial policies and plans have been implemented to reduce the vulnerability of economic activities
I 16	Planning and management of human settlements incorporate disaster risk reduction components, including enforcement of building codes.
I 17	Disaster risk reduction measures are integrated into post disaster recovery and rehabilitation processes
I 18	Procedures are in place to assess the disaster risk impacts of major development projects, especially infrastructure.
PRIORITY 5:	
Strengthen disaster preparedness for effective response at all levels	
I 19	Strong policy, technical and institutional capacities and mechanisms for disaster risk management, with a disaster risk reduction perspective are in place.
I 20	Disaster preparedness plans and contingency plans are in place at all administrative levels, and regular training drills and rehearsals are held to test and develop disaster response programs.
I 21	Financial reserves and contingency mechanisms are in place to support effective response and recovery when required.
I 22	Procedures are in place to exchange relevant information during hazard events and disasters, and to undertake post-event reviews

The expiration of Hyogo and its ten-year plan prompted a new framework known as Sendai Framework. This framework is the evolved version of the HFA and is meant to replace HFA in coming years. The Sendai Framework was a product of the Third World Conference on Disaster Risk Reduction in Sendai, Japan (2015) [17]. Even though the HFA was widely credited as raising awareness for disaster risk reduction, a significant loss of lives was recorded during the 10-year span of its implementation. Consequently, the Sendai framework stresses on the significance of risk assessment and early warning systems. The UN have set a plan to define the risk bases and to embrace new indicators in order to quantify the resilience improvement made by the participating countries. This is

anticipated to be discussed at another session in 2017 [18]. The new framework outlines the following four priorities for action:

- Understanding disaster risk;
- Strengthening disaster risk governance to manage disaster risk;
- Investing in disaster risk reduction for resilience;
- Enhancing disaster preparedness for effective response and to "Build Back Better" in recovery, rehabilitation and reconstruction.

Table 3. The questions that are asked by the UN to assess the first indicator [16].

Indicator 1	National policy and legal framework for disaster risk reduction exists with decentralized responsibilities and capacities at all levels.	Answer type
Questions	-Is disaster risk taken into account in public investment and planning decisions?	YES/NO
	-National development plan	YES/NO
	-Sector strategies and plans	YES/NO
	-Climate change policy and strategy	YES/NO
	-Poverty reduction strategy papers	YES/NO
	-CCA/ UNDAF (Common Country Assessment/ UN Development Assistance Framework)	YES/NO
	-Civil defense policy, strategy and contingency planning	YES/NO
	-Have legislative and/or regulatory provisions been made for managing disaster risk?	YES/NO
	-Description	Write text
	-Context & Constraints	Write text
Level of progress achieved:		(1-5)

1.2. The World Risk Report (WRR)

The World Risk Report is a work performed by the United Nations University for Environment and Human Security (UNU-EHS), and published by the relief organizations in the Alliance Development Works [19]. The report adopts different measures in order to rank the countries around the world according to their vulnerability, exposure, and risk levels. In this study, we use the exposure results of the WRR in the resilience assessment. Fig. 2 reveals the 10 most exposed countries around the world. In that figure, exposure percentage is merely the proportion of people that are exposed to disasters.

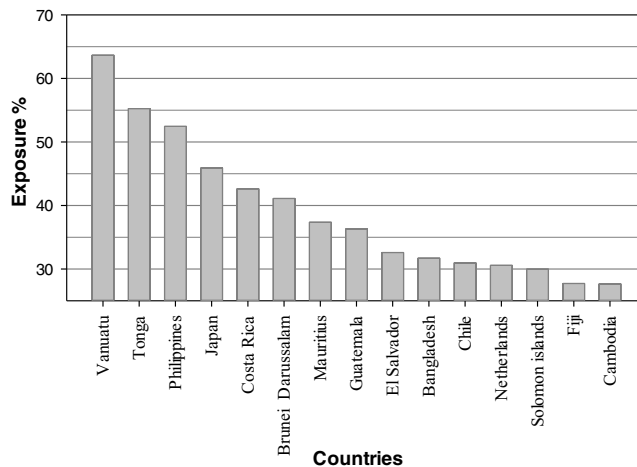

Fig. 2. The ten most exposed countries according to the WRR [19].

2. The methodology: resilience assessment of communities

As we mentioned earlier, the primary goal of this research is to provide a normalized index that enables us to compare the resilience among different nations. The framework we follow in this work is illustrated in Fig. 3. In the figure, the intrinsic resilience represents the interior characteristics of a system. It is therefore independent of any external agents. Comparing communities based only on their intrinsic resilience is not very useful because the level of exposure faced by each country is different. Countries with minimal exposure levels may find it uneconomic to prepare for infrequent disasters. As an example, coastal areas are normally exposed to tsunamis and they must have a well-defined strategy to face this kind of events. Such strategies adopted in coastal areas may not be suitable for internal areas, where the likelihood of occurrence of tsunamis is nearly zero. Nevertheless, one cannot say that coastal regions are less dangerous in times of tsunamis simply because they are prepared for it. For this reason, we combine intrinsic resilience with exposure and hazard in order to get a comparable resilience index.

The intrinsic resilience can be obtained from a wide range of sources. In the present work, we choose the data of Hyogo Framework for Action (HFA) as a source to compute the intrinsic resilience. On the other hand, exposure is obtained from the World Risk Report (WRR), while hazard is obtained from previous data on hazards, and expressed in terms of probability of occurrence.

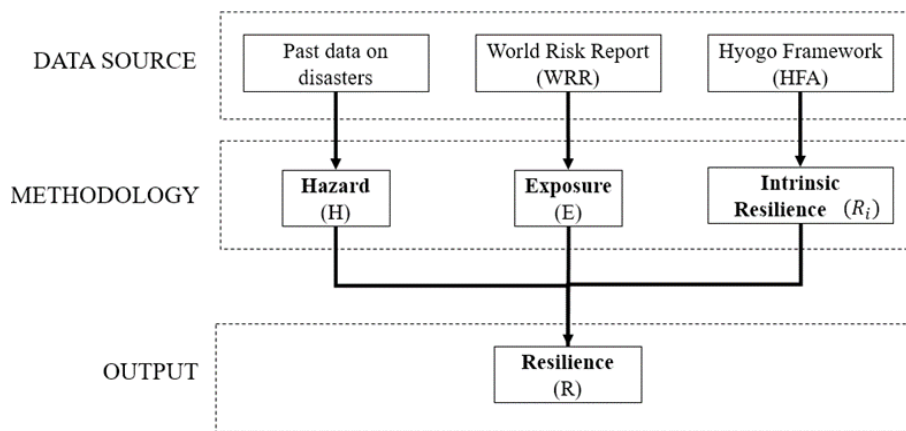

Fig. 3. The proposed framework.

2.1. The resilience index (R)

The resilience index refers to the ability of a community to recover and attain its original functional state [20]. This index can be calculated with the following equation:

$$R = 1 - (1 - R_i) \times E \times H \tag{1}$$

where R represents the resilience index, R_i is the intrinsic resilience index, E is the exposure to natural disasters, and H contains information about the hazard.

2.2. The intrinsic resilience index (R_i)

The intrinsic resilience index (R_i) is obtained using the data of the UN report (HFA). As already indicated, the 22 indicators in HFA are equally weighted, and this implies that all indicators have the same level of importance. However, it has been found that the indicators vary in importance, and therefore they must be weighted in a specific

way in order to successfully aggregate them into one scalar number. To do that, we propose a new method, referred to as the Dependence Tree Analysis (DTA). This method captures the correlation between a component and its sub-components in a quantitative manner. DTA enables computing the effect caused by the non-fulfillment of one sub-component on the underlying component. The value '1' is the highest output that can be obtained by the main component, and this value can only be achieved once all sub-components are fulfilled. The failure to fulfill any of the sub-components leads to a final output that is not up to '1'. The next section has a detailed description on how to build the Dependence Tree and execute the necessary computations.

2.2.1. Building the dependence tree

Building the Dependence Tree begins with the identification of all possible potential components that are capable of influencing the main output. The most common way to do this is by brainstorming or relating to lessons learned. The types of components that exist are: the main or the underlying component, the intermediate component, and the basic component. The task required to get out of a system is known as the main component, and this component is located on the top of the tree. The essential components required for the successful achievement of the main component are known as the intermediate components, while the primary or basic components refer to those that cannot be further split into sub-components.

Fig. 4 illustrates an example of a dependence tree diagram whose top component is to achieve a high level of resilience for a building. First, Resilience is divided into two components: Recovery Capacity and Preparedness. A building is said to have a high level of preparedness if it has successfully undergone a risk assessment, is designed efficiently, and is redundant. It is also possible to further split each of the aforementioned components into sub-elements. For instance, the design efficiency of the building can be achieved if we possess a computing machine and data on previous earthquakes (e.g. response spectrum). However, the availability of a computing machine and earthquake data is not enough, as the process requires the presence of an engineer for the practical usage of those tools. In this case, the component 'engineer' is placed as a basic component under each of the two intermediate components. It is worth mentioning that the level of accuracy that is sought is another factor that can determine the decomposition of the tree. It is important to note that the non-accomplishment of one of the intermediate components does not eliminate the accomplishment of the top event. That is, if the two intermediate components 'Preparedness' and 'Recovery' are just partly accomplished, the main component 'Resilience' will also be partly accomplished.

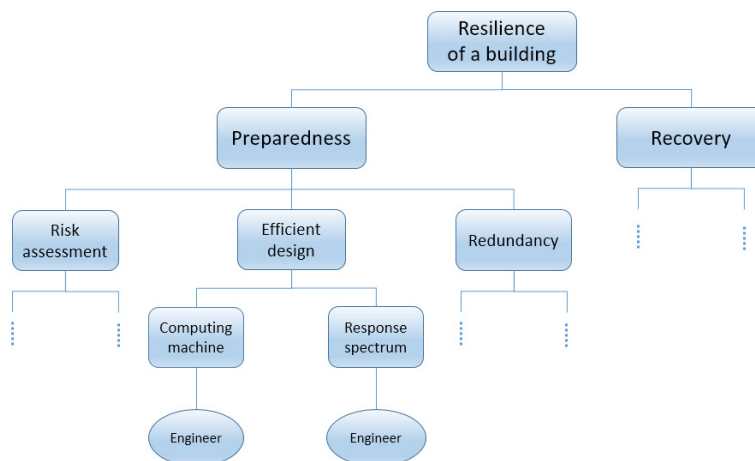

Fig. 4. A dependence tree diagram of a building whose top component is to achieve a high level of resilience.

2.2.2. Quantitative analysis

The Dependence Tree Analysis (DTA) is governed by a basic mathematical equation, just like the Fault Tree Analysis (FTA). The accomplishment of a component depends on not only the accomplishment of its subsequent components, but also on the component itself. For this reason, we introduce the term ‘Existence’, which represents the internal characteristics of a component. This term can take the values ‘zero’ or ‘one’. A value of ‘zero’ implies that the component cannot be accomplished, disregarding the accomplishment of its sub-components. In contrast, a value of ‘one’ means that the component’s accomplishment is strictly dependent on the accomplishment of its sub-components.

The relationship between a component and its subsequent components is given in Equation (2). In that equation, the parameter A represents the accomplishment factor of a component, E represents the existence coefficient of the underlying component, i represents the component number, k is the number of subsequent components under the main component i .

$$A_i = \frac{(A_{i,1} + A_{i,2} + \dots + A_{i,k})}{k} \times E_i = 0 \rightarrow 1 \quad (2)$$

The formulation of Equation (2) is based on the following:

- The value of ‘Existence’ is either zero or one, $E = 0$ or 1
- The individual contributions made by all subsequent components towards the underlying component are equal.
- Basic components are described by their ‘Existence’ term only, $A_i = E_i$

2.2.3. Sensitivity analysis

After filling out the tree, a sensitivity analysis is conducted to find out the percentile contribution made by each component towards the main (top) component. The existence coefficient is set to zero ($E=0$) for each intermediate and basic component once at a time while keeping the existence coefficients of all other components equal to one. Equation (2) is used to compute the accomplishment of the top component whenever the Existence of a component is set to zero. The component is said to be significant if the accomplishment of the top component tends to approach zero.

2.2.4. Weighting factor

The execution of the sensitivity analysis enables classifying the components starting from the most to the least important. A weighting factor for every component (i.e. indicator) of the HFA is subsequently calculated using Equation (3). In this equation, the weighting factor uses the results of the sensitivity analysis that we conducted in the previous step.

$$W_i = \frac{1 - I_i}{\text{avg}(1 - I_1, 1 - I_2, \dots, 1 - I_j)} = \frac{1 - I_i}{\sum_{n=1}^j (1 - I_n)} \quad (3)$$

Where W_i is for the weighting factor of component i , I_i represents the impact value of component i ; that is the accomplishment value of the top component when the ‘Existence’ of a component i is set to zero, j is the total number of the components (in HFA $j = 22$ indicators).

3.1.2. The methodology: the Dependence Tree Analysis (DTA)

At this stage, the Dependence Tree Analysis (DTA) is used to weight the indicators shown in Table 2. Fig. 5 shows the final form of the dependence tree, in which all components (indicators) were arranged according to their logical relationship with other components.

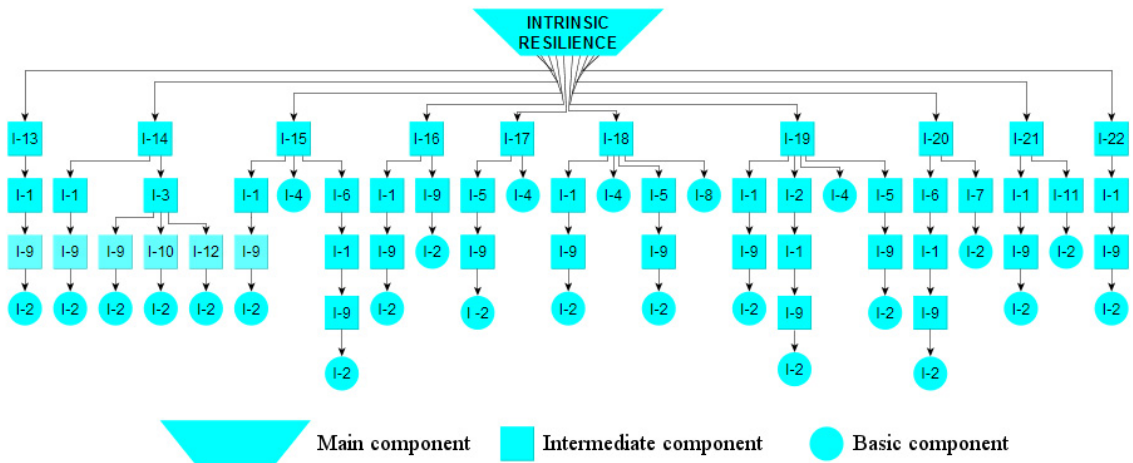

Fig. 5. The dependence tree of the indicators of the Hyogo Framework.

3.1.3. Output: the intrinsic resilience index (R_i)

A new list of scores is generated by executing a quantitative analysis followed by a sensitivity analysis using Equations (2) and (3). The results of the impact and weighting factors of the 22 indicators are shown in Table 5. We can clearly notice significant changes in the weights of the indicators. Most of the indicators obtained a weighting factor that is less than 1, which implies that they had a reduction in their importance. Only few had their importance increased. For instance, indicator 2 (I-2) recorded the highest weighting factor ‘5.70’, which implies that it is now 5.7 times more significant than what it used to be in the HFA. In fact, this indicator ‘Dedicated and adequate resources are available to implement disaster risk reduction plans and activities at all administrative levels’ is a financial indicator, and almost all other indicators were dependent on it in the DTA (Fig. 5). Generally, financial indicators are very important because resources are necessary for the accomplishment of any task, and this justifies the high weighting factor obtained by that indicator.

Table 5. The weighting factors of the indicators.

Indicator	Impact factor	Weighting factor W_i	Indicator	Impact factor	Weighting factor W_i	Indicator	Impact factor	Weighting factor W_i
I-1	0.45	3.90	I-9	0.341	4.74	I-17	0.90	0.72
I-2	0.21	5.70	I-10	0.983	0.12	I-18	0.90	0.72
I-3	0.95	0.36	I-11	0.95	0.36	I-19	0.90	0.72
I-4	0.86	0.96	I-12	0.98	0.14	I-20	0.90	0.72
I-5	0.9	0.72	I-13	0.90	0.72	I-21	0.90	0.72
I-6	0.91	0.60	I-14	0.90	0.72	I-22	0.90	0.72
I-7	0.95	0.36	I-15	0.90	0.72			
I-8	0.975	0.18	I-16	0.90	0.72			

The weighting factors shown in the table above are multiplied by its corresponding indicator’s score recorded in the Hyogo Framework (Table 4). The new 22 indicators’ scores are subsequently summed up into a total score (out of 110 points). This score represents the modified intrinsic resilience. A comparison between the unmodified intrinsic resilience (from HFA) and the modified intrinsic resilience (after applying the DTA) is shown in Fig. 6(a). From the figure, we can observe some changes in the intrinsic resilience scores of the countries. These changes are attributed to the new weights that were assigned to the indicators. Fig. 6(b) shows a graphical representation of the intrinsic resilience difference for each country before and after the modification. We can see that some countries have recorded a significant increase in their intrinsic resilience while others indicated a decrease. The country that was considerably affected is Monaco, which recorded a 20% decrease in its intrinsic resilience. Only a few number of countries have witnessed no change.

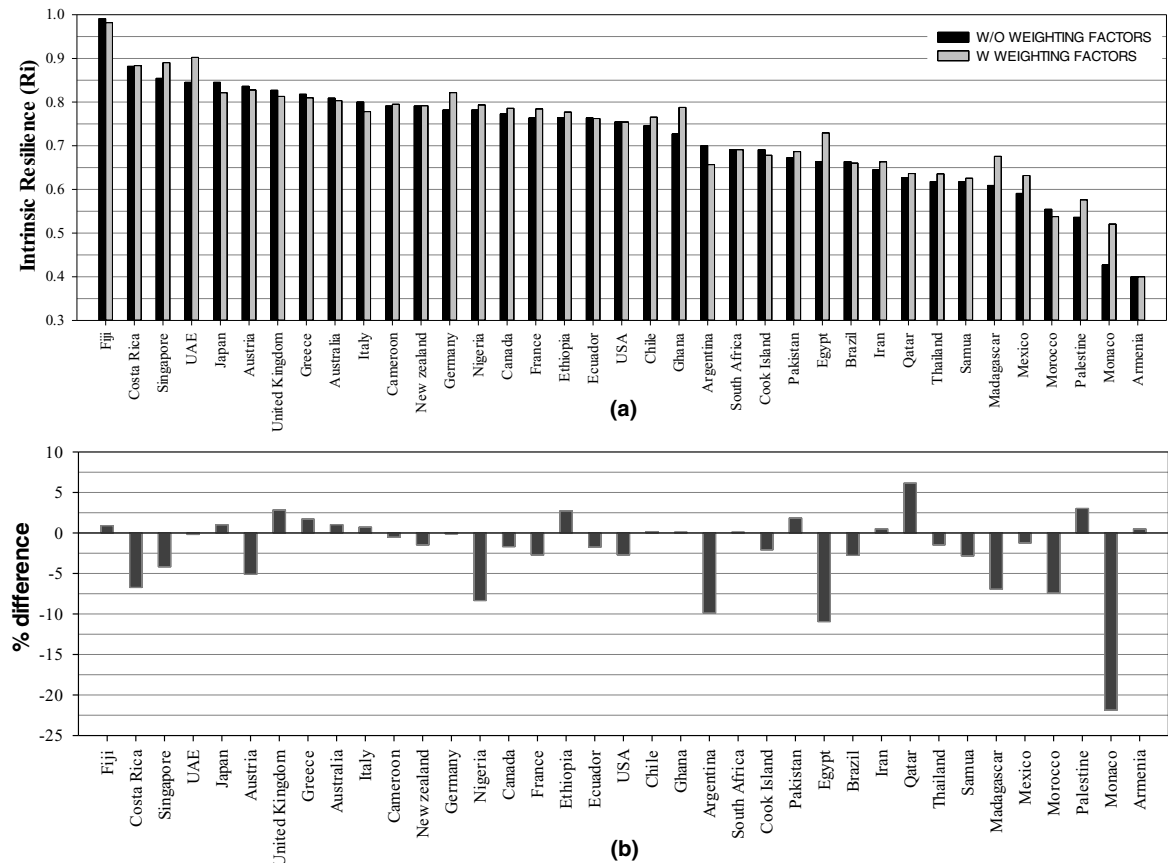

Fig. 6. (a) resilience scores before and after modification, (b) percentage difference of the resilience scores before and after modification.

The intrinsic resilience rankings of the countries prior and after modification are shown in Table 6. From the table, we can easily observe the changes recorded by most of the countries. It is worth mentioning that the new ranking is more representative. For instance, Japan is widely known for its high preparedness level against natural disasters. The HFA ranking system placed Japan in the 5th position, behind each of Fiji, Costa Rica, Singapore, and UAE. However, Japan was able to attain the 2nd position after using the Dependence Tree method. Japan’s new position is obviously more meaningful. Similarly, the position of Germany moved from 13th to 6th place. This confirms that weighting the indicators of Hyogo framework is more effective at describing the resilience of the nations. Nevertheless, Fiji achieved the first position in the resilience ranking, which is an unexpected outcome. This

can be attributed to several reasons, such as the subjectivity in filling the HFA reports in the first place. In addition, the DTA method was ineffective in changing the rank of Fiji. The reason is that Fiji has initially achieved a score of 109 out of 110 in the HFA evaluation (Table 4), which implies that whatever weighting strategy was adopted, it would still be ineffective.

Table 6. The ranking of the countries before and after scores modification.

Country	Rank before	Rank After	Country	Rank before	Rank After	Country	Rank before	Rank After
Fiji	1	1	Nigeria	14	12	Brazil	26	22
Costa Rica	2	4	Canada	15	15	Egypt	27	28
Singapore	3	3	France	16	16	Iran	28	27
UAE	4	7	Ecuador	17	18	Qatar	29	30
Japan	5	2	Ethiopia	18	20	Samoa	30	31
Austria	6	5	USA	19	21	Thailand	31	33
UK	7	8	Chile	20	19	Madagascar	32	26
Greece	8	9	Ghana	21	14	Mexico	33	32
Australia	9	10	Argentina	22	29	Morocco	34	35
Italy	10	17	South Africa	23	23	Palestine	35	34
Cameroon	11	11	Cook Island	24	25	Monaco	36	36
New Zealand	12	13	Pakistan	25	24	Armenia	37	37
Germany	13	6						

3.2. Computing the resilience index (R)

In this framework, the last step is to obtain the resilience index (R). As already indicated, the resilience index is the combination between intrinsic resilience, exposure, and hazard. For the sake of this example, the hazard is assumed to be ‘1’ in an attempt to disregard its effect. Therefore, in this specific case study, the resilience index is a function of just the exposure and the intrinsic resilience. The table below shows the resilience results that we acquired in the preceding step, the exposure level of each of the analyzed states that we obtained from the World Risk Report, and the resilience index of every state, which was computed using Equation (1). The final resilience ranking of the states is presented in Fig. 7. We can see that the new ranking is significantly different from the intrinsic resilience’s ranking in Fig. 6(a) (black bars), and this supports the notion that the most prepared nations (having high intrinsic resilience) are not necessarily the most resilient to disasters. For instance, Japan was second in the modified intrinsic resilience ranking (Table 6) and then it went back to the 26th place in the resilience ranking, and this is because Japan is among the most exposed nations.

Table 7. The intrinsic resilience index (R_i), exposure (E), and resilience index (R) of each of the analysed countries.

Country	R _i	E	R	Country	R _i	E	R	Country	R _i	E	R
Fiji	98.2	27.71	0.99	New Zealand	79.18	15.44	0.96	Madagascar	67.57	16.03	0.94
Japan	90.23	45.91	0.95	Ghana	78.8	14.48	0.96	Iran	66.33	10.19	0.96
Singapore	89.03	7.82	0.99	Canada	78.58	10.25	0.97	Egypt	66.02	4.71	0.98
Costa Rica	88.35	42.61	0.95	France	78.45	9.25	0.98	Argentina	65.7	9.55	0.96
Austria	82.78	13.6	0.97	Italy	77.82	13.85	0.96	Qatar	63.65	30.3	0.89
Germany	82.18	11.41	0.97	Ecuador	77.71	16.15	0.96	Mexico	63.2	13.84	0.95
UAE	82.15	5.93	0.98	Chile	76.56	30.95	0.92	Thailand	62.59	13.7	0.95
UK	81.31	11.6	0.97	Ethiopia	76.23	11.12	0.97	Palestine	57.62	6.41	0.97
Greece	80.98	21.11	0.95	USA	75.45	12.25	0.96	Morocco	53.78	13.25	0.94
Australia	80.33	15.05	0.97	Brazil	72.93	9.53	0.97	Monaco	52.07	9.25	0.95
Cameroon	79.51	18.19	0.96	South Africa	69.09	12.08	0.96	Armenia	40	14.51	0.91
Nigeria	79.35	12.06	0.97	Pakistan	68.68	21.11	0.93				

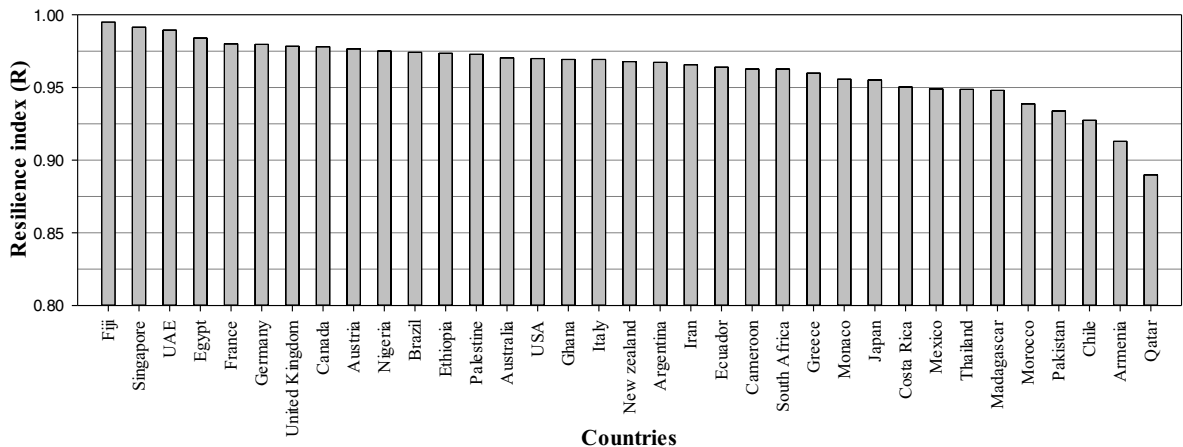

Fig. 7. The resilience indexes of the analysed countries.

4. Conclusions

This paper presented a new analytical approach for calculating the resilience of nations and communities. The analytical formulation of resilience resembles the older risk evaluation method in many ways. In fact, there is just one difference between the two concepts. This difference lies in the parameters that are being considered. In the older risk evaluation method, risk is a function of vulnerability, exposure, and hazard, while in the evaluation of resilience, vulnerability is substituted with the intrinsic resilience of the country. In addition, a new methodology to compute the intrinsic resilience was introduced. The method is based on the data of Hyogo Framework for Action (HFA). As we mentioned earlier, one of the main issues of the HFA is that the indicators used in the intrinsic resilience assessment are weighted equally. It has been figured out that those indicators do not really make equal contribution towards the intrinsic resilience output. To solve this problem, we introduced the Dependence Tree Analysis (DTA). This method identifies the correlation between the indicators and the resilience in a quantitative manner, assigning new weights the indicators accordingly. The applicability of the presented methodology was tested on 37 countries by calculating their respective intrinsic resilience and resilience indexes.

The analytical approach introduced in this study provides new ways through which the hazard can be understood. It enables us to have a proper estimation of how long it would take a system or a community to bounce back to its original and functional state. Future research will be oriented towards substituting the “Hyogo Framework for Action” with its successor “Sendai Framework” in the evaluation of resilience. This will lead to a better representation of the resilience of the countries given that the new UN framework is an enhanced version of the previous one.

Acknowledgements

The research leading to these results has received funding from the European Research Council under the Grant Agreement n° ERC_IDEal reSCUE_637842 of the project IDEAL RESCUE— Integrated DEsign and control of Sustainable CommUNITies during Emergencies.

References

- [1] G. P. Cimellaro, Renschler, C., Reinhorn, A. M., and Arendt, L., PEOPLES: a framework for evaluating resilience, *Journal of Structural Engineering*, ASCE, 2016.
- [2] I. Wagner, P. Breil, The role of ecohydrology in creating more resilient cities, *Ecohydrology & Hydrobiology* 13 (2013), pp. 113-134.

- [3] M. Bruneau, S. E. Chang, R. T. Eguchi, G. C. Lee, T. D. O'Rourke, A. M. Reinhorn, et al., A Framework to Quantitatively Assess and Enhance the Seismic Resilience of Communities, *Earthquake Spectra* 19 (2003), pp. 733-752.
- [4] B. Allenby, J. Fink, Toward Inherently Secure and Resilient Societies, *Science* 309 (2005), pp. 1034-1036.
- [5] S. Hosseini, K. Barker, J. E. Ramirez-Marquez, A review of definitions and measures of system resilience, *Reliability Engineering & System Safety* 145 (2016), pp. 47-61.
- [6] G. Papadopoulos, *Tsunamis in the European-Mediterranean Region*, chapter 6, first ed, Elsevier, Boston, 2016, pp. 137-178.
- [7] J. T. K. Richard, M. J. Smit, H. Goosen, C. H. Hulsbergen, Resilience and Vulnerability: Coastal Dynamics or Dutch Dikes?, *The Geographical Journal* 164 (1998), pp. 259-268.
- [8] O.D. Cardon, V. A. Maarten, B. Joern, F. Maureen, M. Glenn, R. Mechler, *Determinants of Risk: Exposure and Vulnerability Managing the Risks of Extreme Events and Disasters to Advance Climate Change Adaptation*, Cambridge University Press, 2012.
- [9] R. J. T. Klein, R. J. Nicholls, F. Thomalla, Resilience to natural hazards: How useful is this concept?, *Global Environmental Change Part B: Environmental Hazards* 5 (2003), pp. 35-45.
- [10] G. C. Gallopín, Linkages between vulnerability, resilience, and adaptive capacity, *Global Environmental Change* 16 (2006) pp. 293-303.
- [11] S. B. Manyena, The concept of resilience revisited, *Disasters* 30 (2006), pp. 434-450.
- [12] O. kammouh, G. Dervishaj, and G. P. Cimellaro, Resilience assessment at the state level, in 1st international conference on natural hazards & infrastructure, Chania, Greece, 2016.
- [13] UNISDR, *Hyogo Framework for Action 2005-2015: Building the Resilience of Nations and Communities to Disasters*, 2007.
- [14] G. P. Cimellaro, *Urban Resilience for Emergency Response and Recovery - Fundamental Concepts and Applications*, Springer, Netherland 2016.
- [15] UNISDR, *Indicators of progress: guidance on measuring the reduction of disaster risks and the implementation of the Hyogo Framework for Action*, 2008.
- [16] UNISDR, *Hyogo Framework for Action 2005-2015 mid-term review*, 2011.
- [17] UNISDR, *Sendai Framework for Disaster Risk Reduction 2015-2030*, 2015.
- [18] UNISDR, *Reading the Sendai Framework for Disaster Risk Reduction 2015 - 2030*, 2015.
- [19] P. Mucke, *WorldRiskReport*, United Nations University for Environment and Human Security (UNU-EHS), 2015.
- [20] G. P. Cimellaro, A. M. Reinhorn, and M. Bruneau, Framework for analytical quantification of disaster resilience, *Engineering Structures* 32 (2010), pp. 3639-3649.