

Electronic Thesis and Dissertation Repository

6-27-2017 12:00 AM

Investigating The Acute Levodopa Response In Early To Advanced Parkinson's Disease

Marcus M. Pieterman
The University of Western Ontario

Supervisor
Dr. Mandar Jog
The University of Western Ontario

Graduate Program in Physiology and Pharmacology
A thesis submitted in partial fulfillment of the requirements for the degree in Master of Science
© Marcus M. Pieterman 2017

Follow this and additional works at: <https://ir.lib.uwo.ca/etd>



Part of the [Neurology Commons](#)

Recommended Citation

Pieterman, Marcus M., "Investigating The Acute Levodopa Response In Early To Advanced Parkinson's Disease" (2017). *Electronic Thesis and Dissertation Repository*. 4641.
<https://ir.lib.uwo.ca/etd/4641>

This Dissertation/Thesis is brought to you for free and open access by Scholarship@Western. It has been accepted for inclusion in Electronic Thesis and Dissertation Repository by an authorized administrator of Scholarship@Western. For more information, please contact wlsadmin@uwo.ca.

Abstract

Parkinson's disease (PD) is a neurodegenerative movement disorder that often requires surgical interventions such as deep brain stimulation (DBS) when motor complications arise from long term levodopa therapy. Understanding the level of motor improvement received by patients from levodopa (levodopa response; LR) at each stage of disease duration is integral to optimizing both current treatment and DBS implementation. In this study, the levodopa challenge test was employed to investigate the LR in early to advanced stages of disease in 70 PD participants. The LR only moderately correlated with disease duration, suggesting large interindividual variability in the LR between patients of similar disease durations. The LR correlated most strongly with motor symptom severity in the OFF-medication state. We proposed that this was in part due to whether an individual relies more heavily on a nigral or extra-nigral control of dopamine in the PD brain. These findings offer support for implementing DBS in individuals earlier in disease and with smaller motor responses to levodopa.

Keywords

Parkinson's disease, levodopa, levodopa response, disease duration, UPDRS, short duration response, long duration response, motor symptoms, ON, OFF, deep brain stimulation, levodopa challenge test

List of Abbreviations

| | |
|-----------|---|
| %LR | Levodopa Response as a Percent Change |
| AADC | Aromatic Acid Decarboxylase |
| aLR | Absolute Levodopa Response |
| BG | Basal Ganglia |
| cAMP | Cyclic Adenosine Monophosphate |
| CAPSIT-PD | Core Assessment Program for Surgical Interventional Therapies in Parkinson's Disease |
| DAT | Dopamine Transporter |
| DBS | Deep Brain Stimulation |
| GPe | Globus Pallidus externa |
| GPi | Globus Pallidus interna |
| LAAT | L-Amino Acid Transporter |
| L-DOPA | Levodopa; L-3,4-dihydroxyphenylalanine |
| LDR | Long Duration Response |
| LID | Levodopa-induced Dyskinesia |
| MDS | Movement Disorders Society |
| MSN | Medium Spiny Neurons |
| PD | Parkinson's Disease |
| SEM | Standard Error of the Mean |
| SDR | Short Duration Response |
| SNc | Substantia Nigra pars compacta |
| SNr | Substantia Nigra pars reticulata |
| STD | Standard Deviation |
| STN | Subthalamic Nucleus |
| TH | Tyrosine Hydroxylase |
| Tmax | Maximum Plasma Concentration |
| UPDRS-III | Unified Parkinson Disease Rating Scale- Motor Examination |
| VMAT | Vesicular Monoamine Transporter |

Acknowledgments

First, I would like to extend my deepest thanks to my supervisor, Dr. Mandar Jog. His brilliance and dedication to science in a field of intellectual titans is unrivaled. Thanks to his mentorship over the past two years, I have experienced an unprecedented maturation in the way I view and understand the scientific world that unfolds before me each day.

Always thinking, always challenging, never satisfied; Dr. Jog embodies the true spirit of what it means to be a revolutionary thinker in our modern time. Winston Churchill eloquently captures a principle Dr. Jog has imparted on me, one I will carry always:

“Never give up on something that you can't go a day without thinking about.”

-Winston Churchill

I would like to thank my advisory committee: Dr. Donglin Bai, Dr. Matthew Heath, and Dr. Tim Doherty for their unwavering support and scientific insight.

I would like to extend thanks to all members of the Movement Disorders Centre; with a special thanks to Greydon Gilmore, Dr. Phil Rizek, Dr. Niraj Kumar, Dr. Aditya Murgai, and Jack Lee.

I would like to offer my sincerest thanks to Olivia Petersons for her unconditional support and patience. I would certainly not be where I am today if not for you. Furthermore, I would like to express thanks for the encouragement and confidence my friends and family have had in me from the start.

Lastly, I would like to offer a special thanks to all the participants recruited from the Movement Disorders Centre at University Hospital. You made this project possible, and your willingness to participate has not gone unnoticed.

Table of Contents

| | |
|--|------|
| Abstract | i |
| Keywords | i |
| List of Abbreviations..... | ii |
| Acknowledgments..... | iii |
| Table of Contents | iv |
| List of Tables..... | vii |
| List of Figures | viii |
| List of Appendices | ix |
| Chapter 1 | 1 |
| 1.0 Introduction..... | 1 |
| 1.1 Background of Parkinson’s Disease..... | 1 |
| 1.1.1 Epidemiology and Etiology..... | 1 |
| 1.1.2 Basal Ganglia Circuitry..... | 2 |
| 1.1.3 Pathology of PD..... | 5 |
| 1.2 Pharmacology of Levodopa | 6 |
| 1.2.1 Levodopa and its Metabolism | 6 |
| 1.2.2 Dopamine and its Metabolism | 8 |
| 1.2.3 Compensatory Mechanisms in PD..... | 10 |
| 1.3 PD Motor Symptoms | 12 |
| 1.3.1 Motor Symptom Assessment in PD..... | 12 |
| 1.3.2 Bradykinesia..... | 13 |
| 1.3.3 Tremor..... | 15 |
| 1.3.4 Rigidity..... | 16 |

| | |
|---|----|
| 1.3.5 Postural Instability and Gait Dysfunction | 17 |
| 1.4 Role of the Levodopa Response in PD | 19 |
| 1.4.1 The Levodopa Response | 19 |
| 1.4.2 Rationale | 20 |
| 1.4.3 Studies Investigating Levodopa Response in PD | 21 |
| 1.4.4 Summary of Current Studies | 23 |
| 1.4.5 Hypothesis | 24 |
| 1.4.6 Objectives | 24 |
| Chapter 2 | 26 |
| 2.1 Methods | 26 |
| 2.1.1 Study Participants | 26 |
| 2.1.2 Levodopa Challenge Test | 26 |
| 2.1.3 Clinical Questionnaires | 29 |
| 2.1.4 Statistical Analyses | 31 |
| Chapter 3 | 32 |
| 3.1 Results | 32 |
| 3.1.1 PD Participants: Clinical Outcomes | 32 |
| 3.1.2 UPDRS-III: Total Motor Outcomes | 34 |
| 3.1.3 UPDRS-III: Motor Subscore Outcomes | 40 |
| 3.1.4 Clinical Scales and Self-Reported Questionnaires | 48 |
| Chapter 4 | 50 |
| 4.0 Discussion | 50 |
| 4.1 Discussion: Part A | 51 |
| 4.1.1 Reporting the aLR versus the %LR | 51 |
| 4.1.2 The Influence of Age and Disease Duration on the LR | 52 |

| | |
|--|----|
| 4.1.3 The Short and Long Duration Response to Levodopa..... | 53 |
| 4.1.4 Nigral versus Extra-nigral Control Systems | 55 |
| 4.2 Discussion: Part B | 57 |
| 4.2.1 Akinesia | 57 |
| 4.2.2 Rigidity..... | 58 |
| 4.2.3 Tremor..... | 58 |
| 4.2.4 Axial Symptoms..... | 59 |
| 4.2.5 Summary of Motor Symptoms..... | 60 |
| 4.2.6 Clinical Questionnaires | 61 |
| 4.3 Discussion: Part C | 62 |
| 4.3.1 Limitations | 62 |
| 4.3.2 Future Directions..... | 62 |
| 4.3.3 Summary | 63 |
| References..... | 66 |
| Appendices..... | 83 |
| Appendix A: Letter of Information and Consent | 83 |
| Appendix B: Ethics Approval | 89 |
| Appendix C: Z-Score Formula..... | 90 |
| Appendix D: Montreal Cognitive Assessment (MoCA) Scale | 91 |
| Appendix E: Activities-specific Balance Confidence (ABC) Scale | 92 |
| Appendix F: Geriatric Depression Scale (GDS | 93 |
| Appendix G: Freezing of Gait Questionnaire (FOG-Q) | 94 |
| Appendix H: Parkinson’s Disease Quality of Life Questionnaire (PDQ-8) .. | 96 |
| Appendix I: Unified Parkinson Disease Rating Scale..... | 97 |
| Curriculum Vitae..... | 99 |

List of Tables

| | |
|---|----|
| Table 1. Features and movements assessed using the UPDRS-III and their respective scoring. Higher scores represent increased motor impairment. | 27 |
| Table 2. Clinical Questionnaires completed by all PD participants..... | 30 |
| Table 3. Clinical data of 70 PD participants enrolled in the study. | 33 |

List of Figures

| | |
|--|----|
| Diagram 1. Schematic of the basal ganglia-thalamocortical motor circuit in the normal and Parkinson's disease state. | 4 |
| Figure 1. Absolute levodopa response is significantly influenced by disease duration and levodopa duration..... | 34 |
| Figure 2. Absolute levodopa response is significantly associated with LED and OFF motor scores. | 36 |
| Figure 3. A) OFF motor scores increase significantly after 13 years of disease while ON motor scores remain relatively stable. B) The levodopa response initially widens and then plateaus in later stages of disease duration..... | 37 |
| Figure 4. Mean daily levodopa equivalency dose significantly increases after 9 years of PD..... | 39 |
| Figure 5. A) Akinesia significantly worsens after 13 years of disease. B) Tremor appears to gradually worsen and then spontaneously improve after 13 years of disease. C) Rigidity remains relatively stable throughout disease. D) Axial symptoms significantly worsen after 13 years of disease..... | 40 |
| Figure 6. Standardized OFF UPDRS-III subscores for tremor, akinesia, rigidity, and axial symptoms at different stages of disease duration. | 42 |
| Figure 7. Tremor, akinesia, rigidity and axial symptom response to levodopa at each stage of disease duration. | 44 |
| Figure 8. A) Retropulsion test scores OFF medication were significantly more severe after 13 years of PD. B) Retropulsion test scores significantly responded to levodopa after 13 years of disease. | 46 |
| Figure 9. The relationship between ON UPDRS-III scores and clinical scales measuring cognition, freezing of gait, confidence in balance, quality of life, and depression..... | 48 |

List of Appendices

| | |
|--|----|
| Appendix A: Letter of Information and Consent..... | 83 |
| Appendix B: Ethics Approval..... | 89 |
| Appendix C: Z-Score Formula..... | 90 |
| Appendix D: Montreal Cognitive Assessment (MoCA) Scale..... | 91 |
| Appendix E: Activities-specific Balance Confidence (ABC) Scale..... | 92 |
| Appendix F: Geriatric Depression Scale (GDS)..... | 93 |
| Appendix G: Freezing of Gait Questionnaire (FOG-Q)..... | 94 |
| Appendix H: Parkinson’s Disease Quality of Life Questionnaire (PDQ-8)..... | 96 |
| Appendix I: Unified Parkinson Disease Rating Scale..... | 97 |

Chapter 1

1.0 Introduction

This body of work investigates the acute levodopa response in early to advanced stages of Parkinson's disease. Parkinson's disease is a complex neurodegenerative movement disorder that is yet to be fully understood. The clinical nature of this study aims to bridge the gap from bench to bedside so that those suffering from Parkinson's disease might see an improvement in their quality of life today, not tomorrow. Let us begin with an in-depth review of the foundations of Parkinson's disease so that the clinical material discussed might be understood at a more fundamental level.

1.1 Background of Parkinson's Disease

1.1.1 Epidemiology and Etiology

Parkinson's disease (PD) is the most common movement disorder and second most common neurodegenerative disorder after Alzheimer's disease. PD has a general incidence rate of 14 in 100,000 persons which increases sharply in those over 65 years of age, climbing to 160 in 100,000 persons (De Lau & Breteler, 2006; Lill & Klein, 2017). This generates a range in prevalence, anywhere from 100 to 200 per 100,000 persons. Furthermore, there exists a 2% life-time risk of developing PD for men and 1.3% for women (Tysnes & Storstein, 2017; Lill & Klein, 2017). The disparity in risk between genders, however, is not yet fully understood (Haaxma et al., 2007). Given the significant portion of our population affected by the disease, it places an exceptional burden on the health care system. Alleviating this burden rests on the shoulders of physicians and scientists dedicated to fully understanding the nature of the disease.

Most cases of PD are idiopathic and thought to be of a multifactorial nature. With the discovery of mutations like LRRK2, Parkin, and Pink1, monogenetic causes are now thought to contribute to 5-10% of PD cases (Tysnes & Storstein, 2017). Beyond monogenic causes, idiopathic PD likely develops due to a combination of genetic,

environmental and lifestyle factors. An additional 26 genetic loci are thought to be involved in idiopathic PD, but further research elucidating underlying disease mechanisms is still needed (Lill & Klein, 2017). Substantiated environmental and lifestyle risk factors include exposure to pesticides and head trauma; whereas smoking, alcohol and caffeine's influence on disease is still up for debate (Lill & Klein, 2017). Although the causes of PD are less well understood, there has been extensive research on the anatomical circuitry involved in Parkinson disease.

1.1.2 Basal Ganglia Circuitry

The basal ganglia (BG) are a family of highly organized subcortical nuclei responsible for facilitating inhibition and initiation of motor behavior. The BG are situated at the base of the cerebral hemispheres and partially within the brainstem (Obeso et al., 2008). BG nuclei include the caudate and putamen (known collectively as the striatum), globus pallidus interna and externa (GPi and GPe; respectively), subthalamic nucleus (STN), substantia nigra pars reticulata (SNr), and the substantia nigra pars compacta (SNc) (Obeso et al., 2008). The BG belong to a set of parallel and largely closed circuits, of which are grouped based on their functional role in the cortex (DeLong & Wichmann, 2015). These circuits include the oculomotor, limbic, prefrontal and motor circuit (DeLong & Wichmann, 2015). However, our focus will be on the motor circuit given its involvement in movement and PD (see Diagram 1).

BG motor circuit begins by extending excitatory glutamatergic projections from cortical motor areas to both the STN and striatum of the BG (Squire et al. 2012). The striatum also receives dopaminergic input from the SNc, which has a modulating effect on the corticostriatal inputs via two distinct pathways. The 'direct' pathway sends projections from striatal inhibitory GABAergic neurons (medium spiny neurons; MSN) in the putamen to the GPi/SNr complex (Obeso et al., 2008). MSNs of the direct pathway exhibit excitatory dopamine D-1 receptors and co-express the peptides substance-P and dynorphin (Obeso et al., 2008). In contrast, the 'indirect' pathway involves striatal medium spiny neurons which co-express enkephalin and bear inhibitory dopamine D-2 receptors (Obeso et al., 2008). The indirect pathway projects to the GPe,

which then extends both directly and indirectly (via the STN) to the GPi/SNr output complex (Obeso et al., 2008). Hence, the direct pathway is thought to inhibit the output complex, whereas the indirect pathway tends to excite it. However, recent findings suggest that the roles of the direct and indirect pathway are not as dichotomous as once thought. There is likely a much more intricate balance between the two pathways determining the level of activity at the GPi/SNr complex.

The GPi/SNr serves as the main efferent point for the BG, exhibiting a tonic inhibitory effect on the ventral anterior and ventral lateral nuclei (motor nuclei) of the thalamus (DeLong & Wichmann, 2015). From the thalamus, the circuit completes itself by projecting back to the motor cortex. Pathologic dysfunction within the BG motor loop is what gives rise to many of the motor symptoms observed in Parkinson's disease (DeLong & Wichmann, 2015). It is important to note that basal ganglia circuitry far exceeds the complexities noted here.

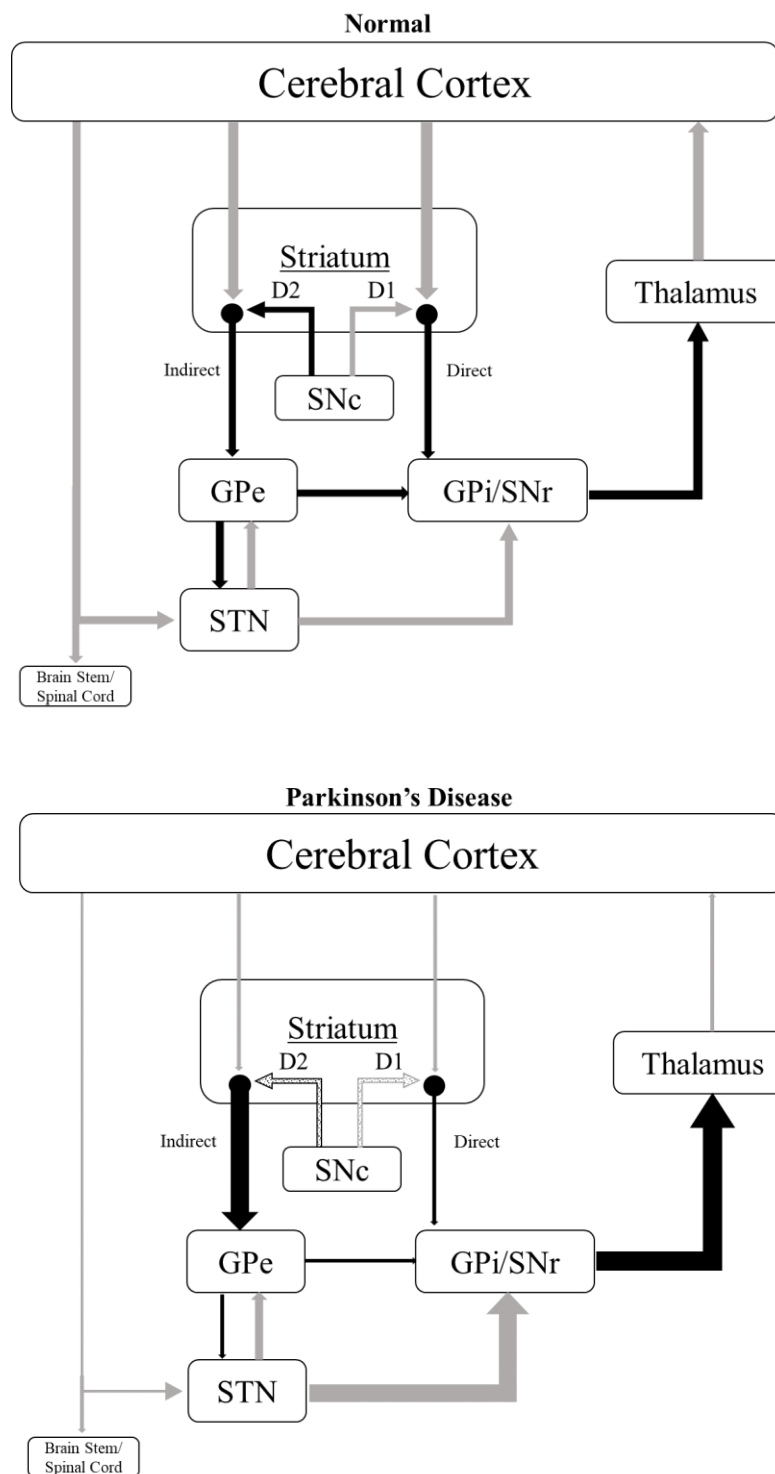

Diagram 1. Schematic of the basal ganglia-thalamocortical motor circuit in the normal and Parkinson's disease state. Thickness of arrows corresponds to level of neuronal activity. Black arrows indicate inhibitory projections; grey arrows indicate excitatory projections.

1.1.3 Pathology of PD

Parkinson's disease is classically described as a neurodegenerative disorder characterized by the progressive loss of dopaminergic neurons within the SNc. Dopamine functions to fine-tune neuronal excitability in the striatum, thereby facilitating movement (Obeso et al., 2008). Simply put, depletion of dopamine leads to reduced signaling of the excitatory D-1 (direct pathway) and inhibitory D-2 (indirect pathway) receptors (Fuxe, Manger, Genedani, & Agnati, 2006). This results in reduced activity of the direct pathway and overactivity of the indirect pathway; ultimately increasing inhibition at the level of the thalamus (Fuxe et al., 2006). It is this shift to a state of physiologic imbalance within the BG that results in the physical manifestation of motor symptoms seen in PD (DeLong & Wichmann, 2015). Accompanying the motor symptoms observed in PD are several pathologic features.

Abnormal folding and accumulation of protein is not uncommon among neurodegenerative diseases (Kalia, Lang & Shulman, 2015). In fact, it is by these intracellular protein inclusions that degenerative diseases are often categorized (Kalia et al., 2015). The protein associated with PD is α -synuclein. Insoluble aggregates of α -synuclein found within the cell body of a neuron are known as Lewy bodies (Braak et al., 2003). When found within neuronal processes, they are known as Lewy neurites (Braak et al., 2003). In addition to the loss of dopaminergic neurons in the SNc, Lewy pathology is the second widely recognized pathologic hallmark of PD (Braak & Del Tredici, 2017). However, it is still unknown whether the presence of Lewy bodies in nigral and extra-nigral neurons is toxic to the system or perhaps even neuroprotective (Gallagher & Schapira, 2014). A staging system developed by Braak et al. (2003) proposes six stages by which Lewy pathology progresses spatially and temporally in PD. The first stage affects the peripheral nervous system, olfactory system and medulla oblongata (lesions seen in the dorsal motor nucleus of the vagus). This is supported by the early premotor symptoms observed in PD including autonomic dysfunction (particularly gastrointestinal issues) and olfactory impairment (Gallagher & Schapira, 2014). Although controversial, it is posited that Lewy pathology may be spreading in a prion-like manner up the vagal nerve to the CNS from the gut (Svensson et al., 2015).

Braak's second stage includes pathology in the pons, and with the third stage comes nigral pathology. Third stage nigral pathology provides an explanation for the presentation of motor symptoms seen in PD, given its role in the BG motor loop. The fourth, fifth and sixth stages involves the spreading of Lewy pathology to include lesions in the limbic system, thalamus, and several different cortical regions. The presence of cortical Lewy pathology has been shown to correlate with dementia, providing evidence for the cognitive decline sometimes seen in advanced stages of PD (Irwin et al., 2012). Although no cure exists for treating PD pathology, year 2017 marks the 50th anniversary for a molecule that has been instrumental in improving quality of life for PD patients.

1.2 Pharmacology of Levodopa

1.2.1 Levodopa and its Metabolism

In 1967, a study was published in which a racemic mixture of D/L-DOPA was used for the first time in the treatment of PD (Cotzias, Van Woert & Schiffer, 1967). Harvard medical school researchers lead by Dr. George Cotzias were responsible for the study, demonstrating a novel treatment that could provide significant motor relief for PD patients. At first, this revolutionary treatment was received with much skepticism by the scientific community (Fahn & Poewe, 2015). It was not until their follow up study published in 1969, which used a 100% pure formulation of L-DOPA, that doubts were put to rest (Cotzias, Papavasiliou & Gillene, 1969). L-DOPA or levodopa (L-3,4-dihydroxyphenylalanine) has been the absolute gold-standard for the treatment of motor symptoms in Parkinson's disease ever since (Fahn & Poewe, 2015).

Levodopa is a naturally occurring neutral amino acid that is found in some foods and as an intermediate in human metabolic pathways (Muller, 2013). Levodopa is converted to dopamine in both the central (CNS) and peripheral (PNS) nervous system via aromatic acid decarboxylase (AADC) (Muller, 2013). Levodopa undergoes significant systemic metabolism by peripheral AADC prior to entering the CNS. Peripheral conversion of levodopa to dopamine greatly reduces efficacy, given dopamine's inability to cross the blood-brain barrier (LeWitt, 2015). To combat this,

oral formulations also contain an AADC inhibitor (carbidopa), increasing bioavailability at the CNS (Muller, 2013).

There are several challenges that orally administered levodopa faces during transport to the brain. First, there is only a brief region of the duodenum and proximal-jejunum where sodium-dependent neutral amino acid carrier systems exist (LeWitt, 2015). Within this region, levodopa competes for absorption in the gut with other neutral amino acids found in the diet via facilitated transport (LeWitt, 2015). Hence, physicians instruct PD patients not to eat one hour before, or two hours after taking levodopa orally. Not taking levodopa with food optimizes drug absorption in the small intestine (Nutt et al., 1984). From here, much of the absorbed levodopa either undergoes significant first-pass metabolism in the liver or is delivered to skeletal muscle and only a small percentage is delivered to the CNS (LeWitt, 2015). Levodopa has a plasma half-life of about 90 minutes, which is nearly doubled when given with carbidopa (Yeh et al., 1989). Orally administered tablets often consist of 100 mg of levodopa and 25 mg of carbidopa; and require 45-60 minutes (\pm 20 minutes) to reach maximum drug concentration in plasma (Yeh et al., 1989). It is around this 45-60 minute mark when levodopa reaches maximum plasma concentration that we usually see the greatest effect in managing motor symptoms. It is the central action of levodopa responsible for providing motor relief.

Levodopa crosses the blood-brain barrier into the CNS via the same sodium-dependent amino acid transporter seen in the gut (Nutt et al., 1984). Once in the CNS, L-amino acid transporters (LAAT) present on the surface of SNc neurons take up exogenous levodopa into the cytosol (Vieira-Coelho & Soares Da Silva, 1998). These transporters are also present on the surface of extra-nigral neurons. Now exposed to AADC and cofactor pyridoxal phosphate, levodopa is converted to dopamine. Excluding dopamine supply via exogenously administered levodopa, the primary pathway for dopamine biosynthesis within neurons begins with phenylalanine (Daubner, Le, & Wang, 2011). Phenylalanine is first converted to L-tyrosine by phenylalanine hydroxylase with help from co-factor tetrahydrobiopterin (BH₄) (Daubner et al., 2011). This step is characterized by the addition of a hydroxyl group to phenylalanine (Daubner

et al., 2011). This is followed by rate limiting enzyme tyrosine hydroxylase (TH) and cofactors oxygen, BH₄, and iron (Fe²⁺) in adding a second hydroxyl group to tyrosine (Ramsey & Fitzpatrick, 2000). The rate limiting addition of a hydroxyl group to tyrosine produces L-DOPA (Ramsey and Fitzpatrick, 2000). As discussed earlier, L-DOPA is then converted to dopamine via AADC. Dopamine begins its journey by being packaged into vesicles in the cytosol.

1.2.2 Dopamine and its Metabolism

Dopamine present in SNc neurons must first be packaged into vesicles before release of the neurotransmitter can occur. Vesicular monoamine transporters (VMAT2) depend on vesicular proton pumps (V-type H⁺-ATPase) to generate the H⁺-gradient required for vesicular packaging of cytosolic dopamine (Erickson et al., 1996). Peter et al., (1995) detected the highest concentrations of VMAT2 in the soma, axon terminals and proximal dendrites of dopamine neurons as demonstrated by increased immunoreactivity for VMAT2 in those regions. This suggests vesicular packaging of monoamines may occur in several areas throughout the neuron. However, given the proximity to dendritic spines of medium spiny neurons, the bulk of packaging is likely to occur in the axon terminals of dopaminergic neurons (Mosharov, Borgkvist, & Sulzer, 2015).

SNc neurons are tonically active with a basal firing rate of approximately ~4 Hz. Upon stimulation, firing frequency rises to roughly ~15 Hz (Mosharov et al., 2015). Thus, quantal release of dopamine must be tightly regulated. Stimulation-dependent exocytosis is an efficient means of regulating this release. Elsworth and Roth (1997) explain that when an action potential arrives, a shift in resting membrane potential results in conformational changes in membrane proteins. This allows calcium ions to flow into the cytosol, thereby stimulating dopamine concentrated vesicles to fuse with the membrane via exocytosis (Kelly, 1993). Upon fusion, dopamine is dumped into the synaptic cleft to reach its target post-synaptic membrane. Interestingly, Freund, Powell, and Smith (1984) showed that pre-synaptic nigrostriatal neurons often terminate specifically on the necks of medium spiny neuron dendrites. This serves to mediate

excitatory glutamatergic stimulation by cortical neurons synapsing on the distal ends of MSN dendritic spines. Moreover, this provides dopaminergic neurons from the SNc the ability to regulate the MSN's output by regulating its input. This finding vastly improved our understanding of the basal ganglia circuitry discussed earlier.

Following stimulation-dependent exocytosis of dopamine into the synaptic cleft, the neurotransmitter may befall several different fates. First, dopamine can stimulate dopamine receptors on the post-synaptic membrane. Dopamine receptors belong to a class of transmembrane g-protein coupled receptors (Keefe & Gerfen, 1995). Elsworth and Roth (1997) explain that there are 5 subtypes of dopamine receptors: D1, D2, D3, D4, and D5. These subtypes are then grouped into either the D1-like receptor family (includes subtypes D1 and D5) or the D2-like receptor family (includes subtypes D2, D3, and D4). D1 receptors typically have an excitatory effect when bound by a ligand; exerting its effect by increasing intracellular levels of the second messenger cyclic adenosine monophosphate (cAMP) (Beaulieu & Gainetdinov, 2011). In contrast, D2 receptors are largely inhibitory when bound by ligand; inhibiting cAMP formation (Beaulieu & Gainetdinov, 2011). D1 and D2 receptors are both found on the postsynaptic medium spiny neuron, with D1 being primarily involved in the direct pathway (as mentioned earlier) and D2 with the indirect pathway. According to further research by Elsworth and Roth (1996), D2 receptors are also found on the pre-synaptic dopaminergic neuron which are referred to as D2 autoreceptors. D2 autoreceptors give feedback to the pre-synaptic neuron, providing dopamine autoregulation based on the concentration of extracellular ligand available. D2 autoregulation involves adjusting the firing rate of the neuron and regulating the biosynthesis of dopamine and its release. In addition to receptor-mediated regulation of dopamine, the primary means by which dopamine is cleared from the synapse is by dopamine transporters (Elsworth & Roth, 1996).

Hitri et al. (1994) showed that dopamine transporters (DAT) are an energy dependent protein transporter capable of both releasing dopamine and managing reuptake. However, under physiologic conditions, DAT is known for its ability to help clear the synaptic cleft of dopamine through reuptake. DAT serves as a symporter

during reuptake, using high extracellular sodium (Na^+) levels to drive dopamine back into the presynaptic terminal. Na^+/K^+ -ATPase pumps help maintain this gradient by pumping sodium back into the extracellular space. Hitri et al. (1994) demonstrated this by showing that dopamine reuptake is impaired following Na^+/K^+ -ATPase inhibition, effectively lowering the extracellular sodium levels needed to drive the DAT symporter. Once dopamine has been pumped back inside the terminal bouton, it can either be metabolized or recycled back into vesicles to await release. Aside from its presence on the pre-synaptic membrane, DAT can also be found on microglia. Through DAT, microglia take up residual dopamine to be metabolized.

Microglia and dopaminergic neurons both have the enzyme monoamine oxidase (MAO) located subcellularly on the outer membrane of the mitochondria. In addition to MAO, microglia also contain soluble, cytoplasmic catechol-O-methyltransferase (COMT) whereas dopaminergic neurons lack this enzyme (Meiser, Weindl, & Hiller, 2013). MAO catabolizes dopamine via deamination whereas COMT introduces a methyl group (Meiser et al., 2013). A few of the main end-point metabolites of dopamine catabolism include homovanillic acid (HVA) and 3,4-dihydroxyphenylethanol (DOPET) (Goldstein & Lieberman, 1992).

1.2.3 Compensatory Mechanisms in PD

As previously discussed in the pathology of PD, we typically see a 30% loss of neuromelanin pigmentation in the SNc before PD motor symptoms manifest. In other words, this loss of pigmentation translates to 30% nigral cell death. Moreover, due to axonal branching at the level of the striatum we see an even higher 50-70% loss of nigral terminals before motor symptoms present (Burke & O'Malley, 2013). Hence, dopamine release is somehow sufficient even after substantial cell death and loss of innervation to the striatum occurs (Mosharov et al., 2015). Three compensatory responses seen in pre and postsynaptic terminal sites are likely responsible for correcting basal ganglia function in a worsening pathologic state: 1) under lower levels of extracellular dopamine, D2 autoreceptors on the presynaptic neuron are stimulated far less, causing them to upregulate dopamine biosynthesis and release in the surviving

terminals (Zigmond, 1997); 2) reduced dopamine stimulation on postsynaptic MSNs results in a compensatory upregulation of MSN-D2 receptors (Berti, Pupi & Mosconi, 2011); 3) nigral terminal death reduces the overall number of dopamine reuptake transporters, increasing the volume of dopamine remaining in the extracellular space following release (Venton et al., 2003). These compensatory responses in conjunction with exogenous levodopa therapy are likely responsible for restoring much of the basal ganglia function in PD.

Levodopa has been shown to increase cytosolic dopamine levels (Mosharov et al., 2009), increase vesicular dopamine storage (Omiatek et al., 2013), and increase quantal size of dopamine release from vesicles (Pothos, Davila, & Sulzer, 1998). Overall, this results in a largely increased volume of transmission of dopamine. An important feature of monoamine neurotransmitter synapses such as with dopamine is the concept of 'social transmission'. Social transmission occurs when the neurotransmitters released overflow to interact at sites distant from the intended post-synaptic membrane (Sulzer & Pothos, 2000); termed perisynaptic zones (Venton et al., 2003). Social transmission of dopamine at the striatum allows dopamine to interact with receptors on MSN dendritic spines far from the initial release site. It also results in dopamine interacting with receptors found on extra-nigral serotonergic neurons, corticostriatal synapses and GABAergic and cholinergic interneurons (Venton et al., 2003). Social transmission helps explain in part how motor function improves with the use of levodopa when so few dopamine terminals remain. As discussed, levodopa increases the volume of transmission of dopamine; and reduced DAT due to terminal loss results in increased synaptic concentrations of dopamine. These two features in conjunction with social transmission allows dopamine to venture to sites of low terminal receptor density, increasing stimulation in these denervated areas (Mosharov et al., 2015). Thus, temporarily restoring basal ganglia homeostasis and improving motor functioning in individuals with PD. This reasoning provides grounds for why we likely do not see a change in motor behavior if levodopa were to be given to a healthy individual. Healthy individuals do not experience the same level of SNc terminal density loss as those with PD (Burke & O'Malley, 2013). Hence, D2 autoreceptors have not increased the overall

volume of dopamine transmission from each neuron, postsynaptic striatal D2 receptor upregulation has not occurred, and DAT levels remain normal. Quantal release of dopamine is highly controlled, and a high number of dopamine reuptake transporters remain to rapidly clear the synaptic space of excess dopamine. Therefore, exogenous administration of levodopa to healthy individuals has no effect. These compensatory mechanisms highlight why levodopa has been so successful in treating PD. Given the abovementioned compensatory mechanisms, the PD brain clearly strives to maintain physiologic balance in a worsening pathologic state. Although exogenous levodopa administration proves useful, an array of motor symptoms persists.

1.3 PD Motor Symptoms

1.3.1 Motor Symptom Assessment in PD

The four cardinal motor symptoms recognized in PD include bradykinesia, rest tremor, muscular rigidity, and postural instability (Kalia et al., 2015). The most commonly used method of assessment for determining severity of these symptoms is the Movement Disorders Society- Unified Parkinson Disease Rating Scale; Part 3: Motor Examination (MDS-UPDRS-III) (Martinez-Martin et al., 2013). In 2008, the Movement Disorders Society revised the existing UPDRS (Goetz et al., 2008) based on published criticisms of the scale. The MDS-UPDRS boasts 4 comprehensive sections including 1) non-motor experiences of daily living; 2) motor experiences of daily living; 3) motor examination; and 4) motor complications. Our study employed the use of the motor examination (Part 3) portion of the MDS clinical scale, and will simply be referred to hereafter as the ‘UPDRS-III’.

The UPDRS-III includes 18 items which are given individual scores based on highly specific rating criteria. The ratings given to each item range in severity on a 5-point scale from 0 = normal, 1 = slight, 2 = mild, 3 = moderate, and 4 = severe (Goetz et al., 2008). The UPDRS-III is an essential part of the ‘Core Assessment Program for Surgical Interventional Therapies in Parkinson’s Disease’ (CAPSIT-PD) that was put forth by Defer, Widner, Marie, Remy, and Levivier in 1999. CAPSIT-PD outlines the steps to determine if a PD patient would make a suitable candidate for more intensive

surgical interventions like deep brain stimulation (DBS). DBS is often implemented when PD motor symptoms are no longer sufficiently managed by oral anti-parkinsonian medications and complications arise. One of the CAPSIT-PD criterium states that PD patients should have a minimum 33% dopaminergic responsiveness (levodopa response) when undergoing the ‘single-dose L-dopa test’ or the ‘levodopa challenge test’. This involves performing the UPDRS-III after a PD patient has been without antiparkinsonian medication for a minimum of 12 hours (i.e. when they are in their ‘defined-off’ state; ‘OFF’ medication). The patient is then given a single dose of levodopa and reassessed using the UPDRS-III. They are either reassessed 45-60 minutes after levodopa administration, or when the patient is at their best clinically ‘defined-on’ state. The defined-on state refers to when both the patient and clinical rater agree that the individual is receiving the highest level of therapeutic benefit from the administered levodopa. Per CAPSIT-PD protocol, the degree of change measured by the UPDRS-III as a result of the levodopa is calculated as: $(\text{OFF UPDRS-III score} - \text{ON UPDRS-III score}) / \text{OFF UPDRS-III score} \times 100\%$. The value produced by this formula is the levodopa response. If this resulted in a levodopa response of 33%, it would indicate that the OFF UPDRS-III score decreased by 33% following levodopa administration. CAPSIT-PD protocol states that an individual with a 33% dopaminergic response demonstrates the minimum response to medication needed to move forward in the screening process. Although commonly used to assess an individual’s suitability for surgical intervention, the levodopa challenge test has been widely adopted for research purposes and will be used in this study. This method for determining an individual’s response to medication has become the gold-standard in both the clinical and research realm (Albanese et al., 2001). Although the levodopa response generally indicates a patient’s overall motor improvement, subscores of the UPDRS-III like those for bradykinesia can provide insight into the severity of individual symptoms. Next, is a brief overview of the cardinal motor symptoms of PD.

1.3.2 Bradykinesia

Per Braak’s staging, the one absolute symptom that must be present to diagnose an individual with PD is bradykinesia. Bradykinesia is defined as ‘slowness of movement’

and has been shown to correlate highly with the degree of cell loss in the substantia nigra pars compacta (Greffard et al., 2006). Thus, bradykinesia is expected to progressively worsen with disease. Bradykinesia is often used interchangeably with terms such as akinesia (poverty of spontaneous movement) and hypokinesia (amplitude of movements are smaller than normal). Bradykinesia is evident in PD patients when asked to perform UPDRS-III tasks like rapid finger tapping or opening and closing of the fist. In both instances, bradykinesia presents as a gradual decline in the speed of which the task is performed. In this example, hypokinesia presents as a decrement in amplitude of the performed task, such that the fingers do not open as big and as wide as they did at the beginning of the task. Furthermore, akinesia can manifest as a lack of spontaneous facial expression during conversation or reduced arm swing during walking. Although these three terms have slightly different definitions, they are likely the result of similar etiology.

The primary pathophysiological reason bradykinesia is seen in PD is likely due to basal ganglia dysfunction. However, several secondary causes including rigidity, tremor, muscle weakness and slowing of thought likely contribute (Berardelli, Rothwell, Thompson, & Hallet, 2001). The following research provides support for these secondary causes: a) muscle weakness- a study by Corcos et al., (1996) demonstrated that PD participants showed an average 30% reduction in muscle strength when assessed OFF levodopa as compared to ON; b) tremor- research by Wierzbicka et al. (1993) and Hallet et al. (1977) have shown that patients exhibiting rest or action tremor try to time the tremor contraction of their agonist muscle with the initiation of movement, which results in an overall delay in initiation (slowness); c) given that PD movements are less accurate than healthy controls (Phillips et al., 1994), it has been theorized that bradykinesia is actually a trade-off strategy actively employed to improve accuracy by reducing speed (Sheridan & Flowers, 1990); and d) lastly, slowness of thought (bradyphrenia), although controversial, may interfere with the planning and execution of movement (Cooper, Sagar, Tidswell, & Jordan, 1994; Pate & Margolin, 1994). Combined, these studies provide evidence for some of the secondary causes that may lead to bradykinesia.

The primary pathophysiological reason for bradykinesia (as reviewed by Berardelli et al., 2001), simplistically put, is that during movement initiation there is insufficient recruitment of muscle force, which stems from basal ganglia dysfunction. During movement planning and execution, the basal ganglia are responsible for the selection and reinforcement of specific patterns of cortical activity. Therefore, a breakdown in basal ganglia circuitry leads to deficits in cortical movement commands, followed by poor recruitment of muscle force, resulting in underscaled movements; and hence, bradykinesia.

1.3.3 Tremor

Most PD patients experience tremor at some point in disease (Jankovic, 2008). Hughes, Daniel, Blankson, and Lees (1993) explain that tremor in PD can be peculiar and doesn't always progress predictably. Patients may have tremor at onset but see a spontaneous remission of the symptom later in disease. Others might be less fortunate, having onset tremor that progresses in severity (seen as an increase in tremor amplitude) with disease duration.

Tremor in PD can present as rest, postural or kinetic (action) tremor (Duval, Daneault, Hutchison, & Sadikot, 2016). Rest tremor occurs when the limbs are at rest; such that the limb might be supported or loosely hanging, or in absence of anti-gravity muscle contraction (Duval et al., 2016). Rest tremor typically occurs at a frequency of 4 – 6 Hz and can be observed in the upper and lower limbs, lip, chin, jaw and head (Jankovic, 2008). Postural tremor usually occurs at a slightly higher frequency (8 – 9 Hz) than rest tremor (Deuschl, Bain & Brin, 1998) and can be observed when a patient holds their arms out horizontally in front of their chest. Postural tremor is often accompanied by a unique phenomenon known as 're-emergent tremor'; where tremor recedes when patients move their hands into a horizontally outstretched position and returns moments later. This contrasts with a closely related pathologic condition known as essential tremor, where there is no latency of tremor when moving from a resting to an outstretched, postural position (Jankovic, Schwartz, & Ondo, 1999). Furthermore, kinetic or action tremor occurs when performing a voluntary movement, often hindering

one's ability to perform fine motor movements (Rana, Siddiqui, Qureshi, Fattah, & Awan, 2014).

The pathophysiology of tremor is not yet fully understood; however, a theory known as the 'finger-switch-dimmer' model of tremor in PD has been popularized by Duval and colleagues (2016). Although the theory stands to be more complex than what will be discussed, its basic elements are that the basal ganglia functions as the finger, the thalamus as the switch, and the cerebellum as the dimmer. Briefly, tremor in PD is thought to be induced by basal ganglia dysfunction. This results in abnormal thalamic activity which the cerebellum attempts to modulate. Ultimately, this leads to a rhythmic, oscillatory contraction of agonist and antagonist muscles visually identified as tremor.

1.3.4 Rigidity

Rigidity is a form of muscle hypertonia characterized by an increase in resistance to passive mobilization of a limb (Delwaide, 2001). Parkinsonian rigidity is direction and velocity independent; unlike spasticity (a different form of hypertonia), where tone is velocity dependent and exaggerated during extension, rather than flexion movements. Baradaran and colleagues (2013) explain that the general stiffness or rigidity observed in PD is a sign that often goes unnoticed by patients until detected upon examination by a clinician. In patients that do notice, it is commonly misdiagnosed as arthritis or a torn rotator cuff when they are in fact suffering from parkinsonian rigidity or 'frozen shoulder' (a common musculoskeletal disease of PD associated with long term pain).

Clinicians detect rigidity by passive flexion, extension, and rotation about a joint in the upper and lower limbs. In early stages, a slightly increased resistance unilaterally to passive movement might be detected that would not be felt in a healthy individual. This subjective examination can prove difficult, and is often accompanied by an 'activation manoeuvre' when trying to determine if pathologic stiffness is indeed present. This activation manoeuvre or 'Froment's manoeuvre' is a technique whereby the examiner instructs the patient to voluntarily move the contralateral limb (patients commonly told to tap fingers to their thumb in the hand not being examined) (Broussolle, Krack, Thobois, Xie-Brustolin, & Goetz, 2007). Activation manoeuvres are

performed to unmask latent rigidity or simply to accentuate existing stiffness (Baradaran, 2013).

There are commonly two classifications of parkinsonian rigidity as discussed by Broussolle et al (2007); leadpipe and cogwheel. Patients with leadpipe rigidity experience a uniform increase in muscle tone throughout the passive mobilization of a limb, which increases in severity (tone) with disease duration. In contrast, those with cogwheel rigidity experience interruptions in increased muscle tone during passive movement. These interruptions occur at a frequency of approximately 4-6 Hz. During passive movement, an examiner will experience a sort of 'catch and release' in muscle tone; and hence, a cogwheel pattern is felt through the range of movement.

After bradykinesia, rigidity correlates second most strongly with nigral degeneration but its pathophysiology is not well understood. Rigidity is typically hypothesized to stem from more than just basal ganglia dysfunction alone. Older theories discuss the possible involvement of long-loop reflex pathways that relay in the brain; or perhaps inappropriate short reflex pathways in the spinal cord occurring because of dysfunctional descending pathways (Delwaide, 2001). A more recent study by Baradaran et al. (2013) suggests that stiffness manifests because of the wide spread changes seen in the PD brain, and that pinning the underlying pathology of rigidity on one discrete locus seems inappropriate.

1.3.5 Postural Instability and Gait Dysfunction

Significant balance and gait impairment is not typically seen in PD until 10 years of disease (Wenning et al., 1999). Postural instability leading to falls is the number one reason for hospitalization in advanced stages of PD, significantly contributing to morbidity (Temlett & Thompson, 2006). Patients who experience falls often develop anxiety living alone. Some even develop a phobia of falls, commonly referred to as 'fear of falling'. Fear of falling can itself be largely incapacitating for patients, reducing the number of activities they once felt comfortable undertaking (Adkin, Frank, & Jog, 2003). Moreover, postural instability largely contributes to patients reporting increased

depression, avoidance of physical activity, social isolation, and an overall reduced quality of life (Kim, Allen, Canning, & Fung, 2013).

Clinically, postural instability and gait impairment is assessed by several different ways as outlined by the UPDRS-III (Kimmel, Pulusu, Bharucha, & Ross, 2015). First, it can be assessed by instructing a patient to cross their arms and stand up from a chair without assistance. Examiners will often observe patients rising slowly from the chair, making use of the chair's armrests; and in severe instances, requiring assistance from the examiner to stand up.

The next method involves an examination of the individual's posture while standing. Individuals are instructed to stand up, and then told to do their best in correcting their posture if it seems abnormal. PD patients can develop a stooped posture and asymmetrical leaning to one side (scoliosis) later in disease that often cannot be corrected volitionally (Kim et al., 2013).

A balance test is conducted whereby a patient stands upright and the examiner abruptly pulls back on their shoulders while standing behind them. This is commonly referred to as the retropulsion test or pull-back test. Of the postural instability assessment methods, the retropulsion test is believed by physicians to best represent axial or truncal impairment in PD. In the retropulsion test, the patient is instructed to try and remain upright while taking as few steps behind them to regain their balance as possible when pulled backwards (Grimbergen, Munneke, & Bloem, 2004). More than two steps required to maintain balance is indicative of postural instability or axial impairment (Jankovic, 2008).

Finally, gait is evaluated by instructing a patient to walk 10 metres away from the examiner, turn 180 degrees, and walk back towards the examiner. During this task, many features can be examined including stride length and speed, height the foot is lifted after each step, arm swing, and overall gait performance while walking and turning. Clinicians will commonly observe decreased stride length and speed, shuffling of the feet, and reduced arm swing asymmetrically.

Again, the pathophysiology of postural instability and gait impairment has not fully been brought to light. Given that several of the features discussed above are generally considered non-dopa responsive, it is thought that extra-nigral structures are likely involved (Crouse, Phillips, Jahanshahi, & Moustafa, 2016).

1.4 Role of the Levodopa Response in PD

1.4.1 The Levodopa Response

PD individuals will typically have a 70% loss in nigral terminal density when motor symptoms manifest. At this point, endogenous dopamine alone is insufficient and exogenous levodopa treatment is initiated. PD patients then benefit from what is classified as either the short or long duration response to levodopa. The short duration response (SDR) is the motor benefit patients receive that rises and falls with plasma L-DOPA concentrations (Anderson & Nutt, 2011). This acute motor benefit is the direct result of corticostriatal modulation via D1-D2 (i.e. direct and indirect pathway) receptor activation (Zhuang, Mazzoni & Kang, 2013). The motor benefit provided by the SDR in this study will be measured as the magnitude of improvement in UPDRS-III scores from OFF to ON levodopa. In contrast, the long duration response (LDR) is not the result of acute modulation but rather neuroplasticity of striatal cell excitability that occurs over time in response to consistent levodopa therapy. Classically, the LDR is when PD patients on long-term levodopa treatment receive sustained motor benefit even after discontinuation of levodopa, which can last for days to weeks (Nutt, Carter & Woodward, 1995). The LDR can take anywhere from one week to a year to buildup, demonstrating large variability between patients (Holford, Chan, Nutt, Kieburtz & Shoulson, 2006). The complex mechanisms behind the neuroplastic changes in the corticostriatal pathway giving way to the LDR are not yet fully understood (Zhuang et al., 2013). The motor benefit provided by the LDR in this study will be represented by the UPDRS-III score in the OFF state (i.e. the benefit that persists after levodopa withdrawal determines the severity of the OFF-motor state). The combination of the SDR and LDR to levodopa is what determines the magnitude of an individual's overall motor response (Nutt & Holford, 1996).

The long duration response is significant early in disease and is often referred to as the ‘honeymoon’ period (Wider et al., 2006). In the honeymoon period, long-term treatment with levodopa can reduce the severity of the OFF state, somewhat preserving normal motor functioning even after levodopa withdrawal. This results in relatively stable short duration responses of smaller amplitude, typical of the honeymoon period. The LDR is expected to decline with disease progression, giving way to disabling motor fluctuations (Zappia et al., 1999). However, early research by Ogasahara and colleagues (1984) have found the LDR to provide significant motor benefit even after 9 years of PD. Anderson and Nutt (2011) propose that when the LDR is still providing significant motor benefit (early in disease), it may be contributing one third to half of the overall effect on motor symptoms. The more immediate SDR is thought to contribute one half to two thirds of the overall effect on motor improvement. The relative contribution of the LDR and SDR at each stage of disease is not yet clear.

As the LDR wanes, the SDR is thought to persist and perhaps take over, eventually providing the bulk of the overall motor response. Given that the SDR is thought to take over, the amplitude of motor benefit following acute doses of levodopa are expected to increase with disease duration. In other words, the amplitude of change in UPDRS-III scores from OFF to ON levodopa (as a result of the SDR) will increase as disease progresses. This study seeks to further understand how motor improvement as a result of the SDR (which will simply be referred to hereafter as the ‘levodopa response’) relates to factors like disease duration, levodopa duration, age, medication, and motor scores in PD.

1.4.2 Rationale

The goal of our study is to investigate how the levodopa response changes from early to advanced stages of disease duration in 70 PD participants. Recall that the levodopa response is a critical tool for determining suitability for more serious interventions in PD like deep brain stimulation (Defer et al., 1999). Successful DBS selection also heavily depends on a patient’s age and disease duration. Shedding light on how the levodopa response relates to factors like age and disease duration allows neurologists to make

more highly informed treatment decisions when planning a therapeutic timeline for their PD patients. Optimizing implementation of surgical treatments in PD could enhance quality of life for longer and earlier in disease.

The CAPSIT-PD protocol (Defer et al., 1999) recommends PD patients not be considered for DBS surgery until at least 5 years of disease duration. Volkmann (2004) reported that of 122 candidates who received the implanted DBS device, the average disease duration at time of surgery was 14.2 years. Interestingly, a study by Espay and colleagues (2010) used computer modelling to predict that patients who undergo DBS earlier in disease would see an increase of 2.5 quality-adjusted life years (QALYs) as compared to those who wait until later in disease. Although they recommend further clinical trials to confirm, there is a growing interest in performing surgery earlier in disease provided the substantial benefits seen by patients. DBS has been shown to efficiently manage PD motor symptoms, with benefit persisting in populations even after 8 to 10 years of stimulation (Fasano et al., 2010; Castrioto et al., 2011; Zibetti et al., 2011). Depending on the locus of implantation, PD patients have observed up to a 50% reduction in their baseline OFF medication UPDRS-III score after 3 to 4 years of stimulation (Rodriguez-Oroz et al., 2005). If we can deepen our understanding of disease progression as it relates to the levodopa response, perhaps we can consider implanting the device earlier in disease or at more optimized times to yield best results. Our study aims to provide such information so that PD patients might enjoy a higher quality of life for longer. First, an overview of studies that have investigated the levodopa response as it relates to age and disease duration is necessary.

1.4.3 Studies Investigating Levodopa Response in PD

A longitudinal study by Clissold, McColl, Reardon, Shiff and Kempster (2006) followed 34 PD patients over a mean period of 11.4 years of disease. Patients in the study were assessed every 3 years in their defined OFF and ON states. 12 patients were lost due to death and other reasons, demonstrating just one of the difficulties in undertaking a longitudinal study of this magnitude. Instead of measuring the levodopa response as a percent change from OFF to ON, they reported an absolute change in motor score, or

simply OFF minus ON. Their main findings were that the OFF and ON motor scores rose in parallel during early stages of disease. However, after early stages of disease (after at least 3 years of treatment), they found that the magnitude of response widens due to increasing severity of OFF medication motor scores. They concluded that PD patients do not lose their capacity to respond to levodopa as you might expect with the degeneration of dopaminergic neurons over the course of disease.

A follow-up report on Clissold et al.'s (2006) longitudinal study was recently published in 2013 by Ganga et al. Now, only 8 patients remained of the original 34 with a mean disease duration of approximately 18 years. Keeping with the original protocol, they reported on the advanced stages of PD with their surviving 8 participants. They discussed that from early stages of disease up until approximately 15 years, motor disability appears to progress in a linear fashion. However, after 15 years of disease a rapid decline was observed, suggesting an exponential deterioration of motor scores in advanced PD. Furthermore, they remark that OFF medication motor scores are the best indicator of the rate of disease progression in PD, likely linked closely to the level of cell death in the SNc. Ganga and colleagues comment on how much of the existing literature asserts that axial symptoms like postural instability and gait impairment (symptoms which classically progress later in disease) are relatively non-dopa responsive (Bonnet, Loria Saint-Hilaire, Lhermitte, & Agid, 1987). Their results challenge this assertion, finding that although disabling axial symptoms contribute largely to the OFF-phase motor score, the magnitude of axial response to levodopa is preserved. Lastly, they found no significant difference in levodopa response between tremor-dominant and non-tremor dominant phenotypes. Admitted by the authors, this study's main weakness is an outdated method of motor examination; the 'modified Webster scale,' that was selected for use when the study commenced over 20 years ago. The authors state the preferred UPDRS-III would have been the ideal method for tracking motor progression in PD.

A study conducted by Durso, Isaac, Perry, Saint-Hilaire, and Feldman in 1993 had 45 PD patients (39 males and 6 females) undergo the levodopa challenge test followed by an assessment using the motor examination portion of the UPDRS. To their

surprise, they found that the levodopa response (in this case, measured as a percent change from OFF to ON) was primarily influenced by age, rather than by disease duration. They observed a negative correlation ($r = -0.537$) between age and magnitude of response. They speculated that this negative correlation might be the result of a natural loss of nigral cells and striatal dopamine receptors that occurs with age, which is of course compounded by Parkinson's pathology. More specifically, they found that the response of rest tremor to levodopa was least influenced by disease duration, as compared to bradykinesia, rigidity, and gait. Lastly, they concluded that disease duration did not appear to have a significant relationship with levodopa response.

The most recent study investigating acute levodopa response as it relates to age and disease duration was published by Aygun, Kocabicak, Yildiz, and Temel in June of 2016. This retrospective study evaluated the preoperative levodopa response as a measure of percent change in 54 patients with advanced PD who were being considered for DBS surgery. Their main findings were that levodopa response was primarily influenced by age, rather than by disease duration, which corroborates findings by Durso et al. (1993) as was just discussed. No significant correlation was found between disease duration and levodopa response, whereas a negative correlation was found between age and levodopa response. In addition, they observed no significant difference in levodopa response when comparing tremor-dominant with the non-tremor dominant phenotype of PD.

1.4.4 Summary of Current Studies

Based on the aforementioned studies, it is clear there remains much debate regarding the levodopa response as it relates to variables like age and disease duration. The 20-year longitudinal study reported on by both Clissold et al. (2006) and Ganga et al. (2013) found that the levodopa response is maintained with increasing disease duration, with no mention of age. Moreover, they found that levodopa response was significantly larger in magnitude after 15 years of PD as compared to earlier in PD (less than 5 years of disease). However, they used an outdated method of PD motor assessment (modified

Webster scale) and only reported on levodopa response as an absolute change in motor score from OFF to ON.

In contrast, studies performed by Durso et al. (1993) and Aygun et al. (2016) found that age negatively correlated with levodopa response and that disease duration had no influence. Durso and Aygun employed the use of the UPDRS-III but only reported levodopa response as a measure of percent change in motor scores. The highest n-value of any of the studies was 54; followed by 45 and 34 total PD participants. Furthermore, Aygun et al.'s (2016) study (which most closely resembles the body of work contained in this thesis) was limited by its retrospective inclusion of only patients in advanced stages of PD bound for DBS. Moreover, this led to all but 2 patients recruited having a disease duration of greater than 4 years. Inevitably, Aygun et al. (2016) was unable to provide a comprehensive picture of levodopa response as it relates to all stages of Parkinson's disease.

1.4.5 Hypothesis

We hypothesize that the motor improvement provided by the short duration response (or simply the 'levodopa response') will increase in amplitude as disease duration increases in PD.

1.4.6 Objectives

- 1) To determine the relationship between levodopa response (measured as both percent change and absolute change in motor score) and disease duration, age, OFF motor scores and LED (daily levodopa equivalency dose).
- 2) To determine how motor severity and the levodopa response for tremor, akinesia, rigidity and axial symptoms change from early to advanced stages of disease duration.

3) To determine how the results of self-reported questionnaires on depression, cognition, confidence in balance, freezing of gait and quality of life relate to motor scores in the ON medication state.

Chapter 2

2.1 Methods

This chapter outlines the methods employed in this study. The study protocol followed that of the well-established and clinically validated ‘levodopa challenge test’. The UPDRS-III was the clinical rating scale used for assessing the severity of participants’ motor symptoms. Self-reported clinical questionnaires were also used to provide insight on non-motor symptoms and observed motor findings.

2.1.1 Study Participants

Seventy PD participants were recruited from the Movement Disorders Centre, University Hospital, London, Ontario, Canada. This study was approved by the Human Research Ethics Board (REB #107253) of Western University. Participants were included based on the following criteria: 1) have been diagnosed with idiopathic PD for at least 2 or more years; 2) be 45 to 85 years of age; 3) have been on stable doses of anti-Parkinson medication, including any levodopa preparation; and 4) able to give informed consent. Participants were excluded on the following criteria: 1) history of any surgical intervention for treating PD (i.e. deep brain stimulation, Duodopa pump); 2) extreme physical disability that impairs mobility assessment; 3) history or current diagnosis of unstable psychiatric condition; 4) presence of dementia or any other condition that prevents the ability of the participant to provide fully informed consent; 5) pregnant, planning on becoming pregnant or breastfeeding; and 6) deemed unable to understand or speak sufficient English.

2.1.2 Levodopa Challenge Test

According to the CAPSIT-PD protocol (Defer et al., 1999), participants participated in the levodopa challenge test. This test involved participants visiting the Movement Disorders Lab in University Hospital after at least 12 hours without antiparkinsonian drugs. Participants were typically instructed to take their last dose of PD medication at 8:00 PM on the night before the study. Their research visit was then scheduled for 9:00

AM the following morning so that they arrived in an OFF-medication state. This was to allow for an appropriate washout of levodopa.

Upon arrival, a detailed medical history of the participants Parkinson's disease was completed to corroborate details found in the participant's clinical chart. This involved confirming the patient's age, gender, date of PD diagnosis, date of first intervention with levodopa, and current medications. Current medications were recorded as the daily levodopa equivalency dose (LED) which uses conversion factors provided by Tomlinson et al. (2010). LED is a convenient way to convert different classes of antiparkinsonian drugs to their levodopa equivalent in milligrams. Next, the motor examination portion (Part 3) of the Unified Parkinson Disease Rating Scale was performed to provide a clinically defined-OFF motor score (when the PD patient has been without any antiparkinsonian medications for a minimum of 12 hours). A breakdown of the items scored in the UPDRS-III can be found in **Table 1**. After the motor examination was completed, participants were instructed to take three 100/25 mg (levodopa/carbidopa) tablets. Participants were then reassessed using the UPDRS-III when found to be in their clinically defined-ON medication state (when both the patient and clinical rater agree that the individual is receiving the highest level of therapeutic benefit from the administered levodopa or approximately 45-60 mins after levodopa is given). This provided us with their ON-medication motor score. Individual features and specific movements assessed in the UPDRS-III are rated based on specific criteria as outlined by the International Parkinson and Movement Disorder Society. Each item is scored as either 0 = normal, 1 = slight, 2 = mild, 3 = moderate, and 4 = severe.

Table 1. Features and movements assessed using the UPDRS-III and their respective scoring. Higher scores represent increased motor impairment.

| <u>UPDRS-Part 3: Motor Examination</u> | <u>Scored</u> |
|---|----------------------|
| 3.1 Speech | x/4 |
| 3.2 Facial Expression | x/4 |
| 3.3 Rigidity | |
| <i>Neck</i> | x/4 |

| | |
|---|--------------|
| <i>Right Upper Extremity</i> | x/4 |
| <i>Left Upper Extremity</i> | x/4 |
| <i>Right Lower Extremity</i> | x/4 |
| <i>Left Lower Extremity</i> | x/4 |
| 3.4 Finger Tapping | |
| <i>Right</i> | x/4 |
| <i>Left</i> | x/4 |
| 3.5 Hand Movements | |
| <i>Right</i> | x/4 |
| <i>Left</i> | x/4 |
| 3.6 Pronation-Supination Movements of Hands | |
| <i>Right</i> | x/4 |
| <i>Left</i> | x/4 |
| 3.7 Toe Tapping | |
| <i>Right</i> | x/4 |
| <i>Left</i> | x/4 |
| 3.8 Leg Agility | |
| <i>Right</i> | x/4 |
| <i>Left</i> | x/4 |
| 3.9 Arising From Chair | x/4 |
| 3.10 Gait | x/4 |
| 3.11 Postural Stability | x/4 |
| 3.12 Posture | x/4 |
| 3.13 Global Spontaneity of Movement | x/4 |
| 3.14 Postural Tremor of the Hands | |
| <i>Right</i> | x/4 |
| <i>Left</i> | x/4 |
| 3.15 Rest Tremor Amplitude | |
| <i>Lip/Jaw</i> | x/4 |
| <i>Right Upper Extremity</i> | x/4 |
| <i>Left Upper Extremity</i> | x/4 |
| <i>Right Lower Extremity</i> | x/4 |
| <i>Left Lower Extremity</i> | x/4 |
| Rigidity Total (Sum of 3.3) | x/20 |
| Akinesia Total (Sum of 3.4 - 3.8) | x/40 |
| Axial Total (Sum of 3.9 - 3.13) | x/20 |
| Tremor Total (Sum of 3.14 - 3.15) | x/28 |
| UPDRS-III Total | x/108 |

2.1.3 Clinical Questionnaires

Once all motor assessments were finished, a series of clinical questionnaires were completed. All clinical questionnaires used can be found in **Table 2**. The first questionnaire used was the Activities-specific Balance Confidence (ABC) Scale. ABC is a self-reported questionnaire inquiring about the individual's confidence in completing daily tasks such as walking up or down stairs. The questionnaire requires the participant to assign their balance confidence a value from 0 (no confidence) to 100 (absolute confidence) in completing the indicated task. Bello-Haas, Klassen, Sheppard and Metcalfe (2011) report that the ABC scale is valid for use in PD populations with good test-retest reliability.

The freezing of gait questionnaire (FOG-Q) was used to determine if participants experienced freezing episodes and disturbances in gait (Giladi et al., 2000). It is a 6-item scale with each item ranked from 0 (absence of symptoms) to 4 (most severe) for a maximum possible score of 24. Therefore, a higher score represents increased frequency and severity of freezing and gait disturbances. The participants were instructed to complete the scale while considering their condition over the past week. Giladi et al. (2009) found FOG-Q correlated highly with UPDRS-III ratings for gait and mobility scores, and confirmed the scale as a reliable tool for assessment in PD.

The next scale used was the Montreal Cognitive Assessment (MoCA) which served as a measure of cognitive impairment. It was used to assess cognitive faculties including attention, memory, concentration, language, and visuospatial reasoning. A maximum possible score of 30 can be achieved by correctly completing all administered sections, with a score of 26 to 30 being considered normal. The MoCA has been validated for use in PD and has found to be more sensitive than other cognitive tests in identifying early cognitive impairment (Zadikoff et al., 2008).

The geriatric depression scale (GDS) is a 30-item self-reported questionnaire asking yes or no questions to assess an individual's level of depression. Individual scores of 5-10 indicate the possibility of depression, and a score greater than 10 is

almost always an indication of depression. Ertan and colleagues (2005) recommend the use of GDS given its reasonably clear cutoffs and high sensitivity for detecting depression when tested in a cohort of 109 PD patients.

The last scale used was the 8-item Parkinson's Disease Questionnaire (PDQ-8). This questionnaire was used to assess quality of life in PD patients. The scale addresses factors like mobility, emotional well-being, communication, bodily discomfort and communication. Each self-reported question is answered as either never, occasionally, sometimes, often, or always. These answers are then converted to a value of 0, 25, 50, 75, or 100, respectively. The lower the average value across all 8 questions, the better the quality of life as reported by the individual completing the questionnaire.

Table 2. Clinical Questionnaires completed by all PD participants.

| Clinical Questionnaire: | Number of Items: | Maximum Total: | Total Indicates: |
|--|-------------------------|-----------------------|--|
| Activities-specific Balance Confidence Scale (ABC) | 16 | (mean) 100 | High level of confidence |
| Freezing of Gait Questionnaire (FOG-Q) | 6 | (sum) 24 | High level of gait/freezing impairment |
| Montreal Cognitive Assessment (MoCA) | 30 | (sum) 30 | Cognitively normal |
| Geriatric Depression Scale (GDS) | 30 | (sum) 30 | High level of depression |
| Parkinson's Disease Questionnaire (PDQ-8) | 8 | (mean) 100 | Low quality of life |

2.1.4 Statistical Analyses

GraphPad Prism 7.00 was used for all statistical analyses performed. All data were tested for normality. Parametric tests were performed for normally distributed data, while non-parametric tests were used for non-normally distributed data. The significance threshold was set at $p < 0.05$ for all statistical analyses performed. Spearman's rank-order correlation was used in Figure 1, 2 and 9. A Kruskal-Wallis H test followed by Dunn's post hoc multiple comparisons test was used in Figure 8. Repeated measures two-way ANOVA followed by Tukey's multiple comparisons was used in Figure 3A. A one-way ANOVA followed by Tukey's post-hoc multiple comparisons test was used for Figures 3A, 4, 5, and 7. A z-score or standard score was used in Figure 6.

Chapter 3

3.1 Results

This chapter outlines the results of 70 PD participants who performed the levodopa challenge test and completed subsequent clinical questionnaires.

3.1.1 PD Participants: Clinical Outcomes

Although 70 PD participants successfully completed the study, it should be noted that a total of 85 were recruited. Thus, 15 participants either cancelled on the morning of their scheduled study visit or voluntarily removed themselves from the study after its commencement. Participants who cancelled on the morning of the study did so due to poor driving conditions, fatigue or a high degree of mobility impairment because of being OFF-medication for an extended period. Participants who began the study but then chose to opt out did so due to pain, fatigue, discomfort, high levels of motor disability or a combination thereof. All recorded data from the failed 15 participants were excluded from the data set to be examined.

Seventy PD participants included in the analysis (19 females, 51 males) met the inclusion and exclusion criteria. Clinical outcomes for all participants can be found in Table 3. Mean age was 66.13 ± 7.2 years with a range of 47 to 82 years while mean disease duration was 9.16 ± 4.3 years with a range of 2 to 18 years. Mean levodopa duration was 7.49 ± 4.2 with a range of 1 to 17 years whereas mean daily levodopa equivalency dose (LED) was 988.42 ± 437 mg (range of 300 to 2200 mg). Motor examination provided a mean OFF-medication UPDRS-III total score of 30.64 ± 10.23 with a range of 6 to 60. Mean ON-medication UPDRS-III total score was 16.57 ± 8.17 with a range of 3 to 49. Concerning levodopa response measured as absolute change (aLR) in UPDRS-III score (OFF-ON), the mean was 14.07 ± 6.07 with a range of 3 to 29. Mean levodopa response measured as percent change (%LR) in UPDRS-III score ((OFF-ON)/OFF*100) was 46.80% (± 15.03) with a range of 18.33% to 88.88%.

Table 3. Clinical measures of the 70 PD participants enrolled.

| <u>Clinical Measure</u> | <u>Quantitative Data</u> |
|--|--------------------------------------|
| Age: years; mean \pm SD | 66.13 \pm 7.2 |
| Sex: female/male; n (%) | 19/51 (27.1/72.9) |
| Disease duration: years; mean \pm SD | 9.16 \pm 4.3 |
| Levodopa duration: years; mean \pm SD | 7.49 \pm 4.2 |
| LED: mg; mean \pm SD | 988.42 \pm 437 |
| OFF : ON UPDRS-III Score; mean \pm SD | 30.64 \pm 10.23 : 16.57 \pm 8.17 |
| Levodopa response: OFF-ON; mean \pm SD | 14.07 \pm 6.07 |
| Levodopa response: (OFF-ON)/OFF*100(%); \pm SD | 46.80 \pm 15.03 |

SD, standard deviation of the mean; Disease duration refers to time since first intervention with levodopa; LED, levodopa equivalency dose; LED calculated based on conversion factors provided by Tomlinson et al. (2010); OFF refers to the state in which a participant has been without anti-parkinsonian medication for at least 12 hours; ON refers the state in which both the participant and clinical rater agree that the participant is receiving the highest level of therapeutic benefit from the administered levodopa or approximately 45-60 mins after levodopa is given.

3.1.2 UPDRS-III: Total Motor Outcomes

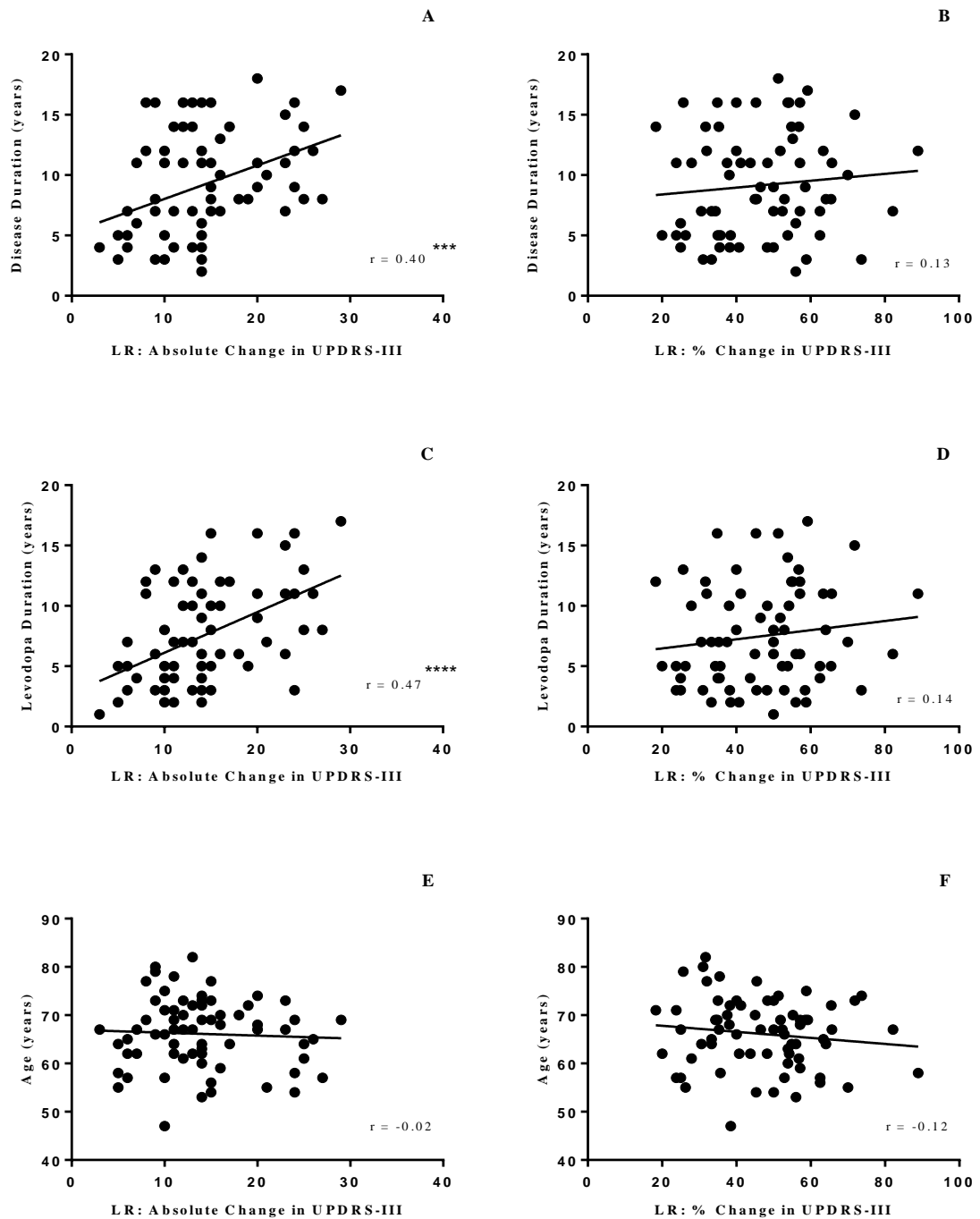

Figure 2. Absolute levodopa response is significantly influenced by disease duration and levodopa duration.

Spearman's rank-order correlation was used to determine the relationship between absolute change in UPDRS-III and disease duration (A), levodopa duration (C) and age

(E). There was a statistically significant positive correlation with both disease duration ($n = 70$, $r = 0.40$, $p = 0.0005^{***}$) and levodopa duration ($n = 70$, $r = 0.47$, $p < 0.0001^{****}$). No significant relationship was observed between absolute change in UPDRS-III and age ($p = 0.85$). Spearman's rank-order correlation was also used to determine the relationship between % change in UPDRS-III and disease duration (B), levodopa duration (D), and age (F). No significant relationship was observed for B ($p = 0.291$), D ($p = 0.245$), or F ($p = 0.325$). Spearman's correlation coefficient is represented as 'r' on plots A through F. Black line indicates line of best fit. LR; levodopa response.

In Figure 1, the levodopa response measured as a percent change (%LR) in OFF to ON UPDRS-III scores did not significantly correlate with disease duration, levodopa duration or age. Similarly, %LR did not significantly correlate with levodopa equivalency dose or OFF UPDRS-III scores in Figure 2. However, in Figures 1 and 2 the levodopa response measured as an absolute change (aLR) had a significant positive correlation with disease duration ($r = 0.40$, $p = 0.0005$), levodopa duration ($r = 0.47$, $p < 0.0001$), LED ($r = 0.31$, $p = 0.0097$) and OFF UPDRS-III scores ($r = 0.58$, $p < 0.0001$). Among those variables correlated with aLR, age was the only one found not to have a statistically significant correlation. Per lines of best fit, the aLR increases by 3.6 UPDRS-III points per year after PD diagnosis. Given that levodopa treatment is often started shortly after diagnosis with PD, the aLR similarly increases by 2.97 UPDRS-III points per year after initial intervention with levodopa. Furthermore, LED increases by 21 mg for every 1 point increase in aLR; or LED increases by close to 100 mg every year since first intervention with levodopa. Lastly, the aLR increases in approximately a 1:1 ratio with OFF medication UPDRS-III total scores.

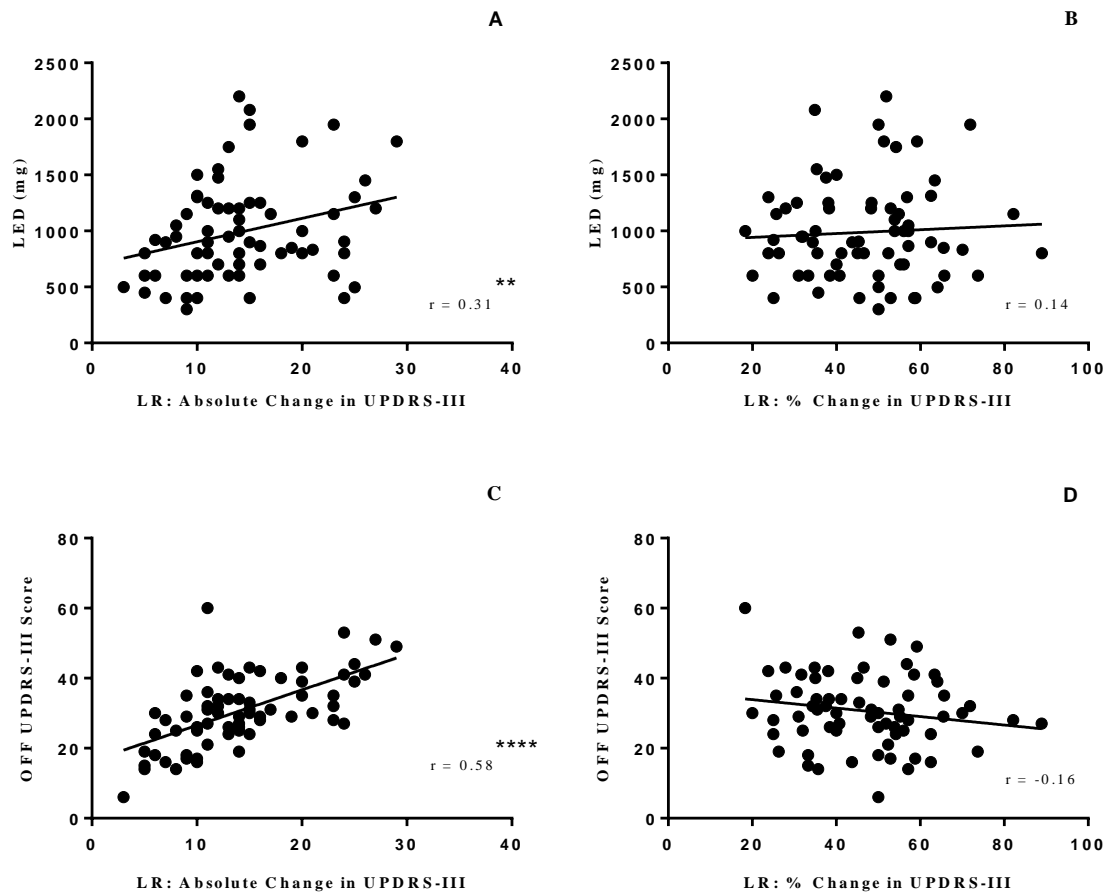

Figure 3. Absolute levodopa response is significantly associated with LED and OFF motor scores.

Spearman's rank-order correlation was used to determine the relationship between absolute change in UPDRS-III and LED (A) and OFF-UPDRS-III score (C). There was a statistically significant positive correlation with both LED ($n = 70$, $r = 0.31$, $p = 0.0097**$) and OFF UPDRS-III ($n = 70$, $r = 0.58$, $p < 0.0001****$). Spearman's rank-order correlation was also used to determine the relationship between % change in UPDRS-III and LED (B) and OFF-UPDRS-III score (D). No significant relationship was observed for B ($p = 0.1779$) or D ($p = 0.8515$). LR; levodopa response. LED; levodopa equivalency dose in milligrams. Spearman's correlation coefficient is represented as 'r' on plots A through D. Black line indicates line of best fit.

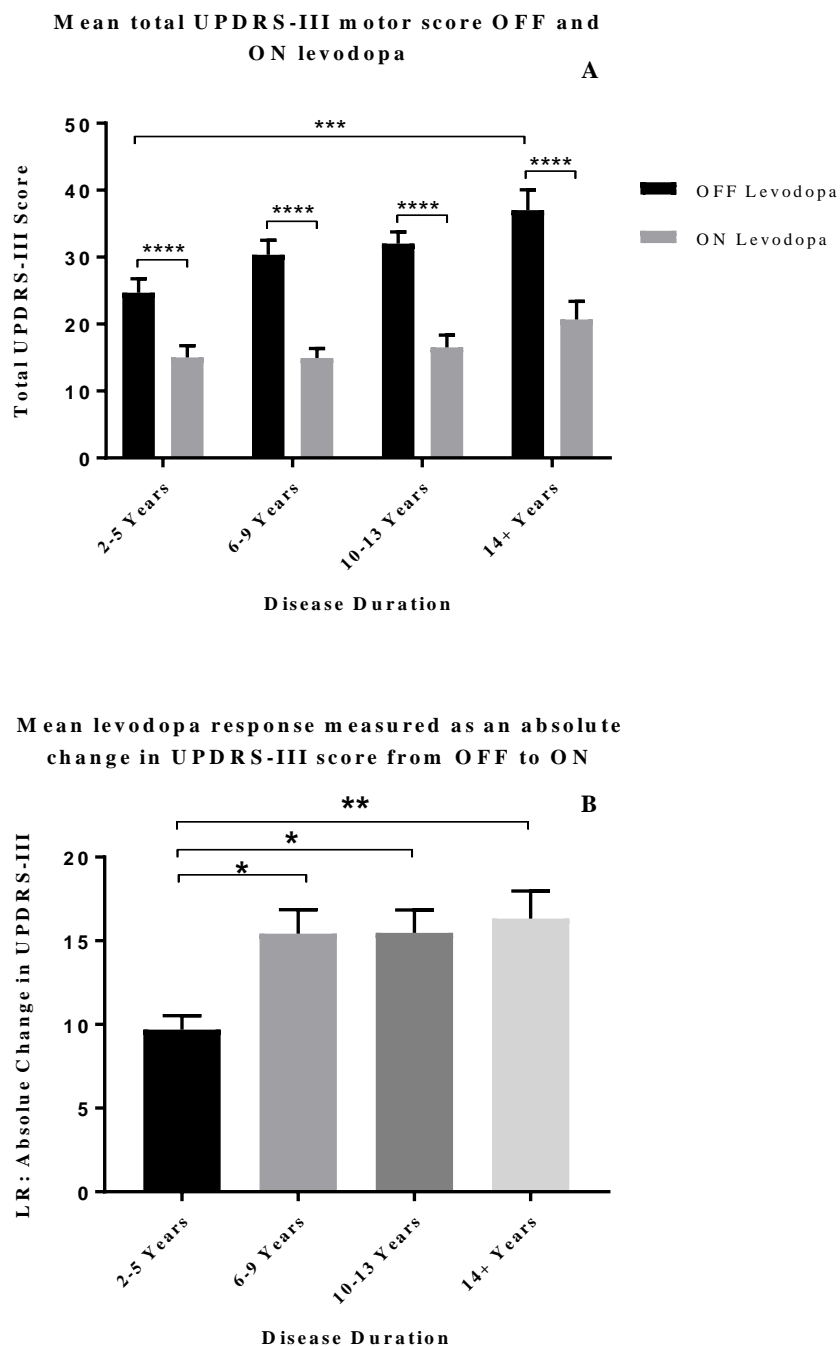

Figure 4. A) OFF motor scores increase significantly after 13 years of disease while ON motor scores remain relatively stable. B) The levodopa response initially widens and then plateaus in later stages of disease duration.

A) There was a statistically significant difference between UPDRS-III scores OFF and ON Levodopa at 2-5 years ($n = 19$, $p < 0.0001$ ****), 6-9 years ($n = 19$, $p < 0.0001$ ****), 10-13 years ($n = 17$, $p < 0.0001$ ****), and 14+ years ($n = 15$, $p < 0.0001$ ****). A significant interaction was also observed between participants of 2-5

years and 14+ years of disease duration OFF levodopa ($p = 0.0005^{***}$). Repeated measures two-way ANOVA and Tukey's multiple comparisons were conducted. Results are reported as the mean \pm SEM. B) A one-way ANOVA followed by Tukey's post-hoc test revealed a significant difference between groups 2-5 years and 6-9 years ($p = 0.0115^*$), 2-5 years and 10-13 years ($p = 0.0138^*$) and 2-5 years and 14+ years ($p = 0.005^{**}$). Results are reported as the mean \pm SEM. LR; levodopa response

In Figure 3, all 70 participants were further divided into separate groups based on early (2-5 years, $n = 19$), middle (6-9 years, $n = 19$), late (10-13 years, $n = 17$) and advanced (14+ years, $n = 15$) stages of disease duration. Mean (\pm STD) OFF motor scores increased at each stage of disease duration; beginning at 24.68 (± 9.1) and then increasing to 30.37 (± 9.4), 32 (± 7.3), and finally 37.00 (± 11.9) points. OFF motor scores were significantly different ($p = 0.0005$) when the 3-5 year and 14+ year groups were compared. The difference in mean OFF scores between the early and advanced group was 12.32 points. Mean (\pm STD) ON motor scores for early, middle, late and advanced stages were 15.00 (± 7.7), 14.95 (± 6.2), 16.53 (± 7.6), and 20.67 (± 10.65), respectively. The difference in mean ON scores between the early and advanced stage was 5.7; however, no statistically significant differences were found between ON scores. When comparing the OFF and ON scores at each stage of disease duration, we can see that a significant response to medication is maintained at all stages of disease ($p < 0.0001$) (See Figure 3A). The difference in means from OFF to ON (aLR) was taken at each stage of disease to produce Figure 3B. The aLR was investigated over the %LR due to the %LR's insignificant findings in Figure 1 and 2. The aLR at 3-5 years (mean \pm STD; 9.68 \pm 3.7) was significantly less than that at 6-9 years (mean \pm STD; 15.42 \pm 6.3, $p = 0.0115$), 10-13 years (mean \pm STD; 15.47 \pm 5.6, $p = 0.0138$), and 14+ years (mean \pm STD; 16.33 \pm 6.4, $p = 0.0050$). The aLR appears initially to rise and then plateau after 5 years of disease.

In Figure 4, the mean (\pm STD) levodopa equivalency dose at early, middle, late and advanced stages of disease was 793.9 mg (± 276.9), 727.0 mg (± 287), 1186 (± 437.3), and 1342 mg (± 438.9). Mean LED in the early group was significantly less than both the late ($p = 0.0097$) and advanced ($p = 0.0002$) groups. Mean LED in the middle group

was also found to be significantly less than that of the late ($p = 0.0018$) and advanced ($p < 0.0001$) groups. Interestingly, we fail to see the same significant jump in OFF-UPDRS score from middle to late stages (Figure 3A) as we do in LED from the middle to late stage. Hence, after approximately 9 years of disease, a large increase of ~450 mg in LED is seen (Figure 4) without a significant increase in OFF motor score (see Figure 3A). By advanced stages, mean LED increased by a further 165 mg, producing a 615 mg difference between middle and advanced stages of disease.

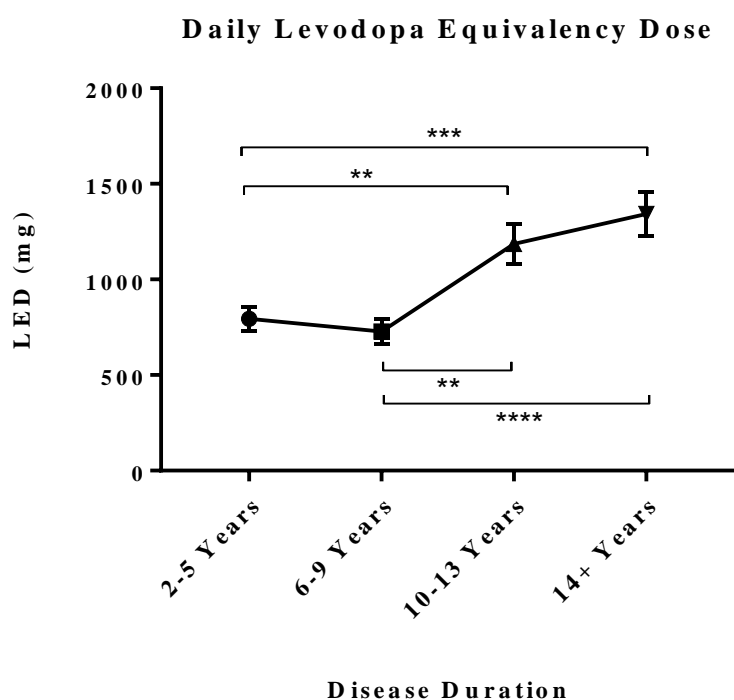

Figure 5. Mean daily levodopa equivalency dose significantly increases after 9 years of PD.

A significant difference was revealed between groups 2-5 years ($n = 19$) and 10-13 years ($n = 17$) ($p = 0.0097^{**}$), and between groups 2-5 years and 14+ years ($n = 15$) ($p = 0.0002^{***}$). A significant difference was also observed between groups 6-9 years ($n = 19$) and 10-13 years ($p = 0.0018^{**}$) and between groups 6-9 years and 14+ years ($p < 0.0001^{****}$). Results are reported as the mean \pm SEM. A one-way ANOVA followed by Tukey's post-hoc multiple comparisons test was completed. LR; levodopa response. LED; levodopa equivalency dose in milligrams.

3.1.3 UPDRS-III: Motor Subscore Outcomes

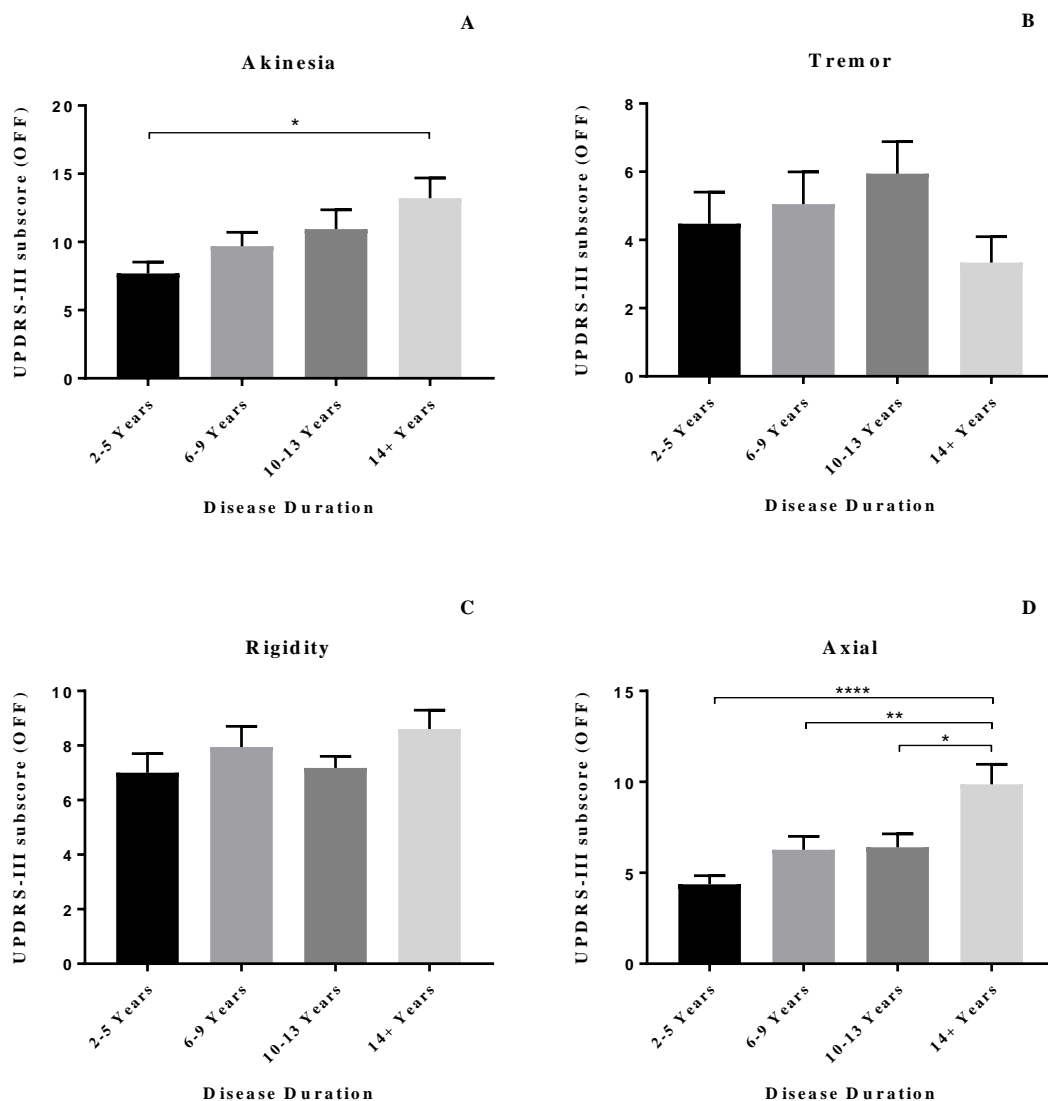

Figure 6. A) Akinesia significantly worsens after 13 years of disease. B) Tremor appears to gradually worsen and then spontaneously improve after 13 years of disease. C) Rigidity remains relatively stable throughout disease. D) Axial symptoms significantly worsen after 13 years of disease.

A) Mean UPDRS-III (OFF) subscore for Akinesia in the 2-5 year group ($n = 19$) was statistically significantly lower than the 14+ year group ($n = 15$) ($p = 0.0100^*$). B-C) No statistically significant difference in mean UPDRS-III (OFF) subscores were found between any of the disease duration groups for tremor or rigidity. D) Mean UPDRS-III (OFF) axial subscores of the 14+ year group ($n = 15$) were statistically significantly larger than the 10-13 year group ($n = 17$, $p = 0.0166^*$), the 6-9 year group ($n = 19$, $p =$

0.0091**), and the 2-5 year group ($n = 19$, $p < 0.0001$ ****). Results are reported as the mean \pm SEM. A one-way ANOVA followed by Tukey's post-hoc multiple comparisons test was completed for A-D.

In Figure 5, the total UPDRS-III OFF scores were further broken down into their respective subscores for akinesia (x/40), tremor (x/28), rigidity (x/20), and axial (x/20) symptoms. In Figure 5A, a general upward trend for akinesia was seen as disease duration increased. Mean (\pm STD) akinesia subscore at 3-5 years (7.68 ± 3.7) was statistically significantly less ($p = 0.01$) than at 14+ years (13.20 ± 5.8). There was an increase of ~ 5.5 points in akinesia from early to advanced stages of disease. In Figure 5B, no statistical significance was observed; however, a general upward trend is seen followed by a sudden recession of mean tremor score after 10-13 years. Mean tremor subscore at 10-13 years was $5.94 (\pm 3.9)$ and at 14+ years it was $3.33 (\pm 2.9)$, resulting in a 2.6-point drop in mean tremor from late to advanced stages of disease. Rigidity appears to be the most stable of the symptoms, with a slight upward trend and no significant differences between groups (Figure 5C). In early stages, mean rigidity was $7.00 (\pm 3.1)$ and by advanced stages rose to $8.60 (\pm 2.7)$, providing an increase of only 1.6 points. In Figure 5D, axial symptom subscores increased modestly with increasing disease duration, and then increased sharply after 13 years of disease. Axial subscores increased by ~ 3.5 points from 10-13 years (6.41 ± 3.0) to 14+ years (9.87 ± 4.3) of PD. Mean advanced stage axial subscore was significantly greater than that of late ($p = 0.0166$), middle (mean \pm STD; 6.26 ± 3.3 , $p = 0.0091$), and early (mean \pm STD; 4.37 ± 2.1 , $p < 0.0001$) stages of PD.

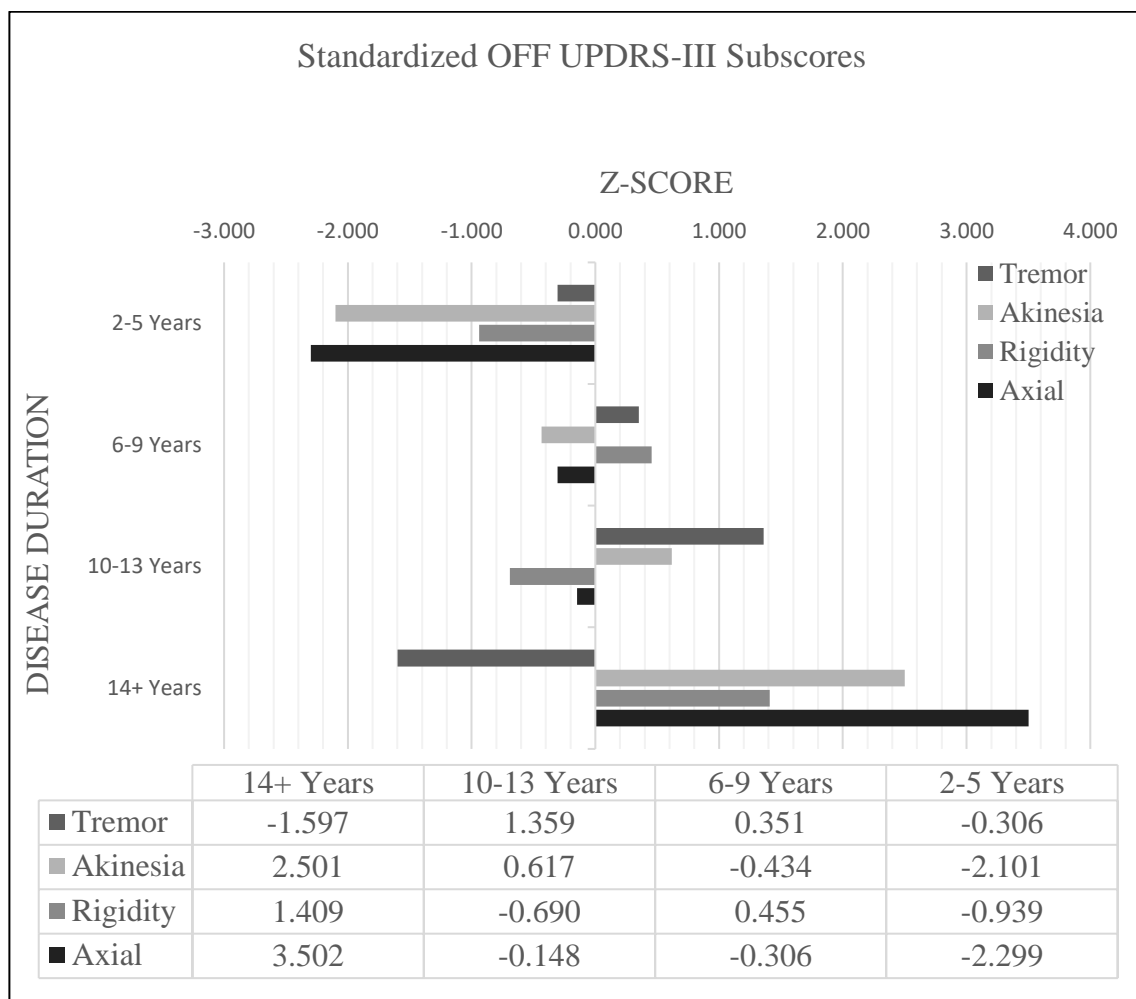

Figure 7. Standardized OFF UPDRS-III subscores for tremor, akinesia, rigidity, and axial symptoms at different stages of disease duration.

All UPDRS-III (OFF) subscores for tremor, akinesia, rigidity and axial symptoms were standardized by converting each value to its respective z-score. The z-score represents the number of standard deviations a group's mean is above (positive z-score) or below (negative z-score) the sample population mean. The mean of the sample population (n = 70) is represented as zero for each symptom. See Appendix-C for z-score formula.

Given that the UPDRS-III focuses more heavily on subscores like akinesia ($x/40$) as compared to rigidity ($x/20$), all subscore totals recorded OFF-medication were standardized by converting them to a common 'z-score' or 'standard score'. This allowed us to group the subscores together and provide a motor profile demonstrating which symptoms predominate at each stage of disease duration (See Figure 6). Negative z-scores represent how many standard deviations the group mean is below the sample population mean, whereas positive z-scores refer to the number of standard deviations above the sample population mean. In the 2-5 year group, all symptom subscores fell below the sample population means. Akinesia and axial subscores fell well below the sample population mean with z-scores of -2.1 and -2.3, respectively. Hence, at early stages of disease, individuals appear more affected by tremor and rigidity than akinesia or axial impairment. In the 6-9 year group, symptom subscores hovered closely around the sample population mean. Only tremor (0.35) and rigidity (0.46) produced positive z-scores. By 6-9 years of disease, all four symptoms worsened (relative to the early disease duration group), with tremor and rigidity predominating once again. In the 10-13 year group, tremor (z-score = 1.36) and akinesia (z-score = 0.62) dominated the motor profile while rigidity (z-score = -0.69) and axial symptoms (z-score = -0.15) fell slightly below sample population means. By 14+ years of PD, a radical phenotypic shift in the motor profile was observed. In the advanced disease duration group, tremor shifted from being the most dominant symptom to the least, receding well below the sample population mean (z-score = -1.60). Moreover, axial impairment increased dramatically, taking over the motor profile as the most dominant symptom (z-score = 3.50). In addition to axial involvement, the advanced stages were also heavily affected by akinesia (z-score = 2.50) and rigidity (z-score = 1.41).

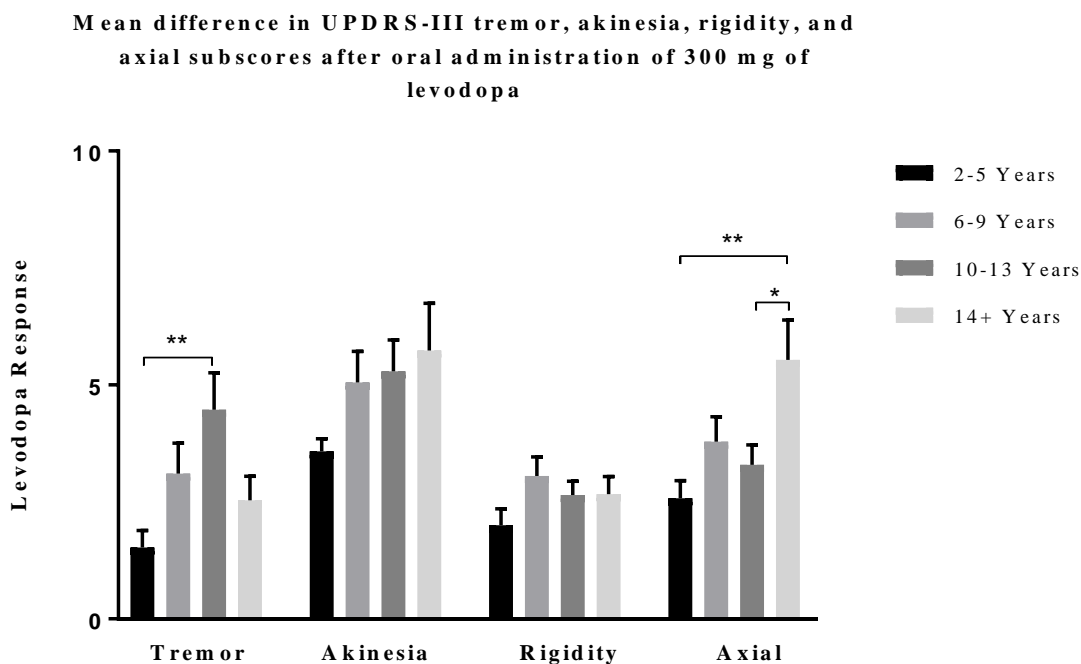

Figure 8. Tremor, akinesia, rigidity and axial symptom response to levodopa at each stage of disease duration.

Tremor's levodopa response in the 10-13 year group ($n = 17$) was significantly greater ($p = 0.0043^{**}$) than in the 2-5 year group ($n = 19$). No significant differences in levodopa response were observed within akinesia or rigidity. Axial symptom response to levodopa at 14+ years ($n = 15$) was significantly greater than the response at 2-5 years ($n = 19$, $p = 0.0023^{**}$) and 10-13 years ($n = 17$, $p = 0.0377^{*}$). A one-way ANOVA followed by Tukey's post-hoc multiple comparisons test was completed for each symptom. Results are reported as the mean \pm SEM. Levodopa response was calculated as the mean difference in UPDRS-III subscores from OFF to ON medication.

In Figure 7, the aLR was established for each symptom at different stages of disease. Trends seen in Figure 7 for the aLR matched closely with those seen for OFF scores in Figure 5. Mean (\pm STD) tremor response was best at 10-13 years of disease (4.47 ± 3.2) and significantly greater than the response at 2-5 years (1.53 ± 1.58). The aLR for akinesia was not significantly different at any stage of disease, although its response maintained a general upward trend. Mean (\pm STD) aLR for akinesia at 3-5 years was $3.58 (\pm 1.2)$ and at 14+ years it was $5.73 (\pm 3.9)$, providing a difference of 2.15 UPDRS-III points. The aLR for rigidity remained relatively stable with no significant differences

between stages of disease duration. The aLR for axial symptoms was highest (5.53 ± 3.3) in advanced stages, and significantly greater than the response at late (3.29 ± 1.8 , $p = 0.0377$) and early (2.58 ± 1.6 , $p = 0.0023$) stages. Interesting to note is the finding that axial symptoms remained responsive to medication at 14+ years of PD.

Figure 8 was produced to further isolate what is felt by physicians to best represent axial response to medication. OFF medication retropulsion test scores were significantly worse ($p < 0.0001$) in advanced stages (mean \pm SEM; 2.00 ± 0.26 , mean rank; 52.5) as compared to early stages (mean \pm SEM; 0.32 ± 0.11 , mean rank; 22.05) of disease. No significant differences were observed between any other stages of disease. Retropulsion test response to levodopa (Figure 8B) was also significantly greater ($p = 0.0485$) in advanced stages (mean \pm SEM; 0.93 ± 0.21 , mean rank; 44.3) as compared to early stages (mean \pm SEM; 0.26 ± 0.10 , mean rank; 27.66) of disease. No significant differences in levodopa response were observed between any other stages of disease.

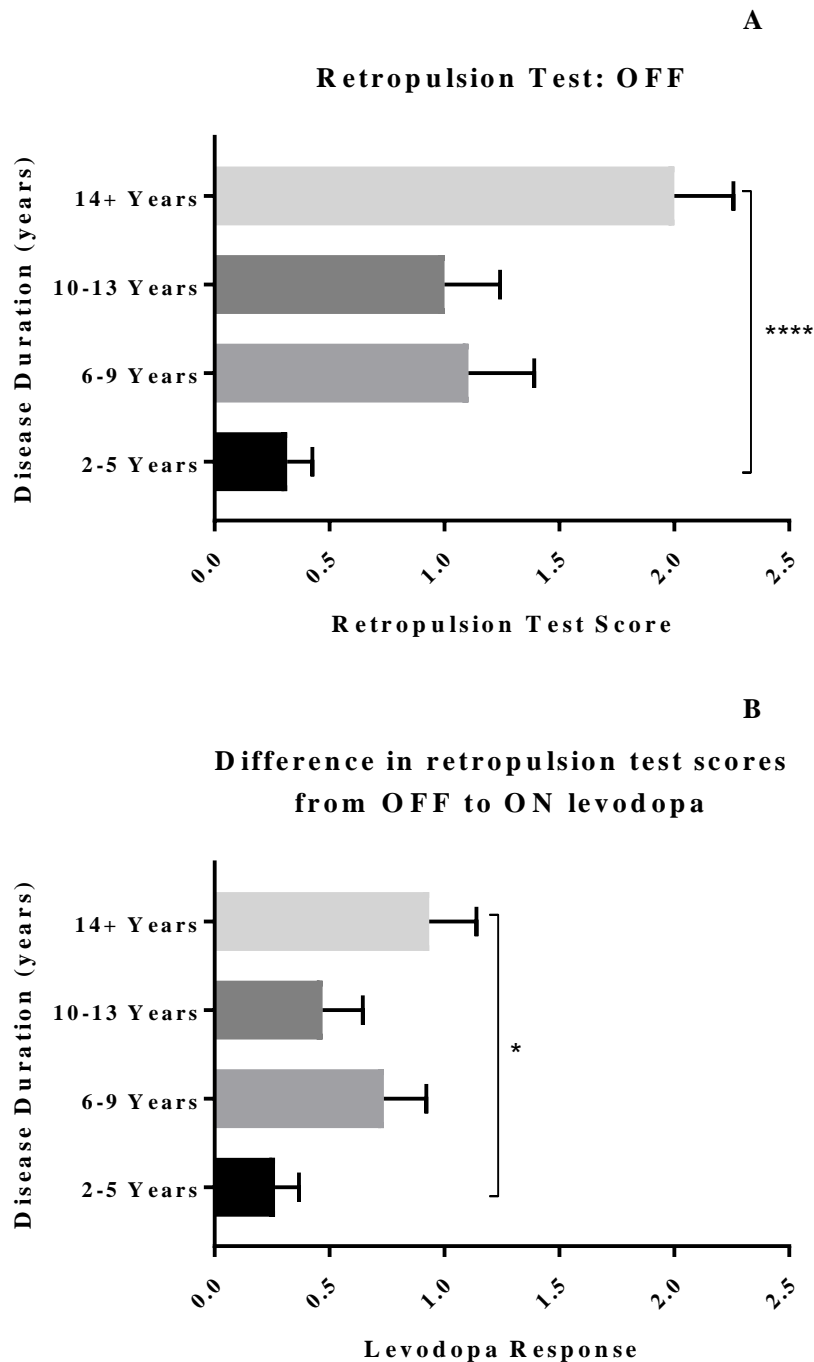

Figure 9. A) Retropulsion test scores OFF medication were significantly more severe after 13 years of PD. B) Retropulsion test scores significantly responded to levodopa after 13 years of disease.

A) Retropulsion test scores at 14+ years (n = 15) of disease were significantly greater ($p < 0.0001$ ****) than those at 2-5 years (n = 19). No significant differences were found

between any other disease duration groups. B) Differences in retropulsion test scores from OFF to ON medication (levodopa response) at 14+ years (n = 15) of disease were significantly greater ($p = 0.0485^*$) than those at 2-5 years (n = 19). No significant differences were found between any other disease duration groups. A Kruskal-Wallis H test followed by Dunn's post hoc multiple comparisons test was used for A and B. Results are reported as the mean \pm SEM. Retropulsion test also known as UPDRS-III item 'Postural Stability'.

3.1.4 Clinical Scales and Self-Reported Questionnaires

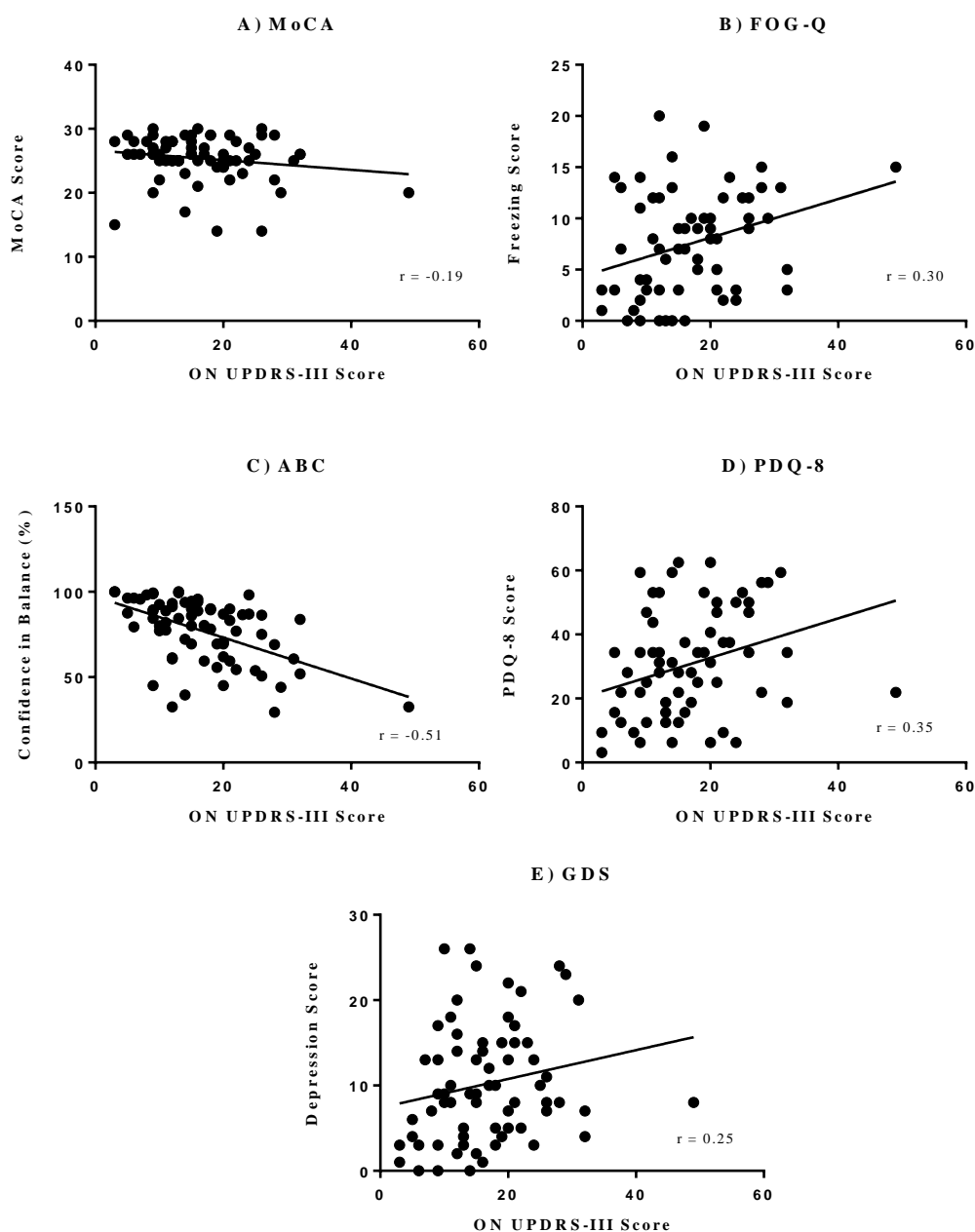

Figure 10. The relationship between ON UPDRS-III scores and clinical scales measuring cognition, freezing of gait, confidence in balance, quality of life, and depression.

A) No significant correlation was observed with the MoCA scale ($n = 70$, $r = -0.19$, $p = 0.1176$). C) ON UPDRS-III scores were observed to have a statistically significant negative correlation with the ABC scale ($n = 70$, $r = -0.51$, $p < 0.0001$). B,D,E) A statistically significant positive correlation was found with FOG-Q ($n = 70$, $r = 0.30$, $p =$

0.0118), PDQ-8 ($n = 70$, $r = 0.35$, $p = 0.0026$), and GDS ($n = 70$, $r = 0.25$, $p = 0.0339$). Spearman's rank order correlation was used. Spearman's correlation coefficient is represented as 'r' on plots A through E. Results are reported as the mean \pm SEM. MoCA; Montreal Cognitive Assessment. FOG-Q; Freezing of Gait Questionnaire. ABC; Activities-specific Confidence in Balance. PDQ-8; Parkinson's Disease Quality of Life. GDS; Geriatric Depression Scale. Black line indicates line of best fit.

In Figure 9, the results from a series of clinical scales and questionnaires were correlated with ON UPDRS-III total scores. They were correlated with ON scores because the questionnaires were administered while the patient was ON medication and the questionnaires often referred to their average ON motor condition. The Montreal Cognitive Assessment was the only scale that did not significantly correlate with ON motor scores. Freezing of gait ($r = 0.30$, $p = 0.0118$) and depression ($r = 0.25$, $p = 0.0339$) both had a significant positive correlation with ON score, thus demonstrating a rise in depression and axial impairment with worsening ON scores. Similarly, the Parkinson's disease quality of life scale also revealed a significant positive correlation ($r = 0.35$, $p = 0.0026$) with ON scores. However, increasing PDQ-8 scores represent a decline in quality of life. The activities-specific confidence in balance scale was the only scale that produced a statistically significant negative correlation ($r = -0.51$, $p < 0.0001$) with ON scores. Thus, confidence in balance declines as motor severity worsens in the ON medication state.

Chapter 4

4.0 Discussion

The levodopa challenge test assessing levodopa response in PD patients remains a hallmark step in determining DBS (deep brain stimulation) eligibility. Other important factors such as age, disease duration, time since first intervention with levodopa, OFF motor scores, and LED are all considered by neurologists when planning for further therapeutic intervention (Lang & Widner, 2002). The current understanding is that a patient might receive up to the same level of motor benefit from DBS as they would from levodopa, but not more. Therefore, if a patient has a 33% response to levodopa, DBS may provide up to but not more than a 33% improvement in motor score. This underscores the importance of determining a patient's levodopa response (LR) prior to surgery.

The LR sets a benchmark for the expected motor benefit, providing answers to common patient questions like 'How will my motor symptoms improve with DBS?'. As previously stated, there is growing interest in implementing DBS earlier in disease stages (Charles et al., 2008; Schuepbach et al., 2013). Preliminary evidence suggests early intervention with DBS might even be neuroprotective (Spieles-Engemenn et al., 2010; Maesawa et al., 2004). It is thought that by stimulating in areas such as the STN or GPi, you reduce the workload of the surviving nigrostriatal neurons in the PD brain. Sparing SNc neurons earlier in disease from attempting to maintain adequate neurotransmission in a depleted system may keep them alive longer. Overworked nigral neurons may lead to increased levels of reactive oxygen species and mitochondrial dysfunction, further contributing to neurotoxicity and cell death in PD (Spencer et al., 1998; Tieu, Ischiropoulos & Przedborski, 2003). In the event that early intervention with DBS is proved not to be neuroprotective, it is at least expected to introduce and maintain a higher quality of life for patients earlier in disease (Schnitzler et al., 2010).

DBS often reduces the frequency of which patients are required to take their medication throughout the day, or eliminates the need for oral anti-parkinsonian medications altogether (Schnitzler et al., 2010). Although eliminating the need to

swallow pills 3-5 times a day may seem insignificant, it can vastly improve quality of life for some. It allows patients to carry on with their day uninterrupted, reduces anxiety and reminders associated with taking Parkinson medications, and may help restore 'normal' behaviors. Furthermore, DBS reduces the frequency of motor fluctuations, whereby patients experience unpredictable and sudden OFF's (period where a patient does not receive motor benefit) (Østergaard, Sunde, & Dupont, 2002). Motor fluctuations can be debilitating and incredibly disruptive to daily routine.

Before early intervention with DBS can be seriously considered, physicians must first understand a patient's disease trajectory so that informed decisions can be made. Part of this understanding stems from knowing a patient's levodopa response and how it relates to the abovementioned factors like age, disease duration and LED.

4.1 Discussion: Part A

4.1.1 Reporting the aLR versus the %LR

The short duration response to levodopa is reported in this research as both an absolute value (aLR) and as a percent change (%LR) in motor scores from OFF to ON medication. Since 1999, the CAPSIT-PD protocol (Defer et al., 1999) has relied on the %LR in screening PD patients for DBS. Hence, the clinical realm tends to rely on and make treatment decisions founded on the %LR. One inherent issue with only reporting the levodopa response as a percent change is that it often tells a different story.

For example: a patient early in disease (patient A) with an OFF score of 15 and an ON score of 10 has a 33.33% LR, but only a 5 point aLR. A patient with advanced PD (patient B) who goes from a score of 30 OFF medication to 20 ON medication also has a 33.33% LR, but their aLR is twice that of the first patient's.

According to the CAPSIT-PD protocol, patient A and B have the same response (33.33%); however, according to the aLR, patient B arguably had a greater response to medication (10-point difference versus 5). Thus, reporting the %LR alone may be misleading. Moreover, in this study the %LR was found not to significantly correlate with disease duration, levodopa duration, age, LED or OFF score (Figures 1 and 2).

Whereas aLR significantly correlated with all factors except age. The aLR is a seemingly more powerful and sensitive means of reporting on the LR. Not only should future research studies consider reporting both the %LR and the aLR, but perhaps the aLR should be incorporated into clinical protocols as well. Shifting away from the sole use of the %LR to paired reporting with the aLR will only enrich data sets of future studies and potentially improve clinical outcomes for PD patients.

4.1.2 The Influence of Age and Disease Duration on the LR

In figure 1, we showed that the %LR neither correlated with age nor disease duration. In a study by Aygun et al. (2016), they also found that %LR did not correlate with disease duration, however they did find a weak negative correlation with age. The %LR's correlation with age in their study may have been the result of experimental design flaws. Aygun and colleagues acknowledge that their PD cohort consisted mainly of individuals of 5-15 years of disease duration and that the retrospective methodology naturally resulted in a biased sample population. Their study retrospectively reviewed the %LR of 54 candidates who were screened for STN-DBS, skewing the representation of the general PD population to those who fit basic criteria for DBS surgery. These individuals might have experienced frequent motor fluctuations and exhibited symptoms thought to best benefit from DBS. Although only 37 of 54 patients went forward with surgery, the cohort likely does not accurately reflect the general PD population. Furthermore, approximately only 2 patients were included with less than 5 years of PD. In our study, 11 patients with less than 5 years of PD were included and patients were randomly selected in efforts to reduce sample bias. A study by Durso et al. (1993), similarly to Aygun et al. (2016), also found a negative correlation between age and the %LR in a sample size of 47. To the best of our knowledge, there has only been 3 studies (including this thesis) investigating age as it relates to the %LR. Perhaps future studies are warranted to settle the effects of age on the %LR.

Concerning the aLR, our results showed response improves with increasing disease duration, levodopa duration, LED, and OFF scores (Figures 1 and 2). This corroborates results found in the 20-year longitudinal study reported on by Clissold et al.

(2006) and Ganga et al. (2013) as they also concluded that the aLR increases with disease duration. These researchers found that a significant response to levodopa was seen at all stages of disease, matching our results in Figure 3A. The question then is, what mechanisms allow for the maintenance in amplitude of the levodopa response throughout disease?

The levodopa response is likely maintained in part through upregulation of postsynaptic striatal D2 receptors. In a condition known as Parkinson plus syndrome (PPS), both the striatum and the SNc degenerate (Kägi, Bhatia & Tolosa, 2010). Imaging has shown significant loss of pre- and postsynaptic striatal D2 receptor binding in PPS (Berti et al., 2011; Ishii, 2014). Given the striatal degeneration seen in PPS, it is well established that these patients have a poor response to levodopa. In contrast, the striatum of PD patients does not degenerate. Positron emission tomography studies have shown an upregulation of striatal D2 receptors in PD patients (Berti et al., 2011). Opposed to PPS, the intact striatum in PD patients is likely responsible for providing a good response to levodopa as nigral terminals degenerate (Brooks et al., 1990). Upregulated striatal D2 receptors allows OFF motor scores to return to relatively stable ON scores (Figure 3A) following single doses of levodopa. This may be why no significant differences in ON scores were found between groups of different disease duration (Figure 3A). Moreover, it has been suggested that OFF-motor scores best represent the level of SNc degeneration (Lees, 2009). This would explain the gradual increase in OFF scores observed in Figure 3A and resultant widening of the aLR in Figure 3B.

4.1.3 The Short and Long Duration Response to Levodopa

Ganga et al. (2013) showed that the short duration motor response to levodopa widens in amplitude after 3 years of disease due to accelerated worsening of OFF scores and relatively stable ON scores. Although our study was cross-sectional in nature, results displayed in Figure 3A and B produced the same pattern of response over the disease course. Our original hypothesis stated that because the LDR is known to decline, we predicted that the SDR to levodopa will increase in amplitude (i.e. the aLR will

increase) as disease duration increases. Our results (Figure 3B) showed that the SDR does increase in amplitude, but appears to plateau after 5 years of disease and increase only modestly thereafter. This matches closely to the results seen in Figure 1A, where all 70 participants' aLR was plotted against disease duration. The correlation was only moderate ($r = 0.40$) due to interindividual variability in the aLR for similar disease durations. In other words, many participants of similar disease durations produced largely different aLRs, lowering the correlation coefficient. This leads us to question what might account for this variability.

Consider this example: two participants enrolled in our study were 11 years into disease at the time of assessment. One had an OFF score of 30 and an ON score of 10 (patient X) while the other (patient Y) had an OFF score of 20 and an ON score of 10. Therefore, patient X had the 'better' 20-point response while patient Y only had a 10-point response. What underlying mechanisms allows patient X to have a response twice the amplitude of patient Y's when both participants are 11 years into disease?

Although difficult to confirm without pathological imaging, we can theorize that patient Y may still be experiencing a higher level of motor benefit from the LDR compared to Patient X. After at least 12 hours without medication, patient Y's OFF score was considerably better (~33.33%) than patient X's. From this, we can infer that corticostriatal neuroplasticity as a result of the LDR may be more pronounced in patient Y than patient X. This pronounced LDR manifests as a reduction in the motor severity of the OFF state in periods of extended medication withdrawal. When patient Y is then given 300 mg as part of the study, their motor improvement does not seem as drastic as patient X's due to LDR compensation in a levodopa starved state.

In contrast, patient X arrives the morning of the study in a more severe OFF medication state. We can conjecture that with the same disease duration, patient X is experiencing a more rapid degeneration of nigral neurons and experiencing less motor benefit from the LDR. When patient X is then given 300 mg of levodopa, a larger amplitude of change in motor score is seen relative to patient Y. Hence, patient X experiences a larger SDR contribution than LDR contribution to overall motor

improvement. This explains why aLR only mildly correlates with disease duration (Figure 1A; $r = 0.40$) but more strongly correlates with total OFF score (Figure 2C; $r = 0.58$). The OFF score is more representative than disease duration of nigral cell loss and the LDR. In conclusion, it is partly due to the intricacies of the SDR and LDR that PD patients of the same disease duration can have vastly different levodopa challenge results. The aLR therefore does not increase linearly with disease duration but rather increases and then plateaus due to variability in degeneration between participants.

4.1.4 Nigral versus Extra-nigral Control Systems

With supposedly far fewer nigral terminals remaining in patient X relative to patient Y, how is a significant SDR to levodopa still generated? Where patient Y likely still relies on a primarily nigral regulation and release of dopamine, patient X may now largely depend on extra-nigral systems. In addition to nigral dopaminergic innervation of striatal medium spiny neurons, there exists ‘extra-nigral’ histaminergic and serotonergic neurons, striatal interneurons, and microglia (Melamed, Hefti, Liebman, Schlosberg & Wurtman, 1980; Tashiro et al., 1989; Mura et al., 1995; Lopez-Real et al., 2003). These extra-nigral neuronal and non-neuronal systems have the capacity to take up exogenous levodopa, but lack the sophistication to properly regulate its conversion and release as dopamine (Mosharov et al., 2015). Nigral neurons regulate an intricate process of synthesizing, storing, releasing and reuptaking dopamine to disinhibit the thalamus so that movement can occur. When these dopaminergic neurons degenerate, this complex responsibility may be handed off to surrounding extra-nigral systems with the expectation that they can successfully perform the same job. They are likely unable to appropriately regulate dopamine release, generating further motor complications such as motor fluctuations and levodopa-induced dyskinesias (LIDs) (Carta & Bezard, 2011). Levodopa-induced dyskinesias (abnormal involuntary movements) are often seen in PD after 5-6 years of disease (Ahlskog & Meunter, 2001). The occurrence of LIDs is suggestive of a switch to extra-nigral control systems (Cenci & Lundblad, 2006). Mosharov et al. (2015) discusses how extra-nigral serotonergic (5-HT) neurons increase in density in advanced stages, perhaps to compensate for the loss of nigral neurons.

They further suggest that the dysregulated release of dopamine from striatal 5-HT receptors may be responsible for LIDs.

Although adaptive, extra-nigral systems were simply not designed to synthesize and store dopamine as effectively as SNc neurons once did in the PD brain (Mosharov et al., 2015). This means that PD patients who have made the switch to largely extra-nigral control systems lack the benefits of nigral buffered dopamine and its highly regulated release. These patients rely on more frequent administration and higher doses of levodopa throughout the day to manage motor symptoms (Mosharov et al., 2015). This might explain the sudden significant increase in LED observed after 9 years of disease (Figure 4). It may be that up to approximately 9 years of disease, a predominately nigral control system is still in place, and a significant LDR to levodopa remains. Patients at this stage are effectively managed with lower daily doses of levodopa (6-9 year LED; $727.0 \text{ mg} \pm 287$). However, by 10-13 years of disease (LED; $1186 \text{ mg} \pm 437.3$) a switch from nigral to largely non-nigral control systems would explain the sudden needed increase ($\sim 450 \text{ mg}$) in LED. Patients at this stage now require an increase in both frequency and dose of levodopa to provide the same level of motor benefit received by those in the 6-9 year group.

Although a large aLR has generally been considered a 'good' thing in PD patients, it may be an indicator that a patient has switched from a largely nigral control of dopamine release to a poorly regulated extra-nigral control system. Some PD patients in this study complained that they don't 'feel any different' after taking a single dose of levodopa, frustrated that they are seeing little to no benefit from the drug. In contrast, other participants could identify the exact moment they came 'ON', receiving significant and immediate motor benefit shortly after taking their scheduled PD medications. If these patients are of similar disease durations, it might be a relatively good thing if your response is minimal. As discussed, it may indicate that you are still benefitting from the long duration response, relying primarily on a well-regulated nigral control of dopamine, and are experiencing a slower rate of degeneration. Rethinking the levodopa response could have large implications for its use in screening DBS candidates.

Typically, PD patients with a high magnitude of levodopa response are selected for DBS so that the surgery might provide a similar level of benefit (Defer et al., 1999). Based on our conjecture, selecting a patient with a high aLR means implementing DBS in a patient that has already switched to an extra-nigral control system. Clearly, this is needed to help manage those already suffering from unfortunate side effects like levodopa induced dyskinesias and motor fluctuations. However, neurologists may want to start considering implementing DBS in patients with smaller responses to levodopa. DBS in patients exhibiting smaller responses early in disease means including those still dependent on a largely nigral control of dopamine. Early DBS intervention could theoretically delay the switch to an extra-nigral control system by reducing the workload of the surviving nigral system early on.

4.2 Discussion: Part B

4.2.1 Akinesia

Akinesia has been shown to serve as the best clinical marker of progression in PD. Among all the cardinal PD motor symptoms, akinesia correlates most highly with nigrostriatal dopaminergic degeneration as demonstrated by Fluorodopa-PET imaging (Vingerhoets, Schulzer, Calne & Snow, 1997). Furthermore, ON akinesia scores have been shown to increase in severity with disease duration (Pålhagen et al., 2006; Louis et al., 1999; Goetz, Stebbins & Blasucci, 2000). However, the influence of disease duration from early to advanced stages on akinesia in the OFF state has not been closely investigated until now (Maetzler, Liepelt & Berg, 2009). Like ON scores, we demonstrated that akinesia scores OFF medication progressively worsen with disease duration (Figure 5A), mirroring the deteriorating nigra. It is also clinically relevant to note that akinesia remains dopa-responsive at all stages of disease (Figure 7). Although expected, this provides patients with peace of mind knowing that their slowness will continue seeing benefit from levodopa even after 13 years of disease. Furthermore, we demonstrated that akinesia is a dominant feature of a patient's motor profile after 13 years of disease (Figure 6), significantly contributing to motor impairment in the OFF medication state.

4.2.2 Rigidity

Rigidity, after bradykinesia, has been shown based on Fluorodopa-PET imaging to correlate second most highly with SNc cell death in PD (Vingerhoets et al., 1997). Louis et al. (1999) demonstrated that rigidity in the ON medication state is expected to increase with disease duration, which was later corroborated by Pålhagen et al. in 2006. However, in studies by Goetz et al. (2000) and Ransmayr et al. (1995), they found that in PD patients with a mean disease duration over 8 years, ON state rigidity no longer significantly correlated with disease duration. Thus, Maetzler and colleagues (2009) suggest that rigidity rapidly worsens early in disease, and after 8 years of disease duration only gradually increases in severity. Maetzler et al. (2009) also found that few studies have comprehensively covered rigidity progression OFF medication. In our study, we demonstrate that the severity of rigidity in the OFF-medication state remains relatively stable throughout disease, with a slight but insignificant upward trend (Figure 5C). Similar to OFF scores, rigidity's improvement following levodopa administration remained relatively stable at each stage of disease duration (Figure 7). Relative to other symptoms, rigidity did not have a dominant presence in the PD motor profile until 14+ years of disease (Figure 6). Given that rigidity and akinesia best represent nigral degeneration, it fits that these symptoms would contribute largely to motor impairment in advanced stages of disease.

4.2.3 Tremor

In contrast to rigidity and akinesia, tremor does not correlate with nigral degeneration as shown by various imaging techniques (Vingerhoets et al., 1997; Benamer et al., 2003; Eidelberg et al., 1994). Tremor also does not correlate in its progression or severity with other cardinal motor symptoms and responds poorly to levodopa in comparison with rigidity and bradykinesia (Louis et al., 2001). Furthermore, tremor is peculiar in that it has been shown to improve late in disease (Helmich, Hallet, Deuschl, Toni, & Bloem, 2012; Toth, Rajput M & Rajput A, 2004; Lees, 2007; Hughes et al., 1993). In figure 5B, we showed that tremor severity appeared to suddenly decline after 13 years of disease. In addition, we demonstrated that relative to akinesia, rigidity, and axial symptoms, patients are least affected by tremor in advanced stages of PD. Thus, our study supports

previous findings that in some patients, tremor improves late in disease. The spread of Lewy pathology to cortical areas thought to be responsible for producing tremor may explain its spontaneous remission in advanced stages of disease (Berardelli et al., 2001). Tremor may have initially appeared in an attempt to overcome an akinetic state.

Tremor has been proposed as a compensatory mechanism in the face of akinesia (Hallett & Khoshbin, 1980; Rivlin-Etzion et al., 2006; Helmich et al., 2012). Given that voluntary movement is produced in phase with tremor, tremor itself may develop as a means of facilitating movement initiation in an akinetic state (Hallett et al., 1977). This is further supported by evidence in MPTP induced parkinsonian primate models. In MPTP lesioned primates, symptoms of akinesia and rigidity presented first, followed by tremor several days after (Zaidel, Arkadir, Israel & Bergman, 2009). Presumably, tremor emerges as a cerebral compensatory response to dysfunctional basal ganglia output.

In the akinetic/bradykinetic state, there is an insufficient and slow recruitment of muscle force. This is thought to be due to underactivity in the supplementary motor cortex (SMA) (Berardelli et al., 2001). If the resting state SMA activity of an akinetic individual is low, areas elsewhere in the motor cortex may be compensating via overactivity (Berardelli et al., 2001). Tremor provides this solution by increasing cortical resting state activity, allowing faster recruitment of muscle force to help overcome akinesia. Furthermore, per Braak's staging, Lewy body pathology is known to progress to the primary motor cortex in advanced stages of PD (Braak et al., 2003). This may disrupt the cortical areas responsible for producing tremor. Hence, previously healthy cortical areas compensating for akinesia (via tremor) experience neurodegeneration late in PD; and thus, an explanation for the disappearance of tremor at this stage.

4.2.4 Axial Symptoms

Axial symptoms including gait and balance impairment usually do not significantly progress until late stages of PD (Wenning et al., 1999; Curtze et al., 2015). This supports our finding that OFF axial scores did not significantly worsen until 14 years of disease (Figure 5D). Many axial symptoms have been found refractory to levodopa treatment,

thought to manifest because of non-nigral pathology in PD (Bryant et al., 2011; Lord, Baker, Nieuwboer, Burn & Rochester, 2011). Balance and gait are further complicated by their control via several overlapping and distinct neural circuits (Lord et al., 2011). This has resulted in many studies providing conflicting results regarding axial response to levodopa. Imaging studies have shown lesions in locomotor areas of the brainstem, cortex, and cerebellum in addition to the basal ganglia (Jahn et al., 2008; Fling et al., 2013). This offers support for why some features of gait and balance respond well to levodopa while others do not. Curtze et al. (2015) suggests that beyond levodopa, pharmacological therapies with aims of alleviating axial symptoms should consider targeting non-nigrostriatal pathways.

In Figure 7, we demonstrated that axial response to levodopa was significant even after 13 years of PD. However, this axial improvement may be indirectly driven by dopa-responsive appendicular symptoms like akinesia and rigidity. Reduced slowness and stiffness following levodopa administration may allow for appendicular compensation of gait and balance impairment. To ensure that appendicular compensation was not the sole reason for the apparent improvement in axial subscores, retropulsion test results were isolated (Figure 8). The retropulsion test is a component of the axial subscore which assesses balance. It is thought to be least influenced by bradykinesia and rigidity and therefore best represent axial response (Bloem, Grimbergen, Cramer, Willemsen & Zwinderman, 2001; Adkin et al., 2003). Hence, any improvement in the retropulsion test can be attributed to a purer axial response mechanism. Interestingly, the retropulsion test indicated a significant response to levodopa after 13 years of PD. This suggests the involvement of the nigrostriatal pathway in axial control systems responsible for maintaining balance. Furthermore, it demonstrates that PD patients with postural instability can still benefit from levodopa late in disease, in accord with findings by Curtze et al. (2015).

4.2.5 Summary of Motor Symptoms

As disease duration advances, we have demonstrated (per Figures 5, 6, and 7) a shift in phenotype towards a highly akinetic-rigid state accompanied by disabling axial

symptoms. This shift may be explained by our theory of a switch from primarily nigral to extra-nigral control systems later in disease. Early in disease, akinesia and rigidity scores are low in the OFF-medication state, and have minimal responses to levodopa. This suggests that these dopa-responsive symptoms are still seeing motor benefit from the LDR and are under a primarily nigral control of dopamine. As the long duration response wanes and nigral degeneration increases, there is a shift to extra-nigral control systems. Extra-nigral control systems are unable to provide the same motor benefit for rigidity and akinesia in the OFF state, and so we see significantly increased scores in advanced stages of disease. A switch to primarily extra-nigral control systems means significant degeneration has likely occurred not only in the nigra, but in the cortex as well. This is supported by our findings of a sudden decline in tremor and significant worsening of axial symptoms after 13 years of PD.

4.2.6 Clinical Questionnaires

In Figure 9, we found that an increase in ON scores was significantly associated with a decline in confidence in balance (C) and increased freezing of gait (B). A decreased confidence in balance supports our finding of retropulsion test scores and axial symptoms being most severe in advanced stages of disease, when ON scores are highest. Confidence in completing simple everyday tasks demanding balance and gait likely diminishes as patients begin to suffer from disabling axial symptoms later in disease. Increased axial impairment leading to a lack of confidence may contribute to the significant increase in depression and reduced quality of life shown in D and E of Figure 9. However, depression and perceived quality of life was only weakly associated with ON scores, suggesting other factors at play. Although motor symptom progression late in disease likely contributes, quality of life and emotional well-being are likely also dictated by social factors such as family support, financial security, and independence (Schrag, Jahanshahi & Quinn, 2000). Further investigation into these factors may explain some of the variability in the non-motor questionnaires.

4.3 Discussion: Part C

4.3.1 Limitations

Although 70 participants were included in this study, a higher n-value may be needed to provide a better representation of the general Parkinson's population. A higher n-value would also have afforded us the ability to potentially group participants based on several different phenotypes. Furthermore, 73% of the participants included in this study were male, although the incidence of PD is higher among males than females. Hence, our results may provide more insight into the levodopa response in males than females. However, it is unclear at this time if Parkinson's disease mechanisms differ between genders (Haaxma et al., 2007). A further limitation may have been the exclusion of patients with severe walking difficulties and high levels of cognitive impairment. This may have excluded patients at the extreme end of the disease spectrum, suffering from incredibly widespread neurodegeneration. Finally, the cross-sectional nature of the study is inherently weaker than a longitudinal study. A longitudinal study following the same set of patients would have provided more power in drawing conclusions about the levodopa response over the disease course.

4.3.2 Future Directions

Future studies should consider reporting both the aLR and the %LR so that a more comprehensive understanding of the motor response to levodopa is provided. Performing a similarly designed study complemented by CNS imaging techniques to corroborate the motor findings and theories proposed in this body of work would be ideal. In addition, a study with a levodopa washout period of days instead of hours would assist in isolating the short duration response to levodopa at each stage of disease duration. However, asking patients to refrain from treatment for days may prove unethical. Lastly, it would be of great interest to follow the progression of early disease participants with smaller aLRs in this study who go for DBS. Observing clinical outcomes of early deep brain stimulated patients would provide evidence either in support of or against the theories proposed in this thesis.

4.3.3 Summary

In this body of work, we improve upon the existing literature in the following ways: 1) a total of 70 PD participants were recruited with more than 15 participants in each group of early (2-5 years), middle (6-9 years), late (10-13 years) and advanced (14+ years) stages of disease duration; 2) the most commonly used and highly recommended scale for motor examination in PD was used (UPDRS-III); 3) the short duration response to levodopa is reported as both a measure of percent change (%LR) and absolute change (aLR) in motor scores from OFF to ON; 4) the levodopa response as it relates to age, disease duration and OFF scores is included; 5) levodopa response for UPDRS-III subscores are reported (this includes tremor, rigidity, bradykinesia, and axial symptom subscores) as they relate to disease duration; and 6) lastly, self-reported questionnaires were completed by participants to help provide us with further explanation and clarity regarding the observed motor scores. Note that only individuals equal to or greater than 2 years of disease duration were included in the study. Pahwa and Lyons (2010) report that in its early stages, Parkinson's disease is commonly mistaken for other neurological conditions like multiple systems atrophy, progressive supranuclear palsy, Lewy body dementia, corticobasal degeneration, and essential tremor. Hence, PD patients diagnosed within the last 2 years were not included in our study to avoid the risk of including misdiagnosed individuals. The aLR and %LR measured in this study are just different ways of reporting motor improvement as a result of the SDR.

We suggest that future research and perhaps even clinical protocols should consider reporting both the aLR and %LR. This provides a more complete picture from which to draw conclusions. The aLR was found to be significantly associated with disease duration, levodopa duration, LED and OFF motor scores but not age. The aLR correlated more strongly with OFF motor scores than with disease duration likely because OFF motor scores are more representative of the degenerative state and LDR contribution. Participants of similar disease durations may be on different trajectories of nigral degeneration, explaining variability in their aLR. Further explaining variability in the motor response to levodopa at different stages of disease is the relative contribution of the LDR:SDR. We hypothesized that as the LDR declines with advancing disease

duration, the amplitude of motor change (aLR) provided by the SDR will increase. The aLR was found to rise quickly after 5 years of disease, but then plateau and increase only modestly thereafter. However, the aLR was still found to be significant at all stages of disease duration. We conjectured that in a state of gradual nigral cell death, extra-nigral control systems eventually take over in order to maintain a significant response. This is further supported by our findings of a large increase in LED required after 9 years and a phenotypic shift to an akinetic-rigid state accompanied by disabling axial symptoms in advanced stages.

Akinesia in the OFF state was found to increase in severity with disease duration while rigidity remained relatively stable. Both akinesia and rigidity remain responsive to levodopa throughout disease. Tremor progression is much less predictable, found to decline in severity in advanced disease. Axial symptoms did significantly worsen until 14 years of disease, dominating the motor profile at this time. The retropulsion test was found responsive to levodopa even in advanced stages, providing relief for those suffering from postural instability. Non-motor clinical questionnaires suggest axial impairment affects an individual's confidence in balance, and perhaps other affective domains like depression and perceived quality of life.

These findings will allow physicians to make more highly informed treatment decisions for their PD patients. Rethinking the levodopa response may be necessary so that patients early in disease might be considered in the screening process for DBS. Individuals in early PD who have a minimal response to levodopa may be still be receiving motor benefit from the LDR and relying on a primarily nigral control system. Waiting for patients to switch to a poorly regulated extra-nigral control system characterized by further motor complications before initiating DBS may be too late. Early stimulation could prove neuroprotective, sparing the surviving nigral neurons from being overworked and thereby slowing the rate of degeneration. This study provides support for the implementation of DBS earlier in disease. Moreover, it provides a deeper understanding of how the cardinal motor symptoms of PD progress and respond to levodopa at each stage of disease. We hope that these findings can be used by

clinicians to optimize treatment so that patients suffering from Parkinson's disease might enjoy a higher quality of life.

References

- Adkin, A. L., Frank, J. S., & Jog, M. S. (2003). Fear of falling and postural control in Parkinson's disease. *Movement Disorders, 18*(5), 496-502.
- Ahlskog, J. E., & Muenter, M. D. (2001). Frequency of levodopa-related dyskinesias and motor fluctuations as estimated from the cumulative literature. *Movement disorders, 16*(3), 448-458.
- Albanese, A., Bonuccelli, U., Brefel, C., Chaudhuri, K., Colosimo, C., Eichhorn, T., ... & Zappia, M. (2001). Consensus statement on the role of acute dopaminergic challenge in Parkinson's disease. *Movement disorders, 16*(2), 197-201.
- Anderson, E., & Nutt, J. (2011). The long-duration response to levodopa: phenomenology, potential mechanisms and clinical implications. *Parkinsonism & related disorders, 17*(8), 587-592.
- Baradaran, N., Tan, S. N., Liu, A., Ashoori, A., Palmer, S. J., Wang, Z. J., ... & McKeown, M. J. (2013). Parkinson's disease rigidity: relation to brain connectivity and motor performance. *Frontiers in neurology, 4*, 67.
- Beaulieu, J. M., & Gainetdinov, R. R. (2011). The physiology, signaling, and pharmacology of dopamine receptors. *Pharmacological reviews, 63*(1), 182-217.
- Benamer, H. T., Oertel, W. H., Patterson, J., Hadley, D. M., Pogarell, O., Höffken, H., ... & Grosset, D. G. (2003). Prospective study of presynaptic dopaminergic imaging in patients with mild parkinsonism and tremor disorders: Part 1. Baseline and 3-month observations. *Movement Disorders, 18*(9), 977-984.
- Berardelli, A., Rothwell, J. C., Thompson, P. D., & Hallett, M. (2001). Pathophysiology of bradykinesia in Parkinson's disease. *Brain, 124*(11), 2131-2146.
- Berti, V., Pupi, A., & Mosconi, L. (2011). PET/CT in diagnosis of movement disorders. *Annals of the New York Academy of Sciences, 1228*(1), 93-108.

- Berti, V., Pupi, A., & Mosconi, L. (2011). PET/CT in diagnosis of movement disorders. *Annals of the New York Academy of Sciences*, 1228(1), 93-108.
- Bloem, B. R., Grimbergen, Y. A., Cramer, M., Willemsen, M., & Zwinderman, A. H. (2001). Prospective assessment of falls in Parkinson's disease. *Journal of neurology*, 248(11), 950-958.
- Bonnet, A. M., Loria, Y., Saint-Hilaire, M. H., Lhermitte, F., & Agid, Y. (1987). Does long-term aggravation of Parkinson's disease result from nondopaminergic lesions?. *Neurology*, 37(9), 1539-1539.
- Braak, H., & Del Tredici, K. (2017). Neuropathological Staging of Brain Pathology in Sporadic Parkinson's disease: Separating the Wheat from the Chaff. *Journal of Parkinson's Disease*, 7(s1), S73–S87.
- Braak, H., Del Tredici, K., Rüb, U., De Vos, R. A. I., Jansen Steur, E. N. H., & Braak, E. (2003). Staging of brain pathology related to sporadic Parkinson's disease. *Neurobiology of Aging*, 24(2), 197–211.
- Brooks, D. J., Ibanez, V., Sawle, G. V., Quinn, N., Lees, A. J., Mathias, C. J., ... & Frackowiak, R. S. J. (1990). Differing patterns of striatal 18F-dopa uptake in Parkinson's disease, multiple system atrophy, and progressive supranuclear palsy. *Annals of neurology*, 28(4), 547-555.
- Broussolle, E., Krack, P., Thobois, S., Xie-Brustolin, J., Pollak, P., & Goetz, C. G. (2007). Contribution of Jules Froment to the study of parkinsonian rigidity. *Movement disorders*, 22(7), 909-914.
- Bryant, M. S., Rintala, D. H., Hou, J. G., Lai, E. C., & Protas, E. J. (2011). Effects of levodopa on forward and backward gait patterns in persons with Parkinson's disease. *NeuroRehabilitation*, 29(3), 247-252.
- Burke, R. E., & O'Malley, K. (2013). Axon degeneration in Parkinson's disease. *Experimental Neurology*, 246, 72–83.

- Cantello, R., Gianelli, M., Civardi, C., & Mutani, R. (1995). Pathophysiology of Parkinson's disease rigidity. Role of corticospinal motor projections. *Advances in neurology*, *69*, 129-133.
- Carta, M., & Bezard, E. (2011). Contribution of pre-synaptic mechanisms to L-DOPA-induced dyskinesia. *Neuroscience*, *198*, 245-251.
- Castrioto, A., Lozano, A. M., Poon, Y. Y., Lang, A. E., Fallis, M., & Moro, E. (2011). Ten-year outcome of subthalamic stimulation in Parkinson disease: a blinded evaluation. *Archives of neurology*, *68*(12), 1550-1556.
- Cenci, M. A., & Lundblad, M. (2006). Post-versus presynaptic plasticity in L-DOPA-induced dyskinesia. *Journal of neurochemistry*, *99*(2), 381-392.
- Charles, P. D., Gill, C. E., Davis, T. L., Konrad, P. E., & Benabid, A. L. (2008). Is deep brain stimulation neuroprotective if applied early in the course of PD?. *Nature clinical practice Neurology*, *4*(8), 424-426.
- Clissold, B. G., McColl, C. D., Reardon, K. R., Shiff, M., & Kempster, P. A. (2006). Longitudinal study of the motor response to levodopa in Parkinson's disease. *Movement disorders*, *21*(12), 2116-2121.
- Cooper, J. A., Sagar, H. J., Tidswell, P., & Jordan, N. (1994). Slowed central processing in simple and go/no-go reaction time tasks in Parkinson's disease. *Brain*, *117*(3), 517-529.
- Corcos, D. M., Chen, C. M., Quinn, N. P., McAuley, J., & Rothwell, J. C. (1996). Strength in Parkinson's disease: Relationship to rate of force generation and clinical status. *Annals of neurology*, *39*(1), 79-88.
- Cotzias, G. C., Papavasiliou, P. S., & Gellene, R. (1969). Modification of Parkinsonism—chronic treatment with L-dopa. *New England Journal of Medicine*, *280*(7), 337-345.

Cotzias, G. C., Van Woert, M. H., & Schiffer, L. M. (1967). Aromatic amino acids and modification of parkinsonism. *New England Journal of Medicine*, 276(7), 374-379.

Crouse, J. J., Phillips, J. R., Jahanshahi, M., & Moustafa, A. A. (2016). Postural instability and falls in Parkinson's disease. *Reviews in the neurosciences*, 27(5), 549-555.

Curtze, C., Nutt, J. G., Carlson-Kuhta, P., Mancini, M., & Horak, F. B. (2015). Levodopa Is a Double-Edged Sword for Balance and Gait in People With Parkinson's Disease. *Movement Disorders*, 30(10), 1361-1370.

Dal Bello-Haas, V., Klassen, L., Sheppard, M. S., & Metcalfe, A. (2011). Psychometric properties of activity, self-efficacy, and quality-of-life measures in individuals with Parkinson disease. *Physiotherapy Canada*, 63(1), 47-57.

Daubner, S. C., Le, T., & Wang, S. (2011). Tyrosine hydroxylase and regulation of dopamine synthesis. *Archives of biochemistry and biophysics*, 508(1), 1-12.

De Lau, L. M., & Breteler, M. M. (2006). Epidemiology of Parkinson's disease. *The Lancet Neurology*, 5(6), 525-535.

Defer, G. L., Widner, H., Marié, R. M., Rémy, P., & Levivier, M. (1999). Core assessment program for surgical interventional therapies in Parkinson's disease (CAPSIT-PD). *Movement Disorders*, 14(4), 572-584.

DeLong, M. R., & Wichmann, T. (2015). Basal ganglia circuits as targets for neuromodulation in Parkinson disease. *JAMA neurology*, 72(11), 1354-1360.

Delwaide, P. J. (2001). Parkinsonian rigidity. *Functional neurology*, 16(2), 147-156.

Deuschl, G., Bain, P., & Brin, M. (1998). Consensus statement of the movement disorder society on tremor. *Movement Disorders*, 13(S3), 2-23.

- Durso, R., Isaac, K., Perry, L., Saint-Hilaire, M., & Feldman, R. G. (1993). Age influences magnitude but not duration of response to levodopa. *Journal of Neurology, Neurosurgery & Psychiatry*, 56(1), 65-68.
- Duval, C., Daneault, J. F., Hutchison, W. D., & Sadikot, A. F. (2016). A brain network model explaining tremor in Parkinson's disease. *Neurobiology of disease*, 85, 49-59.
- Eidelberg, D., Moeller, J. R., Dhawan, V., Spetsieris, P., Takikawa, S., Ishikawa, T., ... & Fahn, S. (1994). The metabolic topography of parkinsonism. *Journal of Cerebral Blood Flow & Metabolism*, 14(5), 783-801.
- Elsworth, J. D., & Roth, R. H. (1996). Dopamine autoreceptor pharmacology and function. In *The dopamine receptors* (pp. 223-265). Humana Press.
- Elsworth, J. D., & Roth, R. H. (1997). Dopamine synthesis, uptake, metabolism, and receptors: relevance to gene therapy of Parkinson's disease. *Experimental neurology*, 144(1), 4-9.
- Erickson, J. D., Schafer, M. K., Bonner, T. I., Eiden, L. E., & Weihe, E. (1996). Distinct pharmacological properties and distribution in neurons and endocrine cells of two isoforms of the human vesicular monoamine transporter. *Proceedings of the National Academy of Sciences*, 93(10), 5166-5171.
- Ertan, F. S., Ertan, T., Kızıltan, G., & Uygucgil, H. (2005). Reliability and validity of the Geriatric Depression Scale in depression in Parkinson's disease. *Journal of Neurology, Neurosurgery & Psychiatry*, 76(10), 1445-1447.
- Espay AJ, Vaughan JE, Marras C, Fowler R, Eckman MH. Early versus delayed bilateral subthalamic deep brain stimulation for Parkinson's disease: a decision analysis. *Mov Disord* (2010) 25:1456–63. doi:10.1002/mds.23111
- Evans, J. R., Mason, S. L., Williams-Gray, C. H., Foltynie, T., Trotter, M., & Barker, R. A. (2011). The factor structure of the UPDRS as an index of disease progression in Parkinson's disease. *Journal of Parkinson's disease*, 1(1), 75-82.

- Fahn, S. (2015). The medical treatment of Parkinson disease from James Parkinson to George Cotzias. *Movement Disorders*, 30(1), 4–18.
- Fahn, S., & Poewe, W. (2015). Levodopa: 50 years of a revolutionary drug for Parkinson disease. *Movement Disorders*, 30(1), 1–3.
- Fasano, A., Romito, L. M., Daniele, A., Piano, C., Zinno, M., Bentivoglio, A. R., & Albanese, A. (2010). Motor and cognitive outcome in patients with Parkinson's disease 8 years after subthalamic implants. *Brain*, 133(9), 2664-2676.
- Fling, B. W., Cohen, R. G., Mancini, M., Nutt, J. G., Fair, D. A., & Horak, F. B. (2013). Asymmetric pedunculopontine network connectivity in parkinsonian patients with freezing of gait. *Brain*, 136(8), 2405-2418.
- Freund, T. F., Powell, J. F., & Smith, A. D. (1984). Tyrosine hydroxylase-immunoreactive boutons in synaptic contact with identified striatonigral neurons, with particular reference to dendritic spines. *Neuroscience*, 13(4), 1189-1215.
- Fuxe, K., Manger, P., Genedani, S., & Agnati, L. (2006). The nigrostriatal DA pathway and Parkinson's disease. *In Parkinson's Disease and Related Disorders* (pp. 71-83). Springer Vienna.
- Gallagher, D. A., & Schapira, A. H. (2014). Non-motor symptoms and pre-motor diagnosis of Parkinson's disease. *International Journal of Gerontology*, 10.
- Ganga, G., Alty, J. E., Clissold, B. G., McColl, C. D., Reardon, K. A., Schiff, M., & Kempster, P. A. (2013). Longitudinal study of levodopa in Parkinson's disease: effects of the advanced disease phase. *Movement Disorders*, 28(4), 476-481.
- Giladi, N., Shabtai, H., Simon, E. S., Biran, S., Tal, J., & Korczyn, A. D. (2000). Construction of freezing of gait questionnaire for patients with Parkinsonism. *Parkinsonism & related disorders*, 6(3), 165-170.

- Giladi, N., Tal, J., Azulay, T., Rascol, O., Brooks, D. J., Melamed, E., ... & Tolosa, E. (2009). Validation of the freezing of gait questionnaire in patients with Parkinson's disease. *Movement Disorders*, *24*(5), 655-661.
- Goetz, C. G., Stebbins, G. T., & Blasucci, L. M. (2000). Differential progression of motor impairment in levodopa-treated Parkinson's disease. *Movement disorders*, *15*(3), 479-484.
- Goetz, C. G., Tilley, B. C., Shaftman, S. R., Stebbins, G. T., Fahn, S., Martinez-Martin, P., ... & Dubois, B. (2008). Movement Disorder Society-sponsored revision of the Unified Parkinson's Disease Rating Scale (MDS-UPDRS): Sca
- Goldstein, M., & Lieberman, A. (1992). The role of the regulatory enzymes of catecholamine synthesis in Parkinson's disease. *Neurology*, *42*(4 Suppl 4), 8-12.
- Greffard, S., Verny, M., Bonnet, A. M., Beinis, J. Y., Gallinari, C., Meaume, S., ... & Duyckaerts, C. (2006). Motor score of the Unified Parkinson Disease Rating Scale as a good predictor of Lewy body-associated neuronal loss in the substantia nigra. *Archives of neurology*, *63*(4), 584-588.
- Grimbergen, Y. A., Munneke, M., & Bloem, B. R. (2004). Falls in Parkinson's disease. *Current opinion in neurology*, *17*(4), 405-415.
- Haaxma, C. A., Bloem, B. R., Borm, G. F., Oyen, W. J., Leenders, K. L., Eshuis, S., ... & Horstink, M. W. (2007). Gender differences in Parkinson's disease. *Journal of Neurology, Neurosurgery & Psychiatry*, *78*(8), 819-824.
- Hallett, M. (2014). Tremor: pathophysiology. *Parkinsonism & related disorders*, *20*, S118-S122.
- Hallett, M., & Khoshbin, S. (1980). A physiological mechanism of bradykinesia. *Brain*, *103*(2), 301-314.

Hallett, M., Shahani, B. T., & Young, R. R. (1977). Analysis of stereotyped voluntary movements at the elbow in patients with Parkinson's disease. *Journal of Neurology, Neurosurgery & Psychiatry*, 40(12), 1129-1135.

Hallett, M., Shahani, B. T., & Young, R. R. (1977). Analysis of stereotyped voluntary movements at the elbow in patients with Parkinson's disease. *Journal of Neurology, Neurosurgery & Psychiatry*, 40(12), 1129-1135.

Helmich, R. C., Hallett, M., Deuschl, G., Toni, I., & Bloem, B. R. (2012). Cerebral causes and consequences of parkinsonian resting tremor: a tale of two circuits?. *Brain*, 135(11), 3206-3226.

Hitri, A., Hurd, Y. L., Wyatt, R. J., & Deutsch, S. I. (1994). Molecular, functional and biochemical characteristics of the dopamine transporter: regional differences and clinical relevance. *Clinical neuropharmacology*, 17(1), 1-22.

Hitri, A., Hurd, Y. L., Wyatt, R. J., & Deutsch, S. I. (1994). Molecular, functional and biochemical characteristics of the dopamine transporter: regional differences and clinical relevance. *Clinical neuropharmacology*, 17(1), 1-22.

Holford, N. H., Chan, P. L., Nutt, J. G., Kieburtz, K., & Shoulson, I. (2006). Disease progression and pharmacodynamics in Parkinson disease—evidence for functional protection with levodopa and other treatments. *Journal of pharmacokinetics and pharmacodynamics*, 33(3), 281-311.

Hughes, A. J., Daniel, S. E., Blankson, S., & Lees, A. J. (1993). A clinicopathologic study of 100 cases of Parkinson's disease. *Archives of neurology*, 50(2), 140-148.

Irwin, D. J., White, M. T., Toledo, J. B., Xie, S. X., Robinson, J. L., Van Deerlin, V., & Trojanowski, J. Q. (2012). Neuropathologic substrates of parkinson disease dementia. *Annals of Neurology*, 72(4), 587-598.

Ishii K. PET approaches for diagnosis of dementia. *AMJR Am J Neuroradiol* (2014) 35:2030–8. doi:10.3174/ajnr.A3695

- Jahn, K., Deuschländer, A., Stephan, T., Kalla, R., Wiesmann, M., Strupp, M., & Brandt, T. (2008). Imaging human supraspinal locomotor centers in brainstem and cerebellum. *Neuroimage*, *39*(2), 786-792.
- Jankovic, J. (2008). Parkinson's disease: clinical features and diagnosis. *Journal of Neurology, Neurosurgery & Psychiatry*, *79*(4), 368-376.
- Jankovic, J., Schwartz, K. S., & Ondo, W. (1999). Re-emergent tremor of Parkinson's disease. *Journal of Neurology, Neurosurgery & Psychiatry*, *67*(5), 646-650.
- Kägi, G., Bhatia, K. P., & Tolosa, E. (2010). The role of DAT-SPECT in movement disorders. *Journal of Neurology, Neurosurgery & Psychiatry*, *81*(1), 5-12.
- Kalia, L. V, Lang, A. E., & Shulman, G. (2015). Parkinson's disease. *The Lancet*, *386*, 896-912.
- Keefe, K. A., & Gerfen, C. R. (1995). D1-D2 dopamine receptor synergy in striatum: effects of intrastriatal infusions of dopamine agonists and antagonists on immediate early gene expression. *Neuroscience*, *66*(4), 903-913.
- Kelly, R. B. (1993). Storage and release of neurotransmitters. *Cell*, *72*, 43-53.
- Kim, S. D., Allen, N. E., Canning, C. G., & Fung, V. S. (2013). Postural instability in patients with Parkinson's disease. *CNS drugs*, *27*(2), 97-112.
- Kimmell, K., Pulusu, V. K., Bharucha, K. J., & Ross, E. D. (2015). Postural instability in Parkinson Disease: To step or not to step. *Journal of the neurological sciences*, *357*(1), 146-151.
- Lang, A. E., & Widner, H. (2002). Deep brain stimulation for Parkinson's disease: patient selection and evaluation. *Movement Disorders*, *17*(S3), S94-S101.
- Lees, A. J. (2007). Unresolved issues relating to the shaking palsy on the celebration of James Parkinson's 250th birthday. *Movement Disorders*, *22*(S17), S327-S334.

- Lees, A. J. (2009). The Parkinson chimera. *Neurology*, 72(7 Supplement 2), S2-S11.
- LeWitt, P. A. (2015). Levodopa therapy for Parkinson's disease: Pharmacokinetics and pharmacodynamics. *Movement Disorders : Official Journal of the Movement Disorder Society*, 30(1), 64–72. <http://doi.org/10.1002/mds.26082>
- Lill, C. M., & Klein, C. (2017). Epidemiology and causes of Parkinson's disease. *Der Nervenarzt*.
- Lopez-Real, A., Rodriguez-Pallares, J., Guerra, M. J., & Labandeira-Garcia, J. L. (2003). Localization and functional significance of striatal neurons immunoreactive to aromatic L-amino acid decarboxylase or tyrosine hydroxylase in rat Parkinsonian models. *Brain research*, 969(1), 135-146.
- Lord, S., Baker, K., Nieuwboer, A., Burn, D., & Rochester, L. (2011). Gait variability in Parkinson's disease: an indicator of non-dopaminergic contributors to gait dysfunction?. *Journal of neurology*, 258(4), 566-572.
- Louis, E. D., Levy, G., Côte, L. J., Mejia, H., Fahn, S., & Marder, K. (2001). Clinical correlates of action tremor in Parkinson disease. *Archives of neurology*, 58(10), 1630-1634.
- Louis, E. D., Tang, M. X., Cote, L., Alfaró, B., Mejia, H., & Marder, K. (1999). Progression of parkinsonian signs in Parkinson disease. *Archives of Neurology*, 56(3), 334-337.
- Maesawa, S., Kaneoke, Y., Kajita, Y., Usui, N., Misawa, N., Nakayama, A., & Yoshida, J. (2004). Long-term stimulation of the subthalamic nucleus in hemiparkinsonian rats: neuroprotection of dopaminergic neurons. *Journal of neurosurgery*, 100(4), 679-687.
- Maetzler, W., Liepelt, I., & Berg, D. (2009). Progression of Parkinson's disease in the clinical phase: potential markers. *The Lancet Neurology*, 8(12), 1158-1171.
- Martinez-Martin, P., Rodriguez-Blazquez, C., Alvarez-Sanchez, M., Arakaki, T., Bergareche-Yarza, A., Chade, A., & ... Mendoza-Rodriguez, A. (2013). Expanded and

independent validation of the Movement Disorder Society–Unified Parkinson's Disease Rating Scale (MDS-UPDRS). *Journal of neurology*, 260(1), 228-236. le presentation and clinimetric testing results. *Movement disorders*, 23(15), 2129-2170.

Meiser, J., Weindl, D., & Hiller, K. (2013). Complexity of dopamine metabolism. *Cell Communication and Signaling*, 11(1), 34.

Melamed, E., Hefti, F., Liebman, J., Schlosberg, A. J., & Wurtman, R. J. (1980). Serotonergic neurones are not involved in action of L-dopa in Parkinson's disease.

Mosharov, E. V., Borgkvist, A., & Sulzer, D. (2015). Presynaptic effects of levodopa and their possible role in dyskinesia. *Movement Disorders*, 30(1), 45-53.

Mosharov, E. V., Larsen, K. E., Kanter, E., Phillips, K. A., Wilson, K., Schmitz, Y., ... & Sulzer, D. (2009). Interplay between cytosolic dopamine, calcium, and α -synuclein causes selective death of substantia nigra neurons. *Neuron*, 62(2), 218-229.

Müller, T. (2013). Pharmacokinetic considerations for the use of levodopa in the treatment of Parkinson disease: focus on levodopa/carbidopa/entacapone for treatment of levodopa-associated motor complications. *Clinical Neuropharmacology*, 36(3), 84–91.

Mura, A., Jackson, D., Manley, M. S., Young, S. J., & Groves, P. M. (1995). Aromaticl-amino acid decarboxylase immunoreactive cells in the rat striatum: a possible site for the conversion of exogenousl-DOPA to dopamine. *Brain research*, 704(1), 51-60.

Mura, A., Jackson, D., Manley, M. S., Young, S. J., & Groves, P. M. (1995). Aromaticl-amino acid decarboxylase immunoreactive cells in the rat striatum: a possible site for the conversion of exogenousl-DOPA to dopamine. *Brain research*, 704(1), 51-60.

Nutt, J. G., & Holford, N. H. (1996). The response to levodopa in Parkinson's disease: imposing pharmacological law and order. *Annals of neurology*, 39(5), 561-573.

Nutt, J. G., Carter, J. H., & Woodward, W. R. (1995). Long-duration response to levodopa. *Neurology*, 45(8), 1613-1616.

- Nutt, J. G., Carter, J. H., Van Houten, L., & Woodward, W. R. (1997). Short-and long-duration responses to levodopa during the first year of levodopa therapy. *Annals of neurology*, 42(3), 349-355.
- Nutt, J. G., Woodward, W. R., Hammerstad, J. P., Carter, J. H., & Anderson, J. L. (1984). The on-off phenomenon in Parkinson's disease: relation to levodopa absorption and transport. *New England Journal of Medicine*, 310(8), 483-488.
- Obeso, J. A., Rodríguez-Oroz, M. C., Benitez-Temino, B., Blesa, F. J., Guridi, J., Marin, C., & Rodriguez, M. (2008). Functional organization of the basal ganglia: therapeutic implications for Parkinson's disease. *Movement Disorders*, 23(S3), S548-S559.
- Ogasahara, S., Nishikawa, Y., Takahashi, M., Wada, K., Nakamura, Y., Yorifuji, S., & Tarui, S. (1984). Dopamine metabolism in the central nervous system after discontinuation of L-dopa therapy in patients with Parkinson disease. *Journal of the neurological sciences*, 66(2), 151-163.
- Omiatek, D. M., Bressler, A. J., Cans, A. S., Andrews, A. M., Heien, M. L., & Ewing, A. G. (2013). The real catecholamine content of secretory vesicles in the CNS revealed by electrochemical cytometry. *Scientific reports*, 3, 1447.
- Østergaard, K., Sunde, N., & Dupont, E. (2002). Effects of bilateral stimulation of the subthalamic nucleus in patients with severe Parkinson's disease and motor fluctuations. *Movement Disorders*, 17(4), 693-700.
- Pahwa, R., & Lyons, K. E. (2010). Early diagnosis of Parkinson's disease: recommendations from diagnostic clinical guidelines. *Am J Manag Care*, 16(4), 94-99.
- Pålhagen, S., Heinonen, E., Hägglund, J., Kaugesaar, T., Mäki-Ikola, O., Palm, R., & Swedish Parkinson Study Group. (2006). Selegiline slows the progression of the symptoms of Parkinson disease. *Neurology*, 66(8), 1200-1206.
- Pate, D. S., & Margolin, D. I. (1994). Cognitive slowing in Parkinson's and Alzheimer's patients Distinguishing bradyphrenia from dementia. *Neurology*, 44(4), 669-669.

Peter, D., Liu, Y. O. N. G. J. I. A. N., Sternini, C., De Giorgio, R., Brecha, N., & Edwards, R. H. (1995). Differential expression of two vesicular monoamine transporters. *Journal of Neuroscience*, *15*(9), 6179-6188.

Phillips, J. G., Martin, K. E., Bradshaw, J. L., & Iansek, R. (1994). Could bradykinesia in Parkinson's disease simply be compensation?. *Journal of neurology*, *241*(7), 439-447.

Pothos, E. N., Davila, V., & Sulzer, D. (1998). Presynaptic recording of quanta from midbrain dopamine neurons and modulation of the quantal size. *Journal of Neuroscience*, *18*(11), 4106-4118.

Ramsey, A. J., & Fitzpatrick, P. F. (2000). Effects of phosphorylation on binding of catecholamines to tyrosine hydroxylase: specificity and thermodynamics. *Biochemistry*, *39*(4), 773-778.

Rana, A. Q., Siddiqui, I., Mosabbir, A. A., Qureshi, A. R. M., Fattah, A., & Awan, N. (2014). Is action tremor in Parkinson's disease related to resting tremor?. *Neurological research*, *36*(2), 107-111.

Ransmayr, G., König, G., Neubauer, M., Wagner, M., & Falk, M. (1995). Effect of age and disease duration on parkinsonian motor scores under levodopa therapy. *Journal of Neural Transmission-Parkinson's Disease and Dementia Section*, *9*(2-3), 177-188.

Rivlin-Etzion, M., Marmor, O., Heimer, G., Raz, A., Nini, A., & Bergman, H. (2006). Basal ganglia oscillations and pathophysiology of movement disorders. *Current opinion in neurobiology*, *16*(6), 629-637.

Rodriguez-Oroz, M. C., Obeso, J. A., Lang, A. E., Houeto, J. L., Pollak, P., Rehncrona, S., ... & Quinn, N. P. (2005). Bilateral deep brain stimulation in Parkinson's disease: a multicentre study with 4 years follow-up. *Brain*, *128*(10), 2240-2249.

Schnitzler, A., Fuchs, G., Baas, H., Dillmann, U., Hilker, R., & Oechsner, M. (2010). Early deep brain stimulation for Parkinson's disease. *Fortschritte der Neurologie-Psychiatrie*, *78*, S37-40.

Schrag, A., Jahanshahi, M., & Quinn, N. (2000). What contributes to quality of life in patients with Parkinson's disease?. *Journal of Neurology, Neurosurgery & Psychiatry*, 69(3), 308-312.

Schuepbach, W. M. M., Rau, J., Knudsen, K., Volkmann, J., Krack, P., Timmermann, L., ... & Falk, D. (2013). Neurostimulation for Parkinson's disease with early motor complications. *New England Journal of Medicine*, 368(7), 610-622.

Sheridan, M. R., & Flowers, K. A. (1990). Movement variability and bradykinesia in Parkinson's disease. *Brain*, 113(4), 1149-1161.

Spencer, J. P., Jenner, P., Daniel, S. E., Lees, A. J., Marsden, D. C., & Halliwell, B. (1998). Conjugates of catecholamines with cysteine and GSH in Parkinson's disease: possible mechanisms of formation involving reactive oxygen species. *Journal of neurochemistry*, 71(5), 2112-2122.

Spieles-Engemann, A. L., Behbehani, M. M., Collier, T. J., Wohlgenant, S. L., Steece-Collier, K., Paumier, K., ... & Lipton, J. W. (2010). Stimulation of the rat subthalamic nucleus is neuroprotective following significant nigral dopamine neuron loss. *Neurobiology of disease*, 39(1), 105-115.

Squire, L., Berg, D., Bloom, F. E., Du Lac, S., Ghosh, A., & Spitzer, N. C. (Eds.). (2012). *Fundamental neuroscience*. Academic Press.

Sulzer, D., & Pothos, E. N. (2000). Regulation of quantal size by presynaptic mechanisms. *Reviews in the neurosciences*, 11(2/3), 159-212.

Svensson, E., Horváth-Puhó, E., Thomsen, R. W., Djurhuus, J. C., Pedersen, L., Borghammer, P., & Sørensen, H. T. (2015). Vagotomy and subsequent risk of Parkinson's disease. *Annals of Neurology*, 78(4), 522-529.

Svensson, E., Horvth-Puh, E., Thomsen, R. W., Djurhuus, J. C., Pedersen, L., Borghammer, P., & Srensen, H. T. (2015). Does vagotomy reduce the risk of Parkinson's disease: The authors reply. *Annals of Neurology*, 78(6), 1012-1013.

- Tashiro, Y., Kaneko, T., Sugimoto, T., Nagatsu, I., Kikuchi, H., & Mizuno, N. (1989). Striatal neurons with aromatic L-amino acid decarboxylase-like immunoreactivity in the rat. *Neuroscience letters*, *100*(1), 29-34.
- Temlett, J. A., & Thompson, P. D. (2006). Reasons for admission to hospital for Parkinson's disease. *Internal medicine journal*, *36*(8), 524-526.
- Tieu, K., Ischiropoulos, H., & Przedborski, S. (2003). Nitric oxide and reactive oxygen species in Parkinson's disease. *IUBMB life*, *55*(6), 329-335.
- Tomlinson, C. L., Stowe, R., Patel, S., Rick, C., Gray, R., & Clarke, C. E. (2010). Systematic review of levodopa dose equivalency reporting in Parkinson's disease. *Movement disorders*, *25*(15), 2649-2653.
- Toth, C., Rajput, M., & Rajput, A. H. (2004). Anomalies of asymmetry of clinical signs in parkinsonism. *Movement disorders*, *19*(2), 151-157.
- Tysnes, O. B., & Storstein, A. (2017). Epidemiology of Parkinson's disease. *Journal of Neural Transmission*, 1-5.
- Venton, B. J., Zhang, H., Garris, P. A., Phillips, P. E., Sulzer, D., & Wightman, R. M. (2003). Real-time decoding of dopamine concentration changes in the caudate-putamen during tonic and phasic firing. *Journal of neurochemistry*, *87*(5), 1284-1295.
- Vieira-Coelho, M. A., & Soares-Da-Silva, P. (1998). Uptake and intracellular fate of L-DOPA in a human intestinal epithelial cell line: Caco-2. *American Journal of Physiology-Cell Physiology*, *275*(1), C104-C112.
- Vingerhoets, F. J., Schulzer, M., Calne, D. B., & Snow, B. J. (1997). Which clinical sign of Parkinson's disease best reflects the nigrostriatal lesion?. *Annals of neurology*, *41*(1), 58-64.
- Volkman, J. (2004). Deep brain stimulation for the treatment of Parkinson's disease. *Journal of clinical neurophysiology*, *21*(1), 6-17.

Wenning, G. K., Ebersbach, G., Verny, M., Chaudhuri, K., Jellinger, K., McKee, A., ... & Litvan, I. (1999). Progression of falls in postmortem-confirmed parkinsonian disorders. *Movement Disorders*, 14(6), 947-950.

Wider, C., Russmann, H., Villemure, J. G., Robert, B., Bogousslavsky, J., Burkhard, P. R., & Vingerhoets, F. J. (2006). Long-duration response to levodopa in patients with advanced Parkinson disease treated with subthalamic deep brain stimulation. *Archives of neurology*, 63(7), 951-955.

Wierzbicka, M. M., Staude, G., Wolf, W., & Dengler, R. (1993). Relationship between tremor and the onset of rapid voluntary contraction in Parkinson's disease. *Journal of Neurology, Neurosurgery & Psychiatry*, 56(7), 782-787.

Yeh, K. C., August, T. F., Bush, D. F., Lasseter, K. C., Musson, D. G., Schwartz, S., ... & Titus, D. C. (1989). Pharmacokinetics and bioavailability of Sinemet CR: a summary of human studies. *Neurology*, 39(11 Suppl 2), 25-38.

Zadikoff, C., Fox, S. H., Tang-Wai, D. F., Thomsen, T., de Bie, R., Wadia, P., ... & Marras, C. (2008). A comparison of the mini mental state exam to the Montreal cognitive assessment in identifying cognitive deficits in Parkinson's disease. *Movement disorders*, 23(2), 297-299.

Zaidel, A., Arkadir, D., Israel, Z., & Bergman, H. (2009). Akineto-rigid vs. tremor syndromes in Parkinsonism. *Current opinion in neurology*, 22(4), 387-393.

Zappia, M., Oliveri, R. L., Montesanti, R., Rizzo, M., Bosco, D., Plastino, M., ... & Quattrone, A. (1999). Loss of long-duration response to levodopa over time in PD Implications for wearing-off. *Neurology*, 52(4), 763-763.

Zhuang, X., Mazzoni, P., & Kang, U. J. (2013). The role of neuroplasticity in dopaminergic therapy for Parkinson disease. *Nature Reviews Neurology*, 9(5), 248-256.

Zibetti, M., Merola, A., Rizzi, L., Ricchi, V., Angrisano, S., Azzaro, C., ... & Rizzone, M. (2011). Beyond nine years of continuous subthalamic nucleus deep brain stimulation in Parkinson's disease. *Movement Disorders*, 26(13), 2327-2334.

Zigmond, M. J. (1997). Do compensatory processes underlie the preclinical phase of neurodegenerative disease? Insights from an animal model of parkinsonism. *Neurobiology of disease*, 4(3), 247-253.

Zoli, M., Jansson, A., Syková, E., Agnati, L. F., & Fuxe, K. (1999). Volume transmission in the CNS and its relevance for neuropsychopharmacology. *Trends in pharmacological sciences*, 20(4), 142-150.

Appendices

Appendix A: Letter of Information and Consent

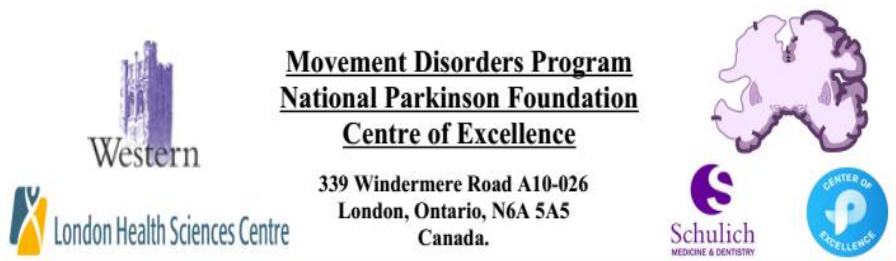

Letter of Information and Consent- PD Patient group

Study Title

Normative whole-body kinematic data of responsiveness to levodopa in a Parkinson disease cohort.

Principal Investigator

Dr. Mandar Jog, MD Neurology, London Health Science Movement Disorders Clinic
University Hospital (XXX) XXX-XXXX ext. XXXX

This consent form explains the research study you are invited to join as part of the Parkinson disease (PD) patient group. Please ask the study doctors or the study personnel to explain any words or facts that you do not understand. You should keep a signed copy of this consent form. You may wish to discuss this study with your family and friends before making your decision. If you decide to take part in the research study, you must sign this form before you have anything done for this research study.

Study Doctors and Personnel

- Dr. Mandar Jog
- Dr. Rajni V. Patel
- Dr. Philippe Rizek
- Dr. Niraj Kumar
- Mr. Marcus Pieterman
- Mr. Greydon Gilmore
- Mr. Navid Baktash
- Mr. Jai Patel
- Ms. Adrianna Tsang
- Ms. Shahbazi Mahya
- Mr. Farokh Atashzar
- Mr. Christopher Ward
- Ms. Lauren Tindale
- Mr. Mitchell Adamson
- Ms. Carly Jackson

Background and Purpose of Study

The gold standard of care for Parkinson disease (PD) is the use of levodopa to manage common motor symptoms associated with the disorder. Common motor symptoms include tremor, slowness of movement, rigidity and postural instability. However, in advanced stages of PD, the efficacy of levodopa can decline and motor symptoms fluctuate throughout the day. As these motor fluctuations occur, significant impact to the individual's quality of life makes treatment difficult. After 5 years of oral levodopa treatment, more than half of all individuals with PD develop levodopa-related complications, such as motor fluctuation and dyskinesia's (involuntary muscle movements).

Our observational project will study 80 participants with PD and 80 control participants. It is considered an observational study because no therapeutic intervention is involved. PD participants will be further divided into disease duration cohorts to examine motor fluctuations at various stages in PD. A combination of clinical rating scales and full-body kinematic measurements will be used to assess motor symptoms in participants. By using motion sensors that are miniaturized and non-intrusive, these wearable devices will accurately measure motor symptoms. PD participants will be assessed OFF (where therapy is not providing benefit in terms of stiffness and mobility) and ON (where therapy is providing benefit in terms of stiffness and mobility) levodopa. In this study, a participant is to be considered OFF levodopa when it has been 12 or more hours since their last dose of levodopa medication has been taken. A participant is to be considered ON levodopa at approximately 45 minutes after taking their normal dose of levodopa. By assessing PD participants in the ON and OFF state, responsivity to the drug can be defined at different points in the disease duration. This will assist in characterizing which motor symptoms become more or less responsive to levodopa as PD progresses. Furthermore, insight into the evolution of motor symptoms in response to levodopa in PD participants will assist physicians in optimizing levodopa treatment at each point in disease duration.

Study Procedures

Based on your screening information, the study doctor will determine if you are eligible to join this study.

If you decide to join, you will be asked to sign this consent form and you must agree to follow the instructions given by the research staff during the study.

This study requires you to attend 1 visit (approximately 3 hours) at the research facility. The visit will require you to come to Dr. Jog's research facilities located in Thomson Hall Engineering Building at Western University in London, Ontario. Please note that the participant must be **OFF** all levodopa medication for 12 hours prior to the visit. The last dose taken by the participant should be the evening before the visit at no later than 8:00 PM.

You will undergo the following procedures and tests during your visit:

- You will be asked about your medical history, any ongoing medical conditions you may have and specific information about the history of your Parkinson's disease. You will be asked to provide your current medications with specific information about the length of time you have been on your PD medications.
- You will be asked to use a haptic device to perform a task in a virtual environment displayed on a monitor.
- You will be asked to perform a walking task with sensors placed on your leg and shoes.
- You will be asked to use an assistive writing device while writing.
- You will be asked for your height and weight, and specific limb measurements will be taken (i.e. Foot length).
- You will be videotaped from the neck down. Videotape recordings help to corroborate and validate the kinematic recordings to actual participant state during analysis. Videotape recordings will be kept for 5 years.
- A UPDRS test will be performed in both ON and OFF state. This UPDRS test is commonly used to assess Parkinson's motor symptoms and includes assessments of your speech, facial expressions, balance, and arm and leg movements.
- You will be asked to place a motion capture suit over your regular clothes in order to conduct various motor tasks.
- You will be asked to perform sitting tasks such as arms at rest, arms held up in front of your body and turning each hand over in a pronation-supination motion. Following this, you will be asked to walk around a 25 meter walkway at your normal pace, four times. You will then be asked to walk at your fast-as-possible pace around the track, four times. Finally, you will be asked to walk backwards for 10 meters, twice.
- You will be asked to perform speech tasks into a microphone which will involve the repetition of certain lingual sounds and the reading of passages aloud.
- You will be asked to complete all motor and speech tasks during both your OFF and ON medication state.
- You will be asked to take your normal dosage of medication mid-way through the visit.
- You will complete several clinical scales including: geriatric depression scale, Montreal cognitive assessment, unified dyskinesia rating scale, activity balance confidence scale, speech assessment scale, Parkinson's disease questionnaire and

freezing of gait questionnaire.

At the end of your visit you will resume your usual PD medication schedule.

Potential Benefits

There may be no direct benefit from taking part in the study, but the information gained from this study may help to better treat patients with Parkinson's disease in the future.

Risks and Discomforts

The full body suit is a light weight and fully portable technology for collecting information about your mobility. There is a minimal risk associated with wearing such a suit as the system only uses simple sensors that are attached to the suit. Some study participants may experience discomfort such as itching and sweating while wearing the suit.

Some study participants may experience minor emotional distress with completing the scales and questionnaires. Scales will be administered by an experienced researcher trained in administering items in a sensitive manner. You will be allowed rest periods as necessary during the scales and questionnaires to facilitate comfort.

Some study participants may experience fatigue with the laboratory walking tasks. The walking tasks are simple walking and turning tasks that do not contain any obstacles or barriers. The tasks are not designed to evaluate falling. Therefore, the risk of falling will be equal to the risk of falling during routine walking and turning in everyday life. The data is collected wirelessly, so there are no intrusive wires in the walking path.

Voluntary Participation

Participation in this study is voluntary. At any point during the study, you may refuse to participate, refuse to answer any questions or withdraw from the study with no effect on your future care.

Any new information learned during your participation in the study that may affect your decision to partake in the study will be relayed to you.

You are free to withdraw from the study at any time.

If you withdraw from the study, we will need to use the data collected up to your withdrawal (data will not identify you).

Physical Injury Resulting from Participation

You should report any discomforts, problems, or research related injuries immediately to Dr. Mandar Jog at XXX-XXX-XXXX Ext. XXXXX. If you are injured and that injury was caused by direct participation in the study, your doctor will provide usual

medical care. If this occurs, you will not be financially responsible for medical expenses.

Participation Discontinuation

You may be asked to leave the study if you do not follow directions or if the study shows signs of causing medical harm to you. If you are asked to leave the study, the reasons will be discussed with you.

Compensation

You will not receive any monetary compensation for your participation in this study.

Study-related Communications

In order to participate in the program we will ask for you to provide your phone number to the study team and to advise the study team if your phone number changes during the study.

Data Collection, Use of information and Confidentiality

The data collected from you for the study will be kept electronically and securely using the LHSC computer network. No information identifying you will be sent outside of the hospital. The study doctor and staff will keep all study data in a secure and confidential location for 15 years. A list linking your study number with your name will be kept by the study doctor in a secure place, separate from your study file.

Information and data obtained in the study will not be labeled with any of your personal information that will be collected (name, initials, partial date of birth, medical record number, etc.). To help ensure that your information is kept confidential, you will be assigned a unique participant number, a number special to you for this study. Only research study staff will be able to access this number and link it with your personal information. .

Representatives from University of Western Ontario Health Sciences Research Ethics Board and Lawson's Quality Assurance and Education Program may have access to study related information in order to ensure the study is following the proper laws and regulations. De-identified information (all identity will be blacked out & not revealed) from your health records may be copied and used to confirm the study procedures. Your records will be kept as private as possible under the law. Total privacy cannot be promised. By signing this consent form, you are allowing someone to review your records.

Conflict of Interest

All of the doctors treating you have an interest in completing this study. Their interests should not influence your decision to participate in this study.

Questions about the Study

For more information about this research study, or if you believe that you may have a research related injury or experienced any side effects as a result of participating in this study you may call Dr. Mandar Jog at XXX-XXX-XXXX. If you have questions about the conduct of the study or your rights as a research participant, you may call Dr. David Hill, Scientific Director, Lawson Health Research Institute at XXX-XXX-XXXX.

You do not waive any legal rights by signing the consent form. You will receive a copy of the letter of information for your records.

Consent to Participate- PD Patient Group

I have read the Letter of Information, have had the nature of the study explained to me and I agree to participate. All questions have been answered to my satisfaction.

| | | |
|-----------------------------------|--------------|------|
| Signature of Research Participant | Printed Name | Date |
|-----------------------------------|--------------|------|

| | | |
|---------------------------|--------------|------|
| Signature of Investigator | Printed Name | Date |
|---------------------------|--------------|------|

| | | |
|---------------------------------------|--------------|------|
| Signature of Person Obtaining Consent | Printed Name | Date |
|---------------------------------------|--------------|------|

Appendix B: Ethics Approval



Research Ethics

Western University Health Science Research Ethics Board HSREB Amendment Approval Notice

Principal Investigator: Dr. Mandar Jog
Department & Institution: Schulich School of Medicine and Dentistry/Clinical Neurological Sciences, London Health Sciences Centre

Review Type: Full Board
HSREB File Number: 107253
Study Title: Normative whole-body kinematic data of responsivity to Levodopa in Parkinson disease

HSREB Amendment Approval Date: December 30, 2015
HSREB Expiry Date: November 27, 2016

Documents Approved and/or Received for Information:

| Document Name | Comments | Version Date |
|---|---------------------------|--------------|
| Revised Western University Protocol | | 2015/12/11 |
| Revised Letter of Information & Consent | Control Group-Version 3.0 | 2015/12/11 |
| Revised Letter of Information & Consent | PD group-version 3.0 | 2015/12/11 |

The Western University Health Science Research Ethics Board (HSREB) has reviewed and approved the amendment to the above named study, as of the HSREB Initial Approval Date noted above.

HSREB approval for this study remains valid until the HSREB Expiry Date noted above, conditional to timely submission and acceptance of HSREB Continuing Ethics Review.

The Western University HSREB operates in compliance with the Tri-Council Policy Statement Ethical Conduct for Research Involving Humans (TCPS2), the International Conference on Harmonization of Technical Requirements for Registration of Pharmaceuticals for Human Use Guideline for Good Clinical Practice Practices (ICH E6 R1), the Ontario Personal Health Information Protection Act (PHIPA, 2004), Part 4 of the Natural Health Product Regulations, Health Canada Medical Device Regulations and Part C, Division 5, of the Food and Drug Regulations of Health Canada.

Members of the HSREB who are named as Investigators in research studies do not participate in discussions related to, nor vote on such studies when they are presented to the REB.

The HSREB is registered with the U.S. Department of Health & Human Services under the IRB registration number IRB 00000940.

 _____
Ethics Officer, on behalf of Dr. Marcelo Kremenutzky, HSREB Vice Chair

Ethics Officer to Contact for Further Information: Erika Basila Nicole Kaniki Grace Kelly Mina Mekhail Vikki Tran

This is an official document. Please retain the original in your files

Appendix C: Z-Score Formula

$$Z\text{-score} = (SM - PM) / (\text{STD of PM} / \sqrt{n})$$

Where:

SM; sample mean

PM; population mean

STD; standard deviation

$\sqrt{\quad}$; square root

n; sample size

Appendix D: Montreal Cognitive Assessment (MoCA) Scale

NAME: _____
 Education: _____ Date of birth: _____
 Sex: _____ DATE: _____

MONTREAL COGNITIVE ASSESSMENT (MOCA)
 Version 7.1 Original Version

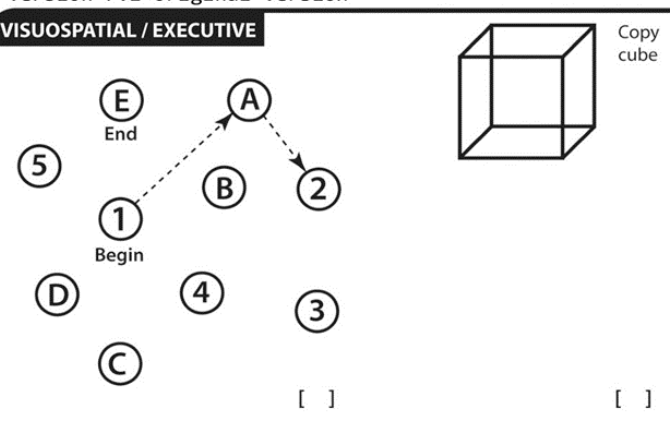
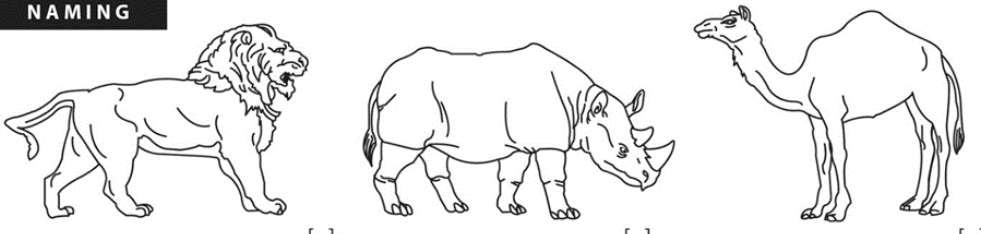
| VISUOSPATIAL / EXECUTIVE | | | | | | | POINTS |
|---|-----------|--|--------|--------|-------|-----|-------------------------------|
|  <p style="text-align: right;">[] []</p> | Copy cube | Draw CLOCK (Ten past eleven) (3 points) | | | | | [] / 5 |
| NAMING | | | | | | | |
|  <p style="text-align: center;">[] [] []</p> | | | | | | | ___/3 |
| MEMORY | | | | | | | |
| Read list of words, subject must repeat them. Do 2 trials, even if 1st trial is successful. Do a recall after 5 minutes. | | FACE | VELVET | CHURCH | DAISY | RED | No points |
| 1st trial | | | | | | | |
| 2nd trial | | | | | | | |
| ATTENTION | | | | | | | |
| Read list of digits (1 digit/ sec.). Subject has to repeat them in the forward order [] 2 1 8 5 4 Subject has to repeat them in the backward order [] 7 4 2 | | | | | | | ___/2 |
| Read list of letters. The subject must tap with his hand at each letter A. No points if ≥ 2 errors [] F B A C M N A A J K L B A F A K D E A A A J A M O F A A B | | | | | | | ___/1 |
| Serial 7 subtraction starting at 100 [] 93 [] 86 [] 79 [] 72 [] 65 4 or 5 correct subtractions: 3 pts , 2 or 3 correct: 2 pts , 1 correct: 1 pt , 0 correct: 0 pt | | | | | | | ___/3 |
| LANGUAGE | | | | | | | |
| Repeat: I only know that John is the one to help today. [] The cat always hid under the couch when dogs were in the room. [] | | | | | | | ___/2 |
| Fluency / Name maximum number of words in one minute that begin with the letter F [] ____ (N ≥ 11 words) | | | | | | | ___/1 |
| ABSTRACTION | | | | | | | |
| Similarity between e.g. banana - orange = fruit [] train - bicycle [] watch - ruler | | | | | | | ___/2 |
| DELAYED RECALL | | | | | | | |
| Has to recall words WITH NO CUE | | FACE | VELVET | CHURCH | DAISY | RED | Points for UNCUEd recall only |
| | | [] | [] | [] | [] | [] | |
| Optional | | | | | | | |
| Category cue | | | | | | | |
| Multiple choice cue | | | | | | | |
| ORIENTATION | | | | | | | |
| [] Date [] Month [] Year [] Day [] Place [] City | | | | | | | ___/6 |
| © Z.Nasreddine MD www.mocatest.org Normal ≥ 26 / 30 | | TOTAL | | | | | ___/30 |
| Administered by: _____ | | Add 1 point if ≤ 12 yr edu | | | | | |

Appendix E: Activities-specific Balance Confidence (ABC) Scale

Instructions to Participants:

For each of the following, please indicate your level of confidence in doing the activity without losing your balance or becoming unsteady from choosing one of the percentage points on the scale from 0% to 100%. If you do not currently do the activity in question, try and imagine how confident you would be if you had to do the activity. If you normally use a walking aid to do the activity or hold onto someone, rate your confidence as it you were using these supports. If you have any questions about answering any of these items, please ask the administrator. The Activities-specific Balance Confidence (ABC) Scale* For each of the following activities, please indicate your level of self-confidence by choosing a corresponding number from the following rating scale:

0% 10 % 20% 30% 40% 50% 60% 70% 80% 90% 100%

no confidence

completely confident

“How confident are you that you will not lose your balance or become unsteady when you...

1. ...walk around the house? ____%
2. ...walk up or down stairs? ____%
3. ...bend over and pick up a slipper from the front of a closet floor ____%
4. ...reach for a small can off a shelf at eye level? ____%
5. ...stand on your tiptoes and reach for something above your head? ____%
6. ...stand on a chair and reach for something? ____%
7. ...sweep the floor? ____%
8. ...walk outside the house to a car parked in the driveway? ____%
9. ...get into or out of a car? ____%
10. ...walk across a parking lot to the mall? ____%
11. ...walk up or down a ramp? ____%
12. ...walk in a crowded mall where people rapidly walk past you? ____%
13. ...are bumped into by people as you walk through the mall? ____%
14. ...step onto or off an escalator while you are holding onto a railing? ____%
15. ... step onto or off an escalator while holding onto parcels such that you cannot hold onto the railing? ____%
16. ...walk outside on icy sidewalks? ____%

*Powell, LE & Myers AM. The Activities-specific Balance Confidence (ABC) Scale. *J Gerontol Med Sci* 1995; 50(1): M28-34

Appendix F: Geriatric Depression Scale (GDS)

Please indicate 'Yes' or 'No' for the following questions:

1. Are you basically satisfied with your life? _____
2. Have you dropped many of your activities and interests? _____
3. Do you feel that your life is empty? _____
4. Do you often get bored? _____
5. Are you hopeful about the future? _____
6. Are you bothered by thoughts you can't get out of your head? _____
7. Are you in good spirits most of the time? _____
8. Are you afraid that something bad is going to happen to you? _____
9. Do you feel happy most of the time? _____
10. Do you often feel helpless? _____
11. Do you often get restless and fidgety? _____
12. Do you prefer to stay at home, rather than going out and doing new things? _____
13. Do you frequently worry about the future? _____
14. Do you feel you have more problems with memory than most? _____
15. Do you think it is wonderful to be alive now? _____
16. Do you often feel downhearted and blue? _____
17. Do you feel pretty worthless the way you are now? _____
18. Do you worry a lot about the past? _____
19. Do you find life very exciting? _____
20. Is it hard for you to get started on new projects? _____
21. Do you feel full of energy? _____
22. Do you feel that your situation is hopeless? _____
23. Do you think that most people are better off than you are? _____
24. Do you frequently get upset over little things? _____
25. Do you frequently feel like crying? _____
26. Do you have trouble concentrating? _____
27. Do you enjoy getting up in the morning? _____
28. Do you prefer to avoid social gatherings? _____
29. Is it easy for you to make decisions? _____
30. Is your mind as clear as it used to be? _____

Appendix G: Freezing of Gait Questionnaire (FOG-Q)

- 1. During your worst state—Do you walk: _____**
 - 0 Normally
 - 1 Almost normally—somewhat slow
 - 2 Slow but fully independent
 - 3 Need assistance or walking aid
 - 4 Unable to walk

- 2. Are your gait difficulties affecting your daily activities and independence?
_____**
 - 0 Not at all
 - 1 Mildly
 - 2 Moderately
 - 3 Severely
 - 4 Unable to walk

- 3. Do you feel that your feet get glued to the floor while walking, making a turn or when trying to initiate walking (freezing)? _____**
 - 0 Never
 - 1 Very rarely—about once a month
 - 2 Rarely—about once a week
 - 3 Often—about once a day
 - 4 Always—whenever walking

- 4. How long is your longest freezing episode? _____**
 - 0 Never happened
 - 1 1–2 s

- 2 3–10 s
- 3 11–30 s
- 4 Unable to walk for more than 30 s

5. How long is your typical start hesitation episode (freezing when initiating the first step)? _____

- 0 None
- 1 Takes longer than 1 s to start walking
- 2 Takes longer than 3 s to start walking
- 3 Takes longer than 10 s to start walking
- 4 Takes longer than 30 s to start walking

6. How long is your typical turning hesitation: (freezing when turning) _____

- 0 None
- 1 Resume turning in 1–2 s
- 2 Resume turning in 3–10 s
- 3 Resume turning in 11–30 s
- 4 Unable to resume turning for more than 30 s

Appendix H: Parkinson's Disease Quality of Life Questionnaire (PDQ-8)

1. Had difficulty getting around in public?

Never Occasionally Sometimes Often Always

2. Had difficulty dressing yourself?

Never Occasionally Sometimes Often Always

3. Felt depressed?

Never Occasionally Sometimes Often Always

4. Felt embarrassed in public due to having Parkinson's disease?

Never Occasionally Sometimes Often Always

5. Had problems with your close personal relationships?

Never Occasionally Sometimes Often Always

6. Had problems with your concentration, e.g. when reading or watching TV?

Never Occasionally Sometimes Often Always

7. Felt unable to communicate with people properly?

Never Occasionally Sometimes Often Always

8. Had painful muscle cramps or spasms?

Never Occasionally Sometimes Often Always

Appendix I: Unified Parkinson Disease Rating Scale

Unified Parkinson's Disease Data Form



PD *workbook*
THE **WE MOVE** CLINICIANS' GUIDE TO PARKINSON'S DISEASE

Name _____ Unit Number _____

| Date | DOPA mg/day | hrs DOPA lasts | | | | | | | | | | | | | | | | |
|---------------------------------------|-------------|----------------|----|-----|----|-----|----|-----|----|-----|----|-----|----|-----|----|-----|----|-----|
| | | | ON | OFF | ON | OFF | ON | OFF | ON | OFF | ON | OFF | ON | OFF | ON | OFF | ON | OFF |
| 1. Mentation | | | | | | | | | | | | | | | | | | |
| 2. Thought Disorder | | | | | | | | | | | | | | | | | | |
| 3. Depression | | | | | | | | | | | | | | | | | | |
| 4. Motivation/Initiative | | | | | | | | | | | | | | | | | | |
| Subtotal 1–4 (maximum = 16) | | | | | | | | | | | | | | | | | | |
| 5. Speech | | | | | | | | | | | | | | | | | | |
| 6. Salivation | | | | | | | | | | | | | | | | | | |
| 7. Swallowing | | | | | | | | | | | | | | | | | | |
| 8. Handwriting | | | | | | | | | | | | | | | | | | |
| 9. Cutting food | | | | | | | | | | | | | | | | | | |
| 10. Dressing | | | | | | | | | | | | | | | | | | |
| 11. Hygiene | | | | | | | | | | | | | | | | | | |
| 12. Turning in bed | | | | | | | | | | | | | | | | | | |
| 13. Falling | | | | | | | | | | | | | | | | | | |
| 14. Freezing | | | | | | | | | | | | | | | | | | |
| 15. Walking | | | | | | | | | | | | | | | | | | |
| 16. Tremor | | | | | | | | | | | | | | | | | | |
| 17. Sensory symptoms | | | | | | | | | | | | | | | | | | |
| Subtotal 5 – 17 (maximum = 52) | | | | | | | | | | | | | | | | | | |
| 18 Speech | | | | | | | | | | | | | | | | | | |
| 19. Facial expression | | | | | | | | | | | | | | | | | | |
| 20. Tremor at rest: face,lips,chin | | | | | | | | | | | | | | | | | | |
| Hands: right | | | | | | | | | | | | | | | | | | |
| left | | | | | | | | | | | | | | | | | | |
| Feet: right | | | | | | | | | | | | | | | | | | |
| left | | | | | | | | | | | | | | | | | | |
| 21. Action tremor: right | | | | | | | | | | | | | | | | | | |
| left | | | | | | | | | | | | | | | | | | |
| 22. Rigidity: neck | | | | | | | | | | | | | | | | | | |
| Upper extremity: right | | | | | | | | | | | | | | | | | | |
| left | | | | | | | | | | | | | | | | | | |
| Lower extremity: right | | | | | | | | | | | | | | | | | | |
| left | | | | | | | | | | | | | | | | | | |

Unified Parkinson's Disease Data Form



| Date | | | | | | | | | | | | | | | | |
|---------------------------------------|------|-------|------|-------|------|-------|------|-------|------|-------|------|-------|------|-------|------|-------|
| | ON | OFF | ON | OFF | ON | OFF | ON | OFF | ON | OFF | ON | OFF | ON | OFF | ON | OFF |
| 23. Finger taps: right | | | | | | | | | | | | | | | | |
| left | | | | | | | | | | | | | | | | |
| 24. Hand grips: right | | | | | | | | | | | | | | | | |
| left | | | | | | | | | | | | | | | | |
| 25. Hand pronate/supinate: right | | | | | | | | | | | | | | | | |
| left | | | | | | | | | | | | | | | | |
| 26. Leg agility: right | | | | | | | | | | | | | | | | |
| left | | | | | | | | | | | | | | | | |
| 27. Arise from chair | | | | | | | | | | | | | | | | |
| 28. Posture | | | | | | | | | | | | | | | | |
| 29. Gait | | | | | | | | | | | | | | | | |
| 30. Postural stability | | | | | | | | | | | | | | | | |
| 31. Body bradykinesia | | | | | | | | | | | | | | | | |
| Sub-total:18-31 (maximum =108) | | | | | | | | | | | | | | | | |
| Total points: 1-31 (max=176) | | | | | | | | | | | | | | | | |
| 32. Dyskinesia (duration) | | | | | | | | | | | | | | | | |
| 33. Dyskinesia (disability) | | | | | | | | | | | | | | | | |
| 34. Dyskinesia (pain) | | | | | | | | | | | | | | | | |
| 35. Early morning dystonia | | | | | | | | | | | | | | | | |
| 36. "Offs" (predictable) | | | | | | | | | | | | | | | | |
| 37. "Offs" (unpredictable) | | | | | | | | | | | | | | | | |
| 38. "Offs" (sudden) | | | | | | | | | | | | | | | | |
| 39. "Offs" (duration) | | | | | | | | | | | | | | | | |
| 40. Anorexia, nausea, vomiting | | | | | | | | | | | | | | | | |
| 41. Sleep disturbance | | | | | | | | | | | | | | | | |
| 42. Symptomatic orthostasis | | | | | | | | | | | | | | | | |
| Blood Pressure: seated | | | | | | | | | | | | | | | | |
| supine | | | | | | | | | | | | | | | | |
| standing | | | | | | | | | | | | | | | | |
| Weight | | | | | | | | | | | | | | | | |
| Pulse: seated | | | | | | | | | | | | | | | | |
| standing | | | | | | | | | | | | | | | | |
| Name of Examiner | | | | | | | | | | | | | | | | |
| | BEST | WORST | BEST | WORST | BEST | WORST | BEST | WORST | BEST | WORST | BEST | WORST | BEST | WORST | BEST | WORST |
| Hoehn & Yahr Stage | | | | | | | | | | | | | | | | |
| % ADL Score (PD) | | | | | | | | | | | | | | | | |
| % ADL (with dyskinesia) | | | | | | | | | | | | | | | | |

Fahn S, Elton R, Members of the UPDRS Development Committee. In: Fahn S, Marsden CD, Calne DB, Goldstein M, eds. Recent Developments in Parkinson's Disease, Vol 2. Florham Park, NJ: Macmillan Health Care Information 1987, pp 153-163, 293-304

Curriculum Vitae

Name: Marcus Pieterman

Post-secondary Education and Degrees: Western University
London, Ontario, Canada
2015-2017; MSc, Master of Science
2010-2015; BMSc, Bachelor of Medical Science

Honours and Awards: Western Graduate Research Scholarship
2015-2017

Mitacs Graduate Research Internship
2016-2017

AGE-WELL Graduate Research Scholarship
2015-2016

Related Work Experience Teaching Assistant
Western University
2015-2017; Human Physiology 3120
2016-2017; Fetal Physiology 4700