



Aalborg Universitet

AALBORG UNIVERSITY  
DENMARK

## Using Smart Meters Data for Energy Management Operations and Power Quality Monitoring in a Microgrid

Palacios-Garcia, Emilio José; Diaz, Enrique Rodriguez; Anvari-Moghaddam, Amjad; Savaghebi, Mehdi; Quintero, Juan Carlos Vasquez; Guerrero, Josep M.; Moreno-Munoz, Antonio

*Published in:*

Proceedings of the 2017 IEEE 26th International Symposium on Industrial Electronics (ISIE)

*DOI (link to publication from Publisher):*

[10.1109/ISIE.2017.8001508](https://doi.org/10.1109/ISIE.2017.8001508)

*Publication date:*

2017

*Document Version*

Accepted author manuscript, peer reviewed version

[Link to publication from Aalborg University](#)

*Citation for published version (APA):*

Palacios-Garcia, E. J., Diaz, E. R., Anvari-Moghaddam, A., Savaghebi, M., Quintero, J. C. V., Guerrero, J. M., & Moreno-Munoz, A. (2017). Using Smart Meters Data for Energy Management Operations and Power Quality Monitoring in a Microgrid. In *Proceedings of the 2017 IEEE 26th International Symposium on Industrial Electronics (ISIE)* IEEE Press. IEEE International Symposium on Industrial Electronics (ISIE) Vol. 2017 <https://doi.org/10.1109/ISIE.2017.8001508>

### General rights

Copyright and moral rights for the publications made accessible in the public portal are retained by the authors and/or other copyright owners and it is a condition of accessing publications that users recognise and abide by the legal requirements associated with these rights.

- ? Users may download and print one copy of any publication from the public portal for the purpose of private study or research.
- ? You may not further distribute the material or use it for any profit-making activity or commercial gain
- ? You may freely distribute the URL identifying the publication in the public portal ?

# Using Smart Meters Data for Energy Management Operations and Power Quality Monitoring in a Microgrid

Emilio J. Palacios-Garcia<sup>1</sup>, Enrique Rodriguez-Diaz<sup>2</sup>, Amjad Anvari-Moghaddam<sup>2</sup>, Mehdi Savaghebi<sup>2</sup>,  
Juan C. Vasquez<sup>2</sup>, Josep M. Guerrero<sup>2</sup>, and Antonio Moreno-Munoz<sup>1</sup>

<sup>1</sup>Department of Computer Architecture, Electronics and Electronic Technology. University of Cordoba. Cordoba, Spain.

<sup>2</sup>Department of Energy Technology. Aalborg University. Aalborg, Denmark.

{p92pagae, amoreno}@uco.es, {erd, aam, mes, juq, joz}@et.aau.dk

**Abstract**—Smart metering devices have become an essential part in the development of the current electrical network toward the paradigm of Smart Grid. These meters present in most of the cases, functionalities whose analysis capabilities go further beyond the basic automated meter readings for billing purposes, integrating HAN/BAN communications, alarms and power quality indicators in some cases. All those characteristics make this widely spread equipment a free, accurate and flexible source of information that can replace expensive and dedicated devices. Therefore, this paper presents the integration of a commercial advanced metering infrastructure (AMI) in the context of a smart building with an energy management system (EMS). Furthermore, power quality monitoring based on this AMI is explained. All the details regarding the implementation in a laboratory scale application, as well as the obtained results, are provided.

**Index Terms**—Advanced metering infrastructure, smart meter, energy management system, power quality, microgrid

## I. INTRODUCTION

Nowadays, smart meters (SMs) are rapidly spreading among the European Countries, as well as the United States due to a global consensus about the necessity of decreasing the electrical consumption and changing the centralized paradigm of the grid to a distributed architecture. This trend is being promoted in some cases by national or international commissions, as in the case of Europe, and, although the penetration rate is not homogeneous [1], these devices are playing and will play a main role in the new smart grid [2].

The advanced features that they add to the electrical grid fully justify the success and significance of the SMs against the classical metering equipment, where the periodic manual billing has been replaced by a bidirectional information flow between customers and utilities [3]. All of these, mainly due to the development of a vast network infrastructure and specific international communication standards [4].

In this context, the advanced metering infrastructures (AMI) have found two principal fields of application that go beyond the simple energy billing. Those fields are the energy management systems (EMS) [5] and the system state monitoring, specifically in terms of power quality (PQ).

In the first case, for the development of EMS or demand response (DR) strategies, additional metering devices were to be installed to successfully implement the control and energy

reduction measures [6]. Nevertheless, the SMs provide now power measurements of each household or even a whole buildings with time intervals that range from 5 minutes up to 1 hour. This is fast enough for performing the optimization tasks [7]. Moreover, it is even possible to disaggregate each appliance used by the dwellings, although this operation requires advanced processing and higher sampling rates [8].

Likewise, the assessment of the network state, although performed in a relatively simple way, can be provided by the SMs [9]. Thus, not only have these devices benefits for the end users, but the network operator can take advantage of the distributed measures. Therefore, the basic PQ capabilities of the meters can be used in order to have real-time information of the whole system with a minimum investment [10].

Therefore, this paper describes the integration of an AMI in a microgrid to perform energy management operations and power quality monitoring. This integration is addressed with a proposed network topology and using a commercial AMI that was implemented in different scenarios employing a laboratory scale simulation of an actual microgrid applied to a building.

## II. SYSTEM ARCHITECTURE

In order to contextualize the integration of the SMs in a microgrid regulated by an EMS, the system is described first from the hardware point of view and, subsequently, from the information and communication technology (ICT) viewpoint.

### A. Hardware Installation

The proposed framework is shown in Fig. 1. As it can be seen, an AC/DC microgrid was selected, where the individual consumers (Apartments) have an AC connection, whereas the distributed energy resources (Wind Turbine and Solar PV Panels), the common facilities (Load) and other elements such as electrical vehicles (EV) are connected to a DC bus.

This DC side is interfaced with the AC grid of the building so all the individual proprietaries can benefit from the energy generation in order to decrease the amount of energy that must be supplied by the main grid, whilst the DC side reduces the number of necessary converters. Therefore, as proposed in [11] this architecture has been selected since it increases the efficiency of the whole system.

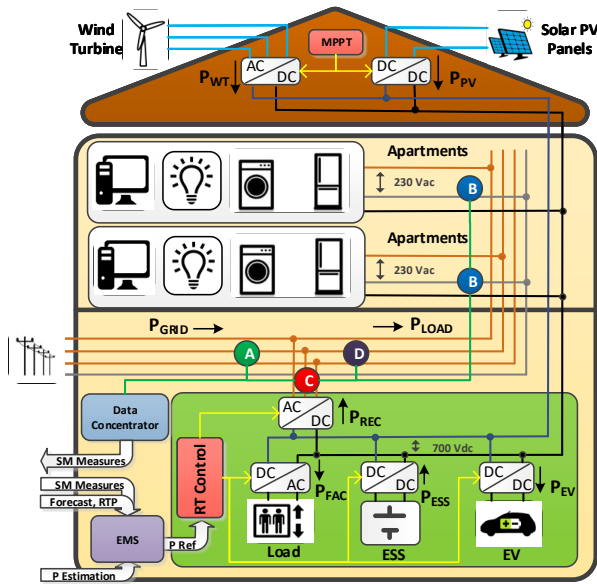

Fig. 1. Architecture of a AC/DC microgrid for a residential building.

In this framework, if energy management operations, as well as power quality supervision, are to be implemented, the SMs can be used at different points of the system. First, since the whole building or community is operating as a microgrid that is able to exchange energy with the grid, and this energy has to be billed, a metering device should be placed in the connection represented by the green circle A.

In addition, each household has a different consumption pattern, so an individual SM is needed to account for this, as it is shown in Fig. 1 by the blue circles named B. If SMs are installed in A and B, both the individual consumption and the energy exchanged with the grid can be measured for billing purposes. Furthermore, information about the individual consumption is available for the EMS, as well as

global (A) and individual (B) indicators for PQ monitoring.

Nevertheless, additional SMs can be installed in the interface between the building AC grid and the rectifier (red circle C) if additional information about the energy exchanges and the PQ of the power injected into the AC building network want to be collected. Moreover, for more detailed information, an additional SM can be placed in the common AC bus of the building, represented in Fig. 1 by the purple circle D. This SM might not send new information to the EMS since it measures the aggregate demand of each individual SMs B, but it will provide information about the global state of the AC bus, and can help to detect PQ issues such as voltage events or total harmonic distortion (THD).

### B. Communications and logical architecture of the system

From the communication point of view, as it can be seen in Fig. 2, the system consists of three main logical blocks, which are the AMI, composed of the physical devices, as well as the software for obtaining the measurements, the meter data management system (MDMS), and the EMS.

The AMI is divided into two levels. In the first layer, the AMI physical Network can be found (red block). This part comprises all the physical SMs, as well as the data concentrator that collects their measures periodically, and it is permanently connected to a Network Time Protocol (NTP) server to synchronize the timestamps. The communication between the SMs and the data concentrator is based on the standard EN 13757-5 that implements a radio mesh topology. Moreover, they are compliance with the IEC 62056, the international standard of the DLMS/COSEM specification (Device Language Message Specification / Companion Specification for Energy Metering).

Regarding the electrical measures, all the model of Smart Meters that are being used (3-phase meters, single-phase meters and CT-Meters), belonging to the Kamstrup OMNIA suite, are compliance with international standards. They

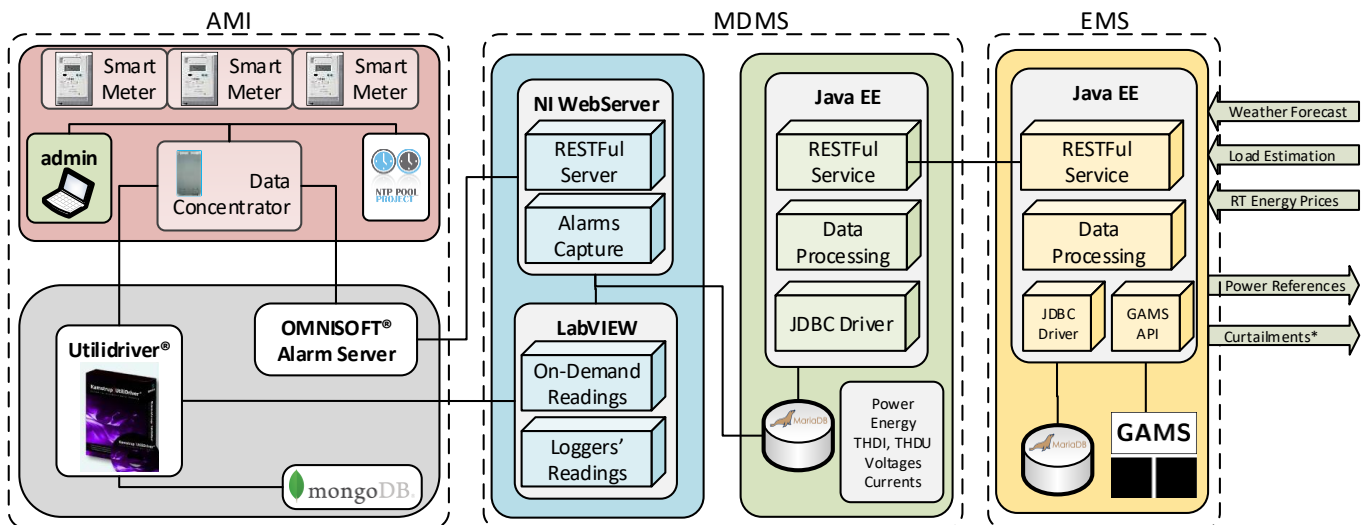

Fig. 2. Logical Architecture of the System.

measure active positive energy (EN 50470-1 and EN 50470-3), reactive energy, and active negative energy (IEC 62052-11, IEC 62053-21 and IEC 62053-23), as well as PQ according to EN 50160.

The second layer (gray block) integrates the logical software provided by the manufacturer to ensure efficient interoperability with the AMI network. This software communicates over Ethernet with the data concentrator and implements all the back-end processes that are necessary to configure the system, perform on-demand operation readings and capture the periodic records. In parallel with this, the data concentrator is also able to forward the alarms produced with the AMI network. For that aim, a service is constantly listening and capturing these events that can subsequently be sent by email or posted to a web service.

The MDMS block is responsible for capturing the data, store them and make them accessible. Therefore, it is the key connection point between the AMI and additional features to be implemented. It is composed of two layers. The first one is the management unit (blue block). This software was implemented using the LabVIEW visual programming language and is composed of two main systems. On the one hand, a RESTful server was built using the NI WebServer in order to capture the Alarms that are forwarded by the Alarm Server. The information contained in these alarms, sent as an XML packet, is read by the LabVIEW program and subsequently stored. On the other hand, a desktop application with a general user interface (GUI) was developed for performing two tasks: to query on-demand readings from the AMI Network and to read the periodic measurements stored in the SMs' loggers.

It should be pointed out that although the head-end software is connected to a local MongoDB database, it is a temporal storage with a maximum deep of 3 days and with a fixed structure that cannot be modified. Moreover, the alarms triggered in the system are not recorded by this database. Thus, the second layer of the MDMS is the storage system (green block), implemented using the database engine MariaDB. This database is structured in a flexible way, so new meters and types of measurements can be added. Furthermore, it is not limited to a specific manufacturer, since the measured variables are defined by their standard OBIS codes (IEC 62056).

On top of this, the JAVA application implements a RESTful service for reading the data with various layers of security for the measures, allowing a simple communication using the HTTPS protocol and JSON or XML format. This makes the system compatible with any other third-party software.

Finally, the EMS (yellow block) queries the necessary measurements from the SMs to the data management system and together with additional information such as weather forecast, real-time energy prices or load estimation generates the power references that can be used by the converters. Another JAVA EE server is used for this task, connected to GAMS software for running the optimization process.

Regarding the PQ supervision, the MDMS is able to record global indicators such as a current and voltage THD (THDI,

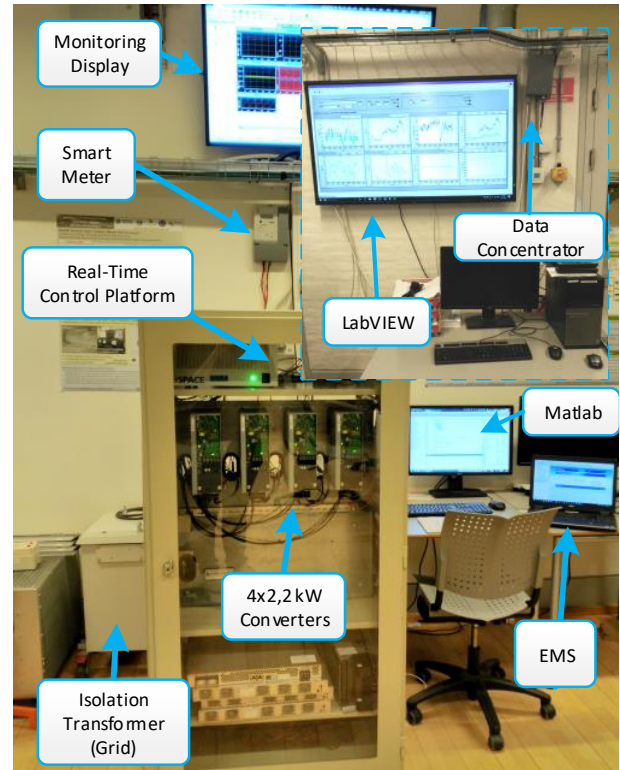

Fig. 3. Hardware Setup for the tests.

THDU) and power factor, as well as different PQ events (voltage variations, unbalances, etc). Those indicators can be read using the web service and also by means of the LabVIEW application that will be described in the subsection III.B.

### III. EXPERIMENTAL RESULTS

The system was tested using a small scale laboratory setup that can emulate different element of the building microgrid such as the households consumption, the battery charger or the rectifier. This setup is equipped with the SMs.

#### A. Setup installation

The test bench for the experiments can be visualized in Fig. 3, as well as the central system and data concentrator for the AMI (block in the top-right corner). This setup is part of the Microgrids Research Laboratory at Aalborg University [12].

The setup is composed of 4 converters with a total nominal power of 8 kW connected to the AC grid through an AC isolation transformer and to a common DC bus. In this system, the SMs are placed in the AC connection. These SMs are connected, as was mentioned in Section II.B, to a data concentrator using a wireless mesh network. This data concentrator, shown in the block located at the top-right site of Fig. 3, is connected to a central PC where the MDMS is running, which will be described in the following section.

Regarding the four converters, they are commanded from a real-time control platform which contains the necessary inner voltage, current and power control loops to ensure the stability of the system. Using an Ethernet communication, the



Fig. 4. Screenshot of the developed GUI.

real-time control platform is linked to a PC where the system is monitored. In addition, the power references for the power control are sent to the platform from a PC running MATLAB which uses the same Ethernet communication.

On the top of that, these power references are obtained from an EMS previously developed [13]. This EMS is running on a laptop connected to the local network of the laboratory through a wireless protocol (Wi-Fi). The system has as one of the input vectors the SMs readings corresponding to the households and global consumption, so it communicates with the MDMS for obtaining the readings, therefore, closing the loop.

As far as the PQ monitoring is concerned, no specific application has been developed, yet the THDI and THDU of each meter, as well as the voltage and PQ events, can be read from the MDMS using the provided web service, and visualized through a LabVIEW application whose functionalities will be described in the next subsection.

### B. Application for smart metering monitoring

As explained in Section II.B, the communication between the AMI and the MDMS is implemented by using a LabVIEW application. This application integrates most of the functionalities needed for the communication with the SMs installed in the above-described setup, and provides a GUI to manage the system. The GUI, shown in Fig. 4, is composed of two main parts. On the top of the screen, the panels corresponding to different configuration options and notifications can be found. The rest of the screen is devoted to a tab structure with different capabilities.

In the first panel, (*Monitoring parameters*) the basic configuration to communicate with the head-end and subsequently the meters is made. The next panel named *Real-Time Monitoring* is used for the configuration of the

on-demand reading module, as well as for checking the status of the performed queries, whereas the communication with the database is controlled in the panel named *Capture*. In addition, The LabVIEW interface is not only able to generate on-demand requests for the measurement of selected variables, but different configuration commands and loggers can also be read. Therefore, to check the status of this queries, the panel *On-Demand Commands* was developed. Finally, the last panel that can be found in the LabVIEW interface is devoted to the system alarms.

Regarding the tab structure, the first panel in Fig. 4 and named as *Monitoring*, shows the real-time measures of the on-demand readings, which are from left to right and from top to bottom, 3-phase voltages, 3-phase currents, frequency, powers, THDU, THDI, global power factor, and energy. The second tab allows configuring and querying the voltage quality logger of the SMs for voltage events, whose possibilities are shown in the last subsection III.D. The third tab with the name *Load Profile* is employed for the visualization and configuration of the load profile logger. This logger automatically records the energy measurements of the SMs for a given time interval that can be configured by the user. The tab four named as *Analysis Logger* is used for setting up and visualizing the analysis logger of the SMs, similar to the Profile Logger, but configurable by the user. In this test, it recorded information regarding current and voltage THDs and power factor for the PQ monitoring. Finally, the last tab is used for querying the power quality logger, where different PQ events are registered according to the EN 50160.

### C. Profiles Monitoring for EMS

In the first scenario, the profile of a single household was generated by a 3-phase inverter, whilst measuring the output



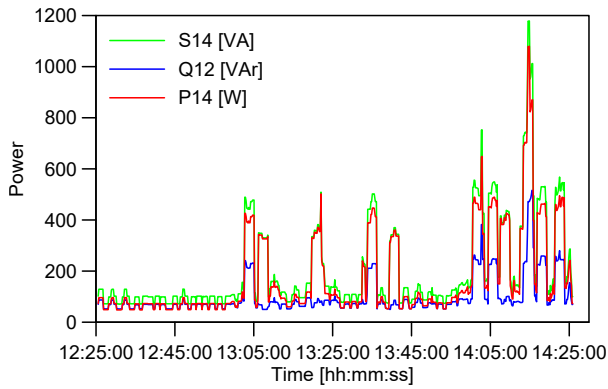

(a) Single Household Profile

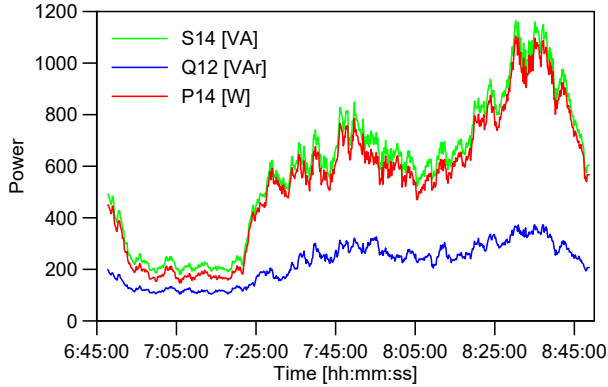

(b) Aggregated Households Profile

Fig. 5. Consumption profiles measured using the laboratory AMI and the test bench installation.

with a 3-phase OMNIA direct meter. This will emulate the measurements that will be recorded by one of the  $N$  SMs installed in each apartment of the building, denoted as the blue circles B in Fig. 1.

The profile was generated using a stochastic high temporal resolution model where each appliance in the household is simulated individually and then aggregated. In this way, not only the active power references can be given to the inverter, but also the reactive power [14].

The resolution of the model is 1 minute, so the generated active and reactive power daily profile was composed of 1440 points. Thus, in order to downsize the length of the experiment each minute of the real profile was transform in 5 seconds of the simulation, so instead of needing a day for the experiment only 2 hours were employed. The on-demand readings feature was used, although, in a real implementation where the time is not downsized, the analysis logger will be employed with a maximum resolution of 5 minutes.

In this case, The number of data point obtained from the SM was 716 readings of 26 registers queried simultaneously. If the length was 2 hours or 7200 seconds, a new data point was obtained with approximately an average period of 10 seconds, that in the real implementation without downsizing the time will be a measure every 2 minutes, therefore, the resolution will be slightly lower. Nevertheless, the results for the active,

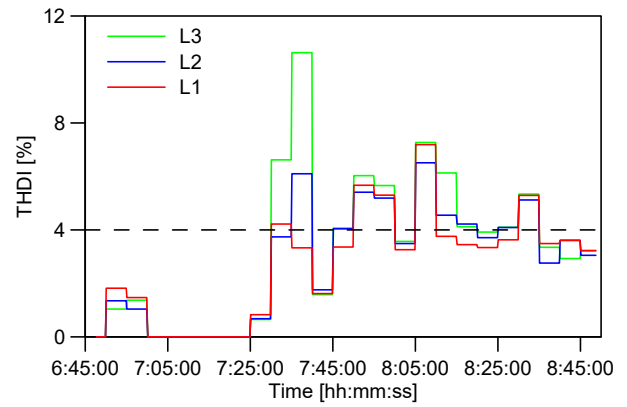

Fig. 6. Current THD in the AC Building Bus.

reactive and apparent power are shown in Fig. 5 (a), and as it can be observed the resolution is more than enough to detect the fast power changes related to the switch on and off events in the household.

In the same way, a second scenario was tested, but using the daily profile of an aggregate of households, emulating the profile that can be read by an SM installed in the AC bus of the building (purple circle D). Using the above-mentioned stochastic model, in this case an aggregate profile of 16 households was simulated with 1-minute resolution, downsize in this case both the time, as in the previous scenario, as also the power, since the maximum peak obtained from the model was 18 kW and the maximum power of the converters is 2.2 kW. The obtained results for the power are shown in Figure 5 (b). This scenario also corresponds with the graphs represented in the GUI shown in Fig. 4.

#### D. Continuous PQ monitoring

As well as monitoring the basic powers, voltages, currents or frequency, the SMs can monitor the THDI and the THDU. Therefore, in the above-presented scenario where the aggregated profile was simulated, additional harmonic distortion was added, and some PQ indices were also recorded.

The results are illustrated in Fig. 6 were the THDI in the 3-phase is represented. The Figure depicts that the THDI value is updated in the system every 5 minutes. Thus, as it was expected the information that can be obtained from the SMs cannot be compared with the PQ information recorded with a network analyzed. However, taking into account that PQ monitoring is not their main goal, they provide features that can be used for a rough estimation, and also compatible with the international standard that defines THD values for 10 minutes intervals.

#### E. PQ Events Detection

Finally, another PQ feature that most of the SMs implement is the detection of voltage deviations and PQ events. In these SMs, three types of voltage quality events can be detected.

- Long-term deviations: The system detects as long-term deviations, voltage changes that take longer than 10 s.

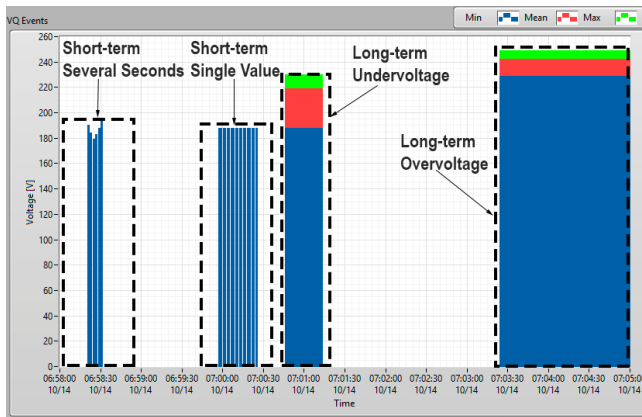

Fig. 7. Detail of the VQ Logger tab of the LabVIEW application.

- Short-term deviations: The short-term deviations are those between 1 and 10 seconds.
- Voltage Outage: The voltage outage detects the periods when a very low voltage is applied to the SM.

In order to test this feature, the SMs were connected to a Grid Simulator (Chroma 61800) where short and long-term deviations were generated to test the detection features.

The detected events are shown in Fig. 7. When a long-term voltage deviation is detected 3 values are recorded: the maximum (green), minimum (blue) and the mean (red) voltage for the period. Two cases of long-term deviations are shown, one for an undervoltage and the other for an overvoltage.

In the case of the short-term deviations, if the value is out of range for several seconds, the start and end points are recorded together with the maximum/minimum value as can be seen in the first events. However, if the event is shorter than two seconds, only the extreme value is accounted.

#### IV. CONCLUSION

This work has addressed the additional functionalities that the new AMI adds to the paradigm of Smart Grids providing bi-directional communication and advanced measurements that can be included in other algorithmic layers. The application has been described from a hardware point of view and subsequently related to the communication architecture of a self-developed system based on a commercial AMI.

The system implementation has been shown from both the physical deployment in a test bench and from the software application built to collect the measurements. The results for different placement of the SM in the proposed architecture were shown for daily profiles generated with the inverters installed on the test bench and using all the AMI installed in the laboratory. The implementation proved that these profiles can be directly used in the EMS, therefore, enhancing the management capabilities of each individual consumer.

Finally, the PQ monitoring features of the SMs were shown. The results illustrated how the global current THD of the building can be assessed in a basic way without the usage of advanced devices, but only with the SMs. In addition, PQ

quality events can also be detected being an essential tool not only for the users but also for the network operator.

Thus, this solution establishes evidence of the main role of the SMs in the Smart Grid infrastructure and the implementation of novel management strategies.

#### ACKNOWLEDGMENT

This work has been supported by the Danish Energy Technology Development and Demonstration Program (EUDP) through the Sino-Danish Project Microgrid Technology Research and Demonstration (meter.et.aau.dk) and also by the International Science & Technology Cooperation Program of China, project Number: 2014DFG62610.

#### REFERENCES

- [1] S. Zhou and M. A. Brown, "Smart Meter Deployment in Europe: A Comparative Case Study on the Impacts of National Policy Schemes," *Journal of Cleaner Production*, vol. 144, pp. 22–32, feb 2016.
- [2] E. J. Palacios-Garcia, Y. Guan, M. Savaghebi, J. C. Vasquez, J. M. Guerrero, A. Moreno-Munoz, and B. S. Ipsen, "Smart Metering System for Microgrids," in *IECON 2015 - 41st Annual Conference of the IEEE Industrial Electronics Society*, 2015.
- [3] A. Moreno-Munoz and J. J. González de la Rosa, "Integrating power quality to automated meter reading," *IEEE Industrial Electronics Magazine*, vol. 2, no. 2, pp. 10–18, jun 2008.
- [4] Y. Kabalci, "A survey on smart metering and smart grid communication," *Renewable and Sustainable Energy Reviews*, vol. 57, pp. 302–318, 2016.
- [5] E. Rodriguez-Diaz, E. J. Palacios-Garcia, M. Savaghebi, J. C. Vasquez, and J. M. Guerrero, "Development and integration of a HEMS with an advanced smart metering infrastructure," in *2016 IEEE International Conference on Consumer Electronics (ICCE)*. IEEE, jan 2016, pp. 544–545.
- [6] L. I. Minchala-Avila, J. Armijos, D. Pesántez, and Y. Zhang, "Design and Implementation of a Smart Meter with Demand Response Capabilities," *Energy Procedia*, vol. 103, pp. 195–200, 2016.
- [7] Yang Bai, Haiwang Zhong, and Qing Xia, "Real-time demand response potential evaluation: A smart meter driven method," in *2016 IEEE Power and Energy Society General Meeting*. IEEE, jul 2016, pp. 1–5.
- [8] W. Kong, Z. Y. Dong, J. Ma, D. Hill, J. Zhao, and F. Luo, "An Extensible Approach for Non-Intrusive Load Disaggregation with Smart Meter Data," *IEEE Transactions on Smart Grid*, vol. 3053, no. c, pp. 1–1, 2016.
- [9] M. M. Albu, S. Member, S. Mihai, and C. St, "Syncretic Use of Smart Meters for Power Quality Monitoring in Emerging Networks," *IEEE Transactions on Smart Grid*, vol. 8, no. 1, pp. 485–492, 2017.
- [10] T. Demirci, A. Kalaycoglu, D. Kucuk, O. Salor, M. Guder, S. Pakhuylu, T. Atalk, T. Inan, I. Cadrc, Y. Akkaya, S. Bilgen, and M. Ermis, "Nationwide real-time monitoring system for electrical quantities and power quality of the electricity transmission system," *IET Generation, Transmission & Distribution*, vol. 5, no. 5, p. 540, 2011.
- [11] E. Rodriguez-Diaz, F. Chen, J. C. Vasquez, J. M. Guerrero, R. Burgos, and D. Boroyevich, "Voltage-Level Selection of Future Two-Level LVdc Distribution Grids: A Compromise between Grid Compatibility, Safety, and Efficiency," *IEEE Electrification Magazine*, vol. 4, no. 2, pp. 20–28, jun 2016.
- [12] L. Meng, A. Luna, E. Diaz, B. Sun, T. Dragicevic, M. Savaghebi, J. Vasquez, J. Guerrero, and M. Graells, "Flexible System Integration and Advanced Hierarchical Control Architectures in the Microgrid Research Laboratory of Aalborg University," *IEEE Transactions on Industry Applications*, pp. 1–1, 2015.
- [13] A. Anvari-Moghaddam, J. C. Vasquez, and J. M. Guerrero, "Load shifting control and management of domestic microgeneration systems for improved energy efficiency and comfort," in *IECON 2015 - 41st Annual Conference of the IEEE Industrial Electronics Society*. IEEE, nov 2016, pp. 96–101.
- [14] E. J. Palacios-Garcia, A. Moreno-Munoz, I. Santiago, I. M. Moreno-Garcia, and M. I. Milanés-Montero, "Smart community load matching using stochastic demand modeling and historical production data," in *2016 IEEE 16th International Conference on Environment and Electrical Engineering (EEEIC)*, 2016, pp. 1–6.