

Research Article

Open Access

Conrad Zeidler*, Vincent Vrakking, Matthew Bamsey, Lucie Poulet, Paul Zabel, Daniel Schubert, Christel Paille, Erik Mazzoleni, Nico Domurath

Greenhouse Module for Space System: A Lunar Greenhouse Design

DOI 10.1515/opag-2017-0011

Received December 29, 2016; accepted February 21, 2017

Abstract: In the next 10 to 20 years humankind will return to the Moon and/or travel to Mars. It is likely that astronauts will eventually build permanent settlements there, as a base for long-term crew tended research tasks. It is obvious that the crew of such settlements will need food to survive. With current mission architectures the provision of food for long-duration missions away from Earth requires a significant number of resupply flights. Furthermore, it would be infeasible to provide the crew with continuous access to fresh produce, specifically crops with high water content such as tomatoes and peppers, on account of their limited shelf life. A greenhouse as an integrated part of a planetary surface base would be one solution to solve this challenge for long-duration missions. Astronauts could grow their own fresh fruit and vegetables in-situ to be more independent from supply from Earth. This paper presents the results of the design project for such a greenhouse, which was carried out by DLR and its partners within the framework of the Micro-Ecological Life Support System Alternative (MELiSSA) program. The consortium performed an extensive system analysis followed by a definition of system and subsystem requirements for greenhouse modules. Over 270 requirements were defined in this process. Afterwards the consortium performed an in-depth analysis of illumination strategies,

potential growth accommodations and shapes for the external structure. Five different options for the outer shape were investigated, each of them with a set of possible internal configurations. Using the Analytical Hierarchy Process, the different concept options were evaluated and ranked against each other. The design option with the highest ranking was an inflatable outer structure with a rigid inner core, in which the subsystems are mounted. The inflatable shell is wrapped around the core during launch and transit to the lunar surface. The paper provides an overview of the final design, which was further detailed in a concurrent engineering design study. During the study, the subsystem parameters (e.g. mass, power, performance) were calculated and evaluated. The results of the study were further elaborated, leading to a lunar greenhouse concept that fulfils all initial requirements. The greenhouse module has a total cultivation area of more than 650 m² and provides more than 4100 kg of edible dry mass over the duration of the mission. Based on the study, the consortium also identified technology and knowledge gaps (not part of this paper), which have to be addressed in future projects to make the actual development of such a lunar greenhouse, and permanent settlements for long-term human-tended research tasks on other terrestrial bodies, feasible in the first place.

Keywords: lunar greenhouse; lunar infrastructure; closed-loop; bio-regenerative; life support system

*Corresponding author: Conrad Zeidler, German Aerospace Center (DLR), Institute of Space Systems, Robert-Hooke-Str. 7, 28359, Bremen, Germany, E-mail: Conrad.Zeidler@dlr.de

Vincent Vrakking, Matthew Bamsey, Lucie Poulet, Paul Zabel, Daniel Schubert, German Aerospace Center (DLR), Institute of Space Systems, Robert-Hooke-Str. 7, 28359, Bremen, Germany

Lucie Poulet, Université Clermont Auvergne, Institut Pascal, BP 10448, F-63000 Clermont-Ferrand, France

Lucie Poulet, Research Associate, CNRS, UMR 6602, IP, F-63178 Aubiere, France

Christel Paille, European Space Agency (ESA), Noordwijk, the Netherlands

Erik Mazzoleni, EnginSoft S.p.A., 24126 Bergamo, Italy

Nico Domurath, Integar, Dresden, Germany

1 Introduction

The project Greenhouse Module for Space System was one part of European activities focused on developing a regenerative life support system (LSS). The bulk of these activities take place within the ESA Micro-Ecological Life Support System Alternative (MELiSSA) framework. The MELiSSA framework aims to develop a micro-organism and higher plant based ecosystem, which would function as a closed-loop bio-regenerative life support system, required for future long-duration human space flight.

MELiSSA is based on an “aquatic” ecosystem consisting of five distinct sections, or compartments (Lasseur et al. 2000, and Lasseur et al. 2005).

The goal of the project was to perform a preliminary sizing of a greenhouse module (GHM) capable of producing the MELiSSA menu for six crew and to compile the associated data for oxygen and water production. The MELiSSA menu is a set of recipes based on specific crops such as bread wheat, durum wheat, soybean, potato, rice, lettuce and beet root (Pieters 2010, and Pieters 2011). This greenhouse module could be deployed independently of other lunar base systems and then be integrated into an already-established lunar infrastructure. The long term goal of such a GHM is to decrease overall mission (resupply) launch masses. ESA imposed several specific requirements on the project. One of the overarching requirements was that the greenhouse had to operate for a period of at least 24 lunar sidereal days (ca. 655 Earth days and 17 hours).

The main objective of the GHM was in-situ crop production to provide 100% of the dietary requirements for a crew of six via the production of specific quantities of selected plants. The facility had to produce the following amounts of edible dry mass per month for the following crops; bread wheat (33 kg), durum wheat (31 kg), potato (41.2 kg), soybean (25 kg), lettuce (1 kg), beet root (2.2 kg) and rice (38.8 kg). In addition, the facility was developed for atmospheric revitalization, water purification and to support crew well-being.

The GHM is integrated into the MELiSSA loop, which constitutes the secondary life-support system of the habitat in the initial phase. When operations within the GHM reach a steady state, the MELiSSA loop will become

the primary LSS. The GHM receives its inputs (e.g. water, air, CO₂, nutrients) from the MELiSSA loop and sends its outputs (e.g. harvested crops, inedible parts of the plants, O₂, fresh water) to the loop. Overall wastes from the GHM are managed by the MELiSSA loop or by the physical/chemical backup LSS. Therefore, the GHM does not include a waste management system, only a short-term waste storage unit. Furthermore, power generation is considered to be outside the scope of the GHM, and the assumption is made that the module receives power from the habitat infrastructure. Two different greenhouse operation modes were investigated in detail to aid in system sizing: a nominal operation mode as well as a combined emergency and hibernation mode.

Although the GHM would likely not be deployed to the Moon for several decades, the design team attempted to employ already available technologies in order to provide for more realistic estimates. When this was not possible, the team used a best estimate and identified knowledge and technology gaps. This paper summarizes the final GHM design of the project.

2 General Design

The design (see Figure 1) consists of a rigid core module with four inflatable growth petals, two connection corridors to lunar base structures, four deployable light concentrators to enable a hybrid natural and artificial Illumination System (ILS), and emergency radiators (not shown in figure below). A sintered regolith cover (not shown in the figure below) around the structure is envisioned to provide micro-meteoroid and radiation protection, as well as to facilitate the thermal management of the greenhouse.

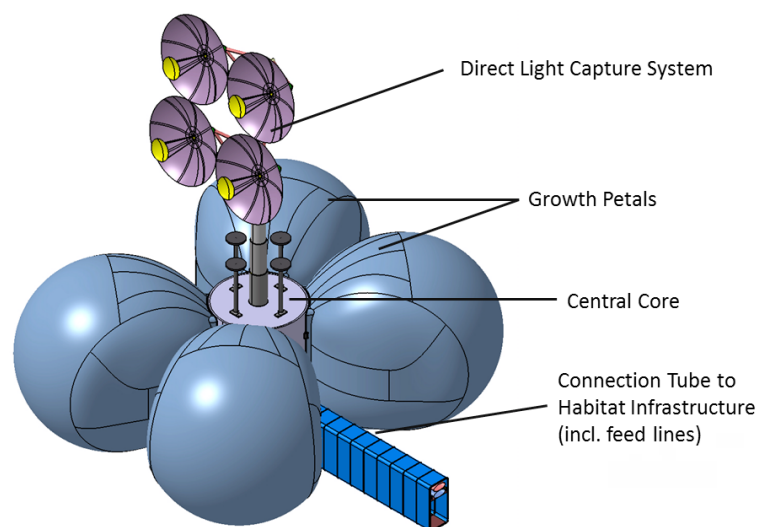

Figure 1: Main elements of the GHM system.

The inflatable petals are connected to the core via airlocks, to provide compartmentalized growth areas with environmental conditions optimized for a given crop. Similarly, the connections from the core module to the habitat (lunar base structures) can be sealed off to prevent any adverse events in the GHM from impacting the habitat and vice versa.

The main dimensions of the deployed GHM system can be seen in Table 1.

Table 1: Overview of main dimensions of the GHM system.

Type	Dimension
Total GHM height (incl. direct light concentrator)	26.2 m
Central rigid core height	8.0 m
Central rigid core outer wall (diameter)	5.4 m
Central rigid core inner wall (diameter)	5.2 m
Approx. petal height	ca. 10.0 m
Approx. petal width	ca. 9.0 m
Single growth petal volume	ca. 620 m ³

2.1 Core

The inner core (see Figure 2) offers space for a three-level configuration. All connections from the rigid core to the petals (e.g. cooling fluid, irrigation water, power lines, light cables and air), and the habitat connection corridors can be sealed off by specialized seals/ valves (vacuum proof) or (with respect to the larger air tubes) with shutters.

2.1.1 Upper Level

On the top level of the central core, four independent Air Management Systems (AMS) (incl. fans, filters, water recovery units, sensors etc.) are incorporated. Each AMS is connected to one growth petal via ducting which allows for air recirculation in the petals, or air exchange with the habitat. A comparatively simple AMS unit is also located here to revitalize the air within the core. Furthermore, the atmospheric pressurization system (incl. gas buffer storage and compressor unit) is foreseen on this level, with the necessary interfaces to the AMS. Lastly, the upper level houses the interface with the direct light capture system and the fibre optics which pass through into the petals.

2.1.2 Middle Level

The middle level of the central core houses the Pre- and Post-Processing System (PPPS) for the crops, the Command and Data Handling System (CDHS), and several working desks. Furthermore, the astronauts can access the petals from this level. All petals are independent from each other. Emergency airlocks can be utilized in order to seal off each petal from the rigid core. In the nominal operation mode the airlock doors are moved down to the lower level. The storage envelopes for the petal airlock doors have been taken into account in the configuration design of the lower level. Dedicated mechanisms located underneath the stored airlock doors will aid the astronauts

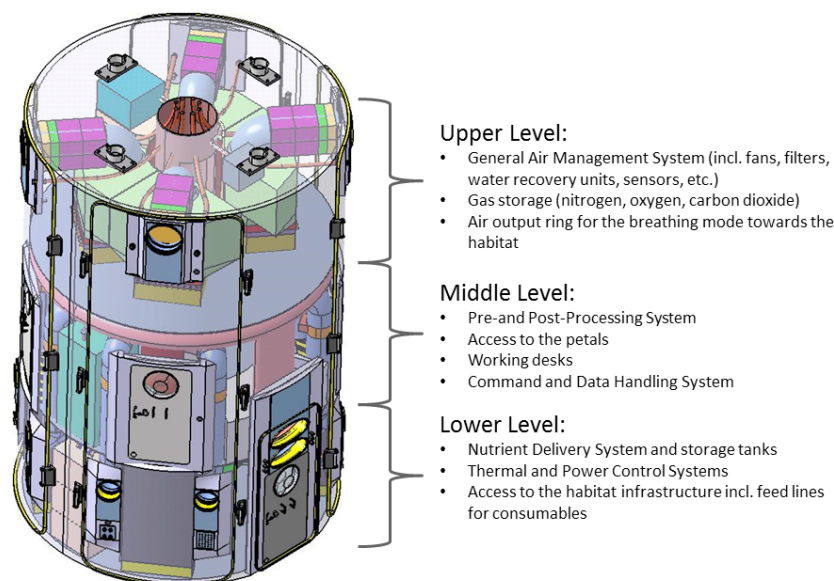

Figure 2: The three levels of the inner rigid core of the GHM system.

in rapidly closing the airlock doors in case of emergency scenarios (e.g. rapid decompression).

2.1.3 Lower Level

The lower level is the main connection point to the habitat, where two (out of safety and redundancy reasons) independent pressurized corridors lead to the habitat infrastructure. The lower level of the rigid core houses the Nutrient Delivery System (NDS), including storage tanks, the Thermal Control System (TCS), and the Power Control and Distribution System (PCDS). The lower level also

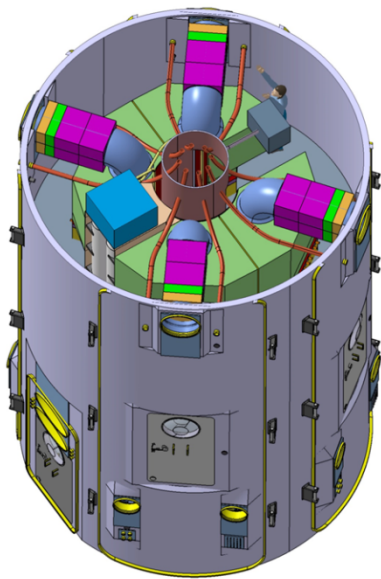

Figure 3: The upper level of the inner rigid core of the GHM system.

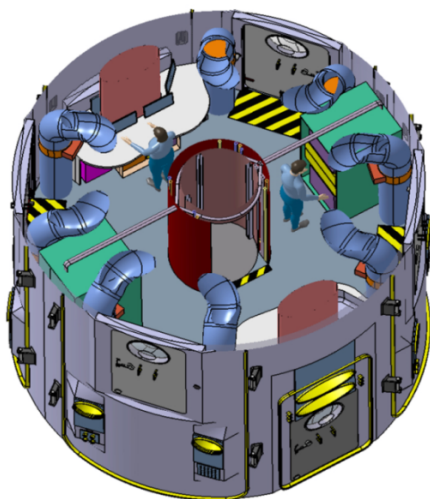

Figure 4: The middle level of the inner rigid core of the GHM system.

accommodates a tubing system, including several valves and shutters for the air exchange with the habitat, as well as interface panels for the exchange of resources between the core and the inflatable petals.

2.2 Petal Design

The petals function as growth chambers. They are connected to the various controlled environment agriculture (CEA) subsystems within the central rigid core. Each petal of the design is dedicated to a single cultivation environment, suitable for one or two crop types, throughout the mission duration.

As mentioned in the previous section, the GHM concept has four petals, with identical configuration. Each petal has a central corridor; with vertically stacked growth channels on either side. Figure 6 shows the floor plan of one petal. The central corridor width was designed to be 1.20 meters to accommodate crew movement, with guiderails installed at the sides for a lift platform to access the upper cultivation levels. To the left and right side of the corridor next to the entrance are the service area, the air ducts and other piping. The rest of the petal to either side of the corridor is utilized to cultivate plants. A deployable airlock is incorporated at the entrance of each petal, separating the petal environment from the environment within the core.

The upper section of each petal (see Figure 6) is dedicated to plant growth and contains the plant support structure, ILS equipment, AMS and TCS ducts and tubing, as well as NDS piping and misters. An interface panel fixed to the core provides a connection point for the AMS

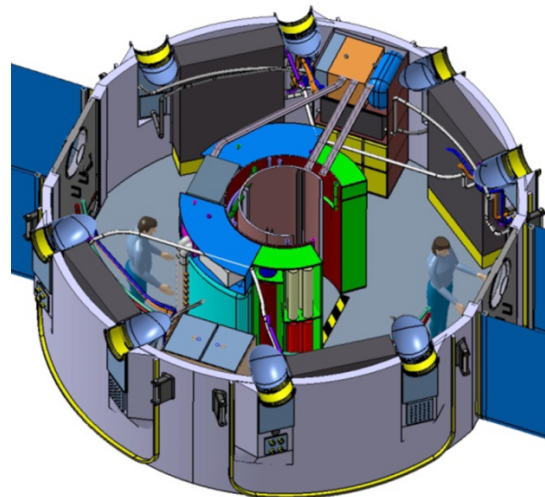

Figure 5: The lower level of the inner rigid core of the GHM system.

ducts and the fibre optics. The lower section of the petal (see Figure 6) is reserved for storage and placement of additional subsystem components, such as inflatable NDS tanks and pumps, as well as interface panels for resource flows (e.g. water, cooling fluid) to and from the core module.

2.3 Packing Analysis

NASA's Space Launch System (SLS) (NASA 2014), which is currently being developed, will provide sufficient thrust to deliver the GHM to low Earth orbit (LEO) with a single launch, at which point a transfer vehicle will move the greenhouse to the Moon. As the SLS payload capacity

was, at the time, the largest of all existing and planned launchers, the fairing dimensions of the SLS were used as a limit for sizing the GHM.

A total payload mass of 70-130 tons and an $\sim 8.4 \times 17.3$ m fairing (NASA 2014; Bergin 2014) of the SLS made it possible to stow the inflatable petals, along with the secondary structure, such as load-bearing ribs and floor panels, on the outside of the rigid core module. Similarly, the increased height of the SLS payload fairing compared to the Ariane 5, or other existing launchers, made it possible to stow the solar collector on top of the rigid core module (see Figure 7).

The core and deployed petals rest flat on the lunar surface or, if necessary, a prepared support platform. Rigid ground plates, shown in Figure 7, were subsequently

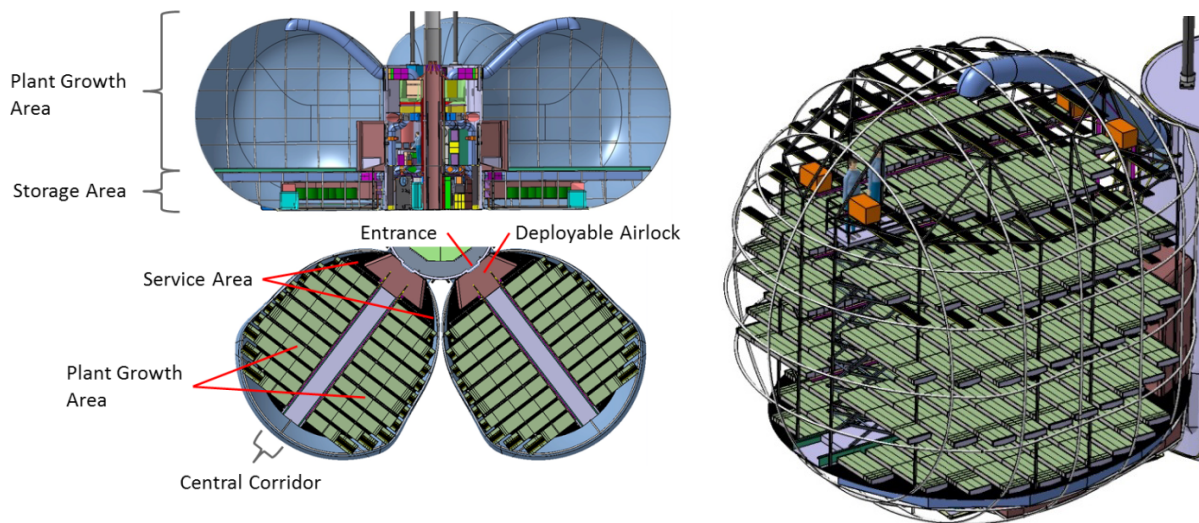

Figure 6: Left Top: Side view of the GHM in its final version; Left Bottom: Top view of two petals in their final version, Right: Petal configuration (inside view).

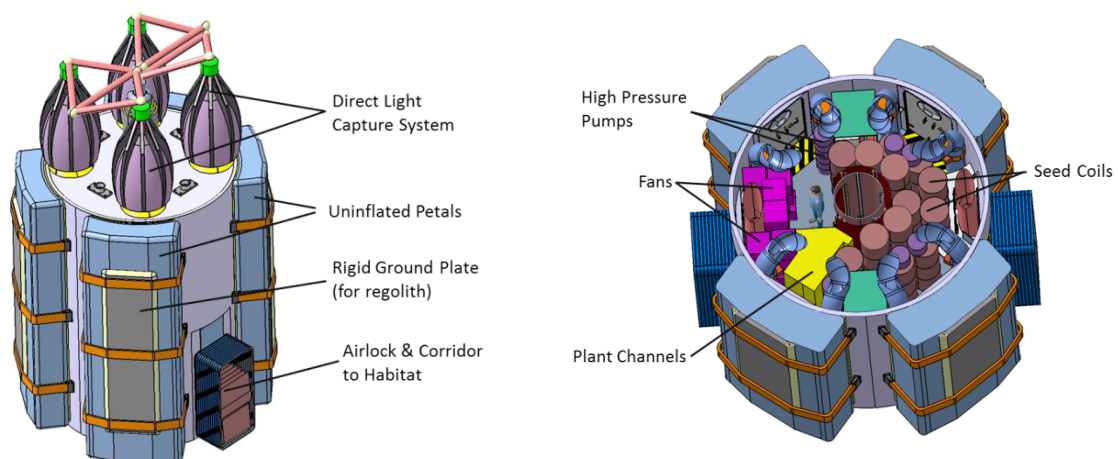

Figure 7: Left: Stowed GHM configuration. Right: Stowed configuration showing middle floor section cut as a representative example of the internal stowed configuration of the GHM.

incorporated within the inflatable petals to provide a load-path from the petal to the lunar surface/ support platform. These rigid ground plates provide walkways for the astronauts accessing the storage area of the petals and provide interfaces to the structural elements supporting the petal wall and the internal configuration.

The uninflated petal volumes indicated in the stowed configuration (see Figure 7) are sized to accommodate not only the actual petal wall material (with margin for packaging efficiency), but also the structural elements which will be needed in the deployed configuration, as well as a number of deployable subsystem components (e.g. struts, floors). The exact packaging method and an optimized deployment method requiring minimal crew time will need to be studied in more detail during future studies. Restraint ribbons are used to hold the stowed petals and, most likely, the deployable habitat corridors, in place during the launch and transfer mission phases.

As part of the deployment process, a device will cut or release these ribbons, allowing the rigid ground plates to fall down to the lunar surface, at which point the petals will be inflated. The interior of the petals will be stiffened by a skeleton of aluminium struts. Gas canisters on the top level of the rigid core will supply the gas components (oxygen, nitrogen and trace gases) to establish the desired atmospheric conditions (see Figure 6).

The interior of the core in the stowed configuration houses not just the pre-installed systems, but also the seed coils, LED panels, ventilation fans and other subsystem components, while still providing a corridor for astronauts to move through in the deployment phase. The deployment phase refers to the installation and outfitting processes/ procedures, following the initial inflation of the petals. On account of the volume of the combined stowed equipment and consumables, it will be necessary to set up the petals sequentially. Once the first petal has been deployed and outfitted with the required equipment, there should be sufficient space in the core to access the second petal and subsequently the third and fourth petal.

A preliminary configuration for the stowed GHM is shown for the middle floor in Figure 7 as a representative example of the internal stowed configuration of the various floors. It should be noted that not all the equipment is visible in these pictures as a result of the selected stacking configuration. The preliminary analysis of the stowed configuration indicates that there is sufficient space to house all the GHM equipment, consumables as well as system spares for the duration of the mission.

3 Subsystem Design

3.1 Cultivation System

A fixed-shelf plant cultivation system concept is chosen for its advantages over a moveable product line type system in several categories including harvest, climate and pathogen control. Within this concept, the design of V-shaped Channels (VCs) is used to allow for the combination of permanent growth channels with a disposable deployed *seed cultivation coil* (SCC), which is fixed to the channel as shown in Figure 8. A new section of a crop specific cultivation coil is attached at the start of each growth cycle and then disposed of and replaced once the crop has been harvested.

Figure 9 shows how the coils are formed of three components, a plastic film as the outer layer with the grow-fibre beneath it which absorbs the nutrient solution to enhance growth, and then the seed is sandwiched in between. The coil would be cut into sections of predetermined length to fit onto the growth channels, and fixed into place using holding mechanisms on the growth channels. As the crop develops, it will pass through the thin plastic film into the shoot zone area. The concept of such a cultivation coil would need to be tested prior to the mission to determine its performance and storage longevity, among other aspects. No seed to seed cultivation is foreseen, so all the seeds required for the entire mission duration would be brought from Earth, pre-packaged in such seed coils.

As mentioned previously, a fixed stacking configuration is used for all crop types. In this configuration the channels are spaced 1.50 m apart vertically, which takes into account not only the maximum plant height, but also the necessary separation between the top of the shoot zone and the LED panels, and the thickness of those illumination panels as well as the support structure struts. Channels are spaced 15 cm apart horizontally, to accommodate the shoot zone sizes of the various plants, which might extend beyond the actual seed coil width. Furthermore, spacing between the channels is desirable to allow for sufficient air flow through the crop canopies.

The channels vary in length, on account of the curvature of the outer petal wall. To minimize the amount of wasted space, each channel will have a specified length, based on the local distance between the service corridor and the outer wall. In the proposed stacking configuration, each petal has a total of 96 channels, divided into two sections and five vertical layers, with a total length of approximately 274 m. With a width of 60 cm for the deployed seed coil, this gives a plant growth area

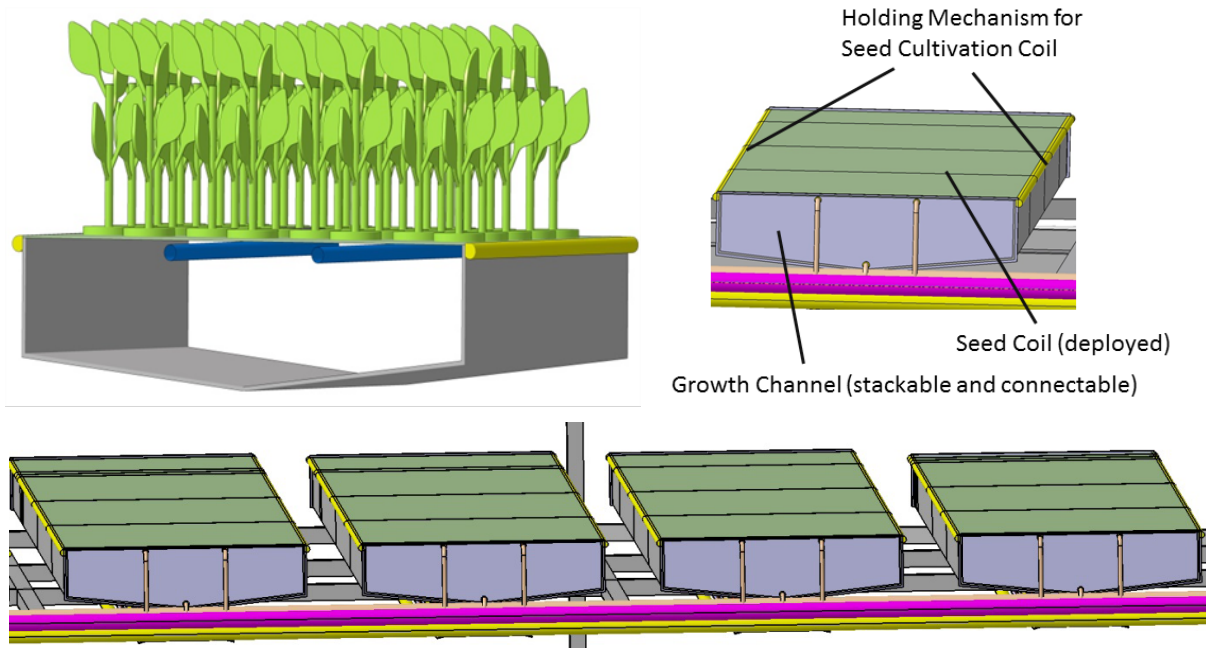

Figure 8: V-shaped growth channel design.

of 165 m² per petal. Hence, with four petals, the GHM has a total plant growth area of 658 m². Using these values, and the total lengths of cultivation coil required per crop for the specified mission duration (including a 20% margin), the total number of seed cultivation coils required per mission is 124, with a total weight of 383 kg. Assuming a cube with 0.6 m edge length, each coil occupies 0.216 m³, and the total volume occupied by the 124 SCCs is then 26.78 m³. After deployment of the GHM the SCCs are stored on the ground floor of the four petals until use.

3.2 Nutrient Delivery System

The NDS stores, mixes, and delivers fertigation solution to the GHM plants. The NDS exhibits control of water and nutrient solution temperature and quality at the chemical and microbial level. The NDS is designed such that a dedicated nutrient recipe can be provided to each of the four GHM petals. The capacity to provide four disparate nutrient solution recipes represents a trade-off between overall system complexity and the provision of some solution tailoring capability to enhance yield.

A hybrid aeroponic-NFT (nutrient film technique) system is the selected nutrient delivery technique. The aeroponic tubing and misters are designed so that they can be easily installed within the top of the growth trays. The architecture includes pairs of misters spaced at 20 cm intervals.

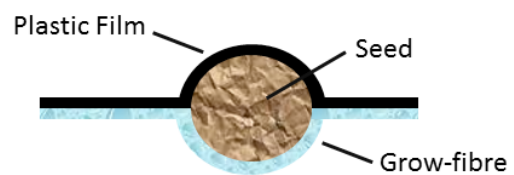

Figure 9: Composition of the cultivation coil.

The top-level configuration of the NDS is illustrated in Figure 10. In addition to the NDS adjustment manifold, the central core includes a storage reservoir for the habitat/MELiSSA input water, as well as a reservoir for processed condensate water. Each petal has a common NDS design, including a main reservoir which provides its specific nutrient solution to the different planting levels by way of four high pressure pumps.

The nominal mode of operations of the NDS follows a general sequence. Nutrient rich water returned from the MELiSSA loop water enters the GHM and is stored in the MELiSSA input storage reservoir within the central core to permit solution tailoring and use in off-nominal conditions. When a nutrient solution within a given petal requires adjustment, solenoid valves are commanded to open and the solution is pumped and continuously circulated through the NDS adjustment manifold. The solution is analysed (e.g. ion-selective, EC, pH and dissolved oxygen sensors) and composition adjustments are then made accordingly. Upon attainment of the desired solution set-

points, the specific valves are closed, the pump is switched off, and the solution within the given petal is ready for use. To account for the nutrients which are absorbed by the crops, the MELiSSA loop has to provide 8.74 kg of nutrient salts to the GHM every day, via the MELiSSA loop water. In addition 333.9 kg of nutrient salts have to be brought from Earth to the Moon to adjust the MELiSSA loop water over the entire mission duration. The values were estimated primarily from NASA Biomass Production Chamber values with the inclusion of a 10% margin and scaling factors to account for the differences in ESA and NASA assumed crop production values (Wheeler et al. 2003).

During nominal operations, the four high pressure aeroponic pumps within a given petal are activated

(cycled at different times to reduce peak power demands) and each provides nutrient solution to approximately a quarter of the plants within the petal. A fine nutrient mist is sprayed within the plant channels (see Figure 11). The unabsorbed fertigation solution flows down the angled channels where it may also be taken up by the plants. The unabsorbed or non-evaporated water drains back into the storage reservoir contained within the petal. Basic sensing information within the petal storage reservoir, as well as a regular adjustment schedule, defines the frequency of nutrient solution modification via the NDS adjustment manifold. Collected evapotranspired water is pumped into the core for sterilization and subsequent use within the habitat or in further nutrient solution make-up/ tailoring.

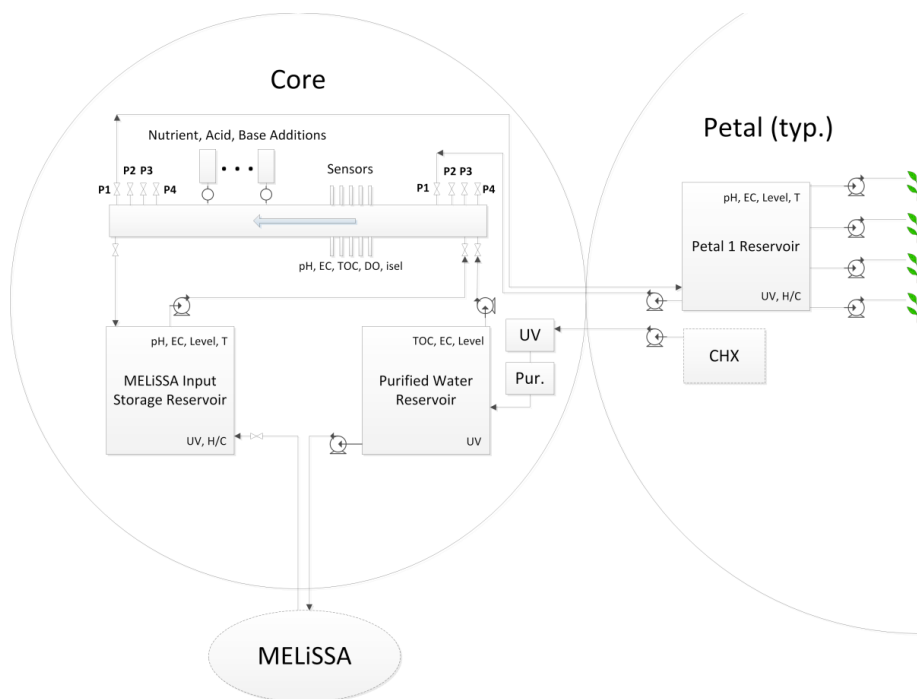

Figure 10: Top-level concept of the NDS (EC – Electrical Conductivity, TOC – Total Organic Carbon, DO – Dissolved Oxygen, isel – Ion Selective Sensor, Level – Level Sensor, T – Temperature Sensor, H/C – Heating and Cooling System, Pur. – Purification System, CHX – Condensing Heat Exchanger, P1 ... P4 – Pump).

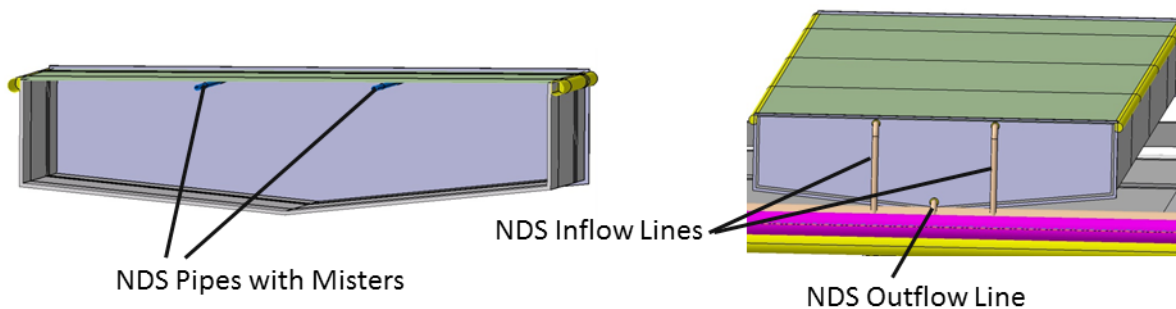

Figure 11: Implementation of the NDS within each growth channel.

3.3 Air Management System

The AMS has to create adequate climate conditions for the plants, to facilitate their growth inside the GHM. Each crop requires a proper environment (nutrient, light and air condition) that is usually different from the environment needed by other plants. Therefore, the air in each petal is managed separately to provide dedicated environmental settings for each batch production. The air inside the core of the GHM is conditioned by a separate unit (there is one air conditioning unit on each level). The air flow paths and the schematic position of the components of the AMS for a single petal are summarized in Figure 12.

The GHM is a part of the MELiSSA loop. Therefore CO_2 is received from the MELiSSA loop and the produced O_2 is returned back to the loop (habitat). These gases are exchanged directly as air components and not separately. In fact the extraction of O_2 or CO_2 from air cannot be realized in the GHM volume with currently available systems. This has led to the implementation of two AMS operating modes to manage the air exchange between the GHM and the habitat (see also Figure 13):

Nominal Mode: Each petal has a dedicated closed air loop with continuous air recirculation. Temperature, pressure and air composition (e.g. CO_2 injection) are monitored and regulated. In this mode there is no air exchange with the habitat.

Breathing Mode: Each petal is directly connected to the habitat air loop via connection rings. In this mode

O_2 -rich air can flow from the petal to the habitat and CO_2 -rich air can move in the opposite direction. Both air flows are filtered (e.g. UV sterilizer and particle filter) and their humidity is adjusted. The breathing mode can be activated for a single petal at a time.

When the nominal mode is active, the air inside the petal is completely recirculated. During the nominal mode each petal is a separate growth chamber with a dedicated AMS to control the climate. The AMS transports the air from the petal, moving it to the top part of the top floor of the core. For each petal the sensor packages provide instant feedback to the AMS in order to subsequently reach the desired temperature, pressure, humidity, and CO_2 level. The heat produced by the illumination system and the gas and water exchange between the crops and the air result in changes to the environmental conditions over time. To ensure optimal growth, the AMS needs to counteract these changes. For example, the AMS cools the air coming from the petals using a cooling coil, while capturing and processing the water which condenses as a result. The water is then provided to the NDS. Furthermore, to prevent crop disease, potentially harmful micro-organisms are removed via filtration and sterilization, using UV lamps, particle and trace gas filters. Once the air reaches the desired environmental parameters, it is blown down toward the top part of the bottom level. The air can reach the petal from the core through supply air ducts which are directly connected to two separate plenums. Each plenum is positioned underneath the petal floor, on either side of the corridor (see Figure 14).

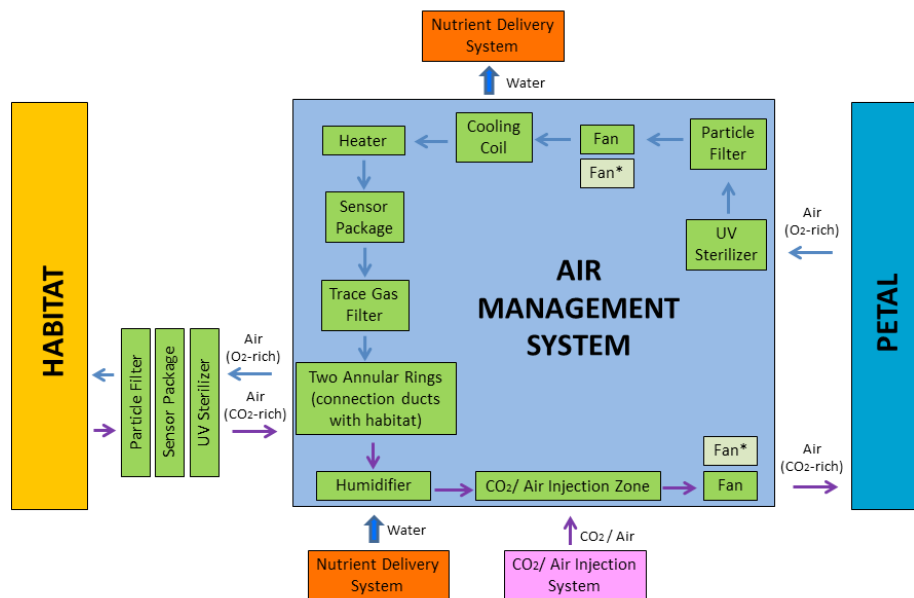

Figure 12: Air path and the position of the different components of the AMS for a single petal (*redundant fan).

Due to the complete recirculation in nominal mode, the O₂ level cannot be continuously regulated, but it will be maintained in a predefined range, from 21% to 26.5% (NASA 2006). When the maximum O₂ level is reached, the nominal mode is modified into the breathing mode.

Through a set of regulation valves at specific locations within the connection rings to the habitat it is possible to switch from nominal to breathing mode. In the breathing mode, those valves are partially or completely open and the O₂-rich air can flow from the petal to the habitat and the CO₂-rich air can flow in the opposite direction (from habitat to petal). During the breathing mode the O₂ level inside the petal decreases until the minimum value is reached and the nominal mode can start again.

3.4 Illumination System

The ILS is a hybrid system mixing natural light collection technologies and LED technologies. The two systems are complementary to one another but not fully redundant. If one of the two fails, the other can provide about half of the light requirements but not 100% (i.e. the natural ILS has been sized to provide 64% of the total illumination requirements of the plants). A short duration failure (up to one week) of one of the lighting systems would lead to a prolonged growth cycle but would not endanger overall crop production. This design was chosen because it involves two different technologies, providing better redundancy and reducing the overall electrical requirements in nominal operations.

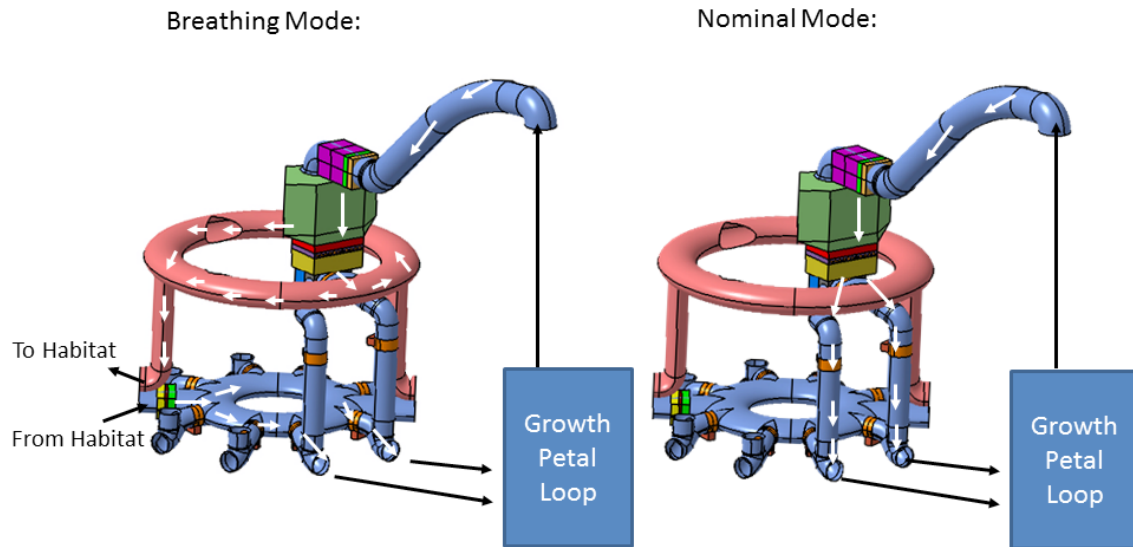

Figure 13: Illustration of the two operation modes.

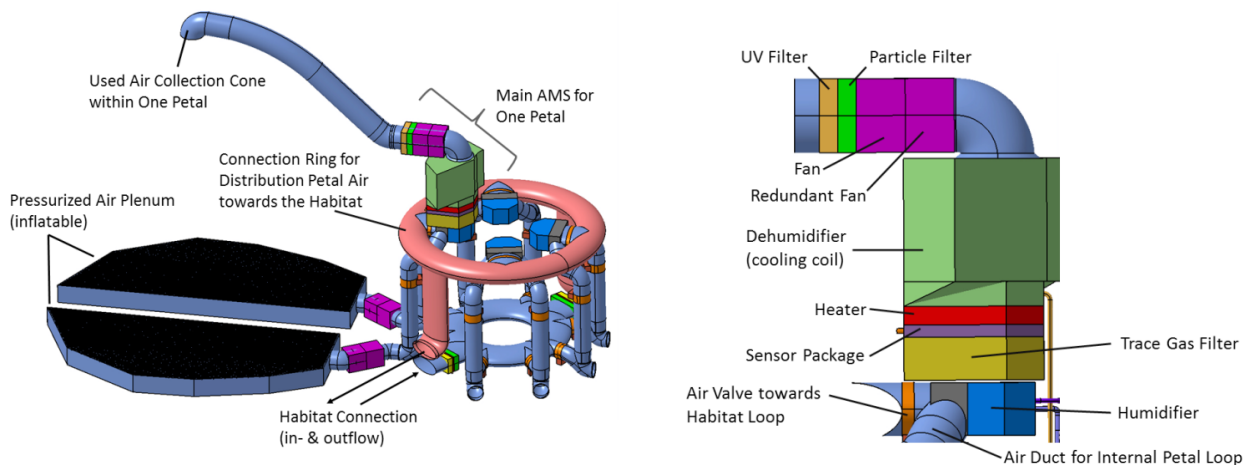

Figure 14: Illustration of the main AMS components.

The GHM is foreseen to be located on the rim of Peary crater, between latitude 89.34° and 89.39° and longitude 126.21° and 131.09°. This location near the lunar north pole provides almost constant illumination (84% of the time at ground level; 86.6% 10 m above ground level), which allows the use of an indirect natural lighting system. Though the selected location is among the sites which receive the most illumination, there will be periods where the GHM will not receive natural illumination. During this time, the LED lighting will provide only part of the required illumination to the crops. This may result in a prolonged growth cycle, but will not be critical for the overall plant production. Although considered, providing more, or all, of the required illumination via LED lighting would result in unacceptably high energy demand and system mass. A different landing site, for example, in proximity to the lunar equator, would result in a different design of the ILS due to the specific illumination conditions in this area.

The indirect natural lighting system is inspired by the work of Dr. Nakamura (Nakamura et al. 1996, Nakamura et al. 2009) with collection of natural light and transmission through fibre optics. The Optical Waveguide System (Nakamura et al. 1996) is the reference used to design the natural light collection system. The system of this design project consists of four sun-tracking 5 m-diameter parabolic concentrators (see Figure 1). At the focal point of each concentrator is an optical fibre cable consisting of approximately 4386 optical fibres of 1.2 mm diameter and an average length of 26.9 m. Each collector is equipped with a dichroic reflector, which only reflects visible light when placed behind a light source. This allows heat to be dissipated on the other end of the fixture and enables the collection system to transmit only visible light, thus reducing the thermal load by removing the infrared light (Nakamura et al. 2013). This concentrated photosynthetic active radiation (PAR) is then transmitted to light panels within each petal of the GHM. Each panel consists of 20 optical fibres with diffusor optics for uniform light distribution.

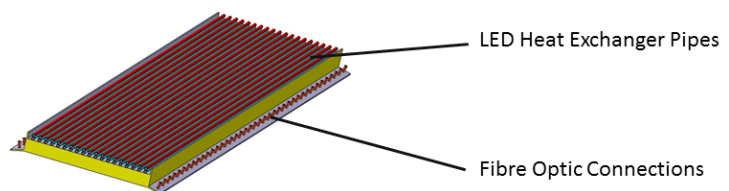
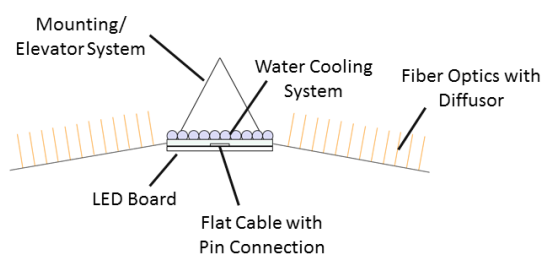

Figure 15: Schematic front view of light panels and CAD rendering of the light panels.

The light panels combine fibre optics and LEDs, as shown in Figure 15, and are equipped with an elevator mechanism which allows for adjustment of the distance between the lights and the plants. It is envisioned that the light panels will always be maintained at a distance of 15 cm from the plant canopy, to ensure optimal lighting conditions.

The LEDs are assumed to be 30% efficient. They are fully dimmable and equipped with shutter function (adjustable on/off-modus in millisecond-range to create an artificial intermittent light).

3.5 Thermal Control System

The baseline design of the TCS consists of three heat dissipation systems:

- Water cooling system: dissipates heat from LED panels,
- Air heat exchangers/ condensers: part of the AMS to cool down the air, and
- Radiative surfaces for passive heat dissipation.

Table 2 shows the total heat dissipation of the GHM, dissipated through the AMS and the water cooling system for the LED panels.

Table 2: Greenhouse thermal budget in nominal mode (worst case).

Nominal Mode	
Heat Sources	Heat [kW]
Petals (heat to air)*	247.1
Petals (heat to water cooling system)	172.3
Core	74.9
Total on System Level	494.3
Total with 10 % Margin	543.73

* The heat dissipated to the air is the sum of the 37% of the LED system power demand and the natural light in the petals, with a 10% margin.

3.5.1 Water Cooling System

As previously described, the LED panels are assumed to be 30% efficient, meaning 70% of the electrical power supply will be transformed into heat. The water cooling system is designed to transport 90% of this heat out of the GHM into the habitat structure, which in the worst case scenario, amounts to 172.3 kW (with a 10% margin included) for all petals combined. By staggering the lighting periods of the various petals, the electrical power consumption (and thus thermal load) can be better balanced, thereby reducing the peak power consumption. Since each crop has different requirements for the level of PAR, sizing of the liquid-to-liquid heat exchangers for the petals was done based on the most demanding crop cultivation scenario, which for this GHM was durum wheat cultivation. The maximum amount of heat which should be dissipated by the water cooling system for the durum wheat petal is 89.8 kW (including a 10% margin), as such the liquid-to-liquid heat exchangers were sized to transfer this amount of heat from water to the coolant liquid.

3.5.2 Air Heat Exchanger

As listed in Table 2, the heat which needs to be removed from the air in the core is 74.9 kW (with a 10% margin

included) in the worst case. The heat load which needs to be removed from the air of all petals combined in the worst case scenario is 247.1 kW (with a 10% margin included). However, the most demanding crop cultivation scenario is durum wheat cultivation. For a single durum wheat petal the worst case scenario results in a heat load of 128.7 kW (with a 10% margin included). Thus, each of the cooling coils used for dehumidification and cooling of the petal air was sized to transfer this amount of heat from the air to the coolant liquid.

3.5.3 Radiative Surface

The dimensioning of the radiative surface is driven by the amount of heat to be dissipated in hibernation mode (145.9 kW for the petals and 39.5 kW for the core including a 10% margin), during which the active TCS will be shut down. Considering a maximum temperature in the greenhouse of 28 °C and an emissivity of 0.9, the total radiative area should be 442.5 m². The radiators will most likely be positioned in the Peary crater, which would reduce the exposure to sunlight, allowing for more effective heat rejection. Alternatively, the sintered regolith shell around the GHM could be covered with radiator panels. The thermal system would then utilize only those panels which are not exposed to sunlight at that specific time.

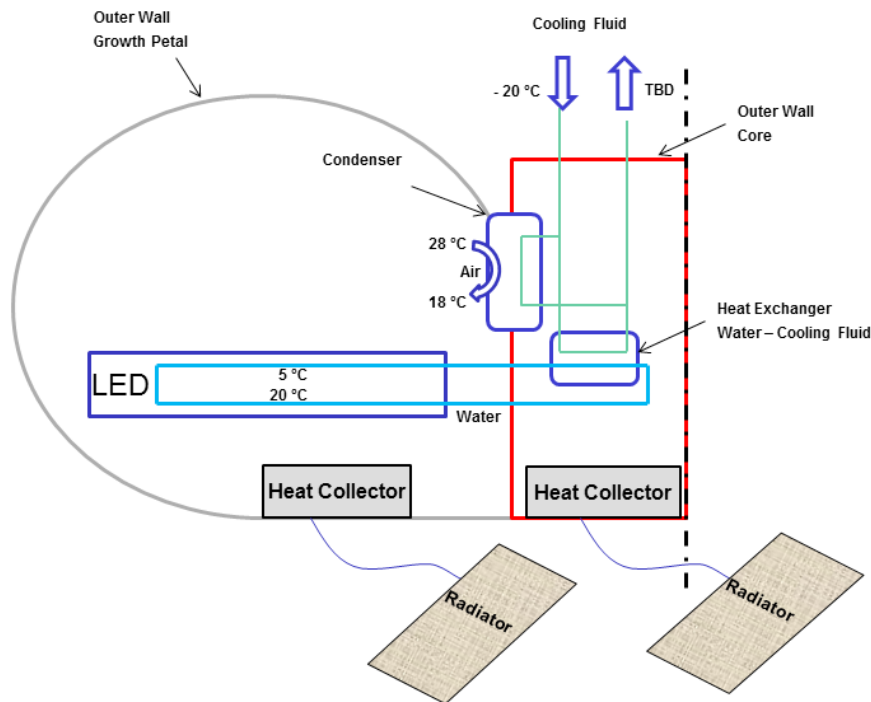

Figure 16: Schematic representation of the TCS (in the picture, the condenser works as an air heat exchanger).

4 Modes

Prior to the design study, 11 operational modes of the GHM were defined. Due to time constraints only two of these modes were analysed in detail during the design study. In particular, only the nominal operation mode of the GHM as well as a mode combining the initially defined emergency mode and the hibernation mode were investigated. In this combined mode, it is foreseen that the GHM system is cut-off from the supply lines of the habitat (e.g. power or thermal lines). The mode was assumed to last for a maximum of 48 hours during which the GHM relies on batteries and shall maintain the basic support functions of the GHM system. In this mode, the plants will receive a reduced amount of PAR from the ILS and the environmental conditions will not be controlled as strictly as during nominal operations, but the system should provide the basic conditions for the plants to survive the duration of the failure. The LED fixtures will be out of order during this mode. Therefore the emergency/hibernation mode only uses natural light and the LED panels will be turned off, along with the water cooling system. A power blackout would also mean that the tracking system for the collectors would be out of order. Since the needed corrections to track the Sun are only on the order of a few centimetres per hour, a power blackout would lead to a relatively slow decline of natural light intensities in the petals from 64% of the required light input to approximately 40%. The non-PAR spectrum does not contribute to plant growth and is removed from the solar collector. However it contains valuable energy which could be used for power generation. This could be used for powering a Sun tracking system with which the decrease in light intensity could be avoided during hibernation mode. Because the emergency/hibernation mode is supposed to last for a maximum of 48 hours, no yield losses are expected. However, the resulting lower light intensities can be responsible for a prolonged cultivation period.

Whereas the temporary loss of illumination from the LED panels is not expected to result in (significant) yield

losses, a breakdown of the AMS would weaken the plants to the point of irreversible damage, due to increases in temperatures within the petals over the 48 hour time period. As such, it is necessary to maintain at least partial functionality in the AMS. As a conservative estimate it is projected that the power requirement would be 50% of the nominal case. A similar power budget analysis was carried out for the other subsystems in order to determine the critical functionality which would need to be supported in this mode, such as the thermal system's ability to reject heat via the emergency radiators.

5 System Overview

5.1 Output

Plant cultivation within the GHM is organized in batched production cycles. There is typically only one plant species growing in each petal at a given time. Durum wheat, bread wheat and soybean are grown continuously. Potato and rice are grown in an alternating fashion. Lettuce and beet, because of their relatively minor output requirements, and thus small production areas, are grown in tandem with the primary crops in a given petal. This cycled production is feasible, because the selected plants can be stored for several weeks to months after harvest. Having only one plant species in one petal at a time allows the crew to optimize the environmental conditions for that crop, which leads to a higher biomass output per cycle. Based on the different growth cycle durations, the schedule shown in Table 3 was developed to fulfil the biomass production requirement. Lettuce and beet root are excluded from Table 3 since they are continuously cultivated to match the required output. Note that petal 2 has four cycles of durum wheat cultivation and 1 cycle of bread wheat cultivation. Due to differences in growth cycle duration, it was not possible to have five cycles of bread wheat cultivation in petal 1 within the mission duration, whereas a fifth cycle of bread wheat was possible by utilizing petal 2.

Table 3: Plant allocation in petals during cycles.

	Petal 1	Petal 2	Petal 3	Petal 4
Cycle 1	Bread Wheat	Durum Wheat	Soybean	Potato
Cycle 2	Bread Wheat	Durum Wheat	Soybean	Rice
Cycle 3	Bread Wheat	Durum Wheat	Soybean	Potato
Cycle 4	Bread Wheat	Durum Wheat	Soybean	Potato
Cycle 5		Bread Wheat		Rice

Table 4 shows the dry edible biomass production of each species grown within the GHM per day, per cycle, and during the whole mission. A linear approximation is used here, based on average production values. The metabolic and morphological parameters of each crop type used for the calculations during this design project were taken from the MELISSA's reference crop data (Sasidharan 2013) and NASA's Advanced Life Support Baseline Values and Assumptions Document (Hanford 2004). The values were gathered from previous experimental studies, conducted by the two research entities. The quantities produced were enough to sustain six people on the surface of the Moon and the crops were chosen according to the MELISSA recipes, hence fulfilling nutritional dietary requirements (Pieters 2010, and Pieters 2011).

Table 5 shows the CO₂ binding and O₂ production of each species grown within the GHM per day, per cycle and during the whole mission.

Table 4: Dry edible biomass production.

Mass [kg]	Bread Wheat	Durum Wheat	Potato	Soybean	Rice	Total
per day*	1.0	1.8	3.0	1.1	5.0	-
per cycle	147.4	222.7	307.9	154.0	473.6	-
during mission	737.1	890.9	923.6	616.1	947.3	4115.0

* The daily yields display the daily yields during crop production, not the average daily yields over the entire mission.

Table 5: Average CO₂ binding and O₂ production.

Mass [kg]	Bread Wheat	Durum Wheat	Potato	Soybean	Rice	Total
CO ₂ per day	2.7	3.2	3.8	2.9	4.2	-
O ₂ per day	2.0	2.4	2.9	2.2	3.2	-
CO ₂ per cycle	394.7	394.7	394.7	394.7	394.7	-
O ₂ per cycle	296.0	296.0	296.0	296.0	296.0	-
CO ₂ during mission	1973.5	1578.8	1184.1	1578.8	789.4	7105.0
O ₂ during mission	1480.1	1184.1	888.1	1184.1	592.1	5329.0

Table 6: Overview of the system mass budgets and the power budgets including system margins.

Subsystem	Mass per Subsystem with Margin [kg]	Nominal	Emergency/ Hibernation
		Power per Subsystem [kW]	Power per Subsystem [kW]
Air Management System	5873.48	33.34	15.38
Plant Health Monitoring System	1769.18	5.50	1.51
Nutrient Delivery System	3135.58	7.35	2.22
Illumination System	10567.85	277.77	0.00
Design & Structure	52549.37	0.00	0.00
Pre- and Post-Processing System	1882.77	2.18	0.65
Horticulture	394.73	0.00	0.00
Thermal and Power Control Systems	2631.20	21.78	13.75
Total on System Level	78804.15	347.91	33.51
20 % System Margin	15760.83	69.58	6.70
Total with 20 % Margin	94564.98	417.49	40.21

5.2 Mass, Power and Water

Table 6 displays the summary of the mass and power budget of the GHM system. Within each domain a 5% margin was applied for the mass and power budget when the technology was known and used; a 10% margin was used when the technology was still under development; a 20% margin was used when the technology had never been tested before. On a system level, on the overall budgets, an extra 20% margin was applied everywhere.

The overall GHM system has a total mass of 95 tons (includes the 20% system margin), which can fit into one SLS launch (to LEO). The power consumption during nominal operations is ~418 kW (and ~40 kW during emergency/ hibernation mode). Since this system mass is dry weight mass, the necessary water for start-up and full operation of the GHM system needs to be either transported from Earth or produced directly in-situ on the

lunar surface. An in-situ water production system should be taken into consideration, considering the total required water for full operation of the GHM system, which amounts to a total of ca. 29 tons including water in the plants, in the air, in the cooling lines of the ILS as well as in the tanks and pipes of the NDS.

5.3 Interface with the Habitat

One goal of the design project was to investigate the necessary interface architecture of the GHM system with the habitat infrastructure. The main exchange will be located within the two corridors connecting the GHM with the habitat structures. Each corridor has a dedicated exchange section above the walk way (see Figure 17).

The deployable corridor incorporates the feed lines and air ducts:

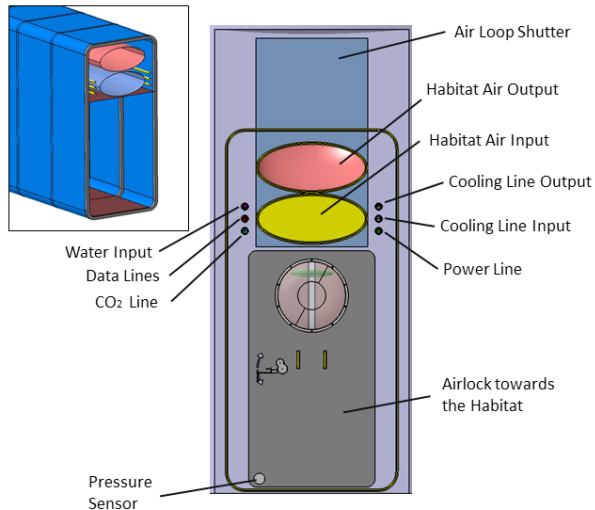

Figure 17: Dedicated exchange section.

These sections include the cooling fluid lines (input/output line), concentrated CO_2 gas lines (resulting from the by-products of other MELiSSA processes), inflow air ducts (CO_2 enriched cabin air), outflow air ducts (O_2 enriched petal air), power lines, data lines and fresh water lines.

A non-pressurized corridor is assumed here for crew movement between the GHM and the habitat. An assessment of the benefits and drawbacks of a pressurized versus a non-pressurized corridor has not, however, been performed within the scope of this project.

6 Detailed Analysis & Simulation

Two steady computational fluid dynamics (CFD) models have been developed to simulate the flow behaviour (e.g.

velocity, pressure and temperature distribution) and to calculate the local concentration of O_2 , CO_2 and water vapour within the GHM petals, considering two types of crops (one crop for each petal): Petal A with cultivation of potato and Petal B with cultivation of durum wheat.

Petal A, potato cultivation, is representative of the other crops, aside from durum wheat, in terms of power input per area, which was approximately 300 W/m^2 . In contrast, durum wheat required a power input per area of around 650 W/m^2 . As such, analysis of a petal cultivating this crop serves to assess the worst case scenario. This power input per area refers to the power which is needed by the LED panels in order to provide the desired PAR-levels.

The models were built and the simulations carried out using ANSYS CFD tools: ANSYS Design Modeler for the geometry, ANSYS ICEM for the mesh and ANSYS CFX for the run of the analyses and post-processing of the results (ANSYS PRODUCTS 2014). The computational mesh (for Petal A and B) is composed of about 41.1 million elements. The generated mesh is specially refined near small passages and gaps. The following conclusions can be drawn:

1. The velocity inside both Petal A and B near the plants remains below 1 m/s : this velocity gradient could be acceptable for the growth of plants. Indeed it was shown in a ground experiment that above an air current velocity of 0.2 m/s leaf gas exchange was not limited by convection (Kitaya *et al.* 2004, Kitaya *et al.* 2003). Higher velocity values are only present in the plenum for the supply air and around the suction duct.
2. The temperature inside Petal A, which has a heat load equal to 53037 W , remains in the range from $20 \text{ }^\circ\text{C}$ to $30 \text{ }^\circ\text{C}$, with a temperature of $26 \text{ }^\circ\text{C}$ at the outlet duct. The highest temperature values are present in the top part of the chamber where the heat is transported due to buoyancy effects. The temperature inside Petal B has a range from $20 \text{ }^\circ\text{C}$ to $56 \text{ }^\circ\text{C}$, with a temperature of $49 \text{ }^\circ\text{C}$ at the outlet duct, because the heat absorbed by air, equal to 116993 W , is not managed effectively enough with the current design. The high temperature values in Petal B would not be suitable for a correct growth of durum wheat. Possible solutions could be to decrease the temperature of the cooling fluid or add additional cooling fluid ducts for the ILS in this petal (see example Figure 18).
3. The production of water vapor (740 l/d) creates a relative humidity change from 70% to 74% for Petal A. For Petal B the drastic reduction of humidity from

70% to 21% is due to the high temperature values as discussed in the previous point.

- The rates of production/ consumption of O_2 and CO_2 by the plants are small compared to the initial mass composition of air inside the petal. These sources/ sinks, in steady analyses, generate only minor local effects with respect to the global balance of concentration.

An additional design iteration to implement such design improvements couldn't be performed in the scope of this project due to time and budget constraints.

7 Conclusion

This paper summarizes the detailed analysis of a phase A design project performed on a subsystem level on a lunar GHM concept at the DLR Bremen in September 2014.

The result is a hybrid rigid-inflatable greenhouse which can fulfil the function of the higher plant compartment sized to sustain six crew, within a larger closed loop system (MELiSSA) over a mission period of, at least, 24 lunar days. The greenhouse design parameters, including margins to account for the uncertainties inherent in early design efforts, indicate that the greenhouse structure, along with the internal equipment and outfitting, could be delivered to LEO using a single SLS launch. However, the initial supply of resources, such as water and power, as well as the construction of a sintered regolith radiation shield, necessitate the presence of substantial infrastructure on the Moon, prior to arrival of this greenhouse. This lunar infrastructure could be provided by the ESA Moon Village

(Wörner 2016; Messina et al. 2016), which in the long term will be a permanent base on the Moon. Such a greenhouse module would be an essential part of a Moon Village-like permanent base, where humans would work and live and therefore need to sustain their basic metabolic needs.

The design budgets (e.g. mass, power, volume) reflect current state-of-the-art technologies in an attempt to reduce the level of uncertainty in the overall design. While an actual Moon mission incorporating significant habitat infrastructure is still decades in the future and technologies at that time will likely allow for a reduction in these budgets, this was not taken into account during this phase of the design.

A computational fluid dynamics analysis was performed on the petal growing durum wheat and on the petal growing potato, which resulted in an air flow and overall mass balance analysis. A critical finding was the excessive heat load during the wheat simulation. Due to the high heat dissipation of the ILS in this scenario, a temperature of approximately 50 °C was reached at the growth level. Design improvement suggestions to solve this thermal load were made, but not yet implemented within the scope of the project. This issue will have to be solved in future design iterations.

This project enabled the assessment of technology readiness levels of the various GHM subsystems and the identification of technology and knowledge gaps. It also provided the basis to generate a list of recommendations to complete all the remaining activities required for the further development of the concept and to identify the activities required to address the critical areas in technological maturity, tool availability and scientific knowledge.

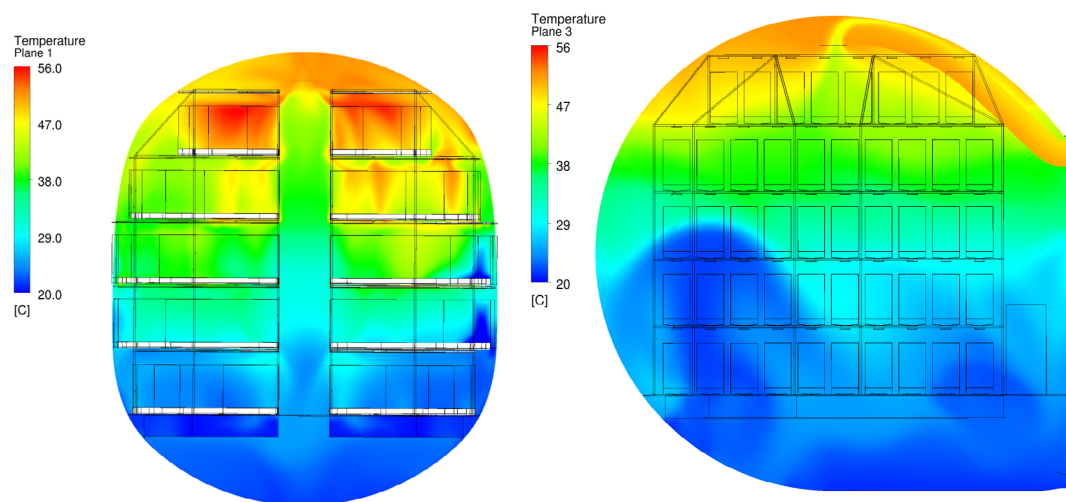

Figure 18: Temperature distribution for both planes (left front view, right side view) for one simulation case (durum wheat).

Acknowledgement: This project received funding from the European Space Agency (ESA) under grant No 4000100293/10/NL/PA “Greenhouse Module for Space System”. The authors would like to acknowledge the work of the other members of the concurrent engineering study team; Alexander Bell, Dávid Gyimesi, Silvio Schröder, Jürgen Kempf, Peter Kern, Fritz-Gerald Schröder and Rosa Paris Lopez for their input to the GHM design project. The authors would also like to thank Ondrej Doule and Katarina Eriksson, the space architects who provided the initial design of the greenhouse module.

References

- ANSYS PRODUCTS, ANSYS, <http://www.ansys.com/Products>
- Bergin C., NASA interested in payload fairing options for multi-mission SLS capability, NASA Spaceflight.com, 12 November 2012, <http://www.nasaspaceflight.com/2012/11/nasa-payload-fairings-options-multi-mission-sls-capability/>
- Hanford A. J., Advanced Life Support Baseline Values and Assumptions Document, NASA-JSC, NASA/CR-2004-208941.
- Kitaya Y., Shibuya T., Yoshida M., Kiyota M., Effects of air velocity on photosynthesis of plant canopies under elevated CO₂ levels in a plant culture system, *Advances in Space Research*, 2004, 34, 1466–1469
- Kitaya Y., Tsuruyama J., Shibuya T., Yoshida M., Kiyota M., Effects of Air Current Speed On Gas Exchange In Plant Leaves And Plant Canopies, *Advances in Space Research*, 2003, 31(1), 177-182
- Lasseur C., Dixon M., Dubertret G., Dussap G., Godia F., Gros J. B., et al., MELISSA: 10 Years of Research, Results, Status and Perspectives, in 30th International Conference on Environmental Systems, Toulouse, France, 2000
- Lasseur C., Paillé C., Lamaze B., Rebeyre P., et al., MELISSA: Overview of the Project and Perspectives, SAE Technical Paper Series, 2005, 2005-01-3066
- Messina P., Haignere C., Schrogl K.-U., The Moon Village Concept, 29th IAA Symposium on space policy, regulations and economics, 2016
- NASA, Space Launch System, <http://www.nasa.gov/exploration/systems/sls/#.VGJlofmG-So>
- NASA, Recommendations for Exploration Spacecraft Internal Atmospheres, JSC-63309, 2006
- Nakamura T., Case J. A., Mankamy M., Optical waveguide solar lighting system for space-based plant growing, *The American Society of Mechanical Engineers*, NY, 1996, 347-358
- Nakamura T., Van Pelt A. D., Yorio N. C., Drysdale A. E., Wheeler R. M., Sager J. C., Transmission and distribution of photosynthetically active radiation (PAR) from solar and electric light sources, *Habitation*, 2009, 12, 103–117
- Nakamura T., Monje O., Bugbee B., “Solar Food Production and Life Support in Space Exploration,” in AIAA Space 2013 Conference and Exposition, San Diego, CA, 2013
- Pieters S., Preliminary Trade-Off Of Menu Elaboration: Test Plan And Procedures, Test Performances And Test Results Evaluation, Technical Note: 98.6.0, MELISSA Food Characterization: Phase 1, 2010
- Pieters S., Review Of Menu Elaboration Strategy, Identification Of Critical Points And Proposed Selection Method, Technical Note: 98.3.32, MELISSA Food Characterization: Phase 1, 2011
- Sasidharan S., “MELISSA reference crop data,” ESA, 2013
- Wheeler R., Sager J., Prince R., Knott W., Mackowiak C., Stutte G., et al., Crop Production for Advanced Life Support Systems - Observations From the Kennedy Space Center Breadboard Project, NASA/TM-2003-211184, 2003
- Wörner J., Ministerial Council 2016 - Moon Village, ESA, http://www.esa.int/About_Us/Ministerial_Council_2016/Moon_Village