



Blair, S.M. and Burt, G.M. and Lof, A. and Hänninen, S. and Kedra, B. and Kosmecki, M. and Merino, J. and Belloni, F.R. and Pala, D. and Valov, M. and Lüers, B. and Temiz, A. (2017) Minimising the impact of disturbances in future highly-distributed power systems. In: 2017 CIGRE B5 Colloquium, 2017-09-11 - 2017-09-15. ,

This version is available at <https://strathprints.strath.ac.uk/61382/>

Strathprints is designed to allow users to access the research output of the University of Strathclyde. Unless otherwise explicitly stated on the manuscript, Copyright © and Moral Rights for the papers on this site are retained by the individual authors and/or other copyright owners. Please check the manuscript for details of any other licences that may have been applied. You may not engage in further distribution of the material for any profitmaking activities or any commercial gain. You may freely distribute both the url (<https://strathprints.strath.ac.uk/>) and the content of this paper for research or private study, educational, or not-for-profit purposes without prior permission or charge.

Any correspondence concerning this service should be sent to the Strathprints administrator: strathprints@strath.ac.uk



Minimising the Impact of Disturbances in Future Highly-Distributed Power Systems

S.M. BLAIR, G.M. BURT
University of Strathclyde
UK
steven.m.blair@strath.ac.uk

A. LOF, S. HÄNNINEN
VTT
Finland

B. KEDRA, M.
KOSMECKI
IEn
Poland

J. MERINO
Tecnalia
Spain

F.R. BELLONI, D. PALA
RSE
Italy

M. VALOV
Fraunhofer-IWES
Germany

B. LÜERS
OFFIS
Germany

A. TEMIZ
TUBITAK
Turkey

Summary

It is expected that future power systems will require radical distributed control approaches to accommodate the significant expansion of renewable energy sources and other flexible grid devices. It is important to rapidly and efficiently respond to disturbances by, for example: utilising adaptive, wide-area protection schemes; proactive control of available grid resources (such as managing the fault level contribution from converter-interfaced generation) to optimise protection functionality; and taking post-fault action to ensure protection stability and optimal system operation. This paper analyses and highlights the protection functions which will be especially important to minimising the impact of disturbances in future power systems. These functions include: fast-acting wide-area protection methods using Phasor Measurement Units (PMUs); adaptive and “self-organising” protection under varying system conditions; protection with distributed Intelligent Electronic Devices (IEDs); enhanced fault ride-through; and pattern recognition based schemes. In particular, the paper illustrates how the increased availability of measurements and communications can enable improved protection functionality within distribution systems, which is especially important to accommodate the connection of highly-distributed generation at medium- and low-voltages.

Keywords

Adaptive protection, distributed IEDs, fault ride-through, future power systems, highly-distributed systems, self-organising protection, and wide-area protection.

1. Introduction

The unprecedented large-scale integration of distributed, renewable energy sources presents significant challenges for the real-time control and protection of electrical power systems [1]. In the coming decades, there will be a sharp rise in the number of available grid measurements and controllable resources [2], such as converter-interfaced generation, energy storage, and demand-side response. In particular, the stability of future grid operation will be enhanced by providing more and faster-acting frequency response services, and this will be delivered through a large number of diverse resources, rather than centralised generation. However, such services must be designed in a manner that is computationally feasible and efficient, and where real-time control and protection actions are not unduly delayed by communications systems or other factors.

A radical new control architecture has been designed within the EU-funded ELECTRA IRP research project [3] to directly address the challenges associated with the real-time operation of grids with highly-distributed resources. This paper reports on the work within the ELECTRA IRP project to minimise the impact of disturbances in future highly-distributed

power systems. The most relevant and critical protection functions have been analysed, and a selection of simulation results are presented to highlight key protection strategies for future systems.

2. Future Power System Control Architecture and Protection Requirements

a. Architecture Overview

The envisioned future power system architecture, named web of cells (WoC), decentralises critical system functions – such as the provision of inertia, frequency containment, and balancing – into zones or “cells” which are smaller than conventional Load Frequency Control (LFC) areas. This concept is illustrated in Figure 1. Each cell is responsible for the provision and activation of reserves, communicating with neighbouring cells where necessary; this process will be automated without requiring manual input. This “divide and conquer” approach allows the grid to efficiently scale to a very large number of measurable and controllable devices – without excessive computational requirements or communications delays. It is also assumed that communications systems will be widely available in such future systems.

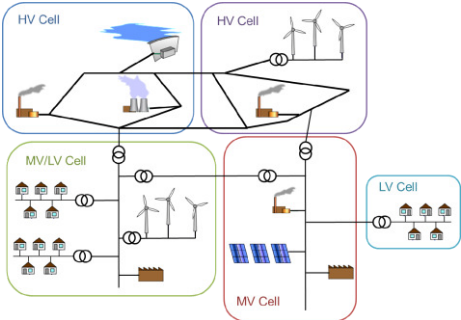

Figure 1: WoC concept

b. Protection Requirements for Future Power Systems

Under the radical new WoC control paradigm, protection and automation strategies are required to detect emergent issues in real-time and instruct a fast-acting response utilising flexible grid resources. Figure 2 summarises the key technical requirements identified for minimising the impact of disturbances in future power systems. These requirements represent the three distinct areas of focus for the research work described in this paper.

<p>Requirement 1 Flexible, wide-area adaptive protection</p>	<ul style="list-style-type: none"> Protection systems must respond to power system events or measurements, then protection settings are updated in real-time.
<p>Requirement 2 Proactive control of flexible resources to optimise protection systems</p>	<ul style="list-style-type: none"> Protection systems take advantage of the flexibility of network devices; these devices are controlled to optimise protection functionality. Functions are proactive, rather than responsive.
<p>Requirement 3 Post-fault/post-disturbance automation</p>	<ul style="list-style-type: none"> Intelligent post-fault actions, rather than directly providing optimised protection functionality for detecting and isolating faults (and other disturbances).

Figure 2: Summary of protection requirements

c. Analysis Methodology

An analysis of the impact of suitable protection schemes for future power systems has been conducted using the methodology summarised in Figure 3. This process leads to the identification of “high-impact” protection functions, which are investigated further through detailed simulation studies, using representative grid models. Quantitative factors, such as reduced trip times, have been used to evaluate the performance of the proposed functions.

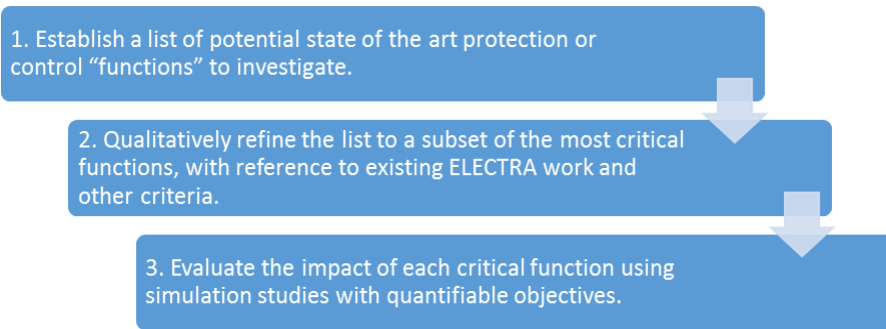

Figure 3: Overview of methodology

3. Technical Results

a. Key Identified Protection and Control Functions

Table 1 summarises the results of stage 1 and stage 2 of the methodology given in Figure 3. The table highlights the key protection functions which will be especially important in future highly-distributed power systems.

Protection and Control Function	Description and Justification for Investigation
Wide-area protection using Phasor Measurement Units (PMUs)	The use of PMU voltage and/or current measurements to quickly detect and locate faults. Even considering communications delays, this has the potential to provide faster-acting protection than existing backup protection methods (e.g. within 150 ms). It is also important to be able to accurately characterise the latency of PMUs for real-time applications, and for informing simulation studies.
Detection and location of large disturbances	Identification of events such as a large loss of generation, or loss of an inter-cell tie-line. This is important in a WoC architecture, because the "responsible" cell may need to be identified to correctly respond. Furthermore, signals from neighbouring cells may need to be considered.
Self-organising protection	Automated configuration of protection for arbitrary, varying network topologies. Coordination of protection devices for detection and location of faults in case of a reconfigurable network such as the WoC.
Protection with distributed Intelligent Electronic Devices (IEDs)	Self-healing concept and fault distance computation in MV overhead networks (in context of overcurrent protection).
Fault Ride Through (FRT)	Impact of high penetration of wind energy on system behaviour during voltage disturbances.
Pattern recognition based schemes	The detection of abnormal events in the system by analysing characteristic patterns, and the identification of the most interesting pattern (and variable) for fault location and detection in a WoC architecture.
Adaptive overcurrent protection	Primary protection of distribution networks with very high levels of distributed generation, by optimisation of the overcurrent relay time and pickup current settings.

Table 1: Key identified protection and control functions

b. Modelling Overview

To provide consistency of the simulation results, two reference models have been defined for testing the proposed protection and control functions, rather than using an arbitrary model for each function. These models are intended to provide representative examples of typical distribution system (based on a CIGRE MV model, Figure 4) and a larger Pan-European transmission system (Figure 5). Each model has been separated into defined cells.

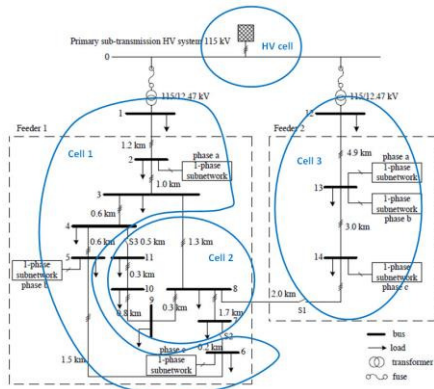

Figure 4: CIGRE MV model

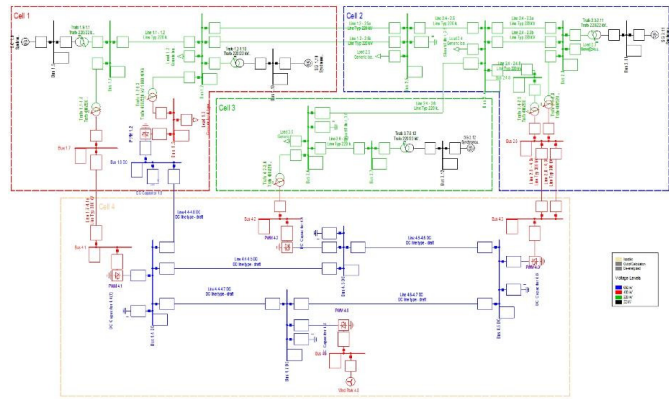

Figure 5: Pan-European model

4. Analysis Highlights

a. Wind Farm Low Voltage Ride Through

Distributed wind generation resources will be important in the WoC architecture to maintain reactive power reserves and as an active power source, by means of Low Voltage Ride Through (LVRT) employed during restoration of the power system following severe disturbances. Taking into account unprecedented high penetration of wind generation equipped with LVRT option, this protection function may be regarded as high-impact. Hence, investigation of this protection function through detailed simulation studies using representative Pan-European Model and CIGRE MV models have been performed. Figure 6 illustrates simulation results for wind turbine voltage behaviour following a disturbance at the point of common (indicated by the black line), for three initial grid voltage levels (0.9, 1.0, and 1.1 pu).

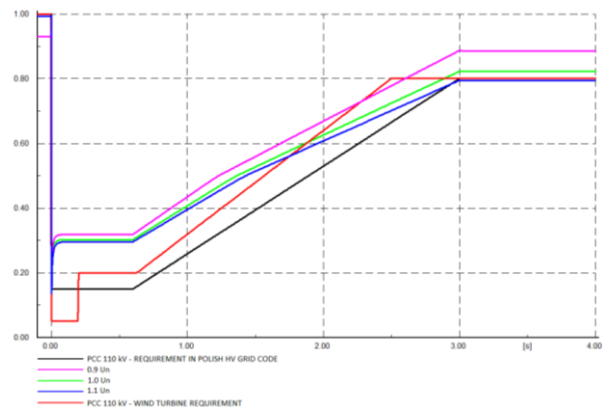

Figure 6: Wind turbine voltage characteristics during fault for different grid voltage levels

b. Accurate PMU Latency Measurement Characterisation

Fast-acting response to power system events is becoming critical to ensuring power system stability [4]. Wide-area phasor measurement unit (PMU) monitoring schemes are being utilised to enable new system functions, such as fast-acting frequency control [5] distributed control paradigms [6], and will therefore underpin the real-time operation of the WoC architecture. In these applications, it is essential that measurement and communications latency is minimised, and it is therefore important that latency can be correctly characterised. Figure 7 illustrates a method for accurately measuring PMU reporting latency. This can also be extended to measuring the total latency perceived when communicating PMU data over wide-area networks (WANs), with typical results given in Figure 8. This information is important for understanding dynamic system behaviour, and for realistically accommodating communications delays within complex power system simulations.

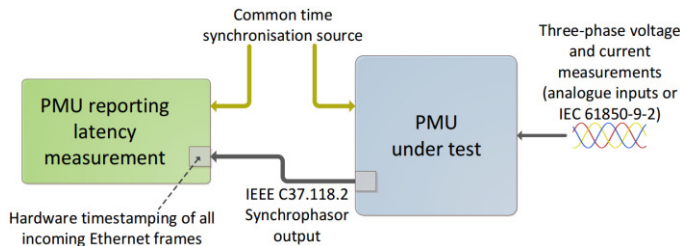

Figure 7: Overview of PMU reporting latency measurement method

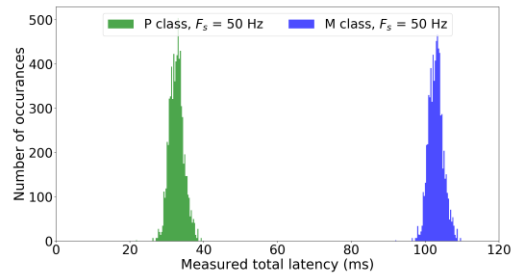

Figure 8: PMU WAN latency results

c. Adaptive Overcurrent Protection for Distribution Systems

The WoC paradigm will include challenges relating to: changing, bi-directional power flows; differences in behaviour of converter-coupled sources in terms of short-circuit current feed to faults; and necessary reconfiguration capabilities, where islanded mode may be necessary for operational or economic reasons. These factors require the implementation of adaptive protection systems. Adaptive overcurrent protection systems update the set points – i.e. Pick-up Current (PC) and Time Multiplier Settings (TMS) – of overcurrent relays (OCRs) to fulfil the OCR coordination for any network topology change as well as to provide fast responses to varying distributed generation. An adaptive algorithm has been developed to be applied on the CIGRE MV reference network, and provides necessary network arrangements after a short circuit fault and calculates new OCR settings. The algorithm shown in Figure 9 is triggered after a short circuit fault or a DER status change occurred in the protection area.

The test network includes eight OCRs located in specific parts of the network. Thus, it represents eight possible fault zones, which requires to be simulated in separate scenarios using DIgSILENT PowerFactory. Considering general simulation outcomes, the adaptive algorithm increases the network reliability in case of a fault due to the topology rearrangement capability. Some fault zones can be isolated, thus supply to customers can be restored by reorganizing normally open points in the protected area. Relay coordination can fully be satisfied considering the back-up protection and grading margins. Figure 10 and Figure 11 present the standard inverse time-current curves of four series OCRs located in the test network. For three OCRs, changing OCR settings (adaptive) after a change DER power output provides a 0.1 s faster fault response compared to using static relay settings.

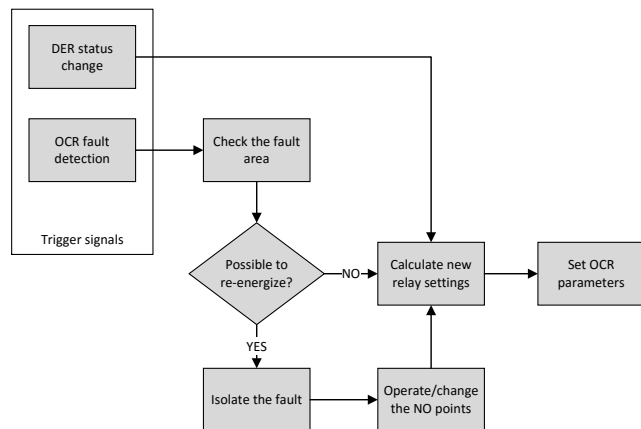

Figure 9: The adaptive algorithm

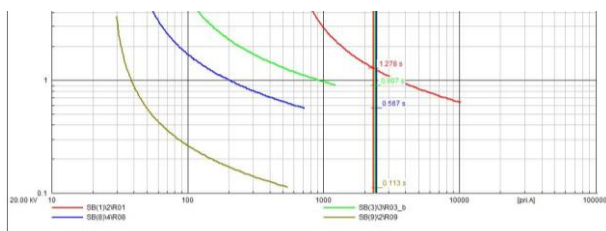

Figure 10: Relay operating times (static settings)

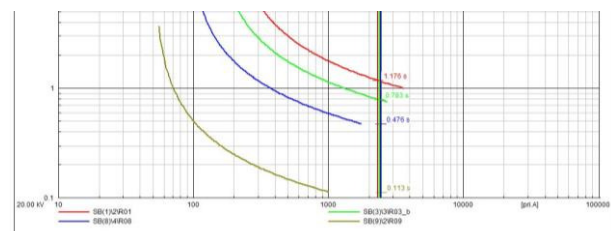

Figure 11: Relay operating times (adaptive settings)

d. Protection with Distributed Intelligent Electronic Devices (IEDs)

The automated measurement, monitoring, control and communications capabilities of Intelligent Electronic Devices (IED) provide the information needed to implement the self-healing concept, providing automated fault identification and location, fault isolation, and power restoration. As a result, power outages can be shortened and system reliability improved significantly. Fault location in a WoC concept network is challenging because major distributed generation is connected at the MV and LV levels. To enable improved fault

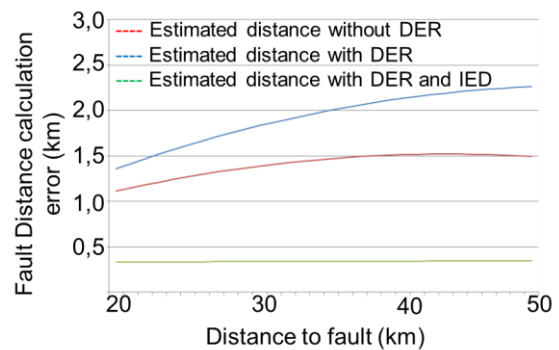

Figure 12: Fault distance algorithm error

location, a fault distance calculation algorithm has been developed based on the current and voltage measurements from the substations and/or distributed IEDs. The main error source of the reactance relays in fault location is the reactive fault current superposed on the measured fault current. To mitigate this problem, the fault location algorithm estimates the load currents from the measured quantities before, during, and after the fault, and to compensate for the load current superposed on the fault current. After the load current compensation, the fault distance is computed as reactance. Figure 12 illustrates the improvement in fault distance calculation error, using simulations with the CIGRE MV model.

5. Conclusions

This paper has provided guidance for the key areas of protection research that will underpin the realisation of stable and efficient future power systems. In particular, it is shown how PMU measurements can be characterised and how distribution system protection can be adapted to take advantage of additional measurements and communications to counter the impact of highly-distributed generation connected at MV and LV. Future work will involve more detailed simulation results for each protection function identified in Section 3.a. This will be reported on in a future publicly-available report.

Bibliography

- [1] CIGRE Working Group B5.14, "Wide area protection & Control technologies," 2016.
- [2] Bell Labs, "Bell Labs Advisory Service for Smart Grid Network Transformation," 2014.
- [3] ELECTRA IRP, "European Liaison on Electricity Committed Towards long-term Research Activity - Integrated Research Programme," 2013. [Online]. Available: <http://www.electrairp.eu/>.
- [4] A. J. Roscoe, M. Yu, R. Ierna, J. Zhu, A. Dyško, H. Urdal, and C. Booth, "A VSM (virtual synchronous machine) convertor control model suitable for RMS studies for resolving system operator/owner challenges," in 15th Wind Integration Workshop, 2016.
- [5] P. Wall, N. Shams, V. Terzija, V. Hamidi, C. Grant, D. Wilson, S. Norris, K. Maleka, C. Booth, Q. Hong, and A. Roscoe, "Smart frequency control for the future GB power system," in IEEE PES ISGT Europe, 2016.
- [6] E. G. Sansano, M. H. Syed, A. Roscoe, G. Burt, M. Stanovich, and K. Schoder, "Controller HIL testing of real-time distributed frequency control for future power systems," in IEEE PES Innovative Smart Grid Technologies, Europe, 2016.

Acknowledgement

The work in this paper has been supported by the European Commission, under the FP7 project ELECTRA (grant no: 609687). Any opinions, findings, and conclusions or recommendations expressed in this material are those of the authors and do not necessarily reflect those of the European Commission.