

Description of the detailed Functional Architecture of the Frequency and Voltage control solution (functional and information layer)

Caerts, Chris ; Rikos, Evangelos; Syed, Mazheruddin; Guillo Sansano, Efren; Merino-Fernández, Julia ; Rodriguez Seco, Emilio; Evenblij , Berend ; Rezkalla, Michel M.N.; Kosmecki, Michal; Temiz, Armagan; Cabiati, Mattia; Tornelli, Carlo; Uslar, Mathias; Heussen, Kai; Marinelli, Mattia

Publication date:
2017

Document Version
Publisher's PDF, also known as Version of record

[Link back to DTU Orbit](#)

Citation (APA):
Caerts, C., Rikos, E., Syed, M., Guillo Sansano, E., Merino-Fernández, J., Rodriguez Seco, E., ... Marinelli, M. (2017). Description of the detailed Functional Architecture of the Frequency and Voltage control solution (functional and information layer).

DTU Library

Technical Information Center of Denmark

General rights

Copyright and moral rights for the publications made accessible in the public portal are retained by the authors and/or other copyright owners and it is a condition of accessing publications that users recognise and abide by the legal requirements associated with these rights.

- Users may download and print one copy of any publication from the public portal for the purpose of private study or research.
- You may not further distribute the material or use it for any profit-making activity or commercial gain
- You may freely distribute the URL identifying the publication in the public portal

If you believe that this document breaches copyright please contact us providing details, and we will remove access to the work immediately and investigate your claim.

Project No. 609687
FP7-ENERGY-2013-IRP

ELECTRA

European Liaison on Electricity Committed Towards long-term Research Activities for Smart Grids

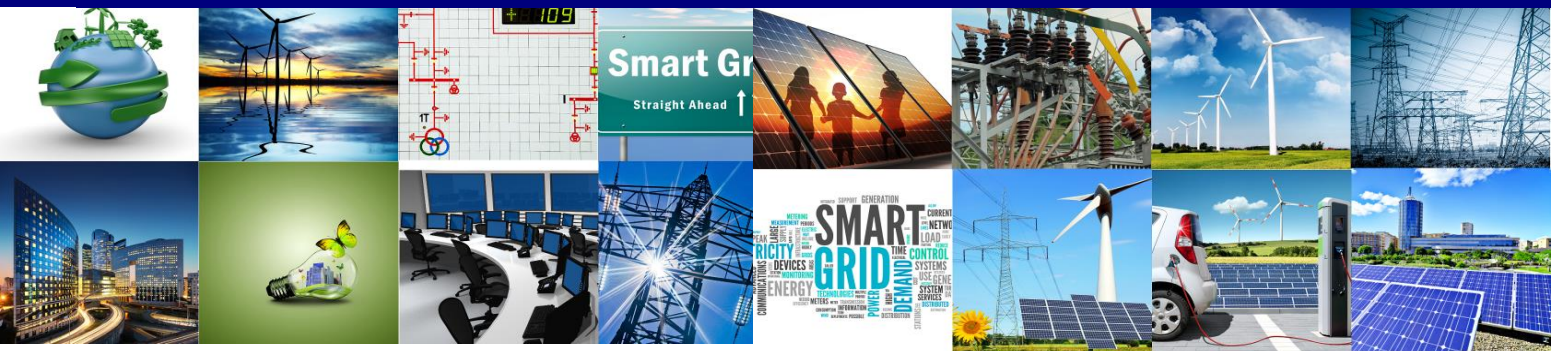

WP 4

Fully Interoperable systems

Deliverable D4.2

**Description of the detailed Functional Architecture of
the Frequency and Voltage control solution (functional
and information layer)**

17/01/2017

ID&Title	D4.2 Description of the detailed Functional Architecture of the Frequency and Voltage Control solution (functional and information layer)	Number of pages:	115
Short description (Max. 50 words):			
This D4.2 document provides the description of the detailed functional architecture of the selected solutions that will be implemented and tested. This is documented by combining a function-based IEC 62559 Use Case description with an SGAM mapping of these functions and the interactions among these functions on the Function and Information layer.			
Version			
Date			
Modification's nature			
V0.01	22/02/2016	First draft submitted for the Y2 review	
V0.5	05/12/2016	First partial update after Technical Workshop	
V0.7	23/12/2016	Major complete update after Technical Workshop	
V0.9	11/01/2017	Submitted for internal TOQA Review	
V0.95	19/01/2017	Updated after internal TOQA Review	
V1.0	17/01/2017	Final	
Accessibility			
<input checked="" type="checkbox"/> PU, Public			
<input type="checkbox"/> PP, Restricted to other program participants (including the Commission Services)			
<input type="checkbox"/> RE, Restricted to other a group specified by the consortium (including the Commission Services)			
<input type="checkbox"/> CO, Confidential, only for members of the consortium (including the Commission Services)			
If restricted, please specify here the group:			
Owner / Main responsible:			
WP4 Leader	Chris Caerts (VITO)	17/01/2017	
Reviewed by:			
WP 4 Leader:	Chris Caerts (VITO)	17/01/2017	
Technical Project Coordinator:	Helfried Brunner (AIT)		
Final Approval by:			
ELECTRA Technical Committee TOQA appointed Reviewer:	Helfried Brunner (AIT) Seppo Hanninen (VTT)	17/01/2017	

Authors

Name	Last Name	Organization	Country
Chris	Caerts	VITO	Belgium
Evangelos	Rikos	CRES	Greece
Mazheruddin	Syed	USTRATH	UK
Efren	Guillo Sansano	USTRATH	UK
Julia	Merino Fernandez	TEC	Spain
Emilio	Rodriguez Seco	TEC	Spain
Berend	Evenblij	TNO	The Netherlands
Michel	Rezkalla	DTU	Denmark
Michal	Kosmecki	IEN	Poland
Armagan	Temiz	TUBITAK	Turkey
Mattia	Cabiati	RSE	Italy
Carlo	Tornelli	RSE	Italy
Mathias	Uslar	OFFIS	Germany
Kai	Heussen	DTU	Denmark
Mattia	Marinelli	DTU	Denmark

Copyright

© Copyright 2013-2017 The ELECTRA Consortium

Consisting of:

Coordinator	
Ricerca Sul Sistema Energetico – (RSE)	Italy
Participants	
Austrian Institute of Technology GmbH - (AIT)	Austria
Vlaamse Instelling Voor Technologisch Onderzoek N.V. - (VITO)	Belgium
Belgisch Laboratorium Van De Elektriciteitsindustrie - (LABORELEC)	Belgium
Danmarks Tekniske Universitet - (DTU)	Denmark
Teknologian Tutkimuskeskus VTT Oy- (VTT)	Finland
Commissariat A L'Énergie Atomique Et Aux Énergies Alternatives - (CEA)	France
Fraunhofer-Gesellschaft Zur Förderung Der Angewandten Forschung E.V – (IWES)	Germany
Centre For Renewable Energy Sources And Saving - (CRESES)	Greece
Agenzia Nazionale per Le Nuove Tecnologie, L'Énergia E Lo Sviluppo Economico Sostenibile - (ENEA)	Italy
Fizikālas Enerģētikas Institūts - (IPE)	Latvia
SINTEF Energi AS - (SINTEF)	Norway
Instytut Energetyki - (IEN)	Poland
Instituto De Engenharia De Sistemas E Computadores Do Porto - (INESC_P)	Portugal
Fundacion Tecnalia Research & Innovation - (TECNALIA)	Spain
Joint Research Centre European Commission - (JRC)	Belgium
Nederlandse Organisatie Voor Toegepast Natuurwetenschappelijk Onderzoek – (TNO)	Netherlands
Türkiye Bilimsel Ve Teknolojik Arastirma Kurumu - (TUBITAK)	Turkey
University Of Strathclyde - (USTRATH)	UK
European Distributed Energy Resources Laboratories (DERlab)	Germany
Institute for Information Technology at University of Oldenburg (OFFIS)	Germany

This document may not be copied, reproduced, or modified in whole or in part for any purpose without written permission from the ELECTRA Consortium. In addition to such written permission to copy, reproduce, or modify this document in whole or part, an acknowledgment of the authors of the document and all applicable portions of the copyright notice must be clearly referenced.

All rights reserved.

This document may change without notice.

Executive summary

This D4.2 document contains the description of the detailed functional architecture of the selected ELECTRA Web-of-Cells control scheme Use Cases that will be implemented and validated by simulation and laboratory tests. This functional architecture is documented by combining a function-based IEC 62559 Use Case description – defining the essential functions and interactions between these functions..

The ELECTRA Web-of-Cells concept is a proposed control schemes for the realtime frequency/balance and voltage control of the future grid. It is designed for a future where large parts of traditional fuel-based synchronous generators – connected to the high voltage grid – are replaced by large amounts of smaller – intermittent – renewables at all voltage levels, and where flexible loads and affordable storage is omnipresent. It applies a ‘solve local problems locally’ paradigm, where the responsibility for detecting the need for activating reserves, as well as the responsibility to do activations in a grid secure manner, is delegated to smaller grid areas – called cells – that act as a web of connected microgrids. This results in a distributed control strategy, where system balance is restored in a bottom-up grid-secure manner (through the combined functionality of Inertia Response Power Control, Adaptive Frequency Containment Control, Balance Restoration Control and Balance Steering Control) based on local observables, and where a continuous voltage control (through the combined functionality of Post-Primary Voltage Control and Primary Voltage Control) minimizes losses and avoids local voltage problems at all voltage levels.

The functions and interactions are kept as limited as possible in view of what is needed to test and validate the control scheme. This means that a number of functions that would be required for a realistic deployment (like an aggregation of reserves) is left out (though its impact related to additional latencies in information exchanges are modelled in a parametrizable manner). Besides, the focus (in the sequence diagrams and scenario descriptions) is on the CTL-2/3 functions (cell level and inter-cell level) and not on the CTL-0/1 functions (device and aggregated resource level). Concerning the functions that provide the observables (like frequency or tie-line powerflow deviation error signal) or that actuate the control signal (like droop behaviour) a distinction is made between those for which a novel approach has been developed in the project, and those for which standard existing technology (and libraries in the simulation environment) can be used. Besides, other functions that are needed for the simulation and testing, but are not the focus of the control scheme itself, like the forecasting of load and generation profiles, or the determining of the availability profile and cost of reserves, are modelled and abstracted by means of a database of file read implementation.

Terminologies

Abbreviations

aFCC	Adaptive Frequency Containment Control
AVC	Automatic Voltage Controller
AVR	Automatic Voltage Regulator
BRC	Balance Restoration Control
BSC	Balance Steering Control
CPFC	Cell Power Frequency Characteristic
CTS	Control Time Scale
CTL	Control Topology Level
DER	Distributed Energy Resource
ICT	Information and Communication Technology
IED	Intelligent Electronic Device
IPM	Interior Point Method
IRPC	Inertia Response Power Control
J	Moment of Inertia (but also used to denote Inertia in general)
LCR	The Inductance (L), Capacitance (C) and Resistance (R) of an electric component or system
LV	Low Voltage
MV	Medium Voltage
NPFC	Network Power Frequency Characteristic
OLTC	On-Load Tap Changing Transformer
OPF	Optimal Power Flow
PVC	Primary Voltage Control
PPVC	Post Primary Voltage Control
PVR	Reactive Power (Q) Regulator of a single power plant
ROCOF	Rate of Change of Frequency
SG	Smart Grid
SGAM	Smart Grid Architecture Model
SG-CG	Smart Grid Coordination Group
TSO	Transmission System Operator
UC	Use Case

Table of contents

Terminologies	6
1 Introduction.....	11
1.1 Scope.....	11
1.2 Structure	11
2 Process and Methodology.....	12
3 Use Case descriptions	15
3.1 Inertia Response Power Control.....	17
3.1.1 Description of the use case.....	17
3.1.2 Diagrams of use case	21
3.1.3 Technical details	23
3.1.4 Step by step analysis of use case.....	25
3.1.5 Information exchanged	27
3.1.6 Requirements (will be completed based on experimental testing and validation results).....	28
3.1.7 Common Terms and Definitions.....	28
3.1.8 Controller Conflicts and Misuse cases.	29
3.2 Adaptive Frequency Containment Control	30
3.2.1 Description of the use case.....	30
3.2.2 Diagrams of use case	34
3.2.3 Technical details	37
3.2.4 Step by step analysis of use case.....	40
3.2.5 Information exchanged	43
3.2.6 Requirements (will be completed based on experimental testing and validation results).....	44
3.2.7 Common Terms and Definitions.....	44
3.2.8 Controller Conflicts and Misuse cases	44
3.3 Balance Restoration Control.....	46
3.3.1 Description of the use case.....	46
3.3.2 Diagrams of use case	50
3.3.3 Technical details	53
3.3.4 Step by step analysis of use case.....	55
3.3.5 Information exchanged	58
3.3.6 Requirements (will be completed based on experimental testing and validation results).....	59
3.4 Balance Steering Control	60

3.4.1	Description of the use case.....	60
3.5	Diagrams of use case.....	63
3.6	Technical details	65
3.6.2	Step by step analysis of use case.....	66
3.6.3	Information exchanged	68
3.6.4	Requirements (will be completed based on experimental testing and validation results).....	69
3.7	Post-Primary Voltage Control.....	70
3.7.1	Description of the use case.....	70
3.7.2	Diagrams of use case	75
3.7.3	Technical details.....	78
3.7.4	Step by step analysis of use case.....	80
3.7.5	Information exchanged	82
3.7.6	Requirements (will be completed based on experimental testing and validation results).....	84
3.8	Primary Voltage Control	85
3.8.1	Description of the use case.....	85
3.8.2	Diagrams of use case	88
3.8.3	Technical details.....	89
3.8.4	Step by step analysis of use case.....	89
3.8.5	Information exchanged	90
3.8.6	Requirements (will be completed based on experimental testing and validation results).....	91
3.8.7	Controller Conflicts and Misuse cases	91
4	Conclusions and next steps	92
5	References	94
6	Disclaimer.....	95
7	Annex 1: Cross-tab of functions	96
8	Annex 2: Grey-box function descriptions.....	99
8.1	In-Scope Functions	99
8.1.1	Merit Order Collection.....	99
8.1.2	Merit Order Decision.....	99
8.1.3	Frequency Droop Parameter Determination.....	99
8.1.4	Adaptive CPFC Determination.....	100
8.1.5	Imbalance Determination	100
8.1.6	Imbalance Correction.....	100
8.1.7	Cell Setpoint Adjusting.....	101

8.1.8	Tie-line Limits Calculation	101
8.1.9	df/dt Droop Slope Determination	102
8.1.10	PPVC Controlling	102
8.1.11	PPVC Setpoint Providing	102
8.2	Observables and Actuator Functions	103
8.2.1	Frequency Observation	103
8.2.2	Tie-line Active Powerflow Observation	103
8.2.3	Voltage Observation	103
8.2.4	DER - ROCOF droop device	104
8.2.5	DER - frequency droop device	104
8.2.6	DER – controllable P device	104
8.2.7	DER - AVR device	104
8.2.8	DER – controllable Q device	104
8.2.9	Capacitor Bank	104
8.2.10	OLTC device	105
8.2.11	Voltage Pilot Node device	105
8.3	Emulated (out-of-scope) Functions	105
8.3.1	Cell CPFC Setpoint Provider	105
8.3.2	Tie-line Active Powerflow Setpoint Provider	105
8.3.3	Tie-line Powerflow Setpoint Provider	105
8.3.4	Cell Inertia Setpoint Provider	105
8.3.5	Reserves Information Provider	106
8.3.6	Load & Generation Forecaster	106
9	Annex 3: List of Information Exchanges	107

List of figures

Figure 1 Top-down elaboration of high-level functionalities into Variant Conceptual Solutions.....	13
Figure 2 Simplifying the Use Case variances to capture their essence.	13
Figure 3 Balance / Frequency / Inertia control scheme functionalities	15
Figure 4 Voltage Control Scheme functionalities	16

List of tables

Table 1 List of In-scope functions.....	96
Table 2 List of Observer/Actuator functions.....	97
Table 3 List of Emulated functions	98
Table 4 List of Information Exchanges	115

1 Introduction

This D4.2 document contains the description of the detailed functional architecture of the selected ELECTRA Web-of-Cells control scheme Use Cases that will be implemented and validated by simulations and laboratory tests. This functional architecture is documented by combining a function-based IEC 62559 Use Case description – defining the essential functions and interactions between these functions - with an SGAM mapping of these functions and interactions on the Function and Information layer.

1.1 Scope

This document describes the selected 6 use cases / solutions related to the ELECTRA Web-of-Cells concept that will be implemented and validated by simulation and laboratory tests. One for each of the identified high-level functionalities: inertia (Inertia Response Power Control - IRPC), frequency (Adaptive Frequency Containment Control - FCC), balance (Balance Restoration Control – BRC and Balance Steering Control - BSC) and voltage (Primary Voltage Control – PVC and Post-Primary Voltage Control - PPVC) control.

In these descriptions, the functions and interactions are kept as limited as possible based on their relevance for testing and validating the control scheme. This means that a number of functions that would be required for a realistic deployment (like an aggregation of reserves) is left out (though its impact related to additional latencies in information exchanges are modelled in a parametrizable manner). Besides, the focus (in the sequence diagrams and scenario descriptions) is on the CTL-2/3¹ functions (cell level and inter-cell level) and not on the CTL-0/1 functions (device and aggregated resource level). Specifically, for what the functions concerns that provide the observables (like frequency or tie-line deviation error signal) or that actuate the control signal (like droop behaviour) a distinction is made between those for which a novel approach has been developed in the project, or those for which standard existing technology (and libraries in the simulation environment) can be used. Besides, other functions that are needed for the simulation and testing, but are not the focus of the control scheme itself, like the forecasting of load and generation profiles or the determining of the availability profile and cost of reserves, are modelled and abstracted by means of a database of file read implementation.

1.2 Structure

This document starts with a description of the process and methodology that was followed to derive these use cases from the high-level functionalities that were defined in ***D3.1 Specification of Smart Grids High-level Functional Architecture for Frequency and Voltage control***, and the subsequent 70+ Use Case variants that were identified in ***D6.1 Functional Specification of the Control Functions for the Control of Flexibility across the different Control Boundaries Annex A (Selected Conceptual Solutions for Balance and Voltage Control)***.

After that, the 6 Use Cases are described, based on the IEC 62559 template and focussing on the SGAM function and information layer views. The process and methodology that were used build further on ***Internal Report R4.1 “Description of the SGAM methodology that will be used for the detailed functional specification of the ELECTRA solution”***. This is then followed by a conclusion and next steps description. To conclude, three annexes are included: 1) List of functions, 2) List of interactions and 3) a grey-box description of the functions.

¹ Control Topology Level = characteristic topology level at which a control loop operates: physical or single device level (CTL-0), cluster or aggregate of devices (CTL-1), cell level (CTL-2) or coordinated inter-cell level (CTL-3).

2 Process and Methodology

The 6 Use Cases that will be developed and tested were derived in a structured top-down manner from the six high-level functionalities that were defined in ELECTRA D3.1: Inertia Control (IRPC), Frequency/Balance Control (FCC, BRC, BSC) and Voltage Control (PPVC, PVC).

As a first step (Figure 1), for each of these high-level functionalities, a number of different conceptual solutions were defined, by distinguishing between:

- different specific objectives: these typically relate to different sets of setpoints and observables that can be used to achieve the overarching objective of inertia, frequency, balance or voltage control.
 - Example 1: a cell balance setpoint could be defined as a scheduled power profile for each on the cell's individual tie-lines, or as an aggregated profile (cell net import/export profile)
 - Example 2: the control objective could be to only correct imbalances that are caused by the cell itself, or to correct all imbalance that are observed and this way achieve a collaborative restoration of the balance
- different architectural options: these typically related to the selection of a cell central, decentral or distributed approach of deciding whether a correction is needed, and how this is effectuated. Other options relate to the way in which reserves activations are done (direct control, indirect by sending incentive signals, etc.).

This resulted in 70+ conceptual variants – that differ either in the black-box functions² that are needed and/or in the interactions between these functions – that were listed in ***D6.1 Functional Specification of the Control Functions for the Control of Flexibility across the different Control Boundaries Annex A (Selected Conceptual Solutions for Balance and Voltage Control)***.

As a second step, a selection was done. The ELECTRA project researchers made a selection based on their best understanding of the most important and critical functionalities of the future WoC concept. Additional feedback was received from stakeholders (TSOs, DSOs) e.g. in a CIRED workshop in Helsinki 2016 and a discussion with EDSO4SG representatives in Paris. Feedback was also received through joint workshops which were organized with the European Technology Platform of Smart Grids and with other related European project, e.g. GRID4EU, IDE4L.

As a third step (Figure 2), the list of black-box functions and interactions was analysed and simplified to distinguish between:

- **In focus functions** of the specific use case / functionality: mainly at CTL-2/3 level.
- Functions(/Device) related to **observables** (input for detecting if a corrective action is needed) or **actuators** (e.g. activating power to realize the correction): mainly at CTL-0/1 level.
- **Supportive functions** that are needed for testing and validation, but are not part of the control loop itself and can be emulated (e.g. using a database or file read access of previously stored values). Examples are functions that provide load and generation forecasts.

² Black-box functions focus on WHAT a function does, e.g. what output (for another function, or an actuation action) it produces based on what input without making a decision yet on HOW the function will generate this output from the input (there may be multiple ways to do it i.e. multiple alternative design choices may result in the same black box behaviour).

D3.1

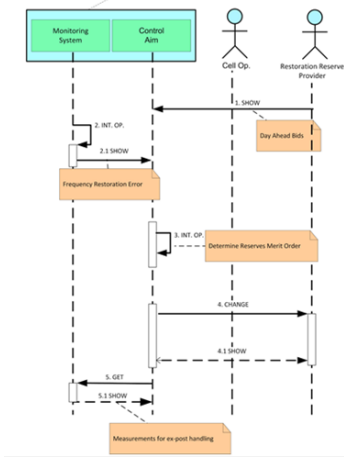

D6.1 Annex A

- Actors : Black-Box functions
- Information Exchanges, Interactions

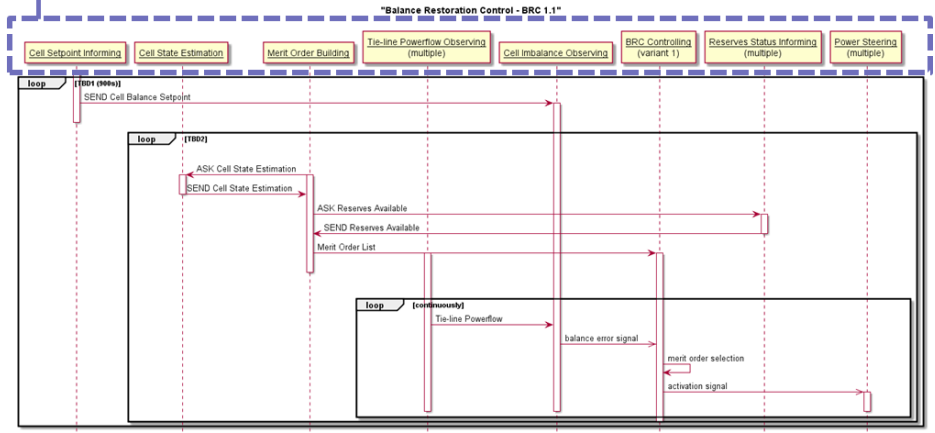
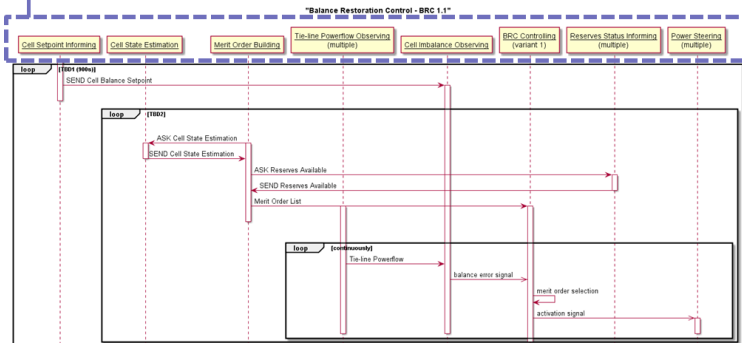

Figure 1 - Top-down elaboration of high-level functionalities into Variant Conceptual Solutions.

D6.1 Annex A

- Actors : Black-Box functions
- Information Exchanges, Interactions



D.4.2

- **Simplified** Black-Box functions and Interactions

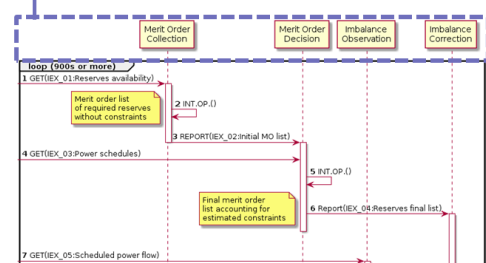

Figure 2 - Simplifying the Use Case variances to capture their essence.

In the Use Case description tables, black-box function descriptions are given that focus on WHAT functions (must) do i.e. what inputs are processed to generate what outputs or results without focusing on specific design decisions yet. In Annex 2 a more detailed grey-box description is given for each function, explaining the (considered) approach and high-level design choices/approaches (HOW); these grey-box descriptions facilitate detailed discussions on the functionality can be peer-reviewed to mitigate the risk of ambiguities or missing functionality. They are as well the basis for the subsequent implementation and simulation testing in WP6 and validation by laboratory tests in WP7. As part of the implementation and testing and validation activity, the detailed design decisions and implementation details will be captured in white-box descriptions in the planned update of D6.1.

The description of the information exchanges between the black-box functions (section 5 in the Use Case template) focus on the information content (WHAT: cfr SGAM Information Layer **Business Context View** as proposed by the DISCERN project). These descriptions need to be concrete enough so that they can serve as a 'contract' between those that will implement the functions that send the information, and those implementing the functions that receive the information. Besides, this is the basis for the standards selection and gap analysis in ***D4.3 Gap analysis and existing standards for proposed frequency and voltage control solutions***. This standards selection will decide on HOW the information is modelled and mapped.

3 Use Case descriptions

In this chapter, 6 Use Cases are described – one for each of the high-level functionalities – that together constitute a possible Web-of-Cells control scheme. Specific characteristics of this control scheme are that:

- It is a *solve local problems locally* approach where local observables are used to decide on local corrective actions to counter local issues: *localization and responsabilization*
- It minimizes communication complexity and latencies, as well as computation complexity (*divide and conquer*)
- It explicitly takes local grid conditions into consideration when deciding what resources to use
- It provides a distributed bottom-up approach for restoring system balance
- It focuses more on balance restoration (Balance Restoration Control – BRC) – and thereby restoring frequency as well rather than the current traditional sequence of Frequency Containment followed by Frequency Restoration. This balance restoration runs at the same timescale as frequency containment; but the frequency containment is made ‘adaptive’ (Adaptive Frequency Containment Control – FCC) to activate it mainly/only in cells that are causing the imbalance and frequency deviation.
- To compensate for the missing Imbalance Netting effect in a bottom-up restoration approach, a balance steering control (BSC) is added. This eliminates non-needed balance restoration reserves activations by implementing a localized imbalance netting mechanism by inter-cell setpoint adjustments. This can be done in a proactive manner – pre-empting activations -, or in a corrective manner – undoing activations.
- An Inertia Response Power Control (IRPC) ensures that there is a constant amount of inertia in the system irrespective of the amount of physical inertia by activating virtual inertia in a way that there is a fair contribution of each cell.

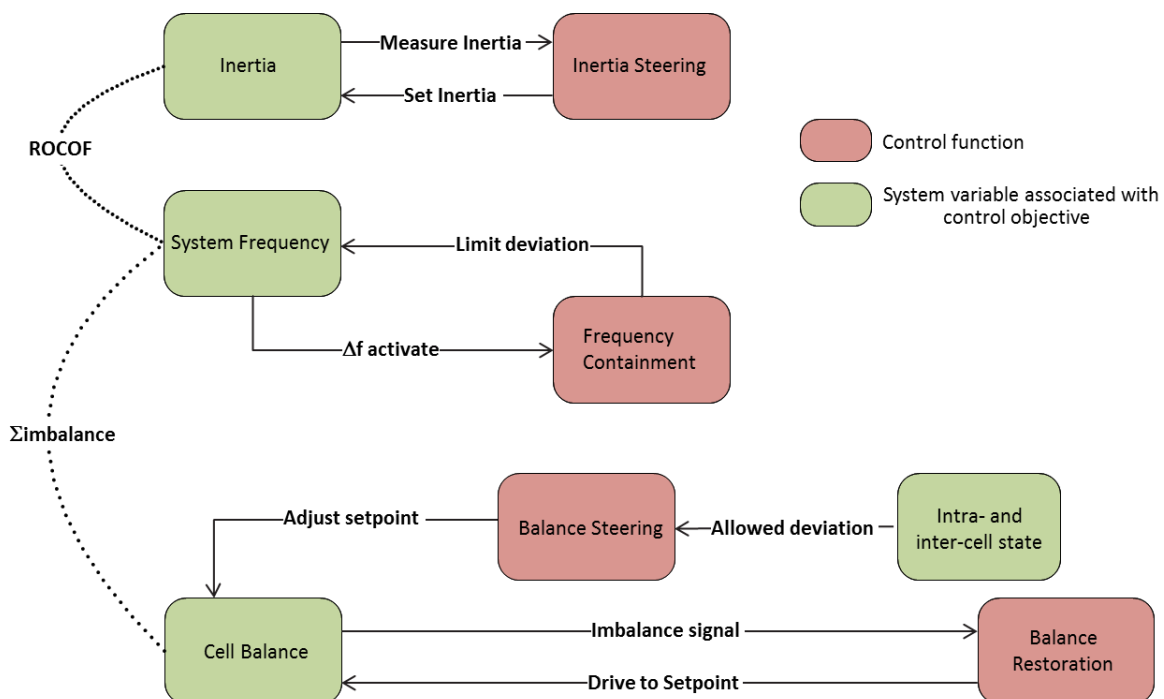

Figure 3 - Balance / Frequency / Inertia control scheme functionalities

- There is a Primary Voltage Control (PVC) very similar as of today, but at all voltage levels and actively steering both active and reactive power, and receiving its setpoints from a Post-Primary Voltage Control (PPVC)
- This PPVC determines optimal setpoints for PVC AVR resources as well as controllable Q devices, On-load-tap-changers (OLTCs) and capacitor banks: setpoints are recalculated whenever a too large deviation is measured as well as periodically to minimize losses.

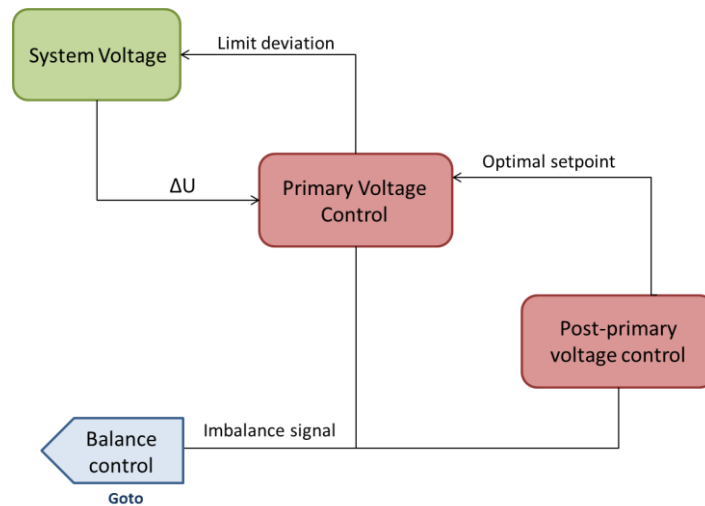

Figure 4 - Voltage Control Scheme functionalities

3.1 Inertia Response Power Control

3.1.1 Description of the use case

3.1.1.1 Name of use case

<i>Use case identification</i>		
<i>ID</i>	<i>Area Domain(s)/ Zone(s)</i>	<i>Name of use case</i>
IRPC 1.2.1	Transmission, Distribution, DER / Process, Field, Station, Operation	Inertia Response Power Control (IRPC)

3.1.1.2 Scope and objectives of use case

<i>Scope and objectives of use case</i>	
<i>Scope</i>	<p>This use case describes the Inertia Response Power Control functionality in the ELECTRA Web-of-Cells concept. This IRPC functionality ensures that each cell adapts the provided amount of (mainly virtual) inertia in response to an inertia setpoint received from a (system level) process (the setpoint generation is out-of-scope for ELECTRA).</p> <p>The rationale for this functionality is to ensure the availability of a constant amount of inertia in the system irrespective of the varying energy mix (synchronous generation versus inverter-coupled generation), and to decompose this inertia to cells in a way that local disturbances and incidents are contained in the cell (and neighboring cells) where they occur.</p>
<i>Objective(s)</i>	<p>O1: distribute the cell's received inertia (J) setpoint over a number of J providing resources taking into account the forecasted cell's state so that J activations do not cause grid problems.</p> <p>O2: optimal selection of J providing resources to maximize the containment of local deviations or incidents (and minimize frequency deviation df that would be observed by distant cells)</p>
<i>Related Higher-level use case(s)</i>	N/A (this is the highest level)
<i>Control Domain</i>	An ELECTRA cell.

3.1.1.3 Narrative of use case

<i>Narrative of use case</i>	
Short description	
<p>The CTL-2 cell-central controller receives a J setpoint for the next timestep, and decomposes this J into a $dP/(df/dt)$ droop setpoints of J providing devices in the cell.</p> <p>The J providing device continuously monitors df/dt and injects/absorbs active power in response to its $P/(df/dt)$ droop slope.</p>	
Complete description	
<p>The cell central df/dt Droop Slope Determination function receives a cell's J setpoint (cell's contribution to the system inertia) for the next timestep.</p> <p>The Merit Order Decision function (though the Merit Order Collection function) orders the available ROCOF Droop devices based on cost and location. This is done based on availability and cost information received from these ROCOF Droop devices, load and generation forecasts of all busses (nodes), and a local grid model.</p> <p>Location information is important to ensure that the power activations of the ROCOF Droop devices will not cause local grid problems.</p> <p>The resulting ordered list is sent to the df/dt Droop Slope determination function that determines the request df/dt droop slope setting (can be 0) for each ROCOF Droop device.</p> <p>Each ROCOF Droop device receives its droop setting for the next timestep, and will continuously monitor df/dt and activate/absorb power in accordance to its droop setting.</p> <p>No deadband will be used so that an action is taken even on the slightest variation of $\Delta f/\Delta t$. This choice is made to reap the side-effect of limiting the frequency fluctuation also during normal operation; i.e. the frequency fluctuation due to small variations of load and generation changes. A deadband combined with a low amount of inertia provided by synchronous generators could result in high frequency fluctuation tripping some of the connected generation. Besides, by acting on the normal rippling of the frequency, the IRPC provides a low pass filtering of this ripple.</p>	

3.1.1.4 Key Performance Indicators

<i>Key performance indicators</i>			
<i>ID</i>	<i>Name</i>	<i>Description</i>	<i>Reference to mentioned use case objectives</i>
1	Extent of affected area around the cell where Reference Incident occurs	Distance from node where Reference Incident occurs where the frequency deviation is reduced to 10% of the RoCoF tripping value of the RoCoF relays	O.1 – CTL-3
2	Maximum RoCoF	Respect the limit of the maximum RoCoF (e.g. 1 Hz/s)	O.3 – CT-L0

3.1.1.5 Use case conditions

<i>Use case conditions</i>
Assumptions
<ul style="list-style-type: none"> ➤ Sufficient synthetic inertia providing resources to provide the cell's J are available. ➤ Synthetic inertia providing resources are exclusively committed for providing synthetic inertia (i.e. not used for other use cases in the same timestep)
Prerequisites
<ul style="list-style-type: none"> ➤ The cell's J setpoint is calculated in an appropriate manner by an out-of-context function, and is provided in a timely manner. ➤ A list of procured synthetic inertia providing resources and their location in the local grid is available (the procurement itself is out of scope for this use case). ➤ A model of the local grid is available. ➤ Load and generation forecasts of all busses are available (either provided or estimated)

3.1.1.6 Further information to the use case for classification / mapping

<i>Classification Information</i>
Relation to other use cases
BRC and FCC: the amount of inertia, as well as the nature of inertia (synthetic or not), will play an important role in the FCC and BRC dynamics.
Nature of use case
Technical Use Case (Distributed Control)
Further keywords for classification
ELECTRA, Web-of-Cells, Inertia

3.1.1.7 General remarks

<i>General remarks</i>
<p>Synthetic inertia providing resources are inverter-based DER (RES, Storage, Loads): they have a faster ramping rate than synchronous generators, but only act after a small ICT delay.</p> <p>At CTL-0, each participating unit gets activated locally and automatically. The amount of delivered power depends on the proportionality parameter (droop slope) and the error signal. Since the controller is activated by $\Delta f/\Delta t \neq 0$, it will always get activated even with the slightest variation of $\Delta f/\Delta t$. This choice is made to reap the side-effect of limiting the frequency fluctuation also during normal operation; i.e. the frequency fluctuation due to small variations of load and generation changes. If not, due to the reducing number of physical rotating mass based inertia, adding a dead band to synthetic inertia providers could result in high</p>

frequency fluctuation tripping some of the connected generation.

Synchronous machines give instantaneous Inertia Response Power. For synthetic inertia, it takes a few periods for the CTL-0 droop controller to detect that the frequency is changing, especially in case of single phase converters and when PLL techniques are used.

The effect and impact of having large numbers of distributed small synthetic inertia providers, as opposed to a small number of large physical inertia providers, need to be analyzed. E.g. could interference patterns cause oscillations and system instability? It is known that large generators connected by long tie-lines can cause inter area oscillations. There are reasons to expect similar oscillations at shorter distances between numerous small devices providing synthetic inertia.

3.1.2 Diagrams of use case

Diagram(s) of use case

a) Context diagram:

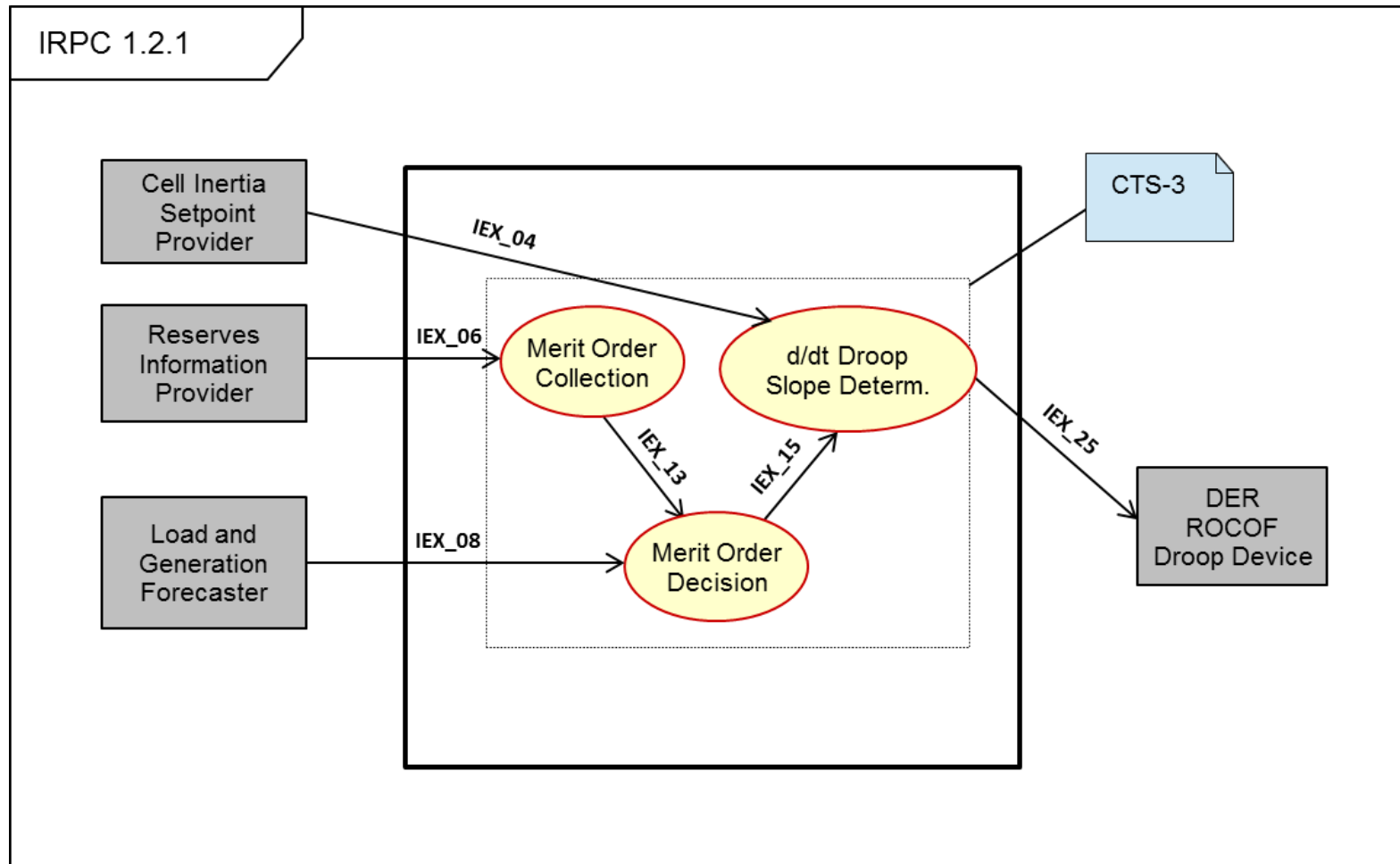

b) Sequence diagram:

Scenario 1.a: Normal operation – preparing next timestep

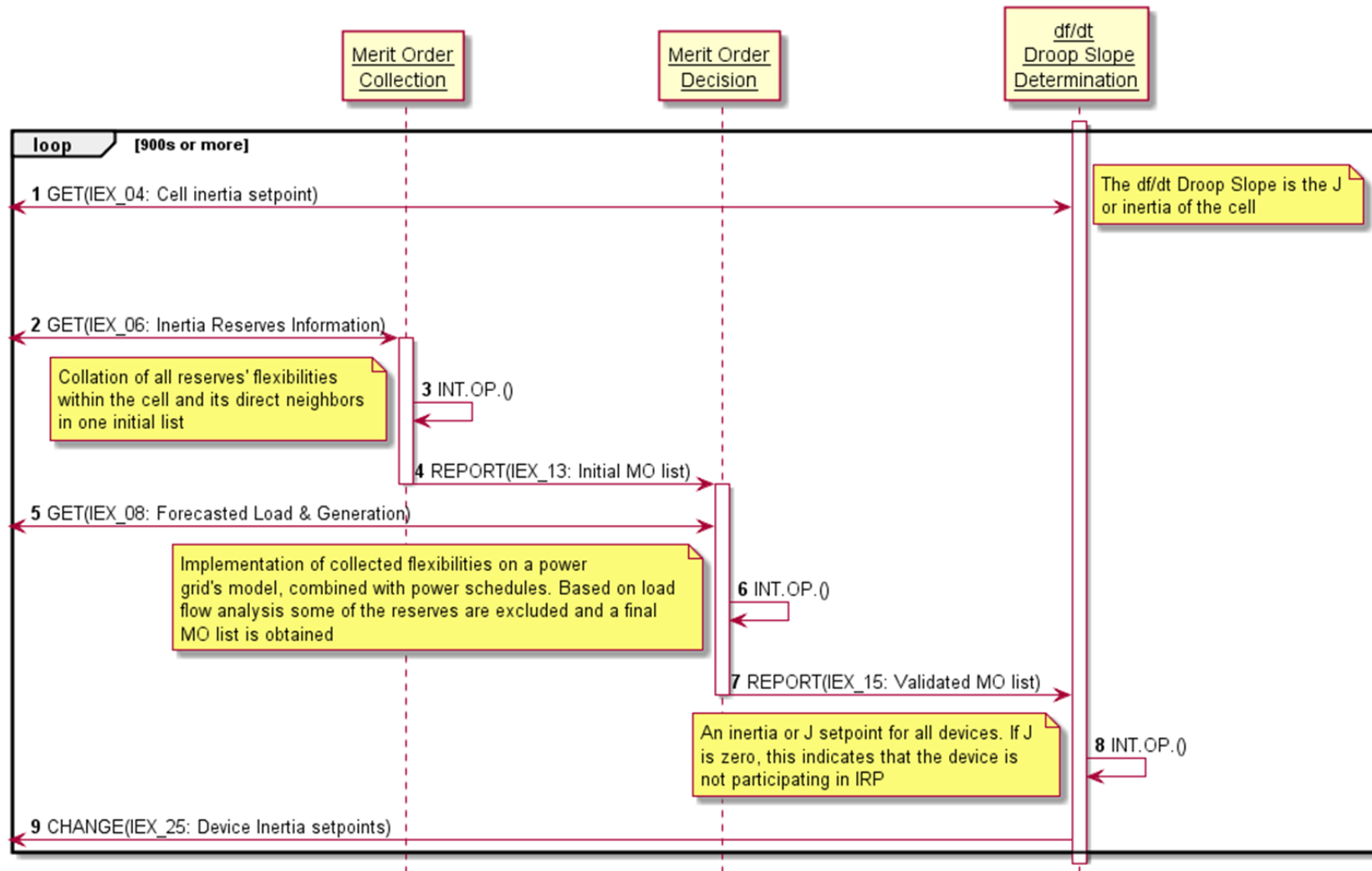

Scenario 1.b: Normal operation – real-time control

CTL-0 local ROCOF droop control

c) Timing diagram:

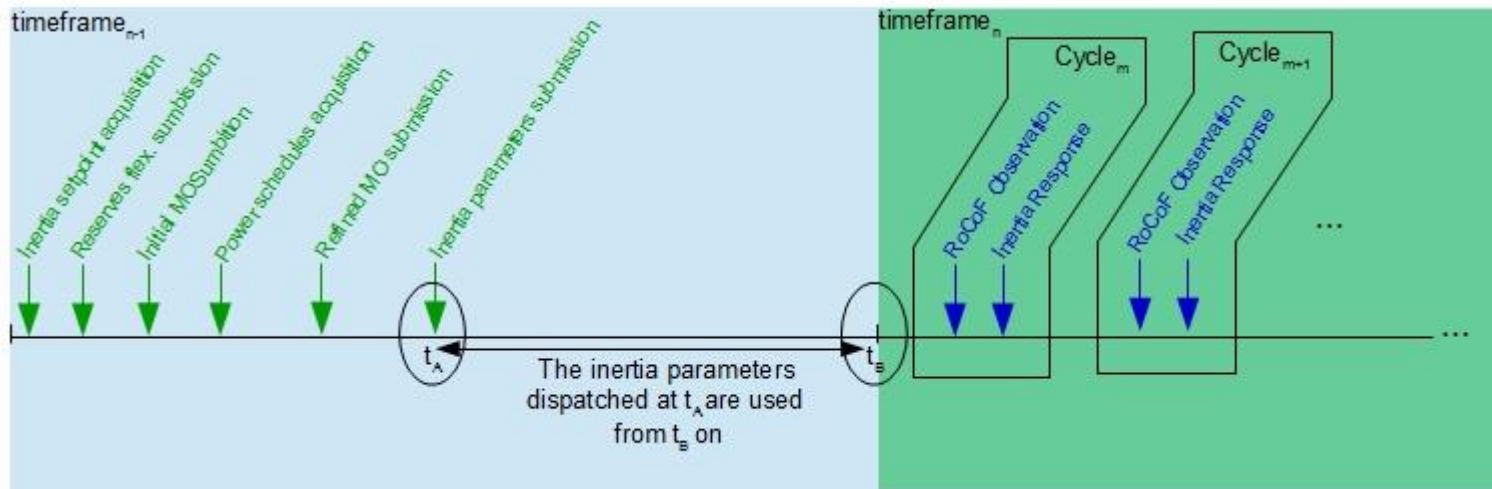

3.1.3 Technical details

3.1.3.1 Actors

Actors	
Grouping	Group description
In-focus functions	Functionality that will be implemented and tested
Emulated functions	Functionality that is 'out-of-scope' and will be emulated (e.g. reading information from a file or database)
Observer/Actuator functions	Functionality that is related to measurement or actuation devices

Actor name	Actor type	Actor description	Further information specific to this use case
Merit Order Collection	In-focus Function	This function receives reserves flexibilities (or availabilities) from the <i>Reserves Information provider function</i> , and collates them in a list ranked by cost. The resulted list is submitted to the <i>Merit Order Decision function</i> for final improvements.	The function is performed by the cell controller (CTL-2) and activated at CTS-3.
Merit Order Decision	In-focus Function	This function calculates the final Merit Order list by taking into consideration the operating constraints of the grid on which these reserves are to be deployed. The function receives the initial input by the <i>Merit Order Collection function</i> and delivers the final Merit Order list to the <i>df/dt Droop Slope determination function</i> .	The function is performed by the cell controller (CTL-2) and activated at CTS-3. <i>This function has/uses (assumed) static grid model information (topology, characteristics like impedances, and EANi information i.e. what is connected where).</i>
df/dt Droop Slope Determination	In-focus Function	Based on the Merit Order list provided by the <i>Merit Order Decision function</i> , this function determines the J or df/dt droop slope of DER units by decomposing the cell inertia df/dt droop slope that it received from the <i>Cell Inertia setpoint provider function</i> into device inertia or df/dt droop slopes in such a manner that the aggregated droop slope is equal to the set point for the cell inertia.	The function is performed by the cell controller (CTL-2) and activated at CTS-3.
Cell Inertia setpoint provider	Emulated Function	This function provides the cell inertia or J setpoint to the <i>df/dt Droop Slope Determination function</i> .	Emulated functionality implemented as a file read (the cell setpoint calculation functionality is out of scope). Activated at CTS-3.
Reserves Information provider	Emulated Function	It provides the available power capacity that is needed for the compilation of the Merit Order List by the Merit Order Collection function. It can be part of a DER.	Emulated functionality implemented as a file read (the availability and cost forecasting functionality is out of scope). Activated at CTS-3

			This functionality could be mapped DER – ROCOF Droop devices.
Load & Generator forecaster	Emulated Function	It provides the scheduled production and consumption of all generators and loads in order to be used by the Merit Order Decision for the calculation of the optimal reserves. This function can be a database (or file) that contains schedules over a specific time horizon (e.g. one day).	Emulated functionality implemented as a file read (the load and generation forecasting functionality is out of scope). Activates at CTS-3.
DER – ROCOF droop device	Device (multiple) with observer and actuation functionality	Continuously measures df/dt and activates active power in accordance with the droop setpoint that it received.	New droop setpoint is received at CTS-3. The continuous control is running at CTS-1.

3.1.4 Step by step analysis of use case

3.1.4.1 Overview of scenarios

<i>Scenario conditions</i>						
<i>No.</i>	<i>Scenario name</i>	<i>Scenario description</i>	<i>Primary actor</i>	<i>Triggering event</i>	<i>Pre-condition</i>	<i>Post-condition</i>
1.a	Normal operation – preparing next timestep	Decomposing the cell's assigned synthetic inertia over available resources	Df/dt Droop Slope determination	Time Trigger	DER – ROCOF Droop devices are procured	All DER – ROCOF Droop devices received their setpoint
1.b	Normal operation – realtime control	Responding to continuous stream of small deviations (validation case 1) as well as load steps (validation case 2)	DER – ROCOF Droop devices	$\Delta f/\Delta t \neq 0$	All DER – ROCOF Droop devices received their setpoint.	Synthetic inertia is delivered

3.1.4.2 Steps – Scenarios

<i>Scenario 1.a</i>

Scenario name:		Normal operation – preparing next timestep						
Step No.	Event	Name of process/activity	Description of process/activity	Service	Information producer (actor)	Information receiver (actor)	Information exchanged (IDs)	Requirements R-ID
1	Time Trigger	GET Cell Inertia setpoint	The Cell Inertia setpoint for the next time step is received		Cell Inertia Setpoint provider	Df/dt Droop Slope determination	IEX_04	CTS-3
2	Time Trigger	GET Reserves Status information	Collect information from the Reserves Information Provider		Reserves Information Provider	Merit Order Collection	IEX_06	CTS-3
3		Building initial Merit Order list (cost based)	Internal processing: ordering of the DER – ROCOF Droop devices that can provide a service in the next timestep (cheapest first)		Merit Order Collection	Merit Order Collection	-	
4		REPORT initial Merit Order list	Send the initial Merit Order list to the Merit Order Decision function		Merit Order Collection	Merit Order Decision	IEX_13	
5	Time Trigger	GET load and generation forecasts	Collect information concerning the load and generation forecast of all busses/nodes		Load & Generation forecaster	Merit Order Decision	IEX_08	CTS-3
6		Calculating final Merit Order list (location aware)	Internal processing: determining the final merit order list by taking into account location information and grid status forecasts		Merit Order Decision	Merit Order Decision	-	
7		REPORT final Merit Order list	Send the final merit order list to the df/dt droop		Merit Order Decision	Df/dt Droop Slope determination	IEX_15	

			slope determination					
8		Calculating the droop slopes for all DER ROCOF Droop devices in the final merit order list	Internal processing: calculate the droop factors for all DER ROCOF Droop devices of the final merit order list		Df/dt Droop Slope determination	Df/dt Droop Slope determination	-	
9		CHANGE DER ROCOF droop device settings	Send the updated droop information for the next time step to all DER ROCOF Droop devices		Df/dt Droop Slope determination	DER – ROCOF Droop devices	IEX_25	
Scenario 1.b								
Scenario name:		Normal operation – realtime control						
Step No.	Event	Name of process/activity	Description of process/activity	Service	Information producer (actor)	Information receiver (actor)	Information exchanged (IDs)	Requirements R-ID
10	Continuously	dP/(df/dt) droop control	Internal Processing: activate active power in response to df/dt measurement.	INTERNAL OPERATION	df/dt observer at DER – ROCOF Droop device	Active Power Controller at DER – ROCOF Droop device	-	CTS-1

3.1.5 Information exchanged

Information Exchanged			
Information exchanged ID	Name of information exchanged	Description of information exchanged	Requirements IDs
IEX_04	Cell Inertia setpoint	Value of requested cell (virtual) inertia (J ; flat number) in kgm2 with resolution 1 kgm2 ; CTS3 timescale (e.g. every 15min).	
IEX_06	Inertia Reserves information	Vector of (virtual) inertia (J) in kgm2 with resolution 1 kgm and cost (euros/kgm2) ; CTS3 timescale (e.g. every 15min).	

		(EANi optionally depending on communication approach)	
IEX_08	Forecasted Load and Generation	Vector of active and reactive power values (P, Q ; flat numbers) in Watt with resolution 1 Watt and VAr with resolution 1 VAr respectively ; CTS3 timescale (e.g. every 15min) (EANi optionally depending on communication approach)	
IEX_13	Inertia Initial Merit Order list	Matrix of (virtual) inertia (J) in kgm2 with resolution 1 kgm2 in conjunction with EANi (location) ; CTS3 timescale (e.g. every 15min). (ordered in increasing cost ; cost information could be added optionally).	
IEX_15	Inertia Validated Merit Order list	Matrix of (virtual) inertia (J) in kgm2 with resolution 1 kgm2 in conjunction with EANi (location) ; CTS3 timescale (e.g. every 15min). (only those that can be activated securely ; ordered in increasing cost ; cost information could be added optionally).	
IEX_25	Device Inertia Setpoints	Value of (virtual) inertia (J ; flat number) in kgm2 with resolution 1 kgm2 ; CTS3 timescale (e.g. every 15min). or (Broadcast mode) Matrix of (virtual) inertia (J ; flat number) in kgm2 with resolution 1 kgm2 in conjunction with EANi (location) ; CTS3 (e.g. every 15min)	

3.1.6 Requirements (will be completed based on experimental testing and validation results)

<i>Requirements</i>		
<i>Categories ID</i>	<i>Category name for requirements</i>	<i>Category description</i>
<i>Requirement ID</i>	<i>Requirement name</i>	<i>Requirement description</i>

3.1.7 Common Terms and Definitions

<i>Common terms and definitions</i>

<i>Term</i>	<i>Definition</i>
Moment of Inertia J [kg m²]	The moment of inertia, otherwise known as the angular mass or rotational inertia, of a rigid body determines the torque needed for a desired angular acceleration about a rotational axis. It depends on the body's mass distribution and the axis chosen, with larger moments requiring more torque to change the body's rotation.
Inertia Constant H [s]	Time constant which expresses the amount of kinetic energy stored in a rotating mass, namely a synchronous generator's rotor, divided by the rated power of the generator

3.1.8 Controller Conflicts and Misuse cases.

<i>id</i>	<i>Case Name</i>	<i>Description</i>	<i>Related Requirements</i>	<i>Related objective</i>	<i>Recommended mitigation</i>
CC_01	Potential oscillation behavior	The distributed J in combination with properties of line and cables and in combination with activated frequency droop causes frequency oscillations.	The device participates in both IRPC and FCC services	Reducing the current and potential oscillation	Depending on the analysis of the LCR model adapt the assignment procedure for droop lines both for df/dt and for Δf . The latter has to be in agreement with the FCC use case.

3.2 Adaptive Frequency Containment Control

3.2.1 Description of the use case

3.2.1.1 Name of use case

<i>Use case identification</i>		
<i>ID</i>	<i>Area Domain(s)/ Zone(s)</i>	<i>Name of use case</i>
FCC.2.5.1	Transmission, Distribution, DER / Process, Field, Station, Operation	Adaptive Frequency Containment Control with central location-aware merit order based Cell Power Frequency Characteristic decomposition.

3.2.1.2 Scope and objectives of use case

<i>Scope and objectives of use case</i>	
Scope	<p>This use case describes the Adaptive Frequency Containment Control functionality in the ELECTRA Web-of-Cells concept. This Adaptive FCC functionality ensures that each cell adapts its amount of provided dP/df droop in response to a CPFC (Cell Power Frequency Characteristic) setpoint received from a (system-level) process (which is out of the ELECTRA project scope). The actual droop that a cell actually provides is further scaled to reduce the activation of FCC resources in cells that are not causing the deviation (this is the Adaptive aspect).</p> <p>The rationale for the Adaptive aspect is to make cells responsible for solving the deviations they are causing, and limit the amount of imbalances caused by FCC activations in cells that otherwise would be in balance.</p> <p>In contrast to 'traditional' frequency control, this adaptive FCC is not a primary response that is followed by a slower secondary response that takes over from this primary response: instead it runs at the same timescale as the Balance Restoration Control. But where BRC is acting on a pure local observable (tie-line powerflow deviation), the Adaptive FCC is acting on a system level observable (frequency deviation) but its actions are scaled in relation to its local state.</p>
Objective(s)	<p>O1: Decomposition of the cell's received CPFC into dP/df droop settings of available FCC resources taking into account the cell's forecasted grid state so that FCC activations do not cause grid problems</p> <p>O2: Contain dynamic and steady-state frequency deviations (at the same timescale as BRC)</p> <p>O3: Activation of FCC reserves mainly within cells causing the deviation (and minimizing activations in balanced cells)</p> <p>O4: Reduce the overall use of FCC reserves all over the synchronous area</p>

Related Higher-level use case(s)	N/A (this is the highest level)
Control Domain	An ELECTRA Cell.

3.2.1.3 Narrative of use case

Narrative of use case
Short description
<p>The CLT2 cell-central controller receives a CPFC setpoint for the next timestep and decomposes this CPFC into dP/df droop setpoints for FCC providing devices in the cell.</p> <p>The resulting droop slopes are continuously scaled taking into account the cell's balance state so that cells that are not causing the deviation are activating less. The FCC devices continuously monitor df and inject/absorb active power in response to its – scaled – droop slope in order to contain both dynamic and steady-state frequency deviation.</p> <p>This control is running at the same timescale as BRC.</p>
Complete description
<p>The cell central Frequency Droop Parameter Determination function receives the cell's CPFC setpoint (cell's contribution to the system NPFC – Network Power Frequency Characteristic) for the next timestep.</p> <p>The Merit Order Decision function (through the Merit Order Collection function) orders the available Frequency Droop devices based on cost and location. This is done based on availability and cost information received from these Frequency Droop devices, and load and generation forecasts of all busses (nodes), and a local grid model.</p> <p>Location information is important to ensure that the power activations of the DER - Frequency Droop devices will not cause local grid problems.</p> <p>The resulting ordered list is sent to the Frequency Droop Parameter Determination function that determines the requested dP/df droop setting (can be 0) for each Frequency Droop device.</p> <p>Each Frequency Droop device receives its droop setting (droop slope and deadband) for the next timestep, and will continuously monitor df and activate/absorb active power in accordance to its droop setting.</p> <p>This droop setting is continuously adapted by the Adaptive CPFC Determination function by means of a scaling factor that is determined based on the cell's imbalance state. Based on frequency and cell imbalance error signals, this function will calculate a scaling factor to achieve that most FCC activations are done in cells that cause the deviation, and less in cells that do not cause the deviation.</p> <p>In contrast to 'traditional' frequency control, this adaptive FCC is not a primary response that is followed by a slower secondary response that takes over from this primary response: instead it runs at the same timescale as the Balance Restoration Control and it helps to contain frequency deviations. But where BRC is acting on a pure local observable (tie-line powerflow deviation), the Adaptive FCC is acting on a system level observable (frequency deviation) but its actions are scaled in relation to its local state.</p>

3.2.1.4 Key Performance Indicators

Key performance indicators			
ID	Name	Description	Reference to mentioned use case objectives
1	Contribution to NPFC	$ \Delta P_{\Delta f} _{ref.} - \Delta P_{\Delta f} _{act.} < error (\%)$	O.1, O.3
2	Maximum dynamic frequency deviation	$ \Delta f_{dyn} < \Delta f_{dyn,max} $	O.2
3	Maximum steady-state frequency deviation	$ \Delta f_{static} < \Delta f_{static,max} $	O.2
4	Maximum response time for steady-state deviation	$t_{static,max} < 30sec$	O.2
5	Reduction of FCC reserves	$EFCC_{dyn} < EFCC_{max}$	O.4

3.2.1.5 Use case conditions

Use case conditions
Assumptions
<ul style="list-style-type: none"> ➤ Sufficient FCC resources to provide the cell's CPFC are available, even after the location aware merit order decision function removed or curtailed some of them.
Prerequisites
<ul style="list-style-type: none"> ➤ The cell's CPFC setpoint is calculated in an appropriate manner by an out-of-context function, and is provided in a timely manner. ➤ A list of procured FCC resources and their location in the local grid is available (the procurement itself is out of scope for this use case). ➤ A model of the local grid is available. ➤ Load and generation forecasts of all busses are available (either provided or estimated) ➤ FCC providing resources are exclusively committed for providing FCC support (i.e. not used for other use cases in the same timestep)

3.2.1.6 Further information to the use case for classification / mapping

Classification Information
Relation to other use cases
IRPC: the amount of inertia, as well as the nature of inertia (synthetic or not) will play an important role in the FCC dynamics. BRC: BRC running at the same time scale – rather than slower and taking over – will play an important role in the FCC dynamics. Therefore, for an optimal design the NPFC/CPFC decomposition should take into account parameters related to the IRPC and BRC functionalities.

PVC and PPVC: active power activations for FCC may cause voltage perturbations to nearby nodes, influencing voltage controllers.
<i>Nature of use case</i>
Technical Use Case (Distributed Control)
<i>Further keywords for classification</i>
ELECTRA, Web-of-Cells, Adaptive Frequency Containment

3.2.1.7 General remarks

<i>General remarks</i>
<p>The core idea of this use case originates from the classic droop control function of synchronous generators, with or without a frequency deadband, which can be applied to various other resources, including DER and loads. The droop control is considered at CTL-0 (device level) that utilises a linear power regulation as a function of frequency deviations. Although it is easy to extrapolate the assumptions and to implement a very similar control strategy at CTL1 (aggregation of devices). FCC resources are assumed to be primarily inverter-based DER (RES, Storage, DGs and Loads), which provide a substantial granularity in terms of CPFC optimal configuration and are capable of adapting much faster to changes imposed by the control by contrast with the slow synchronous generators</p> <p>Currently this droop is defined at Synchronous Area level and distributed to Control Areas based on their characteristics. In the Web-of-Cells concept, there is a further decomposition to cell level. For instance this could be based on the dynamic characteristics related to its dynamic generation mix and/or the expected deviations from setpoints that would cause imbalances and setpoint deviations. In each timestep (control time window: e.g. 15'), a cell will receive a Cell Power Frequency Control (CPFC) setpoint which defines the cell's expected contribution to Frequency Containment Control for the next timestep. The calculation of this CPFC setpoint – which is the cell's dP/df droop slope contribution to the overall system droop slope, is out-of-context for this use case.</p> <p>Based on the forecasted grid status, resources whose activations could cause a local grid problem are curtailed/scaled down or filtered out completely, resulting in a location aware merit order list that ranks these resources from cheapest to most expensive.</p> <p>The Adaptive FCC gives priority to FCC activations within the cell that has an imbalance and reduces the contribution of neighbouring cells, without however compromising the overall stability To ensure that activations are mainly done in cells that cause the deviation, a combination of the frequency measurement and imbalance status of the cell is used to determine whether a cell is causing the deviation or not. Depending on this, the device droop slopes receive a droop scaling factor (between 0 and 1) that limits a droop slope if the deviation is not caused in the cell.</p> <p>The controller incorporates a dead-band response governed by a frequency threshold value determined by the Droop Parameter Determination function. Technically speaking, this case is the most general since by setting the threshold value to zero a response under normal operation of the device is obtained. By setting the frequency threshold of different devices at different values it is possible to achieve a more optimal reserves activation under normal operation, or reserve specific resources to only act on large incidents. Besides, deadbands could be set to a value that cause FCC activations only in case the BRC that is running at the same timescale is not restoring and containing frequency deviations fast enough</p>

3.2.2 Diagrams of use case

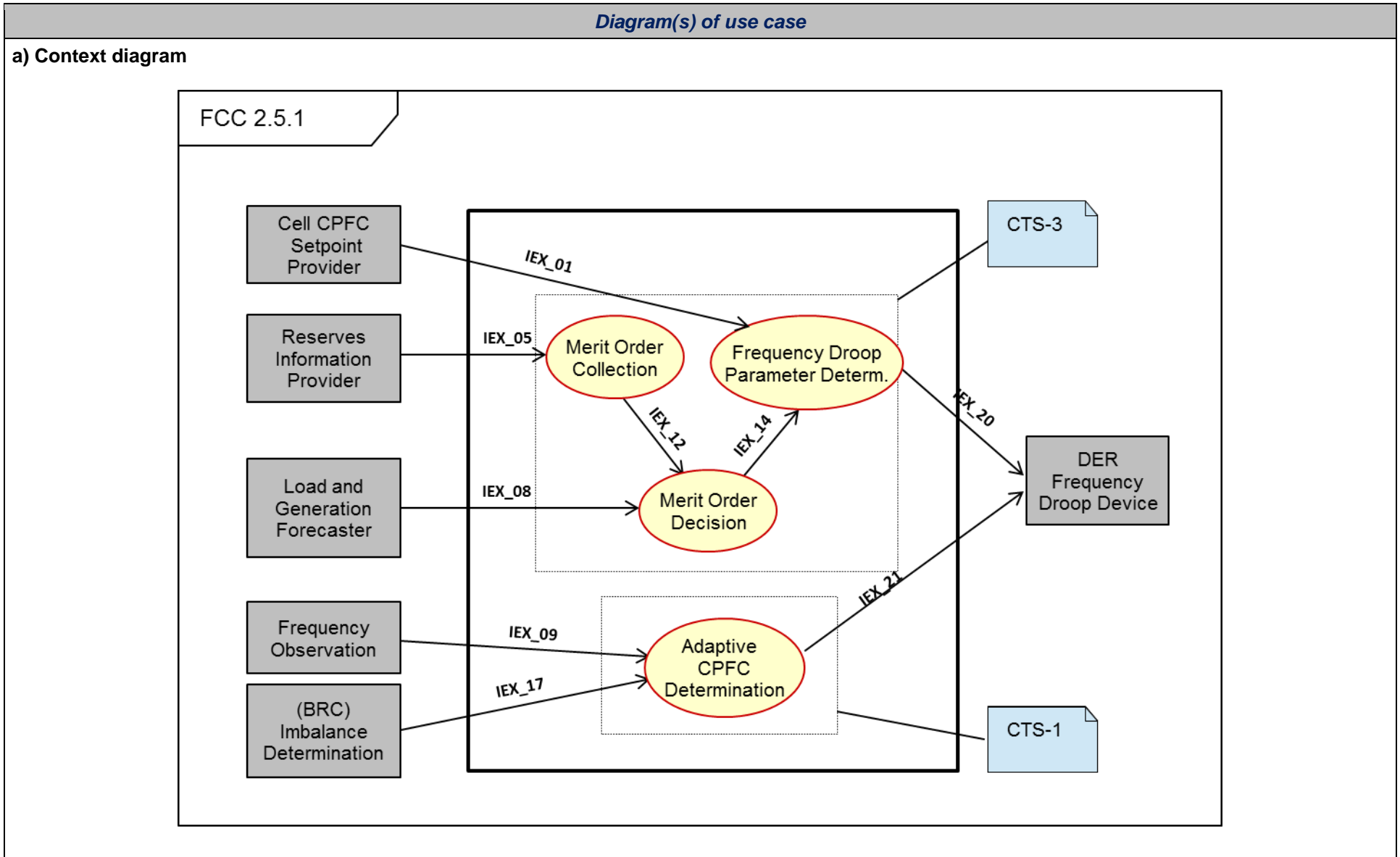

b) Sequence diagram

Scenario 1.a: Normal operation – preparing next timestep

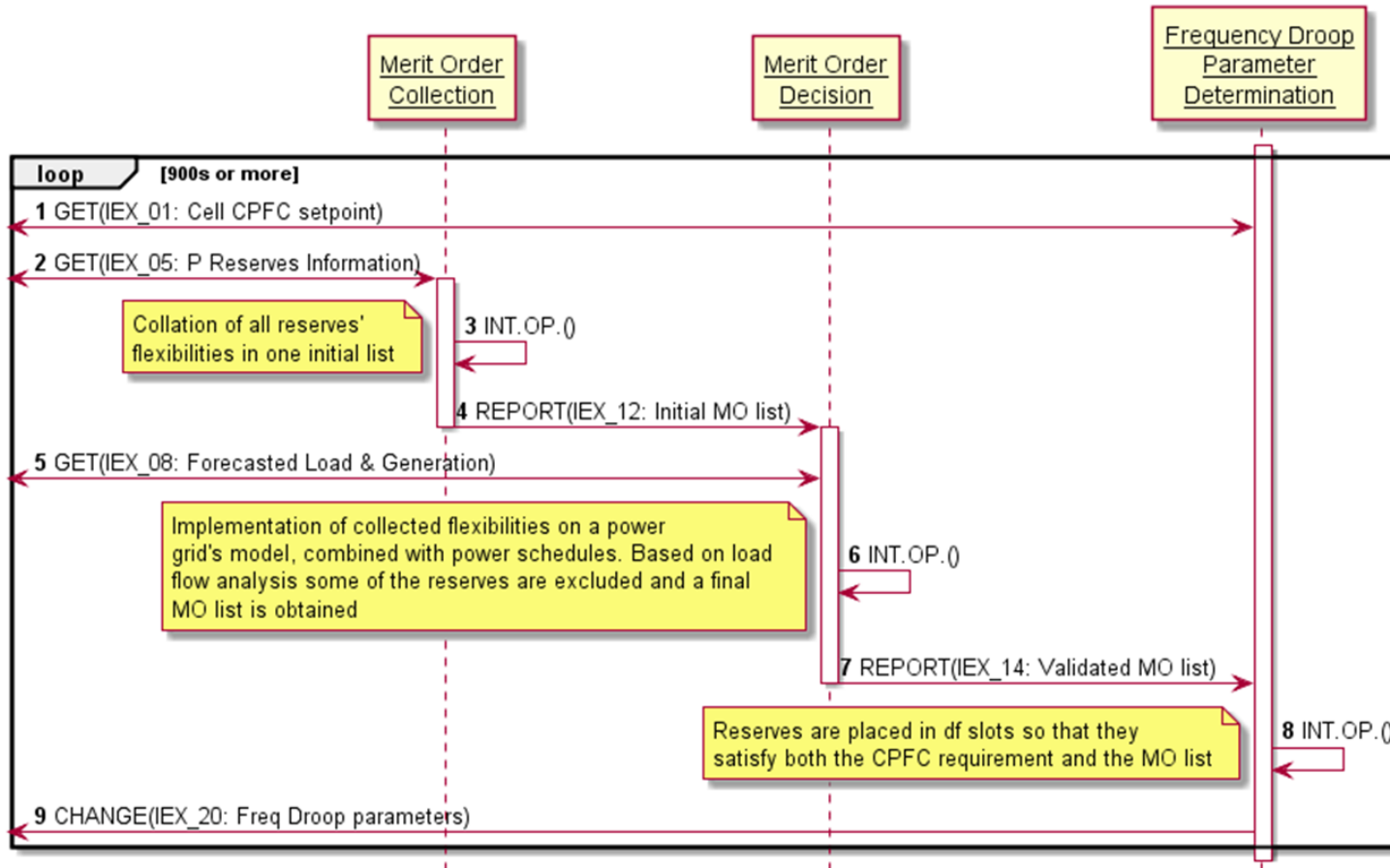

Scenario 1.b: Normal operation – realtime droop scaling factor calculation

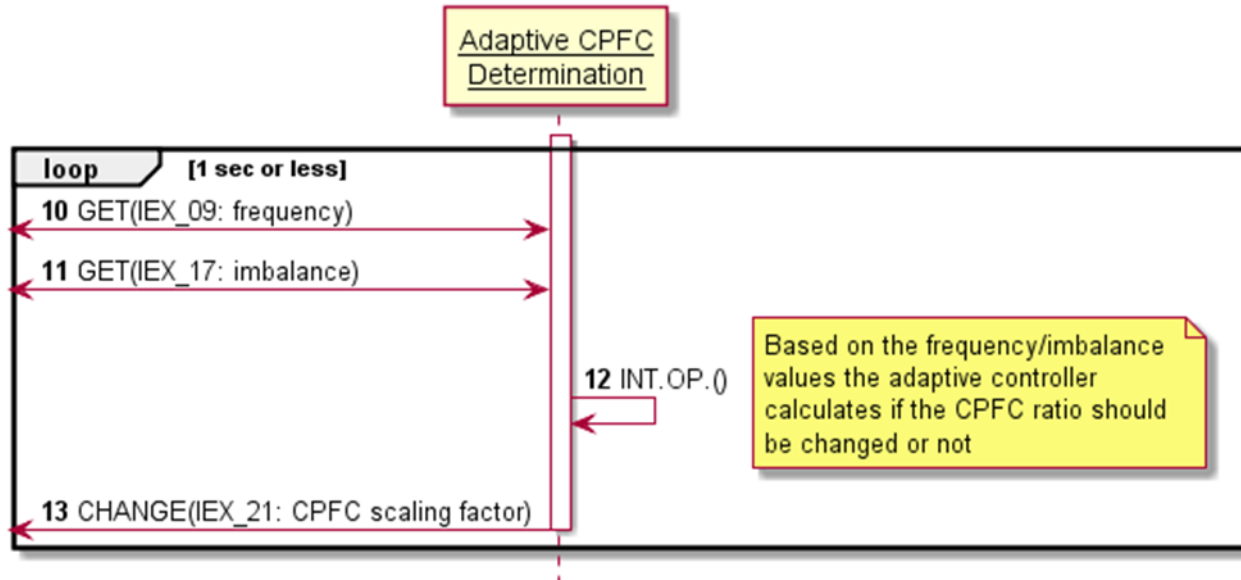

Scenario 1.c: Normal operation – realtime control

CTL-0 local frequency droop control

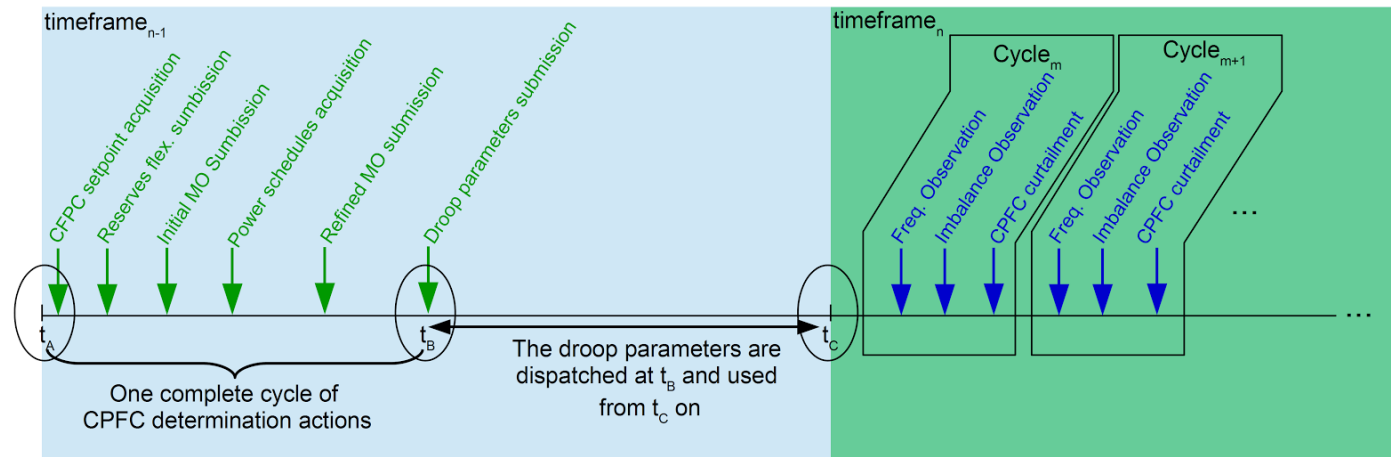
c) Timing diagram:

t_A : Start time of scenario 1 (one CPFC calculations cycle)
 t_B : End time of scenario 1 (one CPFC calculations cycle)
 t_C : Time at which the droop parameters are used

3.2.3 Technical details

3.2.3.1 Actors

Actors	
Grouping	Group description
In-focus functions	Functionality that will be implemented and tested
Emulated functions	Functionality that is 'out-of-scope' and will be emulated (e.g. reading information from a file or database)
Observer/Actuator functions	Functionality that is related to measurement or actuation devices

Actor name	Actor type	Actor description	Further information specific to this use case
Frequency Droop Parameter Determination	In-focus Function	This function receives the cell's CPFC from the <i>Cell CPFC Setpoint Provider function</i> for the next timestep. Based on the final Merit Order list it receives from the <i>Merit Decision Order function</i> , it determines the droop slopes and deadbands for each <i>Frequency Droop Device</i> in such a manner that the aggregated droop slope is equal to the CPFC.	The function is performed by the cell controller and belongs to CTL-2 and is activated at CTS-3. <i>Static information needed for this function: minimum/maximum frequency deviation (e.g. ± 3Hz)</i>
Merit Order Collection	In-focus Function	This function receives reserves flexibilities (or availabilities) from the <i>Reserves Information provider function</i> , and collates them in a list ranked by cost. The resulted list is submitted to the <i>Merit Order Decision function</i> for final improvements.	The function is performed by the cell controller and belongs to CTL-2 and is activated at CTS-3.
Merit Order Decision	In-focus Function	This function calculates the final Merit Order list by taking into consideration the operating constraints of the grid on which these reserves are to be deployed. The function receives the initial input by the <i>Merit Order Collection function</i> and delivers the final Merit Order list to the <i>Frequency Droop Parameter determination function</i> .	The function is performed by the cell controller and belongs to CTL-2 and is activated at CTS-3. <i>This function has/uses (assumed) static grid model information (topology, characteristics like impedances, and EANI information i.e. what is connected where).</i>
Adaptive CPFC Determination	In-focus Function	This function calculates the instantaneous droop scaling factor (CPFC_ratio: a value between 0 and 1) based on the cells' imbalance state it receives from the <i>(BRC) Imbalance Determination function</i> and the frequency it receives from the <i>Frequency Observation function</i> . This scaling factor is sent to all <i>Frequency Droop devices</i> .	The function is performed by the cell controller and belongs to CTL-2 and is activated at CTS-1. <i>Static information needed for this function: -minimum/maximum allowable CPFC ratio -minimum/maximum frequency deviation -minimum/maximum tie-line power deviation</i>
Cell CPFC Setpoint Provider	Emulated Function	This function provides the cell's CPFC setpoint to the <i>Frequency Droop Parameter Determination function</i> .	Emulated functionality implemented as a file read (the cell CPFC setpoint calculation)

			functionality is out of scope). Activated at CTS3.
Reserves Information Provider	Emulated Function	It provides the available power capacity that is needed for the compilation of the Merit Order List by the Merit Order Collection function.	Emulated functionality implemented as a file read (the availability and cost forecasting functionality is out of scope). Activated at CTS-3. This functionality could be mapped DER – Frequency Droop devices.
Load & Generator Forecaster	Emulated Function	It provides the scheduled production and consumption of all generators and loads in order to be used by the Merit Order Decision for the calculation of the optimal reserves. This function can be a database (or file) containing schedules over a specific time horizon (e.g. one day).	Emulated functionality implemented as a file read (the load and generation forecasting functionality is out of scope). Activated at CTS-3.
Frequency Observation	Observer Function	It calculates and provides frequency measurements to the <i>Adaptive CPFC Determination function</i> .	The function is performed by the cell controller and belongs to CTL-2 and is activated at CTS-1.
<i>(BRC) Imbalance Determination</i>	<i>In-focus Function</i>	<i>It provides the determined imbalance calculated by BRC.</i>	<i>Out-of-scope: BRC functionality whose output is used in this FCC use case.</i>
DER – Frequency Droop Device	Device (multiple) with observer and actuation functionality	Continuously measures df and activates active power in accordance with the droop settings it received from the <i>Frequency Droop Parameter Determination function</i> and the scaling factor it received from the <i>Adaptive CPFC Determination function</i> .	New droop parameters are received at CTS-3. New droop slope scaling factors are received at CTS-1. The continuous control is running at CTS-1.

3.2.4 Step by step analysis of use case

3.2.4.1 Overview of scenarios

Scenario conditions						
No.	Scenario name	Scenario description	Primary actor	Triggering event	Pre-condition	Post-condition
1.a	Normal operation - preparing next timestep	Decomposing the cell's assigned CPFC over available resources	Device Droop Slope Determination function	Time Trigger	DER – Frequency Droop devices are procured	DER – Frequency Droop devices received their droop parameters
1.b	Normal operation – realtime droop scaling factor calculation	Calculating a cell droop scaling factor to limit FCC activations in cells that are not causing the deviation	Adaptive CPFC Determination	Periodic (at CTS_1)	Cell Imbalance error signal is available	DER – Frequency Droop devices received their droop scaling factor
1.c	Normal operation – realtime control	Responding to continuous stream of small frequency deviations (validation case 1) as well as load steps (validation case 2)	DER – Frequency Droop devices	$\Delta f \neq 0$	All DER – Frequency Droop devices received their droop setpoint and droop scaling factor.	FCC is delivered

3.2.4.2 Steps – Scenarios

Scenario 1.a								
Scenario name:		Normal operation - preparing next timestep						
Step No.	Event	Name of process/ activity	Description of process/ activity	Service	Information producer (actor)	Information receiver (actor)	Information exchanged (IDs)	Requirements R-ID
1	Time Trigger	GET CPFC Setpoint	The cell CPFC setpoint for the next timestep is received	GET/REPLY	Cell CPFC Setpoint Provider	Frequency Droop Parameter Determination	IEX_01	CTS-3
2	Time Trigger	GET Reserves Status Information	Collect information from the Reserves Information Provider	GET/REPLY	Reserves Information Provider	Merit Order Collection	IEX_05	CTS-3

3		Building initial Merit Order list (cost based)	Internal processing: ordering of the DER – Frequency Droop devices that can provide a service in the next timestep (cheapest first)	INTERNAL OPERATION	Merit Order Collection	Merit Order Collection	-	
4		REPORT initial Merit Order list	Send the initial Merit Order list to the Merit Order Decision function	REPORT	Merit Order Collection	Merit Order Decision	IEX_12	
5	Time Trigger	GET load and generation forecasts	Collect information concerning the load and generation forecasts of all busses/nodes for the next timestep	GET/REPLY	Load & Generation Forecaster	Merit Order Decision	IEX_08	CTS-3
6		Calculating final Merit Order list	Internal processing: determining the final merit order list by taking into account location information and grid status information (eliminating all non-secure reserves)	INTERNAL OPERATION	Merit Order Decision	Merit Order Decision	-	
7		REPORT final Merit Order list	Send the final Merit Order list to the Frequency Parameter Slope Determination function	REPORT	Merit Order Decision	Frequency Droop Parameter Determination	IEX_14	
8		Calculating the droop parameters for each device in the final Merit Order list.	Internal processing: determining the droop parameters (droop slopes and frequency thresholds) for each device in the final Merit Order list	INTERNAL OPERATION	Frequency Droop Parameter Determination	Frequency Droop Parameter Determination	-	
9		CHANGE DER Frequency Droop	Send the updated droop information for the next	CHANGE	Frequency Droop Parameter	DER – Frequency Droop devices	IEX_20	CTS-3

		device settings	timestep to all DER Frequency Droop devices		Determination			
Scenario 1.b								
Scenario name:		Normal operation – realtime droop scaling factor calculation						
Step No.	Event	Name of process/ activity	Description of process/ activity	Service	Information producer (actor)	Information receiver (actor)	Information exchanged (IDs)	Requirements R-ID
10	Continuously	GET Frequency value	Obtain the current frequency value	GET/REPLY	Frequency Observation	Adaptive CPFC Determination	IEX_09	CTS-1
11	Continuously	GET Imbalance value	Obtain the current cell imbalance value	GET/REPLY	Imbalance Determination (from BRC)	Adaptive CPFC Determination	IEX_17	CTS-1
12		Calculating Droop Scaling factor	Internal processing: calculating the cell's droop scaling factor based on the frequency and imbalance values	INTERNAL OPERATION	Adaptive CPFC Determination	Adaptive CPFC Determination	-	
13		CHANGE Droop Scaling factor	Send the updated Droop Scaling factor to all DER Frequency Droop devices	CHANGE	Adaptive CPFC Determination	DER – Frequency Droop devices	IEX_21	
Scenario 1.c								
Scenario name		Normal operation – realtime control						
Step No.	Event	Name of process/ activity	Description of process/ activity	Service	Information producer (actor)	Information receiver (actor)	Information exchanged (IDs)	Requirements R-ID
14	Continuously	dP/df droop control	Internal Processing: activate active power in response to df measurement	INTERNAL OPERATION	df observer at DER Frequency Droop device	Active Power Controller at DER – Frequency Droop device	-	CTS-1

3.2.5 Information exchanged

<i>Information Exchanged</i>			
<i>Information exchanged ID</i>	<i>Name of information exchanged</i>	<i>Description of information exchanged</i>	<i>Requirements IDs</i>
IEX_01	Cell CPFC Setpoint	Value of requested cell frequency droop contribution in Watts/Hz with resolution 1 Watt/Hz ; CTS-3 timescale (e.g. every 15-min)	
IEX_05	Active Power Reserves Information	Vector of active power values (forecasted P_{max} , P_{min} , $P_{baseline}$; flat numbers) in Watt with resolution 1 Watt, and Cost (€/Watt); CTS-3 timescale (e.g. every 15min) (EANi optionally depending on communication approach)	
IEX_12	Active Power initial Merit Order list	Matrix of active power values (forecasted P_{max} , P_{min} , $P_{baseline}$; flat numbers) in Watt with resolution 1 Watt in conjunction with EANi (location); CTS-3 timescale (e.g. every 15min) (ordered in increasing cost ; cost information could be added optionally)	
IEX_08	Forecasted Load and Generation	Vector of active and reactive power values (P, Q ; flat numbers) in Watt with resolution 1 Watt and VAR with resolution 1 VAR respectively; CTS-3 timescale (e.g. every 15min) (EANi optionally depending on communication approach)	
IEX_14	Active Power Final Merit Order list	Matrix of active power values (forecasted P_{max} , P_{min} , $P_{baseline}$; flat numbers) in Watt with resolution 1 Watt in conjunction with EANi (location); CTS-3 timescale (e.g. every 15min) (only those that can be activated securely; ordered in increasing cost ; cost information could be added optionally)	
IEX_20	Frequency Droop Parameters	Vector of droop slope and frequency threshold in Watts/Hz with resolution 1 Watt/Hz and in mHz with resolution 10 mHz respectively; CTS-3 timescale (e.g. every 15min) or (Broadcast mode) Matrix of droop slope and frequency threshold in Watts/Hz with resolution 1 Watt/Hz and in mHz with resolution 10 mHz respectively in conjunction with EANi (location) ; CTS-3 timescale (e.g. every 15min)	
IEX_09	Measured Frequency	Value in mHz with resolution 10 mHz ; CTS-2 timescale (e.g. every 10 periods - 200msec)	
IEX_17	Cell Imbalance Error	Value of active power (P) in Watt with resolution 1 Watt ; CTS-1 timescale (as fast as possible) or CTS-2 timescale (10 periods-200msec) (aggregated error signal)	

IEX_21	CPFC Scaling Factor	Value between 0.00 and 1.00 with resolution 0.01; CTS-1 timescale (as fast as possible) or (Broadcast mode) matrix of values between 0.00 and 0.01 with resolution 0.01 in conjunction with EANi (location); CTS-1 timescale (as fast as possible)	
--------	---------------------	--	--

3.2.6 Requirements (will be completed based on experimental testing and validation results)

<i>Requirements</i>		
<i>Categories ID</i>	<i>Category name for requirements</i>	<i>Category description</i>
<i>Requirement ID</i>	<i>Requirement name</i>	<i>Requirement description</i>

3.2.7 Common Terms and Definitions

<i>Common terms and definitions</i>	
<i>Term</i>	<i>Definition</i>
Network Power Frequency Characteristic-NPFC	The NETWORK POWER FREQUENCY CHARACTERISTIC defines the sensitivity, given in megawatts per Hertz (MW/Hz), usually associated with a (single) CONTROL AREA / BLOCK or the entire SYNCHRONOUS AREA, that relates the difference between scheduled and actual SYSTEM FREQUENCY to the amount of generation required to correct the power IMBALANCE for that CONTROL AREA / BLOCK (or, vice versa, the stationary change of the SYSTEM FREQUENCY in case of a DISTURBANCE of the generation-load equilibrium in the CONTROL AREA without being connected to other CONTROL AREAS. The NETWORK POWER FREQUENCY CHARACTERISTIC includes all active PRIMARY CONTROL and SELF-REGULATION OF LOAD and changes due to modifications in the generation pattern and the demand.
Cell Power Frequency Characteristic-CPFC	Cell Power Frequency Characteristic: The Network Power-Frequency Characteristic of a cell

3.2.8 Controller Conflicts and Misuse cases

<i>id</i>	<i>Case Name</i>	<i>Description</i>	<i>Related Objective</i>	<i>Recommended mitigation</i>
-----------	------------------	--------------------	--------------------------	-------------------------------

CC_01	Voltage interference	Changes of active power (e.g. by switching loads) may cause voltage fluctuations to nearby nodes, influencing voltage controllers	Voltage variations should not change beyond specific limits by the activation of FCC	<ul style="list-style-type: none"> -Robustness of primary voltage controllers in order to readily compensate fluctuations -Power changes within specific limits -Appropriate reservation (market process) schedule which should lead to an optimal capacity distribution
CC_02	False activation	FCC controller is activated due to noise or erroneous frequency observation. As a result it influences balance (even slightly) and exhausts the resource capacity	The input signal to the FCC controller should be measured with sufficient reliability-noise immunity	<ul style="list-style-type: none"> -Noise rejection via filters embedded in the Sensor/Frequency Observer. -Local measurement mitigate risks imposed by one central observation and control
CC_03	Frequency oscillations	FCC controllers cause oscillations instead of stabilizing frequency	The response of devices should not cause instability	<ul style="list-style-type: none"> -Not very fast activation of devices -Robust design of controllers (e.g. controller gain selection)

3.3 Balance Restoration Control

3.3.1 Description of the use case

3.3.1.1 Name of use case

<i>Use case identification</i>		
<i>ID</i>	<i>Area Domain(s)/ Zone(s)</i>	<i>Name of use case</i>
BRC.1.1	Transmission, Distribution, DER / Process, Field, Station, Operation	Balance Restoration Control (BRC)

3.3.1.2 Scope and objectives of use case

<i>Scope and objectives of use case</i>	
Scope	<p>This use case describes the Balance Restoration Control functionality in the ELECTRA Web-of-Cells concept. This BRC functionality monitors a cell's instantaneous active power import/export profile and compares this against a setpoint import/export profile that was received. In response of observed deviations (imbalances), active power is controlled to correct these deviations (= cell imbalances).</p> <p>This way, the system balance (as well as frequency) is restored in a bottom-up approach based on local observables (cell tie-line powerflows): the cell setpoints correspond to a system balance, and if each cell adheres to its setpoint, the system balance is kept.</p> <p>This BRC shows resemblance to the current FRC (secondary control) that is responsible for restoring the system balance, yet in a centralistic manner. In contrast to FRC which is a secondary control and takes over from FCC, in the ELECTRA Web-of-Cells concept the BRC runs at the same timescale as FCC and therefore contributes to frequency containment as well as balance/frequency restoration. But where BRC is acting on a pure local observable (tie-line powerflow deviation), the Adaptive FCC is acting on a system level observable (frequency deviation) but its actions are scaled in relation to its local state.</p>
Objective(s)	<p>O1: Maintain the cell balance (= sum of cell tie-line import/Export powerflows) in line with the received setpoint</p> <p>O2: Restore frequency next to balance).</p>
Related use case(s)	FCC (also responsible for frequency control) and BSC (optimization of, amount of reserves activations by local imbalance netting between neighbouring cells).
Control Domain	An ELECTRA Cell.

3.3.1.3 Narrative of use case

<i>Narrative of use case</i>
<p>Short description</p> <p>The CTL2 cell-central controller receives a cell balance setpoint (= netto aggregated active power import/export profile) for the next timestep.</p> <p>The instantaneous tie-line powerflows are measured and an aggregated error signal (deviation from setpoint) is determined. Based on that error signal active power is activated/deactivated to correct the error and restore the cell balance.</p>
<p>Complete description</p> <p>The cell central Imbalance Determination function receives the cell's balance setpoint (= tie-line active powerflow profile setpoints) for the next timestep. The Merit Order Decision function (through the Merit Order Collection function) orders the available DER - Controllable P devices based on cost and location. This is done based on availability and cost information received from these Controllable P devices, load and generation forecasts of all busses (nodes), and a local grid model.</p> <p>Location information is important to ensure that the power activations of the Controllable P devices will not cause local grid problems. The resulting ordered list is sent to the Imbalance Correction function that will use this list to determine for each observed imbalance which Controllable P devices must (de)activate how much power.</p> <p>Continuously, the Imbalance Determination function will determine the cell's imbalance status based on tie-line powerflow measurements received from the Tie-line Active Powerflow Observation functions and comparing the aggregated result against the setpoint received from the Tie-line Active Powerflow Setpoint Provider function. The observed imbalance error signal is sent to the Imbalance Correction function, that uses the final Merit Order list to send active power (de)activation commands to selected Controllable P devices.</p>

3.3.1.4 Key performance indicators (KPI)

<i>Key performance indicators</i>			
<i>ID</i>	<i>Name</i>	<i>Description</i>	<i>Reference to mentioned use case objectives</i>
1	Balance/Frequency Restoration control effectivity	The quality of BRC is assessed in a similar manner to the assessment of current secondary control in control areas, where trumpet-shaped curves are defined on the basis of values obtained from experience and the monitoring of system frequency over a period of years*. When the frequency is maintained within the trumpet-shaped curve during the BRC process it is considered effective in terms of technical control.	O.1

		*More info on UCTE OH - Appendix 1: Load Frequency Control and Performance (final 1.9 E, 16.06.2004) A1-20.	
2	Percentage of reduction in power losses from activated reserves.	This is measured as the difference between the transmission losses in a business as usual case and a scenario with BRC for the activated reserves during a frequency event.	O.2
3	Speed of Response	Determining the average speed of response of BRC, in terms of resolving cell imbalances, by applying multiple scenarios with different inputs (e.g. different generation portfolios)	O.3

3.3.1.5 Use case conditions

<i>Use case conditions</i>
Assumptions
➤ Sufficient BRC resources to correct all 'normal' imbalances are available, even after the location aware merit order decision function removed or curtailed some of them..
Prerequisites
<ul style="list-style-type: none"> ➤ The cell tie-line setpoints are calculated in an appropriate manner by an out-of-context function, and is provided in a timely manner. ➤ A list of procured BRC resources and their location in the local grid is available (the procurement itself is out of scope for this use case). ➤ A model of the local grid is available. ➤ Load and generation forecasts of all busses are available (either provided or estimated) ➤ BRC providing resources are exclusively committed for providing BRC support (i.e. not used for other use cases in the same timestep)

3.3.1.6 Further information to the use case for classification/mapping

<i>Classification Information</i>
Relation to other use cases
IRPC: the amount of inertia, as well as the nature of inertia (synthetic or not) will play an important role in the BRC dynamics (especially its frequency containment capabilities)
FCC: FCC running at the same time scale – rather than slower and taking over – will play an important role in the BRC dynamics.
PVC and PPVC: active power activations for BRC may cause voltage perturbations to nearby nodes, influencing voltage controllers.
Nature of Use Case
Technical Use Case (Distributed Control)

Further keywords for classification

ELECTRA, Web-of-Cells, Balance Control

3.3.1.7 General remarks**General remarks**

Any views and opinions presented in this document are those of the authors.

3.3.2 Diagrams of use case

Diagram(s) of use case

a) Context diagram:

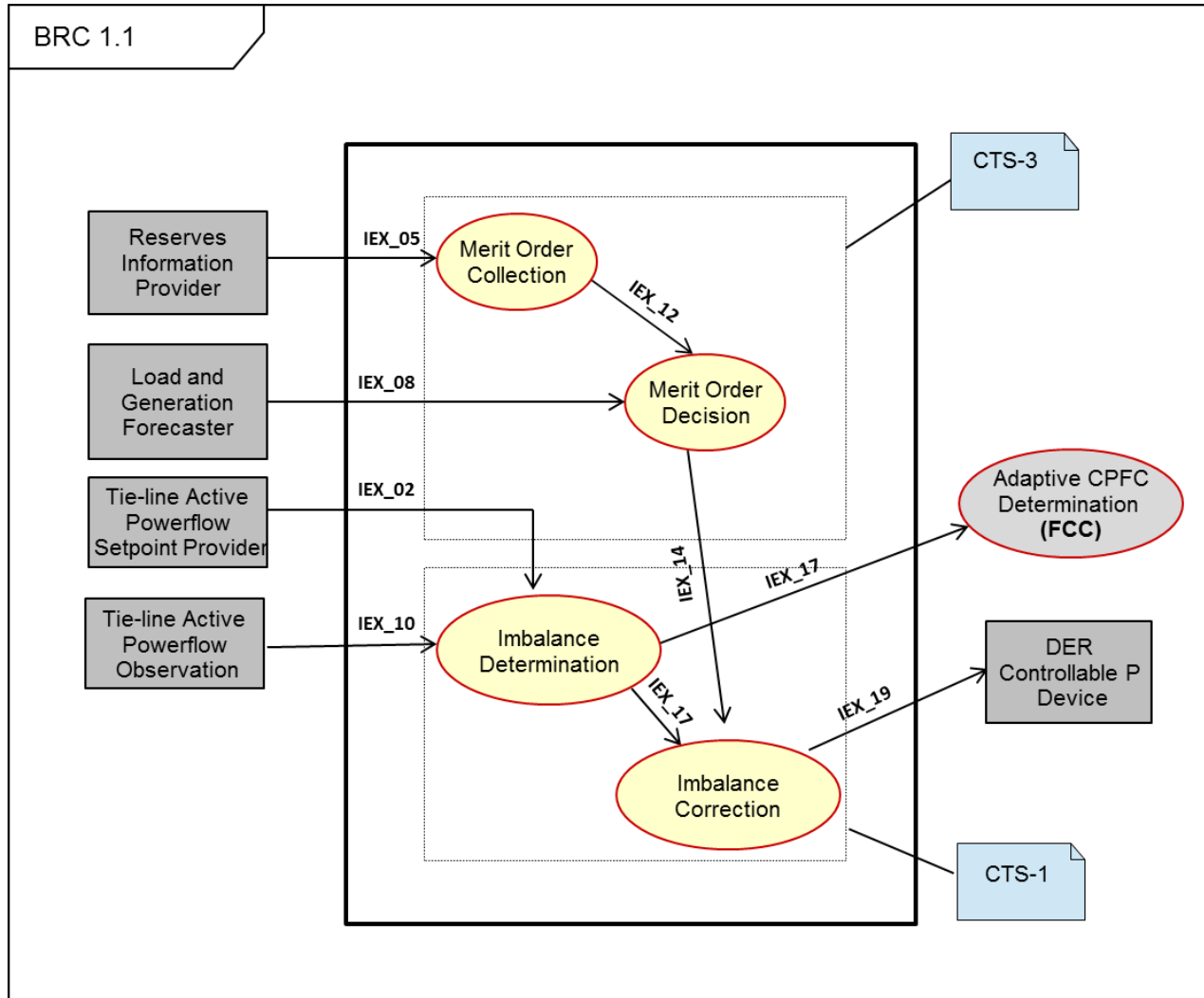

b) Sequence diagram:

Scenario 1.a: Normal operation – preparing next timestep

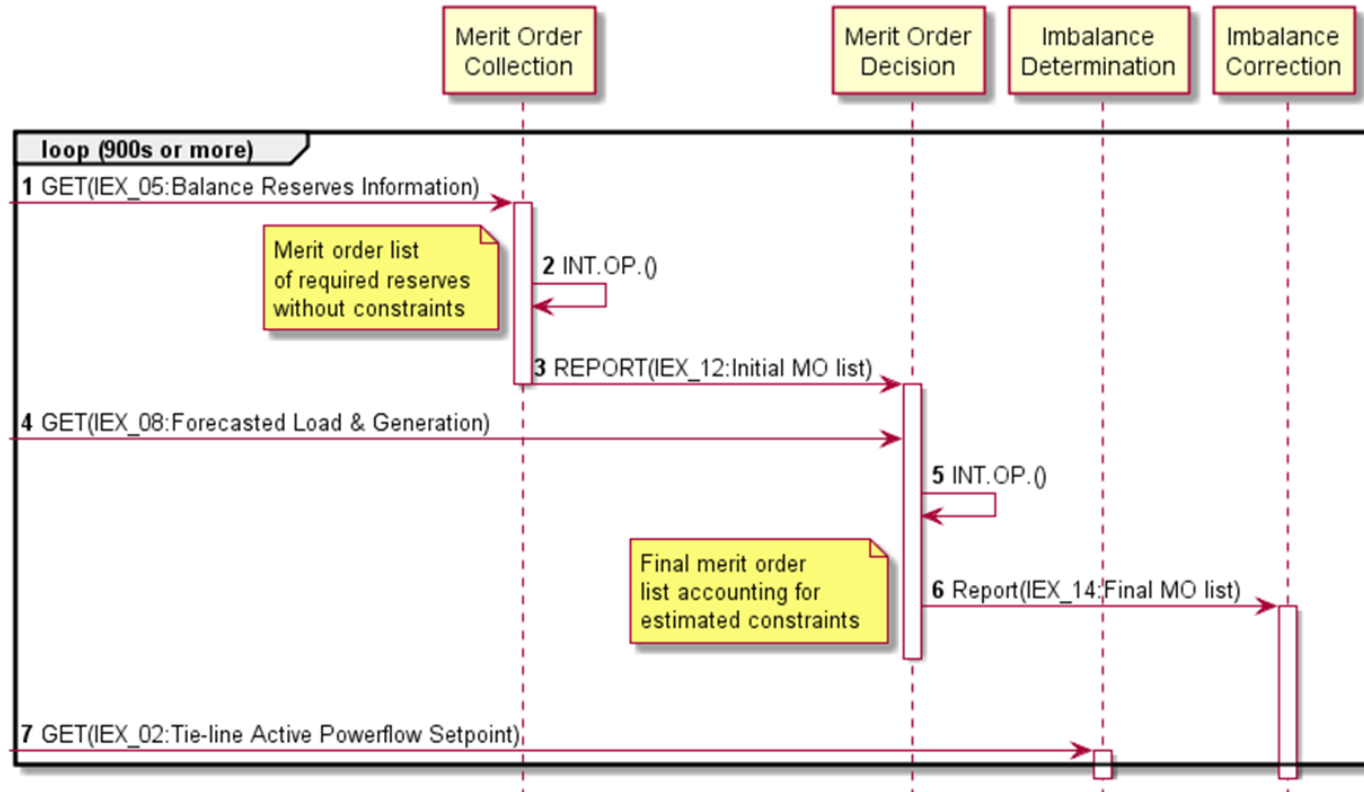

Scenario 1.b: Normal operation – realtime control

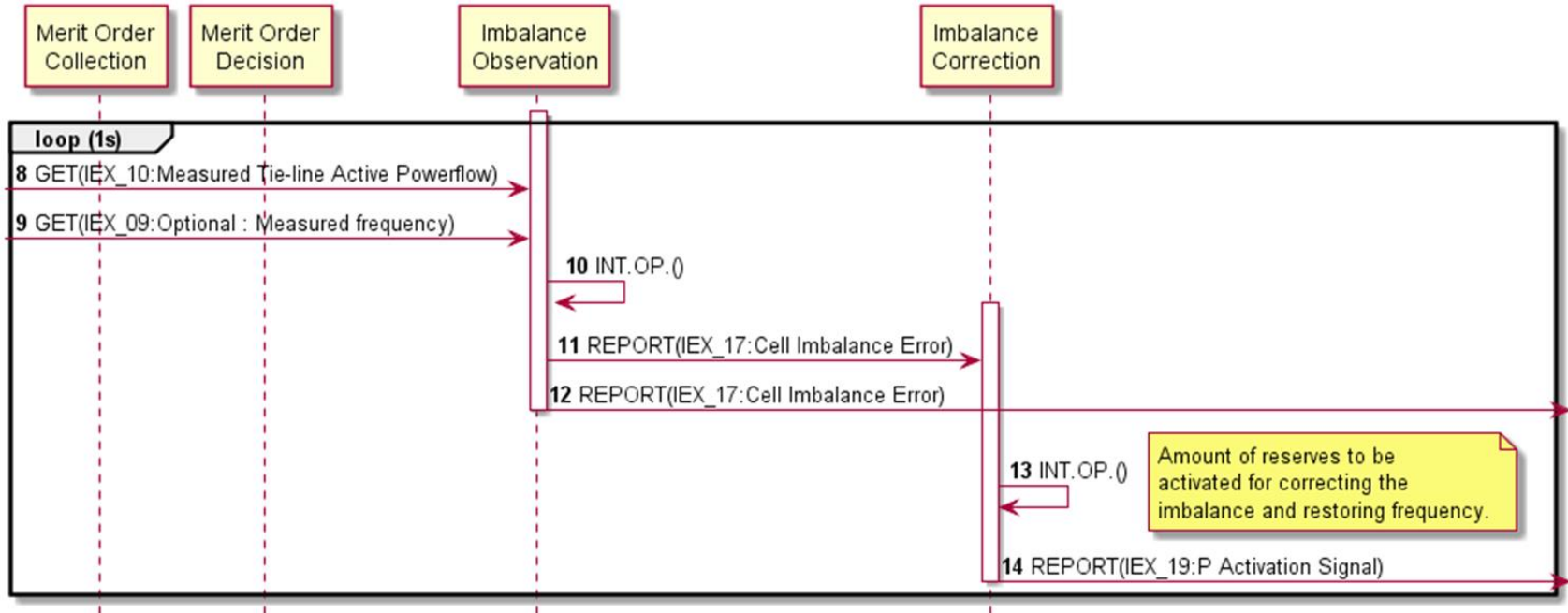

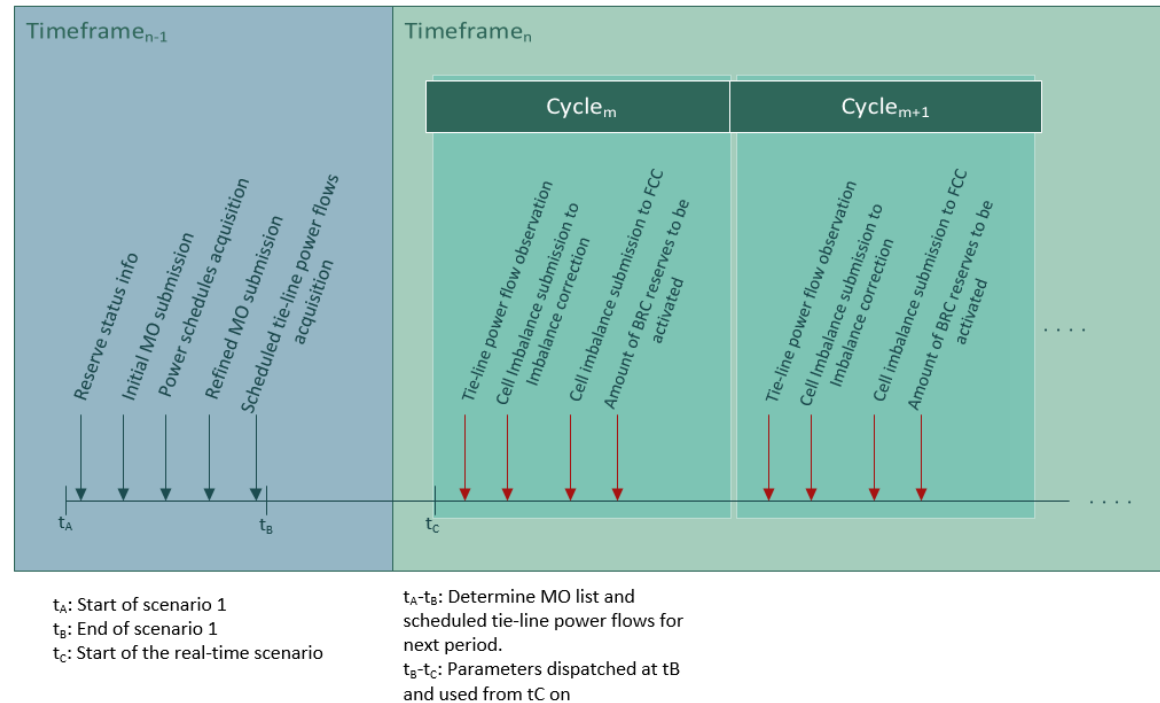
c) Timing diagram:

3.3.3 Technical details

3.3.3.1 Actors

Actors	
Grouping	Group description
In-focus functions	Functionality that will be implemented and tested
Emulated functions	Functionality that is 'out-of-scope' and will be emulated (e.g. reading information from a file or database)
Observer/Actuator functions	Functionality that is related to measurement or actuation devices

Actor name	Actor type	Actor description	Further information specific to this use case
Merit Order Collection	In-focus Function	This function receives reserves flexibilities (or availabilities) from the <i>Reserves Information provider function</i> , and collates them in a list ranked by cost. The resulted list is submitted to the <i>Merit Order Decision function</i> for final improvements.	The function is performed by the cell controller and belongs to CTL-2 and is activated at CTS-3.
Merit Order Decision	In-focus Function	This function calculates the final Merit Order list by taking into consideration the operating constraints of the grid on which these reserves are to be deployed. The function receives the initial input by the <i>Merit Order Collection function</i> and delivers the final Merit Order list to the <i>Imbalance Correction function</i> .	The function is performed by the cell controller and belongs to CTL-2 and is activated at CTS-3. <i>This function has/uses (assumed) static grid model information (topology, characteristics like impedances, and EANi information i.e. what is connected where).</i>
Imbalance Determination	In-focus Function	This cell central function collects and aggregates the tie-line observed active powerflows received from the <i>Tie-line Active Powerflow Observation function</i> and compares this against the cell setpoint received from the <i>Tie-line Active Powerflow Setpoint Provider function</i> to determine a cell balance error signal that is provided to the <i>Imbalance Correction function</i> .	The function is performed by the cell controller and belongs to CTL-2 and is activated at CTS-1.
Imbalance Correction	In-focus Function	This cell-central function receives the cell balance error signal from the <i>Imbalance Determination function</i> , and uses the final Merit Order list that it received from the <i>Merit Order Decision function</i> to send active power dispatch commands to <i>Controllable P devices</i> .	The function is performed by the cell controller and belongs to CTL-2 and is activated at CTS-1.
Reserves Information provider	Emulated Function	It provides the available power capacity that is needed for the compilation of the Merit Order List by the Merit Order Collection function. It can be part of a DER.	Emulated functionality implemented as a file read (the availability and cost forecasting functionality is out of scope). Activated at CTS-3. This functionality could be mapped DER – Controllable P devices.
Load & Generator	Emulated	It provides the scheduled production and consumption of all generators and loads	Emulated functionality implemented as a

forecaster	Function	in order to be used by the Merit Order Decision for the calculation of the optimal reserves.	file read (the load and generation forecasting functionality is out of scope). Activated at CTS3.
Tie-Line Active Power Setpoint provider	Emulated Function	It provides the individual tie-line power flows for calculating the total cell imbalance.	Emulated functionality implemented as a file read (the cell setpoint calculation functionality is out of scope of the ELECTRA project). Activated at CTS-3.
Tie-line Active Power Observation	Observer Function	It calculates and provides active powerflow measurements to the <i>Imbalance Determination function</i> .	The function is performed by the cell controller and belongs to CTL-2. Activated at CTS-1.
DER – Controllable P device	Device	Continuously receiving and responding to active power (de)activation commands from the <i>Imbalance Correction function</i> .	This functionality is performed by distributed resources and belongs to CTL-0. New power (de)activation commands are received at CTS-1.

3.3.4 Step by step analysis of use case

3.3.4.1 Overview of scenarios

Scenario conditions						
No.	Scenario name	Scenario description	Primary actor	Triggering event	Pre-condition	Post-condition
1.a	Normal Operation – preparing next timestep	Determining all setpoints that are needed for the realtime control in the next timestep	Merit Order Decision	Periodic at CTS-3	DER – Controllable P devices are procured	Location aware Merit Order list available
1.b	Normal Operation – realtime control	Responding to continuous stream of small deviations (validation case 1) as well as load steps (validation case 2)	Imbalance Correction	Continuously (CTS-1)	Location aware merit order has been determined for the current time window.	BRC is delivered

3.3.4.2 Steps – Scenarios

Scenario 1.a								
Scenario name:		Normal Operation – preparing next timestep						
Step No.	Event	Name of process/ activity	Description of process/ activity	Service	Information producer (actor)	Information receiver (actor)	Information exchanged (IDs)	Requirements R-ID
1	Time Trigger	GET Reserves Status Information	Collect information from the Reserves Information Provider	GET/REPLY	Reserves Information Provider	Merit Order Collection	IEX_05	CTS--3
2		Building initial Merit Order list (cost based)	Internal processing: ordering of the DER – Frequency Droop devices that can provide a service in the next timestep (cheapest first)	INTERNAL OPERATION	Merit Order Collection	Merit Order Collection	-	CTS-3
3		REPORT initial Merit Order list	Send the initial Merit Order list to the Merit Order Decision function	REPORT	Merit Order Collection	Merit Order Decision	IEX_12	CTS-3
4		GET load and generation forecasts	Collect information concerning the load and generation forecasts of all busses/nodes for the next timestep	GET/REPLY	Load & Generation forecaster	Merit Order Decision	IEX_08	CTS-3
5		Calculating final Merit Order list	Internal processing: determining the final merit order list by taking into account location information and grid status information (eliminating all non-secure reserves)	INTERNAL OPERATION	Merit Order Decision	Merit Order Decision	-	CTS-3
6		REPORT final Merit Order list	Send the final Merit Order list to the Frequency Parameter Slope Determination function	REPORT	Merit Order Decision	Frequency Droop Parameter Determination	IEX_14	CTS-3

7	Time Trigger	GET cell balance setpoint	Receive the Cell balance setpoint for the next timestep	GET/REPLY	Tie-line Active Powerflow Setpoint Provider	Imbalance Determination	IEX_02	CTS-3
Scenario 1.b								
Scenario name:		Normal Operation – realtime control						
Step No.	Event	Name of process/ activity	Description of process/ activity	Service	Information producer (actor)	Information receiver (actor)	Information exchanged (IDs)	Requirements R-ID
10	Continuously	GET Tie-line Active Powerflow measurements	Collect tie-line Active powerflow values	GET/REPLY	Tie-line Active Powerflow Observation	Imbalance Determination	IEX_10	CTS-1
11		Calculating Cell Imbalance	Internal processing: aggregating the tie-line active powerflow values and calculating the error signal compared to the cell setpoint	INTERNAL OPERATION	Imbalance Determination	Imbalance Determination	-	
12		REPORT cell balance error signal	Send the cell balance error signal to the Imbalance Correction function	REPORT	Imbalance Determination	Imbalance Correction	IEX_17	
13		REPORT cell balance error signal	Send the cell balance error signal to Adaptive CPFC Determination function (of FCC)	REPORT	Imbalance Determination	Adaptive CPFC Determination (FCC)	IEX_17	
14		Determine active power (de-activation commands	Internal processing: determine the active power (de)activation commands for all which Controllable P devices	INTERNAL OPERATION	Imbalance Correction	Imbalance Correction	-	
14		CHANGE DER Controllable P device settings	Send the calculated (deactivation command to each Controllable P device	CHANGE	Imbalance Correction	DER – Controllable P devices	IEX_19	

3.3.5 Information exchanged

<i>Information Exchanged</i>			
<i>Information exchanged ID</i>	<i>Name of information exchanged</i>	<i>Description of information exchanged</i>	<i>Requirements IDs</i>
IEX_02	Tie-line Active Powerflow setpoints	Vector of individual tie-lines active powerflow schedules (P_i ; flat numbers) in Watt with resolution 1 Watt in conjunction with EANi (location); CTS-3 timescale (e.g. every 15min).	
IEX_05	Balance Reserves information	Vector of active power values (forecasted P_{max} , P_{min} , $P_{baseline}$; flat numbers) in Watt with resolution 1 Watt, and Cost (s€/Watt); CTS-3 timescale (e.g. every 15min) (EANi optionally depending on communication approach)	
IEX_08	Forecasted Load and Generation	Vector of active and reactive power values (P , Q ; flat numbers) in Watt with resolution 1 Watt and VAr with resolution 1 VAr respectively; CTS-3 timescale (e.g. every 15min) (EANi optionally depending on communication approach)	
IEX_10	Measured Tie-line Active Powerflow	Value of tie-lines power flow (P) in Watt with resolution 1 Watt; CTS-1 timescale (as fast as possible). (EANi optionally depending on communication approach)	
IEX_12	Balance Initial Merit Order list	Matrix of active power values (forecasted P_{max} , P_{min} , $P_{baseline}$; flat numbers) in Watt with resolution 1 Watt in conjunction with EANi (location); CTS-3 timescale (e.g. every 15min) (ordered in increasing cost; cost information could be added optionally)	
IEX_14	Balance Final Merit Order list	Matrix of active power values (forecasted P_{max} , P_{min} , $P_{baseline}$; flat numbers) in Watt with resolution 1 Watt in conjunction with EANi (location); CTS-3 timescale (e.g. every 15min) (only those that can be activated securely; ordered in increasing cost; cost information could be added optionally)	
IEX_17	Cell Imbalance error	Value of active power (P) in Watt with resolution 1 Watt; CTS-1 timescale (as fast as possible) or CTS-2 timescale (10 periods-200msec)	

		(aggregated error signal)	
IEX_19	P Activation Signal	Value of active power (P) in Watt with resolution 1 Watt Or (Broadcast mode) Matrix of Values of active Power (P) in Watt with resolution 1 Watt in conjunction with EANi (location)	

3.3.6 Requirements (will be completed based on experimental testing and validation results)

<i>Requirements (optional)</i>		
<i>Categories ID</i>	<i>Category name for requirements</i>	<i>Category description</i>
<i>Requirement ID</i>	<i>Requirement name</i>	<i>Requirement description</i>

3.4 Balance Steering Control

3.4.1 Description of the use case

3.4.1.1 Name of use case

<i>Use case identification</i>		
<i>ID</i>	<i>Area Domain(s)/ Zone(s)</i>	<i>Name of use case</i>
BSC.1.1.1	Transmission, Distribution, DER / Process, Field, Station, Operation	Balance Steering Control (BSC) that determines new cell setpoints resulting in the deactivation of previously activated reserves in a coordinated peer-to-peer manner

3.4.1.2 Scope and objectives of use case

<i>Scope and objectives of use case</i>	
Scope	<p>This use case describes the Corrective Balance Steering Control functionality in the ELECTRA Web-of-Cells concept. This BSC functionality tries to counter the excessive amount of bottom-up BRC activations that are based on local observables and therefore lost the benefits of imbalance netting.</p> <p>BSC will implement a distributed/decentralized coordination scheme where neighboring cells mutually agree on changing their tie-line active powerflow setpoints – without violating operating limits - and this way reduce the amount of BRC reserves that would be activated in each cell ; this can be considered as an implementation of a localized imbalance netting mechanism.</p> <p>Specifically, this use case will implement a Corrective BSC functionality, which determines new setpoints for the BRC controller, thereby causing the deactivation of resources that previously were activated by BRC.</p>
Objective(s)	<p>O1: Minimisation and/or optimisation of activated balancing reserves (active power (de)activations)</p> <p>O2: Not violating tie-line power flow constraints</p>
Related Higher-level use case(s)	N/A (this is the highest level)
Control Domain	An ELECTRA cell.

3.4.1.3 Narrative of use case

<i>Narrative of use case</i>	
Short description	
<p>The CTL-2 cell-central controller receives trigger when the cell-imbalance (or BRC activations) surpasses a threshold.</p> <p>The controller will then engage in a CTL-3 coordination with its neighbours to – it possible – agree on changed Active Powerflow setpoints for each tie-line in a way that it reduces the number of activated BRC resources while not diminishing the contribution to the system level balance restoration.</p> <p>This variant will implement a Corrective BSC functionality, which caused the deactivation of resources that previously were activated by BRC.</p>	
Complete description	
<p>The cell central Tie-line Limits Calculation function calculates acceptable tie-line deviations based on information received from the Load and Generation Forecaster function. The resulting allowed tie-line deviations are provided to the cell-central Cell Setpoint Adjusting function.</p> <p>When an imbalance error signal is received that is larger than a set (static) threshold, the Cell Setpoint Adjusting function will calculate for each of its neighbours a proposed tie-line setpoint change, taking into account the previously calculated allowed deviations. This proposed new tie-line setpoint is sent to each neighbours's Cell Setpoint Adjusting function.</p> <p>The neighbours's Cell Setpoint Adjusting function will use that information to calculate an acceptable setpoint change (can be the same as the proposed one, can be a different value, or can be zero i.e. no setpoint change acceptable).</p> <p>On receipts of the neighbour's response, the Cell Setpoint Adjusting function calculates the aggregated balance setpoint change and sends this information to the Imbalance Determination function (from BRC).</p>	

3.4.1.4 Key Performance Indicators

<i>Key performance indicators</i>			
<i>ID</i>	<i>Name</i>	<i>Description</i>	<i>Reference to mentioned use case objectives</i>
1	Amount of BRC reserves	$((\Delta G_i) + (\Delta D))_{BRC} = \min$	O.1
2	Tie-line operation limits	$P_{TieLine,new} \leq P_{TieLine,max}$	O.2

3.4.1.5 Use case conditions

<i>Use case conditions</i>
Assumptions
➤ BSC does only alter BRC setpoints, and does not (de)activates resources itself.
Prerequisites
➤ A model of the local grid is available. ➤ Load and generation forecasts of all busses are available (either provided or estimated)

3.4.1.6 Further information to the use case for classification / mapping

<i>Classification Information</i>
Relation to other use cases
The variant is directly related to BRC control (CTL-2) since it updates tie-line set-points and directly informs BRC of any such modification of the schedule. Any connection of the variant to FCC control is only indirect in the sense that it influences the imbalances and therefore the activation of FCC reserves.
Nature of use case
Technical Use Case (Distributed Control)
Further keywords for classification
ELECTRA, Web-of-Cells, Balance Steering

3.4.1.7 General remarks

<i>General remarks</i>
The distributed BRC control with bottom up balance restoration loses the benefits of imbalance netting. Despite the fact that an abundance of cheap and easily controlled resources will exist, the need for minimizing avoidable reserves activations will still exist in future systems. This can be done by slightly modifying the agreed setpoints and hence exchanges by taking advantage of different sign imbalances in adjacent cells (i.e. local peer-to-peer imbalance netting). Obviously, limitations on power transmission in tie-lines have to be taken into account as a constraint of the new operating point.
The selected corrective variant in this use case will try this way to deactivate avoidable reserves activations.

3.5 Diagrams of use case

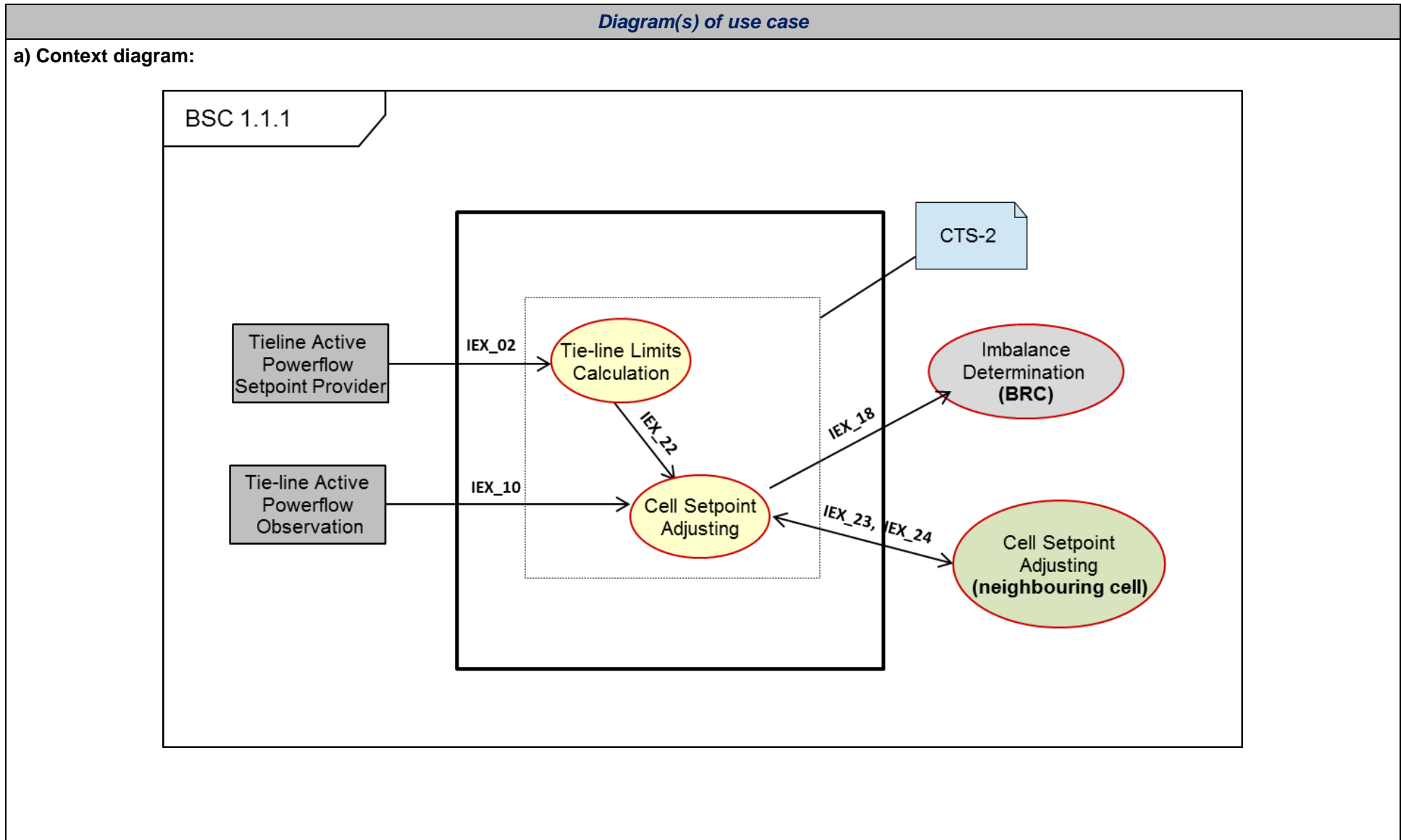

b) Sequence diagram:

Scenario 1: Normal Operation

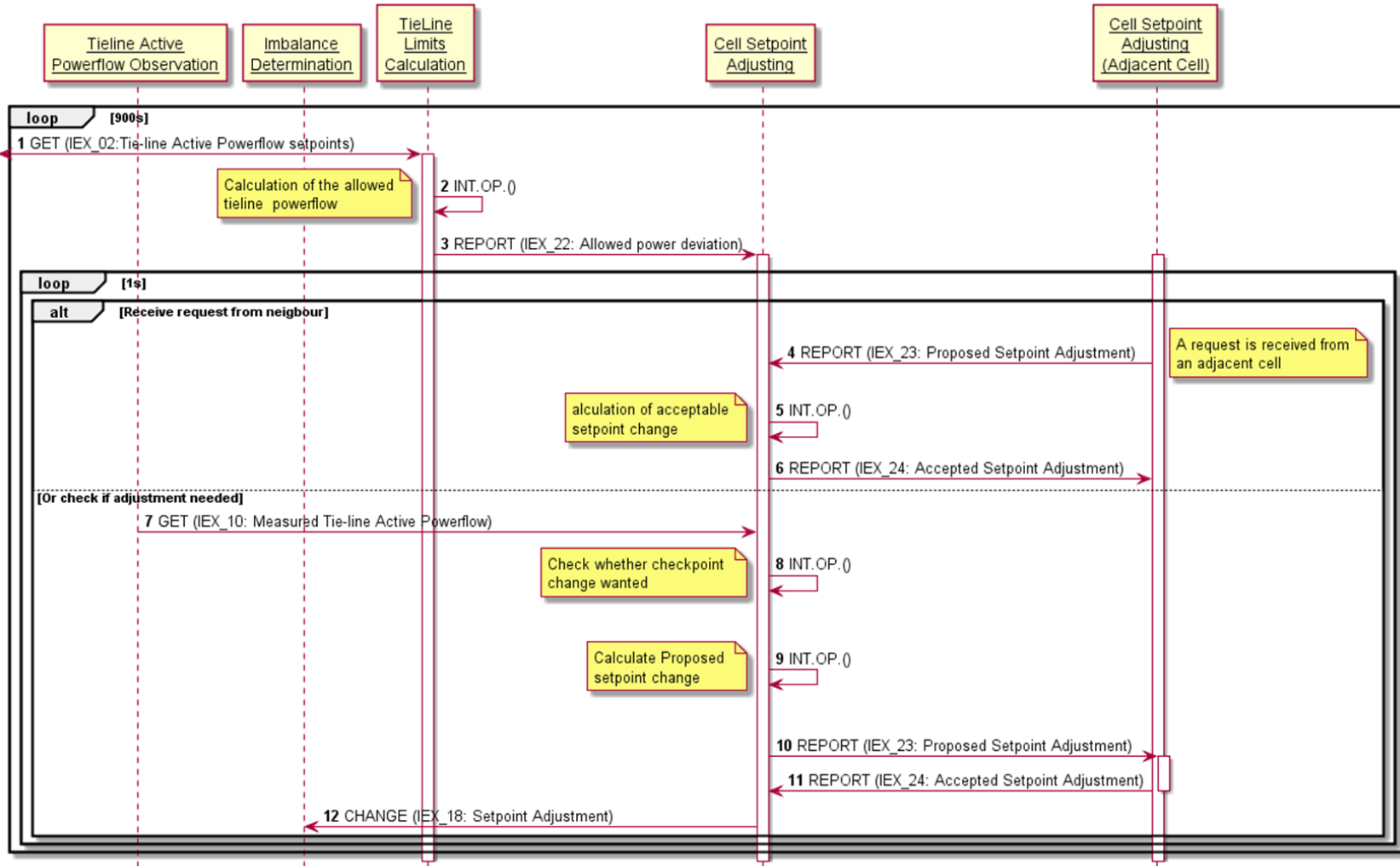

b) Timing diagram:

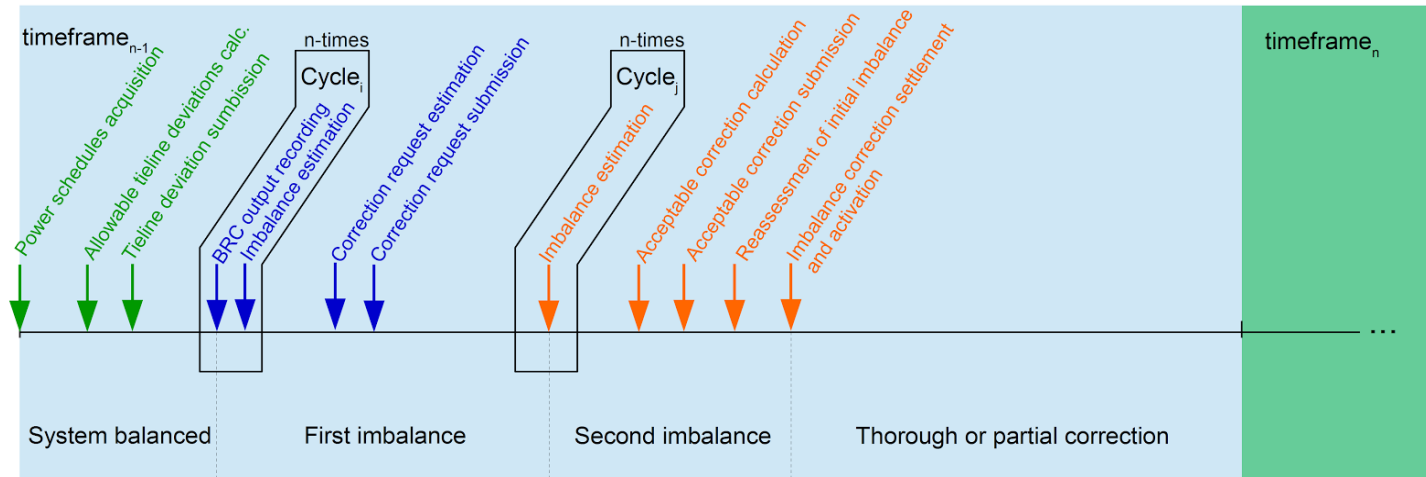

3.6 Technical details

3.6.1.1 Actors

Actors			
Grouping		Group description	
In-focus functions		Functionality that will be implemented and tested	
Emulated functions		Functionality that is 'out-of-scope' and will be emulated (e.g. reading information from a file or database)	
Observer/Actuator functions		Functionality that is related to measurement or actuation devices	
Actor name	Actor type	Actor description	Further information specific to this use case
Tie-line Limits Calculation	In-focus Function	This cell central function calculates the maximum allowable deviations based on the scheduled tie-line power flows and the capacity limits of the tie-lines	The function is performed by the cell controller and belongs to CTL2.

			<p><i>Static information needed for this function:</i> <i>Capacity limits of all tie-lines</i></p>
Cell Setpoint Adjusting	In-focus Function	This cell central function communicates the own cell's imbalance state with its neighbouring cells and learns about their respective imbalances. Based on this it proposes (negotiates) a new setpoint that fulfil the stated specific control aims.	The function is performed by the cell controller and belongs to CTL2.
Tie-Line Active Powerflow Setpoint provider	Emulated Function	It provides the individual tie-line power flows for calculating the total cell imbalance.	Emulated functionality implemented as a file read (the cell setpoint calculation functionality is out of scope). Activated at CTS3.
Tie-line Active Power Observation	Observer Function	It calculates and provides active powerflow measurements to the <i>Imbalance Determination function</i> .	The function is performed by the cell controller and belongs to CTL2. Activated at CTS1.
Imbalance Determination	In-focus Function (BRC)	This cell central function collects and aggregates the tie-line observed active powerflows received from the <i>Tie-line Active Powerflow Observation function</i> and compares this against the cell setpoint received from the <i>Tie-line Active Powerflow Setpoint Provider function</i> (possibly adjusted by the <i>Cell Setpoint Adjusting function</i>) to determine a cell balance error signal that is provided to the <i>Imbalance Correction function</i> .	The function is performed by the cell controller and belongs to CTL2. Activates at CTS1.

3.6.2 Step by step analysis of use case

3.6.2.1 Overview of scenarios

Scenario conditions						
No.	Scenario name	Scenario description	Primary actor	Triggering event	Pre-condition	Post-condition
1	Normal Operation	Coordinated determination of new secure tie-line active powerflow setpoints.	Cell Setpoint Adjusting	Imbalance larger than a set (static) threshold value	Tie-line limits are know	Cell(s) received new tie-line active powerflow setpoint

3.6.2.2 Steps – Scenarios

Scenario 1								
Scenario name:		Normal Operation – taking the initiative						
Step No.	Event	Name of process/ activity	Description of process/ activity	Service	Information producer (actor)	Information receiver (actor)	Information exchanged (IDs)	Requirements R-ID
1	Time Trigger	GET cell balance setpoint	Receive the Cell balance setpoint for the next timestep	GET/REPLY	Tie-line Active Powerflow Setpoint Provider	Tie-Line Limits Calculation	IEX_02	CTS-3
2		Calculation of Allowable Tie-line Deviations	Internal processing: The Tie-line Limits Calculation function calculates the maximum active power deviations per tie-line	INTERNAL OPERATION	Tie-Line Limits Calculation	Tie-Line Limits Calculation	-	
3		REPORT max deviations	Send the max deviations to the Cell Setpoint Adjusting function	REPORT	Tie-Line Limits Calculation	Cell Setpoint Adjusting		
4	“Adjustment Request from neighbor” Trigger	REPORT proposed tie-line setpoint adjustments	Receive a proposed tie-line adjustment from neighbour	REPORT	Cell Setpoint Adjusting (Adjacent Cell)	Cell Setpoint Adjusting	IEX_23	
5		Calculation of accepted / counter proposed tie-line setpoint adjustment	Internal processing: The Cell Setpoint Adjusting function calculates the accepted / counterproposed tie-line setpoint change.	INTERNAL OPERATION	Cell Setpoint Adjusting	Cell Setpoint Adjusting	-	
6		REPORT accepted / counterproposed tie-line	The Cell Setpoint Adjusting function sends the accepted /	REPORT	Cell Setpoint Adjusting	Cell Setpoint Adjusting	IEX_24	

		setpoint adjustment to each neighbour	counterproposed change to the neighbor (can be zero)			(Adjacent Cell)		
7	Time Trigger	GET Tie-line Active Powerflow measurements	Collect tie-line Active powerflow values	GET/REPLY	Tie-line Active Powerflow Observation	Cell Setpoint Adjusting	IEX_10	CTS-1
8		Calculate deviation and compare against threshold	Internal processing: if deviation larger than threshold set TRIGGER 1	INTERNAL OPERATION	Cell Setpoint Adjusting	Cell Setpoint Adjusting		
9	TRIGGER 1	Calculation of proposed tie-line setpoint adjustments	Internal processing: The Cell Setpoint Adjusting function calculates the proposed tie-line setpoint change for each setpoint	INTERNAL OPERATION	Cell Setpoint Adjusting	Cell Setpoint Adjusting	-	
10		REPORT proposed tie-line setpoint adjustment to each neighbour	The Cell Setpoint Adjusting function sends the proposed change to each neighbour	REPORT	Cell Setpoint Adjusting	Cell Setpoint Adjusting (Adjacent Cell)	IEX_23	
11		REPORT counter-proposed/accepted tie-line setpoint adjustment	The Cell Setpoint Adjusting function receives an accepted (counter-proposed) setpoint adjustment from each neighbor (can be zero)	REPORT	Cell Setpoint Adjusting (Adjacent Cell)	Cell Setpoint Adjusting	IEX_24	
12		CHANGE setpoint	Send the new setpoint to the Imbalance Determination function (BRC overwriting the previous setpoint)	CHANGE	Cell Setpoint Adjusting	Imbalance Determination (BRC)	IEX_18	

3.6.3 Information exchanged

<i>Information Exchanged</i>			
<i>Information exchanged ID</i>	<i>Name of information exchanged</i>	<i>Description of information exchanged</i>	<i>Requirements IDs</i>
IEX_08	Forecasted Load and	Vector of active and reactive power values (P, Q; flat numbers) in Watt with resolution 1 Watt and	

	Generation	VAR with resolution 1 VAR respectively; CTS3 timescale (e.g. every 15min) (EANi optionally depending on communication approach)	
IEX_16	Instantaneous Imbalance	Value of active power (P) in Watt with resolution 1 Watt; CTS2 timescale (sampling time 1 sec or less)	
IEX_18	Setpoint Change	Value of active power (P) in Watt with resolution 1 Watt; CTS2 timescale (sampling time 1 sec or less)	
IEX_22	Allowed tie-line deviations	Vector of active power values (P; flat number) in Watt with resolution 1 Watt in conjunction with EANi; CTS3 timescale (e.g. every 15min)	
IEX_23	Proposed balance setpoint adjustment	Value of active power (P; flat number) in Watt resolution 1 Watt; CTS3 timescale (e.g. every 15min)	
IEX_24	Accepted balance setpoint adjustment	Value of active power (P; flat number) in Watt resolution 1 Watt; CTS3 timescale (e.g. every 15min)	

3.6.4 Requirements (will be completed based on experimental testing and validation results)

<i>Requirements</i>		
<i>Categories ID</i>	<i>Category name for requirements</i>	<i>Category description</i>
<i>Requirement ID</i>	<i>Requirement name</i>	<i>Requirement description</i>

3.7 Post-Primary Voltage Control

3.7.1 Description of the use case

3.7.1.1 Name of use case

<i>Use case identification</i>		
<i>ID</i>	<i>Area Domain(s)/ Zone(s)</i>	<i>Name of use case</i>
PPVC 1.1.1	Transmission, Distribution, DER / Process, Field, Station, Operation	Post-Primary Voltage Control (PPVC) generating Voltage deadband/setpoint for PVC AVR devices (next to settings for Q controllable devices, OLTCs and Capacitor banks) using the Interior Point Methods (IPM) as OPF algorithm.

3.7.1.2 Scope and objectives of use case

<i>Scope and objectives of use case</i>	
Scope	<p>This use case describes the Post-Primary Voltage Control functionality in the ELECTRA Web-of-Cell concept. This PPVC functionality maintains the voltages in the nodes of the cell within the applicable regulated values by providing setpoints to AVR nodes, controllable Q nodes, capacitor banks and OLTCs.</p> <p>These setpoints are determined by an Optimal Power Flow (OPF) using the Interior Point Method (IPM) to minimize the losses in the system.</p> <p>New setpoints are calculated either periodically (proactive mode: loss optimization check and update) or when a safeband violation occurs at a pilot node (corrective mode: new setpoint calculations incl. loss minimization).</p> <p>Note: all nodes may be pilot nodes i.e. all nodes in the cell may be equipped with voltage monitoring functionality to report a voltage violation at the node.</p>
Objective(s)	<p>O1: Cell node voltages are kept within the regulatory safeband.</p> <p>O2: Minimal line losses in the cell.</p>
Related Higher-level use	N/A (this is the highest level)

case(s)	
Control Domain	An ELECTRA cell.

3.7.1.3 Narrative of use case

<i>Narrative of use case</i>
<p>Short description</p> <p>The CTL2 cell central controller determines optimal voltage set-points for nodes with continuous voltage control (Primary Voltage Control nodes with AVR functionality) and status/position for nodes with discrete voltage control (without AVR functionality, like transformers with on-load tap changers (OLTC), capacitor banks, shifting transformers or controllable loads) within the safebands defined by the Regulations, while minimizing power losses by using an OPF (IPM) algorithm.</p> <p>The optimality in the system is determined by the OPF using IPM algorithm, which calculates the optimal voltage set-points that ensure power flow losses minimization and voltage profile within the regulatory safeband (defined in grid codes and standards: e.g. EN 50160).</p> <p>The set-point recalculations are done either periodically (proactive PPVC) or when voltage violations are observed (corrective PPVC).</p> <ul style="list-style-type: none"> • The setpoints for AVR nodes calculated in this variant of PPVC, are deadband values for the PVC droop controller. (note: as a special case, deadband setpoints are calculated as $V_{db_min} = V_{db_max} = V_{setpoint}$) • The setpoints for directly controllable nodes calculated in this variant of PPVC, are delta_Q values. • Also setpoints for OLTCs and Capacitor Banks are calculated.
<p>Complete description</p> <p>The cell central PPVC Controlling function is activated either by means of a CTS-3 time trigger (proactive setpoint recalculation), or when one of the pilot nodes reports a voltage violation (i.e. voltage moving outside the regulatory safeband limits: corrective setpoint recalculation). (note: ELECTRA assumes there is no constant polling by the PPVC Controlling function of all pilot nodes, but that pilot nodes autonomously monitor their local voltage and send a signal when they detect a violation).</p> <p>On receipt of the activation trigger (timer or voltage violation error), the PPVC Controlling function will send a trigger signal to the PPVC Setpoint Providing function to initiate the calculation of new setpoints.</p> <p>As input for this setpoint calculation, information is collected from the (voltage) Reserves Information Provider function (availability of voltage reserves), the</p>

Tieline Powerflow Setpoint provider function (reactive powerflow profile setpoint at the cell tielines), and the **Load & Generation Forecast Provider function** (load and generation forecasts). A local grid model is assumed to be available.

Based on all this information, the **PPVC Setpoint Providing** function performs an OPF (using the Interior Point Method) to calculate voltage setpoint settings that keep all nodes within the regulatory defined safebands and that minimizes powerflow losses in the cell. Setpoints are determined for DER - **AVR Devices, DER - Controllable Q Devices, Capacitor Banks and OLTCs** and sent to the **PPVC Controlling function**.

The **PPVC Controlling function** then sends the calculated setpoints to the **PVC (AVR) droop nodes, Controllable Q nodes, Capacitor Banks and OLTCs**.

3.7.1.4 Key Performance Indicators

<i>Key performance indicators</i>			
<i>ID</i>	<i>Name</i>	<i>Description</i>	<i>Reference to mentioned use case objectives</i>
1	Cell node voltages within the safeband	Calculate voltage set-points that are within the safeband specified by the regulation considering a tolerance around the safeband limits to avoid the recalculation of the set-points too often. $V_{sb, min\ limit} - \Delta V < V < V_{sb, max\ limit} + \Delta V$ Where $V_{sb, min\ limit}$ and $V_{sb, max\ limit}$ are the lower and upper limits of the safeband, and ΔV is an additional margin to those limits, in order to avoid undesirable OPF processes.	O1
2	Minimum active power losses	Calculate voltage set-points that optimize power flows for minimum losses: $MIN P_L = \frac{1}{2} \sum_{i=1}^N \sum_{\substack{j=1 \\ j \neq i}}^N g_{ij} [V_i^2 + V_j^2 - 2V_i V_j \cos(\delta_i - \delta_j)]$ where P_L are the total losses in transmission lines, N is the number of nodes, g_{ij} is the conductance between nodes i and j , and V_i and V_j are the voltages in nodes i and j with angles δ_i and δ_j	O2

3.7.1.5 Use case conditions

Use case conditions
Assumptions
<ul style="list-style-type: none"> ➤ Sufficient voltage control resources are available.
Prerequisites
<ul style="list-style-type: none"> ➤ The cell's tie-line powerflow profile setpoint is calculated in an appropriate manner by an out-of-context function, and is provided in a timely manner. ➤ A list of procured voltage control providing resources and their location in the local grid is available (the procurement itself is out of scope for this use case). ➤ A list of voltage pilot nodes and their location in the local grid is available. ➤ A model of the local grid is available. ➤ Load and generation forecasts of all busses are available (either provided or estimated) ➤ PPVC providing resources are exclusively committed for providing PPVC support (i.e. not used for other use cases in the same timestep)

3.7.1.6 Further information to the use case for classification / mapping

Classification Information
Relation to other use cases
PVC: acts on setpoints provided by PPVC FCC, BSC, BRC: PPVC setpoints – e.g. to Controllable Q devices or AVR devices in LV/resistive grids - may result in active power (de)activations and thereby cause imbalances
Nature of use case
Technical Use Case (Distributed Control)
Further keywords for classification
ELECTRA, Web-of-Cells, Voltage control, OPF with IPM algorithm

3.7.1.7 *General remarks*

General remarks

Every cell is an independent structure with own capabilities for the voltage control itself.

The power flows in the tie lines are agreed setpoints that are established by an ELECTRA out-of-scope (market based) process.

The OPF uses a local grid model, load & generation forecast data and tie-line reactive powerflow profiles as main inputs. Power flow limits of lines, power generation limits of generators, voltage limits of busbars/terminals (specified by the regulation) are constraints.

3.7.2 Diagrams of use case

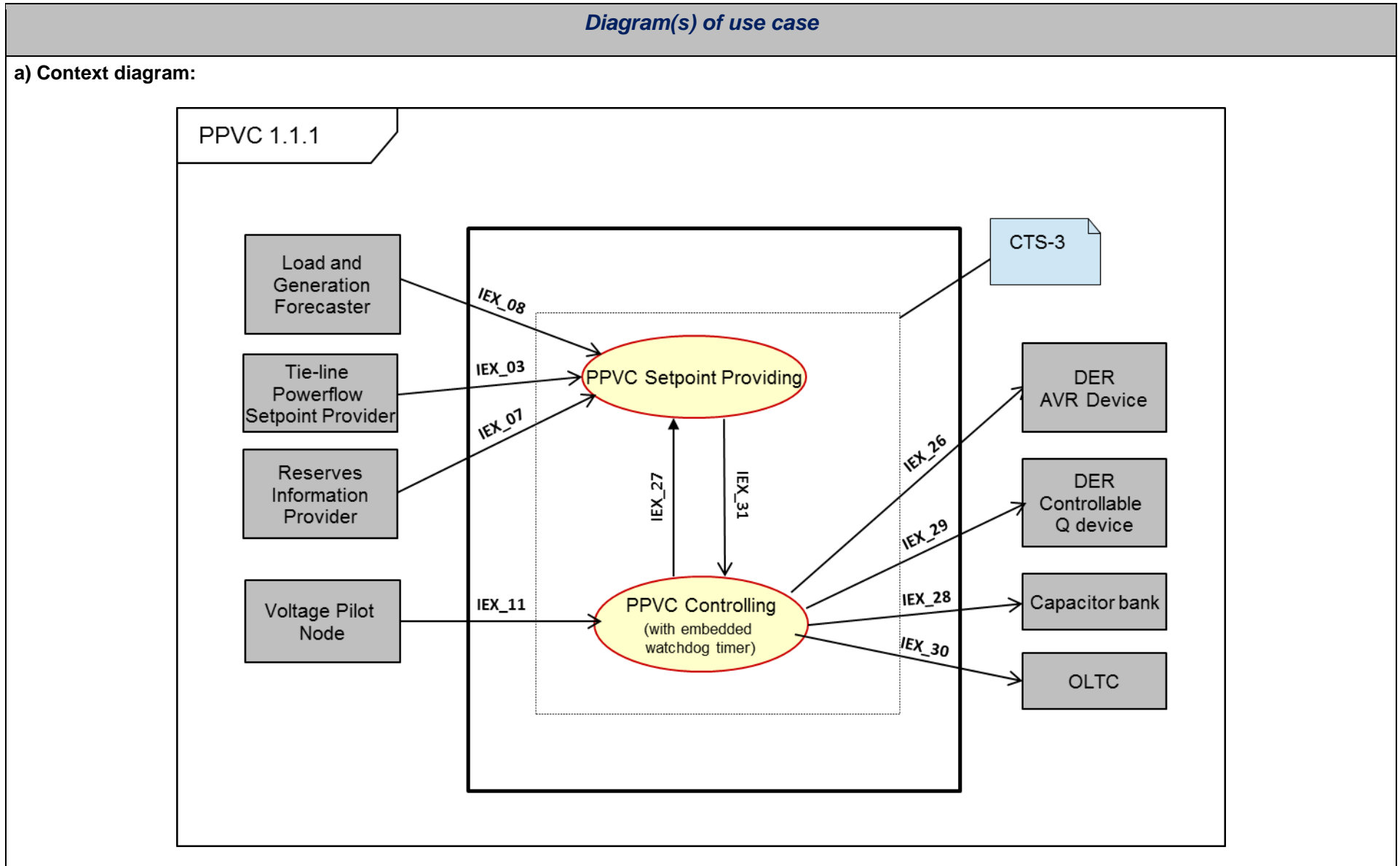

b) Sequence diagram:

Scenario 1: Normal operation – calculating setpoints for next timestep

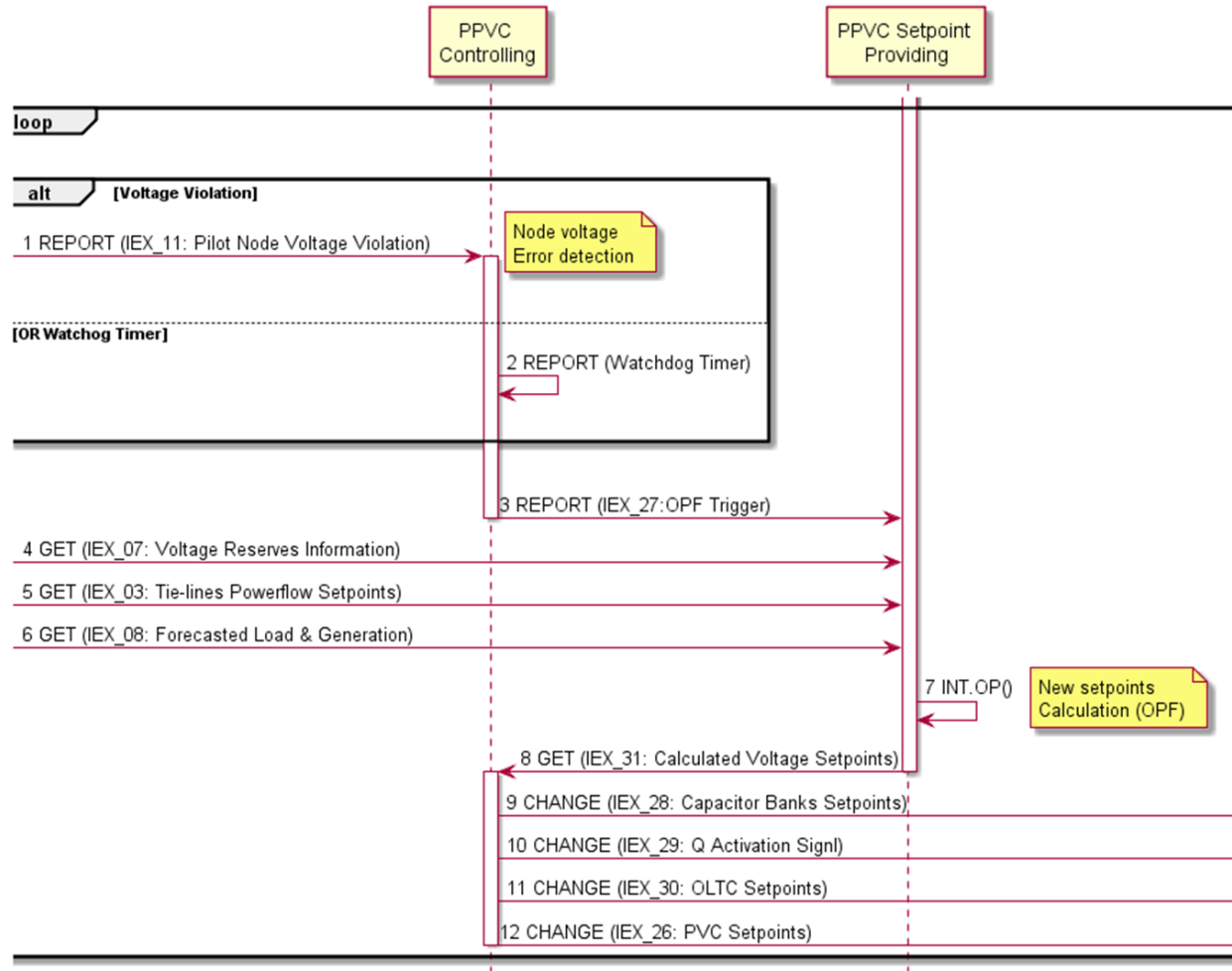

a) Timing diagram:

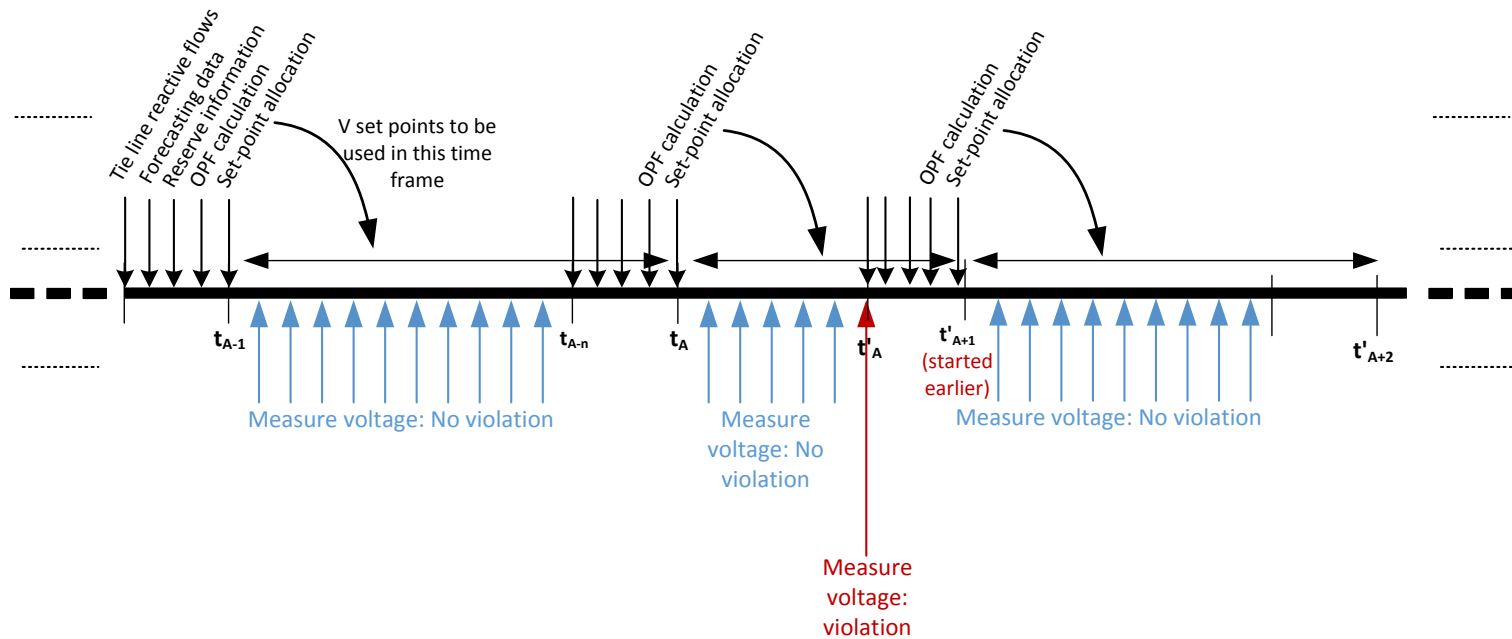

- t'_A : Voltage error detection (Start time of Corrective Scenario)
- $\Delta t' = t'_{A+1} - t_A < 15 \text{ min}$: Time interval of the voltage error detection
- $\Delta n = t_A - t_{A-n}$: One cycle of Control actions (a few seconds, it depends on controller process capability)
- $\Delta t = t_A - t_{A-1} = t'_{A+2} - t'_{A+1}$: One cycle of Proactive Scenario (15 min)

3.7.3 Technical details

3.7.3.1 Actors

Actors			
Grouping		Group description	
In-focus functions		Functionality that will be implemented and tested	
Emulated functions		Functionality that is 'out-of-scope' and will be emulated (e.g. reading information from a file or database)	
Observer/Actuator functions		Functionality that is related to measurement or actuation devices	
Actor name	Actor type	Actor description	Further information specific to this use case
PPVC Controlling	In-focus Function	<p>This function receives either a <i>timer</i> trigger or a voltage violation error signal from <i>voltage pilot nodes</i>.</p> <p>Upon receipt of a timer trigger or an voltage violation error signal, it sends a trigger to the <i>PPVC Setpoint Providing function</i> to calculate new voltage control setpoints.</p> <p>It next sends the new setpoints received from the <i>PPVC Setpoint Provider function</i> to the DER – (<i>AVR devices, DER - Controllable Q Devices, Capacitor Banks and OLTCs</i>).</p>	<p>This function is performed by a cell controller (CTL-2) and activated at CTS-3 (proactive setpoint recalculation) or whenever a voltage violation occurs in one of the pilot nodes.</p>
PPVC Set-point Providing	In-focus Function	<p>Upon receipt of a trigger from the <i>PPVC Controlling function</i>, this function determines new voltage control setpoints for controllable nodes to ensure all node voltages in the cell are within the regulatory safeband, while minimizing powerflow losses in the cell.</p> <p>These new setpoints are calculated based on information received from the (voltage) <i>Reserves Information provider function</i>, the <i>Load & Generation Forecaster function</i>, and the <i>Tie-line Powerflow Setpoint Provider function</i>.</p> <p>The calculates setpoints are sent back to the PPVC Controlling function.</p>	<p>This function is performed by a cell controller (CTL-2) and activated at CTS-3 (proactive setpoint recalculation) or whenever a voltage violation occurs in one of the pilot nodes</p> <p>The setpoint calculation is done with and OPF algorithm using the Interior Point Method.</p>

			<i>This function has/uses (assumed) static grid model information (topology, characteristics like impedances, and EAni information i.e. what is connected where).</i>
Voltage Pilot nodes	Observer Function	Locally measure voltage and compare against the regulatory safeband. If there is a violation, send a voltage violation error signal to the <i>PPVC controlling function</i> .	This function is performed by distributed resources (CTL-1) and performed continuously at CTS-1.
Reserves Information Provider	Emulated Function	It provides the available voltage control resources needed for the OPF calculations in the <i>PPVC Setpoint Providing function</i> . It can be part of a DER.	Emulated functionality implemented as a file read (the availability and cost forecasting functionality is out of scope). Activated at CTS-3.
Load & Generator Forecaster	Emulated Function	It provides the scheduled production and consumption of all generators and loads in order to be used by the OPF in the <i>PPVC Setpoint Providing function</i> .	Emulated functionality implemented as a file read (the load and generation forecasting functionality is out of scope). Activated at CTS-3.
Tie-Line Powerflow Setpoint provider	Emulated Function	It provides the individual tie-line powerflow setpoints to be used by the OPF in the <i>PPVC Setpoint Providing function</i> .	Emulated functionality implemented as a file read (the cell setpoint calculation functionality is out of scope). Activated at CTS-3.
DER – AVR device	Observer/Actuation Function	Continuously measures V and activates reactive power – according to its droop characteristics – when a value outside the deadband setpoint (received from the <i>PPVC Controlling function</i>) is observed.	New deadband setpoints are received at CTS-3. The continuous control is at CTS-1.
DER – Controllable Q device	Observer/Actuation Function	(De)Activates reactive power as requested by the <i>PPVC Controlling function</i> .	New setpoints are received at CTS-3.
Capacitor banks	Actuation Function	Switches to the position requested by the <i>PPVC Controlling function</i> .	New setpoints are received at CTS-3.

OLTC	Actuation Function	Switches to the position requested by the PPVC Controlling function.	New setpoints are received at CTS-3.
------	--------------------	--	--------------------------------------

3.7.4 Step by step analysis of use case

3.7.4.1 Overview of scenarios

<i>Scenario conditions</i>						
<i>No.</i>	<i>Scenario name</i>	<i>Scenario description</i>	<i>Primary actor</i>	<i>Triggering event</i>	<i>Pre-condition</i>	<i>Post-condition</i>
1	Normal operation – calculating setpoints for next timestep	Calculating new voltage control setpoints for the next timestep	PPVC Setpoint Provider	Time Trigger of Voltage Violation Error signal from a voltage pilot node	Voltage control resources are procured	New setpoints are calculated and set.

3.7.4.2 Steps – Scenarios

<i>Scenario 1</i>								
<i>Scenario name:</i>		Normal operation – calculating setpoints for next timestep						
<i>Step No.</i>	<i>Event</i>	<i>Name of process/ activity</i>	<i>Description of process/ activity</i>	<i>Service</i>	<i>Information producer (actor)</i>	<i>Information receiver (actor)</i>	<i>Information exchanged (IDs)</i>	<i>Requirements R-ID</i>
1	Time Trigger or Voltage Violation Trigger	REPORT trigger to PPVC Controlling	A trigger is received to start the calculation of new setpoints	REPORT	Timer or Voltage Pilot Node	PPVC Controlling	IEX_11	CTS-3
2		REPORT trigger to PPVC	A trigger is sent to start the	REPORT	PPVC controlling	PPVC Setpoint Providing	IEX_27	

		Setpoint Providing	calculation of new setpoints					
3		GET Reserves Status Information	Collect information from the voltage control resources	GET/REPLY	Reserves Information Providing	PPVC Setpoint Providing	IEX_07	
4		GET tie-line powerflow profiles	Receive the tie-line powerflow setpoint	GET/REPLY	Tie-line Powerflow Setpoint Provider	PPVC Setpoint Providing	IEX_03	
5		GET load and generation forecasts	Collect information concerning the load and generation forecasts of all busses/nodes for the next timestep	GET/REPLY	Load Generation & forecaster	PPVC Setpoint Providing	IEX_08	
6		OPF	Internal processing: Apply OPF algorithm in order to calculate optimal voltage set-points	INTERNAL OPERATION	PPVC Set-point providing	PPVC Set-point providing	-	
7		REPORT Calculated Optimal set-points	PPVC controlling function gets the calculated set-points after OPF	REPORT	PPVC Set-point providing	PPVC controlling	IEX_31	
8		CHANGE Set-points for capacitor banks	PPVC controlling function changes the set-points for	CHANGE	PPVC controlling	Capacitor Banks	IEX_28	

			NC-1					
9		CHANGE Set-points for DER – Q Controllable Devices	PPVC controlling function changes the set-points for NC-2	CHANGE	PPVC controlling	DER – Q Controllable Devices	IEX_29	
10		CHANGE Set-points for OLTCs	PPVC controlling function changes the set-points for NC-3	CHANGE	PPVC controlling	OLTCs)	IEX_30	
11		CHANGE Set-points for DER – AVR Devices	PPVC controlling function changes the set-points for PVC controller	CHANGE	PPVC controlling	DER – AVR Devices	IEX_26	

3.7.5 Information exchanged

<i>Information Exchanged</i>			
<i>Information exchanged ID</i>	<i>Name of information exchanged</i>	<i>Description of information exchanged</i>	<i>Requirements IDs</i>
IEX_03	Tie-line Powerflow setpoints	Vector of individual tie-lines powerflow schedules (P_i , Q_i ; flat numbers) in Watt with 1 Watt resolution and in VAR with 1 VAR resolution in conjunction with EANi (location) ; CTS-3 timescale (e.g. every 15min).	
IEX_07	Voltage Reserves information	For AVR nodes: Vector of three reactive power values (forecasted Q_{max} , Q_{min} , $Q_{baseline}$; flat numbers) in VAR with 1 VAR resolution; CTS-3 timescale (e.g. every 15min) (EANi optionally depending on communication approach) For controllable Q nodes: Vector of three reactive power values (forecasted Q_{max} , Q_{min} ,	

		<p>Qbaseline ; flat numbers) in VAR with 1 VAR resolution ; CTS-3 timescale (e.g. every 15min) (EANi optionally depending on communication approach)</p> <p>For capacitor banks: none: it is assumed that the PPVC setpoint providing knows/remembers the current state and the possible alternative states.</p> <p>For OLTC nodes: it is assumed that the PPVC setpoint providing knows/remembers the current position and the possible alternative positions.</p>	
IEX_08	Forecasted Load and Generation	Vector of active and reactive power values (P, Q ; flat numbers) in Watt with resolution 1 Watt and VAR with resolution 1 VAR respectively ; CTS-3 timescale (e.g. every 15min) (EANi optionally depending on communication approach)	
IEX_11	Voltage Violation Trigger	Value of voltage set-point (V) in mV with resolution 10mV ; CTS-3 timescale (e.g. every 15min) in proactive mode (EANi optionally depending on communication approach)	
IEX_26	PVC setpoint	Value of voltage set-point (V) in mV with resolution 10mV ; CTS-3 timescale (e.g. every 15min) in proactive mode	
IEX_27	OPF trigger	On/Off Trigger ; CTS-3 timescale (e.g. every 15min) in proactive mode	
IEX_28	Capacitor Bank setting	On/Off Trigger ; CTS-3 timescale (e.g. every 15min) in proactive mode or (Broadcast mode) Matrix of On/Off Triggers in conjunction with EANi (location) ; CTS3 timescale (e.g. every 15min) in proactive mode	
IEX_29	Q Activation signal	Value of reactive power (Q) in VAR with resolution 1 VAR ; CTS-3 timescale (e.g. every 15min) in proactive mode or (Broadcast mode) Matrix of values of reactive power (Q) in VAR with resolution 1 VAR in conjunction with EANi (location) ; CTS-3 timescale (e.g. every 15min) in proactive mode	
IEX_30	OLTC setting	Value of tap position change (-a, +a) ; CTS-3 timescale (e.g. every 15min) in proactive mode or (Broadcast mode) Matrix of tap position changes (-a, +a) in conjunction with EANi (location) ;	

		CTS3 timescale (e.g. every 15min) in proactive mode	
IEX_31	Calculated voltage setpoints	(set-point matrix): 1. Switching positions for capacitor banks (on/off (1/0)) 2. Curtailment/shedding for controllable reactive loads (Qseti in VAr) 3. Voltage level (tap position -a / +a where a is positive real value) of activation command (OLCT) 4. Voltage set-points for AVRs and other PVC controllers (V in V)	

3.7.6 Requirements (will be completed based on experimental testing and validation results)

<i>Requirements</i>		
<i>Categories ID</i>	<i>Category name for requirements</i>	<i>Category description</i>
<i>Requirement ID</i>	<i>Requirement name</i>	<i>Requirement description</i>

3.8 Primary Voltage Control

3.8.1 Description of the use case

3.8.1.1 Name of use case

<i>Use case identification</i>		
<i>ID</i>	<i>Area Domain(s)/ Zone(s)</i>	<i>Name of use case</i>
PVC 1.5	Transmission, Distribution, DER / Process, Field, Station, Operation	Primary voltage control by AVR devices

3.8.1.2 Scope and objectives of use case

<i>Scope and objectives of use case</i>	
Scope	This use case describes the Primary Voltage Control functionality in the ELECTRA Web-of-Cells context. This PVC functionality ensures that the AVR (Automated Voltage Regulation) node locally maintains its voltage using automatic local droop functionality and according to setpoints received from the Post-Primary Voltage Control (PPVC).
Objective(s)	O1: Constitute an “actuator” for VSC O2: Minimize local transient voltage deviations (limit Vdyn)
Related Higher-level use case(s)	N/A (this is the highest level)
Control Domain	An ELECTRA Cell

3.8.1.3 Narrative of use case

<i>Narrative of use case</i>
Short description
The CTLO decentralized monitor and controller (AVR node/device) receives its voltage deadband setpoints from the VSC cell-central controller for the next timestep.
The AVR node/device continuously monitors dV and when a deviation outside the set safe-band is observed, it activates reactive and/or active power in

accordance to its droop characteristic to drive the voltage back to a value within the safeband.

PVC is responsible not only for voltage stabilization during and after transients, but also for maintaining voltage at a desired (optimal) levels – as determined by the VSC setpoint calculations - in a steady state.

Complete description

The **AVR device** receives its voltage deadband/setpoints from the VSC controller for the next timestep.

The AVR device continuously monitors dV and when a deviation (outside the deadband) is observed, it activates reactive power according to its local droop characteristics to drive the voltage back to a setpoint value (or value within the deadband.)

3.8.1.4 Key Performance Indicators

Key performance indicators			
ID	Name	Description	Reference to mentioned use case objectives
1	Voltage violation	Time or voltage-time area for voltage being out of permissible bounds (e.g. $\pm 10\%$)	O1, O2

3.8.1.5 Use case conditions

Use case conditions
Assumptions
➤ Sufficient Voltage control resources are available.
Prerequisites
➤ A list of procured voltage control resources and their location in the local grid is available (the procurement itself is out of scope for this use case)
➤ PVC providing resources are exclusively committed for providing PVC support (i.e. not used for other use cases in the same timestep)

3.8.1.6 Further information to the use case for classification / mapping

Classification Information
Relation to other use cases
VSC: determines the setpoints for PVC

FCC, BSC, BRC (possible conflict - if PVC uses active power for voltage control, it might affect other use cases by causing imbalances or by causing conflict with access to resources' active power)

Nature of use case

Technical Use Case

Further keywords for classification

ELECTRA, Web-of-Cells, Voltage control, automatic control

3.8.1.7 General remarks

General remarks

This variant of the PVC use case assumes that the voltage can be controlled by means of active, reactive power or both simultaneously, depending on the impedance characteristic of the grid as seen from the connection point. For this, a grid impedance estimation functionality is needed. The purpose of this function is to provide estimation of the R/X ratio of the grid impedance in the point of connection of the resource. This information may be used in order to control voltage in optimal manner, i.e. using combination of active and reactive power corresponding to the current grid impedance characteristic.

Option 1: Grid impedance estimation provided by VSC:

The VSC is expected to have a complete model of the grid. From this model, the Thevenin impedance for any point in the network can be calculated in a straightforward manner and sent to PVC controller.

Option 2: Internal grid impedance estimation function:

The PVC controller can estimate the grid impedance at its location itself by sending the requests from PVC to the flexible resource to generate P and Q and observe the subsequent change in voltage amplitude V and phase. Based on these measurements R/X ratio can be calculated.

The PVC functionality is located at the level of the flexible resource controller (CTL-0), which enables the process to be fast and autonomous. The local monitor has the task to measure and convert the instantaneous values of voltages and current into voltage, current and power rms (root mean square) and phase angles. For the simplest controllers voltage rms is sufficient to fulfil the control objective, however if other functionalities need be assured, e.g. voltage droop characteristic, additional observables need to be provided (current, power, angles).

3.8.2 Diagrams of use case

Diagram(s) of use case

a) Context diagram:

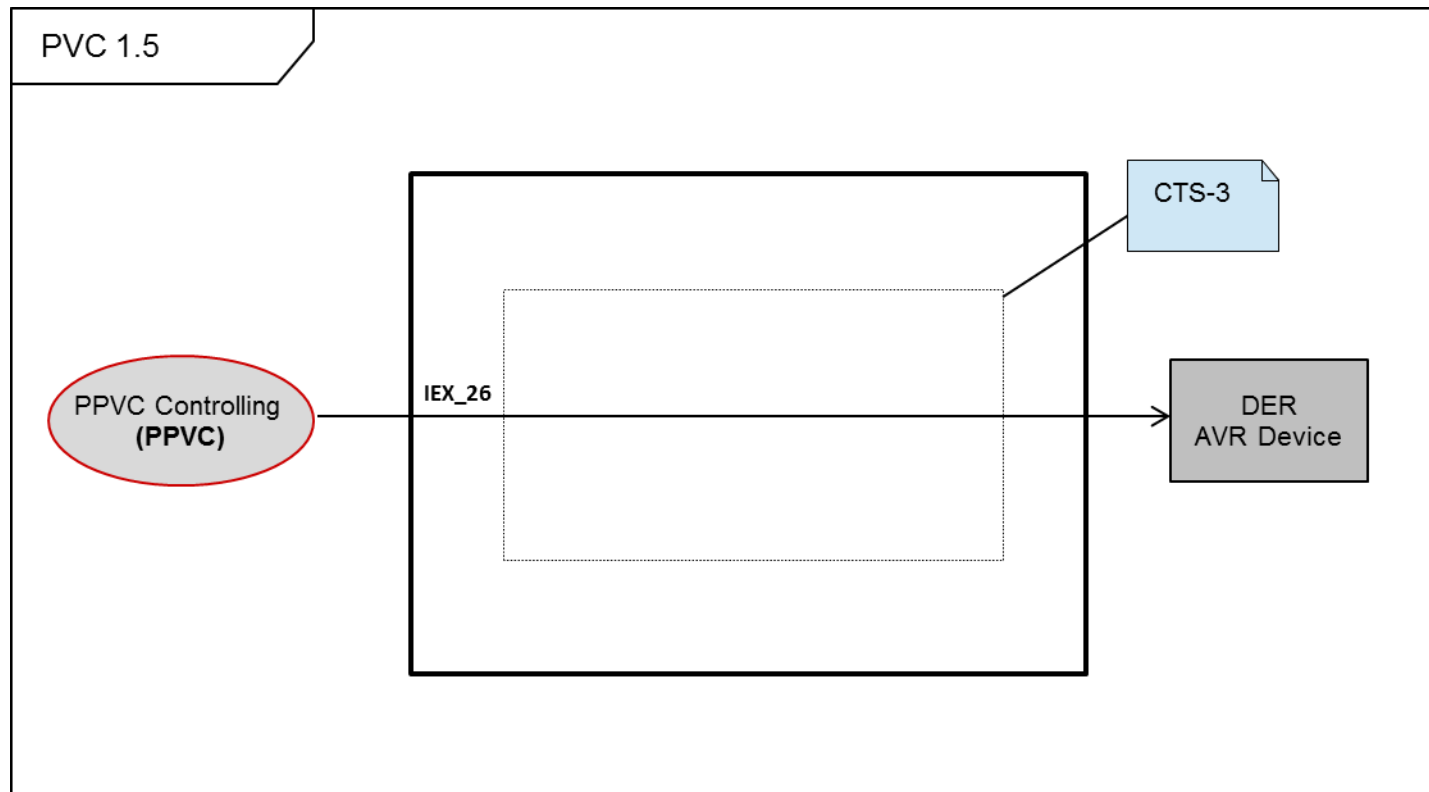

3.8.3 Technical details

3.8.3.1 Actors

<i>Actors</i>			
<i>Grouping</i>		<i>Group description</i>	
In-focus functions		Functionality that will be implemented and tested	
Emulated functions		Functionality that is 'out-of-scope' and will be emulated (e.g. reading information from a file or database)	
Observer/Actuator functions		Functionality that is related to measurement or actuation devices	
<i>Actor name</i>	<i>Actor type</i>	<i>Actor description</i>	<i>Further information specific to this use case</i>
DER AVR device	– Observer/Actuator function	Continuously monitors voltage and activates power in accordance to its droop characteristic if a voltage value outside the safeband setpoint that it received, is detected.	New voltage safeband setpoint is received at CTS-3. The continuous control is running at CTS-1.

3.8.4 Step by step analysis of use case

3.8.4.1 Overview of scenarios

<i>Scenario conditions</i>						
<i>No.</i>	<i>Scenario name</i>	<i>Scenario description</i>	<i>Primary actor</i>	<i>Triggering event</i>	<i>Pre-condition</i>	<i>Post-condition</i>
1.a	Normal Operation – receiving setpoints	New setpoints for the next time-step are received from VSC	AVR device	Periodic (at CTS-3)	AVR node is procured	AVR node received its setpoints for the next timestep
1.b	Normal Operation – realtime control	Responding to voltage deviation outside the deadband	AVR device	$ dV < dV_{db} $	AVR node is active	PVC is delivered

3.8.4.2 Steps – Scenarios

Scenario 1.a								
Scenario name:		Normal Operation – receiving setpoints						
Step No.	Event	Name of process/activity	Description of process/activity	Service	Information producer (actor)	Information receiver (actor)	Information exchanged (IDs)	Requirements R-ID
1	Time Trigger	CHANGE PVC setpoint	Receive the new setpoint for the next timestep	CHANGE	VSC Controlling System	AVR device	IEX_26	CTS-3
Scenario 1.b								
Scenario name:								
Step No.	Event	Name of process/activity	Description of process/activity	Service	Information producer (actor)	Information receiver (actor)	Information exchanged (IDs)	Requirements R-ID
2	Continuously	dQ/dV droop control	Internal Processing: activate reactive power in response to dV measurement	INTERNAL OPERATION	dV observer at DER – AVR device	Reactive Power Controller at DER – AVR device	-	CTS-1

3.8.5 Information exchanged

Information Exchanged			
Information exchanged ID	Name of information exchanged	Description of information exchanged	Requirements IDs
IEX_26	PVC setpoint	Two safeband voltage values (Vmin, Vmax) in mV with resolution 10mV ; CTS3 timescale (e.g. every 15min)	

3.8.6 Requirements (will be completed based on experimental testing and validation results)

<i>Requirements</i>		
<i>Categories ID</i>	<i>Category name for requirements</i>	<i>Category description</i>
<i>Requirement ID</i>	<i>Requirement name</i>	<i>Requirement description</i>

3.8.7 Controller Conflicts and Misuse cases

<i>id</i>	<i>Case Name</i>	<i>Description</i>	<i>Related Requirements</i>	<i>Related objective</i>	<i>Recommended mitigation</i>
CC_1	Access to resource	Voltage control process carried out with use of active power requires a particular resource to change generated active power according to a new setpoint. This will affect cell (and system) balances and cause frequency and balance deviations.	A resource controls voltage by means of active power and (PVC or VSC) and any of the remaining use cases act on this flexibility resource	O1 and O2	Appropriate selection of resources for given use cases
CC_2	Controller hunting	In case of voltage setpoints for 'nearby' nodes, the two controllers may be counter-acting each other's control inputs			

4 Conclusions and next steps

This D4.2 document describes the detailed functional architecture for the control solutions related to the ELECTRA Web-of-Cells concept. The functional architecture is presented as 6 specific control functionalities (Use Cases) that combined constitute the ELECTRA Web-of-Cells control scheme. The control functionalities (Use Cases) are: Inertia Response Power Control (IRPC), Adaptive Frequency Containment Control (FCC), Balance Restoration Control (BRC), Balance Steering Control (BSC), Post-Primary Voltage Control (PPVC) and Primary Voltage Control (PVC). This functional architecture is presented using an IEC 62559 based Use Case table format, focusing specifically on CTL-2/3 functionality. As this is meant to be implementation independent, the focus is on black box functions and interactions between the functions, giving freedom to individual development teams to make their own design choices and experiment with and compare different implementations.

The Use Cases were selected based on the best understanding of the most important and critical functionalities of the future for Web-of-Cells concept. The functions and interactions are kept as limited as possible in view of what is needed to test and validate the control scheme. This means that a number of functions that would be required for a realistic deployment (like an aggregation of reserves) is left out (though its impact related to additional latencies in information exchanges are modelled in a parametrizable manner). Besides, the focus (in the sequence diagrams and scenario descriptions) is on the Control Topology Level (CTL) 2/3 functions (cell level and inter-cell level) and not on the CLT 0/1 functions (device and aggregate resource level). Concerning the functions that provide the observables (like frequency or tie-line deviation error signal) or that actuate the control signal (like droop behaviour) a distinction is made between those for which a novel approach has been developed in the project, and those for which standard existing technology (and libraries in the simulation environment) can be used. Besides, other functions that are needed for the simulation and testing, but are not the focus of the control scheme itself, like the forecasting of load and generation profiles, or the determining of the availability profile and cost of reserves, will be emulated in a manner is most suitable for a specific test and validation context.

In parallel with the completion and finalization of the this deliverable, the Use Case and Control Scheme development has started and is ongoing following a staged methodology. In the first stage, grey-box descriptions of the defined functions are taken as the basis for deciding on design choices (white-boxing) so that implementations for simulation purposes can be developed. White-box description include among others the detailed specifications of the operation principles, possible block diagrams of the control implementation, algorithms, mathematical equations, as well as decomposition of black-box functions into finer granularity functionality. Based on these specifications the single functions will be implemented by coding and proving its functionality in a simple simulation model. At the same time, representative test networks and test scenarios are defined. The specifications of test network include among others the number of cells, combinations of voltage levels, share of different types of DER, simulation setup requirements (simulation time step) etc. The development of the test network was started in WP5 in previous year. Simulation testing will be carried out using two network models, the Pan-European model and CIGRE model. Power Factory and Matlab Simulink simulation model files are available for both networks. Test scenarios and reference test events are also defined for each Use Case. ENTSO-E Control implementation will be the reference case against which the simulation results will be compared.

The second stage consists of the Use Case integration and testing. The single functions of each Use Case will be integrated into test network and the functionality in the stand-alone operation of

the whole use-case will be proven in a representative test grid by simulations. Simulation of different scenarios and results will be compared against ENTS-OE Reference case. The third stage is the testing and validation of combinations of Use Cases. Multiple Use Cases will be integrated into test network and the functionality in combined operation of use-cases will be proven in representative test grids by simulations. The results of simulations will be compared against ENTSO-E Reference case to certain extent. Based on the results, selected functionalities and test scenarios will be transferred for validation by laboratory tests to partner laboratories.

5 References

- [1] "ELECTRA Project," <http://www.electrairp.eu> .
- [2] EU, "DIRECTIVE 2009/28/EC OF THE EUROPEAN PARLIAMENT AND OF THE COUNCIL," 2009.
- [3] ELECTRA Deliverable D3.1 "Specification of Smart Grids high level functional architecture for Frequency and Voltage Control".
- [4] ELECTRA Internal Report R3.1 "Problem description: specification of the requirements for the overall Smart Grid voltage and frequency control".
- [5] ELECTRA Deliverable D6.1 "Functional Specification of the Control Functions for the Control of Flexibility across the different Control Boundaries".
- [6] ELECTRA Internal Report R4.1 " Description of the SGAM methodology that will be used for the detailed functional specification of the ELECTRA solution".
- [7] DISCERN Deliverable D5.4 "Standardisation assessment regarding canonical data models".
- [8] ELECTRA Deliverable D4.3 "Gap analysis and existing standards for proposed frequency and voltage control solutions".

6 Disclaimer

The ELECTRA project is co-funded by the European Commission under the 7th Framework Programme 2013.

The sole responsibility for the content of this publication lies with the authors. It does not necessarily reflect the opinion of the European Commission.

The European Commission is not responsible for any use that may be made of the information contained therein.

7 Annex 1: Cross-tab of functions

In-focus Functions

y Part of the Use Case / To be implemented for the Use Case

(y) Belonging to and implemented for another Use Case, but needed by this Use Case

Name	IRPC 1.2.1	FCC 2.5.1	BRC 1.1	BSC 1.1.1	PVC 1.5	PPVC 1.1.1
Merit Order Collection	y	y	y			
Merit Order Decision	y	y	y			
Frequency Droop Parameter Determination		y				
Adaptive CPFC Determination		y	(y)			
Imbalance Determination		(y)	y	(y)		
Imbalance Correction			y			
Cell Setpoint Adjusting				y		
Tie Line Limits Calculation				y		
df/dt Droop Slope Determination	y					
PPVC Controlling						y
PPVC Setpoint Providing						y

Table 1 - List of In-scope functions

Observer and Actuator functions

O Observer

A Actuator

Name	IRPC 1.2.1	FCC 2.5.1	BRC 1.1	BSC 1.1.1	PVC 1.5	PPVC 1.1.1
Frequency Observation		O				
Tie-line Active Powerflow Observation			O			
Voltage Observation					O	O
DER - ROCOF droop device	O, A					
DER - frequency droop device		O, A				
DER - AVR device					O, A	
Capacitor Bank						A
OLTC						A
DER - controllable P device			A			
DER - controllable Q device						A
Voltage Pilot node						O

Table 2 - List of Observer/Actuator functions

Emulated (Out-of-ELECTRA-Scope) functions

Name	IRPC 1.2.1	FCC 2.5.1	BRC 1.1	BSC 1.1.1	PVC 1.5	PPVC 1.1.1
Cell CPFC Setpoint Provider		y				
Tie-line Active Powerflow Setpoint Provider			y			
Tie-line Powerflow Setpoint Provider						y
Cell Inertia Setpoint Provider	y					
Reserves Information Provider	y	y	y			y
Load & Generation Forecaster	y	y	y	y		y

Table 3 - List of Emulated functions

8 Annex 2: Grey-box function descriptions

8.1 In-Scope Functions

8.1.1 Merit Order Collection

Needed for IRPC, FCC, BRC

1. Receives reserves availabilities
2. Implements a sorting algorithm to rank the reserves based on their cost
3. Sends the compiled list

8.1.2 Merit Order Decision

Needed for IRPC, FCC, BRC

1. Receives MO list
2. Retrieves grid data (internal, static)
3. Receives active/reactive power schedules for all DER units
4. Aggregates all units based on the nodes they are connected to
5. Implements Active power changes due to the MO list reserves for a maximum deviation
6. Calculates all voltages/currents based on load flow
7. If $\Delta V_i, I_i$ > specific thresholds it (partly) eliminates the directly connected reserves and goes to step 4
8. Else sends the last MO update

8.1.3 Frequency Droop Parameter Determination

Needed for FCC

1. Receives the CFPC value
2. Divides maximum frequency deviation in concrete steps (0.25Hz)
3. Calculates the Total Power required for each step till the max deviation
4. Starts with the lowest frequency intervals (0 to 0.25Hz and -0.25 to 0Hz)
5. Adds up the cheapest reserves capacities from the MO list

6. If the sum of step4 is equal to the total required capacity (step3) it calculates the sum for the next frequency step, i.e. 0.25 to 0.5Hz and -0.5 to -0.25Hz.
7. Else goes back to step4
8. Continues steps 4 to 6 until the maximum frequency limits ± 3 Hz
9. Sets the droop slope of the unnecessary reserves to zero
10. Dispatches only to the non-zero values based on their EAN

8.1.4 Adaptive CPFC Determination

Needed for FCC, (BRC)

1. Receives frequency
2. Receives voltage
3. Averages (if necessary) over a short period (<1sec)
4. Estimates the imbalance location
5. Calculates the corresponding CPFC_ratio from 0.00 to 1.00
6. If CPFC ratio changed it dispatches it to all reserves

8.1.5 Imbalance Determination

Needed for BRC, (FCC, BSC)

1. Receives scheduled tie-line power flow for the next period.
2. Receives measured tie-line power flow.
3. Receives frequency measurement.
4. Calculates tie-line error.
5. Calculates frequency error.
6. Calculates cell imbalance with frequency and tie-line error.
7. Sends cell imbalance.

8.1.6 Imbalance Correction

Needed for BRC

1. Receives cell imbalance.
2. Receives final merit order list.
3. Calculates the amount of power required for correcting the measured cell imbalance.
4. Sends the required amount of reserves to be activated to the resource providers according to the merit order list.

8.1.7 Cell Setpoint Adjusting

Needed for BSC

1. Read the cell balance setpoint (= scheduled profile for each tieline)
2. Calculate the max deviation for each tie-line (using internal static grid model information that knows what the limits are)
3. Every second (for instance)
4. Monitor the tieline powerflow from each tieline (1sec: same as for BRC controller Imbalance Determination function input) and calculate the sum of deviations (or a vector of deviations) and check if sum of deviations (= same number as cell imbalance) is smaller than a threshold value (or one individual tieline has a larger deviation) = TRIGGER 1
5. Check if there is a setpoint change request from a neighbor = TRIGGER 2
6. ALT Trigger 1
 7. Calculate proposed tieline deviations as $\min(\text{tieline deviation}, 80\% \text{ of max tieline deviation})$ for each tieline
 8. Send for each tieline the proposed tieline deviation to the corresponding neighbor
 9. Receive for each tieline the counterproposed/accepted tieline deviation from the corresponding neighbor (can be 0 meaning 'no deviation allowed').
 10. Send the new tieline setpoints (may be unchanged) to the Imbalance determination function (overwriting the cell setpoint information).
11. ALT TRIGGER 2
 12. Receive a proposed tieline setpoint deviation from a neighbor (TRIGGER to do something)
 13. Determine own imbalance per tieline (but by definition this is likely the same number as the proposed deviation that is received, or is it 80% of the max deviation: as what is measured at both sides of the tieline must be the same: but the tieline limits could be different at both sides of the tieline ?)
 14. Send counterproposal for each tieline ($= \min(\text{proposed deviation}, 80\% \text{ of } - \text{own- tieline limits})$) (by sending back the minimum you ensure that nothing gets violated).

8.1.8 Tie-line Limits Calculation

Needed for BSC

1. Receives the values of power schedules of the tielines corresponding to the beginning of the selected timeframe
2. It retrieves the static information regarding the maximum power limits of the tielines
3. It subtracts the scheduled powers from the maximum ones to calculate the difference (allowable power changes)

4. It issues the vector of allowed change to the Cell Setpoint Adjuster together with the identity of each tieline

8.1.9 df/dt Droop Slope Determination

Needed for IRPC

8.1.10 PPVC Controlling

Needed for PPVC

1. It receives the voltage magnitude measurements from all (pilot) nodes of the cell, every 1 s
2. For each node, it compares the voltage measurement with the safeband limits imposed by Regulation. A tolerance is considered around the limits:

$$V_{sb,min\ limit} - \Delta V < V < V_{sb,max\ limit} + \Delta V$$

3. If voltage magnitude measurement is out of the safe-band, it sends a trigger signal to PPVC Setpoint Provider to launch the OPF algorithm.
4. It waits until the OPF is solved and receive its results from the by the PPVC Setpoint Provider.
5. It classifies and adapts format according to the different nodes (PVC, PVC NC-1, PPVC NC-2, PPVC NC-3)
6. It sends the appropriate set-points to the different resources: on/off signal to capacitor banks (PPVC NC-1 nodes), reactive power value (VAr) for controllable reactive loads (PPVC NC-2 nodes), tap position for OLTC transformers (PPVC NC-3 nodes), voltage set-point (V) for AVR capability resources (PVC nodes).
7. It returns to point 1.
8. Else if (point 3) voltage magnitude is inside the safe-band and timer trigger has not been received (cycle: 15 min), it returns to point 1.
9. Else if (point 3) voltage magnitude is inside the safe-band but a timer trigger is received (cycle: 15 min), it sends a trigger signal to PPVC Setpoint Provider to launch the OPF algorithm.
10. It goes to point 4.

8.1.11 PPVC Setpoint Providing

Needed for PPVC

1. It is in stand-by until it receives a trigger signal from the PPVC Controller.
2. When the trigger is received, it request and gets information from the Resource Status Information Provider about availability, capacity and location of reserves, for the next 15 min period.
3. When the trigger is received, it request and gets information about reactive set-points of each tie-line for the next 15 min period.

4. When the trigger is received, it requests and gets information from the Load and Generation Forecast Provider about the forecast generation (P, Q) and load (P, Q) in the cell for the next 15 min period.
5. Using information from 2, 3, and 4 and some static information (network model containing the grid topology with connection points, lines and transformer parameters, etc, generator parameters, etc.), an OPF (based on IPM or genetic algorithm) algorithm is launched.
6. OPF results are sent back to PPVC Controller.
7. It returns to point 1.

8.2 Observables and Actuator Functions

8.2.1 Frequency Observation

Needed for FCC, BSC 1.3.1

It calculates and provides the frequency measurement that is needed by each concerned function.

Observables for Actual Synchronous Grid Phase and Frequency: Akagi PLL; Dual Second Order Generalised Integrator-Frequency Locked Loop (DSOGI-FLL) (both tested). See D5.2 Annex 2.1 "Numerical Algorithms for determination of identified observables in ELECTRA Use Cases" for details.

8.2.2 Tie-line Active Powerflow Observation

Needed for BRC

8.2.3 Voltage Observation

Needed for PVC, PPVC

1. It measures and the voltage wave form.
2. From the instantaneous time values, the root mean square (RMS) value is calculated according to its definition:

$$V_{rms} = \sqrt{\frac{1}{T} \int_{t_1}^{t_1+T} v^2(t) dt}$$

3. This value is updated every cycle (20 ms).

8.2.4 DER - ROCOF droop device

Needed for IRPC

8.2.5 DER - frequency droop device

Needed for FCC

A variety of small, grid-connected devices that generate or store Distributed generation, also distributed energy, on-site generation (OSG) or district/decentralized energy

8.2.6 DER – controllable P device

Needed for BRC

8.2.7 DER - AVR device

Needed for PVC

8.2.8 DER – controllable Q device

Needed for PPVC

After receiving a reactive power set-point, this controllable device adjusts its injection or consumption of reactive power to reach the set-point.

8.2.9 Capacitor Bank

Needed for PPVC

After receiving a switching set-point (ON/OFF), the capacitor bank is connected or disconnected to the grid.

8.2.10 OLTC device

Needed for PPVC

After receiving a switching set-point, the transformer tap is changed accordingly to the new position.

8.2.11 Voltage Pilot Node device

Needed for PPVC

8.3 Emulated (out-of-scope) Functions

8.3.1 Cell CPFC Setpoint Provider

Needed for FCC, BSC 1.3.1

It provides the CPFC setpoint to the Device Droop Slope Determination. This function can be a database (or file) that contains the schedules of CPFC for a specific time horizon (e.g. one day).

8.3.2 Tie-line Active Powerflow Setpoint Provider

Needed for BRC

It provides the scheduled active powerflow set-points for each individual tie-line connecting the cell with the neighbouring cells. This function can be a database (or file) that contains schedules over a specific time horizon (e.g. one day).

8.3.3 Tie-line Powerflow Setpoint Provider

Needed for PPVC

It provides the scheduled (active and reactive) powerflow set-points for each individual tie-line connecting the cell with the neighbouring cells. This function can be a database (or file) that contains schedules over a specific time horizon (e.g. one day).

8.3.4 Cell Inertia Setpoint Provider

Needed for IRPC

8.3.5 Reserves Information Provider

Needed for IRPC, FCC, BRC, PPVC

It provides the available power capacity that is needed for the compilation of the Merit Order List by the Merit Order Collection function. It can be part of a DER.

8.3.6 Load & Generation Forecaster

Needed for IRPC, FCC, BRC, BSC, PPVC

It provides the scheduled production (P, Q) and consumption (P, Q) of all generators and loads. This function can be a database (or file) that contains schedules over a specific time horizon (e.g. one day).

9 Annex 3: List of Information Exchanges

Legend: In-Scope
In-scope, from other UC
Observables/Actuators
Emulated

ID	Information Exchange Name	Information Exchange Description	From Function	To Function	Use Case
IEX_01	Cell CPFC setpoint	Value of requested cell freq droop contribution in Watts/Hz with resolution 1 Watt/Hz ; CTS-3 timescale (e.g. every 15-min)	Cell CPFC Setpoint Provider	Frequency Droop Parameter Determination	FCC
			Cell CPFC Setpoint Provider	Cell Setpoint Adjusting	BSC 1.3.1
IEX_02	Tie-line Active Powerflow setpoints	Vector of individual tie-lines active powerflow schedules (P_i ; flat numbers) in Watt with resolution 1 Watt in conjunction with EAni (location) ; CTS-3 timescale (e.g. every 15min).	Tie-line Active Powerflow Setpoint Provider	Imbalance Determination	BRC 1.1
IEX_03	Tie-line Powerflow setpoints	Vector of individual tie-lines powerflow schedules (P_i, Q_i ; flat numbers) in Watt with 1 Watt resolution and in VAR with 1 VAR resolution in conjunction with EAni (location) ; CTS-3 timescale (e.g. every 15min).	Tie-line Powerflow Setpoint Provider	PPVC Setpoint Providing	PPVC
IEX_04	Cell Inertia setpoint	Value of requested cell (virtual) inertia (J ; flat number) in kgm2 with resolution 1 kgm2 ; CTS-3 timescale (e.g. every 15min).	Cell Inertia Setpoint Provider	df/dt Droop Slope Determination	IRPC 1.2.1
IEX_05	Balance Reserves information	Vector of active power values (forecasted $P_{max}, P_{min}, P_{baseline}$; flat numbers) in Watt with resolution 1 Watt, and Cost	Active Power Reserves Information provider	Merit Order Collection	FCC

ID	Information Exchange Name	Information Exchange Description	From Function	To Function	Use Case
		(euros/Watt) ; CTS-3 timescale (e.g. every 15min) (EANi optionally depending on communication approach)	Active Power Reserves Information provider	Merit Order Collection	BRC 1.1
IEX_06	Inertia Reserves information	Vector of (virtual) inertia (J) in kgm2 with resolution 1 kgm2 and cost (€/kgm2) ; CTS-3 timescale (e.g. every 15min). (EANi optionally depending on communication approach)	Inertia Reserves Information provider	Merit Order Collection	IRPC 1.2.1
IEX_07	Voltage Reserves information	<p><u>For AVR nodes:</u> Vector of three reactive power values (forecasted Q_{max}, Q_{min}, $Q_{baseline}$; flat numbers) in VAR with 1 VAR resolution ; CTS-3 timescale (e.g. every 15min) (EANi optionally depending on communication approach)</p> <p><u>For controllable Q nodes:</u> Vector of three reactive power values (forecasted Q_{max}, Q_{min}, $Q_{baseline}$; flat numbers) in VAR with 1 VAR resolution ; CTS-3 timescale (e.g. every 15min) (EANi optionally depending on communication approach)</p> <p><u>For capacitor banks:</u> none: it is assumed that the PPVC setpoint providing knows/remembers the current state and the possible alternative states.</p> <p><u>For OLTC nodes:</u> it is assumed that the PPVC setpoint providing knows/remembers the current position and the possible alternative positions.</p>	Voltage Reserves Information provider	PPVC Setpoint Providing	PPVC
IEX_08	Forecasted Load and Generation	Vector of active and reactive power values (P, Q ; flat numbers) in Watt with resolution 1 Watt and VAR with	Load & Generation Forecaster	Merit Order Decision	FCC

ID	Information Exchange Name	Information Exchange Description	From Function	To Function	Use Case
		resolution 1 VAr respectively ; CTS-3 timescale (e.g. every 15min) (EANi optionally depending on communication approach)	Load & Generation forecaster	Merit Order Decision	BRC 1.1
			Load & Generation forecaster	Tie-line Limits Calculation	BSC 1.3.1
			Load & Generation forecaster	Tie-line Limits Calculation	BSC 1.1.1
			Load & Generation forecaster	Merit Order Decision	IRPC 1.2.1
			Load & Generation forecaster	PPVC Setpoint Providing	PPVC
IEX_09	Measured Frequency	Value in mHz with resolution 10 mHz ; CTS-2 timescale (e.g. every 10 periods - 200msec)	Frequency Observation	Adaptive CPFC Determination	FCC
			Frequency Observation	Cell Setpoint Adjusting	BSC 1.3.1
			Frequency Observation	DER - Frequency Droop Device	FCC
IEX_10	Measured Tie-line Active Powerflow	Value of tie-lines power flow (P) in Watt with resolution 1 Watt ; CTS-1 timescale (as fast as possible). (EANi optionally depending on communication approach)	Tie-line Active Powerflow Observation	Imbalance Determination	BRC 1.1

ID	Information Exchange Name	Information Exchange Description	From Function	To Function	Use Case
IEX_11	Voltage Violation Trigger	Value of voltage set-point (V) in mV with resolution 10mV; CTS-3 timescale (e.g. every 15min) in proactive mode (EANi optionally depending on communication approach)	Voltage Observation	PPVC Controlling	PPVC
IEX_12	Balance Initial Merit Order list	Matrix of active power values (forecasted P_{max} , P_{min} , $P_{baseline}$; flat numbers) in Watt with resolution 1 Watt in conjunction with EANi (location) ; CTS-3 timescale (e.g. every 15min) (ordered in increasing cost ; cost information could be added optionally)	Merit Order Collection	Merit Order Decision	FCC
			Merit Order Collection	Merit Order Decision	BRC 1.1
IEX_13	Inertia Initial Merit Order list	Matrix of (virtual) inertia (J) in kgm2 with resolution 1 kgm2 in conjunction with EANi (location) ; CTS-3 timescale (e.g. every 15min). (ordered in increasing cost ; cost information could be added optionally).	Merit Order Collection	Merit Order Decision	IRPC 1.2.1
IEX_14	Balance Final Merit Order list	Matrix of active power values (forecasted P_{max} , P_{min} , $P_{baseline}$; flat numbers) in Watt with resolution 1 Watt in conjunction with EANi (location) ; CTS-3 timescale (e.g. every 15min) (only those that can be activated securely ; ordered in increasing cost ; cost information could be added optionally)	Merit Order Decision	Frequency Droop Parameter Determination	FCC
			Merit Order Decision	Imbalance Correction	BRC 1.1

ID	Information Exchange Name	Information Exchange Description	From Function	To Function	Use Case
IEX_15	Inertia Validated Merit Order list	Matrix of (virtual) inertia (J) in kgm2 with resolution 1 kgm2 in conjunction with EAni (location) ; CTS-3 timescale (e.g. every 15min). (only those that can be activated securely ; ordered in increasing cost ; cost information could be added optionally).	Merit Order Decision	df/dt Droop Slope Determination	IRPC 1.2.1
IEX_16	Instantaneous Imbalance	Value of active power (P) in Watt with resolution 1 Watt ; CTS-2 timescale (sampling time 1 sec or less)	Imbalance Determination	Cell Setpoint Adjusting	BSC 1.1.1
IEX_17	Cell Imbalance error	Value of active power (P) in Watt with resolution 1 Watt ; CTS-1 timescale (as fast as possible) or CTS-2 timescale (10 periods-200msec) (aggregated error signal)	Imbalance Determination	Adaptive CPFC Determination	BRC 1.1
			Imbalance Determination	Adaptive CPFC Determination	FCC
			Imbalance Determination	Imbalance Correction	BRC 1.1
			Cell Setpoint Adjusting Imbalance Determination	Imbalance Determination Cell Setpoint Adjusting	BSC 1.3.1
IEX_18	Setpoint Change	Value of active power (P) in Watt with resolution 1 Watt ; CTS-2 timescale (sampling time 1 sec or less)	Cell Setpoint Adjusting	Imbalance Determination	BSC 1.1.1
			Cell Setpoint Adjusting Imbalance Determination	Imbalance Determination Cell Setpoint Adjusting	BSC 1.3.1

ID	Information Exchange Name	Information Exchange Description	From Function	To Function	Use Case
IEX_19	P Activation Signal	Value of active power (P) in Watt with resolution 1 Watt or (Broadcast mode) Matrix of Values of active Power (P) in Watt with resolution 1 Watt in conjunction with EANi (location)	Imbalance Correction	DER - Controllable P Device	BRC 1.1
IEX_20	Freq Droop Parameters	Vector of droop slope and frequency threshold in Watts/Hz with resolution 1 Watt/Hz and in mHz with resolution 10 mHz respectively ; CTS-3 timescale (e.g. every 15min) or (Broadcast mode) Matrix of droop slope and frequency threshold in Watts/Hz with resolution 1 Watt/Hz and in mHz with resolution 10 mHz respectively in conjunction with EANi (location) ; CTS-3 timescale (e.g. every 15min)	Frequency Droop Parameter Determination	DER - Frequency Droop Device	FCC
IEX_21	CPFC Scaling factor	Value between 0.00 and 1.00 with resolution 0.01 ; CTS-1 timescale (as fast as possible) or (Broadcast mode) matrix of values between 0.00 and 0.01 with resolution 0.01 in conjunction with EANi (location) ; CTS-1 timescale (as fast as possible)	Adaptive CPFC Determination	DER - Frequency Droop Device	FCC
IEX_22	Allowed tie-line deviations	Vector of active power values (P ; flat number) in Watt with resolution 1 Watt in conjunction with EANi ; CTS-3 timescale (e.g. every 15min)	Tie-line Limits Calculation	Cell Setpoint Adjusting	BSC 1.3.1
			Tie-line Limits Calculation	Cell Setpoint Adjusting	BSC 1.1.1

ID	Information Exchange Name	Information Exchange Description	From Function	To Function	Use Case
IEX_23	Proposed balance setpoint adjustment	Value of active power (P ; flat number) in Watt resolution 1 Watt ; CTS-3 timescale (e.g. every 15min)	Cell Setpoint Adjusting Cell Setpoint Adjusting (adjacent cell)	Cell Setpoint Adjusting (adjacent cell) Cell Setpoint Adjusting	BSC 1.3.1
			Cell Setpoint Adjusting Cell Setpoint Adjusting (adjacent cell)	Cell Setpoint Adjusting (adjacent cell) Cell Setpoint Adjusting	BSC 1.1.1
IEX_24	Accepted balance setpoint adjustment	Value of active power (P ; flat number) in Watt resolution 1 Watt ; CTS-3 timescale (e.g. every 15min)	Cell Setpoint Adjusting Cell Setpoint Adjusting (adjacent cell)	Cell Setpoint Adjusting (adjacent cell) Cell Setpoint Adjusting	BSC 1.3.1
			Cell Setpoint Adjusting Cell Setpoint Adjusting(adjacent cell)	Cell Setpoint Adjusting (adjacent cell) Cell Setpoint Adjusting	BSC 1.1.1
IEX_25	Device Inertia Setpoints	Value of (virtual) inertia (J ; flat number) in kgm2 with resolution 1 kgm2 ; CTS-3 timescale (e.g. every 15min). or (Broadcast mode) Matrix of (virtual) inertia (J ; flat number) in kgm2 with resolution 1 kgm2 in conjunction with EANi (location) ; CTS-3 (e.g. every 15min)	df/dt Droop Slope Determination	DER - ROCOF Droop Device	IRPC 1.2.1
IEX_26	PVC setpoint	Value of voltage set-point (V) in mV with resolution 10mV ; CTS-3 timescale (e.g. every 15min) in proactive mode	PPVC Controlling	DER - AVR Device	PVC
			PPVC Controlling	DER - AVR Device	PPVC
IEX_27	OPF trigger	On/Off Trigger ; CTS-3 timescale (e.g. every 15min) in proactive mode	PPVC Controlling	PPVC Setpoint Providing	PPVC

ID	Information Exchange Name	Information Exchange Description	From Function	To Function	Use Case
IEX_28	Capacitor Bank setting	On/Off Trigger ; CTS-3 timescale (e.g. every 15min) in proactive mode or (Broadcast mode) Matrix of On/Off Triggers in conjunction with EANi (location) ; CTS-3 timescale (e.g. every 15min) in proactive mode	PPVC Controlling	Capacitor Bank	PPVC
IEX_29	Q Activation signal	Value of reactive power (Q) in VAR with resolution 1 VAR ; CTS-3 timescale (e.g. every 15min) in proactive mode or (Broadcast mode) Matrix of values of reactive power (Q) in VAR with resolution 1 VAR in conjunction with EANi (location) ; CTS-3 timescale (e.g. every 15min) in proactive mode	PPVC Controlling	DER - Controllable Q Device	PPVC
IEX_30	OLTC setting	Value of tap position change (-a, +a) ; CTS-3 timescale (e.g. every 15min) in proactive mode or (Broadcast mode) Matrix of tap position changes (-a, +a) in conjunction with EANi (location) ; CTS-3 timescale (e.g. every 15min) in proactive mode	PPVC Controlling	OLTC	PPVC

ID	Information Exchange Name	Information Exchange Description	From Function	To Function	Use Case
IEX_31	Calculated voltage setpoints	(set-point matrix): 1. Switching positions for capacitor banks (on/off (1/0)) 2. Curtailment/shedding for controllable reactive loads (Qseti in VAR) 3. Voltage level (tap position -a / +a where a is positive real value) of activation command (OLCT) 4. Voltage set-points for AVRs and other PVC controllers (V in V)	PPVC Setpoint Providing	PPVC Controlling	PPVC

Table 4 - List of Information Exchanges