

## Environmental Sustainability Assessment of Integrated Food and Bioenergy Production with Case Studies from Ghana

Kamp, Andreas; Østergård, Hanne; Bolwig, Simon

*Publication date:*  
2016

*Document Version*  
Publisher's PDF, also known as Version of record

[Link back to DTU Orbit](#)

*Citation (APA):*

Kamp, A., Østergård, H., & Bolwig, S. (2016). Environmental Sustainability Assessment of Integrated Food and Bioenergy Production with Case Studies from Ghana. Technical University of Denmark, Department of Chemical and Biochemical Engineering.

## DTU Library

Technical Information Center of Denmark

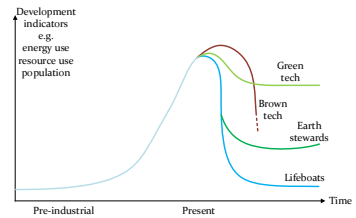
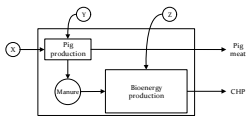
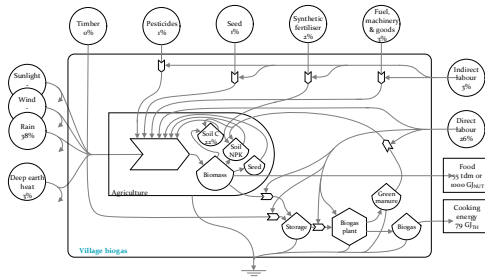
---

### General rights

Copyright and moral rights for the publications made accessible in the public portal are retained by the authors and/or other copyright owners and it is a condition of accessing publications that users recognise and abide by the legal requirements associated with these rights.

- Users may download and print one copy of any publication from the public portal for the purpose of private study or research.
- You may not further distribute the material or use it for any profit-making activity or commercial gain
- You may freely distribute the URL identifying the publication in the public portal

If you believe that this document breaches copyright please contact us providing details, and we will remove access to the work immediately and investigate your claim.



# Environmental Sustainability Assessment of Integrated Food and Bioenergy Production with Case Studies from Ghana



Environmental Sustainability  
Assessment of Integrated Food  
and Bioenergy Production with  
Case Studies from Ghana

PhD thesis by Andreas Kamp

© Andreas Kamp

Submitted March 2016

Supervisors: Hanne Østergård. Co-supervisor: Simon Bolwig

Center for Bioprocess Engineering (BIOENG)

Department of Chemical and Biochemical Engineering

Technical University of Denmark

Søltofts Plads 229, 2800 Kgs. Lyngby

## PREFACE

This thesis consists of two parts. The first part is a synthesis of the research I have carried out in the course of the last 4½ years. The objective of the synthesis is to illuminate the main points of my work with respect to questions that are relevant in my field of research, their investigation, and the resulting recommendations. It is possible to read the synthesis as a stand-alone document.

The second part is an appendix with six scientific papers that were prepared in the same period. The appended papers treat in detail the development and application of Emergy Assessment for evaluating residue-based bioenergy production. Reading these papers provides a more thorough understanding of the state-of-the-art within the studied topics as well as more extensive discussion of the results.

I hope that my work may contribute to a better understanding of how we can thrive and take good care of our home. I wish you an enjoyable read.

The thesis is submitted in partial fulfilment of the requirements for the degree of Doctor of Philosophy. The thesis has been prepared during my employment with the Center for Bioprocess Engineering, Department of Chemical and Biochemical Engineering, Technical University of Denmark in 2011-2016. The period was interfered by two extended paternity leaves of absence. The PhD project was supported with a grant from the Danida Fellowship Centre (DFC) of the Danish Ministry of Foreign Affairs to the research project “Biofuel production from lignocellulosic materials – 2GBIONRG”, DFC journal number 10-018RISØ. I have been supervised by Hanne Østergård and co-supervised by Simon Bolwig.

Sincerely,

A handwritten signature in black ink that reads "AKamp". The letters are cursive and connected.

Andreas Kamp, Svanholm, 21<sup>st</sup> of March 2016.



## ACKNOWLEDGEMENTS

The satisfaction of completing a PhD cannot compare with the joy of a loving and supporting family. I am eternally grateful to my wife and my children for patience, support and smiling faces after a long day.

The thesis is written in first person singular. None of the results, however, would have been possible without the dedicated cooperation, guidance and support of my supervisor Hanne Østergård. Thank you for our many debates and for showing me that there is something called energy.

I acknowledge the teaching and fellowship of my co-supervisor Simon Bolwig, of Fabiana Morandi and of others that I have been privileged to author with.

I would like to recognise the residents of Zambrama village and the management of a certain fruit factory in Ghana for warm welcomes, time to walk and talk, and the willingness to share knowledge with me. *Me daa si*, I must have been born on a Sunday to have this luck.

Thanks to Francis for your assistance in field work, and to Sune, Jorge and Stefan for constructive dialogues about low-tech biogas production. Thanks to the remaining project partners for fruitful discussion and collaboration, and for practical help during my visits to Ghana.

I acknowledge the effort invested by Freja, Jens, Sune, Niall, and Patricia in reviewing this thesis. Special thanks to Freja for answering my countless inquiries into LCA methodology over the years.

Finally, I express my gratitude to colleagues at DTU in Risø and Lyngby for inspiration and companionship.





## ABSTRACT

The use of agricultural residues for the production of bioenergy offers tantalising prospects of reduced pollution and greater food sovereignty. Integrated food and bioenergy systems seek to optimise the joint production of food and energy. Integrated food and bioenergy systems may be evaluated and compared with other food and energy systems using Environmental Sustainability Assessment (ESA).

This thesis investigates a range of integrated food and residue-based bioenergy production systems and provide methodological developments that are relevant for the assessment of such systems. The methodological developments concern distribution of environmental burden in multifunctional systems; consistent accounting of human labour inputs; and modelling of uncertainty regarding future conditions.

Residue-based bioenergy relies on feedstock from production systems that are multifunctional, which means that they provide several outputs. Environmental impact assessment of residue-based bioenergy, therefore, involves the identification of relevant impacts occurring prior to the conversion of residues into bioenergy. Dividing the environmental burden of food production between food and crop residues to maintain a single-product focus is a contentious practice, since no obvious allocation factor is available. In evaluations of bioenergy production systems that are based on residues from food production, it is recommended to expand the assessment's system perspective to include food production and food outputs.

Human labour is an indispensable input in all agricultural and bioenergy production activities evaluated in ESA. Assessment methods, however, differ with respect to accounting for human labour inputs. Emergy Assessment (EmA) routinely includes human labour inputs, but based on a variety of calculation approaches. The collection of methods referred to as LCA (Life Cycle Assessment) methods usually disregard human labour as a relevant input. It is

suggested to adhere to a systematic approach to estimating the environmental impact of human labour inputs that is applicable in EmA and other ESAs. I recommend that human labour be accounted in labour time, and that labour's environmental impact be based on all inputs required for making labour available.

Practices and technologies that are expected to be implemented several decades into the future and that are compared with existing alternatives should not solely be compared using current conditions. The evaluation of these systems must take into consideration that future conditions may be significantly different from current conditions. It is suggested to use explorative scenarios based on narratives of the future to emphasise and be transparent about the uncertainty involved with planning for the medium- to long-term. Modelling parameters may be deduced from such scenarios, making it possible to calculate scenario-dependent results.

Applying the methodological developments above, two cases of integrated food and bioenergy production in Ghana are described. Crop residue-based biogas production and nutrient cycling in a remote village was shown to be a viable alternative to wood fuel and synthetic fertiliser use, in spite of increased labour inputs. In future scenarios where materials are scarce and labour plentiful, the investigated biogas-based and agroforestry technologies appear relatively more attractive. Fruit and cocoa residue-based biogas production in a fruit processing facility, with return of compost to pineapple farmers also proved to be a viable technology. It is recommended that relevant stakeholders explore the implementation of biogas and nutrient recycling technologies in preparation of reduced access to existing energy and nutrient sources.

Primary contributions to the research field are suggested improvements to specific methods of evaluating integrated food and residue-based bioenergy systems. Evaluation of such systems requires an expanded system perspective that encompasses multiple outputs. It requires ways to properly account for labour, since energy and material input reductions, often associated with integration,

result in increased labour inputs, as observed in the case studies. Evaluation also requires consideration of scenario uncertainty since implementation takes time and societal conditions may change significantly during the implementation phase. The contribution includes empirical data concerning farming and bioenergy conversion technologies in Ghana and a recommendation to implement biogas and nutrient recycling practices.



## DANSK RESUMÉ

Der er stor interesse i at udnytte restprodukter fra landbruget til produktion af bioenergi for at reducere forurening samt bidrage til energi- og fødevarerens sikkerhed. Integrerede fødevarer- og bioenergisystemer har som formål at optimere samproduktionen af mad og energi. Anvendte og foreslåede produktionsmetoder kan prioriteres ved hjælp af bæredygtighedsvurderinger med fokus på miljø (Environmental Sustainability Assessment, ESA). I denne afhandling undersøger jeg en række integrerede fødevarer- og bioenergiproduktionsystemer og jeg redegør for metodeudvikling af ESA, som er relevant for vurderingen af netop denne type systemer. Metodeudviklingen omfatter fordeling af miljøpåvirkning i multifunktionelle systemer, systematisk redegørelse for miljøpåvirkning forbundet med menneskelig arbejdskraft, samt modelanalyse af usikkerhed forbundet med langtidsplanlægning.

Rest-baseret bioenergi modtager råmateriale fra processer der er multifunktionelle, hvilket betyder, at de resulterer i mere end ét output. Bæredygtighedsvurdering der omfatter rest-produkter indebærer derfor at man overvejer hvorledes miljøpåvirkninger i de processer der genererer rest-produkterne deles mellem forskellige output. Det kan for eksempel være mellem madvarer og rester fra landbrug og bearbejdningsindustri i fødevarerproduktion. Allokering af miljøpåvirkninger for at opretholde et enkeltproduktfokus er en omdiskuteret praksis da der ikke eksisterer et universelt accepteret allokeringgrundlag. I vurderinger af bioenergiproduktion, der baseres på rester fra fødevarerproduktion, anbefaler jeg at udvide vurderingens perspektiv til at omfatte fødevarerproduktionen inklusive output af fødevarer.

Menneskelig arbejdskraft er et uundværligt input i fødevarer- og bioenergiproduktionsprocesser der evalueres med ESA. Visse vurderingsværktøjer undtager imidlertid menneskelig arbejdskraft, mens de som medregner menneskelig arbejdskraft, vurderer dens miljøpåvirkning på forskellig vis. Det er normalt at inddrage menneskelig arbejdskraft i Emergy Assessment (EmA), men der

findes forskellige beregningstilgange inden for metoden. Blandt metoder der samlet set refereres til som LCA (Life Cycle Assessment) betragtes menneskelig arbejdskraft normalt ikke som et relevant input. Jeg foreslår en specifik, systematisk tilgang til at redegøre for miljøpåvirkninger forbundet med menneskelig arbejdskraft, som kan anvendes inden for såvel EmA som andre ESA-metoder. Jeg anbefaler at menneskelig arbejdskraft regnes i arbejdstid og at miljøpåvirkningen baseres på alle input, der er nødvendige for at have arbejdskraft til rådighed.

Produktionsmetoder og -teknologier, som tages i brug i løbet af de næste årtier og som ved hjælp af ESA sammenlignes med nuværende alternativer bør ikke alene sammenlignes under gældende forhold. Vurderingen af disse systemer bør afspejle, at relevante, fremtidige forhold kan være væsentligt forskellige fra de gældende forhold. Jeg foreslår at bruge eksplorative scenarier for at understrege og være åben om usikkerheden forbundet med langtidsplanlægning. Modelparametre kan udledes af sådanne scenarier, hvilket gør det muligt at beregne scenarie-afhængige resultater.

De nævnte metodeudviklinger blev demonstreret i to case-studier af integreret fødevarer- og bioenergiproduktion i Ghana. Det blev påvist at biogas baseret på afgrøderester med tilhørende recirkulering af næringsstoffer er et funktionsdygtigt alternativ til brugen af træ-baseret brændsel og kunstgødning i en afsidesliggende landsby, på trods af øget arbejdsindsats. I fremtidsscenarioer hvor materialer er knappe og arbejdskraft rigelig, fremstår de undersøgte biogas- og agerskovbrugsteknologier som relativt mere attraktive. Det blev ligeledes påvist at frugt- og kakao-restbaseret biogasproduktion på en frugtfabrik, med tilhørende recirkulering af kompost til ananasdyrkere er en funktionsdygtig praksis. Jeg anbefaler relevante interessenter at undersøge mulighederne for at igangsætte biogas- og næringsstof-recirkuleringsteknologier som forberedelse på reduceret adgang til nuværende energi- og næringsstofkilder.

Mit primære bidrag til mit forskningsfelt er specifikke metoder til at vurdere integreret fødevarer- og bioenergiproduktion. Vurdering af netop disse systemer kræver et udvidet systemperspektiv som indbefatter at flere output kan betragtes samtidigt. Det kræver endvidere detaljerede måder at redegøre for arbejdskraftinput. Det skyldes at reduktioner i energi- og materialeinput, ofte forbundet med samproduktion, resulterer i øget forbrug af arbejdskraft, som observeret i casestudierne. Endelig kræver vurdering af de nævnte integrerede systemer overvejelser af scenarie-usikkerhed, eftersom samfundet kan ændre sig betragteligt i den tid det tager at implementere teknologierne. Mit bidrag omfatter empirisk viden om landbrug og bioenergiproduktion i Ghana og en anbefaling om at implementere biogas og praksisser for recirkulering af næringsstoffer.



## LIST OF PUBLICATIONS

Scientific papers that are published in, accepted for publication in or submitted to journals and conference proceedings and included in the thesis:

- Paper I: **Kamp, A., Østergård, H.** (2013). How to manage co-product inputs in emergy accounting exemplified by willow production for bioenergy. *Ecological Modelling*, 253, 70–78.
- Paper II: **Kamp, A., Østergård, H., Bolwig, S.** (2016a). Environmental assessment of integrated food and cooking fuel production for a village in Ghana. Submitted to *Sustainability*.
- Paper III: **Kamp, A., Morandi, F., Østergård, H.** (2016b). Development of concepts for human labour accounting in Emergy Assessment and other Environmental Sustainability Assessment methods. *Ecological Indicators*, 60, 884–892.
- Paper IV: **Kamp A., Østergård H.** (2016a). Future scenario modelling and resilience indicators. A case study of small-scale food and energy production in a village in Ghana. In press for Emergy Conference 2016 proceedings, *Emergy Synthesis 9: Theory and Applications of the Emergy Methodology*. University of Florida, Gainesville, USA.
- Paper V: **Kamp A., Østergård H.** (2016b). Environmental assessment of fruit cultivation and processing using fruit and cocoa residues for bioenergy and compost. Case study from Ghana. Submitted to *Journal of Cleaner Production*.
- Paper VI: **Kamp A., Østergård H.** (2016c). Explorative scenario analysis and resilience indicators in Emergy Assessment. Submitted to *Biophysical Economics and Resource Quality*.

Other documents prepared during the PhD period:

**Kamp A.**, Østergård H. (2013). How to manage inputs from co-production processes in emergy accounting. *Emergy Synthesis 7: Theory and Applications of the Emergy Methodology*. University of Florida, Gainesville, USA, 503-511.

Kemausuor, F., **Kamp, A.**, Thomsen, S. T., Bensah, E. C., Østergård, H. (2014). Assessment of biomass residue availability and bioenergy yields in Ghana. *Resources, Conservation and Recycling*, 86, 28-37.

Kemausuor, F., Yakah, E., **Kamp, A.** (2014). Regional assessment of agricultural residues for bioenergy production in Ghana. In Roscoe (ed.), *Ghana. Social, economic and political issues*. Nova Science Publishers, Inc. New York, USA, 147-174.

**Kamp, A.**, Rasmussen, F. (2015). Bæredygtig udvikling af storkollektivet Svanholm. *Tidsskrift om permakultur*, 13, 26-29. [Sustainable development of the collective Svanholm. *Journal of Permaculture*].

Morandi, F., **Kamp, A.**, Østergård, H. (2015). Renewability and support area of electricity produced from different mixtures of biomass: a case study of Miajadas, Spain. In Kordas et al. (eds), *Proceedings of the 9th Biennial International Workshop Advances in Energy Studies*. Verlag der Technischen Universität Graz, Austria, 167-173.

**Kamp A.**, Østergård H. (2015). Food and biogas production in a Ghanaian village – results and new perspectives on labor UEVs. *Emergy Synthesis 8: Theory and Applications of the Emergy Methodology*. University of Florida, Gainesville, USA, 185-200.

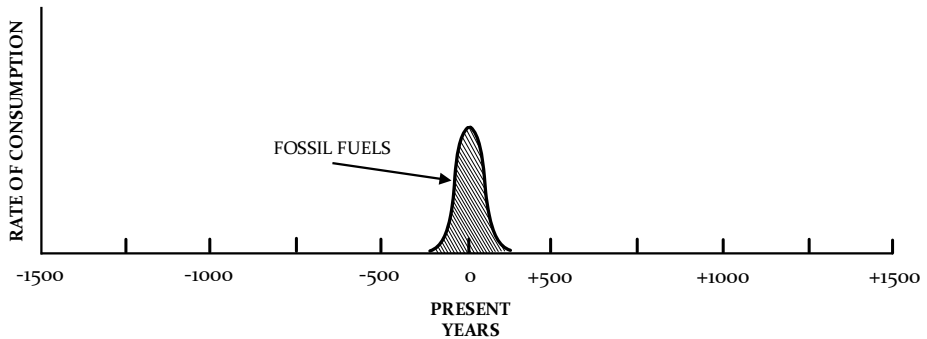
# TABLE OF CONTENTS

PREFACE .....	IV
ACKNOWLEDGEMENTS.....	VI
ABSTRACT .....	VIII
DANSK RESUMÉ .....	XII
LIST OF PUBLICATIONS .....	XV
TABLE OF CONTENTS .....	XVII
LIST OF ABBREVIATIONS .....	XIX
<b>1. INTRODUCTION.....</b>	<b>1</b>
1.1    BIOENERGY PRODUCTION AND BIOMASS RESIDUES IN GHANA .....	2
1.2    IDENTIFIED CASE STUDIES.....	3
1.3    ENVIRONMENTAL SUSTAINABILITY ASSESSMENT (ESA) .....	4
1.3.1 <i>Emergy Assessment (EmA)</i> .....	4
1.3.2 <i>Other Environmental Sustainability Assessment methods</i> .....	6
1.3.3 <i>Methodological challenges</i> .....	8
1.4    RESEARCH QUESTIONS AND OBJECTIVES .....	11
<b>2. DEVELOPMENT OF THE EMERGY ASSESSMENT</b>	
<b>METHODOLOGY .....</b>	<b>13</b>
2.1    SYSTEMS WITH MULTIPLE PRODUCTS.....	15
2.1.1 <i>Problem identification</i> .....	15
2.1.2 <i>Co-production in Emergy literature</i> .....	17
2.1.3 <i>Multifunctionality in LCA literature</i> .....	18
2.1.4 <i>Using approaches in LCA literature for a bioenergy production system, part I</i> .....	20
2.1.5 <i>Using approaches in LCA literature for bioenergy production systems, part II</i> .....	24
2.1.6 <i>The recommended approach to manage co-production in Emergy Assessment</i> .....	26
2.2    HUMAN LABOUR ACCOUNTING .....	31
2.2.1 <i>A common formula for calculation of labour UEVs</i> .....	32
2.2.2 <i>Distinction between direct labour and indirect labour</i> .....	33
2.2.3 <i>Labour UEVs used in the case study assessments</i> .....	36
2.3    EXPLORATIVE SCENARIOS.....	39
2.3.1 <i>Narratives as a basis for explorative scenario modelling</i> .....	41
2.3.2 <i>Parameterisation of narratives to create modelling scenarios</i> ...	44
2.3.3 <i>Demonstration of the influence of altered parameter values</i> .....	47

<b>3.</b>	<b>INTEGRATED FOOD AND BIOENERGY SYSTEMS IN GHANA..</b>	<b>51</b>
3.1	INTEGRATED MAIZE-BEANS AND BIOENERGY PRODUCTION IN A GHANAIAN VILLAGE.....	53
3.1.1	<i>Technology options for provision of food and cooking energy ..</i> .....	54
3.1.2	<i>Key assumptions and uncertainty analysis.....</i>	55
3.1.3	<i>Mass balance and labour inputs.....</i>	56
3.1.4	<i>Emergy Assessment of the four technology options .....</i>	57
3.1.5	<i>Explorative scenario analysis.....</i>	61
3.2	INTEGRATED FRUIT, COCOA AND BIOGAS-BASED ELECTRICITY PRODUCTION IN GHANA.....	65
3.2.1	<i>Technology options for provision of processed fruit and cocoa nibs .....</i>	66
3.2.2	<i>Key assumptions and uncertainty analyses .....</i>	70
3.2.3	<i>Mass balance and labour flows.....</i>	71
3.2.4	<i>Environmental Sustainability Assessment.....</i>	72
<b>4.</b>	<b>CONCLUSION .....</b>	<b>75</b>
4.1	SUMMARY OF FINDINGS .....	75
4.1.1	<i>EmA and burden sharing.....</i>	75
4.1.2	<i>EmA and human labour accounting.....</i>	76
4.1.3	<i>Modelling uncertainty concerning future conditions in EmA ...</i> .....	77
4.1.4	<i>Technology options for food and bioenergy in a Ghanaian village.....</i>	78
4.1.5	<i>Technology options for fruit and cocoa production.....</i>	79
4.1.6	<i>Practical implications .....</i>	79
4.2	FURTHER SCIENTIFIC WORK REGARDING ESA METHODOLOGY.....	81
4.2.1	<i>Highly complex, multi-functional systems.....</i>	81
4.2.2	<i>Emergy method .....</i>	81
4.2.3	<i>Human labour accounting.....</i>	82
4.2.4	<i>Explorative scenarios .....</i>	82
4.3	PERSONAL REFLECTIONS ON STUDY AREA.....	84
<b>5.</b>	<b>BIBLIOGRAPHY .....</b>	<b>85</b>
	<b>APPENDIX .....</b>	<b>95</b>
	PAPER I.....	96
	PAPER II .....	106
	PAPER III .....	123
	PAPER IV .....	133
	PAPER V.....	146
	PAPER VI.....	170

## LIST OF ABBREVIATIONS

C:	Carbon
CED:	Cumulative Energy Demand
CHP:	Combined Heat and Power
CO <sub>2</sub> :	Carbon dioxide
DL:	Direct labour
EJ:	Exajoule (10 <sup>18</sup> joule)
EmA:	Emergy Assessment
EROI:	Energy Return On energy Invested
ESA:	Environmental Sustainability Assessment
g:	gram
GWP:	Global Warming Potential
ha:	hectare
HH:	Household-scale
IL:	Indirect labour
IPCC:	Intergovernmental Panel on Climate Change
J:	joule
LCA:	Life Cycle Assessment
PJ:	Petajoule (10 <sup>15</sup> joule)
PP:	Present Practice
sej:	solar emjoule
t:	tonne/metric ton
tdm:	tonnes of dry matter
UEV:	Unit Emergy Value
%R:	Renewability Fraction
%R <sub>global</sub> :	Global Renewability Fraction



*Adapted from (Hubbert, 1956)*

## 1. INTRODUCTION

In our industrial society we have grown accustomed to easy access to plentiful amounts of energy. Since the beginning of the latest century, fossil energy resources have been the dominant source of an astounding increase in global energy use. As fossil energy resources are depleted to the point where extraction rates cease growing, we are increasingly interested in the potential of alternative sources. The most prominent among these are nuclear, wind, solar, hydro- and bioenergy. My research deals with the latter, energy derived from biomass, and concentrates on biogas based on residues from food production in Ghana.

Part of the investigation of alternative energy sources, including bioenergy, focuses on the evaluation of environmental effects. With the use of a set of accounting tools in what is referred to in the following text as Environmental Sustainability Assessment, the environmental effects of obtaining energy from alternative sources are estimated. Tools include methods that focus on resource use such as Energy Assessment and Cumulative Energy Demand as well as methods that focus on pollution such as the IPCC method for estimating Global Warming Potential associated with climate

change. My research deals primarily with Energy Assessment and concentrates on its application in the study of integrated food and bioenergy systems.

In this chapter, I introduce the energy potential of different biomass sources and the conversion technologies used to make the energy available for use, with particular interest in Ghana. I provide an introduction to Environmental Sustainability Assessment methods used in the thesis with special emphasis on Energy Assessment. I outline current methodological issues that I find hinder adequate Energy Assessments of bioenergy production based on residues from food production.

## 1.1 BIOENERGY PRODUCTION AND BIOMASS RESIDUES IN GHANA

The International Energy Agency (2012) projects that biomass may supply 160 EJ in 2050 in 8-11 billion dry tonnes (t) of biomass as wastes, residues and purpose-grown energy crops, a dramatic increase from 50 EJ in 2010. Haberl et al. (2011) and IRENA (2014) expect that harvesting and processing residues may alone constitute approximately a quarter of global bioenergy potentials only a few decades from now. Global energy supply in 2013 was 570 EJ of which 460 EJ originated from the fossil sources oil, coal and natural gas (International Energy Agency, 2015). Even though biomass is inadequate to fully substitute for fossil sources, its currently unused potential places biomass among the most important energy sources to be developed further.

Biomass may be converted to useful energy through a number of conversion technologies. Simple, small-scale technologies range from wood stoves for heating, or three-stone stoves and charcoal stoves for cooking to relatively simple wood gas generators or 'gasifiers' providing a gas that may be used in engines. The simpler bioenergy technologies include biogas production, where organic matter is biologically degraded under anaerobic conditions to biogas, a mixture of methane and CO<sub>2</sub> with traces of other gases. Biogas may be used for cooking, heating or electricity generation. Larger-scale

conversions of biomass are applied in power plants or combined heat and power plants and in most liquid biofuel production, i.e. bioethanol and biodiesel.

Biomass already supplies the majority of energy used in developing countries. Most of this biomass is utilised inefficiently in the form of wood fuel, i.e. firewood and charcoal, for cooking and heating. In the future, less wasteful biomass usage is expected to be based on biogas and liquid fuels for cooking, transport and power production (Kemausuor et al., 2014). Competition over land associated with the use of dedicated energy crops including edible plant parts for bioenergy, has encouraged production based on biomass residues and wastes. I participated in a study mapping currently unused and recoverable residues and wastes in Ghana (Kemausuor et al., 2014). Agricultural and agroindustrial residues were shown to constitute the bulk of available resources, and have an energy potential of approximately 80 PJ/year. This is a drop in the ocean when compared to global energy use, but sufficient to make substantial contributions to replace the country's wood fuel use if converted to biogas or transport fuel use, if converted to ethanol. The study by Kemausuor et al. set the scene for investigating how to utilise the mapped potential.

## 1.2 IDENTIFIED CASE STUDIES

The 2GBIONRG research project was established to map Ghanaian bioenergy potentials, identify relevant conversion technologies, and assess the sustainability of possible bioenergy production based on selected case study systems. In cooperation, project participants from the Technical University of Denmark and Kwame Nkrumah University of Science and Technology (in Ghana) selected two systems for detailed assessment: 1) Biogas production based on crop residues from small-scale, semi-mechanised, pesticide and synthetic fertiliser-based food production in a remote village, and 2) Biogas production based on agro-industrial residues from processing of pineapple, mango and other tropical fruits at a fruit factory. Current technologies and possible, alternative technology



options were evaluated with Environmental Sustainability Assessment. The case studies and the assessments are included in this thesis.

### 1.3 ENVIRONMENTAL SUSTAINABILITY ASSESSMENT (ESA)

Environmental Sustainability Assessment applies a range of tools to identify and quantify the resource use and pollution associated with, usually, production processes (Ulgiati et al., 2006). ESA provides a basis for selecting among technologies and practices in order to reduce environmental impact (Moldan et al., 2012; Ulgiati et al., 2011). It is useful to describe ESA in general terms as methods that combine 1) *indicators that estimate specific environmental impacts* and 2) *assessment procedures and rules*. ESA methods include, but are not limited to, Emergy Assessment (EmA) (Odum, 1996), Life Cycle Assessment (LCA) (ISO, 2006a) and Energy Return On (energy) Invested (EROI) (Murphy et al., 2011).

The various methods highlight different focus areas as expressed in the choice of indicators. In addition, different methods emphasise different perspectives, e.g. with respect to temporal and spatial scale. This includes considering the assessment scope, where relevant information for the assessment is sorted from information that is irrelevant. A typical ESA systematically includes inputs that are required for the process under study and which, in a life-cycle perspective, are considered to significantly impact the environment (Kamp et al., 2016b).

#### 1.3.1 Emergy Assessment (EmA)

The theories and concepts of the emergy methodology are based on thermodynamics and system theory (Odum, 1996). EmA focuses on resource use and is considered a measure of environmental support, e.g. as “the work of the environment that would be needed to replace what is consumed” (Raugei et al., 2014). Popularly speaking, EmA considers all things as energy carriers and evaluates all things according to an accumulation, or memorisation,

of energy loss associated with their production. Brown (2015) states that in EmA all forms of energy, materials and human labour that contribute - directly or indirectly - to a production process are taken into account and converted into the common unit of solar emjoules (sej). This conversion takes place using energy quality conversion factors, called Unit Energy Values (UEVs), given in energy per unit of input (e.g. sej/J, sej/g, sej/man-hour).

EmA indicators include the UEV, estimating the emergy of a certain physical amount of product and reflecting the resource use efficiency of its production. The Renewability Fraction indicates the share of emergy originating from a renewable energy flow, i.e. directly from the sun, wind, rain, deep earth heat or tidal energy on the study site. As recommended by Cavalett (2006) and Wright and Østergård (2015), the Global Renewability Fraction ( $\%R_{\text{global}}$ ) also includes renewable energy embodied in any other input that depends on the mentioned sources in their production. Recently suggested as a supplement to the list of EmA indicators, the Local Supply Fraction estimates the percentage of inputs considered to be local, attempting to evaluate the embeddedness of a system in its immediately surrounding system (Wright and Østergård, 2015; Kamp and Østergård, 2016c). Additional indicators also derive from the total emergy flow and the categorisation of inputs as renewable/non-renewable and local/non-local.

The procedure for EmA includes the establishment of a system boundary and definition of a reference flow. The system boundary effectively distinguishes inputs that are relevant for the studied system from irrelevant inputs. The reference flow may be any specified amount of input or output that other flows are normalised to. In studies of agricultural systems, the reference flow is typically the used land area or one hectare of land, per year. Relevant inputs and outputs are accounted and listed in an emergy table along with input UEVs and sometimes Global Renewability and/or Local Supply Fractions (for an example including all three, see the emergy table in the Supplementary material of Kamp and Østergård (2016b)).

EmA follows a set of calculation rules referred to as energy algebra, defined by Brown (in Brown and Herendeen, 1996). The energy algebra specifies that energy memorises energy use, and that the total energy of a given process is assigned to each output, regardless of their quantity. This aspect is particularly relevant in assessment of residue-based processes, as will be shown. Energy algebra is elaborated on in Section 2.1.1.

### 1.3.2 Other Environmental Sustainability Assessment methods

Life Cycle Assessment (LCA) is an often used method to quantify “all relevant emissions and resources consumed and the related environmental and health impacts and resource depletion issues that are associated with any goods or services (“products”)” (EC, 2010). LCA can be considered an ‘umbrella method’ since it applies indicators from a wide range of disciplines, and provides calculation procedures to be used consistently across all indicators.

Commonly applied Life Cycle Impact Assessment indicators include Global Warming Potential (GWP), Cumulative Energy Demand (CED), Eutrophication Potential, Acidification Potential, and various Toxicity Potentials. The GWP and CED are introduced here. For an LCA example and introduction to other indicators, see Ingwersen (2012) and for a more thorough introduction to Life Cycle Impact Assessment methods, see Hischier et al. (2010).

*The GWP indicator* is based on methods developed by the Intergovernmental Panel on Climate Change (IPCC, 2014a). When used in LCA, the GWP aggregates estimates of emissions of carbon dioxide, methane, nitrous oxide and other greenhouse gases associated with the studied production process. This includes background emissions related to the provision of required inputs, e.g. in the production of fertiliser, and foreground emissions occurring when the inputs are used, e.g. as fertiliser is applied. In the calculation, different types of emission are converted to CO<sub>2</sub>-equivalents with GWP conversion factors, according to their respective radiative efficiency relative to carbon dioxide.

*The CED indicator* is based on Cumulative Energy Requirement Analysis and estimates the accumulated energy resource use associated with a production process (Hischier et al., 2010). The CED indicator aggregates eight categories of fossil and non-fossil energy carriers, making it possible to also calculate more specific indicators such as the Cumulative fossil Energy Demand (Fossil CED). The Cumulative Energy Requirement Analysis method does appear similar to EmA in scope but a defining difference is that EmA includes energy used to create energy carriers, e.g. solar radiation to grow biomass, while the CERA accounts for only the energy content of energy carriers at the point of withdrawal from nature, e.g. the upper heating value of biomass (Hischier et al., 2010).

The procedure for LCA follows a detailed methodological framework, including the specification of the defined goal and scope of the analysis, establishment of a life cycle inventory with relevant flows, and the calculation of life cycle impact assessment results using selected methods and indicators (ISO, 2006; EC, 2010). System boundary and reference flow considerations are generally similar to those for EmA. LCA, however, includes the definition of a functional unit that specifies the function(s) of the studied system. The functional unit is typically a certain output, and the reference flow based on an amount of this output.

An additional ESA method is the Energy Return On (energy) Invested, EROI (Cleveland et al., 1984; Murphy et al., 2011). The EROI method compares accumulated energy demand, e.g. as based on the CED (see above), to the gross energy output of a studied process. In that way, EROI estimates the amount of energy output per energy input. The EROI is typically used in studies of energy production, comparing gross energy output to the sum of accumulated energy use associated with operation and in infrastructure establishment and decommission. The method has also been used in energy analysis of food production, including in the calculation of Food EROI (Markussen and Østergård, 2013). The Food EROI indicator assesses the efficiency in converting available energy into food energy.

For the sake of later discussion (Section 2.3), it is relevant to add that the level of EROI for a representative mix of a society's energy sources is associated with societal complexity and living standard, with high EROIs related to growth and increased complexity (Lambert et al., 2012, 2014). It has been suggested that the transition to non-fossil fuel sources involves reduced average EROIs, with significant consequences for current lifestyles (McPherson and Weltzin, 2008; Hall et al., 2009; Murphy and Hall, 2011).

### 1.3.3 Methodological challenges

This thesis identifies three methodological challenges that were identified as particularly relevant for evaluating residue-based bioenergy production systems with Emergy Assessment. The challenges are associated with managing multiple products, accounting consistently for labour inputs, and including uncertainty regarding future conditions. A brief introduction to each is provided.

#### *Systems providing multiple products*

Production systems that provide more than one output are referred to as co-production systems (Bastianoni and Marchettini, 2000) or as multifunctional systems (EC, 2010). In comparisons of product ESAs, the managing of several, jointly produced products poses a practical problem, treated in EmA (Bastianoni and Marchettini, 2000; Cavalett et al., 2006; Cao and Feng, 2007) and, extensively, in LCA (e.g. Heijungs and Guinée, 2007; EC, 2010; Cherubini et al., 2011; Pelletier et al., 2015). If one of the compared systems is multifunctional and the other is not, the basis for comparison of a single product is unreasonable. A straightforward approach would appear to be to distribute the environmental burden among co-products. In EmA, however, such a distribution is hindered by one of the calculation rules stating that each co-product accounts for the entire emergy flow of the co-production process.

This aspect of EmA methodology becomes particularly relevant in studies of bioenergy production based on residues. Do residues account for the entire emergy associated with their

production? According to emergy algebra they do, and in some cases this significantly influences the assessment and leads to unexpected results that tend to disfavour co-production.

### *Accounting for human labour inputs*

EmA is distinguished from other ESAs by the standard inclusion of human labour (in the following, labour) as a relevant input (Ulgiati and Brown, 2014). This sets EmA apart from LCA, Energy Analysis, and Exergy Analysis studies, where labour is rarely considered a relevant input. In EmA methodology, it is recognised that labour inputs are central to the functioning of any human-influenced process. Without human control, no information is applied and no material and energy inputs are organised. While labour inputs are routinely included in EmA, using several approaches for labour accounting suggests inconsistency (Kamp et al., 2016b). Labour inputs are particularly relevant in low-tech approaches since low-tech may be defined as associated with relatively large labour inputs compared to energy and material inputs. Additionally, closer analysis of labour inputs relevant for the case studies revealed that different types of labour should be accounted for separately.

### *Uncertainty regarding future societal conditions*

The implementation of changed energy production technologies and agricultural production practices requires a medium- to long-term time perspective. The life-time of the associated infrastructure and the time required to develop technical know-how is counted in decades (Hirsch, 2008). It follows that strategic prioritisation of technologies associated with long implementation time ought to be supported by considerations of the possible, future conditions under which they are expected to function. Nevertheless, uncertainty regarding future conditions is rarely assessed specifically, in ESA in general, and not at all in EmA, in spite of the apparent interest in future, societal conditions within Emergy literature (Odum and Odum, 2006; Markussen et al., 2014). The existing approach is to apply current conditions in the

evaluation of technologies that we intend to implement over future decades. This is problematic because we may assume that current conditions are not representative of conditions a few decades from now.

## 1.4 RESEARCH QUESTIONS AND OBJECTIVES

The research topic addressed in this thesis is the development and application of Emergy Assessment for evaluating residue-based bioenergy production.

The identified methodological challenges outlined above and the desire to evaluate the use of residues for bioenergy production in the case study systems result in a set of research questions that will be dealt with in the remainder of this thesis:

- a) How can EmA methodology address the specific issue of burden sharing arising in assessments of residue-based bioenergy production systems?
- b) How can labour inputs be categorised and systematically accounted for in order to properly and consistently reflect the significance of these inputs in EmAs of production systems?
- c) How can we include the uncertainty concerning future conditions in assessments of technologies that are expected to function in the future and will doing so affect results?
- d) How do different technology options for producing food and bioenergy perform against present practice in a Ghanaian village in terms of environmental sustainability assessed with EmA?
- e) How does the utilisation of residues for biogas production at a Ghanaian fruit processing facility compare to present practice in terms of environmental sustainability assessed with a multi-method ESA?

I will explore and answer these questions based on the following specific objectives:

1. Investigate alternatives to energy algebra with inspiration from LCA methodology and identify a procedure that is adequate for the study of residue-based bioenergy systems;



2. Review current approaches to human labour accounting in EmA and develop a consistent methodological approach;
3. Investigate explorative scenario analysis and demonstrate how it may be applied in EmA;
4. Carry out an Emergy Assessment of three technology options for providing food and bioenergy in a Ghanaian village and compare them to present practice; and
5. Carry out a multi-method ESA of a biogas-based technology option for providing processed fruit and compare it to present practice in a Ghanaian fruit factory.

I address objectives 1-3 in chapter 2. This part of my thesis has been published or is submitted for publication in papers I, III, IV, V, and VI. I will summarise my work on objectives 4 and 5 in chapter 3. The assessments of food and bioenergy systems are presented in the submitted papers II and V. Finally, I will provide my answers to the stated research questions and offer some perspectives on the topics of my work.

## 2. DEVELOPMENT OF THE EMERGY ASSESSMENT METHODOLOGY

I make three suggestions on how to develop the EmA methodology regarding *systems with multiple products*, *human labour accounting* and *explorative scenario analysis*, respectively. These issues are debated in the literature concerning other methods, inspiring my suggestions. The suggested approaches are provided specifically for EmA but may be considered relevant for the development of ESA methodology in general. Each of this chapter's three sections provides an introduction to the method issue, a summary of my investigation, and my recommendations regarding the topic including how they affect the design of the case study assessments.





*Pig farming is a classic example of a production system with multiple products.*

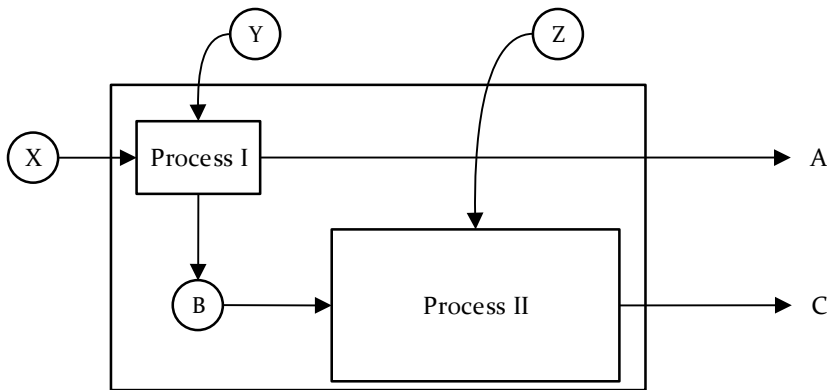
## 2.1 SYSTEMS WITH MULTIPLE PRODUCTS

### 2.1.1 Problem identification

Emergy algebra contains four calculation rules (Brown and Herendeen, 1996; Odum, 1996):

- Rule 1: All source emergy to a process is assigned to the process' output(s);
- Rule 2: Co-products from a process have the total emergy assigned to each pathway;
- Rule 3: When a pathway splits, the emergy is assigned to each 'leg' of the split based on its percent of the total energy flow of the pathway; and
- Rule 4: Emergy cannot be counted twice within a system:
  - (a) emergy in feedbacks cannot be double counted;
  - (b) co-products, when reunited, cannot be added to equal a sum greater than the source emergy from which they were derived.

A residue-based bioenergy production system may be depicted as in Figure 1. Figure 1 is a simplified illustration of a production process (Process II) that is dependent on an input from a process with multiple products (Process I). Process I could be e.g. animal production providing meat and manure, or crop production providing grain and straw, while Process II could be bioenergy production.



**Figure 1:** Schematic example of a residue-based production process. Adapted from Kamp and Østergård (2013).

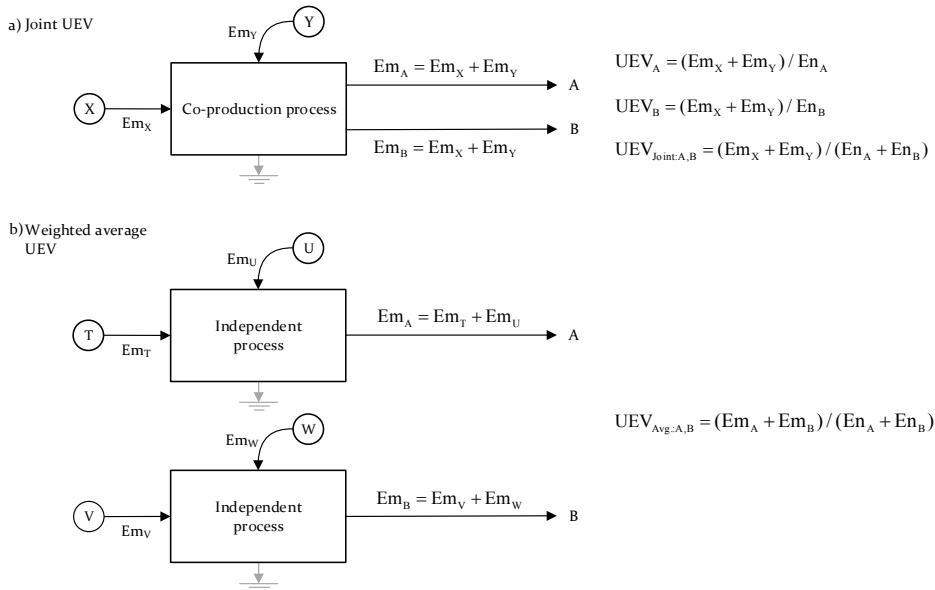
The emergy of product C is the sum of the emergy of B and Z, according to rule 1. The emergy of product B, in turn, is the sum of the emergy of inputs to Process I, which is X and Y. Process I is a co-production process that delivers two products and the emergy of A is equal to the emergy of B, according to rule 2. Product C may be compared to other, similar products that do not depend on co-production processes. In some comparisons, it may be considered unreasonable that C should account for the entire emergy of Process I, since Process I also delivers another product (A).

An example of such a comparison concerns the use of pig manure (i.e. B in Figure 1) in the production of willow, used for combined heat and power (CHP) (Kamp et al., 2011) (willow and CHP can be considered Process II in Figure 1). In that study, the emergy of manure was based on a UEV found in the literature (Cavalett et al., 2006). The resulting emergy of CHP was found to be 81% from manure. It was concluded that nutrient application constitutes a

significant input, regardless that manure is often considered a 'waste'. Concern was expressed, however, over the practice of assigning all emergy of pig production to pig manure, according to rule 2, and it was suggested to apply a kind of allocation between pig meat and pig manure. A similar example is manure used for biogas where solid manure constituted nearly half of inputs (Zhou et al., 2010).

### 2.1.2 Co-production in Emergy literature

A few authors have studied co-production in EmA with focus on Process I (Bastianoni and Marchettini, 2000; Cavalett et al., 2006; Cao and Feng, 2007). Bastianoni and Marchettini (2000) recognise the problem of comparing a product from a co-production process with a product from a process that yields only one product. They suggest the use of a *joint UEV* to specify that co-products are produced jointly. The joint UEV is calculated by dividing total emergy (in sej) with total energy in the output (in J) (Figure 2a). It is pointed out that the joint UEV cannot be treated as a 'regular' UEV and be used for further emergy calculations. A joint UEV may, however, be compared to a *weighted UEV*, which is based on the total emergy of providing comparable outputs in separate processes, divided by their total energy (Figure 2b).



**Figure 2:** The calculation of joint UEV (a) and weighted average UEV (b) according to Bastianoni and Marchettini (2000). *Em* = emergy and *En* = energy. Adapted from Kamp and Østergård (2013).

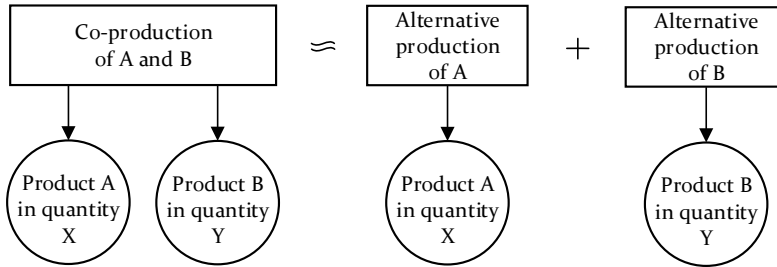
A comparison is proposed for milk and methane produced jointly and milk and methane produced independently (Bastianoni and Marchettini, 2000). Cavalett et al. (2006) use the methodology by Bastianoni and Marchettini to make a comparison between *integrated production* of grain, pigs and fish and *separately produced* grain, pigs and fish. The comparisons in the two papers suggest that integrated production requires less emergy per output than separate production.

### 2.1.3 Multifunctionality in LCA literature

LCA guidelines suggest tackling the issue of multifunctionality with the following approaches for assessment of inseparable multiple product systems (EC, 2010). The approaches focus on the ability to compare outputs. Square boxes represent *processes* and circles *inputs* and *outputs*.

### System expansion

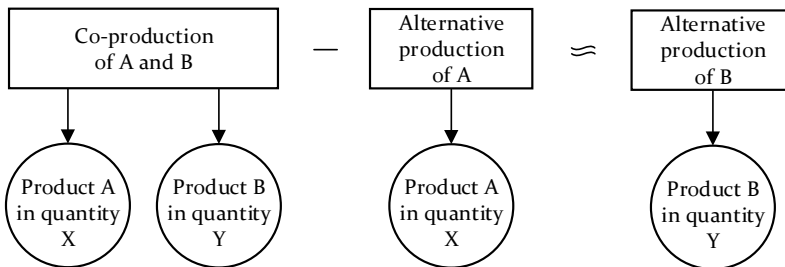
Maintain all outputs from the co-production process and compare to a set of processes that are added to provide the same outputs.



**Figure 3:** Schematic representation of system expansion. Adapted from (EC, 2010)

### System reduction (also referred to as ‘substitution’)

Reduce the co-production process until its output matches that of the process it is compared to. Reduction is done by subtracting from the co-production process those products that are not required in the comparison. An alternative way of providing each non-required product must be found, and it is these substitutes that are used in the subtraction.



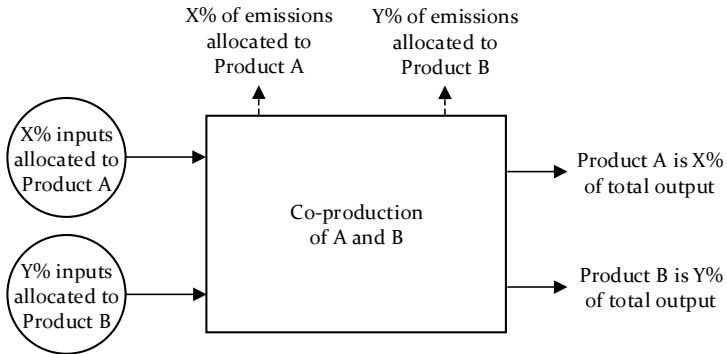
**Figure 4:** Schematic representation of system reduction. Adapted from (EC, 2010)

### Allocation

Split up the environmental burden between co-products according to a chosen allocation basis, e.g. element content, energy



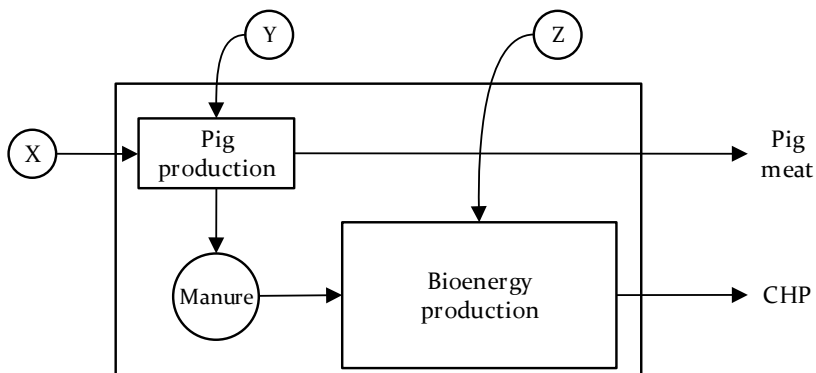
content, mass, market price. The allocation basis should preferably reflect an underlying causal physical/chemical/biological relationship between the products and the environmental burden.



**Figure 5:** Schematic representation of the allocation approach.

#### 2.1.4 Using approaches in LCA literature for a bioenergy production system, part I

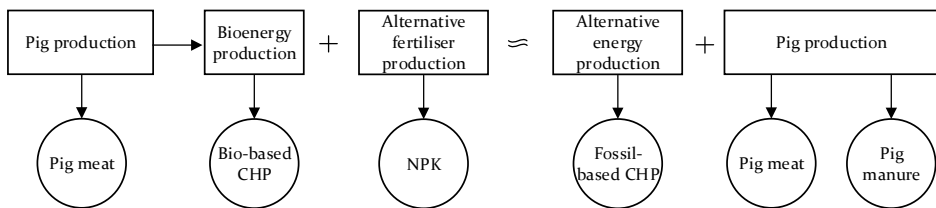
I investigated the applicability of system expansion, system reduction and allocation in two studies (Kamp and Østergård, 2013, 2016b). The first study considers an emergy assessment of bioenergy production based on willow wood chips. Willow is produced using pig manure, and manure is a co-product of pig production (Figure 6). The assessment was used to compare bio-based CHP to fossil-based CHP.



**Figure 6:** Schematic representation of pig and bioenergy production.

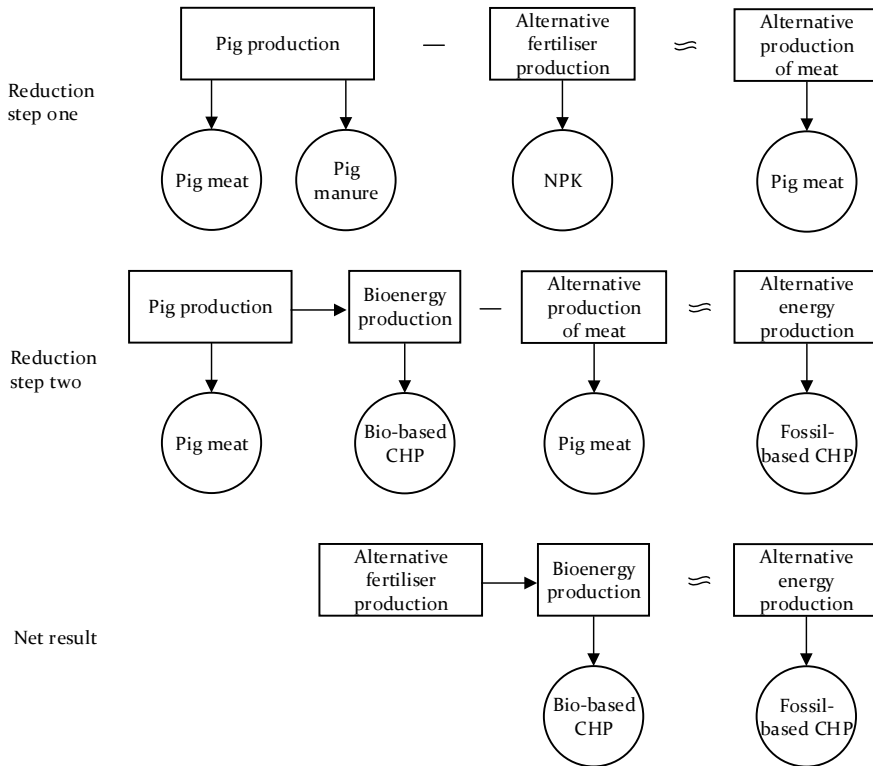
The study specifically considered the influence on UEV and %R<sub>global</sub> resulting from system expansion, system reduction and allocation approaches to manage the input of the co-product pig manure.

Applying the system expansion approach involved adding pig meat production to fossil-based CHP production, so both compared systems provided CHP and pig meat. Doing so, however, meant that the expanded, fossil-based CHP system had three products: CHP, meat and manure. To even things out, the production of NPK fertiliser was added to the bio-based system (Figure 7). A crucial assumption was made when doing this: To consider NPK as a functional substitute to manure. This assumption was based on the use of manure for fertiliser in Danish agriculture.



**Figure 7:** System expansion to obtain comparable outputs of CHP, meat and fertiliser.

Applying the system reduction approach, it was again assumed that NPK could serve as a substitute for manure. With respect to function, ‘pig production’ could thus be considered as the sum of meat and fertiliser provision. The reduction took place in two steps. First, ‘pig production’ was reduced to meat by subtracting NPK. Subsequently, meat could be subtracted from the bio-based system (Figure 8). In effect, the exercise is equivalent to assuming that NPK is used as fertiliser instead of manure.



**Figure 8:** System reduction in two steps.

Five allocation bases for the partitioning of energy between pig meat and pig manure were selected to demonstrate the importance of allocation basis choice (Table 1).

**Table 1:** Allocation bases for allocation of energy of pig production between meat and manure. Adapted from Kamp and Østergård (2013).

Allocation basis	Meat	Manure
Energy content	39%	61%
Mass	54%	46%
Phosphorus content	27%	73%
Nitrogen content	34%	66%
Market price	100%	0%

The system reduction and five allocations provided six single-product comparisons between bio-based CHP (Table 2) and fossil-based CHP (Table 3). The system expansion provided an additional multiple-product comparison between bio-based CHP, meat and fertiliser and fossil-based CHP (Table 2), meat and fertiliser (Table 3).

**Table 2:** Summary of results for bio-based CHP production using different assessment approaches. Adapted from Kamp and Østergård (2013).

Assessment approach	UEV (sej/J)	%R <sub>global</sub>
<i>Single-product perspective (only bio-based CHP)</i>		
Reference energy approach	2.31E+05	17%
Allocation, energy content	1.55E+05	16%
Allocation, mass	1.27E+05	15%
Allocation, P content	1.79E+05	16%
Allocation, N content	1.62E+05	16%
Allocation, market price	0.37E+05	9%
System reduction	0.48E+05	7%
<i>Multiple-product perspective (bio-based CHP, meat, fertiliser)</i>		
System expansion	2.21E+05	16%

The reference energy approach refers to accounting for the entire energy of pig production in the manure. The choice of assessment approach significantly influences the resulting indicators. Within the allocation approach, the choice of allocation basis is also of significant importance. The estimated indicators in the single-product and multiple-product perspective are comparable to fossil-based CHP and, respectively, fossil-based CHP, meat and fertiliser (Table 3).

**Table 3:** UEVs and Global Renewability Fractions for fossil-based production of CHP. Adapted from Kamp and Østergård (2013).

Comparable products	UEV (sej/J)	%R <sub>global</sub>
<i>Single-product perspective (only CHP)</i>		
Fossil-based CHP <sup>a</sup>	0.88E+05	1%
<i>Multiple-product perspective (CHP, meat, fertiliser)</i>		
Fossil-based CHP, meat, fertiliser	2.29E+05	13%

<sup>a</sup>: Based on (Raugei et al., 2005).

The choice of assessment approach influences the conclusion of the comparison. In a single-product perspective, market price-based allocation and system reduction approaches lead to the conclusion that bio-based CHP is associated with lower resource use than fossil-based CHP. Applying other allocation bases or the reference approach present bio-based CHP as less resource efficient than fossil-based CHP. Applying system expansion, it appears that the bio-based production system provides CHP, meat and fertiliser more efficiently than the fossil-based system. In all comparisons, bio-based production depends on a higher fraction of renewable energy than fossil-based production.

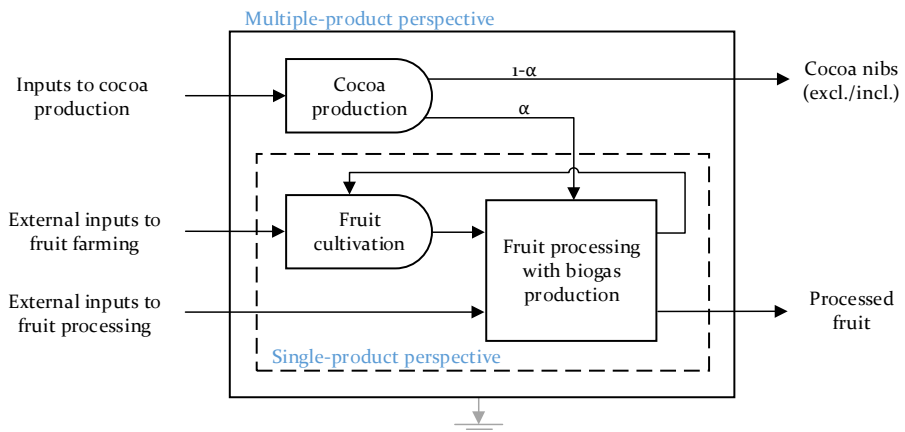
### 2.1.5 Using approaches in LCA literature for bioenergy production systems, part II

In Kamp and Østergård (2016b), production of processed fruit in Ghana was studied. The results of the study are treated in detail in a later section, but the methodological considerations will be outlined here following a short introduction.

The study assesses two technology options for the cultivation and processing of fresh, tropical fruit, ‘Present practice’ and ‘Biogas’. ‘Present practice’ is characterised by grid and diesel generator electricity in processing and synthetic fertiliser use in cultivation. ‘Biogas’ is characterised by residue-based biogas production for electricity generation and compost production for fertiliser used in cultivation. The biogas production requires cocoa shells as a

substrate, and this leads to considerations concerning the environmental burden of cocoa production. Cocoa production jointly provides cocoa nibs and cocoa shells, separated after harvest.

The fruit cultivation and processing, with return of compost material from the biogas production to farmers, is considered as an integrated system (Figure 9, dashed sub-system boundary). How to account for the cocoa shells, however, is a part of the study. The influence on results of the choice of assessment approach is analysed specifically, similar to the analysis in Kamp and Østergård (2013). Three allocation bases are applied in a single-product perspective: 0%, based on market price; 12%, based on energy content; and 100%, based on energy algebra rule 2. When considered in a multiple-product perspective, cocoa production is included entirely and cocoa nibs are considered a relevant output (Figure 9, full system boundary).



**Figure 9:** Two assessment perspectives regarding production of processed fruit. Different allocation bases determine the allocation factor  $\alpha$  for cocoa shells. Adapted from Kamp and Østergård (2016b).

Again, it became clear that the choice of approach had decisive influence on results (Table 4). Cocoa production is associated with high energy, mainly because the yield per area is low.

Therefore, the indicators are very sensitive to the percentage of cocoa production that is accounted for in the shells.

**Table 4:** Energy indicators for production of processed fruit or processed fruit & cocoa nibs with a biogas-based technology option, applying different assessment approaches. Adapted from Kamp and Østergård (2016b).

Assessment approach	UEV (sej/J)	%R <sub>global</sub>
<i>Single-product perspective (only processed fruit)</i>		
Allocation, market price (0%)	3.7E+06	14%
Allocation, energy content (12%)	5.5E+06	37%
Allocation, energy (100%)	1.9E+07	69%
<i>Multiple-product perspective (processed fruit &amp; cocoa nibs)</i>		
System expansion	3.3E+06	69%

The estimated indicators for the biogas-based technology option may be compared to those of present practice (Table 5). In a single-product perspective, ‘Biogas’ is comparably resource efficient only if no energy is allocated to cocoa shells. In a multiple-product perspective, the two technology options show no significant difference.

**Table 5:** UEVs and Global Renewability Fractions for present practice production of processed fruit and processed fruit & cocoa nibs. Kamp and Østergård (2016b).

Comparable products	UEV (sej/J)	%R <sub>global</sub>
<i>Single-product perspective (only processed fruit)</i>		
Present practice	3.8E+06	15%
<i>Multiple-product perspective (processed fruit &amp; cocoa nibs)</i>		
Present practice	3.4E+06	69%

### 2.1.6 The recommended approach to manage co-production in Energy Assessment

Emergy is the memory of all the energy required for providing each co-product. In assessments where a co-product is an input, this rule can significantly influence results, as shown. In assessments of

bioenergy production, we are likely to encounter this problem. The investigated, alternative approaches are system expansion, system reduction and allocation.

### *System expansion*

System expansion that includes co-production of inputs to bioenergy production ensures that 1) the entire energy is accounted for and 2) that the system is credited for providing multiple products. The accounting of energy on an individual co-product basis is avoided by turning the residue into an internal flow. System expansion obeys energy algebra, and is in accordance with the approach suggested by Bastianoni and Marchettini (2000), and demonstrated by Cavalett et al. (2006). It should be clear, however, that system expansion has some practical implications. Expanding the scope in effect turns an assessment of bioenergy production into an assessment of, at least, biomass production and conversion. In the two studies, it was possible to limit the amount of relevant, expanded system outputs to three and two, respectively. In other cases, as discussed by Heijungs and Guinée (2007), system expansion may lead to 'endless regression', i.e. ever-increasing system boundaries and outputs, if the added processes are themselves co-production processes.

### *System reduction*

System reduction builds on the assumption of substitutability between different products that are considered to have the same function, e.g. manure and synthetic fertiliser. System reduction requires that relevant substitutes from mono-functional processes are available, to avoid endless regression. We may think that such mono-functional processes are plentiful, but Heijungs and Guinée (2007) indicate that multi-functional processes are more abundant than we think. Nevertheless, system reduction may be useful in LCA, if focus is on the net effect of producing one product instead of another. But in EmA, system reduction disrupts the memorisation of energy use. A UEV that is estimated partially by subtracting energy avoided elsewhere will not be useful for further calculations.



## *Allocation*

Allocation is a pragmatic approach for single-product assessment. However, the core assumption that the environmental burden is distributed according to either of the allocation bases may be impossible to substantiate. While the energy and nutrient content probably indicate the ability to do harm in the *use* of the co-product, we cannot with reasonable certainty say the same regarding the *production* of the co-product. Market price is not a property of the co-product itself, but an indicator of its usefulness according to existing preferences and economic system balances, including taxation and subsidisation. Using market price to allocate the environmental burden between co-products implies that the environmental burden of a co-product increases if it becomes more popular. Such a logic does not contribute to the robustness of an assessment.

The principle of allocation conflicts with emergy algebra. Rule 3 does state that emergy may be distributed according to energy content when a pathway splits. A pathway, however, represents an energy flow of the same *type* or *kind* (Odum, 1996: 90-94) or *form* (Scienceman, 1987), and distinct co-products do not belong on the same pathway. Whether co-products are of the same type is a question of the level of detail, a context-specific matter. In the context of biomass production, I consider co-products that are edible and inedible as distinct types.

As a concluding remark on allocation, we cannot in principle dismiss the possibility that Nature, including the human economy, does self-organise according to any or all of the discussed characteristics.

## *Single-product and multiple-product perspective*

The choice of approach to manage co-production is also a choice between the number of products the assessment will consider. System expansion considers multiple products simultaneously while allocation considers only one. A multiple-product focus may be

associated with a societal perspective where overall optimisation is emphasised. A single-product focus may be associated with a business focus where the placement of the environmental burden is important. Given the context, both may be relevant.

### *Managing co-production in the case study assessments*

Based on the above, I used a system expansion approach to encompass biomass production and conversion in the case studies of *integrated food and bioenergy production*. The system expansion approach entailed a multiple-product perspective that in each case includes two products in the calculation of joint UEVs and other indicators. In the study of biogas in fruit production, the multiple-product perspective assessment is supplemented with a single-product perspective assessment that includes allocation factors between 0% and 100%.





*Maize de-husking. The collection of agricultural residues in the fields is labour intensive, while some residues, as maize husks, are more easily accessible.*

## 2.2 HUMAN LABOUR ACCOUNTING

Human labour inputs are necessary for the functioning of any production system. It is human labour that organises material and energy inputs, that designs and controls production processes and in other ways transfer information. Without human labour, little would happen in the way of production in the vast majority of systems assessed with ESA. If labour is incorrectly accounted for or omitted altogether, the environmental burden may be under- or overestimated. Incorrect estimates of the environmental burden associated with labour involves the risk of inadequate or biased information for decision-making (a research hypothesis for further study, see Section 4.2.3). Some researchers recognise labour as a relevant contribution for a more complete assessment of production systems, e.g. in LCA (Nguyen et al., 2007; Silalertruksa and Gheewala, 2009; Rugani and Benetto, 2012; Rugani et al., 2012; Arbault et al., 2013), Energy Analysis (Fluck, 1992; Herendeen, 2004; Cleveland, 2013), and Exergy Analysis (Sciubba, 2003, 2001; Fukuda, 2003). In EmA labour is included as standard and the development of calculation procedures for the emergy of labour is the topic in several

publications. It has been suggested to base the emergy of labour on human metabolism (Odum and Odum, 1981; Odum, 1996), the money value of labour (Odum, 1983; Brown and Herendeen, 1996; Ulgiati and Brown, 2014), education and experience (Odum, 1996; Abel, 2011; Bergquist et al., 2011; Campbell, 2013), socio-economic hierarchy (Abel, 2010), and income class (Kamp and Østergård, 2015).

### 2.2.1 A common formula for calculation of labour UEVs

Accounting for labour inputs implies clarifying the amount of labour involved, the unit to use for its accounting, and an association of labour with resource use (or other environmental burdens). As understood from the several approaches enlisted above, there are various ways of doing that. Reviewing the various approaches it was revealed that a common method for calculating the UEV of labour is universally applied, where

$$UEV = \frac{\alpha\beta_1}{\gamma\beta_2} \quad (\text{Eq. 1})$$

$\alpha$  is the resource basis that is considered to be necessary for the provision of labour,  $\beta_1$  and  $\beta_2$  are optional allocation factors and  $\gamma$  is the relevant labour amount and unit that the resource basis is distributed among (Kamp et al., 2016b). The factors are described and exemplified in Table 6.

**Table 6:** Specification of information for labour UEV calculation. From Kamp et al. (2016).

Factor	Description	Examples
Resource basis ( $\alpha$ )	Emergy flow considered necessary for provision of labour	Emergy flow for territory (World, region, country, etc.), sector (education) or other defined boundary (village, farm)
Allocation ( $\beta_1, \beta_2$ )	Provide deviation from the average UEV (i.e. $\alpha/\gamma$ ) by taking into account the quality of the labour	Educational level, income level, metabolism, knowledge, age
Proxy ( $\gamma$ )	Accounted quantity	Metabolised energy, worked or lived time period, # of people, money flow

Three calculation examples demonstrate the applicability of the formula (Table 7). The considered labour provision systems regard USA (in Odum, 1996), Ghana (in Kamp and Østergård, 2015) and the World (based on Brown and Ulgiati, 2011).

*Table 7: Characteristics of three labour systems, used to calculate labour UEVs. UEVs are not directly comparable. Adapted from Kamp et al. (2016).*

Labour system	$\alpha$	$\beta_1$	$\gamma$	$\beta_2$	UEV <sub>labour</sub>
USA, year 1980	Emergy flow of USA	Not allocated	Metabolised energy by people in specific educational category (J)	% people with certain education level	8.9E+06 - 2.1E+09 sej/J
Ghana, year 2000	Ghanaian emergy flow	% appropriated by people with specific consumption level	Worked hours by people in specific income group (man-hours)	% people with certain consumption level	3.2E+12 - 2.7E+13 sej/man-hour
World, year 2008	Global emergy flow	Not allocated	Global monetary flow (USD)	Not allocated	1.7E+12 sej/USD

### 2.2.2 Distinction between direct labour and indirect labour

In EmA, labour inputs are often categorised as either Direct Labour (DL) or Indirect Labour (IL). DL labour takes place in the foreground of the assessment, carrying out activities within the foreground system boundary, and may be thought of as applied labour. IL takes place outside the foreground system boundary or, colloquially, 'in the background', and is imported into the system accompanying external inputs. IL can be thought of as embodied labour (Ulgiati and Brown, 2014; Kamp et al., 2016). The same labour may thus be considered as direct in the production system where it is applied, and indirect in the production system that requires the product that the labour was applied to produce. The distinction is

relevant because different types of labour are supported by different types and amounts of emergy.

The relationship between DL and IL can be described with a few equations and an example (from Kamp et al., 2016). Let us consider any external material input  $m_i$  as the end product of a supply chain represented as a hierarchy with  $t_i$  levels which may differ between the different inputs. The levels of each supply chain may be different and are denoted by the index  $h$  where  $h = (0, 1, \dots, t-1, t)$ . We define supply chain level  $h = 0$  to represent the bottom of the hierarchy being the level where supply comes directly from nature. At level 0 there is no labour, i.e. for all  $i$ ,  $dl_i^{(0)} = il_i^{(1)} = 0$ .

The embodied labour component (as opposed to the material component) for a specific input  $m_i$  at an input-specific level  $t$ ,  $il_i^{(t)}$ , may be decomposed into:

$$il_i^{(t)} = dl_i^{(t-1)} + il_i^{(t-1)} \quad (\text{Eq. 2})$$

where  $il_i^{(t-1)}$  is the direct labour and indirect labour embodied in the materials required at level  $t-1$  for producing  $m_i$ :

$$il_i^{(t-1)} = dl_i^{(t-2)} + il_i^{(t-2)} \quad (\text{Eq. 3})$$

This argument may be continued until level  $h = 1$ , obtaining

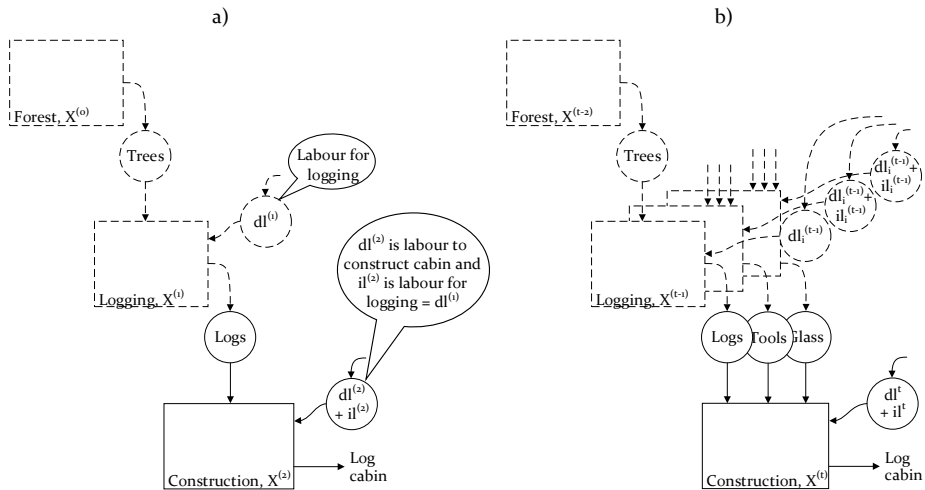
$$il_i^{(t)} = \sum_{h=1}^{t-1} dl_i^{(h)} \quad (\text{Eq. 4})$$

When the sum of direct labour inputs in the foreground system indexed by  $j$  are added to the sum of indirect labour inputs (Eq. 4) added over all  $i$ , we have

$$\text{total labour} = \sum_j dl_j + \sum_i \sum_{h=1}^{t_i-1} dl_i^{(h)} \quad (\text{Eq. 5})$$

where the different number of supply chain levels for different inputs are specified with the index  $t_i$ . We conclude that the total labour input (Eq. 5) is the sum of direct labour inputs.

Figure 10 depicts the concepts of DL and IL in a simplified illustration of a log cabin production system comprised of three sub-systems, Construction, Logging and Forest. In a), Forest is a natural system providing trees, considered as level 0. In level 1, Logging, direct labour is applied to produce an output of logs. This labour accompanies the logs as they enter level 2, the Construction subsystem, where the labour is considered an indirect labour input. Total labour is DL in Construction plus IL in Construction, representing the DL in the background system. Illustration b) suggests the existence of several supply chains, each with their own set of material and labour inputs. The supply chain for logs spans two levels, while other inputs to Construction may have longer supply chains.



**Figure 10:** Illustration with indication of labour inputs of a simplified log cabin construction example. a) focuses on the supply of logs and b) indicates less simplicity. Adapted from Kamp et al. (2016).

DL and IL are distinct types of labour with respect to their associated resource use. Since DL is supplied directly, we may expect that the labour is predominantly locally sourced. Consequently, the



resource use supporting DL may be associated with local, regional and national energy flows. IL accompanies inputs that may have been produced anywhere. In a globalised economy, where supply chains span many countries, we may assume that products rely on 'global labour'. The resource use supporting IL must therefore be associated with global energy flows, unless detailed information of the location of IL is available. DL and IL are also distinct regarding the typical information we use to account for them. While DL is sometimes registered in amounts of persons and time used, this is rarely the case for labour associated with external material inputs. For these, current accounting is usually limited to the monetary compensation given in return for laboured time, aggregated along supply chains, i.e. the price.

It follows that different labour inputs have different UEVs. Some are derived from national energy flows of which there is one for each country; some are derived from a global energy flow; and UEVs may be provided as sej/J, sej/man-hour, sej/USD etc. Traditionally, labour inputs have been compiled in one or two entries in EmAs but more thorough investigation of labour inputs may justify a more elaborate representation of labour inputs. This appears reasonable in production systems that are characterised by a high labour fraction, i.e. by a high percentage of total energy represented by labour.

### 2.2.3 Labour UEVs used in the case study assessments

The study of labour inputs in Ghanaian food production carried out in preparation of the case study assessments revealed three different, significant labour types: Direct labour by farmers and farmhands, direct labour by specialised personnel, and indirect labour in the various purchased inputs in cultivation, transport and processing. It was also clear that labour inputs constitute a large fraction of total energy of the considered systems. The use of a single labour UEV, based on the Ghanaian energy flow was abandoned and more specific labour UEVs calculated, according to Eq. 1.

### *Direct labour UEVs*

The UEVs for DL were based on the emergy flow for Ghana in 2000 (the latest year for which information was available), and an estimate of  $1.4E+10$  laboured man-hours in the same year. Furthermore, the labour force was divided into three classes based on income level: 20% with low income, 60% with medium income and 20% with high income. The emergy was distributed among the three groups according to Ghanaian income distribution, with the assumption that the country's resource use (in emergy) is distributed along the same pattern: 6% to the 20% with low income, 48% to the 60% with medium income, and 47% to the 20% with high income. This resulted in a UEV for labourers with low income of  $3.2E+12$  sej/man-hour, a UEV for labourers with medium income of  $9.1E+12$  sej/man-hour, and a UEV for labourers with high income of  $2.7E+13$  sej/man-hour.

### *Indirect labour UEV*

The identified material inputs in the case study systems included pesticides and other chemicals almost exclusively imported from China, tractors produced in USA, synthetic fertiliser from Norway, electricity, concrete and other building materials most likely produced in Ghana, and plastic and liquid fuels of unknown origin. UEVs for the labour component of each of these inputs could be calculated based on information about emergy flow, labour force etc. for the respective countries of origin. It must be assumed, however, that production of the mentioned inputs in those countries rely on material and labour inputs occurring in yet other countries etc. Estimating indirect labour UEVs for specific commodities requires extensive analysis and detailed knowledge of supply chains and involved types of labour. Instead, an approximation to be used for the labour component of all external material inputs was used.

The UEV for IL was based on Gross World Product ( $6E+13$  USD) and the global emergy budget ( $1E+26$  sej) in 2008 (Brown and Ulgiati, 2011). This provides an average emergy support of  $1.7E+12$  sej/USD. I converted this UEV into emergy per man-hour in order to

maintain the same unit for all types of labour in the list of inputs included in the assessments. This provided the added advantage of being able to compare direct and indirect labour inputs in terms of man-hours. The conversion from USD to global average man-hours was made using information about the global labour force and an assumed average formal working year of 1840 hours. It was found that Gross World Product per global average man-hour is around 11 USD/man-hour, which was used to estimate IL in man-hours. The resulting UEV for indirect labour was  $1.8E+13$  sej/global avg. man-hour (Kamp and Østergård, 2016b).



*We do not know what the future brings but we can be that sure it will be different from the present.*

### 2.3 EXPLORATIVE SCENARIOS

EmA and similar methods are associated with various kinds of uncertainty. Knowledge of relevant inputs may e.g. be outdated, insufficient, inaccurate, disregarding variability or taken from literature that examines different study conditions. Knowledge of the environmental impact associated with relevant inputs and the production and use of studied products may be assumed, approximated, simplified, averaged or relevant only under specific conditions or concern specific locations or time-scales (Heijungs and Huijbregts, 2004; Hudson and Tilley, 2014; Huijbregts, 1998). Uncertainty may be categorised accordingly as either parameter, model or scenario uncertainty (Zamagni et al., 2008; Ingwersen, 2010). A number of approaches to deal with uncertainty are available, including expert judgement, the application of data ranges with stochastic modelling (e.g. in Monte Carlo simulations), and simple,

what-if-analysis (e.g. what if biogas conversion efficiency is 35% instead of 50%).

An under-investigated type of uncertainty regards the temporal aspect in scenario uncertainty modelling (Börjeson et al., 2006; Höjer et al., 2008; Zamagni et al., 2008). A useful technique for studies of technologies that are supposed to function in the medium- to long-term future is *explorative scenario modelling*. Selected scenarios represent different, possible sets of future conditions, with focus on profound changes and a long time horizon. In the study of possible, future energy technologies and food production practices in a context of probable, large-scale societal change, I find explorative scenario modelling to be particularly relevant.

Considering the effect of changes in societal conditions for food and bioenergy production is relevant because the implementation of infrastructure on a larger scale, development of required know-how and obtaining experience with using new technologies and practices are expected to require a few decades. Furthermore, we should be careful with dismissing technologies that are not competitive under current conditions. Some of the technologies and practices that we regard as inefficient today may be competitive a few decades into the future if conditions are significantly different, and vice versa.

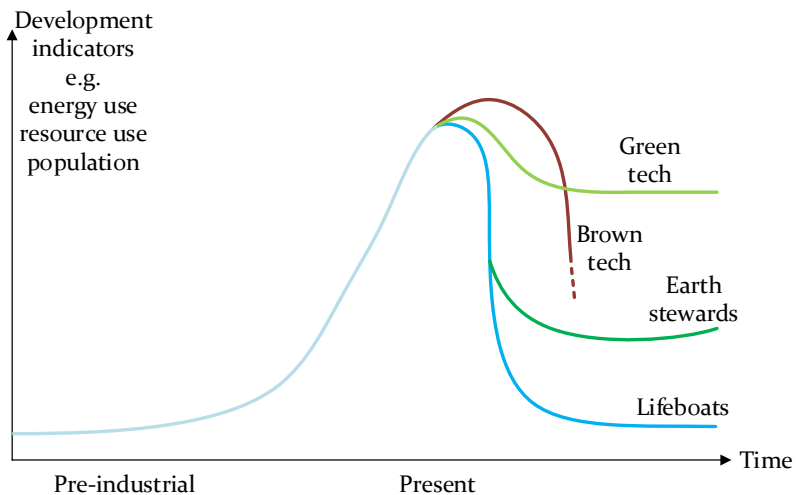
Perhaps the main argument for developing and implementing bioenergy solutions is that we require substitutes for fossil energy resources that will probably be less available from now on (Hirsch 2008; Mohr et al. 2015). The dynamics of an energy transition, however, extend beyond the substitution of one set of energy sources with another set of energy sources. The implications of a transition away from concentrated and plentiful fossil fuels with a high EROI to energy sources that are dispersed and have low EROIs are profound (Lambert and Lambert, 2011; Neff et al., 2011; Tverberg, 2012; Markussen, 2013). We may consequently expect changes in global trade networks and international cooperation, economic recession, increased social tension, conflict and migratory pressure. The list of calamities associated with reduced access to fossil fuels is additive to

problems regarding climate change, population growth and inequality (Ehrlich and Ehrlich, 2013).

We cannot predict the future, but we do have information that makes it possible for us to discursively construct probable futures. Scenarios have been established on the basis of climate change projections (Ipcc, 2014; Schubert et al., 2007), ecosystem dynamics in the Limits to Growth model (Meadows et al., 1972; Turner, 2008) and in the Millennium Ecosystem Assessment (Cork et al., 2000; Millennium Ecosystem Assessment, 2005; Carpenter et al., 2006), and societal effects of ‘energy descent’ (Holmgren, 2009). In Kamp and Østergård (2016a, 2016c) I demonstrate that narratives of future scenarios can be expressed in terms of modelling parameters to enable systematic, scenario-dependent Emergy Assessment.

### 2.3.1 Narratives as a basis for explorative scenario modelling

Four narratives of possible societal development were created with inspiration from Heinberg (2004), Hopkins (2006) and Holmgren (2009) (Figure 11).



**Figure 11:** Suggested trajectories of human development in four future scenarios. Inspired by Holmgren (2009).

The narratives from Kamp and Østergård (2016c) are included in their full versions:

### *Green tech*

In a Green tech future, a significant part of the energy supply from fossil fuels is successfully replaced by renewable alternatives without major supply disturbances and social unrest. The relatively smooth transition and stabilisation is facilitated by increased efficiency in infrastructure production, energy conversion, storage and transport; and cultural acceptance through education and subsidisation. The success is primarily attributed to political leadership and cooperation, technological breakthroughs, vigorous engagement by for-profit and not-for-profit organisations and the popular support of large groups of citizens demanding a proactive approach to planetary boundary-related problems, including climate change. After a period of structural reorganisation of political and financial markets (in the form of minor bubbles and collapses), a new era of economic growth begins that is decoupled from growth in resource use. The characteristics of this future are low-cost and renewable energy supply, sustainable use of renewable and slowly renewable materials, strategic use of fossil fuels and other non-renewables with careful recycling, and increased but environmentally-conscious consumption.

### *Brown tech*

In the Brown tech world, the demand for energy outruns the development and establishment of renewable energy technologies. The pressure for economic growth leads to removal of environmental taxation and subsidisation schemes, attempts to increase consumption, and emphasis on centralised, large-scale energy supply, factory-scale biofuels and food production typically managed by states or large corporations. For some time, this secures growth and the supply of most goods, albeit at a higher cost and, in general, based on non- or slowly renewable resources like unconventional oil and gas, synthetic fertiliser, top soil and forests with increasing inputs per output. International trade is maintained by forceful state

and corporate influence that are necessary to secure the long supply chains of centralised production. The result is increased dependence on fossil and nuclear fuels, at an increasing cost, and deterioration of social, economic and political institutions involving social unrest, and a tendency for centralisation of power in certain areas and collapses of the most vulnerable countries. Two important reasons for the failed transition are the underestimation of a consumption-based culture and the popular misunderstanding that renewable energy technologies are sufficient to fully replace modern world energy demands and support continued economic growth. After a series of crises initiated primarily by high commodity prices, and involving political conflicts causing internal strife, military actions to secure vital resources, extreme weather events, and migratory pressures, the global economy moves into a seemingly steady recession.

### *Earth stewards*

The story of Earth stewards pictures a harmonic relationship between man and nature in a society that is rebuilt from the bottom after a tumultuous transition away from fossil fuels. The narrative takes place after the world has gone through a succession of overwhelming collapses, including failures of nation states, severe economic recession, major conflicts, mass migration, population loss, and breakdown of national and international political institutions and trade. Locally, however, pockets of relative stability are able to develop and prosper, partially from the craftsmanship and entrepreneurial, experimental spirit of individuals and partially from the sudden demand for locally produced goods. In this process, development objectives shift from growth and material wealth to sufficiency and distribution, based on the realisation that environmental balance and social cohesion are the foundations of a sustainable society. In the course of some decades, a culture of local government, permaculture philosophy, low-tech approaches, cooperation and social inclusion spread to include the majority of mankind. In this world of Earth stewards, the use of non-renewable resources is almost abandoned since trade networks are small and supply chains very short, making centralised production



uneconomical. Most production has small net outputs due to resource scarcity and extreme environmental caution.

### *Lifeboats*

Following an extended, unsuccessful transition away from fossil fuels (as in the Brown tech narrative), society tumbles into a devastating breakdown, not unlike the succession of collapses described in Earth stewards, exacerbated by uncontrollable climatic changes. While single communities in certain well-protected areas are able to pursue a constructive but very slow rebuilding of social, economic and political institutions, the dominating life-style is nomadic, hunter-gatherer and characterised by insecurity, famine, disease, grief, violence and no development. Trade is extremely limited and production is inefficient due to the lack of security, necessary knowledge, skills and tools. Most activities are based on renewable resources, since there is close to no access to refined fuels, metals and other industrial society goods apart from those salvageable from abandoned population centres.

#### 2.3.2 Parameterisation of narratives to create modelling scenarios

In the work with scenarios, I focused on three energy indicators, the UEV, Global Renewability Fraction and Local Supply Fraction. This focus led to the identification of four relevant parameters to alter according to the dynamics expressed in the narratives. The parameters regard the inputs used in an EmA of a production system and include 1) The amount of indirect labour, 2) the UEVs of labour and material inputs, 3) the Global Renewability Fraction, and 4) the Local Supply Fraction. I associate the amount of indirect labour with the availability of purchased materials, i.e., the less available something is, the costlier it is in terms of indirect labour. I regard the UEVs of direct and indirect labour as indicators of material living standard, i.e., the higher material living standard, the higher is the resource use per unit of labour. I expect the UEVs of materials to alter according to changed material and energetic efficiencies in the discovery, extraction, processing and transport of

material inputs. The Global Renewability Fractions and Local Supply Fractions of inputs will change when production and transport of inputs adapt to scenario conditions.

The parameter values provide modelling conditions for scenario analysis that are alternative to reference conditions (Table 8). Reference conditions refer to the use of parameter values found in the literature or in other ways reflecting current circumstances. For the UEVs of inputs in scenarios, alternative values are given as percentage changes. For Global Renewability and Local Supply Fractions of inputs, alternative values are simply stated. To simplify and demonstrate the method, I categorised inputs according to the perceived influence of changes in scenario conditions. E.g. I assume that refined fuels and metals are similarly affected. Ideally, inputs are considered on an individual basis.

**Table 8:** Modelling parameters for inputs under reference and future scenario conditions. Adapted from (Kamp and Østergård, 2016a).

	Reference	Green tech	Brown tech	Earth stewards	Life-boats
<i>Amount of indirect labour</i>	-	same	+50%	+100%	+400%
<i>UEV of inputs, relative to reference scenario</i>					
- Fossil fuels, their derivatives, metals & minerals	-	-50%	same	+100%	+200%
- On-site renewables	-	same	same	same	same
- Biological material	-	-50%	+100%	+100%	+200%
- Direct and indirect labour	-	+100%	-50%	-50%	-90%
<i>Global Renewability Fraction</i>					
- Fossil fuels, their derivatives, metals & minerals	5%	50%	1%	100% <sup>a</sup>	50%
- On-site renewables	100%	100%	100%	100%	100%
- Biological material	50%	100%	1%	100%	100%
- Direct and indirect labour	16%	50%	5%	100%	50%
<i>Local Supply Fraction</i>					
- Fossil fuels, their derivatives, metals & minerals	0%	0%	0%	100%	100%
- On-site renewables	100%	100%	100%	100%	100%
- Biological material	50%	50%	10%	100%	100%
- Direct labour	100%	100%	100%	100%	100%
- Indirect labour	0%	0%	0%	0%	0%

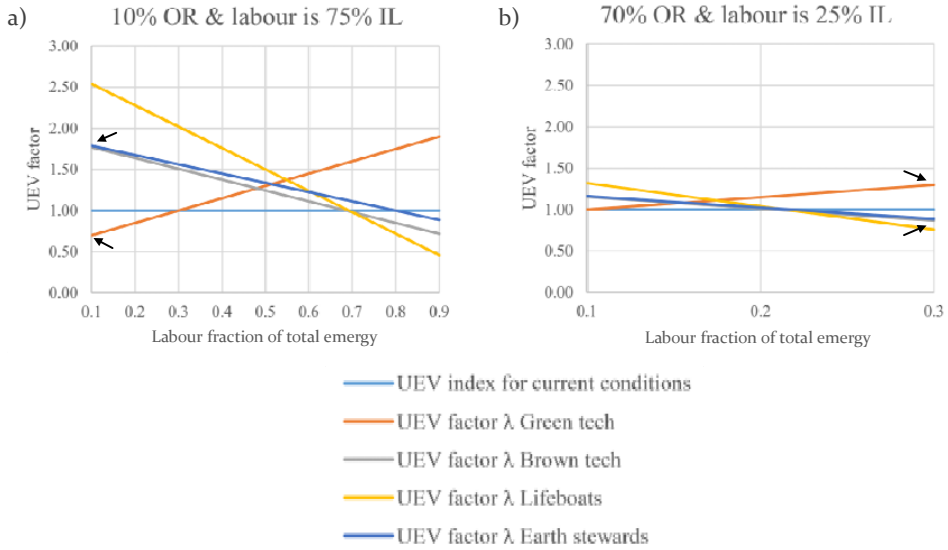
<sup>a</sup>: Use does not exceed generation rate or it involves full recycling

The Green tech scenario stands out from the other scenarios in terms of generally improved UEVs and increased Global Renewability Fractions. This reflects the optimism regarding efficiency improvements and a successful shift away from the use of non-renewable resources in the Green tech narrative. The remaining scenarios generally have increased inputs per output and a reduced labour UEV. This reflects reduced efficiencies and material standard of living associated with the destructive dynamics of these more radical energy descent scenarios. In the Brown tech scenario,

external inputs are assumed to come from production processes and a global economic system that depend primarily on non-renewable resources. These could be fossil fuel-based or soils and forests used faster than their re-generation rate. The Earth stewards and Lifeboats scenarios are partially defined through high dependence on renewable and local resources since little else is available.

### 2.3.3 Demonstration of the influence of altered parameter values

I analysed the influence of the estimated parameter values on the UEV of output from different hypothetical production systems (Figure 12). The hypothetical production systems represent combinations of dependence on different input categories. Two archetype systems were defined: The '*non-renewable and material intensive in a trade network*' system, characterised as relying on 10% (in terms of emergy) on-site renewable resources (OR), 10% labour, primarily indirect (IL), and 80% other resources (Figure 12a). 'Other resources' represent an even mix of the remaining two categories (Fossil fuels, their derivatives, metals & minerals and Biological material). The '*renewable and labour intensive in a local economy*' system is characterised as depending on 70% on-site renewable resources and 30% labour, primarily direct (Figure 12b).



**Figure 12:** Adjustment factors  $\lambda$  for the UEV of an output under future scenario conditions, relative to the UEV under current conditions. a) factors for systems characterised by low dependence on on-site renewable energy and where labour is primarily indirect. b) factors for systems characterised by high dependence on on-site renewable energy and where labour is primarily direct. Arrows indicate studied data points in Green tech and Brown tech scenarios explained below. In b) most of the Brown tech graph is hidden by the Earth stewards graph. Adapted from (Kamp and Østergård, 2016a).

Calculation of the aggregate effect of parameter value changes (in Table 8) allows for estimating what a production system output would be, if we assume scenario conditions. A production system characterised as *non-renewable and material intensive in a trade network* can be expected to have a reduced UEV under Green tech conditions but an increased UEV under Brown tech conditions (indicated in Figure 12a). On the contrary, a system characterised as *renewable and labour intensive in a local economy* can be expected to have an increased UEV under Green tech conditions but reduced UEV under Brown tech conditions (indicated in Figure 12b).

In general, the expected scenario can have decisive influence on which production system to prioritise and implement. The types of inputs that characterise systems in Figure 12a are relatively sensitive to altered scenarios, and this results in relatively high

adjustment factors for the UEV of outputs from these systems. Similarly, systems with high dependence on on-site renewable energy are less sensitive to scenario changes, as indicated by the tighter range of UEV factor values (Figure 12b). High dependence on on-site renewable flows and direct labour act as buffers against the kind of scenario uncertainty that is included in the demonstrated analysis. The comparison of the archetype systems illuminate the dynamics of the analysis method. In other comparisons, technologies will be less distinct than the technologies the archetype system represent.

### *Explorative scenario analysis in the case study assessments*

Explorative scenario analysis with the parameter values in Table 8 was demonstrated in the case study of food and energy production in a Ghanaian village (Kamp and Østergård, 2016c). The study compares four technologies under reference conditions and four future scenario conditions. The results of this study are presented and discussed in section 3.1.5.



### 3. INTEGRATED FOOD AND BIOENERGY SYSTEMS IN GHANA

I have assessed the utilisation of agricultural and agro-industrial residues in two integrated food and bioenergy production systems in Ghana. Knowledge about the case study systems was gained during several visits in 2012 and 2013. The assessments were based on two case studies of current food and energy production practices where residues are unused. The first case study considers small-scale, traditional maize-beans production and wood fuel use for cooking energy in a remote village. The second case study considers the production of processed, fresh fruit production and grid electricity use for fruit processing. The research design of both assessments includes a multiple-product perspective with human labour accounting in man-hours and differentiated labour UEVs. Explorative scenario analysis was considered in only the maize-beans and bioenergy assessment. A short introduction to the context for the specific study is given in each case.







*Cooking in a Ghanaian village. Firewood is burning in a three-stone stove (center) while charcoal smoulders in a coal pot stove (bottom left).*

### 3.1 INTEGRATED MAIZE-BEANS AND BIOENERGY PRODUCTION IN A GHANAIAN VILLAGE

Concern over increased scarcity of key production inputs, pollution associated with refined fossil-fuel based products, such as diesel, synthetic fertiliser and petrochemicals, soil deterioration and biodiversity loss call for a paradigm shift in modern agriculture (IAASTD, 2009; Østergård et al., 2009; Markussen, 2013). For rural development in Ghana, additional challenges include deforestation (Agyeman et al., 2012; Owusu et al., 2012), soil loss (Botchie et al., 2003) and nutrient leaching (Cobo et al., 2010), contributing to the undermining of productivity and livelihood (Pittelkow et al., 2014; Ray et al., 2012). Low-tech solutions with biogas (Arthur et al., 2011; Bond and Templeton, 2011; Amigun et al., 2012) and agroforestry (Akinnifesi et al., 2010; Altieri and Nicholls, 2012) have been suggested as they meet several of the criteria for a successful transition of agriculture and, at the same time, contribute to energy sovereignty.

In the first case study, I investigated food and cooking energy provision in a remote village near Ejura, Ghana (Kamp et al., 2016a). Empirical data on material and labour inputs in present practice farming and wood fuel provision, and the resulting food, residue and wood fuel outputs was collected in 2012-13. The study covered 45 hectares (ha) of farmland and cooking energy use by the seven households farming that area. Three alternatives to present practice, based on integrated approaches for production of food and energy were put forth. EmA was used to compare the four *technology options* ‘Present practice’, ‘Household-scale biogas’, ‘Village-scale biogas’, and ‘Agroforestry’.

### 3.1.1 Technology options for provision of food and cooking energy

#### *Present practice technology option (PP)*

Current farming in the area is predominantly a rotational bush fallow system with maize (89% of area), beans (4% of area), a few other crops (7%) and no livestock. Agricultural practice is characterised by manual labour and external inputs of synthetic fertiliser, pesticides, diesel and tractor use (for ploughing, de-husking and local transport). Cooking energy is in the form of wood fuel (firewood and charcoal) sourced beyond the farmed area. Wood fuel is used entirely for cooking; firewood in a three-stone stove with a thermal energy yield of 8% and charcoal in a coal pot stove with a thermal energy yield of 22%.

#### *Household-scale biogas technology option (HH biogas)*

The technology option ‘HH biogas’ includes farming methods similar to ‘PP’, but supplemented with nutrients and carbon recycled in the effluent from biogas production. No wood fuel is used. Instead, seven household biogas plants with an assumed conversion efficiency of 43% provide gas for seven biogas cook stoves with a thermal energy yield of 55%.

### *Village-scale biogas technology option (Village biogas)*

The technology option ‘Village biogas’ is as ‘HH biogas’ but with only one, larger biogas production unit supplying biogas to satisfy the current demand of the seven households. The conversion efficiency is assumed 50% of the feedstock’s biomethane potential. Biomass losses before and after digestion are assumed slightly lower than for ‘HH biogas’.

### *Agroforestry technology option (Agroforestry)*

The technology option ‘Agroforestry’ involves growing maize and beans in alleys between rows of nitrogen-fixing trees. Moisture retention and soil cover abilities contribute to reducing soil erosion, while N uptake from the air and littered leaves reduce external nitrogen demand. The studied tree species yields approximately 5 t of wood per ha each year. The wood is partly used as firewood in a three-stone stove and partly pyrolysed and used in a coal pot stove.

For all technology options, unused crop residues are burned in the field to avoid wildfires and reduce pest pressure.

#### **3.1.2 Key assumptions and uncertainty analysis**

The empirical data spans three growing seasons over the course of a year and a half. Natural variability is thus almost ignored, but there was no indication that the studied period was significantly different from average climatic conditions, pest pressure, etc. While soil loss and deterioration have been related to the studied farming practices, I had no information regarding the study site and erosion of 1 mm/year was assumed (based on Lefroy and Rydberg, 2003). Because the performance of nutrient recycling, biogas production and agroforestry were based on literature study and support from bioenergy experts at DTU, the modelling involved central assumptions. Furthermore, both types of biogas digester were experimental, high-solids fermentation designs for which there is little available information. Assumptions include the conversion efficiencies during digestion, carbon and nutrient loss during storage

before and after digestion, and the ability of soil organisms to take up and utilise the returned material. Finally, the labour requirement for recovery and transport of crop residues, for biogas plant management, and for return and application of de-gassed material to fields should be considered critical assumptions. Assumptions are presented in Kamp et al. (2016a) and its supplementary material.

A sensitivity analysis focussing on specific parameters of biogas conversion efficiency, soil loss reduction in Agroforestry and the amount of required labour was carried out with respect to their influence on the Energy Assessment results. A set of relatively optimistic assumptions and a set of relatively pessimistic assumptions were applied. The results of this what-if-analysis provides energy indicator values in ranges.

Another uncertainty analysis was carried out to highlight the temporal uncertainty concerning implementation of food and energy technologies. This type of uncertainty is investigated with explorative scenario analysis, using four sets of parameter values developed for this purpose and described in section 2.3.2. The results of the scenario analysis provides four additional sets of technology option comparisons, one for each scenario.

### 3.1.3 Mass balance and labour inputs

Inputs of imported external wood fuel and fertiliser, soil loss and labour requirements were evaluated for each technology (Table 9). The modelling was designed to ensure that the outputs from all technologies were the same, allowing for simple comparison.

**Table 9:** Selected physical and labour flows for food and energy provision. Yearly flows for seven households farming 45 ha. From Kamp et al. (2016a).

	Unit	PP	HH biogas	Village biogas	Agro-forestry
<i>Input</i>					
Imported cooking fuel	t	67	0	0	0
Synthetic fertiliser use	kg	3,200	2,400	2,100	1,800
Soil organic carbon loss	t	18	14	13	2.3
Direct labour	man-hours	18,000	23,000	22,000	20,000
Indirect labour	man-hours <sup>a</sup>	510	510	480	410
<i>Output</i>					
Food	tdm	55	55	55	55
Useful cooking energy	GJ th. <sup>b</sup> energy	79	79	79	79

<sup>a</sup>: Global average man-hours.

<sup>b</sup>: thermal

All integrated technologies are able to eliminate the import of wood fuel. Synthetic fertiliser use and soil organic carbon loss are reduced by, respectively, 24% and 22% (HH biogas), 35% and 29% (Village biogas), and 44% and 87% (Agroforestry). The integrated technologies are associated with increased direct labour inputs and, for ‘Village biogas’ and ‘Agroforestry’, reduced dependence on purchased inputs. Food production is 55 tonnes of dry matter (tdm), mainly maize, of which the majority is sold on the local market. Useful cooking energy is the heat transferred from the cook stove, i.e., it includes the higher efficiencies of the coal pot and biogas stoves, relative to the firewood stove.

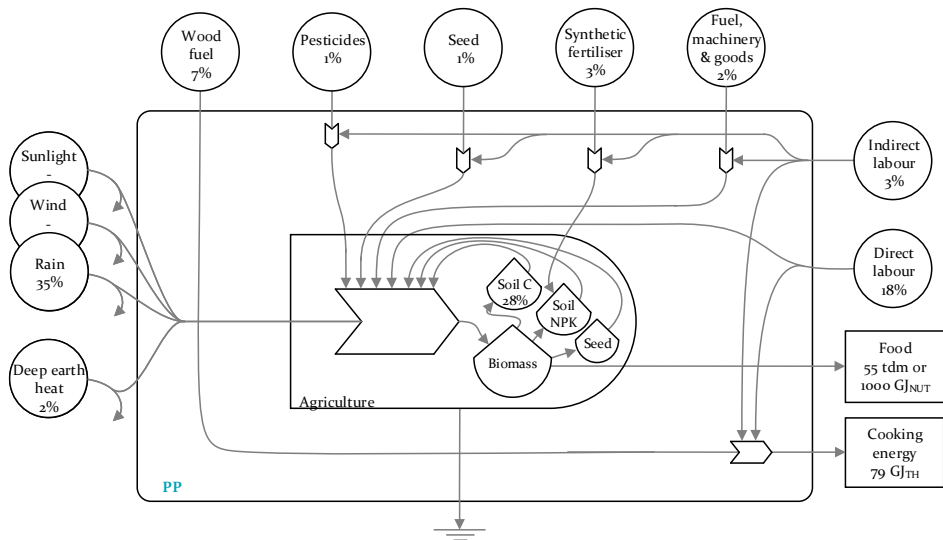
### 3.1.4 Emergy Assessment of the four technology options

Including all significant inputs for the functioning of the studied technologies, and adjusting for energy quality with solar emjoule conversion factors, the resource use is 260,000-300,000 sej/J of output in PP, with 38-48% of renewable origin (Table 10). Approximately 220,000 sej/J are from non-labour inputs, representing 48-55% renewable emergy.

**Table 10:** Emery indicator ranges for joint production of food and energy. From Kamp et al. (2016a).

	Unit	PP	HH biogas	Village biogas	Agro-forestry
UEV, incl. labour	$10^5$ sej/J	2.6-3.0	2.5-2.8	2.4-2.6	1.7-2.4
UEV, excl. labour	$10^5$ sej/J	2.2	1.8-1.9	1.6-1.9	1.2-1.5
Global Ren. Fraction, incl. labour	%	38-48	41-46	45-47	49-66
Global Ren. Fraction, excl. labour	%	48-55	55-60	66-70	69-87

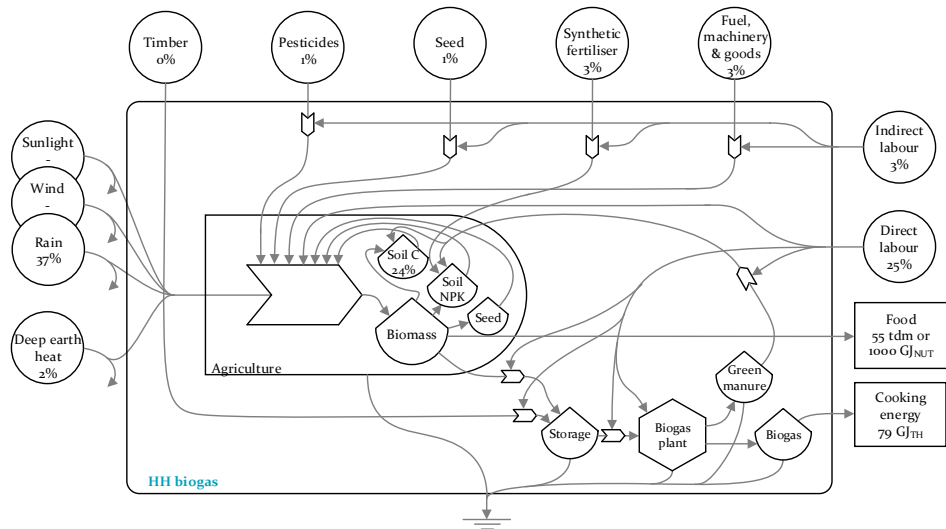
The distribution of emery support across the identified inputs in ‘PP’ is given in % of the total energy flow in Figure 13. The most significant energy flows are represented by rain, soil, direct labour and wood fuel.



**Figure 13:** System diagram of Present practice with separate food and cooking fuel provision. Inputs are in percentage of the total energy flow  $3.1E+17$  sej/year/45 ha.  $GJ_{NUT}$ : Gigajoules of nutritional energy that can be metabolised from the food. From Kamp et al. (2016a).

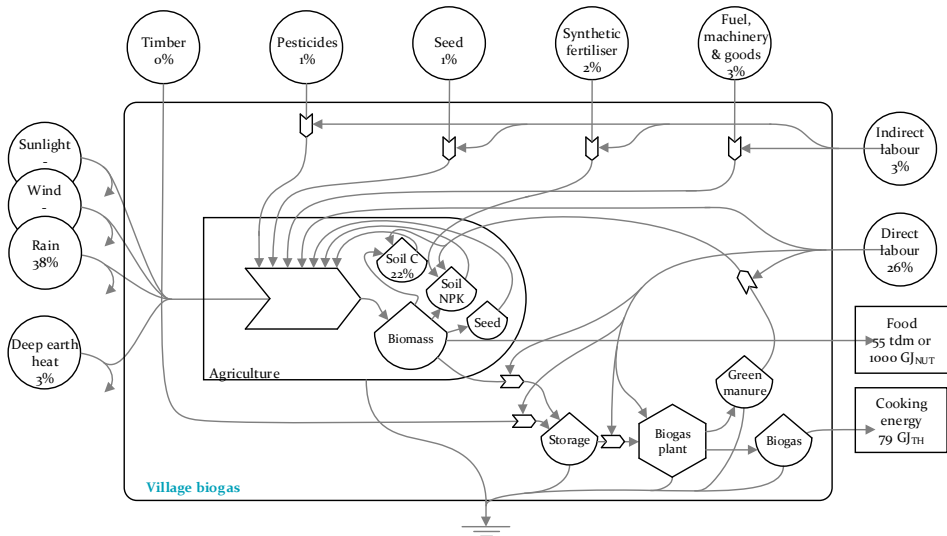
‘HH biogas’ may be more resource efficient and renewable flow-based, but the difference to ‘PP’ is too small to conclude it

(Table 10). ‘Village biogas’ and ‘Agroforestry’ are more resource efficient than ‘PP’, but only ‘Agroforestry’ can be characterised as less dependent on non-renewable flows. The relative contribution of energy in the included inputs in the integrated technologies are provided in Figures 14-16. The emergy support from soil carbon and imported wood fuel in ‘PP’ are reduced in the integrated technologies. Integrated technologies are characterised by a higher labour fraction. Synthetic fertiliser, indirect labour and the remaining inputs play a relatively small role.

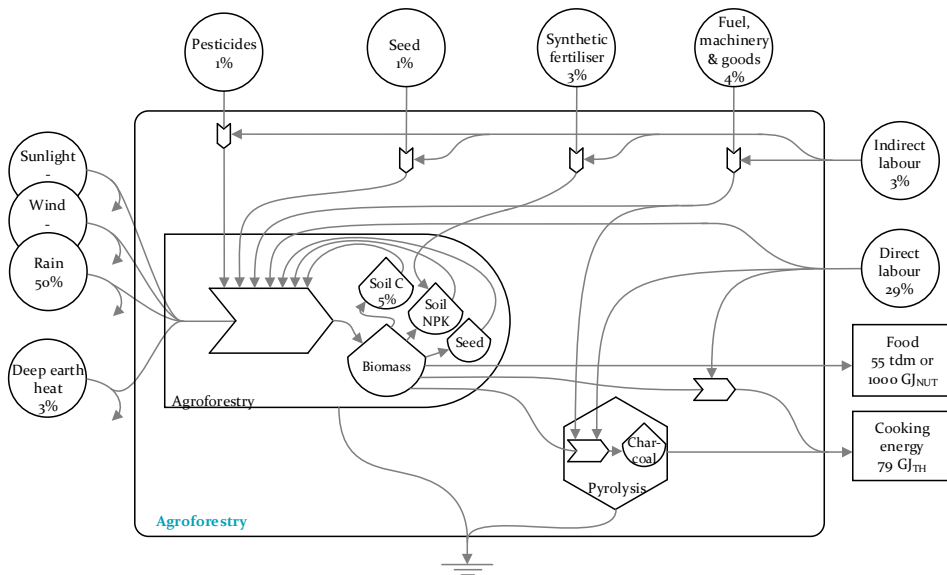


**Figure 14:** Integrated food and cooking fuel production based on household-scale biogas production with recycling of nutrients and carbon. Inputs are in percentage of the total emergy flow  $2.9E+17$  sej/year on 45 ha. From Kamp et al. (2016a).





**Figure 15:** Integrated food and cooking fuel production based on village-scale biogas production with recycling of nutrients and carbon. Inputs are in percentage of the total energy flow  $2.8E+17$  sej/year on 45 ha. From Kamp et al. (2016a).



**Figure 16:** Integrated food and cooking fuel production based on alley cropping with maize and leucaena. Inputs are in percentage of the total energy flow  $2.2E+17$  sej/year on 45 ha. From Kamp et al. (2016a).

The investigated integrated technologies are able to simultaneously address dependence on synthetic fertiliser, the use of wood fuel associated with deforestation, and soil organic carbon loss from erosion. However, the reductions in material inputs are achievable at the expense of increased labour inputs. The EmA showed that in terms of resource use supporting material and labour inputs, the integrated technologies appear to be slightly-to-moderately more efficient, overall. A small improvement is discernible also in the dependence on renewable energy. To test the robustness of the comparison in a context of possible, significant societal changes, the results were subjected to an explorative scenario analysis.

### 3.1.5 Explorative scenario analysis

The scenario analysis regards three emergy indicators, UEV to indicate resource use efficiency in a biophysical perspective, Global Renewability Fraction to indicate dependence on renewable energy flows, and Local Supply Fraction to indicate the extent to which inputs are sourced locally. The indicators are used to compare the four technology options for provision of food and cooking energy described in 3.1.1. The technology options are considered under Reference conditions (Table 11) and four future scenario conditions (Tables 12-15) as described in 2.3.1 and 2.3.2.

**Table 11:** Performance according to emergy indicators of technologies for food and energy provision under reference conditions. From (Kamp and Østergård, 2016c).

Reference	UEV (sej/J)	%R <sub>global</sub>	%Local
PP	2.8E+05	43%	87%
HH biogas	2.7E+05	43%	89%
Village biogas	2.6E+05	45%	90%
Agroforestry	2.0E+05	57%	88%

**Table 12:** Performance according to emergy indicators of technologies for food and energy provision under Green tech conditions. From (Kamp and Østergård, 2016c).

<b>Green Tech</b>	<b>UEV (sej/J)</b>	<b>%R<sub>global</sub></b>	<b>%Local</b>
PP	3.2E+05	55%	91%
HH biogas	3.2E+05	57%	92%
Village biogas	3.2E+05	58%	92%
Agroforestry	2.5E+05	69%	91%

**Table 13:** Performance according to emergy indicators of technologies for food and energy provision under Brown tech conditions. From (Kamp and Østergård, 2016c).

<b>Brown Tech</b>	<b>UEV (sej/J)</b>	<b>%R<sub>global</sub></b>	<b>%Local</b>
PP	2.9E+05	37%	73%
HH biogas	2.5E+05	43%	80%
Village biogas	2.4E+05	44%	81%
Agroforestry	1.8E+05	58%	79%

**Table 14:** Performance according to emergy indicators of technologies for food and energy provision under Earth stewards conditions. From (Kamp and Østergård, 2016c).

<b>Earth stewards</b>	<b>UEV (sej/J)</b>	<b>%R<sub>global</sub></b>	<b>%Local</b>
PP	2.9E+05	73%	100%
HH biogas	2.5E+05	75%	100%
Village biogas	2.4E+05	76%	100%
Agroforestry	1.8E+05	94%	100%

**Table 15:** Performance according to emergy indicators of technologies for food and energy provision under Lifeboats conditions. From (Kamp and Østergård, 2016c).

<b>Lifeboats</b>	<b>UEV (sej/J)</b>	<b>%R<sub>global</sub></b>	<b>%Local</b>
PP	3.1E+05	54%	100%
HH biogas	2.4E+05	59%	100%
Village biogas	2.3E+05	60%	100%
Agroforestry	1.8E+05	77%	100%

The scenario analysis allows us to compare technologies within a chosen scenario, but also to compare the sensitivity of a single technology to scenario changes.

Under Green tech scenario conditions the small difference in UEV between 'PP' and 'Biogas' technologies is removed. Renewability and dependence on local supply are generally increased but the relative difference between technologies is insignificantly changed. The conditions in the remaining, more radical energy descent scenarios have the general effect of increasing the difference between technologies. The ranking in e.g. UEV remains the same, but the relative difference becomes larger: 'Village biogas' uses 91% of the resources used in 'PP' to deliver the same output under reference conditions. Under Brown tech, Earth stewards and Lifeboats scenario conditions the fraction is 82%, 83% and 76%, respectively. Expectations of a Brown tech, Earth stewards of Lifeboats scenario thus support the prioritisation of biogas-based or agroforestry technologies.

The indicators of a given technology vary relatively little across scenarios. E.g., for 'PP', the UEV range is 2.8-3.2E+05 sej/J (least variation) while for 'Village biogas' it is 2.3-3.2E+05 sej/J (most variation). The highest UEV factor change is 1.3 for 'Agroforestry' in the Green tech scenario, a low value when compared to the factors in Figure 12. The technologies generally rely heavily on on-site renewable energy and direct labour – the identified buffers against societal change (Section 2.3.3).

The scenario analysis contributes to the assessment with information about technology performance under conditions that may be more relevant for the prioritisation between choices. Concluding on the basis of Reference and Green tech conditions, we should not bother to implement the two biogas-based technologies, while 'Agroforestry' appears to be an attractive possibility. If we conclude on the basis of the remaining scenarios, all energy indicators point toward integrated approaches.





*Fruit residues at fruit factory. About two thirds of the fruit is discarded during processing.*

### 3.2 INTEGRATED FRUIT, COCOA AND BIOGAS-BASED ELECTRICITY PRODUCTION IN GHANA

Utilising agro-industrial residues for energy production in agro-industry provides a range of benefits. Agro-industrial production is often energy intensive and in regions with unreliable electricity supply, on-site production may significantly reduce costs of purchased electricity and electricity back-up generation with diesel generators (Daniel and Schneider, 2013). Residue-based bioenergy production is a way to deal with an undesired by-product and a means to reduce the environmental burden associated with non-renewable energy sources (Bond and Templeton, 2011). Furthermore, making use of the nutrients and carbon in the residue by recycling it to agricultural production after biogas production can reduce the dependence on synthetic fertiliser and remediate soil deterioration (Smil, 1999).

In this case study I investigated a concrete initiative in a strategy to reduce grid electricity dependence for a fruit factory in South-eastern Ghana (Kamp and Østergård, 2016b). Empirical data was collected during a series of interviews in 2012-13 and includes material and labour flows in pineapple cultivation and fruit processing. Literature study supplemented information about mango (NoorMmemon et al., 2015), cocoa production (Opoku-Ameyaw et al., 2010) and an existing plan for biogas and CHP production at the factory (Daniel and Schneider, 2013). The study encompasses cultivation, transport and processing of fruit, and also the cultivation, transport and processing of cocoa shells, a necessary co-substrate in the suggested biogas production due to its high nitrogen content. Two assessment perspectives were considered, *single-product* and *multiple-product* (see section 2.1.5), in the comparison of two technology options, Present practice and Biogas.

### 3.2.1 Technology options for provision of processed fruit and cocoa nibs

#### *Present practice technology option (PP)*

The technology option ‘PP’ represents observed practices for pineapple cultivation, the information gathered concerning cultivation of mango, other fruits and cocoa, their transport between farms and processing facilities and the processing itself. The cultivation of pineapple and cocoa and the processing of fruit and cocoa beans will be introduced here.

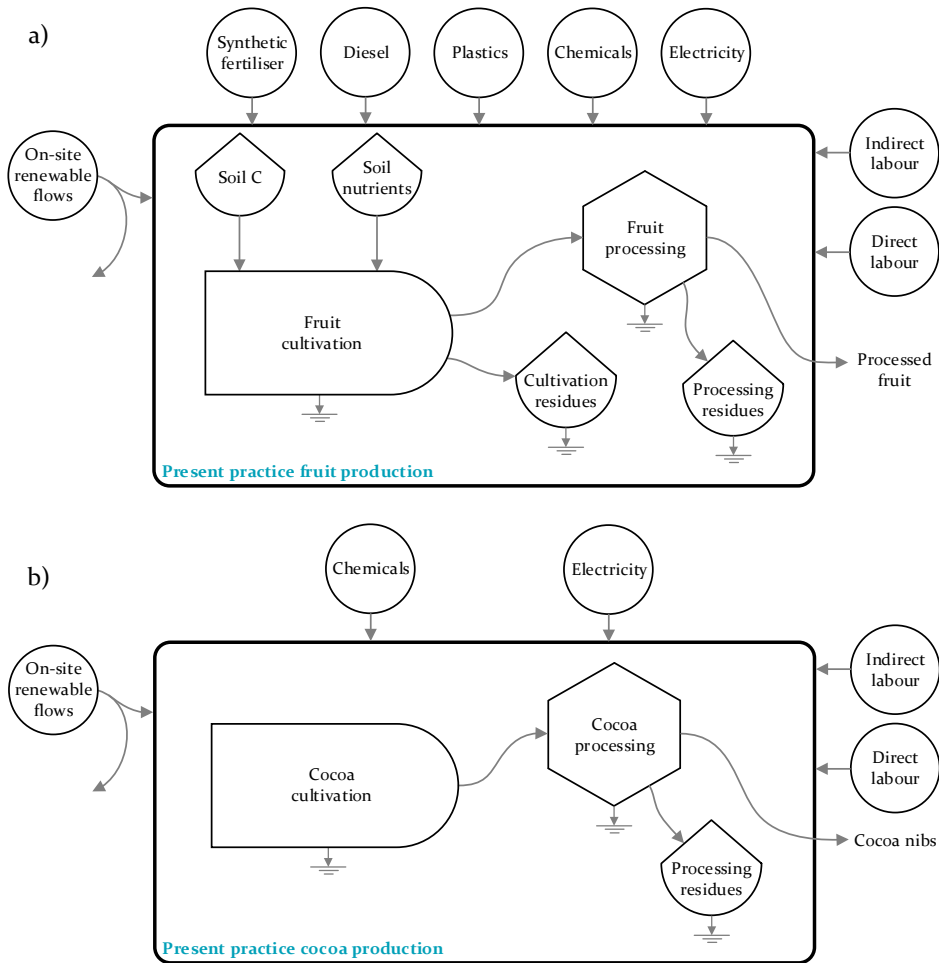
Two categories of pineapple cultivation was observed: *High input-high output* production with semi-industrial and industrial practices involving several tractor operations, large amounts of synthetic fertiliser, pesticides and other chemical treatments, plastic sheet mulching, and average yield around 50 t/ha/year. *Medium input-medium output* production was characterised by large amounts of fertiliser, moderate use of other chemicals, no plastic mulching or machinery use, and yield around 43 t/ha/year. Because pineapple is often grown on sloping ground and with relatively high soil exposure, pineapple production is associated with significant erosion. After

harvest, pineapple mother plants, a considerable co-product, remain in the field. It is considered as waste and burned by the farmers (Figure 17a).

Fruit processing is labour intensive and further characterised by significant electricity use, mainly for cooling during pre-processing storage. In 2012, 13,600 t of fruit arrived at the fruit factory yearly, and was processed to yield 4,600 t of fresh, tropical fruit in portion-size plastic boxes for retail sale and 9,000 t of discarded stems, peels, crowns, pits, etc. The fruit processing residues are currently composted but only negligibly used. Electricity demand is high, grid supply is intermittent and back-up diesel generators run regularly, producing approximately  $\frac{1}{4}$  of the total electricity used over the course of a year.

Cocoa is grown extensively in Ghana. Most cocoa cultivation requires very little in the way of inputs other than land and labour. Yields are low compared to other crops, approximately 0.4 t/ha/year. Cocoa beans are sun-dried before transportation to cocoa processing. On arrival, beans are de-shelled to separate the cocoa nib (constituting 87% of the mass) from the cocoa shell (13% of the mass). Only the nibs are processed further and the shells are discarded. Minor amounts are used as organic fertiliser but thousands of tonnes are currently unused (Figure 17b).





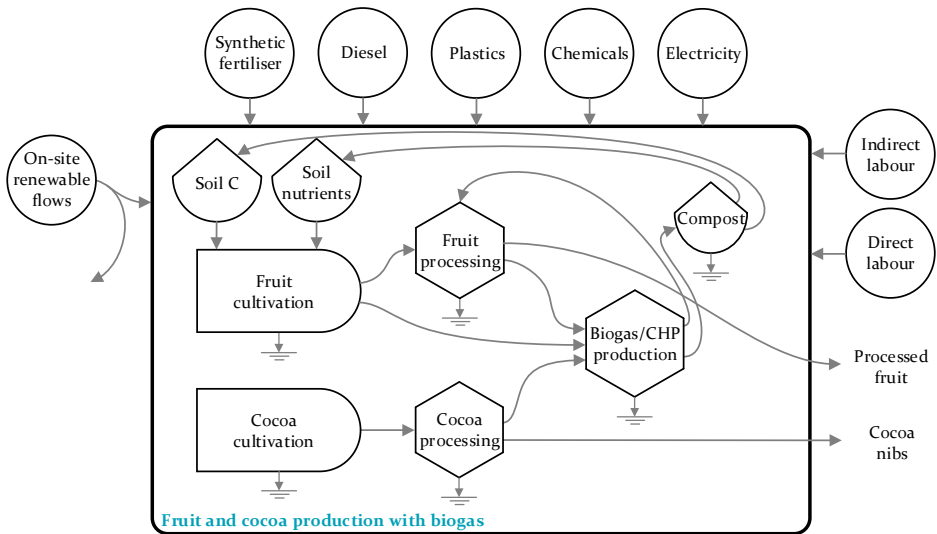
**Figure 17:** System diagrams of present practice fruit (a) and cocoa (b) production as separate processes. Residues are unused.

*Alternative technology option (Biogas)*

The technology option ‘Biogas’ is a hypothetical situation, based on ‘PP’ but with altered practices and technologies (Figure 18). In ‘Biogas’, a combination of fruit processing residues, pineapple mother plants and cocoa shells are converted to biogas used for combined heat and electricity generation at the fruit factory. The produced heat and electricity suffice to cover the heat demand of the fermentation system and to operate the refrigeration systems. Diesel

will still be used in composting activities and occasional back-up supply.

The digestion residue is composted to a mulching material that is returned to primarily pineapple farmers. The objective is to reduce synthetic fertiliser demand and to compensate for the soil carbon lost in erosion. Delivery is by truck (not illustrated) and application is manual. Manual application is similar to most other farm activities, since the technology option includes the shift to a medium input-medium output pineapple production practice. This was considered necessary to be able to successfully apply the compost material, since high input-high output relies on plastic sheet mulching, effectively covering the soil directly below the plant. This shift of cultivation practice results in lower yield and thus higher land use to supply the same amount.



**Figure 18:** Processed fruit and cocoa nib production with residue-based biogas production, considered as one system.

### 3.2.2 Key assumptions and uncertainty analyses

#### *Key assumptions*

Three pineapple growers were interviewed and only one applied what is referred to as medium input-medium output cultivation practice, so the obtained data regarding that practice does not include variability. Diesel and machinery use in transport was inferred from knowledge of trucks used and estimates of the distances between growers and processing facilities. No detailed information on mango production in Ghana was found and the study assumes that mango production in Pakistan, for which information was available, is representative. Material and labour inputs in systematic delivery of compost material and its application were assumed. Lacking detailed information, the ability of returned nutrients to substitute for synthetic fertiliser was estimated based on elemental N content in the biogas feedstock and synthetic fertiliser, and assuming a one-to-one replacement (after storage losses). The supplementary material to Kamp and Østergård (2016b) provides details.

#### *Sensitivity analysis*

A sensitivity analysis with eight models and 72 assessments considered variability in fruit and cocoa yields, altered uptakes of nutrients and carbon in returned compost, increased labour in compost application, altered methane leakage, and oil as the energy source in grid electricity production instead of the Ghanaian mix. The analysis considered the sensitivity of calculated indicators to each change separately.

#### *Assessment perspective*

##### **Single-product perspective**

The comparison of the two technology options was carried out using a single-product perspective that applies the allocation approach to divide environmental burdens between cocoa nibs and cocoa shells. No other allocation is considered necessary, since fruit

cultivation, transport and processing is already considered as an integrated system. Furthermore, the produced electricity is not regarded as an output since it is used entirely within processing. Three allocation bases are applied to highlight the lack of agreement within ESA regarding allocation. The environmental burden is allocated based on price (0% to cocoa shells), energy content (12% to cocoa shells), and according to emergy algebra (100% to each). In the single-product perspective the only relevant output is 4,600 t of processed fruit.

### Multiple-product perspective

The comparison of the two technology options was also carried out using a multiple-product perspective that regards fruit cultivation, transport and processing, and cocoa cultivation, transport and de-shelling as one integrated system. The relevant output in the multiple-product perspective is 4,600 t and 18,900 t of cocoa nibs. The 18,900 t are produced jointly with 2,700 t of cocoa shells, the amount required as co-substrate in biogas production.

#### 3.2.3 Mass balance and labour flows

Relevant, yearly inputs in the production of 4,600 t of processed fruit and 18,900 t of cocoa nibs were collected (Table 16). Four comparisons can be carried out using the physical and labour flows compiled in Table 16.

Three comparisons regard ‘PP, fruit only’ and ‘Biogas, fruit only’, considering either of the allocation bases. If we regard cocoa shells as ‘free’ in terms of inputs required for their production, the ‘Biogas’ technology reduces all inputs except for land and labour, compared to ‘PP’. If we regard all inputs in cocoa production as necessary for the availability of cocoa shells, all inputs are decreased in ‘Biogas’ compared to ‘PP’, with the exception of land, chemicals and labour.

The fourth comparison, between ‘PP, with fruit and nibs’ produced separately and ‘Biogas, with fruit and nibs’ considered as

an integrated system, reveals the same absolute difference as between ‘PP, fruit only’ and ‘Biogas, fruit only (waste)’. The negative soil organic carbon use reflects a net soil carbon increase since more carbon is returned to fields than is lost in erosion.

**Table 16:** Selected<sup>a</sup> physical and labour flows of two technologies to produce processed fruit or processed fruit and cocoa nibs. Adapted from Kamp and Østergård (2016b).

Unit		Single-product perspective				Multiple-product perspective	
		PP, fruit only	Biogas, fruit only			PP, fruit & nibs	Biogas, fruit & nibs
			$\alpha = 0$ (waste)	$\alpha = 12\%$ (energy)	$\alpha = 100\%$ (energy algebra)		
<i>Input/year</i>							
Land	ha	804	846	7,170	52,900	52,850	52,900
Soil organic carbon	t C	23	-144	-144	-144	23	-144
Diesel	L	196,000	138,000	143,000	167,000	224,000	167,000
Fertiliser	t	275	150	150	150	275	150
Chemicals	t active ingr.	23	21	23	31	33	31
Plastics	t	270	250	250	250	270	250
Electricity	MWh	2,960	218	276	693	3,430	693
Direct labour	10 <sup>6</sup> man-hours	3.9	4.1	5.2	13.3	13.1	13.3
Indirect labour	10 <sup>6</sup> man-hours <sup>b</sup>	0.2	0.2	0.2	0.3	0.3	0.3
<i>Output/year</i>							
Processed fruit	t	4,600	4,600	4,600	4,600	4,600	4,600
Cocoa nibs	t	0	0	0	0	18,900	18,900

<sup>a</sup> The selection includes inputs with energy flow above 1E+17 sej/year.

<sup>b</sup> Global average man-hours.

### 3.2.4 Environmental Sustainability Assessment

A multi-method ESA was carried out on the basis of the physical and labour flows in Table 16. The ESA included three energy indicators (UEV per tonne and joule, Global Renewability Fraction and Local Supply Fraction), four energy balance indicators

(Cumulative Energy Demand (CED), Fossil CED, Food Energy Return On energy Invested (EROI) and Food Energy Return On Fossil energy Invested), and the Global Warming Potential indicator (Table 17). The indicators are relative, i.e., per unit of output.

**Table 17:** Environmental sustainability indicators for two technologies to provide processed fruit or processed fruit and cocoa nibs considered in two assessment perspectives. Adapted from Kamp and Østergård (2016b).

Unit	Single-product perspective					Multiple-product perspective	
	PP, fruit only	Biogas, fruit only			PP, fruit & nibs	Biogas, fruit & nibs	
		'waste'	'energy'	'emergy algebra'			
UEV	sej/t	9.2E+15	8.9E+15	1.3E+16	4.5E+16	8.8E+15	8.8E+15
UEV	sej/J	3.8E+06	3.7E+06	5.5E+06	1.9E+07	3.4E+06	3.3E+06
Labour fraction	sej/sej	76%	80%	60%	31%	31%	31%
Global Ren. Fraction	sej/sej	15%	14%	37%	69%	69%	69%
Local Supply Fraction	sej/sej	75%	79%	53%	16%	94%	95%
CED	GJ/t <sub>output</sub>	15	8.4	8.6	10	3.4	2.0
Fossil CED	GJ <sub>fossil</sub> /t <sub>output</sub>	13	7.7	7.9	9.4	2.8	1.8
Food EROI	J <sub>food output</sub> /J <sub>input</sub>	0.16	0.29	0.28	0.23	0.78	1.3
Food EROI (fossil)	J <sub>food output</sub> /J <sub>fossil input</sub>	0.19	0.31	0.30	0.26	0.94	1.4
GWP	kg CO <sub>2</sub> -equiv./t <sub>output</sub>	790	430	440	540	230	160

In a single-product perspective, the emergy indicators are more sensitive to the allocation basis than the energy balance and GWP indicators. This is because 'Biogas' significantly reduces diesel, synthetic fertiliser and soil carbon loss, irrespective of allocation method, and these inputs weigh heavily in the energy balance and GWP methods. The emergy indicators, on the other hand, include substantial emergy flows from cocoa production that are unaccounted for in the other methods, e.g. rain and labour.

In the multiple-product perspective comparison, all indicators consistently favour Biogas, but the difference between the

two technologies is insignificant for the energy indicators. This is because the energy flow of cocoa production vastly exceeds the energy flow of the remaining processes. Therefore, the absolute improvement of 'Biogas' compared to 'PP' appears relatively small.

The energy balance and GWP results are sensitive (defined as changing more than 10%) to the assumption that grid electricity is a mixture of the country's supply and the assumption that all compost is applied to fields. If the viewpoint is taken that electricity usage relies on the marginal electricity supply, which is considered to be oil, then results change in favour of 'Biogas'. If half or none of the compost is returned, results change in favour of 'PP'. The sensitivity to amount of returned compost material shows that reduction of GWP is a question of substituting synthetic fertiliser rather than of substituting grid electricity. GWP results are sensitive to the assumption that all returned carbon is incorporated in the soil instead of only half, and the assumption of 3% biogas leakage instead of 10%. Tripling the labour to apply compost material does not affect results.

The single-product perspective provides no decisive conclusion. However, the single-product perspective provides estimates of the environmental burden of 'Biogas' that for most indicators is lower than 'PP'. The energy indicators stand out from the other indicators because of their focus on types of resource use that are unnoticed by the energy balance and GWP indicators. The different sustainability perspectives provided by the different indicators emphasise the importance of including an assortment of methods in an ESA.

Of the two perspectives, the multiple-product perspective provides the simpler comparison in the sense that all inputs and outputs are accounted for. Additionally, all indicators point to Biogas as the preferred technology option.

## 4. CONCLUSION

### 4.1 SUMMARY OF FINDINGS

The investigation into EmA, LCA and uncertainty analysis methods, and the application of identified approaches in two case studies allows me to answer the thesis' research questions.

#### 4.1.1 EmA and burden sharing

LCA methodology provides a range of techniques to account for the environmental burden of production systems that provide multiple outputs. Having applied these techniques in EmA of a range of food and bioenergy production systems I find that only system expansion is compatible with emergy theory. Emergy assessments of residue-based bioenergy systems should thus follow the logic of Bastianoni and Marchettini (2000) who suggested the calculation of joint UEVs.

I expect that future ESAs, including EmAs, will, to an increasing extent, evaluate systems that are integrated in several ways and yield several products like the systems studied in this thesis. I anticipate that a single-product perspective with either allocation or substitution will be poorly suited for such assessments. System reduction appears useful in simple co-production systems, but as the amount of co-production and inter-dependent systems is increased, this approach will appear less agreeable. I am concerned that allocation will lead to wrong decisions, particularly if it is based on price, since the economic value changes according to scarcity of alternatives. Will an allocation by price-based accounting imply recalculation when the price changes? I recommend that scientific analysis avoid choosing an allocation basis for which causality between the allocation and an environmental burden is not firmly established.

I presume that co-production occurs in the supply chain of any production system. A strict adherence to a system expansion



principle will therefore lead all assessments to encompass the entire universe, rendering the method useless. I therefore advise using system expansion with a multiple-product perspective as a principle in EmAs where an input is associated with a major environmental burden relative to the total burden of the studied process. A multiple-product perspective precludes the placement of burden on any single product. If information about a possible distribution between parts of a system is imperative, a single-product perspective analysis may be appended to a system expansion analysis. I recommend that such a single-product perspective provide the full span of possible environmental burden per product, i.e. includes the allocation factors 0% and 100%.

#### 4.1.2 EmA and human labour accounting

I have shown that human labour accounting in EmA follows a common method for the calculation of labour UEVs. Systematic accounting demands specification of the information included in the labour UEV calculation. Systematic accounting may follow the formula I have suggested with *resource basis*, *labour proxy*, and *allocation factors*. The formula provided clarifies the choices that must be made in the calculation of a labour UEV. It should not be understood as an agreement on how to calculate specific labour UEVs. I recommend presenting assessment results with and without labour included to allow for re-calculation of labour according to an alternative approach.

High labour fractions in the case studies (21%-80%) demonstrated the significance of labour inputs. UEVs for different types of direct and indirect labour were found to be appropriate for the different types of labour inputs. The logic behind including the resource use of labour appears strong when we see that material input reduction is associated with increased labour input.

Categories of direct and indirect labour and of labour quality according to resource use for making labour available allows for labour UEV differentiation. Because of the variation in emergy per labour unit input, I recommend that EmAs where labour plays a large

role include several types of labour inputs without, or at least before, grouping labour inputs.

Increased labour may – all else being equal – appear undesirable from a resource use perspective. That viewpoint should be balanced by the possible benefits of employment, of information sharing, and of sovereignty and rural empowerment stemming from increased use of local labour.

#### 4.1.3 Modelling uncertainty concerning future conditions in EmA

Subjectivity comes from disregarding the presence of variability in data and uncertainty in assumptions. The remedy is transparency. A few types of uncertainty analysis were demonstrated in the thesis. When the time perspective is relevant for the assessment, as I believe it is for the type of systems I have studied, I strongly recommend the use of explorative scenario analysis.

Explorative scenarios are useful for articulating medium- to long-term societal developments. Narratives of possible future conditions provide a starting point for the construction of explorative scenarios, providing information that may be interpreted in the form of modelling parameter adjustments. This is a relatively novel research field in ESA, and hitherto untouched in EmA.

Explorative scenario analysis in EmA was demonstrated for a number of production systems, with a generic example and in a case study. It is clear that the strategy applied when choosing between technologies that are supposed to be in place in a medium- to long-term perspective depends on the expected, future conditions. Reducing dependence on external inputs, substituting human labour inputs for material and energy inputs, and integrating technologies by recycling locally available resources appear to be a good strategy if the future is perceived to be less connected and materially poorer.

I have provided four scenarios with respective calculation parameters. These may be utilised in Emergy Assessments as they are, or adjusted according to context.

#### 4.1.4 Technology options for food and bioenergy in a Ghanaian village

The emergy assessment of food and energy production in a remote village suggests integrated food and bioenergy production as an attractive replacement of current practice in terms of resource use, renewability and dependence on local inputs. The integrated technologies that were investigated address issues of dependence on non-renewable resources, deforestation and soil erosion.

Much uncertainty is associated with the model assumptions. It is not possible to conclude whether small-scale biogas production or agroforestry actually constitute workable substitutes, until some kind of real-scale demonstration is carried out. A problem with demonstrating the benefits of low-tech solutions may be that they cannot compete with an existing system that is based on easily available, subsidised synthetic fertiliser, soil degradation and wood fuel imported from a region that is characterised by deforestation. I believe that these types of inputs are currently incorrectly valued, because we appreciate them as if they were continuously available.

In the developed scenario analysis, inputs were re-evaluated according to expectations of future availability. It was shown that radical energy descent scenario conditions tend to emphasise the benefits of low-tech, integrated technologies. The Green tech, energy stabilisation scenario conditions tend to favour the present practice technology relative to the other technologies, compared to reference conditions. The analysis results point to integrated approaches as being competitive with present practice under current and Green tech conditions and superior in conditions associated with radical energy descent scenarios.

#### 4.1.5 Technology options for fruit and cocoa production

The utilisation of fruit residues for biogas production, with cocoa shells as a co-substrate, and return of compost material to farmers was found to significantly reduce material inputs in the production of processed fruit. In absolute terms, the resource use accounted in energy, energy use and pollution were reduced. This reduction can either be attributed entirely to fruit production, it can be divided between fruit and cocoa production, it can be carried entirely by both fruit and cocoa production, or it can be shared by fruit and cocoa production.

Focussing on the results of a multiple-product assessment where we regard environmental impacts as being shared by outputs, the biogas-based production technology performs well according to all indicators in comparison with present practice.

The return of compost material to primarily local pineapple farmers strongly affects the feasibility of the integrated technology with respect to energy use and GWP. This calls for increased attention to the nutrient and carbon recycling part of the suggested technology, an aspect that was originally considered to be a side-effect of lesser importance.

The production of cocoa provides an interesting case for the comparison of assessment methods. This is because cocoa production relies primarily on inputs of sun, rain and labour, inputs that are unaccounted for in energy balance and GWP indicators, but which are evaluated as having high importance in EmA. We see the effect of this in the multiple-product ESA where energy indicators are insignificantly affected by a change in technology, while other indicators are significantly affected.

#### 4.1.6 Practical implications

I regard my treatment of methodological concerns as providing a basis for future assessments of integrated systems, including residue-based bioenergy production. I recommend

embracing multiple-product assessment, applying a transparent and consistent approach to labour accounting, and considering alternative modelling scenarios in studies of food and energy production. The approaches to labour accounting and explorative scenario analysis are applicable also for other types of systems, and they may serve as inspiration in the development of other ESA methods.

I hope that the case study assessments sufficiently justify demonstration of micro- and village-scale biogas, agroforestry and biogas/compost production under Ghanaian conditions. Practice and experience with low-tech, integrated food and bioenergy production is an important part of the transition away from our current dependence on fossil-based resources.

## 4.2 FURTHER SCIENTIFIC WORK REGARDING ESA METHODOLOGY

My work with ESA presented in this thesis has brought attention to additional, seemingly inadequate methodological practices. We should consider ESA, including EmA, as a young science with much still to be understood and many practices to be refined. I see this process involving the following:

### 4.2.1 Highly complex, multi-functional systems

- Application of multiple-product EmA in the study of a highly complex, multi-functional production system, e.g. a diversified farm or a forest garden. This would test the hypothesis suggested in the assessments in this thesis: That integrated production systems are superior. The definition of relevant functions could go beyond the typical, simple, consumption-related focus on physical products and include e.g. maintenance and support of 'local storages' such as biological diversity, knowledge and adaptability. This requires a systems perspective, where processes are seen as parts of a whole rather than entities that can be isolated from their surroundings.

### 4.2.2 Emergy method

- The elaboration of a set of guidelines for EmA similar to the ILCD handbook in LCA (EC, 2010). The emergy method is based on a few key publications, most notably Odum (1996) but many developments and data material are scattered throughout published (and unpublished!) material from the last few decades. A document that focuses on procedure for EmA while leaving the scientific background of emergy thinking out is a helpful step toward consolidation of EmA as an Environmental Sustainability Assessment tool. A similar prerequisite for consistent emergy modelling regards the collection in databases of UEVs, renewability fractions, labour fractions

etc. The Biennial Energy Conference appears to be a suitable platform for coordination of such work.

#### 4.2.3 Human labour accounting

- Emphasis on the uncertainty about human labour accounting. Labour UEVs remain crude approximations. If we want to be serious about the accounting of resource use supporting labour, more work needs to be put into this part of the methodology. The indirect labour concept provides an interesting venue for embodied labour analysis.
- Agreement on a standard method for labour accounting with EmA is one way to go. The investigation of sensitivity of selected study results to the chosen labour accounting approach (salary-based, income class-based, skill-based, metabolism-based) could provide some of the basis for such an agreement. Sensitivity to inclusion/exclusion of labour could be a part of such a study.
- Detailed analysis to establish labour UEVs for selected commodities, based on knowledge of the labour chain. The study could investigate the distribution of labour inputs across countries and help suggest a UEV for the labour part of a category of globally traded commodities.
- Pursuance of a matrix algebra technique approach (input/output models) to better understand the origins and destinations of labour inputs and their resource basis. This would also cast light on the issue of double counting discussed in Kamp et al. (2016b).

#### 4.2.4 Explorative scenarios

- Identification of a set of standard scenarios with respective parameter values to be used in explorative scenario

modelling in ESA. Scenario development will remain normative, but there is opportunity for increased transparency. The parameter values provided in this thesis are subjective, and the basis for parameter value choice is extensive, requiring a document of its own. A suggestion is to apply a panel procedure to ensure broader acceptance. Such an approach has been used with similar objective before, e.g. to establish weighting factors in the ECO indicator 99 method (Goedkoop and Spriensma, 2000).



### 4.3 PERSONAL REFLECTIONS ON STUDY AREA

Who would have thought that working with accounting principles would lead to philosophical ponderings? My path to identifying principles for burden sharing led to the border between reality and our constructed understanding of it. I see that we run into problems in the attempt to subdivide a seamless and timeless reality. Our level of understanding of the interconnectedness of the natural system, with us included, lead us to think that the sum is dividable into single constituents. We expect that our understanding that certain sets of molecules are inputs, others are outputs, that some are 'waste' or 'by-products' is compatible with the true workings of things.

When we apply certain sets of accounting principles we can only hope that they reflect nature's self-organising dynamics sufficiently. Nature self-organises according to everything at the same time – there are no system boundaries in reality, no waste, no by-products. So when we use GWP, energy use, emergy or any other single method to describe ecosystem functioning, we should be humbly aware that we are only considering one among an endless amount of variables in nature's matrix.

I anticipate that we will prioritise wrongly if we focus on our ability to produce products to describe our behaviour. We should decompose as little as possible, because every time we try to isolate one component from a larger system, we are likely to lose most of the information that is necessary for understanding the larger system. We have much more to learn from combining systems than we have from taking them apart in our eagerness to compare single products.

## 5. BIBLIOGRAPHY

- Abel, T., 2011. Culture in information cycles: An emergy evaluation of conversation, in: Brown, M.T., Sweeney, S., Campbell, D.E., Huang, S., Ortega, E., Rydberg, T., Tilley, D., Ulgiati, S. (Eds.), *Emergy Synthesis 6: Theory and Applications of the Emergy Methodology: Proceedings from the 6th Biennial Emergy Conference*. Center for Environmental Policy, University of Florida, Gainesville, USA, pp. 9–26.
- Abel, T., 2010. Human transformities in a global hierarchy: Emergy and scale in the production of people and culture. *Ecol. Modell.* 221, 2112–2117. doi:10.1016/j.ecolmodel.2010.05.014
- Agyeman, K.O., Amponsah, O., Braimah, I., Lurumuah, S., 2012. Commercial charcoal production and sustainable community development of the Upper West Region, Ghana. *J. Sustain. Dev.* 5, 149–164. doi:10.5539/jsd.v5n4p149
- Akinnifesi, F.K., Ajayi, O.C., Sileshi, G., Chirwa, P.W., Chianu, J., 2010. Fertiliser trees for sustainable food security in the maize-based production systems of East and Southern Africa . A review. *Agron. Sustain. Dev.* 30, 615–629. doi:10.1051/agro/2009058
- Altieri, M.A., Nicholls, C.I., 2012. Agroecology scaling up for food sovereignty and resiliency. *Sustain. Agric. Rev.* 11, 1–29. doi:10.1007/978-94-007-5449-2
- Amigun, B., Parawira, W., Musango, J.K., 2012. Anaerobic biogas generation for rural area energy provision in Africa, in: Kumar, S. (Ed.), *Biogas*. pp. 35–62. doi:10.5772/32630
- Arbault, D., Rugani, B., Marvuglia, A., Tiruta-Barna, L., Benetto, E., 2013. Accounting for the emergy value of life cycle inventory systems: insights from recent methodological advances. *J. Environ. Account. Manag.* 1, 103–117. doi:10.5890/JEAM.2013.05.001
- Arthur, R., Baidoo, M.F., Antwi, E., 2011. Biogas as a potential renewable energy source: A Ghanaian case study. *Renew. Energy* 36, 1510–1516. doi:10.1016/j.renene.2010.11.012
- Bastianoni, S., Marchettini, N., 2000. The problem of co-production in environmental accounting by emergy analysis. *Ecol. Modell.* 129, 187–193. doi:10.1016/S0304-3800(00)00232-5
- Bergquist, D.A., Ingwersen, W., Liebenow, D.K., 2011. Emergy in labor - Approaches for evaluating knowledge, in: Brown, M.T., Sweeney, S., Campbell, D.E.,

- Huang, S., Ortega, E., Rydberg, T., Tilley, D., Ulgiati, S. (Eds.), *Emergy Synthesis 6: Theory and Applications of the Emergy Methodology: Proceedings from the 6th Biennial Emergy Conference*. Center for Environmental Policy, University of Florida, Gainesville, USA, pp. 501–508.
- Bond, T., Templeton, M.R., 2011. History and future of domestic biogas plants in the developing world. *Energy Sustain. Dev.* 15, 347–354. doi:10.1016/j.esd.2011.09.003
- Botchie, G., Seini, W., Asuming-Brempong, S., 2003. FAO Roles of Agriculture (ROA) project. Socio-economic analysis and the roles of agriculture in developing countries. Country case study Ghana.
- Brown, M., Herendeen, R., 1996. Embodied energy analysis and EMERGY analysis: a comparative view. *Ecol. Econ.* 19, 219–235. doi:10.1016/S0921-8009(96)00046-8
- Brown, M.T., 2015. Introduction, in: Brown, M.T., Sweeney, S., Campbell, D.E., Huang, S., Rydberg, T., Ulgiati, S. (Eds.), *Emergy Synthesis 8, Theory and Applications of the Emergy Methodology*. The Center for Environmental Policy, Department of Environmental Engineering Sciences, University of Florida, Gainesville, Florida, Gainesville, Florida.
- Brown, M.T., Ulgiati, S., 2011. Understanding the global economic crisis: A biophysical perspective. *Ecol. Modell.* 223, 4–13. doi:10.1016/j.ecolmodel.2011.05.019
- Börjeson, L., Höjer, M., Dreborg, K.-H., Ekvall, T., Finnveden, G., 2006. Scenario types and techniques: Towards a user's guide. *Futures* 38, 723–739. doi:10.1016/j.futures.2005.12.002
- Campbell, D.E., 2013. Keeping the books for the environment and society: The unification of emergy and financial accounting methods. *J. Environ. Account. Manag.* 1, 25 – 41. doi:10.5890/JEAM.2013.01.003
- Cao, K., Feng, X., 2007. The Emergy Analysis of multi-product systems. *Process Saf. Environ. Prot.* 85, 494–500. doi:10.1205/psepo7007
- Carpenter, S.R., Bennett, E.M., Peterson, G.D., 2006. Scenarios for ecosystem services: an overview 11, 29. doi:29\Artn 29
- Cavalett, O., Queiroz, J.F. De, Ortega, E., 2006. Emergy assessment of integrated production systems of grains, pig and fish in small farms in the South Brazil. *Ecol. Modell.* 193, 205–224. doi:10.1016/j.ecolmodel.2005.07.023

- Cherubini, F., Strømman, A.H., Ulgiati, S., 2011. Influence of allocation methods on the environmental performance of biorefinery products—A case study. *Resour. Conserv. Recycl.* 55, 1070–1077. doi:10.1016/j.resconrec.2011.06.001
- Cleveland, C.J., 2013. Net energy analysis [WWW Document]. *Encycl. Earth*. URL <http://www.eoearth.org/view/article/154821> (accessed 3.15.16).
- Cleveland, C.J., Costanza, R., Hall, C.A.S., Kaufmann, R., 1984. Energy and the U.S. Economy: A Biophysical Perspective 225, 890–897.
- Cobo, J.G., Dercon, G., Cadisch, G., 2010. Nutrient balances in African land use systems across different spatial scales: A review of approaches, challenges and progress. *Agric. Ecosyst. Environ.* 136, 1–15. doi:10.1016/j.agee.2009.11.006
- Cork, S., Peterson, G., Petschel-Held, G., Al., E., 2000. Chapter 8: Four Scenarios, Millenium Ecosystem Assessment. *Ecosystems & Human Wellbeing*. doi:10.1136/jme.29.5.267
- Daniel, U., Schneider, J., 2013. Feasibility and profitability study. Assessing the feasibility and financial viability of establishing a waste-to-energy biomass facility at (undisclosed) in Ghana. Halle, Germany.
- EC, 2010. European Commission - Joint Research Centre - Institute for Environment and Sustainability. International Reference Life Cycle Data System (ILCD) Handbook - General guide for Life Cycle Assessment - Detailed guidance, Constraints. Publications Office of the European Union, Luxembourg. doi:10.2788/38479
- Ehrlich, P.R., Ehrlich, A.H., 2013. Can a collapse of global civilization be avoided? *Proc Biol Sci* 280, 20122845. doi:10.1098/rspb.2012.2845
- Fluck, R.C., 1992. Energy of human labor, in: Fluck, R.C. (Ed.), *Energy in Farm Production*. Elsevier, Amsterdam, pp. 31–37.
- Fukuda, K., 2003. Production of exergy from labour and energy resources. *Appl. Energy* 76, 435–448. doi:10.1016/S0306-2619(02)00175-7
- Goedkoop, M., Spriensma, R., 2000. *The Eco-indicator 99: A damage oriented method for Life Cycle Impact Assessment Methodology*. The Hague, The Netherlands.
- Hall, C.A.S., Balogh, S., Murphy, D.J.R., 2009. What is the minimum EROI that a sustainable society must have? *Energies* 2, 25–47. doi:10.3390/en20100025
- Heijungs, R., Guinée, J.B., 2007. Allocation and “what-if” scenarios in life cycle

- assessment of waste management systems. *Waste Manag.* 27, 997–1005. doi:10.1016/j.wasman.2007.02.013
- Heijungs, R., Huijbregts, M.A.J., 2004. A review of approaches to treat uncertainty in LCA. *iEMSs 2004 Int. Congr.* 8. doi:http://www.iemss.org/iemss2004/pdf/lca/heijarev.pdf
- Heinberg, R., 2004. *Powerdown - Options and Actions for a Post-Carbon World.* New Society Publishers, Gabriola Island.
- Herendeen, R.A., 2004. Energy analysis and EMERGY analysis - A comparison. *Ecol. Modell.* 178, 227–237. doi:10.1016/j.ecolmodel.2003.12.017
- Hirsch, R.L., 2008. Mitigation of maximum world oil production: Shortage scenarios. *Energy Policy* 36, 881–889. doi:10.1016/j.enpol.2007.11.009
- Hischier, R., Weidema, B., Althaus, H.-J., Bauer, C., Doka, G., Dones, R., Frischknecht, R., Hellweg, S., Humbert, S., Jungbluth, N., Köllner, T., Loerincik, Y., Margni, M., Nemecek, T., 2010. *Implementation of Life Cycle Impact Assessment Methods.*ecoinvent report No.3, v2.2. Dübendorf.
- Holmgren, D., 2009. *Future Scenarios: How Communities Can Adapt to Peak Oil and Climate Change.* Chelsea Green Publishing, Vermont.
- Hopkins, R., 2006. *Energy Descent Pathways: evaluating potential responses to Peak Oil.* University of Plymouth.
- Hubbert, M.K., 1956. *Nuclear Energy and the Fossil Fuels, Drilling and Production Practice.* Texas.
- Hudson, A., Tilley, D.R., 2014. Assessment of uncertainty in emergy evaluations using Monte Carlo simulations. *Ecol. Modell.* 271, 52–61. doi:10.1016/j.ecolmodel.2013.05.018
- Huijbregts, M., 1998. Application of uncertainty and variability in LCA. *Int. J. Life Cycle Assess.* 3, 273–280. doi:10.1007/BF02979835
- Höjer, M., Ahlroth, S., Dreborg, K.H., Ekvall, T., Finnveden, G., Hjelm, O., Hochschorner, E., Nilsson, M., Palm, V., 2008. Scenarios in selected tools for environmental systems analysis. *J. Clean. Prod.* 16, 1958–1970. doi:10.1016/j.jclepro.2008.01.008
- Ingwersen, W.W., 2012. Life cycle assessment of fresh pineapple from Costa Rica. *J. Clean. Prod.* 35, 152–163. doi:10.1016/j.jclepro.2012.05.035

- Ingwersen, W.W., 2010. Uncertainty characterization for emergy values. *Ecol. Modell.* 221, 445–452. doi:10.1016/j.ecolmodel.2009.10.032
- International Energy Agency, 2015. Key World Energy Statistics 2015. doi:10.1787/9789264039537-en
- IPCC, 2014a. Climate Change 2014: Synthesis Report. Contribution of Working Groups I, II and III to the Fifth Assessment Report of the Intergovernmental Panel on Climate Change.
- IPCC, 2014b. Climate Change 2014: Impacts, Adaptation and Vulnerability. Summary for policy makers, Climate Change 2014: Impacts, Adaptation and Vulnerability - Contributions of the Working Group II to the Fifth Assessment Report. doi:10.1016/j.renene.2009.11.012
- ISO, 2006a. ISO 14040: Environmental management — Life cycle assessment — Principles and framework. The International Organization for Standardization (ISO), Geneva, Switzerland.
- ISO, 2006b. ISO 14044: Environmental management - life cycle assessment - requirements and guidelines. The International Organization for Standardization (ISO). Geneva, Switzerland.
- IAASTD, 2009. Agriculture at a crossroads. Synthesis Report. Agricultural Knowledge, Science and Technology for Development.
- Kamp, A., Bolwig, S., Østergård, H., 2016a. Environmental assessment of food and cooking fuel production. Case study from Ghana. Submitt. to *Sustain.*
- Kamp, A., Morandi, F., Østergård, H., 2016b. Development of concepts for human labour accounting in Emergy Assessment and other Environmental Sustainability Assessment methods. *Ecol. Indic.* 60, 884–892. doi:10.1016/j.ecolind.2015.08.011
- Kamp, A., Østergård, H., 2016a. Explorative scenario analysis and resilience indicators in Emergy Assessment. Submitt. to *Biophys. Econ. Resour. Qual.*
- Kamp, A., Østergård, H., 2016b. Environmental assessment of fruit cultivation and processing using fruit and cocoa residues for bioenergy and compost. Case study from Ghana. Submitt. to *J. Clean. Prod.*
- Kamp, A., Østergård, H., 2016c. Future scenario modelling and resilience indicators. A case study of small-scale food and energy production in a village in Ghana, in: Brown, M.T., Sweeney, S., Campbell, D.E., Huang, S., Ortega, E., Rydberg, T., Tilley, D., Ulgiati, S. (Eds.), Submitted to *Emergy Synthesis 9*:

Theory and Applications of the Emergy Methodology. Proceedings of the 9th Biennial Emergy Conference, 2016. Center for Environmental Policy, University of Florida, Gainesville, USA. In press.

- Kamp, A., Østergård, H., 2015. Food and biogas production in a Ghanaian village – Results and new perspectives on labor UEVs, in: Brown, M.T., Sweeney, S., Campbell, D.E., Huang, S., Ortega, E., Rydberg, T., Tilley, D., Ulgiati, S. (Eds.), *Emergy Synthesis 8: Theory and Applications of the Emergy Methodology: Proceedings of the 8th Biennial Emergy Conference*. Center for Environmental Policy, University of Florida, Gainesville, USA, pp. 503–5011.
- Kamp, A., Østergård, H., 2013. How to manage co-product inputs in emergy accounting exemplified by willow production for bioenergy. *Ecol. Modell.* 253, 70–78. doi:10.1016/j.ecolmodel.2012.12.027
- Kamp, A., Østergård, H., Gylling, M., 2011. Sustainability assessment of growing and using willow for CHP production. *Proc. 19th Eur. Biomass Conf. Exhib.* Berlin 2645–2656.
- Kemausuor, F., Kamp, A., Thomsen, S.T., Bensch, E.C., Østergård, H., 2014. Assessment of biomass residue availability and bioenergy yields in Ghana. *Resour. Conserv. Recycl.* 86, 28–37. doi:10.1016/j.resconrec.2014.01.007
- Lambert, J., Hall, C., Balogh, S., Poisson, A., Gupta, A., 2012. *EROI of Global Energy Resources. Preliminary Status and Trends*. College of Environmental Science and Forestry. New York.
- Lambert, J.G., Hall, C.A.S., Balogh, S., Gupta, A., Arnold, M., 2014. Energy, EROI and quality of life. *Energy Policy* 64, 153–167. doi:10.1016/j.enpol.2013.07.001
- Lambert, J.G., Lambert, G.P., 2011. Predicting the psychological response of the American people to oil depletion and declining energy return on investment (EROI). *Sustainability* 3, 2129–2156. doi:10.3390/su3112129
- Lefroy, E., Rydberg, T., 2003. Emergy evaluation of three cropping systems in southwestern Australia. *Ecol. Modell.* 161, 195–211. doi:10.1016/S0304-3800(02)00341-1
- Markussen, M. V., Østergård, H., 2013. Energy analysis of the Danish food production system: Food-EROI and fossil fuel dependency. *Energies* 6, 4170–4186. doi:10.3390/en6084170
- Markussen, M., Kulak, M., Smith, L., Nemecek, T., Østergård, H., 2014. Evaluating the sustainability of a small-scale low-input organic vegetable supply system in the United Kingdom. *Sustainability* 6, 1913–1945. doi:10.3390/su6041913

- Markussen, M.V., 2013. Sustainability Assessment of Food and Bioenergy Systems in a Societal Context – In a Time of Crisis. PhD thesis. Technical University of Denmark, DTU.
- McPherson, G.R., Weltzin, J.F., 2008. Implications of peak oil for industrialized societies. *Bull. Sci. Technol. Soc.* 28, 187–191. doi:10.1177/0270467608316098
- Meadows, D.H., Meadows, D.L., Randers, J., Behrens, W.W., 1972. *The Limits to Growth*. Chelsea. doi:10.1111/j.1752-1688.1972.tb05230.x
- Millennium Ecosystem Assessment, 2005. *Ecosystems and Human Well-being: Synthesis*. Washington. doi:10.1196/annals.1439.003
- Mohr, S.H., Wang, J., Ellem, G., Ward, J., Giurco, D., 2015. Projection of world fossil fuels by country. *Fuel* 141, 120–135. doi:10.1016/j.fuel.2014.10.030
- Moldan, B., Janouskova, S., Hak, T., 2012. How to understand and measure environmental sustainability: Indicators and targets. *Ecol. Indic.* 17, 4–13. doi:10.1016/j.ecolind.2011.04.033
- Murphy, D.J., Hall, C.A.S., 2011. Energy return on investment, peak oil, and the end of economic growth. *Ann. N. Y. Acad. Sci.* 1219, 52–72. doi:10.1111/j.1749-6632.2010.05940.x
- Murphy, D.J., Hall, C.A.S., Dale, M., Cleveland, C., 2011. Order from chaos: A preliminary protocol for determining the EROI of fuels. *Sustainability* 3, 1888–1907. doi:10.3390/su3101888
- Neff, R.A., Parker, C.L., Kirshenmann, F.L., Tinch, J., Lawrence, R.S., 2011. Peak oil, food systems and public health. *Am. J. Public Health* 101, 1587–1597. doi:10.2105/AJPH.2011.300123
- Nguyen, T.L.T., Gheewala, S.H., Garivait, S., 2007. Energy balance and GHG-abatement cost of cassava utilization for fuel ethanol in Thailand. *Energy Policy* 35, 4585–4596. doi:10.1016/j.enpol.2007.03.012
- NoorMmemon, I., Noonari, S., Muhammad, Y.S., U.A., M., Riaz, H.J., Aamir, A.M., Akbar, K.K., Sajid, A.S., Rizwan, J., Abdul, H.J., 2015. Economics analysis of mango orchard production under contract farming in Taluka Tando Adam District Sanghar Sindh, Pakistan. *J. Biol. Agric. Healthc.* 5, 24–36.
- Odum, H.T., 1996. *Environmental Accounting. Emergy and Environmental Decision Making*. Wiley and Sons, New York.
- Odum, H.T., 1983. *Systems Ecology: An Introduction*, First. ed. Wiley and Sons.



- Odum, H.T., Odum, E.C., 2006. The prosperous way down. *Energy* 31, 21–32. doi:10.1016/j.energy.2004.05.012
- Odum, H.T., Odum, E.C., 1981. *Energy Basis for Man and Nature*, Second. ed. McGraw-Hill Companies.
- Opoku-Ameyaw, K., Baah, F., Gyedu-Akoto, E., Anchirinah, V., Dzahini-Obiatey, H.K., Cudjoe, A.R., Aquaye, S., Opoku, S.Y., 2010. *Cocoa Manual*. Cocoa Research Institute of Ghana. Accra.
- Owusu, V., Fosu, K.Y., Burger, K., 2012. Intersectoral labor mobility and deforestation in Ghana. *Environ. Dev. Econ.* 17, 741–762. doi:10.1017/S1355770X12000253
- Pelletier, N., Ardente, F., Brandão, M., De Camillis, C., Pennington, D., 2015. Rationales for and limitations of preferred solutions for multi-functionality problems in LCA: is increased consistency possible? *Int. J. Life Cycle Assess.* 20, 74–86. doi:10.1007/s11367-014-0812-4
- Pittelkow, C.M., Liang, X., Linnquist, B. a., van Groenigen, K.J., Lee, J., Lundy, M.E., van Gestel, N., Six, J., Venterea, R.T., van Kessel, C., 2014. Productivity limits and potentials of the principles of conservation agriculture. *Nature* 517, 365–367. doi:10.1038/nature13809
- Raugei, M., Bargigli, S., Ulgiati, S., 2005. A multi-criteria life cycle assessment of molten carbonate fuel cells (MCFC) - A comparison to natural gas turbines. *Int. J. Hydrogen Energy* 30, 123–130. doi:10.1016/j.ijhydene.2004.04.009
- Raugei, M., Rugani, B., Benetto, E., Ingwersen, W.W., 2014. Integrating emergy into LCA: Potential added value and lingering obstacles. *Ecol. Modell.* 271, 4–9. doi:10.1016/j.ecolmodel.2012.11.025
- Ray, D.K., Ramankutty, N., Mueller, N.D., West, P.C., Foley, J. a, 2012. Recent patterns of crop yield growth and stagnation. *Nat. Commun.* 3, 1293. doi:10.1038/ncomms2296
- Rugani, B., Benetto, E., 2012. Improvements to emergy evaluations by using life cycle assessment. *Environ. Sci. Technol.* 46, 4701–4712. doi:10.1021/es203440n
- Rugani, B., Panasiuk, D., Benetto, E., 2012. An input-output based framework to evaluate human labour in life cycle assessment. *Int. J. Life Cycle Assess.* 17, 795–812. doi:10.1007/s11367-012-0403-1
- Schubert, R., Schellnhuber, H.J., Buchmann, N., Epiney, A., Griefshammer, R., Kulesa, M.E., Messner, D., Rahmstorf, S., Schmid, J., 2007. *Climate Change*

as a Security Risk, German Advisory Council on Global Change (WBGU). Earthscan, London.

- Scienceman, D.M., 1987. Energy and emergy, in: Pillet, G., Murota, T. (Eds.), *Environmental Economics - The Analysis of a Major Interface*. Roland Leimgruber, Geneva, Switzerland, p. 307.
- Sciubba, E., 2003. Cost analysis of energy conversion systems via a novel resource-based quantifier. *Energy* 28, 457–477. doi:10.1016/S0360-5442(02)00096-8
- Sciubba, E., 2001. Beyond thermoeconomics? The concept of Extended Exergy Accounting and its application to the analysis and design of thermal systems. *Exergy, An Int. J.* 1, 68–84. doi:10.1016/S1164-0235(01)00012-7
- Silalertruksa, T., Gheewala, S.H., 2009. Environmental sustainability assessment of bio-ethanol production in Thailand. *Energy* 34, 1933–1946. doi:10.1016/j.energy.2009.08.002
- Smil, V., 1999. Crop Residues : Agriculture ' s Largest Harvest. *Bioscience* 49, 299–308.
- Turner, G.M., 2008. A comparison of The Limits to Growth with 30 years of reality. *Glob. Environ. Chang.* 18, 397–411.
- Tverberg, G.E., 2012. Oil supply limits and the continuing financial crisis. *Energy* 37, 27–34. doi:10.1016/j.energy.2011.05.049
- Ulgianti, S., Ascione, M., Bargigli, S., Cherubini, F., Franzese, P.P., Raugei, M., Viglia, S., Zucaro, A., 2011. Material, energy and environmental performance of technological and social systems under a Life Cycle Assessment perspective. *Ecol. Modell.* 222, 176–189. doi:10.1016/j.ecolmodel.2010.09.005
- Ulgianti, S., Brown, M.T., 2014. Labor and Services as Information Carriers in Emergy-LCA Accounting. *J. Environ. Account. Manag.* 2, 163–170. doi:10.5890/JEAM.2014.06.006
- Ulgianti, S., Raugei, M., Bargigli, S., 2006. Overcoming the inadequacy of single-criterion approaches to Life Cycle Assessment. *Ecol. Modell.* 190, 432–442. doi:10.1016/j.ecolmodel.2005.03.022
- Wright, C., Østergård, H., 2015. Scales of renewability exemplified by a case study of three Danish pig production systems. *Ecol. Modell.* 315, 28–36. doi:10.1016/j.ecolmodel.2015.04.018
- Zamagni, A., Buttol, P., Porta, P.L., Buonamici, R., Masoni, P., Guinée, J., Heijungs,

R., Ekvall, T., Bersani, R., Biénkowska, A., Pretato, U., 2008. Critical review of the current research needs and limitations related to ISO-LCA practice - Deliverable D7 of work package 5 of the CALCAS project.

Zhou, S.Y., Zhang, B., Cai, Z.F., 2010. Emergy analysis of a farm biogas project in China: A biophysical perspective of agricultural ecological engineering. *Commun. Nonlinear Sci. Numer. Simul.* 15, 1408–1418. doi:10.1016/j.cnsns.2009.06.001

Østergård, H., Finckh, M.R., Fontaine, L., Goldringer, I., Hoad, S.P., Kristensen, K., Lammerts van Bueren, E.T., Mascher, F., Munk, L., Wolfe, M.S., 2009. Time for a shift in crop production: Embracing complexity through diversity at all levels. *J. Sci. Food Agric.* 89, 1439–1445. doi:10.1002/jsfa.3615

## APPENDIX

Scientific papers that are published in, accepted for publication in or submitted to journals and conference proceedings and included in the thesis:

- Paper I: **Kamp**, A., Østergård, H. (2013). How to manage co-product inputs in emergy accounting exemplified by willow production for bioenergy. *Ecological Modelling*, 253, 70–78.
- Paper II: **Kamp**, A., Østergård, H., Bolwig, S. (2016a). Environmental assessment of integrated food and cooking fuel production for a village in Ghana. Submitted to *Sustainability*.
- Paper III: **Kamp**, A., Morandi, F., Østergård, H. (2016b). Development of concepts for human labour accounting in Emergy Assessment and other Environmental Sustainability Assessment methods. *Ecological Indicators*, 60, 884–892.
- Paper IV: **Kamp** A., Østergård H. (2016a). Future scenario modelling and resilience indicators. A case study of small-scale food and energy production in a village in Ghana. In press for Emergy Conference 2016 proceedings, *Emergy Synthesis 9: Theory and Applications of the Emergy Methodology*. University of Florida, Gainesville, USA.
- Paper V: **Kamp** A., Østergård H. (2016b). Environmental assessment of fruit cultivation and processing using fruit and cocoa residues for bioenergy and compost. Case study from Ghana. Submitted to *Journal of Cleaner Production*.
- Paper VI: **Kamp** A., Østergård H. (2016c). Explorative scenario analysis and resilience indicators in Emergy Assessment. Submitted to *Biophysical Economics and Resource Quality*.

## PAPER I

**In-text citation:**

(Kamp and Østergård, 2013)

**Authors:**

Andreas Kamp and Hanne Østergård

**Title:**

How to manage co-product inputs in emergy accounting exemplified by willow production for bioenergy

**Submission and publication details:**

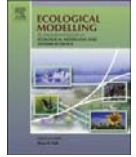
Submitted to Ecological Modelling 6<sup>th</sup> of July 2012

Re-submitted after minor adjustment 19<sup>th</sup> of December 2012

Published in Volume 253 in March 2013

**Note:**

Three minor mistakes were discovered in the published version. The appended paper is a corrected version with specific notice of the corrections in Table 1, Table 3 and Figure 2.



# How to manage co-product inputs in emergy accounting exemplified by willow production for bioenergy

Andreas Kamp\*, Hanne Østergård

Department of Chemical and Biochemical Engineering, Technical University of Denmark, DTU, 2800 Kgs. Lyngby, Denmark

## ARTICLE INFO

### Article history:

Received 6 July 2012

Received in revised form

19 December 2012

Accepted 20 December 2012

### Keywords:

Emergy

Co-production

Multifunctionality

Bio-based combined heat and power

Environmental impact assessment

## ABSTRACT

Assessments of environmental performance are challenged by multifunctionality of production systems where impacts cannot be assigned to any one specific output. In the assessment method emergy accounting, all available energy used up for a process is summed up after being converted to solar equivalent Joules. In emergy accounting each output carries the resource use burden of all co-produced outputs. When comparing emergy indicators on a product-to-product basis (reference approach), products from single-output processes tend to be favoured. This constitutes a method bias. Building on emergy algebra rules, we describe approaches to calculate solar transformities when co-production is involved and give guidelines on how to compare products and systems. The approaches are exemplified in a comparison between willow biomass, fertilised with manure, and natural gas used as feedstock for combined heat and power (CHP) production. A Danish willow-based CHP model system was assessed whereas data for the fossil-based system was from literature. When compared on a product-to-product basis using the reference approach, bio-based CHP production is inferior to fossil-based CHP with respect to resource use (transformities of  $2.31 \text{ E}+05 \text{ seJ/J}$  and  $0.88 \text{ E}+05 \text{ seJ/J}$ , respectively). If the manure is considered as a waste and modelled as heat loss, the single-product transformity for bio-based production is only  $0.37 \text{ E}+05 \text{ seJ/J}$ . When compared on a system-to-system basis, bio-based production is competitive with fossil-based production (transformities of  $2.21 \text{ E}+05 \text{ seJ/J}$  and  $2.29 \text{ E}+05 \text{ seJ/J}$ , respectively). The paper evaluates compatibility of suggested approaches with emergy theory and practices and presents a discussion of the distinction between waste and resource.

© 2013 Elsevier B.V. All rights reserved.

## 1. Introduction

### 1.1. Co-production and assessment of environmental performance

Assessments of environmental performance are used to evaluate resource use and pollution resulting from production and provision of goods and services. Increasingly, these assessments are being used for making decisions on the political level, but also by citizens in their consumption choices. The assessments are used specifically to compare similar products and processes with the aim of ranking these according to a selection of impact categories. The desire to associate each individual good or service with up- or downstream environmental impact indicators is a result of increased concern for the use of diminishing natural resources.

In the comparison of specific products, a methodological problem emerges when a single process yields two or more outputs, i.e. in co-production. Co-production and the resulting

multifunctionality is often seen in biological processes, e.g. in agriculture when milk and beef are outputs from livestock production or grain and straw are outputs from plant production. Since the resources used in production and their related emissions are not directly tied to a specific output in any transparent manner, the allocation of resource use and downstream environmental impacts between outputs of co-production processes is challenging. An example of this is in assessing environmental impacts of biomass for bioenergy production, e.g. wheat straw for heating. Inputs in wheat farming are used to produce grain and straw together, but if only the straw is used for bioenergy, no correct way of dividing inputs is apparent. Often, agricultural co-products are considered residues (waste) which result in simplifying assessments, since residues are commonly understood to be free in terms of environmental impacts.

### 1.2. Emergy accounting and co-production

Emergy accounting is an example of an environmental assessment method. Emergy accounting is a thermodynamics-based approach that focuses on upstream energy use. Emergy is defined as 'the available solar energy used up directly or indirectly to make a

\* Corresponding author. Tel.: +45 2133 0517.

E-mail address: [ankam@kt.dtu.dk](mailto:ankam@kt.dtu.dk) (A. Kamp).

service or product' (Odum, 1996). The emergy support of a product accounts for accumulated energy (exergy), converted to a common energy unit based on solar equivalent Joules (sej). Central to the method is the calculation of the (solar) transformity of a product, a ratio that indicates the efficiency of resource use in upstream energy transformations (transformity = emergy support to product/available energy in product).

In emergy accounting the challenge of attributing energy use to products is further complicated by the practice of assigning the full energy flow to each co-produced output (Brown and Herendeen, 1996; Odum, 1996). Thereby, each output accounts for all inputs to a co-production process reflecting the actual energy used to make the particular output irrespective of the fact that it shares that energy use with one or more other products. When products are compared on a single-product basis using single-product transformities, a bias against co-production may occur since co-production often relies on more emergy support than single-product processes. Bastianoni and Marchettini (2000) suggested to group outputs and calculate joint transformities and other joint indices for co-production systems.

The proposal of Bastianoni and Marchettini (2000), however, focuses on the output side and does not elaborate on the further implications of how to manage an input that is an output from a co-production system. As a consequence, a product or service that relies on inputs from co-production processes may appear to compete poorly with similar products or services that do not have to account for co-products appearing upstream. This is counter to perceived benefits of integrated production systems and it may limit emergy accounting's practical application in making decisions. In this paper we discuss different solutions for this problem based on practices used in standardised LCA (Life Cycle Assessment) procedures (International Organization for Standardization, 2006). This adds to current efforts of bridging the two methods (Raugei et al., 2012; Rugani and Benetto, 2012).

### 1.3. Options for handling co-production in LCA literature

According to the ISO 14044 standard for LCA, sufficient comparability between studied systems is to be ensured by, in prioritised order, either division into independent sub-processes, system expansion, or partitioning (allocation) based on physical or other properties, e.g. the economic value of products. In this paper's context of integrated, co-production systems, division into sub-processes is irrelevant. System expansion entails adding additional functions or, as system expansion with substitution, subtracting functions to make systems comparable. System expansion with substitution is also referred to as just 'substitution' (the preferred term in this paper), (European Commission, 2010), the 'displacement method' (Wang et al., 2011), 'system reduction' or the 'avoided burden approach' (European Commission, 2010) and substitution/displacement is typically referred to as 'crediting'. Allocation is preferably based on the underlying causal physical relationship between the different outputs, e.g. mass, energy content, or nutrient content. If a clear causal physical relationship between the co-production outputs does not present itself, allocation may be based on economic relationships.

If the causal relationship can be defined, allocation based on physical, including chemical and biological, properties is most often straightforward. System expansion and substitution, on the other hand, pose some additional challenges in terms of finding suitable alternatives to considered outputs and, secondarily, obtaining life cycle data for them while balancing effort and accuracy.

The consequences of using different approaches in standardised LCA have been shown for fossil energy use and GHG emissions in U.S. biofuel production by Wang et al. (2011) and for GHG emissions from biorefinery products by Cherubini et al. (2011), among

others. No consensus has been reached on the preferred approach (see review by Cherubini and Strømman, 2011).

### 1.4. This study

This paper applies present approaches to manage co-production in standardised LCA to emergy accounting. We investigate four approaches to estimate and compare transformities in emergy assessments. We discuss how and when to apply single-product versus joint transformities. The different approaches are exemplified in a case study where two combined heat and power (CHP) production systems are compared. One system is based on willow as feedstock and with pig manure as fertiliser for willow production (Kamp et al., 2011). The use of pig manure as an input to willow production, and consequently CHP production, demonstrates the methodological issues discussed in the present paper. The other system is CHP based on natural gas in Italy (Raugei et al., 2005). Finally, we discuss the limitations of the present emergy accounting algebra, and suggest how the methodology can be improved.

## 2. Materials and methods

The problem of assessing environmental performance of a product (C) which requires an input (A) which is a co-product from another process is generic and not just relevant for emergy assessments (Fig. 1). The ideal process system to assess consists of Process II producing C as well as Process I producing A and B (Fig. 1). A number of examples are found; in relation to bioenergy, C may be an energy carrier and A may be an agricultural residue.

The environmental performance of product C may be calculated including the information about co-production in Process I and then either consider both products B and C as outputs of the system or allocate the impact of the production of A as part of A + B. Alternatively the calculation can be done omitting information about co-production in Process I. The implications of these choices for the calculation of emergy indicators are considered in the following. At first, the basic rules for emergy accounting are listed, then the consequences of these rules for calculation of performance of co-products (like from Process I in Fig. 1) are presented and finally, formulas for emergy calculations in the considered system (Fig. 1) are given.

### 2.1. Presently used emergy calculation procedures

In (Brown and Herendeen, 1996) Brown defines 4 emergy algebra rules:

Rule 1: All source emergy to a process is assigned to the process' output(s);

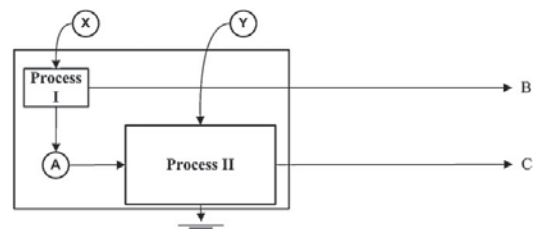
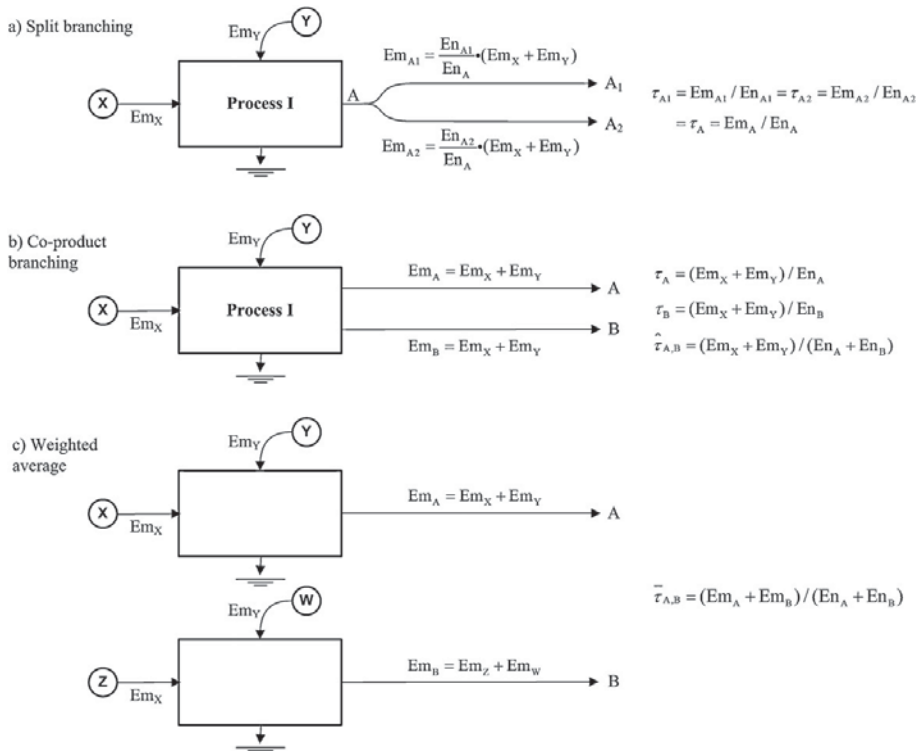


Fig. 1. System with co-production output as input. C is an output of Process II which is based on inputs A and Y. A is co-produced with output B in Process I based on input X. For simplicity, here, Process I is considered to be supported from only one source.



**Fig. 2.** Illustrative overview and formulas for calculating energy flows and transformities for split branches, co-product branches and weighted average of parallel processes. Em = energy, En = energy. NB: Post-publication note: Energy flows for inputs z and w should be  $Em_z$  and  $Em_w$ , respectively.

- Rule 2: Co-products from a process have the total energy assigned to each pathway;
- Rule 3: When a pathway splits, the energy is assigned to each 'leg' of the split based on its percent of the total energy flow of the pathway; and
- Rule 4: Energy cannot be counted twice within a system: (a) energy in feedbacks cannot be double counted; (b) co-products, when reunited, cannot be added to equal a sum greater than the source energy from which they were derived.

These rules can be used to calculate the resource use efficiency (transformity,  $\tau$ ) of any product, process or system by adding the energy support for the specific item and dividing with the available energy provided by the product, process or system. For co-products this may be applied as in Fig. 2a, b.

Split branching involves flows of the same type and each split branch has equal transformity (Fig. 2a). Co-product branching involves flows of different type that have different transformities, except for when the energy content happens to be the same for each co-product branch (Fig. 2b). The cause of this are rules 1 and 2 that in practice let each output carry the production burden of all outputs combined. As a consequence, a product being a co-product will have a tendency to have a higher transformity and consequently lower resource use efficiency than the similar product produced as a single product (whenever this is possible). Bastianoni and Marchettini (2000) identified this apparent tendency to decide against processes that supply several outputs in favour of processes with only one output. They went on to suggest the use of joint transformities ( $\hat{\tau}$ ,

following Bastianoni and Marchettini's notation) for such systems. The joint transformity of a group of outputs is the sum of energy of inputs divided by the sum of available energy of outputs (Fig. 2b). If the products of a co-production system can be provided by other, single-product processes, the joint transformity can be compared to the weighted average transformity of single product system outputs (Fig. 2c). For those systems where the joint transformity is lower than the weighted average transformity ( $\bar{\tau}$ ) of alternative single-output processes, co-production represents the most efficient energy use.

## 2.2. Energy accounting with co-product as input

Four different methods for calculating transformities are suggested.

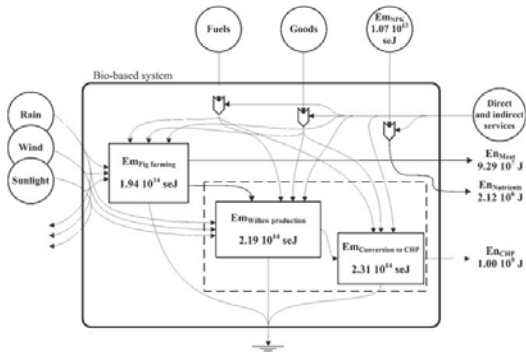
*Full system:* When information from the full system is considered (Fig. 1), the joint transformity of the products B and C,  $\tau_{B+C}$ , is

$$\hat{\tau}_{B+C} = \frac{Em_X + Em_Y}{En_B + En_C} \tag{1}$$

where  $Em_i$  is energy support of inputs  $i$  and  $En_j$  is available energy of output  $j$ . The joint transformity can be compared to the weighted average transformity  $\bar{\tau}_{B,C}$  of independent, single-product processes (cf. Fig. 2c).

When the transformity of C alone is required (the single-product transformity  $\tau_C$ ), three ways of calculation may be applied:





**Fig. 3.** Energy flows of joint pig meat and CHP production. The CHP system (in dashed frame) is expanded to include the meat output from pig farming and the added fertiliser mixture (NPK) that makes the system comparable to a fossil-based CHP and meat + nutrients producing system. Energy of pig farming, willow production, CHP production and NPK are shown, normalised to 1 GJ CHP. Emery support not related to pig farming is referred to as  $Em_{other}$ .  $Em$  = energy flow,  $En$  = available energy in output.

*Single product reference:* The emery support of input A is calculated according to the co-product branching rule implying that all energy flows for Process I are accounted for in A:

$$\tau_C = \frac{Em_A + Em_Y}{En_C} = \frac{Em_X + Em_Y}{En_C} \quad (2)$$

*Allocation:* The input A is considered as the result of a split (despite being a co-product) and the emery support of Process I is allocated to A according to a weight factor  $w$ :

$$\tau_C = \frac{w \cdot Em_X + Em_Y}{En_C} \quad (3)$$

Allocation of energy flows between co-products violates rules 1 and 2. The weight factor may be based on available energy, mass, nutrient content, monetary value of outputs, or similar. If allocation is based on available energy, in accordance with emery rule 3,

$$w = \frac{En_A}{En_A + En_B}$$

In case input A is considered a residue with no monetary value and market price is used as allocation basis then the formula will be

$$\tau_C = \frac{Em_Y}{En_C} \quad (4)$$

Applying Eq. (4) is equivalent to considering A as a heat loss.

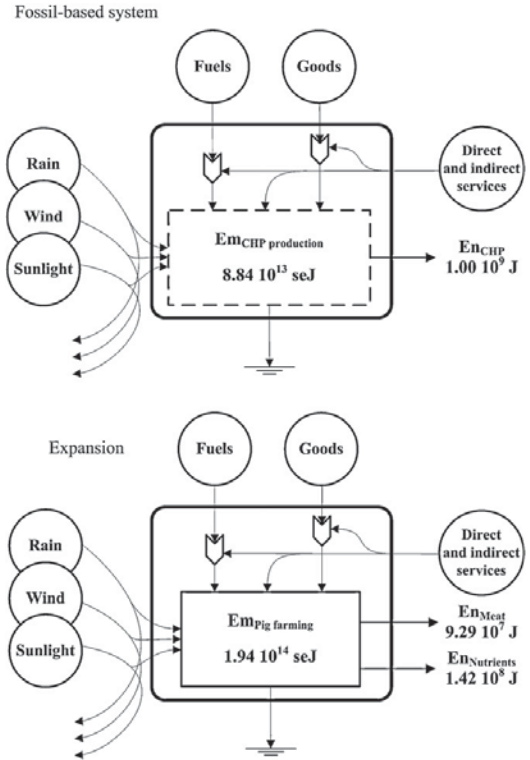
*Substitution:* The input A is considered to be substitutable with another, single product process output as input A' with similar functionality. This may be feasible if the emery support of the substitute is well-defined and can be used instead of trying to calculate the emery support for A:

$$\tau_C = \frac{Em_{A'} + Em_Y}{En_C} \quad (5)$$

The single-product transformities (Eqs. (2)–(5)) may be used for product-to-product comparisons but the joint transformities calculated in a full system approach (Eq. (1)) are only useful for system-to-system comparisons.

### 2.3. Case study materials, methods and indices

Two CHP production systems (Figs. 3 and 4) are compared to exemplify the challenges of (1) how to manage co-products as



**Fig. 4.** Energy flows of joint meat, nutrients and fossil-based CHP production. The CHP system (in dashed frame) is expanded to include the outputs from pig farming, namely meat and nutrients contained in manure. Energy of pig farming and CHP production are shown, normalised to 1 GJ CHP.  $Em$  = energy flow,  $En$  = available energy in output.

inputs when estimating transformities and (2) how to make systems comparable to compare transformities.

The bio-based system (Fig. 3) builds on an assessment of CHP production based on willow biomass in Denmark (Kamp et al., 2011). The system includes willow farming under commercial conditions, dependent on pig manure as fertiliser, all associated transport and post-harvest handling, and conversion into heat and power in a large-scale plant. The study uses Danish conditions for willow production and energy conversion but relies on data from a Brazilian study for pig and manure production (Cavalett et al., 2006). The part of the system corresponding to Process II is indicated by the dashed system boundary, and pig farming corresponds to Process I (Fig. 1).

An inventory of inputs, Unit Energy Values and corresponding energy flows to the studied system have been established, normalised to a functional unit of 1 GJ CHP (Table 1). The most significant input, manure used as fertiliser in willow production, represents 84% of the total energy support for the system outputs. Other notable entries in the table include externalities (€), the distinction between direct labour (h) and indirect labour (€), and the use of land (€). Externalities attempt to estimate the externalised costs of nitrate and phosphate leaching, ammonia, nitrous oxide and CO<sub>2</sub> emissions from fertiliser application and transport. Direct labour is the amount of work hours used in willow production, transport and conversion activities, multiplied by a transformity based on metabolic energy use and the emery support of food.

**Table 1**  
Energy table for production of CHP based on willow farming that uses manure from pig farming for nutrient application. See Appendix A for notes for lines 5, 32 and 33.

Note	Flow (unit/G <sub>CHP</sub> )	Unit Energy Value <sup>a</sup> (sej/unit)	Flow (sej/G <sub>CHP</sub> )	Share of total emergy (>0.5%)	Renewability fraction <sup>b</sup>
<i>Inputs in the agricultural phase</i>					
Local, renewable inputs (R)					
1. Sun (J)	1.16E+11	1 <sup>c</sup>	1.98E+12		100%
2. Wind (J)	1.77E+08	2.51E+03 <sup>c</sup>	4.44E+11		100%
3. Rain (J)	6.48E+07	3.06E+04 <sup>c</sup>	1.98E+12	1%	100%
Purchased fuels and goods (M)					
4. Willow seedlings (kg)	1.05E–01	3.98E+12 <sup>d</sup>	4.16E+11		18%
5. Manure (kg dm)	8.28E+00	2.34E+13 <sup>c</sup>	1.94E+14	84%	18%
6. Herbicides (kg)	3.02E–03	2.49E+13 <sup>f</sup>	7.51E+10		1%
7. Agricultural equipment (kg)	5.24E–03	8.20E+12 <sup>g</sup>	4.29E+10		5%
8. Fuels (l)	4.65E–01	9.14E+12 <sup>g</sup>	4.25E+12	2%	1%
Labour and services (L+S)					
9. Labour (h)	2.16E–02	2.05E+12 <sup>g</sup>	4.42E+10		50%
10. Fuels (€)	6.24E–01	2.79E+12 <sup>h</sup>	1.74E+12	1%	4%
11. Willow seedlings (€)	2.25E–01	2.79E+12 <sup>h</sup>	6.29E+11		4%
12. Herbicides (€)	1.58E–02	2.79E+12 <sup>h</sup>	4.40E+10		4%
13. Manure (€)	6.47E–01	2.79E+12 <sup>h</sup>	1.81E+12	1%	4%
14. Harvest (€)	2.67E–01	2.79E+12 <sup>h</sup>	7.46E+11		4%
15. Depreciation of equipment (€)	3.08E–01	2.79E+12 <sup>h</sup>	8.60E+11		4%
16. Externalities (€)	3.77E+00	2.79E+12 <sup>h</sup>	1.05E+13	5%	4%
17. Add. labour cost (€)	3.32E–02	2.79E+12 <sup>h</sup>	9.27E+10		4%
18. Use of land (€)	7.55E–01	2.79E+12 <sup>h</sup>	2.11E+12	1%	4%
<i>Inputs in transport, storage and chipping</i>					
Purchased fuels and goods (M)					
19. Transport equipment (kg)	4.05E–03	8.20E+12 <sup>g</sup>	3.32E+10		5%
20. Chipping equipment (kg)	7.94E–04	8.20E+12 <sup>g</sup>	6.51E+09		5%
21. Fuels (l)	1.89E–01	9.14E+12 <sup>g</sup>	1.72E+12	1%	1%
Labour and services (L+S)					
22. Labour (h)	6.78E–03	2.05E+12 <sup>g</sup>	1.39E+10		50%
23. Fuels (€)	2.53E–01	2.79E+12 <sup>h</sup>	7.07E+11		4%
24. Depreciation of equipment (€)	1.94E–01	2.79E+12 <sup>h</sup>	5.41E+11		4%
25. Externalities (€)	8.22E–03	2.79E+12 <sup>h</sup>	2.30E+10		4%
26. Labour cost (€)	1.36E–01	2.79E+12 <sup>h</sup>	3.81E+11		4%
<i>Inputs in production of heat and power</i>					
Purchased fuels and goods (M)					
27. Plant equipment (kg)	8.10E–03	2.43E+12 <sup>g</sup>	1.97E+10		5%
Labour and services (L+S)					
28. Labour (h)	2.60E–03	2.05E+12 <sup>g</sup>	5.33E+09		50%
29. Depreciation of equipment (€)	2.96E+00	2.79E+12 <sup>h</sup>	8.25E+12	4%	4%
30. Labour cost (€)	6.98E–02	2.79E+12 <sup>h</sup>	1.95E+11		4%
Output (U)					
31. Heat and power (J)	1.00E+09	2.31E+05	2.31E+14	100%	17%
32. Pig meat (kg)	9.54E+00	2.03E+13 <sup>i</sup>	1.94E+14		18%
33. Pig meat (J)	9.29E+07	2.09E+06 <sup>i</sup>	1.94E+14		18%

<sup>a</sup> Unit Energy Value (UEV): transformity (sej/J), specific emery (sej/mass) or money to emery ratio (sej/D). UEVs refer to the 15.83 × 1024 sej/year baseline calculated by Odum (2000). NB: Post-publication note: 15.83 1024 sej/year should be 15.83 10<sup>24</sup> sej/year.

<sup>b</sup> Part of emery flow that is considered to be based on renewable sources.

<sup>c</sup> Odum (1996).

<sup>d</sup> Recalculated based on Kamp et al. (2011).

<sup>e</sup> Recalculated to sej/kg dm based on Cavalett et al. (2006).

<sup>f</sup> Brown and Arding (1991) (updated to new baseline).

<sup>g</sup> Kamp et al. (2011).

<sup>h</sup> Sahel database (2000).

<sup>i</sup> This work, based on emery support of pig production estimated by Cavalett et al. (2006).

Indirect labour is the accumulated monetary expenditures paid to compensate labourers for the time and effort expended in acquiring the necessary skills to provide required services. Use of land attempts to estimate the cost of access to land based on land value.

The fossil-based CHP production system is correspondingly represented by the dashed system boundary (Fig. 4). The data applied are from an emery assessment of natural gas turbines (Raugei et al., 2005). Their study provides the emery support of a natural gas combined cycle plant, the electricity produced and the corresponding transformity. The useful heat delivered by the system is also provided which makes it possible to calculate a joint transformity for combined heat and power production.

In order to show how significant the choice of calculation method is, four approaches to compare the two CHP production methods are considered. In the present context heat and power

are considered as one output. One approach makes it possible to compare full system performance by using joint transformities and three to compare single-product transformities. In the full system approach (Eq. (1)), joint transformities are calculated for the two systems' outputs. In order to compare the systems on a fair basis, the systems are expanded to generate the same outputs namely CHP, meat, and nutrients. The single-product reference method (Eq. (2)) ignores the co-product pig meat in the bio-based system and compares bio-based CHP directly with fossil-based CHP. In the allocation approach, the bioenergy system is simplified to provide CHP as the only output by means of allocating the emery of pig production between meat and manure (Eq. (3)). Since the allocation basis can influence the outcome of an analysis significantly, allocations based on energy content, weight, nutrient content, and market value, respectively, are compared to gain perspective (Table 2). In

**Table 2**

Weight factors (*w*) for allocation of emergy support of pig farming between meat and manure. For calculations and references, see Appendix B.

Basiss	Meat (1 – <i>w</i> )	Manure ( <i>w</i> )
Energy content (MJ/G) <sub>CHP</sub>	92 (39%) <sup>a</sup>	142 (61%) <sup>b</sup>
Mass (kg/G) <sub>CHP</sub>	10 (54%) <sup>c</sup>	8 (46%) <sup>d</sup>
Phosphorus content (g P/G) <sub>CHP</sub>	54 (27%)	149 (73%)
Nitrogen content (g N/G) <sub>CHP</sub>	374 (34%)	737 (66%)
Market price (DKK/G) <sub>CHP</sub>	81 (100%)	<0 (0%)

<sup>a</sup> 9.7 MJ/kg.

<sup>b</sup> 17.2 MJ/kg dm.

<sup>c</sup> Live weight.

<sup>d</sup> 6.6% dry matter in 125 kg.

the substitution approach (Eq. (5)) the bioenergy system is reduced to CHP as the sole output by substituting mineral fertiliser (NPK) for pig manure.

Two emergy indicators are calculated, the transformity and the renewability fraction (% *R*). For systems with more outputs than CHP, the transformity calculated is a joint transformity. The % *R* indicates the system's dependence on renewable sources, estimated by a weighted average of the renewable fraction of each input (Ortega et al., 2005). Usually, all non-local flows from processes providing inputs to the studied system are regarded as non-renewable, even if those inputs are supported by renewable flows locally at their production location. Maintaining the emergy profile of each input, as practiced by Ortega et al. (2005) and in this paper, changes % *R* from indicating dependence on local, renewable support to global, renewable support. This approach is practical for assessing the renewability of small-scale systems.

### 3. Results

#### 3.1. Reference method (product-to-product comparison)

An emergy analysis of willow-based CHP production that does not consider co-products will implicitly account for all inputs to pig farming. If the only considered output is CHP, this product will carry the emergy burden of all inputs and the transformity of bio-based CHP will be 2.31 E+05 se/J (Table 3). In a comparison on a product-to-product basis with CHP from a production system based on natural gas, with a transformity of 0.88 E+05 se/J, the bio-based option is clearly inferior in terms of resource use efficiency. The % *R* of the fossil-based CHP is assumed to be 1%, a conservative estimate since the system is closer to entirely dependent on natural gas and other non-renewable inputs (see Tonon and Mirandola, 2002). The renewability fraction of pig manure, 18%, is a main reason for the % *R* of the bio-based CHP being 17%. Details of the calculation of transformities and % *R* are shown in Appendix B.

#### 3.2. Allocation (product-to-product comparison)

Acknowledging co-production, allocation of the emergy support of pig production between the two considered outputs, pig meat and pig manure, can be done using different allocation bases. The allocation-based transformities are in the range 0.37–1.79 E+05 se/J, the lowest representing present Danish market price as allocation basis (0 € for manure). The transformity of fossil-based CHP, 0.88 E+05 se/J, is within this range. Of the allocation bases used, energy content is the only one that appears to be in compliance with emergy thinking. Allocation based on energy results in a transformity of 1.55 E+05 se/J. Since manure is the main emergy support to the system, any significant alteration due to allocation will be duly reflected in the transformity as well as the % *R*. For allocation based on market price, the % *R* of CHP is 9%, for energy content 16%.

#### 3.3. Substitution (product-to-product comparison)

A more straightforward approach is to avoid the challenge of co-production of pig meat and manure by replacing manure with mineral fertiliser (NPK), a single-product process output, in the calculation. This entails substituting manure with NPK and results in a substitution-based transformity for bio-based CHP of 0.48 E+05 se/J. This transformity can be compared to the fossil-based CHP transformity of 0.88 E+05 se/J. Substitution reduces the % *R* of the bio-based system to 7%.

#### 3.4. Full system with system expansion (system-to-system comparison)

If the meat from pig farming is added as an output from the bio-based system, the joint transformity, 2.12 E+05 se/J, is a bit lower than in the reference method since the emergy support is shared between more outputs. This system output, however, is not comparable to the fossil-based system. Expanding the fossil-based system to include meat production unavoidably leads to the inclusion of pig manure, since no pig meat can be produced without it. To balance the two systems' outputs, an alternative nutrient carrier, NPK with the same N, P, and K proportions as pig manure, is added to the bioenergy system. It is assumed that equal amounts of nutrient elements are equally available for plant growth. Thus, both systems have been expanded to yield the same functional outputs and the joint transformity of CHP, meat and nutrients – in equivalent amounts for the two systems – can be calculated and compared: bio-based CHP, pig meat and mineral fertiliser (NPK) have a joint transformity of 2.22 E+05 se/J while fossil-based CHP, pig meat and pig manure have a joint transformity of 2.29 E+05 se/J. The % *R* is 16% and 15% for the bio-based and fossil-based systems, respectively.

#### 3.5. Comparison of the approaches

Transformities for CHP based on willow have been calculated using different approaches and compared to CHP based on natural gas. Using the reference method, bio-based CHP has a higher transformity (2.31 E+05 se/J) than fossil-based CHP (0.88 E+05 se/J). Separating manure and pig meat emergy support by means of allocation, gives different transformities depending on the allocation basis chosen. An allocation basis of either energy content, mass, phosphorus or nitrogen content, gives transformities higher than for fossil-based CHP, respectively 1.55 E+05 se/J (energy content), 1.27 E+05 se/J (mass), 1.79 E+05 se/J (P content) and 1.62 se/J (N content). Allocation based on market price gives a transformity of 0.37 se/J, well below that for fossil-based CHP. If mineral fertiliser, NPK, is substituted for manure in the calculation of bio-based CHP, the transformity is 0.48 E+05 se/J. When comparing bio-based and fossil-based CHP production systems that have been expanded to provide the same types of output (CHP, meat and nutrients), joint transformities are 2.21 E+05 se/J (bio) and 2.29 E+05 se/J (fossil). Regardless of the calculation approach, the bio-based CHP has a higher % *R* than for fossil-based CHP.

### 4. Discussion

#### 4.1. Case study

Multifunctionality complicates comparison of single products in environmental performance assessments. The desire to link each output to specific inputs and their associated environmental impacts is understandable. However, the underlying assumption that an intradependent entity can be reduced to and described as the sum of independent parts, is incompatible with integrated

**Table 3**  
 Considered systems, procedures for calculating transformity, transformities and renewability fraction (% R) for system output(s). See Appendix B for detailed calculations and notes.

Systems <sup>a</sup>	Transformity calculation procedure <sup>b</sup>	Transformity <sup>c</sup> (se/J)	% R
Reference method			
Bio (CHP) <sup>d</sup>	$(Em_{pig\ f.} + Em_{other})/En_{CHP}$	2.31E+05	17%
Fossil (CHP) <sup>e</sup>	$Em_{CHP}/En_{CHP}$	8.80E+04	1%
Allocation (split)			
Bio (CHP), energy content	$(W_{energy} \cdot Em_{pig\ f.} + Em_{other})/En_{CHP}$	1.55E+05	16%
Bio (CHP), mass	$(W_{mass} \cdot Em_{pig\ f.} + Em_{other})/En_{CHP}$	1.27E+05	15%
Bio (CHP), P content	$(W_{P\ content} \cdot Em_{pig\ f.} + Em_{other})/En_{CHP}$	1.79E+05	16%
Bio (CHP), N content	$(W_{N\ content} \cdot Em_{pig\ f.} + Em_{other})/En_{CHP}$	1.62E+05	16%
Bio (CHP), market price	$(W_{price} \cdot Em_{pig\ f.} + Em_{other})/En_{CHP}$	3.70E+04	9%
Substitution			
Bio (CHP)	$(Em_{other} + Em_{NPK})/En_{CHP}$	4.80E+04	7%
Full system, expanded systems (co-products)			
Bio (CHP, meat)	$(Em_{pig\ f.} + Em_{other})/(En_{CHP} + En_{meat})$	2.12E+05	17%
Bio (CHP, meat, nutrients)	$(Em_{pig\ f.} + Em_{other} + Em_{NPK})/(En_{CHP} + En_{meat} + En_{NPK})$	2.21E+05	16%
Fossil (CHP, meat, nutrients)	$(Em_{CHP} + Em_{pig\ f.})/(En_{CHP} + En_{meat} + En_{manure})$	2.29E+05	13%

<sup>a</sup> Considered outputs indicated in parenthesis. Indices based on full system, allocation of outputs from pig farming and substitution approaches are calculated in this study.

<sup>b</sup> For explanation, see Figs. 3 and 4 and Table 2.

<sup>c</sup> For the full system approach, the transformities are joint, otherwise they are single-product transformities.

<sup>d</sup> Recalculated, based on Kamp et al. (2011).

<sup>e</sup> Own calculations based on Raugi et al. (2005). Em = energy flow, En = available energy in output, Em<sub>other</sub>: see legend for Fig. 3, w = weight factor.

NB: Post-publication note: 8.80E+04 se/J in fossil-based system should be 8.84E+04 se/J.

system functioning. That integrated systems and processes cannot be divided into non-overlapping sub-systems or sub-processes is obvious for biological processes and it has implications for environmental performance assessments of bioenergy production. As an example, the resource use of pig farming cannot easily be attributed to its two main outputs, pig meat and pig manure. The case study also indicates that in energy accounting, the presently used calculation approach, the reference method, is inadequate. There is an inherent bias against systems that include co-products as inputs and in favour of systems with inputs from single-product processes, e.g. fossil-based inputs. The comparison of the suggested alternative approaches also shows that method choice significantly influences the energy indicators and, in the case of a full system approach, may alter the conclusion altogether: When comparing bio-based CHP with fossil-based CHP ignoring co-products from the bio-based system, the transformities are 2.31 E+05 se/J and 0.88 E+05 se/J, respectively. Expanding the system perspective to include upstream co-products and aligning the two systems with respect to outputs for fair comparison, provides joint transformities of 2.21 E+05 se/J (bio-based) and 2.29 E+05 se/J (fossil-based). In terms of resource use efficiency, the bio-based system goes from being significantly inferior to being competitive. The case example builds support for central energy theory, namely that integrated systems are likely to make better use of resources by avoiding heat loss.

Buonocore et al. (2012) studied CHP production using willow irrigated and fertilised with municipal wastewater in Sweden. They estimated transformities of electricity and heat as 1.2 E+05 and 6.1 E+04, respectively, i.e. considering the final outputs as splits. The transformities appear to be within the range of results found in this case study and thereby provide some support even if the studies are not directly comparable. Unfortunately, Buonocore et al. do not specify how they dealt methodologically with co-products, particularly the wastewater input, a co-product of urban metabolism. Therefore, it is difficult to know which of the transformities found in our study can be compared to their results.

#### 4.2. Full system approach and system expansion

The calculation of joint transformities adheres to the rules mentioned in Section 2.1 and can be used to compare systems. Considering full systems represents an embedded systems perspective which appears to fit well with energy thinking. Furthermore,

expanding systems to include more outputs does not conflict with established energy algebra and it supports the progress made by Bastianoni and Marchettini (2000) of considering joint transformities for integrated systems. Joint transformities will be used differently than single-product transformities. Since it is unlikely that any system will use all outputs of a co-production system as input, the joint transformity will most often not be used as a regular transformity. Additionally, since the composition of a co-production system is likely to be unique, the joint transformity will rarely be directly comparable to the transformity of any other process. As demonstrated in the case study, system expansion was needed to make the studied systems comparable. Applying the full system approach for comparison across systems will tend to favour integrated systems, involving additional subsystem analyses. From a pragmatic viewpoint, the latter may constitute a challenge for its widespread implementation since it is likely to complicate the establishment of energy analysis inventories. If this challenge is overcome, systematic use of system expansion could support a general shift towards systems thinking in energy calculations that is more in line with the systems thinking behind energy theory.

#### 4.3. Substitution

The procedure of using substitution to reduce system outputs is widely used in standardised LCA when crediting co-products of bioenergy production. As an example from wheat-based bioethanol production, DDGS (Dried Distiller's Grains with Solubles) is a co-product that can be used for animal feed. The argument for crediting the bioethanol production is that the production of equivalent amounts of animal feed needs not take place and thus associated resource use and emissions are 'saved'. The approach is in accordance with recommendations found in the EU guidebook for LCA (European Commission, 2010). It appears that the procedure is intended for crediting a system for co-product outputs, but the underlying consequential system perspective is valid also for debiting a system for co-product inputs. In the case of pig manure, substitution assumes that other farmers will have to use mineral fertiliser for their nutrient application as a consequence of the willow farmer's pig manure use, leading to a net increase in mineral fertiliser use. Considering increased mineral fertiliser use as the net effect of using pig manure for nutrient application amounts to ignoring pig farming and debiting the bioenergy system with

mineral fertiliser, i.e. substitution. In practice it means using the energy of mineral fertiliser as a proxy for the energy of pig manure. However, applying the substitution approach to equalise the functional outputs of two systems, whether it credits or debits, rests on strong assumptions. These assumptions regard the expected alternative production path, i.e. the substitutability of the products, and include a fixed total demand for the co-product and its substitute, in the present case, fertiliser. There is a risk that when using substitution-based results for strategic decisions of future resource use, these context specific assumptions are not taken into account. As an example, with a future scarcity of easily available nutrient carriers, manure will not be considered a waste.

Furthermore, the substitution only avoids the inconvenient issue of co-production if the substitute is the result of a single-output production process. In theory, this would support a tendency to model a complex, integrated, co-production system as the sum of similar products from single-output processes. In addition, substitution provides a transformity that is relative to business-as-usual of the surrounding system, i.e. it reflects the net effect, and as such it is unlikely to be useful for modelling in other contexts. Also, a transformity based on substitution is not in compliance with Brown's energy algebra rules 1 and 2. In conclusion, substitution does not appear to be compatible with the donor-side perspective of energy thinking; it represents a reductionist, single-output approach and it is recommended to avoid substitution for system reduction.

#### 4.4. Allocation

Allocation of energy on the basis of biophysical traits is straightforward once the particular biophysical allocation basis has been determined. Allocation simplifies calculations but requires the assumption that the allocation basis approximates energy flow distribution. It was shown how it is possible to manipulate the results in the choice of basis, with market price as the most extreme since it allocates none of the energy of pig farming to manure. The market price of manure (in Denmark) is presently 0 or below, and the approach thus represents considering manure as a 'waste', free in terms of available energy required to provide it. Treating manure as a waste implies considering manure as a heat loss in pig farming. This emphasises the present inability of the economic system to reflect the value of available energy which may change, but in general, allocation based on economic basis should be discouraged. Regardless of the chosen basis, allocation implies regarding co-products as splits, i.e. of the same type, and this is conflicting with energy algebra rules 1 and 2, going against principles of energy accounting (Odum, 1996). Nevertheless, energy-based allocation could be used as a second-best option if expansion to a full system is not relevant or practically possible. This implies the assumption that energy flow is distributed to co-products as if they were splits. Alternatively, energy-based allocation could be used only for explicitly defined 'background' processes. Allowing for this deviation from established energy theory will give each co-product the same transformity. There is a risk, however, that such allocation-based transformities will be used out of context and it is suggested to always be explicit about the type of transformity used, i.e. whether it is a joint transformity or an allocation-based, substitution-based, or reference method single-product transformity.

#### 4.5. Ingenuous set theory

A mathematical language, based on ingenuous set theory, where flows are considered as sets of photons with unique space and time parameters has been suggested to support energy algebra (Bastianoni et al., 2011). This language is used by the authors to

discuss double-counting and feedback, but whether it is applicable for solving the issues concerning co-production discussed in this paper remains to be seen.

#### 4.6. Using waste as a resource

What is a co-product, what is a by-product and what is waste? It is commonly understood that outputs of a process can be categorised as (1) main products, (2) secondary products or (3) unwanted products based on the socio-economic context, in effect based on the price we are willing to pay for the product. The IEA Bioenergy task 38 software tool, BIOMITRE, defines a co-product as involving similar revenues to the main product, a by-product resulting in smaller revenues and waste products providing little or no revenue (Horne and Matthews, 2004). In ISO 14044 the direct valuation in money is avoided by defining a co-product as any of two or more products coming from the same unit process or production system, and waste as substances that the holder intends or is required to dispose of (International Organization for Standardization, 2006). These definitions represent implicit allocations based on monetary value founded in an anthropocentric value system, where value is measured in the amount of time and effort required by humans to perform a task, e.g. disposing of an inconvenient output. Made to support operational guidelines for regulation, these definitions are clearly unsuitable for modelling the performance of biological systems, e.g. by deciding that the available energy in manure is valueless.

As a principle, energy accounting should avoid the distinction between waste and resource by maintaining that all outputs should be considered co-products. Further, any assumption concerning the omission of significant co-products should be explicit. Here, significance should be based on available energy in the output. Unused co-products may then be modelled as heat loss as long as they are unused. If such co-products are used as inputs (e.g. when waste is seen as a resource), the assessment must take the co-production system and all its outputs into account.

### 5. Conclusion

Co-production processes yield several outputs whose environmental impacts cannot be separated. How to manage co-products is a challenge in environmental assessment methods. We focused on how to manage co-product outputs used as inputs and applied approaches from standardised LCA in energy accounting. We have shown that the single-product reference method in energy accounting is insufficient for assessing environmental impact of products with inputs from co-production. Further, we conclude that environmental impacts of such inputs must be accounted for even if they were perceived to be valueless at the time of their (co-)production. Specifically for energy accounting, the present algebra needs to be expanded with a 'full system' approach that includes upstream co-product outputs in the calculation of a joint transformity. The full system approach involves combining alternative production processes to align the functionality of compared systems and does not, as typically done in standardised LCA, reduce the system to evaluate only one output. When compared to the usual calculation method in energy accounting, this approach highlights the efficiency of integrated food and energy production, as exemplified in the case study. We argue that this extension of energy algebra will improve the use of energy accounting when it is applied to assess processes that depend on inputs from co-production, e.g. integrated food and bioenergy systems. Acknowledging the additional need for an operational approach

that evaluates only one product, allocation based on energy content may be used as a second-best alternative to a full system approach.

### Appendix A. Supplementary data

Supplementary data associated with this article can be found, in the online version, at <http://dx.doi.org/10.1016/j.ecolmodel.2012.12.027>.

### References

- Bastianoni, S., Marchettini, N., 2000. The problem of co-production in environmental accounting by energy analysis. *Ecological Modelling* 129, 187–193.
- Bastianoni, S., Morandi, F., Flaminio, T., Pulselli, R.M., Tiezzi, E.P.B., 2011. Energy and energy algebra explained by means of ingenious set theory. *Ecological Modelling* 222, 2903–2907.
- Brown, M.T., Herendeen, R.A., 1996. Embodied energy analysis and EMERGY analysis: a comparative view. *Ecological Economics* 19, 219–235.
- Brown, M.T., Arding, J., 1991. Transformities Working Paper. Center for Wetlands, University of Florida, Gainesville.
- Buonocore, E., Franzese, P.P., Ulgiati, S., 2012. Assessing the environmental performance and sustainability of bioenergy production in Sweden: a life cycle assessment perspective. *Energy* 37, 69–78.
- Cavalett, O., Queiroz, J.F., Ortega, E., 2006. Emery assessment of integrated production systems of grains, pig and fish in small farms in the South Brazil. *Ecological Modelling* 193, 205–224.
- Cherubini, F., Strømman, A.H., 2011. Life cycle assessment of bioenergy systems: state of the art and future challenges. *Bioresource Technology* 102, 437–451.
- Cherubini, F., Strømman, A.H., Ulgiati, S., 2011. Influence of allocation methods on the environmental performance of biorefinery products – a case study. *Resources, Conservation and Recycling* 55, 1070–1077.
- European Commission – Joint Research Centre – Institute for Environment and Sustainability, 2010. International Reference Life Cycle Data System (ILCD) Handbook – General Guide for Life Cycle Assessment – Detailed Guidance. First edition March 2010. EUR 24708 EN. Publications Office of the European Union, Luxembourg.
- Horne, R.E., Matthews, R., 2004. BIOMITRE Technical Manual. BIOMass-based Climate Change MITigation, through Renewable Energy (BIOMITRE). <http://www.ieabioenergy-task38.org/systemdefining/biomitre-technical-manual.pdf>, accessed 29th of June 2012.
- International Organization for Standardization, 2006. ISO 14044. Environmental Management – Life Cycle Assessment – Requirements and Guidelines. International Organization for Standardization, Geneva, Switzerland.
- Kamp, A., Østergård, H., Cylling, M., 2011. Sustainability assessment of growing and using willow for CHP production. In: Faulstich, M., Ossenbrink, H., Grassi, A., Helm, P. (Eds.), Proceedings of the 19th European Biomass Conference and Exhibition, Berlin, pp. 2645–2656.
- Odum, H.T., 1996. Environmental Accounting: Emery and Environmental Decision Making. Wiley and Sons, New York.
- Odum, H.T., 2000. Emery of Global Processes. Handbook of Emery Evaluation. Environmental Engineering Sciences; Folio no. 2. Center for Environmental Policy, University of Florida, Gainesville, USA.
- Ortega, E., Cavalett, O., Bonifácio, R., Watanabe, M., 2005. Brazilian soybean production: emery analysis with an expanded scope. *Bulletin of Science, Technology & Society* 25, 323–334.
- Raugei, M., Bargigli, S., Ulgiati, S., 2005. A multi-criteria life cycle assessment of molten carbonate fuel cells (MFC) – a comparison to natural gas turbines. *International Journal of Hydrogen Energy* 30, 123–130.
- Raugei, M., Rugani, B., Benetto, E., Ingwersen W.W., 2012. Integrating emery into LCA: potential added value and lingering obstacles. *Ecological Modelling*, <http://dx.doi.org/10.1016/j.ecolmodel.2012.11.025>
- Rugani, B., Benetto, E., 2012. Improvement to emery evaluations by using life cycle assessment. *Environmental Science and Technology* 46 (9), 4701–4712.
- Sahel database, 2000. Environmental Accounting and Systems Synthesis of Land Management Interventions at Multiple Scales in the Sahel Region of West Africa. Center for Wetlands, University of Florida, Gainesville, USA [http://sahel.ees.ufl.edu/database\\_resources.php?search.type=basic&country=DNK](http://sahel.ees.ufl.edu/database_resources.php?search.type=basic&country=DNK), accessed 17th of May 2011.
- Tonon, S., Mirandola, A., 2002. Emergetic and exergetic analysis of a combined cycle power plant. In: Brown, M.T. (Ed.), Emery Synthesis 2: Proceedings of the 2nd Biennial Emery Research Conference. Center for Environmental Policy, University of Florida, Gainesville, USA, pp. 157–170.
- Wang, M., Huo, H., Arora, S., 2011. Methods of dealing with co-products of biofuels in life-cycle analysis and consequent results within the US context. *Energy Policy* 39, 5726–5736.

## PAPER II

**In-text citation:**

(Kamp et al., 2016a)

**Authors:**

Andreas Kamp, Hanne Østergård and Simon Bolwig

**Title:**

Environmental assessment of integrated food and cooking fuel production for a village in Ghana

**Submission and publication details:**

Submitted to *Energy for Sustainable Development* 6<sup>th</sup> of Nov. 2015

Rejected 25<sup>th</sup> of February 2016

Submitted to *Sustainability* 7<sup>th</sup> of March 2016

**Note:**

Supplementary material is available at

[https://www.dropbox.com/sh/whifke4u4itnauz/AAC\\_IZ6vByCYQJ68obCBB56Aa?dl=0](https://www.dropbox.com/sh/whifke4u4itnauz/AAC_IZ6vByCYQJ68obCBB56Aa?dl=0)

# Environmental assessment of integrated food and cooking fuel production for a village in Ghana

Andreas Kamp <sup>1</sup>, Hanne Østergård <sup>1,\*</sup> and Simon Bolwig <sup>2</sup>

<sup>1</sup> Department of Chemical and Biochemical Engineering, Technical University of Denmark, DTU, 2800 Kgs. Lyngby, Denmark; [ankam@kt.dtu.dk](mailto:ankam@kt.dtu.dk) and [haqs@kt.dtu.dk](mailto:haqs@kt.dtu.dk)

<sup>2</sup> Department of Management Engineering, Technical University of Denmark, DTU, 2800 Kgs. Lyngby, Denmark, [sibo@dtu.dk](mailto:sibo@dtu.dk)

\* Correspondence: [haqs@kt.dtu.dk](mailto:haqs@kt.dtu.dk); Tel.: +45 21 32 69 55

Academic Editor: name

Received: date; Accepted: date; Published: date

**Abstract:** Small-scale farming in Ghana is typically associated with synthetic fertiliser dependence and soil degradation. The same farmers rely on wood fuel for cooking imported from outside the farmland, a practice that is associated with deforestation. We study approaches to providing food and fuel for cooking in a small-scale farming community. Present practice (PP) of synthetic fertiliser based food production and provision of wood fuel from outside the farming area is compared to three modelled, integrated technology options: integrated food and household-scale biogas production (HH Biogas), integrated food and village-scale biogas production (Village Biogas), and integrated food and wood fuel production (Agroforestry). Integrated approaches are able to eliminate the import of wood fuel, reduce synthetic fertiliser use by 24%, 35% and 44% and soil loss by 15%, 20% and 87%, respectively, compared to present practice. An Emergy Assessment shows that integrated approaches are relevant substitutes to present practice considering biophysical efficiency indicated by Unit Emergy Value (in solar emjoules (sej) per J of output) and dependence on renewable inputs indicated by the Global Renewability Fraction (in %): 2.6-3.0E+05 sej/J and 38-48% (PP), 2.5-2.8E+05 sej/J and 41-46% (HH biogas), 2.4-2.6E+05 sej/J and 45-47% (Village biogas), 1.7-2.4E+05 sej/J and 49-66% (Agroforestry). Systematic recycling and use of local resources may play a pivotal role in reducing the dependence on non-renewable resources in Ghanaian farming, ensuring long-term soil fertility and stemming the current deforestation of wood reserves.

**Keywords:** Biogas, agroforestry, nutrient recycling, transition, sustainable development, emergy, Ghana, case study

---

## 1. Introduction

A key argument in the debate on sustainable development is that societies must transition away from the high use of fossil fuels and other non-renewable resources because of increased scarcity and/or due to their harmful effects on the environment including the climate [1–3]. For agriculture, such a transition involves finding alternatives to a range of common farm inputs without further depleting soil and forest resources. In developing countries, low-tech solutions are often suggested as they are deemed more suitable to economic and institutional conditions than advanced technologies. In this paper, we study farming and wood fuel provision in rural area Ghana and assess three low-tech alternatives to present practices with respect to reducing soil loss, deforestation and the use of synthetic fertilisers.

The high rates of resource extraction as well as the climate effects of fossil fuels call into question the sustainability of dominant food production technologies. These technologies depend strongly on the use of fossil fuels, especially for the production of synthetic fertilisers and running of farm machinery, and of other non-renewable resources such as phosphorus [4–7]. Østergård et al. thus



suggest that a paradigm shift in modern agriculture is necessary to deal with major environmental problems, especially soil deterioration, biodiversity loss, resource depletion, and pollution [8].

Yet reducing the use of fossil fuels and other non-renewable resources is often difficult due to limited local availability of biological resources above and below the ground, particularly forests and soil organic matter. In Ghana, the current rate of deforestation is around 2% per year [9,10] and the use of wood fuel for heating and cooking has been identified as a main driver [11,12]. Prevalent farming practices deteriorate soil quality through the loss of soil carbon from erosion and tilling [13] and through the removal of plant nutrients due to leaching and in the harvested product [14]. Together these processes undermine agricultural productivity and the livelihood of farmers [15,16]. In light of the above, a key premise of this paper is that sustainable agricultural development in Ghana and other developing countries must simultaneously address issues of increasing non-renewable resource scarcity and their polluting effects as well as deforestation and soil degradation.

The knowledge base for adapting farming systems to the resource and pollution challenges just outlined is already largely available. It includes the incorporation of organic matter into soils, reducing soil tillage, appropriate crop and husbandry management, and more general 'low tech' or 'soft technology' approaches [8]. Biogas and agroforestry are part of this knowledge base. The benefits and applicability of biogas in developing countries are well documented [e.g. 17–19]. Benefits include reduced dependence on imported energy and fertiliser, improved health, workload reduction, and the proximity of feedstock and biogas users. High-solids, non-manure-based digestion is particularly relevant in many developing countries, since water and manure are often not easily available [20]. Agroforestry practices have shown to improve crop yields, reduce erosion, provide fodder and protect crops on millions of hectares in Africa [21]. It has been shown that certain tree species in agroforestry systems provide significant amounts of N through nitrogen fixation, constituting a profitable alternative to conventional fertilisation methods [22].

Biogas and agroforestry meet several of the criteria for technologies that are central for a successful transition of agriculture. Few studies, however, have emphasised the specific ability of these technologies to address simultaneously the issues of organic substitutes for synthetic fertilisers, deforestation, and soil degradation. To fill this gap we studied the provision of food and cooking fuel in a village in rural area Ghana through a comparison of four technology options (also referred to as 'approaches'): present practice, household-scale biogas, village-scale biogas, and agroforestry, where the latter three approaches integrate food and energy production in different ways. We used case study data on small-scale farming and wood fuel production collected in Ghana and data from the literature on biogas and agroforestry production. Two of the four technology options consider high solids digestion of crop residues, a technique that has received little scholarly attention compared to low solids, manure-based digestion.

Our assessment applies a systems perspective by considering the production of food and energy as one integrated system. This follows the concept of Integrated Food and Energy Systems that combine food and energy production on a local level with the objective of achieving synergy effects in the larger, integrated system [23].

We compare and analyse technology profiles in terms of mass balance and labour requirements. Using emergy methodology [24], we assess the environmental performance of the four technology options with respect to resource use efficiency in a biophysical perspective and the degree to which each approach depends on renewable resources. Emergy assessment systematically includes labour inputs along with material and energy inputs, allowing for detailed labour analyses. We elaborate on the role of labour and account for labour embodied in imported inputs in a novel way.

Our results are used to evaluate whether the three integrated food and energy systems are relevant alternatives to present food and energy provision practices since these may no longer be relevant during a transition of society. Our hypothesis is that the studied alternatives are as biophysically efficient and as independent from non-renewable resources as present practice.

## **2. Materials and Methods**

### *2.1 Present practice case study*

The study area, the village of Zambrama and its farmlands, is located in the transitional zone of the semi-deciduous forest and Guinea Savannah zones near Ejura town, Ghana. The climate is tropical with average annual rainfall of 1200 mm and solar irradiation of 5.2 kWh/m<sup>2</sup>/day. Data on material, energy and labour inputs in farming and the resulting outputs was collected by interviewing randomly selected farmers before and after key farming activities during three growing seasons in the period 2012-13. Data on wood fuel usage and charcoal production in Zambrama was collected in 2013. The studied farm area comprises 45 hectares (ha), approximately a fourth of the village's farmed hinterland. Seven households farm this area.

The dominant farming system in the study area is a rotational bush fallow system characterised by a dominance of maize (89% of the area), followed by cowpea (4%), and a few other subsistence and cash crops (7%). No significant livestock were held. Farming is characterised by a high degree of manual labour and the external inputs of synthetic fertiliser, pesticides, machinery, and diesel (for ploughing, de-husking and local transport of produce).

The current technology option for obtaining food and cooking energy, present practice (PP), is small-scale, semi-mechanised, pesticide and synthetic fertiliser-based food production with imported wood fuel. The wood fuel is used entirely for cooking using a three-stone stove for firewood with a thermal energy yield of 8% or a coal pot stove for charcoal with a thermal energy yield of 22% [25].

## 2.2 Integrated Food and Energy Systems

The suggested substitutes for present practice are combinations of food and cooking energy provision technologies with the following characteristics and modelling assumptions:

*The household-scale biogas technology option (HH biogas)* is characterised by farming methods similar to PP but supplemented with recycled nutrients and carbon in the effluent from biogas production. Cooking fuel is assumed provided by seven household biogas plants, following an experimental high-solids anaerobic digestion design with plastic tanks [26]. Conversion efficiency is 43% of biomethane potential [26,27].

*The village-scale biogas technology option (Village biogas)* is the same as the HH biogas option but with a larger scale biogas production using a high-solids anaerobic digestion design in a shipping container. This design was tested at pilot scale at KNUST in Kumasi, Ghana [28]. Conversion efficiency is assumed 50%.

For the PP, HH biogas, and Village biogas options soil organic carbon loss is set to 570 kg/ha/year (before recycling), based on [29] and [30]. Biogas production is modelled with residue-to-product ratios from [31], estimated recovery fractions of 44% (HH biogas) and 36% (Village biogas), and biogas potentials from [32] and [31]. For HH biogas and Village biogas, respectively, pre-digestion storage losses are 21% and 10% [33] while post-digestion, pre-application losses are set to 50% and 25% [34]. The biogas is used in a biogas cook stove with a thermal energy yield of 55% [35].

*The agroforestry technology option (Agroforestry)* is characterised by highly integrated wood and food crop production [21,36]. Maize and beans are grown in four-meter wide alleys between rows of leucaena trees (*Leucaena Leucocephala*, see [37] as demonstrated by [38]). Nutrient uptake from air and soil combined with mulching of pruning materials and littered leaves reduce synthetic fertiliser requirement by 50% [based on 38] and soil organic matter loss by 87% [39]. Leucaena yields 5 t/ha/year firewood on the relevant part of the sample area (i.e. 40 ha) [40]. Labour requirements for leucaena cultivation, pruning and mulching are 50 man-hours/ha/year on 40 ha [based on 41]; these inputs are considered in addition to PP farming labour inputs. A part of the harvested/collected wood is used for firewood in a three-stone stove and a part is turned into charcoal and used in a coal-pot

stove. The time used to collect wood fuel is assumed half of that in PP due to reduced distance to the wood resources.

For all technology options, the unrecovered crop residues are burned. This is a common practice to avoid wildfires and reduce pest pressure.

### 2.3 *Emergy Assessment (EmA)*

The Environmental Sustainability Assessment is carried out using EmA. EmA applies embodied energy analysis founded in thermodynamics. Emergy is defined as the solar energy required directly and indirectly to make a product or service [24]. All forms of energy, materials and human labour that contribute - directly or indirectly - to a production process are taken into account and converted into the common unit of solar emjoules (sej) [42]. The conversion takes place by multiplying physical quantities with their respective Unit Emergy Values (UEV), where the UEV is the emergy per unit (e.g. sej/J, sej/g, sej/man-hour). A high UEV is indicative of large, accumulated energy losses in the creation, extraction, transport, manufacture, etc. of a given item. The emergy value is considered an estimate of accumulated resource use. It follows that resource efficient processes result in low UEVs, and therefore it is a common objective in emergy assessments to compare processes that yield similar outputs and to conclude on resource efficiency.

#### 2.3.1 UEV calculation

The assessment of resource use in this study is based on an emergy baseline of 15.83 E24 sej/year [43]. The UEVs of the outputs are calculated as joint UEVs [44] applying a 'full system' perspective [45]. The output is a 'basket' of different food products and cooking energy, constituting in this context the most significant co-production outputs of the systems. The resulting resource use efficiency indicator, the UEV, is the solar emjoules required to provide one joule of output of basket mix. The food and useful cooking energy output for all options is defined by PP production. In HH biogas, the conversion efficiency is set to match the cooking energy output of PP. In Village biogas, where the conversion efficiency is assumed higher and storage losses smaller than in HH biogas, a comparable output is ensured by recovering less crop residues. In Agroforestry, the positive and negative effects of co-production on crop yield have been considered and are assumed to balance out, based on the mentioned research (see 2.2). Matching cooking energy output in Agroforestry to that of PP is possible since there is much more wood available (approximately 200 t) than necessary (approximately 55 t). Unrecovered residues and wood are not accounted for as output. This is a conservative assumption regarding unused wood in Agroforestry.

#### 2.3.2 Renewability Fraction

EmA allows for the categorisation of resource use according to renewability, making it possible to quantify how renewable an output is [46]. All inputs that are required to make the studied system function are divided into three input categories: on-site renewable resources (R), on-site non-renewable resources (N) and feedbacks from society (F) - i.e. external inputs. The Renewability Fraction (i.e.  $R/(R+N+F)$ ) indicates the dependence on resources that are considered to be on-site and renewable [24]. When the renewability fraction of external inputs ( $F_R$ ) are included, the resulting renewability fraction of the output is not the fraction of on-site, renewable flows but the fraction of global, renewable flows ( $(R+F_R)/(R+N+F)$ ) [47]. In the following, we refer to the Global Renewability Fraction to distinguish from the Renewability Fraction based on on-site, renewable inputs. The higher Global Renewability Fraction, the less dependent on non-renewable inputs the system is.

#### 2.3.3 Labour accounting

EmA routinely accounts for what can be referred to as ‘the biophysical cost of human labour’. The accounting of labour inputs follows the guidelines presented in [48] and distinguishes between direct labour and indirect labour. Direct labour takes place in the ‘foreground’ of the assessment and comprises the man-hours required for farming and cooking fuel collection or production. The resource use supporting direct labour is differentiated across different labour types, using a UEV of 3.2E+12 sej/man-hour for farm work and 9.1E+12 sej/man-hour for specialist labour (chainsaw operation and village biogas plant management) [48].

Indirect labour takes place in the ‘background’, i.e., in production systems that supply inputs to farming and cooking energy production (e.g. diesel production), and this labour accompanies purchased goods and services in the form of an estimate of man-hours required. If detailed knowledge of specific labour inputs in background systems is missing, an estimate may be approximated through the monetary cost of individual inputs. Monetary cost is converted to average, global man-hours using an average global conversion rate, assuming that each USD of indirect labour is equally dependent on all activities of the global economy. This rate is based on an estimate of the laboured hours in a year (5.7E+12 man-hours/year, own calculation) divided by the Gross World Product (6.1E+13 USD/year [49]) to give an average, global man-hour/USD (0.09 man-hours/USD). The UEV for indirect labour, 1.8E+13 sej/global avg. man-hour, is calculated as global energy flow (1.1E+26 sej/year [49]) divided with global labour force (3.1E+09 persons [50] and average work year (1840 hours/person/year, own estimate).

### 2.3.4 UEVs of firewood and charcoal

As part of the calculations for PP, the UEVs of firewood and charcoal are calculated. For charcoal, the estimate is based on an interview with a charcoal producer and a chainsaw operator. The UEVs are estimated to 3.06E+11 sej/kg and 2.09E+12 sej/kg, for firewood and charcoal, respectively, excluding labour, and 3.70E+11 sej/kg and 2.17E+12 sej/kg, respectively, including labour. These calculations are shown in the Supplementary Material.

## 2.4 Sensitivity analysis

We evaluate the sensitivity of energy indicator results to selected parameter values. We compare reference model assumptions with two alternative sets of values for five parameters, designated ‘More inputs, non-renewable imported wood’ and ‘Less inputs, renewable imported wood’ (Table 1). Results from the sensitivity analysis are presented as UEV and Global Renewability Fraction ranges for each technology option.

**Table 1.** Parameter value changes in the sensitivity analysis.

<b>Technology option</b>	<b>Parameter</b>	<b>More inputs, non-renewable imported wood</b>	<b>Reference model parameter values</b>	<b>Less inputs, renewable imported wood</b>
All	Labour inputs	+ 30%	Present practice	– 30%
All	Global Ren. Fraction of wood	0%	50%	100%
HH biogas	Conversion efficiency	30%	43%	52%
Village biogas	Conversion efficiency	35%	50%	55%
Agroforestry	Soil loss reduction	61%	87%	100%

### 3. Results

The assessment of technology options leads to profiles that include outputs, ability to cycle nutrients and reduce soil loss and labour requirements. The emergy indicators for resource use efficiency and renewability are presented with and without labour inputs. Full emergy tables and calculation notes are available in the Supplementary Material.

#### 3.1 Mass balance and labour inputs

##### 3.1.1 Present practice

Production outputs of 55 tons (dry matter) of food and 79 GJ of end-use thermal energy are obtained using approximately 3,200 kg of synthetic fertiliser, 18 tons of soil organic carbon, 67 tons of wood, 18,000 man-hours in the fields and to transport and convert fuels, and 510 global avg. man-hours embodied in purchased inputs (Table 2).

**Table 2.** Technology profiles. Values are for an agricultural system of 45 hectares in one year, unless otherwise stated.

	Unit	PP	HH biogas	Village biogas	Agro-forestry
<i>Input</i>					
Imported cooking fuel	tons	67	0	0	0
Synthetic fertiliser use	kg	3,200	2,400	2,100	1,800
Soil loss	tons	18	14	13	2.3
Direct labour	man-hours	18,000	23,000	22,000	20,000
Indirect labour	global avg. man-hours	510	510	480	410
<i>Output</i>					
Food	tdm	55	55	55	55
Useful cooking energy	GJ thermal energy	79	79	79	79

##### 3.1.2 Integrated Food and Energy Systems

Production outputs of the three integrated systems are equal to PP (Table 2). All integrated approaches fully substitute for imported wood fuel. The following results are relative to PP:

The nutrient cycling supported by residue recovery, anaerobic digestion and subsequent effluent return to fields is able to substitute 24% of synthetic fertiliser in the case of HH biogas and 35% in the case of Village biogas, while mulching of leucaena leaf litter is able to reduce synthetic fertiliser inputs by 44% with agroforestry. The carbon management practices can reduce the net loss of soil carbon by 22% and 29% for the two biogas-based systems, respectively, and 87% with agroforestry.

Direct labour requirements are larger in the integrated approaches (HH biogas: +31%, Village biogas: +24% and Agroforestry: +10%) indicating that a reduced dependence on material inputs comes at the cost of higher labour inputs.

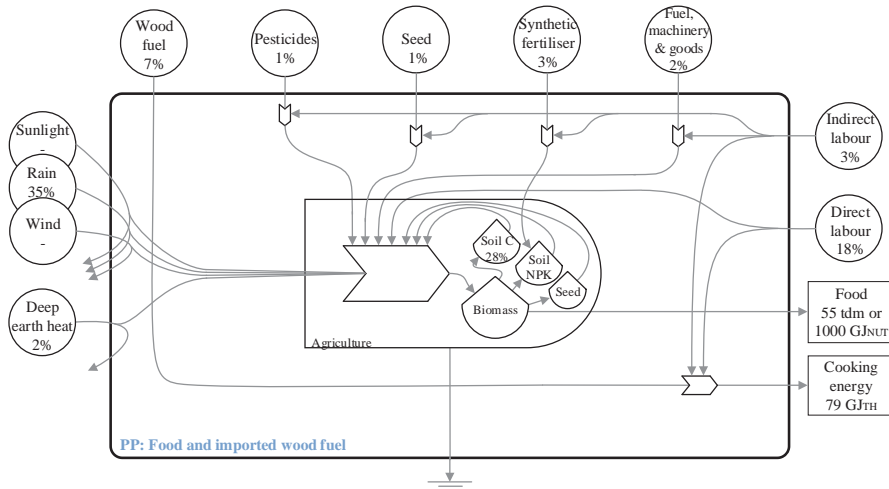
Indirect labour requirements are similar or lower in the integrated approaches (HH biogas: 510 global avg. man-hours/year, Village biogas: -5% and Agroforestry -20%). This suggests that integrated food and cooking energy production relies less on labour embodied in purchased inputs. Indirect labour represents merely 2-3% of labour inputs.

#### 3.2 Emergy analysis

##### 3.2.1 Present practice

When accounting inputs in emergy, the resource use is 280,000 sej/joule of output with approximately 51% of renewable origin (Table 3). The relative importance of inputs are shown as

percentages of the total input (Figure 1). The most dominant inputs are rain (35%), soil (28%), direct labour (18%), and wood fuel (7%). Among the inter-dependent flows of sun, wind and rain, rain is the most prominent at this location and thus the only one included in the calculations.



**Figure 1.** Separate food and cooking fuel production. Inputs are in percentage of the total energy flow  $3.1E+17$  sej/year on 45 ha.

When excluding labour inputs, the resource use per unit of output is considerably lower and the Global Renewability Fraction higher (Table 3). This is because labour inputs constitute 21% of total inputs and because the Global Renewability Fractions of labour are low (see Supplementary Material). Soil loss, synthetic fertiliser and diesel inputs are the remaining significant sources of non-renewable inputs (not shown).

**Table 3.** Technology profiles with emergy indicators. Values are for an agricultural system of 45 hectares in one year, unless otherwise stated.

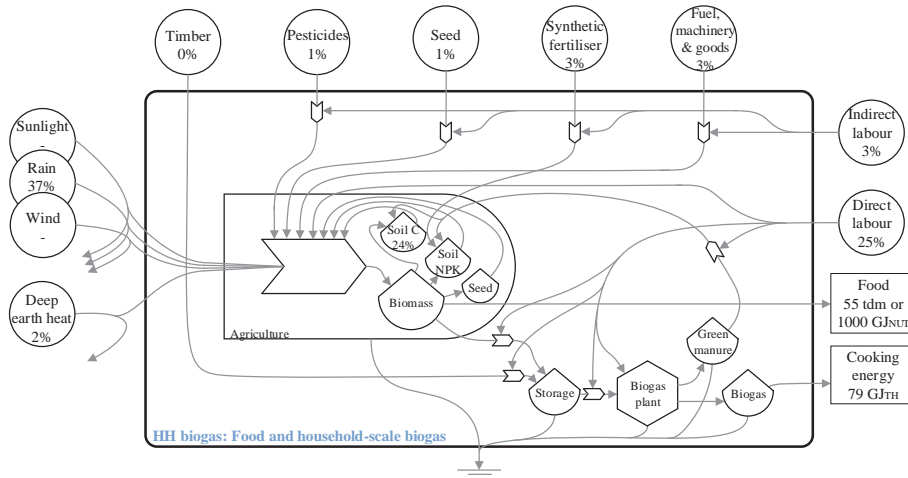
	Unit	HH PP	Village biogas	Agro-forestry
UEV, incl. labour	$10^5$ sej/J	2.8	2.7	2.6
UEV, excl. labour	$10^5$ sej/J	2.2	1.9	1.8
Global Ren. Fraction, incl. labour	%	43	43	58
Global Ren. Fraction, excl. labour	%	51	56	80

### 3.2.2 Integrated Food and Energy Systems

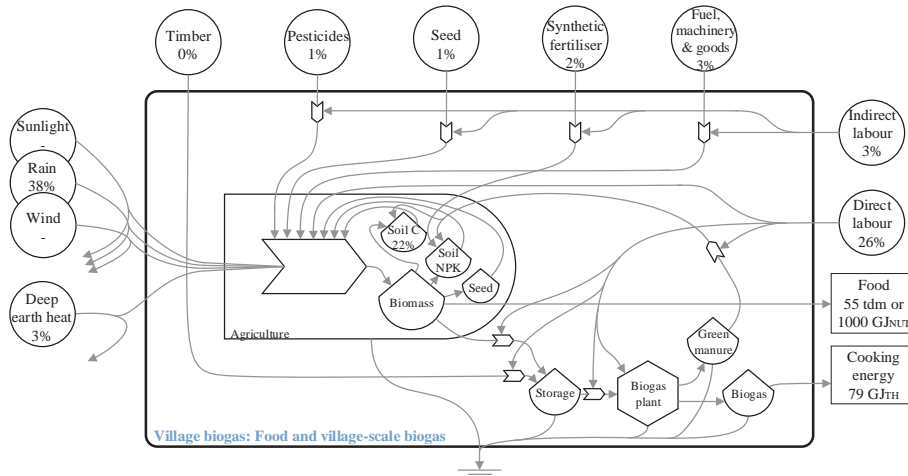
The Emergy Assessment of biophysical resource efficiency ranks Agroforestry as 31% more efficient than PP. HH biogas and Village biogas are 6% and 9% more efficient than PP, respectively (Table 3). The relative importance of inputs are shown as percentages of the total input in Figures 2-4. In all three integrated approaches, labour plays a larger role, and for Agroforestry, soil loss is significantly reduced, compared to PP.

The Global Renewability Fractions of HH biogas and Village biogas are similar to PP. The agroforestry approach is considerably better at reducing dependence on non-renewable inputs. This is primarily because agroforestry significantly reduces soil loss and leaching and fixates nitrogen from the air.

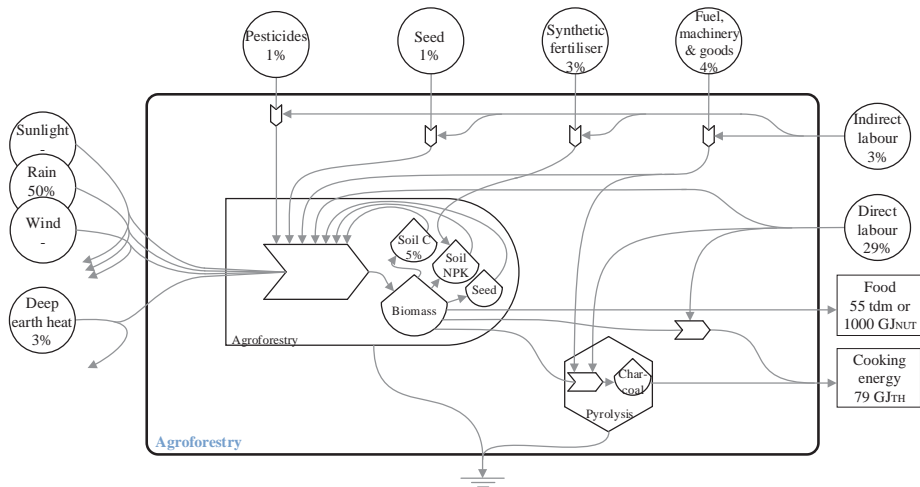
Excluding labour from the calculation provides a consistent picture of improved efficiency and renewability of integrated approaches compared to PP.



**Figure 2.** Integrated food and cooking fuel production based on household-scale biogas production with recycling of nutrients and carbon. Inputs are in percentage of the total energy flow  $2.9E+17$  sej/year on 45 ha.



**Figure 3.** Integrated food and cooking fuel production based on village-scale biogas production with recycling of nutrients and carbon. Inputs are in percentage of the total energy flow  $2.8E+17$  sej/year on 45 ha.



**Figure 4:** Integrated food and cooking fuel production based on alley cropping with maize and leucaena. Inputs are in percentage of the total energy flow  $2.2E+17$  sej/year on 45 ha.

### 3.3 Sensitivity analysis

The sensitivity analysis is based on changes in five parameters values, which we expect to be especially uncertain (see 2.4). At first, we suggest a substantial margin for labour input estimates in farming, biogas production management and agroforestry. We also consider the conversion efficiency in biogas production to be subject to significant variation since the biogas digester designs are not thoroughly tested. The ability of agroforestry practices to reduce soil loss is dependent on a range of variables that may or may not apply under the specific conditions. Finally, the renewability fraction of wood used for wood fuel depends on how to define renewability of a resource that is based primarily on renewable flows and at the same time is subject to a use that exceeds the regeneration rate. This debate is beyond our scope and we choose to apply three different Global Renewability Fractions for wood fuel.

Altering the values of the selected parameters results in ranges for each of the calculated indicators (Table 4). Ranges are slightly larger for biogas and agroforestry since the uncertainty of biogas conversion efficiency and soil loss reduction in agroforestry apply to these technologies.

**Table 2.** Results of sensitivity analysis applying two alternative sets of parameter values.

	Unit	PP	HH biogas	Village biogas	Agro-forestry
UEV, incl. labour	$10^5$ sej/J	2.6-3.0	2.5-2.8	2.4-2.6	1.7-2.4
UEV, excl. labour	$10^5$ sej/J	2.2	1.8-1.9	1.6-1.9	1.2-1.5
Global Ren. Fraction, incl. labour	%	38-48	41-46	45-47	49-66
Global Ren. Fraction, excl. labour	%	48-55	55-60	66-70	69-87

Focussing on results with labour included, the overlap of ranges indicates that the differences of the results are too small to rank technology options with certainty. Only Agroforestry has indicators that are significantly better than PP when labour is included, based on the sensitivity analysis. In results excluding labour, there is a stronger trend that integrated approaches have lower UEVs and higher Global Renewability Fractions, specifically Agroforestry.

Adjusting only the Global Renewability Fraction of imported wood fuel explains about half of the Global Renewability Fraction range in PP when including labour and all of the range when excluding labour (not shown).



## **4. Discussion**

The performance of the three integrated technology options compared to the present practice shows that it is possible to reduce simultaneously deforestation pressure, soil loss and synthetic fertiliser dependence. Agroforestry is the most effective technology in obtaining these reductions, followed by Village biogas. An apparent trade-off is the increased reliance on direct labour inputs, particularly for Village biogas. The Emergy Assessment indicates that the integrated approaches are at least as biophysically efficient and independent from non-renewable resources as present practice. This makes the integrated approaches strong candidates as substitutes for present practices in agricultural development during a transition of society toward independence from non-renewable resources. The implications of these findings are discussed below.

### *4.1 Deforestation*

Deforestation entails severe consequences related to carbon loss, pollution, biodiversity and livelihood of peoples living in and near forests. Deforestation is caused by the interplay of several dynamics and it is difficult to isolate the effect of wood fuel usage [11]. We cannot determine whether the integrated approaches are sufficient to avoid deforestation, but large-scale implementation of practices that use farmland resources for cooking fuel, like the ones analysed in this study, appears to be a significant contribution to stem the current deforestation trend. Kemausuor et al. [31] found that biogas production alone could replace more than a quarter of wood fuel use in Ghana, perhaps sufficient to stop net deforestation. Since maize and beans are grown extensively in Ghana, large-scale implementation of agroforestry practices with leucaena could also significantly reduce traditional wood fuel production practices and so lessen deforestation.

### *4.2 Fossil-fuel independence*

Fossil-fuel derived agricultural inputs include synthetic nitrogen fertiliser, usually based on natural gas, pesticides, and fuels derived from oil. Fossil fuels are consumed also in the production of farm machinery and equipment. It has been argued that the sustainable development of farming systems should apply a step-wise approach by making incremental changes to existing technologies rather than attempting to implement radically new solutions that could lock systems onto a path that may prove unsustainable in the long-term [51]. The low-tech approaches studied in this paper focus on reducing synthetic fertiliser inputs. Yet we stress that further adaptation to a fossil fuel-scarce future of the studied farming system is needed to substitute the functions provided by other fossil-based inputs, such as diesel and pesticides, with those based on renewable resources, such as sustainable biofuels and integrated pest management techniques.

### *4.3 Soil degradation*

Soil loss and soil degradation in Africa are caused primarily by vegetation cover removal, overgrazing and compaction from livestock, leaching and drastically reduced fallow periods [13]. The reduction in soil organic carbon (SOC) caused by such agricultural practices makes it difficult to maintain soil fertility, and in most parts of West African agro-ecosystems (except the forest zone), soils are inherently low in SOC [52]. Most of the nutrient balance studies from Africa show negative balances for nitrogen, potassium and phosphorus [14]. Soil degradation may be addressed through continued addition of external nutrients in the form of synthetic fertiliser. However, such a strategy may be unsustainable because of the stock-limited supply of critical plant nutrients (especially phosphorus) and may constitute a technological lock-in of agriculture with external inputs. The farming techniques involved in the integrated approaches analysed above - e.g. the incorporation of organic matter and on-site nutrient recycling - can significantly reduce the dependence of the current system on external inputs without undermining soil fertility. Consequently, the carbon-building and nutrient-providing properties of tree species suitable for agroforestry, such as leucaena, may play a central role in maintaining productivity in maize-beans production systems in Ghana. The technologies in the integrated approaches do not depend strongly on livestock production but require

only small quantities of manure to start up the biogas reactors. This places the technologies within reach of the many farmers in Ghana who do not rear significant amounts of livestock.

#### 4.4 *Resource use*

Emergy Assessment provides insight on the resource use associated with all significant inputs, and the dependence of inputs on renewable energy. When inputs are considered in a life-cycle perspective and adjusted for quality differences by conversion to the common metric of solar emjoules, it is possible to compare the technology options in an even setting. In the future, farming approaches that use resources more efficiently and that depend less on non-renewable energy resources have an advantage over currently used approaches. This suggests that biophysical efficiency and Global Renewability Fraction are relevant to include among indicators for the resilience of future farming systems.

In the integrated technology approaches, external material inputs and their associated embodied labour are substituted by direct labour inputs. This apparent dematerialisation may signify a localisation effect since direct labour may be expected to be local. However, whether increased dependence on direct labour makes the integrated food and energy systems less vulnerable to external changes overall through increased dependence on local inputs is difficult to evaluate. Increased labour inputs will, all else held equal, contribute to lower biophysical efficiency (higher UEV), but employing more people in agriculture may be desirable for the empowerment of rural areas [53,54].

#### 4.5 *Accounting for labour*

The emergy assessment is carried out both with and without labour inputs. Including labour provides the full picture by accounting for the total resource requirements of production, acknowledging that any human-influenced activity relies on information from and organisation by humans, and that the availability of these inputs are associated with resource use. In addition, inclusion of labour inputs demonstrates that there is a trade-off between material and energy inputs, on the one hand, and labour inputs on the other. Excluding labour focuses attention on material and energy inputs, enables use of the calculated UEVs for inputs in other assessment, and facilitates recalculations that apply alternative labour accounting methods (see [48]).

Converting monetary cost to indirect labour counted in global avg. man-hours is a development of the typical procedure that converts monetary cost directly to emergy. The applied approach maintains accounting of labour in physical units and facilitates the comparison of direct and indirect labour inputs.

Finally, our conclusion that biogas production increases labour requirements challenges the argument of workload reduction often made in favour of biogas production as an alternative to wood fuel [18,19]. Our results suggest that labour reductions in wood fuel provision are merely shifted to crop residue provision, biogas plant management and effluent return to fields. The hypothesis that biogas is a labour-saving substitute to wood fuel appears sensitive to feedstock/wood fuel type and distance to the feedstock/wood fuel source. The balance between labour reduction and labour increase is an issue that should be investigated further to ensure that an expectation of timesaving is not a false hope.

## 5. Conclusion

Are integrated food and bioenergy systems the way ahead for transitioning small-scale agriculture in Ghana? Our analyses have demonstrated that the integrated approaches are functional alternatives to the present farming system in the study area and relevant in terms of key biophysical indicators. The crop residue-based biogas and maize/beans/leucaena agroforestry approaches depend less on non-renewable inputs (synthetic fertiliser), reduce soil degradation, and may contribute to limiting deforestation in surrounding areas. How these approaches compare to present

practice in terms of social and economic indicators of sustainable development should be topics of further research.

Reductions in external energy and material input use are associated with increased labour inputs, but overall and with the applied assumptions, the integrated approaches are as efficient in providing food and cooking fuel. Furthermore, the integrated approaches are at least as 'renewable' in the sense that fractions of renewable flows relative to the total input are the same or higher for these technologies compared to the present farming system.

Faced with multiple constraints in the form of increased scarcity of key farming inputs, reduced availability of wood fuels and degrading soil, farmers in the developing world are forced to adapt. For farmers in a rural area as the one we have studied in Ghana, integrated food and energy systems based on biogas or agroforestry are concrete and ready-to-implement solutions. These solutions simultaneously reduce external fertiliser inputs, reduce soil loss and lessen the pressure on deforestation.

**Supplementary Materials:** The following are available online at [www.mdpi.com/link](http://www.mdpi.com/link), Emergy table with calculation notes.

**Acknowledgments:** We acknowledge Francis Kemausuor for providing primary data on recoverability fractions and wood fuel usage, Evans Yakah (KNUST, Ghana) for field work assistance, Sune Thomsen, Stefan Heiske and Jorge Londoño (DTU, Denmark) for biogas expertise, Henrik Haugaard (RUC, Denmark) for soil fertility expertise, and farmers from Zambrama for taking time to talk and teach. This research was financially supported by DANIDA through the project "Biofuel production from lignocellulosic materials – 2GBIONRG", DFC journal no. 10-018RISØ.

**Author Contributions:** Andreas Kamp, Simon Bolwig and Hanne Østergård designed the collection of empirical data; Andreas Kamp collected and analyzed the data. All authors took part in writing the paper.

**Conflicts of Interest:** The authors declare no conflict of interest.

## Abbreviations

The following abbreviations are used in this manuscript:

PP: Present practice

HH: Household

sej: solar emjoule

tdm: ton dry matter

UEV: Unit Emergy Value

USD: United States Dollar

Global Ren. Fraction: Global Renewability Fraction

## References

1. Hirsch, R. The inevitable peaking of world oil production. *Atl. Counc. United States*, XVI **2005**, XVI, 1–10.
2. Krausmann, F.; Gingrich, S.; Eisenmenger, N.; Erb, K. H.; Haberl, H.; Fischer-Kowalski, M. Growth in global materials use, GDP and population during the 20th century. *Ecol. Econ.* **2009**, *68*, 2696–2705.
3. UNEP *Decoupling natural resource use and environmental impacts from economic growth, A Report of the Working Group on Decoupling to the International Resource Panel*; 2011.
4. IAASTD *Agriculture at a crossroads*; 2009.
5. UNEP *Assessing the environmental impacts of consumption and production*; 2010.

6. Neff, R. A.; Parker, C. L.; Kirshenmann, F. L.; Tinch, J.; Lawrence, R. S. Peak oil, food systems and public health. *Am. J. Public Health* **2011**, *101*, 1587–1597.
7. Markussen, M. V. Sustainability assessment of food and bioenergy systems in a societal context – In a time of crisis. PhD thesis, Technical University of Denmark, DTU, 2013.
8. Østergård, H.; Finckh, M. R.; Fontaine, L.; Goldringer, I.; Hoard, S. P.; Kristensen, K.; Lammerts van Bueren, E. T.; Mascher, F.; Munk, L.; Wolfe, M. S. Time for a shift in crop production: Embracing complexity through diversity at all levels. *J. Sci. Food Agric.* **2009**, *89*, 1439–1445.
9. Owusu, V.; Fosu, K. Y.; Burger, K. Intersectoral Labor Mobility and Deforestation in Ghana. *Environ. Dev. Econ.* **2012**, *17*, 741–762.
10. Ministry of Lands and Natural Resources *Ghana Investment Plan for the Forest Investment Program*; 2012.
11. Boucher, D.; Elias, P.; Lininger, K.; May-Tobin, C.; Roquemore, S.; Saxon, E. *The root of the problem. What's driving tropical deforestation today?*; 2011.
12. Agyeman, K. O.; Amponsah, O.; Braimah, I.; Lurumuah, S. Commercial Charcoal Production and Sustainable Community Development of the Upper West Region, Ghana. *J. Sustain. Dev.* **2012**, *5*, 149–164.
13. Botchie, G.; Seini, W.; Asuming-Brempong, S. *FAO Roles of Agriculture (ROA) project. Socio-economic analysis and the roles of agriculture in developing countries. Country case study Ghana*; 2003.
14. Cobo, J. G.; Dercon, G.; Cadisch, G. Nutrient balances in African land use systems across different spatial scales: A review of approaches, challenges and progress. *Agric. Ecosyst. Environ.* **2010**, *136*, 1–15.
15. Ray, D. K.; Ramankutty, N.; Mueller, N. D.; West, P. C.; Foley, J. A recent patterns of crop yield growth and stagnation. *Nat. Commun.* **2012**, *3*, 1293.
16. Pittelkow, C. M.; Liang, X.; Linquist, B. a.; van Groenigen, K. J.; Lee, J.; Lundy, M. E.; van Gestel, N.; Six, J.; Venterea, R. T.; van Kessel, C. Productivity limits and potentials of the principles of conservation agriculture. *Nature* **2014**, *517*, 365–367.
17. Bond, T.; Templeton, M. R. History and future of domestic biogas plants in the developing world. *Energy Sustain. Dev.* **2011**, *15*, 347–354.
18. Amigun, B.; Parawira, W.; Musango, J. K. Anaerobic Biogas Generation for Rural Area Energy Provision in Africa. In *Biogas*; Kumar, S., Ed.; 2012; pp. 35–62.
19. Arthur, R.; Baidoo, M. F.; Antwi, E. Biogas as a potential renewable energy source: A Ghanaian case study. *Renew. Energy* **2011**, *36*, 1510–1516.
20. Chanakya, H. N.; Bhogle, S.; Arun, R. S. Field experience with leaf litter-based biogas plants.

*Energy Sustain. Dev.* **2005**, *9*, 49–62.

21. Altieri, M. A.; Nicholls, C. I. Agroecology Scaling Up for Food Sovereignty and Resiliency. *Sustain. Agric. Rev.* **2012**, *11*, 1–29.

22. Akinnifesi, F. K.; Ajayi, O. C.; Sileshi, G.; Chirwa, P. W.; Chianu, J. Fertiliser trees for sustainable food security in the maize-based production systems of East and Southern Africa . A review. *Agron. Sustain. Dev.* **2010**, *30*, 615–629.

23. Bogdanski, A.; Ismail, M.; NRC Integrated food energy systems (IFES). *Environ. Nat. Resour. Manag. Work. Pap.* **2012**, *49*, 1–10.

24. Odum, H. T. *Emergy and Environmental Decision Making*; Wiley and Sons: New York, 1996.

25. Keita, J. D. Wood or charcoal - which is better? *Unasylva* **1987**, *39*, 137–138.

26. Thomsen, Sune Tjalfe (formerly Technical University of Denmark); Heiske, Stefan (formerly Technical University of Denmark). Personal communication **2013**.

27. Chanakya, H. N.; Ganguli, N. K.; Anand, V.; Jagadish, K. S. Performance characteristics of a solid-phase biogas fermentor. *Energy Sustain. Dev.* **1995**, *1*, 43–46.

28. Burri, M.; Martius, G. Biogas from solid waste. Conception and construction of a dry fermentation pilot plant for developing countries, Swiss Federal Institute of Technology in Zürich (ETH), 2011.

29. Lefroy, E.; Rydberg, T. Emergy evaluation of three cropping systems in southwestern Australia. *Ecol. Modell.* **2003**, *161*, 195–211.

30. Wilhelm, W. W.; Johnson, J. M. F.; Karlen, D. L.; Lightle, D. T. Corn Stover to Sustain Soil Organic Carbon Further Constrains Biomass Supply. *Agron. J.* **2007**, *99*, 1665.

31. Kemausuor, F.; Kamp, A.; Thomsen, S. T.; Bensah, E. C.; Østergård, H. Assessment of biomass residue availability and bioenergy yields in Ghana. *Resour. Conserv. Recycl.* **2014**, *86*, 28–37.

32. Thomsen, S. T.; Spliid, H.; Østergård, H. Statistical prediction of biomethane potentials based on the composition of lignocellulosic biomass. *Bioresour. Technol.* **2014**, *154*, 80–86.

33. Emery, I. R.; Mosier, N. S. The impact of dry matter loss during herbaceous biomass storage on net greenhouse gas emissions from biofuels production. *Biomass and Bioenergy* **2012**, *39*, 237–246.

34. Heiske, Stefan (formerly Technical University of Denmark); Londoño, Jorge (Technical University of Denmark) Personal communication 2013.

35. Bhattacharya, S. C.; Abdul Salam, P. Low greenhouse gas biomass options for cooking in the developing countries. *Biomass and Bioenergy* **2002**, *22*, 305–317.

36. Kang, B. T.; Wilson, G. F.; Sipkens, L. Alley cropping maize (*Zea mays* L.) and leucaena (*Leucaena leucocephala* Lam) in southern Nigeria. *Plant Soil* **1981**, *63*, 165–179.

37. Cook, B. G.; Pengelly, B. C.; Brown, S. D.; Donnelly, J. L.; Eagles, D. A.; Franco, M. A.; Hanson, J.; Mullen, B. F.; Partridge, I. J.; Peters, M.; Schultze-Kraft, R. Tropical Forages: an interactive selection tool [http://www.tropicalforages.info/key/Forages/Media/Html/Leucaena\\_leucocephala.htm](http://www.tropicalforages.info/key/Forages/Media/Html/Leucaena_leucocephala.htm), last accessed 6th of August 2015.
38. Kang, B. T.; Grimme, H.; Lawson, T. L. Alley cropping sequentially cropped maize and cowpea with *Leucaena* on a sandy soil in Southern Nigeria. *Plant Soil* **1985**, *85*, 267–277.
39. Lal, R. Agroforestry systems and soil surface management of a tropical alfisol: I: Soil moisture and crop yields. *Agrofor. Syst.* **1989**, *8*, 7–29.
40. Remington, T.; Eklou-Takpani, K. Alley farming in central Togo. In *Alley farming in the humid and subhumid tropics: proceedings of an international workshop held at Ibadan, Nigeria, 10-14 March 1986*; International Development Research Centre, 1989; pp. 137–138.
41. Ngambeki, D. S. Economic evaluation of alley cropping *leucaena* with Maize-Maize and Maize-Cowpea in Southern Nigeria. *Agric. Syst.* **1985**, *17*, 243–258.
42. *Emergy synthesis 8: Theory and Applications of the Emergy Methodology*; Brown, M. T.; Sweeney, S.; Campbell, D. E.; Huang, S.-L.; Rydberg, T.; Ulgiati, S., Eds.; The Center for Environmental Policy, Department of Environmental Engineering Sciences, University of Florida, Gainesville, Florida, 2015.
43. Odum, H. T.; Brown, M. T.; Brandt-Williams, S. Handbook of emergy evaluation Folio 1: Introduction and global budget. *Univ. Florida, Gainesv.* **2000**.
44. Bastianoni, S.; Marchettini, N. The problem of co-production in environmental accounting by emergy analysis. *Ecol. Modell.* **2000**, *129*, 187–193.
45. Kamp, A.; Østergård, H. How to manage co-product inputs in emergy accounting exemplified by willow production for bioenergy. *Ecol. Modell.* **2013**, *253*, 70–78.
46. Wright, C.; Østergård, H. Scales of renewability exemplified by a case study of three Danish pig production systems. *Ecol. Modell.* **2015**, *315*, 28–36.
47. Cavalett, O.; Queiroz, J. F. De; Ortega, E. Emergy assessment of integrated production systems of grains, pig and fish in small farms in the South Brazil. *Ecol. Modell.* **2006**, *193*, 205–224.
48. Kamp, A.; Morandi, F.; Østergård, H. Development of concepts for human labour accounting in Emergy Assessment and other Environmental Sustainability Assessment methods. *Ecol. Indic.* **2016**, *60*, 884–892.
49. Brown, M. T.; Ulgiati, S. Understanding the global economic crisis: A biophysical perspective. *Ecol. Modell.* **2011**, *223*, 4–13.
50. World Bank Labor force, total datasheet <http://data.worldbank.org/indicator/SL.TLF.TOTL.IN> (accessed Feb 16, 2016).

51. Robèrt, K. H.; Broman, G. I.; Basile, G. Analyzing the concept of planetary boundaries from a strategic sustainability perspective: How does humanity avoid tipping the planet? *Ecol. Soc.* **2013**, *18*.
52. Bationo, A.; Kihara, J.; Vanlauwe, B.; Waswa, B.; Kimetu, J. Soil organic carbon dynamics, functions and management in West African agro-ecosystems. *Agric. Syst.* **2007**, *94*, 13–25.
53. Agostinho, F.; Ortega, E. Integrated food, energy and environmental services production as an alternative for small rural properties in Brazil. *Energy* **2012**, *37*, 103–114.
54. Ikerd, J. E. The need for a system approach to sustainable agriculture. *Agric. Ecosyst. Environ.* **1993**, *46*, 147–160.



© 2016 by the authors; licensee MDPI, Basel, Switzerland. This article is an open access article distributed under the terms and conditions of the Creative Commons by Attribution (CC-BY) license (<http://creativecommons.org/licenses/by/4.0/>).

## PAPER III

**In-text citation:**

(Kamp et al., 2016b)

**Authors:**

Andreas Kamp, Fabiana Morandi and Hanne Østergård

**Title:**

Development of concepts for human labour accounting in Emergy Assessment and other Environmental Sustainability Assessment methods

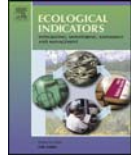
**Submission and publication details:**

Submitted to *Ecological Indicators* 31<sup>st</sup> of March 2015

Re-submitted after minor adjustments September 2<sup>nd</sup> 2015

Published in Volume 60 in January 2016





# Development of concepts for human labour accounting in Emergy Assessment and other Environmental Sustainability Assessment methods

Andreas Kamp, Fabiana Morandi, Hanne Østergård\*

Department of Chemical and Biochemical Engineering, Technical University of Denmark, DTU, 2800 Kgs. Lyngby, Denmark

## ARTICLE INFO

### Article history:

Received 31 March 2015

Received in revised form 13 July 2015

Accepted 5 August 2015

### Keywords:

Labour

UEV

Emergy

Embodied energy

LCA

Sustainability assessment

## ABSTRACT

Human labour is central to the functioning of any human-influenced process. Nevertheless, Environmental Sustainability Assessments (ESAs) do not systematically include human labour as an input. Systematic omission of labour inputs in ESAs may constitute an unfortunate, significant bias in favour of labour intensive processes and a systematic underestimation of environmental impacts has implications for decision-making. A brief review of the evaluation of human labour in ESAs reveals that only Emergy Assessment (EmA) accounts for labour as standard. Focussing on EmA, we find, however, that there is no agreement on the calculation method for labour. We formalise the calculation of human labour unit energy values (UEVs) as being the ratio between the emergy resource basis of the labour system and a proxy for labour, with or without allocation to account for different qualities of labour. The formalised calculation approach is demonstrated using examples from the literature (USA, with allocation based on educational level; Ghana, with allocation based on income level; the World, with no allocation). We elaborate on how labour may be considered as endogenous or exogenous to the studied system, and how inputs can be categorised as direct labour taking place in the system under study and indirect labour occurring upstream in the supply chain associated with the studied system. With appropriate modifications, the formalised calculation approach and the distinction between direct and indirect labour may be transferred to other ESA methodologies. Concerning EmA, we recommend that product UEVs should systematically be calculated with and without labour, and that working hours rather than salary should be used when accounting for labour inputs. We recognise that there is a risk of double counting of environmental impacts when including labour. We conclude, however, that it can be ignored for most production systems, since only a negligible fraction of emergy already accounted for is likely to be included in the emergy flow from labour inputs.

© 2015 Elsevier Ltd. All rights reserved.

## 1. Human labour in Environmental Sustainability Assessments

Potential environmental impacts of human activities are estimated in Environmental Sustainability Assessments (in the following designated ESAs) with the goal of reducing resource use and/or environmental pollution (Moldan et al., 2012; Ulgiati et al., 2011). A multitude of ESA methods and approaches exist, e.g. Life Cycle Assessment (LCA) (EC, 2010), Energy Analysis (Herendeen, 2004), Exergy Analysis (Wall, 1977), Emergy Assessment (Odum, 1996). The methods originate from various scientific branches and

emphasise different specific aspects and perspectives. Many apply a life-cycle perspective, indicating that ESA includes activities associated with various life-cycle stages of a product or service. ESAs must also embrace activities in a spatial scope through the selection of those activities that are supposed to be relevant. Such activities are sufficiently associated with the studied system and cause significant impact according to specified cut-off criteria (EC, 2010:102). Thus, a typical ESA systematically includes inputs that are required for the process under study and that, in a life-cycle perspective, are considered to significantly impact the environment.

Usually, ESAs are focused on material and energy inputs (e.g. ISO, 2006:3.21) while labour inputs are considered outside of the scope and therefore not systematically included. All processes of production and provision of services to society, however, involve human intervention, represented by the input of labour. Human labour inputs constitute the process control function without

\* Corresponding author. Tel.: +45 21 32 69 55.  
E-mail address: [haqs@kt.dtu.dk](mailto:haqs@kt.dtu.dk) (H. Østergård).

which little would happen. With no human control, there is no application of information and there is no organisation of material and energy inputs. Nevertheless, standard ESA inventories rarely include human labour inputs and few attempts have been made to establish relevant data basis, e.g. human labour intensities for Life Cycle Assessment (LCA) software.

The rationale behind including labour inputs is the same as the rationale for including material and energy inputs: when the provisioning of an input has a significant up- or downstream environmental effect, i.e. is 'quantitatively relevant', and that effect is attributable to the system, then that input shall be accounted for (EC, 2010:102). ESAs that do not include labour inputs do not provide the full picture of the system under study. There is a risk that systematic omission of labour inputs in ESA constitutes a leakage of environmental effects linked to human labour necessary for specific processes. This externalisation of environmental impacts is likely to result in miscalculation of the environmental profile of production and service systems, particularly if they are labour intensive considered in a life-cycle perspective. Studies exist where results are shown with and without labour and where it is concluded that labour plays a dominating role (46% of total energy use in Bonilla et al., 2010; 65–71% of total energy use in Kamp and Østergård, 2014; 89% of total energy use in Markussen et al., 2014). As of yet, however, emphasis has not been put on showing whether conclusions change when labour is excluded/included. By raising this hypothesis in the paper, we hope to provide a starting point for further elaboration on this issue. It follows that the interpretation of results based solely on material and energy flows may lead to different conclusions compared to when results are based on material, energy and human labour flows combined. This clearly has implications for decision-making.

By including labour, it is possible to recognise the potential environmental effects of establishing and maintaining information infrastructure (e.g. education, media), living infrastructure (e.g. housing, food), transport infrastructure (e.g. roads, vehicles), administration infrastructure (e.g. state organisation, laws and protection) and other goods and services that are supportive of, and necessary for, human labour availability. Proponents of including labour in ESAs argue that the functioning of specific production systems is unequally dependent on these structures through unequal dependence on labour (Rugani et al., 2012; Kamp and Østergård, 2014; Markussen et al., 2014). Therefore, environmental sustainability should be assessed also through estimates of actual labour requirement and linkages between labour input and different labour provision support structures that, in turn, have up- and downstream environmental effects. The development of methods for including labour in standardised LCA, Energy Analysis, Exergy Analysis and Emery Assessment (EmA) is ongoing, and briefly outlined here.

LCA is a widely recognised and popular method to quantify "all relevant emissions and resources consumed and the related environmental and health impacts and resource depletion issues that are associated with any goods or services ("products")" (EC, 2010). Attempts have been made to incorporate labour as an input flow similar to other flows in product systems: Nguyen et al. (2007) and Silalertruksa and Gheewala (2009) applied different approaches to estimate the energy intensity of agricultural labour in Thailand measured in MJ/h. Lately, the methodological challenges and opportunities were discussed when Rugani and Benetto (2012) and Arbault et al. (2013) highlighted similarities and discrepancies between energy and LCA. Among these were how environmental effects of labour inputs could and should be modelled. Further, Rugani et al. (2012) provided detailed estimates of human labour LCIA indicators for 15 EU countries, based on household expenditures.

Energy analysis is a method used to determine the embodied energy required to produce a product or service (IFIAS, 1974) and it can be seen as an indicator of environmental impact (Herendeen, 2004). According to Herendeen (2004), it is not usual to consider human labour in Energy Analysis but many authors do consider labour a valid input (Brown and Herendeen, 1996), often in assessments of different types of agriculture. For instance, Fluck (1992) summarised methods and values for energy content of labour, while Freedman (1982) showed the importance of human labour in a rice production by considering the worker hours and the energy cost per hectare. Cleveland (2013) associated an energy cost to human labour composed by the caloric value of the food consumed by the worker, the embodied energy of that food and the fuel purchased with salary.

Exergy analysis is a measure of the maximum amount of work that a system can perform when it is brought into thermodynamic equilibrium with its environment (Wall, 1977). Sciubba (2001, 2003) proposed a resource-based quantifier method, called "extended exergy accounting" in which both labour and financial services are linked to equivalent resource consumption by quantifying the total exergy consumption to generate one man-hour of work or one monetary unit of currency. Fukuda (2003) affirmed that "labour itself is exergy" and characterised a human being as a thermodynamic system that generates force from food. Accordingly, the exergy of human labour should then be calculated based on exergy from food and on exergy from the inputs to produce food.

Emery Assessment (EmA) is a thermodynamics-based method centred on the approach of accounting for different forms of energy using different energy quality conversion factors, called Unit Emery Values (UEVs). Solar energy is the available solar energy used up directly and indirectly to make a service or product (Odum, 1996) and we refer to the unit as solar equivalent joule, abbreviated *sej*.<sup>1</sup> The conversion of inputs, given in physical (J, kg, L, kWh, etc.) or monetary units to (solar) emery takes place by multiplication with the respective UEVs. As an example, a UEV for gasoline is 187,000 *sej*/J, indicating that the equivalent of 187,000 J of solar energy have been dissipated in the creation, production, refining and transport to gas stations per joule of exergy in gasoline (Brown et al., 2011). EmA is more thoroughly described in Odum (1996). Among ESA methods, EmA stands out because of its systematic inclusion of work provided by nature (e.g. creation of oil) and of its systematic inclusion of human labour, even if the approach for considering the latter, as will be shown in Section 2, is not agreed upon.

This brief review shows that it is not new to consider labour as an input, but also that doing so remains peripheral. We interpret the reason for this to be the lack of a conceptual approach that is compatible across ESA methods. We will elaborate on methodological issues relevant for labour calculations in EmA with the aim of establishing a robust conceptual framework for the evaluation of human labour. Afterwards, this advancement may facilitate the development of routine calculation for the value of human labour in ESA. In Section 2, we illustrate how labour can be considered as either an endogenous flow or an exogenous flow. We summarise the different approaches in EmA for calculating the emery flow related to human labour, propose a general procedure for assessing labour in emery evaluations and demonstrate this procedure in three calculation examples. In Section 3, we conceptualise the distinction between direct and indirect labour and we show how emery of labour can be aggregated across various inputs and supply chain levels. In Section 4, we discuss methodological issues related to

<sup>1</sup> Currently, there is no consensus concerning how to designate the unit. The unit is also referred to as solar emjoule or solar energy joule and with the abbreviations *semj* or *sej*.

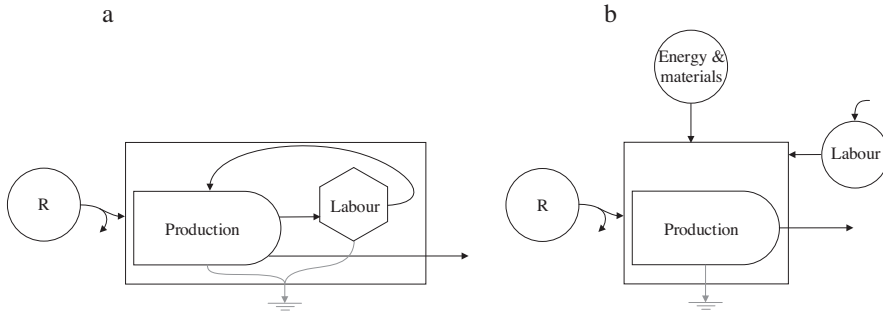


Fig. 1. Simplified system diagrams with labour considered endogenous (a) or exogenous (b).

evaluating labour, specifically for EmA but applicable for ESA in general: Whether money or labour time is the more proper unit in which to account for labour, why product UEVs should be provided with and without labour included, and the challenge of counting some environmental impacts twice when labour inputs are accounted for.

## 2. Approaches for including human labour in energy accounting

When making an Energy Assessment, inputs, outputs, components and system boundary delineations are represented in a system diagram. Concerning labour, some inputs may be considered endogenous and some inputs may be considered exogenous to the studied system (Fig. 1). When considered endogenous, labour is within the system boundary as an internal flow and therefore it is already accounted for by other inputs to the system (Fig. 1a). If we consider labour exogenous, it is an external input coming from somewhere else, and we assume that in principle, no part of the labour is already accounted for by other inputs to the studied system (Fig. 1b).

In practice, the accounted labour is usually considered as exogenous (Fig. 1b). There are studies of systems, however, where external labour inputs are considered to be non-existent, e.g. planet Earth, isolated tribes, or farms that are considered completely self-sufficient (Fig. 1a). Studies of countries are typical examples of mixtures, where only labour imported from abroad is accounted for, while domestic labour is considered endogenous (e.g. NEAD, 2012 for mixture example). In this paper we provide approaches for labour that is considered as exogenous input, since endogenous labour does not require detailed accounting procedures.

Before continuing, we emphasise that an energy flow is calculated as a given quantity  $x$  (e.g. J, g), representing the input, multiplied with its corresponding UEV (e.g. seJ/J, seJ/g).

To account for labour, Odum and Odum (1981) suggested to use food metabolism calories as the correct unit to quantify the energy supporting a person. An additional approach was suggested shortly after, when Odum (1983) stated that “it is a reasonable approximation to estimate the energy for labour by multiplying by the average energy:dollar ratio with energy expressed in equivalents of the same quality” (Odum, 1983:490). Let us note that at that time, the energy concept had only recently been introduced, and that today the quotation can be interpreted as labour in energy terms is the dollar value of labour ( $x$ ) multiplied by the national Energy to Money Ratio (EMR) (the UEV). The EMR is the total, national energy flow divided by the monetary value of production, the GDP. The suggested approximation relies on the observation that the economy mostly converges on human services. Odum also concluded

that “the most energy-intensive item in embodied energy is human labour” (ibid).

Further developments lead to two specific calculation approaches, i.e., considering emergy of labour as a function of the education level or as a function of human metabolism (Odum, 1996). In particular, the emergy of human labour should be calculated, respectively, by “multiplying the energy expended by a human being ( $x$ , our insertion) by the transformity<sup>2</sup> of that person’s education and experience (the UEV, our insertion)” or by dividing “the total national energy flow by the number of people and the metabolism” (Odum, 1996:230) to obtain the UEV and then multiply with number of people providing labour ( $x$ ).

Campbell and Lu (2014) refined the approach based on educational level by considering three educational subsystems: elementary, secondary and college/university. The evaluation of human labour as a function of the educational level was the subject also in Campbell et al. (2013) where the authors calculated UEVs for more than 500 occupations in the USA and found fairly strong correlation between energy of education and salary. Abel (2011) revised work by Odum and estimated UEVs of six population classes, based on education and experience (information). A similar, theoretical approach was presented by Bergquist et al. (2011) who suggested accounting for labour by using, respectively, the formal and informal knowledge level of individuals.

Kamp and Østergård (2014) calculated the emergy of labour by multiplying the amount of laboured hours ( $x$ ) with the average emergy per man-hour (the UEV). The authors showed how this average UEV may be differentiated according to the perceived consumption level of the labourer. This is useful when assessing systems with substantial inputs of labour by people whose consumption is expected to differ markedly from the national average. A practical way of estimating the UEV for labour supplied by people belonging to different consumption classes is to assume that distribution of energy (i.e. consumption) follows the distribution of income. This assumption allows for the use of (money-based) income distribution indices that specify the share of income for e.g. the poorest and the richest population groups (e.g. the United Nations Development Index). With estimates of laboured time for each of the groups, labour UEVs can then be established for low income labourers, middle-class labourers, and high-income labourers on a per man-hour basis. Alternatively, the UEV can be calculated on a per lived-hour basis.

The use of salary as the basis for labour inputs ( $x$ ) and subsequent application of the EMR as UEV has been repeatedly suggested (Odum, 1983; Brown and Herendeen, 1996; Ulgiati and Brown,

<sup>2</sup> Transformity is defined as energy required to make one joule of a service or product (Odum, 1996). It is a particular UEV.

**Table 1**  
Specification of information required to calculate a labour UEV.

Factor	Description	Examples
Resource basis ( $\alpha$ )	Energy flow considered necessary for provision of labour	Energy flow for territory (World, region, country, etc.), sector (education) or other defined boundary (village, farm)
Allocation ( $\beta_1, \beta_2$ )	Provide deviation from the avg. UEV (i.e. $\alpha/\gamma$ ) by taking into account the quality of the labour	Educational level, income level, metabolism, knowledge, age
Proxy ( $\gamma$ )	Accounted quantity	Metabolised energy, worked or lived time period, # of people, money flow

2014). The rationale for this appears to be the assumption that salary is representative of the quality of work done. [Ulgiati and Brown \(2014\)](#) specified that labour inputs originating from different countries should be used in combination with country-specific EMRs.

2.1. Labour systems and labour UEV calculation

According to the definition of the UEV, it is calculated as the supporting energy flow divided by a relevant physical quantity or monetary value. To estimate the labour requirement for a given process, it is necessary to refer to the societal system that provides this labour (in the following designated labour system). To evaluate labour systems and UEVs of labour, we suggest the terminology that the UEV is the resource basis divided by a proxy for labour. The resource basis is the energy flow that is required for the provision of labour and the proxy is the quantity that labour is accounted in and that defines the unit to use. A published UEV for labour that is applicable for a specific energy assessment is often not readily available, and this leads analysts to undertake a back-of-the-envelope labour system analysis. Based on the literature review above, we find that a simplified labour system analysis can be formalised by incorporating two optional allocation factors into the UEV formula:

$$UEV = \frac{\alpha\beta_1}{\gamma\beta_2} \tag{1}$$

where  $\alpha$  = resource basis,  $\beta_1, \beta_2$  = allocation (optional),  $\gamma$  = proxy. Description and examples of these factors are listed in [Table 1](#).

In the analysis of a labour system, the chosen resource basis and proxy must be at corresponding organisational level and span the same time period: e.g., the yearly, national energy budget corresponds to either of the following proxies: (1) the yearly, national metabolism; (2) the yearly, national, monetary wealth creation (GDP); (3) the yearly, national work provided (sum of man-hours laboured). The UEV must be applicable in terms of relevance and temporal and spatial scope. In the inventory of a specific energy assessment, the chosen proxy of the UEV provides the unit that

labour inputs have to be accounted in. Three calculation examples provide insight into the practicalities of calculating labour UEVs ([Table 2](#). See appendix for elaboration).

In the first example, the labour system is USA in the year 1980. By considering the national energy flow in that year, [Odum \(1996\)](#) provides six labour UEVs ranging from 8.9E+06 seJ/J of metabolised energy in food consumption per person with preschool level training to 2.1E+09 seJ/J of metabolised energy per person with so-called legacy status, the highest level of education ([Appendix A1](#)). This differentiation results in an approximate factor 200 difference between least and most qualified labour. These UEVs are applicable when formal education level is considered to best characterise the energy of labour used. In the calculation of the labour UEV for preschool level training, the total resource basis is distributed evenly among the entire population, in effect providing  $\alpha/\gamma$ , a labour UEV calculated without any allocation, i.e., that does not take the quality of labour into account.

The labour system in the second example is Ghana in the year 2000. By considering the Ghanaian energy flow in that year, [Kamp and Østergård \(2014\)](#) provide three labour UEVs: 3.2E+12 seJ/man-hour by a person whose energy support (resource use) is considered to be below average, 9.1E+12 seJ/man-hour by a person with considered medium energy support, and 2.7E+13 seJ/man-hour by a person whose energy support is considered to be above average ([Appendix A2](#)). The differentiation results in an approximate factor 10 difference between labour inputs by people considered to consume little and much, respectively.

The third example considers money flow as proxy and as the labour system the World in the year 2008. The global energy flow is divided by the World Domestic Product to provide the global EMR of 1.7E+12 seJ/USD ([Appendix A3](#)). The global EMR is applicable for labour inputs that are accounted in money and that are considered to be a mixture of labour from different countries and, therefore, may be assumed to have an average resource basis. It can be argued that in a globalised economy, where supply chains span many countries, most consumer products rely on 'global labour'. The use of a global EMR, however, implies the risk of bias since national EMRs vary significantly from the global average.

As shown by the examples found in the literature, there is no universally agreed-upon calculation procedure for labour UEVs. Rather, a combination of associated energy flow and quantity of a chosen unit for labour inputs are selected, sometimes complemented by allocation to specific categories. The provided formula can be used for any combination. The technique for assessing the energy of labour can be supplemented by the distinction between direct and indirect labour.

3. Conceptualising direct and indirect labour

In many recent publications, authors distinguish between two types of labour, traditionally referred to as labour and services (e.g. [Markussen et al., 2014; Jaklič et al., 2014; Cruz and Nascimento, 2012; Vassallo et al., 2007; Ulgiati and Brown, 2002](#)). Instead of labour and services, we support the suggestion to use, respectively, the terms direct labour (DL) and indirect labour (IL) ([Ulgiati and Brown, 2014; Kamp and Østergård, 2014; Wright and Østergård,](#)

**Table 2**  
Examples of combinations of resource requirement, allocation basis and proxy for calculations of labour UEVs.

Labour system	$\alpha$	$\beta_1, \beta_2$	$\gamma$	Appendix
USA, year 1980	USA energy flow	Educational level	Metabolised energy of people in specific educational category	A1
Ghana, year 2000	Ghanaian energy flow	Consumption level	Worked hours by individual in specific income group	A2
World, year 2008	Global energy flow	–	Money flow	A3

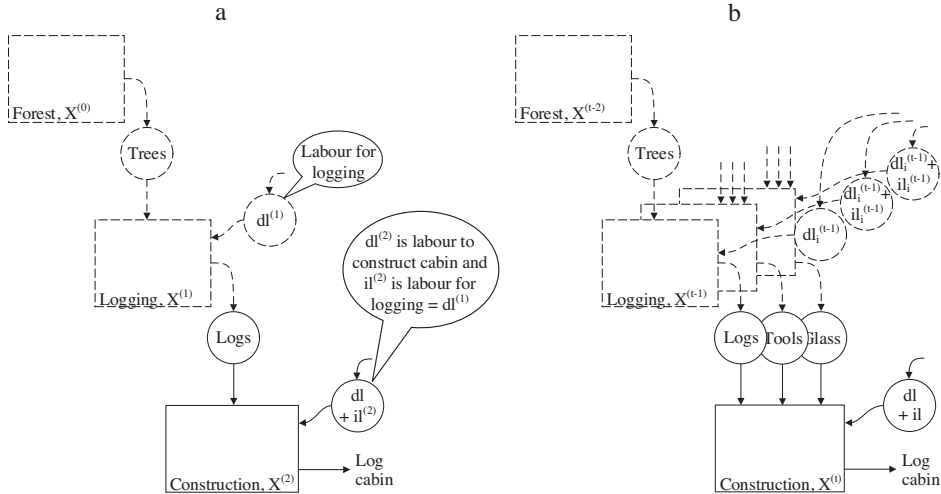


Fig. 2. (a) Simplified log cabin production supply chain. (b) As (a) but with additional inputs and their respective supply chains. Foreground system indicated in full lines, background systems indicated in dashed lines.

2015). We define DL as the labour taking place in the foreground of the assessment, supporting processes within the (foreground) system boundary, and to be thought of as applied labour. IL is the labour taking place outside the (foreground) system boundary or, colloquially, 'in the background', and it is imported into the system accompanying external inputs. IL can be thought of as embodied labour. In this section we will treat the relationship between DL and IL in detail.

In EmA, every system is supported by inputs divided into three categories indicated by R, N, and F. Each category includes a number of system-specific inputs, in the following indexed by *i*: on-site, renewable inputs (*r<sub>i</sub>*),  $R = \sum r_i$ ; on-site, non-renewable inputs (*n<sub>i</sub>*),  $N = \sum n_i$ ; and feedback from society, *F*, being materials *M* and labour *L* such that  $F = M + L$ . Further,  $M = \sum m_i$  accounts for the sum of material inputs (*m<sub>i</sub>*) and *L* is divided into direct labour (DL) and indirect labour (IL), such that  $L = DL + IL$ . DL is the applied labour in the foreground system and IL is the sum of all embodied labour required for providing the inputs in *M*. We consider any input *m<sub>i</sub>* as the end product of a supply chain represented as a hierarchy with *t<sub>i</sub>* levels which may differ between the different inputs. The levels of the supply chain are denoted by the index *h*, and  $h = (0, 1, \dots, t-1, t)$ . We define supply chain level  $h = 0$  to represent the bottom of the hierarchy being the geobiosphere level before the resource extraction boundary, i.e. for all *i*,  $dl_i^{(0)} = il_i^{(1)} = 0$ .

The embodied labour component (in physical or monetary units) for a specific input *m<sub>i</sub>* at an input-specific level *t*,  $il_i^{(t)}$ , may be decomposed into:

$$il_i^{(t)} = dl_i^{(t-1)} + il_i^{(t-1)} \tag{2}$$

where  $il_i^{(t-1)}$  is the direct labour and indirect labour embodied in the materials required at level *t* - 1 for producing *m<sub>i</sub>*:

$$il_i^{(t-1)} = dl_i^{(t-2)} + il_i^{(t-2)} \tag{3}$$

This argument may be continued till level  $h = 1$ , obtaining

$$il_i^{(t)} = \sum_{h=1}^{t-1} dl_i^{(h)} \tag{4}$$

When the sum of direct labour inputs in the foreground system indexed by *j* are added to the sum of indirect labour inputs (Eq. (4)) added over all *i*, the total labour input is

$$L = \sum_j dl_j + \sum_i \sum_{h=1}^{t_i-1} dl_i^{(h)} \tag{5}$$

where the different number of supply chain levels for different inputs are specified with the index *t<sub>i</sub>*. We conclude that the total labour input (Eq. (5)) is the sum of direct labour inputs.

To illustrate the described method we consider the production of a log cabin as an example (Fig. 2). In the example, a three-level ( $h = 0, 1, 2$ ) supply chain is considered: log cabin construction ( $h = 2$ ), logging ( $h = 1$ ) and biomass growth ( $h = 0$ ), taking place in the systems Construction, Logging, and Forest, respectively. Here we consider the process as a set of dependent but individual systems with Construction as the foreground system, Logging as background to Construction and Forest as background to Logging. Fig. 2a is a simplified representation that comprises only the flows of trees, logs and the associated labour. The labour input is, in turn, dependent on its own inputs (see Section 2.1 on labour UEV calculation). Fig. 2b indicates the presence of similar supply chains for other inputs for the construction of the log cabin, suggesting a dendrogram of supply systems that support log cabin construction.

The emery of labour can now be expressed as the sum of direct labour inputs, each multiplied with an input- and level-specific labour UEV, calculated according to Eq. (1), that is:

$$\begin{aligned} \text{Emery of labour} = DL + IL &= \sum_j dl_j \cdot UEV_j \\ &+ \sum_i \sum_{h=1}^{t_i-1} dl_i^{(h)} \cdot UEV_{i,h} \end{aligned} \tag{6}$$

We conclude that the total emery of labour for a given production system is the sum of all direct labour inputs occurring at all production levels multiplied with the respective UEV for each input.

#### 4. Discussion

The methodology we have proposed for accounting human labour inputs and the formula we have provided for calculating labour UEVs are useful not only to have formal procedures to refer to but also as a starting point for a discussion of some of the main methodological issues related to human labour. In this section we will consider the use of time rather than money as a proxy, the provision of product UEVs both with and without labour inputs, and the problem of double counting that could appear when considering human labour.

##### 4.1. Money or time as a proxy for labour

Brown and Herendeen (1996) state that “There is no logical reason that embodied energy is related to money, carbon, labour or anything else”. We agree with this line of thinking and we consider the practice of using money as a proxy for labour as particularly problematic. The use of money as a proxy for labour should be avoided because the uncertainties and biases concerned with the value of money are too large to ignore. First of all, money is a social construct that has no value in itself. Money value is based on flawed, preference-based utility theory. Currency valuations are victim of supply and demand on the financial markets. Prices of inputs are affected by fashion and scarcity, and are usually distorted by taxation and subsidisation. The use of the EMR is flawed because it assumes an average energy per money unit and this disregards the fact that purchases have different environmental effect even if the price is the same. Usually, conversion of price or salary into energy is done too hastily, ignoring that not all labour has taken place in the ‘foreground country’ (i.e. the country in which the foreground system is located), thereby disregarding that a part of the price/salary is associated with environmental effects abroad.

This paper shares much of the conceptual understanding, many arguments and some of the conclusions with Ulgiati and Brown (2014), including the need for increased standardisation of accounting procedures within EmA. We disagree, however, on their general acceptance of money as a proxy for labour and the associated application of the Energy-to-Money-Ratio (EMR), the index that represents the perceived energy value of money. We encourage the pursuit of a different line of labour calculation. It is our opinion that it is possible to systematically account for labour using time as a proxy and also that it is possible to keep track of what is DL and IL. Time is a physical quantity, time does not change because of scarcity or speculation, and an hour is the same everywhere. We find that when arguments are considered together, time is a better proxy than money for accounting for both DL and IL, and that using time constitutes a more reliable basis for energy calculations. We recognise that assessing labour inputs in terms of hours and years is not an easily implementable alternative, and that accounting in time is not immune to all the arguments posed against the use of money as a proxy. We expect that with practice and continued development of methods, the challenges will be overcome. Thus, we attempt to conceptualise without referring specifically to money and seek to provide a theoretically robust framework based on accounting of time that can be implemented in later computerisation of actual values.

##### 4.2. Providing product UEVs with and without labour

We have shown that it is theoretically possible to identify all labour inputs for any production system, including its supply systems, and to categorise them as either direct or indirect labour. At present, it is customary (but not compulsory) to inventory labour

inputs apart from non-labour inputs and provide UEVs exclusive of labour and, as a preferable addition, inclusive of labour. There are arguments for and against this custom.

Provision of two UEVs is meant to offer the possibility to re-use most of the original assessment (the material and energy flows) in another country of study, and simply apply other labour UEVs, applicable for that country. Thereby, the UEV is perceived to have been adjusted to reflect local conditions (Odum, 1996; Franzese et al., 2009; Ulgiati and Brown, 2014). The underlying assumption is that non-labour flows are directly transferable while labour flows are location-specific. Since UEV databases are far from complete, the availability of UEVs without labour supports a welcome technique to adjust UEVs for a particular system. We support the practice of providing the UEV exclusive and inclusive of labour inputs, but we find that the so-called adjustment to local conditions, should be done only cautiously, if at all. The reasons for this are that (1) the mentioned assumption probably does not hold – the flows of materials and energy are not independent from the labour input (e.g., the reduced non-labour inputs in precision farming requires additional labour); and (2) the adjustment typically occurs by applying the UEV without labour and adding the price of the input in the foreground country. This has the actual effect of considering all labour inputs in the supply chain (IL) as if they took place in the foreground country of study, which rarely is justifiable. In fact, the adjusted UEV becomes a hybrid that is neither applicable in the original study nor in the study it is supposed to be adjusted to.

As we have shown, the identification of labour inputs, accumulated across supply chains, provides an estimate of the resource use of specifically labour. In some analyses, this estimate may be relevant to discuss separately from other inputs, and vice versa. Since a single approach for calculating labour is not agreed upon, the practice of providing UEVs with and without labour is particularly important.

##### 4.3. Double counting caused by including labour

As stated, exogenous labour is considered independent of the output of the studied system, but this is a simplifying assumption. In fact, a fraction of the output of the system will typically be counted twice when we include labour alongside energy and material inputs. The reason for this is that the calculation of the labour UEV typically is based on a sum of energy flows that includes those already considered in the studied system. However, we do not need to be overly concerned about this in assessments of systems that are small compared to the resource basis that labour is based on ( $\alpha$  in the suggested formula), since the double counting will be correspondingly small (Odum, 1996:108). This is because the non-labour energy flow to the assessed system represents only a small fraction of the energy flow of the societal system that provides the labour. There will, however, be instances where double counting reaches unacceptable proportions. As an example, the material and energy inputs in farming in a Ghanaian village constitute a tiny part of the Ghanaian energy budget (the labour system). Thus, when the analysis calculating labour UEV includes the entire national energy budget, only a very small part of labour inputs represent material and energy already accounted for in an assessment of farming in a Ghanaian village. In that case, we can ignore the risk of bias resulting from double counting. If, on the other hand, the study is of Ghanaian farming in general, and Ghanaian farming appropriate, say, 50% of the Ghanaian energy budget, then half of the labour input (using avg. values) would already be accounted for by the material and energy inputs to farming, constituting a significant double counting.

The scope of the fundamental problem is broad, possibly extending to all inputs. Production and consumption regularly ‘bite each

other's tail': trucks are used in the supply chain of truck production, concrete in the supply chain of concrete production, electricity in the supply chain of electricity production, and so on, just like agricultural products are found in the supply chain for agricultural production.

The challenge of double counting energy or, more generally, environmental effects of an activity caused by including labour has been discussed before. Costanza (1980) and Fluck (1981, 1992) consider the criticism valid, and Brown and Herendeen (1996) recognise double counting as a methodological concern. Conclusions converge on whether to consider labour a by-product of all human activity, in which case double counting seems inevitable, or whether labour is the result of only a part of human activity (in energy, a 'split'), in which case double counting can be avoided, theoretically. As theoretical tools to avoid bias from double counting, Bastianoni et al. (2011) suggest the use of set theory, Kazanci et al. (2012) suggest individual-based energy computation and Rugani and Benetto (2012) suggest matrix algebra techniques, in line with Costanza (1980). With correctly designed software, the double counting of, at least, 'easily identifiable' inputs, like electricity, steel, etc., can be avoided, e.g. through a 'net output' approach, even if the extent of double counting is most likely ignorable. But, whether software is able to cancel out flows that are double counted because labour inputs are included remains to be seen – the more inputs considered necessary for labour availability, the more complex their identification through supply chains becomes.

A typical approach to simplify this challenge is to be selective when establishing the resource basis for labour: one could ignore everything but the resource basis of, e.g., the education system through some kind of allocation. This means to consider labour as a split rather than a co-product (for splits and co-products, see Bastianoni and Marchettini (2000) or Kamp and Østergård (2013)). Or alternatively, derive industrial sector energy use per worker-hour from only non-industrial energy supply, i.e., to simply assume that industrial sector workers do not rely on energy use in the industrial sector (Zhang and Dornfeld, 2007). We argue that things are not that simple – the education system and the industrial sector are in turn dependent on, probably, all other sectors of the economy.

At present, we accept the uncertainty concerning labour-related double counting. This is because we want to cast light on the role of labour even if we cannot in practice estimate with currently available methods the energy flow that is counted twice through the inclusion of labour. Until further research is able to clarify which energy flows occur twice we may assume that double counting related to labour inputs is equally distributed across different production systems.

## 5. Conclusion for EmA and perspectives for ESA

We have investigated approaches for evaluating labour in Energy Assessment (EmA) and conceptualised the calculation of labour UEVs and the distinction between direct and indirect labour. The calculation of the environmental effect of labour inputs in EmA, the UEV for labour, follows a formalised procedure taking into account the resource basis of labour provision, the proxy used to account labour and two optional allocation factors adjusting for quality of the labour. The distinction between direct and indirect labour allows for, on the one hand, a detailed labour supply chain analysis and on the other, systematic accumulation of human labour inputs required to provide a good or service. The total labour input for a given production system is the sum of direct labour inputs in the foreground system and all direct labour inputs in associated background systems (i.e. indirect labour). In order to

maintain the distinction between IL and DL, we recommend always to present UEVs with and without labour. The calculation procedure and the method for identifying specific labour inputs allow for estimation and detailed analysis of the energy of labour. The choice of proxy for labour and resource basis for calculation of labour UEV is up to the investigator. We recommend to avoid using a proxy based on monetary values and provide a theoretically robust framework that is compatible with accounting of labour in time units.

The conceptual understanding and procedures provided establish formal reference points for further discussions and development of how to formalise the accounting of labour, not only in EmA but in Environmental Sustainability Assessment (ESA) in general. The typical omission of labour inputs in ESA constitutes an unfortunate bias resulting in leaking of environmental effects and, thereby, systematically misinformed decision-making. The hypothesis that environmental assessments which consider labour inputs as 'free' from environmental impact will tend to favour labour-intensive processes requires additional elaboration. Nevertheless, we argue that labour should methodically be considered alongside material and energy inputs, a viewpoint that is shared broadly with researchers in EmA and Extended Exergy Accounting (ExA) and peripherally with researchers in Energy Analysis (EA) and standardised Life Cycle Assessment (LCA). We suggest to use the labour value perspectives and accounting approaches in EmA to establish a robust conceptual framework for routine calculations of human labour in ESA in general. The risk of double counting may act as a barrier to including labour in ESAs so we encourage the development of tools and approaches that help avoid double counting of inputs. The approach of distinguishing between DL and IL, the method of accumulating DL inputs along the supply chain and the formula to calculate the energy of labour may be transferred, with appropriate modifications, to ExA, EA, LCA and similar methodologies. The provided conceptual understanding may be used in the calculation of labour footprints, to highlight particularly labour intensive production steps, or to emphasise the location of specific labour-related environmental impacts.

## Acknowledgements

We would like to acknowledge Christina Wright and Jens Rasmussen who took part in discussions of early versions of the paper. The writing of this paper was supported by funding from DANIDA DFC journal no. 10-018RISØ and from the EU FP7 project LogistEC (N° 311858).

## Appendix. Explanation of the UEV calculation for the examples reported in Table 2

### A.1. Labour system: USA 1980

Data for this calculation are taken from Odum (1996:232).

$\alpha$ :	USA national energy flow (1980): 7.85E+24 seJ/year.
$\gamma$ :	Metabolised energy by US population: 3.82E+09 J/person/year * 2.34E08 persons = 8.94E17 J/year.
$\beta_1$ :	All energy allocated to each educational category, i.e. $\beta_1 = 1$ (100%) for each category.
$\beta_2$ :	Educational categories (# of persons and percent of total): Preschool (2.34E+08, 100%), school (8.3E+07, 35%), college (2.8E+07, 12%), post college (6E+06, 3%), public status (2E+06 estimated, 1%), legacy (1E+06 estimated, 0.4%).

This results in the following labour UEVs:

$UEV_{LABOUR+Preschool} = \alpha * \beta_1 / (\gamma * \beta_2) =$	$7.85E+24 \text{ sej/year} * 100\% / ((8.94E+17) / \text{year} * 100\%) =$	$8.9E+06 \text{ sej/J}$ of metabolised energy by a person with preschool level training.
$UEV_{LABOUR+School} = \alpha * \beta_1 / (\gamma * \beta_2) =$	$7.85E+24 \text{ sej/year} * 100\% / ((8.94E+17) / \text{year} * 35\%) =$	$2.5E+07 \text{ sej/J}$ of metabolised energy by a person with school education.
$UEV_{LABOUR+College} = \alpha * \beta_1 / (\gamma * \beta_2) =$	$7.85E+24 \text{ sej/year} * 100\% / ((8.94E+17) / \text{year} * 12\%) =$	$7.3E+07 \text{ sej/J}$ of metabolised energy by a person with college education.
$UEV_{LABOUR+Post college} = \alpha * \beta_1 / (\gamma * \beta_2) =$	$7.85E+24 \text{ sej/year} * 100\% / ((8.94E+17) / \text{year} * 3\%) =$	$3.4E+08 \text{ sej/J}$ of metabolised energy by a person with post college education.
$UEV_{LABOUR+Public status} = \alpha * \beta_1 / (\gamma * \beta_2) =$	$7.85E+24 \text{ sej/year} * 100\% / ((8.94E+17) / \text{year} * 1\%) =$	$1.0E+09 \text{ sej/J}$ of metabolised energy by a person with public status.
$UEV_{LABOUR+Legacy} = \alpha * \beta_1 / (\gamma * \beta_2) =$	$7.85E+24 \text{ sej/year} * 100\% / ((8.94E+17) / \text{year} * 0.4\%) =$	$2.1E+09 \text{ sej/J}$ of metabolised energy by a person with legacy status.

### A.2. Labour system: Ghana 2000

Data for this calculation are taken from [Kamp and Østergård \(2014\)](#).

- $\alpha$ : **Ghana national energy flow (2000):**  $1.6E+23 \text{ sej/year}$ . It is assumed that resource use measured in energy is distributed similarly to income.
- $\gamma$ : **Total worked hours in Ghana (man-hours):** Assumptions include: 57% of population are of working age (15–64 yrs), 11% unemployment, working week including underemployment is 30 h/week, total population is  $2E+07$  persons, 46 working weeks in a year. This gives an estimate of  $1.4E+10$  man-hours/year.
- $\beta_1$ : **Consumption level ( $\beta_1$ ):** Fraction of total income distributed to low consumption group is 5.6%. Fraction of total income distributed to medium consumption group is 47.8%. Fraction of total income distributed to high consumption group is 46.6%.
- $\beta_2$ : **Income level population groups:** 20% of population in low consumption group, 60% of population in medium consumption group, and 20% of population in high consumption group.

This results in the following labour UEVs:

$UEV_{LABOUR-low consumption} = \alpha * \beta_1 / (\gamma * \beta_2) =$	$1.6E+23 \text{ sej/year} * 5.6\% / (1.4E+10 \text{ labour hours/year} * 20\%) =$	$3.2E+12 \text{ sej/man-hour}$ .
$UEV_{LABOUR-medium consumption} = \alpha * \beta_1 / (\gamma * \beta_2) =$	$1.6E+23 \text{ sej/year} * 47.8\% / (1.4E+10 \text{ labour hours/year} * 60\%) =$	$9.1E+12 \text{ sej/man-hour}$ .
$UEV_{LABOUR-high consumption} = \alpha * \beta_1 / (\gamma * \beta_2) =$	$1.6E+23 \text{ sej/year} * 46.6\% / (1.4E+10 \text{ labour hours/year} * 20\%) =$	$2.7E+13 \text{ sej/man-hour}$ .

### A.3. Labour system: Global 2008

Data for this calculation are taken from [Brown et al. \(2011:6\)](#).

- $\alpha$ : **Global energy flow (2008):**  $1.05E+26 \text{ sej/year}$ .
- $\gamma$ : **Money flow:**  $6.06E+13 \text{ USD/year}$ .
- $\beta_1, \beta_2$ : **No allocation:**  $UEV_{LABOUR-Global avg.} = \alpha / \gamma = 1.05E+26 \text{ sej/year} / 6.06E+13 \text{ USD/year} = 1.74E+12 \text{ sej/USD}$ .

## References

Abel, T., 2011. Culture in information cycles: an energy evaluation of conversation. In: Brown, M.T., Sweeney, S., Campbell, D.E., Huang, S., Ortega, E., Rydberg, T., Tilley, D., Ulgiati, S. (Eds.), *Emergy Synthesis 6: Theory and Applications of the Emergy Methodology*. Proceedings of the 6th Biennial Emergy Conference, 2012. Center for Environmental Policy, University of Florida, Gainesville, pp. 9–26.

Arbault, D., Rugani, B., Marvuglia, A., Tiruta-Barna, L., Benetto, E., 2013. Accounting for the energy value of life cycle inventory systems: insight from recent methodological advances. *J. Environ. Account. Manag.* 1 (2), 103–117.

Bastianoni, S., Morandi, F., Flaminio, T., Pulseli, R.M., Tiezzi, E.B.P., 2011. Emergy and energy algebra explained by means of ingenious set theory. *Ecol. Model.* 222, 2903–2907.

Bastianoni, S., Marchettini, N., 2000. The problem of co-production in environmental accounting by emergy analysis. *Ecol. Model.* 129, 187–193.

Bergquist, D.A., Ingwersen, W., Liebenow, D.K., 2011. Emergy in labour – approaches for evaluating knowledge. In: Brown, M.T., Sweeney, S., Campbell, D.E., Huang, S., Ortega, E., Rydberg, T., Tilley, D., Ulgiati, S. (Eds.), *Emergy Synthesis 6: Theory and Applications of the Emergy Methodology*. Proceedings of the 6th Biennial Emergy Conference, 2012. Center for Environmental Policy, University of Florida, Gainesville, pp. 501–508.

Bonilla, S.H., Guarnetti, R.L., Almeida, C.M.V.B., Giannetti, B.F., 2010. Sustainability assessment of a giant bamboo plantation in Brazil: exploring the influence of labour, time and space. *J. Clean. Prod.* 18, 83–91.

Brown, M.T., Herendeen, R.A., 1996. Embodied energy analysis and emergy assessment: a comparative view. *Ecol. Econ.* 19, 219–235.

Brown, M.T., Protano, G., Ulgiati, S., 2011. Assessing geobiosphere work of generating global reserves of coal, crude oil, and natural gas. *Ecol. Model.* 222, 879–887.

Campbell, D.E., Lu, H., 2014. Emergy evaluation of formal education in the United States: 1870 to 2011. *Systems* 2 (3), 328–365.

Campbell, D.E., White, D., Boggess, C.F., 2013. Emergy of the occupations. In: Brown, M.T., Sweeney, S., Campbell, D.E., Huang, S., Ortega, E., Rydberg, T., Tilley, D., Ulgiati, S. (Eds.), *Emergy Synthesis 7: Theory and Applications of the Emergy Methodology*. Proceedings of the 7th Biennial Emergy Conference, Center for Environmental Policy, University of Florida, Gainesville, pp. 381–404.

Cleveland, C., 2013. Net Emergy Analysis. Encyclopedia of Earth, Retrieved from <http://www.eoearth.org/view/article/154821> on March 2nd, 2015.

Costanza, R., 1980. Embodied energy and economic valuation. *Science* 210, 1219–1224.

Cruz, R.V.A., Nascimento, C.A.O., 2012. 2012 – Emergy analysis of oil production from microalgae. *Biomass Bioenergy* 47, 418–425.

EC, 2010. European Commission – Joint Research Centre – Institute for Environment and Sustainability: International Reference Life Cycle Data System (ILCD) Handbook – General Guide for Life Cycle Assessment – Detailed Guidance, 2010. EUR 24708 EN. Publications Office of the European Union, Luxembourg.

Fluck, R.C., 1981. Net emergy sequestered in agricultural labor. *Trans. ASAE* 24, 1449–1455, <http://dx.doi.org/10.13031/2013.34471>.

Fluck, R.C., 1992. Emergy of human labor. In: Fluck, R.C. (Ed.), *Emergy in Farm Production*. pp. 31–37, <http://dx.doi.org/10.1016/B978-0-444-88681-1.50003-X>, ISBN: 978-0-444-88681-1.

Freedman, S.M., 1982. Human labour as an energy source for rice production in the developing world. *Agro-Ecosystems* 8, 125–136.

Franzese, P.P., Rydberg, T., Russo, G.F., Ulgiati, S., 2009. Sustainable biomass production: a comparison between gross emergy requirement and emergy synthesis methods. *Ecol. Indic.* 9, 959–970.

Fukuda, K., 2003. Production of emergy from labour and energy resources. *Appl. Energy* 76, 435–448.

Herendeen, R.A., 2004. Emergy analysis and emergy assessment – a comparison. *Ecol. Econ.* 178, 227–237.

IFIAS, 1974. *Emergy Analysis Workshop on Methodology and Conventions*. International Federation of Institutes for Advanced Study, Nobel House, Stockholm, Sweden.

ISO, International Organization for Standardization, 2006. International Standard 14040, Environmental Management – Life Cycle Assessment – Principles and Framework.

Jaklič, T., Juvančič, L., Kavčič, S., Debeljak, M., 2014. Complementarity of socio-economic and emergy evaluation of agricultural production systems: the case of Slovenian dairy sector. *Ecol. Econ.* 107, 469–481.

Kamp, A., Østergård, H., 2013. How to manage co-product inputs in emergy accounting exemplified by willow production for bioenergy. *Ecol. Model.* 253, 70–78.

Kamp, A., Østergård, H., 2014. Food and Biogas Production in a Ghanaian Village – Results and New Perspectives on Labor UEVs. Submitted for the Proceedings of the 8th Biennial Emergy Conference on October 13th, 2014.

Kazanci, C., Schramski, J.R., Bastianoni, S., 2012. Individual based emergy analysis: a Lagrangian model of emergy memory. *Ecol. Complex.* 11, 103–108.

Markussen, M.V., Kulak, M., Smith, L.G., Nemecek, T., Østergård, H., 2014. Evaluating the sustainability of a small-scale low-input organic vegetable supply system in the United Kingdom. *Sustainability* 6, 1913–1945.

Moldan, B., Janoušková, S., Hák, T., 2012. How to understand and measure environmental sustainability: indicators and targets. *Ecol. Indic.* 17, 4–13.

NEAD, Update 2012. National Environmental Accounting Database, Center for Environmental Policy, University of Florida, Gainesville, FL, Retrieved from <http://www.cep.usf.edu/need/> on 27th of February 2015.

Nguyen, T.L.T., Gheewala, S.H., Garivait, S., 2007. Emergy balance and GHG-abatement cost of cassava utilization for fuel ethanol in Thailand. *Energy Policy* 35, 4585–4596.

Odum, H.T., 1983. *Systems Ecology: An Introduction*. John Wiley, New York.

Odum, H.T., 1996. *Environmental Accounting: Emergy and Environmental Decision Making*. John Wiley and Sons, New York.

Odum, H.T., Odum, E.C., 1981. *Emergy Basis for Man and Nature*, revised second ed. McGraw Hill, New York.

Rugani, B., Benetto, E., 2012. Improvements to emergy evaluations by using life cycle assessment. *Environ. Sci. Technol.* 46, 4701–4712.

Rugani, B., Panasiuk, D., Benetto, E., 2012. An input–output based framework to evaluate human labour in life cycle assessment. *Int. J. Life Cycle Assess.* 17, 795–812.

Sciubba, E., 2001. Beyond thermo-economics? The concept of extended emergy accounting and its application to the analysis and design of thermal systems. *Int. J. Exergy* 1 (2), 68–84.



- Sciubba, E., 2003. Cost analysis of energy conversion system via a novel resource-based quantifier. *Energy* 28, 457–477.
- Silalertruksa, T., Gheewala, S.H., 2009. Environmental sustainability assessment of bio-ethanol production in Thailand. *Energy* 34, 1933–1946.
- Ulgiati, S., Brown, M.T., 2002. Quantifying the environmental support for dilution and abatement of process emissions: the case of electricity production. *J. Clean. Prod.* 10, 335–348.
- Ulgiati, S., Brown, M.T., 2014. Labour and services as information carriers in energy-LCA accounting. *J. Environ. Account. Manag.* 2 (2), 163–170.
- Ulgiati, S., Ascione, M., Bargigli, S., Cherubini, F., Franzese, P.P., Raugei, M., Viglia, S., Zucaro, A., 2011. Material, energy and environmental performance of technological and social systems under a life cycle assessment perspective. *Ecol. Model.* 222, 176–189.
- Vassallo, P., Bastianoni, S., Beiso, I., Ridolfi, R., Fabiano, M., 2007. Emergy analysis for the environmental sustainability of an inshore fish farming system. *Ecol. Indic.* 7, 290–298.
- Wall, G., 1977. Exergy – A Useful Concept Within Resource Accounting. Report No. 77-42. Institute of Theoretical Physics, Göteborg.
- Wright, C., Østergård, H., 2015. Scales of renewability exemplified by a case study of three Danish pig production systems. *Ecol. Model.*, <http://dx.doi.org/10.1016/j.ecolmodel.2015.04.018>.
- Zhang, T.W., Dornfeld, D.A., 2007. Energy use per worker-hour: evaluating the contribution of labor to manufacturing energy use. In: Takata, S., Umeda, Y. (Eds.), *Advances in Life Cycle Engineering for Sustainable Manufacturing Businesses*. Proceedings of the 14th CIRP Conference on Life Cycle Engineering, Tokyo, Japan, 2007. Springer-Verlag London Limited, pp. 189–193.

## PAPER IV

**In-text citation:**

(Kamp and Østergård, 2016a)

**Authors:**

Andreas Kamp and Hanne Østergård

**Title:**

Future scenario modelling and resilience indicators. A case study of small-scale food and energy production in a village in Ghana

**Submission and publication details:**

Submitted to the conference proceedings *Emergy Synthesis 9: Theory and Applications of the Emergy Methodology* 4th of March 2016

Accepted for publication 18<sup>th</sup> of March 2016

---

## Future scenario modelling and resilience indicators. A case study of small-scale food and energy production in a village in Ghana

Andreas Kamp & Hanne Østergård

### ABSTRACT

*The Prosperous Way Down (PWD) view envisions an imminent decrease in the availability of fossil energy associated with a radical transition to a low-energy world. Resilient systems may persevere in this process, while others succumb to the significantly constrained conditions of a low energy world. Finding a PWD implies knowledge about specific resilience characteristics of systems and about specific future conditions. Quantitative resilience indicators and systematic, explorative scenario analysis constitute two methodological developments of Emergy Assessment which will be considered.*

*The Emergy Sustainability Index (EmSI = EYR/ELR) indicates that a system is sustainable if it makes good use of external input without compromising dependence on local, renewable inputs. This sustainability perspective can be supplemented with an emergy resilience indicator set that includes biophysical efficiency (the UEV), dependence on stock-unlimited flows (Global Renewability Fraction), and dependence on local inputs (Local Supply Fraction).*

*Societal contexts influence modelling parameters, e.g. through changed efficiencies, altered supply chains, and increased or reduced availability of inputs including labor. Making decision that are valid in the future therefore implies adjusting analyses to reflect possible future conditions. Future narratives may be expressed in terms of modelling parameters (UEV adjustment factors, Global Renewability and Local Supply Fractions) for specific input categories, enabling systematic, scenario-dependent emergy assessment.*

*We demonstrate this approach in an emergy assessment of four technologies for small-scale, combined food and energy production in Ghana under future societal conditions envisioned in four narratives. The assessment of resilience with the suggested indicator set shows only minor differences between technologies under present conditions or in a 'Green Tech' scenario. In more radical energy descent scenarios, biogas and agroforestry technologies stand out as more resilient to reduced access to external inputs, including embodied labor.*

## INTRODUCTION

### *Resilience*

The objective of many emergy assessments is to inform processes of decision-making related to medium-long term timeframes. Examples of choices made today regarding human activities several decades into the future include the selection of energy technologies (Brown & Ulgiati 2002; Watanabe & Ortega 2009; Markussen et al. 2015) and farming practices (Lefroy & Rydberg 2003; Jaklič et al. 2014; Wright & Østergård 2015). Emergy indicators are calculated with the aim of prioritizing specific technologies and practices based on their biophysical performance as seen from an emergy perspective. The most often used indicators are the UEV, indicating thermodynamic efficiency as required environmental activity per output; the Renewability Fraction, indicating reliance on stock-unlimited flows; the Emergy Yield Ratio (EYR), indicating ability to exploit local resources, and the Environmental Loading Ratio (ELR), indicating pressure on the local ecosystem. The Emergy Sustainability Index ( $EmSI = EYR/ELR = (Y/F)/((F+N)/R)$ ) indicates that a system is 'relatively sustainable' if it provides a good yield per external input without compromising dependence on local, renewable inputs (Brown & Ulgiati 1997; Brown et al. 2009). Recently, it has been suggested to also evaluate systems based on the location of inputs to emphasize the embeddedness of a system in its immediately surrounding system (Wright & Østergård 2015).

It is expected that systems with superior biophysical performance according to these indicators are better suited to stand the test of time. The reason for this is that systems with higher thermodynamic efficiency, lower dependence on non-renewable inputs, higher return on the use of external inputs, and lower pressure on local equilibria will tend to outcompete alternatives. The underlying assumption is that selection happens under conditions where resources in general and non-renewable resources in particular are increasingly scarce and that ecosystem function is sensitive to external impact (Odum 1988; Brown & Ulgiati 1997).

The mentioned prioritization criteria are consistent with resilience and resilience thinking (Folke et al. 2010; Moberg et al. 2014; Rist et al. 2014), an emerging research field that increasingly targets the ability of social and social-ecological systems "to absorb disturbance and reorganize while undergoing change so as to retain essentially the same function, structure, identity, and feedbacks" (Walker et al. 2004). Distinction is made between general and specific resilience, where only specific resilience identifies the particular type of expected change to which a given system must adapt. The scientific literature provides no general quantitative indicators of resilience and it seems that emergy theory may be able to help fill this gap. One way to do this is to supplement the sustainability perspective of the EmSI with an emergy resilience indicator set that includes biophysical efficiency (the UEV), dependence on stock-unlimited flows (Global Renewability Fraction), and dependence on local inputs (Local Supply Fraction).

### *Future scenario modelling*

Dealing with uncertainty in Emergy Assessment is not novel. It is generally accepted that emergy estimates are associated with plenty of approximations and that even the most detailed study operates with a significant error margin. This does not distinguish the quality of data used in emergy studies from the quality of data used in other types of environmental assessment since data uncertainty is an issue across the board (e.g. Zamagni et al. 2008). One approach to managing uncertainty is to be explicit about it, and use methods to identify uncertainties that are likely to be significant for results. As an example, Buonocore et al. (2012) identify transport distance as a key uncertainty and calculate the sensitivity of their results to three alternative distances. Hudson & Tilley (2014) approached the topic methodically

and used the probability-based tool of Monte Carlo simulation to assess the importance of uncertainty of both input quantities and UEVs used in agricultural systems.

Zamagni et al. (2009) consider the topic of uncertainty in general and the question of time in particular as crucial in the development of Life Cycle Assessment. Not only should the more typical uncertainty evaluation tools such as Monte Carlo be improved and universally applied, but ‘major effort should be spent on scenario uncertainty’. An approach that is highly relevant for studies of systems/technologies supposed to be in place in the medium-long term future, is explorative scenario modelling (Börjeson et al. 2006). Explorative scenarios aim to explore the future from various perspectives, focusing on profound changes and a relatively long time horizon (Höjer et al. 2008). Explorative scenario modelling is a particularly relevant approach when studying possible, future energy technologies and food production practices, including integrated food and energy systems.

Qualitative explorative scenarios are widely used, e.g. as narratives or storylines. However, actual modelling of environmental sustainability based on the quantification of explorative scenario characteristics has been demonstrated in only a few cases. Spielmann et al. (2005) explore four scenarios for regional transport based on altering specific unit processes from the LCA database ecoinvent 2000. The effect on transport technologies of socio-economic variables are quantified using “educated estimates” of changed greenhouse gas and NOx emissions. Results are used to rank transport alternatives under different future conditions. Fortes et al. (2015) link socio-economic storylines to energy modeling on a national level for Portugal. Determining growth rates of socio-economic indicators (e.g. GDP, population, economic growth of certain energy intensive sectors) is supported by “experts’ best guess judgment” of the chosen scenario narratives. The result is the identification of the most cost-effective set of energy technologies and the associated greenhouse gas emission trajectories for each scenario.

Analyses that elaborate on significant changes in societal conditions are different from traditional forecasting approaches. Explorative scenario analyses are characterized by considering multiple futures and by system thinking (Gausemeier et al. 1995 in Spielmann et al. 2005). Using multiple futures highlights that much uncertainty is beyond the control of decision makers and that societal development can go in several directions, with different implications for the study results. System thinking represents the view that complex systems are internally linked in myriad ways and influence each other non-linearly, making it impossible to isolate the effect of, e.g. oil prices, on fertilizer or food prices.

The ongoing debate of a near-term peak in the production of fossil energy (Hirsch 2008; Lambert & Lambert 2011; Mohr et al. 2015), the consequences of significant climatic changes (Ipcc 2014; Nordås & Gleditsch 2007; Schubert et al. 2007) and the possible social and political implications of these phenomena lead to believe that decision-making under business-as-usual conditions is increasingly inadequate. If we are approaching a long-term financial crisis caused by energy prices (Tverberg 2012), the consumer climax threshold in the ‘pulsing paradigm’ of Odum et al. (2007), the peak of Hubbert’s oil production projection (1949), or any other significant change in societal conditions, the study of any system that is dependent on the wider socio-economic environment is likely to be affected.

This paper contributes to the sparse literature on the topic of explorative scenario modelling by considering how specific technologies may be evaluated under different socio-economic conditions, or, societal states. We exemplify the conceptual approach of narrative-based, explorative scenario modelling with a case study of four food and energy production technologies in a village in Ghana. This study proceeds by comparing the technologies under not only reference conditions but also using four alternative sets of modelling parameters. Each parameter set is associated with a scenario, formulated based on narratives of future, societal states. The characteristics of each scenario are outlined. We calculate the energy resilience indicator set for each technology in each scenario.

## MATERIALS & METHODS

The case study assesses resilience indicators of four technologies used to provide rural farmers in Ghana with food and cooking energy, studied by Kamp et al. (n.d.) (Table 1). The technologies are Present Technology (PT): synthetic fertilizer based food production and wood fuel from outside the farming area for cooking, HH Biogas: integrated food and household-scale biogas production with biogas for cooking and application of biogas effluent as fertilizer to partially substitute for synthetic fertilizer, Village Biogas: integrated food and village-scale biogas production with biogas for cooking and application of biogas effluent as fertilizer to partially substitute for synthetic fertilizer, and Agroforestry: integrated food and wood fuel production with no external fertilizer or cooking energy inputs.

**Table 1:** Technology option characteristics. Food production is mainly corn, but with some beans and subsistence crops.

Technology option	Food production	Cooking energy provision
<b>Present Technology (PT)</b>	No nutrient recycling, residues are burned	Firewood and charcoal from outside the farming area used in simple stoves
<b>HH Biogas</b>	Recycling of composted biogas effluent, some external fertilizer	Household-scale biogas based on crop residues, used in biogas stove
<b>Village Biogas</b>	Recycling of composted biogas effluent, some external fertilizer	Village-scale biogas based on crop residues, used in biogas stove
<b>Agroforestry</b>	Alley cropping of corn and N-fixating trees, no external fertilizer	Firewood and charcoal from trees grown on-farm, used in simple stoves

The resilience assessment is subjected to a scenario analysis that includes reference conditions and four alternative sets of modelling parameters that each describes a socio-economic context that we consider possible within the next few decades. An important, general assumption is that practices and infrastructure of the technologies remain similar. That is, we do not model adaptation of the different technologies through e.g. cultural changes or the introduction of improved or novel practices and technical parts. Rather, we assess the technologies as if they maintain the original characteristics. As an example, the Present Technology will in all scenarios depend on synthetic fertilizer, tractor ploughing, firewood and charcoal in the same proportions, the same direct labor, etc. Attempting to predict the development of individual technologies would cross the limit of what we consider to be reasonably speculative in this context.

The Reference scenario applies Unit Energy Values (UEVs) and Global Renewability Fractions from published literature mainly (some are calculated in-study) and accounted inputs from the analysis of the suggested technologies under present-time conditions (Kamp et al., n.d.). Reference scenario assumptions also include current amounts of embodied labor of external inputs, and Local Supply Fractions based on current trade networks. The future scenarios are inspired by various sources, including narratives by Holmgren (2009), Hopkins (2006) and Heinberg (2004). The scenarios are termed Green Tech, Brown Tech, Lifeboats, and Earth Stewards. For our modelling, each scenario has been assigned a set of calculation assumptions. The parameters we find relevant to alter are: the amount of indirect labor which we consider indicative of the availability of purchased materials, the UEVs of direct labor and indirect labor which we consider indicative of material standard of living (MSOL), the UEVs of materials that account for the resource use to create, extract and process material inputs, the Global Renewability Fraction and Local Supply Fraction of inputs (Table 2).

**Table 2:** Calculation assumptions for reference conditions and four future scenarios. Inputs have been grouped in categories. For the full list of inputs and their resilience profiles, see appendix (Table A-1).

Scenario	Embodied labor input, relative to reference conditions	UEV, relative to reference conditions		Renewability fraction				Local supply fraction			
		Fuel, mach., fert., etc.	Labor	Fuel, mach., fert., etc.	Wood, timber, seed	Direct labor	Embodied labor	Fuel, mach., fert., etc.	Wood, timber, seed	Direct labor	Embodied labor
Reference	100%	100%	100%	1%	50%	10%	16%	0%	50%	100%	0%
Green Tech	100%	50%	200%	50%	100%	50%	50%	0%	50%	100%	0%
Brown Tech	150%	200%	50%	1%	1%	5%	5%	0%	10%	100%	0%
Lifeboats	500%	300%	10%	50%	50%	50%	50%	100%	100%	100%	100%
Earth Stewards	200%	200%	50%	100%	100%	100%	100%	100%	100%	100%	100%

In the Green Tech scenario, we assume higher renewability per input, less resource use per material and external energy input, increased MSOL reflected in higher resource use per labor input, and a Local Supply Fraction similar to Reference. The Brown Tech scenario envisions lower MSOL, increased resource and labor use per input, lower renewability and increased centralization in production of purchased inputs reflected in reduced local supply. The Lifeboats scenario pictures radically reduced MSOL, inefficient production and very low availability of inputs. Renewability is assumed to be high while purchased inputs are expected to be local, since extended trade networks are non-existing. The Earth Stewards scenario considers a reduction in MSOL, higher resource and labor use per unit and a fully renewable and local production. With the exception of the Green Tech scenario, the general expectation is one of reduced access to resources and associated reduction in the amount of resources appropriated per person (the MSOL).

Using the parameter adjustment factors for embodied labor and UEVs, and the parameter values for Global Renewability Fraction (% $R_{global}$ ) and Local Supply Fraction (% $Local$ ) in Table 2, the quantitative resilience indicator set is calculated for each scenario. We use

$$UEV(O) = (\sum I_i * UEV_i) / O \quad (\text{Eq.1}),$$

$$\%R_{global} = (\sum Em_i * \%R_{global,i}) / Em \quad (\text{Eq.2}) \text{ and}$$

$$\%Local = (\sum Em_i * \%Local_i) / Em \quad (\text{Eq.3})$$

in the calculation of the Unit Energy Value (UEV), Global Renewability Fraction (% $R_{global}$ ) and Local Supply Fraction (% $Local$ ) of output O, produced with I inputs.

As suggested by Cavalett et al. (2006), we maintain the Renewability Fraction of external inputs. Thereby, the resulting Renewability Fraction of the output becomes the fraction of global, renewable flows, which we abbreviate % $R_{global}$ . The Local Supply Fraction (abbreviated % $Local$ ) for a system and its outputs is estimated as the weighted average of the % $Local$  of all required inputs. The degree to which specific inputs are on-site or nearby resources and therefore considered ‘local’, is based on knowledge of the respective supply chains.

## RESULTS

The resilience assessment of the four technologies for providing food and energy for cooking is first calculated using reference conditions. Results include labor. The results show only minor differences in the resilience profiles (Table 3). Present Technology (PT) is the least efficient in converting solar enjoules into food and energy. The two technologies that include biogas production are slightly more efficient while agroforestry is the most efficient. The %R<sub>global</sub> and %Local are similar for all technologies, with the exception of a higher %R<sub>global</sub> for Agroforestry.

**Table 3:** Resilience indicators of four food and energy technologies under reference conditions. %R<sub>global</sub> = Global Renewability Fraction, %Local = Local Supply Fraction.

Reference	UEV	%R <sub>global</sub>	%Local
PT	2.8E+05	43%	87%
HH biogas	2.7E+05	43%	89%
Village biogas	2.6E+05	45%	90%
Agroforestry	2.0E+05	57%	88%

Results of the scenario analysis are based on the four alternative sets of calculation assumptions from the Green Tech, Brown Tech, Lifeboats and Earth Stewards scenarios according to Table 2.

In the Green Tech scenario, the technologies with biogas do not outperform PT with respect to biophysical efficiency as measured by the UEV (Table 4). Agroforestry has significantly higher efficiency than the other technologies. Under Green Tech conditions, all technologies are expected to have reduced reliance on non-renewable flows and to rely more on local supply. The increase in the Local Supply Fraction is the result of less resource use associated with external inputs, and more resource use associated with labor inputs, most of which are considered local.

**Table 4:** Resilience indicators of four food and energy technologies under Green Tech scenario conditions.

Green Tech	UEV	%R <sub>global</sub>	%Local
PT	3.2E+05	55%	91%
HH biogas	3.2E+05	57%	92%
Village biogas	3.2E+05	58%	92%
Agroforestry	2.5E+05	69%	91%

As a general trend for the resilience of the four technologies in the remaining scenarios, PT performs the poorest and Agroforestry has the best performance (Tables 5-7). The technologies with biogas are not significantly different to each other but are more efficient and rely to a higher extent on renewable flows and local supply than PT. The ranking of technologies remains the same as under reference conditions, but the relative improvement of using biogas-based and agroforestry-based technologies compared to the present technology is more apparent. To exemplify, HH Biogas, Village Biogas and Agroforestry use 94%, 91%, and 69% of the resources that PT requires to provide the same output under reference conditions. For the Brown Tech, Lifeboats and Earth Stewards scenarios, the corresponding, relative resource use is 86%, 82%, and 63% of PT; 79%, 76%, and 57% of PT; and 86%, 83%, and 63% of PT, respectively.



**Table 5:** Resilience indicators of four food and energy technologies under Brown Tech scenario conditions.

Brown Tech	UEV	%R <sub>global</sub>	%Local
PP	2.9E+05	37%	73%
HH biogas	2.5E+05	43%	80%
Village biogas	2.4E+05	44%	81%
Agroforestry	1.8E+05	58%	79%

**Table 6:** Resilience indicators of four food and energy technologies under Lifeboat scenario conditions.

Lifeboats	UEV	%R <sub>global</sub>	%Local
PP	3.1E+05	54%	100%
HH biogas	2.4E+05	59%	100%
Village biogas	2.3E+05	60%	100%
Agroforestry	1.8E+05	77%	100%

**Table 7:** Resilience indicators of four food and energy technologies under Earth Stewards scenario conditions.

	UEV	%R <sub>global</sub>	%Local
PP	2.9E+05	73%	100%
HH biogas	2.5E+05	75%	100%
Village biogas	2.4E+05	76%	100%
Agroforestry	1.8E+05	94%	100%

## DISCUSSION

### *Resilience indicators*

We consider the UEV, the Global Renewability Fraction and the Local Supply Fraction as a resilience indicator set based on Emergy Assessment. The set provides a relatively simple assessment of the ability of a system to make efficient use of resources and to function on the basis of renewable and locally available resources. Whether a system that performs well according to these indicators is sufficiently resilient according to the definition by Walker et al. (2004) is difficult to assess. A problem with the broad definition by Walker et al. is that the ability to ‘absorb disturbance and reorganize’ and to ‘retain essentially the same function, structure, identity, and feedbacks’ are hardly quantifiable.

We introduce the Local Supply Fraction in relation to resilience in this study for two reasons. The primary reason is that the calculation of the Renewability Fraction based on global flows undoes the link between renewable and local flows found in conventional emergy methodology (Odum 1996; Brown & Ulgiati 1997). Since renewable flows are no longer automatically local when renewability is ‘considered in a global scope’ (Wright & Østergård 2015), the importance of the Renewability Fraction changes. The origin in terms of location is still important, however: imported inputs may be more vulnerable than local inputs to events that are beyond the control of local agents and the long-term compatibility of e.g. local ecosystems with influences from far away is less certain. Therefore, the ‘local-ness’ of the system should

be assessed separately. The second reason is the desire to link the resilience set with the emerging concept of sovereignty. Sovereignty (in the context of resilience) is most often referred to in relation to food but also discussed with respect to energy and technology. Reardon & Pérez (2010) report on the development of food sovereignty indicators including land ownership and food and seed self-sufficiency. Altieri & Toledo (2011) directly link sovereignty with resilient agroecology and distinguish between food sovereignty, energy sovereignty and technological sovereignty. In this context, the presence of locally available resources and the right to use them are the defining characteristics of sovereignty. We therefore suggest to consider the Local Supply Fraction as a resilience indicator of sovereignty.

Resilience is often associated with diversity, e.g. in the form of genetic variation of plants or animals, or multiple technologies that may perform the same or a similar function should the others fail. The emergy resilience indicator set suggested here does not deal with diversity, but this is not supposed to imply that diversity is irrelevant. Rather, we find that the link between emergy, resilience and diversity is too intricate for the aim of this paper. Increased understanding of the importance of diversity for resilience and further development of emergy indicators may provide a useful emergy resilience indicator for diversity.

#### *Case study results*

The use of quantitative resilience indicators based on the Emergy Assessment methodology and the use of explorative scenarios based on future narratives were demonstrated in a case study of food and energy production in a rural village in Ghana. The present technology, characterized by food production without recycling of nutrients and the import of energy for cooking, was shown to be inferior to integrated production systems characterized by biogas production or agroforestry, when evaluated with the suggested resilience indicators (Table 3). The difference between the technologies was relatively small, however, providing no obvious reason to suggest altered practices nor the implementation of new technology.

The expectation that reference conditions constitute an inadequate basis for choosing technologies led to the formulation of alternative calculation assumptions, based on possible, future socio-economic states. The Green Growth scenario results did not motivate a change of technology either. In a Green Growth world the expected resource use of material and external energy inputs is reduced and people are better off, which leads to higher resource use per labor input. Since the integrated technologies substitute direct labor inputs for imported inputs, these trends work to improve the performance of the present technology relative to the other technologies. In the more radical energy descent scenarios the general tendency is that inputs become scarcer and are associated with higher resource use while human labor is associated with lower resource use. This increases the gap between the present technology and integrated technologies, which was found under reference conditions. There is a minor difference in the Global Renewability Fraction of the present technology and the technologies with biogas. In all scenarios, the integrated technologies are consistently less dependent on non-local inputs than the present technology. Agroforestry stands out as a particularly robust technology, and appears to be a resilient technology in all of the considered scenarios.

It is clear that the strategy applied when choosing between technologies that are supposed to be in place in a medium-long term time perspective depends on the expected, future conditions. Intentional localization, substitution of human labor inputs for material and energy inputs, and integrating technologies by recycling locally available resources appears to be a good strategy when the future is perceived to be smaller and materially poorer.

## **CONCLUSION**

Associating emergy assessment with quantitative resilience indicators can be a natural development of the lines of thinking concerning sustainability, evolutionary processes, ecology, and energy as the basis for man and nature, already well-established in emergy theory. The UEV as an efficiency indicator, the Global Renewability Fraction as an indicator of the independence from non-renewable inputs, and the Local Supply Fraction as a sovereignty indicator constitutes a simple indicator set of resilience for systems that are expected to adapt to changing conditions.

The use of scenario modelling is a thought-evoking practice to assess the robustness of systems under uncertainty. We have provided an example of how to approach this uncertainty in emergy modelling by interpreting possible socio-economic trends and quantifying the impact on what we find are relevant parameters. The suggested scenarios may be considered as 'cornerstone' or 'generic' and used along with the provided parameters as inspiration in other studies. The development of scenarios, however, will in some cases be sensitive to the topic of study. The demonstrated, conceptual approach of interpreting socio-economic trends based on future scenario narratives to obtain different sets of modelling parameters may be refined for broad use within life cycle assessment research.

## REFERENCES

- Altieri, M. & Toledo, V.M., 2011. The agroecological revolution in Latin America: rescuing nature, ensuring food sovereignty and empowering peasants. *The Journal of Peasant Studies*, 38(3), pp.587–612.
- Brown, M.T., Cohen, M.J. & Sweeney, S., 2009. Predicting national sustainability: The convergence of energetic, economic and environmental realities. *Ecological Modelling*, 220(23), pp.3424–3438.
- Brown, M.T. & Ulgiati, S., 2002. Emergy evaluations and environmental loading of electricity production systems. *Journal of Cleaner Production*, 10(4), pp.321–334.
- Brown, M.T. & Ulgiati, S., 1997. Emergy-based indices and ratios to evaluate sustainability: Monitoring economies and technology toward environmentally sound innovation. *Ecological Engineering*, 9(1-2), pp.51–69.
- Buonocore, E., Franzese, P.P. & Ulgiati, S., 2012. Assessing the environmental performance and sustainability of bioenergy production in Sweden: A life cycle assessment perspective. *Energy*, 37(1), pp.69–78. Available at: <http://dx.doi.org/10.1016/j.energy.2011.07.032>.
- Börjeson, L. et al., 2006. Scenario types and techniques: Towards a user's guide. *Futures*, 38(7), pp.723–739. Available at: <http://linkinghub.elsevier.com/retrieve/pii/S0016328705002132>.
- Cavalett, O., Queiroz, J.F. De & Ortega, E., 2006. Emergy assessment of integrated production systems of grains, pig and fish in small farms in the South Brazil. *Ecological Modelling*, 193(3-4), pp.205–224.
- Folke, C. et al., 2010. Resilience Thinking : Integrating Resilience , Adaptability and . , 15(4).
- Fortes, P. et al., 2015. Long-term energy scenarios: Bridging the gap between socio-economic storylines and energy modeling. *Technological Forecasting and Social Change*, 91, pp.161–178. Available at: <http://linkinghub.elsevier.com/retrieve/pii/S0040162514000559>.
- Heinberg, R., 2004. *Powerdown - Options and Actions for a Post-Carbon World*, Gabriola Island: New Society Publishers.
- Hirsch, R.L., 2008. Mitigation of maximum world oil production: Shortage scenarios. *Energy Policy*, 36(2), pp.881–889.
- Holmgren, D., 2009. *Future Scenarios: How Communities Can Adapt to Peak Oil and Climate Change*, Vermont: Chelsea Green Publishing.
- Hopkins, R., 2006. *Emergy Descent Pathways: evaluating potential responses to Peak Oil*. University of Plymouth.
- Hubbert, M.K., 1949. Energy from Fossil Fuels. *Science (New York, N.Y.)*, 109(2823), pp.103–109.
- Hudson, A. & Tilley, D.R., 2014. Assessment of uncertainty in emergy evaluations using Monte Carlo simulations. *Ecological Modelling*, 271, pp.52–61. Available at: <http://dx.doi.org/10.1016/j.ecolmodel.2013.05.018>.
- Höjer, M. et al., 2008. Scenarios in selected tools for environmental systems analysis. *Journal of Cleaner Production*, 16(18), pp.1958–1970.
- Ippc, 2014. Summary for Policy Makers. *Climate Change 2014: Impacts, Adaptation and Vulnerability - Contributions of the Working Group II to the Fifth Assessment Report*, pp.1–32.
- Jaklič, T. et al., 2014. Complementarity of socio-economic and emergy evaluation of agricultural production systems: The case of Slovenian dairy sector. *Ecological Economics*, 107, pp.469–481. Available at: <http://www.sciencedirect.com/science/article/pii/S0921800914002948>.
- Kamp, A., Bolwig, S. & Østergård, H., no date. Environmental assessment of integrated food and cooking fuel production for a village in Ghana. *Submitted to Sustainability*.
- Kamp, A., Morandi, F. & Østergård, H., 2016. Development of concepts for human labour accounting in Emergy Assessment and other Environmental Sustainability Assessment methods. *Ecological Indicators*, 60, pp.884–892. Available at: <http://www.scopus.com/inward/record.url?eid=2-s2.0-84941088488&partnerID=tZOtx3y1>.
- Lambert, J.G. & Lambert, G.P., 2011. Predicting the psychological response of the American people to

- oil depletion and declining energy return on investment (EROI). *Sustainability*, 3(11), pp.2129–2156.
- Lefroy, E. & Rydberg, T., 2003. Emergy evaluation of three cropping systems in southwestern Australia. *Ecological Modelling*, 161(3), pp.195–211. Available at: [http://dx.doi.org/10.1016/S0304-3800\(02\)00341-1](http://dx.doi.org/10.1016/S0304-3800(02)00341-1).
- Markussen, M.V. et al., 2015. Net-Energy Analysis of Integrated Food and Bioenergy Systems Exemplified by a Model of a Self-Sufficient System of Dairy Farms. *Frontiers in Energy Research*, 3, pp.1–11. Available at: <http://journal.frontiersin.org/Article/10.3389/fenrg.2015.00049/abstract>.
- Moberg, F. et al., 2014. What is resilience? An introduction to social-ecological research. , pp.1–20.
- Mohr, S.H. et al., 2015. Projection of world fossil fuels by country. *Fuel*, 141, pp.120–135. Available at: <http://www.sciencedirect.com/science/article/pii/S0016236114010254>.
- Nordås, R. & Gleditsch, N.P., 2007. Climate change and conflict. *Political Geography*, 26(November), p.12.
- Odum, H.T., 1996. *Emergy and Environmental Decision Making*, New York: Wiley and Sons.
- Odum, H.T., 1988. Self-Organization, Transformity, and Information Howard. *Science*, 242(4882), pp.1132–1139.
- Odum, W.E., Odum, E.P. & Odum, H.T., 2007. Nature ' s Pulsing Paradigm Nature ' s Pulsing Paradigm. , 18(4), pp.547–555.
- Rist, L. et al., 2014. Applying resilience thinking to production ecosystems. *Ecosphere*, 5(June), pp.1–11. Available at: <http://www.esajournals.org/doi/abs/10.1890/ES13-00330.1>.
- Schubert, R. et al., 2007. *Climate Change as a Security Risk*, London: Earthscan. Available at: [http://www.eaac-net.org/conferences/fifteen/Presentations/EEAC Internal Day/071011\\_D-WBGU\\_ClimateChangeSecurityRisk\\_Schulz Baldes.pdf](http://www.eaac-net.org/conferences/fifteen/Presentations/EEAC%20Internal%20Day/071011_D-WBGU_ClimateChangeSecurityRisk_Schulz%20Baldes.pdf).
- Simón Reardon, J.A. & Pérez, R.A., 2010. Agroecology and the Development of Indicators of Food Sovereignty in Cuban Food Systems. *Journal of Sustainable Agriculture*, 34(8), pp.907–922. Available at: <http://www.tandfonline.com/doi/abs/10.1080/10440046.2010.519205>.
- Spielmann, M. et al., 2005. Scenario Modelling in Prospective LCA of Transport Systems. Application of Formative Scenario Analysis (11 pp). *The International Journal of Life Cycle Assessment*, 10(2002), pp.325–335. Available at: <http://link.springer.com/article/10.1065/lca2004.10.188>.
- Tverberg, G.E., 2012. Oil supply limits and the continuing financial crisis. *Energy*, 37(1), pp.27–34.
- Walker, B. et al., 2004. Resilience , Adaptability and Transformability in Social – ecological Systems. *Ecology and Society*, 9(2), p.5. Available at: <http://www.ecologyandsociety.org/vol9/iss2/art5/>.
- Watanabe, M. & Ortega, E.R., 2009. Biofuel sustainability according to emergy assessment. *32nd International Association for Energy Economics Conference*, pp.1–9. Available at: [http://www.usaee.org/usaee2009/submissions/OnlineProceedings/8513-Watanabe Online Proceeding 32nd IAEE Cf.pdf](http://www.usaee.org/usaee2009/submissions/OnlineProceedings/8513-Watanabe%20Online%20Proceeding%2032nd%20IAEE%20Cf.pdf)<http://www.usaee.org/usaee2009/submissions/Presentations/SFWatanabe.pdf>.
- Wright, C. & Østergård, H., 2015. Scales of renewability exemplified by a case study of three Danish pig production systems. *Ecological Modelling*, 315, pp.28–36. Available at: <http://linkinghub.elsevier.com/retrieve/pii/S0304380015001696>.
- Zamagni, A. et al., 2008. Critical review of the current research needs and limitations related to ISO-LCA practice - Deliverable D7 of work package 5 of the CALCAS project, p.106.

**Table A-1:** Unit energy value (UEV) in sej/unit, Global Renewability Fraction (%R<sub>global</sub>) and Local Supply Fraction (%Local) of inputs required to produce food and energy in the studied systems in different future scenarios. a: For labor accounting details, see Kamp et al. (2016) and Kamp et al. (n.d.).

	Reference		Green Tech		Brown Tech		Lifeboats		Earth Stewards	
	UEV	%R <sub>global</sub>	UEV	%R <sub>global</sub>	UEV	%R <sub>global</sub>	UEV	%R <sub>global</sub>	UEV	%R <sub>global</sub>
<b>Material and energy inputs</b>										
Sun (J)	1.0E+00	1.00	1.00	1.00	1.00	1.00	1.00	1.00	1.00	1.00
Wind (J)	2.5E+03	1.00	1.00	1.00	1.00	1.00	1.00	1.00	1.00	1.00
Geothermal heat (J)	1.2E+04	1.00	1.00	1.00	1.00	1.00	1.00	1.00	1.00	1.00
Rain (J)	3.1E+04	1.00	1.00	1.00	1.00	1.00	1.00	1.00	1.00	1.00
Soil loss (kg Corg)	1.6E+12	0.00	1.00	1.00	1.00	1.00	1.00	1.00	1.00	1.00
Water (L)	1.9E+09	1.00	1.00	9.4E+08	1.00	1.00	3.8E+09	1.00	5.6E+09	1.00
Manure (kg)	1.3E+11	0.29	0.50	6.4E+10	1.00	0.50	2.5E+11	0.01	3.8E+11	0.50
Firewood (kgdm)	3.1E+11	0.50	0.50	1.5E+11	1.00	0.50	6.1E+11	0.01	9.2E+11	0.50
Timber (kg)	1.5E+12	0.50	0.50	7.4E+11	1.00	0.50	3.0E+12	0.01	4.4E+12	0.50
Charcoal (kg)	2.1E+12	0.50	0.50	1.0E+12	1.00	0.50	4.2E+12	0.01	6.3E+12	0.50
Seed (Agroforestry) (kg)	2.7E+12	0.42	0.50	1.3E+12	1.00	0.50	5.4E+12	0.01	8.0E+12	0.50
Synthetic fertilizer (kg)	3.3E+12	0.01	0.00	1.7E+12	0.50	0.00	6.6E+12	0.01	1.0E+13	0.50
Seed (PP, Biogas) (kg)	4.2E+12	0.42	0.50	2.1E+12	1.00	0.50	8.4E+12	0.01	1.3E+13	0.50
Steel (kg)	6.9E+12	0.01	0.00	3.5E+12	0.50	0.00	1.4E+13	0.01	2.1E+13	0.50
Diesel (L)	9.1E+12	0.01	0.00	4.6E+12	0.50	0.00	1.8E+13	0.01	2.7E+13	0.50
Plastics (kg)	9.8E+12	0.01	0.00	4.9E+12	0.50	0.00	2.0E+13	0.01	2.9E+13	0.50
Machinery (kg)	1.4E+13	0.01	0.00	6.9E+12	0.50	0.00	2.8E+13	0.01	4.1E+13	0.50
Pesticide chemicals (kg active ingredient)	2.5E+13	0.01	0.00	1.2E+13	0.50	0.00	5.0E+13	0.01	7.5E+13	0.50
<b>Labor inputs<sup>a</sup></b>										
Direct labor, low UEV (man-hours)	3.2E+12	0.10	1.00	6.4E+12	0.50	1.00	1.6E+12	0.05	3.2E+11	0.50
Direct labor, middle UEV (man-hours)	9.1E+12	0.10	1.00	1.8E+13	0.50	1.00	4.6E+12	0.05	9.1E+11	0.50
Ind. labor, low UEV (man-hours)	3.2E+12	0.16	0.00	6.4E+12	0.50	0.00	1.6E+12	0.05	3.2E+11	0.50
Ind. labor, middle UEV (man-hours)	9.1E+12	0.16	0.00	1.8E+13	0.50	0.00	4.6E+12	0.05	9.1E+11	0.50
Ind. labor, global UEV (gl. avg. man-hours)	1.8E+13	0.16	0.00	3.7E+13	0.50	0.00	9.2E+12	0.05	1.8E+12	0.50

## PAPER V

**In-text citation:**

(Kamp and Østergård, 2016b)

**Authors:**

Andreas Kamp and Hanne Østergård

**Title:**

Environmental assessment of fruit cultivation and processing using fruit and cocoa residues for bioenergy and compost. Case study from Ghana

**Submission and publication details:**

Submitted to *Journal of Cleaner Development* 26<sup>th</sup> of February 2016

**Note:**

Supplementary material is available at

[https://www.dropbox.com/sh/wh1fke4u4itnauz/AAC\\_IZ6vByCYQJ68obCBB56Aa?dl=0](https://www.dropbox.com/sh/wh1fke4u4itnauz/AAC_IZ6vByCYQJ68obCBB56Aa?dl=0)

# Environmental assessment of fruit cultivation and processing using fruit and cocoa residues for bioenergy and compost. Case study from Ghana

Andreas Kamp<sup>a</sup> and Hanne Østergård<sup>a\*</sup>

<sup>a</sup> Department of Chemical and Biochemical Engineering, Technical University of Denmark, DTU, Søtofts Plads 229, 2800 Kgs. Lyngby, Denmark

\* Corresponding author. Tel.: +45 21 32 69 55, e-mail address: [haqs@kt.dtu.dk](mailto:haqs@kt.dtu.dk)

## Abstract:

Agro-industrial businesses often have easy access to agricultural and processing residues with which they may reduce costs and pollution by integrating their production with bioenergy production. In regions with unreliable power supply, on-site electricity generation is a means to secure stable production conditions. Furthermore, recycling of nutrients may help to reduce biomass suppliers' dependence on synthetic fertiliser. In this environmental sustainability assessment (ESA) of fruit production in Ghana we compare two technology options for the production of mixed, fresh, tropical fruit, including cultivation, transport and processing. The option 'Present practice' presents data from a case study where production is characterised by soil loss and synthetic fertiliser dependence in cultivation and grid supply of electricity in processing. The option 'Biogas' is hypothetical and characterised by biogas and electricity production using farming and processing residues and by recycling of nutrients and carbon to soil. Cocoa shells are used as a co-substrate in the biogas production. Estimating the environmental impact of cocoa shell residues exposes the multifunctionality issue, continuously debated in ESA, particularly concerning bioenergy production. We compare the use of allocation to system expansion with multiple products as possible methods to manage multifunctionality. Using the latter method, we find that in comparison with 'Present practice', the option 'Biogas' eliminates net soil carbon loss and reduces synthetic fertiliser, diesel and external electricity requirements at the expense of a relatively small increase in human labour input. The ESA includes the following indicators and shows that the 'Biogas' option is superior to 'Present practice' with regard to Cumulative Energy Demand (-39%), Cumulative fossil Energy Demand (-34%), Food Energy Return On energy Investment (+65%), Food Energy Return On fossil energy Investment (+53) and Carbon Footprint (-29%) and similar in terms of the Energy Assessment indicators Unit Energy Value (UEV), Global Renewability Fraction, and Local Supply Fraction.

**Keywords:** Bioenergy, sustainability assessment, tropical fruit, agroindustry, residues, multifunctionality

## 1. Introduction

Utilising agricultural and agroindustrial residues for bioenergy production is considered to significantly contribute to the transition away from fossil fuel use. Hoogwijk et al. (2003) considers global bioenergy potential to be in the range of 10-32 EJ/year and Haberl et al. (2011) project that residues from cropland alone make up a quarter of global bioenergy potentials in 2050. Kemausuor



et al. (2014) mapped currently unused and recoverable agricultural and agroindustrial residues in Ghana and estimated bioenergy potential from these to approximately 80 PJ/year, equivalent in terms of energy content to 13 million barrels of oil.

Agricultural residues are scattered around the countryside, but as they are collected for agroindustrial processing, concentrated bioenergy feedstock resources are created. Agroindustrial processes are themselves often energy intensive and utilising feedstock that is already concentrated on the premises appears to be a straightforward option to optimise overall resource efficiency. In regions with regular electricity supply interruptions, on-site, residue-based electricity production may substitute the use of back-up diesel generators. Besides incurring environmental benefits, such a substitution increases energy sovereignty since it relies on a resource already under control. Residue-based bioenergy production is also an option to reduce or eliminate undesired co-products that may otherwise require significant storage or treatment efforts. Finally, since agroindustrial residues often contain significant amounts of carbon, macro- and micronutrients, the return of these residues to farmers constitutes an important means of replenishing soils and reducing external nutrient dependence (Smil, 1999).

Environmental Sustainability Assessment (ESA) is used to evaluate the trade-offs of using different technologies, applying a range of specific methods to identify and estimate the importance of inputs that are associated with undesired resource use and pollution (Ulgiate et al., 2006). ESA provides a basis for prioritising the technologies and practices that are compatible with market and regulatory trends (e.g. resource availability, pollution control). Recent examples include Life Cycle Assessments (LCAs) of biogas and bioethanol production based on agro-industrial residues (Tonini et al., 2015; Tufvesson et al., 2013) and of tropical fruit production (Aguilera et al., 2015; Ingwersen, 2012; Yan et al., 2015), Emergy Assessment (EmA) of bioethanol partly based on agricultural residues (Coppola et al., 2009), and Net Energy Analysis of food production (Markussen and Østergård, 2013).

Assessment methods are developed continuously and distinct methodological perspectives emerge (e.g. Brown & Herendeen, 1996; Raugei et al., 2014). An interesting question is whether assessments should focus on single products or apply a larger system perspective involving multiple outputs. The typical choice of functional unit (reference flow) of an assessment as a certain amount of one product gives the impression that it is possible to isolate environmental impacts of one particular product. This is convenient for regulatory (European Parliament, 2009, article 81) and marketing purposes. In many cases, however, this custom is deceitful, since e.g. agricultural, agro-industrial and other processes with inputs of biological origin usually result in several outputs between which environmental impacts cannot be unambiguously distributed. In addition, distinct production systems that use outputs from such co-production systems are therefore linked together. This important methodological topic is the subject of much debate, in LCA where it is referred to as the multifunctionality issue (Cherubini et al., 2011; Heijungs and Guinée, 2007; Pelletier et al., 2015; Weidema and Schmidt, 2010) and in Emergy Assessment in relation to co-products (Bastianoni and Marchettini, 2000; Kamp and Østergård, 2013).

Typically, the multifunctionality issue is approached from the ‘output side’ by focusing on a product whose production results in one or more co-products. Plenty of examples of studies that consider ‘output multifunctionality’ exist, e.g. regarding transportation fuels (Curran, 2007), biorefinery products (Cherubini et al., 2011), biofuels (Wang et al., 2011), and sheep farming (Eady et al., 2012). The issue may also be approached from the ‘input side’, when a study of a production process reveals that a background system providing inputs to the foreground system (system in focus) yields multiple outputs. Multifunctionality regarding inputs is the norm in the study of residue-based bioenergy, nevertheless, we have found only few studies that deal specifically with multifunctionality in background systems, e.g. concerning leaves and straw in ethanol production based on sugar beet and wheat (Malça and Freire, 2004), manure used for fertilising bioenergy crops (Kamp and Østergård, 2013), and forestry products in biorefinery production based on pulpwood (Sandin et al., 2015).

Guidelines on how to deal with multifunctionality in ESA suggest *system expansion* to encompass several outputs within the system boundary or distribute environmental burdens among co-products using *allocation* (ISO, 2006; EC, 2010). Because of the desire to report environmental impacts at the individual co-product level, system expansion is almost always followed by *substitution* (also called the avoided burden method), where impacts of co-products other than the one defined as the functional unit are subtracted from the assessment. The selected substitutes used in the subtraction are supposed to be functionally equivalent to the co-product and in order to solve the multifunctionality issue, they should be outputs from mono-functional processes. We may expect that there are plenty of such mono-functional processes, but in fact, multi-functional processes are more abundant than what we think (Heijungs and Guinée, 2007). Allocation is an alternative to system expansion where environmental impacts are simply partitioned between outputs, applying an allocation method that is argued to be relevant. In the context of environmental burden distribution, the choice of allocation method is considered subjective which is why guidelines suggest avoiding this approach. Finally, situations arise where system expansion with substitution is practically undoable because there are no relevant substitutes that are not themselves co-products and where allocation is sought avoided. In such assessments, no choice remains but to expand the system and consider multiple products in the functional unit.

In this paper, we present a case study of cultivation and processing of mixed tropical fruit in Ghana, mainly pineapple and mango. We consider the possibility of utilising fruit production residues and cocoa shells for biogas production at the fruit processing facility to reduce the current dependence on grid electricity and synthetic fertiliser, and to maintain soil carbon levels. The use of cocoa shells represents a situation with multifunctionality (in a background system) where neither substitution nor allocation is desirable, which leads us to demonstrate and discuss ESA of an expanded system with multiple products. We calculate indicators from the Emery Assessment methodology, energy demand indicators and Carbon Footprint considering greenhouse gas emissions.

## 2. Methods & Materials

## 2.1 Study area and empirical data

Fruit production is studied in South-Eastern Ghana where the climate is tropical with average rainfall of 1200 mm/year and solar irradiation of 5.2 kWh/m<sup>2</sup>/day. Throughout, inventory and result figures are presented with two significant digits. Calculations are carried out using all available digits. Empirical data on pineapple production and on fruit factory operations are obtained through interviews with farmers and managers in 2012-13, and supplemented with literature studies. Information about mango and cocoa production is based predominantly on literature (NoorMmemon et al., 2015; Opoku-Ameyaw et al., 2010). Information about biogas and electricity production is based primarily on an internal report, prepared for the fruit processing company (Daniel and Schneider, 2013). Company details are not disclosed according to a confidentiality agreement.

In the region, pineapple production is typically labour-, fertiliser- and pesticide intensive. Pineapple can be regarded as an annual crop, even if the total production time is 15 months. Because of the relatively stable climate, pineapple can be grown year round. Pineapple yield among interviewed farmers ranges from 43 t/hectare per harvest for a cultivation practice categorised as medium input-medium output, to 50 t/hectare per harvest for practices categorised as high input-high output. Throughout, masses are given as wet weight unless stated as dry matter. After harvest, the pineapple plants remain as either mother plants for sucker (seedling) production or as a sizable by-product that is considered waste and currently burned on the field by the farmers. Mango is a tree crop grown in orchards and is also input intensive. In this study we use a mango yield of 11 t/ha/year on average over the plantation's life time. Other fruits processed at the fruit factory include papaya, passion fruit, coconut, banana, lime and pomegranate. Lacking sufficiently detailed knowledge, the assessment considers average pineapple and mango production and transport inputs as representative for these secondary fruits (constituting approx. 10% of total fruit mass).

Cocoa cultivation and processing is a large industry in Ghana, with 1.6 million hectares grown. Cocoa is particularly frugal with respect to material and labour inputs, but the land requirement is high, since cocoa yields are very low, approximately 0.4 t beans/ha/year. Cocoa beans are sun-dried and transported an assumed average of 60 km for processing.

In the case study, the average distance between fruit farmers and the fruit factory is approximately 25 km for pineapple and 60 km for mango. Fruit is typically delivered in 3-5 ton trucks. Fruit processing is labour intensive and characterised by significant electricity use for cooling before and after processing. Approximately 2/3 of the fruit delivered to the fruit factory is discarded during processing, mainly as cut off stems, peels, crowns, pits, etc. The processing of cocoa beans includes de-shelling, separating the nib (87% of mass) from the shell (13%). Some cocoa shells are used as organic fertiliser but the majority, counted in thousands of tons, are currently discarded. The distance from cocoa processing to the fruit factory is approximately 25 km, and cocoa beans and shells can be transported in 30 ton trucks.

## 2.2 Technology options

Two technology options for the production (i.e. cultivation, transport and processing) of mixed, fresh, tropical fruit and the production (i.e. cultivation, transport and processing) of cocoa beans are

evaluated. 'Present practice' represents practices observed in the case study while 'Biogas' represents a hypothetical situation with some altered methods and technologies.

### 2.2.1 Present practice 'PP'

Present practice is characterised by the use of predominantly synthetic fertiliser in fruit farming, electricity from the national grid and back-up diesel generators in fruit processing, and negligible use of composted processing residues. About  $\frac{3}{4}$  of electricity use is supplied by the national grid, but because of common supply interruptions, back-up diesel generators run regularly, supplying approximately  $\frac{1}{4}$  of the total electricity requirement over the course of a year.

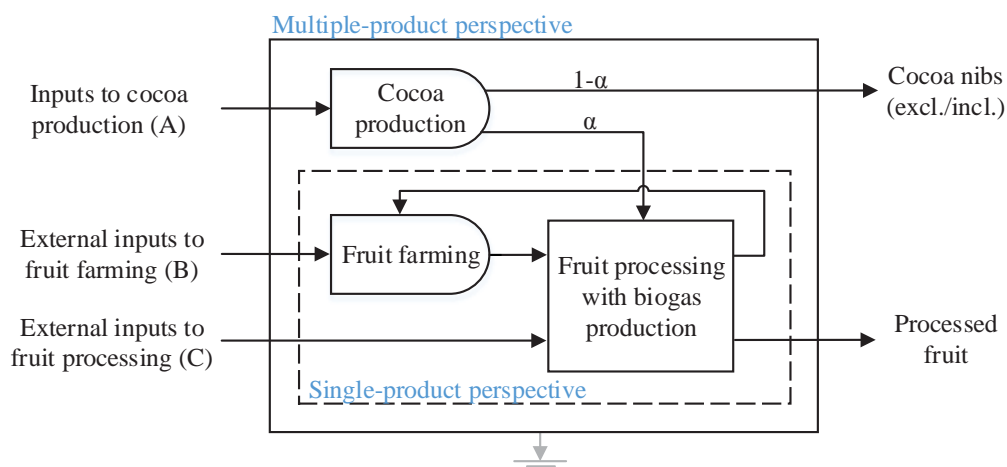
### 2.2.2 Alternative practice 'Biogas'

In the alternative, hypothetical technology option 'Biogas', biogas is produced at the fruit factory using a combination of fruit processing residues already there and two co-substrates that need to be transported. The first co-substrate is pineapple plant waste, available from the farmers that also supply pineapple fruit. The second co-substrate is cocoa shells available from nearby cocoa factories. The biogas is converted to electricity in two 250 kW combined heat and power (CHP) plants. The CHP output is scaled to be sufficient to operate the refrigeration system and secure the necessary heat demand of the fermentation system. Some electricity back-up supply is expected during plant downtime (Daniel and Schneider, 2013).

The digestion residue is composted to a mulching material that is relatively rich in carbon and nutrients. This material is returned to pineapple and mango farmers to primarily reduce the requirements of purchased, synthetic fertiliser but also to avoid soil organic carbon depletion. Compost transport from the fruit factory is by truck and spreading of compost on fields is manual, similar to most other farm activities. The application of compost material on pineapple farms requires a change of cultivation practice that excludes the commonly applied plastic sheet mulching. We suggest a practice that is in general similar to the medium input-medium output practice applied by the farmers with yields in the lower end of the range. This means that a larger area is required to supply the same amount of pineapple for processing.

### 2.3 Single-product versus multiple-product perspective

The utilisation of cocoa shells as a co-substrate in biogas production links fruit production with cocoa production. This necessitates methodological considerations regarding system boundaries in multifunctional systems. Two approaches are compared: Using allocation in a single-product perspective (Fig. 1, dashed system boundary line) and expansion of the system boundary to include two products in a multiple-product perspective (Fig. 1, full system boundary line). A single-product focus is associated with a (fruit factory) business perspective where the placement of the environmental burden is important. A multiple-product focus is associated with a regional or societal perspective where burden placement matters less than optimisation of the larger system.



**Figure 1:** Overview of system components and connections. The dashed line demarcates the single-product perspective.  $\alpha$ : The fraction of the environmental impact from cocoa production that is accounted for as associated with cocoa shells. Cocoa nibs are considered among the outputs when a multiple-product assessment perspective is applied.

### 2.3.1 Single-product perspective

Applying the single-product perspective, the inputs to cocoa growing, transport to the cocoa factory and de-shelling are allocated between the cocoa nib and the cocoa shell, based on different allocation parameters: price ( $\alpha = 0\%$ , i.e. shells are considered a waste), energy content ( $\alpha = 12\%$ ) or according to emergy algebra rules ( $\alpha = 100\%$ , i.e. all environmental impact is assigned to each co-product, see 2.4.1). Only processed fruit is considered as a relevant output and the technology assessment is referred to as ‘Biogas, fruit only’. The results of ‘Biogas, fruit only’ are comparable to ‘PP, fruit only’ (not illustrated). The functional unit in the single-product perspective is 4,600 tons of processed fruit at the fruit factory gate per year, the actual production in 2012.

### 2.3.2 Multiple-product perspective

Applying the multiple-product perspective entails including cocoa growing, transportation and de-shelling in the foreground system and accounting for all associated inputs. Thereby, cocoa shells are considered an internal flow rather than as an input to the system. The expanded system yields two products, processed fruit and cocoa nibs. Both products are included in the assessment ‘Biogas, fruit & nibs’, providing results that are comparable with ‘PP, fruit & nibs’.

‘PP, fruit & nibs’ assesses cocoa production and fruit production as two separate systems but aggregates their inputs and outputs. The functional unit in the multiple-product perspective is 23,500 tons/year of biomass, including processed fruit (4,600 tons) and cocoa nibs (18,900 tons). The 18,900 tons are produced jointly with 2,700 tons of cocoa shells, the amount required as co-substrate in biogas production.

Unused cocoa shells and other residues are not considered as outputs. Table 1 summarises the technologies and assessment perspectives.

**Table 1:** Characteristics of compared technology assessments.  $\alpha$ , A, B and C: As in Fig. 1.

Technology assessment	Allocation ( $\alpha$ )	Inputs	Outputs
<i>Single-product perspective</i>			
PP, fruit only	-	B,C	Fruit
Biogas, fruit only (waste)	0%	B,C	Fruit
Biogas, fruit only (energy)	12%	12%*A,B,C	Fruit
Biogas, fruit only (emergy algebra)	100%	A,B,C	Fruit
<i>Multiple-product perspective</i>			
PP, fruit & nibs	-	A,B,C	Fruit & nibs
Biogas, fruit & nibs	-	A,B,C	Fruit & nibs

## 2.4 Environmental Sustainability Assessment (ESA) methods

### 2.4.1 Emergy Assessment (EmA)

The theories and concepts of emergy methodology are based on thermodynamics and system theory (Odum, 1996). Emergy is the availability of energy (exergy) of one kind that is used up in transformations directly and indirectly to make a product or service. Emergy is considered a measure of environmental support. In EmA, all forms of energy, materials and human labour that contribute - directly or indirectly - to a production process are taken into account and converted into the common unit of solar emjoules (sej) (Brown et al., 2015). Production inputs are converted to emergy by multiplying physical inputs with Unit Emergy Values (UEV), where the UEV is the emergy per unit of input (e.g. sej/J, sej/g, sej/man-hour).

#### 2.4.1.1 Emergy indicators

Important emergy indicators include the UEV, the Global Renewability Fraction, the Local Supply Fraction and the Emergy Yield Ratio. The calculated UEV of the studied product(s) is considered an estimate of accumulated resource use per unit product (or group of products) and the lower the UEV is, the higher is the efficiency of the system as considered in a biophysical perspective. The Global Renewability Fraction indicates the share of emergy originating from a renewable energy flow, either directly from the sun, wind, rain, deep earth heat or tidal energy on the study site, or indirectly, embodied in any other input that depends on the mentioned sources in their production (Cavalett et al., 2006; Wright and Østergård, 2015). The Local Supply Fraction indicates the fraction of inputs to the foreground system that are considered to be locally sourced (Wright and Østergård, 2015). The Emergy Yield Ratio compares the total emergy embodied in the outputs relative to emergy provided by the human economy (Brown & Ulgiati, 1997). This makes the Emergy Yield Ratio similar to the Energy Return On energy Invested (EROI) indicator (Murphy et al., 2011). Emergy indicators are based on an emergy baseline of 15.83E+24 sej/year.

#### 2.4.1.2 Human labour inputs

In this study, human labour inputs are accounted for following the guidelines presented in Kamp et al. (2016), distinguishing between direct labour and indirect labour. Direct labour takes place in the defined ‘foreground’ of the assessment, comprising the man-hours required for farming, transportation and fruit processing (in the systems assessed with a single-product perspective). Indirect labour takes place in the ‘background’, i.e., in support systems to farming, transport and fruit production (e.g. machinery, diesel and synthetic fertiliser production). This ‘embodied labour’ accompanies purchased goods and services. Indirect labour is accounted for with an estimate of global average man-hours required, approximated using the monetary cost of the input as demonstrated by Kamp et al. (n.d.). Total labour adds direct and indirect labour inputs, using the unit man-hours. Different UEVs are applied for direct labour and indirect labour since human labour relies on different environmental support, depending on type and location.

#### 2.4.1.3 Emergy algebra

EmA follows a set of calculation rules referred to as emergy algebra (Brown and Herendeen, 1996; Kamp and Østergård, 2013). Emergy theory revolves around the memorisation of foregone emergy which is explicit in the algebra rule that “co-products from a process have the total emergy assigned to each pathway”, since all the emergy is required for the production of each. At first glance this seems illogical, since the same emergy may then be counted multiple times if co-products are included in different EmAs. Thereby, EmA appears unfit for assessments of multifunctional systems, an unintended consequence because systems thinking is central to EmA theory. However, another algebra rule states that “emergy cannot be counted twice within a system: (a) emergy in feedbacks cannot be double-counted; (b) co-products, when reunited, cannot be added to equal a sum greater than the source emergy from which they were derived”. Herein lies the explanation and way out of the conundrum. It is the breaking up of connected processes that causes the seemingly counter-intuitive approach. Once the perspective is changed to include the pathway end of all co-products, conservation of embodied energy is regained. The algebra therefore leads in the direction of a larger system perspective.

#### 2.4.2 Energy demand indicators

The dependence on external energy inputs is assessed using the following four indicators.

##### 2.4.2.1 Cumulative Energy Demand (CED)

Estimates of external energy inputs are modelled with SimaPro version 8 using the Cumulative Energy Demand version 1.09 method by EcoInvent. SimaPro models are included in the supplementary material. The CED aggregates eight categories of fossil and non-fossil energy inputs (Hischier et al., 2010). Only the harvested amount of energy is included, e.g. for hydro power it is the rotation energy of the turbine, not the potential energy of the water (Frischknecht et al., 2015). The CED indicator is in  $\text{MJ}/\text{kg}_{\text{output}}$ .

##### 2.4.2.2 Cumulative fossil Energy Demand (fossil CED)

The fossil CED includes only the ‘non-renewable, fossil’ category of the CED method. This indicator, given in  $\text{MJ}_{\text{fossil}}/\text{kg}_{\text{output}}$ , assesses the efficiency of fossil energy use in the production of food.

#### 2.4.2.3 Food Energy Return On energy Investment (Food EROI)

The Food EROI is the ratio of food energy output to the energy inputs included in the CED. This indicator assesses the efficiency in turning available energy into food energy and is given as  $J_{\text{food output}}/J_{\text{input}}$ . The used energy content of food outputs is 2.4 MJ/kg for fruit and 19 MJ/kg for cocoa nibs. The indicator builds on the EROI method, typically used for analysis of energy carriers (Murphy et al., 2011), but also in energy analysis of food production (Markussen and Østergård, 2013).

#### 2.4.2.4 Food Energy Return On fossil energy Investment (Food EROI (fossil))

The food EROI (fossil) indicator compares food energy output to fossil energy inputs. The indicator identifies the role of fossil energy as being a key input in contemporary food production, using  $J_{\text{food output}}/J_{\text{fossil input}}$  as unit.

#### 2.4.3 Carbon Footprint

The Carbon Footprint is estimated in kg of CO<sub>2</sub> equivalents per ton of output and consists of five components: 1) Carbon emissions from the production of fuels, synthetic fertiliser, electricity etc. are modelled with SimaPro version 8 using the IPCC 2013 GWP 100a (global warming potential in a 100-year perspective) impact assessment method. Soil erosion and direct field emissions are not included in the SimaPro model. 2) The loss of soil organic carbon (SOC) in pineapple production is estimated assuming soil loss from erosion of 3.6 t/ha/year based on a study by Ingwersen (2012). Soil loss is converted to SOC using 5% soil organic matter (Lefroy and Rydberg, 2003) and 56% carbon in soil organic matter (Wilhelm et al., 2007). 3) The return to the soil of carbon in compost material is subtracted from the SOC loss from erosion. 4) Nitrous oxide emissions from applied nitrogen in synthetic fertiliser and compost material are estimated using 0.01 kg N<sub>2</sub>O per kg applied N (Intergovernmental Panel on Climate Change, 2006) and 265 kg CO<sub>2</sub>-eq./kg N<sub>2</sub>O in cumulative forcing over 100 years (IPCC, 2014). 5) We include a 3% leakage from the biogas plant (Flesch et al., 2011), applying the conversion factors 0.66 kg/m<sup>3</sup> and 28 kg CO<sub>2</sub>-eq./kg methane to estimate the impact (IPCC, 2014).

The calculated estimates include only a part of the actual carbon footprint associated with the assessed activities: Soil carbon emissions resulting from ploughing and harrowing in present practice pineapple cultivation, and changes in these from applying the medium input-medium output practice have not been assessed, probably incurring a bias in favour of 'Present practice'. Additionally, emissions occurring during the composting of digestate prior to application (namely as methane) are not accounted for, probably favouring 'Biogas'. We assume that these emissions balance out each other.

#### 2.5 Sensitivity analysis

A range of calculation assumptions and data inputs that were expected to significantly influence the results of the reference model described in sections 2.2 and 2.3 were altered. The analysis includes eight sensitivity models: 1) changing the source of electricity from national grid mix to oil power which is considered to be the country's marginal supply; 2) reducing the contribution of compost material as fertiliser to 50% or 0% instead of 100%; 3) assuming different soil carbon uptake effect



(50% instead of 100%); 4) adjusting the yield of cocoa (-10% and +10%); 5) adjusting the bioenergy conversion efficiency (-10% and +10%) implying a change of scale in biogas and CHP production and required inputs; 6) assuming higher methane leakage (10% instead of 3%); 7) adjusting the yields/ha of pineapple and mango (-10% and +10%); and 8) increasing the labour input for applying compost material by 200%.

### **3. Results & Discussion:**

#### **3.1 Physical flows**

In this section, present practice is compared to the technology option with biogas under two assessment perspectives in terms of selected physical flows (Table 2). It is important to notice that results may only be compared within each perspective. Note also, that the inputs for  $\alpha = 100\%$  are equal to the inputs for 'Biogas, fruit & nibs'. Finally, providing numbers with two significant digits conceals that the difference between 'PP, fruit only' and 'Biogas, fruit only (waste)' is the same as the difference between 'PP, fruit & nibs' and 'Biogas, fruit & nibs'.

Table 2 summarises selected physical inputs and relevant outputs. A complete emergy table with all inputs and outputs in physical units and solar emjoules is provided as Supplementary Material.

Table 2 to be positioned here.

##### **3.1.1 Single-product perspective**

###### **3.1.1.1 'PP, fruit only'**

'PP, fruit only' is characterised by soil loss, synthetic fertiliser demand, diesel and electricity use in processing. Soil loss is estimated to 790 t of soil, equivalent to 23 t of soil organic carbon (SOC). Labour inputs amount to approximately 4 million man-hours, corresponding to 0.87 man-hours/kg of processed fruit, predominantly direct labour in fruit processing (2.8 million man-hours).

###### **3.1.1.2 'Biogas, fruit only' (three assessments)**

The 'Biogas, fruit only' assessments assign three different degrees of environmental burden to cocoa shells (see section 2.3). Common for the assessments based on allocation is that synthetic fertiliser demand is significantly reduced (-45 %), compared to 'PP, fruit only', and net SOC loss is avoided. This is the result of returning nutrients and carbon in approximately 2400 t (80% dry matter) of compost material to pineapple and mango fields. In fact, the carbon content in the returned material exceeds the carbon lost in erosion from pineapple farms, leading to a net increase in the soil carbon storage (the net build-up of SOC is not considered as an output). Making use of the compost material is associated with a change in pineapple cultivation practices that reduces synthetic fertiliser, machinery, chemicals, plastic and diesel demand (see section 2.2.2). Changed cultivation practice is associated with a lower output per area, resulting in additional land use (+5.2%). Direct labour input is slightly increased in pineapple cultivation because of more manual tasks and insignificantly influenced by the small additional labour requirement of running the biogas and CHP plant. Indirect labour inputs are reduced a little in farming by the reduced need for purchased fertiliser, while the establishment of the biogas and CHP plant increase indirect labour overall.

#### 3.1.1.2.1 ‘Biogas, fruit only (waste)’

On-site feedstock is utilised for energy production to reduce external electricity demand (-93%) and diesel (-29%). Transport diesel demand is somewhat increased (for bringing cocoa shells from cocoa processing to the fruit factory), but diesel for pineapple cultivation and backup generators are significantly reduced. 4.9% additional labour is associated with increased manual tasks, primarily in pineapple cultivation, and extra transport.

#### 3.1.1.2.2 ‘Biogas, fruit only (energy)’

Accounting for 12% of cocoa production significantly increases the land area associated with fruit production (+790%, incl. the small increment caused by lower pineapple yields). External electricity and diesel demand are reduced by 91% and 27%, respectively. Labour ascribed to cocoa shells contributes significantly to a 34% increase in total labour.

#### 3.1.1.2.3 ‘Biogas, fruit only (emergy algebra)’

Associating all inputs of cocoa production with cocoa shells increases total land requirement for fruit production by a factor 65. External electricity and diesel demand are reduced by 77% and 15%, respectively. Total labour increases 240%.

### 3.1.2 Multiple-product perspective

#### 3.1.2.1 ‘PP, fruit and nibs’

‘PP, fruit and nibs’ is characterised by large land area and significant labour inputs, occurring primarily in cocoa growing. Other characteristics include soil loss and synthetic fertiliser use, associated with pineapple production. Labour inputs are 13 million man-hours/year, corresponding to 0.57 man-hours/kg of food output.

#### 3.1.2.2 ‘Biogas, fruit & nibs’

Recycling with compost material results in avoided SOC loss and a 45% reduction of synthetic fertiliser requirement, compared to ‘PP, fruit and nibs’. Diesel use is reduced 25% and electricity demand 80%. There is no significant increase in land use and labour inputs.

### 3.2 Environmental Sustainability Assessment (ESA)

The ESA results in two sets of comparison, one for each assessment perspective (Table 3). Contrary to the pattern observed for the physical flows, the difference between the ESA indicators for ‘PP, fruit only’ and ‘Biogas, fruit only (waste)’ and, respectively, ‘PP, fruit & nibs’ and ‘Biogas, fruit & nibs’ is different since the functional unit for the single-product assessments is much smaller than the functional unit for the multiple-product assessments.

Table 3 to be positioned here.

#### 3.2.1 Single-product perspective

The UEV of the technology choice ‘PP, fruit only’ is  $9.2E+15$  solar emjoules per ton, indicating the environmental support required in order to provide a ton of processed fruit. This support is mainly non-renewable emergy (85%) and of local origin (75%). The CED amounts to 15 GJ/t, of which

83% is fossil energy. Food EROI and Food EROI (fossil) are estimated to 0.16 and 0.19, respectively, while the carbon footprint is approximately 790 kg/t.

When considered in a single-product perspective, the suggested introduction of biogas-based CHP and recycling of nutrients does not necessarily reduce the environmental support and thereby improve the biophysical resource use efficiency. While the emergy of soil loss, external electricity and fertiliser use are indeed reduced, significant additional labour inputs are required to achieve those reductions. Only if cocoa shells are unaccounted for, do we see an improvement in the UEV (-3.6%). If 12% or all of the inputs associated with cocoa shell provision are included, the biophysical efficiency of making available one ton of processed fruit is lower (44% or 390% more inputs, respectively) with biogas than without.

A lower biophysical efficiency may be justified by an increased reliance on renewable and/or local resources. Renewability of cocoa production is high (primarily rain input) but local supply low (shells are regarded as non-local). Therefore, the more of the cocoa production that is accounted for, the higher renewability fraction and the lower local supply fraction, but also the lower biophysical efficiency. The emergy yield ratio is very low in all cases, meaning that the invested resources yield access to very little additional resources.

Irrespective of method for allocation of cocoa shells, production with biogas reduces CED (31%-45% lower). This is directly reflected in higher Food EROIs (46%-81% higher) and Food EROIs (fossil) (35%-64% higher). Fossil CED decreases (-26 to -39%), but the fraction of fossil energy in the CED increases (from 83% to 90%-92%), primarily because the replaced electricity is mainly hydropower. The Carbon Footprint is reduced by 32%-46%.

### 3.2.2 Multiple-product perspective

Expanding the assessment perspective to encompass also cocoa production reduces the relative effect of introducing biogas, as compared to in a single-product perspective with  $\alpha = 0$ . The resource use in 'Biogas, fruit & nibs' is similar to the resource use in 'PP, fruit and nibs' (-0.73%). Similar results are found for the Global Renewability Fraction (+0.48%) and Local Supply Fractions (+1.1%). Production with biogas decreases CED (-39%), fossil CED (-34%) and Carbon Footprint (-29%) of the larger system. Food EROI and Food EROI (fossil) are improved (+67% and +54%, respectively) to above parity, meaning that more food energy is available than energy used. With biogas, fruit and cocoa production becomes a net energy contributor.

### 3.2.3 Sensitivity analysis

The eight sensitivity models produce 72 adjusted assessments. The conclusions shown as deviations from the reference model are combined in Table 4 and the actual figures may be found in the Supplementary Material. The model is sensitive to several of the considered changes.

Table 4 to be positioned here.

#### 3.2.3.1 Oil as marginal electricity source

Considering oil as marginal supply in the national electricity grid implies that all external electricity input is based on oil instead of on a mix of hydro, oil and gas. This significantly affects the energy demand indicators and Carbon Footprint in favour of the biogas technology.

#### 3.2.3.2 Reduced return of compost material

Lower returns of compost significantly affects only energy demand indicators and Carbon Footprint. Compared to the reference model, the carbon footprint is increased 16%-29% if only half is returned and 39%-77% if no compost is returned. The potential impact change associated with 'Biogas' as an alternative to 'PP' is characterised by nutrient recycling as a substitute for synthetic fertiliser rather than the on-site production of electricity to substitute grid electricity and diesel.

#### 3.2.3.3 Reduced uptake of returned carbon

If only half of the returned carbon in compost is taken up in the soil, it results in a net addition of 59 t C/year compared to 144 t/year in the reference model. This significantly influences the Carbon Footprint (+8%-17%).

#### 3.2.3.4 Adjusted cocoa yields

Cocoa cultivation is associated with very few of the inputs considered in the energy demand methods. Therefore, changed cocoa yields (+/- 10%) affect only energy indicators, and less than 10%. Nevertheless, the model suggests that increased cocoa production efficiency holds large potential for increased, overall resource efficiency improvement because of the large requirements for land.

#### 3.2.3.5 Adjusted bioenergy conversion efficiency

Changed bioenergy conversion efficiency (+/-10%) implies slightly changed infrastructure to maintain the desired electricity output. With lower efficiency, we assume that the increased substrate demand is satisfied by additional cocoa shells and pineapple mother plants. For both increased and decreased efficiency, we assume no significant effect on compost composition but amounts do change about 10%. The changes affect most indicators less than 10% compared to the reference model.

#### 3.2.3.6 Higher methane leakage

Increased methane leakage at the biogas plant (10%) significantly affects the Carbon Footprint (+35%-68%) in favour of 'PP'. Effects on lower biogas output are modelled in the reduced bioenergy conversion efficiency analysis (3.2.3.5).

#### 3.2.3.7 Adjusted fruit yields

Changed fruit yields (+/- 10%) affect only the cultivation of fruit. This has no significant influence on the calculated indicators contrary to the effect of changing the cocoa yield.

#### 3.2.3.8 Increased labour in compost application

Tripling the amount of labour in compost field application does not affect any indicator significantly.

### 3.3 Comparison with other studies:

Our combination of study target and methodological considerations is novel, so no directly comparable results are available in the literature. Ingwersen (2012), however, studied fresh pineapple production in Costa Rica and provide results that are relevant to compare with present practice fruit production in this study. Ingwersen estimate a Unit Emery Value of  $1.0E+06$  sej/J (excl. 4% in distribution to USA), 1% renewability, and 460 kg CO<sub>2</sub>-eq./t of fruit (excl. 15% in distribution). Higher yields per hectare and larger amounts of fuel, synthetic fertiliser and pesticides in Costa Rican production may explain the differences. Carbon footprint studies of fruit tree orchards indicate significantly lower impact in the range 140-370 kg/t at farm gate (Aguilera et al., 2015; Yan et al., 2015). Our study supports the hypothesis that tree fruits are associated with lower GHG emissions than pineapple.

Markussen and Østergård (2013) refer to food EROIs of 0.8 (US crop and livestock in 1970) to 3.9 (Danish agriculture in 1936) before estimating contemporary Danish food EROI to 0.28. The food EROI for processed fruit is in the vicinity of the one for contemporary Danish food. Low food EROIs characterise luxury foods as considered from an energy input perspective.

Kamp et al. (n.d.) studied integrated food (maize-beans) and biogas production in a Ghanaian village. Resource use efficiency increased slightly by implementing biogas production and nutrient and carbon recycling. Similar to this study's multiple-product perspective results, increased labour inputs in that study are justified by reductions in synthetic fertiliser, soil and external energy use.

Kemausuor et al. (2014) estimated 4.3 million tons of crop processing residues in Ghana with a methane production potential of 750 million m<sup>3</sup>. In the present study, 11,000 t of residues are considered necessary to produce approx. 1 million m<sup>3</sup> methane, indicating that the methane potential per average ton of residue used by Kemausuor et al. (1 million m<sup>3</sup> / 5,700 t) may be too optimistic when actual production is considered. The scale of the studied use of fruit and cocoa residues suggests that more than 400 such projects should be implemented to utilise the estimated current crop processing residues.

### 3.4 Strategic considerations

Our study suggests that biogas production using available residues to replace dependence on grid electricity, synthetic fertiliser and avoid soil loss is achievable. Yet, whether the integration of farming practices, utilisation of the cocoa shell co-product from another production process, and bioenergy production can be justified by improvements in environmental effects cannot be concluded with certainty. Our interpretation, however, of the estimated environmental effects is that integration is generally favourable: the increase in overall resource use (emergy) is acceptable because it allows for reductions in energy demand, fossil energy use and carbon emissions.

The establishment of production practices associated with the biogas technology option seems compatible with goals of reducing environmental impact. Moreover, utilisation of available resources to replace inputs of synthetic fertiliser, grid electricity and maintain soil quality may secure increased control over key production resources, contributing to energy and land sovereignty. In that perspective, integrating residues in the production process before others

discover them as useful resources is strategically important. If we expect synthetic fertiliser, centralised electricity supply and fertile soils to become increasingly scarcer, the timing of a transition to other production models is crucial. Using the residue estimates for Ghana from Kemausuor et al. (2014), there is not nearly enough residues to replace current energy use. First-movers have the benefit of choice among agro-industrial residues.

The substitution of labour inputs for material and energy inputs found in this study and in Kamp et al. (n.d.) is in contrast to the mechanisation trend seen in agriculture during the last century (e.g. Mrema et al., 2008). Typically, labour is considered the scarcer input, and labour inputs are attempted reduced by diesel-powered machinery and fossil-fuel-based fertilisers and chemicals. The current debate about limits to growth suggests that we should prepare for a future in which materials are the scarcer resource and human labour is plentiful. In the current assessment, it seems that the resource base supporting increased labour inputs are more or less in balance with the resource base supporting the replaced material inputs. This balance is likely to tip in favour of labour intensive processes, as materials become scarcer and the labour base increases (and consequently, relies on less, reducing the relative cost of labour). Secondly, the employment of people in agriculture may be seen as an empowerment of rural areas as Ikerd (1993), Agostinho and Pereira (2013) have put forward. For agro-industrial businesses, empowerment of rural areas may be the single-most important strategy to secure local labour supply and local demand for products.

### 3.5 Dealing with multifunctionality

The issue of multifunctionality is typical in studies that include biogas production, since the biogas feedstock is often a residue. In an economic sense, residues are often regarded as valueless which, however, contradicts the apparent value they have when they are used in biogas production. Approaches for evaluating co-products are to apply a single-product perspective with allocation between co-products based on e.g. economic value, energy content or emergy, or include co-products through system expansion (ISO, 2006; EC, 2010). As demonstrated, allocation is not a straightforward approach, since the allocation basis can be any that is meant to be associated with the value of the residue. The possible bias imposed on results through allocation may negatively affect the analysis and blur the conclusion.

We exemplified how a multi-product perspective avoids the acceptance of any allocation basis when accounting for a co-product that is used as an input. Expanding the system boundary to include all co-production processes associated with inputs ensures that the entire environmental burden is accounted for. Expanding the system simply avoids accounting for inputs from co-production processes individually by turning these inputs into internal flows. This approach precludes the placement of burden on any single output product. This trade-off is the crux of the matter when selecting the assessment perspective: Should we accept an ambiguous allocation or should we forego the ability to place the environmental burden on a single output product?

In our study, we were able to limit the amount of relevant outputs to two when aligning the compared technologies for comparison. Often, possibly in most cases, system expansion as suggested may result in ever-increasing system boundaries when inputs come from co-production

processes that themselves are based on co-production processes, etc., referred to as endless regression (Heijungs and Guinée, 2007). Nevertheless, we suggest that system expansion with a multiple-product perspective should be applied as a principle in assessments where a residue constitutes a major input based on a combination of ESA indicators. In this assessment, cocoa shells constituted 80% of the UEV in the single-product perspective with  $\alpha = 100\%$  (see Supplementary Material), clearly making it a major input according to a central EmA indicator.

As a supplement to a multiple-product perspective, a single-product perspective may be applied if the included allocation parameters include allocating 0% and 100% to residues to emphasise the possible span of environmental burden distribution.

The study suggests that system expansion may conceal the effect of technological changes. As an example, the suggested technology change is associated with a resource use reduction in absolute terms of approximately  $1.5E+18$  sej/year, which is the difference in energy flow between 'PP fruit only', and 'Biogas, fruit only (waste)' or between 'PP, fruit and nibs' and 'Biogas, fruit and nibs' (see Supplementary Material). This appears to be an achievement in relative terms when compared to 'PP, fruit only' (a 3.6% improvement from  $4.2E+19$  sej/year), but not when compared to 'PP, fruit and nibs' (0.73% improvement from  $2.1E+20$  sej/year). All three numbers are relevant to communicate;  $1.5E+18$  sej/year is the actual effect, 3.6% is in comparison to the scale of resource use in present fruit production while 0.73% is the improvement in a societal perspective. Comparing the absolute change to the energy flow of the larger system (fruit and cocoa production) is relevant because control over or access to the total energy flow is required in order to obtain the change.

#### **4. Conclusion**

Available residues from pineapple cultivation and fruit and cocoa processing in Ghana were identified as useful for a change of technology in fruit processing and pineapple cultivation. We conclude that additional inputs, primarily human labour inputs, associated with the implementation of biogas, onsite power production and nutrient recycling are acceptable based on achieved reductions in grid electricity, synthetic fertiliser and soil carbon loss. We base this conclusion on estimated environmental impacts indicated using a range of energy resource use and pollution assessment methods: Compared to present practice, the biogas-based technology option is associated with similar overall resource use and renewability according to the energy assessment method, but with significant improvements in fossil energy demand, food EROI and carbon footprint. In light of the necessity of a transition away from fossil energy resources and harmful land use practices, we recommend to carry out the suggested technology change.

We have demonstrated the problematic issue of how to deal with multifunctionality, an assessment issue particularly relevant for energy production based on residue feedstocks. We highlighted the particular dilemma associated with assessing single products by allocating environmental impacts from multifunctional systems using different allocation bases. The suggested alternative is to consider not only fruit production providing processed fruit as a single product, but rather a food production system providing multiple products. In this case, the system expansion resulted in processed fruit and cocoa as outputs. The expanded system was chosen based on the physical flows

of residues necessary for the biogas process and it was possible to limit the expansion to include only two sub-systems. We suggest using system expansion with a multiple-product perspective as a principle in assessments where an input residue is considered to be associated with a major environmental burden relative to the total burden of the studied process.

## Acknowledgements

We acknowledge Simon Bolwig for participating in the preparation and design of the study, fruit farmers and factory employees for help with data collection, and fruit factory management for cooperation and exchange of ideas. This research was financially supported by DANIDA through the project “Biofuel production from lignocellulosic materials –2GBIONRG”, DFC journal no. 10-018RISØ.

## References

- Agostinho, F., Pereira, L., 2013. Support area as an indicator of environmental load: Comparison between Embodied Energy, Ecological Footprint, and Emergy Accounting methods. *Ecol. Indic.* 24, 494–503. doi:10.1016/j.ecolind.2012.08.006
- Aguilera, E., Guzmán, G., Alonso, A., 2015. Greenhouse gas emissions from conventional and organic cropping systems in Spain. II. Fruit tree orchards. *Agron. Sustain. Dev.* 35, 725–737. doi:10.1007/s13593-014-0265-y
- Bastianoni, S., Marchettini, N., 2000. The problem of co-production in environmental accounting by emergy analysis. *Ecol. Modell.* 129, 187–193. doi:10.1016/S0304-3800(00)00232-5
- Brown, M., Herendeen, R., 1996. Embodied energy analysis and EMERGY analysis: a comparative view. *Ecol. Econ.* 19, 219–235. doi:10.1016/S0921-8009(96)00046-8
- Brown, M.T., 2015. Introduction, in: Brown, M.T., Sweeney, S., Campbell, D.E., Huang, S., Rydberg, T., Ulgiati, S. (Eds.), *Emergy Synthesis 8, Theory and Applications of the Emergy Methodology*. The Center for Environmental Policy, Department of Environmental Engineering Sciences, University of Florida, Gainesville, Florida, Gainesville, Florida, p. 319.
- Brown, M.T., Ulgiati, S., 1997. Emergy-based indices and ratios to evaluate sustainability: Monitoring economies and technology toward environmentally sound innovation. *Ecol. Eng.* 9, 51–69. doi:10.1016/S0925-8574(97)00033-5
- Cavalett, O., Queiroz, J.F. De, Ortega, E., 2006. Emergy assessment of integrated production systems of grains, pig and fish in small farms in the South Brazil. *Ecol. Modell.* 193, 205–224. doi:10.1016/j.ecolmodel.2005.07.023
- Cherubini, F., Strømman, A.H., Ulgiati, S., 2011. Influence of allocation methods on the environmental performance of biorefinery products—A case study. *Resour. Conserv. Recycl.* 55, 1070–1077. doi:10.1016/j.resconrec.2011.06.001
- Coppola, F., Bastianoni, S., Østergård, H., 2009. Sustainability of bioethanol production from wheat with recycled residues as evaluated by Emergy assessment. *Biomass and Bioenergy* 33, 1626–1642. doi:10.1016/j.biombioe.2009.08.003



- Curran, M.A., 2007. Studying the effect on system preference by varying coproduct allocation in creating life-cycle inventory. *Environ. Sci. Technol.* 41, 7145–7151. doi:10.1021/es070033f
- Daniel, U., Schneider, J., 2013. Feasibility and profitability study. Assessing the feasibility and financial viability of establishing a waste-to-energy biomass facility at (undisclosed) in Ghana. Halle, Germany.
- Eady, S., Carre, A., Grant, T., 2012. Life cycle assessment modelling of complex agricultural systems with multiple food and fibre co-products. *J. Clean. Prod.* 28, 143–149. doi:10.1016/j.jclepro.2011.10.005
- EC, 2010. European Commission - Joint Research Centre - Institute for Environment and Sustainability. International Reference Life Cycle Data System (ILCD) Handbook - General guide for Life Cycle Assessment - Detailed guidance, Constraints. Publications Office of the European Union, Luxembourg. doi:10.2788/38479
- European Parliament, 2009. Directive 2009/28/EC of the European Parliament and of the Council of 23 April 2009. *Off. J. Eur. Union* 140, 16–62. doi:10.3000/17252555.L\_2009.140.eng
- Flesch, T.K., Desjardins, R.L., Worth, D., 2011. Fugitive methane emissions from an agricultural biogas digester. *Biomass and Bioenergy* 35, 3927–3935. doi:10.1016/j.biombioe.2011.06.009
- Frischknecht, R., Wyss, F., B?sser Kn?pfel, S., L?tzkendorf, T., Balouktsi, M., 2015. Cumulative energy demand in LCA: the energy harvested approach. *Int. J. Life Cycle Assess.* 957–969. doi:10.1007/s11367-015-0897-4
- Haberl, H., Erb, K.H., Krausmann, F., Bondeau, A., Lauk, C., Müller, C., Plutzar, C., Steinberger, J.K., 2011. Global bioenergy potentials from agricultural land in 2050: Sensitivity to climate change, diets and yields. *Biomass and Bioenergy* 35, 4753–4769. doi:10.1016/j.biombioe.2011.04.035
- Heijungs, R., Guinée, J.B., 2007. Allocation and “what-if” scenarios in life cycle assessment of waste management systems. *Waste Manag.* 27, 997–1005. doi:10.1016/j.wasman.2007.02.013
- Hischier, R., Weidema, B., Althaus, H.-J., Bauer, C., Doka, G., Dones, R., Frischknecht, R., Hellweg, S., Humbert, S., Jungbluth, N., Köllner, T., Loerincik, Y., Margni, M., Nemecek, T., 2010. Implementation of Life Cycle Impact Assessment Methods Data v2.2 (2010).
- Hoogwijk, M., Faaij, A., van den Broek, R., Berndes, G., Gielen, D., Turkenburg, W., 2003. Exploration of the ranges of the global potential of biomass for energy. *Biomass and Bioenergy* 25, 119–133. doi:10.1016/S0961-9534(02)00191-5
- Ikerd, J.E., 1993. The need for a system approach to sustainable agriculture. *Agric. Ecosyst. Environ.* 46, 147–160. doi:10.1016/0167-8809(93)90020-P
- Ingwersen, W.W., 2012. Life cycle assessment of fresh pineapple from Costa Rica. *J. Clean. Prod.* 35, 152–163. doi:10.1016/j.jclepro.2012.05.035
- Intergovernmental Panel on Climate Change, 2006. N<sub>2</sub>O Emissions From Managed Soils, and CO<sub>2</sub> Emissions From Lime and Urea application. 2006 IPCC Guidel. Natl. Greenh. Gas Invent. 11.1–11.54.

- IPCC, 2014. Climate Change 2014: Synthesis Report. Contribution of Working Groups I, II and III to the Fifth Assessment Report of the Intergovernmental Panel on Climate Change, Ipcc.
- ISO, 2006. ISO 14044: Environmental management - life cycle assessment - requirements and guidelines. The International Organization for Standardization (ISO). Geneva, Switzerland. doi:10.1007/s11367-011-0297-3
- Kamp, A., Bolwig, S., Østergård, H., n.d. Environmental assessment of food and cooking fuel production. Submitt. to Energy Sustain. Dev.
- Kamp, A., Morandi, F., Østergård, H., 2016. Development of concepts for human labour accounting in Energy Assessment and other Environmental Sustainability Assessment methods. *Ecol. Indic.* 60, 884–892. doi:10.1016/j.ecolind.2015.08.011
- Kamp, A., Østergård, H., 2013. How to manage co-product inputs in emergy accounting exemplified by willow production for bioenergy. *Ecol. Modell.* 253, 70–78. doi:10.1016/j.ecolmodel.2012.12.027
- Kemausuor, F., Kamp, A., Thomsen, S.T., Bensah, E.C., Østergård, H., 2014. Assessment of biomass residue availability and bioenergy yields in Ghana. *Resour. Conserv. Recycl.* 86, 28–37. doi:10.1016/j.resconrec.2014.01.007
- Lefroy, E., Rydberg, T., 2003. Emergy evaluation of three cropping systems in southwestern Australia. *Ecol. Modell.* 161, 195–211. doi:10.1016/S0304-3800(02)00341-1
- Malça, J., Freire, F., 2004. Life cycle energy analysis for bioethanol : allocation methods and implications for energy efficiency and renewability. *Energy* 1–13.
- Markussen, M. V., Østergård, H., 2013. Energy Analysis of the Danish Food Production System: Food-EROI and Fossil Fuel Dependency. *Energies* 6, 4170–4186. doi:10.3390/en6084170
- Mrema, G.C., Baker, D., Kahan, D., 2008. Agricultural mechanization in sub-Saharan Africa: time for a new look, Food and Agriculture Organization of the United Nations, Rome.
- Murphy, D.J., Hall, C.A.S., Dale, M., Cleveland, C., 2011. Order from Chaos: A Preliminary Protocol for Determining the EROI of Fuels. *Sustainability* 3, 1888–1907. doi:10.3390/su3101888
- NoorMmemon, I., Noonari, S., Muhammad, Y.S., U.A., M., Riaz, H.J., Aamir, A.M., Akbar, K.K., Sajid, A.S., Rizwan, J., Abdul, H.J., 2015. Economics Analysis of Mango Orchard Production under Contract Farming in Taluka Tando Adam District Sanghar Sindh . *J. Biol. Agric. Healthc.* 5, 24–36.
- Odum, H.T., 1996. *Emergy and Environmental Decision Making*. Wiley and Sons, New York.
- Odum, H.T., Brown, M.T., Brandt-Williams, S., 2000. *Handbook of emergy evaluation Folio 1: Introduction and global budget*. Univ. Florida, Gainesv.
- Opoku-Ameyaw, K., Baah, F., Gyedu-Akoto, E., Anchirinah, V., Dzahini-Obiatey, H.K., Cudjoe, A.R., Aquaye, S., Opoku, S.Y., 2010. *Cocoa Manual*. Accra.
- Pelletier, N., Ardente, F., Brand??o, M., De Camillis, C., Pennington, D., 2015. Rationales for and

- limitations of preferred solutions for multi-functionality problems in LCA: is increased consistency possible? *Int. J. Life Cycle Assess.* 20, 74–86. doi:10.1007/s11367-014-0812-4
- Raugei, M., Rugani, B., Benetto, E., Ingwersen, W.W., 2014. Integrating emergy into LCA: Potential added value and lingering obstacles. *Ecol. Modell.* 271, 4–9. doi:10.1016/j.ecolmodel.2012.11.025
- Sandin, G., Røyne, F., Berlin, J., Peters, G.M., Svanström, M., 2015. Allocation in LCAs of biorefinery products: implications for results and decision-making. *J. Clean. Prod.* 93, 213–221. doi:10.1016/j.jclepro.2015.01.013
- Smil, V., 1999. Crop Residues : Agriculture ' s Largest Harvest. *Bioscience* 49, 299–308.
- Tonini, D., Hamelin, L., Astrup, T.F., 2015. Environmental implications of the use of agro-industrial residues for biorefineries: Application of a deterministic model for indirect land-use changes. *GCB Bioenergy* 1–17. doi:10.1111/gcbb.12290
- Tufvesson, L.M., Lantz, M., Börjesson, P., 2013. Environmental performance of biogas produced from industrial residues including competition with animal feed – life-cycle calculations according to different methodologies and standards. *J. Clean. Prod.* 53, 214–223. doi:10.1016/j.jclepro.2013.04.005
- Ulgianti, S., Raugei, M., Bargigli, S., 2006. Overcoming the inadequacy of single-criterion approaches to Life Cycle Assessment. *Ecol. Modell.* 190, 432–442. doi:10.1016/j.ecolmodel.2005.03.022
- Wang, M., Huo, H., Arora, S., 2011. Methods of dealing with co-products of biofuels in life-cycle analysis and consequent results within the U.S. context. *Energy Policy* 39, 5726–5736. doi:10.1016/j.enpol.2010.03.052
- Weidema, B.P., Schmidt, J.H., 2010. Avoiding Allocation in Life Cycle Assessment Revisited. *J. Ind. Ecol.* 14, 192–195. doi:10.1111/j.1530-9290.2010.00236.x
- Wilhelm, W.W., Johnson, J.M.F., Karlen, D.L., Lightle, D.T., 2007. Corn Stover to Sustain Soil Organic Carbon Further Constrains Biomass Supply. *Agron. J.* 99, 1665. doi:10.2134/agronj2007.0150
- Wright, C., Østergård, H., 2015. Scales of renewability exemplified by a case study of three Danish pig production systems. *Ecol. Modell.* 315, 28–36. doi:10.1016/j.ecolmodel.2015.04.018
- Yan, M., Cheng, K., Yue, Q., Yan, Y., Rees, R.M., Pan, G., 2015. Farm and product carbon footprints of China ' s fruit production — life cycle inventory of representative orchards of five major fruits. doi:10.1007/s11356-015-5670-5

**Table 2:** Selected<sup>a</sup> physical inputs and outputs, rounded to two significant digits. For fruit production with biogas in a single-product perspective, allocation bases for the input of cocoa shells are given in parenthesis.

	Unit	Single-product perspective			Multiple-product perspective	
		Biogas, fruit only			PP, fruit & nibs	Biogas, fruit & nibs
		$\alpha = 0$ (waste)	$\alpha = 12\%$ (energy)	$\alpha = 100\%$ (energy algebra)		
<i>Input/year</i>						
Land	ha	800	7,200	53,000	53,000	53,000
Soil organic carbon	t C	23	-140	-140	23	-140
Diesel	L	200,000	140,000	170,000	220,000	170,000
Fertiliser	t	280	150	150	280	150
Chemicals	t active ingr.	23	21	31	33	31
Plastics	t	270	250	250	270	250
Electricity	MWh	3,000	220	700	3,400	700
Labour <sup>b</sup>	10 <sup>6</sup> man-hours	4.0	4.2	5.4	13	14
<i>Output/year</i>						
Processed fruit	t	4,600	4,600	4,600	4,600	4,600
Cocoa nibs	t	0	0	0	19,000	19,000

<sup>a</sup> The selection includes inputs with energy flow above 1E+17 sej/year.

<sup>b</sup> Sum of direct labour (man-hours) and indirect labour (global avg. man-hours).

**Table 3:** Results from the environmental assessment, rounded to two significant digits.

	Unit	Single-product perspective			Multiple-product perspective	
		Biogas, fruit only			PP, fruit & nibs	Biogas, fruit & nibs
		PP, fruit only	$\alpha = 0$ (waste)	$\alpha = 12\%$ (energy)		
Environmental support (UEV) <sup>a</sup>	sej/t	9.2E+15	8.9E+15	1.3E+16	4.5E+16	8.8E+15
Environmental support (UEV)	sej/J	3.8E+06	3.7E+06	5.5E+06	1.9E+07	3.4E+06
Labour fraction	sej/sej	76%	80%	60%	31%	31%
Global Renewability Fraction	sej/sej	15%	14%	37%	69%	69%
Local Supply Fraction	sej/sej	75%	79%	53%	16%	94%
Energy Yield Ratio	sej/sej	1.1	1.1	1.0	1.0	2.9
Cumulative Energy Demand	GJ/ $t_{\text{output}}$	15	8.4	8.6	10	3.4
Cum. fossil Energy Demand	GJ $_{\text{fossil}}/t_{\text{output}}$	13	7.7	7.9	9.4	2.8
Food EROI	$J_{\text{food output}}/J_{\text{input}}$	0.16	0.29	0.28	0.23	0.78
Food EROI (fossil)	$J_{\text{food output}}/J_{\text{fossil input}}$	0.19	0.31	0.30	0.26	0.94
Carbon Footprint	kg CO <sub>2</sub> -equiv./t output	790	430	440	540	230

<sup>a</sup> Energy calculations apply an energy baseline of 15.83 EJ/year (Odum et al., 2000)

**Table 4:** Results of the sensitivity analysis are given as deviations from reference model <sup>a</sup>.

	1: Oil as marginal electricity source	2: Reduced return of compost material		3: Reduced uptake of returned carbon		4: Adjusted cocoa yield		5: Adjusted bioenergy conversion efficiency		6: Higher methane leakage		7: Adjusted fruit yields		8: Increased labour for compost application		
		-50%	-100%	-50%	+10%	-10%	+10%	-10%	+10%	-10%	+10%	-10%	+10%	-10%	+10%	+200%
Environmental support (UEV)				n.c.		+			+							
Environmental support (UEV)				n.c.		+			+							
Labour fraction				n.c.		-	+		+							
Global Renewability Fraction	+		+	n.c.		+			+				+			
Local Supply Fraction				n.c.		-	+		-							
Energy Yield Ratio				n.c.		+			+							
Cumulative Energy Demand	++	+	++	n.c.					-							
Cum. fossil Energy Demand	+++	+	++	n.c.					+							
Food EROI	--	-	--	n.c.					+							
Food EROI (fossil)	---	-	--	n.c.					+							
Carbon Footprint	+++	+++	+++	++					-				+			

<sup>a</sup>No entry: less than 3% deviation in all six assessments; -: 3%-10% reduction in at least one assessment; --: 10%-25% reduction in at least one assessment; - - -: more than 25% reduction in at least one assessment; +: 3%-10% increase in at least one assessment; ++: 10%-25% increase in at least one assessment; +++: more than 25% increase in at least one assessment; n.c.: not considered. The full sensitivity analysis is available as Supplementary Material.

## PAPER VI

**In-text citation:**

(Kamp and Østergård, 2016c)

**Authors:**

Andreas Kamp and Hanne Østergård

**Title:**

Explorative scenario analysis and resilience indicators in Emergy Assessment

**Submission and publication details:**

Submitted to *Biophysical Economics and Resource Quality* 18<sup>th</sup> of March 2016

## Explorative scenario analysis and resilience indicators in Emery Assessment

Andreas Kamp<sup>1</sup> and Hanne Østergård<sup>1,\*</sup>

<sup>1</sup> Department of Chemical and Biochemical Engineering, Technical University of Denmark, DTU, 2800 Kgs. Lyngby, Denmark; [ankam@kt.dtu.dk](mailto:ankam@kt.dtu.dk) and [haqs@kt.dtu.dk](mailto:haqs@kt.dtu.dk)

\* Correspondence: [haqs@kt.dtu.dk](mailto:haqs@kt.dtu.dk); Tel.: +45 21 32 69 55

### Abstract:

Imaginable, societal changes caused by fossil energy depletion (specifically peak oil) and climate change require specific resilience of production systems to persist and maintain function. The concept of resilience is continually developed but still rarely associated with simple quantifiable indicators, constituting a barrier to the inclusion of resilience in Environmental Sustainability Assessment (ESA). To systematically test resilience in ESA, modelling conditions are required to be adaptable to future societal conditions. Emery Assessment (EmA) indicators of biophysical efficiency (UEV), the degree of dependence on free, renewable, natural flows of energy (%R) and the degree of dependence on local inputs (%Local) are suggested as a resilience indicator set in EmA. Based on narratives about possible futures, context-relevant categorisation of inputs and systematic adjustment of modelling parameters according to possible futures, EmAs of production systems can be compared under different future scenarios. Generic formulas for explorative scenario parameterisation are provided. We demonstrate the approach by parameterising modelling conditions for four narratives of the future. Four sets of alternative calculation assumptions for Explorative Scenario Analysis in EmA are provided. The aggregated effect on UEVs of different futures is analysed for a range of system profiles that differ in terms of dependence of on-site renewable resources, human labour and other contributions, respectively. Production systems that rely primarily on on-site resources and human labour appear the most resilient in terms of UEV.

**Keywords:** Explorative scenario analysis, resilience, adaptation, emery, sustainability assessment

---

## 1. Introduction

Sustainability assessments are used to support strategic planning and prioritisation in the face of larger societal and environmental changes. Popular assessment methods include Life Cycle Assessment (LCA), Emery Assessment (EmA) and other quantitative techniques. Temporal issues arise when assessments are used for making strategic, long-term decisions, but so far, modelling that includes the possible effects of larger societal and environmental changes are nearly absent from LCA and EmA. Resilience is often mentioned as a prerequisite for sustainable development, but so far, resilience indicators have not been specified based on indicators in LCA and EmA.

### 1.1. Explorative scenario analysis

Concern over a 'peak' in the production of fossil energy (Hirsch 2008; Lambert and Lambert 2011; Tverberg 2012; Mohr et al. 2015), the consequences of significant climatic changes (Nordås and Gleditsch 2007; Schubert et al. 2007; IPCC 2014) and the possible social and political implications of these phenomena lead to believe that decision-making under business-as-usual conditions is increasingly inadequate.

Analyses that elaborate on the combination of several significant changes in societal conditions are different from traditional forecasting approaches. Explorative scenario analyses are characterized by considering *multiple futures* and by *system thinking* (Gausemeier et al. 1995 in Spielmann et al. 2005). The typical selection of a variety of fundamentally different scenarios highlights that societal development can go



in several directions, exposing the study results to a broad range of possible influences. System thinking represents the view that complex systems are internally linked in myriad ways and influence each other non-linearly and with strong reciprocal feedbacks, making it impossible to isolate the effect of, e.g. oil prices, on fertiliser or food prices. Explorative scenario modelling is a useful approach to analyse uncertainty in studies of systems/technologies that may be expected to function in the medium to long term future (Börjeson et al. 2006). Explorative scenarios aim to explore the future from various perspectives, focusing on profound changes and a relatively long time horizon (Höjer et al. 2008).

Qualitative explorative scenarios are widely used, e.g. as narratives or storylines. However, actual modelling of environmental sustainability based on the quantification of explorative scenario characteristics has been demonstrated in only a few cases. Spielmann et al. (2005) explore four scenarios for regional transport based on altering specific unit processes from the LCA database ecoinvent 2000. The effect on transport technologies of socio-economic variables are quantified using “educated estimates” of changed greenhouse gas and NOx emissions. Results are used to rank transport alternatives under different future conditions. Fortes et al. (2015) link socio-economic storylines to energy modelling on a national level for Portugal. Determination of growth rates of socio-economic indicators (e.g. GDP, population, economic growth of certain energy intensive sectors) is supported by “experts’ best guess judgment” of the chosen scenario narratives. The result is the identification of the most cost-effective set of energy technologies and the associated greenhouse gas emission trajectories for each scenario. The lack of development of explorative scenarios in LCA and EmA is problematic since we use these tools to prioritise policies and technologies that entail resource use and emissions occurring in the future.

## 1.2. Resilience

Resilience for social-ecological systems has been defined as “the capacity of a system to absorb disturbance and reorganize while undergoing change so as to still retain essentially the same function, structure, identity and feedbacks” (Walker et al. 2004). An additional definition is provided by (Kupers (ed.) 2014): “Resilience is the capacity of business, economic and social structures to survive, adapt and grow in the face of change and uncertainty related to disturbances, whether they be caused by resource stresses, societal stresses and/or acute events.” Carpenter et al. (2001) attempt to concretise resilience by distinguishing between specified and general resilience. The provided definitions relate to general resilience while specified resilience poses the question “resilience of what to what?”

Much effort has been put into developing quantifiable resilience indicators that may help to understand resilience dynamics and simplify decision making. Walker et al. (2004) show that selected state variables determine the position of a system in a state space with basins of attraction. The depth and width of a basin where a system is located, and the distance to the basin’s edge are suggested to quantify. The approach is complex to use in practice without extraordinary data modelling (Carpenter, 2001). Carpenter et al. (2001) use the adaptive cycle (Holling, 1986) as starting point and associate several influential indicators with the distinct phases of the cycle, e.g. surrounding soil phosphorus and stock density as resilience indicators of a lake’s clear-water state to a short-term increase in phosphorus input due to weather or human influence. However, the indicators proposed by Carpenter et al. (2001) are case-specific and build on meticulous, long-term study of detailed societal-ecological relationships. Cabell and Oelofse (2012) argue that because of its complexity, resilience of agroecosystems defies measurement. However, based on an extensive review, Cabell and Oelofse do compile rules of thumb, that may be used to assess resilience in agroecosystems. As an alternative to estimate resilience directly, Bennett et al. (2005) suggest to monitor quantifiable attributes of systems that are related to

resilience. At this point however, no simple, resilience indicator is available for screening of production systems that are particularly sensitive to specified changes on a societal level.

### **1.3. Emergy Assessment (EmA)**

EmA is an environmental accounting method for the study of resource use. EmA, as other ESA methods, face the challenge of knowing the future scenarios in which the assessed activities take place and the related environmental effects occur. The systematic inclusion of work done by nature and human labour inputs make EmA particularly interesting in the study of effects of resource scarcity and altered living standards.

### **1.4. This paper**

The remainder of this article can be divided in four parts: In section 2 we make two suggestions for developing the EmA method: We suggest to consider three existing emergy indicators as an emergy resilience indicator set and we develop a systematic approach to explorative scenario analysis in EmA. In section 3 we demonstrate our approach to explorative scenario analysis based on four narratives of the future. To exemplify the analytical potential of the approach we examine the specific importance of human labour inputs. In section 4 we discuss the applicability and limitations of resilience indicators and scenario analysis and use the insight gained in the case study to suggest venues for sustainable development under changing societal conditions.

## **2. Materials and Methods**

### **2.1. Emergy Assessment**

EmA is an embodied energy analysis method founded in thermodynamics. Emergy is defined as the solar energy required, directly and indirectly, to make a product or service (Odum 1996). All forms of energy, materials and human labour that contribute, directly or indirectly, to a production process are evaluated using the common emergy unit of solar emergy joules (sej). The valuation of materials, energy carriers and human labour, based on accumulated energy dissipation, has been referred to as “biosphere currency” (Franzese et al. 2009). The valuation of human labour in natural resource terms implies considering humans and human activity as a part of, rather than apart from, nature.

In EmA practice, the conversion of physical quantities to emergy is done by multiplication with Unit Emergy Values (UEV), where the UEV is the emergy per unit (e.g. sej/J, sej/g, sej/man-hour). Converting all inputs to sej makes EmA a strong analytical tool able to calculate a range of sustainability indicators, including the UEV and the Renewability Fraction (for an extensive list, see Brown and Ulgiati, 1997). The UEV (= emergy of inputs / emergy of outputs) indicates biophysical efficiency and a high UEV is indicative of large, accumulated energy losses in the creation, extraction, transport, design, manufacture, etc. per unit of a given output. In comparisons of systems that yield similar outputs, a relatively low UEV points to superior biophysical efficiency. The Renewability Fraction (%R =  $R/R+N+F$ ) is found by the routine categorisation of inputs based on source as either on-site renewable resources (R), on-site non-renewable resources (N) or feedbacks from society (F), i.e. external inputs. External inputs (F) may also be evaluated based on their respective R-N-F profile (Ulgiati et al. 2005, Cavalett et al. 2006) and provide information for the calculation of the Global Renewability Fraction (%R<sub>global</sub>). It has recently been suggested to evaluate systems based on the location of inputs to emphasise the embeddedness of a system in its immediately surrounding system (Wright and Østergård, 2015). The Local Supply Fraction (%Local) for a system and its outputs is estimated as the weighted

average of the Local Supply Fraction of all required inputs. The categorisation of inputs as on-site or nearby resources is based on knowledge of the relevant supply chains.

In EmA, inventory values are typically empirical data and/or published data from similar studies. The energy characteristics of inputs are from other publications or calculated in the study. It is implicitly understood that the conditions that apply in the studies where input data are taken from apply also in the assessment being made. In analyses of future scenarios, input data will typically be outdated since it represents prior or present conditions. This identifies two types of uncertainty: specific data uncertainty deriving from transferring data from one study to another under present conditions, and uncertainty deriving from differences between prior/present conditions and future conditions. Hudson and Tilley (2014) suggested the use of Monte Carlo simulations as an approach to specific data uncertainty. We will focus on the latter and refer to *reference scenario conditions* (for prior/present conditions) and *future scenario conditions*.

## 2.2. A quantitative resilience indicator set based on energy indicators

We suggest to consider biophysical efficiency (UEV) as a resilience indicator because systems that make efficient use of available resources can be expected to outlast those that carry out comparable functions less efficiently. We suggest to consider the Global Renewability Fraction (%R<sub>global</sub>) as a resilience indicator because renewable resources are by definition available indefinitely. In an era of rapid depletion of non-renewable resources, a high Global Renewability Fraction reduces the risk of system failure caused by supply unavailability. We suggest to consider the Local Supply Fraction (%Local) as an indicator for autonomy, i.e. to indicate the level of access to and control over direct inputs. This implies that the farther away inputs originate, the less autonomous the system is. The Local Supply Fraction may be considered a resilience indicator because shorter supply chains can be expected to be less vulnerable to disruption by uncontrolled social factors and resource limits than longer supply chains.

## 2.3. Development of a systematic approach to explorative scenario analysis in EmA

A systematic approach to scenario analysis based on input categorisation and parameter adjustment to scenario conditions is presented.

Explorative scenario analysis involves three steps: 1) Define reference scenario conditions and associated parameter values ('status quo'), 2) Identify alternative scenarios and associated parameter values based on best knowledge, and 3) Redo assessment with altered parameters.

To systematically alter reference conditions to future scenario conditions, we use the generic formulas

$$UEV(O) = (\sum I_i * UEV_i) / O \quad (\text{Eq.1})$$

for the biophysical efficiency (UEV) of production of output *O* from a system with *i* inputs of amount *I<sub>i</sub>* and respective biophysical efficiencies UEV<sub>*i*</sub> (in sej/unit),

$$\%R_{global}(O) = (\sum Em_i * \%R_{global,i}) / Em_O \quad (\text{Eq.2})$$

for the Global Renewability Fraction (%R<sub>global</sub>) of output *O*, where Em<sub>*i*</sub> = energy flow of input *i*, %R<sub>global,*i*</sub> is the Global Renewability Fraction of input *i*, and Em<sub>*O*</sub> is the energy of output *O*, and

$$\%Local(O) = (\sum Em_i * \%Local_i) / Em_O \quad (\text{Eq.3})$$

for the Local Supply Fraction (%Local) of output(s) *O* with %Local<sub>*i*</sub> being the Local Supply Fraction of input *i*. The absence of scenario specification in the variable indicates reference conditions.

We group inputs into categories: On-site Renewables (OR) being sun, wind, rain and deep earth heat; Mined resources (M) being fossil fuels, their derivatives plastics, synthetic fertilisers, pesticides etc., metals and minerals; Biological material (B) like wood, crops, incl. their residues etc.; Direct Labour (DL), being applied labour; and Indirect Labour (IL), being labour embodied in external material and energy inputs.

For category  $c$  (i.e. OR, M, B, DL or IL) and scenario  $s$ , we consider the scenario-dependent adjustment factors  $\alpha_{c,s}$  for input quantity and  $\beta_{c,s}$  for input UEVs. In a similar manner, we refer to the scenario-dependent Global Renewability Fractions  $\%R_{global,c,s}$  and Local Supply Fractions  $\%Local_{c,s}$ .

Taking into account that inputs, UEVs, Global Renewability Fractions and Local Supply Fractions will differ between the different categories, the scenario parameterisation for the calculation of UEV, Global Renewability Fraction and Local Supply Fraction of output  $O$  under scenario  $s$  conditions for five categories of inputs may be expressed as

$$UEV_s(O) = (\sum I_i * \alpha_{c,s} * UEV_i * \beta_{c,s}) / O \quad (\text{Eq.4})$$

$$\%R_{global,s}(O) = (\sum Em_{i,s} * \%R_{global,c,s}) / Em_{O,s} \quad (\text{Eq.5})$$

$$\%Local_s(O) = (\sum Em_{i,s} * \%Local_{c,s}) / Em_{O,s} \quad (\text{Eq.6})$$

To be able to quantify the influence of different future scenarios on future UEV<sub>s</sub> of output from a specific production system in scenario  $s$ , a UEV factor  $\lambda_s$  is defined as follows assuming that the output  $O$  is kept constant.

$$\lambda_s = UEV_s(O) / UEV(O) \quad (\text{Eq.7})$$

Eq.4 may then be elaborated on, using that  $\%Em_c$  equals the percentage of total emergy flow in category  $c$  under reference conditions, so that

$$\begin{aligned} UEV_s(O) &= (\sum_c \alpha_{c,s} * \beta_{c,s} * \sum_{i \in c} (I_i * UEV_i)) / O \\ &= \sum_c \alpha_{c,s} * \beta_{c,s} * \%Em_c * UEV(O) \end{aligned} \quad (\text{Eq.8})$$

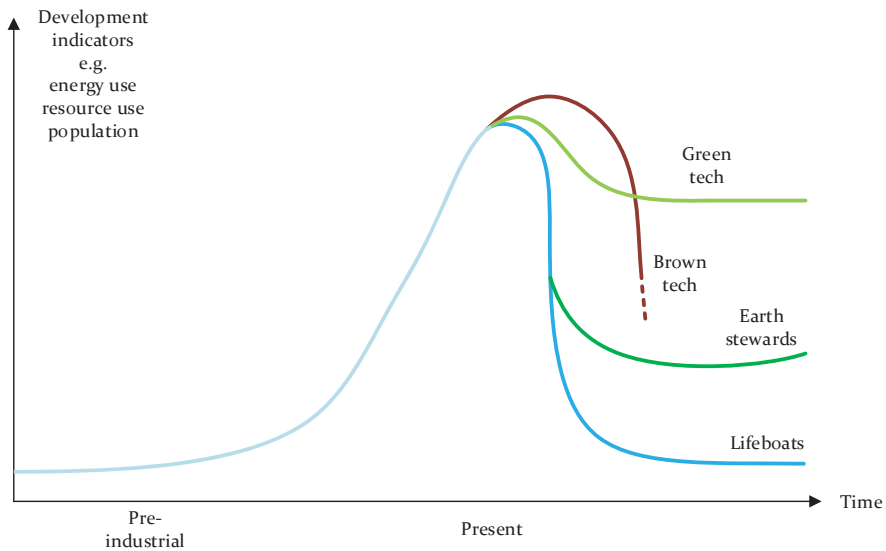
Furthermore,  $\lambda_s$  may be calculated using Eq.8 as

$$\lambda_s = \sum_c \alpha_{c,s} * \beta_{c,s} * \%Em_c \quad (\text{Eq.9})$$

### 3. Results

#### 3.1. Demonstration of explorative scenario analysis based on energy descent narratives

The parameterisation of future conditions to use in explorative scenario analysis for a production system is demonstrated with four energy descent narratives that focus on societal changes caused by resource scarcity (inspired by Heinberg 2004; Hopkins 2006; Holmgren 2009) (Fig 1).



**Figure 1** Possible trajectories of human development in four energy descent narratives. Inspired by Holmgren (2009).

### 3.1.1. Green tech

In the Green tech future, a significant part of the energy supply from fossil fuels is successfully replaced by renewable alternatives without major supply disturbances and social unrest. The relatively smooth transition and stabilisation (Fig 1) is facilitated by increased efficiency in infrastructure production, energy conversion, storage and transport; and cultural acceptance through education and subsidisation. The success is primarily attributed to political leadership and cooperation, technological breakthroughs, vigorous engagement by for-profit and not-for-profit organisations and the popular support of large groups of citizens demanding a proactive approach to planetary boundary-related problems, including climate change. After a period of structural reorganisation of political and financial markets (in the form of minor bubbles and collapses), a new era of economic growth begins that is decoupled from growth in resource use. The characteristics of this future are low-cost and renewable energy supply, sustainable use of renewable and slowly renewable materials, strategic use of fossil fuels and other non-renewables with careful recycling, and increased but environmentally-conscious consumption.

### 3.1.2. Brown tech

In the Brown tech world, the demand for energy outruns the development and establishment of renewable energy technologies. The pressure for economic growth leads to removal of environmental taxation and subsidisation schemes, attempts to increase consumption, and emphasis on centralised, large-scale energy supply, factory-scale biofuels and food production typically managed by states or large corporations. For some time, this secures some growth (Fig 1) and the supply of most goods, albeit at a higher cost and, in general, based on non- or slowly renewable resources like unconventional oil and gas, synthetic fertiliser, top soil and forests with increasing inputs per output. The result is increased dependence on fossil and nuclear fuels, at an increasing cost, and deterioration of social, economic and political institutions involving social unrest and a tendency for centralisation of power in certain areas, and collapses of the most vulnerable nation states. International trade is maintained by forceful state and corporate influence that are necessary to secure the long

supply chains of centralised production. Two important reasons for the failed transition are the underestimation of a consumption-based culture and the popular misunderstanding that renewable energy technologies are sufficient to fully replace modern world energy demands and support continued economic growth. After a series of crises initiated primarily by high commodity prices, and involving political conflicts causing internal strife, military actions to secure vital resources, extreme weather events, and migratory pressures, the global economy moves into a seemingly steady recession.

### **3.1.3. Earth stewards**

The story of Earth stewards pictures a harmonic relationship between man and nature in a society that is rebuilt almost from the bottom after a tumultuous transition away from fossil fuels (Fig 1). The narrative takes place after the world has gone through a succession of overwhelming collapses, including failures of nation states, severe economic recession, major conflicts, mass migration, population loss, and breakdown of national and international political institutions and trade. Locally, however, pockets of relative stability are able to develop and prosper, partially from the craftsmanship and entrepreneurial, experimental spirit of individuals and partially from the sudden demand for locally produced goods. In this process, development objectives shift from growth and material wealth to sufficiency and distribution, based on the realisation that environmental balance and social cohesion are the foundations of a sustainable society. In the course of some decades, a culture of local government, permaculture philosophy, low-tech approaches, cooperation and social inclusion spread to include the majority of mankind. In this world of Earth stewards, the use of non-renewable resources is almost abandoned since trade networks are small and supply chains very short, making centralised production uneconomical. Most production has small net outputs due to resource scarcity and extreme environmental caution.

### **3.1.4. Lifeboats**

Following an extended, unsuccessful transition away from fossil fuels (as in the Brown tech narrative), society tumbles into a devastating breakdown (Fig 1), not unlike the succession of collapses described in Earth stewards, exacerbated by uncontrollable climatic changes. While single communities in certain well-protected areas are able to pursue a constructive but very slow rebuilding of social, economic and political institutions, the dominating life-style is nomadic, hunter-gatherer and characterised by insecurity, famine, disease, grief, violence and no development. Trade is extremely limited and production is inefficient due to the lack of security, necessary knowledge, skills and tools. Most activities are based on renewable resources, since there is close to no access to refined fuels, metals and other industrial society goods apart from those salvageable from abandoned population centres.

### **3.1.5. Parameterisation**

The parameterisation follows the methodology described in 2.3. The altered parameters are: 1) the amount of indirect labour which we consider indicative of the availability of purchased materials since the less available a material is, the more labour is necessary to acquire it, raising its price; 2) the UEVs of direct labour and indirect labour which we consider indicative of material standard of living (MSOL) since a higher MSOL is associated with more resources appropriated per unit of labour input; 3) the UEVs of materials that account for the resource use (material and energy inputs) to form, extract and process material inputs; 4) the Global Renewability Fraction of inputs and 5) the Local Supply Fraction of inputs.

### **3.1.6. Scenario conditions**

Our parameterisation of the four scenarios are presented alongside the reference conditions (Table 1). Reference conditions are representing current modelling assumptions. Notice that the amount of indirect labour

( $\alpha_c$ ) and the UEV of inputs ( $\beta_c$ ) of the future scenarios relative to reference scenario are adjustment factors to multiply with reference indirect labour amounts and UEVs, respectively, while the Global Renewability Fraction ( $\%R_{\text{global},c}$ ) and Local Supply Fraction ( $\%Local_c$ ) of the future scenarios should be used instead of  $\%R_{\text{global,ref}}$  and  $\%Local_{\text{ref}}$ .

The parameterisation of the four scenarios is based on the following interpretation of the respective narratives. The Green Tech scenario assumes higher renewability of inputs, less resource use per material and purchased energy input, i.e., increased efficiency, increased material standard of living (MSOL) reflected in higher resource use per labour input, and autonomy similar to Reference. The Brown Tech scenario envisions lower MSOL, increased resource and labour use per input, lower renewability and increased centralisation reflected in decreased autonomy. The Lifeboats scenario pictures radically reduced MSOL, inefficient production and very low availability of external inputs. Renewability is assumed to increase, since renewable energy inputs will constitute a higher fraction of the economy. The Earth Stewards scenario considers a reduction in MSOL, higher resource use per unit and a fully renewable production. With the exception of the Green Tech scenario, the general expectation is one of increased resource use in production and reduced access to resources and the amount of resources appropriated per person (the resource cost of labour).

**Table 1** Modelling parameters for inputs in Energy Assessment under reference and four future scenario conditions based on the four narratives

	Reference	Green tech	Brown tech	Life-boats	Earth stewards
<b>Input quantity, relative to reference conditions</b>					
<b>(<math>\alpha_{c,s}</math>)</b>					
- Amount of Indirect Labour (IL)	-	100%	150%	500%	200%
<b>UEV of inputs, relative to reference conditions (<math>\beta_{c,s}</math>)</b>					
- Fossil Fuels, their Derivatives, Metals, Minerals (M)	-	50%	200%	300%	200%
- On-site Renewables (OR)	-	100%	100%	100%	100%
- Biological material (SR)	-	50%	200%	300%	200%
- Direct Labour (DL) and Indirect Labour (IL)	-	200%	50%	10%	50%
<b>Global Renewability Fraction (<math>\%R_{\text{global},c,s}</math>)</b>					
- Fossil Fuels, their Derivatives, Metals, Minerals (M)	5% <sup>a</sup>	50%	1%	50%	100%
- On-site Renewables (OR)	100% <sup>b</sup>	100%	100%	100%	100%
- Biological material (SR)	50% <sup>c</sup>	100%	1%	100%	100%
- Direct Labour (DL) and Indirect Labour (IL)	16% <sup>d</sup>	50%	5%	50%	100%
<b>Local Supply Fraction (<math>\%Local_{c,s}</math>)</b>					
- Fossil Fuels, their Derivatives, Metals, Minerals (M)	0% <sup>c</sup>	0%	0%	100%	100%
- On-site Renewables (OR)	100% <sup>b</sup>	100%	100%	100%	100%
- Biological material (SR)	50% <sup>c</sup>	50%	10%	100%	100%
- Direct Labour (DL)	100% <sup>c</sup>	100%	100%	100%	100%
- Indirect Labour (IL)	0% <sup>c</sup>	0%	0%	0%	0%

<sup>a</sup>: Cavalett et al. (2006), <sup>b</sup>: By definition, <sup>c</sup>: Assumption, <sup>d</sup>: Brown and Ulgiati (2011). For  $\alpha$  and  $\beta$ , the parameter values are given as percentages of the reference values which vary within each category.

Input quantities are generally expected to remain fixed when performing a scenario analysis. Adjusting input quantities by  $\alpha_c$  implies using a different technology or in other ways alter the defining characteristics of

a studied system and this is not the aim of scenario analysis. An exception is indirect labour. The increased indirect labour input in Brown tech, Lifeboats and Earth stewards reflects that external inputs are generally more difficult to obtain, and thus require additional human labour inputs, e.g. in discovery, development, extraction, processing and transport of fuels, metals, water, etc. Non-labour inputs may also require additional material and energy inputs, e.g. more energy inputs to obtain oil, and this is reflected in higher UEVs.

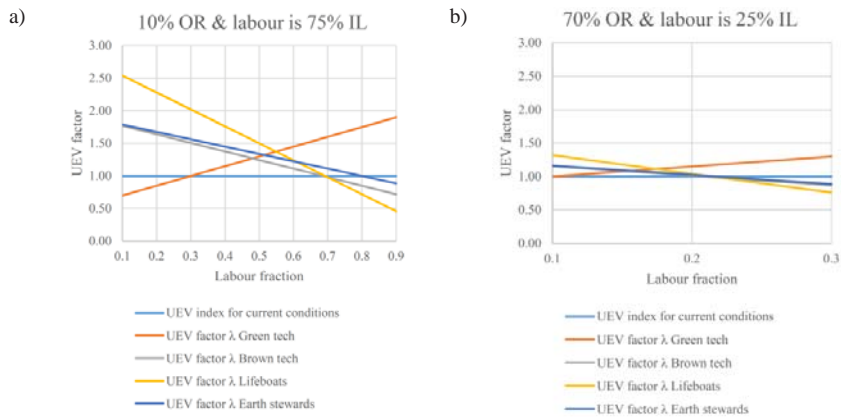
In comparison with reference assumptions, the ‘Green tech’ scenario assumes increased biophysical efficiency in production (UEVs are 50% of reference) and unchanged availability (indirect labour is 100% of reference) of material and energy inputs, higher resource use associated with labour inputs (UEV of labour is 200% of reference), higher renewability fractions (various) and unchanged local supply fractions (various). The ‘Brown tech’ scenario assumes reduced biophysical efficiency in production (200%) and reduced availability (150%) of material and energy inputs, less resource use associated with labour inputs (50%), lower renewability and Local Supply Fractions (various). The ‘Lifeboats’ scenario assumes reduced biophysical efficiency in production (300%) and reduced availability (500%) of material and energy inputs, less resource use associated with labour inputs (10%), higher renewability fractions (various) and entirely local supply. The ‘Earth stewardship’ scenario assumes reduced biophysical efficiency in production of material and energy inputs (200%) and reduced availability of those inputs (200%), less resource use associated with labour inputs (50%), and 100 % renewable and local supply.

### **3.2. The role of labour inputs in the assessment of biophysical efficiency**

With the modelling parameters in place as suggested, it is possible to analyse how certain types of production systems will perform in different scenarios. As an example, we consider systems with different profiles in terms of dependence on on-site renewable (OR) inputs (10% or 70% of total energy flow under reference conditions), labour fraction (labour in % of total energy flow under reference conditions), and balance between indirect and direct labour (75%/25% or 25%/75% of energy of labour). The remaining energy flow is supporting inputs of fossil fuels, their derivatives, metals, minerals and biological material.

The extreme profiles, i.e., only 10% OR and 10% labour, predominantly indirect (shown in Fig 2a), and 70% OR and 30% labour, predominantly direct (shown in Fig 2b), are useful to consider as archetypes. They are characteristic of systems that may be referred to as, respectively, ‘non-renewable and material intensive in a trade network’ and ‘renewable and labour intensive in a local economy’. Other combinations are provided in the Appendix. The estimated UEV factor  $\lambda$  applies to the UEV of a given system’s output and adjusts for all scenario-specific parameter changes. The UEV factor is relative to the UEV under reference scenario conditions (Eq 7).





**Figure 2** The UEV factor adjustment in different systems characterised by dependence on a) 10% on-site renewable inputs, 75% of total labour is indirect labour (IL), and b) 70% on-site renewable inputs, 25% of total labour is direct labour. Other inputs are fossil fuels, their derivatives, metals, minerals and biological material.

Two fictive production technologies that provide the same output are considered to demonstrate the applicability of the analysis. Technology I is characterised by a UEV of  $1\text{E}+05$  sej/J consisting of 10% OR, 80% energy flow from other inputs, and 10% labour of which 75% is IL (Fig 2a, far left). Technology II is characterised by a UEV of  $1\text{E}+05$  sej/J consisting of 70% OR and 30% labour of which 25% is IL (Fig 2b far right). Under current conditions, the two technologies are considered to be equally efficient. In a Green tech scenario, the UEV of Technology I is adjusted by a factor 0.70 and the UEV of Technology II is adjusted by a factor 1.3. The resulting UEVs are  $0.7\text{E}+05$  sej/J and  $1.3\text{E}+05$  sej/J, respectively. In a Brown tech scenario, the UEV of Technology I is adjusted by a factor 1.8 and the UEV of Technology II is adjusted by a factor 0.9. The resulting UEVs are  $1.8\text{E}+05$  sej/J and  $0.9\text{E}+05$  sej/J, respectively. If the UEV is used to select the technology to implement, an expectation of a Green tech future will point to implementing Technology I and an expectation of a Brown tech future will point to Technology II.

The analysis shows a consistent picture of scenario significance: UEVs may in some cases be less than half of and in other cases as much as 2.5 times more than UEVs calculated with reference assumptions. The most dramatic changes to UEV results are in the Lifeboats scenario. Using Earth Stewards and Brown tech assumptions significantly influence UEV results when labour fractions are relatively low, while Green tech assumptions influence the UEV most when labour fractions are high. A high fraction of on-site, renewable input has a stabilising effect on results. Generally, scenario values are higher UEVs than under reference assumptions, with a couple of exceptions: in Green tech when labour inputs are small compared to other non-OR inputs and, in the other scenarios, when labour inputs are relatively high compared to other non-OR inputs. With the suggested scenario assumptions, the balance between direct and indirect labour is not very influential on UEV results. The context of some scenario analyses will support different  $\beta_c$  for direct and indirect labour, respectively (i.e., different changes in resource use associated with the two types of labour), increasing the importance of the balance between the two types of labour input.

The analysis reveals that, in the pursuit of thermodynamic efficiency, strategy appears dependent on expectations of the future. A strategy to substitute material inputs for labour inputs (i.e. use more materials and less labour) is a good idea from a biophysical efficiency perspective only in a Green tech scenario. In other

scenarios, increasing labour inputs while reducing inputs of fossil fuels, their derivatives, metals, minerals and biological material will reduce overall resource use. This conclusion is in line with an emphasis on resource productivity rather than labour productivity (Hinterberger and Schmidt-Bleek 1999; Møller 2011).

#### 4. Discussion

We regard resource use efficiency and reliance on renewable and local inputs as associated with resilience. EmA is able to categorise inputs as renewable and non-renewable, local and non-local, and to provide a consistent measure of resource use efficiency. This allows for the screening of activities/systems/approaches/technologies that can be considered relatively resilient. The Global Renewability Fraction and Local Supply Fraction are alternatives to typical eco-efficiency indicators (as the UEV in EmA or CO<sub>2</sub>-eq. per output in typical LCA). It has been argued that eco-efficiency indicators are insufficient to assess resilience (Korhonen and Seager 2008; Markussen and Østergard 2013). Korhonen and Seager imply that focus on eco-efficiency, as in increased output per resource used or pollution caused, may undermine resilience pathways and thus be counterproductive in the pursuit of sustainable development. The Global Renewability Fraction and Local Supply Fraction provide a counterweight to resource efficiency indicated with the UEV.

We do not propose the emergy resilience indicator set as substitutes for the very specific resilience indicators found in the literature. For this, they are too rudimentary. We find, however, that the selected foci are useful as a first step in assessment of general resilience.

The exact characteristics of possible, future socio-economic conditions are unknown. We find it is possible, nevertheless, to improve analyses by making qualified guesses about changes to parameters that are central to results. We suggest to do this through simplistic narratives and associated adjustments to calculation assumptions. The procedure acts as guidance on how to manage uncertainty about future scenarios – the suggested parameter values are not set in stone. Being explicit about the future may be controversial, but modelling as if conditions will not change will surely provide biased results. Scenario analysis is a procedure that opens up the space of possible futures, not with the specific objective of claiming to know unknowable details, but to put forward what is considered to be within the probable. Putting words on some of the challenges that we may encounter will help prioritise selection of relevant adaptation strategies.

Exploratory scenario analysis with the UEV, Global Renewability and Local Supply Fraction parameter values developed in this paper was recently carried out in a comparison of four food and bioenergy production practices for a village in Ghana (Kamp and Østergård 2016). In that study, reference conditions showed only minor differences between the studied practices. In the scenario analysis, the Green tech scenario supported business-as-usual practice while the more radical energy descent scenarios supported practices characterised by local, renewable inputs, and the recycling of nutrients.

**Acknowledgments:** This research was financially supported by DANIDA through the project “Biofuel production from lignocellulosic materials –2GBIONRG”, DFC journal no. 10-018RISØ.

**Conflict of Interest:** The authors declare that they have no conflict of interest.

## References

- Bennett EM, Cumming GS, Peterson GD (2005) A systems model approach to determining resilience surrogates for case studies. *Ecosystems* 8:945–957. doi: 10.1007/s10021-005-0141-3
- Brown MT, Ulgiati S (2011) Understanding the global economic crisis: A biophysical perspective. *Ecol Modell* 223:4–13. doi: 10.1016/j.ecolmodel.2011.05.019
- Börjeson L, Höjer M, Dreborg K-H, et al (2006) Scenario types and techniques: Towards a user's guide. *Futures* 38:723–739. doi: 10.1016/j.futures.2005.12.002
- Cabel JF, Oelofse M (2012) An indicator framework for assessing agroecosystem resilience. *Ecol Soc*. doi: 10.5751/ES-04666-170118
- Carpenter S, Walker B, Anderies JM, Abel N (2001) From Metaphor to Measurement: Resilience of What to What? *Ecosystems* 4:765–781. doi: 10.1007/s10021-001-0045-9
- Cavalett O, Queiroz JF De, Ortega E (2006) Emergy assessment of integrated production systems of grains, pig and fish in small farms in the South Brazil. *Ecol Modell* 193:205–224. doi: 10.1016/j.ecolmodel.2005.07.023
- Fortes P, Alvarenga A, Seixas J, Rodrigues S (2015) Long-term energy scenarios: Bridging the gap between socio-economic storylines and energy modeling. *Technol Forecast Soc Change* 91:161–178. doi: 10.1016/j.techfore.2014.02.006
- Franzese PP, Rydberg T, Russo GF, Ulgiati S (2009) Sustainable biomass production: A comparison between Gross Energy Requirement and Emergy Synthesis methods. *Ecol Indic* 9:959–970. doi: 10.1016/j.ecolind.2008.11.004
- Heinberg R (2004) *Powerdown - Options and Actions for a Post-Carbon World*. New Society Publishers, Gabriola Island
- Hinterberger F, Schmidt-Bleek F (1999) Dematerialization, MIPS and factor 10 physical sustainability indicators as a social device. *Ecol Econ* 29:53–56. doi: 10.1016/S0921-8009(98)00080-9
- Hirsch RL (2008) Mitigation of maximum world oil production: Shortage scenarios. *Energy Policy* 36:881–889. doi: 10.1016/j.enpol.2007.11.009
- Holmgren D (2009) *Future Scenarios: How Communities Can Adapt to Peak Oil and Climate Change*. Chelsea Green Publishing, Vermont
- Hopkins R (2006) *Energy Descent Pathways: evaluating potential responses to Peak Oil*. University of Plymouth
- Hudson A, Tilley DR (2014) Assessment of uncertainty in emergy evaluations using Monte Carlo simulations. *Ecol Modell* 271:52–61. doi: 10.1016/j.ecolmodel.2013.05.018
- Höjer M, Ahlroth S, Dreborg KH, et al (2008) Scenarios in selected tools for environmental systems analysis.

J Clean Prod 16:1958–1970. doi: 10.1016/j.jclepro.2008.01.008

IPCC (2014) Climate Change 2014: Impacts, Adaptation and Vulnerability. Summary for policy makers.

Kamp A, Østergård H (2016) Future scenario modelling and resilience indicators. A case study of small-scale food and energy production in a village in Ghana. In: Brown MT, Sweeney S, Campbell DE, et al. (eds) *Emergy synthesis 9: Theory and applications of the emergy methodology*. Proceedings of the 9th biennial emergy conference, 2016. Center for Environmental Policy, University of Florida, Gainesville, USA. *In press*.

Korhonen J, Seager TP (2008) Beyond eco-efficiency: A resilience perspective. *Bus Strateg Environ* 17:411–419. doi: 10.1002/bse.635

Kupers (ed.) R (2014) *Turbulence. A Corporate Perspective on Collaborating for Resilience*. Amsterdam University Press, Amsterdam

Lambert JG, Lambert GP (2011) Predicting the psychological response of the American people to oil depletion and declining energy return on investment (EROI). *Sustainability* 3:2129–2156. doi: 10.3390/su3112129

Markussen M V, Østergård H (2013) Energy Analysis of the Danish Food Production System: Food-EROI and Fossil Fuel Dependency. *Energies* 6:4170–4186. doi: 10.3390/en6084170

Mohr SH, Wang J, Ellem G, et al (2015) Projection of world fossil fuels by country. *Fuel* 141:120–135. doi: 10.1016/j.fuel.2014.10.030

Møller JØ (2011) Conventional Economic Theory - a Critique Highlighting Flaws in American Style Capitalism. *Singapore Econ Rev* 56:1–18. doi: 10.1142/S0217590811004067

Nordås R, Gleditsch NP (2007) Climate change and conflict. *Polit Geogr* 26:12. doi: 10.1016/j.polgeo.2007.06.003

Odum HT (1996) *Environmental Accounting. Emergy and Environmental Decision Making*. Wiley and Sons, New York

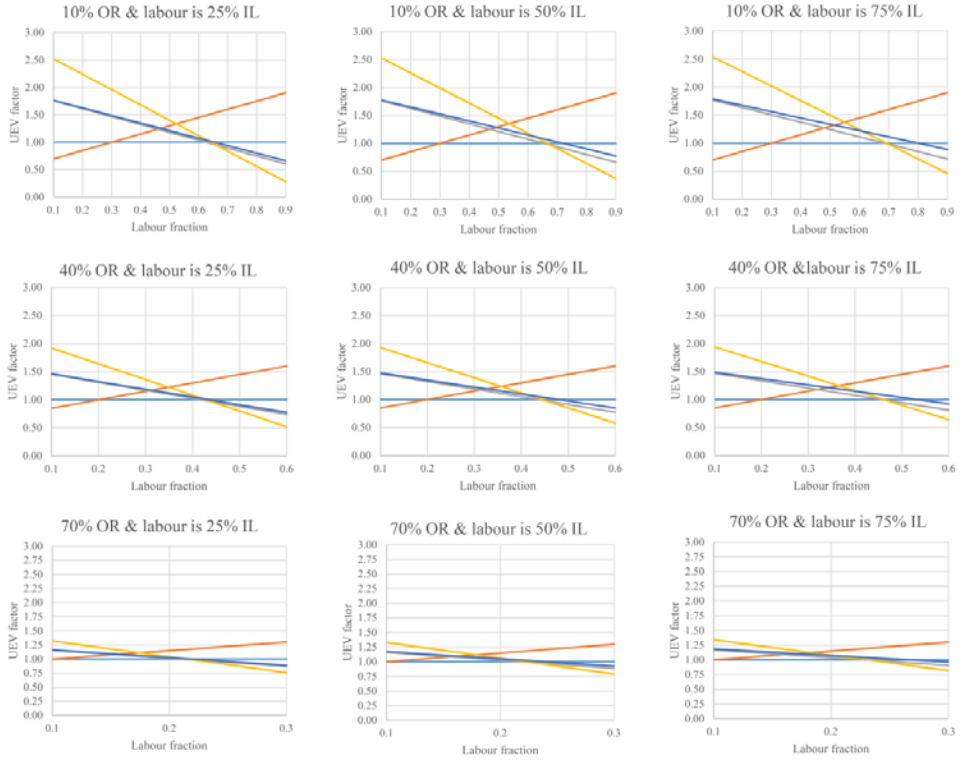
Schubert R, Schellnhuber HJ, Buchmann N, et al (2007) *Climate Change as a Security Risk*. Earthscan, London

Spielmann M, Scholz R, Tietje O, Haan P De (2005) Scenario Modelling in Prospective LCA of Transport Systems. Application of Formative Scenario Analysis (11 pp). *Int J Life Cycle Assess* 10:325–335. doi: 10.1065/lca2004.10.188

Tverberg GE (2012) Oil supply limits and the continuing financial crisis. *Energy* 37:27–34. doi: 10.1016/j.energy.2011.05.049

Walker B, Holling CS, Carpenter SR, Kinzig A (2004) Resilience, Adaptability and Transformability in Social – ecological Systems. *Ecol Soc* 9:5. doi: 10.1103/PhysRevLett.95.258101

## Appendix A



**Figure A1** UEV adjustment factors in different systems characterised by dependence on on-site renewable resources (10%, 40%, 70% OR), total labour fraction (x-axis), indirect labour fraction of total labour (25%, 50%, 75% IL), and other inputs. Other inputs are fossil fuels, their derivatives, metals, minerals and biological material.