

Technical University of Denmark



Management of Power Quality Issues in Low Voltage Networks using Electric Vehicles: Experimental Validation

Martinenas, Sergejus; Knezovic, Katarina; Marinelli, Mattia

Published in:
IEEE Transactions on Power Delivery

Link to article, DOI:
[10.1109/TPWRD.2016.2614582](https://doi.org/10.1109/TPWRD.2016.2614582)

Publication date:
2017

Document Version
Peer reviewed version

[Link back to DTU Orbit](#)

Citation (APA):
Martinenas, S., Knezovic, K., & Marinelli, M. (2017). Management of Power Quality Issues in Low Voltage Networks using Electric Vehicles: Experimental Validation. IEEE Transactions on Power Delivery, 32(2), 971 - 979. DOI: 10.1109/TPWRD.2016.2614582

DTU Library
Technical Information Center of Denmark

General rights

Copyright and moral rights for the publications made accessible in the public portal are retained by the authors and/or other copyright owners and it is a condition of accessing publications that users recognise and abide by the legal requirements associated with these rights.

- Users may download and print one copy of any publication from the public portal for the purpose of private study or research.
- You may not further distribute the material or use it for any profit-making activity or commercial gain
- You may freely distribute the URL identifying the publication in the public portal

If you believe that this document breaches copyright please contact us providing details, and we will remove access to the work immediately and investigate your claim.

Management of Power Quality Issues in Low Voltage Networks using Electric Vehicles: Experimental Validation

Sergejus Martinenas, *Student Member, IEEE*, Katarina Knezović, *Student Member, IEEE*, Mattia Marinelli, *Member, IEEE*

Abstract—As Electric Vehicles (EVs) are becoming more wide spread, their high power consumption presents challenges for the residential low voltage networks, especially when connected to long feeders with unevenly distributed loads. However, if intelligently integrated, EVs can also partially solve the existing and future power quality problems. One of the main aspects of the power quality relates to voltage quality. The aim of this work is to experimentally analyse whether series-produced EVs, adhering to contemporary standard and without relying on any V2G capability, can mitigate line voltage drops and voltage unbalances by a local smart charging algorithm based on a droop controller. In order to validate this capability, a low-voltage grid with a share of renewable resources is recreated in SYSLAB PowerLabDK. The experimental results demonstrate the advantages of the intelligent EV charging in improving the power quality of a highly unbalanced grid.

Index Terms—Electric vehicles, power distribution testing, power quality, unbalanced distribution grids, voltage control.

I. INTRODUCTION

DISTRIBUTION system operators (DSOs) have historically designed and operated their networks in order to follow a predicted demand with uni-direction power flows only. Nowadays, due to increased share of renewable energy resources, DSOs are confronted with changes in the low-voltage grid operation with even greater system complexity imposed by electric vehicle (EV) integration [1], [2]. Danish Energy Association predicts 47,000 EVs in Denmark by 2020 in a moderate penetration scenario [3], meaning that distribution networks will have to cope with overall voltage degradation, especially in unbalanced systems where voltage quality is already decreased. Unlike in other European countries, the three-phase connection in Denmark is not reserved only for industrial consumers, but is also available for residential customers. Therefore, Distribution System Operators (DSOs) experience high voltage unbalances due to the lack of regulation for per phase load connection [4]. Uncontrolled EV charging in such grids may result in large power quality deterioration, i.e., higher voltage unbalances [5], and the rise of neutral-to-ground voltage due to single-phase charging [6].

As an economic alternative to grid reinforcement, different EV charging strategies can be used for supporting the

grid and enhancing both the efficiency and the reliability of the distribution system [7]. An extensive amount of research shows that intelligent integration, namely smart EV charging, can be used for lowering the impact on the power system or providing different ancillary services [8]–[14]. In order to integrate electric vehicles in the distribution grid, both centralised and decentralised charging strategies have been explored [15]–[17]. It has been found that centralised algorithms lead to the least cost solution and are easily extended to a hierarchical scheme, but they require great communication infrastructure for information exchange. On the other hand, decentralised control provided similar results to the centralised one without the complex communication infrastructure.

A decentralised voltage dependent charging strategy, which requires only local voltage measurements, can be used for mitigating the low EV-induced voltages [18], [19]. That is, EV charging power can be modulated in accordance to local voltage measurements in order to compensate the voltage unbalances and improve the overall power quality [20], [21]. However, technical challenges may arise and DSOs may be sceptical about the possibility of the distributed demand participating in the grid regulation. Therefore an extensive experimental activity is required for proving the feasibility of these solutions.

A. Objectives

As stated in [22], electric power quality is a term that refers to maintaining the near sinusoidal waveform of power distribution bus voltages and currents at rated magnitude and frequency. Thus power quality is often used to express voltage quality, current quality, reliability of service, etc. While frequency regulation is a system wide service, experimentally addressed in previous work [23], this paper is focusing on the other main aspect of power quality in LV networks i.e. voltage quality. To the authors' knowledge, most of the literature focuses on modelling the EV voltage support, whereas the experimental validation is rarely touched upon. Therefore, this work mainly focuses on the experimental evaluation of the real EV's ability to reduce voltage unbalances by modulating their charging current according to local voltage measurements. This autonomous control could partially solve voltage quality issues without the need for grid upgrades or costly communication infrastructure,

The authors are with the Centre for Electric Power and Energy, Department of Electrical Engineering, Technical University of Denmark (DTU), Roskilde, Denmark (e-mail: smar@elektro.dtu.dk; kknez@elektro.dtu.dk; matm@elektro.dtu.dk)

therefore enabling the integration of higher EV numbers in the existing power network. The experiment is carried out with commercially available vehicles without any Vehicle-to-Grid (V2G) capability, but with the possibility to modulate the charging current in steps according to the predefined droop control. Several scenarios differing in load unbalances and implemented droop controller have been tested in order to assess the influence of EV smart charging on improving power quality in the low voltage grid.

The paper is organised as follows. Section II briefly recalls the standards regarding the voltage power quality and the motivation for implemented voltage control. In Section III, the applied methodology and experimental setup are presented in details with a description of conducted scenarios. Finally, the results are discussed in Section IV followed by the conclusion in Section V.

II. VOLTAGE CONTROL

The modern three-phase distribution systems supply a great diversity of customers imposing a permanent unbalanced running state. Contrary to other disturbances in the power system for which the performance is evident for the ordinary customers, voltage unbalance belongs to those disturbances whose perceptible effects are produced in the long run. Unsymmetrical consumption and production lead to voltage and current unbalances which imply greater system power losses, interference with the protection systems, components' performance degradation and overheating possibly to the point-of-burnout. Further on, the main effects of unbalanced voltages are mostly noticeable on the three-phase components e.g., transformers, synchronous machines and induction motors which are designed and manufactured so that all three phase windings are carefully balanced with respect to the number of turns, winding placement, and winding resistance [24]. Essentially, the unbalanced voltages are equivalent to the introduction of a negative sequence component with an opposite rotation to the one of the balanced voltages, resulting in reduced net torque and speed, as well as torque pulsations. In addition, large negative sequence currents introduce a complex problem in selecting the proper overloading protection. Particularly since devices selected for one set of unbalanced conditions may be inadequate for others.

To ensure that electric appliances are operated in a safe manner, the European standard EN50160 [25] defines acceptable limits for several grid parameters. More precisely, the standard defines the limits for Root Mean Square (RMS) phase-to-neutral voltage magnitude $|U_{pn}|$ and the Voltage Unbalance Factor (VUF) as follows:

$$0.9 U_{nom} \leq |U_{pn}| \leq 1.1 U_{nom} \quad (1)$$

$$VUF \leq 2\%, \quad (2)$$

for > 95% of all weekly 10 minute intervals, and

$$0.85 U_{nom} \leq |U_{pn}| \leq 0.9 U_{nom}, \quad (3)$$

for < 5% of all weekly 10 minute intervals. In addition, the standard defines the VUF as:

$$VUF[\%] = \frac{|U_{inverse}|}{|U_{direct}|} \times 100. \quad (4)$$

where $|U_{direct}|$, and $|U_{inverse}|$ are the direct (positive) and the inverse (negative) voltage symmetrical component respectively. Since the definition described in (4) involves voltage magnitudes and angles, i.e., complex algebra for calculating the positive and negative components, equations (5) and (6) give a good approximation while avoiding the use of complex algebra [26].

$$VUF[\%] = \frac{\max\{\Delta|U_a^i|, \Delta|U_b^i|, \Delta|U_c^i|\}}{|U_{avg}^i|} \times 100 \quad (5)$$

$$|U_{avg}^i| = \frac{|U_{an}^i| + |U_{bn}^i| + |U_{cn}^i|}{3}, \quad (6)$$

where $\Delta|U_a|, \Delta|U_b|, \Delta|U_c|$ are deviations of the respective phase-to-neutral voltage magnitudes from the average phase-to-neutral voltage magnitude $|U_{avg}|$, for the observed time window i . These equations will be used later on for assessing the voltage unbalances in the tested study case.

A. Voltage controller implemented in the EVs

Generally droop controllers are used in power systems for distributing the regulation services among multiple machines regardless of the service purpose: frequency with active power control, voltage with reactive power control or voltage with active power control, etc. The chosen droop controller has been adjusted to the application needs by choosing the thresholds corresponding to the acceptable voltage limits. Three different threshold pairs have been tested, with two different proportional slope/gain values.

The used droop controllers have been inspired by the aforementioned standard. Firstly, an upper threshold for the droop controlled voltage is set to $0.95 U_{nom}$, above which EVs charge at the maximum current I_{max} of 16 A. Secondly, they can either charge at minimum current I_{min} of 6 A or stop the charging process if the voltage drops below $0.9 U_{nom}$, corresponding respectively to the *real droop 1* and *real droop 2* seen in Fig. 1a. The values in-between the EV charging limits would ideally be linear according to the voltage measurement. However, the current controller has the minimum charging current limit of 6 A and the steps of 1 A as defined in the IEC 61851 [27]. Therefore using a typical 3.7 kW EV charger, there are 10 current steps in total. In the implemented controller, these steps are equally distributed between 0.9 and $0.95 U_{nom}$. In addition, a steeper droop control corresponding to *real droop 3* in Fig. 1b has also been tested. Similarly to the first droop control, this control also has 10 current steps equally distributed between the charging limits, but the lower voltage limit is set to $0.925 U_{nom}$.

Defining an exact droop value for EVs or loads in general, may not be straightforward as it may not be clear what is the nominal power of the load. In this case, it has been considered that the available range of regulating power (i.e., 2.3 kW) is equal to the EV's nominal power instead of the overall EV charging power which amounts to 3.7 kW. The following parameters have been defined for the described droop controls, i.e., (7) for the droop control seen in Fig. 1a and (8) for the droop control seen in Fig. 1b:

$$\begin{cases} \Delta U = 11.5V; U_{nom} = 230V \\ \Delta P = 2.3kW; P_{nom} = 2.3kW \\ k_{droop} = \frac{\Delta U / U_{nom}}{\Delta P / P_{nom}} = 5\% \end{cases} \quad (7)$$

$$\begin{cases} \Delta U = 5.75V; U_{nom} = 230V \\ \Delta P = 2.3kW; P_{nom} = 2.3kW \\ k_{droop} = \frac{\Delta U / U_{nom}}{\Delta P / P_{nom}} = 2.5\% \end{cases} \quad (8)$$

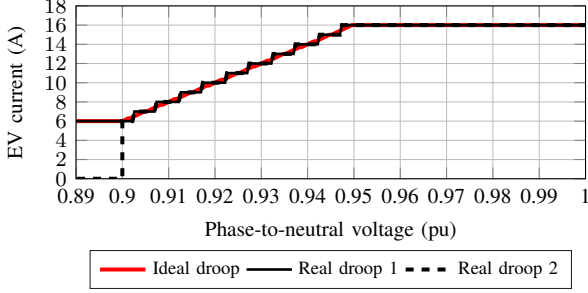

(a)

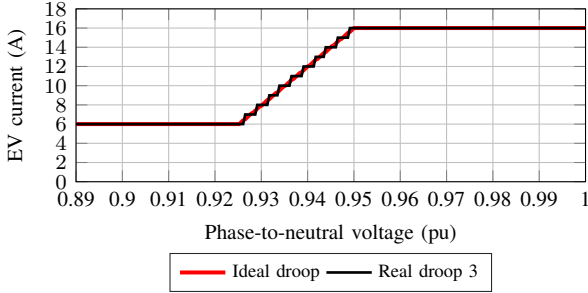

(b)

Fig. 1: Implemented droop controls: (a) $k=5\%$, and (b) $k=2.5\%$

Droop controller calculates the EV charging current limit I_{droop} using the following formula:

$$I_{droop} = \frac{(U_{meas} - U_{nom}) * (I_{max} - I_{min})}{(U_{nom} * k_{droop})} + I_{base} \quad (9)$$

where U_{meas} is the actual voltage measurement and I_{base} is a base EV charging current when voltage is at the nominal value and corresponds to 11A.

$$I_{EV} = \begin{cases} I_{droop}, & I_{min} \leq I_{droop} \leq I_{max} \\ I_{max}, & I_{droop} > I_{max} \\ I_{min}, & I_{droop} < I_{min} \end{cases} \quad (10)$$

I_{max} value represents the available power connection current rating at the consumer site, which is typically 16A, and can be further upgraded to 32A or higher. While I_{min} is chosen from lower charging current limit from IEC 61851 standard.

III. METHODOLOGY AND EXPERIMENTAL PROCEDURE

To validate the previously described controller in real EV charging processes, typical low voltage distribution feeder has

been recreated in a laboratory environment. The feeder is grid connected through a typical MV/LV 200 kVA distribution transformer, whereas the EVs are connected in the end of the feeder next to the resistive load, representing a common home charging setup. Additionally, the feeder includes a set of renewable sources such as a wind turbine along with a controllable resistive load capable of modulating the consumption independently per phase.

The EV voltage support can theoretically be done by modulating the active and/or the reactive power. However, since the reactive power control is currently not available in commercial EVs, this experiment focuses on active power control for voltage support. Each electric vehicle supply equipment (EVSE) is equipped with a local smart charging controller which adjusts the EV charging power according to the droop control described in II-A. Since the controller is independent for each vehicle, the charging current is calculated based only on local voltage measurement meaning that the EVs connected to different phases will react differently. Therefore, the vehicles connected to heavy loaded phases will provide more voltage support due to lower measured voltages resulting in being a less burden to the already unbalanced grid.

A. Experimental setup

The experiments are performed in SYSLAB (part of PowerLabDK) which is a flexible laboratory for distributed energy resources consisted of real power components paralleled with communication infrastructure and control nodes in a dedicated network. The complete test setup is distributed over the Risø Campus of Technical University of Denmark. The studied experimental setup is depicted in Fig. 2 and Fig. 3. As seen in the figures, the setup consists of the following components:

- 3 commercially available EVs (Nissan Leaf) with single phase 16 A (230 V) charger and 24 kWh Li-Ion battery.
- 2-blade wind turbine Gaia with rated power $P_n = 11$ kW.
- 45 kW resistive load (15 kW per phase) controllable per single-phase in 1 kW steps.
- set of Al 240 mm² underground cables approximately 1.95 km in length with AC resistance at 45°C $R_{AC} = 0.14\Omega/km$ and series reactance $X = 0.078\Omega/km$
- 75 m of Cu 16 mm² cable with AC resistance at 45°C $R_{AC} = 1.26\Omega/km$ and series reactance $X = 0.076\Omega/km$
- 10/0.4 kV, 200 kVA transformer.

The wind turbine connected to the test grid, although not significantly large as active power source, provides stochastic active and reactive power variation to the system. Additionally, it makes the test grid closer to a possible realistic distribution grid with more diverse components than just pure resistive loads.

From the line parameters above, the X/R ratio is calculated to highlight the impedance characteristic of the grid: X/R equals to 0.43. The X/R ratio of the test system is quite low i.e., in the range of the typical LV system and is comparable to CIGRE network [28] as well as other benchmark systems.

Therefore, active power modulation is the most effective way to control voltage levels although reactive power control could also be effective to a certain extent as shown in reference [11].

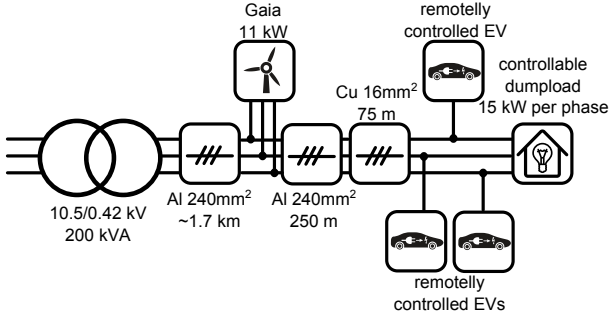

Fig. 2: Schematic overview of the experimental setup

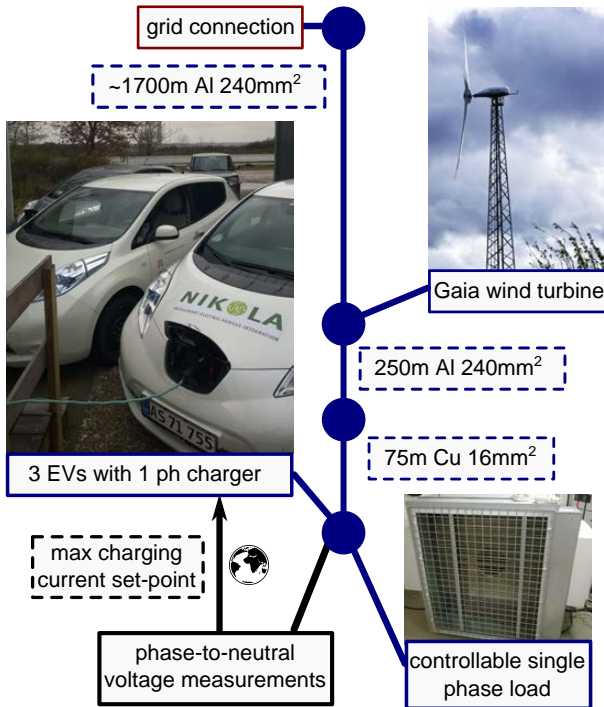

Fig. 3: Experimental setup for the voltage unbalance testing

The EV chargers are not equipped with Vehicle-to-Grid capability, but unidirectional charging rate can be remotely enabled and modulated between 6 A and 16 A with 1 A steps.

B. EV control algorithm

To enable EV smart charging, a control loop has to be established. The control loop typical consists of three components connected to the system: measurement device, controller and actuator. In this work, the measurement equipment providing the input for the controller is DEIF MIC-2 multi-instrument meter with 0.5% accuracy and 1 second sampling rate. The actuator that transfers the control signal to the system under control is Nissan Leaf EV with controllable charging current. The controller is designed as a simple, yet robust droop control algorithm, as described in II-A, and integrated to the following control loop:

- 1) Phase-to-neutral voltage is measured locally at each EVSE on second basis
- 2) The EV smart charging controller receives and evaluates:
 - Phase-to-neutral voltages at the connection point
 - The actual charging rate
- 3) The controller sends a control signal to the Electric Vehicle Supply Equipment (EVSE) for adjusting the EV charging current limit.

The control architecture, with the entire control loop, is shown in Fig. 4.

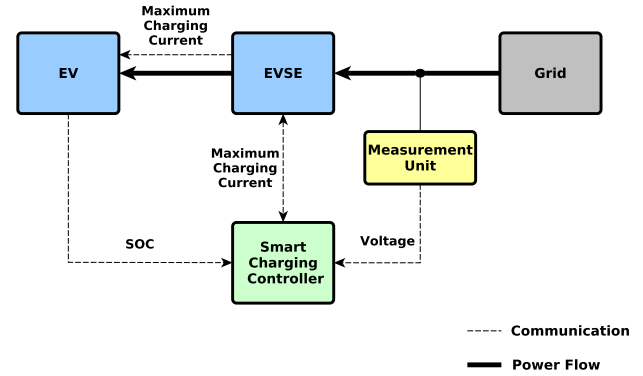

Fig. 4: Information and control flow for the smart charging of each vehicle

In this approach, the flexibility in the EV charging power could be exploited to preserve stable phase-to-neutral voltages while maintaining the user comfort since the EV is primarily used for transportation functions. The phase-to-neutral voltages are measured locally at the (EVSE) using the built-in power meter, which are then compared to the nominal voltage and chosen thresholds. Since the primary goal of this validation is proving that the controlled EV charging can improve the power quality, smart charging function for reaching the target State of Charge (SOC) by the scheduled time of departure has been omitted and left for future work.

C. Experimental procedure and result evaluation

The experiments are intended to test the EV capability to modulate the charge level according to the voltage measurements in order to provide voltage support and partially mitigate the voltage unbalances. The per-phase controllable load is used to represent a realistic variable household consumption, creating voltage unbalances due to different load fractions per phase.

Several test-cases will be analysed to evaluate the power quality in such a system. The full overview of conducted test scenarios is shown in Table I. The scenarios could be grouped into four main groups:

- 1) Uncontrolled charging scenario with no EV charging control - test scenario I.
- 2) Controlled charging scenario with 5% droop and minimum charging current of 6 A - test scenarios II to IV.

- 3) Controlled charging scenario with 5% droop and minimum charging current of 0 A - test scenarios V - VII.
- 4) Controlled charging scenario with 2.5% droop and minimum charging current of 6 A - test scenario VIII.

For each test scenario the single-phase load is increased from 0 up to 43 A in 5 steps.

The system performance is evaluated by measuring relevant phase-to-neutral voltages as well as VUFs. This analysis allows the investigation of issues arising when dealing with practical implementation of voltage support, such as communication latency, power and voltage measurement inaccuracies, and coordination of more sources. Additionally, it should be noted that the experimental setup is only using communication and control equipment that follows existing industry standards. Hence, tested control algorithms can be applied to any real grid operation, ensuring the interoperability and minimal integration effort.

IV. RESULTS

To demonstrate the differences between uncontrolled and controlled EV charging, test scenarios shown in Table I were executed. Following subsections present the most relevant findings for each of the conducted scenarios.

A. Voltage quality using uncontrolled EV charging

Firstly, the setup is tested using the most occurring situation nowadays - uncontrolled EV charging, while the resistive load at the end of the feeder, representing the domestic consumption, is gradually increasing. Measured voltages at the EVSE, load increase steps and corresponding EV charging currents can be seen in Fig. 5.

Clearly, such voltage quality is unsatisfactory as phase-to-neutral voltages drop below $0.9 U_n$ on all phases for the maximum load step. Meanwhile, the EVs are steadily charging at the maximum current regardless of the grid status since there is no implemented control. It should be noted that one of the EVs is charging at 17 A even though the same 16 A rated current applies to all of the cars. This shows how even the same EV models differing only in the production year can have different impact on the power quality. Similar findings will be discussed later on for controlled charging scenarios. In addition, one can notice how the load steps are not completely synchronised for all three phases which will also apply to later on scenarios. The reason lies in the lack of automatic control, i.e., the steps had to be manually input into the device. However, this fact does not influence the EV behaviour.

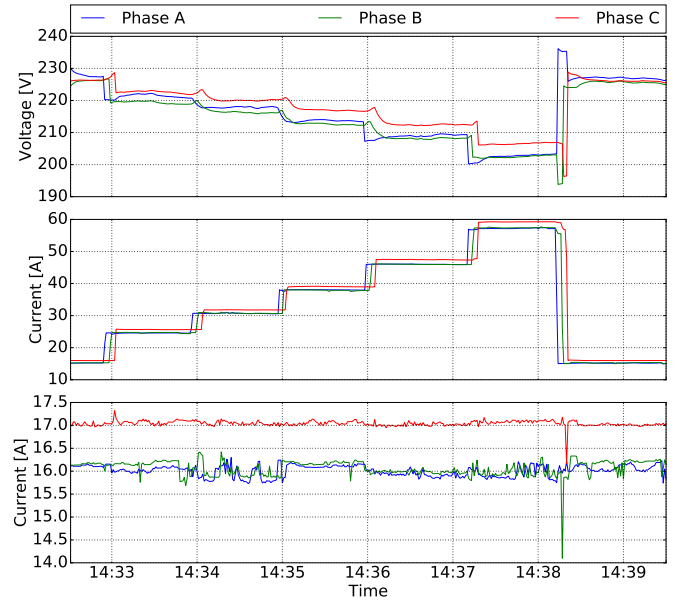

Fig. 5: Voltage and load current measurements for EV uncontrolled charging - test scenario I

B. Voltage quality using EV droop control

Firstly, the droop controller with a 5% droop and minimum charging current of 6 A, shown as *real droop 1* in Fig. 1a, is applied to the EV charging. Measured voltage at the EVSE, load increase steps and corresponding EV charging currents can be seen in Fig. 6, whereas Fig. 7 shows the correlation between the measured phase-to-neutral voltage and the measured EV response for each of the phases. The correlation plot closely resembles the droop characteristic shown in Fig. 1a.

It can be observed that the EVs already start responding at the second load step since the voltage exceeds the droop control boundary of $0.95 U_n$. Even for the maximum loading, the voltages are kept above $0.9 U_n$ as EVs are reducing the charging currents to a minimum value of 6 A. Another interesting phenomena to notice is that the phase-to-neutral voltage on the unloaded phase is rising when the load is increased on the other phases. That is due to a floating, not grounded, neutral line, which introduces a greater voltage unbalance.

TABLE I: Overview of conducted scenarios

Scenario	I	II	III	IV	V	VI	VII	VIII
Load	3 phase	3 phase	2 phase	1 phase	3 phase	2 phase	1 phase	3 phase
Droop Control	-	5%	5%	5%	5%	5%	5%	2.5%
Min EV Current	16A	6A	6A	6A	0A	0A	0A	6A
Maximum load current on phase a [A]	43	43	43	0	43	43	0	43
Maximum load current on phase b [A]	43	43	43	0	43	43	0	43
Maximum load current on phase c [A]	43	43	0	43	43	0	43	43

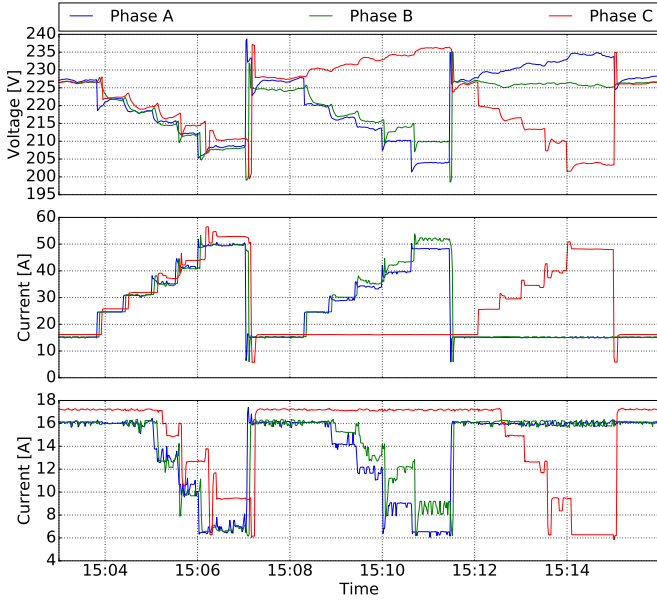

Fig. 6: Voltage, load and charging current measurements for EV smart charging test scenarios: II - 15:03 to 15:08, III - 15:08 to 15:12 and IV - 15:12 to 15:16

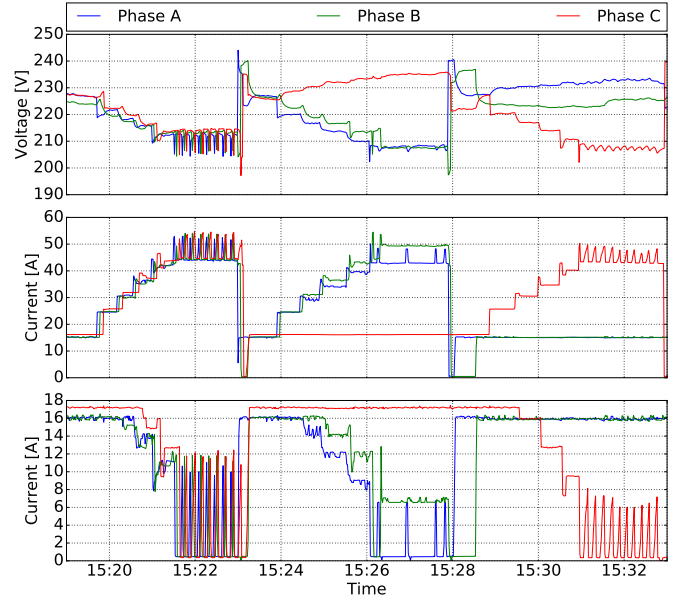

Fig. 8: Voltage, load and charging current measurements for EV smart charging test scenarios: V - 15:19 to 15:24, VI - 15:24 to 15:28 and VII 15:28 to 15:33

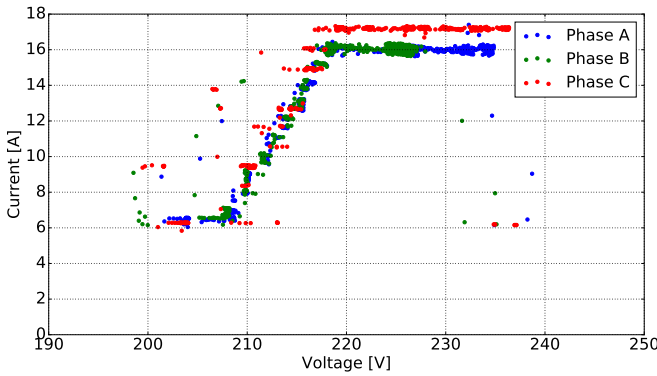

Fig. 7: Correlation plot between measured phase-to-neutral voltage and EV current for test scenarios II to V

10 A are present. The second drop appears due to controller induced oscillation explained further.

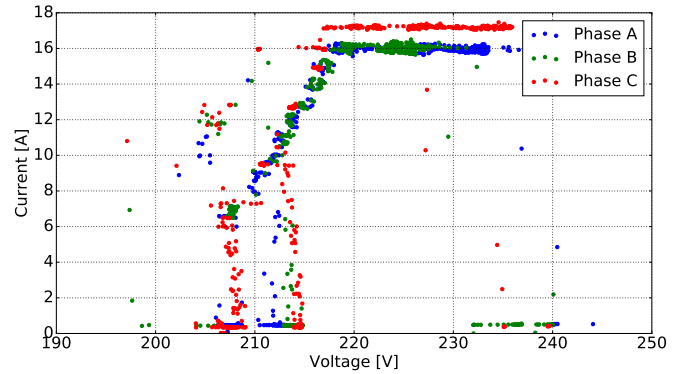

Fig. 9: Correlation plot between measured voltage and EV current for test scenarios V to VII

C. Voltage quality using EV droop control with stopping the charge

Controlled EV charging according to IEC61851 also has the ability to stop and restart the charging of the vehicle. This function could potentially further improve the power quality in the system as the load from the EV could temporarily be removed. Therefore, the same droop controller with 5% slope, but minimum charging current of 0 A is studied. The modification of the droop curve is done as shown in Fig. 1a as *real droop 2*.

Similarly to previous scenarios, Fig. 8 shows the measured voltage at the EVSE, load increase steps and corresponding EV charging currents.

Fig. 9 presents the correlation between the controller’s input voltage and the measured EV response. The relation pattern is partly resembling the curve shown on Fig. 1a as *real droop 2*. Although, unlike in the droop curve two clear drops at 6 and

Fig. 8 shows that the system response is almost identical to the test scenarios II to IV, besides in the maximum loading case. At that point, one can notice oscillations in test scenario V and VII which occur due to the brief voltage dip for the last load step. This step briefly puts the voltage under $0.9 U_n$, which triggers the controller to stop the charging of the EVs. As the EVs stop charging, the voltages rise to about $0.93 U_n$, which makes the controller restart the EV charging since the voltage is now high enough. The restarting process takes about 8 seconds. However, as the EVs restart the charging, the voltage briefly dips under $0.9 U_n$ again making the controller to stop the charging. This instability repeats as long as the voltage level stays close to $0.9 U_n$. In scenario VI, EV on phase *a* stably mitigates the voltage unbalance by stopping the charge. At the same time, EV on phase *b* also stabilises the

charging current at 7 A, right at the lower limit of stopping the charge. The aforementioned oscillation issues could be solved by modifying the controller to detect the voltage transients and only react for the steady state voltage measurements. However, this has been omitted from the conducted study and left for future work.

D. Voltage quality using EV droop control with steeper droop characteristic

The droop control has then been modified, making it more steep as shown in Fig. 1b. As for the previous scenarios, measured voltage at the EVSE, load increase steps and corresponding EV charging currents can be seen in Fig. 10, whereas the correlation is depicted in Fig. 11. As the droop curve used in this scenario is more steep, minor oscillations are present on phase *c* due to a slower response of the EV on this phase.

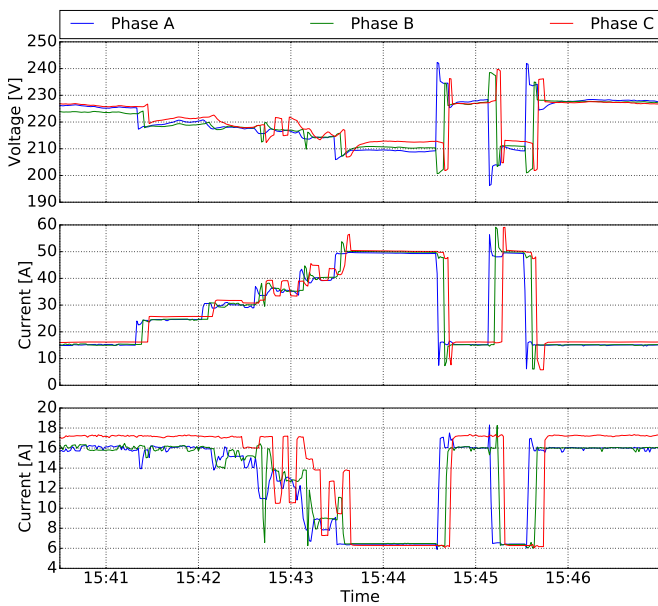

Fig. 10: Voltage, load and charging current measurements for EV smart charging - test scenario VIII

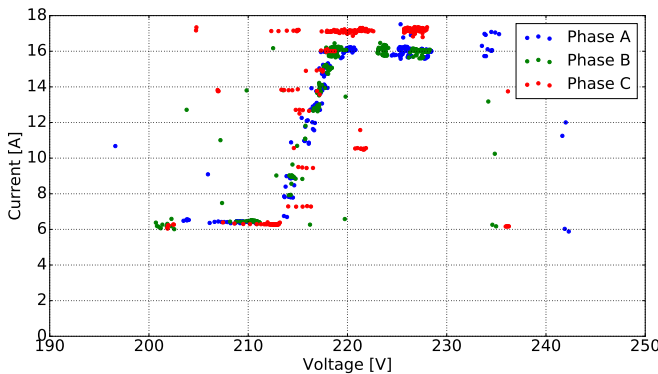

Fig. 11: Correlation plot between measured voltage and EV current for test scenario VIII

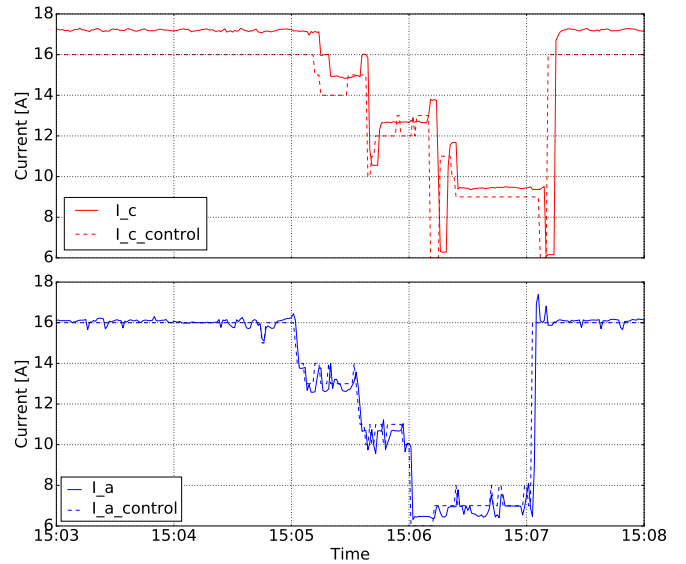

Fig. 12: Sample charging current control signal and measured value for EV smart charging - test scenario II

Moreover, Fig. 12 illustrates the difference between the control and the actual EV charging current. The EVs on phase *a* and *b* respond to the control signal in 1 to 2 seconds, while EV on phase *c* takes 4 to 5 seconds. The difference is due to a older production year for the EV connected to phase *c*. It is also important to note that the control signal sent to the EV is merely an upper limit for the charging current. Hence, the actual charging current of the vehicle should be below the set limit. However, EV on phase *c* is violating the set charging current limit by 1 A. It is an atypical behaviour possibly caused by a recent charger firmware update.

E. Result overview

According to EN50160, the voltage quality is typically assessed over a week with 10 minutes average intervals. However, the main reason to focus on a shorter period of time in this paper, is to evaluate the performance of the controller. The limited 10 minute intervals show the system response to the load event and control actions taken, in this period the voltage in the system stabilizes to new steady states, therefore this experimental time window can be extrapolated to longer time periods. Additionally, vehicles are solving the problem partly caused by themselves thus, it is reasonable to experience less voltage problems if EVs are not charging.

The setup was tested in 8 test scenarios with the result summary shown in Table II. Maximum VUF is calculated from the values observed at the maximum feeder loading. Steady state voltage values in the maximum load case are also shown for each test scenario. Finally, the voltage drops between the grid and EV connection points at the maximum load case are shown.

Firstly, one should note that smart charging when all 3 phases are evenly loaded (test scenarios I, II, V and VIII) improves the VUF. Secondly, VUF in heavily unbalanced scenarios is much beyond the standard limit for scenarios III,

TABLE II: Maximum VUF, steady state voltage values and voltage drop from grid connection to the EV connection point

Scenario	I	II	III	IV	V	VI	VII	VIII
Load	3 phase	3 phase	2 phase	1 phase	3 phase	2 phase	1 phase	3 phase
Droop Control	-	5%	5%	5%	5%	5%	5%	2.5%
Min EV Current	16A	6A	6A	6A	0A	0A	0A	6A
VUF _{max} [%]	1.3	0.8	9.0	7.9	0.6	8.4	6.4	1.0
U _{an,maxloadss} [V]	202.8	208.4	203.6	234.5	212.5	208.0	233.0	209.0
U _{bn,maxloadss} [V]	202.6	207.9	209.6	225.7	213.5	207.5	225.0	210.5
U _{cn,maxloadss} [V]	206.6	210.5	235.9	203.5	214.0	235.0	208.5	212.6
ΔU _{an} [V]	33.0	27.4	32.1	1.6	23.5	27.8	3.0	27.0
ΔU _{bn} [V]	30.3	25.1	23.1	7.3	20.7	25.4	7.2	22.6
ΔU _{cn} [V]	28.3	24.4	-1.2	31.3	19.7	-0.1	27.5	22.3

IV, VI and VII. Here, the controller tries to minimise the unbalance by setting EV charging current to the minimum value specified for each scenario. However, vehicles alone can not eliminate the unbalance in the case of maximum loading, since controllable EVs represent only 17 % of the total load. This flexibility could be extended to 25 % if the charging is stopped. It should be noted that values of smart charging scenarios V, and VII were calculated from the measurements of the steady states between the oscillations. Nevertheless, greater controllable power amount results in significant improvements in power quality for scenarios V to VII.

V. CONCLUSION

This work presented a method for improving the power quality of a low voltage network by intelligently controlling EV charging current. The validation showed how uncontrolled EV charging can significantly reduce the power quality of low voltage networks, especially in unbalanced networks with long feeder lines. It is shown that EV smart charging, even with a simple decentralised autonomous droop controller, can solve some of the power quality issues. The improvements include reduced voltage drops at the long feeder branches and potentially reduced VUFs in the cases of unbalanced loading. However, EVs should be integrated carefully, as shown in scenarios V and VII, since large power steps at the nodes with poor voltage quality could introduce even more severe problems like large voltage oscillations. Mitigating such problems requires more sophisticated control which accounts for transient voltage drops or introduces input filters. Nevertheless, it has been shown that local smart charging controllers can improve power quality in the distribution systems even in extreme cases. Consequently, this allows the integration of higher EV amount in the distribution grids without the need for unplanned and costly grid reinforcements. As the controller and the supporting infrastructure is made from standardised components, such control schemes could potentially be integrated in the EVSE with minimal development effort which makes such solution economically attractive.

Further research will continue to investigate the effects of the EV charging on the power quality by expanding the list of test scenarios, implementing more sophisticated control algorithms and exploring the effects on other power quality indicators, such as total harmonic distortion. Another topic

not touched upon in this work is the user comfort. While controllable charging provides improvements in the power quality, it could potentially inconvenience the vehicle owner by not providing required state of charge level when EV is needed. This issue should be addressed as a part of the smart charging algorithm allowing the user to have a conveniently charged vehicle while still providing the voltage support service when EV is charging.

ACKNOWLEDGMENT

This work is supported by the Danish Research Project “NIKOLA - Intelligent Electric Vehicle Integration” under ForskEL kontrakt nr. 2013-1-12088. More information at www.nikolaproject.info.

REFERENCES

- [1] R. Walling, R. Saint, R. Dugan, J. Burke, and L. Kojovic, “Summary of distributed resources impact on power delivery systems,” *Power Delivery, IEEE Transactions on*, vol. 23, no. 3, pp. 1636–1644, July 2008.
- [2] K. Clement-Nyns, E. Haesen, and J. Driesen, “The impact of vehicle-to-grid on the distribution grid,” *Electric Power Systems Research*, vol. 81, no. 1, pp. 185–192, Jan. 2011.
- [3] Dansk Energi, Dong Energy, and Energinet.dk, “Analysis no. 5 – Scenarios for the deployment of electric vehicles (in Danish),” Tech. Rep., 2013. [Online]. Available: <http://www.danskeenergi.dk/Analyse/Analyser/>
- [4] M. Coppo, R. Turri, M. Marinelli, and X. Han, “Voltage management in unbalanced low voltage networks using a decoupled phase-tap-changer transformer,” *Power Engineering Conference (UPEC), 2014 49th International Universities*, pp. 1–6, Sept 2014.
- [5] M. Gray and W. Morsi, “Power quality assessment in distribution systems embedded with plug-in hybrid and battery electric vehicles,” *Power Systems, IEEE Transactions on*, vol. 30, no. 2, pp. 663–671, March 2015.
- [6] C. Jiang, R. Torquato, D. Salles, and W. Xu, “Method to assess the power-quality impact of plug-in electric vehicles,” *Power Delivery, IEEE Transactions on*, vol. 29, no. 2, pp. 958–965, April 2014.
- [7] P. Andersen, M. Marinelli, O. Olesen, C. Andersen, G. Poilasne, B. Christensen, and O. Alm, “The Nikola project Intelligent electric vehicle integration,” pp. 1–6, Oct 2014.
- [8] J. García-Villalobos, I. Zamora, J. I. San Martín, F. J. Asensio, and V. Aperribay, “Plug-in electric vehicles in electric distribution networks: A review of smart charging approaches,” *Renewable and Sustainable Energy Reviews*, vol. 38, pp. 717–731, 2014.
- [9] W. Kempton and J. Tomić, “Vehicle-to-grid power implementation: From stabilizing the grid to supporting large-scale renewable energy,” *Journal of Power Sources*, vol. 144, pp. 280–294, 2005.
- [10] S. Martinenas, A. Pedersen, M. Marinelli, P. Andersen, and C. Treaholt, “Electric vehicle smart charging using dynamic price signal,” *Electric Vehicle Conference (IEVC), 2014 IEEE International*, pp. 1–6, Dec 2014.

- [11] K. Knezović, M. Marinelli, R. Moller, P. Andersen, C. Treholt, and F. Sossan, "Analysis of voltage support by electric vehicles and photovoltaic in a real danish low voltage network," *Power Engineering Conference (UPEC), 2014 49th International Universities*, pp. 1–6, Sept 2014.
- [12] K. Knezović, P. Codani, M. Marinelli, and Y. Perez, "Distribution grid services and flexibility provision by electric vehicles: a review of options," *Power Engineering Conference (UPEC), 2015 50th International Universities*, pp. 1–6, Sept 2015.
- [13] Z. Wang and S. Wang, "Grid power peak shaving and valley filling using vehicle-to-grid systems," *Power Delivery, IEEE Transactions on*, vol. 28, no. 3, pp. 1822–1829, July 2013.
- [14] S. Mocci, N. Natale, F. Pilo and S. Ruggeri, "Demand side integration in LV smart grids with multi-agent control system," *Electric Power Systems Research*, vol. 125, pp. 23 – 33, 2015.
- [15] M. Gonzalez Vaya and G. Andersson, "Centralized and decentralized approaches to smart charging of plug-in vehicles," *Power and Energy Society General Meeting, 2012 IEEE*, pp. 1–8, July 2012.
- [16] P. Richardson, D. Flynn, and A. Keane, "Local versus centralized charging strategies for electric vehicles in low voltage distribution systems," *Smart Grid, IEEE Transactions on*, vol. 3, no. 2, pp. 1020–1028, June 2012.
- [17] S. Habib, M. Kamran, and U. Rashid, "Impact analysis of vehicle-to-grid technology and charging strategies of electric vehicles on distribution networks – a review," *Journal of Power Sources*, vol. 277, pp. 205 – 214, 2015.
- [18] M. Singh, I. Kar, and P. Kumar, "Influence of EV on grid power quality and optimizing the charging schedule to mitigate voltage imbalance and reduce power loss," *Power Electronics and Motion Control Conference (EPE/PEMC), 2010 14th International*, pp. 196–203, Sept 2010.
- [19] N. Leemput, F. Geth, J. Van Roy, A. Delnooz, J. Buscher, and J. Driesen, "Impact of electric vehicle on-board single-phase charging strategies on a Flemish residential grid," *Smart Grid, IEEE Transactions on*, vol. 5, no. 4, pp. 1815–1822, July 2014.
- [20] S. Weckx and J. Driesen, "Load balancing with EV chargers and PV inverters in unbalanced distribution grids," *Sustainable Energy, IEEE Transactions on*, vol. 6, no. 2, pp. 635–643, April 2015.
- [21] J. P. Lopes, S. A. Polenz, C. Moreira, and R. Cherkaoui, "Identification of control and management strategies for LV unbalanced microgrids with plugged-in electric vehicles," *Electric Power Systems Research*, vol. 80, no. 8, pp. 898 – 906, 2010.
- [22] Chattopadhyay, Surajit. and Mitra, Madhuchhanda. and Sengupta, Samarjit., "Electric power quality," pp. 1 – 182, 2011.
- [23] M. Marinelli, S. Martinenas, K. Knezović and P. B. Andersen, "Validating a centralized approach to primary frequency control with series-produced electric vehicles," *Journal of Energy Storage*, vol. 7, pp. 63–73, 2016.
- [24] P. Gnacinski, "Windings temperature and loss of life of an induction machine under voltage unbalance combined with over- or undervoltages," *Energy Conversion, IEEE Transactions on*, vol. 23, no. 2, pp. 363–371, June 2008.
- [25] H. Markiewicz and A. Klajn, "Voltage disturbances standard EN 50160," pp. 1–16, 2004.
- [26] "IEEE Recommended Practice for Monitoring Electric Power Quality," *IEEE Std 1159-1995*, 1995.
- [27] IEC TC69, "IS 61851-1:2010 Ed. 2.0," *IEC Standard*, 2010.
- [28] K. Strunz, N. Hatzigryriou, and C. Andrieu, "Benchmark systems for network integration of renewable and distributed energy resources," *Cigre Task Force C*, vol. 6, pp. 04–02, 2009.



Sergejus Martinenas (S'14) was born in Elektrenai, Lithuania, in 1989. He received a BSc degree in mechatronics engineering from the University of Southern Denmark in 2011, and an MSc degree in electrical engineering from the Technical University of Denmark in 2014. He is currently pursuing the Ph.D. degree in electrical engineering at DTU.

His research focuses on enabling technologies for electric vehicle integration into smart grids.



Katarina Knezović (S'13) was born in Zagreb, Croatia, in 1989. She has received her BSc and MSc degrees in electrical engineering from the University of Zagreb, Croatia, in 2011 and 2013 respectively. She is currently pursuing a Ph.D. degree in electrical engineering at DTU.

Her research interests include power-system modeling, distribution networks, grid-coupling of electric vehicles, and the services they can provide, both in local and system-wide cases.



Mattia Marinelli (S'10-M'12) was born in Genova, Italy, in 1983. He received BSc and MSc degrees in electrical engineering from the University of Genova in 2005 and 2007. In March 2011 he achieved the European Ph.D. degree in power systems. Since September 2012 he has been with the Technical University of Denmark (DTU).

His research regards power system integration studies, wind and solar data analysis, electric vehicles and distributed energy resources modeling.