

FAT CHANCE?

EATING WELL WITH MARGARINE

Submitted by Suzanne Hocknell to the University of Exeter as a thesis for the degree of Doctor of Philosophy in Geography on October 24th, 2016.

This thesis is available for Library use on the understanding that it is copyright material and that no quotation from the thesis may be published without proper acknowledgement.

I certify that all material in this thesis which is not my own work has been identified and that no material has previously been submitted and approved for the award of a degree by this or any other University.

Signature:

ABSTRACT

Since its invention nearly 150 years ago, margarine has proven itself adaptable to multiple ingredients and techniques whilst continuing to mimic the fatty tastes familiar to eaters in Northern Europe. In this thesis I argue that it is this malleability that makes margarine a useful subject with which to explore constructions of eating-well. This thesis examines the ways in which margarine is done, why it is done in the ways that it is, and explores how such doings frame possibilities for eating-together-well. Eating-well has become something of a social obsession in the UK in recent years. Individual eating practices have become framed as a responsibility of care for personal and societal health, for agricultural workers, animal welfare and for the future of the planet. Nonetheless, it is commonly believed that although deeply personal, food habits are culturally and socially engrained, and as such are hard to change.

This empirically led thesis, examines the knowledges and practices of producers and consumers, and establishes habit formation as a typical response by both producers and consumers to becoming overwhelmed with incompatible knowledges and information, compelling them to choose, prioritise and juggle 'moral' values. Yet, I demonstrate that such habits only remain stable until disrupted by an event which overflows and troubles this settlement. Building on this, this thesis then examines the possibilities offered by the creation of micro-events for encountering, knowing, and relating with, margarine matters anew. In this way, this thesis investigates the values, norms and power relations entangled with the presentation and enactment of margarine and its constituent parts as 'good' or 'bad' foods, examining both what these framings do, and how they are maintained.

In approaching margarine matters in this way, this thesis offers three key contributions to the area of food geographies. Firstly, I demonstrate how commodity frameworks shift political problems in to a technical and administrative realm and close down spaces of critical thought and political intervention. Secondly, I establish that 'strange encounters' are events which can add to understandings of the more-than human world-making of food knowledges, practices, and habits. Thirdly, I determine that the novel methodological approach of 'playing with our food' is a productive technique with which to prefigure and rehearse more nuanced ethical understandings of eating-well as a relational doing that is excessive to consuming-well.

We shall not cease from exploration
And the end of all our exploring
Will be to arrive where we started
And to know this place for the first time

T.S. Eliot, Little Gidding (1942)

TABLE OF CONTENTS

	Page Number
Acknowledgements	11
List of Figures	13
List of Accompanying Materials	15
List of Acronyms	15
PRELUDE:	17
a brief and partial history of margarine (relations are co-constructed)	
CHAPTER ONE:	20
introducing the thesis (why research margarine?)	
Introduction	20
Encountering Margarine Matters	21
Research Aims & Research Questions	26
Thesis Outline	29
INTERLUDE ONE:	34
fats act and labels matter (relationships change)	
CHAPTER TWO:	38
literature matters (eat my words)	
Introduction	38
Food Geographies (mapping eating bodies)	38
Provocation One (troubling the subject)	42
Provocation Two (encountering food matters)	48
Provocation Three (rehearsing a mundane politics)	52
Applying Literature Matters (eat my words)	57
INTERLUDE TWO:	60
between cynicism and sentimentality (entering the field)	
CHAPTER THREE:	63
researching eating-well with margarine (methodology)	
Introduction	63
Establishing the Field	65
Doing Ethical Research	67
Researching Ethically with People and Organisations	69
Researching Ethically with Non-Human Others	73

Entering the Field	74
Exploring Margarine Production	75
Making Connections	83
Accessing the Doing of Margarine	88
Researching Knowledges and Practices of Production	94
Researching Consumer Knowledges, Beliefs and Practices	94
Planned Discussion Groups	96
Researching Other Ways of Knowing and Relating with Margarine	103
Strange Encounters (creating space to play with matters of fats)	104
Playing With Our Food (rehearsing other ways of living together)	110
Analysis	113
Chapter Summary	116
INTERLUDE THREE:	120
flibbiddybibbydob (disrupting consumer knowledges)	
CHAPTER FOUR:	124
chewing the fat (consumer knowledges and practices)	
Introduction	124
Habits (consumer practices)	127
Knowing the Fats	133
Distaste (knowledges that push)	134
Care (knowledges that pull)	140
Doubt (knowing about knowing)	147
Chapter Conclusions	152
INTERLUDE FOUR:	155
from seed to spread (the slipperiness of the ‘natural’)	
CHAPTER FIVE:	160
things becoming food (industry knowledges and practices)	
Introduction	160
Habits (how margarine is done)	163
Knowing the Fats	177
Translations (representing things)	177
Tensions (negotiating knowledges)	186
The Consumer (communicating doings)	197
Chapter Conclusion	205
INTERLUDE FIVE:	207
playing with our food (food becoming things)	

CHAPTER SIX:	210
matters of fat (experimental strange encounters with material others)	
Introduction	210
Disrupting Habits (Seeds of Change?)	213
Knowing the Fats	219
Re-evaluating	221
Encountering Anew	223
Juxtapositions	231
Chapter conclusions	235
INTERLUDE SIX:	238
conclusion of the interludes (margarine and me)	
CHAPTER SEVEN:	241
concluding remarks (eating without consuming?)	
Introduction	241
The interludes: thesis in miniature	242
Chapter contributions	243
Methodological contributions	254
Thesis Limitations	258
Future Research Directions	260
Concluding Remarks	261
AFTERWORD:	268
adding fat to the fire (prefiguring uncertain eater-eaten relations)	
Appendices	270
Appendix one: Participant Recruitment Letter	271
Appendix two: Participant Consent Form	272
Appendix three: Oil Press Instruction Manual	273
Appendix four: Margarine Recipes	275
References	278

ACKNOWLEDGEMENTS

For Protag (1961 – 2014)
Ta Fut Croggy

There have been many moments over the last four years when I did not know why I thought I could do this, or how it might one day be an actual thing. Its thingness would not have been possible without the help and support of friends and colleagues. In particular I would like to offer massive thanks to:

Alasdair Gordon for making me believe that people from our background can, and should, do this sort of thing.

John Wylie and the SWDTC for giving me the chance to be here to do this.

Steve Hinchliffe and Ian Cook for patience and advice, and for somehow trusting that I was listening and learning, and that amidst all the mess and confusion was some kind of sense.

Louise MacAllister, Katie Ledingham and Anna Jackman for sharing the ups and downs throughout, for being fantastic friends and colleagues and for having faith in us.

Callum Sutherland for just being cool as fuck, and for prompting me to re-evaluate some of my prejudices.

Paula Crutchlow for your passion, resilience, and noshitness.

Paul Cloke and Nick Gill for being interested enough to ask.

Sarah Dyer, Matt Finn, Ewan Woodley and Andrew Williams for your supportive enthusiasm.

Karen Bickerstaff for saying the right thing at the right moment.

The Amory 385D crew for tolerating my northern, swearsy, intolerant grump-arseness with grace and humour; and the rest of Exeter University Geography department for just being so bloody nice.

Andre Pusey for the pep talks; Emma Neave for demonstrating that the two Bs are challenges that can be overcome; Richard Cubesville for the co-counselling through some dark times; Sarah Everson for cat sitting and general supportive neighbourliness; and Kim for choosing to still be here.

Everyone who agreed to participate in the research, it was brilliant to meet you.

And, finally for sneaking up on me just when I needed to be reminded of who I am, why I am here and what it means to belong to something bigger and better than all of us, Rob Kito you are ace!

Ta all! I feel very privileged, it's been a brilliant journey.

LIST OF FIGURES

		Page
figure one:	Butter is good for you, says heart doctor	72
figure two:	Key industry participants	84
figure three:	Planned discussion group participants	91
figure four:	The oil press as it arrived in the post	98
figure five:	The oil press in operation	99
figure six:	Coconut oil rising to the top	100
figure seven:	Wick and oil collection	101
figure eight:	Operating the press	101
figure nine:	Separation of oil and sediment	102
figure ten:	Making margarine	102
figure eleven:	Eating margarine	103
figure twelve:	Letter sent to 'Stork Wives Club' members, 1958	114
figure thirteen:	Frontpiece from 1958 Unilever pamphlet	115
figure fourteen:	Still from 'Seed to Spread' advert	149
figure fifteen:	Still from 'Power of Plants' advert	151
figure sixteen:	Still from 'Flora Freedom' advert	151
figure seventeen:	Springton Course, Certificate of Completion	156
figure eighteen:	Page from my Springton course workbook	158
figure nineteen:	Examples of Flora / Becel aimed at different markets	178
figure twenty:	Image in the lift to the Schilling boardroom	187
figure twenty-one:	The oil press before mounting	206
figure twenty-two:	Putting the oil press together	207
figure twenty-three:	The oil press in action	207
figure twenty-four:	Exerting energy	208
figure twenty-five:	The 'waste' oil-cake produced	209
figure twenty-six:	A lipid crystallisation curve	219

LIST OF ACCOMPANYING MATERIALS

‘Entering the Field’

(<https://www.youtube.com/watch?v=woFZ59pqmYQ>)

LIST OF ACRONYMS

AFN	Alternative Food Network
ALA	Alpha Linoleic Acid
DHA	Docosahexaenoic Acid (long chain omega-3 fatty acid, colloquially known as fish oil)
DNA	Deoxyribonucleic Acid
EPA	Eicosapentaenoic Acid (long chain omega-3 fatty acid, colloquially known as fish oil)
EU	European Union
FIC	Food Information to Consumer Legislation
NGO	Non-Governmental Organisation
NVDA	Non Violent Direct Action
PhD	Doctor of Philosophy
PDG	Planned Discussion Group
RSPO	Roundtable for Sustainable Palm Oil
STS	Science and Technology Studies
TFA	Trans Fatty Acid
UK	United Kingdom

A brief and partial history of margarine (relations are co-constructed)

Oleomargarine

Forms: 18 *oleomargarin*, 18– *oleomargarine*.

Etymology: < French *oléomargarine* (P. E. M. Berthelot 1854, in *Ann. de Chim. et de Physique* **41** 235, 242) < *oléo-* oleo- comb. form + *margarine* margarin n.

On the pronunciation history see note s.v. margarine n.

A fatty substance obtained by extracting the liquid portion from purified beef fat under pressure and allowing it to solidify, which formed the basis of the original butter substitute, margarine (made from it by adding milk, etc., and churning). Also (U.S.): artificial butter so produced; margarine. The French name *oléomargarine* was given by Berthelot (1854, loc. cit.) to a solid substance obtained from olive oil in 1838 by Pelouze and Boudet (*Comptes Rendus de l'Acad. des Sci.* 7 665), which was regarded by them as a combination of the *oléine* and *margarine* of Chevreul (see margarin n.). According to the view then held, *oléine*, *margarine*, and *stéarine* were regarded as the essential constituents of animal fat. Since butter, or the fat of milk, consisted according to Chevreul mainly of *oléine* and *margarine*, with a small amount of butyric and related compounds, H. Mège-Mouriés in 1869–71 experimented with its artificial production by extracting the *oléine* and *margarine* from animal fat, with the subsequent addition of butyric, etc. Hence the name *oléomargarine* for the supposed combination of *oléine* and *margarine* thus obtained. As subsequent research showed that neither the *margarine* of Chevreul, nor the *oléomargarine* of Berthelot, were definite chemical compounds, these names are no longer in chemical use. (O.E.D. 2013)

'Margarine' was the outcome of a competition launched by Napoleon III for research that would lead to the development of a cheap 'nutritive fat' that could potentially feed France's growing (Hoffmann 1969), and unruly (see Gould 1995: 65-67) urban population. Soon to reach its 150th anniversary, margarine is a non-traditional foodstuff. The patent for this novel fat was awarded in 1869 to the French chemist, Mege Meuries (van Alphen 1969). Mege Meuries had noticed that fasting cows still lactate, and deducing (wrongly) from this observation that the udder must convert body fat into milk (Flack 1997), he mixed rendered beef tallow with milk and minced udder flesh - crystallising and pressing the resulting emulsion, so as to create an environmentally stable edible fat (van Alphen 1969). Mege Meuries' attempts to

market the product failed, but in 1871 he sold the recipe to the butter manufacturing company Jurgens of Rotterdam (later incorporated into Unilever (Clark 1986)).

The margarine first marketed by Jurgens was an animal fat based product. Edible plant oils were not considered suitable for processing into margarine, partly because northern European eaters accustomed to the tastes of butter, lard, and tallow tended to find other fatty flavours off-putting; and partly because oils (lipids that are liquid at room temperature) do not readily give the desired butter-like consistency (Boldningh 1969; Hunt 1969). Nonetheless, the margarine industry only became possible 'through the assistance of many other changes in associated areas of the economy' (Hunt 1969: 62). For example, the introduction of refrigerated ships combined with the shift from animal to mineral oils in lighting made it economically viable to ship fatty waste products from Chicago slaughterhouses to Dutch margarine manufacturers (Hunt 1969).

The development of lipid hydrogenation in 1903, however, facilitated the folding of novel oils into the cow and pig fat orientated diets of northern European eaters¹ (Hunt 1969; Feron 1969). The more a lipid is hydrogenated, the straighter its component fatty acid chains become. This straightening mimics the shape of saturated fatty acids and allows them to pack together more tightly, raising the melting point so that the lipid will become solid at temperatures high enough to make them suitable for use in margarine (Feron 1969). When *partial* hydrogenation was combined with new refining techniques that removed the colour (Feron 1969), odour, and flavour of oils (Hunt 1969) the range of lively bodies that could be transformed into resources for the semi-solid melt-in-your-mouth, butter-mimicking stuff of margarine was dramatically increased. From its birth as a glimmer of an idea in the imagination of Napoleon III, political, economic and technological logics have framed and co-constructed margarine, working to map 'a real that is yet to come' (Deleuze & Guattari 2004 (1980): 22).

The early years of margarine manufacture saw efforts to attract consumers by producing an economically thrifty foodstuff that mimicked butter not only in appearance and functionality, but also in flavour and nutritional make-up (Riepma

¹ e.g. whaleoil, cotton seed oil and palm oil.

1970). Nonetheless, transforming fats into margarine created a novel foodstuff that both consumers and societal norms had yet to learn a taste for and, although margarine became a frugal inevitability for some UK households, it carried with it significant social stigma within its greasy presence on the table (Levene 2014). Second World War rationing, however, was to make butter a rare treat for much of the UK population, and the relative availability of margarine over butter began to normalise margarine consumption across a broad demographic (Levene 2014). As a generation of Britain's grew up for whom margarine eating was entangled with the visceral familiarities and quotidian practices of childhood, the social ignominy of margarine consumption began to lessen.

Nonetheless, it wasn't until the late 1960s (a century after margarine was first marketed) and the launch of soft, spreadable margarines with lipid profiles thought to be beneficial for heart-health, that margarine became widely experienced as a desirable foodstuff in and of itself (Upritchard et al. 2005)². Margarine has been heavily advertised to consumers in the UK since at least the 1900s (Clark 1986), yet margarine's historically slow growth in popularity suggests that advertising alone is not sufficient to make margarine desirable as a food commodity (cf. Pred 1998). Knowing the stuff of margarine as good to eat required the co-construction of commodity-margarine and margarine-consumers. Such co-construction is not an insignificant occurrence: It required a cultural shift.

² Typically using oils from temperate oil crops. Initially sunflower, but soya, rape, olive and more recently linseed formed the basis of these spreads.

CHAPTER ONE

introducing the thesis (why research margarine?)

Introduction

Eating-well as individuals, and as a society, appears to have become something of a social obsession in recent years. In popular culture, and in the media, UK consumers are rebuked for being fatter than is good for health, more reliant on animal products than is good for the climate, or more dependent on global supply networks than is good for communities. Individual eating practices have become narrated as a responsibility of care for ourselves, our families, institutions, nation, those that produce or become our food, and to the future of our planet. This research engages the stuff of margarine³ to explore how eating-well is framed and done.

Margarine is a novel food. Patented in 1869, margarine was one of the earliest industrial foodstuffs and it introduced eaters to a combination of bodies, relationships, and processes never encountered before. First imagined, designed and produced as a cheap butter substitute to provide calories for the urban poor, in the mid-twentieth century margarine was re-imagined, re-invented and re-produced as a butter alternative that could readily intervene in the diets of eaters believed to be malnourished but overfed. Margarine can be produced with textures, flavours and constituent parts that resonate with consumer tastes, nutritional guidelines, cultural norms and dietary strictures but also with recommendations for food justice, global sustainability and food security. This adaptability of margarine to multiple ingredients and processes makes margarine a valuable subject through which to explore the situatedness of eating-well.

In this thesis I examine the ways in which bodies and relationships are 'made to matter and not matter' (Evans & Miele 2012) with and in the doing of margarine. My intention is not, however, to unveil every body or relationship that is subjected to care, disregard or harm within the production-consumption pathways of margarine but rather to investigate the ways in which margarine is done, why it is done in the ways

³ For a product to be labelled as margarine in the UK it must have 'a fat content of not less than 80%' (FSA 2010). However, throughout this thesis I have used the term to include 'spreadable fats' as is normal in colloquial English.

that it is, and to explore how doing margarine in these ways frames the ways it is possible to live (and die) together. To this end, in this research I explore both consumer and industry knowledges and practices of and with margarine, and I develop an experimental methodological approach within which it is possible to rehearse other ways of knowing and doing margarine matters.

Encountering Margarine Matters

UK consumers have perhaps never had so much choice in fat. Our supermarket shelves, our kitchen cupboards, our bellies, and our flesh are populated by butter, margarine, olive oil, oilseed rape, sunflower oil, coconut oil, palm oil, dripping, lard, pumpkin oil, avocado oil, corn oil, duck fat and more. Further, within each fat type choices abound. Consumers can choose organic fats, extra-virgin, spray-able, high-oleic, high-omega, low in saturates, high in polyunsaturates, trans-fat free, palm-free, gm-free, free-from, and even low-fat fats. Fatty tastes are deeply personal. Yet, fat is not only on the plates or in the bellies and flesh of eaters. Fatty tastes are shaped by a complex interplay of material, sensory and symbolic factors, and entangled with social and cultural norms, hierarchies, and affective environments. Powerful discursive constructions of embodied and edible fat, in public health campaigns, the media, policy, and advertisements (Forth 2013) attempt to harness fatty materialities with the affective potential of eaters for capacities as diverse as guilt, shame and fear, or pleasure, belonging, and care. Focusing on margarine, this project examines the values, norms and power relationships entangled with the ways in which fats becomes framed and enacted as 'good' and 'bad' food, and investigates what these framings do, and how they are maintained.

As a foodstuff, fat is different to many other commodities in that it is a biological necessity. Nonetheless, the matters people ingest as food are not as straightforward as what is edible, or nutritious. Not all of the substances that have the capacity to facilitate the reproduction of hominoid bodies are everywhere classified as food. Cultural designations and norms of what it is good to ingest vary considerably. Thus, if food is not only central to bodily integrity, but to the making of cultures and of communities then what it might be to eat-well suddenly becomes quite slippery. Margarine is well-placed as an actant with which to research this. Ever since its early

years, margarine promotions have encouraged eaters to make margarine consumption part of the storying of self. As with other forms of knowledge, the desires and possibilities of actual or potential margarine consumers are entangled with the geographies of power relations and practices.

So far in this thesis, I have re-presented margarine production as an attempt to nourish urban populations - from Napoleon III's desire to feed the Parisian poor, through to the development of 'heart-healthy' polyunsaturated spreads. Yet, I could have told the story of margarine production in other ways. For example, through a history of colonialism in which margarine is co-created with Chicago abattoirs, Malaysian palm plantations, and the exporting of northern European tastes for yellow fats across the globe. A third story might tell margarine as co-produced with and in the technologies of refrigeration, hydrogenation and interesterification. A fourth could focus on the entanglements of margarine materialities with food insecurity; from the ubiquity of food riots in nineteenth century Paris, to the second world war and the development of edible oil seed rape in Canada (Busch & Juska 1997) and synthetic fats from coal in Germany (Pyke 1970). Whilst a fifth might situate the margarine matters in the doings of futures markets. Within each story, what it is to eat-well with margarine looks very different (cf. Gallegos 2011).

As Probyn has demonstrated, eating 'juxtaposes the near and the far, the individual and the social, the natural and the cultural' (Probyn 2000: 8). To return to the stories of margarine production outlined above, each story is a framing of margarine which foregrounds some bodies and relationships and absences others. By framing, I mean systemic, discursive or other ways of ordering and sense-making (Barnett et al. 2008). The stuff of margarine can be, and has been, framed as both natural and processed, healthy and unhealthy, sustainable and unsustainable. Within each framing, intentionally or otherwise, bodies and relationships are expressed, enacted, reordered and circumscribed. For example, in stories told on contemporary margarine packaging, sunflowers and olives abound, whilst palm oil is often only made to matter when it is labelled as absent. Exploring the ways in which each framing limits the ways it is possible to encounter, to know, and to relate with the stuff of food, can help better theorise the world making of food relationships. In this thesis, by juxtaposing these,

and other, framings, I will overlay their geographies of intimacy and distancing to explore the bodies and relationships valorised (allowing them a degree of liveliness, of becoming), or immobilised (reduced, bounded, silenced consumed) with and in different framings. Yet food matters do not, however, simply conform to the structures and narratives to which people subject them. At each moment, at each place, the stuff of margarine is not merely acted on. Food is not simply consumed; bite, chew, swallow – gone. Eating trans fats, for example, does not make them disappear. They co-create new material formations with, in, and beyond the body of the eater. When food is eaten, eater and eaten fold together and both eater and eaten are forever changed. If food can act with and in eaters' bodies in ways that are healthy or unhealthy, then space is created where eaters are reminded of food's liveliness. Eating is already and always excessive to framings where one consumes the other. Recognising matter as lively is, however, insufficient to empower change in the ways eater and eaten encounter each other, and live together. At best it risks the extension of humanist individualism to selected non-human others, leaving little room for the otherness of the other. In this thesis, I argue that moving beyond this impasse must involve learning to eat ethically-well, as well as morally-well (cf. Puig de la Bellacasa 2010, 2011, 2012; Braidotti 2013b).

'Eating-well' has been the topic of a great deal of research in multiple disciplines in recent years, and nutrition (Hayes-Conroy & Hayes-Conroy 2016), animal-welfare (Evans & Miele 2012), localism (DuPuis & Goodman 2005), labour relations (Goodman 2004), neo-colonialism (Friedberg 2003), soil health (Puig de la Bellacasa 2015), food waste (Evans 2012) and more, have all clamoured for space in policy, the media and consumer practices. Further, such research has informed campaigns which have led to significant changes in the ways in which food is produced, processed and distributed. Nonetheless, in this thesis I wish to step back from such movements. As will be explored in chapter four, my participants were all too aware of the moral dilemmas entangled with their food choices, yet they felt that the options available to them combined with the constraints of time, money, family life and mental health, highlighted the limitations of such single-issue campaigns. They described feeling compelled firstly to prioritise (for example, to buy conventionally produced local foods from independent retailers rather than organic or higher-welfare from a supermarket

– or vice-versa); and secondly, to choose ‘strategic ignorance’ (McGoey 2012) (for example opting to buy a product with labelling that is opaque about its precise ingredients and their origins). My participants also worried about what impacts are hidden in the ways in which foods are presented to them. They thought that food is too cheap to have been done well, but also too expensive for them to buy. They questioned whether regulation is more than a tick box exercise to make people feel better, and their experiences in their working lives prompted them to wonder what happens in the gaps between inspections at farms or on plantations. They explained that the combination of these uncertainties all too often leaves them with a ‘bad taste in their mouth’. They feel that they do not have enough capacity to ‘eat-well’ and so they engage habitual practices to suppress the need to think about all the moral values that are entangled with their eating practices.

My participants’ dilemmas around food choices, resonate with that outlined by Derrida (1991) in ‘the calculation of the subject’:

The moral question is thus not, nor has it ever been: should one eat or not eat, eat this and not that, the living or the nonliving, man or animal, but since one must eat in any case and since it is and tastes good to eat, and since there’s no other definition of the good how for goodness sake should one eat well?... One never eats entirely on one’s own: the rule underlying the statement, "One must eat well." It is a rule offering infinite hospitality...’

Further, Derrida has, elsewhere, articulated the impossibility of such hospitality. For Derrida (2011) ‘there is no world, only islands’. Like my participants, in starting with the impossibility of an island offering absolute hospitality, Derrida sets off down a path that necessitates the juggling and ordering of food values and priorities. As such to ‘eat-well’ it becomes necessary to decide in advance the bodies and relationships that any individual or community has the duty, the capacity, or the desire to care for (see e.g. Stengers 2005).

Nonetheless, work by Probyn (2000), Haraway (2008), Puig de la Bellacasa (2010; 2012) and others, on the more-than human subject suggests *that there are no islands, only worlds*. For Probyn (following Heldke 1992):

...we face the fact that we are connected. And those connections cannot be sorted into neat bundles according to who eats what, or even what species to

privilege. The world in which we live is already composed of hectic rhizomatic and wired connections... (2000: 58).

Such relationally-orientated conceptualisations of living-together do not require 'infinite hospitality', neither are they compatible with concepts of a universal, morally correct, way to eat-well. Different stories are not simply differing perspectives on, and framings of a singular, linear, world. In smaller and larger ways, new worlds are created whenever bodies meet. Eating-well becomes reframed not as 'a right response to a radically exterior/ised other, but about responsibility and accountability for the lively relationalities of becoming of which we are a part' (Barad 2007: 393). As such, to become ethical, eating must be understood as situated, negotiated, lived and living relationships that cultivate 'power-with' (rather than 'power-over') the wider more-than human world (Puig de la Bellacasa 2010). For the relational-subject, eating-well is situated and emergent (cf. Lynn 1998) and involves care that is excessive both to a liberal democratic project of representation and the epistemological limitations of 'consumption'. Building on this, following Deleuze & Guattari (2004 (1980)) my starting question to explore what it might be to eat-well, is not 'how much hospitality?' but 'how might we live together?' To explore this question I take seriously the proposal of Mol that,

we play with our food, that is, explore the possibilities of models to do with growing, cooking, tasting and digesting. And that, finally, we infuse our theorizing with food metaphors. Many things will change as we engage in such experiments. Subjectivity among them... unexpected things are bound to happen. Like eating, experimenting offers no control (2008a: 34).

To recap: Over time margarine has been constituted from cattle, whales, herring, coal, cotton, sunflowers, palm, rape, olives and more. Margarine is adaptable. In the context of social and political concerns about climate change, food security, food justice and malnutrition, such adaptability to multiple ingredients, whilst maintaining consistency in the taste, texture, and health properties consumers seek in a yellow fat, make margarine a valuable subject through which to explore eating-well. Yet, margarine is a top-down food, a technological achievement designed and marketed as a commodity. Many of its constituent ingredients and processes are unlabelled and

mysterious. Raising questions as to who decides what is good to eat. As Irigaray explains, if 'we cannot perceive the place in which we live' then neither can we fully perceive the modes of relations that our attempts at hospitality co-produce (2008: 24). As such, a key aim of this thesis is to create a hesitation in constructions 'regarding what is meant by "good"' (Stengers 2005: 995), not to offer yet another critique of commodity culture, but to make space to reconsider our responsibilities to our mutually constitutive companions. In making present ways in which bodies and relationships are excessive to normative framings, it is possible to in Law's words 'catch some of the realities we are currently missing' (Law 2004: 2).

In this thesis I explore the knowledges and practices of margarine eaters and producers, juxtapose the ways in which bodies and relationships are 'made to matter and not matter' (Evans & Miele 2012) within the doing of margarine, and investigate the implications of this for constructions of eating-well with margarine. In so doing, I engage conceptualisations of the subject as a situated and precariously symbiotic ecology to demonstrate that the responsibility to eat-well does not involve 'infinite hospitality', yet it is excessive to a juggling of the moralities entangled with different framings of the stuff of margarine. Moreover, I argue that to trouble the boundaries of things so as to open up a politics of the mundane and an ethics attuned to difference and the possible. Momentarily making present what eating and eaten subjects get up to beyond, despite, and because of the framings that they are entangled in, and with, is a 'micro-resistance' (Pignarre & Stengers 2011) within which eaters can begin to 'play with their food' and so rehearse other ways of encountering, knowing and practicing self-other relations. For '[o]nce "we have met", we can never be "the same" again. Propelled by the tasty but risky obligation of curiosity among companion species, once we know, we cannot not know. If we know well... we care. That is how responsibility grows' (Haraway 2008: 287).

Research Aims & Research Questions

The research aims of this thesis orientate around conceptualisations of eating-well as more-than human subjects. Geographical literatures addressing how bodies and relationships are 'made to matter, and not matter' (Evans & Miele 2012) with, and in,

food knowledges and practices have done valuable work adding to knowledges of food and eating as making worlds (e.g. Probyn 2000). In this thesis I build on these literatures in response to Guthman's call for food research which co-creates 'more collectivist political subjects who in time would develop forms of governance more commensurate to the socialized problems before us' (2007: 474). As such a key question for this project is how to make actants that are 'made not to matter', that are disempowered by existing power-relations, present as bodies that matter. In response to this problem, I engage the stuff of margarine to disrupt, and trouble, normative knowledges and practices of, and with, matters of fat.

Inspired by Ahmed's (2000) analysis of constructions of the post-colonial other, I create a methodological experiment in which I engage her concept of 'strange encounters' to an exploration of more-than human relationships and eating-well. To this end, I acknowledge that methodology makes 'some realities realer, others less so' (Law 2004: 67), and engage Pignarre and Stengers (2011) understanding of 'the event' as a hesitation in power relations, but situate it in the everyday of food encounters to respond to the research of Puig de la Bellacasa (2010, 2011, 2012) on practising a feminist ethics of care, Ruddick (forthcoming) on the relational-self, and Braidotti's (2006) exploration of micro-resistances.

In sum, eating is simultaneously a mundane act repeated multiple times a day, and an encounter in which bodies and relationships become entangled and forever changed. The recognition of more-than human social, demands that eaters and producers are responsive to all the relations, whether of connection or detachment, that constitute food structures. To this end, I investigate and critique not only how margarine is known and done, but make space for experimenting with ways of encountering, knowing, and doing, which whilst decentring the human, promote 'the flourishing of human life' (Puig de la Bellacasa 2010).

The research aims and questions that guide the thesis can be mapped onto three empirically focussed chapters (Chapters Four, Five and Six). In Chapter Four I engage the matter of margarine to respond to the first of my research aims, which is: **'to contribute to theoretical and empirical understandings of consumer knowledges,**

beliefs and practices of and with the matter of fats'. To address this research aim I employ 'planned discussion groups' (PDG's) (O'Reilly 2005) to explore three key questions: *How do consumers negotiate different framings of margarine? Who and what are valued by margarine consumers? In what ways do consumer practices with margarine relate to their knowledges and beliefs about fat?* Thus, in investigating how my participants negotiate pressures and choices in their mundane eating practices, I extend discussions of the visceral to better theorise the multifarious interactions between material encounters, sense of self, and styles of valuing the matters of fats.

My second aim '**to add to geographical understandings of the knowledges and practices of fat production'** is addressed in Chapter Five. In attending to this research aim, I undertook interviews and participant-observation at selected nodes across the oils and fats industry to generate data pertinent to the following research questions: *How does matter get organised into margarine? Who and what are valued in the production of margarine? How are margarine values constructed and communicated?* In this way, I interrogate the micro-politics of the ways in which margarine is done with and in the spaces of production, policy making and technological innovation, why margarine is done the ways it is, and the bodies and relationships rendered indiscernible within these doings. Such attention adds to knowledges of the complex, situated and co-productive interconnections between co-constructions of consumer and consumed.

In Chapter Six, I turn to research aim three '**to explore other ways of knowing and relating with the matter of fats'**. Here I employ the experimental method of 'playful strange encounters' to trouble the knowledges mobilised by my first two research questions. I ask three key questions of the methodological approach: *Does the experimental intervention of 'strange encounters' disrupt normative framings of and with margarine? Does the event of 'playing with our food' impact on the ways in which margarine is valued? To what extent is the methodological practice of 'playing with our food' a careful micro-resistance to normative practices and values of consumption?* By creating a hesitation in normative values, knowledges and practices I make space for careful encounters. In this way, by developing a situated practice of mundane politics, I add to explorations of feminist ethics of care as material doings.

Thesis Outline

Having detailed the research aims, highlighted the theoretical context in which it is situated and outlined the empirical approach taken, I now turn to the structure of the thesis itself. The thesis is divided into seven chapters interspersed with a series of short interludes. The interludes add context to each chapter by exploring some of the ways in which margarine is represented and valued within textual sources. Chapter Two examines the key academic literatures relevant to the doing of this research. Chapter Three outlines the methodological approach taken. Chapters Four, Five and Six are empirically focused around each of the research aims. To conclude Chapter Seven, summarises the thesis in relation to the research aims, detailing the key findings.

In Interlude One I tell a short history of trans fats and omega's within margarine to illustrate how framings matter. In Chapter Two I take as my starting point the many ways in which research within food geographies demonstrates how the doing of food valorises some bodies and relations rather than others. Nonetheless, in the light of my research aims I move beyond the sub-discipline of food geographies to engage wider geographical, and social science, literatures which explore the values, power relations, ethics and world-making entangled with such mattering. Drawing on tensions, translations and gaps between these literatures I identify three provocations which map on to each of my research aims. The first engages STS and post-structuralist literatures to question the framing of eaters as individual consumers, and the eaten as resource that can be consumed. The second introduces feminist and post-colonial literatures which trouble the power relationships entangled with encountering other people, but employs them to explore relations with more-than human and non-human margarine matters. The third attends to feminist and autonomist literatures which explore prefigurative relations, but applies them to eating, to argue for a mundane politics 'in, against and beyond' (Holloway 2010) consumer-consumed relations. I bring these literatures together in conversation with empirical work within this thesis to extend existing geographical approaches to, and knowledges of, eating-well.

In Interlude Two I begin to unpack my own knowledges of, and practices with, the stuff of margarine and explore the bodies and relationships 'made to matter, and not matter' (Evans & Miele 2012) within the texts of margarine packaging. In Chapter

Three I outline the methodological approach to, and methodological doings of, this research. Here, I detail the ways in which the theoretical focus, and the methods employed, interwove and shifted as the research progressed. Methodologies are interventions which shift relations (Law 2004). The kinds of associations that are made more or less possible through the doing of research, are demarcated within the research design. To respond to my research aims I needed a methodological approach that would not merely produce a snapshot of what my participants say about their doings with margarine, but that could work to reveal tensions and translations between knowledges, beliefs and practices. To attend to my first research aim I engage close personal and familial relationships within ‘planned discussion groups’ to encourage frank discussions which prompt my participants to explore tensions, translations and incompatibilities within and between their visceral, intellectual and affective knowledges of, beliefs about, and practices with margarine matters. Data generation in relation to my second aim, involved the creation and juxtaposition of ‘snapshots’ of the bodies and relations conceptualised as entangled with the stuff of margarine at selected industrial, academic and policy nodes within margarine networks. Integral to the investigation of my third aim was an experimental methodological approach of ‘playful strange encounters’. This method was designed to be an intervention in habitual ways of encountering the stuff of fat which sought to move my participants in their awareness of the bodies and relationships entangled with and in fat matters, and to create a hesitation within which they could rehearse other possible ways of living together.

In Interlude Three I engage margarine promotional campaigns to situate margarine in the storying of modern life. Chapter Four is the first of three empirically focused chapters. Here, I engage conversations generated by six ‘planned discussion groups’ to explore my participants’ descriptions of their day-to-day performances with (or without) the matter of margarine, and I analyse the narratives, knowledges, communities and visceral experiences that they articulated as entangled with the establishment and perpetuation of their fatty choices and practices. The information generated from this approach not only pertains to the practices of my participants, but also considers the complex ways in which their routines and regimes with the stuff of fat are negotiated, articulated, and performed. I consider the ways in which my

participants' knowledges and practices are co-constituted, and map their representations within habitual behaviours. I investigate the ways in which participants perceive, remember and explain the shopping, cooking and eating habits of themselves and of others and draw attention to the 'push power' of distaste, the 'pull power' of care, and the hesitation of doubt. I conclude the chapter by demonstrating that understanding the complex interactions between material encounters, sense of self, and styles of valuing are key to better theorising relations between consumer knowledges and eating practices.

In Interlude Four I attend to current margarine advertising campaigns, so as to investigate the slipperiness of the natural – processed binary in the doing of fats. In Chapter Five I explore the assembling of margarine in industry and in policy. Using a follow-the-thing (Cook 2004) type ethnography, I map knowledges of, beliefs about, and practices with the stuff of margarine at selected nodes, and explore how multiple, diverse bodies and relationships become enmeshed with and in the stuff of margarine in ways that fit with cultural understandings of the edible. I investigate the power relations and values entangled with different framings of the matter of fats to attend to the ways in which margarine is understood, represented, reproduced, enacted and perpetuated, and I examine how these framings are co-constructed and communicated. I demonstrate that more knowledge from within a framework tends to overcode moral pathways, making their gaps and absences less available to critical discussion. I show that margarine is a mess of multiple framings, hyper complex processes and articulations of 'the natural', and by juxtaposing framings, I explore who and what is valorised, ignored or hidden in the doing of margarine, and I scrutinise the ways in which such bodies and relationships make themselves present and problematic to the smooth doing of margarine. To conclude, I argue that attending to the micro-politics of social norms is key to the co-creation of food systems in which it is possible to eat-well with multiple entangled others.

Interlude Five differs from the interludes that precede it, as, rather than asking you, the reader, to engage with texts about the stuff of margarine, I propose that you play with your food, encountering margarine with your lips, nose, fingers and tongue. Chapter Six is the last of my three empirical chapters. Here, I return to my 'planned discussion

groups' but introduce an experimental methodological intervention to create space where my respondents could participate as minded-bodies, as eaters. The chapter is structured around the ways that 'playing with our food' created 'strange encounters' which disrupted, disturbed or challenged my participants' knowledges, values or practices with the matters of fats, troubling taken for granted consumption habits. I investigate the extent to which strange encounters with the stuff of fat creates a hesitation where eaters are empowered to meet matters of fat anew. I attend to the impact of these 'strange encounters' on my participants' articulations of eating-well, and explore the extent to which 'playing with our food' is an intervention in to the mundane which makes space to rehearse different ways of knowing and practicing complexity. I conclude by assessing the methodology as a situated practice of mundane politics, a micro-resistance in which eating-well is framed not as the responsibility of autonomous individual consumers, but as a negotiated, lived and living relationships with the more-than human world.

Interlude Six is the conclusion of the interludes. Here, I explore my own knowledges and practices with margarine in the shift from working with texts about margarine, to reflecting on how such texts interweave with my own habits, to the strange encounter of playing with my food. In Chapter Seven I summarise the thesis in relation to the research aims, detailing the key findings. I then introduce three methodological contributions emerging from the thesis which respond to the provocations raised in Chapter Two. The first, 'working with disjunctures', is an approach which prompts participants to juxtapose their knowledges and practices, and in engaging the overflows of these doings momentarily makes present the relational-subject, raising new questions about eating-together-well. The second approach, 'attending to strange encounters', creates a hesitation which breaks through the possibilities for living together offered by 'infernal alternatives' (Pignarre & Stengers 2011) to add to geographical understandings of the more-than human world-making of consumer-consumed relations. The third methodological contribution, 'building an uncertain ethics', introduces 'playing with our food' as an experimental approach which produces and refines micro-events to rehearse eating-together-well 'in, against, and beyond' (Holloway 2010) commodity frameworks.

Within these themes I address eating-well as it is co-constructed within consumer-consumed relations. I draw attention to the normalisation of consumer confusion about how best to eat, and I discuss the disciplinary structures of anxiety, risk and responsibility promulgated by 'non-knowledges' across and within multiple framings of the stuff of fat. I discuss eating-well as excessive to the moralities of consuming-well, and develop an analysis of eating-well situated in an uncertain feminist ethics of care. To conclude, I reflect on the limitations of the study, and develop recommendations for future research. I end this thesis with an afterword which reflects on my personal journey into, with and through this research.

INTERLUDE ONE

fats act and labels matter (relationships change)

In the early twentieth century, the introduction of the technique of partial hydrogenation appeared to facilitate the reduction of diverse lively bodies to passive resources for the stuff of margarine. A bonus of the partial hydrogenation process for industry had been that it reduced the amounts of omegas present in the oils used Allport (2007(2006)). Omegas were known by industry to be environmentally unstable in that they readily oxidized and turned oils rancid. Removing the omegas from margarine had the side effect of increasing shelf life and reducing waste (Allport 2007 (2006)). It became evident, however, that some of the hydrogen bonds created in lipids by the partial⁴ hydrogenation process are on the opposite side of the fat molecule to each other - creating trans fats. This was not initially understood to be a problem, as trans bonds also exist in butter. Nonetheless, in partially hydrogenated fats the trans bonds do appear at novel points along the fat molecules and it seems that, although environmentally stable, these fats are problematically *active within human bodies* acting towards (rather than mitigating against) atherosclerosis and heart disease (Mozaffarian et al. 2006). If the eaten can act with-in our bodies for ill, then they cannot be completely imagined as passive entities that are destroyed through consumption. Trans fats revealed themselves to be excessive to framings that represent the stuff of food as mere resources for human liveliness.

Nowadays a process called interesterification is used rather than partial hydrogenation. Unlike partial hydrogenation, interesterification does not create chemical changes in the lipid chains themselves and hence does not create trans fats or impact on omega content (Allport 2007 (2006); Scrinis 2013). It is now not uncommon for interesterified margarine to be promoted as a functional food high in omegas - omega-3 in particular. Omegas are forms of polyunsaturated 'essential fatty acids' that cannot be manufactured within human bodies. Omega-3 is the term used for a group of essential fatty acids that are unsaturated with hydrogen three carbon

⁴ Full (as opposed to partial) hydrogenation of lipids does not appear to produce trans fats (Scrinis 2013).

atoms in from the end of the lipid chain. Research suggests that long-chain omega-3s (docosahexaenoic acid (DHA) and eicosapentaenoic acid (EPA)) predominantly found in fish oils (but also in pastured animals and algae) are thought by nutritionists to be beneficial to human health, and it is recommended that we eat more of them. The shorter chain alpha-linoleic acid (ALA) omega-3 found principally in green leaves seems to be beneficial so long as the receptors that facilitate ALA's transformation to long chain omega-3 are not blocked by the presence of too much linoleic acid⁵ (omega-6) within the eater's body (Allport 2007 (2006); Scrinis 2013).

Margarine tends to contain lots of linoleic omega-6 and some ALA short-chain omega-3, rather than the long-chain omega-3s that nutritionists recommend consumers eat more of⁶. Several (although by no means all) of the people working within the oils and fats industry that I interviewed in the course of this research, suggested to me that the use of omega-3 labelling on margarine containing ALA is: Legal, accurate and a positive selling point, if nutritionally essentially meaningless. Any conversion there might have been from ALA to the more beneficial long-chain omega-3s is swamped out by the presence of large amounts of linoleic acid. The labelling of ALA containing margarine as 'high in omega-3' is perhaps a somewhat shrewd industry translation of consumer concerns for body-care.

In contrast to the disruptive lively presence of trans fats, omega-3 containing margarine is carefully articulated by the industry not as *acting* with-in the eater to co-construct a new body, but as *passive* resource that can be cannibalised for parts in order to maintain the lively integrity of the body of the eater. Meanwhile that margarine consuming body is framed if not quite as ill, then certainly in need of optimization via the mindful work of careful consumption. This re-domestication of the transgressive liveliness of margarine is not the outcome of a system wide conspiracy, but rather of the mundane 'managing' of economic relations (Pignarre & Stengers 2011) re-articulating the eater and the eaten, the human and the non-human as different kinds of things (Nimmo 2008). The folding of legal, economic and nutritional knowledges into the marketing and labelling of omega-3 margarines can be

⁵ Linoleic acid is found primarily in seeds, sunflower in particular (Allport 2007 (2006)).

⁶ The proportion of linoleic to ALA will vary depending on the oils used in making the margarine (Allport 2007 (2006)).

understood as an example of how the presences and silences within framings, and the ways these fold together, matter. Nonetheless, if consumer and consumed is a constructed relationship, then that relationship can change and can be changed.

CHAPTER TWO

literature matters (eat my words)

Introduction

Many areas of literature within and beyond geography touch on issues of eating-well. Here, I take as my starting point some of the ways in which research within food geographies explores how bodies and relationships are 'made to matter, and not matter' in the doing of food (Evans & Miele 2012). Nonetheless, in the light of my research questions, I then move beyond the sub-discipline of food geographies to engage wider geographical, and social science, literatures to trouble the values, power relations, ethics and world-making entangled with such mattering. Drawing on tensions, translations and gaps between these literatures I identify three provocations which map on to each of my three research aims to argue for the further development of approaches to research that in starting from conceptualisations of the more-than human subject do not situate eaters as consumers, or the eaten as things to be consumed.

In the first provocation, I engage STS and post-structuralist literatures to momentarily upset the framing of eating as consumption. By this I mean the conceptualisation of eaters as individual, autonomous consumers, and the eaten as different kinds of things, as resources that can be consumed. In this way, I ground this thesis in a more-than human approach to eating-well as relational subjects. I use the second provocation to introduce feminist and post-colonial literatures which explore the possibilities offered by a feminist ethics of care to trouble the power relationships entangled with encountering 'othered' people. I suggest that bringing such texts into conversation with more-than human understandings of the world can help map tensions, translations and gaps in the knowledges and practices of the co-production of consumer – consumed binaries, adding to geographical understandings of the relational doings of foodways. In the final provocation, I attend to activist and autonomist literatures which explore prefigurative relations. However, by applying them to the more-than human relational subject, I argue for an approach to research which explores other ways of knowing and relating with the 'other' of food matters so as to rehearse a mundane politics 'in, against and beyond' (Holloway 2010) consumer-

consumed relations. To conclude, I highlight the way that, in this thesis, I bring these literatures together with empirical work to extend existing geographical approaches to, knowledges about, and practices of 'eating-well'.

Food Geographies (mapping eating bodies)

Food geographies has been a vibrant area of research in recent years. Food geographers have brought together work in rural, urban, political, economic, feminist and more-than human geographies, and drawn on diverse theoretical contributions to construct a distinct sub-field which explores what food knowledges, practices and systems do, where and to whom (e.g. Bell's (2002) use of Bourdieu (1984) on taste, Nally's (2011) exploration of Foucault (2008) on biopower, Cook's (2004) engagement with Marx on capitalist relations, and Whatmore (1997) and Roe (2006b) use of Latour's (1993 (1991)) conceptualisation of networks). This is a diverse and multi-faceted field, and within it some literatures lean towards informing consumers (e.g. Cook 2004), some push for changes in systems or in policy (e.g. Whatmore et al. 2003) whilst others reveal powerful associations between mundane food tastes, and power-relations and structures (e.g. Probyn 2000; Hayes-Conroy & Hayes-Conroy 2008b). In short (by engaging food matters to explore, for example, the issues of food justice (Guthman 2008), food sovereignty (Wilson 2013), or food security (Kirwan & Maye 2013) in the context of the problems of sustainability, health, animal welfare, or labour relations) food geographies investigate, and unveil the ways in which bodies and relations are reproduced with and in the doing of food.

To this end, following Marcus (1995), a number of researchers have employed 'follow the thing' type ethnographies (e.g. Cook 2004). Mapping commodities with, and in, the lives of multiple others defetishises them, demonstrating that no thing is entirely passive (cf. Goodman 2004; Bennett 2010). As such, follow the thing ethnographies unveil materialities as becoming with and in multiple relations. Further, by joining up places and bodies that social norms frame as separate, such approaches bridge the production – consumption binary to investigate what food matters do, how they are done in different locations, and unpack what consuming-well might look like. In framing space as topological, such research makes present food relations as places

within networks (Coles & Hallett 2012), and reveals spaces where consumers can usefully intervene to make meaningful change.

Follow the thing research builds on a Marxist critique of the opaque nature of commodity production. Arguing that commodities have their histories and relations of material extraction, processing and distribution ‘virtually obliterated’ before they are presented to consumers as commodities (Sack 1992; Harvey 2010), a key follow the thing approach involves defetishisation. Margarine, for example, may be marketed as ‘sunshine’ in a tub, a purification that overlooks the involvement of farmers, pesticides, chloroplasts, combine harvesters, plants, stock markets and oil refiners in the manufacturing process⁷. Much of this defetishisation oriented research has focused on the human lives entangled with the lives of commodities. Given the Marxist origins of the approach, a primary focus on labour will come as no surprise, nonetheless ‘following’ approaches have begun to be used to unveil more-than human bodies and relationships. For example, Schleifer (2012) reveals the interplay of knowledges, practices and bodies that made the movement of trans fats into, and then out of, commercially available foodstuffs both desirable and possible.

Defetishisation is not, however, the only follow the thing approach to commodity research, nor the only one to draw on Marx’s imperative to get behind the fetishism of the market. Refetishisation approaches take as their starting place the understanding that consumers cannot possibly know all there is to know about the lives of commodities prior to purchase, and that knowing cannot in and of itself create change in production practices. As such, refetishisation work attempts to modify a commodity fetish so as to build a relational ethic of care into production-consumption networks (Goodman 2004). As with defetishisation work, refetishisation has most commonly been orientated towards labour relations, coalescing for example around ‘fairtrade’ practices (Goodman 2004). Nonetheless, refetishisation work can facilitate the performance of other care relationships. For example, Heath and Meneley’s (2010) multi-site ethnography of foie gras re-presents artisanal (as opposed to industrial) foie

⁷ Ingredient labelling for margarine was something Which? Magazine was calling for at least as early as 1973 (Consumer’s Association 02/1973), but it wasn’t until EU legislation of November 2014 that labelling of the fats within a margarine became a requirement in the UK. Even today it is only the macro ingredients that appear on margarine labels.

gras production as a 'good to eat' collaboration between goose, farmer, and consumer that, they argue, enables geese and people to live (and die) together well.

A key objective of follow the thing approaches is to empower consumers (and legislators) by giving them new information about the lives entangled with commodities, and by making public links between, for example, poor welfare standards, maltreated workers, and consumer safety. By making present some of the bodies and relations entangled with and in commodities, such attention, enables very real interventions to be made, processes put in place. Yet commodity activism, by suggesting that things can be 'fixed' by consumer choice, or by technological intervention, can bridge specific gaps, making things less awful at particular nodes within specific systems, but they cannot so easily challenge the logics of systems themselves. For example, systemic separations of chickens and chicken, life and death, creates a 'gap' in which 'happy' chickens have a particularly miserable death (Buller 2013).

A second key geographical approach to understanding food relations as power relations is through the visceral (Probyn 2000). As with follow the thing approaches, attending to the visceral troubles understandings where food is framed as a resource that moves in a straight line to the consumer and then is gone; conceptualisations where consumption is presented as the end link in a chain. Probyn approaches this problem, not by following the materialities of the eaten other, but by folding her focus inwards to the situated body, and its gut reactions. To this end Probyn employs Deleuze and Guattari's (2004 (1980)) concept of the rhizome to facilitate her exploration of the ways in which systemic power relations act on, and are reproduced by, eating practices, beliefs, knowledges and encounters.

Eating is necessary for the embodied continuation of the self. Food desires and wants are not, however, a straightforward response to biological need. The ways people shop, cook and eat say something about the person they would like to be and the society they would like to live in, as well as the society they do live in and their perception of their place within it (Bourdieu 2013; Coff et al 2008). Food matters are intertwined with socio-cultural relationships such as gender, shopping, home-life,

work, health or species; socio-technical relationships of infrastructure, technology and transport; socio-political power relationships and configurations; and socio-economic logics that value economies of 'massification', food which is financially 'cheap' to produce with the potential for 'added value' (e.g. Waltner-Toews & Lang 2000). Eating is an intensely personal encounter which connects the eater to multiple biopolitical relations and identities (for example class, gender, ethnicity or sub-culture). For example, as I am writing this one of today's newspapers is carrying an article about a tweet sent by Kirstie Allsopp. The tweet reads: 'Just saw a guy have a glass of coke, a cappuccino, a croissant and a ham and cheese sandwich for breakfast. #ourNHSistoast #worldgonemad'. Allsopp, explains that she wishes to 'start a national conversation' because 'if we want a functioning NHS we all need to take a pull' (30/09/16 Guardian). In other words, for Allsopp, the consumer choices of this man are a selfish and disgusting moral failing to care both for himself and society. Such a focus on the responsabilisation of the consumer is not unique to Allsopp (see e.g. Rose 1999; Barnett et al. 2008). Views such as Allsopp's represents a particular classed perspective, but capitalist relations need the informal labour of a responsabilised commons as a resource for accumulation (Hardt & Negri 2009).

Visceral geographies can investigate how such beliefs, knowledges and values materialise and are remade with and in embodied encounters (Lavis et al. 2016: 11). The visceral realm is a reminder that 'relations with others are not optional' (Heldke 1992: 320); outside and inside, eater and eaten fold together and are forever changed (Roe 2006). Building on this, Hayes-Conroy & Hayes-Conroy (2008) have enrolled the concept of 'taking back taste' to explore visceral encounters as excessive spaces in which relationships with foodstuffs are shaped (see provocation two). Thinking with the visceral acts to subvert simplistic notions around good and bad foods and food practices; a framing which perpetuates narratives which obscure the social, cultural and political relations and systems within which people eat (cf. Guthman 2012; Jackson 2015).

In sum, food possibilities, are entangled with geographies of belonging, and of power relations and practices (Korsmeyer 1999). Hence, a key problem attended to by following the thing and visceral approaches is how to 'do' a politics of consuming-well. Both

follow the thing and visceral approaches do valuable work in revealing food and consumers as co-constructed, entangled and becoming. As such they trouble smooth, linear, stories and beliefs about food matters and food relations. Nonetheless, in focusing on the situated experiences or knowledges of individuals they also risk further responsabilising the individual to make a difference (Rose 1999; Barnett et al. 2008; Goodman 2016). In response to this, in the following provocations I bring these approaches into conversation with theorisations which further trouble concepts of the bounded subject and autonomous consumer.

Provocation One (troubling the subject)

Food matters are often valorised for their abilities to transgress self-other boundaries (e.g. Probyn 2000). For example, Bennett (2007) analysed how eating fats co-creates affective states - eating, literally and figuratively, gets under the skin of the eater. Within the consumer-consumed framing, however, the consumed other can transgress the boundary of the consuming-self, but in so doing it either remains othered or appears to disappear completely, ceasing to become. Yet, as outlined above, follow the thing approaches have demonstrated that the geographies of food matters are more complex than, and excessive to, the geographies of consumption. In this provocation I build on this research to contend that work which situates eating as consumption recreates a binary distinction between self and other. I go on to argue that bringing theorisations of the more-than human subject into conversation with follow-the thing ethnographies can momentarily upset the reproduction of the consumer-consumed binary. Such research can make present limitations to the possibilities for change offered by tweaking practices within production-consumption chains, and can begin to make space to explore how eaters might relate with food and food relationships in ways that cultivate situations of power-with rather than power-over multiple entangled others.

A framing is a sense-making which defines the understanding of the context of situations by placing them within imaginary boundaries (Callon 1998; Donaldson et al. 2013). Such boundaries are not fixed, natural or given, but 'drawn by mapping practices' (Haraway 1988: 595) which acknowledge and represent some elements and exclude others (Sultana 1992; Doel 1996). Framing eating as consumption, for

example, frames food and eater, consumer and consumed, society and nature as *distinct* bodies, different kinds of things. Framings are performative manifestations of power and truth-making which delineate what constitutes a legitimate perspective on the world (cf. Foucault 1977). Understanding framing as a mapping, however, prompts investigation of 'events, institutions, actors, and other things' beyond a frame that are nevertheless entangled with things within a frame (Donaldson et al. 2013: 604), for example, climate change, soil erosion, food wastage or poor nutrition through which different food matters are co-constructed.

Food matters are done within multiple framings and framings interact. Framing the subject as autonomous, locates care not in the social, but in abstract moral notions of limiting harm (Braidotti 2013b). If consumers seek moral closure in one frame (e.g. local, fairtrade, organic or personal health) then this may negate, or even add to, ethical problems in other frames (see e.g. (Mol 2008b)). Consumers must co-construct their knowledges, performances and relationships with food matters through the negotiation of the truth-making of multiple intertwining frameworks. No matter how consciously 'ethical' an individual's consumption choices and practices are, framing eating as consumption engages a mode of relation which 'limits the ways it is possible to think, act, feel' (Pignarre 2011: 42) and become. Such truth-making becomes present when events overflow these gaps, disturbing the smoothing activities of mundane practices (Callon 1998). Eating is not *the* end or *the* beginning of matters, but is always a middle from which bodies grow and overflow (cf. Callon 1998; Deleuze & Guattari 2004 (1980)), both eater and eaten are forever changed (Mol 2008).

Nonetheless, such social norms exist for a reason. Framing the world creates rules which enable people to understand each other and live together. 'As foods circulate and are shaped into edible and affective commodities, they also processually shape the worlds both from which they originate and through which they move...' (Probyn, 2013): 289). As such food knowledges and practices cannot be reduced to the individual intentionality of autonomous consumers. Framing eating as consumption creates a map in which administrative solutions to the apparent wants and needs of autonomous individuals 'overcode' the political problem of living together (cf. Puig de la Bellacasa 2010; Pignarre & Stengers 2011). A case in point is the 2011 UN call for

global food production to double by 2050 (UN 2011). The call frames non-human others as resources to feed people. Within this frame it is hard to fully comprehend eating as a lived relationship in which more-than human communities are networked, nested, overlapping and interdependent (Braidotti 2013b), rather it makes sense to push for growth and innovation in food production.

For each framing to function smoothly, knowledges and practices must be able to make 'little leaps' over small discontinuities where framings meet (Latour 2013). If the common sense realities of a situation are to be understood and resisted, then the local knowledges and practices that reproduce it, and the overflowings which threaten it, must be explored and analysed (Deleuze & Guattari 2004 (1980); Braidotti 2008; Yusoff 2011). Deleuze and Parnett argue that 'bringing in new elements' cannot break dualistic norms, rather knowledges and practices must be shifted 'like a load' (2007: 132). One way to do this in research is by juxtaposing the normative knowledges of multiple framings. Contrasting such sense-making mechanisms creates fragmented narratives by exposing the gaps and inconsistencies that fall between framings, making present the ways in which such inconsistencies and awkwardness's are smoothed over in everyday practice (cf. Doel 1996; Callon 1998; Law 2002; Tsing 2011; Connolly 2013; Latour 2013).

As discussed in the first section of this chapter, work in food geographies, following things such as papaya (Cook 2004), fish (Mansfield 2003), beef (Stassart & Whatmore 2003), or green beans (Friedberg 2004) amongst many other commodities, has done valuable work in examining the coming together and the reproduction of bodies within production-consumption chains. Follow the thing methodologies have demonstrated that juxtaposing framings can upset norms, revealing their construction and their inconsistencies. This work has investigated gaps between regulations and practices, explored nodes where consumers, third sector organisations and policy makers can, and should, demand transparency and change, and suggested means through which this can be done. Follow the thing exposes multiple bodies and relations entangled with the movement, restructuring, (dis)assembly and commodification of materialities, but also the ways in which such matters, papaya enzymes for example (Cook 2006), 'resist human wishes' (Sousa & Busch 1998, 351). Moreover, such juxtaposition

reveals the situated, 'contingent and botched encounters' which shape both what is, and those who resist (Tsing 2011: 272). For example between campylobacter, chicken guts and economies of scale (Hinchliffe et al 2013).

Much of the follow the thing oriented research to date has focused on the human lives entangled with the lives of commodities, often attempting to modify a commodity fetish so as to build care into a production-consumption chain (Goodman, 2004). Given the Marxist origins of the approach, a primary focus on labour is no surprise, nonetheless 'following' approaches have begun to be used to unveil more-than human bodies and relationships. Schleifer (2012), for example, reveals the interplay of knowledges, practices and bodies that made the movement of trans fats into, and then out of, commercially available foodstuffs both desirable and possible, and Cook's work on papaya explores the interplay between the fruit and the skin of the pickers (Cook 2006)..

In revealing commodity and other networks to be interwoven, co-influential and co-constituting (if asymmetrical) relationships, follow the thing approaches work to unsettle normative accounts of commodities (Whatmore, 1997) (Jackson 2002) and of eating-well. Indeed, one of Cook's students when introduced to movement / network oriented approaches wrote: 'Now I found myself asking questions, and with every question I found myself wanting to ask more questions and wanting, no needing, to know more about the hidden networks' (Cook et al:2007:117). Yet Goss (2004) has argued that making present the complexity of commodity chains in this way does not help consumers know how to intervene in them for the best. Indeed, Guthman (2003) has shown that organic salad mixes are often grown in resource intensive out of place, out of season ways, depend on marginalized labour, and led the way in the development of 'convenience' packaging. Following commodities tells us a lot about commodity chains and relationships, but engaging commodities to create change leaves the binary of consuming-selves and consumed-others undisturbed, and so cannot trouble the entanglement of identity with consumption practices and performances (Jackson 2002). In this thesis, I argue that the re-appropriation of commodities in this way is at best counterhegemonic (see chapter one), a tweak is

required if following is to add to understandings of more-than human relations beyond commodity frameworks.

Conceptualising the eating subject as slippery, more-than human and relational is a framing that troubles such dualistic norms. Spinoza's concept of the composite individual, for example, frames the subject not as a 'bounded entity... but a composition of forces' (Ruddick forthcoming). Likewise, Ahmed argues that the self is 'always already *the social experience of dwelling with other bodies*'. Conceptualisations of the more-than human subject illustrate that the 'body multiple' (see Mol 2002) engendered by eating is 'connected to other bodies, human and non-human, and also to practices, technologies and objects that produce diverse kinds of bodies and ways of being human' (Lavis et al, 2016: 10). Such interdependencies are topological. In eating, landscapes, species, pesticides, weather patterns, labour, bodies and more fold together, inside out, outside in (Probyn 2000). Eating trans fats for example does not make them disappear (bite-swallow-absorb-gone), they co-create new material formations with, and in, the body of the eater (Schleifer 2012). Demonstrating our more-than-human interdependencies in this way, suggests both that the particularity of 'my body' is only possible with and through 'encountering other bodies' (Ahmed 2000: 46-47), and that the individualism of framing the other as resource that can be consumed, is 'a historically and culturally discursive formation' (Braidotti 2013b: 24).

Knowing in theory that the subject is relational, constituted with and through multiple others rather than 'a stand alone agent acting *on* the world' (Ruddick, forthcoming: 5), although problematising the consumer – consumed binary does not in itself create change in how food relations are done. It is one thing to know this conceptually, and another to enact it in ways which interfere with the normative practices of production-consumption networks. To this end Roe (2006b) argues for research that in turning towards the bodies and relations materially allied through the doing of foodways, makes space to explore the visceral experiences and mundane goings-on of consumption practices. In this vein, work on the microbiome has remodelled the subject as situated, precarious, dynamic and ecological. Building on this, Paxson follows the microbial relations of cheese in and out of policy, practices and bodies to illustrate the ways in which 'dissent over how to live with microorganisms reflects

disagreement about how humans ought to live with one another' (2008:16). Paxson's research brings elements of follow-the thing ethnographies together with the visceral experiences of taste and its entanglements with beliefs about health, heritage and locality. Thinking with taste in this way raised new questions about the stuff of cheese, prompting taken-for-granted practices to be opened up to exploration. In revealing the self not as autonomous but an interdependent subject, such work troubles the binary of consumer and consumed and is an engagement with the more-than human subject in practice. Further, troubling embodied experiences of the boundaries between self and eaten reworks 'one's attachment and connection to a shared world' (Braidotti 2013b: 193) and demands that we are responsive to all the relations, whether of connection or detachment, that constitute the subject. Engaging following approaches to explore eating as excessive to its framing as consumption in practice is to raise new questions about eating-together-well with, in and across such relationalities.

In sum, in framing eating as consumption, eater and eaten, self and other, nature and society are coconstructed as different kinds of things. As such it is hard to comprehend how one might eat-well-- if bodies are distinct bounded entities then to eat, one must destroy the other-- at best the eater can endeavour to engage consumption-production practices of least harm to that other. Nonetheless in foodways bodies meet, species meet, and they are interfered with by local practices, legislation, labour relations, value systems, and global markets. Follow-the thing research has done valuable empirical work in unveiling the bodies and relations entangled with food systems, and in pushing for administrative and technical changes in the regulation and doing of those relations (cf. Pignarre & Stengers 2011). Such work has demonstrated how consumer-consumed practices remake bodies and worlds in particular ways. Meanwhile, work on the more-than human subject has troubled the binaries of both self and species. Such binaries are maintained by the doing of norms, values, and their associated knowledges and practices. Yet eating is already excessive to framings where one consumes the other - the consumed is not an inert object that is used-up, rather both consumer and consumed are forever changed. As such my first provocation is to argue that practices need to be further developed which bring together follow-the thing ethnographies with conceptualisations of the more-than human subject. Such research could not only produce more evidence of how human

and non-human others are entangled with and remade by relationships of consumption, but could begin to trouble mundane practices which act to re-inscribe the consumer – consumed binary. A separation which by necessity makes some relationships, some bodies and some futures, matter more than others.

Provocation Two (encountering food matters)

Post-colonial and feminist research has explored how political, systemic and cultural norms and hierarchies frame the ways through which bodies are understood to matter, and the modes through which it becomes possible to relate to multiple others (e.g. Ahmed 2000). In this second provocation, I contend that bringing such approaches in to conversation with each other, and with conceptualisations of the more-than human subject, can create hesitations in the ways eater and eaten encounter each other so as to ‘catch some of the realities we are currently missing’ (Law 2004: 2). I build on the arguments of provocation one to argue for empirical research that, in disrupting the mundane reproduction of consumer-consumed relations, adds to geographical understandings of the world-making of food systems and encounters by exploring how, and why, bodies and relations become framed as things that do, or do not, matter.

Eaters, are not passive recipients for messages about food matters, subjects are perpetually co-constituted through encounters with others (Ahmed 2000). Eaters belong to, and are co-constituted with, multiple communities ‘with shared geographical, social, political, economic or cultural characteristics (Herman 2016: 69), their food practices shaped by a complex interplay of material, sensory and symbolic factors and entangled with the construction and presentation of self. Eaters are parents, neighbours, workers, friends, gardeners, companions and more, and they are situated, framed, judged and offered potential to act by their social and cultural capital (e.g. class, gender, ethnicity, age, income or (dis)ability) (cf. Bourdieu 2013). Eaters are more than consumers. Eating is an intermingling and remaking of bodies (Probyn 2000). Indeed Roe (2006) has demonstrated that to understand food’s relationalities it must simultaneously be followed as it moves through networks, and through shifts in meaning as bodies interact. Roe’s work on ‘things becoming food’ explores the post-

purchase processes involved in transforming bodies into food. To eat 'food is to eat its geography' (Coles 2016:257). The materialities of soil, water, weather, pesticides, labour, microrhizomal fungi, earthworms, decomposing others, harvesting equipment, transport systems and preservatives fold with discourses, technologies, places, systems and power relations with and in the stuff of food, and the bodies of eaters; and together they, in part, become flesh. No-one eats alone (Derrida & Weber 1995: 109).

Hayes-Conroy & Hayes-Conroy in 'Taking back Taste' (2008) explore how embodied-minds, the stuff of food, and the framings of food are relationally linked the experiences of eating so as 'to critically reflect upon, and perhaps transform', how our embodied 'feelings and sensations inform our actions' (Hayes-Conroy & Hayes-Conroy 2008: 734). In attuning to bodily sensations, the more-than words approach of visceral methodologies requires a slowing down of reasoning which challenges researchers and participant alike to acknowledge and explore the ways in which 'our own bodies and the bodies of others have come to be affected by things in the world' (Hayes-Conroy & Hayes-Conroy 2010a: 741), and to encourage 'skepticism of boundaries... not through a complete dismissal of such dualisms but through insistence on the imagining and practicing of our (political) lives in, through, and beyond such tensions (Hayes-Conroy & Hayes-Conroy 2010b: 1274).

Visceral research explores food as more-than food (Goodman 2016: 259), nonetheless it remains a commodity, a thing that can be consumed. Yet, Bennett (2010) demonstrated that non-human bodies and materialities matter. In this regard, Irigaray's work (in response to Derrida) is useful here. Irigaray contests that current framings leave 'us' unable to 'perceive the place in which we live' (2008: 24). Living (and consuming) well with others can only consist of offering them 'a room' in the 'loop of the interlacing of relations where we ourselves are situated by our culture, our language, our surroundings' (Irigaray 2008: 245). Irigaray is unpacking the production of hierarchical differences within human relations to build on the feminist argument that equal rights or opportunities within a paternalistic world not only is not equality, but recreates worlds that are detrimental to all entangled with them. In applying her arguments to more-than encounters I contend that careful consumption too can only

make space within the same framings that leave consumers less than fully aware of the multiple ways in which they themselves are contained.

Framing bodies and relations as commodities perpetuate 'non-knowledges' (McGoey 2012b) not only by making absent multiple other lives, but by shutting down or redirecting questioning about the effects and affects of the systems, knowledges and practices of consumption. Care directed toward bodies already valued in the doing of food can harm both other, less visible, bodies, and systemic resilience (Folke et al. 2010). Framing is a necessity to making sense of, navigating, and living-in, the world, but in its unavoidable partiality framing also co-creates lived realities. For example, framing the subject as an autonomous consumer limits the amount of care and hospitality that any individual can give, and so tends toward the limited possibilities for care offered by moral norms. As 'consumers' eaters are compelled to prioritise between bodies and relations, new performances of consumer 'identity' and 'belonging' cannot worry knowledges which co-construct food and eaters as fundamentally different kinds of things.

Yet, materialities do not passively conform to the structures and processes that we subject them to, or the narratives we tell about them. 'All things strive to enhance their capacity to act' (Ruddick forthcoming: 8). Such '[s]triving... is not only internal to a 'thing' but courses through things, a multiplicity of subjects of varying capacities...a complex coming together of many 'things' that are concerned with themselves in a myriad of scales and in a myriad of sites' (Ruddick forthcoming: 29). The lifeways of human and non-human selves entangle, co-create and limit the possibilities of multiple others (Tsing 2015). As such, conceptualisations of more-than-human subjectivity offer 'co-ordinates for a different politics, unforeseen alliances, orientations towards more expansive affective connections to a lively world'(Ruddick forthcoming: 5). Nobody and no body is an autonomous subject.

If the subject is understood as a 'composition of relations' (Ruddick forthcoming) then the question of care shifts from a linear, moral, one of how much hospitality is possible (cf. Derrida 2011) to the holistic, ethical, one of what does any given hospitality do (cf. Deleuze & Guattari 2004 (1980): 284). For example, in 'the body multiple' (Mol, 2002)

explores how different practices are not merely different perspectives on a singular reality, but act to produce different realities. As such she calls for an ontological politics which investigates the political and ethical rationales for, and outcomes of, enacting one possible kind of reality rather than any other. In this regard, Ruddick (and Puig de la Bellacasa 2012) point to permaculture approaches to food production as examples of practices where *'potential* (the capacity inherent to things) and *potestas* (a system of their organization) come into closer alignment, such that the system affects maximal thriving' (Ruddick, forthcoming: 29). Yet, 'eating is a habitual practice, like cleaning teeth, much of the time there is little consideration about what the process of eating is like or what you are actually doing' (Roe 2006b: 112). Change can only begin from troubling such encounters in the here and now.

In her explorations of constructions of the postcolonial other, Ahmed has proposed the 'strange encounter' as a means to create a hesitation in habitual knowledges and performances. Such encounters 'shift the boundaries of what is familiar' to facilitate catching a glimpse of the otherness of the other (Ahmed 2000: 8). In this way strange encounters momentarily expose the power-relations entangled with the ways in which the others othernesses are framed, contained and represented (Ahmed 2000; Irigaray 2008), and 'how that figure is put to work... in particular times and places' (Ahmed 2000: 15). In the emerging situations of 'strange encounters' the ways in which subjects will respond to the interaction of self, other and their framings are hard to predict (Milne et al. 2011). Within such spaces other worlds can manifest (cf. Irigaray 2008), if only momentarily. Although Ahmed is writing about the construction of postcolonial others, I contend that orienting the 'strange encounter' to non-human others and more-than human relationalities is potentially a productive methodological intervention to disrupt the normative constructions of consumer and consumed. One way to do this would be to bring 'strange encounters' together with the visceral approaches developed by Hayes-Conroy & Hayes-Conroy (2008; 2010), Longhurst et al (2009) and others. Indeed the Hayes-Conroy's have themselves argued that troubling encounters between expectations about food and visceral experiences of it 'could allow geography to make a powerful link between the everyday judgements that bodies make... and the ethico-political decision-making that happens in thinking through the consequences of consumption' (2008: 462).

In sum, every other is too vast to be comprehended in its entirety and so will always be a stranger to us (Ahmed 2000; Morton 2012), yet framing eating as consumption creates modes of eating where food is reduced to resource, even known as mere fuel for the eater's body. Naming the self as consumer, is not a neutral act (Rose 1999). However, recognising the subject as becoming with multiple more-than human relations and belongings, creates a conceptual shift where to thrive rather than merely survive is a question of acknowledging and enhancing our awkward interdependences (cf. Puig de la Bellacasa 2010; Braidotti 2013b). Connecting the personal to the collective in this way 'decentres the human... grounding ethical obligation in concrete relationalities in the making' (Puig de la Bellacasa 2010: 67). Here, what it is to 'eat-well' can be understood, not as a juggling of universal moral rules, but as an uncertain, situated and dynamic everyday doing. To explore possibilities for eating-well as relational more-than human subjects, space must be created that does not decide in advance who matters and who does not (cf. Stengers 2005). I have suggested that Ahmed's concept of the 'strange encounter', when brought into conversation with notions of the more-than human, can upset such norms by offering glimpses of both eater and eaten as excessive to this consumer-consumed framing. The problem of eating-well thus becomes a question of how to interfere with framings so as to ask 'which version [of reality] might be better to live with?... How, and for whom?' (Mol 2012: 3). In re-framing our more-than human interdependences, some may still come to matter more than others, but 'they all have to be present in the mode that makes the decision as difficult as possible' (Stengers 2005: 1003). With this provocation I contend that developing approaches to research which build on visceral approaches to create embodied 'strange encounters' with food matters can upset the reproduction of 'common-sense' conceptualisations of, and practices with, the 'other'. Such work can not only add to geographical understandings of the more-than human world-making of consumption knowledges and practices, but make space to further explore possibilities for eating together as relational subjects.

Provocation Three (rehearsing a mundane politics)

In provocations one and two I demonstrated that eating-well is a problem of politics that is excessive to the technical and administrative solutions to consuming-well. If the

more complex a subject's relations, the more resilient (Ruddick forthcoming), then care for the world, and care for the self, correspond in the heightening of possibilities for expanding capacities for intersubjective flourishing (Puig de la Bellacasa 2012; Ruddick forthcoming). As Puig de la Bellacasa (2010) argues, doing food ethically cannot be a matter of searching for universal, stable norms and moralities (and the means through which to enact them), but must involve the biopolitical intervention of constructing new material configurations that can sustain the situated co-flourishing of humans and non-humans. Eating-well as more-than human subjects necessitates a persistent situated 'tinkering' (Mol 2015). In my final provocation, I propose that applying literatures which explore prefigurative relations 'in, against and beyond' (Holloway 2010) capitalist relations to a more-than human relational self can respond to the question of how to 'do' such a politics. This approach demands the development of methodological interventions which make space to explore and rehearse other ways of knowing, relating and eating with others.

Work on the body has become a resource for primary accumulation (Hardt and Negri 2001). Commodity relations frame eating bodies as 'others' that must be remade so as to represent the 'true' self (Gillespie 1997). The abilities of consumers to do so are limited by social divisions such as class and gender, and by financial means. Such inequalities cannot be ignored, and valuable work is being done in areas such as food poverty (Williams et al. 2016) and obesity (Guthman 2014). Nonetheless, for Pignarre and Stengers (2011) although neo-liberal relations are asymmetrical, to feel guilty about relative privilege is to be caught in the realm of 'infernal alternatives' (Pignarre & Stengers 2011). By this they mean that consumers are 'empowered' to choose between reform and sacrifice - for example, immigration or a free health service; nuclear power or climate change; GM foods or hunger for the poorest (Pignarre & Stengers 2011).

The possibilities for living together offered by capitalist relations capture both consumer and consumed by shutting down thought. Creating the illusion of choice 'without having created the means for posing the problems differently is to behave as if everything could be sorted out with a bit of good will or humanity' (Pignarre & Stengers 2011: 6). Whatmore (1997) also hints at this in her discussions of a 'relational ethic'. For example, care for global inequalities may necessitate the deprioritisation of

familial care, and vice versa (Miller 2001). Such alternatives are often presented as pragmatic and realist, a refusal of the either-or dismissed as hopeless romanticism.

Pignarre and Stengers (2011) engage the concept of sorcery to denote how consumer relations 'enchant' people into accepting such 'infernal alternatives'. Consumer-consumed relations work to convince consumers that they are creative, free agents whilst simultaneously framing the possible (Deleuze & Guattari 2004 (1980)). For example, consumers are encouraged to feel 'empowered' to choose to engage their consumer clout to care for their health, the local economy, climate change or animal welfare. Within consumer-consumed framings, eating-well is not an option, only choosing which named others to care for, and which not. Puig de la Bellacasa critiques this individualistic notion of care. To return to the relational-self outlined in provocation two, if we are no longer sure where the self ends and the other begins then this obliges us to reconsider care as collective (2010).

Eating is an event; a generative encounter between bodies, technologies, systems and things; eating brings about a body multiple (Mol 2002; Lavis et al. 2016). It is in such small everyday doings of multitudes of relations that framings are created and maintained 'with the self-evidence of unavoidable alternatives' (Pignarre & Stengers 2011: 31). In capitalist relations hope and despair are intimately connected. As such it is important to develop techniques which can identify questions and answers that have been 'imposed'.

Given current inequalities such a project can be critiqued as naïve, and it is certainly not going to change anything over night. Exploring more-than human living together is not pragmatic, it will not and does not try to tinker with capitalist relations to redistribute scarce resources or services. Attending to systemic inequalities through researching food access, food justice and food sovereignty is necessary 'in the meantime' (Cloke et al. 2016), but is not the subject of this provocation. Indeed, I want to suggest that to break out of the administrative problem of 'infernal alternatives' it is essential to develop ways to explore living together otherwise.

To live well together it is important to pay attention not only to the means through which systems work the way they do (who and what is valued, why, and what this does), but to look for things that do not quite fit the narrative (Chadwick 2014) - the

gaps, tensions and translations between food knowledges and food practices (cf. Eden et al 2008). Nonetheless, although paying attention may unveil such little leaps of logic within and between framings (cf. Latour 2013), it is knowledges *and* practices which co-create realities (Mol & Law 2004)). If other ways of ordering reality, of framing the world, are to be prompted and negotiated then that which 'proves the rule' of a framing must be mobilised (Braidotti 2013b). Methods employed within which in smaller and larger ways it is possible to experiment, to prefigure other ways of encountering and relating 'in, against and beyond' consumer relations.

In provocation two, I argued that strange encounters are events that can momentarily break the spell of the habitual. Such events create spaces within which it is possible to politicise issues that tend to rely on the idea that people do not need to think. This does not mean opposing every technical or administrative decision, rather to create shifts in knowledge systems to understand that consumer choice is 'a kind of politics that is the denial of politics' (Goffey 2011: xiv). This, however, gets to the nub of the problem. In food networks, bodies meet, species meet, and they are interfered with by local practices, legislation, labour relations, value systems, and global markets. Ethical relations are mutual, situated, emergent and unequal. Every body is situated, every relation is local (Pignarre & Stengers 2011). Encountering, relating and caring, with, and for, ourselves and our collective others - living-together, is always negotiated in the moment in mundane practices, with and in 'the trajectories that we have, in one way or another, been implicated in' (Pignarre & Stengers 2011: 77). There is not a singular way to live together, no technical fix to eating-well.

The concept of the relational self is useful here. The relational self is not autonomous. If subjects are relational, then living and eating-together-well is not given, and it can never be done: 'it is a project' (Braidotti 2006: 201). Ways of living together 'do not emerge fully coherent, but are tentative, contradictory, creating new value systems in some aspects of life, whilst clinging to / being grounded by pre-existing norms in others' (Chadwick 2014: 475). 'The event' is an encounter where, if only momentarily, a relation is taken into the political domain. It is, however, not enough for each subject or each group to experiment in isolation 'in order for what holds us, miraculously, to give way and collapse' (Pignarre & Stengers 2011: 122).

For the relational self, flourishing is reliant on the quality of relations and quantity of bodies with whom the self is intimately connected and co-dependent (Braidotti 2006). The more complex the connectivities the more resilient the subject is to changes in some of those connectivities. If relations are to be protected from capture within such antagonistic framings as self-other, consumer-consumed or nature-society, relational subjects must continually coproduce these relations with their mutually constitutive companions (Pignarre & Stengers 2011). For Pignarre and Stengers this 'calls for a culture of recipes' (2011: 133)⁸. Recipes are not prescriptive, they suggest possible ingredients, outline methods, give tips on troubleshooting.

Recipes are a technique of empowerment which enable 'a creating together that which none would have been capable of by themselves' (Pignarre & Stengers 2011: 143). Such doings are a decentred, collective, means of trying out speculative scenarios of imaginary futures, which can 'encourage others to look more closely at their own performances in this or that domain' (Connolly 2013: 185). The event produced by a recipe 'is not reproducible, but it is possible to explore the possibilities of bringing about its repetition, which is risky and different each time' (Pignarre & Stengers 2011: 133). There are no assured outcomes, but they avoid 'the need for each new group to have to "reinvent everything" from scratch' (Pignarre & Stengers 2011: 133). Although such small-steps 'can be criticised as naïve... It remains that in such cases an important transition, associated with the learning (again) of nonconformist expertise, has occurred' (Pignarre & Stengers 2011: 76). Small-steps are important. They are micro-resistances that can be reproduced over and over, creating new material formations which interrupt and shift the experiences of the eater but also outlive them.

In sum, framing eating as consumption is a powerful cultural performance that limits the ways it is possible to think, act, feel and become. Mundane ways of living together (of knowing and relating, of eating and being eaten) co-create realities. To 'do' food politics is to create hesitations in such everyday doings where eating together differently might become possible (cf. Pignarre & Stengers 2011; Connolly 2013). Thinking with the relational subject, shifts conceptualisations of boundaries between

⁸ Examples given by Pignarre and Stengers include Non Violent Direct Action (NVDA), permaculture and witchcraft.

self and other so that eating-well is a responsibility that cannot be codified within a moral schema, rather it becomes a mundane doing of ethics (cf. Braidotti 2006; Puig de la Bellacasa 2010) within ‘mutually embedded nests of shared interests’ (Braidotti 2006: 162). If the subject is relational, people, animals, plants, soil and more, are embedded in multiple more-than human networks, communities, and structures of care, companionship and responsibility, and as such the question of eating-well is a political one (cf. Mol 2002). I have argued that eating-well involves a more-than human mundane doing of politics ‘in, against and beyond’ (Holloway 2010) consumer-consumed relations. The problem remains, however, how to make other ways of knowing, doing and relating “sticky’ in the slippery worlds of consumerist capitalism’ (Goodman 2008: 12). Thus, my final provocation is to propose that such a doing should involve the development of approaches to research which co-create prefigurative micro-resistances to the framing of bodies as autonomous subjects that must consume or be consumed. Experimental methods which produce, rehearse and refine events where other ways of knowing, relating and eating with others (if only momentarily and partially), are possible.

Applying literature matters (eat my words)

Consumer – consumed framings, although alienating and asymmetrical, have, in large parts of the world (for now at least) done away with other forms of alienation where most people for much of the time do not have enough to eat (Pignarre & Stengers 2011). In engaging prefigurative and feminist thought to argue against the autonomous self, I am arguing for experiments that are far from pragmatic - my research is not about attempting to make capitalist relations fairer. Yet, research in food geographies has demonstrated that food production, consumption and distribution are entangled with key issues of our times, from climate change, to population growth, war, migration, and inequality, and valuable work has been done around consuming better. From the outset, this research acknowledges that what consuming-well means is constructed and contested. For example, fats are caught in conflicting narratives, from being central to the ‘good-life’, to narratives of greed, morality, care, and fecklessness. Researching the knowledges and practices of consuming-well makes present the ways in which subjects both negotiate a messy

world and co-produce a sense of continuity from different (often incompatible) and situated knowledges, encounters, and experiences. Nonetheless, I have argued that more 'factual' knowledge to facilitate tinkering within consumer-consumed framings is not sufficient to construct a way out of the democratic and environmental mess in which we find ourselves.

In this thesis I have contested that naming the other as consumable frames the eater and the eaten as different kinds of things. Naming the other as consumable frames the other as a resource that can be reduced to commodity - a thing that may be cared for, but is destined to cease to become (see e.g. Bennett 2007). This framing presents the political problem of how to live together as an administrative one of the micro-management of scarce resources. By the same token, framing the self as consumer makes for a technical, administrative and individual problem of consuming-well (Pignarre & Stengers 2011). Conceptualisations of consumer and consumed, self and other, nature and society, as discrete subjects, are maintained by norms, values and their associated knowledges and practices (Goodman 2008). Events can prompt the possibility of change, but realities are reproduced through mundane doings. What is thought to be true, matters. If ingestion is to be conceptualised as other than the 'end of the road' for food matters then the 'knowledge practices made flesh' with and in the mundane practices of eating must be troubled (Stassart 2003: 460).

In this thesis, I begin to respond to my own provocations by developing experimental methodological approaches to investigate a prefigurative co-creation of eater-eaten material formations in, against, and beyond consumer relationships. The bodies and relationships of consumer and consumed are co-constructed and remade within the structures, tellings, affects, and performances of consumption. It is not enough merely to attempt to do away with consumer relations without first prefiguring other ways of living together. If an event is to take hold, it is important to explore the norms, values and practices in the home and in industry that are so taken for granted that they go unnoticed and unchallenged. Margarine, in its adaptability to multiple ingredients, processes, tastes, textures and nutritional needs is a useful stuff through which to explore such constructions. To this end, by investigating how margarine is known and done, and by juxtaposing the different framings and practices of consuming-well with

the stuff of margarine, this research produces snapshots of the tensions, translations and gaps between situated experiences and structural framings.

In chapter three, I outline how I apply the literatures and provocations delineated here to the doing of this research so as to explore imaginary futures of eating without consuming, and so extend existing geographical approaches to, and knowledges of, eating-well. In chapters four and five I respond to provocation one by applying methods which facilitate the juxtaposition of different framings of margarine matters, and in so doing demonstrate the subject as relational. So as to ask, for example, if the self is relational, what might mean for a fat to be 'healthier'? In chapter six I respond to provocation two by engaging the event of an experimental methodology to create hesitations in which it is possible to explore eating as excessive to consumption. By developing a methodology of 'strange encounters' I create a means to think outside of the box of the inequalities and possibilities of currently existing food systems. Further, I develop play as a method through which to engage 'moments of excess' (The Free Association 2011) within which it is possible to rehearse micro-resistant events as a means with which to begin to 'do' a situated, relational and embodied politics of eating-well. Finally, in chapter seven I build on this empirical work to explore the possibilities offered by bringing practical experiences of prefiguration together with academic conceptualisations of the relational self. In this way I begin to respond to provocation three by developing a politics of the mundane, which through repetition and difference can develop, rehearse and negotiate, more-than human possibilities for convivial eater-eaten encounters, practices and relations.

INTERLUDE TWO:

between cynicism and sentimentality (entering the field)

When I embarked on this research, the refrigerator in my city centre home contained a range of, what to my tastes were delicious, shop-bought fats – unpasteurised salted butter, clarified butter, coconut oil, a nub end of goats' butter and goose fat. One product I did not have was margarine⁹. I found its flavour disappointing, its smell unpleasant. It was not just that I was indifferent to margarine, I detested the stuff. Margarine seemed to be symbolic of a food system that valued nutrients more than it valued nourishment.

Yet I have eaten margarine for most of my life. When I was a small it was Stork or Blue Ribbon. As a child I dug vegetables, gathered fruit, milked goats, watched rabbits being skinned and pheasants plucked - but if I made any kind of differentiation between 'natural' and 'industrial' foods it was to opine that processed foods were 'better', more exciting. I did not stop to think about what food was or where it came from. Then, in my mid-teens I experienced strong negative visceral reactions to the overwhelming smell of death of the carcasses I encountered both at home and at work (a supermarket with a large butchery section), and I became vegetarian, and then vegan.

I began to pay close attention to what and who went into the foods that I ate. Stork and Blue Ribbon with their fish oils, milk fats, and animal based E-numbers were out. I needed more niche products, products that could not be found in the supermarket (although neither could I make them at home), hence I entered a subcultural world of 'ethical' consumption, and it felt good. In the long-term the lack of omega-3 may not have done my health many favours, neither will all the trans fats that were in vegetable based fats at the time. Nonetheless, this naïve foray into consciously attempting to trouble power relationships, and find other ways of living together, changed my outlook on life, I began to learn to notice and to question social norms.

⁹ For a product to be labelled as margarine in the UK it must have 'a fat content of not less than 80%' (FSA2010). However, here I am using the word to include 'spreadable fats' as is common in colloquial British English.

My veganism lasted for several years, but after spending time living with Southern Europeans my attitudes towards the stuff of food shifted again. In financial terms we were a poor household, our individual average weekly incomes were less than that offered by the benefits systems, and yet we collectively ate well and with abundance every day. Here, I learned a visceral understanding of food as convivial, as nourishment, and in listening to my body I slowly reconciled myself to the eating of animals. Like Pollan (2007 (2006)) I became suspicious as to how 'industrial' commodities might be 'better' to eat than foodstuffs that humanity has been eating for millennia. Better for who? Yet as a geographer I understood the intellectual critique of the natural-technological binary¹⁰.

Tastes are affected by the ways in which the world is understood, represented and framed (Mol 2008). In order to make space for the possibility of knowing margarine as food I needed to learn more about what this stuff we call margarine is, how it comes to be, and how we come to be consumers of it. The initial point of encounter between eaters and margarine is typically the supermarket shelf, so I went to Waitrose to see what claims were emblazoned across margarine packaging¹¹.

There were nearly sixty products in the margarine and 'spreads' section, although the majority of these can be grouped into 'families' (e.g. flora original, flora buttery, flora light, flora extra light, flora pro-activ olive, flora pro-activ buttery, flora pro-activ light), made by a couple of transnationals. There were also smaller sections of organic, gm free, and dairy free / lactose reduced products. None of the products made claims to be fairtrade, or local. Within each 'family' there were two predominant strands of assertions - products that claimed to be 'healthier,' 'lighter,' or to lower cholesterol; and products that are 'tastier' or 'buttery.' Sometimes claims from both categories were made on a single product, sometimes not. Margarine was simultaneously being promoted as not only 'all the goodness of plant oils', but also lively ingredients that will for example 'actively lower cholesterol', protect your heart and, in some countries, to

¹⁰ See for example, Latour (1993 (1991)).

¹¹ I also went to a health-food store, here I found Biona margarine, the current 'Ethical Consumer' best buy (Ethical Consumer: 2009). Although it is an expensive product, Biona do not make any 'health' or taste claims, the price mark-up appears to be framed in the ethics of traceability: *Ingredients: Sunflower oil*, palm fat*, coconut oil*, water, carrot juice*, emulsifier: soya lecithin, lemon juice**. *= Certified organic ingredients *The Organic Palm fat in our margarines comes from a certified sustainable project in Columbia*'. Curiously, although the packaging twice mentions that the palm oil is traced to sustainable sources, I am left none the wiser as to the origins of the other tropical plant oils - coconut, sunflower and soya.

boost brainpower. Such simultaneous claims to being both 'natural' and 'novel' reveals the cynicism and sentimentality of a binary division between the two.

There appeared to be a direct relationship between the number and specificity of the claims made and the price of the products. Brands that 'lower cholesterol' cost more than 'healthier; 'buttery' was more expensive than 'tastier'. One of the cheaper products was Waitrose's own brand sunflower margarine, no claims are made of this product other than that it is a 'sunflower spread.' Printed on the bottom of the product, however, was a full list of ingredients: Water, sunflower oil (35%), palm oil, linseed oil, salt (1.3%), buttermilk powder, emulsifier mono- and diglycerides of fatty acids, flavouring, Vitamin E, Vitamin B6, Vitamin B12, folic acid, Vitamin A, colour carotenes, Vitamin D). Such a list was unusual, for most products the list simply said vegetable oils (at best giving a percentage for sunflower/soya/olive if it is advertised as containing one of them)¹².

Although rarely mentioned on margarine packaging, palm oil has become ubiquitous within 'yellow spreads' over the last twenty-years. Palm oil is a tropical lipid that is solid at (temperate) room temperatures, so using it in 'spreads' gives a product with 'butter like' consistency without the need for trans-fat producing hydrogenation. That might be a great selling point if not for concerns about palm oil being linked to massive deforestation, loss of biodiversity, displacing indigenous people, climate change, land grabbing and the destruction of rural communities. What we eat has consequences for disparate others, but margarine labelling reveals some connections and hide others.

¹² Since I began this research there has been a change in EU legislation requiring oils to be specified on product labels.

CHAPTER THREE

methodology (researching eating-well with margarine)

Introduction

This project places the matter of margarine at the centre of things and the fieldwork is comprised of three key areas of empirical research: consumer knowledges and practices, industry knowledges and practices and experimental strange encounters with material others. These areas of course overlap. Employees of the margarine industry are also consumers of yellow fats; and consumers who may not work directly in the margarine industry will have scientific, advertising, catering, growing, policy or other experiences that make them 'more than' consumers. This chapter will guide the reader through the doing of this research project, detailing the ways in which the theoretical focus, the research aims, and the methods employed, shifted, and were refined as I, the researcher, changed and developed in relationship with the research.

Fat is not just consumed, it is eaten, and eating is transgressive. The eaten other becomes enmeshed with the corporeal self of the eater. To understand how fat is known and practiced, it is necessary to taste, sniff, lick, chew and swallow. Yet although visceral encounters influence tastes, so do knowledges, beliefs and framings. For example, margarine has become discursively associated with things as diverse as heart health and the destruction of palm forests. Fatty knowledges and practices are co-constructed in the interplay of multiple material, sensory and symbolic factors (cf. Wenger 1999; Dwyer and Limb 2001; Garsten and Nyqvist 2013). In the processes of eating, discourses, industrial practices, bodies, prejudices, beliefs, fears, and desires mingle and are re-made. As such my methodology needs to take into account that we know and relate with fatty others, not only through the senses, but through the flesh, through the intellect, through social relations and through cultural norms.

To explore how eating well is understood, enacted and hoped for by different actors I need an approach that will facilitate exploration of 'the enactment of and the interactions between different realities' (Law 2004: 122). In other words, this research needs to begin to map how margarine is known and practiced, why it is

known and practiced in the ways that it is, and what such knowledges and practices do. To this end, I build on the multi-site ethnographies described by Marcus, which, through following paths of circulation allow 'the sense of system to emerge' (1995: 107). By engaging ethnographic methods to follow connections (or their lack) with and in the circulations of the matter of margarine, I hope to begin to reveal how margarine framings are produced, maintained, negotiated and resisted.

For the practical purposes of this thesis, ethnography is understood as a framing for a range of methods including participant-observation, planned discussion groups and interviewing that seek 'to understand parts of the world more or less as they are experienced and understood in the everyday lives of the people who 'live them out' (Crang & Cook 2007: 1). However, '*people*', in the case of this research includes non-human actants, the stuff of margarine and those who intertwine with it. This ethnography will explore the different ways in which margarine is framed and practiced by people and by organisations.

By juxtaposing framings I map tensions and translations between framings of the stuff of margarine to investigate 'how a multitude of organisms' livelihoods shape and are shaped by political, economic, and cultural forces' (Kirksey & Helmreich 2010: 545) that enfold margarine. In this way and in the midst of this mess, I investigate how framings simultaneously conjoin and separate; I explore the boundary as something that cleaves. Influenced by the work of Pignarre and Stengers (2011) on the micro-resistance of 'the event' and Ahmed's (2000) descriptions of 'strange encounters', I play with such boundaries so as to explore other possible ways of living together.

Employing such an empirical approach to this project will make space for the stuff of margarine to be emergent and surprising. It does, however, also create a very broad research field. The first part of this chapter, 'establishing the field', will explain how I established the field for this research, before exploring the ethical implications and responsibilities of doing research within this field. Whilst the second section, 'accessing the doing of margarine', elucidates the nitty gritty, the compromises, the serendipity and the learning processes of the doing of the research with and in this field.

Establishing the Field

Research is situated both materially and socially within a defined 'field'. In recent years, however, conceptualisations of the research 'field' have shifted. The field is now commonly understood to be an active subject rather than either a passive backdrop for the lives of others, or an object to be mined for data (Coleman & Collins 2006b). In this understanding, the field is co-constructed with and in relations, communications and encounters established between researcher and participants (Coleman & Collins 2006b). The field is also dynamic, co-created 'anew each time the ethnographer, with or without informants being physically present, invokes the field' (Coleman & Collins, 2006b: 12) whether this is through the performances of encountering, observing, participating, intervening, recording, analysing or writing.

In delineating the field for this research I began with my own reflections and remembrances of my encounters with the stuff of margarine. The methods I used and the sites I chose emerged from my questioning of the knowledges and practices that pertain to my consumption (and non-consumption) of margarine. I reflected on how my fatty eating practices had shifted - from being a passive margarine eater as a child, to an active one as a teenage vegan, to my gradual shift towards butter. I considered the situations in which I did still eat margarine, before noting down what I knew (or thought I knew) about the stuff of margarine. In looking at my notes I became aware that it was not just my eating habits, but margarine itself that had changed since my childhood. I remembered a product that used to come in waxed paper or a circular tub, not in a rectangular one. I recalled my surprise when I discovered that the margarine I was eating contained fish oils and I recollected the emergence of evidence about the health risk of trans fats. I realised that as my knowledges of, and my beliefs about margarine have shifted, so has the way I perceive its tastes, textures and smells. As I wrote down more and more memories, beliefs and knowledges about the stuff of margarine the page became full of scrawlings, with arrows and circles connecting and dividing them. My field was starting to emerge.

As I cogitated on my own messy, shifting, and contradictory knowledges about, and practices with, margarine, I realised quite how situated they were. I also discovered that I knew very little about the stuff of margarine itself - where the constituent parts come from, how they come together, or what other bodies they may be entangled

with. I knew even less about the interactions between the stuff of margarine and the body of the eater. I was aware that most nutritionists recommend that the British population eat a diet lower in fat, with a higher proportion of that fat from polyunsaturated sources than is generally the case because this reduces 'furring' of the arteries, but I did not know why. I had never thought about how fat might get from my stomach to my bloodstream. Indeed, when I began to think about it I was no longer even sure where eating happened, or who exactly was doing the eating.

My next step was a trip to a supermarket in order to explore how margarine is displayed, and what knowledges imparted, or relations suggested to consumers at the point of purchase (see interlude two). I then undertook secondary research into the histories of the development of margarine, its promotion to consumers, its representation within national and international policy, and its depiction in the media. Through following margarine through these sources I began to sketch-out some of the frameworks within which the stuff of margarine is situated, including: health, sustainability, technology, animal welfare and familial care.

To understand how margarine is known and done I needed to follow the stuff of margarine with, through, and in multiple sites. Marcus describes the field in multi-site research as being held together through 'an explicit logic of association' (1995: 105), and identifies seven 'modes of technique' through which such a field may be established and delineated: follow the people, follow the thing, follow the metaphor, follow the plot, story or allegory, follow the life or biography, follow the conflict, and the strategically situated (single-site) ethnography (1995: 106). My first research aim is to explore how eaters make sense of conflicting knowledges about margarine in order to construct narratives that enable them to make food decisions, and so bears some similarities to 'follow the plot, story or allegory'. Nevertheless, none of these seven 'modes of the technique' seemed to quite work for my research. As such, I employ an eighth 'mode of technique' which I identify as 'follow the refrain'. This approach takes elements from 'follow the thing' and 'follow the plot', but in overtly acknowledging the co-construction of knowledges and materialities it enables me to research how eater knowledges, the stuff of margarine, and the self that eats, can all shift and multiply (like a jazz refrain) whilst remaining recognisably themselves.

In following the refrain, I do not need to have the stuff of margarine in my hand at all times. Following the refrain takes me to places where the stuff of margarine is and where it used to be, but it also takes me to places where it is believed to be, or thought not to be. Following the refrain allows me to follow materialities, knowledges and practices that pertain to margarine in and out of health, technological, environmental and other framings. Such a multi-site approach produces a very broad field with a multitude of possible entry points for research. This carries the risk that the 'ethnographic gaze may sometimes disturbingly turn into a glance, and a partial and unfocused one at that' (Coleman & Collins 2006a: 8). Nevertheless, although it is imperative that I be mindful of this risk, I am not trying to find out everything there is to know about margarine. Following the refrain allows me to juxtapose multiple situated snapshots so as to do research that responds to specific research questions about knowledges, practices and relations of, and with, the stuff of margarine. Before I could move into the field, however, I needed to think about who the participants might be, and how I might engage with them ethically.

Doing Ethical Research

Ethical approval for this research was obtained prior to entering the field according to the procedures of the Geography department of Exeter (University of Exeter Ethics Committee Ref. 2014 / 394). In undertaking the research, I took care to adhere to the University of Exeter's 'Code of Good Practice in the Conduct of Research'. Whether negotiating access to the knowledges and practices of consumers, industry professionals, or their organisations, I made my research questions, themes, and goals explicit both to gatekeepers and to interviewees (see appendix one), and took care to obtain their explicit consent to be part of this research (see appendix two). As the research proceeded I took care to protect data and maintain the anonymity of participants and their organisations. Nonetheless, although such institutional checks and procedures are extremely important, 'doing' ethical research cannot be reduced to such guidelines (Dyer & Demeritt 2008). Ethical research must be achieved with and in multiple relations, events and practices that emerge each time the field is encountered or revisited (England 1994; Cloke et al. 2000). This includes the ethical dilemma of representation. Encounters are represented in field-notes and

transcriptions, which are then coded and recoded. Complex lived realities appear as written narratives that respond to research themes.

As when establishing the field, doing ethical research is dynamic. For example, data may be produced when participants are more relaxed - eating lunch or travelling between sites – which is very different to that generated in more formal research situations. As the researcher becomes immersed in the lives of their participants, she occupies multiple positionalities both within, and external to, the research, as such insider - outsider boundaries become blurred (Latham 2003; Law & Urry, 2004, Hopkins 2007; Han 2010). Relationships shift. Further, participants may have knowledges or experiences that make them recognizable to others in the field, making maintaining anonymity more complex than a simple not naming. Research aims are not static, new questions, sites, and priorities emerge as the research progresses and data is generated. The research that is done may be quite different to that which the participants originally consent to. Ethics cannot be condensed to strictures about how research participants will be approached, engaged with, responded to, and represented - their very involvement changes things.

This project has the added dynamic of explicitly researching not only with people, but with their organisations, and with the stuff of margarine and its multiple connected others. The non-human participants with and in this research project were not extended the privilege of being named on an ethics application, or of signing a consent form to agree to my representing them, their doings, and their relationships. Yet, as is the case with all participants in my research, I, the researcher, have an ethical duty not to exploit, harm or knowingly misrepresent them. Practicing reflexivity is important here; critical reflection can work towards making me, the researcher, more aware of the interconnected relations and power-dynamics entangled with the research. For example, field diaries and discussing the work with other researchers can facilitate the making present of problematic issues hidden in plain sight.

For the beliefs, practices, knowledges and relationships of others to appear in this thesis at all, then I must first notice them. No matter, what methods I employ, ultimately this research is bounded and interpreted through my embodied experiences, knowledges, relationships and cultural norms (cf. Cloke et al. 2000;

(Braidotti 2013b; Connolly 2013), and the trouble with norms is that they are norms. Even whilst making some normative frameworks present so as to question them, others may remain hidden and be contributing to exploitation.

Connolly has demonstrated that one way to raise awareness of normative knowledges and practices and hence create space for change 'is to extend and broaden our identities, interests, and ethos of interconnectedness as we multiply the sites of political action' (Connolly 2013: 193-194). In my description of what I did within the field, why, and what happened, I attempt to reflect on my shifting positionalities, the negotiations, doubts, mistakes, politics, preconceptions and misunderstandings that arose in the field, and how these may have impacted on the way the research got done, analysed and interpreted. Research is generative.

As researchers (and as people within communities) we can recreate more of the same, or we can make interventions that create the possibility of shifting the framings within which we relate to others. To this end, doing ethical research must engage practices that work to make present more of the connections between 'self' and 'others' (cf. Braidotti 2013b: 227). Ethical research is a 'performative accomplishment' (Cloeke et al. 2000). It is a doing not a rule following (Ahmed 2000; Braidotti 2008).

Researching ethically with people and organisations

The people who participated in this research can be divided into two broad groups. Those that took part in planned discussion groups to explore their knowledges and practices of and with margarine as consumers and as eaters. And those who agreed to be interviewed because of their role within an organisation that had some connection with the oils and fats industry, although they too, are of course people who eat.

Prior to their taking part in the research, my participants were informed about the research and its aims, and their consent gained (see appendices one and two). They were also advised that:

1. With their permission the interview would be recorded on a Dictaphone.
2. All information will be held securely.

3. No information in this thesis or any subsequent papers will be linked, in any way, to any individual participant or the organisation that they work for.
4. Any data that could potentially be used to identify the participant or their organisation will not be reported without the explicit permission of the participants and all names will be replaced with pseudonyms.
5. The interviewee is free to decline to answer particular questions, and to request that answers to specific questions are not recorded.
6. The participant may stop the interview at any point, and has the right to withdraw from the research at any point up to publication.

In the industry part of the research, there were at times tensions between my research subjects' perceptions of themselves as eating subjects, and their role as a representative of an organisation. Some participants, although happy for our discussions to inform my research, asked that not all elements of our interactions be directly referred to within it. As such, in addition to the safeguards outlined above, interviewees who were taking part in a professional capacity requested, and were given the opportunity to view, and comment on transcripts prior to publication – an opportunity that I also extended to participants in the planned discussion groups.

Nonetheless, further ethical issues arose in the doing of the research. Some of these will be discussed in the empirical chapters, but the two it is important to mention here pertain to anonymity and consent. To turn first to anonymity, although keeping data secure and creating pseudonyms for participants is standard practice in research, this is not always sufficient to guarantee anonymity. For example, pseudonyms would not maintain confidentiality for research participants who had been given the job of taking part in my research by a superior in their organisation. Further, I quickly discovered that 'oils and fats' is a community that is well connected beyond as well as within individual corporations and institutions. People know each other and each other's companies. Within the industry, some people, projects and companies are easily identifiable because of what they do. My participants go to the same conferences and training days, had previously studied or worked together, and supplied each other's companies with goods and services. As such, to remain anonymous, my participants

could not be in any way identifiable by name, organisation, what they produce, or in some cases country of origin.

The ethical issue that emerged around consent is that my research participants were giving their permission to participate in my research project as I understood and articulated it, at the moment they consented to it. The project however has not remained static. Through engaging in and reflecting on the research processes, my knowledges and positionality have shifted, as has the emphasis of the research questions. When I first wrote the information sheet that accompanied the consent form (see appendix two), the aims of this research were as follows:

- i. To explore cultural understandings of the edible:**
Originally developed as a butter substitute, the differentiation of margarine into spreads, baking fats and cooking fats, has propelled margarine into regions far beyond the butter eating areas of the world. I will examine whether the flexibility in possible tastes and textures of margarine makes margarine a valuable exemplar for foods that aid consumers in eating well, whilst avoiding the stress of major changes in food habits.
- ii. To investigate the interactions of human bodies and margarine:**
When we eat, previously unconnected bodies become enmeshed, and both are forever changed. I will investigate margarine's value as a functional food by conceptualising margarine as an actor that after ingestion works on and with the eater's body.
- iii. To investigate the interactions of non-human bodies and margarine:**
This section will examine whether margarine's adaptability to multiple raw ingredients, and particularly to diverse plant oils, serves as a valuable model for eating well not only for individual pleasure and health, but also for global sustainability and food security.

However, through the processes of doing research, the research aims and questions have subtly shifted to be framed like this:

- Aim i. **To contribute to theoretical and empirical understandings of consumer knowledges, beliefs and practices of and with the matter of fats.**
- Question 1. How do consumers negotiate different framings of margarine?
- Question 2. Who and what are valued by margarine consumers?

Question 3. In what ways do consumer practices with margarine relate to their knowledges and beliefs about margarine?

Aim ii. **To add to geographical understandings of the knowledges and practices of fat production.**

Question 4. How does matter get organised into margarine?

Question 5. Who and what are valued in the production of margarine?

Question 6. How are margarine values constructed and communicated?

Aim iii. **To explore other ways of knowing and relating with matters of fat.**

Question 7. Does the experimental intervention of 'strange encounters' disrupt normative framings of and with margarine?

Question 8. Does the event of 'playing with our food' impact on the ways in which margarine is valued?

Question 9. To what extent is the methodological practice of 'playing with our food' a careful micro-resistance to normative practices and values of consumption?

As the project progressed, the emphasis of my research shifted from focussing on the interactions between the bodies of eaters and the stuff of margarine, to an investigation into the relationships co-created in encounters between the matter of margarine, the framings of margarine, consumer values, and eating bodies. Such a shift in the aims of the research raises the problem of how it is possible for participants to give informed consent to a research project when their very participation will in some way change the knowledges of the researcher, and hence change the nature of the research (cf. Crang & Cook 2007). In this respect, the relative vulnerability of participants matters.

Participants in my research include corporations, research institutes, employees, consumers and the matter of margarine. The asymmetrical power relations between these groups is something that cannot be ignored in the ways in which the research is conducted, analysed and disseminated. This is nonetheless a problem for all research, as such a balance must be found between the protection of individual participants, and the kinds of relationships that are made more or less possible through the doing of the research (Bennett 2010). Ethical research must not only have the 'moral prompts' of procedures designed to protect individuals from harm, but have an underlying 'moral imagining' of better possible futures for all, particularly the most vulnerable,

participants (cf. Cloke et al. 2000). It was this that I kept in mind as the research progressed and my research questions shifted.

Researching ethically with non-human others

The shifting nature of what my participants were agreeing to was not the only ethical concern around gaining consent. Although informed consent may be a principle to aspire to in research, it is not always possible or even desirable. Much has been written about, for example, the ethics of covert work, or researching crowds (e.g. Parr, 2001). It was these approaches, in combination with Ahmed's (2000) discussions of the power-relationships of post-colonial research, which I drew on when thinking through how to research ethically with non-human others who cannot give their consent.

For Parr, it is ethically justifiable not to gain informed consent if achieving an awareness of the dynamics of discriminatory or harmful processes and relations is 'to be better placed to offer solutions or ways to end such practices' (Parr 2001: 165). It is not possible to get inside the 'particularity of an other' to experience the world as they experience it (Ahmed 2000). However, covert ethnography is a means to an understanding of the 'making of the body' (Parr 2001: 166) through the 'modes of encounter' (Ahmed 2000: 144) of everyday social life. Although both Ahmed and Parr are writing about the ethics of research with people, their argument that ethical research calls for reflexive examination both of the conditions and the relationships that make such encounters possible and the kinds of relationships, spaces and futures that such encounters facilitate is a valid one. Non-human others are vulnerable both to the whims of individual humans, and to the systemic harm of anthropocentric norms and structures which treat them as resource to be exploited.

In adapting covert approaches to research with the non-human, I am not seeking equality for the non-human within an anthropocentric framework. Rather I hope to momentarily lift the veil of habitual relations so as to greet the other as other (cf. Doel 1994). This is also what the anthropologist Augé writes of in his plea not only for a 'sense of the other...but also a *sense for the other* – an appreciation of otherness which is emotional, connected and committed' (1998: v). Encountering the non-human in

this way does not involve indifference to the human condition. Rather, it encompasses an ethics that situates the human within a sense of community that includes non-human others (Braidotti 2013b: 190). In the context of this research, such encounters disturb normative framings so as to be surprised and to surprise and work to reveal normative relations between eating and eaten bodies as constructed. In acknowledging that methodology makes 'some realities realer, others less so' (Law 2004: 67), I hope to make space for relations which are more than the encounter which names them, and to open discussion about the kinds of worlds such relations are co-creating (cf. Bennett 2007: 104).

Entering the Field

As discussed in the introduction to this chapter, I began this research armed with some awareness of my own prejudices but very little actual knowledge about the processes of the production of margarine. I realised that the first task was to challenge those prejudices by gathering information about the matter of margarine from diverse knowledge frameworks and sources. To this end I turned to the internet, to the library and to social media.

I read books on the chemistry of margarine and the history of its development. I learned that companies produce different margarines for different climates, and discovered that it is possible to make margarine at home. I looked at advertising messages stretching back to the early twentieth century, and researched the shifting patterns of margarine policy and margarine consumption. On social media I followed campaign groups that professed strong opinions about the pros and cons of margarine whether that is because they were anti-palm, pro-'natural' foods, or pro-plant based foods. I researched European policy on labelling and international agreements on the transport of margarine and its constituent ingredients. I perused papers from nutritionists about heart health, cholesterol and omega-3s, and I read the newspaper articles that responded to the findings of these papers. Yet three months of reading everything I could find about margarine left me more confused than when I had started.

Around this time, however, press coverage began to appear which proclaimed that margarine is 'bad' for the health of eaters and that suggested a return to butter (e.g. Blythmann 2013; Bosely 2013). Margarine had suddenly become a thing of public concern, and it seemed that everyone I mentioned my research to had an opinion on the matter. Complete strangers told me with seeming confidence that margarine is 'the same as plastic', that margarine is better for the environment, that 'scientists' say that butter is healthy, that margarine is grey until it is dyed yellow, that margarine was originally invented as turkey food but it could not be used because it killed the turkeys, that margarine never goes off and even insects will not touch it.

Engaging with, and beginning to code these texts helped me to appreciate some of the ways in which everyday life is in dialogue with texts (cf. Shurmer-Smith 2001).

Through this preliminary textual analysis, I gained an understanding of the margarine multiple. I realised that to research eating well with margarine it is not necessary (or even desirable) to follow or encounter all those that are entangled with the stuff of margarine. Rather it is important to understand how margarine is known and done, why it is known and done in particular ways, and what effects (and affects) this has. As such, representing, knowing and doing are key themes within which I can begin to seek snapshots of the tensions and translations between different frameworks and the matter of fats.

Exploring margarine production

To begin to understand some of the knowledges and practices that lay behind the texts I was encountering, I needed a way in to the margarine industry. This, however, is not straightforward, I required access to a gatekeeper. When I saw an advertisement for a three day 'oils and fats – production, properties and uses' course, run by a leading food research organisation that boasts of members from across the global food and drink industry, it seemed ideal. The course offered a session specifically covering the science, ingredients and processing of butter, margarine and spreads. Other sessions promised training on the physical and chemical properties, geographical origins, transportation, processing, modification, applications, and troubleshooting of different oils and fats, a legislative overview of the industry, analysis of market trends in the field, and advice around nutrition and health indications. Not everything was desk

based though, there were also oil tastings and the opportunity to get a feel for the relationship between physical and chemical properties of fats through having a go at chocolate tempering. Further, the course was being taught by people based in organisations from across the European oils and fats industry. The main disadvantage was, like many events organised for industry professionals, the advertised attendance cost was substantial – equivalent to almost my entire research grant. Undeterred I got in touch with the organisers, explained my project and negotiated a reduced fee.

All attendees were asked to provide information about themselves that would be shared with both tutors and students. In my delegate profile I introduced myself as a researcher and explained a little about my project. And then the morning of my first face-to-face meeting with food industry people arrived. My field diary entry for that day begins:

I walked from the train station to the start of the 'Oils and Fats: production, properties and uses' training course with a degree of trepidation. I'd submitted my delegate profile, made business cards, hopefully produced user friendly information sheets about my research, I'd looked up the speakers online and I'd dressed for what I assumed was the part I was playing in something resembling business attire. Such preparation is of course standard, but I still felt that both my role as a researcher and my background working with community food projects meant that I was from a different world, and was almost expecting red flashing alarms to go off as I walked in the door.

Prior to undertaking the course, I had envisaged that it would work to increase my knowledges, and that this in turn would give me the confidence to approach industry professionals. I also hoped that spending three days with people with connections to the oils and fats industry might provide some leads as to which organisations and which individuals within them it might be productive to engage with. In fact, the days I spent on the course, offered very much more than that. The next entry in my field diary reads:

Unsurprisingly, as it turned out, I was welcomed by the receptionist, and whilst I signed in she picked out my name badge and information pack, before directing me to the all-important pre-conference coffee. A small group who appeared to already know each other gathered around one table where a couple of older men held sway. At nearby tables, other delegates were seated, each with a polite empty chair between themselves and another person. Some

were checking their phones, others flicking through the course information pack. I got talking to another delegate over the biscuit selection, and as we chatted about where we'd travelled from, and what we did for a living, somehow the ice was broken and others joined in. Quickly it became clear that we may all work in very different areas but were all united by being excited about the stuff of food and its tastes, textures, and possibilities.

The majority of people I met left me with the impression that it was their genuine interest and visceral joy in food that drew them into the industry. This shared passion about the stuff of food has proven instrumental across all stages of this research in facilitating the opening of doors, and the building of relationships. Also invaluable were my experiences within the catering industry which on some level enabled me to be encountered as a 'colleague' with real world experience, and hence an implicit understanding of the predictable unpredictability of the stuff of food that comes with this familiarity. Together these factors eased me in to a position of partial insider, partial outsider. A positionality I shared with many of my participants as they move across departments or network at conferences.

Attending the 'oils and fats' course furnished me with basic knowledges about oils and fats, about margarine, and about the industry, that helped me to refine the structure of future interviews. Equally valuable, however, was that participating in the social aspects of the course helped me to understand the connections between people in different parts of the industry. Oils and fats is a transnational business, and if they wish to, people can move relatively easily between countries and between companies and research institutes. Delegates from diverse parts of the industry go on the same courses and to the same conferences and trade shows. The companies also trade amongst themselves whether that is for emulsifiers, speciality oils, or fats modified to have particular properties, so employees, at least on a macro-level, know what each other do and have inter-personal working relationships and sometimes friendships. It was not all sweetness and light though. At lunch on the second day of the course it was suggested to me by Simone, another course delegate, that John, one of the course tutors, had been less than entirely truthful about the fat and oil modification processes employed by the company he worked for. This interaction reminded me to be more critical of what I was being told and to not be deceived by the apparently cosy atmosphere I found myself in. Attending this course, whilst originally conceptualised

by me as a way of making contacts, became a part of the research field. Such liminal spaces play an important role in flows of knowledge, they are a node where diverse experiences and frameworks of understanding come together.

Nonetheless, relationships established on this course opened doors to further fieldwork. Simone, and Max, one of the course tutors, agreed to be interviewees and to arrange for me to come and visit their workplaces; an oil mill, and a margarine factory. This however involved an overseas European trip which is not something I had initially planned for as part of my fieldwork. As such I had to submit a risk assessment, apply for extra funding and arrange travel insurance all through the university systems. These processes, as well as the difficulty of arranging a time when all three of us could fit the visits into our schedules, meant that this part of the fieldwork took five months to come to fruition.

Attending this course at the early stages of my research emphasized for me what (Emerson et al. 1995) describe as a *resocialization* of the researcher. By putting myself in a situation where I am the only non-industry professional present it is my knowledges, experiences and sense of self that are being challenged. As discussed in Chapter One, as someone with a background in AFN's I had developed prejudices about the mainstream food industry that were tied to notions of 'the natural'. Again from my field diary:

I expected the food provided to be 'weird' - experimental, packaged, processed – in fact it was the best catering I had experienced in any institution or event in a very long time. It was definitely not university standard beige.

The quality and range of food I ate not only on this course but in all of the food industry and food research institutions I visited, as well as the enthusiasm for 'good-food' from all those that I met, served to counter my prejudices about people within the food industry caring only about profit.

In this disconnect between my expectations about the industry and those who work in it, and my research experiences. I became aware of my ability to hold and perform multiple, not necessarily compatible beliefs simultaneously which disturbed the narrative I held of my sense of myself as rational. I realised that my knowledges are not solid, but that I habitually construct meaning across and within uncertainty. Even

though I went in to the field wanting to trouble my beliefs as to what it might mean to eat well, I found such challenges to deeply held assumptions about myself as someone who knows about the stuff of food to be discombobulating. The research seemed to expand exponentially as these experiences generated more and more questions. I no longer knew what to think, or what was important as regards research data. As such, although at this early stage of the fieldwork I had much to learn about industry knowledges and practices of and with margarine, ethnographic reflection on my experiences of the doing of the research was already proving to be a useful approach to exploring the slippery construction of my own knowledges and values.

The morning of the second day of the course opened with a spontaneous interaction between Denis, the course leader, and Jim, the lead tutor. Both men are in their mid-fifties. Denis is tall, thin and balding, Jim chubby, with a mass of hair and an air of 'professional

Butter is good for you, says heart doctor

Chris Smyth Health Correspondent
Published at 12:01AM, October 23 2013

Butter should replace low-cholesterol spreads in our sandwiches, one of the country's leading cardiologists warns today. Aseem Malhotra claims that dairy products and fat from "real food" may actually protect the heart.

Sugar and refined carbohydrates, such as white bread, are the real driver of obesity and heart disease, he argues in the *British Medical Journal*.

"If you have a choice between butter and margarine, have the butter every time," Dr Malhotra, of Croydon University Hospital, says.

A Mediterranean diet of olive oil, fish, meat, fruit and vegetables is the best way to protect your heart he argues. taking a

Figure 1: Article from 'The Times' Newspaper. 'Butter is Good for You'.

Yorkshireness'. Once all us students were assembled in the teaching room they stood at the head of the room and treated us to several minutes of gleeful pronouncements about the deliciousness of butter, and of the rightness of chips cooked in dripping. Their elation was a response to that day's newspaper headlines regarding Aseem Malhotra's (2013) paper entitled 'Saturated Fat is not the Major Issue' (see figure 1). The joyful behaviour of both men suggested that they felt vindicated in their fatty preferences. This performance made me aware that even specialists within the field hold their own prejudices about what is good to eat. Creating their personal realities by picking and choosing the evidence that they are inclined to accept as true.

In this way, even when playing a peripheral role in proceedings, I was in the middle of the things. As DeLyser has demonstrated, the body of the researcher is not merely a research instrument recording that which is projected onto it, it is a research site that

intermingles with, and projects onto, the research field (DeLyser 2001). My position within the group, the parameters of my knowledges, senses and competences, and my interests and prejudices, limited what it was possible for me to perceive, and what did and did not get recorded was entirely in my hands.

Following the oils and fats course, I went on to participate in an industry conference that looked at sustainability across the production-retail cycles of a particular plant-based fat, a public-meeting about the development of a genetically modified fat, a symposium that brought together academics, policy makers, industry professionals and activists to think around the problem of food sustainability, as well as a number of sessions in which academics and food activists came together to talk about such topics as valuing eating, eating better and food justice. Attending conferences and meetings as part of my fieldwork process, presented new challenges for me with regards to recording what I was experiencing and witnessing.

Recording my experiences whilst at conferences was complicated by the multiple things I was trying to be aware of at the same time. I found myself, mapping words, sounds, smells, and bodies interacting in place whilst simultaneously participating, observing, learning, reflecting. I was personally trying to learn from, and understand, the (sometimes very technical and acronym ridden) information that was being shared, whilst also recording how delegates were interacting with it, and with each other. I also worried about my diaries being read by others and so was careful both in how I identified people and what I wrote about them.

In this way, I realised that my field diaries could not be a dispassionate representation of what was happening around me, but were centred on me as the researcher and my experiences, feelings, doubts, beliefs and reactions. Nonetheless, I did endeavour to take time out to reflect on what Spradley calls 'grand tour observations' (1980: 78) so as to present an overview of the social situation to which I could return as part of my analysis. On the inside cover of my field diary I had pasted instructions of myself to note down my reflections on:

1. Space: the physical place or places.
2. Actors: the people involved.
3. Activities: sets of related acts people do.
4. Objects: the physical things that are present.

5. Acts: single actions that people do.
6. Events: sets of related activities that people are trying to accomplish.
7. Time: the sequencing that takes place over time.
8. Goals: the things that people are trying to accomplish.
9. Feelings: the emotions felt and expressed.

Although broad, these grand tour questions prompted me to note the details that at the time seemed so obvious as to not be worth recording, and would otherwise get lost, and forgotten in the mass of data generated. Yet, it was such self-evident obviousness that warranted further reflection as to the co-production of norms and values. From my field diary record of the public meeting I attended:

1. Lecture theatre that feels like an actual theatre (not the seating though). No-one checks my ticket as I walk in. Outside the theatre is a table with some info about the institute, although no-one appears to be manning it. There is a bouncer on the door (the only black guy in the room) and two police officers to the right inside the door at the back of the room. They are very fluorescent. Most of the people present appear to be late middle age or older. I said hello to Steven and went to sit at the back corner furthest from the door giving me a view of the whole of the room other than the row of people sitting against the back wall (these seats were pretty much all already taken - possibly by staff from the institute as they are a slightly different demographic to the main body of the room). There were evaluation forms sitting on each of the seats as we came in. Most of the audience is late middle aged to elderly - 2/3? And well to do - clothes, accent, bearing. The rest are mostly very young - possibly students at the institute?
2. The room is almost full. There is a central block of approximately 88 seats, and two side blocks of approx. 32 each, and about 15 people sitting against the back wall. There are also some people in the upstairs gallery. Can't see how many, just the top of a few heads. Not sure if these are members of the public as didn't see any directions to take us up there. (Just seen two of them stand up and they appear quite elderly)...

Although such accounts will always be partial, they facilitate rich descriptions of an unfamiliar space, create maps of knowledges and practices in different situations, and aid embodied recall of the event. Responding to these questions helped to guide me away from my inclination towards prioritising verbal information, and made me pay attention to the interplay of other aspects of social life. This enabled a paying attention to the connection between different elements. For example, to ask which

actors are included or excluded from which events? Or to explore the relationship between feelings and goals (Spradley 1980: 82-83). These broad commentaries also enabled me to add depth to the data recorded in transcripts, invaluable in providing insights into the co-production of knowledge within a group, and helped guide future research questions.

Attending to these questions helped me to become aware of the situatedness of my observing, participating and recording. I participated in my observations and observed my participations. With this in mind I supplemented the grand tour questions glued into the front of my field diary with some more reflective ones:

- a. What surprises you?
- b. What fits your pre expectations? How?
- c. What is or is not happening? What if anything ties actions together?
- d. What are you encouraged to notice? What are you led away from?
- e. What tensions, blockages or flows are evident?
- f. How are bodies brought together for particular purposes? Are they complicit?

At the public meeting, these supplementary questions helped flesh out my broad observations of the event with personal reflections. From my research diary:

- a. The public meeting served to turn me off to the idea of the transgenic crop. Somehow the way we were being manipulated seemed to become clear – possibly because the meeting wasn't really aimed at me. The researchers appear to tell very different stories to different audiences, and it makes me uncomfortable¹³.
The apparent smugness of the audience re. Their superiority to 'luddites,' 'greens,' 'daily mail readers,' and their delight in 'telling the experts how to do their job'.
- b. How little people in the audience apparently know about lipids, despite expressing considerable concern and strong opinions about what is the 'right' way to eat.
- c. Debate never gets heated and is never amongst the audience members, always directed at the 'experts'.
- d. Rather than go into the complexities of an issue, Steven seems to avoid answering questions directly, or says he does not know (even on subjects on

¹³ I had previously carried out an interview with the main speaker at the public meeting.

which he has expressed strong opinions in interview). He also seems to interrupt Patricya (the lead researcher on the project) or add qualifiers if she is being too 'honest'.

We are being told this is the sustainable solution to a problem of excess in fishing, but the option of not being excessive not put in front of us.

- e. I naively assumed there would be a debate, and that was what the point was. It seems that lots of the audience have a self-image that involves undertaking actions that allows them to feel a part of / engaged with what is going on at the institute, and that the meeting was more about relationships with dignitaries of the local town than about the specific research. It is also possible that the class dynamics and apparent 'self-satisfied atmosphere' left some people unwilling to ask questions – I didn't ask anything, why not?

This work of recording relationships within events, meetings and conferences presented difficulties. As a lone researcher I was simultaneously learning about fats, observing norms of behaviour, investigating relationships within and between groups, endeavouring to note verbal and non-verbal communication of speakers, other panellists and delegates, and recording auto-ethnographic reflections on the experience. All of this, whilst maintaining awareness of the ethical complexities of not having direct consent from the majority of participants and trying to make connections for possible future interviews and participant-interview. The experience was emotionally, physically and intellectually exhausting.

Making Connections

Gaining access is one of the major challenges in doing fieldwork in industry (Garsten & Nyqvist 2013). Companies have data and technologies which they have no desire to inadvertently reveal to competitors, and a public image they wish to maintain. Large companies also often have their own researchers, such companies potentially have little to gain, and a lot to lose, by letting outsiders wander in to their premises. Even if access to an organisation is gained, research that accesses a knowledge realm where the tensions, anomalies, and actual ways of doing things is practiced and discussed, rather than the veneer of an organisation's self-presentation is in no way guaranteed (cf. Moeran 2013). In research there is 'no intimacy without reciprocity' (Oakley & Roberts 1981: 49).

Gaining trust in complex organisations takes time and commitment from all parties, and I knew that many of my inquiries may not develop into something more. With this in mind I initially cast my net wide, following up contacts from conferences and making on spec contact with individuals and organisations situated at multiple nodes within the industry. Indeed, there were a number of lines of investigation which I pursued but with whom it was unfortunately not possible to arrange an interview. On spec approaches worked relatively well in opening doors to research with academics, however there were no contacts within industry that came to fruition without gaining an introduction via an industry event. I was, for example, unfortunately unable to set up a visit or interview with Suma Wholefoods, a major supplier within UK Alternative Food Networks. What had piqued my interest in them was a post on their website from June 2010¹⁴ which contains the sentence: 'The margarine industry is a beast, small manufacturers are consumed by bigger ones and it becomes more and more difficult for independent brands to survive. Please support those that remain'. Having friends of friends working within the co-operative, I assumed that a meeting would be straightforward to arrange, but, despite trying multiple routes in, I did not manage to access anyone who felt that they would be able to help me. Nonetheless, I kept their online comment in mind when undertaking fieldwork with other margarine manufacturers. Connections are everything in research, they open up knowledges to the researcher (Moeran 2013). As an outsider to the industry I needed to make insider connections.

At conferences and in meetings, opportunities for direct interactions with other participants were largely limited to breaks. I tried to make the best use of the time available by going in for a bit of name badge spotting, manoeuvring myself into the vicinity of those who I thought might be useful to my research. However, at conferences most participants have people they want to network with. If, as an outsider, I was to get in to the conversation I needed a different strategy. The tactic that seemed most effective, was that of loitering around the coffee. Often the people who set up coffee stations at events do not think that much about how they will be used by a large group of people. As such, there is no logical order to the way the different elements are presented to the consumer, and there is nowhere to put down

¹⁴ <http://www.suma.coop/2010/06/where-did-all-the-organic-margarine-go/> (Accessed 17/07/2015)

your delegate pack or phone whilst you are making your drink. This often results in a blockage in the queue, something which I used to my advantage¹⁵. Helpfully passing the sugar or the milk to delegates who had their hands full proved to be a means through which to introduce myself. Often the conversation did not get further than this, or resulted in a 'you should get in touch with my colleague' type of conversation (most of whom were not interested enough to reply to me enquiries). As such I tended to have multiple short conversations in quick succession, involving a flurry of business cards, we would then be straight into another session at which I was trying to detail what was being said in the now, as well as what had just occurred. Nonetheless, the technique was worth it for the few instances in which it did pay off and I made connections that led to new fieldwork opportunities.

Putting myself in the room made making connections more possible (cf. Moeran 2013). Many of the most productive exchanges I had within conferences were chance conversations with delegates working in areas slightly removed from my area of research and who I would have been unlikely to encounter in any other way. Whether because these individuals were less worried about me 'doing' research on them, or because I was less conscious of 'doing' research, these conversations tended to be slower and more natural. I have already mentioned that people I met in the industry tended to be really interested in food, this then immediately serves as an ice breaker. Often it was these unexpected meetings that took the research in productive (and unforeseen) directions. For example, I had long conversation over lunch with a delegate from a transnational corporation that uses palm fat in its confectionary, and a delegate from a company that has broken through, from the health food, to the supermarket market with its products. This dialogue gave me a much deeper understanding of food industry framings, priorities, concerns and networks, and in particular it shifted my understanding of how the industry thinks about, and performs, sustainability and consumer choice. Something that I was able to carry forward into the design of future interviews.

It was in these social spaces between sessions that I also became aware that conferences often work on at least two levels – the formal presentations and the informal hierarchies. At one conference, whilst moving between sessions, I had a

¹⁵ One of my former jobs involved events catering management.

chance encounter on the stairs with a delegate who worked for a company I had not previously heard of but that is a leading global player on the production side of the industry. This delegate had been given a supplementary delegate pack which gave him access to background information about all of the other conference delegates (something that was not available to everyone and certainly not to me) as well as a pass into a more private lunch area. He did not volunteer to take part in the research himself but by referring to the delegate list he had been given was able to point me in potentially productive directions, including providing me with a name of someone extremely high up within a major margarine making transnational. This name proved invaluable. I had spent some time contacting numerous offices within transnational companies using their publicly available contact numbers but to no avail. However, armed with the names of the individual and the company they worked for, I was able to employ skills gained from a WEA course in information management to uncover a single pdf of some meeting minutes from several years earlier which contained an email address for this individual. Contacting him directly, with an explanation as to why he had been recommended to me, opened doors that had remained firmly shut for the previous eighteen months, and I was able to set up a factory visit and interviews within this transnational.

Designed serendipity thus played a role in the shape of my fieldwork. Attending courses, conferences and symposiums proved to be a valuable step in preliminary trust building (cf. Dwyer & Limb 2001). These processes of making connections also served a further research purpose which was to gain an embodied understanding of how connections are made and relationships built within and between industries, and the role that such connections play in everyday business practices (cf. Moeran 2013). Following these connections allowed me to engage with the stuff of margarine from within multiple organisations and knowledge frameworks. Through transgressing knowledge boundaries, I began to map their borders, translations, and frictions. As such, it was these connections that would facilitate depth as well as breadth in the multi-site research. In following these connections, I co-constructed the field I was trying to understand.

After making connections at conferences I built deeper rapport through email conversations, and interactions on twitter. Indeed, I formed sufficient relationships to

be able to visit and undertake some degree of ethnographic participant-observation at a small to medium sized factory that was the spreads production facility of a retail co-operative; a mid-sized family owned oil refinery; the margarine research and development site of a major transnational; and a research institute that was attempting to develop a transgenic oil crop. These organisations were situated in three European countries including the UK.

Accessing the Doing of Margarine

Factory and institutional visits were a key element of this more in depth work. In these spaces, the knowledges gained, on the 'oils and fats' training course proved invaluable in two key ways. Firstly, they enabled me to present myself as 'knowledgeable as well as curious' (Cragg & Cook 2007) and thus to be seen to be taking my participants' time seriously. Secondly, they empowered me to structure questions from a position of 'informed-naivety'. For example, asking questions along the lines of: 'On the training course they talked about this, but I don't understand the application' drew out knowledges that I may not otherwise have been able to access about how theories of margarine production are translated in practice.

Although the different elements of the fieldwork were intermingled chronologically, the time I spent visiting factories and research institutions can be thought of as a qualitatively different sort of participant-observation to that which I undertook when attending industry events. At conferences, symposiums and training courses I was there as a participant in the event, whereas on factory and institutional visits I was largely an observer being guided around the premises. My guides for these tours were not undertaking their 'normal' tasks, their role for the day entailed hosting me. As such I did not observe how my participants 'do' margarine within their day-to-day roles, but what they thought it important to show me about how margarine is done. Nonetheless, in moving with my guides through different parts of their organisations I was able to observe how they interacted with colleagues, how their colleagues responded to me, and also to note the areas which I was discouraged from entering. Additionally, through spending anything from several hours to several days in an institution, I participated in coffee and lunch breaks and the more informal side of work-life.

The quotes in this section are from field diary entries rather than transcriptions as I did not record the early interviews. In part this was to do with the practicalities of moving around a noisy factory environment which also entailed frequent hand washing, and in which electronic equipment was prohibited in some areas. But to some extent this was a result of my own inexperience as a researcher. In retrospect I should have organised a time to sit down with my research subjects where I could record their reiterations and reflections of the subjects we had covered whilst on the factory floor, and ask further questions as they arose. This was something I became considerably more adept at as the research progressed and I grew in confidence in myself as a researcher.

What I found most surprising when I did go on to reconcile notes with interview recordings is how much of what was going on in the recordings I had missed at the time of the interview. In part this is because I was taking care to record sights, body language and smells that the tape could not. However, in research that is, in large part, investigating how people negotiate and make sense of disparate knowledges in order to function in the world, the partiality of my own engagement with such knowledges is in itself important grounds for reflection. In the moment of the research encounter, the snapshots of the doing of margarine were interpreted and framed with and in my pre-existing knowledges and beliefs about margarine, and about myself as a consumer. Exploring how the doing of the research reinforced or created friction with my pre-existing beliefs and knowledges is one reason why a partial auto-ethnographic approach is invaluable in the empirical chapters. A second motivation is that writing about the interviews through my experiences of them also helps to maintain the anonymity of the participants.

Whilst in production facilities, my background in the catering industry again proved useful in traversing the insider - outsider boundary. I could for example, use stories from my work-life to open conversations about the predictable unpredictability of foodstuffs, the fallibility of recipes, and the work necessary to ensure the standardisation of a product. This approach had two key advantages, it worked to facilitate the construction of a story about my research that 'worked' in the languages of the industry, and it demonstrated that my interest is grounded in experience rather than just being an intellectual exercise. The balance between articulating my own

stories and confusions in order to draw out the participants and unintentionally steering the conversation is, however, a fine one. The risk being that my preconceptions about what is interesting leads to 'talking past' stories that may upset my prejudices. However, at later stages of the research, my having done interviews at other sites enabled a refinement of this tactic, for example, the experience of having seen, smelt, and breathed in the dust at an oil refinery furnished me with embodied knowledges which enabled me to ask questions about the potential of cross-contamination in refining a trans-genic crop.

Nonetheless, recording what I was encountering entailed all the difficulties outlined in my description of doing fieldwork at conferences with the added complication that I was moving through unfamiliar (and often noisy) spaces. Such movement, alongside commercial confidentiality, ethical issues, and the need to wear protective clothing and re-sterilise my person as I crossed between food areas, not only made using the Dictaphone to record the factory tours impossible, but meant that often my field diary did not get completed until late in the evening on the day of the visits. Such a delay in notetaking potentially creates problems with recall - what is remembered, what is forgotten, and what is misremembered¹⁶. It was for this reason that I supplemented my observations with more formal interviews. The recorded interviews accessed the ways in which my participants' verbally presented their knowledges, whilst within my field diary I noted my embodied and affectual responses to what I had observed.

Interviews were undertaken not only as a supplement to participant-observation but also with a number of respondents with whom it was either not possible or deemed not necessary to set up institutional visits. Towards the end of each interview I asked each of the participants who else I should interview in order to do the research justice, and as can be seen from figure 2 I was able to undertake interviews with individuals

¹⁶ I found trying to capture smell particularly problematic. Field diary entry from my first visit to the oil refinery where Simone worked in marketing:

The smell is distinct and pungent, although if I hadn't previously seen the oil seed rape then I would not have known that that is what I am smelling. It was not unpleasant, but not like food either - grassy, sour, a bit like silage, definitely not a smell I had encountered within a bottle of oil.

Smell is key to the experience of food, and at times was overpowering, yet it is a sense that I seem to lack the vocabulary to describe adequately.

and organisations situated at multiple industry nodes including manufacture, processing, production, development, health, sustainability, marketing and policy¹⁷:

Pseudonym	Organisation	Job	Bio
Max	Small/Medium margarine manufacturer that is part of a Retail Co-operative	Research & Development manager	Male, thirties. Learnt on the job. Personally interested in food, taste, health and sustainability.
Simone	Family owned Oil Refinery	Marketing	Female, thirties, about to become a parent. Nutritionist.
Judith	Transnational Margarine Manufacturer	Nutrition Manager	Female, thirties, mother. Nutritionist.
Erik	Transnational Margarine Manufacturer	Research & Development manager	Male, thirties, father. Biochemist.
Steven	Crop Research Institute	Head of biotech research	Male, fifties. Biotechnologist
Helen	University	Professor of Nutrition, specialising in fats	Female, forties, mother.
Tom	University	Professor of Biology, working on oil crop development	Male, fifties.
Lars	Certification & Verification of industry standards for a tropical oil	Auditor	Male, twenties.
Lynn	Lobbies on behalf of the margarine industry	Head of organisation	Female, fifties.

Figure 2: key industry participants.

Each interview was very different, for example, they varied in length from forty-five minutes to several hours. This is unsurprising as each interviewee is more than the product of their job role, they are ‘actants not objects’ (Fontana & Frey 1994: 370). The uniqueness of each interview situation precludes preparing prompts and probes in advance of the meeting (Valentine 1997). As such, although I planned the interviews to be semi-structured, I allowed the format to be largely conversational and interviewee led and found that most of the questions were covered this way, any that were not I returned to in a pause in conversation.

¹⁷ This table details my key interviewees; those that I chatted to more informally or who presented information at conferences etc. are introduced as they appear in the empirical chapters.

It is important to note here that my interviewees were on the most part well used to presenting their research or their products, and as such I was aware that it was likely that they would be practiced at subverting the direction of the dialogue (cf. Schoenberger 1991; Valentine 1997). This, however, does not negate the value of the interview. Unpacking such story-telling can work to make present the normative values and beliefs within an organisation (Shurmer-Smith 2001). Approaching the interviews from a position of 'informed-naivety' (Valentine 1997) allowed me to ask the same question from slightly different angles¹⁸. One unexpected boost to this approach is that many of my interviewees spoke English as a second language. This of course carries the risk of misunderstanding, but within this there is the possibility of being able to slow the conversation down, rearticulate questions and to ask for clarification. Nonetheless, there was one moment in my first interview where a subject got frustrated as I reiterated a question that they had glossed over. And although I was able to explain my genuine fascination with the subject, the question was never really answered. Avoidance of questions thus became something that I began to look out for in coding the field notes and transcripts. I also asked questions that I 'knew the answer to' in order to explore how the participants positioned themselves, their knowledges, and experiences, in relation to the question.

Such a combination of planning and creativity built flexibility into the fieldwork (cf. Crang & Cook 2007). For example, in order to help the conversation feel as 'natural' as possible I as the researcher could create space for an active process of discussion and dialogue by inserting a part of myself in to an interview, or appearing to go off track (cf. Schoenberger 1991; Arksey & Knight 1999). In this way, qualitative interviewing can be thought of as akin to musical 'jamming' (Arksey & Knight 1999). I found that this 'jamming' element of the conversational approach worked to facilitate some degree of back and forth between the ways margarine is done and related to within different roles - whether that be myself as researcher / chef / eater or my interviewees as industry professionals / eaters / and in some cases parents.

¹⁸ In interviews, there were times when my interviewees requested I turn the tape off whilst they gave examples to illustrate the point they were making. As such my discussions of the data generated are informed by data which, for ethical and data protection reasons, I cannot refer to directly.

Juxtaposing the differing explanations of my participants as they explained and illustrated complex structures and processes to me, aided me in building up a more complete picture of the multiple ways in which margarine is known and done. Such juxtaposition made present inconsistencies between some of the different knowledge frameworks entangled with the stuff of margarine. (cf. Schoenberger 1991), and when combined with my multi-site approach this interviewing tactic also began to access dissonance between what is being articulated and what practiced in the doing of margarine. For example, in the two days I spent with Max a number of examples of the friction between different knowledge realms emerged. In one field diary entry detailing our first day together I note:

Standing outside the building, it transpires that Max's company is somewhat unusual in that one of their margarine lines contains animal fat. Later, whilst explaining how temperature is maintained in the hot storage room Max explained that knowledge of the presence of animal fats in the building created disquiet in the mind of the Rabbi who was responsible for checking the company's procedures for the production of kosher products. Although the company have a separate line from the point of delivery for tallow and lard, for the Rabbi such separation is not the same as being kosher as there is an assumption that 'unkosherness' can be passed through the hot water heating system somehow. 'Kosherness' can be contaminated almost by a 'miasma' that can pass through the water pipes and back again. Max used this story as a way of flagging up problems that can occur when different approaches / belief systems come together. He explained that it is important to ask questions in order to understand each other's realities. As when a problem is flagged from within one approach, it is hard to find a way to reconcile this using the techniques, practices or beliefs of the other.

Further, on my second day with Max I discussed with him the marketing booklet produced by the parent company of the production facility that he worked in. The booklet states that our 'benchmark for margarine is to get as close to possible as butter'. Max had never looked at this marketing material one and his reaction included the statement that he had 'never had one project to make margarine taste like butter'. These short interactions serve to illustrate that different knowledge frameworks are in operation not only between, but also within organisations.

Researching Knowledges and Practices of Production

In undertaking the 'knowledges and practices of production' element of the fieldwork I found myself less of an outsider than I expected to be. The margarine industry is staffed by people who eat, and involves interactions and translations within and between multiple organisations, knowledge frameworks and the stuff of food. Everyone is to some degree simultaneously an insider and an outsider. Max, for example, expressed intrigue at the growth in consumer concern about food and health in recent years. From my field diary:

To quote: 'There is a meta trend where food is not just food – food was food but now it is loaded with ethics. We don't just eat, we eat for something'. For Max the loss of religious spirit perhaps has something to do with an enhanced fear of the unknown, and the desire to engage an idealised nature to try to prolong life'.

Max went on to explain to me that the reason he was interested in participating in my research is that he hopes that I can offer a view of the business that he cannot see from deep inside.

Bringing together ethnographic and conversational approaches worked to challenge my own beliefs about both corporations and the people that work within them, and began to illustrate to me how actors negotiate conflicting knowledges, and play multiple roles whilst maintaining a coherent sense of self. This in turn facilitated research not only into how the matter of margarine is done in industry, but also into the ideas, practices, and beliefs that influence my participants' work practices and fatty choices, and how those values are constructed, communicated and perpetuated.

Researching consumer knowledges, beliefs and practices

In the introduction to this thesis I argued that consumer and consumed are co-constructed. Consumer products are not made in isolation from cultural norms, technological possibilities, political partialities or societal values. As such, for the consumer knowledges, beliefs and practices elements of the fieldwork I needed a methodology that would not merely produce a snapshot of what eaters say about their decision making and practices, but that could work to reveal tensions and translations

between knowledges, beliefs, and practices, about the self, and about the matter of fats.

In designing the fieldwork, I reflected first on a number of factors including my own shifting relationship with margarine, informal discussions I had had with a number of 'eaters', and on comments and questions I received as part of my upgrade presentation which were concerned with the touch of fats against fingers, lips and tongue. Food knowledges, beliefs and prejudices shape what is eaten, but so do visceral experiences and embodied encounters. Food decisions and habits although containing logical elements, are influenced by an entanglement of material, sensory, economic and symbolic factors and as such are often messy, even contradictory (Eden et al. 2008; Goodman 2008).

In thinking all of this through, I considered a number of possible approaches to this research. Participant-observation of people's behaviour around and with margarine could have accessed what participants do rather than what they say they do. It would, however, not have been practical timewise, would have been invasive of people's lives, and would not necessarily have accessed the thought processes, or cultural norms and values behind current food choices (cf. O'Reilly 2005). Conversely, interviews would allow the participants to represent an imagining of the logic of their food choices from the time-place of the interview and are a good way to learn how the participants make sense of their knowledges, beliefs and actions (cf. Coffey & Atkinson 1996). However, perceptions and attitudes are not static, neither are they formed in isolation, but in interaction with multiple others.

I needed a methodology that, rather than generating a snapshot of what eaters say about their fatty choices, would work to unpack how practices develop and are maintained. To this end, I drew inspiration from the work of Eden et al. (2008) who used focus groups to explore how consumers negotiate the interplay between the 'material immediacy of 'mucky carrots'' and the 'abstract remoteness' of organic certification'. Group discussions, in their multi-directionality are more faithful to the interactive nature of real-world decision making than are individual interviews (Lunt and Livingstone 1996; Bennett 2001; O'Reilly 2005). As Goodman states 'tastes, preferences and notions of distinction are never the product of autonomous mind, but

always directly or indirectly constructed through participation in quotidian practices and their associated power relations' (2008: 7).

Eden et al. found that within the back and forth of their group discussions, gaps and tensions emerged between food knowledges and food practices. As such they contend that providing information such as better labelling is not sufficient to shift eating habits. Rather they argue for methodological approaches, which, in situating consumers as active participants in research co-produce a 'politics of reconnection' (2008: 1044). The sentiment of taking encounters between consumers and food matters seriously is an important one. Food is such a mundane, routine and necessary part of daily life that when asked directly about their practices, eaters tend to present simple, coherent narratives. Yet habitual practices are shaped by a complex interplay of material, sensory, and social factors.

To understand the relationships between consumer knowledges, beliefs, and practices, I needed to design research that would facilitate my participants to take part not as imagined 'rational' consumers but as minded-bodies - as *eaters*, situated within families, and communities. To this end I used a combination of two approaches within the format of 'planned discussion groups' (PDG's) (O'Reilly 2005). In the first part of the PDG's my participants collectively recalled their own shifting knowledges and practices of and with margarine, whilst in the second part we used kitchen equipment to make margarine in the home to create visceral 'strange encounters' (cf. Ahmed 2000) in which habituated knowledges and practices about and with the matter of margarine could be made present, explored and played with.

Planned Discussion Groups

Food and food practices although often habitual, are entangled with the construction, and presentation of self-identity (Pink 2015: 76), and sense of belonging. I am interested both in how my participants frame margarine, and how they negotiate the meanings within those framings (cf. Lunt & Livingstone 1996). Yet, a great deal of individual food practice can escape self-scrutiny because it is 'so familiar, so close, that one does not even see it' (Braidotti 2013a: 12). Nonetheless, listening to, and engaging with, the experiences and beliefs of others can stimulate memories and subconscious knowledges that de-territorialize such normative beliefs and practices

(Lindlof & Taylor 2002; Braidotti 2013a). Using group interviews is therefore a theoretically informed means through which to facilitate reflexivity on the part of participants with regards to the sense-making entangled with their shifting food choices.

Troubling norms of behaviour of participants can, however, upset their sense of self and as such be emotionally challenging (Braidotti 2013b). I needed a methodological approach which would not just stimulate reflexivity, but would minimise negative impacts by creating atmospheres in which my participants felt supported in their explorations. Using PDG's for this research facilitated the creation of safe space in which to do this. Planned discussion groups are in many ways similar to focus groups, with two principal differences. The participants are chosen because of their relationship to each other rather than their knowledge of a subject, and the setting is one familiar to the participants rather than one more likely to be chosen for its 'neutrality' (O'Reilly 2005).

I used snowballing techniques to find participants for the project. I was seeking a diverse rather than a representative group, so used my personal network of family, friends and old work colleagues in order to recruit six contacts. These contacts ranged in age from twenty-nine to seventy, were from a mix of working and middle class backgrounds, and worked as librarian, teacher, gardener, retired nurse, personal secretary and shop assistant. One self-defined as a margarine consumer, one a butter consumer, three used both, and one neither. The contacts all lived in the UK - in Exeter, Bristol, Wimbledon, North Lincolnshire, Bradford and Leeds. Each of the contacts invited up to three friends, colleagues, or family members to join us.

The PDG's were held in the kitchens and dining areas of the hosts, and were made up of people from a wide range of age groups and from different class backgrounds (although all are white British). Figure 3, below, gives pseudonyms, brief biographies and details of the relationships between group members:

Location	Contact	Group Member	Group Member	Intermittent Participants
Exeter	Andy – a friend of an old work mate who I was introduced to when I first moved to Exeter. Male. Late twenties. Ex-engineer now works on an organic farm. Step-dad to a teenage boy. Vegan. Doesn't habitually eat yellow fats.	Steph - Andy's partner. Female. Early-thirties. Ex-early year's teacher, now works in local-food retail. Mother of a teenage boy. Vegan. Doesn't habitually eat yellow fats.		
Bristol	Ruth – housemate in first year of undergraduate degree. Female. Early forties. FE teacher. Mother of two boys. Omnivore ex-vegetarian. Butter eater.	Jane - Friend of Ruth & Claire. Female. Mid-forties. Student Union Administrator. Mother of two children. Omnivore. Butter eater.	Claire - Friend of Ruth & Jane. Female. Early-forties. HE Co-ordinator. Mother of two children. Omnivore. Margarine eater.	Ruth's boys, Mal 16, and Col 11. Dropped in and out of the group activities. Butter eaters.
Shipley	Milly – subject librarian when I was doing my undergraduate degree. Female. Late thirties. Librarian. Mother of two. Omnivore, ex-vegetarian. Eats both butter and margarine, mostly butter.	John - Milly's dad. Male. Late sixties. Retired entomologist. Omnivore. Margarine eater.	Catherine - Milly's Mum. Female. Late-sixties. Omnivore. Retired from milk board. Margarine eater.	Ian - Milly's partner and someone I already knew through her. Male. Late forties. IT manager. Father of three. Omnivore. Butter eater.
Bradford	Lyn – old workmate of mine on a LA21 funded community food project.	Sarah - Friend of Lyn's. Female. Mid-fifties. Food growing with a local	Anna - Works with Lyn. Female. Late twenties. Vegan. Margarine	Mike - Lyn's partner. Male. Late-forties. Primary School support worker.

	Female. Late-forties. Manager community based nature conservation and education group. Mother of two adult children. Vegetarian. Eats butter and margarine, currently mostly butter.	school. Mother of one grown up son. Omnivore. Butter eater.	eater.	Father of two. Vegetarian. Eats butter and margarine, mainly margarine.
Lincolnshire	Joan – my mum. Female. Late-sixties. Retired Nurse. Mother of two adult children. Pescetarian. Margarine eater.	Martin - Joan's partner (and my dad) Male. Early seventies. Retired businessman. Father of two adult children. Omnivore. Margarine eater.		
London	Alice – old school friend. Female. Early forties Public sector P.A. Omnivore ex vegetarian. Eats butter and margarine, mostly butter.	Paul. Alice's partner. Male Early fifties. Museum Curator. Omnivore. Butter eater.		

Figure 3: Planned Discussion Group Participants.

It is clear from Figure 3 that the PDG's were dominated by women. With the notable exception of Andy, the men that I asked to host groups declined to take part. The explanation given by Richard, an electrician in his early-fifties, that: 'I don't know anything about food' was typical of the replies I got back from the men that I approached. I responded by explaining that I do not believe there to be a 'right' way to eat, rather I am interested in how people make eating decisions in the midst of multiple conflicting messages. Again the rejoinder I received from Richard that: 'I just eat what I like' was typical. This answer is one that I found frustrating. I have known

all of the men who declined to host groups for at least ten years (and Richard for over twenty), and in all cases the food that they 'like' and choose to eat has changed significantly over that time.

As the research progressed I found that it was not just that men did not want to host groups, but that there was a general reluctance on the part of some men to formally take part in sessions that their partners were hosting. Yet they did appear to be interested. In all cases they were at home, and they loitered around the discussion groups. They came in and out of the room, listened, asked questions, made comments and to some extent joined in. However, if I asked them questions directly they tended to leave. Mike later explained to me that he felt intimidated because he knew that both I and his partner: 'knew more about food than him'. Whilst Mike said that although he does cook the kitchen is not a space he is comfortable in.

This perception of my power and expertise came as something of a surprise to me. I felt that I was entering the field as someone who was confused about my own eating habits and practices, and so wanted to explore how food decisions are made and negotiated. I had not considered that designing the research around the kitchen, which to me represents a safe-space of food and sociality, might intimidate and exclude. For some time, I worried about how this gender and skills imbalance might skew my research. However, on talking it through with the men that declined to take part I came to the understanding that the research I had done with people who are comfortable around food raised valuable questions that could potentially be used to design research with and for people who are daunted by it. Everybody eats, but no-one eats everything that can be eaten. Everybody makes food decisions in the midst of messy knowledges, beliefs and affects.

Nonetheless, it was not only those who declined to take part in the research that looked to me as an expert in eating-well. Although I opened the PDG's by explaining that I believe eating well to be situated - that I do not think that there is a singular right way to eat for everyone at all times, and that I am interested in how people make sense of conflicting messages about the stuff of fat, there were still times when the respondents turned to me as an 'expert'. Asking, for example, whether there is any palm oil that it is 'okay' to eat, or if oil seed rape is 'better' than sunflower oil. I

responded to such questions by presenting some of the conflicting evidence and allowing my participants space to work through the information amongst themselves.

The session transcripts revealed the PDG discussions to be very different to the corporate interviews. This is not only because they were in a group setting rather than one-to-one, as this was for the case for some of the corporate interviews too. Neither was it just because the participants already knew each other, this too is the case amongst colleagues. However, the power relations were very different. In the industry setting I was in an unfamiliar situation, whereas the PDG's took place in the homes of the key contacts, and I was introduced to the rest of the group as an old friend, which drew me in to the discussions as a participant-observer-facilitator rather than as interviewer. Discussions were also more informal than were the industry interviews, and much less focussed. However, this, in many ways, reflects the ways in which food is habitually done in the home. In the midst of food preparation, the phone rings, cups of tea are made and laundry gets tidied away, whilst work, school and social plans are all discussed. It is surprising what emerges both in the loop of conversation as the talk wanders off to seemingly unrelated topics, and when attention is paid to the more-than words part of the dialogue - the nose wrinkling and wry smiles of group participants.

At the start of the discussions my participants had described their practices as 'just habitual'. Unchanging. But what is notable is that although each believed their own practices to be routine, they did not hold back in challenging the narratives put forward by their fellow group members. The personal fatty narratives of my participants' were discussed and challenged by their fellow group members and they pulled each other up on the differences between what they say they do, and what they actually do, revealing their insinuations that they always buy this or that to be slippery. For example, one participant, Alice, claimed to always buy butter, until her partner Paul pointed out the times when she did not. Within the PDG's my participants' had the kinds of frank discussions that would be considered rude amongst colleagues. They argued, talked over each other, riffed off each other, mocked each other and challenged the validity of each other's narratives. Through such back and forth of disagreement, the conversations shifted in focus and it emerged quite how much my participants' practices had altered over their life-course, making it difficult for them to

present a simple and idealised version of their fat choices. Indeed, attempting to present oneself as any kind of expert commonly got short shrift.

Indeed, the PDG discussions prompted my participants to face some of the disjunctures in their beliefs about their own fatty habits. Jane, for example, conceptualises herself as someone who eats 'proper food'. Early in her PDG she insisted that she had never liked or bought margarine, and described feeling vindicated when reports appeared in the media which suggested that butter might be the healthier option after all. However, on being challenged by Ruth, Jane conceded that: "Yes. I think of it now, and it's true, we did have Flora". Within the PDG conversations my participants were able to explore the relationships between each other's beliefs about, knowledges of, and performances with, the stuff of margarine. Entangled with such disagreements is the risk of the conversations being skewed by a 'herd mentality' in which participants in seeking a harmonious dynamic move from initially divergent positions, to coming to agree with each other. Although this tendency of groups is often portrayed as problematic, in the context of this research such discussions facilitated reflection on my part as to the shifting constructions of professed beliefs and practices of my participants even within a single interview.

Within each session my participants commonly presented multiple, contradictory, beliefs. Claire, for example, initially expressed her belief that her choice of olive spread lay in the healthfulness of the named ingredient. When challenged by her fellow group members about the difference between olives and olive spread, she shifted her position to explain she is a habitual buyer who prefers it because it is not bright yellow. Before pausing and going on to explore the cultural habit of eating spreads at all, rather than using olive oil directly on bread and in cakes. In this way, this discussion began to reveal messy normative frameworks and the ways in which my participants negotiate, translate and reimagine them.

Within the discussions, the bodies and relationships knotted with and in the stuff of fat emerged as things that matter to my participants, and they talked about the development of their fat practices as entangled with careful practices. Care for local agriculture, for health, for local communities, for landscape, for biodiversity, animal welfare, and for familial conviviality. My participants described how they try to enact

care through their eating practices but explained that they feel compelled to juggle priorities. In endeavouring to eat well they feel obliged to create hierarchies about who matters the most, and to try not to think about all of the others. Such divergence between the care priorities of participants within each group prompted exploration of the multiple values (and possible futures) entangled with and in fatty practices.

In sum, the familiarity of the settings for the PDG's and of the interpersonal relationships within them facilitated an unpacking of the habitual practices of my participants to reveal some of the work that has gone in to establishing and maintaining them. The structure of the groups worked to create space in which the practices, beliefs and knowledges of my participants could be revealed and troubled. A hesitation where habits can be explored not as mere common sense, but as a performance of a sense of self, community and belonging that reproduces those relationships in particular ways. As the sessions progressed, themes started to emerge with regards to both the explanations participants gave for their yellow fat choices, and the kinds of questions they wanted to know from me. The number of PDG's was determined by the declining rate at which new information was revealed (in combination with time and financial constraints) (cf. Lunt & Livingstone 1996).

Researching other ways of knowing and relating with margarine

As described in the previous section of this chapter, I opened each PDG with an introduction from me about the project, and about research ethics and consent. This was followed by space in which I asked my PDG participants to engage their memories in order to discuss their current and historical yellow fat knowledges and practices. These conversations began to reveal tensions in the narratives my participants have constructed about themselves as consumers. However, food practices are shaped by the complex interplay of material, sensory and symbolic factors (Fenko & Schifferstein 2012). Eating is a relationship, nobody ever eats alone (Derrida & Weber 1995). Food knowledges, beliefs and prejudices influence fat choices, but so do visceral experiences and embodied encounters. Recall alone cannot access such sense-making in action across and within these multiple ways of knowing. The mundane, habitual nature of eating practices can make it hard to access to the ways in which eating can re-inscribe or challenge norms (Hallenbeck 2012).

Pink has shown that introducing objects into discussions can invoke memories (Pink 2015: 85). As such, when my participants' initial conversations began to tail off I involved the matter of margarine as a participant in the happenings of the PDG events. Touching, sniffing, manipulating and tasting work to engage the emotional and visceral knowing of the participants' gut-feelings (Probyn 2000). However, I did not simply bring commercial margarines to which my participants are already accustomed in to the conversations. I could see how encountering margarine in this way within the PDG might stimulate talk around differences between products, or the changing nature of margarine over time, but I wanted to do more than this. Influenced by Braidotti's (2013b) philosophy of the posthuman, the work of Ahmed (2000) on 'strange encounters' and Pignarre and Stengers (2011) on the micro-resistance of 'the event', I designed an experimental methodology which aimed to create a hesitation in my participants' mundane acceptance of the matter of margarine so as to create space to rehearse other ways of knowing and relating with margarine.

Strange Encounters (creating space to play with the matter of fats)

Whatmore has demonstrated that accessing how participants experience and make sense of the interplay of multiple knowledges requires 'practices that amplify other sensory, bodily and affective registers' (2006: 606). Whilst Connolly has argued that disrupting habits can encourage participants to question their own performances (2013: 185). To this end I sought to make the matter of margarine present not as mere object for consumption, but as strange other so that my participants could encounter it anew. To do this I disrupted the idea of margarine as a processed food, a technological achievement, by making homemade margarine with my participants using domestic equipment and store-cupboard ingredients. I predicted that such a strange encounter would work to create an interruption where the common sense beliefs and norms that my participants hold about and with the stuff of margarine could be revealed and re-evaluated. Further, influenced by the work of Pignarre & Stengers (2011) on the micro-resistance of 'the event', I hoped that 'playing with our food' in this way would create space to rehearse other ways of knowing and relating with the matter of margarine.

Nonetheless, my research in to the doing of margarine within industry had shown me that merely making margarine at home is unlikely in itself sufficient to make margarine strange (see interlude four). It is not just margarine that it is an industrial product but also the oils and fats from which it is produced. Creating margarine from such oils produces a spread not dissimilar in flavour to commercially available varieties, and so carries the danger of shutting down questioning by reassuring participants that the processes used in industry are just like cooking. They are not. As such, I took things back a step further and we began the process by making oil from whole sunflower seeds.



Figure 4: My oil press as it arrived in the post.

Crushing seeds to make oil is not something easy to do with equipment commonly found in British kitchens, and so I bought in a specialised crank press from a company in the Netherlands that produces machines it suggests are suitable for micro-businesses in the Global South (see figure 4). The structure and operation of the crank press is very similar to an old-fashioned domestic meat mincer, the principal difference being that it has a slit in the casing of the shaft through which the oil is collected. As such, my participants were comfortable in accepting the press as a piece of domestic-type equipment.

The press is cheap but basic, and before use a number of additions are required (see figure 5). Firstly, the press needs to be mounted on a stable surface (mine was attached to a post and platform structure that was just about transportable by train¹⁹). Secondly, a funnel must be added through which the seeds can be fed into the crank (the instructions recommended the top half of a plastic drinks bottle, and this is what I used). Thirdly, a container needs to be placed in the frame to collect the oil produced (I found a gherkin jar most suitable to the space available, and I held it in place with two hair bands). Fourthly, although not essential, to reduce mess it is a



Figure 5: The oil press in operation.

good idea to have a basin in which to catch the ‘waste’ oil-cake that is produced as part of the process. The press is suitable for use with a range of seeds and nuts including oil seed rape, sunflower, olive, palm fruit, palm kernel and coconut²⁰.

In the manufacture of margarine, combining oils with different properties helps to create a product that mimics the melt-in-your-mouth properties of butter. Temperate oil crops such as sunflower or rape are liquid at room in temperate climates, whilst tropical oils such as palm, shea, or coconut have a higher melting point and so are solid or semi-solid. The most commonly used oils used in UK margarines at the time of writing are oil seed rape and palm. They are also the cheapest to use on a commercial scale. Neither rape seeds nor palm fruits are, however, readily available for UK consumers to purchase, so for the liquid oil component of this project I used black²¹ sunflower seeds, and for the solid component coconut. I did not worry unduly about using sunflower seeds instead of oil seed rape as sunflower oil is a common component in margarine manufacture, indeed it is the ingredient my participants most

¹⁹ Big thanks to Neville England of Exeter Geography.

²⁰ Although I had difficulties in getting men to take part in the research, the men that did get involved were typically fascinated by the crank press, wanting to know how it worked and suggesting ways to improve the functionality.

²¹ Black sunflower seeds contain more oil than the grey ones.

readily associate with margarine. This is perhaps not surprising given that margarine packaging rarely mentions oilseed rape as one of the ingredients, whilst pictures of sunflowers abound²². I did however spend some time trying (and failing) to find a source of palm fruit, before deciding to use coconut as my solid oil component. Coconut oil is used in some of the more expensive margarines but it is far from ubiquitous. Whole coconuts are, however, readily available in most supermarkets. An unanticipated advantage of my choice of ingredients for the oil making turned out to be that the presence of the unexpected components was sufficient in itself to spark discussions about the strangeness of the matter of margarine.

Making coconut oil, although straightforward, is however somewhat noisy and time-consuming so in all but the first session we used readymade raw coconut oil.



Making Coconut Oil:

- Open a coconut
- Blend the coconut flesh and coconut water together, adding extra water if necessary
- Strain the resulting pulp through muslin into a sterilised jar
- The coconut oil will rise to the top over the next few days (see figure 6).
- The pulp in the muslin can be used as desiccated coconut²³.

Figure 6: Coconut oil rising to the top.

²² Prior to a change in EU legislation in November 2014 it was not necessary to label the constituent oils of a margarine or spread.

²³ Wikipediawiki. Undated. "How to Make Virgin Coconut Oil." <http://www.wikihow.com/Make-Virgin-Coconut-Oil>. (Accessed 15/03/2015).

To make sunflower oil, seeds are poured into the crank press through the funnel. The shaft is then heated by lighting a wick above a small paraffin burner which is supplied with the press (the small glass bottle in figure 7). Heating the shaft eases the extraction of the oil when the crank is turned to draw the seeds through the press. The first few seeds fall straight out the open end of the press, but gradually 'cake' forms which increases the resistance in the crank acting to squeeze the oil out of the seeds (see figure 8). The oil



Figure 7: wick (left); oil collection (right).



Figure 8: Operating the press

extracted contains sediment from the seeds. This takes a few days to settle out before it can be separated from the oil (see figure 9). As such, for each PDG I took a jar of oil made at a previous session that I had filtered so that the groups could see, taste and smell any differences between the two.

Once we had produced our oils, the next stage was to make our homemade margarine. This we did using basic cooking equipment available in the home of the hosts. I had first discovered that margarine could be made at home through the serendipity of an internet keyword search for 'making margarine'. Primarily this

search pulled up links to information about the chemistry and history of margarine, advertisements for commercial equipment, and opinions about the ‘non-food’ status



Figure 9: Separation of oil and sediment.

of the stuff of margarine, but, amidst all of this, I found a link to a Washington Post article about making margarine in the home²⁴. Once I became aware that such a thing was possible, I changed my search to “homemade margarine” and discovered multiple recipes. Most of them, however, involved buying in lecithin, which is not something I think of as a ‘cooking’ ingredient. Nonetheless, recipes were available that only used foodstuffs that I commonly have in my kitchen and these were the ones I planned to experiment with within the PDG’s.

Below is an amalgamation of a couple of recipes, with the proportions scaled to that which was suitable for my PDGs, and it is these instructions that I gave to my first group of participants:

Home-Cooked Margarine:

- Put 3 tablespoons of sunflower oil in a bowl, place that bowl in iced water
- Gently heat 2 tablespoons of coconut oil – pour into the bowl
- Whisk until the colour begins to change
- Add a teaspoon of egg yolk (or mustard) and a dash of milk
- Keep whisking until the

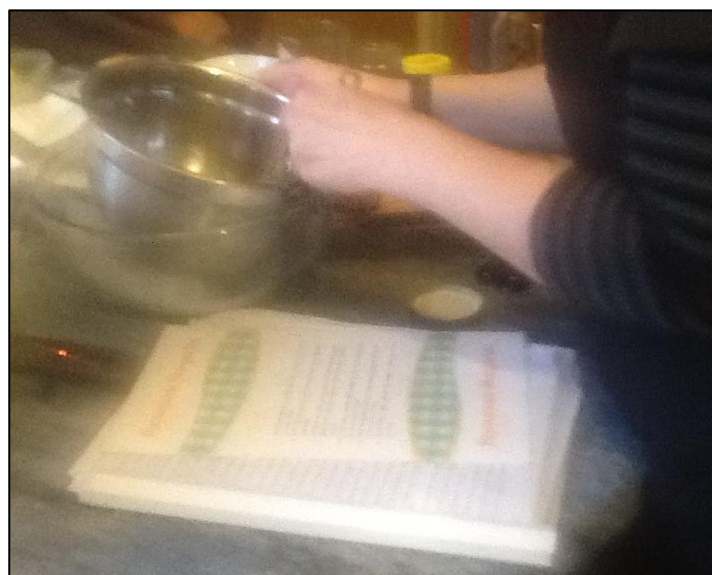

Figure 10: Making margarine.

²⁴ Washington Post: Available: <http://www.washingtonpost.com/wp-dyn/content/article/2010/09/28/AR2010092802826.html> [Accessed 29/05/2013 2013].

mixture takes on the consistency of margarine

- Remove from the ice and add salt, pepper, lemon juice, herbs etc. to taste (Viestad 2010; Meyer 2014.)

However, in the course of my fieldwork within industry, I was surprised to find myself in a research kitchen of a major transnational corporation making homemade margarine from a recipe not dissimilar to the one above. The company had produced a 'homemade margarine' recipe card (see appendix four), and it was this card that I gave to the subsequent PDG's as their primary recipe.²⁵



Figure 11: Eating margarine.

Research methods are intrusions that work to make 'things more or less different' (Law 2004: 143; Schillmeier 2013). Making homemade margarine was designed to be a 'strange encounter' (Ahmed, 2000), an interruption in which normative food practices momentarily become alien. 'Slowing down reasoning' (Stengers 2005) in this way stimulated discussions that would reveal something about conceptualisations of self and otherness entangled with and in the sense-making of food practices. Indeed, making margarine significantly extended the length of the PDG discussions. Depending on the group, they lasted between ninety minutes and over three hours. I recorded the whole session. These recordings included the conversations each group had before the matters of fat were introduced to the proceedings, as well as the discussions during the cooking processes, and whilst my participants took tea afterwards - tasting the margarine on muffins, crumpets or boiled new potatoes.

²⁵ For discussion about the production of this recipe card, and attempts by companies to present margarine as 'natural and cooked' see interlude four.

Playing with our food (rehearsing other ways of living together)

The novel intervention of making and eating margarine within the safe-space of a PDG was designed to culture a hesitation where the situated, fragmented and contingent nature of our knowledges and the contradictory and fluid subjectivities of the 'fractured self' (Rose 1997) could be made present and discussed. Nonetheless, thinking differently about the world is not the same as performing a different kind of world. As such, there was a third strand to the 'knowledges and practices of eaters' element of the fieldwork, where, inspired by the work of (Mol 2008a: 28) we 'played with our food'.

Food decisions and practices are performed multiple times every day. The ways in which it is possible to live together are remade with and in such mundane practices (Rose 1997). Technical, political, economic, social and cultural framings all play a role. Within each framing some relationships can be practiced as careful reciprocity, nonetheless multiple others are silenced and consumed. What feels 'natural' has forgotten the construct from which it first emerged (Schillmeier 2013). Touching, feeling, tasting and smelling homemade margarine was intended not only to re-present normative social realities, but also to be a political intervention.

Such an approach to food research is not without precedent. (Hayes-Conroy & Hayes-Conroy 2008) in their work on 'taking back taste' detail an interview with a 'slow food leader' about a project where schoolchildren were encouraged to blind taste both homemade and shop bought jams. In the taste-test, despite expecting to favour the homemade jams, the children actually preferred the shop bought flavours to which they were more accustomed. As such, this apparently mundane attempt to 'take back taste' engaged visceral knowing to open up awareness of the production of jammy norms.

In my research I wanted to see if opening consumers to the possibility of 'taking back taste' through 'strange encounters with fats and oils, created space in which it is possible to prefigure other kinds of fatty relationships. Particularly whether 'taking back' taste' contains the potential to make space for convivial encounters with the matter of margarine. Yet, as previously discussed, the recipe I use to make margarine with my participants is one developed by a margarine making transnational. The production of this recipe card coincided with an advertising campaign that portrayed

margarine as natural and wholesome. As such, this might suggest that attempting to 'take back taste' using this approach is something of a nonstarter. However, my participants did not encounter the recipe card in conjunction with an advert; they encountered it within planned discussion groups in which their knowledges and practices of and with margarine had already been disturbed. On learning that a margarine manufacturer had produced the recipe card, my research participants, although interested and excited by the matter of margarine, tended not to trust this message. They wanted to know the differences between the matter entangled with this recipe, and that found in commercial tubs of margarine. Many of them even went to find a margarine tub so that they could compare the ingredients used.

The 'strange encounter' created a hesitation where the research participants could question what had previously been mundane, taken for granted, norms. It disrupted my participants' quotidian habits and expectations, creating new experiences in which the 'non-expected Other' (Schillmeier 2013: 101) can (if fleetingly) become present as bodies and relationships that matter. For example:

Paul It tastes of sunflowers.

Alice Yes.

Paul Yes, quite nice.

Alice Whereas bought sunflower oil...

Paul doesn't taste of anything. Why is that, then?

In this way, making and tasting homemade margarine can be understood as cultivating a hesitation where the matter of margarine can slip into presence as an actant. Playing with our food momentarily revealed something of the co-construction of consumer and consumed.

It should be reiterated, however, that the matter of margarine was a participant in the research that could not give informed consent. Indeed, sunflower seeds with the potential to grow in to new plants were instead crushed so that their oils could become part of the stuff of margarine. Rather than upsetting normative relations, it is possible that this research uses the façade of inclusivity in order to create the illusion of radicalism whilst continuing to re-inscribe normalising possibilities. Nonetheless, method is a process of 'shaping, mediating and separating' relations (Law 2004: 122)

and I think what is important here is that reworking conceptions of the boundaries between self and eaten reworks 'one's sense of attachment and connection to a shared world' (Braidotti 2013b: 193). The body of the eater is not reproduced unchanged whilst the eaten, the stuff of margarine, is destroyed. Eating changes who we are, and the world we are living in, hence 'strange encounters' are a tentative process of visceral learning which (momentarily) shifts my participants' 'relations with his or her own knowledges, hopes, fears and memories' (Stengers 2005: 1002) so as to acknowledge 'the collective nature and outward-bound direction of what we still call the self' (Braidotti 2013b: 193).

In sum, Law has called for the creation of methodologies that enable the exploration of enactments of otherness with-in the performance of, and interactions between, realities (2004: 122). With this in mind the 'consumer knowledges and practices' part of my fieldwork was designed with two aims: Firstly, the safe spaces and sociality of group discussions were intended to expose some of the tensions and translations between food knowledges. Secondly, allowing the stuff of margarine to be present as a research participant was envisioned to reveal a sense of normative boundaries between self and other. By making the mundane strange I momentarily revealed something of the arbitrariness as to who and what are made present (and absent) by normative framings of the matter of fats. This was done not by me explaining the links along margarine food chains, but by creating space for visceral learning within 'strange encounters'. However fleeting, such encounters facilitate an exploration of the ways in which both the self and the social world are co-produced with and in the relationships between eaters and fatty materialities. Strange encounters are a lesson in the refusal of socio-political norms. They are a micro-resistance which cultivate a hesitation in what 'is' so as to create space to play with possibilities of what might become.

Analysis

My time in the field generated field notes, recordings and photographs from six focus groups, participant-observation in industry, and twelve individual interviews. Bringing together such a diverse range of data is a key challenge in qualitative research.

Interview transcriptions were supplemented with field notes taken during and after each discussion, and from looking at photos and videos taken during the research process. This included notes on the participant's laughter, sarcasm, silences, body language and any apparent subject side-stepping. Inevitably this produced vast quantities of data, not all of which can be used in this thesis.

Formal analysis begins once the data has been generated, transcribed and compiled, however in actuality the process is ongoing throughout the research as research encounters are remembered and recounted. Analysis is not a linear process contained within the confines of the transcripts, but takes place in messy and dynamic 'webs of encounters with ideas, others, texts... the never-ending flow of connections between the texts and their multiple 'outsides' (Braidotti 2013b: 165) which allow new stories to emerge from and with the data. Thoughts and remembrances generated in this way inform the research as it continues. As they occur I note them in my field diaries and use them to add context to interview transcripts. These texts acted as relays between the field, the lives of my participants and my thinking processes (cf. Braidotti 2013b). As such, this shuttling process is part of the warp and weft of qualitative research.

In shaping a coherent narrative from the 'disparate events' (Coffey & Atkinson 1996) of the data generated I chose to use coding as my key analytical tool. This process involved several stages of coding and recoding as suggested by (Jackson 2001), and I decided to do it by hand – I felt that using a computer software package could only put another layer of distance between myself and my participants. Neither did I want to use deductive coding structured around the research questions as this would have carried the risk of my analysis being too subject to my preconceptions, I wanted to allow the knowledges, beliefs, values and decision making of my participants to rise to the surface.

The first stage involved 'open coding', working through my transcripts line by line, noting keywords and themes so as to fold together research encounters and interpretations. It was not just the words spoken I coded in this way but also the silences and tensions. I then created a map in which I grouped these themes together, so as to allow key themes to emerge. Next I recoded the transcripts line-by-line using these key themes. On this second round of coding, I began to shift from open to axial

coding (cf. Coffey & Atkinson 1996). The code 'eating-well', for example, became 'what is involved in eating-well?' Following, this second go-through, I created a new map in which I further developed the axial codes. I then repeated the whole process a third time. This processes of re-treading, and rethinking a two-year journey whilst sitting at my desk continually astonished me. For example, I encountered discussions of which I had absolutely no recollection. It was also a surprisingly vivid experience. As I was coding, and even as I am writing now, I can smell and taste margarine and its constituent oils.

The repeated line-by-line analysis also deepened my understanding of my data, and the themes to which my participants were responding. My coding map, however did not quite sit right. I could not make sense of the story was emerging. I felt that it was there within the map, but the themes that had emerged through this process were somehow concealing the nodes that were at the crux of my research questions. Indeed, at this point the process of coding felt a bit like playing 'consequences', the children's game where the first player draws a part of a picture, then folds the paper over leaving a trace of an idea for the next encounter. Within the game, this process continues until the paper is used up, then the whole image is revealed and the players laugh and despair in equal measure at what they have co-produced. Coding felt like doing this over and over again, but on my own, and with more despair. It captured snippets of what my participants were articulating, but there was a gap in communication that meant that the map was malformed and simplistic. There were shared values lying within the nodes of the map that I could not quite access. I was lost in data.

In talking through my despair to an empathetic colleague²⁶, however, I had to step back from this up-close, 'nose against the glass', line-by-line coding to give her an overview of what my research is doing. Through this conversation I realised that the major themes in my research are 'habits' and 'knowledges' - how margarine relationships are performed, and the understandings, beliefs and values entangled with, and perpetuated by, these practices. Within this were three key motifs: taste, care and doubt. And cutting across each of these motifs were references to materialities, the production of knowledges, and tensions between knowledges. I have

²⁶ Thankyou, Louise MacAllister

employed this coding system as the basis of each of my three empirical chapters: consumer practices and knowledges; industry practices and knowledges; and other ways of knowing and relating with margarine. This is not to say that the line-by-line coding was not necessary to the process, it was key to getting to know my data. However, once I had done this, to understand what was emerging I needed to step back and gain more of a 'birds-eye' view. Analysis is a way of knowing (Pink 2015) and as such it creates worlds (Marcus & Fischer 2014). On each coding round a slightly different, slightly clearer, narrative of the world we had co-created emerged.

Chapter Summary

For the first few months of the project, in attempting to follow supervisory advice, I kept my fingers metaphorically gripped around the stuff of margarine. However, I came to realise that in clinging to margarine in this way I was interpreting both the advice, and the thingness of margarine, too literally. In trying to follow oilseed rape, sunflower, palm, lecithin and more, from tub, to field, to mouth, I quickly stretched myself too thin. Gaining access to do research in a commercially sensitive industry is difficult, time-consuming and requires a certain amount of serendipity. On top of this, the restrictions of time and money that limit any PhD project meant that my time in the field at any particular site would be limited. Stepping back from the midst of the research, and talking things through with colleagues helped me to realise that what I was actually interested in was not finding out everything there is to know about how margarine is done. Rather my research interest was to understand the refrains and values within which commodity margarine and margarine consumer were co-constructed, and to explore whether it might be possible to create new refrains in which margarine could be eaten without being consumed. This realisation raised three broad aims:

- Aim i: To contribute to theoretical and empirical understandings of consumer knowledges, beliefs and practices of and with the matter of fats.

- Aim ii. To add to geographical understandings of the knowledges and practices of fat production.

- Aim iii. To explore other ways of knowing and relating with matters of fat.

Entangled with these specific aims is the goal of further developing methodologies that work to engage and enhance cohesion and solidarity within, and between, more-than human communities.

Law describes how methods work to craft and enact the '*boundaries* between presence, manifest absence and ... whatever is absent but is *Other* because, while it is necessary to presence, it is not or cannot be made manifest' (2004: 84-85). Such boundaries are inevitable, it is not possible to be aware of all relationships and connectivities at any moment. Nevertheless, the kinds of relationships that are made more or less possible through the processes of the research are delineated through the research design. If ethical encounters involve responsibility for the worlds they co-construct then I must endeavour to be aware of the boundaries I am reproducing with and through both the design of my methods, and the frameworks I use to interpret the results. However, 'neither the researcher nor the researched remains unchanged through the research encounter' (Rose 1997: 16). The design and the coding of this research have been influenced at every stage by what has gone before. Methodology involves a feedback loop between the texts, the interviewees, and my experiences. Data generation becomes inseparable from analysis, analysis inseparable from the discussion, and discussion inseparable from data generation. To be ethical, it is imperative that I am reflexive as to what has been lost as well as what has been gained in the doing of the research.

For my work with industry participants, research that leaned more strongly on the participant side of participant-observation would have brought new dimensions and a more embodied understanding of the doing of margarine in industry. However, in choosing to attend to the tensions, translations, and overflows between knowledge frameworks I was able to make present oft unnoticed bodies and relationships that are nonetheless entangled with the doing of margarine. Taking a topological perspective to following margarine refrains enabled the creation of 'snapshots' of the bodies and relationships understood as entangled with the stuff of margarine from multiple

positionalities. Juxtaposing these 'snapshots' within the coding process, revealed unexpected continuities and discontinuities with, in, and between, knowledges and practices of margarine (cf. Røyrvik 2013).

I carried this search for the unexpected over in to my research with margarine eaters. I wanted to engage methods that would facilitate my participants in articulating what they knew intellectually, viscerally and affectively about and with the stuff of margarine, no matter how incompatible these knowledges may be. To this end, the close personal relationships and familiar spaces of my planned discussion groups, encouraged the kinds of frank discussions that would be considered rude amongst strangers and facilitated my investigation of zones of tension, translation and overflow between knowledge frameworks with which the matter of margarine is entangled.

The third element of my fieldwork, was an experiment in exploring other ways of knowing and relating with margarine. Influenced by both Braidotti's (2013b) political philosophy of the posthuman, and Ahmed's (2000) work with post-colonial Others, I designed the research to include 'strange encounters' with the matter of margarine. The hope being that in making the mundane momentarily present as alien, such 'strange encounters' work to create a disjuncture in social norms and cultural values, troubling them. For some of my participants this hesitation came in the act of making, Jamie, for example, was enthralled by sunflower seed, crank press and elbow grease co-creating oil. Whilst for other participants, such as Ruth, taste mattered. The methodological approach of 'strange encounters' sought to move people in their awareness of the bodies and relationships entangled with the matter of margarine without defining or even knowing in what ways it might be possible to move. Influenced by the work of Pignarre and Stengers (2011) on micro-resistance of 'the event' I hoped that within this hesitation, my participants would be able to play with norms and values so as to rehearse other possible ways of living together (see interlude five).

The next three chapters explore and critique the empirical findings generated by my methodological processes. Chapter Four examines tensions and translations in knowledges and practices of margarine production. Chapter Five investigates sense-

making with-in the knowledges and practices of margarine consumption. Whilst Chapter Six explores some of the overflows of normative constructs of the stuff of margarine as revealed by the 'strange encounters', and by attending to the bodies and relationships that are made present (or make themselves present) as things that matter begin to rehearse other possible ways of living together.

flibbiddydibbiddob²⁷ (disrupting consumer knowledges)

Stork Wives Club

ORGANISED BY THE STORK COOKERY SERVICE

KILDARE HOUSE · DORSET RISE · LONDON · E.C.4 Secretary, Margery Appleton

Dear Member,

Here is the latest booklet from the Stork Cookery Service - "Feeding the Family". It has recipes for the sort of things many people ask for - Brawns, Pâté, pressed meats, and directions for boiling a Fowl or a Ham as well as many other savoury dishes. Some delicious cakes and pastry dishes are also included.

And now, as so many of you have asked for a Club brooch, I have persuaded the makers of Stork to get one for us. Here it is. Isn't it pretty? This attractive brooch can also be used as a scarf-pin, and it's made of silver plate inset with real marcasite. You can send for it - 3/6d. post free. Don't forget to include your name, address and membership number - and address your letter to Brooch Department.



There will not be any regular Christmas leaflets sent out this year, but I have plenty of recipes here, so if you want any recipes at any time, do write to me, but please write for your brooch separately as directed above.

Yours sincerely,
Margery Appleton
(Margery Appleton)

P.S. If you happen to be a Domestic Science Mistress and you're not yet on our special school mailing list, please let us know your school address.

WRITE IN BLOCK CAPITALS

Name

Address

.....

.....

.....

If undelivered please return to:
Stork Wives Club, Kildare House,
Dorset Rise, London, E.C.4.

CUT HERE

Please send me a Stork Wives Club Brooch.

I enclose 3/6d. Postal Order (crossed and made payable to Stork Wives

Membership No.

Postal Order No.

(Please do not enclose cookery queries with this request.)

SPONSORED BY VAN DEN BERGHS LTD, DISTRIBUTORS OF STORK MA

Figure 12: A letter sent to Stork Wives Club members along with a copy of 'Feeding the Family with Stork' Cookbook on August 29, 1958.

Margarine is not a 'traditional' foodstuff. Advertising is a means through which industry can endeavour to weave novel foodstuffs into the memories and affective environments of consumers (Carolan 2012: 41). Margarine has been heavily

²⁷ Flibbiddydibbiddob is the title of an EP released in 1990 by the London based punk band snuff on Workers Playtime Records which included cover versions of advertising jingles.

advertised to consumers in the UK since at least the 1900s, and from the early days has included multiple modes of dissemination, a mixture of message and method (Clark 1986). Tastings, recipe sheets, 'wives clubs' (see figure 12) and competitions were (and continue to be) used alongside nutritional advice and images of contented families in a cultural performance that

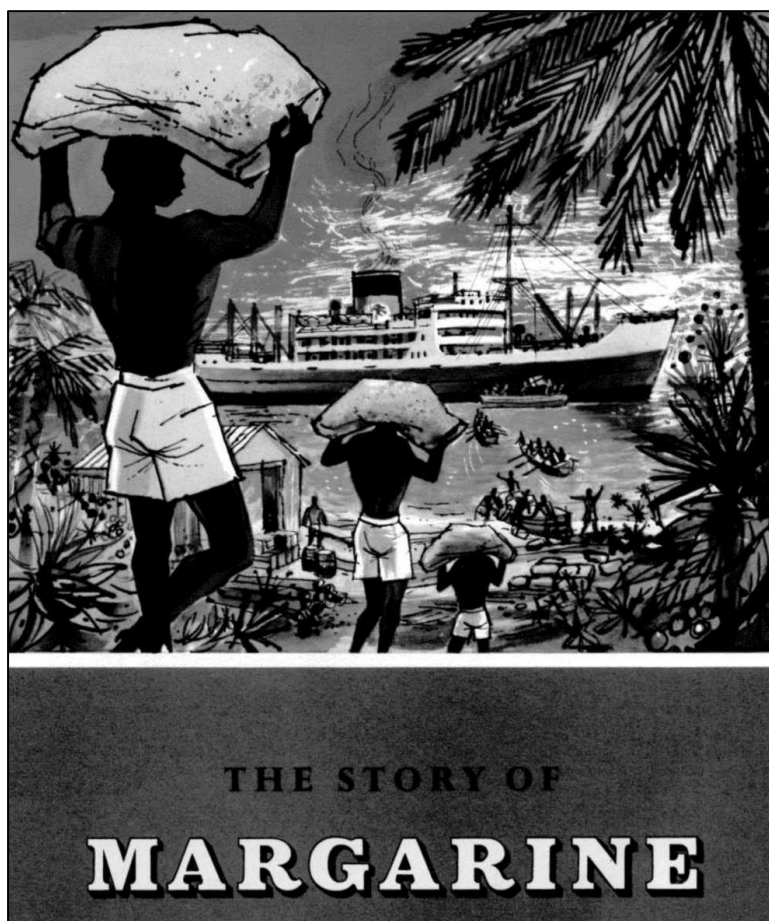

attempts to create myths that address the concerns and desires of consumers (cf. Holt 2004).

In the first half of the twentieth century, margarine marketing campaigns tended to direct 'factual' knowledge or domestic science practices towards women as carers or children as pesterers. In knowledge-type adverts aimed at women, 'expert' men (grocers, husbands or scientists) informed women of the sense of eating such an economic / nutritious / tasty / sophisticated modern butter substitute. Whilst in food practice orientated promotions, women shared sisterly or motherly margarine-oriented advice and recipes that it was claimed would help the busy housewife better care for herself, and her family. Similarly, the targeting of children took two distinct forms – one 'scientific' and 'educational', the other embodied and practical. For example, Van den Berghs / Unilever produced educational booklets for schools which explained the exciting science of margarine manufacture, and the exotic places from around the world where local workers were apparently delighted to be

Figure 13: Front piece of 1958 Unilever Pamphlet

cultivating oil crops for the people in the Global North who needed the calories because they ‘tend to be more active, perhaps because they naturally move faster to keep warm’ (Edwards 1958: 2). Van den Berghs / Unilever also targeted domestic science teachers through a membership club and by providing free cookbooks for schools.

As the century progressed, advertising became increasingly segmented. By the 1970s Van den Berghs (Unilever) had identified five key target consumer groups who they differentiated via concerns about price, status, the convenience of spreadability, calorie counting, and health concerns (Broadbent 1983 in Hooley et al. 2008: 178-179). And advertisements from this period to date do largely appear orientated towards these broad concerns. Cutting across all of these categories, however, is an additional theme – that of ‘the natural’²⁸. Promoting yellow fats as the ‘natural’ choice pops up in adverts from the high status orientated ‘Anchor cows’ campaigns; to the 1954 promotion of spreadable Stork as containing the ‘fresh, golden goodness... of sunshine’ (Levene 2014: 156); to ‘health’-brand Flora’s ‘seed to spread’ campaign in 2015.

Now please settle back and enjoy a short advert break:

²⁸ Some examples of yellow fat adverts and the themes they invoke:

The margarine for men!	Flora	1980	<u>Care/Health</u>
Helps a good mum become a super mum.	Stork	1976	
It’s a good good feeling!	Blue Band		
Bece! Love your heart.			
For the heart you love.			
Bece! takes your life to heart.	Bece!		
Our Outline helps your outline	Outline	1970	<u>Calories</u>
It's time to believe.			<u>Taste</u>
Believe.			
Cheat on butter.			
You can have it all.			
Now we know better!			
Unbelievably buttery taste.	I can’t believe it’s not butter		
The Stork Challenge:	Stork	1978	
Can you tell Stork from butter?			
Seven out of ten people can’t tell Stork from butter.			
Tastes so good you won’t believe it.	Krona	1988	
Tastes good enough to eat with nothing on!	Stork		
Spreads like butter	Kraft		<u>Spreadability</u>
Crowned with quality.	Imperial.		<u>Status</u>
Makes you feel like a queen	Summer County		
What am I gonna spread on my toast?	Vitalite	1984?	<u>Naturalness</u>

<u>Advert</u>	<u>Minutes</u>
1. https://youtu.be/1zUq6ZWhT8U Bruce Forsyth, Stork, Try it with nothing on, 1977	0:29
2. https://youtu.be/9YewNrLNJQM Outline. Our Outline helps your outline, 1970s	0:31
3. https://youtu.be/JmS3t5R3O6M Flora, The margarine for men, 1970s	0:28
4. https://youtu.be/wdD5kz9oN2o St Ivel, spread – aim low, 1980s	0:20
5. https://youtu.be/A9aORSroAkU Vitalite, 1980s	0:38
6. https://youtu.be/hLAyoOvbMrU Golden Churn, Kings Breakfast	0:28
7. https://youtu.be/LV8z98yOO5Q I can't believe it's not butter – light, cows, 1995	0:11
8. https://youtu.be/FPFYh6fNYC4 Bertolli, Enjoy Life, 2013	0:30
9. https://youtu.be/g27Qj3WKJdQ Flora Pro-Active, 2010s	0:29
	4:26

I hope that you enjoyed the advert break, and that it invoked memories for you of advertising as part of the storying of modern life and of your changing knowledges and practices of and with yellow fats, of childhood tea times, and of the fears and aspirations of shifting societal norms.

The adverts were selected to illustrate appeals to the consumer groups identified by the Van den Berghs research. These themes also arose in this research when, within the PDGs, the research participants were discussing the factors that have influenced their yellow fat choices and practices across their life-course. This is not to suggest however that the participants were influenced by adverts in any straightforward or deterministic ways (cf. Gillespie 2002).

In revealing something of 1970's gender norms, the Bruce Forsyth Stork, the Outline, and the Flora 'margarine for men' adverts horrify me. Yet although I undoubtedly saw

all of them when they were originally aired I do not recall having watched any of them before. At the time of their airing, none of these adverts appear to have spoken to me directly as a located subject (cf. Ahmed 2000: 15). My reaction to the Vitalite advert though, is visceral in a more pleasing way. The Vitalite advert spoke to me as a child of the 70s. Too young to understand any significance (or possible offence) that could be entwined with adapting the lyrics of Desmond Dekkers 'Israelites' to a jingle about margarine, Vitalite promotions worked (alongside campaigns for other novel foods like Smash) to introduce me to the notion that food could be more than a necessity to be endured. Yet, much as I love the advert, I do not recall ever buying Vitalite margarine for my own use. Power is asymmetrical but not unidirectional (Willis 1990: 19).

Adverts are a powerful cultural product (Willis 1990: 20) that play a role in the storying of food encounters, connectivities and communities. But consumers encounter advertising amongst a jumble of situated, material, sensory, economic, visceral and symbolic knowledges, practices and beliefs (Pred 1998) and our interpretations and integrations of them play a role in the co-creation of 'new meanings, new identities' (cf. Probyn 2000: 17) for ourselves and our communities.

CHAPTER FOUR

chewing the fat (consumer knowledges and practices)

Introduction

Building on the review of the literature (chapter two) and the explanation of the development of the methodology (chapter three), this chapter uses planned discussion group (PDG) generated conversations to explore my participants' knowledges, beliefs and practices of, and with, yellow fats. To this end, I analyse the fatty shopping, cooking and eating practice of my respondents, and the knowledges and assumptions with which they are interwoven as they were expressed within the PDG's. These semi-structured discussions took up the first part of the six PDG sessions and varied in length from approximately sixty to ninety minutes.

One of the advantages of using the PDG format was that within each of the groups the participants knew each other well, and I as the researcher was introduced to the rest of the group as a trusted friend of the host. The artificial constraints of the subject matter notwithstanding, these personal connections, alongside the domestic setting, facilitated the creation of a safe-space where beliefs about, and practices with, yellow fats could be revealed without fear of giving a 'wrong' answer. At the start of each PDG I introduced myself and my research, and took care to explain that I did not believe there to be a single right way to eat. I stressed that everyone is different, that eaters have diverse needs and priorities, that those priorities may change over time and that what is right for one person is unlikely to be right for others. I then opened the discussion with the deceptively straightforward question of 'what fats do you eat and why?'

Conversation flowed easily, if in a somewhat scattergun manner, as participants picked up on one or other element of each other's comments. In Ruth's group, in the space of ten minutes the discussion went from relative cost, to processing, to health, to traditional diets, to taste, to moderation, back to processing, to veganism, back to taste, to traceability, to childhood diet, to visceral knowing. For example:

- Jane There's also lots of stuff around at the minute around the benefits of saturated oil, and saturated fats. So what is that, is that a myth or is that real?
- Ruth I dunno. I just want to eat food that we've kind of been eating for a very long time and is proper food. I think what I always, I want to look at me plate and know what it is and where it's come from. I'm not really into kind of...
- Jane I haven't eaten a margarine that tastes nice
- Ruth Well there is that as well. I don't even like the kind of, you know the spreadable butter, I hate that

The mundane, habitual nature of food practices can make it hard for the researcher to access the ways in which consumption can re-inscribe or trouble normative knowledges and practices, but using PDG's made it difficult for participants to present smoothed-out versions of their food habits. As each participant revealed their yellow fat histories, other group members would comment, ask questions, challenge or support the validity of the narrative.

Participants agreed and disagreed, were confident and self-deprecating, contradicted themselves, changed their minds, talked across each other, riffed off each other, mocked each other, voiced frustration at the limitations of their own knowledges and of the information available to them, and expressed surprise at quite how much they had to say about yellow fats. Yet throughout these conversations yellow fats were the node through which multiple bodies and relationships were juxtaposed. In this way discussions shifted from description to an exploration of the beliefs, values, practices and restrictions that were entangled with the respondents fatty shopping, cooking and eating decisions.

On beginning the analysis of my participants' articulations of their practices, three things immediately struck me: Firstly, the wide range of oil and fat products regularly used. Secondly, that except for butter, all of those oils and fats were of vegetable origin. (The complete list of products was: butter, margarine, sunflower oil, rape oil, coconut oil, sesame oil, olive oil, peanut oil, walnut oil and vegetable suet). Thirdly, the participants had something of a tendency to misremember their own habits and

practices, or at least to shift their stories when challenged by other members of the group. For example:

- Martin and Joan disagreed as to the oils and fats which they had in their home.
- When Paul said he never bought margarine, Alice reminded him that he has been known to buy spreadable, as well as 'proper', butter.
- Alice claimed not to use margarine, yet a quick rummage around her fridge by this researcher revealed a tub of Flora. On being quizzed about this, Alice explained that she had bought the margarine when her doctor told her that she needed to reduce her cholesterol, but really she knew that that wasn't the real problem, and so it just sits there and she uses it when she's in a hurry because it spreads easily.

By drawing on the detailed qualitative representations of the discussion group interactions a variety of insights emerged as to the ways in which participants perceive, remember and explain the shopping, cooking and eating habits of themselves and of others. Analysis revealed vivid portrayals of i. the 'push power' of the entanglement of distaste for a product with beliefs about the self. ii. The 'pull power' of the entwining of caring identities with consumer decision making. And iii. the torpor that accompanies feelings of doubt at not being able to eat carefully enough, or not understanding what to do for the best.

Through situating these dialogues within the broader context of geographical approaches to consumption, this chapter will attend to the first of my three research aims: To contribute to theoretical and empirical understandings of consumer knowledges, beliefs and practices of and with the matter of fats'. To this end, I explore three key questions: How do consumers negotiate different framings of margarine? Who and what are valued by margarine consumers? In what ways do consumer practices with margarine relate to their knowledges and beliefs about fat? In section one, 'habits', I explore my participants' descriptions of their day to day performances of shopping, cooking, and eating with or without margarine across their life-course. Whilst in section two, 'knowledges', I examine the visceral encounters, narratives, communities and decision making processes that my participants articulate as entangled with the establishment and maintenance of those practices.

Habits (consumer practices)

In explaining their current practices with oils and fats my PDG participants reported predominantly using yellow fats as a spread and for baking. Although, in addition to the yellow fats each of my participants reported that they regularly used at least one olive oil, and at least one or other of oil-seed rape or sunflower oil for frying, braising, roasting and salad dressings. The oils and fats used, and the purposes they were used for, varied, however, from one participant to the next (including between individuals within a household)²⁹.

During the early stages of the PDG's my participants explained that on a day-to-day basis their fatty practices are habitual. For example, Ruth, a Bristol based full-time teacher and single mum in her late thirties, felt that:

you just get into your habit, because a lot of what you eat is habitual... I think, my shopping list is the same every week, and of course it gets tracked by Tescos because I do the club card thing, which I'm GOING to not do any more, and erm...

Whilst in my London group Paul, a museum curator in his early fifties, felt that for him shopping habitually is:

just easier. It's easier. There's enough else going on in my head to start thinking about what different. It's mechanical, I tend to stick with things that, after I've made the choice about, you know, what kind of product I'm going to buy, I will just, kind of, stick with it.

Shopping habitually for mundane products like yellow fats, was felt by Paul and Ruth to be an efficient use of limited time and energy; an act of self-care. Yet, as Paul describes, in order to form that habit at some point the options were weighed up, criteria prioritised, and a decision taken. Whilst Ruth wondered how her weighing up of options and her habits might be influenced by the manipulation of her knowledges by corporate marketing strategies.

²⁹ Ruth, Jane, Ian, Sarah, Alice and Paul said that they only use, or predominantly use, butter rather than margarine. Jack and Bill also mostly ate butter, although being eleven and fifteen they generally eat what Ruth provides for them and so have little choice in the matter. Lyn, Steve and Milly felt that they used both butter and margarine equally. Claire, Catherine, John, Martin & Joan predominantly used margarine, whilst Anna used only margarine. Andy and Steph used neither butter nor margarine regularly, preferring instead to use oil or nut butters for spreading and baking. It should be noted however that Andy, Steph and Anna were vegan at the time of the research.

I was interested to explore further the development and maintenance of my participant's fatty habits. To do this it is necessary to access the messy complexity of shifting, overlapping and nested food knowledges and practices entangled with habit formation. To begin to enable this I shifted the foci of the stories my participants were telling me, by asking them to tell me about the fats they had eaten as children.

Joan, a retired nurse in her late sixties, described growing up in 1940s Lincolnshire and eating home-produced lard and dripping in addition to shop-bought butter and hard margarine³⁰. She continued:

Well, mum used to make pastry with lard... Margarine was for cakes, and she always used to cook roast potatoes in lard. The potatoes were nearly covered in it, her roast potatoes... We didn't buy oils. There weren't oils in bottles.

It is often believed that food habits feel natural because they are learned in childhood, a comforting reminder of home. At the time of her PDG, however, Joan habitually ate vegetable based spreads and oils from bottles.

At the time of their PDG Paul and his partner Alice were habitual consumers of butter and olive oil. Yet Alice remembered that as a child in the 1970s and 1980s, she ate soft-margarine and sunflower oil. Whilst Paul, who was born in the 1960s, remembers his family making a shift from butter to margarine when he was a teenager. He explained that:

In the old days, you know, the 70s, or whenever, the time when we would have used margarine at home would have probably been to cook with, baking, there's that whole thing. Was it Stork? When I was very, very young. We probably always mostly had butter, though, at home. When I was very young we would have had butter and then when I was a bit older we probably did go through phases of buying Flora and things for a bit

Neither Alice or Paul, nor Joan could recall when or why, olive oil became a mundane part of their diet.

³⁰ At this time margarine would have contained whale and / or fish oils.

At first glance it appears that the fatty practices of my PDG participants were not a product of habits set within childhood visceral learning. In recalling their fatty practices across their life-course, my PDG participants reported significant shifts in the ways in which they buy, use and eat fats and oils, noting in particular a swing from solid animal-based fats to soft vegetable-based margarines and oils in the late 1970s and early 1980s. Asking my participants about their childhood diets momentarily made present to them the striated space between then and now. Awareness of these gaps troubled their descriptions of their fatty practices as merely habitual and prompted them to explore why their habits had changed, and how their current habits developed and were maintained. Thinking about shifts in eating practices in this way was a novel experience for many of the participants, and one that troubled them. They conveyed a degree of confusion as to the gaps between practices then and habits now.

Both Paul and Martin, Joan's partner, explained that when they were children their aspirational families had considered margarine suitable only for use within baking; whilst for the display of the table, the more expensive butter, specifically *Lurpak* butter, was the valued yellow fat of choice. This class-based social stigma around the use of butter rather than margarine was not something my younger participants recalled. Regardless of their class background they had grown up primarily eating margarine rather than butter. Paul's partner Alice, for example, who is from a solidly middle-class family did not recall ever

having butter at home when I was a child. We always had Flora and those kind of things, which now I find really just greasy and horrible. We had Flora, but then we had this Outline thing. It was the most disgusting, it used to make me almost gag, it was really revolting. The texture was weird; I think it was like a diet one. Every now and again mum would go on a diet, even though she really didn't need to diet.

Alice felt that in addition to price, her mum was influenced in her fat choices by social norms, but that any stigma was entangled with mores about body shape, and social expectations of care for the health of their families that were both subtler and more complex than what type of fat was seen on their kitchen table.

In looking back to her formative years Alice expressed confusion on encountering a dissonance between what she understands to be the 'proper' / 'natural' cooking that took place in her childhood home and the appearance of a 'substitute' food like margarine on the kitchen table. Alice discussed a number of possibilities as to what might have triggered these shifts in fatty habits, but was unable to find explanations that adequately smoothed over this gap in ways that made sense to her.

In the 1970s, however, the UK government endorsed health guidelines recommending a relative increase of polyunsaturated to saturated fats in the diet. In the same period Unilever promoted the polyunsaturated fat-based Flora in its the 'margarine for men' campaign which situated eating Flora as an act of health-care, rather than as a thrifty, or spreadable butter substitute. Indeed, Lyn, who is several years older than Alice, was able to situate her family's choice of margarine within the context of such contemporaneous advice about cholesterol and heart health:

When I grew up we only had margarine and occasional butter, and my mum is well known for, you know she has her bit of bread with her butter, rather than the other way round. And because erm, and I always believed, and my dad was a doctor that dealt with innards that it's that clogging of your arteries and yeah, the cholesterol thing that it was unhealthy.

As such, the gap articulated by Alice between conceptions of 'eating-well' in the 1970s and currently would seem to echo research that notes a shift in attitude to margarine following shifting nutritional advice and the advent of such polyunsaturated spreads (Levene 2014).

Conversely, when explaining their current fatty habits, the participants tended to talk first not about health but about price. However, they disagreed as to which category of yellow fat was the cheaper. Some participants insisted that margarine cost less than butter, others that margarine was more expensive, and others that it was much of a muchness. This intrigued me and so I went online to check prices at a high-end, a mid-range and a low-cost supermarket. Within these shops, when all yellow fat products

are taken into account, the price ranges of butter and margarine largely overlapped³¹. At the time of writing examples of both butter and margarine were being sold within a price range of £1.50 to £8.40 per kilogram.

My participants' perceptions of yellow fat price seem to relate to the products that they habitually buy rather than the range actually available. Joan felt that margarine is the more expensive. Indeed, the product Joan uses is more than twice the price of an average pack of butter, but she feels that as both she and her partner had been diagnosed with high cholesterol then it is a price worth paying. In contrast Cath, although also a habitual margarine buyer, felt margarine to be the cheaper of the two. At the time of writing, the cheapest margarine was cheaper than the cheapest butter at all three of the supermarkets I looked at. Cath explained that after checking the ingredients list, she had concluded that a supermarket's own olive margarine was 'just the same' as a branded one.

A similar pattern emerged with the butter eaters. Paul felt that butter was cheaper than margarine even though he habitually chose an expensive product, explaining that 'dairy farmers get very, very, very screwed by supermarkets and don't get enough money for what they're producing, and so... I feel like... it's important to support that industry and also, I suppose, buying a slightly premium product if... it's a way of perhaps supporting the industry, you know, by buying something that possibly pays them a slightly more acceptable amount of money.' Conversely, Ruth although also choosing butter over margarine, accurately felt that margarine is the cheaper of the two. She went on to explain that she had 'bought value, Tesco's value, because we had an experiment me and the kids, because I mean things aren't quite so tight now, touch wood and I hope they'll stay that way, but they were really tight last year and whenever, erm, I sort of thought I'm going to try some of the value products and just see if they're good.' Ruth felt that her income limited her buying possibilities but went on to describe how her lack of money had forced her to work through what her food priorities actually were.

³¹ On the day I wrote this (08/02/16) I checked prices for butter and margarine on the websites of each of a low, mid and high end supermarket. Butter prices ranged from £1.56 - £5.16 at Aldi, £3.40 - £7.60 per kg at Tesco, and £3.80 - £8.40 per kg at Waitrose. Margarine prices ranged from £1.38 - £2.98 at Aldi, £1.35 - £7.60 per kg at Tesco, and £2.00 - £9.96 per kg at Waitrose. Across these three supermarkets the price range per kg for butter was £1.56 - £8.40. And for margarine was £1.35 - £9.96.

Price then was not in itself sufficient to explain the development of the participants' mundane habits with yellow fats. The participants felt price and value to be different things. In thinking through her habits Lyn explained that she valued butter for its flavour, and margarine for its spreadability, because 'that's the thing. So when I'm making sandwiches, I can't, I can never spread the butter well enough. So that's when I use margarine because of, well when I'm quickly doing it, it just takes work. If I'm having my lunch here I'd use butter'.

Other participants noted that margarine's ease of spreading meant that eaters tended to use less. Ruth felt that this meant that the product lasted longer and so was better value for money; whilst her friend Jane felt that 'some women' might prefer this because then they would be consuming fewer calories. This comment about calorie-control prompted protestations from Ruth who argued that health is entangled with nourishment, not something that can be quantified by the reductive nutritionalism of calorie counting. For Ruth margarine is not 'proper' food and is no solution to 'eating properly.' Yet later in the session Ruth went on to describe the low-fat cheese that she buys because she is on a calorie-controlled diet as part of a weight-loss, health, and fitness regime. This dialogue between Jane and Ruth is an example of how the PDG's worked to create space in which compromises and translations between knowledges, beliefs and practices can emerge.

So far in this chapter, I have demonstrated how my participants' yellow fat habits although experienced as habitual and apparently entrenched have changed substantially over the lifetimes of each of the respondents as their priorities, knowledges and beliefs had also shifted³². For my participants, eating yellow fats is about something more than a habitual obtaining of the calories necessary to survive another day. They were, to varying degrees, active choosers as to the types of yellow fats that they habitually ate. Indeed prior to forming their current habits, my

³² The production processes and ingredients used in margarine have changed significantly over time but the participants tended not to speak about that. Rather when they were discussing changing habits they were referring to product type or brand.

participants described taking some considerable time weighing up the options and deciding.

Knowing the fats

What feels 'natural' has forgotten the construct from which it first emerged (Schillmeir 2013). Throughout their descriptions of their mundane practices with yellow fats, price, convenience, gender norms and societal expectations were made present as being in tension and interweaving with nutritional science knowledges and visceral experiences. Yellow fat practices were formed with and through such food knowledges, food encounters, budgets and social network and often remained stable for long periods, but go through times of turbulence when new knowledges, encounters and networks force a reappraisal of comfortable habits. My participants felt that it took a 'significant' piece of information (e.g. about saturated fats and health) or change in circumstances (e.g. personal finances) to shift shopping habits. The PDG's were designed to draw out how my participants negotiate such knowledges. In the remainder of this chapter I shall explore the contradictory knowledges, beliefs, pressures, and senses of self, entangled with such habit formation in more depth.

On analysing the PDG transcripts for the factors entangled with the formation of mundane practices with yellow fats, three key themes emerged: Distaste, care and doubt. In recoiling away from some yellow fats, and being drawn to others, my participants filtered the range of products from which they have to choose. Yet in doing this they experienced friction within the push-pull of 'choice' as they attempted to juggle multiple regimes of value. I will examine each of these three themes in turn so as to explore how consumers make-sense from, and partially co-create the often incongruent margarine knowledges and practices that emerge from and with different margarine framings and the regimes of value entangled with them.

Distaste (knowledges that push)

It is perhaps not surprising that when my participants began to describe their knowledges of, rather than their practices with, yellow fats, taste emerged as a way of knowing the stuff of fat. Butter was typically described by my participants as flavour-full. Ruth, for example, had been brought up eating margarine, but recalled first eating

butter whilst on holiday in France ‘and going bloody hell this is delicious!’ When she is talking about her knowledges of butter, Ruth is animated and joyful. She gesticulates, her eyes light up and ‘mmm’ noises are made. The experience of eating margarine was, however, described by my margarine eating participants in less lively, less enthusiastic terms. Anna’s description of margarine as ‘quite bland... just there to moisturise the bread or something’ is a concise reflection of its representation within the PDG discussions.

At the outset of their conversations, my participants, including the habitual margarine eaters, described the flavour role played by margarine as at best accentuating the palatability of other, more interesting foodstuffs rather than being a remarkable flavour in and of itself. Yet when the conversations moved from discussing generic margarine to specific products, some of these were pronounced as being incredible flavourful. Olive based margarines, in particular, were singled out by the participants because of their distinctive flavour. For, Ruth and Jane’s friend, Claire, the characteristic olive-like flavour was described as a bonus, one of the factors shaping her choice of the spread. It emerged, however, that the olive-flavour was not attractive to Claire primarily because she liked the flavour in and of itself. Claire explained that:

I am probably sold on the fact it says olive to be honest...if it said sunflower oil, sunflower margarine and it was bright yellow, I’d probably go yuck, but because it’s like, it says olive, and you open it and its er lighter, it’s not a bright yellow, it’s kind of mid-, so yeah.

Although Claire did not particularly like the flavour of olive-based margarine, the presence of the flavour confirmed to her the actuality of olives within the product. The tastefulness of the spread was encountered by her as entwined with her knowledges and beliefs about the health properties of olives. She went on to explain that if she were eating a fat in order to enjoy the flavour of that fat on ‘say a crumpet or a slice of toast’ then she would use butter. A gap emerged between Claire’s explanations of her visceral *liking of the flavour* of a product and the experience of the *tastefulness* of that same product.

Milly however, felt olive-based margarines to be strongly flavoured, but not of olives. This gap between the flavour expected and the flavour experienced, revealed something distasteful to Milly about the processes of production. She explained:

the more things are processed, the less close things are to their original form. It's just at some point it must sort of stop really being food, I mean we can eat it, we can eat it and we will feel sated, but... There was a lot in the media back in the in the 1980s and 1990s about kind of you know the Mediterranean diet and how health... people lived longer and stuff and that was part of the whole thing that you were being sold that if you introduced elements of this Mediterranean diet when actually possibly what the Mediterranean diet contained was an awful lot less processed food full stop, you know rather than kind of the idea of having olive margarine, you'd have olives, you'd have olive oil. Rather than eating a processed thing, you'd have things closer to their original form.

Milly experienced distaste in the disjuncture between representations of olive-based margarines and the visceral experience of eating them. This distaste was not a product of her knowledges about the ingredients of margarine – Milly knew that margarine contained oils, and was comfortable with this as she used the same oils in their liquid form. Distaste for Milly was knotted with her beliefs about the 'stickiness' (cf. Ahmed 2013) of food processing practices. Milly felt that production processes folded with and in the stuff of margarine in ways that nullified any potential healthful activity of the olives themselves.

Claire and Milly's differing interpretations of the flavour of margarine notwithstanding, their embodied encounters with tastefulness reveals them to be conceptualising eating as something other than a passive transference of energy from eater to eaten. Eating yellow fats was felt by both Claire and Milly to be an active entanglement of the eating-self and *lively* matters of fat. The likely healthy or unhealthy activities of the stuff of fat with and in the body of the eater were believed by them to be made present to the eater through the visceral experience of tastefulness. In this way the experience of tastefulness can be understood as a form of 'visceral politics' (cf. Hayes-Conroy & Hayes-Conroy 2008) within which matters of fat are differentiated, valued and enacted.

Ruth, too, felt that she trusted her embodied encounters with the stuff of fat to inform her eating practices. She explained that encounters with yellow fats are a visceral prompt to their likely tastefulness. Ruth described the experience of eating margarine as 'horrible,' 'synthetic, really fake,' yet Ruth did not experience distaste because margarine had made her sick, nor because of a primary reaction to the flavours, texture, smell or appearance of margarine. Indeed, she explained that 'as a child, we just never had butter, so I never really, just, we had *Flora*, and I was fine with that'. In the intervening years something had shifted in Ruth's experience of her embodied encounters with the stuff of margarine.

In the visceral realm knowledge is embodied and bodies are minded; 'representations join and become part of old memories, new intensities, triggers, aches, tempers, commotions, tranquilities' (Hayes-Conroy & Hayes-Conroy 2008: 467). As outlined above, the first time Ruth tasted butter she found it to be delicious; however, her awakening to the tastefulness of butter was not simply a product of flavour. Ruth went on to explain that butter felt to her 'like proper food. Absolutely lovely. Nourishment!' 'Unpacking' Ruth's distasteful encounters with margarine reveals that she felt that the experience of 'nourishment' had roused her visceral self to the distasteful 'unnatural' otherness of the flavours, smells and textures of margarine. Ruth encounters the tastefulness of fats with and in her identity and culture, and in combination with her health and other knowledges. In this way Ruth learned to perceive the production processes of margarine almost as a contagious miasma that fold into, and sully, both margarine and margarine eaters (cf. Ahmed 2013).

Like Ruth, Martin wanted to trust his embodied experience as to what tastes 'good' to eat, and he enthusiastically described the visceral 'goodness' of butter, pork scratchings, and of bread dipped in hot beef dripping. Yet Martin did not have complete faith in his visceral knowledges. Martin habitually eats margarine, even though he considered it to be functional rather than tasty, explaining that he 'went in to buying' margarines because they felt they were 'supposed to be thinking that they're quite healthy'. However, he expressed some uncertainty as to how he had come to know this, or even what the stuff of margarine is. Martin explained that he had not 'really thought about it, but if you had asked me I would have thought of

margarine as a factory-produced product with various chemicals thrown in, and no doubt heated to very high temperatures, and you know.'

Martin had learned that margarine had been designed to do good for, with, and in his body, and he explained that in most circumstances it was an acceptable butter substitute as 'it does the job well enough.' Yet he went on to describe how he always serves butter, rather than margarine, when feeding guests. Martin judged the functionality of margarine to be doing good for his health, while he deemed the visceral joy of encounters with butter as good for his social relations. Martin understood health and social framings of yellow fats to be incompatible, his yellow fat choices to be slippery depending on which framing is prioritised within the encounter. Thinking with taste facilitates an 'unpacking' of the ways in which Martin makes and assesses his yellow fat choices, and shows that he experiences taste in ways that are material and cultural as well as visceral.

Despite her insistence, Ruth's visceral knowing of the stuff of fat is also not sufficient to fully explain her yellow fat practices. To return to Ruth's description of how she had previously bought a supermarket 'value butter'. She explained that she encountered the product viscerally as 'absolutely lovely... exactly the same, butter and salt, nothing else. It's just a pack of butter'. However, she went on to explain 'I'm not buying value butter now... I don't like the value packaging. There is a stigma about it isn't there... it's that cultural thing, it's like there's a stigma about those value products'. Ruth's belief that the experience of nourishment reveals the stuff of fat as acting with and in her body in ways that are healthful, created space in which the liveliness of the stuff of fat became known to her. However, in her assessment of how value butter can be stigmatizing, Ruth illuminated how such liveliness can, in part, be captured within other knowledge frameworks and sold to consumers as discrete packages subject to "lifestyle choice." She did not just buy any brand of butter, no matter that it tastes "exactly the same." Ruth's experience of the tastefulness of butter was entangled with her material knowledges, her cultural positionality, and her regimes of value (cf. Hayes-Conroy & Hayes-Conroy 2008: 467).

My participants' experience of distastefulness, then, was not merely the product of an encounter with the flavour or texture of the fatty other. The observations of Martin and Ruth suggest that they tasted not only the stuff of margarine, but also other matters, relationships, practices, and discourses that were entangled with it, and stuck to its constituent parts (cf. Abbots & Lavis 2013; Ahmed 2013). When these different ways of knowing were in conflict, compelling them to juggle priorities, Martin and Ruth experienced distaste. By the same token, Jane reported experiencing the visceral pleasure of "good taste" when her different ways of knowing were in alignment. Jane vividly described wanting to trust her embodied experiences of the tasteful nourishment within butter and reported feeling "vindicated" when she read about study findings that suggested that saturated fats may not be implicated in raised cholesterol levels; "I just thought SO I was right all along, you know, I guess that's what lots of us did . . . it's a taste thing."

Unsurprisingly, all of my participants expressed a desire to make "good" food choices; however, one participant, Andy, was particularly distinctive in this regard. Andy said that he was deeply concerned about the social and environmental implications of the relationships and connectivities entwined with the stuff of food. He described himself as a careful eater who, despite his low income, habitually buys from "ethical" local businesses, often going without if something is not in stock, out of season, or outside of his price bracket. Andy is also vegan, choosing not to eat butter for sustainability and animal welfare reasons. Unlike Ruth, Andy articulated his knowledges about the bodies and relationships entangled with the stuff of fat as more important to the "goodness" of his eating practices than his visceral experience. Yet for Andy the visceral experience of distastefulness was part of margarine's attraction. He explained that "when we'd be totally cacking out, we'd go and get a white baguette and then it would just be loads of marg and some other nasty stuff . . . proper cacky like.'

In recalling 'cacking out,' as when Ruth was describing eating butter, Andy's body language was animated and joyful. Loveliness was not, however, the kind of word he used to describe his experience of eating margarine. Andy described margarine as an overly processed food "substitute." Yet his attempts to juggle multiple regimes of value ensnared with and in his yellow fat choices left him relaying back and forth

between the differing distastes of self-denial and culpability. Andy's joyous "naughty" distaste in the self-indulgent rebellion of 'cacking out' can be understood as a momentary break from the habitual effort he puts into enacting care for others with and through his mundane eating practices. Sometimes the affectual joy of visceral "wrongness" was a more immediate priority for his self-care than long-term health or ethical concerns.

For my participants, encounters between fat and tongue constitutes only a tiny part of webs of relationships between lively bodies entangled with and in the stuff of fat (Bennett 2010). From the human labour of animal and plant husbandry, to the multiple life forms that must make space for agriculture, eating cannot happen in isolation (Davis 2003). Probyn suggests that in the experience of distaste 'things, categories, people are just too close for comfort' (2000: 133). Yet although my participants did describe the embodied experience of eating as a form of knowing that made lively others knotted within the stuff of fats present in their consciousness, the pull of the medicinal felt by Martin and the rebellion described by Andy suggest that sometimes there is a comfort to be found in such closeness.

Distastefulness, then, is not simply a fearful "not-in-my body" (DuPuis 2000) response to the proximal stranger. My participants experience a fatty encounter as distasteful when the ways in which the stuff of fat is known and framed revealed disjunctures in the storying of self. As Deleuze reminds us, 'the object that does not agree with me jeopardizes my cohesion, and tends to divide me into subsets, which, in the extreme case, enter into relations that are incompatible with my constitutive relation' (1988: 21). Distasteful encounters are an embodied consequence of my participants' attempts to maintain self-cohesion when different regimes of value are in tension. In this way thinking with distaste can momentarily "unpack" normative knowledges, practices, and systemic structures entangled with and in mundane eating practices, making their complex interactions more open to investigation.

Food 'enters into what we become' (Bennett 2007: 133). In this section, I have looked to demonstrate that caring for self through attentiveness to the embodied experiences of eating yellow fats was articulated by my participants as a responsibility they took

seriously. It is perhaps not surprising that taste emerged as a key mechanism through which my participants came to know the stuff of fat. What is significant, however, is that their perceptions of the distastefulness of a fat did not rest in any straightforward way on their visceral disliking of the flavour of that same product.

Thinking with distaste reveals that my participants' encounters with the stuff of fats cannot be contained in meetings between the stuff of fat and lips, mouth, or guts. My participants do not ingest a fat in any straightforward accordance with their understanding of its flavour or nutritive properties. The stuff of fat is experienced as folded with multiple human and nonhuman others, and my participants expressed concern about the kinds of bodies and relationships with which they were to become viscerally entangled (cf. Probyn 2000; Ahmed 2013). Yet any practice of relation is also an exclusion of other bodies, communities, and styles of valuing. Thinking with distaste is a tool through which those 'that which we have already designated as the beyond' can be made present (Ahmed 2000: 3). The experience of distastefulness is, however, not simply an embodied rejection of perceived topologies of proximity. For my participants, distaste, although shaped by visceral experiences and embodied encounters, was primarily a product of notions of the self being out of accord with the ways in which a fat stuff is framed. The distasteful encounters described by my participants reveal as much about their constructions of self as they do about the fatty objects of their distaste.

Care (knowledges that pull)

On the face of it, it might appear that a distaste response to fatty materialities suggests that my participants are attempting to isolate themselves from bodies or discourses perceived as contaminating to the self in some way. Lyn's description of the distasteful action of saturated fat as 'clogging', for example, seems an apt description of an encounter which she believes reduces flows within her body, limiting its possible becomings. Whilst Ruth's distaste at value brands is a response to social stigma. However, in this next section I shall illustrate how my participants articulate such self-care as inseparable from care for others.

Paul lives and works in London, and as we have seen, he thinks of himself as a 'habitual shopper'. Yet by examining the development of Paul's habits, this statement can be

understood as being much more complex than it first appears. Paul has chosen to build his fatty habits around the eating of premium butter, in part, because he wants to support the income and way of life of British dairy farmers who he feels 'have had a really particularly shit time of it in recent years'. In this way, Paul's butter buying habits are a materialisation of his awareness of his proximity to the farmers folded with his buttery encounters. Paul went on to explain, however, that,

the other thing for me about butter and how I buy it is about plastic. I normally buy, you know, packs of butter and put them in a ceramic butter dish, because I want to support the ceramic industry by having a butter dish.

In putting his premium butter in a butter dish, although presenting himself as a butter eater, Paul is not advertising to others what brand of butter he has bought, nonetheless he is performing his prioritisation of relationships of care, with farmers and ceramicists.

Shopping by habit is easier for Paul because a lot of emotional and intellectual work has gone in to deciding which is the best 'wider value thing, I suppose'. Choosing to eat premium butter was simultaneously a turning away from spreadable butters and understood by Paul to be a positive 'in-my-body' choice to entangle himself with foods which taste good to his knowledges and beliefs about living together. A choice which involves substantially more effort than simply continuing to eat what he has always eaten.

Ruth also articulated her choice of butter over margarine as an enactment of care. However, in explaining this she recalled how as a young adult as part of establishing her 'practice of self', Ruth had very consciously changed her fatty habits. When she first left home, Ruth 'became vegan, lived with a big load of hippies.... we used a kitty and ate together. And I suppose when I was first responsible for what I ate... it was margarine and I was fine about that... But I never really liked it. You had it because it's like that's what you had.' As a teenager, the moral strictures of veganism combined with the mutuality of eating together were important to the performance and co-production of Ruth's identity and belonging, more important in fact than a visceral liking of the stuff she was eating. Recalling this left Ruth somewhat bemused by the

practices of her younger self. Shaking her head, she continued, 'when I think about how I ate when I was vegan, the crap I ate. I mean all those soya products, all those weird substitutes!'

Ruth feels that as she has got to know herself better, her choices have become more nuanced and respectful. Nowadays, Ruth rejects margarine as 'synthetic', choosing butter because she perceives butter to be 'simple', 'traditional', 'natural', and 'local': 'proper' food. Ruth contrasts this to when she was vegan, having to try and interpret all the labels and 'agonising over every decision I ever made was painful.' Nowadays, she feels that eating-well is about the positive connections of what is eaten, rather than the negative ones of what is not eaten. For Ruth eating butter is 'nourishing' not only to the trajectory of her bodily health, but an act of care for herself in and with a wider world.

Nonetheless, Ruth proclaimed entanglements with another 'simple', locally produced fat - oil-seed rape, to be a materialisation of disrespect for the countryside. She explained:

I don't like seeing it, I just think, cos some people say look at that lovely field, and I just think monocrop, I associate it with you know the rooting up of hedgerows... I suppose I remember before rape and after rape, and it's changed hasn't it? It's like my landscape of my childhood did change. I kind of remember, I kind of was aware cos of there being no fields of rape, and then there being fields of rape. Where does that plant, oilseed rape, come from originally? That doesn't feel to me like an English sight, those fields of rape, and I think that's why I don't like it.

When pushed, Ruth could list the possible advantages of locally grown oil producing crops, but her sense of herself cannot be separated from affective cultural belonging with a landscape that does not contain them. Landscape for Ruth is not something that is merely gazed upon, landscape remakes her and her sense of herself as her practices remake it. Eating butter is tied up with Ruth's sense of perpetuating that landscape, eating oil-seed rape with destroying it.

By the same token, Paul explained that his turning towards premium butters was about more than performing care for the livelihoods of ceramicists or farmers who produce the products he uses. He continued:

I also want to not buy additional amounts of plastic packaging and I like the fact that you can just buy butter in a block just in a bit of paper, or foil, whatever. It seems much less impactful... That was definitely a motivation to switch from spreadable butter to blocks.

Paul's desire to eat in ways that are 'less impactful' suggests that he feels proximity and responsibility not just to those already materialised within his buttery practices, but to others too numerous to name within a world yet to come. Paul went on to explain that he felt that his butter eating did well by 'the environment in general' and the 'gene pool that exists in the, you know, in the natural kind of flora of the country', suggesting that within Paul's use of the term 'less impactful' is an understanding that eating is in fact always impactful and so it is important to eat not only for those directly impacted in the production of food but for imagined future others too.

The fatty choices of my participants cannot be contained within ingestion, or within a production-consumption chain. Their fatty practices are convoked by their knowledges about the stuff of food *and* their affectual sense of themselves *and* their place in the world. As Ruth explained, 'it's not just about feeding our bodies, it's so tied up with cultural norms, or what we're used to, and I was talking about my mum's cooking, and family traditions, and what we perceive to be, you know good for us and good for our families... *But that's because we are more than, we are way more than these kind of machines that just process.*' Ruth primarily chooses butter because it tastes good to her body and to her cultural memory, but entangled with its good taste is her hope that fatty consumer choice is a means through which economic, social, political and ethical relationships can in smaller or larger ways be carefully reconstituted (cf. Probyn 2000; Anderson 2005; Goodman et al. 2010).

Nonetheless, Ruth is concerned that in engaging her consumer choice to try to enact care towards the countryside and her children, she is simultaneously ignoring, if not actively harming, multiple entangled others. Ruth thinks that she uses,

a lot of double think - I kind of persuade myself, because, I mean I can't afford to buy, if I, you know, if I won the lottery tomorrow, I would only shop at little independents, I would buy local, I would buy organic. I can't afford to do that and eat what I would say is proper food, and what I want to feed my children... But I'm aware of how, the chain of production behind that, you know butter - the way the cows are treated and you know all of those ethical issues, I suppose I've just taken the decision that I'm not going to prioritise that, you know. I can't afford to prioritise it and you know, and eat the way I want to eat.

Yellow fat practices are felt by Ruth to be a node where self and world fold together in multiple intimate ways. She finds it is impossible to account for all these ways when making fat choices, and so she goes with her gut instinct about what is 'good'. Ruth's fat choices and practices are entangled with a sense of belonging (cf. Bourdieu 2013; Goodman 2015). Belonging to a family, a class, a culture, a political movement, a sense of self. Belonging is a performance that, like tastefulness, involves avoiding dissonance between knowledge frameworks as well as understanding the processes within them.

Time and money were described by Ruth as key limiting factors to the nodes at which she can perform care and belonging with, and through, her consumption practices. Sarah, however, feels that they are not the only ones. Sarah is a workmate of Lyn, a woman in her fifties with a grown up son. For Sarah consuming-well is a necessary practice for the enactment of 'good' citizenship (cf. Lavis et al. 2016: 8) and she explained how she tries to buy butter that supports small businesses, local producers and the environment. However, she continued:

I do have issues with the farming and everything. But then I think, I get to the point and I think, well we make so many compromises all the time, that yeah it is something that perhaps I should be more conscious about. But then again with your, if it's organic and from South America and I can get it and it's not organic but it's more local then I'll buy the more local. Because what's the point of organic if you've been flying it. That's how I feel.

Sarah is frustrated that her abilities to perform care through fat choice are limited by the options available, as well as by her individual capacities and desires to choose them. Her words are an illustration of the difficulties my participants experience when

they feel they are having to make binary decisions between framings about who matters, and in what ways they matter.

My participants want to do well by others, but each consumer framing is gridded-space where some bodies and relationships get 'star-billing'³³. In choosing between products, consumers must choose who and what to prioritise and what form that caring takes (cf. Lavis et al. 2016: 8). For Milly the difficulties she experiences in negotiating these framings are because:

an awful lot of it ends up reduced to sound-bitey gubbins doesn't it that is... relatively meaningless. Which is why I think... I mean personally, people look at me now, and think that I'm really weird and inconsistent but I do have a set of sort of food relationships and food rules that I have. But they're my own things – they're partly rational, and partly irrational.

Milly's words suggest that the apparent lack of time, money, or even information needed to use consumption practices to enact sufficient care are but symptoms of a greater problem - that there is a gap, an impasse, between what my participants understand to be the active caring and careful values of their home lives, and the bounded framings of commodities.

For Milly, the 'sound-bitey gubbins' of consumer frameworks do not contain adequate means for a respectful living together. She continued:

eating anything, being alive, means that you're taking in energy from the world around you, doesn't it, so you're not... just being alive isn't a neutral thing... I think that... there's a whole lot of stuff to do with, to do with respect really. And I think we, it's far too easy to not get as far as respect in whatever you're doing, the food you're eating...

Milly experiences systemic limits to the possibilities of using consumer 'choice' to care for entangled others. She can choose to engage her consumption practices to care for others if they are already designated as 'suitable to be cared for through ethical consumption' (Goodman 2015: 213), but in so doing her actions perpetuate a

³³ For example, Lyn explained that she tried to avoid palm products because of the impact on biodiversity, sustainability and traditional ways of life. Cath chose to eschew animal-based fats as an easy way for her to limit her carbon footprint. Whilst for Alice avoiding genetically modified foods was an act of resistance against the monocultures of corporate food.

hegemonic power dynamic in which she must juggle moral framings, leaving little space for experiments in living together otherwise (cf. Pignarre & Stengers 2011; Lavis et al. 2016).

In thinking with care, my participants choose particular yellow fats for the affective pleasure of eating them, but also to enact care for the bodily and social health of themselves and their families, their local communities, food producers and the environment. They have an affectual awareness of the proximity and liveliness of multiple bodies and relationships folded within the stuff of fat, but who and what it is possible for them to care for is constrained by the moral possibilities offered by the cultural norms of consumer-consumed frameworks. As such their careful eating practices work to re-create and re-enact hierarchies of care, including economic relations, that may not be experienced as caring by all entangled with them (cf. Goodman 2008; 2015).

The structure of the PDG's allowed my participants space to struggle with, and critique these frictions and fissures in their endeavours to eat-well, but it should be remembered that in day-to-day life my participants do prioritise, and do stick to habitual practices. For example, Sarah articulated eating-well as a responsibility to self and others that she takes seriously but she also explained that:

I do think I choose not to think about some aspects of it, because I think I wouldn't eat anything probably if I was being completely ethical or whatever it is because there's so many things to take into account and in the end you think well we live in this society...

In their fatty practices, my participants feel compelled to choose some bodies and relationships to care about, and to try not think about all of the others. In this way enacting care through consumption can create change within a framework, but is not sufficient to empower change in the framings within which eater and eaten encounter each other, and live together. Indeed, it works to reconstruct the truth-making translations, divisions, and structural unknowns of those same frameworks. In this regard the 'ignorance' of 'not thinking about' can be understood as a strategic

response (cf. McGoey, 2012a; 2012b) borne of the awareness that knowing more is not likely to help any.

Doubt (knowing about knowing)

As a foodstuff, fat is different to many other commodities in that it is a biological necessity. My participants, however, do not ingest a fat in any straightforward accordance with the edibility or nutritive properties of that fat. Some fats are pushed away as distasteful, whilst others are embraced within performances of care. We have seen, for example, that Paul sees his fat choices as an important way to support communities, traditional ways of living together and biodiversity as well as to reduce waste. These are all values that are about being part of something bigger than himself. The push and pull of distaste and care, however, is, for Paul and my other participants, riddled with doubt. This section of the chapter will engage my participants' articulations of doubt so as to further explore the diverse forms of value entangled with my participants' fatty knowledges and practices.

Lyn is described by her friends and family as confident and knowledgeable around food. Lyn enjoys cooking for others, and as part of her job engaging local communities in environmental and conservation work she sometimes runs cafes at community events. Lyn eats both butter and margarine. She values the flavour of butter and the convenience of margarine. However, another reason for her use of both is that she has doubts over which one is 'better'. She explained:

So I can understand that thing with each level up the food chain you go you're only passing a certain amount of energy. So 10% or whatever. So your milk, to milk... Butter has come at the expense you know of all that. But so that you know with sustainability, it's the energy needed for all the processing as well that has to, you have to understand whether that balanced out...

In thinking about the energy used in both the production and processing of butter and margarine, Lyn is already setting a difficult task for herself to negotiate. However, she feels that making fat choices is more complex than that. To illustrate this, she started to read from the ingredient list printed on a tub of margarine:

It's saying palm oil in there, because I try and avoid palm oil, but I've just found it impossible. But then I try and think I mean that isn't organic is it but... on this spread it does say what's, erm... like vitamin E, vitamin A, vitamin D2 and B12. Whereas the butter doesn't mention any of those things, but it'll have some stuff in won't it? So those are added. But it's a bit, for me to decide which one's going to be better... but erm I don't know what I'm getting at... But I think I definitely see like margarine as quite a processed thing, and so that decision you know about having more butter and thinking it's just a bit purer somehow. But it doesn't come out of a cow like that does it, so. And the cow's received some nutrition beforehand, and err. And then if I suppose the cows are being fed imported food maybe... But you know if we're not, if we don't have a climate that's great for sunflowers and we're importing stuff, whatever. So, I haven't really, I don't really know what...

Lyn thinks of herself as someone who is engaged with food and eating. Through her work she understands eating as important to physical and mental health, community cohesion, livelihoods and the environment, and it is important to Lyn's sense of self that she seeks out information about the implications of different ways of doing food.

In the above two quotes Lyn touches on narratives about climate change, food processing, food miles, the sustainability of mono-cropping, nutritional value, and conceptions of 'the natural'. Entangled with Lyn's narratives are concerns for both the immediate impacts of her practices on entangled others, and on the kinds of worlds such relationships were making more or less possible. Nonetheless, she went on to describe how she engaged uncertainty in order to be able to make fat decisions:

when I realised that you can't not buy palm oil... I remember looking for this, I remember looking and thinking I'll get the one that's ambiguous because then I can pretend that I don't know.

Lyn expresses frustration that the options available to her are out of accord with her conception of herself as an eater, yet feels that if she allowed herself to think 'too much' about her fat choices then she would have to eat everything or nothing.

Alice, too, is lacking neither information about fat nor the desire to eat-well, but expresses doubt about the efficacy of her fatty practices. Alice is in her early forties, and has been diagnosed with raised cholesterol levels. She currently lives and works in London but grew up on Humberside in an area where intensive mono-cropping met

intensive animal farming, particularly of chickens. She explained the difficulties she encounters just in buying lunch at work when confronted with the option of chicken or dairy:

I think I'm constantly, sort of, fretting about it on a low level, because there are food choices all the time, so if I'm at work I'm trying to decide what to eat and I'm thinking, you know: 'Which thing am I going to eat?' because I'm thinking: 'Ooh, my cholesterol,' but then there's a chicken thing and I think: 'But I don't know where the chicken's from,' and then what happens is I end up eating a pavlova for pudding, blowing out of the water all of the things that I agonised about.

Alice feels that diverse forms of value can and do coexist within consumer food practices, yet as her words also attest, such multiple forms of valuing are a poor fit with the available consumer choices, leading to doubts about what to do for the best and as such her choices as to which bodies towards whom to direct care are peppered with compromises. She is caught in a spiral where she is anxious about the right thing to do for herself and for those entangled with the stuff of food, but is overwhelmed by the tensions between different framings of eating-well. Such tensions create a hesitation within which Alice is riddled with doubt and makes choices which she feels are arbitrary, irrational and counterproductive.

Jackson and Everts (2010) have developed a theory of anxiety as social practice, through which they explore how anxiety reworks habitual practices following food scares. Food scares are however exceptional events. In daily circumstances Alice and Lyn are not responding to one specific food scare, but to multiple incompatible knowledges about the stuff of fat. Because no single narrative is demanding their attention more than any other, they experience an overload of criteria which must be juggled and prioritised. Both Lyn and Alice experience dissonance at the nodes between visceral, health, environmental and other framings as they feel compelled to channel and translate their desire to eat-well with multiple others into a binary choice between this or that foodstuff. They do not know what to do for the best and so experience a low-level anxiety which I am characterising here as doubt, and from such doubt grows not change but inertia which works to perpetuate their habitual practices.

John, too, feels that the decisions he makes are often arbitrary, explaining that it is, 'an awful lot of effort that you're putting into it isn't it really as an individual when you're confronted with 60 brands or 60... in order to kid yourself really that you are actually making an informed choice, because in many cases you're not'. That is not to suggest that John does not worry about the right thing to eat however he has found a way to turn such doubt outwards. Like Lyn, John went to get a tub of margarine, proffering it towards me, he continued:

It's not really saying this is a box of fat, you want, you need fat in your diet, this is a box of fat... It's putting it in these subliminal messages, and that's what I find upsetting about capitalism that it, it seduces me rather like a rather glamorous woman, she might be an awfully nasty sort of piece of work but she will still seduce me...

John doubts that consumer choice is anything but a misnomer, an illusion which is constrained by capitalist structurings of 'choice' and which facilitates the re-articulation of social, cultural and material relations in economic terms (cf. Goodman et al. 2012). John, it is safe to say, is not a fan of what he terms 'capitalist factory produced fat'. However, he also feels there is no alternative because 'you cannot create an alternative, if your alternative is sufficiently radical, you can't do it'. John has his doubts about his fatty practices but in choosing to blame 'the system' he has decided that there is nothing much he can do about it.

John may be somewhat of an outlier amongst my participants in his pronouncements on capitalist power relations, nonetheless, other of my participants do have doubts about the ways in which fats are represented to them. Lyn, for example, feels that:

you do find, erm, contradictory stuff, I think sometimes like you know if I listen to Radio 4 and the morning, you know just hearing the news headlines and I think if you could extract all the food related stuff through a year or two, there'd be this and then that, and you know it's quite contradictory.

Lyn finds that learning more about food relationships and connectivities tends to increase, not lessen, her confusion, leaving her doubtful about the efficacy of her own practices. Lyn understands that the same product is nourishing or contaminating within different regimes of value but feels unable to negotiate the moral values

framing fat stuffs, and, unlike John, she feels that this is a product of her own inadequacy both in negotiating narratives, but also at what Tomkins has described as 'the shame at "needing" to take so much from the other' (Tomkins 1991 in Probyn, 2000: 141). Sarah, however, came to her defence, explaining that:

we all know that quite a lot of empirical research, of things that are done, are actually funded by people who have a vested interest, and the findings are what they want. I mean... I know it's not all like that, but quite a lot is, and as somebody who is interested but... a lay person or whatever... to a great extent you're reading, or listening to other people's prejudices, or if they've got an axe to grind. And not everybody has... their best, what's the word, their best intent...

Sarah doubts her abilities to get below the surface of the presentation of products in order to evaluate who and what they make present, who absent, and the styles of that valuing. But like John, she feels that this is because products have been intentionally framed in opaque particular ways and she is suspicious as to who such framings are designed to benefit.

Eating is a power relationship that remakes bodies, relationships and communities and it has sometimes been argued that reflexive consumption is a way in which consumers can reshape the food industry (Willis 1990; DuPuis & Goodman 2005). That, as consumers turn away from one foodstuff, they turn towards others, and in this way values such as animal welfare or sustainability can become integrated into the products available. Yet although my participants want to believe this, and do try to enact positive relationships with and through their fat choices they are doubtful of the efficacy of their actions. They feel overwhelmed by the slippery problems and possibilities teeming within the stuff of fat and by the volume of information available, and feel none the wiser as to what to do for the best. Consumer choice can induce anxious inertia in the consumer when they feel unable to use their consumption practices to create the kinds of relationships to which they aspire.

Studies looking at care and disregard for the *human* other have looked at the moralisation of care within neoliberal structures and hierarchies of deservingness (e.g. Williams et al. 2014). The doubts of my participants about the efficacy of their food practices make present the moralisation of care regarding the non-human as well as

the human within consumer-consumed modes of relation. As others have argued, such entanglements often become veiled within commodity relationships (e.g. Jackson 1999); within each framing some bodies and relationships are made present as things that matter, others less so, or not at all (Guthman 2003; Jarosz 2006; Goodman 2008). In this way 'ethical' consumption becomes a moral act which rather than transforming social relations may work to reinscribe and reproduce consumer-consumed relationships as modes of life (cf. Guthman 2007: 473). Thinking with doubt, however, begins to make present tensions and translations between framings of eater and eaten.

Doubt is an individual experience embedded in social relations with material things and their representations. Thinking with doubt works to reveal some of the tensions and translations that my participants feel between different framings of eating and eaten bodies that are not immediately obvious in their articulations of their habitual practices. Thinking with doubt can momentarily reveal who and what are made present, and who and what are made to matter with-in framings of consumption and as such can deterritorialise normative framings allowing them to be questioned and challenged.

Chapter Conclusions

The focus of this research is on eating-well with fats, and this chapter has narrated and explored the explanations that respondents give for their food practices. When attention is paid to the complex and subtle ways in which eaters make and understand their fatty decisions, "taste" loses its privileged status. Fatty practices are shaped by a complex interplay of material, sensory and symbolic factors and different consumers eat different fats in different ways. Articulating their doubts allowed my participants to articulate food practices as messy performances that both deliberately and incidentally traverse, connect and transform bodies (cf. Mol 2008; Probyn 2010). Fat it seems is everywhere not just on our plates or in our bellies, but a matter for political and social concern and intervention. Fat is on the news, in policy, in livelihoods, in flesh, and in the landscape. My participants feel that fat is a matter of concern: that they are eating too much of it to be healthy, or possibly not enough of the right sort. That fat is too

animal based, too plantation based or too resource hungry to be sustainable; too entwined with opaque globalised networks to be fair.

In this chapter I have demonstrated that thinking with distaste, care and doubt cultivates a hesitation in what “is,” and creates space in which tensions and translations between the framings of bodies and relationships entangled with the stuff of fat can be “unpacked” and investigated. My participants initially claimed to eat habitually, but such habitual eating can be thought of as analogous to a duck gliding serenely across a pond whilst its legs work furiously underneath. My participants habitual eating has not remained constant through their lives but has shifted as they attempt to keep up with, juggle and prioritise the and, and, and of multiple knowledges and framings about the stuff of fat and its entangled others. My participants eat in ways which resonate with their conceptions of self, community and belonging.

My participants feel that in larger or smaller ways fatty practices reshape bodies and relationships, but to negotiate consumer choice in fat they must first decide what kind of eater they are. They must then perform that identity as best they can by creating a hierarchy of priorities within the options available that are a ‘best fit’ to this sense of self, community and belonging. In this way the desires and possibilities of consumers become entangled with geographies of power relations (cf. Heath & Meneley 2007; Goodman 2008; Carolan 2012) yet the politics of who is made to matter and why and how is missing: messy, situated bodies somehow disappear from view, replaced by symbolic tropes. Thinking with distaste, care and doubt has made present the multiple entanglements of eater and eaten and the ways in which they are excessive to attempts to frame them.

As omnivorous creatures it is perhaps necessary to create food rules so as to limit choice and so make the world easier to negotiate, yet such framings also limit the ways it is possible to construct and represent the eating self and the eaten other. There is a difference, however, between facts within a frame, and knowledge about what a frame does. My participants yearn to eat in a way that would concern itself with the types of connections that are mapped in particular modes of eating, rather than the impact on named bodies (cf. Ruddick, forthcoming: 130), but their awareness of the

lively materialities of the stuff of fat is not in itself sufficient to create change in these relationships. Indeed, the mundane, habitual nature of food practices can make it hard to access the ways in which consumption can re-inscribe or trouble normative knowledges and practices.

In distasteful encounters 'material relations and immaterial forces all intersect with individuals' sensory grasp of the world, complicating one's visceral experience' (Hayes-Conroy & Hayes-Conroy 2008: 465). Thinking with distaste in revealing knowledges as out of accord makes space for the liveliness of the other. Whilst thinking with care revealed such knowledges as culturally normative and makes space in which something of the framings of relationships and bodies can become present. Finally, attending to doubt is a tool through which the enactment of othernesses in 'the interactions between different realities' (Law 2004: 122) can begin to be explored.

As such, thinking with distaste, care and doubt are experiments in intensities that can make present not only the ways in which the stuff of fat is encountered by an eater, but also how it is known and valued. As such they are a productive approach to researching the material and embodied processes that shape knowing food, and accepting matter as food. In this way thinking with distaste, care and doubt are tools through which discussions of the visceral can be extended to better theorize the complex interactions between material encounters, sense of self, and styles of valuing the stuff of fats.

INTERLUDE FOUR

from seed to spread (the slipperiness of the ‘natural’)

One of the research aims for this project revolves around unveiling snapshots of the doing of margarine from seed to spread. To this end, I visited the development centre for spreads of a major transnational margarine manufacturer. The centre houses people undertaking fatty research, development and implementation – including nutrition, taste, texture, microbiology, regional variation as well the technological advancement - of new spreads, and is situated in an industrial area of a major port in mainland Europe. On entering the building foyer, I encountered people (mostly men, mostly white) of multiple nationalities but communicating mostly in English. I introduced myself to security and waited for Judith my guide for the day. Judith is a nutritionist who works on supporting product formulation, the claims made and their communication in different regions, both within European and globally. Judith is of a different European nationality and language background to the port town where she works, and her partner is from a third country and language group. Judith escorted me through the building to her office so that I could leave my bag and coat, and then somewhat to my surprise whisked me off to a research kitchen where I was to make margarine.

Once in the kitchen, I put on a white lab coat, tie back my hair and wash my hands and arms; before being led to a work surface. In front of me is a food warmer (of the type often found on the tables of Chinese restaurants) a small pan, a small bowl, a large bowl, some ice, a whisk, a spoon, some coconut fat, a bottle of sunflower oil, an egg, half a lemon, milk, some salt and a recipe card (see appendix four). I was then encouraged to make margarine from these ingredients. The ingredients and method detailed on the recipe card³⁴ were almost identical to the ones that I had been using with my participants within the planned discussion groups. The main difference in the approach is that here I was starting with pre-made, pre-refined ingredients rather than making my own oils and fats. And so I made margarine with domestic cooking

³⁴ It is noteworthy that the recipe card is not branded, neither the parent company nor any of its products are mentioned on it.

equipment in a kitchen in the research and development headquarters of a major transnational.

In Chapter Four we read that my participants were concerned with eating ‘proper’, ‘natural’ foodstuffs. Ruth, for example, felt that butter resonated with the remembered landscapes of her childhood, and her embodied knowledge of making it ‘by just shaking [cream] in a bottle’. Ruth could not square margarine with this ‘natural’ imaginary and so she classified it as a distasteful non-food. Yet, in the global headquarters for margarine development of a major transnational company, I had just made margarine from coconut fat, sunflower oil and an egg using only domestic cooking equipment. Her fellow group member Jane, however, pointed out that she ‘didn’t milk the cow though’ and, later in the session, they went on to discuss the ‘unnatural’ ways in which ‘the cows are treated and you know all of those ethical issues’. Ruth’s ‘natural’ framing of foodstuffs, as linked to a notion of ‘belonging’ and the romantic idea that a foodstuff could be produced and processed at a household scale is somewhat slippery.



Figure 13: Still from 'Seed to Spread' Advert

Two weeks after my visit to this development centre, an advert for Flora appeared on you tube entitled ‘How Flora is Made – From Seed to Spread’ (figure 13): <https://www.youtube.com/watch?v=mgLPn7FMJT4>. Within this advert, the viewer sees margarine being made by virtually the same method that I was encouraged to use when visiting the development kitchen. The advert opens by asking the viewer: ‘Ever asked yourself... how margarine is made? Four food bloggers and a celebrity baker

went to find out...’ The setting is a ‘bake-off’ style tent, erected in the grounds of an oil-seed rape farm in Cambridgeshire. At the beginning of the advert the ‘celebrities’ profess their innocence as to the ingredients and processes involved in making margarine. We then meet a farmer who crouched in a rape field, seedpod in hand, informs the viewer that the seeds are ‘dried and crushed and really natural ingredients added such as water’. Cut back to the tent and a woman, seated at a table amidst vases of sunflowers, is making margarine. She explains that ‘to go from seed to spread, the seeds are crushed and refined, blended with sunflower and linseed oils, and *a few other simple ingredients*’. The advert closes with the ‘celebrities’ cooking with *Flora* and expressing their pleasure at knowing that the spread in the plastic tub ‘is actually from the kind of core *natural* ingredients’.

At the time of writing, the ‘few other simple ingredients’ within *Flora* include - ‘buttermilk, salt (1.4%), emulsifiers (mono- and diglycerides of fatty acids, sunflower lecithin), flavouring (contains milk), preservative (potassium sorbate), citric acid, vitamins A and D, colour (carotene)’³⁵. Most of which although produced from ‘natural’ foods are far from simple in their production. More than this, oil seed rape is a hungry crop, yet there is no fertiliser or irrigations shown in the advert. There are no pesticides³⁶, trucks, or oil refineries. We cannot smell the crush or taste the dust. We do not see the neutralising, bleaching, or sterilising processes used both to stabilise the oil for longevity and to remove its flavour so as to create a blank canvas for the butter mimicking stuff of margarine. There is no mention of interesterification, or of the habitats changed by draining the Cambridgeshire fenland peat in order to create the field in which the oil seed rape is grown, or of the controversial stuff of palm oil.

Indeed, in the advert Unilever chef, Sue Batty apparently makes margarine from rape, sunflower and linseed oils, but to make an emulsion without including a hard fat would produce a consistency akin to mayonnaise not margarine. The advert is not untrue, but the truth told is very carefully selected and framed. Within the advert, the materiality of *Flora* is presented to viewers as synonymous with a romantic, gingham-

³⁵ <http://www.flora.com/product/detail/1097536/flora-original> (Accessed: 23/10/2016).

³⁶ Recent research has implicated neonicotinoid use on oil-seed rape as a particular culprit in the decline of wild bee populations (Woodcock, B A et al (2016)) Impacts of neonicotinoid use on long-term population changes in wild bees in England. *Nat. Commun.*: 7.

printed, notion of Englishness and the English countryside. It would seem, therefore, that desire of consumers to eat fats that they can frame as 'natural' is not something of which, Unilever, the manufacturer of Flora is unaware. To date, however, the 'seed to spread' advert has not made the transition from you tube to television.

Flora adverts on British terrestrial TV have for several years revolved around a 'Flora family'. In 2016 viewers were introduced to a new 'Flora family' and a repackaged Flora that is identified as 'powered by plants'. At the time of writing two adverts have been produced featuring this family, both are



Figure 15: Still from Flora 'Power of Plants' Advert

situated in the family's kitchen. The first of the two to be released is also entitled 'powered by plants' (figure 14) and features mum explaining to her young son that 'the biggest dinosaurs only eat plants and Flora is made from plants'. The second advert is called 'Flora freedom' (figure 15) and features the teenage daughter insisting that this dairy free flora freedom is 'all mine'. These 'powered by plants' adverts keep the emphasis on 'the natural' portrayed in the you tube advert but situate it within Flora's more established healthy families branding.



Figure 16: Still from 'Flora Freedom' Advert.

Illich has argued that access to such already packaged information narrows perspectives of seeing, subtly shifting values and norms (Illich 1973). I demonstrated

in Chapter Four that for my PDG participants, their sense making of their visceral experiences is entangled with a merging, translating and juggling of the knowledges and information available to them. They are unsure as to whether they can trust their senses about the stuff of food. The *Flora* 'seed to spread' and 'powered by plants' adverts, and my being invited to make margarine in the homely kitchen of a research and development facility, can both be understood as endeavouring to reframe knowledges and beliefs about the stuff of margarine within the slippery realm of 'the natural'. As an attempt to foreclose consumer concern about exactly what this stuff of margarine is.

'things becoming food' (industry knowledges and practices)

Introduction

Cultural expectations about what does and does not constitute the stuff of food do not shift readily. Yet the flexibility in possible tastes and textures of margarine, combined with the possibility of stabilising those properties from differing raw ingredients and processes, raises questions as to the potential uses of margarine as a model for foods that allow consumers to eat-well without the stress and difficulty of major changes in individual food practices. In this chapter, I temporarily step away from the PDGs in to industry in order to explore some of the questions raised by my participants, and to add to geographical understandings of the knowledges and practices of the production and representation of the margarine matters. To this end, this chapter engages data generated within a follow-the-thing type ethnography (Cook 2002), following the stuff of margarine and its framings through selected nodes across industry, research, policy making and academia.

In the early stages of this work I undertook participant-observation whilst completing a three-day industry accredited oils and fats training course run by industry professionals, and whilst attending an international conference that brought together individuals and organisations from across the spectrum of the production, processing, accreditation, transportation, retail and legislation of a tropical oil. Through contacts made at these events, I was able to undertake participant-observation and interviews in a family run refinery; the margarine-manufacturing factory of a retail co-operative; and the global research and development headquarters for the spreads division of a major transnational corporation. I also carried out interviews with Mike, a Professor of Biology working on more sustainable strains of oil-seed rape; Steven, a Biotechnologist attempting to develop oil-seed crops genetically modified with algal DNA so as to produce long-chain omega-3; Lars, who is an auditor for the certification of a tropical oil; Helen, a Professor of Nutrition specialising in fats; and Lynn who lobbies the EU government on behalf of the margarine and spreads industry. This fieldwork enabled me to learn about multiple aspects of the doing of margarine; the how and why of

producing, processing and bringing together of raw materials in products that meet consumer demands whilst maintaining consistency, shelf-life and adaptability to available ingredients. However, I explore little of the precise detail of this chemical and physical manipulation here - rather I use these experiences in order to inform my investigation of the knowledges, beliefs, bodies and relationships entangled with the practices of margarine production.

Over the twentieth century, the materialities and framings of margarine have changed from that of cheap butter substitute to one of alternative choice, yet margarine's historically slow growth in popularity suggests that neither political will nor advertising were sufficient to make margarine desirable as a food commodity. Things did shift somewhat in the mid-twentieth century when changing dietary advice and the spread of refrigerators created a hesitation in cultural norms within which it was possible to frame margarine as a healthier and more convenient choice than solid and saturated butterfat. Nonetheless, this framing shifted again when the trans-fat content of margarine was revealed to be a risk to cardiac health, and although margarine has been reformulated to be trans-fat free, falling sales and the doubts of my PDG participants suggest that margarine continues to have something of an image problem.

The rest of this chapter has been removed due to corporate sensitivity.

INTERLUDE FIVE

playing with our food (food becoming things)

As a child I had little or no choice over the foods available to me, and as was common at the time my diet was largely utilitarian. Tastes are affected by the ways in which the stuff of food is encountered, understood, represented and framed (cf. Mol 2008) and for the most part I would simply eat what was placed in front of me in the hope that something sugar-based might follow. When I did have the option of choosing I opted for processed foods. Junk food was bright, fun, exciting, playful, surprising and in the darkness of the 1970s North it felt hopeful, futuristic. My adult tastes are, thankfully, not for the likes of *Angel Delight* or *Vesta curries*, but I do expect food, including fat, to offer affectual interest. Today at home I have a salted lactic butter, an unsalted cream butter, coconut oil, palm fat and goose fat as well as a wide selection of oils. It is not uncommon for me to stand, fridge door open, taking slices off a butter block and letting them melt on my tongue.

Max the margarine developer, described my desire for the experience of eating fat to be interesting as not only somewhat unusual, but as expecting quite a lot from the stuff of fat. Max suggested that most people are not 'fine tasters'; that as a rule consumers want fat to be functional, convenient and pleasant enough. For Max the 'typical' consumer is simply not bothered about taste in the way that I am, particularly when it comes to something as mundane as yellow fat. I recalled Max's words when transcribing Ruth's vivid descriptions of her sudden experience of tasteful nourishment the first time she ate butter. Like Ruth, my interest in the tastefulness of food was something that I had become awakened to, and in this regard Max's words continued to linger.

Illich has argued that industrial tools produce convenience whilst convivial tools maximise relationships (Illich 1973). So far in this thesis we have heard the voices of my participants as they talk about their encounters with the materialities of fats. But thinking with fats has been text based, experienced with, and through, their representations in advertising, policy and the media. Eaters are overwhelmed by disjunctures between these representations, and so shut down thinking by eating habitually. It has been argued that engaging visceral knowing of the stuff of food, to

'take back taste', can open up space for resistance to normative habits and practices (Hayes-Conroy & Hayes-Conroy 2008). Yet visceral knowing alone is not sufficient to explain the fatty practices of myself or my participants. Habitual practices shut down thinking, limiting the possibilities for doing, encountering or becoming otherwise (cf. Woodyer & Geoghegan 2013).

Visceral knowing is entangled with multiple other ways of representing, knowing and prioritising fatty materialities. Tensions between and within these different ways of knowing self and the stuff of fat can be experienced as distastefulness. As such 'taking back taste' may open up space, but within that space the eater may be at a loss as to what to do. I was pondering on this when a chance conversation with a friend, a Steiner teacher who works with troubled teenagers, some of whom struggle to empathise with others, led me to a book entitled: 'The Genius of Play' (Jenkinson 2001). For Jenkinson, access to already packaged information restricts possible perspectives on the world

[T]oday's sophisticated, technological toys leave today's children very little room to be creative and original, only endlessly to repeat what has been done before... In cocooned safety they watch television, video, play computer games, and learn how to think, feel, and react to the world as they experience it – as it has been designed for them to experience (2001: xiv).

Although Jenkinson is primarily writing about children, she argues that everybody needs creative play if they are to develop their 'transformative powers' (Jenkinson, 2001): 109). As with 'taking back taste', the everyday creativity of play interrupts norms of practice, but amidst the 'what if?' of play, players can explore 'below, behind and to the side of' representations and norms (Schechner 2003: 43).

This argument resonates with my findings in Chapters Four and Five, that the ways in which food is framed limit the ways it is possible to encounter others and eat with them. It also reminded me of my experiences as a teenager when I lived in a household where everyone but me was French, Italian or Moroccan. Cooking and eating in this house was not the chore it was in my childhood home. Through cooking and eating together, we learned other ways of relating to the stuff of food. In this way I was not merely awakened to the visceral joys of food, I learned how to learn with

food, and I did so by convivial experimentation, by paying attention, and by playing with my food.

Sutherland (In Press) has demonstrated that social change involves the work of 'developing a muscle' for openness to others. To this end, the creativity of play offers space for players to practice, prefigure and rehearse changing their world (cf. Schechner 1993; Jenkinson 2001; Katz 2004). The 'what if?' of play facilitates twists and loosening of habitual practices, creating space for imaginative interludes where it is possible to experiment with what is, and what might be, through creating multiple worlds each with its own norms, practices and possibilities (Jenkinson 2001).

At this juncture, I would like to suggest that you take a moment to begin to learn to play with your food. I would like you to drag whatever oils and fats you have out of your kitchen cupboards and refrigerator, and if you have sunflower seeds, olives, or any of the other bodies from which the oils and fats are made then get them out too. Look at them, feel them, smell them, taste them, compare the whole food to the refined oil, and write down below your observations, thoughts and questions. Then, if you would like to use your assembled ingredients to have try making your own margarine then please turn to the recipes in appendix four and give it a go...

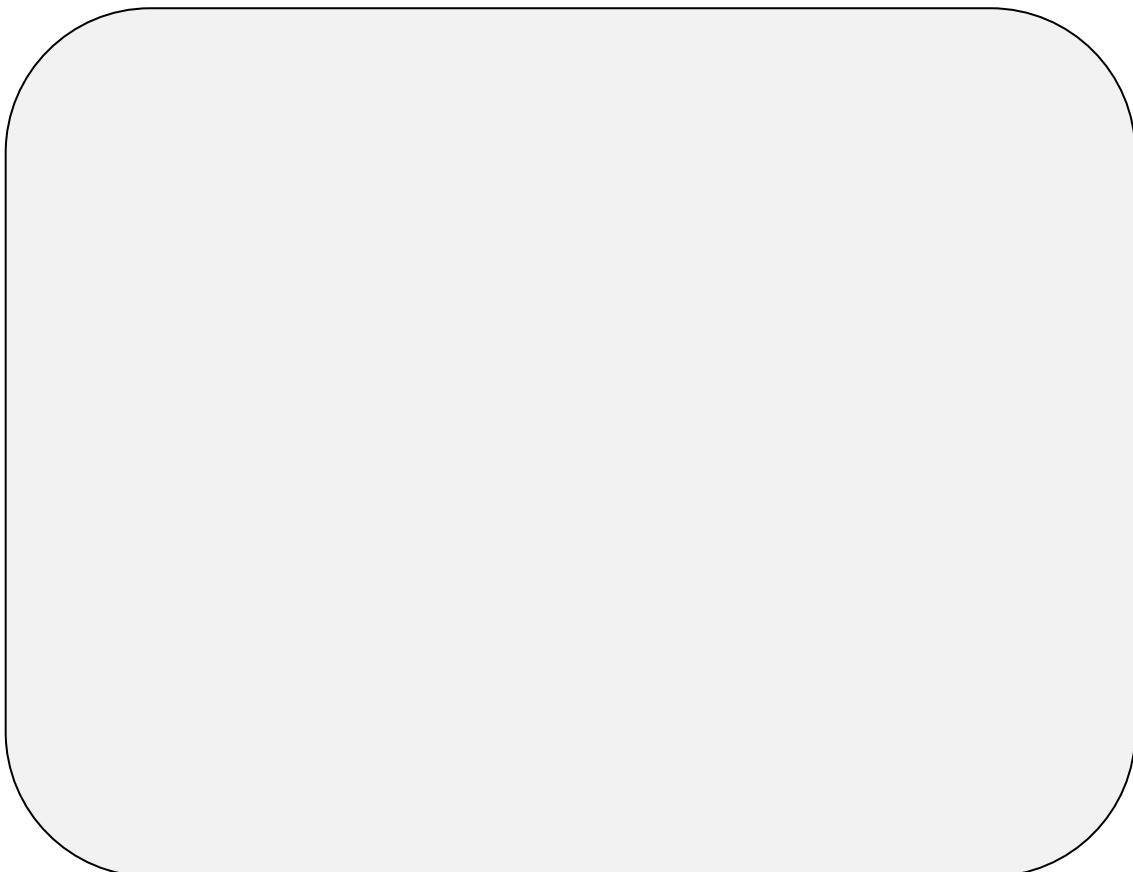

CHAPTER SIX

matters of fat (experimental strange encounters with material others)

Introduction

In this chapter I explore the extent to which the methodological intervention of 'strange encounters' created a hesitation in habitual relationships where the stuff of fat could be encountered anew so as to be engaged as a participant in the research. Further, I investigate the extent to which 'playful encounters' with the stuff of fat generated space within the PDG's for my participants to explore translations and tensions in the framings of fats, and to prefigure and rehearse other ways of knowing and relating with matters of fats.

Within alternative food movements it is often argued that it is the eater's responsibility to be informed about the backstory of foodstuffs and to decide whether they wish to perpetuate such practices (Curtin 1992: 17). Nonetheless, we read in Chapter Four that my participants feel that knowing more does not necessarily help them to make good food decisions. Alice, for example, can see harm to herself and to others in every food choice she makes. For Alice, food practices are simultaneously routine and hyper-complex doings that impact on the lives, and becomings of multiple others. There are foods she does not want to eat because of the impact on specific individuals, and foods she does not want to eat because to do so would offer financial support to structures that she understands to be harmful, but she often eats them anyway because there is a limit to the amount of energy she can put in to thinking about the consequences of lunch. A situation which Alice understandably finds stressful, frustrating and disempowering.

Alice feels compelled to attempt to juggle and prioritise moral imperatives about who and what is deserving of care so as to 'best' care for herself, and the multiple others entangled with and in the stuff of fat. However, her abilities to enact care in this way are entangled with the power-dynamics of the social and cultural tools available to her (Illich 1973). Within the imaginary of consumer-consumed relations, care involves juggling moral responsibilities, and Alice feels that she ends up making somewhat

arbitrary choices about who matters. This is something that Alice both recognised and struggled with.

Eating is a mundane doing, but the asymmetric nature of food relations has small and large implications for multiple entangled others (Herman 2016). Puig de la Bellacasa (2010) has demonstrated that care which does not recognise the interdependency of all forms of life cannot create a flourishing of life. As such, Alice's enactment of good care cannot be taken for granted by her 'moral intention' (Puig de la Bellacasa 2010: 166). Indeed, the doubt and anxiety expressed by Alice about her fat choices suggest that being unable to practice careful interdependency obstructed a flourishing even of her own life. Alice's problem is not necessarily a lack of knowledge, more knowledge about the stuff of fat is not helpful to her if such knowledge is irreconcilable with her other knowledges or her sense of self.

Permaculture practice has been proposed by Puig de la Bellacasa as 'an everyday *doing* that connects the personal to the collective and decentres the human' (2010: 152). Her words resonate with my own experiences of training in permaculture design practice. Permaculture is not a set of moral rules to live by, rather it is a relational practice of living together. The three key principles of permaculture are earth care, people care and fair shares (an example of fair shares at a household level might include leaving a proportion of fruits unharvested for birds to eat). The principles are deceptively simple, however permaculture training is expensive and time-consuming and routine enactment of the principles takes significant practice. 'Playing with our food' is a mundane, small intervention with the same principles at heart. Eating cannot be separated from the others that must enact, or make way for, growing, harvesting, killing, processing, transporting or wasting. If it is possible to hold open the entangled relations between self and other for the duration of the experiment to promote 'a mode of attention that resists falling automatically into the 'human' perspective'" (Puig de la Bellacasa 2010: 158) then 'playing with our food' can be understood as a rehearsal of the possibility of caring with, for and in this interconnectivity, with, and through, the practices of eating (cf. Puig de la Bellacasa 2010; Braidotti 2013b). To this end, for the remainder of this chapter I explore data generated when my participants moved from sitting and discussing food and their fatty knowledges and practices, to playing and discussing as they encountered matters of fat in novel ways.

My participants used simple cooking methods to extract oil from seeds and to make that oil into margarine, all the time encountering fats anew with their hands, mouths, noses, eyes and muscles. Within the sessions we tasted fats, but did not make a meal of them unless my participants chose to. My participants had never encountered fats in this way before, and they approached the encounter playfully and with a desire to get to know the stuff of fat anew. In undertaking this research I did not have a preconceived idea as to what eating well with margarine might look or taste like. As such, I made it clear to my participants from the outset of each session that I did not feel that there is a singular right way to eat - that what is 'good' will vary between communities, from person to person, and at different stages of the life of any individual.

This chapter is structured around the ways 'playing with our food' created 'strange encounters' which disrupted, disturbed or challenged my participants' knowledges, values and practices, and explores the extent to which such disturbances created space to rehearse other ways of knowing and relating with matters of fats. On starting to analyse the data generated with and in these strange encounters, the first thing that struck me was that the material presence of the stuff of fat drew in new participants. Mike is Lyn's partner, Mal and Col are Ruth's sons, and Ian is Milly's partner. All four had initially declined to take part in the research, but got involved to smaller or larger degrees when we started to press the seeds. Touching, sniffing, tasting: encountering.

In section one, entitled 'disrupting habits,' I explore whether 'strange encounters' with the stuff of margarine disrupted the reasoning of my participants by troubling taken for granted habits. In section two, 're-evaluating,' I examine whether 'playing with our food' disrupted how my participants prioritised values. In section three, 'encountering anew,' I investigate the impact of these encounters on my participants' articulations of concern and affiliation with entangled others. In section four, 'juxtapositions,' I explore whether playing with our food facilitated the creation of space where my participants could rehearse changing the framings of their food relationships so as to momentarily eat without consuming. To conclude, I assess the potential of the methodology for facilitating the reworking of value systems entangled with eating-well.

Disrupting Habits (Seeds of Change?)

Prior to starting to play with margarine matters, I asked my participants what they thought margarine was currently made from, and what it had been made from historically. Discussions of olive-based margarine notwithstanding, 'sunflowers' and 'palm' were typically the answers given to the first part of the question. As for the second part, answers included 'animals?' and 'fish?' Ruth, however, thought it was petrol, and Jane suggested whales. These answers are surprisingly accurate (see prelude), although it was coal rather than oil from which synthetic fats are documented as having been extracted (see e.g. Pyke 1970). Jane went on to say that 'it is common belief in the internet that margarine was developed for the turkey industry', adding that 'the experiment was abandoned because [the turkeys] all died'. This myth is one I encountered repeatedly when in the field, although it is not one that Ruth had heard before. She was however open to believing it. Ruth was suspicious of the stuff of margarine, she felt that margarine is not 'proper food' and that 'the long-term effect' of including it in her diet is unknowable. She explained that she wants 'to look at 'me' plate and know what it is, and where it's come from... We've been eating butter for millennia, you know'.

Strange encounters began with me unpacking the stuff that I had brought with me. Sunflower seeds, coconut shells, desiccated coconut, coconut fat, eggs, mustard, milk, lemons, salt, ice, and the crank



Figure 21: The oil press before mounting

press. Whilst I was setting up the press, my participants asked about it and how it worked, but also thought about the food stuffs. Despite her doubts about the stuff of margarine, Ruth was not surprised when I produced sunflower seeds as the basis for our homemade spread. Ruth knew that nowadays margarine is often promoted as made from

sunflower oil. Nonetheless, there was a gap between her beliefs about sunflowers and sunflower oil, and her conceptualisations of margarine as 'unnatural'. Ruth was sceptical that we could bring this combination of things together into margarine-type matter.

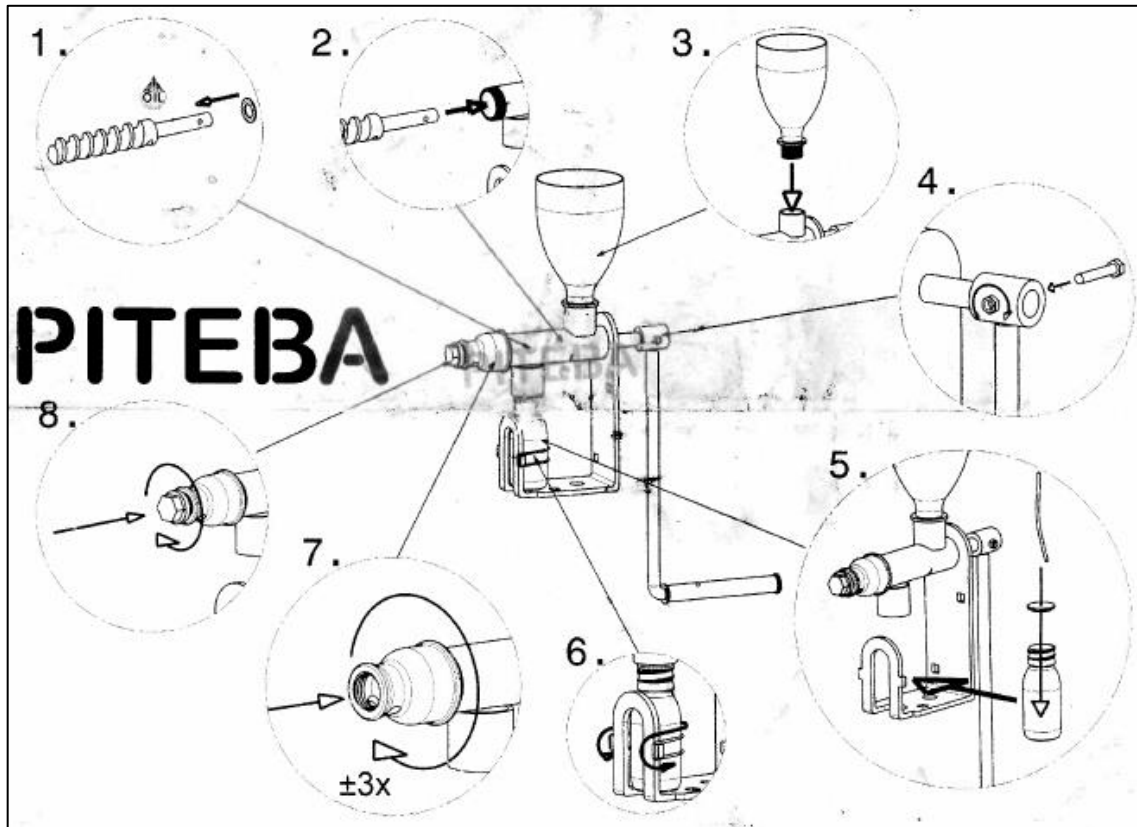

Figure 22: putting the oil press together

Our first task was to press the seeds, ostensibly to produce oil. Sunflower seeds are tipped into a funnel at the top of the press (see figure 22). Turning the crank draws them down through the machine. At first this is deceptively easy – the crank is empty and so it turns freely. The first seeds to pass into the machine, pass straight through and fall out of the open end of the press apparently unchanged. Gradually however as the turning of the crank draws more and more seeds in to the chamber, the pressure of all this stuff squeezes the seeds together, crushing them. This slows down their movement through the press, increasing the resistance as more and more seeds are drawn in by the turning of the crank. Operating the seed press requires elbow grease (see figure 23):

- Ruth Erchh. God! [Panting]. Urghh. Blumming 'eck! This is good! You kind of burn the calories that you're going to consume I suppose as well by doing this [panting] process. I feel like I'm getting there now! Okay! Yes!
- Jane If I had to do this before I had a bit of toast every time, I wouldn't!

Eventually oil drips out through a slit in the horizontal shaft of the press, but before that a mass of dry 'stuff' begins to emerge from the end of this shaft. This 'stuff' reminds me of the ash at the end of an unattended lit cigarette (see figure 22).



Figure 23: The oil press in action

Typically, my participants were enthralled by the 'waste' produced by this process (see figure 24). The 'waste' produced is bigger in volume than the seeds from which it has been produced, and this combined with the knowledge that it was 'just crushed sunflower seeds' (Steph) created a strangeness that my participants found engrossing. Lyn expressed confusion because 'that wouldn't all fit back in the packet. It's weird isn't it? It's so...' Alison described the 'waste' as 'like Christmas decorations' whilst others made more bodily associations. For example, Martin, a grandfather in his seventies, commented 'I don't want to spoil the conversation but that looks like a turd coming out of there'. Alice and Paul pronounced the whole thing weird, stopped turning the crank and took the matter in to their own hands:

- Alice It's really. That is so dry... There isn't even any oil on my fingers. It's amazing. Feel how dry that is!

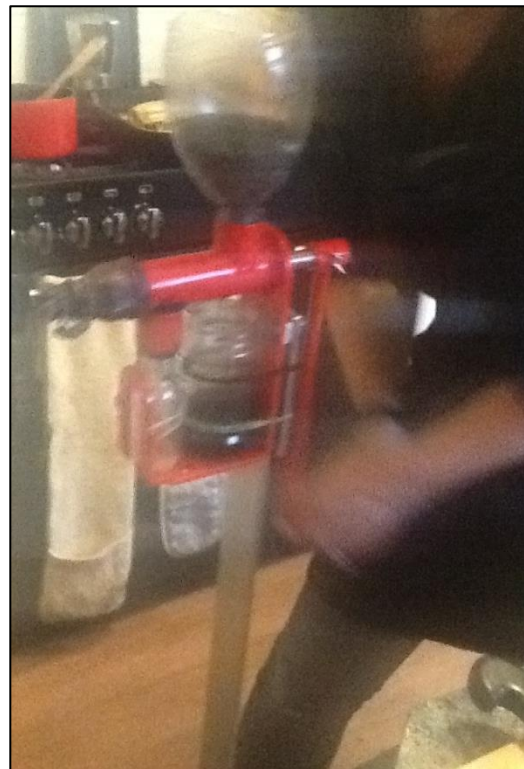

Figure 24: Exerting energy

Paul Oh gosh. Yes. Yes, it's weird! It's funny to think of oil being in these, kind of, seeds because you don't... You know, if you eat them, you don't really have a sense of them being, kind of, full of oil, do you? So those nuts or whatever...



Figure 25: The 'waste' oil-cake produced

This surprise at the efficiency of the process was typical of my participants, as was the realisation that although they ate both seeds and seed oils they had never before thought of seeds as oily. The strange material presence of the stuff of fat upset their beliefs and expectations.

The response of Ruth's group to the look of the solid 'waste' was a resounding 'eugh!' They pronounced it 'not nice,' 'so disgusting,' 'unpleasant,' and 'like a squashed bird'. Yet the embodied knowledge that the matter was just crushed sunflower seeds, indeed that they had crushed them, appeared to compel them to challenge their disgust reaction by integrating visceral knowing into their understandings of these matters of fat:

Col It smells a bit like tahini
Ruth Ooh it smells delicious actually. I think the birds might like that.
Jane I'm quite impressed at how dry it is
Col It's proper minging in it that, at the bottom
Ruth But actually if you smell it, it smells delicious.
Jane What could you do with it?
Ruth I reckon birds
Jane What about flapjacks? Trouble is all the husk, you're just going to poo that out...
Ruth Have you tried a bit – have you eaten a bit?
Col It doesn't look like it should be edible.
Ruth It's not an unpleasant flavour though... It's very like those kind of hippy hemp bars, or something like that, some kind of energy bar.

Tastefulness, is not straightforwardly a product of the flavour of a food but is entangled with knowledges and beliefs about self and other (see Chapter Four). Playing with the stuff of fat generated a strange encounter for Ruth's group, which

created a crack in their habitual thinking about food matters, within which it was acceptable for them to contemplate 'waste' as food.

The presence of the 'waste' was, however, not contained in the moment of the encounter, but also triggered questions about industrial oil making processes. My participants had never before considered that there might be a by-product from oil production. Given that they had never thought about oil production this is hardly surprising. However, the mass of stuff in front of them compelled them to ask questions. They were concerned to know if such a large volume of 'stuff' was really wasted, and typically they were relieved to learn that it is commonly used in animal feed. As Ruth said, 'well that's something. I do like it when everything has a use you know'. Steph, however, is vegan, and she wondered if maybe it would make good compost or bird food. Steph, was not unaware that her vegan diet involves agricultural practices that are not vegan, but this encounter with the waste-stuff of fat prompted an extension to her map of connectivities.

The responses of my participants to the strange presence of fat troubling their expectations, raises questions as to how my participants judge value, and why they value what they value. We have read that Ruth described wanting to eat 'natural' foods, which she explained were foodstuffs that humanity has been eating for a long-time. Ruth felt that such products were more likely to be good for her, for those tasked with producing them, and for sustainable futures. During the early stages of her PDG she was adamant in her descriptions of butter as proper, natural, wholesome and good to eat, and margarine as the antithesis to this. However, the 'strange encounter' engendered by oil production created a hesitation in her habitual thinking:

So far the whole process [of making sunflower oil] is really wholesome and you know, it is actually reassuring... you know. Which I'm sure if you went to a dairy farm you probably wouldn't feel that the production of butter was particularly wholesome, in fact it's probably really depressing and miserable. But yet the end product you feel like, oh yeah proper butter, mmm.

Within this hesitation Ruth revealed that intellectually she knew that butter is made on an industrial scale; that cows are bred to produce vast quantities of milk, kept in sheds, artificially inseminated and their milk pasteurised. Yet, because she cannot reconcile

these knowledges with her beliefs about what is 'good' to eat she is unable to pay regard to them in her habitual practices. Although Ruth understands that her desire to enact care through her consumption practices is limited in practice by the necessity of juggling and prioritising moral frameworks, it took the embodied doing of 'playing with her food' for her to articulate her embodied knowledge that her 'good intentions may have bad effects' (Mol, Moser & Pol 2015: 12).

Although food relationships can, and do change, they do not necessarily do so easily, or to the benefit of many of the bodies, places and relationships entangled with them. Ruth's construction of 'the natural' as good to eat, represents a decision about the kind of consumer, and the kind of eater, she wishes to be. Yet, deciding to eat 'natural' things is not the end of the matter. The natural - processed binary is slippery and continues to create moral framings, hybrids (cf. Latour 1993 (1991)) between which she is compelled to prioritise. In endeavouring to enact care in this way Ruth becomes caught in a Derridean way of thinking about how much hospitality is possible.

Pignarre and Stengers use the term 'infernal alternatives' to describe situations where 'even those who resist may be trapped... [and] define their opposition in the terms fabricated by the alternative' (2011: 23-25). For Ruth, playing with her food constituted what Pignarre and Stengers call 'an event'. In an event pre-existing components 'vibrate together' in novel ways, from which participants can draw 'new capacities to imagine and to situate themselves' (2011: 76). As such, although it can be argued that Ruth already knew that her imagined natural-processed binary was slippery, this knowledge was generalised and seemingly distant until the strange encountered called it to her minds-eye.

For Ruth, the 'stickiness' of her food habits is not a result of a lack of knowledge, rather she is overwhelmed by information and feels unable to juggle the different regimes of value bound up with these knowledges. It took the event of the encounter for Ruth to break her habitual thinking and get a hold on her construction and perpetuation of the natural-processed binary. Playing with her food was an intervention that disrupted Ruth's habitual framings of care and responsibility, creating a hesitation where she could explore the kinds of worlds her fatty relationships make more or less possible.

This is a qualitatively different question to 'how much hospitality'? The latter asks who might I care for, the former how might we live together?

Prior to my introduction of fatty materialities into the PDG discussions, my participants had first described their fatty practices as just habit, before going on to articulate the distaste, care and doubt that lay behind these habits. Being confronted with the unexpected material other was a surprisingly effective way in which my participants' habitual ways of meeting the stuff of fat could be put on hold. Indeed, on reflecting on her own practices in the light of the strange encounter, Sarah explained 'it's funny, you know when you look at your own habits, and think well that's a bit odd'. In 'playing with their food', my participants conveyed curiosity in getting to know the stuff of fat, rather than a need for reassurance that they were making the 'right' food choices. Within play my participants were empowered to meet the stuff of fat anew.

Knowing the Fats

So far in this chapter I have spent some time representing my participants' engagement with the 'waste' produced in the production of sunflower oil, and how this disrupted their habitual thinking. This is no accident, my participants were so engrossed in the embodied process of crushing seeds, and so fascinated by the waste produced, that they initially did not notice the oil at all. At the outset this is perhaps because none is visible. The 'waste' starts to extrude from the end of the press long before oil begins to drip into the collection jar. When oil does start to emerge it does so slowly and coincides with needing a significantly increased amount of effort to turn the crank. The exertions of doing so tend to come as a surprise to the crankee, and a source of amusement to the rest of the group, distracting attention from the matters of fat towards the energy efficiency of the process.

When my participants did notice the oil, they tended to be somewhat disturbed by its appearance. Alice however was excited by the volume of stuff that her exertions had produced: 'Look how much oil I've got. It's all black as well. I thought it would be yellow'. Seed debris suspended in the oil gives it an unappetising murky, dark colour. When my participants began to comment on the colour of the oil I went to my bag,

and brought out a sample that I had extracted earlier. This oil looks very different to that which has been freshly produced. If the extruded oil is left to stand undisturbed for a few days then the solid matter sinks to the bottom of the jar, the clarified oil can then be poured off. I explained that it would be this strained oil that we would be playing with next.

Re-evaluating (knowledges that push)

My participants expressed relief that the strained oil looks more like the vegetable oils that they were accustomed to eating. Nonetheless, although clear rather than murky it is not the yellow of supermarket sunflower oil. The oil's unexpected greenness reminded Alice of the 'goodness' of olive oil. Whilst the green tinge prompted Ruth to wonder what other material differences might be entangled with colour:

Is that green oil better for you than that yellow oil... because generally the rule of thumb is the less messed about a food source is, generally speaking the better it is for you the less processed. What about trace elements?

Intrigued by this thought, Ruth momentarily disappeared into her kitchen before returning with teaspoons for everyone so that we could explore the flavour of the oil:

Ruth That's a really pleasant nutty taste isn't it, that's delicious, that is delicious actually that would be delicious as a salad dressing

Claire I mean that oil is delicious

Ruth Definitely, I like the fact that that tastes of something! That tasted like what it was made of! Because I mean like I would make a salad dressing out of that horrible yellow oil in there which I'm now thinking errgghh I'm getting rid of that. You think there's nothing good in that and it makes me think that I ought to chuck that oil in the bin, whereas that oil feels like it's got something good in it!

Claire I would buy oil that tasted more like oil

Ruth's momentary pushing away of bought sunflower oil is an articulation of her unforeseen embodied experience (cf. Probyn 2000). Meeting sunflower oil that 'tastes of itself' upset Ruth's expectations and created a hesitation in her values. In an attempt to shore up her sense of self as an eater, she re-framed commercially produced oils as unnatural and pushed them away. Ruth's 'errgghh,' her sudden experience of distaste, is a product of the encounter - it is a collective doing.

Joan too expressed surprised at the flavour of the oil. Joan is no stranger to sunflower oil. She habitually uses it in cooking because she believes it to be good for her cholesterol levels, yet she does not like the flavour, describing it as 'manky'.

Conversely, Joan pronounced our oil as tasting 'fresh' and wondered if 'perhaps that's the answer. Perhaps it's sitting in the shop that makes it like that'. Prior to the encounter it had not occurred to Joan to think about why sunflower oil tastes the way it does, or why it did not taste of sunflower seeds.

Lyn pushed this line of thinking a little further. The flavour of our oil prompted Lyn to wonder about material differences between our oil and commercially available varieties, and what pros and cons may be entangled with these differences. Like Joan, Lyn assumed that the difference had something to do with shelf-life, although she rationalised that this was a deliberate intervention in order to increase longevity, rather than a straightforward loss of freshness. She continued:

Why doesn't ordinary sunflower oil taste of sunflower seeds? Are they basically taking out the nutrients for longevity or for visuals? Although I don't eat sunflower oil for my nutrition I suppose... I suppose I don't think... I expect the olive oil to offer some nutrition, but I don't think sunflower oil does, I don't know I guess I think of fats more of serving a cooking function *or* a flavour function.

Wondering what else is lost along with the sunflower seed taste, prompted Lyn to juxtapose her knowledges about cooking, pleasure and nutrition. Out of this emerged the realisation that she did not expect nutrition from sunflower oil, something which came as somewhat of a surprise to her. The strange difference in taste between our homemade oil and the products to which Lyn was habituated to, not only raised questions for her as to why this might be, it created space in which she could explore the values entangled with her oily practices.

In the first session, Andy and Steph, also made coconut oil. This involves blending the flesh and water from a fresh coconut and straining the mix through muslin to leave desiccated coconut in the cloth, and a weak emulsion of the fatty and aqueous amalgams in a jar. If left to stand for a few days, the emulsion breaks down and the oil separates out and floats to the top from where it can be scooped off. Although straightforward, getting the flesh out of the coconut is hard work, and something at

which I am not very skilled. Attacking coconuts with a hammer, chisel, and saw, did not seem to be something that I should be doing around my participants. I could have taken pre-extracted coconut pieces along instead, but the blending requires a particularly powerful food processor which is heavy to carry. As such, in the later sessions we used a jar of shop bought, cold-pressed, coconut oil instead. I did, however, also take along the coconut shells and the desiccated coconut left over from making the original batch of coconut oil in order to illustrate the process.

Steph was surprised to learn that although she had thought about margarine as processed, she had never considered how oil was made. She mused that:

This is the sort of thing you like to be aware of. Because... whenever I buy a bag of anything like that, I think, how many - I can appreciate just how many plants that is, even to buy a bag of seeds, nuts. Let alone then processing that further. I think that about seeds and nuts, but I don't think when it's oil, although I might do now! So much energy again. Energy for fertiliser, energy for temperature, moisture, humidity, like all these things. Having said that now is making me think, could we live without oil? It's made me think a whole bunch of things, and asking new questions that [I] don't know the answer to...

Steph's words are an example of how playful strange encounters with the stuff of fat subtly shifted the focus of the conversations within the PDGs. When the groups were just sitting and discussing their fatty habits and practices, the conversations were largely descriptive (I eat this, I think that), but also contained questions of a somewhat anxious (am I right to eat this, to think that?) nature. However, when they began to play with the stuff of fat the conversations became more reflective. Playing with their food simultaneously made present, and disrupted, my participants' beliefs, rules and knowledges about fatty materialities, co-creating a shift in, and a re-evaluation of, the balance of their knowledges. Participants wondered why they ate what they ate, how they knew what they knew and why how things had come to be that way.

Prior to playing with or food, my participants had told stories about their fatty practices which demonstrated how the fats they habitually ate were entangled with their sense of themselves not only as individuals, but within communities (cf. Bourdieu 2013). Yet, they had also expressed frustration that in making food choices they felt compelled to prioritise between different regimes of value entangled with the stuff of food. They wanted, amongst other things, to eat healthily, to be good parents,

to minimise harm to the environment, a living-wage for the producers of their food, to balance their household budget, and to enjoy their food. Nonetheless, they found it impossible to do right by all these value regimes, and so they prioritised and compromised, and in so doing experienced distaste.

'Playing with our food' engendered a strange encounter which shifted something in my participants' thinking and upset their habitual distinctions between ways of valuing. 'Playing with our food' worried their imagined cut-off points where processing becomes cooking, the novel becomes tradition, and momentarily made present the slipperiness of the concept of the 'natural', provoking a re-evaluation in the ways in which my participants drew the boundaries of their natural-processed food classification binaries. For some, such as Ruth, this shift brought new fats into the refusal of distaste. Yet as Holloway has argued, 'The No is rarely mere No... in its refusal of that which exists, it projects some idea of what might exist in its place' (Holloway 2005: 208). Thus, such rethinking is not simply a reversal within a food framing, but a re-evaluation and realignment of knowledge fragments.

Encountering Anew

In each session, my participants crushed a half kilogram bag of black sunflower seeds, which typically produced just over a jam jar full of oil. Once the groups were satisfied with the explorations of our homemade oil, we began to think about margarine. Many of my participants were sceptical that it would be possible to make it. Those that were cooks took one look at the ingredients I had provided and assumed as Ruth did that 'it's going to be like a mayonnaise almost isn't it?' To these participants I explained that the process sat somewhere between chocolate tempering and ice cream making. That we were using temperature and mixing to control the crystallisation (solidification) of the emulsion.

I gave the groups two margarine recipes to choose from (see appendix four). The first, was the recipe card that I had followed earlier in my fieldwork in the research kitchen of the transnational that I had visited; whilst the second was one that I had found on the internet when I had first discovered that it was possible to make homemade margarine (see discussion in Chapter Three). I included this second recipe because it

used mustard rather than raw egg yolk as an emulsifier as I was concerned that some participants might be uneasy about eating raw egg yolk.

I left the groups to study the recipes as I set out the ingredients and equipment we would need to make the margarine. The equipment included a small pan, a small bowl with good heat transfer, a large bowl, a wooden spoon, a whisk and some ice cubes.

Ruth's group were critical of the recipes I had provided:

Ruth Let's follow the recipe shall we? Or not? Or do we want to not indulge; maybe we want to do it without dairy, what do you think?

Claire I don't quite see the point of making a thing with vegetable oil with eggs and milk in, why not just have butter

Ruth Yeah, actually that's a good point. Can we make it without the eggs and the milk? I think that's a good idea.

Jane Let's split the mix, make two batches.

Ruth is a confident cook. She is a single mum and a full-time teacher who feels that she cooks quickly and efficiently every evening. She sees recipes as merely a guide, measuring as unnecessarily proscriptive, and ingredients as interchangeable.

Nonetheless, her group's differentiation between animal and plant based ingredients is a noteworthy one. The *Bertolli* spread which Claire habitually buys contains both whey powder and buttermilk as well as vegetable oils, only about a third of which are olive based. Claire readily admits that she is won over by the olive headline. In having the raw ingredients laid out in front of her Claire was prompted to re-encounter the stuff of margarine.

The decision to split the ingredients and follow both recipes was typical of my groups⁶¹. To make margarine by these recipes two tablespoons of coconut oil is gently heated until it has completely melted⁶², it is then poured into a bowl containing three to four tablespoons of sunflower oil. This bowl sits in a larger bowl containing ice cubes. Then the oils are whisked together over the ice until the mix begins to change colour, this is the 'fatty phase'. To this mix is then added the 'aqueous phase', which consists of a tablespoon of liquid, a teaspoon of either egg yolk or mustard, a few drops of lemon juice and some salt. Our recipes suggested that a basis of milk for the aqueous phase would give the nicest mouth feel, but water would have worked, as did

⁶¹ Steph and Andy are both vegan so chose not to make the version containing egg.

⁶² At a later date, I made margarine on a stall at Exeter University's fiftieth anniversary community day using unrefined palm oil, which produced a bright orange spread.

the soya milk that Steph and Andy chose to use. Once the phases have been combined the recipes suggest that the bowl should be removed from the ice and the phases whisked together until a material emerges which has the consistency of margarine⁶³, however my participants found that if the room was warm then they had to intermittently return the mixture to the ice bath. Although straightforward, this process takes time and a lot of elbow grease.

As making margarine was new to her, Steph initially followed the recipes closely, measuring out ingredients and applying heat as instructed. Andy then took over with the stirring. However, Steph soon began playing around, making small adjustments to the recipe:

The bits that had separated have now gone frothy... Maybe we could leave it for a couple of minutes, and see if a film forms. I don't know how the process works, because it gets... gets a skin or something. It looked like it was going on the bottom then, as well. You tipped it out! Maybe we should leave it... I might put a little bit more mustard in... It's definitely more mayonnaise now.

Following the recipe to the letter did not produce the texture Steph was hoping for. Andy, meanwhile, declared 'I'm just fascinated anyway. It's an eye opener and an arm hurter'. As he stirred and looked, and Steph looked and adjusted, Andy continued, 'because then I've started thinking - how do you make mustard?'⁶⁴ To which Steph responded:

Well, that's what I was thinking. Yes, that's the kind of thing why I think it's valuable to do it, because it does, it gets you thinking about all sorts of things. When you're working with natural things, it's so variable, isn't it? When you think about everything that's gone into those seeds, though, different nutrients and minerals, different weather... They must have a standard to conform to. And how do they do that? How do they do this on a big scale?

Cooking is a playful dance between cook and cooked. Simply following a recipe is not sufficient to guarantee the desired result. Reflecting on the minor adjustments they made as the stuff of margarine responded to temperature, mixing, and new ingredients, raised multiple questions and connections for Steph and Andy. And provoked them to explore some of the gaps between the strictures of the recipe they were using and the lively materialities of foodstuffs.

⁶³ A method not dissimilar to making French dressing, mayonnaise or hollandaise.

⁶⁴ Mustard is also straightforward to make at home. I took the decision that doing so within the PDG's was an unnecessary extra step.

In different ways, 'playing with their food' prompted both Steph and Andy to re-encounter the stuff of food. Combining ingredients to make margarine prompted Andy to question his mundane taken-for-grantedness of products such as mustard. Whilst Steph was more explicit about the significance of encountering fatty materialities in novel ways. She explained that getting:

hands on with things, it starts your mind ticking in the right way rather in the way that we're used to which is not really ticking at all much. You just end up trying to recall facts from some out-there source of which you don't really know where it's come from. For example, us just talking about, wondering why, how this time is different then you immediately think, surely, how do they do this on a big scale? Straight away it's the first thing you think of. If I can make margarine, and then another [time] it's completely different – how do they make it so standard?

Re-encountering the materiality of fat, prompted Steph to re-evaluate her knowledges and practices. But then, Steph was interrupted as Andy proclaimed: 'Bloody hell! Wow, look at that! This is the real deal!' After whisking, for what to the one doing the whisking can feel like an eternity, the mix abruptly changes in consistency as the emulsion crystallizes out. All the time my participants were whisking, crystallization was beginning but the crystallization curve for our emulsion is steep. As such to the naked eye, it appears that nothing is happening, until all of a sudden 'it' looks like margarine (see figure 25).

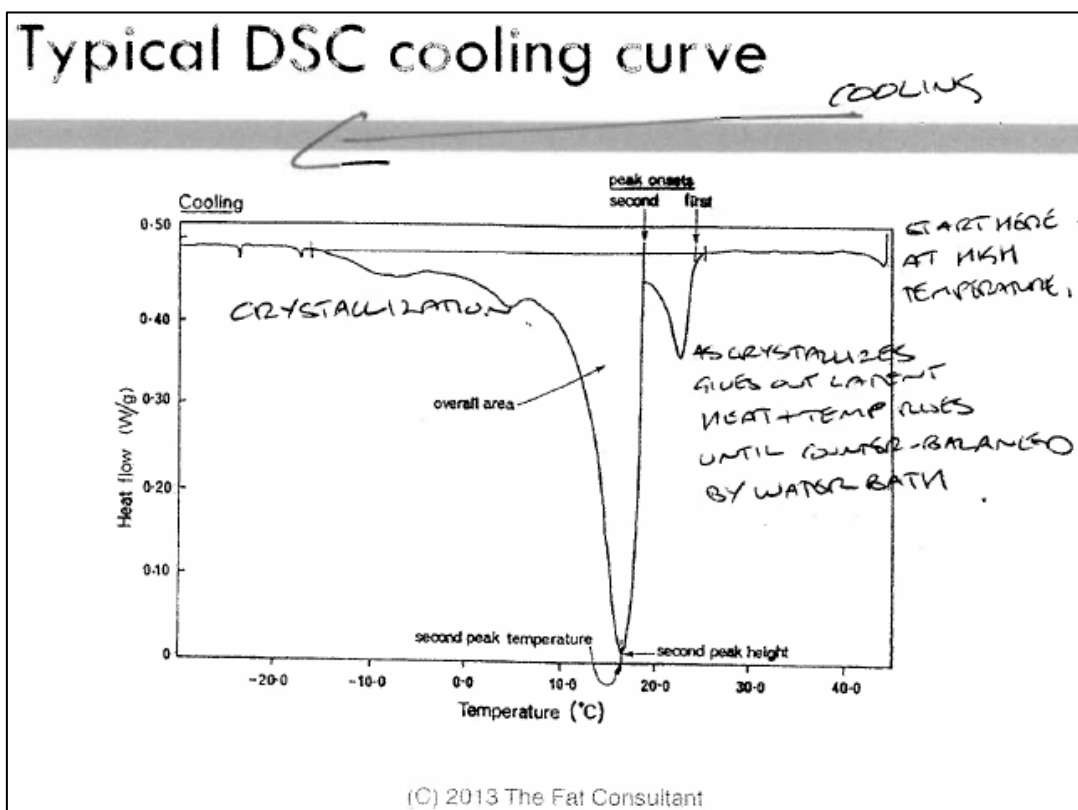

Figure 25: A lipid crystallization curve from mySprington course notes

The consistency of the margarine my participants produced was variable, as Steph suggests, part of this will be down to differences in the materialities of the ingredients. However, a far greater influence is likely to have been my participants approach to cooking. Alice followed the recipe card exactly, measuring out ingredients precisely and following the method to the letter; whilst Ruth and Lyn both gave the recipe a cursory glance, scooped the ingredients into the bowls and continually made adjustments until they were satisfied. Ruth's margarine was relatively hard, Lyn's much softer.

Like Andy, Lyn was initially excited when a recognisably margarine-like substance emerged, exclaiming: 'ooh look, it looks like margarine doesn't it!' On examining it more closely, however, Lyn hesitated slightly, adding: 'well I was thinking. Erm. You would need - you can see why they colour it. Cos it, you know, is quite pale. What I was more thinking is that if served as mayonnaise it would look the right colour. So you can see why they'd add colour. Indeed, Lyn was so intrigued by her reaction to the colours of our homemade margarines, she got a supermarket own-brand margarine out of the fridge so as to compare the two:

And so that's got colour added to it, although it seems rather garish doesn't it? But, erm, if you were having mayonnaise and it looked like that you'd think ugh how artificial! You want it to look like that [the homemade margarine] so it's sort of funny isn't it, this sort of expectation of what, different things have different colours even though they're sort of - the ingredients are similar.

Milly too, found the colour of our margarine to be unsettling, although she made a comparison not with a product made from similar ingredients, but with the product that she expected margarine to mimic:

They do look weird don't they? I think the yellowy one looks more ascetically appealing - that's the mustardy one isn't it? And I think, I probably have a...this looks... White fat I associate with lard. And yellow fat I associate with butter and creamy and more natural. You know the colour is actually quite an important part of the experience isn't it? Even though lard is natural.

Their 'strange encounter' with the colour of our homemade margarine created a hesitation where Milly and Lyn were independently able to articulate some of the logical-leaps, translations and strategic ignorances (cf. McGoey 2012a) entangled with their habitual practices. Within this hiatus, knowledges about different foodstuffs

were juxtaposed and as such they were prompted to re-evaluate their constructions of, and beliefs about, the natural - unnatural binary.

This realisation that colour mattered in their choice of spread came as a surprise to Ruth's group too. Ruth explained that she wanted 'it to be yellow.' Before musing, 'the thing is what are we trying to achieve? We are trying to achieve something that looks like butter I suppose. Although it doesn't look unpleasant does it?' Jane agreed, adding that, 'it is funny that we want it to mimic those foods. That's cultural isn't it really? Because we want to eat what we eat already'. Jane's understanding that food is laden with cultural as well as nutritional expectations, although by no means a novel realisation, is important.

Companies are well aware that consumers are overwhelmed with food knowledges and so frequently make purchase decisions based on habit, aesthetics and cultural expectation. Standardisation is one way of maintaining consumer confidence in a product, indeed it is not uncommon for there to be uproar when a recipe is changed and a product promoted as 'new and improved'⁶⁵. Social norms are 'made flesh in the everyday conduct of provisioning, cooking, and eating' (Stassart 2003: 460). In keeping products apparently the same (even though ingredients and processes may change) companies can perpetuate a form of non-knowledge (cf. McGoey 2012b) in which eaters do not particular notice the materialities of that which they are eating - they eat it because it has become habitual to do so. When a product changes, however, it becomes conspicuous, running the risk that consumers may reject it.

Likewise, the unexpected colour of my participants' home-cooked margarine created a 'strange encounter' which made margarine conspicuous to my participants, however it did not only do this. Our margarine was not something to be consumed – bite, swallow, gone; our margarine garnered the attention of my participants by being an accomplice in the experiment. My participants were invested in getting to know margarine, so when its colour did not fit with their expectations they were obliged to encounter margarine anew. This created a hesitation within which they could explore

⁶⁵ For example, Unilever eventually withdrew its £29 million relaunched 'healthier' Flora after a drop in sales and customer complaints that it did not taste like Flora was supposed to (The Grocer, July 9th, 2013).

the ways in which, within their habitual practices, the colour of a fat is accepted as symbolic of the presence of other desirable characteristics, properties and values.

Nonetheless, as with our homemade oil, it was not only the colour of our margarine that surprised my participants. Anna is a lifelong margarine eater, choosing margarine mostly for its functionality, although she also feels that as a predominantly plant-based product it is likely to be more sustainable than butter. On tasting our homemade margarine, however, Anna proclaimed: 'It's very nice it's very coconut, it is very nice actually... I like this! (She laughs). I've never thought before about why margarine tastes the way it does! It's just there to moisturise the bread or something. Yes, hmmm.' Anna's groupmate Lyn, attempted to help her out of her confusion by referring back to their earlier discussions about material differences between cold-pressed and refined oils, wondering 'what would it taste like if you were using processed oil rather than the fresh oil?'

In encountering the flavour of our homemade margarine, my participants became aware that commercial margarine is purposefully made to mimic the flavour of butter. Ruth felt this is 'because we think of those [butter] flavours as real food'. Prompting Jane to wonder if the nutty flavour is removed from commercial oils to make it easier to imitate the butter flavours eaters have come to expect. This last point is one I had not previously considered. Having spent time in a refinery I had rationalised that the flavour of refined oils was merely a by-product of removing any volatile compounds which might reduce shelf-life. Yet, it is the case that in Northern Europe vegetable oils were turned in to margarine decades before they were available commercially as cooking oils, and it was almost a century before margarine was promoted as anything other than a cheap butter substitute (see interlude one). Nonetheless, Ruth's group did not find the non-butterlike flavour of our margarine to be at all distasteful:

Ruth It tastes nutty, you can taste the sunflower!

Jane It actually tastes of sunflower seeds!

Ruth That's amazing!

Claire Ooh yeh it tastes proper doesn't 'it, I've never ever tasted marg like that out of a plastic tub

Ruth Mmm

Jane To make this delicious now, I would put more mustard, turmeric and fresh garlic

Ruth Do it. I want delicious!

Ruth's group liked that our margarine tasted of itself, rather than attempting to mimic butter. Indeed, the spread containing mustard, which was their favourite, is the one with the least butter-like flavour, tasting to my mouth very much like French dressing.

Claire was particularly excited by the flavour of our margarine, exclaiming 'it is a standalone spread isn't it really that?' This encounter changed something in Claire's demeanour. Early on in the PDG, Claire had described herself as a habitual margarine eater, a practice that was criticised by her fellow group members. Claire quickly shut down this discussion by saying 'it's just a personal preference', she then remained relatively quiet for much of the rest of the session. After tasting our homemade product, however, Claire opened up. Something about the encounter seemed to shift the power dynamics in the group slightly. Claire explained that when she ate butter it was for its standalone flavour, whereas margarine 'it's just the lubricant'. The flavour of our margarine, opened space for Claire to explore her own habits without disapproval from the others. She began to think, not just about why she habitually ate margarine, but about why she used yellow fats at all. She explained that she had a Spanish friend who found the British reliance on yellow fats to be somewhat bizarre, and that when she had spent time with her in Spain she had used olive oil on bread and in cakes. This triggered a comment from Ruth about 'all the kind of pastries, and even sweet, like Cornish saffron cakes and things like that are supposed to be made with lard, Eccles cakes, taste delicious! (She laughs)', and opened a line of thought within the group which used olive oil and lard to think with. Juxtaposing knowledges in this way allowed the group to explore not only the shifting foods and food practices valued by individual eaters, but how those valued by societies and by communities shift over time.

Knowledges of self and other, accumulate, morph, and shift, with and through the interaction of materialities, practices, conversations, representations, and structures (cf. Probyn 2000; Goodman 2008; Carolan 2012). For my participants, something as simple as disturbing the expectation that margarine tastes like butter, created a shift in their framings of the familiar. Within 'the event' of tasting our margarine my participants became aware of the situated and partial nature of their habitual knowledges and practices. My participants were, for example, surprised to discover

quite how much they relied on aesthetics in negotiating their fatty choices. What is key though, is that, rather than making them retreat into defending their position, 'playing with their food' created a conducive space to encounter margarine anew. In this space, in smaller or larger ways, they were able to engage the creativity of play to experiment with rearranging some of their knowledge framings and begin to explore the relationships between knowledge framings and habitual practices.

Juxtapositions

We read in Chapter Four that prior to our experiment, my participants had not thought much about the materialities of margarine. They classified it in a general way as convenient, healthy or unnatural. They ate it or they did not. When I asked them what it was, how it was made? Martin's reply that 'I haven't really thought about it, but... I would have thought of margarine as a factory-produced product with various chemicals thrown in, and no doubt heated to very high temperatures, and you know', was a common one. Ruth, for example, described margarine as a pseudo-food.

Yet my participants had just made margarine using domestic kitchen equipment from store-cupboard ingredients with no chemicals. On making margarine, Andy exclaimed, 'awesome. We've fucking made margarine. I'm going to go back [to work] and just be like, "fucking made margarine. You all thought I was nuts" [Laughter]. Everybody just looked at me like I was a mentalist, just going like: "isn't that some massive industrial...?"'. The intervention of making margarine in a domestic kitchen tended towards my participants framing our encounters within the norms of cooking. If all the experiment had done, however, was to show that margarine could be cooked it would have achieved little. As Paul commented on learning that one of the recipes we were using was produced by a major margarine manufacturer: 'Is it... not an ulterior motive? More of a changing perceptions exercise rather than actually expecting people to do it?' I wonder about this too.

It is notable, however, that neither the recipe card we were using, nor *Unilever's* bake-off style advert for *Flora* have had mainstream launches by the companies that produced them. Indeed, *Flora's* current 'powered by plants' campaign works to

enhance an impression of 'the natural' without prompting too much thought about how materialities might be brought together in the stuff of margarine (see Interlude Four). Conversely, the hands on 'playing with our food' involved in making margarine prompted Lyn to compare the ingredients listed on a bought tub of margarine with the ones we were using. She explained that:

Margarine I always feel is a processed food but we basically just cooked it you know, so it's that balance, cooking and processing. But how long would that last? I'm just wondering, yeah, cos the emulsifier is mono and diglycerides of vegetable fatty acids, whatever they are. That's not a cupboard, a store cupboard, ingredient is it?

For my participants, encountering material differences between homemade margarine and commercial products did not change their perceptions in ways which further domesticated margarine by reassuring them about its 'naturalness'. Rather it provoked them to ask questions of this framing. They wanted to know what was added, what was taken out, who was entangled with the production processes, and why things are the ways that they are.

A particular advantage of using the PDG format is that my participants were able to bounce half-formed thoughts about the strange material presence of the stuff of fat off each other. This is not just because they did not need to try and present themselves as experts, but also that their relationships with the others in the group did not facilitate it. When, for example, Milly commented that making margarine: 'Feels like chemistry. Cos its. Cos you're taking - cos they both needed the emulsifier'. Her partner, Ian⁶⁶, pointed out that when making jam, Milly knows that she needs to use fruit high in pectin if the jam is to set. To which, her dad, John retorted: 'right, obviously you wouldn't think that you're behaving illogically would you love, none of us would?'

In play, eaters and the stuff of fat are not 'already constituted subjects'; they did not already know each other (cf. Ahmed 2000: 8). In thinking through the complex entanglements of the stuff of fat with human and non-human others, John is

⁶⁶ Ian had declined to take part in the PDG because he was watching the football. Nonetheless he had popped in and out of the room throughout the discussions, had got involved in setting up crank press, and had joined the group once we started to make margarine.

overwhelmed. He remarked: 'I'm thinking that all three of us would have a completely different take on it and what we will take into the future'. John does not know what to do for the best, and cannot imagine ever having enough knowledge to do so. He continued:

So as a consequence of that it seems to me it will be far better if there was an expert who formulated the fat spread that we were going to eat from the best nutritional and environmental point of view, and we just had that issued to us. I mean that's the way I look at it you see, I look at it in a, err, sort of outcome based thing. What we really want if we are talking about sustainability is some, err, centralised, rather than us making, as Milly is talking about, preference choices... I'm much less worried about experts dictating what we have than individual pressure groups dictating... misapprehensions about what is good for us, or what is bad for us.

John is a habitual buyer of olive margarine, who had earlier explained how this is a sensible healthy option. John's overtly expressed desire for decisions about how best to eat for his health, and the planet, to be made for him by others was somewhat unusual. Nonetheless, it is notable that the strangeness of playing with his food created a hesitation which engendered his articulation that systemic power is as entangled with his consumer choice as is personal taste.

It emerged however that John is a 'poor' taster. Ian, took one bite of our margarine on a piece of toast and announced: 'mmm, coconut, yummy coconut!' This comment amazed John:

How do people do that? How can you say coconut? You can just eat that? I can't tell any difference between the two. But I mean, the point is, it functions to make it palatable, and that's it really, I mean it is, I really can't see... But then my taste has never been very good. They're both palatable. And they're both fat – it sort of makes things slip down doesn't it.

John's inability to identify flavour might go some way to explaining why he would be happy for experts to decide what he should be eating. It was also a limitation to his ability to encounter our margarine in all of its strangeness. He was interested in observing the process, but showed more curiosity in getting to know the crank press and its workings than the stuff of fat itself. Nonetheless, it was not only the taste of the stuff of fat, but the presence of its connected others – the seeds, the 'waste', the energy – that co-created playful strange encounters.

In response to John's comment that fat just makes things palatable, Milly pointed out that it is also concentrated energy. Something which prompted Cath to remember the muscle power involved in operating the crank press. Her embodied awareness of the energy involved in producing something so apparently simple and minimally processed as a vegetable oil troubled the habitual ways in which she thought (or didn't think) about the stuff of fats. She pondered which out of grinding seeds or churning butter would be the most energy intensive, which prompted a group discussion about farming, topography and local food. For Cath, the 'strange encounter' between muscles, sunflower seeds and machine slowed down reasoning enough for her to begin to explore eating well as situated and multiple (cf. Puig de la Bellacasa 2010). An investigation which suggested that there is not one right way to eat for all people at all times, and so opened a gap in John's pronouncements about leaving things to experts.

Similarly, in response to John's accusation that she was 'being illogical'. Milly explained that 'well there are some times when I know I am behaving illogically... but I don't think it's as simple as that'. Milly feels, that what is important, is not to know all the answers but to practice 'respect in whatever you're doing'. For Milly, eating minimally processed food seemed to be a way to do that. Partly this is because she assumes it uses less energy, but also she does not want to hide from herself who and what she is eating. The natural-processed binary helped Milly to justify and explain her food choices and maintain her habits.

Nonetheless, playing with her food did not fit with these learned narratives and beliefs. In allowing herself to meet the otherness of the other (cf. Ahmed 2000) Milly became aware of some of the exclusions, separations and temporal freezing entangled with her framings of fats (cf. Holloway 2005). 'Strange encounters' with matters of fat revealed to Milly the situated and partial nature of her fatty beliefs, knowledges and practices, and created disjunctures from her taken for granted realities and ideas of tastefulness. It would, however, be ethically problematic if all the experiment had done, merely leaving my participants with fragmented knowledges of bodies and relationships to try to take into account when making consumer choices. Although it is important to remind ourselves that framings are purifications (cf. Latour 1993 (1991)), we do need to frame the world in order to continue to function within it.

Playing with the troublesome and unpredictable materialities of fats within the safe space of the PDG's did not, however, merely 'break the spell' (Pignarre & Stengers 2011) of Milly's habitual shopping and eating practices. It facilitated tensions and translations between her taken for granted knowledges, norms and values to be re-evaluated. For example, in explaining to her dad why she was struggling to reconcile the simple cooking practice of whisking egg yolk or mustard into a mixture of fat and milk with her beliefs about the processed nature of margarine. Milly was able to articulate that playing with her food was excessive to the doing of cooking.

From the disappearance of the flavour of sunflowers, to soil being made more or less hospitable to worms, plant roots, or people, through entanglement with farming methods. The event of the encounter made the stuff of fat the focus of my participants' interest; the node through which multiple bodies and relationships were juxtaposed. Within the doing of play, space was created for social and material relations that are so mundane that they often go unnoticed to be represented and toyed with. As Sarah exclaimed 'it's funny, you know when you look at your own habits, and think well that's a bit odd'. In this way, 'playing with our food' created a hesitation in normative framings which upset my participants' taken for granted expectations of commercially available oils and fats. As such 'playing with our food' was a doing that raised the possibility of experimenting with the 'resources for thought that survive on the margins' (Pignarre 2011: 5); to think outside of the box by making new connections between knowledge fragments.

Chapter Conclusions

In this chapter I have demonstrated how engaging play within the safe space of the PDG created an exploratory and open-minded atmosphere that disturbed my participants' pre-conceptions, both about the stuff of fat, and about themselves as eaters. In situating my participants in an experimental relationship with the stuff of fat, space is created for an exploration of the norms and values entangled with different food framings. Framings are not fixed, diverse forms of value can and do co-exist. The strangeness of the encounters created space for an openness to meeting the fatty other as interesting and valuable in its own right. This openness worked to make fats present to my participants as knots of bodies and relationships, rather than

as a commodity that must be shaped to fit with multiple personal, cultural and societal value judgements. Further, playing with our food within these strange encounters created a hesitation in my participants' normative habits that facilitated 'what if?' explorations into other possible modes of relation between eating and eaten bodies.

For my participants, strange encounters with the stuff of fat engendered thought about knowledge structures as co-produced with, and in, political, cultural and social frameworks and hierarchies of interest (cf. Roe 2006a). Fat is encountered at particular moments but its relationships 'generate certain possibilities and foreclose others' (Ahmed 2000: 15). 'Playing with our food', in making present topologies of proximity and distancing, revealed some of the translations, tensions and absences entangled with juggling different framings of the stuff of fat. In consumer-orientated societies, eaters are framed, valued and enacted by, and with, their abilities to make consumer choices (Coff et al. 2008), and my participants had come to know themselves and others through the lens of their interpretations of such representations. 'Playing with our food' made space to ask how our food systems work. What effects do they have? (cf. Deleuze and Guattari 2004 (1980)).

Ways of encountering are to smaller or larger degrees, world-making. Subjects are reconstituted within their mundane meetings with others and play creates a safe-space to rehearse other ways of living together. Not all norms up for negotiation at all times, 'playing with our food' is an intervention that allows some knowledge boundaries to be pushed, even reconstructed, because others are kept as a safety net. Indeed, my participants' different readings of the 'strange encounters' serves as an illustration of the mediated and partial nature of all encounters. Nonetheless, 'playing with our food' is a practice which relates to the collective of entangled others. The play raised questions as to how fatty choices foster (or neglect) relationships and in this way troubled the notion that eaters might aspire to be autonomous individual consumers.

'Playing with our food' was a fleeting refusal of objectification where other ways of valuing, other ways of framing the world and living together, can perhaps be made more possible (cf. Connolly 1999; Pignarre & Stengers 2011). Yet, as Goodman demonstrates making other ways of living together "sticky" in the slippery worlds... of

consumerist capitalism' is not so simple (2008: 12). Consumer-consumed relations are maintained through constant tinkering. In this regard it is the very smallness of play as an intervention that is key. Play is a micro-resistance, an event, that can be practiced by my participants' multiple times a day so as to 'draw from it new capacities to imagine and to situate themselves' (Pignarre & Stengers 2011: 76).

In sum, within the playful encounters, space was created to kick-start thinking in which the values and norms with which habits are enfolded could be worried and subverted. Such 'lines of flight' are at once pragmatic, speculative and transformative (cf. Guattari 2005). The strange encounter of playing with our food is a learning to learn -- a trying on for size of other ways of relating and representing - an exploration in changing the rules of play. Most of these experiments will fade, but in repeatedly playing with our food, connectivities can emerge that might just create a knot of recognition that decentres the human and enables a relational ethic of conviviality.

INTERLUDE SIX

conclusion of the interludes (margarine and me)

Doing this research has been a long journey.

In interlude two I explained that I was once a habitual margarine eater, but by the time I started this project I had come to experience its tastes, textures and odours as distasteful. Unpleasant, unnatural and entangled with the uncaring priorities of capital. This shift in my own tastes fascinated me. My understanding was that the stuff of margarine had changed, but for the better. No longer partially hydrogenated, it was believed to be healthier, more sustainable, better for animal welfare than ever before, and better than butter. It was also available within alternative food networks. Yet something deep within me rejected it as food.

I did not set out on this research to confirm my prejudices, to shut out whole categories of foods from my beliefs about the edible. Indeed in my research within the margarine industry I met intelligent, informed and dedicated people who love food and want to create products that they themselves want to eat, and that they would feed their children. They think about health, sustainability, labour relations, economic cost, tastes and utility. They are excited by food matters and they want to make it easier for people to consume-well.

Yet I still do not eat margarine.

Actually that is not the whole story, I still do not eat margarine if I can avoid it, and I now try to avoid vegetable oils too.

In fact, that is not the whole story either. I try to avoid commercially available margarine and refined vegetable oils. I do, however, occasionally make homemade margarine because it is quick and easy and I like the flavour.

So is that it? Four years, thousands of pounds, 90,000 words and a new recipe to add to my repertoire? Well no. Things are not so simple.

Although I do make margarine I am indecisive about which fats to use. I have not pressed my own oils outside of the doing of the research because it is messy, hard work, expensive and inefficient, so I use commercially available cold-pressed oils. At first I worried about my choices: Animal fats can be local in origin, organic and involve minimal processing of food that might otherwise become waste, yet I cannot overcome my queasiness about using animal fats as a spread, and then there's my elevated cholesterol levels to take into account. But, although local, oil seed rape is resource hungry and most likely entangled with a catastrophic decline in bee populations. Coconut, often promoted as some kind of superfood, is growing rapidly as a palm alternative without the regulation necessarily keeping up with practice, but I love the flavour it brings to my spread. I feel I should support regulated palm, but that I do not entirely trust the regulations, and what I know of processing practices makes me uncomfortable. I am however tickled that the margarine produced from unrefined palm is a particularly fluorescent shade of orange that bears no relation to the mellow yellow of butter. Pumpkin oil is expensive, but the musty flavour works well on wholegrain bread and the spread has a sophisticated green tinge.

In experimenting with these different fats I became more and more fascinated by matters of fat but I still did not know what to do for the best. I worried that in learning to hesitate, to pay attention to the consumed other, maybe all I learned on this journey was a secular form of saying grace. That is not to suggest that thankful, contemplative reflection on the food on my plate (how it got there, and what it can do for, and with, me) is not important, it is. Taking the time to be thankful may help me to appreciate my connections with the lives in things but it is not sufficient to repoliticise relationships which have become framed as technical or administrative problems.

I repeat. Is that it? Is the major outcome of the last four years that in coming to accept that consumer-consumed frameworks inevitably continue to reproduce the inequalities and injustices of moral framings I no longer feel angst about my fat choices

(or not much anyway). Rather I mix it up, spreading different goods and different harms with each batch I make.

Well no. Again, things are not so simple. I am a consumer, I consume the consumable other. Nothing has changed. Except, everything has. I remain a consumer of fats, but my fat choices are no longer habitual. Strange encounters with the stuff of fat have stayed with me in a very embodied way. In sitting at my desk writing about the experience I am involuntarily almost overwhelmed by the smell and the taste of the 'waste' produced from making the oil. Although I know these sensations are remembered, they are simultaneously very real. This is not to suggest they are unpleasant, but the unexpected nature of the look, feel, smell and taste of the stuff produced has stayed with me long after leaving the field. Especially the smell. Since undertaking the research I have not been able to cook with sunflower oil without an embodied awareness of this part of its production.

More than this, in encountering matters of fat as strange - I have become more aware of myself as relational. Aware that the margarine my mum ate in the 1960's contained about seventeen percent whale oil (Gorman 2002). Years later as she grew and nourished my body, ghosts of whales passed from her to me. Ghosts of whales are still becoming with and in assemblage-me. And they are meeting and interacting with trans fats, interesterified fats, palm, rape, sunflower and more. As we fold together, my microbiome changes, my cells change, I change.

Convivial relations must be perpetually negotiated and remade. Hesitations in habitual practices, are micro-resistances. They are spaces of refusal which trouble the mundane reproduction of norms; spaces of excess in which relationships can be changed from the bottom up. Again and again for a brief moment I tweak the recipe, I encounter the other and change is possible. Strange encounters are a big fat chance; a learning to learn and this has been my journey, and it is long, and it continues. Relations matter.

concluding remarks (eating without consuming?)

Introduction

Throughout this thesis I have attended to eating-well with the stuff of margarine, both as it is constructed within frameworks of consumption, and as it is excessive to such mappings. In my empirical work I have engaged mundane encounters with margarine matters to examine how margarine is done, explore why it has come to be done in the ways that it is, and consider the bodies and relations 'made to matter, and not matter' (Evans & Miele 2012) within these doings. I have used juxtaposition as methodological and an analytical tool to expose some of the ways in which eating overflows consuming, and I have developed novel methodological approaches which through enrolling margarine as a participant in the research begin to prefigure a resilient mundane politics of more-than human eating-well-together.

In this final chapter, I will give an overview of the thesis in miniature as explored through the interludes, before summarising the key conclusions of each substantive chapter in relation to the research aims and questions outlined in chapter one. I then step back from the chapters to take an overview of the doings of the thesis as a whole by introducing three methodological contributions emerging from the thesis which speak to the provocations raised in chapter two. In the first, 'working with disjunctures', I respond to provocation one in which I called for the development of practices which disrupt the everyday smooth functioning of consumer-consumed relations so as to raise new questions about the doings of such binary divisions as consumer-consumed or self-other. In the second theme, 'harnessing strange encounters', I attend to provocation two, here, I explore in more detail the possibilities for geographical conceptualisations of living-with a more-than human world engendered by my methodology of strange encounters. In the final theme, 'building an uncertain ethics', I reflect on possibilities offered by the empirical doings of this thesis for further investigating the micro-resistances offered by the event of play. Discussion of these contributions and themes is followed by attention to the limitations of the study, recommendations for future research and my concluding remarks.

The Interludes (thesis in miniature)

Including the prelude and afterword, this thesis contains eight interludes. In the first four I predominantly used secondary sources to explore some of the shifting ways in which margarine has been presented in policy and in the media, whilst in the latter four I shifted focus to an exploration of situated encounters between texts, margarine and myself as an eater, as well as inviting you, the reader, to encounter margarine anew through engaging with these representations. The prelude engaged a history of the development of margarine to illustrate power-relations entangled with the co-construction of consumer and consumed. In interlude one I used a story about trans fats to introduce the concept of the relational subject, and to begin to think about who and what is made to matter in the co-construction of consumer and consumed. I then suggested that if relationships between eating and eaten bodies have been changed, then they can be changed. In interlude two I illustrated margarine labelling as a mapping of knowledges that attempts to direct the attention and the practices of the consumer. I then engaged my own shifting tastes to think about margarine encounters as a space in which practices, beliefs, knowledges and bodies interact and are prioritised, juggled and remade. I used interlude three to explore advertising as a means through which to implant and invoke memories, and to situate the novel within social norms and values. In so doing, I demonstrated that although the power to construct framings is asymmetrical, it is not uni-directional. In interlude four, I turned to recent presentations of margarine as 'natural' to, following Latour (1993 (1991)), interrogate the production of 'non-knowledges' (McGoey 2012a), within dualistic framings. Then, in interlude five I encouraged you to step away from textual constructions of margarine and hoped that by playing (or imagining playing) with your food, tensions between your own knowledges and practices of and with margarine would begin to emerge and that you would encounter the stuff of margarine anew. Interlude six detailed my personal journey through this research and my ongoing attempts to tinker with 'recipes' (Pignarre & Stengers 2011), to change the rules of play so as to learn to eat without consuming. To close, following this chapter is an afterword that situates this research in my life outside of academia. In bringing together knowing, doing and encountering in this way the interludes can be thought of as the thesis in miniature.

Chapter Contributions

In **chapter one** I presented the context and aims of this research, situating the thesis within contemporary social concerns about fat, consumer-choice and eating-well, and outlined the empirical approaches taken. I introduced the stuff of margarine and its production and reproduction as a commodity, before representing consumption and eating as mundane political and ethical acts that co-produce bodies, relationships and realities. I argued that the event of making present the stuff of margarine as a strange other, is a hesitation within which it is possible to begin to prefigure and rehearse other ways of knowing and doing food.

In **chapter two** I located this thesis in existing food geographies literatures before developing three provocations which respond to gaps, tensions and translations in these texts. Focusing on follow the thing and visceral approaches, I examined how research in food geographies has demonstrated that food production, consumption and distribution are entangled with key issues of our times, for example - climate change, population growth, war, or migration. I showed that the bodies and relationships of consumer and consumed are co-constructed and remade within the structures, tellings, affects, and performances of consumption. Then following Pignarre and Stengers (2011), I argued that the consumer-consumed construction shifts the political problem of how to live together in to an administrative one of the micro-management of scarce resources and eating bodies. As such, I demonstrated that more factual knowledges about or within consumer – consumed framings is insufficient to construct a way out of the political and environmental mess in which we find ourselves. Thus I suggested that a key problem exposed in the gap between follow the thing and visceral approaches to food research is how to explore and unpack the co-construction of consumer and consumed.

In provocation one I established that recognition of our more-than human interdependencies, begins to trouble conceptualisations of the autonomous consuming subject. Eater, eaten, gut bacteria and more, fold together co-creating new material formations with, in and beyond the body of the eater (Probyn 2000; Mol, 2008). Together they are entangled with amongst other things soil flora, labour relations, agricultural technologies, packing machines, sewage systems, public health policies, marketing strategies and socio-economic norms about who should eat what

and how much. As such, eating is already and always excessive to framings where one body consumes another. Thus, I argued for the development of geographies which explore eating-well as, and with, relational subjects.

In provocation two I demonstrated that what is thought to be true matters; knowledge and action co-constitute each other and shape reality (Mol & Law 2004). Thus, if people are to eat-well then space must be created to 'do' a politics of eating, and to explore eating-well not as a moral problem of least harm, but an ethical one that does not decide in advance who matters and who does not (Pignarre & Stengers 2011). Next I discussed 'strange encounters' (Ahmed 2000) as a methodological means to produce a hesitation in habitual beliefs, tellings, affects, and performances so as to explore the norms, values and 'infernal alternatives' (Pignarre & Stengers 2011) entangled with framing bodies as autonomous subjects that must consume or be consumed. As such, I contended that approaches to research which co-create 'strange encounters' (Ahmed 2000) with food matters can add to geographical understandings of the world-making of framing eating as consumption.

In provocation three, I acknowledged that there is no single, stable, reality; bodies are multiple, and relations are situated (Probyn 2000; Mol 2008). As such, I accepted that there is unpredictability and risk entangled with resistance; no matter how well intentioned, change is neither straightforward nor necessarily good (Law 2004). Nonetheless, I argued that accepting the status quo, the reduction of self and other to consumer and consumed carries greater risks. (Braidotti 2006). Building on this, I demonstrated the need to develop approaches to research which facilitate the negotiation and rehearsal of situated knowledges and practices of eating-well with relational (rather than autonomous) subjects. As such, I argued for the necessity of an embodied politics of the mundane, which through 'difference and repetition' (Deleuze & Patton 2004) explores possibilities for convivial eater-eaten encounters, practices, and systems, with, in, and across, difference.

In sum, this chapter engaged geographical, and wider social science, literatures to explore limitations for living-together offered by the binary construction of consumer and consumed. I then introduced the relational-subject as a conceptual intervention which troubles perceptions of consumer–consumed. I suggested that making the stuff

of margarine present as simultaneously produced and producing, mediated and mediator, momentarily reveals the subject as relational. Finally, I argued that an exploration of excess and micro-resistance is invaluable to avoiding the pitfalls of the inequalities and possibilities presented by existing food systems, to begin to 'do' a situated, relational and embodied politics of eating-well.

In **chapter three** I outlined my methodological approach to the doing of the research in the context of the literatures introduced in chapter two. The chapter was broadly divided into three sections: establishing, doing, and analysing. Firstly, I explained how I delineated the research field, and why for the purposes of this project I divided this field into three key areas: consumer knowledges and practices, industry knowledges and practices, and experimental strange encounters with material others. I went on to detail how engaging ethnographic methods to follow the stuff of margarine and its representations within and across these areas would begin to reveal how knowledges and practices of margarine are produced, maintained, resisted, and made to matter, with, and in, eating and eaten bodies. I then spent some time exploring the ethical implications of doing research which seeks to disrupt norms and values without knowing in advance exactly what this is going to do, or to whom.

In the second section, I discussed entering the field and the practicalities of the doing of the research. Turning first to the oils and fats industry, I deliberated on the problems of gaining access, and on the experience of being overwhelmed by knowledges, environments, and practices that were new to me, yet often strangely familiar. I reflected on being simultaneously both insider and outsider, on being utterly disturbed both by having my prejudices made apparent to me, and in having them turned upside down through unfamiliar encounters. I then outlined how I became momentarily entranced by some of the 'infernal alternatives' presented to me by my participants. In so doing, I demonstrated that bringing together conversational and ethnographic approaches begins to illustrate how people negotiate conflicting knowledges so as to maintain a consistent sense of self, and how these knowledges are constructed with, and communicated to, others.

I then turned to the doing of research with consumers. I explained my choice of planned discussion groups' (O'Reilly 2005) as an approach that facilitated the

unpacking of the relationships between knowledges, practices, sense of self and matters of fat, and created a safe environment in which my participants could explore and trouble their habitual doings with fats. Finally, I detailed the experimental approach I took in researching other ways of knowing and relating with fatty materialities. I described how, influenced by Ahmed's (2000) conceptualisation of 'strange encounters', and the figure of the 'relational self' as outlined by (Ruddick, forthcoming) I disrupted the idea of margarine as a technological achievement by playfully introducing the matters of margarine in to the research proceedings. As such, I argued that, however fleetingly, such encounters cultivate a hesitation in which it is possible to explore ways of living together 'in, against, and beyond (Holloway 2010) consumer-consumed relations.

The final section of chapter three, presented my approach to the analysis of the data generated by the methods outlined above, and outlined how it would be explored in the three empirical chapters. I designed my analysis to generate reflections on how the stuff of margarine and margarine consumers are framed and what these mappings do. I used juxtaposition both to deliberately fragment existing narratives so as to expose gaps, logical leaps, and what falls through them, and to create hesitations in the possible in which new narratives could be momentarily constructed out of the fragments.

Chapter Four was the first of three empirical chapters. Here, I analysed the fatty knowledges, practices and beliefs of my participants as expressed within their PDG conversations in relation to my first three research questions, and first research aim. In my investigations of '**who and what are valued by margarine consumers?**' I demonstrated what my participants' think they value is more complex than they are easily able to express. At the start of the discussions, my participants articulated their valuing of the ease of habitual practices and value for money. Through the back and forth of conversation it emerged however, that they felt price and value to be very different things, and far from being habitual their fatty practices have changed considerably over time. Digging deeper, it emerged that they valued fatty eating practices that they could reconcile with their sense of self as consumers, and as members of communities. In this way they articulated eating with fatty matters as

entangled with social and cultural values such as landscape, climate change or labour relations as well as bodily health, familial care, or body shape.

Such juggling of multiple values by my participants leads neatly on to my second research question: ***'how do consumers negotiate different framings of margarine?'*** My participants wanted to engage their fatty practices to do well by entangled others, however they felt this was incompatible with the fat choices available. In unpacking this, it became evident that although my participants experience their fatty habits as hard to change, particular events act as triggers for a re-evaluation of practices. My participants typically spent a considerable amount of effort working through such events, explaining that they struggle to reconcile new knowledges with existing beliefs. New events create turbulence as my participants become aware of how they juggle and prioritise different bodies and relations within their food practices, something which they are uncomfortable about. In this way, I demonstrated that my participants understand consumer choice as a means through which economic, social and ethical relations are in smaller or larger ways reconstituted.

My third question asked: ***'In what ways do consumer practices with margarine relate to their knowledges and beliefs about fat?'*** I demonstrated that my participants' fatty practices cannot be contained within either their visceral experiences or their knowledges and discourses. They experience the tastefulness of fatty matters as folded with multiple relationships; as continuing to act in the world, and in the body, after the fat has been ostensibly consumed. Fats that taste good to them are ones that they can rationalise as acting in the world in ways which accord with their sense of self, and in this way my participants use fats in ways that are simultaneously material, cultural, social and political. Nonetheless, my participants when overwhelmed by seemingly incompatible knowledges about the stuff of fat, often strategically embrace the non-knowledge (McGoey 2012a) of ambiguity.

The research aim attended to by this chapter was ***'to contribute to theoretical and empirical understandings of consumer knowledges, beliefs and practices of and with the matter of fats'***. My use of PDG's created safe-spaces which enabled my participants to articulate their food practices as messy performances that, both deliberately and incidentally, connect and transform bodies and relationships. As

such, I established that when attention is paid to the multifaceted ways through which eaters make fatty decisions, 'taste' loses its privileged status. I demonstrated that in making fatty decisions, my participants must balance the pushing away of distaste, the pulling towards of care, and the torpor of doubt about what they do and do not know. As such, in investigating how my participants negotiate knowledges, beliefs and choices in their mundane eating practices, I make eating present as a political relationship that makes worlds, and extend discussions of the visceral to better theorise the complex, co-productive connections between material encounters, sense of self, sense of belonging, and knowing food.

In **Chapter Five** my focus shifted from the consumer to how margarine is known and done in industry. Here, by scrutinising how my participants in industry understood, explained, justified, queried and did margarine matters, I interrogated the micro-politics of the ways in which margarine is done with and in the spaces of production, policy making, and technological innovation. The first of the three research questions which relate to this chapter, is: '**How does matter get organised into margarine?**' In answering this question, I did not try to follow every relationship and process from seed to spread, such a following would have taken up the entirety of this thesis and still there would be multiple unknowns. It would also have produced an overload of information about consuming-well without necessarily helping to explore the key question of eating-well. As such, in attending to this question, I focussed on the systems and framings which facilitate the organisation of matter into margarine. Margarine producers use administrative and technological tools to juggle and prioritise the possibilities and limitations of the physical, chemical and nutritional properties of matter, the strictures of regulatory schemes, the priorities of lobbyists and policy makers, technological know-how, the need to make a profit, and social and cultural norms and values of what is good to eat. Margarine matters get organised by being fragmented: From its invention onwards, margarine has been a technological achievement. Yet, it is not corporations which organise matter into margarine, but people within them. People in industry are also eaters, consumers, members of communities, and so must reconcile their work practices with their wider sense of self. Each of these people is situated, they may have expertise in some elements of the process, but the journey from seed to spread is complex and so they have to trust the

knowledges and experiences of multiple others. There are tensions and translations between these fragmented knowledges that must be smoothed over in the habitual doings of industry, yet margarine matters overflow such doings and are experienced as disruptive.

The second question in this section relates to: **‘Who and what are valued in the production of margarine?’** In attending to this question I again juxtaposed different framings of margarine. As a collective body, companies value products which turn a reliable profit. Hence, some of the things that are valued are efficiency, longevity and reliability. Linked to this is that companies’ value the intellectual property of the techniques which sustain this profit. However, margarine is done by people who want, typically, to avoid distasteful disjunctures in the storying of self by creating products that they can be proud of. As with my PDG participants, the people I encountered in industry want to do well by others, whether that is the forest, the cholesterol levels of eaters, or local economies. As such, I demonstrate that what it is to eat-well can look very different from within different specialisms, and so in their day-to-day practices my participants endeavour to juggle multiple regimes of value by choosing between ‘infernal alternatives’.

This then leads neatly on to my third question: **‘How are margarine values constructed and communicated?’** The outcome of the negotiations of multiple values within and between organisations is a range of, often conflicting, messages to consumers about what is good to eat. Margarine is a complex product; its constituent parts are entangled with values about health, neo-colonialism, biodiversity, climate change and more. My participants tended to blame the perpetuation of simple messages, designed to stimulate affectual rather than intellectual responses, on consumer unwillingness or inability to make sense of this complexity. Like my PDG participants, people in industry believe practices are habitual and hard to change, and so they make decisions about what matters to consumers, then shut down questioning to nudge consumers towards these ‘right’ choices. Hence, I demonstrate that margarine values are generated and maintained through administrative and technical solutions of production, which act to police the boundaries between knowledges, keeping them out of the political realm.

My aim in this chapter was **‘to add to geographical understandings of the knowledges and practices of fat production’**. In approaching my participants as people, as eaters, members of communities, as well as producers, I have illustrated knowledges and practices of margarine production as being in tension with organisational structures, regimes of value and the mundane doings of situated people. Habits emerge through everyday encounters within networks and structures which promulgate ‘infernal alternatives’ (Pignarre & Stengers 2011). Events may change things, and the power to construct and change framings is asymmetrical, but margarine is done in a coming together of individual knowledges and practices within institutional, social and cultural norms and values. Within a single factory there are multiple ways of knowing and doing margarine, as such, for framings to continue to work the translations and gaps between them must be smoothed over. I demonstrated that juxtaposition is an important means through which to reveal the translations that facilitate the reproduction of consumer-consumed framings. Such juxtapositions reveal that both margarine and consumers ‘misbehave’, and producers do not understand why. The people I spoke to tended to frame the unpredictability of margarine matters as a technological problem, however they hoped that from me they could gain greater understanding of why many new products fail to gain consumer acceptance. Here, I argue that this is a problem of politics. Negotiating between ‘infernal alternatives’, between reform and sacrifice, on every aspect of something as mundane as margarine is overwhelming and so consumers and producers stick to the habitual, until ‘an event’ breaks through, triggering a rethink.

In **chapter six** I detailed my methodological experiments in to other ways of encountering, knowing and relating with the stuff of margarine. Within geography and STS much work has been done theorising and evidencing the more than human subject, and exploring the situated and relational ethics that emerge from this relational, porous and fluid understanding of the self (e.g Mol 2002; Ruddick forthcoming, Puig de la Bellacasa 2010) (see chapter two). However, as explored in Chapter Four, ‘knowing’ something is not in itself sufficient to create change in habitual practices. As I have outlined above, my participants appreciated that their eating practices co-create their world. Yet, they also articulated how such practices are themselves the product of juggling multiple knowledges and sense of self with the

constraints of time, money, the needs of others, and social norms and expectations. The opportunities of my participants to produce or consume well are entangled with 'infernal alternatives' which must be ordered and prioritised. As such, systemic change must begin from encounters in the here and now.

To this end, I involved the matter of margarine as a participant in the happenings of the PDG events. My first research question in this chapter asked: ***'Does the experimental intervention of 'strange encounters' disrupt normative framings of and with margarine?'*** Touching, sniffing, manipulating and tasting work to engage the emotional and visceral knowing of the participants' gut-feelings (Probyn 2000). However, I did not simply bring commercial margarines to which my participants are already accustomed in to the conversations. I could see how encountering margarine in this way within the PDG might stimulate talk around differences between products, or the changing nature of margarine over time, but I wanted to do more than this. Influenced by Braidotti's (2013b) philosophy of the posthuman, the work of Ahmed (2000) on 'strange encounters' and Pignarre and Stengers (2011) on the micro-resistance of 'the event', I designed an experimental methodology which aimed to create a hesitation in my participants' mundane acceptance of the matter of margarine so as to create space to rehearse other ways of knowing and relating with margarine.

Through this experiment, I demonstrated that for my participants, a doing as small as unsettling the expectation that margarine tastes like butter, was sufficient to create a hesitation in the everyday reproduction of margarine relations. Strange encounters with fatty materialities, momentarily disrupted their taken for granted, 'common-sense', beliefs and knowledges about the stuff of fat. Applying Ahmed's (2000) theorisation of 'strange encounters' to the doing of more-than human empirical research, facilitated a *juxtaposition by doing* which momentarily troubled and fragmented binary separations such as cooked-processed, natural-technological, producer-consumer. A doing which exposed the limitations of the administrative and technical changes to relations at nodes across production-consumption chains that can be pressed for by the actions of 'autonomous' consumers. Indeed, my participants became themselves aware of, and articulated how, by keeping products largely the same, margarine producers can shut down questioning.

Building on this, my second research question in this section was: **‘Does the event of ‘playing with our food’ impact on the ways in which margarine is valued?’** I

demonstrated in chapter four that knowing more facts from within a frame does not necessarily help consumers to eat well – that there are only so many ‘infernal alternatives’ that can be juggled before consumers feel overwhelmed and disempowered. As such, developing mundane habits is a practical approach to living with such information overload. My participants explained and justified their habits using binary divisions of ‘infernal alternatives’, particularly those of natural-technological, cooked-processed and health-pleasure. ‘Playing with their food’ acted to make these divisions slippery, revealing their gaps, translations and unintentional harms. ‘Playing with our food’ was a juxtaposition by doing, which disrupted the proliferation of non-knowledges. For example, exploring the taste of oil, the colour of margarine, or food becoming waste, compelled my participants to ask different kinds of questions. Such questions tended to explore the doings of food relations rather than expressing angst about not knowing enough.

I demonstrated that although participants come to know themselves and others through and with the world-making of their mundane practices, more-than human, playful, ‘strange encounters’ are events which trouble these settlements, creating space in which my participants could explore the subjects and relationships co-produced with and in particular practices. Playing with our food produced a hesitation in which my participants, if only momentarily, tweaked the connectivities of their mappings to trouble how they know and judge value. This was an embodied doing which created a safer space within which participants ‘juxtaposed’ (Law 2004) their knowledges and practices, explored the ‘little leaps’ (Latour 2013) that smooth over gaps and incongruities between them, and critiqued the hoped for relations and the relations being co-produced. In this way some of the ethical and political implications of more-than human relationality were felt and investigated by my research participants. As such, I argue that situating eaters in an experimental relationship with food matters, however fleetingly, made the relational-subject present as embodied, as well as conceptual, knowledge.

My final research question, ***'to what extent is the methodological practice of 'playing with our food' a careful micro-resistance to normative practices and values of consumption?'*** explores the application of the doings of the interventions outlined above. Within the PDG discussions, the bodies and relations knotted with and in the stuff of fat emerged as things that matter to my participants. They described how in larger or smaller ways eating practices reshape bodies and relationships. Yet, to negotiate consumer choice in fat my participants' first decide what kind of eater they are, then perform that identity as best they can by creating a hierarchy of priorities within the options available that are a 'best fit' to this sense of self, community and belonging. In performing consumption in this way some relationships can be practiced as careful reciprocity, nonetheless multiple others are silenced and consumed. Enacting care within the framework of consumption can prioritise named bodies and relations, but it cannot trouble its truth-making structures and mechanisms, hence leaves little room for the otherness of the other. Recognising matter as lively is, in itself, insufficient to empower change in the ways eater and eaten encounter each other, and live together.

As omnivorous creatures it is perhaps necessary to create food rules so as to limit choice and so make the world easier to negotiate. Yet such framings also limit the ways it is possible to envisage, construct and represent the eating self and the eaten other. There is a difference, however, between facts within a frame, and knowledge about what a frame does. In creating a hesitation in normative values, knowledges, and practices, play made space in which my participants felt safe to explore their identities as constructed and performed with, and through, consumption practices. In playing with their food my participants did not retreat and defend their practices, but were interested in encountering the materialities and their relationships. I argue that playing with our food is a 'recipe' (Pignarre & Stengers 2011) for intervention which, through repetition and tinkering, rehearses eating in ways that are mindful of the ethics of the relationships co-created, rather than of the moralities of avoiding direct harm to named subjects. For my participants, the doing of play did not further domesticate (leading, for example, to the acceptance of commercial margarine as natural or cooked) but facilitated an exploration of how good intentions can have bad effects. In this way, 'playing with our food' can be understood to be a novel

methodological approach to creating careful micro-resistances to taken for granted normative relations between consumer and consumed.

The research questions attended to in this chapter worked together towards my final research aim: **'To explore other ways of knowing and relating with the matter of fats'**. When 'playing with their food', my participants displayed curiosity, rather than defensiveness or the need for reassurance. Their questioning of why things are the way they are, was entangled with the realisation that both fats and eaters are made with, and in, situated knots of bodies, relations and structures that have been made and are remade. In this way, my participants were prompted to wonder what food framings deflected them from thinking about, and to begin to explore and rehearse possibilities of remaking them differently. I argue that, by holding open awareness of the relational-self in this way, the methodological approach of playing with our food is a learning to learn which adds to feminist explorations of care as material doings. Further, by beginning to promote a resilient mode of attention that is more-than human, playing with our food creates possibilities for caring for, and with, this interconnectivity.

Methodological contributions

Building on the chapter overviews of the previous section, here I approach the thesis as a whole to provide brief reflections on the methodological contributions made by my research and so respond to the provocations made in Chapter Two. In these provocations I demonstrated the need to develop methodological approaches which build on theorisations of lively matter and the more-than human subject to trouble and critique notions of the autonomous consumer.

I have entitled my first methodological contribution **'follow the refrain'**. This approach works with disjunctures to attend to provocations one and two. In provocation one I engaged STS and post-structuralist literatures to explore gaps between knowledges within a frame and knowledges about what a frame does. In this way I trouble binary constructions of eaters as autonomous consumers and the eaten as resource that can

be consumed. Nonetheless, although frames are purifications (Latour 1994) they are also a necessary tool for understanding the world and living together. Hence, in provocation two, by attending to feminist and post-colonial literatures which explore the reproduction of hierarchical and binary relations but applying these knowledges to the more-than human self outlined in provocation one, I argued that there is a need to develop empirical approaches which explore how knowledges taking hold in practice.

Whether in their working lives, or their domestic ones, my participants were concerned with maintaining a cohesive sense of self when different regimes of value were in tension. However, this balancing act is of course subject to power dynamics. The food industry has economic, advertising and lobbying power through which it can attempt to influence consumer norms and consumer demands, yet more new products fail than succeed (Foxall 2014: 7). It takes work to create preferences for industrial foods, and consumer-consumed relations are maintained by doing and reaffirming knowledges and practices of consumption. Nonetheless, the reverse is also true (Carolan 2012). Shopping and eating practices with fats are shaped by a complex interplay of material, sensory, and symbolic factors, and consumer responses to products can be unexpected both to the producers and the consumer themselves. Building on this, 'following the refrain' as a methodological intervention facilitated the juxtaposition of multiple framings to create space to explore the world-making of consumer-consumed relations.

'Follow the refrain' sits in the gap between follow the thing and visceral approaches to add to geographical understandings of consumer-consumed relations. Following the refrain does not restrict the researcher to encountering food matters at nodes within production-consumption chains, rather, following the refrain allows the following of materialities, knowledges and practices that pertain to margarine in and out of health, technological, environmental and other framings, as well as socially, culturally, and economically situated, minded-bodies. Such a multi-site approach facilitates the juxtaposition of multiple situated snapshots.

Following the assembly and disassembly of margarine within multiple knowledge framings, technologies, policies, bodies, and habitual practices works to reveal the disjunctures between them. 'Following the refrain' enables research in to how eater

knowledges, the stuff of margarine, and the self that eats, can all shift and multiply whilst remaining recognisably themselves. This has three elements: Firstly, to investigate the values, knowledges and practices within which commodity margarine and margarine consumer were and are co-constructed, and the bodies and relationships which slip between value framings. Secondly, prompting new connections between knowledge fragments to make eating as excessive to consumption present as embodied as well as conceptual knowledge. And thirdly, (and in response to provocation three) to begin to explore whether in taking seriously the more-than human self it might be possible to create new refrains which create space to rehearse a relational and ecological ethic of eating-with. Working across such disjunctures is a powerful technique for exploring what food framings do and do not map, and what such mappings do, and to whom. By using planned discussion groups, I developed a method where such juxtaposition was done by my participants themselves through their explorations of their own shifting practices and embodied experiences. By the same token, interviewing my industry participants not only as professionals, but as eaters and members of families made present to them, and to me, some of the ways in which fatty materialities overflow attempts to frame them.

My second methodological contribution was explored in chapter six and relates directly to provocation three in which I called for the creation of experimental methods which produce, rehearse or refine 'the resources for thought that survive on the margins' (Pignarre & Stengers 2011: 5) to explore a more-than human eating together 'in, against, and beyond' (Holloway 2010) the consumer-consumed binary. As such, it was an experiment in creating a hesitation in which the more-than human subject could be momentarily made present not just as an academic concept but encountered as an embodied relationality. However fleetingly, this approach was a doing that worked to move my participants' awarenesses of the bodies and relations entangled with both food matters and the eating subject, without defining or even knowing 'a priori' in what ways or directions it might be possible to move. In facilitating an embodied exploration of the ways in which both the subject and the social world are co-produced with and in mundane relationships such encounters are micro-resistances which cultivate a hesitation in what 'is' so as to create space in which a situated ethics of eating-well could begin to be prefigured, refined and rehearsed.

I have given this approach the acronym 'CoPSE'. Influenced by the work of Pignarre and Stengers (2011) on the micro-resistance of 'the event' and Ahmed's (2000) descriptions of 'strange encounters', CoPSE was designed to trouble habitual framings. Short for 'Collective, Playful & Prefigurative Strange Encounters', as the name suggests, CoPSE draws on three principles: collective doings, playful practices and prefigurative strange encounters, but also on imaginaries of wooded places:

Collective Doings because no-one ever eats alone (Derrida 1995) and because participatory and ethnographic approaches are valuable for the insights that they give into the situated experiences, beliefs and doings of participants (Richards et al 2004). *Playful practices* because although troubling norms of behaviour can upset sense of self (Braidotti 2013b), the 'what if' of play scenarios, creates safer spaces where the bodies and relationships that matter have not already been settled, and different rules, roles and relationships can be trialled, rehearsed and negotiated (Schechner 1993; Jenkinson 2001; Katz 2004). *Prefigurative Strange Encounters* because knowledges and actions co-constitute each other, shaping lived realities (Ahmed 2000) (Mol & Law 2004), as such, disrupting habitual practices can encourage participants to question what is (Connolly, 2013: 185) and explore what might be (Holloway 2005). *Copse* because woodlands in European folk traditions are outsider spaces. Not exactly wild, but also not entirely constrained by the gaze of societal mores and hierarchies - places for plotting, witchcraft and indecent liaison of all kinds. Further, the word copse is derived from coppice, a woodland which is managed in ways that work with biodiverse, more-than human relations. In sum, CoPSE is an experiment in co-creating mundane spaces where human selves and human communities can rehearse living in ecological relations with non-human others, whilst those others have space to be present as themselves.

Inspired by the work of Mol (2015) and Pignarre & Stengers (2011), the everyday creativity of CoPSE is a 'recipe' to be shared and tinkered with. The approach is exciting, ambiguous and compelling precisely because of its unpredictability of outcomes. 'Playing with our food' is a creative form of 'work' (as opposed to labour), which can be dark and disturbing just as easily and just as importantly as it can be fun. Yet that creativity is not boundless, but contained and delineated by the players, as

such play is a safe interlude where particular social norms can be put on hold, and where it is possible to rehearse changing our world. 'CoPSE' does not create fixed ways to represent the world, but is a methodological intervention which facilitates an exploration of the way things are, and the way things might be, so as to prefigure and make resilient other possible ways of knowing and practicing complexity.

Thesis Limitations

Throughout the presentation of this thesis, I have touched on some of the limitations of the doing of the research. Noting in particular the difficulty of gaining access to the spaces of margarine production, and the female dominance of my planned research groups. Here, I briefly reflect upon the scope of the project as a whole, and what it could, and could not, do.

Turning first to researching the production of margarine. Margarine is a highly technological commercial product, as such its making involves techniques and matters which are commercial secrets, limiting what I could uncover about the precise means through which margarine is done. Whilst remaining cognisant of this limitation, in taking an approach to researching eating-well with margarine which did not necessitate unveiling all of its relations I have demonstrated that there are alternative empirical approaches to researching the doings of food systems. Nonetheless, further work could, both methodologically and conceptually, investigate the access issues themselves, particularly at the nodes where affective presentations of the natural, meets technological and secretive knowledges. In developing these discussions I could revisit my data to draw out the moments where access was denied, my attention diverted, or my questions deflected. Related to this is are the limitations to access shaped by my own perceptions and prejudices. Through the methodological and analytical frameworks I put in place I have worked wherever possible to militate against this. Nonetheless, as I reflect on my own shifting fatty practices, knowledges and beliefs in the writing of this thesis, I am aware that there were moments within the doing of research where I was seduced by the technological solutions presented to me by my participants. In chapter five, I described my encounters with Steven the GM researcher, and also my experiences of making margarine in the research kitchen of a

transnational corporation. In revisiting this data, I could draw out in more detail my shifting interpretations of events, so as to refine my methods to grapple further with the seductions of 'infernal alternatives' (Pignarre & Stengers 2011).

A second area of limitation relates to my planned discussion groups. My participants were all white British, and predominantly female. The sample was small, and not intended to be a representation of 'all' consumers, nonetheless, I am aware that eating-well is subject to stigma, and to assumptions about what is 'right', that are entangled with class, gender, age and ethnicity. Whilst this research focused on the situated ways in which my participants encountered the stuff of margarine, rather than what they ate, framing the research slightly differently could have drawn in a more diverse group of participants. To further develop this research, it would be productive to explore the ways in which 'strange encounters' engaged new participants, specifically men. When I, or the group hosts, had invited these men they had declined to take part, claiming to have little knowledge or interest in the project or in the food they eat, however, when the groups began to focus on materialities and doing, rather than on knowledges, they suddenly engaged. As such, I think revisiting this to further tinker with the concept of 'recipes' (Pignarre & Stengers 2011) could be productive in adapting the method to engage with, and work for, different groups. Everybody eats, and everyone has embodied knowledge about what tastes good.

Thirdly, I approached this research with the intention of unpacking the consumer – consumed binary. Yet in the doing of the research other binaries emerged, in particular those of natural – technological, cooked – processed, and health - pleasure. As such in revisiting this research I could tinker with the presentation of the project so as to explore disjunctures in other framings of doing food, for example, as it relates to climate change, biodiversity, animal welfare, eco-region, food aid, agricultural production or food waste. In this way it could be possible to explore in more depth what happens if we start to think about food systems rather than a food system.

Future Research Directions

In addition to considering the limitations of this research, it is appropriate to turn to the spaces opened up by this thesis in terms of future research. Whilst not limited to these areas, here I identify three themes:

In attending to some of the translations, tensions, gaps and blockages, in knowing and doing margarine matters, the focus of the thesis shifted away from understanding consumption practices, to developing novel methodologies to facilitate the investigation of the framing of political and ethical problems as administrative and technological ones. It would therefore be productive to engage these methodologies to examine such doings in other realms. Particularly pertinent in the UK at the moment would be an exploration of ‘infernally alternatives’ (Pignarre & Stengers 2011) entangled with **‘Food, Brexit and what democracy looks like’**. Such research could productively ask: *What food futures are on offer? Who is invited to be involved in forming these narratives? And, how are these narratives formed and circulated?*

A second, avenue for research would be to explore the **‘framings of eating-well within alternative food communities’**. Here I am thinking of a diverse range of groups, from slow fooders, to vegans, survivalists, food reclaimers, or the Weston Price community. Such research could tinker with the ‘recipes’ (Pignarre & Stengers 2011) for doing research presented in this thesis to explore: *How are alternative food communities framing eating-well? How do alternative food communities conceptualise self and other? And, how is what they do communicated with others?*

My third recommendation is for research which explores whether the affective desire engendered by products which are presented as familiar but better, can be shifted to an aspiration for **‘strange encounters with more-than human relations**. To this end, I propose research which revisits the permaculture communities that were the inspiration for my methodological approach, to explore whether encountering otherness can become something which eaters aspire to. Research questions could include: *How are permaculture practices taken up and applied across different realms of everyday life? How do permaculture practitioners frame and encounter the subject? And, what changes when permaculture practitioners tinker with my research recipes?*

Concluding Remarks

The main contributions of this thesis are to food geographies. To this end, I engage the stuff of margarine to attend to the micro-politics of societal norms and to introduce the innovative methodologies of 'Follow the Refrain' and 'Collective, Playful & Prefigurative Strange Encounters' (CoPSE) which by disrupting, and troubling, habitual knowledges and practices make space firstly to explore the world-making of consumer-consumed relations and secondly to trial and rehearse a resilient, uncertain ethic for living together.

Eating is a mundane act performed multiple times every day, and an encounter in which discourses, industrial practices, bodies, prejudices, beliefs, fears, and desires mingle and are re-made (Rose 1997; Probyn 2000; Stassart 2003; Mol, 2008). Nonetheless, what it is to consume-well remains complex and contested. Within alternative food movements it is often contended that it is the eater's responsibility to be informed about the backstory of foodstuffs and to decide whether they wish to perpetuate such practices (Curtin 1992: 17). By making present some of the bodies and relations entangled with and in commodities, such attention, enables very real interventions to be made, processes put in place. Yet commodity-oriented activism thinks within framings of commodities and commodity chains. By drawing on the work of feminist writers, including Irigaray (2008), I have argued that such activism can improve specific relations at particular nodes within production-consumption networks, but they cannot so easily challenge the internal logics of systems themselves. Margarine is a productive substance with which to research this.

Margarine was one of the earliest industrial foodstuffs; a technological achievement. First designed and produced as a cheap butter substitute to provide calories for the urban poor, margarine introduced eaters to a combination of bodies, relationships, and processes never encountered before. It took powerful work to make margarine knowledges, beliefs and practices ubiquitous and mundane (cf. Winner 1980). Ever since its early years, margarine promotions have encouraged eaters to make margarine consumption part of the storying of self. The food industry has economic, advertising and lobbying power through which it can attempt to influence consumer norms and consumer demands. Margarine materialities are generated and maintained

through administrative and technical solutions of production, which act to police the boundaries between knowledges, keeping them out of the political realm (Pignarre & Stengers 2011). Yet, the constituent parts, and the production processes, of margarine are entangled with shifting frames of health, trade, human and non-human 'resources' and more. The ongoing adaptability of margarine to the multiple ingredients, processes and narratives produced within such dynamic situations makes margarine a valuable subject through which to explore the bodies and relations 'made to matter, and not matter' (Evans & Miele 2012) in constructions of eating-well.

Framing eating as consumption is a powerful cultural performance that limits the ways it is possible to think, act, feel and become. Constructions of eating-well are influenced not just by visceral encounters, but by knowledges, beliefs and priorities (Hocknell 2016; Hocknell & MacAllister forthcoming). Consumer knowledges and relations are co-constructed, normalised and maintained by doing and reaffirming performances of consumption (cf. Wenger 1999; Dwyer and Limb 2001; Garsten and Nyqvist 2013). Attending to systemic inequalities may be necessary 'in the meantime' (Cloke et al. 2016), yet such knowledges are likely to re-inscribe moral framings in which some bodies are made to matter more than others. Such knowledges cannot create a way out of the democratic and environmental mess in which we find ourselves. As others have demonstrated, in the commodity relationship messy, situated, relational bodies disappear from view, replaced by symbolic tropes (e.g. Jackson 1999).

Consumers are empowered to choose between moral goods. Such goods are often framed as reform versus sacrifice. For example, between accepting GM foods or hunger for the poorest (Pignarre & Stengers 2011), or human and non-human others as 'resource' ripe for exploitation, or 'threat' to be controlled (cf. Gilbert 2008: 34-35). Such choices work to convince consumers that they are creative, free agents whilst simultaneously framing the ways it is possible to live (and die) together (cf. Deleuze & Guattari 2004 (1980)). Hence, what feels 'natural' has forgotten the construct from which it first emerged (Schillmeier 2013). The outcome of this is a range of, often conflicting, messages to consumers about what is good to eat that must be juggled and prioritised. As with other forms of knowledge, the desires and possibilities of

consumers are entangled with the geographies of power relations and practices. If other ways of ordering reality, of framing the world, are to be prompted and negotiated then what matters is paying attention not only to the structuring of thought but to what such knowledges do. There is not a singular way to live together. Knowledges which do not demand a responsivity to all relations, whether of connection or detachment, cannot generate a flourishing of life (cf. Puig de la Bellacasa 2010).

In this thesis, by 'following the refrain' and 'playing with our food' - by transgressing the boundaries of consumer-consumed frameworks, by not looking at nodes in isolation, but at embodied encounters within systems – a number of theorisations have emerged regarding the kinds of possible worlds my participants' careful practices are co-creating. These contributions fall in to three key areas:

Firstly, by following the refrains of margarine I have extended understandings of how eaters struggle to eat-well within consumer-consumed framings, and I have demonstrated how in engaging administrative and technical know-how to better negotiate the 'infernal alternatives' (Pignarre & Stengers 2011) of such systems, the mundane actions of people within the food industry close down spaces of critical thought and intervention. Companies are not unaware that consumers are overwhelmed and troubled by multiple and conflicting food knowledges. As such, consistency in texture and flavour is one means of maintaining consumer confidence in a product. In keeping products materially apparently the same (even though ingredients, processes or ethical labelling may change) companies can perpetuate forms of non-knowledge (cf. McGoey 2012b) in which eaters do not particular notice the materialities of that which they are eating - they eat it because it has become habitual to do so. When a product changes, however, it becomes conspicuous, running the risk that consumers may reject it. This is not to suggest that 'the consuming public' is ignorant, or that individual 'industry professionals' necessarily set out to mislead them, but that non-knowledges are actively produced within the mess of the world-making of production and consumption beliefs and practices. Professionals within the food industry are eaters too, and like everyone else, they are busy people without the time or energy to be constantly re-evaluating their food

choices. Like my PDG participants, my interviewees in industry described food practices as habitual and hard to change. They tended to blame the perpetuation of simple advertising messages, designed to stimulate affectual rather than intellectual responses, on consumer unwillingness or inability to make sense of this complexity, and so they make decisions about what 'should' matter to consumers, then shut down questioning to nudge consumers towards these 'right' choices.

Secondly, in exploring the history of margarine through policy, advertising, technological developments, and nutritional science I demonstrated that margarine and margarine producers were co-imagined, co-designed and co-produced. As such, the available possibilities for eating-well are entangled with asymmetrical power relations. Yet, forty years ago, Illich argued that the primary difference between 'industrial' and 'convivial' tools is that industrial tools produce convenience but do not maximise relationships. For Illich, access to already packaged information narrows perspectives of seeing until the easily read surfaces of aesthetics or convenience become valued in and of themselves (1973). Such translations are evidenced in the stories my participants told about their relationships with margarine about how they feel powerless to negotiate the complexity behind the label, and so make arbitrary prioritisations in their habitual food practices. Nonetheless, eating is an act of enfolding the self into the world, whilst unfolding the world within. Thus, what matters is creating knowledges and practices which pay 'attention to the difference between questions that are 'imposed' and those it succeeds in (re)creating' (Pignarre & Stengers 2011: 143). To this end, by engaging visceral approaches I have demonstrated that, it is not just the presentation of foodstuffs but, the routine reproductive mundanity of eating that can make it hard for eaters to trouble the beliefs and values that are materialised within food tastes and habits.

This is not to suggest that it is the responsibility of autonomous consumers to make a difference through their individual consumption, such an approach is disempowering both in its asymmetry of possibility, and in its ultimate futility, caught as it is in the realm of 'infernal alternatives' (Pignarre & Stengers 2011). Rather, in this thesis I have responded to Guthman's call for food research which co-produces 'more collectivist political subjects who in time would develop forms of governance more

commensurate to the socialised problems before us' (2007: 474). Building on Puig de la Bellacasa's (2010 & 2012) work on the practicing a feminist ethics of care, Ahmed's (2000) conceptualisation of the 'strange encounter', and the theorisations of Pignarre & Stengers (2011) on the role of the 'event' in creating space for political change, I have proposed 'playing with our food' as a mundane form of prefigurative politics. To this end I developed 'CoPSE' as a methodology which in troubling 'the reproduction of the same' enables participants to engage their embodied experience of distaste to access already held knowledges, explore their own practices, and to question their shifting interpretations of those knowledges.

Thirdly, I investigated interplays between different knowledge framings, and the kinds of bodies, and relationships, that structures, technologies and processes combine to facilitate. I took as my starting point theorisations and empirical evidencing of the relational more-than human subject. Such knowledges demand responses to the nature of relations, but *knowing* is not in itself sufficient to create space for changes in norms of behaviour. Indeed, I found that my participants were overwhelmed with the multiple knowledge framings that must be prioritised when making food decisions - advice on food waste differs from that on hygiene, health, or cooking for flavour and texture - and so they chose to practice strategic ignorance and habit formation. Raising questions as to which knowledges and practices take hold, how and why.

My participants made margarine in their homes from a coconut, sunflower seeds and an egg. A simple enough intervention, but by engaging the stuff of margarine in this way, I experimented in troubling commonsense settlements. In framing my research within play to create safer spaces outside of normative practices, space was created to explore, and try out, other ways of knowing and doing where the bodies and relationships that matter have not already been settled. Spaces where the mundane could become strange; where other ways of relating, different roles, rules and relationships, could be imagined, trialled and negotiated, and it was okay to fail. Failure within play is part of learning to live together (Jenkinson 2001). By developing 'CoPSE' as a recipe with which to prefigure and rehearse other ways of knowing, relating, and living together, I have brought more-than human, participatory, prefigurative, and food geographies in to generative conversation with one another.

'CoPSE' are micro-events which can add to understandings of the more-than human world-making of food knowledges and practices.

Margarine is a complex product a technological achievement that was imagined, designed and produced to be a consumer product - an administrative fix to a social problem. My focus in this thesis on the reproductive work of mundane practices is by no means to suggest that that macro change is not necessary. Shifts in such power structures do not happen without being pushed, and there is a need to understand existing situated practices, norms, knowledges and beliefs if new knowledges can be made relevant so they take hold beyond academia, and translate in to meaningful change that feed into products, policy and social norms. By finding the 'cracks' (Holloway 2010), the little leaps where consumer-consumed framings do not quite make sense, the tacit, visceral, and affective knowledges that are excessive to such framings, but are hard to put in to words, can be accessed and engaged. But to have hope of success requires building resiliencies 'in, against and beyond' (Holloway 2010) such already existing relations. Ways of living together do not emerge fully coherent, they are tentative, contradictory, difficult, and embodied. For another world to really be possible, the ways in which it is imaginable to live together cannot be made in advance but must be co-produced with, and in, the hesitation of 'events' (Holloway 2005; Goffey 2011; Pignarre & Stengers 2011). Creating space in this way is no guarantee of success, but neither is it condemned in advance (Pignarre & Stengers 2011); within such hesitations, it is possible to encounter, and relate with, the world as co-created precarious and situated collaboration, rather than an external thing that can be consumed.

In the introduction to this thesis I stated that a key aim of the project was to respond to Guthman's call for food research which co-creates 'more collectivist political subjects who in time would develop forms of governance more commensurate to the socialized problems before us' (2007: 474). The finding out together of this project is both a different way of learning and a more radical form of public engagement that raises important questions about re-politicising relationships. In foodways, bodies and species meet, and they are interfered with by local practices, legislation, technologies, labour relations, value systems, and global markets. Every body is situated, every

relation is local (Pignarre & Stengers 2011). There is not a singular way to live together, no technical fix to eating-well. Ethical relations are mutual, situated, emergent and unequal. Encountering, relating and caring, with, and for, ourselves and our collective others - living-together, is always negotiated in the moment in mundane practices, with and in 'the trajectories that we have, in one way or another, been implicated in' (Pignarre & Stengers 2011: 77). As such a key question for this project is how to make actants that are 'made not to matter', that are disempowered by existing power-relations, present as bodies that matter.

In sum, the process, the journey matters in how the possible is rehearsed and becomes framed. Following the refrain not only strengthens the evidence for the argument that eating is already and always excessive to the consumption of one body by another, but in making present mundane practices which act to reinscribe binary concepts of nature and society, wild and domesticated, self and other, consumer and consumed, eater and eaten, demonstrates that systemic change can only begin from embodied encounters in the here and now. In ever so slightly changing the world, by momentarily making the subject present as a multispecies achievement, CoPSE builds on this to disturb common-sense discourses and practices of living-together. This does not mean opposing every technical or administrative decision, but rather to create shifts in practices to create an embodied understanding that consumer choice is 'a kind of politics that is the denial of politics' (Goffey 2011: xiv). CoPSE are events that can momentarily break the spell of the habitual. Such events create spaces within which it is possible to politicise issues that tend to rely on the idea that people do not need to think. Such events, are a learning again of embodied non-conformist expertise (Law 2002; Pignarre & Stengers 2011). They are micro-resistances that can be reproduced, and adapted as the situation demands, each time creating new material formations which interrupt and shift the experiences of participants in the moment, but also outlive them. As such there is a need for further research which develops, refines and rehearses the methodological 'recipes' of 'Follow the Refrain' and 'CoPSE' with, and for, different situations and communities until more-than human living-together takes hold as mundane political and ethical practice.

AFTERWORD

adding fat to the fire (prefiguring uncertain eater-eaten relations)

I came into this research after twenty years of being involved with what is often known as prefigurative politics. Prefiguration is a doing which involves finding little cracks in social norms where other ways of living together can be played with and rehearsed, and using those rehearsals so as to widen the cracks (cf. Holloway 2010). Within my community people were (and are) involved in housing cooperatives, social centres, protest camps and more.

Through all of this I was cooking. In community cafes, at protest camps, in squatted social centres, at festivals, at community projects, for meetings, for celebrations, for funerals, for community cohesion projects, for conferences, I cooked and people came together over a shared meal. The food we cooked was designed to be as accessible as possible to our wider communities. Through experimentation we learned to cook meals which everyone could eat, where no-one was made to feel odd or annoying because of their religious, ethical or medical dietary requirements. This ethos stretched to the procurement of food, which we tried to source from our own communities or from within alternative food networks. We ate together in solidarity and hoped for equality. Integral to this work was the understanding that eating is more-than consumption. Food is not mere fuel for the body. Doing food is social, a performance of belonging. Eating together builds relations. The rhythms of food and eating together create a shift in the pace of things. This research grew out of that experience. Eating is mundane but it is also transformatory.

Yet I became frustrated that for many of those around me, such politics was becoming increasingly insular and self-referential. Each intervention had to be a piece of activism bigger and more spectacular than the one before - there had to be media coverage, court cases and personal sacrifice. 'People' had to notice, and with people noticing came police interest and something of a siege mentality. Group rules and group identity seemed to tighten. Veganism was promoted as the only way to eat, people who ate differently pilloried. Social spaces that played lip service to engaging

with their wider communities refused to allow people to take milk with their tea. Little things, but they are exclusionary. The playfulness seemed to be being replaced with a posturing militancy that had simple answers about how we should live together. I became disillusioned, confused and riddled with doubt not about what we were trying to do, but the ways in which we were doing it. I needed space to think.

When I entered academia it was with the dual aims of learning to play again and of building on the reproductive work that I understood as key to prefigurative politics. I chose margarine partly because it is a food accepted by vegans. Vegans do not eat butter because of the slaughter of male calves and because of the domestication and containment of dairy cows. Yet to produce margarine, ecosystems are changed, biodiversity is lost, pesticides are used, soil is degraded – animals die. Veganism is an administrative response to the political and ethical problem of living together well. My desire was to use the opportunity offered by PhD funding to take a step back so as to reflect and analyse. I have endeavoured not to take from my community by using my experiences of our resistance and our solidarity for my own career-orientated ends but to learn from our mistakes as well as our successes, and to use them to engage wider audiences and communities.

In this research I have engaged the conviviality of food and eating to attempt to prefigure a politics of the mundane that is excessive to frameworks of consumption. By consumption I do not just mean a capitalist relation, but a framing of the other as a resource to be used up; bite, chew, swallow – gone. A politics that is not prescriptive about what should or should not be eaten, but which creates an event where food matters can become fascinatingly strange and so have to be met anew. By playing with my food I wanted to explore whether it might be possible to eat without consuming. Moreover, I hope that by bringing practical experiences in prefiguration into conversation with academic conceptualisations of the relational self then I can offer something back to my community for all that they have given me. A recipe tweak, a new 'crack' (Holloway 2010) the very mundanity of which offers new opportunities to relate 'in, against and beyond' frameworks of consumption.

APPENDICES

- Appendix one: Participant Recruitment Letter**
- Appendix two: Participant Consent Form**
- Appendix three: Oil Press Instruction Manual**
- Appendix four: Margarine Recipes**

appendix one participant recruitment letter



GEOGRAPHY

College of Life and Environmental Sciences
Amory Building
Rennes Drive
Exeter UK EX4 4RJ

t +44 (0) 1392 722257
f +44 (0) 1392 723700
e geography.com@exeter.ac.uk
w www.exeter.ac.uk/geography

Is margarine a model for eating well?

Part I. Research Participant Information Sheet:

I am inviting you to take part in this original ESRC funded research project because of your specialist knowledge of the oils and fats industry. Before you decide whether or not you want to take part, it is important for you to understand why the research is being done and what your participation will involve. Please take time to read the following information carefully, and please ask if there is anything that is not clear.

Project overview:

Soon to reach its 150th anniversary, margarine was one of the first modern foods, and over time has been constituted from cattle, whales, coal, herring, cotton, sunflowers and more. This research considers whether margarine's ability to adapt to the availability of raw materials, whilst maintaining consistency in the taste, texture and health properties consumers seek in a yellow fat, constitutes sustainability and food security, and is this eating well? I am supported in this project by my supervisors Prof. Steve Hinchliffe who sits on the Social Science Research Council of the FSA, and Dr. Ian Cook a food geographer who co-developed the 'Follow-the-Thing' methodology to explore how bodies relate through and with commodities.

The research can be broken down into three key themes:

- i. **Margarine and cultural understandings of the edible:** Originally developed as a butter substitute, the differentiation of margarine into spreads, baking fats and cooking fats, has propelled margarine into regions far beyond the butter eating areas of the world. I will examine whether the flexibility in possible tastes and textures of margarine makes margarine a valuable exemplar for foods that aid consumers in eating well, whilst avoiding the stress of major changes in food habits.
- ii. **The interaction of human bodies and margarine:** When we eat, previously unconnected bodies become enmeshed, and both are forever changed. I will investigate margarine's value as a functional food by conceptualising margarine as an actor that after ingestion works on and with the eater's body.
- iii. **The interaction of non-human bodies and margarine:** This section will examine whether margarine's adaptability to multiple raw ingredients, and particularly to diverse plant oils, serves as a valuable model for eating well not only for individual pleasure and health, but also for global sustainability and food security.

Fieldwork comprises two stages:

- a. **Engaging with the production of margarine:** Determining how diverse raw ingredients are sourced, processed and brought together in products that meet consumer demands, whilst maintaining consistency, shelf-life and adaptability to available ingredients.
- b. **Consumer focus groups:** Explorations of our relationships with margarine, and in what ways, taste, conviviality, health, sustainability and food security influence our choices in yellow fats.

p.t.o.

If you are interested in participating in this research, please read and sign the form below.

**appendix two
participant consent form**

Is margarine a model for eating well?

Part 2. Research Participant Consent Form (participant's copy):

(2 copies to be signed by both interviewee and researcher, one kept by each)

Anonymity and Confidentiality

Confidentiality and anonymity will be maintained and it will not be possible to identify you, or your organisation in any publications. Interview tapes, transcripts and field notes will be password protected / kept in a locked cabinet as appropriate. They will not be used other than for the purposes described above and third parties will not be allowed access to them (except as may be required by the law). However you will be supplied with a copy of *your* interview transcript so that you can comment on and edit it as you see fit (please give your email below). Your data will be held in accordance with the Data Protection Act. Whilst on your premises I will not take any photographs or videos without first gaining explicit permission.

I understand that anonymity and confidentiality will be maintained.

Please circle: **yes | no**

Consent

I voluntarily agree to participate and to the use of my data for the purposes specified above. I am aware that I can withdraw consent at any time up to the point of publication by notifying the researcher.

Please Circle: **yes | no**

I agree for the researcher to contact me at a future date about further participation in this project.

Please Circle: **yes | no**

Signature of Interviewee: Date:

Name: Email/phone:

Note: Your contact details are kept separately from your interview data

Signature of Researcher: Date:

Suzanne Hocknell - PhD Researcher. University of Exeter Ethics Committee Ref: 2014/394.
Contact: sh422@exeter.ac.uk

Thank you for your time, Suzanne Hocknell.

If you have concerns/questions about the research you would like to discuss with someone else at the University, please contact:

Prof. Steve Hinchliffe: Stephen.Hinchliffe@exeter.ac.uk
or Dr. Ian Cook: I.J.Cook@exeter.ac.uk

PITEBA

Users manual

1. Prior to first use

- Clean inside of press cage and the expeller screw with hot water and detergent.
- Mount the expeller with lock bolts and nuts on a vertical timber or directly on a sturdy table. Extraction of some seeds requires much power meaning the use of a very sturdy table or vertical timber.
- Slip the biggest washer over the shaft of the expeller screw and grease this washer immediately with some edible oil. – Do not use any other oil! – This washer is exposed to very high pressure and should always be well greased.
- Insert expeller screw into the press cage.
- Turn the cap onto the press cage.

- Depending on the type of seed the adjustment bolt can be turned into the cap.
- Prepare a funnel by cutting a plastic soft drink bottle at 15 cm from the outlet. (The outside diameter of this outlet should be 28 mm).
- Slip crank over the expeller shaft and fixate the crank with the small bolt and nut.
- Fill the glass container with coloured lamp oil. Place the wick holder with the wick on top of the glass container. Place the glass container on the foot of the expeller under the chimney. Tighten the container with an elastic band over the 2 projections on the vertical. Always check the quality of the elastic band before use!
- Place a small container under the oil outlet or place a small funnel through the hole under the oil outlet and connect with a tube to a bucket. This means drilling a hole in the table to accommodate the funnel.
- The oil expeller is now ready for use.

2. Seed

- Seed should be well dried.
- Sift the seed through a fine sieve to remove sand and through a coarse sieve to remove particles bigger than the seed such as straw and stones.
- Store well dried seed in plastic bags or well closed drums to avoid moisture attraction. Damp seed can not be expelled.
- Coarse seeds have to be broken or ground. Do not prepare more seed than can be processed the same day to avoid decay due to attraction of moisture from the air.

3. Oil expelling

- Grease the washer at the end of the expeller shaft with edible oil. This is very important!
- Verify the use of the adjustment bolt according to the recommendation for the seed type. If the use of the adjustment bolt is recommended: leave the 2 press cage outlets fully open. When the press cage appears, the adjustment bolt can be tightened gradually to obtain a good flow of the oil and increased pressure.
- Light the wick.
- Fill the funnel with seed.
- Wait 10 minutes to heat the press cage.
- Start turning the crank clockwise quietly.
- The press cake will appear through the 2 holes in the cap. In the beginning some seeds may appear. Lightly stop the seed from appearing by use of your fingers.
- The oil will appear through the oil slit in the press cage.
- Check regularly the flow of the seed through the funnel. Use a small wooden stick to break any bridge formation in the funnel. Coarse or broken or angular seeds may lead to bridge formation.
- Clean the oil slit regularly with a small knife to avoid blockage.
- Do not extinguish the flame when pressing is resumed within 5 – 10 minutes. The press cake will remain plastic. In case the interruption is longer remove the cap and clean out the press cake before the cap cools down.

4. The oil

- The warm oil runs during expelling from the press cage head to the oil outlet halfway the press cage.
- Collect the oil in a small cup or tin.
- Leave the oil at room temperature for a few hours so that solids will settle. Oil with a high melting point, such as oil from oil palm kernel or coconut, should be kept hot or filtered immediately after expelling.
- Decant the oil and keep it in a closed container in a dark and cool place until used or sold.
- Important: never expel edible oil after expelling inedible oil without cleaning the expeller very well.
- Indicate type and origin of the oil and date of expelling on the label of the container to keep track of oil stocks.

5. Press cake

- The press cake of most oil seeds is suitable as animal feed (protein concentrate). Your extension officer can inform you.
- Do not add any oil to the press cake. Only press cake with a low oil content is suitable as an animal feed.

- Store the press cake immediately in a plastic bag or tightly closed drum to avoid spoilage by attraction of moisture.

6. After expelling

- Extinguish the burner.
- Remove and clean the cap at the end of the press cage immediately after expelling. If the cap is allowed to cool down the press cake becomes hard like stone and is difficult to clean out.
- Expelling with the adjustment bolt: remove the adjustment bolt. Add some seed in the funnel. By turning the crank the press cake will be pushed out of the cap. Clean the thread inside the cap with a small knife without damaging the thread. When turning the adjustment bolt in a dirty thread of the cap you may crack the cast iron cap.
- Expelling without adjustment bolt: remove the cap from the press cage and clean the cap with a small knife without damaging the thread. Clean the thread inside the cap with hot water. Forgotten to clean to clean cap immediately after expelling: The press cake is hard like stone and cannot be removed easily. Soak the cap for a few hours in hot water. The press cake will soften and can be removed easily.
- Wipe the press cage and the expeller screw with a slightly oily cloth.
- Pour the oil of the day in a closed container and place the container in a warm place to allow any dirt to settle during 1 – 2 days. Oil with a high melting point, such as from oil palm kernel, babasu or coprah, should be kept quite warm to allow dirt to settle. Decant the oil in a clean vessel for storage.

7. Questions and answers

- The expeller screw makes a scraping noise and turns difficult. Iron filings may be visible at the shaft near the press cage.
Solution: Stop turning the crank immediately. The washer at the end of the expeller shaft was not greased or is absent. Expeller use without greasing the washer leads to excessive wear. Remove the cap, remove the expeller screw from the press cage, remove any filings and grease the washer.
- The press cake is squeezed from the oil slit
Solution: The press cake runs backwards, because the 2 exits for the press cake in the cap are too small. Release the adjustment bolt to allow a bigger opening for the press cake.
- The expeller screw makes a scraping noise and turns difficult. Iron filings may be visible at the shaft near the press cage.
Solution: Stop turning the crank immediately. The washer at the end of the expeller shaft was not greased or is absent. Expeller use without greasing the washer leads to excessive wear. Remove the cap, remove the expeller screw from the press cage, remove any filings and grease the washer.
- The press cake is squeezed from the oil slit
Solution: The press cake runs backwards, because the 2 exits for the press cake in the cap are too small. Release the adjustment bolt to allow a bigger opening for the press cake.

- Seed may be too damp and the press cake may run backwards. Dry the seed well.
- Oil appears with the press cake
Solution: Reduce the exit openings for the press cake. The expeller may be overheated. Reduce the flame of the burner by reducing the wick protruding above the wick holder. In some cases no flame is needed with a high ambient temperature once expelling has started with a preheated press cage



• The expeller cage fills up with oil

- The oil slit is blocked. Clean the oil slit with a knife.
- The seed has a high oil content or is very small. The oil has no time to run to the oil slit. Turn the crank at a lower speed of about 45 rpm or less.
- Turning of the crank goes suddenly very lightly
Solution: There is bridge formation in the funnel. This can be prevented by pushing in the funnel with a small stick. Never put your finger or an iron rod into the funnel.
- The adjustment bolt does not fit into the cap
Solution: The thread inside the cap has not been cleaned properly. Clean the thread inside the cap with hot water. Subsequently the adjustment cap can easily mounted inside the cap.
- The expeller is too hot
Solution: The heater has not been extinguished after expelling and the expeller is overheated. Remove and clean the cap. Cool down the expeller somewhat and continue expelling.

• The expeller is too cold

- The wick is too short. Extinguish the heater and pull the wick out slightly and light the flame again. (Watch out the wick holder is hot!)
- The flame extinguished spontaneously. Fill the container with lamp oil again.
- Soot formation on the press cage
Solution: The wick is too long. Extinguish the flame, remove the wick holder from the bottle and pull the wick slightly downwards. The flame will now be smaller and soot formation will stop.

<p>General information</p> <ul style="list-style-type: none"> • grease all rotating parts with vegetable oil only. • remove sand and stones from the seed. • use a wooden stick to avoid bridge formation in the funnel. • all seeds can be pressed undecorticated. • nuts may be coarsely grinded or hammered. • seed and nuts should be well dried. Best moisture content for most seeds and nuts is 8%. • Seed too moist: press cake leaves the press through the oil slid: dry the seed. • Seed too dry: press cake gets too hard and no oil leaves from the oil slid. Mix 40 ml water per kilo seed, mix it thoroughly and store it for 2 days in a plastic bag. <p>Easy determination of the moisture content of the seed: Weigh exactly 100 gram seed and dry it ± 1 hour at 100 °C in an open bowl in the oven or at low temperature in an open frying pan. Mix frequently. After drying: wait until the seeds are cold and weigh them. The difference in weight is the moisture content: 100 gram - gram (weight after drying) = gram =% moisture. (example: 100 gram - 77 gram = 23 gram = 23% (= initial moisture contents of the seed)).</p>

<p>Pressure adjustment (use of the adjustment bolt)</p> <p>No adjustment bolt</p> 	<p>Sunflower seed (black oil seed) Babassu Safflower seed Pumpkin seed Niger seed Coprah (in 0,5 cm. cubes / dried) Jatropha Hemp seed</p>
<p>With adjustment bolt</p>  <p>Insert adjustment bolt and tighten during pressing until optimal oil extraction.</p>	<p>Walnut Sesame seed Peanut (groundnut), not roasted, shelled Oil palm kernel Linseed Hazelnut Canola seed (Rape seed) Beechnut</p>

--- press cake hard as stone ---

--- no oil extraction ---



seed too dry
 (add 40 ml water per kilo seed and store for 2 days in a plastic bag)

(see above for the procedure)

often too dry:

ARTIFICIALLY DRIED SEEDS OR NUTS

(in a dryer, near a heating etc.)

SEEDS AND NUTS IN ARID REGIONS

more information:

www.piteba.com

Homemade Margarine

the tools

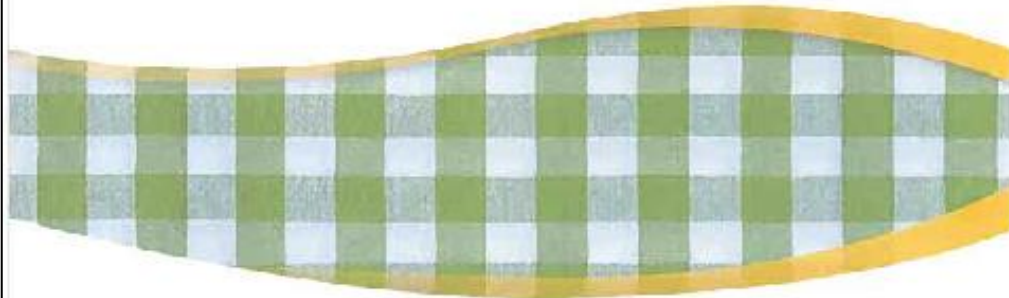

What do you need to make margarine? *the checklist*

- 3 table spoons of vegetable oils**
- 2 table spoons of coconut oil**
- 2 tea spoons of milk**
- 2 tea spoons of egg yolk (preferably pasteurised)**
- Some drops of lemon juice**
- A bowl with ice water**
- Salt, pepper and any other herbs to your liking**
- Some bread to taste the result**

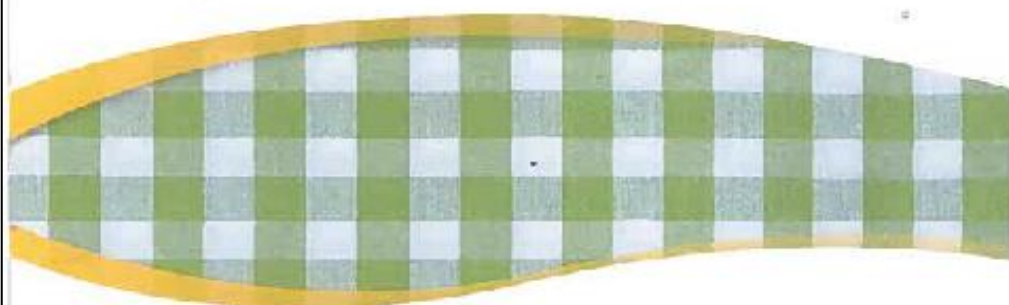

Homemade Margarine

the tools

Homemade Margarine

the tools

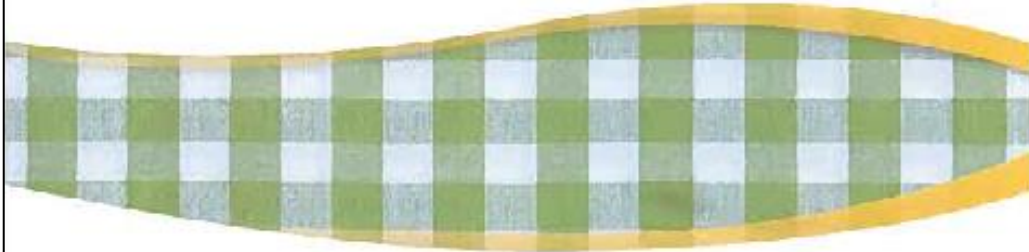

Try it yourself

the recipe

1. Melt **2 table spoons** of **coconut oil** in the small metal bowl on top of the candle holder
2. In the meantime, fill the transparent larger bowl with **ice cubes** and some **water**
3. As soon as the coconut oil has melted, add **3 table spoons** of **vegetable oil** to the metal bowl and put the smaller bowl into the prepared ice water
4. Use the whisk to **mix the oils together** and keep mixing until you see the color slightly changing
5. Add **2 tea spoons** of **milk** and **2 tea spoons** of **egg yolk** and take the bowl out of the ice water
6. Add the drops of **lemon juice** and **salt, pepper** or other **herbs** to your own liking

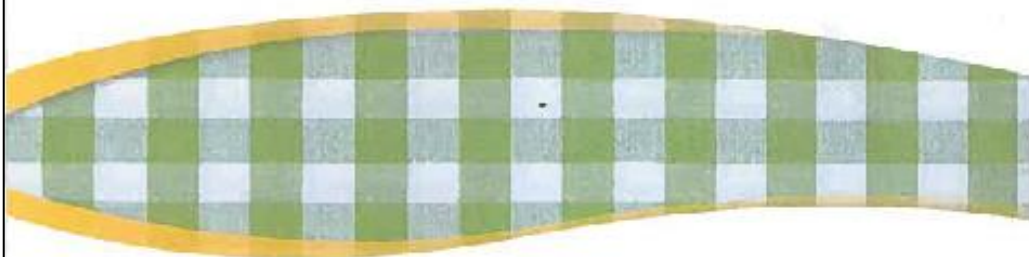

Homemade Margarine

the tools

Homemade Herbed Margarine
The Washington Post, September 29, 2010

Fresh herb flavor makes this great as an accompaniment for melting on poultry or fish, or as a spread on sandwiches. For a sweeter taste, use apple juice instead of water.

MAKE AHEAD: The margarine can be covered in an airtight container and refrigerated for up to 2 weeks.

Makes about 2 cups

Ingredients:

- * 2/3 cup sunflower oil
- * 1/4 cup water, milk or apple juice
- * 2 teaspoons fresh thyme
- * 2 teaspoons fresh rosemary
- * 1 medium clove garlic, or more to taste
- * Leaves from 1/2 bunch flat-leaf parsley (packed 1/2 cup)
- * 8 ounces coconut oil, solidified
- * 2 to 3 teaspoons Dijon-style mustard
- * Finely grated zest and freshly squeezed juice from 1 lemon (1 teaspoon zest, 2 tablespoons juice)
- * 1 teaspoon sugar (optional)

Directions:

Combine the sunflower oil; the water, milk or apple juice (choose one); thyme; rosemary; garlic and parsley to taste in a blender. Pulse to form a smooth green mixture.

Use a wooden spoon or flexible spatula to push the mixture through a fine-mesh strainer into a medium heatproof mixing bowl, pressing firmly to release as much oil and water as possible. Discard the solids. This will create an herb oil.

Fill a mixing bowl with cold water and ice cubes.

Add the coconut oil, mustard (to taste) and the lemon juice and zest to the bowl of freshly made herb oil. Fill a saucepan with a few inches of hot water and set it over medium-low heat. Suspend the bowl over the saucepan to create a double-boiler effect, making sure the bottom of the bowl does not touch the water in the pot; stir constantly. When the mixture reaches 120 degrees, remove the bowl from the heat and keep stirring.

Nestle the bowl inside the ice-water bath. Continue to stir until the mixture firms up; taste, and add the sugar if needed. Transfer to a container with a tight-fitting lid and refrigerate for up to 2 weeks.

Recipe Source:

From Gastronomer columnist Andreas Viestad. Fresh herb flavor makes this great as an accompaniment for melting on poultry or fish, or as a spread on sandwiches. For a sweeter taste, use apple juice instead of water.

MAKE AHEAD: The margarine can be covered in an airtight container and refrigerated for up to 2 weeks.

Makes about 2 cups

Ingredients:

- * 2/3 cup sunflower oil
- * 1/4 cup water, milk or apple juice
- * 2 teaspoons fresh thyme
- * 2 teaspoons fresh rosemary
- * 1 medium clove garlic, or more to taste
- * Leaves from 1/2 bunch flat-leaf parsley (packed 1/2 cup)
- * 8 ounces coconut oil, solidified
- * 2 to 3 teaspoons Dijon-style mustard
- * Finely grated zest and freshly squeezed juice from 1 lemon (1 teaspoon zest, 2 tablespoons juice)
- * 1 teaspoon sugar (optional)

REFERENCES

- AHMED, S. 2000. *Strange Encounters: Embodied Others in Post-Coloniality*, Taylor & Francis, London.
- AHMED, S. 2013. *The Cultural Politics of Emotion*, Taylor & Francis, London.
- ALLPORT, S. 2007(2006). *The Queen of Fats: why omega-3s were removed from the Western diet and what we can do to replace them*, Berkeley, CA, University of California Press.
- ANDERSON, B. 2005. Practices of judgement and domestic geographies of affect. *Social & Cultural Geography*, 6, 645-659.
- ARKSEY, H. & KNIGHT, P. T. 1999. *Interviewing for social scientists: An introductory resource with examples*, Sage, London.
- AUGÉ, M. 1998. *A sense for the other: the timeliness and relevance of anthropology*, Stanford University Press, Stanford.
- BARAD, K. 2007 Meeting the Universe Halfway: Quantum Physics and the Entanglement of Matter and Meaning. Duke University Press, Durham.
- BARNETT, C., CLARKE, N., CLOKE, P. & MALPASS, A. 2008. The elusive subjects of neo-liberalism: beyond the analytics of governmentality. *Cultural Studies*, 22, 624-653.
- BELL, D. 2002. Fragments for a New Urban Culinary Geography. *Journal for the Study of Food and Society*, 6, 10-21.
- BENNETT, J. 2007. Edible Matter. *New Left Review* (45), 133 – 145.
- BENNETT, J. 2010. *Vibrant matter: A political ecology of things*, Duke University Press Books, London.
- BENNETT, K. 2001. Interviews and focus groups. *Doing cultural geography*.
- BLYTHMANN, J. 2013. At last, the truth: Butter is GOOD for you - and margarine is chemical gunk. *Daily Mail*, 07/02/2013.
- BOLDNINGH, J. 1969. Research. In: VAN STUYVENBERG, J. H. (ed.) *Margarine: an economic, social, and scientific history 1869-1969*. Liverpool: Liverpool University Press.
- BOSELY, S. 2013. Butter and cheese better than trans-fat margarines, says heart specialist *Guardian*, 23/10.2016.

- BOURDIEU, P. 2013. *Distinction: A Social Critique of the Judgement of Taste*, Taylor & Francis, London.
- BRAIDOTTI, R. 2006. *Transpositions: On Nomadic Ethics*, Polity: Cambridge.
- BRAIDOTTI, R. 2008. The Politics of Radical Immanence: May 1968 as an event. *New Formations*, 68, 42-57.
- BRAIDOTTI, R. 2013a. *Metamorphoses: Towards a Materialist Theory of Becoming*, Polity: Cambridge.
- BRAIDOTTI, R. 2013b. *The posthuman*, Polity: Cambridge
- BULLER, H. 2013. Do Organic Chickens Die Naturally? *European Society for Rural Sociology Bi-Annual Conference*. Florence.
- BUSCH, L. & JUSKA, A. 1997. Beyond Political Economy: actor networks and the globalization of agriculture. *Review of International Political Economy*, 4, 688-708.
- CALLON, M. 1998. An Essay on Framing and Overflowing: economic externalities revisited by sociology. In: CALLON, M. (ed.) *The Laws of the Markets*. Blackwell / The Sociological Review: Oxford, 244-269.
- CAROLAN, M. S. 2012. *Embodied Food Politics*, Routledge: London.
- CHADWICK, R. 2014. On the challenges of hearing childbirth counter stories. In McKenzie-Mohr, S & Lafrance, M (eds.) *Women Voicing Resistance: Discursive and Narrative Explorations*, Routledge: London, 44-63.
- CLARK, P. 1986. The Marketing of Margarine. *European Journal of Marketing*, 20, 52-65.
- CLOKE, P., COOKE, P., CURSONS, J., MILBOURNE, P. & WIDDOWFIELD, R. 2000. Ethics, reflexivity and research: Encounters with homeless people. *Ethics, Place & Environment*, 3, 133-154.
- CLOKE, P., MAY, J. & WILLIAMS, A. 2016. The geographies of food banks in the meantime. *Progress in Human Geography*, 0309132516655881.
- COFF, C. B., D.; KORTHALS, M.; NIELSEN, T. 2008. Ethical Traceability and Communicating Food, *The International Library of Environmental, Agricultural and Food Ethics*, 15.
- COFFEY, A. & ATKINSON, P. 1996. *Making sense of qualitative data: complementary research strategies*, Sage: London.

- COLEMAN, S. & COLLINS, P. 2006a. "Being... Where? "Performing Fields on Shifting Grounds. In: COLLINS, P., Coleman, S. (ed.) *Locating the Field: space, place and context in anthropology*. Berg: Oxford.
- COLEMAN, S. & COLLINS, P. 2006b. *Locating the Field: Space, Place and Context in Anthropology*, Bloomsbury: London.
- COLES, B. 2016. Ingesting places: embodied geographies of coffee. In Abbots, E-J & Lavis, A (eds.) *Why We Eat, How We Eat: Contemporary Encounters Between Foods and Bodies*, Ashgate: Abingdon, 255-270.
- COLES, B. & HALLETT, L. 2012. Eating from the bin: salmon heads, waste and the markets that make them. *The Sociological Review*, 60, 156-173.
- CONNOLLY, W. E. 1999. Brain waves, transcendental fields and techniques of thought. *Radical Philosophy*, 94, 19-28.
- CONNOLLY, W. E. 2013. *The Fragility of Things: Self-Organizing Processes, Neoliberal Fantasies, and Democratic Activism*, Duke University: Durham.
- COOK, I. E. A. 2004. Follow the Thing: papaya. *Antipode*, 36 (4), 642-664.
- CRANG, M. & COOK, I. 2007. *Doing Ethnographies*, Sage: London.
- CURTIN, D. 1992. Food/Body/Person. In: Curtin, D. & Heldke, L. (eds.) *Cooking, Eating, Thinking: Transformative Philosophies of Food*. Indiana University: Bloomington.
- DAVIS, S. 2003. The least harm principle may require that humans consume a diet containing large herbivores, not a vegan diet. *Journal of Agricultural and Environmental Ethics*, 16, 387-394.
- DELEUZE, G. 1988. *Spinoza: Practical Philosophy*, City Lights: Michigan.
- DELEUZE, G. & GUATTARI, F. 2004 (1980). *Capitalism and Schizophrenia: A Thousand Plateaus*, Continuum: London.
- DELEUZE, G. & PARNET, C. 2007. *Dialogues II*, Columbia University: New York.
- DELEUZE, G. & PATTON, P. 2004. *Difference and Repetition*, Bloomsbury: London.
- DELYSER, D. 2001. "Do You Really Live Here?" Thoughts on insider research. *Geographical Review*, 91, 441-453.
- DERRIDA, J. 199. Eating Well, Or the Calculation of the Subject: An Interview. In Cadava, E., Connor, P., Nancy, J-L. (Eds.) *Who Comes After The Subject?* Routledge, London, 96-119.
- DERRIDA, J. 1995. In Weber, E. (ed.) *Points....: Interviews, 1974-1994*, Stanford

University: Stanford.

- DERRIDA, J. 2011. Book of the Synergies, Volume 2. *
- DOEL, M. 1994. Deconstruction on the move: from libidinal economy to liminal materialism. *Environment and Planning A*, 26, 1041-1059.
- DOEL, M. A. 1996. A hundred thousand lines of flight: a machinic introduction to the nomad thought and scrumpled geography of Gilles Deleuze and Felix Guattari. *Environment and Planning D*, 14, 421-439.
- DONALDSON, A., LANE, S., WARD, N. & WHATMORE, S. 2013. Overflowing with issues: following the political trajectories of flooding. *Environment and Planning C: Government and Policy*, 31, 603-618.
- DUPUIS, E. M. 2000. Not in my body: BGH and the rise of organic milk. *Agriculture and human values*, 17, 285-295.
- DUPUIS, E. M. & GOODMAN, D. 2005. Should we go "home" to eat?: toward a reflexive politics of localism. *Journal of rural studies*, 21, 359-371.
- DWYER, C. & LIMB, M. 2001. Doing qualitative research in geography. In: Dwyer, C. Limb, M. (eds.) *Qualitative Methodologies for Geographers: Issues and debates*. London: Arnold, 1-22.
- DYER, S. & DEMERITT, D. 2008. Un-ethical review? Why it is wrong to apply the medical model of research governance to human geography. *Progress in Human Geography*, 33 (1), 46-64.
- EDEN, S., BEAR, C. & WALKER, G. 2008. Mucky carrots and other proxies: problematising the knowledge-fix for sustainable and ethical consumption. *Geoforum*, 39, 1044-1057.
- EDWARDS, G. 1958. Vegetable Oils and Fats. Unilever Limited: London.
- EMERSON, R., FRETZ, R. & SHAW, L. 1995. Writing ethnographic fieldnotes. Chicago University: Chicago.
- ENGLAND, K. 1994. Getting personal: Reflexivity, positionality, and feminist research*. *The Professional Geographer*, 46, 80-89.
- EVANS, A. MIELE., M. 2012. Between Food and Flesh: how animals are made to matter (and not matter) within food consumption practices. *Environment and Planning D: Society and Space*, 30, 298-314.

- FENKO, A. & SCHIFFERSTEIN, H. 2012. The influence of sensory product properties on affective and symbolic product experience. In *Out of control; proceedings of the 8th international conference on design and emotion*, Cumulus: London.
- FERON, R. 1969. Technology and Production. In: VAN STUYVENBERG, J. (ed.) *Margarine: an economic, social, and scientific history, 1869-1969*. Liverpool University Press: Liverpool, 83-122.
- FLACK, E. 1997. Margarines and spreads. In Hasenhuettl, G. & Hartel, R. (eds.) *Food Emulsifiers and Their Applications*. Springer: Dordrecht, 255-279.
- FREE ASSOCIATION (The). 2011. *Moments of excess: Movements, protest and everyday life*, PM Press, Oakland.
- FOLKE, C., CARPENTER, S. R., WALKER, B., SCHEFFER, M., CHAPIN, T. & ROCKSTROM, J. 2010. Resilience thinking: integrating resilience, adaptability and transformability. *Ecology and Society*, 15 (4): 20 – 29.
- FONTANA, A. & FREY, J. 1994. The art of science. In Denzin, N. & Lincoln, Y. *The handbook of qualitative research*, Sage: London, 361-376.
- FOOD STANDARDS AGENCY 2010
<https://www.food.gov.uk/sites/default/files/multimedia/pdfs/yellowfatguidance0610.pdf>. Accessed 23/10/16.
- FORTH, C. E. 2013. The qualities of fat: Bodies, history, and materiality. *Journal of Material Culture*, 18, 135-154.
- FOUCAULT, M. 1977. *Discipline and Punish: The Birth of the Prison*, Vintage: New York.
- FOXALL, G. 2014. *Corporate Innovation (RLE Marketing): Marketing and Strategy*, Routledge: Abingdon.
- FRIEDBERG, S. 2003. Cleaning up Down South: Supermarkets, ethical trade and African horticulture. *Social and Cultural Geography*, 4 (1): 27-43.
- FRIEDBERG, S. 2004. *French Beans and Food Scares: Culture and Commerce in an Anxious Age*. Oxford University Press, Oxford.
- GALLEGOS, D. 2011. Palm Oil Tensions. *New Formations*, 74, 18-32.
- GARSTEN, C. & NYQVIST, A. 2013. Entries: Engaging organisational worlds. In: Garsten, C. & Nyquist, A. (eds.) *Organisational Anthropology: Doing ethnography in and among complex organisations*. London: Pluto, 1-28.
- GILBERT, J. 2008. After'68: Narratives of the New Capitalism. *New Formations*, 65, 34-53.

- GILLESPIE, M. 2002. *Television, Ethnicity and Cultural Change*, Routledge: London.
- GILLESPIE, R. 1997. Women, the body and brand extension in Medicine: cosmetic surgery and the paradox of choice. *Women & health*, 24, 69-85.
- GOFFEY, A. 2011. Introduction: On the Witch's Broomstick. *Capitalist Sorcery: Breaking the Spell*. Palgrave Macmillan: Basingstoke, viii-xxiv.
- GOODMAN, D., DUPUIS, E. & GOODMAN, M. 2012. *Alternative Food Networks: Knowledge, Practice, and Politics*, Routledge: Abingdon.
- GOODMAN, M. 2008. Towards visceral entanglements: knowing and growing economic geographies of food, In Leyson, A., Lee, R., McDowell, L., & Sunley, P. (eds.) *The Sage Handbook of Economic Geography*, Sage: London, 242-257.
- GOODMAN, M. K. 2004. Reading fair trade: political ecological imaginary and the moral economy of fair trade foods. *Political Geography*, 23, 891-915.
- GOODMAN, M. K. 2015. The Everyday Biopolitics of Care-full Eating. In: Abbots, E.-J. Lavis, A., & Attala, L. (eds.) *Careful Eating: Bodies, Food and Care*. Ashgate: Farnham, 213-220.
- GOODMAN, M., MAYE, D., & HOLLOWAY, L. 2010. Ethical foodscapes?: premises, promises, and possibilities. *Environment and planning. A*, 42, 1782.
- GORMAN, M. 2002. *Whale Oil Uses: Margarine*. University of Aberdeen.
http://www.scran.ac.uk/packs/exhibitions/learning_materials/webs/40/margarine.htm [Accessed 27/05/2013 2013].
- GOSS, J. 2004 Geographies of Consumption. *Progress in Human Geography* 28: 369-380.
- GOULD, R. 1995. *Insurgent Identities: Class, Community, and Protest in Paris from 1848 to the Commune*, University of Chicago: Chicago.
- GUITTARI, F. 2005. *The Three Ecologies*. Continuum: London.
- GUTHMAN, J. 2003. Fast food/organic food: Reflexive tastes and the making of 'yuppie chow'. *Social & Cultural Geography*, 4, 45-58.
- GUTHMAN, J. 2007. The Polanyian way? Voluntary food labels as neoliberal governance. *Antipode*, 39, 456-478.
- GUTHMAN, J. 2008. Bringing good food to others: Investigating the subjects of alternative food practice. *Cultural geographies*, 15, 431-447.

- GUTHMAN, J. 2012. Opening up the black box of the body in geographical obesity research: Toward a critical political ecology of fat. *Annals of the Association of American Geographers*, 102, 951-957.
- GUTHMAN, J. 2014. Doing justice to bodies? Reflections on food justice, race, and biology. *Antipode*, 46, 1153-1171.
- HALLENBECK, S. 2012. Toward a Posthuman Perspective: Feminist Rhetorical Methodologies and Everyday Practices. *Advances in the History of Rhetoric*, 15, 9-27.
- HAN, J. 2010. Neither friends nor foes: Thoughts on ethnographic distance. *Geoforum*, 41, 11-14.
- HARAWAY, D. 1988. Situated knowledges: The science question in feminism and the privilege of partial perspective. *Feminist studies*, 575-599.
- HARAWAY, D. 2008 *When Species Meet*. University of Minnesota Press, Minneapolis.
- HARDT, M. & NEGRI, A. 2009. *Commonwealth*, Harvard University: Cambridge.
- HARDT, P. M. & NEGRI, A. 2001. *Empire*, Harvard University: Cambridge.
- HARVEY, D. 2010. *A Companion to Marx's Capital*, Verso: London.
- HAYES-CONROY, A. & HAYES-CONROY, J. 2008. Taking Back Taste: Feminism, food and visceral politics. *Gender, Place and Culture*, 15, 461-473.
- HAYES-CONROY, A. & HAYES-CONROY, J. 2010. Visceral Geographies: Mateering, relating and defying. *Geography Compass* 4 (9): 1273-1282.
- HAYES-CONROY, A. & HAYES-CONROY, J. 2016. Feminist Nutrition: Difference, Decolonization and Dietary Change. In Hayes-Conroy A & Hayes-Conroy J (eds) *Doing Nutrition Differently: Critical Approaches to Diet and Dietary Intervention*, Routledge, London, 173-190.
- HEATH, D. & MENELEY, A. 2007. Techne, technoscience, and the circulation of comestible commodities: An introduction. *American Anthropologist*, 109, 593-602.
- HEATH, D., MENELEY., A. 2010. The Naturecultures of Foie Gras. *Food, Culture & Society*, 13, 421-452.
- HELDKE, L. 1992. Food Politics, Political Food. In: CURTIN, D., Heldke, L. (eds.) *Cooking, Eating, Thinking: Transformative philosophies of food*. Indiana University Press: Bloomington, 301-327.

- HERMAN, A. 2016. 'More-than-human' resilience(s)? Enhancing community in Finnish forest farms. *Geoforum*, 69, 34-43.
- HINCHLIFFE, S., ALLEN, J., LAVAU, S., BINGHAM, N., & CARTER, S. 2013 Biosecurity and the topologies of infected life: from borderlines to borderlands. *Transactions of the Institute of British Geographers*. 38 (4): 531-543.
- HOFFMANN, W. 1969. 100 Years of the Margarine Industry. In: VAN STUYVENBERG, J. H. (ed.) *Margarine: an economic, social, and scientific history 1869-1969*. Liverpool University: Liverpool, 9-36.
- HOLLOWAY, J. 2005. *Change the world without taking power: The meaning of revolution today*, Pluto: London.
- HOLLOWAY, J. 2010. Cracks and the crisis of abstract labour. *Antipode*, 42, 909-923.
- HOLT, D. 2004. *How Brands Become Icons: The Principles of Cultural Branding*, Harvard Business School Press: Boston.
- HOOLEY, G., PIERCY, N. & NICOLAUD, B. 2008. *Marketing Strategy and Competitive Positioning*, Prentice Hall: Harlow.
- HOPKINS, P. 2007. Positionalities and knowledge: Negotiating ethics in practice. *ACME: An International E-Journal for Critical Geographies*, 6, 386-394.
- HUNT, K. 1969. Raw Materials. In: VAN STUYVENBERG, J. H. (ed.) *Margarine: an economic, social, and scientific history 1869-1869*. Liverpool University Press: Liverpool, 37-82.
- ILLICH, I. 1973. *Tools for Conviviality*, Calder & Boyars: London.
- IRIGARAY, L. 2008. *Sharing the World*, Continuum: London.
- JACKSON, P. 1999. Commodity Cultures: the traffic in things. *Transactions of the Institute of British Geographers*, 24, 95-108.
- JACKSON, P. 2001. Making sense of qualitative data. In Limb, M. & Dwyer, C. (eds.) *Qualitative methodologies for geographers: Issues and debates*, Arnold, London, 199-214.
- JACKSON, P. 2015. *Anxious Appetites: Food and Consumer Culture*, Bloomsbury: London.
- JACKSON, P. & EVERTS, J. 2010. Anxiety as social practice. *Environment and planning A*, 42, 2791-2806.
- JAROSZ, L. 2006. French Beans and Food Scares: Culture and Commerce in an Anxious Age. *Annals of the Association of American Geographers*, 96, 230-232.

- JENKINSON, S. 2001. *The Genius of Play: Celebrating the Spirit of Childhood*, Hawthorn: Stroud.
- KATZ, C. 2004. *Growing Up Global: Economic Restructuring and Children's Everyday Lives*, University of Minnesota Press: Minneapolis.
- KIRKSEY, S. HELMREICH, S. 2010. The Emergence of Multispecies Ethnography. *Cultural Anthropology*, 25, 545-576.
- KIRWAN, J. & MAYE, D. 2013. Food security framings within the UK and the integration of local food systems. *Journal of Rural Studies*, 29, 91-100.
- KORSMEYER, C. 1999. *Making Sense of Taste: food and philosophy*, Cornell University: Ithica.
- LATHAM, A. 2003. Research, performance, and doing human geography: some reflections on the diary-photograph, diary-interview method. *Environment and Planning A*, 35, 1993-2018.
- LATOUR, B. 1993(1991). *We Have Never Been Modern*, Harvard: Cambridge.
- LATOUR, B. 2013. *An inquiry into modes of existence*, Harvard: Cambridge.
- LAVIS, A., ABBOTS, E-J; ATTALA, L. 2016. Careful Eating: Reflecting on the Embodied Intersections of Eating and Care. In: Abbots, E-J., Lavis, A., Attala, L. (eds.) *Careful Eating: The Embodied Entanglements of Food and Care*, Routledge: London.
- LAW, J. 2002. *Aircraft Stories: decentering the object in technoscience*, Duke University: Durham.
- LAW, J. 2004. *After Method: Mess in Social Science Research*, Routledge: London.
- LAW, J. & URRY, J. 2004. Enacting the social. *Economy and society*, 33, 390-410.
- LEVENE, A. 2014. The Meanings of Margarine in England: Class, Consumption and Material Culture from 1918 to 1953. *Contemporary British History*, 28, 145-165.
- LINDLOF, T. & TAYLOR, B. 2002. *Qualitative communication research methods*, Sage: London.
- LUNT, P. & LIVINGSTONE, S. 1996. Rethinking the focus group in media and communications research. *Journal of communication*, 46, 79-98.
- LYNN, W. 1998. Animals, ethics and geography. In Wolch, J., Emel, J. (Eds). *Animal geographies: Place, politics, and identity in the nature-culture borderlands*, Verso. London, 280-297.

- MARCUS, G. 1995. Ethnography in/of the World System: The Emergence of Multi-Sited Ethnography. *Annual Review of Anthropology*, 24, 95-117.
- MARCUS, G. E. & FISCHER, M. 2014. *Anthropology as Cultural Critique: An Experimental Moment in the Human Sciences*, University of Chicago Press: Chicago.
- MARIOD, A., MATTHAUS, B., EICHNER, K., HUSSAIN, I. 2006. Effects of processing on the quality and stability of three unconventional Sudanese oils. *European Journal of Lipid Science and Technology*, 108, 298-308.
- MCGOEY, L. 2012a. The logic of strategic ignorance. *The British journal of sociology*, 63, 533-576.
- MCGOEY, L. 2012b. Strategic unknowns: Towards a sociology of ignorance. *Economy and society*, 41, 1-16.
- MEYER, C. 2014. "Getting our Fats Straight Event"
<http://cheryldietitian.com/2014/08/30/getting-our-fats-straight-event/>
 [Accessed 03/03/2015].
- MILLER, D. 2001. The poverty of morality. *Journal of consumer culture*, 1, 225-243.
- MILNE, R., WENZER, J., BREMBECK, H. & BRODIN, M. 2011. Fraught cuisine: food scares and the modulation of anxieties. *Distinktion: Journal of Social Theory*, 12, 177-192.
- MOERAN, B. 2013. Working Connections, Helping Friends: Fieldwork, organisations and cultural styles. In: Garsten, C. & Nyquist, A. (eds.) *Organisational Anthropology: Doing ethnography in and among complex organisations*. London: Pluto, 155-168.
- MOL, A. 2002. *The Body Multiple: ontology in medical practice*, Duke University: Durham.
- MOL, A. 2008a. I eat an apple. On theorizing subjectivities. *Subjectivity*, 22, 28-37.
- MOL, A. 2008b. *The Logic of Care: Health and the Problem of Patient Choice*, Routledge: London.
- MOL, A. 2012. Mind your plate! The ontonorms of Dutch dieting. *Social Studies of Science* 43 (3), 379-396.
- MOL, A. & LAW, J. 2004. Embodied Action, Enacted Bodies: the Example of Hypoglycaemia. *Body & Society*, 10, 43-62.

- MOL, A. MOSER, I. POLS, J, 2015. Care: Putting practice into theory. In Mol, A., Moser, I., Pols, J. (eds.) *Care in Practice: On Tinkering in Clinics, Homes and Farms*. Transaction: New Brunswick, 7-27.
- MORTON, T. 2012. *The Ecological Thought*, Harvard University Press: Cambridge.
- MOZAFFARIAN, D., KATAN, M., ASCHERIO, A., STAMPFER, M. & WILLETT, W. 2006. Trans Fatty Acids and Cardiovascular Disease. *New England Journal of Medicine*, 354, 1601-1613.
- NALLY, D. 2011. The biopolitics of food provisioning. *Transactions of the Institute of British Geographers*, 36, 37-53.
- NIMMO, R. 2008. Governing Nonhumans: Knowledge, Sanitation and Discipline in the Late 19th and Early 20th-Century British Milk Trade. *Distinktion: Scandinavian Journal of Social Theory*, 9, 77-97.
- O.E.D. 2013. Margarine. *Oxford English Dictionary*, Oxford University: Oxford.
- O'REILLY, K. 2005. *Ethnographic methods*, Routledge: London.
- OAKLEY, A. & ROBERTS, H. 1981. Interviewing women: A contradiction in terms. *Doing feminist research*, 30, 1.
- PARR, H. 2001. Feeling, Reading, and Making Bodies in Space. *Geographical Review*, 91, 158-167.
- PIGNARRE, P. S., I. 2011. *Capitalist Sorcery: Breaking the Spell*, Palgrave Macmillan: New York.
- PINK, S. 2015. *Doing Sensory Ethnography*, SAGE: London.
- POLLAN, M. 2007 (2006). *The Omnivore's Dilemma: the search for a perfect meal in a fast-food world*, Bloomsbury: London.
- PRED, A. 1998. The nature of denaturalized consumption and everyday life. In Braun, B., Castree, N (Eds). *Remaking reality: Nature at the end of the millennium*, Routledge, London, 150-168.
- PROBYN, E. 2000. *Carnal appetites: food sex identities*, Routledge: New York.
- PROBYN, E. 2010. Feeding the world: towards a messy ethics of eating. In: Lewis, T. Potter, L. (eds.) *Ethical Consumption: A critical introduction*. Routledge: London, 103-115.
- PUIG DE LA BELLACASA, M. 2010. Ethical doings in naturecultures. *Ethics, place and environment*, 13, 151-169.

- PUIG DE LA BELLACASA, M. 2011. Matters of care in technoscience: Assembling neglected things. *Social Studies of Science*, 41, 85-106.
- PUIG DE LA BELLACASA, M. 2012. 'Nothing comes without its world': thinking with care. *The Sociological Review*, 60, 197-216.
- PUIG DE LA BELLACASA, M. 2015. Making Time for Soil: Technoscientific futurity and the pace of care. *Social Studies of Science*, 45 (5): 691-716.
- PYKE, M. 1970. *Synthetic Food*, John Murray: London.
- RIEPMAN, S. 1970. *The Story of Margarine*, Public Affairs Press: New York.
- ROE, E. J. 2006a. Material connectivity, the immaterial and the aesthetic of eating practices: an argument for how genetically modified foodstuff becomes inedible. *Environment and Planning A*, 38, 465.
- ROE, E. J. 2006b. Things becoming food and the embodied, material practices of an organic food consumer. *Sociologia Ruralis*, 46, 104-121.
- ROSE, G. 1997. Situating knowledges: positionality, reflexivities and other tactics. *Progress in human geography*, 21, 305-320.
- ROSE, N. 1999. *Governing the soul: the shaping of the private self*, Free Association Books: London.
- RØYRVIK, E. 2013. Oblique Ethnography: Engaging collaborative complicity among globalised corporate managers. In: Garsten, C. & Nyquist, A. (eds.) *Organisational Anthropology: Doing ethnography in and among complex organisations*. London: Pluto, 72-88.
- RUDDICK, S. M. forthcoming. Learning the Language of Earth: Rethinking the subject, reimagining worlds. *Dialogues in Human Geography*.
http://s3.amazonaws.com/academia.edu.documents/42346033/Ruddick_Learning_the_language_of_Earth_Dialogues_in_Human_Geography.pdf?AWSAccessKeyId=AKIAIWOWYYGZ2Y53UL3A&Expires=1491411707&Signature=AAI0m0xEf%2B0xNvBVuaZyuxFQaTo%3D&response-content-disposition=inline%3B%20filename%3DLearning_the_Language_of_Earth_Rethinking.pdf
- SACK, R. 1992. *Place, Modernity, and the Consumer's World*, John Hopkins University Press: Baltimore.
- SCHNEIDER, R. 2003. *The Future of Ritual: Writings on Culture and Performance*, Routledge: London.

- SCHILLMEIER, M. 2013. Realities to be-come: on Cosmopolitics. *Informática na educação: teoria & prática*, 16, 101 - 122.
- SCHLEIFER, D. 2012. The Perfect Solution: How Trans fats became the healthy replacement for Saturated fats. *Technology and Culture*, 53, 94-119.
- SCHOENBERGER, E. 1991. The Corporate Interview as a Research Method in Economic Geography, *The Professional Geographer*, 43, 180-189.
- SCRINIS, G. 2013. *Nutritionism: The Science and Politics of Dietary Advice*, Columbia University Press: New York.
- SHURMER-SMITH, P. 2001. Methods and methodology. In Shurmer-Smith, P., (ed.) *Doing cultural geography*, Sage: London, 95-100.
- SMYTH, C. 2013. The Times. Available: <http://www.thetimes.co.uk/tto/health/news/article3901745.ece> (Accessed 10/10/16).
- SOUSA, I. BUSCH L. 1998. Networks and Agricultural Development: The case of soybean production and consumption in Brazil. *Rural Sociology*, 63 (3): 349-371.
- SPRADLEY, J. P. 1980. *Participant Observation*, Holt, Rinehart and Winston: New York.
- STASSART, P., WHATMORE. S., 2003. Metabolising Risk: food scares and the un/re-making of Belgian beef. *Environment and Planning A*, 35, 449-462.
- STENGERS, I. 2005. The cosmopolitical proposal. In Latour, B., Weibel, P. (Eds.) *Making things public: Atmospheres of democracy*, Centre for Art & Media: Karlsruhe, 994-1003.
- SULTANA, R. 1992. Ethnography and the Politics of Absence. *International Studies of Qualitative Studies in Education*, 5, 19-27.
- SUTHERLAND, C. In Press. Theography: Subject, theology, and praxis in geographies of religion, *Progress in Human Geography*.
<http://journals.sagepub.com/doi/abs/10.1177/0309132516644513>
- TSING, A. 2011. *Friction: An Ethnography of Global Connection*, Princeton University Press: Princeton.
- TSING, A. 2015. *The Mushroom at the End of the World: On the Possibility of Life in Capitalist Ruins*, Princeton University Press: Princeton.
- UNITED NATIONS (the). 2011. World Economic and Social Survey 2011. United Nations: New York.

- UPRITCHARD, J., ZEELLENBERG, M., HUIZINGA, H., VERSCHUREN, P. & TRAUTWEIN, E. 2005. Modern fat technology: what is the potential for heart health? *Proceedings of the Nutrition Society*, 64, 379-386.
- VALENTINE, G. 1997. Tell me about...: using interviews as a research methodology. *Methods in human geography*, 2, 27-54.
- VAN ALPHEN, J. 1969. Hippolyte Mege Mouriés. In: VAN STUYVENBERG, J. H. (ed.) *Margarine: an economic, social, and scientific history, 1869-1969*. Liverpool University Press: Liverpool, 5-8.
- VIESTAD, A. 2010. *Gastronomer: Make your own margarine*. The Washington Post. Available: <http://www.washingtonpost.com/wp-dyn/content/article/2010/09/28/AR2010092802826.html> [Accessed 29/05/2013 2013].
- WALTNER-TOEWS, D. & LANG, T. 2000. A New Conceptual Base for Food and Agricultural Policy: The Emerging Model of Links between Agriculture, Food, Health, Environment and Society. *Global Change and Human Health*, 1, 116-130.
- WENGER, E. 1999. *Communities of Practice: Learning, Meaning, and Identity*, Cambridge University Press: Cambridge.
- WHATMORE, S. 2006. Materialist returns: practising cultural geography in and for a more-than-human world. *Cultural Geographies*, 13, 600-609.
- WHATMORE, S., STASSART, P. & RENTING, H. 2003. What's alternative about alternative food networks? *Environment and Planning A*, 35, 389 - 391.
- WHATMORE, S. T., LORRAINE 1997. Nourishing Networks: Alternative geographies of food. In: Goodman, D, & Goodman M., (eds.) *Globalising food: Agrarian questions and global restructuring*. Routledge: Abingdon, 211 - 224.
- WILLIAMS, A., CLOKE, P., MAY, J. & GOODWIN, M. 2016. Contested space: The contradictory political dynamics of food banking in the UK. *Environment and Planning A*, 0308518X16658292.
- WILLIAMS, A., GOODWIN, M. & CLOKE, P. 2014. Neoliberalism, Big Society, and Progressive Localism. *Environment and Planning A*, 46, 2798-2815.
- WILLIS, P. 1990. *Common culture: symbolic work at play in the everyday cultures of the young*, Open University Press: Milton Keynes.

- WILSON, M. 2013. *Everyday Moral Economies: Food, Politics and Scale in Cuba*,
Routledge: London.
- WINNER, L. 1980. Do artefacts have politics? *Daedalus*, 109, 121-136.
- WOODYER, T. & GEOGHEGAN, H. 2013. (Re)enchanted geography? The nature of
being critical and the character of critique in human geography. *Progress in
Human Geography*, 37, 195-214.
- YUSOFF, K. 2011. Aesthetics of Loss: biodiversity, banal violence and biotic subjects.
Transactions of the Institute of British Geographers, preview, 1-15.