



LUND UNIVERSITY

Safe drinking water in a changing environment

Membrane filtration in a Swedish context

LIDÉN, ANGELICA

2016

Document Version:

Publisher's PDF, also known as Version of record

[Link to publication](#)

Citation for published version (APA):

LIDÉN, ANGELICA. (2016). *Safe drinking water in a changing environment: Membrane filtration in a Swedish context*. Water Resources Engineering, Lund University.

Total number of authors:

1

General rights

Unless other specific re-use rights are stated the following general rights apply:

Copyright and moral rights for the publications made accessible in the public portal are retained by the authors and/or other copyright owners and it is a condition of accessing publications that users recognise and abide by the legal requirements associated with these rights.

- Users may download and print one copy of any publication from the public portal for the purpose of private study or research.
- You may not further distribute the material or use it for any profit-making activity or commercial gain
- You may freely distribute the URL identifying the publication in the public portal

Read more about Creative commons licenses: <https://creativecommons.org/licenses/>

Take down policy

If you believe that this document breaches copyright please contact us providing details, and we will remove access to the work immediately and investigate your claim.

LUND UNIVERSITY

PO Box 117
221 00 Lund
+46 46-222 00 00

Safe drinking water in a changing environment

Membrane filtration in a Swedish context

Angelica Lidén



LUND
UNIVERSITY

DOCTORAL DISSERTATION

by due permission of the Faculty of Engineering, Lund University, Sweden.
To be defended at the Faculty of Engineering, V-building, John Ericssons
väg 1, Lund, room V:C on October 28th, 2016 at 10.15 a.m.

Faculty opponent
Prof. Dr. Wolfgang Uhl

Organization LUND UNIVERSITY Div. of Water Resources Engineering Box 118 SE-221 00 Lund, Sweden	Document name: DOCTORAL THESIS	
	Date of issue: 2016-10-04	
	Coden: LUTVDG/TVVR-1067(2016)	
Author Angelica Lidén	Sponsoring organizations: Sweden Water Research, Sydsvatten, ViVAB, Norrvatten, Tekniska Verken i Linköping, Gästrikvatten and Svenskt Vatten Utveckling	
Title and subtitle: Safe drinking water in a changing environment - Membrane filtration in a Swedish context		
Abstract <p>Surface water is vital for Swedish drinking water supply. In the past decades, a trend of increased total organic carbon (TOC) concentrations has led to higher consumption of coagulants in drinking water treatment, and has pushed the levels in the outgoing water closer to the allowed levels of TOC. Also, two occasions of cryptosporidium outbreaks in northern Sweden have stressed the importance of reliable microbiological barriers. Ultrafilters and tighter membranes can, due to size exclusion, produce a safe water by reducing the occurrence of parasites, bacteria and virus 10,000-fold or more. Combined with a coagulation pretreatment, ultrafiltration has the additional benefit of removing natural organic matter (NOM), whereas nanofiltration can remove NOM without coagulant.</p> <p>This dissertation presents results for NOM removal by ultrafiltration and nanofiltration from several raw water sources. The results were collected in mobile pilot plants at several locations. The coagulation and ultrafiltration process could achieve similar NOM removal as current chemical treatment, to a similar cost, and with a lower environmental impact. Hollow fiber nanofiltration achieved advanced NOM removal, reducing TOC with around 90 % and UV-absorbing species at 254 nm of up to 97 %. Thus, it is selective to aromatic NOM, similar to conventional treatment. The cost for the operation of a treatment process would increase if coagulation/sedimentation would be replaced with a nanofiltration step, but the environmental impact would decrease substantially.</p> <p>The NOM removal was studied by the aid of fluorescence spectrometry. Fluorescence can be related to characteristics of NOM, which has been implemented in this study. The application of fluorescence as a monitoring method has been evaluated through indices and other fluorescence derived parameters. Some of these, e.g. fluorescence index, have showed significant correlations to treatment efficiencies. Similar to TOC and UV-absorbance, significant changes in the nanofilter permeate was possible to relate to integrity breaches, and these NOM related parameters have shown potential for integrity monitoring.</p> <p>With such advanced NOM removal and advanced monitoring techniques, membrane filtration has a promising future in Swedish drinking water treatment. It decreases the risk for waterborne pathogens. Specifically, nanofiltration can lead to lower risks for disinfection by-products and regrowth in the distribution system.</p>		
Key words: boreal lakes, drinking water, nanofiltration, natural organic matter, ultrafiltration		
Classification system and/or index terms (if any)		
Supplementary bibliographical information		Language: English
ISSN and key title: 1101-9824		ISBN: 978-91-7623-990-2 (print) 978-91-7623-991-9 (e-version)
Recipient's notes	Number of pages: 176	Price: -
	Security classification	

I, the undersigned, being the copyright owner of the abstract of the above-mentioned dissertation, hereby grant to all reference sources permission to publish and disseminate the abstract of the above-mentioned dissertation.

Signature _____ Date: 20 September 2016

Safe drinking water in a changing environment

Membrane filtration in a Swedish context

Angelica Lidén



LUND
UNIVERSITY

Coverphoto by Magnus Persson

Copyright Angelica Lidén

Faculty of Engineering, Department of Building & Environmental Technology
Division of Water Resource Engineering

CODEN: LUTVDG/TVVR-1067(2016)

ISBN print: 978-91-7623-990-2

ISBN e-version: 978-91-7623-991-9

ISSN: 1101-9824

REPORT: 1067

Printed in Sweden by Media-Tryck, Lund University
Lund 2016



To my mother and father, for giving me life, love and laughter. Your kindness, curiosity and creativity have been an inspiration and have made me who I am today.

Acknowledgements

I am grateful to recognize the large number of people who have played an important part in my life during the course of my PhD work. This is my opportunity to thank you for helping me reach the goal of writing this dissertation.

First of all, I would like to express my gratitude to my supervisor, Prof. Kenneth M. Persson for giving me this opportunity to discover the complexity and importance of reliable drinking water treatment. Your encouragement, positive attitude and expertise have guided me through this work. I would also like to thank my co-supervisor, Prof. Ann-Sofi Jönsson. Your deep knowledge in the workings of membranes, your ability and your humility have been a true inspiration.

I would like to thank Andrew Holmes at Purac for helping me out in the pilot study when I struggled the most. You were not the least hesitant of sharing your experiences and knowledge of membrane filtration, and I am deeply thankful for that. Also, thank you Ingemar Heidefors at Purac. The assistance of Helena Stavklint and her colleagues at Tekniska verken i Linköping are truly appreciated. I would also like to include Malin Delin and Karolina Stenroth at Gästrikevatten. Elin Lavonen, fluorescence expert and my co-author, has played an important role, by performing the analysis and explaining the results. Additional thanks to Kristina and Per at Norrvatten, Stephan Köhler at SLU and Bjørnar at Sintef for sharing your knowledge of NOM and water treatment. Additional thanks to my co-author Alexander Keucken, your zealotry is difficult to keep up with. It has been a pleasure working with all of you in GenoMembran, the meetings and discussions have been vital for this research to move forward. Many thanks to you all, and to Svensk Vatten Utveckling that financially supported the project.

Sweden Water Research was founded during my time as a PhD student, and it has been a pleasure seeing this company take off. I am happy for the meetings we have had so far, and I wish all PhD students in the group the best of luck in the future.

Sydvatten, my employer, has a large number of employees I would like to thank. I would not have been able to perform the pilot studies at Ringsjö WTP if it had not been for Janne and Peter. There are so many more, Per, Bo, Morgan, Jörgen and, of course, Oskar, to mention a few, that have played vital parts for the project's realization. Marianne, you and your colleagues in the lab have been so helpful. Bitte, you know the raw waters at Sydvatten like no one else, and Tobias, your interest in my membrane trials have made them feel extra interesting. Anna-Karin, who makes sure that people outside of Sydvatten get to hear about what we are doing.

There are also many persons at my other working place, Water Resource Engineering at Lund University that I must be allowed to thank. Prof. Cintia Bertacchi Uvo, your guidance through my master thesis made me interested in working in research, and you helped me do so. Thank you for encouraging me, and for presenting me to Kenneth! Thank you Prof. Magnus Larson, for happily getting involved in our membrane world, and engaging in co-writing an article. Thanks to Dr. Catherine Paul, for sharing your enthusiasm about the microbial community. Prof. Hans Hanson, thank you for making sure that the division runs smoothly. To all the supporting staff, Carina, Lennart and Görel among others, making sure that all needed documents have been filled in and solving any practical problems. To Claudia, Johanna, Feifei and Mike, for inviting me to join your excursions. To Jaime, for being such a wonderful office mate, and to Erik and Hossein, for all the conversations. Thank you everyone at the division, for all the work and non-work related activities, for all the lunches and all the fikas, it has been a pleasure working with you, and to get a glimpse of your interesting research.

Thank you Jing, who led many of us into Toastmasters International. Because of you and our friends at Toastmasters@Ideon I may now step onto a stage with more confidence. And this is only the beginning!

Big thanks to my parents, who have answered the phone at any time of the day or night to aid or comfort me. To my brothers, Mattias and Patrik, and to the rest of my relatives who have been supportive all through my studies. To my friends; Amy, Filippa, Gustav, Mehmet, Cajsa, Carl, Robert et al. Your existence is my blessing! I owe you a lot, for sharing my laughter, and for your willingness to talk, or not to talk. And, I do not know what I would do without my fellow Swing cats. Some nights, the only thing that makes sense is to dance!

I am truly indebted to Magnus Persson, for all your help with text editing, photographing and providing me with food and chocolate. I have put your patience and gentleness to a test numerous times, but they have never failed.

Popular summary

How brown water becomes drinkable

Imagine your life without water. Can you do it? Of course not! Water is an essential part of our lives because it is essential for all living things. It keeps us fed and clean, it can offer splendid views and fun activities.

Thirsty? The taps in our homes will give you instant relief! In boreal countries like Sweden, the water often started out in a lake or a river before traveling kilometers of pipes before ending in the tap. Fortunately, it does not come directly, but passes through a treatment plant in between. At the treatment plant, the operators ensure that the water is healthy and appealing to drink, so that no one needs to be worried about their daily glass of water. Not all treatment plants look the same. Generally, they all make sure that there are no microorganisms or viruses that cause illness. But depending on the exact need, what there is in the water that needs to be removed, plants are designed differently.

In northern parts of the globe, water often contains organic matter; degraded plant material flushed of the ground during rain. Organic matter discolors the water in lakes and rivers, making it brown. The organic matter in lakes and rivers has increased in concentration in the northern hemisphere during recent decades, a phenomenon called brownification. This brownification is probably connected to the lower emissions of acidifying gases from industry. An acidic water cannot contain as much organics as a more neutral water. There are also reasons to believe that the brownification can be related to more frequent occurrence of heavy rainfall. With climate change, these will likely be even more frequent in the northern hemisphere in the future.

Brown water is a nuisance for summer house owners, who have noticed that the water in the lakes they swim in has become less and less inviting. Drinking water companies have also noticed that the water coming to their plants gets browner and browner. A browner water into the treatment plants increases the risk for a brown water distributed into the network.

Organic matter must be removed in the plants. It is not appealing for the consumers to drink, and there is a risk of more microorganisms in the water, living from degrading these organics. Most of them are so small that sand filters would need to be very thick to remove them. Thick sand filters give very good results, but are only an economical alternative when they are naturally available. Otherwise, you need to find other, engineered solutions. Many treatment plants choose to add an (unhazardous) chemical,

often a metal salt, that makes the organics collect in bigger groups that is so heavy that they no longer can be kept suspended in the water. In large tanks, the water is slowly flowing through, so that these clusters can fall to the bottom. After that, the water is often filtered through sand beds, and they exist of different types depending on how large the sand particles are. Rapid sand filters mechanically remove the remaining larger clusters while in slow sand filters the main job is done by bacteria that are safely separated from the finished water by the sand. The bacteria eat the organics that otherwise would be available for the undesired bacteria in the pipes.

There is a newer alternative to sand filters that could improve the treatment capacity. They are types of filters with very small pores, that do not allow virus and bacteria through. If the pores are small enough, even the organics will be removed. These filters are called membranes. The word originates from the walls of any living cells – that selectively let some types of molecules through the walls, and others cannot pass. Water can flow free through the walls of the cells. Those constructed membranes can be of various types. One alternative consists of meter-long spaghetti-like fibers that have a hole all through the middle. The untreated water flows through these fibers, and the water can pass through the walls, while coloring substances stay on the other side. This has been able to produce just as clean, or cleaner, water compared to the traditional cleaning using chemicals. Viruses and bacteria are almost entirely removed.

These spaghetti-like fibers may break. There are thousands of them in a treatment plant, and there is risk is small in the short-term when one of them start leaking. But the faster they can be detected, the better it is. When found, the broken fiber will be plugged and taken out of the process. If a leaking fiber is detected, it is usually relatively easy to find which fiber it is. To do that, the process needs to be shut down, which takes time. By constantly checking parameters related to the organics and color of the water it could be possible to tell when there is a need to find a leaking fiber and plug it. This information is also possible to use to follow what is happening with the treatment process.

In the water from lakes and rivers, the mix of organics is a cocktail of numerous molecules that varies in size, from nanoscale, almost up to microscale. These are hard to identify, and there are still types of molecules that cannot be detected with available methods. This matters, since different types of organics have different levels of reactivity with chlorine, or they may or may not be able to feed bacteria. The quicker they can be detected with readily available instruments, the safer and better the drinking water would be.

One alternative is to use light rays. Some molecules absorb rays of light at specific wavelength, of which some reemits rays at other wavelength. By finding out how these characteristics can relate to the safety of the drinking water, it can help operators of drinking water treatment processes to ensure a good tap water.

All this put together – better technology and quick ways to find out that the water is safe – can keep us supplied with great drinking water. Membranes will be able to produce clean water, as the water in the lakes becomes browner. It is not the only

possible method, but the water quality and the level of effort required for a stable operation are clear advantages. It also has less negative effect for the local environment, and may even lead to less emissions of greenhouse gases. They are, most of the time, connected to increased cost, since the price is relatively high. It is up to the consumers and the decision makers to decide what they want to pay for. There is actually the risk of paying for unnecessary clean water.

Abstract

Surface water is vital for Swedish drinking water supply. In the past decades, a trend of increased total organic carbon (TOC) concentrations has led to higher consumption of coagulants in drinking water treatment, and has pushed the levels in the outgoing water closer to the allowed levels of TOC. Also, two occasions of cryptosporidium outbreaks in northern Sweden have stressed the importance of reliable microbiological barriers.

Ultrafilters and tighter membranes can, due to size exclusion, produce a safe water by reducing the occurrence of parasites, bacteria and virus 10,000-fold or more. Combined with a coagulation pretreatment, ultrafiltration has the additional benefit of removing natural organic matter (NOM), whereas nanofiltration can remove NOM without coagulant.

This dissertation presents results for NOM removal by ultrafiltration and nanofiltration from several raw water sources. The results were collected in mobile pilot plants at several locations. The coagulation and ultrafiltration process could achieve similar NOM removal as current chemical treatment, to a similar cost, and with a lower environmental impact. Hollow fiber nanofiltration achieved advanced NOM removal, reducing TOC with around 90 % and UV-absorbing species at 254 nm of up to 97 %. Thus, it is selective to aromatic NOM, similar to conventional treatment. The cost for the operation of a treatment process would increase if coagulation/sedimentation would be replaced with a nanofiltration step, but the environmental impact would decrease substantially.

The NOM removal was studied by the aid of fluorescence spectrometry. Fluorescence can be related to characteristics of NOM, which has been implemented in this study. The application of fluorescence as a monitoring method has been evaluated through indices and other fluorescence derived parameters. Some of these, e.g. fluorescence index, have showed significant correlations to treatment efficiencies. Similar to TOC and UV-absorbance, significant changes in the nanofilter permeate was possible to relate to integrity breaches, and these NOM related parameters have shown potential for integrity monitoring.

With such advanced NOM removal and advanced monitoring techniques, membrane filtration has a promising future in Swedish drinking water treatment. It decreases the risk for waterborne pathogens. Specifically, nanofiltration can lead to lower risks for disinfection by-products and regrowth in the distribution system.

Sammanfattning

Tillgång till rent dricksvatten är en självklarhet för alla i Sverige. Under senare år har dock flera händelser satt våra dricksvattenverk på prov. Ytvatten har en stor betydelse för svensk dricksvattenförsörjning, sjöar och vattendrag är tre gånger så vanliga som källor för dricksvatten än naturligt grundvattnen. I många svenska ytvatten har koncentrationen av totalt organiskt kol (TOC) ökat under de senaste decennierna. Som konsekvens har kostnaderna för dricksvattenproducenterna ökat eftersom de har behövt tillsätta mer fällningskemikalier i reningsprocessen. De två stora svenska utbrotten relaterade till *Cryptosporidium* under vintern 2010-2011 har visat på vikten av pålitliga mikrobiella barriärer i ytvattenverkan. Dessa utmaningar för dricksvattenproducenterna måste hanteras, antingen genom att förbättra existerande reningsmetoder eller genom att utveckla nya. En teknik, som ganska nyligen har blivit ett realistiskt alternativ för storskalig vattenrening, är membranfiltrering. Membranen som är aktuella för våra dricksvattenverk delas in i två typer beroende på deras genomsläpplighet, ultra- och nanofiltrering. Ultrafiltrering och tätare typer av membranprocesser, kan reducera parasiter, bakterier och virus till en 10 000-del (eller ännu mindre) jämfört med det inkommande vattnet. Om ultrafiltrering kombineras med förfällning, kan processen även reducera mängden TOC i vattnet. Nanofiltrering kan t.o.m. reducera TOC utan tillsatt fällningskemikalie.

I denna avhandling presenteras resultat från studier där ultra- och nanofiltrering har använts för att minska halten organiskt kol i dricksvatten. Pilotstudier genomfördes på ett flertal vattenverk i flyttbara pilotanläggningar. Förfällning och ultrafilter gav en minskning av organiskt kol som var i nivå med existerande beredningar i vattenverken till ungefär samma kostnad, men med mindre miljöpåverkan. Nanofiltren kunde minska halten organiskt kol betydligt mer, med en TOC-reduktion på ca 90 % och UV-absorbans med våglängd 254 nm reducerades med 97 %. Båda processerna hade större reduktion av UV-absorbans än TOC, vilket visar att båda är selektiva mot aromatiska kolväten. Nanofiltrering är ett dyrare alternativ i ett vattenverk, både jämfört med existerande processer och med ultrafiltrering, däremot skulle miljöpåverkan minskas väsentligt.

För att utvärdera hur det organiska kolet avskildes användes fluorescens. Fluorescens i ett vattenprov har tidigare relaterats till specifika egenskaper hos det organiska kolet. Sammansättningen av det organiska kolet, som delvis går att utläsa ur fluorescens data, har använts för utvärdering av processernas förmåga och specifika skillnader. Genom att använda index och andra uppmätta intensiteter i ett vattenprov har denna metod

stora möjligheter att användas för att bevaka en vattenreningsprocess. De har uppvisat signifikanta korrelationer med processerna förmåga att reducera TOC. Signifikanta förändringar av fluorescens, TOC och UV-absorbans i nanofilterpermeatet kunde visas vara relaterade till trasiga fiber i membranmodulerna. Därmed har dessa mätmetoder visat potential som alternativ för bevakning av membranets integritet.

Resultaten i studien visar att med sådan god avskiljning av organiskt kol och sådana bra bevakningsmetoder av processen har membranfiltrering goda chanser att bli en process att räkna med för framtida vattenreningsprocesses. Den minskar risken för vattenrelaterade sjukdomsutbrott. Nanofiltrering har även möjlighet att minska risken för desinfektionsbiprodukter och återväxt i ledningsnätet.

Papers

Appended papers

This thesis is based on the following papers which will be referred to by their roman numerals in the body of the text. The papers are appended at the end of the thesis.

- I. **Lidén, A.**, Persson, K.M., 2016. Comparison between ultrafiltration and nanofiltration hollow-fiber membranes for removal of natural organic matter: a pilot study. *J. Water Supply Res. Technol. - Aqua* 65(1), 43–53. doi:10.2166/aqua.2015.065
- II. **Lidén A.**, Keucken A., Persson K.M., 2016. Uses of fluorescence excitation-emissions indices in predicting water treatment efficiency. *Journal of Water Process Engineering* (Submitted)
- III. **Lidén A.**, Lavonen E., Persson K.M., Larson M., 2016. Integrity breaches in a hollow fiber nanofilter – effects on natural organic matter and virus-like particle removal. *Water Research* 105, 231–240 doi:10.1016/j.watres.2016.08.056
- IV. **Lidén, A.**, Persson, K.M., 2016. Feasibility Study of Advanced NOM-Reduction by Hollow Fiber Ultrafiltration and Nanofiltration at a Swedish Surface Water Treatment Plant. *Water* 8, 150. doi:10.3390/w8040150
- V. **Lidén, A.**, Persson, K.M., 2016. Membrane filtration for a resilient drinking water treatment in Nordic countries. (Manuscript)

Author's contribution to appended papers

- I. The author planned the study together with the co-author, performed the pilot study, analyzed the results, and was the main contributor to the writing of all sections and of the discussion and the final review of the paper, with the assistance of the co-author.
- II. The author planned and performed part of the pilot study together with the co-authors, performed the statistical analysis and was the main contributor to

the writing of all sections and of the discussion, with the assistance of the co-authors.

- III. The author planned the study together with the co-authors, performed the pilot study, analyzed the results, wrote the article together with the co-authors and did the final review of the paper.
- IV. The author planned the study together with the co-author, performed the pilot study, analyzed the results, and was the main contributor to the writing of all sections and of the discussion and the final review of the paper, with the assistance of the co-author.
- V. The author planned the study together with the co-author, performed the pilot study, analyzed the results, and was the main contributor to the writing of all sections and of the discussion and the final review of the paper, with the assistance of the co-author.

Other related publications

Conference abstracts

Lidén A., Holmes A., Heidfors I., Rydberg H., Persson, K.M., April 2013, Nationell Dricksvattenkonferens (National drinking water conference), Gothenburg, Sweden: *GenoMembran i Råberga – resultat av ultrafilterberedning* (Swedish)

Lidén, A., Holmes, A., Persson K.M., August 2013, 7th IWA Specialised Membrane Technology Conference, Toronto, ON, Canada, *Nom-removal in Drinking Water with Coagulation on UF*

Lidén A., Holmes, A., Lavonen, E., Persson, K.M., October 2013, 5th IWA Specialist Conference on Natural Organic Matter Research, Perth, Australia, *Effect by NOM Characteristics on the Membrane Process*

Lidén, A., Holmes, A., Dekker, R. and Persson, K.M., June 2014, 9th Nordic Drinking Water Conference, Helsinki, Finland, *Membrane Trials at Ringsjöverket -Experiences from removing NOM with UF and NF membranes*

Lidén, A., Holmes, A., Persson, K.M., April 2015, Nationell Dricksvattenkonferens (National drinking water conference), Gothenburg, Sweden: *Driftjämförelse mellan ultrafilter och nanofilter av hålfibertyp* (Swedish)

Lidén, A., Lavonen, E., Persson, K.M., September 2015, 6th IWA Specialist Conference on Natural Organic Matter in Water, Malmö, Sweden, *Conditions affecting NOM removal efficiency by a hollow fibre nanofilter and Comparison of the NOM character in NF permeate and chemically treated water.*

Lidén, A., Persson, K.M., September 2016, 10th Nordic Drinking Water Conference, Reykjavik, Iceland, *Effects and detection of leaking fibers in a hollow fiber nanofilter.*

Reports

Lidén, A., Keucken, A. och Persson, K.M., 2015. GenoMembran. Slutrapport från projekt 2012–2015, Svenskt vatten utveckling, rapport 2015–20, Bromma, Sweden

Journals and Magazines

Lidén, A., Holmes, A., Dekker, R. and Persson, K.M., 2014. Kalvotekniikkakokeilu orgaanisen aineksen poistamiseksi Ruotsissa, *Vesitalous* 6/2015, 22-25 (in Finnish, translated from English)

Abbreviations

$\beta:\alpha$	freshness index, calculated from an EEM
AIT	air integrity test
AOC	assimilable organic carbon
BDOC	biodegradable dissolved organic carbon
CEB	chemically enhanced backwash
CEFF	chemically enhanced forward flush
DBP	disinfection by-product
DOC	dissolved organic carbon
DW	drinking water
EEM	excitation-emission matrix
FI	fluorescence index, calculated from an EEM
GHG	greenhouse gas
GW	groundwater
HC	hydraulic clean
HFNF	hollow fiber nanofilter
HFUF	hollow fiber ultrafilter
HIX	humification index, calculated from an EEM
LRV	log removal value
MWCO	molecular weight cut-off
NF	nanofiltration
NOM	natural organic carbon
SUVA	specific UV-absorbance

TMP	transmembrane pressure
TOC	total organic carbon
UF	ultrafiltration
UVA ₂₅₄	absorbance at wavelength 254 nm
VLP	virus-like particle
WTP	water treatment plant

Contents

1. Introduction.....	1
1.1 GenoMembran – research project.....	2
1.2 Objectives.....	2
2. Theoretical background.....	5
2.1 Natural Organic Matter and Surface Water.....	5
2.1.1 Brownification.....	6
2.1.2 Implication for drinking water producers.....	7
2.1.3 Analysis methods.....	8
2.2 NOM removal in conventional treatment.....	10
2.3 Membrane technology and NOM removal.....	11
2.3.1 Ultrafiltration.....	12
2.3.2 Nanofiltration.....	13
2.3.3 Membrane integrity – breaches and monitoring.....	14
3. Methods and materials.....	17
3.1 Raw water sources.....	17
3.1.1. Lake Bolmen.....	17
3.1.2 Lake Ringsjön.....	18
3.1.3 River Stångån.....	18
3.1.4 Görvältn Bay (Lake Mälaren).....	19
3.1.5 Lake Stora Neden.....	19
3.1.6 Valbo Esker and Lake Hyen.....	19
3.2 Studied water treatment plants.....	20
3.3 Membrane modules.....	20
3.4 Pilot plants.....	22
3.4.1. NF-pilot 80.....	22
3.4.2 Quick Scan.....	24
3.4.3 Spiral wound NF-pilot.....	25
3.4.4 UF-pilot.....	25
3.5 Sampling and analyses.....	26
3.5.1 Operational data and online measurements.....	26
3.5.2 Traditional chemical analyses.....	26
3.5.3 Virus-like particles.....	27
3.5.4 Fluorescence and indices.....	27

3.6 Operation scheme and methodology	28
3.6.1 NF-pilot 80 operation.....	29
3.6.2 Other pilot studies.....	32
3.6.3 Analyses of the data.....	32
4. Improved NOM removal by membrane filtration.....	35
4.1 NOM removal.....	35
4.2 NOM characterization for better treatment (Paper II)	36
4.3 Microbiological barrier and breaches in the integrity (Paper III)	38
4.4 Membrane filtration for polishing.....	41
4.5 Economic and environmental assessment (Paper IV)	44
4.5.1 Operational data.....	44
4.5.2 Economic estimation	48
4.5.3 Environmental impact	48
4.5.4 Remarks.....	50
4.6 Membrane resistance	50
5. Future considerations for surface water treatment	55
5.1 Options for additional resilience (Paper V).....	56
5.2 DBPs.....	57
5.3 Biological availability.....	58
5.4 The future for membrane filtration in Sweden.....	59
6. Limitations of the study and continuation from here	61
6.1 What is next?.....	62
7. Conclusions.....	65
References.....	67

1. Introduction



“If there is magic on this planet, it is contained in water.” - Loren Eiseley



Water. A thirst quencher. A divider and a connector. A provider of dignity and a fundament for development. There is no reason to doubt the importance of water; for a creature’s physical survival, and for her mental wellbeing. It is impossible to overstress the significance of healthy aquatic systems, well-functioning wastewater systems and dependable drinking water. The fact that UN did not declare water as a human right until 2010 is a mystery. No one should have to become ill from the most basic of all needs. No one should have to carry the burden to provide water for their family daily.

UN’s report on Water and jobs from 2016 (WWAP, 2016) identified that 78 % of all jobs are dependent on water. In reality, all jobs should be noted as dependent on water, because everyone is dependent on water. This heavy task, of supplying the world with water and taking care of the wastewater, is tackled by around 1 % of the global population.

Sweden is lucky, because water is abundant. The ice age created 100,000’s of lakes and today the waterbodies cover 9 % of the Swedish land area. There is, however, a low access to groundwater, thus the lakes are not only valuable for recreational purposes, but they are vital for the Swedish drinking water supply.

The boreal freshwater ecosystems have been changing in recent decades, with higher level of natural organic carbon (NOM) in the water. There are several suspected causes for the increased color, which has been named *brownification*. This increased water color has been noticed by many drinking water producers, which must adapt to new prerequisites. Many Swedish drinking water treatment plants (WTPs) were built in the middle of 20th century, and was adapted to the much clearer water from the lakes during that time.

1.1 GenoMembran – research project

The work presented in this dissertation was part of a national project, GenoMembran, which involved five water utilities, three universities, a couple of private companies and a research institute. This project ran over the course of four years, and research was realized within three separate doctoral projects.

An urgent need for improved microbiological barriers in drinking water supply was evident after a couple of cases of *cryptosporidium* that caused outbreaks in the winter of 2010-2011, spreading through the municipal water supply. This had made the Swedish drinking water producer wary of the risk from failing microbial barriers. Membrane filtration processes, ultrafiltration (UF) and nanofiltration (NF), are good microbiological barriers, that can add barriers in the treatment plants. It is certain that they remove parasites, but also reduces the number of virus particles. But, Swedish drinking water producers had a limited experience of membrane filtration, and its applications.

The drinking water producers were facing the challenges with increasing color and higher total organic carbon (TOC) concentrations of the raw water. To handle that, there was a need for new methods for NOM removal, and more knowledge about the NOM and its influence on the treatment efficiency. Membrane filtration was, and still is, an interesting alternative for introducing a dependable microbiological barrier with the additional advantage of a possible NOM removal.

These perspectives were incorporated in GenoMembran, which was a project that combined practical experiences with analytical studies of the NOM characteristics. Within GenoMembran, ultrafilters and nanofilters were trialed at several drinking WTPs. Trials evaluated NOM removal by UF with coagulation pretreatment and NF with and without pretreatment. Fluorescence spectrometry has been the chemical analysis in focus for the NOM characterization. In addition to other more established water analysis methods, fluorescence has been a part of the tools to evaluate the capacity and performance of the membrane filtration.

1.2 Objectives

To investigate the possibility of an improved NOM removal by membrane filtration was the overarching theme of this dissertation. Additional focus has been placed on the viability of membrane filtration applications at Swedish surface water treatment plants. The specific objectives of this thesis were:

- Through pilot studies, evaluate the NOM removal by membrane filtration: ultrafiltration with coagulation pretreatment or nanofiltration.

- To identify NOM related parameters that may influence the NOM removal efficiency of the membrane filtration processes and the existing conventional treatment by comparing data from several raw water sources.
- Evaluate if and how NOM related parameters can be used for online and offline monitoring of process performance, specifically in the application of membrane filtration and microbiological barrier effect.
- Investigate what chemical characteristics, such as NOM related parameters, influences the NOM removal and the process performance.
- Evaluate the affordability and the environmental impact of the processes.
- To assess what implications the results from the pilot studies may have for the future development of Swedish drinking water treatment plants.

2. Theoretical background

In boreal areas, surface water treatment aims to reduce the content of NOM and pathogens in the process. For this to be efficient, there is a need for thorough knowledge in water chemistry, process adaptation and monitoring methods of the pathogens and NOM, to ensure a stability of the treatment process.

2.1 Natural Organic Matter and Surface Water

NOM is a complex mix of substances of various molecular sizes, complexes and functional groups (Fabris et al., 2008). It varies in weight, charge and orientation, and therefore, it is hard to characterize and predict the specific NOM in a water body. The substances are terrestrial matter transported into the aquatic ecosystem, or aquatic matter from production by algae, bacteria and aquatic plants (Sillanpää, 2015). All freshwater systems contains NOM, but the character differs depending on their geochemical system and hydrological conditions (Sillanpää, 2015).

Humic substances constitute a major part of NOM in freshwaters, and around 50 % of the TOC in water has been characterized as humic (Sillanpää, 2015). These humic substances are mostly acids, either humic or fulvic acids, which are aromatic compounds bridged by aliphatic chains. Fabris et al. (2008) showed that the largest part of the NOM in surface waters in Norway and Australia is strong hydrophobic acids. These are generally humic acids of higher molecular weight (Fabris et al., 2008). The compounds with the second largest prevalence in most raw water sources is the fulvic acids (or slightly hydrophobic acids) (Fabris et al., 2008).

Since the mix of compounds is so complex, there is a need for useful analysis methods. NOM can be measured, analyzed and characterized by various methods. Many of these illustrate only one aspect of the character: physical (such as weight and size), chemical or biochemical (Filella, 2009). For a complete understanding of the constituents in the mix of NOM, several methods should be combined, yet, there will still be several unknowns about the species in the water. For engineering applications, the analysis methods can be chosen based on the information a specific method can supply, and by the needed time and equipment for each method. The most relevant for water treatment studies are in general bulk measurements, chemical characterization and biological liability of the NOM. Bulk measurements give the least complete picture

of the NOM character, but is useful as an indicator for the overall process performance. Characteristics of the NOM, such as liability, indicated by the biodegradable dissolved organic carbon (BDOC) or assimilable organic carbon (AOC), is useful for the microbiological stability of the drinking water. For many forms of water treatment, e.g. with coagulation, chemical character of the NOM is important for the expected performance of the process.

2.1.1 Brownification

During the past decades, surface water in boreal areas in the northern hemisphere has shown trends of increased concentrations of organic carbon, and an additional increase in color, a phenomenon that has been named *brownification*. These trends have been seen in large parts of Scandinavia (Hongve et al., 2004; Ledesma et al., 2012), in North America (Evans et al., 2005; Monteith et al., 2007) and in the UK (Evans et al., 2006; Worrall et al., 2004). Lake Bolmen, situated on one of the most affected latitudes, has demonstrated a trend of decreasing secchi depth and increasing TOC concentration (Figure 1). These trends started in the middle of the 1990's, and although it has been relatively stable in 2010's, the new levels are higher for TOC and color, and the secchi depth has decreased (Figure 1). A change of the NOM character has been seen, and color and UV-absorbance have increased more rapidly than TOC (Figure 1b and c), which likely is related to changes in the composition of NOM, with an increasing concentration of humic substances causing the steeper trends of browning color in the water.

It has been shown that the acidification from the industrial air emissions is a possible cause for the change in the NOM content; acidic soils lead to a lower mobility of humic substances and other types of NOM (Ekström et al., 2011). Monteith et al., (2007) saw that watersheds with a lower degree of acidification had higher concentrations of TOC in the water bodies. Other explanations have been suggested, connected to increased precipitation levels, linking rainfall data with TOC concentrations in Scandinavian watersheds (Köhler et al., 2009). Due to the climate change, Scandinavia, UK and North America have predicted increases of precipitation, hence, the changes in NOM could still be ongoing in these watersheds.

Land use change have also been seen to impact the mobility of NOM (Friberg et al., 1998). A forth type of study have seen connections between water color increase and increased iron concentrations in the watersheds (Kritzberg and Ekström, 2012). Thus, the *brownification* has been discussed as a possible regression back to original state of the aquatic environments, before the industrialization and acidic rains (Ekström, 2013). Yet, it might also be one of the many consequences of human exploitation of earth, or possibly a combination of both. In any case, it has brought on new challenges for the drinking water producers in the boreal areas of the globe, and the new situation must be met by adapting the processes.

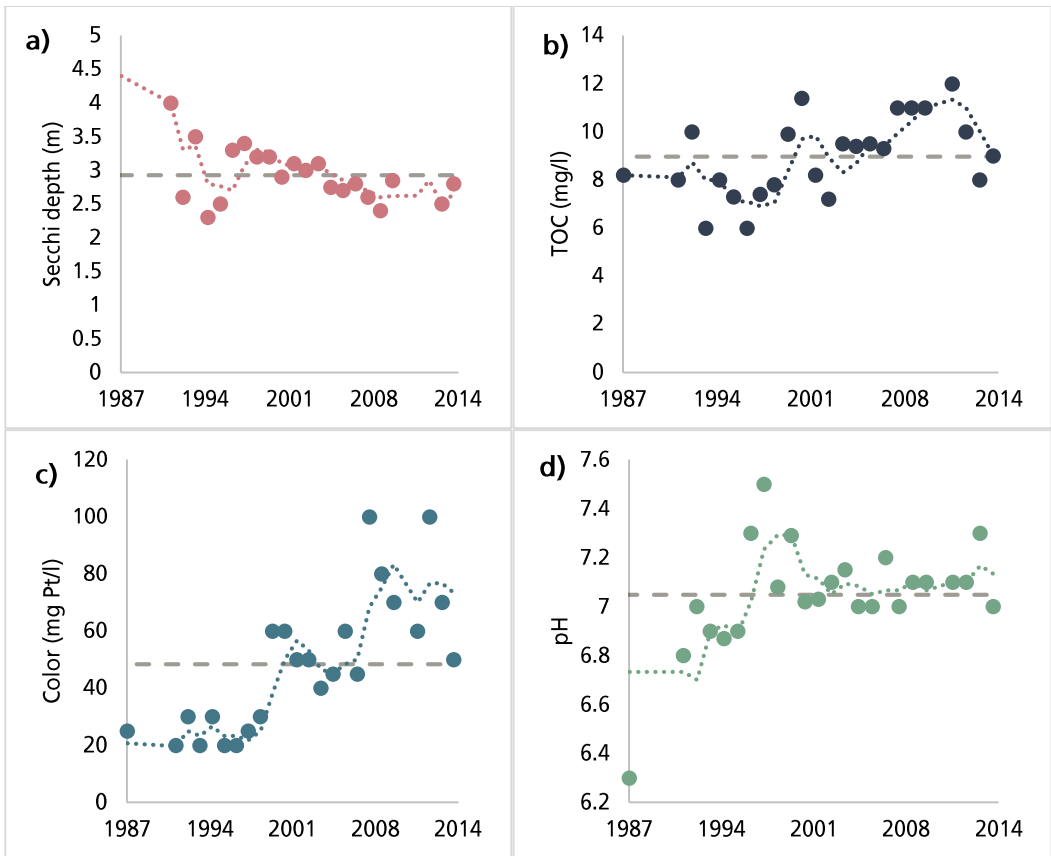

Figure 1 a) Secchi depth, b) total organic carbon (TOC), c) Color and d) pH (with moving average) in southern Lake Bolmen, where the inlet to Ringsjö water treatment plant is located, one of the largest water treatment plants in Sweden.

2.1.2 Implication for drinking water producers

NOM in the raw water is a major task for the drinking water producers. Too much NOM in the outgoing water can cause aesthetical problems. A water with a bad taste and smell is not hazardous to health, but can be unappealing, and damage the confidence of the consumers. The same is true for colored raw water.

NOM in the drinking water can lead to undesirable substances or contamination. A prevalent risk for the drinking water supplier is bacterial growth in the distribution system, due to the bacterial nourishments from TOC and nitrogen (Camper, 2004). UV-disinfection has an increasing popularity among drinking water producers, but NOM brings negative effects on its efficiency. Humic substances, one of the dominating constituents of NOM (Sillanpää et al., 2015), has a high UV-absorbance at 254 nm (UVA_{254}), the wavelength that is the main output for UV lamps used in

disinfection (Hijnen et al., 2006). In addition, NOM reacts with the disinfecting chlorine. This increases the needed dose of chlorine to assure a safe drinking water, but it also leads to the formation of disinfection by-product (DBPs). These DBPs have a suspected adverse health effects, and some of them has been shown to be carcinogenic (Hrudey, 2009; Nikolaou et al., 2004; Richardson et al., 2007).

Consequently, the *brownification* creates a demanding new situation for the drinking water producers. With higher ingoing concentrations of TOC to the WTPs, the processes must be improved for an increased NOM removal efficiency. Most WTPs in Sweden were built in the mid-20th century, and most use flocculation/sedimentation and sand filtration processes, with few innovating updates since the time they were built. As the TOC in the raw water has increased, the WTPs have increased their coagulant dose in response (Figure 2). This has been the easiest way for the WTPs to meet the requirements under the new conditions without new investments, but it has also resulted in higher operation costs for the drinking water producers. In addition, most coagulants will eventually reach a maximum efficiency, after which the NOM removal may not be improved.

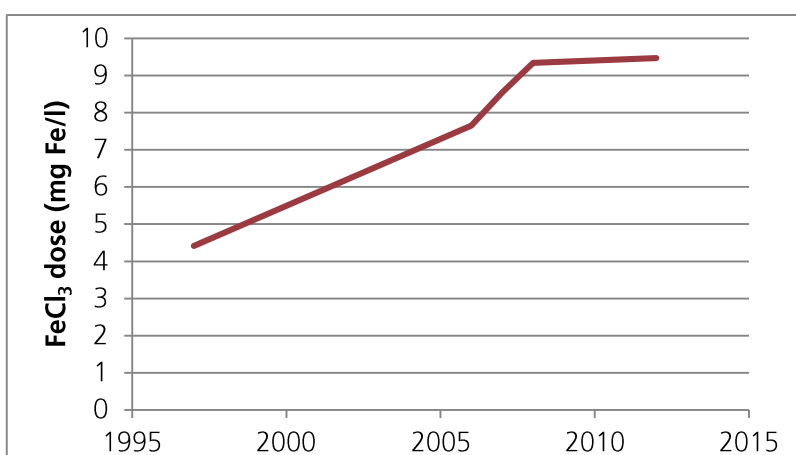

Figure 2 Coagulant dose of FeCl₃ as mg Fe/L at Ringsjö WTP, receiving water from Lake Bolmen (Data on chemical consumption from the annual technical reports from Sydsvatten 1996-2013).

2.1.3 Analysis methods

It is impossible to evaluate a process without monitoring, and for water quality, chemical analyses are needed. Bulk measurements are often quick and, with the right equipment, relatively straight-forward to carry out. With the complex chemistry of natural waters, other methods that can distinguish between different kinds of moieties are needed. Advanced methods offer fractionation of the NOM in relation to size and functional groups. Chromatography, nuclear magnetic resonance and mass

spectrometry give detailed information of the type of organic matter that is found in a sample. Due to the required equipment, time and knowledge, these methods are seldom possible to use frequently for operators. Quick analyses, preferably online methods, are sought.

Traditional analyses are often bulk measurements. Metal concentrations, by inductively coupled plasma atomic emission spectroscopy (ICP-AES), give information about water hardness and other inorganic substance in the water. TOC, or alternatively chemical oxygen demand (COD), quantify the total concentration of organic carbon, i.e. organic matter content. COD and TOC are not interchangeable, since they measure different chemical characters, but they provide results in similar in ranges. If the samples are first filtered through a 0.45 μm filter, the TOC results are considered as dissolved organic carbon (DOC).

UV absorbance at 272 nm have a correlation to the content of humic substances, or rather the aromatic substances (Traina et al., 1990). A close correlation was found between DOC and UVA_{254} by Brandstetter et al., (1996), likely related to the proportion aromatic substances, which, as mentioned above, is often a majority of the TOC in freshwater samples. Weishaar et al. (2003) showed that specific UV absorbance (SUVA), which is quota between the UVA_{254} and DOC concentration, can be an indication of the reactivity of the DOC, foremost in relation to formation potential of DBPs.

In the past decades, fluorescence spectroscopy has been used for the characterization, quantification and identification of the dynamics of NOM (Hudson et al., 2007). Some organic compounds absorbs light at certain wavelength (chemophores) of which some re-emits light after absorption (fluorophores) (Mopper et al., 1996). The wavelength and intensity of the re-emitted light can give a fingerprint of the fluorophores in a sample. These are generated by excitation of the samples over various wavelengths, for which the intensities of multiple emission wavelengths are measured. The result for a sample is illustrated in an excitation-emission matrix (EEM).

There are methods to quantify differences between EEMs for different samples. Common ways are established indices and “peak picking” (Fellman et al., 2010). Fluorescence index (FI) (see chap 3.5.3) is an established index which show the relative content between aromatic versus non-aromatic matter, that can be interpreted as microbial derived matter versus terrestrial derived matter, or level of decomposition (Cory and McKnight, 2005; Fellman et al., 2010). Indices like FI are often calculated from difference in intensities of specific peaks in the EEM. It is also possible to analyze these peaks separately, which give information about the relative abundance of a specific character of NOM. Five peaks were established relatively early (Coble, 1996; Coble et al., 1990), of which two have been related to protein-like substances (peak T and peak B), one to low molecular humic-like matter (peak M), and two to high molecular weight humic-like matter (peak A and peak C) (Coble, 1996; Fellman et al., 2010).

Fluorescence can be a possible online method, and already today probes are available for monitoring an operating process (Singh et al., 2015). Changes in fluorescence

compounds, analyzed by differences in the EEMs such as indices and peaks, have been applied in evaluation of drinking water processes, coupled with e.g. TOC, and have shown promise as a analyzing method for optimization of treatment processes (Baghoth et al., 2011a; Köhler et al., 2016; Lavonen et al., 2015, 2013).

Cultivable bacteria are often used for evaluation of the safety of the drinking water. A more complete alternative is to count all bacteria in a sample by adding SYBR Green I that stains DNA and RNA with a fluorescing color. This method, called virus-like particles (VLPs) enumeration, counts all bacteria and virus, thus it is not limited to cultivable bacteria, which is the case of the generally applied heterotrophic plate count (Patel et al., 2007). It does not, however, distinguish between living or dead cells. The great advantage of counting both viruses and bacteria makes this method very suitable for evaluating the microbiological barrier effect from a treatment method, since it will count most cells and viruses that pass through the system.

2.2 NOM removal in conventional treatment

Chemical treatment, flocculation followed by sedimentation, has been the main process for NOM removal in conventional drinking water treatment. It is often combined with sand filtration; both rapid and slow sand filtration are common in Sweden. Aluminum or ferric based coagulants are appropriate for NOM reduction, which has no hazardous effects on human health after proper treatment and polishing steps (Livsmedelsverket, 2015). This combination of treatment steps is common in large Swedish WTPs, which provides a good NOM removal and multiple microbiological barriers.

Coagulation is often the treatment step that contributes to the largest removal of NOM, measured as TOC and UVA_{254} (Baghoth et al., 2011b; Eikebrokk and Juhna, 2010; Lavonen et al., 2015). The level of optimal coagulant dose is dependent on the chemical character of NOM in the treated raw water (Baghoth et al., 2011b; Eikebrokk and Juhna, 2010; Ødegaard et al., 2010). Generally, species of high molecular mass and hydrophilic character is charge dependent and is easily removed, while low molecular weight species require higher doses of coagulants, due to a removal based on adsorption as opposed to charge neutralization (Matilainen et al., 2010). The coagulants within drinking water treatment selectively removes humic substances (Rebhun and Lurie, 1993), and SUVA usually decreases after chemical treatment. The level of NOM removal by chemical treatment has been related to SUVA in the raw water, and the higher SUVA values, the higher the NOM removal (Matilainen et al., 2010).

2.3 Membrane technology and NOM removal

Parallel to the advances in the development of membranes, the interest of incorporating membrane technology in drinking water treatment has risen. Membrane technology is a space efficient alternative for treatment processes, and it may also reduce the chemical consumption (Zularisam et al., 2010). Ultrafilters and tighter membranes can, by size exclusion and other mechanisms, entirely remove bacteria and protozoa, such as *cryptosporidium*, and to a large extent reduce virus (Antony et al., 2012; Huang et al., 2012). There are difference in the viruses depending on size, but ultrafiltration has been able to remove MS2 bacteriophage (which is similar to noroviruses in size and morphology) with a log removal value (LRV) of 4-log (ElHadidy et al., 2013; Fiksdal and Leiknes, 2006). Similar level of virus removal can be achieved by coagulation, and a combination of both could possibly enhance the virus removal (Matsushita et al., 2013). Even tighter membrane have, consequently, a higher removal (Antony et al., 2012; Matsushita et al., 2013), and a combination of ultrafiltration and reverse osmosis have been applied for a reuse of wastewater with good results on virus removal (e.g. Tam et al., 2007).

Membrane filtration can also be applied for NOM removal. WTPs across Europe has integrated a membrane treatment step, and both UF and NF have been added for improved NOM removal (Ødegaard et al., 2000). For membrane filtration, the character of the NOM substances in the feed water influences the level of removal that can be achieved. Hydrophobic substances are removed to a greater extent than hydrophilic, likely related to the size of the substances, but also to the interaction with the membrane material (Cho et al., 2000; de la Rubia et al., 2008; Lee et al., 2005).

Accumulated matter on the membrane surface by rejected substances creates an extra barrier in the filtration process (Hilal et al., 2004; Zularisam et al., 2010). Due to the flux through the membrane, the transportation towards the membrane surface is larger than the diffusion back to the bulk, a progression that has been named concentration polarization (Baker, 2012a). An added crossflow can repress this polarization by increasing the shear stress. A highly pronounced concentration polarization can lead to irreversible fouling, which is not possible to clean with chemicals. In UF, the process is often a dead-end, and fouling is repressed with membrane cleaning, preferably flushing and backwashing, at an optimized frequency.

In many cases, fouling of the membrane surface has been related to high concentrations of NOM in the feed water (Cho et al., 2000; Howe and Clark, 2002; Peiris et al., 2013), although there are also fouling because of scaling, biological fouling and deposition of particles (Zularisam et al., 2010). Studies have shown that biopolymers and colloidal substances are the main causes for organic fouling, and specifically irreversible fouling (Amy, 2008; Matilainen et al., 2010), but others have found an influence by humic substances (Fan et al., 2001; Peiris et al., 2010).

Fouling can affect the length of the membrane lifetime, but fouling can lead to other negative consequences. Operation may also be affected, and may increase the energy demand due to an increase of the required pressure. The filtering capacity of a membrane is related to the transmembrane pressure (TMP), i.e. the difference in pressure between the feed side and the permeate side (ΔP). The flux is based on *Darcy's equation*, which shows that the flux (J) is proportional to the pressure drop over the membrane (i.e. TMP) and inversely proportional to the fluid viscosity (μ), and a constant that is referred to as resistance (R) (see further in Jönsson and Jönsson, 2012):

$$J = \frac{\Delta P}{\mu \cdot R}$$

Eq. 1

Thus, it is possible to either run a process with a constant flux, adapting the pressure to counteract any changes in the other two parameters. If the process is run with a constant pressure instead, the flux will be affected with changes in the viscosity or resistance. In cold climate, the low water temperatures in the winter mean that the operators either must accept a lower flux during the wintertime, or they must increase the pressure.

Depending on the membrane pore size, the feed chemistry and the state of matter of the filtrate, the transport theory changes (Baker, 2012b). In this application, with water and porous (UF) to semi-porous (NF) membranes, Eq. 1 is applicable. The R parameter is a combined effect between different types of resistance. The membrane resistance, R_m , is the measured resistance during filtration with clean water, which is considered as the physical resistance by the material for transport through the membrane. During filtration, substances will adsorb to the membrane surface, leading to an additional resistance, R_a , and this parameter increases with more fouling. If there is an accumulation of matter on the membrane surface, it can create a cake layer, which may lead to an additional filtering effect, but also increase resistance, R_c . With or without a cake layer, the boundary layer could lead to an increased resistance, R_{bl} .

2.3.1 Ultrafiltration

Ultrafilters with a low molecular weight cut-off (MWCO), i.e. 10 kDa or larger, are not able to remove NOM at any sufficient level (Cho et al., 1999; Mijatović et al., 2004). It has been shown that a coagulant is needed to create flocs and clusters large enough to reduce TOC and UVA_{254} (Guigui et al., 2002; Kabsch-Korbutowicz, 2006; Konieczny et al., 2007). These studies have shown that the TOC reduction is in the same range as what usually achieved by conventional treatment.

Ultrafilters are often of hollow fiber type, with relatively low pressures; i.e. a TMP lower than 1 bar, and they are possible to backwash and clean with chemicals. It has become a cost efficient method to remove viruses and other pathogens: they can be run at a constant flux, as a dead-end process, with well-developed methods for flushing, backwashing and cleaning by air sparging (Baker, 2012c).

NOM that passes through the membrane has a potential to foul the membrane by adsorption on pore walls or pore blockage, which is more irreversible than cake fouling or other surface fouling (Amy, 2008). A coagulation pretreatment can reduce the fouling potential of the NOM (Dong et al., 2007; Matilainen et al., 2010; Park et al., 2002), thus having the combined effect of improved NOM removal and better operation performance.

2.3.2 Nanofiltration

NF has a MWCO smaller than the size of most NOM species, and can achieve an advanced NOM removal exceeding conventional treatment, (de la Rubia et al., 2008; Köhler et al., 2016). Norwegian experiences have shown that, over time, NF in full-scale processes can remove color at a level of 86 % (Ødegaard et al., 2000). If the MWCO is tight enough, NF can remove low molecular weight organics with 90 % (Gorenflo et al., 2003). The high removal of small molecules mean a partial removal of BDOC and AOC (Liu et al., 2013; Meylan et al., 2007; Park et al., 2005) and has demonstrated a removal of DBP precursors better than conventional treatment and UF (de la Rubia et al., 2008; Mijatović et al., 2004; Patterson et al., 2011). The NOM character matters for the level of removal, and nanofilters often have higher reduction of aromatic substances and hydrophobic fractions than total organic removal, as TOC or DOC (de la Rubia et al., 2008; Lee et al., 2005).

Nanofilters are most commonly of the spiral-wound type in process applications, which often balances the different considerations for the installment (Sagle and Freeman, 2016; Schwinge et al., 2004). Spiral-wound has a good packing density, and is relatively easy to operate. However, a concern for the spiral-wound is that they are not possible to backwash. In addition, many nanofilters are degraded by NaOCl, which decreases the possibility to disinfect the membrane (Regula et al., 2014). This entail a risk for irreversible NOM fouling, along with biofouling, especially on the feed spacers (Vrouwenvelder et al., 2009). Spiral-wound are sensitive to particles, and a good pre-filter is needed to avoid destruction of the membrane, or cake fouling.

Most Swedish raw waters are soft, commonly 4°dH (i.e. 25 mg/l as Ca) or less, which mean that there are little problems with scaling. On the other hand, hardness is important for buffering capacity, human health and chemical stability of the water in the distribution system. A tight nanofilter may reduce the divalent ions (i.e. Mg²⁺ and Ca²⁺), which then, in the context of boreal lakes, must be added again through liming.

A new type of hollow-fiber nanofilter (HFNF) was developed for the specific conditions found in boreal areas; aiming for a low ion retention, but high color removal (Frank et al., 2001; Futselaar et al., 2002; Veríssimo et al., 2005). The HFNF, also referred to as a capillary nanofilter, can be cleaned by backwashing, and chemically cleaned with NaOCl (Frank et al., 2001). The retention of ions has been shown to be lower than spiral-wound modules (Veríssimo et al., 2005), while the NOM retention is high (Futselaar et al., 2002).

NF in drinking water treatment is a relatively expensive alternative, and increases the cost for drinking water producers, compared to a conventional treatment (Gorenflo et al., 2003; Liikanen et al., 2006). Membrane module replacements and energy consumption by the pumps are the main reasons for the increased costs. The NF step was, in those studies, added to the treatment process, which should entail higher costs. Ultrafiltration may compete with conventional treatment in terms of cost (Owen et al., 1995), while nanofilters, and especially the HFNF, are more expensive and will be more expensive in most circumstances (Futselaar et al., 2002).

Due to the high energy demand, nanofiltration has been acclaimed to have a large environmental impact (Friedrich, 2002). The difference between conventional treatment and membrane filtration is dependent on what other steps there are in the conventional treatment (Bonton et al., 2012), the type of energy production (Friedrich, 2002) and whether the nanofiltration is an additional step (Liikanen et al., 2006) or if it replaces one of the conventional steps (Bonton et al., 2012).

2.3.3 Membrane integrity – breaches and monitoring

Membrane integrity is important for many types of membranes, and the development of membrane filtration for wastewater reuse has increased the importance for reliable microbiological barriers. That is, however, also a current issue in surface water treatment. Two large outbreaks of *cryptosporidium* in the winter of 2010/2011, that stagnated the two afflicted cities, has increased the concern for multiple, reliable microbiological barriers in Sweden. Several drinking water producers have turned to membrane filtration as viable options for increasing their total LRV of parasites, bacteria and viruses. Although the LRV is high for ultrafilters and tighter, it is not possible to entirely depend on the membranes as barriers if the integrity is not regularly checked.

In hollow fiber membrane, there is a risk for any individual fiber to fail. Fibers may either totally break, or the leakage is a seepage through a pinhole (Huisman and Williams, 2004). Gijsbertsen-Abrahamse et al., (2006) found that an average of fiber failure is one fiber out of 10,000-100,000 fibers per year, which could be up to one fiber in each module every year. However, integrity breaches are not an issue isolated to hollow fiber membranes, but breaches occurs for several reasons in any membrane

system (Gijsbertsen-Abrahamse et al., 2006; Huisman and Williams, 2004; Pype et al., 2016).

There have been numerous studies and innovations for integrity monitoring. There are two main types: indirect monitoring, that is aimed as an online method, and direct methods that can find the membrane module with the leak, or the exact fiber. The latter are necessary, and the online measurements needs to be combined with offline methods, such as pressure decay test, diffusive air test, and bubble point test, so that the leaking can be located (Crozes et al., 2002; Guo et al., 2010; Kruithof et al., 2001). These methods require a stop in the operation, and/or manual labor, which has no possibility to achieve an early warning when a breach occurs. Thus, a reliable online integrity monitoring method would have the economic advantage of less downtime from integrity testing, and it would mean that the membrane filtration is a more dependable disinfection step.

In the tight membranes of reverse osmosis, monitoring schemes have been based on several parameters related to the high retention of inorganic substances as well as organic substances. Conductivity, turbidity, sulfate and challenge testing by bacteriophages were all identified by Kumar et al., (2007). The latter can be performed online, but must be initiated manually. Adham et al., (1998) showed that TOC could be a possible alternative for monitoring. This has been further developed by Henderson et al. (2009) & Singh et al. (2015) who have been studying fluorescence as a monitoring method for the process. This method has shown potential for detecting small changes in the dissolved part of NOM character (Henderson et al., 2009) and have been useful for online monitoring of the performance (Singh et al., 2015).

For low pressure membranes, research has confirmed that TOC is a possible option for monitoring the performance (Henderson et al., 2010) or integrity (Walsh et al., 2005). For microfiltration and UF, online monitoring of turbidity and particle count have been applied for integrity monitoring (Naismith, 2005; Panglisch et al., 1998; Walsh et al., 2005). Walsh et al. (2005) noticed that the particle counters could not detect any changes when a fiber was compromised, and there was no statistically significant difference between a compromised membrane and their control membrane. The particle counters require sensitive meters to be successful as indication of a breach (Panglisch et al., 1998), but those are expensive, must be calibrated regularly, and requires knowledgeable operators (Guo et al., 2010).

Methods related to NOM characteristics have thus shown a great potential as indirect methods for integrity monitoring (Adham et al., 1998; Guo et al., 2010). Walsh et al. (2005) did find a significant difference in DOC and color in permeate from a compromised membrane compared to the control membrane, which they also considered an indication of the potential for monitoring the integrity by UVA_{254} . There have been few studies for UVA_{254} specifically as a monitoring parameter. Ferrer et al. (2015) and Galvañ et al., (2014) found no correlation between UVA_{254} in permeate and LRV for virus or other microorganisms. Their membrane had a comparatively large pores size, 40 nm, which is too large to remove all types of viruses. The reduction of

UVA₂₅₄ and TOC were 15 % and 16 % respectively, and they experienced no breaches in the integrity during their 2-year trial (Ferrer et al., 2015). Consequently, any changes in the retention of NOM cannot have been pronounced, and under those circumstances the suggested microorganisms are a better alternative to UVA₂₅₄ for integrity monitoring (Galvañ et al., 2014).

3. Methods and materials

This thesis is based on the data acquired during several pilot studies. Full scale membrane modules were trialed on site at six WTPs in Sweden. Five of these WTPs treat surface water, four receives water from lakes, one from a watercourse, and one water from an Esker with a large part infiltrated water from an adjacent river. One of the WTPs has an additional lake as a reserve water source which was included in the pilot study.

Pilot studies and sampling were performed over the course of three years. At two of the locations, the author of this thesis was involved in executing the pilot studies, while the other locations mainly were carried out by collaborators. These two locations, Ringsjö WTP (Lake Bolmen and Lake Ringsjön) and Råberga WTP (River Stångån) have thus been the chief focus of this thesis, although data from the four remaining WTPs have been included for comparison in statistical analyses.

3.1 Raw water sources

Due to the crystalline basement that dominates the bedrock of the Scandinavian Peninsula, the water sources are generally soft. Additionally, more than half of Sweden is covered by forests, which results in a high production rate of humus that is later transported by the abundant precipitation to the water bodies. Consequently, Swedish lakes and rivers have a high content of NOM and often a low buffering capacity. The water bodies included in this work supplies around a quarter of the Swedish populations, thus they are not only exemplifying possible conditions and NOM character that can be found in Sweden, but are also of great importance for the Swedish society.

3.1.1. Lake Bolmen

Lake Bolmen is located in the province Småland, just north of Skåne. The catchment area is mainly forest (48 %), marsh lands (22 %) and lakes (20 %), with only a small fraction cultivated land (9 %). In the aquatic system, NOM of terrestrial origin

dominates, and there are few outlets from human activities. The lake is oligotrophic, but has a TOC of around 10 mg/L and a high humic content (Table 1).

The water from the lake travels through a bedrock tunnel of 80 km and a pressurized pipe for 25 km, before it reaches Ringsjö WTP. Due to intrusion in the tunnel, the water entering the WTP contains around 6 % groundwater.

Table 1 Water quality in the raw water sources, averages during the study period. (GW=groundwater, n.d. = no data)

Water body	TOC (mg/L)	UVA (cm ⁻¹)	SUVA (L/(mg·m))	Hardness (mg/L as CaCO ₃)	Turbidity (FNU)
River Stångån	9.4	0.30	3.2	46	4.4
Lake Bolmen	9.6	0.39	4.1	23	2.0
Lake Ringsjön	8.0	0.23	2.9	98	3.5
Görväln Bay	9.3	0.29	3.1	30	n.d.
Lake Stora Neden	3.5	0.11	3.6	13	n.d.
Valbo Esker (GW)	2.5	0.05	2.0	128	0.2
Lake Hyen	6.5	0.18	2.7	11	0.6

3.1.2 Lake Ringsjön

Lake Ringsjön is a eutrophic lake in southern Sweden. The catchment area is dominated by agriculture (41 %), forest (31 %), fields (11 %) and lakes (10 %). It is a relatively alkaline lake, with a higher hardness compared to most other Swedish water sources (Table 1). During summer time, the lake has a problem with algal blooms due to the nutrient discharge by the surrounding agriculture.

Lake Ringsjön used to be the main water source for Ringsjö WTP, that is located close to the lake. Today, the lake is a reserve water source and it has been used when the tunnel from Lake Bolmen has been closed for reparation.

3.1.3 River Stångån

River Stångån is a watercourse in south-eastern Sweden. It runs in a northward direction, through a lake system and woodlands, passing through the city of Linköping before discharging into Lake Roxen. The catchment area consists mainly of boreal forest (66 %) with a small portion agricultural land (10 %) and lakes (9 %). Storm water outlets and other human activities mean that the river can be affected after rainfall, and the turbidity can increase from 6 FNU to 80 FNU within hours. The TOC concentration and hardness are similar to Lake Bolmen and Görväln Bay (Table 1).

River Stångån serves as one of the water sources of the city, and supplies water to Råberga WTP. The WTP is located next to the river, from which water is pumped from an intake well.

3.1.4 Görväln Bay (Lake Mälaren)

Görväln Bay is a part of Lake Mälaren, which is the third largest lake in Sweden. Located in the southeast part of the country, it meets the Baltic Sea in Stockholm. The catchment area is dominated by forest (60 %), cultivated land (20 %) and lakes (11 %). There are many people living in the catchment area, thus the remaining land area is mainly domestic or industrial. Görväln Bay is located in the northeastern part of Lake Mälaren, with a mix of the discharge from the north, and the water in the lake as a whole. The water quality varies over the year, due to the changing mixing conditions.

The WTP is located on an island on the shore of Görväln Bay. The intake to the WTP has two different depths, depending on the ice cover and the water quality conditions at the two depths (4 m or 22 m).

3.1.5 Lake Stora Neden

Lake Stora Neden has a catchment area that is dominated by boreal forest (69 %) and lakes (20 %). The lake mixed with a groundwater source (10 %) is the water source for Kvarnagårdens WTP in Varberg. It is an oligotrophic lake, with low values of TOC concentration (Table 1) that has increased due to the *brownification*. Until recently, there was no coagulation at the WTP, but due to the increased concentration of TOC, a remodeling of the WTP was needed. Nowadays, the WTP includes a direct filtration by ultrafiltration, with coagulation pretreatment.

3.1.6 Valbo Esker and Lake Hyen

The water received from the Valbo Esker is part groundwater and part infiltrated water from the River Gavleån. The land use in the catchment area of the river is forest (64 %), lakes (17 %), urban (8 %) and clearings (5 %). River Gavleån has experienced increasing concentrations of TOC and color during the past decades, and a pretreatment step has been installed to remove some of the NOM before infiltration into the esker. Lake Hyen is part of the same catchment area, but is located where there is no urban land use. Forest still dominates (65 %) but there is a larger part lakes (30 %) and similar part clearings (6 %). The water in the lake and river has a low alkalinity, and the TOC concentration is around the Swedish average for surface water (Table 1). However, the soil layer is a calcium rich glacial till, thus, the hardness increase from

infiltration, and the artificial groundwater has become hard when it reaches the treatment plant (Table 1).

3.2 Studied water treatment plants

Five surface WTPs and one groundwater WTP were included in this study. At the time of the sampling, four of the surface WTPs applied coagulation, two with alum (Råberga WTP and Görväln WTP), one with PACl (Hofors WTP) and one with ferric chloride (Ringsjö WTP). Four treatment trains included rapid sand filtration, which in two was followed by slow sand filtration (Ringsjö WTP and Råberga WTP), and in one followed by activated carbon filtration (Görväln WTP). The fifth surface WTP (Hofors WTP) had a vertical upflow sand filter followed by an activated carbon filter. All WTPs chlorinated the water before it left the WTPs. The groundwater treatment plant only applied disinfection after intake.

After the pilot studies were performed, some of the WTP processes have been upgraded, and thus the circumstances for the WTPs have changed to a varying degree.

3.3 Membrane modules

Three types of membranes have been trialed in this study. Two are inside-out hollow fiber membranes, with the same inner diameter of the fibers, 0.8 mm. They came from Pentair X-Flow and have the same size of the encasing, making them interchangeable in a pilot plant adapted for the two processes.

The hollow-fiber ultrafilter (HFUF), Aquaflex, is a porous ultrafilter with a MWCO of 150 kDa. It is made from polyethersulfone (PES), which is stable to oxidizing substances within the pH range allowed (pH 2 – 13). One module contains 15,000 fibers, and has a membrane area of 55 m².

The hollow-fiber nanofilter (HFNF), HFW 1000, is a membrane especially developed for high organic retention but low ion retention. The MWCO is 1 kDa, and it is made from modified polyethersulfone (SPES) which is resistant to oxidizing detergents (pH 2 – 11). The membrane area is 40 m², which is due to a lower amount of fibers per module compared to the HFUF: 11,000 fibers.

A thin-film composite nanofilter from Dow was used for a smaller study. The MWCO of this membrane is 0.3 kDa, and it is commonly used for NOM removal due to the low MWCO. It is a spiral-wound membrane with a membrane surface of 7.6 m² made from polyamide.



Figure 3 The study sites in this project: 1) Lake Hyen and Hofors WTP, 2) Valbo Esker and Sätra WTP, 3) Görvån Bay and Görvån WTP, 4) River Stångån and Råberga WTP, 5) Lake Bolmen, 6) Lake Ringsjön and Ringsjö WTP.

3.4 Pilot plants

Three different types of pilot plants were used for this study. One was a fully equipped pilot plant located in a mobile 20 feet container, and the others were smaller ones on platforms that could be placed inside the treatment plants.

3.4.1. NF-pilot 80

This pilot plant, which was constructed and owned by Pentair X-flow, was an automated system in a 20 feet (6.1 m x 2.4 m) isolated container. A steering and logging system was adapted to fit the pilot and the specific conditions at the sight. Pentair X-flow has developed a control software, ViCA, that operated the pilot plant with settings adapted for the current module and raw water. The operation was based on a fixed flux from which the TMP was changed in a feedback loop to maintain the flux.

Figure 4 show a schematic diagram of the pilot plant system. The pilot was fed with water from the intake to the WTPs, and treated the same raw water as the full scale process. Before reaching the feed tank in the pilot, the raw water was filtered in a strainer of 300 μm . In the feed tank, coagulant and pH-adjusting chemicals, i.e. an acid (HCl) and a base (NaOH), could be dosed, which was implemented during the HFUF operation. The feed pump fed the membrane from the top of the vertically oriented module, after which permeate was collected in the feed tank. If necessary, the concentrate was bled through a waste stream, decided by a set value for the gross recovery.

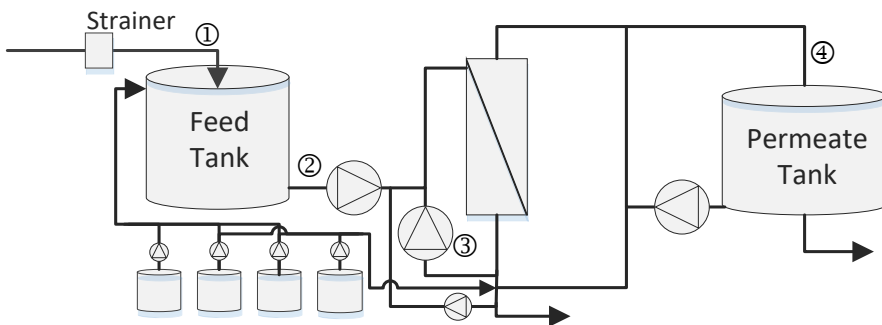

Figure 4 Schematic diagram of the pilot plant. Numbers show locations of sampling points (from Paper I).

Due to the difference in MWCO, the operation of the pilot differed depending on what module that was in use. The HFUF could be operated as a dead-end process, after adding coagulant and pH-adjusting chemicals. The low MWCO of the HFNF demanded a circulation, to control the concentration polarization on the membrane surface. The HFNF was operated with a bleed flow, while the HFUF was not. Both

modules was regularly cleaned; every 20 – 30 min for the HFUF and every 60 min for the HFNF, the membranes had a hydraulic clean (HC) (see Table 2 for specification). The HFUF required a HC more often than the HFNF due to the coagulant and the lack of circulation and bleed flow. The chemical clean differed to some extent between the two modules (described in Table 2) and the chemically enhanced backwash (CEB) used for the HFUF took less time, but was needed more often than the chemical enhanced forward flush (CEFF) used for the HFNF. CEB and CEFF both had two types, type A that removed organic contaminants and disinfected the system, and type B that removed inorganic contaminants. Due to the soft waters, type B of CEFF was rarely performed since there was little indication of any fouling problems due to the inorganic contaminants.

Table 2 Cleaning regimes for the programs in the pilot plant (adapted from Paper I).

Cleaning regimes	Chemicals	Duration	Steps	Module
Hydraulic clean (HC)	None	1.5 min (30 s for each step)	1) down-to-top flushing 2) top-down flushing coupled with backwash 3) top-down flushing coupled with backwash and air sparging	Both
Chemical enhanced backwash (CEB)	NaOH and NaOCl, pH 11, 350 ppm Cl (A) HCl pH 2 (B)	15 min for each of A and B	1) Module filled with permeate and chemicals 2) 10 min Soaking 3) Backwashed 4) Rinsed	HFUF
Chemical Enhanced forward flush (CEFF)	NaOH and NaOCl, pH 11, 350 ppm Cl (A) HCl pH 2 (B)	70 min for each of A and B	1) Module filled with permeate and chemicals 2) Chemical mix circulated slowly over membrane surface for 60 min 3) Flushed 4) Backwashed	HFNF

In the papers, a normalized flow is presented when considered useful, to aid comparisons to other studies. All normalized fluxes are calculated for 20°C (J_{20}):

$$J_{20} = J_T \cdot \frac{\mu_T}{\mu_{20}}$$

Eq. 2

Where J_T is the operation flux at the water temperature T , μ_T the dynamic viscosity at the water temperature T , and μ_{20} the dynamic viscosity at temperature 20°C.

3.4.1.1 Air integrity test

Due to the risk of breaches in the integrity, this pilot, NF-pilot 80, was equipped with the equipment for an air integrity test (AIT). It was a manually initiated diffusive airflow test that, after draining the membrane, pressurized the feed side with air (1 bar). The flow on the permeate side was checked against a normalized/expected level of airflow, and when the flow was higher the integrity was considered breached. The difference in diffusion through intact and compromised membrane fibers is 100-fold and this method has proven to be able to find 1 compromised fiber among 10^6 (Guo et al. 2010).

The AITs was performed regularly, with extra occasions when suspicions of a fiber failure were raised. If a leaking fiber was confirmed, the module needed to be detached, and through a bubble point test the leaking fibers were identified and plugged. In this test, the modules was pressurized with air on the permeate side, before it was submerged into a container of water (Figure 5). Any leakage is found by the extra air leaving that specific fiber. After plugging the identified fiber(s), the module was reattached, and another AIT was performed to verify that the plugging was satisfactory.



Figure 5 The setup for a bubble point test. The membrane was submerged into the blue box, containing water deep enough to cover the whole membrane.

3.4.2 Quick Scan

One of the platform pilot plants was constructed to accommodate a HFNF module. This pilot plant had a feed pump for pressurizing the feed side, and a circulation pump to add the necessary crossflow. These pumps maintained a flux of $15 \text{ l/m}^2\text{h}$ and a crossflow of 0.5 m/s . The circulation pump was also used for flushing the membrane,

and no backwash was possible. This pilot plant was not operated by the author of this work, and more information about this plant is found in (Köhler et al., 2016).

3.4.3 Spiral wound NF-pilot

A pilot plant was borrowed from Gothenburg water (Göteborg Krestlopp och vatten), which had been used in a project that ended in 2006. A renovation of the pilot was performed and it was placed as a polishing step in the end of the treatment process (Figure 6), because of the requirement for pretreatment for this membrane. It was also used as a treatment for groundwater. The pilot included three pressure vessels that could contain one membrane each. The pilot plant had a pressurizing pump and a circulation pump, and the latter was used for flushing the membrane. A pre-filter of 10 μm was also included in the pilot plant, to ensure that no particles could damage the membranes.



Figure 6 The spiral wound NF-pilot, placed in the basement of Ringsjö WTP.

3.4.4 UF-pilot

This pilot plant was also constructed on a platform. It had room for two HFUF modules with a membrane surface of 40 m^2 each. It had a pressurizing pump and a filter for removing particles. A small permeate tank was included in the pilot plant for

flushing and for chemical cleaning of the membrane, but chemicals had to be added and mixed manually. The flux was fixed due to a mechanically set feed flow of 2 m³/h, i.e. a flux of ca 25 l/m²h.

3.5 Sampling and analyses

For the NF-pilot 80, four sampling locations were used: 1) raw water before feed tank; 2) feed with coagulant (only for HFUF); 3) concentrate from circulation pump (only for NF); 4) permeate just before permeate tank (Figure 4). All other pilot plants had similar sampling locations and samples were taken from the feed water, concentrate and permeate. From the conventional treatment trains, samples were taken for raw water, rapid sand filtrate, before disinfection and from the outgoing water (drinking water).

3.5.1 Operational data and online measurements

The pilot plants had a different set of online measurements. All pilots had meters for flows and pressures, both before and after the membrane. The Quick Scan had meters for operative parameters, and online chemistry meters, i.e. an S::can, added by the industrious operators. The UF-pilot had additionally a temperature meter, and all of the meters were connected to a logger.

The NF-pilot 80 had several flow meters, for feed, circulation and permeate. Pressures were measured on the inlet to the membrane module, the outlet on the feed side and the outlet on the permeate side. Additionally, conductivity was measured in feed, concentrate and permeate, and feed water turbidity and temperature were measured. The computerized system logged all the data every 10 s from these meters.

3.5.2 Traditional chemical analyses

Samples were analyzed for TOC, color, UVA₂₅₄ and hardness (from Mg and Ca concentrations). For one of the raw water sources (Stångån), alkalinity and concentrations of iron (for iron based coagulant) or aluminum (aluminum based coagulant) were measured. On all study sites, an accredited laboratory reported TOC concentrations and hardness (based on calcium and magnesium concentrations), and UVA₂₅₄ was measured in the local laboratories connected to the WTPs. At Ringsjö WTP, the spectrophotometer was a Hach-Lange DR 5000 UV-Vis Spectrophotometer with a sipper module (1 cm quartz cuvette). Specific UV-absorbance (SUVA), as presented by Weishaar et al. (2003), has been calculated from:

$$SUVA = \frac{UVA_{254} [m^{-1}]}{DOC [mg/L]}$$

3.5.3 Virus-like particles

Approximately once a week, samples were analyzed for VLP at Göteborg kretslopp och vatten, Gothenburg, Sweden. This method uses the fluorescing SYBR Green I to stain DNA and RNA. By radiating the particles during numeration, the number of cells and viruses can be counted. Based on the size, they are either considered as virus or cells. The protocol for this method can be found in Patel et al. (2007).

3.5.4 Fluorescence and indices

During the pilot trials, samples were sent to the Swedish University of Agricultural Sciences (SLU) for fluorescence analyses. Excitation wavelengths varied between 240 - 450 nm at 2 nm intervals, and emissions were measured at 213 – 619 nm, 3.2 nm intervals using an Aqualog (Horiba Jobin Yvon). Correction for scatter from the water Raman peak, instrument/spectral biases, inner filtering effects and nullification of regions where Rayleigh scattering appeared were applied. The methods for corrections are described in Lavonen (2015). Established fluorescence indices were calculated from the EEM for each sample. 1-5 samples from each pilot study and 4 to 12 from each drinking water trains were included in this work.

These established dimensionless indices have been related to specific moieties and formations of the NOM. One of them, the humification index (HIX), is related to the degree of humification of the NOM, as the name implies. Higher HIX indicate a higher degree of humification (Ohno, 2002), and it is found at a excitation wavelength of 254 nm:

$$HIX = \sum I_{435 \rightarrow 480} / (\sum I_{300 \rightarrow 345} + \sum I_{435 \rightarrow 480})$$

FI indicate the source of the NOM, low number (from 1.3) indicate microbial origin, high number (up to 1.8) indicate terrestrial origin (Cory and McKnight, 2005), with an excitation wavelength at 370 nm:

$$FI = Em_{470} / Em_{520}$$

The freshness index ($\beta:\alpha$) indicate the age or degree of decomposition, and higher number indicate more freshly produced NOM (Parlanti et al., 2000). With an excitation wavelength at 310 nm:

$$\beta: \alpha = Em_{380} / \max(Em_{420 \rightarrow 435})$$

Two peaks in the EEMs were identified for analysis. Peak C (fulvic-like fluorescence) has been related to aromaticity and hydrophobicity, and have been possible to relate to molecular weight (Baker et al., 2008). Peak T (tryptophan-like fluorescence) has been seen to be related to microbial and algal derived NOM (Baker et al., 2008), sometimes referred to as protein-like fluorescence (Parlanti et al., 2000). These peaks have been used as monitoring parameters with good results (Baker et al., 2008; Singh et al., 2015, 2012).

3.6 Operation scheme and methodology

The pilot trials were performed during 2012-2014. The author of this work took part in most of the practical work at two of the locations, and performed some of the water analysis (mainly absorbance) but was assisted in the setting up, sampling and maintenance of the pilot plant.



Figure 7 The inside of NF-pilot 80, with the membrane module in the foreground, pumps, valves and tanks can be seen behind it.

3.6.1 NF-pilot 80 operation

The mobile pilot plant, NF-pilot 80 (Figure 7), was placed at three different locations over 19 months. During that period, the pilot treated four raw water sources with one or two membrane modules. The time frame at each location is shown in Table 3.

At Råberga WTP, most of the trial period was consumed by the trial of treating water from River Stångån by the HFUF. The first months were used for orientation and to learn how the process and membrane worked. First, FeCl₃ was chosen as a coagulant. FeCl₃ is the best coagulant in reducing NOM in water and less sensitive to changes in temperature (Matilainen et al., 2010) and is efficient at a wider range of pH (Eikebrokk, 1999). The first period during the fall of 2012, with a low dose of FeCl₃ and little pH-adjustment, the operation could not reach stable conditions with a good TOC reduction. The dose was in the end of the year so low that the coagulant concentration was not enough to prompt any removal.

Table 3 Time periods for the different pilot trails with the NF-pilot 80 (last location in italics was operated by a colleague).

Period	Module and coagulant	Water source
October 18 th – December 14 th 2012	Aquaflex + FeCl ₃	River Stångån
December 14 th 2012 – January 15 th 2013	Aquaflex	River Stångån
January 15 th – February 14 th 2013	Aquaflex + PACl	River Stångån
February 14 th – March 3 rd 2013	Aquaflex + FeCl ₃	River Stångån
March 3 rd – March 25 th 2013	HFW 1000	River Stångån
July 19 th – October 24 th 2013	HFW 1000	Lake Bolmen
October 24 th – November 25 th 2013	HFW 1000	Lake Ringsjön
November 25 th – December 3 rd 2013	HFW 1000	Lake Bolmen
December 3 rd 2013 – January 9 th 2014	Aquaflex + alum	Lake Bolmen
January 20 th – May 2014	HFW 1000	Görväln Bay

After problems with fouling of the membrane the coagulant dosing was stopped. The membrane module was replaced with a new one, but there were additional indications of fouling, but this time likely by the organic content in the water. In the first week of 2013, a jar test was performed and the coagulant was changed to PACl. The new coagulant was trialed for a month at different pH. Since FeCl_3 had shown the best results in the jar tests, it was once again trialed, but there were still problems with fouling. The fouling was likely due to an unstable pH, which was fluctuating between pH 3.5 to pH 6.5. Already a small increase of pH (ΔpH 0.5) have been shown to affect the floc development, and releasing DOC and UVA_{254} from the flocs after the pH increase (Slavik et al., 2012). Unstable flocs and changes in the iron solubility were likely connected to the fouling of the membrane surface.

During the trial with the HFUF, the flux varied from 40 $\text{l/m}^2\text{h}$ up to 75 $\text{l/m}^2\text{h}$, and it was run as a dead end process. The intervals between the HC varied from 20 min to 30 min, and the CEB A+B was generally performed every 12 h. This was somewhat adapted due to the rate of fouling that was observed.

The HFNF was trialed at the same sight for a few weeks, starting with a week of the 20-point experiment (see 3.6.1.1 below). Flux and crossflow was then set to 20 $\text{l/m}^2\text{h}$ and 0.5 m/s respectively, and the membrane was regularly cleaned by a HC, but no CEFF took place until the end of the trial. During these weeks, different retentions were trialed: 50 %, 75 % and 87.5 %. However, after restarting the pilot at the next location, it was discovered that the integrity had been breached, and since no AIT was performed during the trial with HFNF at Råberga WTP, the date when the leaking came about is unknown.

The NF-pilot 80 was moved to a new location, Ringsjö WTP (Figure 8), and this time the trial started with treating water from Lake Bolmen by HFNF. Again, the flux and crossflow were set to 20 $\text{l/m}^2\text{h}$ and 0.5 m/s respectively, and a HC was performed every hour. After a period of trying different intervals, the CEFF A was set at a frequency of once every 36 h. Due to occasions of fiber failures, and a faulty valve that needed replacement, the trials was on several occasions temporarily stopped. Due to the delay in the plans, there was only time for a month of feeding the raw water from Lake Ringsjön to the HFNF module. This part of the trial ended with a week for the 20-point experiment, and then the water source was once again changed to Lake Bolmen, so that the 20-point experiment could be performed with that raw water too. A week with a lower flux, 15 $\text{l/m}^2\text{h}$, was trialed and then the HFNF was changed to the HFUF.

Alum was the most convenient option as coagulant, since it was accessible on site, and only alum was used in the membrane pilot study at Ringsjö WTP. Due to the limited time, only water from Lake Bolmen was fed to the HFUF. The coagulant was tested in a jar test, to approximate the dose, followed by trying out the optimal dose in pilot scale. The optimal pH was found in parallel to the coagulant dose. From the beginning, the flux was set to 40 $\text{l/m}^2\text{h}$, but was increased to 50 $\text{l/m}^2\text{h}$, which was the

level for most of the trial. The last week of the pilot study at Ringsjö WTP, the flux was increased, to 60 l/m²h, and further to 76.5 l/m²h.

After that, the pilot plant was moved to a new location, where it was fed with raw water from Görväln Bay. The 20-point experiment was performed again. Flux, crossflows and recoveries were adjusted to illustrate different scenarios for a HFNF treatment process at the conditions present at Görväln WTP. For this trial, a new membrane module was installed, which was a newer version of the HFNF membrane, modified for a higher permeability.



Figure 8 The NF-pilot 80 was located in this container, here placed at the pumping station of Ringsjö WTP.

3.6.1.1 20-point experiment

In this experiment, the crossflow and flux were varied, so that the impact of each on the membrane retention of NOM could be evaluated. The method can be used to estimate the diffusion rate between the concentration polarization on the membrane surface to the bulk feed water, or to optimize the flux and crossflow. Four crossflows (0.25, 0.5, 0.75 and 1.0 m/s) and five fluxes (5, 10, 15, 20 and 25 l/m²h) were coupled in 20 experiments, and each filtration was run for 1.5 h. In the end of each experiment, concentrate and permeate were sampled and analyzed for TOC concentration and

UVA₂₅₄, with a sample for the raw water twice a day. After sampling, the module was emptied and refilled, and next filtration started, changing both flux and crossflow for all new experiments.

During the experiments with water from Lake Bolmen, the feed pump could not manage the required pressure for a flux of 25 l/m²h, therefore, the fluxes were changed to 5, 10, 15, 19 and 23 l/m²h, but coupled with the same crossflows.

3.6.2 Other pilot studies

Other pilot studies took place in-house, with the three platform pilots. The QuickScan was first used in trials at Kvarnagården WTP, and then moved to Görväln WTP. At Kvarnagården WTP, the first type of the HFNF was trialed, fed with raw water from the intake to the WTP. After moving the pilot plant to Görväln WTP, the module was changed two times, of which the third was a similar module as the one that was trialed at Råberga WTP and Ringsjö WTP. At Görväln WTP, the pilot was fed with rapid sand filtrate, and was followed by a pilot of activated carbon, which has been part of other papers and reports (Köhler et al., 2016; Lidén et al., 2015).

The spiral wound NF-pilot was fed with slow sand filtrate at Ringsjö WTP. Within the possible range for the pilot, the flux and crossflow was set at different levels, to evaluate the effect. The flux varied from 15 l/m²h to 22 l/m²h, and the recovery was set to 25 %. After several months, the pilot was moved to Sättra WTP in Gävle, for treatment of groundwater. This WTP was the only location in this project where it was desired to achieve a removal of the hardness by the membrane filtration, thus making this membrane a suitable option. The feed water was pH-adjusted with an acid before treatment, so to avoid scaling and problems with increase pH. Different levels of acid dosing, leading to some time without any acid pretreatment, were tried over the course of the pilot study.

The UF-pilot was trialed at Hofors WTP, in Gästrikland, where direct filtration by HFUF was trialed for raw water from Lake Hyen with PACl as coagulant (Tirén Ström, 2016). It was compared to the direct sand filtration, the current process at the WTP.

3.6.3 Analyses of the data

The data acquired in the pilot studies have been analyzed from a water qualitative perspective and an operational perspective. A general evaluation of the achieved reduction by the treatment methods, i.e. the level and concentrations in permeates and drinking water, were compared to the corresponding raw water. The comparison included the bulk analyses for NOM, i.e. TOC concentration and UVA₂₅₄, to give a general picture. The data from the fluorescence analyses have been analyzed to evaluate if there is any difference between water that has been treated in a membrane process to

water that has been conventionally treated with chemical coagulation. Additionally, the fluorescence data have been used as an indication of the influence of difference characteristics of the NOM on the treatment efficiency.

As a side study to the NOM removal, the microbiological barrier effect was evaluated. Due to the occasions of integrity breaches during the pilot study of HFNF, the opportunity to evaluate the effect of a leaking fiber presented itself. The effect on permeate, with a hydraulic explanation, was presented. Additionally, the use of TOC, UVA₂₅₄ and fluorescence data for indirect integrity monitoring was evaluated.

The operational data has been evaluated to find the optimal settings for these specific conditions. Based on the life cycle assessment (LCA) methodology, the costs and environmental impacts have been evaluated for a membrane process compared to a conventional process. It is based on the inputs, outputs and consumptions at Ringsjö WTP compared to the results from the pilot study. The costs were based on the actual expenses for Ringsjö WTP, while the environmental impact was based on numbers found in the literature. The LCA encompassed the operations of the plants, while the construction was not included. Although it would be a large investment to build, the major part for both costs and environmental impact come from the operation. However, membrane modules were considered as part of the operation costs, since their lifetime is considerably shorter than other parts of the construction.

Matlab has been the general tool for visualizing the data and statistical analyses. When calculating correlations, Spearman correlations were chosen, to avoid any false correlations due to outliers. Some water qualitative data was visualized in Microsoft Excel, which was also used for simple calculations, such as average values and standard deviations.

4. Improved NOM removal by membrane filtration

4.1 NOM removal

In the pilot trials, the membrane treatment has demonstrated a high reduction of TOC and UVA_{254} in general, and specifically, an advanced removal achieved by the HFNF. It is evident that the HFNF membrane was developed for soft, colored waters. The best removal was seen with water from Lake Bolmen (Table 4). Lake Bolmen is the softest lake, with a high content of humic substances. There is a logarithmical relation between the hardness in the raw water and the reduction of both TOC and UVA_{254} by HFNF (Paper II), which verifies that hardness likely influences the membrane efficiency (Gutierrez et al., 2015). This is a factor that is also favoring removal from Lake Bolmen. Furthermore, the choice of the process parameters has an influence on the NOM retention, but this influence was relatively small, especially if considering the flux and crossflow that are of highest economical interest (Paper I).

Regarding the UF, the process has similar results as the traditional coagulation process, considering that the drinking water treatment also includes slow sand filtration that has an additional effect on the water chemistry. Ringsjö WTP, that treats the water from Lake Bolmen, has a better coagulation step than what was seen for the HFUF. Water samples after coagulation/sedimentation and rapid sand filters had on average a lower TOC concentration, and the difference was around 1 mg/l. This can partly be justified by the difference in the process conditions: another coagulant and pH were used in the pilot than what is used at Ringsjö WTP. The WTP operates at a pH 5, and the coagulant is ferric chloride, while the coagulant in the HFUF was alum at pH 6.2. Ferric chloride has been shown to reduce TOC and UVA_{254} to a higher degree than alum, partly due to the lower pH (Eikebrokk, 1999; Matilainen et al., 2010). The HFUF treatment and the WTP process treating water from River Stångån both used aluminum based coagulants (PACl and alum respectively), and the resulting NOM removal is in the same range for both water sources (Table 4).

At the pilot trial at Hofors WTP, where, in this context, the raw water has an intermediate concentration of TOC, the HFUF could reduce the TOC and UVA_{254} in the same range as the direct rapid sand filtration (Tirén Ström, 2016). This, however, required optimal conditions, which was not the outcome of this trial, where once again

there was trouble with fouling of the membrane. Similar to the other raw water sources, UVA_{254} was more reduced than TOC, and the SUVA decreased from treatment. This shows that both HFUF and HFNF selectively removed aromatic substances, similar to the selectivity of the conventional treatment.

Table 4 Reduction of parameters from raw water to treated water by the different methods. In the Lake Hyen case, the data in the TOC column is taken for the reduction of DOC, which is assumed comparable (n.d.=no data).

Raw water	Drinking water		HFUF and coagulant		HFNF	
	TOC	UVA_{254}	TOC	UVA_{254}	TOC	UVA_{254}
Lake Bolmen	76 %	90 %	65 %	77 %	91 %	97 %
Lake Ringsjön	n.d.	n.d.	n.d.	n.d.	85 %	90 %
River Stångån	57 %	73 %	54 %	77 %	87 %	91 %
Lake Hyen	46 %	66 %	50 %	66 %	n.d.	n.d.

4.2 NOM characterization for better treatment (Paper II)

The fluorescence derived parameters could possibly be related to the treatment efficiency. It has been shown that the fraction of humic substances in raw waters affect the outcome from both coagulation and membrane treatment (Baghoth et al., 2011a; Keucken et al., 2016; Köhler et al., 2016). SUVA is the common index for the prevalence of humics (Weishaar et al., 2003), thus, SUVA in the raw water was related to the TOC and UVA_{254} removal by conventional treatment and by the HFNF. The drinking water had a very significant correlation (Spearman $P < 0.001$) between the removals and SUVA in the raw water, while the correlation for the HFNF was weak (Spearman $P < 0.05$). This strong significance for the conventional treatment may be influenced by the difference in the coagulation process in the treatment trains for the included WTPs (see chap 3.2).

The fluorescence indices showed potential as indicators for the process performance. FI may be an indicator for the better choice of process steps for a specific raw water. Although HIX is inherently related to the humification level of the NOM in the water, it showed the lowest correlations to the treatment efficiencies. A correlation between HIX and the HFNF treatment efficiency was found, but the values in the different raw waters were similar, and the variability in the raw water might not be enough for HIX to be useful.

FI and $\beta:\alpha$ have both shown a correlation to the treatment efficiencies. Excluding some samples when HFNF treatment was chemically pretreated, $\beta:\alpha$ shows a very significant correlation (Spearman $P < 0.001$) to the UVA_{254} reduction of the HFNF, and

the FI has a significant correlation (Spearman $P < 0.01$) to them both. There were weak correlations (Spearman $P < 0.05$) between both indices and TOC reduction by the HFNF if the pretreated samples were included. The two indices, FI and $\beta:\alpha$, in the raw water were very significantly correlated (Spearman $P > 0.001$) to the TOC and UVA_{254} reduction by the conventional treatment. Again, this was likely affected by the two types of coagulation processes at the included WTPs.

FI and $\beta:\alpha$ have both been related in natural waters to microbial derived NOM, either by level of decomposition ($\beta:\alpha$) or terrestrial versus aquatic origin (FI). This explains the almost linear relationship ($R^2 = 0.83$) between the two indices in the raw waters (Figure 9). The linear relation ($R^2 = 0.88$) is present for the HFNF permeate as well, with a slope in the same range as the raw waters (Figure 9). The relation is altered by the chemical treatment, and the correlation becomes slightly negative and weak between the two indices. This indicates that higher FI and $\beta:\alpha$ is seen for smaller molecules, because the small molecules constitute the NOM in the HFNF permeate. The size dependence is logical, since bacterial derived matter is smaller than terrestrial, and these increase in relative abundance from treatment – both conventional and membrane treatments (Köhler et al., 2016).

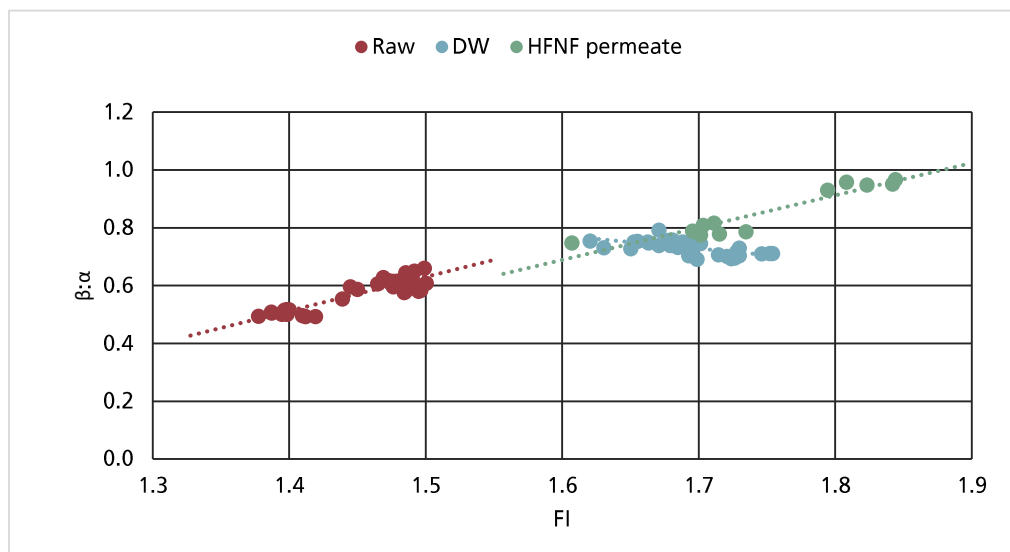

Figure 9 Relations between FI and $\beta\alpha$ in the same samples, divided between samples from raw water (Raw), drinking water (DW) and HFNF permeate from four water sources and three WTPs (Paper II).

4.3 Microbiological barrier and breaches in the integrity (Paper III)

Ultrafilters and tighter membranes are generally great microbial barriers for drinking water treatment. Size exclusion leads to a complete reduction of *cryptosporidium*. According to the manufacturers, the membranes included in this study have LRV values of 6-log, and 4-log for bacteria and viruses respectively. The results in this trial often showed levels of viruses below the detection rate, and overall achieved a reduction of 5-log (Figure 10). Bacteria had a lower reduction, mostly due to the lower levels in the feed compared to the VLP in the feed, but partly because of regrowth in the piping system on the permeate side.

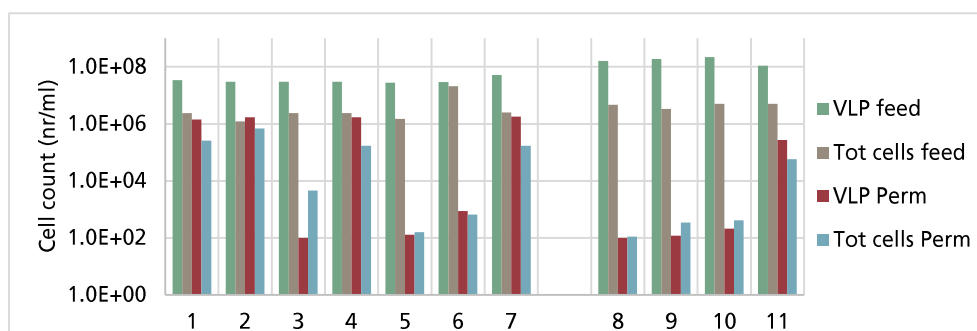

Figure 10 Cells and VLP in feed and permeate at 11 sampling occasions. Samples 1-7 came from Lake Bolmen, while 8-11 came from Lake Ringsjön. At occasions 1, 2, 4 and 11 there were fibers leaking (Paper III).

During the pilot study, several occasions of fiber failures occurred. This led to elevated levels of TOC in the permeate, in addition to the higher number of VLP and cells (Figure 11). During the study with water from Lake Bolmen, there was a very significant ($P < 0.001$) difference between the TOC concentration in permeate when the membrane was intact, and when the integrity was compromised. For UVA_{254} , the increase in permeate due to the leakage is even greater. Additional data from Lake Ringsjön is included in Figure 11. At the occasion when a fiber was leaking during this part of the study, there was an intrusion of water from Lake Bolmen, which slightly complicates the comparison between the data from when the membrane was intact, to the data for leakage.

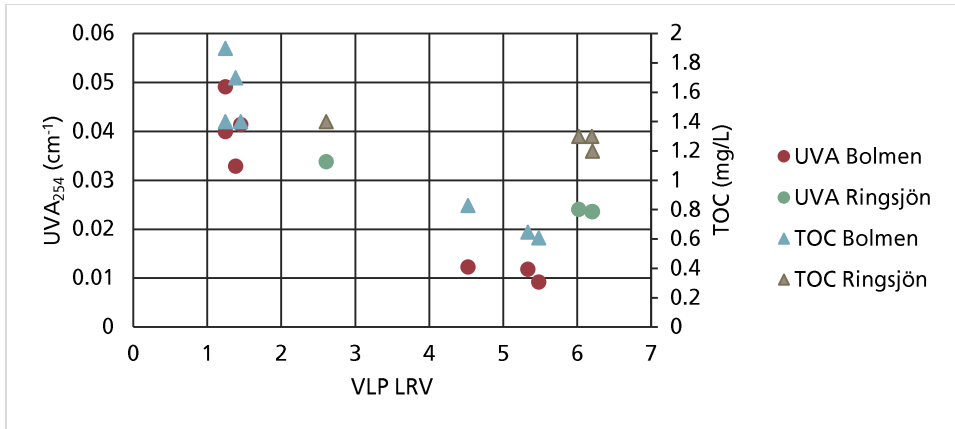

Figure 11 The UVA absorbance (UVA_{254}) and total organic carbon (TOC) concentration in permeate after the HFNF versus the log removal of VLP (Paper III).

In the data from Lake Ringsjön, although uncertain due to the intrusion, there is a greater effect on the UVA_{254} than TOC concentration in permeate due to leakage. Regarding data from Lake Bolmen, the UVA_{254} in permeate is on average three times higher due to a leaking fiber. TOC concentration is around the double after an increase (Table 5). The larger impact on the UVA_{254} in the permeate due to leakage is related to the selectivity of aromatic substances by this membrane, which lead to a larger reduction of UVA_{254} than of TOC (see chap 4.1). In addition, the maximum value of TOC concentration in permeate from an intact membrane was 1.0 mg/l, whereas the minimum value for a leaking fiber was 1.1 mg/l. For UVA_{254} the highest value for an intact membrane was 0.0137 cm^{-1} , while the lowest value for a leaking membrane was 0.0223 cm^{-1} . Thus, the lowest increase detected for TOC concentration increase due to leakage was 10 %, while for UVA_{254} the same event led to an increase of 60 %.

Table 5 The difference in the levels of UVA_{254} and TOC concentration in the permeate in an intact membrane compared to a leaking fiber, with water from Lake Bolmen (Paper III).

	Intact				Leakage			
	mean	std	max	min	mean	std	Max	Min
UVA_{254} (cm^{-1})	0.0126	0.002	0.0137	0.0092	0.041	0.007	0.0501	0.0223
TOC (mg/l)	0.85	0.10	1.0	0.61	1.6	0.25	2.2	1.1

Fluorescence could be an alternative for process monitoring, and have been able to detect changes in the NOM character, that was not seen in the TOC concentration (Henderson et al., 2010). Online studies have been performed for RO-permeate, for wastewater reuse, for which changes could have a large effect on the health of the consumer. Although the effects are often less dramatic, changes in the surface water

treatment may also have consequences, especially considering parasites like *cryptosporidium*. Two of the sampling occasions for fluorescence in Lake Bolmen water were realized during fiber failure (fiber in the membrane module were plugged in between), while three were intact. During the trial with water from Lake Ringsjön, there was one occasion of leaking fibers out of four sampling occasions. However, during the same week, there was the intrusion of water from Lake Bolmen into the intake from Lake Ringsjön, which makes the comparison between leakage and fiber failure futile.

There were significant differences between the samples for occasions of fiber failures compared to intact fiber (FI and $\beta:\alpha$ $P < 0.001$, Peak C $P < 0.01$, Peak T $P < 0.05$). The feed values, compared to the two groups of data are shown in Figure 12, where the lower change from feed to permeate can be seen for the leaking fiber. This shows a potential for fluorescence as an indicator of breaches in the integrity.

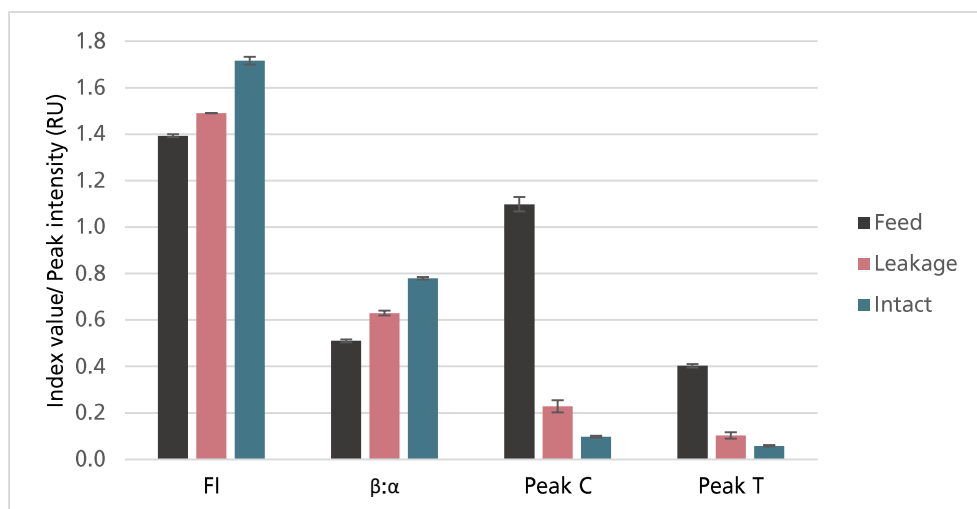

Figure 12 The levels of the fluorescence derived parameters in the feed (n=5), and in the permeate during occasion of leakage (n=2) compared to intact membrane (n=3). Results from the Lake Bolmen trial (modified from paper III).

Baker et al. (2008) identified fluorescence indices that had correlations to the level of hydrophilicity of the NOM. Due to the selective removal of hydrophobic matter, expected from a hydrophilic membrane as the HFNF, the hydrophilicity in the permeate should be possible to use as indicators of the membrane performance. An index correlated to NOM hydrophilicity, Peak T/Peak C in permeate, is plotted against the VLP LRV by the membrane (Figure 13). It shows that the leakage can be related to a drop in hydrophilicity of the NOM in permeate, also for the occasion for Lake Ringsjön when the raw waters were mixed in the feed.

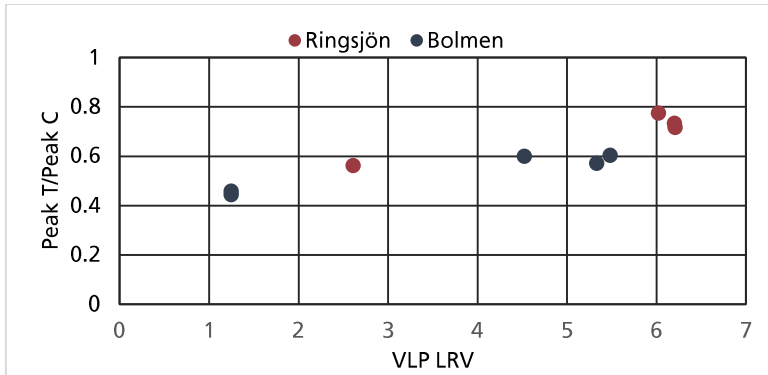

Figure 13 The LRV of VLP (log(no. particles)) versus the Peak T/Peak C, presented in Baker et al. (2008) as correlated to the hydrophilicity of the NOM (Paper III).

4.4 Membrane filtration for polishing

Nanofilters of the spiral-wound type is preferably used as a late step in a treatment train, e.g. before the liming and the disinfection. A placement in the end of the train mean that they have a “polishing” effect, i.e. removes the most of the remaining NOM and microorganisms, as a buffer in case the process is not fully functioning, or if the general removal is not satisfactory to the operators. In the pilot study in this work, the spiral-wound nanofilter was fed with groundwater from the Valbo Esker, or slow sand filtrate at Ringsjö WTP. It is probable that, at Ringsjö WTP, the feed water need not to be so thoroughly treated before nanofiltration, but for practical reasons, this location on the treatment was chosen.

At Sätra WTP, part of the aim with a nanofiltration trial was to remove some of the hardness. Currently, the supplied water is hard, and a lower hardness would be better for the detergent economy of the consumers and for the distribution system. The UVA_{254} and TOC concentration have increased in the groundwater, thus it would be an additional effect. Figure 14 show the reduction of hardness (from ion concentrations and conductivity) and of UVA_{254} by the spiral-wound NF-pilot. The reduction of UVA_{254} was evident, which was expected by this membrane with a MWCO of 0.3 kDa. It did reduce hardness towards a more soft water, and permeate was only a couple of degrees from soft (Figure 16). The larger reduction of hardness than conductivity is likely related to the higher reduction of divalent ions than monovalent ions. The trial included a pH adjustment with acid, to reduce the risk for scaling, but there was no indication of scaling problems for the lowest dose, thus it might not be necessary, if there instead were an optimized cleaning regime.

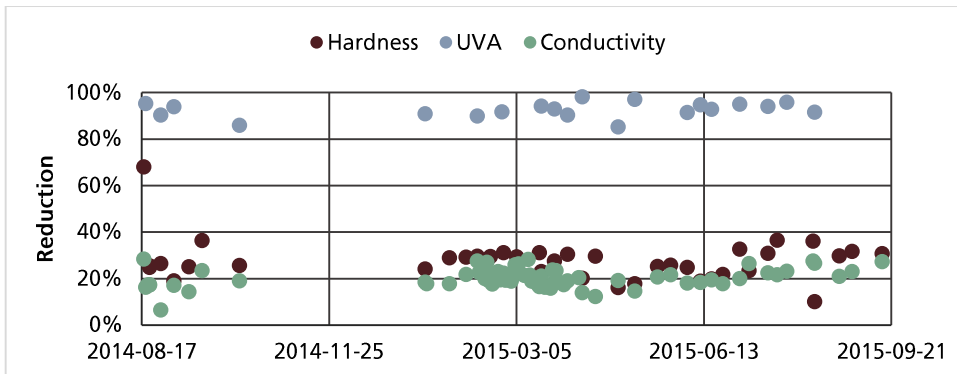

Figure 14 Reduction of UVA₂₅₄, hardness and conductivity at Sättra WTP (Valbo Esker, part infiltrated river water). NF-pilot, spiralwound nanofilter.

At Ringsjö WTP, a reduction of the hardness would be an undesirable side effect. At this stage in the WTP, the water has been limed two times, for an increase of pH and a removal of residual iron in the water after sedimentation. This hardness was reduced to a large extent (30 % - 40 %, see Figure 15), which must be added again before distribution.

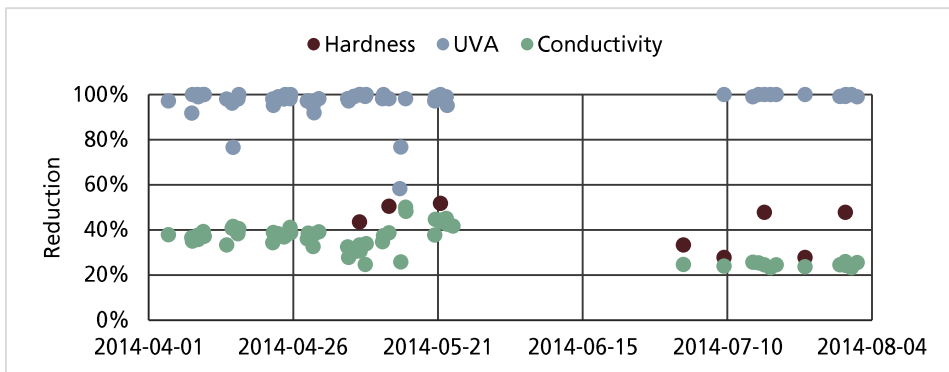

Figure 15 Reduction of UVA, hardness and conductivity from slow sand filtrate at Ringsjö WTP (Lake Bolmen). NF-pilot, spiralwound nanofilter.

Comparing the removal between the two WTPs, the actual reduction of hardness (Figure 16), UVA₂₅₄ (Figure 17) and conductivity (Figure 18) are very similar between the two raw waters, with only a slightly higher removal at Sättra WTP, which had higher concentrations in the feed. Likely related to the concentration of ions on the feed side, the reduction of the hardness (and conductivity) seems to be very similar between the two WTPs, independent of the feed water concentration. Possibly, a higher reduction could have been achieved at Sättra WTP with a higher bleed flow (in both cases it was 25 % of the feed flow). It is also possible that it is more related to the material characteristics, which could have had a limitation on the repulsion of ions.

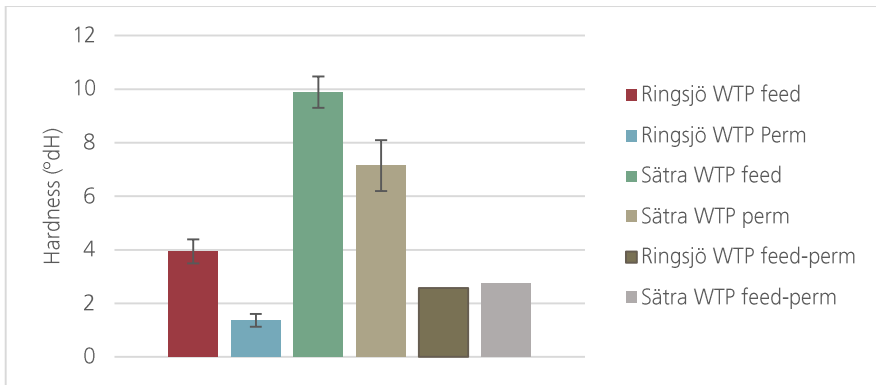

Figure 16 Hardness in feed and permeate, and the difference at the feed and permeate for WTP where the spiralwound NF was trialed (error bars show the standard deviation).

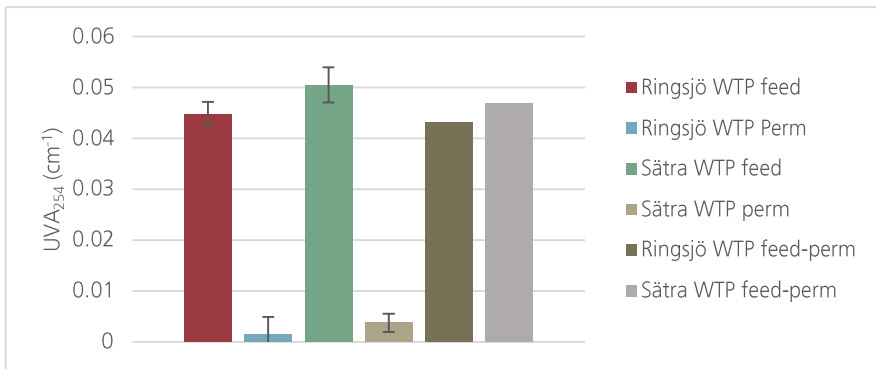

Figure 17 UVA₂₅₄ in feed and permeate, and the difference at the feed and permeate for WTP where the spiralwound NF was trialed (error bars show the standard deviation).

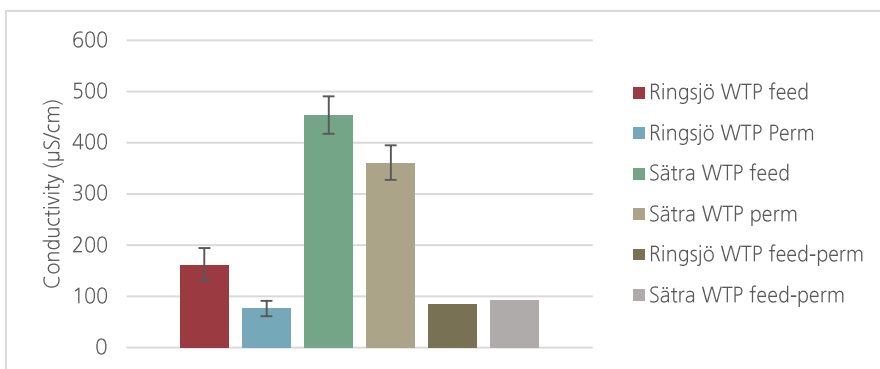

Figure 18 Conductivity in feed and permeate, and the difference at the feed and permeate for WTP where the spiralwound NF was trialed (error bars show the standard deviation).

4.5 Economic and environmental assessment (Paper IV)

It is not only water quality that has an importance for decisions regarding water treatment process alternatives. There is always a need to find a balance between the costs and the expected resulting water quality. Additionally, with an imminent climate change and a destruction of many ecosystems globally, the environmental impact becomes more and more important to consider. Therefore, the technical data for operations of conventional treatment, HFUF and HFNF were collected in the case of Ringsjö WTP, i.e. with Lake Bolmen as raw water source. These data were the basis for an economic and environmental comparison, comparing the production of 1 m³ deliverable water that could be distributed to the consumers.

Only operational costs and consumptions are included in the comparison; construction is assumed to entail similar costs and emissions between the methods. Additionally, previous studies have shown that the major impact, 90 %, come from the operation, and only 10 % from the construction (Bonton et al., 2012; Friedrich, 2002). The large difference is the investment in the membrane modules, which have been included in the comparison since their lifetime (7 years) is short compared to the buildings and other constructions. In a full-scale membrane filtration, both with HFUF and with HFNF, there would be a need for additional treatment steps. Thus, the HFUF and HFNF have been assumed as substitutes for the coagulation/sedimentation/rapid sand filtration in the calculations, and the other current process steps have been included in the calculations for the membrane processes.

4.5.1 Operational data

Different settings were trialed in the pilot study with the two membranes. HFUF was run as a dead-end process, and the flux was varied between 40 l/m²h to 76.5 l/m²h, all with good results for the NOM removal, considering both TOC concentration and UVA₂₅₄. During the trial with raw water from Lake Bolmen, the cleaning scheme was difficult to optimize. The low temperature and the non-optimal coagulation condition can have been the reasons. During the study with water from River Stångån, the hydraulic cleans were 30 min apart, and the CEB was required twice a day. At Ringsjö WTP, the hydraulic cleans were performed every 20 min, and a CEB was initiated four times a day.

The NOM removal by HFNF proved to be little impacted by crossflow and flux changes, and the manufacturer's recommended settings of a flux of 20 l/m²h and a crossflow of 0.5 m/s, which were used during the majority of the pilot study. Hydraulic cleans were performed every hour (60 min long filtration time). After a short trial, the optimal interval for the CEFF A was found at 36 hours.

4.5.1.1 Water recovery, downtime and number of modules

For the conventional treatment process at Ringsjö WTP, there is little water loss in the process. Some is lost due to the sludge from the sedimentation, in addition to a small loss due to the liming and cleaning of sand for the filters. In total, the recovery is around 99.1 % at Ringsjö WTP today.

In a UF process, the cleaning of the membrane is the main water loss. The water from hydraulic clean can be reused, while the water after the CEB A+B must be discarded. Thus, the water loss is dependent on the frequency of the two types of cleaning. Under the conditions during the pilot trial at Ringsjö WTP, the volume reduction, i.e. the deliverable water, from the HFUF was 76 %, but by reusing the backwash, actual recovery would be 94 %. These numbers were, however, unreasonably low, probably due to the combination of low water temperature (6°C) and non-optimal coagulation dosing. The pilot study with raw water from River Stångån showed that a recovery of 90 % was possible, which mean a total recovery of 97 %. This is, of course, site-specific, and needs to be adapted to the raw water chemistry and chosen coagulant. Therefore, a gross recovery of 86 % was used for the calculations, as that is possible to achieve.

In a process with HFNF, a crossflow would be required. From this crossflow, part of the concentrate has to be bled, which has a large effect on the recovery. For this HFNF to be economic, the general recommendation is to create a continuous process with internal circulation (Figure 19), which decreases the water loss. Additional losses are the hydraulic and chemical clean, for which water is taken from permeate. In total, a single module has a recovery of 46.5 %, without reusing the flush and backwash water. With a three stages continuous process and reuse of the flush and backwash water, the total recovery would be 85.8 %.

The cleaning of the membranes also entails that each rack of membrane has a scheduled amount of downtime that has to be compensated for by an extra number of modules. The downtime is dependent on the frequency of the hydraulic and chemical cleans. For the HFNF, an optimized cleaning interval was found, which would lead to a downtime of 5.6 %. Due to the non-optimal conditions with the HFUF, the actual needed downtime was ambiguous. For a more frequent cleaning (with a recovery of 76 %), the downtime would be 16 %, while for a better adapted process, with a recovery of 86 %, the downtime would be 9 %. The latter would be reasonable to expect in a full-scale process.

Due to the difference in flux, the number of HFNF needed for a process the size of Ringsjö WTP is greater than the number of HFUF. Including the mentioned downtime, the lost permeate from cleaning, and a flux of 20 l/m²h the number of needed HFNF modules is 7400 modules for the same capacity as Ringsjö WTP has today. Ringsjö WTP would need 1670 – 3120 HFUF modules for the same capacity, with the highest number including the high frequent cleaning experienced in the pilot study.

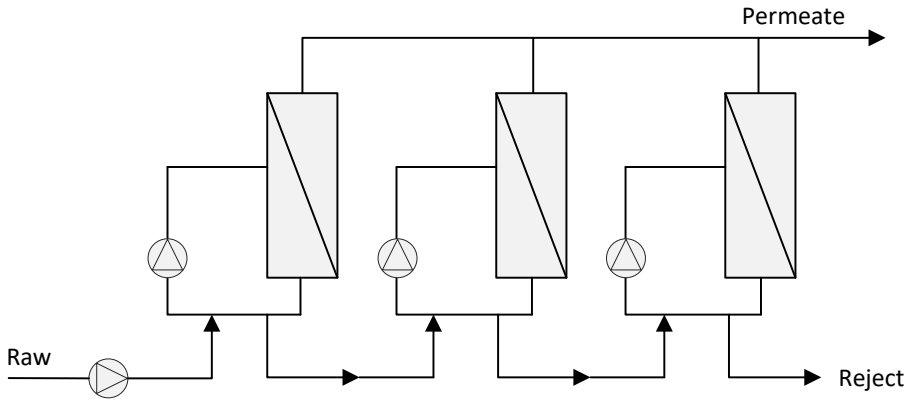

Figure 19 A continuous process with internal circulation – the bleed flow from the previous stage become the feed for the next. Commonly, there are more modules in stage 1, around half in stage 2, and a fourth in stage 3. (Paper IV).

4.5.1.2 Energy

Ringsjö WTP has been awarded because it is an energy efficient WTP. Thus, the energy consumption is low, and today it is only 0.29 kWh/m³, if all the energy usage is divided over the total drinking water production by the company. Therefore, since this number is already low and most are used for the big pumps for raw water and to the distribution net, these are considered as unalterable if a membrane filtration was added to the process. Although the coagulation/sedimentation would be removed, it is expected that most of this energy would still be required.

Due to the pumping requirements, the membrane processes are generally considered as energy demanding. For UF, a pressurizing pump is the main energy consumer, and that energy consumption (W_{feed}) can be calculated from:

$$W_{feed} = \frac{\Delta P}{\eta \cdot VR} \quad [J/m^3]$$

Eq. 3

Where ΔP [Pa] is the TMP, η is the pump efficiency and the VR is the volume reduction, i.e. the gross recovery. A pump efficiency of 80 % is a reasonable assumption, and the VR is the recovery without reused backwash. At a flux of 76.5 l/m²h and at the winter water temperature (6°C), the mean TMP was 0.33 bar. At the yearly average water temperature (10-11°C) of Lake Bolmen, the TMP could be expected to be around 0.2 bar. If Eq. 3 is computed with these numbers, the energy demand for the HFUF process is 0.01 kWh/m³. However, the frequent backwashing also entail a water demand, and adding it to W_{feed} , the total energy demand becomes 0.014 kWh/m³.

With the added crossflow and higher TMP, the process with HFNF is expected to entail a higher energy demand than the HFUF. One feed pump is needed in the

continuous process with internal recirculation (Figure 19), which means a VR of 85.8 %. Over the whole trial period, with various water temperatures, the average TMP was 0.29 bar. Computing Eq. 3, this mean a feed pump energy demand of 0.11 kWh/m³.

To this, the energy demand from the circulation pump (W_{recirc}) must be added:

$$W_{recirc} = \frac{\Delta P_f \cdot Q_{mod}}{\eta \cdot J_{av} \cdot A_{mod}} \quad [J/m^3] \quad \text{Eq. 4}$$

Where ΔP_f [Pa] is the friction pressure drop inside one module, Q_{mod} [m³/s] the flow through one module, J_{av} [m/s] the average flux for one module and the A_{mod} [m²] the membrane area for one module. The average friction pressure drop over the trial period was 0.56 bar, and the flow 0.003 m³/s (crossflow of 0.5 m/s). Computing Eq. 4 with these numbers result in a circulation energy demand of 0.27 kWh/m³. Thus, the total energy demand for the process with HFNF was 0.39 kWh/m³.

4.5.1.3 Summary

Table 6 gives an overview of the operation details based on the experiences from the pilot studies.

Table 6 The calculated numbers for the three processes.

	Recovery	Downtime per module	No. modules	Energy (kWh/m ³)
Existing treatment	99.1 %	n/a	n/a	0.29
HFUF	86 % (96 %)	9 % - 16 %	1670 – 3120	0.014
HFNF	85.8 %	5.6 %	7400	0.39

4.5.1.4 Chemicals

A process with HFUF still requires a coagulant and pH adjustment, while a process with the HFNF would lower the chemical consumption substantially. Liming and disinfection with NaOCl would still be needed in a full scale process with membrane filtration. It is assumed that the same level of liming would be required for a non-corrosive water, and the same amount used today would be included in a process with both HFUF and HFNF. With a lower TOC concentration in the outgoing water, it could be possible to decrease the dose of NaCOI after a membrane filtration, but that amount is assumed the same to avoid unnecessary speculation. The amount of chemicals needed for the three treatment methods are collected in Table 7 based on the current process at Ringsjö WTP and the results from the pilot study. For the tentative

full-scale process with the membrane modules, the lime and NaOCl have been added in the economic and environmental quantifications in subsequent chapters.

Table 7 Amount of chemicals consumed by the three processes (mole). Note that NaOCl and Lime in the existing treatment must be kept even with altered treatment steps. HFNF requires HCl if an acidic clean is added.

	HCl	NaOH	Coagulant	NaOCl	Lime
Existing treatment	0	0.12	0.17	0.032	0.452
HFUF	0.14	0.29	0.06	0.018	0
HFNF	0	0.033	0	0.013	0

4.5.2 Economic estimation

The costs are based on actual prices for Ringsjö WTP for 2015, per ton chemical or kWh. The prices for chemicals and energy was collected in SEK and then converted into Euros with the exchange rate 1€ = 9 SEK. Table 8 presents the calculated costs based on the numbers presented in Table 6 and Table 7. It shows that the operational costs for ultrafiltration would be slightly higher (6 %) than the existing process, or even lower if a more economically favorable operation setting for the membrane cleaning was found. The drinking water production by HFNF would be around 30 % more expensive with the current membrane modification and operation settings.

Table 8 Process costs (in €) (Paper IV).

	HCl	NaOH	Coagulant	Mod-ules	NaOCl	Lime	Energy	Overh. etc	Sum
Existing treatment	n/a	0.0022	0.012	n/a	0.0046	0.085	0.037	0.19	0.33
HFUF	0.001	0.0052	0.008	0.0075	0.017	0.085	0.038	0.19	0.35
HFNF	0.0003	0.0006	0	0.084	0.0066	0.085	0.072	0.19	0.43

4.5.3 Environmental impact

Environmental impact is difficult to compare in quantitative terms. The life-cycle assessment methodology is a way of comparing inputs and outputs for different process, which may vary in type. Greenhouse gas (GHG) emissions are commonly illustrated in CO₂-equivalents, to illustrate the climate impact. Table 9 summarize the calculations of the climate impact by the three processes, based on the number presented in Table 6 and Table 7. For the impact by the chemical production, numbers were found in Alvarez-Gaitan et al. (2013) for all but HCl, for which information was found in Kuckshinrichs (2012). Since the data come from an Australian context, who have a strongly fossil fuel dependent energy production, the climate impact from the

production could be smaller with other energy sources. Thus, a sensitivity analysis of the results includes a comparison where the impact from the chemicals are cut in half (Table 9).

The impact by the membrane modules were calculated from Bonton et al. (2012), that has found that the production of that type of membrane module emitted 3 g CO₂-eq/m³. Regarding the difference in flux and lifetime between the modules, the productions of these hollow fiber membranes are assumed to emit 6 g CO₂-eq/m³ and 2 g CO₂-eq/m³ for the HFNF and HFUF respectively.

GHG emissions by the energy production was found on Svensk Energi (2016). The emissions from the Swedish grids (20 g CO₂-eq /kWh) is lower than the European average (450 g CO₂-eq/kWh). The Nordic grid is somewhere in between (100 g CO₂-eq/kWh), thus Swedish and Nordic grids were included in the comparison between the processes (Table 9).

Table 9 GHG emissions (g CO₂/m³ deliverable water) (Paper IV).

	Calculated chemical impact		Half chemical impact	
	Nordic grid	Swedish grid	Nordic grid	Swedish grid
Existing treatment	185	161	107	83
HFUF	151	127	92	67
HFNF	138	83	106	51

Although NF has an overall higher energy demand than conventional treatment, while UF only lead to a marginal increase (Table 6), the total climate impact was lower for the membrane processes than conventional treatment in all cases presented in Table 9. This illustrates how it is not only the direct energy demand that should be considered, but also all the consumptions that the productions of the chemicals. For drinking water production, the climate impact is not of great importance – the drinking water counts for less than one per mille of the total GHG emissions for an average Swede. Nonetheless, it shows that membrane filtration cannot be dismissed only because of the climate impact from the relatively high energy demand.

Climate change is a current and acute problem, but there are more aspects to consider for a well-informed decision. The chemical production causes several other emissions, and have a depleting effect on natural resources. This is probably also true for the production of the membrane modules, which also involve plastics and other chemicals. Swedish energy production is, however, very clean, with few emissions due to the large part hydropower. Consequently, the impact on human health is very low, while the hydropower plants do affect the ecosystems in numerous watercourses.

From several perspectives, the environmental impact and human health would be gained by a decrease of chemical consumption in the process (Bonton et al., 2012). Mining, transport and production of the chemicals all result in waste and emissions. Currently, the sludge from the sedimentation at Ringsjö WTP is disposed of on a bog

where it is left to be dewatered. So far, the proportion that have been of interest to reuse have been relatively small compared to the formation of the sludge (Babatunde and Zhao, 2007), and it is often only reused once, before being disposed of as waste (Razali et al., 2007). Thus, the coagulation is more or less an end use of the metals.

With a process with little chemicals, the waste water from the HFNF would improve the local ecosystem, i.e. the bog that is now heavily affected by the sediments. HFUF would decrease the amount of metals used and dumped on the bog, but the issue would still remain. On the other hand, the bleed from the HFNF would produce a large volume of water, with heightened levels of color, TOC and virus. The location of the Lake in relation the WTP is a complication since the bleed stream cannot be fed back to the origin of the water. Instead, the alternative would be to let it out on the bog, creating a wetland, and discharge it to the creek dewatering the bog. For a full-scale process with HFNF corresponding to the production at Ringsjö WTP, the bleed flow would be around 1 % of the average flow in the creek that dewateres the bog.

4.5.4 Remarks

For the decision makers, when rebuilding or building a WTP, the investment cost is often an admissible consideration for the choice of process. Building a membrane filtration step is a large investment, and the tighter the membrane, the larger membrane surface area required and the higher the cost. This data show, that a higher direct energy consumption by the membrane is not the main issue with the membrane – neither the environment nor the operation cost will be a problem, since a lower chemical consumption lower them both. The issue seems to be membrane modules, and the number of membranes influences the cost prominently. The cost for membrane replacement makes the large difference between the sums of operation cost for HFUF and HFNF (Table 8). The cost is relatively large due to the expensive HFNF modules (ca €2,500 apiece) with a relatively low flux, if comparing to a less tight membrane such as the HFUF (ca €1,500 apiece).

4.6 Membrane resistance

Membrane resistance affects the operation cost and performance of the filtration process. Material properties are the basis for the membrane resistance, but it may also change overtime, due to chemical reactions, exhaustion, fouling and scaling. During surface water treatment, the relatively high concentration of NOM in the feed water entails a risk of absorbance of NOM on the membrane surface and in the pores. The development of the membrane resistance over time gives an indication to the actual fouling. The resistance is calculated by solving Eq. 1:

$$R = \frac{\Delta P}{\mu \cdot J}$$

Eq. 5

Thus, the resistance calculations are based on the flow and pressure data, combined with the viscosity, which is related to the water temperature. The trials during the fall of 2013, when HFNF was fed with water from Lake Bolmen and then Lake Ringsjön, experienced an increasing resistance over the whole period (Figure 20). However, the trial with water from Lake Görvål, during the winter and spring of 2014, had only an increasing resistance in the beginning of the trial, followed by a decrease of the resistance (Figure 20). The difference in the level of the two membranes (Lake Görvål is about half of Lake Bolmen and Lake Ringsjön), is due to a modification of the membrane module, and the trial at Görvål WTP was performed with a newer model with a higher permeability (i.e. lower resistance).

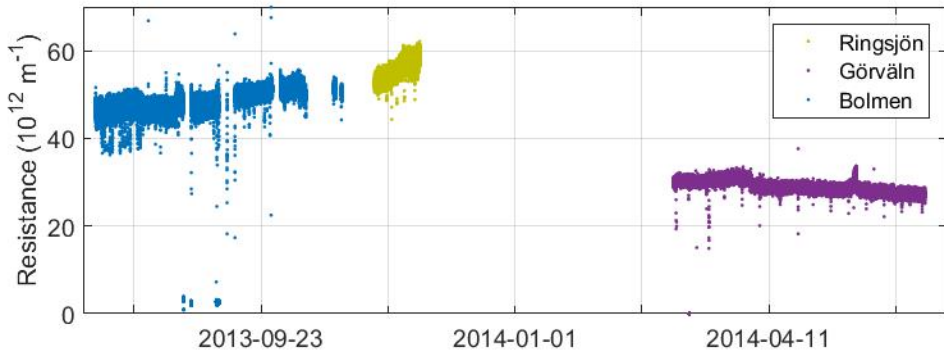

Figure 20 The change of total resistance of the two HFNF modules over time for the three water sources with NF-pilot 80. The trial at Görvål was performed with a newer modification of HFNF, that had an increased permeability to achieve a lower energy demand. The jagged look of the trial with Lake Bolmen water is due to the integrity breaches, which meant stops in the operation for plugging.

In the fall trials, the water temperature was decreasing over the whole period, and in the spring trial, the water temperature was increasing. Nilsson et al. (2008) showed how the membrane permeability was related to the temperature of the feed. Higher temperature was correlated to higher permeability (see forward in Nilsson et al., 2008). In that study, permeability (P_0) was defined as:

$$P_0 = \frac{J}{\Delta P - \Delta \Pi}$$

Eq. 6

Where $\Delta \Pi$ is the osmotic pressure, and the other parameters are the same as in eq. 1. Hence, the permeability has an inverse relationship to the resistance, but it is not

corrected for changes in viscosity due to temperature changes. Nonetheless, the permeability changes was considered to be related to a higher flexibility of the polymers in the membrane with increasing temperatures (Nilsson et al., 2006). On the other hand, this study was about elevated temperatures, between 20°C and 50°C, while in drinking water application, the temperature rarely increases over 20°C, but can be below 4°C. The changes in the flexibility could still be applicable, but there might be other explanations.

The evolution of the membrane resistance of the HFNF seems to be related to temperature in a more or less linear way. Figure 21 shows that the lower temperature leads to a higher resistance of the membrane modules. Again, the large difference between Lake Görvälän and the other two can be explained by the newer modification of the membrane. Yet, the temperature dependence can be seen for both of them. Interestingly, the membrane resistance is increasing with increasing temperature for Lake Görvälän at temperatures $\leq 4^\circ\text{C}$, indicating that there may be a connection to the density. However, the chemical scheme was changed around the same time, and the increased resistance could also be related to a buildup of fouling layers due to a cleaning that was not frequent enough.

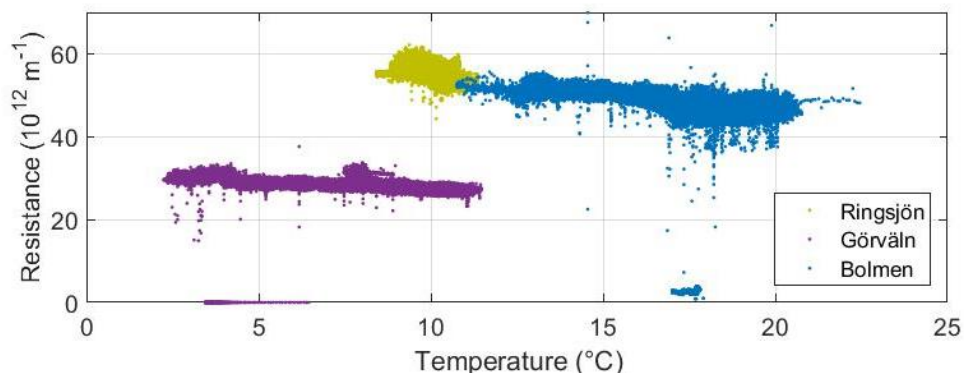

Figure 21 Total resistance of the two HFNF modules, plotted against temperature.

The membrane resistance seems to be related to the TMP. This seems as a natural consequence of the increasing TMP with decreasing temperature, and the resistance increasing in parallel. However, the linearity between the TMP and the resistance has a smoother look (Figure 22) than if it is plotted against the temperature (Figure 21).

Although the temperature dependence of the membrane resistance is known to membrane manufacturers and others (personal communication), it has been difficult to find publications about the resistance changes in applied contexts of membrane treatment. The changes in the membrane resistance require higher TMP in the wintertime, when the viscosity already leads to higher pressures. As result, the energy demand is considerably higher in the winter, when the electricity has the highest price per kWh.

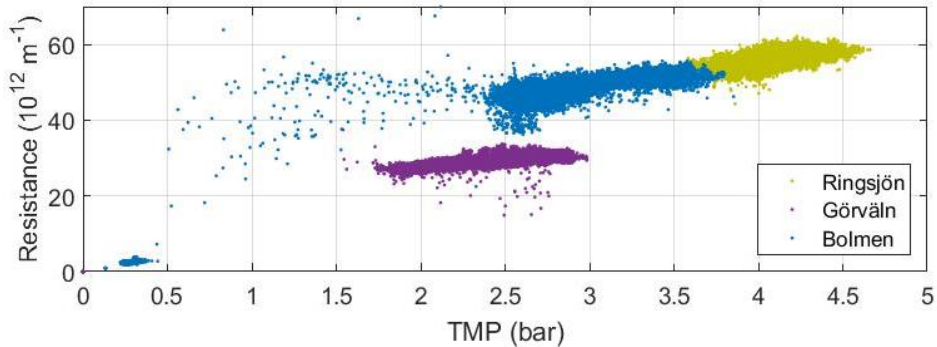

Figure 22 Total resistance of the two HFNF modules, plotted against TMP.

Considering the four terms in the resistance, $R_m + R_a + R_c + R_{bl}$, there are several possible explanation to the increased resistance. As mentioned above, the material properties of the membrane, affecting R_m , can be the reason, with a lower flexibility of the polymers with lower temperatures, but also from higher compaction due to the increased TMP from viscosity changes.

Another plausible explanation can be related to the diffusion constant from the concentration polarization layer or boundary layer on the membrane surface to the bulk feed. A decreased diffusion could impact the three parameters, R_a , R_c and R_{bl} , since that would mean a larger accumulation on the membrane surface.

No significant change in retention of NOM was seen overtime, which neither confirms nor rejects the theories. With a compaction and lower flexibility, however, the retention would be expected to increase. Since the retention was not only based on size exclusion, but also electrical repulsion (Köhler et al., 2016), the impact of the flexibility could be too small to be noticeable. Regarding a change in diffusion, an accumulation on the membrane surface, i.e. a higher concentration polarization, could decrease the retention. On the other hand, if a cake layer is built up, and NOM is absorbed on the pore walls, the retention could increase.

There were no indications of problems with fouling during this pilot study, if considering the optimal cleaning strategy. The changes in resistance are more likely related to water temperature changes than fouling build-up. Lake Ringsjön has a steeper change in the resistance compared to the other two. This could be related to the hardness in the water, with a divalent cation concentration more than double compared to Görväln Bay, and four times the concentration of Lake Bolmen.

5. Future considerations for surface water treatment

////////////////////////////////////

“Far from being a niche concern, water is at the heart of everything we do”,

~ Angel Gurría, Secretary-General of OECD at the Opening plenary of World Water Week 2016

////////////////////////////////////

The once discussed possibility of a global climate change has turned into a fact, and the anthropogenic influence on the climate is certain to a degree of 95 % according to IPCC (2014). Now, the human society needs to adapt to the new challenges. Aquatic systems are far from spared from the risks that climate change entails, and in many ways they are truly vulnerable. Higher temperatures will likely affect the aquatic ecosystems: marine and freshwaters are sensitive systems to temperature changes and its consequences. Effects on the water cycle due to climate change, such as higher evaporation, less snowfall and more unevenly distributed rainfall, pose risks for the human community (IPCC, 2014).

Resilience is a common term in the water sector. From engineers and researcher to policymakers and politicians, the word is likely to appear in a water related discussion. For a surface water treatment plant, resilience is a key for a safe drinking water supply when the surface water ecosystems are changing. A resilient process would be able to provide a safe and aesthetically appealing drinking water even with changing raw water chemistry. Changes of both quantitative and qualitative character must not entail risks for the health of the consumers.

The currently dominating methods, with the main NOM reduction by the chemical treatment, are dependent on the combination of inorganic and organic chemical composition in the water. Buffering capacity, content of iron, and TOC concentration needs to be managed. Practical experiences and theoretical knowledge needs to be combined, which is a large task for the drinking water producers. The change in the

NOM character complicates the situation additionally. Color and UV-absorbing species are increasing more than TOC concentrations, which luckily are the type of NOM that are best removed by current methods; the higher the SUVA, the better removal (Bagtho et al., 2011a; Köhler et al., 2016; Matilainen et al., 2010; Paper I&II). However, a higher dose of coagulants and pH adjusting chemicals means larger costs for the producers, and a larger footprint on the ecosystems and global climate.

5.1 Options for additional resilience (Paper V)

After extreme events, with rapid changes in the raw water quality, some WTPs have been struggling to keep the organic carbon in the outgoing water below the allowed values. At Ringsjö WTP, storms and seasonal changes have brought changes in the NOM content to a degree at which the coagulation process no longer was running with the optimal coagulation dose and pH, which resulted in a reduced efficiency of NOM-removal in the drinking water treatment process. That is not merely an issue due to the capacity of NOM removal by the coagulant, but it is also a consequence of a time demanding process, with a possible lag time of 24 h from the changes in the incoming raw water to the plant, before it is noticed in the drinking water.

There are several alternatives for the drinking water producers to handle this issue. Quick, online analyses of the raw water that are simple to interpret would help the operators to understand the dynamics and character of the NOM in the incoming water, and accordingly adapt the process. Fluorescence has shown promise as such a tool for online measurements (Singh et al., 2015; Paper II). A simultaneous measurement of the raw water and the produced water would give interesting information, and a representation of the process performance. The research has not yet reached a universal conclusion on what part of the fluorescence matrix should be used and how to use it in an applied process, mostly because of all the unknowns of the complex mix of species in the NOM. Nonetheless, FI has shown possible relations to treatment efficiency, both to HFNF and to conventional treatment (Paper II), and this and other indices could be used for monitoring of integrity (Paper III) and possibly other types of performance. The faster more online fluorescence instruments become available, the more information the freshwater community may get on how the fluorophores affect and are affected by the processes. Coupled with color, TOC and absorbance, as well as other advanced offline analyses, these instruments could provide a set of information that can be used in analytical research and engineering applications.

UF, or tighter membrane filtration processes, may provide a method with a faster response to changes in the raw water, and thus faster response of changes in process parameters, such as coagulation dose, pH or flux. The coagulation pretreatment before an ultrafilter requires only a couple of minutes, and the filtration itself is instant, thus changes in the process would be noticed within minutes. Even more likely so if it is

combined with online measurements before and after the coagulation-membrane filtration process. This process would have similar reduction levels as the current flocculation/sedimentation process, but the lag time would be more or less removed. The mixing time for the coagulation in the UF study were 10-15 min with good NOM removal (Paper I), and mixing times as short as 2 min are probably enough to create flocs of optimal size for UF.

A third option would be an improved NOM reduction capacity by the process. Introducing a nanofilter, either the HFNF instead of the flocculation/sedimentation, or another type of nanofilter as a polishing step, would be the safest, most resilient alternative, but also the most expensive (Paper IV). A better retention of NOM would mean a small risk of elevated levels in the drinking water, and there would be next to no risk for pathogens passing through the treatment train uncaught (Paper III). Ultimately, the drinking water producers must decide what quality of the drinking water they are prepared to pay for. The extra NOM reduction does come with a price.

5.2 DBPs

Except for barriers for microorganisms, there are two important aspects to pay attention to regarding drinking water safety from surface water. One aspect is the DBPs, of which there is a consensus of the relation between the concentration of TOC and the formation of several carcinogenic species, although in small concentrations (Richardson et al., 2007).

Regarding the DBPs, the best and safest option would be to reduce the NOM content to low levels. This is the best tradeoff between the certainty of an acute risk for pathogens if disinfection is not applied, and the uncertainty of the effects from the formation of DBPs (Hrudey, 2009). Alternative disinfection methods could be better for human health (Richardson et al., 2007), but the knowledge gap of the DBPs adverse health effect and their formation is still not enough for motivating the abandonment of chlorination (Hrudey, 2009; Richardson et al., 2007). A low content of NOM in the drinking water seems, however, to reduce the risk for DBPs, with or without chlorination (Hrudey, 2009).

Trihalomethanes (THMs) are a carcinogenic type of DBPs that often are regulated and monitored (Hrudey, 2009). A study by Sutherland et al. (2015) found that a safe water with a low formation of THMs, on average required a TOC concentration below 1.1 mg/l, albeit it was site specific. This level would limit the risk for formations due to seasonal variations. However, this was only the average concentration with low THM formation potential, and water with safe water regarding THMs in the third quantile required a concentration of 0.4 mg/l or lower. It was also noted that the formation of THMs had no actual correlation to the TOC concentration, but depended on the type

of treatment, and it differed between different nanofilter, and between different characteristics of the NOM (Sutherland et al., 2015).

These levels are very low, compared to conventional surface treatment in northern Europe. They are difficult to achieve with coagulation/sedimentation, and only the nanofilters have been able to produce water with such low concentrations. The HFNF could achieve levels below 1.1 mg/l as sole treatment (Paper I), and in combination with other treatments, lower levels can be achieved (Köhler et al., 2016). Other nanofilters, such as the spiral-wound nanofilter in this project, has demonstrated a reduction of the formation potential (de la Rubia et al., 2008). Yet, a better reduction in the conventional treatment is possible, and compared to the existing treatment, the formation potential of THMs could likely be reduced by an ozonation step with a biologically active filter (Vasyukova et al., 2013). This would also be a possible combination with coagulation and UF to reduce the formation potential.

5.3 Biological availability

The concentration and character of organic carbon and organic nitrogen are important for the regrowth potential in the distribution system. Biofilms in the piping system are unavoidable, but the less they are promoted, the smaller the risk is for promoting pathogens. Drinking water must safe. This means that the level of pathogens must not only be low in the water leaving the WTP, but also the water reaching the tap of the consumer. Not all type of NOM are available for bacterial growth, but the BDOC and AOC have been found in all fractions of NOM, if divided into building block, biopolymers and low molecular fraction (Vasyukova et al., 2014; Volk et al., 2000), although biopolymers have been shown to constitute a major part of the BDOC (Vasyukova et al., 2014). Luckily, these are selectively removed by conventional treatment and membrane filtration (Keucken et al., 2016; Vasyukova et al., 2014).

What is worrying, is the strong connection between the low molecular weight fraction of NOM and AOC, illustrated by the similarities in the range between AOC and TOC concentrations in a nanofilter permeate (Meylan et al., 2007). This show that most of the NOM that passes through the treatment processes are available for bacterial growth, since the low molecular weight fraction is the fraction with the lowest reduction by NF, and a major part passes through conventional treatment (Köhler et al., 2016). NF does, however, reduce the concentration of AOC, as a part of the overall TOC reduction (Meylan et al., 2007; Park et al., 2005), and may still produce a drinking water with a supreme drinking water compared to the conventional treatment, including the biological stability of the water.

For both types of treatment, there is a need for an additional step – as a microbiological barrier, and as biological treatment of the BDOC and AOC. The low concentration after a treatment like the HFNF filtration, would likely have little

influence on the health of the consumer. However, with the risk for fiber failure, there is a remaining risk for contamination of the permeate (see chap. 4.3 or Paper III). There is a need for an additional microbiological barrier, preferably with at least a virus LRV of 2-log for a safe water (Figure 10), that can mitigate the increased passage through the membrane due to an integrity breach.

If that barrier would be combined with a biological degradation, such as slow sand filtration, the additional risk for biological available NOM passing through the treatment would be reduced. Similar to the coagulation process, nanofiltration reduces substances that, in fluorescence analysis, reemits light at relatively long wavelengths (Köhler et al., 2016). Slow sand filtration has the opposite selectivity, with a small, but significant removal of DOC, and specifically matter that reemits at shorter wavelengths (Lavonen et al., 2015). Hence, the two processes should be a good combination for removing as many types of species as possible. Both types of processes have showed removal of biopolymers (Keucken et al., 2016; Lavonen et al., 2015), thus, hopefully, the major constituent of BDOC would be reduced by such treatment train.

There is a more critical need for additional treatment after UF. The level of NOM reduction is not enough for a biologically stable water, and a lower TOC concentration would be preferable before chlorination. The combination between ozonation and slow sand filtration have shown increased reduction of TOC compared to slow sand filtration alone (Graham, 1999). Ozonation has proved to increase the AOC in the water, why it is improving the bioavailability of the NOM (Lehtola et al., 2001), thus it is good to combine ozonation with a biofilter, but it should not be applied only as a final disinfection step. This combination should be able to have an additional reduction of NOM, decrease the bioavailable matter (Vasyukova et al., 2014), and add two extra microbiological barriers. That would truly produce a safe water, but possibly with elevated values of DBPs compared to nanofiltered water. For a raw water with relatively low TOC concentration, e.g. Lake Stora Neden with 3.5 mg/l, a UF treatment with coagulation pretreatment, followed by e.g. ozonation and slow sand filtration would likely be the best option (Paper V).

5.4 The future for membrane filtration in Sweden

Since the start of this project, two of the involved drinking water producers have introduced membrane filtration in their treatment trains, and one is looking into a membrane treatment alternative for a WTP that was not included in this study. That demonstrates the interest for implementing membrane filtration into surface water treatment in Sweden. Because of the clear proof that membranes are great

microbiological barriers, more ultrafilters and nanofilters in drinking water production will lead to a safer drinking water in Sweden.

It is, however, important not to put all eggs in one basket. Even the best technology fails occasionally, and there must be backups. In this case, this means an additional step with NOM reduction and microbiological barrier effect. Changes in the NOM removal efficiency due to changes in the raw water, or integrity breaches could lead to consequences for the consumer's health, if there were no other barrier (Paper III). There is also a risk that a new UF installment could not keep up with the changes in the raw water. Most of the water sources in this project had TOC concentrations of around 10 mg/l, and with the advances in the knowledge about NOM in the drinking water, it is possible that the treatment efficiency will be considered insufficient in the future (Paper I), either due to changes in the raw water sources, or due to more knowledge about the DPB formation and bioavailability of the NOM.

NF has a great potential for being a future universal alternative in drinking water production. The environmental impact of the membrane filtration is, in contrast to popular belief, possibly lower than of conventional treatment, including climate impact (Paper IV). It seems to be the most reasonable option for minimizing the DBP formation from chlorination, and the BDOC. With a good performance monitoring, including monitoring of the integrity, NF is a reliable process that is relatively simple to operate.

There are two big issues remaining regarding nanofiltration. The major one is the cost. With the current flux by the HFNF, the investment cost for a WTP in the size range as Ringsjö WTP and Görväln WTP would be great, in magnitude many times more than what UF would cost. From that perspective, a UF treatment would probably be considered a more affordable option, with "good enough" quality of the produced water. This is a problem that is not possible to go around, and the investment cost is crucial for the decisions regarding what process to choose.

The other issue is the rejected water. In Sweden, the water is abundant, and loss of water is not a problem per se. However, if the NF would be placed in the end of a treatment train, there would be a loss of treated water, which have required energy, chemicals and labor to produce. If the raw water is treated, the large concentration in the reject would probably entail issue, especially for a case like Ringsjö WTP, where Lake Bolmen is located 100 km away from the treatment plant. There will probably be innovative solutions in the future for this issue, but they are not yet found. More research is needed.

6. Limitations of the study and continuation from here

Any project has its limitations and assumptions that restrict the width of the conclusions. In all research projects, time is a limiting factor. In a project about surface water treatment, it is impossible to cover all situations. A surface water changes over time, not only seasonal changes, but also after extreme events. All this is impossible to cover in a research projects. The most useful knowledge is gathered over decades of operation, and the real experts are the operators at the WTPs. A pilot study may only give an idea of how to operate a process.

In a project like this, with a restricted time frame, but with several water sources available, the desire to have data from as many circumstances for each source as possible had to be balanced between the water sources. Long time series are always desirable for a reliable conclusion in a specific situation, but multiple raw water sources gives a more general picture. This is also true for balancing the different membrane modules and coagulants etc. Decisions made for this specific research project also included balancing the wishes of multiple stakeholders and funders. All this put together with the restrictions of my own time, the time of other project managers and technicians, the resources were probably not used in an optimal way from a research perspective. Yet, there are a multitude of data and other outcomes from the project as a whole.

Pilot studies are important, and is needed before moving forward. However, there are pieces of the puzzle that are missing. The conditions are similar to a full-scale process, with an uncontrolled feed water. Although the membranes are thought to replace parts of the process, it should be complemented with other steps. Information on how the new water quality would affect the following steps, and how the end water quality would be like, are in reality more useful than the results from the stand alone membrane step.

The integrity breaches were a limiting factor in this pilot study. Although the results were useful for evaluation of NOM related integrity indicators, the stops in the process led to involuntary delays. Additionally, some of the sampling occasions have been excluded in the data analysis; in the beginning of the pilot study the AITs were not performed often enough. As result, the integrity status during many sampling occasions was not known, but with a low retention indicating fiber leakage. The reasons behind the relatively frequent integrity breaches have not been fully explained. Compared to

other studies with the same type of membrane (e.g. Heidfors et al., 2015; Keucken et al., 2016), this was untypical for this membrane, and it must have been circumstantial. The issues could be related to water hammering because of a faulty valve, which was replaced halfway through the project. However, the breaches occurred both before it broke and after it was replaced, thus it might not be the only explanation. Another theory is a possible problem with microparticles, which were found in the strainer at the inlet. A strainer of 300 µm might not have been tight enough to catch particles that were destructive to the membrane.

6.1 What is next?

In this thesis, I have already touched upon what is needed for future development of the ideas in this thesis. There are several aspects the drinking water producers may be interested in for further research. For this, I have put together a “wish list” of things that I imagine would be in the interest of surface water treatment utilities.

There are available probes for online fluorescence. Thus, although they might not be of the preferred wavelengths, it would be possible to collect information online in full-scale processes. Installments could be used to monitor the raw water and other stages in the process. Combined with information on removal, such as UVA₂₅₄ and TOC, this could give information about the treatment process itself, and how fluorescence monitoring could be applied. There is also a need for more information on bioavailable NOM, and if fluorescence derived parameters, that can be implemented online, could be related to AOC or BDOC in any way. This research should be very useful for the drinking water producers.

Pilot studies are indispensable, but the more they can mimic a full-scale process, the better it is. Continued studies on membrane filtration are encouraged to include a biological treatment step that follows the membrane filtration. For the UF, the combination of UF, ozonation and biofilter should be researched. Specifically, the bioavailability and the DBP formation potential need more research, especially concerning membrane filtration. If more data would be simultaneously collected, e.g. online measurements of UV-Vis and fluorescence, and supplementing offline analysis, such as LC-OCD fractionation, the easier it will be to determine the use of the online methods. This would also give useful information before the process would be implemented as a full-scale process.

In this study, it was difficult to optimize the UF-process, or rather the coagulation conditions prior to UF. Type of coagulant, level of dose and pH affect the membrane performance, such as TMP, and likely the lifetime of the membrane, which have also been demonstrated in another study (Arkhangelsky et al., 2011). The reoccurring metal and/or organic fouling of the membrane indicate a need to optimize, not only with regard to the raw water character, but also to membrane itself. There is a need for

assuring a stable pH adjustment. In this study, the distance from the acid/base dosing point to the pH-meter was so long that it made the adjustment extra difficult in the waters with almost no buffering capacity.

Regarding nanofiltration, the reject, or bleed flow, is a problem; a 14 % loss of raw water is not negligible. At Görväln WTP, that is located on the shore of the big Lake Mälaren, it would probably be possible to discharge it back into the lake without any detrimental consequences on the ecosystem. Ringsjö WTP would have a unique difficulty, being located so far from the lake. The nearby Lake Ringsjön would not be an option for discharge, because it would not be sensible to release concentrated content from one lake into another one. Yet, other plants that has a small lake or water course as raw water source, could also mean issue, with the risk for affecting the ecosystem negatively due to concentrated NOM, bacteria and viruses. Before implementing a process like the HFNF at a WTP, the pilot study should include research on the reject flow. For example, it could be further treated – the high content of humic should make it relatively treatable. However, it is reasonable to believe that the produced water from this reject would not be appropriate as drinking water, with too high levels of NOM and maybe viruses. It could, however, be used for irrigation, or to create bogs and wetlands. NOM may be further concentrated for fertilizer use. If reject would be further treated with membranes for disinfection, it could be possible to use for irrigation. Alas, the high TOC concentration would likely cause problem with fouling if it was treated further.

For researchers that are interested in the application of nanofiltration, the dependence on hardness for NOM removal efficiency would be interesting to investigate further. For example, it remains unclear how the divalent ion concentration affects the retention of NOM species. It could be possible that the hardness affects the retention of specific characters of NOM. The chemical conditions in an alkaline lake may have another NOM composition, due to the formation of other types of complexes and what type of microbial community that lives in the water body. Maybe the influence of that is low, compared to the effect on the membrane surface charge due to the presence of cations, but it could be worthwhile looking into.

Although a large part of the Swedish population is supplied with tap water from the large WTPs, the majority of municipal treatment plants are small, with operators dividing their time over several plants. Ringsjö WTP is not only lucky with the available water source, but is also well staffed. There are two highly educated process engineers in addition to other competent and able personnel. This company is doing something admirable, being the forerunners in water research, developing new process strategies and finding new process alternatives for Swedish conditions. However, the smaller companies cannot merely duplicate the process, thus they have still a lack of resources. The earlier small companies can be part of research efforts within the field, the wider the picture will get. In GenoMembran, the small companies took actively part, and hopefully they will also be invited in future research project. This will gain the small companies as well as the research field of water process engineering as a whole.

From this study, it is clear that a membrane like the HFNF is an alternative for safer water. Albeit the advanced NOM removal is desirable, the present attached to it can be hard to justify – especially since the drinking water quality in Sweden is, overall, considered good, by decision makers and by consumers. Although it is not the energy demand that is the main problem, the manufacturer of the HFNF decided to modify the HFNF to reduce the needed TMP. Sadly, that has decreased the removal capacity, without affecting the cost to any satisfying degree. In fact, a similar membrane with a higher flux would be the preferred alternative for a process the size of Ringsjö WTP, which could allow for a somewhat lower NOM removal. That would reduce both the investment and the operation costs.

7. Conclusions

From the results presented in my dissertation the following conclusions can be drawn:

- Membrane filtration is a strong competitor for an advance NOM removal in future surface water treatment.
- The hollow fiber nanofilter can achieve an advanced NOM removal: it produces a water with a lower risk of DBPs and bacterial regrowth than conventional chemical treatment.
- Ultrafiltration with coagulation could, for humic rich waters, replace the current flocculation/sedimentation/rapid sand filtration process, with an additional improvement on the microbiological barrier effect. Especially for a raw water with a lower TOC concentration (< 5 mg/l), this is likely the most affordable option. There is, however, a need for further studies to optimize the coagulation process, to find the right balance between the operation cost and NOM removal.
- To eliminate the risk for pathogens, membrane filtration should be monitored online for integrity breaches, and, optimally, be followed by an additional filtration step as a safeguard for uncaught microorganisms, e.g. in the event of integrity breaches. This step could be combined with a biological treatment, to remove remaining TOC concentration that could be biologically available.
- Fluorescence has the potential to be a useful tool for analysis of the treatment efficiency in surface water treatment. Fluorescence index could be an indicator for the potential NOM removal in a nanofiltration process and the conditions for the coagulation process. It could supplement SUVA as a parameter to represent the NOM character influencing the treatment process.
- NOM related parameters can be used for indirect monitoring of membrane integrity, and possibly other performance aspects, for this type of membranes. Foremost changes in UVA_{254} has successfully been related to leaking fibers, but changes in TOC, Fluorescence index, peak C and peak T have also been related to leakage. A reliable online monitoring makes it possible to trust the membrane filtration as a safe microbiological barrier, without requiring frequent stops for air integrity tests.
- The operational costs would increase slightly or not at all if the conventional treatment were replaced with ultrafiltration in Swedish surface water

treatment. A treatment step with hollow fiber nanofilters would increase the operational costs with 30 % - mostly due to the module replacements.

- The electricity demand increases by a nanofiltration step – but the overall environmental impact of membrane filtration compared to conventional treatment is generally lower due to the lower chemical dosing.

References

- Adham, S., Gagliardo, P., Smith, D., Ross, D., Gramith, K., Trussell, R., 1998. Monitoring the integrity of reverse osmosis membranes. *Desalination* 119, 143–150. doi:10.1016/S0011-9164(98)00134-9
- Alvarez-Gaitan, J.P., Peters, G.M., Rowley, H. V, Moore, S., Short, M.D., 2013. A hybrid life cycle assessment of water treatment chemicals: an Australian experience. *Int. J. Life Cycle Assess.* 18, 1291–1301. doi:10.1007/s11367-013-0574-4
- Amy, G., 2008. Fundamental understanding of organic matter fouling of membranes. *Desalination* 231, 44–51. doi:10.1016/j.desal.2007.11.037
- Antony, A., Blackbeard, J., Leslie, G., 2012. Removal Efficiency and Integrity Monitoring Techniques for Virus Removal by Membrane Processes. *Crit. Rev. Environ. Sci. Technol.* 42, 891–933. doi:10.1080/10643389.2011.556539
- Arkhangelsky, E., Lerch, A., Uhl, W., Gitis, V., 2011. Organic fouling and floc transport in capillaries. *Sep. Purif. Technol.* 80, 482–489. doi:10.1016/j.seppur.2011.06.001
- Babatunde, A.O., Zhao, Y.Q., 2007. Constructive Approaches Toward Water Treatment Works Sludge Management: An International Review of Beneficial Reuses. *Crit. Rev. Environ. Sci. Technol.* 37, 129–164. doi:10.1080/10643380600776239
- Baghoth, S.A., Sharma, S.K., Amy, G.L., 2011a. Tracking natural organic matter (NOM) in a drinking water treatment plant using fluorescence excitation-emission matrices and PARAFAC. *Water Res.* 45, 797–809. doi:10.1016/j.watres.2010.09.005
- Baghoth, S.A., Sharma, S.K., Guitard, M., Heim, V., Croué, J.-P., Amy, G.L., 2011b. Removal of NOM-constituents as characterized by LC-OCD and F-EEM during drinking water treatment. *J. Water Supply Res. Technol. - Aqua* 60, 412–424.
- Baker, A., Tipping, E., Thacker, S.A., Gondar, D., 2008. Relating dissolved organic matter fluorescence and functional properties. *Chemosphere* 73, 1765–1772. doi:10.1016/j.chemosphere.2008.09.018
- Baker, R.W., 2012a. Concentration Polarization, in: *Membrane Technology and Applications*. John Wiley & Sons, Ltd, pp. 179–206. doi:10.1002/9781118359686.ch4
- Baker, R.W., 2012b. Membrane Transport Theory, in: *Membrane Technology and Applications*. John Wiley & Sons, Ltd, pp. 15–96. doi:10.1002/9781118359686.ch2
- Baker, R.W., 2012c. Ultrafiltration, in: *Membrane Technology and Applications*. John Wiley & Sons, Ltd, pp. 253–302. doi:10.1002/9781118359686.ch6
- Bonton, A., Bouchard, C., Barbeau, B., Jedrzejak, S., 2012. Comparative life cycle assessment

- of water treatment plants. *Desalination* 284, 42–54. doi:10.1016/j.desal.2011.08.035
- Brandstetter, A., Sletten, R.S., Mentler, A., Wenzel, W.W., 1996. Estimating dissolved organic carbon in natural waters by UV absorbance (254 nm). *Zeitschrift für Pflanzenernährung und Bodenkd.* 159, 605–607. doi:10.1002/jpln.1996.3581590612
- Cho, J., Amy, G., Pellegrino, J., 2000. Membrane filtration of natural organic matter: Factors and mechanisms affecting rejection and flux decline with charged ultrafiltration (UF) membrane. *J. Memb. Sci.* 164, 89–110. doi:10.1016/S0376-7388(99)00176-3
- Cho, J., Amy, G., Pellegrino, J., 1999. Membrane filtration of natural organic matter: initial comparison of rejection and flux decline characteristics with ultrafiltration and nanofiltration membranes. *Water Res.* 33, 2517–2526. doi:10.1016/S0043-1354(98)00498-9
- Coble, P.G., 1996. Characterization of marine and terrestrial DOM in seawater using excitation-emission matrix spectroscopy. *Mar. Chem.* 51, 325–346. doi:10.1016/0304-4203(95)00062-3
- Coble, P.G., Green, S.A., Blough, N. V, Gagosian, R.B., 1990. Characterization of dissolved organic matter in the Black Sea by fluorescence spectroscopy. *Nature* 348, 432–435.
- Cory, R.M., McKnight, D.M., 2005. Fluorescence Spectroscopy Reveals Ubiquitous Presence of Oxidized and Reduced Quinones in Dissolved Organic Matter. *Environ. Sci. Technol.* 39, 8142–8149. doi:10.1021/es0506962
- Crozes, G.F., Sethi, S., Mi, B., Curl, J., Mariñas, B., 2002. Improving membrane integrity monitoring indirect methods to reduce plant downtime and increase microbial removal credit. *Desalination* 149, 493–497. doi:10.1016/S0011-9164(02)00787-7
- de la Rubia, A., Rodríguez, M., León, V.M., Prats, D., 2008. Removal of natural organic matter and THM formation potential by ultra- and nanofiltration of surface water. *Water Res.* 42, 714–22. doi:10.1016/j.watres.2007.07.049
- Dong, B. zhi, Chen, Y., Gao, N. yun, Fan, J. chu, 2007. Effect of coagulation pretreatment on the fouling of ultrafiltration membrane. *J. Environ. Sci.* 19, 278–283. doi:10.1016/S1001-0742(07)60045-X
- Eikebrokk, B., 1999. Coagulation-direct filtration of soft, low alkalinity humic waters. *Water Sci. Technol.* 40(9), 55–62. doi:10.1016/S0273-1223(99)00640-X
- Eikebrokk, B., Juhna, T., 2010. Optimization of water treatment: Enhanced coagulation and ozonation-biofiltration. Nieuwegein, NL.
- Ekström, S., 2013. Brownification of freshwaters: the role of dissolved organic matter and iron. Lund: Department of Biology, Lund University, 2013.
- Ekström, S.M., Kritzberg, E.S., Kleja, D.B., Larsson, N., Nilsson, P.A., Graneli, W., Bergkvist, B., 2011. Effect of Acid Deposition on Quantity and Quality of Dissolved Organic Matter in Soil–Water. *Environ. Sci. Technol.* 45, 4733–4739. doi:10.1021/es104126f
- ElHadidy, A.M., Peldszus, S., Van Dyke, M.I., 2013. An evaluation of virus removal mechanisms by ultrafiltration membranes using MS2 and φX174 bacteriophage. *Sep.*

- Purif. Technol. 120, 215–223. doi:10.1016/j.seppur.2013.09.026
- Evans, C.D., Chapman, P.J., Clark, J.M., Monteith, D.T., Cresser, M.S., 2006. Alternative explanations for rising dissolved organic carbon export from organic soils. *Glob. Chang. Biol.* 12, 2044–2053. doi:10.1111/j.1365-2486.2006.01241.x
- Evans, C.D., Monteith, D.T., Cooper, D.M., 2005. Long-term increases in surface water dissolved organic carbon: observations, possible causes and environmental impacts. *Environ. Pollut.* 137, 55–71. doi:10.1016/j.envpol.2004.12.031
- Fabris, R., Chow, C.W.K., Drikas, M., Eikebrokk, B., 2008. Comparison of NOM character in selected Australian and Norwegian drinking waters. *Water Res.* 42, 4188–4196.
- Fan, L., Harris, J.L., Roddick, F.A., Booker, N.A., 2001. Influence of the characteristics of natural organic matter on the fouling of microfiltration membranes. *Water Res.* 35, 4455–4463. doi:10.1016/S0043-1354(01)00183-X
- Fellman, J.B., Hood, E., Spencer, R.G.M., 2010. Fluorescence spectroscopy opens new windows into dissolved organic matter dynamics in freshwater ecosystems: A review. *Limnol. Oceanogr.* 55(6), 2452–2462.
- Ferrer, O., Casas, S., Galvañ, C., Lucena, F., Bosch, A., Galofré, B., Mesa, J., Jofre, J., Bernat, X., 2015. Direct ultrafiltration performance and membrane integrity monitoring by microbiological analysis. *Water Res.* 83, 121–131. doi:10.1016/j.watres.2015.06.039
- Fiksdal, L., Leiknes, T., 2006. The effect of coagulation with MF/UF membrane filtration for the removal of virus in drinking water. *J. Memb. Sci.* 279, 364–371. doi:10.1016/j.memsci.2005.12.023
- Filella, M., 2009. Freshwaters: which NOM matters? *Environ. Chem. Lett.* 7, 21–35. doi:10.1007/s10311-008-0158-x
- Frank, M., Bargeman, G., Zwijnenburg, A., Wessling, M., 2001. Capillary hollow fiber nanofiltration membranes. *Sep. Purif. Technol.* 22, 499–506. doi:10.1016/S1383-5866(00)00171-4
- Friberg, N., Rebsdorf, A., Larsen, S.E., 1998. Effects of Afforestation on Acidity and Invertebrates in Danish Streams and Implications for Freshwater Communities in Denmark. *Water. Air. Soil Pollut.* 101, 235–256. doi:10.1023/A:1004949203686
- Friedrich, E., 2002. Life-cycle assessment as an environmental management tool in the production of potable water. *Water Sci. Technol.* 46(9), 29–36.
- Futselaar, H., Schonewille, H., Van Der Meer, W., 2002. Direct capillary nanofiltration - A new high-grade purification concept. *Desalination* 145, 75–80. doi:10.1016/S0011-9164(02)00389-2
- Galvañ, C., Casas, S., Llombart, M., Mesa, J., Ferrer, O., Gibert, O., Bernat, X., 2014. Direct pre-treatment of surface water through submerged hollow fibre ultrafiltration membranes. *Water Sci. Technol. Water Supply* 14, 461–469.
- Gijsbertsen-Abrahamse, A.J., Cornelissen, E.R., Hofman, J.A.M.H., 2006. Fiber failure frequency and causes of hollow fiber integrity loss. *Desalination* 194, 251–258.

doi:10.1016/j.desal.2005.11.010

- Gorenflo, A., Velázquez-Padrón, D., Frimmel, F.H., 2003. Nanofiltration of a German groundwater of high hardness and NOM content: performance and costs. *Desalination* 151, 253–265. doi:10.1016/S0011-9164(02)01018-4
- Graham, N.J.D., 1999. Removal of Humic Substances by Oxidation/Biofiltration Processes - a Review. *Water Sci. Technol.* 40, 141–148.
- Guigui, C., Rouch, J.C., Durand-Bourlier, L., Bonnelye, V., Aptel, P., 2002. Impact of coagulation conditions on the in-line coagulation/UF process for drinking water production. *Desalination* 147, 95–100. doi:10.1016/S0011-9164(02)00582-9
- Guo, H., Wyart, Y., Perot, J., Nauleau, F., Moulin, P., 2010. Low-pressure membrane integrity tests for drinking water treatment: A review. *Water Res.* 44, 41–57. doi:10.1016/j.watres.2009.09.032
- Gutierrez, L., Aubry, C., Valladares Linares, R., Croue, J.P., 2015. Natural organic matter interactions with polyamide and polysulfone membranes: Formation of conditioning film. *Colloids Surfaces A Physicochem. Eng. Asp.* 477, 1–8. doi:10.1016/j.colsurfa.2015.03.031
- Heidfors, I., Vredendregt, L.H.J., Holmes, A., van Es, M.B., 2015. Pilot testing with hollow fiber nanofiltration membranes for removal of NOM from surface water in Sweden, in: 6th IWA Specialist Conference on Natural Organic Matter in Water. Malmö.
- Henderson, R.K., Baker, A., Murphy, K.R., Hambly, A., Stuetz, R.M., Khan, S.J., 2009. Fluorescence as a potential monitoring tool for recycled water systems: A review. *Water Res.* 43, 863–881. doi:10.1016/j.watres.2008.11.027
- Henderson, R.K., Stuetz, R.M., Khan, S.J., 2010. Demonstrating ultra-filtration and reverse osmosis performance using size exclusion chromatography. *Water Sci. Technol.* 62(12), 2747–2753. doi:10.2166/wst.2010.423
- Hilal, N., Al-Zoubi, H., Darwish, N.A., Mohamma, A.W., Abu Arabi, M., 2004. A comprehensive review of nanofiltration membranes: Treatment, pretreatment, modelling, and atomic force microscopy. *Desalination* 170, 281–308. doi:10.1016/j.desal.2004.01.007
- Hongve, D., Riise, G., Kristiansen, J.F., 2004. Increased colour and organic acid concentrations in Norwegian forest lakes and drinking water -- a result of increased precipitation? *Aquat. Sci.* 66, 231–238. doi:10.1007/s00027-004-0708-7
- Howe, K.J., Clark, M.M., 2002. Fouling of Microfiltration and Ultrafiltration Membranes by Natural Waters. *Environ. Sci. Technol.* 36, 3571–3576. doi:10.1021/es025587r
- Hrudey, S.E., 2009. Chlorination disinfection by-products, public health risk tradeoffs and me. *Water Res.* 43, 2057–92. doi:10.1016/j.watres.2009.02.011
- Huang, H., Young, T.A., Schwab, K.J., Jacangelo, J.G., 2012. Mechanisms of virus removal from secondary wastewater effluent by low pressure membrane filtration. *J. Memb. Sci.* 409, 1–8. doi:10.1016/j.memsci.2011.12.050

- Hudson, N., Baker, A., Reynolds, D., 2007. Fluorescence analysis of dissolved organic matter in natural, waste and polluted waters—a review. *River Res. Appl.* 23, 631–649. doi:10.1002/rra.1005
- Huisman, I.H., Williams, K., 2004. Autopsy and failure analysis of ultrafiltration membranes from a waste-water treatment system. *Desalination* 165, 161–164. doi:10.1016/j.desal.2004.06.052
- IPCC, 2014: Climate Change 2014: Synthesis Report. Contribution of Working Groups I, II and III to the Fifth Assessment Report of the Intergovernmental Panel on Climate Change [Core Writing Team, R.K. Pachauri and L.A. Meyer (eds.)]. IPCC, Geneva, Switzerland, 151 pp.
- Jönsson, A.-S., Jönsson, B., 2012. Membranprocesser. Lunds Tekniska Högskola, Lund.
- Kabsch-Korbutowicz, M., 2006. Removal of natural organic matter from water by in-line coagulation/ultrafiltration process. *Desalination* 200, 421–423. doi:10.1016/j.desal.2006.03.389
- Keucken, A., Wang, Y., Tng, K.H., Leslie, G.L., Persson, K.M., Köhler, S.J., Spanjer, T., 2016. Evaluation of novel hollow fibre membranes for NOM removal by advanced membrane autopsy. *Water Sci. Technol. Water Supply* 16(3), 628–640.
- Konieczny, K., Bodzek, M., Kopeć, A., Szczepanek, A., 2007. Coagulation - Submerged membrane system for NOM removal from water. *Polish J. Environ. Stud.* 16, 563–569.
- Kritzberg, E.S., Ekström, S.M., 2012. Increasing iron concentrations in surface waters – a factor behind brownification? *Biogeosciences* 9, 1465–1478. doi:10.5194/bg-9-1465-2012
- Kruithof, J.C., Kamp, P.C., Folmer, H.C., Nederlof, M.M., van Hoof, S.C.J.M., 2001. Development of a membrane integrity monitoring strategy for the UF/RO Heemskerk drinking water treatment plant. *Water Sci. Technol. Water Supply* 1, 261–271.
- Kuckshinrichs, W., 2012. Managing CO₂ Emissions in the Chemical Industry. Von H.-J. Leimkühler. *Chemie Ing. Tech.* 84, 1140–1140. doi:10.1002/cite.201290056
- Kumar, M., Adham, S., DeCarolis, J., 2007. Reverse osmosis integrity monitoring. *Desalination* 214, 138–149. doi:10.1016/j.desal.2006.10.021
- Köhler, S.J., Buffam, I., Seibert, J., Bishop, K.H., Laudon, H., 2009. Dynamics of stream water TOC concentrations in a boreal headwater catchment: Controlling factors and implications for climate scenarios. *J. Hydrol.* 373, 44–56. doi:10.1016/j.jhydrol.2009.04.012
- Köhler, S.J., Lavonen, E., Keucken, A., Schmitt-Kopplin, P., Spanjer, T., Persson, K., 2016. Upgrading coagulation with hollow-fibre nanofiltration for improved organic matter removal during surface water treatment. *Water Res.* 89, 232–240. doi:10.1016/j.watres.2015.11.048
- Lagans vattenråd, 2016. <http://www.vattenorganisationer.se/lagansvr/> [accessed on May 2016]
- Lavonen, E., 2015. Tracking changes in dissolved natural organic matter composition: evaluating drinking water production using optical and molecular level tools. (Doctoral

- thesis). *Acta Universitatis agriculturae Sueciae*: 2015:42. Swedish University of Agricultural Sciences.
- Lavonen, E.E., Gonsior, M., Tranvik, L.J., Schmitt-Kopplin, P., Köhler, S.J., 2013. Selective Chlorination of Natural Organic Matter: Identification of Previously Unknown Disinfection Byproducts. *Environ. Sci. Technol.* 47, 2264–2271.
- Lavonen, E.E., Kothawala, D.N., Tranvik, L.J., Gonsior, M., Schmitt-Kopplin, P., Köhler, S.J., 2015. Tracking changes in the optical properties and molecular composition of dissolved organic matter during drinking water production. *Water Res.* 85, 286–294. doi:10.1016/j.watres.2015.08.024
- Ledesma, J.L.J., Köhler, S.J., Futter, M.N., 2012. Long-term dynamics of dissolved organic carbon: implications for drinking water supply. *Sci. Total Environ.* 432, 1–11. doi:10.1016/j.scitotenv.2012.05.071
- Lee, S., Kwon, B., Sun, M., Cho, J., 2005. Characterizations of NOM included in NF and UF membrane permeates. *Desalination* 173, 131–142. doi:10.1016/j.desal.2004.08.030
- Lehtola, M.J., Miettinen, I.T., Vartiainen, T., Myllykangas, T., Martikainen, P.J., 2001. Microbially available organic carbon, phosphorus, and microbial growth in ozonated drinking water. *Water Res.* 35, 1635–1640. doi:10.1016/S0043-1354(00)00449-8
- Lidén, A., Keucken, A., Persson, K.M., 2015. *GenoMembran Slutrapport från projekt 2012–2015 (SVU Rapport Nr 2015-20)*. Bromma, Sweden
- Liikanen, R., Yli-Kuivila, J., Tenhunen, J., Laukkanen, R., 2006. Cost and environmental impact of nanofiltration in treating chemically pre-treated surface water. *Desalination* 201, 58–70. doi:10.1016/j.desal.2006.03.520
- Liu, G., Lut, M.C., Verberk, J.Q.J.C., Van Dijk, J.C., 2013. A comparison of additional treatment processes to limit particle accumulation and microbial growth during drinking water distribution. *Water Res.* 47, 2719–2728. doi:10.1016/j.watres.2013.02.035
- Livsmedelsverket, 2015. *Livsmedelsverkets föreskrifter om dricksvatten*.
- Matilainen, A., Vepsäläinen, M., Sillanpää, M., 2010. Natural organic matter removal by coagulation during drinking water treatment: A review. *Adv. Colloid Interface Sci.* 159, 189–197. doi:10.1016/j.cis.2010.06.007
- Matsushita, T., Shirasaki, N., Tatsuki, Y., Matsui, Y., 2013. Investigating norovirus removal by microfiltration, ultrafiltration, and pre-coagulation–microfiltration processes using recombinant norovirus virus-like particles and real-time immuno-PCR. *Water Res.* 47, 5819–5827. doi:10.1016/j.watres.2013.07.004
- Meylan, S., Hammes, F., Traber, J., Salhi, E., von Gunten, U., Pronk, W., 2007. Permeability of low molecular weight organics through nanofiltration membranes. *Water Res.* 41, 3968–3976. doi:10.1016/j.watres.2007.05.031
- Mijatović, I., Matošić, M., Hajduk Černeha, B., Bratulić, D., 2004. Removal of natural organic matter by ultrafiltration and nanofiltration for drinking water production. *Desalination* 169, 223–230. doi:10.1016/j.desal.2004.01.002

- Monteith, D.T., Stoddard, J.L., Evans, C.D., de Wit, H.A., Forsius, M., Hogasen, T., Wilander, A., Skjelkvale, B.L., Jeffries, D.S., Vuorenmaa, J., Keller, B., Kopacek, J., Vesely, J., 2007. Dissolved organic carbon trends resulting from changes in atmospheric deposition chemistry. *Nature* 450, 537–540.
- Mopper, K., Feng, Z., Bentjen, S.B., Chen, R.F., 1996. Effects of cross-flow filtration on the absorption and fluorescence properties of seawater. *Mar. Chem.* 55, 53–74. doi:10.1016/S0304-4203(96)00048-5
- Naismith, J., 2005. Membrane integrity — direct turbidity measurement of filtrate from MF membrane modules at an operating potable water treatment plant. *Desalination* 179, 25–30. doi:10.1016/j.desal.2004.11.052
- Nikolaou, A.D., Goufopoulos, S.K., Lekkas, T.D., Kostopoulou, M.N., 2004. DBP Levels in Chlorinated Drinking Water: Effect of Humic Substances. *Environ. Monit. Assess.* 93, 301–319. doi:10.1023/B:EMAS.0000016798.53163.43
- Nilsson, M., Trägårdh, G., Östergren, K., 2008. The influence of pH, salt and temperature on nanofiltration performance. *J. Memb. Sci.* 312, 97–106. doi:10.1016/j.memsci.2007.12.059
- Nilsson, M., Trägårdh, G., Östergren, K., 2006. The influence of sodium chloride on mass transfer in a polyamide nanofiltration membrane at elevated temperatures. *J. Memb. Sci.* 280, 928–936. doi:10.1016/j.memsci.2006.03.013
- Ohno, T., 2002. Fluorescence inner-filtering correction for determining the humification index of dissolved organic matter. *Environ. Sci. Technol.* 36, 742–746. doi:10.1021/es0155276
- Owen, G., Bandi, M., Howell, J.A., Churchouse, S.J., 1995. Economic assessment of membrane processes for water and waste water treatment. *J. Memb. Sci.* 102, 77–91. doi:10.1016/0376-7388(94)00261-V
- Panglisch, S., Deinert, U., Dautzenberg, W., Kiepke, O., Gimbel, R., 1998. Monitoring the integrity of capillary membranes by particle counters. *Desalination* 119, 65–72. doi:10.1016/S0011-9164(98)00108-8
- Park, N., Kwon, B., Sun, M., Ahn, H., Kim, C., Kwoak, C., Lee, D., Chae, S., Hyung, H., Cho, J., 2005. Application of various membranes to remove NOM typically occurring in Korea with respect to DBP, AOC and transport parameters. *Desalination* 178, 161–169. doi:10.1016/j.desal.2004.11.035
- Park, P., Lee, C., Choi, S.-J., Choo, K.-H., Kim, S.-H., Yoon, C.-H., 2002. Effect of the removal of DOMs on the performance of a coagulation-UF membrane system for drinking water production. *Desalination* 145, 237–245. doi:10.1016/S0011-9164(02)00418-6
- Parlanti, E., Wörz, K., Geoffroy, L., Lamotte, M., 2000. Dissolved organic matter fluorescence spectroscopy as a tool to estimate biological activity in a coastal zone submitted to anthropogenic inputs. *Org. Geochem.* 31, 1765–1781. doi:10.1016/S0146-6380(00)00124-8
- Patel, A., Noble, R.T., Steele, J.A., Schwalbach, M.S., Hewson, I., Fuhrman, J.A., 2007. Virus

- and prokaryote enumeration from planktonic aquatic environments by epifluorescence microscopy with SYBR Green I. *Nat. Protoc.* 2, 269–276.
- Patterson, C., Anderson, A., Sinha, R., Muhammad, N., Pearson, D., 2011. Nanofiltration Membranes for Removal of Color and Pathogens in Small Public Drinking Water Sources. *J. Environ. Eng.* 138, 48–57. doi:10.1061/(ASCE)EE.1943-7870.0000463
- Peiris, R.H., Budman, H., Moresoli, C., Legge, R.L., 2010. Understanding fouling behaviour of ultrafiltration membrane processes and natural water using principal component analysis of fluorescence excitation-emission matrices. *J. Memb. Sci.* 357, 62–72. doi:10.1016/j.memsci.2010.03.047
- Peiris, R.H., Jaklewicz, M., Budman, H., Legge, R.L., Moresoli, C., 2013. Assessing the role of feed water constituents in irreversible membrane fouling of pilot-scale ultrafiltration drinking water treatment systems. *Water Res.* 47, 3364–3374. doi:10.1016/j.watres.2013.03.015
- Pype, M.-L., Donose, B.C., Martí, L., Patureau, D., Wery, N., Gernjak, W., 2016. Virus removal and integrity in aged RO membranes. *Water Res.* 90, 167–175. doi:10.1016/j.watres.2015.12.023
- Razali, M., Zhao, Y.Q., Bruen, M., 2007. Effectiveness of a drinking-water treatment sludge in removing different phosphorus species from aqueous solution. *Sep. Purif. Technol.* 55, 300–306. doi:10.1016/j.seppur.2006.12.004
- Rebhun, M., Lurie, M., 1993. Control of Organic Matter by Coagulation and Flocc Separation. *Water Sci. Technol.* 27, 1–20.
- Regula, C., Carretier, E., Wyart, Y., Gésan-Guiziou, G., Vincent, A., Boudot, D., Moulin, P., 2014. Chemical cleaning/disinfection and ageing of organic UF membranes: A review. *Water Res.* 56, 325–365. doi:10.1016/j.watres.2014.02.050
- Richardson, S.D., Plewa, M.J., Wagner, E.D., Schoeny, R., DeMarini, D.M., 2007. Occurrence, genotoxicity, and carcinogenicity of regulated and emerging disinfection by-products in drinking water: A review and roadmap for research. *Mutat. Res. - Rev. Mutat. Res.* 636(1-3),178–242. doi:10.1016/j.mrrev.2007.09.001
- Sagle, A., Freeman, B., 2016. *Fundamentals of Membranes for Water Treatment*. Austin, TX.
- Schwinge, J., Neal, P.R., Wiley, D.E., Fletcher, D.F., Fane, A.G., 2004. Spiral wound modules and spacers: Review and analysis. *J. Memb. Sci.* 242, 129–153. doi:10.1016/j.memsci.2003.09.031
- Sillanpää, M., 2015. Natural Organic Matter in Water, *Natural Organic Matter in Water*. doi:10.1016/B978-0-12-801503-2.00001-X
- Sillanpää, M., Metsämuuronen, S., Mänttari, M., 2015. Natural Organic Matter in Water, *Natural Organic Matter in Water*. doi:10.1016/B978-0-12-801503-2.00005-7
- Singh, S., Henderson, R.K., Baker, A., Stuetz, R.M., Khan, S.J., 2015. Online fluorescence monitoring of RO fouling and integrity: analysis of two contrasting recycled water schemes. *Environ. Sci. Water Res. Technol.* 1, 689–698. doi:10.1039/C5EW00090D

- Singh, S., Henderson, R.K., Baker, A., Stuetz, R.M., Khan, S.J., 2012. Characterisation of reverse osmosis permeates from municipal recycled water systems using fluorescence spectroscopy: Implications for integrity monitoring. *J. Memb. Sci.* 421, 180–189. doi:10.1016/j.memsci.2012.07.008
- Slavik, I., Müller, S., Mocosch, R., Azongbilla, J.A., Uhl, W., 2012. Impact of shear stress and pH changes on floc size and removal of dissolved organic matter (DOM). *Water Res.* 46, 6543–6553. doi:10.1016/j.watres.2012.09.033
- Sutherland, S., Parsons, S.A., Daneshkhah, A., Jarvis, P., Judd, S.J., 2015. THM precursor rejection by UF membranes treating Scottish surface waters. *Sep. Purif. Technol.* 149, 381–388. doi:10.1016/j.seppur.2015.06.009
- Svensk Energi, 2016. Klimatpåverkan och växthusgaser [WWW Document]. URL www.svenskenergi.se (accessed 8.9.16).
- Tam, L.S., Tang, T.W., Lau, G.N., Sharma, K.R., Chen, G.H., 2007. A pilot study for wastewater reclamation and reuse with MBR/RO and MF/RO systems. *Desalination* 202, 106–113. doi:10.1016/j.desal.2005.12.045
- Tirén Ström, J., 2016. Utvärdering av processen vid Hofors vattenverk med avseende på avskiljning av NOM – fällning och membranfilterteknik. Sveriges lantbruksuniversitet and Uppsala University.
- Traina, S.J., Novak, J., Smeck, N.E., 1990. An ultraviolet absorbance method of estimating the percent aromatic carbon content of humic acids. *J. Environ. Qual.* 19(1), 151-153
- Walsh, M.E., Chaulk, M.P., Gagnon, G.A., 2005. Indirect integrity testing on a pilot-scale UF membrane. *J. Water Supply Res. Technol. - Aqua* 54, 105-114.
- Vasyukova, E., Proft, R., Jousten, J., Slavik, I., Uhl, W., 2013. Removal of natural organic matter and trihalomethane formation potential in a full-scale drinking water treatment plant. *Water Sci. Technol. Water Supply* 13, 1099 -1108.
- Vasyukova, E., Proft, R., Uhl, W., 2014. Evaluation of dissolved organic matter fractions removal due to biodegradation, in: *Progress in Slow Sand and Alternative Biofiltration Processes*. pp. 59–66.
- Weishaar, J.L., Aiken, G.R., Bergamaschi, B.A., Fram, M.S., Fujii, R., Mopper, K., 2003. Evaluation of Specific Ultraviolet Absorbance as an Indicator of the Chemical Composition and Reactivity of Dissolved Organic Carbon. *Environ. Sci. Technol.* 37, 4702–4708. doi:10.1021/es030360x
- Veríssimo, S., Peinemann, K.-V., Bordado, J., 2005. New composite hollow fiber membrane for nanofiltration. *Desalination* 184, 1–11. doi:10.1016/j.desal.2005.03.069
- Volk, C., Bell, K., Ibrahim, E., Verges, D., Amy, G., Lechevallier, M., 2000. Impact of enhanced and optimized coagulation on removal of organic matter and its biodegradable fraction in drinking water. *Water Res.* 34, 3247–3257. doi:10.1016/S0043-1354(00)00033-6
- WWAP (United Nations World Water Assessment Programme). 2016. The United Nations World Water Development Report 2016: Water and Jobs. Paris, UNESCO.

- Worrall, F., Harriman, R., Evans, C.D., Watts, C.D., Adamson, J., Neal, C., Tipping, E., Burt, T., Grieve, I., Monteith, D., Naden, P.S., Nisbet, T., Reynolds, B., Stevens, P., 2004. Trends in Dissolved Organic Carbon in UK Rivers and Lakes. *Biogeochemistry* 70, 369–402. doi:10.1007/s10533-004-8131-7
- Vrouwenvelder, J.S., Graf von der Schulenburg, D.A., Kruithof, J.C., Johns, M.L., van Loosdrecht, M.C.M., 2009. Biofouling of spiral-wound nanofiltration and reverse osmosis membranes: A feed spacer problem. *Water Res.* 43, 583–594. doi:10.1016/j.watres.2008.11.019
- Zularisam, A.W., Ismail, A.F., Sakinah, M., 2010. Application and Challenges of Membrane in Surface Water Treatment. *J. Appl. Sci.* 10(5), 380–390.
- Ødegaard, H., Thorsen, T., Melin, E., 2000. Practical experiences from membrane filtration plants for humic substance removal. *Water Sci. Technol.* 41, 33–41.
- Ødegaard, H., Østerhus, S., Melin, E., Eikebrokk, B., 2010. NOM removal technologies -- Norwegian experiences. *Drink. Water Eng. Sci.* 3, 1–9.