



LUND UNIVERSITY

Integration of Wind Power in Medium Voltage Networks - Voltage Control and Losses

Leisse, Ingmar

2011

[Link to publication](#)

Citation for published version (APA):

Leisse, I. (2011). *Integration of Wind Power in Medium Voltage Networks - Voltage Control and Losses*.

Total number of authors:

1

General rights

Unless other specific re-use rights are stated the following general rights apply:

Copyright and moral rights for the publications made accessible in the public portal are retained by the authors and/or other copyright owners and it is a condition of accessing publications that users recognise and abide by the legal requirements associated with these rights.

- Users may download and print one copy of any publication from the public portal for the purpose of private study or research.
- You may not further distribute the material or use it for any profit-making activity or commercial gain
- You may freely distribute the URL identifying the publication in the public portal

Read more about Creative commons licenses: <https://creativecommons.org/licenses/>

Take down policy

If you believe that this document breaches copyright please contact us providing details, and we will remove access to the work immediately and investigate your claim.

LUND UNIVERSITY

PO Box 117
221 00 Lund
+46 46-222 00 00

Integration of Wind Power in Medium Voltage Networks

Voltage Control and Losses



Ingmar Leiß

Division of Industrial Electrical Engineering and Automation
Faculty of Engineering, Lund University

Integration of Wind Power in Medium Voltage Networks

Voltage Control and Losses

Ingmar Leiß



LUND UNIVERSITY

Licentiate Thesis
Department of Measurement Technology and
Industrial Electrical Engineering

2011

Department of Measurement Technology and Industrial Electrical Engineering
Faculty of Engineering
Lund University
Box 118
221 00 Lund
SWEDEN

<http://www.iea.lth.se>

ISBN: 978-91-88934-54-3
CODEN: LUTEDX/TEIE-1062/1-144/(2011)

© Ingmar Leißer, 2011
Printed in Sweden by Media-Tryck, Lund University
Lund 2011

There are no problems, only solutions.

(John Lennon)

Abstract

Since some years ago greenhouse gases and especially carbon dioxide have become one of the most widely debated issues. To reduce the emission of carbon dioxide and nuclear waste, renewable energy sources as for example wind power plants have become very successful. These generation units are normally small compared to common thermal power plants and they are often placed distributed and connected to the distribution network. Therefore they are also called distributed generation (DG) units.

For the distribution network the connection of generation units is a challenge since distributed networks were planned and built and dimensioned for the connection of load. Customers are normally connected to the distribution network and therefore voltage quality is an important issue for distribution networks. Medium and low voltage distribution networks are quite passive today with none or only somewhat communication and voltage control. In many cases the only feasibility to control the network voltage is the on-load tap changer at the high voltage/medium voltage transformer. Voltage variations and varying network losses are two important aspects when connecting generation units to the distribution network.

To reinforce an existing network by building new lines to cope with the voltage variations caused by DG units and in such a way increase the DG capacity in a distribution network is always a solution but it is an expensive one. In this thesis other solutions which allow an increase of the DG capacity without network reinforcement are considered. Three different methods for voltage control in medium voltage distribution networks are mentioned in this work: coordinated control of the on-load tap changer, reactive power consumption and active power curtailment.

A voltage control algorithm to maintain the voltage within the limits at all

network nodes has been developed within this work. The voltage control algorithm is able to perform three different control strategies: local on-load tap changer (OLTC) control, DG control and coordinated OLTC control. Local OLTC control is often used in medium voltage networks today. With DG control the voltage is controlled at the connection point of the DG units by the use of reactive power consumption and active power curtailment. In the case of coordinated OLTC control the voltage is controlled by a coordination of the on-load tap changer, reactive power consumption and active power curtailment. In addition to previous work done within this area voltage measurement values from already installed electricity meters are used as feedback for the OLTC control. The voltages obtained by the control algorithm and the network losses are simulated within this work.

Simulations of the network voltages and the losses in the network were done on a generic network with three typical kinds of feeders. It is shown that the DG capacity in this generic network can be increased if the network becomes more active and the DG units are participating in the network voltage control as in the case of local DG control and coordinated OLTC control. Furthermore a more fair distribution of the curtailment has been tested but that increases the totally used curtailment. To exemplify on a real existing network, the network of Svalöv substation (Sweden) was analysed and transferred into the simulation tool. The Svalöv area has already today a lot of wind turbines connected and more are planned. The simulations from the generic network were repeated on this existing network and also here the DG capacity could be increased significantly by a more active voltage control in the network.

Acknowledgements

I would like to thank my supervisor Dr. Olof Samuelsson for his support during my two and a half years as PhD student. He has contributed with suggestions, guidance and ideas during the process of my work. Another thanks goes to my co-supervisor Dr. Jörgen Svensson for productive discussions and "triggering" ideas. I am also thankful for their proofreading of this thesis.

The project "New generation for new electricity distribution" was financed by E.ON. The simulations of the real existing network would not have been possible without the great support from the people at E.ON Elnät Sverige AB in Malmö. In this context I would like to thank Christian Andersson, Pierre Andersson-Ek, Anton Dahlgren, Charlotte Klippel and Ulf Thorén for their time and the patient answers on my questions. Special thanks are also addressed to Professor Torbjörn Thiringer from Chalmers University of Technology for his helpful comments and suggestions during the meetings.

I would like to thank all my colleagues working at the division of Industrial Electrical Engineering and Automation for the great time and discussions. Especially my friends and room mates Johan Björnstedt and Francesco Sulla receive special thanks for their help and our discussions, in addition Johan for the marvellous team work during several projects and Francesco for serious contributions in various situations.

Last but not least I would like to dedicate this thesis to all the nice people around me. This regards especially my parents, my brother and my girlfriend Anne.

Lund, January 2011
Ingmar Leißer

Contents

1	Introduction	1
1.1	Motivation	1
1.2	Objectives	8
1.3	Contributions	9
1.4	Outline of the Thesis	10
1.5	Publications	11
2	Medium Voltage Network Overview	13
2.1	Structure	13
2.2	Components	14
2.2.1	Overhead Lines and Underground Cables	14
2.2.2	Transformer	17
2.2.3	Shunt Capacitors/Reactors	19
2.3	Requirements	20
2.4	DG Expansion	22
2.5	Metering	23
2.6	Communication	24
2.7	Challenges	24
3	Network Voltage	27
3.1	Voltage Changes	27
3.2	Voltage Control	34
3.2.1	On-load Tap Changer	34
3.2.2	Reactive Power	38
3.2.3	Active Power Curtailment	40
3.2.4	Summary of Voltage Control Methods	43
4	Voltage Control Algorithm	45
4.1	Local OLTC Control	47

4.2	DG Control	49
4.3	Coordinated OLTC Control	54
5	Network Losses	59
5.1	Shunt and Series Losses	59
5.2	Network Losses with DG Connected	61
5.2.1	Simple Cases for Network Losses with and without DG Connected	63
6	Generic Network	67
6.1	Test System	67
6.2	Simulation Program and Models	69
6.3	Simulations	71
6.3.1	Local OLTC Control	71
6.3.2	DG Control	73
6.3.3	Coordinated OLTC Control	80
6.4	Summary	90
7	Svalöv Network	95
7.1	Test System	95
7.2	Simulations	97
7.2.1	Local OLTC Control with Existing DG Units	99
7.2.2	Local OLTC Control	101
7.2.3	DG Control	103
7.2.4	Coordinated OLTC Control	109
7.3	Summary	115
8	Conclusions	121
9	Future Work	125
	References	127

Chapter 1

Introduction

The focus of this work is to describe methods for using the medium voltage distribution network more flexibly through an extended and more active voltage control and by this increase the amount of connected distributed generation (DG) capacity without need for rebuilding the network. A closer look has been taken at the opportunities for active voltage control obtained from the use of reactive power consumption, generation curtailment and a coordinated control of the on-load tap changer (OLTC) at the substation transformer. New electricity meters, installed in all Swedish households and at other customers, are capable to measure the voltage at the customer side. Using voltage values from these meters as input for the voltage control is considered within this work.

This chapter introduces the work presented in this thesis. The motivation for the work is described and the contributions obtained are summarized.

1.1 Motivation

In the early days of electrification local networks with local generation and consumption were built. Since then networks have been increasingly interconnected. In our days electricity is mostly generated in large power plants and then transferred via the transmission network to the distribution network where the customers are connected. These large generation units can be both coal or gas fired thermal power plants, nuclear thermal power plants or large

hydropower stations. The common ground for all these power plants is that they are connected to the high voltage transmission network.

During the last years, with a focus on reducing the emission of carbon dioxide, renewable energy sources have become more popular for the generation of electricity [1]. A huge development of renewable energy sources took place during the last decade caused by the increased demand for environmentally friendly electric power production. Today the most established ones are wind power, biomass-fired combined heat and power (CHP) and photovoltaic installations.

These generation units are small compared to the conventional power plants and therefore they are often, like customers, connected to the distribution network, which is one possible definition of distributed generation [2]. Thus the splitting between generation and consumption has been blurred and the traditional power flow from the large generation units in the high voltage transmission grid to the customers connected to the low voltage distribution network is not necessarily valid for all cases today.

A large number of these previously named DG units are placed in rural areas and therefore they are connected to weak parts of the distribution network where even small units can influence the voltage at and around their connection point. This is one of the most important factors limiting the amount of DG that can be connected in a certain network.

DG units are often connected to the medium voltage distribution network as shown in figure 1.1 or to the low voltage distribution network. In this work the DG units under study are at the size of several 100kW up to some few MW and therefore typically connected to the medium voltage distribution network, where 10kV and 20kV are common voltage levels.

Due to the historical application field of traditional medium voltage distribution networks, they are equipped with none or only some communication and voltage control. Therefore these networks are mainly passive. The voltage is maintained by dimensioning the network according to the expected voltage drop caused by the connected loads. The only active component is normally the on-load tap changer at the substation that keeps the voltage at

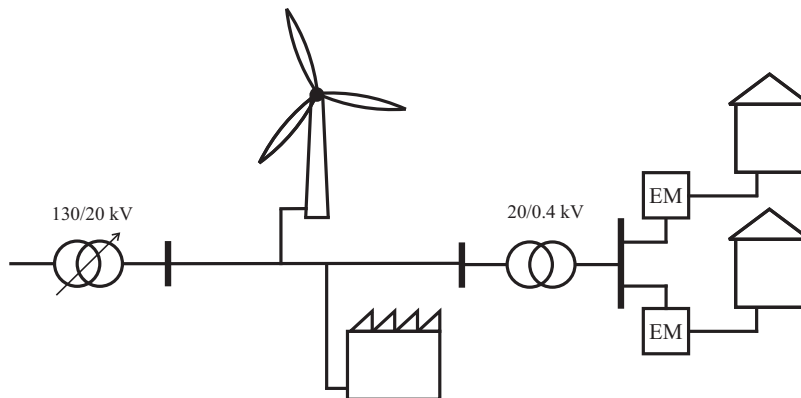

Figure 1.1: Simple single-line diagram of a typical medium voltage and low voltage distribution network with load and generation connected (EM: electricity meter at customer connection point)

the substation within a deadband. Therefore the actual voltage in the network is depending on the on-load tap changer setting and the network loading. The focus is on avoiding undervoltages. When generation is connected to the grid it brings the risk of overvoltage which was previously not an issue.

Until now, a certain amount of DG units is allowed to be connected to existing feeders of medium voltage distribution networks. Before they are connected, a simple analysis of the expected voltage at the connection point is carried out but otherwise DG units are often treated as negative loads. If the expected voltage at the connection point in the worst case scenario is over the limit, the connection at the existing feeder is normally considered not possible. Then the network will either be reinforced or the DG unit will not be connected if the costs for the network reinforcement are too expensive.

Until some years ago, but even today, medium voltage networks, especially in rural areas, were often consisting of non-isolated overhead lines. They were cost-efficient and easy to repair but vulnerable to extreme weather conditions and falling trees. Typical overhead lines have an inductive characteristic. To make the distribution network in Sweden more reliable and less susceptible to weather related disturbances, many of the overhead lines have been replaced by underground cables, hanging cables or isolated overhead lines during the

last years. This replacement changed the characteristics of the network from inductive to more capacitive.

In a traditional overhead line medium voltage distribution network with an inductive characteristic the highest voltage could typically be found at the substation medium voltage side. This voltage is often maintained by an on-load tap changer located at the HV/MV transformer. To maintain the voltage in all network nodes the grid is designed so that the voltage drop is acceptable also in the case of maximum loading. When load is connected, the voltage decreases from the substation along the feeder as presented in figure 1.2 (solid black line), where the voltage at the substation is shown on the left side. To compensate for the voltage drop along the feeder and to keep the voltage within the limits, the voltage at the substation is chosen above 1 p.u. to shift the voltage profile up (dotted black line in figure 1.2). Since the connection of DG units acts to increase the voltage at the connection point, the assumption that the voltage is always lower with increasing distance from the substation is no longer necessarily valid under all circumstances (dash-dotted black line in figure 1.2). In this case it would be preferable to set the voltage at the substation below 1 p.u. (dashed black line in figure 1.2) to maintain the voltage within the limits along the feeder. Although generation is connected to a feeder, the voltage will still decrease, if the load along the feeder is larger than the generation. In contrast, the voltage will increase along the feeder or in some parts of the feeder, if the generation is larger than the load. For the case of equally distributed load and generation with the same amounts, the voltage may actually remain constant along the feeder (solid blue line in figure 1.2).

The possibility of voltage rises brings new challenges to the operation of distribution networks which are designed and operated considering only consumption [3]. Until now they were purely passive networks and not designed to cope with generation units and increasing voltages caused by the injected power [4]. Since network voltage is important to power quality and also directly affects all the other units and customers connected to the grid, voltage control to keep the voltage within the limits is an important matter. More active distribution networks, in the literature often referred as Smart Grids, may be one solution for this problem [5, 6, 7]. The benefits from active management of distribution networks are discussed in [8]. Active power curtailment,

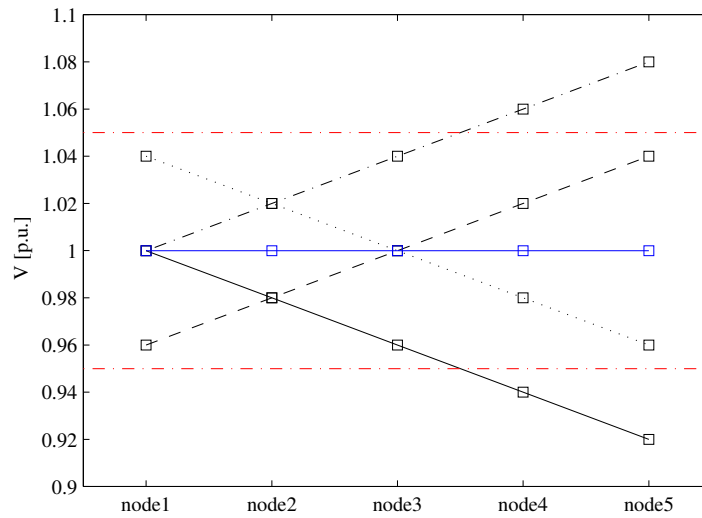

Figure 1.2: Voltage at substation (node 1) and along a feeder with only load connected and without OLTC (solid black), with only load and a traditional OLTC (dotted black), with only DG connected (dash-dot black), with only DG and traditional OLTC (dashed black) and with equal amounts of load and DG connected (solid blue) and assumed voltage limits (dash-dotted red) which are not respected here

reactive power management and coordinated voltage control are mentioned as active management strategies. In an example for a wind farm of 8MW it is shown that the need of generation curtailment could be decreased from 6.04 % to 1.61 % when the power factor is decreased from 0.98 to 0.95. In the same network configuration not more than 5.3 % of the total available energy in a year had to be curtailed for a wind farm of 16MW when the on-load tap changer was used for voltage control.

The numerous publications in this research area during the last years reflect a great interest in connecting generation to the distribution network. Some recent papers covering the most important topics are introduced below.

The voltage rise caused by the DG units is one of the limiting factors when in-

stalling distributed generation especially in rural distribution networks where the line impedance is comparatively large [1]. The maximum amount of distributed generation capacity, that can be connected to an existing network is in the literature also referred as hosting capacity [9].

Particularly for generators, which are connected to the grid by inverters, the output or consumption of reactive power is controllable in a large range [10]. The feasibility to control the reactive power output independent of the active power output makes it possible to contribute to the voltage control in some extent and is taken into account in many papers discussing voltage control in medium voltage networks.

When using reactive power for voltage control, the total flow of reactive power and thereby also the network losses may increase as shown in other work [11]. Therefore network losses have to be considered if a noticeable amount of reactive power is used in the network.

To cope with voltage variations in distribution networks caused by DG units, an advanced control of the on-load tap changer has been proposed [12, 13]. Voltage measurements at some network nodes combined with state estimation were used to adapt the voltage setpoint of the on-load tap changer to the actual network loading situation.

However, nearly ten years ago in 2002 active management of distribution networks to control the voltage rise effect was mentioned in [14]. Simulations on a large medium voltage network have been performed and active power curtailment is mentioned as reasonable when it is only needed during some short time and the DG capacity can be increased during the rest of the time. The use of increasing reactive power compensation for avoiding active power curtailment has been discussed and the benefit for that strategy has been shown. In addition benefits of OLTC coordinated voltage control were mentioned. Both strategies reduced the need of curtailment but a combination of the strategies was not applied as the studies were mainly focussing on monetary benefits from the various strategies. Furthermore it is not mentioned how the setpoint for the OLTC is obtained.

An advanced on-load tap changer control combined with reactive power out-

put of the generation units was proposed in another paper [15]. Here a repeated load flow on the network was used to determine the voltages at all network nodes. Based on the calculated voltages the OLTC position and the reactive power were adjusted by the control algorithm.

Reactive compensation alone will not be sufficient to maintain the voltage in distribution networks due to their low X/R-ratio [16]. While close to the substation, where the influence of the transformer is significant, the X/R-ratio may still be comparatively large it will decrease further out in the network. Three methods for voltage control in highly resistive networks are proposed: active power, a variable series inductor and combination of parallel and serial converters.

In Finland research was done on local and coordinated voltage control in distribution networks presented in [17]. A combination of local control and coordinated control has been proposed. For the local voltage control local reactive power control and production curtailment was introduced. The coordinated control was carried out by changing the set point of the on-load tap changer. Local voltage measurements are used to limit the voltage by absorption of reactive power. By state estimations of the network voltages the voltage setpoint of the on-load tap changer is adjusted which is called substation voltage control. A continuous voltage control has been proposed as well as optimization algorithms to choose the priorities of the different control variables. The proposed control algorithm was tested for primary control of the substation voltage and primary control of the DG reactive power. Due to the fact that the absolute voltages were known, a smooth restore control could be implemented. In a further step substation voltage control and DG reactive power control have been simulated in a RTDS environment [18].

An approach in which a coordinated control of the OLTC, reactive power consumption and active power curtailment are used is presented in the Austrian DG DemoNet-Concept [19, 20]. Various voltage control strategies including local control and coordinated voltage control are discussed in these papers. For the coordinated control of the on-load tap changer voltage measurements are assumed at critical nodes of the system. Due to absolute voltage measurements a smooth control of the OLTC is possible here as well. To minimize the use of curtailment, a ranking table for the DG units was created. Thus,

several units increase their reactive power consumption to maintain the node voltage before active power curtailment is activated. A case study of an Austrian distribution grid has been carried out and economical aspects have been considered [21].

During the last years new electricity meters have been installed in all households in Sweden, as it is compulsory to read the customers' measurement values on a monthly basis since July 2009. These electricity meters come with communication to report the measurement values of consumed energy at least once per month to the distribution network operator. Beside consumed energy, also other measurement values as for example for the determination of voltage limit violations are available. These values are a potentially valuable resource for voltage control in an active network.

1.2 Objectives

The purpose of this work is to find solutions for increasing the DG capacity connected to a medium voltage distribution network with respect to the voltage limits but without reinforcement or rebuilding of the network. As wind turbines currently are the most common type of DG units in Swedish medium voltage distribution networks, they will be in the focus of this thesis. Although rebuilding and reconstruction of the existing networks are always solutions to avoid inadequate voltage rise in the distribution grid, other solutions may be preferred because of the high costs and the much time consuming process of changing existing lines or installing new lines. Instead several voltage control strategies available in a medium voltage distribution network could be used to obtain a voltage control which fits to the needs of DG. The voltage control could be done locally by the DG units as well as on the entire network by the on-load tap changer at the substation transformer.

The major objectives for this work are:

- Local voltage control at the DG connection points by the use of reactive power consumption as well as active power curtailment should be implemented.

- The control of the OLTC should be adapted in such a way that it is set according to the situation in the entire network.
- A central coordination controller should be used to decide which methods are activated to maintain the network voltage. The coordination controller can get feedback about the network voltage in form of voltage limit violation alarms from electricity meters.
- The part of the voltage band which is available for the distributed generation units should be increased during most of the time by the use of an active network control.
- Network losses should be considered when reactive power is used for voltage control.
- The theoretical considerations derived from this work should be verified by simulations on a realistic network.

1.3 Contributions

The voltage control methods on-load tap changer, reactive power consumption and active power curtailment discussed in this thesis are well known and have been discussed before. Also some combinations of them have been considered.

The main contribution from and innovative feature of this thesis is a continuous monitoring of the voltage limit violations at the customer connection point at the low voltage level by already existing electricity meters. Therefore the margins to the voltage limits which are normally applied today when distributed generation is connected to the distribution network can be reduced.

The main contributions obtained from this work are:

- A control algorithm for coordinated voltage control which includes a

combination of coordinated OLTC control, reactive power consumption and active power curtailment has been developed within this work. Restore control to go back to normal system operation is included in the algorithm.

- Voltage limit violation alarms obtained from the electricity meters were taken into account and used as feedback for the coordination controller. Hence, the voltage situation at the customer connection point was monitored continuously and therefore margins could be decreased.
- Simulations on a large, real existing medium voltage distribution network with high penetration of wind turbines were carried out. Load and generation profiles over 15 days were obtained by measured values.
- The total network losses were simulated. Thus the impact on the losses from the use of reactive power could be determined. Therefore a simple cost analysis to identify the most advantageous control strategy could be done.

1.4 Outline of the Thesis

In chapter 2 an overview of typical medium voltage networks is given. It starts with the network structure, typical components used in a medium voltage distribution network and which requirements regarding the voltage that need to be met. Then changes caused by the introduction of distributed generation are described. The possibility brought by the new energy meters and the potential of more and more available communication are shown. In the end of the chapter some challenges of modern medium voltage distribution networks are mentioned.

The various methods to maintain the voltage in a medium voltage distribution network are more detailed explained in chapter 3. Beside the theory also some examples will be given. The three most common ways of voltage control in medium voltage distribution networks (on-load tap changer, reactive power and active power curtailment) are described more in detail.

A voltage control algorithm for an extended voltage control in medium voltage networks is presented in chapter 4. Three different voltage control strategies which will be used for the simulations in following chapters are described and discussed.

In chapter 5 some background about losses in a typical medium voltage network is given. Also an example for a typical calculation of losses in such a distribution network is shown.

Chapter 6 describes the structure and the characteristics of the generic test network. The network is first considered with only local voltage control of the on-load tap changer. Then voltages and losses are simulated for local voltage control at the node of DG connection. Finally coordinated voltage control in the entire generic medium voltage distribution network is described.

The real medium voltage distribution network of Svalöv substation is presented in chapter 7. First the test system is presented and some characteristics of the network are pointed out. Later on the simulations done on the real network are described and in the last section of the chapter the results from these simulations are summarized. Also some economical aspects of the integration of distributed generation into distribution networks are given in this chapter by comparing the costs for tap operations, reactive power consumption and active power curtailment.

A short summary of this thesis and the conclusions obtained by this work are presented in chapter 8. Moreover the results obtained from the simulations are discussed.

An outlook on further work that could be done within this area is given in the last chapter 9.

1.5 Publications

Two papers have been published based on this work:

I. Leisse; O. Samuelsson; J. Svensson; "Increasing DG Capacity of Existing Networks Through Reactive Power Control and Curtailment" (2010) presented at *9th Nordic Distribution and Asset Management Conference (NORDAC) 2010*, Aalborg, Denmark.

I. Leisse; O. Samuelsson; J. Svensson; "Electricity Meters for Coordinated Voltage Control in Medium Voltage Networks with Wind Power" (2010) presented at *IEEE PES Conference on Innovative Smart Grid Technologies Europe*, Göteborg, Sweden.

Chapter 2

Medium Voltage Network Overview

This chapter will give a short overview over the structure and the components of current medium voltage distribution networks and show in which way they will be affected by the increasing number of DG units connected to the distribution networks.

2.1 Structure

The medium voltage network is a part of the distribution network. Usually distribution networks including medium voltage networks are built to transfer energy from the high voltage transmission network to the customers in the low voltage distribution grid. There are also some customers with larger loads directly connected to the medium voltage distribution network. As a result of having the generation units connected to the transmission grid and the customers to the distribution network, until now the power flow was unidirectional from the transmission network to the customers. This leads under normal conditions to a decreasing voltage from the substation to the customer point of connection. Especially in urban areas medium voltage networks are often built in a meshed structure. However, on the countryside a radial network structure is more common. Although medium voltage networks built as meshed networks also may be operated as meshed, they are normally operated as radial networks [22, 23].

Common voltages for the medium voltage distribution grids in Sweden are 10kV and 20kV. There are also medium voltage networks with higher voltages as for example 40kV, 50kV and 70kV depending on the network operator.

Medium voltage networks in Sweden are both consisting of underground cables and overhead lines. After the storms Gudrun (2005) [24] and Per (2007) [25] tenths of thousands of kilometres of overhead lines have been replaced by underground cables and covered conductor overhead lines which are much less sensitive for wind, snow and falling trees compared to the old non-isolated overhead lines. In the area of the network operator E.ON more than 17000km of lines have been replaced in the years 2006 to 2010 [26]. Several medium voltage distribution feeders are usually connected to one substation and from there they spread out to the medium voltage/ low voltage substations. The feeders can both be pure load, pure generation and mixed load and generation feeders.

2.2 Components

In this section typical main components of an ordinary medium voltage distribution network are described.

2.2.1 Overhead Lines and Underground Cables

In medium voltage distribution networks overhead lines as well as underground cables are common. While medium voltage networks in urban regions are almost always built with cables there are still quite a lot of rural areas where overhead lines are used. In Sweden a lot of non-isolated overhead lines have been replaced by underground cables or isolated overhead lines during the past years.

Underground cables and isolated overhead lines are more robust regarding extreme weather conditions as for example storms with falling trees, icing

and lightning. Therefore they become more common even in rural areas especially those with large forest areas. A drawback of underground cables is that fault diagnostics and repair are more time consuming than for overhead lines. Overhead lines are normally less expensive but they are more visible and space consuming.

In medium voltage distribution networks the lines have to be dimensioned with respect to the voltage drop (see chapter 3), the thermal conditions and also network losses (see chapter 5). All of them are depending on the total line impedance, which is the product of the impedance per length and the line length, and the current through the line, i.e. the loading. In rural areas the loads are usually more distributed as in urban areas where the consumption is more concentrated. Thus network lines on the countryside are often lower loaded than lines in urban areas. Since the cross section area of a line is selected based on the current that should be transferred through the line, lines in urban areas are often of larger cross section than in rural areas. The larger cross section implies a smaller line impedance. A rule of thumb says that an economic rating for aluminium cables in newly built medium voltage networks is achieved with an ampacity of 1 A/mm² [27]. This is a trade-off between investment costs, network losses and the voltage drop. Under normal conditions this value is rather far below the thermal limit for which reason higher loading may be acceptable during some periods of time [28].

Lines are characterized by their series resistance, series conductance and shunt capacitance. They differ for each individual type of line. The series resistance is equal to the line resistance R_s and the line reactance X_s is obtained from the line inductance L_s . The sum of them is the series impedance Z_s as shown in (2.1). As shown in (2.2) the line admittance Y_{sh} is the sum of the line conductance G_{sh} and susceptance B_{sh} , which is obtained from the shunt capacitance C_{sh} .

$$Z_{line} = Z_s = R_s + jX_s = R_s + j\omega L_s \quad (2.1)$$

$$Y_{sh} = G_{sh} + jB_{sh} = G_{sh} + j\omega C_{sh} \quad (2.2)$$

The line impedance Z_{line} , used for determining the X/R-ratio, is normally only considering the series impedance Z_s . The line impedance and admittance can

be calculated from the line parameters as resistance, inductance and capacitance which are shown in table 2.1 for some common types of overhead lines and underground cables used in Swedish medium voltage distribution networks. Since the shunt conductance is very small, it is normally neglected. Due to the much shorter distance between the conductors, the characteristic of underground cables is much less inductive and more capacitive than the one of overhead lines. This affects both behaviour on faults and on the transfer of reactive power. A possibility to describe the lines characteristic is the X_s/R_s -ratio.

When calculations on lines are done, lines can be modelled in different ways depending on the length of the line [29]. Short lines are often modelled as pure series connections of the resistance and (positive) reactance. Medium long lines are either modelled as a T - or a π - (see figure 2.1 and 2.2) networks where the difference is the placement of the line capacitance. For long lines the π -model extended with the shunt admittance is the most suitable. In the π -model for medium long lines the line consists of a series connection of the line resistance and the line reactance. The line capacity is divided in two parts and placed at each end of the line. For very long lines it may be reasonable to divide the line in shorter sections and use a number of π -models in series connections. Typical line data, the current-carrying capacity and the X/R -ratio for some common types of overhead lines and underground cables are shown in table 2.1 [30] [27].

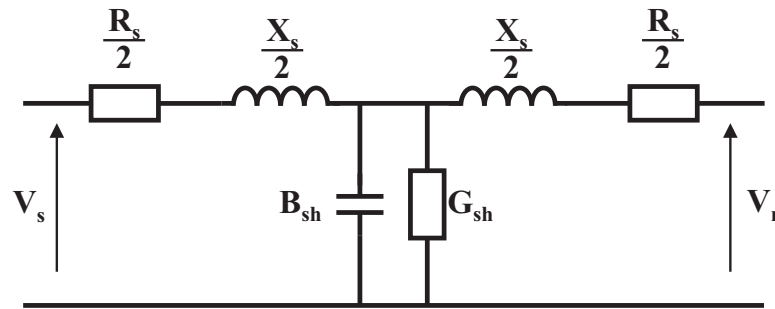

Figure 2.1: T -equivalent of a medium long line with series resistance R_s and reactance X_s as well as shunt conductance G_{sh} and susceptance B_{sh}

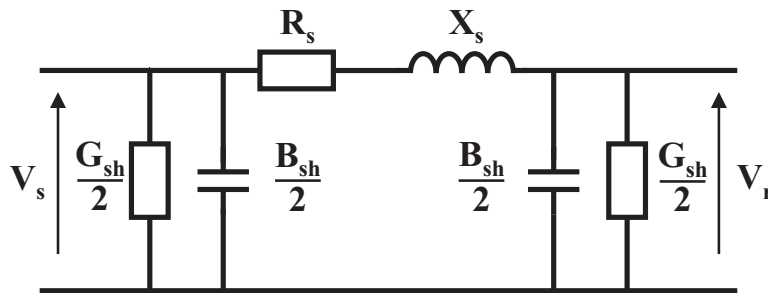

Figure 2.2: π -equivalent of a medium long line with series resistance R_s and reactance X_s as well as shunt conductance G_{sh} and susceptance B_{sh}

2.2.2 Transformer

Transformers form the interface between the medium voltage distribution network and networks on other voltage levels as the high voltage (HV) and low voltage (LV) level. When calculations on transformer characteristics are done, the values are often presented in per unit (p.u.) values since this is a convenient way to handle the turns ratio.

High Voltage/Medium Voltage Transformer

High voltage/medium voltage transformers change the voltage level from e.g. 130kV to 20kV. These transformers have a typical power rating of some tens of MVA depending of the size of the HV/MV substation. HV/MV transformers are normally equipped with on-load tap changers which are automatically controlled. The on-load tap changer changes the turns ratio of the transformer and consequently the voltage ratio under operation without disconnecting the load (see chapter 3.2.1).

The equivalent circuit of a two-winding transformer as shown in figure 2.3 consists of two series impedances $Z_P = R_P + jX_P$ and $Z_S = R_S + jX_S$ as well as a magnetizing branch, consisting of the magnetizing reactance X_M and the

	type	cross section area [mm ²]	current-carrying capacity [A]	R [Ω/km]	L [mH/km]	C [μF/km]	$\frac{X}{R}$
cable (3-phase)	AXCEL	3*50/16	145	0.641	0.38	0.16	0.19
	AXCEL	3*95/25	205	0.320	0.35	0.21	0.34
	AXCEL	3*150/25	260	0.206	0.32	0.24	0.49
	AXCEL	3*185/25	290	0.164	0.31	0.27	0.59
	AXCEL	3*240/35	340	0.125	0.30	0.29	0.75
overhead line	FeAl62	62	155	0.535	1.132	0.0061	1.50
	FeAl99	99	205	0.336	1.085	0.0061	1.01
	FeAl157	157	270	0.214	1.036	0.0061	1.52
	FeAl234	234	345	0.143	0.996	0.0061	2.19

Table 2.1: Typical line impedance for some types of underground cables and overhead lines in medium voltage networks. AXCEL cable was chosen as a reference for PEX insulated aluminium cables for 12kV and 24kV rated voltage. The current-carrying capacity is valid for underground installation of the cables and a conductor temperature of 60°C. For overhead lines the current-carrying capacity is valid for a maximum conductor temperature of 100°C and an ambient temperature of 30°C.

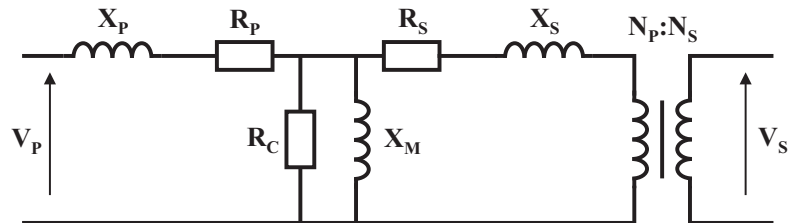

Figure 2.3: Equivalent circuit of a transformer

core losses R_C , between the series impedances. The series impedances form the leakage impedances and the windings resistances. The shunt impedance is a parallel connection of the magnetizing inductance and the no-load losses. Normally the current through the shunt admittance in power transformers is very small compared to the load current and can therefore be neglected [29]. In this case the series impedances can be combined into one, where the resistance is often neglected. The remaining reactance is called the short-circuit reactance [31]. A typical value for the transformer short-circuit reactance is ten percent of the base impedance which calculates as shown in (2.3) [29].

$$Z_{base} = \frac{U_{rated}^2}{S_{rated}} \quad (2.3)$$

Medium Voltage/Low Voltage Transformer

Medium voltage/low voltage transformers bring the voltage down from e.g. 20kV to the normal voltage at households, offices and small industries of 230/400V. Typical values for the apparent power of such transformers are between 50kVA and 500kVA in rural areas. In urban areas up to 800kVA are common. MV/LV transformers often have manual tap changers with some few steps that can be adjusted manually to adapt the transformer to the voltage conditions of the local network. These adjustments are normally done once during the installation of the transformer.

2.2.3 Shunt Capacitors/Reactors

In inductive networks shunt capacitors are used to increase the voltage and to avoid reactive power transfer over longer distances. Since the reactive power delivered by a capacitor is depending on the voltage ($Q_C = U^2/X_C$) less reactive power will be produced during times of low voltage, equivalent with high network load, which is when it is most needed. For the varying reactive power needs capacitors are often connected in banks where the capacity can be switched and also variable reactive power sources as Static Var Compensator [32] and Static Synchronous Compensator [33] are available.

In medium voltage networks with long underground cables a large amount of reactive power is produced due to the capacitance of the cables. In some cases shunt reactors are connected to consume reactive power. Local reactive power compensation at the HV/MV substation avoids the transfer of reactive power through the transformer and through the high voltage network. In this way network losses can be decreased.

2.3 Requirements

The medium voltage distribution network is the link between the high voltage transmission network and the customers. They are either connected to the low voltage distribution network, which is fed by the medium voltage network, or, in the case of large energy consumption industries, directly to the medium voltage distribution grid. Since the low voltage distribution network normally does not have voltage regulation, the voltage at the customer point of connection is also directly depending on the voltage in the medium voltage grid.

To avoid damaging the equipment connected to the medium voltage distribution network it is important to define limits for the network voltage. For distribution networks and so also for medium voltage distribution networks the European standard EN 50160 [34] is the most important one.

Beside the general European standard for the voltage in the network there are also national regulations which have to be considered and which can be more strict than the standard. For small scale distributed generation connected to the low voltage network at 400 V and medium voltage networks at a voltage level between 10 kV and 20 kV Svensk Energi¹ has issued recommendations called "Anslutning av mindre produktionsanläggningar till elnätet - AMP" [35] that translates as "Connection of Smaller Power Plants to Electrical Networks". The guideline is including generation units up to 1.5 MW but is often used also for larger generation units up to 10 MW which so far are not covered

¹ Svensk Energi (Swedenergy) is the industry organization which represents companies involved in the production, distribution and trading of electricity in Sweden.

by other documents². In a simplified way and with some limitations according to this document long term voltage variations caused by a DG unit are calculated as shown in (2.4)

$$\frac{\Delta U}{U} \cong \frac{R_{line} \cdot P_{DG} + X_{line} \cdot Q_{DG}}{U^2} \cdot 100\% \quad (2.4)$$

where R and X are the series line resistance and line reactance. P_{DG} and Q_{DG} are the active and reactive power delivered by the DG unit. According to the AMP the voltage variations caused by the DG unit should generally not exceed more than 2.5% of the nominal voltage. In this value also the deadband of the on-load tap changer has to be included. Larger voltage variations can be acceptable if accurate calculations have been done to ensure that the voltage at the customer connection point is within the limits during all operating conditions.

The European standard EN 50160 defines the power quality that can be expected to be supplied to electricity customers. This standard describes among other things limits both for frequency, voltage magnitude variations (long term voltage variations), rapid voltage changes and supply voltage dips. Related to the network voltage at the consumer connection point the standard is rather generous. Voltage magnitude variations in low voltage and medium voltage networks should be limited to $\pm 10\%$ for 95% of a week when measured as mean 10 minutes RMS values.

As a compromise between the recommendations in the strict AMP and the generous but mandatory standard for the study in this work a voltage variation of $\pm 5\%$ which corresponds to 0.95 p.u. and 1.05 p.u. is chosen. This interval seems reasonable since the voltage at the customer connection point is monitored but some reserve is still desirable as safety margin. In this work the focus is on long term voltage magnitude variations. Therefore rapid voltage changes and supply voltage dips are not taken into account.

The voltage span which should be reserved for the on-load tap changer deadband calculates according to AMP as shown in (2.5). For a common OLTC

² Generation units of 10MW and more are covered by the "ASP - Anslutning av större produktionsanläggningar till elnätet". A new document for both small and large generation units, "Handbok för Anslutning av elProduktion (HAP)", is currently being developed.

with a step size of 1.67% and a safety margin of 20% of the stepsize the deadband for the OLTC is 1.0%.

$$\text{deadband} = \pm \text{stepsize} \cdot \text{safetyfactor} = \pm 1.67 \cdot 1.2 = 2.0\% \quad (2.5)$$

To obtain the total voltage change at a node the maximum voltage rise from the infed power and the deadband from the OLTC have to be summarized. For a mixed medium voltage feeder the maximum voltage rise introduced by the connected DG units is therefore in practice limited to only 1.5% ($2.5\% - \frac{2.0}{2}\%$) which is a much less than the total allowed voltage change at the customer point of connection specified in EN 50160.

2.4 DG Expansion

Small scale generation units have become popular during the last years. At the medium voltage level in Sweden wind turbines are the most common DG units which are newly connected to the grid. But also other types of generation units as solar power plants and combined heat and power (CHP) are conceivable on the medium voltage level even if they are not common in Swedish medium voltage networks today. Wind turbines are often placed in the countryside where the distribution network is rather weak. Thus the impact on the network is comparatively large.

As mentioned before distribution networks are traditionally planned and constructed to transfer power unidirectionally from the high voltage/medium voltage transformer to the customer. Thus a decreasing voltage from the substation to the customer point of connection is assumed. When connecting larger distributed generation units to the medium voltage network, the generation can become larger than the consumption during some time in some areas. These areas are consequently no longer load but generation areas seen from a network perspective. Therefore the power flow may reverse whereby some assumptions made for the traditional medium voltage network are no longer valid. Now, when feeding in active power, the voltage can be higher in some network nodes than at the substation. As the distribution networks are built today there is no way to limit the voltage at individual network nodes where the voltage is above the voltage at the feeder header.

Beside the potentially inverted voltage profile along the feeder the connection of DG units may also affect short circuit currents. These issues have to be considered when planning protection systems for distribution networks with distributed generation but they are out of scope for this work and will not be considered here.

2.5 Metering

Metering of power consumption is done at the customers. Until some years ago electromechanical electricity meters working according to the Ferraris principle were exclusively used. Measurement values were displayed on a mechanical counter device and the readings were taken once a year manually. For common households only the active power is measured and charged.

In Sweden the electricity consumption of all households has according to the law to be read at least once a month since July 2009. Therefore electricity meters (Smart Meters) which can be read remotely have been installed.

The new generation of electricity meters provides more functions than only measuring the consumed energy during a period of time. One example is to provide other measurement values as voltage limit violations, voltage magnitude values and the actual consumption of active and reactive power whenever needed. For the network operator this makes it possible to get a more precise overview of the actual network situation by for example continuously reading voltage or power measurement values from electricity meters. The obtained measurement values can be used to operate the network in a more efficient way for example by a more detailed voltage control. Some other features that are provided by these new energy meters are power outage detection, remote control of relays, gathering of metering values from other units such as gas and water meters, remote disconnection and connection as well as manipulation alarms.

Communication with the electricity meters is established in different ways. In urban areas often power line communication is used, but short distance wireless techniques as ZigBee are also common. If the number of electricity

meters per area is low, often other wireless techniques such as GPRS are used. Since the request of measurement values is done for each individual electricity meter the communication capacity is limited in some manner.

2.6 Communication

For the most part the medium voltage distribution network is by now a quite passive network with only little communication installed. Normally the HV/-MV substation has communication and monitoring equipment installed. But farther from the HV/MV substation out in the medium voltage network only some few MV/LV substations are equipped with remote control and communication.

Communication has become more available and less expensive during the last years and probably the availability of communication for network control will increase also in medium voltage distribution networks. It could be used to obtain a more detailed network overview by the reading of actual measurement values at the substations. Furthermore new protection relays are developed and some of them can make use of communication between the units installed at different places in the network.

2.7 Challenges

The introduction of generation units in the medium voltage network is a challenge for the future network operation. Until now the planning of medium voltage distribution networks was more or less done only with respect to the maximum load and voltage drop as well as the fault conditions.

Essential for the network design is the knowledge about the loads connected to the network. The maximum load that could be expected can be calculated and the network will be designed for that plus probably some additional margin for future load increase. Even though an individual load is not really predictable, aggregated loads are following a pattern which is fairly predictable.

Hence the load variations are also well known.

The distributed generation active power output is for the most common type of units, wind turbines, not or only to some extent predictable. With much DG connected to the network the generated power may exceed the consumed power during some time. Therefore the power flow in the network or a part of the network can be reversed during some periods. Then the network voltage is not necessarily decreasing from the substation along the feeder but can also increase. Therefore overvoltage suddenly becomes an issue when connecting DG units to distribution networks.

Rebuilding or extending existing networks often means new underground cables which is expensive and time consuming. Therefore the integration of distributed generation units without rebuilding of existing networks is a precondition for the large scale integration of distributed generation within reasonable costs. An extended and more advanced voltage control scheme is one of the most important means for solving this problem.

Chapter 3

Network Voltage

The network voltage is one of the key values in distribution networks. In this chapter an introduction to voltage control in medium voltage distribution networks will be given. The first section is about the voltage changes in the network and what causes them. Different methods for voltage control in medium voltage networks will finally be shown in the second section.

3.1 Voltage Changes

As mentioned in section 2.3 the network voltage is one of the most important key values of a distribution network and has to fulfil some requirements. The voltage at each network node of a medium voltage distribution network is depending on the voltage at the substation, the current in the lines and the line properties. In this section the relation between these factors will be shown. The high voltage network which feeds the medium voltage distribution network will be seen as infinitely strong and the voltage there is not affected by the medium voltage network.

The difference between the lower voltage limit and the upper voltage limit is the available voltage band within which the node voltages may vary in the network. Furthermore the used voltage band is the difference between the voltage at the lowest node voltage and the highest node voltage of all network nodes. Thus a more narrow used voltage band allows a larger degree of freedom to adjust the voltage level in the entire network.

In traditional medium voltage networks without generation the highest voltage is usually at the secondary side busbar of the HV/MV transformer in the substation. In loaded networks the voltage is decreasing from the substation along the feeders depending on the current and the line impedance. Apart from that the voltage can also increase along the feeders in networks with long underground cables during periods of low load due to the large shunt capacity of underground cables. The voltages in each feeder are independent of each other except the voltage at the substation busbar which depends on the total load of the transformer.

As mentioned before the voltage is not necessarily decreasing from the substation along the feeders to the outer nodes of the network in medium voltage distribution networks with generation connected. During some periods of time the power flow can be reversed. Thus the voltage may increase on nodes farther out in the network. Hence, the term voltage drop is in this thesis used both for positive voltage drops and negative voltage drops (voltage rise).

Figure 3.1 shows a line with the voltage at the sending end \bar{V}_s and the voltage at the receiving end \bar{V}_r . The voltage drop along a line is in general calculated according to (3.1) where \bar{I}_{line} is the current through the line and \bar{Z}_{line} the impedance of the line [31]. The line current \bar{I}_{line} can be divided into a real I_p and an imaginary part I_q , thus obtaining $\bar{I}_{line} = I_p + jI_q$.

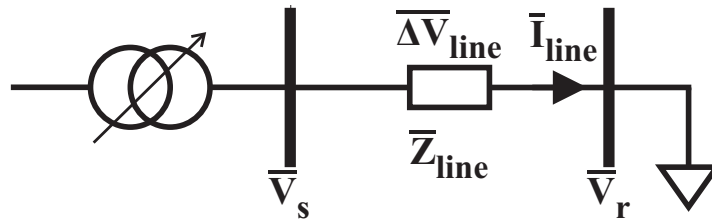

Figure 3.1: Voltage drop along a line

In figure 3.2 a vector diagram of the sending end voltage \bar{V}_s , the receiving end voltage \bar{V}_r and the voltage drop $\overline{\Delta V_{line}}$ is shown. The phase of the voltage at the sending end is set to reference voltage with angle zero degrees.

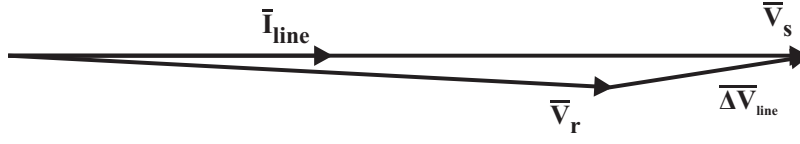

Figure 3.2: Vector diagram of the sending end voltage \overline{V}_s , receiving end voltage \overline{V}_r and the voltage drop $\overline{\Delta V}_{line}$ with a small angle difference between the sending end voltage and the receiving end voltage as well as the current through the line (\overline{I}_{line})

$$\begin{aligned}
 \overline{\Delta V}_{line} &= \overline{I}_{line} \cdot \overline{Z}_{line} \\
 &= (I_p + jI_q) \cdot (R_{line} + jX_{line}) \\
 &= R_{line}I_p + jR_{line}I_q + jX_{line}I_p - X_{line}I_q \\
 &= (RI_p - XI_q) + j(RI_q + XI_p)
 \end{aligned}$$

with $\Delta V_{line,p} = R_{line}I_p - X_{line}I_q$ and $\Delta V_{line,q} = R_{line}I_q + X_{line}I_p$

$$\begin{aligned}
 &= \Delta V_{line,p} + j\Delta V_{line,q} \\
 &= \sqrt{\Delta V_{line,p}^2 + \Delta V_{line,q}^2} e^{j \arctan\left(\frac{\Delta V_{line,q}}{\Delta V_{line,p}}\right)} \quad (3.1)
 \end{aligned}$$

If the reactive current transferred through a line I_q is small compared to the active current I_p and the X/R-ratio of the line is small too, the active voltage drop $\Delta V_{line,p}$ is significantly larger than the reactive voltage drop $\Delta V_{line,q}$. Therefore the difference in phase angle between the voltages of both sides of the line normally is small and it is assumed that $\varphi = \arg(\overline{\Delta V}_{line}) \approx 0$ and thus a close approximation for the voltage drop over a line is obtained by (3.2).

$$\begin{aligned}
 \Delta V_{line} &\approx \Delta V_{line,p} \\
 &= \sqrt{(R_{line}I_p - X_{line}I_q)^2} \\
 &= (R_{line}I_p - X_{line}I_q) \\
 &\text{with } \varphi = \arctan\left(\frac{I_q}{I_p}\right) \\
 &= R_{line}I_{line} \cos\varphi + X_{line}I_{line} \sin\varphi \quad (3.2)
 \end{aligned}$$

In distribution networks the voltage drop thus practically becomes the voltage difference between the voltage magnitudes at the sending end V_s and at the receiving end V_r of a line. Still assuming the approximated voltage drop ΔV_{line} shown in (3.2), the expression in (3.3) will be obtained.

$$\begin{aligned} V_s &= V_r + \Delta V_{line} \\ \Rightarrow |\overline{\Delta V_{line}}| &= |\overline{V_s} - \overline{V_r}| \\ &\approx |\overline{V_s}| - |\overline{V_r}| \\ &\approx R I_{line} \cos \varphi + X I_{line} \sin \varphi \end{aligned} \quad (3.3)$$

Since in distribution networks power is often a more common entity than current it is preferred to describe the voltage drop depending on the active and reactive power flow in the network. For only a small difference in the angle between the voltage on the sending end and the voltage at the receiving end, the current through the line $\overline{I_{line}}$ can be calculated according to (3.4), where $\overline{S_r}$ is the apparent power at the receiving end.

$$\overline{I_{line}} = \left[\frac{\overline{S_r}}{\overline{V_r}} \right]^* = \left[\frac{P_r + jQ_r}{\overline{V_r}} \right]^* \quad (3.4)$$

With $\overline{V_r}$ as reference and $\arg(\overline{V_s}) - \arg(\overline{V_r}) \approx 0$ becomes

$$\overline{I_{line}} = I_p + jI_q = \left[\frac{P_r}{V_r} + j \frac{Q_r}{V_r} \right]^* \quad (3.5)$$

Equations (3.2) and (3.4) give the voltage drop ΔV_{line} depending on the transferred apparent power as shown in (3.6), where per unit values have to be used for the quantities. In the literature V_r and V_s are often assumed to be about the nominal voltage $V = V_s = V_r$. Thus (3.6) can be simplified to (3.7). As it can be seen from the equation both active and reactive power flow affect the voltage change in a distribution network where the line series resistance R_{line} can not be neglected compared to the line series reactance X_{line} .

$$\Delta V_{line} = R_{line} I_p - X_{line} I_q = R \frac{P_r}{V_r} + X \frac{Q_r}{V_r} = \frac{R_{line} P_r + X_{line} Q_r}{V_r} \quad (3.6)$$

$$\Delta V_{line} \approx \frac{R_{line} P_r + X_{line} Q_r}{V} \quad (3.7)$$

If the voltage drop is expected to be large or the accuracy should be increased, the assumption that $V_r = V_s$ is no longer applicable. When the voltage at the receiving end V_r is unknown it has to be replaced by the difference of the voltage at the sending end and the voltage drop $\bar{V}_r = \bar{V}_s - \Delta\bar{V}_{line}$. In this case it has to be distinguished if the connected loads have constant impedance or constant power characteristics since the current through the line, thus also the voltage drop, are depending on the loads characteristic.

In (3.8) the voltage drop is calculated for the case of constant power loads and the voltage drop is referred to the sending end voltage V_s . The angle between the voltages V_s and V_r is still assumed to be close to zero. Since the voltage drop has to be zero without any load connected to the receiving end, the alternative with the negative square root has to be taken from (3.8).

$$\begin{aligned}
\Delta V_{line} &\approx \frac{R_{line}P_r + X_{line}Q_r}{V_r} = \frac{R_{line}P_r + X_{line}Q_r}{V_s - \Delta V_{line}} \\
\Leftrightarrow \Delta V_{line}(V_s - \Delta V_{line}) &\approx R_{line}P_r + X_{line}Q_r \\
\Leftrightarrow 0 &\approx -\Delta V_{line}^2 + \Delta V_{line}V_s - (R_{line}P_r + X_{line}Q_r) \\
\Rightarrow \Delta V_{line} &\approx \frac{V_s}{2} \pm \sqrt{\left(\frac{V_s}{2}\right)^2 - (R_{line}P_r + X_{line}Q_r)} \quad (3.8)
\end{aligned}$$

For loads with constant impedance $Z_{load} = R_{load} + jX_{load}$ the current is calculated according to (3.9). With the current obtained from (3.9) the voltage drop can be calculated as shown in (3.10) when the phaseshift between the sending end and receiving end voltage is negligible.

$$\begin{aligned}
\bar{I} &= \frac{V_r}{Z_{load}} = \frac{V_r}{R_{load} + jX_{load}} = \frac{V_r R_{load} - jV_r X_{load}}{R_{load}^2 + X_{load}^2} \\
&= \frac{V_r}{R_{load}^2 + X_{load}^2} (R_{load} - jX_{load}) \\
\Rightarrow I_p &= \frac{V_r R_{load}}{R_{load}^2 + X_{load}^2} \quad \text{and} \quad I_q = \frac{-V_r X_{load}}{R_{load}^2 + X_{load}^2} \quad (3.9)
\end{aligned}$$

$$\begin{aligned}
\Delta V_{line} &\approx R_{line}I_p - X_{line}I_q \\
&= \frac{V_r}{R_{load}^2 + X_{load}^2} (R_{line}R_{load} + X_{line}X_{load}) \\
&= \frac{V_s - \Delta V}{R_{load}^2 + X_{load}^2} (R_{line}R_{load} + X_{line}X_{load}) \\
&= V_s \frac{R_{line}R_{load} + X_{line}X_{load}}{R_{load}^2 + X_{load}^2 + R_{line}R_{load} + X_{line}X_{load}} \quad (3.10)
\end{aligned}$$

As (3.8) shows the voltage drop over a line for constant power loads depends on the square root of the line impedance and the power of the connected load. For constant impedance loads the voltage drop is inversely proportional to the load impedance when the line impedance Z_{line} is much less than the load impedance Z_{load} as shown in (3.10). In practice both loads with constant power characteristics and constant impedance characteristics are common. Thus the voltage drop will be a mixture of these cases.

Example: Voltage Variations caused by the transfer of active and reactive power

Since the reactance of an overhead line is normally notably larger than the one for underground cables, the voltage change differs between those different types of lines even though the load and the cross sectional area of the conductors are the same. Figure 3.3 shows the change in voltage when transferring active and/or reactive power over an overhead line and an underground cable of 8 km length and a conductor cross section area of 95 mm² respectively.

Especially in the front corner and the back corner of the figure, where both active and reactive power are transferred in the same direction, the difference in the voltage variations caused by the transfer of active and reactive power can be seen.

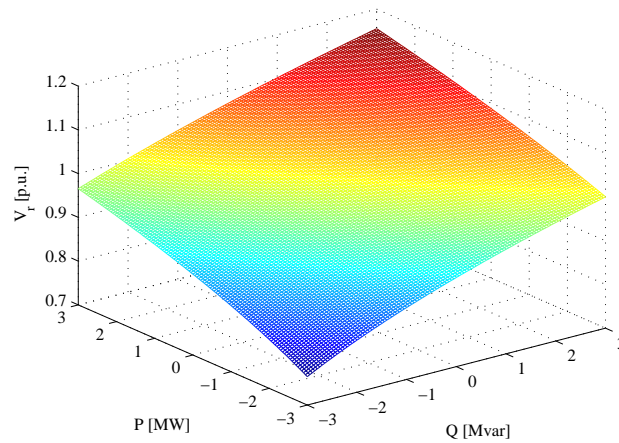

(a) overhead lines

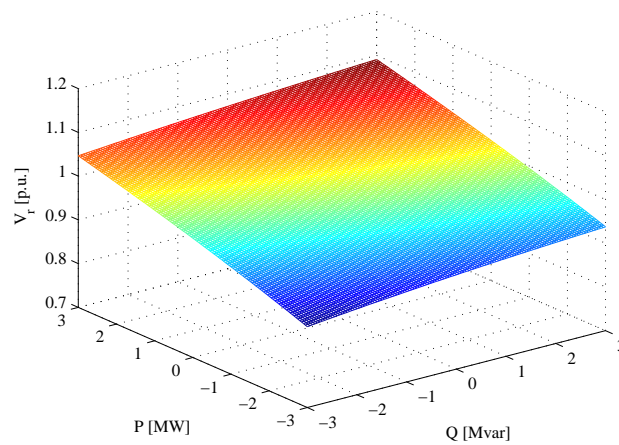

(b) underground cables

Figure 3.3: Voltage at the receiving end of a 8km long line when $V_s = 1$ and the active and reactive power at the end of the lines are varying between -3MW/Mvar and $+3\text{MW/Mvar}$

3.2 Voltage Control

In a medium voltage network there are several methods to control the network voltage. Since in pure load networks the voltage is decreasing from the feeder head along the lines to the outer nodes of the network, the voltage drop during high load periods has been the most relevant issue for years. It is also presumed that the voltage drop occurs in all feeders at the same time in about the same proportion. Therefore it was sufficient to have the possibility to alter the voltage in the entire medium voltage network. As the assumption of equal voltage changes in all feeders at the same time is no longer valid with DG connected to the grid, it may be desirable to have the possibility to control the voltage more locally [36].

3.2.1 On-load Tap Changer

The use of on-load tap changers is one method of controlling the voltage in a medium voltage network. A tap changer alternates the turns ratio of the transformer and in this way also the ratio between the primary and secondary side voltage. To avoid interruption of the current flow through the transformer advanced switching with two switches is used to alter the position. By doing this the tap changer becomes an on-load tap changer in the literature also referred as under-load tap changer [37]. A step size of 1.67% is reasonable for avoiding voltage disturbances at the customers' point of connection and is therefore often used for OLTC in Sweden but also other step sizes are quite normal. The number of steps is typically ± 9 steps if the step size is 1.67% which allows the ration to vary around $\pm 15\%$ in total. These characteristics will also be assumed later in this work (see chapter 6 and 7).

Different control modes are available to operate an OLTC. The most common way in Sweden is the automatic voltage control mode. In this mode the voltage at the secondary side busbar is controlled to be constant. Therefore a sensing relay is connected to the secondary side busbar and adjusting the on-load tap changer according to the busbar voltage. This control eliminates the impact of voltage variations on the high voltage side and the voltage drop in the transformer, which is depending on the load. To maintain the voltage

at the customers point of connection within the limits it is still necessary to set the voltage setpoint at the secondary side busbar rather high so that it is adequate to compensate for the voltage drop over the lines during high load periods.

Another control strategy for the OLTC is the line drop compensation (LDC). LDC is an attempt to control the voltage at a more remote node in the network by increasing the medium voltage side busbar voltage with an offset depending on the voltage drop over the line. To model the voltage drop of the line, a current proportional to the transformer load current is injected through an impedance corresponding to the network impedance. Since the network impedance has to be modelled, line drop compensation is more complex than simply keeping the voltage constant.

As the on-load tap changer is located at the HV/MV transformer, the voltage will be changed downstream in all connected feeders of the entire network. Therefore the OLTC is most suitable for networks where the voltage varies in the same manner on all feeders. Other advantages of the OLTC are the large voltage range in which the voltage can be adjusted and low losses. One drawback of on-load tap changers are the mechanical contacts which need maintenance from time to time. The interaction of cascaded tap changers and how to decrease the number of tap changer operations has been studied in [38]. In which way the OLTC is affected by the connection of DG has also been studied before [39].

Case 1: Simple network with voltage control by an OLTC and only load connected

A generic medium voltage network is shown in figure 3.4. When the OLTC is performing a tap change operation, the voltage changes in both feeders and therefore the voltage at the load feeder (node 3) is changing as well as the voltage in the feeder with load and generation (node 7).

To start with the OLTC in the basic position gives a voltage of 1.0p.u. at the secondary side busbar of the HV/MV transformer (node 2). In the network two constant power loads, L_3 at node 3 and L_7 at node 7, are connected.

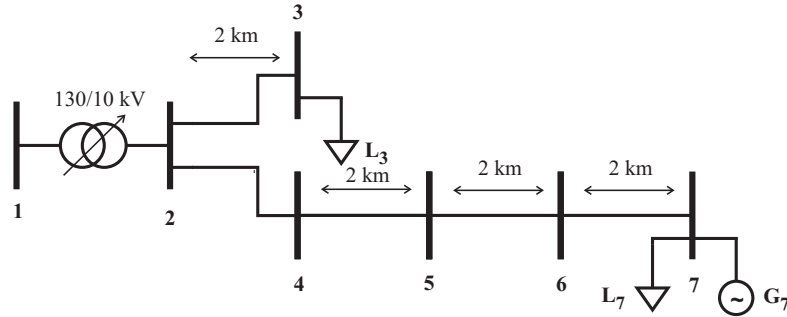

Figure 3.4: Medium voltage network with OLTC

The loads are 2.000 MW and 0.657 MVar which corresponds to 2.105 MVA with $\text{PF} = 0.95(\text{ind})$. All lines in the network are FeAl99 overhead lines. Base values for the network voltage and the power are $V_{base} = 10 \text{ kV}$ and $S_{base} = 1 \text{ MVA}$. Thus the per unit values of the line impedance are calculated as shown in (3.11).

$$\begin{aligned} R_{line,p.u.} &= \frac{R_{line,SI}}{Z_{base}} = R_{line,SI} \frac{S_{base}}{V_{base}^2} \\ &= 0.336 \Omega/\text{km} \frac{10^6 \text{ MVA}}{(10^4 \text{ V})^2} = 3.360 \cdot 10^{-3} \text{ p.u./km} \end{aligned} \quad (3.11a)$$

$$\begin{aligned} X_{line,p.u.} &= \frac{X_{line,SI}}{Z_{base}} = X_{line,SI} \frac{S_{base}}{V_{base}^2} \\ &= 2 \cdot \pi 50 \cdot 1.085 \cdot 10^{-3} \Omega/\text{km} \frac{10^6 \text{ MVA}}{(10^4 \text{ V})^2} = 3.419 \cdot 10^{-3} \text{ p.u./km} \end{aligned} \quad (3.11b)$$

The load values also have to be converted into per unit values as shown in (3.12).

$$P_{L3,p.u.} = \frac{P_{L3,SI}}{S_{base}} = \frac{2 \text{ MW}}{1 \text{ MVA}} = 2 \text{ p.u.} \quad (3.12a)$$

$$Q_{L3,p.u.} = P_{L3,p.u.} \cdot \tan(\arccos(0.95)) = 0.657 \text{ p.u.} \quad (3.12b)$$

According to (3.8) the voltage drop over the line between node 2 and node 3 is calculated as shown in (3.13). Equivalently the voltage drop between node

2 and node 7 can be calculated as in (3.14).

$$\begin{aligned}\Delta V_{node2-3} &\approx \frac{V_s}{2} - \sqrt{\left(\frac{V_s}{2}\right)^2 - (R_{node2-3}P_{L_3} + X_{node2-3}Q_{L_3})} \\ &= \frac{1}{2} - \sqrt{\left(\frac{1}{2}\right)^2 - (2 \cdot 3.360 \cdot 10^{-3} \cdot 2 + 2 \cdot 3.419 \cdot 10^{-3} \cdot 0.657)} \\ &= 0.018 \text{ p.u.}\end{aligned}\quad (3.13)$$

$$\begin{aligned}\Delta V_{node2-7} &\approx \frac{1}{2} - \sqrt{\left(\frac{1}{2}\right)^2 - (8 \cdot 3.360 \cdot 10^{-3} \cdot 2 + 8 \cdot 3.419 \cdot 10^{-3} \cdot 0.657)} \\ &= 0.078 \text{ p.u.}\end{aligned}\quad (3.14)$$

If the maximum allowed voltage variation is $\pm 5\%$ as assumed in chapter 2, the voltage at node 7 is 2.8% under the lower limit. To bring the voltage back within the limits, at least two steps of the OLTC will be needed to increase the voltage at the substations secondary busbar to 1.033 p.u. Afterwards both voltages are within the limits again.

As shown in this example the OLTC located at the substation is sufficient to keep the voltage within its limits at all network nodes in a network where only load is connected.

Case 2: Simple network with voltage control by an OLTC and load as well as generation with unity power factor connected

Now the load at node 7 from case 1 is replaced by a DG unit with a rated capacity of 3MW at unity power factor while the rest of the network configuration remains unchanged. The injection of active power at node 7 leads to an increased voltage in this network node which can be calculated as shown in (3.15).

$$\begin{aligned}\Delta V_{node2-7} &\approx \frac{1}{2} - \sqrt{\left(\frac{1}{2}\right)^2 - (8 \cdot 3.360 \cdot 10^{-3} \cdot -3)} \\ &= -0.075 \text{ p.u.}\end{aligned}\quad (3.15)$$

To maintain the voltage within the limits and to obtain an acceptable voltage level at node 7, the OLTC needs at least two steps to decrease the voltage at the transformer secondary busbar. Notwithstanding the tap position changes, not all node voltages are within the limits since now the voltage at node 3 is too low. The used voltage band, that is the difference between the lowest and highest node voltage, $V_{min} = 0.949$ p.u. and $V_{max} = 1.042$ p.u., is nearly 10% and the step size of the OLTC is too wide to get both voltages back within the limits. Therefore the OLTC alone is not enough to maintain all node voltages within the limits.

These two cases show the capability of the on-load tap changer and its limits for maintaining the network voltage within the limitation. In case of a pure load network that was possible since the voltage was below the nominal voltage in both feeders. The used voltage band was thus rather narrow. For the mixed load and generation network as in case 2 the OLTC was not capable to maintain all network voltages within the limits. In other network configurations this may be different but definitively when the voltage band between the voltage at the node with the lowest voltage and the node with highest voltage is larger than 10% at the same moment, other methods as described in 3.2.2 and 3.2.3 have to be used as well.

3.2.2 Reactive Power

In transmission networks voltage control is normally done by reactive power. Transmission lines have a large X/R-ratio [3] and voltage control is therefore very efficient with a small amount of reactive power compared to the active power transferred through the lines. For large X/R-ratios as in transmission lines ($R_{line} \ll X_{line}$) (3.6) can be simplified to (3.16) [29].

$$\Delta V_{line} \approx \frac{XQ_r}{V_r} \quad (3.16)$$

As mentioned this simplification is only valid for lines with a large X/R-ratio. However, the X/R-ratio of medium voltage distribution lines is much smaller than for high voltage transmission lines and therefore the line resistance can not be neglected. Voltage control by reactive power is also possible for lower X/R-ratio. In that case (3.6) has to be used to calculate the total voltage drop.

In (3.6) it is shown that more reactive power is needed in relation to the transferred active power when the X/R-ratio is low. For this reason voltage control with reactive power is more efficient in networks with overhead lines than in networks with underground cables with lower X/R-ratios. Voltage control, by the use of reactive power, is finally limited by the increasing line losses and the thermal capacity limit of the line.

Traditionally shunt capacitors are used to deliver reactive power and in consequence also a current which raises the voltage in the point of connection. In extensive cable networks shunt reactors at the end of the feeder can be used to decrease the voltage during periods of low load when the line capacitance causes unwanted voltage rise. When connecting DG units to the network they are often connected by power electronic inverters which can both deliver and absorb reactive power. In this case the reactive power output is mostly independent on the active power output. Some standard wind turbines allow a power factor (PF) as low as $PF = 0.89$ at rated capacity. With such units quite large reactive power variations are available.

Case 3: Simple network with voltage control by an OLTC and load as well as generation consuming reactive power connected

The same network configuration as in figure 3.4 is assumed and again a DG unit with a rated capacity of 3 MW is connected at node 7 and the load at that node is removed. As before the voltage at node 7 will increase to 1.075 p.u. when the OLTC is in nominal position. Now the power factor of the DG unit is changed to $PF = 0.92$ with the DG consuming reactive power. The value of the consumed reactive power is calculated in (3.17).

$$Q_{G_3,p.u.} = P_{G_3,p.u.} \cdot \tan(\arccos(0.92)) = 1.176 \text{ p.u.} \quad (3.17)$$

The calculation of the new voltage increase at node 7 with a DG unit of 3 MW and $PF = 0.92$ connected is shown in (3.18). The voltage rise is now only 0.046 p.u. and thus the minimum and the maximum network voltage are both

within the limits of ± 0.05 p.u.

$$\begin{aligned}\Delta V_{node2-7} &\approx \frac{1}{2} - \sqrt{\left(\frac{1}{2}\right)^2 - (8 \cdot 3.360 \cdot 10^{-3} \cdot (-3)) + 8 \cdot 3.419 \cdot 10^{-3} \cdot 1.176} \\ &= -0.046 \text{ p.u.}\end{aligned}\quad (3.18)$$

As shown in this example the consumption of reactive power by DG units can be used to decrease the network voltage at the point of connection to an acceptable limit. This technique is limited by the reactive power consumption capability of the DG unit as well as the line capacity and the network losses.

3.2.3 Active Power Curtailment

In contrast to transmission lines the X/R-ratio is significantly lower on distribution network lines. Therefore the line resistance R_{line} is larger compared to the line reactance X_{line} than on high voltage overhead lines. Thus the active power has a comparatively large effect on the voltage drop over lines in medium voltage distribution networks. In transmission systems with large X/R-ratios the effect of active power is low compared to the effect achieved by reactive power. Hence, voltage control by active power is not a matter in transmission systems. However, it becomes an option in distribution networks. Considering voltage control both consumption and generation is applicable to maintain the voltage.

In the case of overvoltage the consumption could be increased or the generation decreased which is called active power generation curtailment. However, when active power is curtailed to control the voltage, the amount of energy delivered by the DG unit decreases. The energy which could not be transferred is lost because it is not possible to store the energy from DG units as wind turbines. To increase the consumption for voltage control seems not to be reasonable under normal conditions since the surplus of injected power has to be consumed directly.

Since disconnecting loads for voltage control purposes during times of high load will probably be unacceptable in the most cases, this is not an realistic

issue for avoiding undervoltage. However, curtailing the active power output of DG units to limit the voltage rise during some time may be an option if costs for network reinforcement can be avoided. If it is a question of short time periods and only marginal curtailment it can be beneficial also from an economic perspective. An example for the use of active power curtailment during short time periods is shown in figure 3.5. Notwithstanding the maximum curtailment is close to 50%, during 45 hours of the total 48 hours no curtailment is needed at all. Furthermore active power curtailment is generally needed during times when the generation from wind power is large and the consumption low. During this time the price for electricity is comparatively low with increasing wind power capacity in the network. Thus the economical losses caused by active power curtailment are maybe acceptable to some extent. Otherwise a small change in the expected income from a wind turbine can also make projects non-profitable.

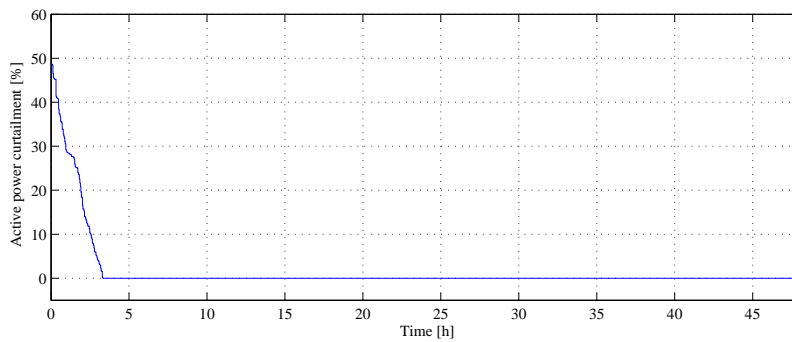

Figure 3.5: Example for the use of active power curtailment during short time periods where the curtailment is shown in relation to the available active power

Case 4: Simple network with voltage control by an OLTC and load as well as generation with active power curtailment connected

Assuming the same network configuration as in 3.2.1 and replacing the load at node 7 again by a DG unit with 3 MW and unity power factor will lead to a

network configuration in which the voltage at node 7 is above the upper limit of 1.05 p.u. As the rated capacity of a DG unit like a wind turbine is only reached during some periods of time as shown by the duration curve in figure 3.6 it may be reasonable to limit the voltage by decreasing the active power output during this time. The maximum active power which can be injected without violating the upper voltage limit is shown in (3.19).

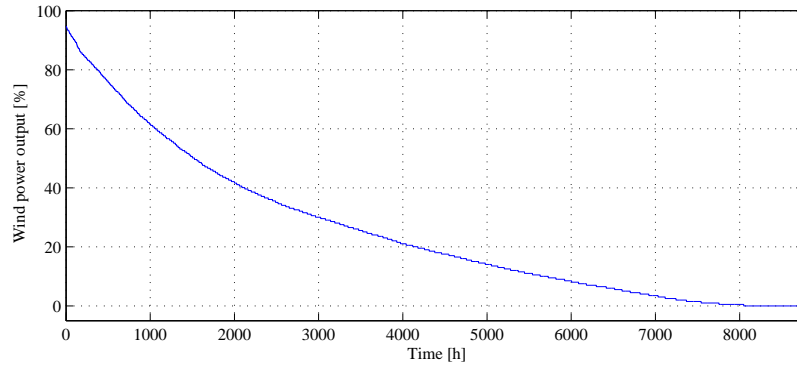

Figure 3.6: Output power duration curve of a wind farm during a year in relation to the rated capacity of the wind farm

From (3.8) and with $PF = 1$ the following is obtained:

$$\begin{aligned}
 0 &\approx -\Delta V_{line}^2 + \Delta V_{line} V_s - (R_{line} P_r + X_{line} Q_r) \\
 P_{max} &\approx \frac{-\Delta V^2 + V_s \Delta V}{R_{line}} \\
 &= \frac{-(0.05)^2 + 1 \cdot 0.05}{8 \cdot 3.360 \cdot 10^{-3}} \\
 &= 1.77 \text{ p.u.}
 \end{aligned} \tag{3.19}$$

As the example shows the active power generated by the DG unit at node 7 has in the worst case to be limited to 1.77 p.u. $\hat{=} 1.77 \text{ MW}$ for unity power factor when the voltage rise should not exceed 5%. The worst case assumption is valid during times where no power is consumed at node 7 and the entire power generated by the DG unit at this node has to be transferred through the 8 km long line between node 7 and node 2 at the main substation. Whether active power curtailment of 1.23 MW (41%) is reasonable, depends on the

duration of the curtailment. A measure for the total curtailment is the amount of active power curtailment times the periods when curtailment is needed.

3.2.4 Summary of Voltage Control Methods

To obtain as much energy as possible from the DG units, voltage control by the OLTC must be the first choice since the network losses are not increasing and all available active power can be fed-in to the grid. When the OLTC is not able to maintain the voltage at all network nodes within the limits or the voltage variations occur too often, reactive power consumption is the second choice. Still all active power can be fed-in to the network but the network losses are increasing. Active power curtailment is the last choice to reduce the network voltage, if no more reactive power consumption is available, if the line capacity is reached or if the increase in losses is larger than the benefit in active power output.

Hence the order of the methods for voltage control in a medium voltage distribution network is depending on the network structure, the DG units and the preferences according to the different methods. In general the most cost effective method seems to be the one where most active power is fed-in to the network.

Chapter 4

Voltage Control Algorithm

Until now medium voltage distribution networks are mainly passive (see chapter 1) but to handle the integration of distributed generation a more active voltage control is needed in the future. Various modes for voltage control in a medium voltage distribution network are available and as mentioned in chapter 1 most of them have been discussed in the literature. In this work three different strategies of voltage control in medium voltage distribution networks will be discussed and simulated. These three types of control are described in this chapter. First the traditional case of a locally controlled OLTC is considered and acts as a base case which is mainly used today. Next a local voltage control of the DG units by using reactive power consumption and active power curtailment is presented. Finally a coordinated OLTC control is presented. Here the OLTC is used for a voltage control depending on the network node voltages enhanced with voltage control by the DG units using reactive power consumption and active power curtailment. The three control strategies have in common that they use a constant cycle time to check for voltage limit violations and to take action. In this work the cycle time was set to 60s to obtain a compromise of fast response and low calculation requirements. The delay time for the on-load tap changer is set to 20 minutes to limit the number of tap changer operations and consequently the need of maintenance.

The power connections and the communication used for control of the units in a medium voltage distribution network are shown by the single-line diagram of the power lines (solid) and the communication lines (dashed) in figure 4.1.

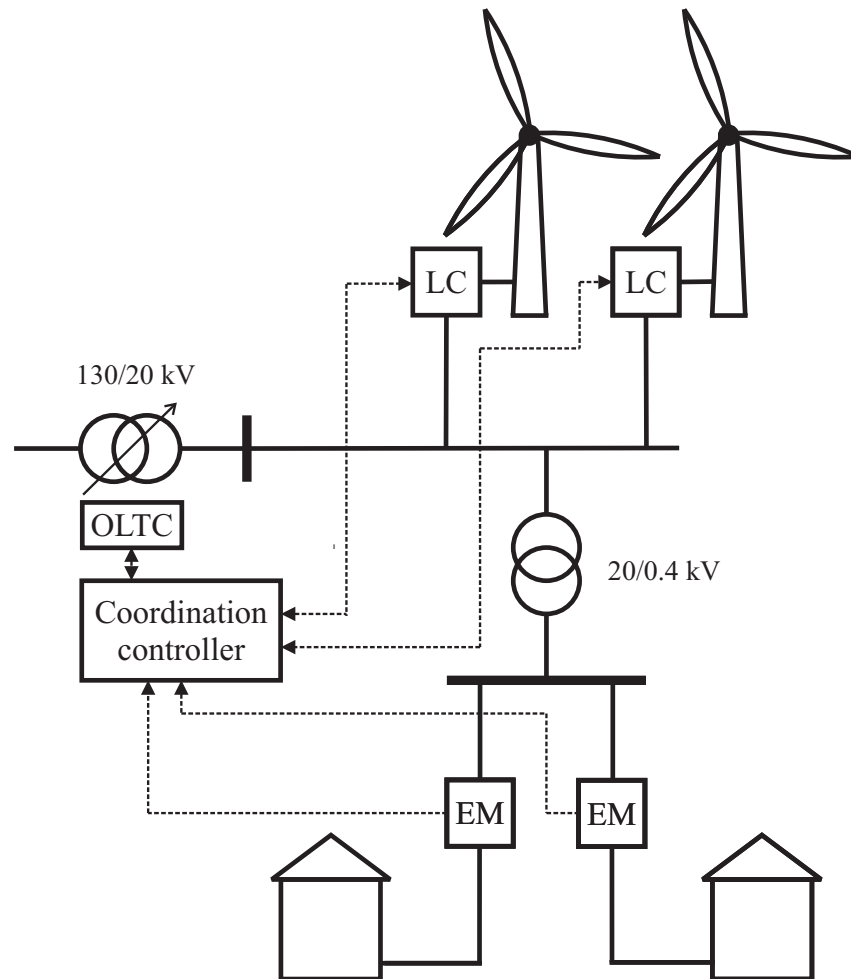

Figure 4.1: Single-line diagram of a distribution network with wind turbines including local control (LC) and a 20/0.4kV substation connected and electricity meters (EM) for voltage limit violation alarms at the customers side

4.1 Local OLTC Control

Local OLTC voltage control means that the voltage is kept constant within the defined deadband by the on-load tap changer at the secondary side busbar of the HV/MV transformer. Since medium voltage networks are normally built to supply only loads and dimensioned to handle maximum load, no more voltage control is needed to ensure proper voltage at all network nodes when only load is connected to the network.

Local OLTC control is the dominating type of voltage control in medium voltage distribution networks today. It is mainly used to compensate for voltage variations in the high voltage network and the voltage drop over the HV/MV transformer. Figure 4.2 shows the principle of operation of a local OLTC controller. Since the voltage for the control of the OLTC is measured at the medium voltage busbar of the HV/MV transformer, actual voltages further out in the medium voltage network are not considered. A constant compensation for the voltage drop along the feeders of the network can be achieved by selecting a voltage setpoint at the transformers busbar that is above the nominal voltage. Voltage increases as caused by DG units are not considered by the traditional local OLTC control, as it is assumed that the highest voltage in the network occurs always at the substation. The local OLTC controller used for the simulations in this work checks the voltage at the medium voltage busbar in the main substation within each cycle. When the set delay time of 20 minutes since the last tap change has elapsed, a change of the tap position is possible. In this case the algorithm checks if the voltage at the substation is within or outside the deadband around the setpoint. If the voltage is outside the deadband a tap change is performed as long as the tap changer is not already in one of the end positions.

Main parameters of the OLTC control are the step size, which is determined by the physical unit at the HV/MV transformer, the deadband and the delay time to prevent the OLTC from unnecessary tap changes caused by short voltage variations. A common value (1.67%) for the step size of the on-load tap changer and an in practice established value for the OLTC deadband (2%) were also assumed in this work.

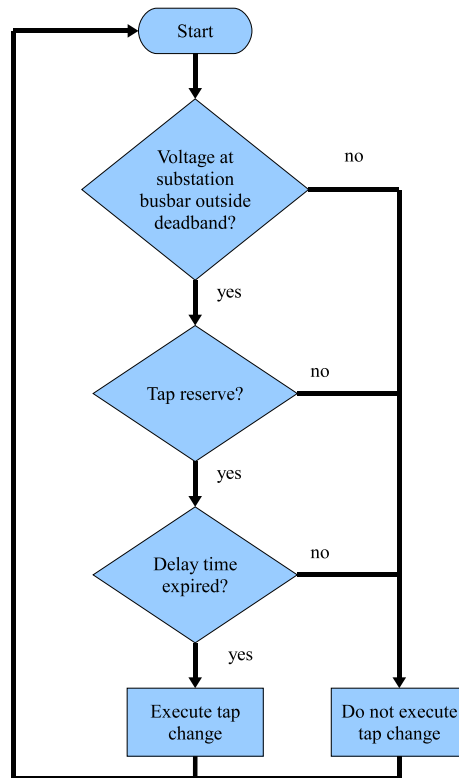

Figure 4.2: In common medium voltage networks with mainly load connected local OLTC control as in this flowchart is often used for voltage control.

The local OLTC control is very efficient in networks with only load connected and thus the highest voltage at the substation busbar. In networks with both load and generation connected it is not sufficient to keep the voltage at the substation constant. One alternative is to control also the generation units.

4.2 DG Control

Nowadays many DG units are controllable and thus they are capable of consuming reactive power or/and reducing the active power output when needed. These control options can be used to maintain the voltage at the point of connection.

In general DG control means that the network node voltage can be altered by some unit which is connected to the specific node and has knowledge about the node voltage. For this work DG control implies that the generation unit connected to a network node measures the node voltage and takes, if needed, some action to control the voltage at this node. The function of the local DG control as implemented for the simulations in this work is shown in figure 4.3.

As the generation and feed-in of active power to the network is the main issue when connecting DG units, the active power output should not be limited more than necessary. Therefore control through reactive power consumption by the generating units is preferred before active power curtailment is used. Since the voltage control is only done locally by the DG units, the on-load tap changer still acts to keep the voltage constant at the substations secondary side.

When local voltage control by the DG units is activated in this work, the control algorithm is checking all network voltages locally and individually at each cycle. If overvoltage is found at any node the algorithm is first looking for the availability of increasing reactive power consumption. How the reactive power controller is working is shown in figure 4.4. The reactive power consumption is increased with 5% of the maximum reactive power consumption in each step when the voltage is above the limit and reactive power con-

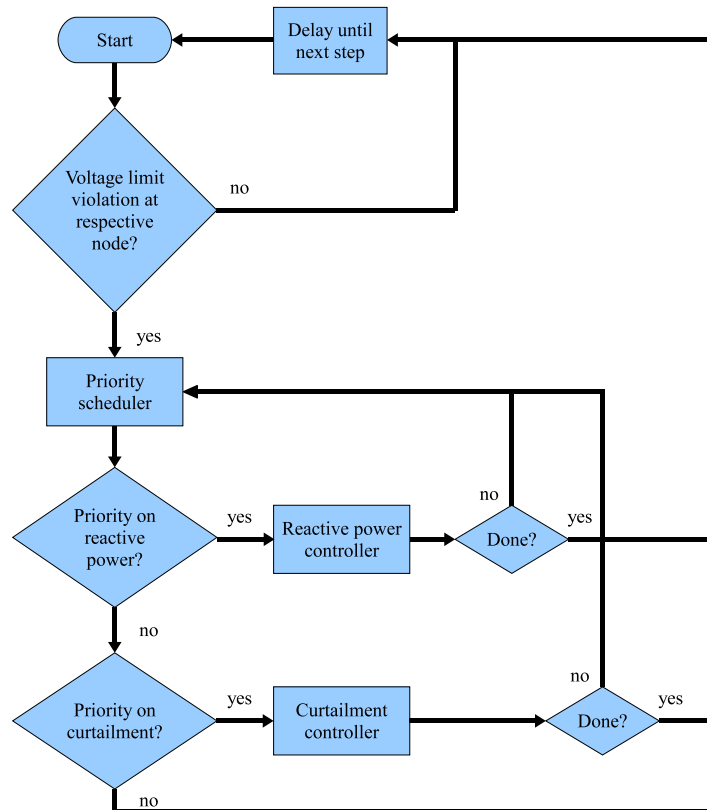

Figure 4.3: The function of DG control as used in this work is shown as flowchart.

sumption is still available. Reactive power generation is not considered in this algorithm as the increase of the voltage at nodes with generation is normally not needed. Since a constant cycle time is used in this work, reactive power changes are done at all nodes with overvoltage simultaneously which is not necessary in practice.

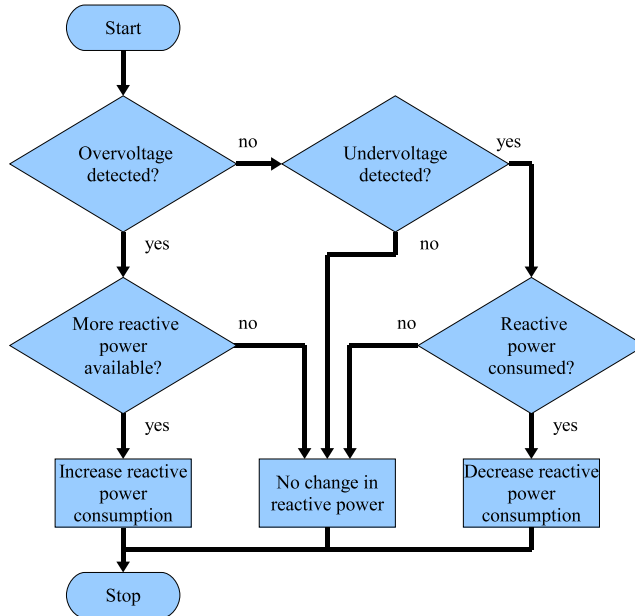

Figure 4.4: The reactive power controller is responsible for the reactive power consumption of the controllable DG units

To avoid undervoltages, caused by the excessive consumption of reactive power during times where the active power generation has decreased rapidly, the algorithm is also checking for undervoltages. In case of undervoltage and still activated consumption of reactive power, the reactive power consumption will decrease with the same step size at affected nodes.

Decreasing the reactive power consumption when not needed is necessary to keep the losses as low as possible. Therefore the control algorithm tries to decrease the reactive power consumption by itself after three minutes if the reactive power consumption has not been increasing during this time. Also

the decrease of the reactive power consumption is done with the same step size as the increase.

If the node voltage is over the limit and no more reactive power consumption is available to reduce the voltage, the algorithm starts active power curtailment to keep the voltage at the upper voltage limit. The active power curtailment is done by the curtailment controller which is shown in figure 4.5. The controller identifies the nodes at which the voltage is too high and starts locally to decrease the active power output from the generation units connected to these nodes.

As the curtailment is implemented by now the active power output is decreased with a constant value at all generation units connected to nodes where the voltage is above the limit. For the generic network an additional feature to decrease the active power output at all nodes in a feeder where overvoltage occurs with the same amount has been implemented (see left side of figure 4.5). By this feature a more fair distribution of the curtailment is achieved. But also other solutions as curtailing with a constant share are imaginable if communication is available. At the moment the curtailment controller is allowed to restrict the active power output as much as needed to get the voltage back into the limits. Therefore also a curtailment to zero active power output is possible if needed.

Of course active power curtailment should be used as little as possible. Therefore the algorithm attempts to reduce curtailment two percent of the maximum active power output ten minutes after the last increase of the curtailment. Then the active power output is increasing each following minute until overvoltage occurs or the active power output has reached the maximum available.

By using the options presented in this section, local voltage control can avoid overvoltage caused by the connection of DG in a certain manner. Since the use of reactive power consumption is limited by technical reasons and both the use of reactive power consumption and active power curtailment are generating costs, the use of local control needs to be limited.

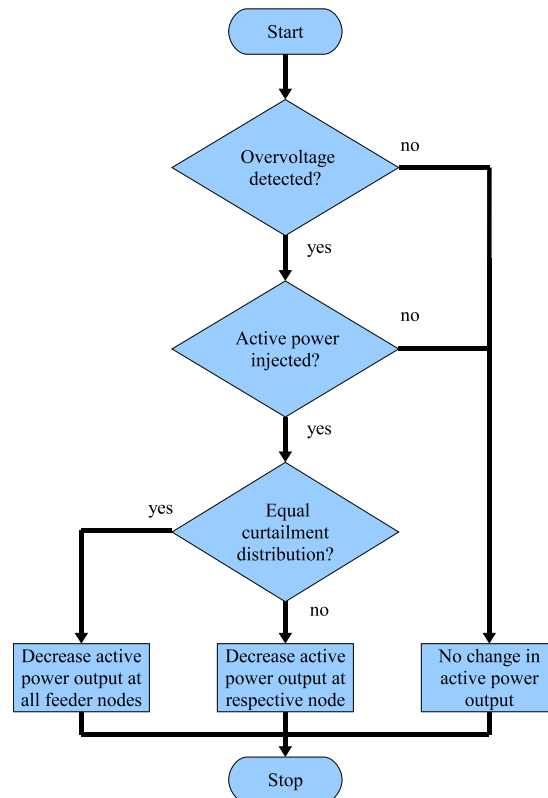

Figure 4.5: Flowchart of the curtailment controller that is responsible for the active power curtailment of the DG units in the case of overvoltage.

4.3 Coordinated OLTC Control

Coordinated voltage control is combining the local control with the control of the on-load tap changer. It is used for coordination of the on-load tap changer together with the reactive power consumption and curtailment of the active power. The overall target of the coordinated voltage control is still to maintain the voltage at all network nodes within the limits. The voltage measurement values are assumed to be obtained from the electricity meters at the customers. Since only voltage limit violations are assumed to be registered, the actual voltage magnitude is unknown and the coordinated voltage controller only knows if the lower or upper voltage limit has been violated.

The main issue of using coordinated OLTC control is to minimize the lossy use of the reactive power consumption and active power curtailment. The power generation of DG units such as wind turbines is often not matching the load. This general disadvantage, that causes increasing network losses and a wider voltage band, can be an advantage when load and generation are connected to the same network but different feeders since it avoids the occurrence of low and high voltages at the same time. This is leading to a narrow voltage band and therefore the OLTC can be used to adapt the voltage level in the entire network according to the operation state. However, the OLTC is no longer keeping the voltage at the transformers medium voltage side constant. The coordinated OLTC control applies this option to reduce the use of reactive power consumption and active power curtailment when possible.

Figure 4.6 shows the implementation of the coordinated OLTC control algorithm in this work. Initially the voltage is checked at each specific node of the network. If all voltages are within the limit a delay is started and the voltages will be checked again after a while (here one minute). If the voltage limits are violated at any node, action will be taken according to the settings of the priority scheduler. It decides which of the three modules, on-load tap changer, reactive power controller and curtailment controller, is activated first to restore the voltage. If the chosen controller is not able to handle the voltage any longer, it is communicated to the coordination controller and the control module with the next priority will be activated in addition.

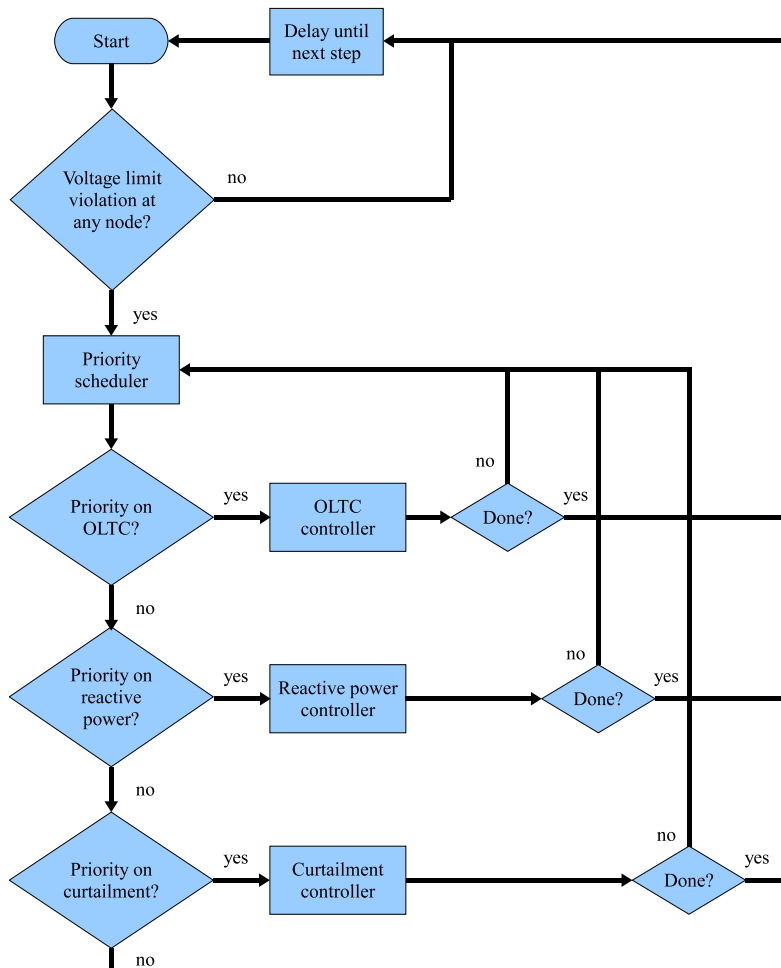

Figure 4.6: Flowchart of the coordinated OLTC control in which the three controllers for the voltage control in the network are activated

For the simulations in this work the priority order is as follows:

1. OLTC controller
2. Reactive power controller
3. Curtailment controller.

While the lowest priority on the curtailment controller is obvious, the priority of the two other controllers could also be switched depending on the preferences for reactive power transfer and tap changes. The reactive power and curtailment control modules used by the coordinated OLTC control are the same as described in chapter 4.2 and shown in figure 4.4 and figure 4.5.

For the OLTC the base values from 4.1 were used but as mentioned before, it is no longer desirable to keep the voltage constant at the HV/MV transformer secondary side. Instead the OLTC is now reacting on over- and undervoltages at the network nodes. A scheme for principle of operation of the coordinated OLTC controller is presented in figure 4.7. When the on-load tap changer controller is chosen by the coordination controller, it is checking the voltage at all network nodes. If for example overvoltage is detected at one or more network nodes, the controller is looking for undervoltage at all other nodes. If no undervoltage is detected and at least one more tap position is available and the delay time has expired, the controller will move the tap changer one step to decrease the voltage. In the case of undervoltage at one or more nodes the same procedure is done the other way round.

Since it was assumed that only voltage limit violations are reported to the controller and not the voltage magnitudes at the network nodes, it is possible that a tap position change is leading to voltages outside the limit at some node. This will be corrected by the tap changer after the delay time has run out. However, this behaviour has to be recognized, for example by adding some margin, when the setpoints for the controller are chosen. In some manner this behaviour can also be found in the reactive power consumption and curtailment control.

Coordinated OLTC control is very flexible and also adequate for networks

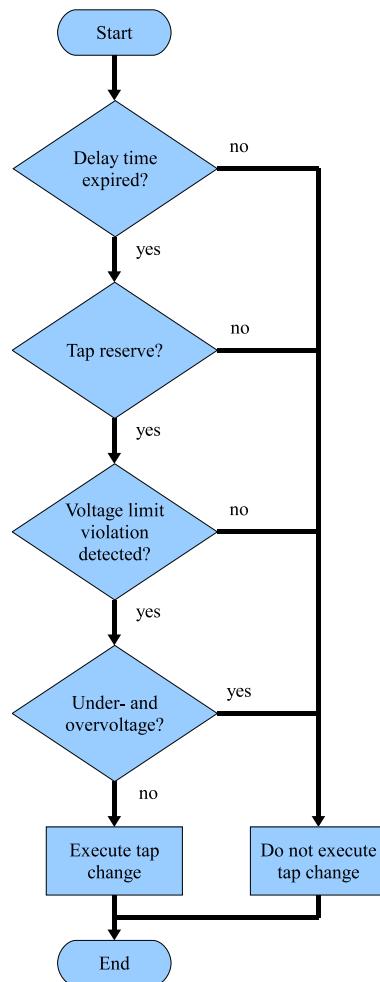

Figure 4.7: Flowchart of the coordinated OLTC controller

with both load and generation. It combines the advantages of the different methods to feed-in as much energy as possible to the medium voltage network without violating the voltage limits. Coordinated OLTC control makes use of communication between at least the most exposed network nodes and the central controller. For the design presented in figure 4.6 the loss of communication during some time is not jeopardizing the network voltages since the controller can fall back to a safe mode where only local control modes are used. A less optimal operation of the generation units is possible during this time to keep the voltage within the limits.

Chapter 5

Network Losses

In this chapter losses in medium voltage distribution networks will be discussed. Losses occur always when power is transferred in a network. In the literature it is distinguished between technical and non-technical losses as for instance theft and non-payment [40]. Since the focus in this work is on the losses caused by power transfer, only technical losses will be considered. They are an important issue both from an economical point of view and from a technical perspective since normally losses will be converted to heat. Permanent high temperatures caused by stressing the components above the rated current values can be a reason for faster ageing of insulation or melting of conductors or insulation for excessive temperatures which also becomes an economical aspect. For this reason losses are one of the limiting factors for the maximum power transfer through a line of a distribution system.

5.1 Shunt and Series Losses

The losses which occur in power networks are of two types. Shunt losses are depending on the shunt impedance consisting of the shunt resistance R_{sh} and shunt reactance X_{sh} . Since the shunt resistance is in parallel to the shunt reactance, it is more common to use the shunt admittance $Y_{sh} = G_{sh} + jB_{sh}$ that consists of the shunt conductance G_{sh} in parallel with the shunt susceptance B_{sh} . The losses caused by the shunt admittance are proportional to the network voltage squared and fairly independent of the transferred power. Therefore they are often assumed to be fixed losses when the voltage variations are

neglected. Shunt losses are also called iron losses as they are often related to magnetization current in transformers and reactors. The shunt losses are calculated according to equations (5.1a) and (5.1b). Shunt losses will not be taken into account in this work since the power flow changes caused by DG units are not affecting this kind of losses in a larger manner.

$$P_{loss,sh} = U^2 G_{sh} \quad (5.1a)$$

$$Q_{loss,sh} = U^2 B_{sh} \quad (5.1b)$$

Another and for the case of DG connection more relevant type of losses are the series losses which are varying depending on the current. Since these losses are caused by the current flow through the series impedance $Z_s = Z_{line}$, consisting of the line resistance R_{line} and line reactance X_{line} , their active part shown in (5.2a) is also called copper losses. These losses are directly dependent on the current flow through the network lines and therefore a changed power flow due to the connection of DG units is affecting the variable losses. How to calculate the active and reactive series losses is shown in (5.2a) and (5.2b) [31].

$$P_{loss,s} = 3I^2 R_{line} = \left[\frac{P}{U} \right]^2 R_{line} + \left[\frac{Q}{U} \right]^2 R_{line} \quad (5.2a)$$

$$Q_{loss,s} = 3I^2 X_{line} = \left[\frac{P}{U} \right]^2 X_{line} + \left[\frac{Q}{U} \right]^2 X_{line} \quad (5.2b)$$

As it is shown in equation (5.1) and (5.2) there are both active and reactive losses in a network. Active power losses are always positive but reactive power losses can become both positive and negative which is depending on the component where the losses occur. Since only active losses result in heating and costs for lost energy reactive losses are not in the focus of this work.

From (5.2a) it is obvious that also the transfer of reactive power causes active power losses. Therefore the unneeded transfer of reactive power should be avoided as much as possible which is often done by local reactive power compensation. As most of the loads are of inductive character and for that reason consuming reactive power, reactive power compensation is often done

by connecting capacitors. In extensive cable networks especially in rural areas the generation of reactive power due to the cable capacitance may exceed the reactive power consumption and thus shunt reactors are connected to compensate for the reactive power production. Even though local compensation is beneficial regarding network losses, it is not guaranteed that the local placement of an inductor or capacitor will also provide economic benefits compared with central compensation.

While the total network losses are the sum of all partial losses in the lines and the network components, the maximum acceptable loading of a line regarding the thermal limits is determined by the largest losses that can arise on this specific line. Regarding the ageing of components both the time and the amount of losses are of interest. However the total sum of the losses over a time period is the most important issue from the economical perspective. In case of pure load networks these energy losses W_{loss} are calculated according to equation (5.3) where P_{loss} can be obtained from the load curve for each node. When generation is connected to the network the difference of generated and consumed active power has to be used.

$$W_{loss} = \int_0^T P_{loss}(t) dt = 3R \int_0^T I^2(t) dt \quad (5.3)$$

5.2 Network Losses with DG Connected

When connecting DG units to the medium voltage distribution network, the power flow is changing and losses either increase or decrease or remain unchanged in some special cases. In which way the losses change depends on the place where the DG units are connected, to what extent the generation profile and the load profile match each other and on the capacity of the connected DG unit.

As shown in (5.3) the energy losses are depending on the current through the line squared. If the generation profile of the DG units is fitting the consumption profile of the loads, the power which has to be transferred S_{trans} will decrease according to (5.4). Therefore the losses decrease as well. Are the

profiles not matching each other the integration of the current squared over the time will increase and in consequence also the losses will increase.

$$S_{trans} = S_{load} - S_{gen} = (P_{load} - P_{gen}) + j(Q_{load} - Q_{gen}) \quad (5.4)$$

Even though the amount of losses increases in some cases in a network when DG units are connected that may still increase the efficiency of the total network since the percentage of losses decrease due to the increase of transferred energy injected by the DG unit.

When the losses in the medium voltage network are reduced by the connection of DG under normal circumstances the losses will often also be reduced in the feeding transmission network since the power flow from the transmission network to the medium voltage network is decreasing [3]. If the amount of connected DG energy is large enough to reverse the power flow between the feeding transmission network and the distribution network, losses in the feeding network may even increase. However, the feeding network is out of the scope for this work.

To determine the losses added by each load or generation unit connected to the network, marginal loss coefficients ρ_i are introduced [41]. The marginal loss coefficients (MLC) describe the change in the losses as a result of marginal changes in the transferred active and reactive power. MLC can be defined for both the losses in active power and the losses in reactive power. Equation (5.5) shows the marginal loss coefficients for the active power with P_i and Q_i as changes in active and reactive power in node i . Marginal loss coefficients can be used to determine the value of distributed generation in a certain network or feeder in general [11]. When using the reactive power for voltage control, the loss coefficients can be used to identify if there is a benefit regarding the losses when increasing the reactive power consumption for an increase of active power injection.

$$\rho_{P_i} = \frac{\partial P_{loss}}{\partial P_i} \quad \rho_{Q_i} = \frac{\partial P_{loss}}{\partial Q_i} \quad (5.5)$$

When determining the marginal loss coefficients as in (5.5) the reactive power consumption or generation of the DG units connected to the respective nodes has to be considered as well. Today most of the connected DG units should operate with unity power factor, i.e. not generate or consume any reactive

power, or only consume reactive power in some manner. But in case of voltage control by the use of reactive power the losses introduced by this reactive power flow will be an issue and probably also the limiting factor for the use of reactive power for voltage control in medium voltage distribution networks. In case of extensive cable networks where cables generate a large amount of reactive power, at least during periods of low network load it can be beneficial if the DG units consume some reactive power to maintain the voltage.

Figure 5.1 shows the active power network losses for the simple network in figure 3.4 when injecting or consuming active and reactive power at node 7. As it can be seen, especially in the corners, the losses increase if the transfer of active and/or reactive power increases. The losses are larger in case of overhead lines, although the cross section area is about the same for both lines. This is caused by the higher current which is needed to compensate for the larger voltage drop of the overhead line when the same amount of power should be transferred.

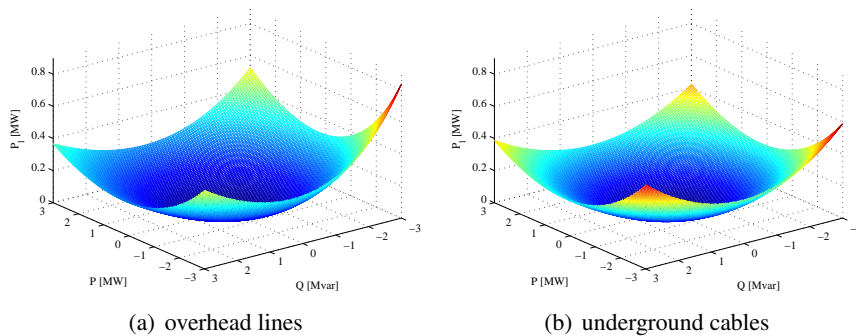

Figure 5.1: Network losses caused by the transfer of active and reactive power through overhead lines and underground cables with same cross section area

5.2.1 Simple Cases for Network Losses with and without DG Connected

The given cases are based on the network shown in figure 3.4 and will compare two different network configurations. In the first case the load and the

generation unit are connected to different network nodes. This corresponds to a situation in which load and generation are physically displaced or in which the load and generation profiles are not matching. In the second case load and generation are placed at the same node and also their load and generation profiles are assumed to match.

Case 1: Network losses in a network with physically displaced load and generation

For the calculation of the series losses equation (5.2a) is used. In the first case it is assumed to have a load of 2.0MW and PF = 0.95(*ind*) connected to node 3. The DG unit has a rated capacity of 2.0MW and unity power factor and is placed at node 7. The active series network losses consist of the losses in the line between node 2 and node 3 and the lines between node 2 and node 7 which are calculated in equation (5.6).

$$\begin{aligned}
 P_{node2-3} &= 3I^2R_{line} = \left[\frac{P}{U}\right]^2 R_{line} + \left[\frac{Q}{U}\right]^2 R_{line} \\
 &= \left[\frac{2}{1}\right]^2 \cdot 2 \cdot 3.360^{-3} + \left[\frac{0.657}{1}\right]^2 \cdot 2 \cdot 3.360^{-3} \\
 &= 0.030 \text{ p.u.}
 \end{aligned} \tag{5.6a}$$

$$\begin{aligned}
 P_{node2-7} &= \left[\frac{-2}{1}\right]^2 \cdot 8 \cdot 3.360^{-3} \\
 &= 0.108 \text{ p.u.}
 \end{aligned} \tag{5.6b}$$

$$P_{loss} = P_{node2-3} + P_{node2-7} = 0.030 \text{ p.u.} + 0.108 \text{ p.u.} = 0.138 \text{ p.u.} \tag{5.6c}$$

In the shown case the losses increase due to the connection of a DG unit. Without the DG unit connected only the losses for the line between node 2 and node 3 will occur. The power dissipation is in this case 0.030p.u. $\hat{=}$ 0.030MW. When the DG unit is connected to node 7 the losses will increase to 0.138p.u. $\hat{=}$ 0.138MW.

Case 2: Network losses in a network with load and generation placed close to each other

In the following case the same network configuration as in case 1 is assumed. But to start with the DG unit at node 7 is replaced by a load of 1.5 MW and $PF = 0.95$ (*ind*). Now the network is a pure load network without any generation connected. The network losses for this configuration are calculated in equation (5.7d). In a further step also a DG unit with a rated capacity of 2.0 MW and unity power factor is connected at node 7 without removing the already connected load at that node. Since the DG units decreased the amount of transferred active power, the losses will decrease as shown in equation (5.7e).

$$\begin{aligned}
 P_{node2-3} &= 3I^2R_l = \left[\frac{P}{U}\right]^2 R_l + \left[\frac{Q}{U}\right]^2 R_l \\
 &= \left[\frac{2}{1}\right]^2 \cdot 2 \cdot 3.360^{-3} + \left[\frac{0.657}{1}\right]^2 \cdot 2 \cdot 3.360^{-3} \\
 &= 0.030 \text{ p.u.}
 \end{aligned} \tag{5.7a}$$

$$\begin{aligned}
 P_{node2-7,load} &= \left[\frac{1.5}{1}\right]^2 \cdot 8 \cdot 3.360^{-3} + \left[\frac{0.493}{1}\right]^2 \cdot 8 \cdot 3.360^{-3} \\
 &= 0.067 \text{ p.u.}
 \end{aligned} \tag{5.7b}$$

$$\begin{aligned}
 P_{node2-7,load-gen} &= \left[\frac{1.5-2.0}{1}\right]^2 \cdot 8 \cdot 3.360^{-3} + \left[\frac{0.493}{1}\right]^2 \cdot 8 \cdot 3.360^{-3} \\
 &= 0.013 \text{ p.u.}
 \end{aligned} \tag{5.7c}$$

$$\begin{aligned}
 P_{loss} &= P_{node2-3} + P_{node2-7,load} \\
 &= 0.030 \text{ p.u.} + 0.067 \text{ p.u.} = 0.097 \text{ p.u.}
 \end{aligned} \tag{5.7d}$$

$$\begin{aligned}
 P_{loss} &= P_{node2-3} + P_{node2-7,load-gen} \\
 &= 0.030 \text{ p.u.} + 0.013 \text{ p.u.} = 0.043 \text{ p.u.}
 \end{aligned} \tag{5.7e}$$

For the example shown here, the connection of a DG unit is beneficial from the perspective of losses. The network losses will decrease from 0.097 p.u. $\hat{=}$ 0.097 MW to 0.043 p.u. $\hat{=}$ 0.043 MW since the load and the generation are placed at the same node.

Summary of Case 1 and Case 2

As shown in the cases above losses may both increase and decrease when a DG unit is connected to the network depending on whether the total amount of transferred power is increasing or decreasing. Even though the connection of a DG unit is beneficial for case 2 this may change if the generation from the DG unit mainly is fed in to the grid during times where the load is low and vice versa.

Chapter 6

Generic Network

Simulations of voltage control and losses in a generic medium voltage network consisting of three feeders are presented in this chapter. First the test system is illustrated and then the simulation program and the models are presented. Finally the simulation for the different ways of voltage control results are shown.

6.1 Test System

Since DG units and especially wind turbines are often located in rural areas and connected to weak networks, a test system depicting the characteristics for a typical countryside medium voltage cable network was used for the simulations. Typical for a medium voltage network in a rural area are feeders consisting of long lines and comparatively low power flows which implies weak lines with large impedance. Furthermore the network should also include the most common cases of DG connection and network feeders.

As test system a generic medium voltage network with a nominal voltage of 10kV was assumed. The generic medium voltage network is connected to the high voltage transmission network by a 130/10kV transformer with an integrated on-load tap changer. As shown in figure 6.1 the network has 16 network nodes. Node 1 is the primary side of the HV/MV transformer, while node 2 is the secondary side busbar of the transformer. All lines in the network are of the same type. For this generic network 95mm² aluminium

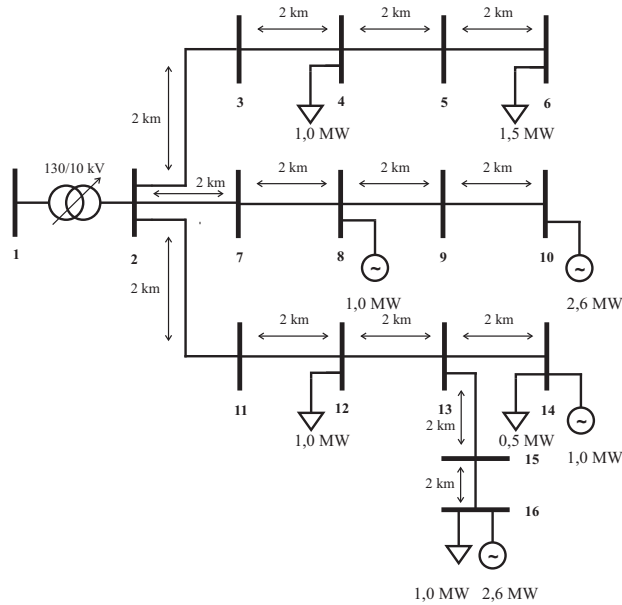

Figure 6.1: One-line diagram of the generic test system

underground cables (AXCEL 95 mm²) are used and each cable section has a length of 2 km. Hence the parameters of each line section are as shown in (6.1a) to (6.1c).

$$R = 2 \text{ km} \cdot 0.320 \Omega/\text{km} = 0.640 \Omega \quad (6.1a)$$

$$L = 2 \text{ km} \cdot 0.35 \text{ mH}/\text{km} = 0.70 \text{ mH} \quad (6.1b)$$

$$C = 2 \text{ km} \cdot 0.32 \mu\text{F}/\text{km} = 0.64 \mu\text{F} \quad (6.1c)$$

This implies that node 16 is with 10 km distance the node with the largest impedance between the substation and the node.

The HV/MV transformer has a rated capacity of 10 MVA. With an assumed short circuit voltage of 10% and $S_{base} = 1 \text{ MVA}$ a transformer impedance of 0.01 p.u. is obtained.

The long term voltage variations at the network nodes where load and/or generation are connected should be limited to $\pm 5\%$ at the medium voltage node to allocate some part of the voltage band for voltage changes in the low

voltage distribution network. As explained in chapter 2 more generous limits can be assumed to be reasonable when the voltage is monitored.

6.2 Simulation Program and Models

For the simulations MATLAB was used together with MATPOWER [42]. MATPOWER is a package for solving power flow and optimal power flow problems and was developed of the Power System Engineering Research Center (PSERC) at Cornell University. For the simulations in this work version 4.0 of the MATPOWER package was used. Some modifications have been done to fit the needs of this work especially to run time series. The calculation of the network state was done by the MATPOWER package running a power flow solver using Newton's method.

Network transmission lines are modelled as standard π -models. As described in chapter 2.2.1 the π -model consists of a series impedance and a shunt capacitance.

Normal loads connected to the low voltage distribution network are aggregated and connected as one load directly to the medium voltage network at that place where the MV/LV substation would have been placed. All loads connected to the network are assumed to be constant power loads with a constant power factor. Notwithstanding other load characteristics are also common, many loads connected via power electronics are behaving as constant power loads. During the simulations the power consumed by each load is scaled with the load profile where the rated power of the load is the largest value. All loads are scaled with the same factor at each time. In this work each load has been modelled as complex power consumption in the MATPOWER package.

Since the generation units have a rated power of up to 2.6MW they are supposed to be connected to the medium voltage network, probably by their own transformer. The generation units connected to the generic medium voltage network have a variable power factor. Unity power factor and consuming reactive power with power factors between $PF = 0.89$ and $PF = 1$ are possible

for the whole active power range from zero to rated active power output. The active power output is scaled with a factor derived from the generation profile. In the MATPOWER package each generator is modelled as complex power injection at a specific bus.

A strong connection to the high voltage transmission network is assumed and therefore the voltage at the HV/MV transformers primary side is not affected by the connected medium voltage network. Moreover the voltage of the high voltage network is understood to be constant at 1 p.u. during the simulations.

An on-load tap changer is placed at the HV/MV transformer. The OLTC can change the transformer tap ratio with ± 9 steps and each step changes the voltage at the transformers secondary side with 1.67%. The voltage dead-band for the constant voltage control of the on-load tap changer is 2%.

For the simulation of the time variation of the load and the generation units time profiles as shown in figure 6.2 were used. The profiles span over a time frame of 48 hours with repetition after 24 hours and a time resolution of one minute values. The load profile is a generic profile whereas the generation profile is logged from real wind turbines and scaled. Even if the load profile is missing a detailed resolution, the two profiles together include the two worst cases of maximum load and low generation (around hour 4 in figure 6.2) as well as no load and maximum generation (around hour 21 in figure 6.2).

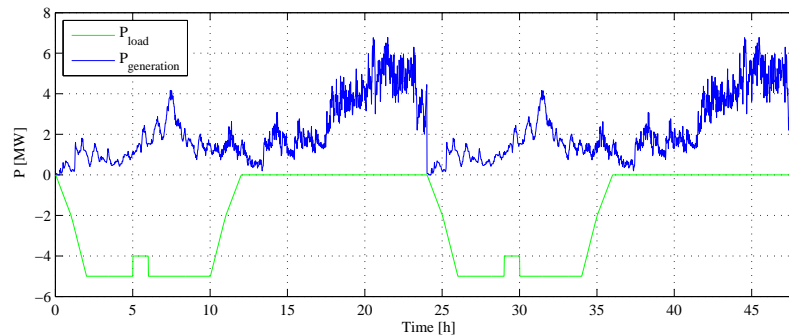

Figure 6.2: Load and generation profiles of the total load and generation used in the simulation

6.3 Simulations

In the simulations the network node voltages and the network active power losses were determined for each time step. This was done for different control modes: local OLTC control, DG control and coordinated OLTC control. The results of the simulations for all three control strategies are presented in the following sections.

6.3.1 Local OLTC Control

Local OLTC control is used for the simulation of the network node voltages and the losses which are presented in this section. First the traditional case of a pure load network will be presented and then also the case with all DG units connected as shown in figure 6.1 (without any local voltage control) will be shown in these simulations. The generated and consumed active and reactive power at each specific network node is presented in figure 6.3.

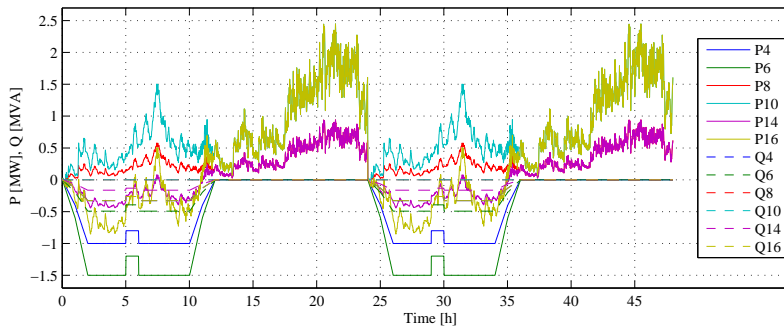

Figure 6.3: Consumed and generated active and reactive power at each network node

Voltage

Since the network is built to keep the voltage above the lower limit at maximum load, the case of only load should not be a problem from the perspective of the voltage. The voltage at the secondary side busbar is set to 1.033 p.u. (two steps of the OLTC) so that the lower voltage limit will not be exceeded. Hence undervoltage is no longer an issue in this case. However, large generation units are connected to some nodes of the network without any voltage regulation. Due to the capacity of the DG units and the already high voltage level caused by the basic on-load tap changer setting the voltage will exceed the upper voltage limit during some time periods considerably. The voltage profiles for the 48 hours time period are shown in figure 6.4. The lowest net-

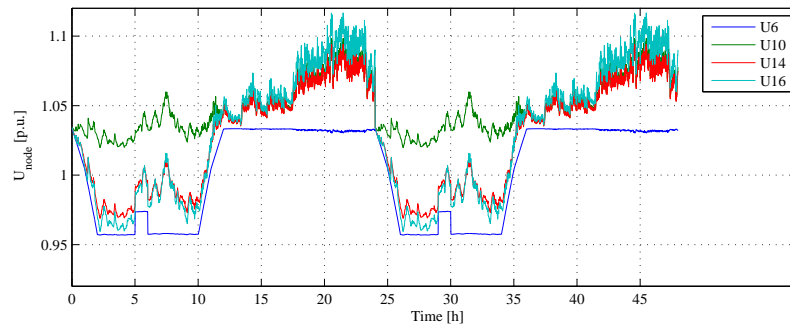

Figure 6.4: Voltage at the network nodes during the simulation without voltage control

work voltage will occur at node 6 since large load is connected in that node far out on the feeder and no generation unit is placed there. Under maximum load conditions the node voltage is as low as $V_{node6} = 0.957$ p.u. Since the voltage at the secondary side busbar in the HV/MV substation is set to 1.033 p.u. there are only 0.017 p.u. left to the upper voltage limit of 1.05 p.u. The upper voltage limit will in this case be violated at all nodes where generation units are connected. The largest voltage in the network can be found at node 16 where the voltage is as high as 1.117 p.u.

The voltage difference between the lowest voltage and the highest voltage, i.e. the used voltage band, is 0.160 p.u. corresponding to 16.0% of the nominal

voltage. With a wide voltage band like in this case it is impossible to find a constant voltage at the substations secondary busbar which is adequate. Either the lower or the upper voltage limit will be violated.

Losses

With no generation connected to the network the losses are 4.5MWh during the simulated time span of 48 hours. As the total amount of transferred energy is 96.0MWh during this time, the losses in percentage are 4.7%. If the DG units were connected without any voltage limitation the transferred energy will increase to 199.8MWh whereof 103.8MWh are produced by the DG units. The total network losses would increase to 6.4MWh but due to the increase of the transferred energy and the correlation between some of the consumption and generation, the relative losses are decreasing to 3.2%. The variation of the losses when load and generation are connected to the network with local control of the OLTC is shown in figure 6.5.

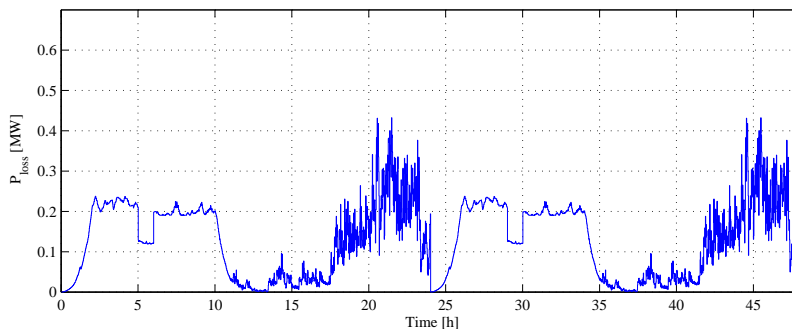

Figure 6.5: Losses in the network

6.3.2 DG Control

Results for the simulations of distributed generation control, as introduced in section 4.2, on the generic network are presented in this section. When using

DG control the voltage at node 2 is still kept as constant (beside the OLTC deadband) as possible by the OLTC. Also in this case the voltage at the MV busbar has to be chosen in such a way that the lowest voltage in the network will never go below 0.95 p.u., which is equivalent to at least two OLTC steps corresponding to a voltage of 1.033 p.u. at node 2.

With local OLTC control and a variable power factor as well as curtailment for the active power generation different cases are feasible. In the first case only curtailment will be used to limit the voltage and the output of the generation units has still unity power factor. Secondly the reactive power consumption of the DG units can be activated at a constant level which is proportional to the active power output (constant PF). A more advanced control strategy is a variable power factor where the reactive power consumption is set according to the voltage at the network node where the DG unit is connected. For this third case the voltage at the network node will first be controlled by increasing the reactive power consumption until the minimum power factor (or the maximum reactive power consumption) is reached. Subsequently active power curtailment is used to maintain the voltage below the upper voltage limit. In the end a constant reactive power consumption is imaginable as well but this case is not taken into account here since it is not reasonable.

Figure 6.6 shows the active and reactive power consumption and generation in each specific network node of the generic network for the three different modes of DG control. The rectangular variation in the active power output of the wind turbines comes from the curtailment controller that tries to decrease the curtailment after that the voltage has been below the upper limit for some time. This is done to avoid unnecessary curtailment. The totally consumed active energy during the 48 hours simulation period is still 96.0 MWh. During that time 103.8 MWh of wind energy would be available from the installed generation units if no curtailment would be used. As expected there is no reactive power consumed at the nodes where only DG units are connected if only curtailment is used for the DG control. The total amount of energy generated by the connected DG units has to be curtailed to 64.0 MWh. When using a constant power factor the reactive power consumption at the nodes is proportional to the active power generation. By this 69.3 MWh of the total available wind energy can be transferred to the grid without violating the upper voltage limit. In the case of variable power factor the reactive power is set

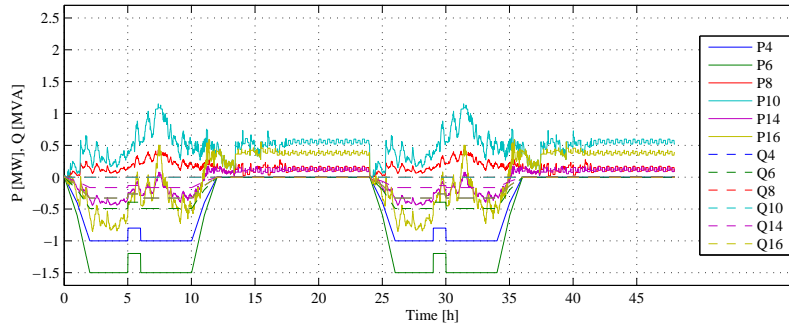

(a) with only curtailment

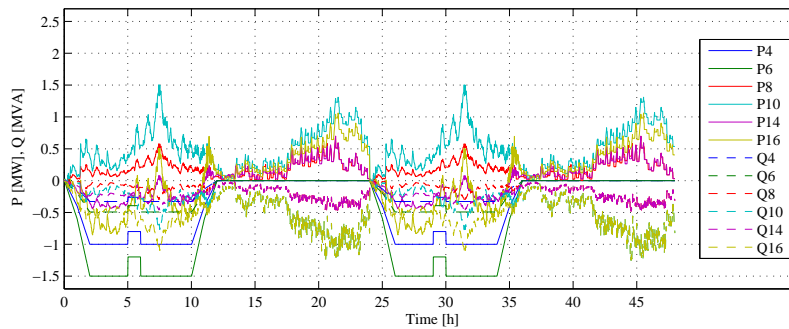

(b) with constant power factor (PF = 0.89)

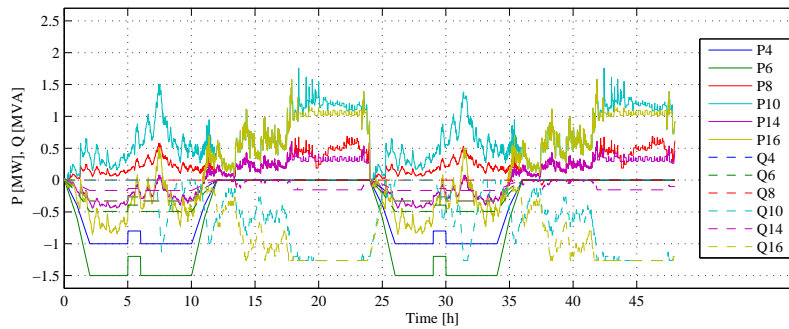

(c) with variable power factor

Figure 6.6: Active and reactive power consumption and generation at each network node

to keep the voltage within the limits. The reactive power consumption is limited by maximum reactive power capacity of the DG unit which corresponds to the reactive power with minimum power factor at rated capacity. This implies that the power factor during some operation points may be below the lowest power factor for rated active power output ($PF = 0.89$) and therefore totally 88.8MWh are injected into the grid with keeping the voltage within the limits.

The curtailed active power and the reactive power consumption used for the various strategies of DG control are presented in figure 6.7. If only curtailment is available for the DG control a large amount of the DG capacity has to be curtailed during the periods of low load and high generation. To avoid the violation of the upper voltage limit as much as 39.8MWh corresponding to 38.3% of the available wind energy has to be curtailed. If the reactive power consumption is proportional to the active power generation less curtailment is needed to keep the voltage below respectively at the upper limit. With the data used in the simulations 53.2Mvarh of reactive power are consumed by the DG units and curtailment decreases to 34.5MWh equivalent to 33.3%. In the case of a variable power factor the need for curtailment is going down to 15.1MWh (14.5%) but the use of reactive power is increased to 54.7MVarh since during periods of less than maximum active power output a smaller power factor is available and used before curtailment is activated.

Voltage

The lowest voltage in the network is obtained for all three cases of DG control at node 6 where only load is connected. As it can be seen in figure 6.8(a) compared to figures 6.8(b) and 6.8(c) the voltage at the pure load feeder (node 3 - node 6) is affected by the reactive power consumption of the DG units connected at the other feeders. Due to the fact that the current through the HV/MV transformer and for this reason also the voltage drop in the transformer varies with the reactive power consumption also the voltage at the MV busbar varies. As long as the voltage variation is below the threshold of the OLTC's deadband no action will be taken of the on-load tap changer. The lowest voltage of 0.953p.u. therefore occurs when using a constant power factor. For the two other cases of unity power factor and variable power fac-

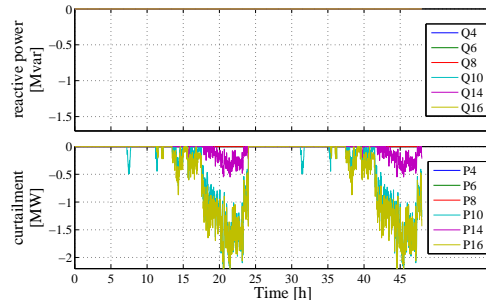

(a) with only curtailment

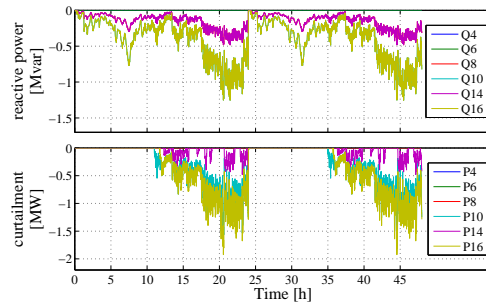

(b) with constant power factor (PF = 0.89)

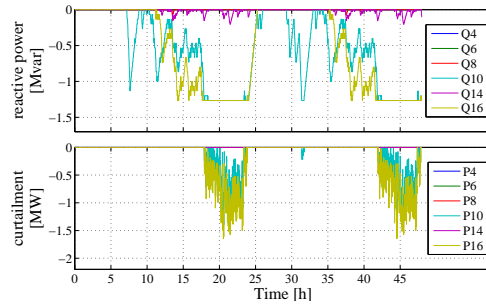

(c) with variable power factor

Figure 6.7: Reactive power consumption and active power curtailment at each network node if local DG control is used. With unity power factor as in 6.7(a) no reactive power is consumed.

tor the lowest voltages are 0.957 p.u. and 0.954 p.u. respectively. In the case of a constant power factor in general a lower voltage level as needed is kept as it can be seen in figure 6.8(b). Due to the large variations especially in the reactive power flow the number of tap changes is increasing from two to three when reactive power is used for the voltage control.

At the upper limit of 1.05 p.u. the voltage should be limited by the controller. Since the controller is first taking action when the upper voltage limit is violated voltage peaks where the voltage is over the upper limit during a short time may appear. For all cases the highest voltage is found at node 16. In case of unity power factor the highest voltage is at 1.058 p.u. For a constant power factor and variable power factor these values are 1.062 p.u. and 1.071 p.u. respectively. The voltages at the relevant network nodes for the different strategies of DG control are shown in figure 6.8.

Losses

For the three different modes of DG control, the losses are varying a lot due to the various amount of active and reactive power which are transferred through the lines. In absolute numbers the lowest losses (4.0 MWh) occur by the use of unity power factor but at the same time the amount of totally transferred active power is also the lowest for this control strategy and when this is taken into account the losses in percentage are at 2.5 % of the transferred energy. When a constant power factor is used the absolute losses increase to 5.5 MWh hours even though the totally transferred power is increasing the percentage losses are increasing to 3.3 %. For a variable power factor the losses (6.6 MWh) are increasing further because of the more extended use of reactive power for the voltage control but also due to the increasing amount of energy that is injected to the grid. Nevertheless even the losses in percentage are increasing to 3.6 %.

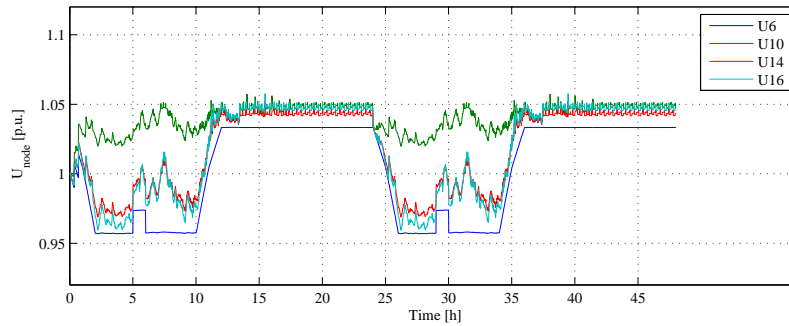

(a) with only curtailment

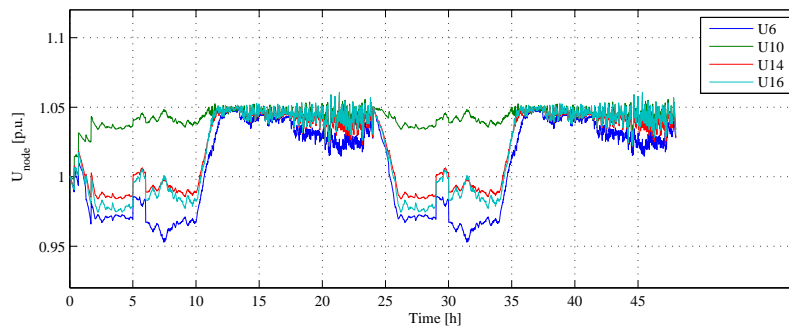

(b) with constant power factor (PF = 0.89)

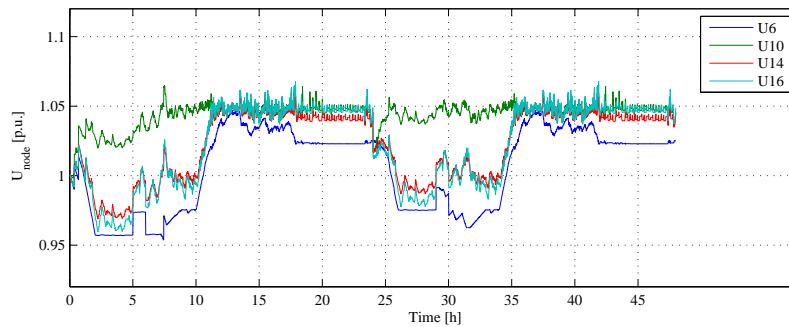

(c) with variable power factor

Figure 6.8: Voltages at the relevant network nodes

Summary of the Results from DG Control

The results obtained from the simulations with DG control are summarized in table 6.1.

Moreover than the results shown in table 6.1 for the DG control also the feature for the more fair distribution of the curtailment was simulated. Since active power curtailment has the lowest priority of the three voltage control methods, only the amount of curtailment and its distribution between the various DG units is changing. If the fair distribution is activated, in total more curtailment is needed, depending on the fact that curtailment of generation units at nodes which are closer to the substation is less efficient. The total curtailment with unity power factor is increasing from 39.8 MWh to 45.3 MWh, from 34.5 MWh to 40.6 MWh with a constant power factor ($PF = 0.89$) and from 15.1 MWh to 17.0 MWh with variable power factor.

In the case of individual distribution curtailment at the nodes closer to the substation (node 8 and node 14) is decreasing and nearly all curtailment is provided by the DG units at node 10 and node 16. In the case of unity power factor for example the need of curtailment at node 8 decreases from 7.0 MWh to 0 MWh and at node 14 from 7.3 MWh to 2.5 MWh when changing from fairly distributed curtailment to individual curtailment. At the same time the curtailment at node 10 is increases from 14.0 MWh to 17.7 MWh and at node 16 the values are 17.0 MWh and 20.0 MWh.

6.3.3 Coordinated OLTC Control

In this section coordinated voltage control as described in section 4.3 is studied by simulations on the generic medium voltage network (figure 6.1). The main issue with using coordinated on-load tap changer control is to take more advantage of the available voltage band by changing the voltage level in the entire network according to the actual voltage situation on the network nodes, i.e. the actual consumption and generation in the network.

However, there are still different strategies to handle the control of the reac-

Table 6.1: Basic values from the simulation cases of DG control

	Load and generation, $\cos\phi = 1$, local OLTC, curtailment	Load and generation, $\cos\phi = 0.89$, local OLTC, curtailment	Load and generation, $\cos\phi \text{ var}$, local OLTC, curtailment
Transferred energy [MWh]	160.0	165.3	184.8
Consumed energy [MWh]	96.0	96.0	96.0
Uncurtailed energy from DG units [MWh]	103.8	103.8	103.8
Obtained DG energy [MWh]	64.0	69.3	88.8
Curtailed DG energy [MWh]	39.8	34.5	15.1
Curtailed DG energy [% of uncurtailed energy]	38.3	33.3	14.5
Consumed reactive power [Mvar]	0	53.2	54.7
Network losses [MWh]	4.0	5.5	6.6
Network losses [% of transferred energy]	2.5	3.3	3.6
Number of OLTC steps	2	3	3
Minimum network voltage [p.u.]	0.957	0.953	0.954
Maximum network voltage [p.u.]	1.058	1.062	1.071

tive power in the network to control the voltage by the corresponding controller. Both a constant power factor as well as a variable power factor and unity power factor are alternatives which can be taken into account. The active and reactive power going in to and out from all nodes for the three different cases mentioned before is shown in figure 6.9.

As the load has not been changed since the simulations in 6.3.2 the total amount of consumed active energy during the simulation period will remain unchanged 96.0MWh. With unity power factor and a coordinated controlled on-load tap changer totally 100.3MWh of the available 103.8MWh wind energy can be transferred into the grid. Only 3.6MWh which is equal to 3.4% have to be curtailed. When reactive power is consumed by the DG units corresponding to a constant power factor of $PF = 0.89$ all available wind power can be absorbed by the grid without violating the upper voltage limit. No curtailment of active power is needed in this case. For a variable power factor the situation is as expected the same as for the case of a constant power factor. All wind energy can be transferred into the medium voltage network and of course no curtailment is needed in this case either.

Figure 6.10 shows the distribution of reactive power consumption and active power curtailment over the simulated time period. When unity power factor is used no reactive power can be consumed to maintain the voltage. As shown in figure 6.10(a) there are some moments when curtailment is needed at node 10 and node 16 to keep the upper voltage limit. Totally 3.6MWh (3.4%) from the wind turbines has to be curtailed to fulfil the voltage limits. A constant power factor together with the coordinated control of the on-load tap changer is sufficient to keep the voltage at all nodes within the limits. In figure 6.10(b) the variation of the reactive power consumption which is proportional to the active power generation is illustrated. Furthermore it shows that no curtailment is needed. The total reactive energy consumption is 53.2Mvarh. The coordinated use of the on-load tap changer and a variable power factor are also able to maintain the voltage at all nodes without the need for any curtailment. Only at node 10 and node 16 reactive power consumption is needed during some short time periods as figure 6.10(c) illustrates. Not more than 3.0Mvarh need to be consumed to keep the voltage within the limits.

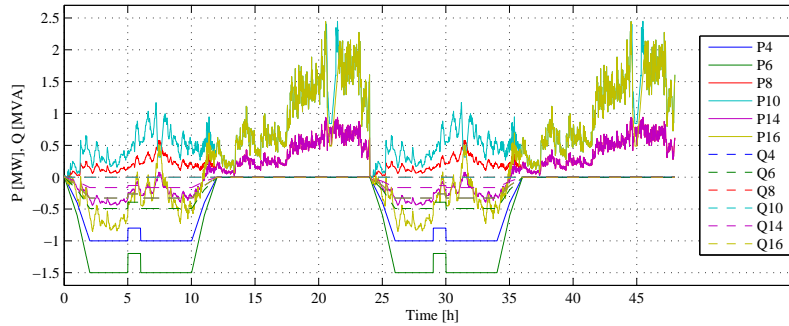

(a) with only curtailment

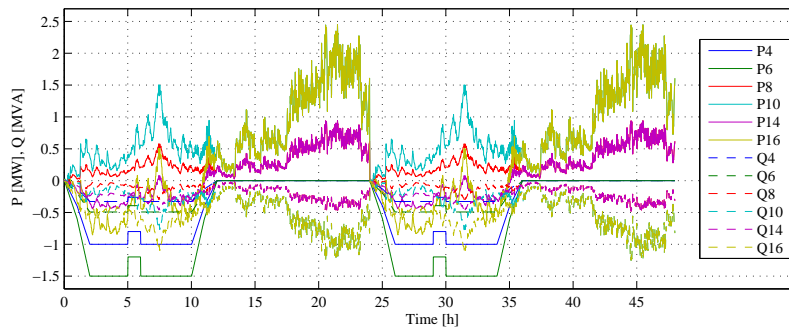

(b) with constant power factor (PF = 0.89)

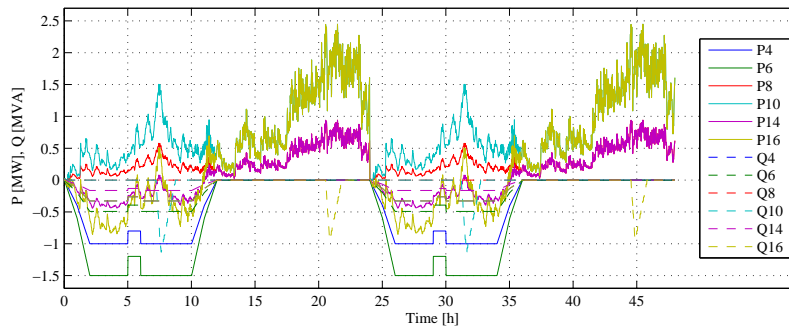

(c) with variable power factor

Figure 6.9: Active and reactive power consumption and generation at each network node

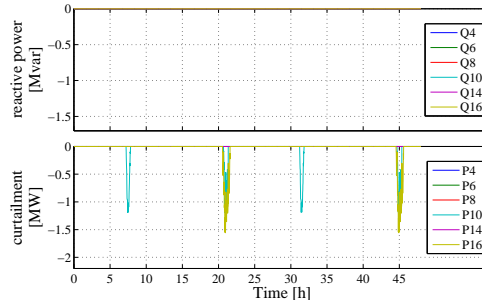

(a) with only curtailment

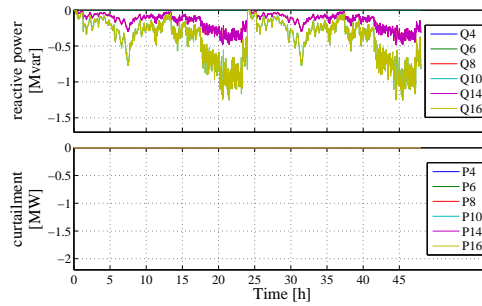

(b) with constant power factor (PF = 0.89)

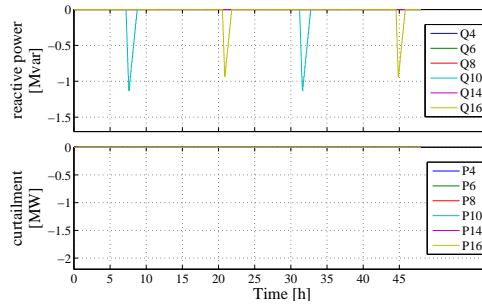

(c) with variable power factor

Figure 6.10: Reactive power consumption and active power curtailment at the network nodes with generation if coordinated OLTC control is used. For the use of unity power factor as in 6.10(a) no reactive power is consumed. In 6.10(b) and 6.10(c) no curtailment is needed.

Voltage

The lowest voltage occurs for all reactive power control strategies in node 6 where only load is connected (figure 6.11). Since only voltage limit violations are taken into account by the coordination controller and due to some delay in the on-load tap changer the lowest voltage will be below the lower voltage limit during some short periods until the voltage is returned by the OLTC. The lowest voltage with unity power factor is 0.940p.u. as shown in figure 6.11(a). For a constant power factor the lowest voltage is down to 0.937p.u. and actually down to 0.930p.u. for a variable power factor as it is illustrated in figure 6.11(b) and figure 6.11(c) respectively.

Both for unity power factor and for a variable power factor the maximum voltage is limited to 1.054p.u. With a constant power factor the upper voltage never increases above 1.052p.u. The oscillations of the voltage during some time periods are caused by the tap changing controller that tries to go back to the basic settings after a while without undervoltage. As the coordination controller obtains information only when voltage limit violations occur, it is difficult to avoid this behaviour. The strong influence from the reactive power consumption of the DG units on the voltage on the pure load feeder is also clearly illustrated in figure 6.11(b) and figure 6.11(c). If the on-load tap changer is used for coordinated voltage control the number of tap changes will probably increase significantly. For coordinated voltage control the on-load tap changer has no longer only the function to compensate for the voltage changes on the HV network and the varying voltage drop over the transformer but it should also balance voltage variations which are caused by the varying power flow in the medium voltage network. All tap changes during the simulated period are shown in figure 6.12.

When only active power curtailment is used for the voltage control by the DG units, the tap changer is doing 22 step changes during the simulated period of 48 hours. As expected the tap position and by that also the voltage at the secondary side busbar is increased during times of heavy load and low generation. Vice versa the tap position is decreased when the load is low and generation high. In the case of a constant power factor 40 tap changes occur during the simulation time. This large number is caused by oscillation which occur due to low voltage on the load feeder when the tap change controller

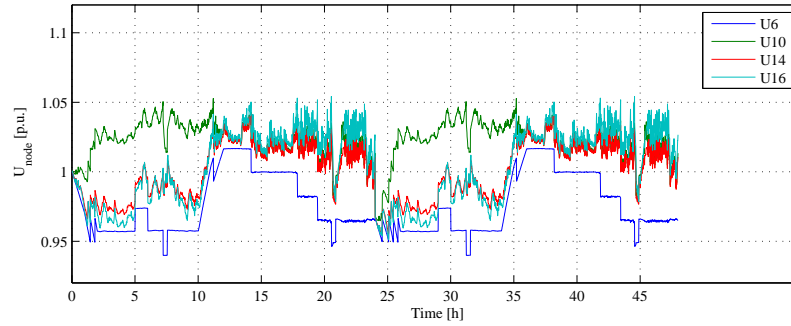

(a) with only curtailment

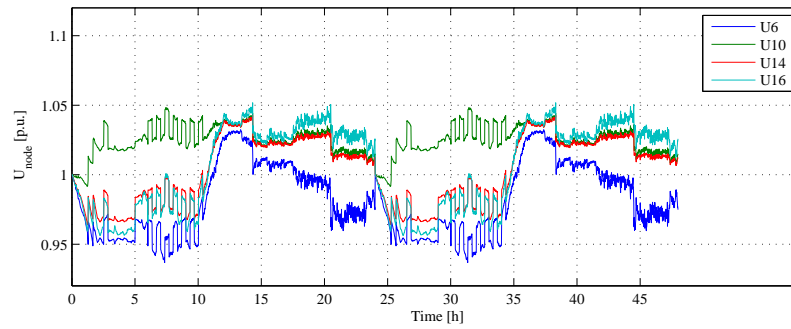

(b) with constant power factor (PF = 0.89)

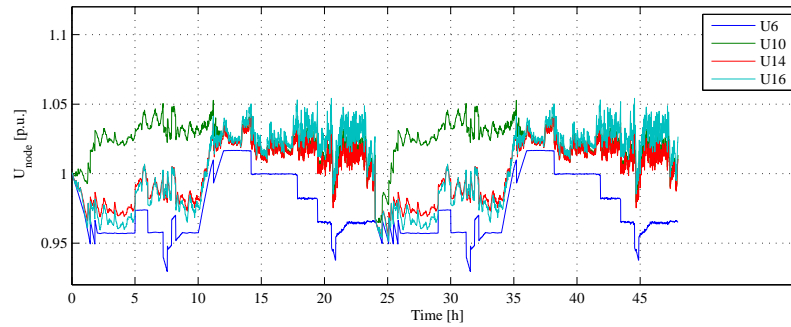

(c) with variable power factor

Figure 6.11: Voltages at the relevant network nodes

tries to go back to the basic settings. For a combination of a coordinated OLTC and a variable power factor 26 step are done by the tap changer to keep the voltage within the limits.

Voltages at the upper voltage limit can be affected by all three controllers. However the OLTC is the only unit in the actual control that can increase the network voltage when it comes close to the lower limit. Thus voltages which are below the lower voltage limit have to lead to an operation of the on-load tap changer.

Losses

Over the simulation time the active power losses of the entire generic medium voltage network are summarized to 6.4 MWh corresponding to 3.2% if only active power curtailment and the tap changer are used for voltage control. The losses increase to 7.9 MWh with a constant power factor for the consumption of reactive power by the DG units. Accordingly 4.0% of the total transferred energy will be lost. With a variable power factor activated the losses are going down again (6.8 MWh). Even though the total transferred energy is increasing the relative losses for this case are 3.4% of the total energy transfer which is just marginally higher than in the case of unity power factor.

Summary of the Results from DG Control

The results from the simulation of coordinated OLTC control are summarized in table 6.2.

Beside the individual control of the voltage at its own node, also the fair distribution of curtailment has been simulated with coordinated OLTC control. Since curtailment is only needed for the case of unity power factor and the amount of curtailed energy is very low, the results for the total curtailment remain unchanged.

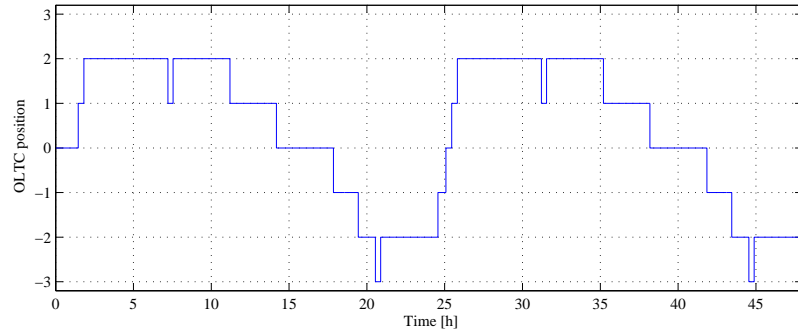

(a) with only curtailment

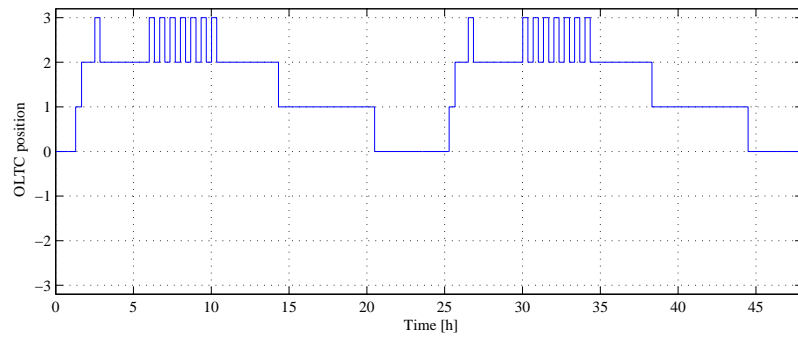

(b) with constant power factor (PF = 0.89)

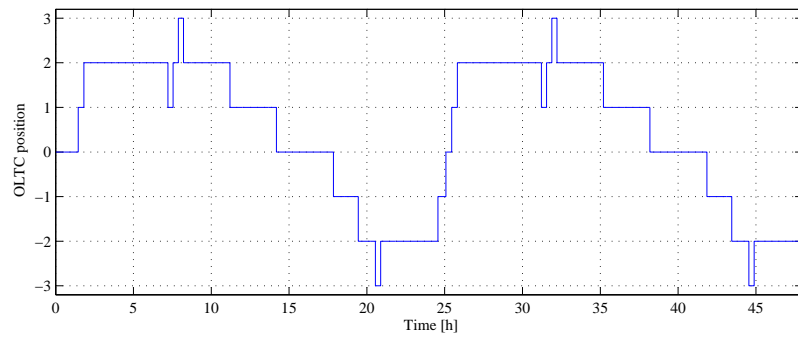

(c) with variable power factor

Figure 6.12: Position of the on-load tap changer (OLTC)

Table 6.2: Basic values from the simulation cases of coordinated OLTC control

	Load and generation, $\cos\phi = 1$, coordinated OLTC, curtailment	Load and generation, $\cos\phi = 0.89$, coordinated OLTC, curtailment	Load and generation, $\cos\phi$ var, coordinated OLTC, curtailment
Transferred energy [MWh]	196.3	199.8	199.8
Consumed energy [MWh]	96.0	96.0	96.0
Uncurtailed energy from DG units [MWh]	103.8	103.8	103.8
Obtained DG energy [MWh]	100.3	103.8	103.8
Curtailed DG energy [MWh]	3.6	0	0
Curtailed DG energy [% of uncurtailed energy]	3.4	0	0
Consumed reactive power [Mvar]	0	53.2	3.0
Network losses [MWh]	6.4	7.9	6.8
Network losses [% of transferred energy]	3.2	4.0	3.4
Number of OLTC steps	22	40	26
Minimum network voltage [p.u.]	0.940	0.937	0.930
Maximum network voltage [p.u.]	1.054	1.052	1.054

6.4 Summary

Several strategies for voltage control in a medium voltage distribution network have been presented in the previous sections of this chapter. A coordinated control of the OLTC, reactive power consumption and active power curtailment have been used to maintain the voltage within the defined limits. The most relevant cases that have been simulated and the key values of the results are listed in table 6.3.

As the results show it is possible to maintain the voltage roughly within the predefined limits when the presented voltage control is used. Since the voltage controller is only taking action in course of voltage limit violation, the defined limits will be violated for some short time. To prevent this absolute voltage measurements can be used or the limits can be set comfortable to obtain some reserve. The last named solution is wasting a part of the available voltage band during most of the time and is therefore maybe not the preferred solution. According to the standard EN 50160 voltages just outside the limit during short time periods are tolerable. Which strategy to prefer depends on the priorities regarding the number of movements of the OLTC, the losses caused by the reactive power transfer and the not available energy due to active power curtailment.

As shown in table 6.3 the totally most beneficial strategies seems to be the use of the coordinated OLTC control and a unity power factor (*Load and generation, $\cos\phi = 1$, controlled OLTC, curtailment*) and variable power factor (*Load and generation, $\cos\phi_{var}$, controlled OLTC, curtailment*) respectively if communication is available and thus measurement values from the electricity meters are obtained. Without communication and voltage measurement values to obtain network voltages, local voltage control with reactive power and active power curtailment may be an acceptable alternative. In this case a variable power factor seems to be the most advantageous mode. If neither communication nor reactive power is available for the voltage control, only active power curtailment can be used. In most cases the loss of the active power is probably too expensive but this is depending on the specific network structure and the load and generation profiles.

Table 6.3: Basic values from the major simulation cases

	Pure load, local OLTC	Load and generation, $\cos\phi = 1$, local OLTC, curtailment	Load and generation, $\cos\phi = 1$, coordinated OLTC, curtailment	Load and generation, $\cos\phi = 0.89$, coordinated OLTC, curtailment	Load and generation, $\cos\phi$ var, local OLTC, curtailment	Load and generation, $\cos\phi$ var, coordinated OLTC, curtailment
Transferred energy [MWh]	96.0	160.0	196.3	199.8	184.8	199.8
Consumed energy [MWh]	96.0	96.0	96.0	96.0	96.0	96.0
Uncurtailed energy from DG units [MWh]	0	103.8	103.8	103.8	103.8	103.8
Obtained DG energy [MWh]	0	64.0	100.3	103.8	88.8	103.8
Curtailed DG energy [MWh]	0	39.8	3.6	0	15.1	0
Curtailed DG energy [% of uncurtailed energy]	0	38.3	3.4	0	14.5	0
Consumed reactive power [Mvar]	0	0	0	53.2	54.8	3.0
Network losses [MWh]	4.5	4.0	6.4	7.9	6.6	6.8
Network losses [% of transferred energy]	4.7	2.5	3.2	4.0	3.6	3.4
Number of OLTC steps	0	2	22	40	3	26
Minimum network voltage [p.u.]	0.955	0.957	0.940	0.937	0.954	0.930
Maximum network voltage [p.u.]	1.017	1.058	1.054	1.052	1.071	1.054

Table 6.4 shows the key values for the favoured mode with coordinated control of the on-load tap changer and various modes for the control of the reactive power. The number of tap changes will be minimized by the use of unity power factor. Losses are lowest for unity power factor, too, but only slightly increasing for variable power factor.

Table 6.4: Key values for using various power factors

	Load and generation, $\cos\phi = 1$, coordinated OLTC, curtailment	Load and generation, $\cos\phi = 0.89$, coordinated OLTC, curtailment	Load and generation, $\cos\phi$ var, coordinated OLTC, curtailment
Curtailed DG energy [MWh]	3.3	1.1	0
Losses [MWh]	6.3	7.9	6.8
Number of OLTC steps	22	40	26

Even though the use of active power curtailment is always a solution to avoid overvoltages caused by the injection of active power produced by DG units it is of course not the favoured way since the target is just to transfer as much active power from the DG units to the network as possible whenever it is available. Therefore it should be preferred to use the other methods of voltage control as much as possible. For the use of reactive power, beside the maximum available reactive power consumption by the DG unit, the increasing network losses caused by the reactive power transfer is a consequence that has to be taken into account. The reactive power consumption may be limited by the thermal limits of the line or by the fact that the ratio of the increase in losses is larger than the ratio of increase in active power transfer. Coordinated control of the OLTC is limited by the total width of the voltage band. If the difference between the lowest voltage and the highest voltage, i.e. the used voltage band, is larger than that between the lower and upper voltage limit, i.e. the available voltage band, the on-load tap changer alone can not be used for a sufficient voltage control. Another limitation for the OLTC is the limit in the number of steps that can be accepted considering maintenance.

During normal operation coordinated voltage control needs communication to obtain the alarm signals when the voltage is outside the limits at any node. If communications breaks down the network can still be run in DG voltage control mode. In this kind of fall-back operation probably more active power curtailment is needed to maintain the voltage within the limits. But still voltage control is possible and the DG units may remain connected during this time.

Regarding the energy values in the results it is important to point out that they are strongly dependent on the profile of the active power generation and consumption. If the profiles are matching and load and generation are placed close to each other, the power transfer in the network will decrease notably and this causes a reduction in the network losses. In the opposite case for example when the load and generation feeders are separated totally the transfer of power may increase since additional to the load power also the power from the DG units has to be transferred through the network.

Chapter 7

Svalöv Network

In chapter 6 the network node voltages and the total network losses in a generic medium voltage distribution network were simulated. It was shown that it is possible to increase the DG capacity connected to a network by the use of coordinated control of the OLTC, reactive power consumption and active power curtailment for voltage control. To exemplify on a real existing network this chapter will take a closer look on such a network. The medium voltage network discussed in this chapter is connected to the HV/MV substation in Svalöv (Sweden) and is operated by E.ON Elnät Sverige AB.

7.1 Test System

The medium voltage network in Svalöv was chosen for this work since it is a comparatively weak country side grid with a large amount of wind power connected. The maximum load in the network is around 28MW and by now nearly 13MW of wind power generation are connected to the network. Since the minimum load of the entire Svalöv network is only around 5MW the generation in the network is larger than consumption during some periods of time already today. Requests for the connection of more wind power are already in progress and it is expected that the DG penetration in this area will increase substantially during the next years.

The medium voltage distribution network in Svalöv is connected to the regional high voltage network at 130kV by the substation in Svalöv where the

130kV/20kV transformer and the switchgear are located. As shown in figure 7.1 the substation in Svalöv has eight 20kV feeders connected. Only three feeders in the network are still pure load feeders without any generation connected. Four of the eight feeders are mixed load and generation feeders and one feeder is a pure generation feeder. Thus, the network includes all three types of feeders. Table 7.1 shows load and generation connected to each feeder. Totally around 170 20kV/0.4kV substations and three 20kV/10kV substations are connected to the eight feeders.

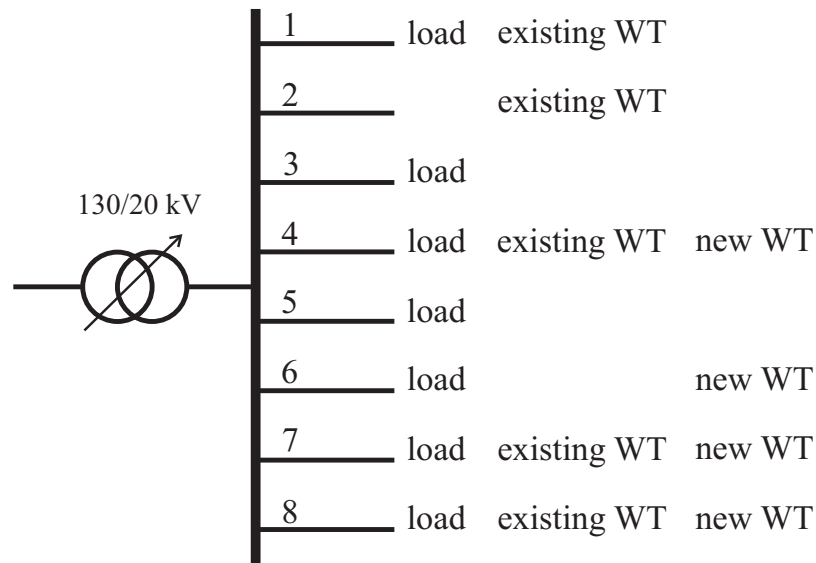

Figure 7.1: Schematic of the busbar at Svalöv substation with feeder types indicated

Since the network in Svalöv is in a rural area a large part of the network is consisting of overhead lines. All feeders except the pure generation feeder, which is quite new, are mixed feeders with both underground cables and overhead lines. Underground cables are mainly used in the urban areas while overhead lines are more common in the countryside. The total length of all 20kV lines in the network is around 130km. Due to the combination of overhead lines and underground cables the network has around 250 network nodes.

Table 7.1: Load and generation capacity connected to the feeders of Svalöv network

Feeder	Load [MW]	Existing WT [MW]	New WT [MW]
1	5.8	0.7	0
2	0	9.0	0
3	5.1	0	0
4	1.7	0.9	6.0
5	4.0	0	0
6	1.9	0	3.0
7	5.3	1.4	13.0
8	4.2	0.8	3.0
Σ	28.0	12.8	25.0

In addition to the 20kV network also three 10kV networks are belonging to the Svalöv network. These three networks are located in small places outside Svalöv and they are fed by the 20kV feeders. To reduce the complexity each of these networks is concentrated as a single load at a 20kV node.

7.2 Simulations

To carry out simulations of the Svalöv network, the structure and the line data of the network were analysed and converted into the required data format for the simulation tool. Minute-by-minute measurement values of the consumption and generation in each network feeder recorded during November 2010 were obtained from E.ON Elnät. The total active and reactive power in each feeder had to be spread out to the individual network nodes. Due to the huge amount of data, the period for the simulation was reduced to a time period of 15 days in the beginning of the month. During this time the voltage in all network nodes and the total network losses were computed once a minute. Thus 21600 values for each node voltage and the network losses were obtained.

Some simplifications were introduced to reduce the total complexity of the network:

1. Three 10kV networks have been aggregated and considered as single loads.
2. The number of the network nodes has been reduced from around 250 to 228 nodes. This was done by eliminating and/or combining some short line sections which do not affect the voltage drop or the network losses in a mentionable manner. In addition some substations located close to each other have been combined.
3. It was assumed that the feeder load is equally distributed at all nodes along the feeder according to the rated power of each node obtained by Velander's equation.
4. The active power generation of each connected wind turbine was supposed to be the same fraction of the rated power for all connected units.
5. For all loads a constant power factor of $PF = 0.95$ (*ind*) was assumed.

The DG units which are already connected to the network were included in the simulations. It was assumed that these units are operated at unity power factor and that they are not controllable. Since the network is operated in this way with broad margins, violations of the voltage limits are not expected. To increase the stress of the network and analyse the impact of increasing DG capacity, seven new wind turbines with a rated capacity of 25MW in total were placed in the network. The location of the new wind turbines was chosen to be at weak places in the network and their rated power is set close to thermal limit of the existing lines. The added DG units are assumed to be controllable meaning that the active power output can be curtailed and the power factor can be maintained from $PF = 1$ to $PF = 0.89$ with rated active power output to consume reactive power.

It is assumed that one 40MVA HV/MV transformer is in operation to feed the network. This transformer has an on-load tap changer which can change the tap ratio with ± 9 steps. The step size is set to the commonly used value 1.67% and the voltage deadband is set to 2.0%.

While the maximum voltage rise caused by DG units connected to combined

load and generation feeders is usually limited to 2.5% of the nominal voltage, thus 1.025 p.u., the voltage limits in this work were set to 0.950 p.u. and 1.050 p.u., corresponding to $\pm 5.0\%$. This increase of the limits should be acceptable since the voltage at the network nodes is now monitored.

7.2.1 Local OLTC Control with Existing DG Units

In the first case which is presented in this section the medium voltage network of Svalöv was simulated only with already installed DG units connected. The DG units are not equipped with any voltage control capacity and they are operating at unity power factor. Voltage regulation in this network is done only by local OLTC control. Figure 7.2 shows the load and generation profiles that were derived from the measurement values.

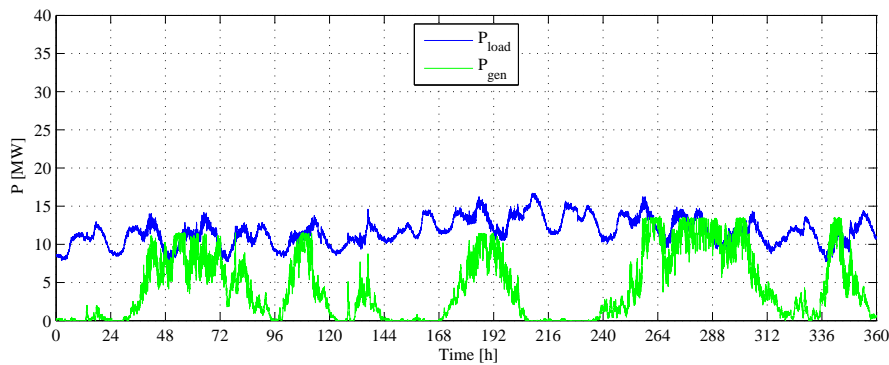

Figure 7.2: Total load and generation in Svalöv network with existing DG units

Voltage

Networks are planned and built to handle the maximum load without going below the lower voltage limit. Therefore the lower voltage limit is as expected not an issue when the voltage at the secondary busbar is chosen properly.

Here it was set to 1.033 p.u. Under this conditions the lowest voltage in the network was 0.952 p.u. Since the network was simulated in about the same manner as it is operated today it is not surprising that also the highest voltage (1.049 p.u.) occurring at the pure generation feeder is within the limits without any additional voltage control as shown in figure 7.3. Beside the largest voltage both the voltage at the substation and the voltage at the node with the lowest voltage are shown.

The voltage setpoint at the substation was chosen to keep the lowest voltage, that occurs during the time of highest loading, over the lower voltage limit. Furthermore the voltage at the feeding point of the substation work was assumed to be constant. Thus no tap changer operations were necessary during the simulated time period with only local OLTC control activated.

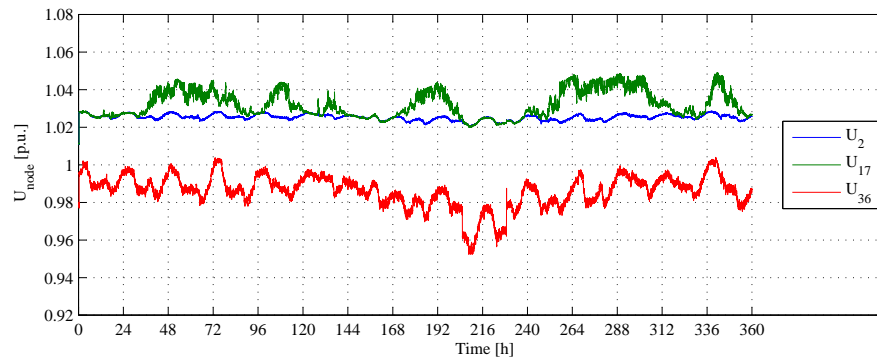

Figure 7.3: Voltage at the substation, the node with the lowest voltage and the node with the highest voltage in Svalöv network with existing DG units and only local OLTC control

Losses

When the network is simulated in normal operation as it is today, totally 55 MWh are lost. This is corresponding to 1.0% of the totally transferred energy of 5732 MWh. The total generation within the network is calculated to 1520 MWh and the load is 4212 MWh during the 15 days.

7.2.2 Local OLTC Control

By adding seven additional generation units with a total rated capacity of 25 MW which totally adds 2777.5 MWh, the total available energy from DG units is increasing to 4297.5 MWh. The total load and generation for the entire network with the additional DG units connected are shown in figure 7.4. During the simulation time the lowest load was at 7.7 MW and the highest load 16.7 MW. The power from the generation units was varying between 0 MW and 38.9 MW which slightly higher than the nominal capacity of 37.8 MW. Since the capacity of the connected DG units was increased, the upper voltage limit is violated during some time when no additional control is implemented.

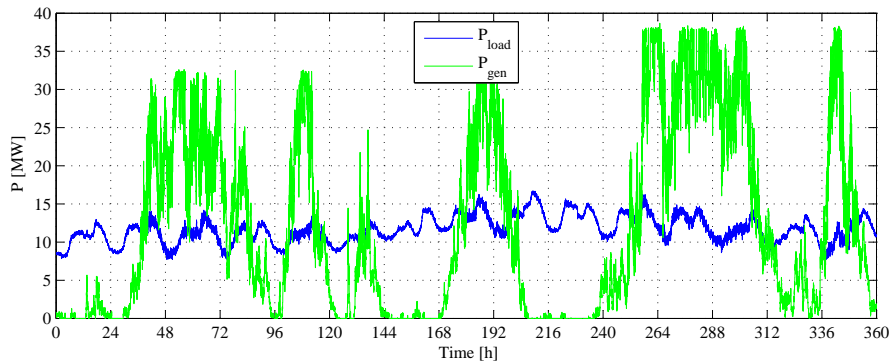

Figure 7.4: Total load and generation in Svalöv network with seven additional DG units connected at weak network nodes

Voltage

As mentioned in 7.2.1 the lower voltage limit should not be a problem in this case. It is reasonable to try to decrease the voltage setpoint of the OLTC, if there is sufficient margin to the lower voltage limit for obtaining a larger range to the upper voltage limit. Here the substation voltage was still set to 1.033 p.u. Thus the lowest voltage obtained during the 15 days of simulation

time was 0.952 p.u. Without any voltage control in the network and the added generating units the voltage would increase to 1.079 p.u. at one node during some periods of time. Beside the voltages at the nodes with generation figure 7.5 shows the voltage at the substation and at the node where the lowest voltage occurs.

For the same reason as in 7.2.1 no tap changer operations are executed for local OLTC control at the substations secondary busbar.

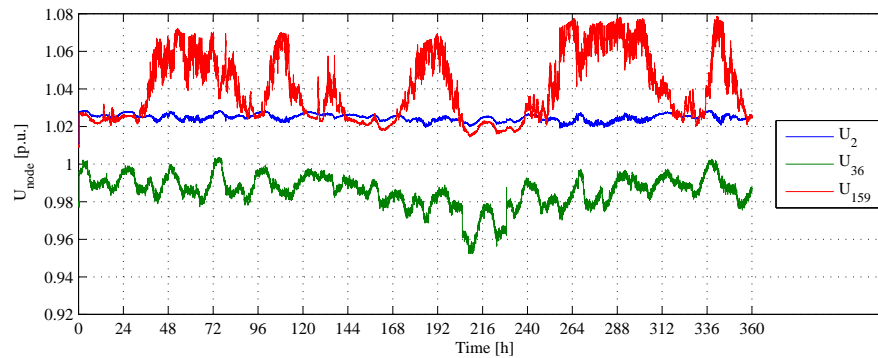

Figure 7.5: Voltage at the substation, at the node with the lowest voltage and the node with the highest voltage in Svalöv network when 25 MW of DG capacity were added

Losses

If no additional control of the DG units is implemented all available energy from the DG units which is 4298 MWh is delivered to the network. During the simulation span of 15 days network losses are 104 MWh corresponding to 1.2% of the total transferred energy of 8905 MWh.

7.2.3 DG Control

For this part of the simulations the DG control was activated. In a first step only curtailment was activated and in a second step both reactive power consumption and active power curtailment were activated for the added DG units. Figure 7.6 shows the load and generation profile of the entire network in these control modes. The minimum and maximum loads as well as the minimum and maximum available generation are the same as in 7.2.2. Figure 7.6(a) compared to figure 7.6(b) shows that the active power output from some DG units has to be curtailed during the periods of highest generation and that higher DG output can be allowed with variable power factor. This results in P_{gen} reaching higher in 7.6(a) than in 7.6(b). The total absorbed DG power has to be curtailed to around 33 MW with unity power factor compared to around 38 MW in the case of a variable power factor.

Voltage

For the local DG control the voltage at the substation busbar has still to be chosen to take care of the maximum load without violating the lower voltage limit. The OLTC setpoint was therefore set to 1.033 p.u. As seen in 7.2.2 the voltage at some nodes exceeds the upper voltage limit if no local control is implemented. The voltages at the substation, at the node where the lowest voltage occurs and at the node where the highest voltage occurs are shown in figures 7.7(a) and 7.7(b). The local DG control limits the maximum voltages to 1.062 p.u. and 1.067 p.u. respectively.

With unity power factor no tap changer operation is needed to keep the voltage at the substation within the deadband around the setpoint and for a variable power factor the on-load tap changer is changing the position once.

Losses

When unity power factor is used, a large amount of the active power output (269 MWh), which is corresponding to 6.3 % of the totally available DG

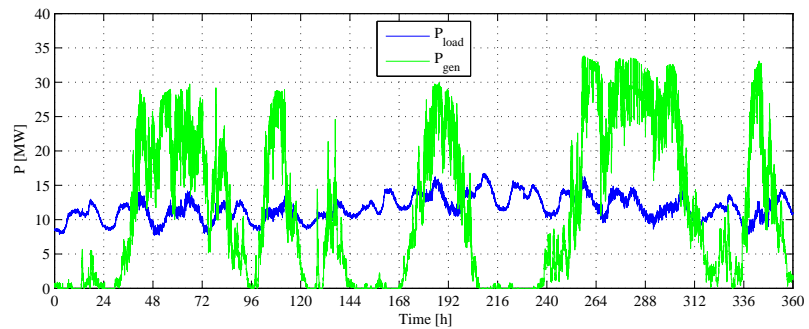

(a) with only curtailment

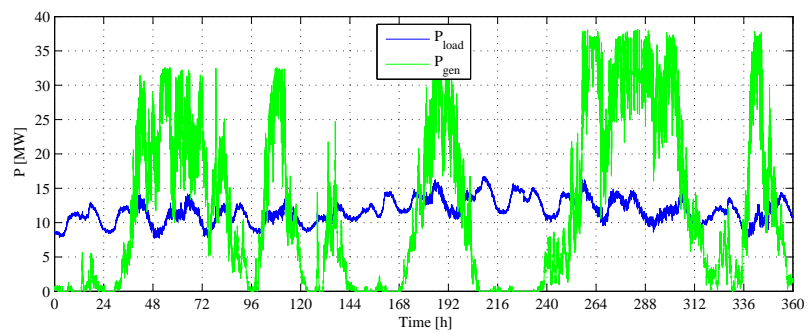

(b) with curtailment and variable power factor

Figure 7.6: Total load and generation in Svalöv network with additional DG units connected and local control of the DG activated

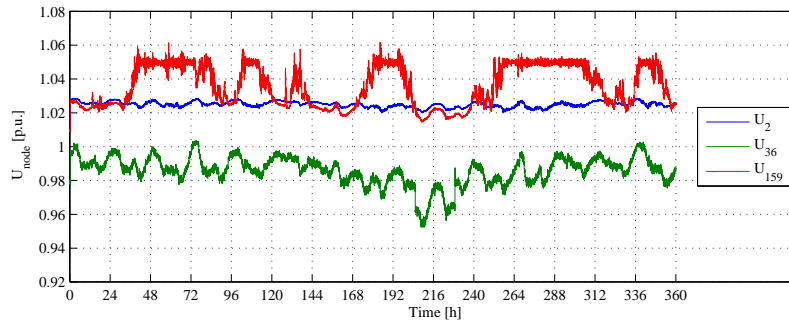

(a) with only curtailment

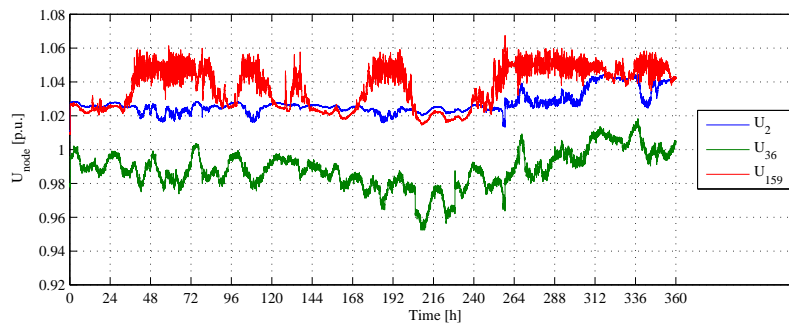

(b) with curtailment and variable power factor

Figure 7.7: Voltages at the substation, the network node with the lowest voltage and at the node with highest voltage

energy, has to be curtailed by means of voltage control. During the 15 simulated days the losses in the network amount to 87MWh which is corresponding to 1.1 % of the total transferred energy of 8239MWh. However, with a variable power factor only 13MWh, corresponding to 0.3 % needs to be curtailed to maintain the voltage below or at the upper limit. Since reactive power consumption, i.e. variable power factor, both increases the amount of transferred energy and the transfer of reactive power, the losses are increasing to 109MWh or 1.3 % of 8497MWh transferred energy. The curtailment and the reactive power which are needed to keep the voltage within the limits are presented in figures 7.8(a) and 7.8(b).

Summary of the Results from DG Control

A summary of the results from the simulations of DG control are shown in table 7.2. The increase in obtained DG energy should be worth the small increasing losses and a single tap operation.

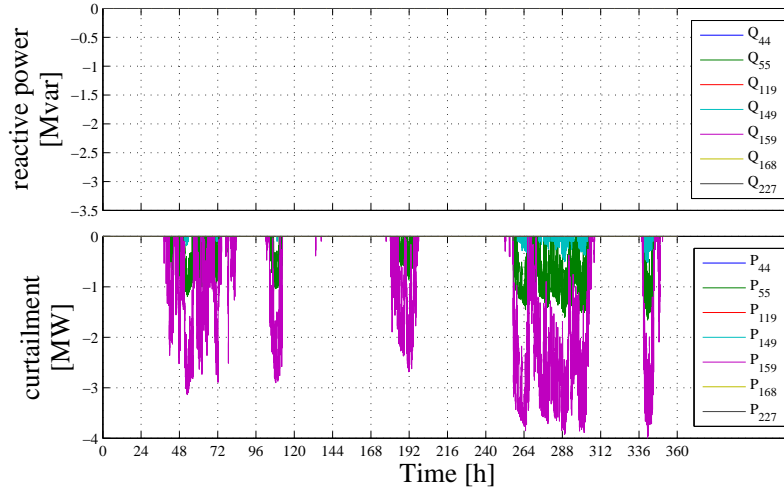

(a) with only curtailment

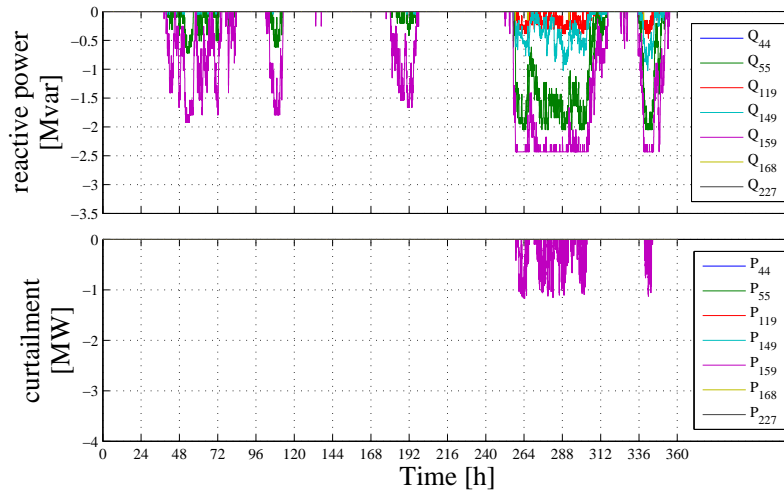

(b) with curtailment and variable power factor

Figure 7.8: Reactive power consumption and active power curtailment at the nodes where DG units are connected. The shown amounts are needed to limit the voltage to 1.05 p.u.. When using unity power factor as in 7.8(a) no reactive power will be used.

Table 7.2: Basic values from the simulation cases of DG control

	Additional DG, $\cos\phi = 1$, local OLTC, curtailment	Additional DG, $\cos\phi var$, local OLTC, curtailment
Transferred energy [MWh]	8239.3	8496.7
Consumed energy [MWh]	4211.7	4211.7
Uncurtailed energy from DG units [MWh]	4297.5	4297.5
Obtained DG energy [MWh]	4027.6	4285.0
Curtailed DG energy [MWh]	268.9	12.5
Curtailed DG energy [% of uncurtailed energy]	6.3	0.3
Consumed reactive power [Mvar]	0	348.9
Network losses [MWh]	87.3	109.4
Network losses [% of transferred energy]	1.1	1.3
Number of OLTC steps	0	1
Minimum network voltage [p.u.]	0.952	0.952
Maximum network voltage [p.u.]	1.062	1.067

7.2.4 Coordinated OLTC Control

For the coordinated OLTC control three different modes for the power factor were simulated for the Svalöv network. First a unity power factor was used, then the power factor was set to $PF = 0.89$ and finally a variable power factor was used. The minimum/maximum load and available generation were still the same as in 7.2.2. Figure 7.9 shows the resulting total load and generation of Svalöv network during the simulation period. From the generation curve it can be seen, that the generated power is close to the maximum value shown in figure 7.4. Thus in all three cases only a little or no active power curtailment is needed.

Voltage

When a coordinated control of the on-load tap changer is activated, undervoltage can also become an issue since the voltage at the substations busbar is no longer set to a defined value but varying depending on the operation state of the network. Even though the lower voltage limit is set to 0.950 p.u. slightly lower voltages can occur due to the fact that only a voltage limit violation is recognized by the controller.

For unity power factor the lowest voltage during the 15 days is 0.935 p.u. If a constant power factor is set, the lowest voltage is 0.948 p.u. and in case of a variable power factor 0.932 p.u. is actually the lowest voltage that occurs. The upper voltage is limited by the use of reactive power consumption and active power curtailment. In that way it is possible to limit the voltage to 1.059 p.u. when using unity power factor. With a constant and variable power factor the highest voltages are 1.050 p.u. and 1.058 p.u. respectively if the controller's upper voltage limit setpoint is 1.050 p.u. Figure 7.10 shows the voltage magnitudes at the substation busbar, the node with the lowest and the node with the highest voltage in the network.

The number of the tap changer operations is varying a lot between the different methods. While a constant power factor of $PF = 0.89$ keeps the voltage profile flat and therefore only three tap changer operations are needed, the

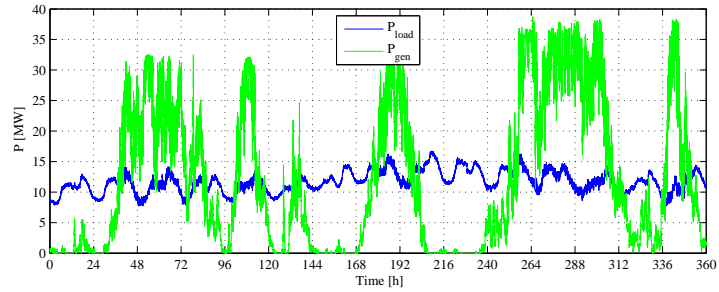

(a) with only curtailment

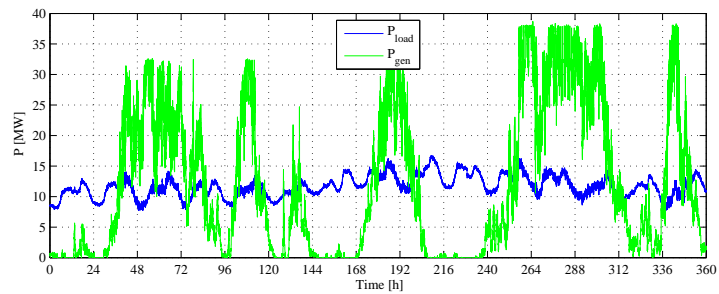

(b) with curtailment and constant power factor

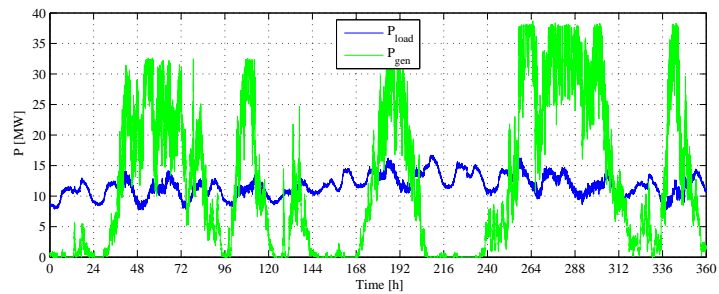

(c) with curtailment and variable power factor

Figure 7.9: Total load and generation in Svalöv network with additional DG units connected and coordinated OLTC control

number of tap changer operations increases to 123 for unity power factor and to 105 for a variable power factor. The repeating voltage variations (for example around hour 100 in 7.10(a)) are as for the generic network caused by the on-load tap changer control trying to go back to normal position.

Losses

Without using reactive power, that means with unity power factor, some active power has to be curtailed to maintain a proper network voltage. In this case 27 MWh, thus 0.6%, were curtailed. This is resulting in less power transfer (8482 MWh) than in the other cases and therefore the losses are only 107 MWh which is the same as 1.3%.

For a constant power factor of $PF = 0.89$ no more curtailment is needed but additional 1423 Mvarh of reactive power are transferred in the network. This large transfer of reactive power increases the losses that become 126 MWh corresponding to 1.5% of the total transferred power (8509 MWh).

In case of a variable power factor again there is no need to curtail the active power at any time. All available 4298 MWh from the DG units can be absorbed by the network. Since some reactive power (42 Mvarh) is needed to maintain the network voltage within the limits and more active power is transferred, the losses are about the same as for unity power factor but less than for the constant power factor. Totally 109 MWh are lost during the simulated time and that corresponds to 1.3% of the total transferred energy which was 8509 MWh. The amount of reactive power and curtailment which is used to maintain the voltage is presented in figure 7.11.

Summary of the Results from Coordinated OLTC Control

The results from the simulations of coordinated OLTC control are summarized in table 7.3. The decrease in network losses may be worth the increased number of tap changes for unity and variable power factor.

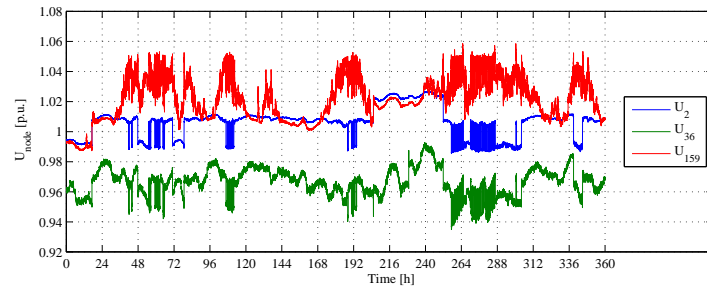

(a) with only curtailment

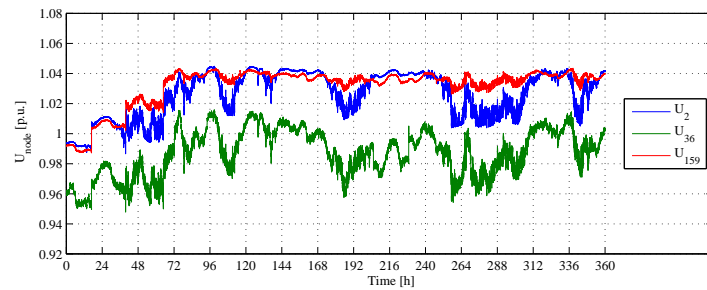

(b) with curtailment and constant power factor

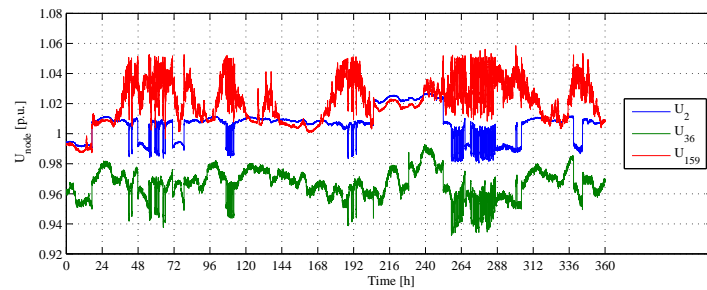

(c) with curtailment and variable power factor

Figure 7.10: Voltage at some characteristic network nodes which are the substations busbar, the node with the lowest voltage in the network and the node where the highest voltage occurs

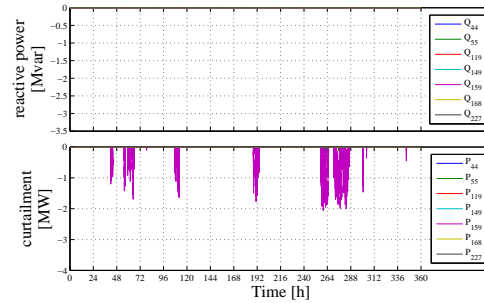

(a) with only curtailment

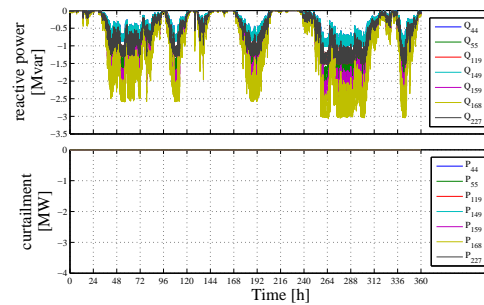

(b) with curtailment and constant power factor

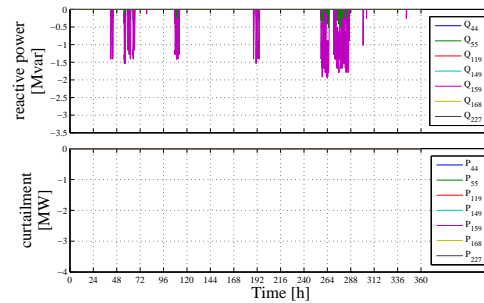

(c) with curtailment and variable power factor

Figure 7.11: Reactive power consumption and active power curtailment of the DG units which were added to Svalöv network when using coordinated OLTC control. Since unity power factor is used, the reactive power consumptions is zero in 7.11(a). In 7.11(b) and 7.11(c) the curtailment is not needed and therefore zero.

Table 7.3: Basic values from the simulation cases of DG control

	Additional DG, $\cos\phi = 1$, coordinated OLTC, curtailment	Additional DG, $\cos\phi = 0.89$, coordinated OLTC, curtailment	Additional DG, $\cos\phi$ var, coordinated OLTC, curtailment
Transferred energy [MWh]	8482.3	8509.2	8509.2
Consumed energy [MWh]	4211.7	4211.7	4211.7
Uncurtailed energy from DG units [MWh]	4297.5	4297.5	4297.5
Obtained DG energy [MWh]	4270.6	4297.5	4297.5
Curtailed DG energy [MWh]	26.9	0	0
Curtailed DG energy [% of uncurtailed energy]	0.6	0	0
Consumed reactive power [Mvar]	0	1423.0	41.9
Network losses [MWh]	106.7	126.2	109.4
Network losses [% of transferred energy]	1.3	1.5	1.3
Number of OLTC steps	123	3	105
Minimum network voltage [p.u.]	0.935	0.948	0.932
Maximum network voltage [p.u.]	1.059	1.050	1.058

7.3 Summary

In this chapter network node voltages and losses in an existing medium voltage network with a large amount of DG have been simulated. Real measurement values for both the connected loads and generation units have been used to generate load and generation profiles. After a simulation of the base case the already existing DG units have been completed with seven more generation units and in this way the installed DG capacity was increased from 12.8MW to 37.8MW.

Three different control strategies, local OLTC control which is mainly used today, local DG control and coordinated OLTC control, were simulated. For two of these control strategies several modes for the local control have been analysed and compared to each other concerning the network node voltages, the active power curtailment, the total network losses and the tap changer operations.

As the results show, regarding to the voltage, much more DG can be connected to existing distribution networks as soon as local DG control is activated to limit the voltage at the connection points of the DG units. With the additional wind turbines connected and without local DG control the voltage would exceed the upper limit during some time as it is shown in section 7.2.2. Since the controller is triggered by voltage limit violations the minimum and maximum voltage setpoints in the controller are exceeded during some short time periods before the control is reacting.

As expected the use of reactive power consumption decreases the need of curtailment. When also coordinated OLTC control is used, the need of reactive power consumption is decreasing and thereby also the losses but the number of OLTC steps is increasing. For the DG units used in this study the use of reactive power consumption is sufficient to avoid any active power curtailment.

The most advantageous results are obtained by using coordinated OLTC control with variable power factor as shown in column *Additional DG, cos ϕ var, controlled OLTC, curtailment*. No active power curtailment was needed in

this case and the network losses are still acceptable compared to the amount of transferred energy. Only the minimum voltage occurring during some time before the control reacts is somewhat too low. The number of tap changes is comparatively large compared to some other cases but in relation to the time span it does not seem to be unreasonable when regarding the costs for tap changer operations.

By using a constant power factor as shown in column *Additional DG, $\cos\phi = 0.89$, coordinated OLTC, curtailment* proper voltages are obtained with only a few tap changes. Compared to other cases the generous reactive power consumption leads to larger network losses. Maybe a constant power factor closer to unity power factor could solve this problem.

Using either local DG control with a variable power factor (see column *Additional DG, $\cos\phi$ var, local OLTC, curtailment*) or coordinated OLTC control with unity power (see column *Additional DG, $\cos\phi = 1$, coordinated OLTC, curtailment*) seem also to be reasonable solutions. Both curtailment and losses are comparatively low in these cases too.

Of course the pure use of active power curtailment (column *Additional DG, $\cos\phi = 1$, local OLTC, curtailment*) as already mentioned in chapter 4 is always a solution to limit the voltage in network nodes where generation is connected but in most cases this will not be acceptable in a larger extent. Thus other methods as for example discussed in this thesis should be preferred.

Some key values from the most advantageous strategies have been extracted out from table 7.4 and are summarized in table 7.5. In two of the shown cases no active power curtailment is needed at all. Moreover the results are varying in the total network losses and the number of tap changes.

To evaluate the economic consequence of the different voltage control strategies, a simple analysis of the costs for tap changer operations as well as reactive power consumption and active power curtailment is done here. The cost of tap changer operations is depending on the increased need of maintenance and it is assumed that a tap changer operation costs 1 SEK /tap operation corresponding to 0.11 €/tap operation.

Table 7.4: Simulation results from Svalöv network

	Only existing DG, local OLTC	Additional DG, $\cos\phi = 1$, local OLTC, curtailment	Additional DG, $\cos\phi = 1$, coordinated OLTC, curtailment	Additional DG, $\cos\phi = 0.89$, coordinated OLTC, curtailment	Additional DG, $\cos\phi$ var, local OLTC, curtailment	Additional DG, $\cos\phi$ var, coordinated OLTC, curtailment
Transferred energy [MWh]	5731.7	8239.3	8482.3	8509.2	8496.7	8509.2
Consumed energy [MWh]	4211.7	4211.7	4211.7	4211.7	4211.7	4211.7
Uncurtailed energy from DG units [MWh]	1520.0	4297.5	4297.5	4297.5	4297.5	4297.5
Obtained DG energy [MWh]	1520.0	4027.6	4270.6	4297.5	4285.0	4297.5
Curtailed DG energy [MWh]	0	268.9	26.9	0	12.5	0
Curtailed DG energy [% of uncurtailed energy]	0	6.3	0.6	0	0.3	0
Consumed reactive power [Mvar]	0	0	0	1423.0	348.9	41.9
Network losses [MWh]	55.7	87.3	106.7	126.2	109.4	109.4
Network losses [% of transferred energy]	1.0	1.1	1.3	1.5	1.3	1.3
Number of OLTC steps	0	0	123	3	1	105
Minimum network voltage [p.u.]	0.952	0.952	0.935	0.948	0.952	0.932
Maximum network voltage [p.u.]	1.049	1.062	1.059	1.050	1.067	1.058

Table 7.5: Key values for using various power factors

	Additional DG, $\cos\phi$ var, local OLTC, curtailment	Additional DG, $\cos\phi = 1$, coordinated OLTC, curtailment	Additional DG, $\cos\phi = 0.89$, coordinated OLTC, curtailment	Additional DG, $\cos\phi$ var, coordinated OLTC, curtailment
Curtailed DG energy [MWh]	12.5	26.9	0	0
Losses [MWh]	109.4	106.7	126.2	109.4
Number of OLTC steps	1	123	3	105

During the simulated time period in the beginning of November 2010 the electricity price at the Nordic power market was in average 49€/MWh for Sweden [43]. To support the production of electricity from renewable energy sources, electricity certificates were introduced in Sweden in 2003. These certificates are issued to the producer with one certificate per MWh. In the beginning of November 2010 the price per certificate, thus per MWh, was in average about 28€/MWh (262 SEK /MWh) [44].

Due to the electricity certificate system it should be distinguished between losses and curtailed energy from the wind turbines. The price for losses is assumed to be the same as the price at Nordic power market, thus 49€/MWh. However, the electricity price for curtailed energy from the DG units is the sum of the price at the Nordic power market and the electricity certificate, thus 77€/MWh.

The costs for voltage regulation by the different control strategies are shown in table 7.6. As this simple cost analysis shows there is a large benefit from using coordinated OLTC control and a variable power factor (column *Additional DG, $\cos\phi$ var, controlled OLTC, curtailment*). Although the first case (*Additional DG, $\cos\phi = 1$, local OLTC, curtailment*) with additional DG units and only curtailment would probably never be realized because of the huge costs for the curtailment, it is presented here. Since this is only a simple cost analysis, price variations during the simulated time period are not considered.

Table 7.6: Costs for voltage regulation with OLTC, reactive power consumption and active power curtailment

	Additional DG, $\cos\varphi = 1$, local OLTC, curtailment	Additional DG, $\cos\varphi \text{ var}$, local OLTC, curtailment	Additional DG, $\cos\varphi = 1$, controlled OLTC, curtailment	Additional DG, $\cos\varphi = 0.89$, controlled OLTC, curtailment	Additional DG, $\cos\varphi \text{ var}$, controlled OLTC, curtailment
Curtailment [€]	20705	963	2071	0	0
Losses [€]	4278	5361	5228	6184	5361
Tap changer operations [€]	0	0	14	0	12
Total Σ [€]	24983	6324	7313	6184	5373

Even though these simulations are done with parameters of an existing network, it is important to point out that only measurement values for 15 days have been used. This time period is not necessarily representative for the rest of the year and therefore especially the energy values can not simply be scaled up to longer periods. The placement of the additional DG units was also chosen based on network parameters and not depending on the wind conditions.

Notwithstanding some simplifications and limitations in this study, the increase of the DG capacity in the existing medium voltage network which was simulated within this work is clearly possible without reinforcement of the network.

Chapter 8

Conclusions

In this thesis a closer look is taken at the possibility to increase the DG capacity in existing medium voltage networks without reinforcement of the network. To start with the general structure of medium voltage networks was presented and some common components of medium voltage networks were described. The voltage control options in medium voltage networks were analysed. A control algorithm to maintain the voltage at all network nodes within defined limits was developed. The control algorithm and the various control strategies were simulated in a generic network. Finally, an existing medium voltage network was analysed and implemented in the simulation tool and simulations on this network were run with load and generation profiles derived from real measurement values.

In contrast to other work done in this area before, the voltage control in this work is using measurement values from electricity meters and DG units to obtain the actual state of the network voltage. Thus the voltage setpoint at the substation can be adapted to the actual network operating situation. Furthermore it is assumed that the DG units are equipped with a local control unit to control the reactive power consumption and the active power curtailment. Therefore no reactive and active power setpoints have to be transmitted to the DG units. This is beneficial when the communication may be lost during some time.

Reinforcing existing networks by adding or changing cables and in that way ensure that the voltage limit never will exceed by the feeding of active power is always a solution to avoid voltage limit violations. However, it is an ex-

pensive practice especially when it is only needed some short time periods. The ambition of this work was to find solutions for increasing the DG capacity in existing medium voltage networks without such network reinforcement but with a more advanced voltage control as it is normally used in medium voltage distribution networks today. Three different strategies of voltage control have been identified: local OLTC control, DG control and coordinated OLTC control. Local OLTC control is normally the only voltage control that is present in medium voltage networks today. The DG control can be implemented to various extents. The simplest way is only curtailment, but it can be extended with reactive power control and thus a variable power factor. Coordinated OLTC control is dependent on knowing actual network voltages. Therefore communication is needed for this control strategy. But as new electronic electricity meters are introduced, communication is already in place in large scale in distribution networks. To use voltage violation alarms from these meters seems to be a practicable way to obtain feedback about the voltage to the controller, even though some oscillations appear when the on-load tap changer algorithm tries to go back to normal position. This could probably be solved by using voltages values instead of limit violation signals.

A generic network as example for a weak rural area network with a large amount of DG was set up in the simulation tool and the different control strategies have been simulated to evaluate these extended voltage control strategies presented in chapter 4. In this way the voltage was maintained within the limits and the use of curtailment could be decreased from 38% to zero by only slightly increasing network losses and some few tap changer operations. While actual voltages are most important regarding the voltage limits, average values, i.e. energy, are the most interesting when it comes to network losses and active power curtailment. To include the energy aspect, time series consisting of load and generation profiles were implemented in the simulations. In the generic test network a kind of fair curtailment distribution has been simulated as well. The results show that the curtailment needed for some DG units could be decreased as expected but nevertheless the total amount of curtailment was increased in this case.

In chapter 7 an existing medium voltage network was analysed and transferred into the simulation environment. For the first time the algorithm for coordinated voltage control developed within this work was used for simu-

lations in a real existing Swedish medium voltage network. Recorded measurement values of load and wind turbine power generation from the network were used to carry out the simulations over a time period of 15 days and to include energy values. First the network was simulated as it is today. In a next step seven new wind turbines with a total capacity of 25 MW, in addition to nearly 13 MW already installed, were added to the network and the simulations were repeated with the existing local OLTC control which was not sufficient to handle the network voltage for the large DG capacity. Finally the advanced voltage control strategies developed in this work were simulated. The results have shown that it was possible to control the network voltage in a proper way and they indicate a considerable benefit from using coordinated voltage control to increase the DG capacity in existing medium voltage networks.

The DG capacity in the Svalöv network was increased with a capacity corresponding to nearly twice the installed capacity and neither network reinforcement nor active power curtailment was needed, when a coordinated voltage control as presented in this thesis was implemented in the simulations. The amount of energy transferred in the network during the simulated time period increased with around 44 % due to the extension of the DG capacity.

Both the analysis of the generic network and the real network indicate that an increasing DG capacity in medium voltage networks could be handled without the need of physical network reinforcement. This can be achieved by upgrading the traditionally passive medium voltage distribution networks to more active networks. In the discussed cases active networks means to make the DG unit active and reactive power controllable and to introduce an active network controller which takes care of the actual network state and coordinates the OLTC setting.

Notwithstanding the results from the two networks differ in details and can not directly be generalized for other networks, they have in common that they demonstrate a benefit from the advanced voltage control strategies. The combination of extended control of the DG units (active and reactive power) and a central controller being responsible for the control of the OLTC by having information about the actual network state, integrates distributed generation in a proper way.

The use of extended voltage control instead of network reinforcement is especially interesting in networks where the voltage limits otherwise would be violated only during short time periods and where the load and generation profiles characteristics allow benefits from a more advanced voltage control. Wind turbines are a good example of such a type of DG units since their rated power is often available only for short times and these may coincide with times of low network load. During these times a large voltage span can be made available for the DG units.

A simple cost analysis has shown that there is a large value of using the OLTC and in some extent also reactive power consumption for a coordinated voltage control to minimize the need of active power curtailment. By the use of coordinated voltage control with a coordinated OLTC and variable power factor the costs for network losses and active power curtailment could be cut significantly, around 27%, compared to the case where only a coordinated OLTC control with unity power factor is used. Compared to the exclusive use of curtailment for maintaining the voltage, the costs could actually be reduced with 78% even though such a large amount of curtailment is not realistic.

Communication has become less expensive during the last years and is already existing in form of remotely readable electricity meters for example in Swedish distribution networks where monthly meter readings are already compulsory. The advanced electricity meters and their under- and overvoltage alarm functions have been used in this work to obtain the network state. By this the voltage, directly at the customer connection point, was taken into account and therefore smaller margins are needed.

Even though the focus of this thesis was on wind turbines, there is no limitation to a special type of distributed generation in medium voltage networks. More decisive for the efficiency of the proposed methods for voltage control is the type of the network, the control feasibility of the DG units and the correlation between the load profile and the generation profile.

Chapter 9

Future Work

This work focussed on the increase of the DG capacity (especially wind power) in existing medium voltage distribution networks. Different control strategies have been compared from a technical perspective and simulations have been held. But there is still a lot of work that can be done in the continued work.

In the work presented in this thesis simulations have been performed on data of an existing medium voltage network. To verify the results obtained in this thesis one of the next steps should be to implement and test the advanced voltage control strategies in a laboratory. Later on, the implementation in a real network is aimed to obtain practical results over a longer time period.

As the results obtained by the simulations are strongly depending on the time series used for the load and generation, it is important to find realistic time series. In addition, the impact of the resolution of the time series and the delay time in the control algorithm could be analysed.

The interaction with low voltage networks could also be investigated. Until now low voltage networks are normally consuming electricity and therefore they contribute to the lowering of the voltage in medium voltage distribution grids. Especially when distributed generation finds its way into the low voltage distribution network, it has to be clarified how the total available voltage band should be distributed between the networks on the different voltage levels. In addition it can be necessary to introduce active voltage control in low voltage distribution networks as well.

Since the voltage is exceeding the set voltage limits during some short time periods an improvement or optimization of the voltage control algorithm could be necessary. However, the performance of the voltage control algorithm is also strongly depending on the input data. In a concept, like the one used in this thesis, where the control algorithm is reacting on limit violations and also time delays have to be taken into account, it is difficult to keep the voltage always within the limits. Beside keeping the voltage within the limits, network losses are also of interest. To minimize the network losses it could be advantageous to introduce optimal power flow.

For obtaining the actual network status only information about voltage limit violations were used in in this work. To obtain a more complete network state it would be advantageous to use voltage magnitude values. DG units are often already equipped with both voltage measurement units and communication. In a further step calculating the actual network state with load and generation data of all connected units is also an opportunity. But depending on the time step size this would generate a large amount of data that has to be transferred and computed.

Within the simulations in this work the voltage was checked at all network nodes. For the future it would may be reasonable to identify some key nodes where the voltage is measured. This would decrease both the required communication capacity and the needed computing power.

In this work the contribution of each individual DG unit to the voltage change was not taken into account. All distributed generation units were treated in the same way independently from their contribution to the voltage change.

The costs for and benefits from active power curtailment, changing network losses and varying number of tap steps were only briefly compared to each other. As well as a comparison to the costs for network reinforcement was outside the scope of this work. Economical aspects should be investigated further to decide which solution is most beneficial.

References

- [1] N. Jenkins, R. Allan, P. Crossley, D. Kirschen, and G. Strbac. *Embedded Generation*. The Institution of Electrical Engineers, 2000.
- [2] Thomas Ackermann, Göran Andersson, and Lennart Söder. Distributed Generation: A Definition. *Electric Power Systems Research*, 57(3):195–204, April 2001.
- [3] T. Ackermann and V. Knyazkin. Interaction between Distributed Generation and the Distribution Network: Operation Aspects. In *Transmission and Distribution Conference and Exhibition 2002: Asia Pacific, IEEE/PES*, volume 2, pages 1357 – 1362, October 2002.
- [4] F. Bignucolo, R. Caldon, V. Prandoni, S. Spelta, and M. Vezzola. The Voltage Control on MV Distribution Networks with Aggregated DG Units (VPP). In *Proceedings of the 41st International Universities Power Engineering Conference (UPEC '06), 2006*, volume 1, pages 187 – 192, September 2006.
- [5] European Commission. EUR 22040 - European Technology Platform SmartGrids - Vision and Strategy for Europe's Electricity Networks of the Future. Luxembourg, 2006.
- [6] M. Granger Morgan, Jay Apt, Lester B. Lave, Marija D. Ilic, Marvin Sirbu, and Jon M. Peha. The Many Meanings of "Smart Grid", July 2009. Department of Engineering and Public Policy, Carnegie Mellon University.
- [7] F. Bignucolo, R. Caldon, and V. Prandoni. Radial MV Networks Voltage

- Regulation with Distribution Management System Coordinated Controller. *Electric Power Systems Research*, 78(4):634–645, 2008.
- [8] G. Strbac, P. Djapić, T. Bopp, and N. Jenkins. Chapter 21: Benefits of Active Management on Distribution Systems. In Thomas Ackermann, editor, *Wind Power in Power Systems*. John Wiley & Sons, Ltd, Chichester, 2005.
- [9] C. Schwaegerl, M.H.J. Bollen, K. Karoui, and A. Yagmur. Voltage Control in Distribution Systems as a Limitation of the Hosting Capacity for Distributed Energy Resources. In *18th International Conference on Electricity Distribution*, Turin, Italy, June 2005.
- [10] Martin Braun. Reactive Power Supply by Distributed Generators. *Power and Energy Society General Meeting on Conversion and Delivery of Electrical Energy in the 21st Century, 2008 IEEE*, pages 1–8, 2008.
- [11] T. Lund, A. H. Nielsen, and P. Sørensen. Loss Allocation in a Distribution System with Distributed Generation Units. In *Nordic Wind Power Conference (NWPC 2007)*, Roskilde, Denmark, November 2007.
- [12] M. Hird, N. Jenkins, and P. Taylor. An Active 11kV Voltage Controller: Practical Considerations. In *17th International Conference on Electricity Distribution*, Barcelona, Spain, May 2003.
- [13] C.M. Hird, H. Leite, N. Jenkins, and H. Li. Network Voltage Controller for Distributed Generation. *IEE Proceedings on Generation, Transmission and Distribution*, 151(2):150 – 156, March 2004.
- [14] S.N. Liew and G. Strbac. Maximising Penetration of Wind Generation in Existing Distribution Networks. *IEE Proceedings on Generation, Transmission and Distribution*, 149(3):256 – 262, May 2002.
- [15] S. Conti and A. M. Greco. Innovative Voltage Regulation Method For Distribution Networks With Distributed Generation. In *CIGRE 19th International Conference on Electricity Distribution (CIGRE 2007)*, Vienna, Austria, May 2007.

-
- [16] J. Morren, S.W.H. de Haan, and J.A. Ferreira. Contribution of DG units to voltage control: Active and reactive power limitations. In *Power Tech, 2005 IEEE Russia*, pages 1 – 7, St. Petersburg, Russia, June 2005.
- [17] A. Kulmala, S. Repo, and P. Järventausta. Increasing Penetration of Distributed Generation in Existing Distribution Networks using Coordinated Voltage Control. *International Journal of Distributed Energy Resources*, 5(3):227 – 255, 2009.
- [18] A. Kulmala, A. Mutanen, A. Koto, S. Repo, and P. Järventausta. RTDS Verification of a Coordinated Voltage Control Implementation for Distribution Networks with Distributed Generation. In *Innovative Smart Grid Technologies Conference Europe (ISGT Europe), 2010 IEEE PES*, pages 1 – 8, October 2010.
- [19] F. Kupzog, H. Brunner, W. Pruggler, T. Pfajfar, and A. Lugmaier. DG DemoNet-Concept - A new Algorithm for active Distribution Grid Operation facilitating high DG penetration. In *Industrial Informatics, 2007 5th IEEE International Conference on*, volume 2, pages 1197 – 1202, June 2007.
- [20] A. Lugmaier, H. Brunner, B. Bletterie, F. Kupzog, and A. Abart. Intelligent Distribution Grids in Respect of a Growing Share of Distributed Generation. In *CIREN 19th international Conference on Electricity Distribution*, pages 1–4, Vienna, Austria, May 2007.
- [21] W. Pruggler, F. Kupzog, B. Bletterie, and B. Helfried. Active Grid Integration of Distributed Generation Utilizing Existing Infrastructure more Efficiently - an Austrian Case Study. In *Electricity Market, 2008. EEM 2008. 5th International Conference on European*, pages 1–6, May 2008.
- [22] S. Repo, A. Nikander, A. Laaksonen, and P. Järventausta. A Method to Increase the Integration Capacity of Distributed Generation on Weak Distribution Networks. In *17th International Conference on Electricity Distribution*, Barcelona, Spain, May 2003.
- [23] F.A. Viawan and D. Karlsson. Voltage and Reactive Power Control in

- Closed Loop Feeders with Distributed Generation. In *Power Tech, 2007 IEEE Lausanne*, pages 549 – 554, Lausanne, Switzerland, July 2007.
- [24] J. Johansson, S. Lindahl, O. Samuelsson, and H. Ottoson. The Storm Gudrun a Seven-Weeks Power Outage in Sweden. In *Third Conference on Critical Infrastructures (CRIS 2006)*, Alexandria, VA, USA, September 2006.
- [25] Swedish Energy Agency. Storm Per - Lessons for a More Secure Energy Supply After the Second Severe Storm in the 21st Century (ET2007:35), May 2008.
- [26] E.ON. Krafttag (in Swedish). <http://www.eon.se/templates/Eon2TextPage.aspx?id=48507&epslanguage=SV>. (2010-11-30).
- [27] Ericsson Network Technologies AB. *Kraftkabel Handboken (in Swedish)*. Ericsson Network Technologies AB, 2004.
- [28] ABB. *XLPE Land Cable Systems - User's guide*. ABB's high voltage cable unit in Sweden, 2006.
- [29] B.M. Weedy and B.J. Cory. *Electric Power Systems*. John Wiley & Sons Ltd, Chichester, 4th edition, 1998.
- [30] Janolof Hagelberg, Karl Axel Jacobsson, and Richard Westöö. Chapter 12: Formler och Data. In Liber AB, editor, *Elkraftsystem 2 (in Swedish)*. Berlings, Arlöv, 2nd edition, 1997.
- [31] E. Lakervi and E.J. Holmes. *Electricity Distribution Network Design*. The Institution of Engineering and Technology, 2nd edition, 1995.
- [32] Carson W. Taylor. *Power System Voltage Stability*. McGraw-Hill, 1st edition, 1994.
- [33] J. E. Hill. A Practical Example of the Use of Distribution Static Compensator (D-STATCOM) to Reduce Voltage Fluctuations. In *IEE*

-
- Colloquium on Power Electronics for Renewable Energy (Digest No: 1997/170)*, pages 7/1 – 7/5, June 1997.
- [34] EN 50160. Voltage Characteristics of Electricity Supplied by Public Distribution Systems. IEC standard voltages, 1999. EN 50160:1999, CENELEC, Belgium.
- [35] Svensk Energi -Swedenenergy- AB. AMP - Anslutning av mindre produktionsanläggningar till elnätet (in Swedish), 2001.
- [36] J.G. Slootweg, S.W.H. de Haan, H. Polinder, and W.L. Kling. Chapter 19: Wind Power and Voltage Control. In Thomas Ackermann, editor, *Wind Power in Power Systems*. John Wiley & Sons, Ltd, Chichester, 2005.
- [37] P. Kundur. *Power System Stability and Control*. McGraw-Hill, Inc., New York, 1994.
- [38] Mats Larsson and Daniel Karlsson. Coordinated Control of Cascaded Tap Changers in a Radial Distribution Network. In *Stockholm Power Tech, International Symposium on Electric Power Engineering, IEEE, Stockholm, Sweden*, June 1995.
- [39] F. A. Viawan, A. Sannino, and J. Daalder. Voltage Control with On-load Tap Changers in Medium Voltage Feeders in Presence of Distributed Generation. *Electric Power System Research*, 77(10):1314 – 1322, 2007.
- [40] C.-A. Dortolina and R. Nadira. The Loss that Is Unknown Is no Loss at All: A Top-down/bottom-up Approach for Estimating Distribution Losses. *IEEE Transactions on Power Systems*, 20(2):1119–1125, 2005.
- [41] J. Mutale, G. Strbac, S. Curcic, and N. Jenkins. Allocation of Losses in Distribution Systems with Embedded Generation. *IEE Proceedings on Generation, Transmission and Distribution*, 147(1):7 – 14, January 2000.

- [42] R.D. Zimmermann, C.E. Murillo-Sánchez, and J. Thomas. MAT-POWER's Extensible Optimal Power Flow Architecture. In *Power Energy Society General Meeting, 2009. PES '09. IEEE*, pages 1 – 7, July 2009.
- [43] Nord Pool Spot. Area Prices. <http://www.nordpoolspot.com/reports/areaprice/>. (2011-01-10).
- [44] Svenska Kraftnät. Cesar (Prices of Electricity Certificates) (in Swedish). <https://elcertifikat.svk.se/cmcall.asp>. (2011-01-10).