



LUND UNIVERSITY

Closed-Loop Combustion Control Using Ion-Current Signals in a 6-Cylinder Port-Injected Natural-gas Engine

Kaiadi, Mehrzad; Tunestål, Per; Johansson, Bengt

Published in:
SAE technical paper series

DOI:
[10.4271/2008-01-2453](https://doi.org/10.4271/2008-01-2453)

2008

[Link to publication](#)

Citation for published version (APA):

Kaiadi, M., Tunestål, P., & Johansson, B. (2008). Closed-Loop Combustion Control Using Ion-Current Signals in a 6-Cylinder Port-Injected Natural-gas Engine. In *SAE technical paper series* [2008-01-245] <https://doi.org/10.4271/2008-01-2453>

Total number of authors:
3

General rights

Unless other specific re-use rights are stated the following general rights apply:
Copyright and moral rights for the publications made accessible in the public portal are retained by the authors and/or other copyright owners and it is a condition of accessing publications that users recognise and abide by the legal requirements associated with these rights.

- Users may download and print one copy of any publication from the public portal for the purpose of private study or research.
- You may not further distribute the material or use it for any profit-making activity or commercial gain
- You may freely distribute the URL identifying the publication in the public portal

Read more about Creative commons licenses: <https://creativecommons.org/licenses/>

Take down policy

If you believe that this document breaches copyright please contact us providing details, and we will remove access to the work immediately and investigate your claim.

LUND UNIVERSITY

PO Box 117
221 00 Lund
+46 46-222 00 00

Closed-Loop Combustion Control Using Ion-current Signals in a 6-Cylinder Port-Injected Natural-gas Engine

Mehrzad Kaiadi, Per Tunestål and Bengt Johansson

Division of Combustion Engines, Lund University, Faculty of Engineering

Copyright © 2008 SAE International

ABSTRACT

High EGR rates combined with turbocharging has been identified as a promising way to increase the maximum load and efficiency of heavy duty spark ignition engines. With stoichiometric conditions a three way catalyst can be used which means that regulated emissions can be kept at very low levels. Obtaining reliable spark ignition is difficult however with high pressure and dilution. There will be a limit to the amount of EGR that can be tolerated for each operating point. Open loop operation based on steady state maps is difficult since there is substantial dynamics both from the turbocharger and from the wall heat interaction. The proposed approach applies standard closed loop lambda control for controlling the overall air/fuel ratio. Furthermore, ion-current based dilution limit control is applied on the EGR in order to maximize EGR rate as long as combustion stability is preserved. The proposed control strategy has been successfully tested on a heavy duty 6-cylinder port injected natural gas engine and our findings show that 1.5-2.5 % units (depending on the operating points) improvement in Brake Efficiency can be achieved.

INTRODUCTION

Heavy duty spark ignited (SI) natural-gas engines can be operated either lean or stoichiometric. Recent work at the department of energy sciences at Lund University has shown better results with stoichiometric operation [1]. Since stoichiometric operation with a three way catalyst results in very low emissions while keeping efficiency at a reasonable level. Exhaust Gas Recirculation (EGR) is also a well-known practice to improve engine fuel economy, decreasing knock tendency¹ and reducing NO_x emissions in certain operating regimes. By increasing EGR the specific heat ratio will be slightly lower and combustion duration will be longer but it can be compensated somewhat by

advancing the ignition timing. Improvement in fuel economy is gained because of the following reasons [2]:

- **Reduced throttling losses (at low/part loads):** The addition of inert exhaust gas into the intake system means that for a given power output, the throttle plate must be opened further, resulting in increased inlet manifold pressure and reduced throttling losses.
- **Reduced heat rejection:** Lowered peak combustion temperatures not only reduce NO_x formation, it also reduces the loss of thermal energy to combustion chamber surfaces, leaving more available for conversion to mechanical work during the expansion stroke.
- **Reduced chemical dissociation:** The lower peak temperatures result in more of the released energy remaining as sensible energy near TDC, rather than being bound up (early in the expansion stroke) in the dissociation of combustion products. This effect is relatively minor compared to the first two.

Using EGR has the named advantages which results in increasing the maximum efficiency of heavy duty spark ignition engines at low/part loads, in other words it is desired to run these engines as diluted as possible. The dilution limit is imposed by increased cyclic variation of the combustion intensity that reduces the drivability and the effect is usually quantified through the coefficient of variation (COV) of the indicated mean effective pressure (IMEP) [2-4]. Thus, there will be a limit to the amount of EGR that can be tolerated for each operating point. However, closed loop control of EGR needs online calculation of COV(IMEP) which is a well known in-cylinder pressure based measurement for combustion stability. Since these sensors are not cost effective to use, it is desirable to find alternative sensors.

A lot of researchers have showed interests for ion sensing in recent years concerning measurement

¹ Achieving maximum load in SI engines is limited by knocking and / or high exhaust gas temperatures. Using EGR can solve this problem and allow the engine to reach the higher loads.

techniques and its possible applications, some of these works are reported in [5, 6, 7, 8]. The main advantages of using the spark plug to measure ion current are its presence as a part of SI engines, low cost and reliability. One proposal divides the ion current in three parts, the ignition phase, the chemical-ionization phase and the thermal-ionization phase [9]. Figure 1 shows a typical ion current trace and a pressure signal of an average of 400 cycles from the test engine. The ignition phase starts with charging the ignition coil and ends with the coil ringing after the spark. The chemical-ionization phase reflects the early flame development in the spark gap and thermal-ionization phase appears in the burned gases behind the flame front.

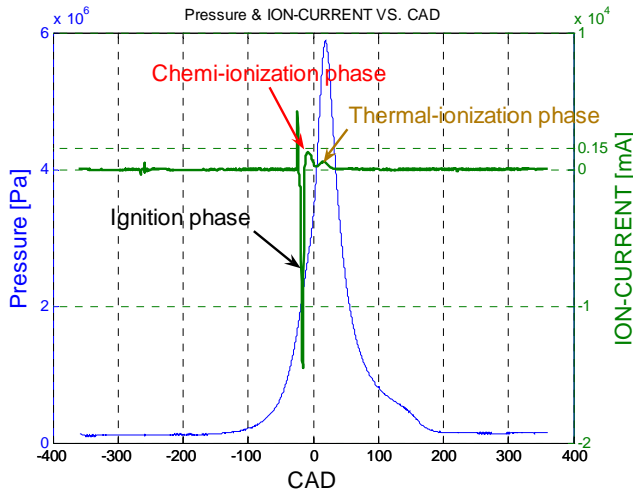

Figure 1: Typical Pressure and Ion-current signals Vs. Crank Angle Degree (CAD)

Some work has been performed for finding the correlation between combustion stability parameters derived from ion-current signals and COV(IMEP) which is a combustion stability indicator from pressure signals. In [10] the correlation between COV(ion-integral) and COV(IMEP) was investigated in a 1.8 liter direct injected spark ignited (SI) engine. The tests were performed at low loads where the engine operates lean with a stratified charge. However, their results show that the COV(ion-integral) and COV(IMEP) is proportional in log scale and ion-current is independent to engine speed. In [11] the correlation between standard deviation of the ion-current duration and COV(IMEP) is established and is proposed for EGR limit detection and control, however the effect of engine speed on the correlation is not investigated.

The objective of this work is to develop a tool based on ion-current measurements for mapping the best positions of the throttle and EGR valve at different loads and speeds in order to minimize pumping losses while preserving combustion stability. For developing this tool a combustion stability index based on ion-current (named COV(INDEX) in this paper) is derived by finding a correlation between COV(Ion-integral) and COV(IMEP). COV(INDEX) which is calculated based on ion-current signals is found to be a compatible

parameter to COV(IMEP). Three different regulators have been designed. A standard closed loop lambda control for controlling the overall air/fuel ratio and a standard closed loop load control were developed. Furthermore, ion-current based dilution limit control is applied in order to keep the COV(INDEX) at the desired level of 5%.

EXPERIMENTAL SETUP

This section covers the information about the experimental engine and the modifications, the engine control system, measurement system and gas data.

THE ENGINE & MODIFICATIONS

The experimental engine was originally a diesel engine from Volvo which has been converted to a natural gas engine, see Table 1 for specification. The engine is equipped with a short route cooled EGR system and also turbocharger with wastegate.

Number of Cylinder	6
Displacement	9,4 Liter
Bore	120 mm
Stroke	138 mm
Compression ratio	10,5 :1
Fuel	Natural gas

Table 1: Specification of the engine

The following modifications were performed on the engine:

- **Multi-Port injection System:** Originally the engine has single point injection, with four injectors at the fuel injector assembly. The gas pressure is approximately 10 bar. The test bench engine is supplied with natural gas at 4.6 bar, so the port injection system is equipped with 12 injectors (2 per cylinder) to be able to cover the whole load range, see Figure 2.

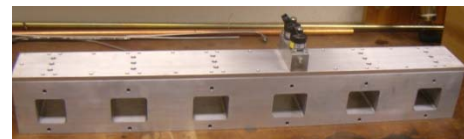

Figure 2: Designed Multi-Port Fuel Injection

- **Mouthpieces:** in order to prevent cross breathing of natural gas between cylinders, six mouthpieces were designed to pass the gas flow in the same direction as the cylinders, see Figure 3.

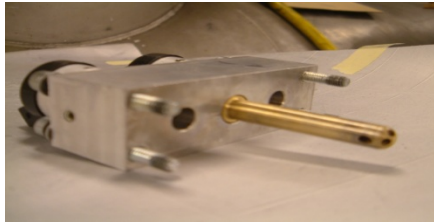

Figure 3: Designed injector mouthpiece

ENGINE CONTROL SYSTEM

A master PC based on GNU/Linux operating system is used as a control system. It communicates with three cylinder-control-modules (CCM) for cylinder-individual control of ignition and fuel injection via CAN communication, see Figure 4. Crank and cam information are used to synchronize the CCMs with the crank rotation.

Flexible controller implementation is achieved using Simulink and C-code is generated using the automatic code generation tool of Real Time Workshop. The C-code is then compiled to an executable program which communicates with the main control program. The controllers used for this experiment are lambda, load and EGR controller which determine the offset amount of fuel, air and EGR. The controllers can be activated from the Graphical User Interface (GUI).

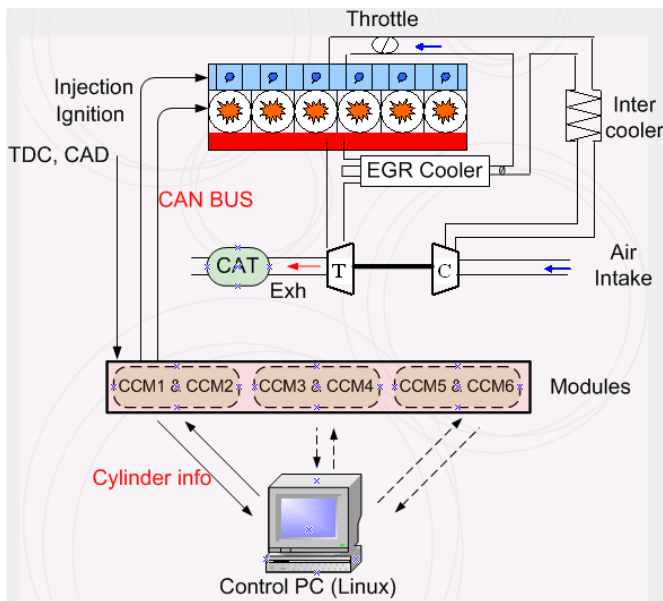

Figure 4: The Engine and its control system

MEASUREMENT SYSTEMS

Each cylinder head is equipped with a piezo electric pressure transducer of type Kistler 7061B to monitor cylinder pressures for heat release calculations. The ion-currents are sampled by CCM's using the spark plugs².

² The principle of ion current measurements is to apply a constant voltage (~100 volt) over the spark gap after ignition. When the gas in the gap becomes conductive due to ionization of the charge a current flows through the spark gap.

Cylinder pressure and ion-current data are sampled by a Microstar 5400A data acquisition processor. EGR was calculated by measuring CO₂ at inlet and exhaust. Emissions (HC, CO, NO, NO₂, NO_x, CO₂, O₂) are measured before and after catalyst. Also, temperatures at inlet/exhaust, pressures at inlet/exhaust, fuel and air flow, lambda, torque and engine speed are measured.

GAS DATA

The composition of the natural gas, which varies slightly³ over time, is shown in Table 2. The lower heating value is 48,4 MJ/kg.

Composition	%	Structure
Methane	89,84	CH ₄
Ethane	5,82	C ₂ H ₆
Propane	2,33	C ₃ H ₈
I-Butane	0,38	C ₄ H ₁₀
N-Butane	0,52	C ₄ H ₁₀
I-Pentane	0,11	C ₅ H ₁₂
N-Pentane	0,07	C ₅ H ₁₂
Hexane	0,05	C ₆ H ₁₄
Nitrogen	0,27	N ₂
CO ₂	0,6	CO ₂

Table 2: The natural gas composition

EXPERIMENTS

The objective of this study is to find a good correlation between COV(IMEP) and COV(Ion-Integral) and make a maximum dilution limit controller based on that correlation. Two different experiments have been performed in this study. The first one investigates the correlation and the second one runs the controller.

Experiment (1)

The first step was to perform an EGR sweep for capturing the behavior of the ion-sensing with different rate of EGR. This test was performed at 1000 RPM and with 0-10-15 and 20 % EGR rate. This experiment was performed in order to investigate a suitable ion-current based parameter (which can be used as a feedback signal for a maximum dilution limit closed loop control) in the next experiments.

After the first investigation, COV(ion-integral) was identified as a suitable parameter for a EGR closed loop control. The second step was to investigate the correlation between COV(ion-integral) and the corresponding parameter derived by pressure signals viz. COV(IMEP). The engine was operated at 800, 1000, 1200 and 1400 RPM with different amounts of EGR (see Table 3) and this correlation was investigated.

³ For example lower heating value increased by 0.00223 % from April 2008 to May 2008

The results of these experiments are demonstrated in EXPERIMENTAL RESULTS (PART 1) section.

Speed (RPM)	EGR Rate (%)
800	0-4-8-10-12-15
1000	0-4-8-10-12-15-20
1200	0-4-8-10-12-15-20
1400	0-4-8-10-12-15-20

Table 3: Engine test operating condition for capturing the correlation between COV(ion-integral) and COV(IMEP)

Experiment (2)

After finding the correlation and the control parameters it was desired to test the regulators and evaluate the results, so the engine was tested with a variety of speed / loads at steady state condition. In order to evaluate the results, it was decided to run the engine at three different loads (2.5, 4 and 5.5 bar⁴) and at three different speed levels (800, 1000, and 1200). Table 4 lists those points and the running strategies. Lower loads have been chosen because pumping losses are more crucial in this region.

To provide a basis for a fair comparison, testing was conducted in two stages, first without adding EGR and without any regulator. In the second stage by using closed loop load and lambda control the load and lambda were kept constant, the amount of EGR was increased by the regulator up to the highest possible EGR while keeping COV(INDEX)⁵ < 5%. The limit of COV(INDEX) is predefined to 5% and “the highest possible EGR rate” means the amount of EGR before the level of COV(INDEX) passes 5%.

INJECTION AND IGNITION TIMING

Injection timing was fixed for all cases but ignition timing varied in order to get MBT (Maximum Break Torque) for each case. A common rule says that MBT timing results if 50% of the fuel is burned at about 10 CAD after top dead center (ATDC) [2]. The results of the comparison between these points are presented in the next section.

Speed	BMEP	Strategies
800	2,5	NO EGR / NO regulator
800	2,5	With regulator
800	4	NO EGR / NO regulator
800	4	With regulator
800	5,5	NO EGR / NO regulator
800	5,5	With regulator
1000	2,5	NO EGR / NO regulator
1000	2,5	With regulator
1000	4	NO EGR / NO regulator
1000	4	With regulator
1000	5,5	NO EGR / NO regulator
1000	5,5	With regulator
1200	2,5	NO EGR / NO regulator
1200	2,5	With regulator
1200	4	NO EGR / NO regulator
1200	4	With regulator
1200	5,5	NO EGR / NO regulator
1200	5,5	With regulator

Table 4: Engine test operating conditions

METHOD AND EXPERIMENTAL RESULTS (2 PARTS)

This section will cover the used methods and results of the engine testing. As mentioned in EXPERIMENT section two different experiments are performed and the results are divided and discussed into the following two parts. The first part describes how ion sensing behaves as a function of EGR which finally results in finding a suitable parameter for this study. After finding the suitable parameter, the dilution limit controller tool and the used controllers are also described in the first part. The second part of this section discusses the results of the developed dilution limit controller.

CORRELATION BETWEEN ION-CURRENT AND PRESSURE SIGNALS & CONTROL METHOD (PART 1)

In the first step of this experiment the engine was operated stoichiometric at 1000 RPM and the EGR rate was varied from zero up to 20%. Figure 5 shows the ion-current signal behavior with different amounts of EGR. Figure 5 illustrates that by increasing the amount of EGR the amplitudes of the first and the second peaks decrease. This effect is strongest on the second peak and it almost disappears for the highest EGR ratio. This means that the second peak cannot be used for combustion diagnostic when using high rates of EGR.

⁴ Loads are written in form of BMEP (Break Mean Effective Pressure)

⁵ COV(INDEX) is a compatible parameter to COV(IMEP), and more clarification will be find in the later part of the paper

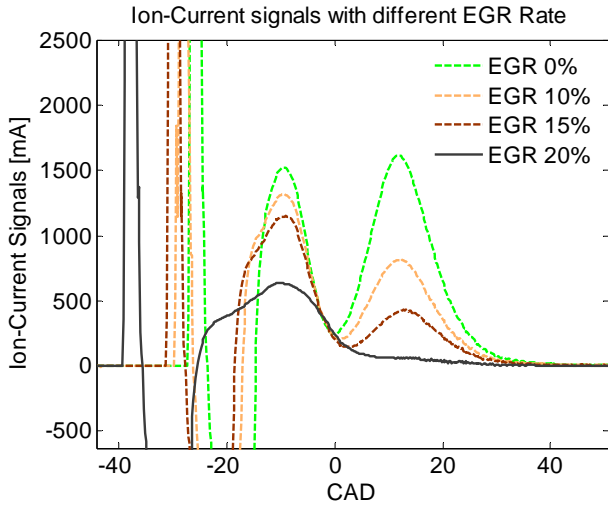

Figure 5: Second peak of the ion-current signals disappears by increasing the amount of EGR

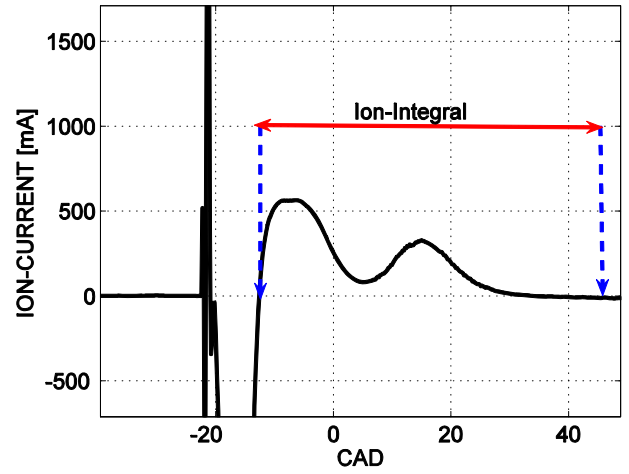

Figure 6: Ion-integral includes both the first and the second peak of the ion-current signals

Another ion-current based parameter viz. ion-current integral is defined as

$$Ion - Integral = \int_{\theta_1}^{\theta_2} U_{ion}(\theta) d\theta \quad (1)$$

where $U_{ion}(\theta)$ is the voltage produced by the ion current interface. The ion-integral limits θ_1 and θ_2 must be chosen so that the ignition phase is not a part of the integral and also such that it includes the whole part of the first and the second peaks (see Figure 6). It was seen in Figure 6 that by increasing the EGR rate the first peak decreases a lot and the second peak almost disappears which means that using these two peaks will not be reliable parameters for combustion control with high dilution, but the area created by the first and the second peak even with high rate of EGR contains some information and can be used as a useful parameter for combustion diagnostic and control.

The start point of the ion-current integral always starts when the first peak starts (see Figure 6) and the end point is somewhere when the second peak finishes. Since the ignition timing differs in different operating points the start point may vary for different operating points and different EGR rates, so the crank range is not necessarily same for different operating points. It is also good to mention that the ignition timing is varied in order to get the MBT for each case and as it is described in the "Injection and Ignition timing" section that the ignition timing was set in a way that CA50 was equal to 10 for all cases where MBT is gained.

There is always some variability in cylinder-to-cylinder variation in COV(IMEP) and COV(ion-integral). Our previous experience with the test engine shows that the third cylinder has always the highest COV(IMEP) and COV(ion-integrals) and it is because of the location of this cylinder related to the intake manifold which results in more flow variation and thereby more cyclic variation. Since the cyclic variation is a stability parameter and data from cylinder 3 has the highest values, the data from this cylinder is the most suitable one for using as feedback signal to the controller. Data acquisition equipment for ion-sensing was available for only two cylinders so cylinder 1 and 3 were chosen for measuring the ion-current signals, and the ion-current data from cylinder 3 was used in the later experiments as feedback to regulate the amount of EGR. In order to show the variability in cylinder-to-cylinder, COV(IMEP) for all 6 cylinders were plotted in Figures 7 and COV(ion-integral) for cylinders 3 and 1 were plotted in Figure 8. The variation is significant between cylinders especially for cylinder 3. At this test the engine was run at 1000 RPM and with 18% EGR.

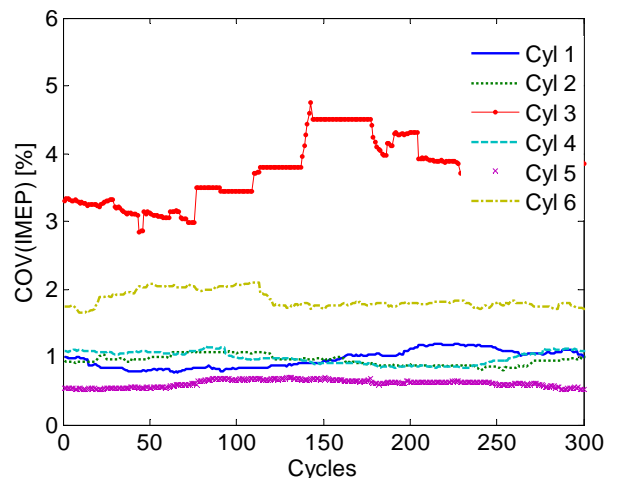

Figure 7: Cylinder-to-Cylinder variability in COV(IMEP)

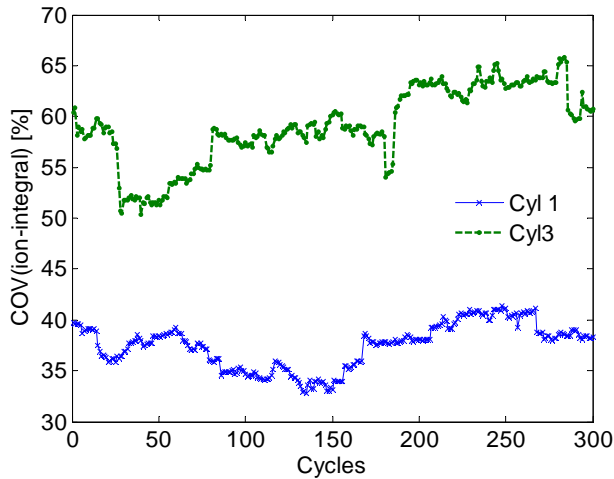

Figure 8: Cylinder-to-Cylinder variability in COV(ion-integral)

Deriving combustion stability parameter from Ion-integral

The experiment according to table 3 was performed. Since it was desired to make a regulator which is valid for all the operating points the engine was operated at different speeds with different EGR levels (see table 3).

For computing the COV(IMEP) and COV(ion-integral) 100 cycles of the data were used. Figure 9 illustrates how COV(ion-integral) correlates with COV(IMEP). It can be seen that COV(ion-integral) has a linear correlation with COV(IMEP) with all different speeds.

Figure 9 also shows that the level of COV(ion-integral) is much higher than the COV(IMEP). The slope for each speed test also differs for different engine speed. These slopes show that by increasing EGR the COV increases and it is because of the colder and longer combustion which is the consequences of higher EGR rates. With lower speeds, COV(ion-integral) is much higher than the higher speeds. Figure 10 demonstrates ion-current signals (mean value of 400 cycles) for different engine speed; it shows that chemical-ionization phase of the ion current signals become stronger with higher speeds. The possible explanation can be the better establishment of early flame development in the spark gap with higher speeds. With higher speed the turbulence is higher and the combustion is faster which results in lower level of COV(ion-integral) and since the level of COV(ion-integral) is much higher than COV(IMEP) this effect can be seen obviously in COV(ion-integral) but not in COV(IMEP).

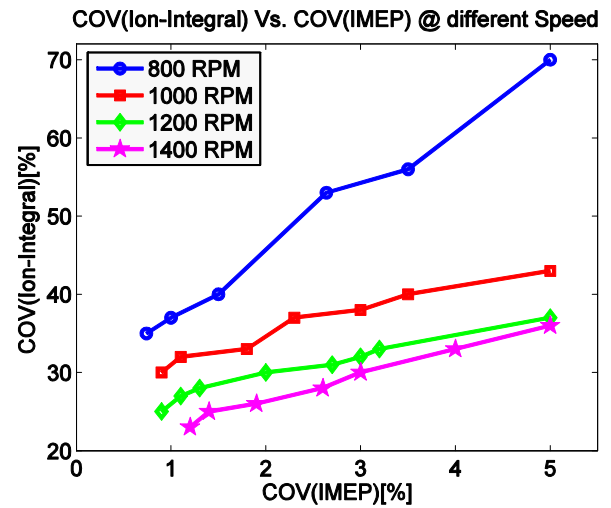

Figure 9: COV(Ion-integral) seems to be a function of speed

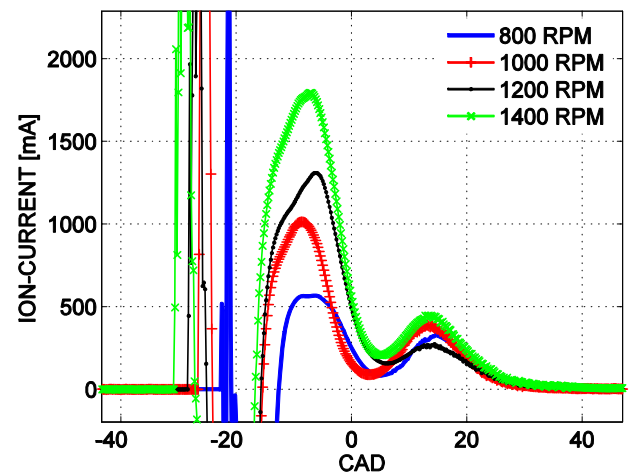

Figure 10: Ion-current signals become stronger with higher speed

A new parameter named COV(INDEX) was defined as a combustion stability parameter. COV(INDEX) is based on COV(ion-integral) and the product of engine speed and COV(ion-integral). This parameter will be used as a compatible parameter to COV(IMEP).

A multiple regression was done which took into account both effects from COV(Ion-integrals) and the product of engine speed and COV(ion-integral) and calculates the statistics for a line that best fits the data. The following formula describes the correlation line.

$$\text{COV(INDEX)} = 0.000238 \times (\text{Speed} \times \text{COV(Ion-integral)}) - (0.007 \times \text{COV(Ion-integral)}) - 5.97 \quad (2)$$

COV(INDEX) was calculated for the experimental data. Figure 11 shows how COV(INDEX) correlates with COV(IMEP) of the experimental data. The standard deviation for the residuals of the calculated COV(INDEX) was about 0.55 % which ensures the accuracy of this improved parameter.

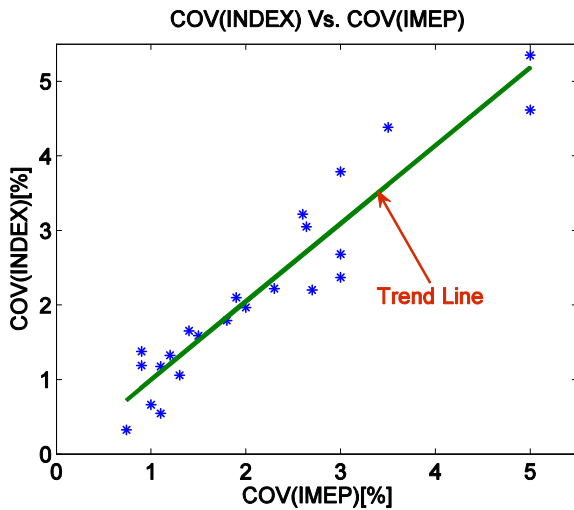

Figure 11: The derived COV(INDEX) correlates well with COV(IMEP)

CONTROL METHOD & THE CONTROLLERS

As mentioned before the main objective of this work is to develop an ion-current based tool for mapping the best positions of the throttle and EGR valve at different loads and speeds in order to minimize pumping losses and keep COV(INDEX) below 5%. For developing this tool different regulators were needed. Three different regulators were designed for controlling overall air / fuel ratio, load and EGR level, see Figure 12. Bumpless transfer and Anti-Windup algorithms were applied during the design of the regulators.

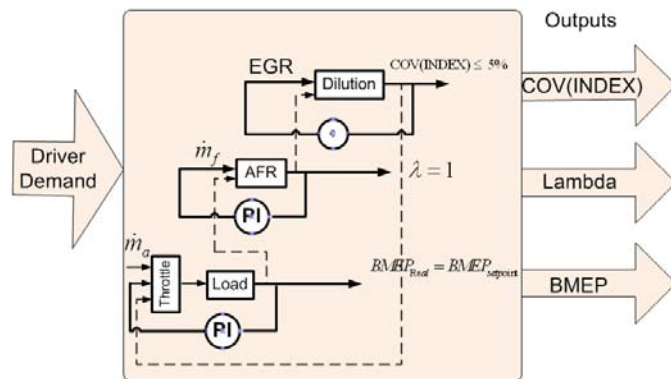

Figure 12: Closed-Loop Combustion Control

CLOSED LOOP LAMBDA CONTROL

Closed loop lambda control evaluates the signals from the broadband lambda sensor. The sensor measures the oxygen content in the exhaust gas, and thus provides information about the mixture composition. The closed-loop lambda control strategy uses the injected fuel quantity as the manipulated variable and can compensate for the lambda error. A Proportional Integral (PI) control strategy is used for controlling lambda. The error signal was based on the differences between the

measured lambda and a desired setpoint lambda and the PI controller generates a fuel offset based on this.

CLOSED LOOP EGR CONTROL

The important measure of cyclic variability, derived from ion-current data, is the defined parameter COV(INDEX). EGR closed loop control evaluates the calculated COV(INDEX) to control the EGR valve. The error signal was based on the differences between the calculated COV(INDEX) and a setpoint COV(INDEX) for 5%. The EGR valve opens more as long as the COV(INDEX) is less than 5%, and if COV(INDEX) exceeds 5% the regulator starts to close the EGR valve. So the regulator always attempts to keep the EGR valve in a position such that COV(INDEX) is around 5%.

CLOSED LOOP LOAD CONTROL

The reason that the load controller was developed and used was that by increasing EGR the load decreases if the throttle wouldn't open more, but it was desired to keep the load constant in order to have a fair comparison.

The engine is connected to an electric dynamometer, and the torque is measured with a load cell. BMEP is calculated from the measured torque according to the following formula [12].

$$B_{mep} = \frac{2\pi n_T T}{V_D} \quad (3)$$

n_T = Stroke factor (2 for 4-stroke engines)

T = Torque

V_D = Engines Volume

Closed loop load control evaluates the signals from the load cell. The error signal was based on the differences between the measured BMEP and a desired setpoint BMEP and, a throttle offset was generated from that. The throttle was adjusted by the regulator to keep the measured BMEP at the same level as the desired BMEP.

REGULATORS PERFORMANCE

Figures 13 and 14 illustrate the performance of the regulators. In this attempt setpoint of the BMEP was set to 2.5 bar, setpoint of the lambda was set to 0,99 and the COV(INDEX) limit was set to 5%. Figure 13 shows how the load regulator, by opening and closing the throttle try to keep the load near the reference value which is 2.5 bar. Figure 13 also shows that the lambda regulator by adjusting the fuel injection regulates the lambda near the setpoint lambda. Figure 14 shows the performance of the third regulator viz. Closed Loop EGR Controller. The EGR valve opens more as long as the COV(INDEX) is less than 5%, and if COV(INDEX)

exceeds 5% the regulator starts to close the EGR valve. Since these three regulators work together and the output of each controller can affect results of the other controllers in a undesirable way, the EGR regulator is designed in a way that it is slower than the other regulators.

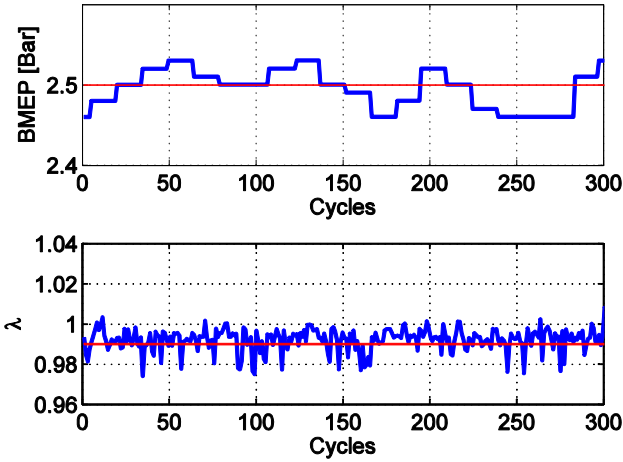

Figure 13: Closed Loop Load and lambda controllers' performance

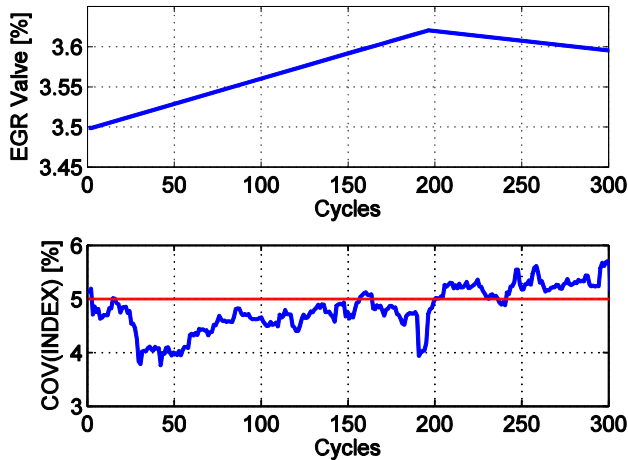

Figure 14: Closed Loop EGR controllers' performance

DEVELOPED MAXIMUM DILUTION LIMIT CONTROLLER (PART 2)

This testing program was performed at a variety of speed / loads at steady state condition. The tests were performed in two stages for each speed and load condition. The first was the regular running of the engine, where no EGR was added and no lambda or load regulator were activated. In the second stage the regulators (Lambda, Load and EGR closed loop control) were activated.

The operating points are evaluated in terms of Brake Efficiency, pumping losses, fuel consumption and stability. Engine runs with stoichiometric operation with 3-way catalyst and emissions were measured after the

catalyst but, since the changes in emissions were not significant, those are not presented in the paper.

EFFICIENCIES

Brake Efficiency is a product of different efficiencies as follows:

$$\eta_b = \eta_{GI} \times \eta_{GE} \times \eta_m \quad (4)$$

Where

η_b = Brake efficiency

η_{GI} = Gross Indicated efficiency

η_{GE} = Gas-Exchange efficiency

η_m = Mechanical efficiency

Figures 15 to 17 show all these different efficiencies for the two named cases with different speeds.

Gross Indicated efficiency is the product of thermodynamic and combustion efficiencies and it can be calculated as follows

$$\eta_{GI} = \left(\frac{IMEP_{gross}}{\left(\frac{m_f Q_{LHV}}{V_D} \right)} \right) \quad (5)$$

Where

m_f = fuel mass per cycle

Q_{LHV} = lower heating value of the fuel

V_D = displaced volume

Figure 15-17 show slightly higher gross indicated efficiency in the cases with regulator. By increasing EGR the specific heat ratio will be slightly lower and combustion duration will be longer but it can be compensated somewhat by advancing the ignition timing. The combustion efficiency increases however since the exhaust gas has a second chance to be combusted. The net result is a slight increase in gross indicated efficiency. As was discussed before, by using the regulators the EGR valve will open more resulting in increasing pressure after the throttle and thereby the throttle will be opened more in order to keep the same amount of load. Thus the gas exchange efficiency increases with EGR.

Gas-Exchange efficiency is a measure to evaluate the pumping losses in the engine.

$$\eta_{GE} = \left(\frac{IMEP_{net}}{IMEP_{gross}} \right) \quad (6)$$

$$IMEP_{net} = \frac{\int_{-360}^{360} p dv}{V_D} \quad (7)$$

$$IMEP_{gross} = \frac{\int_{-180}^{180} p dv}{V_D} \quad (8)$$

Figure 15-17 show that gas exchange efficiency increases as the load increases due to the more open throttle resulting in higher inlet pressure. Figures 15-17 also show that the gas exchange efficiency is higher in the case with regulator since using EGR lets the throttle open even further to keep the load at the same level. Table 5 shows how the inlet pressure increases with EGR.

Mechanical efficiency is a measure to evaluate the mechanical losses, comprising in particular friction losses, drive losses in oil, water and fuel supply pumps. The definition of the mechanical efficiency is the relationship between the effective work and the indicated work:

$$\eta_m = \frac{BMEP}{IMEP_{net}} \quad (9)$$

The differences in mechanical efficiency between running without EGR or with EGR are almost negligible, see Figure 15-17.

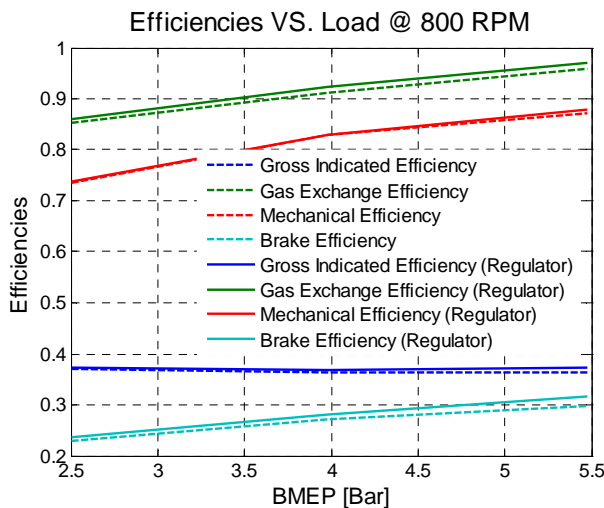

Figure 15: Efficiencies vs. BMEP @ 800 RPM

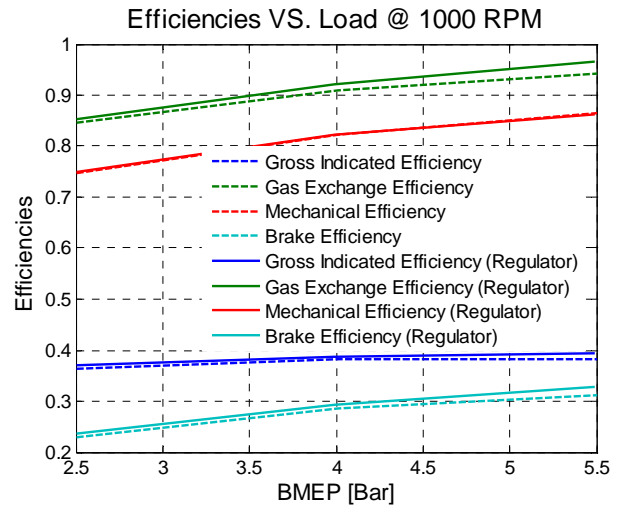

Figure 16: Efficiencies vs. BMEP @ 1000 RPM

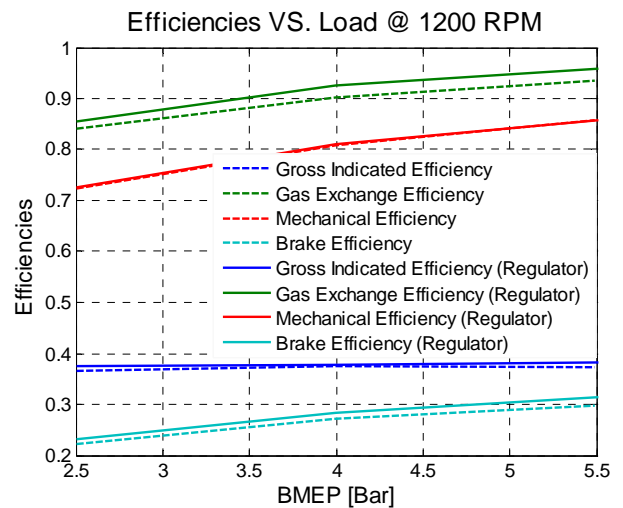

Figure 17: Efficiencies vs. BMEP @ 1200 RPM

Speed	BMEP	Strategies	Inlet P
800	2,5	NO EGR	0,49
800	2,5	With regulator	0,51
800	4	NO EGR	0,62
800	4	With regulator	0,68
800	5,5	NO EGR	0,77
800	5,5	With regulator	0,89
1000	2,5	NO EGR	0,48
1000	2,5	With regulator	0,51
1000	4	NO EGR	0,63
1000	4	With regulator	0,72
1000	5,5	NO EGR	0,77
1000	5,5	With regulator	0,93
1200	2,5	NO EGR	0,48
1200	2,5	With regulator	0,54
1200	4	NO EGR	0,63
1200	4	With regulator	0,77
1200	5,5	NO EGR	0,77
1200	5,5	With regulator	0,94

Table 5: Inlet pressures for different cases

Figure 18-20 show the stable region (the region where COV(INDEX) is lower than 5%) for different loads and speeds. X-axis shows BMEP in bar, Y-axis shows the rate of EGR in percentage and the colored region shows the level of COV(INDEX). As load and speed increases, more EGR can be tolerated in the engine because of lower residual fraction and higher turbulence level. These figures also verify the effect of EGR on increasing of COV(INDEX). The maximum EGR rate in different load and speed while the engine runs in a stable condition can be read from the figures.

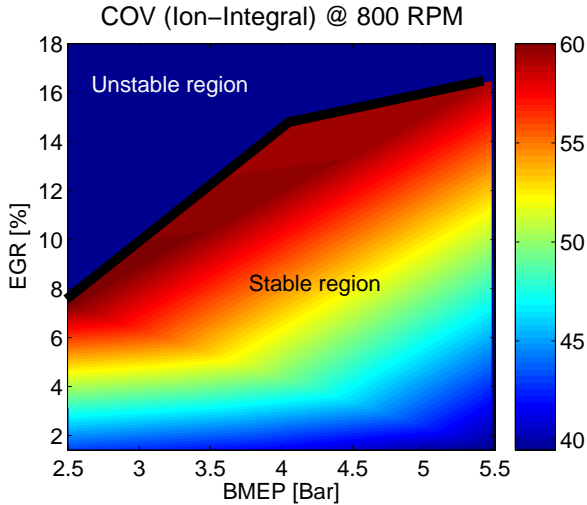

Figure 18: Stable region @ 800 RPM where COV(INDEX) is lower than 5%

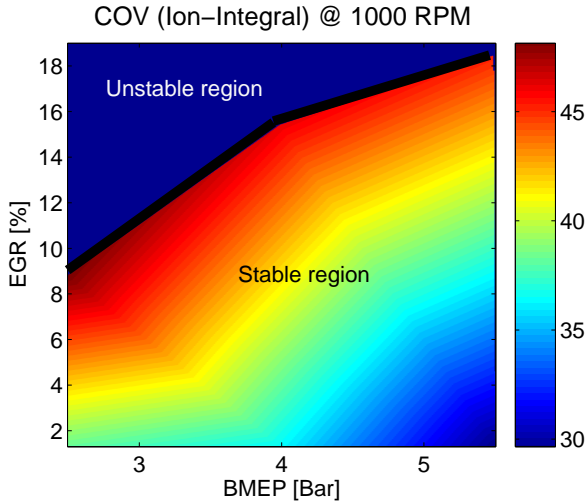

Figure 19: Stable region @ 1000 RPM where COV(INDEX) is lower than 5%

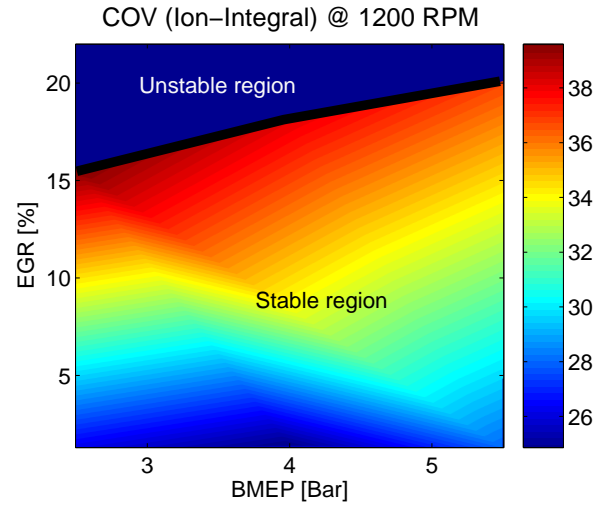

Figure 20: Stable region @ 1200 RPM where COV(INDEX) is lower than 5%

Pumping losses can be calculated and presented by means of mean effective pressure as follows:

$$P_{mep} = IMEP_{gross} - IMEP_{net} \quad (10)$$

Figures 21-23 show P_{mep} for different loads and speeds. X-axis shows the EGR valve position in percentage and Y-axis shows the throttle position in percentage. The triangle shapes in the figures show the stable region for three loads (2.5, 4, and 5.5). When EGR valve opens more the pressure after throttle increases and the regulator opens the throttle more in order to keep the engine at the same level of load which results in decreasing pumping losses.

The tests were performed at three loads viz. 2.5, 4 and 5.5 bar, once without EGR (without regulator) and once with the regulators. The loads are shown in black lines in figures 21-23. Each black line shows the measuring of two points when the EGR valve is closed and when the EGR valve opens by regulator. Black lines in Figure 21-23 show that P_{mep} is decreasing in all the tests with regulator due to the more open throttle resulting in higher inlet pressure.

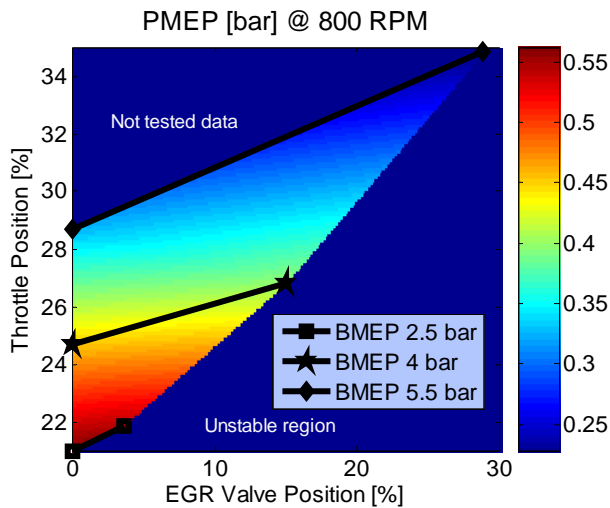

Figure 21: Pmep [bar] in stable region @ 800 RPM (where COV(INDEX) is lower than 5%) decreases by increasing EGR while keeping the load at same level

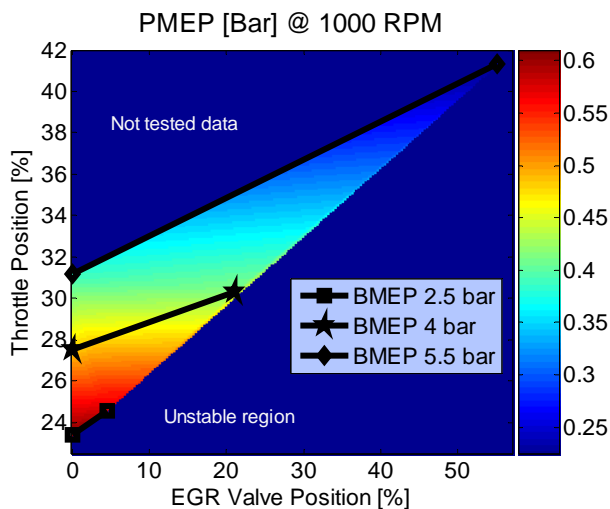

Figure 22: Pmep [bar] in stable region @ 1000 RPM (where COV(INDEX) is lower than 5%) decreases by increasing EGR while keeping the load at same level

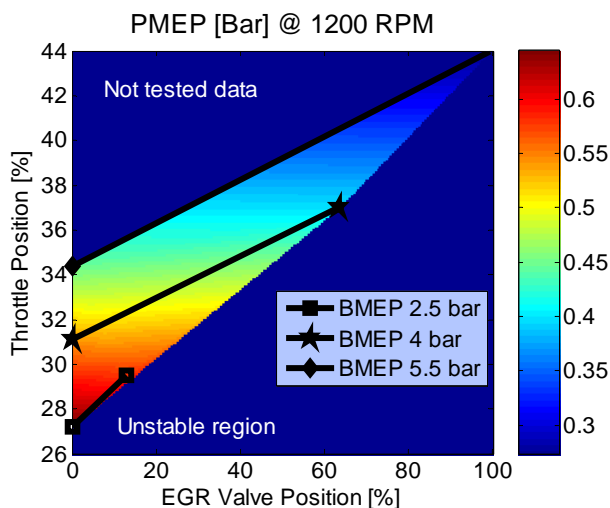

Figure 23: Pmep [bar] in stable region @ 1200 RPM (where COV(INDEX) is lower than 5%) decreases by increasing EGR while keeping the load at same level

Figures 24-26 show specific fuel consumption for different loads and speeds. X-axis shows the throttle position in percentage and Y-axis shows EGR valve position in percentage. The triangle shapes in the figures show the stable region for the three loads (2.5, 4, and 5.5). As throttle and EGR valve opens more the fuel consumptions decreases because of lower pumping losses and thereby better efficiency is achieved. It can also be pointed out that by increasing EGR, fuel consumption increases (if throttle will not be opened more) due to more heat losses.

The loads are shown in black lines in figures 24-26. Black lines in Figure 24-26 show that fuel consumption is decreasing in all the tests with regulator due to the more open throttle resulting in less pumping losses and thereby better efficiency.

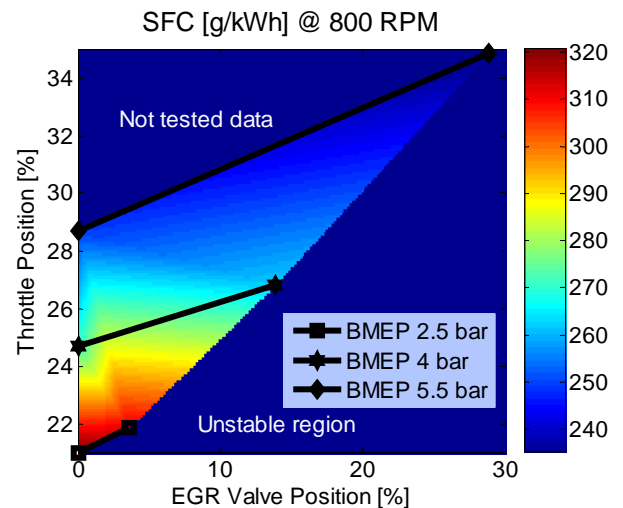

Figure 24: Specific fuel consumption [g/kWh] in stable region @ 800 RPM (where COV(INDEX) is lower than 5%) decreases by increasing EGR while keeping the load at same level

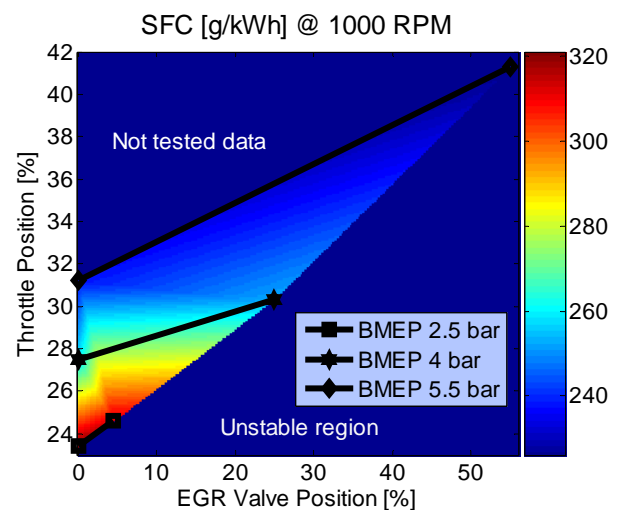

Figure 25: Specific fuel consumption [g/kWh] in stable region @ 1000 RPM (where COV(INDEX) is lower than 5%) decreases by increasing EGR while keeping the load at same level

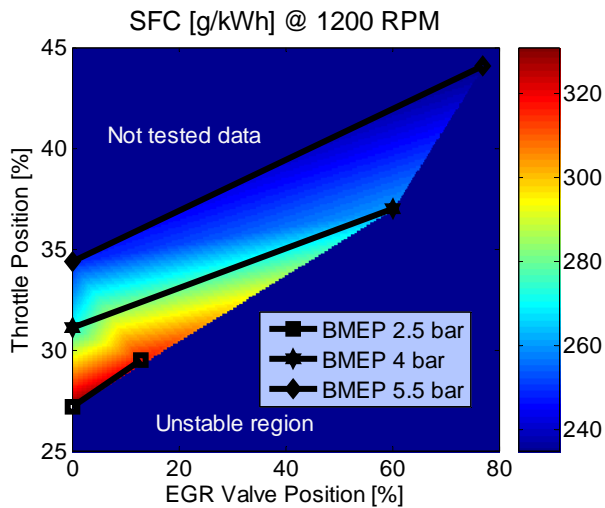

Figure 26: Specific fuel consumption [g/kWh] in stable region @ 1200 RPM (where COV(INDEX) is lower than 5%) decreases by increasing EGR while keeping the load at same level

CONCLUSION

The conclusions obtained from this study are as follows:

1. The correlation between the defined combustion stability named COV(INDEX) which is based on COV(Ion-Integral) is proportional to COV(IMEP)
2. Controlling Lambda, Load and EGR was found to work well. The controller made it possible to have the maximum amount of EGR in the cylinder while keeping the COV(INDEX) less than 5%.
3. The results verified 1.5-2.5 % units improvement in Brake Efficiency at low /part loads by using the controller.
4. The proposed controller can be used as a tool for mapping the best positions of the throttle and EGR valve in terms of efficiency.
5. The map created by the tool can be used as a feedforward map combined with a feedback controller for faster response

Running the engine and evaluating the controller under transient operating conditions will be the follow on program of this project.

REFERENCES

1. Patrik Einewall, Per Tunestål and Bengt Johansson. "Lean Burn Natural Gas Operation vs. Stoichiometric Operation with EGR and a Three Way Catalyst." Lund Institute of Technology, SAE Paper 2005-01-0250

2. Heywood, John B. "Internal Combustion Engine Fundamentals," international edition, McGraw Hill, 1988. page 837
3. Younis, A. F. and Raine R.R., (2000), "Application of a New Technique for the Evaluation of Cycle-by-Cycle Variation of Completeness of Combustion to Changes of Compression Ratio", SAE Paper 2000-01-1213.
4. Han, S.B. and Chung, Y.J.,(1999), "The Influence of Air-Fuel Ratio on Combustion Stability of a Gasoline Engine at Idle", SAE Paper 1999-01-1488.
5. Jürgen Förster, Achim Gunther, Markus Ketterer, and Klaus-Jurgen Wald. Ion current sensing for spark ignition engines, SAE 1999-01-0204.
6. André Saitzkoff, Raymond Reinmann, and Fabian Mauss. In cylinder pressure measurements using the spark plug as an ionization sensor. SAE paper No. 970857, pages 187– 197
7. M. Hellring, T. Munther, T. Rögnvaldsson, N. Wickström, C. Carlsson, M. Larsson, and J. Nytomt. Robust AFR estimation using the ion current and neural networks, SAE 1999-01-1161
8. A. Abdel-Rahim, N. Henein, E. Vandyne, Ion current in a spark ignition engine using negative polarity on center electrode, SAE 2007-01-0646
9. Lars Eriksson, Lars Nielsen, and Jan Nytomt. Ignition control by ionization current interpretation. SAE SP 1149, (SAE paper No. 960045):73–79, 1996.
10. I. Andersson, L. Eriksson, Ion sensing for combustion stability control of a spark ignited direct injected engine, SAE 2000-01-0552
11. I. Haskara, G. Zhu, Ch. Daniels, J. Winkelman. Closed loop maximum dilution limit control using in-cylinder ionization signal, SAE 2005-01-3751
12. Johansson, Bengt. "Förbränningsmotorer", Lund 2004

CONTACT

Mehrzad Kaiadi

Email: Mehrzad.kaiadi@energy.lth.se