



LUND UNIVERSITY

Carbon dioxide removal in indirect gasification

Svensson, Helena; Tunå, Per; Hulteberg, Christian

2013

[Link to publication](#)

Citation for published version (APA):

Svensson, H., Tunå, P., & Hulteberg, C. (2013). *Carbon dioxide removal in indirect gasification*. (SGC Rapport; Vol. 2013:277). Swedish Gas Technology Centre. <http://www.sgc.se/ckfinder/userfiles/files/SGC277.pdf>

Total number of authors:

3

General rights

Unless other specific re-use rights are stated the following general rights apply:

Copyright and moral rights for the publications made accessible in the public portal are retained by the authors and/or other copyright owners and it is a condition of accessing publications that users recognise and abide by the legal requirements associated with these rights.

- Users may download and print one copy of any publication from the public portal for the purpose of private study or research.
- You may not further distribute the material or use it for any profit-making activity or commercial gain
- You may freely distribute the URL identifying the publication in the public portal

Read more about Creative commons licenses: <https://creativecommons.org/licenses/>

Take down policy

If you believe that this document breaches copyright please contact us providing details, and we will remove access to the work immediately and investigate your claim.

LUND UNIVERSITY

PO Box 117
221 00 Lund
+46 46-222 00 00



Carbon dioxide removal in indirect gasification (Koldioxidavskiljning vid indirekt förgasning)

Helena Svensson, Per Tunå, Christian Hulteberg

*"Catalyzing energygas development
for sustainable solutions"*

© Svenskt Gastekniskt Center AB

Svenskt Gastekniskt Center/Swedish Gas Technology Centre
Scheelegatan 3
SE-211 28 MALMÖ
+46 40 6800760
info@sgc.se
www.sgc.se

Denna rapport är tryckt på papperskvaliteten MultiDesign Ivory 240 g/m² (pärm) samt 90 g/m² (inlaga). Vårt val av papper är mycket medvetet. MultiDesign Ivory är tillverkat av VIDA Paper AB i Lessebo i Småland. Pappersmassan utgörs av svensk granvedsråvara, förvaltd i enlighet med PEFC, som framställts till massa med hjälp av en sur magnesiumbisulfitprocess följd av väterperoxidblekning (TCF). Pappret är fritt från optiska vitmedel (OBA), vilka oftast är fossilbaserade. Inte heller är pappret bestruket med något icke-förnybart mineral. Papprets CIE-vithet är 60. Denna svaga gulton ger bästa möjliga läsbarhet och innebär jämfört med ett kritvitt papper en kostnadseffektivare produktion och en avsevärt lägre miljöpåverkan vid massablekningen.

Tryckt av Lunds kommun, Serviceförvaltningen, Lund 2013
ISSN 1102-7371

CARBON DIOXIDE REMOVAL IN INDIRECT GASIFICATION (KOLDIOXIDAVSKILJNING VID INDIREKT FÖRGASNING)

Helena Svensson, Per Tunå, Christian Hulteberg

Denna studie har finansierats av:
Energimyndigheten
agnion Highterm-Research GmbH
Danish Gas Technology Centre
E.ON Gasification Development AB
Greenlane Biogas AB
Göteborg Energi AB
Lunds Energikoncernen AB
MemfoAct
Paul Scherrer Institute
Purac Puregas AB
SP Sveriges Tekniska Forskningsinstitut
Stockholm Gas AB
Vattenfall AB
VTT
Öresundskraft AB

© Svenskt Gastekniskt Center AB

Postadress och Besöksadress
Scheelegatan 3
212 28 MALMÖ

Telefonväxel
040-680 07 60

Telefax
0735-279104

E-post
info@sgc.se

Hemsida
www.sgc.se



Svenskt Gastekniskt Center AB, SGC

SGC är ett spjutspetsföretag inom hållbar utveckling med ett nationellt uppdrag. Vi arbetar under devisen "*Catalyzing energygas development for sustainable solutions*". Vi samordnar branschgemensam utveckling kring framställning, distribution och användning av energigas och sprider kunskap om energigas. Fokus ligger på förnybara gaser från rötning och förgasning. Tillsammans med företag och med Energimyndigheten och dess kollektivforskningsprogram *Energigastekniskt utvecklingsprogram* utvecklar vi nya möjligheter för energigaserna att bidra till ett hållbart samhälle. Tillsammans med våra fokusgrupper inom *Rötning, Förgasning och bränslesyntes, Distribution och lagring, Kraft/Värme* och *Gasformiga drivmedel* identifierar vi frågeställningar av branschgemensamt intresse att genomföra forsknings-, utvecklings och/eller demonstrationsprojekt kring. Som medlem i den europeiska gasforskningsorganisationen GERG fångar SGC också upp internationella perspektiv på utvecklingen inom energigasområdet.

Resultaten från projekt drivna av SGC publiceras i en särskild rapportserie – *SGC Rapport*. Rapporterna kan laddas ned från hemsidan – www.sgc.se. Det är också möjligt att prenumerera på de tryckta rapporterna. SGC svarar för utgivningen av rapporterna medan rapportförfattarna svarar för rapporternas innehåll.

SGC ger också ut faktabroschyrer kring olika aspekter av energigasens framställning, distribution och användning. Broschyrer kan köpas via SGC:s kansli.

SGC har sedan starten 1990 sitt säte i Malmö. Vi ägs av Eon Gas Sverige AB, Energigas Sverige, Swedegas AB, Göteborg Energi AB, Lunds Energikoncernen AB (publ) och Öresundskraft AB.

Malmö 2013

Martin Ragnar
Verkställande direktör



Swedish Gas Technology Centre, SGC

SGC is a leading-edge company within the field of sustainable development having a national Swedish assignment. We work under the vision of “*Catalyzing energygas development for sustainable solutions*”. We co-ordinate technical development including manufacture, distribution and utilization of energy gases and spread knowledge on energy gases. Focus is on renewable gases from anaerobic digestion and gasification. Together with private companies and the Swedish Energy Agency and its frame program *Development program for energy gas technology* we develop new solutions where the energygases could provide benefits for a sustainable society. Together with our focus groups on *Anaerobic digestion, Gasification and fuel synthesis, Distribution and storage, Power/Heat and Gaseous fuels* we identify issues of joint interest for the industry to build common research, development and/or demonstrations projects around. As a member of the European gas research organization GERG SGC provides an international perspective to the development within the energygas sector

Results from the SGC projects are published in a report series – *SGC Rapport*. The reports could be downloaded from our website – www.sgc.se. It is also possible to subscribe to the printed reports. SGC is responsible for the publishing of the reports, whereas the authors of the report are responsible for the content of the reports.

SGC also publishes fact brochures and the results from our research projects in the report series *SGC Rapport*. Brochures could be purchase from the webiste.

SGC is since the start in 1990 located to Malmö. We are owned by Eon Gas Sverige AB, Energigas Sverige, Swedegas AB, Göteborg Energi AB, Lunds Energikoncernen AB (publ) and Öresundskraft AB.

Malmö, Sweden 2013

Martin Ragnar
Chief Executive Officer



Authors' foreword

The project was initiated by Jörgen Held and conducted during the period of June 2012 – February 2013 by Helena Svensson, Per Tunå and Christian Hulteberg at Lund University in collaboration with Christiaan van der Meijden, Energy Research Centre of the Netherlands and Tobias Persson, SGC. Additional input has been given by different working groups consisting of members from the reference group.

Following persons have constituted the reference group;

Jörgen Held, SGC on consultancy basis (project coordinator)
Thomas Kienberger, agnion Highterm-Research GmbH
Niels Bjarne Rasmussen, Danish Gas Technology Centre
Anders Molin/Björn Fredriksson, E.ON Gasification Development AB
Ulf Jonsson, Greenlane Biogas AB
Ingemar Gunnarsson, Göteborg Energi AB
Liisa Fransson, Lunds Energikoncernen AB
Håvard Fjeldvaer, MemfoAct
Serge Biollaz, Paul Scherrer Institute
Max Strandberg, Purac Puregas AB
Ingmar Schüssler, SP Sveriges Tekniska Forskningsinstitut
Håkan Schyl, Stockholm Gas AB
Jürgen Jacoby, Vattenfall AB
Pia Anttila, VTT
Jesper Baaring, Öresundskraft AB



Summary

There are two technologies for producing biomethane, one based on anaerobic digestion and one based on biomass gasification. Out of the two, the pathway based on anaerobic digestion is the more mature. In both cases, there is a requirement for removing the CO₂ which is co-produced with the methane. This study investigates the possibilities and opportunities for using existing CO₂ removal technologies (water scrubbing and amine scrubbing) commercialized for anaerobic digestion in the biomass gasification case.

The most likely gasification technology to be used in small scale gasification for production of substitute natural gas (SNG) from biomass is the indirect gasifier. Therefore two cases based on different gasifier technologies have been investigated. The investigation has been performed using existing models for gasification and CO₂ separation which have been used together in an iterative fashion to close the heat and mass balances for the systems. The two cases have been 10 MW_{th} and 100 MW_{th} input of biomass with 50% moisture content. In the larger case, the methanation is performed in a fixed multi-stage bed while in the smaller case the methanation is performed in a moving bed reactor. The systems have been evaluated for efficiency and assessed for exporting the product to the natural gas grid in a Swedish context. The major findings in the report are summarized in table S.1.

Table S.1 summary of major simulation results.

	10 MW _{th}		100 MW _{th}			
	Post-methanation		Pre-methanation		Post-methanation	
	Water scrubbing	Amine scrubbing	Water scrubbing	Amine scrubbing	Water scrubbing	Amine scrubbing
Methane slip (% of inlet)	1	0.05	1%	0.04	1%	0.05
Propane addition (kg/Nm ³)	0.007	0	0.11	0.004	0.04	0.002
η_{SNG}	60.6%	61.2%	67.9%	68.4%	68.1%	68.7%
η_{ee}	60.7%	60.9%	68.3%	75.6%	73.9%	76.6%

The major conclusions from the case studies are that the smaller system investigated is quite similar in gas composition, flow rate and impurities to a traditional anaerobic digester. Therefore the same trade-offs between amine and water scrubbers apply in this case as in the anaerobic digester case. In the larger scale case, it is clear that post-methanation purification is to be preferred; from a gas quality and efficiency standpoint.



Sammanfattning

Det finns två metoder för att producera biogas. Den ena metoden är rötning och den andra är termisk förgasning av biomassa följt av katalytisk metanisering. Den första metoden är den mest mogna av de två och ett relativt stort antal anläggningar finns världen över. Trots att det finns stora skillnader mellan teknikerna finns det en stor likhet: båda producerar en biogas som har relativt hög halt CO_2 . Denna koldioxid måste renas bort innan gasen kan användas antingen som fordonsgas eller exporteras till gasnätet. Denna studie tar fasta i de tekniker för koldioxidavskiljning som finns utvecklade för rötning (de som är relativt kostnadseffektiva i den skala som avses, vatten- och aminskrubbning) och undersöker deras lämplighet i förgasningssystem för produktion av syntetisk naturgas (SNG).

Den teknik som bedöms som mest lämplig för produktion av SNG via biomassa är indirekt förgasning. Denna förgasning sker med indirekt tillförsel av värme, varför betingelserna i förgasaren blir gynnsam och relativt stora mängder metan produceras redan i förgasaren. Den producerade gasen måste därefter renas från orenheter såsom aska och tjära innan den CO och H_2 som produceras kan reageras vidare till CH_4 . Den koldioxid som bildas i processen kan antingen skiljas av innan CO och H_2 reageras till metan eller efter. Studien har gjorts genom simulering av olika delsystem (förgasare, gasrening etc.) var för sig i befintliga modeller. Genom ett iterativt förfarande har dessa därefter passats till varandra för att ge en enhetlig mass- och värmebalans. Indata till modellen presenteras i tabell S.2.

Tabell S.2. Indata till de utförda simuleringarna.

Faktor	Värde	
	Stor skala	Liten skala
Biomassa in	100 MW _{th}	10 MW _{th}
Biomassans fukthalt	50%	50%
Biomassans fukthalt in i förgasaren	25%	25%
CO_2 avskiljning	Före och efter metanisering	Efter metanisering
CO_2 avskiljningsteknik	Amin- och vattenskrubbning	Amin- och vattenskrubbning
Wobbe index _{LHV} SNG-produkt	45.5	45.5
Leveranstryck	60 bar	60 bar
Metan slip (max)	1%	1%

Som kan ses i tabellen är det två fall som simulerats, 10 och 100 MW_{th}. För vardera fallet har en eller två olika koldioxidavskiljningsmetoder integrerats med förgasningsprocessen. I det mindre fallet har avskiljning efter metanisering undersökts medan för det större fallet undersöktes avskiljning både före och efter metanisering. Den producerade gaskvaliteten skiljer sig dock från den svenska standarden för naturgas och då syftet var att exportera produkten till naturgasnätet måste gasen konditioneras för att möta de önskade specifikationerna. Detta görs genom att sätta till propan för att möta kraven på gasensenergitäthet.

De resulterande mass- och värmebalanser som erhålls genom simuleringarna har använts för att bestämma ett antal nyckelparametrar. Bland dessa återfinns



förändringen i kemisk energi genom systemet och verkningsgrader. Två verkningsgradsmått har används (η_{SNG} och η_{ee}) som beskriver den termiska verkningsgraden till SNG respektive verkningsgraden uttryckt på elekvivalentbasis. I figur S.1. återfinns ett Sankeydiagram som beskriver tillförsel och förändringen i energi vid omvandling av biomassa till SNG för det lilla systemet.

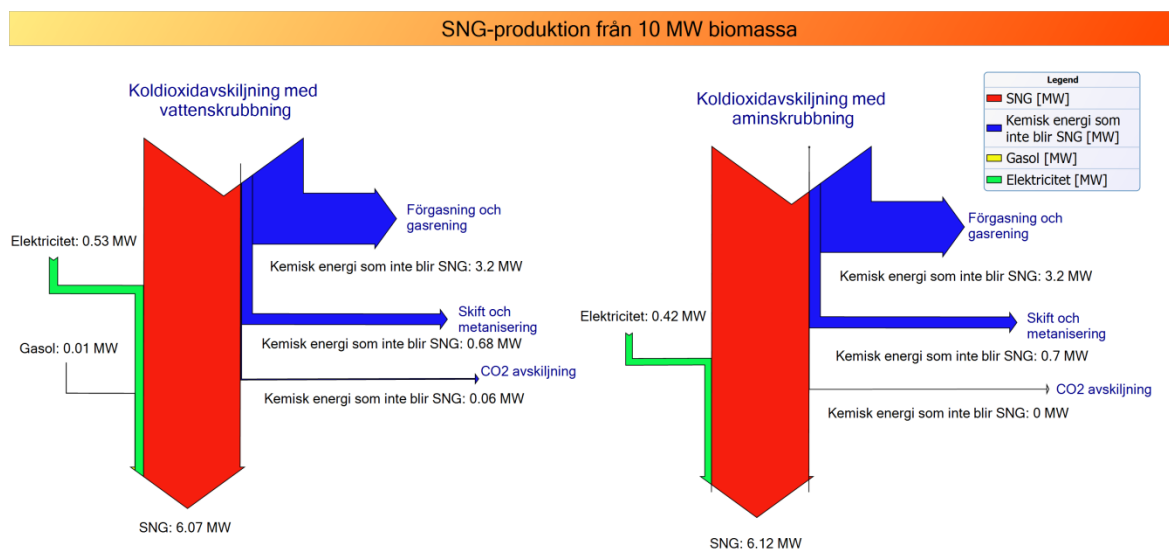

Figur S.1 Sankeydiagram över tillförd/bortförd energi vid omvandling av biomassa till SNG i det mindre fallet.

Som kan ses i figuren krävs det utöver biomassa elektricitet, och i vattenskrubberfallet också gasol, för att producera SNG. Den största förlusten av kemisk energi görs över förgasningen och gasreningdelen i systemet, men även skiftning av gasen (så förhållandet mellan CO och H₂ blir lämpligt för metanproduktion) ger upphov till viss förlust. För det större fallet återfinns motsvarande Sankeydiagram i figur S.2a och b.

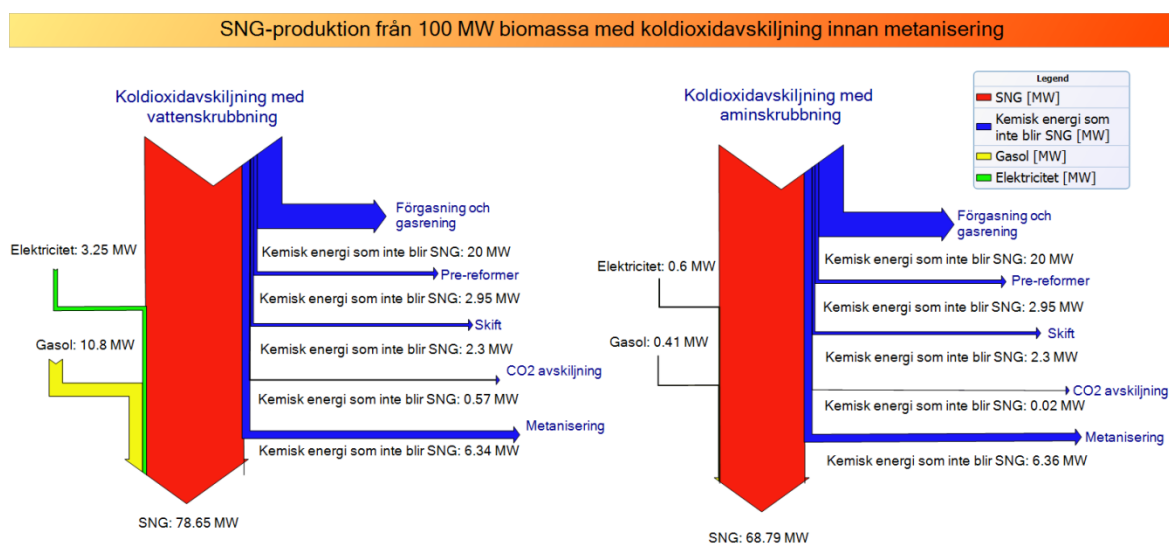

Figur S.2a Sankeydiagram över tillförd/bortförd energi vid omvandling av biomassa till SNG för det större fallet med koldioxidavskiljning innan metanisering.



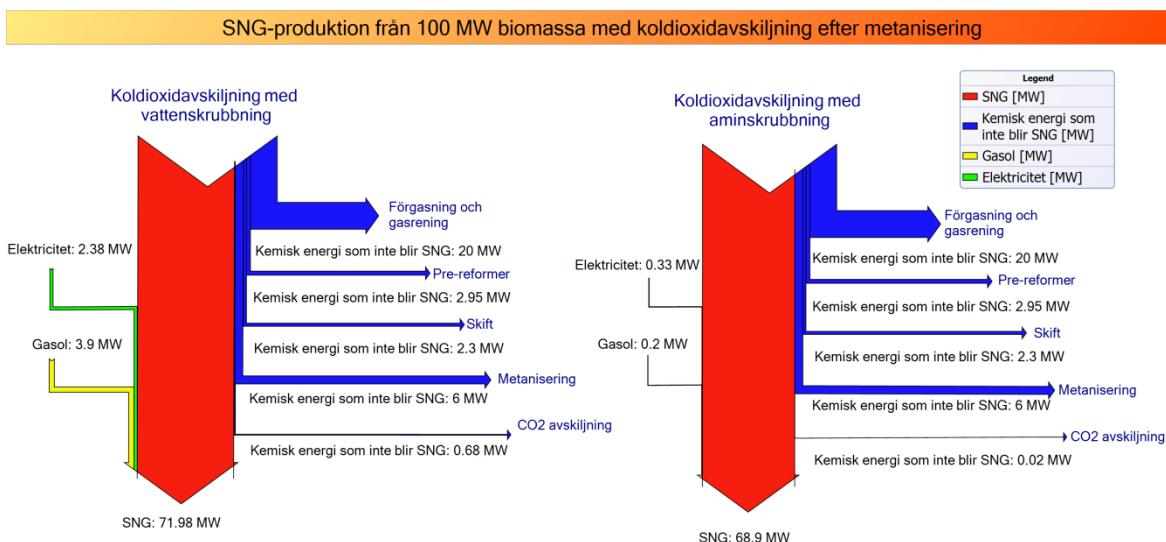

Figur S.2b Sankeydiagram över tillförd/bortförd energi vid omvandling av biomassa till SNG för det större fallet med koldioxidavskiljning efter metanisering.

Som kan ses i figurerna upprepas mönstret från det mindre fallet. Det är vid omvandlingen från fast biomassa till gas och efterföljande gasrening som huvuddelen av den kemiska energin går förlorad. I tabell S.2 sammanfattas studiens viktigaste resultat.

Tabell S.2 Sammanfattning av viktiga resultat

	10 MW _{th}		100 MW _{th}			
	Efter metanisering		Före metanisering		Efter metanisering	
	Vatten-skrubber	Amin-skrubber	Vatten-skrubber	Amin-skrubber	Vattenskrubber	Amin-skrubber
Metanslip (% av in)	1	0.05	1%	0.04	1%	0.05
Gasol (kg/Nm ³)	0.007	0	0.11	0.004	0.04	0.002
η_{SNG}	60.6%	61.2%	67.9%	68.4%	68.1%	68.7%
η_{ee}	60.7%	60.9%	68.3%	75.6%	73.9%	76.6%

Från tabellen går det att utläsa att de fall där vattenskrubbing används krävs mer gasoltillsats. Den högre metanslipen gör också att de resulterande verkningsgraderna till SNG blir något lägre än för aaminskrubberfallen. Den högre propantillsatsen gör dock att elverkningsgraderna påverkas mer i vattenskrubberfallen. Därutöver går det att konstatera att det mindre systemet är relativt likt normal rening efter rötning. Detta gäller gassammansättning, flöden och föroreningar. Därför bör samma avvägningar mellan amin- och vattenskrubber gälla som i rötningssystemet. I det större fallet är det klart att koldioxidavskiljning efter metanisering är att föredra då både verkningsgraden och gaskvaliteten blir bättre än rening före metaniseringen.



Table of Content

1	Introduction	12
1.1	Aim	12
1.2	Report structure.....	12
2	Production of SNG	13
2.1	H ₂ /CO-ratio.....	14
2.2	Reactor Designs.....	14
2.2.1	Recycle Gas Processes.....	14
2.2.2	TWR – Throughwall Cooled Reactor	15
2.2.3	Fluidized-bed reactor	16
2.3	Gas quality	16
3	Gasification, gas cleaning and gas conditioning	18
3.1	Gasification technologies	20
3.1.1	Fixed Bed Gasification.....	20
3.1.2	Fluidized Bed Gasification	21
3.1.3	Entrained Flow Gasification	23
3.1.4	Indirect gasification	23
3.2	Gas impurities and cleaning techniques.....	25
3.2.1	Particles.....	25
3.2.2	Tar	25
3.2.3	Sulphur	27
3.2.4	Ammonia.....	27
3.3	Gas conditioning.....	27
3.4	Process configurations.....	28
4	CO ₂ -capture technologies.....	31
4.1	Physical absorption	31
4.1.1	Methanol (Rectisol process)	31
4.1.2	N-methyl-2-pyrrolidone (Purisol).....	31
4.1.3	Dimethylether of polyethylene glycol (Selexol process).....	32
4.1.4	Water scrubbing.....	32
4.2	Chemical absorption.....	33
4.2.1	Monoethanolamine (MEA).....	33
4.2.2	Piperazine activated N-methyldiethanolamine (MDEA/PZ).....	34



4.2.3	Chilled ammonia	34
4.2.4	Potassium carbonate	34
4.3	Physical separation techniques	35
4.3.1	Pressure Swing Adsorption.....	35
4.3.2	Membrane separation.....	36
5	Models	39
5.1	System model.....	39
5.2	Gasification models	40
5.3	CO ₂ separation models	40
5.3.1	Water-scrubbing model.....	40
5.3.2	Amine absorption model	41
6	Case study	46
6.1	Case 1 – 10 MW _{th}	46
6.2	Case 2 – 100 MW _{th}	47
6.3	Results	49
6.3.1	Case 1 – 10 MW _{th}	50
6.3.2	Case 2 – 100 MW _{th}	52
6.3.3	On the absorption of inert gases.....	57
6.4	Discussion.....	60
6.5	Conclusions.....	61
7	Results and discussion	62
7.1	Future work	62
8	Conclusions	63
9	Acknowledgements	64
10	Literature.....	65



1 Introduction

The production of substitute natural gas (SNG) from biomass is an interesting route for CO₂ emissions reduction and substitution of fossil natural gas. SNG can be produced by gasification of biomass and subsequent upgrading of the producer gas. In the gasification of biomass a producer gas, which mainly contains hydrogen, carbon monoxide, carbon dioxide, methane and water, is produced. This gas can be upgraded via for example methanation and CO₂-removal to produce SNG. Several gas cleaning steps are also necessary.

The produced methane may be used as vehicle fuel or in any other application where fossil-based natural gas is used. To be able to use the gas as vehicle gas or for export to the gas grid the Wobbe-index has to be adjusted to the correct interval. If the gas is to be used as vehicle fuel the motor octane number also has to be sufficiently high. There are two ways of adjusting the Wobbe-index and that is to either add a hydrocarbon with a higher energy density than methane or to remove carbon dioxide. This specific project focuses on the second way of adjusting the Wobbe-index.

1.1 Aim

The purpose of the study was to investigate whether any of the existing carbon dioxide separation methods already used for biogas upgrading applications (water scrubbing, amine scrubbing or PSA) is suitable for use in biomass gasification and subsequent SNG production.

The gasification system simulations were performed using available operational data, models and literature information and focused on indirect gasification technology. Indirect gasification was chosen, as it is the biomass gasification technology with the most demonstration activities, the best data availability and the highest inherent methane formation. The technology is however limited with respect to scale-of-operation and thus the conclusions from this study will be relevant only up to circa 80-100 MW_{th}.

1.2 Report structure

The structure of the report is as follows. A brief description on how SNG is produced from biomass through gasification will be given in section 2 together with a short summary of the existing plants. In section 3 different gasification technologies will be described as well as the most common gas impurities encountered in gasification and the existing gas cleaning technologies to address these issues. A review of the most common CO₂-removal techniques will be presented in section 4, which is divided into physical absorption, chemical absorption and physical separation methods.

To investigate which parameters that are of critical importance for the CO₂-removal process a case study has been performed for small scale (10 MW_{th}) and large scale (100 MW_{th}) SNG-process. Two CO₂-removal techniques have been included in the case study namely water scrubbing (physical absorption) and amine scrubbing with MDEA/PZ (chemical absorption). These are described in section 5 with a detailed discussions on the specific problems related to a gasifier product gas and the results of the case study are reported in section 6. Section 7 summarizes the results for the entire project and section 8 is a summary of the main conclusions drawn within the project.



2 Production of SNG

The first step in synthesizing methane or SNG is production of synthesis gas (CO and H₂). This may be done from any kind of carbon containing material such as coal or biomass; more about syngas production in the next section. In order to increase the CH₄ content of the produced gas, methanation is required. The reaction is strongly exothermic and due to that, heat removal from the reactors is essential. [1]; a more extensive summary may be found here [2]. Methanation occurs according to reaction (1) and (2). Due to the high amount of heat that is released and to the high concentrations of the reactants, measures have to be taken to avoid hot-spots and to limit the temperature increase in the reactor. The temperature should also be kept low to favor the equilibrium [1].



The catalyst used in methanation reactors is most commonly nickel-based and supported on alumina, kaolin or calcium aluminate. Sulphur as well as arsenic is severe catalyst poisons, which must be removed upstream of the catalyst. The catalyst contain < 15 wt % nickel and precaution must be taken to prevent formation of the highly toxic nickel carbonyl Ni(CO)₄. The formation of the carbonyl is favored by low temperatures < 200°C and high carbon monoxide partial pressures. It is therefore important to have proper procedures for start-up and shutdown [1].

CO also reacts with iron to form iron carbonyl which is poisonous and cause problems with corrosion. Iron carbonyl also decomposes on the catalyst when the temperature is increased. Thus carbon monoxide must be heated in stainless steel heat exchangers. Years of plant operations have shown that with the right precautions, carbonyl formation can be suppressed successfully [1].

Carbon dioxide, in reaction (2), is first converted to carbon monoxide with the reverse shift reaction and then it is converted to methane according to reaction (1) [3]. The Boudouard reaction (3) will be thermodynamically favored at elevated temperatures, e.g. at the outlet of the reactor. However if temperatures are kept moderately low and small residual hydrogen exists in the gas outlet, it can be avoided [1].

Typically the reaction is operated at inlet temperatures of 250-300°C and at pressures in excess of 30 bar. The high pressure favors the equilibrium and also improves the kinetics [1]. As will be shown in the next section, CO₂ is co-produced when producing the synthesis gas used in the methanation. This carbon dioxide may be removed either upstream or downstream the methanation unit [4].



2.1 H₂/CO-ratio

Synthesis gas for methane production is often classified by their stoichiometric number (SN) which is the ratio between the hydrogen and carbon oxides according to equation (A) [5].

$$SN = \frac{v_{H_2}}{3v_{CO} + 4v_{CO_2} + 2v_{C_2H_4}} \quad (A)$$

For stoichiometric methanation, there is little risk of carbon formation according to the Boudouard reaction, even at elevated temperatures of up to 700°C. This becomes a problem at lower SN. Lower SN also requires carbon dioxide removal to a greater extent.

2.2 Reactor Designs

In order to control the heat of reaction in methanation there are several different reactors that have shown success. There are a number of commercially available methanation systems in use. Most of them are designed for methanation of syngas produced from coal gasification at high pressures. Thus, the methanation reactors are designed for pressures of 40-60 bar [2, 6].

2.2.1 Recycle Gas Processes

The recycle gas process uses adiabatic reactors with product gas recycling. The recycled gas increases the mass-throughput over the reactor, thus increasing the amount of heat that can be absorbed. The recycled gas is cooled and compressed to the reactor inlet pressure before it is mixed with fresh syngas.

Haldor Topsoe has developed a methanation process that is called TREMP™ (Figure 1), Topsoe's Recycle Energy-efficient Methanation Process. The system uses three adiabatic reactors that utilize product recycle and intermediate cooling. The temperature of the reactors is controlled by the recycle ratio and is held below the maximum allowed for the catalyst. The catalyst is developed by Topsoe as well and has good temperature resistance allowing temperatures of 250-700°C. The catalyst is called MCR-2X and according to Topsoe has excellent durability [2, 7].



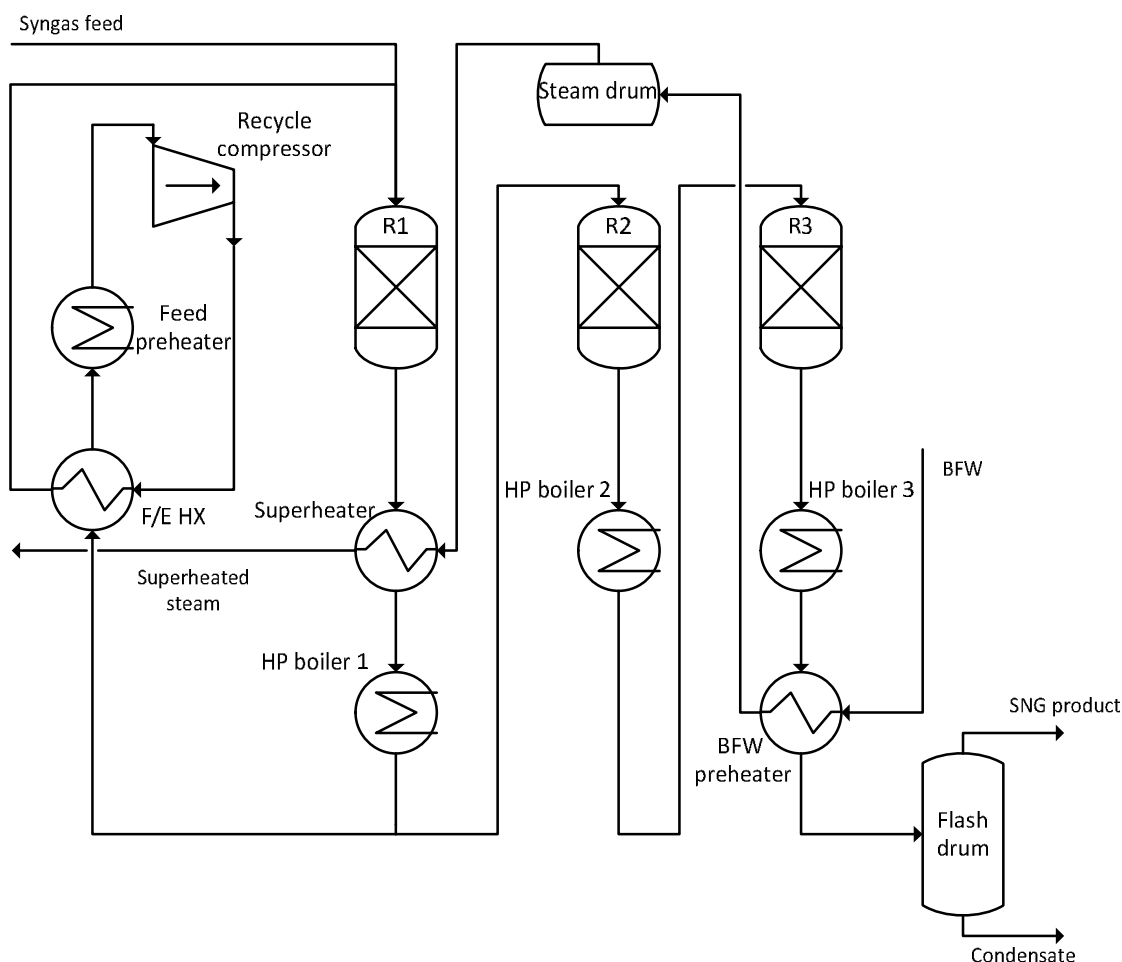

Figure 1. Haldor Topsoe's methanation process TREMP [7].

The disadvantage with recycling the product gas is the higher volume of gas that needs to be processed and the dilution of the reactant gases. It also increases the cost and energy loss due to the need to compress the recycled gas.

2.2.2 TWR – Throughwall Cooled Reactor

Throughwall cooled reactors are commonly used reactors in chemical processes that utilize heterogeneous gas reactions and is also known as the plug-flow reactor. The reactor design is relatively simple and uses a shell and tube approach. The tubes are filled with catalyst and the tubes are cooled either by boiling water or oil. Figure 2 shows a TWR system [1].

The cooling method utilized in these types of reactors increases the difficulties of controlling the heat of reaction. As the methanation reactions are highly exothermic, the temperature control becomes increasingly difficult and thus, hot-spots can pose a problem in TWR reactors [1].

The main advantage with the plug-flow reactor is that only one reactor is needed and this is because the reactor can contain any number of tubes. This results in lower investment and operating cost. The biggest disadvantage of the reactor is the problems involved in replacing depleted catalyst [1].



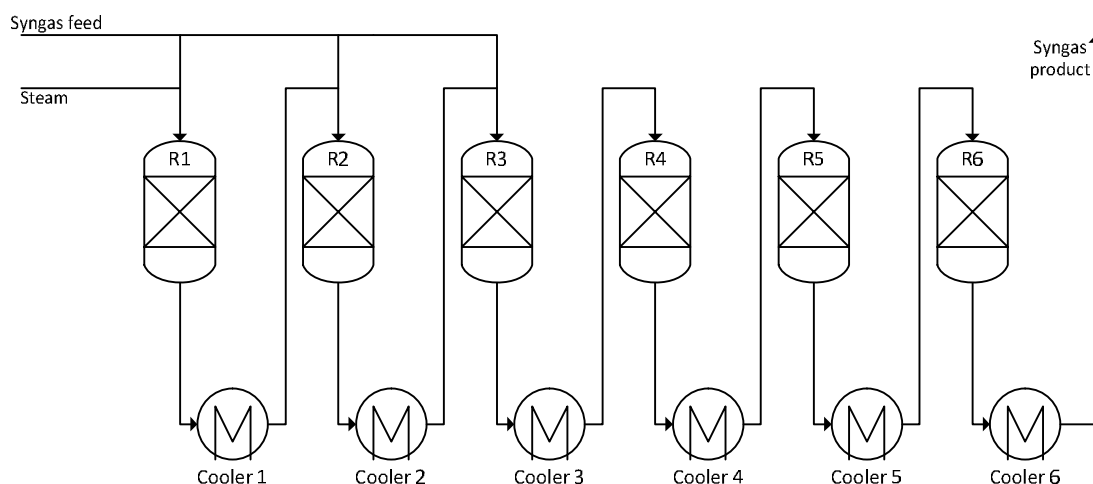

Figure 2. Single-pass throughwall cooled methanation process [1].

2.2.3 Fluidized-bed reactor

Methanation as well as other highly exothermic processes can favorably be carried out in a fluidized reactor. The main advantages with fluidized bed reactors are; evenly dispersed catalyst and reactant gases, low thermal gradients and thus better temperature control and easy catalyst replacement.

Two processes were found in the literature that uses a fluidized-bed – developed at Thyssen and Paul Scherrer Institute. The *Comflux* methanation was operated 1980-1985, for about 8,000 h and was developed by Thyssengas. The process was run at 60 bar and with a H_2/CO of 2.7-4. This has several advantages such as minimizing the carbon dioxide formation from the water-gas shift reaction [8]. In addition to this, further work has been performed in recent years at Paul Scherrer Institute [9-11].

2.3 Gas quality

There are significant differences in gas quality within Europe. Describing the differences in the various gas qualities is outside the scope of this report. For more information on the various gas qualities the webpage of Swedish Gas Technology Centre, www.sgc.se, is recommended. In this report the Swedish standard for vehicle gas has been used as a target quality [12], more specific the type A quality. The major properties are summarized in Table 1. The motor octane number is determined using calculations as per ISO 15403 [13]. The problem with using this definition in this case is the hydrogen content. The standard does not take into account any hydrogen content in the gas. An alternative method is to use the definition in SAE 922359 [14]. However, also this expression has been developed without hydrogen in the gas and even though it may be used for determining the motor octane number in this case, its validity may be questioned for the gas mixture at hand. Therefore, the motor octane number has not been reported for the case study although they are within range of that specified in ISO 15403.



Table 1. Summary of gas quality used in the project

Property	Unit
Energy content expressed as lower Wobbe index (MJ/m³)	44.7-46.4
Motor octane number MON	130
Dew point	5 degrees below the lowest daily average monthly temperature
Water content (mg/m³)	32
Inert gas (max vol-%)	4%
Oxygen content (max vol-%)	1%
Sulphur (mg/m³)	23
Nitrogen compounds (mg/m³)	20



3 Gasification, gas cleaning and gas conditioning

The first useful gasifier was constructed during the 1840's in France and the technology has been in development ever since. The intensity of the development, especially for fuel and chemical production, has to a large extent been dependent on the crude-oil price, something that became very evident after the oil crisis during the 1970's, when intense development was commenced in Austria, Sweden, Finland and the US, aiming at producing substitutes for oil. During the 1990's the development focused on the production of electricity and demonstration plants were built in Sweden and England.

In the gasification process a carbonaceous fuel, e.g. coal or biomass, is reacted with air or oxygen (and in some cases steam) to yield a gas containing mainly hydrogen, carbon monoxide, carbon dioxide, methane and water. This is normally performed at temperatures between 500°C and 1,400°C, with pressures ranging from atmospheric to 35 bars.

The gasification can be divided into four phases, depending on what is happening to the biomass introduced into the gasifier. The first phase is drying, during which the moisture in the biomass is driven off until the fuel is completely dry. After that pyrolysis occur; non-condensable gases and tar is produced from the biomass, the solid fraction of which forms charcoal. Part of the charcoal and the combustible part of the non-condensable gases react with the oxygen present in a partial combustion. This combustion of charcoal and combustible gases is what supplies the heat to the other three phases of gasification. The oxygen introduced into the system is sufficient to make the overall process auto-thermal. The amount of oxygen required depends on things like moisture content of the biomass, the amount of steam introduced, the heat-losses associated with the gasification etc. The last phase is a reduction phase where charcoal and hydrocarbons are reacted with gaseous carbon dioxide and water to form carbon monoxide and hydrogen. The different phases are summarized for both direct [15] (Figure 3) and indirect gasification (Figure 4).



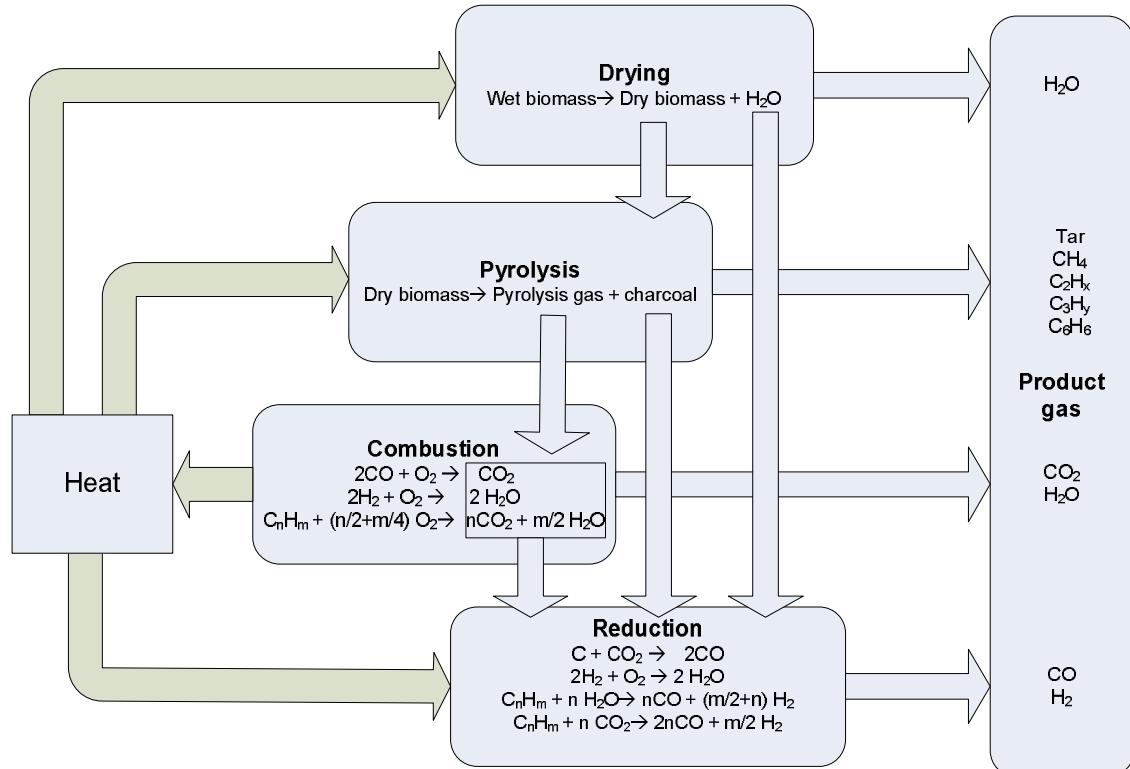

Figure 3. Schematic overview of the four phases of gasification, including reactions and products [15].

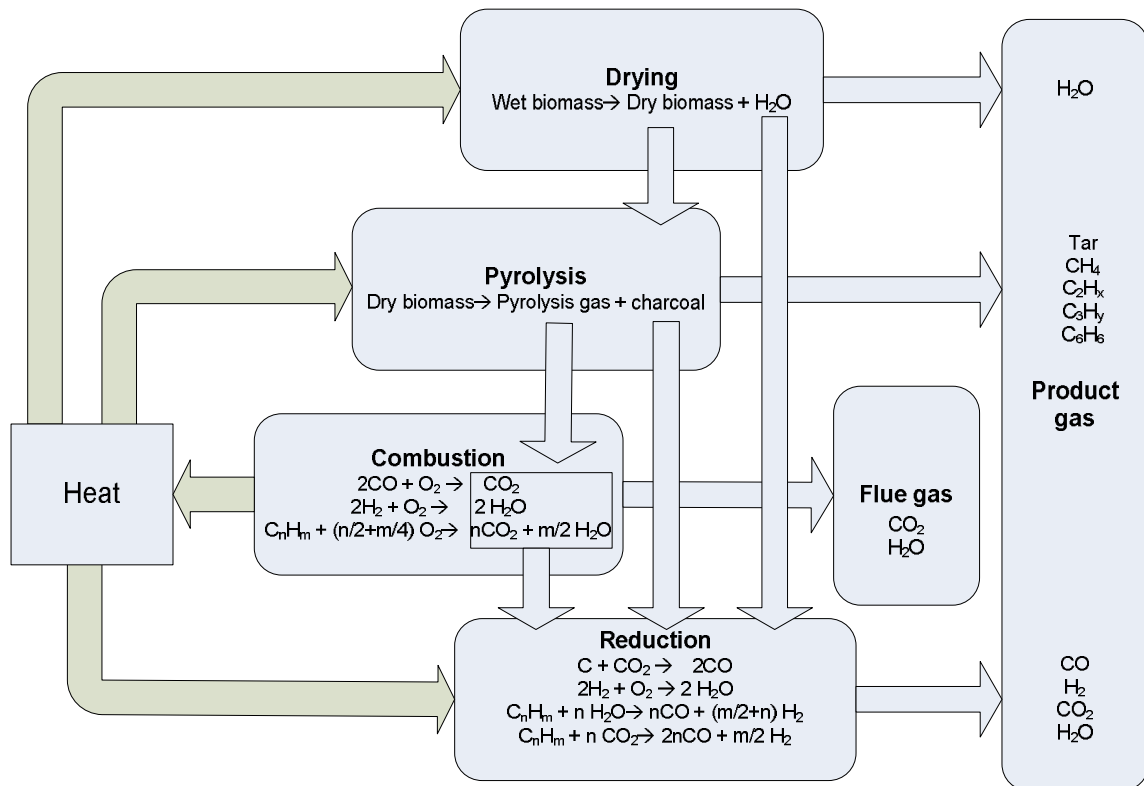

Figure 4. Schematic overview of the four phases for indirect gasification.



The gas leaving the gasifier hence contains CO, CO₂, H₂O, H₂, CH₄, other gaseous hydrocarbons and N₂ (the N₂ level depends to a very large degree on whether air or pure oxygen is used in the gasifier as oxidant). These components are considered to be the main products of the gas. Aside from these, charcoal and ash is obtained as solids. Tar and trace amounts of HCN, NH₃, HCl, H₂S, as well as other sulphur-containing species, are obtained as contaminants in the gas.

The gas composition for some of the most common gasifier types is given in table 2.

Table 2. The gas composition leaving common gasifiers, Atmospheric Circulating Fluidized Bed with steam/oxygen (ACFB), Pressurized Circulating Fluidized Bed with steam/oxygen at 20 bar (PCFB) and Indirectly heated gasifier (MILENA) [16].

	Unit	ACFB	PCFB	Indirect
CO	Vol-%	27	20	40-43
H₂	Vol-%	32	19	15-20
CO₂	Vol-%	29	40	10-12
CH₄	Vol-%	8	15	15-17
N₂	Vol-%	0	0	1-4
C₂⁺	Vol-%	3	5	5-6
Benzene	Vol-%	1	1	1
Tar	g/Nm ³	11	16	40

As shown in Table 2, the product distribution is dependent on the conditions used in the gasification, e.g. the gasification medium, gasifier design and residence time etc. In general, the process is kinetically limited and hence the thermodynamic equilibrium is not obtained, something further emphasised by the presence of tars in the producer gas.

3.1 Gasification technologies

There are a number of gasification designs that can be used to produce gas from biomass. The different designs are more or less well investigated and which type of gasifier chosen depends to a large extent on the planned power output of the gasifier. One classification that is done on biomass gasifiers is, as mentioned above, fixed (or moving) bed, fluidized bed and entrained flow gasifiers. Where fixed bed gasifiers are used in small-scales (<5MW_{th}), fluidized beds are used in medium size gasifiers (5-200 MW_{th}) and entrained flow gasifiers are preferred in large scale (>100-700 MW_{th}) [17]. The different gasifiers will give different gas qualities that can be of interest when choosing gasification technology, depending on the application of the gas. Aside from these three types, indirect gasification should be mentioned, where the heat required for reaction is added without introducing the means of oxidation into the gasifier. Indirect gasification can be implemented in any of the three main categories of gasification technologies described above.

3.1.1 Fixed Bed Gasification

Fixed bed gasification is the simplest way to convert biomass to a useful gas, and the first gasifiers ever built were of this type. The wood-gas generators used for car propulsion in Sweden during the Second World War belonged to this category.



This category of gasifier is usually divided into three sub-groups, depending on the flow direction in the gasifier. These subgroups of fixed bed gasifiers are updraft, downdraft and crossdraft gasifiers and are grouped according to the gas flow direction. Examples of these three subgroups are shown in Figure 5.

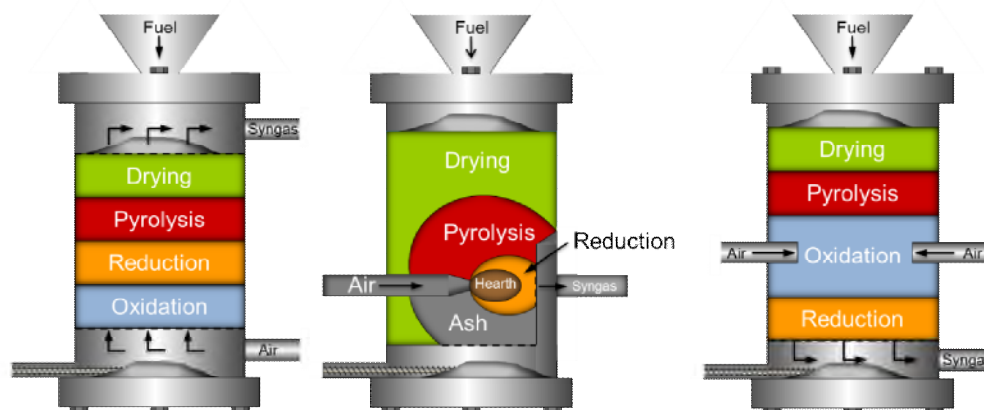

Figure 5. Different types of fixed bed gasifiers, from the left: updraft, crossdraft and downdraft, adapted from [18].

Independent of the type of fixed bed gasifier used, the fuel is introduced in the top of the gasifier and the operating temperature is between 300°C and 1,000°C, depending on where in the bed it is measured. What determines which sub-category the gasifier end up in is determined by the flow path of the oxidant (air, oxygen, steam) through the reactor and where it is introduced. In updraft gasification, the oxidant is introduced in the bottom of the reactor and producer gas exits in the top. This means that the pyrolysis zone is closer to the exit than in the other two sub-categories. In downdraft and crossdraft gasification, the oxidant is introduced in the middle of the gasifier; however the exit is situated in different positions (in the bottom and the side) for the two types of gasifiers. The fixed bed gasifiers are primarily run at atmospheric pressure.

The advantages with fixed bed gasifiers are that they are simple in construction and that the exiting gas has a relatively high heating value. Updraft gasifiers are in-fact the gasifier with the highest tolerance with regards to particle sizes and moisture content of the fuel. Downdraft gasifiers generate, despite its simple construction, a gas with relatively high quality, low tar content and low amounts of particulate matter. Out of the three sub-categories, crossdraft gasifiers are the ones generating the lowest quality gas, with low energy content and high tar contents. Updraft gasifiers have, due to the design, inherently high tar levels in the gas (10-20 %) and the high temperature at the ash grit indicate problems with clogging in this region. Clogging of the ash-grit is a problem in downdraft gasification as well as higher air/oxygen requirements, bad fuel conversion (4-7 % non-converted charcoal) and high requirements on the biomass quality (moisture content, particle sizes etc.) [18].

3.1.2 Fluidized Bed Gasification

The fluidized bed, with a bed material commonly consisting of sand that improves the heat transfer, is well suited for gasification. This category of gasifiers can be divided in bubbling bed gasifiers, where the gas bubbles through the sand bed and



circulating fluidized bed gasifiers where the bed material exits the gasifier with the gas stream; the fluid bed material is then separated from the gas stream and brought back into the gasifier. As mentioned above, indirect gasification can be of any kind of gasifier but is usually a variation on the fluid bed theme, Figure 6 show the two types of fluidized bed gasifiers used.

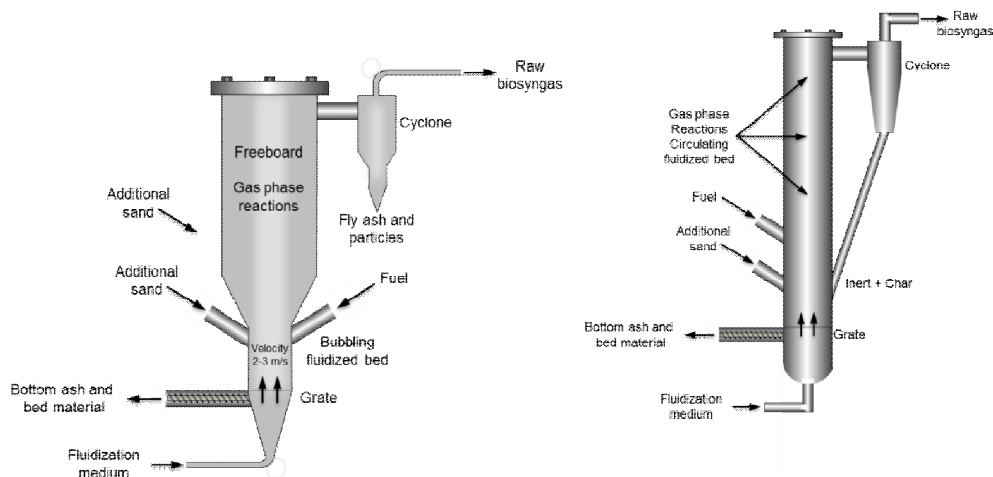

Figure 6. The different categories of fluidized bed gasification, bubbling bed to the left and circulating fluidized bed to the right, adapted from [18].

In the bubbling bed gasifier, the fuel is fed into or just above the bed and the oxidant (oxygen, air, steam) is introduced from below with speeds of about 1-3 m/s through the bed, resulting in bubbles up through the bed. The most important factor is the velocity of the oxidant, which decides the size and speed of the bubbles and in turn the heat transfer and mixing in the system. The gas exiting the top of the gasifier is cleaned from sand and ash using a cyclone filter. The operating temperature is in the 650°C to 950°C range.

In circulating fluidized bed gasifiers a higher gas velocity is used, 5-10 m/s, which suspends particles in the entire reactor and pulls parts of the sand and charcoal out of the reactor with the exiting gas stream. A cyclone filter separates and returns the particles to the bed; the gas is removed from the top of the cyclone. The temperature is usually in the 800°C to 1,000°C range. Both types of fluidized bed gasifiers are operated at both atmospheric pressure and under higher pressures, 35 bar (bubbling bed) and 20 bar (circulating bed) [18].

Fluid beds allow higher gas throughput than fixed bed gasifiers, with the highest gas throughput for the circulating bed. This result in good mixing, optimized kinetics, good gas/particle contact, high heat transfer rates and long residence times. These factors help in obtaining a high conversion of charcoal and a high yield. Aside from that, the tar content of the exiting gas is approximately 10 g/Nm³, which is considered low, but not as low as in downdraft fixed bed gasification and entrained flow gasification. The use of a bed material also gives the opportunity to introduce catalysts into the bed to e.g. lower the tar content of the gas. The disadvantage of this kind of gasifiers is the higher amount of particulate matter in the gas, there is also a risk of bed agglomeration due to the high alkaline content of the biomass [18].



3.1.3 Entrained Flow Gasification

This type of gasification takes place at higher temperatures than the other gasifier designs described ($>1,200^{\circ}\text{C}$). It also requires significantly smaller fuel particles than any other gasifier design. The residence time in the entrained flow gasifier is short, in the magnitude of a few seconds, and the produced gas is virtually tar free. Another advantage is that the ashes produced contain no water-soluble compounds. However, a larger part of the energy content in the fuel is consumed to heat the gases. Figure 7 show two designs of entrained flow gasifiers [18].

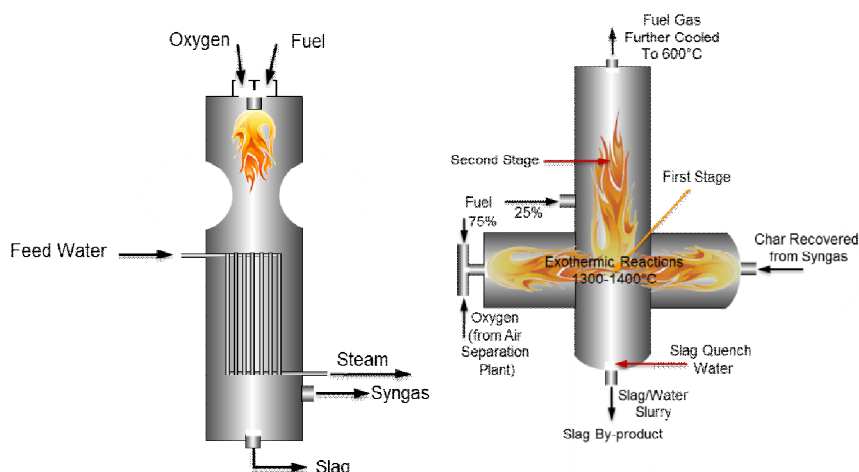

Figure 7. Different designs of entrained flow gasifiers, a downstream gasifier to the left and an upstream gasifier to the right, adapted from [18].

A mixture of oxygen and finely ground biomass is introduced in the inlet of the gasifiers and the fuel is gasified in a flame during a few seconds. The gas is then quenched to avoid too much strain on the material in the gasifier exit. During the quenching there is large amounts of steam produced, which has to be utilized either in electricity production or some other industrial application to enable an economically feasible operation. However, a large amount of the heating value in the fuel is used for heating the gases. The production of the fine powder needed for this kind of operation is also energy intense. Yet another drawback is that the materials needed to handle the high temperatures of the gasifier are expensive [18]. Variations of entrained flow gasification include the use of coal powder to provide the cooling instead of steam and the use of a pre-pyrolysis step. In the pyrolysis step, the biomass is heated rapidly and then quenched producing a liquid which is then used in the gasifier.

3.1.4 Indirect gasification

Indirect gasification indicates that heat is added through some kind of heat exchange, avoiding dilution of the product gas. This type of gasification can be performed using any kind of gasification principle, but is mostly performed in fluidized bed gasification. The heat can be added by e.g. heat exchanging, using steam in the bottom section of the gasifier, or by adding heat to the fluidization material before it enters the gasifier. An example of this type of twin-bed gasifier is given in Figure 8. Gasification is performed in one fluidized bed while combustion of charcoal residue is performed in the other and the hot sand is returned to the gasifier.



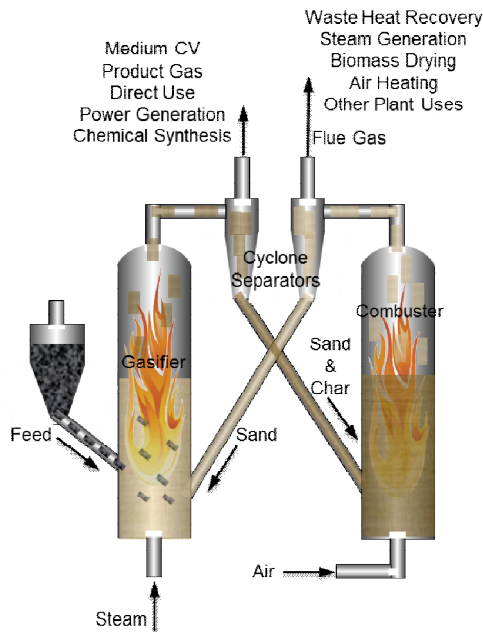

Figure 8. Example of indirect gasification with the gasification bed to the left and the combustion bed to the right, adapted from [19].

There are two alternative developments of indirect gasifiers, based on fluidized bed technology, with commercial activities available in Europe at the time of writing this report. This is the MILENA concept out of ECN [20] and the FICFB concept out of TU Vienna [21]. The two systems for the synthesis of SNG was compared in 2010 [4]. The FICFB-based concept is based on an integration of gasification, gas filtering, and gas scrubbing and tar plays an important part. Since the filter in the FICFB operates below 150°C, the tar dew point should be less than 150°C. Furthermore, the scrubber consumes RME to remove tars. FICFB aims at relatively low tar production, contrary to the MILENA. The low tar yield in the FICFB concept is achieved by using olivine as bed material and adding more steam to the gasification; 5 times more steam is required in FICFB compared to MILENA. The conversion of solid biomass in the gasification zone is relatively high (90%) in FICFB and in the MILENA case 80-85% carbon conversion. Because of the differences in conversion and steam consumption, the energy balances of FICFB and MILENA are different. The FICFB gasification zone requires higher heat influx to supply the energy for the endothermic reactions and steam heating. The higher conversion also indicates a higher requirement for supplementary fuel in the combustion part of the FICFB gasifier. The MILENA gasifier needs less energy in the gasification zone, because conversion within the gasification zone is lower. At the same time, more char is left to supply the heat for the gasification zone from the combustion zone. But also the MILENA concept generally will require supplementary fuel. In the MILENA process the tar from the gas cleaning system is used as additional fuel. In the FICFB additional producer gas is recycled to supply the additional heat.



3.2 Gas impurities and cleaning techniques

Before using the producer gas it has to be purified in different ways. The largest issues are particles and tars, but also presence of sulphur and ammonia will complicate some applications.

3.2.1 Particles

Particles are formed to a high degree in gasification, independent of the gasifier type, and have to be removed before any downstream processing. A first, crude separation is usually performed in one or several cyclone filters at high temperature. After that, ordinary bag-house filters (e.g. ceramic or textile) can be used to remove the finer particles. A problem with this technique is tar condensation in the filters and there is much work performed on trying to achieve filtration at as high a temperature as possible. High temperature filters, operating above 400°C is not uncommon, and in that case tar condensation is not an issue. However, small aerosols that pass the filter can agglomerate to larger particles and cause problems downstream [22].

3.2.2 Tar

The composition, analysis and decomposition of tar are areas of research with a lot of activity, and this has resulted in several ways of classifying the tars. One definition of tar component is:

"very complex heterogeneous aqueous mixtures of organic molecules (aromatics, phenols, bases, asphaltenes, preasphaltenes, and particulate matter) in a broad range of concentrations related to the formation conditions (temperature, residence time pressure, feedstock, reactor design)" [23].

Aside from this, a number of experts within the field have accepted a definition that all species with a molecular weight larger than benzene is to be considered as tar in a gasification context [24]. Although the definitions may differ, everybody is in agreement that tars are one of the largest technical challenges of gasification.

As mentioned before, the amount of tar in the exit gas of the gasifier is very much dependent on gasifier design and operation, but is in the 1-5 wt% range or approximately 10 % of the inlet lower heating value (at least for non-entrained bed gasifiers). The functional group and formation temperature of the tar can be described as below:

Mixed oxygenates (400°C) → Phenol-ethers (500°C) → Alkyl-phenoles (600°C) → Heterocyclic-phenoles (700°C) → Poly-aromatic species (800°C) → Larger Poly-aromatic species (900°C)

A classification of different tars is to divide them into four groups, depending on their formation. These groups are primary products, secondary products, alkylated tertiary products and condensed tertiary products, which is shown in Figure 9 [25].



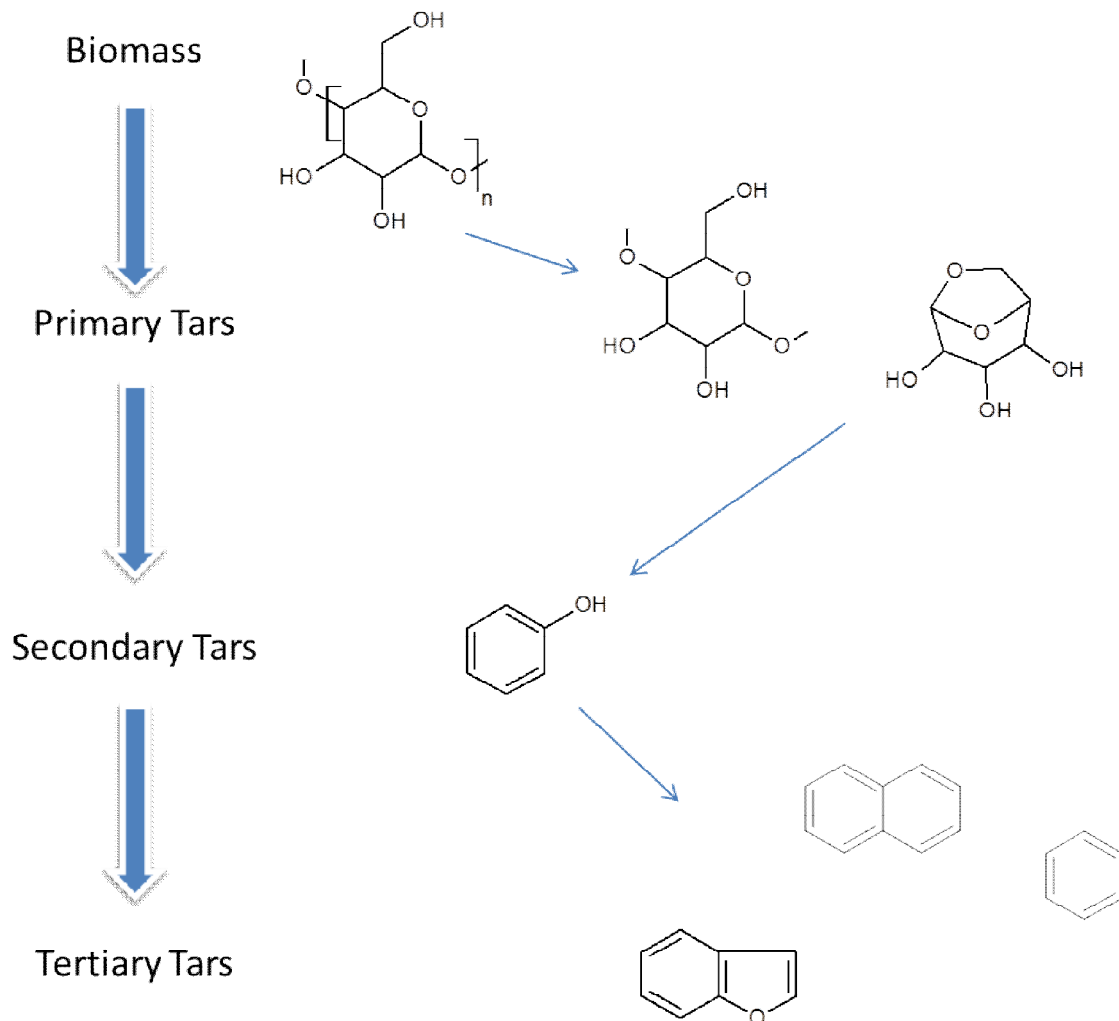

Figure 9. The first classes of tars and their origin [25].

Those organic species that are derived from cellulose, hemi-cellulose and lignin, are sorted in the first class, while phenols and olefins are classified as secondary products. The alkylated tertiary products are methylated aromatic species, while the condensed tertiary products are aromatic compounds such as benzene, naphthalene, acenaphthylene, anthracene and pyrene.

These tar classes are formed at different temperatures, and rearrangements from one tar class to another will happen as temperature increases. The primary tars are present at 500°C to 800°C, the secondary tars between 500°C and 1,000°C, the alkylated tertiary products are present between 650°C and 1,000°C while the condensable exist above 750°C. The formation of tar as well as the transition between the various classes of tar is a function of residence time and temperature.

Removing the tar from the producer gas can be done using any of a number of available unit operations, but the most important thing is that the gasifier is operated at optimal conditions to minimize the initial tar formation. In fluid bed and entrained flow gasification a first step can be catalytic tar cracking after particle removal. In fluid bed gasification a catalyst, active for tar cracking, can be added to the fluidizing bed to further remove any tar formed already in the bed. In this kind



of tar removal, natural minerals, such as dolomite and olivine, are normally used. Another option would be to use catalysts normally used in hydrocarbon reforming or cracking. The tar can also be reformed to CO and hydrogen by thermal reforming, where the temperature is increased to 1,300°C and the tar decomposes. Another method to remove tar from the gas is to scrub it by using hot oil (200-300°C). The tar dissolves in the hot oil, which can be regenerated to some part and re-used; the other tar containing part is either burnt or sent back to the gasifier for regasification.

3.2.3 Sulphur

The sulphur content of the gas depends on which type of biomass is used, gasification agent etc. However, a sulphur content at or above 100 ppm is not unusual. Sulphur levels this high are not acceptable if there are catalytic processes downstream. The sulphur in the process is in both organic (COS and CS₂) form as well as H₂S. The organic sulphur is transformed into H₂S either in the water-gas shift or in a separate hydrolysis reactor. The H₂S can be separated by adsorbing it in ZnO, an irreversible process, or a reversible adsorbent that is commercially available can be used [26]. It is also possible to scrub the gas with an amine solution (or water for that matter) to remove the sulphur compounds. If a reversible alternative is chosen, elementary sulphur can be produced using the Claus process.

3.2.4 Ammonia

The levels of ammonia formed in gasification (3,000 ppm is not uncommon) are normally not considered a problem for downstream combustion applications. When combusting the gas, nitrogen or in worst case NO_x (so called fuel NO_x) is formed. There are however indications that the ammonia content could be problematic for other applications, especially when the gasification is followed by downstream catalytic processes, e.g. steam reforming where the catalyst might suffer from deactivation by long term exposure of ammonia.

3.3 Gas conditioning

After leaving the gasifier and gas cleaning units, the gas has to be conditioned. At this point, the gas does not have the correct composition with respect to producing SNG. Therefore the SN has to be adjusted before sending the gas into the SNG synthesis. This is done using the water-gas shift reaction [27]:



The water-gas shift is an equilibrium reaction and is usually performed in two adiabatic reactors in series. The first reactor contains a FeCr-oxide catalyst operating at higher temperature and the second a CuZn catalyst operating at lower temperature. The procedure may be seen in Figure 10.



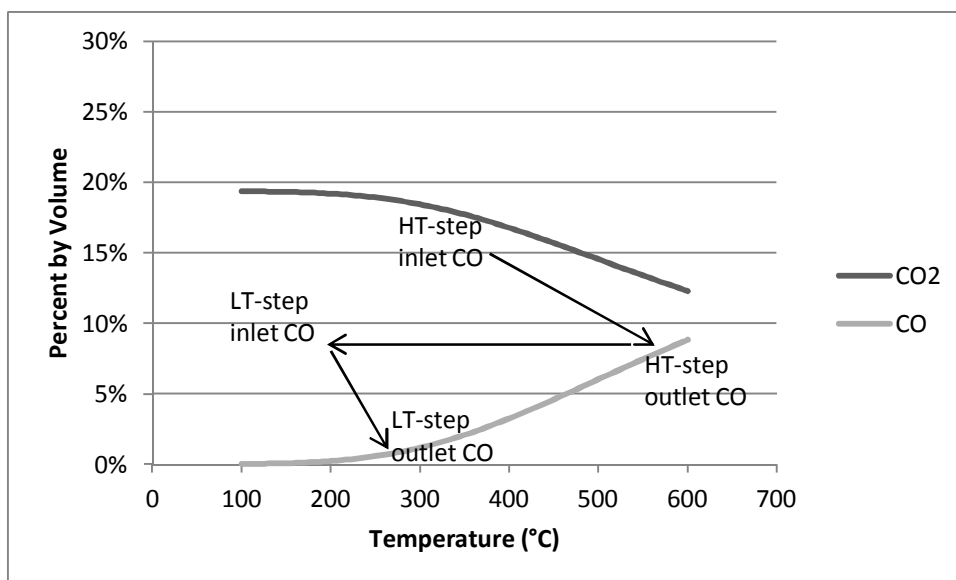

Figure 10. Schematic representation of the water-gas shift reaction, adapted from [27].

The first stage catalyst may tolerate sulphur, but the second stage catalyst will be permanently deactivated by the presence of sulphur [28]. The general strategy for tuning the SN is by splitting the gas stream upstream of the water-gas shift and converting the CO in the stream passing through the reactor to as high a degree as possible [29].

3.4 Process configurations

First of all, it should be realized that what gasifier technology to prefer (from the ones mentioned above) and which oxidant to use is to a large extent depending on the planned application of the gas. The first criterion for choosing gasification technology is the desired plant size. After that the oxidant is chosen, depending on the gas quality desired. If an energy dense gas is required, the oxidant of choice would be oxygen and/or steam or indirect gasification. If downstream processes are favoured by high pressures, the gasifier is usually pressurized to avoid (or at least minimize) any compression of the gas.

The combination of gasifier, gas cleaning, gas conditioning, carbon dioxide removal and SNG synthesis can be performed in many ways. Depending on the sulphur-tolerance of the catalysts used, the sulphur removal may be performed upstream or downstream the water-gas shift and/or the SNG synthesis. The CO₂ removal may also be performed either before or after the SNG synthesis. The upstream removal will create higher temperature in the SNG synthesis. In Figure 11 some alternative process configuration has been suggested.



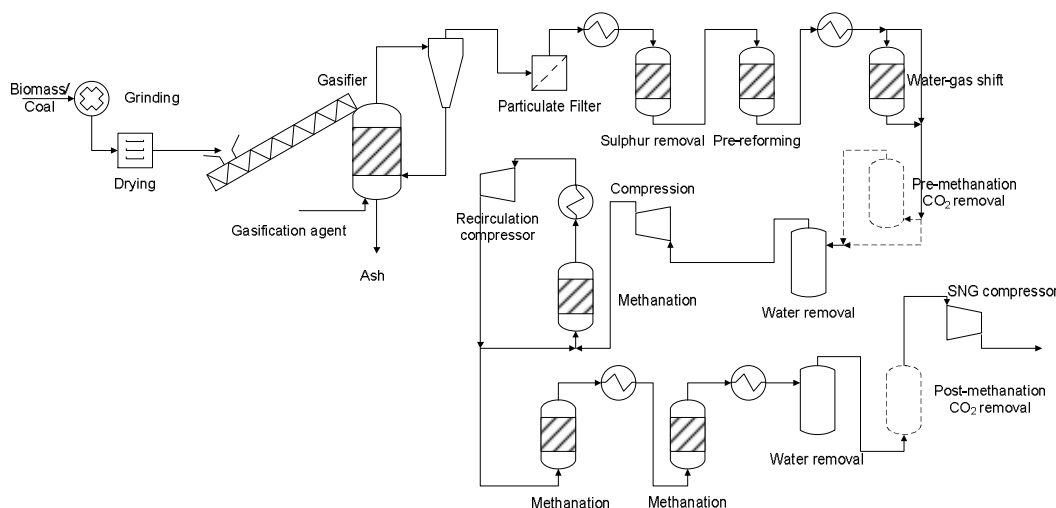

Figure 11. Possible reactor configuration for producing SNG from solid carbon feedstocks.

As may be viewed in the figure, the carbon dioxide removal may be positioned either before or after the methanation/SNG-synthesis. However, only one of these should be required in any given case. The advantage of pre-methanation removal is that CO and H₂ has much lower solubility in the scrubbing media, should a scrubbing method be used for CO₂ removal.

For evaluating the system there are two measures used in this report. The SNG efficiency which is the lower heating value of the SNG produced divided by the biomass input, Eq. B.

$$\eta_{SNG} = \frac{LHV_{SNG}}{LHV_{Biomass}} \quad (B)$$

This measure is quite simple and does not take parasitic power input, such as electricity for pumps, compressors control system etc. into account. However, its simplicity makes it quite attractive. Another measure which is useful when using mixed energy carriers in efficiency calculations is the electricity equivalents method used to represent the overall exergy of the system [30]. It is calculated using power generation efficiencies, using the best technology to the knowledge of the author's, as described in Table 3. The resulting overall efficiency of the system, on electricity equivalents basis, is designated η_{ee} below with the unit MW_{ee} where ee denotes electricity equivalents.

Table 3. The used conversion factors for determining the $\eta_{el\ equiv}$.

Energy Carrier	Power Generation Efficiency (LHV to electricity in %)	Reference
Biomass	46	Efficiency in IGCC Plant [31]
Hot water	10	Use of Opcon Powerbox [32]
SNG	50	Combined cycle [33]



The resulting equation becomes, Eq. C:

$$\eta_{ee} = \frac{Output}{Input} = \frac{Q_{SNG} * 0.6 + Q_{Hot\ water} * 0.1 + Electricity\ export}{(Q_{Biomass} * 0.46 + Electricity\ input + Heat\ input * 0.1)} \quad (C)$$

It should be noted that this efficiency is calculated before any addition of propane has been done.



4 CO₂-capture technologies

CO₂ capture technologies can refer to many forms of CO₂ removal such as chemical absorption using amines and physical absorption using various solvents, membrane technology, as well as pressure swing adsorption. As mentioned above, the carbon dioxide may be removed either upstream or downstream the methanation unit [4]. The two methods chosen for use in the simulations are described in more detail in the next chapter.

4.1 Physical absorption

Physical absorption occurs by mass transfer of gas molecules into a solvent described, a process by Henry's law which states that the amount of absorbed gas is proportional to the partial pressure of the gas. Physical absorption can be used for both the removal of CO₂ and the removal of sulphur. By sharing the equipment between the absorption systems some economy of scale can be achieved.

The most commonly used physical solvents and processes are methanol at low temperature (Rectisol process), N-methyl-2-pyrrolidone (Purisol process), propylene carbonate (Fluor process), dimethyl ether of polyethylene glycol (Selexol process) and water scrubbing.

The physical solvent scrubbing technology uses various solvents in which the CO₂ is dissolved and does not chemically react with the solvent. The CO₂ is separated from the solvent in the stripper mainly by reducing the pressure. Thus the physical solvent scrubbing technologies usually have lower specific energy consumption than the chemical absorption technologies. A main disadvantage is the lower loading capacity of the solvent since this is determined by the partial pressure of the CO₂.

4.1.1 Methanol (Rectisol process)

The Rectisol process was developed and licensed by Linde AG and Lurgi AG in 1989. The process utilizes a cooled methanol solvent for absorption of CO₂ and H₂S from a fuel gas. The fuel gas can be produced via gasification or other processes. The Rectisol process is often used for the production of synthesis gas via gasification as the methanol solvent can also remove some trace elements present in the raw synthesis gas, such as COS, CS₂, mercaptans, ammonia, HCN and higher hydrocarbons. Ammonia and HCN are removed in the Lurgi-process in a cold methanol pre-wash step and the sulfur components are removed using the CO₂-loaded methanol solvent. The carbon dioxide is absorbed in the methanol using a two stage absorption process operating at a low temperature, -30 – -5°C. Because the process operates at such a low temperature it also facilitates dehydration. A consequence of the low temperature needed for absorption the operational cost for refrigeration of the solvent is high [34, 35].

An interesting aspect of the Rectisol solvent is that it has the ability to separate absorbed impurities, such as HCN, aromatics and organic sulfur compounds [34].

4.1.2 N-methyl-2-pyrrolidone (Purisol)

The Purisol process was developed and commercialized by Lurgi AG. The Purisol process uses N-methyl-2-pyrrolidone (NMP) as the solvent and is often used for selective H₂S removal, since NMP has a very high solubility for H₂S. The solubility of hydrocarbons is also rather high, increasing with molecular weight [34].



4.1.3 Dimethylether of polyethylene glycol (Selexol process)

The Selexol process uses dimethyl ethers of polyethylene glycol as the solvent for absorption of carbon dioxide. The Selexol solvent has a high capacity for absorption of impurities such as sulfur impurities, mercaptans, as well as ammonia, HCN and other higher hydrocarbons.

H₂S is up to nine times more soluble in the Selexol solvent than CO₂, which makes it suitable for selective removal of H₂S. Hydrocarbons are also very soluble in the solvent and the solubility increases with increasing molecular weight. Water is also highly soluble in the Selexol solvent. Due to this quality the Selexol process is often used for simultaneous hydrocarbon and water dew point control [34].

4.1.4 Water scrubbing

Water-scrubbing uses the different solubilities of carbon dioxide and methane in water, especially at low temperatures and high pressures. An example of a water-scrubber process is given in Figure 12.

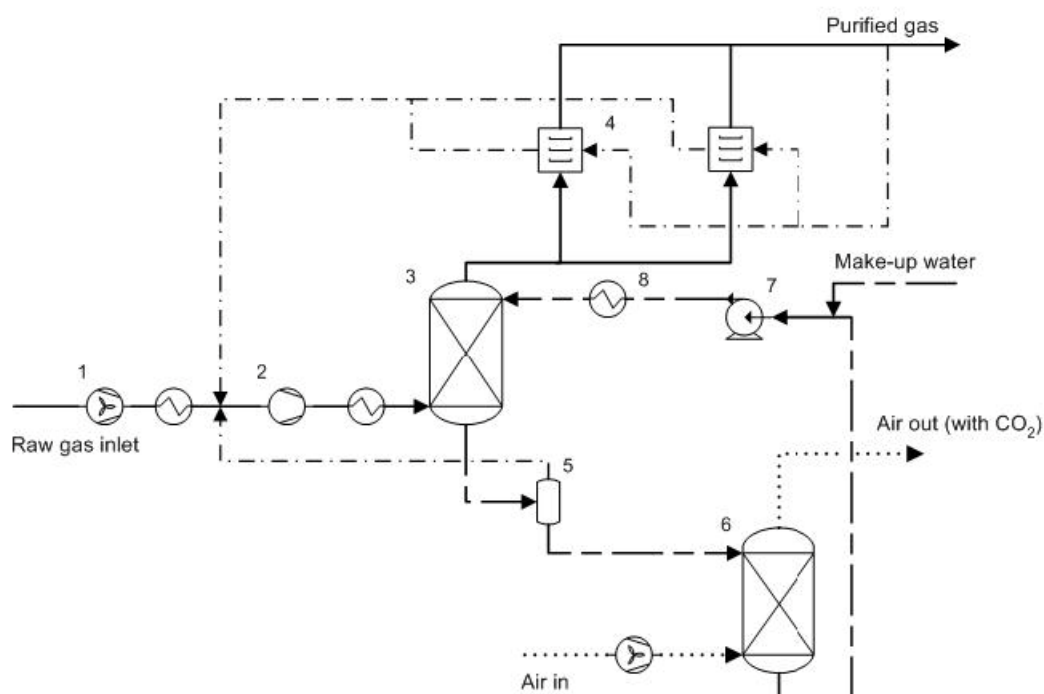

Figure 12. An overview of the water scrubbing process. The streams connected to the main gas flow, the recirculating water flow, the stripping gas, and the recirculating gas streams are represented by solid, dashed, dotted, and dash/dotted lines, respectively. The most important components are: 1 Raw gas fan, 2 Compressor, 3 Absorber, 4 Adsorber (drying), 5 Flash tank, 6 Stripper, 7 Pump, 8 Cooler [36].

The removal of carbon dioxide takes place in an absorption column where the gas is introduced in the bottom of the column and the water is sprinkled from the top over the packing in the column which is there to enhance the contact area between the gas and the liquid phases. The process takes place at a low temperature and at elevated pressure. Assuming raw biogas fed to the system, the gas leaving the scrubber has very high methane content, up to 99% dry volume, but is



saturated with water and needs to be dried. The water leaving the scrubber has adsorbed some methane in addition to the carbon dioxide. Some of this methane is removed from the water stream in a flash tank where the pressure is lowered. Some carbon dioxide is removed as well but because of the much higher partial pressure of carbon dioxide compared to that of methane in the flash tank a much higher fraction of the methane is recovered. This vapor stream from the flash tank can be recirculated to the raw gas inlet. The liquid stream is introduced to the top of a desorption column meeting fresh air from the bottom and most of the carbon dioxide is desorbed from the water stream following the gas out. This gas stream is then removed for further gas treatment. The desorption takes place at ambient pressure. The liquid is then cooled and recirculated to the absorption column for a new round of carbon dioxide removal. Hydrogen sulphide is also soluble in water and leaves with the liquid stream and can also be removed in the desorption column but some remains in the water. Therefore other removal options like filters on the water flow can be used or by removing some of the process water and replacing it with fresh water when the amounts of hydrogen sulphide reaches too high levels. Water scrubbing has advantages in no heat use, no use of chemicals and desulphurization is carried out in the same step. The draw-backs are the relatively high electricity costs for compression of the gas and fairly high use of water [36-38].

4.2 Chemical absorption

In chemical absorption the heat of absorption is higher than for physical absorption because the carbon dioxide not only dissolves in the solvent but also reacts with a reagent in the solvent. A low heat of absorption is beneficial since it lowers the energy demand of the desorption process, as well as the cooling demand of the absorption process. Obtained from the absorption process is low value energy which is costly to dispose of whilst the desorption process demands costly high quality energy. The overall regeneration cost is thus positively affected by a low heat of absorption.

The amine scrubbing technology has been in use for over 60 years in the chemical and oil industries for removal of hydrogen sulphide and CO₂ from gas streams. The main concerns with amine solvent are corrosion in the presence of O₂ and other impurities, the large amounts of energy required for regeneration and high solvent degradation rates from reaction with impurities in the gas. These factors generally contribute to large equipment, high energy losses and high solvent consumption. In order to improve the performance of these technologies there is a great need for improved solvents with faster absorption rates, higher absorption capacities, high degradation resistance, low corrosiveness and low regeneration energy demand.

4.2.1 Monoethanolamine (MEA)

The chemical solvent scrubbing with monoethanolamine (MEA) is one of the most commonly used solvent for removing CO₂ from low pressure flue gas. The flue gas is cooled and impurities are removed before the actual CO₂ removal. The flue gas passes to an absorption vessel and comes in contact with the chemical solvent which absorbs the CO₂ by chemically reacting with it to form a loosely bound compound. From the bottom of the absorber the CO₂-rich solvent is passed into the



stripper column where it is heated to reverse the CO₂-absorption reactions. From the stripper the lean solvent can be recycled in to the absorption vessel [39].

The main problem associated with MEA is corrosion in the absorption equipment in the presence of oxygen and other impurities. It is highly corrosive compared to other alkanolamine solvents. The operational cost is high due to the large amount of energy needed for regeneration of the MEA-solvent. This is due to the high heat of reaction of MEA with CO₂. Because of this MEA is now largely being replaced by other alkanolamines. However, for gas streams containing smaller amounts of H₂S and CO₂, with no impurities present, MEA is still preferred because of its high solution capacity. Unfortunately MEA has the disadvantage of forming irreversible reaction products with COS and CS₂, which deteriorates the solvent. If SO₂ and NO₂ are present in the gas this also causes solvent degradation due to reaction with the amine [34, 39, 40].

4.2.2 Piperazine activated N-methyldiethanolamine (MDEA/PZ)

The removal of CO₂ is a vital process for biogas upgrading and in synthesis gas production from renewable resources. CO₂ is most commonly removed by absorption in aqueous solutions of amines, where the CO₂ reacts with the amine. The most widely used solvents are aqueous alkanolamines, like N-methyldiethanolamine (MDEA). MDEA is widely used since it has a low vapor pressure which means that it can be used in high concentration, up to 60 wt%, without noticeable evaporation losses. MDEA is highly resistant to degradation and is practically non-corrosive. It also has a very low heat of reaction compared to other alkanolamines. The heat of reaction is an important parameter due to the fact that the heat required for the regeneration step is usually the largest cost in running a CO₂-removal unit. However, MDEA has a low reaction rate for the reaction with CO₂, compared to other alkanolamines and is therefore often activated by adding piperazine (PZ) as a promoter [34, 41, 42].

Absorption of H₂S in MDEA solutions is a common technique for selective removal of H₂S from CO₂-rich gases. However, other impurities, such as higher hydrocarbons absorbed in the solvent, may cause foaming in the absorption equipment which significantly reduces the absorption capacity of the process. MDEA itself is only moderately miscible with hydrocarbons [34].

4.2.3 Chilled ammonia

The ammonia process is similar to that of alkanolamines. The reaction of ammonia with CO₂, however, has a much lower heat of reaction than that of conventional amine solutions with leads to considerable energy savings [43].

The chilled ammonia process has been developed by Alstom. In the chilled ammonia process the flue gas has to be cooled prior to the absorption process. The absorption is run at a low temperature, below 20°C, to reduce ammonia slip. Most impurities in the gas are removed prior to the absorption step as the gas is passed through a desulfurization unit and cooling towers [44].

4.2.4 Potassium carbonate

The hot potassium carbonate process is suitable for the production of synthesis gas because of the high temperature of the process which makes it more energy efficient. The high temperature also increases the solubility of potassium bicarbonate, which makes the process able to operate with a highly concentrated solution [34, 40, 45].



The use of a promoter has been shown to give improvements in the mass transfer rates leading to a higher reaction rate. However, traditional promoters are often toxic and hazardous to the environment [40, 45, 46].

Little information on the effect of gas impurities on the potassium carbonate process is currently available. However, the process is a potential solvent for simultaneous removal of SO_x and NO_x as well as CO_2 [40, 45].

4.3 Physical separation techniques

The physical separation techniques utilize other means of separation than absorption into liquids and pressure swing adsorption and membranes should be mentioned. Pressure swing adsorption (PSA) is a dry method used to separate gases via physical properties. Membrane separation uses a membrane with different permeability for the different gas components and thus achieves separation.

4.3.1 Pressure Swing Adsorption

Pressure swing adsorption (PSA) is a dry method used to separate gases via physical properties. Explaining PSA on a macro level, the raw biogas is compressed to an elevated pressure and then fed into an adsorption column which retains the carbon dioxide but not the methane. When the column material is saturated with carbon dioxide the pressure is released and the carbon dioxide can be desorbed and led into an off-gas stream. For a continuous production, several columns are needed as they will be closed and opened consecutively. PSA unit characteristics include feeding pressure, purging pressure, adsorbent, cycle time, and column interconnectedness among other things. In Figure 13 a simplified process diagram for a PSA upgrading unit is shown. A more thorough description of the PSA technology for biomethane enrichment can be found in SGC report 270 [47].

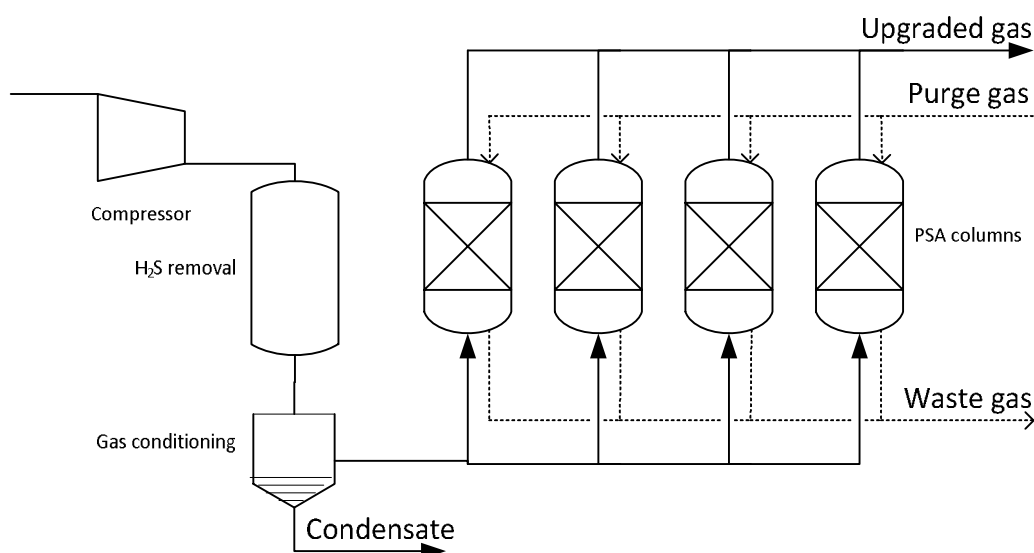

Figure 13. Process diagram for upgrading of biogas with PSA. H_2S and water vapour is separated from the raw biogas before it is fed to the adsorption column. Multiple columns work in parallel cycles for a continuous process. Figure adapted from [48].



A PSA column cycle basically consists of four phases; a so called Skarstrom cycle is pressurization (1), feed (2), blowdown (3) purge (4), which is shown below in Figure 14 together with a pressure profile of the cycle phases. During the feed phase the column is fed with raw biogas. The carbon dioxide is adsorbed on the bed material while the methane flows through the column. When the bed is saturated with carbon dioxide the feed is closed and the blowdown phase is initiated. The pressure is decreased considerably to desorb the carbon dioxide from the adsorbent and the carbon dioxide rich gas is pumped out of the column. As the column in the beginning of this phase was filled with raw biogas, some methane is lost with the desorbed carbon dioxide. At the lowest column pressure the purge is initiated. Upgraded gas is blown through the column to empty it from all the carbon dioxide that has desorbed from the column bed. The column is now regenerated and can be repressurized, either with raw biogas or with upgraded gas, and the cycle is complete [49].

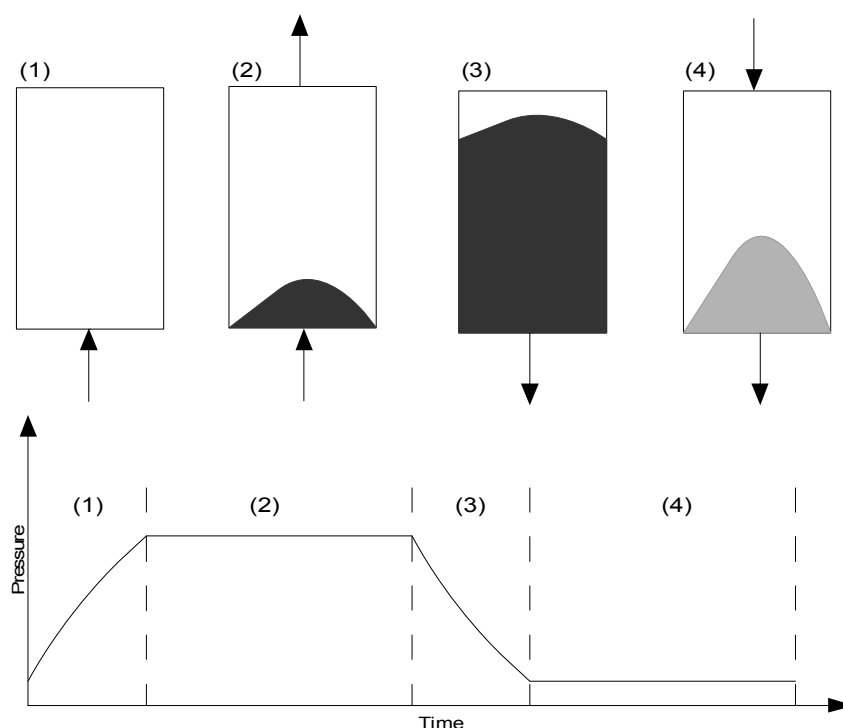

Figure 14. Schematics of the four phases in the Skarstrom cycle and a pressure profile of the cycle. Figure adapted from [50].

As this cycle consists of four phases, a common design for PSA units includes four columns. Thus one of the columns is always engaged in adsorption while the other three are in different phases of regeneration. To reduce the loss of methane from the process the columns are usually interconnected so that the exiting gasflow from one column during blowdown is used to pressurize another column in a pressure equalization phase, which also reduces the energy consumption of the process. A PSA column cycle is typically 2-10 min long [49, 51].

4.3.2 Membrane separation

This presentation of membrane systems used for gas separation is very limited and mainly built on the works of Baker [52]. A more thorough description of mem-



brane systems used for gas separation is available in SGC report 270 [47]. A membrane is a dense filter that can separate the components in a gas or a liquid down to the molecular level. The membranes used for biogas upgrading are mainly manufactured from polymeric materials. The membranes used for biogas upgrading retain methane while the carbon dioxide is able to permeate through the membrane. During the separation of carbon dioxide from the raw gas other compounds such as water vapor, hydrogen and to some degree oxygen are removed from the biomethane. The permeation rate through a glassy polymer, commonly used in the biogas applications, is mainly depending on the size of the molecules, which gives the relative permeation rates shown in Figure 15.

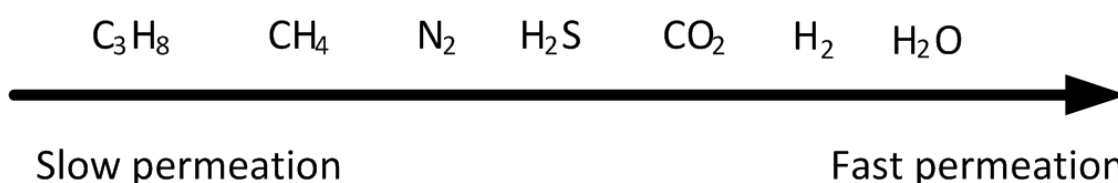

Figure 15. Relative permeation rate of different molecules through a membrane used for upgrading of biomethane.

The gas stream going into a membrane is called the feed stream. The feed is separated into permeate and retentate inside the membrane. Retentate is the gas stream that do not pass through the membrane while permeate is the gas stream that pass through the membrane. An example of a membrane process for upgrading of bio-SNG is depicted in Figure 16. The membrane unit can consist of several membrane stages. The producer gas is cleaned from pollutants, e.g. water and hydrogen sulphide, before it is compressed and fed to the membrane unit. In cases where ammonia and volatile organic carbons are expected in significant concentrations in the producer gas, these components are also removed before the biogas upgrading. Additional to this cleaning, it is also common to have a particle filter to protect the compressor and the membranes.

After gas cleaning, the biogas is compressed to 5-20 barg. Since oil lubricated compressors are commonly used, it is important to have efficient oil separation after compression. This oil separation is important not only for the oil residues from the compressor but also for removing oil naturally occurring in the biogas. The oil will otherwise foul the membrane and decrease its lifetime. In the membrane unit itself the carbon dioxide is separated from the main gas stream, but since a minor share of the methane and other compounds will permeate, the off-gas stream from one stage is recirculated to the compressor to reach an acceptable yield.

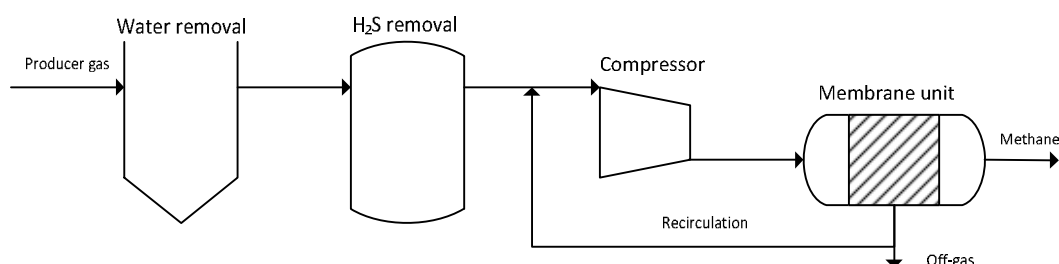

Figure 16. Simplified process design for a membrane process that can be used for upgrading of bio-SNG.

Different process designs for membrane gas separation units are available today, depending on the manufacturer of the system and the membranes that are used. Three existing designs on the market today are shown in Figure 17.

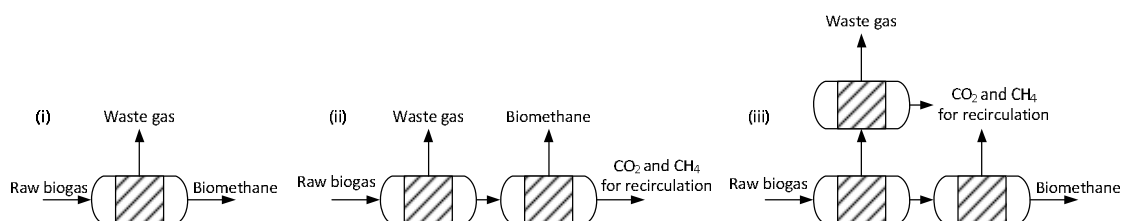

Figure 17. Three design options for membrane units for gas upgrading.

The first design (i) includes no internal circulation of the gas and therefore lower energy consumption for the compression. However, the methane loss will be higher and it is important to use membranes with high selectivity, i.e. large difference between the permeation rate of methane and carbon dioxide, to minimize the methane loss. It is also beneficial if methane in the off-gas can be used in an efficient way by e.g. cogeneration in a boiler or CHP. The second design (ii) increases the methane recovery compared to design (i). In this case the permeate (the gas passing through the membrane) from the first membrane is removed from the system while the permeate from the second membrane is recirculated back to the compressor to minimize the methane slip, which will increase the energy consumption. In the third design (iii) the retentate from the first stage is polished in the second membrane stage, in a similar way as in design (ii) to obtain a product gas with a higher quality. Additional to design (ii), also the permeate of the first stage is polished in a third membrane stage, to minimise the CH₄ concentration in the off-gas and the volume of gas circulated back to the compressor. The permeate stream of the second stage and the retentate of the third stage are combined and recycled to the compressor. The most common design until today has been design option (ii), however several plants that were taken into operation during 2012 used design option (iii).



5 Models

In this section, the system model will be described along with the gasification models and the two methods for CO₂ capture that has been chosen for modeling (water scrubbing and amine absorption using N-methyldiethanolamine (MDEA) and piperazine (PZ)). The choice was based on availability of models, maturity of technology and aim of the project. As the project focused on indirect gasification the models for the MILENA gasifier was chosen to represent the 100 MW_{th} case and the Agnion gasifier was chosen to represent the 10 MW_{th} case. These also include the models for methanation and other necessary process steps. Other means of CO₂ capture, such as membranes, are becoming more commercially available [47]. However, no model for this type of system was available within the project and it was therefore decided not to include it.

The modeling work has been performed in an iterative fashion working with several different models. The cases simulated will be described more in detail in the next chapter. However, two general concepts have been investigated and those are pre-methanation and post-methanation CO₂ removal. In figure 18 the different iterative simulation procedures are described. These two separation modes have been investigated in a case where larger scale production has been investigated (100 MW_{th} input biomass); a smaller case (10 MW_{th} input) has also been considered, but only for post-methanation CO₂ removal. The larger scale has been based on the MILENA gasifier and the smaller one on a scaled-up version of the Agnion gasifier.

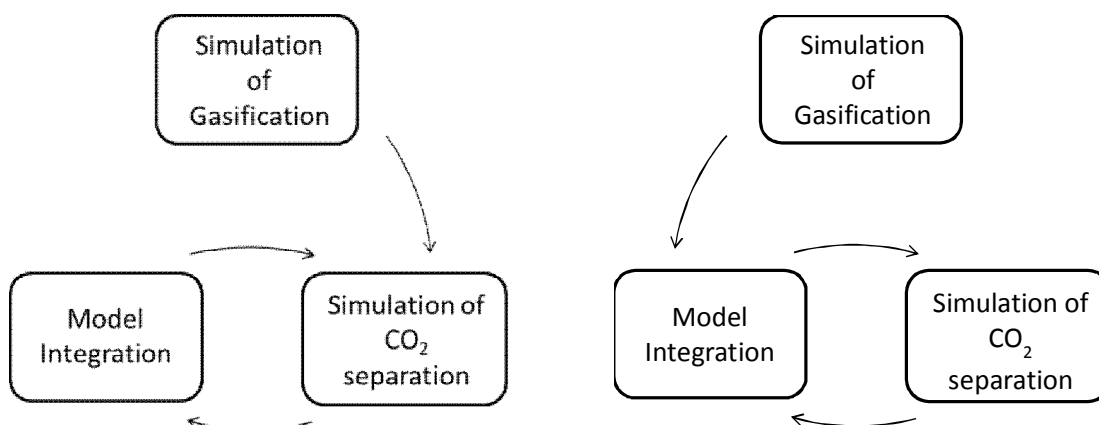

Figure 18. The order of simulation in the case of pre-methanation CO₂ removal and post-methanation CO₂ removal respectively.

5.1 System model

The system model is made in Aspen PLUS and describes the unit operations necessary for conversion of biomass to SNG. No gasification model is present, instead the gasification is calculated by mass and energy balances based on real gas composition and energy requirement of the MILENA gasifier. The energy required for drying and grinding is included in the model, as is the steam requirement of the gasifier. Downstream the gasifier is a desulphurization step followed by a pre-reformer that converts lower hydrocarbons and tars into synthesis gas and methane. The next step is a water-gas shift reactor that sets the H₂:CO ratio of the synthesis gas to 3:1. Depending on where the CO₂ separation is placed there are a few different scenarios available downstream of the water-gas shift.



The first is to place the CO₂ separation after the water-gas shift reactor and then remove water in a knock-out drum. The second is to place the CO₂ after the methanation. Either way, water needs to be removed prior to compression to 30 bar, which is done in a multistage compressor operating with 4 steps and inter-cooling to 70°C.

Methanation is performed according to the process layout in TREMP in which three adiabatic reactors are operating adiabatically [2]. All reactors have an inlet temperature of 300°C. Recirculation over the first reactor is performed to keep the temperature below 700°C. It should be noted here that for the cases with CO₂ separation after the methanation, the temperature of the first reactor never reaches 700°C even without recirculation. The second and third methanation reactors reach an outlet temperature of about 530°C and 375°C respectively.

If CO₂ separation is performed after the methanation, this is placed after the last methanation reactor. Lastly a water knock-out drum is used to give a liquid-free gas at 15°C that is fed to the product compressor that compresses the gas to 60 bar. The compressor operates with the same parameters as the syngas compressor.

5.2 Gasification models

The gas composition and utility consumption/requirement of the gasifiers used in the modeling has been supplied from ECN and Agnion. The ECN MILENA with OLGA gas cleaning has been used in the larger scale case investigated and the Agnion heat-pipe system has been used in the smaller scale case. In the case of the small scale case, the Agnion system heat and mass balance has been used for the integration with the CO₂ separation.

5.3 CO₂ separation models

Two separation methods have been considered in this project, these and the models used will be described in the following.

5.3.1 Water-scrubbing model

A model of the water scrubbing process has been previously developed [36]. This was performed in Aspen Plus[®] V 7.2 by AspenTech. Aspen Plus[®] is a chemical process modeling tool based around the flow sheet of the process. By placing the unit operations of choice, defining the operating conditions and the physical properties model to be used the performance of complex processes can be studied and optimized. Aspen Plus[®] predicts process behavior using engineering relationships such as material and energy balances, phase and chemical equilibrium, and reaction kinetics. Aspen Plus[®] can be used for dynamic and steady state solutions to a wide variety of processes.

To be able to model the process in Aspen some changes had to be made to the process compared to the flow sheet seen in Figure 12 (section 4.1.1). The incoming gas is first introduced to a flash tank together with a water stream to simulate its saturation with water leaving the digester.

The drying machine was considered too complex to model and instead the product gas was cooled to -40°C at the pressure of 4 bar and the condensed water removed. The gas was then reheated to its original temperature. 10 % of the gas stream was split to simulate the regeneration stream of the dryer. This stream was



then saturated with water in a flash tank before being reintroduced in the first flash tank after the fan. Also the air flow going into the stripper was saturated with water in a flash tank before entering the stripper.

The impact of electrolytes and their reactions were assumed to be negligible. Since low to moderate pressures are used in the model, the choice of physical property method became the NRTL method. The NRTL property method uses the ideal gas equation of state for the vapor phase and the NRTL activity coefficient model for the liquid phase. The NRTL method is good for describing strongly non-ideal solutions when dealing with moderate temperatures and pressures. The correlations used for random packing mass transfer and interfacial area calculations have been described by Onda et al [53]. The model was calibrated against a set of data obtained from Malmberg Water. To better adjust the model for the case of SNG-production, the model has been expanded to include H₂, CO, ethylene and benzene.

5.3.2 Amine absorption model

For the purpose of purifying the gas from the SNG-process from CO₂ a simulation model of the CO₂-capture process was used. This model was developed earlier at the Department of Chemical Engineering for modeling of the CO₂-removal from a biohythane process [54]. The model uses an industry standard amine solution for the carbon dioxide removal consisting of 50% water, 40% MDEA and 10% PZ. The exact composition can of course vary between suppliers and other components, such as e.g. anti-foaming agents, are also present in the solution. The model calculates the required dimensions of the absorber, stripper and heat exchangers in order to purify the gas. For an overview of the process layout for the gas separation process, see Figure 19.

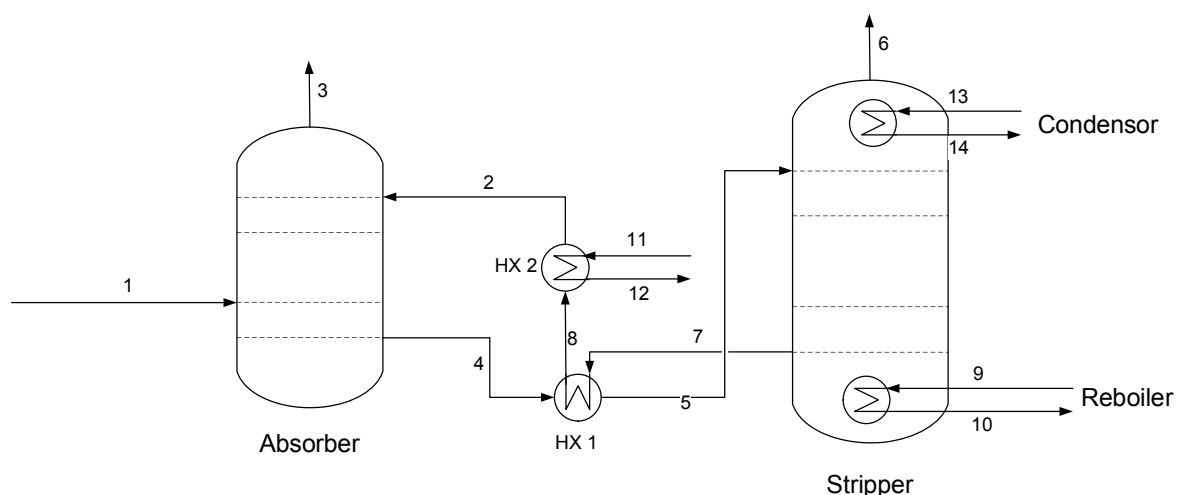

Figure 19. Process flow diagram for the gas separation process.

The amine solution used for the absorption of CO₂ consists of a mixture of 40 % *N*-methyldiethanolamine (MDEA), 10 % piperazine (PZ) and 50 % water, by weight. This is a very common solvent mixture used in industrial applications for the separation of carbon dioxide from various gases, e.g. for biogas upgrading.



For the building of an accurate gas separation model, a number of fundamental physical and chemical data is required.

For the physical properties of the system - such as density, viscosity, surface tension, diffusivity of the amines in water solution, diffusivity of gases in the amine solution, gas solubility in the amine solution and heat capacity - data was taken from the literature [41, 55-69]. However, only one journal publication on the heat of reaction for the investigated system was found with very limited data [70]. The only other reference found was an interim report from North Carolina State University [71]. For this reason an investigation on the heat of reaction for the system was conducted for the MDEA/PZ-system [72]. The data acquired from this investigation was used in the simulation model.

In order to perform the calculations on the absorber and the stripper, integral balances for each unit have to be solved prior to the differential balances. For the calculation on the absorber the principle for the simulation model is as follows. The integral balances for the absorption tower give the flow rates of the incoming and outgoing gas and liquid streams, as well as the incoming and outgoing temperatures of the gas and liquid, according to Figure 20. The incoming gas flow is given by the previous steps. From the integral balances the diameter required for the absorption column can be determined, as well as the pressure drop over the column.

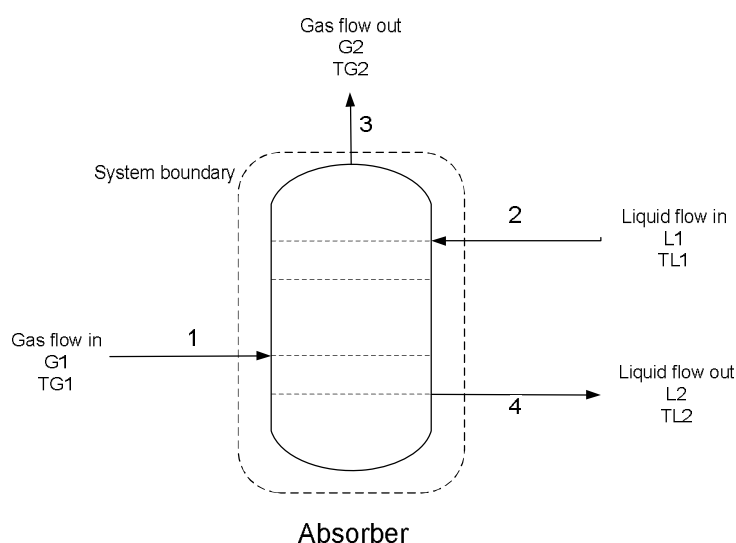

Figure 20. System boundary, gas flows, liquid flows and temperature used for the integral balances.

For the differential calculations the principle of the model is illustrated in Figure 21. Data from the literature has been used for the differential calculations for the absorber [53, 73-76]. The calculations start at the top of the absorption tower, i.e. for the outgoing gas and incoming liquid flow. The calculations are performed within a given column volume, given by the height, dh . This height is then added to the total height of the column for each calculation step ($h = h + dh$), as the calculations proceed. The size of the step should be small enough to ensure that the temperature for the previous step does not differ significantly from that of the current step. Mass and energy balances are solved for each step, giving the concentration and



temperature profile over the column as a function of column height. The calculation is terminated when the CO₂ concentration of the gas in the calculation-element, $G(n)$, is the same as the concentration of CO₂ in the incoming gas stream, $G1$.

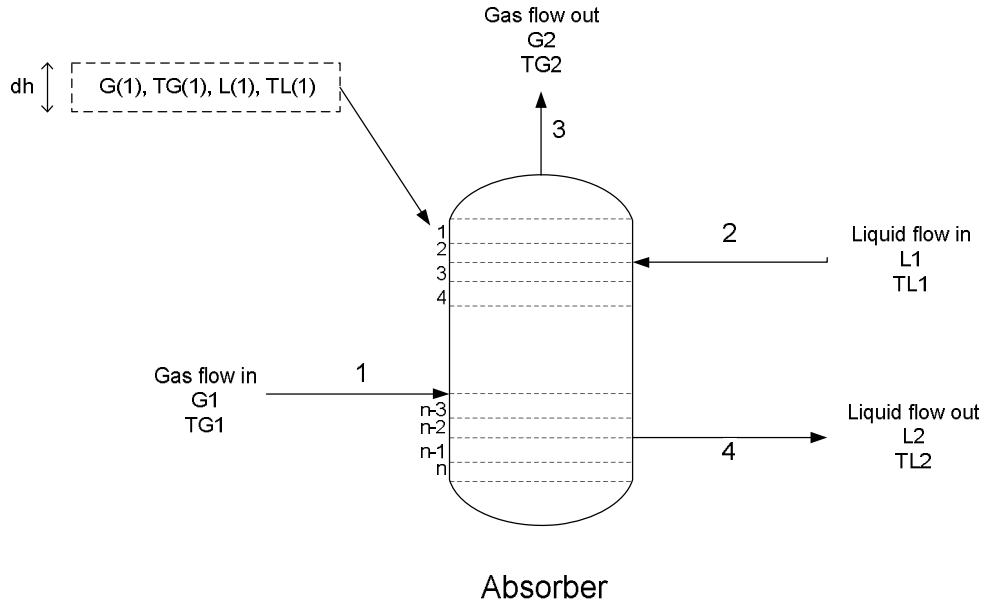
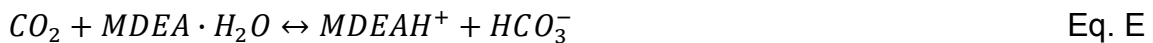
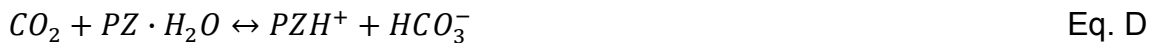

Figure 21. Calculation principle for the differential balances. All concentrations and temperatures are determined for each element, with height dh .

A simple kinetic model was used to describe the reactions of CO₂ with MDEA and PZ, see equation D and E.



The model is a reduced version of that developed by Zhang et al., [77], and consists of two reactions describing the reaction of CO₂ with PZ and MDEA respectively. The values for the equilibrium (k_i) and rate constants (K_i) for these reactions were taken from the literature and the relationships are given by equations F-I, [78, 79].

$$k_{PZ} = 53700 \cdot e^{\left(-\frac{33600}{8.314} \cdot \left(\frac{1}{T} - \frac{1}{298.15}\right)\right)} \quad \text{Eq. F}$$

$$k_{MDEA} = 15.584 - \frac{3984}{T} \quad \text{Eq. G}$$

$$K_{PZ} = \frac{e^{\left(\frac{231.4 - \frac{12092}{T} - 36.78 \cdot \ln(T)}{T}\right)}}{e^{\left(-\frac{4531}{T}\right)}} \quad \text{Eq. H}$$



$$K_{MDEA} = \frac{e^{\left(\frac{231.4}{T} - \frac{12092}{T^2} - 36.78 \cdot \ln(T)\right)}}{e^{\left(\frac{-9.4165}{T} - \frac{4234.98}{T^2}\right)}} \quad \text{Eq. I}$$

The calculations for the stripper column are executed in the same manner as those for the absorption column, with integral balances solved first, followed by the differential calculations. Because of the difficulties associated with solving the differential balances for the stripper, [34], a second method was also applied for the determination of the stripper height. The second calculation method is a short-cut-method that was developed to simplify stripper height calculations [80]. For this method, equilibrium data for the system is required, which was taken from the literature [81]. Data from the literature have also been used for the differential calculations for the stripper [63, 82-87]. The final stripper height was chosen to be the highest value obtained from the two methods applied. The reboiler duty for the stripper is determined from the integral balances and the dimensions of the reboiler can be determined from that data. This is also the case for the cooling effect for the condenser. The dimensions of the heat exchangers are determined using conventional theory.

In order to determine the amount of higher hydrocarbons that will be absorbed in the amine solution an investigation of the solubility was carried out. The Henry's constant for the gases H₂, CO, CH₄, C₂H₄ and C₆H₆ were collected from the NIST database, which include the results of several studies. Mean estimates of all the values reported in the NIST database were used for evaluation of the solubility of the gases H₂, CO, CH₄, C₂H₄ and C₆H₆ in the amine solution. The Henry's constant used are summarized in Table 4.

Table 4. Summary of Henry's constant used for evaluation of solubility from the NIST database.

Component	$k_{H,cp}(T^\ominus)$ ((mol bar)/kg)	C (K)
H ₂	0.00078	543
CO	0.00096	1400
CH ₄	0.00135	1750
C ₂ H ₄	0.0047	1800
C ₆ H ₆	0.177	3950

The Henry's constant, $k_{H,cp}$, describes the relationship between the concentration of soluted gas in the liquid, c_{aq} , and the partial pressure of the gas, p , according to Equation J. It is also dependent on the temperature according to Equation K, where $k_{H,cp}(T^\ominus)$ denotes the value at the reference temperature, T^\ominus 25°C, and C is a constant given in Table 3.

$$k_{H,cp} = \frac{c_{aq}}{p} \quad \text{Eq. J}$$

$$k_{H,cp}(T) = k_{H,cp}(T^\ominus) \exp\left(C \left(\frac{1}{T} - \frac{1}{T^\ominus}\right)\right) \quad \text{Eq. K}$$



SGC Rapport 2013:277

The amount of absorbed component will therefore depend on the pressure of the gas as well as the temperature of the gas. At higher temperatures the gases are less soluble.



6 Case study

Two cases have been investigated in detail. The choice of cases to investigate was thoroughly discussed within the project during the reference group meetings to ensure that relevant cases were chosen. The first case is a smaller system where 10 MW_{th} is fed to the system and the Agnion gasification, gas cleaning and methanation system. It was decided that the only relevant case was the post-methanation CO₂ separation. The second case is centered on the MILENA-gasifier with OLGA clean-up. The input is significantly larger in this case (100 MW_{th}) and two different approaches to CO₂-removal have been investigated: pre-methanation and post-methanation. In all cases water scrubbing and scrubbing with MDEA/PZ has been investigated. A summary of the modeling assumptions are found in Table 5.

Table 5. Summary of modeling assumptions.

Factor	Value	
	Large scale	Small scale
Biomass input	100 MW _{th}	10 MW _{th}
Biomass moisture content	50%	50%
Biomass moisture content into gasifier	25%	25%
CO ₂ removal	Pre and post methanation	Post methanation
CO ₂ removal technology	Amine and water scrubbing	Amine and water scrubbing
SN	Chosen to give low CO outlet	As per Agnions specifications
Wobbe index _{LHV} SNG product	45.5	45.5
Delivery pressure	60 bar	60 bar
Methane slip (max)	1%	1%

6.1 Case 1 – 10 MW_{th}

The smaller system has an input of 10 MW_{th} and is based on the Agnion heat-pipe indirect gasifier. Biomass (80% dry matter) is fed to the heat-pipe reformer and to the combustor part of the unit (83% to the reformer and 17% to the combustor). Heat is recuperated in several stages and used for air pre-heating, steam production and district heat production. The particulate matter is removed when the synthesis gas is washed. The reported cold gas efficiency of biomass to synthesis gas is 68% resulting in 6.8 MW clean, particle free synthesis gas fed to the water-gas shift unit. After shifting to an appropriate SN, the gas is methanated. The shift reaction may be internal or external to the methanation vessel. The gas composition of the gas to be cleaned of CO₂ has been supplied by Agnion and can be viewed in Table 6. A process overview of the Agnion-process can be seen in figure 22.



Table 6. Gas composition and flow rate after the Agnion system on a dry-gas basis.

	10 MW _{th} Post-methanation
Component (Vol-%)	
CO ₂	43.8
CH ₄	54.2
CO	4.7*10 ⁻³
H ₂	1.97
C ₂ H ₄	0
C ₆ H ₆	0
N ₂	0
O ₂	0
Gas flow (Nm ³ /h)	1 125

As may be viewed, the composition of the gas mainly consists of carbon dioxide and methane, with slightly more methane than carbon dioxide. There are minute amounts of carbon monoxide and the major difference compared to traditional gas upgrading is the circa 2% hydrogen. Some nitrogen is also likely present in the gas although it was not specified for the current case.

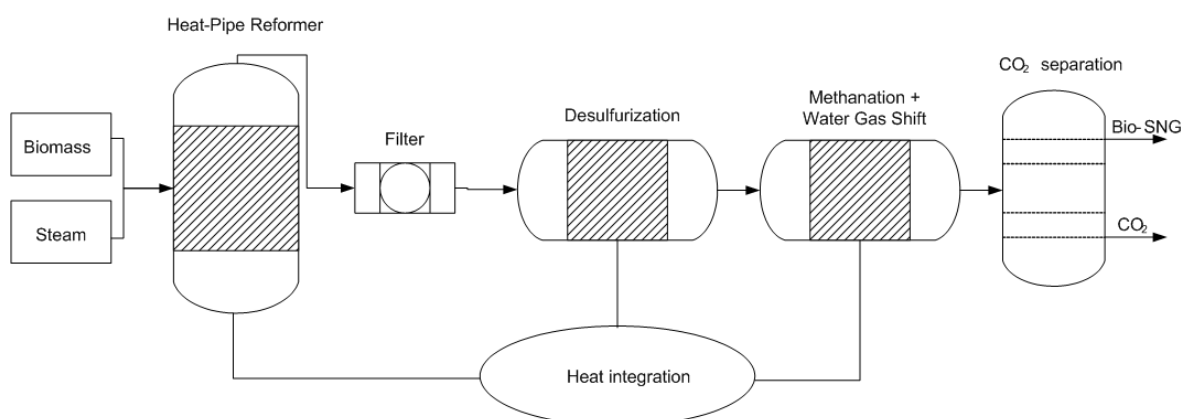

Figure 22. Schematic diagram of the Agnion process.

There is extensive heat recovery in the Agnion process and from the syngas production alone 1.6 tonnes of steam (saturated at 10 bar) is produced hourly. This steam may be exported as district heat or used internally in the process; in the current set-up this is used for biomass drying from 50% to 20% moisture content using 4.5 MJ/kg of water [88] In addition, the methanation step generates additional heat (about 0.7 MW_{th}) which may be used for additional steam generation. In addition to the biomass input, the electricity requirement of the system is 134 kW.

6.2 Case 2 – 100 MW_{th}

The 100 MW_{th} case has been constructed using a combination of MILENA and OLGA. Thereafter the downstream system has been put together using unit operations with information from the open literature. In this case two separation positions have been investigated, before and after methanation. The pre-methanation



case is the case that has the largest differences compared to traditional biogas upgrading as there is low methane content and high content of hydrogen and carbon monoxide in the gas, table 7.

Table 7. The 100 MW gas mixtures and flow rate on a dry-gas basis.

Component	100 MW _{th} Pre-methanation (Vol-%)	100 MW _{th} Post-methanation (Vol-%)
CO ₂	35.4	47.6
CH ₄	24.5	48.8
CO	9.5	0.1*10 ⁻³
H ₂	29.6	2.0
C ₂ H _x	6.4*10 ⁻⁴	7.9*10 ⁻⁴
C ₆ H ₆	2.4*10 ⁻⁶	0
N ₂	1.1	1.6
O ₂	0	0
Gas flow (Nm ³ /h)	20 400	15 700

As can be seen in the table, there is about 35% CO₂ in the gas mixture before methanation and 48% after methanation. The gas mixture before methanation contains 30% hydrogen and 10% carbon monoxide as well as trace amounts of ethylene and benzene. After the methanation, the CO is reduced to trace amounts while there is still 2% hydrogen in the mixture as well as trace amounts of C₂H_x which is about 10% of both ethane and acetylene while 80% is ethylene. For the purpose of these calculations all C₂H_x has been considered as ethane or ethylene.

The cases have been constructed using the MILENA and OLGA gasification and gas purification as already stated. The methanation has been modeled based on the TREMP set-up and using information in the open literature with respect to operating conditions energy is exported [2]. In the current set-up heat is also used for biomass drying from 50% to 25% moisture content using 4.5 MJ/kg of water [88]. The cases simulated are quite close to the process lay-out in Figure 11 but for clarity figure 23a and 23b contains the two alternatives considered here.

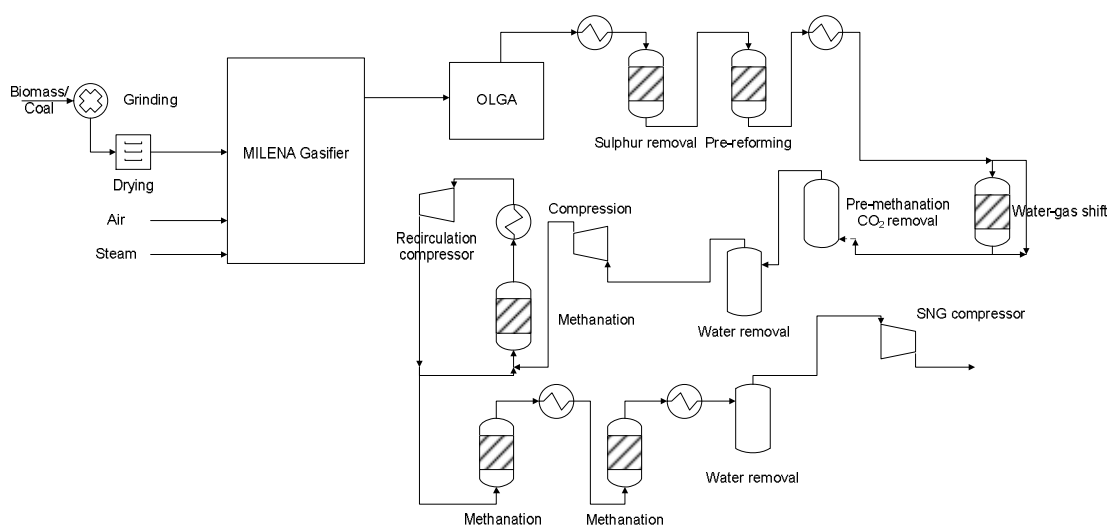

Figure 23a. MILENA with OLGA and TREMP using pre-methanation CO₂ separation.

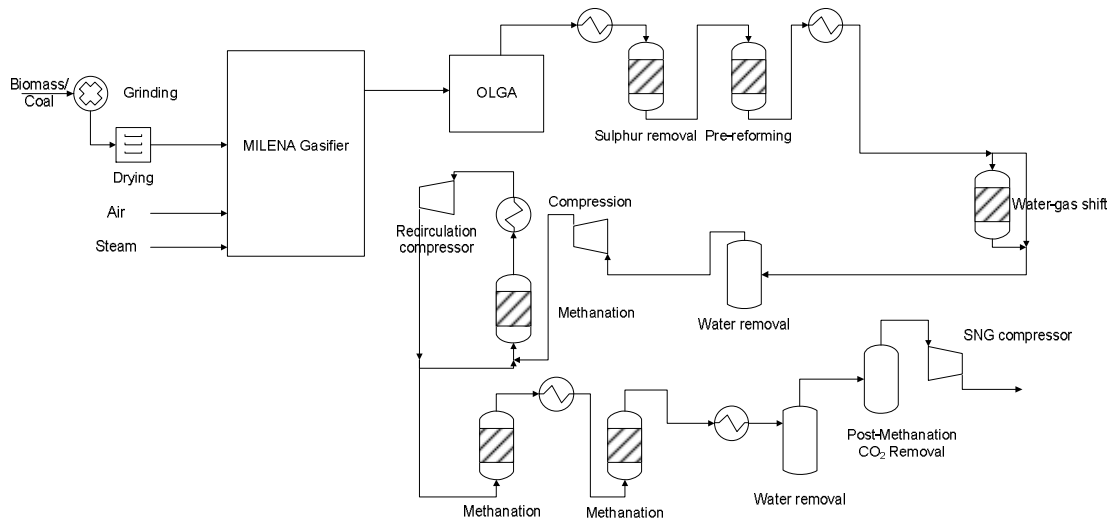

Figure 23b. MILENA with OLGA and TREMP using post-methanation CO₂ separation.

6.3 Results

As described above, three different process configurations were considered. These are characterized by the thermal input (10 MW_{th} and 100 MW_{th}) and using pre-methanation and post-methanation separation in the 100 MW_{th} case. The three different gas compositions from these cases were studied with the two down-selected CO₂ separation methods. These are summarized in Table 8.



Table 8. Summary of studied gas compositions on a dry-gas basis.

	10 MW_{th} Post-methanation	100 MW_{th} Pre-methanation	100 MW_{th} Post-methanation
Component	(Vol-%)	(Vol-%)	(Vol-%)
CO ₂	43.8	35.4	47.6
CH ₄	54.2	24.5	48.8
CO	4.7*10 ⁻³	9.5	1.0*10 ⁻⁴
H ₂	2.0	29.6	2.0
C ₂ H _x	0	6.4*10 ⁻⁴	7.9*10 ⁻⁴
C ₆ H ₆	0	2.4*10 ⁻⁶	0
N ₂	0	1.1	1.6
O ₂	0	0	0

6.3.1 Case 1 – 10 MW_{th}

In this case, only the post-methanation CO₂-removal has been considered for water scrubbing and amine scrubbing. The system has been modeled after the Agnion system. The composition after the gasifier and after methanation can be seen in Table 9.

Table 9. Gas compositions in the 10 MW_{th} case on a dry-gas basis; the moisture content is for hot gases after each respective unit operation.

	After gasifier	After methanation
Component (Vol-%)		
CO ₂	22.9	43.8
CH ₄	10.8	54.2
CO	15.3	4.7*10 ⁻³
H ₂	50.9	2.0
C ₂ H _x	0	0
C ₆ H ₆	0	0
N ₂	0	0
O ₂	0	0
Moisture content	45.6%	70%

As can be seen in Table 9, the methane content out of the gasifier is quite high, above 10%, making the gas mixture quite suitable for methanation. Using the definition in Eq. A, the SN is calculated to 0.37 for the gasifier exit composition showing the need of the water-gas shift reaction. Out of the 10 MW_{th} that is entered into the system, 6.8 MW_{th} is recovered as synthesis gas after gasification and gas conditioning; after the SNG production, 6.1 MW_{th} of SNG is left. The gas after the methanation is then sent to a scrubber for gas upgrading and the gas compositions after the upgrading may be seen in Table 10.



Table 10. Gas compositions and other properties in the 10 MW_{th} case after up-grading, on a dry-gas basis.

	Using water scrubbing	Using amine scrubbing
Component (Vol-%)		
CO ₂	1	0.2
CH ₄	93.4	96.3
CO	3.45*10 ⁻⁵	8.4*10 ⁻⁵
H ₂	3.4	3.5
C ₂ H _x	0	0
C ₆ H ₆	0	0
N ₂	1.4	0
O ₂	0.8	0
Methane slip (% of inlet)	1	0.05
Propane required for Wobbe index _{LHV} 45.5 (kg/Nm ³)	0.007	0

The major difference between the two systems is the operating pressure. The water scrubber system operate at 7 bar(a) while the amine scrubber system operate close to 1 bar(a). The use of air as stripper gas in the CO₂ stripping system and the rather high water pump-around rate is the explanation for the nitrogen and oxygen in the gas after purification in the water scrubber case. There is no need for propane addition in the amine purification case while there is a small requirement in the air separation case (0.007 kg/Nm³). Taking the methane losses into account over the purification stage, the η_{SNG} becomes 61.2% in the amine scrubber case and 60.6% in the water scrubber case. In Figure 24, the changes in chemical energy are visualized; please note that the blue and red arrows add up to the inlet 10 MW_{th} biomass.

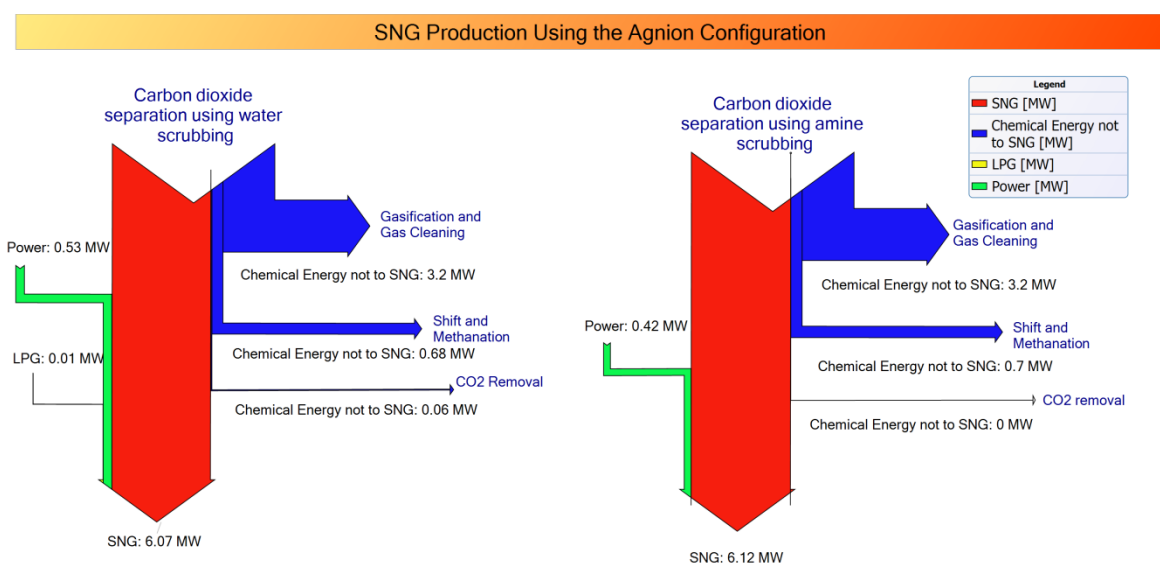

Figure 24. Representation of the changes in chemical energy with reaction.



In addition to the chemical energy change, the overall electricity efficiency has been determined using the definition in section 3.4. Based on these assumptions, the case with the water scrubber comes out at 60.7% and the amine case to 60.9%, the inputs and outputs are summarized in Table 11.

Table 11. Summary of inputs and outputs from the 10 MW_{th} systems.

	Water scrubber	Amine scrubber
Input		
Biomass	10 MW _{th} (4.6 MW _{ee})	10 MW _{th} (4.6 MW _{ee})
Power	0.53 MW _{ee}	0.43 MW _{ee}
LPG	0.01 MW _{th} (0.005 MW _{ee})	0
Output		
SNG	6.06 MW _{th} (3.0 MW _{ee})	6.11 MW _{th} (3.1 MW _{ee})
Heat	0.8 MW _{th} (0.08 MW _{ee})	0

6.3.2 Case 2 – 100 MW_{th}

The second case has been centered on the MILENA indirect gasifier and using the OLGA gas clean-up. In this case, CO₂ separation has been considered both before and after the methanation. Some gas compositions from the system may be viewed in Table 12.



Table 12. Gas compositions in the 100 MW_{th} case on a dry-gas basis; the moisture content is for hot gases after each respective unit operation.

	After gasifier and cyclone	After gasifier and OLGA gas clean-up
Component (Vol-%)		
CO ₂	15.9	16.0
CH ₄	14.1	14.2
CO	34.3	34.6
H ₂	26.9	27.1
C ₂ H _x	5.3	5.3
C ₆ H ₆	1.2	0.8
C ₇ H ₈	0.2	0.1
N ₂	1.3	1.3
O ₂	0	0
Moisture	37.6	37.6
Trace compounds (Vol-ppm)		
H ₂ S	182	182
COS	18	18
Thiophene	7	7
Ammonia	1 983	1 983
HCl	46	46
Tar (mg/Nm ³)	20 000	<40
Dust (mg/Nm ³)	1 500	< 5

As may be seen in the table, the gas contains mainly CO and H₂, but also significant amounts of CH₄ and CO₂. There is some nitrogen content in the fuel, which show up as N₂ in the gas mixture. It is clear from the table that the tar compounds are significantly reduced over the OLGA system. Also benzene and dust is reduced over this unit operation. Using Eq. A to calculate the SN it becomes 0.15 and the need for shifting is obvious, Table 13 shows the gas compositions that has been subject to CO₂ removal.

Table 13. Gas compositions subject for CO₂ removal in the 100 MW_{th} case on a dry-gas basis.

Component	Pre-methanation (Vol-%)	Post-methanation (Vol-%)
CO ₂	35.4	47.6
CH ₄	24.5	48.8
CO	9.5	1.0*10 ⁻⁴
H ₂	29.6	2.0
C ₂ H _x	6.4*10 ⁻⁴	7.9*10 ⁻⁴
C ₆ H ₆	2.4*10 ⁻⁶	0
N ₂	1.1	1.6
O ₂	0	0



The most apparent difference between the two gas compositions, the major components aside, is the benzene concentration which is zero after the methanation. Looking at the carbon dioxide content of the gas this is increased with methanation because of the stoichiometry of the methanation reaction producing fewer gas molecules. Out of the 100 MW_{th} entered into the system, 89 MW_{th} is left after gasification and 80 MW_{th} is left after gasification and gas cleaning. Additional losses are accounted for in the water-gas shift, CO₂ separation and gas compression. The CO₂-separations have been performed at normal operating pressure for the respective processes. Simulations of CO₂-separation performed at high pressure with the technology at hand displayed either a high methane loss or an unreasonably high recycle power consumption to lower the methane loss. The gas composition after separation in the pre-methanation case is displayed in Table 14a for the water scrubber case and Table 14b for the amine scrubber case.

Table 14a. Gas compositions and other properties in the 100 MW_{th} case after upgrading pre-methanation with water scrubbing, on a dry-gas basis.

Component (Vol-%)	After separation	After methanation
CO ₂	1	1.8
CH ₄	36.8	90.5
CO	14.3	1.8*10 ⁻²
H ₂	44.8	3.2
C ₂ H _x	6.4*10 ⁻⁴	7.9*10 ⁻⁴
C ₆ H ₆	2.1*10 ⁻⁶	0
N ₂	2.6	4.6
O ₂	0.5	0
Methane slip (% of inlet)	1	N/A
Propane required for Wobbe index _{LHV} 45.5 (kg/Nm ³)	N/A	0.11



Table 14b. Gas compositions and other properties in the 100 MW_{th} case after up-grading pre-methanation with amine scrubbing, on a dry-gas basis.

Component (Vol-%)	After separation	After methanation
CO ₂	0.1	0.2
CH ₄	37.9	92.7
CO	15.2	9.3*10 ⁻³
H ₂	45.17	4.0
C ₂ H _x	6.4*10 ⁻⁴	7.9*10 ⁻⁴
C ₆ H ₆	2.1*10 ⁻⁶	0
N ₂	1.7	3.1
O ₂	0	0
Methane slip (% of inlet)	0.05	N/A
Propane required for Wobbe index _{LHV} 45.5 (kg/Nm ³)	N/A	0.004

The SNG-efficiency (η_{SNG}) for the cases with pre-methanation CO₂-removal has been calculated to 67.9% and 68.4% for water and amine scrubbing respectively. The amount of propane which is required for reaching the target Wobbe index is however significantly higher in the water scrubber case. This is due to the high level of nitrogen which the separation method results in, which is further emphasised by the gas volume reduction over the methanation stage. The electricity consumption of the gasification system was set to 1.5% of the overall biomass input or 1.5 MW [89]. The water scrubber consumed 5.1 MW while the amine scrubber consumed 2.5 MW; in both cases 3.4 MW electricity was produced in the system. In Figure 25 the changes in chemical energy is visualised in the pre-methanation separation case, please note that the red and blue arrows add up to the inlet 100 MW_{th} and that the power is the net input, some electricity is generated internally.

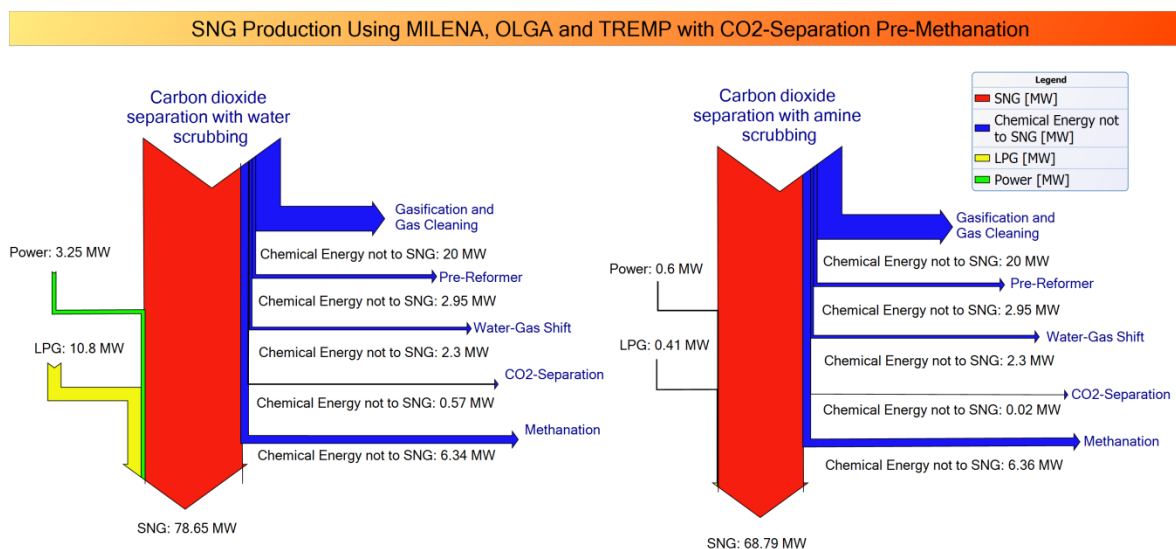

Figure 25. Representation of the changes in chemical energy with reaction.

Much of the chemical energy on the conversion side is lost in the same stages, there are however some differences in the separation and methanation stages. A summary of the inputs and outputs in the pre-methanation separation case may be viewed in Table 15.

Table 15. Summary of inputs and outputs from the 100 MW_{th} system, pre-methanation separation.

	Water scrubber	Amine scrubber
Input		
Biomass	100 MW _{th} (46 MW _{ee})	100 MW _{th} (46 MW _{ee})
Power	3.3 MW _{ee}	0.6 MW _{ee}
LPG	10.80 MW _{th} (5.4 MW _{ee})	0.41 MW _{th} (0.2 MW _{ee})
Output		
SNG	67.85 MW _{th} (33.9 MW _{ee})	68.38 MW _{th} (34.2 MW _{ee})
SNG+LPG	78.65 MW _{th} (39.3 MW _{ee})	68.79 MW _{th} (34.4 MW _{ee})
Heat	23.22 MW _{th} (2.3 MW _{ee})	3.91 MW _{th} (0.4 MW _{ee})

The same exercise as in the pre-methanation case has been performed for the case with post-methanation purification. The results from the separations are shown in table 16 for water and amine scrubbing respectively.

Table 16. Gas compositions and other properties in the 100 MW_{th} case after up-grading post-methanation, on a dry-gas basis.

Component (Vol-%)	Water scrubbing	Amine scrubbing
CO ₂	1.0	0.2
CH ₄	90.8	92.8
CO	1.81*10 ⁻⁴	1.9*10 ⁻⁴
H ₂	3.9	3.9
C ₂ H _x	1.46*10 ⁻³	1.53*10 ⁻³
C ₆ H ₆	0	0
N ₂	3.9	3.1
O ₂	0.4	0
Methane slip (% of inlet)	1	0.05
Propane required for Wobbe index _{LHV} 45.5 (kg/Nm ³)	0.04	0.002

The SNG-efficiency (η_{SNG}) for the cases with post-methanation CO₂-removal has been calculated to 68.1% and 68.7% for water and amine scrubbing respectively. The amount of propane which is required for reaching the target Wobbe index is however significantly lower in the water scrubber post-methanation case compared to the pre-methanation case (0.04 kg/Nm³ compared to 0.11 kg/Nm³). The electricity consumption of the gasification system was set to 1.5% of the



overall biomass input of 1.5 MW [89]. The water scrubber consumed 3.9 MW while the amine scrubber consumed 1.9 MW; in both cases 3.1 MW was produced in the system. In Figure 26 the changes in chemical energy is visualised in the post-methanation separation case. Please note that the red and blue arrows add up to the inlet 100 MW_{th} and that the power is the net input, some electricity is generated internally.

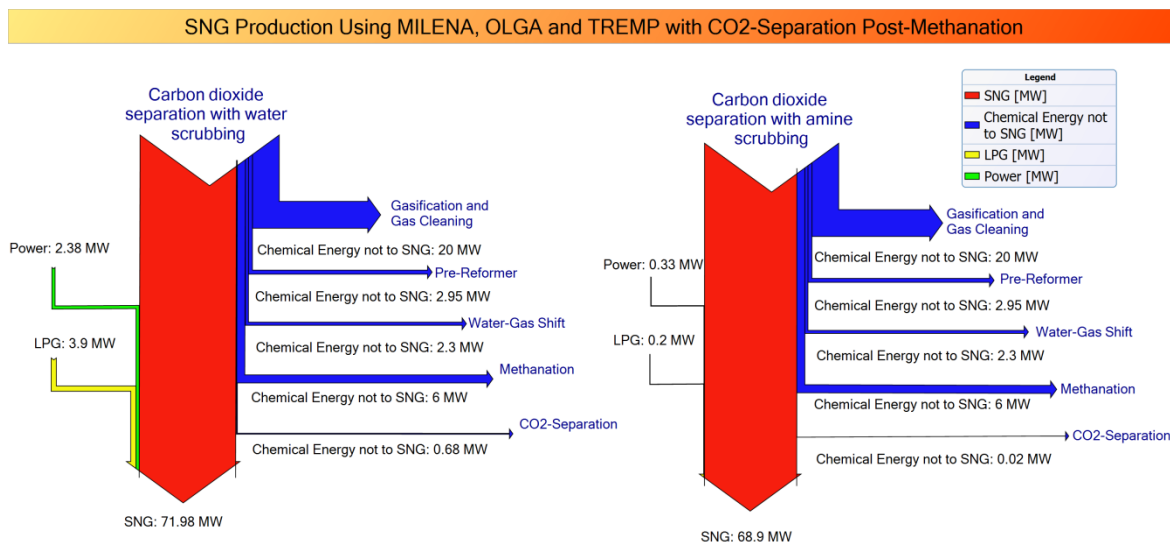

Figure 26. Representation of the changes in chemical energy with reaction.

As may be viewed in Figures 25 and 26, less LPG is required in both post-methanation cases compared to the pre-methanation separation. The energy penalty of separation is however larger in the post-separation. This is much due to the lower losses of energy-containing gases (CO, H₂ and CH₄) in the pre-methanation separation. The inputs and outputs of the post-methanation system is summarised in Table 17.

Table 17. Summary of inputs and outputs from the 100 MW_{th} system, post-methanation separation.

	Water scrubber	Amine scrubber
Input		
Biomass	100 MW _{th} (46 MW _{ee})	100 MW _{th} (46 MW _{ee})
Power	2.4 MW _{ee}	0.3 MW _{ee}
LPG	3.9 MW _{th} (2.0 MW _{ee})	0.2 MW _{th} (0.1 MW _{ee})
Output		
SNG	68.08 MW _{th} (34.1 MW _{ee})	68.73 MW _{th} (34.4 MW _{ee})
SNG+LPG	71.98 MW _{th} (36.0 MW _{ee})	68.93 MW _{th} (34.5 MW _{ee})
Heat	23.49 MW _{th} (2.4 MW _{ee})	4.91 MW _{th} (0.5 MW _{ee})

6.3.3 On the absorption of inert gases

To better illustrate the absorption of inert gases in both the amine scrubber and the water scrubber, the following calculations have been performed. The calculations have been performed for the amine case; however the effect in the water



scrubber is twice that of the one reported here (since the amine solution is composed of 50% water). The amount of the gas that was absorbed in the amine solution was calculated as a function of pressure at 25°C and is shown in Figures 27-29. The temperature of 25°C was chosen to give a conservative estimate of the maximum amount absorbed in the amine solution. In reality the absorbed amount will be lower since the temperature of the liquid will be higher than 25°C, in the range of 50-55°C depending on the amount of carbon dioxide absorbed.

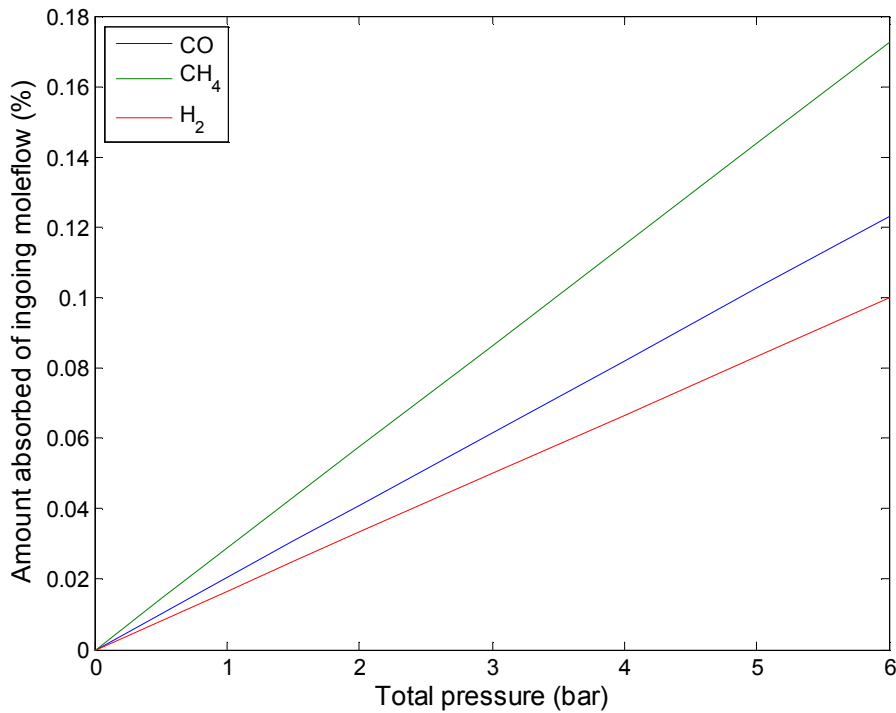

Figure 27. Amount of gas phase component that will be absorbed by the amine solution as function of the total pressure for the 10 MW_{th} case, after methanation.



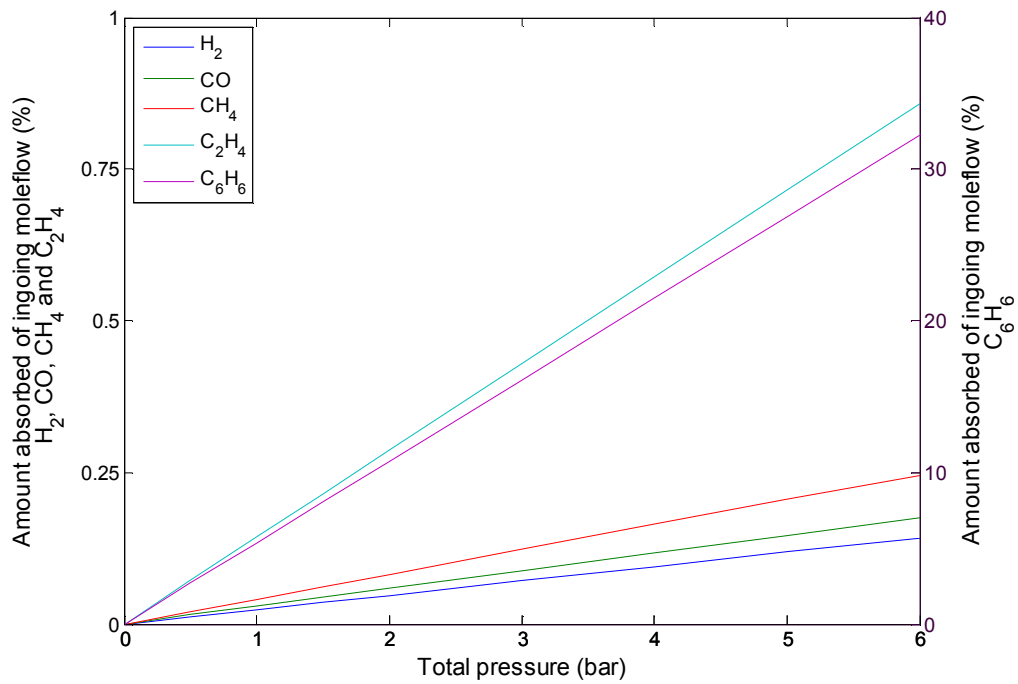

Figure 28. Amount of gas phase component that will be absorbed by the amine solution as function of the total pressure for the 100 MW_{th} case, before methanation; please observe that benzene (C₆H₆) is denoted on a secondary y-axis.

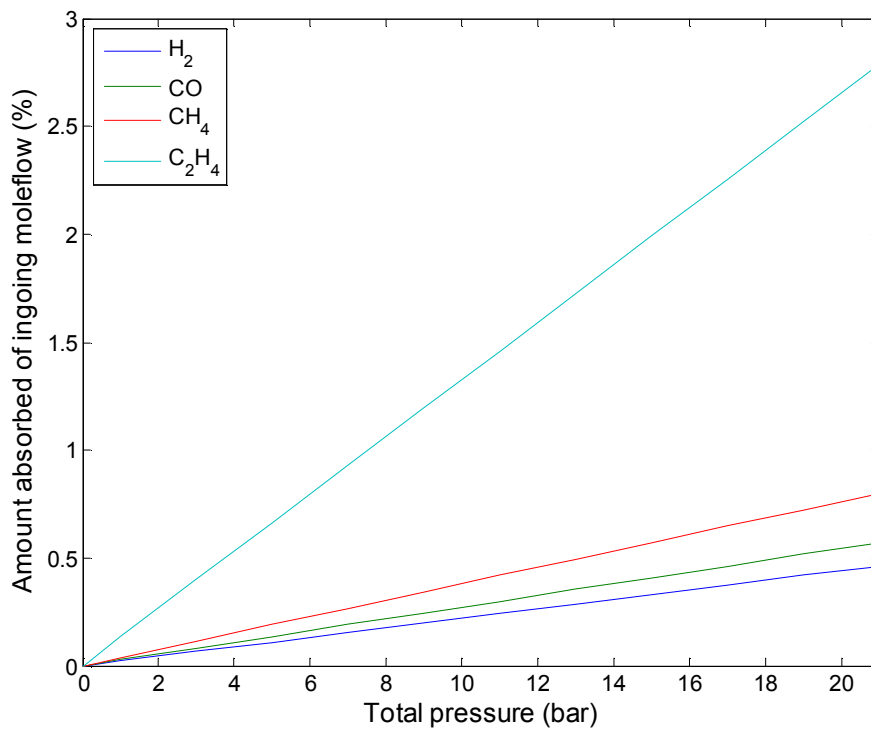

Figure 29. Amount of gas phase component that will be absorbed by the amine solution as function of the total pressure for the 100 MW_{th} case, after methanation.

The results of the investigation show that only small amounts of the gases H₂, CO, CH₄ and C₂H₄ will be absorbed in the amine solution. A larger amount of C₆H₆ will be absorbed compared to the other components in the 100 MW_{th} case before methanation, as can be seen in Figure 28. At a total pressure of 6 bar more than 30 % of the C₆H₆ present in the gas will be absorbed in the amine solution. However, the amount of C₆H₆ in the gas is very small.

6.4 Discussion

The CO₂-upgrading methods used in fermented biogas upgrading investigated in this report (water and amine scrubbing) appear possible to apply also in the synthesis gas route to SNG from biomass. The small-scale system, or case 1, considered with its 44% inlet CO₂ content and approximately 1,100 Nm³/h of gas is a good fit with the existing plants sizes and inlet concentrations offered by the existing suppliers [47]. There are suppliers offering the technology for both water and amine scrubbers from approximately 500 Nm³/h to approximately 2,000 Nm³/h. In this case, only post-methanation purification has been considered and it is clear that both methods investigated may be used for separating the CO₂ from the gas mixture. When using the water scrubber, there will be significant amounts of excess heat available, which may be used in district heating or the like. The heat available in the system, however, perfectly matches the heat requirement of the amine system. The η_{SNG} is in the favor of the amine scrubber (61.2% vs. 60.6%) due to lower losses of methane in the amine system. The electric equivalent efficiency on the other hand shows almost no difference between the two cases (60.7% vs. 60.9% in favor of the amine system). This is because of the credit the water scrubber system gets from exporting the heat as district heating. Therefore the choice between the two becomes similar to the one in upgrading fermented biogas. The gas composition of the SNG has been used as reported but it should also contain some N₂. The presence of nitrogen in the gas will not change any of the major conclusions in this part of the report, but more inert gases will require more LPG addition.

In the second case, 100 MW_{th}, the options investigated have been both gas upgrading before and after methanation. In theory, both methods should work well in removing CO₂ in the purified stream before the methanation. After performing the calculations, it is however clear that the use of a water scrubber in the position before methanation is not recommendable. The gas volume to be purified in the pre-methanation (20,000 Nm³/h before and 15,000 Nm³/h after methanation) will not only have its CO₂ content removed in the water scrubber, but nitrogen and oxygen will be transferred to the gas from the stripper section. The oxygen will be removed in the methanation stage where it reacts with hydrogen or some other combustible gas component. The nitrogen on the other hand, being an inert, will be carried through and end up in the product gas. The problem is that as the gas is methanated, the gas volume shrinks significantly and the nitrogen content becomes as high as 4.6%. The same is true for the CO₂-part of the gas, even though the gas is cleaned to 1% the exit composition after the methanation is 1.8%. This inert concentration-effect makes this particular solution require significant amounts



of LPG addition and makes it unsuitable in this case. The η_{SNG} and η_{ee} for this case are summarized in Table 18.

Table 18. Summary of η_{SNG} and η_{ee} for the 100 MW_{th} case

η_{SNG}	Water scrubbing	Amine scrubbing
Pre-methanation	67.9%	68.4%
Post-methanation	68.1%	68.7%
η_{ee}		
Pre-methanation	68.3%	75.6%
Post-methanation	73.9%	76.6%

It is clear from the table that the η_{SNG} and η_{ee} for this larger case is higher than for the smaller case, which is not surprising. The amine scrubber shows almost the same η_{SNG} independent of the position of purification, much due to the high degree of CO₂-removal. There is however a significant benefit to the η_{ee} in the post-methanation case. This is due to a slightly higher η_{SNG} (0.3%), to a lower heat requirement in the stripper section of the reboiler, allowing for the export of 1 more MW_{th} of district heating and to a lower net electricity consumption due to the lower system flow rate. The accumulation of higher hydrocarbons will cause the amine solution to reach the saturation point which can cause grave problems in the absorption. The absorbed higher hydrocarbons are likely to cause foaming in the amine solution which will seriously impede the absorption process. This is another reason, efficiency aside, for positioning the amine scrubber after the methanation.

The size of the separation systems required is outside the scope of traditional equipment suppliers. However these suppliers have solved this by delivering multiple, parallel units adding up to the required gas flows. Up to and above 10,000 Nm³/h has been reported for parallel units.

6.5 Conclusions

The major conclusions from the case studies are that the smaller system investigated is quite similar in gas composition, flow rate and impurities to a traditional anaerobic digester. Therefore the same trade-offs between amine and water scrubbers apply in this case as in the aerobic digester case. In the larger scale case, it is clear that post-methanation purification is to be preferred; from a gas quality standpoint when considering the water scrubber and from a gas purity standpoint when considering the amine scrubber.



7 Results and discussion

The η_{SNG} reported in the study, ranging from about 60% for the small scale system to 69% in the large scale system, is well in line with previous studies. These studies have shown η_{SNG} ranging from 55% to 75% depending on system configurations [90-96]. There appears to be an obvious synergy between smaller scale SNG production and existing separation methods for carbon dioxide, since both compositions and flow rates are well in line with what is treated as of today. The Achilles heel of the amine purification technology is the high heat demand of the stripper reboiler. The investigation has however showed that there will be enough heat available in the system for supplying the heat of this unit operation. The use of an amine purification system would therefore not have any (or little) heat to export, but the location of such a combination is more flexible since no external heat sink is required.

The use of both water scrubbing and amine purification should be avoided in the pre-methanation position. In the water scrubber case, the transfer of air to the product gas and the CO_2 remaining in the gas after purification makes the product gas after methanation require too much LPG addition. The amine system may be positioned up-stream the methanation, but care will have to be taken to avoid foaming issues. The calculations also show that post methanation have slightly better performance with respect to efficiency. In the larger scale, multiple parallel units will have to be used to provide enough throughput.

7.1 Future work

It would be interesting to perform the same exercise with other separation methods as well, such as PSA, membranes and some of the physical absorption methods, e.g. Selexol. Investigating combination effects of these methods would also be of interest. Could any of these be combined to achieve a better and more efficient separation?

The study has to date investigated the integration of the systems from an energy point of view. It would also be interesting to look at the integration from a physical standpoint and see how the various flows (stripper gas, CO_2 etc.) may be used in various points in the gasification system as oxidant or as inerting agent. Especially as an inerting agent there should be uses for the CO_2 , e.g. in the biomass feeding system, but the additional compression of this stream need to be valued against the use of another inert such as nitrogen.

There is also not much information on the effect of the trace components specific to the gasification context on the different separation methods. This would be an area where further work should be performed.



8 Conclusions

The major conclusions from the case studies are that the smaller system investigated is quite similar in gas composition, flow rate and impurities to a traditional anaerobic digester. Therefore the same trade-offs between amine and water scrubbers apply in this case as in the anaerobic digester case. In the larger scale case, it is clear that post-methanation purification is to be preferred; from a gas quality standpoint when considering the water scrubber and from a gas purity standpoint when considering the amine scrubber.

The efficiencies reached, both with respect to SNG and electricity, are well in line with earlier findings in the literature. It is not surprising to find the smaller system performing at about 7% lower η_{SNG} and 15% lower η_{ee} than the larger system.



9 Acknowledgements

The authors acknowledge the support provided by the Swedish Energy Agency and the industrial partners coordinated through the Swedish Gas Technology Centre.



10 Literature

1. Elvers, B., *Ullmann's Encyclopedia of Industrial Chemistry - 7th Edition in Print / Sample Volume* 2011: Wiley-VCH Verlag GmbH.
2. Kopyscinski, J., T.J. Schildhauer, and S.M.A. Biollaz, *Production of synthetic natural gas (SNG) from coal and dry biomass – A technology review from 1950 to 2009*. *Fuel*, 2010. **89**(8): p. 1763-1783.
3. Lackner, M., *Combustion Science and Technology*, in *Kirk-Othmer Encyclopedia of Chemical Technology* 2000, John Wiley & Sons, Inc.
4. van der Drift, A., et al., *Comparing the options to produce SNG from biomass*, in *18th European Biomass Conference and Exhibition* 2010: Lyon, France.
5. Gassner, M. and F. Maréchal, *Thermo-economic optimisation of the integration of electrolysis in synthetic natural gas production from wood*. *Energy*, 2008. **33**(2): p. 189-198.
6. Bengtsson, K., *Twin-Bed Gasification Concepts for Bio-SNG Production*, in *Chemical Engineering* 2007, Lund University: Lund.
7. *From solid fuels to substitute natural gas (SNG) using TREMP*, 2009, Haldor Topsoe: Kgs. Lyngby. p. 8.
8. Duret, A., C. Friedli, and F. Maréchal, *Process design of Synthetic Natural Gas (SNG) production using wood gasification*. *Journal of Cleaner Production*, 2005. **13**(15): p. 1434-1446.
9. Kopyscinski, J., T.J. Schildhauer, and S.M.A. Biollaz, *Methanation in a fluidized bed reactor with high initial CO partial pressure: Part I— Experimental investigation of hydrodynamics, mass transfer effects, and carbon deposition*. *Chemical Engineering Science*, 2011. **66**(5): p. 924-934.
10. Kopyscinski, J., T.J. Schildhauer, and S.M.A. Biollaz, *Methanation in a fluidized bed reactor with high initial CO partial pressure: Part II— Modeling and sensitivity study*. *Chemical Engineering Science*, 2011. **66**(8): p. 1612-1621.
11. Rüdüsüli, M., et al., *Monte Carlo simulation of the bubble size distribution in a fluidized bed with intrusive probes*. *International Journal of Multiphase Flow*, 2012. **44**(0): p. 1-14.
12. Standards, S.I.f., *SS 15 54 38 Motorbränslen - Biogas som bränsle till snabbgående ottomotorer*, 1999, SIS.
13. ISO, *ISO 15403-1:2006 Natural gas -- Natural gas for use as a compressed fuel for vehicles -- Part 1: Designation of the quality*, 2001.
14. SAE, *Effect of Gas Composition on Octane Number of Natural Gas Fuels* Society of Automotive Engineers, Inc., SAE 922359, 1992.
15. *Biomass Technology Group*. Available from: <http://www.btgworld.com/technologies/gasification.html>.
16. Boerrigter, H. and R. Rauch, *Review of applications of gases from biomass gasification*, 2006, Energy Research Centre of the Netherlands: Petten. p. 64.
17. *SGC Förgasning av biobränslen - Möjligheter att framställa syntesgas och drivmedel från fasta biobränslen*.
18. Olofsson, I., A. Nordin, and U. Söderlind, *Initial Review and Evaluation of Process Technologies Suitable for Cost-Efficient Medium-Scale Gasification for Biomass to Liquid Fuels*, in *ETPC Report 05-022002*.



19. Paysly, M.A. and R.P. Overend, *The SilvaGas Process from Future Energy Resources - A commercialization success*, in *12th European Conference and Technology Exhibition on Biomass for Energy, Industry and Climate Protection 2002*: Amsterdam, Netherlands.
20. *MILENA Biomass Gasification process*. 2012; Available from: <http://www.milenatechnology.com/>.
21. *FIFCB*. 2012; Available from: <http://www.ficfb.at/>.
22. Hinds, W.C., *Aerosol Technology - Properties, Behaviour and Measurement of Airborne Particles* 1999, New York: John Wiley and Sons inc.
23. Claes, B., et al., *Use of amino phase adsorbent for biomass tar sampling and separation*. *Fuel*, 1997. **76**: p. 137-142.
24. Stevens, D.J., *Hot gas conditioning: Recent Progress with Larger-Scale Biomass gasification system*, in *NREL/SR-510-29952* 2001.
25. Devi, L., et al., *Catalytic decomposition of biomass tars: use of dolomite and untreated olivine*. *Renewable Energy*, 2005. **30**: p. 565-587.
26. Sánchez, J.M., E. Ruiz, and J. Otero, *Selective Removal of Hydrogen Sulfide from Gaseous Streams Using a Zinc-Based Sorbent*. *Ind. Eng. Chem. Res.*, 2004. **44**(2): p. 241-249.
27. Hulteberg, C., *Sulphur-tolerant catalysts in small-scale hydrogen production, a review*. *International Journal of Hydrogen Energy*, 2012. **37**(5): p. 3978-3992.
28. Ertl, G., et al., *Handbook of Heterogeneous Catalysis, 8 Volumes* 2008: Wiley.
29. Albertazzi, S., et al., *The technical feasibility of biomass gasification for hydrogen production*. *Catalysis Today*, 2005. **106**(1-4): p. 297-300.
30. Larson, E.D., et al., *A Cost-Benefit Assessment of Gasification-Based Biorefining in the Kraft Pulp and Paper Industry*, 2006, Princeton Environmental Institute: Princeton. p. 152.
31. *Värnamoverket - En demonstrationsanläggning för el- och värmeproduktion ur biobränsle, baserad på trycksatt förgasning. Demonstrationsprogrammet 1996-2000* 2000: Sydkraft Miljö och Utveckling
32. Tunå, P., et al., *Synergies from combined pulp&paper and fuel production*. *Biomass and Bioenergy*, 2012. **40**(0): p. 174-180.
33. *Combined heat and power: a federal manager's resource guide (Final Report)*, 2000, US Department of Energy.
34. Kohl, A. and F. Riesenfeld, *Gas Purification*. Fifth edition ed 1997, Houston: Gulf Publishing Company.
35. *Lurgi Web Page*. 2012; Available from: www.lurgi.com.
36. Swanson, C., *Process Modeling of a Water Scrubbing System for Upgrading of Biogas to Grid Injection Standards - Model Development and Process Optimization* in *Department of Chemical Engineering* 2011, Lund University.
37. Persson, M., O. Jönsson, and R. Braun, *Biogas Upgrading to Vehicle Fuel Standards and Grid Injection*, 2006, IEA Bioenergy.
38. Benjaminsson, J., *Nya renings- och uppgraderingstekniker för biogas*, in *Svenskt Gastekniskt Center, Report SGC 1632006*.
39. Thambimuthu, K., J. Davison, and G. Murlidhar, *CO₂ Capture and Reuse*, in *ECN: IPCC2002*.



40. Mumford, K.A., et al., *Post-combustion Capture of CO₂: Results from the Solvent Absorption Capture Plant at Hazelwood Station Using Potassium Carbonate Solvent*. Energy & Fuels, 2012. **26**: p. 138-146.
41. Derks, P.W., *Carbon Dioxide Absorption in Piperazine Activated N-Methyldiethanolamine*, 2006, University of Twent: Enschede. p. 244.
42. Bishnoi, S. and G.T. Rochelle, *Thermodynamics of Piperazine/Methyldiethanolamine/Water/Carbon Dioxide*. Industrial & Engineering Chemistry Research, 2002. **41**(3): p. 604-612.
43. Figueroa, J.D., et al., *Advances in CO₂ capture technology - The U.S. Department of Energy's Carbon Sequestration Program*. Int J Greenhouse Gas Control, 2008. **2**: p. 9-20.
44. Kozak, F., et al., *Chilled Ammonia Process for CO₂ Capture*. Energy Procedia, 2009. **1**: p. 1419-1426.
45. Smith, K., et al., *Recent developments in solvent absorption technologies at the CO₂CRC in Australia*. Energy Procedia, 2009. **1**: p. 1549-1555.
46. Thee, H., et al., *A kinetic and process modeling study of CO₂ capture with MEA-promoted potassium carbonate solutions*. Chem Eng J, 2012. **210**: p. 271-279.
47. SGC report 270. *Biogas upgrading*, 2013.
48. de Hullu, J., et al., *Comparing different biogas upgrading techniques*, 2008, Eindhoven University of Technology: Eindhoven. p. 20-23.
49. Grande, C.A., *Biogas Upgrading by Pressure Swing Adsorption*, in *Biofuel's Engineering Process Technology*, InTech. p. 65-84.
50. Rege, S.U., et al., *Air-prepurification by pressure swing adsorption using single/layered beds*. Chemical Engineering Science, 2001. **56**(8): p. 2745-2759.
51. Spoorthi, G., et al., *Process intensification in PSA processes for upgrading synthetic landfill and lean natural gases*. Adsorption. **17**(1): p. 121-133.
52. Baker, R.W. and K. Lokhandwala, *Natural Gas Processing with Membranes: An Overview*. Industrial & Engineering Chemistry Research, 2008. **47**(7): p. 2109-2121.
53. Onda, K., H. Takeuchi, and Y. Okumoto, *Mass transfer coefficients between gas and liquid phase in packed columns*. J Chem Eng Jpn, 1968. **1**.
54. Willquist, K., et al., *Design of a novel biohythane process with high H₂ and CH₄ production rates*. International Journal of Hydrogen Energy, 2012. **37**(23): p. 17749-17762.
55. Aguila-Hernández, J., A. Trejo, and J. Gracia-Fadrique, *Surface tension of aqueous solutions of alkanolamines: single amines, blended amines and systems with nonionic surfactants*. Fluid Phase Equilib, 2001. **185**(1-2): p. 165-175.
56. Asprion, N., *Surface Tension Models for Aqueous Amine Blends*. Ind Eng Chem Res, 2005. **44**(18): p. 7270-7278.
57. Chen, Y.-R., et al., *Liquid heat capacity of the solvent system (piperazine;n-methyldiethanolamine;water)*. J Chem Thermodyn, 2010. **42**(1): p. 54-59.
58. Derks, P.W., K.J. Hogendoorn, and G.F. Versteeg, *Solubility of N₂O in and Density, Viscosity, and Surface Tension of Aqueous Piperazine Solutions*. J Chem Eng Data, 2005. **50**(6): p. 1947-1950.



59. Kamps, Á.P.-S., J. Xia, and G. Maurer, *Solubility of CO₂ in (H₂O+piperazine) and in (H₂O+MDEA+piperazine)*. *AIChE J*, 2003. **49**(10): p. 2662-2670.
60. Li, M.H. and K.P. Shen, *Densities and solubilities of solutions of carbon dioxide in water + monoethanolamine + N-methyldiethanolamine*. *J Chem Eng Data*, 1992. **37**(3): p. 288-290.
61. Paul, S. and B. Mandal, *Density and Viscosity of Aqueous Solutions of (N-Methyldiethanolamine + Piperazine) and (2-Amino-2-methyl-1-propanol + Piperazine) from (288 to 333) K*. *J Chem Eng Data*, 2006. **51**(5): p. 1808-1810.
62. Paul, S. and B. Mandal, *Density and Viscosity of Aqueous Solutions of (2-Piperidineethanol + Piperazine) from (288 to 333) K and Surface Tension of Aqueous Solutions of (N-Methyldiethanolamine + Piperazine), (2-Amino-2-methyl-1-propanol + Piperazine), and (2-Piperidineethanol + Piperazine) from (293 to 323) K*. *J Chem Eng Data*, 2006. **51**(6): p. 2242-2245.
63. Posey, M.L., K.G. Tapperson, and G.T. Rochelle, *A simple model for prediction of acid gas solubilities in alkanolamines*. *Gas Sep Purif*, 1996. **10**(3): p. 181-186.
64. Rinker, E.B., et al., *Viscosity, Density, and Surface Tension of Binary Mixtures of Water and N-Methyldiethanolamine and Water and Diethanolamine and Tertiary Mixtures of These Amines with Water over the Temperature Range 20-100.degree.C*. *J Chem Eng Data*, 1994. **39**(2): p. 392-395.
65. Samanta, A., S. Roy, and S.S. Bandyopadhyay, *Physical Solubility and Diffusivity of N₂O and CO₂ in Aqueous Solutions of Piperazine and (N-Methyldiethanolamine + Piperazine)*. *J Chem Eng Data*, 2007. **52**(4): p. 1381-1385.
66. Snijder, E.D., et al., *Diffusion coefficients of several aqueous alkanolamine solutions*. *J Chem Eng Data*, 1993. **38**(3): p. 475-480.
67. Teng, T.T., et al., *Viscosity of Aqueous Solutions of N-Methyldiethanolamine and of Diethanolamine*. *J Chem Eng Data*, 1994. **39**(2): p. 290-293.
68. Vahidi, M., et al., *Correlation of CO₂ solubility in N-methyldiethanolamine;piperazine aqueous solutions using extended Debye-Hückel model*. *J Chem Thermodyn*, 2009. **41**(11): p. 1272-1278.
69. Weiland, R.H., et al., *Density and Viscosity of Some Partially Carbonated Aqueous Alkanolamine Solutions and Their Blends*. *J Chem Eng Data*, 1998. **43**(3): p. 378-382.
70. Schäfer, B., A.E. Mather, and K.N. Marsh, *Enthalpies of solution of carbon dioxide in mixed solvents*. *Fluid Phase Equilib*, 2002. **194-197**(0): p. 929-935.
71. Kabadi, V.N., *Heat of Dissolution Measurements for CO₂ in Mixed Alkanolamine Solvents*, 2006, North Carolina A&T State University: Greensboro.
72. Svensson, H., C. Hulteberg, and H.T. Karlsson, *Heat of absorption of CO₂ in aqueous solutions of N-methyldiethanolamine and piperazine*. Manuscript submitted to the *International Journal of Greenhouse Gas Control*, 2012.



73. Klingspor, J., H.T. Karlsson, and I. Bjerle, *A kinetic study of the dry SO₂-limestone reaction at low temperature*. Chem Eng Commun, 1983. **22**: p. 81-103.
74. Trulsson, S.-G., *Design of absorption/desorption towers*, 1979, LTH.
75. Sherwood, T.K., *Mass Transfer* 1975, New York: McGraw-Hill.
76. Bishnoi, S. and G.T. Rochelle, *Absorption of carbon dioxide in aqueous piperazine/methyldiethanolamine*. AIChE J, 2002. **48**(12): p. 2788-2799.
77. Zhang, X., et al., *A kinetics study on the absorption of carbon dioxide into a mixed aqueous solution of methyldiethanolamine and piperazine*. Ind Eng Chem Res, 2001. **40**.
78. Bishnoi, S. and G.T. Rochelle, *Absorption of carbon dioxide into aqueous piperazine: reaction kinetics, mass transfer and solubility*. Chem Eng Sci, 2000. **55**(22): p. 5531-5543.
79. Bishnoi, S. and G.T. Rochelle, *Thermodynamics of Piperazine/Methyldiethanolamine/Water/Carbon Dioxide*. Ind Eng Chem Res, 2002. **41**(3): p. 604-612.
80. Zyugula, T.M., *A design review of steam stripping columns for wastewater service*, in *Proceedings of the 2007 AIChE Spring Meeting* 2007.
81. Closmann, F., T. Nguyen, and G.T. Rochelle, *MDEA/Piperazine as a solvent for CO₂ capture*. Energy Procedia, 2009. **1**(1): p. 1351-1357.
82. Dang, H. and G.T. Rochelle, *CO₂ absorption rate and solubility in monoethanolamine/piperazine/water*. Sep Sci Technol, 2003. **38**(2): p. 337-357.
83. Oyekan, B.A. and G.T. Rochelle, *Energy Performance of Stripper Configurations for CO₂ Capture by Aqueous Amines*. Ind Eng Chem Res, 2006. **45**(8): p. 2457-2464.
84. Oyekan, B.A. and G.T. Rochelle, *Alternative stripper configurations for CO₂ capture by aqueous amines*. AIChE J, 2007. **53**(12): p. 3144-3154.
85. Arcis, H., et al., *Enthalpy of solution of CO₂ in aqueous solutions of methyldiethanolamine at T = 322.5K and pressure up to 5 MPa*. J Chem Thermodyn, 2008. **40**(6): p. 1022-1029.
86. Tobelsen, F.A. and H.F. Svendsen, *Study of modified amine-based regeneration unit*. Ind Eng Chem Res, 2006. **45**: p. 2489-2496.
87. Xu, W.-G., et al., *Desorption of CO₂ from MDEA and Activated MDEA solutions*. Ind Eng Chem Res, 1995. **34**.
88. Fagernäs, L., et al., *Drying of biomass for second generation syngas production*. Biomass and Bioenergy, 2010. **34**(9): p. 1267-1277.
89. van der Meijden, C.M., *Development of the MILENA gasification technology for the production of Bio-SNG*, 2010, ECN: Petten. p. 194.
90. Hayne, S. and S. Harvey, *Consistent assessment of the energy and economic performance of second generation biofuel production processes using energy market scenarios*, in *6th Dubrovnik Conference on Sustainable Development of Energy, Water and Environment Systems* 2011: Dubrovnik.
91. Holmgren, K.M., et al. *Evaluating the greenhouse gas impact from biomass gasification systems in industrial clusters - methodology and examples*. in *World Renewable Energy Congress 2011*. 2011. Linköping.



92. Heyne, S., H. Thunman, and S. Harvey, *Extending existing combined heat and power plants for synthetic natural gas production*. International Journal of Energy Research, 2012. **36**(5): p. 670-681.
93. Heyne, S., M.C. Seemann, and S. Harvey. *Integration study for alternative methanation technologies for the production of synthetic natural gas from gasified biomass*. in *13th Conference on Process Integration, Modelling and Optimisation for Energy Saving and Pollution Reduction*. 2010. Prague: Chemical Engineering Transactions.
94. Hayne, S. and S. Harvey. *Production of synthetic natural gas from biomass, process integration drying*. in *22nd International conference on Efficiency, Cost, Optimization Simulation and Environmental Impact of Energy Systems*. 2009. Foz do Iguacu, Parana, Brazil.
95. Arvidsson, M., et al., *Integration opportunities for substitute natural gas (SNG) production in an industrial process plant*, in *15th Conference on Process Integration, Modelling and Optimisation for Energy Saving and Pollution Reduction*, P.S. Varbanov, H.L. Lam, and J.J. Klemes, Editors. 2012.
96. van der Meijden, C.M., H.J. Veringa, and L.P.L.M. Rabou, *The production of synthetic natural gas (SNG): A comparison of three wood gasification systems for energy balance and overall efficiency*. Biomass and Bioenergy, 2010. **34**(3): p. 302-311.

