



LUND UNIVERSITY

The Importance of High-Frequency, Small-Eddy Turbulence in Spark Ignited, Premixed Engine Combustion

Ting, David S-K; Checkel, M. David; Johansson, Bengt

Published in:
SAE Technical Paper Series

1995

[Link to publication](#)

Citation for published version (APA):

Ting, D. S-K., Checkel, M. D., & Johansson, B. (1995). The Importance of High-Frequency, Small-Eddy Turbulence in Spark Ignited, Premixed Engine Combustion. In *SAE Technical Paper Series* Society of Automotive Engineers. <http://www.sae.org/technical/papers/952409>

Total number of authors:
3

General rights

Unless other specific re-use rights are stated the following general rights apply:
Copyright and moral rights for the publications made accessible in the public portal are retained by the authors and/or other copyright owners and it is a condition of accessing publications that users recognise and abide by the legal requirements associated with these rights.

- Users may download and print one copy of any publication from the public portal for the purpose of private study or research.
- You may not further distribute the material or use it for any profit-making activity or commercial gain
- You may freely distribute the URL identifying the publication in the public portal

Read more about Creative commons licenses: <https://creativecommons.org/licenses/>

Take down policy

If you believe that this document breaches copyright please contact us providing details, and we will remove access to the work immediately and investigate your claim.

LUND UNIVERSITY

PO Box 117
221 00 Lund
+46 46-222 00 00

The Importance of High-Frequency, Small-Eddy Turbulence in Spark Ignited, Premixed Engine Combustion

David S-K. Ting and M. David Checkel
University of Alberta

Bengt Johansson
Lund Institute of Technology

The appearance of the ISSN code at the bottom of this page indicates SAE's consent that copies of the paper may be made for personal or internal use of specific clients. This consent is given on the condition however, that the copier pay a \$7.00 per article copy fee through the Copyright Clearance Center, Inc. Operations Center, 222 Rosewood Drive., MA 01923 for copying beyond that permitted by Sections 107 or 108 of the U.S. Copyright Law. This consent does not extend to other kinds of copying such as copying for general distribution, for advertising or promotional purposes, for creating new collective works, or for resale.

SAE routinely stocks printed papers for a period of three years following date of publication. Direct your orders to SAE Customer Sales and Satisfaction Department.

Quantity reprint rates can be obtained from the Customer Sales and Satisfaction Department.

To request permission to reprint a technical paper or permission to use copyrighted SAE publications in other works, contact the SAE Publications Group.

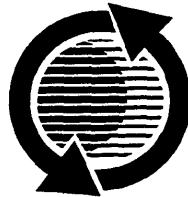

GLOBAL MOBILITY DATABASE

All SAE papers, standards, and selected books are abstracted and indexed in the Global Mobility Database.

No part of this publication may be reproduced in any form, in an electronic retrieval system or otherwise, without the prior written permission of the publisher.

ISSN 0148-7191

Copyright 1995 Society of Automotive Engineers, Inc.

Positions and opinions advanced in this paper are those of the author(s) and not necessarily those of SAE. The author is solely responsible for the content of the paper. A process is available by which discussions will be printed with the paper if it is published in SAE transactions. For permission to publish this paper in full or in part, contact the SAE Publications Group.

Persons wishing to submit papers to be considered for presentation or publication through SAE should send the manuscript or a 300 word abstract of a proposed manuscript to: Secretary, Engineering Activity Board, SAE.

The Importance of High-Frequency, Small-Eddy Turbulence in Spark Ignited, Premixed Engine Combustion

David S-K. Ting and M. David Checkel
University of Alberta

Bengt Johansson
Lund Institute of Technology

ABSTRACT

The different roles played by small and large eddies in engine combustion were studied. Experiments compared natural gas combustion in a converted, single cylinder Volvo TD 102 engine and in a 125 mm cubical cell. Turbulence is used to enhance flame growth, ideally giving better efficiency and reduced cyclic variation. Both engine and test cell results showed that flame growth rate correlated best with the level of high frequency, small eddy turbulence. The more effective, small eddy turbulence also tended to lower cyclic variations. Large scales and bulk flows convected the flame relative to cool surfaces and were most important to the initial flame kernel.

INTRODUCTION

Although combustion chamber turbulence has been around since the invention of the first combustion engine, its role was overlooked until the early twentieth century. Clerk and Hopkinson [1] were the first researchers to discover the vital role of turbulence in engine combustion with their experiments on turbulence effects on combustion rate as early as 1912. As stated in [1], gas engines would have been impracticable had the rates of explosion been the same in actual engine cylinders as in closed-vessel experiments. Since then, many researchers have studied the effects of turbulence on the combustion process, (for example, [2, 3, 4]). In

general, the more intense the eddying motion, the faster the combustion rate. However, under very lean or high exhaust-gas-recirculation (EGR) conditions, an excessive level of turbulence may not be desired. With lean burn or high EGR mixture, the high intensity turbulence can lead to an increase in cyclic variations and engine misfire.

This paper focuses on the different roles played by the higher frequency, smaller scales and the lower frequency, larger scales of turbulence in engine combustion. It is the authors' belief that further advancement in high turbulence, lean burn, highly efficient combustion engines depends on a better understanding of turbulence influences on the combustion process.

SMALL EDDY TURBULENCE VERSUS LARGE EDDY TURBULENCE - The different roles played by small scale and large scale mixture motions in engine combustion have been debated for many decades. The issue is particularly confused by the presence of large scale, organized motions such as swirl, tumble and squish which may break down into smaller scale turbulence during combustion, (see for example [5]). Frequently, researchers overlook the importance of keeping comparable turbulence intensity over the period of combustion when making a comparison. Such comparisons become extremely complex when very different engine chamber designs are involved. One way of decoupling different turbulence effects is into

"flame-turbulence" and "flame-electrode/wall" problems. "Flame-turbulence" interactions can be regarded as the enhancement of the combustion rate, predominantly by high frequency, small scale turbulence. The "flame-electrode/wall" interactions relate to the flame ball being convected, predominantly by low frequency, large scale turbulence or organized motions such as swirl and tumble, in a chamber containing electrodes and walls. Variable amounts of electrode and wall contact give variable quenching. Loss of flame area due to quenching is most critical when the flame kernel is small and is one of the major factors giving cycle to cycle variations in combustion rate. (Other major causes of the cycle to cycle variation are fluctuations in turbulence and inhomogeneities in the fuel / air / residual gas mixture.)

When the flame ball is small relative to the average eddy size, (whether due to small flame ball or large eddy size), the high frequency, smaller eddies are most effective in shearing and wrinkling the flame front [6]. Eddies larger than the flame ball mostly convect the flame around. Figure 1a portrays a schematic of small flame ball / eddy case. The relatively small flame ball is wrinkled by the small scale, closely spaced corrugations. On the other hand, the largest eddies are like wandering giants, who occasionally kick the flame ball around. This flame convection by the "Kicking effect" is very much related to cyclic variation. Depending on the relative location of the flame ball, large eddies, and quench surfaces in the combustion chamber, the outcome of flame convection can be very different. The largest scales of motion such as swirl and tumble tend to provide a consistent direction of motion on each cycle. However, large scale, random turbulence eddies can impart a variable extra motion resulting in variable quench surface contact. This variation contributes part of the cycle to cycle variation in engine combustion.

Variation in rate of turbulent flame growth is another important factor in cyclic variability of combustion. Depending on the relative location of the flame kernel among the eddies, the increase in flame front corrugation and flame ball distortion may vary notably. The variation in turbulent flame growth will generally be greater if the turbulence enhancement is produced by larger scale turbulence than by small scale turbulence, due to the greater spatial uniformity of small scale turbulence.

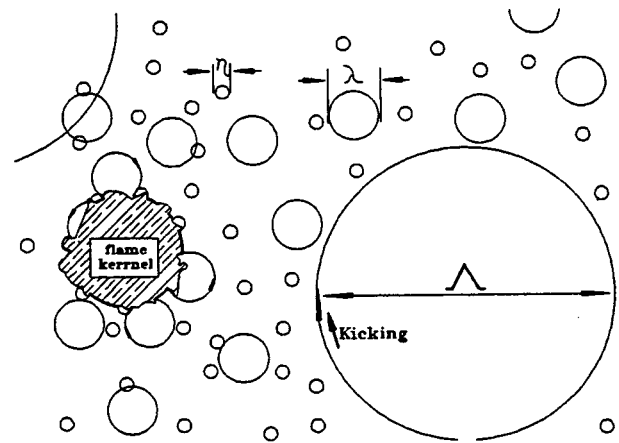

Figure 1a A small flame kernel in the midst of relatively large eddies of different sizes. (η =Kolmogorov scale, λ =Taylor microscale, Δ =integral length scale).

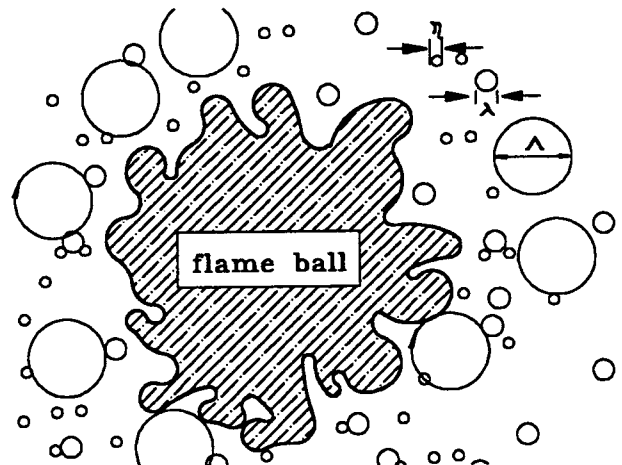

Figure 1b A large flame ball in the midst of relatively small eddies of different sizes.

As the flame kernel grows larger (or with fine scale, small eddy turbulence), a larger portion of eddies in the turbulence spectrum contribute to wrinkling of the flame front, directly enhancing the burning rate. This large flame ball / small eddy size case, as shown in Figure 1b, provides more effective turbulence enhancement for the same turbulence intensity. As the flame grows, the larger flame ball is too big to be kicked around and can take direct advantage of all the eddy sizes.

Based on the above physical arguments, small-eddy turbulence seems to be more favourable for fast-burn, low-cyclic-variation engines. Why then do engine designs still employ high swirl and tumble, which are organized large scale motions? The main reason is that small eddy turbulence decays much faster than large scale mixture motions. Bulk mixture motions such as swirl and tumble provide a consistent direction of flow relative to the electrodes and chamber walls to reduce quenching variability. They also store kinetic energy which can be converted to small scale turbulence when the large scale motion is squished during the compression and combustion period [7, 8, 9]. Thus, while not as useful in directly enhancing flame growth as small scale turbulence, the bulk motions are important in maintaining the more favourable, small eddy turbulence at a high level over the combustion process. In other words, large scale turbulence decays slower and hence, maintains a higher overall turbulence level over the combustion period.

Engine and idealized combustion experiments tend to show advantages of smaller scale turbulence. For example, Hill and Kapil [10, 11] found a good relation between the ratio of Taylor microscale over laminar burning velocity and the standard deviations in burning time in spark-ignition engines. According to their studies, cyclic variation can be reduced proportionally by decreasing the turbulent length scale. However, there is a lack of systematic studies which correctly separate the influences of turbulence intensity and scale, particularly considering the variation of both those quantities over the combustion period. This study considers combustion in an engine and in an idealized turbulent combustion cell. In both situations, turbulence could be varied over a range of scales and intensities and combustion rate could be measured. This allowed systematic consideration of turbulence intensity, turbulence scale, and flame size effects on combustion.

EXPERIMENT AND ANALYSIS

ENGINE - The single cylinder engine used was based on a six-cylinder Volvo TD 102 diesel engine converted to spark ignition with natural gas fuel. This engine has been described in detail in [12, 13] and basic dimensions are provided in Table 1. Figure 2 is a schematic of the experimental apparatus used. The flow motion was measured using a two-component, cycle-resolved Laser Doppler Velocimetry system. The velocity measurements were processed with a frequency and a time domain filtering technique to obtain turbulence at different frequencies. The cylinder pressure was measured simultaneously to the velocity registrations. A one-zone heat release analysis was then applied to the pressure trace to extract the rate of heat release. This one zone heat release model was used in this study to estimate the early heat release rate in the engine cylinder. The rate at which the first 0.5 % of the heat was released was correlated with the turbulence parameters.

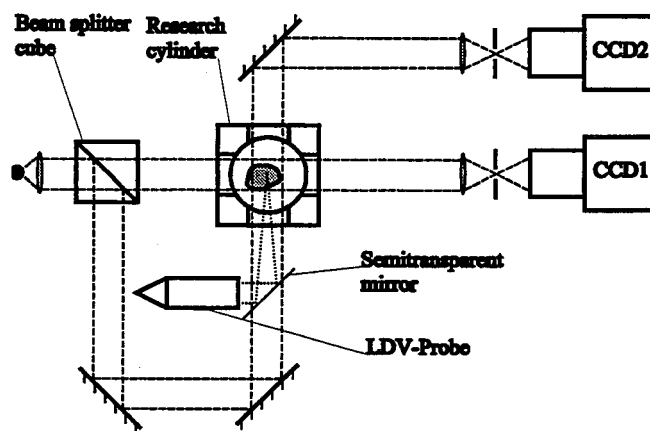

Figure 2 A schematic of the experimental apparatus involved in the Volvo TD 102 diesel engine cylinder test.

Table 1 Geometric properties of the engine.

Displaced volume	1600 cm ³
Bore	120.65 mm
Stroke	140 mm
Connection rod	160 mm
Compression ratio	10:1

TEST CELL - The idealized study was conducted in a 125 mm cubical combustion chamber which is shown schematically in Figure 3. Premixed methane-air mixtures were centrally spark-ignited at 101 kPa and 300 K. Both high speed schlieren video and pressure trace analyses using a multi-zone equilibrium model were employed to study the turbulent flame growth. Details of the experiment and analysis can be found in [14, 15]. Turbulence with ignition-time intensity up to 2 m/s and controllable integral scale of 2, 4 or 8 mm was produced by pulling a perforated plate across the chamber prior to ignition. Turbulence levels and decay rate were measured at the centre of the cell during cold runs, without combustion, and justified using detailed wind tunnel measurements [16]. This "cold" turbulence was adjusted for the effects of geometric distortion, caused by the propagating flame front, and compression, due to combustion chamber pressure rise. The rapid distortion model of Chew and Britter [17] was used and the validity of the adjustment is discussed in [14]. Figure 4 shows the effects of geometric distortion and compression on the flame front turbulence according to the rapid distortion model. The case shown is a typical, 0.7 equivalence ratio methane-air flame with ignition-time turbulence of 1.2 m/s and roughly 4 mm integral scale. Curve 1 in Figure 4 shows the decline in turbulence intensity due to viscous decay. A more rapidly burning flame would allow less time for decay and thus maintaining a higher turbulence level over the combustion period. Conversely, a slower burning flame would allow the turbulence intensity to decay more. Right after ignition, the turbulence ahead of the flame front is enhanced by geometric distortion, (Curve 2), as the growing flame kernel stretches the surrounding mixture. This geometric distortion enhancement decreases to zero as the flame approaches the walls. However, the compression-related enhancement, (Curve 3), increases as the combustion chamber pressure rise increases. The combined effect on turbulence intensity due to viscous decay, geometric distortion and compression is shown by Curve 4.

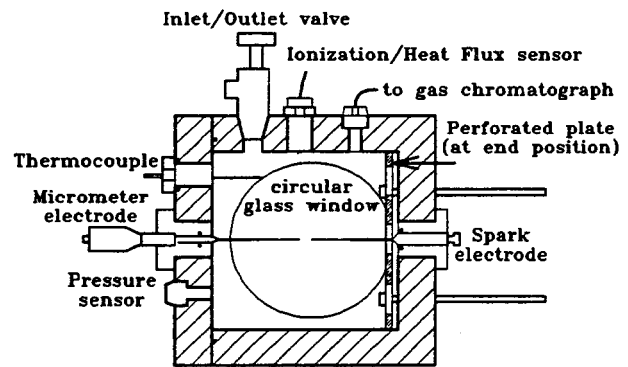

Figure 3 The 125 mm cubical combustion cell with a hydraulic cell radius of 76.6 mm.

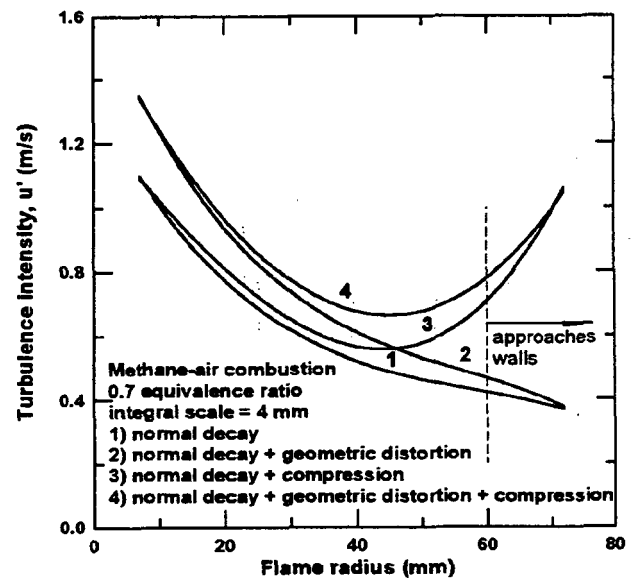

Figure 4 The decaying turbulence in the cubical chamber as affected by the expanding flame according to the rapid distortion theory.

As well as combustion chamber pressure rise rate, the combustion rate can be expressed in terms of burning velocity. The burning velocity is variously called the flame velocity, normal combustion velocity or flame speed [18]. Laminar burning velocity is defined as the velocity at which the combustion wave consumes the unburned mixture, (as viewed from the unburned mixture), in the direction normal to the wave surface.

From the pressure trace, the multi-zone thermodynamic equilibrium model was used to extract mass fraction burned, mean flame radius, burnt and unburnt temperatures as functions of time. The multi-zone thermodynamic equilibrium model is described in detail in [14, 15]. The model assumes an adiabatic combustion wave of zero thickness which propagates radially from the ignition point. The code for this model is an energy balance and thermodynamic equilibrium solver based on ideal gas property relationships. The flame growth rate changes significantly over the combustion period in a closed vessel mostly due to the increasing vessel pressure. Therefore, the flame growth rate does not correspond to the burning rate. However, the burning velocity which signifies the burning rate, can be calculated as the amount of unburnt volume consumed by the flame per unit area, per unit time. For the quiescent mixture, the flame ball remained fairly spherical over the early combustion period considered. Hence, the laminar burning velocity (thickness of the concentric shell of unburnt element consumed by the spherical flame ball over a small time step) was basically calculated according to the definition. With turbulence, the flame ball becomes wrinkled and distorted so that, at high turbulence, the notion of the flame front can be vague. Under these conditions, the turbulent burning velocity can still be calculated analogous to the quiescent case. Turbulent burning velocity was evaluated by considering the burnt volume as though it was a smooth-surfaced sphere. The turbulent burning velocity was estimated as the volume of unburnt mixture consumed per unit area of the smooth-surfaced sphere, per unit time.

ENGINE EXPERIMENTS AND RESULTS

THE IMPORTANCE OF HIGH FREQUENCY FLUID MOTION IN ENGINES - In a real engine, the turbulence does not always decay in a predictable manner

as in the cubical chamber experiments. Recent, measurements of the fluid flow in ten different combustion chambers for medium size natural gas engines [7, 19] have shown that the turbulence can be significantly altered especially during the later part of the compression stroke. If the engine combustion chamber is using a large squish area, the interaction between squish, swirl and tumble can be very complex and unpredictable. The result can be a relatively early peak in turbulence as with the Ricardo NebulaTM or a later peak with a combustion chamber that uses more piston-cylinder head squish area. The turbulence intensity, rate of heat release (ROHR) and the mean velocity have been plotted as a function of crank angle degree (CAD) in Figure 5. Figures 5a through 5j correspond to results with different bowl-in-piston chamber shapes described as: the square, the cylinder, the cross, the square with a compression ratio of 16:1, the Nebula, the conical, the hemi with a compression ratio of 16:1, the turbine, the hemi and the flat combustion chamber respectively. Except where noted, all chambers had a compression ratio of 12:1. The geometry and other details of these chambers are given in [19]. The solid and the dashed lines in Figure 5 represent the velocity in the x and y direction respectively as shown in Figure 6.

The rate of combustion during the main part of the combustion (10-90% heat release) has previously been shown to correlate well to the average level of high frequency turbulence during that time period. Figure 7 shows a plot of the rate of heat release as a function of turbulence intensity. This figure shows that there are two combustion chambers that have a faster combustion rate than expected from the level of turbulence, the Nebula and cross. It is interesting to note that these combustion chambers have a significantly lower level of turbulence 50 CAD after top-dead-centre (TDC), compared to other chambers. We know that a turbulent flow field with smaller scales has a faster rate of turbulence decay and the lower level of turbulence 50 CAD after TDC is one indication that the scales of turbulence in the Nebula and Cross chambers are smaller than average. If this hypothesis is true, Figure 7 shows that the smaller scales in Nebula and Cross generates a favourable environment for the combustion.

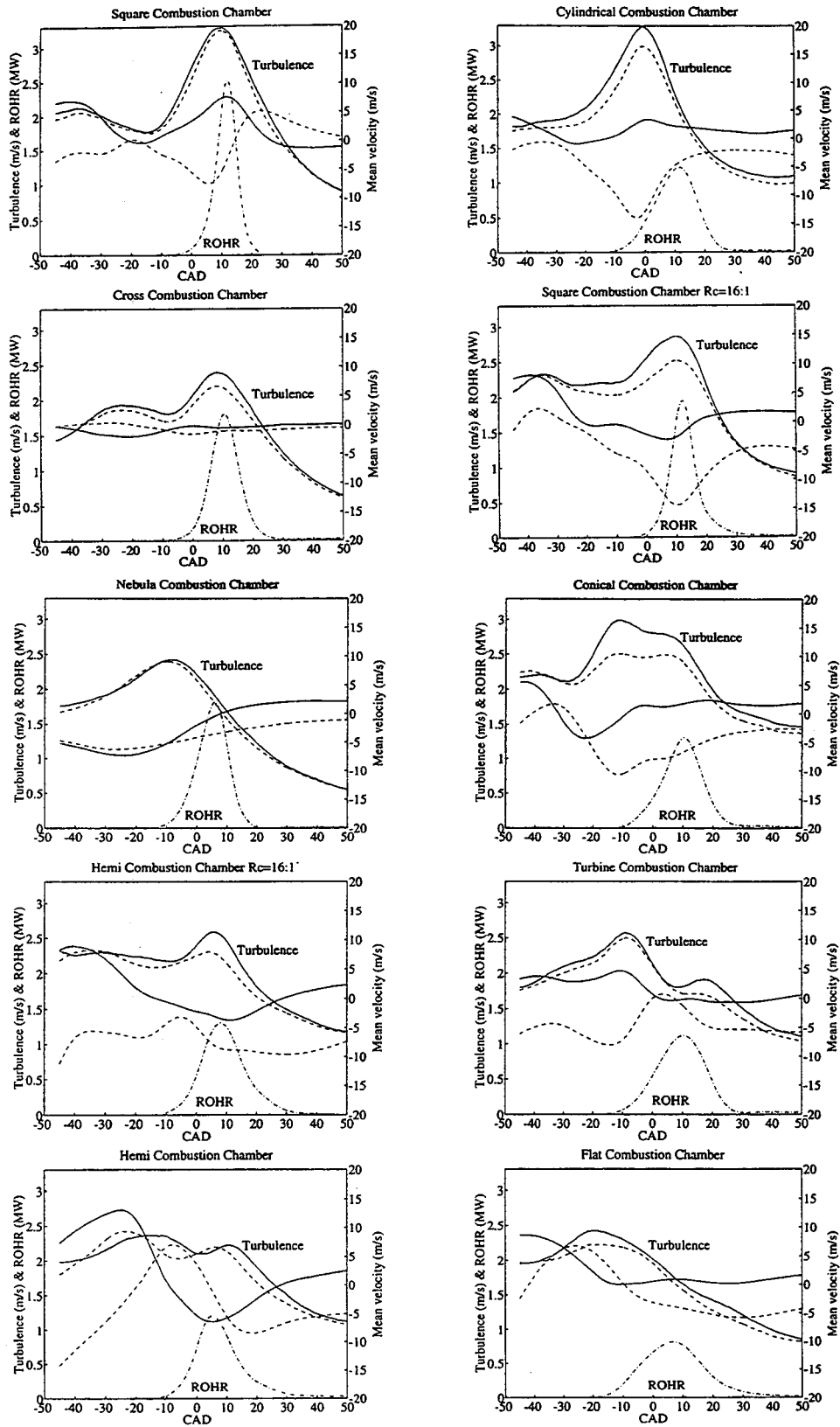

Figure 5 Mixture turbulence and the rate of heat release as functions of crank angle degree for various combustion chambers used in the engine experiment. The solid and the dashed lines represent the velocity in the x and y directions respectively (see Figure 6).

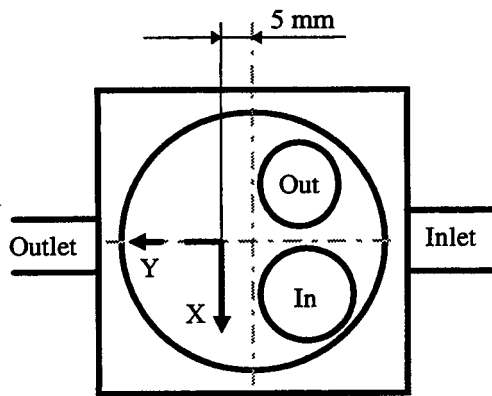

Figure 6 Schematic view of the engine with the measured velocity components. The swirl is rotating clockwise.

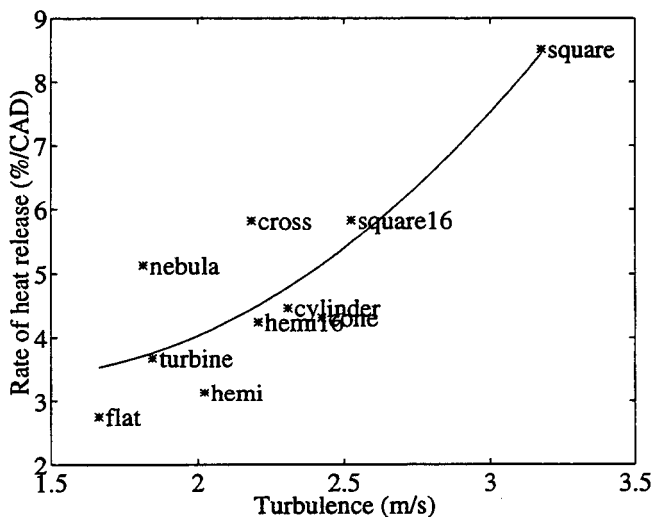

Figure 7 Rate of heat release in the 10-90% heat release interval as a function of average turbulence in the same interval.

THE IMPORTANCE OF HIGH AND LOW FREQUENCY FLOW WITH DIFFERENT FLAME SIZES - The previous results have shown that high frequency turbulence is most beneficial for burning velocity or flame speed enhancement in the main stage of flame growth. However, with a very small flame, the turbulence wrinkling of the flame may not have progressed sufficiently. Simultaneous schlieren images of the flame and Laser Doppler Velocimetry (LDV) measurements of the flow in

the engine have shown that it is the low frequency flow component, mean velocity, that is most important for flame propagation in the very early part of the propagation process. Figure 8 is a plot of correlation between flame speed and flow parameters as a function of CAD, (see [7] for details). The figure shows that the "mean velocity" gives a higher correlation with the combustion rate for small flames. The reason behind this is that the initial small flame kernel has not yet been wrinkled significantly. The burning rate has not reached such a high value that it can ignore the cooling caused by the electrode. Hence, it is more important at this very early stage to reduce the cooling effect of the electrodes by moving the flame away from the electrodes. After a notable fraction of the fuel has burnt, the relative importance of bulk flow and turbulence (higher frequency part) is changed. When only 0.5% of the fuel is burnt, the flame is big enough to average out all bulk flow irregularities and by then the small scale turbulence is the major parameter controlling the burning velocity.

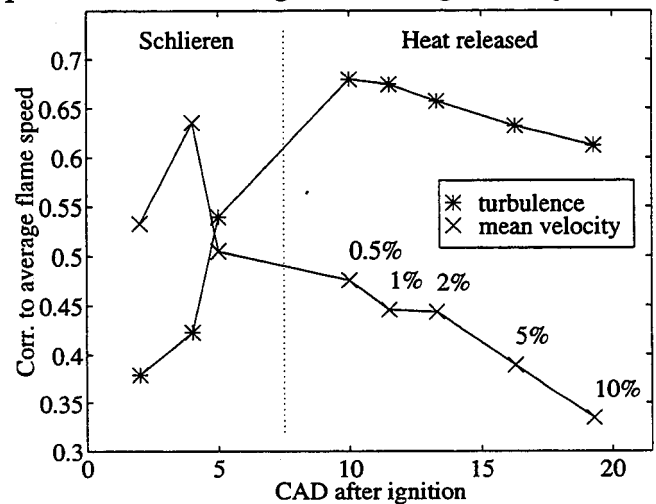

Figure 8 The correlation obtained when mean velocity, turbulence and spark charge are used to explain the variation in the early rate of heat release 0-0.5% HR.

CORRELATION BETWEEN TURBULENCE AT DIFFERENT FREQUENCIES AND FLAME SPEED - From the results discussed above, we know that the bulk flow pattern is most important for the very early flame propagation. However, there is still an interesting question regarding the size of turbulent eddies that is responsible for the flame speed enhancement. Previous work [12] has shown that it is possible to split the turbulence into several different frequency parts. By correlating the energy content in each frequency interval to the rate of heat release, it is possible to find the most important frequencies of the turbulence in enhancing the burning rate. When the 0-0.5% heat release duration is used as a

measure of early flame speed, it was found that frequencies in the 2-6 kHz interval gave the best correlation between flame speed and energy content. The flame has, however, grown to be more than 30 mm in radius by the end of this period. To see how the correlation would be for a smaller flame, the same kind of frequency resolved turbulence correlation is performed using the flame size at 5 CAD after ignition. Figure 9 shows the result from this evaluation. The results from the larger flame are also included in this figure. Despite the experimental scatter, a trend towards a higher correlation between high frequency turbulence and flame size at 5 CAD is detectable. The frequency of turbulence can be translated into eddy size using Taylor's hypothesis, which states that a length scale can be deduced from a time scale by using the mean velocity. In this work, the average bulk flow velocities (mean velocities) for all cycles have been used to translate frequency into length scale. Figure 10 shows the same correlation as Figure 9 plotted against the estimated length scale of the turbulence. This figure shows that the lower correlation obtained between low frequency turbulence and flame size at 5 CAD after ignition translates into a lower correlation between large eddies and flame propagation in this very early period. This is as expected as a larger eddy is less likely to wrinkle the flame surface, especially when the flame is small.

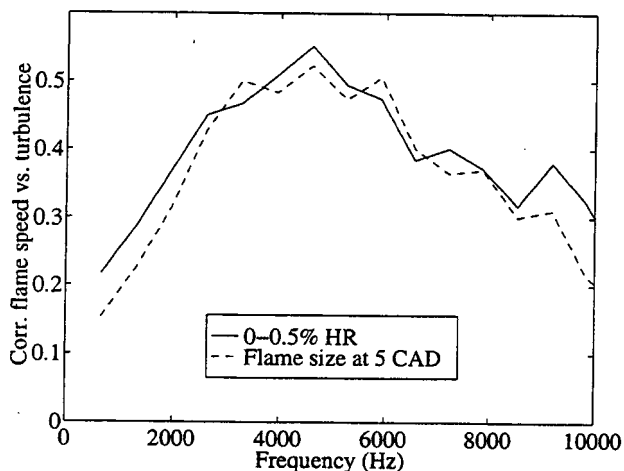

Figure 9 Correlation of flame speed versus turbulence as a function of turbulence frequency.

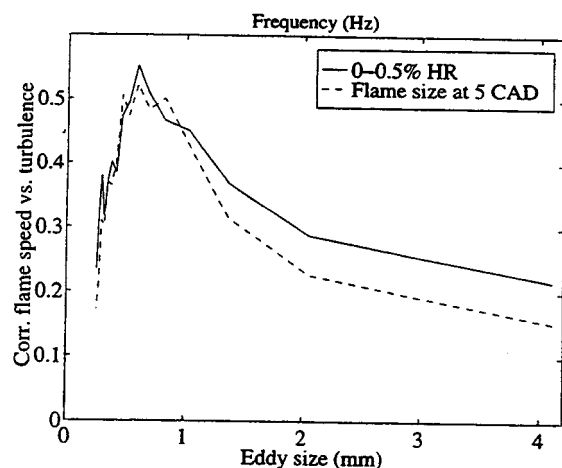

Figure 10 Correlation of flame speed versus turbulence as a function of eddy size.

There is perhaps a question about the results presented in the last two sections. From the correlation with both the mean velocity and turbulence, (Figure 8), we found that the low frequency, mean velocity was more important for very small flames. The frequency resolved analysis showed, however, that the low frequency portion in the turbulence was less useful for flame speed enhancement, (Figures 9 and 10). There are two possible explanations to this discrepancy. One reason for this conflict in results is how the velocity data were handled. When the velocity trace was low-pass filtered with the moving window technique to obtain the mean velocity, the direction of the flow was given as the sign of the mean velocity. But with frequency resolved procedure the sign information was lost. The other explanation is based on physical arguments. The mean velocity obtained by the low-pass filtering was a measure of the bulk motion in the cylinder. This bulk flow moves the flame kernel and leads to a changing contact area to the cool walls. Therefore, it is expected that the bulk flow would have a large impact on the very small flame measured by schlieren imaging. This was also noted. In the section presenting the frequency resolved turbulence, the energy content in each frequency interval was interpreted as a measure of how intense the eddies were in that specific interval. The lack of correlation between low frequency turbulence and combustion rate was then interpreted as a slower turbulent flame speed enhancement by larger eddies. This could be expected from the arguments in the introduction.

CUBICAL CELL EXPERIMENTS AND RESULTS

INCREASING COMBUSTION RATE WITH INCREASING TURBULENCE INTENSITY - It has been well established that, in general, combustion rate increases roughly proportionally with increasing turbulence intensity [20, 21, 22]. Hence, one of the most effective ways of enhancing the burning rate is to increase the mixture turbulence. This is exactly what was shown from the engine results in Figure 7; the square chamber produces the highest turbulence and hence the fastest heat release rate. The following paragraphs present more detailed results, with regards to the role of turbulence intensity from the cubical cell.

Figure 11 shows typical laminar and turbulent schlieren flame growth images. Premixed methane-air mixtures of 0.7 equivalence ratio were spark-ignited at 101 kPa and 300 K in the cubical cell. At ignition time, the turbulence intensities were 0, 1.0 m/s, 1.2 m/s and 2.0 m/s for (a), (b), (c) and (d) respectively. The integral scale was fixed at about 8 mm with variable intensity by drawing the same plate across the chamber at different speeds. It is clear from the figure that the higher the turbulence intensity, the faster the flame growth. For decaying turbulence with a specific integral scale, the decay rate increases significantly with increasing intensity. If the turbulence decay rate did not increase with increasing intensity, the increase in flame growth with increasing turbulence intensity would be even more notable. Any decrease in flame front wrinkling scale with increasing turbulence intensity is, however, not very obvious in Figure 11.

The burning velocities of the cases shown in Figure 11 are plotted against flame radius in Figure 12. The figure shows that the laminar burning velocity is roughly constant over the range of flame sizes considered. A perfectly spherical flame growing from the centre of the chamber would approach the chamber walls when it exceeded 60 mm radius. The laminar burning velocity increases slightly as the flame grows towards 60 mm radius due to rising unburnt temperature. It then decreases when the flame exceeds 60 mm radius due to flame contacting the cool cell walls. The introduction of any turbulence increases the burning velocity significantly

and further increases in turbulence intensity continue to increase the turbulent burning rate for the range of intensities considered. In addition, the figure shows that the turbulent burning velocity increases as the flame grows larger, until it is quenched by the chamber walls. This increasing turbulent burning velocity is also known as progressive development of a turbulent flame. Results for developing turbulent flame growth in the current cubical cell have been discussed in [15]. When comparing the video analysis (thin symbols) with the pressure trace analysis (thick symbols), the following points can be noted. The figure shows that the laminar burning velocities deduced from the video images agree well with those deduced from the pressure traces (the crosses over the range, $30 \text{ mm} < R < 40 \text{ mm}$). The video analysis is limited by the window size as the flame growth estimation requires the whole flame ball to be within the view of the circular windows. On the other hand, the noise to signal ratio in the pressure trace is high during the very early flame growth period when the pressure rise is small. Hence, the weakness in the video analysis corresponds to the strength in the pressure trace analysis and vice versa. In the turbulent case, the flames are less symmetrical compared to a laminar flame and the plate motion leads to larger noise in the pressure trace. As a result, the agreement between the two analyses is less satisfying for the turbulent case.

A faster burning mixture provides less time for turbulence to decay and also provides a larger rapid distortion enhancement as discussed earlier. Therefore, the effect of increasing turbulence intensity is expected to be larger for richer, faster burning mixtures compared with leaner mixtures. The burning velocities of 0.9 equivalence ratio methane-air mixtures are plotted against the flame radius in Figure 13. Similar to the 0.7 equivalence ratio mixture shown in Figure 12, the laminar burning velocity remained quasi-steady while the turbulent burning velocity increases as the flame grows. As expected, the progressive increase in turbulent burning velocity as the flame grows is larger for this faster burning mixture since the turbulence intensity is less affected by viscous decay. This faster burning mixture along with the higher overall turbulence level lead to more wrinkled and distorted flames. The highly wrinkled flame front tend to include some unburnt mixture.

This phenomenon along with the interference of flame front from the third dimension of the projected flame ball leads to over-estimation of burning velocity in the video analysis for turbulent flames. The higher noise in the early pressure trace also delays accurate pressure trace analysis to later combustion process. The enhancement in burning velocity for this faster burning mixture seems to overshadow the attenuation due to partial flame front quenching for the combustion period considered.

In short, Figures 11, 12 and 13 show that an effective way of enhancing the combustion rate is to increase the turbulence intensity. Over the range of conditions considered, the turbulent burning velocity increases roughly linearly with increasing turbulence intensity.



(a) Quiescent (no turbulence).



(b) Ignition-time turbulence intensity of 1.0 m/s with 8 mm integral scale.



(c) Ignition-time turbulence intensity of 1.2 m/s with 8 mm integral scale.



(d) Ignition-time turbulence intensity of 2.0 m/s with 8 mm integral scale.

Figure 11 The effects of turbulence intensity on 0.7 equivalence ratio methane-air flame growth. Schlieren flame growth images at 5.0 ms time interval. Premixed methane-air mixtures were spark-ignited at 101 kPa and 300 K in the 125 mm cubical chamber.

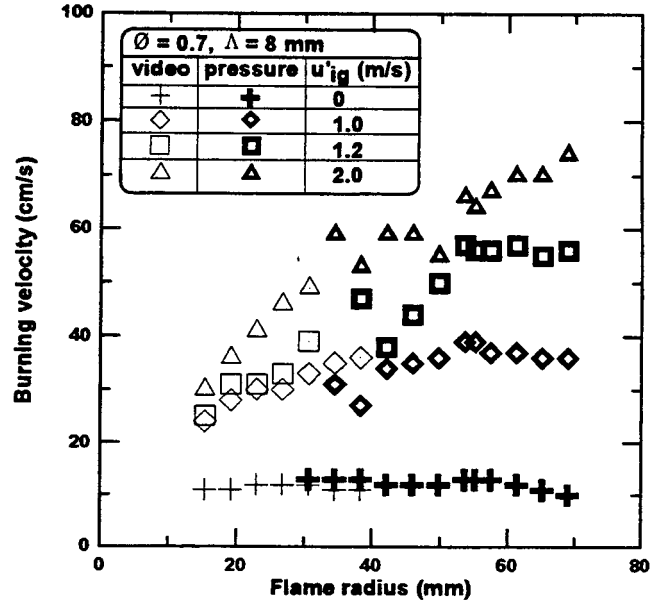

Figure 12 The effect of turbulence intensity on the turbulent burning velocity as the flame grows. Premixed, $\phi=0.7$, methane-air mixtures were spark-ignited at 101 kPa and 300 K in the test cell. $u'_{ig} \approx 0, 1.0, 1.2$ or 2.0 m/s; $\Lambda \approx 8$ mm.

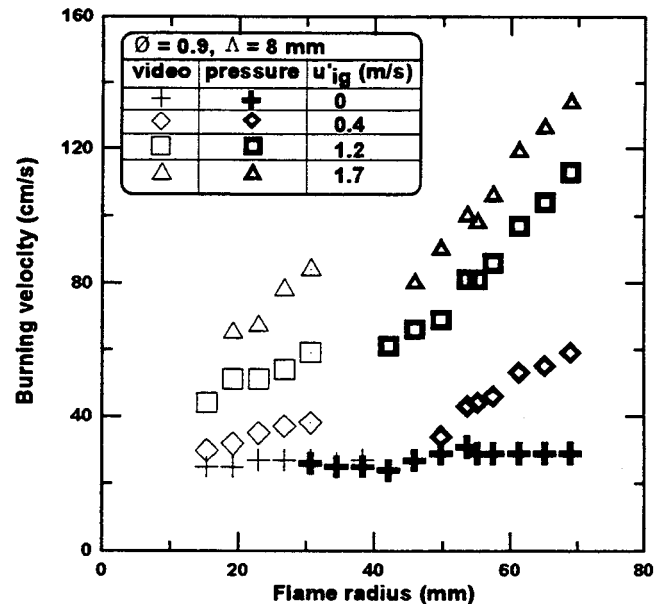

Figure 13 The effect of turbulence intensity on the turbulent burning velocity as the flame grows. Premixed, $\phi=0.9$, methane-air mixtures were spark-ignited at 101 kPa and 300 K in the test cell. $u'_{ig} \approx 0, 0.4, 1.2$ or 1.7 m/s; $\Lambda \approx 8$ mm.

MORE EFFECTIVE SMALL SCALE TURBULENCE ENHANCEMENT - Even in the idealized test cell, turbulent flame growth is a highly transient phenomenon. Hence, it is important to minimize changes in other parameters when studying the effect of a particular parameter. The effects of turbulent length scale on flame growth are more subtle than turbulence intensity. However, they can be studied by fixing the turbulence intensity and flame size when making the comparison. Figure 14 is a plot of the normalized turbulent burning velocity, $S_T/S_L - 1$, as a function of the normalized turbulence intensity, u'/S_L . The particular case shown is the 0.9 equivalence ratio methane-air mixtures, influenced by turbulence with 2, 4 or 8 mm integral scale. Pressure trace results of 54 mm radius flames are used because this corresponds to a large flame just prior to contact with the chamber walls. The signal-to-noise ratio of burning velocity based on the pressure is high at this flame size. For clarification purpose, straight lines passing through the origin are used to fit the data points. The figure shows that, for a given flame size and turbulence intensity, smaller scale turbulence is substantially more effective at enhancing burning velocity.

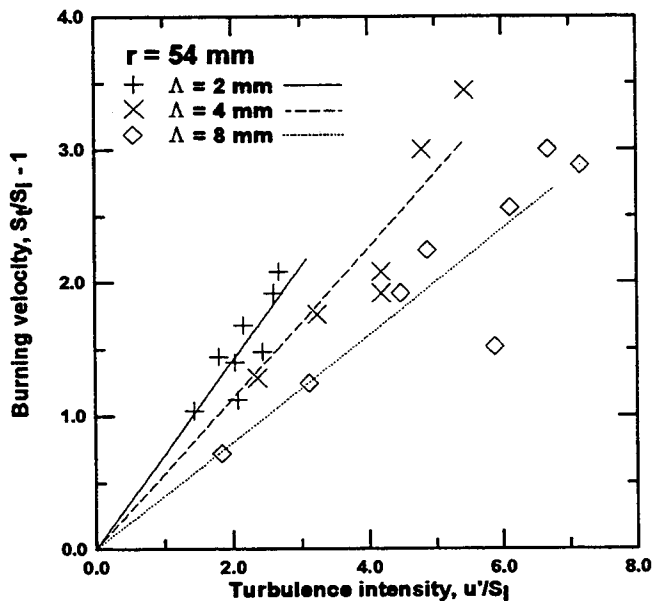

Figure 14 The effects of integral scale on the effectiveness of turbulence enhancement on the burning rate of 54 mm radius premixed, 0.9 equivalence ratio, methane-air flames.

In engine combustion, however, the entire combustion period has to be considered when making comparison with regard to the potential benefits of small scale turbulence. Parameters such as chamber shape, size and mixture stoichiometry can alter the total combustion duration significantly. A finite combustion duration can allow a significant amount of turbulence decay. As smaller scale turbulence decays faster than larger scale turbulence, the benefit of more effective, smaller scale turbulence diminishes when considered over a finite combustion duration. To illustrate this, the burning velocity results from premixed, 0.9 equivalence ratio, methane-air mixtures ignited in the cubical cell are shown in Figure 15. The ignition-time turbulence intensity was fixed around 1 m/s with integral scale varied between 2, 4 or 8 mm. (The curve marked 0 mm integral scale corresponds to the quiescent case). Over the range of flame sizes considered, altering the integral scale from 2 to 8 mm only led to small changes in turbulent burning velocity over the combustion period. Due to scatter in the experimental data, there is no obvious trend as shown by the figure.

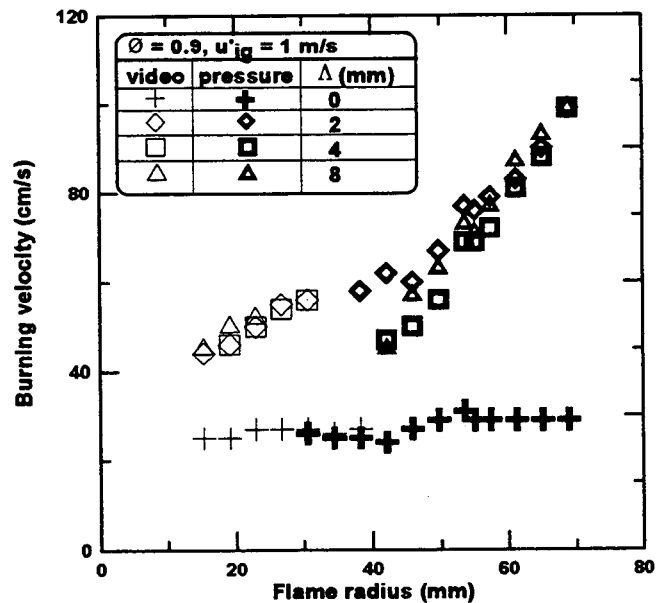

Figure 15 The effect of integral scale on the turbulent burning velocity as the flame grows. Premixed, $\phi=0.9$, methane-air mixtures were spark-ignited at 101 kPa and 300 K in the test cell. $u'_{ig} \approx 1.0 \text{ m/s}$; $\Delta \approx 2, 4 \text{ or } 8 \text{ mm}$. $\Delta \approx 0$ signifies S_L .

The underlying turbulence intensity for the combustion cycles shown in Figure 15 is plotted against the mean flame radius in Figure 16. (All turbulence curves are based on turbulence decay with geometric distortion and compression effects fully accounted for). The figure illustrates clearly that the overall level of turbulence intensity decreases significantly with smaller integral scale. Between 40 to 60 mm flame radius, turbulence intensity with 2 mm integral scale turbulence is only about 60% of the intensity with 8 mm integral scale turbulence. Despite of its notably lower intensity, the 2 mm integral scale turbulence produces comparable turbulent burning velocity to that of 8 mm integral scale turbulence, (see Figure 15). In other words, while the smaller eddy turbulence decays faster than larger eddy turbulence, it is more effective in enhancing the combustion rate. With the current combustion duration, the two effects are almost equal. On the other hand, larger eddy turbulence maintains a higher turbulence level, so, if the combustion duration is long enough, larger eddy turbulence may become more effective in the later stages of the combustion process.

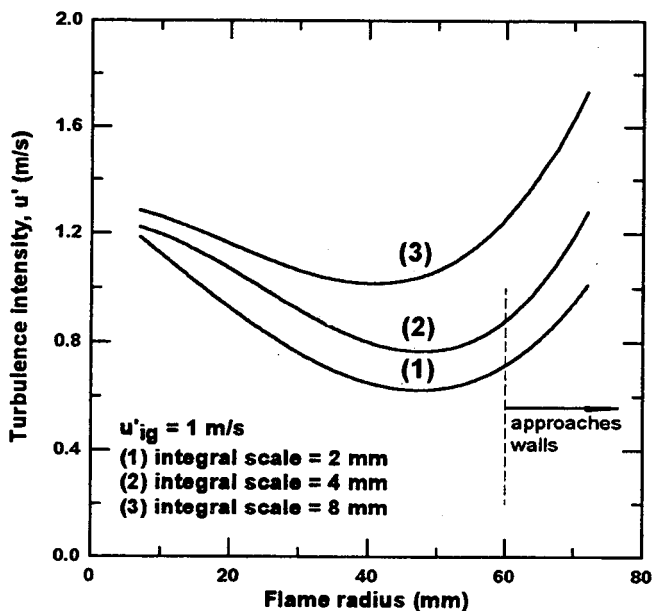

Figure 16 The effects of integral scale on the turbulence decay rate as the flame grows. Premixed, $\phi=0.9$, methane-air mixtures were spark-ignited at 101 kPa and 300 K in the test cell. $u'_{ig} \approx 1.0$ m/s; $\Lambda \approx 2, 4$ or 8 mm.



(a) Quiescent (no turbulence).



(b) Ignition-time turbulence intensity of 1 m/s with 2 mm integral scale.



(c) Ignition-time turbulence intensity of 1 m/s with 4 mm integral scale.

Figure 17 The effects of integral scale on 0.7 equivalence ratio methane-air flame growth. Schlieren flame growth images at 5.0 ms time interval. Premixed methane-air mixtures were spark-ignited at 101 kPa and 300 K in the 125 mm cubical chamber.

Figure 17 shows typical schlieren images of laminar and turbulent flame growth for slower burning, 0.7 equivalence ratio methane-air mixtures. The ignition-time turbulence intensity was fixed at about 1 m/s with integral scale of 2 or 4 mm for the turbulent mixtures. The figure shows that the turbulent flames, (b) and (c), burned significantly faster than the laminar flame, (a). However, between the two turbulent cases there is little difference. Changing the integral scale from 2 mm to 4 mm does not seem to affect the mean flame growth rate. This trend can be explained using the same arguments of more effective small scale turbulence with more rapid decay. The 2 mm integral scale turbulence consists of more smaller eddies compared with the 4 mm integral scale turbulence and is more effective in wrinkling and enhancing the growing flame very early in the combustion process. However, the 2 mm integral scale turbulence also decays faster compared with the 4 mm integral scale turbulence. (The difference in turbulence decay rate is more significant in this slower burning mixture). Therefore, 4 mm integral scale may eventually become more effective in

enhancing the flame growth rate at the later stages of this longer combustion period. The plot of turbulent burning velocity against mean flame radius in Figure 18 shows that this is what happened.

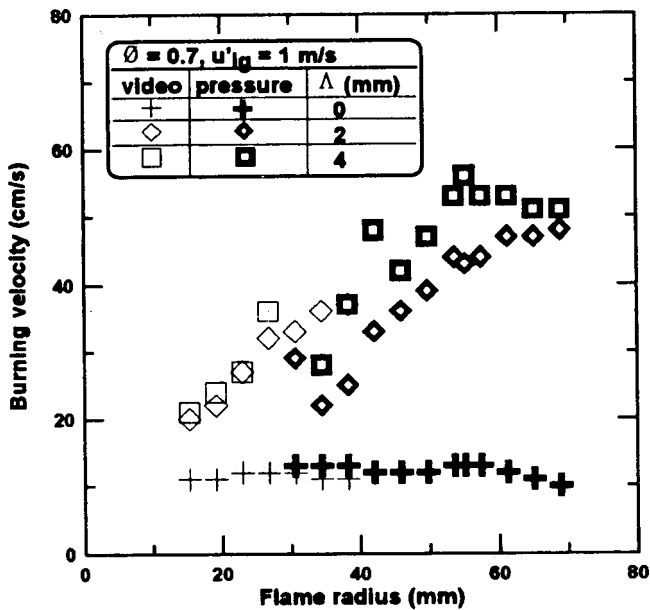

Figure 18 The effect of integral scale on the turbulent burning velocity as the flame grows. Premixed, $\phi=0.7$, methane-air mixtures were spark-ignited at 101 kPa and 300 K in the test cell. $u'_{ig} \approx 1.0 \text{ m/s}$; $\Lambda \approx 2$ or 4 mm; $\Lambda \approx 0$ signifies S_{fl} .

Figure 18 shows that the 2 mm integral scale turbulence starts out with approximately the same turbulent burning velocity when the flame is small, (flame radius < 20 mm). At $R=20$ mm, due to different turbulence decay rates, the intensity of the 4 mm integral scale turbulence is about 7% higher than that of the 2 mm integral scale turbulence (see Figure 19). Despite this difference, the corresponding turbulent burning velocities for the two cases are roughly equal. This implies that the small scale turbulence is somewhat more effective in enhancing turbulent burning velocity, for the same turbulence level. However, due to its faster decay rate, the small scale turbulence becomes somewhat less effective as the flame grows, as compared with the slower decaying, 4 mm integral scale turbulence. The underlying turbulence intensity for these cases is plotted as a function

of mean flame radius in Figure 19. Figure 19 portrays clearly that the 4 mm integral scale turbulence maintained a significantly higher level of turbulence over the combustion period. This higher turbulence level resulted in marginally higher turbulent burning velocity at the later stages of combustion, as shown in Figure 18. In short, small scale turbulence decays faster so that it could be at first better and then less beneficial, particularly with a large combustion chamber or a slow burning mixture.

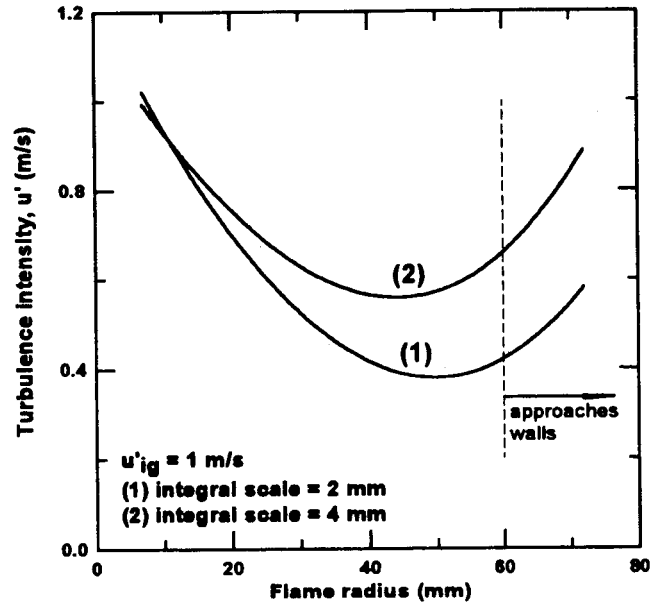

Figure 19 The effects of integral scale on the turbulence decay rate as the flame grows. Premixed, $\phi=0.7$, methane-air mixtures were spark-ignited at 101 kPa and 300 K in the test cell. $u'_{ig} \approx 1.0 \text{ m/s}$; $\Lambda \approx 2$ or 4 mm.

CONCLUSIONS

Premixed turbulent flame growth measurements were made in spark ignition engine cylinders and a 125 mm cubical test cell. These experiments aimed at uncovering the different roles played by the high frequency, small eddies and the low frequency, large eddies of the turbulence in affecting the flame growth. Premixed natural gas / air mixtures were spark-ignited over a range of engine operating conditions in the research engine cylinders. Premixed methane / air mixtures were ignited at 101 kPa and 300 K in the cubical cell. The following conclusions are drawn from this study.

1. Both engine and test cell showed that the burning rate increases with increasing turbulence intensity, as expected.

2. Experiments in both engine and cubical cell showed that the higher frequency, smaller scale turbulence is more effective in enhancing the combustion rate for the same intensity and flame size. However, smaller scale turbulence decayed faster and the enhancement for the complete combustion period could be less than with larger scale turbulence, which maintained a higher overall turbulence level. The longer lasting, larger eddies would be most beneficial if they could be broken down into smaller eddies just before they encounter the flame.

3. Based on physical arguments and studies in the literature, it was concluded that high frequency, small eddies can also lead to lower cyclic variations.

4. The engine experiments showed a lack of correlation between low frequency turbulence and very early flame development. The bulk flow pattern was most important to the initial flame kernel during the very early flame propagation period in the engine. The bulk flow convected the flame kernel around leading to varying contact area between the hot flame and the cool combustion chamber walls.

5. The best correlation between turbulence energy content within a frequency interval and the combustion rate in the engine was noted at 4 kHz, corresponding to an eddy size of roughly 0.5 mm.

6. Unlike the quiescent mixtures, turbulent flames in the cubical cell were highly transient and the turbulent burning velocity tended to increase with increasing flame size.

NOMENCLATURE

CAD	crank angle degree
EGR	exhaust-gas-recirculation
ROHR	rate of heat release
R	mean flame radius
S_l	laminar burning velocity
S_t	turbulent burning velocity
U'	root-mean-square turbulence intensity
U'_{ig}	root-mean-square turbulence intensity at ignition time
ϕ	equivalence ratio
η	Kolmogorov scale
Λ	turbulent integral length scale
λ	Taylor microscale

ACKNOWLEDGEMENTS

This work was partially supported by an NSERC grant and the Swedish Board for Technical Development, NUTEK. We thank Tech. Lic. Karl Marforio for evaluating the flame areas from the schlieren images in the engine.

REFERENCES

- 1 D. Clerk, "The working fluid of internal-combustion engines", Engineering, 28-63, July 4, 1913.
- 2 D. MacKenzie and R.K. Honaman, "The velocity of flame propagation in engine cylinders", SAE Journal, Vol. 6, No. 2, 119-122, 1920.
- 3 C.F. Marvin, "Observations of flame in an engine", SAE Journal, Vol. 35, No. 5, 391-462, November 1934.
- 4 H. Endres, H-J. Neuber and R. Wurms, "Influence of swirl and tumble on economy and emissions of multi valve SI engines", SAE paper 920516, 1992.
- 5 M.R. Belmont, J. Hacothen and P.W. Carpenter, "Tumble and swirl: are they a mixed blessing?", Proc. Instn. Mech. Engrs., Part D, Vol 208, 223-226, 1994.
- 6 R.G. Abdel-Gayed, D. Bradley, M.N. Hamid and M. Lawes, "Lewis number effects on turbulent burning velocity", Twentieth Symposium (International) on Combustion, 505-512, 1984.
- 7 K. Marforio, B. Lassesson and B. Johansson, "Influence of flow parameters and spark characteristics on the early flame development in a SI engine", The Third International Symposium on Diagnostics and Modeling of Combustion in Internal Combustion Engines, COMODIA 94, 107-112, July 1994.
- 8 R.L. Evans, "Combustion chamber design for a lean-burn SI engine", SAE paper 921545, 1992.
- 9 R.L. Evans and E.C. Tippet, "The effects of squish motion on the burn-rate and performance of a spark-ignition engine",

- SAE paper 901533, 1990.
- 10 P.G. Hill and A. Kapil, "The relationship between cyclic variations in spark-ignition engines and the small structure of turbulence", *Combustion and Flame* 78: 237-247, 1989.
- 11 P.G. Hill, "Cyclic variations and turbulence structure in spark-ignition engines", *Combustion and Flame* 72: 73-89, 1988.
- 12 B.Johansson, "The influence of different frequencies in the turbulence on early flame development in a spark ignition engine", SAE paper 940990, 1994.
- 13 B. Johansson, "Correlation between velocity parameters measured with cycle-resolved 2-D LDV and early combustion in a spark ignition engine", PhD Thesis, Department of Heat and Power Engineering, Lund Institute of Technology, 1993.
- 14 D.S-K.Ting, "Modelling turbulent flame growth in a cubical chamber", PhD Thesis, Mechanical Engineering Department, University of Alberta, 1995.
- 15 D.S-K. Ting, M.D. Checkel, R. Haley and P.R. Smy, "Early flame acceleration measurements in a turbulent spark-ignited mixture", SAE paper 940687, 1994.
- 16 M.D. Checkel, "Measurements of turbulence generated by 60% solid perforated plates", ASME paper 85-WA/FE-2, 1986.
- 17 T.C. Chew and R.E. Britter, "Effect of flame-induced geometrical straining on turbulence levels in explosions and common burner configurations", *Int. J. Engng. Sci.*, Vol. 30, No. 8, 983-1002, 1992.
- 18 I. Glassman, "Combustion", second edition, Academic Press Inc., 114, 1987.
- 19 B. Johansson and K. Olsson, "Combustion chambers for natural gas SI engines Part I: fluid flow and combustion", SAE paper 950469, 1995.
- 20 R.V.Wheeler, "The inflammation of mixtures of ethane and air in a closed vessel: the effects of turbulence", *Journal of the Chemical Society*, Vol. 115, 81-94, 1919.
- 21 D.R. Lancaster, R.B. Krieger, S.C. Sorenson and W.L. Hull, "Effects of turbulence on spark-ignition engine combustion", SAE paper 760160, 1976.
- 22 M.J. Jennings, "Multi-dimensional modelling of turbulent premixed charge combustion", SAE paper 920589, 1992.