



LUND UNIVERSITY

Controlling the Influent Load to Wastewater Treatment Plants

Bolmstedt, Jon

2004

[Link to publication](#)

Citation for published version (APA):

Bolmstedt, J. (2004). *Controlling the Influent Load to Wastewater Treatment Plants*. Department of Industrial Electrical Engineering and Automation, Lund Institute of Technology.
<http://www.iea.lth.se/publications/Theses/LTH-IEA-1040.pdf>

Total number of authors:

1

General rights

Unless other specific re-use rights are stated the following general rights apply:

Copyright and moral rights for the publications made accessible in the public portal are retained by the authors and/or other copyright owners and it is a condition of accessing publications that users recognise and abide by the legal requirements associated with these rights.

- Users may download and print one copy of any publication from the public portal for the purpose of private study or research.
- You may not further distribute the material or use it for any profit-making activity or commercial gain
- You may freely distribute the URL identifying the publication in the public portal

Read more about Creative commons licenses: <https://creativecommons.org/licenses/>

Take down policy

If you believe that this document breaches copyright please contact us providing details, and we will remove access to the work immediately and investigate your claim.

LUND UNIVERSITY

PO Box 117
221 00 Lund
+46 46-222 00 00

Controlling the Influent Load to Wastewater Treatment Plants

Jon Bolmstedt



LUND UNIVERSITY
Licentiate Thesis
Department of Industrial Electrical Engineering
and Automation

Department of
Industrial Electrical Engineering and Automation
Lund University
P.O. Box 118
SE-221 00 LUND
SWEDEN

<http://www.iea.lth.se>

ISBN 91-88934-33-0
CODEN: LUTEDX/(TEIE-1040)/1-132/(2004)

©Jon Bolmstedt, 2004
Printed in Sweden by Universitetsstryckeriet
Lund University
Lund, 2004

Abstract

The need for control of the influent load to a wastewater treatment plant (WWTP) is becoming more important. One reason for this is that there are a number of things that cannot be achieved with plant-focused control. For instance it is hard to avoid sludge loss as a result of poor settling or reducing a too high influent flow rate by in-plant control actions. It is also difficult to reduce the effects of a toxin in the influent, if the entire influent is to be biologically treated. Optimisation of the various parts of the collection system, with respect to locally defined objectives, may be counter-productive as it may increase the effluent loads when taking the whole system into account. This is typically the case as optimisation of the control of the sewer net with respect to combined sewer overflows (CSOs) leads to an increased flow to the WWTP. Equalization basins are used to control the flow rate or the load in the sewer net as well as at the WWTPs. The focus has recently been shifted from only reducing the amount of CSOs to reduce the effluent load from the sewer and the WWTP. To minimize the total load from the system the methods previously used to optimise the individual sub-systems must be used together and information from various parts of the system should be available system wide.

Due to the cost associated with the construction of equalization basins, the current approach is to increase storage volume by constructing and controlling gates in the sewer net. The potential of system wide control is difficult to estimate, which is exemplified by a discussion on some existing implementations. In this thesis an equalization basin is modelled and used with an existing model of a WWTP. This system is operated with some commonly applied control strategies of equalization basins to estimate the result of control during ideal conditions. Without control of the basin, the possible benefit of construction, or providing an equal amount of storage capacity in the sewer net, is evaluated.

Acknowledgements

First of all, I would like to express my most sincere gratitude to my supervisor Professor Gustaf Olsson, who has given me the opportunity to undertake this work. His optimism and ability to put things into perspective has been a great source of inspiration. I also want to thank Ulf and Christian for their encouragement and interesting discussions.

The Department of Industrial and Electrical Engineering is a great place to work at. I want to thank all of the people at the Department for contributing to a good working environment.

During the work with this thesis my family has grown. My beloved Malin and I now share our lives with our son Jonatan. Kassiopeja and Sär, you are deeply missed.

This work was partially supported by VINNOVA. The support is greatly acknowledged.

*Lund, March 31, 2004
Jon Bolmstedt*

Contents

CHAPTER 1 INTRODUCTION.....	1
1.1 MOTIVATION.....	1
1.2 CONTRIBUTIONS	3
1.3 OUTLINE OF THE THESIS	3
CHAPTER 2 OPERATION	5
2.1 DISTURBANCE REJECTION.....	5
2.2 NOMENCLATURE.....	9
2.3 SEWER NET OPERATION	10
2.4 INTEGRATED OPERATION OF WWTP AND SEWER NET	19
2.5 ALTERNATIVE TREATMENT METHODS.....	29
CHAPTER 3 THE MODELLED PLANT	33
3.1 THE BENCHMARK SIMULATION MODEL BSM1	33
3.2 ADDITIONAL MODELS	38
CHAPTER 4 THE BASE CASE SCENARIO	51
4.1 THE RAINS.....	51
4.2 EVALUATION	55
4.3 USING A SMALLER SETTLER.....	60
CHAPTER 5 SIMULATIONS	65
5.1 NO CONTROL - CONSTANT INFLUENT FLOW RATE	65
5.2 FEEDBACK CONTROL	71
5.3 EARLY EMPTYING	82
5.4 BYPASS TO RECEIVING WATERS.....	98
CHAPTER 6 CONCLUSIONS	107
6.1 SUMMARY OF RESULTS	107

6.2	FUTURE WORK.....	111
	CHAPTER 7 BIBLIOGRAPHY.....	113
	APPENDIX A DRIVING FORCES	119
A.1	NATIONAL CONSIDERATIONS	119

Chapter 1

Introduction

In this chapter, the motivation of the research and the outline of the work are presented.

1.1 Motivation

Wastewater treatment plants are designed to handle a design load and a design flow. These conditions seldom appear in reality, especially not in the timeframe of a few hours. It is well known that the plant must operate under dynamic conditions, which is the reason that control is needed. Due to physical limitations some problems always persist even with optimal control. For instance, the negative effect of higher flow rates may only partially be counteracted if all wastewater is to be treated, which is the case in a plant without flow equalization volumes and where the influent flow rate is uncontrollable. Considerable higher flow rates than the daily average are usually the result of rain. During these events the load to the plant is lower, with exception for a brief initial period known as the first flush. The lower load and higher flow rate result in partial washout of the organisms and it will take the plant some time to recover. In extreme cases the plant capacity is severely reduced during the recovery period as new bacteria are grown.

In Germany the annual pollution load discharged into the recipient is roughly equally distributed between WWTP effluents and combined sewer overflows, CSOs, which are untreated discharges from the sewer net (Bixio *et al.*, 2002). In Belgium it is estimated that 6% of the pollution load originates from the sewer network and the remaining 94% from WWTPs and plant located detention basins (Niemann and Orth., 2001). In

Sweden the average volume of wastewater bypassed without complete treatment ranges from 0.4% to 1.8% in performed studies (Hernebring *et al.*, 2000). The most part of this comes from one of the largest WWTPs. The majority of the WWTPs do not bypass at all but the treatment process at smaller plants is generally less complicated as well as less effective.

There are two main approaches to reduce the damages from CSOs: local treatment at the overflow point or reducing the CSO volume. Detention basins in the sewer net or at the WWTP may be used to attenuate peaks and transport more water through the treatment process. The higher flow rate through the WWTP can lead to increased WWTP effluent concentrations so it is important to consider also the WWTP and not only the sewer net. With daily operation of the detention basins it is also possible to improve the treatment capacity during dry weather, which in many cases is the dominating weather situation. Daily variations in influent load and flow rate can be attenuated and it is possible to plan the arriving load from industries if this load is different in composition or out of phase with the domestic load. Daily operation and control based on recent measurements is usually referred to as *real time control*, RTC. The concept of RTC in sewer systems is not new and an excellent introduction to the subject is found in Schilling (1989).

Variations in the influent load create similar problems as variations in the influent flow rate. As the load increases, a higher concentration of bacteria is needed in order to keep the effluent concentration of for instance ammonium constant. Provided the load can be handled at all, the concentration of bacteria will eventually increase to a level where the effluent again is as clean as it was prior to the increased load, a process that is hard to speed up using control. The load may also be variable in composition, in which case additives of nutrients or carbon would enhance the efficiency of the treatment process. Problems associated with variations are commonly solved using existing technology and control theory by controlling in-plant flow rates and mainly aeration but also the addition of other substances. Consequently, aeration and other additives such as carbon, nutrients and polymers constitute a large part of the operating costs at a wastewater treatment plant. If the misbalanced composition of the wastewater is a result of a permanent lack of one substance there is no choice other than adding an external source. If the composition is unbalanced only in time it is possible to retain some of the wastewater and manipulate its composition using only the influent

wastewater itself, thus reducing the need for external additives. The control authority in this case is increased if there exist separate influents with different composition.

1.2 Contributions

The contributions of this thesis are mainly presented in Chapter 5 and summarized in Chapter 6. A brief summary of the main results is given here:

- A model for an equalization basin is presented that can be used with the COST Simulation Benchmark
- The effect of optimal control of a plant located equalization basin on the effluent ammonium load is estimated.

With a constant influent flow rate to the plant made possible by an equalization basin designed to equalize the dry weather flow, ammonium load during dry weather with no rain was reduced about 50% and peak concentrations about 60%. With basin control using on-line ammonium measurements an additional 10% reduction in effluent ammonium load was achieved. The total nitrogen load depends also on internal plant control and the denitrification capacity; the load was not affected in this study. Phosphorous was not modelled but the suspended solids load was not significantly reduced during wet or dry weather. The basin was not large enough to equalize flows from smaller storms but the effluent load at high concentrations could be reduced even if peak concentrations were unaffected.

1.3 Outline of the thesis

In Chapter 1, the motivation and main contributions of this thesis are presented.

In Chapter 2, the problems with variations of concentration and flow rate in the wastewater are presented. Common control principles used in wastewater treatment and specific control strategies used during high flow

rates are described. An overview of common software and models used for simulation of wastewater treatment plants and sewer nets is presented.

In Chapter 3, the simulation model used for evaluation of the control strategies in this thesis is presented.

In Chapter 4, the assumptions about the simulated wastewater treatment plant operation are stated and the base case, to which the evaluated strategies are compared, is presented.

In Chapter 5, evaluation of some common control strategies of in-plant equalization basins is performed using the presented model.

In Chapter 6, general conclusions are made and directions for future work are presented.

Chapter 2

Operation

In this chapter, general operating issues of a wastewater treatment plant (WWTP) and of a sewer net during wet weather are discussed. Sources to problems, such as high flow rates and sediments, are presented as motivation for the equalization basin model and the chosen control strategies presented in the thesis.

2.1 Disturbance rejection

Disturbances are changes in the operating conditions that could lead to unacceptable changes in the quality of the effluent water if left unattended. Typical disturbances in the wastewater treatment process are variations in the influent flow rate, composition or load. These variations depend on the amount and type of connected sources and if the sewer system is combined, which means transportation of both domestic wastewater and stormwater, or separate. The variations of domestic origin are usually diurnal with morning and afternoon peaks and a low night flow. Variations of industrial origin show also a weekly periodicity. The variation in composition is usually in phase with the variation in flow, with the exception of other disturbances such as rain. There are certain compositional changes that are important to detect since they may have a substantial impact on the treatment process. Such changes may be the result of a toxic substance in the influent wastewater, which still may be very difficult to detect with analytical methods due to low concentrations and long test times, or a sudden or cyclic point source of a wastewater with a composition very different from the rest. It is common that the influent wastewater contains substances that inhibit the nitrification process.

Nitrification is the first process of two in the most common method for nitrogen removal in Sweden. A Swedish study shows that some inhibition occurs in 60% of the WWTPs and severe inhibition in 4%. The sources are often of industrial origin but also from processes within a WWTP such as sludge incineration (Jönsson *et al.*, 2001). The variation in the influent load is a combination of variations in flow and composition and the discussion is the same as for those.

Attenuation of the environmental impacts of the daily variations in a cost-effective manner is basically what WWTP control is all about. The most commonly applied control in European WWTPs are aeration control for nitrification and COD removal, carbon dosage and internal recirculation control for denitrification, return and waste sludge control for sludge inventory and chemical addition control for pH, flocculation and phosphate precipitation. Most controllers operate by feedback or a constant set point although feedforward controllers are used for processes with longer response times such as biomass distribution or nitrification (Jeppsson *et al.*, 2002). Control strategies give the best result when applied to daily variations and the reasonable disturbances for which they are designed. There is no principal difference between everyday variations and extreme events and well stated control strategies would still function as planned, although not being as effective as during normal operating conditions. A sufficient control authority from the actuators is required.

Feedback control

Feedback control is the most commonly applied control principle. It is simple and effective as it for step-like disturbances returns the process to the desired state, if the process has the right actuators and is given enough time. The principle of feedback control is that the actuator output is based on measurement of the controlled variable. An example of feedback control is when pH is measured and the lye-dosage is controlled. Feedback control requires one sensor per controlled variable.

Feedforward control

With feedforward control the effect of a disturbance is estimated, allowing some control action to be taken before the effect of the disturbance is seen or measured in the controlled variable. If there is a response time from

measurement to the result from the control action, feedforward control can improve the control since the control actions are based on earlier measurements in the hydraulic timeline. Ideal feedforward control will completely attenuate the disturbance but usually a combination of feedback and feedforward control is applied to handle also remaining errors. Feedforward is a common control principle in wastewater treatment but if used in combination with feedback control additional sensor signals are needed, which could require additional sensors also. An example is in carbon dosage control when the amount of added carbon is calculated based on the influent flow rate or load. It is common practice to base the dosage of chemicals for phosphorous precipitation on the influent flow. Such a proportional feedforward is not at all optimal but gives a first approximation of the required dosage. It is also common to use the influent flow rate for control of the return sludge flow. In this case the control signal must be smoothed or hydraulic shocks may disturb the sedimentation process.

Model-based control

Model-based control uses models that estimate values upon which control actions are based. It could be values of measured parameters at places other than the measuring point or values of non-measured variables. Compensation for lag times is an example of model-based control using a very simple model. Since the term model is vaguely defined only the most primitive controllers are excluded from this category. With process models control algorithms can also be predictive and include estimations of the outcome of possible control actions. It is then possible for a supervisory control program to simulate the process behaviour for a certain time into the future and then calculate the control variable so that the process will reach the required output value at that point in time.

Kolla ref som Gustaf skrev in.

Model based control of wastewater treatment systems is described in Olsson-Newell (1999) and in chemical process industry in Lee et al. (1998).

Gain scheduling and adaptive control

Gain scheduling and adaptive control are methods that improve control when an absolute change in the controlled variable requires different absolute control outputs depending on the operating conditions. In aeration control the control response could be determined by the current concentration of dissolved oxygen using gain scheduling. At high concentrations the controller needs a higher gain to compensate for the lower driving force, which is a physical limitation. The gain as a function of oxygen concentration is fixed and does not take into account other process variations. In adaptive control, measurements and control responses are used to update internal controller parameters or parameters used in the process model.

Rule-based and fuzzy-logic control

With rule-based control a set of rules determines the output of the controller. Rule-based control looks natural but is still not very common in wastewater treatment systems despite its simplicity and intuitive nature. Rule-based control is inherently discrete and the number of rules is kept to a minimum for clarity. In controlling a tank outflow with a valve, rule-based control spans from on-off control, which implies two rules, to an infinite number of rules if there is a static relationship between valve opening and water height. Rule-based control can replace PID-control but the two methods can also be used together, as the set point and parameters for a PID-controller may be determined by a set of rules. When multiple inputs determine the output of a rule-based controller the response can be made smoother with fuzzy-logic control. Fuzzy-logic control combines the discrete result of few rules with the infinite number of rules in cases where there is a static relationship between input and output by assigning each input a group membership. A measured variable can be a member of many groups but with varying strength (0-100%). If the output values calculated from two inputs are plotted as a surface, the fuzzy-logic controller will generate a smoother surface compared to ordinary rule-based control, without increasing the number of rules. The additional information a fuzzy-logic controller needs is how the group membership translates into the control output value. If the actuators operate discretely as for instance on-off pumps, fuzzy-logic will not have much advantage over ordinary rule-based controllers. A comprehensible introduction to fuzzy-logic control can be found in the MATLAB user's reference for the Fuzzy Logic

Toolbox and an example applied to detention basin control in Klepiszewski and Schmitt (2002).

2.2 Nomenclature

There exist no standard nomenclature for sewers and wastewater treatment plants. The temporary storage of water in a (separate) container is most commonly divided in the following manner:

- Storage tanks
 - Equalisation tanks/basins
 - Stormwater tanks/basins

Equalization basins are used for the equalization of the flow and the load and used in the daily operation. They need not be controlled. It is often possible to divert incoming flow, before or after the basin, in order to protect the biological reactors or the settler. Tanks, or basins, operating in this manner are also called wet basins, since they normally contain water.

Stormwater tanks are used only during periods outside the normal operating range. During a rain event when the flow rate exceeds the highest acceptable, some influent flow is diverted to the tank. When the tank is filled the remaining flow will bypass the plant, protecting the biology. As the influent flow rate decreases all the water in the tank will be diverted into the biological treatment system. Also if a toxin is measured upstream, some of the influent water may be collected in the tank or bypassed. These tanks, or large open basins, are also called *dry basins* since they are normally empty.

The terms bypassing and overflows are used when the flow is diverted from its normal route. Bypassing is a deliberate action made possible by control as opposed to overflows, which are non-controlled and unwanted. Bypass control is often local, meaning that the primary control objective often is not improving quality of the water entering the recipient but the conditions upstream. Overflow will occur in a sewer net if the pipe downstream cannot handle the high flow rate and if the pipe has an opening, which typically is where water is supposed to flow into the sewer. Basements are examples of poorly selected overflow points, whereas

structures capable of overflow treatment are optimal. Bypassing is commonly used within a WWTP to protect one process from high flow rates. Commonly during such conditions the wastewater undergoes primary sedimentation only, which results in no nitrogen removal. In Sweden the pollutant load in in-plant bypassed water is added to the normal effluent load, which makes bypassing something to be avoided. The pollutant load in overflows in the sewer net, CSOs, is less strictly regulated but increasingly monitored or estimated.

2.3 Sewer net operation

Detention basins are commonly used as a part of the sewer net to attenuate the problems associated with periods of high peak flows that typically occur during storms. It is the limited capacity of the sewer network that causes these problems due to the relationship between flow rate and water level in gravitational sewer pipes. Sewers are classified as gravitational or pressurised systems or a combination of the two, with respect to the method of transportation. In a gravitational sewer the flow rate and water level depend on pipe characteristics (slope and internal resistance) and on gravity. For a certain flow rate the water level is higher in pipes with less slope, with smaller diameter or with more resistance. In pressurised sections of a sewer the flow rate is achieved with pumps and such sections normally have no problem with delivering the necessary flow rate. In gravitational sewers the water level theoretically limits the maximum flow rate since it must not be allowed to rise over the point where the water instead of flowing down the pipe flows up into basements. In order to provide sufficient flow rates under the constraint of a maximum allowable water level the slope is increased by dividing the net into smaller parts with greater slope joint with pump stations that lift the water from one part to the other. It is usually the capacity of the pumping stations that limits the capacity in gravitational sewer networks. Further prevention of basement flooding is achieved by inserting points into the sewer net where it is allowed to overflow untreated into the surrounding environment.

Old sewer systems are usually of the combined type but newer are often of the separate type where the domestic wastewater and the stormwater are not mixed. Even in separate sewer system the drainwater from house property is usually connected to the sewer system and increases the flow to the WWTPs during rain events. Bottlenecks in the transportation of

wastewater are usually located in the main sewer close to the wastewater treatment plant as a result of an increasing population and more connected households. Bottlenecks also occur in separate sewer systems where infiltrating rain temporarily leads to excess wastewater. Constructing detention basins is one way to reduce overflows due a temporary under capacity by increasing the average flow transported through the sewer to the treatment plant.

Combined sewer overflows

A sewer network, also called sewer system, that transports both domestic wastewater and stormwater, which is urban runoff after rain events, is called a combined sewer. Sewer networks can also be classified as separate if they have separate pipes for domestic wastewater and stormwater. If a sewer transports only stormwater it is called a storm sewer. All wastewater with a domestic content is usually transported to a wastewater treatment plant (WWTP), whereas pure stormwater is discharged into the recipient without treatment. Combined sewer systems are common in Europe but exist in Sweden only as the oldest part of the sewer systems of larger cities. The flow in combined sewer systems experience large fluctuations as it is immediately affected by rain. Also the domestic sewer flow in a separate sewer system is affected by rain, as most of the pipes are not waterproof. The transportation of water is usually from the outside and into the pip, infiltration, since the water pressure is higher on the outside (the water height in a sewer is at maximum the diameter of the sewer whereas the water height outside the sewer is at maximum equal to the depth at which the pipe is located) but exfiltration also occurs in dryer areas. A significant infiltration also occurs as a result of commonly connected drainwater from house property. It is not uncommon that the flow is tripled during rain events in separate sewer systems. As a security measure there exist exit points in the sewer system where water may leave before reaching the WWTP. The wastewater leaving in this manner is called an overflow and if it occurs in a combined sewer system it is known as a combined sewer overflow, CSO.

Infiltration to a sewer system depends on many factors and is hard to describe or model. It could be described by two factors called the fast and the slow runoff component, FRC and SRC (Gustafsson *et al.*, 1993). The parameter values are only locally applicable and in a large sewer system

these parameters have many different values. The FRC depends on the amount and the characteristic of the impervious area connected to the sewer, which result in a fast response to the rain. Examples of impervious areas are rooftops and pavements, each affecting the pollutants in the runoff in different ways. The SRC is the hardest to model as it describes the leakage from ground located water into the sewer. This leakage does not immediately increase during a rain event, as the ground first must become saturated with water, a process in which soil type plays an important role. The time to saturate the ground depends also on the degree of saturation at the beginning of the event, which in turn depends on the time elapsed from the previous rain and the characteristics of that rain. Because of the SRC it could be impossible to find a statistic relationship between a rain and the corresponding flow. Two identical rains will result in two completely different flows depending if the ground is saturated with water from a previous rain. Statistical correlations between rain and flow must then be found for combinations of rains during a longer period of time rather than for single rain events.

In USA the Clean Water Act, CWA from 1986 prohibits untreated point-source pollutions, such as CSOs. The CWA corresponds roughly to the 15 Swedish environmental goals, see Appendix 1 and states for instance that water bodies should be both fishable and swimmable. The national combined sewer overflow policy issued by the Environmental Protection Agency (EPA) does however permit some discharges during heavy rain, a discrepancy that often results in inconsistent enforcements (Mealey, 1999). The EPA has a policy that requires cities to meet short- and long-term goals for addressing the CSO problems. There are nine minimum short-term controls that are relatively cheap and include measures such as monitoring, documenting and raising public awareness. The long-term goals include the treatment of all point-source pollutions. Five years after the policy was issued half the communities had implemented the minimum controls and about a third the long-term control plan. Compliance with the long-term goals means huge investments, since the system must function during all storms. An economic optimisation is prevented by the judicial system, since the fines for non-compliance are insignificant compared to the unpredictable outcomes of civil lawsuits against cities with CSOs. During the El Niño storms and the associated sewer spills the city of Los Angeles was fined \$1 per inhabitant by the regional water quality control board but in a lawsuit an environmental group demanded \$60 per

inhabitant in fines and an additional \$110 per inhabitant over the following 10 years for improvements of the collection system.

CSO treatment and other means to reduce CSOs

Without the use of basins and their control there still exists ways to reduce both the amount of CSOs as well as the CSO pollution load. All methods in which the amount of water in the collection system is reduced improve the performance of control due to increased control authority (with basins having generally less volume stored).

The CSO volume can be reduced if only peak flow values are reduced or if the general level of stormwater in the sewer is reduced. Reducing the stormwater fraction during rain events is in combined systems achieved by *reduction of the impervious areas*, RIA, that convey rainwater into the sewer. Almost any urban area is suitable for RIA but in order to plan ahead for times when stormwater should also be subjected to treatment, the choice of disconnected areas could depend on the type of area, i.e. roofs, streets or playgrounds. In order for RIA to be an option there must be enough pervious areas with enough capacity to receive the extra water. Porous soil types with a low groundwater level are optimal. The possible RIA depends on the type of city but values of around 15% are found in the literature (Frehmann *et al.*, 2002). A flow reduction can also be achieved by consuming less water. If the pollutant concentration also increases the gain is twofold. The re-use of rainwater for irrigation or other purposes will reduce the peak values since rainwater will be stored at each rain event in multiple basins and then discharged over a longer period of time. Re-using rainwater will also lower the total amount of water inflow to the collection system since less water is consumed. In Germany a “booming market” for rainwater usage related products has resulted in 7 litres of rainwater storage per capita on average (Herrmann and Schmida, 1999).

In stormwater treatment low-tech solutions, such as infiltration rather than filtration and wet detention basins, are optimal when including the cost (Landphair, 2000). Wet ponds, constructed wetlands, vegetated filter strips surface sand filters, dry detention basins and grassed swales all give about 50% reduction in TSS, N, P and metals. The reductions have wide ranges and depend on local factors and that the reduction goal for the investigated principles was different. The low reduction of metals in common units for

stormwater treatment or infiltration is known. The question has been raised that what is best management practice for stormwater flow reduction is not optimal for stormwater pollutant removal, especially for heavy metals (Bäckström *et al.*, 2002). Most data are found on the removal of suspended solids and German data yield 80% to 90% reduction for the abovementioned principles (Geiger, 1998). Maintenance costs and the need for education or experienced personnel favour low-tech solutions.

Sewer sediments

Sewers are designed to have a high enough flow rate during dry weather to prevent sediments from accumulating on the bottom of the sewer pipe. There will always be some deposit but frequent peaks in the influent flow rate as result of rainy weather may result in a beneficial washout of these sediments before they accumulate to levels that inhibit the performance of the sewer system. Sewer sediments restrict the flow in the sewer and bind pollutants but the removal of obstacles, such as tree roots in a sewer pipe, will lead to a reduced rate of deposition (Fraser *et al.*, 2002). Bound pollutants may at high flow rates travel with the sediments and either temporarily overload the treatment plant or in case of sewer overflow result in an overflow with high pollutant load. With the insertion of detention basins into the sewer net the peak flow rates are intentionally reduced and thus the risk for downstream sediment build-up increases. There may also be problems with sediment build-ups in the detention basin if it is poorly managed or subjected to unfavourable influent loads. Sediments in sewers lead to many problems including increased abrasion of pump impellers and increased risk for unwanted anaerobic foul-smelling reactions (Ashley *et al.*, 2002). On the other hand, sediment settling may be a desired process, as it allows for the removal of harmful sediments, which can be subjected to special treatment (Huebner and Geiger, 1996).

The suspension of sewer sediments in the combined wastewater under a rain event following a period of dry weather flow poses a problem. Known as the first flush this peak in the concentration of suspended solids and sediment-bound pollutants may damage pumps in both the sewer net and the WWTP, may cause problems at the WWTP with overflowing settlers could result in CSOs with high environmental impacts. The concentration of heavy metals and other substances not usually found in domestic sewage may be very high in the first flush and in urban runoff during the

initial phase of rain events that increase the urban run-off. The relationship between the stormwater pollutant load and the domestic sewerage load depends on the urban area connected to the sewer net. In a French study from 1992 (Nascimento *et al.*, 1999), the load of lead was found to be 2000 times larger from stormwater and on a yearly basis 27 times larger. The Kjeldahl nitrogen load and BOD₅ load was about 4 times larger on an hourly basis but insignificant on a yearly basis.

Much effort has been put into describing sediment transportation, sediment accumulation and sediment bound pollutants (Gent *et al.*, 1996). One approach is modelling of the physical and biological processes that occur in sewers. This approach is chosen in the software packages Mouse (by DHI) and Mosquito (by Wallingford software). The models use several types of sewer sediments that respond in certain ways to the shear stress imposed by the water flow and interact with dissolved pollutants in unique ways. Due to the large number of parameters that are not uniquely identifiable by experiments these models are not easily calibrated. Another approach is a statistical analysis of concentration and loads in sewer effluents as a result of multiple environmental parameters such as the antecedent dry weather period, maximum rain intensity, total flow, maximum flow and many more. The first flush load is both site-specific and time dependent. Multiple regression analyses to predict the characteristics of the first flush load performed by Gupta and Saul (1996), Deletic (1998) and Saget *et al.* (1995) do not provide a unifying relationship. Different independent variables with different coefficients give the best fit for different urban catchments even if the catchments appear to be similar. Also within a given catchment area different variables are necessary to describe the load and the concentration. Naturally the variables to describe soluble and particulate components are different even within the same catchment area. In the studies it is pointed out that reported results often are hard to compare due to different definitions of the first flush, the start of the first flush event and poor quality data with respect to resolution in time.

For predictions of the first flush statistical methods have an advantage over model-based methods in their simplicity and the availability of data (Gupta and Saul, 1996). Actual comparisons between the operation of sewer nets where the sizes and locations of the basins are determined with the two methods are not found in the literature. The CSO composition also

depends on many factors such as time and location, which make assumptions about specific locations unreliable.

Current practice

Real time control of sewer networks has been tested in several case studies.

German experiences

Most of the treatment plants in Germany receive wastewater from combined sewers and it is practice to include detention tanks in combined sewer nets. The Ruhr River Association operates about 90 WWTPs and about 500 detention tanks, which are either off-line (a separate basin), or in-line (in series with the sewer pipe) (Bode and Weyand, 2002). The objective is to reduce CSOs, which will lead to a larger flow reaching the WWTP. Filling of both types of detention basins begin at high flow rates and emptying starts as soon as the flow rate has returned to normal. Both tank types have sediments removed after each emptying. A CSO from in-line tanks that are not completely emptied before the next rain event lead to a more polluted CSO because of sedimentation. On the other hand an in-line storage tank will experience less problems with sediments, since it always receives the dry-weather flow and is thus flushed regularly. To reduce problems with sediments the tanks are equipped with hydrodynamic separators at the inlet to screen out sediments. The average basin size is 1000 m³ and the average investment cost 1000 Euro/m³. For smaller tanks the specific cost is higher because of control devices and instrumentation. In some smaller systems RTC of the sewer net has been implemented to achieve the same degrees of filling in the detention tanks, thus ensuring optimal use of the total volume if the conditions at all basins are identical. Compared to a system without RTC the basin volume can be reduced by 20% and give the same performance.

Danish experiences

Jørgensen *et al.*, (1995) showed in a simulation study of simple sewer networks that the potential of RTC, compared to local control, increased with increasing storage volume up to a normalised total volume of 15 mm of rain. The potential improvement is generally larger for control of

downstream basins since these receive a larger flow. As a rule of thumb improvements in existing systems of about 25% are possible. The more complex the system is, the larger is the optimal RTC potential. The optimal performance is optimized with respect to CSO volume using linear programming. This study was performed to improve the use of RTC in a trunk sewer in Copenhagen, a city in which studies of RTC of the combined sewer system started 1988. The current control is rule based with a dry weather, a rainy weather and an emptying phase. Together with an increase of the available detention volume by installing gates, the system reduces CSO volume by 80% (Andersen *et al.*, 1997).

Swedish experiences

Sweden has a relatively small amount of combined sewers, most of them constituting the oldest part of the sewer system in larger cities. Thus CSOs is a problem in the larger cities only with more than 100 000 PE, although a controlled sewer network could be used to improve flow conditions at the WWTP. In Sweden advanced RTC of the sewer network to minimize CSOs has been evaluated with the use of a simulation software (MOUSE) for description of the wastewater and sediment transportation. It has been tested in at least three locations with 800 000 PE (Göteborg), 200 000 PE (Helsingborg) and 100 000 PE (Halmstad). The theoretical studies show about 60% reduction in CSO volume for all cases but in practise only rule-based RTC has been successfully implemented.

In Halmstad (Hernebring *et al.*, 1998) the work with a sewer rehabilitation plan started 1991. There are eight treatment plants and the largest one receives 30 000 m³ wastewater daily from about 100 000 PE (75% of the households). Continuous work to separate impervious area from the combined sewer has lowered the connected area from 200 ha (1990) to 130 ha (2002). The flow varies with the rain, which constitutes 40% of the total flow. There are two basins in the system: a larg one at the WWTP and a small one in the sewer net. About 3% of the total flow to the WWTP is bypassed without full treatment, most of this at the WWTP basin. The WWTP inlet flow is restricted to 65% above the dimensioning dry weather flow because of the limited capacity of the secondary settler. With RTC of the two basins, rule-based control with respect to the type of rain, a considerable reduction in overflow volume is achieved, although the previous control strategy is not presented.

In Helsingborg (Hernebring *et al.*, 2002) Öresundsverket receives an inflow of about 50 000 m³ wastewater per day from about 200 000 PE. The sewer system is partly combined and about 330 ha impervious area is connected to the sewers, which experiences CSOs. Two trunk sewers and one basin at the WWTP can be used for flow equalization. In 1990 the treatment plant was expanded for biological nitrogen and phosphorous removal. Helsingborg has been a partner under the EU Innovation programme 1997-99 and could be regarded as a model for RTC implementations. During the programme the sewer net and the infiltration to the sewer system was investigated. Tracer studies were performed to calibrate the MOUSE model (Mark *et al.*, 1998). The sediment transport was also modelled to find potential conflicts with real time control strategies and high sediment levels in the CSOs. An issue for future integration is the non-standardised communication between the systems, which calls for an individual solution. Trusted predictions also increase the risk of trusting the wrong predictions, thus fine-tuning of the error correction procedure in MOUSE ONLINE is necessary (Hernebring *et al.*, 2002). In June 2003 Öresundverket was interviewed about their current status in RTC. They are still evaluating MOUSE ONLINE and use it off-line. The preliminary study of pollution-based RTC of the sewer net and basins has yet to be implemented but the vision is to use the concentration in the wastewater for control. For rain predictions they are developing a system based on radar measurements with about 1 hour predictions. This is in an early phase and the major issue to resolve is how to use the data received. The specific pollutant reduction is larger for phosphorous than nitrogen because of more efficient treatment at the WWTP.

In Göteborg the catchment area for the sewer system is 20 000 ha and the WWTP receives wastewater from about 800 000 PE. All wastewater is pumped to the WWTP from a trunk sewer, which is used today for equalization of the daily flow. Local control of the pump station with the most CSOs aims to reduce first flush CSOs by pumping more water to the trunk sewer during the beginning of rain events. On-line control with predictions from MOUSE is possible today but the predictions are currently not used.

Additional experiences

In Oslo a theoretical case study was performed by Weinreich *et al.*, (1997) to compare the effects of pollution based versus volume based real time control (PBRTC, VBRTC) when increasing the available storage volume in the sewer net. With PBRTC the CSO pollutant load rather than the CSO volume was minimized but this method requires additional concentration measurements of ammonium and phosphorous in and before the basins. The increased load from the WWTP due to the CSO volume reduction is not included in the effluent load. This case study has not resulted in real life implementation due to issues regarding sensor performance and total cost. Overflow is possible before and after each basin. The control is rule-based with two general principles for PBRTC when overflow cannot be avoided. The first rule states that the purest influent, if multiple, is bypassed. The second rule states that the basin with the purest overflow receives the most influent flow. For VBRTC the rules are not presented. For the simulation it is assumed that the available storage volume is increased with about 40%. The PBRTC extension reduces the total CSO load of phosphorous with 48% and ammonium with 51%, which is 11% and 15% better than with VBRTC. The overflow volume is the same with PBRTC and VBRTC, 40% less than before.

The different approaches by different academic principles show in a case study from 2001 on control of the storm sewer in Spain (Cembrano *et al.*, 2004). Instead of modelling the sewer using the white box approach common in wastewater engineering, the control engineers use MATLAB's System Identification Toolbox with good results. Although the real system has 16 gates and 24 rain gauges the example focuses on control of one basin using two gates. The optimisation method GAMS is used as it handles physical constraints of gates and basin overflows.

2.4 Integrated operation of WWTP and sewer net

Although the methods for control of storm sewers can also be applied to combined sewers, the same is not true for the benefits. An increased flow to the WWTP will have a negative effect on the performance of the WWTP and it is no longer possible to only take the discharge of CSOs into account (Rauch and Harremoes, 1997).

Integrated operation takes more than one part of the system into account. These system boundaries include runoff, sewer net and WWTP and recently also the river quality. When including river quality the effect of CSOs and WWTP effluent depend on the actual status of the river. Load from CSO discharge points upstream will take some time to reach the discharge point of the WWTP and thus the resulting maximum concentration of discharged pollutants can be minimized.

Pioneer reports on detention basin control surfaced with the introduction of the modern computer in the late 1970's (Dold *et al.*, 1981). Until the early 1990's this field of research was primarily limited by computer speed but during the 1980's and 1990's both models for biological reactions as well as simulation software for these models began to form. Today, the bottleneck is not computer speed but reliable and cheap sensor technology. Lack of money for investments has driven the current development towards software solutions, i.e. soft sensors, better use of available data and better human machine interfaces. The present simulation software and biological models are capable of simulating the entire system with acceptable accuracy fast enough for real time control but the lack of accurate, reliable and cheap sensors has limited the practical implementations to a handful of cases. A much wider bottleneck is the modelling of sediment transportation and sedimentation. When these models, which are usually three-dimensional, become more accurate the bottleneck could again become computer speed.

Control issues for the entire system

Overflow structures in the sewer network aim to maximize the flow transported in the sewer to the treatment plant. Thus treatment plant performance will be affected by higher flow rates on an average but also of higher maximum influent flow rates. A successful optimization of the control of the sewer net could lead to higher effluent loads and concentrations if the WWTP is also considered. Thus the decisions made when controlling the sewer net should be based on information describing the current operation of the treatment plant in order to optimize the combined system. The design of the supervisory control system depends on the actual system and the priorities made to balance the risks associated with combined sewer overflows with predicted effluents from the WWTP. Following this reasoning makes it evident that in order to minimize the

maximum concentration of a pollutant in the recipient this pollutant must be measured in the recipient so that the discharge may be timed correctly. Information is a prerequisite to successful operation of the collection system, which could include the whole chain from households and urban runoff to the final recipient. If detention basins are available for control of the sewer net it is often wise to include their control in the operation of the WWTP. Most local controllers at a treatment plant respond to variations in the influent and attenuate variations in the effluent but they usually rely on bacterial growth, which is a far slower process than other control measures such as chemical flocculation. The sewer network adds to variations in flow and composition, as the effluent flow usually is larger than the influent due to rain. Also separate sewer networks reacts to rain because of the leakage into it as a result of a high water pressure on the outside. Normally there is no leakage out of the sewer net due to a low water pressure but in a separate sewer system the storm sewer is normally located at a higher level than the domestic sewer. Detention basins or other structures that affect the flow in the sewer can be operated so that the problematic variations at the WWTP are attenuated. This could also allow the controllers at the WWTP to perform even better, or allow them to meet different objectives than before. If the sewer system receives wastewater from distinct and heterogeneous sources the WWTP may benefit even more from its control. Few systems meet this criterion and the effect is limited due to mixing and diffusion in the pipes.

Models and software for simulation

Models formalize our perception of reality and the model of choice is best determined by the intended use. A schematic diagram of a WWTP is a visual model, simple yet often a pre-requisite for more complex models. Models can be refined to more accurately describe the behaviour of the real process but the optimal model takes also into account the cost of development and simulation time.

With mathematical models the formalization is taken further. Depending on the level of detail models can be classified as black box, lowest detail, or white box, highest detail. White box models are based upon the knowledge of the process that is modelled using deterministic relationships between the modelled states. Black box models are based on input-output relationships and give, in contrast to a white box model, no motivation to

the results. Black box models that establish input-output relationships generally require the inputs to stay within a small space, thus these models have a more limited scope than white box models. There exist more detailed black box models, or less detailed white box models, which are called grey box models. The colour label indicates the level of detail rather than providing a distinct classification. As the knowledge of the modelled process increases, some deterministic relationships previously used in a white box model may very well be regarded as a black box sub-model. The scope and accuracy of black box models can be improved by continuous parameter estimation or by using artificial neural network models.

There are primarily two problems with integrated modelling and simulation of the entire system from urban runoff to the recipient via the sewer net and a WWTP (Erbe *et al.*, 2002). Firstly there exist no simulation software specifically designed for this task and secondly the models used often use different parameters and modelled substances. Simba Sewer, for instance uses 3 substances that need to be translated into the 20 or so used in the activated sludge models. The problem with unifying simulation software is not a bottleneck, as there exist multiple general simulation languages and simulation software such as MATLAB/Simulink, WEST and GPS-X. As long as the simulation is performed in one of these programs it is possible, if the problem with unique model parameters is overcome, to perform parallel simulations of the entire system. Parallel simulation has the advantage over sequential simulation that information is interchangeable in the entire scope of the system at all times. Using sequential simulation, where the different parts are simulated in the environment best suited for the individual sub-systems, control decisions cannot be based on information from other sub-systems. Thus it is not possible to control gates in the sewer network on the basis of the current status of the treatment plant, nor is it possible to select the optimal location for sewer overflow given the current status of the river (Schütze *et al.*, 2002).

Software

There exist few commercial products for modelling, simulation and control of wastewater treatment systems even fewer that consider the entire chain from sewer to river. For sewer modelling Mouse (by DHI) is the leading product. It is an integrated tool for modelling and control of sewer

networks, including transportation of sediments, runoff and water quality. It is possible to link simulations in the DHI supported software to model the entire chain from sewer to river. The commercial simulation programs WEST (by Hemmis), GPS-X (by Hydromantis), EFOR (DHI) and STOAT (by WRC) do not specifically simulate anything else than wastewater treatment processes. It is possible, however, to model sewer networks and rivers using tanks with user-defined biological models. In all of the commercial simulators it is also possible to evaluate control strategies. Simba (by ifak) is a toolbox extension to MATLAB/Simulink (by Mathworks) and includes model libraries for WWTPs and sewer nets. MATLAB/Simulink is a software package for modelling and simulation in general and has an extensive library of toolboxes for specialized applications as well as user-contributed toolboxes and functions. Modelica (Modelica association) is an object-oriented model building language and a free library for WWTP simulation is provided by Reichl. Modelica requires a simulation platform with a solver, such as the commercial Dymola (by Dynasim), that supports the Modelica language.

There exist numerous non-commercial, or at least non-professional, simulation packages, which include parts of the urban wastewater system. Many combine other non-commercial software, or models, either as one integrated tool or as exchangeable models. Schütze (1999) presents Synopsis; a tool for simulation and control of the entire system from runoff to river using exchangeable modules although the simulation is sequential with respect to river water quality. Weinreich *et al.*, (1997) presents Popcorn that also uses other non-commercial models and is used for simulation and control of sewer networks. Meirlaen *et al.* (2002) have integrated Kosim, an ASM2d (see below) WWTP and a RWQM1 (see below) based on CSTRs in series for use in WEST.

Physical models

Models of the biological processes are included in all commercial software and it is often possible for the user to define both the biological as well as the physical processes that occur in the modelled vessels. For biological reactions in WWTPs the activated sludge model no 1 (ASM1) proposed by Henze *et al.* (1986) is still the most commonly used but due to its simplicity and that phosphorous is not modelled, more advanced versions such as ASM2 and ASM2d has been developed. Models for anaerobic

processes, biofilms and for certain industrial wastewaters are under development but not at all evaluated to the same extent as the activated sludge models. There exist no de facto standard for modelling of surface runoff, sewer processes or river quality. Models not already implicitly mentioned as parts of the simulation software include: Kosim for sewers (with WEST implementation by Bauwens *et al.*, 1996), RWQM1 (Shanahan *et al.*, 2001) and Mike11 (DHI) for river quality modelling and Plaski (Alex, Risholt and Schilling) and Mouse for runoff modelling. The RWQM1 is designed with the activated sludge models in mind and thus this translation is somewhat facilitated although the modelled substances are not identical.

Observing the influent

The periodic nature of wastewater flow rates allows for good predictions of the dry weather flow. Carstensen (1998) compares three methods of 1 h flow predictions for a 330 000 PE plant with an average dry weather flow of about 40 000 m³. The simplest method, periodic functions for prediction of the dry weather flow and runoff hydrograph for rain, gives good results. The runoff hydrograph depends on the soil conditions, which limits the scope for this method to the soil conditions that matches the hydrograph. A more complicated method that gives slightly better predictions is a grey box model where noise processes are added to the previous method. Thus the dry weather flow is modelled as the sum of a deterministic diurnal profile and a stochastic model to describe deviations from this profile. Similarly, the rain flow is the sum of the output from the hydrograph and a stochastic model that describes deviations from this profile. A Kalman filter is used to update the dry weather flow and the rainfall runoff. The most complex model, used in MOUSE, gave the poorest predictions but this is due to poor calibration. All the three methods get data from only one rain gauge and flow estimation from the pumps at the WWTP inlet only.

Radar measurement of rainfall is an indirect method since information about rain intensity is achieved by image processing of radar echoes. Although the method as such is well known its practical use for real time control is limited. In a survey (Einfalt *et al.*, 2002) 80% of the responding countries used radar measurements. However, only about half of the contacted countries replied and most of them have in common a long history of rainfall data measurements. From 1995 to autumn 2002 there are

15 articles in Water Science and Technology with the word radar in the abstract. 6 of these are purely theoretical and present simulations of real systems. Unfortunately, they do not focus on the use of radar for rainfall prediction or details about the real time control strategies used. One article presents both theoretical and practical results and focuses on the problem of information management for use in real time control strategies (Faure *et al.*, 2002). Only one article presents practical results from a real time application of radar measurements for rainfall prediction (Aspegren *et al.*, 2001), where the method is diplomatically described as promising. Four articles address method development in image processing or radar measurements and the remaining three are either summaries or not about real time control.

Alternative wet weather operation

During wet weather the hydraulic retention time becomes lower and while the removal of particulate pollutants such as suspended solids and phosphorus can be increased by flocculants the removal of nitrogen and ammonium requires enough biomass, enough oxygen and enough time. It is impossible to increase the biomass to a sufficient level in the short time scale associated with wet weather flows and the physical limit of the maximum concentration dissolved oxygen may not be high enough should it even be practically possible to reach it. It is possible, however, that with control of the present system making best use of the volumes and biomass present. Sludge can be redistributed and the effective area for sedimentation temporarily increased to solve the problem of sludge loss at the cost of elevated nitrogen levels. Even if the applied control actions do not lower the effluent pollutant load they may be able to shift the effluent peak load in time and possibly lower the resulting maximum pollutant concentration in the recipient.

One theoretical method of redistributing sludge is by storing sludge that is continuously replaced in a separate tank with an optimal size of 10% of the biological volume. In this way there is always some extra biomass at hand for a rainy day and the plant may be designed for a lower sludge retention time (Yuan *et al.*, 1998). The active biomass is increased and 20% less biological volume would be sufficient for maintained efficiency. About the same volume reduction would be possible by applying in-sewer

sedimentation and the addition of nitrate in the sewer to produce an anoxic influent (Äsöy *et al.*, 1998).

Increasing second clarifier capacity

The secondary clarifier is often the bottleneck at the WWTP and the sludge blanket level will rise during periods of high flow rates or high hydraulic loads. Increasing the settling area will lower the flow velocity and allow for adequate operation with higher influent flow rates. Optimisation of clarifier design by improving conditions at the inlet and outlet will increase its capacity during both dry and wet weather. However, two methods applicable for wet weather conditions are aeration tank settling (ATS) and detention basin settling (DBS). These methods result in an increase of the effective area and volume of the secondary clarifier and allow the plant to operate at higher flow rates during wet weather without risking sludge loss.

At about 20 treatment plants in Belgium DBS is a standard operating procedure during wet weather since the start of a project in 2000 (Bixio *et al.*, 2002). The sewer systems are dominantly of the combined type and the standard protocol allows $5 Q_{DW}$ through the biological line and $10 Q_{DW}$ through primary treatment. Using DBS it has been possible to operate plants with $10 Q_{DW}$ through the biological line and in one case also with a lower combined effluent load from the detention basin and the WWTP. In the presented case the loads of total nitrogen, BOD, COD and SS are reduced by 40%, 30%, 20% and 70% respectively. In general the method leads to lower average loads but occasional higher peak values but since the size of the detention basin is not presented the results may be highly dependent of the present plant conditions.

Aeration tank settling is a method endorsed by Nielsen (1996, 2000). ATS is developed for alternating plants but may be applied to pre- and post-denitrification configurations as well. The underlying principle is to lower the suspended solids load to the settler and thereby allowing a higher flow rate. By using the normally aerated tank as an intermittent settler a vertical sludge gradient is achieved and unlike the step-feed method more sludge is retained in the aeration tank. ATS requires less time for preparation than step-feed but the treatment quality is increased significantly with about one hour preparation during which the sludge is properly distributed between

the clarifier and the aeration tank. With ATS the hydraulic capacity is increased up to 50% and although claimed not to reduce denitrification, a 40% reduction in effluent inorganic nitrogen (nitrate?) would indicate a corresponding increase in effluent ammonium.

Step-feed

Step-feed is a process where the sludge is deliberately distributed between the biological reactors. By moving the inlet of the influent wastewater downstream, the volumes upstream will have a higher hydraulic retention time and thus a higher concentration of sludge. The method is principally similar to ATS and DBS, in that a deliberately created sludge gradient will lower the sludge concentration in the influent flow to the clarifier and that some amount of sludge is stored in the biological reactors. The difference is that step-feed will create a gradient along the direction of the flow instead of a vertical gradient perpendicular to the direction of the flow. Contrary to ATS and DBS step-feed is usually not directly applicable as a control method as it requires an infrastructure that allows the influent wastewater to be directed into different parts of the biological reactors.

Step-feed can improve the operation of multi-stage denitrification-denitrification plants with a constant distribution of influent wastewater flow between the anoxic reactors with a possible reduction of the hydraulic retention time by 20% (Larrea *et al.*, 2001). Step-feed operation to improve wet weather operation has been successfully tested in Malmö where it was used to avoid sludge loss (Nyberg *et al.*, 1996). The plant was already designed to allow step-feed, allowing the influent to be sent one quarter of the basin length downstream at the beginning of the rain event. During the event the sludge blanket level in the clarifier was raised by 2 m, leaving a marginal of about 0.5m to the top. In the case study the nitrogen removal was lowered.

Although step-feed allows for improved wet weather operation it is not commonly used at wastewater treatment plants if judged by the reports in the literature. The reason could be that retrofitting often is necessary and thus step-feed is only considered at times where a plant is close to meeting its effluent standards. In those events it is possible that a more robust solution such as increasing the biological volumes or an easier implemented solution such as retrofitting with carriers is the preferred

choice. Step-feed requires a preparation time for successful operation. Depending on the actual sewer net it will sometimes be necessary to rely on prediction of future rain events in order to start the step-feed with enough time for preparation. During preparation and step-feed operation, the nitrogen removal efficiency is reduced. Should the step-feed operation be initiated at the wrong time, or at times when the predicted flow does not require step-feed, the result will be reduced nitrogen removal. A short preparation time or a long time from the actual rain before an increased flow arrives at the WWTP reduces the needed accuracy and cost of any used model.

Aeration

During wet and dry weather aeration may be extended in a pre-denitrification plant to include the normally anoxic compartments. This will attenuate primarily ammonium peaks although COD would also be affected. The method would be the opposite of ATS where aeration is intermittently shut off to encourage reactor sedimentation. This method is evaluated using a pilot plant and the reduction of the maximum ammonium concentration was 50% (Niemann and Orth, 2001). Since the anoxic volume used for denitrification is reduced the total nitrogen will increase given that the relationship between ammonium and nitrate nitrogen is optimal before the extended aeration (Ingildsen, 2002). The lowest ammonium load and concentration was achieved when the controller had a few hours prediction of the future flow but the method could also be triggered by the influent load or, least effectively, by the influent concentration. In a theoretical simulation study the amount of aerated volume in a post-denitrification plant is controlled in a feedforward fashion to attenuate the effect of high influent ammonium concentrations during dry weather (Samuelsson and Carlsson, 2001). The controller estimates the current rate of nitrogen removal using ASM1 reactions to calculate the desired aeration volume and increase it accordingly. This controller effectively reduces the effluent ammonium load by 70% and the maximum effluent concentration by 30% by allowing faster ammonium removal rates. The autotrophic biomass would eventually adapt to a higher influent ammonium concentration giving the same effluent ammonium load as before but the variation in influent concentration is too fast for this to be a possible solution. For lower flow rates the reduction in the maximum effluent ammonium concentration is bigger than at higher flow

rates indicating that the current operating conditions will determine the possible outcome of the method at any given plant.

2.5 Alternative treatment methods

Large loads may be utilized in the process, provided the right control. A large load of COD or of nutrients may be delayed and used when the rest of the water is deficient in these compounds.

Wastewaters rich in COD

Wastewaters from the production of baker's yeast are rich in readily biodegradable COD (Getha, 1998). This makes treatment in anaerobic reactors possible (Gulmez *et al.*, 1998), which is a less costly process than aerobic treatment. However, the readily biodegradable carbon could be used in a post-denitrifying activated sludge plant as a carbon addition to the anoxic reactor in order to improve denitrification.

Provided that a COD-rich separate influent exists, this influent must be coordinated in time to reach the plant when it's needed in order to improve the effluent quality. Left unattended (in open-loop) the effect could be the opposite. Assuming that the state of the plant is constant the controller needs information from both the sewer net and the specific industry to create the best mix of wastewaters. Since the state of the plant is dynamic, so is the "best" influent composition. Thus, the control algorithm should yield a better result if it also received information regarding the state of the plant. The number of measurements points in the plant may be kept low, as existing models may be used to estimate unmeasured states.

In order to evaluate yeast-containing waters and various control strategies data describing yeast wastewater was needed. A literature study revealed only one case of presented data, which are shown in Table 2.1 (Gulmez *et al.*, 1998). There was a 400% difference between the highest and the lowest concentrations (including pH) in this water, implying good control authority provided proper measurements. The analysis describes the water in the industry's buffer tanks, implying a higher variation in the immediate effluent.

Average	
pH	5.9
Alkalinity (mg/L)	1675
COD (mg/L)	17100
TKN (mg/L)	1185
NH ₄ -N (mg/L)	250
P-tot	21

Table 2.1. Wastewater from yeast factory.

Ammonium and the organically bound nitrogen constitute the total Kjeldahl nitrogen (TKN, N_{Kj}). Compared to municipal water both these concentrations are high, probably as a result of loss of nutrients from the process and a concentrating process prior to the buffer tanks. In spite of the high concentration of COD, the high concentration of ammonium could limit the use of this wastewater as a carbon source for denitrifying plants. This pre-study does not evaluate the wastewater as a carbon source, or control strategies using a more suitable but hypothetical, wastewater.

Space-distributed dosing

Space-distributed dosing is the concept where substances are added to the process at various places. An example is the addition of a carbon source to improve denitrification, which is a reaction that occurs in an oxygen-free, nitrate-rich environment as long as there is readily biodegradable carbon present. In the process, nitrate is reduced to nitrogen gas. If this conversion occurs in the end of the plant, the readily biodegradable carbon is depleted and must be added. Carbon addition may also improve denitrification in pre-denitrification plants denitrification. Any carbon source might be used and it is usually the (high) price that decides which one.

An alternative to a bought, external, source the wastewater itself can be used as an internal source. Such a source is the sludge from the primary sedimentation provided that it is hydrolysed into smaller molecules. This process is used in Helsingborg and is by Kemira called the LE-process, for Low Energy. The process promotes denitrification by providing easily biodegradable carbon from the hydrolysis of the sludge from the primary sedimentation. Also nitrification is promoted by pre-sedimentation since the lower ratio of carbon to nitrogen gives the autotrophic bacteria (the nitrifying) an advantage over the heterotrophic bacteria. After the primary

sedimentation the sludge is fermented with a sludge retention time of at least one day and then to another separator where the supernatant is collected and used as a carbon source. A rough figure (unverified) of the yield is that 20% of the mass of suspended material fermented is converted into easily biodegradable carbon (Canziani *et al.*, 1995).

Another internal source of carbon is the methane-rich biogas from an anaerobic process. The methane is after biological oxidation by certain bacteria converted into a more biodegradable form (Houbroun *et al.*, 1999). This process is associated with a high alternative cost since the biogas could be used for production of heat or electricity. The process demands a hydraulic retention time of no less than 6 hours, which is slightly more than the average European activated sludge process: 4 hours (Kemira, 1989).

There is also the possibility to divert a stream of the original influent directly to the reactor that needs a substance that is removed in the process. This form of step-feed could have the opposite effect, since the water that is redirected will have a lower hydraulic retention time. Ammonium, for instance, is hardly affected in an anoxic step and thus it could be unwise to divert an ammonium rich effluent to the last reactor to improve denitrification.

Chapter 3

The modelled plant

The simulations in this work are performed on the Benchmark Simulation Model 1 (BSM1) with an extension of an equalization basin. The equalization basin is modelled as part of this thesis and will be described in more detail in this chapter. The BSM1 is fully described elsewhere for the reader to digest, (Copp *et al.*, 2002) and will only be discussed briefly. The simulation is performed in MATLAB, using the graphical Simulink interface (Mathworks, 1999). Most models are written in C, since that allows for faster calculation in earlier versions of MATLAB than 6.5.

The models are formulated as ordinary differential equations, ODE's and solved with ode45 using minimum tolerance 10^{-4} and absolute tolerance 10^{-7} . Outputs are limited to 15-minute intervals. Initial conditions are set using the internal state option in Simulink, which handles hidden states such as regulator integrators.

3.1 The Benchmark Simulation Model BSM1

The treatment process is a pre-denitrifying activated sludge process with sedimentation (pre-sedimentation partly assumed but not modelled). Biological reactions are modelled using the Activated Sludge Model No 1 (ASM1) (Henze *et al.*, 1986). The settler is modelled as a 10 layer one-dimensional settler with settling characteristics described by the double-exponential settling function of Takács *et al.* (1991). The MATLAB-Simulink implementation of BSM1 used in this work is also described in Copp *et al.* (2002). The plant, see Figure 3.1, consists of five basins and a settler in series with characteristics as described in Table 3.1. A proposed

index (by the COST group) for the purity of the water is called the Effluent Quality Index and is defined as:

$$2*SS+1*COD+20*N_{Kj}+20*NO_3+2*BOD_5 \quad (3.1)$$

Where SS is suspended solids, COD and BOD₅ the chemical and biochemical oxygen demand (composite variables) N_{Kj} the Kjeldahl Nitrogen (composite variable) and NO_3 nitrate. It is a composite parameter and reflects mainly the total nitrogen, as the weights indicate. The proposed weights as well as the included parameters are arbitrarily chosen and serve as a unifying evaluation criterion for BSM1.

Reactor	Volume (m ³)	Area (m ²)
1 (Anoxic)	1000	
2 (Anoxic)	1000	
3 (Aerobic)	1333	
4 (Aerobic)	1333	
5 (Aerobic)	1333	
Settler	6000	1500 / 400

Table 3.1: Benchmark vessels.

Plant control

The plant has three internal actuators for control of the biological reactions: an internal recycle pump for nitrate recirculation control, dissolved oxygen control and control of the waste sludge removal. The internal recycle flow rate is controlled using feedback measurements of the nitrate level in the last anoxic reactor and the feedforward of the influent flow rate to the plant. The controller aims to keep the measured nitrate level at 1 mg/l. Aeration in the last reactor is controlled to keep the oxygen level at 2 mg/l. In the first two aerobic tanks the $K_L a$ is 240/d, which also is the maximum achievable $K_L a$ for the DO-controller. The outtake of waste sludge is constant 385 m³/d. These controllers are not modified with the addition of the equalization basin, nor are the set points changed as a result of the new influent flow rate control.

Extensions to the BSM1

The BSM1 was developed to test control strategies on an existing plant, using only the present volumes. Several control handles exist: the plant is prepared for sludge inventory control, internal recycle control and step-feed control. Extensions to the BSM1 are the nitrate controller and the equalization basin with pumps. Simulations are also performed with two different settlers: one with BSM1 area 1500 m² and one smaller with an area of 400 m².

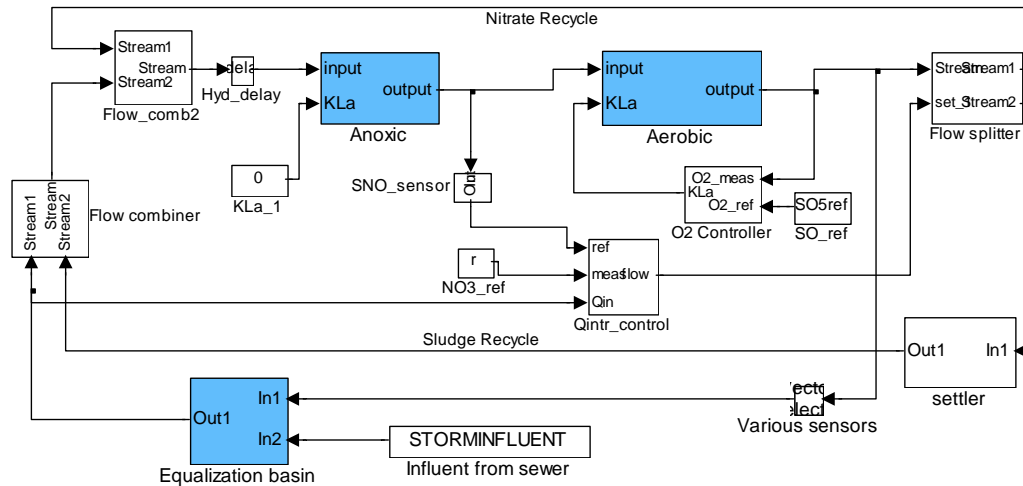

Figure 3.1: The Simulink implementation.

The equalization basin

The equalization basin (EqB) is an ASM1 reactor with variable volume. Since the volume is not constant the equations are based on masses instead of concentrations. Integration with the other tanks is achieved, as the equalization basin has the 14 ASM1 concentration and one flow rate as output signals. It is optional to use the models for the biological reactions. The modelled EqB has one influent and two possible effluents: one weir overflow if the basin becomes full and one controlled outflow. To allow MATLAB to calculate the basin overflow the influent and the controlled

effluent flow rates must be known. The weir overflow creates a problem in Simulink C-functions. It is not possible to accurately access the volume inside the C-function and a direct feedback creates an algebraic loop. Thus, the volume is also calculated outside the c-function redundantly.

The flows to the basin are not calculated in the basin model in order to keep this flexible. The controlled effluent flow as well as the overflow and the influent must be provided for the calculations for the basin. This requires a separate model for the weir (that in turn uses the volume from the basin) and a controller for the effluent controlled flow rate. The implementation for this in Simulink is shown in Figure 3.2, which is the subsystem classified as “Equalization Basin” earlier in Figure 3.1. In the figure it is seen that all of the flow leaving the basin, both the overflow and the controlled flow, is treated in the plant. It is easy to change this by adding the overflow to the effluent from the settler instead.

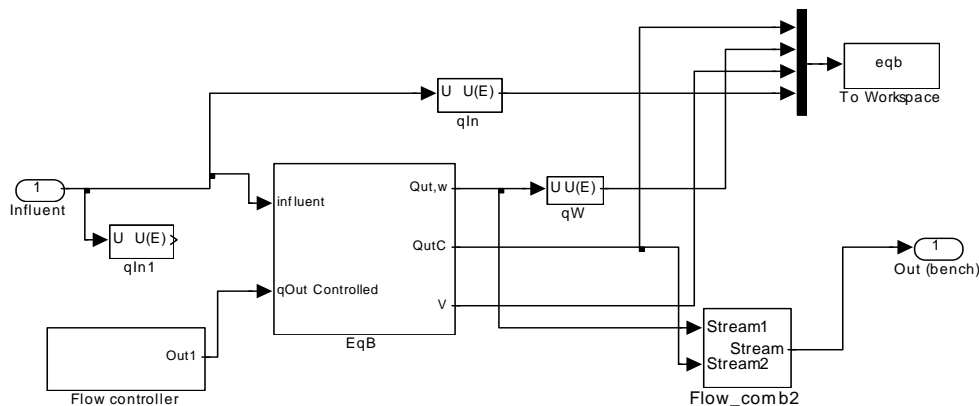

Figure 3.2: The block describing the equalization basin interface with the other blocks.

The code for the equalization basin is written in c, making it platform independent when used in MATLAB. Simulation in Simulink is also faster when the blocks are written in C and later compiled by MATLAB. Parameters such as initial states and basin volume and area are all editable

in the Simulink model. A simplified and faster model could be accomplished by including the equations describing the weir in the code describing the equalization basin. However, this would require the user possessing knowledge of C-programming in MATLAB in order to change the characteristics for the basin. With the proposed model, one must only be familiar with Simulink.

The flow controller block provides the reactor block with the controlled effluent flow rate. This flow rate is necessary for the calculation of basin overflow and volume by the basin block. If the basin volume is controlled by a weir overflow or if the basin has a weir overflow of certain shape, the equations for this should be inside the controller block. The included weir overflow is a on/off flow calculated by the “ $V = V_{full}$ ” block in Figure 3.3, which is an enabled sub-system with zero-crossing detection. Early versions of the basin did not use the zero-crossing feature, or included the weir in the C-code, which did not guarantee that the maximum volume was not exceeded. At fast changes in flow rates the volume would typically be exceeded by 1-5%.

In Figure 3.3 the calculations of the volume and concentrations are shown. Calculation of the volume and concentrations are performed by an S-function in the block “conc-calc”. For calculations of basin overflow the volume must be known but it is not possible to feedback the stored volume from the S-function due to an algebraic loop that slows down the calculation. Thus, the calculation of volume is also performed outside the S-function in the lower part of Figure 3.3. The volume calculation by integration requires a parameter input of the initial volume even if the initial states option in Simulink is used.

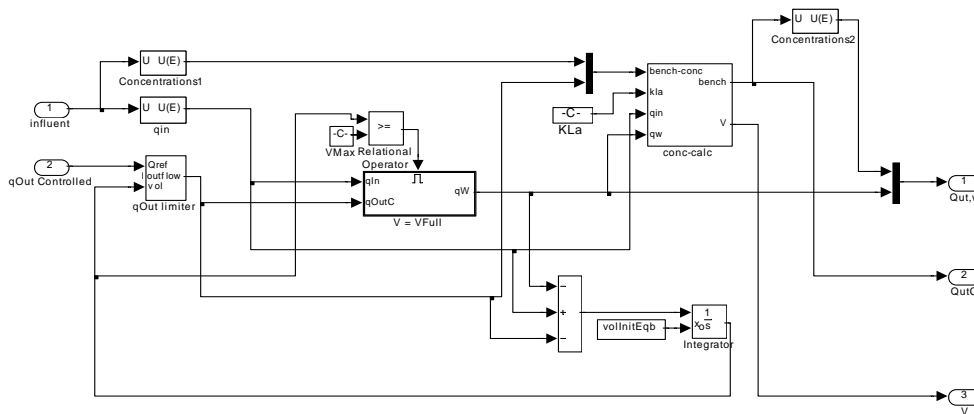

Figure 3.3: Equalization basin calculation of volume and concentrations.

3.2 Additional models

These include biological processes and physical processes such as aeration, sedimentation and flows.

Modelling biological processes

The biological reactions are modelled using the Activated Sludge Model 1, ASM1 (Henze *et al.*, 1986). Presented in 1986 by the organization which now is known as IWA, it has since been improved, modified and most of all recognized. Substances containing carbon are oxidized to carbon dioxide by *aerobic growth* and those containing nitrogen are reduced to nitrogen gas by *denitrification*. The latter process reduces nitrate but since the wastewater usually contains little nitrate, the nitrogen present must first be oxidized in a process called *nitrification*.

Modelling aeration

Aeration is a mass-transfer process of oxygen and described by the expression:

$$\begin{aligned} \text{(rate of mass transfer)} = & \\ & \text{(mass transfer coefficient)} * \text{(contact area)} * \text{(concentration} \\ & \text{difference)} \\ & k_L * a * (\text{saturation concentration} - \text{current concentration}) \end{aligned}$$

All three factors on the right hand side are more or less controllable variables in the process. The mass transfer coefficient, k_L and the contact area, a , are the least measurable (although in some way controllable) and usually estimated as their product. Membrane diffusors give small bubbles with high contact area and result in a lower shear stress than for instance surface aerators. The concentration difference depends on the amount of oxygen in the added air and the saturation concentration of oxygen in the water. Saturation concentrations are mostly temperature dependent but factors specific for the water also has some effect. Water can contain about 1% oxygen by mass. Pure oxygen may be added instead of air (with only 21% of oxygen) to increase the driving force.

In experiments it is difficult to separate the mass transfer coefficient from the contact area and hence the product $k_L a$ is usually determined. This product can be determined by small-scale experiments, or some familiar empirical correlation may be used. Correlations are often based on the fact that if more air is added, turbulence and mass transfer increases. The predicted oxygen concentration could be used for validation of other parameters, such as biological parameters or characterisation of the water. This demands that the mass transfer coefficient and the solubility of oxygen in the water are experimentally determined.

Modelling sedimentation

Sedimentation can be regarded as three sub-processes: clarification, thickening and compaction. Clarification takes place in the top of the settler where the wastewater is dilute. Thickening takes place below the sludge blanket level where the concentration of particles is much higher and where there no longer is unhindered settling. Compaction takes place at the bottom of the settler where the sludge concentration is high.

Factors with negative influences on sedimentation are hydraulic shocks and sludge swelling. Hydraulic shocks are the result of rapid changes in the flow velocity, causing turbulence and increase the concentration of suspended solids in the effluent water. Sludge swelling could be the result of too high a concentration of filamentous bacteria that form sludge with poor settling properties. This problem may be avoided by creating an environment with the right ratio between filamentous bacteria and floc-forming bacteria. Factors that favour filamentous bacteria are low concentrations of oxygen, substrate and nutrients. This is due to their larger specific surface area that allows them to grow more efficiently at lower concentrations of nutrients, as seen in Figure 3.4. Poor settling conditions may also be the result of denitrification, where particles adhere to bubbles of nitrogen gas and are brought to the surface (rising sludge). This opposite process of sedimentation is also deliberately used in some cases but then called *flotation*.

Since sedimentation is a crucial step in current wastewater treatment there are ways to improve the process. Settling velocity is increased if the settling particles have a higher density. This may be achieved by *flocculation*, where a flocculent, often a polymer, is added to create larger flocs of particles. Another way is to create particles that later may settle by *precipitation*. An example is the removal of phosphate by precipitation with an iron- or aluminium salt, a process that of course leads to emissions of other ions. In order to reduce the importance of the settler in sludge recovery, the bacteria may be cultivated in fixed *biofilms*. The carrier material, on which the bacteria grow, may be suspended and float around in the reactor or may be a fixed grid with a large surface area.

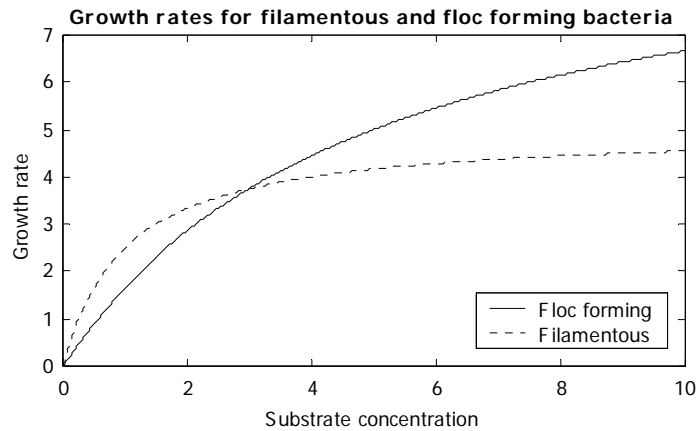

Figure 3.4: At lower substrate concentrations the filamentous bacteria are the fittest.

When modelling the sedimentation process both the physical properties of the water as well as the hydraulics in the settler must be considered. Two principally different models are described: an ideal settler and a one-dimensional layer-model.

Ideal sedimentation is instantaneous and neglects hydraulic effects. The settler itself is not modelled and its volume is neglected. Two concepts often used when describing sedimentation are the thickening factor, g and the sludge retention time, SRT, or sludge age, SA. The sludge age is similar to the hydraulic retention time, except that it applies to the sludge. There are many ways to calculate the sludge age depending on the plant layout and on the simplifications made. The sludge age is often used as a control parameter at wastewater treatment plants but under the assumption that flows and concentrations are at steady state. For modelling purposes the thickening factor is the only parameter to consider, thus it has great impact on the performance of the modelled settler. By default the effluent is free from suspended material but may be assigned some arbitrarily chosen amount.

Figure 3.5 shows a typical activated sludge process followed by a mathematical description of the ideal settler.

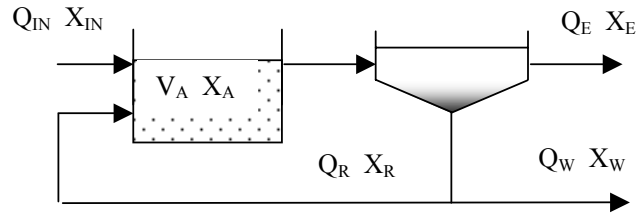

Figure 3.5: A typical activated sludge process with an aeration basin and a settler.

Q_{IN} - influent flow rate	m^3/d
Q_E - effluent flow rate	m^3/d
Q_W - waste sludge flow rate	m^3/d
Q_R - return sludge flow rate	m^3/d
V_A - active volume	m^3
X_{IN} - biomass concentration in influent flow	kg/m^3
X_A - biomass concentration in biological reactor	kg/m^3
X_E - biomass concentration in effluent flow	kg/m^3
X_W - biomass concentration in waste flow	kg/m^3

All particulate matter is assumed to behave in the same way and is described by the variable X . The sludge retention time, SRT and the thickening factor, γ , are defined as:

$$SRT = (\text{Amount of sludge}) / (\text{Effluent sludge}) [\text{time}]$$

$$\gamma = X_W/X_A$$

The sludge retention time is usually calculated with Equation 3.2, where it is implied that the sludge is inert in the settler. Any suspended solids in the influent or settler are neglected, as they are not part of the activated sludge.

$$\text{SRT} = \frac{V_A \cdot X_A}{Q_E \cdot X_E + Q_W \cdot X_W} \left[\frac{\text{m}^3 \cdot \left[\frac{\text{kg}}{\text{m}^3} \right]}{\left[\frac{\text{m}^3}{\text{d}} \right] \cdot \left[\frac{\text{kg}}{\text{m}^3} \right]} \right] = [\text{d}] \quad (3.2)$$

If the concentration in the effluent is considered negligible, a simplified and overestimated SRT is described by Equation 3.3 or 3.4 if the waste sludge is withdrawn from the aerobic reactor directly:

$$\text{SRT} = \frac{V_A \cdot X_A}{Q_W \cdot X_W} \quad (3.3)$$

$$\text{SRT} = \frac{V_A}{Q_W} \quad (3.4)$$

The equations for the ideal settler must be used with care, especially those where the concentration in any flow is assumed negligible.

A more realistic model that also describes dynamics is the layer model (Vitasovic, 1989). The settler is divided into several layers, each assumed completely mixed and both gravity settling and hydraulics describe the sludge flux between each layer. Settling velocity is often modelled as a function of sludge concentration as seen in Figure 3.6 (Takács *et al.*, 1991). The correlation, Equation 3.5, is empirical and describes the fact that both dilute and thick sludge settles poorly:

$$v = \max(0, \min(v_{\max}, v_0 \cdot (e^{-rh \cdot (X - fns \cdot XF)} - e^{-rp \cdot (X - fns \cdot XF)}))) \quad (3.5)$$

where:

- v_i – settling velocity
- v_0 – maximum theoretical settling velocity
- v_{\max} – maximum practical settling velocity
- XF – concentration of suspended solids in feed
- rh – settling characteristic of the hindered settling zone

fns – non-settling fraction of sludge (used in settler calculations)

rp – settling characteristic at low concentrations of suspended solids

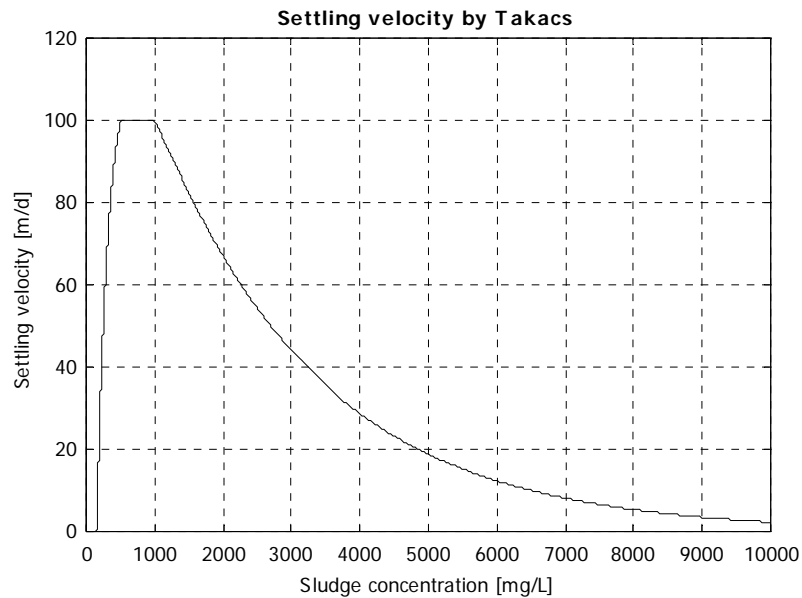

Figure 3.6: Settling velocity as described by the double exponential function by Takács.

Flux is defined as the concentration times the velocity:

$$\text{Flux} = \left[\frac{\text{kg}}{\text{m}^3} \right] \cdot \left[\frac{\text{m}}{\text{s}} \right] = \left[\frac{\text{kg}}{\text{m}^2 \cdot \text{s}} \right] \quad (3.6)$$

In Figure 3.7 it is shown how the flux to and from the layer indexed i (above the feed layer) is described by the layer model.

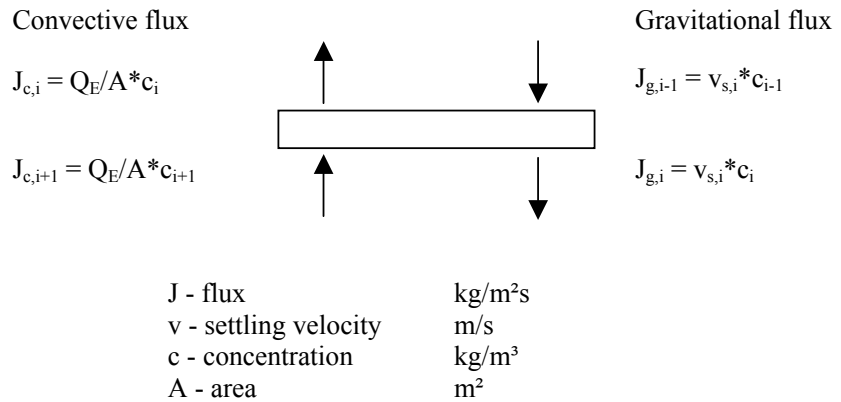

Figure 3.7: Mass balance over a layer in the settler model.

The mass balance for layer i becomes:

$$V_i \frac{dc_i}{dt} = A \cdot (J_{c,i+1} - J_{c,i} + J_{g,i-1} - J_{g,i}) \quad (3.7)$$

One state variable for every layer describes the concentrations in the settler. Usually ten layers are used in the model. Some boundary conditions have to be satisfied. One condition is given at the feeding point, while another one is defined by the underflow concentration. For particles with no interaction between each other Stoke's law (Equation 3.8) may be used with good approximation to describe the settling velocity for a particle. The Stoke's law is adequate for the clarifier section of the settler, where the particles are considered to be isolated from each other and is only valid for roughly spherical particles.

$$v = \frac{D_p^2 \cdot g \cdot (\rho_p - \rho)}{18\mu} \quad \left[\frac{m}{s} \right] \quad (3.8)$$

D_p - diameter of particle [m]
 ρ - density of particle or water [kg/m³]
 μ - viscosity of water [kg/(m.s)]
 g - acceleration [m/s²]

Modelling pumps

A simplified model of a centrifugal pump allows for a slightly more realistic system but considerably more robust. In order to give smooth flows as the suction head goes to zero, as is the case when emptying a basin, the produced flow can be described by the following relationship:

$$Q_{\text{pumped}} = Q_{\text{setpoint}} * h / (k + h) \quad (3.9)$$

By Equation 3.9 the produced flow will smoothly go to zero when the basin is empty and will assume the reference value otherwise. This model does not include any other real processes, such as cavitation.

Modelling weirs

Weirs are used for passive flow variation attenuation and flow measurement. For flow measurements in open channels the Parshall flume is better suited. The weir model can also be used to more realistically describe flow exiting a unit, as it produces a smoother flow rate. In a weir, see Figure 3.8, the flow is a function of the water height. The flow through a weir can be calculated by the velocity-area method. It is based on the fact that the flow through a cross-section equals the velocity of the water times the area of the cross-section, as described by Equation 3.10.

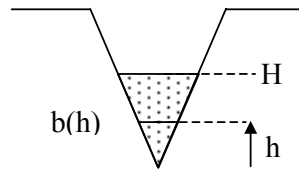

Figure 3.8: A triangular weir.

$$q = v * A \quad (3.10)$$

The flow velocity can be found using Equation 3.11, the Bernoulli equation. The indexes refer to a point before and after the weir, p is the (air) pressure, h is the height over a reference level and L are the composite losses due to friction and vortices.

$$p_1 + \rho g h_1 + \frac{\rho v_1^2}{2} = p_2 + \rho g h_2 + \frac{\rho v_2^2}{2} + L \quad (3.11)$$

The losses can be modelled by Equation 3.12, where ξ depends on the type and status of the weir and on the properties of the flow, for instance its viscosity.

$$L = \xi \frac{\rho v^2}{2} \quad (3.12)$$

The air pressure is the same before and after the weir, allowing the flow rate to be calculated by solving the Bernoulli equation:

$$v_2 = \sqrt{\frac{2g(h_1 - h_2)}{1 + \xi}} \quad (3.13)$$

The flow varies with the height of the water level in the weir. By combining the Equations 3.10 - 3.13 the flow through different parts of the cross-section are described by Equation 3.14. A summation of these flows yields the total flow through the weir. Regardless of the shape of the weir (triangular, rectangular or other) the first part of Equation 3.14 is the same. The shape of the weir determines how the width and thus the area of the smaller cross-sections, depends on the height. For a rectangular weir the area equals the width times the area, giving ΔA as $b \cdot \Delta h$ using the notation of Figure 3.8. The total flow is given by integration of Equation 3.16. As the differential cross-sectional area increases, the head and driving force decrease. The solution, Equation 3.17, describes the flow over a rectangular weir as a function of the water level.

$$\Delta q = \sqrt{\frac{2gh}{1 + \xi}} * \Delta A \quad (3.14)$$

$$\Delta q = \sqrt{\frac{2gh}{1 + \xi}} * b * \Delta h \quad (3.15)$$

$$Q = \int_0^H \sqrt{\frac{2g(H-h)}{1+\xi}} * b * dh \quad (3.16)$$

$$Q = \sqrt{\frac{2g}{1+\xi}} * b * \frac{1}{1.5} H^{1.5} \quad (3.17)$$

Rearranging gives Equation 3.18, also known as the Poleni (Marcus Giovanni Poleni, 1683-1786) or Kindsvater-Carter equation (Kindsvater and Carter, 1959). Several ways to estimate the flow resistance C_e is described in Naturvårdsverket (1994), Allmänna Råd 90:2. There are also several ISO standards that govern the measurement of flow, which will not be discussed here.

$$Q = C_e * \sqrt{2g} * b * \frac{1}{1.5} H^{1.5} \quad (3.18)$$

The calculations are repeated for triangular shaped weirs. When the base angle α is 90 degrees the tan-expression equals 1.

$$A = h * \tan\left(\frac{\alpha}{2}\right) * dh \quad (3.19)$$

$$Q = \int_0^H C_e * \sqrt{2g(H-h)} * 2 * h * \tan\left(\frac{\alpha}{2}\right) * dh \quad (3.20)$$

$$Q = C_e * \sqrt{2g} * \tan\left(\frac{\alpha}{2}\right) * \frac{8}{15} H^{2.5} \quad (3.21)$$

The shape of the weir can be chosen to get a more desired relation between the flow and the water level. In Figure 3.9 a comparison between three shapes is made and the weir flow is plotted for increasing water levels. The weirs are a triangular, a rectangular and an inverted triangular and produce the same maximum flow (when the water level is highest). By using and inverted (upside down) triangular shape the flow is almost proportional to

the water level. There exist more complicated shapes that give a flow that is directly proportional to the water level, at least in theory.

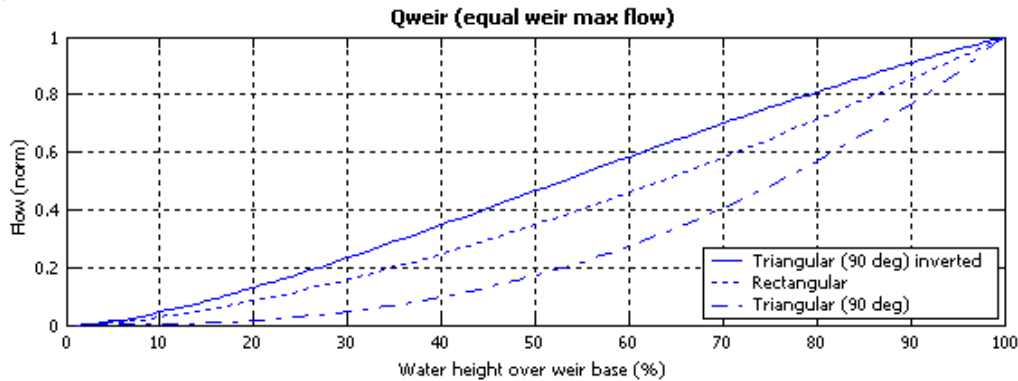

Figure 3.9: Comparing weirs with equal capacity.

The pattern emerging in Equation 3.18 and 3.21 can be used to simplify the equation for standard-shaped weirs and let their flow throughput be described by Equation 3.22. This requires calibration with the real weir, since the parameters k and n lack a direct physical interpretation. Since calibration is necessary even with more complicated equations, the simplified two-parameter equation is more flexible to use. Commercial weir flow meters may allow simplified as well as complex equations to be used. If the logarithm is taken for both sides of 3.22 we get the equation for a line, Equation 3.23 from which the parameters k and n can be determined. Without real weirs to calibrate the equations, the following approximate values for the flow resistance C_c can be used: rectangular $C_c = 0.66$, triangular $C_c = 0.59$.

$$Q = k \cdot H^n \quad (3.22)$$

$$\ln(Q) = n \ln(H) + \ln(k) \quad (3.23)$$

Modelling hydraulic transportation

The hydraulic, or convective, transportation of a substance could be described by the continuity equation, as shown in Equation 3.24. Without

nuclear reactions the change in mass will be the difference of the mass entering and the mass leaving the system. Since measurements of substances describe their concentrations, it is convenient to rewrite into Equation 3.25, under the assumption that the system is homogenous with respect to the concentration. A homogenous concentration can be assumed if the system is well mixed or the volume is small. In Equation 3.25 the term r_V is the volumetric reaction rate. To describe the change in concentration (and not mass) in the system, Equation 3.26 can be used under the assumption that the volume of the system is constant.

$$\frac{dm}{dt} = m_{in} - m_{out} + m_{reac} \quad (3.24)$$

$$\frac{dm}{dt} = q_{in} * c_{in} - q_{out} * c + V * r_V \quad (3.25)$$

$$\frac{dc}{dt} = \frac{q_{in} * c_{in} - q_{out} * c}{V} + r_V \quad (3.26)$$

Considering water as a substance, the amount of water in the system can be described similarly. In Equation 3.27 it is assumed that the density is constant.

$$\frac{dV}{dt} = q_{in} - q_{out} \quad (3.27)$$

Chapter 4

The base case scenario

In this chapter the assumptions for the simulations are presented. The rain events are described and the performance with a small and a large settler without an equalization basin is presented.

4.1 The rains

The rain data comes from the BSM1 influent file “storminfluent”, which consist of two identical weeks with dry weather, except for two rain events that occur in the second week, see Figure 4.1. During the first rain event some influent concentrations are elevated as a result of the first flush, which reflects on the suspended solids concentration shown in Figure 4.2. During the second rain event the wastewater flow is only diluted. The motivation for using these data is their “standardized” nature.

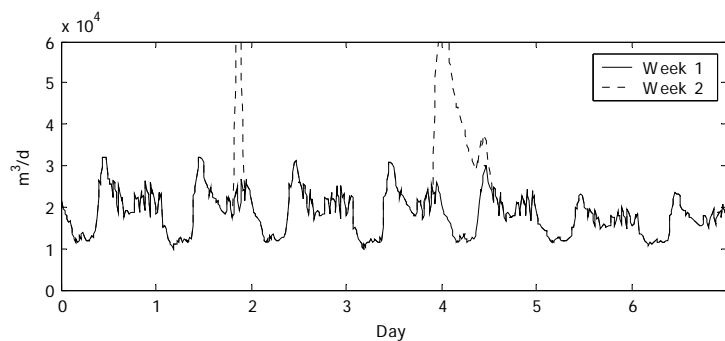

Figure 4.1: Influent flow rate from the sewer net.

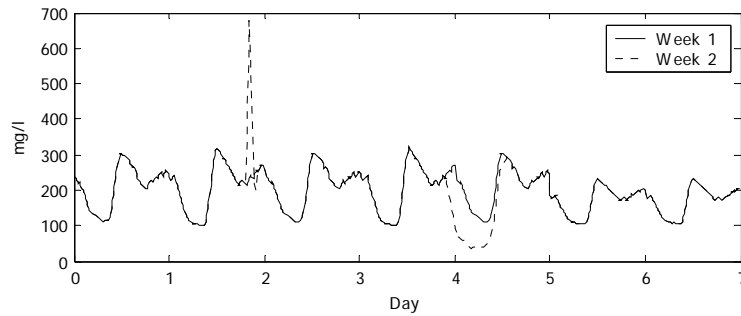

Figure 4.2: Influent concentration of suspended solids from the sewer net.

The actual rain is not described in terms of duration or amount of precipitation; only the effect the rain has on the influent data file, which is used as the influent to the WWTP. Thus, any reference to the rains means by default the effect the rains have had on the wastewater as it reaches the WWTP. The effect of the first rain on the influent lasts for 3.5 hours. The peak flow is 60 000 m³/d, which is twice that of a normal day and three times the daily average. The total volume, not including the wastewater flow, is 3000 m³, which is twice the volume for the time period. The effect of the second rain on the influent lasts for 15 hours. The peak flow is 60 000 m³/d, which is twice that of a normal day and three times the daily average. The total volume, not including the wastewater flow, is 17 000 m³, which is 1.5 times more than normal for the period.

Additional rains

The “storminfluent” data file is a combination of the, for the user, unknown “pure rain influent” and the “dryinfluent” data files. Rains at other times than those specified by BSM1 were created by back calculating the pure rain flow and combining this with the dry weather flow using Simulink blocks as seen in Figure 4.3. The flow and concentrations of the small rain event was calculated knowing that the wet weather flow is a combination of the dry weather flow and the flow from the rain. The separate contribution from the rain was then added to the dry weather flow at various times of the day. This is probably how the BSM1 weather files

were created, although no reference to this is found in the documentation. In the figure the back-calculated pure rain flow “rain” is added to the dry weather flow using an “if” and “if action” subsystem combination. If the if-condition is false there is no output from the “if action” subsystem and the combined flows contains only the dry weather flow. The digital clock has a sampling rate of 30 seconds. Output data are in the BSM1 format with 15 minutes sampling interval. Back calculation is performed for the same time index, i.e. the pure rain in one sampling interval is calculated from the dry weather and the rainy weather data files at the same time index.

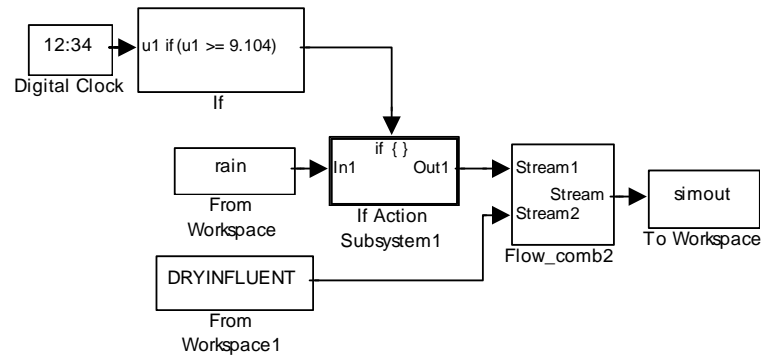

Figure 4.3: Creating combined flow from rain and dry weather data.

For each control strategy simulation with the additional rains there is a corresponding base case for reference. These are presented in Table 4.1. In Figure 4.4, the flow rates during the additional rains during R1 are illustrated. The original first rain shown in Figure 4.1 corresponds roughly to additional rain no. 5. In Figure 4.5, the ammonium concentration in the influent wastewater to the basin is shown for the additional rains.

Sub-rain	NH ₄	TSS
1	74.1	58.0
2	76.1	58.9
3	88.9	60.4
4	81.1	60.0
5	77.1	60.4
6	83.8	61.1
7	84.3	60.2
8	64.0	57.6

Table 4.1: Effluent loads (kg) with additional rains. Basin with base case control.

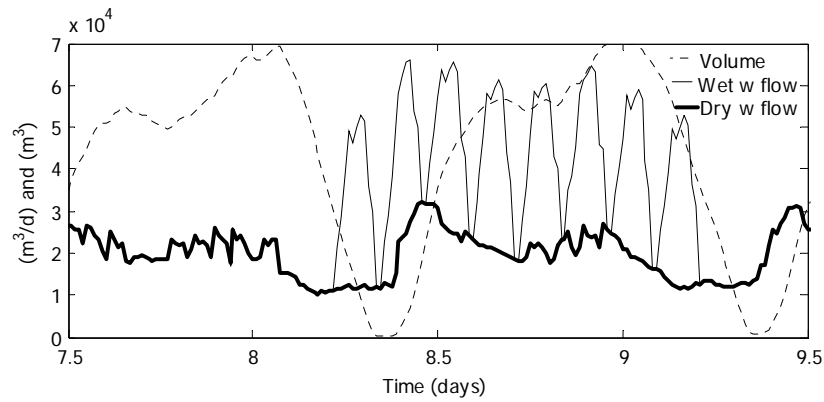

Figure 4.4: Dry weather flow rate and volume variation for base case. Rain alternatives superimposed.

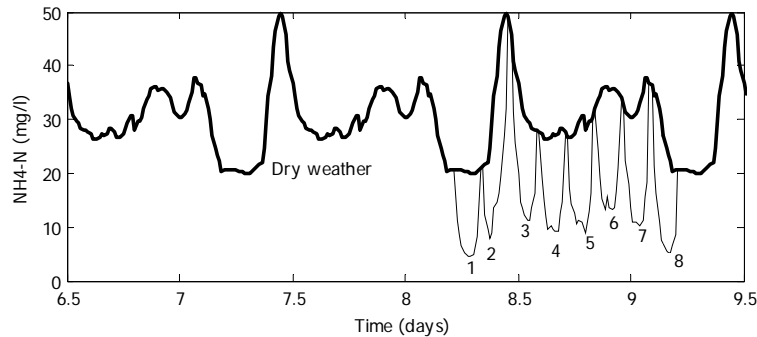

Figure 4.5: Ammonium concentration in influent wastewater to basin.

4.2 Evaluation

The data from the simulations are evaluated using primarily three criteria; effluent quality index, effluent ammonium load and effluent suspended solids load. Each strategy is often compared to a “base case”, which is a plant with an equalization basin with a constant pumped flow rate. The idea is that the comparison will reflect the effect of the control strategy and not the combined effect of a basin and a specific strategy, as would be the case if comparison is made to a plant with no basin. An effluent quality index, EQ, is used as a composite variable for comparison of the results. How the index is calculated is presented in Equation 3.1, where the relative weight of the parameters and their relationship to the ASM1-variables are presented. The factors used in the calculation of the suspended solids and of BOD₅ are dynamic and dependent on the wastewater. The relative weights are arbitrarily chosen but kept constant over the evaluation period. The effluent quality index is flow-weighted and calculated on load basis, thus reduction in peak concentrations and benefits thereof are not seen when comparing the EQ only. However, during periods of elevated flow rates as a result of rain, the flow is usually diluted and the effluent concentrations lower than normal. In these cases a non flow-weighted EQ would only be relevant at peak flow rates with settler overflow. In the discussion where rain is mentioned, it is usually the effect of the rain at the treatment plant inlet that is referred to. The comparison of the effluent load of suspended solids and ammonium also neglect any

decrease, or increase, of the maximum concentration of these substances. Unlike the peak concentration, peak loads are of little importance as it may be a result of low concentration and high flow rate.

The two rains are evaluated over 2 days, long enough as indicated by the recovery phase of the plant by preliminary simulations. The period covering the first rain, R1, shown in Figure 4.6, is divided into three shorter periods: before the rain (day 8 to 8.8), R1a, during the rain (day 8.8 to 9.4), R1b and after the rain (day 9.4 to 10), R1c. The period before the rain is of interest, as actions based on predictions affects the operation also during dry weather. The second rain, R2, shown in Figure 4.7, is for the same reasons as R1 divided into 2 periods (day 10 to 11 and day 11 to 12), R2a and R2b. A too long evaluation period will correctly predict the effect of the control strategy but there will be no way to distinguish between the effect during the normal conditions without rain, the effect during rain and the effect during any recovery phase.

The time periods showing the rain events were arbitrarily chosen, as well as the shorter periods within each rain event. This ensures a good base for evaluation of the strategies, rather than having time periods depend on the control strategy. However, the first period of the events was chosen so that it ended just before the rain. This ensures normal weather conditions in the period and any effects of the control actions are easily distinguishable. A limitation when using the same rain events for evaluation is that they are not necessarily representative for longer time periods. The conditions during weekends differ significantly from those at weekdays and for short time periods a weekday cannot be considered to have constant influent conditions. Thus the control methods should be tested for representative rains with representative properties at representative times. Several years of real data would give accurate prediction but finding data for the desired parameter for any longer time period is often impossible. However, statistical data with information on the return time, duration and intensity of rain events often exist. This data may be used to produce long time series of data. The drawback with this method is that the information does not tell if certain rain events are prone to occur on certain times. The occurrence of some rain events is seasonal dependant and of some it depends on the time of day. Rain data created from statistical data should incorporate also this information, if possible. In this work, some simulations are performed for a copy of the smaller rain event but for other times of the day. The wastewater shows a daily profile with two peaks, so

the time of arrival of the rain event may be of interest. The generation of the additional rains where the shorter rain is set to arrive at other times than specified in the BSM1 influent file are discussed later.

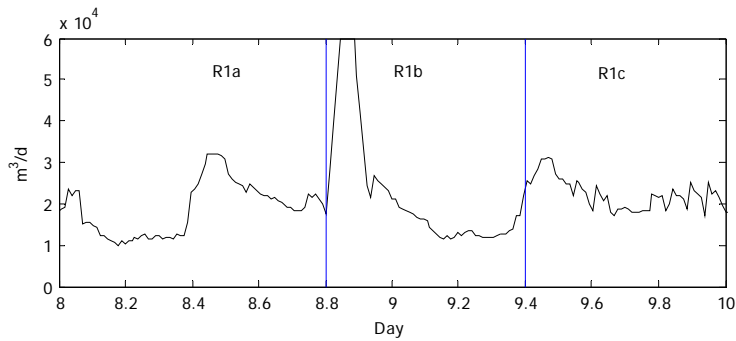

Figure 4.6: The time around the first rain event divided into three smaller periods.

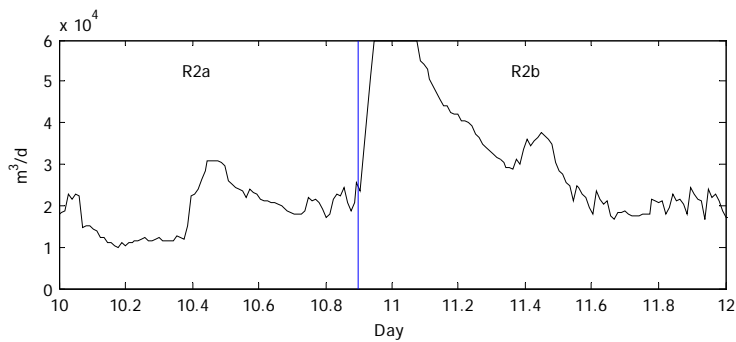

Figure 4.7: The second, longer, rain event. The first period is evaluated as pre-rain.

In Table 4.2, the results for dry weather without equalization basin are presented. There is no rain during the rain periods, R1 and R2, which are included for reference. In Table 4.3, the results for stormy weather without equalization basin are presented. It now rains during R1 and R2. In Table 4.4, the base case is presented. It presents the results with a non-controlled equalization basin, based on Strategy 1a presented in Chapter 5.

Period	EQ	NH ₄ (kg)	TSS (kg)
R1	6.31	115	51.5
R1a	2.51	48.7	19.9
R1b	1.63	26.3	13.0
R1c	2.17	39.9	18.6
R2	5.90	99.4	49.1
R2a	2.76	49.0	22.5
R2b	3.14	50.3	26.6
Day 1-7	19.8	295	164

Table 4.2: Effluent loads during dry weather without basin (no rain during R1, R2).

Period	EQ	NH ₄ (kg)	TSS (kg)
R1	6.96	152	62.6
R1a	2.52	48.7	19.9
R1b	2.27	56.0	23.9
R1c	2.18	47.6	18.8
R2	7.79	172	93.9
R2a	2.84	57.0	23.0
R2b	4.95	115	70.9

Table 4.3: Effluent loads during stormy weather without basin.

Period	EQ	NH ₄ (kg)	TSS (kg)
R1	6.49	81.5	60.9
R1a	2.30	18.0	19.5
R1b	2.42	43.5	25.8
R1c	1.77	19.9	15.6
R2	7.37	116	91.3
R2a	2.58	25.9	2.20
R2b	4.79	90.1	6.92
Day 1-7	18.5	137	160

Table 4.4: The base case used for reference with a basin (Strategy 1a).

Ammonium

An equalization basin affects the effluent ammonium load as well as the maximum concentration. With the default controllers the effluent ammonium concentration exhibits large variations, with maximum concentrations of about 8 mg/l and minimum of about 1 mg/l. If the last aerobic reactor is aerated like the previous two at maximum rate the effluent maximum concentration is reduced to about 5 mg/l. This value is an estimate of the lowest possible achievable for any oxygen controller.

In the base case scenario the reduction of ammonium nitrogen is 93% and the reduction of soluble nitrogen 51%. In BSM1 (without equalization basin) dry weather open loop (no control) gives 85% ammonium reduction and closed loop control 92% (for details see Copp, 2002).

	In	Out	Δ Settler	Δ Basin
Ammonium	4077	295	0	0
Nitrate	0	1690	0	0

Table 4.5: Soluble nitrogen balance (in kg) for the base case during one week of dry weather.

Energy

Pumping water from the equalization basin requires ideally an energy input proportional to the amount of water in the basin, using $E = Q\rho gh$. The dry weather flow of 20000 m³/d requires about 150 kWh/d if the basin on average is half empty, has a height (h) of 5 m and with pump efficiency of 80%. Using basin and pump data from the base case scenario results in 190 kWh/d, which is 0.01 kWh/m³ waste water. The energy required for aeration is about 7200 kWh/d for this plant, which is 0.36 kWh/m³.

The aeration energy is presented in Table 4.6. Neglecting the energy required for other purposes than oxidation of ammonium, the specific energy required for nitrification is 13.3 kWh/kg NH₄-N during dry weather. The BSM1 has similar results.

Period	kWh
Day 1-7	50 300
R1	15 100
R2	14 500

Table 4.6: Aeration energy requirement for the base case scenario (Strategy 1a).

4.3 Using a smaller settler

With the BSM1 it is difficult to study effects related to the periods of high flows that occurs during storms. First, the BSM1 is designed to primarily for studies of nitrogen removal and has a large settler capable of providing high sludge ages. Second, the settling velocity function describes the thickening process well but has more problems with clarification. Third, the model of the settler is one-dimensional and may not describe the hydraulic behaviour properly, especially in the short time scale. In order to further evaluate the effect of a basin on the treatment plant effluent, the performance of the plant was evaluated with an under-designed settler, with an area of 400 m² instead of the previously used 1500 m². The objective was to create a system where the settler is sensitive to higher flow rates and one where settler overflows would occur during rain events. The sludge blanket level in the large settler is shown in Figure 4.8 for three operating conditions: the low night flow, the morning peak and the first rain. For each event the profile is chosen when the concentration of suspended solids is the highest. The sludge blanket level is low in all three cases and there is a proportional relationship between the increase in the effluent suspended solids concentration and the influent flow rate. In Figure 4.9 the suspended solids profile in the small settler is shown again for the three typical influent conditions. The smaller settler has generally lower waste sludge concentrations partly as a result of more sludge loss in the effluent. The concentration of suspended solids in the effluent is higher than for the larger settler but the smaller settler performs relatively well during night and morning peaks. An observer would not suspect the limited capacity that becomes evident as the effluent concentration drastically increases during the smaller rain event.

With the smaller settler more sludge is lost during the second rain. This increases the recovery time of the plant, which reflects upon the effluent ammonium concentrations shown in Figure 4.10. The reduced treatment

capacity is especially evident for the afternoon peaks and the weekend (last two days). In Figure 4.11 it is seen that the suspended solids concentration in the return sludge flow takes a long time to return to the initial level after the sludge loss during the second rain. The effluent loads are presented in Table 4.7.

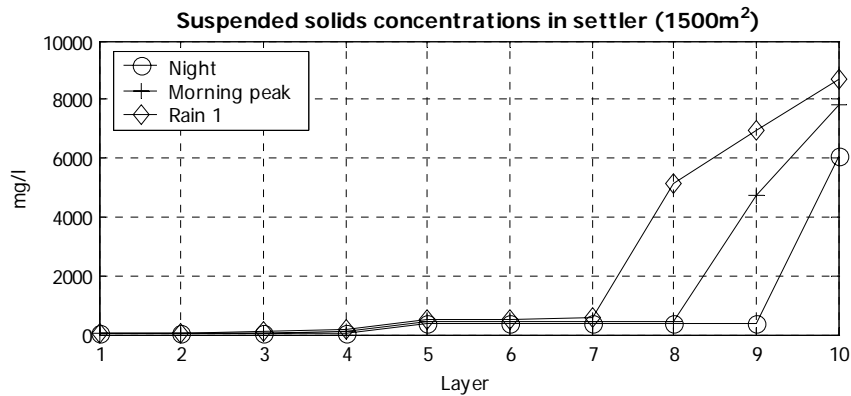

Figure 4.8: Maximum suspended solids concentration for the larger settler.

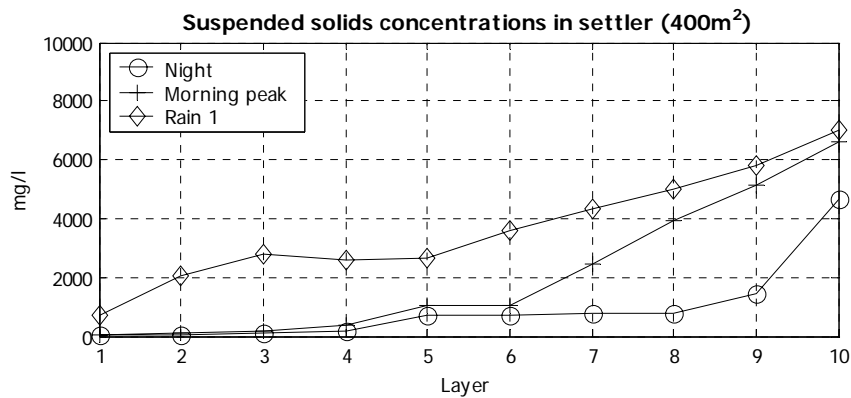

Figure 4.9: Maximum suspended solids concentration for the smaller settler.

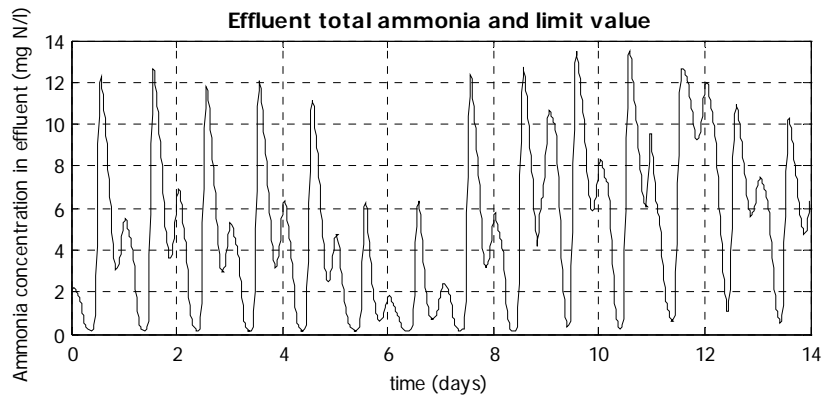

Figure 4.10: Effluent ammonium with the smaller settler.

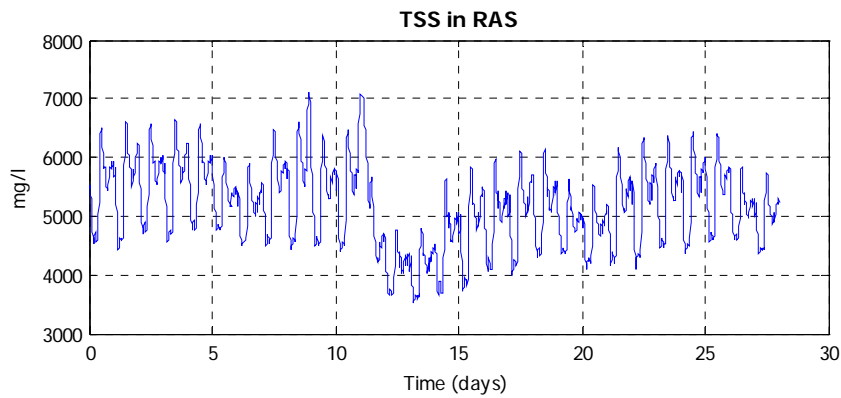

Figure 4.11: TSS concentration in the RAS flow after the longer rain event with the smaller settler.

Period	EQ	NH ₄ (kg)	TSS (kg)
R1	15,1	234	516
R1a	3,11	39,1	56,3
R1b	9,40	142	415
R1c	2,58	53,1	44,6
R2	12,5	181	471
R2a	21,4	441	760
R2b	3,66	70,7	61,8
Day 1-7	17,7	371	698

Table 4.7: Effluent dry weather loads with small settler (no rain during R1 and R2).

Chapter 5

Simulations

This chapter presents and discusses the control strategies. The pumped influent flow rate to the plant is controlled using information from measurements in the basin, in the plant, or in the sewer net. The general control objective is to minimize the variation of the influent flow rate. Normally there is no bypass of the plant and any basin overflow is combined with the controlled basin outflow and led to the plant. Information of historical flow rates is used in the first strategy to pump water from the basin to the plant at a constant rate. In the second strategy the pumped influent flow rate is determined by a feedback of either the stored volume or the concentration of effluent ammonium. The third strategy predicts future flow rates and increases the pumped flow rate in advance to avoid basin overflow. In the fourth strategy bypassing of the plant is allowed. The evaluates strategies all use a 2000 m³ basin with reactions modelled with the ASM1.

- Weekly and daily constant influent flow rate (no control)
- Feedback of stored volume (local control) or effluent ammonium concentration (plant-wide control)
- Early emptying (global control)
- Early emptying and bypassing to receiving waters (global control)

5.1 No control - constant influent flow rate

This strategy (Strategy 1) will mainly show the effects of basin operation during dry weather since no specific action is taken because of the rain. In the strategy the effluent flow from the basin is kept at the daily flow

average for weekdays, which in this case is 20 000 m³/d. All weekdays have average flow rates close to the weekly average. The basin volume of 2000 m³ is chosen so that the basin will be almost completely filled and emptied each day for the simulated influent flow rates. Thus complete equalization of the daily normal flow can be achieved and the risk of accumulated sediments is reduced. During and after days with elevated flow rates the basin will not return to an empty state directly, since the effluent flow rate is pre-determined. The general strategy is evaluated with two variations – one with a weekly set point (1a) and one with daily set points (1b), based on the predicted flow rate for the following day. This makes it possible to keep the lowest constant daily flow rate each day. The results from Strategy 1a are presented in Table 4.4, Strategy 1b in Table 5.1 and from Strategy 1a with a small settler in Table 5.2. The need for aeration is not significantly affected, as seen in Table 5.3.

In Figure 5.1 the rainy period is shown as the basin is controlled according to Strategy 1a. The scale is normalized; the flows to the weekly average flow rate and the water level to the maximum water level (or maximum wastewater volume in the basin). During some days with lower flow rate than the average the basin is not completely filled as the set point for the constant flow rate is maintained. This is evident for the weekend, day 12 and 13 but also for day 9, a weekday with lower average flow. During some weekdays with slightly larger flow rates than the average, not shown in Figure 5.1, the basin overflows. In Figure 5.2 a new set point is used every day based on future knowledge of average flow rates, Strategy 1b. The basin is still emptied once every day but now more often completely filled than with Strategy 1a. During these days the flow rate to the plant can be lowered. During the weekend the lower flow rate makes it impossible to both empty and fill the basin using a constant pumped flow rate. A pumped flow rate low enough to fill the basin is lower than the influent daily flow and thus the basin will not empty completely afterwards. It is the influent flow pattern that determines if the basin may be filled completely with one set point of the pumped flow rate. In Strategy 1b the flow set point is kept as low as possible each day for the basin to empty once every day. In Figure 5.1 and Figure 5.2 the flow rates are normalized to the dry weather flow rate and the current basin volume to the maximum basin volume. The two strategies are also applied to a plant with a much smaller settler, 400 m² instead of the standard 1500 m².

In Figure 5.3 and Figure 5.4 the effluent ammonium concentration and load are shown during dry weather conditions. Without equalization basin the effluent concentration has weekday peaks of 7 mg/l and 2 mg/l, which corresponds to the weekday variation in both influent ammonium concentration and load. During weekends, when the influent flow is slightly lower, the effluent concentration peaks at 2 mg/l, which could be an indication that the plant is operating close to the maximum nitrification capacity. With both strategy 1a and 1b the peaks are reduced to about 2 mg/l during weekdays. Strategy 1b uses the information about lower flow rates to reduce the weekend peaks to about 1 mg/l. Consequently, the effluent ammonium load is considerably reduced with both variations of Strategy 1. Strategy 1b gives additional improvement, mainly because of the better performance during weekends. The increased nitrification does not come to the high price of increased aeration. Rather, the absence of flow rate peaks allows for better utilization of the existing oxygen. The control of oxygen is not affected by Strategy 1 and is the same as in the plant description with full aeration in the first two aerated vessels and a DO set point of 2 mg/l in the last.

In Figure 5.5 it is seen that the averaging effect on the effluent suspended solids is similar to that of ammonium. The effluent load of ammonium and suspended solids when the plant has a significantly smaller settler is shown in Figure 5.6 and Figure 5.7. The relative performance of the strategies is similar although the loads are higher.

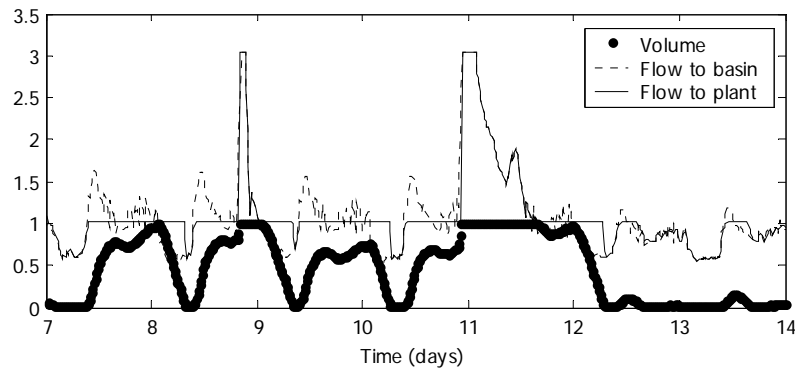

Figure 5.1: Constant flow rate strategy during the rainy period.

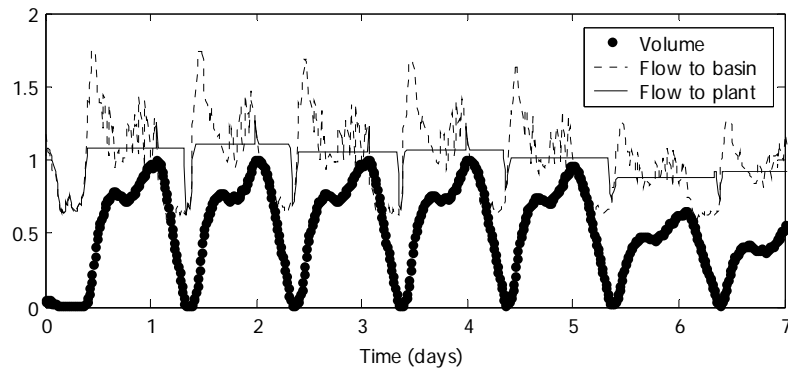

Figure 5.2: Daily constant flow rate strategy, dry period.

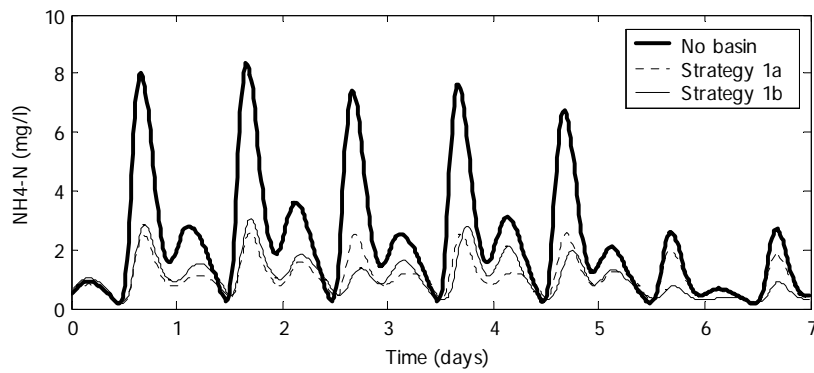

Figure 5.3: Effluent ammonium concentration with Strategy 1.

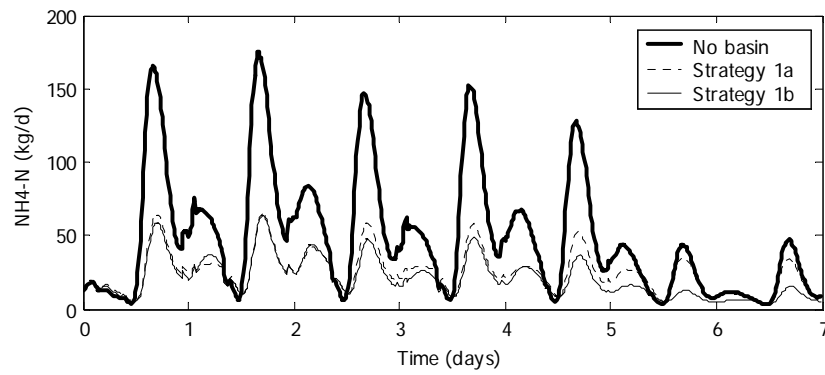

Figure 5.4: Effluent ammonium load with Strategy 1.

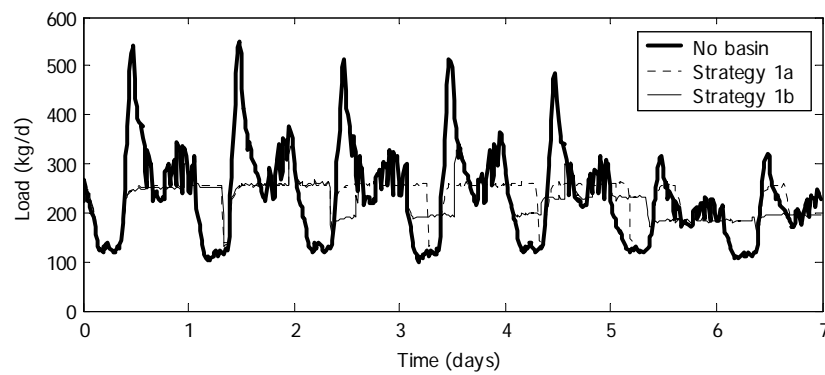

Figure 5.5: Effluent TSS load with Strategy 1.

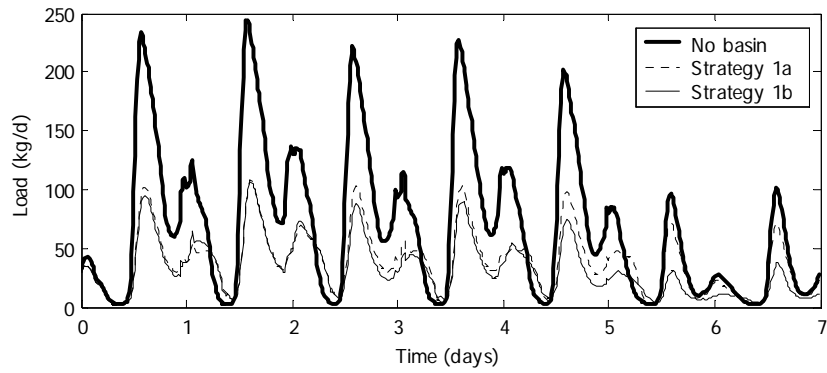

Figure 5.6: Effluent ammonium load with Strategy 1 and small settler.

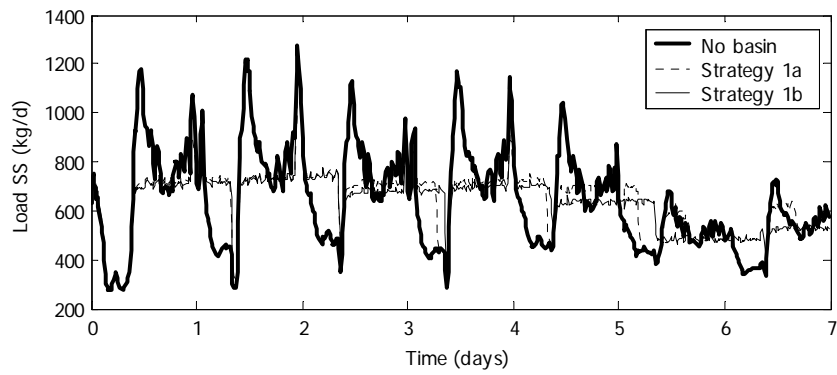

Figure 5.7: Effluent TSS load with Strategy 1 and small settler.

	1b	%
NH ₄ -load day 1-7	114	-17
NH ₄ -load R1	-	-
NH ₄ -load R2	-	-
TSS-load day 1-7	157	-2
TSS-load R1	-	-
TSS-load R2	-	-
EQ day 1-7	18.3	-1

Table 5.1: Effluent loads (kg) with Strategy 1b. Compared to Strategy 1a (the base case).

	1a	1b	%	%
NH ₄ -load day 1-7	263	214	-49	-58
NH ₄ -load R1	163	157	-38	-40
TSS-load day 1-7	455	452		
TSS-load R1	376	378		
TSS-load R2	628	635		
EQ day 1-7			-9	-10

Table 5.2: Effluent loads (kg) from Strategy 1 with small settler. Comparison is to case with no basin.

	1a	1b	%	%
kWh 1-7	49 600	49 200	-1	-2
kWh R1	14 900	14 900	-1	-1
kWh R2	14 300	14 200	-2	-2

Table 5.3: Aeration energy (kWh). Comparison is to case with no basin.

5.2 Feedback control

This strategy shows two principles of feedback control. In the first example (Strategy 2a) focus lies on the equalization basin and the objective is to make the degree of filling vary from zero to one on a daily basis in a smooth way. This will prevent sediments from accumulating and reduce the variation in the influent flow rate. It is assumed that a lower variation of the flow rate is beneficial for the WWTP but there is no feedback of the actual effluent concentrations.

In the second example (Strategy 2b) the effluent ammonium concentration from the WWTP is used to control the pumped influent flow rate. The degree of filling in the equalization basin will vary as a result of this but this information is not used for control.

Feedback of stored volume

With this strategy (Strategy 2a) the basin effluent flow rate is controlled using measurements of the current basin volume, as seen in Figure 5.8. The aim is to fill and empty the basin once per day in a smooth pattern, based on the assumption that this will lead to dampened variations in the influent flow rate with improved operation of the WWTP as a consequence of the relieved pressure on the WWTP actuators. The beneficial effect is however only assumed, as no qualitative measurements are used for the control, which makes the control local to the basin. To achieve a smooth variation of the wastewater volume in the basin between full and empty, the PI-controller intentionally produces a slow response with a volume set point of half the maximum. A fast and accurate controller would keep the volume equal to the set point, which would result in equal influent and effluent flow rates in the basin and a constant volume of wastewater. Planning of future volume profile has been investigated but the task is not trivial. A triangular profile of the desired degree of filling would be optimal only when the influent flow rate is constant or experiences little variation but for other influent flow rate profiles the variance in the resulting pumped flow from the basin would be higher. Since no information of effluent concentrations is used to motivate any specific profile of the degree of filling, the presented strategy will only show the performance of a slow, easily calibrated controller that produces a pumped flow rate close to the daily average with smooth variation.

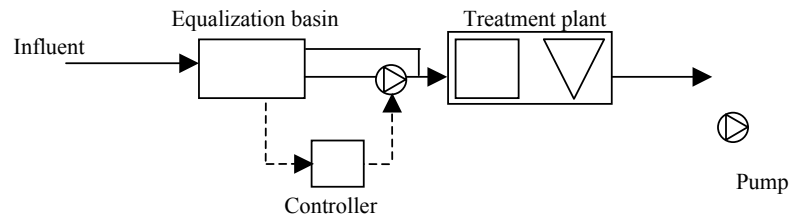

Figure 5.8: Control structure for feedback of current basin volume.

The effect this strategy has on the pumped flow rate and the resulting effect on the degree of filling is shown in Figure 5.9 and the resulting effluent loads in Table 5.4. With this control strategy the basin empties almost completely each day, minimizing the risk of accumulation of suspended solids. The influent flow rate is equalized also during the weekend without the need for altered control parameters. The strategy does not consider other disturbances than the statistically known influent flow rate variation, which in a sense was used for calibration, so its performance during elevated flow events cannot be truly evaluated with the weather files used in the simulations. With the BSM1 influent files, the early morning rains will be captured in an almost empty basin and afternoon rains will meet an almost full basin. Thus it is necessary to investigate the effect of rains that arrive at other times to evaluate a more realistic long-term behaviour.

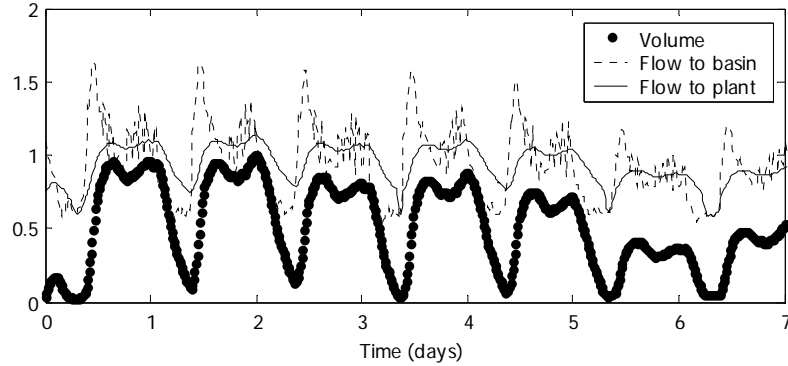

Figure 5.9: Control based on measurements of current basin volume.

	Vol FB	%
NH ₄ -load day 1-7	133	-3
NH ₄ -load R1	91.4	12
NH ₄ -load R2	128	10
TSS-load day 1-7	158	-1
TSS-load R1	61.6	1
TSS-load R2	93.4	2
EQ day 1-7	18.5	0

Table 5.4: Effluent ammonium and TSS with local control of basin volume.

	Vol FB	%
kWh 1-7	49 400	-2
kWh R1	15 000	-1
kWh R2	14 400	-1

Table 5.5: Aeration energy (kWh). Compared to case with no basin.

Feedback of ammonium concentration

If the concentration of ammonium is measured on-line it can be controlled directly by feedback control of the pumped flow rate from the basin, as

shown in Figure 5.10. A controller with proportional gain was chosen, as the simple design is robust and easily implemented in the simulation software. The implemented controller is presented in Figure 5.11, with the control laws:

$$Q = 20000 + 4000(\text{NH}_{4,\text{ref}} - \text{NH}_{4,\text{meas}}) \quad (5.1)$$

$$0 < Q < 20000 \text{ m}^3/\text{d}$$

The volume of wastewater in the basin is allowed to vary without control as the flow rate into the plant is controlled by feedback control. In the discussion two alternative locations of the ammonium sensor are presented: before and after the final clarifier. The results from two set points are presented: a lower, 0 mg/l, (Strategy 2b.l) and a higher, 1.2 mg/l (Strategy 2b.h). A low set point leads to a lower average effluent concentration at the expense of higher peak values than experienced with a higher set point. This is due to the higher margin of safety with a higher set point where generally less water is stored in the basin.

Since no information about future rains is known, this type of control is useful primarily during normal weather conditions. That condition is the most frequent and makes it possible to estimate the long-term effects. As seen in Figure 5.12, the basin empties daily with a set point of 1.2 mg/l. With a set point of 0 mg/l the basin is not completely emptied each day and the peak flow to the plant is higher (see Figure 5.13).

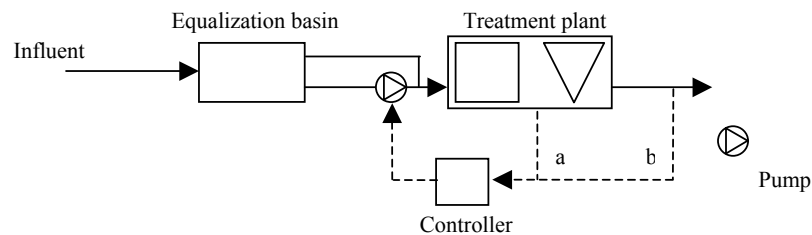

Figure 5.10: Control structure for feedback of ammonium concentration.

For control it is assumed that the concentration of ammonium after the aerated reactors increases with increased flow rates and vice versa, which is true since the nitrification process is driven further with a longer

hydraulic retention time. Nitrification is a nonlinear process that depends on physical parameters such as temperature and is dynamically affected by the aeration process, which is also a nonlinear process. Depending on the operating condition in the plant, the controller could benefit from some form of automatic recalibration, for instance provided by gain scheduling. Predictions of influent flow rates and concentrations based on measurements in the sewer net and on model predictions may be used in more advanced control algorithms for further improvement. More complex control without the need for additional measurements can be achieved by adding integrative and derivative actions. In Figure 5.12 it is seen that the basin is mostly empty during the weekend, which indicates that a lower set point could be used successfully. To determine the proper set point a number of factors can be included, such as the current nitrification capacity and the risk of having a higher degree of filling in the basin. Statistic data could also be used for less complex determination of the optimal set point. In this example the influent flow rate is known to be lower during weekends, which makes it possible to have a lower set point without increasing the average degree of filling in the basin.

The influence of the sensor location with the modelled P-controller is investigated for two cases: sensor location before (a) or after (b) the final clarifier, as shown in Figure 5.10. In Table 5.6 and Table 5.7, the effluent load of ammonium and suspended solids are presented for the two sensor locations. The loads are also compared to the base case, which is a constant influent flow rate equal to the weekly average. Apparently, the sensor should be located before the settler, rather than after, to reduce the load of effluent ammonium compared to base case control. A key reason is that the information from the position (b) is much more delayed as compared to (a). Reactions involving ammonium takes place only to a limited extent in the settler due to the low oxygen concentration, which makes information from an ammonium sensor located after the settler older and less useful for control. In the simulations it is assumed that no reactions occur in the settler. The settler equalizes the effluent ammonium concentration, which could be seen as a low pass filter process. With the settler volume 6000 m³, the time constant is about 4 hours, sufficient to make this type of control worse than local control of the basin volume. A sensor location earlier in the biological stage has not been investigated. However, it is apparent that it is most favourable to locate a sensor used for feedback control in the last biological reactor since only further equalization of the concentration occurs downstream. Lower variations in

the measured variable as well as lower absolute concentrations makes changes in the variable harder to detect as the signal to noise ratio decreases. A more thorough discussion on the location of ammonium sensors for aeration rate controllers is found in Ingildsen (2002).

In Table 5.8 and Table 5.9 the aeration energy requirement is presented compared to a case without basin. There is a slight reduction, which is insignificant given the uncertainties.

With direct feedback control of the effluent ammonium concentration the variations are low around 1 mg/l, as seen in Figure 5.14. There is no significant difference during weekends.

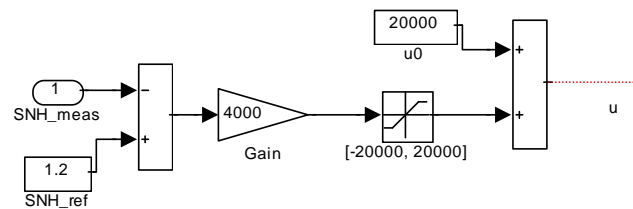

Figure 5.11: The feedback control block in Simulink.

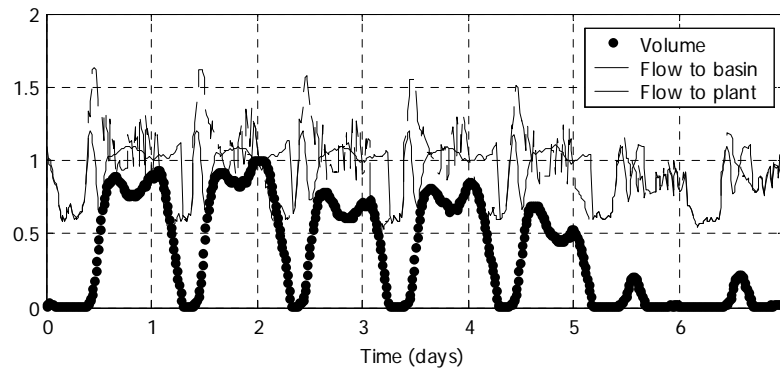

Figure 5.12: Flows and basin volume with set point 1.2 mg/l. Measurement before settler.

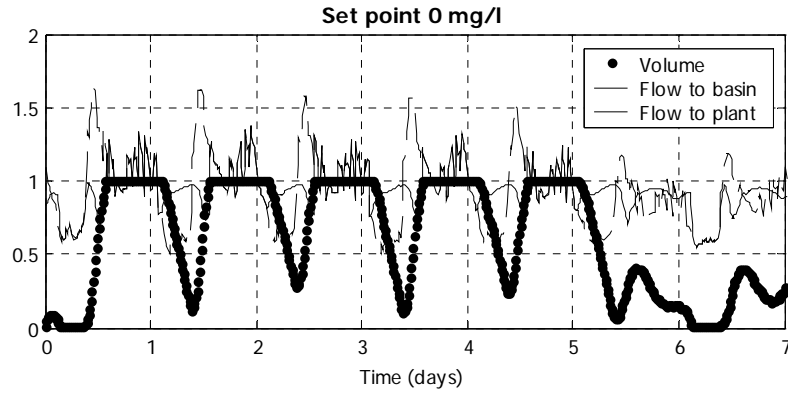

Figure 5.13: Flows and basin volume with set point 0 mg/l. Measurement before settler.

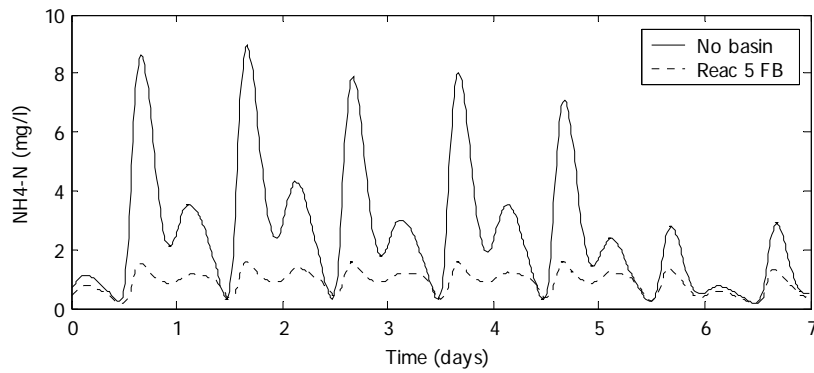

Figure 5.14: Ammonium concentration after settler with measurement before the settler and set point 1.2 mg/l

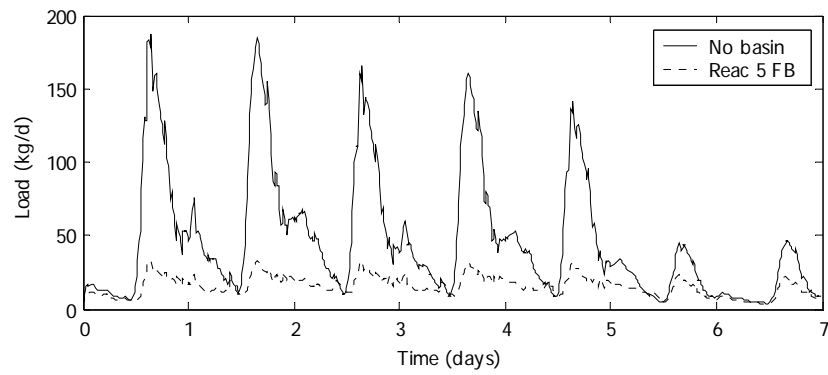

Figure 5.15: Effluent ammonium load with set point 1.2 mg/l and measurement after the settler.

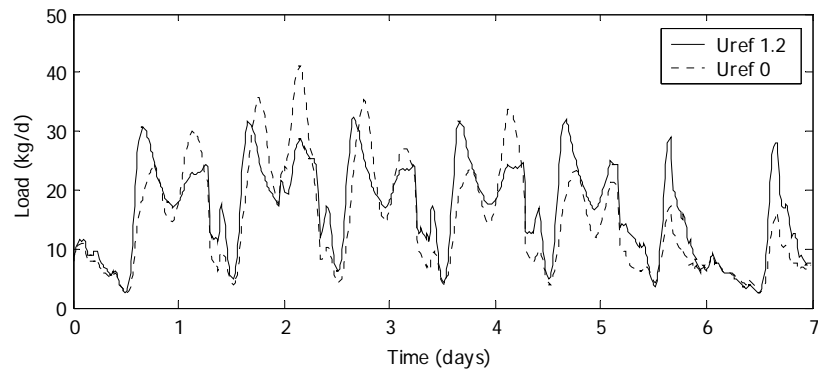

Figure 5.16: Effluent ammonium load measurement before settler. Two set points are compared, 1.2 and 0 mg/l.

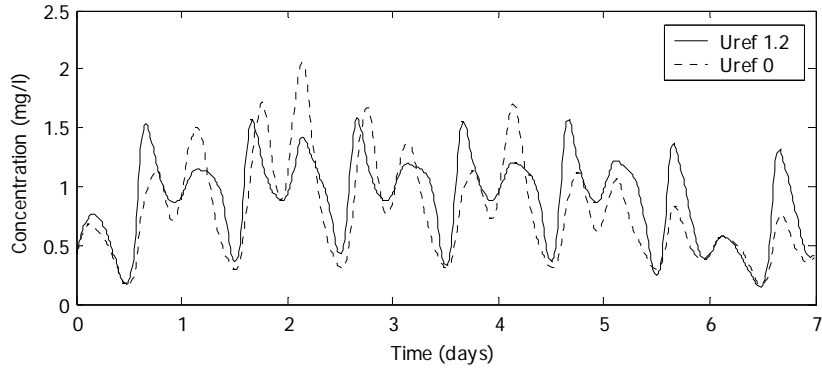

Figure 5.17: Comparison of ammonium concentration before settler. Two set points are compared, 1.2 and 0 mg/l.

	NH_4, ref 1.2 mg/l	NH_4, ref 0 mg/l	%	%
NH_4 -load day 1-7	150	153	9	12
NH_4 -load R1	92.3	106	13	31
NH_4 -load R2	131	149	6	38
TSS-load day 1-7	164	161	2	1
TSS-load R1	61.9	62.0	2	1
TSS-load R2	93.7	93.7	2	3
EQ day 1-7	18.6	19.2	1	4

Table 5.6: Feedback control of influent flow rate based on ammonium measurements after the settler (location b). Comparison is made to the base case scenario with basin.

	NH _{4, ref} 1.2 mg/l	NH _{4, ref} 0 mg/l	%	%
NH ₄ -load day 1-7	120	105	-13	-24
NH ₄ -load R1	71.9	80.9	-12	-1
NH ₄ -load R2	114	127	-2	10
TSS-load day 1-7	161	160	1	0
TSS-load R1	60.8	61.0	0	0
TSS-load R2	92.4	93.1	1	2
EQ day 1-7	18.3	18.5	-1	0

Table 5.7: Feedback control of influent flow rate based on ammonium measurements before the settler (location a). Comparison is made to the base case scenario with basin.

	NH _{4, ref} 1.2 mg/l	NH _{4, ref} 0 mg/l	%	%
kWh 1-7	49 500	49 200	-2	-2
kWh R1	14 900	14 800	-2	-2
kWh R2	14 300	14 200	-2	-2

Table 5.8: Aeration energy (kWh). Compared is made to the case with no basin.

	NH _{4, ref} 1.2 mg/l	NH _{4, ref} 0 mg/l	%	%
kWh 1-7	49 500	49 000	-2	-3
kWh R1	14 900	14 800	-2	-2
kWh R2	14 200	14 200	-2	-2

Table 5.9: Before settler. Aeration energy (kWh). Comparison is made to the case with no basin.

Simulations with additional rains

The strategy that had the lowest effluent ammonium load during the first rain event (feedback of ammonium concentration based on measurements located before the settler) was evaluated for the additional rains and the result is presented in Table 5.10. These rains are identical to the first, shorter, rain but arrive at other times of the day as shown in Figure 4.4. One rain per seven-day period of otherwise dry weather is evaluated. Each rain has its own reference base case operated with a constant pumped flow

rate. The arrival time of the smaller rain has only little influence on the results; the Strategy reduces the effluent ammonium load with about 10% for the smaller rain. The presented reductions in load are probably over-estimated, as the evaluation period contains one day of dry weather and two days that include rain and recovery.

Sub-rain	Base case	NH _{4, ref} 1.2 mg/l	%
1	74.1	64.3	-13
2	76.1	68.3	-10
3	88.9	79.0	-11
4	81.1	74.4	-8
5	77.1	70.3	-9
6	83.8	73.7	-12
7	84.3	72.1	-14
8	64.0	60.1	-6

Table 5.10: Effluent ammonium loads for additional rains and measurements before settler.

5.3 Early emptying

This control strategy (Strategy 3) aims to have an empty basin at the arrival of the elevated flow rate. Information about future elevated flow rates will be used to lower the degree of filling in the basin to reserve space for a possible polluted first flush. The strategy requires prediction of the flow rate for the entire preparation phase to allow for calculation of the optimal pumped influent flow rate and the structure is illustrated in Figure 5.18. In these simulations the pumped flow rate is increased and kept constant at a level high enough to provide an empty basin just at the end of the preparation phase. This will minimize the variance of the control signal but will not consider any effect on the effluent concentrations. After the preparation phase the pumped flow set point is reset to its previous value. Flow predictions can be realized by statistical or model-based approaches and in this study it is assumed that ideal predictions exist. During dry weather the basin is operated in the complete equalization mode described for Strategy 1 with a constant set point of the pumped flow rate. This strategy is evaluated for the short rain event only, as the wastewater

volume stored in the basin is small compared to the volume in the longer rain event. Also, the first-flush effect is only present in the shorter event.

The strategy is evaluated for two time horizons: 9 hours and 1.5 hours. A short time horizon reduces the complexity of models and sensors needed for accurate predictions of the performance of the WWTP or the sewer net. In this case, the shorter time horizon corresponds to the hydraulic time constant of the sewer network in smaller cities, which could allow for an accurate estimation of the quality of the treated wastewater during this time period and possibly during a shorter period of recovery. With the BSM1 influent files, the pumped flow rate during the 9-hour preparation phase is 20% higher than with base case control, 24 000 m³/d and during the 1.5-hour 120% higher, 44 000 m³/d. The strategy is also evaluated during the additional rain events, i.e. the shorter rain event at eight different times.

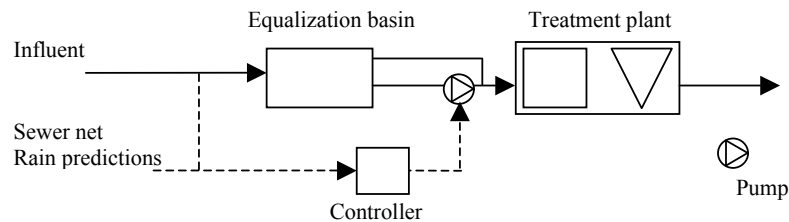

Figure 5.18: Control structure for early emptying.

As seen in Figure 5.19 and Figure 5.20, the pumped flow rate is lowered after the emptying phase and stays low during the arrival of the rain and initial filling of the basin. This is because the strategy aimed to have an empty basin at the arrival of the increased flow but uses base case control otherwise. Using a longer preparation period can be regarded as a period with a higher safety margin for basin overflows. The increased flow results in worse treatment but it could be worth the risk. Calculating safety margins for basins located in the sewer network is further discussed by Faure *et al.*, (2002).

The effluent load of ammonium is reduced about 5% for both preparation periods compared to base case control, as seen in Table 5.11. The suspended solids load is not reduced with the shorter emptying period.

Although the flow rate during the 1.5-hour preparation period is elevated by 120% compared to the base case and 20% during the 9-hour period, the lowest effluent ammonium concentration is reached for the 1.5-hour period, as seen in Figure 5.22. The reason is the interplay between the plant and the influent flow during both the preparation phase and the time of the elevated flow rate. A control strategy based solely on flow rates, which neglects the actual state of the plant, will produce unpredictable results and could also produce worse results than the base case approach. The increased complexity related to a longer time horizon is questionable in this particular case, if the information is used in this way. A plant model and measurements of effluent concentrations can more efficiently make use of the preparation period. In Figure 5.22, the task of choosing the correct control action during the preparation phase is illustrated. The vertical line at day 8.8 indicates when the basin is empty using the two emptying periods. After this time the flow and concentrations are identical at the inlet to the WWTP but because of the wastewater in the reactors and in the settler the effluent concentrations differ. Thus, depending on the control objective, the plant effluent must be predicted for some additional time to encompass the recovery phase resulting from the control action. The strategy is sensitive to the conditions in the plant and to the time of the rain. Figure 4.5 that shows the different ammonium concentration in the influent wastewater motivates simulations with additional rains also.

Short periods of emptying results in less treated wastewater. It is possible to extend the period used in this study to include also the initial rain flow and perhaps use a slightly lower controlled flow rate. When the basin is empty the controlled flow rate can be set to match the influent flow rate. In this way the basin remains empty even if the rain arrives later than expected. It is also possible to experiment with other pumped flow rates during the rain, to avoid overflow as long as possible. Still, the decisions are not based on effluent concentrations but on an expected response to different flow rates.

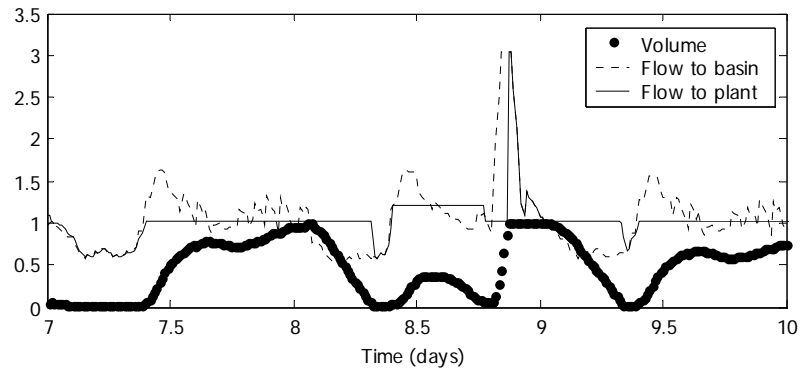

Figure 5.19: Start of emptying phase 9 hours before the first rain event. The flow rate to the plant is raised 20% during the 9 hours.

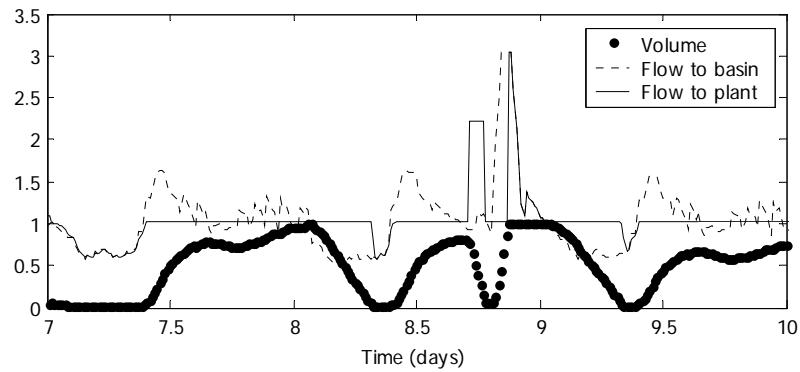

Figure 5.20: Start of emptying phase 1.5 hours before the first rain event. The flow rate to the plant is raised 120% during the 1.5 hours.

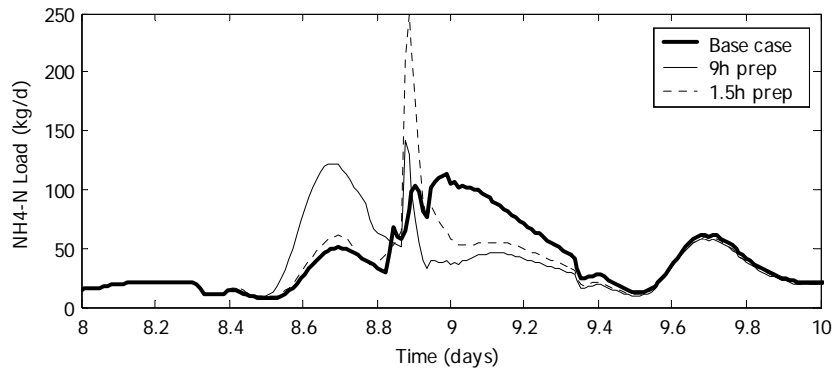

Figure 5.21: Effluent ammonium load during R1 with Strategy 3.

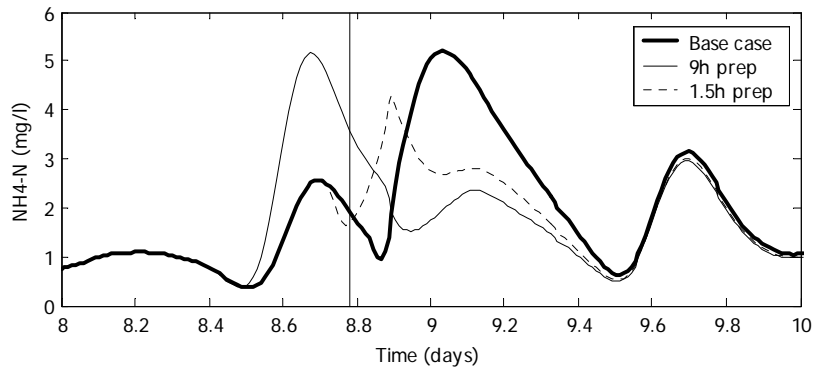

Figure 5.22: Effluent ammonium concentrations during R1 with Strategy 3.

	9 h	1.5 h	%	%
NH ₄ -load R1	77.2	76.5	-5	-6
TSS-load R1	58.9	60.1	-3	-1

Table 5.11: Pre-emptying strategies with large settler. Comparison is made to the base case

Simulation with additional rains

With multiple occurrences of the same rain a better estimation of an average, quantitative effect of the strategy is achieved. A qualitative analysis of the strategy is also made easier as the rains now produce a spectrum of total flow rates and arrive at times where the degree of filling in the basin using the base case scenario is different. In this section the rains will be referred to as R1 up to R8 but should not be confused with the otherwise used R1 (the shorter rain) and R2 (the longer rain). The influent flow rates due to the rains are shown in Figure 4.4 together with the wastewater volume in the basin during dry weather flow and base case control. In Table 5.14 the relative effluent ammonium loads compared to the base case are presented. The rains do not affect the influent ammonium load since the rainwater contains no ammonium. In Figure 5.23, the ammonium concentration in the last aerobic reactor is shown for base case control.

With both preparation periods the effluent ammonium load is lower in two cases, higher in four cases and unchanged in two cases compared to base case control for each rain, as seen in Table 5.13. The average result for the eight rains with either preparation period is slightly worse for ammonium and slightly better for suspended solids when compared to the base case scenario with a constant set point of the pumped flow rate to the plant. Choosing the best preparation period for each rain, with respect to ammonium, gives that the longer phase should be used in two cases, the shorter in one case and that the basin should not be emptied in five cases. With this combination the reduction in effluent ammonium load is 3% for all rains, which is an indication of the long-term reduction for short rain events. For suspended solids the 9 h preparation period generally is the best choice, resulting in about 3% lower load than with base case control.

In order to explain the optimal choice a qualitative analysis of the following rains is performed: R3, R6, R7 and R8. In R3 the shorter preparation period performs better and the longer worse compared to the base case. In R6 both preparation periods performs significantly better than the base case. In R7 the longer preparation period gives the best results found for any rain while the shorter preparation period performs worse. In

R8 both periods lead to significantly worse results, especially the 1.5-hour period. The results for R8 are similar to those of R4 but more pronounced and both rains occur slightly after a peak in the dry weather flow. These rain events are discussed in more detail but a complete explanation to the relative results is not presented.

Sub-rain	Base case	Ammonium		Suspended solids		
		1.5 h	9 h	Base case	1.5 h	9 h
1	74.1	77.1	76.9	58.0	57.5	56.7
2	76.1	76.1	76.1	58.9	58.9	58.9
3	88.9	85.6	93.6	60.4	59.6	60.6
4	81.1	88.2	86.2	60.0	59.1	58.5
5	77.1	76.2	77.9	60.4	58.9	58.3
6	83.8	79.3	77.7	61.1	60.0	59.1
7	84.3	87.5	75.0	60.2	59.9	58.4
8	64.0	74.6	68.2	57.6	57.2	56.0
Sum	629	645	632	477	471	467
Best	610			466		

Table 5.13: Ammonium and TSS loads (kg) for the two preparation periods and the corresponding base cases.

Sub-rain	Ammonium		Suspended solids	
	1.5 hours	9 hours	1.5 hours	9 hours
1	4	4	-1	-2
2	0	0	0	0
3	-4	5	-1	0
4	9	6	-2	-3
5	-1	1	-2	-3
6	-5	-7	-2	-3
7	4	-11	0	-3
8	17	7	-1	-3

Table 5.14: Comparison of ammonium and TSS loads between the two preparation periods and the base case (in %).

	1.5 h	9 h
1	31 000	22 000
2	20 000	20 000
3	33 000	30 000
4	40 000	27 500
5	41 000	24 500
6	42 000	24 500
7	48 000	25 000
8	44 000	25 000

Table 5.15: Required controlled flow rates during preparation.

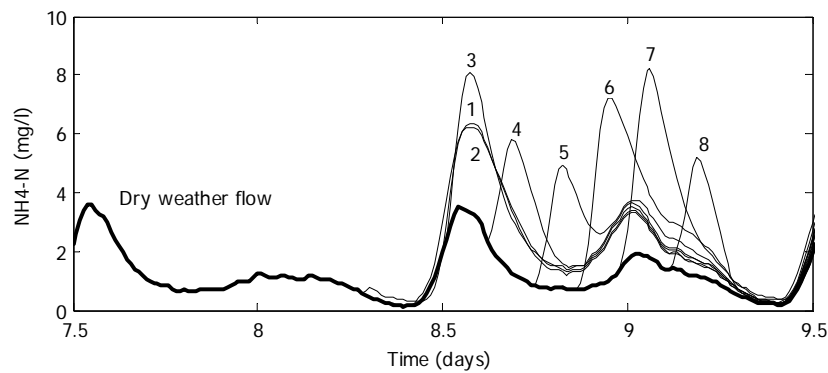

Figure 5.23: Ammonium concentration in last reactor for all rains with base case control.

Discussion on R3

In R3, the longer preparation period performs worse than the base case and the shorter one better than the base case. The reason that the shorter period behaves better than the longer one is due to the formulation of the strategy: increasing the flow a constant amount during the entire preparation period. In the base case scenario the basin will empty due to the low flow rate during night and just begin to fill up before the higher flow arrives, as seen in Figure 5.24. With the longer preparation period the pumped flow rate will increase before the “normal” emptying, then be equal to the influent flow rate to the basin when the basin is empty and then finally increase

again before the rain. The increase before the normal emptying is unnecessary as it results in higher effluent ammonium load without preparing the basin for the rain. Since the basin is almost empty as the elevated flow arrives it is sufficient with the shorter preparation period, which also performs better than the base case.

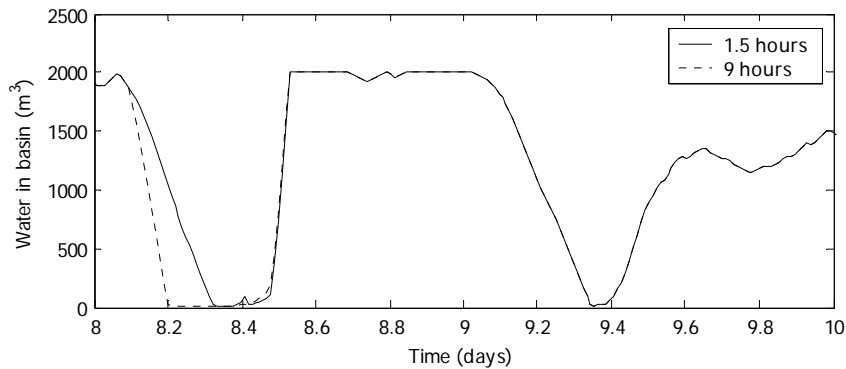

Figure 5.24: Basin volume for rain 3. The two preparation periods are represented.

Discussion on R6

Pre-emptying lowers the effluent ammonium load in both cases; relative loads are 0.95 and 0.93 compared to the base case. As seen in Figure 5.26 the maximum effluent ammonium concentration is also reduced, from 6 mg/l to about 5 mg/l in both cases.

In Figure 5.25 the concentration of autotrophic bacteria, which are responsible for oxidation of ammonium into nitrate, is shown. The concentration is reduced as the flow rate increases during the rain and the controlled emptying. In Figure 5.25 the 1.5-hour emptying takes place between the vertical lines. Both emptying periods end at the rightmost line, with an empty basin. After this time the concentration in the equalization basin is identical for the longer and shorter emptying phase. Still the concentration in the plant and in the effluent, differs between the emptying phases due to propagation of the concentration profile, as seen in Figure 5.25, which shows the conditions in the third reactor (the first aerobic). A

drastic reduction in the autotrophic concentration is seen when the basin is full and overflows, which occurs at time 8.87 days. For the base case this happens at time 8.92 days.

In Figure 5.27 a peak in effluent ammonium load is seen for the 1.5-hour emptying phase. The explanation is that the concentration peak due to the emptying arrives at the settler at the same time as the basin overflows. In the model the flow propagates instantly, whereas the concentration takes some time. The time lag for the concentration is illustrated in Figure 5.26, which shows the concentration of autotrophic bacteria in the last reactor. Comparison with Figure 5.25 gives a hydraulic time lag of slightly above 1 hour between the third and fifth reactor. It is also seen in Figure 5.27 that the peak in ammonium effluent occurs mainly before the rain for the 9-hour case. With both preparation phases the basin is empty as the rain flow arrives and as seen in Figure 5.28 about half of the rain can be stored. This makes it possible to avoid the low concentration of autotrophic bacteria with base case control, see Figure 5.25. A low concentration of bacteria not only lowers the immediate oxidation of ammonium, it also results in a lower growth rate.

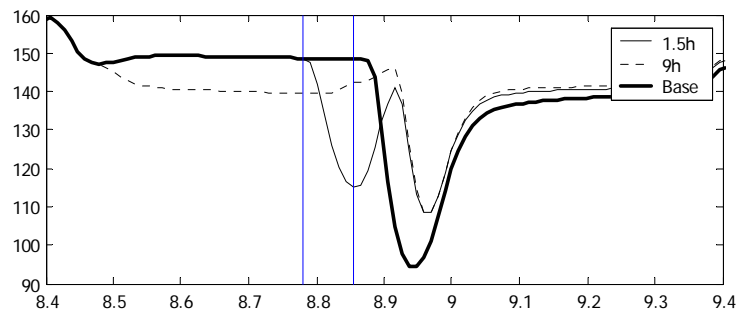

Figure 5.25: Nitrifying bacteria in first aerobic reactor. The vertical bars indicate the 1.5-hour preparation time.

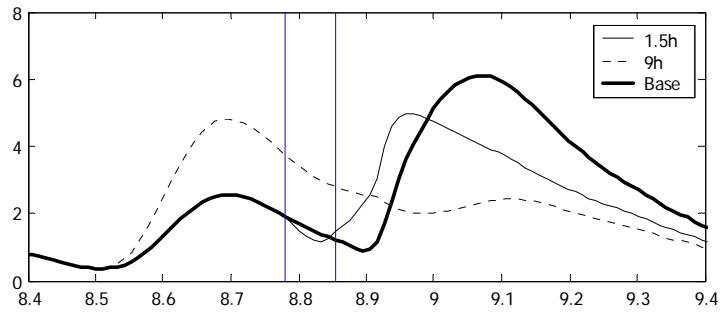

Figure 5.26: Ammonium concentration in settler effluent. The vertical bars indicate the 1.5-hour preparation time.

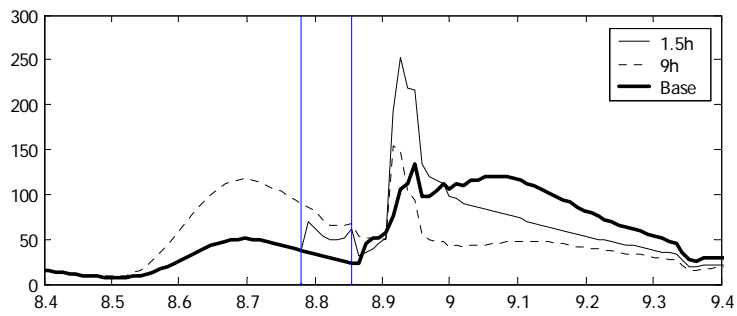

Figure 5.27: Effluent ammonium load from settler. The vertical bars indicate the 1.5-hour preparation time.

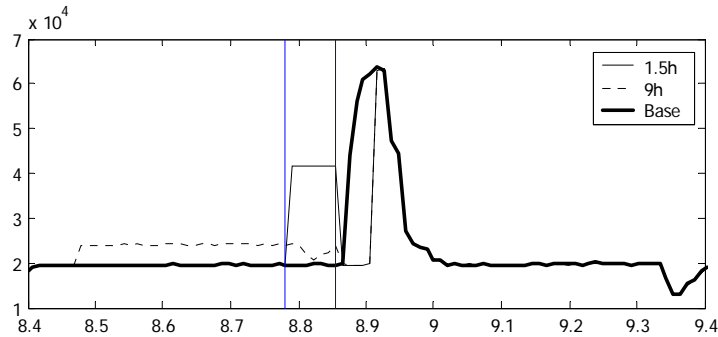

Figure 5.28: Influent flow rates to the plant. The vertical bars indicate the 1.5-hour preparation time.

Discussion on R7

With this rain the 9 hours preparation gives the best result compared to the base case: an 11% reduction but the 1.5-hours preparation results in a higher load, a 4% increase. An attempt to explain why the 9 hours preparation gives the best result for this rain begins by comparing R7 to R6. The base case strategy should also be compared, since it also gives different results for each rain. Between R6 and R7 the performance for the base case is almost identical; base case for R6 is less than 1% better than base case for R7. The different result for R6 and R7 with 1.5-hours preparation can be explained by the higher flow rate needed to empty the basin in R7. The rain now arrives just after the afternoon peak and not before as in R6. To empty the basin in R7 a flow rate of 48 000 m³/d is required compared to 42 000 m³/d for R6. For the 9-hour preparation the flow rates are almost the same, as see Table 5.15 (for R7 the flow rate is slightly higher).

Discussion on R8

For R8 no preparation period improves the base case result. R8 has the best result when the base cases are compared (about 20% lower than the

others, see Appendix), which could indicate that the potential for improvement is limited. The afternoon flow rate prior to the rain is high and the influent wastewater is rich in ammonium. In Figure 5.32 it is seen that although the 9-hour preparation keeps the autotrophic biomass fairly high and constant, the base case has lower effluent ammonium load. This indicates that allowing high flow rates and dilution of the biomass may be the optimal solution in some cases.

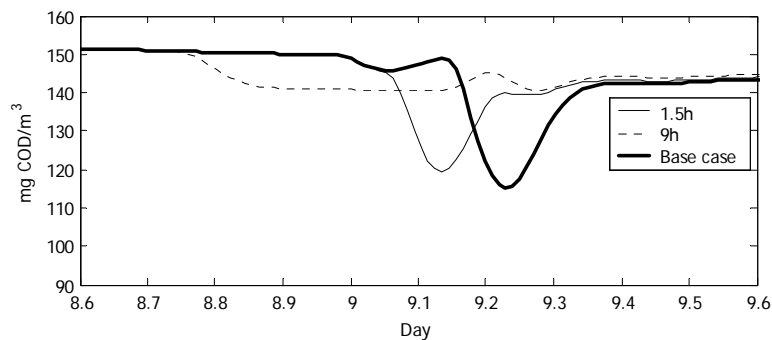

Figure 5.32: Autotrophic biomass in the last reactor.

Evaluation of effluent suspended solids

In order to discuss the control strategies with respect to particulate effluents, the modelled suspended solids concentration is chosen. In Figure 5.33 the base case control is compared to early emptying. The limited basin volume results in the same maximum flow rate, as well as the same maximum level of suspended solids, in the effluent. The peak value is not affected much but the duration of the highest concentrations is shorter with early emptying. In this case, with a small basin compared to the influent flow but with a relatively large settler it is possible to bring forward or postpone the peak of suspended solids in the effluent. The total load of suspended solids with 9 h and 1,5 h early emptying are 94% and 96% compared to the reference load for the period R1. It is expected that the total load remains the same for any longer period since no reactions occur in the modelled settler.

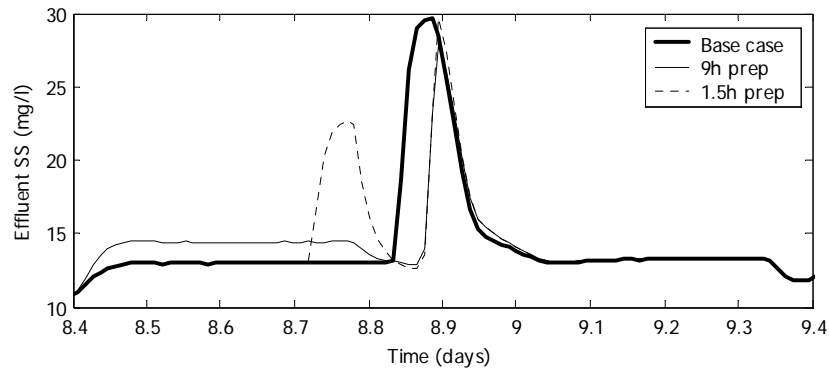

Figure 5.33: Effluent suspended solids with large settler during R1.

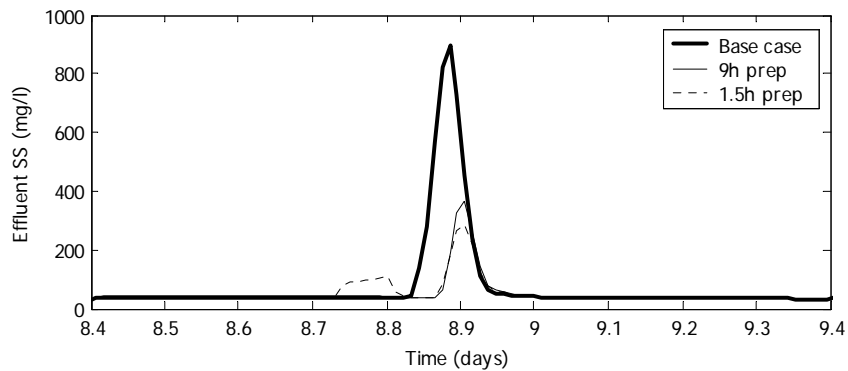

Figure 5.34: Effluent suspended solids with small settler during R1.

Simulation with small settler

The influence of the smaller settler on the plant performance is evaluated during both rain events. When the sludge loss is greater and the recovery phase longer the two rains in the influent weather file can no longer be regarded as separate events, thus for evaluation of the longer event the first rain has been erased from the weather file. The time for preparation is 1.5

hours. An increase in EQ as the basin empties is seen between day 10.8 and 11 in Figure 5.35. During the elevated flow rate due to the rain the settler overflows and the increase in EQ is a result of higher effluent concentrations of suspended solids. With the smaller settler there is a significant recovery period, about 6 days with respect to the suspended solids concentration in the plant. Early emptying makes it possible to keep more sludge in the biological reactors, although a decrease occurs during the emptying phase, as seen in Figure 5.36 and Figure 5.37. To not take pre-emptive action and empty the basin would give the same result as without a basin.

During the overflow of the settler the influent quality index is much lower than the effluent, as seen in Figure 5.35. This motivates a bypass of the plant or the final clarifier during this period, as it is the high flow rate through the plant that pushes the sludge out of the settler. Bypassing can be initiated at certain influent flow rates or use information from measurements of concentration levels in the influent, effluent or settler. The quality index used in this study is not suitable for control since it requires measurements or estimations of Kjeldahl nitrogen, nitrate, COD, BOD and suspended solids. Limiting measurements to the concentration of suspended solids or the sludge blanket level would still make it possible to determine when bypassing is necessary depending on the current situation and the remaining capacity of the plant and the settler.

	Base case	9 h	1.5 h	%	%
NH ₄ -load R1	234	179	180	-24	-23
NH ₄ -load R2	441	309	409	-30	-7
TSS-load R1	516	298	299	-42	-42
TSS-load R2	760	662	864	-13	14
EQ R1	15,1	11,2	11,1	-26	-26
EQ R2	21,4	22,6	18,2	6	-15

Table 5.16: Results for a small settler and early emptying. Comparison is made to the base case with basin.

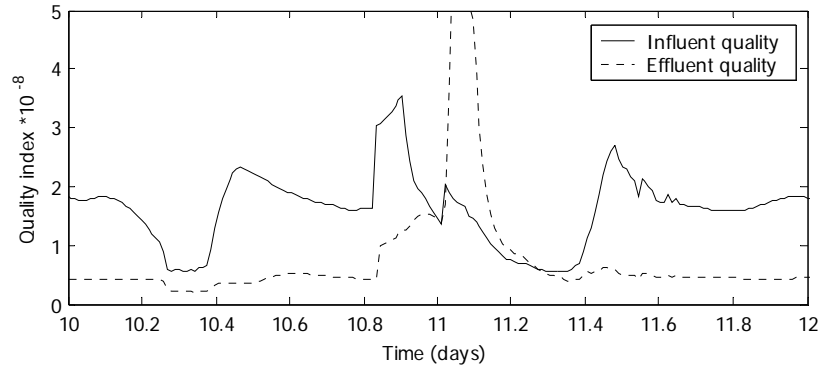

Figure 5.35: Quality indexes with small settler during large rain. The preparation period is 1.5 hours.

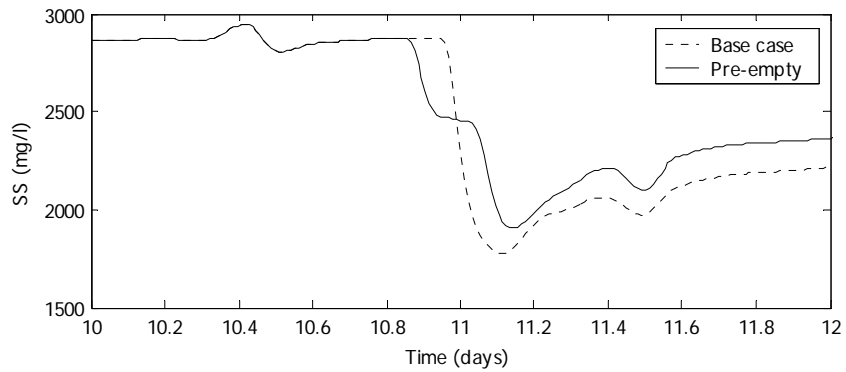

Figure 5.36: Suspended solids concentration in last reactor. Small settler during large rain and 1.5 hours preparation.

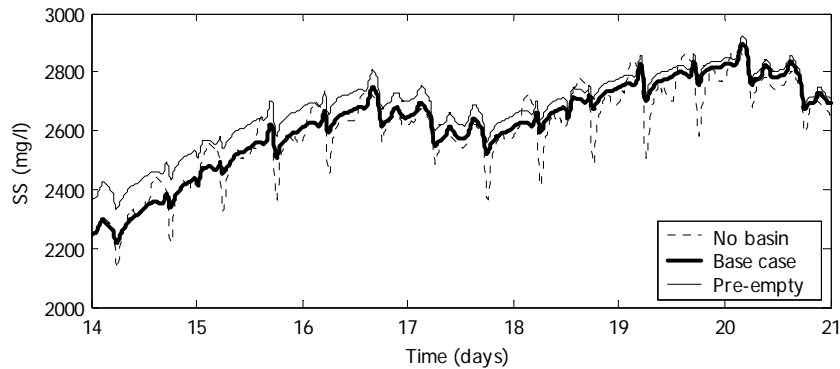

Figure 5.37: Suspended solids concentration in last reactor after the second rain with small settler. The preparation period is 1.5 hours.

5.4 Bypass to receiving waters

It is common practise to protect the biological reactors against wash-out and the settler from sludge loss by bypassing either unit during high influent flow rates. In the previous strategies all the influent wastewater has undergone both biological and physical treatment during the rain events. In this section some alternatives for bypassing have been evaluated for plants with or without equalization basins and with large or small settlers. The bypassed water undergoes no further treatment, such as precipitation, before it reaches the recipient. The effluent load from the system is calculated as the sum of the bypass load and the effluent load from the settler, as if they originated from the same point. Effluent concentrations are based on the combined flow from the bypass and the settler. The following cases have been evaluated:

- A. No basin. All flow over a certain limit is bypassed to the recipient (both the biology and the final clarifier is bypassed).
- B. 2000 m³ basin and constant set point of effluent flow rate. The basin overflows to the recipient when it is full.
- C. 3 h early emptying. The basin overflows to the recipient when it is full.
- D. 3 h early emptying in combination with bypassing.

Case A

Case A corresponds to a plant without a basin that applies a hard limit to the maximum allowable flow rate through the plant and bypasses the entire plant (with exception to pre-sedimentation) to keep the flow below this limit. This sort of bypass control gave always worse results when applied to the plant with the larger settler, so a modified strategy is presented and evaluated. It still involves hard limits and uses no information about the state of the plant or the conditions in the influent flow and aims to allow as much influent wastewater as possible before bypassing. In Figure 5.38 the controller is shown. When the flow rate is higher than the trigger flow rate the counter sub-system integrates the time and an “if-action” block selects between two maximum allowable influent flow rates. There are two bypass limits, one for normal operation that is high enough to ensure no bypass and one for storm operation. If the flow rate falls below the trigger limit the counter and the bypass limit are reset to normal. With a trigger time the risk of false alarms due to measurement errors is reduced. It is also possible to temporarily allow a higher flow rate (than the flow rate during bypass) before protecting the settler by bypassing.

Several combinations of trigger times and trigger flow rates are evaluated for the larger (A.1–A.4) and the smaller settler (As.1-As.3) and the results are presented in Table 5.18 and in Table 5.20. They use combinations of bypass and trigger limits of 40 000 and 30 000 m³/d and counters from 30 minutes up to 2 hours. It is the capacity of the settler that limits the maximum influent flow rate. However, the maximum limit can be exceeded for some time as the sludge blanket level rises. Although only two rain events are evaluated similar results are expected for rains at other times of the day when the influent concentrations are different, since the rains in both cases have a dominating effect on both the concentration and the flow rate of the influent. Also, no basin is used in Case A. For shorter rains with the larger settler the conditions in the settler at the time of bypassing may still be relevant, if this settler can handle the flow rate and the bypassing is the dominating source of pollutant load.

With the large settler the diluting effect from either rain is small enough not to cause any sludge loss from the settler. Any attempt to bypass will result in an equal amount of suspended solids load at best, as seen in Table

5.18. Specifications for trigger flow rates and times are given in Table 5.17. In Figure 5.39 it is shown that when the settler has enough capacity, bypassing will lead to higher effluent concentrations.

With a smaller settler that cannot handle high flow rates the effect of the strategy is different. In Table 5.20 the results are presented for the same control strategies but with a much smaller settler. The controller specifications are given in Table 5.19. It is now better to avoid an overflowing settler than to bypass it during both rain events, as seen in Figure 5.40. The bypass strategy is also favourable during the shorter rain event as it reduces the load of ammonium and suspended solids. The ammonium effluent load with bypass is lower due to the lower load after bypassing, as seen in Figure 5.41. During the first rain event the effluent load is higher during the bypass but the total ammonium load during the event (day 8 – 10) is lower.

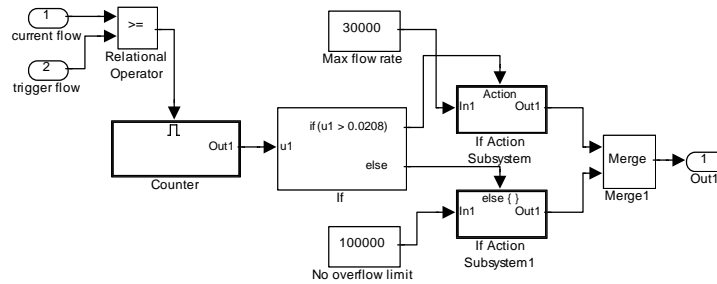

Figure 5.38: A Simulink implementation that measures the flow rate and time to trigger bypassing.

case	Trigger flow rate m ³ /d	Trigger time h	Bypass flow rate m ³ /d
A.1	40 000	2	30 000
A.2	40 000	1	30 000
A.3	30 000	1	30 000
A.4	30 000	0.5	30 000

Table 5.17: Control information for bypass strategies (large settler).

	No bypass	A.1	A.2	A.3	A.4
NH ₄ -load R1	152	152	148	148	146
NH ₄ -load R2	172	150	170	192	192
TSS-load R1	62.6	62.5	88.1	105	143
TSS-load R2	93.9	83.2	109	126	135

Table 5.18: Comparison of bypass strategies. (Case A, large settler, no basin).

case	Trigger flow rate m ³ /d	Trigger time h	Bypass flow rate m ³ /d
As.1	30 000	2	40 000
As.2	30 000	1	40 000
As.3	30 000	0.5	30 000

Table 5.19: Control information for bypass strategies (small settler).

	No bypass	As.1	As.2	As.3
NH ₄ -load R1	263	262	243	227
NH ₄ -load R2	345	327	280	264
TSS-load R1	382	377	260	255
TSS-load R2	600	443	372	280

Table 5.20: Comparison of bypass strategies. (Case A, small settler, no basin).

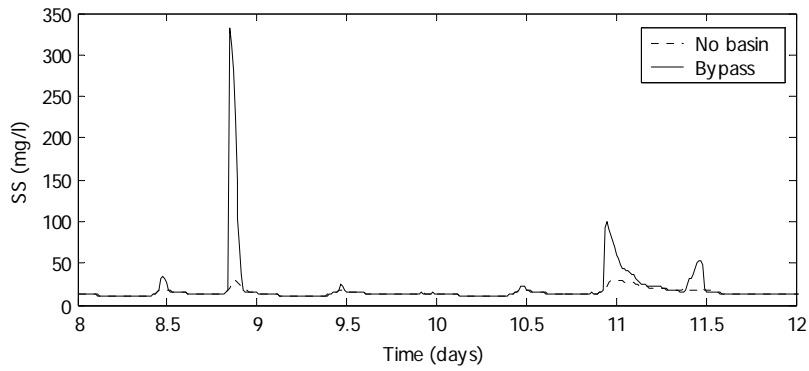

Figure 5.39: Effluent concentration of suspended solids. Large settler (no improvement). Bypass limit and trigger $30000 \text{ m}^3/\text{d}$, trigger time 30 min.

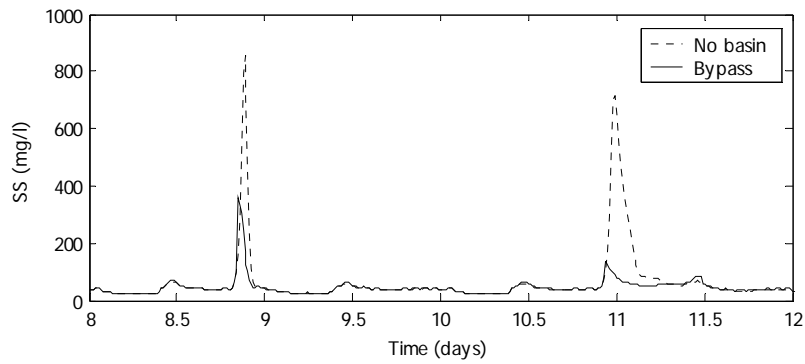

Figure 5.40: Effluent concentration of suspended solids. Small settler. Bypass limit and trigger $30000 \text{ m}^3/\text{d}$, trigger time 30 min.

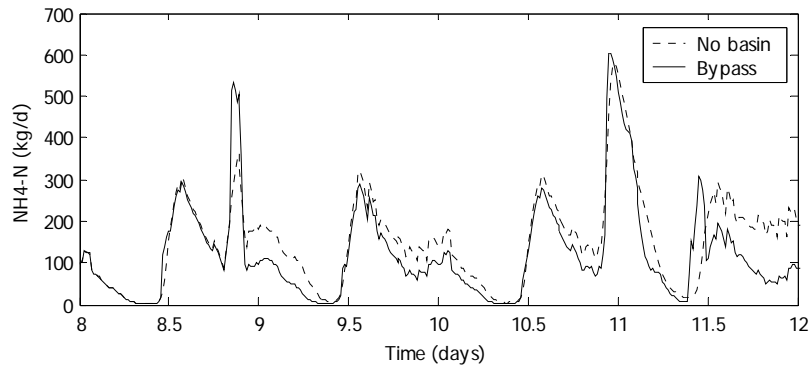

Figure 5.41: Effluent load of ammonium. Small settler. Bypass limit and trigger 30000 m³/d, trigger time 30 min.

Case B

In Case B, the performance depends on the basin volume and the time of arrival of the elevated flow rate when the ordinary influent weather files are used. The two rains arrive at a time when the basin is almost full, which makes the situation resemble Case A, since the stored amount is low.

Case C

In Case C the basin is controlled with Strategy 3 and emptied completely before the arrival of the rains. Unlike in Strategy 3, the overflow is now bypassed to the recipient. In Figure 5.20 it is seen that there is a substantial amount of bypassed wastewater (the differences from the case in Strategy 3 are 1.5 h early emptying and that the basin overflow is bypassed).

Case D

This case is evaluated for the longer rain event only and a new influent weather file is used where the shorter rain event is left out. The plant bypasses at high flow rates and the equalization basin is used for early emptying. The plant is simulated with the smaller settler, where the risk of

sludge loss is high. Pre-emptying occurs with $37\,000\text{ m}^3/\text{d}$, 3 h before the elevated flow rate and flows above $40\,000\text{ m}^3/\text{d}$ are bypassed. In Figure 5.42 the effluent concentration of suspended solids is shown for the two cases pre-emptying and pre-emptying in combination with bypassing. It is seen that there is considerable sludge loss without pre-emptying and that even a small equalization basin can make a difference. This is because settler overflow is a discrete event and that the sludge blanket is allowed to rise. The effluent concentration for the plant with bypass is calculated as the combined load from the settler effluent and the basin bypass flow.

The sludge loss results in elevated ammonium load and concentration for some days and the effect is seen in Figure 5.43 as higher effluent ammonium concentrations. The bypass flow is not treated in any way but bypass is still the best option with the smaller settler.

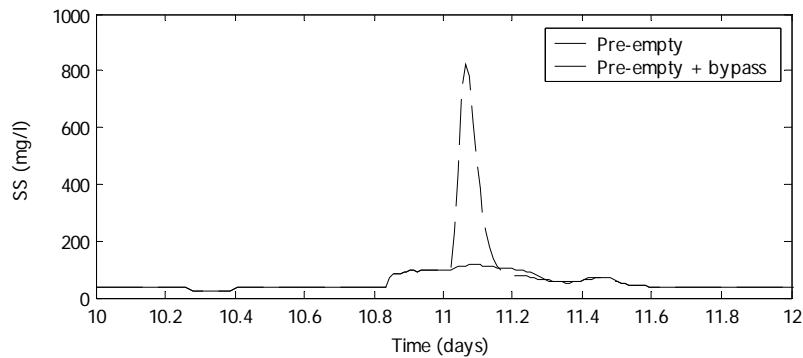

Figure 5.42: Settler overflow prevented with bypass set at $40\,000\text{ m}^3/\text{d}$.

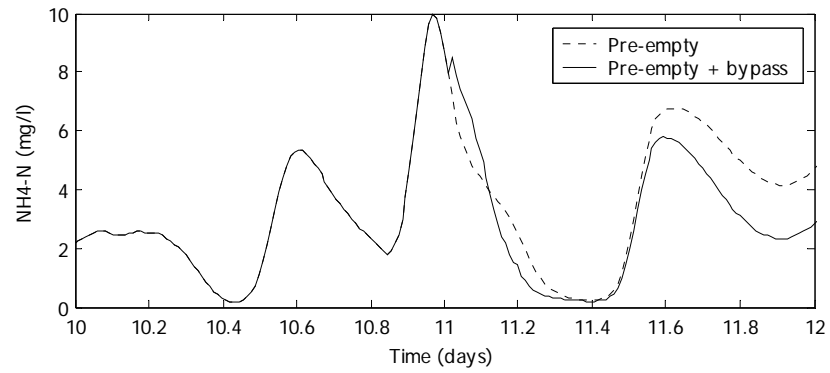

Figure 5.43: Effluent ammonium concentration during large rain event and small settler.

Chapter 6

Conclusions

The topic of this thesis is controlling the influent load to wastewater treatment plants. Benefits with plant located equalization basins are analyzed. In the first part of this chapter a summary of the results are given. Guidelines for future research are discussed in the second part of the chapter.

6.1 Summary of results

A plant with equalization basin, controlled by the presented strategies, is compared with the same plant with no basin. In this section the control strategies are presented and how various wastewater parameters are affected.

Optimal result, with respect to the effluent ammonium load, is achieved with feedback of the ammonium concentration in the last aerobic reactor. The desired effluent ammonium concentration should be dynamic, since a constant value is not optimal during both dry and wet weather. The evaluated cases are summarized in Table 6.1.

B	Base case, constant pumped flow rate based on weekly average
1b	Constant pumped flow rate based on daily average
2a	Basin volume control by feedback of basin volume
2b.b	Influent flow rate control (ammonium measurements after settler)
2b.a	Influent flow rate control (ammonium measurements before settler) (two sets of controller parameters presented)
3	Early emptying of basin before rain

Table 6.1: A summary of the evaluated strategies.

Base case control is a dry weather strategy with need for measurement of the current wastewater volume in the basin only. With base case control the pumped flow rate is constant and equal to the weekly average influent flow rate from the sewer net. Control strategies 1b, 2b and 3 require additional measurements not required for the base case scenario. Strategy 1b is a dry weather strategy that requires estimation of the influent flow rate profile for the following day. Strategy 2a is both a dry and a wet weather strategy with the volume sensor from base case control. Strategy 2a is also a dry and wet weather strategy that uses ammonium measurements in the effluent wastewater, a location where ammonium is already measured, albeit possibly unsatisfactory frequent. Strategy 2b is also a dry and wet weather strategy that requires ammonium measurements in the last aerobic reactor. For plants with ammonium sensors already used for control this is the most common location. The results from two set points are presented since one is better during the storm and the other one during dry weather. Strategy 3 is a wet weather strategy that requires estimations of the future flow rate profile, including the effect of rain and other disturbances. The result in Table 6.2 is found by selecting between 1.5 h, 9 h and no early emptying for each of the 8 additional rains. This strategy uses base case control during dry weather.

For each evaluated factor below, the result is compared to the base case, where there is a constant outtake of wastewater from the basin. A “-3” means that the result is 3% lower than the base case. Strategy 1b was designed for dry weather use and the results for the rains are not always evaluated. The dry weather condition is evaluated during one week with no rains. The comparison is calculated as $(\text{Base load} - \text{New load})/\text{Base load}$.

Ammonium

There is a considerable reduction in the ammonium load, about 50% compared to a case without basin, during dry weather with base case control. Using an ammonium sensor located in the last aerated basin for feedback control of the influent flow rate is the control strategy that gives the largest reduction in the effluent ammonium load, 64%. It is also the only strategy that gives a significant reduction during dry weather compared to base case control. A lower ammonium set point is better

during dry weather (2b.l.a) but since this results in more water being stored in the basin on an average, a higher set point is better when rain is expected (2b.h.a). If the next days average flow rate is known, as in Strategy 1b, the base case control strategy can be improved, since the pumped influent flow rate can be the lowest possible without risk of overflow. During dry weather this strategy reduces the effluent ammonium load almost as much as with feedback of the ammonium concentration. Using only the current volume of wastewater in the basin for control is not an improvement compared to base case control.

Without basin the effluent ammonium load is about 40 kg/day with an average concentration of 2.3 mg/l and with daily peaks of 7 and 3 mg/l respectively. The reduction of influent ammonium is 93%. With Strategy 2b.h.a, the 59% reduction in effluent ammonium load compared to the no basin case corresponds to a 97% reduction of the influent ammonium load.

Ammonium load	B	1b	2a	2b.h.b	2b.h.a	2b.l.a	3*
Dry weather	-54	-61	-55	-49	-59	-64	-
R1	-46	-	-40	-35	-53	-47	-48
R2	-32	-	-26	-19	-34	-26	-

Table 6.2: Effluent ammonium load with basin and large settler (% change compared to no basin case).

* Estimation based on 3% improvement compared to the base case.

Suspended solids

The load of suspended solids is slightly reduced with the base case scenario and not particularly affected by the presented control strategies. However, the uncertainty is probably in the same range as the reported reduction as a result of the inherent integrative properties of this parameter. The insignificant improvement is most likely due to the efficient settler at the plant. Inaccurate modeling of the distribution of the suspended solids in the settler during varying flow conditions is also a source of uncertainty.

Suspended solids load	B	1b	2a	2b.h.b	2b.h.a	2b.l.a	3*
Dry weather	-3	-3	-4	-4	-2	-2	0
R1	-3	-	-2	-2	-3	-3	-2
R2	-3	-	-1	-1	-2	-1	0

Table 6.3: Effluent suspended solids load with basin and large settler (% change compared to case with no basin).

Total nitrogen

This parameter is not important to minimize in a short time-scale and is thus only evaluated for control strategies that affect the operation during the dry weather period. The nitrate contribution to the effluent nitrogen load is 85% for the plant with no basin during dry weather. Although the conversion of ammonium into nitrate is increased with base case control, the reduction of nitrate into nitrogen gas is about the same; an indication that the denitrification capacity is reached. The relative increase in effluent nitrogen is small, in spite of a large relative increase in nitrification, since the absolute increase is small.

Total nitrogen load	B	1	2	3	4a	4b	5
Dry weather	0	2	-	0	-	2	-

Table 6.4: Effluent total nitrogen load with basin and control strategies (% change compared to case with no basin).

Aeration

The energy required for aeration in order to meet the pre-defined plant operating rules is slightly reduced for all control strategies. The reduction is within the region of uncertainty but shows that the improved ammonium reduction does not come to the price of a significantly increased aeration cost.

Aeration energy	B	1	2	3	4a	4b	5
Dry weather	-1	-2	-2	-2	-3	-1	-1
R1	-1	-1	-1	-1	-2	-1	-1
R2	-1	-2	-1	-2	-2	-1	-1

Table 6.5: Aeration energy with basin and control strategies (% change compared to case with no basin).

Effluent Quality index

This is evaluated for the dry weather conditions only, since this parameter is weighted for optimization during longer time periods. Strategy 5 uses base case control during dry weather but since the early emptying starts during this period, the relative improvement is lower.

EQ	B	1	2	3	4a	4b	5
Dry weather	-6	-6	-6	-6	-7	-6	-1

Table 6.6: Effluent quality index with basin and control strategies (% change compared to case with no basin).

6.2 Future work

A number of topics are possible subjects for future work. In this section the main directions for continuation of the work in this thesis are suggested.

Increasing the complexity

The presented control strategies use mainly ideal conditions, given the circumstances, for controllers, actuators and plant operation. It is possible to extend the theoretical study to evaluate the strategies for longer time periods, other extreme events such as toxic spills and malfunctions of sensors and actuators.

Expanding the system boundary

Models and software for sewer net simulation with the possibility for control strategy evaluation exist but many are specific to certain applications or geographical locations. Using existing software the system boundary could be extended, or the necessary models could be developed locally.

Experimental verification

So far this study has been purely theoretical. A true validation of these results, or an experimental validation of simulations of the entire collection system is probably not realistic. To do this one would ideally need an existing infrastructure with means to reduce the environmental impacts of poor strategies, such as duplicate or redundant systems. However, a calibrated model of an existing WWTP and/or sewer system would serve as a starting point for future evaluation. Ideally, the entire system may not need to exist in reality if experimentally verified sub-models exist.

Chapter 7

Bibliography

- Ander, E. (2003). Karlstad körde huvudet i väggen. Vatten (3).
- Andersen, N.K., Harremoës, P., Sørensen, S. andersen, H.S. (1997). Monitoring and real time control in a trunk sewer, *Wat. Sci. Tech.*, **36**(8-9): 337-342.
- Ashley, R.M., Dudley, J., Vollertsen, J., Saul, A., Jack, A., Blanksby, J.R. (2002). The effect of extended in-sewer storage on wastewater treatment plant performance, *Wat. Sci. Tech.*, **45**(3): 239–246.
- Aspegren, H., Bailly, C., Mpé, A., Bazzurro, N., Morgavi, A., Prem, E., Jensen, N. E. (2001). Radar based rainfall forecast for sewage systems control, *Wat. Sci. Tech.*, **43**(5): 79–86.
- Bernoulli, D. *Hydrodynamica*. 1783.
- Bauwens, W., Vanrolleghem, P., Smeets, M. (1996). An evaluation of the efficiency of the combined sewer – wastewater treatment system under transient conditions. *Wat. Sci. Tech.*, **33**(2): 199-208.
- Bixio, D., Carrette, R., Thoeye, C. (2002). Two years of full-scale storm operation experience, *Wat. Sci. Tech.*, **46**(6-7): 167–172.
- Bode, H., Weyand, M. (2002). The influence of stormwater treatment on the hydraulic and pollution load - balance for an entire river basin, *Wat. Sci. Tech.*, **45**(3): 167–174.
- Bäckström, M., Malmqvist, P-A., Viklander, M. (2002). Stormwater management in a catchbasin perspective – best practices or sustainable practices, *Wat. Sci. Tech.*, **46**(6-7): 159–166.
- Canziani, R., Pollice, A., Ragazzi, M. (1995). Feasibility of using primary-sludge mesophilic hydrolysis for biological removal of nitrogen and phosphorous from wastewater. *Bioresource Technology*. **54**: 255-260.

- Carstensen, J., Nielsen, M. K., Strandbäck, H. (1998). Prediction of hydraulic load for urban storm control of a municipal WWT plant, *Wat. Sci. Tech.*, **37**(12): 363–370.
- Cembrano, G., Quevedo, J., Salamero, M., Puig, V., Figueras, J., Marti, J. Optimal control of urban drainage systems. A case study. (2004). *Control engineering practice* **12**(1): 1-9.
- Copp, J. (ed). (2002). *The COST simulation benchmark. Description and user manual*. ISBN 92-894-1658-0.
- Deletic, A. (1998). The first flush load of urban surface runoff. *Water Research* **32**(8): 2462-2470.
- Dold, P. L., Buhr, H. O., Marais, G. v. R. (1981). Computer-based strategy for the control of equalization, *Wat. Sci. Tech.*, **13**: 349-354.
- Einfalt, T., Arnbjerg-Nielsen, K., Spies, S. (2002). An enquiry into rainfall data measurement and processing for model use in urban hydrology, *Wat. Sci. Tech.*, **45**(2): 147–152.
- Erbe, V., Frehmann, T., Geiger, W.F., Krebs, P., Londong, J., Rosenwinkel, K.-H., Seggelke, K. (2002). Integrated modelling as an analytical and optimisation tool for urban watershed management. *Wat. Sci. Tech.*, **46**(6-7): 141-150.
- Faure, D., Auchet, P., Payraastre, O. (2002). Management of a detention-settling basin using radar data and risk notion, *Wat. Sci. Tech.*, **45**(2): 19-26.
- Fraser, A. G., Sakrabani, R., Ashley, R. M., Johnstone, F. M. (2002). Managing sewer solids for the reduction of foul flush effects - Forfar WTP, *Wat. Sci. Tech.*, **45**(3): 265–272.
- Frehmann, T., Nafu, I., Niemann, A., Geiger, W.F. (2002). Storm water management in an urban catchment: effects of source control and real-time management of sewer systems on receiving water quality, *Wat. Sci. Tech.*, **46**(6-7): 19–26.
- Geiger, W.F., (1998). Combined sewer overflow treatment – knowledge or speculation, *Wat. Sci. Tech.*, **38**(10): 1-8.
- Gent, R., Crabtree, B., Ashley, R. A review of model development based on sewer sediments research in the UK. *Wat. Sci. Tech.*, **33**(9) 1996: 1-7.
- Getha, K. (1998). Isolation and growth of the phototrophic bacterium *Rhodospseudomonas palustris* strain B1 in sago-starch-processing

- wastewater. *World Journal of Microbiology and Biotechnology*. **14**(4): 505-511.
- Gulmez, B., Ozturk, I., Alp, K., Arıkan, O. A. (1998). Common anaerobic treatability of pharmaceutical and yeast industry wastewater, *Wat. Sci. Tech.*, **38**(4-5): 37-44.
- Guptka, K., Saul, A. J. (1996). Specific relationships for the first flush load in combined sewer flows. *Water Research*, **30**(5): 1244-1252.
- Gustafsson, L-G., Lumley, D., Lindeborg, C., Haraldsson, J. (1993). Integrating a catchment simulator into WWTP operation, *Wat. Sci. Tech.*, **28**(11-12): 45-54.
- Henze, M., Grady Jr, C. P. L., Gujer, W., Marais, G. v. R., Matsuo, T. (1986). *Activated sludge model no 1. International Association on Water Pollution Research and Control. Scientific and Technical Reports No 1*, ISSN: 1010-707X.
- Hernebring, C., Ohlsson, L. andreasson, M., Gustafsson, L.-G. (1998). Interaction between the treatment plant and the sewer system in Halmstad: integrated upgrading based on real time control, *Wat. Sci. Tech.*, **37**(9): 127-134.
- Hernebring, C. andréasson, M., Forsberg, B. (2000). *Rapportering av årlig bräddning 1994-98. Erfarenheter från kommuner inom utvalda län, VA-Forsk rapport 2000-14*.
- Hernebring, C., Jönsson, L.-E., Thorén, U.-B., Möller, A. (2002). Dynamic online sewer modelling in Helsingborg, *Wat. Sci. Tech.*, **45**(4-5): 429-436.
- Herrmann, T., Schmida, U. (2002). Rainwater utilization in Germany: efficiency, dimensioning, hydraulic and environmental impacts. *Urban Water* **1**(4): 307-316.
- Houbron, E., Torrijos, M., Capdeville, B. (1999). An alternative use of biogas applied at the water denitrification, *Wat. Sci. Tech.*, **40**(8): 115-122.
- Huebner, M., Geiger, F. (1996). Characterisation of the performance of an off-line storage tank, *Wat. Sci. Tech.*, **34**(3-4): 25-32.
- Ingildsen, P. (2002). *Realizing full-scale control in wastewater treatment systems using in-situ nutrient sensors*. ISBN: 91-88934-22-5.
- Jeppsson, U., Alex, J., Pons, M.N., Spanjers, H., Vanrolleghem, P.A. (2002). Status and future trends of ICA in wastewater treatment - a European perspective, *Wat. Sci. Tech.*, **45**(4-5): 485-494.

- Jönsson, K., Dahlgren Laursen, K., la Cour Jansen, J. (2001). Inhibition of nitrification in municipal wastewater – differences and similarities between Denmark and Sweden. *Vatten* **57**(4).
- Jørgensen, M., Schilling, W., Harremoes, P. (1995). General assessment of potential CSO reduction by means of real time control, *Wat. Sci. Tech.*, **32**(1): 249–257.
- Kemira Kemi AB, division vattenvård. (1989). *Handbok i vattenvård*.
- Klepiszewski, K., Schmitt, T.G. (2002). Comparison of conventional rule based flow control with control processes based on fuzzy logic in an combined sewer system, *Wat. Sci. Tech.*, **46**(6-7): 77–84.
- Landphair, H. C., McFalls, J. A., Thompson, D. (2000). *Design methods, selection and cost-effectiveness of stormwater quality structures*. Report 1837-1. Texas Transportation Institute, The Texas A&M University System College Station, Texas, 77843-3135.
- Larrea, L., Larrea, A., Ayesa, E., Rodrigo, JC, Lopez-Carrasco, MD, Cortacans, JA. (2001). Development and verification of design and operation criteria for the step feed process with nitrogen removal. *Wat. Sci. Tech.*, **43**(1): 261–268.
- Lee, P. L., Newell, R. B., Cameron, I.T. 1998. Process control and management. London. Chapman and Hall.
- Levlin, E., Löwén, M., Stark, K., Hultman, B. (2002). Effects of phosphorus recovery requirements on Swedish sludge management, *Wat. Sci. Tech.*, **46**(4-5): 435–440.
- Mark, O., Hernebring, C., Magnusson, P. (1998). Optimisation and control of the inflow to a wastewater treatment plant using integrated modelling tools, *Wat. Sci. Tech.*, **37**(1): 347–354.
- Mathworks. (1999). *Matlab user's guide*. The Mathworks Inc.
- Mathworks. (1999). *Simulink - dynamic system simulation software, User's guide*. The Mathworks Inc.
- Mealey, M. (1999). The CSO controversy. *Civil Engineering*, sep: 38-41.
- Meirlaen, J., Van Assel, J., Vanrolleghem, P. A. (2002). Real time control of the integrated urban wastewater system using simultaneously simulating surrogate models, *Wat. Sci. Tech.*, **45**(3): 109–116.
- Nascimento, N.O., Ellis, J.B., Baptista, M.B., Deutsch, J.-C. (2000). Using detention basins: operational experience and lessons. *Urban Water* **1**(2): 113-124.

- Naturvårdsverket. (1994). Naturvårdsverkets författningssamling: kungörelse med föreskrifter om rening av avloppsvatten från tätbebyggelse. SNFS (1994:7).
- Nielsen, M., Carstensen, J., Harremoes, P. (1996). Combined control of sewer and treatment plant during rainstorm, *Wat. Sci. Tech.*, **34**(3-4): 181–187.
- Nielsen, M.K., Bechmann, H., Henze, M. (2000). Modelling and test of aeration tank settling (ATS), *Wat. Sci. Tech.*, **41**(9): 179–184.
- Niemann, K., Orth, H. (2001). Control measures for wastewater treatment plants during storm flow, *Wat. Sci. Tech.*, **43**(11): 309–314.
- Nyberg, U., andersson, B., Aspegren, H. (1996). Real time control for minimizing effluent concentrations during storm water events, *Wat. Sci. Tech.*, **34**(3-4): 127–134.
- Olsson, G., Newell, B. (1999). Wastewater treatment systems – Modelling, diagnostics and control. IWA Publishing. ISBN: 1 900222 15 9.
- Rauch, W., Harremoes, P. (1997). Acute pollution of recipients in urban areas, *Wat. Sci. Tech.*, **36**(8-9): 179–184.
- Saget, A., Chebbo, G., Desbordes, M. (1995). Urban discharges during wet weather: what volumes have to be treated? *Wat. Sci. Tech.*, **32**(1): 225–232.
- Samuelsson, P., Carlsson, B. (2001). Feedforward control of the external carbon flow rate in an activated sludge process, *Wat. Sci. Tech.*, **43**(1): 115–122.
- Schilling, W. (ed). 1989. Real-time control of urban drainage systems. *International Association on Water Pollution Research and Control. Scientific and Technical Reports No. 2*, ISBN: 0080401457.
- Schütze, M., butler, D., Beck, M.B. (1999). Optimisation of control strategies for the urban wastewater system – an integrated approach. *Wat. Sci. Tech.*, **39**(9): 209:216.
- Schütze, M., butler, D., Beck, M.B., Verworn, H.-R. (2002). Criteria for assessment of the operational potential of the urban wastewater system, *Wat. Sci. Tech.*, **45**(3): 141–148.
- Shanahan, P., Borchardt, D., Henze, M., Rauch, W., Reichert, P., Somlyódy, L. and Vanrolleghem, P. (2001). River Water Quality Model No. 1 (RWQM1): I. Modelling approach, *Wat. Sci. Tech.*, **43**(5): 1-9.

- Takács, I., Patry, G.G., Nolasco, D. (1991). A dynamic model of the clarification thickening process. *Wat. Res.*, **25**(10): 1263:1271.
- Vitasovic, Z.Z. (1989). Continuous settler operation: a dynamic model. *Dynamic modeling and expert systems in wastewater engineering*, (G.G. Patry, D. Chapman eds.) Lewis Publishers Inc, Chelsea, Michigan, USA: 59-81.
- Weinreich, G., Schilling, W., Birkley, A., Moland, T. (1997). Pollution based real time control strategies for combined sewer systems. *Wat. Sci. Tech.*, **36**(8-9): 331:336.
- Yuan, Z., Bogaert, H., Vansteenkiste, G., Verstraete, W. (1998). Sludge storage for countering nitrogen shock loads and toxicity incidents. *Wat. Sci. Tech.*, **37**(12): 173-180.
- Äsöy, A., Ødegaard, H., Hägh, M., Rislå, F., Bentzen, G. (1998). Upgrading wastewater treatment plants by the use of biofilm carriers, oxygen addition and pre-treatment in the sewer network, *Wat. Sci. Tech.*, **37**(9): 159-166.

Appendix A

Driving forces

In this chapter, the underlying environmental and political reasons that motivate the research of this thesis are presented.

A.1 National considerations

In Sweden the national, regional and local environmental work is governed by 15 environmental objectives, presented in Table A.1, which were approved by Parliament in 1999 (Government Bill 1997/98:145). The Government Bill 2000/01:130, *The Swedish environmental objectives - interim targets and action strategies*, refines the framework of the previous Bill and presents proposals that strengthen the implementation of environmental measures. The environmental objectives are used to coordinate the environmental work and one authority is linked to each objective. County administrations will have the overall responsibility of the regional environmental work, with respect to targets, measures and follow-up. The yearly additional costs, as a consequence of EU directives, for the municipalities for waste treatment (solid and liquid) has been estimated to 500 MSEK.

1	Reduced climate impact
2	Clean air
3	Natural acidification only
4	A non-toxic environment
5	A protective ozone layer
6	A safe radiation environment
7	No eutrophication
8	Flourishing lakes and streams
9	Good-quality groundwater
10	A balanced marine environment, flourishing coastal areas and archipelagos
11	Thriving wetlands
12	Healthy forests
13	A varied agricultural landscape
14	A magnificent mountain landscape
15	A good built environment

Table A.1: The 15 Swedish environmental objectives

Especially relevant for the water and wastewater sector is the 4th and 7th objective. In a *non-toxic environment* there exist only natural substances, in concentration levels close to the background levels. This could effect legislation regarding wastewater treatment plants and sewer nets since they collect and discharge possible unnatural substances. Objective 7, *no eutrophication*, states that the environment should promote the natural variation of species. It has been decided that the marine nutrient levels that meet this requirement are those of 1940. The target is that lakes, streams and coastal waters will have good ecological status no later than 2015, as defined by the EU water framework directive. It is the consensus of the European environmental movements that the agricultural framework in the EU is responsible for a disproportionate part of nitrogen deposition. Agricultural nitrogen deposition is the major source of anthropogenic nitrogen in Swedish waters, as seen in Table A.2. Phosphorous deposition originates mainly from individual households but although most single households have adequate treatment, it is hard to predict future levels because of the mechanisms behind sediment resuspension in rivers and lakes. The largest part of the airborne deposition is foreign and thus the relative contribution is higher in southern Sweden.

	Nitrogen	Phosphorous
Agriculture	45	25
Wastewater	33	50
Airborne deposition	14*	-

Table A.2: Sources of nutrient deposition to Swedish lakes and seas (in % of total).

All five interim targets are relevant for the wastewater industry:

1. By 2009 an action programme in accordance with the Water Framework Directive will be in place, specifying how to achieve a good ecological status in lakes and streams, as well as coastal waters.
2. By 2010 waterborne anthropogenic emissions in Sweden of phosphorus compounds into lakes, streams and coastal waters will have diminished continuously from 1995 levels.
3. By 2010 waterborne anthropogenic nitrogen emissions in Sweden into the sea south of the Åland Sea will have been reduced by 30% compared with 1995 levels, i.e. to 38,500 tonnes.
4. By 2010 ammonium emissions in Sweden will have been reduced by at least 15% compared with 1995 levels to 51,700 tonnes.
5. By 2010 emissions in Sweden of nitrogen oxides into the atmosphere will have been reduced to 148,000 tonnes.

Interim target 1 corresponds to the EU Water Framework Directive, which stipulates that the member states present concrete action programmes that include the necessary changes in national law. The phosphorous issue in target 2 is still under investigation and concrete measures are limited to information to households. In the future phosphorous recycling from wastewater sludge may be economically feasible (Levlin *et al.*, 2002). Interim target 3 will be reached by continued extension of coastal treatment plants and sewer nets in southern Sweden (Figure A.1), where nitrogen is the limiting nutrient. Renovation (sealing against groundwater) of sewer nets will reduce combined sewer overflows as well as the flow to the treatment plant. The Swedish environmental protection agency will also investigate the economic support to artificial wetlands in order to optimise their locations with regard to the actual need for nitrogen reduction in the drainage basin. Interim targets 4 and 5 concerns the agriculture and transportation.

The environmental objectives 8 - 11 all depends on the objectives *a non-toxic environment* and *zero eutrophication* for their fulfilment. Several bodies to which the proposed measures are submitted for consideration, among them the Swedish EPA, propose higher demands for nitrogen reduction for Sweden to fulfil its international undertaking.

Treatment of wastewater from urban areas

Treatment plants must be designed for the local conditions, including seasonal variations. They do not have to be designed for "special events" such as heavy rains during which effluent concentrations not will be taken into consideration (SNFS, 1994). Municipal WWTPs are not obligated to treat industrial wastewater that may have an adverse effect on the operation. Overflows in the treatment plant may still be included in the plant effluent whereas overflows in the net may not. The directions discussed here apply to urban areas with more than 2001 PE connected to the collection system. There are other directions for smaller areas; all wastewater is treated in some way although higher effluent concentrations apply to areas with extremely cold climate. The directions are described in SNFS (1994). The directions are different for the southern treatment plants with more than 10000 PE that lie below the line in Figure A.1, where additional nitrogen removal is required. The directions cover the removal of oxygen consuming compounds and nitrogen. In Table A.3 the guideline and limit values for BOD and total nitrogen in effluents from Swedish wastewater treatment plants are presented. Stormwater is included in the term wastewater. The directions are the minimum requirements and the exact requirements for each plant is determined by the County Administration, who decide on additional weekly, monthly, quarterly and yearly averages. The phosphorous limit is usually 0.3 mg/l in southern Sweden for larger plants and typical recipients. The nitrogen is always measured as a yearly average and usually with the limits in the national directions. Every community may impose stricter rules with lower effluent limits.

The stricter nitrogen regulations have caused some discussion about the interpretation of the directions. Although the directions only apply to coastal areas (5§) they also apply to drainage basins to these areas (7§), which basically means all southern treatment plants. The discussion is

whether the guideline values should be measured in the treatment plant effluent, or if and how, they should take into account the natural denitrification that occurs in rivers and lakes on the way to the coast. A recent case is Karlstad, having Sweden's largest lake Vänern and about 100 km river between the treatment plant and the coast. In this case the courts interpretation of the directions were that Karlstad, with 97000 PE and a natural nitrogen detention of 50% should obey the regulations for 48500 PE plants, which limits their effluent nitrogen to 15 mg/l. Karlstads interpretation was that a 50% detention would allow 30 mg/l nitrogen in the effluent (Ander, 2003). The courts interpretation in this case will clearly allow more nutrients from coastal than from inland plants to reach the sea, for which the directions were designed. A positive side effect of the courts interpretation is the greater protection against eutrophication in rivers and lakes.

Monitoring wastewater from urban areas

All treatment plants larger than 200 PE must monitor and report the yearly effluent of COD, BOD₇, P-tot and N-tot. For plants larger than 10000 PE also NH₄-N and for plants larger than 20000 PE also Hg, Cd, Pb, Cu, Zn, Cr and Ni must be monitored. Overflows are also considered to be effluents and must be monitored. The larger the plant the higher is the demand for sampling frequency in plant effluent and overflows. Since 1991 also the number, location and volume of overflows in the sewer net must be reported for sewer nets larger than 500 PE. Analysing methods are found in SNFS (1990). Guideline values are gradually becoming limit values to reflect the current best management practise.

	Highest concentration (yearly average)	Minimal reduction	
BOD ₇	15 mg O ₂ /l	-	Limit
COD _{Cr}	70 mg O ₂ /l	-	Guideline
P-tot**	0.3 mg P/l	-	Guideline
N-tot < 100 000 PE*	15 mg N/l	70%	Guideline
N-tot > 100 000 PE*	10 mg N/l	70%	Guideline

Table A.3: Guideline and limit values for Swedish wastewater treatment plants

- * Applies to southern treatment plants. N/A for < 10 000 PE.
- ** Current practice by County Administrations. Monthly average.

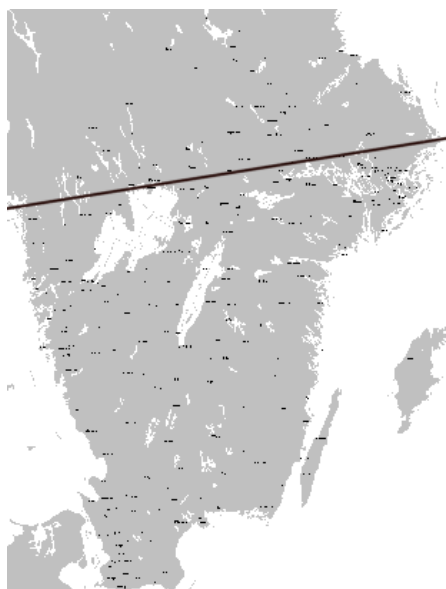

Figure A.1: In southern Sweden additional nitrogen removal is necessary.