



# LUND UNIVERSITY

## Lifetime measurements for excited states of rare-earth atoms using pulse modulation of a cw dye-laser beam

Gustavsson, M; Lundberg, Hans; Nilsson, L; Svanberg, Sune

*Published in:*  
Journal of the Optical Society of America

*DOI:*  
[10.1364/JOSA.69.000984](https://doi.org/10.1364/JOSA.69.000984)

1979

[Link to publication](#)

*Citation for published version (APA):*  
Gustavsson, M., Lundberg, H., Nilsson, L., & Svanberg, S. (1979). Lifetime measurements for excited states of rare-earth atoms using pulse modulation of a cw dye-laser beam. *Journal of the Optical Society of America*, 69(7), 984-992. <https://doi.org/10.1364/JOSA.69.000984>

*Total number of authors:*  
4

### General rights

Unless other specific re-use rights are stated the following general rights apply:  
Copyright and moral rights for the publications made accessible in the public portal are retained by the authors and/or other copyright owners and it is a condition of accessing publications that users recognise and abide by the legal requirements associated with these rights.

- Users may download and print one copy of any publication from the public portal for the purpose of private study or research.
- You may not further distribute the material or use it for any profit-making activity or commercial gain
- You may freely distribute the URL identifying the publication in the public portal

Read more about Creative commons licenses: <https://creativecommons.org/licenses/>

### Take down policy

If you believe that this document breaches copyright please contact us providing details, and we will remove access to the work immediately and investigate your claim.

LUND UNIVERSITY

PO Box 117  
221 00 Lund  
+46 46-222 00 00

$$I_{2k,n+2} = \frac{(n+1)(n+2)}{(n+2+2k)(n+2-2k)} I_{2k,n} - (-1)^{n/2} \frac{4k \sin[\pi(k-n/2)]}{(n+2+2k)(n+2-2k)}. \quad (56)$$

This requires only that two integrals be evaluated, namely:

$$I_{2k,0} = \int_{-\pi/2}^{\pi/2} e^{i2k\omega} d\omega \quad (57)$$

and

$$I_{2k,1} = \int_{-\pi/2}^{\pi/2} e^{i2k\omega} \sin\omega d\omega. \quad (58)$$

These integrals may be evaluated directly or obtained from a table of definite integrals.

The recursion relation in Eq. (56) is obtained by first writing Eq. (45) as

$$\int_{-\pi/2}^{\pi/2} d\omega e^{i2k\omega} \sin^{n+2}\omega = \int_{-\pi/2}^{\pi/2} d\omega e^{i2k\omega} \sin^n\omega - \int_{-\pi/2}^{\pi/2} d\omega e^{i2k\omega} \sin^n\omega \cos^2\omega, \quad (59)$$

where the trigonometric identity,  $\sin^2\omega + \cos^2\omega = 1$ , has been used. The integration by parts of the second integral of the right-hand side gives

$$-\int_{-\pi/2}^{\pi/2} d\omega e^{i2k\omega} \sin^n\omega \cos^2\omega = -\frac{1}{n+1} \int_{-\pi/2}^{\pi/2} d\omega e^{i2k\omega} \sin^{n+2}\omega + i \frac{2k}{n+1} \int_{-\pi/2}^{\pi/2} d\omega e^{i2k\omega} \sin^{n+1}\omega \cos\omega. \quad (60)$$

The integration by parts a second time produces

$$-\int_{-\pi/2}^{\pi/2} d\omega e^{i2k\omega} \sin^n\omega \cos^2\omega$$

$$= -\frac{1}{n+1} \int_{-\pi/2}^{\pi/2} d\omega e^{i2k\omega} \sin^{n+2}\omega - \frac{4k(-1)^{n/2} \sin[\pi(k-n/2)]}{(n+1)(n+2)} + \frac{4k^2}{(n+1)(n+2)} \int_{-\pi/2}^{\pi/2} d\omega e^{i2k\omega} \sin^{n+2}\omega. \quad (61)$$

Combining the results of Eqs. (59)–(61) and collecting terms yields the result in Eq. (56).

\* Present address: Department of Mathematics, University of Minnesota, Minneapolis, Minnesota 55455.

<sup>1</sup>G. Arfken, *Mathematical Methods for Physicists* (Academic, New York, 1966).

<sup>2</sup>H. A. Hill, R. T. Stebbins, and J. R. Oleson, The Finite Fourier Transform Definition of an Edge on the Solar Disk, *Astrophys. J.* **200**, 484–498 (1976).

<sup>3</sup>H. A. Hill and R. T. Stebbins, Recent Solar Oblateness Observations: Data, Interpretation, and Significance for Earlier Works, *Ann. N.Y. Acad. Sci.* **262**, 472–480 (1975).

<sup>4</sup>H. A. Hill, *The New Solar Physics*, edited by J. A. Eddy (Westview, Boulder, 1978) Chap. 5.

<sup>5</sup>I. S. Gradshteyn and I. M. Ryzhik, *Table of Integrals, Series, and Products* (Academic, New York, 1965).

<sup>6</sup>A. Erdélyi, editor *Higher Transcendental Functions*, Vol. I. (McGraw-Hill, New York, 1953).

<sup>7</sup>SCLERA is an acronym for the Santa Catalina Laboratory for Experimental Relativity by Astrometry jointly operated by the University of Arizona and Wesleyan University.

<sup>8</sup>T. M. Brown, R. T. Stebbins and H. A. Hill, Long-Period Oscillations of the Apparent Solar Diameter: Observations, *Astrophys. J.* **223**, 324–338 (1978).

<sup>9</sup>P. T. Ballard, "Development of an Experimental Investigation of Some Theories of Relativity by Daytime Astrometry," Ph.D. Dissertation, University of Arizona, 1978 (unpublished).

<sup>10</sup>H. A. Hill, R. D. Rosenwald, and T. P. Caudell, Solar Oscillations: The Influence of the Sun's Outer Layers on Their Detection, *Astrophys. J.* **225**, 304–317 (1978).

<sup>11</sup>J. B. Rogerson, The Solar Limb Intensity Profile, *Astrophys. J.* **130**, 985–990 (1959).

<sup>12</sup>H. A. Hill and T. P. Caudell, Global Oscillations: Observed as Oscillations in the Apparent Solar Limb Darkening Function, *Mon. Not. R. Astron. Soc.* **186**, 327–342 (1979).

## Lifetime measurements for excited states of rare-earth atoms using pulse modulation of a cw dye-laser beam

M. Gustavsson, H. Lundberg, L. Nilsson, and S. Svanberg

Department of Physics, Chalmers University of Technology, S-412 96 Göteborg, Sweden

(Received 22 December 1978)

By pulse-modulating a cw dye-laser beam and employing the delayed-coincidence technique, we have determined the natural radiative lifetimes of a number of atomic states in rare-earth atoms Eu, Dy, and Yb. In the measurements, which were performed on an atomic beam, exponential decay curves with good statistics were obtained using short measuring times. The general features of the technique are discussed. When possible, oscillator strengths are deduced and compared with literature values.

### INTRODUCTION

Accurate determinations of atomic and molecular natural radiative lifetimes and associated oscillator strengths are of great importance for many reasons. From a theoretical point

of view, experimental values for these radiative quantities are useful for tests of atomic wave functions.<sup>1</sup> In particular, they are sensitive to the electronic coupling schemes and to configuration interaction. Astrophysical determinations of solar and stellar element abundances from observed spectra heavily

rely on the availability of accurate oscillator strength values.<sup>2-4</sup> Further, the radiative properties of atoms, ions, and molecules are of great interest in plasma and laser physics.

A large number of methods for measuring radiative lifetimes have been developed. The different techniques are reviewed in a recent excellent article by Imhof and Read.<sup>5</sup> During the last few years, laser techniques have become increasingly important. Tunable, narrow-band lasers provide efficient selective excitations of chosen states, eliminating the problems of cascading, frequently bothersome when nonselective excitation methods are employed.

Of the many techniques available, those monitoring the exponential decay of the excited state are the most direct. With pulsed lasers a large fraction of the ground-state atoms can be transferred to the excited state. The decay of the state can be studied by measuring the fluorescent light employing a fast transient digitizer or a boxcar integrator. However, the accuracy attainable in measurements of this kind is limited by nonlinearities in the response of the photomultiplier tube used. The delayed-coincidence method, in which the time from the laser pulse until the detection of the first fluorescence photon is measured, does not suffer from this limitation. Dye lasers, pumped by pulsed nitrogen lasers, have been used by several investigators in delayed-coincidence measurements (see, e.g., Refs. 6 and 7). However, the high pulse power of these lasers can not be properly utilized in measurements of this kind, as the probability to detect a fluorescence photon must be kept low in order to avoid an excessive pile-up correction.<sup>8</sup> Thus the count rate is normally adjusted so that a photon is detected every third to tenth laser pulse. With the normal repetition rates of 10–500 Hz for pulsed lasers, the registration of the time histogram, forming the decay curve, will take several hours. In a recent letter<sup>9</sup> we have shown how it is possible to make delayed-coincidence measurements of excited-state lifetimes much more efficient by pulse-modulating a cw dye laser beam to produce short pulses at a very high repetition rate. The PUMOLS technique (pulse modulated laser spectroscopy) is based on the recognition that a pulse peak power of typically only 0.1 W does not represent a serious limitation when the delayed-coincidence technique is used. Typically, one photon is recorded every 100th laser pulse, yielding a totally negligible pile-up, while a repetition rate of about 1 MHz still assures a counting rate of about 10 kHz. Thus it was demonstrated in Ref. 9 how decay curves for the  $7^2P_{3/2}$  and  $7^2P_{1/2}$  states in Cs could be obtained with a good signal-to-noise ratio after just 1 min of sampling.

Modulated beams from fixed-frequency lasers have previously been used in lifetime measurements for molecules, using accidental spectral coincidences. Thus Tango and Zare used the phase-shift method to study  $K_2$  molecules, excited by He-Ne laser light.<sup>10</sup> Demtröder and co-workers performed similar measurements for different alkali dimers<sup>11</sup> as well as for  $NO_2$  (Ref. 12) using the phase shift- or the delayed-coincidence methods. A He-Ne laser and an  $Ar^+$  laser were employed. However, a general applicability of such a technique is obtained only when a continuously tunable cw dye laser is used as in Ref. 9. In these experiments the dye-laser beam was pulse modulated with a very efficient acousto-optic modulator with a short rise time. We have now applied this method to lifetime measurements for a large number of excited states of the rare-earth elements Eu, Yb, and Dy. In the

present paper we describe these measurements. However, we will first in Sec. I discuss different methods of producing a train of laser pulses at a high repetition rate, namely laser mode locking, the use of an ultrafast rotating prism to deflect a laser beam across a slit, and finally the use of an acousto-optic modulator. We will also describe the general features of the PUMOLS technique, as well as our detailed experimental setup. In Sec. II we will discuss some experimental considerations, pertinent to lifetime determinations based on a direct observation of the exponential decay, and the application of these to our specific experiments. The computer procedure for extracting the natural lifetimes from the observed decay curves is described in Sec. III. Test measurements for the  $6s6p^3P_1$  Yb state are discussed in Sec. IV, whereas the lifetime determinations for 14 states in Eu and Dy are presented in Sec. V. Finally, the conclusions drawn from these experiments are given in Sec. VI.

## I. PUMOLS TECHNIQUE

Before describing the basic features of the PUMOLS technique and the experimental setup we have used, we will briefly discuss two alternative methods of obtaining laser pulses at a high repetition rate. The most sophisticated and efficient way of producing a train of short pulses is to use mode locking.<sup>13</sup> Passive mode locking of a cw dye laser can be achieved using a saturable absorber (bleachable dye) inside the resonator. The separation of the pulses will be equal to the round-trip time in the resonator, typically 5–10 ns. The pulse width is inversely proportional to the laser line width, typically 1–100 ps. Because of the difficulty of finding suitable bleachable dyes for wide wavelength ranges, the applicability of the passively mode-locked dye laser is limited. The synchronously pumped dye laser, pumped by an actively mode-locked ion laser, can be operated with a wide range of dyes and is, therefore, much more versatile. If the cavity length of the dye laser is accurately adjusted to the same length as that of the pump laser cavity, dye-laser pulses will be produced at the same rate as the pumping ion laser pulses. By using a cavity dumper, pulses from the dye laser can be extracted more seldom and then at a higher peak power, typically 1 kW. Mode-locked systems are quite complicated and delicate and provide extremely short pulses, more valuable for investigating the short relaxation times in liquids and solids than for measuring the longer excited state lifetimes in free atoms and molecules.

It is considerably more simple to passively slice a cw dye-laser beam into pulses outside the cavity. We have tried two techniques in connection with atomic lifetime determinations. The first one utilizes a high-speed rotating prism, deflecting the beam across a slit, whereas the second one employs an acousto-optic modulator. In the present measurements we found the second method more suitable and it will be described in detail later. A fast pulse excitation rate can also be achieved by using electron-beam excitation in conjunction with a large analyzing spectrograph as applied by Erman *et al.*<sup>14</sup> Laser excitation, however, does not give rise to a repopulation of the studied state through cascades from higher-lying levels.

In Refs. 15 and 9 we have briefly described preliminary experiments on atoms using the technique with a rotating

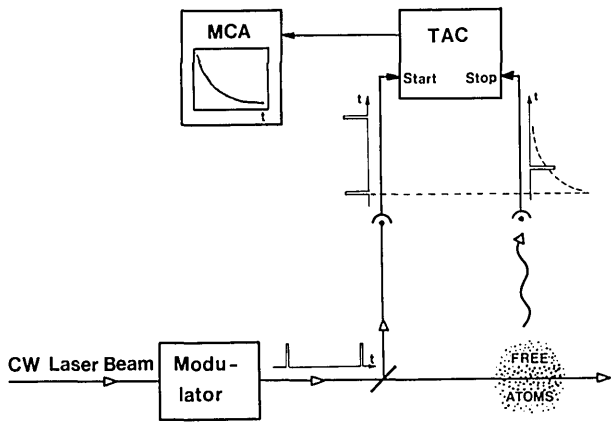

FIG. 1. Principle of delayed-coincidence measurements using the PUMOLS technique.

prism. The technique was first used by Rigler and Ehrenberg in connection with fluorescence relaxation studies of macromolecules in liquids.<sup>16</sup> The prism we utilized was made of titanium and mounted on a dentist's air turbine drill. A convergent laser beam, filling the prism surface, was reflected by the prism and a slit was placed at the focus of the beam. The minimum pulse width and pulse rise time depend on the speed of rotation of the prism, the divergence of the laser beam, and the side length of the prism. We used a cubic 4 mm prism rotating with 7000 revolutions per second and the pulsewidth was about 10 ns. Six-faceted prisms with side length 4 mm, rotating with 20000 revolutions per second driven in a helium atmosphere, can be designed (Lincoln Laser Company, Phoenix, Arizona). It is in this way possible to achieve a pulse width less than 1 ns.

The principal diagram for delayed-coincidence measurements using an acousto-optic modulator to pulse modulate a cw dye-laser beam is shown in Fig. 1. The modulator can produce a train of pulses with arbitrary repetition rates and pulse lengths within the rise-time constraints of the device. The desired train is chosen with the pulse generator controlling the modulator. The modulated beam is fixed in space irrespective of the chosen pulse length in contrast to the case with the rotating prism. With a beam splitter a small fraction of the pulsed light is split off to a detector, and the registered pulse is used to start the internal clock of a time-to-amplitude converter (TAC). The main part of the beam is used to excite the atoms or molecules under investigation. A photomultiplier tube is used to detect the arrival of the first fluorescence photon following an exciting pulse, and the signal pulse is used to stop the clock of the TAC. A pulse with a voltage proportional to the time delay is generated and fed to a multichannel analyzer (MCA), where it is registered as a count in a channel, whose number is proportional to the pulse height (time delay). If the probability of the arrival of a second fluorescence photon is negligible, the histogram, built up in the MCA, will display the exponential decay of the excited state directly. On the other hand, if there is a certain probability for a second photon at a longer delay time, that photon will not be detected, and thus the measuring procedure favors early photon arrivals. This leads to the so called pile-up effect,<sup>8</sup> which can be mathematically compensated for or can be avoided altogether

by electronically rejecting shots for which two or more photons are detected by the photomultiplier tube.

In Fig. 2 the pulses pertinent to the PUMOLS technique are illustrated. Curve (a) shows the voltage pulses of length  $t_p$  and spacing  $T$  generated by the electronic pulse generator, steering the acousto-optic modulator. The pulses have an extremely short risetime and are thus square shaped. Curve (b) shows the power of the modulated laser beam. The optical pulses have rounded edges due to the finite risetime of the modulator, and the train is shifted in time ( $t_d$ ) with respect to the voltage pulse train due to the build-up time of the ultrasonic grating of the modulator. Curve (c) shows start and stop pulses for the TAC. The start pulses are always well defined with respect to the optical pulse, whereas the stop pulses are distributed. If the leading edge of the pulse is used for deriving the start signal, the exponential pumping of the excited state during the pulse will be seen in the delayed-coincidence spectrum together with the exponential decay of the excited state during the dark period [curve (d)]. Both parts of the curve will display the same time constant  $\tau$ , the natural lifetime of the excited state. Clearly, it is easier to measure the tail of the exponential decay during the dark period, when there is no background, if the dark current of the photomultiplier can be neglected. Also from pile-up considerations it is useful to restrict the observation to the decay in the dark. The start pulse for the TAC can then be electronically delayed or can be derived from the trailing edge of the optical pulse. After a time interval of  $3\tau$  the exponential is down to 5% of its initial value. Clearly it is not very useful to let the excitation period go beyond this time. On the other hand, for accurate lifetime measurements it can be advantageous to observe the decay for times extending up to  $5-10\tau$ . It is easy to conceive an automatic procedure, where a lifetime measurement is initiated with a standardized pulse train and then the signal sampled for a short time is used in a computer fit to obtain a rough lifetime value. For this lifetime the optimum pulse train can then be calculated and effectuated by a programmable pulse generator.

We will now briefly describe the actual setup used in our lifetime measurements. The arrangement is illustrated in Fig. 3. We used two different cw laser systems delivered by Co-

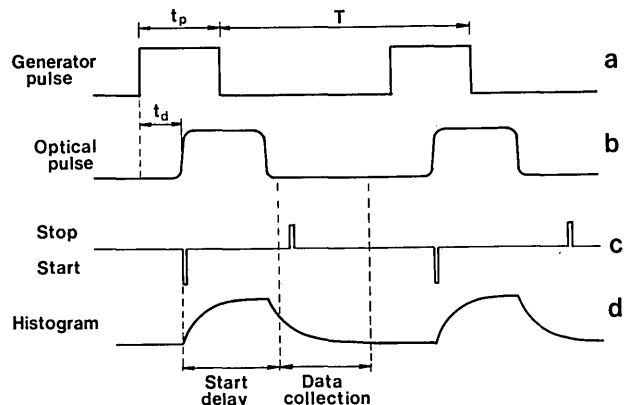

FIG. 2. Temporal signal diagrams relevant in PUMOLS measurements: (a) steering generator pulse train; (b) optical pulse train; (c) Start and Stop pulses for the time-to-amplitude converter; (d) Histogram of time delays displaying experimental build-up during the optical pulse and decay in the dark.

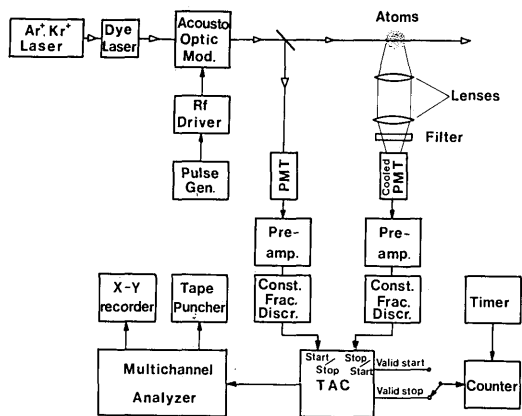

FIG. 3. Experimental arrangement used in the measurements.

herent Radiation Inc. Blue light (450–500 nm) was generated with a Model 490A tight-focus dye laser, pumped by a CR 12 UV Ar<sup>+</sup> laser and using the dye coumarin 47. The region 530–630 nm was covered by the dyes rhodamine 110 and rhodamine 6G in a Model 490 dye laser, pumped by a CR 8 Ar<sup>+</sup> laser. Both dye lasers were run in multimode and had linewidths of about 0.5 Å and output powers ranging from 50–300 mW. For the pulse modulation of the beam we used a SORO M-AR 50 acousto-optic modulator, operating at a carrier frequency of 250 MHz. The rf driver unit was controlled by a HP Model 8013 B pulse generator with a rise time of 3 ns. The rise time of the optical pulses was about 15 ns and the optical efficiency of the device was about 70% when a first-order diffracted beam was used. The light intensity between the pulses, due to leakage through the modulator, was about 0.05% of the peak intensity.

The atoms to be studied were produced as an atomic beam in a vacuum system evacuated by two oil diffusion pumps. Because of the high temperatures needed to produce atomic beams of Yb, Eu, and Dy (500–1000°C), special precautions to reject stray light from the oven, heated by electron bombardment, were taken. Several apertures along the beam path shielded the scattering chamber from oven stray light and collimated the beam to a diameter of 1 cm at the scattering volume, which was situated at about 40 cm from the oven. In order to suppress laser stray light, long inlet and outlet tubes were used for the laser beam, so that the light scattered at the entrance and exit glass windows was efficiently baffled. The walls of the vacuum chamber were blackened with soot for additional stray-light reduction. An EMI 9558 QA photo-multiplier tube (PMT), cooled to –20°C, was used to detect the fluorescence photons. Different lens arrangements to image the resonance volume on the photocathode were tested. It was also possible to run the experiment without any focusing lenses at all. These tests were made to investigate that no flight-out-of-view effects, later more fully discussed, were present. The PMT pulses were amplified and in order to establish well-defined trigger levels for the start and stop signals, constant-fraction discriminators were used. For minimizing TAC dead time in high-repetition-rate measurements, the role of the start and stop pulses could be reversed. The contents of the MCA memory could be read out digitally on paper tape or in analog form on an X-Y recorder. Laser pulse repetition rate and fluorescence photon count rate could

be monitored. The system was carefully calibrated using a crystal-controlled pulse generator with respect to the time axis, and the linearity in the y direction was checked with a precision pulser.

## II. EXPERIMENTAL CONSIDERATIONS

In this section we will discuss a number of effects that can affect lifetime measurements and describe how unwanted influences could be avoided in our experiments.

### A. Pile-up effect

A peculiarity in delayed-coincidence measurements is the pile-up effect previously described. Our experimental setup does not include electronic rejection of this effect and it is therefore necessary to make sure that the counting rate is so low that the effect is negligible or that the experimental conditions allow for a reliable mathematical correction to be applied.<sup>8</sup> With a pulse peak power of the order of 0.1 W, a low counting rate is inevitable if the atomic density is kept at a tolerable level (see point B). As a time average, one photon was typically detected every 100th shot. However, we have to consider that a multimode laser was used, acting on a collimated atomic beam with a residual Doppler width of about 50 MHz. When a laser mode matches a line component, excitation is possible, whereas the excitation probability is zero when the mode has drifted off the line. Thus large intensity fluctuation could be expected, with possible pile-up effects in the intensity maxima, although the average counting rate would seem to be safe. However, in practice the presence of isotope shifts and hyperfine structure as well as the Zeeman splitting in the applied magnetic field results, together with the frequency noise characteristics of the laser, in a quite uniform counting rate. It should also be noted that even a 10 times higher counting rate would yield a lifetime change of only 3% through the pile-up effect. By varying the experimental parameters it was furthermore frequently ensured that no influence of pile up was present. In cases when a single or few line components are present, a single-mode laser locked to a line should be used, or an electronic pile-up rejector should be employed to avoid any possible influences of non-uniform excitation.

### B. Multiple scattering

The present method relies on the fact that the count rate discussed under point A (typically 1 count per 100 laser pulses) can be achieved with the low-energy laser pulses without increasing the atomic density to a point where multiple scattering is significant. Multiple scattering would result in virtually longer lifetimes. It was accurately checked both in the previous work<sup>9</sup> and in the present measurements that multiple-scattering effects were not detectable for operative conditions. Actually, it is then possible to state that multiple scattering will never be a problem in this technique as the desired counting rate can be obtained for correspondingly lower atomic densities when strong transitions, more sensitive to multiple scattering, are used.

### C. Collision effects

If some atoms under investigation undergo collisions with other atoms or molecules while they are in their excited states, they will be collisionally deexcited. The apparent lifetime

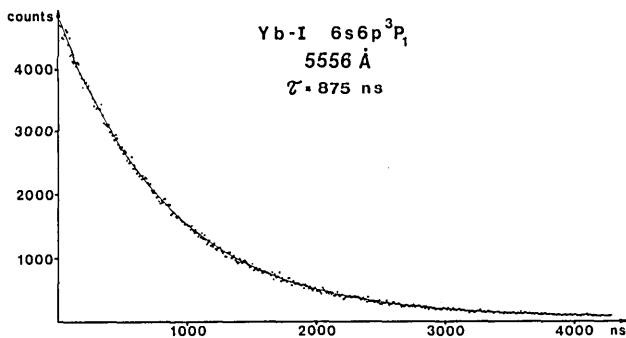

FIG. 4. Decay curve for the  $6s6p^3P_1$  state of ytterbium. The total measuring time for the curve was 15 min. A repetition rate of 70 KHz was used. An exponential has been fitted to the experimental curve.

measured would be too short. Especially long-lived states are sensitive to collisions. With a residual pressure in the vacuum chamber of about  $10^{-6}$  Torr and the moderately strong atomic beams used in our experiments, no indications of collisional effects could be observed.

#### D. Quantum-beat distortions

It is well-known that if an excited state, split up into sub-states, is coherently excited, oscillations at frequencies corresponding to the energy splittings may be observed superimposed on the exponential decay curve. Especially, slow Zeeman quantum beats can strongly distort the decay curve. By suitably choosing the planes of polarization for the exciting and detected light, quantum beats can be totally suppressed.<sup>17</sup> Another possibility to suppress the beats is to use an exciting pulse long compared to the Bohr precession time of the state. However, it should be noted that with the pulse shape used in the present experiments, weak quantum beats can actually be observed for long-pulse excitation.<sup>18</sup> To be sure not to have any influence of quantum beats we applied a magnetic field over the atoms with a sufficient strength to cause Larmor precession with a period very short compared to the pulse length. Unpolarized detection was also used.

#### E. Flight-out-of-view effects

In lifetime measurements it is important to ensure that the detector has the same probability of detecting photons during the whole decay. For long-lived states this is not necessarily automatically fulfilled. For example, in a thermal beam of atoms with mass 150, produced in an oven with a temperature of 1000 K, the atoms will move about 0.4 mm during 1  $\mu$ s. Using a small light source that was moved along the path of the atoms, we tested the detection efficiency for the photomultiplier and made sure that the optical system was adjusted so that the efficiency varied less than 1% over a 4-mm change. In this way we assured that virtually shorter lifetime values would not be obtained for long-lived states.

We will now exemplify the type of curves obtainable with our system, operated in a way so that none of the influences just discussed would perturb the measurements. In Fig. 4 a decay curve for the  $6s6p^3P_1$  state of Yb is shown, measured using the 5556-Å Yb line. The curve was sampled for 15 min using a very low density atomic beam. With a normal pulsed laser, 10–50 h of sampling time would have been needed to obtain a similar signal-to-noise ratio. An exponential has

been fitted to the data using the procedure discussed in the next section. In Fig. 5 a further example is given, where the pumping of the excited state during the light pulse is clearly seen together with the decay, as schematically shown in Fig. 2(d). The curve, which was taken for the 4565-Å line of Dy, also clearly shows the effect of laser stray light during the pulse as the excitation and detection lines were the same. In an analysis of the decay in the dark it is important to use only that part of the curve that is not influenced by the possible stray light from the trailing edge of the exciting pulse.

### III. DATA REDUCTION

Before describing our lifetime measurements in more detail we will discuss the procedure used to obtain lifetime values from the data accumulated in the memory of the MCA. As already mentioned, the data was read out on paper tape together with proper identification. The data, stored on the tape, could then be transferred to a PDP11/20 computer system, equipped with a digital plotter. We fit the data points to the sum of an exponential and a constant background using an iterative least-squares method.<sup>19</sup> The statistical uncertainty in the experimental data points is proportional to the square root of the accumulated counts in the individual MCA channels. Therefore, each square was weighted with the reciprocal of the fitted value for that channel, taken from the earlier iteration. Three parameters, the amplitude and decay constants of the exponential and the background level, were fitted. The background parameter can easily be established in the fit if the exponential decreases to a small value during the recorded time interval. Because of the rather big influence of the background parameter on the decay constants, evaluations were also performed for fixed background settings. In spite of their minor importance, pile-up corrections were made. For a counting rate of one photon per hundred laser shots the correction typically prolonged the lifetimes by 0.3%. The experimental and calculated curves were written out on a digital plotter. Besides visual inspection, the quality of the fits and possible influence of systematic errors in the data points were also tested using the so-called run tests.<sup>20</sup> A sequence of numbers, close to one, was formed by taking the ratio between the experimental and fitted data points of the exponentials. The first test checked how many times this sequence crossed its median value. In the second run test the differences between adjacent numbers are calculated and

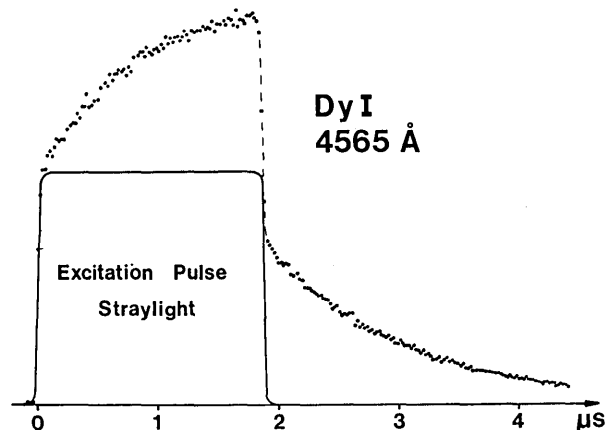

FIG. 5. Curve recorded for the 4565 Å line of dysprosium. Both the exponential pumping and the exponential decay are shown. In addition, the influence of laser stray light is clearly seen.

subsequent differences with the same sign constitute one run (up or down). The number of runs are counted. If the noise is purely statistical, these quantities and their standard deviations follow well-known formulas. This is a sensitive test of the degree to which our experimental curves follow an exponential.

#### IV. TEST MEASUREMENTS FOR Yb

In our previous letter,<sup>9</sup> test measurements were made for the  $7^2P_{3/2}$  and  $2P_{1/2}$  states of Cs. Since many of the states investigated in the present work have a lifetime much longer than those of these Cs states, we chose to make additional test measurements for a long-lived state of known lifetime. We selected the  $6s6p^3P_1$  state of Yb. In a Hanle effect measurement, the value  $\tau = 827(40)$  ns was found,<sup>21</sup> whereas a level-crossing experiment yielded  $\tau = 760(80)$  ns for this state.<sup>22</sup> In a pulsed electron excitation measurement the value  $850(80)$  ns was found.<sup>23</sup> In an experiment using pulsed dye-laser excitation, Gornik *et al.* for the first time observed laser-induced Zeeman quantum beats and also measured the lifetime to be  $860$  ns.<sup>24</sup> In our measurements, a large number of curves were registered for various experimental conditions. Thus the atomic density was varied over a wide range. The pulse length and the repetition rate were also changed. No systematic influences due to these variations could be detected. Random measurements of the number of counts

during a  $0.1$  s time window showed that over such a time interval the count rate did not vary by more than a factor of 3 due to mode drifts. A representative curve has already been shown in Fig. 4. By averaging the lifetime values obtained in the computer fits of the various curves, we obtained the value

$$\tau(6s6p^3P_1 \text{ Yb I}) = 875(20) \text{ ns},$$

where the error should also include any residual systematic influences. This value is in reasonable agreement with three of the previously measured values. However, the value obtained from level-crossing spectroscopy seems to be too low. Since this state can only decay by emitting the  $5556 \text{ \AA}$  line, the absorption oscillator strength of this line can directly be calculated to be<sup>4</sup>

$$f(5556 \text{ \AA Yb I}) = 0.0159(5).$$

Komarovskii and Penkin have used the hook method for a direct measurement of the oscillator strengths in several lines of Yb.<sup>25</sup> For the  $5556 \text{ \AA}$  line they obtained  $f = 0.014$ .

#### V. MEASUREMENTS ON Eu AND Dy

Comparatively little experimental work has been performed that regards direct lifetime determinations for excited states of neutral rare-earth atoms. For Eu a few states have been investigated with the Hanle method.<sup>26,27</sup> At the start of the

### Eu I

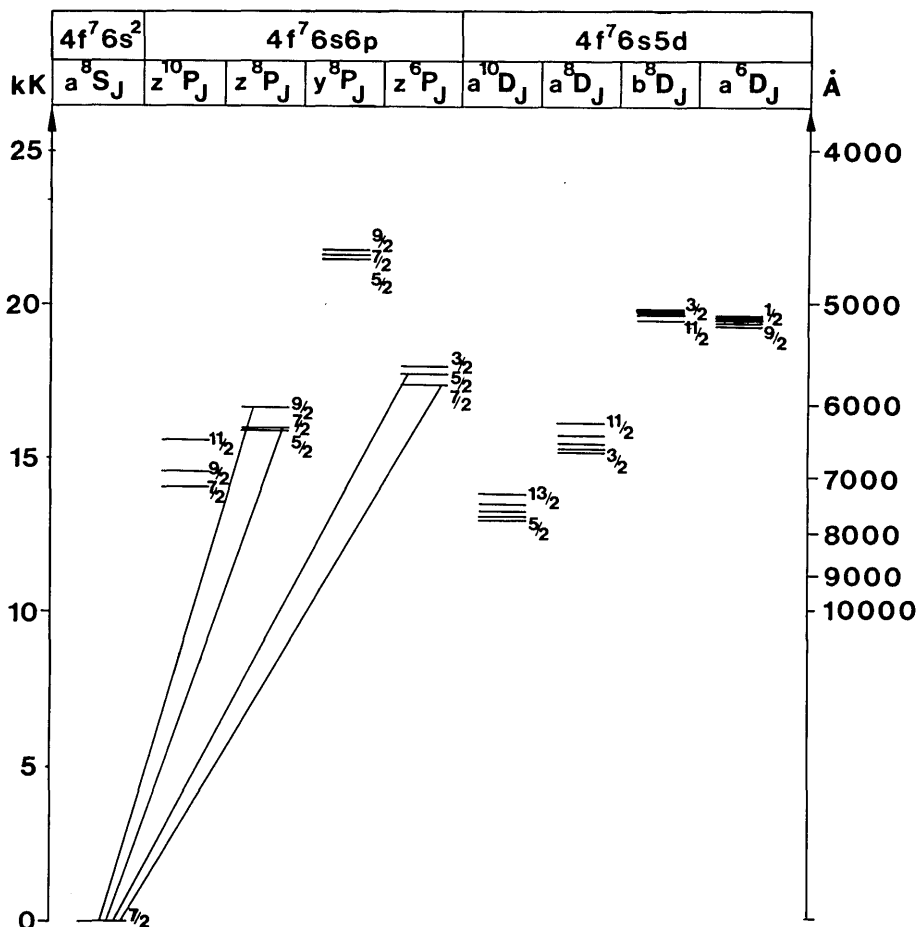

FIG. 6. Partial energy-level diagram for europium. The transitions used in the present work are indicated.

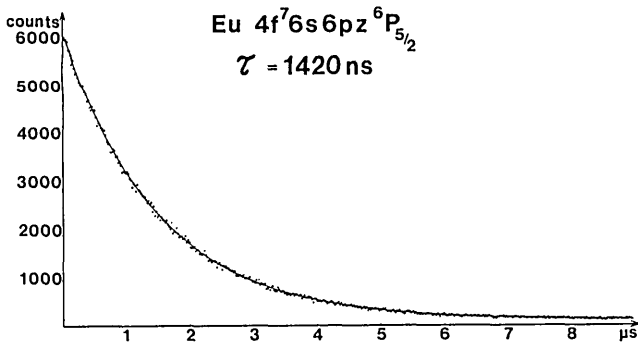

FIG. 7. Experimental decay curve for the  $4f^7 6s 6p z^6 P_{5/2}$  state of europium. Measuring time: 15 min.

present investigation no measurements of Dy lifetimes had been reported. However, during the course of our investigations results for several Dy states were published by Hotop and Marek.<sup>7</sup> Relative values of Dy I oscillator strengths have been measured by Penkin *et al.*<sup>28,29</sup>

A partial energy level scheme for Eu I is shown in Fig. 6. The energy level designations are due to Russell and King.<sup>30</sup>

TABLE I. Natural radiative lifetimes and absorption oscillator strengths for europium.

State	$\tau$ (ns)	$\lambda$ (Å)	$f_{\text{abs}}$ this work	$f_{\text{abs}}$ Refs. 31 and 29
$4f^7 6s 6p z^6 P_{5/2}$	1420(40)	5646	0.0025	0.0035
$4f^7 6s 6p z^3 P_{7/2}$	875(25)	5765	0.0057	0.0072
$4f^7 6s 6p z^3 P_{9/2}$	1065(30)	6018	0.0064	0.0078
$4f^7 6s 6p z^3 P_{5/2}$	5900(300)	6291	0.00075	0.0011

The ground configuration for Eu is  $4f^7 6s^2$ . The  $f^7$  electrons constitute a half-filled  $f$  shell and couple into  $^8S$ ,  $^6P$ ,  $^6D$ ,  $^6F$ ,  $^6G$ ,  $^6H$ ,  $^6I$  terms plus several ones with lower multiplicity. The  $^8S_{7/2}$  term has the lowest energy and all states in the diagram have this one as a parent state. For the ground state the remaining two electrons are  $s$  electrons ( $6s^2$ ), and the lowest excited states arise from configurations  $6s 6p$  and  $6s 5d$ . We have measured the lifetimes of four states belonging to the  $4f^7 6s 6p$  configuration using the lines indicated in the figure. As an example, a decay curve for the  $4f^7 6s 6p z^6 P_{5/2}$  state, excited and analyzed using the 5646 Å line, is shown together with a computer fit in Fig. 7. For each of the studied states,

### Dy I

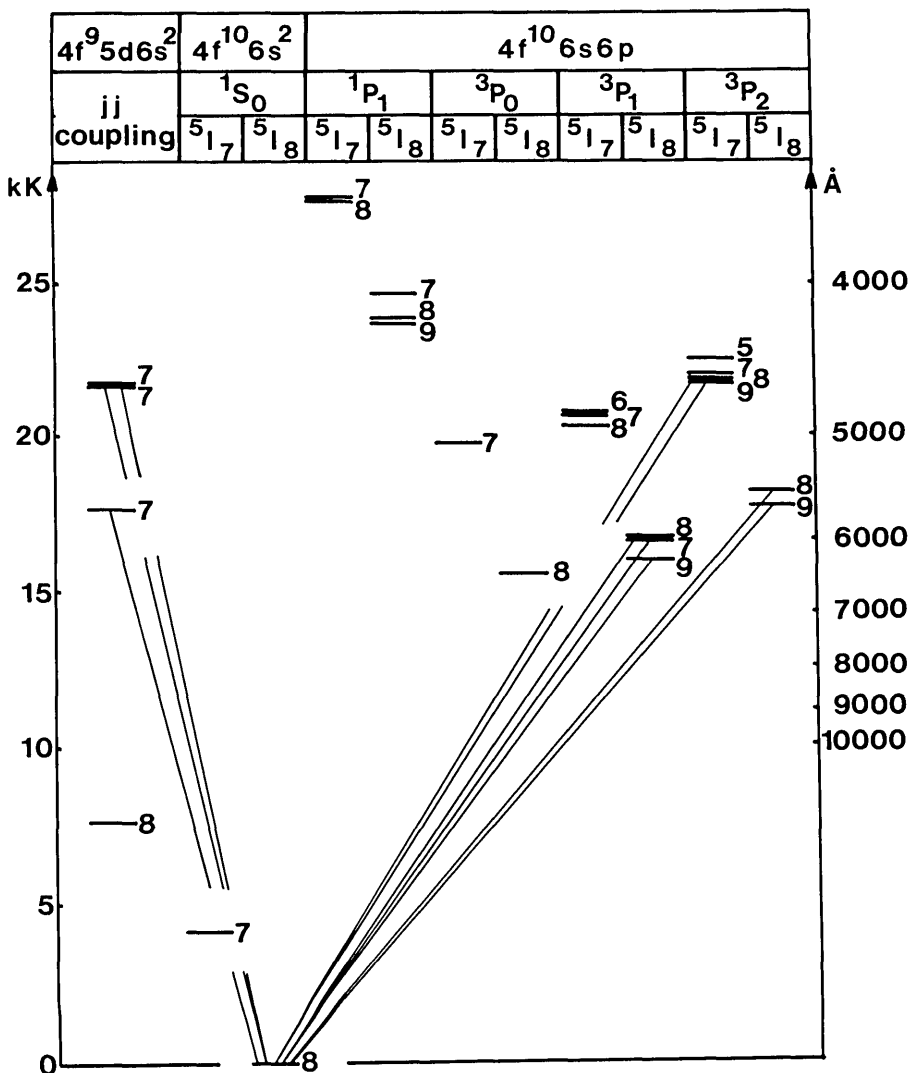

FIG. 8. Partial energy-level diagram for dysprosium. The transitions used in the present work are indicated.



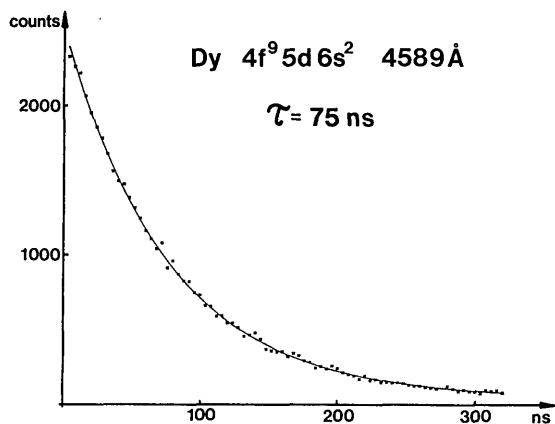

FIG. 9. Experimental decay curve obtained for the 4589 Å dysprosium line.

5–10 curves were measured. The results are given in Table I. Only one of the states has been studied previously. For the  $4f^7 6s 6p z^6 P_{5/2}$  state, Lange *et al.* obtained the lifetime value 740(70) ns.<sup>26</sup> This value is far too low and has actually been changed to 1300(300) ns in a private communication from Lange to Penkin.<sup>29</sup> The revised value, although much less accurate, agrees with our result.

From the measured lifetime values we can, neglecting the expected weak influence of ir transitions, calculate absorption oscillator strengths for the spectral lines used for excitation and detection.<sup>4</sup> These values are included in Table I and are compared with values obtained by Komarovskii *et al.*,<sup>31,29</sup> employing the hook method. As can be seen, our values are 20–30% lower than the hook-method  $f$  values. As the accurate inclusion of ir transitions would further decrease our  $f$  values, it seems that the  $f$  values given in Refs. 31 and 29 are systematically too high.

A partial energy level scheme for DyI is shown in Fig. 8. The energy level designations are due to Griffin *et al.*<sup>32</sup> We measured the lifetimes of 10 states using the lines indicated in the level diagram. All the transitions originate from the ground state. For this state the  $4f^{10}$  core electrons couple to a  $^5I_8$  term, and the outer  $6s^2$  electrons form a  $^1S_0$  state. Whereas these parent terms are found in good LS coupling the  $J$  values of the parents then couple to the resulting  $J$  value, which for the ground state obviously will be 8. Most of the

TABLE II. Natural radiative lifetimes for some dysprosium states.

State	Excitation and detection line $J$ (Å)	$\tau$	$\tau$
		(ns) this work	(ns) Ref. 7
$4f^{10}(^5I_8)6s6p(^3P_1)$	9 6259	1170(30)	1180(100)
	7 5989	1900(70)	
	8 5974	2500(100)	
$4f^{10}(^5I_8)6s6p(^3P_2)$	9 5639	2150(100)	
	8 5547	3750(200)	
$4f^{10}(^5I_7)6s6p(^3P_2)$	9 4578	489(10)	503(40)
	8 4565	1200(50)	1205(97)
$4f^9 5d 6s^2(17688)$	7 5652	1900(70)	1990(160)
	(21675)	4612	121(5)
	(21783)	4589	75(2)
			73(6)

TABLE III. Absorption oscillator strengths and transition probabilities for certain dysprosium lines, originating in the  $4f^{10}(^5I_8)6s^2 ^1S_0 J = 8$  ground state.

Final state	Wave-length $J$ Å	$f_{abs}$ , this work	$A_{ik} \times 10^8 s^{-1}$		
			this work	Ref. 33	Refs. 28 and 29
$4f^{10}(^5I_8)6s6p(^3P_1)$	9 6259	0.0056	0.0085	0.021	0.020
	7 5989	0.0025	0.0053	0.049	0.011
	8 5974	0.0021	0.0040	0.033	0.0094
$4f^{10}(^5I_8)6s6p(^3P_2)$	9 5639	0.0025	0.0047		
	8 5547	0.0012	0.0027		

investigated excited states belong to the  $4f^{10} 6s 6p$  configuration. Whereas the core electrons form a  $^5I_8$  and a  $^5I_7$  state the outer electrons couple to  $^3P_{2,1,0}$  or  $^1P_1$ . Again, the resulting  $J$  is formed in the coupling of the parent states. Fully allowed transitions to the ground state are only those from a state incorporating a  $^1P_1$  parent term and where the  $J$  selection rule  $\Delta J = 0, \pm 1$  is obeyed. Intercombination lines from states with a  $^3P$  parent term are weak.<sup>33</sup> Correspondingly, long lifetimes are expected for the excited states. Seven of the states studied in this work fall in this category. We also studied three states belonging to the  $4f^9 5d 6s^2$  configuration. Since the  $5d$  electron penetrates substantially into the  $4f^9$  core, the coupling situation is more complicated and simple arguments concerning oscillator strengths are not applicable.

In Fig. 9 an experimental curve for one of the three latter states is shown together with a fitted exponential. The lifetime, 75 ns, is the shortest one measured in the present work. As for the Eu measurements, a large number of curves were measured for each state. In Table II our results are given. Comparison is also made with the recent results by Hotop and Marek.<sup>7</sup> A good agreement is obtained for the states where a comparison can be performed.

Energy levels belonging to the  $4f^{10} 6s 6p$  configuration with a  $^5I_8$  parent term have a negligible branching ratio into lower lying levels except for the ground state.<sup>33</sup> For such states it is thus possible to calculate absorption oscillator strengths and transition probabilities directly from the measured lifetime values. In Table III our results are compared with theoretical values calculated by Cowan<sup>33</sup> using semiempirical wave functions. A further comparison is made with results obtained in hook method measurements by Penkin *et al.*<sup>28,29</sup>

## VI. CONCLUSIONS

The present measurements show that the PUMOLS technique is a very powerful one for cascade-free measurements of excited-state lifetimes. The technique is applicable for the full wavelength region covered by cw dye lasers (presently 390–950 nm) and can be extended by using step-wise excitations, as has just been demonstrated in measurements of D- and F-state lifetimes in Cs.<sup>34</sup> The PUMOLS technique combines a high spectral resolution with very short measuring times. A limiting factor is the fall-time of the optical pulses used, which sets a lower limit to the lifetimes that can be directly measured. This limit is about 30 ns with the equipment used. However, by employing a deconvolution procedure, considerably shorter lifetimes can be measured.

Our measurement for Yb, Eu, and Dy allowed several absorption oscillator strengths to be determined. For Yb and Eu a reasonably good agreement with available literature values was found, although the accuracy of the lifetime values is now considerably improved. Previous hook method measurements<sup>31,29</sup> for Eu seem to have given too large absorption oscillator strength values. For Dy a good agreement with recent lifetime measurements by Hotop and Marek<sup>7</sup> was obtained and clearly, previously given<sup>28,29</sup> oscillator strength values for Dy are not entirely reliable.

## ACKNOWLEDGMENTS

The authors gratefully acknowledge the support by Professor I. Lindgren. The substantial help and assistance granted by Ing. P. Standzenieks, Dr. J.-E. Pantzar, and FK. A. Rindby in the computer analysis of the data is highly appreciated. This work was financially supported by the Swedish Natural Research Council.

- <sup>1</sup>A. W. Weiss, "A review of theoretical developments in atomic  $f$ -values," Nucl. Instrum. Methods **90**, 121-131 (1970).
- <sup>2</sup>N. Grevesse and G. Blanquet, "Abundances of the rare earths in the sun," Sol. Phys. **8**, 5-17 (1969).
- <sup>3</sup>O. Engvold and Ö. Hauge, "Solar abundance determination," Nucl. Instrum. Methods **90**, 351-362 (1970).
- <sup>4</sup>P. L. Smith, "Oscillator strengths of astrophysical interest from lifetime data," Nucl. Instrum. Methods **110**, 395-403 (1973).
- <sup>5</sup>R. E. Imhof and F. H. Read, "Lifetimes in atoms, molecules and ions," Rep. Prog. Phys. **40**, 1-103 (1977).
- <sup>6</sup>H. Figger, K. Siomos, and H. Walther, "Lifetime measurements in the Fe I spectrum using tunable dye laser excitation," Z. Physik **270**, 371-376 (1974).
- <sup>7</sup>R. Hotop and J. Marek, "Lifetime measurements of some excited Dy I states," Z. Physik A **287**, 15-17 (1978).
- <sup>8</sup>P. B. Coates, "The correction for photon 'pile-up' in the measurement of radiative lifetimes," J. Phys. E **1**, 878-879 (1968).
- <sup>9</sup>M. Gustavsson, H. Lundberg, and S. Svanberg, "An efficient method for measuring atomic and molecular lifetimes using a modulated or deflected CW dye laser beam," Phys. Lett. A **64**, 289-291 (1977).
- <sup>10</sup>W. J. Tango and R. N. Zare, "Radiative lifetime of the  $B^1\Pi_u$  state of  $K_2$ ," J. Chem. Phys. **53**, 3094-3100 (1970).
- <sup>11</sup>G. Baumgartner, W. Demtröder, and M. Stock, "Lifetime-measurements of alkali-molecules excited by different laser lines," Z. Physik **232**, 462-472 (1970).
- <sup>12</sup>F. Paech, R. Schmiedl, and W. Demtröder, "Collision free lifetimes of excited  $NO_2$  under very high resolution," J. Chem. Phys. **63**, 4369-4378 (1975).
- <sup>13</sup>C. V. Shank and E. P. Ippen, "Mode-locking of dye lasers," in *Topics in Applied Physics: Dye Lasers*, edited by F. P. Schäfer (Springer-Verlag, Berlin, 1973).
- <sup>14</sup>P. Erman, J. Brzozowski, and B. Sigfridsson, "Gas excitations using high frequency deflected electron beams," Nucl. Instrum. Methods **110**, 471-476 (1973).
- <sup>15</sup>M. Gustavsson, H. Lundberg, and S. Svanberg, "An efficient method for measuring atomic lifetimes using a deflected CW dye laser beam

in conjunction with delayed coincidence techniques," Abstracts of the Nordic Symposium on Atomic and Molecular Transition Probabilities, Lund, Sweden, held March 28-29, 1977 (unpublished).

- <sup>16</sup>R. Rigler and M. Ehrenberg, "Fluorescence relaxation spectroscopy in the analysis of macromolecular structure and motion," Q. Rev. Biophys. **9**, 1-19 (1976).
- <sup>17</sup>J. S. Deech, R. Luypaert, and G. W. Series, "Determination of lifetimes and hyperfine structures of the 8, 9 and  $10^2D_{3/2}$  states of  $^{133}Cs$  by quantum-beat spectroscopy," J. Phys. B **8**, 1406-1414 (1975).
- <sup>18</sup>H. Lundberg and S. Svanberg, "Two quantum-beat phenomena observed for magnetically tuned atomic sublevels," Opt. Commun. **27**, 235-238 (1978).
- <sup>19</sup>C. Budtz-Jørgensen, "A Series of Computer Programmes for the Analysis of TDPAC Experiments," (Dept. of Physics, University of Aarhus, April 1975) (unpublished).
- <sup>20</sup>A. Hald, *Statistical Theory with Engineering Applications* (Wiley, New York, 1960).
- <sup>21</sup>M. Baumann and G. Wandel, "Lifetimes of the excited states ( $6s6p$ )  $^1P_1$  and ( $6s6p$ )  $^3P_1$  of ytterbium," Phys. Lett. **22**, 283-285 (1966).
- <sup>22</sup>B. Budick and J. Snir, "Hyperfine structure anomalies of stable ytterbium isotopes," Phys. Rev. A **1**, 545-551 (1970).
- <sup>23</sup>M. L. Burshtein, Ya. F. Verolainen, V. A. Komarovskii, A. L. Osheroich, and N. P. Penkin, "Lifetimes of the  $^3P_1^0$  level of Yb I and the  $^2P_{3/2,1/2}$  level of Yb II," Opt. Spectrosc. **37**, 351-352 (1974).
- <sup>24</sup>W. Gornik, D. Kaiser, W. Lange, J. Luther, and H-H. Schulz, "Quantum beats under pulsed dye laser excitation," Opt. Commun. **6**, 327-328 (1972).
- <sup>25</sup>V. A. Komarovskii and N. P. Penkin, "Oscillator strengths of the spectral lines of Tm I and Yb I," Opt. Spectrosc. **26**, 483-484 (1969).
- <sup>26</sup>W. Lange, J. Luther, A. Steudel, and H. Walther, "Lifetime of the  $4f^76s6p\ ^6P_{5/2}$  state of europium," Phys. Lett. **20**, 166-167 (1966).
- <sup>27</sup>E. Handrich, H. Kretzen, W. Lange, A. Steudel, R. Wallenstein, and H. Walther, "Level crossing and optical double resonance experiments in the Mn I, Eu I, Sm I and Tm I spectra," in *Optical Pumping and Atomic Line Shape*, edited by T. Skalinski (Panstwowe Wydawnictwo Naukowe, Warszawa, 1969).
- <sup>28</sup>N. P. Penkin, W. A. Komarovskii, and V. V. Smirnov, "Relative values of oscillator strengths for spectral lines of Dy I," Opt. Spektrosk. **37**, 393-395 (1974) [Opt. Spectrosc. (USSR) **37**, 223-225 (1974)].
- <sup>29</sup>N. P. Penkin and V. A. Komarovskii, "Oscillator strengths of spectral lines and lifetimes of atoms of rare earth elements with unfilled  $4f$ -shells," J. Quant. Spectrosc. Radiat. Transfer **16**, 217-252 (1976).
- <sup>30</sup>H. N. Russell and A. S. King, "The arc spectrum of europium," Astrophys. J. **90**, 155-203 (1939).
- <sup>31</sup>V. A. Komarovskii, N. P. Penkin, and L. N. Shabanova, "Oscillator strengths of Eu I spectral lines," Opt. Spectrosc. **25**, 81-82 (1968).
- <sup>32</sup>D. C. Griffin, J. S. Ross, and R. D. Cowan, "Configurations  $4f^{10}6s6p$  and  $4f^95d6s^2$  in neutral dysprosium," J. Opt. Soc. Am. **62**, 571-579 (1972).
- <sup>33</sup>R. D. Cowan, "The theory of rare earth energy levels and spectra," Nucl. Instrum. Methods **110**, 173-182 (1973).
- <sup>34</sup>H. Lundberg and S. Svanberg, "Determination of natural radiative lifetimes and Landé factors for highly excited  $F$ -states of cesium," Z. Physik A **290**, 127-130 (1979).