



# LUND UNIVERSITY

## **Heredity in Parkinson's disease. From rare mutations to common genetic risk factors.**

Puschmann, Andreas

2011

[Link to publication](#)

*Citation for published version (APA):*

Puschmann, A. (2011). *Heredity in Parkinson's disease. From rare mutations to common genetic risk factors.* Lund University.

*Total number of authors:*

1

### **General rights**

Unless other specific re-use rights are stated the following general rights apply:

Copyright and moral rights for the publications made accessible in the public portal are retained by the authors and/or other copyright owners and it is a condition of accessing publications that users recognise and abide by the legal requirements associated with these rights.

- Users may download and print one copy of any publication from the public portal for the purpose of private study or research.
- You may not further distribute the material or use it for any profit-making activity or commercial gain
- You may freely distribute the URL identifying the publication in the public portal

Read more about Creative commons licenses: <https://creativecommons.org/licenses/>

### **Take down policy**

If you believe that this document breaches copyright please contact us providing details, and we will remove access to the work immediately and investigate your claim.

LUND UNIVERSITY

PO Box 117  
221 00 Lund  
+46 46-222 00 00

Academic Dissertation

**Heredity in Parkinson's disease**  
**From rare mutations**  
**to common genetic risk factors**

by

**Andreas Puschmann**

Department of Geriatric Psychiatry,  
Clinical Sciences, Lund,  
Faculty of Medicine,  
Lund University, Sweden

With the approval of the Faculty of Medicine at Lund University this  
thesis will be defended on October 14, 2011 at 14:00 in Segerfalksalen,  
Wallenberg Neurocentrum, Lund, Sweden.

Faculty Opponent:  
**Dr. David J. Nicholl,**  
MD, MBChB, FRCP, PhD,  
University of Birmingham, U.K.



**LUND**  
UNIVERSITY

Organization LUND UNIVERSITY		Document name DOCTORAL DISSERTATION
Faculty of Medicine, Clinical Sciences, Lund, Department of Geriatric Psychiatry 221 84 Lund, Sweden		Date of issue October 14, 2011
Author(s) Andreas Puschmann		Sponsoring organization The Swedish Parkinson Academy
Title and subtitle Heredity in Parkinson's disease. From rare mutations to common genetic risk factors.		
Abstract <p>This study investigated genetic causes of Parkinson's disease (PD) and parkinsonism in southern Sweden. The extensive Lister Family with parkinsonism caused by duplications and triplications of the gene for alpha-synuclein (SNCA) was studied. Clinical, genetic and genealogical data were compiled and evaluated. Thirty-five family members with parkinsonism were identified. They share a characteristic clinical subtype of parkinsonism with marked dysfunction of the autonomic nervous system, behavioral changes and cognitive decline. The clinical phenotype, heredity and genetic background of 132 probands from Southern Sweden with PD or parkinsonism was examined. The SNCA, LRRK2, EIF4G1, VPS35, PINK1, ATXN2 and ATXN3 genes were analyzed in all probands; the PARKIN, PINK1 and DJ1 genes were tested in a subgroup of 23 patients with young onset or marked heredity. DNA from the brain tissue of 7 patients with parkinsonism was also analyzed. Common genetic risk factors in DNA samples collected within this study were analyzed in collaboration with other research groups.</p> <p>Gene screening identified two rare causative mutations, SNCA A53T and LRRK2 N1437H. An additional patient was compound heterozygous for PARKIN R275W and R275Q mutations. Detailed information on their clinical picture is presented. We present the first neuropathological description of a patient with PD and LRRK2 N1437H mutation, showing pronounced ubiquitin and moderate alpha-synuclein pathology. A heterozygous PINK1 G411S mutation was present in two PD patients but showed no clear co-segregation with the disease in their families. Screening of 1,107 patients and controls as well as meta-analysis of published reports from 7,800 individuals revealed that the PINK1 G411S mutation is a rare risk variant with a relatively large effect size (odds ratios 4.06-8.42). One multicenter study confirmed that common variants in the SNCA and MAPT genes modify PD risk, and was large enough to refute gene-gene interaction between the MAPT and SNCA variants.</p> <p>These results suggest that specific mutations in PD-genes cause characteristic disease subtypes. Despite extensive screening and a high proportion of familial cases, known pathogenic mutations could only explain a small proportion of parkinsonism in this cohort. This may indicate that mutations causing parkinsonism in the Scandinavian population remain to be discovered. Alternatively, familial clustering and sporadic occurrence of PD may be explained by combinations of rare variants with relatively large effect size, such as PINK1 G411S.</p>		
Key words: Parkinson's disease; parkinsonism; genetics; alpha-synuclein; SNCA duplication; SNCA triplication; LRRK2; PARKIN; VPS35; rare variants; digenic inheritance; heritability		
Classification system and/or index terms (if any):		
Supplementary bibliographical information:		Language English
ISSN and key title: 1652-8220		ISBN 978-91-86871-44-4
Recipient's notes	Number of pages 174	Price
	Security classification	

Distribution by (name and address) Andreas Puschmann, Dept. for Neurology, SUS, 221 85 Lund, Sweden  
I, the undersigned, being the copyright owner of the abstract of the above-mentioned dissertation, hereby grant to all reference sources permission to publish and disseminate the abstract of the above-mentioned dissertation.

Signature A. Puschmann

Date Sept 9, 2011

# Heredity in Parkinson's disease

From rare mutations  
to common genetic risk factors



**LUND**  
UNIVERSITY

Andreas Puschmann

2011

Copyright © Andreas Puschmann

Copyright Articles I and II © Parkinsonism & Related Disorders,  
World Federation of Neurology Research Committee on Parkinsonism and Related Disorders,  
reproduced with permission of Elsevier Ltd. in the format Journal via Copyright Clearance  
Center.

Copyright Article V © Annals of Neurology,  
American Neurological Association, reproduced with permission of John/Wiley & Sons in  
the format Journal via Copyright Clearance Center.

Faculty of Medicine, Clinical Sciences, Lund, Department of Geriatric Psychiatry  
Lund University, Faculty of Medicine Doctoral Dissertation Series 2011:95  
ISBN 978-91-86871-44-4  
ISSN 1652-8220  
Printed in Sweden by Media-Tryck, Lund University  
Lund, Sweden, 2011

# Table of contents

<b>Table of contents</b> .....	7
<i>List of publications</i> .....	9
<b>Abstract</b> .....	11
<b>Abbreviations and Nomenclature</b> .....	12
<b>Background</b> .....	15
<b>Genes in Parkinson's disease</b> .....	17
<i>Monogenic forms</i> .....	17
Dominant PD genes .....	19
Recessive PD genes .....	27
Non-Mendelian patterns in monogenic forms.....	31
Gaps in current knowledge .....	32
<i>Genetic risk factors in PD</i> .....	32
Heritability of PD.....	33
Methods to identify genetic risk factors.....	34
Established genetic risk factors for PD .....	34
<b>Parkinson's disease</b> .....	38
<i>Reconsidering disease definition</i> .....	38
<i>Clinical variability</i> .....	39
<i>Implications for treatment</i> .....	40
<b>Aims</b> .....	42
<b>Methods</b> .....	43
<i>Lister Family (SNCA multiplications)</i> .....	44
Genealogical research.....	44
Genetic analyses.....	45
<i>PARLU Study</i> .....	45
Patient recruitment.....	45

Analyses of PD-genes .....	47
<i>Analysis of DNA from neuropathology specimens</i> .....	49
<i>Participation in multicenter studies</i> .....	49
<b>Results .....</b>	<b>50</b>
<i>Lister Family (SNCA multiplications)</i> .....	50
Identification of additional Lister Family members .....	50
Genetic analysis of Lister Family members .....	55
<i>PARLU Study:</i> .....	57
Study population .....	57
Results of genetic screening.....	57
<i>Analysis of DNA from neuropathology specimens</i> .....	60
<i>Independence of SNCA and MAPT associations</i> .....	60
<b>Discussion .....</b>	<b>62</b>
<i>Lister Family and SNCA multiplication</i> .....	62
Approaching family members.....	64
The neurological disorder(s) in the Lister Family.....	65
Genetical Analyses .....	66
Comparison with other published <i>SNCA</i> multiplication families.....	67
The specific clinical and pathological syndrome of <i>SNCA</i> multiplication.....	69
<i>Other monogenic forms of parkinsonism</i> .....	69
<i>SNCA</i> A53T mutation .....	70
<i>PARKIN</i> R275Q and R275W mutations .....	70
<i>LRRK2</i> N1437H.....	71
Pathogenic mutations define distinct subtypes of parkinsonism.....	72
Low overall yield of comprehensive genetic screening.....	72
Population-specificity of pathogenic mutations .....	74
Comparison to previous PD studies from Sweden .....	75
Does monogenic inheritance explain all of familial PD? .....	76
<i>Tracing genetic risk factors for PD</i> .....	77
<i>PINK1</i> G411S mutation as a genetic risk factor? .....	77
How do the effects of genetic risk factors combine?.....	79
<b>Conclusions.....</b>	<b>82</b>
<b>Acknowledgements .....</b>	<b>85</b>
<b>References .....</b>	<b>88</b>

# List of publications

This thesis is based on studies presented in the following five publications, referred to in the text by their roman numerals.

## **I. Alpha-synuclein multiplications with parkinsonism, dementia or progressive myoclonus?**

Puschmann A, Wszolek ZK, Farrer M, Gustafson L, Widner H, Nilsson C.  
*Parkinsonism Relat Disord* 2009 Jun;15(5):390-392.

## **II. A Swedish family with de novo alpha-synuclein A53T mutation: Evidence for early cortical dysfunction.**

Puschmann A, Ross OA, Vilarino-Güell C, Lincoln SJ, Kachergus JM, Cobb SA, Lindquist SG, Nielsen JE, Wszolek ZK, Farrer M, Widner H, van Westen D, Hägerström D, Markopoulou K, Chase BA, Nilsson K, Reimer J, Nilsson C.  
*Parkinsonism Relat Disord* 2009 Nov;15(9):627-632.

## **III. First neuropathological description of a patient with Parkinson's disease and LRRK2 p.N1437H mutation.**

Puschmann A, Englund E, Ross OA, Vilarino-Güell C, Lincoln SJ, Kachergus JM, Cobb SA, Törnquist AL, Rehncrona S, Widner H, Wszolek ZK, Farrer MJ, Nilsson C.  
*[Submitted]*

## **IV. Screening of recessive Parkinson genes identifies a heterozygous PINK1 variant as risk factor.**

Puschmann A, Ross OA, Vilarino-Güell C, Nishioka K, Wilhoite GJ, Kachergus JM, Cobb SA, Widner H, Wszolek ZK, Farrer MJ, Nilsson C, Aasly JO.  
*[Submitted]*

## **V. Independent and joint effects of the MAPT and SNCA genes in Parkinson's disease.**

Elbaz A, Ross OA, Ioannidis JP, Soto-Ortolaza AI, Moisan F, Aasly J, Annesi G, Bozi M, Brighina L, Chartier-Harlin MC, Destée A, Ferrarese C, Ferraris A, Gibson JM, Gispert S, Hadjigeorgiou GM, Jasinska-Myga B, Klein C, Krüger R, Lambert JC, Lohmann K, van de Loo S, Llorca MA, Lynch T, Mellick GD, Mutez E, Nilsson C, Opala G, Puschmann A, Quattrone A, Sharma M, Silburn PA, Stefanis L, Uitti RJ, Valente EM, Vilarino-Güell C, Wirdefeldt K, Wszolek ZK, Xiromerisiou G, Maraganore DM, Farrer MJ; Genetic Epidemiology of Parkinson's disease (GEO-PD) Consortium.  
*Annals of Neurology* 2011 May;69(5):778-792.



## Publications not included in this dissertation

### Original Articles

#### ***LRKK2* variation and Parkinson's disease in African Americans.**

Ross OA, Wilhoite GJ, Bacon JA, Soto-Ortolaza A, Kachergus J, Cobb SA, [Puschmann A](#), Vilariño-Güell C, Farrer MJ, Graff-Radford N, Meschia JF, Wszolek ZK.  
*Mov Disord* 2010 Sep;25(12):1973-6.

#### **A family with parkinsonism, essential tremor, restless legs syndrome and depression.**

[Puschmann A](#), Pfeiffer RF, A. Stoessl J, Kuriakose R, Lash JL, Searcy JA, Strongosky AJ, Vilariño-Güell C, Farrer MJ, Ross OA, Dickson DW, and Wszolek ZK.  
*Neurology* 2011 May;76(19):1623-30.

#### **Human leukocyte antigen variation and Parkinson's disease.**

[Puschmann A](#), Verbeeck C, Heckman MG, Soto-Ortolaza AI, Lynch T, Jasinska-Myga B, Opala G, Krygowska-Wajs A, Barcikowska M, Uitti RJ, Wszolek ZK, Ross OA.  
*Parkinsonism Relat Disord* 2011 Jun;17(5):376-8.

#### **VPS35 mutations in Parkinson disease.**

Vilariño-Güell C, Wider, Ross OA, Dächsel JA, Lincoln SJ, Kachergus JM, Soto-Ortolaza AI, Cobb SA, Wilhoite GJ, Bacon JA, Behrouz B, Melrose HL, Hentati E, [Puschmann A](#), Conibear E, Wasserman WW, Aasly JO, Burkhard PR, Djaldetti R, Ghika J, Hentati F, Krygowska-Wajs A, Lynch T, Melamed E, Rajput A, Rajput AH, Solida A, Wu R-M, Uitti RJ, Wszolek ZK, Vingerhoets F, Farrer MJ.  
*Am J Hum Genet* 2011 Jul;89(1):162-7.

#### **An African American Family with Dystonia.**

[Puschmann A](#), LeDoux MS, Xiao J, Bastian RW, Searcy JA, Wszolek ZK.  
*Parkinsonism Relat Disord* 2011 Aug;17(7):547-50.

#### **Association of *LRKK2* exonic variants with susceptibility to Parkinson's disease: a case-control study.**

Ross OA, AI Soto-Ortolaza, MG Heckman, JO Aasly, N Abahuni, G Annesi, JA Bacon, S Bardien, M Bozi, A Brice, L Brighina, C Van Broeckhoven, J Carr, M-C Chartier-Harlin, E Dardiotis, DW Dickson, NN Diehl, A Elbaz, C Ferrarese, A Ferraris, B Fiske, JM Gibson, R Gibson, GM Hadjigeorgiou, N Hattori, JPA Ioannidis, B Jasinska-Myga, BS Jeon, YJ Kim, C Klein, R Krüger, E Kyratzi, S Lesage, C-H Lin, T Lynch, DM Maraganore, GD Mellick, E Mutez, C Nilsson, G Opala, SS Park, [A Puschmann](#), A Quattrone, M Sharma, PA Silburn, YH Sohn, L Stefanis, V Tadic, J Theuns, H Tomiyama, RJ Uitti, EM Valente, S van de Loo, DK Vassilatis, C Vilariño-Güell, LR White, K Wirdefelt, ZK Wszolek, R-M Wu, MJ Farrer, on behalf of the Genetic Epidemiology Of Parkinson's Disease (GEO-PD) consortium.  
*Lancet Neurol* 2011 Aug 30 [Epub ahead of print; doi10.1016/S1474-4422(11)70175-2]

### Letter, Review

#### **Unverricht-Lundborg's disease - a misnomer?**

[Puschmann A](#).  
*Mov Disord* 2009 Mar;24(4):629-630.

#### **Diagnosis and Treatment of Common Forms of Tremor.**

[Puschmann A](#), Wszolek ZK.  
*Seminars in Neurology* 2011 Feb;31:65-77.

# Abstract

This study investigated genetic causes of Parkinson's disease (PD) and parkinsonism in southern Sweden.

The extensive Lister Family with parkinsonism caused by duplications and triplications of the gene for alpha-synuclein (*SNCA*) [1] was studied. Clinical, genetic and genealogical data were compiled and evaluated. Thirty-five family members with parkinsonism were identified. They share a characteristic clinical subtype of parkinsonism with marked dysfunction of the autonomic nervous system, behavioral changes and cognitive decline. The clinical phenotype, heredity and genetic background of 132 probands from Southern Sweden with PD or parkinsonism was examined. The *SNCA*, *LRRK2*, *EIF4G1*, *VPS35*, *PINK1*, *ATXN2* and *ATXN3* genes were analyzed in all probands; the *PARKIN*, *PINK1* and *DJI* genes were tested in a subgroup of 23 patients with young onset or marked heredity. DNA from the brain tissue of 7 patients with parkinsonism was also analyzed. Common genetic risk factors in DNA samples collected within this study were analyzed in collaboration with other research groups.

Gene screening identified two rare causative mutations, *SNCA* A53T and *LRRK2* N1437H. An additional patient was compound heterozygous for *PARKIN* R275W and R275Q mutations. Detailed information on their clinical picture is presented. We present the first neuropathological description of a patient with PD and *LRRK2* N1437H mutation, showing pronounced ubiquitin and moderate alpha-synuclein pathology. A heterozygous *PINK1* G411S mutation was present in two PD patients but showed no clear co-segregation with the disease in their families. Screening of 1,107 patients and controls as well as meta-analysis of published reports from 7,800 individuals revealed that the *PINK1* G411S mutation is a rare risk variant with a relatively large effect size (odds ratios 4.06-8.42). One multicenter study confirmed that common variants in the *SNCA* and *MAPT* genes modify PD risk, and was large enough to refute gene-gene interaction between the *MAPT* and *SNCA* variants.

These results suggest that specific mutations in PD-genes cause characteristic disease subtypes. Despite extensive screening and a high proportion of familial cases, known pathogenic mutations could only explain a small proportion of parkinsonism in this cohort. This may indicate that mutations causing parkinsonism in the Scandinavian population remain to be discovered. Alternatively, familial clustering and sporadic occurrence of PD may be explained by combinations of rare variants with relatively large effect size, such as *PINK1* G411S.

# Abbreviations and Nomenclature

A	adenine
ADA	allelic discrimination assay
ATXN2	ataxin-2
ATXN3	ataxin-3
C	cytosine
CI	confidence interval
CSF	cerebrospinal fluid
CSTB	cystatin B
DJ1	parkinson protein 7, oncogene DJ1
DAT	dopamine transporter
DNA	deoxyribonucleic acid
DLB	dementia with Lewy bodies
DLBD	diffuse Lewy body disease
DRD	dopa-responsive dystonia (dystonia-parkinsonism)
EEG	electroencephalogram
EIF4G1	eukaryotic translation initiation factor 4-gamma 1
EOPD	early-onset Parkinson's disease
EPDF	early-onset parkinsonism with diurnal fluctuation
EPM1	epilepsy, progressive myoclonic 1
FMR1	fragile X mental retardation
FUS	fused in sarcoma
G	guanine
GEO-PD	Genetic Epidemiology of Parkinson's Disease Consortium
GRN	granulin precursor, progranulin
GWAS	genome-wide association study / studies
HLA	human leukocyte antigen
iPLEX	Sequenom MassArray iPLEX™ platform
ICD	International Statistical Classification of Diseases and Related Health Problems
LRRK2	leucine-rich repeat kinase 2
MAF	minor allele frequency
MAPT	microtubule-associated protein tau
MLPA	multiplex ligation-dependent probe amplification
MRI	magnetic resonance imaging
MSA	multiple system atrophy
NBIA	neurodegeneration with brain iron accumulation
NINDS	National Institute of Neurological Disorders and Stroke

OR	odds ratio
PARKIN	parkinson protein 2, E3 ubiquitin protein ligase
PARLU	PARkinson LUNd study
PCR	polymerase chain reaction
PD	Parkinson's disease
PDD	Parkinson's disease dementia
PET	positron emission tomography
PINK1	phosphatase and tensin homolog-induced putative kinase1
PLA2G6	phospholipase A2, group VI (cytosolic, calcium-independent)
PSEN2	presenilin-2
ref.	reference
SD	standard deviation
SNCA	alpha-synuclein
SNP	single nucleotide polymorphism
SPECT	single-photon emission computed tomography
SWEDD	subjects without evidence for dopaminergic deficits
T	thymine
TDP43	TAR DNA-binding protein 43
UKPDBB	UK Parkinson's Disease Society brain bank
VPS35	vacuolar protein sorting 35

## Nomenclature

Gene names are written in capital letters and italics (e.g. *LRRK2*, *SNCA*), while the names of their protein products are written without italics (e.g. LRRK2) or with more commonly used names for the encoded proteins (e.g. alpha-synuclein). I largely follow the nomenclature of the HUGO Gene Nomenclature Committee (<http://www.genenames.org/>). The usage of the *PARK* locus designations is not uniform in the literature or databases; while e.g. the *PARK1*, *PARK4*, and *PARK8* locus designations were discarded as soon as the respective genes were discovered, *PARK2* and *PARK7* remain official names, now denoting the genes instead of the loci.

The expressions "mutation" and "variant" or "genetic variant" all describe sequence variations. The classical definition, applicable to Mendelian-type genetics, was that "mutation" denotes sequence variations that are rarer than 1% (minor allele frequency, MAF), and "variant" those with >1% MAF. This also implied that only "mutations" are associated with disease. Expanding knowledge about the risk-modifying role of sequence variations with >1% MAF make this distinction more difficult to justify, and in much of the literature the terms are used interchangeably.

In this text, I use "mutation" or "variant" for sequence alterations in general, regardless of frequency (which differ in various populations) or disease association. "Polymorphism" indicates a sequence variation without known association to disease, but I try to clarify this in the context. "Pathogenic" or "causative" denote mutations (variants) with a large effect on disease risk, frequently causing disease, even though the effect usually is not 100%.

The nomenclature of sequence variations follows the recommendations of the Human Genome Variation Society (<http://www.hgvs.org/mutnomen> and ref. [2]), with the one exception: I generally use the abbreviated designation on protein level, for example SNCA A53T. This has become the standard designation in the clinico-genetical context, even though it is somewhat unsatisfactory as most experimental data stem from the DNA level and not the protein level. For most mutations I add the non-abbreviated protein nomenclature (in this case p.Ala53Thr) and the nucleotide designation (c.209G>A) after their first appearance in the text.

# Background

A genetic background to the pathogenesis of Parkinson's disease (PD) has been postulated for a long time. Initial investigations focused on families where the disease affected several individuals. In Sweden, familial aggregation of PD has been studied in detail by Herman Lundborg in 1913 and by Henry Mjöhnes in 1949. Similar reports came from other parts of the world. Unfortunately, as they often included exceptional families, their potential to help us understand PD as a whole was overlooked. PD was generally considered a disease where genetics plays no major role.

During the 1980s and 1990s, conventional genetic linkage analyses in families with hereditary PD identified a long list of gene loci. In 1997, the first gene for PD, *SNCA*, was identified in a large family originating from southern Italy. Only one year later, the gene product, the alpha-synuclein protein, was found to be an important constituent of Lewy bodies, the characteristic neuropathological lesions seen in PD, and other, previously unknown types of alpha-synuclein aggregates could be visualized in brains from patients with PD and other neurological disorders. At the time of writing, four genes with autosomal dominant and three with recessive mode of inheritance are known.

Researchers also investigated the role of genetic susceptibility to non-familial PD. Increasing amounts of data on genetic risk in PD in various populations have become available over the last years, made possible by three key changes in the research environment: Modern technologies, allowing relatively rapid and more inexpensive analysis of large numbers of genetic variants in extensive sample numbers, the necessary computing power and biostatistics facilities to process an enormous amount of data generated, and the formation of intercontinental research consortia who jointly have access to DNA samples from thousands of PD patients and control subjects from their respective populations.

This has enabled researchers to identify a number of genetic risk factors for sporadic (non-familial) PD, which, in a complex interplay with each other and probably with environmental factors, contribute to the risk for PD in an individual. Furthermore the combination of several genetic risk factors in a person has been shown to increase PD risk more than single risk factors [3]. It remains very difficult to estimate which percentage of PD occurrence in a population is explained by genetics (heritability), as opposed to environmental factors or the possibility of pure chance. Different approaches to this question lead to widely divergent answers. This means we do not know how many genetic risk factors and PD genes still remain

to be discovered. However, most researchers agree that there still is a considerable proportion of the genetic component of PD that remains unknown today.

My interest in PD genetics began when a patient in Lund, who had severe parkinsonism and several close relatives with the same disease, was shown to carry a duplication of the gene for alpha-synuclein (*SNCA*), and when it became clear that the patient's family was related to an American branch with a triplication of the same gene section [1]. Subsequently, we could prove that both families were part of the Lister Family, previously described in detail in 1901-1913 and in 1949. While the initial aim of this thesis was to study the genetic background and clinical course of affected individuals in this family, it has also been our purpose to identify other families with familial PD and possibly define the underlying mutations. This thesis is therefore also based on my clinical and genetic investigations of 132 persons with PD from the catchment area of Skåne University Hospital between 2006 and 2011, and genetic examinations of brain tissue from the collection of the Dept. for Neuropathology in Lund. The project has been carried out in close collaboration with Mayo Clinic, Jacksonville, USA.

The following chapters start with an overview of what is known about the genetics, and genes, of PD today. Next, I discuss in how far this knowledge changes the way we look at the diagnostic entity of "Parkinson's disease". I include a description of those parts of the study that so far have remained unpublished, such as the current state of our studies of the Lister Family, and of patient recruitment. To avoid redundancy, I do not repeat the details of the five articles on which this thesis is based, but only summarize the relevant points. Finally, I try to put some aspects of my work in the wider context of the developments and major accomplishments that have been made by many other active research groups in this field during recent years.

# Genes in Parkinson's disease

This chapter outlines what is known about the role of genes in PD at the time of writing. Pathogenic mutations in genes with dominant or recessive patterns cause very rare forms of PD that follow Mendelian inheritance. Such mutations exert a large effect on disease risk, and the presence of one mutation on one or both alleles is sufficient to explain disease. The clinical picture of PD caused by some of these mutations is clearly distinguishable from idiopathic PD, while the presently available clinical data on the effects of some of the other known mutations is still very limited.

Subsequently, the emerging evidence for an important role of genetic risk factors in sporadic, i.e. non-familial, PD is reviewed. Genetic risk factors may occur commonly in the population and may each convey a relatively small effect, modifying disease risk in a complex interplay with a considerable number of similar genetic risk factors as well as with the environment. The sum of an individual's genetic risk factors, together with environmental factors, is thought to explain the manifestation of sporadic PD. In another scenario, genetic risk variants may be quite rare but have a stronger effect on PD risk, yet not strong enough to cause disease by themselves. Although each and every one of these variants may be rare, a large number of different rare variants may exist in a population. Evidence is increasing that rare variants may better explain the heritability of PD than common variants, but the question has not been resolved, and both types of variants may turn out to be significant to explain the genetic basis of PD in a population. In any case, the interplay between different types of mutations or variants is expected to be complex.

## Monogenic forms

Heredity of PD is most obvious in families with several affected members. Simplistically speaking, if these are spread over several generations, dominant inheritance is suggested, whereas a constellation with several affected siblings but two healthy parents may indicate recessive inheritance.



Gene name	Year of original publication	Number of pathogenic mutations	Commonly associated phenotype, pathology, comments
<b>Autosomal dominant</b>			
<i>SNCA</i>	1997	3, plus gene duplications, triplications	Parkinsonism, cognitive, behavioral and autonomic symptoms, myoclonus, rare patients with severe phenotype from childhood. Alpha-synuclein pathology, DLBD. Point mutations are very rare, multiplications slightly more common.
<i>LRRK2</i>	2004	7	Parkinsonism, variable additional symptoms. Variable pathology. Mutations relatively common in certain populations; rare in most others.
<i>(EIF4G1)</i>	<i>(2009)</i>	<i>(1)</i>	<i>(Only one congress abstract)</i>
<i>VPS35</i>	2011	1	Parkinsonism, possibly cognitive and behavioral changes. Pathology uncertain, probably not DLBD. Probably rare. Newly described.
<b>Autosomal recessive</b>			
<i>PARKIN</i> <i>(PARK2)</i>	1998	>100*	Young-onset parkinsonism. Low risk for cognitive symptoms. Cell loss in brain stem, no cortical pathology. Not infrequent among patients with very young onset.
<i>PINK1</i>	2004	>40*	Young-onset parkinsonism, Low risk for cognitive symptoms. Cell loss in brain stem, no cortical pathology. Rare.
<i>DJ1</i> <i>(PARK7)</i>	2003	>10*	Young-onset parkinsonism, Low risk for cognitive symptoms. Pathology not described. Very rare.

### Established dominant and recessive PD genes [4,5]

This table includes genes with proven pathogenicity for at least some of the mutations. I excluded those genes that have a *PARK* designation but that cause clinical syndromes very different from PD. All presently known monogenic forms associated with PD are autosomal; the only possible exception to this observation, the *FMRI* gene, is discussed in the text. See also text for details, full gene names, and references. DLBD, diffuse Lewy body disease. \*The number of truly pathogenic mutations in the recessive PD-genes remains very uncertain. For these genes, the table mentions the number of mutations described. See text for details. A number of additional genes have been described to be associated with PD, but their significance is uncertain, or they are not associated with a clinical picture of PD. These are not included in the table but most are mentioned in the text.

## Dominant PD genes

Large families where PD occurred in many members spread over several generations have attracted the attention of medical professionals and researchers for a long time. The possibility of (dominant) inheritance is obvious in such families, and it is not surprising that the first gene mutations discovered in PD were dominant and found after careful clinical and genetic analyses of large kindreds. In dominant inheritance fully compatible to Mendel's laws, *one mutation* (on one allele, i.e. one gene copy inherited either from the father or from the mother, *heterozygous*) is sufficient to cause disease.

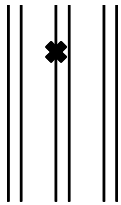

### Dominant inheritance

The effect of a mutation (black cross) on one allele is sufficient to cause disease.

Three pairs of alleles are shown (vertical lines), representative of the 23 pairs of chromosomes that bear pairs of alleles of all genes.

In PD genetics, several factors may modify this basic principle: As PD is a disease with usually late age at onset, some carriers may have died before disease manifestation. Few, if any, dominant PD-gene mutations cause disease in all carriers, which is reflected in the concept of "incomplete penetrance". This may be explained by the fact that carriers may die before disease manifestation, or that the mutation's effect is not strong enough to cause clinical signs of the disease in all carriers. In earlier generations, signs of PD may have been considered a part of normal aging, and today's patients may not recall symptoms in long deceased relatives. Furthermore, some mutations may cause different manifestations of neurodegenerative disease in different members of a family, obscuring the pattern of inheritance.

Today, four dominant PD genes are known. The first two, *SNCA* and *LRRK2*, have been studied in detail, whereas *EIF4G1* has so far only been presented in abstract form [6], and *VPS35* was published just weeks prior to the writing of this thesis [7].

### *SNCA*

The gene encoding alpha-synuclein (*SNCA*) was the first for which an association with PD was found [8]. Today, three pathogenic *SNCA* point mutations are known, and also genomic duplications and triplications of chromosomal segments including *SNCA* are disease-causing.

The first point mutation, A53T (p.Ala53Thr, c.209G >A) was discovered in members of a large Italian-American kindred with autosomal dominant parkinsonism originating from the town of Contursi (southern Italy) and in three families from Greece in 1997 [8]. The Contursi kindred had previously been studied extensively by Golbe et al. [9,10]. Markopoulou et al. had reported a very similar clinical phenotype from the Greek-American Family H [11], which was soon found to harbor the same mutation [12] and which was examined in several successive studies [12-15]. Since its original description, the A53T mutation was identified in a number of families of southern Italian and Greek origin, who all shared a regional common founder haplotype (see Article II). The exact number of families and patients from Greece is somewhat difficult to reconstruct from the available publications; it cannot be excluded that members from the same families may have been investigated by different groups and reported more than once in the initial reports after *SNCA* discovery. A Korean family with a different haplotype [16] was reported, as well as one sporadic case of Polish origin who was unavailable for further investigations [17]. Article II of this thesis describes a Swedish family with *SNCA* A53T mutation, discovered within this study's data collection, and also provides a more comprehensive overview of the previously published families.

The association between familial PD and *SNCA* was further strengthened by the subsequent discoveries of two additional point mutations, A30P (p.Ala30Pro, c.88G>C), in 1998 [18], and E46K (p.Glu46Lys, c.188G>A), in 2004 [19], as well as triplications (in 2003) [20] and duplications (in 2004) [21,22] of the *SNCA* genomic locus in families with parkinsonism.

The A30P mutation was only found in one small German family with three affected members, and with two additional mutation carriers who only had subtle neurological symptoms [18,23, 24]. Despite extensive efforts in many genetic screening studies, the A30P mutation was not reported from any other family worldwide during the last 13 years. Not all workers in the field considered the pathogenicity of A30P to be demonstrated formally beyond doubt [25].

The E46K mutation was found in one large kindred with 5 affected individuals spanning two generations. The family originates from the Basque region in Northern Spain. The phenotype was characterized by memory dysfunction and parkinsonism as the initial symptoms, and subsequent development of profound dementia. The severity of the clinical symptoms and the response to levodopa were variable [19], and studies of mutation carriers without PD symptoms revealed sleep abnormalities [26] and cardiac sympathetic denervation [27]. This mutation has not been found anywhere else in the world either.

In contrast to the rare occurrence of A53T, A30P and E46K point mutations, duplications and triplications in *SNCA* have meanwhile been reported from 28 families worldwide [1,21,22,28-49]. The Lister Family studied as part of this thesis (Article I and Methods and Results) is by far the largest known family with *SNCA* multiplications, and the only one where both *SNCA* gene duplications and triplications occur [1].

The clinical phenotype of PD patients with *SNCA* mutations (including multiplications) has certain characteristics. Besides the cardinal signs of parkinsonism, many carriers develop severe autonomic dysfunction, speech problems, behavioral changes, and cognitive decline. In early stages, levodopa usually improves those PD symptoms that commonly respond to its administration, but later in the disease course side effects limit its use. Advanced disease is often characterized by marked rigidity that cannot be satisfactorily alleviated with levodopa, by dementia to the point of mutism, and by cortical myoclonus. The association of the *SNCA* gene with PD invited neuropathologists to search for its gene product, alpha-synuclein, in the brains of PD patients. This quickly revealed that the alpha-synuclein protein is a principal component of Lewy bodies, the characteristic pathological changes in brains from patients with *SNCA* mutations [50] as well as in sporadic PD [51]. It is difficult to overestimate the significance of this discovery of alpha-synuclein's central role in the pathology of PD. It has led to the widespread use of alpha-synuclein immunohistochemistry in neuropathology. This created new opportunities to stage the disease neuropathologically, based on the distribution in different parts of the brain of deposits staining positively for alpha-synuclein [52], and thus confirmed one of the previous classification schemes based on standard histochemical methods only [53]. Other diseases also showed deposition of alpha-synuclein with neuropathological examination. PD, dementia with Lewy bodies (DLB), PD dementia (PDD) and multiple system atrophy (MSA) are now grouped together as "synucleinopathies" [54-57]. About a quarter of essential tremor patients have brainstem alpha-synuclein pathology [58]. Alpha-synuclein pathology is also found in adult onset dystonia-parkinsonism patients with *PLA2G6* mutations (see below) [59]. On the other hand, not all patients with a clinical picture of PD have alpha-synuclein deposits [60,61]. Alpha-synuclein as a biomarker for PD and other disorders is currently undergoing development and studies (Drs. Sara Hall and Oskar Hansson, Lund, personal communication). Thus, a gene discovery, based on clinical studies of large families with PD, has led to a refinement of disease classification and a profound change in diagnosing, grouping together or un-grouping several neurological disorders, including PD.

The pathology of patients with *SNCA* mutations is rather homogenous and highly characteristic, with widespread alpha-synuclein deposits not only in the brainstem but in the entire cerebrum, mostly located in neurons but also in glial cells. The physiological role of alpha-synuclein remains to be elucidated in detail, but it is located in synaptic terminals and plays a role in vesicle release [62-64]. It remains to be determined if the accumulation and precipitation of large alpha-synuclein polymers, for example in Lewy bodies, is responsible for cell malfunction and death, or if small oligomers have a toxic effect. One recurring hypothesis explaining the presence of Lewy bodies in many neurons at post mortem examination of patients with synucleinopathies is that those neurons survive that are capable of sequestering the toxic oligomers into larger-order structures. Additional lines of evidence suggest that the small alpha-synuclein oligomers are neurotoxic [65].

## *LRRK2*

In 2004, two groups simultaneously reported the discovery of mutations in the *leucine-rich repeat kinase 2 (LRRK2)* gene in PD [66,67]. The original families include Family A, from Northern Germany, Denmark and Canada [68], where a Y1699C (p.Tyr1699Cys, c.5096A>G) mutation was found [66], Family D from Western Nebraska [69] with R1441C (p.Arg1441Cys, c.4321C>T)[66], 4 families from the Basque region of Spain with R1441G (p.Arg1441Gly, originally reported as R1396G, c.4321C>G)[67] and 1 family from the United Kingdom also with Y1699C (originally reported as Y1654C)[67]. Other mutations include I2020T (p.Ile2020Thr, c.6059T>C)[66] that is also responsible for familial PD in a large kindred from Sagami-hara in Japan, which had been described in detail [70,71], R1441H (p.Arg1441His, c.4322G>A) which was only found in three families worldwide, and N1437H that was discovered in two Norwegian families analyzed with exome sequencing [72] - and in one individual examined within this study (Article III). With the exception of R1441G, all of the mutations mentioned above are very rare. The R1441G mutation was found in more than 8% of patients with familial PD from the Basque population [73], where a common founder haplotype was identified [73,74]. It is very rare, or entirely absent, in other populations.

By contrast, the LRRK2 G2019S mutation (p.Gly2019Ser, c.6055G>A)[75] is the most common PD-associated mutation known today. In two widely cited studies, it was reported in 41% of sporadic and 37% of familial PD patients (versus in 3% of healthy controls) from the North African Arab population [76], and in 18.3% of Ashkenazi Jewish patients with Parkinson's disease (versus 1.3% of controls) [77]. It soon became clear that a common founder haplotype explains the accumulation in these populations [78], and that G2019S is quite rare in other populations. About 0-2% of PD patients in other countries carry this mutation [79]; in Europe there is a clear South-to-North gradient. It is rare in Scandinavia in general, but a cluster of several families was found along the coast of Central Norway [80]. Meticulous genealogical research traced back most of these to one common ancestor, and their haplotype was identical to the common Mediterranean one, indicating contact several hundred years ago [78,81,82]. In a recently published international multicenter study, only 49 of 8,371 (0.58%) PD patients of European and Asian origin, as opposed to 72 of 240 (30.25%) Arab Berber PD patients analyzed in the same study, carried a LRRK2 G2019S mutation [5].

Nevertheless, the large number of PD patients with the LRRK2 G2019S mutation for the first time allowed for a clear description of the clinical phenotype attributed to a single mutation in a PD gene, and for statistical analyses [83]. Based on data from 1,045 patients with this mutation, the risk of PD was calculated to be 28% at age 59 years, 51% at 69 years, and 74% at 79 years. Thus, penetrance (the fraction of mutation carriers who develop PD) was age-dependent and incomplete [83]. Motor symptoms and non-motor symptoms of *LRRK2*-associated PD were more benign than those of a control group of patients, for example the risk for dementia was lower [83]. This needs to be interpreted in light of the fact that that study's control group consisted of PD patients collected in a brain bank, which may not reflect the

average idiopathic PD population. Incomplete penetrance has been clearly demonstrated by Carmine-Belin et al., who reported a healthy 95 year old G2019S mutation carrier from Sweden [84].

Clinical data regarding the other, rarer *LRRK2* mutations is available from descriptions of a limited number of cases and families per mutation. It appears probable that the mutations' biological effects are slightly different, as the clinical phenotype can be more or less severe and mean age at onset varies between the mutations, albeit with a wide overlap. No symptoms clearly indicating atypical PD were observed, even though some patients had a rather distinct type of PD (cf. Article III). All in all, seven mutations in *LRRK2* are now considered definitively pathogenic [5].

<b>LRRK2 mutation</b>	<b>First description</b>	<b>Comments</b>
N1437H	2010 [72]	Very rare*, only reported from Norway and Sweden (Article III)
R1441C	2004 [66]	Rare, found in 10 of 8,611 PD patients [5]
R1441G	2004 [67]	Common among Basques (founder effect), very rare in other populations*
R1441H	2005 [86,87]	Very rare
Y1699C	2004 [66,67]	Very rare*
G2019S	2005 [75]	Most common PD-associated mutation, frequent in some Mediterranean populations, but rare in other populations (0.58% in ref.[5])
I2020T	2004 [66]	Very rare*

#### **Pathogenic mutations in *LRRK2***

Summary of the *LRRK2* mutations that are considered definitively pathogenic, according to ref.[5].

\*N1437H, R1441G, Y1699C and I2020T were not found in a multicenter study with 8,611 PD patients [5] and must thus be considered very rare.

The neuropathology of patients with *LRRK2* mutation is variable. Wider et al. reviewed the neuropathological findings of 38 patients with *LRRK2* mutation. The majority showed alpha-synuclein positive pathology, but several other types of pathology also occurred [60]. One possible explanation for this variability is that the LRRK2 protein functions as a kinase, influencing more than one cellular pathways [85]. LRRK2 also regulates neuritic outgrowth and morphology and influences cellular homeostasis [85]. In article III, we present a newly identified patient with LRRK2 N1437H mutation from Sweden, including the first neuropathological examination of a patient with this mutation.

## *EIF4G1*

This gene, encoding eukaryotic translation initiation factor 4-gamma 1, was published during an oral presentation and in abstract form in December 2009 [6]. The p.R1205H mutation co-segregated with parkinsonism in families from France, Ireland, Italy and the US. Further analysis showed that these carry the mutation on the same haplotype, indicating the mutation originated from one common founder. No details have yet been published by August 2011, and clinical data on the affected individuals are not publicly available. In any case, the mutation seems to be rare, as it has not been reported since.

## *VPS35*

In July 2011, this gene, *vacuolar protein sorting 35*, was added to the list of dominant PD genes [7]. Initial analyses were performed by exome sequencing technology in one Swiss family with 11 affected members [88], which revealed a D620N (p.Asp620Asn, c.1858G>A) mutation. Confirmatory analyses identified this mutation in one family each from the United States and Tunisia, and in one family and one sporadic patient from Israel (of Yemenite Jewish origin). The patients from this study's collection were included in the initial analyses [7]. Analyses of the entire gene sequence revealed one family from the United States with a P316S (p.Pro316Ser, c.946C>T) mutation, but the genetic evidence for the pathogenicity of this mutation remained inconclusive. Detailed clinical data on the original Swiss D620N kindred are available [88]. The overall picture seems to be that of tremor-dominant parkinsonism with a mean age at onset of 51 years. Psychosis, dementia and learning disabilities have been described in the clinical article on the original Swiss family, but clinical details are not included in the second article [7]. An incomplete neuropathological examination of only parts of the cortex and basal ganglia (but not the brainstem) did not reveal any alpha-synuclein immunoreactivity in these areas. The D620N mutation was embedded in 4 different haplotypes in 5 families analyzed, arguing against a founder effect and rather suggesting that this location is prone to mutation (mutational hot spot). Penetrance was incomplete with the oldest reported unaffected carrier at 86 years [7]. Simultaneously, a shorter report on three Austrian families with the D620N mutation was published, confirming the pathogenicity of this mutation, and indicating it may not be too rare [89]. The 14 affected members had late-onset PD and one had depression and tremor, and a pathological DATscan indicating incipient PD [89].

## *Other dominant genes of uncertain significance*

Additional mutations have been reported from PD families, but findings could not be replicated. The significance of these genes for PD appears uncertain at present. One possible explanation is that the co-segregation of mutations and disease in the initial families may have occurred by pure chance, as in some cases the same mutations have subsequently been found in healthy individuals as well. Alternatively, they may represent extremely rare events, only

detectable in single families ("private mutations"), or the negative results from replication attempts on moderate numbers of patients may have discouraged other groups to search for mutations in these genes. Rarity by itself does not contradict possible pathogenicity; as I discuss below, rare variants may very well play an important role in overall PD occurrence in a population. Several of these genes have "PARK" designations.

Mutations in *ubiquitin carboxyl-terminal esterase L1 (ubiquitin thiolesterase, UCHL1, PARK5)* was found in one German PD family in 1998 [90]. Several attempts to replicate the finding remained unsuccessful and provided no evidence *UCHL1* would increase PD susceptibility [91,92].

Mutations in *GRB10-interacting GYF protein 2 (GIGYF2, PARK11)* were found in PD families in 2008 [93], but subsequent studies found mutations in controls or not cosegregating with the PD phenotype in families [94-100].

Mutations in *HtrA serine peptidase 2 (HTRA2, Omi/HtrA2, PARK13)* were found in another German family [101], but mutations were subsequently also identified in healthy control subjects [102,103]. An extensive multicenter study within the GEO-PD consortium did not find any more cases among 6,378 PD patients, and also demonstrated that variants in this gene do not alter the risk for (sporadic) PD [104].

Trinucleotide expansions in *ATXN2 (ataxin-2)* or *ATXN3 (ataxin-3)* usually cause spinocerebellar ataxia, type 2 or 3 (Machado-Josephs disease), respectively. There are reports of families with expansions in both of these genes who had a pure parkinsonian phenotype, without other neurological signs, at least during the years following the initial disease manifestation [105-109]. A parkinsonian phenotype was also described when the number of trinucleotides in *ATXN2* was borderline, but when the normal CAG trinucleotide repeat sequence was interrupted by CAA segments [109-111].

Two genes in a common locus on chromosome 17 are associated with frontotemporal dementia with parkinsonism: Mutations in *microtubule-associated protein tau (MAPT)* cause frontotemporal dementia with or without parkinsonism and with tau pathology [112,113]. Mutations in *granulin precursor (GRN; progranulin, PGRN)* cause frontotemporal lobar degeneration with tau-negative, ubiquitin- and TAR DNA-binding protein 43 (TDP43)-positive inclusions (FTLD-U) [114]. Some of the individuals with pathogenic *MAPT* mutations present with parkinsonism; signs of frontotemporal dementia may occur years later [115]. Among the large number of known mutations in *MAPT*, it is predominantly, but not exclusively the N279K mutation and intronic mutations that cause a parkinsonistic phenotype. This frequently has features of an atypical parkinsonian syndrome, with the cardinal signs of PD (with or without tremor at rest), but often an unsatisfactory levodopa response, corticospinal tract signs, vertical gaze palsy and disturbance of saccades, or unilateral dystonia and contractures (reviewed in ref. [116]). The clinical, genetic and pathological commonalities suggest an overlap with corticobasal degeneration and progressive supranuclear



palsy, which are often labeled "tauopathies". Parkinsonism occurs frequently in patients with *GRN* mutations, but usually late in the disease course and only after the manifestation of frontotemporal dementia [117]. Rarely, parkinsonism has been the presenting or predominant clinical manifestation of *GRN* mutation [118]. In summary, mutations in *MAPT* or *GRN* are not considered a major cause of familial parkinsonism, especially in the absence of other clinical signs and symptoms [119,120].

Depending on their length, trinucleotide repeat expansions in an unstable region of the *FMRI* gene (*fragile X mental retardation protein, FMRP; FRAXA*) on the x-chromosome may cause different phenotypes [121]. The inheritance pattern is complex; inheritance from the mother usually leads to further increase in expansion length, whereas expansions may become shorter when inherited from the father. Mosaicism may occur and penetrance is generally reduced. The normal range for the number of CGG repeats is 6 to 45. More than 200 repeats (full mutations) in boys, who do not carry another x-chromosome, may lead to the neurodevelopmental fragile X syndrome with facial dysmorphism, heart valve abnormalities, joint laxity, hypothalamic dysfunctions, developmental delay, anxiety, aggressive outbursts, and seizures. Rarely, girls may develop a milder form of the syndrome. Premutations (55-200 CGG repeats) are relatively common and can be found in an estimated 1:800 males and 1:250 females; frequencies are higher in the Mediterranean. Women with premutations in the range above 70 repeats may develop premature ovarian failure and early menopause. Attention-deficit and hyperactivity disorder and autism are associated with both premutations and full mutations. Men with premutations may develop the fragile X tremor/ataxia syndrome (FXTAS), typically characterized by adult-onset tremor, ataxia, neuropathy, autonomic dysfunction, cognitive decline, behavioral changes with apathy, disinhibition or irritability, and depression [121]. Parkinsonism may form part of FXTAS, and the syndrome may occasionally manifest itself with a clinical picture that is indistinguishable from PD [122]. In fact, 24% of patients with FXTAS were initially diagnosed with PD [123], and the parkinsonism may respond to levodopa [124], but close examination frequently reveals signs of atypical parkinsonism such as in MSA [125]. Two studies found that FXTAS grey-zone alleles (45-55 repeats) or premutations may be seen as genetic risk factors for PD [126,127], but one study included patients with atypical features or non-PD parkinsonism, such as MSA [126], which may have influenced outcome. Other studies found no association with PD [128-132] but may have lacked the power to find or exclude a possible association of these rare variants with PD. At present, the significance of *FMRI* mutations in PD remains uncertain.

Similarly, dopa-responsive dystonia (DRD; dystonia-parkinsonism; *DYT5*) may present with parkinsonism only [133]. DRD can be caused by mutations in several genes involved in dopamine synthesis: *GCHI* (*guanosine triphosphate cyclohydrolase 1*), *TH* (*tyrosin hydroxylase*), *SLC6A3* (*solute carrier family 6 member 3; dopamine transporter*), *SPR* (*sepiapterin reductase*) or others [134]. Classically described as a disease starting in childhood, the disease may also manifest in adulthood, with an adult-onset PD-like phenotype, especially when caused by *GCHI* mutations [135,136]. The phenotype may resemble PD but there are frequently signs of dystonia as well, such as dystonic tremor [136]. *GCHI* mutations are not a common cause

of PD and are not risk factors for PD [137-141]. Mutations in the other genes probably do not cause adult-onset parkinsonism. Two patients have been reported who had adult onset PD and *TH* mutations, but the association remains uncertain, although a pathophysiological connection appears reasonable [140,142]. The *PARK3* locus was initially linked to a genomic region that included the entire *SPR* gene [143], but a large study within the GEO-PD consortium did not show any association of *SPR* with PD [144].

## Recessive PD genes

Several affected members in one generation, especially siblings, but with healthy parents, may indicate recessive inheritance. In this model, *two identical mutations* (one on each of the alleles, inherited from both parents; *homozygous*) are required to cause disease. According to classical Mendelian genetics, the presence of one such mutation does not cause disease, but this classical view has been contested in the context of several recessive PD mutations, as will be discussed below.

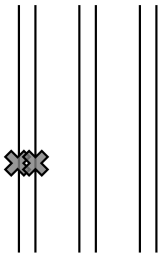

### Recessive inheritance

Mutations (grey crosses) on both alleles are necessary to cause disease.

In contrast to the dominant PD genes, for which between 1 and 7 mutations per gene are known to be pathogenic, a large number of mutations in the recessive PD genes have been reported in association with PD. Some of these are relatively common, have been published from several groups and meanwhile become well-established. Others have only been found in one or a few patients, and their significance is difficult to ascertain. Part of this difficulty may be explained by the very nature of recessive inheritance in human disease: An important criterion for the pathogenicity of a mutation is that of co-segregation within families, meaning that mutation carriers develop disease whereas their relatives without mutations remain unaffected. In large kindreds with dominant inheritance pattern and a reasonable number of affected and unaffected members, co-segregation can be ascertained or refuted relatively easily. In families with recessive patterns of inheritance, few individuals are affected, typically only siblings. More distant relatives are not usually affected, and thus co-segregation analysis is

limited to a few members of the core family. The *a priori* probability for each sibling of a homozygous mutation carrier to be homozygous for this mutation as well is 25%, so disease and homozygous mutation state may co-exist by chance.<sup>1</sup> This may explain why more mutations in recessive genes than in dominant genes have been suspected to be pathogenic, and at the same time, why definite formal proof of pathogenicity is not available for a considerable proportion of these mutations.

## *PARKIN*

*PARKIN* (*PARK2*, encoding parkinson protein 2, E3 ubiquitin protein ligase) was the second gene for which an association with PD was found in 1998 [146]. It was discovered in several siblings from consanguineous families in Japan and Turkey, who had a peculiar clinical syndrome initially designated early-onset parkinsonism with diurnal fluctuation (EPDF) [147,148]. Soon after the initial discovery, *PARKIN* was considered being a common cause of (very) early onset PD. In one study of 100 PD patients with an age at onset below 45 years, 77% percent of those with very young onset, below 20 years of age, carried at least one *PARKIN* mutation (homozygous or heterozygous). This percentage decreased sharply to 26% of those with a disease onset between 20 and 30 years, and only 2-7% of those where symptoms started between 30 and 45 years of age. Unfortunately, homozygous and heterozygous carriers were not reported separately in this analysis, and about half of the PD patients with *PARKIN* mutations had only one mutation (heterozygote) [149]. Other studies found homozygous or compound heterozygous *PARKIN* mutations among a lower percentage of patients with early onset-PD (onset before 40 or 45 years), in the range between 8.2% in Italy [150], 2.7% in Korea [151], 2.5% in Poland [152], and 1.4% in Australia [153]. More than 100 different *PARKIN* mutations have been reported, and they are of various types, including copy number variations (deletions, insertions, multiplications), missense mutations and truncating mutations [4]. In the one previous study on 63 early-onset PD patients from Sweden, Håkansson et al. detected no homozygous *PARKIN* mutation carrier [154].

Features common to *PARKIN*-associated PD, besides young or very young age at onset, is probably a good and lasting effect of levodopa, albeit with the occurrence of dyskinesias during the disease course, and a lower risk for non-motor symptoms such as cognitive decline and dysautonomia [61]. Lower limb dystonia and hyperreflexia as well as psychiatric symptoms have been described. The initial patients with EPDF experienced marked alleviation of their parkinsonism after a night's sleep, at least during the first years of their illness [147]. The

---

<sup>1</sup> Exceptions are consanguineous families, even if intermarriage occurred between very remote family members. Recessive - but not dominant! - mutations may be discovered more easily in secluded areas such as remote valleys, islands, or population groups where consanguinity occurs, for example due to social or religious reasons. Intermarriage has a long history and remains common in many parts of the world. Its social advantages, especially for women, have been highlighted [145].

cardiac sympathetic nervous system is not usually affected, although mild dysautonomia has been reported [148,155]. Pathological changes remain confined to the brain stem and do not involve alpha-synuclein deposition, but consist purely of cell loss in the brainstem, including locus ceruleus and substantia nigra (reviewed in ref. [61]). The Parkin protein has aptly been called "A Top Level Manager in the Cell's Sanitation Department" [156]. Among other functions, it has E3 ubiquitin ligase activity, selectively marking certain proteins for degradation by the ubiquitin proteasome system. Pathogenic *PARKIN* mutations decrease this activity, and proteins accumulate which ought to be degraded [156]. Restoration or increase of Parkin ligase activity by gene therapy is one possible novel avenue of PD treatment that is currently being pursued [157].

### *PINK1*

Homozygous mutations in *phosphatase and tensin homolog-induced putative kinase1* (*PINK1*, *PARK6*) are associated with early-onset PD [158]. Over 40 point mutations and rarely, large deletions, have been detected [4]. The clinical phenotype seems to be similar to that of *PARKIN* mutations, but there are some indications that psychiatric symptoms may occur more commonly among patients with *PINK1* mutations [4].

### *DJ1*

*Oncogene DJ1* (*parkinson protein 7*, *PARK7*) is the third well-established recessive PD gene [159]. It is rare and only very few patients with *DJ1* mutations have been described. Most had early-onset PD, but a family with early dementia, parkinsonism and amyotrophy has also been reported [160-163]. No neuropathology of a patient with *DJ1* mutation has been described yet.

### *Aspects common to PARKIN, PINK1, DJ1*

Mutations in these three genes are associated with a similar clinical phenotype which is distinct from the average patient with idiopathic PD. In general, onset is early or very early in life, and associated non-motor symptoms, if present at all, remain mild. Apart from the tendency to develop dyskinesias common to all patients with early-onset PD, no specific factors distinguish these forms. Furthermore, the neuropathologies of *PARKIN* and *PINK1* are similar, with disease-associated changes confined to the brainstem; the disease process does not seem to spread to involve other parts of the brain [61,164]. The three proteins share functions in common pathways, including the ubiquitine-proteasome pathway, the lysosomal pathways and mitochondrial functioning [4]. The term nigral mitochondrial cytopathy, or "nigropathy", has been coined for the disorder associated with mutations in *PARKIN*, *PINK1* or *DJ1* [61].

The role of heterozygous mutations in *PARKIN*, *PINK1* or *DJ1* has since been debated. In some families, only a homozygous mutation state was associated with disease, while heterozygous carriers remained unaffected, confirming co-segregation and a classical Mendelian recessive inheritance pattern [165]. Heterozygous *PARKIN* mutations were sometimes found in healthy control subjects [166], but significantly more frequently in early-onset PD patients [166]. However, heterozygous mutations were also found in PD patients [150-153,167], and a pathogenic role for heterozygous, single mutations has been postulated [153,165-168].

Analysis of mutations in *PARKIN*, *PINK1* and *DJ1* is both time consuming and expensive. The genes are comparatively large (*PARKIN* consists of 12 exons, *PINK1* of 8 and *DJ1* of 6), and the known mutations are spread out over the whole gene, necessitating sequence analysis of all exons. Besides, separate testing for the frequent copy number variants needs to be performed for each exon. This may explain why stringent large-scale studies have not been performed, which means that the pathogenicity of a considerable number of mutations in these three genes remains uncertain. We do not know with certainty how large the effect of single (heterozygous) mutations in these genes may be. It has been suggested that certain mutations cause early-onset PD when they are present on both alleles, but cause late-onset PD in heterozygote carriers [168]. Other mutations in heterozygous state may not cause PD. It remains possible that some of the mutations detected in earlier studies may turn out to be polymorphisms without clear-cut association to PD.

The information about clinical characteristics of *PARKIN*, *PINK1* and *DJ1* mutation carriers is limited, for similar reasons: Although a large number of different mutations are known, each one of them is comparatively rare. The majority of families with recessive disease are non-consanguineous, which means that besides siblings, no other distant relatives are affected, and co-segregation of the mutation can only be examined for very few individuals. Some studies have grouped together patients with different *PARKIN* mutations and compared this group with a control group without *PARKIN* mutations. This approach has limitations when different biological effects of the various mutations are assumed.

### *Recessive genes of uncertain significance for PD*

*Phospholipase A2, group VI (cytosolic, calcium-independent) (PLA2G6; PARK14?)* was identified in 2006 as the gene causing two types of a rare disorder called neurodegeneration with brain iron accumulation (NBIA), type 2A (also known as infantile neuroaxonal dystrophy) and type 2B [169]. Both are severe neuropediatric disorders that bear no resemblance to PD. Three years later, however, mutations in this gene were also reported from patients who developed what was called adult-onset levodopa-responsive dystonia-parkinsonism [170,171]. However, age at onset was between 10 and 26 years in the six patients described. They also had rapidly declining cognition, psychiatric symptoms and pyramidal signs. Motor function worsened very quickly, and most lost independence within a few years. MRI displayed severe generalized brain atrophy in more advanced patients, but interestingly there was no visible iron deposition

[170,171]. The clinical presentation of this disorder clearly differs from PD, but the few available pathology reports from patients with *PLA2G6* mutations have consistently shown a high load of alpha-synuclein pathology, both in patients with NBIA and with dystonia-parkinsonism [59,172]. Perhaps, analysis of the function of *PLA2G6* may help us understand aspects of alpha-synuclein precipitation in general, but these investigations are still in their early stages. *PLA2G6* protein catalyzes the release of free fatty acids from lipids, and mutations causing NBIA reduce this catalytic activity whereas mutations causing dystonia-parkinsonism do not [173].

Mutations in *ATPase type 13A2 (ATP13A2; PARK9)* were found to cause the rare Kufor-Rakeb syndrome in a Chilean family. The clinical features include early onset levodopa-responsive dystonia and parkinsonism, pyramidal signs, as well as eye movement abnormalities. There is generalized brain atrophy and dementia [174-176], and iron accumulation on MRI [177-179], why the disorder may rather represent another type of NBIA. *ATP13A2* mutations appear to be exceedingly rare. There is one Scandinavian report, on a Greenlandic Inuit family, where the affected members displayed very variable clinical features including a pyramidal-parkinsonian syndrome, cognitive/psychiatric features, ataxia, and axonal neuropathy [179]. Two patients had a severe, symmetrical decrease in dopamine transporter scans, and some but not all members showed generalized brain atrophy on MRI [179]. It has been debated whether heterozygous *ATP13A2* mutations may cause a milder form of this disease. Heterozygous carriers with parkinsonism as the only feature have been described [178,180].

Mutations in *F-box protein 7 (FBXO7; PARK15?)* cause a Parkinson-pyramidal syndrome which is also very different from PD [181]. Patients have pes equinovarus deformity since childhood, develop spasticity in the lower, and sometimes upper extremities, and levodopa-responsive parkinsonism occurs 5 to 20 years after the onset of spasticity [181].

## Non-Mendelian patterns in monogenic forms

As outlined above, although classified as "dominant" or "recessive", most PD gene mutations strictly speaking do not follow Mendel's laws. Penetrance is incomplete and, as PD is a disease that often manifests itself later in life, age-dependent. Most of the pathogenic PD mutations have also been found in patients who do not have an obvious family history of the disease, but a seemingly sporadic, non-familial form. The possibility that heterozygous mutations in "recessive" PD genes may be risk factors is examined more closely below, and forms one of the main themes of Article IV. Digenic inheritance has been described in PD patients [182,183] who had mutations in two different PD-genes, suggesting that combined effect of different mutations may influence a person's risk to develop PD.

## Gaps in current knowledge

Despite very intensive research in PD genetics during the last years, our knowledge about the clinical effects of the established causative mutations is still limited. Only for the most common mutation, LRRK2 G2019S, could the penetrance, or the risk for the carrier to develop disease, be established with reasonable validity [83]. Penetrance data on rarer mutations, where available at all, is often based on very small sample numbers and thus unreliable. This means it remains very difficult to give valid information to PD patients who carry gene mutations.

Some of the known mutations in PD-genes are extremely rare, and all available data comes from a few carriers. I discuss below why some data seems to suggest that rare or very rare mutations may be responsible for a considerable proportion of non-inherited PD. Publications in PD genetics often focus on the discovery of new genes, mutations, and associations, whereas clinical descriptions do not always receive the same degree of attention. In some instances, genetic discoveries were made in sample collections that do not allow retrospective identification of the clinical files on the patients, and the published clinical information remains limited to the basic data accessible with the DNA collection. Thus, we still have a rather incomplete understanding of the clinical phenotypes associated with mutations in PD-related genes. The general picture that has emerged so far is, however, that mutations in PD-genes cause very characteristic types of PD or parkinsonism.

## Genetic risk factors in PD

Pathogenic mutations in any of the genes discussed above can generally only explain the occurrence of PD in a small fraction, perhaps 2-3% [184], of patients. Exceptions may be populations with a high frequency of single mutations, such as the LRRK2 G2019S mutation in North African Arabs [76] and Ashkenazi Jews [77], or the LRRK2 R1441G mutation among Basques [73]. Familial clustering or aggregation has long been described in PD, but this phenomenon has not been investigated in great detail, and a valid theoretical concept for familial clustering seems to be lacking. The majority of PD patients, perhaps 80 or 90%, are not aware of anybody else with PD in their family. Very few of these sporadic cases can be explained by *de novo* pathogenic mutations [29,35,37,185], and some patients may not be aware of a family history of the disease because of adoption, emigration, early death of family members, limited recall, etc. [186].

Several lines of evidence suggest an important contribution of genes to the overall PD risk in non-familial cases. This genetic contribution is thought to be inherited in the form of the individual's specific constellation of genetic risk variants. A number of such genetic risk variants have been identified, although progress in this field has been slower than expected. In particular, most of the genetic risk factors that have been found in genetic association studies

only exert a weak effect on PD risk; a large proportion of the genetic PD risk remains unaccounted for [187]. This section discusses how much of the overall disease risk may be attributed to genes (heritability), mentions the methods employed in the search for genetic risk factors, and outlines the rapidly expanding knowledge on the most reproducible genetic risk factors (risk variants) for PD. The rationales behind the studies in Article IV and V, which investigated genetic risk factors in non-familial PD, are discussed.



### Genetic risk variants

In non-familial PD, the individual amount and constellation of inherited risk factors (grey ovals) determines the PD risk of an individual. In familial PD, these risk factors may influence disease severity, age at onset, etc., together with a pathogenic mutation. Some genetic variants that occur relatively frequently in the population confer a small risk increase for PD (lighter shades of grey), and a few rarer variants have been found that increase risk substantially but are not by themselves pathogenic (dark grey). Together, they form the individual's inherited risk factor profile. The exact degree to which the sum of this genetic setup determines the PD risk in a population (heritability) remains unknown, but can be estimated. Other, non-genetic (environmental, random) factors also come into play.

## Heritability of PD

Heritability provides a measure of how much genes - as opposed to other possible causes, such as the environment - contribute to the overall PD risk. It is defined as the proportion of phenotypic variation in a population that is caused by genetic variation between individuals [188]. Calculation, or rather, estimation of heritability is difficult and may yield widely divergent results depending on study population and methods. Early twin studies in PD, including the studies from the Swedish Twin Registry, have indicated there was no heritability in PD [189]. However, there was no unanimous agreement if the design of these twin studies allowed to draw such conclusions [190,191], and a different design including longitudinal follow-up of the same cohort indeed showed a heritability between 19% and 41% for PD and/or parkinsonism [192]. Heritability was estimated to be above 45% in a study population in Finland [193] and 60% in Europeans [184]. Familial clustering of PD has long been observed to a degree that is greater than what can be attributed to the causative mutations known today. Clustering suggests a genetic contribution to PD risk, although it has partly been explained by a shared environment or the concept of cultural transmission [186,193-



195]. Environmental factors with proven or suspected association to PD have recently been comprehensively reviewed [196].

## Methods to identify genetic risk factors

### *Candidate Gene Association Studies*

These studies test if a selected variant in a certain gene is associated with PD risk. The variants are genotyped in patient and control groups, and it is statistically evaluated if a certain genotype occurs significantly more often in patients than in controls. The gene or locus to be tested must thus be known *a priori*.

### *Genome-wide association studies (GWAS)*

Several GWAS [3,137,139,141,197-205] and large combined analyses of GWAS data [206,207] have now been completed in PD. These studies analyze the genotypes of single nucleotide polymorphisms (SNPs) distributed throughout the genome in large patient and control groups, and determine if a genotype of any of the SNPs occurs significantly more often in the PD group. GWAS are free from *a priori* assumptions about a candidate gene or region. They may detect new loci of interest.

SNPs act as markers for the genomic region (locus) they "tag", and are usually not considered the functional variant, i.e. the variant that actually causes the increase in PD risk. In fact, the relationship between the marker SNP and the presumed functional variant may be complex. The presumed functional variant(s) may be relatively far away from the SNP, and both the allele frequency and effect size of the functional variant may differ from the SNP [208]. Nevertheless, the genomic region tagged by a SNP in GWAS may contain candidate genes to be screened in detail for functional variants [206].

## Established genetic risk factors for PD

The PDGene database (<http://www.pdgene.org/>) attempts to comprehensively list all genes and polymorphisms for which a possible association with PD was studied. At the time of writing this manuscript, it contains entries on 3,434 variants in 908 genes [209]. These include variants whose association to PD has been reproduced in other populations, variants only reported in single studies, and variants that did not show any association.

Generally, genetic variants differ by their frequency in the population, often expressed as a variant's (minor) allele frequency, and by their effect size. Variants with <0.5% frequency have arbitrarily been defined as "rare", and variant frequencies between 0.5% and 5% are

considered "low". Effect sizes of a single variant may be overwhelming (OR >50), such as those of the rare pathogenic mutations in PD [210],<sup>2</sup> intermediate (OR 1.5-50), or, as is the case with most known variants, modest or low (OR <1.5). The simultaneous presence in an individual of several genetic risk variants, that each have low or modest effects, has been shown to increase PD risk with a more substantial cumulative effect [3].

Variants in the genes or genomic regions (loci) of *SNCA*, *MAPT*, *LRRK2* and *GBA* are the most well-established genetic risk factors for PD, and are discussed below. The present knowledge about a possible risk-modifying effect of variants in the loci of the recessive PD genes *PARKIN*, *PINK1* and *DJ1* is included, as this forms the starting point for the studies in Article IV.

### *SNCA locus*

Pathogenic mutations in *SNCA* cause PD. Variants in the *SNCA* genomic region also act as risk factors in non-familial PD. Association of such variants to PD has been found in candidate-gene studies, and SNPs in the *SNCA* locus have solidly been associated with PD in all GWAS and meta-analyses of combined GWAS datasets [209]. The genomic region of *SNCA* is not entirely stable but consists of two haplotype blocks, why the 5' part with the promoter and exons 1-4 needs to be considered separately from the 3' end with exons 5 and 6 and the adjacent 3'- untranslated region. *SNCA Rep1* is a polymorphic microsatellite repeat in the 5' end upstream of the *SNCA* gene that has been shown to influence the transcription rate of *SNCA* [211] and to be associated with PD risk [212,213]. Genotypes that increase *SNCA* transcription and production of alpha-synuclein protein conferred a higher PD risk, which is in line with the dose-dependent effect of genomic duplications and triplications of *SNCA* [1], and with alpha-synuclein pathology [214]. However, several GWAS found stronger association to genetic variation in the 3' end than the 5' end of *SNCA*, which so far remains unexplained.

### *MAPT locus*

The association of the extensive *MAPT* locus and PD has repeatedly been found in both candidate association studies and GWAS [206,215-217]. *MAPT* encodes the tau protein, hallmark in the pathology of several neurodegenerative diseases [214]. The *MAPT* locus represents a large haplotype block that includes several other genes. There are two different and ancient haplotypes, H1 and H2, which do not recombine. Most of the available data indicate that the H1 haplotype is the one that is associated with PD [218]. The functional

---

<sup>2</sup> Probably, *SNCA* triplication is the PD-related mutation with the largest effect size known today.

variants that cause the increase in PD risk have not been identified; we only know the SNP markers that act as signals for the genomic region.

Article V investigates a possible gene-gene interaction (epistasis) between *MAPT* and *SNCA*. Epistasis is a phenomenon observed in genetics which implies that the effect size of disease association of one locus depends on the genotype at another locus [219]. The biological mechanisms and effects underlying epistasis remain poorly understood. In several PD GWAS, the strongest significance of genetic associations identified were with the *MAPT* and *SNCA* loci. With regard to PD pathogenesis, various observations indicate a joint effect of tau and alpha-synuclein proteins: In vitro studies showed that alpha-synuclein protein fibrillizes more easily in the presence of tau (and vice versa) [220]. Tau and alpha-synuclein epitopes co-localize within cells and in Lewy bodies [221,222]. Patients with parkinsonism that had both tau and alpha-synuclein pathology have been described [220,223-227] (see also Article IV). The main aim of the studies in Article V was to test whether certain *MAPT* haplotypes influence the effect size of the known association of *SNCA*, or vice versa. The possibility of gene-gene interaction between *MAPT* and *SNCA* has previously been examined [228,229], but the studies did not lead to uniform results and were too small to prove or reject this hypothesis with reasonable confidence.

### *GBA mutations*

The genetic risk factors with the largest known effect (OR 5.43) on PD risk are mutations in the *glucocerebrosidase* (*GBA*, *acid glucosidase beta*) gene [230]. Homozygous or compound heterozygous mutations in *GBA* cause Gaucher disease, which presents with a wide spectrum of clinical manifestations, often during childhood, and certain forms of which include neurological symptoms. A proportion of the Gaucher disease patients, or their relatives, were observed to develop parkinsonism, which prompted investigations on the role of heterozygous carrier status. The very same mutations that cause Gaucher disease when present on both alleles were found to confer a considerable increase in risk for PD when present in heterozygous state (intermediate effect size). Mutations in *GBA* are very frequent in the Ashkenazi Jewish population. The frequency of (heterozygous) mutations in other populations are around 1% [230], and the variants were thus too rare to be detected by most PD-GWAS. PD patients with heterozygous *GBA* mutations who have come to autopsy had widespread alpha-synuclein positive pathology (diffuse Lewy body disease) [231,232], and interactions between glucocerebrosidase and alpha-synuclein are being investigated [233].

### *LRRK2 variants and HLA locus*

A recent multicenter study, to which we contributed samples from the patients examined in this study [5], found that 27 variants in the *LRRK2* gene increase or decrease PD risk. The highly polymorphic *human leukocyte antigen* (*HLA*) locus was associated with PD [234,235], and an association to the *HLA* locus, with the strongest signal from *HLA-DR*, was found in a

recent GWAS [3]. We tried to replicate these findings in an independent cohort and did find an association with the identical marker in the *HLA-DR* locus, but with a different, perhaps contradicting, type of effect [236]. We concluded that, in view of these diverging results, the exact role of genetic variation at the *HLA* region and susceptibility to PD remains to be resolved.

### *PARKIN, PINK1, or DJ1 as genetic risk variants?*

Article IV suggests that a specific variant, PINK1 G411S, when present in heterozygous form, is a genetic risk factor for PD. Previously, there have been some reports on variants in these genes that have not been reproducible in other populations. PARKIN S167N [237] and R366W [238] were associated with PD in Asian populations but not in German and Italian series [239]. The PDGene database provides updated meta-analyses on variants' association with PD. The following variants reached significant effects in these meta-analyses: PARKIN V380L (OR 0.82; 95% CI 0.68-0.98), PINK1 Q115L (OR 0.69; 0.49-0.96), and PINK1 N521T (rs1043424; OR 0.93; 0.85-1.00). These weak effect sizes and the paucity of data are not easily reconciled with repeated clinical reports that heterozygous relatives of patients with homozygous, early-onset PD show milder forms of subclinical parkinsonism, SPECT abnormalities, and in some cases, late-onset PD [168,240-242]. Genetic association studies may not be able to detect rare variants that may be responsible for this phenomenon.

# Parkinson's disease

A few aspects of the clinical and pathological picture of Parkinson's disease (PD) appear relevant to the issues addressed in this thesis: The diagnosis of PD is made entirely on clinical grounds, based on a constellation of findings in the patient's history, signs and symptoms. The neuropathology usually involves alpha-synuclein deposition, but there are exceptions with additional or different pathologies. There is a remarkable clinical variability, and a number of distinct PD subtypes have been delineated. These factors probably complicate the search for a common genetic cause for PD. More probably, specific genetic factors are associated with certain clinical PD subtypes and pathologies, and not with all disease states that may be encompassed by the wide clinical definition of PD.

## Reconsidering disease definition

As stated above, PD is diagnosed clinically on the basis of patient history, symptoms and the findings on physical examination. The entity of "Parkinson's disease" – previously known as paralysis agitans – has emerged historically, and there is no unanimously accepted definition [243]. Today, three sets of diagnostic criteria are commonly used in research studies, and sometimes in clinical practice: The UK Parkinson's Disease Society Brain Bank (UKPDBB) criteria published by Hughes et al. [244], the National Institute of Neurological Disorders and Stroke (NINDS) criteria published by Gelb et al. [245], and the criteria by Bower et al. [246]. These three sets of diagnostic criteria consist of scoring systems that include cardinal symptoms of PD as well as additional features. They all have several features in common, but there are also important differences. Tremor at rest, bradykinesia, and rigidity are included in all three sets of criteria, but not all need to be present for the diagnosis to be made. The fourth possible cardinal sign varies between postural instability [244], impaired postural reflexes [246], and asymmetric start of disease manifestation [245]. In the NINDS criteria, definite PD can only be diagnosed by post mortem examination, which excludes patients with a clinical picture of PD but atypical pathology. The UKPDBB criteria exclude individuals with more than one affected relative; this criterion is frequently omitted in the context of genetic studies. A different set of diagnostic criteria has been used to select patients for intervention studies [247].

Not surprisingly, the set of diagnostic criteria used influences which patients will receive a PD diagnosis [248]. While a definite PD diagnosis according to the NINDS criteria requires cell

loss in the substantia nigra, Lewy bodies and no pathological signs indicating another disease, the original study defining the UKPDBB criteria showed that only 82% of the patients who fulfilled the UKPDBB criteria had Lewy bodies [244]. This study was performed before the advent of alpha-synuclein immunohistochemistry, and the new staining method makes it easier to find Lewy bodies. Today, the pathological definition of PD rests on cell loss in the substantia nigra plus the presence of alpha-synuclein immunoreactive intraneuronal inclusions collectively referred to as Lewy pathology. This includes Lewy bodies, neuronal perikaryal structures, and inclusions in cell processes such as intraneuritic Lewy bodies, Lewy neurites, dot-like structures, and axonal spheroids [214]. Meanwhile it has also emerged very clearly that certain disorders which fulfill the clinical criteria for PD are associated with entirely different types of pathology dominated by tau [226], TDP-43 [249], or ubiquitin [60], or with isolated nigral cell loss as the only discernible feature [60,214]. Thus, the clinical diagnosis (i.e. syndrome or phenotype) does not always coincide with the expected underlying disease process revealed on neuropathological examination, and a neuropathological examination may not be able to clarify whether a patient had "PD" or a different diagnosis.

Another problem is that early dementia or early signs of dysautonomia are exclusion criteria for a formal (study) diagnosis of PD [244,245]. Both features are common in PD caused by mutations in *SNCA* (see Articles I, II, refs. [43,47]). Certain forms of parkinsonism will thus be excluded from genetic studies when strictly employing diagnostic criteria for PD. Including patients with "parkinsonism" [246] instead of insisting on a "PD" diagnosis may solve this problem, although it will make the studied population more heterogeneous.

## Clinical variability

It has been questioned whether PD is a single entity [243], and more recent observations add arguments that emphasize the existence of different PD subtypes. Surprisingly, up to fifteen percent of patients with PD diagnoses who were included in large treatment studies did not have abnormalities in the dopaminergic system on imaging [250]. This was observed in the CALM-PD-CIT study [251,252] where it was not reported initially. In the REAL-PET study 21 of 186 participants (11.3%) had normal scans [253], 21 of 142 subjects (14.7 %) in the ELLDOPA-study [254], and 91 of 799 of participants (11.4%) in the PRECEPT trial. Scans remained normal at follow up 4 years later [255]. The term SWEDD was coined ("subjects without evidence for dopaminergic deficits"), and these patients were investigated in detail. They seem to represent one or several subgroups of disorders and seem to have certain features in common, such as a peculiar type of tremor and a tendency towards dystonia [256], or lack of gait disturbances [257]. However, findings partly contradict each other at present [122]. It remains to be seen if all patients with SWEDDs share the same pathological process, or if the phenomenon can be associated with different pathophysiologies. For now it is important to note that 10-15% of patients that were diagnosed with PD by experienced movement disorder

specialists within protocols of prestigious clinical trials did not have any dopaminergic deficit, considered to be the *sine qua non* of PD.

Cluster analysis has been used to determine if patients with PD can be divided into distinct subgroups. Seven previously reported cluster analyses consistently differentiated two main groups of patients with old age at onset and rapid disease progression from those with young age at onset and slow disease progression, and also confirmed the clinical distinction between hypokinetic-rigid and tremor-dominant subtypes [258,259]. A new approach, using symptom severity in 12 different motor and non-motor domains, identified 4 different subgroups among PD patients [260]. The finding was reproducible in an independent study cohort. Tremor, bradykinesia and rigidity did not differ markedly between the groups, indicating that all had parkinsonism. Domains such as axial motor symptoms, cognitive impairment and motor fluctuations divided the subgroups [260].

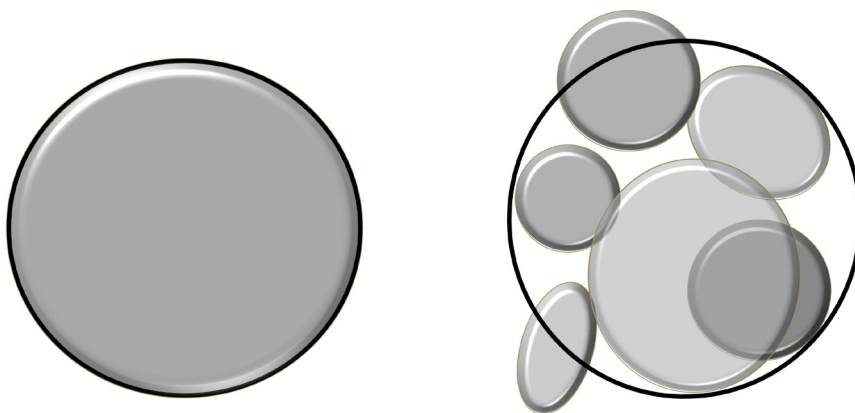

**Parkinson's disease: A single entity (left), or a number of distinct diseases that (largely) fit into the diagnostic criteria (right)?**

## Implications for treatment

All patients with different subtypes, probably including most of the SWEDDs, fulfill the diagnostic criteria for PD. This is well in accordance with observations that the clinical diagnosis of PD is very accurate when patients are followed and regularly re-evaluated longitudinally by experienced movement disorder specialists [61]. A correct diagnosis is important to select appropriate treatment options. All of the presently used diagnostic criteria can select individuals that probably will benefit from dopaminergic therapy, the mainstay of PD treatment today [259]. Response to levodopa has even been reported for a very special

subset of SWEDDs with small expansions in the *FMRI* gene [122]. The presently used criteria are acceptable as long as PD therapies primarily replace dopamine or dopamine's effect.

However, the clinical, genetic and pathological evidence gathered in the last years clearly points in a different direction. PD as a clinical syndrome may be caused by a variety of different pathomechanisms, which are being characterized in detail [259]. There is hope that therapies will emerge which will directly interact with these mechanisms of disease, and expectations are high that such therapies will be able to slow down disease progression and possibly stop or even reverse deterioration. Currently, therapies directed against alpha-synuclein or restoring parkin enzymatic activity are under development [157,261,262]. A first clinical trial inhibiting mixed lineage kinases (such as LRRK2) has been conducted [263]. The recent identification of *VPS35* will direct efforts towards vesicular transport and the recycling of membrane proteins between endosomes and the trans-Golgi network [7], and the lysosomal pathway is involved in Gaucher disease and other storage disorders linked to parkinsonism [264].

It will be of great importance to select the right group of patients who may benefit from such therapies. It appears logical to select patients not according to the clinical picture, but the underlying pathological process modified by the new treatment. Genetic characterization of PD patients may play a decisive role in such selection processes, whether for initial trials or for future routine treatments.



# Aims

This study had the following aims:

1. to collect historical, genealogical, clinical and genetic data on the southern Swedish Lister kindred with *SNCA* duplications and triplications,
2. to recruit a cohort of PD patients from southern Sweden for clinical examination and genetic analysis,
3. to screen these patients genetically for all known pathogenic PD-related mutations,
4. to describe the clinical and pathological picture of PD patients where a pathogenic mutation was identified, with the aim of elucidating possible genotype-phenotype correlations, and
5. to use the genetic data of the cohort, together with data from other populations, for investigations on the effect of heterozygous recessive mutations and other genetic variants on PD risk in the general population.

# Methods

This thesis consists of a number of parts that developed and evolved following this chronology of events:

*SNCA* multiplications had been identified in affected members of the Lister Family shortly before this study began [1]. The first part of this study involves contact with and research on the Lister Family, carried out during the years of 2006 to 2011. Historical notes and medical records were compiled and the family tree was expanded (Article I). Additional family members were included in the study, many of which were genetically analyzed ("Lister Family" section below). The clinical and pathological features of these patients were compared to reports on other individuals with *SNCA* multiplications, mostly published during the time of this study.

Simultaneously, a clinico-genetic study (PARLU, PARKinson LUNd study) was initiated, in which PD patients were included on the grounds that they lived in a certain geographical area or because a family history of PD was suggested. DNA from participants in this study was analyzed comprehensively for all known pathogenic PD mutations, variants, and several known genetic risk factors. Pathogenic mutations were found in a number of individuals (Articles II and IV). DNA samples from this study cohort were also analyzed for genetic risk factors within several multicenter studies, one of which is included in this thesis (Article V).

In a third part of this study, DNA was extracted from seven brains from PD patients from the Department of Pathology at Lund University Hospital, and a rare pathogenic mutation was detected in one of these. For the first time, the pathology of this mutation could be reported (Article III).

In the following sections, these chronological study parts are rearranged and discussed in a more logical order, moving from monogenic familial PD, via intermediate forms, towards genetic risk factors in sporadic PD.

# Lister Family (*SNCA* multiplications)

## Genealogical research

Relevant data from the previous publications on this kindred by Herman Lundborg in 1901 [265], 1903 [266], and 1913 [267], by Henry Mjönes in 1949 [194], Nils Nilsson in 1970 [268] as well as by Farrer et al. in 2004 [269], Fuchs et al. in 2007 [1], and Puschmann et al. in 2009 [36] were entered into a database and a professional software program (Progeny, version 7, Progeny Software, South Bend, Indiana 46601, USA). Original records of the late Dr. Henry Mjönes were kindly made available for this research by his family, and contained additional data which were added to the pedigree. We also included genealogical information from medical records of affected family members examined during the 1930s to 2000s, which were retrieved through information in the sources named above as well as through our own research. Furthermore, we added information provided by contacts with the family and from searches performed in public registries.

### *Identification and contact of study participants*

A number of different ways were employed to identify and contact members of the Lister Family:

Initially, the Swedish index patient's immediate relatives were asked if they would like to donate blood samples for assessment of *SNCA* multiplication carrier status. Anonymous assessment of carrier status was offered to all study participants; individuals could choose to be informed about their test result after genetic counseling, or not to be informed. A core pedigree was drawn based on information from close relatives. It was then definitely proven that the genomic segment duplicated in the Swedish index patient is the same as that triplicated in a Swedish American patient with *SNCA* triplication [269], indicating a common ancestor [1]. Subsequent genealogic work clearly demonstrated that both index patients belonged to the Lister Family described by Mjönes and Lundborg [1,194,267]. We then attempted to invite additional close relatives in the branch of the Swedish index patient to participate by providing study information sheets to known relatives of the index patient, and asked them to hand on the information to other family members, so that they in turn may contact us if they so wished. The Swedish American branch could not be enlarged; the number of patients in this emigrated branch was naturally limited.

Simultaneously, we started the PARKinson LUnd (PARLU) study with the general goal to examine genetic forms of parkinsonism in southern Sweden. This study is described in greater detail below. One part of PARLU was a population-based study of PD patients in three counties in southern Sweden's Region of Blekinge, including and surrounding the Lister

peninsula. We hypothesized that we may find individuals with parkinsonism who know that they belong to the Lister Family, or who carry *SNCA* multiplications.

Furthermore, we directly contacted members of the Lister Family whom we gradually identified through genealogical research. A standardized letter providing basic information was sent to family members, where they were asked to return an answer slip stating if they want to be contacted for further details, or did not wish to participate. In cases where we did not receive an answer within 2 months, we tried to reach the individual by telephone. This was limited to one conversation per individual contacted. The recruitment procedure followed a protocol used by other groups who perform research on hereditary disorders and was approved by the Regional Ethical Review Board responsible for research at Lund University.

### *Collection of clinical data from deceased family members*

New medical information was compiled from the sources mentioned under "genealogical research", and from colleagues in Sweden and the USA, and was added to the genealogical database.

## **Genetic analyses**

*SNCA* dosage was assessed by real-time PCR, comparing the amplification rate of *SNCA* gene to that of the *LRRK2* gene and the *PSEN2* gene [270]. A variety of microsatellite markers (short tandem repeats) in and around the *SNCA* genomic locus were analyzed with the aim to confirm multiplied genomic regions with another method. Furthermore, a microsatellite marker or combination was searched for to facilitate screening efforts in the future. The microsatellite markers and the methods were identical to those described in Article II. The *CSTB* gene was sequenced and the dodecamer repeat region in its promoter was analyzed (Prof. Anna-Elina Lehesjoki, University of Helsinki).

## **PARLU Study**

### **Patient recruitment**

Two groups of individuals were eligible for inclusion in the PARLU study:

1. Individuals with parkinsonism from three counties in West Blekinge (irrespective of family history) (Blekinge group)

2. Patients with parkinsonism from all of southern Sweden, predominantly with positive family history (non-Blekinge group)

Blekinge group: The three counties (Karlshamn, Olofström and Sölvesborg counties) have a total of 60,966 inhabitants (on Dec 31<sup>st</sup> 2007, data from <http://www.gis.lst.se>). All patients were eligible who had a diagnosis of PD (ICD-10 G20.9) or parkinsonism (G21.1, G21.2, G21.9, G23.1, G23.2, G23.8, G90.3, G31.8, or F02.3) in the registries of the region's public hospital in Karlshamn (neurology, medical and rehabilitation clinics), the general practice clinics in these three counties, the regional health care centers of Kristianstad or Karlskrona or the tertiary center in Lund. All individuals were identified who resided within the three counties and had received these diagnoses during the time period of five years preceding study start. These persons were contacted via a letter providing basic study information. The project was announced in the local newspaper [271], via patient associations and public presentations. Individuals originating from the area of these three counties, but now residing elsewhere, were included when they contacted us.

Non-Blekinge group: Patients suspected to have a familial form of PD or parkinsonism were identified via their health care providers in Lund, Malmö, Kristianstad and Ystad. This group included patients with familial PD or parkinsonism from outside of West Blekinge.<sup>3</sup> These patients were initially contacted about this study via their health care providers or were invited to participate via patient associations or public presentations.

Participants in the PARLU study were met and examined by the author during a 90 minute interview at a health care facility close to their residence, or, in several cases, in their home or nursing home. Prior to the exam, patients received standardized questionnaires on possible exposure to environmental risk factors, non-motor symptoms and their family background. During the interview, a set of standardized questions covering all points of the formal diagnostic criteria for PD, as well as on associated signs and symptoms, was administered, and the individuals were examined according to a structured protocol. Unified Parkinson Disease Rating Scale scores were recorded and most patients were videotaped. Blood samples were taken in the cooperating health care facilities. Every effort was made to meet and examine patients personally, however, in a few cases only a request form for blood samples was sent to individuals (who were unavailable for personal examination) and went to have blood drawn at their local health care provider and at their earliest convenience. Unfortunately, from a few patients who were examined within the study, no blood samples arrived at the central biobanking facility, probably indicating that patients after the examination decided not to participate in the study.

---

<sup>3</sup> A few of these individuals turned out not to have a first- or second degree relative with PD or parkinsonism, the exact criteria for "familial" that was used for data analysis. These persons were included as "sporadic" patients.

We asked if the patient's spouses, caregivers or friends would like to donate blood samples to serve as controls for determining the background frequency of genetic variants in this population. Furthermore, in many cases, we obtained blood samples from unaffected family members. Only controls of the same age group as the patients were included.

## Analyses of PD-genes

Blood was drawn and DNA extracted from peripheral blood leucocytes at Region Skåne Competence Centre, Skåne University Hospital, Sweden, according to standard procedures. Genetic analyses were performed at the Mayo Clinic Florida laboratory of Neurogenetics (under the supervision of Profs. Matthew Farrer and Owen Ross). Samples were screened for all known pathogenic mutations in *SNCA* (including multiplication / gene dosage), *LRRK2*, *EIF4G1*, *VPS35*, and for triplet repeat number in *ATXN2* and *ATXN3*. The genetic risk factor, *SNCA Rep1*, was analyzed in 117 samples. The entire coding region of *PINK1*, *DJI* and *PARKIN* was sequenced in a subset 14 probands with age at onset  $\leq 50$  years (average 43.6, SD 3.8, median 44.5, range 36-50) years, and 9 patients from 8 multiplex families (families with several affected members; average age at onset 60.9, SD 5.7 years). The *PINK1* G411S mutation was genotyped in a total of 1,107 patients and controls from Norway (Prof. Jan Aasly, Trondheim) and Sweden as described in detail in Article IV.

Analysis for point mutations was performed by allelic discrimination assays (*TaqMan*<sup>™</sup>, Applied Biosystems, Life Technologies Corporation, Carlsbad, California, 92008, USA) or by direct sequencing according to standard procedures. *PARKIN*, *DJI*, and *PINK1* gene dosage was assessed by multiplex ligation-dependent probe amplification (MLPA, MRC Holland, Amsterdam, Netherlands). Triplet repeat lengths in *ATXN2*, *ATXN3* and in *SNCA Rep1* were assessed according to standard procedures.

*SNCA* dosage was measured in all participants by real-time PCR, comparing the amplification rate of *SNCA* gene to that of the *LRRK2* gene and the *PSEN2* gene [270]. For Lister Family members, this was measured in quadruplicate in at least three independent assays from which average values were calculated. Furthermore, for the Lister Family, microsatellite analysis was performed with markers within and around the *SNCA* gene previously found to be informative in members of the Lister kindred [1,272] (performed in two independent experiments).

All analyses were performed by the author during two appointments as Visiting Researcher at Mayo Clinic during 2009 and 2010, except parts of the *LRRK2* genotyping which was performed within a GEO-PD multicentre study [5] on a Sequenom MassArray iPLEX<sup>™</sup> platform and, similarly, part of the *EIF4G1* genotyping. Additional testing was performed in relatives of those patients where a pathogenic mutation was found, see details in Article II and IV.

### Screening of all 132 samples:

#### SNCA gene:

A30P mutation (sequencing exon 2, or ADA): results from 130 of 132 probands analyzed (130/132)

E46K mutation (sequencing exon 3, or ADA): 132/132

A53T mutation (sequencing exon 3, or ADA): 132/132

Gene dosage (duplication, triplication): 130/132

*SNCA Rep1* risk factor (allele lengths): 117

#### LRRK2 gene:

N1437H mutation (ADA or iPLEX [5]): 131/132

R1441C/G/H mutations (ADA or iPLEX [5]): 131/132

Y1699C mutation (ADA or iPLEX [5]): 132/132

G2019S mutation (ADA, iPLEX [5], or sequencing exon 41): 132/132

I2020T mutation (iPLEX [5], sequencing exon 41): 132/132

M1646T variant / risk factor (iPLEX [5]): 132

115 additional variants / risk factors in LRRK2 (iPLEX [5]): 121-132

#### EIF4G1 gene:

R1205H mutation (within GEO-PD study [5] or ADA) 124/132

#### VPS35 gene:

D620N mutation (ADA): 125/132

P316S variant / unknown significance (ADA): 125/132

#### PINK1 gene:

G411S variant / risk factor (ADA, sequencing): 125/132

#### ATXN2 gene:

Trinucleotide repeat length / risk factor (3730 DNA analyzer): 127/132

#### ATXN3 gene:

Trinucleotide repeat length / risk factor (3730 DNA analyzer): 126/132

### **Additional testing in a young onset / multiplex family subgroup:**

14 probands with age at onset  $\leq$ 50 years and 9 patients from 8 multiplex families:

#### PARKIN gene:

Sequencing of all exons (1-12): 23/23

Gene dosage (MLPA, exons 1-12): 23/23

#### PINK1 gene:

Sequencing of all exons (1-8): 23/23

Gene dosage (MLPA, exons 1-8): 23/23

*DJ1* gene:

Sequencing of all exons (1-6): 22\*/23

Gene dosage (MLPA, exons 1-6): 23/23

### **Comprehensive screening of 132 probands**

Summary of the genetic testing, stating gene name, analysis, analytic method and the number of probands for whom results were obtained. ADA, allelic discrimination assay (TaqMan™ probes); MLPA, multiplex ligation-dependent probe amplification; iPLEX, Sequenom MassArray iPLEX™ platform.

\*Except *DJ1* exon 4 in one patient, 18bp of *DJ1* exon 5 in another.

## **Analysis of DNA from neuropathology specimens**

Brains from 7 patients with clinical diagnoses of PD or marked alpha-synuclein pathology were selected at the Department for Neuropathology, Skåne University Hospital, Lund, Sweden. DNA was extracted from these tissues and sequenced for mutations in *SNCA* and *LRRK2* and multiplications in *SNCA*. Details are provided in Article III.

## **Participation in multicenter studies**

DNA and basic de-identified clinical information from PARLU participants has been made available for multicenter studies [5,7,273]. For the studies in Article V, four genetic markers (SNPs) in the *SNCA* genomic region (rs2583988, rs181489, rs356219, and rs11931074) and two in the *MAPT* locus (rs1052553 and rs242557) were genotyped in the 73 patients from the PARLU cohort that had been included by the time of these analyses. rs1052553 defines the *MAPT* H1-haplotype which is associated with PD and tauopathies. Technical details can be found in Article V.



# Results

## Lister Family (*SNCA* multiplications)

### Identification of additional Lister Family members

The pedigree was expanded by contacts that Lister family members took with us and by identifying additional affected members who had been patients of Skåne University Hospital, in combination with extensive genealogical research. Fifty-nine family members were contacted by mail. Of those, more than 20 donated blood samples within the timeline for genetic analysis (April 2010) for this study. All of these declared in telephone conversations that they do not have movement disorder symptoms or cognitive problems. Several reported they personally knew relatives with neurological illnesses, and most were aware of the fact that neurological disorder(s) occurred in their family.

The database and pedigree of the Lister Family now contain more than 1,000 individuals. In total, 35 members had parkinsonism (these were designated with numbers 1 to 35) and 17 had the progressive myoclonus phenotype (designated F2-F18, F for "Fall" [English: Case] in accordance with Lundborg [265-267]). We excluded the two sisters of patient 2, whom Mjöhnes considered to be *formes frustes* of parkinsonism (but they are mentioned in the table), and excluded the first case (Fall Nr. 1), whom Lundborg described as having progressive myoclonic epilepsy in 1901, but not in 1913. No living family members with these diagnoses were identified within this study.

A complete summary of all described cases is summarized in Appendix 1. A simplified pedigree is shown on the following page.

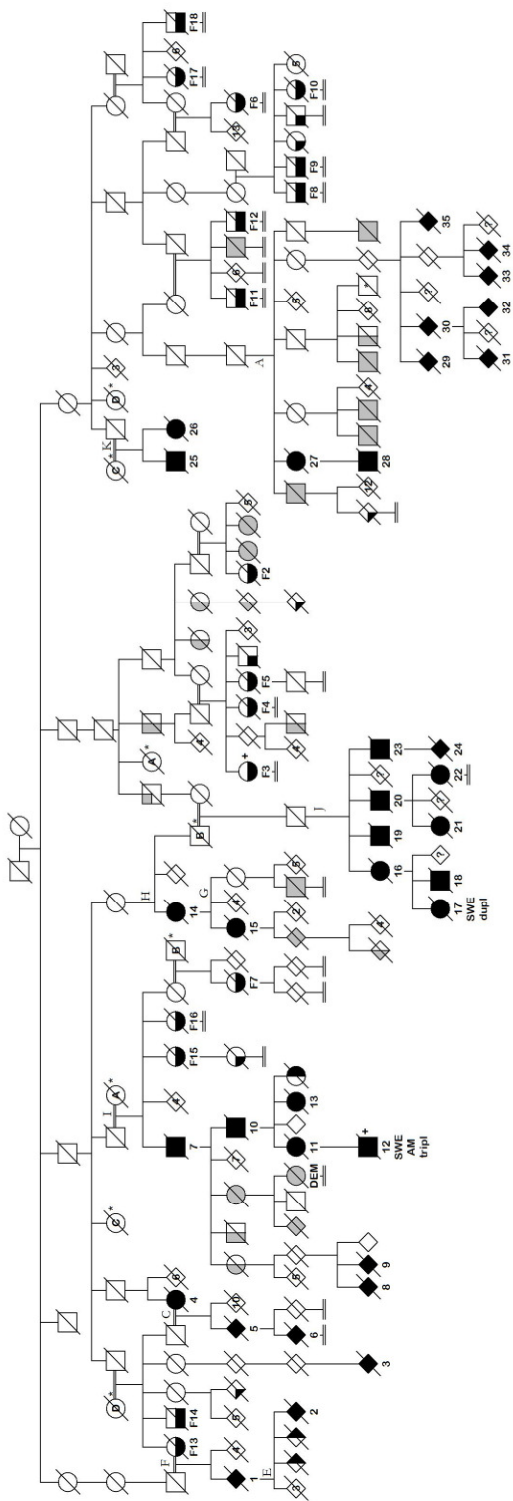

SWGA duplication  
C57B dinucleamer expansion

SWGA triplication

SWGA duplication

- Parkinson's disease / paralysis agitans
  - Unspec Tremor
  - "Progressive Myoklonus-Epilepsie"
  - Seizures/Epilepsy
  - "Dementia praecox"
  - Cogn Decline / Dementia suicide
- A.-K. branch designation acc. to Mjones (1949)

## Updated pedigree of the Lister Family (*previous page*)

Standard symbols are used; circles denote females and squares males. Diamonds are used to disguise gender; a number within a diamond denotes the number of siblings, a question mark an unspecified number of siblings. A diagonal line indicates the person is deceased. Double lines signify consanguineous parenthood. Asterisks (\*) indicate that the individual occurs twice in the pedigree, as marked with the identical capital letter within two symbols. Neurological diagnoses are symbolized as shown in the legend. Numbers 1 to 35 underneath a symbol identify the individuals with parkinsonism, and F2 to F18 identify the persons with "Progressive Myoklonusepilepsie" described by Lundborg [265-267]. Capital letters outside of symbols identify the family branch as in Mjones [194] and ref.[1]. Individuals without children are marked with  $\perp$ . Two family members were examined *post mortem* (+, plus sign): The neuropathology of individual 12 was reported by Farrer et al. [269]. F3 was examined *post mortem* more than 110 years ago; the brain could not be retrieved from the collection of the Dept. of Neuropathology, Lund. For reasons of readability and confidentiality, the pedigree drawing is greatly simplified. Branches without parkinsonism or progressive myoclonus were omitted, but all known Lister Family members with these diagnoses are included in the drawing. According to Lundborg, many additional family members (not shown) suffered from dementia, *dementia praecox*, or alcoholism or showed unusual or socially not accepted behaviour. *SNCA* genomic triplication had already been reported for patient 12 (Swedish-American proband; SWE AM tripl), and *SNCA* duplication for patient 17 (Swedish proband; SWE dupl)[1]. Within this study, *SNCA* duplication was detected in four asymptomatic individuals; these individuals are not shown. A dodecamer repeat expansion in the promoter of the *CSTB* gene was detected in one individual (not shown). The boxes below the pedigree indicate in which branches mutations were found. Generally, none of the individuals who participated in this study are shown, and almost all individuals from present generations who were identified during the course of this study are omitted from this drawing for reasons of confidentiality.

### *Patients with parkinsonism*

Of the 30 Swedish patients with parkinsonism, seven were examined by Lundborg or Mjones, two additional patients were examined by "a doctor" before Lundborg's data collection, and medical records (most from Lund University Hospital) were available from 10 patients. Detailed medical information could thus be compiled from 17 patients with parkinsonism. The Swedish-American branch had been examined by Prof. Zbigniew K. Wszolek [1,269] and the Swedish index patient (nr. 17) by Dr. Christer Nilsson [1]. An additional patient with dementia (identified by DEM in the pedigree drawing) had been examined by Prof. Lars Gustafson and is described in detail in Article I. The clinical data is summarized in Appendix 1.

Compilation of the data allowed for renewed analysis of features common to the affected family members. Akinetic-rigid parkinsonism, postural hypotension, and cognitive impairment were recurring features. Speech and language disturbance with problems articulating and word finding difficulties are described in several individuals. Psychiatrist Dr.

Henry Mjönes' mentioned emotional or behavioral abnormalities in 17 of the 35 patients with parkinsonism, including the two sisters whose diagnosis was uncertain. Imaging showed mild general atrophy of the cerebrum in more advanced stages. Electroencephalograms showed general slowing of the background rhythm. Measurements of cerebral blood flow were performed in two individuals with parkinsonism, and one with dementia, see figure below. SPECT imaging of the dopamine system revealed a pronounced, symmetric reduction in dopamine transporter binding in the striatum (putamen > caudate) [1]. Diagnoses of multiple system atrophy were tentatively entertained in the three most thoroughly investigated patients, in both the USA and Sweden.

### *Patients with "Progressive Myoklonusepilepsie"*

Seventeen patients within the Lister Family, comprising 1,909 related individuals when studied by Lundborg, had a disorder that Lundborg described as "Progressive Myoklonusepilepsie". Lundborg had examined five of these, observed two as inpatients at a neurology ward in Stockholm, and stayed several weeks in the home of an additional patient for observations. Within this study, no living individual with a diagnosis of Unverricht-Lundborg's disease could be identified within the Lister Family (Article I). The clinical details of the 17 patients identified by Lundborg are summarized in the Appendix 2a and 2b. Median age at death was 43 years, with a range of 14 to 72 years. In a majority of progressive myoclonus patients, abnormal shyness or nervousness and other behavioral symptoms were noted. Lundborg noted that patients with progressive myoclonus became childish again towards the end of their lives.

### *Patients with dementia and "dementia praecox"*

Lundborg found that 74 members of the Lister Family had "dementia praecox" [267]. We identified a branch of the family with one proband who had been followed longitudinally at the Dept. for Psychogeriatrics in Lund. This person (DEM in the pedigree and table) developed dementia with frontal and behavioral symptoms at age 77 years, and subsequently postural hypotension and an inability to walk. Genetic testing had not been performed in this patient.

### **Parkinsonism (patient 33)**

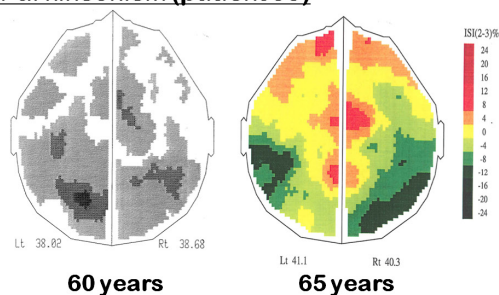

### **Parkinsonism (patient 34)**

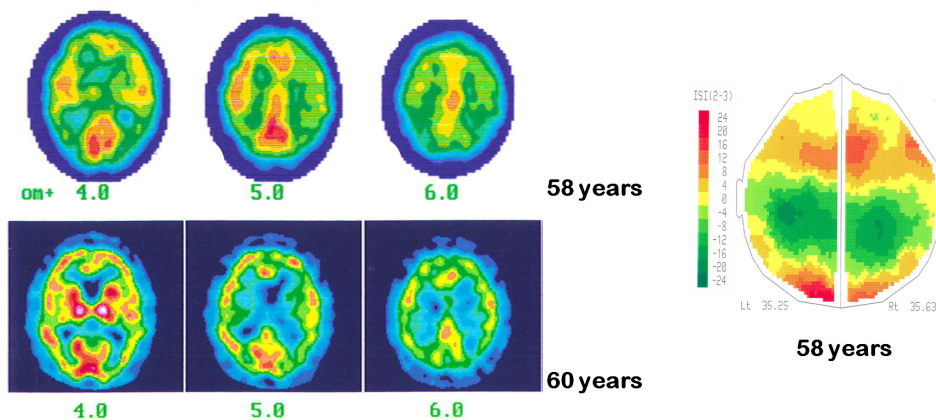

### **Dementia (patient DEM)**

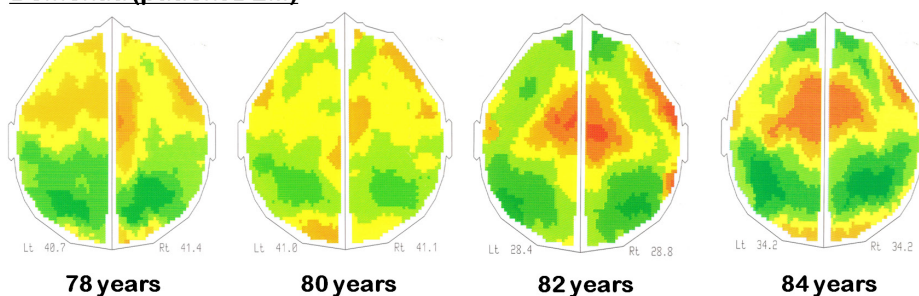

### **Cerebral blood flow examinations of patients from the Lister kindred with different diagnoses**

We retrieved cerebral blood flow (CBF) examinations from three individuals in the Lister kindred.

**Patient 33** (parkinsonism, slowness of thoughts, depression, and speech problems affecting articulation, repetition and verbal memory) was examined twice with  $^{133}\text{Xe}$  inhalation, which allows for quantitative measurements. At age 60 there was a mild regional CBF reduction frontally in the left hemisphere. At age 65 this frontal CBF reduction could not be seen, but there was a moderate reduction of CBF temporally bilaterally and temporo-occipitally on the right side. **Patient 34** (parkinsonism, postural

hypotension, memory problems, perseveration, apraxia and subsequent dementia) was examined three times. <sup>99m</sup>Tc-SPECT imaging was performed at age 58 and 60 years; this method assesses the regional distribution of cerebral blood flow in relation to the cerebellum and does not allow assessment of the overall CBF or quantitative comparison. At age 58 years there was relatively pronounced reduction parietally bilaterally. A <sup>133</sup>Xe inhalation scan obtained the same year revealed a clear reduction of overall blood flow with focal reduction in the temporoparietal regions bilaterally and a mild CBF reduction in the prefrontal region. At age 60 years, CBF in the cortex was moderately to markedly reduced, mostly in the temporal and parietal lobes bilaterally. **Patient DEM** (dementia, postural hypotension, inability to walk, described in Article I) was examined on four occasions during 6 years. The first two images did not reveal a marked general or regional reduction in CBF, although frontal uptake was low bilaterally. When examined at ages 82 and 84 years, there was approximately 30% reduction of overall CBF, and a regional reduction (green) in frontal, temporal and temporoparietal areas.

## Genetic analysis of Lister Family members

Real-time PCR revealed duplications of *SNCA* in the DNA from four unaffected members of the Lister kindred analyzed within the present study. All four carriers are in their 5th to 7th decade of life.

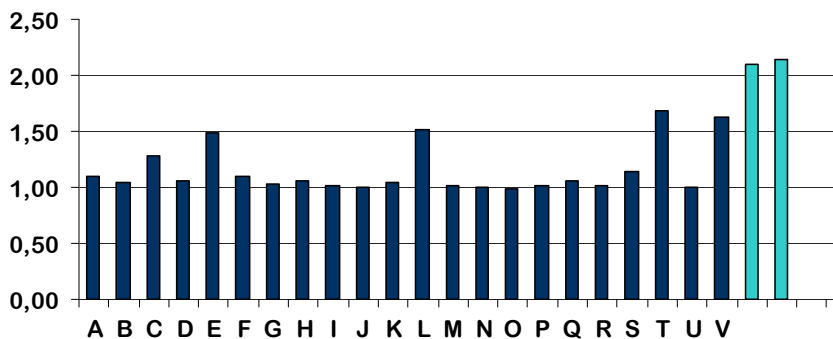

### *SNCA* gene dosage in 22 members of the Lister Family

DNA from 22 members (A-V, not shown in the pedigree) were analyzed for *SNCA* gene dosage with a real-time PCR assay as described in refs. [1] and [270]. Experiments were performed in quadruplicate, and the average results are shown. Individuals E, L, T and V had a dosage of approximately 1.5, indicating gene duplication. Individual C had a value of 1.27, caused by a false high value in the first experiment but normal (around 1.0) in the subsequent three. The two columns to the right are from two *SNCA* triplication carriers from two independent families used as controls. A "no template" control was included as the final sample. All analyses were performed at Mayo Clinic.

Microsatellite analysis identified the following five short tandem repeats that confirmed multiplication of the *SNCA* genomic region in the Lister Family: D4S2304, D4S3475(118K), D4S3474(NACP600), D4S3479(56K), and D4S2458. The number of *SNCA*-positive

individuals was considered too low to reliably determine the sensitivity of a combined use of these 5 markers for screening purposes, but *SNCA* duplication could be confirmed for each of the four newly identified asymptomatic carriers with at least one of the markers (by three different repeat lengths, indicating three alleles instead of two, that were considered clearly distinguishable).

Furthermore, one individual from branch J is a heterozygous carrier of the 5'-CCCCGCCCCGCG-3' dodecamer repeat expansion in the promoter region of the *CSTB* gene.

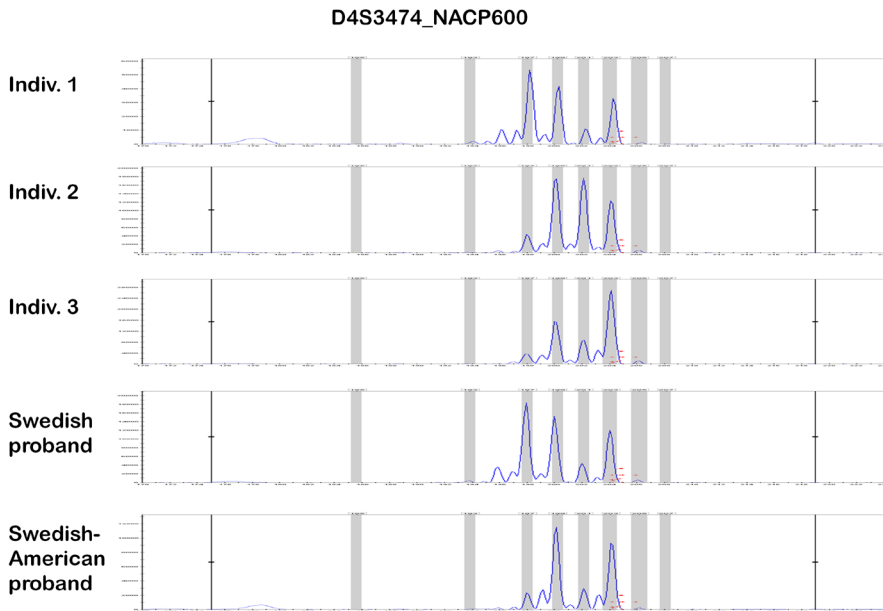

### **Analysis of gene multiplication with microsatellite markers (short tandem repeats)**

This analysis revealed three clearly distinguishable peaks with decreasing amplitude (indicating three different lengths of microsatellite marker D4S3474; 1+1+1 conformation) in the Swedish proband (patient 17 in the pedigree), individuals 1 and 2. This confirms *SNCA* duplication in individuals 1 and 2, who are two of the four newly identified duplication carriers. Individual 3 shows two distinguishable peaks with the last one twice as high as the first, which also suggests gene duplication (1+2 combination). The Swedish-American proband, with known *SNCA* triplication, displays two peaks that are markedly elevated above the background, indicating a 2+2 configuration of genomic triplication. All analyses were performed at Mayo Clinic.

# PARLU Study:

## Study population

We retrieved 133 patients from the three counties in West Blekinge for whom ICD-10 codes for PD or parkinsonism were registered during the 5 years time prior to the data collection. Cross-check with the Swedish Civil Registration (Befolkningsregistret) revealed that, among these, 23 were already deceased at the beginning of our study. We contacted the remaining 110 patients by mail. Of those, 84 (76%) agreed to participate in the study and were included. Twenty-four (of 84, 29%) had one or more first or second degree relatives with parkinsonism<sup>4</sup> and 3 (3.6%) had one or more siblings with parkinsonism, but no other affected family members. The remaining 57 (68%) patients did not have a first or second degree relative with parkinsonism, or were unable to provide this data.

Seventy-seven patients from outside West Blekinge were included. In this group, targeting individuals with familial parkinsonism, 47 (61%) had at least one first or second degree relative with parkinsonism and 17 (22%) had one or more siblings with parkinsonism, but no other affected family members. Thirteen (17%) patients did not have a first or second degree relative with parkinsonism, and were included as sporadic patients.

Fifteen individuals had familial parkinsonism and dementia (DLB or Parkinson Disease Dementia) from both within and outside of West Blekinge.

Of all 161 patients included, 143 represented index patients (proband, cases) and 18 were affected relatives of index patients and were omitted from genetic analyses. Blood samples from 11 examined probands were not received in time for genetic screening, or not at all. One hundred thirty two index patients were analyzed genetically. The average age at their disease onset was 61.7 (SD 9.9, range 36-82, median 62.5) years, 80 were male and 52 female (M:F, 1.53:1). Samples from 44 unaffected and unrelated control subjects were included in Article IV.

## Results of genetic screening

Genetic analyses revealed one proband with an SNCA A53T mutation, described in detail in Article II. The patient reported that her late father had suffered from very similar symptoms. Both the patient and her father had been followed longitudinally in Lund or Malmö

---

<sup>4</sup> Several additional participants reported a family history of dementia or tremor, but these were not included here.



University Hospitals. Reviewing the medical records and interviews with the patient and caregiver revealed that the two affected individuals had early-onset (<31 and 40 years, respectively), severe, levodopa-responsive parkinsonism with prominent dysphasia, dysarthria, and cognitive decline. Longitudinal clinical follow-up, EEG, SPECT and CSF biomarker examinations suggested a pathological process involving the entire brain, including the neocortex. With the proband's and her family's consent, nine relatives were contacted and interviewed in person or via telephone; all were unaffected. DNA samples from unaffected relatives and from the patient were studied further with haplotype analyses (Article II), identifying unique markers in the genomic region of the *SNCA* gene. The mutated allele (c.209A) was present within a haplotype different from that shared among mutation carriers in the Italian (Contursi) and the Greek-American Family H kindreds. One unaffected family member carried the mutation haplotype without the c.209A mutation, strongly suggesting its *de novo* occurrence within this family,

One patient had two mutations affecting the same amino acid of the PARKIN protein in exon 7. Both are located directly next to each other at c.924C>T, resulting in a p.R275W substitution, and c.925G>A, resulting in a p.R275Q substitution. The patient's mother, who was not affected of parkinsonism at the age of 83 years, carried the c.924C>T mutation, but had the wild type c.925G. Thus, the proband carries mutations affecting the amino acid residue 275 in a compound heterozygous manner: PARKIN R275W and R275Q (comp het). Clinically, this patient developed slowness of movements at the age of 46 years. Signs were slowly progressive and still relatively mild five years after onset. There was no cognitive impairment. The patient has been examined with multitracer SPECT of the brain (Dr. A. Jon Stoessl, University of British Columbia & Vancouver Coastal Health, Vancouver, Canada, unpublished results). <sup>18</sup>F-6-fluoro-L-dopa was used to assess dopamine synthesis and storage, <sup>11</sup>C-alpha-dihydrotetraabenazine to assess the vesicular monoamine transporter and <sup>11</sup>C-d-threo-methylphenidate for the membrane dopamine transporter. These showed a substantial reduction in dopaminergic function, with slight asymmetry, affecting the left striatum more than the right. There was a rostro-caudal gradient with the caudate affected more than the putamen, which is affected maximally in the most posterior part. Findings were compared to those in a reference group with sporadic PD patients, and were similar to this group (data not shown). Fibroblast cell lines have been created from this patient and are freely available to the scientific community via <http://ccr.coriell.org/sections/collections/NINDS/> [274].

Two patients were heterozygous carriers of the PINK1 G411S mutation. One patient, SWE-2 (Article IV), developed PD at 46 years of age. Delusions were noted within 2 years of motor symptom onset. During treatment with pramipexole (1.05 mg/day), levodopa (600mg/day) and entacapone (1000mg/day), the patient developed severe psychosis requiring inpatient psychiatric care. Psychosis was partially but not completely reversible after discontinuation of pramipexole and entacapone. This patient also carries the PARKIN D394N variant, which however is not known to influence PD risk. One parent of SWE-2 also carries the PINK1 G411S mutation but is unaffected, whereas the other parent developed parkinsonism at the age of 72 years. No cognitive dysfunction was noted in SWE2 or the parents. SWE-3 (Article

IV) also carries a PINK1 G411S mutation (heterozygous). This individual developed parkinsonism at 54 years of age. Response to levodopa was good initially, but dosage was gradually increased to 1800mg levodopa and 2.25mg ropinirol per day. During this treatment, hypomania, nightmares, hallucinations, mood swings and unusual urge to talk occurred. The patient was operated with deep brain stimulation of the subthalamic nuclei bilaterally at age 64 years, which improved motor symptoms. One first-degree relative had severe psychotic depression. Genetic analysis of the family members of SWE-2 and SWE-3 showed that PINK1 G411S mutation in its heterozygous state does not invariably cause PD, and is thus not pathogenic by itself. Further analysis revealed that this mutation was not present in 122 additional PARLU patients, or in 44 Swedish controls. However, it was found in 6 of 418 PD patients from Norway (Ref. [167] and Prof. Jan Aasly, Trondheim), and in 1 of 520 unaffected Norwegian controls. This prompted a larger meta-analysis of all retrievable publications where this mutation was analyzed (Article IV). Briefly, data emerged that strongly suggests that PINK1 G411S mutation is a rare genetic risk factor with a relatively strong effect size (OR 4.06 to 8.42). Details are given in Article IV.

No pathogenic mutations in *LRRK2*, *EIF4G1*, *VPS35*, or *DJI* were detected in this screening, but results from this sample series were used in connection with the initial discovery of *VPS35* as a disease-causing PD-gene [7]. All *ATXN2* and *ATXN3* alleles were within the normal length range.

Pathogenic mutation:

- 1 proband (AO 40) with SNCA A53T mutation
- 1 proband (AO 46) with PARKIN R275W and R275Q (comp het)\*

Genetic risk factor with intermediate effect size:

- 2 probands (AO 46<sup>°</sup>, 54) with PINK1 G411S (het)

Genetic risk factor with low effect size:

- 4 probands: PARKIN V380L (het) (AO 43<sup>°</sup>, 47, 52, 60)

Variants probably not associated with disease risk:

- 2 probands: PARKIN D394N (het) (AO 43<sup>°</sup>, 46<sup>#</sup>)

<sup>°</sup> identical individual

<sup>#</sup> identical individual

**Results from comprehensive screening of 132 probands from the PARLU study:**

This table summarizes the results from the genetic screening of the PARLU study. Two of 132 (1.5%) analyzed patients had a genotype that was clearly or probably disease-causing. \*The pathogenicity of PARKIN R275Q cannot be proven as this is the first description of this mutation in a PD patient; R275W is well-established, and thus R275Q is also very likely disease-causing. Several other genetic risk factors, such as LRRK2 M1646T or *SNCA Rep1* have been analyzed in these 132 probands (data not shown) within multicenter studies. As their small effect cannot by itself explain disease development in an individual patient, they are not mentioned in the table. Likewise, the effect of PARKIN V380L is low

(see introduction). The pathogenic relevance of PARKIN D394N remains very uncertain; at present there is no evidence that it may increase disease risk. AO, age at symptom onset (years).

## Analysis of DNA from neuropathology specimens

A LRRK2 N1437H mutation was detected in DNA from a brain of a deceased PD patient. Article III describes the methods and results in detail. This patient did not have any obvious family history for parkinsonism. No relationship was established to the only two families described with this mutation so far (both from Norway) [72] despite intensive genealogical research. The clinical phenotype of this severely affected patient is described in Article III, which includes a patient video. The patient's motor symptoms became manifest at the age of 50 years. There was parkinsonism, which initially responded well to levodopa, including tremor. The patient developed very intense motor fluctuations. There was severe and painful ON-dystonia, and severe depression with suicidal thoughts during OFF. In the advanced stage, cognition was slow during motor OFF, but there was no noticeable cognitive decline. There were no signs of autonomic nervous system dysfunction. Bilateral deep brain stimulation of the subthalamic nucleus had unsatisfactory results on motor symptoms. The patient committed suicide; disease duration was 19 years.

We present the first neuropathological examination of a patient with this mutation (Dr. Elisabet Englund, Lund; Article III). This revealed very pronounced ubiquitin-positive pathology in the brainstem, temporolimbic regions and neocortex. Ubiquitin positivity was most pronounced in the white matter. There was marked cell loss and alpha-synuclein positive Lewy body pathology in the brainstem, and sparse Lewy pathology in the cortex. Immunohistochemistry for tau was mildly positive, revealing non-specific changes, but staining for TDP-43 and FUS was negative.

## Independence of *SNCA* and *MAPT* associations

The multicenter study coordinated by Dr. Alexis Elbaz (Hôpital de la Salpêtrière, Paris) successfully genotyped the 4 SNPs in the *SNCA* genomic region and the 2 SNPs marking the *MAPT* locus in more than 95% of 5,302 cases and 4,161 controls. All 4 SNPs in the genomic region of *SNCA* and rs1052553, which defines the *MAPT* H1 haplotype, were highly significantly associated with PD, which further confirmed previous findings. The strongest associations were observed for SNPs in the 3'-end of *SNCA*. None of the 4 *SNCA* SNPs showed any statistical interaction with any of the 2 *MAPT* SNPs. Thus there was no evidence for a gene-gene interaction (epistasis) between *MAPT* and *SNCA*, but the association of both genes with PD is independent and without additional interacting effects. Further analysis

showed that the genotypes of neither *SNCA* nor *MAPT* SNPs influenced age at onset among PD cases.

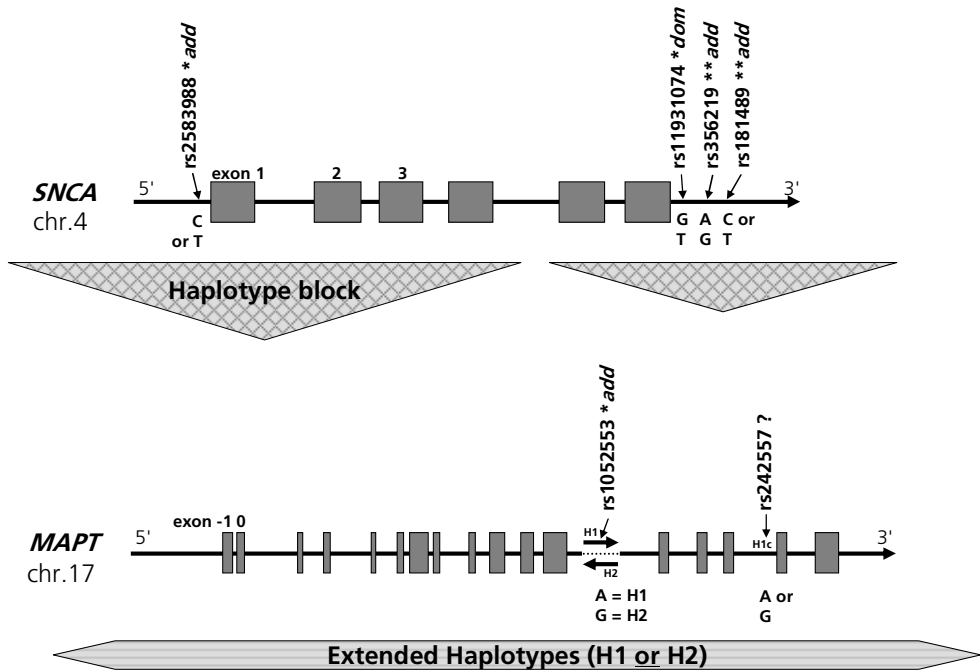

### Study design and findings in Article V

This study genotyped 4 single nucleotide polymorphisms (SNPs) in the *SNCA* gene and two in the *MAPT* gene of 5,302 PD patients and 4,161 control subjects. Five of the 6 SNPs showed significant association with PD (\*, associated; \*\* strongly associated; ?, no clear association). Association was tested with different models, investigating the effects of the combination of SNPs (on both alleles) in an individual with PD risk: For rs2583988 with T as the minor (rare) allele, the additive model "adds" the number of Ts in the genotype, TT (2Ts) > TC(1T) = CT(1T) > CC(0T); the dominant model analyses the effect of TT, CT or TC versus CC, and the recessive model counts only homozygous TT versus TC, CT, or CC. The effect size (OR) and p-value of associations depend somewhat on the model used for analysis; the model demonstrating the strongest association is added behind the SNP name (*add*, additive model; *dom*, dominant model). *SNCA* consists of two haplotype blocks (grey triangles). The *MAPT* gene is always inherited as one of two distinct haplotypes, H1 or H2. The H1 haplotype has various subtypes; rs242557 marks only the H1c subtype. There was no clear association between H1c and PD.

# Discussion

## Lister Family and *SNCA* multiplication

The Lister Family is the largest family with *SNCA* multiplications characterized today, and the only one where both *SNCA* duplications and triplications have been detected [1]. The family offers a unique opportunity to study the clinical phenotype of disease caused by overproduction of (wild-type) alpha-synuclein. As alpha-synuclein is considered to have a central place in the pathogenesis of PD and related disorders (the synucleinopathies), such studies may contribute to the understanding of common disease mechanisms.

The Lister Family is an extensive and ramified kindred from the Lister peninsula in Blekinge province in the South of Sweden. A total of 1,909 descendants of two ancestors, both born in 1691, and their families, have been mapped meticulously by Herman Lundborg in 1913 [267]. Today, the family have an active family association (Listersläktens förening) who studied and compiled historical aspects of their family in several publications between 1970 and 2009 [268,275,276]. From a medical perspective, the family was initially of interest because of the occurrence of a rare neurological disease, studied by Lundborg [265-267]. Lundborg referred to this childhood-onset disorder first as "Familiäre Myoklonie" [265] and then as "Progressive Myoklonusepilepsie" [267] in his German-language publications. It later received the names "Unverricht-Lundborg disease" (ULD), "epilepsy, progressive myoclonic 1" (EPM1), or "Baltic myoclonic epilepsy".

However, Lundborg also noted that paralysis agitans (an old designation for PD) occurred among nine members of the Lister Family, in a distribution suggesting autosomal dominant inheritance [267]. In the late 1940's, branches with paralysis agitans were again studied by Henry Mjönes within his country-wide survey of families with hereditary PD [194]. A patient with parkinsonism and a massive family history for this disease consulted Dr. Christer Nilsson, and was found to harbor an *SNCA* duplication [1]. Genetical and subsequent genealogical analyses proved that this patient was related to a Swedish-American branch carrying a triplication of the identical genomic segment [1]. Within the present study, I found that 10 individuals from this family have been examined at Lund University Hospital during recent decades, and retrieved their medical records. The aim of the present study part was to collect more information on this disease from additional family members.

During the years of this project, we were fortunate enough to establish good contact with several members of the Lister Family. The kindred are painfully aware of Lundborg's publications, in which family members, whose personal data were published in large pedigree drawings, were described in very negative terms: Lundborg classified 15% of the 2,232 Lister Family members as "morally or socially inferior" (for example, "alcoholic", "criminal", "wanton", "of bad character") and another 9.5% as "psychiatrically inferior" [267]. Lundborg explains how he relied on church records or information from school teachers for a large part of his research.<sup>5</sup> He considered church book entries noting "very low knowledge about Christianity" sufficient to classify the individual as feeble-minded (Swedish: "debil"), "imbecile" or "idiot" – designations applied to altogether 117 of the 2,232 family members. Seventy-four members were classified as having "dementia praecox" [267]. Lundborg concluded that the Lister Family was of unusually "low qualitative composition",<sup>6</sup> and in the preface to Lundborg's work, von Gruber called it "society's foremost responsibility" to "prevent the reproduction of the lowest genotypes"<sup>7</sup> [translations by the author]. Lundborg was appointed as professor and head of the "Swedish State-Institute for Race-Biological Investigations", and he advocated the concept that the Swedish race threatened to degenerate [277]. His activity and influence contributed to the implementation of forced sterilization programs in Sweden, which subsequently received strong criticism [278-281]. Highly derogatory utterances on the population on Lister peninsula of prominent Lund medical professionals are also reported from only very few decades ago [282], and the value of eugenics and involuntary sterilization is debated controversially even today [281,283], perhaps reflecting the profound influence of Lundborg's works on some parts of the academia in Sweden.

The scope of this work does not allow for a comprehensive discussion of the historical background to these concepts, or of their reception among various groups of society. Several aspects need to be taken into consideration: Some expressions used by Lundborg were medical terms or diagnoses at the time of publication, rather than derogatory terms. The ideology of race biology had followers in several other countries at that time [284-290]. More advanced methods to study or treat inherited disorders were lacking. Lundborg's work has been credited as the first to ever demonstrate recessive inheritance in humans. Nevertheless, Lundborg's work was received with considerable irritation among Lister Family members [291,292]. Lister

---

5 The official census at that time was the responsibility of the Church of Sweden. Home visits (Swedish: "husförhör") by priests were conducted on a parish-wide basis once every ten years for this purpose. Priests recorded all family members, commented their knowledge about Christianity, and sometimes made notes diseases or causes of death in the family.

6 German original: "Es is naheliegend anzunehmen, daß man [...] nicht besonders oft Geschlechter von so qualitativ schlechter Beschaffenheit antreffen wird" (ref. [267] , p. 442)

7 German original: "Verhinderung der Fortpflanzung der schlechtesten Erbmassen" [...] "eine weise Züchtungspolitik - die höchste Aufgabe der Volksgemeinschaft" (ref. [267] , preface by Max von Gruber)

Family members even today feel stigmatized by Lundborg's association of family members with delinquency, alcoholism, character traits, and neurological disorders, and his use of the Lister Family as an example of the contemporary genetic "degeneration" theory. Despite my doubts and the possibility of alternative explanations (see below), I cannot refute with certainty that "Progressive Myoklonusepilepsie" as described by Lundborg in the Lister Family was a recessive Mendelian disease, or even that it may have been caused by *CSTB* mutations. But even if it were true that all the 17 family members suffered from a recessively inherited neurological disorder, it remains difficult to explain why a quarter of all Lister Family members should display neurological or psychiatric diseases, other mental health problems, or delinquency. It appears impossible to reconstruct all details today, and I mainly concentrated my study on parkinsonism. At the beginning of this work, we were cautioned that studying Lundborg's publications or the Lister Family may be inexpedient. However, we also received very positive feedback from Lister Family members, members of the general population from the Lister peninsula area, local health care providers, and a lot of encouragement from colleagues and international collaborators [293].

## Approaching family members

We did not find any additional affected family members via a systematic population-based study of all individuals with parkinsonism residing in the Lister peninsula or the adjacent geographical areas. This may be due to several factors: Family members may have moved away from the three counties under scrutiny. They may have declined participation for unrelated and personal reasons. In light of our findings that *SNCA* multiplication can lead to different phenotypes and not "normal" idiopathic PD, we may have chosen the wrong ICD-10 codes for inclusion. This may have deterred family members who were contacted in the population-based approach from answering our contact letters. We subsequently found out that a few of the patients whom we have contacted in the population-based part of the PARLU study, and who declined participation, were in fact members of the Lister Family.

Contacting family members directly via a standardized letter, used in similar research in the USA and approved of the Regional Ethical Review Board responsible for this study, yielded a high response and participation rate of almost 50% of those contacted. We interpret this as a sign of the individual family members' interest in research, as well as an awareness that uncommon neurological disorders occurred in family members as part of a hereditary disorder. In contacts with other families with hereditary neurological disorders, we have experienced that members usually are well aware of the presence of a familial disease, and interested in efforts to elucidate its cause.

## The neurological disorder(s) in the Lister Family

In this study we present the compiled clinical details of 35 Lister Family members with parkinsonism, a branch with dementia, and Lundborg's descriptions of 17 patients with "Progressive Myoklonusepilepsie" [265-267]. It remains uncertain what Lundborg classified as dementia praecox, which was a very new concept at the time and which may be similar to but not identical with the modern diagnosis of schizophrenia [294]. An additional branch with four individuals with dementia was described in Article I; one of these patients has been investigated in detail at the Dept. of Geriatric Psychiatry at Lund University.

Similar signs and symptoms were observed in affected family members who had diagnoses of parkinsonism, dementia or "Progressive Myoklonusepilepsie" (Article I). These common features included an akinetic-rigid type of parkinsonism, that often was responsive to levodopa in the early stages but less so as the disease progressed. The dementia phenotype included marked parkinsonism with an inability to walk (Article I), and Lundborg noted that the advanced stage of "Progressive Myoklonusepilepsie" includes parkinsonism [267]. Marked symptomatic postural hypotension was present, and a tentative diagnosis of MSA was made in three patients with parkinsonism who were examined relatively recently. Language and speech problems recurred among many individuals with parkinsonism, dementia, and also those with "Progressive Myoklonusepilepsie". Myoclonus, a characteristic sign of "Progressive Myoklonusepilepsie" has also been observed in the later stages of Lister Family members patients with parkinsonism. Higher cognitive functioning was impaired in a majority of patients, and besides a general slowing of thought, probably indicating subcortical pathology, there were signs of cortical dysfunction. Either a parietal or a frontal and temporal pattern of dysfunction was noted in several family members, and was compatible with the findings of decreased blood flow in these areas and a mild general cerebral atrophy. All of these features have also been noted in patients from the 28 families with *SNCA* multiplication worldwide that have been reported in the literature so far [1,21,22,28-49].

The 17 patients whom Lundborg described as having "Progressive Myoklonusepilepsie" differ in between each other and when compared to clinical reports on patients with confirmed *CSTB* mutations. For example, most individuals with EPM1 (caused by *CSTB* mutations) are thought to have died before they reached an age of 30 years [295], at least in the past when modern methods of treatment and care were not available. This contrasts markedly with the individual whom Lundborg met when she was 70 years old (F17). Four additional Lister Family members with "Progressive Myoklonusepilepsie" lived longer than 50 years. On the other hand we observed that core symptoms that occurred in individuals with parkinsonism and dementia in the Lister Family (and in other families with confirmed *SNCA* multiplications) also were present in patients with "Progressive Myoklonusepilepsie" from the Lister Family. Lundborg identified consanguineous parenthood for most individuals with "Progressive Myoklonusepilepsie", but not for the family of F8, F9 and F10, whose two siblings had a different type of epilepsy. Consanguineous parenthood was not uncommon at the time, and some of the parents of persons with "Progressive Myoklonusepilepsie" were only



remotely related to each other, which decreases the likelihood that the disease is caused by recessive inheritance. Article I hypothesizes that *SNCA* multiplications may be the common genetic cause to the various syndromes in the Lister Family, see below. The published features of EPM1 and "Progressive Myoklonusepilepsie" are compared in Appendix 3.

## Genetical Analyses

In this study we have identified four additional asymptomatic carriers of *SNCA* duplication. All of these are in their 5th to 7th decade of life. The carriers were identified in several branches of the pedigree. This distribution of *SNCA* multiplications in several branches together with the recurrence of an identical subtype of parkinsonism in all closely followed individuals makes it most likely that all or almost all of the 35 patients with parkinsonism had the same genetic cause. However, it cannot be excluded that single patients with a similar phenotype but different genotypes are among the affected members of this extensive pedigree ("phenocopies").

In collaboration with Prof. Anna-Elina Lehesjoki, Helsinki, a heterozygote (asymptomatic) carrier of a dodecamer repeat expansion in the *CSTB* promoter was recently identified among the Lister Family members. This is the commonest mutation found in patients with EPM1 [296]. In Finland the carrier frequency is about 1:65 (Prof. Lehesjoki, personal communication), due to a founder effect in the Finnish population. No epidemiological data are available from Sweden, but EPM1 is rare in Sweden, and in neighboring Denmark the disease incidence is approximately 27-fold lower than in Finland [297]. This makes it difficult to interpret the presence of a *CSTB* mutation in the Lister Family; but it certainly appears possible that (homozygous or compound heterozygous) *CSTB* mutations may explain at least some of the cases of "Progressive Myoklonusepilepsie".

However, this is not easily reconciled with the clear difference in the clinical description of this disease by Lundborg and the observations in large series of *CSTB* mutation carriers [295,298] (Appendix 3). An alternative explanation, which in the light of these newer results seems more likely than the suggestion of higher-order *SNCA* multiplications in Article I, may be a combined effect of *CSTB* mutations, perhaps in heterozygous form, and *SNCA* duplications. Both cystatin B and alpha-synuclein are connected to the lysosomes. Cystatin B is a protease inhibitor that is located on lysosomes. The *CSTB* mutations that cause EPM1 decrease the activity and association with the lysosomes of cystatin B [299], and accumulation of alpha-synuclein occurs in Gaucher disease and other lysosomal storage disorders [264]. SPECT studies have shown a dopaminergic deficit in EPM1 patients [300], and dopamine agonists have led to symptomatic improvement in EPM1 [301].

Lundborg may have included less severe cases of the disorder when studying an entire kindred; only those patients with more severe disease may receive a genetical diagnosis and be included in case series today. Nevertheless, the differences in the available descriptions of the clinical

phenomenology of EPM1 and "Progressive Myoklonusepilepsie" differ markedly. My conclusion is that it remains uncertain what caused the "Progressive Myoklonusepilepsie" phenotype, and if all 17 patients described by Lundborg really had the same diagnosis.

## Comparison with other published *SNCA* multiplication families

As mentioned above, the clinical signs from affected Lister Family members are similar to patients with *SNCA* multiplications described in the literature. Here I compare findings at imaging and pathology and describe three interesting childhood-onset cases with *SNCA* multiplication.

### *Imaging and Pathology*

Cerebral blood flow was reduced in various cortical areas in three examined patients from the Lister Family. Mild generalized cortical atrophy was visible on brain imaging. Atrophy of the frontal and/or temporal lobes in magnetic resonance imaging was previously reported from a patient with advanced disease and *SNCA* multiplication [32]. One published *SNCA* duplication carrier who had motor symptoms for six years but no cognitive disturbance had normal cerebral blood flow [32]. On the other hand, a patient with the same mutation, severe cognitive and motor dysfunction, and 17 years disease duration, displayed bilateral, frontal and temporal hypoperfusion [32]. Brain glucose metabolism was significantly reduced in the parieto-temporo-occipital cortex of six symptomatic *SNCA* duplication carriers [33,39], but unimpaired in three asymptomatic mutation carriers [33]. Thus, there appear to be two different patterns of cerebral blood flow and metabolism changes in patients with *SNCA* duplications, either frontotemporal or parieto-temporo-occipital. This is similar to the findings in the three patients in the Lister Family examined in this study. Although none of these had an *SNCA* duplication confirmed by genetic testing, their position in the pedigree and clinical symptoms strongly suggest that they are duplication carriers. Interestingly, the patient with an *SNCA* A53T mutation described in Article II and below also had cortical atrophy and reduced blood flow in the frontotemporal region.

So far, four patients with confirmed *SNCA* duplication and seven with triplication have come to autopsy, including the brain from the Swedish–American proband of the Lister Family, patient 12 [269]. The macroscopic pathology is described for 6 of the 11 brains, and all of these had atrophy of the frontal and/or temporal lobes [302,303]. It has been pointed out that this distribution of cortical atrophy is typical of DLB and corresponds to cortical regions that are vulnerable to Lewy body pathology in general [303]. Microscopy revealed Lewy pathology in all examined brains. Lewy pathology was diffuse and widespread throughout the central and peripheral nervous system of the published cases, which all represent patients with late-stage disease. A unique feature of the pathology of brains from *SNCA* multiplications (and a few of the brains with *SNCA* point mutations) cases is the cell loss of the cornu ammonis (CA) 2 and 3 areas in the hippocampus, with sparing of CA1 and other hippocampal cell populations.

Some of the remaining neurons had bizarre shapes and gave a "windswept" appearance [302,304], and there was gliosis. It remains unknown why these cells are predominantly affected, as our knowledge about specific CA2 and CA3 connectivity remains limited [305]. The appearance of Lewy bodies was described as typical or atypical with homogenous, lightly eosinophilic matrix in conventional staining methods [304]. Their shapes were pleomorphic and bizarre, and they were located in the perikaryon or in neurites [303]. There were Lewy neurites and Lewy dots [306]. Alpha-synuclein immunoreactive aggregates were also present in glial cells; their appearance differed from glial cytoplasmic inclusions as seen in multiple system atrophy [303]. The findings are in agreement with a general overproduction of alpha-synuclein protein in the entire nervous system, which leads to widespread and diffuse alpha-synuclein aggregation and cell loss. The exact mechanisms remain to be elucidated, and it remains unclear why different cortical brain regions may be predominantly affected.

### *Childhood-onset cases*

Among the patients with *SNCA* multiplications reported from 28 families so far, three had neurological symptoms from a very young age. The first patient ever where a duplication of *SNCA* was seen was a Belgian girl with trisomy of a larger segment of chromosome 4 in her karyogram [28]. This child had mental retardation, low muscle tone in the lower extremities, and balance problems. In her 30's, the patient developed parkinsonism, and renewed analysis confirmed that the duplicated gene segment included the *SNCA* gene [29]. A boy with *SNCA* triplication was born prematurely, with partial syndactyly and loss of pigmentation in the skin and the hair [302]. Mental and motor development was slow from birth. At age 11, this patient was admitted to custodial care, never learned to write, and was always uncoordinated. At age 25 years, bradykinesia developed, the patient spoke less and started to develop a stiff gait. In the terminal stage, there was bizarre body posturing, with arm flexion and elbow supination. From Japan, one individual with *SNCA* duplication with a diagnosis of mental retardation from age one year is reported [32,33]. This patient only spoke a few words at age 12 years, and was sometimes observed to have sudden outbursts of rage. At 15 years of age, generalized seizures developed, and EEGs traced their origin to the right frontal lobe. By age 26, no parkinsonism or myoclonus was noted.

We consider the proportion of early onset cases too high to be explained solely by the normal incidence of neurodevelopmental disturbances. One possible explanation may be an unusually early start of symptoms of *SNCA* multiplications, or, in the case of the extended duplicated segments in the girls from Belgium [29], an effect of duplications of adjacent genes. An alternative explanation is that alpha-synuclein overabundance may act as a catalyst for other genetic or environmental influences that are damaging to nervous system development. Some of the cases of "Progressive Myoklonusepilepsie" in the Lister kindred share similarities to these three childhood-onset cases, and *SNCA* multiplications may not be exclusively associated with adult onset-disease.

## The specific clinical and pathological syndrome of *SNCA* multiplication

In summary, *SNCA* duplications and triplications cause a clinical syndrome with Parkinsonian motor signs, autonomic dysfunction, and cognitive decline. This syndrome probably does not fulfill the commonly used diagnostic criteria for PD, and indeed three of the patients in the Lister Family had tentative clinical diagnoses of MSA. It is important to note that our findings in the large number of well-characterized Lister Family members with parkinsonism are very similar to the published reports from other patients with this mutation. The neuropathology is unique, and all published neuropathology reports bear close resemblance to each other as well as to the pathology of the Lister Family member with triplication [269]. This mutation leads to a specific subtype of parkinsonism in most carriers, and triplication carriers are affected earlier in life than duplication carriers. Some carriers may develop cognitive symptoms prior to the onset of motor symptoms. We presume that this is the case for the patients with dementia diagnoses in the Lister Family (Article I), although we were unable to perform any genetical testing in this branch. It will remain interesting to study the childhood-onset disease reported from some *SNCA* multiplication carriers, and compare it to Lundborg's descriptions of "Progressive Myoklonusepilepsie".

If the Lister Family members that were found to carry *SNCA* multiplications wish to participate in further studies, they will be included in research with the aim to more closely characterize different aspects of this disease. We need to be reminded that the penetrance of *SNCA* mutations is age-dependent and incomplete, with descriptions of *SNCA* duplication carriers who are almost 80 years old and have remained unaffected [33]; carriers thus do not have a 100% risk of developing symptoms. Regardless of incomplete penetrance, these mutation carriers are ideal candidates for neuroprotective trials with inhibitors of alpha-synuclein when such agents will become available [261,262], as the mechanism of their disease is tightly linked to the overproduction of alpha-synuclein.

## Other monogenic forms of parkinsonism

We identified pathogenic mutations in two of 132 examined patients from the PARLU study. One patient carried the *SNCA* A53T mutation (Article II) and the other one was compound heterozygous for *PARKIN* R275Q and R275W. A *LRRK2* N1437H mutation was discovered in one patient, when DNA from seven brains was analyzed. The *SNCA* A53T and the *LRRK2* N1437H mutations are very rare and have only been found in a few families worldwide. Both carriers had been followed at Lund University Hospital and ample documentation was evaluated, providing new insights in the clinical phenotype associated with these mutations. The *PARKIN* R275Q mutation has never been described in a PD patient previously.

## SNCA A53T mutation

Details of the patient and her affected father are described in Article II. The clinical manifestation of their disease was very similar to that of *SNCA* multiplication, with signs of generalized involvement of the entire central and peripheral nervous system. This may be explained by the fact that A53T-mutated alpha-synuclein has an increased tendency to aggregate [307], similar to increased aggregation when larger quantities of the protein are expressed with *SNCA* multiplications. The type of disease in the Swedish patients was very similar to the disease caused by SNCA A53T mutations in other populations, and different from the phenotype of other monogenic forms of parkinsonism, emphasizing a correlation of genotype to phenotype.

## PARKIN R275Q and R275W mutations

One of the patients from the PARLU study was a compound heterozygous carrier of these two mutations. In this case, substitutions of the *PARKIN* gene are expected to cause an amino acid change at residue 275 on both alleles. The changes are from positively charged arginine (R) to tryptophane (W) with its large hydrophobic moiety, or to polar uncharged glutamine (Q); both may influence protein function.

The R275W mutation is perhaps the most frequent point mutation encountered in *PARKIN* [166,308]. Haplotype analysis in 12 carriers of this mutation from different European countries suggested that all were descendants of a common founder [308]. Heterozygote *PARKIN* mutations were suggested to increase susceptibility for PD [166]. *PARKIN* R275W mutations have also been reported from unaffected control subjects from South Tyrol [308]. These were recruited among blood donors, whose age is presumed to be low, and it cannot be excluded that some of these may develop PD later in life. However, our patient's parent who carries the R275W mutation remains unaffected at high age, suggesting that indeed this mutation by itself is not always pathogenic.

We are only aware of one previous description of the *PARKIN* R275Q mutation. It was found as a somatic mutation in cells of a glioblastoma, but not in the same individual's genomic DNA from normal tissue [309]. Likewise, several other somatic *PARKIN* mutations were found in cancer cells, and all were different from the known genomic *PARKIN* mutations in PD patients. Based on these results as well as on functional studies, loss of a tumor-suppressing function of wild type *PARKIN* was postulated [309]. Glioblastoma does not occur in the patient's family. Formal proof for the pathogenicity of the R275Q mutation, with regard to PD, is lacking, but as the mutation also leads to an amino acid substitution at residue 275, we consider it highly probable that this patient's compound heterozygote genotype explains the disease. Clinically, this patient has a slowly progressive disease since age 46 years, with good response to levodopa and no signs of cognitive dysfunction or autonomic nervous system disturbance. This is compatible with the clinical course of other patients with *PARKIN*

mutations, who often begin before 50 years of age but whose underlying pathology remains confined to the brainstem ("nigropathy") and does not tend to spread to involve other parts of the nervous system [61]. After genetic analysis we could inform the patient that the risk for cognitive decline or outright dementia is low in carriers of *PARKIN* mutations.

## LRRK2 N1437H

Extraction and analysis of DNA from formalin-fixed or paraffin embedded brain tissue is technically challenging. In one of seven brains that were selected from among the relatively few brains of patients with parkinsonism in the neuropathology collection at Lund University Hospital, we were able to identify the LRRK2 N1437H substitution. This mutation has only recently been detected in two families from Norway [72], but it is rare and has not been present in 8,611 patients with PD, including samples from Swedish and Norwegian collections [5], nor in any other reports so far. Although our patient shares a Scandinavian origin with the Norwegian families, we did not find genealogical evidence for relationship. Still, a common founder cannot be excluded; the DNA extracted from the brain was not of sufficient quality for haplotype analysis, and there were no first-degree relatives.

The clinical picture of this Swedish patient was that of parkinsonism with severe motor fluctuations and extreme off-dystonia, as will be seen in the video supplement to Article III. The patient had severe depression which had already started much earlier in life, long before the onset of motor symptoms. The neuropathology of *LRRK2* mutations is highly variable, and a prominent finding in this patient was widespread and intense immunoreactivity to ubiquitin. Lewy pathology was present, but relatively less pronounced. This raises questions as to the pathogenesis of this disorder; the findings are counterintuitive to the common notion that alpha-synuclein is the major protein substrate that undergoes ubiquitination during PD pathogenesis [310]. The ubiquitin pathology observed in our patient was not as specific as that previously reported from other patients with *LRRK2* mutations, and it cannot be entirely excluded that it was caused by another neurodegenerative or aging process that also caused the white matter hyperintensity seen in the MRI scans.

Both the clinical and pathological phenotype of parkinsonism caused by different pathogenic *LRRK2* mutations is more varied than the phenotypes associated with *SNCA* or *PARKIN* mutations, which may reflect *LRRK2*'s indirect influence on various cell functions including neuritic outgrowth, cell morphology, and cellular homeostasis [311]. Nevertheless, the majority of patients with one and the same *LRRK2* mutation seem to have a similar disease course. The age at onset of motor symptoms at 50 years in our patient is in line with the mean of  $47.8 \pm 8$  years in the ten patients with this mutation described from Norway, and the clinical course was similar [72]. Psychiatric comorbidity was also present in the Norwegian families [72]. The average age of onset for LRRK2 N1437H mutation carriers lies about a decade earlier than for G2019S mutations in the same gene [83], which may be explained by differences in biological effect of the two mutations as observed in GTP-binding assays [72].

## Pathogenic mutations define distinct subtypes of parkinsonism

The three carriers of pathogenic mutations in PD genes had distinct subtypes of parkinsonism, and their clinical manifestations were similar to published reports of individuals with these mutations (in the case of SNCA A53T and LRRK2 N1437H), or to carriers of homozygous or compound heterozygous *PARKIN* mutations (in the case of the PARKIN R275W / R275Q patient). As noted above, SNCA A53T-related disease is very similar to the clinical syndrome seen in SNCA multiplication carriers. Based on the type and amount of clinical data available from the patients in Lund, I was sometimes also able to document different or additional aspects of the respective diseases compared to other groups. But there were many obvious commonalities between the patients I studied and the cases with identical mutations described in the literature. I would like to see this as evidence in favor of a concept that considers PD, or parkinsonism, as a collection of various disease states that fulfill certain criteria, rather than one uniform entity. When considering that genetic factors play an important role for non-familial parkinsonism, and especially when these genetic risk factors are located in the very same genes as the pathogenic mutations causing the Mendelian forms, it seems logical to think that also non-familial parkinsonism may consist of a number of distinct subgroups. This would lend further support to the concepts derived from clinical observation and cluster analyses [61,243,258,260].

## Low overall yield of comprehensive genetic screening

Despite extensive testing, we can now explain the occurrence of parkinsonism (or PD) in only 1 of 14 (7.1%) with early-onset parkinsonism or 2 of 132 (1.5%) patients in the entire PARLU study.<sup>8</sup>

Only very few studies have reported a comprehensive screening of one patient cohort for such a high number of different genes. Alcalay et al. screened 953 individuals and found genotypes that can explain PD in 6.1% of these. This study was performed in the USA and included only patients with an age at onset before 51 years. The result was mostly driven by 3.2% of participants with the pathogenic LRRK2 G2019S mutation, and more than half of G2019S carriers reported Jewish ancestry. Mutations were rare in individuals with an age at onset above thirty years, as well as in individuals without Jewish ancestry and without first-degree relatives with PD [312].<sup>9</sup> Screening of 72 Korean patients with an age at onset before 51 years for mutations and dosage alterations in *SNCA*, *LRRK2*, *PARKIN*, *PINK1* and *DJ1* revealed

---

<sup>8</sup> The patient with *LRRK2* N1437H mutation was not identified within the PARLU study.

<sup>9</sup> The study's abstract reports that 16.1% of all tested individuals had a mutation in a PD-gene, but this figure includes relatively common genetic risk factors such as *GBA* mutations as well as heterozygote *PARKIN* mutation carriers. These are not considered sufficient to explain the occurrence of disease in their carriers.

pathogenic mutations in 4 patients (5.6%) [151]. A well-characterized cohort of PD patients from the different ethnic groups of South Africa included predominantly early-onset patients and those who reported a positive family history for PD [313]. One of 88 patients carried an *SNCA* triplication [314], 2 of 91 had homozygous *PARKIN* mutations [315] and 1 of 154 patients had a pathogenic *PINK1* mutation [316]. *LRRK2* G2019S mutations were detected in 4 of 205 screened patients, three of the carriers had Jewish and the remaining one German ancestry [317]. Several other cohorts have probably been examined comprehensively, but we are not aware of other compilations that summarize the occurrence of most or all known pathogenic mutations in an entire cohort. Testing for *VPS35* and *EIF4G1* has never been included in any of these previous studies, because these genes have been published only very recently.

The present study analyzed all known dominant pathogenic PD genes in the entire cohort and all known pathogenic recessive PD-genes in all those who developed parkinsonism before 51 years of age. This makes the PARLU cohort one of the most comprehensively studied cohorts worldwide. However, although the study part with patients from outside of West Blekinge specifically included patients with familial disease, we now can only explain the occurrence of PD in 1.5% of participants. This situation is similar to other common diseases with significant familial aggregation or clustering, where the majority of families do not have a known pathogenic mutation [318]. Why is this the case?

There may be more than one answer to this complex problem. The remaining part of the familial patients with parkinsonism (or PD) may have pathogenic mutations in genes that were not examined in this study or are not yet identified. Pathogenic mutations may be highly population-specific, and the mutations that cause familial PD in Sweden may not be known yet. While it is tempting to think there may be a few important genes that explain the majority of all familial cases of parkinsonism worldwide, the opposite may be true. Many different but individually very rare, "private" mutations that only exist in one or a few families in the world may explain the disease. In fact, some of the pathogenic mutations in *SNCA* and *LRRK2* are very rare, as described in the Background section. They would probably never have been detected had they not been in the same genes that harbor more frequent pathogenic mutations.<sup>10</sup> Thus, very rare or rare mutations in other genes that do not harbor more common mutations as well may have evaded detection.

It is conceivable that new methods such as exome sequencing that can identify causal variants without *a priori* assumptions about a candidate gene or genomic region, will help to detect such "private" mutations [319]. Genome-wide association studies (GWAS) were largely unsuccessful in the hunt for such mutations, because they by design cannot identify rare

---

<sup>10</sup> An exception is *LRRK2* N1437H which was found after exome sequencing and not by a candidate gene approach.



mutations, at least not directly. Indirectly, rare causal mutations may be picked up by GWAS but the results are prone to be misinterpreted to stem from common variants that are in fact non-causal (synthetic associations, discussed in detail in refs. [208] and [319]).

Alternatively, we may be wrong when assuming that smaller families with perhaps 3 to 10 patients distributed over several generations in a way that looks compatible with dominant inheritance really are caused by single pathogenic mutations with a strong, dominant effect. Rather, a combination of a few rare genetic risk variants may cause these small familial clusters. This alternative will be discussed further below; here we start by considering that pathogenic mutations can be specific to populations.

## Population-specificity of pathogenic mutations

At first glance it may appear surprising that no individual in the PARLU cohort had a *LRRK2* mutation, since mutations in this gene are known to be the most common genetic cause of PD worldwide. However, *LRRK2* mutations predominantly occur in certain populations (see Background).<sup>11</sup> A previous collaborative study from Stockholm and Göteborg reported four carriers of the *LRRK2* G2019S mutation (from Stockholm) in a total of 284 PD cases and one 95-year-old unaffected carrier (from Göteborg) among 305 controls [154]. The exact ancestry or ethnicity of these individuals was not assessed (Dr. Hans Nissbrandt and Dr. Andrea Carmine-Belin, personal communication). The worldwide incidence of *LRRK2* G2019S mutations has recently been reviewed [79]. Of note, the G2019S mutation was not detected at all in 827 patients from Holland, Belgium, Poland and Austria, in only 0.1% of 604 PD patients from Greece, in 0.8% of 1,828 patients from Germany, and in less than 2% in 6 other European countries [79]. The geographic distribution indicates that the *LRRK2* G2019S mutation may be very rare in individuals without ancestry from North Africa or the Middle East. Nevertheless, in 2009, an European Federation of Neurological Societies (EFNS) task force has published guidelines on genetic screening in PD [320]. The guidelines recommend molecular testing for *LRRK2* in familial cases with dominant inheritance of parkinsonian syndromes. In view of the rarity of the *LRRK2* G2019S mutation in Sweden and central Europe, these guidelines may need to be interpreted carefully.

---

<sup>11</sup>I wish to emphasize that "population" in this context can be very different from the concepts of ethnicity, ancestry, or race; and that many additional concepts that claim to be supported by "genetics" in fact are ill-founded by genetical evidence (reviewed in refs. [325-327]). In fact, research has e.g. shown that the *LRRK2* G2019S mutation was transmitted from an ancient common ancestor to individuals that today belong to very different ethnic groups [82].

## Comparison to previous PD studies from Sweden

What do we know today about the occurrence of mutations in PD-genes in the population of Sweden? We are aware of three studies that have examined pathogenic PD mutations in Sweden: Carmine-Belin et al. studied five *LRRK2* mutations (encoding for R1441G/C/H, G2019S, and I2020T) in 284 patients from Sweden and 304 controls [84], and Håkansson et al. analyzed gene dosage of *SNCA*, *PARKIN*, *DJ1*, and *PINK1* and the sequence of the *PARKIN* gene in 73 PD patients (63 of which had an early age at onset, up to 50 years, and who were from the same sample collection as in Carmine-Belin's work) [154]. Recently, Anvret et al reported a heterozygous synonymous mutation in *DJ1* in one patient from the same cohort. Although functional studies showed a 1.3% difference in biological activity, this heterozygous *DJ1* genotype is not pathogenic [321].

	Göteborg	Stockholm	Lund	Reference
<b><i>SNCA</i></b>				
A53T			1/99	Article II [185]
duplication	0/63 *		5**	Article I [1]
<b><i>LRRK2</i></b>				
N1437H			1***	Article III
G2019S	0/105 patients 1/163 controls	4/179	0/132	[84]
<b><i>EIF4G1</i></b>				
R1205H			0/132	
<b><i>VPS35</i></b>				
D620N			0/132	
<b><i>PARKIN</i></b>				
A82Q (het) †	1/63 *		0/23	[154]
R275W and R275Q (comp het)	0/63 *		1/23	Article IV
H288H° (het) †	2/63 *		0/23	[154]
V380L (het)	1/63 *		4/23	[154]
D394N (het) †	1/63 *		2/23	[154]
<b><i>PINK1</i></b>				
G411S (het)			2/125	Article IV
<b><i>DJ1</i></b>				
A167A° (het) †	2/144		0/23	[321]

### Pathogenic mutations in known PD-genes in Sweden.

The table summarizes all published variants and the results from this study.

\* 63 patients with EOPD ( $\leq 50$  years) from a collection of PD patients from Stockholm (n = 173), Göteborg (n = 116), Falköping (n=45), Skövde (n = 12)

\*\* Identified in initial study and through expansion of the Lister Family (Swedish branches)

\*\*\* Identified by genetic analysis of DNA from brain tissue after neuropathological examination.

° Synonymous mutations (no amino acid change)

<sup>‡</sup>No evidence for disease association. Similarly, there is no formal evidence for a disease association of PARKIN R275Q, but see text.

## Does monogenic inheritance explain all of familial PD?

One observation has - to my knowledge - not received the attention it may deserve: Familial aggregation of PD is most often restricted to clusters of relatively few affected members, from perhaps 3 to not more than 8 or 10 individuals. In a truly dominant disorder, one would expect that many family members have the disease trait as long as they all are descendants of the common founder. The Lister kindred illustrates exactly the latter situation; a kindred that attracted the attention of several generations of lay genealogists and researchers alike, because of the large number of affected individuals. This also applies to the large kindreds with *SNCA* A53T mutations, the Sagamihara kindred with a *LRRK2* mutation, and the extensive families described by Prof. Wszolek [8-15,66,68-71,249]. Genetical evidence has shown that the pathogenic *LRRK2* G2019S mutation must have been continuously transmitted since an ancient origin at least 4,000 or perhaps 9,000 years ago, spreading to almost all present-day carriers who together form an enormous "family" of probably thousands of individuals who now live in different countries and belong to different ethnicities [81,82].

Of course, the number of affected family members can be limited when the causative mutation occurred as a *de novo* event. In Article II we were able to trace the *de novo* establishment of an *SNCA* A53T mutation to the father of our Swedish patient. Similarly, *de novo* occurrence of *SNCA* duplication was shown in a German family [37]. It is difficult to estimate how often such events occur, but they may not occur often enough to explain all cases of familial aggregation. Other explanations commonly provided are reduced penetrance, the facts that families have lost contact with distant relatives suffering from the same disease later in life, or are not aware that relatives who died long ago also had the same disease. Furthermore, as outlined in Article I, an identical mutation may cause different disease phenotypes, so that heredity may not be suspected immediately.

We would like to emphasize another possibility, which appears more likely in the aftermath of the largely negative results from the PD-GWAS: GWAS were based on the "common-variants – common disease" paradigm; the assumption that variation in common genetic variants will explain most of sporadic PD. Although it was possible to show that co-inheritance of several common risk variants instead of only one (or none) conveyed a larger PD risk [3,206], even combined common risk factors only lead to a small increase in absolute disease risk. The overall yield of the GWAS can be considered disappointing. As a consequence, attention has instead shifted towards the alternative possibility that rare(r) variants may be genetic risk factors for common disease such as PD, the "rare-variant – common disease" paradigm. Rare variants are not detected by GWAS. These rare variants do not by themselves cause disease, but lead to an increase in PD risk that is expected to be much higher than the very low risks conferred by the common variants detected in GWAS. In the next section we argue that we

have identified one such rare variant with relatively high risk for PD, more or less by coincidence, during our screening effort of the PARLU study cohort.

The combination within an individual of only a few (maybe only two) such rare variants with intermediate to large effect size may cause non-familial PD. Theoretically, this can also explain the occurrence of familial clustering of PD in small groups with only a few family members affected; PD may occur only in those parts of the family pedigree where there is an overlap of these rare variants. The number of rare variants in a population can potentially be very high, which enables an enormous number of possible combinations; these may form the basis for the wide clinical variability of the disorders with parkinsonism and may be the reason why not more of these variants have been detected or reproduced.

## Tracing genetic risk factors for PD

Genetic risk factors are variants that increase the risk for disease but do not have sufficient effect by themselves to cause disease. They are thought to explain the hereditary component of non-familial (sporadic) PD and the variability regarding age at disease onset, severity or type of PD in carriers of identical pathogenic mutations.

Articles IV and V of this thesis examine genetic risk factors. In article IV, we provide evidence that a heterozygous mutation in the recessive PD-gene *PINK1* may be a genetic risk factor for PD. Article V describes a multi-centre study that examined a possible interaction between the two common PD risk variants which have been reproduced most often: variants in the *SNCA* and *MAPT* genes.

### **PINK1 G411S mutation as a genetic risk factor?**

Screening patients with young-onset parkinsonism from the PARLU study identified a patient who heterozygously carried the *PINK1* c.1231G>A variant, encoding for PINK1 p.G411S (PINK1 G411S).<sup>12</sup> This individual had PD with an early onset of symptoms, but also developed marked psychiatric symptoms with severe psychotic thoughts of unknown cause. One of the proband's parents had clear signs of late-onset parkinsonism but had not consulted a doctor for the relatively mild symptoms. Genetic analysis of several other family members showed that the other, healthy parent carried the mutation but not the parent with late-onset,

---

<sup>12</sup> I am aware of the shortcomings in nomenclature when discussing the PINK1 G411S variant in heterozygous state or in connection with alleles. Strictly speaking, I mean *PINK1* c.1231G>A (het), encoding for p.G411S, but have kept the commoner protein designation for reasons of simplicity.

mild parkinsonism. This very strongly argued against direct pathogenicity of PINK1 G411S. As *PINK1* is a "recessive" gene, the usual notion is that only homozygous (or compound heterozygous) mutation carriers develop disease. However, it has been suggested previously that a single PINK1 G411S allele by itself may cause disease, or act as a genetic risk factor for PD [153,167]. Heterozygous PINK1 G411S mutations have previously been described in Norway and Australia in families with parkinsonism with a seemingly autosomal dominant pattern of inheritance [153,167]. The presence of PINK1 G411S in Sweden and Norway suggested that this mutation may be prevalent in Scandinavia, and we genotyped all PARLU samples and a large collection of Norwegian PD patients and samples for this mutation. We found three additional Norwegian and one additional Swedish mutation carrier among the PD patients, but also unaffected family members and one unrelated unaffected control with the mutation.

A large number of individuals have been published where this mutation has been excluded, most of them in studies on recessive PD genes in cohorts of early-onset PD patients (Article IV, table 3). These studies were included in a meta-analysis of the association of PINK1 G411S mutation with PD. Although the mutation was present in patients with PD and parkinsonism as well as in healthy controls, it statistically occurred more often in the patient group and it conferred a relatively high increase in PD risk. We calculated the risk including all Scandinavian patients, all patients from the meta-analysis of the studies plus our Scandinavian patients, and finally also when excluding one very young unaffected mutation carrier of whom it is too early to say if he may develop disease or not. ORs were 4.06 to 8.42, indicating an intermediate PD risk, p-values were 0.016 to 0.046, suggesting statistical significance, but the 95% confidence intervals for the ORs were very wide, indicating that the exact size of the PD risk conferred by this mutation is difficult to establish.

Despite these shortcomings and the limitations discussed in Article IV, the most likely explanation for the result is that PINK1 G411S is a rare variant that increases PD risk with an intermediate effect size. This is of particular interest as these types of variants have been postulated to exist for a long time, but have largely evaded detection. They are too rare to be picked up by GWAS, and do not cause familial disease in the sense that many individuals in larger families may be affected. A candidate-driven approach, such as ours, may presently be the only way to identify these variants. Rare variants with intermediate to high effect size may explain some of the observations in the genetics of common diseases that have so far remained unaccounted for.

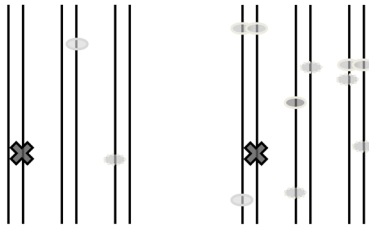

### Intermediate risk variants

Article IV provides evidence that the heterozygous *PINK1* mutation encoding for p.G411S may increase PD risk with an intermediate effect size (OR 4-8). In an interplay with other genetic or environmental risk factors, this may explain why many, but not all, of the mutation carriers developed PD. Left: The effect of the *PINK1* G411S mutation (grey cross) is not large enough to cause PD when the individual has not inherited many additional genetic risk factors (grey ovals). Right: Simultaneous presence of *PINK1* G411S and an unfavorable number of other genetic risk factors may cause PD. Another alternative (see text) is that a few, perhaps only 2 or 3, mutations with relatively strong effect size combined may suffice to cause disease, which could cause interesting patterns of inheritance and probably explain part of the familial clustering observed in PD. Environmental and random factors may influence this balance further.

### How do the effects of genetic risk factors combine?

When we presume that the individual combination of several genetic risk factors causes parkinsonism, it becomes interesting to investigate the rules by which the different genetic factors interact to determine the overall risk. The biological effects of the causal variants, where these are known, can be analyzed in vitro either in isolation or in combination with other factors. Mathematical models can explore simple addition or multiplication, or more complex interactions, of the effect sizes of associations of genes with PD. The interaction of genetic factors influencing the risk for parkinsonism is likely a complex one. For example, it is conceivable that one variant by itself does not influence overall risk because of a compensatory biological mechanism, but this very same variant may have a large effect on disease risk when this compensatory mechanism is weakened by another mutation.

Clinical observations demonstrate that the interaction between pathogenic mutations can be unpredictable: As noted above, the Lister Family provided the most direct evidence so far that *SNCA* triplications lead to a much more severe disease than *SNCA* duplications [1]. In contrast, homozygous carriers of *LRRK2* G2019S mutations cannot be distinguished from heterozygous carriers [313,322]. In this case, a second mutation in a dominant PD gene does not lead to more severe disease. The reason for this observation remains in essence unknown [322,323]. Individuals with parkinsonism and mutations in two different PD-genes have also been described (digenic inheritance) [182,183]. Heterozygous carriers of one *PINK1* plus one *DJ1* mutation had parkinsonism in a Chinese family, although their sibling with the same combination of mutations did not develop symptoms [182]. This may indicate that both mutations combined have a higher effect than single heterozygous mutations, albeit with incomplete penetrance, even though there may be alternative explanations. Spanish patients

with *LRRK2* and *PARKIN* mutations did not have a more severe phenotype than patients with only *LRRK2* mutation [183]. Nevertheless, in vitro experiments suggested possible interaction between these gene products [182,183]. Single (heterozygous) *PARKIN* mutations in the absence of other known mutations in PD-genes have been suggested to increase PD risk (discussed in the Background section).

Article V investigated whether there is an interaction between the associations of *SNCA* with PD and *MAPT* with PD. Marker SNPs in both the *SNCA* and *MAPT* loci have been reproducibly associated with PD risk in almost all GWAS. The association of *SNCA* and *MAPT* with parkinsonism or PD seems biologically plausible, and, as noted in Article V and above, both alpha-synuclein and tau pathology may co-exist in the brains of patients with parkinsonism. In vitro experiments demonstrated that the alpha-synuclein and tau proteins interact. The main purpose of the study was to examine if the associations between *SNCA* and PD and between *MAPT* and PD are independent, or if they may modify each other.

The large number of samples available enabled this question to be resolved. *SNCA* and *MAPT* have independent effects on PD risk. If risk alleles are present in both genes, the PD risk becomes larger than a risk allele in only one of the two genes. But there was no additional interaction between *SNCA* and *MAPT* with regard to their association with PD; they represent truly independent risk factors.

Interpretation of these findings needs to take into account that the observed signals were obtained from easily measurable markers (i.e. the SNPs), and that the causal genetic variants remain unknown. *SNCA* consists of two haplotype blocks. Recombination - between generations or more noticeable in different individuals of a population - occurs between the blocks, but rarely within one block. Article V shows that the strongest association with PD comes from the haplotype block including exons 5 and 6 and the 3' untranslated region. Much previous work has focused on the association of *SNCA Rep1* risk factor in the other haplotype block to the 5' end of the gene. *SNCA Rep1* alters the rate of *SNCA* expression, but the functional implication of genetic variation in the 3' haplotype block remains to be elucidated.

By contrast, the *MAPT* gene is always inherited as one of two distinct haplotypes, H1 or H2. No recombination has been found within the gene, indicating a separation of these two blocks in very ancient times. H1 and H2 differ in the orientation of an intronic DNA segment. Association of H1 with PD was known from previous studies and confirmed here. The *MAPT* H1 haplotype block is about 2 Mb long and may contain up to 15 other genes [324]; an association with a marker in this block may signal a causal variant in one of the other genes on this block and not necessarily within *MAPT*. The H1 haplotype has several subtypes; one SNP marks only the H1c subtype, but there was no clear association between H1c and PD. Even here, we do not know which functional variant(s) really causes the PD risk to increase.

It has been pointed out that the meaning of associations of marker genotypes with disease can be difficult to resolve. Intuitively, one expects a common variant in the marked haplotype block would confer a relatively low risk for PD, in the same order of magnitude as the ORs in GWAS, but the signal may also stem from rare variants with high impact on disease risk that are more often found in association with the marker SNP [208].





## PD genetics: Synopsis

Classical Mendelian patterns of inheritance have been identified in families with hereditary PD. Single mutations in the dominant genes *SNCA*, *LRRK2*, *EIF4G1*, and *VPS35* are definitely pathogenic, even though penetrance is incomplete for most mutations and depends on age. Mutations in both alleles (in homozygous or compound heterozygous state) of the recessive PD genes *PARKIN*, *PINK1* or *DJI* cause disease. For these mutations, that follow classical Mendelian laws, the genetic impact is high.

Environmental factors may play a subordinate role, if any, e.g. by influencing the age of symptom manifestation. Large-scale studies with modern high-throughput methods have identified a number of genetic risk factors, whose presence is associated with disease in extensive study populations. The degree to which these genetic factors may explain PD risk in a population (heritability) remains uncertain, and depends on the statistical methods used and the population studied. Most genetic risk variants identified increase PD risk only slightly (OR of 1.1- 2.0). Only very few risk factors with intermediate effect (defined randomly as OR >4.0) have been identified, notably in the *GBA* gene and in some, but not all populations, in *LRRK2*. Heterozygous carrier status of mutations in the "recessive" PD genes *PARKIN* and *PINK1* may increase PD risk considerably. Heterozygous mutations in "recessive" PD genes may thus contribute to PD risk both in an individual and a population. Rare variants may be difficult to detect, but there is reason to believe they will explain much heritability of PD that still remains to be identified. Heritability is the proportion to which genetic factors contribute to disease risk (at population level).

Research in the genetics of common diseases such as PD or similar disorders with parkinsonism offers the possibility to gain knowledge in several fields. One important question is how much genetics - as opposed to the environment - contributes to disease risk. The heritability of sporadic PD is estimated to somewhere around 50%, which leaves space for environmental factors. Although environmental factors are much more difficult to assess than stable life-long changes in DNA sequence, progress can be made to find environmental influences on PD risk that may be modifiable. Studying persons who have inherited a very high risk for PD may be a much more feasible approach to obtain new knowledge about environmental risk factors than studying entire populations.

Patients with parkinsonism frequently enquire about the possibility for genetic counseling, and may wonder if their children may have inherited the disease. The genetic architecture of PD and parkinsonism is complex. Clear-cut genetic information can today be provided to the very small percentage of individuals who carry an identified mutation in a PD gene. Even when a mutation is discovered, in many cases the available clinical information that may be useful for genetic counseling is very limited. As the number of PD-genes is continuing to increase, we will learn more about other genetically defined subtypes carrying mutations in these genes. It is difficult to define the group of persons for whom genetic screening may be useful; most PD-related mutations are extremely rare. It remains to be seen if modern high-throughput methods of genetic analysis will make gene discovery easier, and if the method will at some point in time be considered for diagnostic purposes, or if it will add further confusion by producing a large amount of data that is impossible to interpret. Exome sequencing frequently detects many thousands sequence variations in every human being (approx 30,000 variants per

person in ref. [7]), and most if not all of these will not have anything to do with disease. When we continue to define the disease phenotypes of monogenic forms of parkinsonism, we shall be able to make informed decisions to recommend genetic testing in patients or families with certain disease subtypes.

The most important aspect of modern research into the genetics of PD is the elucidation of mechanisms of disease. The discovery of *SNCA* mutations in the Italian and Greek families in 1997, followed by the subsequent discovery of alpha-synuclein's important role in the disease process, has revolutionized our understanding of neurodegeneration. New genes will add new information about which pathways can be involved in the pathogenesis of parkinsonism. It seems very plausible that we will not find one pathomechanism common to all patients with parkinsonism. Rather, I would expect that several different mechanisms may lead to disorders with parkinsonism, reflecting the wide clinical variability seen among our patients with one or another subtype of parkinsonism.

Approaches to novel treatments are being made, based on the discovery of PD-genes and pathomechanisms. Theoretically promising examples are gene therapy aimed at restoring the beneficial effects of PARKIN [157] and the inhibition of the kinase activity of LRRK2 [263]. Inhibition of alpha-synuclein expression or aggregation is another avenue that has been pursued by several research groups [261,262]. As long as we do not know the exact physiological function of alpha-synuclein, it may seem dangerous to entirely inhibit this abundant protein. However, when overexpression or an increased tendency to fibril formation is the probable cause of severe parkinsonism, cognitive decline and additional symptoms, reducing *SNCA* expression to normal level appears a promising therapeutic option. Thus, one would expect that individuals with *SNCA* mutations, such as the carriers in the Lister Family, will derive the greatest benefit of therapeutic strategies directed against alpha-synuclein once such therapies will be available.

# Acknowledgements

During this research study, I had the opportunity to learn from experts in very different areas – both regarding location and expertise. I was fortunate to get to know many who work with dedication and enthusiasm in this field: the inter-professional teams at the Parkinson clinics in several Swedish towns, the movement disorder neurologists, neurosurgeons and neuropathologists at Skåne University Hospital, the clinical researchers at Lund University, the experts at Mayo Clinic, and many more. From them and by working with them I received many insights into such diverse areas as individualized patient care, neurogenetics, genealogical research, neuro-pathology, or medical history.

I wish to thank all those who have contributed to my research with their knowledge, advice, and encouragement, both in Sweden and in the USA, which includes many more people than can be listed here.

Particularly, I wish to thank:

**Docent Christer Nilsson**, my thesis supervisor, for constructive support and enthusiasm, scientific advice, guidance through the long journey of this project from its conception to its completion, and for always providing prompt feedback to my ideas and questions;

**Professor Håkan Widner**, my thesis co-supervisor, for his support as head of the Dept. of Neurology, enabling me to combine clinical and research work, for introduction to the clinical work with patients with parkinsonism, and for scientific advice;

**Professor Zbigniew K. Wszolek**, for directing my attention towards the Lister Family, for introducing me to the research of kindreds with parkinsonism, for being my supervisor at Mayo Clinic, as well as for continuing support long after my appointment with Mayo Clinic had ended;

**Professor Matthew J. Farrer**, for introducing me to the basics of genetics as well as more advanced PD genetics, for being my co-supervisor at Mayo Clinic, and for having me at his laboratory;

**Assistant Professor Owen A. Ross** and **Assistant Professor Carles Vilaríño-Güell** for all their support with planning and executing labwork, for their never-ending patience when explaining genetics to a clinician, and for making my stays in Jacksonville productive as well as pleasurable;

**Sarah J. Lincoln**, **Jennifer M. Kachergus**, **Stephanie A. Cobb** for all their help with the laboratory analyses and their evaluation;

**Karin Nilsson** for her expert genealogical work on the Lister Family and for contacting study participants;

**Jan Reimer** for genealogical work and a lot of practical support, for obtaining old medical records from a variety of archives, and for contacting study participants;

**Docent Elisabet Englund** for making the brain tissue samples available and for re-examining the pathology of the patient in Article IV;

**Dr. Katharina Darlison** and **Dr. Maya Malmström** in Karlshamn; **Dr. Caroline Marktorp** and **Susanne Lindskov** in Kristianstad; doctors and nurses at **Vårdcentral Olofström, Sölvesborg,** and **Karlshamn;** **Jeanette Härnberg** and **Dr. Iben Rasmussen** in Ystad; **Eva Berg** and **Docent Jesper Petersson** in Malmö; all in charge of the care of patients with PD and parkinsonism at the respective units in southern Sweden, who keep close contact with their patients; for their tremendous help to establish contact with patients, and for allowing me to meet the patients at their clinics;

**Dr. Klas Wictorin, Dr. Lars Wictor, Prof. Per Odin, Dr. Gesine Paul-Visse, Dr. Carl Rosenblad, Dr. Oskar Hansson, Dr. Yulia Surova, Dr. Sara Hall,** for many stimulating discussions of patients with parkinsonism within the movement disorder team; **Christine Nilsson** and all other members of the movement disorder team in Lund;

my other colleagues at the Department for Neurology in Lund, especially **Dr. Petra Nilsson,** my tutor in neurology during my residency years, and **Docent Jan-Erik Hardebo** for his attempts to establish contact with individuals from Lister peninsula.

**Helena Andersson, Martha Escobar,** and **Ulrika Mundt-Petersen** for their help with many bureaucratic issues of research.

I wish to thank all **patients** who participated in this study, their **caregivers,** and all those who participated as **control subjects,** as well as all **members of the Lister Family** who participated in the study or provided me with additional insights into their family or its history.

My **very special thanks** go to

my **parents Dr. Johannes and Edith Puschmann,** for many useful genetical traits from Bavaria, and for their unlimited support during all these years,

to **Ela and Alexandra,** for reminding me that a visit to the playground or a bicycle ride in the park can be more exciting than formatting a thesis,

and to **Andreea,** for your loving support during these years, and for your understanding even during the times when many hours were spent with research.

I like to thank the following **funding bodies** for their generous contributions to this study:

**The Swedish Parkinson Academy (Svenska Parkinsonakademien),**

**The Swedish Parkinson Foundation (Parkinsonfonden),**

**AFA Försäkring,**

**Stiftelsen Olle Engkvist Byggmästare,**

**Region Skåne / Lund University Hospital / Skåne University Hospital,**

**Lund University, Stiftelsen Apotekare Hedbergs fond,**

**Elsa Schmitz Foundation,**

**The Royal Physiographic Society in Lund,**

**Maggie Stephens Stiftelse,**

**as well as donations from private benefactors**

# References

- [1] Fuchs J, Nilsson C, Kachergus J, Munz M, Larsson EM, Schule B, et al. Phenotypic variation in a large Swedish pedigree due to SNCA duplication and triplication. *Neurology*. 2007 Mar 20;68(12):916-22.
- [2] den Dunnen JT, Antonarakis SE. Mutation nomenclature extensions and suggestions to describe complex mutations: a discussion. *Hum Mutat*. 2000;15(1):7-12.
- [3] Hamza TH, Zabetian CP, Tenesa A, Laederach A, Montimurro J, Yearout D, et al. Common genetic variation in the HLA region is associated with late-onset sporadic Parkinson's disease. *Nat Genet*. 2010 Sep;42(9):781-5.
- [4] Lesage S, Brice A. Parkinson's disease: from monogenic forms to genetic susceptibility factors. *Hum Mol Genet*. 2009 Apr 15;18(R1):R48-59.
- [5] Ross OA, Soto-Ortolaza AI, Heckman MG, Aasly JO, Abahuni N, Annesi G, et al. LRRK2 exonic variants and susceptibility to Parkinson's disease. *Lancet Neurol*. 2011;Aug 30;doi10.1016/S1474-4422(11)70175-2.
- [6] Chartier-Harlin MC, Dachsel JC, Hulihan M, Kachergus J, Lepretre F, Le Rhun E, et al. EIF4G1 mutations in familial parkinsonism. *Parkinsonism Relat Disord*. 2009;15(S2):S145-S6.
- [7] Vilarino-Guell C, Wider C, Ross OA, Dachsel JC, Kachergus JM, Lincoln SJ, et al. VPS35 Mutations in Parkinson Disease. *Am J Hum Genet*. 2011 Jul 15;89(1):162-7.
- [8] Polymeropoulos MH, Lavedan C, Leroy E, Ide SE, Dehejia A, Dutra A, et al. Mutation in the alpha-synuclein gene identified in families with Parkinson's disease. *Science*. 1997 Jun 27;276(5321):2045-7.
- [9] Golbe LI, Di Iorio G, Bonavita V, Miller DC, Duvoisin RC. A large kindred with autosomal dominant Parkinson's disease. *Ann Neurol*. 1990 Mar;27(3):276-82.
- [10] Golbe LI, Di Iorio G, Sanges G, Lazzarini AM, La Sala S, Bonavita V, et al. Clinical genetic analysis of Parkinson's disease in the Contursi kindred. *Ann Neurol*. 1996 Nov;40(5):767-75.
- [11] Markopoulou K, Wszolek ZK, Pfeiffer RF. A Greek-American kindred with autosomal dominant, levodopa-responsive parkinsonism and anticipation. *Ann Neurol*. 1995 Sep;38(3):373-8.
- [12] Markopoulou K, Wszolek ZK, Pfeiffer RF, Chase BA. Reduced expression of the G209A alpha-synuclein allele in familial Parkinsonism. *Ann Neurol*. 1999 Sep;46(3):374-81.
- [13] Samii A, Markopoulou K, Wszolek ZK, Sossi V, Dobko T, Mak E, et al. PET studies of parkinsonism associated with mutation in the alpha-synuclein gene. *Neurology*. 1999 Dec 10;53(9):2097-102.
- [14] Pal PK, Wszolek ZK, Uitti R, Markopoulou K, Calne SM, Stoessl AJ, et al. Positron emission tomography of dopamine pathways in familial Parkinsonian syndromes. *Parkinsonism Relat Disord*. 2001 Sep;8(1):51-6.
- [15] Markopoulou K, Dickson DW, McComb RD, Wszolek ZK, Katechaliadou L, Avery L, et al. Clinical, neuropathological and genotypic variability in SNCA A53T familial Parkinson's disease. Variability in familial Parkinson's disease. *Acta Neuropathol*. 2008 Jul;116(1):25-35.
- [16] Ki CS, Stavrou EF, Davanos N, Lee WY, Chung EJ, Kim JY, et al. The Ala53Thr mutation in the alpha-synuclein gene in a Korean family with Parkinson disease. *Clin Genet*. 2007 May;71(5):471-3.
- [17] Michell AW, Barker RA, Raha SK, Raha-Chowdhury R. A case of late onset sporadic Parkinson's disease with an A53T mutation in alpha-synuclein. *J Neurol Neurosurg Psychiatry*. 2005 Apr;76(4):596-7.
- [18] Kruger R, Kuhn W, Muller T, Woitalla D, Graeber M, Kosel S, et al. Ala30Pro mutation in the gene encoding alpha-synuclein in Parkinson's disease. *Nat Genet*. 1998 Feb;18(2):106-8.
- [19] Zarranz JJ, Alegre J, Gomez-Esteban JC, Lezcano E, Ros R, Ampuero I, et al. The new mutation, E46K, of alpha-synuclein causes Parkinson and Lewy body dementia. *Ann Neurol*. 2004 Feb;55(2):164-73.
- [20] Singleton AB, Farrer M, Johnson J, Singleton A, Hague S, Kachergus J, et al. alpha-Synuclein locus triplication causes Parkinson's disease. *Science*. 2003 Oct 31;302(5646):841.

- [21] Ibanez P, Bonnet AM, Debarges B, Lohmann E, Tison F, Pollak P, et al. Causal relation between alpha-synuclein gene duplication and familial Parkinson's disease. *Lancet*. 2004 Sep 25-Oct 1;364(9440):1169-71.
- [22] Chartier-Harlin MC, Kachergus J, Roumier C, Mouroux V, Douay X, Lincoln S, et al. Alpha-synuclein locus duplication as a cause of familial Parkinson's disease. *Lancet*. 2004 Sep 25-Oct 1;364(9440):1167-9.
- [23] Kruger R, Kuhn W, Leenders KL, Sprengelmeyer R, Muller T, Woitalla D, et al. Familial parkinsonism with synuclein pathology: clinical and PET studies of A30P mutation carriers. *Neurology*. 2001 May 22;56(10):1355-62.
- [24] Seidel K, Schols L, Nuber S, Petrasch-Parwez E, Gierga K, Wszolek Z, et al. First appraisal of brain pathology owing to A30P mutant alpha-synuclein. *Ann Neurol*. 2010 May;67(5):684-9.
- [25] Cookson MR. The biochemistry of Parkinson's disease. *Annual review of biochemistry*. 2005;74:29-52.
- [26] Zarranz JJ, Fernandez-Bedoya A, Lambarri I, Gomez-Esteban JC, Lezcano E, Zamacona J, et al. Abnormal sleep architecture is an early feature in the E46K familial synucleinopathy. *Mov Disord*. 2005 Oct;20(10):1310-5.
- [27] Tijero B, Gomez-Esteban JC, Llorens V, Lezcano E, Gonzalez-Fernandez MC, de Pancorbo MM, et al. Cardiac sympathetic denervation precedes nigrostriatal loss in the E46K mutation of the alpha-synuclein gene (SNCA). *Clin Auton Res*. 2010 Aug;20(4):267-9.
- [28] Hermann B, Distèche C, Ghymers D, Frederic J. A case of Lengthening of a B<sub>1</sub> Chromosome; Demonstration of an Insertion within the Long Arms [46XX:ins.(4:?) (q23:?)]. *Humangenetik*. 1974;22:255-60.
- [29] Garraux G, Vanbellinghen J, Jamar B, Bours V, Moonen G, Dive D. De novo interstitial duplication 4q associated with sporadic young-onset dopa-responsive parkinsonism. *Genetic Epidemiology of Parkinson's Disease (GEOPD) 4th Annual Meeting*. Tübingen, Germany 2009.
- [30] Farrer M, Destee T, Becquet E, Wavrant-De Vrieze F, Mouroux V, Richard F, et al. Linkage exclusion in French families with probable Parkinson's disease. *Mov Disord*. 2000 Nov;15(6):1075-83.
- [31] Ibanez P, Lesage S, Janin S, Lohmann E, Durif F, Destee A, et al. Alpha-synuclein gene rearrangements in dominantly inherited parkinsonism: frequency, phenotype, and mechanisms. *Arch Neurol*. 2009 Jan;66(1):102-8.
- [32] Nishioka K, Hayashi S, Farrer MJ, Singleton AB, Yoshino H, Imai H, et al. Clinical heterogeneity of alpha-synuclein gene duplication in Parkinson's disease. *Ann Neurol*. 2006 Feb;59(2):298-309.
- [33] Nishioka K, Ross OA, Ishii K, Kachergus JM, Ishiwata K, Kitagawa M, et al. Expanding the clinical phenotype of SNCA duplication carriers. *Mov Disord*. 2009 Sep 15;24(12):1811-9.
- [34] Obi T, Nishioka K, Ross OA, Terada T, Yamazaki K, Sugiura A, et al. Clinicopathologic study of a SNCA gene duplication patient with Parkinson disease and dementia. *Neurology*. 2008 Jan 15;70(3):238-41.
- [35] Ahn TB, Kim SY, Kim JY, Park SS, Lee DS, Min HJ, et al. alpha-Synuclein gene duplication is present in sporadic Parkinson disease. *Neurology*. 2008 Jan 1;70(1):43-9.
- [36] Puschmann A, Wszolek ZK, Farrer M, Gustafson L, Widner H, Nilsson C. Alpha-synuclein multiplications with parkinsonism, dementia or progressive myoclonus? *Parkinsonism Relat Disord*. 2009 Jun;15(5):390-2.
- [37] Brueggemann N, Odin P, Gruenewald A, Tadic V, Hagenah J, Seidel G, et al. Re: Alpha-synuclein gene duplication is present in sporadic Parkinson disease. *Neurology*. 2008 Oct 14;71(16):1294.
- [38] Troiano AR, Cazeneuve C, Le Ber I, Bonnet AM, Lesage S, Brice A. Re: Alpha-synuclein gene duplication is present in sporadic Parkinson disease. *Neurology*. 2008 Oct 14;71(16):1295; author reply
- [39] Uchiyama T, Ikeuchi T, Ouchi Y, Sakamoto M, Kasuga K, Shiga A, et al. Prominent psychiatric symptoms and glucose hypometabolism in a family with a SNCA duplication. *Neurology*. 2008 Oct 14;71(16):1289-91.
- [40] Kasuga K, Tokutake T, Ishikawa A, Uchiyama T, Tokuda T, Onodera O, et al. Differential levels of alpha-synuclein, beta-amyloid42 and tau in CSF between patients with dementia with Lewy bodies and Alzheimer's disease. *J Neurol Neurosurg Psychiatry*. 2010 Jun;81(6):608-10.
- [41] Ishikawa A, Takahashi H, Tanaka H, Hayashi T, Tsuji S. Clinical features of familial diffuse Lewy body disease. *Eur Neurol*. 1997;38 Suppl 1:34-8.
- [42] Wakabayashi K, Hayashi S, Ishikawa A, Hayashi T, Okuizumi K, Tanaka H, et al. Autosomal dominant diffuse Lewy body disease. *Acta Neuropathol*. 1998 Aug;96(2):207-10.
- [43] Ikeuchi T, Kakita A, Shiga A, Kasuga K, Kaneko H, Tan CF, et al. Patients homozygous and heterozygous for SNCA duplication in a family with parkinsonism and dementia. *Arch Neurol*. 2008 Apr;65(4):514-9.



- [44] Orimo S, Uchihara T, Nakamura A, Mori F, Ikeuchi T, Onodera O, et al. Cardiac sympathetic denervation in Parkinson's disease linked to SNCA duplication. *Acta Neuropathol.* 2008 Nov;116(5):575-7.
- [45] Nuytemans K, Meeus B, Crosiers D, Brouwers N, Goossens D, Engelborghs S, et al. Relative contribution of simple mutations vs. copy number variations in five Parkinson disease genes in the Belgian population. *Hum Mutat.* 2009 Jul;30(7):1054-61.
- [46] Sironi F, Trotta L, Antonini A, Zini M, Ciccone R, Della Mina E, et al. alpha-Synuclein multiplication analysis in Italian familial Parkinson disease. *Parkinsonism Relat Disord.* 2010 Mar;16(3):228-31.
- [47] Shin CW, Kim HJ, Park SS, Kim SY, Kim JY, Jeon BS. Two Parkinson's disease patients with alpha-synuclein gene duplication and rapid cognitive decline. *Mov Disord.* 2010 May 15;25(7):957-9.
- [48] Keri S, Moustafa AA, Myers CE, Benedek G, Gluck MA. Alpha-synuclein gene duplication impairs reward learning. *Proc Natl Acad Sci U S A.* 2010 Sep 7;107(36):15992-4.
- [49] Sekine T, Kagaya H, Funayama M, Li Y, Yoshino H, Tomiyama H, et al. Clinical course of the first Asian family with Parkinsonism related to SNCA triplication. *Mov Disord.* 2010 Dec 15;25(16):2871-5.
- [50] Langston JW, Sastry S, Chan P, Forno LS, Bolin LM, Di Monte DA. Novel alpha-synuclein-immunoreactive proteins in brain samples from the Contursi kindred, Parkinson's, and Alzheimer's disease. *Exp Neurol.* 1998 Dec;154(2):684-90.
- [51] Mezey E, Dehejia AM, Harta G, Tresser N, Suchy SF, Nussbaum RL, et al. Alpha synuclein is present in Lewy bodies in sporadic Parkinson's disease. *Mol Psychiatry.* 1998 Nov;3(6):493-9.
- [52] Braak H, Del Tredici K, Rub U, de Vos RA, Jansen Steur EN, Braak E. Staging of brain pathology related to sporadic Parkinson's disease. *Neurobiol Aging.* 2003 Mar-Apr;24(2):197-211.
- [53] Kosaka K, Tsuchiya K, Yoshimura M. Lewy body disease with and without dementia: a clinicopathological study of 35 cases. *Clin Neuropathol.* 1988 Nov-Dec;7(6):299-305.
- [54] Dickson DW, Lin W, Liu WK, Yen SH. Multiple system atrophy: a sporadic synucleinopathy. *Brain Pathol.* 1999 Oct;9(4):721-32.
- [55] Michotte A. Recent developments in the neuropathological diagnosis of Parkinson's disease and parkinsonism. *Acta neurologica Belgica.* 2003 Sep;103(3):155-8.
- [56] Beach TG, Adler CH, Lue L, Sue LI, Bachalakuri J, Henry-Watson J, et al. Unified staging system for Lewy body disorders: correlation with nigrostriatal degeneration, cognitive impairment and motor dysfunction. *Acta Neuropathol.* 2009 Jun;117(6):613-34.
- [57] Halliday GM, Holton JL, Revesz T, Dickson DW. Neuropathology underlying clinical variability in patients with synucleinopathies. *Acta Neuropathol.* 2011 Aug;122(2):187-204.
- [58] Louis ED, Faust PL, Vonsattel JP, Honig LS, Rajput A, Robinson CA, et al. Neuropathological changes in essential tremor: 33 cases compared with 21 controls. *Brain.* 2007 Dec;130(Pt 12):3297-307.
- [59] Paisan-Ruiz C, Li A, Schneider SA, Holton JL, Johnson R, Kidd D, et al. Widespread Lewy body and tau accumulation in childhood and adult onset dystonia-parkinsonism cases with PLA2G6 mutations. *Neurobiol Aging.* 2010; Epub ahead of print 9 July. doi:10.1016/j.neurobiolaging.2010.05.009.
- [60] Wider C, Dickson DW, Wszolek ZK. Leucine-rich repeat kinase 2 gene-associated disease: redefining genotype-phenotype correlation. *Neurodegener Dis.* 2010;7(1-3):175-9.
- [61] Ahlskog JE. Parkin and PINK1 parkinsonism may represent nigral mitochondrial cytopathies distinct from Lewy body Parkinson's disease. *Parkinsonism Relat Disord.* 2009 Dec;15(10):721-7.
- [62] Jakes R, Spillantini MG, Goedert M. Identification of two distinct synucleins from human brain. *FEBS Lett.* 1994 May 23;345(1):27-32.
- [63] Uversky VN. Neuropathology, biochemistry, and biophysics of alpha-synuclein aggregation. *J Neurochem.* 2007 Oct;103(1):17-37.
- [64] Nemani VM, Lu W, Berge V, Nakamura K, Onoa B, Lee MK, et al. Increased expression of alpha-synuclein reduces neurotransmitter release by inhibiting synaptic vesicle reclustering after endocytosis. *Neuron.* 2010 Jan 14;65(1):66-79.
- [65] Waxman EA, Giasson BI. Molecular mechanisms of alpha-synuclein neurodegeneration. *Biochim Biophys Acta.* 2009 Jul;1792(7):616-24.
- [66] Zimprich A, Biskup S, Leitner P, Lichtner P, Farrer M, Lincoln S, et al. Mutations in LRRK2 cause autosomal-dominant parkinsonism with pleomorphic pathology. *Neuron.* 2004 Nov 18;44(4):601-7.
- [67] Paisan-Ruiz C, Jain S, Evans EW, Gilks WP, Simon J, van der Brug M, et al. Cloning of the gene containing mutations that cause PARK8-linked Parkinson's disease. *Neuron.* 2004 Nov 18;44(4):595-600.

- [68] Wszolek ZK, Vieregge P, Uitti RJ, Gasser T, Yasuhara O, McGeer P, et al. German-Canadian family (family A) with parkinsonism, amyotrophy, and dementia - Longitudinal observations. *Parkinsonism Relat Disord.* 1997 Nov;3(3):125-39.
- [69] Wszolek ZK, Pfeiffer B, Fulgham JR, Parisi JE, Thompson BM, Uitti RJ, et al. Western Nebraska family (family D) with autosomal dominant parkinsonism. *Neurology.* 1995 Mar;45(3 Pt 1):502-5.
- [70] Hasegawa K, Kowa H. Autosomal dominant familial Parkinson disease: older onset of age, and good response to levodopa therapy. *Eur Neurol.* 1997;38 Suppl 1:39-43.
- [71] Hasegawa K, Stoessel AJ, Yokoyama T, Kowa H, Wszolek ZK, Yagishita S. Familial parkinsonism: study of original Sagami-hara PARK8 (I2020T) kindred with variable clinicopathologic outcomes. *Parkinsonism Relat Disord.* 2009 May;15(4):300-6.
- [72] Aasly JO, Vilarino-Guell C, Dächsel JC, Webber PJ, West AB, Haugarvoll K, et al. Novel pathogenic LRRK2 p.Asn1437His substitution in familial Parkinson's disease. *Mov Disord.* 2010 Oct 15;25(13):2156-63.
- [73] Gonzalez-Fernandez MC, Lezcano E, Ross OA, Gomez-Esteban JC, Gomez-Busto F, Velasco F, et al. Lrrk2-associated parkinsonism is a major cause of disease in Northern Spain. *Parkinsonism Relat Disord.* 2007 Dec;13(8):509-15.
- [74] Mata IF, Hutter CM, Gonzalez-Fernandez MC, de Pancorbo MM, Lezcano E, Huerta C, et al. Lrrk2 R1441G-related Parkinson's disease: evidence of a common founding event in the seventh century in Northern Spain. *Neurogenetics.* 2009 Oct;10(4):347-53.
- [75] Di Fonzo A, Rohe CF, Ferreira J, Chien HF, Vacca L, Stocchi F, et al. A frequent LRRK2 gene mutation associated with autosomal dominant Parkinson's disease. *Lancet.* 2005 Jan 29-Feb 4;365(9457):412-5.
- [76] Lesage S, Durr A, Tazir M, Lohmann E, Leutenegger AL, Janin S, et al. LRRK2 G2019S as a cause of Parkinson's disease in North African Arabs. *N Engl J Med.* 2006 Jan 26;354(4):422-3.
- [77] Ozelius LJ, Senthil G, Saunders-Pullman R, Ohmann E, Deligtisch A, Tagliati M, et al. LRRK2 G2019S as a cause of Parkinson's disease in Ashkenazi Jews. *N Engl J Med.* 2006 Jan 26;354(4):424-5.
- [78] Kachergus J, Mata IF, Hulihan M, Taylor JP, Lincoln S, Aasly J, et al. Identification of a novel LRRK2 mutation linked to autosomal dominant parkinsonism: evidence of a common founder across European populations. *Am J Hum Genet.* 2005 Apr;76(4):672-80.
- [79] Correia Guedes L, Ferreira JJ, Rosa MM, Coelho M, Bonifati V, Sampaio C. Worldwide frequency of G2019S LRRK2 mutation in Parkinson's disease: a systematic review. *Parkinsonism Relat Disord.* 2010 May;16(4):237-42.
- [80] Aasly JO, Toft M, Fernandez-Mata I, Kachergus J, Hulihan M, White LR, et al. Clinical features of LRRK2-associated Parkinson's disease in central Norway. *Ann Neurol.* 2005 May;57(5):762-5.
- [81] Johansen KK, Hasselberg K, White LR, Farrer MJ, Aasly JO. Genealogical studies in LRRK2-associated Parkinson's disease in central Norway. *Parkinsonism Relat Disord.* 2010 Sep;16(8):527-30.
- [82] Lesage S, Patin E, Condroyer C, Leutenegger AL, Lohmann E, Giladi N, et al. Parkinson's disease-related LRRK2 G2019S mutation results from independent mutational events in humans. *Hum Mol Genet.* 2010 May 15;19(10):1998-2004.
- [83] Healy DG, Falchi M, O'Sullivan SS, Bonifati V, Durr A, Bressman S, et al. Phenotype, genotype, and worldwide genetic penetrance of LRRK2-associated Parkinson's disease: a case-control study. *Lancet Neurol.* 2008 Jul;7(7):583-90.
- [84] Carmine Belin A, Westerlund M, Sydow O, Lundstromer K, Hakansson A, Nissbrandt H, et al. Leucine-rich repeat kinase 2 (LRRK2) mutations in a Swedish Parkinson cohort and a healthy nonagenarian. *Mov Disord.* 2006 Oct;21(10):1731-4.
- [85] Dächsel JC, Farrer MJ. LRRK2 and Parkinson disease. *Arch Neurol.* 2010 May;67(5):542-7.
- [86] Mata IF, Kachergus JM, Taylor JP, Lincoln S, Aasly J, Lynch T, et al. Lrrk2 pathogenic substitutions in Parkinson's disease. *Neurogenetics.* 2005 Dec;6(4):171-7.
- [87] Zabetian CP, Samii A, Mosley AD, Roberts JW, Leis BC, Yearout D, et al. A clinic-based study of the LRRK2 gene in Parkinson disease yields new mutations. *Neurology.* 2005 Sep 13;65(5):741-4.
- [88] Wider C, Skipper L, Solida A, Brown L, Farrer M, Dickson D, et al. Autosomal dominant dopa-responsive parkinsonism in a multigenerational Swiss family. *Parkinsonism Relat Disord.* 2008 Aug;14(6):465-70.

- [89] Zimprich A, Benet-Pages A, Struhal W, Graf E, Eck SH, Offman MN, et al. A Mutation in VPS35, Encoding a Subunit of the Retromer Complex, Causes Late-Onset Parkinson Disease. *Am J Hum Genet.* 2011 Jul 15;89(1):168-75.
- [90] Leroy E, Boyer R, Auburger G, Leube B, Ulm G, Mezey E, et al. The ubiquitin pathway in Parkinson's disease. *Nature.* 1998 Oct 1;395(6701):451-2.
- [91] Lincoln S, Vaughan J, Wood N, Baker M, Adamson J, Gwinn-Hardy K, et al. Low frequency of pathogenic mutations in the ubiquitin carboxy-terminal hydrolase gene in familial Parkinson's disease. *Neuroreport.* 1999 Feb 5;10(2):427-9.
- [92] Healy DG, Abou-Sleiman PM, Casas JP, Ahmadi KR, Lynch T, Gandhi S, et al. UCHL-1 is not a Parkinson's disease susceptibility gene. *Ann Neurol.* 2006 Apr;59(4):627-33.
- [93] Lautier C, Goldwurm S, Durr A, Giovannone B, Tsiras WG, Pezzoli G, et al. Mutations in the GIGYF2 (TNRC15) gene at the PARK11 locus in familial Parkinson disease. *Am J Hum Genet.* 2008 Apr;82(4):822-33.
- [94] Nichols WC, Kissell DK, Pankratz N, Pauciulo MW, Elsaesser VE, Clark KA, et al. Variation in GIGYF2 is not associated with Parkinson disease. *Neurology.* 2009 Jun 2;72(22):1886-92.
- [95] Bonetti M, Ferraris A, Petracca M, Bentivoglio AR, Dallapiccola B, Valente EM. GIGYF2 variants are not associated with Parkinson's disease in Italy. *Mov Disord.* 2009 Sep 15;24(12):1867-8.
- [96] Bras J, Simon-Sanchez J, Federoff M, Morgado A, Januario C, Ribeiro M, et al. Lack of replication of association between GIGYF2 variants and Parkinson disease. *Hum Mol Genet.* 2009 Jan 15;18(2):341-6.
- [97] Di Fonzo A, Fabrizio E, Thomas A, Fincati E, Marconi R, Tinazzi M, et al. GIGYF2 mutations are not a frequent cause of familial Parkinson's disease. *Parkinsonism Relat Disord.* 2009 Nov;15(9):703-5.
- [98] Tan EK, Lin CH, Tai CH, Tan LC, Chen ML, Li R, et al. Non-synonymous GIGYF2 variants in Parkinson's disease from two Asian populations. *Human genetics.* 2009 Sep;126(3):425-30.
- [99] Vilarino-Guell C, Ross OA, Soto AI, Farrer MJ, Haugarvoll K, Aasly JO, et al. Reported mutations in GIGYF2 are not a common cause of Parkinson's disease. *Mov Disord.* 2009 Mar 15;24(4):619-20.
- [100] Zimprich A, Schulte C, Reinthaler E, Haubenberger D, Balzar J, Lichtner P, et al. PARK11 gene (GIGYF2) variants Asn56Ser and Asn457Thr are not pathogenic for Parkinson's disease. *Parkinsonism Relat Disord.* 2009 Aug;15(7):532-4.
- [101] Strauss KM, Martins LM, Plun-Favreau H, Marx FP, Kautzmann S, Berg D, et al. Loss of function mutations in the gene encoding Omi/HtrA2 in Parkinson's disease. *Hum Mol Genet.* 2005 Aug 1;14(15):2099-111.
- [102] Ross OA, Soto AI, Vilarino-Guell C, Heckman MG, Diehl NN, Hulihan MM, et al. Genetic variation of Omi/HtrA2 and Parkinson's disease. *Parkinsonism Relat Disord.* 2008 Nov;14(7):539-43.
- [103] Simon-Sanchez J, Singleton AB. Sequencing analysis of OMI/HTRA2 shows previously reported pathogenic mutations in neurologically normal controls. *Hum Mol Genet.* 2008 Jul 1;17(13):1988-93.
- [104] Kruger R, Sharma M, Riess O, Gasser T, Van Broeckhoven C, Theuns J, et al. A large-scale genetic association study to evaluate the contribution of Omi/HtrA2 (PARK13) to Parkinson's disease. *Neurobiol Aging.* 2011 Mar;32(3):548 e9-18.
- [105] Tuite PJ, Rogaeva EA, St George-Hyslop PH, Lang AE. Dopa-responsive parkinsonism phenotype of Machado-Joseph disease: confirmation of 14q CAG expansion. *Ann Neurol.* 1995 Oct;38(4):684-7.
- [106] Gwinn-Hardy K, Chen JY, Liu HC, Liu TY, Boss M, Seltzer W, et al. Spinocerebellar ataxia type 2 with parkinsonism in ethnic Chinese. *Neurology.* 2000 Sep 26;55(6):800-5.
- [107] Furtado S, Farrer M, Tsuboi Y, Klimek ML, de la Fuente-Fernandez R, Hussey J, et al. SCA-2 presenting as parkinsonism in an Alberta family: clinical, genetic, and PET findings. *Neurology.* 2002 Nov 26;59(10):1625-7.
- [108] Lu CS, Chang HC, Kuo PC, Liu YL, Wu WS, Weng YH, et al. The parkinsonian phenotype of spinocerebellar ataxia type 3 in a Taiwanese family. *Parkinsonism Relat Disord.* 2004 Aug;10(6):369-73.
- [109] Socal MP, Emmel VE, Rieder CR, Hilbig A, Saraiva-Pereira ML, Jardim LB. Intrafamilial variability of Parkinson phenotype in SCAs: novel cases due to SCA2 and SCA3 expansions. *Parkinsonism Relat Disord.* 2009 Jun;15(5):374-8.
- [110] Shan DE, Soong BW, Sun CM, Lee SJ, Liao KK, Liu RS. Spinocerebellar ataxia type 2 presenting as familial levodopa-responsive parkinsonism. *Ann Neurol.* 2001 Dec;50(6):812-5.
- [111] Charles P, Camuzat A, Benammar N, Sellal F, Destee A, Bonnet AM, et al. Are interrupted SCA2 CAG repeat expansions responsible for parkinsonism? *Neurology.* 2007 Nov 20;69(21):1970-5.

- [112] Poorkaj P, Bird TD, Wijsman E, Nemens E, Garruto RM, Anderson L, et al. Tau is a candidate gene for chromosome 17 frontotemporal dementia. *Ann Neurol*. 1998 Jun;43(6):815-25.
- [113] Hutton M, Lendon CL, Rizzu P, Baker M, Froelich S, Houlden H, et al. Association of missense and 5'-splice-site mutations in tau with the inherited dementia FTDP-17. *Nature*. 1998 Jun 18;393(6686):702-5.
- [114] Baker M, Mackenzie IR, Pickering-Brown SM, Gass J, Rademakers R, Lindholm C, et al. Mutations in progranulin cause tau-negative frontotemporal dementia linked to chromosome 17. *Nature*. 2006 Aug 24;442(7105):916-9.
- [115] Narozanska E, Jasinska-Myga B, Sitek EJ, Robowski P, Brockhuis B, Lass P, et al. Frontotemporal dementia and parkinsonism linked to chromosome 17--the first Polish family. *Eur J Neurol*. 2011 Mar;18(3):535-7.
- [116] van Swieten J, Spillantini MG. Hereditary frontotemporal dementia caused by Tau gene mutations. *Brain Pathol*. 2007 Jan;17(1):63-73.
- [117] Rademakers R, Baker M, Gass J, Adamson J, Huey ED, Momeni P, et al. Phenotypic variability associated with progranulin haploinsufficiency in patients with the common 1477C-->T (Arg493X) mutation: an international initiative. *Lancet Neurol*. 2007 Oct;6(10):857-68.
- [118] Kelley BJ, Haidar W, Boeve BF, Baker M, Graff-Radford NR, Krefft T, et al. Prominent phenotypic variability associated with mutations in Progranulin. *Neurobiol Aging*. 2009 May;30(5):739-51.
- [119] Ludolph AC, Kassubek J, Landwehrmeyer BG, Mandelkow E, Mandelkow EM, Burn DJ, et al. Tauopathies with parkinsonism: clinical spectrum, neuropathologic basis, biological markers, and treatment options. *Eur J Neurol*. 2009 Mar;16(3):297-309.
- [120] Nuytemans K, Pals P, Sleegers K, Engelborghs S, Corsmit E, Peeters K, et al. Progranulin variability has no major role in Parkinson disease genetic etiology. *Neurology*. 2008 Oct 7;71(15):1147-51.
- [121] Jacquemont S, Hagerman RJ, Hagerman PJ, Leehey MA. Fragile-X syndrome and fragile X-associated tremor/ataxia syndrome: two faces of FMR1. *Lancet Neurol*. 2007 Jan;6(1):45-55.
- [122] Hall DA, Jennings D, Seibyl J, Tassone F, Marek K. FMR1 gene expansion and scans without evidence of dopaminergic deficits in parkinsonism patients. *Parkinsonism Relat Disord*. 2010 Nov;16(9):608-11.
- [123] Hall DA, Berry-Kravis E, Jacquemont S, Rice CD, Cogswell J, Zhang L, et al. Initial diagnoses given to persons with the fragile X associated tremor/ataxia syndrome (FXTAS). *Neurology*. 2005 Jul 26;65(2):299-301.
- [124] Hall DA, Howard K, Hagerman R, Leehey MA. Parkinsonism in FMR1 premutation carriers may be indistinguishable from Parkinson disease. *Parkinsonism Relat Disord*. 2009 Feb;15(2):156-9.
- [125] Hagerman RJ, Leehey M, Heinrichs W, Tassone F, Wilson R, Hills J, et al. Intention tremor, parkinsonism, and generalized brain atrophy in male carriers of fragile X. *Neurology*. 2001 Jul 10;57(1):127-30.
- [126] Loesch DZ, Khaniani MS, Slater HR, Rubio JP, Bui QM, Kotschet K, et al. Small CGG repeat expansion alleles of FMR1 gene are associated with parkinsonism. *Clin Genet*. 2009 Nov;76(5):471-6.
- [127] Hall DA, Berry-Kravis E, Zhang W, Tassone F, Spector E, Zerbe G, et al. FMR1 gray-zone alleles: Association with Parkinson's disease in women? *Mov Disord*. 2011 May 12. doi: 10.1002/mds.23755. [Epub ahead of print]
- [128] Annesi G, Nicoletti G, Tarantino P, Cutuli N, Annesi F, Marco EV, et al. FRAXE intermediate alleles are associated with Parkinson's disease. *Neurosci Lett*. 2004 Sep 16;368(1):21-4.
- [129] Deng H, Le W, Jankovic J. Premutation alleles associated with Parkinson disease and essential tremor. *Jama*. 2004 Oct 13;292(14):1685-6.
- [130] Toft M, Aasly J, Bisceglia G, Adler CH, Uitti RJ, Krygowska-Wajs A, et al. Parkinsonism, FXTAS, and FMR1 premutations. *Mov Disord*. 2005 Feb;20(2):230-3.
- [131] Kurz MW, Schlitter AM, Klenk Y, Mueller T, Larsen JP, Aarsland D, et al. FMR1 alleles in Parkinson's disease: relation to cognitive decline and hallucinations, a longitudinal study. *J Geriatr Psychiatry Neurol*. 2007 Jun;20(2):89-92.
- [132] Costa A, Gao L, Carrillo F, Caceres-Redondo MT, Carballo M, Diaz-Martin J, et al. Intermediate alleles at the FRAXA and FRAXE loci in Parkinson's disease. *Parkinsonism Relat Disord*. 2010 May;17(4):281-4.
- [133] Momma K, Funayama M, Li Y, Ichinose H, Motoyoshi K, Hattori N, et al. A new mutation in the GCH1 gene presents as early-onset Parkinsonism. *Parkinsonism Relat Disord*. 2009 Feb;15(2):160-1.
- [134] Thöny B, Blau N. Mutations in the BH4-metabolizing genes GTP cyclohydrolase I, 6-pyruvoyl-tetrahydropterin synthase, sepiapterin reductase, carbinolamine-4a-dehydratase, and dihydropteridine reductase. *Hum Mutat*. 2006 Sep;27(9):870-8.

- [135] Nygaard TG. Dopa-responsive dystonia. *Curr Opin Neurol*. 1995 Aug;8(4):310-3.
- [136] Trender-Gerhard I, Sweeney MG, Schwingenschuh P, Mir P, Edwards MJ, Gerhard A, et al. Autosomal-dominant GTPCH1-deficient DRD: clinical characteristics and long-term outcome of 34 patients. *J Neurol Neurosurg Psychiatry*. 2009 Aug;80(8):839-45.
- [137] Maraganore DM, de Andrade M, Lesnick TG, Strain KJ, Farrer MJ, Rocca WA, et al. High-resolution whole-genome association study of Parkinson disease. *Am J Hum Genet*. 2005 Nov;77(5):685-93.
- [138] Cobb SA, Wider C, Ross OA, Mata IF, Adler CH, Rajput A, et al. GCH1 in early-onset Parkinson's disease. *Mov Disord*. 2009 Oct 30;24(14):2070-5.
- [139] Fung HC, Scholz S, Matarin M, Simon-Sanchez J, Hernandez D, Britton A, et al. Genome-wide genotyping in Parkinson's disease and neurologically normal controls: first stage analysis and public release of data. *Lancet Neurol*. 2006 Nov;5(11):911-6.
- [140] Hertz JM, Ostergaard K, Juncker I, Pedersen S, Romstad A, Moller LB, et al. Low frequency of Parkin, Tyrosine Hydroxylase, and GTP Cyclohydrolase I gene mutations in a Danish population of early-onset Parkinson's Disease. *Eur J Neurol*. 2006 Apr;13(4):385-90.
- [141] Simon-Sanchez J, Schulte C, Bras JM, Sharma M, Gibbs JR, Berg D, et al. Genome-wide association study reveals genetic risk underlying Parkinson's disease. *Nat Genet*. 2009 Dec;41(12):1308-12.
- [142] Bademci G, Edwards TL, Torres AL, Scott WK, Zuchner S, Martin ER, et al. A rare novel deletion of the tyrosine hydroxylase gene in Parkinson disease. *Hum Mutat*. 2010 Oct;31(10):E1767-71.
- [143] Sharma M, Mueller JC, Zimprich A, Lichtner P, Hofer A, Leitner P, et al. The sepiapterin reductase gene region reveals association in the PARK3 locus: analysis of familial and sporadic Parkinson's disease in European populations. *J Med Genet*. 2006 Jul;43(7):557-62.
- [144] Sharma M, Maraganore DM, Ioannidis JP, Riess O, Aasly JO, Annesi G, et al. Role of sepiapterin reductase gene at the PARK3 locus in Parkinson's disease. *Neurobiol Aging*. 2011 Jul 20.
- [145] Modell B, Darr A. Science and society: genetic counselling and customary consanguineous marriage. *Nature reviews*. 2002 Mar;3(3):225-9.
- [146] Kitada T, Asakawa S, Hattori N, Matsumine H, Yamamura Y, Minoshima S, et al. Mutations in the parkin gene cause autosomal recessive juvenile parkinsonism. *Nature*. 1998 Apr 9;392(6676):605-8.
- [147] Yamamura Y, Sobue I, Ando K, Iida M, Yanagi T. Paralysis agitans of early onset with marked diurnal fluctuation of symptoms. *Neurology*. 1973 Mar;23(3):239-44.
- [148] Yamamura Y. The long journey to the discovery of PARK2. *Neuropathology*. 2011 Jul 27. doi: 10.1111/j.1440-1789.2010.01144.x [Epub ahead of print]
- [149] Lucking CB, Durr A, Bonifati V, Vaughan J, De Michele G, Gasser T, et al. Association between early-onset Parkinson's disease and mutations in the parkin gene. *N Engl J Med*. 2000 May 25;342(21):1560-7.
- [150] Sironi F, Primignani P, Zini M, Tunesi S, Ruffmann C, Ricca S, et al. Parkin analysis in early onset Parkinson's disease. *Parkinsonism Relat Disord*. 2008;14(4):326-33.
- [151] Choi JM, Woo MS, Ma HI, Kang SY, Sung YH, Yong SW, et al. Analysis of PARK genes in a Korean cohort of early-onset Parkinson disease. *Neurogenetics*. 2008 Oct;9(4):263-9.
- [152] Koziarowski D, Hoffman-Zacharska D, Slawek J, Szirkowicz W, Janik P, Bal J, et al. Low frequency of the PARK2 gene mutations in Polish patients with the early-onset form of Parkinson disease. *Parkinsonism Relat Disord*. 2009 Feb;16(2):136-8.
- [153] Mellick GD, Siebert GA, Funayama M, Buchanan DD, Li Y, Imamichi Y, et al. Screening PARK genes for mutations in early-onset Parkinson's disease patients from Queensland, Australia. *Parkinsonism Relat Disord*. 2009 Feb;15(2):105-9.
- [154] Hakansson A, Belin AC, Stiller C, Sydow O, Johnels B, Olson L, et al. Investigation of genes related to familial forms of Parkinson's disease--with focus on the Parkin gene. *Parkinsonism Relat Disord*. 2008 Aug;14(6):520-2.
- [155] Suzuki M, Hattori N, Orimo S, Fukumitsu N, Abo M, Kono Y, et al. Preserved myocardial [123I]metaiodobenzylguanidine uptake in autosomal recessive juvenile parkinsonism: first case report. *Mov Disord*. 2005 May;20(5):634-6.
- [156] Rankin CA, Roy A, Zhang Y, Richter M. Parkin, A Top Level Manager in the Cell's Sanitation Department. *The open biochemistry journal*. 2011;5:9-26.
- [157] Mochizuki H. Parkin gene therapy. *Parkinsonism Relat Disord*. 2009 Jan;15 Suppl 1:S43-5.
- [158] Valente EM, Abou-Sleiman PM, Caputo V, Muqit MM, Harvey K, Gispert S, et al. Hereditary early-onset Parkinson's disease caused by mutations in PINK1. *Science*. 2004 May 21;304(5674):1158-60.

- [159] Bonifati V, Rizzu P, van Baren MJ, Schaap O, Breedveld GJ, Krieger E, et al. Mutations in the DJ-1 gene associated with autosomal recessive early-onset parkinsonism. *Science*. 2003 Jan 10;299(5604):256-9.
- [160] Abou-Sleiman PM, Healy DG, Quinn N, Lees AJ, Wood NW. The role of pathogenic DJ-1 mutations in Parkinson's disease. *Ann Neurol*. 2003 Sep;54(3):283-6.
- [161] Hering R, Strauss KM, Tao X, Bauer A, Woitalla D, Mietz EM, et al. Novel homozygous p.E64D mutation in DJ1 in early onset Parkinson disease (PARK7). *Hum Mutat*. 2004 Oct;24(4):321-9.
- [162] Annesi G, Savettieri G, Pugliese P, D'Amelio M, Tarantino P, Ragonese P, et al. DJ-1 mutations and parkinsonism-dementia-amyotrophic lateral sclerosis complex. *Ann Neurol*. 2005 Nov;58(5):803-7.
- [163] Djarmati A, Hedrich K, Svetel M, Schafer N, Juric V, Vukosavic S, et al. Detection of Parkin (PARK2) and DJ1 (PARK7) mutations in early-onset Parkinson disease: Parkin mutation frequency depends on ethnic origin of patients. *Hum Mutat*. 2004 May;23(5):525.
- [164] Gasser T. Molecular pathogenesis of Parkinson disease: insights from genetic studies. *Expert reviews in molecular medicine*. 2009;11:e22.
- [165] Abbas N, Lucking CB, Ricard S, Durr A, Bonifati V, De Michele G, et al. A wide variety of mutations in the parkin gene are responsible for autosomal recessive parkinsonism in Europe. French Parkinson's Disease Genetics Study Group and the European Consortium on Genetic Susceptibility in Parkinson's Disease. *Hum Mol Genet*. 1999 Apr;8(4):567-74.
- [166] Clark LN, Afridi S, Karlins E, Wang Y, Mejia-Santana H, Harris J, et al. Case-control study of the parkin gene in early-onset Parkinson disease. *Arch Neurol*. 2006 Apr;63(4):548-52.
- [167] Toft M, Myhre R, Pielsticker L, White LR, Aasly JO, Farrer MJ. PINK1 mutation heterozygosity and the risk of Parkinson's disease. *J Neurol Neurosurg Psychiatry*. 2007 Jan;78(1):82-4.
- [168] Klein C, Lohmann-Hedrich K, Rogaeva E, Schlossmacher MG, Lang AE. Deciphering the role of heterozygous mutations in genes associated with parkinsonism. *Lancet Neurol*. 2007;6:652-62.
- [169] Morgan NV, Westaway SK, Morton JE, Gregory A, Gissen P, Sonek S, et al. PLA2G6, encoding a phospholipase A2, is mutated in neurodegenerative disorders with high brain iron. *Nat Genet*. 2006 Jul;38(7):752-4.
- [170] Paisan-Ruiz C, Bhatia KP, Li A, Hernandez D, Davis M, Wood NW, et al. Characterization of PLA2G6 as a locus for dystonia-parkinsonism. *Ann Neurol*. 2009 Jan;65(1):19-23.
- [171] Sina F, Shojaee S, Elahi E, Paisan-Ruiz C. R632W mutation in PLA2G6 segregates with dystonia-parkinsonism in a consanguineous Iranian family. *Eur J Neurol*. 2009 Jan;16(1):101-4.
- [172] Gregory A, Westaway SK, Holm IE, Kotzbauer PT, Hogarth P, Sonek S, et al. Neurodegeneration associated with genetic defects in phospholipase A(2). *Neurology*. 2008 Oct 28;71(18):1402-9.
- [173] Engel LA, Jing Z, O'Brien DE, Sun M, Kotzbauer PT. Catalytic function of PLA2G6 is impaired by mutations associated with infantile neuroaxonal dystrophy but not dystonia-parkinsonism. *PLoS One*. 2010;5(9):e12897.
- [174] Behrens MI, Bruggemann N, Chana P, Venegas P, Kagi M, Parrao T, et al. Clinical spectrum of Kufor-Rakeb syndrome in the Chilean kindred with ATP13A2 mutations. *Mov Disord*. Sep 15;25(12):1929-37.
- [175] Park JS, Mehta P, Cooper AA, Veivers D, Heimbach A, Stiller B, et al. Pathogenic effects of novel mutations in the P-type ATPase ATP13A2 (PARK9) causing Kufor-Rakeb syndrome, a form of early-onset parkinsonism. *Hum Mutat*. Aug;32(8):956-64.
- [176] Ramirez A, Heimbach A, Grundemann J, Stiller B, Hampshire D, Cid LP, et al. Hereditary parkinsonism with dementia is caused by mutations in ATP13A2, encoding a lysosomal type 5 P-type ATPase. *Nat Genet*. 2006 Oct;38(10):1184-91.
- [177] Schneider SA, Paisan-Ruiz C, Quinn NP, Lees AJ, Houlden H, Hardy J, et al. ATP13A2 mutations (PARK9) cause neurodegeneration with brain iron accumulation. *Mov Disord*. Jun 15;25(8):979-84.
- [178] Bruggemann N, Hagenah J, Reetz K, Schmidt A, Kasten M, Buchmann I, et al. Recessively inherited parkinsonism: effect of ATP13A2 mutations on the clinical and neuroimaging phenotype. *Arch Neurol*. 2010 Nov;67(11):1357-63.
- [179] Eiberg H, Hansen L, Korbo L, Nielsen I, Svenstrup K, Bech S, et al. Novel mutation in ATP13A2 widens the spectrum of Kufor-Rakeb syndrome (PARK9). *Clin Genet*. 2011 Jun 23. doi:10.1111/j.399-0004.2011.01745.x. [Epub ahead of print]
- [180] Di Fonzo A, Chien HF, Socal M, Giraudo S, Tassorelli C, Iliceto G, et al. ATP13A2 missense mutations in juvenile parkinsonism and young onset Parkinson disease. *Neurology*. 2007 May 8;68(19):1557-62.

- [181] Shojaee S, Sina F, Banihosseini SS, Kazemi MH, Kalhor R, Shahidi GA, et al. Genome-wide linkage analysis of a Parkinsonian-pyramidal syndrome pedigree by 500 K SNP arrays. *Am J Hum Genet.* 2008 Jun;82(6):1375-84.
- [182] Tang B, Xiong H, Sun P, Zhang Y, Wang D, Hu Z, et al. Association of PINK1 and DJ-1 confers digenic inheritance of early-onset Parkinson's disease. *Hum Mol Genet.* 2006 Jun 1;15(11):1816-25.
- [183] Dachsel JC, Mata IF, Ross OA, Taylor JP, Lincoln SJ, Hinkle KM, et al. Digenic parkinsonism: investigation of the synergistic effects of PRKN and LRRK2. *Neurosci Lett.* 2006 Dec 20;410(2):80-4.
- [184] Hamza TH, Payami H. The heritability of risk and age at onset of Parkinson's disease after accounting for known genetic risk factors. *Journal of human genetics.* 2010 Apr;55(4):241-3.
- [185] Puschmann A, Ross OA, Vilarino-Guell C, Lincoln SJ, Kachergus JM, Cobb SA, et al. A Swedish family with de novo alpha-synuclein A53T mutation: evidence for early cortical dysfunction. *Parkinsonism Relat Disord.* 2009 Nov;15(9):627-32.
- [186] Uitti RJ, Shinotoh H, Hayward M, Schulzer M, Mak E, Calne DB. "Familial Parkinson's disease"--a case-control study of families. *The Canadian journal of neurological sciences.* 1997 May;24(2):127-32.
- [187] Pihlstrom L, Toft M. Parkinson's disease: What remains of the "missing heritability"? *Mov Disord.* 2011 Aug 2.
- [188] Wikipedia [cited 2011 Aug 23]; Available from <http://en.wikipedia.org/wiki/Heritability>
- [189] Wirdefeldt K, Gatz M, Schalling M, Pedersen NL. No evidence for heritability of Parkinson disease in Swedish twins. *Neurology.* 2004 Jul 27;63(2):305-11.
- [190] Johnson WG, Hodge SE, Duvoisin R. Twin studies and the genetics of Parkinson's disease--a reappraisal. *Mov Disord.* 1990;5(3):187-94.
- [191] Nussbaum RL, Polymeropoulos MH. Genetics of Parkinson's disease. *Hum Mol Genet.* 1997;6(10):1687-91.
- [192] Wirdefeldt K, Gatz M, Reynolds CA, Prescott CA, Pedersen NL. Heritability of Parkinson disease in Swedish twins: a longitudinal study. *Neurobiol Aging.* 2011 Oct;32(10):1923 e1-8.
- [193] Moilanen JS, Autere JM, Myllyla VV, Majamaa K. Complex segregation analysis of Parkinson's disease in the Finnish population. *Human genetics.* 2001 Mar;108(3):184-9.
- [194] Mjones H. Paralysis agitans. A clinical and genetic study. *Acta Psychiatrica et Neurologica Supplementum.* 1949;54:195.
- [195] Elbaz A, Grigoletto F, Baldereschi M, Breteler MM, Manubens-Bertran JM, Lopez-Pousa S, et al. Familial aggregation of Parkinson's disease: a population-based case-control study in Europe. EURO-PARKINSON Study Group. *Neurology.* 1999 Jun 10;52(9):1876-82.
- [196] Wirdefeldt K, Adami HO, Cole P, Trichopoulos D, Mandel J. Epidemiology and etiology of Parkinson's disease: a review of the evidence. *European journal of epidemiology.* 2011 Jun;26 Suppl 1:S1-58.
- [197] Saad M, Lesage S, Saint-Pierre A, Corvol JC, Zelenika D, Lambert JC, et al. Genome-wide association study confirms BST1 and suggests a locus on 12q24 as the risk loci for Parkinson's disease in the European population. *Hum Mol Genet.* 2010 Feb 1;20(3):615-27.
- [198] Satake W, Nakabayashi Y, Mizuta I, Hirota Y, Ito C, Kubo M, et al. Genome-wide association study identifies common variants at four loci as genetic risk factors for Parkinson's disease. *Nat Genet.* 2009 Dec;41(12):1303-7.
- [199] Pankratz N, Wilk JB, Latourelle JC, DeStefano AL, Halter C, Pugh EW, et al. Genomewide association study for susceptibility genes contributing to familial Parkinson disease. *Human genetics.* 2009 Jan;124(6):593-605.
- [200] Simon-Sanchez J, van Hilten JJ, van de Warrenburg B, Post B, Berendse HW, Arepalli S, et al. Genome-wide association study confirms extant PD risk loci among the Dutch. *Eur J Hum Genet.* 2011 Jun;19(6):655-61.
- [201] Spencer CC, Plagnol V, Strange A, Gardner M, Paisan-Ruiz C, Band G, et al. Dissection of the genetics of Parkinson's disease identifies an additional association 5' of SNCA and multiple associated haplotypes at 17q21. *Hum Mol Genet.* 2010 Jan 15;20(2):345-53.
- [202] Srinivasan BS, Doostzadeh J, Absalan F, Mohandessi S, Jalili R, Bigdeli S, et al. Whole genome survey of coding SNPs reveals a reproducible pathway determinant of Parkinson disease. *Hum Mutat.* 2009 Feb;30(2):228-38.
- [203] Edwards TL, Scott WK, Almonte C, Burt A, Powell EH, Beecham GW, et al. Genome-wide association study confirms SNPs in SNCA and the MAPT region as common risk factors for Parkinson disease. *Annals of human genetics.* 2010 Mar;74(2):97-109.

- [204] Liu X, Cheng R, Verbitsky M, Kisselev S, Browne A, Mejia-Santana H, et al. Genome-Wide Association Study Identifies Candidate Genes for Parkinson's Disease in an Ashkenazi Jewish Population. *BMC medical genetics*. 2011 Aug 3;12(1):104.doi10.1186/471-2350-12-102.
- [205] Do CB, Tung JY, Dorfman E, Kiefer AK, Drabant EM, Francke U, et al. Web-based genome-wide association study identifies two novel loci and a substantial genetic component for Parkinson's disease. *PLoS genetics*. 2011 Jun;7(6):e1002141.
- [206] Nalls MA, Plagnol V, Hernandez DG, Sharma M, Sheerin UM, Saad M, et al. Imputation of sequence variants for identification of genetic risks for Parkinson's disease: a meta-analysis of genome-wide association studies. *Lancet*. 2011 Feb 19;377(9766):641-9.
- [207] International Parkinson's Disease Genomics Consortium (IPDGC), Wellcome Trust Case Control Consortium 2(WTCCC2). A two-stage meta-analysis identifies several new loci for Parkinson's disease. *PLoS genetics*. 2011 Jun;7(6):e1002142.
- [208] Dickson SP, Wang K, Krantz I, Hakonarson H, Goldstein DB. Rare variants create synthetic genome-wide associations. *PLoS Biol*. 2010;8(1):e1000294.
- [209] Lill C, Bagade S, McQueen M, Roehr JT, Kavvoura F, Schjeide BMM, et al. The PDGene Database. *Alzheimer Research Forum*. 2011 [cited 2011 Sept 5th]; Available from: <http://www.pdgene.org>
- [210] Manolio TA, Collins FS, Cox NJ, Goldstein DB, Hindorff LA, Hunter DJ, et al. Finding the missing heritability of complex diseases. *Nature*. 2009 Oct 8;461(7265):747-53.
- [211] Chiba-Falek O, Nussbaum RL. Effect of allelic variation at the NACP-Rep1 repeat upstream of the alpha-synuclein gene (SNCA) on transcription in a cell culture luciferase reporter system. *Hum Mol Genet*. 2001 Dec 15;10(26):3101-9.
- [212] Farrer M, Maraganore DM, Lockhart P, Singleton A, Lesnick TG, de Andrade M, et al. Alpha-Synuclein gene haplotypes are associated with Parkinson's disease. *Hum Mol Genet*. 2001 Aug 15;10(17):1847-51.
- [213] Maraganore DM, de Andrade M, Elbaz A, Farrer MJ, Ioannidis JP, Kruger R, et al. Collaborative analysis of alpha-synuclein gene promoter variability and Parkinson disease. *Jama*. 2006 Aug 9;296(6):661-70.
- [214] Dickson DW, Braak H, Duda JE, Duyckaerts C, Gasser T, Halliday GM, et al. Neuropathological assessment of Parkinson's disease: refining the diagnostic criteria. *Lancet Neurol*. 2009 Dec;8(12):1150-7.
- [215] Zabetian CP, Hutter CM, Factor SA, Nutt JG, Higgins DS, Griffith A, et al. Association analysis of MAPT H1 haplotype and subhaplotypes in Parkinson's disease. *Ann Neurol*. 2007 Aug;62(2):137-44.
- [216] Wider C, Vilarino-Guell C, Jasinska-Myga B, Heckman MG, Soto-Ortolaza AI, Cobb SA, et al. Association of the MAPT locus with Parkinson's disease. *Eur J Neurol*. 2010 Mar;17(3):483-6.
- [217] Tobin JE, Latourelle JC, Lew MF, Klein C, Suchowersky O, Shill HA, et al. Haplotypes and gene expression implicate the MAPT region for Parkinson disease: the GenePD Study. *Neurology*. 2008 Jul 1;71(1):28-34.
- [218] Skipper L, Wilkes K, Toft M, Baker M, Lincoln S, Hulihan M, et al. Linkage disequilibrium and association of MAPT H1 in Parkinson disease. *Am J Hum Genet*. 2004 Oct;75(4):669-77.
- [219] Carlborg O, Haley CS. Epistasis: too often neglected in complex trait studies? *Nature reviews*. 2004 Aug;5(8):618-25.
- [220] Giasson BI, Forman MS, Higuchi M, Golbe LI, Graves CL, Kotzbauer PT, et al. Initiation and synergistic fibrillization of tau and alpha-synuclein. *Science*. 2003 Apr 25;300(5619):636-40.
- [221] Arima K, Hirai S, Sunohara N, Aoto K, Izumiyama Y, Ueda K, et al. Cellular co-localization of phosphorylated tau- and NACP/alpha-synuclein-epitopes in lewy bodies in sporadic Parkinson's disease and in dementia with Lewy bodies. *Brain Res*. 1999 Oct 2;843(1-2):53-61.
- [222] Ishizawa T, Mattila P, Davies P, Wang D, Dickson DW. Colocalization of tau and alpha-synuclein epitopes in Lewy bodies. *J Neuropathol Exp Neurol*. 2003 Apr;62(4):389-97.
- [223] Mori H, Kondo T, Yokochi M, Matsumine H, Nakagawa-Hattori Y, Miyake T, et al. Pathologic and biochemical studies of juvenile parkinsonism linked to chromosome 6q. *Neurology*. 1998 Sep;51(3):890-2.
- [224] Yamamura Y, Hattori N, Matsumine H, Kuzuhara S, Mizuno Y. Autosomal recessive early-onset parkinsonism with diurnal fluctuation: clinicopathologic characteristics and molecular genetic identification. *Brain Dev*. 2000 Sep;22 Suppl 1:S87-91.
- [225] Duda JE, Giasson BI, Mabon ME, Miller DC, Golbe LI, Lee VM, et al. Concurrence of alpha-synuclein and tau brain pathology in the Contursi kindred. *Acta Neuropathol*. 2002 Jul;104(1):7-11.



- [226] Wszolek ZK, Pfeiffer RF, Tsuboi Y, Uitti RJ, McComb RD, Stoessl AJ, et al. Autosomal dominant parkinsonism associated with variable synuclein and tau pathology. *Neurology*. 2004 May 11;62(9):1619-22.
- [227] Abhinav K, Marsh L, Crain B, Reich SG, Biglan K. Co-existence of Parkinson's disease and progressive supranuclear palsy: case report and a review of the literature. *Neurol Sci*. 2011 Feb;32(1):159-63.
- [228] Mamah CE, Lesnick TG, Lincoln SJ, Strain KJ, de Andrade M, Bower JH, et al. Interaction of alpha-synuclein and tau genotypes in Parkinson's disease. *Ann Neurol*. 2005 Mar;57(3):439-43.
- [229] McCulloch CC, Kay DM, Factor SA, Samii A, Nutt JG, Higgins DS, et al. Exploring gene-environment interactions in Parkinson's disease. *Human genetics*. 2008 Apr;123(3):257-65.
- [230] Sidransky E, Nalls MA, Aasly JO, Aharon-Peretz J, Annesi G, Barbosa ER, et al. Multicenter analysis of glucocerebrosidase mutations in Parkinson's disease. *N Engl J Med*. 2009 Oct 22;361(17):1651-61.
- [231] Neumann J, Bras J, Deas E, O'Sullivan SS, Parkkinen L, Lachmann RH, et al. Glucocerebrosidase mutations in clinical and pathologically proven Parkinson's disease. *Brain*. 2009 Jul;132(Pt 7):1783-94.
- [232] Nishioka K, Ross OA, Vilarino-Guell C, Cobb SA, Kachergus JM, Mann DM, et al. Glucocerebrosidase mutations in diffuse Lewy body disease. *Parkinsonism Relat Disord*. 2011 Jan;17(1):55-7.
- [233] Yap TL, Gruschus JM, Velayati A, Westbroek W, Goldin E, Moaven N, et al. Alpha-Synuclein Interacts with Glucocerebrosidase Providing a Molecular Link between Parkinson and Gaucher Diseases. *J Biol Chem*. 2011 Aug 12;286(32):28080-8.
- [234] McGeer PL, McGeer EG. Inflammation and neurodegeneration in Parkinson's disease. *Parkinsonism & Related Disorders*. 2004;10:S3-0.
- [235] Lampe JB, Gossrau G, Herting B, Kempe A, Sommer U, Fussel M, et al. HLA typing and Parkinson's disease. *Eur Neurol*. 2003;50(2):64-8.
- [236] Puschmann A, Verbeeck C, Heckman MG, Soto-Ortolaza AI, Lynch T, Jasinska-Myga B, et al. Human leukocyte antigen variation and Parkinson's disease. *Parkinsonism Relat Disord*. 2011 Jun;17(5):376-8.
- [237] Satoh J, Kuroda Y. Association of codon 167 Ser/Asn heterozygosity in the parkin gene with sporadic Parkinson's disease. *Neuroreport*. 1999 Sep 9;10(13):2735-9.
- [238] Wang M, Hattori N, Matsumine H, Kobayashi T, Yoshino H, Morioka A, et al. Polymorphism in the parkin gene in sporadic Parkinson's disease. *Ann Neurol*. 1999 May;45(5):655-8.
- [239] Klein C, Schumacher K, Jacobs H, Hagenah J, Kis B, Garrels J, et al. Association studies of Parkinson's disease and parkin polymorphisms. *Ann Neurol*. 2000 Jul;48(1):126-7.
- [240] Crisculo C, Volpe G, De Rosa A, Varrone A, Marongiu R, Mancini P, et al. PINK1 homozygous W437X mutation in a patient with apparent dominant transmission of parkinsonism. *Mov Disord*. 2006 Aug;21(8):1265-7.
- [241] Eggers C, Schmidt A, Hagenah J, Bruggemann N, Klein JC, Tadic V, et al. Progression of subtle motor signs in PINK1 mutation carriers with mild dopaminergic deficit. *Neurology*. 2010 Jun 1;74(22):1798-805.
- [242] Verleger R, Hagenah J, Weiss M, Ewers T, Heberlein I, Pramstaller PP, et al. Responsiveness to distracting stimuli, though increased in Parkinson's disease, is decreased in asymptomatic PINK1 and Parkin mutation carriers. *Neuropsychologia*. 2010 Jan;48(2):467-76.
- [243] Weiner WJ. There is no Parkinson disease. *Arch Neurol*. 2008 Jun;65(6):705-8.
- [244] Hughes AJ, Daniel SE, Kilford L, Lees AJ. Accuracy of clinical diagnosis of idiopathic Parkinson's disease: a clinico-pathological study of 100 cases. *J Neurol Neurosurg Psychiatry*. 1992 Mar;55(3):181-4.
- [245] Gelb DJ, Oliver E, Gilman S. Diagnostic criteria for Parkinson disease. *Arch Neurol*. 1999 Jan;56(1):33-9.
- [246] Bower JH, Maraganore DM, McDonnell SK, Rocca WA. Incidence and distribution of parkinsonism in Olmsted County, Minnesota, 1976-1990. *Neurology*. 1999 Apr 12;52(6):1214-20.
- [247] Langston JW, Widner H, Goetz CG, Brooks D, Fahn S, Freeman T, et al. Core assessment program for intracerebral transplantations (CAPIT). *Mov Disord*. 1992;7(1):2-13.
- [248] Bower JH, Maraganore DM, McDonnell SK, Rocca WA. Influence of strict, intermediate, and broad diagnostic criteria on the age- and sex-specific incidence of Parkinson's disease. *Mov Disord*. 2000 Sep;15(5):819-25.
- [249] Puschmann A, Pfeiffer RF, Stoessl AJ, Kuriakose R, Lash JL, Searcy JA, et al. A family with Parkinsonism, essential tremor, restless legs syndrome, and depression. *Neurology*. 2011 May 10;76(19):1623-30.
- [250] Marek K, Seibyl J, Group PS. Beta-CIT scans without evidence of dopaminergic deficit (SWEDD) in the ELLDOPA-CIT and CALM-cit study: long-term imaging assessment. *Neurology*. 2003;60(Suppl 1):A293.

- [251] ParkinsonStudyGroup. Pramipexole vs levodopa as initial treatment for Parkinson disease: A randomized controlled trial. *Jama*. 2000 Oct 18;284(15):1931-8.
- [252] ParkinsonStudyGroup. Dopamine transporter brain imaging to assess the effects of pramipexole vs levodopa on Parkinson disease progression. *Jama*. 2002 Apr 3;287(13):1653-61.
- [253] Whone AL, Watts RL, Stoessel AJ, Davis M, Reske S, Nahmias C, et al. Slower progression of Parkinson's disease with ropinirole versus levodopa: The REAL-PET study. *Ann Neurol*. 2003 Jul;54(1):93-101.
- [254] Fahn S, Oakes D, Shoulson I, Kieburtz K, Rudolph A, Lang A, et al. Levodopa and the progression of Parkinson's disease. *N Engl J Med*. 2004 Dec 9;351(24):2498-508.
- [255] Marek K, Seibyl J. Long-term follow-up of patients with scans without evidence of dopaminergic deficit (SWEDD) in the ELLDOPA study. *Neurology*. 2005;64(Suppl 1):A274.
- [256] Schwingenschuh P, Ruge D, Edwards MJ, Terranova C, Katschnig P, Carrillo F, et al. Distinguishing SWEDDs patients with asymmetric resting tremor from Parkinson's disease: a clinical and electrophysiological study. *Mov Disord*. 2010 Apr 15;25(5):560-9.
- [257] Mian OS, Schneider SA, Schwingenschuh P, Bhatia KP, Day BL. Gait in SWEDDs patients: comparison with Parkinson's disease patients and healthy controls. *Mov Disord*. 2011 Jun;26(7):1266-73.
- [258] van Rooden SM, Heiser WJ, Kok JN, Verbaan D, van Hilten JJ, Marinus J. The identification of Parkinson's disease subtypes using cluster analysis: a systematic review. *Mov Disord*. 2010 Jun 15;25(8):969-78.
- [259] Sydow O. Parkinson's disease: recent development in therapies for advanced disease with a focus on deep brain stimulation (DBS) and duodenal levodopa infusion. *Febs J*. 2008 Apr;275(7):1370-6.
- [260] van Rooden SM, Colas F, Martinez-Martin P, Visser M, Verbaan D, Marinus J, et al. Clinical subtypes of Parkinson's disease. *Mov Disord*. 2011 Jan;26(1):51-8.
- [261] Maguire-Zeiss KA. alpha-Synuclein: a therapeutic target for Parkinson's disease? *Pharmacol Res*. 2008 Nov-Dec;58(5-6):271-80.
- [262] Danzer KM, McLean PJ. Drug Targets from Genetics: Alpha-Synuclein. *CNS & neurological disorders drug targets*. 2011 Aug 15.
- [263] ParkinsonStudyGroup. Mixed lineage kinase inhibitor CEP-1347 fails to delay disability in early Parkinson disease. *Neurology*. 2007 Oct 9;69(15):1480-90.
- [264] Shachar T, Bianco CL, Recchia A, Wiessner C, Raas-Rothschild A, Futerman AH. Lysosomal storage disorders and Parkinson's disease: Gaucher disease and beyond. *Mov Disord*. 2011 Aug 1;26(9):1593-604.
- [265] Lundborg H. Klinische Studien und Erfahrungen betreffs der familiären Myoklonie und damit verwandten Krankheiten. *Svenska Läkaresällskapets Nya Handlingar*. 1901;Serien III(Delen 3):130.
- [266] Lundborg H. Die progressive Myoklonus-Epilepsie (Unverricht's Myoklonie). Uppsala: Almqvist und Wiksell's Buchdruckerei-A.-G. 1903.
- [267] Lundborg H. Medizinisch-biologische Familienforschungen innerhalb eines 2232köpfigen Bauerngeschlechtes in Schweden (Provinz Blekinge). Jena: Verlag von Gustav Fischer 1913.
- [268] Nilsson N, Jonefors K. Listersläkten: en krönika om en stor släkt med rötter i Mjällby socken, Blekinge. Lister-Mjällby: Listersläktens förening. 1970.
- [269] Farrer M, Kachergus J, Forno L, Lincoln S, Wang DS, Hulihan M, et al. Comparison of kindreds with parkinsonism and alpha-synuclein genomic multiplications. *Annals of neurology*. 2004 Feb;55(2):174-9.
- [270] Lincoln SJ, Ross OA, Milkovic NM, Dickson DW, Rajput A, Robinson CA, et al. Quantitative PCR-based screening of alpha-synuclein multiplication in multiple system atrophy. *Parkinsonism & Related Disorders*. 2007;13(6):340-2.
- [271] Nilsson S. Forskare vill studera Parkinsondrabbade. *Blekinge Läns Tidning*. 2007 June 18, 2007.
- [272] Ross OA, Braithwaite AT, Skipper LM, Kachergus J, Hulihan MM, Middleton FA, et al. Genomic investigation of alpha-synuclein multiplication and parkinsonism. *Ann Neurol*. 2008 Jun;63(6):743-50.
- [273] Elbaz A, Ross OA, Ioannidis JP, Soto-Ortolaza AI, Moisan F, Aasly J, et al. Independent and joint effects of the MAPT and SNCA genes in Parkinson disease. *Ann Neurol*. 2011 May;69(5):778-92.
- [274] Wray S, Self M, Consortium NPsDi, Consortium NHsDi, NINDS ALS iPSC Consortium; Lewis PA, Taanman J-W, et al. Creation of an open-access, mutation-defined fibroblast resource for neurological disease research. *PLoS ONE* 2011 [in press].
- [275] Knutsson B. Listersläkten: Bensagrenen. Lister-Mjällby: Listersläktens förening 2002.
- [276] Nilsson N. Listersläkten. 2009.

- [277] Anderson H. The Swedish State-Institute for Race-Biological Investigation. An account of its origination. Bergvik 1922.
- [278] Amiel B. Sweden's shameful eugenics policies. *Macleans*. 1997 Sep 8;110(36):13.
- [279] Hyatt S. A shared history of shame: Sweden's four-decade policy of forced sterilization and the eugenics movement in the United States. *Indiana Int Comp Law Rev*. 1998;8(2):475-503.
- [280] Ramsay S. Enforced sterilisations in Sweden confirmed. *Lancet*. 2000 Apr 8;355(9211):1252.
- [281] Bjorkman M, Widmalm S. Selling eugenics: the case of Sweden. *Notes Rec R Soc Lond*. 2010 Dec 20;64(4):379-400.
- [282] Rössner S. Erik Ask-Upmark: »Blekinge är Sveriges fossa Douglassi«. *Lakartidningen*. 2005;102(26-27):1983.
- [283] Tännsjö T. Non-voluntary sterilization. *J Med Philos*. 2006 Aug;31(4):401-15.
- [284] Gejman PV, Weillbaeher A. History of the eugenic movement. *Isr J Psychiatry Relat Sci*. 2002;39(4):217-31.
- [285] Wittmann E. To what extent were ideas and beliefs about eugenics held in Nazi Germany shared in Britain and the United States prior to the second world war? *Vesalius*. 2004 Jun;10(1):16-9.
- [286] Otsubo S, Bartholomew JR. Eugenics in Japan: some ironies of modernity, 1883-1945. *Sci Context*. 1998 Autumn-Winter;11(3-4):545-65.
- [287] Japan discloses 16,520 "eugenic" sterilizations. *JOICFP News*. 1997 Nov(281):6.
- [288] Giaever O. [Eugenic indication for abortion--a historical background]. *Tidsskr Nor Laegeforen*. 2005 Dec 15;125(24):3472-6.
- [289] Roll-Hansen N. Eugenic sterilization: a preliminary comparison of the Scandinavian experience to that of Germany. *Genome*. 1989;31(2):890-5.
- [290] Zylberman P. The doers of good. *Scandinavian historians revise the social history of eugenics (1997-2001)*. *Med Secoli*. 2008;20(3):937-64.
- [291] Lundholm A. "En rasbiolog dömd ut min mamma". *Sölvesborgs-Tidningen*. 1997 November 14;Sect. 1.
- [292] Tunbäck B. Han blev professor - vi bands vid skampålen [radio program]: *Sveriges Radio P1*; 1998.
- [293] Petersson J. Hans forskning dödar myten om Listersjukan. 2009 Nov 13, 2009.
- [294] Hafner H. Schizophrenia: still Kraepelin's dementia praecox? *Epidemiol Psychiatr Soc*. 2004 Apr-Jun;13(2):99-112.
- [295] Kälviäinen R, Khyuppenen J, Koskenkorva P, Eriksson K, Vanninen R, Mervaala E. Clinical picture of EPM1-Unverricht-Lundborg disease. *Epilepsia*. 2008;49(4):549-56.
- [296] Joensuu T, Lehesjoki AE, Kopra O. Molecular background of EPM1-Unverricht-Lundborg disease. *Epilepsia*. 2008 Apr;49(4):557-63.
- [297] Puschmann A. Unverricht-Lundborg disease-a misnomer? *Mov Disord*. 2009 Mar 15;24(4):629-30.
- [298] Chew NK, Mir P, Edwards MJ, Cordivari C, Martino D, Schneider SA, et al. The Natural History of Unverricht-Lundborg Disease: A Report of Eight Genetically Proven Cases. *Mov Disord*. 2008;23(1):107-13.
- [299] Alakurtti K, Weber E, Rinne R, Theil G, de Haan GJ, Lindhout D, et al. Loss of lysosomal association of cystatin B proteins representing progressive myoclonus epilepsy, EPM1, mutations. *Eur J Hum Genet*. 2005 Feb;13(2):208-15.
- [300] Korja M, Kaasinen V, Lamusuo S, Parkkola R, Nagren K, Marttila RJ. Substantial thalamostriatal dopaminergic defect in Unverricht-Lundborg disease. *Epilepsia*. 2007 Sep;48(9):1768-73.
- [301] Karvonen MK, Kaasinen V, Korja M, Marttila RJ. Ropinirole diminishes myoclonus and improves writing and postural balance in an ULD patient. *Mov Disord*. 2010 Mar 15;25(4):520-1.
- [302] Muentner MD, Forno LS, Hornykiewicz O, Kish SJ, Maraganore DM, Caselli RJ, et al. Hereditary form of parkinsonism--dementia. *Ann Neurol*. 1998 Jun;43(6):768-81.
- [303] Gwinn-Hardy K, Mehta ND, Farrer M, Maraganore D, Muentner M, Yen SH, et al. Distinctive neuropathology revealed by alpha-synuclein antibodies in hereditary parkinsonism and dementia linked to chromosome 4p. *Acta Neuropathol*. 2000 Jun;99(6):663-72.
- [304] Waters CH, Miller CA. Autosomal dominant Lewy body parkinsonism in a four-generation family. *Ann Neurol*. 1994 Jan;35(1):59-64.
- [305] Duvernoy H. Personal Communication. 2010.
- [306] Caviness JN, Gwinn-Hardy K, Adler CH, Muentner MD. Electrophysiological observations in hereditary parkinsonism-dementia with Lewy body pathology. *Mov Disord*. 2000 Jan;15(1):140-5.
- [307] Kotzbauer PT, Giasson BI, Kravitz AV, Golbe LI, Mark MH, Trojanowski JQ, et al. Fibrillization of alpha-synuclein and tau in familial Parkinson's disease caused by the A53T alpha-synuclein mutation. *Exp Neurol*. 2004 Jun;187(2):279-88.

- [308] Hedrich K, Djarmati A, Schafer N, Hering R, Wellenbrock C, Weiss PH, et al. DJ-1 (PARK7) mutations are less frequent than Parkin (PARK2) mutations in early-onset Parkinson disease. *Neurology*. 2004 Feb 10;62(3):389-94.
- [309] Veeriah S, Taylor BS, Meng S, Fang F, Yilmaz E, Vivanco I, et al. Somatic mutations of the Parkinson's disease-associated gene PARK2 in glioblastoma and other human malignancies. *Nat Genet*. 2010 Jan;42(1):77-82.
- [310] Ferrer I, Martinez A, Blanco R, Dalfo E, Carmona M. Neuropathology of sporadic Parkinson disease before the appearance of parkinsonism: preclinical Parkinson disease. *J Neural Transm*. 2011 Sep 23;118:821-39.
- [311] Dächsel JC, Behrouz B, Yue M, Beevers JE, Melrose HL, Farrer MJ. A comparative study of Lrrk2 function in primary neuronal cultures. *Parkinsonism & Related Disorders*. 2010;16:650-5.
- [312] Alcalay RN, Caccapolo E, Mejia-Santana H, Tang MX, Rosado L, Ross BM, et al. Frequency of known mutations in early-onset Parkinson disease: implication for genetic counseling: the consortium on risk for early onset Parkinson disease study. *Arch Neurol*. 2010 Sep;67(9):1116-22.
- [313] Keyser R. Investigation of the genetic aetiology of Parkinson's disease in South Africa. Cape Town, South Africa: Stellenbosch University; 2011.
- [314] Keyser RJ, Lombard D, Veikondis R, Carr J, Bardien S. Analysis of exon dosage using MLPA in South African Parkinson's disease patients. *Neurogenetics*. 2010 Jul;11(3):305-12.
- [315] Bardien S, Keyser R, Yako Y, Lombard D, Carr J. Molecular analysis of the parkin gene in South African patients diagnosed with Parkinson's disease. *Parkinsonism Relat Disord*. 2009 Feb;15(2):116-21.
- [316] Keyser RJ, Lesage S, Brice A, Carr J, Bardien S. Assessing the prevalence of PINK1 genetic variants in South African patients diagnosed with early- and late-onset Parkinson's disease. *Biochem Biophys Res Commun*. 2010 Jul 16;398(1):125-9.
- [317] Bardien S, Marsberg A, Keyser R, Lombard D, Lesage S, Brice A, et al. LRRK2 G2019S mutation: frequency and haplotype data in South African Parkinson's disease patients. *J Neural Transm*. 2010 Jul;117(7):847-53.
- [318] Hopper JL. Disease-specific prospective family study cohorts enriched for familial risk. *Epidemiologic Perspectives & Innovations*. 2011;8(2).
- [319] Cirulli ET, Goldstein DB. Uncovering the roles of rare variants in common disease through whole-genome sequencing. *Nature Rev Gen*. 2010;11.
- [320] Harbo HF, Finsterer J, Baets J, Van Broeckhoven C, Di Donato S, Fontaine B, et al. EFNS guidelines on the molecular diagnosis of neurogenetic disorders: general issues, Huntington's disease, Parkinson's disease and dystonias. *Eur J Neurol*. 2009 Jul;16(7):777-85.
- [321] Anvret A, Blackinton JG, Westerlund M, Ran C, Sydow O, Willows T, et al. DJ-1 Mutations are Rare in a Swedish Parkinson Cohort. *The open neurology journal*. 2011;5:8-11.
- [322] Ishihara L, Warren L, Gibson R, Amouri R, Lesage S, Durr A, et al. Clinical features of Parkinson disease patients with homozygous leucine-rich repeat kinase 2 G2019S mutations. *Arch Neurol*. 2006 Sep;63(9):1250-4.
- [323] Haugarvoll K, Wszolek ZK. Clinical features of LRRK2 parkinsonism. *Parkinsonism Relat Disord*. 2009 Dec;15 Suppl 3:S205-8.
- [324] Pittman AM, Myers AJ, Duckworth J, Bryden L, Hanson M, Abou-Sleiman P, et al. The structure of the tau haplotype in controls and in progressive supranuclear palsy. *Hum Mol Genet*. 2004 Jun 15;13(12):1267-74.
- [325] Orr HA. Darwin and Darwinism: the (alleged) social implications of the origin of species. *Genetics*. 2009 Nov;183(3):767-72.
- [326] Race, Ethnicity, and Genetics Working Group. The use of racial, ethnic, and ancestral categories in human genetics research. *Am J Hum Genet*. 2005 Oct;77(4):519-32.
- [327] Weiss KM, Lambert BW. When the time seems ripe: eugenics, the annals, and the subtle persistence of typological thinking. *Ann Hum Genet*. 2011 May;75(3):334-43.
- [328] Marseille Consensus Group. Classification of progressive myoclonus epilepsies and related disorders. *Ann Neurol*. 1990 Jul;28(1):113-6.



ID	G	YOB	Lundborg 1913	Nr. in Mjones 1949	Nr. in Farrer 2004	Nr. in Fuchs 2007	examined by / medical records	AO	AD	Clinical Description
1	M	1840s	Y	I:3 Fa		(Fa)		61	86	Typical PA. Depressed, reserved.
2	M	1870s	Y	I3 Ea		(Ea)	M	53	82	O/E (age 67): Tremor, rigidity. Infantile. Labile. Slightly euphoric. Lacking in concentration.
3	F	1920s								Parkinsonism according to a relative.
4	F	1820s	Y	I3 Da		(Da)		ND	74	<i>Uncertain PA according to L.</i>
5	M	1830s	Y	I3 Ca		(Ca)	"d"	46	55	PA. Hallucinations and epileptic seizures during the last years of life. "Inscrutable. Unreliable." Became helpless. Died from marasmus.
6	M	1870s	Y	I3 Ba		(Ba)	L	28	39	Obsinate. Inscrutable. Silent. Increasingly irritable and discontented. At times extremely dispirited. "Died from general exhaustion, as a consequence of his nervousness".
7	M	1830s	Y	I3 Ia		(Ia)	"d"	33	54	Typical PA acc. to "a doctor". Tremor and rigidity. "Cerebral episodes." Extremely silent, pessimistic disposition. Cause of death: Marasmus (M), epilepsy (L).
8	M	*					Rec.		76	<i>No details (yet). Lived in nursing home before his death.</i>
9	M	*					Rec.		71	<i>No details (yet).</i>
10	M	1880s	Y		1			early 40s	52	Included in L but was healthy at that time. Emigrated to the US at age 19. Parkinsonism, dementia.
11	F	*			2			early 40s		Asymmetric resting tremor in one arm after injury. Two brain surgeries for parkinsonian symptoms without much benefit.
12	M	*			Bb	PI 2	W	31	52	Rapidly progressive parkinsonism. Hallucinations, marked paranoia. Severe postural hypotension. Tentative diagnosis of MSA. By age 47 intellectually impaired, difficult to understand. Became severely demented and apathetic with unintelligible speech. Myoclonic jerks occurred spontaneously or were elicited by sound, touch and body movements. Neuropathology (Farrer et al. 2004, ref [269]).
13	F	*				3		early 60s		Parkinsonism.
14	F	1830s	Y	I3 Ha		(Ha)	L		65	Became entirely dependent. Cause of death: PA.
15	F	1850s	Y	I3 Ga				35	55	PA.
16	F	1890s	Y		6			59	69	Rapidly progressive bradykinesia and postural disturbance. Lived several years in a nursing home. Had become unable to walk "later in life".

<b>17</b> <i>SNCA</i> <b>dupl.</b>	F	*			PJ	1	N, rec	71	80	Symptomatic orthostatic hypotension, followed within 1 year by parkinsonism. Tentative MSA diagnosis. Wheelchair bound after 4 years. Rigidity, frequent falls, urinary incontinence. Hand myoclonus. MRI: mild generalized atrophy. Hallucinations and paranoid delusions. Mild dementia (MMSE 18/30).
<b>18</b>	M	*			9			62	69	Diagnosis of idiopathic PD. Rapidly progressive bradykinesia and rigidity, slight tremor, poor levodopa response.
<b>19</b>	M	*	Y							Mentally disabled from birth, had a legal guardian. Later in life developed clear signs of parkinsonism according to family history.
<b>20</b>	M	1890s	Y	I3 Ja	8	rec, M		47	57	At 47 years of age, left-sided hemiparkinsonism, at age 48 bilateral signs. Flexed posture, parkinsonian gait. No improvement on atropine. No cognitive symptoms age 48. At age 51: Infantile, Slightly euphoric, very easily fatigued. Lacked concentration.
<b>21</b>	F	*			12			62	74	Severe psychiatric problems with depression and anxiety before motor symptoms. Bradykinesia, rigidity, rest and action tremor, moderate response to L-dopa. Wheelchair-bound after 7 years, severe dysphagia, gastrostomy. Later: long episodes of paranoid psychosis with visual hallucinations. No dementia at age 67.
<b>22</b>	F	*			11	rec		40	60	Decreased dexterity and tremor in right hand. Bilateral motor symptoms within one year, tremulousness in legs and gait disturbance within 2 years after onset. Levodopa responsive, but develops motor fluctuations and dyskinesias. Severe painful leg dystonia in motor off.
<b>23</b>	M	*	Y		7				52	Parkinsonism according to family history.
<b>24</b>	F	*			10					Psychiatric illness, but developed parkinsonism later in life according to family history.
<b>25</b>	M	1820s	Y	I3 Ka	(Ka)	M		ND	70	Tremor, behavioral symptoms. Twitching of right corner of mouth. Pronounced tremor during last years of life. Repeated "cerebral episodes" from age 63.
<b>26</b>	F	1830s	Y	I3 Kb	(Kb)			ND	74	<i>L: uncertain case of PA. M: Melancholic disposition. During last years of life tremor and rigidity. Confined to bed.</i>
<b>27</b>	F	1840s	Y	I3 Aa	(Aa)	L		51	61	Typical PA. Behavioral symptoms. During the last ten years of life severe tremor in arms, very dependent, no dementia. "Nervous tremulousness"
<b>28</b>	M	1870s	Y	I3 a		M		50	59	Tremor, rigidity, hypomimia, monotonous speech. Possible retropulsion. Nervousness for several years. Sialorrhea.
<b>29</b>	F								71	Parkinsonism according to note in relative's medical record. Neurosurgery for parkinsonian symptoms.
<b>30</b>	M	1890s							83	Parkinsonism according to note in relative's medical record.
<b>31</b>	M	*				rec		46	61	Hemiparkinsonism with rigidity, bradykinesia, tremor. Levodopa-responsive, develops motor fluctuations and dyskinesia. Periodic anxiety and depression. Episode with severe delusions, maybe triggered by apomorphine testing.

<b>32</b>	F	*					rec	48	67	Severe depressive episodes at age 43 and 50, "neurotic" or near-"psychotic". Tremor, rigidity and hypokinesia. Levodopa-positive but develops dyskinesias and sudden off. Slowness of thoughts. Anxiety and depressive symptoms remain. Cognition intact at age 57. Basal ganglia calcification on CT.
<b>33</b>	M	*					rec	56	73	Rigidity, slowness of movements and thoughts, levodopa responsive, motor fluctuations. Depressive, EEG moderate general slowing. Speech problems affecting articulation, repetition and verbal memory.
<b>34</b>	M	*					rec	53	64	Rigidity and gait disturbance. Good levodopa response. No tremor. EEG (55 years) marked generalized slowing. MRI: decreased signal in anterior SN bilateral, moderate, symmetric cerebral atrophy. Pronounced symptomatic postural hypotension, frequent falls. Decreased short term memory and concentration, slowness of thought, fatigability. Perseverations. 63 years: apraxia, very severe akinetic-rigid parkinsonism; dementia. Needs help for feeding. Hallucinations. Tentative diagnoses: DLB, MSA.
<b>35</b>	M	*							69	Parkinsonism acc. to note in relative's medical record.
<b>DEM</b>	F	*					G, rec	77	89	Memory problems since age 77. Symptomatic postural hypotension. Frontal lobe symptoms, irritability, obsession. Unable to walk and severe dementia at age 87.
<i>2's sib1</i>	F	1880s	Y	I3 Eb		(Eb)	M			<i>Examined at age 64 years. Somewhat labile, mentally easily fatigued and distractible. Intermittent tremor in hands and head, often occurring when the patient is nervous, since the age of 30. No progression. "Forme fruste".</i>
<i>2's sib2</i>	F	1880s	Y	I3 Ec		(Ec)	M			<i>Examined at age 62 years. Somewhat tense. Labile. Tremor. "Forme fruste".</i>

### Appendix 1: Individuals with Parkinsonism in the Lister kindred

ID, patient identifier (as in the pedigree drawing). G, gender; M, male; F, female. YOB, year (decade) of birth. AO, age at onset; AD, age at death; PA, paralysis agitans; ND, not determined, or no data. \* indicates individual is born after the year 1899. Y, individual mentioned in Lundborg 1913 [267]. Patient identifiers from the publications by Mjones 1949 [194], Farrer et al. 2004 [269], Fuchs et al. 2007 [1], and Puschmann et al. 2009 (Article 1, [36]) as in the original publications. M, examined by Mjones (around 1947); "d", examined and diagnosed by a doctor according to Lundborg; L, examined by Lundborg; Rec, medical records retrieved in Sweden (most from Lund University Hospital, 1930s-2000s); W, examined by Dr. Zbigniew K. Wszolek, Mayo Clinic, USA; N, examined by Dr. Christer Nilsson, Lund University; G, examined by Dr. Lars Gustafson, Lund University.



ID	Examined by Lundborg	Nr. Article I (ref. [36])	YOB	AO	AD	Description by Lundborg / Notes	Nr. of children	Nr. of grand-children
F1	Yes		1885			<i>Described as PM in Lundborg 1901, but as epilepsy in Lundborg 1913.</i>		
F2	Yes		1887	9	>18	Probably had no children.	?	0
F3	No		1872	9	26	Much more severe disease than Fall Nr. 2. Cause of death: "Tuberc. pulm." (autopsy-confirmed). Post mortem, brain not yet retrieved.	0	0
F4	No		1867	7	22	Much more severe disease than Fall Nr. 2. Cause of death: "Tuberc. pulm."	0	0
F5	No		1876	around 10	20	Much more severe disease than Fall Nr. 2. Cause of death: "Virium org. cordis". Had one child who died with 5 months due to "Gehirnfeber".	1	0
F6	Yes		1864	around 10	>42		0	0
F7	Yes	11	1859*	around 10	>35	*L 1903: year of birth 1855	2	0
F8	Yes		1855	before 12	47	A photograph of this patient is included in ref [Puschmann 2009].	0	0
F9	No		1853	12	19	Cause of death: collapse after ingestion of 5 or 6 tablespoons chloral on one day.	0	0
F10	No		1863	before 12	17		0	0
F11	No		1841	8	55		0	0
F12	No		1853	before 14	14	Had a neurological disease with seizures and frequent falls without loss of consciousness.	0	0
F13	No		1826	before puberty	50	Sudden death during a seizure / fit.	10 (1 P)	10 (1 P, 2 T)
F14	No		1819	before 14	55		0	0
F15	No	9	1832	9	61	Death due to "Gehirnschlag" - probably stroke. One child who died at age 5 months due to convulsions.	1	0
F16	No	8	1847	9	40	Died in an accident (in an amusement park).	0	0
F17	Yes		1828	childhood	72	This patient dies as L. is abroad. He tries to organize a post mortem examination, but his telegram does not reach the pathologist who had been prepared.	0	0
F18	No		1838	ND	46	"Haussohn" (not married, lives with parents/family).	0	0

**Appendix 2a: Individuals with "progressive Myoklonusepilepsie" in the Lister kindred (table)**

ID, identifier. F1 is "Fall Nr.1" (eng. Case number 1) in Lundborg 1901 and 1903 [265,266]; F2, "Fall Nr. 2", etc. YOB, year of birth. P, parkinsonism; T, tremor. Information is compiled from Lundborg [265-267] and genealogical research. See Appendix 2b for more detailed descriptions of the 5 patients whom Lundborg had met and examined (L., Lundborg).

## **Appendix 2b: Individuals with "progressive Myoklonusepilepsie" in the Lister kindred**

More detailed descriptions of the 5 patients whom Lundborg had met and examined. F1 is "Fall Nr.1" (eng. Case number 1) in Lundborg 1901 [265] and 1903 [266]; F2, "Fall Nr. 2", etc. L., Lundborg. Translated from German by the author.

### **Individual F2:**

This girl had slow mental development during early childhood (developmental milestones). She always had difficulty speaking, developed strange neologisms ("bobrittor" instead of Swedish "pengar"). She was unable to attend elementary school until age 8 years (2 years later than normal). At the age of 9 years, she has a first nocturnal fit, where she clenched fists, stiffened, stretched her body and clenched her teeth. According to a letter from the father, she was not conscious during such episodes. Subsequently, the episodes changed: the patient woke during the night, complained about pain in her lower arms, which she held in front of her chest where they began to shake, without large excursions. These episodes lasted 30 seconds to over 30 minutes, during which time the patient was fully conscious. During more vigorous attacks the patient cried aloud. In every attack, the extremities stiffened somewhat, and the patient held her hands in slight flexion with the thumbs approaching the other fingers. In between attacks, a tremor occurred in the hands when she wanted to eat or with manual tasks. At the same time, gait began to be insecure. The patient started to walk cautiously, preferred not to run (unlike she used to), and did not dare to use stairs without handrails. In spring 1898, L. saw the patient, but did not examine her. All symptoms deteriorate. The patient loses manual dexterity, falls occasionally and needs a person to assist her with all stairs. In November 1898, L. asks the patient's school teacher, who reports increasing fatigue on days succeeding nightly fits, which now include vigorous shaking; the patient cries that this is very painful. Depressive symptoms and an inability to play with other children develop. Difficulties pronouncing words. Single, small, fast jerks unilaterally in an arm or hand appear. The severity of symptoms fluctuates over days to weeks. The patient is observed and examined at Seraphimerlasarettet in Stockholm 1899 (where medical records from this time have been accidentally destroyed). She gives a shy impression, and when questioned, answers only intermittently and in a low but otherwise normal voice. L. sleeps in the hospital and sees a number of the nocturnal fits. These are stereotypical; the moment she wakes up, at the beginning of a fit, the patient experiences pain, brings both arms into flexion in front of the chest, the flexor muscles of both lower arms show simultaneous, small, rhythmic clonic contractions, which decrease in frequency. In more intense fits, there is a symmetric tonic extension in the legs, with plantar flexion in the feet. She often asks somebody to hold her as this causes at least subjective relief. Hyperekplexia-like reactions / startle reaction. (L: Sensoclonic and psychoclonic reactions.) Possible intention tremor. Involuntary muscle fibrillations or jerks in the face when the patient reads, closes her eyes. Treated with chloral [hydrate]. Extensive documentation of laboratory and neurography results. Lively tendon reflexes, otherwise normal on examination.

### **Individual F6:**

Nocturnal fits started around age 10 years in this girl. Very similar course as F2. Examined and observed at Seraphimerlasarettet Stockholm in 1899, at age 35 years. On some days there were very vigorous and frequent muscle jerks in the entire body. They interfered with swallowing, and any movement or touch elicit vehement muscle contractions which may or may not lead to movements. These can occur symmetrically or focally / unilaterally. Percussion causes vehement ictal limb movements. Patient is fully dependent on help. When she tries to speak, frequent involuntary jerks in oropharyngeal or respiratory muscles occur, pausing the flow of articulation. Can only walk some steps with a lot of help as legs become stiff and there are muscle jerks. On calm days, there are only very few myoclonic jerks that do

not interfere that much with simple activities. However, they do occur all the time in an irregular manner. Lively tendon reflexes.

### **Individual F7:**

This girl was healthy until around age 10 years, when she had a first nocturnal fit. She woke up, screamed and developed cramps, lost consciousness a short time thereafter. Similar fits occurred from then on, often between 4 and 5 a.m. They became more frequent. A few years later, muscle jerks ("like flashes of lightning") occurred first in arms and legs, then in various body parts. The intensity of these jerks and the frequency of the nocturnal fits, were more pronounced during menstruation. Already during the first years of the disease course, difficulties pronouncing became apparent, and a gait uncertainty developed. The patient was mentally less developed than usual for her age. She was not allowed to marry in Sweden, but got married to the son of a quack doctor (acc. to L.) in Denmark. Alcohol or a mixture of bromides successfully dampened the myoclonic jerks, and the patient consumed alcohol regularly. At times, the jerks were so violent that she was unable to walk across a room without falling. Unexpected discomposure (fierce rage or fright) when walking or standing caused falls, in general without loss of consciousness. Examined in July 1898: The patient appeared about 20 years older than her real age. She is of very peculiar character; she often speaks without eye contact, and appears shy and distrustful. On examination, there are clonic jerks here and there, also in the face and tongue, which appear without rhythm or order. On calm days, all these symptoms are less pronounced, but even then there are occasional spontaneous ictal jerks unilaterally in an arm, leg, trunk or head. The speech has better flow on such days, but occasionally, there are interruptions, as if the tongue would not loosen. On other days, gait and speech can be very impaired. Numerous scars and bruises on the knees and various other body parts bear witness of frequent falls. The speech is hardly intelligible, uneven, severed, and she has difficulty eating. No rigidity age 28 years.

F7's daughter was married but did not have children. We retrieved the archived last will of the late daughter; her signature reveals micrographia, but it was written one day before her death. F7's son was classed as "imbecile" at an age around 10-15 years by L., remained unmarried, had no children. However, we contacted a common friend who knew both siblings when he was a teenager (and they were adults); this common friend denied any obvious abnormalities.

### **Individual F8:**

A "deviating case": L. met this boy and postulated he belonged to the Lister family because of the phenotypic similarity. This turned out to be true, however, his maternal grandmother was born out of wedlock, and the patient's mother did initially not like to acknowledge their relationship with the "People from ... [Lister peninsula]". This family was less well off than the others, and the patient started working as a shepherd at age 10. The mother was unable to state when the symptoms occurred, but when she visited him at 12 years of age, she noticed a pronounced hand tremor as he was eating. The mother reported an episode when he nearly drowned in a lake due to a fit in the daytime, but she suggested that nocturnal fits had occurred earlier. The patient returned to live with his mother, who witnessed nocturnal fits, initially about twice per week. The patient woke up, cried out loud several times, the muscles of arms and legs stiffened, he held the arms flexed and the legs more extended, complained about pain in the wrists and calves and asked his mother to hold his hands or massage his calves, which alleviated the discomfort. In more severe attacks, he started to breathe heavily and occasionally lost consciousness for a short period of time. Consciousness was preserved in milder attacks. In the daytime, muscle jerks were observed. From around 35 years of age, he was unable to perform any chores but needed of a lot of help. He became increasingly stiff in the whole body. Alcohol improved the

jerking. In 1899 he moved to the poorhouse. During an episode with pneumonia and high fever, the muscle jerks disappeared (but reappeared as he was afebrile). On examination in 1899, L. noted dementia. The patient spoke loudly and slowly, with song-like intonation, "like a preacher". L. describes how he reads aloud from the bible. Some words are pronounced correctly, frequently interspersed with "hm, hm", and followed by neologisms with more or less similarity to the words in the text. L. is certain that the patient does not understand what he reads. The patient speaks words and phrases and may answer to simple questions correctly, but often stereotypically adds phrases like "... and all". All movements are slow. Patellar reflexes are lively. There is rigidity in the whole body; fatigue and catalepsy are noted. When L. succeeded in making the patient close his eyes, the muscle jerking in the face increased. Percussion of limb muscles elicited their contraction. L. describes details of visits on several days.

### **Individual F17:**

L. met this patient when she was 70 years old. He also talked to her two sisters, who remembered F 17 had fits as a child, in the early hours of one morning, when she would scream, started to shake, lost consciousness and became stiff in her whole body. Sometimes she remained conscious during the attacks. Gait insecurity developed and she was reproached for frequent falls. Fast muscle jerks increased in intensity and affected different body parts. After menopause there were no more fits/attacks, but the myoclonic jerking remained or increased. Twice, she broke her legs when she was thrown out of bed by violent myoclonic jerks. L. lives in the patient's home for several weeks in the summer of 1899. The patient was frequently fatigued. Her body was stiffened, and she was unable to lie down but slept in seated position. She gave an appearance of a demented person at first glance, but was able to answer and showed good judgment in her replies. Often she would not answer; L. suggests this is because he did not speak her dialect. Her memory was bad. She kept her mouth half opened, and the tongue and other body parts were in almost permanent motion. Voluntary movements increased these involuntary, jerky and arrhythmic movements, and these could also be elicited by touch, slight percussion. The patient remained unmarried in the house of her parents / family.

**Appendix 3: Comparison of published clinical descriptions of "Progressive Myoklonusepilepsie" as described by Lundborg with case series of EPM1 with *CSTB* mutations**

<b>"Progressive Myoklonusepilepsie" as described by Lundborg [265-267]</b>	<b>EPM1 with <i>CSTB</i> mutations [295,298,328]</b>
<b>Age at onset</b>	
6-16 years	6-16 years
<b>Clinical features</b>	
<p>Stage 1: nocturnal attacks Myoclonic jerks and tonic symmetric arm flexion and leg extension Duration of attacks 30 sec - 2 min, onset during sleep, Painful, patients wake up, and are then fully conscious</p> <p>Stage 2 (some years later) Stimulus-sensitive or spontaneous action tremor, myokymia, and myoclonic or tonic muscle contractions: Elicited by auditory and tactile stimuli, Aggravated by psychological stress Falls due to these unexpected muscle contractions Gait disturbance (anxiousness to fall)</p> <p>Stage 3 (several years or decades later): marked generalized muscle rigidity, depression</p>	<p>Stimulus-sensitive myoclonus: elicited by light, noise, physical exertion, or stress may generalize to a shaking attack may lead to a tonic-clonic epileptic seizure with unconsciousness</p> <p>Generalized tonic-clonic epileptic seizures: presenting feature in nearly half of the patients</p> <p>Cerebellar signs: ataxia, cerebellar tremor, dysarthria occur usually some years after onset.</p> <p>Dystonia (in some cases)</p> <p>Emotional instability, depression, mild decline in intellectual performance</p>
<b>EEG</b>	
Not performed at Lundborg's time	Always abnormal, even before symptoms appear; background activity is labile and usually slower than normal; symmetric, generalized, and high-voltage spike and-wave and polyspike-and-wave paroxysms, marked photosensitivity
<b>Life expectancy</b>	
14 to 72 years (median, 43 years)  The patient who reached the age of 72 years was born in 1828 and did not receive modern treatment.	"In the past, life span was shortened; many individuals died between 8 and 15 years after the onset of disease, usually before the age of 30 years." "The oldest genetically verified patients in Finland have lived into their 60's and 70's with modern medical care."
<b>Mutation</b>	
Not established in any affected member. <i>SNCA</i> multiplications occur in the same family, one unaffected member carried a dodecamer expansion in the <i>CSTB</i> gene	<i>CSTB</i> gene dodecamer repeat expansion (ca. 92% of cases) point mutation (rare)

# Article I





Contents lists available at ScienceDirect

## Parkinsonism and Related Disorders

journal homepage: [www.elsevier.com/locate/parkreldis](http://www.elsevier.com/locate/parkreldis)

Short communication

Alpha-synuclein multiplications with parkinsonism, dementia or progressive myoclonus?<sup>☆</sup>Andreas Puschmann<sup>a,b,\*</sup>, Zbigniew K. Wszolek<sup>c</sup>, Matthew Farrer<sup>d</sup>, Lars Gustafson<sup>b</sup>, Håkan Widner<sup>a</sup>, Christer Nilsson<sup>b</sup><sup>a</sup> Department of Neurology, Lund University Hospital, Sweden<sup>b</sup> Department of Psychogeriatrics, Lund University, Sweden<sup>c</sup> Department of Neurology, Mayo Clinic, Jacksonville, FL, USA<sup>d</sup> Molecular Genetics of Movement Disorders, Department of Neuroscience, Mayo Clinic, Jacksonville, FL, USA

## ARTICLE INFO

## Article history:

Received 31 March 2008

Received in revised form 20 July 2008

Accepted 7 August 2008

## Keywords:

Parkinson's disease

Alpha-synuclein

Gene multiplication

Myoclonus

Dementia

Progressive myoclonic epilepsy

Unverricht–Lundborg disease

EPM1

Startle reaction

Hyperekplexia

## ABSTRACT

Duplications and triplications of the alpha-synuclein (*SNCA*) gene have been reported in Parkinson's disease patients belonging to the Southern Swedish "Lister family". Further genealogical research has now shown that these individuals are descended from a large kindred characterized by Herman Lundborg in 1901–1913. In the expanded pedigree, a total of 25 individuals had Parkinson's disease with an autosomal dominant pattern of inheritance. Hereditary dementia, and, historically, *dementia praecox* have been described in other family members. Furthermore, an autosomal recessively inherited pediatric disease with nocturnal tonic–clonic fits, subsequent progressive myoclonus, startle reactions, tremor and muscle rigidity was described by Lundborg in the same pedigree. The entity was later designated Unverricht–Lundborg disease (ULD) or progressive myoclonus epilepsy type 1 (EPM1). However, Lundborg's clinical description of this disease, based on 17 patients within this kindred, differs from the modern definition of EPM1, which relies on patients with a mutation in the cystatin B (*CSTB*) gene. We hypothesize that the former pediatric disease, as well as the parkinsonism and dementia phenotypes, are associated with duplications, triplications and possibly higher-order multiplications of the alpha-synuclein (*SNCA*) gene. This hypothesis is supported by the distribution of afflicted family members within the pedigree and by recently obtained genealogical information.

© 2008 Elsevier Ltd. All rights reserved.

Alpha-synuclein (*SNCA*) gene duplication and triplication are associated with hereditary Parkinson's disease (PD). While *SNCA* multiplications are rare events and were so far reported from only seven families worldwide [1], they provide valuable insights into alpha-synuclein's role in neurodegenerative diseases. Previously, our groups reported that a family with early onset hereditary PD and *SNCA*-triplication [2] was related to a family with late onset hereditary PD and duplication of the identical gene segment [3]. This is the only kindred identified so far with both duplications and triplications of *SNCA* among its members [1].

Further genealogical research has now shown that both these families descend from a kindred described by Herman Lundborg on the Lister peninsula in Southern Sweden in 1901 [4], 1903 [5] and 1913 [6]. Lundborg's work comprised details on a total of 1909 related individuals, of whom nine had paralysis agitans, 74 had a mental

illness then classified as either typical or atypical *dementia praecox*, and 17 had a form of progressive myoclonus epilepsy subsequently referred to as the *Unverricht–Lundborg type*, *Unverricht–Lundborg disease* or *Baltic myoclonus* (epilepsy, progressive myoclonic, type 1, EPM1; OMIM #254800) [6].

The latter disorder typically manifests itself between ages 6 and 16 years with spontaneous and stimulus-sensitive myoclonic jerks, action myoclonus, or generalized tonic–clonic seizures. The disease progresses, albeit with a wide variation in its time course, with cerebellar signs and some extent of cognitive decline occurring regularly. However, the clinical characteristics of the type of EPM1 which Lundborg described [4–6] are not congruent with the present definition criteria for EPM1 put forward by the Marseille consensus group [7], which are based on individuals with a mutation of the cystatin B gene (*CSTB*). In addition to the symptoms mentioned above, Lundborg also noted visual hallucinations, irritability, depression, hypersalivation and progressive extrapyramidal signs with tremor and marked muscle rigidity as symptoms of this disorder, but did not mention any cerebellar signs [5,6].

Lundborg found that this disorder in most cases manifested itself before age 12 years and that girls were afflicted more often

<sup>☆</sup> The review of this paper was entirely handled by the Associate Editor, Dr V. Bonifati.

\* Corresponding author. Department of Psychogeriatrics, Lund University, Sweden. Tel.: +46 46 171 000; fax: +46 46177940.

E-mail address: [andreas.puschmann@med.lu.se](mailto:andreas.puschmann@med.lu.se) (A. Puschmann).



than boys (12 girls and 5 boys in that series) [4]. It typically passed through three distinct stages:

Initially, attacks with involuntary muscle contractions occurred at night (*stage one*). They commenced during sleep, but, being vigorous and painful, woke up the patients. The attacks consisted of myoclonic jerks as well as tonic symmetric arm flexion and leg extension. Lundborg likened them to clonic, tonic–clonic, but also tetanic seizures [4]. The episodes' length and severity varied, but most lasted between 30 s and 2 min. Patients usually remained fully conscious. Only very severe attacks were up to 20 or 30 min long and sometimes impaired consciousness.

Some years later the disease progressed to stage two, characterized by daytime action tremor, myokymia, and myoclonic or dystonic muscle contractions. These symptoms began to appear in the upper extremities but spread subsequently to the voluntary musculature of the whole body. Auditory and tactile stimuli elicited these involuntary movements, reminding of startle reactions, and they were aggravated by psychological stress, but also occurred spontaneously.

In Lundborg's historical descriptions, the disorder continued to progress at a slow pace. Several years to some decades later, the nocturnal attacks disappeared, whereas the other motor symptoms increased in intensity (*stage three*). Many of the patients developed marked generalized muscle rigidity, and some patients in this advanced stage of the disease utterly stiffened in certain poses, incapable of any voluntary movements (Fig. 2). Fourteen of the 17 *progressive myoclonus* patients for whom such data are available deceased between 14 and 72 years (median, 43 years) of age. However, five of the patients, who died before age 41 years, did so due to reasons apparently unrelated to the disorder, and for 10 individuals no cause of death is specified [4].

Based on these clinical descriptions, we consider this disorder a distinct entity from EPM1 or other forms of progressive myoclonus epilepsy. The existing name "progressive myoclonus epilepsy" was coined by Herman Lundborg, but it cannot be ascertained that the disorder was truly epileptic in nature as electroencephalograms were not performed in the patients described by Lundborg. For the purpose of clarity within this article, we, therefore, use the preliminary designation of *progressive myoclonus* for this phenotype.

Despite an intensive search, contacting all family members as well as neurology, clinical genetics and pediatric services in the two Southern Swedish states, Skåne and Blekinge, we have so far been unable to identify any living individuals with this disease phenotype. Lundborg reported intermarriage within this kindred and observed that *progressive myoclonus* followed a recessive mode of inheritance [5,6]. The apparent elimination of the *progressive myoclonus* phenotype may be due to the avoidance of marriage between relatives in modern times.

Inquiring at the health services mentioned above, we identified a total of four individuals with EPM1 with confirmed *CSTB* mutation in the Southern Swedish Health Service district area (1.6 million inhabitants). Two of those patients were siblings of non-Scandinavian origin, and none of the two others had any known relation to the "Lister" kindred. Although some patients may not have been diagnosed correctly and may not have been subjected to genetic testing, the incidence of EPM1 due to *CSTB* mutation in Sweden thus appears considerably lower than the reported 1:20,000 disease incidence in Finland [8].

The "Lister family complex" was also mentioned in Henry Mjõnes' survey of *paralysis agitans* patients known to Swedish neurology services in 1947 (time of data collection) [9]. Mjõnes and subsequent investigators identified more individuals with PD in the kindred. By comparing these works on the same pedigree published in 1949 [9], 2004 [2] and 2007 [3], we have found that PD occurs in 25 persons in five successive generations, in a pattern strongly suggesting dominant inheritance. Already in the 1903 publication, Lundborg observed that *progressive myoclonus* occurred in first-degree

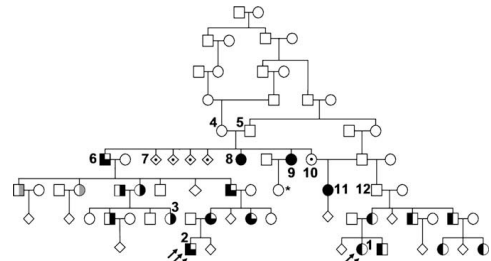

**Fig. 1.** Part of the Lister kindred, spanning nine successive generations. The topmost couple were born in the 1690s. Most individuals shown are deceased, present generations are largely omitted. Classical symbols are used: squares denote males, circles denote females, and diamonds refer to multiple siblings for which the number and gender remain unspecified (for reasons of confidentiality). In two families, sibling order was altered for better readability. For the same reason, further siblings to individuals 4, 5, 12, and in previous generations have been omitted. Black or grey markings indicate neurological disease: right half black: dementia; right half grey: dementia praecox, atypical form (cf. text); three quarters black: young onset Parkinson's disease (PD) (age 31 years to early 40s); solid black: *Progressive myoclonus* as described in the text; left half black: late onset PD (age 60 to 77 years). Individuals 1, 2, and 3 were examined by the authors. 1 Had PD, age of onset, 71 years, with dysautonomia, subsequent cognitive decline, myocloni, and SNCA-duplication (two arrows) [3]. 2 Had PD (age of onset, 31 years), developed dementia and had SNCA-triplication (three arrows) [2]. In the terminal stage of his disease, marked myoclonic jerks occurred spontaneously or were elicited by sound, touch, and body movements (ZKW). 3 Had dementia (see text). 4 died aged 79 years in the 1880s, no medical information about this individual provided by Lundborg [6]. One of 4's sisters committed suicide, and cases of "dementia praecox" even appeared in her family, albeit not in first-degree relatives [6]. 5 Died aged 48 from cancer according to information available to Lundborg [6]. 6 Developed tremor and rigidity at age 33. A physician diagnosed "typical paralysis agitans" [4]. "Cerebral episodes" were noted [6]. 6 And his wife share common great-grandparents. 7 Four siblings, died before age 9 years of unrelated causes (dots). 8 *Progressive myoclonus*: nocturnal episodes started at age 9 years, some years later tremor and myoclonus during daytime developed. The individual's state of health worsened steadily, with periodic improvements after menstruation. No decrease in cognitive functions, but mood swings and a high consumption of chloral and at times alcohol are reported [4]. Did not have children, Lundborg [6] presumed she was infertile. Died at age 40 years in an accident. 9 *Progressive myoclonus*: developed nocturnal epileptic seizures at age 9 years. A few years later myocloni were noticed. The patient's speech became jerky, rough, and hardly intelligible. She had good intellect and memory until she died aged 61 due to stroke. From an unrelated father she had a child (asterisk), who died age 5 months of convulsions [4]. Lundborg does not provide details about the development of the symptoms over time for these individual patients (8 and 9), but states that the disorder developed in the same manner as in the other affected members of this kindred, and in the same manner in these two siblings. 10 married a cousin, and died aged 24 years without neurological symptoms in puerperium after giving birth to a daughter (11), who developed *progressive myoclonus* [4]. 11 Her first nocturnal episode occurred at age 10 years, when she woke up, screamed and had "convulsions". Some years later, she developed myocloni. Dysarthria and gait disturbance developed. The symptoms were most prominent during menstruation but assuaged during the pregnancies. She married and had two children, who both remained without progeny. 12 And his wife share common ancestors five generations previously. Thus, out of eight children of one family (6–10), one had early onset PD, two had *progressive myoclonus* and the remaining five deceased – aged 6 days, 6 weeks, 2, 9, and 24 years – due to unrelated causes in the 1830s–1850s [6]. Combined with intermarriage as documented in this pedigree in previous generations in the 18th century, this constellation suggests that the mother (4) had a duplication and the father (5) a triplication of SNCA, and that the two children (25% of the offspring) with *progressive myoclonus* (8 and 9) had inherited five SNCA copies. The parents (4 and 5) died in the 1860s and 1880s, when initial symptoms of PD may not have reached medical attention.

relatives to individuals with *paralysis agitans* [5]. Also, he noted that the clinical picture of some of these patients in the terminal stage of *progressive myoclonus* reminded of *paralysis agitans* (PD), whereas others showed signs of *dementia praecox* (hebephrenia or catatonia) [4]. This made Lundborg postulate a continuum from *paralysis agitans* via *progressive myoclonus* to these forms of *dementia praecox*.

Furthermore, through comparison of genealogical data, a patient who had been examined by one of the authors (L.G.) and had been

diagnosed with dementia was identified as a close relative to individuals with PD and *progressive myoclonus* within the Lister kindred (Fig. 1, individual 3). This patient, now deceased, had three first-degree relatives with dementia, and, according to the work from 1913, two more second-degree relatives had atypical *dementia praecox* [6]. Clinically, the patient's illness followed a fluctuating course with memory problems becoming apparent at an age of 77 years and with orthostatic hypotension occurring 3 years later. Frontal lobe symptoms, irritability, and obsession were noted. A regional cerebral blood flow examination at the age of 82 showed a 30% flow reduction frontally and temporo-parietally. No *post-mortem* examination was performed.

Possibly, *progressive myoclonus* in members of this family is explained by recessively inherited traits, such as mutations in the *CSTB* gene or other, as yet unidentified genes. However, the distribution of individuals with PD, *progressive myoclonus*, and dementia within this pedigree (Fig. 1) invites us to hypothesize that *SNCA* multiplication may be the sole cause of these clinically variable disease phenotypes.

The age at onset of clinical symptoms was shown to be younger for *SNCA* triplication (30s–40s) compared with *SNCA* duplication (60s–70s) in this pedigree [2,3] as well as in others [1]. *Progressive myoclonus*, with an onset in early teenage years, may have been caused by five copies of the *SNCA* gene. Details are provided in the figure legend. Interestingly, in the previously described PD patients from this pedigree with *SNCA* duplication or triplication, survival time does not correlate with the number of genocopies, but rather with young age at clinical disease onset [3]. Two individuals with PD in the *SNCA* triplication branch of this family died at age 52 years, which is earlier than a minority of the *progressive myoclonus* patients from this kindred [4]. This may be explained similarly by the effects of an individual's overall health, concomitant diseases, age at onset, gender, social and environmental factors, medical care, and others, on survival time. The reported age of death in the individuals with *progressive myoclonus* is spread over a wide interval, possibly emphasizing these factors' significance as well as the non-life-threatening nature of the condition for many of the younger individuals.

The affected individuals within this pedigree as well as in other, unrelated families with *SNCA* multiplication share certain clinical characteristics: among the 32 cases with PD and *SNCA* multiplication published so far, *myoclonus* or seizures were reported in six [1,3,10,11] and dysautonomia and cognitive decline or dementia

each in 10 cases [1–3,10,12] (see also Fig. 1). These symptoms may be underreported in publications concentrating on parkinsonism. Phenotypes with these features but without predominant parkinsonism may be associated with *SNCA* multiplication.

In this "Lister family" kindred, both parents may contribute multiplications of the *SNCA* gene, to their child's homologous chromosomes. A pattern of autosomal dominant inheritance for PD and an autosomal recessive inheritance pattern for *progressive myoclonus* is compatible with gene multiplication as the sole underlying mechanism: Disorders caused by genomic multiplications may be inherited in a dominant mode, e.g., when one parent has the pathogenic multiplication in one allele and a normal (non-multiplicated) second allele, and the other parent has two normal alleles. Diseases caused by higher-order gene multiplication may occur in an autosomal recessive pattern, e.g., in families where both parents have a genomic multiplication. The relatively high age of onset for parkinsonism associated with *SNCA*-duplication and the relatively unspecific initial parkinsonian symptoms may lead to seemingly reduced penetrance.

Thus, *SNCA* multiplications, through different degrees of alpha-synuclein overabundance in the central and peripheral nervous system, may generate different disease phenotypes with extrapyramidal parkinsonian symptoms, dysautonomia, cognitive decline, seizures, and *myoclonus*.

## Disclosure

The authors report no conflicts of interest.

## Acknowledgements

The study was supported by grants from the Swedish Parkinson Foundation and the Swedish Parkinson Academy to AP, CN and HW. ZKW and MJF are funded by the National Institute of Neurological Disorders and Stroke P50 NS40256 Udall Center grant awarded to the Mayo Clinic, Jacksonville, and by the Pacific Alzheimer Research Foundation Center grant (PARF C06-01).

## References

- Ross OA, Braithwaite A, Skipper L, Kachergus J, Hulihan M, Nishioka K, et al. Genomic investigation of alpha-synuclein multiplication and parkinsonism. *Ann Neurol* 2008 Jun;63(6):743–50.
- Farrer M, Kachergus J, Forno L, Lincoln S, Wang DS, Hulihan M, et al. Comparison of kindreds with parkinsonism and alpha-synuclein genomic multiplications. *Ann Neurol* 2004 Feb;55(2):174–9.
- Fuchs J, Nilsson C, Kachergus J, Munz M, Larsson EM, Schule B, et al. Phenotypic variation in a large Swedish pedigree due to *SNCA* duplication and triplication. *Neurology* 2007 Mar 20;68(12):916–22.
- Lundborg H. Klinische Studien und Erfahrungen betreffs der familiären Myoklonie und damit verwandten Krankheiten. *Svenska Läkaresällskapets Nya Handlingar* 1901:130. Serien III (Delen 3).
- Lundborg H. Die progressive Myoklonus-Epilepsie (Unverricht's Myoklonie). Uppsala: Almqvist Und Wiksell's Buchdruckerei-A-G; 1903.
- Lundborg H. Medizinisch-biologische Familienforschungen innerhalb eines 2232köpfigen Bauerngeschlechtes in Schweden (Provinz Blekinge). Jena: Verlag Von Gustav Fischer; 1913.
- Marseille Consensus Group. Classification of progressive myoclonus epilepsies and related disorders. *Ann Neurol* 1990 Jul;28(1):113–6.
- Koskineni M, Donner M, Toivakka E, Norio R. Progressive myoclonus epilepsy (PME). In: Eriksson AV, Forsius H, Nevanlinna HR, Workman PL, Norio RK, editors. Population structure and genetic disorders. New York: Academic Press; 1980. p. 669–72.
- Mjånes H. Paralysis agitans. A clinical and genetic study. *Acta Psychiatrica et Neurologica* 1949;54(Suppl.):195.
- Muentzer MD, Forno LS, Hornykiewicz O, Kish SJ, Maraganore DM, Caselli RJ, et al. Hereditary form of parkinsonism-dementia. *Ann Neurol* 1998 Jun;43(6):768–81.
- Ibanez P, Bonnet AM, Debarges B, Lohmann E, Tison F, Pollak P, et al. Causal relation between alpha-synuclein gene duplication and familial Parkinson's disease. *Lancet* 2004 Sep 25–Oct 1;364(9440):1169–71.
- Nishioka K, Hayashi S, Farrer MJ, Singleton AB, Yoshino H, Imai H, et al. Clinical heterogeneity of alpha-synuclein gene duplication in Parkinson's disease. *Ann Neurol* 2006 Feb;59(2):298–309.

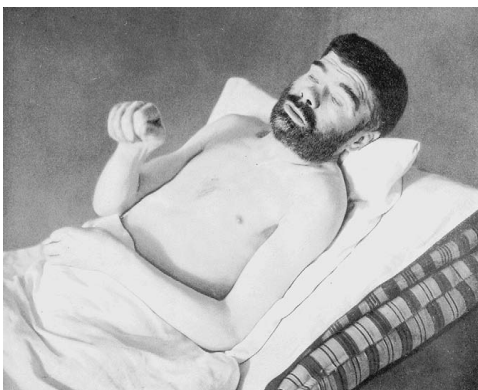

Fig. 2. Patient suffering from stage three *progressive myoclonus*. From [6] with permission of the original publisher's legal successor.



## Article II





Contents lists available at ScienceDirect

## Parkinsonism and Related Disorders

journal homepage: [www.elsevier.com/locate/parkreldis](http://www.elsevier.com/locate/parkreldis)



### A Swedish family with *de novo* $\alpha$ -synuclein A53T mutation: Evidence for early cortical dysfunction

Andreas Puschmann<sup>a,b,\*</sup>, Owen A. Ross<sup>c</sup>, Carles Vilarino-Güell<sup>c</sup>, Sarah J. Lincoln<sup>c</sup>, Jennifer M. Kachergus<sup>c</sup>, Stephanie A. Cobb<sup>c</sup>, Suzanne G. Lindquist<sup>d</sup>, Jørgen E. Nielsen<sup>e,f</sup>, Zbigniew K. Wszolek<sup>g</sup>, Matthew Farrer<sup>c</sup>, Håkan Widner<sup>a</sup>, Danielle van Westen<sup>h</sup>, Douglas Hägerström<sup>i</sup>, Katerina Markopoulou<sup>j</sup>, Bruce A. Chase<sup>k</sup>, Karin Nilsson<sup>b</sup>, Jan Reimer<sup>a</sup>, Christer Nilsson<sup>b,l</sup>

<sup>a</sup> Department of Neurology, Lund University Hospital, Sweden

<sup>b</sup> Department of Clinical Science, Section of Geriatric Psychiatry, Lund University, Sweden

<sup>c</sup> Department of Neuroscience, Mayo Clinic, Jacksonville, FL, USA

<sup>d</sup> Division of Neurogenetics, Rigshospitalet Copenhagen University Hospital, Denmark

<sup>e</sup> Institute of Cellular and Molecular Medicine, Section of Neurogenetics, University of Copenhagen, The Panum Institute, Denmark

<sup>f</sup> Memory Disorders Research Unit, Rigshospitalet, Copenhagen University Hospital, Denmark

<sup>g</sup> Department of Neurology, Mayo Clinic, Jacksonville, FL, USA

<sup>h</sup> Department of Radiology, Lund University Hospital, Sweden

<sup>i</sup> Department of Clinical Neurophysiology, Lund University Hospital, Sweden

<sup>j</sup> University of Thessaly, Medical School, Larissa, Greece

<sup>k</sup> Department of Biology, University of Nebraska at Omaha, Omaha, NE, USA

<sup>l</sup> Department of Cognitive Medicine, Lund University Hospital, Sweden

#### ARTICLE INFO

##### Article history:

Received 15 March 2009

Received in revised form

22 May 2009

Accepted 19 June 2009

##### Keywords:

Parkinson disease  
Parkinsonian conditions  
Autosomal dominant parkinsonism  
Alpha-synuclein  
A53T mutation  
Ala53Thr  
A53T  
Biomarkers  
CSF examination  
Cerebrospinal fluid  
Neuroimaging  
Longitudinal clinical follow-up  
Haplotype analysis  
SPECT  
Single-photon emission computed tomography  
Myoclonus  
Electroencephalogram  
Magnetic resonance imaging

#### ABSTRACT

A *de novo*  $\alpha$ -synuclein A53T (p.Ala53 Thr; c.209G > A) mutation has been identified in a Swedish family with autosomal dominant Parkinson's disease (PD). Two affected individuals had early-onset (before 31 and 40 years), severe levodopa-responsive PD with prominent dysphasia, dysarthria, and cognitive decline. Longitudinal clinical follow-up, EEG, SPECT and CSF biomarker examinations suggested an underlying encephalopathy with cortical involvement. The mutated allele (c.209A) was present within a haplotype different from that shared among mutation carriers in the Italian (Contursi) and the Greek-American Family H kindreds. One unaffected family member carried the mutation haplotype without the c.209A mutation, strongly suggesting its *de novo* occurrence within this family. Furthermore, a novel mutation c.488G > A (p.Arg163His; R163H) in the presenilin-2 (*PSEN2*) gene was detected, but was not associated with disease state.

© 2009 Elsevier Ltd. All rights reserved.

\* Corresponding author. Department for Neurology, Lund University Hospital, Getingevägen 4, 22185 Lund, Sweden. Tel.: +46 46 175421/+46 46 171000; fax: +46 46 177940.

E-mail address: [andreas.puschmann@med.lu.se](mailto:andreas.puschmann@med.lu.se) (A. Puschmann).

## 1. Introduction

Parkinson's disease (PD) is defined by the clinical signs of muscular rigidity, bradykinesia, impaired postural reflexes and, in a majority of patients, resting tremor [1,2]. Cell loss and gliosis in the substantia nigra and the presence of Lewy bodies (LB) at autopsy confirm the diagnosis [1]. In addition, the underlying neurodegenerative process may cause a variety of associated symptoms including autonomic nervous system disturbances, cognitive impairment and sleep rhythm abnormalities. PD is non-hereditary in the majority of cases, but kindreds with hereditary forms have been long reported, particularly in Sweden by Herman Lundborg in 1913 [3] and by Henry Mjönes in 1949 [4].

Golbe et al. described a large Italian-American kindred with autosomal dominant parkinsonism originating from the town of Contursi (southern Italy) [5], and Markopoulou et al. reported a similar phenotype from the Greek-American Family H [6]. In 1997, the A53T (p.Ala53 Th, c.209G > A) mutation in the  $\alpha$ -synuclein gene (SNCA) was found to be associated with PD in members of the Contursi kindred and in three families from Greece [7]. The same mutation has also been identified in Family H.[8] This discovery for the first time linked a gene mutation to PD. Subsequent work revealed that the  $\alpha$ -synuclein protein is a principal component of LB in brains from patients with  $\alpha$ -synuclein A53T mutation [9] as well as in sporadic PD [10]. A haplotype segregating with the disease was identical in Contursi and Greek patients, suggesting a common founder [11].

The  $\alpha$ -synuclein A53T mutation has since been detected in several additional Greek families [12–14] and in patients of Greek origin residing in Australia [15] and Germany [16]. Only three individuals without known Greek or Italian ancestry have so far been reported to carry this mutation: One patient from the United Kingdom, now deceased, displayed symptoms consistent with sporadic late-onset PD [17]. DNA from this patient was not available for haplotype analysis and contact with relatives has been lost [18]. More recently two affected members of a Korean family were studied [19], and their haplotype differed from the Greek/Contursi haplotype [19].

*In vitro*,  $\alpha$ -synuclein proteins with the A53T mutation are more prone to form fibrils than wild type  $\alpha$ -synuclein [20]. To our knowledge, no biomarker data on the evolution of the neurodegenerative process elicited by this mutation *in vivo* have so far been available.

Herein, we report a family from southern Sweden with  $\alpha$ -synuclein A53T mutation. We present for the first time clinical, magnetic resonance imaging (MRI), single-photon emission computed tomography (SPECT), and cerebrospinal fluid (CSF)-biomarker data compiled during a 5 and 10 year longitudinal follow-up of two affected family members. We performed haplotype analysis of this family and the Greek-American Family H, whose haplotype had not yet been determined, and compared it with the previously reported Contursi-kindred haplotype.

## 2. Methods

### 2.1. Samples

Swedish PD patients ( $n = 99$ ) and unaffected subjects ( $n = 56$ ; spouses and siblings of probands) were enrolled in an ongoing clinical genetic research study. Of the affected probands, 61 resided in a confined geographical area (including the Lister peninsula in southern Sweden, from where we previously reported a kindred with SNCA duplication and triplication) [21,22]. The remainder ( $n = 38$ ), were from other areas of southern Sweden and had a first- or second-degree relative with PD. The study was approved by the Institutional Review Board and written informed consent was obtained from all participants.

### 2.2. Genetic analyses

Genomic DNA was extracted from peripheral blood lymphocytes at Region Skåne Competence Centre, Malmö University Hospital, Sweden, using standard

protocols. Leucine rich repeat kinase-2 (Lrrk2) Gly2019Ser, and Tyr1699Cys mutations as well as  $\alpha$ -synuclein Ala30Pro, Glu46Lys and Ala53Thr (A53T) mutations and gene dosage were analyzed by TaqMan™ chemistry as described elsewhere [23]. Samples positive for the  $\alpha$ -synuclein A53T mutation were confirmed by sequencing. PCR products were purified from unincorporated nucleotides using Agencourt bead technology (Beverly, MA) with Biomek FX automation (Beckman Coulter, Fullerton, CA). Sequence analysis was conducted as previously described [23].

Haplotype analysis was performed on samples from a family with two affected members who carried an SNCA c.209G > A mutation (Fig. 1), the Greek-American Family H and the Contursi kindred. Genotypes were normalized to the CEPH (Centre d'étude du Polymorphisme Humain) database (<http://www.cephb.fr/en/cephdb/browser.php>). Eighteen microsatellite markers spanning the SNCA locus and the adjacent areas on chromosome 4 were used (Fig. 1).

For the proband, PCR amplicons of the genes for microtubule-associated protein tau (MAPT, exon 9–13), progranulin (PGRN), presenilin 1 (PSEN1, exon 3–12), presenilin-2 (PSEN2, exon 3–12) and amyloid precursor protein (APP, exon 16–17), including intron/exon boundaries, were sequenced using ABI Big Dye Terminator v. 1.1, Cycle Sequencing Kit (Applied Biosystems Inc., Foster City, CA, USA) and an ABI prism 3130xl Gene Analyzer (Applied Biosystems Inc.). Sequencing results of the PSEN2 gene in DNA from 170 individuals with dementia and suspected heredity for dementia from southern Scandinavia (Denmark and Sweden) were used for comparison. Apolipoprotein E (apoE) genotyping was performed in DNA from the proband and her mother (II:5) with TaqMan™ allelic discrimination. Data were analysed with Sequencing Analysis Software Version 5.2 from Applied Biosystems, and mutation screening was performed using Mutation Surveyor v.3.1 software (SoftGenetics Mutation Surveyor). Primer sequences are available on request.

### 2.3. Medical and family history

Medical records of individuals II:4 and III:1 were reviewed. With the proband's and her family's informed consent, nine relatives were contacted and interviewed in person or via telephone. A Swedish translation (by A.P.) of a validated telephone questionnaire [24] was used to establish whether interviewees had signs or symptoms of PD. The pedigree was drawn with information from family members and publicly available sources.

### 2.4. Clinical studies

Comprehensive general and neurological examinations were conducted. Brain MRI of III:1 was obtained at age 43 (years) in a 1.5T scanner and at age 45, 46 and 47 in a 3T scanner with different protocols. Transversal T2-weighted images were acquired at each time point. Other sequences included diffusion weighted imaging, transversal or coronal fluid-attenuated inversion recovery sequences, a sagittal T1 or T2-weighted sequence, and at age 47 a high resolution T1 weighted sequence. SPECT using <sup>123</sup>I-PP-CIT ([<sup>123</sup>I]-2beta-carbomethoxy-3beta-(4-iodophenyl)-N-(3-fluoropropyl)-nortropine) and regional cerebral blood flow (rCBF) assessment with SPECT using <sup>99m</sup>Tc-d,l-hexamethylpropylene amine oxime (<sup>99m</sup>Tc-HMPAO, exametazime) were performed according to standard clinical procedures. CSF was analysed for the neurochemical biomarkers indicated in Table 1 by the laboratories of the Neurochemistry Section, Sahlgrenska University Hospital, Gothenburg, Sweden.

## 3. Results

### 3.1. Genetic analyses

Though Lrrk2 Gly2019Ser and Tyr1699Cys,  $\alpha$ -synuclein Glu46Lys and Ala30Pro mutations and SNCA multiplications were not found in any of the 155 individuals screened, an  $\alpha$ -synuclein A53T mutation was detected in the proband (III:1) of the family shown in Fig. 1. Haplotype studies indicated that the proband inherited the mutated allele on a haplotype, designated D in Fig. 1, from her affected father (II:4), from whom DNA was unavailable. We found that Family H and the Contursi kindred [11] share a haplotype, but that this haplotype is different from the Swedish D haplotype. An unaffected sibling (II:3) of the proband's father carried the D haplotype without  $\alpha$ -synuclein A53T mutation. The proband's (III:3) apoE genotype was  $\epsilon 3/\epsilon 3$  and the proband's mother's (II:5) was  $\epsilon 2/\epsilon 3$ . No pathogenic mutations in the MAPT, PSEN1, APP, or PGRN genes were found, but the proband was heterozygous for a novel PSEN2 mutation (c.488G > A, GenBank accession no. NM\_000447.2). This mutation is predicted to cause an amino acid change from arginine to histidine at amino acid site 163 (p.Arg163His; R163H). The patient's mother (II:5), unaffected at age 71 years, was subsequently shown to carry the same mutation,

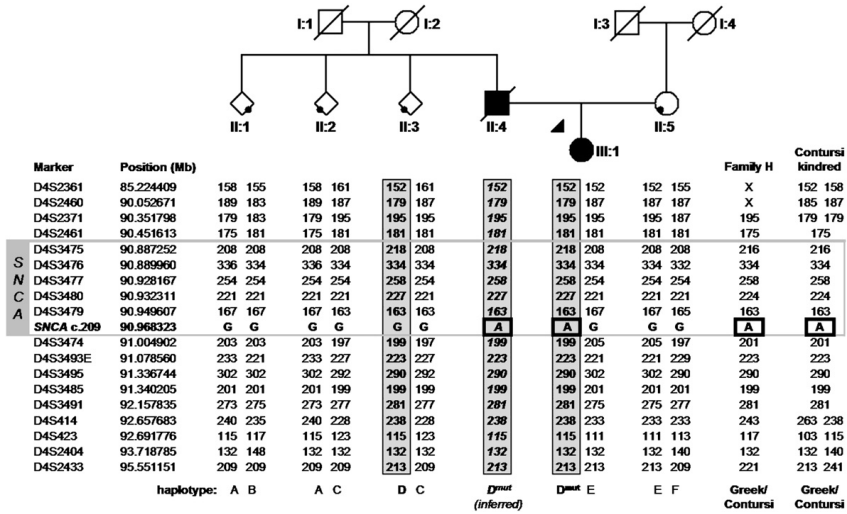

**Fig. 1.** Family pedigree and results from haplotype analysis: Squares indicate males, circles females, and diamonds subjects of unspecified gender to protect confidentiality. Filled symbols indicate subjects diagnosed with PD. Lower-left dots identify individuals interviewed and examined in person (conducted whenever feasible) and lower-right dots identify individuals interviewed by telephone. The black arrowhead identifies the proband. Haplotype analysis results are shown below each individual, and to the right for the Greek-American Family H and the Italian-American Contursi kindred. Letters below each haplotype specify the different or reoccurring haplotypes. Haplotype D, which carries the c.209A mutation in III:1 (designated as D<sup>mut</sup>) and presumably in II:4, but not in II:3, is highlighted with light grey rectangles. Individual I:1 died at age 85 years and I:2 at 93 years of age; both had no signs of Parkinson's disease according to family information and medical records (available for I:1). Five additional relatives (not shown) from generations I and II were contacted and had no signs or symptoms of PD. X, not shared.

which was entered into [www.molgen.ua.ac.be](http://www.molgen.ua.ac.be) database. This mutation was not found in DNA from 170 individuals with dementia and suspected heredity for dementia from southern Scandinavia.

3.2. Clinical information

The family are of Swedish origin, unaware of any Greek, Italian, other Mediterranean, or Asian ancestry, and are unrelated to the

"Lister" kindred described previously from this study's data collection [21,22,25].

3.2.1. III:1

The proband has been followed at our clinics for five years and has been examined by H.W., A.P. and C.N. At age 43, she experienced a decreased range of motion, stiffness and hypokinesia in her right arm and heaviness in her right leg. She indicated that the symptoms started insidiously when she was 39–41 years old. About six months after the onset of motor symptoms, she noted difficulties finding simple words, and sometimes would not finish a sentence. Diction was monotonous, with occasional stuttering. Pramipexole improved the rigidity. At age 43, she was unable to work and became increasingly unable to perform household chores. At age 44, she also had developed difficulty initiating speech, and neurological evaluation revealed signs of motor and sensory dysphasia and dysarthria. Body bradykinesia and hypomimia had become pronounced, and rigidity as well as a slight tremor was noted. At age 45 years, there remained a positive, albeit limited, effect of dopaminergic treatment (500 mg/d levodopa, 1000 mg/d entacapone, and 0.54 mg/d pramipexole), but dyskinesias were observed. Urological examination revealed a neurogenic bladder disturbance, which was alleviated with desmopressin 60 µg/d. At the most recent examination at age 47, the patient's speech was largely unintelligible due to hypophonia and rapid rate. In motor "ON" state, the patient's gait was peculiar as she set her feet directly in front of each other (as in tandem gait) or even slightly to the opposite side of the midline, "rolling" her trunk from side to side. During "OFF"-state, she had difficulties with gait initiation and shuffling gait. Spontaneous, asymmetric myoclonus was noted in the upper extremities and negative myoclonus in the hands and fingers. Eye movements were normal and there was no sensory deficit. Neuropsychological

**Table 1**

Results from cerebrospinal fluid (CSF) analysis of the **proband (III:1)**: The concentration of CSF albumin was elevated in absolute value and when compared to serum-albumin concentration. CSF cell counts were normal. There were no oligoclonal bands after isoelectric focusing and no intrathecal production of IgG. CSF-light-chain neurofilament protein (NFL) concentration was normal at age 45 but slightly elevated at age 46.5, indicating neuronal degeneration. CSF-tau protein, phospho-tau, beta-amyloid, glial fibrillary acidic protein (GFAP) and S-100-protein were within normal limits. However, CSF-beta-amyloid and CSF-GFAP were nearer to the reference range boundaries at age 46.5 when disease had progressed. In **II:4**, CSF total protein was determined instead of CSF albumin, due to different laboratory routines at the time of analysis. In all samples, CSF protein was elevated (0.51 g/l to 1.03 g/l; reference 0.15–0.45 g/l) as was the number of CSF mononuclear cells (6–17 cells/mm<sup>3</sup>; reference <5 cells/mm<sup>3</sup>) (data not shown in Table 1). S, serum; n.d., not determined. **Bold print and asterisks (\*)** identify values outside of the laboratory's reference range.

	Unit	45 years	46.5 years	Normal range
CSF-albumin	g/l	<b>0.67*</b>	<b>0.74*</b>	0.07–0.33
S-albumin to CSF-albumin rate		<b>0.017*</b>	<b>0.019*</b>	0.0021–0.0095
CSF-tau	ng/l	150	140	<400
CSF-phospho-tau	ng/l	24	24	<60
CSF-beta-amyloid	ng/l	620	480	>450
CSF-NFL	ng/l	<250	<b>400*</b>	<250
CSF-GFAP	ng/l	420	590	<750
CSF-S-100	µg/l	n.d.	0.16	<1.7



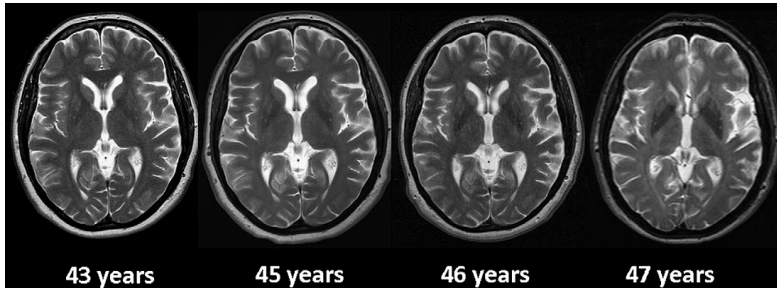

**Fig. 2.** MRI of the proband (III:1): T1-weighted sequence at age 43 years, fluid-attenuated inversion recovery (FLAIR) sequence at age 45, 46 and 47 years. No signal changes are present. Specifically, the basal ganglia are normal and there is no definite focal or general atrophy.

assessment revealed decreased performance in tasks regarding abstraction, visuospatial construction and executive functioning. The Mini-Mental Status Examination score was 19/30 and dementia was diagnosed. Treatment with rivastigmine led to modest cognitive improvement. Repeat brain MRI scans were normal (Fig. 2). EEG background rhythm was 7–8 Hz, no epileptiform activity was detected. Lumbar puncture was performed twice. See Table 1 for results of CSF analyses and Fig. 3 for SPECT examinations.

### 3.2.2. II:4

The proband's father developed resting tremor in his right hand before age 30 years. At age 32 years, he developed imbalance and falls secondary to symptomatic orthostatic hypotension, dysidiadochokinesia, slight generalized rigidity, diminution of facial expression, and myoclonic jerks in the right thumb. He began to walk stiffly and uneasily, and the tremor in his right hand had become more continuous, rendering manual work impossible. EEG background rhythm was 7–8 Hz, epileptic activity was absent. Speech difficulties had arisen at age 33, described as “words stick

in the mouth”, with the patient “stumbling over words when nervous”. Electrocoagulation of the left ventrolateral thalamic nucleus during the 1960s alleviated the tremor in the right hand. However, at age 36, a left hand tremor had developed and generalized rigidity had become pronounced. At age 38, he moved to a nursing home. His speech was monotonous and difficult to understand. Bradykinesia, diplopia and dysconjugate gaze as well as urinary incontinence were noted. Levodopa treatment had a positive effect on bradykinesia and facial expression but caused dyskinesias. At age 40 years, he was aphonic, unable to follow commands, and a diagnosis of dementia was made. While standing, he had camptocormia and held his arms in flexed posture. Repeated lumbar punctures were performed over a 4-year period (caption, Table 1). During the last year of his life, he required the assistance of two aides for walking and was unable to feed himself without help. He died at age 42. An autopsy was not performed.

## 4. Discussion

Herein, we report a family from southern Sweden with an  $\alpha$ -synuclein A53T mutation. The clinical characteristics in the two affected individuals included an early disease manifestation before age 41 and 30 years, rapid progression to a severe phenotype with tremor, rigidity, bradykinesia and gait disturbance, and an initially good response to levodopa treatment. Language and speech difficulties occurred relatively early in the course of the disease, and were followed by cognitive decline. Myoclonic jerks were documented in both individuals.

The proband (III:1) and an unaffected relative (II:3) share identical haplotypes except for the presence of the c.209A mutation in the proband. Although theoretically possible, we consider it highly improbable that I:1 or I:2 would have carried the A53T mutation but remained asymptomatic until their death at age 85 and 93 years. It is impossible to confirm whether II:4 carried the mutation as DNA was not available; however, the parkinsonian symptoms of both II:4 and III:1 were highly similar and have not been reported in any other family member. We conclude that the mutation occurred *de novo* between generation I and II. We consider these findings the strongest evidence so far that this mutation is sufficient by itself to cause disease.

Cognitive impairment like that seen in the affected members of this family has been reported previously in  $\alpha$ -synuclein A53T-associated PD [5,6,14,15,26,27]. However, the severity of cognitive dysfunction was highly variable, occurring early [28] or late [5,28] during the disease course, and several A53T patients remained

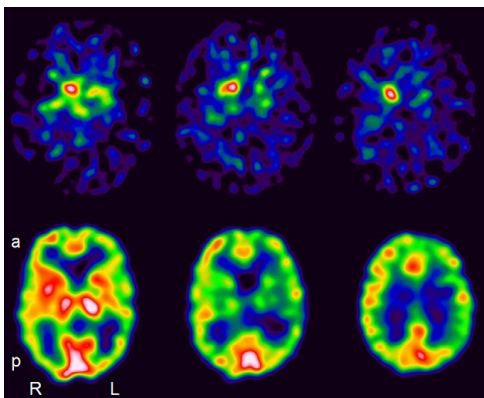

**Fig. 3.** SPECT of the proband (III:1): Top:  $^{123}\text{I}$ -PP-CIT SPECT at age 45 years revealed markedly decreased presynaptic dopamine reuptake capacity in basal ganglia bilaterally, but clearly more so on left side. Bottom:  $^{99\text{m}}\text{Tc}$ -HMPAO SPECT at age 47 years revealed reduced cortical blood flow, most markedly in the parietal lobes. This reduction was more prominent in the left hemisphere, where some reduction of cortical blood flow also occurred in the temporal lobe and the lateral portion of the frontal lobe. R, right; L, left; a, anterior; p, posterior.

cognitively intact [12,29]. Language and speech impairment has also been found in other A53T patients [6,12,19,26,28,29]. Previous reports also identified prominent myoclonus [6, 15], severe orthostatic hypotension [15,26–28], and neurogenic bladder disturbance [15]. These also occurred in this family, and interestingly, in disease associated with SNCA multiplication [21]. The age at symptom onset was highly variable in published reports, spanning the interval from 20 to 85 years [7], with means of 45.6 [7] and 47.9 years [27]. Thus, the two patients reported here have an early onset of symptoms.

Since both the proband and her father developed dementia, we analyzed genes implicated in hereditary dementia. We found a novel mutation c.488G > A (p.Arg163His; R163H) in the presenilin-2 (PSEN2) gene. This mutation was absent in 170 individuals from the same geographical area (southern Scandinavia) who had been examined genetically for suspected hereditary dementia. Thus, the mutation is rare and not commonly associated with hereditary dementia in this population. A modifying effect of the presenilin-2 R163H mutation in individuals with  $\alpha$ -synuclein A53T mutation cannot be excluded with certainty. However, the presenilin-2 R163H mutation was also present in the proband's unaffected mother. We thus suggest that this mutation is a non-pathogenic variant without clinical significance. As DNA was only available from one affected person, no other genetic factors were analysed. A study of members of different families with the  $\alpha$ -synuclein A53T mutation could help elucidate whether other genetic factors contribute to phenotypic variability in A53T-related PD.

Our present understanding of the pathogenic effects of the  $\alpha$ -synuclein A53T mutation has come from clinical descriptions, genetic analyses, and neuropathological examinations. Here, we present longitudinal clinical and biomarker data from individuals II:4 and III:1, obtained over the course of 10 and 5 years, respectively. II:4 was examined repeatedly at our institution in the 1960s and 70s, III:1 during the years prior to this publication. In both patients, the background rhythm was reduced in EEGs performed 2 (II:4) and 4 years (III:3) after the onset of symptoms. A previous report of EEG results from one patient with A53T mutation showed bitemporal slowing with hyperventilation but a normal background rhythm [6]. Repeated brain MRI studies were normal in the proband. Previous reports indicate that cranial CT [6,13] or MRI [13,14] are normal in A53T patients, and one report of mild cerebral atrophy was ascribed to old age [17]. Both III:1 and II:4 exhibited elevated CSF-protein or albumin concentrations, with repeated measurements showing two to four times the mean reference value. CSF mononuclear cells were elevated in all CSF samples analyzed from II:4, but not III:1. In III:1's second lumbar puncture (performed 17 months after the first), the concentration of CSF-light-chain neurofilament protein (NFL), a structural axonal protein, was elevated, while the concentration of beta-amyloid(1–42) was considerably lower, possibly reflecting the evolution of the underlying pathological process. CSF-NFL is considered to aid in differentiating PD, where it is normal, from multiple system atrophy (MSA), where it is elevated. Our results suggest that NFL elevation may simply reflect the extent and rate of neurodegeneration. An  $^{123}\text{I}$ -FP-CIT SPECT analysis in III:1 identified clearly reduced dopamine reuptake capacity and cortical blood flow (Fig. 3). Blood flow reduction was most marked in the dominant hemisphere, consistent with the observed language deficits.

These results suggest that there is an underlying diffuse encephalopathic and/or neurodegenerative process in  $\alpha$ -synuclein A53T-associated disease which affects the cerebral cortex and dopaminergic system, with increased vascular wall permeability causing protein leakage into the CSF, cell death, decreased cortical blood flow, dopamine depletion and slowed EEG background rhythm. These findings are consistent with the abundant cortical

$\alpha$ -synuclein deposition found in *post mortem* examinations of the brains of  $\alpha$ -synuclein A53T-positive individuals [15,28,30].

This study is limited by the low number (two) of affected individuals. There may be alternative explanations for the increase in CSF cell count and protein or albumin levels, such as a gliotic reaction to the neurosurgical treatment in II:4, a low-level asymptomatic infectious disease, or another unknown cause. Repeated lumbar puncture by itself is known to cause slight elevation of CSF-protein and cell count, although this does not explain why both values were raised in the very first examination in both individuals. Additional clinical data from other A53T individuals will reveal whether these conclusions can be applied generally.

## 5. Conclusion

The  $\alpha$ -synuclein A53T mutation leads to a characteristic parkinsonian syndrome with varying degree of cognitive dysfunction. This point mutation, as well as genomic SNCA multiplications, may cause disease by increased  $\alpha$ -synuclein aggregation in different brain regions. Patients with these mutations may be ideal candidates for clinical trials with inhibitors of  $\alpha$ -synuclein expression and aggregation when such agents become available. Prospective biomarker studies on individuals with these mutations would be valuable to elucidate whether there is a common,  $\alpha$ -synuclein mediated pathway in the pathogenesis of all forms of idiopathic PD (for which disease caused by different SNCA mutations would be a highly suitable model) or if a variety of different pathological processes are associated with clinical phenotypes that meet the diagnostic criteria for PD.

## Acknowledgements

The authors wish to express their gratitude to all members of this family who participated in this study.

We thank Ruth Frikke-Schmidt, MD, Ph.D and Karin Møller Hansen, laboratory technician, both at the Department of Clinical Biochemistry, Section for Molecular Genetics, Copenhagen University Hospital, Rigshospitalet, Denmark for their assistance in data compilation on 170 control individuals and for ApoE genotyping.

Andreas Puschmann, Håkan Widner, Karin Nilsson, Jan Reimer, and Christer Nilsson received funding from The Swedish Parkinson Academy, The Research Foundation of the Swedish Parkinson's Disease Association, Lund University Research Fund, and The Royal Physiographic Society in Lund. Owen A. Ross, Carles Vilarinho-Güell, Sarah J. Lincoln, Jennifer M. Kachergus, Stephanie A. Cobb, Zbigniew K. Wszolek, Matthew J. Farrer are supported by NIH/NINDS Morris K. Udall Center for Excellence in PD Research at Mayo Clinic (P50 NS40256) grant, NIH/NIA (P01AG017216) grant, and Pacific Research Alzheimer's Foundation (PARF C06-01) grant. Zbigniew K. Wszolek is also supported by NIH/NIA R01AG015866 grant. Bruce A. Chase received funding from NIH NINDS R15 NS043162. Suzanne G. Lindquist, Jørgen E. Nielsen, Danielle van Westen, Douglas Hägerström, and Katerina Markopoulou: No disclosures.

## Conflict of interest

Authors report no conflict of interests.

## References

- [1] Gelb DJ, Oliver E, Gilman S. Diagnostic criteria for Parkinson disease. *Archives of Neurology* 1999 Jan;56(1):33–9.
- [2] Calne DB, Snow BJ, Lee C. Criteria for diagnosing Parkinson's disease. *Annals of Neurology* 1992;32(Suppl.):S125–127.

- [3] Lundborg H. Medizinisch-biologische Familienforschungen innerhalb eines 2232köpfigen Bauerngeschlechtes in Schweden (Provinz Blekinge). Jena: Verlag von Gustav Fischer; 1913.
- [4] Mjones H. Paralysis agitans. A clinical and genetic study. *Acta Psychiatrica et Neurologica Supplementum* 1949;54:195.
- [5] Golbe LI, Di Iorio G, Bonavita V, Miller DC, Duvoisin RC. A large kindred with autosomal dominant Parkinson's disease. *Annals of Neurology* 1990 Mar;27(3):276–82.
- [6] Markopoulou K, Wszolek ZK, Pfeiffer RF. A Greek-American kindred with autosomal dominant, levodopa-responsive parkinsonism and anticipation. *Annals of Neurology* 1995 Sep;38(3):373–8.
- [7] Polymeropoulos MH, Lavedan C, Leroy E, Ide SE, Dehejia A, Dutra A, et al. Mutation in the alpha-synuclein gene identified in families with Parkinson's disease. *Science (New York, NY)* 1997 Jun 27;276(5321):2045–7.
- [8] Markopoulou K, Wszolek ZK, Pfeiffer RF, Chase BA. Reduced expression of the G209A alpha-synuclein allele in familial Parkinsonism. *Annals of Neurology* 1999 Sep;46(3):374–81.
- [9] Langston JW, Sastry S, Chan P, Formo LS, Bolin LM, Di Monte DA. Novel alpha-synuclein-immunoreactive proteins in brain samples from the Contursi kindred, Parkinson's, and Alzheimer's disease. *Experimental Neurology* 1998 Dec;154(2):684–90.
- [10] Mezey E, Dehejia AM, Harta G, Tresser N, Suchy SF, Nussbaum RL, et al. Alpha synuclein is present in Lewy bodies in sporadic Parkinson's disease. *Molecular Psychiatry* 1998 Nov;3(6):493–9.
- [11] Athanassiadou A, Voutsinas G, Psiouri I, Leroy E, Polymeropoulos MH, Iliass A, et al. Genetic analysis of families with Parkinson disease that carry the Ala531Thr mutation in the gene encoding alpha-synuclein. *American Journal of Human Genetics* 1999 Aug;65(2):555–8.
- [12] Veletza S, Bostantzopoulou S, Hantzigeorgiou G, Kazis A, Papadimitriou A.  $\alpha$ -Synuclein mutation associated with familial Parkinson's disease in two new Greek kindreds (abstract). *Journal of Neurology* 1999;246(Suppl. 1):1–43.
- [13] Papadimitriou A, Veletza V, Hadjigeorgiou GM, Patrikiou A, Hirano M, Anastasopoulos I. Mutated alpha-synuclein gene in two Greek kindreds with familial PD: incomplete penetrance? *Neurology* 1999 Feb;52(3):651–4.
- [14] Bostantzopoulou S, Katsarou Z, Papadimitriou A, Veletza V, Hatzigeorgiou G, Lees A. Clinical features of parkinsonian patients with the alpha-synuclein (G209A) mutation. *Movement Disorders* 2001 Nov;16(6):1007–13.
- [15] Spira PJ, Sharpe DM, Halliday G, Cavanagh J, Nicholson GA. Clinical and pathological features of a Parkinsonian syndrome in a family with an Ala531Thr alpha-synuclein mutation. *Annals of Neurology* 2001 Mar;49(3):313–9.
- [16] Berg D, Niwar M, Maass S, Zimprich A, Moller JC, Wuellner U, et al. Alpha-synuclein and Parkinson's disease: implications from the screening of more than 1,900 patients. *Movement Disorders* 2005 Sep;20(9):1191–4.
- [17] Michell AW, Barker RA, Raha SK, Raha-Chowdhury R. A case of late onset sporadic Parkinson's disease with an A53T mutation in alpha-synuclein. *Journal of Neurology, Neurosurgery, and Psychiatry* 2005 Apr;76(4):596–7.
- [18] Michell AW. Personal communication. 2008 October 22. [Cited with permission].
- [19] Ki CS, Stavrou EF, Davanos N, Lee WY, Chung EJ, Kim JY, et al. The Ala53Thr mutation in the alpha-synuclein gene in a Korean family with Parkinson disease. *Clinical Genetics* 2007 May;71(5):471–3.
- [20] Conway KA, Harper JD, Lansbury PT. Accelerated in vitro fibril formation by a mutant alpha-synuclein linked to early-onset Parkinson disease. *Nature Medicine* 1998 Nov;4(11):1318–20.
- [21] Fuchs J, Nilsson C, Kachergus J, Munz M, Larsson EM, Schule B, et al. Phenotypic variation in a large Swedish pedigree due to SNCA duplication and triplication. *Neurology* 2007 Mar 20;68(12):916–22.
- [22] Puschmann A, Wszolek ZK, Farrer M, Gustafson L, Widner H, Nilsson C. Alpha-synuclein multiplications with parkinsonism, dementia or progressive myoclonus? *Parkinsonism Related Disorders* 2009 June;15(5):390–2.
- [23] Mata IF, Ross OA, Kachergus J, Huerta C, Ribaoca R, Moris G, et al. LRRK2 mutations are a common cause of Parkinson's disease in Spain. *European Journal of Neurology* 2006 Apr;13(4):391–4.
- [24] Rocca WA, Maraganore DM, McDonnell SK, Schaïd DJ. Validation of a telephone questionnaire for Parkinson's disease. *Journal of Clinical Epidemiology* 1998 Jun;51(6):517–23.
- [25] Puschmann A. Unverricht-Lundborg disease-A misnomer? *Movement Disorders* 2009 March 15;24(4):629–30.
- [26] Golbe LI, Di Iorio G, Sanges G, Lazzarini AM, La Sala S, Bonavita V, et al. Clinical genetic analysis of Parkinson's disease in the Contursi kindred. *Annals of Neurology* 1996 Nov;40(5):767–75.
- [27] Papapetropoulos S, Ellul J, Paschalis C, Athanassiadou A, Papadimitriou A, Papapetropoulos T. Clinical characteristics of the alpha-synuclein mutation (C209A)-associated Parkinson's disease in comparison with other forms of familial Parkinson's disease in Greece. *European Journal of Neurology* 2003 May;10(3):281–6.
- [28] Markopoulou K, Dickson DW, McComb RD, Wszolek ZK, Katechaliidou L, Avery L, et al. Clinical, neuropathological and genotypic variability in SNCA A53T familial Parkinson's disease. Variability in familial Parkinson's disease. *Acta Neuropathologica* 2008 Jul;116(1):25–35.
- [29] Kotzbauer PT, Giasson BI, Kravitz AV, Golbe LI, Mark MH, Trojanowski JQ, et al. Fibrillization of alpha-synuclein and tau in familial Parkinson's disease caused by the A53T alpha-synuclein mutation. *Experimental Neurology* 2004 Jun;187(2):279–88.
- [30] Duda JE, Giasson BI, Mabon ME, Miller DC, Golbe LI, Lee VM, et al. Concurrence of alpha-synuclein and tau brain pathology in the Contursi kindred. *Acta Neuropathologica* 2002 Jul;104(1):7–11.

## Article III



## Article IV



# Article V





# Independent and Joint Effects of the *MAPT* and *SNCA* Genes in Parkinson Disease

Alexis Elbaz, MD, PhD,<sup>1,2</sup> Owen A. Ross, PhD,<sup>3</sup> John P. A. Ioannidis, MD, PhD,<sup>4,5</sup>  
 Alexandra I. Soto-Ortolaza, BSc,<sup>3</sup> Frédéric Moisan, MSc,<sup>1,2</sup> Jan Aasly, MD,<sup>6</sup>  
 Grazia Annesi, PhD,<sup>7</sup> Maria Bozi, MD,<sup>8</sup> Laura Brighina, MD, PhD,<sup>9</sup>  
 Marie-Christine Chartier-Harlin, PhD,<sup>10,11</sup> Alain Destée, MD, PhD,<sup>10,11,12</sup>  
 Carlo Ferrarese, MD, PhD,<sup>9</sup> Alessandro Ferraris, MD, PhD,<sup>13</sup> J. Mark Gibson, MD,<sup>14</sup>  
 Suzana Gispert, PhD,<sup>15</sup> Georgios M. Hadjigeorgiou, MD,<sup>16,17</sup>  
 Barbara Jasinska-Myga, MD, PhD,<sup>18</sup> Christine Klein, MD,<sup>19</sup> Rejko Krüger, MD, PhD,<sup>20</sup>  
 Jean-Charles Lambert, PhD,<sup>21</sup> Katja Lohmann, PhD,<sup>19</sup> Simone van de Loo, MD,<sup>15</sup>  
 Marie-Anne Lorient, PharmD, PhD,<sup>22,23,24</sup> Timothy Lynch, MD,<sup>25</sup>  
 George D. Mellick, MD, PhD,<sup>26,27,28</sup> Eugénie Mutez, MD,<sup>10,11,12</sup> Christer Nilsson, MD, PhD,<sup>29</sup>  
 Grzegorz Opala, MD, PhD,<sup>18</sup> Andreas Puschmann, MD,<sup>29,30</sup> Aldo Quattrone, MD,<sup>31</sup>  
 Manu Sharma, PhD,<sup>20</sup> Peter A. Silburn, MD, PhD,<sup>26,27,28,32</sup> Leonidas Stefanis, MD, PhD,<sup>33</sup>  
 Ryan J. Uitti, MD,<sup>34</sup> Enza Maria Valente, MD, PhD,<sup>13</sup> Carles Vilariño-Güell, PhD,<sup>3,37</sup>  
 Karin Wirdefeldt, MD, PhD,<sup>35</sup> Zbigniew K. Wszolek, MD,<sup>34</sup> Georgia Xiromerisiou, MD,<sup>16,17</sup>  
 Demetrius M. Maraganore, MD,<sup>36</sup> Matthew J. Farrer, PhD,<sup>3,37</sup> on behalf of the Genetic  
 Epidemiology of Parkinson's Disease (GEO-PD) consortium

**Objective:** We studied the independent and joint effects of the genes encoding alpha-synuclein (*SNCA*) and microtubule-associated protein tau (*MAPT*) in Parkinson disease (PD) as part of a large meta-analysis of individual data from case-control studies participating in the Genetic Epidemiology of Parkinson's Disease (GEO-PD) consortium.

**Methods:** Participants of Caucasian ancestry were genotyped for a total of 4 *SNCA* (rs2583988, rs181489, rs356219, rs11931074) and 2 *MAPT* (rs1052553, rs242557) single nucleotide polymorphism (SNPs). Individual and joint effects of *SNCA* and *MAPT* SNPs were investigated using fixed- and random-effects logistic regression models. Interactions were studied on both a multiplicative and an additive scale, and using a case-control and case-only approach.

**Results:** Fifteen GEO-PD sites contributed a total of 5,302 cases and 4,161 controls. All 4 *SNCA* SNPs and the *MAPT* H1-haplotype-defining SNP (rs1052553) displayed a highly significant marginal association with PD at the significance level adjusted for multiple comparisons. For *SNCA*, the strongest associations were observed for SNPs located at the 3' end of the gene. There was no evidence of statistical interaction between any of the 4 *SNCA* SNPs and rs1052553 or rs242557, neither on the multiplicative nor on the additive scale.

**Interpretation:** This study confirms the association between PD and both *SNCA* SNPs and the H1 *MAPT* haplotype. It shows, based on a variety of approaches, that the joint action of variants in these 2 loci is consistent with independent effects of the genes without additional interacting effects.

ANN NEUROL 2011;69:778-792

View this article online at [wileyonlinelibrary.com](http://wileyonlinelibrary.com). DOI: 10.1002/ana.22321

Received May 21, 2010, and in revised form Oct 18, 2010. Accepted for publication Oct 22, 2010.

Address correspondence to Dr Elbaz, INSERM U708, Hôpital de la Salpêtrière, 47 boulevard de l'Hôpital, 75651 Paris Cedex 13, France.  
 E-mail: alexis.elbaz@upmc.fr

The microtubule-associated protein tau and  $\alpha$ -synuclein are 2 abundant brain proteins that aggregate in neurodegenerative diseases such as Parkinson disease (PD), Alzheimer disease, and progressive supranuclear palsy (PSP). There is evidence that the formation of pathological inclusions containing tau and  $\alpha$ -synuclein is promoted by common mechanisms,<sup>1</sup> and there are reports of concurrence of  $\alpha$ -synuclein and tau brain pathology in autosomal dominant parkinsonism.<sup>2,3</sup>

There is increasing evidence that genetic susceptibility contributes to the etiology of PD. Using a candidate-gene approach, genetic association studies pointed toward an association between PD and both the  $\alpha$ -synuclein (*SNCA*)<sup>4-6</sup> and microtubule-associated protein tau (*MAPT*) genes.<sup>7-10</sup> More recently, genome-wide association studies (GWASs) confirmed that *SNCA* and *MAPT* were 2 of the main common contributors to PD genetic susceptibility among Caucasians.<sup>11-14</sup> The *MAPT* locus (17q21.31) contains a ~900kb inversion polymorphism with 2 distinct haplotypes, H1 and H2; the major H1 haplotype is associated with PD, PSP, and other tauopathies. The *SNCA* gene lies in a region of relatively high linkage disequilibrium (LD) with single nucleotide polymorphisms (SNPs) at both 3'- and 5' ends of the gene associated with PD. Given the multiple associations at this locus, it remains unclear whether they result from a single functional variant or whether there are different functional variants at both ends.<sup>5</sup> Given the overexpression hypothesis for *SNCA*, there may well be multiple variants affecting transcription factor binding sites at the promoter or miRNA sites in the 3' untranslated region.<sup>15</sup>

Although the functional variant(s) have not been identified, the association between PD and both the *SNCA* and *MAPT* genes is well established. These findings raise the question of a possible gene-gene interaction between *SNCA* and *MAPT*, but few studies have investigated this question and with inconsistent findings.<sup>16-18</sup>

Sample sizes needed to detect interactions between 2 variables are larger than for marginal effects of similar size<sup>19,20</sup>; therefore, larger studies are needed to investigate whether *SNCA* and *MAPT* interact, and collaborative efforts are needed to reach sufficient sample sizes. We invited teams involved in the Genetic Epidemiology of Parkinson's Disease (GEO-PD) consortium to undertake a collaborative effort to investigate the joint effects and potential interactions between *SNCA* and *MAPT* in conferring susceptibility to PD in a large sample of cases and controls.

## Subject and Methods

### Study Population

The aim of the GEO-PD consortium is to conduct collaborative studies of genetic risk factors in PD. Since its creation in 2004, the consortium has regularly met to organize scientific collaborations between participating teams. During the meeting held in Tübingen, Germany in 2009 and following the presentation at scientific meetings of the results of PD GWASs, attending teams were invited to participate in a collaborative effort to study the joint effects of *SNCA* and *MAPT*.

All studies were approved by the local ethical committees following the procedures of each country.

From the <sup>1</sup>INSERM, U708, Neuroepidemiology, F-75013, Paris, France; <sup>2</sup>UPMC Univ Paris 06, UMR\_S708, Neuroepidemiology, F-75005, Paris, France; <sup>3</sup>Division of Neurogenetics, Department of Neuroscience, Mayo Clinic, Jacksonville, FL; <sup>4</sup>Clinical and Molecular Epidemiology Unit, Department of Hygiene and Epidemiology, University of Ioannina Medical School, Ioannina, Greece; <sup>5</sup>Tufts Clinical and Translational Science Institute, Tufts Medical Center, and Tufts University School of Medicine, Boston, MA; <sup>6</sup>Department of Neurology, St Olav Hospital, Trondheim, Norway; <sup>7</sup>Institute of Neurological Sciences, National Research Council, Cosenza, Italy; <sup>8</sup>General Hospital of Syros, Syros, and Second Department of Neurology, University of Athens Medical School, Athens, Greece; <sup>9</sup>Department of Neurology and Neuroscience, University of Milano-Bicocca, San Gerardo Hospital, Monza, Italy; <sup>10</sup>UMR 837 INSERM, Lille, France; <sup>11</sup>Univ Lille Nord de France, Lille, France; <sup>12</sup>University Hospital, CHRU, Lille, France; <sup>13</sup>Mendel Laboratory IRCCS Casa Sollievo della Sofferenza, San Giovanni Rotondo, Italy; <sup>14</sup>Department of Neurology, Royal Victoria Hospital, Belfast, Ireland; <sup>15</sup>Department of Neurology, Goethe University, Frankfurt am Main, Germany; <sup>16</sup>Department of Neurology, Laboratory of Neurogenetics, Faculty of Medicine, University of Thessaly, Larissa, Greece; <sup>17</sup>Institute of Biomedical Research and Technology, CERETETH, Larissa, Greece; <sup>18</sup>Department of Neurology, Medical University of Silesia, Katowice, Poland; <sup>19</sup>Section of Clinical and Molecular Neurogenetics at the Department of Neurology, University of Lübeck, Lübeck, Germany; <sup>20</sup>Center of Neurology and Hertie-Institute for Clinical Brain Research, University of Tübingen, and German Center for Neurodegenerative Diseases, Tübingen, Germany; <sup>21</sup>INSERM, U744, Pasteur Institute from Lille, University of Lille-Nord de France, Lille, France; <sup>22</sup>INSERM, UMR-S 775, Molecular basis of response to xenobiotics, Paris, France; <sup>23</sup>University Paris Descartes, Paris, France; <sup>24</sup>Assistance-Publique Hôpitaux de Paris, Georges Pompidou European Hospital (HEGP), Department of Biochemistry, Pharmacogenetics and Molecular Oncology, Paris, France; <sup>25</sup>Dublin Neurological Institute at the Mater Misericordiae University Hospital and Conway Institute of Biomolecular and Biomedical Research, University College, Dublin, Ireland; <sup>26</sup>National Centre for Adult Stem Cell Research, Eskitis Institute for Cell and Molecular Therapies, Griffith University, Brisbane, Queensland, Australia; <sup>27</sup>Department of Neurology, Princess Alexandra Hospital, Brisbane, Queensland, Australia; <sup>28</sup>Neurology Research Centre, Royal Brisbane and Women's Hospital, Brisbane, Queensland, Australia; <sup>29</sup>Department of Clinical Science, Section of Geriatric Psychiatry, Lund University, Lund, Sweden; <sup>30</sup>Department of Neurology, Skåne University Hospital, Lund, Sweden; <sup>31</sup>Institute of Neurology, University Magna Graecia, Catanzaro and Neuroimaging Research Unit, National Research Council, Germaneto, Italy; <sup>32</sup>School of Medicine and Centre for Clinical Research, University of Queensland, Brisbane, Australia; <sup>33</sup>Division of Basic Neurosciences, Biomedical Research Foundation of the Academy of Athens and Second Department of Neurology, University of Athens Medical School, Athens, Greece; <sup>34</sup>Department of Neurology, Mayo Clinic, Jacksonville, FL; <sup>35</sup>Department of Clinical Neuroscience and Department of Medical Epidemiology and Biostatistics, Karolinska Institutet, Stockholm, Sweden; <sup>36</sup>Department of Neurology, NorthShore University HealthSystem, Evanston, IL; and <sup>37</sup>Centre for Molecular Medicine and Therapeutics, University of British Columbia, Vancouver, British Columbia, Canada.

Additional supporting information can be found in the online version of this article.

## Genotyping Methods

Participating sites were asked to contribute 250ng of DNA. DNA was sent to a central laboratory (Mayo Clinic, Jacksonville, FL), where genotypes were determined blinded to case-control status.

Four *SNCA* (rs2583988, rs181489, rs356219, rs11931074) and 2 *MAPT* (rs1052553, rs242557) SNPs were selected for genotyping. We identified *SNCA* SNPs at the 5' (rs2583988<sup>5,6</sup>) or 3' ends (rs181489,<sup>5,6</sup> rs356219,<sup>6,13,17</sup> rs11931074<sup>11-13,21</sup>) of the gene, which had been previously associated with PD. In addition, rs11931074 (located approximately 7kb downstream from the 3' end) has been associated with multiple system atrophy.<sup>22</sup> We did not select the REP1 polymorphism in the *SNCA* promoter, because the 263bp allele, which is more strongly associated with PD, is rare (<10%), thus leading to insufficient power for interaction analyses.

The rs1052553 A-allele defines the *MAPT* H1 haplotype<sup>10</sup>; rs242557 highlights the *MAPT* H1c subhaplotype associated with PSP.<sup>23</sup>

Genotyping was performed on a Sequenom MassArray iPLEX platform (San Diego, CA); primer sequences are available upon request.

## Statistical Methods

We used exact tests to assess among controls of each site whether genotype distributions for each SNP violated Hardy-Weinberg equilibrium (HWE).<sup>24</sup> Sites with a nominally significant ( $p < 0.05$ ) deviation from HWE were excluded. All participants were of Caucasian ancestry.

We investigated the marginal association between PD and the 6 SNPs by site using fixed-effects logistic regression. For *SNCA* SNPs, the reference allele was the major frequency allele; for *MAPT* SNPs, we considered the minor allele as the reference to be in agreement with previous papers.<sup>10</sup> Odds ratios (OR), 95% confidence intervals (CIs), and  $p$  values were computed using a dummy-coding of the genotypes (model-free analysis), as well as additive, dominant, and recessive models. The Akaike information criterion (AIC) was computed; the lowest AIC indicates the best model when both goodness of fit and parsimony are considered.

Our primary analyses of the interaction between SNPs were performed by estimating ORs for individual and joint effects and by including multiplicative terms in the models to test for statistical multiplicative interaction.<sup>25</sup> We also tested interactions on an additive scale by estimating the relative excess risk due to interaction (RERI, also known as the interaction contrast ratio), the attributable proportion due to interaction (AP), and the synergy index (SI); RERI = AP = 0 and SI = 1 indicate lack of interaction on an additive scale.<sup>26,27</sup> For interaction analyses, our primary analyses focused on *MAPT* rs1052553<sup>10</sup>; we tested the interaction between each of the 4 *SNCA* SNPs and rs1052553. Additional analyses involving the other *MAPT* SNP (rs242557) were also performed and reported

as supplementary data. Analyses unadjusted and adjusted for age and gender were performed.

The results of analyses by site are displayed as forest plots and were used to estimate between-site heterogeneity. We tested for between-site heterogeneity with the chi-square-based Q statistic (significant for  $p < 0.10$ ) and quantified its extent with  $I^2$ , which ranges from 0% to 100% and represents the proportion of between-study variability ascribed to heterogeneity rather than to chance.<sup>28,29</sup> Values for  $I^2$  of 0 to 24% suggest little heterogeneity, 25 to 49% reflect moderate heterogeneity, 50 to 74% reflect large heterogeneity, and >75% reflect very large heterogeneity.

For quantitative syntheses, we used fixed- and random-effects logistic regression models. In the presence of heterogeneity, random-effects syntheses are preferable<sup>30</sup>; because there was evidence of heterogeneity in some analyses, our primary analyses are based on random-effects models, and we present the results of analyses based on fixed-effects models as supplementary data. Fixed-effects models assume that ORs are constant across sites and that observed differences are due to chance; they were implemented by including site as a categorical covariate in the models. Random-effects models allow that results might be genuinely heterogeneous across sites and take into account between-study heterogeneity by including random effects for genotypes; they were implemented using multilevel regression models.<sup>31-34</sup> For analyses of gene-gene interactions, regression models included several random effects, and we used an unstructured variance-covariance matrix for the random effects.

Gene-gene multiplicative interactions were also investigated by looking at the association of *SNCA* and *MAPT* genotypes among cases only using fixed- and random-effects logistic regression (secondary analysis). When genotypes are independent among controls, this approach has generally increased power compared to case-control analyses.<sup>20,35</sup>

*SNCA* haplotypes were defined using Thesias software which allows testing interactions with covariates.<sup>36</sup> We tested the interaction between *SNCA* haplotypes and rs1052553 or rs242557. The relative effect of *SNCA* SNPs was explored using a unified stepwise regression procedure.<sup>37</sup>

Among cases, we followed a similar strategy as described above to investigate, with fixed- and random-effects linear regression models, the effect of SNPs and their interaction on age at onset (AAO) of PD as a continuous outcome.

Both for case-control and case-only analyses, a Bonferroni correction was used to take into account multiple testing. In marginal-effects analyses, we considered 4 models for 6 SNPs;  $p \leq 0.0021$  (0.05/24) was considered statistically significant. For analyses of joint effects, 3 multiplicative interaction models (model-free, dominant, or additive coding of *SNCA* SNPs) were considered for 4 SNPs;  $p \leq 0.0042$  (0.05/12) was considered statistically significant.

The sample size needed to detect interactions on a multiplicative scale was investigated for different gene frequencies, genetic models, and effects (Supporting Information Fig 1). For instance, to detect an interaction OR of 1.5, and assuming that

the marginal OR for a *SNCA* SNP with a frequency of 15% is 1.20 (additive model), and that the marginal OR for a *MAPT* SNP with a frequency of 80% is 1.25 (recessive model), a case-control study (1:1 matching) would need to include ~1,700 cases to reach 80% power at the 2-sided 0.05 significance level. At the 0.0042 significance level, ~2,900 cases would be necessary to reach 80% power.

Analyses were performed using SAS 9.1 (Cary, NC) and STATA 11.0 (College Station, TX).

## Results

Fifteen sites contributed a total of 5,302 cases and 4,161 controls. Their demographic and clinical characteristics are shown in Table 1; 16% of the cases reported a positive history of PD among first-degree relatives. The distributions by site of the 6 SNPs in cases and controls are shown in Supporting Information Table 1. HWE was tested among controls for each SNP and site; rs1052553 was the only SNP for which a significant departure ( $p = 0.0008$ ) was identified in site K. We excluded participants from this site and retained the remaining 5,199 cases and 4,059 controls. Genotyping call rates were >95% for all SNPs and sites. One site (P) contributed only cases; they were included in case-only analyses (therefore based on 5,272 cases).

Table 2 shows the association between each SNP and PD using random-effects logistic regression, together with heterogeneity estimates; results from fixed-effects models are shown in Supporting Information Table 2. Supporting Information Figure 2 shows forest plots under additive, dominant, and recessive genetic models. There was evidence of heterogeneity for some *SNCA* SNPs (rs181489, additive and dominant model; rs356219, recessive model; rs2583988, additive and dominant model; see Table 2), whereas no heterogeneity was detected for *MAPT* SNPs. Fixed- and random-effects models yielded similar conclusions. All *SNCA* SNPs displayed a highly significant association with PD at the Bonferroni-corrected significance level. For rs181489, rs356219, and rs2583988, both heterozygotes and homozygotes for the minor allele were significantly more frequent in cases than controls, but ORs increased with the number of minor alleles, and the additive model displayed the lowest AIC value. For rs11931074, the association pattern was more consistent with a dominant model, but the additive model was also very close in AIC. The strongest associations were detected for rs181489, followed by rs356219 (both located at the 3' end of the gene). Adjustment for age and sex yielded similar findings (not shown).

When all *SNCA* SNPs together with all possible pair-wise interactions were included in the same model and after using a backward selection procedure (Support-

ing Information Table 3), main effects remained highly significant for the 3' SNPs, indicating that they were independently associated with PD. The direction of the independent association between PD and rs356219 was reversed in this analysis compared to univariate analyses (see Table 2); it is likely that the strong LD between SNPs in the *SNCA* gene leads to confounding in univariate analyses, and that an independent effect of rs356219 was confounded in univariate analyses due to its strong association with rs181489. In addition, there was a trend in favor of an interaction between rs11931074 and rs181489, suggesting that the effect of rs11931074 decreased with the number of rs181489 alleles. The main effect for rs2583988 (5' end) was not significant once 3' end SNPs were included in the model; however, there was a trend in favor of interaction between rs2583988 and rs356219, suggesting that rs2583988 has a small effect among carriers of the minor rs356219 allele.

We found a highly significant association between PD and the H1-tagging allele of rs1052553, with the same AIC values for additive and recessive models; the GA rs1052553 genotype was not associated with PD, and it was only the AA genotype (ie, carriers of the H1/H1 haplotype) that was positively associated with PD. A weaker association was found for rs242557 (dominant model). Adjustment for age and sex yielded similar findings (data not shown). After Bonferroni correction, rs1052553 remained significantly associated with PD, whereas rs242557 did not. When both rs1052553 (recessive) and rs242557 (dominant) were included in the same model, the association between PD and rs1052553 remained virtually unchanged (fixed effects; OR, 1.25; 95% CI, 1.14–1.37), whereas the association with rs242557 disappeared (fixed effects; OR, 0.95; 95% CI, 0.84–1.08).

The genotype counts for the cross-tabulation of rs1052553 and each of the *SNCA* SNPs are presented in Supporting Information Table 4 by study. Figure 1 includes forest plots of ORs corresponding to the multiplicative interaction between the H1/H1 *MAPT* haplotype (defined by rs1052553) and each *SNCA* SNP (additive coding); Supporting Information Figure 3 shows the same analysis using a dominant coding of *SNCA* SNPs. Depending on the SNPs, heterogeneity measures suggested weak (rs356219, rs11931074), moderate (rs181489), or large (rs2583988) heterogeneity.

Table 3 presents the results of interaction analyses between each *SNCA* SNP and *MAPT* rs1052553; because of the large sample size, we were able to investigate the interaction between carriers of the H1/H1 *MAPT* haplotype and each of the genotypes of *SNCA* SNPs. Multiplicative interaction was tested using different codings of

TABLE 1: Characteristics of Study Participants by Site

Site	Country	Study PI				Cases				Controls			
		No.	Male Sex, %	Mean Age at Onset, yr (SD)	Mean Age at Study, yr (SD)	Family History, No. <sup>a</sup>	Diagnostic Criteria	No.	Male Sex, %	Mean Age at Study, yr (SD)	Source		
A	Australia	929	62	59.4 (11.4)	72.3 (10.2)	118	Bower	713	36	66.6 (9.9)	Electoral rolls; spouses; unaffected siblings		
B	France	563	54	54.7 (11.5)	63.8 (10.4)	243	Gelb	143	45	65.2 (11.0)	Friends		
C	Germany	232	51	56.2 (10.8)	71.9 (11.4)	20	UKPDDB	47	64	58.8 (9.8)	Blood donors		
D	Germany	522	58	43.9 (12.9)	61.5 (12.3)	0	UKPDDB	289	47	54.9 (13.9)	Spouses		
E	Germany	335	59	—	52.1 (12.5)	NA	UKPDDB	339	55	53.2 (12.2)	Population-based		
F	Greece	135	59	66.4 (10.7)	72.6 (10.4)	24	Gelb	95	44	71.3 (9.5)	Spouses; hospital		
G	Greece	322	50	64.6 (9.4)	68.8 (9.1)	0	Bower	315	50	70.0 (8.6)	Hospital		
H	Ireland	361	58	51.4 (10.4)	67.4 (10.2)	49	UKPDDB	445	36	66.6 (24.2)	Hospital		
I	Italy	190	53	61.3 (9.4)	71.8 (9.4)	0	UKPDDB	168	46	53.6 (9.1)	Population-based		
J	Italy	189	51	58.4 (8.2)	67.6 (8.5)	7	UKPDDB	95	45	69.0 (9.8)	Population-based		
K	Italy	103	53	62.3 (10.4)	67.8 (9.6)	22	Gelb	102	62	62.1 (6.6)	Spouses; blood donors		
L	Norway	603	58	59.3 (10.9)	73.5 (10.7)	136	UKPDDB	526	56	71.3 (12.5)	Blood donors; societies for retired persons		
M	Poland	349	62	57.1 (11.6)	70.1 (10.6)	57	UKPDDB	340	46	64.3 (15.7)	Population-based		
N	Sweden	91	56	65.7 (11.0)	75.6 (8.8)	7	Gelb	180	44	73.7 (10.1)	Population-based		
O	USA	378	55	62.1 (11.9)	71.0 (11.2)	146	UKPDDB	364	52	72.9 (10.8)	Spouses; friends; neighbors		
P	Sweden	73	62	—	71.1 (9.8)	24	UKPDDB	—	—	—	—		

<sup>a</sup>Family history of PD among first-degree relatives.

<sup>b</sup>Part of the samples had been previously included in a study of the marginal association between the *REP1* (*SNCA*) polymorphism and PD (Maraganore et al<sup>4</sup>).

<sup>c</sup>Part of the samples had been previously included in a study of the marginal association between the *MAPT* gene and PD (Wider et al<sup>10</sup>).

PI = principal investigator; SD = standard deviation; UKPDDB = United Kingdom Parkinson's Disease Brain Bank (the exclusion criterion ">1 affected relative" was not included); NA = not available; PD = Parkinson disease.

**TABLE 2: Marginal Association between SNPs in the SNCA and MAPT Genes and Parkinson Disease (Random-Effects Models)**

SNP	Genotype	OR (95% CI) <sup>a</sup>	<i>p</i> <sup>a</sup>	AIC <sup>a,b</sup>	Heterogeneity	
					I <sup>2</sup> % (95% CI)	<i>p</i>
<i>SNCA</i>						
rs181489 (5,043 cases, 3,910 controls)	CC	1.00 (reference)	—	—	—	—
	CT	1.14 (1.04–1.26)	0.0054	—	31 (0–64)	0.13
	TT	1.67 (1.43–1.96)	1.1E-10	11,825	33 (0–64)	0.11
	Additive (T vs C) <sup>c</sup>	1.24 (1.16–1.33)	2.0E-09	11,824 <sup>b</sup>	41 (0–69)	0.054
	Dominant (CT+TT vs CC)	1.23 (1.13–1.34)	1.7E-06	11,844	39 (0–68)	0.065
	Recessive (TT vs CC+CT)	1.57 (1.36–1.80)	3.4E-10	11,827	24 (0–60)	0.20
rs356219 (5,131 cases, 3,995 controls)	AA	1.00 (reference)	—	—	—	—
	AG	1.16 (1.06–1.28)	0.0020	—	0 (0–55)	0.58
	GG	1.53 (1.31–1.79)	8.3E-08	12,062	29 (0–63)	0.15
	Additive (G vs A) <sup>c</sup>	1.22 (1.15–1.29)	2.6E-10	12,059 <sup>b</sup>	23 (0–59)	0.21
	Dominant (AG+GG vs AA)	1.25 (1.14–1.36)	1.1E-06	12,076	0 (0–55)	0.53
	Recessive (GG vs AA+AG)	1.41 (1.21–1.64)	9.0E-06	12,066	41 (0–69)	0.053
rs11931074 (5,159 cases, 4,032 controls)	GG	1.00 (reference)	—	—	—	—
	GT	1.35 (1.20–1.52)	8.7E-07	—	0 (0–55)	0.88
	TT	1.33 (0.79–2.23)	0.28	12,175	0 (0–55)	0.99
	Additive (T vs G) <sup>c</sup>	1.32 (1.18–1.47)	1.1E-06	12,169	0 (0–55)	0.81
	Dominant (GT+TT vs GG)	1.35 (1.20–1.52)	5.4E-07	12,168 <sup>b</sup>	0 (0–55)	0.84
	Recessive (TT vs GG+GT)	1.27 (0.76–2.13)	0.3575	12,192	0 (0–55)	0.99
rs2583988 (5,161 cases, 4,015 controls)	CC	1.00 (reference)	—	—	—	—
	CT	1.25 (1.11–1.39)	0.0001	—	44 (0–70)	0.041
	TT	1.48 (1.23–1.78)	2.7E-05	12,141	39 (0–68)	0.067
	Additive (T vs C) <sup>c</sup>	1.23 (1.13–1.34)	2.5E-06	12,134 <sup>b</sup>	53 (0–74)	0.011
	Dominant (CT+TT vs CC)	1.29 (1.15–1.43)	7.5E-06	12,138	51 (0–74)	0.014
	Recessive (TT vs CC+CT)	1.32 (1.13–1.55)	0.0005	12,156	23 (0–59)	0.21
<i>MAPT</i>						
rs1052553 (5,199 cases, 4,059 controls)	GG	1.00 (reference)	—	—	—	—
	GA	1.12 (0.90–1.40)	0.31	—	0 (0–55)	0.86
	AA	1.38 (1.12–1.71)	0.0028	12,267	0 (0–55)	0.91
	Additive (A vs G) <sup>c</sup>	1.21 (1.12–1.30)	5.4E-07	12,261 <sup>b</sup>	0 (0–55)	0.70
	Dominant (GA+AA vs GG)	1.29 (1.05–1.60)	0.0173	12,280	0 (0–55)	0.90
	Recessive (AA vs GG+GA)	1.25 (1.15–1.37)	7.0E-07	12,261 <sup>b</sup>	0 (0–55)	0.57
rs242557 (5,159 cases, 4,008 controls)	AA	1.00 (reference)	—	—	—	—
	AG	0.87 (0.77–0.99)	0.0340	—	24 (0–60)	0.19
	GG	0.86 (0.76–0.98)	0.0285	12,162	0 (0–55)	0.79
	Additive (G vs A) <sup>c</sup>	0.94 (0.89–1.00)	0.0687	12,158	0 (0–55)	0.93
	Dominant (AG+GG vs AA)	0.87 (0.77–0.98)	0.0214	12,156 <sup>b</sup>	0 (0–55)	0.45
	Recessive (GG vs AA+AG)	0.96 (0.88–1.05)	0.36	12,160	0 (0–55)	0.81

<sup>a</sup>ORs (95% CI) and the corresponding *p* values and AIC were computed using random-effects logistic regression.<sup>b</sup>The lowest value of the AIC indicates a better fit.<sup>c</sup>The OR is computed for an increase of 1 minor allele.

SNP = single nucleotide polymorphism; OR = odds ratio; CI = confidence interval; AIC = Akaike information criterion.

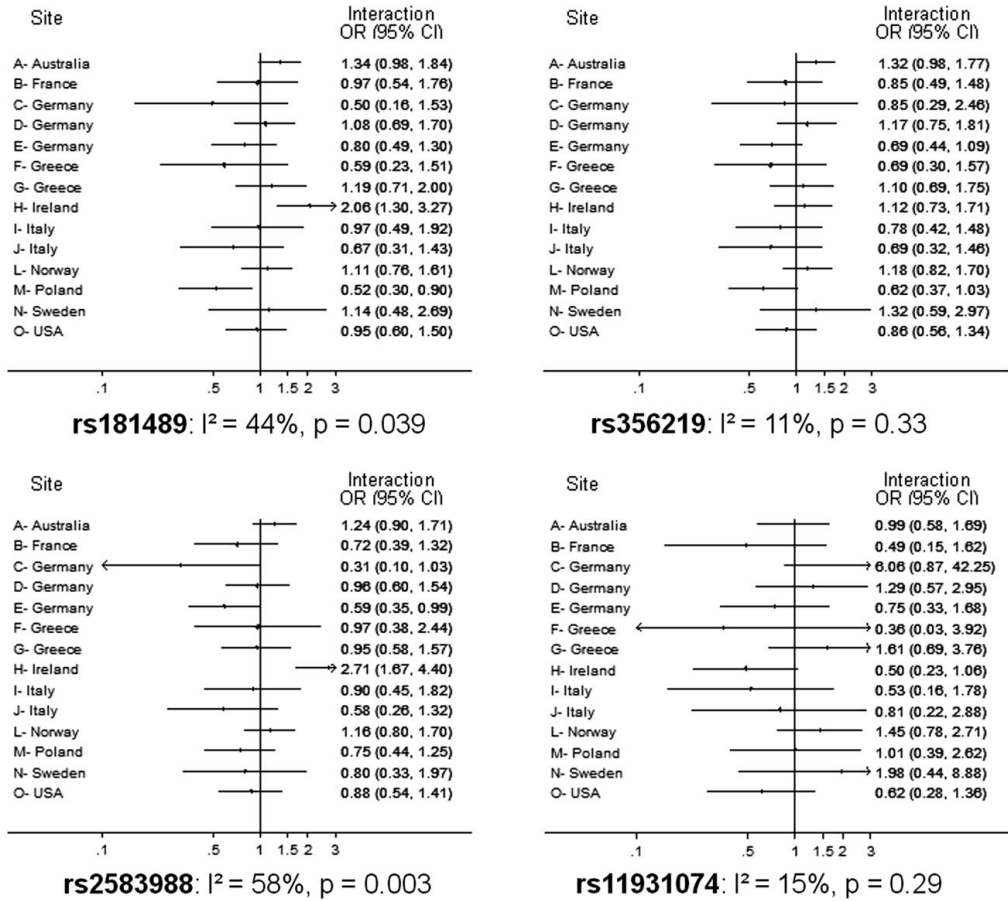

FIGURE 1: Forest plots of the interaction odds ratios (ORs) between rs1052553 and each of the *SNCA* single nucleotide polymorphisms (SNPs; additive coding) by participating site. Multiplicative interaction ORs were computed using an additive coding of *SNCA* SNPs. They compare the OR for an increase in 1 minor allele of *SNCA* SNPs in carriers of the AA genotype for rs1052553 and in noncarriers. Heterogeneity measures ( $I^2$ ,  $p$  value) are shown. Supporting Information Figure 3 shows the same analysis using a dominant coding of *SNCA* SNPs. CI = confidence interval.

*SNCA* SNPs. All interaction tests were far from nominal significance; although both *SNCA* and *MAPT* SNPs independently increased the risk of PD, their joint effects were not different from that expected under a multiplicative model. Fixed-effects models (Supporting Information Table 5) and adjustment for age and gender (data not shown) yielded the same conclusions. For the analyses presented in Figure 2, we used a dominant coding for *SNCA* SNPs to show that there was no interaction using alternative codings of *SNCA* SNPs. In addition, RERI and AP were not different from 0, and SI was not different from 1 in all instances, thus showing that there was no interaction on an additive scale. There was no evidence of interaction using a recessive coding for *SNCA*

SNPs<sup>17</sup> (data not shown). No multiplicative interactions were observed between *MAPT* rs242557 and *SNCA* SNPs (Supporting Information Table 6); there was no evidence of additive interaction either (not shown). Finally, we defined *SNCA* haplotypes and tested their interaction with rs1052553 or rs242557; no interactions were detected on either multiplicative or additive scales (not shown). Analyses restricted to sporadic cases yielded the same conclusions (data not shown).

Supporting Information Table 7 shows the association between *MAPT* rs1052553 and *SNCA* SNPs stratified by disease status. There was no association between either rs1052553 or rs242557 (not shown) and any *SNCA* SNP among controls or cases.



**TABLE 3: Individual and Joint Effects of rs1052553 (*MAPT*) and Each of the SNPs in the *SNCA* Gene for Parkinson Disease and Corresponding Tests of Multiplicative Interaction (Random-Effects Models): Case-Control Analysis**

<i>SNCA</i>	<i>MAPT</i>			Tests of Interaction				
	SNP	rs1052553	OR (95% CI) <sup>a</sup>	<i>p</i> <sup>a</sup>	OR (95% CI) <sup>a,b</sup>	<i>p</i> <sup>a,b</sup>	OR (95% CI) <sup>a,c</sup>	<i>p</i> <sup>a,c</sup>
rs181489 (5,043 cases, 3,910 controls)								
CC	GG or GA	1.00 (reference)	—					
CT	GG or GA	1.15 (0.81–1.63)	0.43					
TT	GG or GA	1.75 (1.15–2.64)	0.0082					
CC	AA	1.21 (0.91–1.62)	0.19					
CT	AA	1.45 (1.07–1.96)	0.0164	1.04 (0.78–1.38)	0.81			
TT	AA	1.93 (1.35–2.75)	0.0003	0.96 (0.61–1.52)	0.88	0.99 (0.78–1.25)	0.92	
rs356219 (5,131 cases, 3,995 controls)								
AA	GG or GA	1.00 (reference)	—					
AG	GG or GA	1.20 (0.97–1.49)	0.0994					
GG	GG or GA	1.71 (1.18–2.48)	0.0049					
AA	AA	1.27 (1.05–1.54)	0.0152					
AG	AA	1.50 (1.23–1.84)	7.5E-05	1.00 (0.72–1.40)	0.98			
GG	AA	1.92 (1.54–2.39)	4.8E-09	0.87 (0.56–1.34)	0.53	0.95 (0.77–1.17)	0.60	
rs11931074 (5,159 cases, 4,032 controls)								
GG	GG or GA	1.00 (reference)	—					
GT	GG or GA	1.43 (1.11–1.84)	0.0053					
TT	GG or GA	1.45 (0.47–4.44)	0.52					
GG	AA	1.26 (1.14–1.39)	3.4E-06					
GT	AA	1.67 (1.43–1.96)	2.3E-10	0.94 (0.73–1.22)	0.65			
TT	AA	1.79 (0.72–4.48)	0.21	1.06 (0.26–4.43)	0.93	0.95 (0.75–1.20)	0.65	
rs2583988 (5,161 cases, 4,015 controls)								
CC	GG or GA	1.00 (reference)	—					
CT	GG or GA	1.24 (0.95–1.62)	0.11					
TT	GG or GA	1.79 (1.19–2.70)	0.0052					
CC	AA	1.23 (1.03–1.46)	0.0201					
CT	AA	1.54 (1.26–1.88)	2.1E-05	1.01 (0.70–1.46)	0.96			
TT	AA	1.66 (1.25–2.19)	0.0004	0.75 (0.44–1.29)	0.30	0.92 (0.71–1.20)	0.54	

<sup>a</sup>ORs (95% CI) and the corresponding *p* values were computed using random-effects logistic regression.

<sup>b</sup>The ORs for the interaction terms compare the effect of heterozygotes and homozygotes for the minor allele of the *SNCA* SNPs in carriers of the AA genotype of *MAPT* rs1052553 and in noncarriers.

<sup>c</sup>Interaction test under an additive coding of the *SNCA* SNPs. The ORs compare the OR for an increase in 1 minor allele of *SNCA* SNPs in carriers of the AA genotype for rs1052553 and in noncarriers.

SNP = single nucleotide polymorphism; OR = odds ratio; CI = confidence interval.

We performed additional analyses restricted to cases to investigate whether *SNCA* and *MAPT* SNPs influenced AAO. Table 4 shows the marginal association

between each SNP and AAO. There was no significant association between any SNP and AAO at the Bonferroni-corrected significance level. Table 5 shows individual

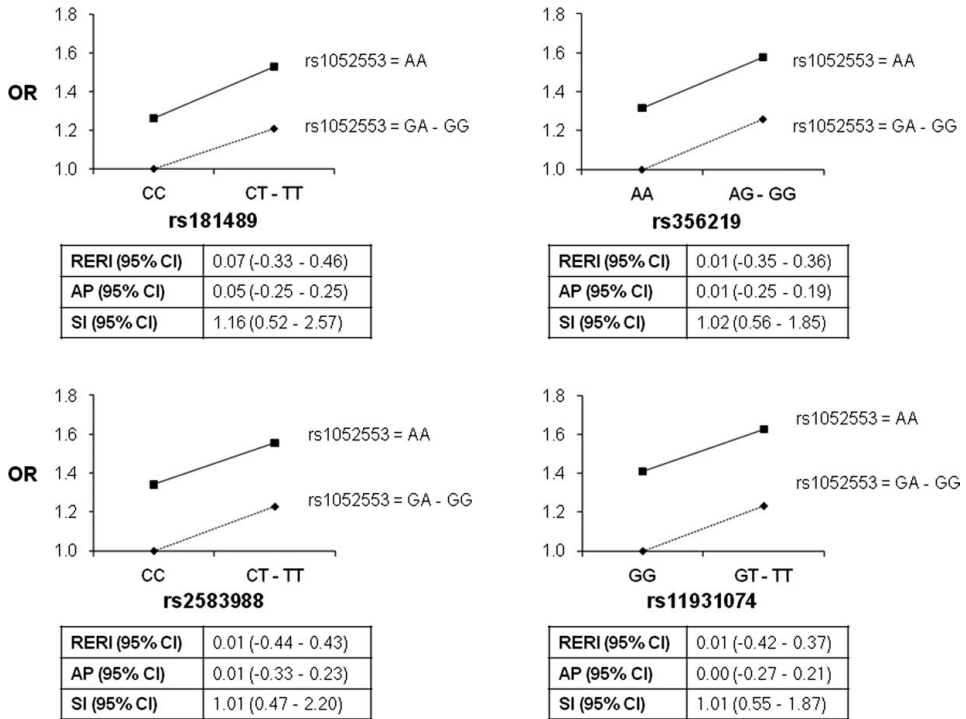

FIGURE 2: Individual and joint effects of *MAPT* rs1052553 and each of the *SNCA* single nucleotide polymorphisms (SNPs; dominant model) estimated using random-effects logistic regression. Solid lines correspond to ORs for *SNCA* SNPs in carriers of *MAPT* rs1052553 AA, whereas dotted lines correspond to ORs in noncarriers. Tests of interaction on the additive scale are shown. Tests of multiplicative interaction were as follows: rs181489,  $p = 0.93$ ; rs356219,  $p = 0.75$ ; rs2583988,  $p = 0.80$ ; rs11931074,  $p = 0.72$ . RERI = relative excess risk due to interaction; CI = confidence interval; AP = attributable proportion due to interaction; SI = synergy index.

and joint effects of *SNCA* SNPs and rs1052553 on AAO; there was no evidence of departure from additivity in linear regression models. No interaction between *SNCA* SNPs and rs242557 was seen for AAO (not shown).

**Discussion**

*SNCA* and *MAPT* have been confirmed by recent GWASs as two of the main contributors to genetic susceptibility in PD among Caucasians.<sup>11–14</sup>  $\alpha$ -Synuclein is one of the main protein components of Lewy bodies, and it has been reported that common mechanisms promote the aggregation of  $\alpha$ -synuclein and tau,<sup>1</sup> supporting findings of concurrent  $\alpha$ -synuclein and tau brain pathology in autosomal dominant parkinsonism.<sup>2,3</sup> These observations raise the possibility of an interaction between *SNCA* and *MAPT*.

In this large case-control study, we confirmed the association between PD and 4 SNPs distributed across the *SNCA* gene as well as with the H1 *MAPT* haplotype.

All *SNCA* SNPs and the *MAPT* H1-defining variant (rs1052553) affected PD susceptibility. Neither *SNCA* nor *MAPT* SNPs influenced AAO among cases. The large sample size allowed us to address the important question of whether there is a *SNCA*-by-*MAPT* interaction. We did not find any evidence in favor of interaction for susceptibility to PD or AAO.

Previously, Mamah et al<sup>16</sup> genotyped 557 case-control pairs for the REP1 polymorphism in the *SNCA* promoter and *MAPT* H1 haplotype, and found a marginal association between PD and both the 261/261 REP1 genotype and the H1/H1 *MAPT* haplotype. They investigated individual and joint effects by implementing several genetic models, without formally testing for statistical interaction, and concluded that the most likely model was one that forced the regression parameters to be equal for individual gene effects and their combination. According to this model, the combined effect of the genes is smaller than expected under a multiplicative model. A subsequent study of the relation between REP1

**TABLE 4: Age at Onset of Parkinson Disease among Cases: Marginal Association with Each of the SNPs in the SNCA and MAPT Genes (Random-Effects Models)**

SNP	Genotype	Beta <sup>a</sup>	SE <sup>a</sup>	p <sup>a</sup>	AIC <sup>b</sup>	Heterogeneity, p
<i>SNCA</i>						
rs181489 (4,357 cases)	CC	0.0 (reference)	—	—	—	—
	CT	-0.472	0.489	0.34	—	0.0468
	TT	-1.039	0.509	0.0414	33,319	0.86
	Additive (T vs C) <sup>c</sup>	-0.439	0.274	0.11	33,317	0.35
	Dominant (CT+TT vs CC)	-0.588	0.453	0.19	33,316 <sup>b</sup>	0.0754
	Recessive (TT vs CC+CT)	-0.679	0.491	0.17	33,317	0.94
rs356219 (4,420 cases)	AA	0.0 (reference)	—	—	—	—
	AG	-0.165	0.372	0.66	—	0.36
	GG	-0.553	0.531	0.30	33,833	0.53
	Additive (G vs A) <sup>c</sup>	-0.252	0.264	0.34	33,784	0.37
	Dominant (AG+GG vs AA)	-0.343	0.411	0.40	33,783 <sup>b</sup>	0.26
	Recessive (GG vs AA+AG)	-0.343	0.420	0.41	33,783 <sup>b</sup>	0.92
rs11931074 (4,439 cases)	GG	0.0 (reference)	—	—	—	—
	GT	-0.432	0.412	0.29	—	0.99
	TT	0.573	2.356	0.81	33,981	0.43
	Additive (T vs G) <sup>c</sup>	-0.167	0.401	0.68	33,929	0.99
	Dominant (GT+TT vs GG)	-0.258	0.429	0.55	33,928	0.99
	Recessive (TT vs GG+GT)	1.246	2.067	0.55	33,925 <sup>b</sup>	0.42
rs2583988 (4,445 cases)	CC	0.0 (reference)	—	—	—	—
	CT	-0.314	0.435	0.47	—	0.21
	TT	0.174	0.565	0.76	34,035	0.80
	Additive (T vs C) <sup>c</sup>	-0.068	0.251	0.79	33,975	0.70
	Dominant (CT+TT vs CC)	-0.223	0.375	0.55	33,974	0.37
	Recessive (TT vs CC+CT)	0.323	0.547	0.55	33,973 <sup>b</sup>	0.70
<i>MAPT</i>						
rs1052553 (4,478 cases)	GG	0.0 (reference)	—	—	—	—
	GA	0.347	0.977	0.72	—	0.79
	AA	1.015	1.013	0.32	34,280	0.55
	Additive (A vs G) <sup>c</sup>	0.634	0.313	0.0427	34,225	0.35
	Dominant (GA+AA vs GG)	0.721	0.958	0.45	34,226	0.61
	Recessive (AA vs GG+GA)	0.765	0.350	0.0287	34,224 <sup>b</sup>	0.53
rs242557 (4,447 cases)	AA	0.0 (reference)	—	—	—	—
	AG	-1.154	0.503	0.0218	—	0.57
	GG	-1.395	0.683	0.0410	34,047	0.0586
	Additive (G vs A) <sup>c</sup>	-0.593	0.345	0.0861	33,983	0.0357
	Dominant (AG+GG vs AA)	-1.213	0.526	0.0211	33,982 <sup>b</sup>	0.25
	Recessive (GG vs AA+AG)	-0.519	0.478	0.28	33,986	0.0376

<sup>a</sup>Linear regression coefficients (beta) and SEs were computed using random-effects linear regression.

<sup>b</sup>The lowest value of the AIC indicates a better fit.

<sup>c</sup>The regression coefficient is computed for an increase of 1 minor allele.

SNP = single nucleotide polymorphism; SE = standard error; AIC = Akaike information criterion.

**TABLE 5: Age at Onset of Parkinson Disease among Cases: Individual and Joint Effects of rs1052553 (MAPT Gene) and Each of the SNPs in the SNCA Gene and Corresponding Tests of Interaction (Random-Effects Models)**

SNCA SNP	MAPT rs1052553	Beta <sup>a</sup>	SE <sup>a</sup>	p <sup>a</sup>	Tests of Interaction					
					Beta <sup>a,b</sup>	SE <sup>a,b</sup>	p <sup>a,b</sup>	Beta <sup>a,c</sup>	SE <sup>a,c</sup>	p <sup>a,c</sup>
rs181489 (4,357 cases)										
CC	GG or GA	0.0 (reference)	—	—						
CT	GG or GA	-0.591	1.427	0.68						
TT	GG or GA	-0.078	1.511	0.96						
CC	AA	0.986	1.229	0.42						
CT	AA	0.539	1.197	0.65	0.261	1.096	0.81			
TT	AA	-0.390	1.219	0.75	-1.268	1.370	0.35	-0.352	0.655	0.59
rs356219 (4,420 cases)										
AA	GG or GA	0.0 (reference)	—	—						
AG	GG or GA	-0.088	1.271	0.94						
GG	GG or GA	0.852	1.367	0.53						
AA	AA	1.567	1.261	0.21						
AG	AA	1.071	1.210	0.38	-0.312	1.309	0.81			
GG	AA	0.290	1.256	0.82	-2.020	1.473	0.17	-0.879	0.724	0.22
rs11931074 (4,439 cases)										
GG	GG or GA	0.0 (reference)	—	—						
GT	GG or GA	0.256	2.334	0.91						
TT	GG or GA	2.621	4.158	0.53						
GG	AA	1.016	2.197	0.64						
GT	AA	0.517	2.230	0.82	-0.823	2.402	0.73			
TT	AA	2.251	3.341	0.51	-1.118	5.002	0.82	-1.233	0.967	0.20
rs2583988 (4,445 cases)										
CC	GG or GA	0.0 (reference)	—	—						
CT	GG or GA	-0.104	1.331	0.94						
TT	GG or GA	2.016	1.521	0.19						
CC	AA	1.218	1.159	0.29						
CT	AA	0.736	1.201	0.54	-0.312	1.357	0.82			
TT	AA	0.585	1.222	0.63	-2.466	1.576	0.12	-0.933	0.711	0.19

<sup>a</sup>The relation between the SNPs and age at Parkinson disease onset was studied using random-effects linear regression models. We present the linear regression coefficients (beta) and their SEs with the corresponding *p* values.

<sup>b</sup>The regression coefficients for the interaction terms compare the effect of heterozygotes and homozygotes for the minor allele of the SNCA SNPs in carriers of the AA genotype of MAPT rs1052553 and in noncarriers.

<sup>c</sup>Interaction test using an additive coding of the SNCA SNPs. The regression coefficients compare the change in age at onset associated with an increase in 1 minor allele of SNCA SNPs in carriers of the AA genotype for rs1052553 and in noncarriers. SNP = single nucleotide polymorphism; SE = standard error.

and PD found that it was not the 261 allele, but the less-frequent 263 allele that was associated with PD.<sup>4</sup> Goris et al<sup>17</sup> genotyped 659 PD cases and 2,176 controls for the H1 MAPT haplotype and one 3' SNCA SNP

(rs356219). They found a marginal association between PD and both H1/H1 MAPT and GG rs356219. In addition, there was evidence of a multiplicative interaction (*p* = 0.03); the combined OR for H1/H1 MAPT and

GG rs356219 (OR, 2.14) was greater than expected under a multiplicative model given their individual ORs (H1/H1*MAPT*: OR, 1.23; GG rs356219: OR, 1.00). As a part of another study that looked at several gene–gene and gene–environment interactions (932 cases, 664 controls), McCulloch et al<sup>18</sup> did not find evidence of an interaction between the H1 *MAPT* haplotype and REP1. Finally, a GWAS did not detect an epistatic interaction between *SNCA* and *MAPT*, but without further information about the interaction models that were tested.<sup>11</sup>

Interestingly, for all *SNCA* SNPs except rs11931074, the best-fitting marginal model was an additive model, and PD risk increased with the number of minor alleles. As duplications and triplications of *SNCA* have been identified in families, overdosage has been postulated as a potential mechanism. In addition, additive models are typically the best fitting for GWAS-discovered SNPs.<sup>38</sup> For rs11931074, the best-fitting model was the dominant model, but the difference in AIC from the additive model was minimal, and it was recently associated with PD in two GWASs using an additive coding.<sup>11,12</sup> In agreement with previous studies,<sup>5,6,11</sup> our analysis of the relative effects of *SNCA* SNPs suggests that the causal variant may be located toward the 3' end and could affect post-transcriptional RNA processing or stability, and thus gene/protein expression; however, we cannot exclude that the 5' end may also play a role, and additional genomic capture and sequencing studies are needed to identify the causal variant(s).

Mutations in the *MAPT* gene cause frontotemporal dementia with parkinsonism, and there is consistent evidence that PSP is associated with the *MAPT* H1 haplotype.<sup>23,39</sup> There is increasing evidence from candidate gene studies<sup>10</sup> and GWASs<sup>11–14</sup> that the H1 *MAPT* haplotype is also associated with PD among Caucasians. In agreement with these studies, we found a strong association with rs1052553. The rs242557 A-allele defines the H1c PSP-associated haplotype, and a recent study reported that PD may be associated with the opposite G-rs242557 allele,<sup>40</sup> but in our study, the association between PD and rs242557 was not significant after correction for multiple testing and is likely to be accounted for by its LD with rs1052553, as demonstrated by analyses in which both SNPs were included in the same model.

One of the main strengths of our study is its large sample size that conferred sufficient power to detect even small interactions. Smaller studies suffer from insufficient numbers of subjects jointly exposed to the two variables investigated, which leads to reduced power and unstable interaction estimates with large confidence intervals. Additional strengths involve the centralized genotyping in a single laboratory, the consideration of several SNPs in the *SNCA* gene located both at its 5' and 3' ends

(compared to previous studies on *SNCA*-by-*MAPT* interaction that considered single SNPs), and implementation of complementary approaches to test for interaction.

The relevant scale to test for statistical interaction has been a subject of intense debate in the epidemiological community, and there is no consensus about the most appropriate method.<sup>41,42</sup> The multiplicative scale has been most often used for dichotomous outcomes mainly due to an easier implementation using logistic regression. It has been argued, however, that biologic interactions are more likely to lead to departure from additive effects of 2 variables.<sup>25,26,43</sup> As we were concerned that we may have failed to detect an interaction on the additive scale, we investigated additive interactions and found that the pattern of association was not suggestive of an interaction on this scale either. In addition, it has been pointed out that the same word, epistasis, that is, interaction between genes, has been used in the literature to describe different concepts,<sup>44</sup> and Phillips<sup>45</sup> recently described 3 main categories: functional, compositional, and statistical epistasis. The extent to which statistical interaction implies functional or compositional epistasis, and vice versa, is unclear,<sup>44,45</sup> but empirical tests have been proposed as a way to detect compositional epistasis (also termed epistasis in the sense of masking)<sup>46,47</sup>; our RERI estimates were clearly not in agreement with this type of mechanism either.

Weaknesses of our study include lack of standardized inclusion/exclusion criteria for cases or controls, different diagnostic criteria across studies, and lack of a standard definition of AAO; however, random-effects models, which take into account heterogeneity between studies, yielded the same results as fixed-effects models, and analyses stratified by diagnostic criteria showed no differences across strata.

In conclusion, this study confirms the association between PD and both *SNCA* SNPs and the H1 *MAPT* haplotype, with similar size effects as previous studies, and it shows, based on a variety of approaches, that the association between PD and *SNCA* is not modified by *MAPT*, and vice versa. Thus, the joint action of variants in these 2 loci is consistent with independent effects. Although these findings do not support a strong gene–gene interaction between *MAPT* and *SNCA* at the level of epidemiological risk, they do not rule out functional interactions at the protein level, and further in vitro and in vivo studies will be necessary to address this question.

## Acknowledgment

The authors acknowledge the following GEO-PD (Genetic Epidemiology of Parkinson's Disease) collaborators and funding sources. France: Philippe Amouyel (INSERM, U744, Lille, France); Christophe Tzourio (INSERM,

U708, Paris, France); Claire Mulot (INSERM, U775; CRB Epigenetec, Paris, France). Funding: National Research Agency (ANR; Environment and Health SEST 2005; Neurological Diseases MNP 2009) (A.E., M.-A.L.), French Agency for Environmental and Occupational Health Safety (Afsset) (A.E., M.-A.L.), France Parkinson (A.E.). USA: Justin A. Bacon and Stephanie A. Cobb (Mayo Clinic, Jacksonville). Funding: Michael J. Fox Foundation (O.A.R., M.J.F.); American Parkinson's Disease Association Research Grant (O.A.R.); Mayo Clinic Jacksonville is a Morris K. Udall Parkinson's Disease Research Center of Excellence (National Institute of Neurological Disorders and Stroke [NINDS] P50 #NS40256); National Institutes of Health (NIH) grant 2R01ES10751 (D.M.M.). Greece/USA: Funding: Scientific support for this project to J.P.A.I. was provided through the Tufts Clinical and Translational Science Institute (Tufts CTSI) under funding from the NIH/National Center for Research Resources (UL1 RR025752; principal investigator: Harry Selker). Points of view or opinions in this paper are those of the authors and do not necessarily represent the official position or policies of Tufts CTSI. Australia (site A): Greg T. Sutherland, Gerhard A. Siebert, Nadeeka Dissanayaka, John D. O'Sullivan, Richard S. Boyle. Funding: National Health and Medical Research Council (Australia) Project Grant #401537; Geriatric Medical Foundation of Queensland; Princess Alexandra Hospital; Royal Brisbane and Women's Hospital Foundations. France (site B): Florence Pasquier and Régis Bordet (Steering Committee of the Paradigm Study); Jean-Philippe Legendre (CHRU-Lille). Funding: Foundation for Medical Research (FRM; Convergence 2006/413) (M.-C.C.-H., A.D.), PHRC (Parkfanord 005/1913, Paradigme 2002/1918) (M.-C.C.-H., A.D.), University of Lille 2 (Synucleothèque) (M.-C.C.-H., A.D.), INSERM-French Research Ministry for support for the biological resources centers (CHRU Lille and Institut Pasteur de Lille) (M.-C.C.-H., A.D.). Germany (site C): Georg Auburger; Rüdiger Hilker; Nadine Abahuni (Goethe University Frankfurt); Christof Geisen (Blood Bank Frankfurt). Funding: BMBF NGFNplus 01GS08138. Germany (site D): Susen Winkler. Funding: Volkswagen Foundation and Hermann and Lilly Schilling Foundation. Germany (site E): Thomas Gasser, Olaf Riess, Daniela Berg, Claudia Schulte. Funding: Work was supported by grants from the German Research Council [DFG, KR2119/3-2] to R.K.; Federal Ministry for Education and Research (BMBF, NGFNplus; 01GS08134) to R.K., T. Gasser, O. Riess; and Michael J. Fox Foundation to M.S., R.K., T. Gasser. Greece (site F): Demetris Vassiliadis, Eleftherios Stamboulis. Funding: Hellenic Secretariat of Research and Tech-

nology (ΠηννηΔ 2003) (L.S.). Greece (site G): Efthimios Dardiotis (Department of Neurology, Faculty of Medicine, University of Thessaly, Larissa, Greece), Ioanna Patrmani (Department of Neurology, Faculty of Medicine, University of Thessaly, Larissa, Greece), Persa-Maria Kounta (Department of Neurology, Laboratory of Neurogenetics, Faculty of Medicine, University of Thessaly, Larissa, Greece), Christina Vogiatzi (Department of Neurology, Faculty of Medicine, University of Thessaly, Larissa, Greece), Katerina Markou (Department of Neurology, Faculty of Medicine, University of Thessaly, Larissa, Greece). Funding: University of Thessaly, Research Committee (code: 2845); Institute of Biomedical Research and Technology, CERETETH (code: 01-04-207). Italy (site I): Patrizia Tarantino, Ferdinanda Annesi (Institute of Neurological Sciences, National Research Council, Cosenza, Italy). Italy (site J): Anna Rita Bentivoglio, Arianna Guidubaldi, Matilde Caccialupi, Francesca De Nigris (Institute of Neurology, Catholic University, Rome, Italy). Funding: Italian Ministry of Health (Ricerca Corrente 2010; Ricerca Finalizzata 2006; Progetto Giovani Ricercatori 2008). Italy (site K): Chiara Riva (Department of Neuroscience and Biomedical Technologies, University of Milano-Bicocca, Monza, Italy). Funding: FIRB 2003 GENOPOLIS Project, grant number RBLA038RMA\_003. Norway (site L): Funding: Research Council of Norway, project 10314000 (J.A.). Sweden (site N): Nancy L. Pedersen. Funding: NIH (ES10758), Swedish Research Council, Swedish Society for Medical Research, Swedish Society of Medicine, Karolinska Institutet, and Parkinson Foundation in Sweden. Sweden (site P): Karin Nilsson (Department of Clinical Science, Section of Geriatric Psychiatry, Lund University, Lund, Sweden); Jan Reimer (Department of Neurology, Skåne University Hospital, Lund, Sweden; Region Skåne Competence Center, Skåne University Hospital, Malmö, Sweden). Funding: Swedish Parkinson Academy (C.N., A.P.), AFA Insurance Research Grant (C.N., A.P.), Elsa Schmitz Foundation (A.P.), Apotekare Hedberg's Foundation for Medical Research (A.P.), Swedish Parkinson Fund (C.N.), Royal Physiographic Society in Lund, Lund University Hospital Research Fund (C.N.). USA (site O): Jay Van Gerpen, Jennifer Lash, Jill Searcy, Audrey Strongosky. Funding: Mayo Clinic Jacksonville, Morris K. Udall Parkinson's Disease Research Center of Excellence, NIH/NINDS P50 #NS40256, NIH/NINDS R01 NS057567 (R.J.U., Z.K.W.), NIH/NINDS RC2 NS070276-01, Mayo Clinic Florida Research Committee CR programs, and gift from Carl Edward Bolch, Jr. and Susan Bass Bolch.

## Authorship

A.E. and O.A.R. contributed equally to this work.

## Potential Conflicts of Interest

B.J.-M.: grants/grants pending, Robert and Clarice Smith Fellowship Program, Pacific Alzheimer Research Foundation grant C06-01. K.L.: grants/grants pending, German Research Foundation (LO 1555/3-1). A.P.: travel expenses, Kungliga Fysiografiska Sällskapet i Lund; employment, Lund University Hospital.

## References

- Giasson BI, Forman MS, Higuchi M, et al. Initiation and synergistic fibrillization of tau and alpha-synuclein. *Science* 2003;300:636–640.
- Wszolek ZK, Pfeiffer RF, Tsuboi Y, et al. Autosomal dominant parkinsonism associated with variable synuclein and tau pathology. *Neurology* 2004;62:1619–1622.
- Duda JE, Giasson BI, Mabon ME, et al. Concurrence of alpha-synuclein and tau brain pathology in the Contursi kindred. *Acta Neuropathol* 2002;104:7–11.
- Maraganore DM, De Andrade M, Elbaz A, et al. Collaborative analysis of the alpha-synuclein gene promoter variability and Parkinson's disease. *JAMA* 2006;296:661–670.
- Winkler S, Hagenah J, Lincoln S, et al. Alpha-synuclein and Parkinson disease susceptibility. *Neurology* 2007;69:1745–1750.
- Mueller JC, Fuchs J, Hofer A, et al. Multiple regions of alpha-synuclein are associated with Parkinson's disease. *Ann Neurol* 2005;57:535–541.
- Farrer M, Skipper L, Berg M, et al. The Tau H1 haplotype is associated with Parkinson's disease in the Norwegian population. *Neurosci Lett* 2002;322:83–86.
- Levecque C, Elbaz A, Clavel J, et al. Association of polymorphisms in the Tau and Saitohin genes with Parkinson's disease. *J Neurol Neurosurg Psychiatry* 2004;75:478–480.
- Healy DG, Abou-Sleiman PM, Lees AJ, et al. Tau gene and Parkinson's disease: a case-control study and meta-analysis. *J Neurol Neurosurg Psychiatry* 2004;75:962–965.
- Wider C, Vilarino-Guell C, Jasinska-Myga B, et al. Association of the MAPT locus with Parkinson's disease. *Eur J Neurol* 2010;17:483–486.
- Simon-Sanchez J, Schulte C, Bras JM, et al. Genome-wide association study reveals genetic risk underlying Parkinson's disease. *Nat Genet* 2009;41:1308–1312.
- Satake W, Nakabayashi Y, Mizuta I, et al. Genome-wide association study identifies common variants at four loci as genetic risk factors for Parkinson's disease. *Nat Genet* 2009;41:1303–1307.
- Pankratz N, Wilk JB, Latourelle JC, et al. Genomewide association study for susceptibility genes contributing to familial Parkinson disease. *Hum Genet* 2009;124:593–605.
- Edwards TL, Scott WK, Almonte C, et al. Genome-wide association study confirms SNPs in SNCA and the MAPT region as common risk factors for Parkinson disease. *Ann Hum Genet* 2010;74:97–109.
- Ross OA, Braithwaite AT, Skipper LM, et al. Genomic investigation of alpha-synuclein multiplication and parkinsonism. *Ann Neurol* 2008;63:743–750.
- Mamah CE, Lesnick TG, Lincoln SJ, et al. Interaction of alpha-synuclein and tau genotypes in Parkinson's disease. *Ann Neurol* 2005;57:439–443.
- Goris A, Williams-Gray CH, Clark GR, et al. Tau and alpha-synuclein in susceptibility to, and dementia in, Parkinson's disease. *Ann Neurol* 2007;62:145–153.
- McCulloch CC, Kay DM, Factor SA, et al. Exploring gene-environment interactions in Parkinson's disease. *Hum Genet* 2008;123:257–265.
- Smith PG, Day NE. The design of case-control studies: the influence of confounding and interaction effects. *Int J Epidemiol* 1984;13:356–365.
- Gauderman WJ. Sample size requirements for association studies of gene-gene interaction. *Am J Epidemiol* 2002;155:478–484.
- Ross OA, Gosal D, Stone JT, et al. Familial genes in sporadic disease: common variants of alpha-synuclein gene associate with Parkinson's disease. *Mech Ageing Dev* 2007;128:378–382.
- Scholz SW, Houlden H, Schulte C, et al. SNCA variants are associated with increased risk for multiple system atrophy. *Ann Neurol* 2009;65:610–614.
- Rademakers R, Melquist S, Cruts M, et al. High-density SNP haplotyping suggests altered regulation of tau gene expression in progressive supranuclear palsy. *Hum Mol Genet* 2005;14:3281–3292.
- Guo SW, Thompson EA. Performing the exact test of Hardy-Weinberg proportion for multiple alleles. *Biometrics* 1992;48:361–372.
- Knol MJ, Egger M, Scott P, et al. When one depends on the other: reporting of interaction in case-control and cohort studies. *Epidemiology* 2009;20:161–166.
- Rothman KJ, Greenland S, Lash TL. *Modern epidemiology*. Philadelphia, PA: Lippincott, Williams & Wilkins, 2008.
- Zou GY. On the estimation of additive interaction by use of the four-by-two table and beyond. *Am J Epidemiol* 2008;168:212–224.
- Chalmers I, Hedges LV, Cooper H. A brief history of research synthesis. *Eval Health Prof* 2002;25:12–37.
- Higgins JPT, Thompson SG. Quantifying heterogeneity in a meta-analysis. *Stat Med* 2002;21:1539–1558.
- Trikalinos TA, Salanti G, Zintzaras E, et al. Meta-analysis methods. *Adv Genet* 2008;60:311–334.
- Turner RM, Omar RZ, Yang M, et al. A multilevel model framework for meta-analysis of clinical trials with binary outcomes. *Stat Med* 2000;19:3417–3432.
- Whitehead A, Omar RZ, Higgins JP, et al. Meta-analysis of ordinal outcomes using individual patient data. *Stat Med* 2001;20:2243–2260.
- Higgins JP, Whitehead A, Turner RM, et al. Meta-analysis of continuous outcome data from individual patients. *Stat Med* 2001;20:2219–2241.
- Bagos PG, Nikolopoulos GK. A method for meta-analysis of case-control genetic association studies using logistic regression. *Stat Appl Genet Mol Biol* 2007;6:Article17.
- Khoury MJ, Flanders WD. Nontraditional epidemiologic approaches in the analysis of gene-environment interaction: case-control studies with no controls! *Am J Epidemiol* 1996;144:207–213.
- Tregouet DA, Garelle V. A new JAVA interface implementation of THESIAS: testing haplotype effects in association studies. *Bioinformatics* 2007;23:1038–1039.
- Cordell HJ, Clayton DG. A unified stepwise regression procedure for evaluating the relative effects of polymorphisms within a gene using case/control or family data: application to HLA in type 1 diabetes. *Am J Hum Genet* 2002;70:124–141.
- Salanti G, Southam L, Altschuler D, et al. Underlying genetic models of inheritance in established type 2 diabetes associations. *Am J Epidemiol* 2009;170:537–545.
- Baker M, Litvan I, Houlden H, et al. Association of an extended haplotype in the tau gene with progressive supranuclear palsy. *Hum Mol Genet* 1999;8:711–715.

40. Ezquerra M, Pastor P, Gaig C, et al. Different MAPT haplotypes are associated with Parkinson's disease and progressive supranuclear palsy. *Neurobiol Aging* doi:10.1016/j.neurobiolaging.2009.09.011
41. Rothman KJ. Synergy and antagonism in cause-effect relationships. *Am J Epidemiol* 1974;99:385–388.
42. Rothman KJ, Greenland S, Walker AM. Concepts of interaction. *Am J Epidemiol* 1980;112:467–470.
43. Vanderweele TJ. Sufficient cause interactions and statistical interactions. *Epidemiology* 2009;20:6–13.
44. Cordell HJ. Detecting gene-gene interactions that underlie human diseases. *Nat Rev Genet* 2009;10:392–404.
45. Phillips PC. Epistasis—the essential role of gene interactions in the structure and evolution of genetic systems. *Nat Rev Genet* 2008;9:855–867.
46. Vanderweele TJ. Empirical tests for compositional epistasis. *Nat Rev Genet* 2010;11:166.
47. Vanderweele TJ. Epistatic interactions. *Stat Appl Genet Mol Biol* 2010;9:1–22.



