



LUND UNIVERSITY

THE ROLE OF PHOSPHODIESTERASE 3B IN CAMP-MEDIATED REGULATION OF INSULIN SECRETION

Jones, Helena

2007

[Link to publication](#)

Citation for published version (APA):

Jones, H. (2007). *THE ROLE OF PHOSPHODIESTERASE 3B IN CAMP-MEDIATED REGULATION OF INSULIN SECRETION*. Medical Faculty, Lund University.

Total number of authors:

1

General rights

Unless other specific re-use rights are stated the following general rights apply:

Copyright and moral rights for the publications made accessible in the public portal are retained by the authors and/or other copyright owners and it is a condition of accessing publications that users recognise and abide by the legal requirements associated with these rights.

- Users may download and print one copy of any publication from the public portal for the purpose of private study or research.
- You may not further distribute the material or use it for any profit-making activity or commercial gain
- You may freely distribute the URL identifying the publication in the public portal

Read more about Creative commons licenses: <https://creativecommons.org/licenses/>

Take down policy

If you believe that this document breaches copyright please contact us providing details, and we will remove access to the work immediately and investigate your claim.

LUND UNIVERSITY

PO Box 117
221 00 Lund
+46 46-222 00 00

**THE ROLE OF PHOSPHODIESTERASE 3B
IN cAMP-MEDIATED REGULATION
OF INSULIN SECRETION**

Helena A. Walz

Department of Experimental Medical Science
Lund University



LUND UNIVERSITY
Faculty of Medicine

Akademisk avhandling som med vederbörligt tillstånd av Medicinska fakulteten vid Lunds Universitet kommer att offentligen försvaras i Lundmarksalen, Astronomi Centrum, Sölvegatan 27, Lund, fredagen den 19 oktober, 2007, kl 09⁰⁰

Fakultetsopponent:
Docent Anders Tengholm
Institutionen för Medicinsk Cellbiologi
Uppsala Universitet
Uppsala
2007

Organization LUND UNIVERSITY Medical Faculty Department of Experimental Medical Science Division for Diabetes, Metabolism and Endocrinology	Document name DOCTORAL DISSERTATION	
	Date of issue 19th of October 2007	
	Sponsoring organization	
Author(s) Helena A. Walz		
Title and subtitle The Role of Phosphodiesterase 3B in cAMP-Mediated Insulin Secretion		
Abstract Type 2 diabetes mellitus (T2DM) is characterized by various combinations of β -cell failure and insulin resistance leading to hyperglycemia and glucose intolerance. In order to maintain glucose tolerance in the insulin resistance state, increased insulin secretion is a requirement and it is because of inadequate islet adaptation that glucose intolerance develops in T2DM. The pathophysiology of T2DM is not fully understood and more knowledge is needed concerning both insulin action and β -cell physiology and adaptation. The general aim of this thesis was to investigate the role of β -cell cAMP-degrading phosphodiesterase 3B (PDE3B) in the regulation of insulin secretion and whole body energy homeostasis. The specific aims were (i) to study the physiological importance of well-regulated β -cell-cAMP levels for insulin release and whole body energy homeostasis during a long-term metabolic challenge, (ii) to evaluate the role of PDE3B in biphasic insulin secretion and its intracellular localization, and (iii) to investigate the mechanisms for regulation of PDE3B activity in β -cells. It was previously shown that PDE3B attenuates glucose-stimulated insulin secretion and glucagon-like peptide-1 (GLP-1) potentiated-insulin secretion. It is shown here that accurate regulation of β -cell cAMP is necessary for adequate islet adaptation to a perturbed metabolic environment and protective for the development of glucose intolerance and insulin resistance. This finding is coupled to the novel discovery that PDE3B, shown to localize to the exocytotic machinery, functions as a specific attenuator of cAMP-mediated potentiation of depolarization-induced insulin secretion. Further, we have begun to elucidate the details concerning the regulation of PDE3B activity in β -cells. Data are presented suggesting that PDE3B activity in β -cells is intricately regulated by phosphorylation and dephosphorylation, probably by the action of several differentially regulated kinases and phosphatases. In conclusion, this thesis contributes to the knowledge regarding the importance and function of cAMP-mediated regulation of stimulus-secretion coupling in pancreatic β -cells and demonstrates that dysfunction of cAMP-PDE3B signalling results in a substantially increased sensitivity to the adverse effects of a high-fat diet.		
Key words: PDE3B, cAMP, exocytosis, insulin		
Classification system and/or index termes (if any):		
Supplementary bibliographical information:	Language English	
ISSN and key title: 1652-8220	ISBN 978-91-85897-11-7	
Recipient's notes	Number of pages 115	Price
	Security classification	

Distribution by (name and address)

I, the undersigned, being the copyright owner of the abstract of the above-mentioned dissertation, hereby grant to all reference sources permission to publish and disseminate the abstract of the above-mentioned dissertation.

Signature

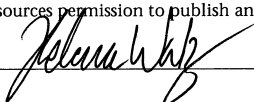

Date

7/9 - 2007

**THE ROLE OF PHOSPHODIESTERASE 3B
IN cAMP-MEDIATED REGULATION
OF INSULIN SECRETION**

Helena A. Walz

Department of Experimental Medical Science
Lund University

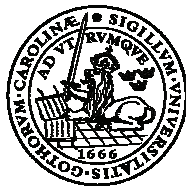

LUND UNIVERSITY
Faculty of Medicine

Sweden

2007

© **Helena A. Walz**
© **2006 Society for Endocrinology**
© **2007 Elsevier Inc.**

Medical Faculty
Department of Experimental Medical Science

Printed in Sweden
Media Tryck AB, Lund 2007
ISBN 978-91-85897-11-7
ISSN 1652-8220



CONTENTS

ABSTRACT	6
LIST OF PAPERS	7
ABBREVIATIONS	8
INTRODUCTION	10
BACKGROUND	11
Regulation of Blood Glucose	11
Type 2 Diabetes	12
Insulin Resistance and Obesity.....	14
Function of β -cells in T2DM.....	15
Endocrine Pancreas & Islets of Langerhans	16
β-cells and Biphasic Insulin Secretion	16
Stimulus-Secretion Coupling	19
cAMP and Compartmentalization	20
cAMP-Regulated Insulin Secretion	21
Cyclic Nucleotide Phosphodiesterases	22
Phosphodiesterase 3.....	23
Role of PDE3B in the Regulation of Metabolism.....	25
Role of PDE3B in Insulin Secretion	26
PRESENT INVESTIGATION	28
Aims	28
Model Systems	29
Transgenic RIP-PDE3B Mice	29
Isolated Islets	31
Insulinoma Cell Lines; INS-1 (832/13) Cells	32
Methods	34
Physiological <i>In Vivo</i> Studies (Paper I).....	34
High Fat Diet Studies.....	34
Intravenous Glucose Tolerance Test	34
Insulin Tolerance Test.....	35
Imaging (Paper I & II)	36
Confocal Microscopy	36
Transmission Electron Microscopy.....	37
Capacitance Recordings (Paper II)	37

RESULTS AND DISCUSSION	39
Main Conclusions.....	46
CONCLUDING REMARKS AND FUTURE PERSPECTIVES	47
POPULÄRVETENSKAPLIG SAMMANFATTNING.....	49
Bakgrund	49
Syfte	50
Resultat	51
Delarbete I.....	51
Delarbete II.....	52
Delarbete III.....	52
Betydelse och tillämpning	52
ACKNOWLEDGEMENTS	54
REFERENCES.....	56

ABSTRACT

Type 2 diabetes mellitus (T2DM) is characterized by various combinations of β -cell failure and insulin resistance leading to hyperglycemia and glucose intolerance. In order to maintain glucose tolerance in the insulin resistance state, increased insulin secretion is a requirement and it is because of inadequate islet adaptation that glucose intolerance develops in T2DM. The pathophysiology of T2DM is not fully understood and more knowledge is needed concerning both insulin action and β -cell physiology and adaptation. The general aim of this thesis was to investigate the role of β -cell cAMP-degrading phosphodiesterase 3B (PDE3B) in the regulation of insulin secretion and whole body energy homeostasis. The specific aims were (i) to study the physiological importance of well-regulated β -cell-cAMP levels for insulin release and whole body energy homeostasis during a long-term metabolic challenge, (ii) to evaluate the role of PDE3B in biphasic insulin secretion and its intracellular localization, and (iii) to investigate the mechanisms for regulation of PDE3B activity in β -cells. It was previously shown that PDE3B attenuates glucose-stimulated insulin secretion and glucagon-like peptide-1 (GLP-1) potentiated-insulin secretion. It is shown here that accurate regulation of β -cell cAMP is necessary for adequate islet adaptation to a perturbed metabolic environment and protective for the development of glucose intolerance and insulin resistance. This finding is coupled to the novel discovery that PDE3B, shown to localize to the exocytotic machinery, functions as a specific attenuator of cAMP-mediated potentiation of depolarization-induced insulin secretion. Further, we have begun to elucidate the details concerning the regulation of PDE3B activity in β -cells. Data are presented suggesting that PDE3B activity in β -cells is intricately regulated by phosphorylation and dephosphorylation, probably by the action of several differentially regulated kinases and phosphatases. In conclusion, this thesis contributes to the knowledge regarding the importance and function of cAMP-mediated regulation of stimulus-secretion coupling in pancreatic β -cells and demonstrates that dysfunction of cAMP-PDE3B signalling results in a substantially increased sensitivity to the adverse effects of a high-fat diet.

LIST OF PAPERS

This thesis is based on the following papers, referred to in the text by their roman numerals:

- I. Walz HA, Härndahl L, Wierup N, Zmuda-Trzebiatowska E, Svannelid F, Manganiello VC, Ploug T, Sundler F, Degerman E, Ahrén B, Stenson Holst L. Early and rapid development of insulin resistance, islet dysfunction and glucose intolerance after high-fat feeding in mice overexpressing phosphodiesterase 3B. *J. Endocrinol.* 2006;189(3):629-641.
- II. Walz HA, Wierup N, Vikman J, Manganiello VC, Degerman E, Eliasson L, Stenson-Holst L. β -cell PDE3B regulates Ca^{2+} -stimulated exocytosis of insulin. *Cell. Signal.* 2007;19(7):1505-1513.
- III. Walz HA, Resjö S, Manganiello VC, Degerman E and Stenson L. Regulation of Phosphodiesterase 3B in β -cells. Manuscript

ABBREVIATIONS

AC	adenylyl cyclase
ADP	adenosine diphosphate
AKAP	A-kinase-anchoring protein
ATP	adenosine triphosphate
AUC	area under the curve
BETA2	β -cell E-box transactivator-2
cAMP	cyclic adenosine monophosphate
CD	control diet
cDNA	complementary deoxyribonucleic acid
cGMP	cyclic guanosine monophosphate
CIC-3	chloride channel-3
CNG	cyclic nucleotide-gated
Da	Dalton
DNA	deoxyribonucleic acid
ELISA	enzyme-linked-immunoadsorbent assay
Epac	exchange protein directly activated by cAMP
ER	endoplasmic reticulum
FA	fatty acid
fF	femto Farad
FFA	free fatty acids
GLP-1	glucagon-like peptide-1
GLUT-2	glucose transporter type 2
GLUT-4	glucose transporter type 4
GPCR	G-protein coupled receptor
GSIS	glucose-stimulated insulin secretion
GTP	guanosine triphosphate
HFD	high-fat diet
HNF-1 α	hepatocyte nuclear factor-1 α
HNF-1 β	hepatocyte nuclear factor-1 β
HNF-4 α	hepatocyte nuclear factor-4 α
IBMX	isobuthylmethylxantine
IGF-1	insulin-like growth factor-1
IGT	impaired glucose tolerance
Il6	interleukin-6
INS	insulinoma
Ip	intraperitoneal
IPF	insulin promoter factor
IR	insulin receptor
ITT	insulin tolerance test
IVGTT	intravenous glucose tolerance test
K _{ATP}	ATP-sensitive K ⁺ -channel
KO	knock out
MODY	maturity onset diabetes mellitus of the young
mRNA	messenger ribonucleic acid
NeuroD	neurogenic differentiation
NIDDM	non-insulin-dependent diabetes mellitus
NPY	neuropeptide Y

PACAP	pituitary adenylyl cyclase-activating polypeptide
PDE	phosphodiesterase
PDX-1	pancreatic-duodenal homeobox-1
PKA	protein kinase A
PKB	protein kinase B
PP	pancreatic polypeptide
PP-2B	calcium/calmodulin protein phosphatase-2B
PPAR γ	peroxisome proliferator-activated receptor- γ
Rab3a	Ras (rat sarcoma)-related in brain 3a
RIA	radioimmunoassay
RIM	Rab3-interacting molecule
RIP2	rat insulin promotor 2
SNAP	soluble NSF (N-ethylmaleimide sensitive factor) attachment protein
SNARE	soluble N-ethylmaleimide-sensitive factor attachment receptor
SUR1	sulfonylurea receptor-1
SV 40	simian virus 40
T1DM	type 1 diabetes mellitus
T2DM	type 2 diabetes mellitus
TEM	transmission electron microscopy
TNF- α	tumor necrosis factor- α
VAMP-2	vesicle-associated membrane protein-2
VDCC	vasoactive intestinal polypeptide
VIP	vasointestinal peptide

INTRODUCTION

The general topic of this thesis concerns the function of pancreatic β -cells and their involvement in the etiology of type 2 diabetes mellitus (T2DM). Today the spread of T2DM can be described as a world wide epidemic. The International Diabetes Federation (IDF) estimates that there are an alarming 246 million people in the world with diabetes in the adult population, 85-95 % of which represents T2DM (1). Translated into prevalence this means that 7.3 % of 20-79 year-olds have diabetes today. With the epidemic nature of this disease it is estimated that by the year 2025 this number will have reached 380 million people (1). It is projected that the basis for the epidemic spread is associated with population ageing, unhealthy diet, a sedentary lifestyle, overweight and obesity. Of patients with diabetes, around 80 % are obese, making obesity the principal risk factor for the development of the disease (2,3). The prevalence of diabetes is higher in developed countries than in developing countries, but urbanization, westernization and economic development in developing countries have already begun to contribute to a substantial rise in diabetes. The human and economic repercussions of this development are distressing. It is estimated by IDF that in the year 2007 diabetes is expected to cause 6 % of the total global mortality. Viewed in an economic perspective, the USA is expected to spend 232 billion dollars to treat and prevent diabetes and its complications in 2007 (1).

Diabetes mellitus is a heterogeneous disease characterized by chronically elevated levels of blood glucose (hyperglycemia). The disease occurs as a result of problems with the production and supply of insulin in the body. There are two principal types of diabetes, type 1 diabetes mellitus (T1DM) and T2DM (4). T1DM is caused by selective auto-immune destruction of insulin-producing pancreatic β -cells, causing loss of insulin production (5). This form of diabetes requires insulin treatment in order to control the levels of glucose in the blood. T2DM is characterized by both impairment of insulin secretion and defective insulin action in target tissues (insulin resistance) leading first to impaired glucose tolerance (IGT) and then eventually to T2DM (5). T2DM has a strong genetic component but is also greatly affected by environmental factors such as obesity, physical inactivity and unhealthy diet (6,7). Common for all categories of diabetes is that improper management of blood glucose, and the consequent hyperglycemia, results in both short and long-term complications affecting the function of the kidneys, eyes, nerves and the cardiovascular system (4). If hyperglycemia is not prevented and left untreated these complications can become fatal. Considering the individual and global human and economic repercussions of diabetes it is of essence to study its etiology in order to

predict, prevent and treat hyperglycemia and its many complications. For this purpose we need to know more about the regulation of energy homeostasis in general and how this regulation is perturbed on a molecular level by genetic variations and environmental factors. The work presented in this thesis contributes to our knowledge of the regulation of energy homeostasis in the perspective of pancreatic β -cells and their function as glucose sensors in health and disease.

BACKGROUND

Regulation of Blood Glucose

Systemic blood glucose is normally maintained within a very narrow range to ensure a constant supply of glucose to the brain and to avoid the detrimental effects of hyperglycemia on the cardiovascular system (8). The level of glucose is coordinated through the regulation of endogenous glucose production, mainly from the liver, and through glucose utilization by peripheral tissues (8,9). The mechanisms of control involve hormones and neurotransmitters. Insulin is the dominant glucose-lowering factor while glucagon and catecholamines, such as adrenalin, and cortisol, are the main glucose-raising or counter-regulatory factors. Since the survival value of preventing hypoglycemia is so large, the counter-regulatory factors are very effective and hypoglycemia is an extremely uncommon clinical situation in healthy individuals.

Insulin suppresses systemic glucose through both direct and indirect effects (10). The direct effects of insulin involve suppression of hepatic glucose production through the inhibition of glycogenolysis and gluconeogenesis. Further, insulin lowers systemic glucose by stimulating glucose utilization by the insulin-sensitive tissues skeletal muscle, adipose tissue and liver (11). The indirect effects of insulin include suppression of glucagon release and suppression of circulating free fatty acids (FFA) (8,11). The glucosuppressive effects of insulin described above are the direct result of increased glucose-induced insulin secretion. However, when insulin levels fall this results in increased glucose production and lowered rates of glucose utilization by other tissues than the brain. In effect, this means that insulin in addition to being the major glucosuppressor also functions as an important counter-regulatory factor when its inhibitory effects subside (8).

During periods of hypoglycemia glucagon is released from pancreatic α -cells (12,13) and raises the systemic glucose levels through stimulation of hepatic glucose production through glycogenolysis and gluconeogenesis (13). The glycemic response initiated by glucagon is very

effective but also transient. This is true for both glycogenolysis and gluconeogenesis. However, in the presence of adrenalin gluconeogenesis can be sustained because adrenalin mobilizes gluconeogenic precursors (glycerol, alanine and lactate)(8). The adrenomedullary hormone adrenalin is, as glucagon, released in response to hypoglycemia. Adrenalin directly increases glucose production, by stimulation of hepatic glycogenolysis and gluconeogenesis, and limits glucose utilization through β -adrenergic stimulation of lipolysis in adipose tissue and through actions on α -adrenergic receptors resulting in constriction of blood flow to non-vital organs (8).

In the event of falling systemic glucose levels there is a hierarchy among the counter-regulatory mechanisms (8). The first response to falling glucose is decreased insulin secretion and the dissipation of insulin from the circulation. This occurs when glucose still is within the physiological range (9). This means that post-absorptive glucose elevations mainly are regulated by variation in insulin levels and that the counter-regulatory factors set in only when systemic glucose levels fall below the physiological range. When glucose falls below the physiological range glucagon, adrenalin, growth hormone, and cortisol are released with similar thresholds (8). These responses are redundant and are the basis for a fail safe system to avoid clinical hypoglycemia with impaired cognitive function. In view of the above, insulin is the primary regulator of plasma glucose and well regulated glucose-induced insulin secretion becomes imperative to maintain glucose homeostasis in the body. In the following the impact of insulin resistance and impaired β -cell function on the glucose-regulatory system will be discussed.

Type 2 Diabetes

T2DM or non-insulin-dependent diabetes mellitus (NIDDM), as it was previously called, is a disease characterized by various combinations of insulin resistance and β -cell dysfunction that precipitate chronic hyperglycemia/glucose intolerance (14,15). The etiology of T2DM is not completely known and the disease is most accurately described as a syndrome. In T2DM there is a pathophysiological spectrum that spans from a predominantly insulin resistant disease with a less pronounced insulin deficiency to a predominantly secretory defect coupled with moderate insulin resistance (7) (Fig. 1). The cause of these two principal defects is proposed to be a combination of genetic variation and the impact of environmental factors, obesity being the most prominent (6). However, there are rare monogenic forms of T2DM that are not so sensitive to environmental factors. Thus, considering the model discussed above (Fig. 1), in one end of the spectrum are the rare, but principally insulin resistant, monogenic T2DM forms that

include mutations in for example the insulin receptor (16) or PPAR γ (17). At the other end of the spectrum are the largely insulin deficient monogenic forms of T2DM (18,19), that include mutations in glucokinase, HNF-1 α , HNF-4 α , HNF-1 β , IPF, NEUROD-1, mitochondrial DNA or insulin genes. In the middle of these two extremes lies the most common group of T2DM that is polygenic and multifactorial in nature (Fig. 7)(7). These multifactorial forms of T2DM are associated with frequent polymorphisms and can be considered susceptibility variants since they are not necessarily causative. The dissection of the genetic causes behind polygenic T2DM with the help of linkage studies has been difficult but a few genes have been identified. Putative causative genetic variants have been found in for example calpain-10 (20,21), transcription factor 7-like 2 (TCF7L2)(22,23) and potassium inwardly-rectifying channel J11 (KCNJ11) (24). Nevertheless, the polygenic forms of T2DM are the result of interplay between the environment and a genetic background with many contributing genes (7). For the pathogenesis of monogenic forms of T2DM the environmental aspects play a smaller role than for the polygenic forms, but can still accelerate the development of disease. Notwithstanding, the generalization can be made that in T2DM both of the key features, insulin resistance and β -cell dysfunction, are the result of genetic polymorphisms in combination with environmental factors. The most common environmental precipitants are obesity, physical inactivity and excessive carbohydrate intake (6,7). Regarding obesity, it should be pointed out that only a minority of obese individuals have T2DM (25). This emphasizes that obesity does not cause T2DM but rather contributes to phenotypic expression of genes that predispose the individual for T2DM.

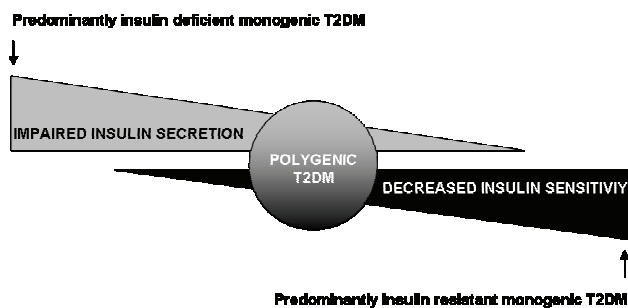

Fig 1. Insulin secretion and insulin sensitivity in T2DM creates a spectrum of interactions. In the two ends of the spectrum are the rare monogenic cases of T2DM characterized by severe insulin secretion impairment or insulin resistance. In the middle are the polygenic and multifactorial cases of T2DM that are the most common.

Insulin Resistance and Obesity

The genetic component of T2DM is certain given the high prevalence for the disease in particular ethnic groups, the inheritance of monogenic diabetes seen in families and the difference in concordance between monozygotic and dizygotic twins (26). However, most commonly T2DM ensues first when the effects of genetic variants are coupled with certain risk factors, such as obesity. Today there are 2.1 billion obese individuals world wide, which has led to an upsurge of obesity-related problems such as insulin resistance (1). During the last decade much research has gone into finding the mechanisms for how obesity and dysregulation of metabolism leads to the development of insulin resistance, glucose intolerance and T2DM. Current ideas of how increased adipose mass predisposes for systemic insulin resistance relates to dysregulation of metabolism and the subsequent release of increased FFAs, and endocrine, inflammatory, neural and cell-intrinsic pathways (6). Many of the obesity-related alterations are coupled to the fact that adipose tissue functions as an endocrine organ (27). Adipose tissue secretes metabolic hormones, such as leptin and adiponectin, inflammatory mediators such as tumor necrosis factor- α (TNF- α) and interleukin 6 (IL-6) and many other factors, such as FFAs and angiotensinogen (27). In the setting of obesity, the endocrine/metabolic communication of adipocytes with the liver, skeletal muscle, the cardiovascular system and β -cells becomes skewed, leading to systemic problems with energy homeostasis. Obesity is associated with increased circulating FFAs, plasma resistin, leptin and cortisol levels and decreased plasma adiponectin levels (28). As an example, elevation in plasma FFAs has negative effects on several tissues involved in the regulation of metabolism, namely the liver, skeletal muscle and β -cells (29). In liver, FFAs accelerate gluconeogenesis, increases the triacylglycerol production, and hampers insulin action, all of which results in hyperglycemia, hyperinsulinemia and excess lipids circulating in the blood (30). Skeletal muscles also contribute to hyperglycemia when FFAs are in abundance since they then switch from glucose to FAs as an oxidative substrate. Further, long-time exposure of β -cells to elevated FFAs impairs glucose-stimulated insulin secretion leading to hyperglycemia (discussed below)(31). Another complication that accompanies excess FFAs in adipose tissue is a chronic, subacute state of inflammation, evidenced by changes in both inflammatory cells and inflammatory signals (30). TNF- α is an example of an inflammatory factor that has been shown to directly cause insulin resistance in adipose tissue (32). The association between obesity and insulin resistance is likely a cause-and-effect relationship since human and animal studies indicate that weight correlates closely to insulin sensitivity. When

adipose tissue is regarded as more than storage of excess energy it becomes clear that excess of this endocrine organ must cause a wide variety of metabolic perturbations.

Function of β -cells in T2DM

Pancreatic islets have the ability to increase their insulin secretion capacity during conditions of reduced insulin sensitivity or T2DM, a process called islet adaptation (15). The reverse is also true; increased insulin sensitivity subsequent to, for example, weight loss or increased physical activity leads to an appropriate reduction in insulin secretion (33,34). The ability of islets to adapt to situations with changed insulin sensitivity is clinically important since failure to do so results in hyperglycemia, impaired glucose tolerance and T2DM (35-39). The underlying mechanisms for islet adaptation with respect to insulin sensitivity are not known. However, there are several candidates for signaling molecules that regulate islet adaptation including glucose, circulating FFAs, autonomic nerves, leptin, and GLP-1 (reviewed in (15)). Of these, FFAs are a good candidate since FFAs are elevated during the development of insulin resistance and since long chained FFAs augment glucose-stimulated insulin secretion in humans and perfused rat pancreases (40,41).

Although islets apparently are equipped to adapt to fluctuations in insulin sensitivity there are situations where the β -cells fail to compensate. There are several proposed causes for such defective compensation including, (i) limited β -cell function caused by genetic defects, for example seen in MODY (discussed above), (ii) secondary alterations of cellular function caused by reduced β -cell mass, improper processing of proinsulin, or toxic effects of glucose and lipids on stimulus-secretion coupling and (iii) inadequate signaling of known and yet unknown signals that regulate islet adaptation *per se* (15). Although glucose and FFAs might be involved in signaling aimed at regulating islet adaptation, chronic hyperglycemia and hyperlipidemia can exert deleterious effects on β -cell function, referred to as glucotoxicity and lipotoxicity, respectively (31). The mechanisms of glucotoxicity involve several transcription factors and is, in part, mediated by the generation of oxidative stress (42,43). Lipotoxicity is probably mediated by negative regulation of gene transcription resulting in inhibition of insulin gene expression and initiation of apoptotic signaling (31). Taken together, it is conceivable that glucotoxicity and lipotoxicity converge toward the generation of damaging effectors of β -cell function, a term referred to as glucolipotoxicity (42). In summary, β -cell failure in T2DM is an evolving process which, depending on the initial defect/defects and the environmental load, gradually worsens over time.

Endocrine Pancreas & Islets of Langerhans

The pancreas has two separate components, the exocrine and the endocrine glands (44). The exocrine portion of the pancreas constitutes 80–85% and is made up of acini glands that secrete digestive enzymes. The endocrine part of the pancreas consists of about a million clusters of cells that are about 100-200 μm in diameter. These clusters are named the islets of Langerhans (islets for short) after their discoverer Paul Langerhans (1869). Islets make up only 2–3 % of the total gland mass and consist of several different cell types that are separated from the acinar parenchyma by a capsule of connective tissue. The cell types, this far identified and characterized, are the α -, β -, δ -, PP- and D_1 -cells. In the adult human pancreas an islet consists mainly of β -cells (68 %) (described below), which make up the core of the structure. This core is then surrounded by a mantle of α - (20 %), δ - (20 %) and PP/ D_1 -cells (2 %). The different cells of islets can be distinguished by both their histological and biochemical characteristics. The α -cells secrete glucagon that prevents hypoglycemia through its actions on the liver (discussed above). δ -cells secrete somatostatin which suppresses both insulin and glucagon release. PP-cells produce and secrete pancreatic polypeptide (PP) that exerts a number of gastrointestinal effects, such as stimulation of the secretion of gastric and intestinal enzymes and inhibition of intestinal motility.

The different islet cells interact with each other directly and/or through paracrine effects of their products that have traveled through the circulatory system (44). This is because the islet is organized so that capillaries enter the mid-region of the islet first and then move gradually to the periphery. Hence, the blood effectively supplies the different celltypes in the sequence, β -cells, α -cells and δ -cells. An example of paracrine signaling through the systemic circulation is the stimulation of insulin secretion by glucagon. Further, islets are densely innervated with autonomic and peptidergic nerves. The parasympathetic vagus nerve stimulates insulin secretion while sympathetic nerves inhibit insulin secretion and stimulate glucagon release. The peptidergic nerves originate from within the pancreas and express vasoactive intestinal polypeptide (VIP) and neuropeptide Y, for example.

β -cells and Biphasic Insulin Secretion

The β -cells of the islets of Langerhans were first identified as the source of insulin in 1938 (44). In β -cells insulin is synthesized in the endoplasmic reticulum, processed and then stored in secretory granules (45). There are an estimated 10,000 insulin granules in a mouse β -cell of which

approximately 500 are docked to the plasma membrane of the cell (46). Of the 500 docked granules around 50 granules appear more firmly attached and thus ready to be immediately released(47). When the blood glucose concentration raises, β -cells release insulin in a biphasic manner (45) that is coupled to the intracellular organization of insulin granules and to different signaling pathways (discussed below). The first phase of insulin secretion is rapid and transient, lasting 5-10 min. In mouse islets, the first phase is estimated to release the insulin content of approximately 15 granules/minute/ β -cell, corresponding to ~ 75 granules/ β -cell during the entire phase (46). The second phase of insulin secretion is sustained with a lower rate of secretion, estimated to 5 granules/minute/mouse β -cell (46).

The kinetically separated components of exocytosis have been proposed to be attributed to secretory vesicles that belong to distinct functional pools which are released sequentially (48). The first phase of insulin secretion is the result of the immediate release of release competent granules that need no further modification after stimulation. However, the vast majority of the insulin granules stored in the β -cell need to undergo a series of ATP-, Ca^{2+} -, time- and temperature-dependent reactions, collectively referred to as priming before they are ready for release (48). Since granule mobilization and priming are energy dependent and need ATP hydrolysis it is hypothesized that these processes precede and are necessary for the second phase of insulin secretion. This mobilization and priming is independent of extensive movement of granules and primarily employs the pool of granules (~ 500) that are already docked to the membrane (46).

Another feature of insulin secretion is that it is pulsatile (49). There are two major frequencies that characterize secretory oscillations *in vivo*, one which has a period of more than 120 min, ultradian oscillations (50), and oscillations that have a period of 5-10 min when measured in portal blood (51). The physiological benefits of pulsatile insulin secretion are suggested to be related to that less insulin is needed to regulate glucose and that insulin resistance is limited due to the rises and falls in insulin levels, thus avoiding tolerance development (49). The pulsatility of insulin secretion has been suggested to result from oscillations in either the process of glucose metabolism or cytosolic Ca^{2+} that occur upon stimulation of β -cells. It has been observed that these oscillations are impaired in patients with T2DM and it has been suggested that such dysregulation contributes to the disease (49).

The molecular machinery that drives regulated exocytosis in β -cells has been well characterized (reviewed in (52)). Briefly, a group of proteins referred to as SNARE (soluble N-ethylmaleimide-

sensitive factor attachment protein receptors) proteins connect insulin granules and the plasma membrane. Upon approach of an insulin granule to the plasma membrane the vesicular protein synaptobrevin/VAMP-2 pairs with its plasma membrane binding partners syntaxin and SNAP-25. This binding tethers the granule to the plasma membrane and to a Ca^{2+} -channel. When the Ca^{2+} -channel opens and Ca^{2+} increases locally the vesicle membrane and plasma membrane fuse and exocytosis can occur. The machinery that drives exocytosis is complex, and there are several other regulating associated proteins that bind SNAREs and the Ca^{2+} -channel, for example the GTP-binding protein Rab3a and RIM (discussed below).

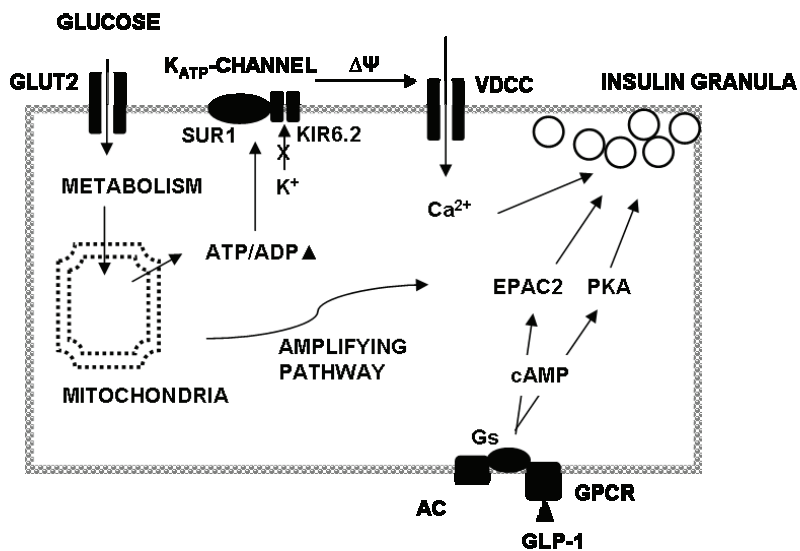

Fig 2. Triggering and amplifying pathways of insulin secretion. Glucose enters the cell by facilitated transport through glucose transporter-2 (GLUT-2) and subsequent mitochondrial metabolism generates ATP. The resulting increase in ATP/ADP ratio closes ATP-sensitive K^+ (K_{ATP}) channels, which depolarizes the plasma membrane. Voltage-dependent Ca^{2+} -channels (VDCC) open and allow for Ca^{2+} influx, triggering exocytosis. G-protein-coupled receptors (GPCR) bind the gut hormone GLP-1 leading to activation of G-protein coupled (Gs) adenylyl cyclase (AC) resulting in the generation of cAMP. cAMP acts both via protein kinase A (PKA) and Epac-dependent pathways to potentiate glucose-stimulated insulin secretion. Glucose metabolites constitute the amplifying pathway.

Stimulus-Secretion Coupling

Pancreatic β -cells function as glucose sensors with the task to adjust blood insulin levels. There is a consensus model for pathways that trigger and amplify insulin secretion induced by glucose (53) (Fig. 2). β -cells are able to function as glucose sensors because they have high- K_m /low affinity glucose transporters (GLUT-2) that allow glucose to equilibrate across the plasma membrane (45). The next key for glucose sensing, of the triggering pathway, is that upon entry glucose is immediately phosphorylated by glucokinase, and glycolysis is initiated (53). Subsequently, mitochondrial metabolism generates ATP that leads to a change in the ATP/ADP ratio. The increase in ATP in relation to ADP leads to the closure of ATP-sensitive K^+ channels (K_{ATP} -channel) situated in the plasma membrane and consequently the halt of K^+ -efflux depolarizes the membrane (54). Next, the depolarization from -60 mV to -10 mV opens voltage-gated Ca^{2+} -channels that results in an influx of Ca^{2+} . The rise in intracellular Ca^{2+} ($[Ca^{2+}]_i$) triggers exocytosis of docked and primed insulin granules and constitutes the initiation of the first phase of insulin secretion. The first phase is transient and needs signals from the amplifying pathway in order to ensure a sustained secretion elicited by glucose (53). The second phase of insulin secretion is dependent on the generation of metabolic factors from the mitochondria as well as Ca^{2+} . The pathways responsible for the amplifying pathway are not firmly established but several metabolites have been suggested as coupling factors such as nucleotides, glutamate and malonyl-CoA (53).

The insulin secretory process induced by glucose via the triggering and amplifying pathways in β -cells can be modified by additional factors. Apart from the autocrine/paracrine effects of hormones originating from the surrounding cells in the islet and neural innervation of the islets (45), β -cells are highly affected by incretin hormones (55,56), also referred to as gut peptides, originating from the gut after a meal. Glucagon-like peptide-1 (GLP-1) and glucose-dependent insulinotropic polypeptide (GIP) are hormones that are secreted in a nutrient-dependent manner and both potentiate glucose-stimulated insulin secretion (56,57). Although the modulatory role of these non-nutrient factors is well appreciated their molecular mechanisms of action need further study. For the work presented here, signaling pathways that modulate glucose-stimulated insulin secretion through the second messenger cAMP are in focus and will be presented below.

cAMP and Compartmentalization

cAMP is a prototypical second messenger, relaying the actions of many extracellular stimuli affecting a variety of cellular functions. A common way that hormones and ligands regulate intracellular cAMP levels ($[cAMP]_i$) is through activation of G-protein coupled receptors (GPCR) coupled to cAMP-synthesizing adenylyl cyclases (58). $[cAMP]_i$ is regulated by the rate of production versus the rate of degradation by cAMP-hydrolyzing phosphodiesterases (PDE) (presented below). Depending on the stimuli the $[cAMP]_i$ varies in amplitude, duration and concentration (59,60) and has been shown to oscillate (49,61), often in concert with oscillating Ca^{2+} , in many cell types. These variations are the result of different stimuli being coupled to different isoforms of adenylyl cyclases and PDEs that exhibit distinct kinetic and regulatory properties. Such an organization leads to a great diversity in cAMP synthesis and degradation as well as the possibility of compartmentalization of the signal.

The concept of compartmentalization was introduced about 20 years ago and is a term used to describe how combinations of protein-protein and protein-lipid interactions contribute to localization of otherwise diffusive signals (62,63). Particularly, means by which cAMP is able to act with discrete local consequences have been given much interest. In theory, cAMP is freely diffusible within the cell and equilibrates rapidly. However, imaging studies have shown that $[cAMP]_i$ levels are unevenly distributed in cells (64,65). This phenomenon is attributed to limited diffusion caused by structural hinders but foremost by degradation by PDEs localized to specific subcellular compartments. In addition to being confined by local production and degradation, cAMP signals are restricted by the discrete localization of its effector proteins and phosphoprotein phosphatases. For example, specific localization of one of the targets proteins of cAMP, protein kinase A (PKA) is mediated by A-kinase anchoring proteins (AKAPs)(63). AKAPs are signaling scaffolds that tether PKA to specific subcellular sites and thus, focuses the activity of PKA toward relevant substrates. Recently, it has also been found that AKAPs bind adenylyl cyclases to regulate cAMP synthesis (66). Further, with regard to specificity, cAMP oscillations may contribute to specificity of cAMP signals since effectors of cAMP are activated by a wide range of $[cAMP]_i$ concentrations (reviewed in (67)), hence favoring certain targets over others. In summary, the specificity of the cAMP message appears spatiotemporally regulated by a tailored protein scaffolding system that holds all the components that govern production, breakdown, effectors, phosphatases and localization.

Today there are several known effector proteins that cAMP act through. cAMP was long thought to act only through PKA. However, it was discovered that there were many cAMP effects that were not attributable to activation of PKA. Instead it was found that cAMP also directly regulates cyclic-nucleotide-gated (CNG) ion channels (68) and exchange protein directly activated by cAMP (Epac) 1 and 2 (69). CNG channels are primarily involved in sensing cAMP in chemosensory cells such as olfactory neurons, and in hepatocytes. Below follows an account of cAMP-signaling through PKA and Epac in the setting of the β -cell.

cAMP-Regulated Insulin Secretion

Glucose stimulation of β -cells increases $[cAMP]_i$, which has potentiating effect on insulin secretion (70,71), although its presence is not necessary for the secretion *per se* (72,73). Ca^{2+} -dependent exocytosis of insulin can also be potentiated by cAMP through the actions of various hormones and neurotransmitters, including GLP-1, GIP, glucagon, VIP and PACAP through a different pathway that results in the generation of cAMP (56). Thus, cAMP has a dual role in the regulation of insulin secretion through the activation of different types of adenylyl cyclases and subsequently also different target proteins (discussed below). This is orchestrated in the way that glucose-stimulated Ca^{2+} -influx is thought to increase $[cAMP]_i$ via activation of Ca^{2+} /calmodulin-stimulated adenylyl cyclases (74) while hormone-stimulated potentiation of glucose-stimulated insulin secretion is thought to act through G-protein-coupled adenylyl cyclases (75). There are eight isoforms of adenylyl cyclases described in β -cells (74,76), variants that are both G-protein-regulated and Ca^{2+} /calmodulin-stimulated.

cAMP has many intracellular effects that lead to the potentiation of insulin secretion, some of which are directly related to $[Ca^{2+}]_i$ (77). Regardless of the origin of cAMP, evidence suggests that the potentiating effect of cAMP requires an interaction between $[cAMP]_i$ and $[Ca^{2+}]_i$ (78). In β -cells, a close oscillatory relationship between Ca^{2+} and cAMP has been demonstrated (61,79). Dyachock *et al.* (61) demonstrate that GLP-1 stimulation leads to $[cAMP]_i$ oscillations and also simultaneous and synchronized oscillations in $[Ca^{2+}]_i$. Further, Landa *et al.* (79) demonstrate that glucose stimulation (in combination with K^+ channel inhibitor tetraethylammonium) triggers oscillations of $[cAMP]_i$ and $[Ca^{2+}]_i$. This phenomena can partly be explained by the reported effects of cAMP in β -cells. $[cAMP]_i$ has been reported to mobilize Ca^{2+} from intracellular stores (80,81) and modulate the activity of ATP-sensitive K^+ channels (82), L-type voltage-dependent Ca^{2+} -channels (83,84) and non-selective cation channels (85). Also, cAMP has been reported to

have direct effects on the release process itself (86,87). Hence, some of these cAMP-mediated effects result in increased $[Ca^{2+}]_i$ which in turn can activate adenylyl cyclases, as discussed above. Although there is knowledge concerning triggering factors for cAMP production and Ca^{2+} effects in the β -cell it is still poorly understood what the mechanism for the oscillations is and how the two signals interrelate kinetically.

It was long thought that all actions of cAMP were mediated through PKA. In pancreatic β -cells it is now clear that cAMP mediates its effects both through PKA-dependent and PKA-independent pathways (77,87). Several studies provide convincing evidence that the latter pathway is mediated by Epac2 (87-91). The first phase of insulin secretion is known to be evoked primarily by Ca^{2+} entry while the second phase is sustained by Ca^{2+} and metabolic signals generated by the metabolism of glucose (53). Detailed electrophysiological analyses indicate that cAMP acts via Epac to increase the probability that docked and primed insulin granules will undergo exocytosis in response to depolarization-induced Ca^{2+} influx (92,93). Seino and co-workers (94) propose that the molecular mechanism for the action of cAMP-Epac on the exocytotic machinery involves heterodimerization with Rab3A GTPase-interacting molecule (Rim2) (95). They propose that in the event of increased $[cAMP]_i$, the specific interaction of Epac2 with the KATP channel subunit sulfonylurea receptor 1 (SUR1) is broken (77,90). This in turn facilitates the heterodimerization of cAMP-Epac with Rim2 and Piccolo in a Ca^{2+} -dependent manner. The macromolecular complex of cAMP-Epac-RIM2-Rab3A then, through a yet unknown mechanism, prime secretory granules rendering them release-competent. In another model proposed by Eliasson *et al.* (91), Epac mediates its effect through the secretory granule membrane bound gSUR1. They propose that gSUR-1-mediated recruitment of Epac2 to the granules allows for Epac2-mediated stimulation of chloride channel-3 (ClC-3) channel function, leading to modulation of the release competence of insulin granules.

Cyclic Nucleotide Phosphodiesterases

Cyclic nucleotides are degraded by cyclic nucleotide phosphodiesterases (PDE) that hydrolyze cAMP and cGMP to 5'AMP and 5'GMP, respectively (96). There are many isoforms of PDEs that contribute to the precise and tissue-specific regulation of cyclic nucleotide signaling. PDEs are organized into eleven gene families (PDE1-11) based on primary structure, affinities for cAMP and cGMP, responses to specific effectors and inhibitors, and mechanisms through which they are regulated (97,98). Many of the gene families contain subfamilies generating isoforms of PDE from the same or related genes by alternative use of promoters, transcription

initiation sites or mRNA splicing. PDEs exist in most cells and cells often contain PDEs from multiple families of which each variant is believed to play a distinct role in regulating cell function. The high degree of individuality between PDEs is the result of expression amount, biochemical characteristics and localization, both tissue-specific and subcellular localization-specific (97).

Structurally PDEs exhibit a common organization where they share a similar C-terminal catalytic domain and an N-terminal membrane-bound regulatory domain (98,99). The catalytic domain contains a histidine-rich PDE-signature sequence, which is homologous between the different PDE families. Further, in the catalytic core there are consensus metal (Zn^{2+} , Mg^{2+}) – binding domains (100). The N-terminal domain of PDEs contain determinants that govern, among other things, regulatory specificity, dimerization, phosphorylation sites and protein-anchoring sites (98). Apart from the conserved catalytic region, PDEs have very different properties. They vary in substrate specificity, tissue distribution and sensitivity to specific inhibitors.

A key tool to understand the role of specific PDE isoforms in various physiological situations has been the discovery of selective PDE inhibitors. The availability of family-specific PDE 1, 2, 3, 4 and 5 inhibitors has especially increased the understanding of some of the functions of these individual PDEs in the regulation of cyclic-nucleotide mediated processes. For example, with the use of selective inhibitors for PDE4 and PDE5 it has been shown that PDE4 has a role in inflammatory responses (96) and that PDE5 regulates vasodilation (101). The specific PDE5 inhibitor sildenafil, also referred to as Viagra®, has gained much attention due to its use as a treatment for erectile dysfunction (101). In relation to the work in this thesis, PDE3B specific inhibitors have been used to ascribe PDE3B a function in the regulation of the antilipolytic action of insulin.

Phosphodiesterase 3

Molecular cloning has revealed that there are two subfamilies within the PDE3 family encoding PDE3A and PDE3B (102,103). These two isoforms are the products of different, but related genes. PDE3s have affinity for both cAMP and cGMP with K_m values of 0.1-0.8 μM (99,104). There are three variants of PDE3A generated from the same gene and the products are found both cytosolically and bound to membranes. The PDE3B gene is thought to code for only one variant of protein which is membrane-associated. PDE3A and PDE3B (Fig. 3) follow the general structural organization of PDEs described above, with an N-terminal regulatory domain

and a C-terminal catalytic domain flanked by a hydrophilic tail. PDE3s have a 44 amino acid insert in the conserved catalytic domain that distinguishes them from each other and other PDE-families (105,106). The regulatory N-terminal regions of PDE3A and PDE3B differ slightly but consist of a large hydrophobic region that constitutes the several transmembrane helices. Located in between the N-terminal and catalytic domain is a regulatory domain that contains multiple phosphorylation sites (107-110).

A defining characteristic of PDEs is that they have distinct tissue expression (111,112) and subcellular localization. PDE3A is predominantly found in platelets, heart, vascular smooth muscle, and oocytes (113). PDE3B is mainly expressed in white and brown adipocytes, hepatocytes, β -cells, renal kidney epithelium and spermatocytes (114). However, there are also reports of PDE3B in vascular smooth muscle, T-lymphocytes and macrophages. To generalize, PDE3B expression is high in cells that are important for energy homeostasis while PDE3A expression is relatively high in cells that are part of the cardiovascular system (99). Subcellularly, PDE3B is membrane-bound and found to be associated with the particulate fraction in adipocytes, hepatocytes and β -cells (105,115,116). Recently, PDE3B has been localized to the endoplasmic reticulum (ER) and the plasma membrane in adipocytes (117). In particular, in adipocytes, PDE3B has been shown to be associated with the membrane structure caveolae (117).

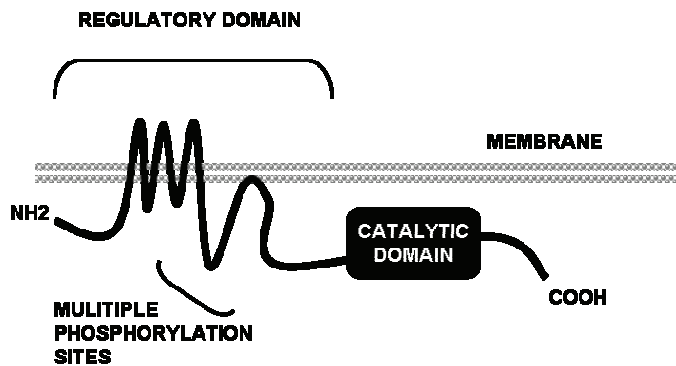

Fig 3. Structural organization of PDE3B. PDE3B consists of (i) a regulatory domain containing a six transmembrane domain anchoring PDE3B to the membrane, consensus sequences for phosphorylation and a second hydrophobic region, and (ii) a catalytic domain containing a 44 amino acid insert specific for the PDE3 family.

Role of PDE3B in the Regulation of Metabolism

PDE3B participates in the regulation of energy metabolism by actions in adipocytes, hepatocytes and pancreatic β -cells (discussed in the next section)(118). The most well-studied cell type when it comes to PDE3B function and regulation is the adipocyte. In adipocytes, PDE3B plays a critical role mediating insulin-induced inhibition of lipolysis (119-121). Further, PDE3B has also been shown to have a role in the regulation of insulin-induced glucose uptake, GLUT-4 translocation and lipogenesis in adipocytes (122). The key event in PDE3B's regulation of the anti-lipolytic effect of insulin is that insulin induces phosphorylation and hence also activation of PDE3B (114,123). The increased PDE3B activity leads to increased hydrolysis of cAMP and consequently inhibition of catecholamine-induced lipolysis (114). Insulin-induced phosphorylation of PDE3B involves tyrosine phosphorylation of IRS proteins, catalysed by the activated insulin receptor, activation of PI3K, and increased production of phosphatidylinositol 3,4,5, phosphates (124). This leads to activation of PKB, believed to be one of the important upstream kinases phosphorylating and activating PDE3B (107-109). In adipocytes, PDE3B has also been shown to be activated in response to cAMP-elevating hormones (125). This activation is thought to constitute feedback regulation of cAMP-mediated responses. The mechanism for this activation is thought to be PKA-mediated phosphorylation of PDE3B. Regarding phosphorylation of PDE3B in response to hormone stimulation it is suggested that PDE3B activity is regulated through phosphorylation at multiple sites (110,126). Some of these sites have been identified and some have been found to be phosphorylated specifically in response to catecholamine and insulin stimulation, respectively, while some are phosphorylated in response to both insulin and catecholamines.

In hepatocytes, PDE3B serves to mediate the anti-glycogenolytic effects of insulin and IGF-1 (127). As for adipocytes, insulin, IGF-1 and cAMP-elevating agents have been found to activate PDE3B in hepatocytes, although the mechanism for this activation is not yet elucidated (110,127). Further, studies of PDE3B knockout (KO) and transgenic RIP-PDE3B mice, that overexpress PDE3B in β -cells specifically, support an important role for PDE3B in the regulation of energy homeostasis. The PDE3B KO mice show signs of insulin resistance and several other metabolic perturbations such as increased lipolysis and blocked insulin-induced suppression of endogenous glucose production, although they do not develop frank diabetes (128). The RIP-PDE3B mice demonstrate defective regulation of insulin secretion and resultant glucose intolerance (129) (further described in the present investigation).

Role of PDE3B in Insulin Secretion

There are at least three known isoforms representing three different families of phosphodiesterases in pancreatic β -cells, PDE1C (130), PDE3B (131,132) and PDE4 (133,134). Of these PDEs, there is strong evidence for a role of PDE3B in the regulation of cAMP-mediated insulin secretion (130,133,134). Several studies, using different PDE3 selective inhibitors, have found that inhibition of PDE3 augments glucose-stimulated insulin secretion from rat and human islets (130,133,135) while selective inhibitors for PDE4 and PDE1/5 does not (134). In addition, inhibition studies in β -cell lines BRIN-BD11 (136) and INS-1 (832/13) cells (116) also showed augmented insulin secretion after inhibition with selective PDE3 inhibitors. Although the effect of PDE3 inhibitors on glucose-stimulated insulin secretion is robust, no investigator has been able to couple it to global increases in islet cyclic AMP concentrations. This discrepancy is probably attributable to the compartmentation of cAMP signals, the general oscillatory nature of cAMP signals and degradation by other PDE isoforms. Even so, it is clear that inhibition of PDE3 in β -cells has similar effects as the effects of stimulation with cAMP-elevating agents (116). For example, the selective PDE3 inhibitor OPC9311 was shown to increase Ca^{2+} -induced exocytosis in INS-1 (832/13) cells in the presence of cAMP but not in the presence of the non-degradable cAMP analogue Sp-cAMPS (116).

The pharmacological studies above, supporting a role for PDE3B in the regulation of insulin secretion, has further been validated by alternative approaches. Härndahl *et al.* (116,129) used adenoviral overexpression of PDE3B in INS-1 (823/13) cells and isolated rat islets and show that a 7-10 fold overexpression of PDE3B results in a dramatic decrease in glucose-stimulated and GLP-1-potentiated glucose-stimulated insulin secretion (116). In the same study, it was shown that overexpression of PDE3B also reduces the augmentation of cAMP on Ca^{2+} -induced exocytosis when measured in single β -cells by capacitance measurements using the patch-clamp techniques. This effect was absent when the non-degradable cAMP analogue Sp-Camps was used instead of cAMP. The role of β -cell PDE3B has also been studied in RIP-PDE3B mice that β -cell-specifically overexpress PDE3B. Isolated islets from RIP-PDE3B mice exhibit impaired glucose-stimulated insulin secretion (129) corroborating the results obtained from insulinoma cell lines. The phenotype of the RIP-PDE3B mice is further described below in the model system section.

With regard to the short-term and long-term regulation of PDE3B in the β -cell very little is known. PDE3 activity seems to be regulated by insulin, IGF-1, leptin and by glucose itself (131,132). The regulation of β -cell PDE3B will further be discussed in association with paper III in the present investigation.

PRESENT INVESTIGATION

Aims

The general aim of this thesis was to study the role of β -cell PDE3B in the regulation of insulin secretion and whole body energy homeostasis. The specific aims were to:

- study the physiological importance of well-regulated β -cell-cAMP levels for insulin release and whole body energy homeostasis during a long-term metabolic challenge
- evaluate the role of PDE3B in biphasic insulin secretion and characterize the sub-cellular localization of the enzyme in β -cells
- investigate the mechanisms for regulation of PDE3B activity in β -cells

Model Systems

In this section I introduce and discuss the model systems that have been used when studying the function and regulation of β -cell PDE3B. This thesis includes studies of β -cell PDE3B that span from studies in mice to phosphorylation and regulation of β -PDE3B in an insulinoma cell line. For these purposes we have used the transgenic RIP-PDE3B mouse line, isolated islets from these mice and a clonal rat insulinoma cell line, the INS-1 (832/13) cells.

Transgenic RIP-PDE3B Mice

One of the model systems used to study β -cell PDE3B is the RIP-PDE3B mouse, created and characterized by Härndahl *et al.* (129). RIP-PDE3B mice exhibit a β -cell-targeted overexpression of PDE3B. This targeted overexpression was engineered by placing full-length mouse PDE3B cDNA under the control of rat insulin promoter (RIP) 2. The construct was then microinjected into the pronucleus of zygotes in the one-cell stage in C57Bl/6xCBA females, generating the C57Bl/6xCBA-Tg(RIP-PDE3B)Lsh mice. This procedure generated 11 founder mice that exhibited a \sim 2-11 fold increase in PDE3B activity and protein expression. From these founder mice, two mouse lines were established, the RIP-PDE3B/2 mice and the RIP-PDE3B/7 mice, that exhibit a \sim 2-fold and a \sim 7-fold overexpression of PDE3B activity, respectively, in β -cells. Control experiments have been performed in these mouse lines to verify that the overexpression of PDE3B is β -cell-specific. Immunoblotting and activity measurements showed that there were no differences in PDE3 expression and activity in adipose tissue, liver, skeletal muscle, hypothalamus or testis when comparing with control littermates (129).

The RIP-PDE3B mice have been characterized with regard to the impact of PDE3B overexpression on metabolic parameters such as fasting glucose, glucose tolerance, insulin tolerance, and islet function (129). When considering these factors, it is clear that there is a dose dependence in the severity of the metabolic perturbations that result from the β -cell targeted overexpression of PDE3B. In essence, RIP-PDE3B/7 mice have a more severe phenotype than RIP-PDE3B/2 mice. For example, RIP-PDE3B/7 mice have elevated fasting plasma glucose compared to their wild-type littermates, a finding which is not the case for RIP-PDE3B/2 mice. In glucose tolerance tests, both RIP-PDE3B/2 and RIP-PDE3B/7 mice show an impaired acute insulin response and reduced glucose elimination. However, there is a marked difference between the two mouse lines since RIP-PDE3B/7 mice exhibit an almost completely abolished

acute insulin response and a more blunted glucose elimination than RIP-PDE3B/2 mice. Although it is clear that RIP-PDE3B/2 mice have perturbed glucose tolerance, assessment of insulin tolerance revealed no signs of insulin resistance (129). Taken together, these findings indicate that the primary β -cell defect in RIP-PDE3B mice cause disturbed glucose tolerance, that is the result of impaired insulin secretion, but does not affect insulin sensitivity.

The impaired insulin secretion in RIP-PDE3B mice, shown by glucose tolerance tests, has been confirmed in experiments where isolated islets were studied *in vitro* (isolated islets as a model system is discussed below). In batch experiments, it has been shown that isolated islets from RIP-PDE3B mice exhibit reduced insulin secretion in response to high glucose, as well as reduced GLP-1-potentiated glucose-stimulated insulin secretion, compared to islets isolated from wild-type littermates (129). Further, *in vitro*, perfusion experiments with islets from RIP-PDE3B/7 mice show that the first and acute phase of insulin secretion is reduced by approximately 40 %. From these experiments it is apparent that islets from RIP-PDE3B mice have hampered stimulus-secretion coupling and this is despite the fact that the islets isolated from RIP-PDE3B/2 and RIP-PDE3B/7 mice are larger in size than wild-type islets (129). Morphometric studies of islets from RIP-PDE3B mice showed that they, on average, were at least double the size of wild-type islets. Also, immunostainings revealed that the cytoarchitecture was disturbed as RIP-PDE3B islets had centrally located α -cells and that the islets more frequently were of irregular shape, both indications of islet dysfunction (137,138).

The RIP-PDE3B mice are a good example of a model system that exhibits a primary β -cell defect that results in metabolic perturbations. A well studied group of disorders with a primary defect in pancreatic β -cell function that leads to the development of diabetes is the maturity-onset diabetes of the young (MODY) (described in the introduction). MODY can result from mutations in any one of at least six different genes that encode the enzyme glucokinase and five transcription factors [hepatocyte nuclear factor (HNF)-4 α , HNF-1 α , insulin promoter factor-1 (IPF-1), HNF-1 β and neurogenic differentiation 1/ β -cell E-box transactivator 2 (NeuroD1/BETA2)](18,19). Mutations in any of these β -cell genes, in the heterozygous state, lead to β -cell dysfunction and eventually the development of diabetes mellitus, provoked or unprovoked, by environmental factors. Thus, the mutations themselves are sufficient to cause diabetes with hyperglycemia, although environmental factors such as obesity or the effect of age will accelerate the development. In a situation where insulin sensitivity is decreased, β -cells that

have genetic defects, which interfere with their glucose-regulatory function, are less equipped to adapt to glucose intolerance via β -cell adaptation and the development of diabetes will ensue (7).

A well studied approach to confront mice with a metabolic challenge in order to study islet adaptation ability is to feed them a high-fat diet. Here, we were interested in the importance of well regulated β -cell-cAMP levels for islet adaptation, insulin release and whole body energy homeostasis during a metabolic challenge. Thus, the RIP-PDE3B/2 mice, that have reduced glucose tolerance, as a result of their primary β -cell defect, were challenged with a high-fat diet for a prolonged period of time (described in Results and Discussion).

Isolated Islets

The unique entity of the islets of Langerhans make them accessible and thus a valuable model system to study stimulus-secretion coupling of β -cells. The fact that the endocrine cells of islets are separated from the exocrine portion of the pancreas by a capsule of connective tissue facilitates their harvest and does not disturb the structure of the islet. In 1967, Lacy *et al.* (139) developed a technique to digest rat pancreases with collagenase to separate islets from exocrine pancreatic tissue. Their approach has been modified and in short, collagenase is injected into the pancreas via the gallbladder duct that enters the dorsal pancreas. The pancreas is excised and incubated at 37° C after which the tissue is shaken to disintegrate it. The digest is then washed and the islets are collected under a stereo-microscope.

Using isolated islets as a model system for studying β -cell function has advantages and disadvantages. The major advantage is that isolated islets can be kept in culture where they easily can be manipulated in batch or perfusion experiments. Batch is a term used to describe experiments in which islets are collected in groups and treated in static incubations in a 96-well plate for example. Perfusion is an experimental setup where, in this case, isolated islets are subjected to a continuous flow of (stimulatory) incubation medium. This allows for collection of aliquots at different time points and can thus be used to study for example insulin secretion over time. Further, it can be argued that keeping β -cells in their “native” environment surrounded by the other endocrine cells of the islet is a more physiological model than clonal cell lines since it allows for paracrine signaling. However, this very point is also a disadvantage since a consequence of islet organization with multiple cell types is that it complicates the interpretation of the results with regard to a specific cell type. In view of this, although islets consist of as much as 60-70% β -cells, it is impossible to distinguish if a stimulus is the primary result of infliction on

the β -cells themselves or other cell types in the islet. A related problem is that keeping islets in culture for a prolonged period of time soon results in overgrowth of fibroblasts. Another factor to consider when working with islets as a model system is that they are denervated and devascularized upon isolation, a problem that is true for *in vitro* work with all primary tissues.

In this work isolated islets from RIP-PDE3B mice and wild-type littermate were used to study islet adaptation to a high-fat diet (paper I). In experiments islets were assessed of their ability to secrete insulin and pancreases were removed to investigate islet size and cytoarchitecture. Further, islets were studied with regard to the two phases of glucose-stimulated insulin secretion and activation of PDE3B in response to glucose and insulin (paper II).

Insulinoma Cell Lines; INS-1 (832/13) Cells

Early studies of β -cell function relied on continuous cultures of isolated pancreatic islets. Although this approach is physiologically relevant, since it enables studies of β -cells in their cytoarchitectural milieu, it poses some problems, as discussed above. Thus, in order to study mechanisms involved in stimulus-secretion coupling in pancreatic β -cells, *per se*, there is a need for stable insulinoma cell lines that mimic the characteristics of the β -cells in islets of Langerhans. For this purpose several insulinoma cell lines originating from different species have been created and characterized with regard to β -cell phenotype.

A common method to establish an insulinoma cell line has been to transform β -cells with the Simian virus 40 (SV40) T antigen, either in β -cells directly, as was done with hamster β -cells (HIT-T15 cells) (140) or through creation of a transgenic mouse that expresses the SV40 T antigen gene placed under the control of the insulin promoter and derive cell clones from the insulinomas that arise (β -TC cells) (141-144). Other cell lines have been created with the use of x-ray-induced transplantable rat insulinomas (RIN cells) (145,146). Although the cell lines, introduced above, maintain many characteristics of the precursor β -cell, they have lost many key traits. A typical problem is that glucose responsiveness is lost as a function of time in tissue culture, as in for example RINm5F cells, HIT-T15 cells and a β TC clone, the β TC6-F7 cells (147-149). This problem is probably related to loss of differentiation during culture. Another common dilemma is that many rodent cell lines exhibit a blunted insulin response to glucose, exemplified here by the rat insulinoma cell line INS-1 (150), that displays a 2-4 fold increase in insulin secretion in response to glucose, which is a fifth of the response normally seen in isolated primary islets. In addition to being less responsive, many rodent cell lines, such as the INS-1

(150) and the RINm5F cell line (147), exhibit a drastically reduced insulin content when compared to primary β -cells. Facing problems with glucose responsiveness, loss of differentiation and growth speed, several attempts have been made to produce clones from already existing cell lines to select for responsive sub-clones that exhibit a more β -cell like phenotype. The cell line INS-1 (832/13) (151) is the result of such a selection and is the cell line used as a model system in this thesis.

The INS-1 cells were originally isolated from an x-ray induced rat transplantable insulinoma (150). These cells are glucose responsive within the physiological range and show morphological characteristics native to β -cells. However, closer examination showed that the phenotypic alterations that appear with prolonged passage is a consequence of the INS-1 cell line not being stringently clonal (150). With this as a hypothesis several sub-clones from the INS-1 cell line were created and characterized (151). Of these, the INS-1 (832/13) sub-clone was singled out and extensively characterized because of its robust response to glucose stimulation. The INS-1 (832/13) cells exhibit several advantageous characteristics over the formerly used β -cell lines (151). Firstly, INS-1 (832/13) cell have been stably transfected to express the human proinsulin gene in order to enhance secretion. Secondly, they exhibit markedly augmented and stable responsiveness to glucose and other common secretagogues. Thirdly, more detailed studies of signal transduction show that they retain both the K_{ATP} -dependent and the K_{ATP} -independent pathways of insulin secretion. A common weakness of many other β -cell lines is that they have lost the K_{ATP} -independent pathway (152), also called the amplifying pathway.

The INS-1 (832/13) cells have been used in this work to study the role of PDE3B in the regulation of insulin secretion and to localize PDE3B with confocal microscopy and subcellular fractionation (paper II). Furthermore, INS-1 (832/13) cells have been used a model system when studying activation and phosphorylation of PDE3B in response to glucose, insulin and the cAMP elevating agent forskolin (paper III).

Methods

Here follows an account and discussion of some of the key experimental setups and techniques used in this thesis.

Physiological *In Vivo* Studies (Paper I)

High Fat Diet Studies

One of the major aims of this thesis was to study the impact of perturbations in the cAMP-system in β -cell for the development of insulin resistance after a metabolic challenge. The RIP-PDE3B/2 mouse line was used as a model system (described above). This mouse line has previously been characterized with regard to metabolic parameters and energy homeostasis in work by Härndahl *et al.* (129). Here we wanted to study the RIP-PDE3B/2 mouse model in the setting of a metabolic challenge, in this case a high-fat diet. The C57Bl/6J mouse line, that the RIP-PDE3B/2 mouse is based on, is a well studied model for diet-induced type-2 diabetes (153,154). When studied by Ahrén *et al.* (154) the C57Bl/6J mice fed a high-fat diet develop hyperglycemia and consequent hyperinsulinemia after only one week on the diet. Here we adopted their approach and fed RIP-PDE3B/2 mice and control littermates a high-fat diet, with 58% energy coming from fat, or a standard diet, with 11% energy coming from fat.

To follow the metabolic status of RIP-PDE3B/2 mice and their wild-type littermates during the high-fat diet study several parameters were monitored and two physiological tests were conducted. Included in the investigation were the following parameters or tests: (i) weight gain, (ii) food intake, (iii) % body fat, (iv) fasting plasma levels of leptin, FFAs, glucose, insulin and glucagon, (v) intravenous glucose tolerance tests (IVGTT), (vi) insulin tolerance tests (ITT), (vii) insulin-stimulated glucose uptake in skeletal muscle, (viii) insulin-induced lipogenesis in adipocytes, and (ix) triacylglycerol status of the liver. These tests were followed up by functional and histochemical studies of the islets of Langerhans. Here follows a description and discussion of the IVGTT and ITT conducted.

Intravenous Glucose Tolerance Test

Intravenous glucose tolerance tests are used to evaluate islet function *in vivo*. In essence, it measures the immediate insulin response to an intravenous glucose load in fasted and anaesthetized animals. In this work, a glucose load of 1 g D-glucose/kg body weight was injected into the tail vein of mice and blood samples were collected at 0, 1, 5, 10, 20, 50, 75 min from the

retrobulbar, intraorbital capillary plexus. Injecting glucose directly into the circulation bypasses the incretin-effect from the gastrointestinal tract seen after an oral glucose load. Thus, the IVGTT tests the insulin response and subsequent glucose elimination to a sudden rise in blood glucose.

The glucose and insulin measurements from the blood samples collected during an IVGTT were used to create a glucose elimination curve and an insulin secretion curve, respectively. Plotting the insulin concentrations vs. time results in a curve gives information about the amplitude of the first phase of insulin secretion and calculations of area under the curve (AUC) gives a figure of the total amount of insulin secreted during the test. Plotting glucose vs. time creates a graph that displays the elimination of glucose from the circulation. The disappearance of glucose results from both insulin-dependent and insulin-independent processes. The insulin-dependent mechanisms are the well known direct consequence of insulin action on peripheral tissues. The insulin-independent processes include the disappearance of glucose by mass action, the ability of glucose to inhibit hepatic glucose production and the ability of glucose to accelerate uptake into the liver and peripheral tissues. Since glucose elimination is not only dependent on the action of insulin but also to a large extent on actions of glucose *per se*, the IVGTT can not be used to evaluate insulin sensitivity. Thus, in summary, IVGTTs gives information about islet function in response to glucose and gives a sense of the glucose tolerance in an animal.

Insulin Tolerance Test

The intraperitoneal insulin tolerance test (ITT) is designed to evaluate insulin sensitivity. This approach is based on the ability of an intraperitoneal insulin load to induce hypoglycemia, which is an index of insulin sensitivity. In this thesis, mice fasted for 24 hours were injected intraperitoneally with insulin and blood samples were collected at 10, 15, 20, 25, 30, 35, 40, 45 and 60 min. The blood glucose concentrations are plotted against time and the resultant glucose elimination curve can be used as an estimate of the insulin sensitivity. The *ip* ITT is a simple test that gives an approximation of an individual's insulin sensitivity but it also has some limitations. These limitations include differential basal glucose levels between groups, counter-regulation, and effects of acute handling stress. For this reason, when alterations in insulin sensitivity (resistance or hypersensitivity) are suspected on the basis of an ITT, a more reliable, quantitative analysis is performed using the euglycemic, hyperinsulinemic clamp technique (not performed here). Thus, the ITT is a quite crude measure of insulin sensitivity that often needs to be

endorsed with other tests. In this work, we further investigated insulin tolerance with biochemical studies of excised adipose tissue, skeletal muscle and liver (paper I).

Imaging (Paper I & II)

One major aim of this thesis has been to localize the PDE3B protein within the β -cell and for this purpose several methods have been employed. Here, imaging techniques will be discussed as a supplement to traditional biochemical localization techniques based on subcellular fractionation. The basis of protein localization using all types of microscopy is the detection of a probe. This probe can either be in the form of a fluorescent tag or, as in the case of electron microscopy, a dense particle. In this work, detection has been aided by specific antibodies towards the target together with secondary antibodies tagged with fluorescent probes or a gold particle. Three different imaging techniques were applied to study β -cell proteins; conventional fluorescence microscopy, confocal microscopy and transmission electron microscopy, of which the latter two will be discussed here.

Confocal Microscopy

The obvious advantage with confocal microscopy, compared to conventional fluorescence microscopy, is that it produces sharp images of structures within thin ($\sim 1 \mu\text{m}$) optical sections representing a single focal plane in a specimen (155). This is made possible since only the fluorescence emitted from the focal plane of the specimen is allowed to reach the photodetector. The screen of emitted fluorescence is facilitated by the confocal pinhole located in front of the detector. The most commonly used confocal microscopes use lasers as a light source and collect images by scanning the laser beam across the specimen. Lasers are so popular because they give intense illumination within a narrow range of wavelengths and can emit several well-separated wavelengths at a time, enabling simultaneous imaging of two or three fluorophores.

In this work, confocal laser scanning microscopy was used to study the co-localization of PDE3B and insulin. In short, INS-1 (832/13) cells were cultured on glass coverslips, fixed in paraformaldehyde, permeabilized with triton-X and then incubated with primary antibodies against PDE3B or insulin. Immunodetection of PDE3B and insulin was then accomplished by addition of secondary fluorophore-conjugated antibodies (cy5 or cy3, respectively). The co-localization of PDE3B and insulin was analyzed in an overlay of the two separate images (paper II).

Transmission Electron Microscopy

Transmission electron microscopy (TEM) is an imaging technique whereby a beam of electrons, focused in a electromagnetic field, are transmitted through a specimen. The electrons that are not scattered in the specimen hit a fluorescent screen, which gives rise to a "shadow image" that can be studied directly by the operator or photographed with a camera. Using this technique, the resulting image displays structures within a cell of varying density and with a resolution of a few Angstrom (10^{-10} m). When using light microscopy the resolution is limited by the wavelength of the photons used as a light source (visible light has wavelengths of 400-700 nm). However, TEMs use electrons as a "light source" and their much lower wavelength makes it possible to get a resolution a thousand times better than with a light microscope.

To study PDE3B localization within β -cells pieces of pancreases from RIP-PDE3B or wild-type mice were fixed and mounted on gold grids (as described (156)). The specimens were then incubated with primary antiserum and thereafter with gold-conjugated IgG antibodies. In electron micrographs PDE3B proteins are indicated by easily distinguishable dense gold particles that appear as black dots (paper II).

Capacitance Recordings (Paper II)

To study β -cell physiology it is essential to be able to assess insulin secretion quantitatively. There are several ways to measure secreted insulin in plasma or in medium from populations of β -cells, such as radioimmuno assay (RIA) or enzyme-linked-immunosorbent assay (ELISA). However, when it comes to studies of single β -cells these detection methods are not sensitive enough or physically possible. Instead, at the single-cell level, insulin secretion can be assessed by an alternative method that does not quantify the insulin released *per se*. Instead, this method quantifies secretion events at the plasma membrane through recordings of changes in total cell surface. This is possible because insulin granules that fuse with the plasma membrane to release their content increase the plasma membrane surface of the cell. In turn, the change in cell surface can be measured as a proportional increase in cell capacitance using the patch-clamp technique (157). To record capacitance changes, a glass pipette is sealed to the plasma membrane of a β -cell that is attached at the bottom of a Petri dish. The relationship between capacitance (C) and cell surface area (A) is given by the following equation, where ϵ is the dielectric constant and d is the membrane thickness (158,159):

$$C = \epsilon * A/d$$

Knowing that biological membranes have a specific capacitance of $\sim 9 \text{ fF}/\mu\text{m}^2$ (160) and the surface area of an insulin granule, it is possible to estimate the number of granules that fuse with the membrane in response to a given stimuli. For a β -cell an insulin granule is estimated to increase the capacitance with $\sim 3 \text{ fF}$ (160).

In this work capacitance recordings were performed using the perforated-patch whole cell configuration of the patch-clamp technique. As opposed to the whole-cell configuration, which is established by removing the membrane patch encircled by the glass pipette in order to establish electrical contact, the perforated-patch technique establishes electrical contact with the cell through small pores. These pores are created with the agent Amphotericin B that is included in the pipette solution (161). This configuration enables measurements of a cell with an intact cytosol since the pores formed by Amphotericin B only allow monovalent ions and molecules of molecular weight less than 200 Da to pass through. Thus, the perforated patch-clamp technique is suitable to study the effects of depolarization-dependent exocytosis *per se*. In paper II exocytosis was stimulated by repetitive depolarizations from the resting potential of -70 mV to 0 mV . Depolarizing the cell in this manner leads to activation of voltage-dependent Ca^{2+} -channels and triggers exocytosis through Ca^{2+} influx, bypassing the first half of the triggering pathway that involves glucose metabolism and closure of ATP-sensitive K^{+} -channels.

Besides the advantage of studying one cell at a time, capacitance measurements also provide information about the kinetics of vesicle fusion with millisecond resolution, something that can not be done with traditional biochemical assays. However, there are limitations and factors to take into consideration when interpreting data from capacitance recordings. Since the technique is based on recordings of changes in capacitance, which is directly proportional to the total surface, not only exocytotic but also endocytotic events are monitored. Thus, in experiments it is not possible to distinguish between the two processes. However, in β -cells the contribution of endocytosis in capacitance measurement experiments has been shown not to influence the results to any significant extent since it occurs at a much slower rate than exocytosis (162). Another aspect that is important to keep in mind is that fusion of insulin granules to the plasma membrane not necessarily is synonymous with insulin release. Barg *et al.* (163) showed with simultaneous recordings of capacitance and confocal microscopy of insulin release that there was a discrepancy between the increase in capacitance and the insulin released. This means that caution should be used when capacitance increases are interpreted directly as actual insulin secretion.

RESULTS AND DISCUSSION

Various combinations of insulin resistance and impaired islet function contribute to the development of glucose intolerance and subsequently also T2DM. The variability in the underlying etiology of T2DM stems from genetic perturbations in one or more genes that span from genotypes with reduced insulin sensitivity to predominant genetic perturbations in β -cells that result in inadequate insulin secretion in relation to the demand. The genotype is often not causative *per se* but becomes discriminating when the environmental load incorporated into the western lifestyle is added to the equation. In the situation of reduced glucose tolerance, regardless of the underlying genetic phenotype and environmental challenges that precipitated it, pancreatic β -cells need to adapt to meet the increased demand of insulin. Defective islet adaptation is therefore a fundamental aspect of the etiology of T2DM. Hence, it is of great importance to study islet/ β -cell physiology, *in vivo* and *in vitro*, and also in the relation to a metabolic challenge in order to identify pathways and mechanisms that govern β -cell adaptation ability and function.

The work presented in this thesis has been focused on studies of β -cell function and adaptation ability with regard to the regulation and fine-tuning of cAMP-based signaling pathways that augment insulin secretion. For this purpose several model systems have been used spanning from the insulinoma β -cell line INS-1 (832/13) to the transgenic mouse model RIP-PDE3B/2 (described in model systems section). cAMP has been found to be important for many β -cell functions, one of which is insulin secretion (77). cAMP is increased in response to glucose stimulation and through the action of incretin hormones. However, little is known about the nature and regulation of the cAMP signal and what effects perturbations of this signal have on β -cell function and adaptation. Here we have studied the system for degradation of cAMP by PDE3B and in what cellular situations PDE3B regulates cAMP signals in relation to stimulated exocytosis of insulin.

An important and new finding in this work is that PDE3B regulates cAMP signals that potentiate both the acute first phase of insulin secretion and the second phase of insulin secretion. In an experiment where single β -cells dissociated from isolated islets of RIP-PDE3B/7 mice and wild-type mice were subjected to successive trains of voltage-clamped depolarizations, the Ca^{2+} -triggered first phase exocytotic response as well as the granule mobilization-dependent second phase was markedly reduced by PDE3B overexpression (paper II, Fig 3). The involvement of PDE3B in the regulation of first phase of insulin secretion was

strengthened by experiments where isolated islets from RIP-PDE3B/7 mice, as well as AdPDE3B infected INS-1 (832/13) cells were stimulated with the first-phase secretagogue K^+ (paper I Fig. 1A and B). In 5 min incubations with high K^+ isolated islets from RIP-PDE3B/7 mice and AdPDE3B infected INS-1 (832/13) cells showed reduced insulin secretion capacity compared to wild-type islets and control infected cells, respectively. In agreement with these findings, in the absence of PDE3B, isolated islets from PDE3B KO mice exhibit increased first phase insulin secretion in response to high K^+ in comparison to control mice (paper I, Fig 1C). Collectively the single-cell experiments and the first phase studies of isolated islets and INS-1 (832/13) cells suggest that PDE3B regulates cAMP signals that are important for the amplitude of biphasic insulin secretion and not only for the potentiating effects of cAMP raising agents, such as GLP-1.

Interesting in relation to the finding that PDE3B regulates cAMP-potentiated depolarization-induced insulin secretion is the discovery, that PDE3B is localized to the membrane of insulin granules and to the plasma membrane (Paper II, Figs. 4, 5 and 6), suggesting a close spatial connection to the exocytotic machinery. Further, it has been shown that depolarization-induced Ca^{2+} influx activates Ca^{2+} -sensitive adenylyl cyclase VIII (74), hence increasing the cAMP concentration in close proximity to the exocytotic machinery. Taken together with the localization of PDE3B, this suggests that PDE3B functions to limit Ca^{2+} -induced cAMP signals that potentiate exocytosis. Thus, there seems to be a subcellular compartment where adenylyl cyclases are in close spatial proximity with phosphodiesterases that confine the cAMP signal. Contributing to the specificity of the cAMP-signal is also, presumably, Epac, a newly identified effector protein of cAMP, that has been localized to this subcellular compartment in the β -cell through its interaction with the SUR1 subunit of the K_{ATP} -channel (77,90). Figure 4 is a model that summarizes the components of the subcellular compartment, associated with the exocytotic machinery, that regulate cAMP-mediated events. It is unclear whether the localization of PDE3B to the plasma membrane has the same putative role in regulating cAMP-signals related to exocytosis as granule membrane anchored PDE3B or if plasma membrane associated PDE3B has functions in other cellular contexts. Unpublished data by Ahmad and Lindh *et al.* from studies in adipocytes suggest that PDE3B anchored to plasma membrane caveole and the ER/golgi (117) have different functional roles and are differentially regulated with regard to insulin-induced and catecholamine-induced effects. Hence, it is possible that plasma membrane PDE3B has a distinct functional role not related to the regulation of exocytosis. Another possibility to account for the localization of PDE3B to both insulin granules and the plasma

membrane is that upon exocytosis granule membrane-anchored PDE3B becomes integrated into the plasma membrane. Hypothetically, this suggests that PDE3B would shuttle between compartments, possibly being recycled by the process of endocytosis. The functional role of PDE3B anchored to different types of membranes in the β -cell needs further investigation. Nonetheless, the novel finding that PDE3B is localized to the subcellular compartment of the exocytotic machinery together with adenylyl cyclase and cAMP effector proteins strongly supports the finding (presented above) that PDE3B regulates depolarization-induced, Ca^{2+} -stimulated insulin secretion through the degradation of cAMP formed in response to Ca^{2+} .

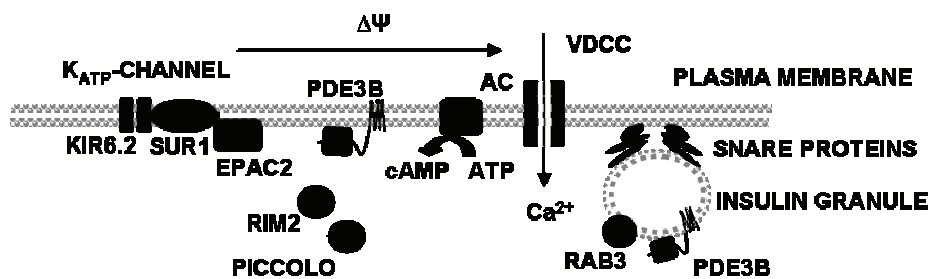

Fig 4. Model of cAMP-mediated exocytosis. Ca^{2+} -induced elevations in $[\text{cAMP}]_i$ is hypothesized to bind Epac2, which thereby dissociates from the SUR1 subunit of the K_{ATP} -channel. cAMP-Epac2 then binds to RIM2, a putative target of the small G protein Rab3-interacting molecule that participates in exocytosis. PDE3B is localized to both the insulin granule membrane and to the plasma membrane. In the context of the exocytotic machinery we hypothesize that PDE3B degrades cAMP, thereby attenuating depolarization-induced exocytosis. Model modified from (94).

From the work discussed above it is clear that cAMP signals important for insulin secretion partly are regulated by PDE3B and that the function of PDE3B in this context is a direct result of its intracellular position. However, the involvement of PDE3B in the regulation of cAMP-mediated signals is not only dependent on its location but also on the regulation of its enzymatic activity. The regulation of PDE3B activity is quite elaborate and it is known, from other experimental systems than β -cells, that PDE3B activity is highly regulated by multi-site phosphorylation (110,126) and dephosphorylation by the action of several differentially regulated kinases and phosphatases. This can be exemplified by the effects of insulin and isopreterenol on PDE3B activity in adipocytes. Stimulating adipocytes with insulin and isopreterenol results in unique patterns of multi-site phosphorylation of PDE3B, respectively (110) (discussed in background). Further, it is becoming apparent that protein-interactions and protein complex

formation are important components of PDE3B function and activity, as studied in adipocytes and hepatocytes (164)(Unpublished, Ahmad and Lindh *et al.*). These findings in adipocytes suggest that PDE3B is differentially regulated when it comes to activity and association to functionally important protein complexes.

In the context of the β -cell, PDE3B functions to attenuate cAMP-mediated potentiation of insulin secretion by degradation of cAMP to 5'AMP. When PDE3 has been examined it has been shown to have a basal activity. Thus, stimuli that activate PDE3 will lead to a faster turnover of cAMP, which impedes the cAMP signal. We show for the first time in INS-1 (832/13) cells that PDE3B is activated in response to glucose, insulin, high K^+ and the cAMP elevating agent forskolin (paper III, Fig 1A). These data are in good agreement with work by Zhao *et al.* (131,132) that show activation of PDE3B in response to insulin, GLP-1 (also IGF-1 and leptin) in HIT-T15 cells. Hence, considering our data it seems as if glucose stimulates the formation of cAMP by activating of Ca^{2+} -sensitive adenylyl cyclase (as discussed above) and also simultaneously stimulates the activation of PDE3B attenuating the cAMP signal, in this manner constituting a feedback loop. A similar feed-back loop seems to exist for the cAMP elevating agents forskolin, presented here, and GLP-1, as investigated by Zhao *et al.* (132). Hence, forskolin activates adenylyl cyclases, thereby elevating the of [cAMP]; and simultaneously activates PDE3B, which attenuates the signal.

With regard to glucose, it is unclear whether the activation of PDE3B by glucose is a direct glucose-mediated effect or is mediated through the action of the subsequent insulin release. We show that both endogenous insulin release, stimulated by high K^+ (glucose-independent), and exogenously administered insulin (during low glucose conditions) are potent stimuli leading to the activation of PDE3. This suggests that PDE3B can be activated in response to insulin independently of glucose. It is well known that PDE3B activity is coupled to phosphorylation from detailed studies in adipocytes (114,123)(see background). When total phosphorylation of PDE3B was investigated in relation to stimulation of INS-1 (832/13) cells with glucose, insulin and forskolin, respectively, it was apparent that glucose stimulation resulted in decreased total phosphorylation (paper III, Fig. 3), insulin stimulation resulted in unchanged total phosphorylation (paper III, Fig. 4A) and forskolin stimulation resulted in increased total phosphorylation (paper III, Fig. 4B). These results suggest that PDE3B is differentially regulated by different types of stimuli and implies that glucose might have an insulin-independent effect on PDE3B activity. Further, it is the first time that decreased total phosphorylation of PDE3B

has been coupled to an increase in PDE3B activity. It is not known what the mechanism behind this new finding is.

At present it is unknown what protein kinases are responsible for the activation of PDE3B in β -cells. Nor have the signaling pathways leading to PDE3B activation by the above mentioned stimuli been elucidated in β -cells. However, based on knowledge attained from adipocyte PDE3B it is likely that PKA and PKB, which are both expressed in β -cells, are responsible for the activation of PDE3B in β -cells as well. As formerly discussed, PKA is activated in response to cAMP elevating agents in β -cells and is responsible for many of the potentiating effects of cAMP on insulin secretion. Speculatively, cAMP-PKA-mediated activation of PDE3B is one mechanism for a feedback loop that attenuates cAMP signals in β -cells. In a similar fashion it can also be speculated that PKB, which has been shown to be activated in response to IGF-1, GLP-1 and insulin in β -cells, can activate PDE3B. To date there are no experimental data showing that PKA and/or PKB directly phosphorylate PDE3B in β -cells. However, as discussed above, stimulation of INS-1 (832/13) cells with glucose, insulin and forskolin, respectively, resulted in activation of PDE3B although with varying total phosphorylation. Interesting in this regard is also that data from tryptic-peptide maps of activated PDE3B indicate that β -cell PDE3B is multi-site phosphorylated (paper III, fig. 5). Taken together this implies that PDE3B is differentially regulated, probably reflecting stimulus-specific phosphorylation sites and uniquely regulated kinases, possibly PKA and PKB. Also, with regard to PDE3B activity being coupled to varying total phosphorylation depending on stimuli, the variability can be a consequence of differentially regulated phosphatases.

In general and from the two above presented studies, it is evident that cAMP is an important second messenger in β -cells and that cAMP is a very well regulated signal. The importance of accurate regulation of the PDE3B-cAMP system in β -cells becomes apparent when this system is manipulated *in vitro* or *in vivo*, for example by increasing PDE3B activity. Increasing PDE3B activity renders cultured β -cells markedly less able to respond to a glucose load (116,129). The significance of well regulated cAMP levels for β -cell function becomes further accentuated when the physiological effect of this experimentally induced functional failure is studied with respect to metabolic homeostasis in mice. The RIP-PDE3B mouse model exhibits a β -cell specific overexpression of PDE3B with a resultant phenotype characterized by impaired glucose tolerance associated with impaired insulin secretion and deranged islet morphology. In the work presented in this thesis this mouse model was further studied with regard to the importance of

well regulated β -cell-cAMP levels for islet adaptation, insulin release and whole body energy homeostasis in the setting of a metabolic challenge. Hence, the RIP-PDE3B/2 mice were challenged with a high-fat diet for an extended period of time (paper I).

An intriguing finding from the high-fat diet (HFD) study of RIP-PDE3B/2 mice is that as little as a doubling in β -cell PDE3B activity substantially increased their sensitivity to the adverse effects of a HFD. We found that HFD fed RIP-PDE3B/2 mice developed glucose intolerance and insulin resistance earlier and more rapidly compared to wild-type littermates. This was evident by hyperglycemia in spite of hyperinsulinemia (paper I, Fig. 2) and decreased ability to eliminate glucose in IVGTTs (paper I, Fig. 3) and ITTs (paper I, Fig 3) compared to wild-type littermates fed the same diet. The wild-type littermates fed a HFD were able to compensate for the adverse effects of HFD-feeding and only showed signs of mild hyperglycemia (paper I, Fig 2) and glucose intolerance (paper I, Fig 3) at least until 4-5 months on the diet. These findings indicate that the islets of HFD-fed RIP-PDE3B/2 mice are less competent to adapt to the combination of for example increased plasma FFA and glucose. When the character of the insulin resistance was investigated it could not be attributed to decreased insulin sensitivity in excised adipose tissue or skeletal muscle (paper I, Fig 5A and B). Interestingly though, HFD feeding resulted in markedly increased liver triacylglycerol stores in RIP-PDE3B/2 mice compared with wild-type mice (paper I, Fig 5B). Steatosis of the liver is associated with hepatic insulin resistance and decreased ability of insulin to suppress hepatic glucose production (165). Hence the markedly elevated triacylglycerol levels found in HFD-fed RIP-PDE3B/2 mice might contribute to their development of insulin resistance. However, further study is needed to determine the molecular mechanism behind the elevated triacylglycerol stores in RIP-PDE3B/2 mice and if this finding is directly linked to the apparent insulin resistance in HFD-fed RIP-PDE3B/2 mice. To further elucidate the details concerning the insulin resistance it would be useful to employ the method of euglycemic-hyperinsulinemic clamp.

In association with the HFD study we found that RIP-PDE3B mice fed a control-diet (CD) also exhibited increased liver triacylglycerol levels compared to wild-type mice. It is quite surprising that the RIP-PDE3B mice with a primary defect in the β -cells show such a marked secondary effect in the liver. Preliminary data show that protein expression of fatty acid synthase (FAS) an enzyme involved in triacylglycerol metabolism (166), was upregulated in hepatocytes from RIP-PDE3B mice compared to wild-type mice. These findings indicate that hepatocytes from RIP-PDE3B/2 mice have increased triacylglycerol synthesis. Also, we found basal and glucagon-

stimulated glucose release to be slightly elevated from RIP-PDE3B/2 mouse hepatocytes. The increased basal glucose output indirectly suggests that they exhibit blunted insulin-stimulated attenuation of glucose release. However, we do not know exactly what the molecular links are between overexpression of PDE3B in β -cells and increased triacylglycerol storage seen in HFD and CD fed RIP-PDE3B/2 mice.

Considering the presented novel findings regarding the regulation of PDE3B activity in response to extracellular stimuli and the subsequent function of PDE3B as a regulator of cAMP signals important for exocytosis, one can construct the following hypothesis to account for the physiological perturbations that characterize CD- and HFD-fed RIP-PDE3B/2 mice. The β -cells of RIP-PDE3B/2 mice exhibit reduced glucose-stimulated insulin secretion as a result of \sim 2-fold greater PDE3B activity leading to reduced potentiation of insulin secretion by cAMP. In addition to this, RIP-PDE3B/2 β -cells have reduced GLP-1-potentiated insulin secretion (129). Hence, in the physiological setting, this implies that RIP-PDE3B/2 islets are less equipped to compensate for postprandial elevations in blood glucose, partly because they have a reduced incretin effect in response to for example GLP-1. This means that for every meal the RIP-PDE3B/2 mice have impaired ability to adequately handle the metabolic load resulting in elevated plasma glucose levels. In the long term perspective it seems as if this eventually results in glucose intolerance, despite for example apparent islet adaptation through increased islet size (129). When the RIP-PDE3B/2 mice are further challenged by the introduction of a HFD the regulation of energy homeostasis becomes even more burdened. The physiological repercussions of a HFD *per se*, such as weight gain and elevated FFA, in combination with the effects of the already impaired β -cell function in RIP-PDE3B/2 mice lead to a fast deterioration with consequent insulin resistance despite islet adaptation attempts. It is probable that this is attributable to the glucolipotoxic effects of the combination of elevated levels of plasma FFAs and glucose. As the novel findings in paper III suggest, it is also plausible that elevated circulating plasma glucose and insulin leads to activation of PDE3B in β -cells with an even higher net attenuating effect on glucose-stimulated and incretin-potentiated insulin secretion, worsening the situation further. The apparent glucose intolerance in CD-fed RIP-PDE3B/2 mice and the fast deterioration of RIP-PDE3B/2 mice fed a HFD, with regard to their overall energy homeostasis, emphasizes the importance of accurate regulation of insulin secretion and the significance of adequate islet adaptation to situations of a metabolic load.

Main Conclusions

- Accurate regulation of β -cell cAMP levels is necessary for adequate adaptation to a perturbed metabolic environment and protective for the development of glucose intolerance and insulin resistance
- PDE3B plays a regulatory role in depolarization-induced insulin secretion through hydrolysis of cAMP pools regulated by Ca^{2+}
- PDE3B is associated to the insulin granule membrane and to the plasma membrane indicating that the enzyme is located to the exocytotic machinery in β -cells
- PDE3B is activated in response to glucose and/or insulin as well as cAMP elevating agents and is regulated by phosphorylation and dephosphorylation, probably by the action of several different kinases and phosphatases

CONCLUDING REMARKS AND FUTURE PERSPECTIVES

The main findings of this thesis open up to the interesting prospect of considering β -cell PDE3B as a pharmacological target for the treatment of diabetes based on modulation of cAMP levels. For this purpose tissue- and isoform-specific inhibitors would need to be developed. However, there are yet many question marks regarding the regulation of cAMP-mediated exocytosis, the regulation of PDE3B in β -cells and the cellular and physiological implication of specific inhibition of PDE3B activity, to mention a few. Hence, to further study β -cell PDE3B it would be interesting to consider some of the following aspects.

PDE3B has been localized to the insulin granule membrane and to the plasma membrane of β -cells indicating that the enzyme is part of the arsenal of proteins associated with the exocytotic machinery. With regard to the function of PDE3B in depolarization-induced exocytosis it is important to elucidate if PDE3B has any binding/interaction partners with regulatory- or localization-related functions. There are several other aspects that are relevant to study in relation to this. For example, it is still unclear whether PDE3B regulates cAMP signals that act through Epac or PKA, or both. Nor is there anything known about the temporal involvement of PDE3B in the kinetics of insulin secretion or the oscillatory nature of cAMP levels.

Closely associated with the functional role of PDE3B in exocytosis is also the regulation of the enzyme itself. It is of great interest to untangle the signaling pathways that lead to activation and deactivation and what kinases and phosphatases are responsible for these actions. In the search for such information, the greater knowledge of the short and long-term regulation of adipocyte PDE3B will be of help.

Lastly, the consequences of manipulated levels of β -cell PDE3B on whole animal physiology and energy homeostasis need further attention.

To address some of the questions discussed above the immediate goals would be to:

- identify potential protein interaction partners of PDE3B in the exocytotic compartment in β -cells
- elucidate the respective roles of Epac- and PKA-mediated signaling in relation to PDE3B's regulation of cAMP

- investigate and identify the upstream kinases and phosphatases of β -cell PDE3B and their specific phosphorylation sites
- study the stimulus-activation pathways that regulate PDE3B activity in β -cells
- characterize the HFD-induced insulin resistance in RIP-PDE3B/2 mice, possibly by euglycemic-hyperinsulinemic clamp
- investigate gene or protein expression profiles in β -cells from RIP-PDE3B mice in comparison with wild-type β -cells

POPULÄRVETENSKAPLIG SAMMANFATTNING

I denna sammanläggningsavhandling ingår två publicerade delarbeten och ett manuskript. Det övergripande syftet för avhandlingen har varit att öka förståelsen för uppkomst av typ 2-diabetes.

Bakgrund

Diabetes är en folksjukdom som sprider sig globalt i mycket snabb takt. Det internationella diabetesförbundet (International Diabetes Federation, IDF) har beräknat att 246 miljoner människor har diabetes, vilket innebär 7,3 % av världens befolkning, och att år 2025 kommer den siffran stiga till 380 miljoner drabbade människor. År 2007 svarar diabetes för ca 6 % av den globala dödligheten. Av olika varianter av diabetes är typ 2, eller åldersdiabetes som den också kallas, den vanligaste och svarar för 85-95 %. Diabetes är en sjukdom som kännetecknas av förhöjda nivåer av socker i blodet (hyperglykemi). Om hyperglykemin inte sänks till normalvärden genom behandling leder den till följdskador på organ såsom ögon, njurar, nerver och blodkärl.

Socker är en av kroppens viktigaste energikällor och hjärnans enda energikälla. Därför är det viktigt att det alltid finns en stabil sockernivå i blodet. Det finns två källor till blodsocker hos människan, dels det vi får i oss direkt från födan och dels det socker som lagrats i levern i form av glykogen. När sockernivån i blodet sjunker stimuleras levern av hormonet glukagon att frigöra delar av sitt lagrade socker till blodbanan, vilket återställer blodsockernivån. I den motsatta situationen, efter måltid, stiger sockernivån i blodet över den nivå som är optimal och måste justeras ner istället. Insulin är det hormon i kroppen som har blodsockersänkande effekt. Insulin verkar för att socker elimineras från blodbanan och tas upp i fettväv, lever och muskel, där det kan lagras eller direkt användas som energi. Upptaget av socker från blodbanan till dessa vävnader är helt beroende av insulin.

Hormonet insulin produceras och utsöndras från specialiserade celler i bukspottkörteln, så kallade β -celler. β -cellerna är konstruerade för att känna av blodsockernivån och fristätta insulin i lagom dos för att sänka blodsockret efter en måltid. Vid typ 1-diabetes, också kallad ungdomsdiabetes, har kroppens egna immunförsvar slagit ut β -cellerna från bukspottkörteln. Total avsaknad av β -celler och därmed utebliven insulinutsöndring betyder kollaps av regleringen av blodsocker, vilket resulterar i hyperglykemi. Förutom de långsiktiga organskador som

hyperglykemi medför är de kortsiktiga allvarliga med dödlig utgång vid svår hyperglykemi. Det är därför viktigt för typ 1-diabetiker att noggrant reglera sitt blodsocker med hjälp av insulininjektioner. Typ 2-diabetes orsakas av försämrad verkan av insulin (insulinresistens) i fettväv, lever och muskel i kombination med försämrad insulinfrisättning från β -cellerna. Dessa defekter orsakas av en kombination av genetiska defekter och omgivningsfaktorer såsom övervikt, osund diet och inaktivitet. Vid typ 2-diabetes fallerar regleringen av blodsocker när β -cellerna inte längre kan öka frisättningen av insulin för att kompensera att verkan av insulin i fett, muskel och lever har försämrats. Detta tillstånd benämns glukosintolerans och leder till typ 2-diabetes om det förblir obehandlat.

β -celler är specialiserade celler byggda för att fungera som sensorer för blodsocker. β -celler tar upp socker från blodbanan vilket aktiverar signalsystem inne i cellen som slutligen leder till att cellen frisätter insulin till blodbanan (Bild 5). Specifikt omvandlas det upptagna sockret till en signal som i sin tur verkar genom att stänga kanaler i cellens membran som transporterar joner. När kanalerna stängs upphör utflödet av jonen kalium (K^+) ur cellen vilket leder till att spänningen över membranet förändras. Förändringen i spänningen över membranet leder till att en spänningskänslig kanal öppnar sig och släpper in jonen kalcium (Ca^{2+}). Ca^{2+} är den signal som sedan initierar frisättningen av insulin från cellen. Förutom denna intracellulära signalväg, som leder till insulinfrisättning, finns andra signalvägar som förstärker den sockerstimulerade insulinfrisättningen. En signalmolekyl med förstärkande effekt på insulinfrisättningen är cykliskt adenosinmonofosfat (cAMP). cAMP bildas bland annat som svar på Ca^{2+} inflöde i cellen. Mängden cAMP i cellen bestäms av dess bildning men också av dess nerbrytning. Det enzym som sköter nedbrytningen av cAMP heter fosfodiesteras 3B (PDE3B). PDE3Bs nerbrytning av cAMP och därmed avstängning av cAMP-signalen har visats påverka insulinfrisättningen från β -celler.

Syfte

Det övergripande syftet för avhandlingen har varit att undersöka regleringen av insulinfrisättning från β -cellerna i bukspottskörteln. Mitt fokus har varit att studera betydelsen av välkontrollerade nivåer av signalmolekylen cAMP och konsekvenserna av experimentellt iscensatta rubbningar av cAMP-innehållet, både i odlade β -celler och i försöksdjur.



Bild 5. Sockerstimulerad insulinfrisättning från β -cellen. Socker tas upp av β -cellen vilket leder till att kaliumkanaler (K^+) i cellmembranet stänger. Detta förändrar den elektriska spänningen över membranet vilket öppnar spänningskänsliga kalciumkanaler (Ca^{2+}) och Ca^{2+} flödar in i cellen. Ca^{2+} stimulerar insulinfrisättning från cellen. cAMP är en signalmolekyl som kan förstärka sockerstimulerad insulinfrisättning. PDE3B är det enzym som bryter ner cAMP-signalen och därmed avbryter cAMPs förstärkande effekt på insulinfrisättningen.

Resultat

Delarbete I

Ett specifikt mål har varit att karakterisera en genetiskt modifierad musmodell, i vilken β -cellernas cAMP-innehåll reducerats genom ökad mängd PDE3B, samt att utreda hur denna förändring kan leda till fysiologiska förändringar hos musen. PDE3B/2-möss är genetiskt förändrade så att de har dubbelt så mycket PDE3B i sina β -celler som möss i en kontrollgrupp. Delvis karakterisering av PDE3B/2-möss har tidigare utförts i forskargruppen. Denna visar att PDE3B/2-mössen har försämrad insulinfrisättning och utvecklar glukosintolerans. Här har vi undersökt PDE3B/2-mössens förmåga att anpassa sig till en metabol belastning i form av behandling med fet kost under en längre period. I studien visar vi att fetkostbehandlade PDE3B/2-möss tidigare och snabbare än kontrollmöss utvecklar glukosintolerans och insulinresistens.

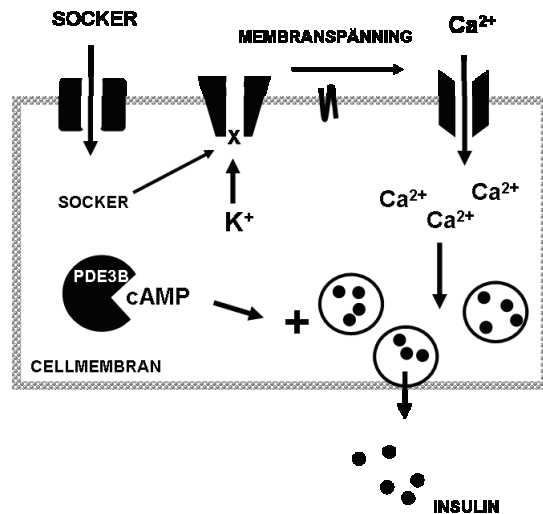
Slutsats: Vi visar att noga kontrollerade cAMP-nivåer är viktiga för β -cellers förmåga att hantera påfrestningarna av en fetkostbelastning.

Delarbete II

Delarbete II syftade till att undersöka dels var PDE3B befinner sig i β -cellen, dvs. dess lokalisation, och dels dess roll i och reglering av insulinfrisättning från β -celler. Studierna har utförts i odlade β -celler och isolerad vävnad från bukspottkörteln. Vi visar, med hjälp av bl.a. mikroskopiska metoder, att PDE3B är bundet till de strukturer som innehåller insulin inuti β -celler. Det betyder att PDE3B är ett av de många proteiner som medverkar till regleringen av själva insulinfrisättningsprocessen.

Slutsats: Vi visar att PDE3B är lokaliserat till den plats där cAMP utövar sin förstärkande effekt på insulinfrisättningen och där PDE3B kan bryta ner cAMP för att dämpa signalen.

Delarbete III

Delarbete III är ett påbörjat projekt som presenteras i manuskriptform. Syftet med studien var att på detaljerad molekylär nivå undersöka regleringen av PDE3Bs förmåga att bryta ner cAMP (enzymatisk aktivitet). Aktivering av PDE3B leder till ökad nedbrytning av cAMP i β -cellen. Vi visar att stimulering av β -cellen med socker och/eller insulin samt ämnen som höjer cAMP nivån leder till en ökad aktivitet av PDE3B. För regleringen av insulinfrisättning betyder det att vid sockerstimulerad insulinfrisättning, som delvis är beroende av cAMP, kommer även PDE3B att aktiveras och därmed cAMP-signalen att dämpas. I cellbiologiska termer kallas den här typen av reglering för en negativ "feed-back loop". De exakta mekanismerna för hur socker och/eller insulin stimulerar ökad enzymatisk aktivitet hos PDE3B är ännu inte kända.

Slutsats: Vi visar att socker och/eller insulin samt ämnen som ökar cAMP leder till aktivering av PDE3B och därmed en ökad nedbrytning av cAMP i β -celler.

Betydelse och tillämpning

Målet med min avhandling har varit att öka kunskapen kring de molekylära mekanismer/signaler som styr sockerstimulerad insulinfrisättning från β -celler och samspelet mellan defekt reglering av insulinfrisättning och omgivningsfaktorer såsom en fetkostdiet. Vi visar att cAMP-medierad förstärkning av insulinfrisättning regleras av det cAMP-nedbrytande proteinet PDE3B och att

störningar i denna reglering leder till ökad mottaglighet för utvecklingen av glukosintolerans och typ 2-diabetes efter fetkostbehandling. Forskning kring regleringen av insulinfrisättning samt utredning av konsekvenserna av defekt insulinfrisättning för energibalansen i kroppen är av stor betydelse för förståelsen för uppkomsten av typ 2-diabetes och för utveckling av nya läkemedel. De nya kunskaperna rörande cAMP-PDE3B-signalering som presenteras här kan utnyttjas för hitta läkemedel ämnade att förstärka den nedsatta förmågan att frisätta insulin som patienter med typ-2 diabetes har. En strategi skulle vara att utveckla en hämmare av PDE3B som specifikt dämpar PDE3Bs cAMP-nedbrytande aktivitet i β -celler vilket skulle ha effekten att förstärka sockerstimulerad insulinfrisättning.

ACKNOWLEDGEMENTS

I want to thank all the people that have contributed to this thesis scientifically and who have made my PhD-studies an enjoyable experience. I also want to thank my friends and family for all the support that I have received. I would especially like to thank:

My supervisors **Lena Stenson** and **Eva Degerman**:

Lena and **Eva**, being your PhD-student has been a pleasure. I am truly satisfied with my studies. I thank you both for your support, excellent guidance and encouragement. I have been extremely spoiled in having two very dedicated, enthusiastic and involved supervisors. **Lena**, you have taught me a lot about science and I am very thankful for all the time you have spent discussing projects and manuscript drafts. You have firmly supervised me without me feeling supervised. I admire your dedication to this project and your wonderful calm attitude when faced with problems. I think you are a fantastic supervisor and person! **Eva**, thank you for taking me into your lab and teaching me all about phosphodiesterases. Thank you for your devotion to and interest in my work and for all valuable advice and guidance. Your enthusiasm for science inspires me and everyone around you. Also, I think we've had a terrific time when attending conferences around the world! You are an incredible supervisor!

My collaborators:

Nils Wierup and **Frank Sundler**, thank you for your valuable contributions to the published work in this thesis. It has been a pleasure to collaborate with you. **Lena Eliasson** and **Jenny Vikman**, thank you for sharing your expertise in electrophysiology and for a very rewarding collaboration. **Bo Ahrén & Lena Kvist**, for helpful suggestions, experimental expertise and successful collaboration **Thorkil Ploug**, for pitching in with much appreciated muscle work. **Vincent C. Manganiello**, for reviewing our work, good suggestions and fruitful collaborations.

The present and former members of the Degerman group:

Rebecka, I want to thank you for being my wing-man during the last four years. You have functioned much like my twin sister Liz has in my life, reminding me about seminars, due dates, conference fees etc. You have been a good friend, great conference pal and a tremendous support. I have been very comfortable with being just a step behind you! **Fredrik Svannelid**, thank you Fred for everything you have done for me! You have been my co-pilot during the last four years. Thank you for challenging me in everything from science to sports. You deserve lots of cred! I think you are fantastic. **Karin Berger**, I thank you for countless laughs at the tiniest shrieks to truly funny stories and anecdotes from the eighties. It has been a blast to work with you, I have especially enjoyed the times we've shared in the lab working and listening to music. You have a wonderful spirit and a great sense of humor. **Olga Göransson**, for being a great inspiration and driving force. You have an admirable sense of detail and always come with constructive suggestions concerning scientific problems. **Svante Resjö**, for nice collaborations, helpfulness and knowledge about protein chemistry. **Emilia Zmuda-Trezbiatowska**, for adding an international touch to the group, much appreciated methodological support and good times. **Ann-Ki Holmen-Pählbrink**, there is so much to thank you for! Thank you for all the help you have given me in countless experiments. Your routine and skill has been the reason for success in many projects. I have had a great time working with you and I'd love to stay tuned to

hear the latest developments about the boys. **Eva Ohlson**, thank you for taking me under your wing during my first project in ED-group. I think you are a great teacher and I am very thankful for all the help that you have given me and the times we have shared over coffee. **Linda Härndahl**, for introducing me to this great project and good collaboration. **Lina Åkesson**, for being a great room-mate and for great chats. **Alina Oknianska**, and **Tova Rahn-Landström**, for contributing scientifically to the ED-research group and for interesting discussions.

The present and former neighbors on the C11 floor:

I want to thank you all for creating a great working- and family-like atmosphere. It's hard to ask for more talented, smart and handsome colleagues!

CH-group: **Kristoffer Ström**, **Peter Osmark**, **Cecilia Klint**, **Birgitta Danielsson**, **Sara Larsson**, **Kristian Krintel**, **Celine Fernandez**, **Stephanie Lucas**, **Ola Hansson**, **Ann-Helen Thorén**, **Håkan Lindvall**, **Jörgen Borg** and **Cecilia Holm**, for being a great sister group, countless coffee break chats, fun and games.

Mulder-group: **Malin Fex**, **Ulrika Fransson**, **Marloes Dekker-Nitert**, **Maria Björkqvist** (former member) for support, gossip, good times, and for being fabulous. **Karl Bacos**, for friendship, lots of help, collaboration, great parties and lots of dancing. You have been a great fellow PhD-student and a fantastic friend. Thank you! **Hindrik Mulder**, for your support, encouragement, help, and valuable input concerning science and academia.

Nils Wierup, for being a great friend, colleague and inspiration. **Andreas Lindqvist**, for help with antibodies, a great dissertation party and good sprit.

Elisbeth Ringsjö, **Ingegerd Persson**, and **Åsa Söderberg**, for fantastic coffee breaks, your wisdom and valuable input on serious and not so serious issues in life!

My friends and family:

My mentor and friend **Peter Strålfors**, thank you Peter for introducing me to scientific research and the field of cell signaling and diabetes. You are a great support and influence in my life. Thank you for being a great listener and for all the good advice during the years.

I thank all my friends and would like to especially acknowledge a wonderful group of women: **Ylva Stewenius**, **Kristina Edh**, **Karin Finn**, **Karolin Hansén-Hallor** and **Helena M. Linge**, thank you for your invaluable support during the last years. You mean everything to me and I hope we will stick together.

I want to thank my family: My twin sister **Liz**, brother **Bobo**, mamma **Annette** and pappa **Harald**, thank you for your love and support. Thank you for believing in me and standing by me through all of this. Farbror **Tomas** and **Lotta**, for housing me in Linköping and coaching me during my studies and in life. Farmor **Maria**, for all your love and support.

REFERENCES

1. www.idf.org/e-atlas.
2. Beck-Nielsen H, Hother-Nielsen, O: Obesity in type-2 diabetes mellitus. In *Diabetes Mellitus, a fundamental and clinical text*, 3rd ed. LeRoith D, Taylor, SI, Olefsky, JM, Ed. Philadelphia, Lippincott Williams &Wilkins, 2004, p. 857-868
3. Jones D, Gill, GV.: Non-insulin-dependent diabetes mellitus: an overview. In *Textbook of Diabetes* Pickup J, Williams, G., Ed. London, Blackwell Science, 1998, p. 17.11-17.13
4. Alberti KG, Zimmet PZ: Definition, diagnosis and classification of diabetes mellitus and its complications. Part 1: diagnosis and classification of diabetes mellitus provisional report of a WHO consultation. *Diabet Med* 15:539-553, 1998
5. Harris M: Definition and Classification of Diabetes Mellitus and Criteria for Diagnosis. In *Diabetes Mellitus, a fundamental and clinical text*, 3rd ed. LeRoith D, Taylor, SI, Olefsky, JM, Ed. Philadelphia, Lippincott Williams &Wilkins, 2004, p. 457-467
6. Roche HM, Phillips C, Gibney MJ: The metabolic syndrome: the crossroads of diet and genetics. *Proc Nutr Soc* 64:371-377, 2005
7. Malecki MT: Genetics of type 2 diabetes mellitus. *Diabetes Res Clin Pract* 68 Suppl1:S10-21, 2005
8. Cryer P: Glucose counterregulatory hormones, physiology, pathophysiology and relevance to clinical hypoglycemia. In *Diabetes Mellitus, a fundamental and clinical text*, 3rd ed. LeRoith D, Taylor, SI, Olefsky, JM, Ed. Philadelphia, Lippincott Williams &Wilkins, 2004, p. 199-206
9. Kruszynska Y: Normal metabolism: the physiology of fule homeostasis. In *Textbook of Diabetes* Pickup J, Williams, G., Ed. London, Blackwell Science, 1998, p. 11.11-11.37
10. Flakoll P, Jensen MD., Cherrington, AD.: Physiologic action of insulin. In *Diabetes Mellitus, a fundamental and clinical text*, 3rd ed. LeRoith D, Taylor, SI, Olefsky, JM, Ed. Philadelphia, Lippincott Williams &Wilkins, 2004, p. 165-181
11. Dimitriadis G, Newsholme, EA: Integration of biochemical and physiologic effects of insulin on the control of blood glucose concentrations. In *Diabetes Mellitus, a fundamental and clinical text*, 3rd ed. LeRoith D, Taylor, SI, Olefsky, JM, Ed. Philadelphia, Lippincott Williams & Wilkins, 2004, p. 183-197
12. Flatt PR: The Hormonal and Neural Control of Endocrine Pancreatic Function. In *Textbook of Diabetes* Pickup J, Williams, G., Ed. London, Blackwell Science, 1998, p. 9.1-9.17
13. Taborsky GJ, Jr., Ahren B, Havel PJ: Autonomic mediation of glucagon secretion during hypoglycemia: implications for impaired alpha-cell responses in type 1 diabetes. *Diabetes* 47:995-1005, 1998
14. Kahn SE: The relative contributions of insulin resistance and beta-cell dysfunction to the pathophysiology of Type 2 diabetes. *Diabetologia* 46:3-19, 2003
15. Ahren B, Pacini G: Islet adaptation to insulin resistance: mechanisms and implications for intervention. *Diabetes, Obesity and Metabolism* 7:2-8, 2005
16. Accili D, Cama A, Barbetti F, Kadowaki H, Kadowaki T, Taylor SI: Insulin resistance due to mutations of the insulin receptor gene: an overview. *J Endocrinol Invest* 15:857-864, 1992
17. Barroso I, Gurnell M, Crowley VE, Agostini M, Schwabe JW, Soos MA, Maslen GL, Williams TD, Lewis H, Schafer AJ, Chatterjee VK, O'Rahilly S: Dominant negative mutations in human PPARgamma associated with severe insulin resistance, diabetes mellitus and hypertension. *Nature* 402:880-883, 1999
18. Mitchell SM, Fraying TM: The role of transcription factors in maturity-onset diabetes of the young. *Mol Genet Metab* 77:35-43, 2002
19. Fajans SS, Bell GI, Polonsky KS: Molecular mechanisms and clinical pathophysiology of maturity-onset diabetes of the young. *N Engl J Med* 345:971-980, 2001

20. Horikawa Y, Oda N, Cox NJ, Li X, Orho-Melander M, Hara M, Hinokio Y, Lindner TH, Mashima H, Schwarz PE, del Bosque-Plata L, Oda Y, Yoshiuchi I, Colilla S, Polonsky KS, Wei S, Concannon P, Iwasaki N, Schulze J, Baier LJ, Bogardus C, Groop L, Boerwinkle E, Hanis CL, Bell GI: Genetic variation in the gene encoding calpain-10 is associated with type 2 diabetes mellitus. *Nat Genet* 26:163-175, 2000
21. Turner MD, Cassell PG, Hitman GA: Calpain-10: from genome search to function. *Diabetes Metab Res Rev* 21:505-514, 2005
22. Shaat N, Lernmark A, Karlsson E, Ivarsson S, Parikh H, Berntorp K, Groop L: A variant in the transcription factor 7-like 2 (TCF7L2) gene is associated with an increased risk of gestational diabetes mellitus. *Diabetologia* 50:972-979, 2007
23. Grant SF, Thorleifsson G, Reynisdottir I, Benediktsson R, Manolescu A, Sainz J, Helgason A, Stefansson H, Emilsson V, Helgadóttir A, Styrkarsdóttir U, Magnusson KP, Walters GB, Palsdóttir E, Jonsdóttir T, Gudmundsdóttir T, Gylfason A, Saemundsdóttir J, Wilensky RL, Reilly MP, Rader DJ, Bagger Y, Christiansen C, Gudnason V, Sigurdsson G, Thorsteinsdóttir U, Gulcher JR, Kong A, Stefansson K: Variant of transcription factor 7-like 2 (TCF7L2) gene confers risk of type 2 diabetes. *Nat Genet* 38:320-323, 2006
24. Sperling MA: ATP-sensitive potassium channels--neonatal diabetes mellitus and beyond. *N Engl J Med* 355:507-510, 2006
25. Yki-Jarvinen H: Prediction of NIDDM. In *Textbook of Diabetes* Pickup J, Williams, G., Ed. London, Blackwell Science, 1998, p. 83.81-83.13
26. Freeman H, Cox RD: Type-2 diabetes: a cocktail of genetic discovery. *Hum Mol Genet* 15 Spec No 2:R202-209, 2006
27. Prins JB: Adipose tissue as an endocrine organ. *Best Pract Res Clin Endocrinol Metab* 16:639-651, 2002
28. Qatanani M, Lazar MA: Mechanisms of obesity-associated insulin resistance: many choices on the menu. *Genes Dev* 21:1443-1455, 2007
29. Petersen KF, Shulman GI: Etiology of insulin resistance. *Am J Med* 119:S10-16, 2006
30. Kahn BB, Flier JS: Obesity and insulin resistance. *J Clin Invest* 106:473-481, 2000
31. Poitout V, Robertson RP: Minireview: Secondary beta-cell failure in type 2 diabetes--a convergence of glucotoxicity and lipotoxicity. *Endocrinology* 143:339-342, 2002
32. Hotamisligil GS: The role of TNF α and TNF receptors in obesity and insulin resistance. *J Intern Med* 245:621-625, 1999
33. Guldstrand M, Ahren B, Adamson U: Improved beta-cell function after standardized weight reduction in severely obese subjects. *Am J Physiol Endocrinol Metab* 284:E557-565, 2003
34. Ahren B, Thorsson O: Increased insulin sensitivity is associated with reduced insulin and glucagon secretion and increased insulin clearance in man. *J Clin Endocrinol Metab* 88:1264-1270, 2003
35. Larsson H, Ahren B: Insulin resistant subjects lack islet adaptation to short-term dexamethasone-induced reduction in insulin sensitivity. *Diabetologia* 42:936-943, 1999
36. Donath MY, Halban PA: Decreased beta-cell mass in diabetes: significance, mechanisms and therapeutic implications. *Diabetologia* 47:581-589, 2004
37. Shulman GI: Cellular mechanisms of insulin resistance. *J Clin Invest* 106:171-176, 2000
38. Ehrmann DA, Sturis J, Byrne MM, Karrison T, Rosenfield RL, Polonsky KS: Insulin secretory defects in polycystic ovary syndrome. Relationship to insulin sensitivity and family history of non-insulin-dependent diabetes mellitus. *J Clin Invest* 96:520-527, 1995
39. Ward WK, Johnston CL, Beard JC, Benedetti TJ, Halter JB, Porte D, Jr.: Insulin resistance and impaired insulin secretion in subjects with histories of gestational diabetes mellitus. *Diabetes* 34:861-869, 1985

40. Stein DT, Stevenson BE, Chester MW, Basit M, Daniels MB, Turley SD, McGarry JD: The insulinotropic potency of fatty acids is influenced profoundly by their chain length and degree of saturation. *J Clin Invest* 100:398-403, 1997
41. Dobbins RL, Chester MW, Daniels MB, McGarry JD, Stein DT: Circulating fatty acids are essential for efficient glucose-stimulated insulin secretion after prolonged fasting in humans. *Diabetes* 47:1613-1618, 1998
42. Robertson RP: Oxidative stress and impaired insulin secretion in type 2 diabetes. *Curr Opin Pharmacol* 6:615-619, 2006
43. Robertson RP, Harmon JS: Diabetes, glucose toxicity, and oxidative stress: A case of double jeopardy for the pancreatic islet beta cell. *Free Radic Biol Med* 41:177-184, 2006
44. Bishop A, Polak, JM.: The anatomy, organization and ultrastructure of the islets of Langerhans. In *Textbook of Diabetes* Pickup J, Williams, G., Ed. London, Blackwell Science, 1998, p. 6.1-6.16
45. Howell SL: The biosynthesis and secretion of insulin. In *Textbook of Diabetes* Pickup J, Williams, G., Ed. London, Blackwell Science, 1998, p. 8.1-8.16
46. Rorsman P, Renstrom E: Insulin granule dynamics in pancreatic beta cells. *Diabetologia* 46:1029-1045, 2003
47. Barg S, Eliasson L, Renstrom E, Rorsman P: A subset of 50 secretory granules in close contact with L-type Ca²⁺ channels accounts for first-phase insulin secretion in mouse β -cells. *Diabetes* 51 Suppl 1:S74-82, 2002
48. Rorsman P, Eliasson L, Renström E, Gromada J, Barg S, Gopel S: The Cell Physiology of Biphasic Insulin Secretion. *News in Physiological Sciences* 15:72-77., 2000
49. Gilon P, Ravier MA, Jonas JC, Henquin JC: Control mechanisms of the oscillations of insulin secretion in vitro and in vivo. *Diabetes* 51 Suppl 1:S144-151, 2002
50. Polonsky KS, Sturis J, Van Cauter E: Temporal profiles and clinical significance of pulsatile insulin secretion. *Horm Res* 49:178-184, 1998
51. Song SH, McIntyre SS, Shah H, Veldhuis JD, Hayes PC, Butler PC: Direct measurement of pulsatile insulin secretion from the portal vein in human subjects. *J Clin Endocrinol Metab* 85:4491-4499, 2000
52. Bruns D, Jahn R: Molecular determinants of exocytosis. *Pflügers Arch* 443:333-338, 2002
53. Henquin JC: Triggering and amplifying pathways of regulation of insulin secretion by glucose. *Diabetes* 49:1751-1760, 2000
54. Ashcroft FM, Rorsman P: Electrophysiology of the pancreatic beta-cell. *Prog Biophys Mol Biol* 54:87-143, 1989
55. Gromada J, Holst JJ, Rorsman P: Cellular regulation of islet hormone secretion by the incretin hormone glucagon-like peptide 1. *Pflügers Archiv European Journal of Physiology* 435:583-594, 1998
56. Holst JJ, Gromada J: Role of incretin hormones in the regulation of insulin secretion in diabetic and nondiabetic humans. *Am J Physiol Endocrinol Metab* 287:E199-206, 2004
57. Holst JJ: Glucagon-like Peptide 1 (GLP-1): An Intestinal Hormone, Signalling Nutritional Abundance, with an Unusual Therapeutic Potential. *Trends Endocrinol Metab* 10:229-235, 1999
58. Cooper DM: Regulation and organization of adenylyl cyclases and cAMP. *Journal of Biochemistry* 375:517-529, 2003
59. Cooper DM: Compartmentalization of adenylyl cyclase and cAMP signalling. *Biochemical Society Transactions* 33:1319-1322, 2005
60. Georget M, Mateo P, Vandecasteele G, Lipskaia L, Defer N, Hanoune J, Hoerter J, Lugnier C, Fischmeister R: Cyclic AMP compartmentation due to increased cAMP-phosphodiesterase activity in transgenic mice with a cardiac-directed expression of the human adenylyl cyclase type 8 (AC8). *Faseb J* 17:1380-1391, 2003

61. Dyachok O, Isakov Y, Sagetorp J, Tengholm A: Oscillations of cyclic AMP in hormone-stimulated insulin-secreting beta-cells. *Nature* 439:349-352, 2006
62. Baillie GS, Houslay MD: Arrestin times for compartmentalised cAMP signalling and phosphodiesterase-4 enzymes. *Curr Opin Cell Biol* 17:129-134, 2005
63. Wong W, Scott JD: AKAP signalling complexes: focal points in space and time. *Nat Rev Mol Cell Biol* 5:959-970, 2004
64. Zaccolo M, Pozzan T: Discrete microdomains with high concentration of cAMP in stimulated rat neonatal cardiac myocytes. *Science* 295:1711-1715., 2002
65. Zaccolo M, Magalhaes P, Pozzan T: Compartmentalisation of cAMP and Ca²⁺ signals. *Curr Opin Cell Biol* 14:160-166, 2002
66. Bauman AL, Soughayer J, Nguyen BT, Willoughby D, Carnegie GK, Wong W, Hoshi N, Langeberg LK, Cooper DM, Dessauer CW, Scott JD: Dynamic regulation of cAMP synthesis through anchored PKA-adenylyl cyclase V/VI complexes. *Mol Cell* 23:925-931, 2006
67. Tengholm A: Cyclic AMP: swing that message! *Cell Mol Life Sci* 64:382-385, 2007
68. Kaupp UB, Seifert R: Cyclic nucleotide-gated ion channels. *Physiol Rev* 82:769-824, 2002
69. Bos JL: Epac: a new cAMP target and new avenues in cAMP research. *Nat Rev Mol Cell Biol* 4:733-738, 2003
70. Grill V, Cerasi E: Activation by glucose of adenylyl cyclase in pancreatic islets of the rat. *FEBS Lett* 33:311-314, 1973
71. Sharp GW: The adenylyl cyclase-cyclic AMP system in islets of Langerhans and its role in the control of insulin release. *Diabetologia* 16:287-296, 1979
72. Howell SL, Jones PM, Persaud SJ: Regulation of insulin secretion: the role of second messengers. *Diabetologia* 37 Suppl 2:S30-35, 1994
73. Holst JJ, Orskov C: Incretin hormones--an update. *Scand J Clin Lab Invest Suppl* 234:75-85, 2001
74. Delmeire D, Flamez D, Hinke SA, Cali JJ, Pipeleers D, Schuit F: Type VIII adenylyl cyclase in rat beta cells: coincidence signal detector/generator for glucose and GLP-1. *Diabetologia* 46:1383-1393, 2003
75. Drucker DJ: Minireview: the glucagon-like peptides. *Endocrinology* 142:521-527, 2001
76. Guenifi A, Portela-Gomes GM, Grimelius L, Efendic S, Abdel-Halim SM: Adenylyl cyclase isoform expression in non-diabetic and diabetic Goto-Kakizaki (GK) rat pancreas. Evidence for distinct overexpression of type-8 adenylyl cyclase in diabetic GK rat islets. *Histochem Cell Biol* 113:81-89, 2000
77. Seino S, Shibasaki T: PKA-dependent and PKA-independent pathways for cAMP-regulated exocytosis. *Physiol Rev* 85:1303-1342, 2005
78. Charles MA, Lawecki J, Pictet R, Grodsky GM: Insulin secretion. Interrelationships of glucose, cyclic adenosine 3:5-monophosphate, and calcium. *J Biol Chem* 250:6134-6140, 1975
79. Landa LR, Jr., Harbeck M, Kaihara K, Chepurny O, Kitiphongspattana K, Graf O, Nikolaev VO, Lohse MJ, Holz GG, Roe MW: Interplay of Ca²⁺ and cAMP signaling in the insulin-secreting MIN6 beta-cell line. *Journal of Biological Chemistry* 280:31294-31302, 2005
80. Holz GG, Leech CA, Heller RS, Castonguay M, Habener JF: cAMP-dependent mobilization of intracellular Ca²⁺ stores by activation of ryanodine receptors in pancreatic beta-cells. A Ca²⁺ signaling system stimulated by the insulinotropic hormone glucagon-like peptide-1-(7-37). *J Biol Chem* 274:14147-14156, 1999
81. Gromada J, Dissing S, Bokvist K, Renstrom E, Frokjaer-Jensen J, Wulff BS, Rorsman P: Glucagon-like peptide I increases cytoplasmic calcium in insulin-secreting beta TC3-cells by enhancement of intracellular calcium mobilization. *Diabetes* 44:767-774, 1995
82. Holz GG, Kuhlreiter WM, Habener JF: Pancreatic beta-cells are rendered glucose-competent by the insulinotropic hormone glucagon-like peptide-1(7-37). *Nature* 361:362-365, 1993

83. Ämmälä C, Ashcroft FM, Rorsman P: Calcium-independent potentiation of insulin release by cyclic AMP in single beta-cells. *Nature* 363:356-358, 1993
84. Britsch S, Krippel-Drews P, Lang F, Gregor M, Drews G: Glucagon-like peptide-1 modulates Ca²⁺ current but not K⁺ATP current in intact mouse pancreatic B-cells. *Biochem Biophys Res Commun* 207:33-39, 1995
85. Leech CA, Habener JF: Insulinotropic glucagon-like peptide-1-mediated activation of non-selective cation currents in insulinoma cells is mimicked by maitotoxin. *J Biol Chem* 272:17987-17993, 1997
86. Jones PM, Salmon DM, Howell SL: Protein phosphorylation in electrically permeabilized islets of Langerhans. Effects of Ca²⁺, cyclic AMP, a phorbol ester and noradrenaline. *Biochem J* 254:397-403, 1988
87. Renström E, Eliasson L, Rorsman P: Protein kinase A-dependent and -independent stimulation of exocytosis by cAMP in mouse pancreatic B-cells. *Journal of Physiology* 502 (Pt 1):105-118, 1997
88. Kang G, Chepurny OG, Holz GG: cAMP-regulated guanine nucleotide exchange factor II (Epac2) mediates Ca²⁺-induced Ca²⁺ release in INS-1 pancreatic beta-cells. *J Physiol* 536:375-385, 2001
89. Nakazaki M, Crane A, Hu M, Seghers V, Ullrich S, Aguilar-Bryan L, Bryan J: cAMP-activated protein kinase-independent potentiation of insulin secretion by cAMP is impaired in SUR1 null islets. *Diabetes* 51:3440-3449., 2002
90. Ozaki N, Shibasaki T, Kashima Y, Miki T, Takahashi K, Ueno H, Sunaga Y, Yano H, Matsuura Y, Iwanaga T, Takai Y, Seino S: cAMP-GEFII is a direct target of cAMP in regulated exocytosis. *Nature Cell Biology* 2:805-811, 2000
91. Eliasson L, Ma X, Renström E, Barg S, Berggren PO, Galvanovskis J, Gromada J, Jing X, Lundquist I, Salehi A, Sewing S, Rorsman P: SUR1 Regulates PKA-independent cAMP-induced Granule Priming in Mouse Pancreatic B-cells. *Journal of General Physiology* 121:181-197, 2003
92. Sakaba T, Neher E: Preferential potentiation of fast-releasing synaptic vesicles by cAMP at the calyx of Held. *Proc Natl Acad Sci U S A* 98:331-336, 2001
93. Kaneko M, Takahashi T: Presynaptic mechanism underlying cAMP-dependent synaptic potentiation. *J Neurosci* 24:5202-5208, 2004
94. Shibasaki T, Sunaga Y, Fujimoto K, Kashima Y, Seino S: Interaction of ATP sensor, cAMP sensor, Ca²⁺ sensor, and voltage-dependent Ca²⁺ channel in insulin granule exocytosis. *Journal of Biological Chemistry* 279:7956-7961, 2004
95. Kashima Y, Miki T, Shibasaki T, Ozaki N, Miyazaki M, Yano H, Seino S: Critical role of cAMP-GEFII--Rim2 complex in incretin-potentiated insulin secretion. *J Biol Chem* 276:46046-46053, 2001
96. Essayan DM: Cyclic nucleotide phosphodiesterases. *J Allergy Clin Immunol* 108:671-680, 2001
97. Francis SH, Turko IV, Corbin JD: Cyclic nucleotide phosphodiesterases: relating structure and function. *Progress in Nucleic Acid Research and Molecular Biology* 65:1-52, 2001
98. Conti M, Jin SL: The molecular biology of cyclic nucleotide phosphodiesterases. *Prog Nucleic Acid Res Mol Biol* 63:1-38, 1999
99. Degerman E, Belfrage P, Manganiello VC: Structure, localization, and regulation of cGMP-inhibited phosphodiesterase (PDE3). *Journal of Biological Chemistry* 272:6823-6826, 1997
100. Francis SH, Colbran JL, McAllister-Lucas LM, Corbin JD: Zinc interactions and conserved motifs of the cGMP-binding cGMP-specific phosphodiesterase suggest that it is a zinc hydrolase. *J Biol Chem* 269:22477-22480, 1994
101. Corbin JD, Francis SH: Pharmacology of phosphodiesterase-5 inhibitors. *Int J Clin Pract* 56:453-459, 2002

102. Meacci E, Taira M, Moos M, Jr., Smith CJ, Movsesian MA, Degerman E, Belfrage P, Manganiello V: Molecular cloning and expression of human myocardial cGMP-inhibited cAMP phosphodiesterase. *Proc Natl Acad Sci U S A* 89:3721-3725, 1992
103. Taira M, Hockman SC, Calvo JC, Belfrage P, Manganiello VC: Molecular cloning of the rat adipocyte hormone-sensitive cyclic GMP-inhibited cyclic nucleotide phosphodiesterase. *Journal of Biological Chemistry* 268:18573-18579, 1993
104. Soderling SH, Bayuga SJ, Beavo JA: Isolation and characterization of a dual-substrate phosphodiesterase gene family: PDE10A. *Proc Natl Acad Sci U S A* 96:7071-7076, 1999
105. Kenan Y, Murata T, Shakur Y, Degerman E, Manganiello VC: Functions of the N-terminal region of cyclic nucleotide phosphodiesterase 3 (PDE 3) isoforms. *Journal of Biological Chemistry* 275:12331-12338, 2000
106. He R, Komasa N, Ekholm D, Murata T, Taira M, Hockman S, Degerman E, Manganiello VC: Expression and characterization of deletion recombinants of two cGMP-inhibited cyclic nucleotide phosphodiesterases (PDE-3). *Cell Biochem Biophys* 29:89-111, 1998
107. Kitamura T, Kitamura Y, Kuroda S, Hino Y, Ando M, Kotani K, Konishi H, Matsuzaki H, Kikkawa U, Ogawa W, Kasuga M: Insulin-induced phosphorylation and activation of cyclic nucleotide phosphodiesterase 3B by the serine-threonine kinase Akt. *Mol Cell Biol* 19:6286-6296., 1999
108. Wijkander J, Landstrom TR, Manganiello V, Belfrage P, Degerman E: Insulin-induced phosphorylation and activation of phosphodiesterase 3B in rat adipocytes: possible role for protein kinase B but not mitogen-activated protein kinase or p70 S6 kinase. *Endocrinology* 139:219-227, 1998
109. Ahmad F, Cong LN, Stenson Holst L, Wang LM, Rahn Landström T, Pierce JH, Quon MJ, Degerman E, Manganiello VC: Cyclic nucleotide phosphodiesterase 3B is a downstream target of protein kinase B and may be involved in regulation of effects of protein kinase B on thymidine incorporation in FDCP2 cells. *Journal of Immunology* 164:4678-4688, 2000
110. Lindh R, Ahmad F, Resjo S, James P, Yang JS, Fales HM, Manganiello V, Degerman E: Multisite phosphorylation of adipocyte and hepatocyte phosphodiesterase 3B. *Biochim Biophys Acta* 1773:584-592, 2007
111. Reinhardt RR, Chin E, Zhou J, Taira M, Murata T, Manganiello VC, Bondy CA: Distinctive anatomical patterns of gene expression for cGMP-inhibited cyclic nucleotide phosphodiesterases. *J Clin Invest* 95:1528-1538, 1995
112. Reinhardt RR, Bondy CA: Differential cellular pattern of gene expression for two distinct cGMP-inhibited cyclic nucleotide phosphodiesterases in developing and mature rat brain. *Neuroscience* 72:567-578, 1996
113. Bender AT, Beavo JA: Cyclic nucleotide phosphodiesterases: molecular regulation to clinical use. *Pharmacol Rev* 58:488-520, 2006
114. Shakur Y, Holst LS, Landstrom TR, Movsesian M, Degerman E, Manganiello V: Regulation and function of the cyclic nucleotide phosphodiesterase (PDE3) gene family. *Prog Nucleic Acid Res Mol Biol* 66:241-277, 2001
115. Shakur Y, Takeda K, Kenan Y, Yu ZX, Rena G, Brandt D, Houslay MD, Degerman E, Ferrans VJ, Manganiello VC: Membrane localization of cyclic nucleotide phosphodiesterase 3 (PDE3). Two N-terminal domains are required for the efficient targeting to, and association of, PDE3 with endoplasmic reticulum. *Journal of Biological Chemistry* 275:38749-38761, 2000
116. Härndahl L, Jing XJ, Ivarsson R, Degerman E, Åhrén B, Manganiello VC, Renström E, Stenson Holst L: Important role of phosphodiesterase 3B for the stimulatory action of cAMP on pancreatic beta-cell exocytosis and release of insulin. *Journal of Biological Chemistry* 277:37446-37455, 2002

117. Nilsson R, Ahmad F, Swärd K, Andersson U, Weston M, Manganiello V, Degerman E: Plasma membrane cyclic nucleotide phosphodiesterase 3B (PDE3B) is associated with caveolae in primary adipocytes. *Cellular Signalling*, 2006
118. Degerman E, Manganiello V: Phosphodiesterase 3B: An Important Regulator of Energy Homeostasis, in: JA. Beavo, S Francis, M. Houslay (Eds.), *Cyclic Nucleotide Phosphodiesterases in Health and Disease. Taylor and Francis CRC Press:79-97*, 2007
119. Elks ML, Manganiello VC: Antilipolytic action of insulin: role of cAMP phosphodiesterase activation. *Endocrinology* 116:2119-2121, 1985
120. Cheung P, Yang G, Boden G: Milrinone, a selective phosphodiesterase 3 inhibitor, stimulates lipolysis, endogenous glucose production, and insulin secretion. *Metabolism* 52:1496-1500, 2003
121. Degerman E, Rahn Landström T, Stenson Holst L, Göransson O, Ahmad F, Choi Y, Masciarelli S, Liu H, Manganiello V: *Diabetes Mellitus, a fundamental and clinical text: Role for phosphodiesterase 3B in regulation of lipolysis and insulin secretion*. Philadelphia, PA, USA, Lippincott Williams & Wilkins, 2004
122. Zmuda-Trzebiatowska E, Oknianska A, Manganiello V, Degerman E: Role of PDE3B in insulin-induced glucose uptake, GLUT-4 translocation and lipogenesis in primary rat adipocytes. *Cell Signal* 18:382-390, 2006
123. Degerman E, Smith CJ, Tornqvist H, Vasta V, Belfrage P, Manganiello VC: Evidence that insulin and isoprenaline activate the cGMP-inhibited low-Km cAMP phosphodiesterase in rat fat cells by phosphorylation. *Proceedings of the National Academy of Sciences of the United States of America* 87:533-537, 1990
124. Rahn T, Ridderstrale M, Tornqvist H, Manganiello V, Fredrikson G, Belfrage P, Degerman E: Essential role of phosphatidylinositol 3-kinase in insulin-induced activation and phosphorylation of the cGMP-inhibited cAMP phosphodiesterase in rat adipocytes. Studies using the selective inhibitor wortmannin. *FEBS Lett* 350:314-318, 1994
125. Smith CJ, Vasta V, Degerman E, Belfrage P, Manganiello VC: Hormone-sensitive cyclic GMP-inhibited cyclic AMP phosphodiesterase in rat adipocytes. Regulation of insulin- and cAMP-dependent activation by phosphorylation. *J Biol Chem* 266:13385-13390, 1991
126. Rahn T, Ronnstrand L, Leroy MJ, Wernstedt C, Tornqvist H, Manganiello VC, Belfrage P, Degerman E: Identification of the site in the cGMP-inhibited phosphodiesterase phosphorylated in adipocytes in response to insulin and isoproterenol. *J Biol Chem* 271:11575-11580, 1996
127. Zhao AZ, Shinohara MM, Huang D, Shimizu M, Eldar-Finkelman H, Krebs EG, Beavo JA, Bornfeldt KE: Leptin induces insulin-like signaling that antagonizes cAMP elevation by glucagon in hepatocytes. *J Biol Chem* 275:11348-11354., 2000
128. Choi YH, Park S, Hockman S, Zmuda-Trzebiatowska E, Svennelid F, Haluzik M, Gavrilova O, Ahmad F, Pepin L, Napolitano M, Taira M, Sundler F, Stenson Holst L, Degerman E, Manganiello VC: Alterations in regulation of energy homeostasis in cyclic nucleotide phosphodiesterase 3B-null mice. *Journal of Clinical Investigation* 116:3240-3251, 2006
129. Härndahl L, Wierup N, Enerbäck S, Mulder H, Manganiello VC, Sundler F, Degerman E, Ahrén B, Stenson Holst L: Beta-cell-targeted overexpression of phosphodiesterase 3B in mice causes impaired insulin secretion, glucose intolerance, and deranged islet morphology. *Journal of Biological Chemistry* 279:15214-15222, 2004
130. Han P, Werber J, Surana M, Fleischer N, Michaeli T: The calcium/calmodulin-dependent phosphodiesterase PDE1C down-regulates glucose-induced insulin secretion. *Journal of Biological Chemistry* 274:22337-22344., 1999
131. Zhao AZ, Zhao H, Teague J, Fujimoto W, Beavo JA: Attenuation of insulin secretion by insulin-like growth factor 1 is mediated through activation of phosphodiesterase 3B. *Proc Natl Acad Sci U S A* 94:3223-3228, 1997

132. Zhao AZ, Bornfeldt KE, Beavo JA: Leptin inhibits insulin secretion by activation of phosphodiesterase 3B. *J Clin Invest* 102:869-873., 1998
133. Parker JC, VanVolkenburg MA, Ketchum RJ, Brayman KL, Andrews KM: Cyclic AMP phosphodiesterases of human and rat islets of Langerhans: contributions of types III and IV to the modulation of insulin secretion. *Biochemical and Biophysical Research Communications* 217:916-923, 1995
134. Shafiee-Nick R, Pyne NJ, Furman BL: Effects of type-selective phosphodiesterase inhibitors on glucose-induced insulin secretion and islet phosphodiesterase activity. *British Journal of Pharmacology* 115:1486-1492, 1995
135. Fujimoto S, Ishida H, Kato S, Okamoto Y, Tsuji K, Mizuno N, Ueda S, Mukai E, Seino Y: The novel insulinotropic mechanism of pimobendan: direct enhancement of the exocytotic process of insulin secretory granules by increased Ca²⁺ sensitivity in beta-cells. *Endocrinology* 139:1133-1140, 1998
136. Ahmad M, Abdel-Wahab YH, Tate R, Flatt PR, Pyne NJ, Furman BL: Effect of type-selective inhibitors on cyclic nucleotide phosphodiesterase activity and insulin secretion in the clonal insulin secreting cell line BRIN-BD11. *Br J Pharmacol* 129:1228-1234, 2000
137. Yoon KH, Ko SH, Cho JH, Lee JM, Ahn YB, Song KH, Yoo SJ, Kang MI, Cha BY, Lee KW, Son HY, Kang SK, Kim HS, Lee IK, Bonner-Weir S: Selective beta-cell loss and alpha-cell expansion in patients with type 2 diabetes mellitus in Korea. *Journal of Clinical Endocrinology & Metabolism* 88:2300-2308, 2003
138. Deng S, Vatamaniuk M, Huang X, Doliba N, Lian MM, Frank A, Velidedeoglu E, Desai NM, Koerberlein B, Wolf B, Barker CF, Najj A, Matschinsky FM, Markmann JF: Structural and functional abnormalities in the islets isolated from type 2 diabetic subjects. *Diabetes* 53:624-632, 2004
139. Lacy PE, Kostianovsky M: Method for the isolation of intact islets of Langerhans from the rat pancreas. *Diabetes* 16:35-39, 1967
140. Ashcroft SJ, Hammonds P, Harrison DE: Insulin secretory responses of a clonal cell line of simian virus 40-transformed B cells. *Diabetologia* 29:727-733, 1986
141. Knaack D, Fiore DM, Surana M, Leiser M, Laurance M, Fusco-DeMane D, Hegre OD, Fleischer N, Efrat S: Clonal insulinoma cell line that stably maintains correct glucose responsiveness. *Diabetes* 43:1413-1417, 1994
142. Liang Y, Bai G, Doliba N, Buettger C, Wang L, Berner DK, Matschinsky FM: Glucose metabolism and insulin release in mouse beta HC9 cells, as model for wild-type pancreatic beta-cells. *Am J Physiol* 270:E846-857, 1996
143. Noda M, Komatsu M, Sharp GW: The betaHC-9 pancreatic beta-cell line preserves the characteristics of progenitor mouse islets. *Diabetes* 45:1766-1773, 1996
144. Miyazaki J, Araki K, Yamato E, Ikegami H, Asano T, Shibasaki Y, Oka Y, Yamamura K: Establishment of a pancreatic beta cell line that retains glucose-inducible insulin secretion: special reference to expression of glucose transporter isoforms. *Endocrinology* 127:126-132, 1990
145. Carrington CA, Rubery ED, Pearson EC, Hales CN: Five new insulin-producing cell lines with differing secretory properties. *J Endocrinol* 109:193-200, 1986
146. Gazdar AF, Chick WL, Oie HK, Sims HL, King DL, Weir GC, Lauris V: Continuous, clonal, insulin- and somatostatin-secreting cell lines established from a transplantable rat islet cell tumor. *Proc Natl Acad Sci U S A* 77:3519-3523, 1980
147. Halban PA, Praz GA, Wollheim CB: Abnormal glucose metabolism accompanies failure of glucose to stimulate insulin release from a rat pancreatic cell line (RINm5F). *Biochem J* 212:439-443, 1983
148. Hill RS, Boyd AE, 3rd: Perfusion of a clonal cell line of Simian virus 40-transformed beta cells. Insulin secretory dynamics in response to glucose, 3-isobutyl-1-methylxanthine, and potassium. *Diabetes* 34:115-120, 1985

149. Zhou D, Sun AM, Li X, Mamujee SN, Vacek I, Georgiou J, Wheeler MB: In vitro and in vivo evaluation of insulin-producing beta TC6-F7 cells in microcapsules. *Am J Physiol* 274:C1356-1362, 1998
150. Asfari M, Janjic D, Meda P, Li G, Halban PA, Wollheim CB: Establishment of 2-mercaptoethanol-dependent differentiated insulin-secreting cell lines. *Endocrinology* 130:167-178, 1992
151. Hohmeier HE, Mulder H, Chen G, Henkel-Rieger R, Prentki M, Newgard CB: Isolation of INS-1-derived cell lines with robust ATP-sensitive K⁺ channel-dependent and -independent glucose-stimulated insulin secretion. *Diabetes* 49:424-430., 2000
152. Straub SG, Yajima H, Komatsu M, Aizawa T, Sharp GW: The effects of cerulenin, an inhibitor of protein acylation, on the two phases of glucose-stimulated insulin secretion. *Diabetes* 51 Suppl 1:S91-95, 2002
153. Surwit RS, Kuhn CM, Cochrane C, McCubbin JA, Feinglos MN: Diet-induced type II diabetes in C57BL/6J mice. *Diabetes* 37:1163-1167, 1988
154. Ahren B, Simonsson E, Scheurink AJ, Mulder H, Myrsen U, Sundler F: Dissociated insulinotropic sensitivity to glucose and carbachol in high-fat diet-induced insulin resistance in C57BL/6J mice. *Metabolism* 46:97-106, 1997
155. Smith CL: Basic Confocal Microscopy. In *Current Protocols in Cell Biology*, John Wiley & Sons, Inc, 1999, p. 4.5.1-4.5.12
156. Larsson LI, Sundler F, Hakanson R: Pancreatic polypeptide - a postulated new hormone: identification of its cellular storage site by light and electron microscopic immunocytochemistry. *Diabetologia* 12:211-226, 1976
157. Hamill OP, Marty A, Neher E, Sakmann B, Sigworth FJ: Improved patch-clamp techniques for high-resolution current recording from cells and cell-free membrane patches. *Pflugers Arch* 391:85-100, 1981
158. Neher E: Vesicle pools and Ca²⁺ microdomains: new tools for understanding their roles in neurotransmitter release. *Neuron* 20:389-399, 1998
159. Neher E, Marty A: Discrete changes of cell membrane capacitance observed under conditions of enhanced secretion in bovine adrenal chromaffin cells. *Proc Natl Acad Sci U S A* 79:6712-6716, 1982
160. Gentet LJ, Stuart GJ, Clements JD: Direct measurement of specific membrane capacitance in neurons. *Biophys J* 79:314-320, 2000
161. Rae J, Cooper K, Gates P, Watsky M: Low access resistance perforated patch recordings using amphotericin B. *Journal of Neuroscience Methods* 37:15-26, 1991
162. Eliasson L, Proks P, Ammala C, Ashcroft FM, Bokvist K, Renstrom E, Rorsman P, Smith PA: Endocytosis of secretory granules in mouse pancreatic beta-cells evoked by transient elevation of cytosolic calcium. *J Physiol* 493 (Pt 3):755-767, 1996
163. Barg S, Olofsson CS, Schriever-Abeln J, Wendt A, Gebre-Medhin S, Renstrom E, Rorsman P: Delay between fusion pore opening and peptide release from large dense-core vesicles in neuroendocrine cells. *Neuron* 33:287-299, 2002
164. Ahmad F, Lindh R, Tang Y, Weston M, Degerman E, Manganiello VC: Insulin-induced formation of macromolecular complexes involved in activation of cyclic nucleotide phosphodiesterase 3B (PDE3B) and its interaction with PKB. *Biochem J* 404:257-268, 2007
165. Seppala-Lindroos A, Vehkavaara S, Hakkinen A-M, Goto T, Westerbacka J, Sovijarvi A, Halavaara J, Yki-Jarvinen H: Fat Accumulation in the Liver Is Associated with Defects in Insulin Suppression of Glucose Production and Serum Free Fatty Acids Independent of Obesity in Normal Men. *The Journal of Clinical Endocrinology & Metabolism* 87:3023-3028, 2002
166. Foufelle F, Girard J, Ferre P: Regulation of lipogenic enzyme expression by glucose in liver and adipose tissue: a review of the potential cellular and molecular mechanisms. *Adv Enzyme Regul* 36:199-226, 1996