



# LUND UNIVERSITY

## Zipper - a Duplex Method for VDSL based on DMT

Sjöberg, F; Isaksson, M; Ödling, Per; Börjesson, Per Ola

*Published in:*  
IEEE Transactions on Communications

*DOI:*  
[10.1109/26.780461](https://doi.org/10.1109/26.780461)

1999

[Link to publication](#)

*Citation for published version (APA):*  
Sjöberg, F., Isaksson, M., Ödling, P., & Börjesson, P. O. (1999). Zipper - a Duplex Method for VDSL based on DMT. *IEEE Transactions on Communications*, 47(8), 1245-1252. <https://doi.org/10.1109/26.780461>

*Total number of authors:*  
4

### General rights

Unless other specific re-use rights are stated the following general rights apply:  
Copyright and moral rights for the publications made accessible in the public portal are retained by the authors and/or other copyright owners and it is a condition of accessing publications that users recognise and abide by the legal requirements associated with these rights.

- Users may download and print one copy of any publication from the public portal for the purpose of private study or research.
- You may not further distribute the material or use it for any profit-making activity or commercial gain
- You may freely distribute the URL identifying the publication in the public portal

Read more about Creative commons licenses: <https://creativecommons.org/licenses/>

### Take down policy

If you believe that this document breaches copyright please contact us providing details, and we will remove access to the work immediately and investigate your claim.

LUND UNIVERSITY

PO Box 117  
221 00 Lund  
+46 46-222 00 00

# Zipper: A Duplex Method for VDSL Based on DMT

Frank Sjöberg, *Student Member, IEEE*, Mikael Isaksson, Rickard Nilsson, *Student Member, IEEE*,  
Per Ödling, *Associate Member, IEEE*, Sarah Kate Wilson, *Member, IEEE*,  
and Per Ola Börjesson, *Member, IEEE*

**Abstract**—In this paper, we present a new duplex scheme, called Zipper, for discrete multitone (DMT)-based very high bit-rate digital subscriber line (VDSL) systems on copper wires. This scheme divides the available bandwidth by assigning different subcarriers for the upstream and downstream directions. It has high flexibility to divide the capacity between the up and downstream, as well as good coexistence possibilities with other systems such as ADSL. Simulation results show high bit-rate performance in different environments such as mixed ADSL and VDSL traffic under radio frequency interference and with different background noise sources.

**Index Terms**—Digital subscriber line, discrete multitone, duplex.

## I. INTRODUCTION

VERY high bit-rate digital subscriber line (VDSL) [1], [2] is the latest digital subscriber line technique for high bit-rate communication on unshielded twisted-pair wires. VDSL will use larger bandwidth and achieve higher bit rates than its precursors, e.g., asymmetrical digital subscriber line (ADSL) [3] and high bit-rate digital subscriber line (HDSL) [4]. The standard for VDSL is currently being developed and is discussed in forums such as the American National Standards Institute (ANSI) [1] and the European Telecommunications Standards Institute (ETSI) [2].

A significant problem VDSL systems confront is near-end crosstalk (NEXT). NEXT occurs when data is transmitted simultaneously in both directions, at the same frequencies, and on several wires in the same binder group. Systems that predominantly transmit in only one direction (such as ADSL) experience mostly far-end crosstalk (FEXT), a markedly less severe problem than NEXT [5]. Avoidance of NEXT by dividing the channel capacity between the upstream and downstream has shaped the existing VDSL proposals. Time-division duplex (TDD) [6] and frequency-division duplex (FDD) [7] are two different proposals for dividing the capacity in time and frequency, respectively.

Paper approved by P. E. Rhyne, the Editor for Copper Wire Access Systems of the IEEE Communications Society. Manuscript received May 14, 1998; revised November 12, 1998 and March 2, 1999. This paper was presented in part at the International Workshop on Copper Wire Access Systems'97 in Budapest, Hungary, and at the International Conference on Communications'98, Atlanta, GA.

F. Sjöberg, R. Nilsson, and S. K. Wilson are with the Department of Signal Processing, Lulea University of Technology, SE-97187 Lulea, Sweden.

M. Isaksson is with Telia Research AB, SE-97775 Lulea, Sweden (e-mail: frank@sm.luth.se).

P. Ödling and P. O. Börjesson are with the Lund Institute of Technology, SE-22100 Lund, Sweden.

Publisher Item Identifier S 0090-6778(99)06303-5.

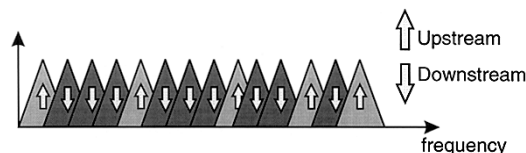

Fig. 1. The Zipper principle of capacity division (each triangle represents a subcarrier).

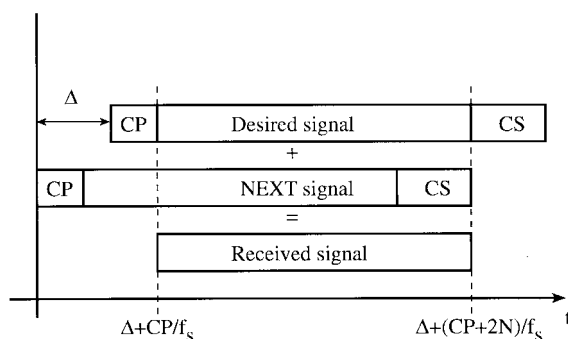

Fig. 2. Timing diagram showing the desired symbol frame, a symbol frame representing NEXT, and the portion of data extracted from the received frame.

In this paper, we introduce a novel discrete multitone (DMT)-based [8], [9] duplex scheme for VDSL called Zipper [10], [11]. Zipper avoids NEXT by using different orthogonal subcarriers in the upstream and downstream directions to divide the capacity. Using several orthogonal signals gives Zipper both variable capacity allocation and high ADSL compatibility.

We evaluate the performance of the Zipper duplex method by calculating achievable bit rates for some scenarios consisting of different types of wires and noise sources. In particular, we consider Zipper performance in a VDSL-only environment, in mixed VDSL and ADSL traffic, and with ETSI models for background noise and radio frequency interference (RFI).

## II. THE ZIPPER DUPLEX METHOD

Zipper extends traditional DMT in the following two ways:

- it uses different DMT carriers in different transmission directions (as shown in Fig. 1);
- it adds a *cyclic suffix* (CS) to ensure orthogonality between the transmitted and received signal (as shown in Fig. 2).

Zipper allocates different subcarriers for upstream and downstream transmission. A sample allocation scheme is sketched in Fig. 1. The allocation of the upstream and downstream subcarriers can be done dynamically, enabling

run-time adaption of the bit rates. The upstream part of one transmitted DMT frame can be modeled as

$$x_{\text{up}}(t) = \begin{cases} \sum_{k \in \mathcal{I}_{\text{up}}} X_k e^{(j2\pi k f_s / 2N)t}, & t \in \left[0, \frac{2N + CP + CS}{f_s}\right] \\ 0, & \text{otherwise} \end{cases} \quad (1)$$

where  $\mathcal{I}_{\text{up}}$  is the index set for the upstream carriers,  $N$  is the total number of subcarriers,  $CP$  is the length (in samples) of the cyclic prefix,  $CS$  is the length of the cyclic suffix, and  $f_s$  is the sampling frequency. Since  $x_{\text{up}}(t)$  is a real-valued baseband signal, the data  $X_k$  must satisfy

$$X_k = X_{2N-k}^* \quad (2)$$

where the asterisk denotes the complex conjugate. The corresponding restriction also applies to the index set  $\mathcal{I}_{\text{up}}$ , i.e., if  $k \in \mathcal{I}_{\text{up}}$  then  $2N - k \in \mathcal{I}_{\text{up}}$ . The downstream part of the DMT frame has a similar index set  $\mathcal{I}_{\text{down}}$  that is a subset of the complement set to  $\mathcal{I}_{\text{up}}$  ( $\mathcal{I}_{\text{down}} \subseteq \{0, 1, \dots, 2N-1\} \setminus \mathcal{I}_{\text{up}}$ ).

Because Zipper transmits and receives simultaneously, the two network ends should be synchronized in both time and frequency in order to maintain orthogonality. As both the upstream and the downstream contribute to a received DMT frame, time synchronization is required to keep the signal contributions within one DMT frame. All transmitters in the access network (which may cause interference to each other) are synchronized to start transmission of a new DMT frame simultaneously. The frame synchronization can be made by having one master clock in the central office that feeds all VDSL-modems with a frame clock. If the physical distance between racks of modems is large, a Global Positioning System (GPS) unit may be used to ensure proper timing [6], [12]. The modems at the customer side then synchronize on the incoming downstream signal and use timing-advance to start transmission of a new DMT frame at the same time as the central office. Sampling frequency synchronization between the two network ends is necessary to ensure the proper spacing between subcarriers. However, this is rarely a problem as the wire-channel is almost stationary and has relatively high signal-to-noise ratio (SNR).

In addition to synchronizing the transmitters and receivers, we add a cyclic suffix to ensure orthogonality between the upstream and downstream signals, thus preventing NEXT and near-echoes. Traditional DMT uses a cyclic prefix to preserve orthogonality between the subcarriers and prevent interblock interference [13], but Zipper adds an extra cyclic suffix to preserve orthogonality between the upstream and downstream carriers. A similar idea involving a longer cyclic extension has recently been suggested for universal ADSL (UADSL) [14].

With the Zipper scheme, a network terminal is not only receiving its intended signal, but also NEXT from nearby transmitters plus its own transmitted signal which appears as a near-echo. In Fig. 3, we sketch a NEXT impulse response (which can also represent a near-echo) together with the wire's impulse response. The desired signal is delayed  $\Delta$  seconds due to the propagation delay, but the disturbing signal arrives

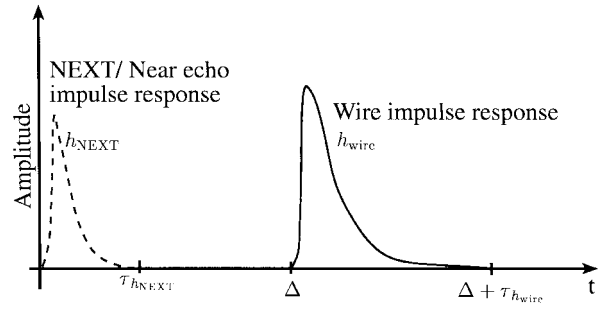

Fig. 3. Channel impulse response from NEXT and desired signal.

almost immediately. A received signal at the central office can be expressed as

$$r(t) = r_{\text{up}}(t) + r_{\text{down}}(t) \quad (3)$$

$$= x_{\text{up}}(t) * h_{\text{wire}}(t) + x_{\text{down}}(t) * h_{\text{NEXT}}(t). \quad (4)$$

The upstream part of the received signal can be rewritten as

$$\begin{aligned} r_{\text{up}}(t) &= \sum_{k \in \mathcal{I}_{\text{up}}} X_k \int_0^{\min(t, \Delta + \tau_{h_{\text{wire}}})} h_{\text{wire}}(\tau) e^{(j2\pi k f_s / 2N)(t-\tau)} d\tau \\ &= \sum_{k \in \mathcal{I}_{\text{up}}} X_k H_{k, \text{wire}} e^{(j2\pi k f_s / 2N)t} \\ &\quad \text{when } t \in \left[ \Delta + \tau_{h_{\text{wire}}}, \frac{(2N + CP + CS)}{f_s} + \Delta \right) \end{aligned} \quad (5)$$

where

$$H_{k, \text{wire}} = \int_0^{\Delta + \tau_{h_{\text{wire}}}} h_{\text{wire}}(\tau) e^{-(j2\pi k f_s / 2N)\tau} d\tau. \quad (6)$$

We do not consider the case when  $t$  is outside the interval specified in (5), since then the integral will depend on  $t$  and we do not have orthogonality. Similarly the downstream part of the received signal can be written as

$$\begin{aligned} r_{\text{down}}(t) &= \sum_{k \in \mathcal{I}_{\text{down}}} X_k \int_0^{\min(t, \tau_{h_{\text{NEXT}}})} h_{\text{NEXT}}(\tau) \\ &\quad \cdot e^{(j2\pi k f_s / 2N)(t-\tau)} d\tau \\ &= \sum_{k \in \mathcal{I}_{\text{down}}} X_k H_{k, \text{NEXT}} e^{(j2\pi k f_s / 2N)t} \\ &\quad \text{when } t \in \left[ \tau_{h_{\text{NEXT}}}, \frac{(2N + CP + CS)}{f_s} \right) \end{aligned} \quad (7)$$

where

$$H_{k, \text{NEXT}} = \int_0^{\tau_{h_{\text{NEXT}}}} h_{\text{NEXT}}(\tau) e^{-(j2\pi k f_s / 2N)\tau} d\tau. \quad (8)$$

To maintain orthogonality in the whole DMT signal in (3), the intersection of the intervals for  $t$  in (5) and (7) must be at least  $2N/f_s$  long. This is true if the cyclic extensions are sufficiently long, i.e.,  $CS/f_s \geq \Delta$  and  $CP/f_s \geq \tau_{h_{\text{wire}}}$ , and if we use the part of the received signal that is indicated in Fig. 2,  $t \in [\Delta + (CP/f_s), \Delta + (2N + CP/f_s)]$ . The received

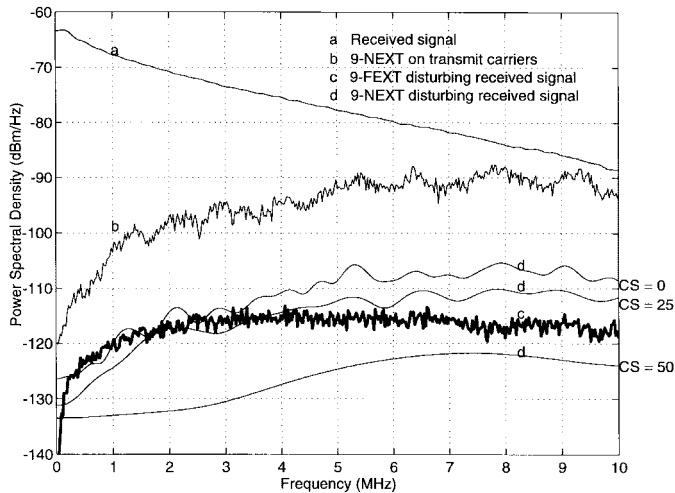

Fig. 4. Level of NEXT that appear if a too short cyclic suffix is used.

signal will then be

$$\begin{aligned}
 r(t) &= r_{\text{down}}(t) + r_{\text{up}}(t) \\
 &= \sum_{k \in \mathcal{I}_{\text{down}}} X_k H_{k, \text{NEXT}} e^{(j2\pi k f_s / 2N)t} \\
 &\quad + \sum_{k \in \mathcal{I}_{\text{up}}} X_k H_{k, \text{wire}} e^{(j2\pi k f_s / 2N)t}. \quad (9)
 \end{aligned}$$

Hence, the upstream and downstream signals are orthogonal.

Since there can be wires of different length in an access network, the cyclic suffix has to be as long as the delay in the longest wire-pair used for transmission. Fig. 4 shows how much NEXT is suppressed by a cyclic suffix of different lengths. For this case, a cyclic suffix of 60 samples would completely suppress the NEXT.

The reason for using each subcarrier in either upstream or downstream direction is to avoid NEXT and near-echoes. But for lower frequencies, the NEXT is not much stronger than the FEXT, and near-echoes can be reduced with an echo-canceller. This implies that higher total bit-rate capacity can be achieved if the subcarriers with moderate NEXT are used in both directions simultaneously. The cost for this is increased complexity since an echo-canceller is needed to take care of the strong near-echoes that will appear.

To summarize this section, Zipper is a DMT-based system transmitting orthogonal signals over different subcarriers in different transmission directions. Maintaining signal orthogonality at the receiver end puts two key system requirements:

- synchronization among all transmitters at both ends;
- a cyclic suffix to compensate for propagation delay.

### III. ZIPPER PROPERTIES

In this section, we discuss some of the properties of Zipper in terms of flexibility, compatibility with existing services, latency, duplex efficiency, and complexity.

#### A. Flexibility and Compatibility

Zipper is a very flexible duplex scheme because it uses (a large number of) subcarriers that can be assigned dynamically

to divide the available capacity (even after the system is installed and running). This has the advantage that almost any desired ratio between up and downstream bit rates can be chosen at any time. The flexibility in subcarrier assignment also allows a Zipper-based VDSL system to be spectrally compatible with other systems.

A valuable feature for VDSL systems is the ability to coexist in the same binder group with other systems, such as ADSL. A reasonable condition for coexistence between ADSL and VDSL is that neither system introduces NEXT to the other. This can be achieved if both ADSL and VDSL transmit in the same direction in the shared-frequency band. With Zipper, the lowermost subcarriers, those where ADSL exists, may be partitioned such that only FEXT is introduced between ADSL and VDSL [15], as depicted in Fig. 5. The signaling bandwidth of ADSL is 1.1 MHz but, due to out-of-band emission, the crosstalk from ADSL contains substantial power up to 2 MHz (see Fig. 6).

#### B. Latency and Efficiency

Latency is a measure of system delay. We define it as the maximum time it takes for one uncoded bit to pass from first entering the transmitter to finally exiting the receiver. Latency is essentially caused by the buffering needed before computing the fast Fourier transform (FFT) and the inverse FFT (IFFT). Thus, the worst case latency with Zipper is not more than<sup>1</sup>

$$\tau_{\text{Zipper}} = 2(2N + CP + CS)/f_s \quad (10)$$

where  $N$  is the number of subcarriers,  $CP$  the number of samples in the cyclic prefix, and  $CS$  the number of samples in the cyclic suffix.

Duplex efficiency is a good measure of how well a system is using the available bandwidth. We define the duplex efficiency as the ratio between the time used for carrying data in both directions divided by total time. For Zipper, this can be expressed as

$$\varepsilon_{\text{Zipper}} = \frac{2N}{2N + CS + CP}. \quad (11)$$

Table I shows the efficiency and latency figures for a Zipper system with a cyclic prefix of 100 samples, a sampling frequency of 22 MHz, and a cyclic suffix of 220 samples. There is a tradeoff between efficiency and latency, but since the latency is not that large with Zipper, it can be possible to use as many as 4096 subcarriers in a VDSL application. Using more subcarriers gives not only better efficiency but also lower out-of-band emission and increased robustness against narrow-band interferences like RFI.

#### C. Analog Complexity

In general, Zipper requires more complex hardware than other duplex methods, such as TDD or FDD.

To transmit in both directions simultaneously, Zipper needs a hybrid to suppress the near-echoes. This is not needed in

<sup>1</sup>The processing needed in the transmitter and receiver can mostly be done in parallel with the buffering. For reasons of simplicity, we do not consider the computational processing time.

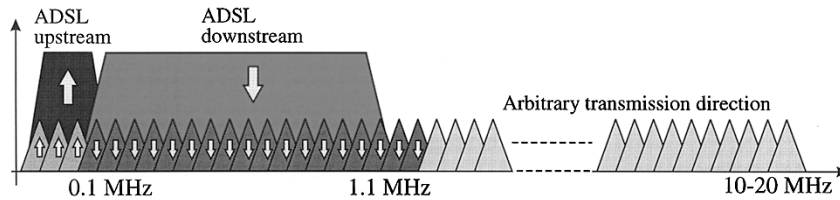

Fig. 5. A Zipper subcarrier assignment demonstrating possible coexistence with ADSL.

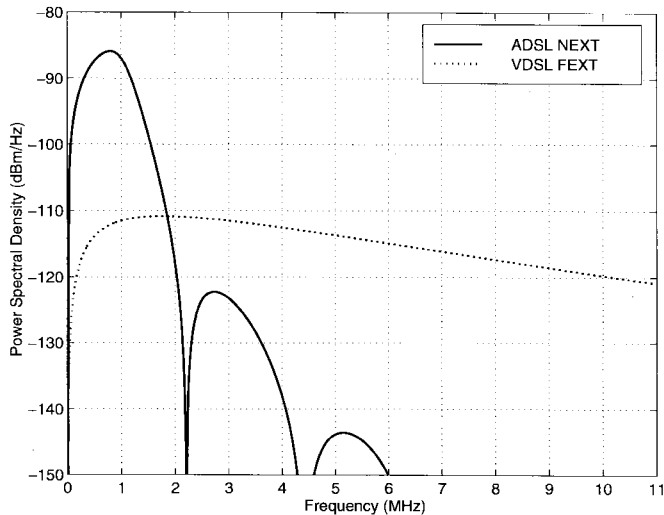

Fig. 6. PSD of NEXT from 25 ADSL systems and FEXT from 25 VDSL systems on a 600-m (2000 ft)-long TP2 wire [1].

TABLE I  
EFFICIENCY AND LATENCY FOR ZIPPER ON A WIRE LENGTH OF 1500 m

Number of Subcarriers	Efficiency	Latency
512	76.2 %	120 $\mu$ s
1024	86.5 %	220 $\mu$ s
2048	92.8 %	400 $\mu$ s
4096	96.2 %	770 $\mu$ s

a time-divided system. Two issues to consider with a hybrid are its linearity and its ability to suppress near-echoes. Since Zipper uses DMT modulation, it seems reasonable that the requirements for the hybrid in terms of linearity will be high. However, measurements on a simple hybrid reveal that its nonlinearities will not significantly inhibit the performance of a VDSL system using the Zipper method.

The performance of the hybrid in terms of trans-hybrid loss and its impact on the dynamic range of the analog-to-digital converter (ADC) have been studied in [16]. Based on a model of a hybrid with 25-dB average attenuation, it is concluded that Zipper needs approximately the same number of bits as TDD for wires shorter than 1200 m. However, in the presence of line impairments, such as bridge-taps and lines consisting of several serially connected wires with different impedances, an attenuation of 25 dB may be overly optimistic. In such

cases, Zipper might need one or more additional bits in the ADC compared to a time-divided system.

#### D. Digital Complexity

A Zipper-based system is likely to be more complex than a comparative TDD system using DMT modulation. The difference is that Zipper needs two FFT's (or one FFT working twice as fast) because transmission and reception take place simultaneously. As a TDD system only transmits or receives on a one-at-a-time basis, only one FFT is needed. In addition to an FFT, a complete DMT system also needs an encoder, a decoder, an equalizer, a synchronization unit, etc. So, the relative increase in complexity resulting from having one more FFT in Zipper is not substantial.

Since it is feasible to use 1024 or more subcarriers with Zipper, it is possible to have a sufficiently long cyclic prefix to avoid the need for a time-domain equalizer [17] and still have high-duplex efficiency. A larger number of subcarriers will, of course, increase the computational complexity and memory requirements of the system. But 1024 or 2048 subcarriers are not unrealistic numbers, considering that the number of subcarriers in the European digital audio broadcasting (DAB) system [18] and digital video broadcasting (DVB) system [19] are 1024 and 2048, respectively (DVB has also an 8192 subcarrier mode).

#### IV. PERFORMANCE EVALUATION

To evaluate the performance of Zipper, we have chosen to calculate achievable bit rates for a Zipper VDSL system in four different noise environments. The first case is a clean VDSL scenario with only additive white Gaussian noise (AWGN) as background noise, representing a best case scenario. The second case is a more realistic case consisting of a mix of ADSL and VDSL services generating ADSL crosstalk in addition to the AWGN. The third and fourth cases use a background noise model specified by ETSI [2], while the fourth case also includes RFI as a worst case scenario. All four cases include VDSL self-FEXT from 25 other users.

Since Zipper uses DMT modulation, it is bit-loading [20] that determines the bit rate of the system. The number of bits that can be loaded onto subcarrier number  $k$  is calculated as [20]

$$b_k = \log_2 \left( \frac{\text{SNR}_k \cdot \gamma_{\text{code}}}{\Gamma \cdot \gamma_{\text{margin}}} + 1 \right) \quad (12)$$

TABLE II  
SYSTEM PARAMETERS

AWGN	-140 dBm/Hz
System margin	$\gamma_{margin} = 6$ dB
Coding gain	$\gamma_{code} = 3$ dB
SNR-gap	$\Gamma = 9.8$ dB
Sampling frequency	22 MHz
Signalling bandwidth	300 kHz - 11 MHz
Number of subcarriers	2048
Length of CP	100 samples
Length of CS	220 samples (2000 m)

where  $SNR_k$  is the signal-to-noise ratio on subcarrier  $k$ ,  $\gamma_{code}$  is the coding gain,  $\Gamma$  is the SNR gap<sup>2</sup> between the Shannon capacity and the data rate achieved with quadrature amplitude modulation (QAM) [21], and  $\gamma_{margin}$  is the system margin. System margin is the additional amount of noise the system can tolerate without exceeding the allowed symbol error rate (SER).

The capacity for the system is the sum of bits loaded onto each subcarrier. Within the VDSL frequency band, there are certain frequency bands reserved for amateur radio users [2], the so called HAM-bands. To comply with the regulations for usage of these bands, they can in practice not be used for transmission. Therefore, subcarriers that correspond to frequencies in the HAM-bands are not used. One subcarrier on each side of the HAM-bands also has to be reserved for further RFI-egress suppression [22].

Achievable bit rates have been calculated for different lengths of TP1 and TP2 wires [1], for a target SER of  $10^{-7}$ . The TP1 wire has a diameter of 0.4 mm and the TP2 wire has a diameter of 0.5 mm. Parameters used in the calculations are listed in Table II.

A. VDSL Environment

Fig. 7 shows achievable (8:1) asymmetrical bit rates versus wire length for the case with only self-FEXT and AWGN as background noise. Here, every ninth subcarrier is used in the upstream direction to get an (8:1) ratio between upstream and downstream bit rates. For wires shorter than 600 m, there is no big difference between the two types of wire, but for longer wires, the thicker TP2 wire gives higher bit rates. This is because self-FEXT is the dominant noise source for shorter wires and AWGN for longer wires and because the TP2 wire attenuates the signal less than the TP1 wire.

B. Mix of VDSL and ADSL

The achievable bit rates for the second case, where Zipper coexists with 25 ADSL users in the same binder group, are

<sup>2</sup>An SNR gap of 9.8 dB [21] is used to achieve an SER of approximately  $10^{-7}$ .

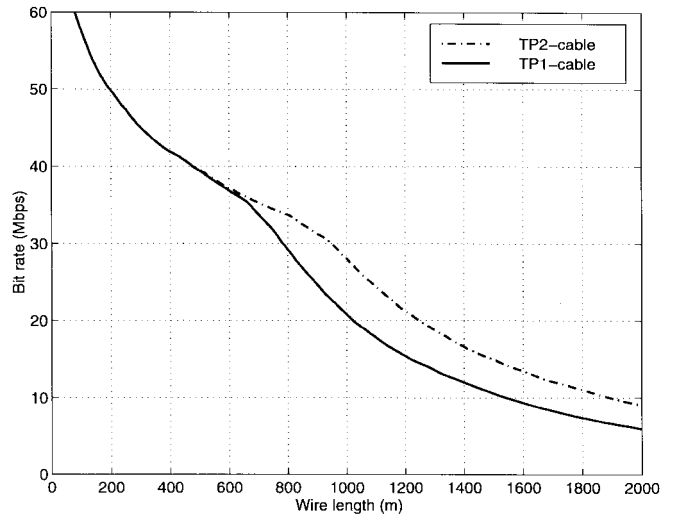

Fig. 7. Achievable (8:1) asymmetrical downstream bit rates, with AWGN and 25 self-FEXT disturbers.

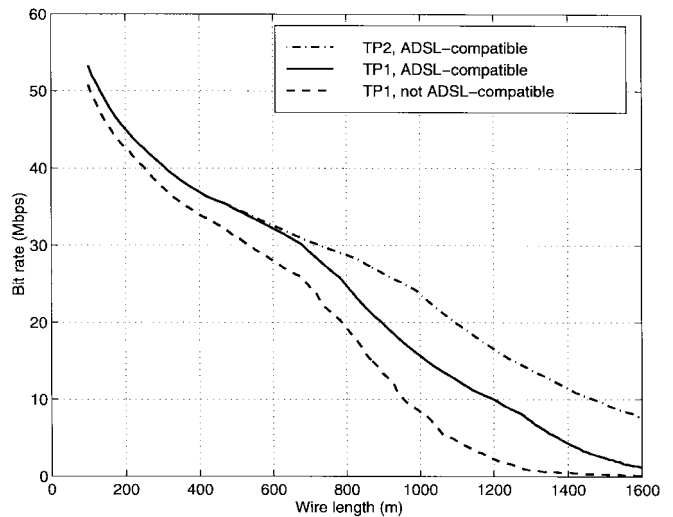

Fig. 8. Achievable (8:1) asymmetrical downstream bit rates for Zipper with 25-ADSL systems and 25 self-FEXT.

shown in Fig. 8. The crosstalk models and ADSL power spectral mask are specified by ANSI in [1]. To make Zipper compatible with ADSL, the lower subcarriers are assigned, as previously shown in Fig. 5. Fig. 8 also shows the results for a case where the subcarrier assignment is made in such a way that the two systems are not spectrally compatible (every ninth subcarrier is used in the upstream direction). We can see that there is a clear advantage in making VDSL spectrally compatible with ADSL. But even when we avoid NEXT from the ADSL systems, the performance is lower than in a clean VDSL environment. The transmit power spectral density (PSD) of the ADSL signal is 20 dB higher than for VDSL, so FEXT from ADSL will be much stronger than the self-FEXT from VDSL in the shared-frequency band.

C. ETSI Noise Model

ETSI has specified noise models for background noise to be used when simulating VDSL systems [2]. These noise models

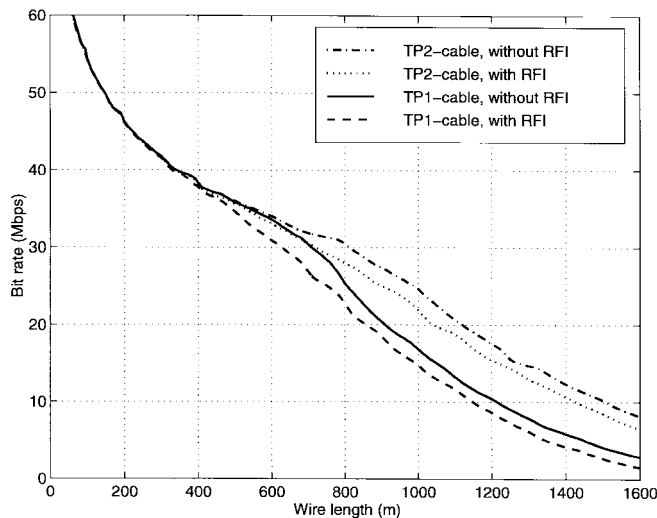

Fig. 9. Achievable (8:1) asymmetrical downstream bit rates, with ETSI background noise model "A," 25 self-FEXT, and RFI-noise.

TABLE III  
CENTER FREQUENCIES FOR THE EIGHT BROADCAST RADIO INTERFERERS AND SIGNAL STRENGTH AT THE CUSTOMER SIDE

Frequency (kHz)	Signal Power (dBm)
711, 801	-60
909, 981, 1458, 6050, 7350, 9650	-40

include AWGN and a mix of crosstalk from other existing services such as ADSL, HDSL, ISDN, etc. In our calculations, we have used noise model "A." Fig. 9 shows the performance for this case. Comparing this with Fig. 8, we see that the performance with the ETSI noise is not much different from the performance for the ADSL case. Correspondingly, the PSD of the ETSI noise model resembles the PSD of crosstalk from ADSL systems.

#### D. ETSI Noise Model Plus RFI

As a worst case scenario, we have added eight broadcast radio interferers to the ETSI noise model "A." The eight RFI signals, specified by ETSI [2], are listed in Table III. The power levels at the central office are 10 dB lower than at the customer side. The RFI signals are generated by filtering white Gaussian noise with a third-order Butterworth filter with 2-kHz cutoff frequency. This signal is then double-sideband modulated giving a 4-kHz passband signal at the desired center frequency.

To suppress this RFI, we have used a nonrectangular time window (raised-cosine) [23] at the receiver. To preserve the orthogonality after the windowing, each DMT frame is extended cyclically by 70 extra samples. Fig. 9 shows the achievable bit rates for this case. The performance is just slightly lower than with only the ETSI background noise.

Traditional DMT, with a rectangular receiver window, is known to be sensitive to strong RFI since the energy is spread out over all DMT subcarriers [24]. Because we use

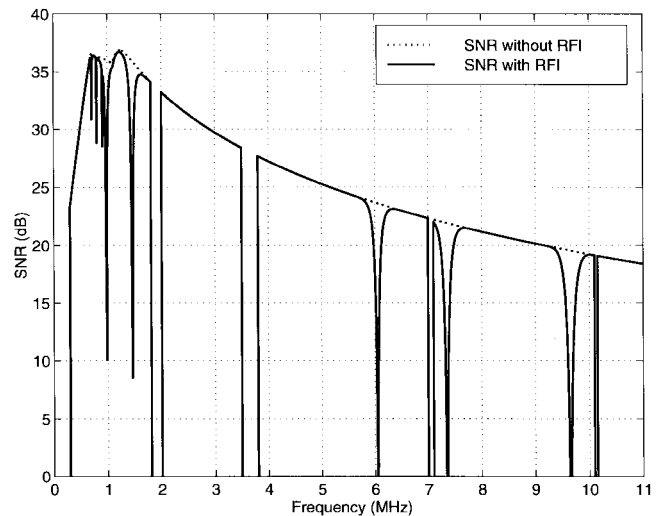

Fig. 10. SNR on a 600-m (2000 ft)-long TP2 wire with and without RFI.

TABLE IV  
REACH FOR DIFFERENT BACKGROUND NOISE SCENARIOS

Bit rates(down:up) (Mbps)	Reach in meters for TP1/TP2 -wires			
	AWGN	ADSL-mix	ETSI	ETSI+RFI
52:6.4	160/160	110/110	130/130	120/120
26:3.2	860/1050	760/900	780/940	700/840
13:1.6	1330/1630	1060/1310	1090/1360	1030/1280
26:26	270/270	180/180	200/200	190/190
13:13	930/1130	800/970	820/1020	750/930

a large number of subcarriers (e.g., 2048) with Zipper and a nonrectangular window in the receiver, the RFI is concentrated to just a few subcarriers. Fig. 10 shows the SNR with and without RFI. It should be noted that HAM-radio interferers can be much stronger than the broadcast interferers used in this case, but they can be almost completely cancelled with RFI-cancellation methods such as [25] and [26].

Table IV shows the maximum length the wires can have for certain bit rates (both symmetrical and asymmetrical) for all different noise scenarios.

#### V. SUMMARY

Briefly summarized, Zipper is a DMT-based duplex method for VDSL possessing three key design elements.

- Each subcarrier is used in either upstream or downstream direction.
- A cyclic suffix is added to compensate for propagation delay and to ensure orthogonality between upstream and downstream signals.
- Maintaining signal orthogonality also requires that all the transmitters are synchronized.

The Zipper duplex method offers several attractive features. Dynamic subcarrier allocation enables simple run-time

adaptation of the bit rates. The possibility to make Zipper spectrally compatible with other frequency-divided systems such as ADSL facilitates the coexistence between VDSL and ADSL. The latency in Zipper depends mainly on the number of subcarriers and is not very large, less than 1 ms with 4096 subcarriers. This allows the use of a large number of subcarriers, which gives advantages in terms of higher duplex efficiency, 93% with 2048 subcarriers. A larger number of subcarriers also helps suppress RFI ingress and out-of-band emission, but will of course increase the computational complexity and require more memory.

A Zipper-based VDSL system is likely to require more complex hardware than systems based on other duplex methods. For example, compared to a time-divided DMT system, Zipper requires two FFT units, since transmission and reception take place simultaneously, and the dynamic range of the ADC may need to be larger. On the other hand, Zipper can easily manage without a time-domain equalizer as a sufficiently long cyclic prefix can be used without significant reduction in duplex efficiency.

With simulations, we showed that Zipper gives good bit-rate performance, even in coexistence with ADSL systems. The best performance is obtained in an environment with only VDSL systems that have a lower level of crosstalk. The simulations also showed that a Zipper system is quite robust against RFI.

#### ACKNOWLEDGMENT

The authors would like to thank P. Petersen for his help in editing this paper. In particular, they would also like to thank P. Deutgen for all her help in developing this paper.

#### REFERENCES

- [1] American National Standards Institute, "Very-high-speed digital subscriber lines—System requirements, draft technical report," ANSI, Austin, TX, Tech. Rep. T1E1.4/98-043R1, 1998.
- [2] American National Standards Institute, "Transmission and multiplexing (TM); access transmission systems on metallic cables; very high speed digital subscriber line (VDSL)—Part 1: Functional requirements," ETSI, Tech. Specification TS 101 270-1 V1.1.1 (1998-04), 1998.
- [3] American National Standards Institute, "For telecommunications—Network and customer installation interfaces—Symmetrical digital subscriber line (ADSL) metallic interface," ANSI, Tech. Rep. T1.413-1995, 1995.
- [4] J. Lechleider, "A review of HDSL progress," *IEEE J. Select. Areas Commun.*, vol. 9, pp. 769–784, Aug. 1991.
- [5] J. J. Werner, "The HDSL environment," *IEEE J. Select. Areas Commun.*, vol. 9, pp. 785–800, Aug. 1991.
- [6] "VDSL alliance SDMT VDSL draft standard proposal," ANSI, Sacramento, CA, Tech. Rep. T1E1.4/98-172, 1998.
- [7] "VDSL coalition technical draft specification (version 5)," ETSI TM6, Luleå, Sweden, Tech. Rep. 983t8, 1998.
- [8] J. A. Bingham, "Multi carrier modulation for data transmission: An idea whose time has come," *IEEE Commun. Mag.*, vol. 28, pp. 5–14, May 1990.
- [9] K. Sistanizadeh, P. Chow, and J. Cioffi, "Multitone transmission for asymmetric digital subscriber lines (ADSL)," in *Proc. Int. Conf. Communications*, May 1993, pp. 756–760.
- [10] M. Isaksson, D. Bengtsson, P. Deutgen, M. Sandell, F. Sjöberg, P. Ödling, and H. Öhman, "Zipper—A duplex scheme for VDSL based on DMT," ANSI, Austin, TX, Tech. Rep. T1E1.4/97-016, 1997.
- [11] M. Isaksson, P. Deutgen, F. Sjöberg, S. K. Wilson, P. Ödling, and P. O. Börjesson, "Zipper—A flexible duplex method for VDSL," in *Proc. Int. Workshop Copper Wire Access Systems (CWAS)*, Budapest, Hungary, Oct. 1997, pp. 95–99.

- [12] S.-R. Olofsson, J. Johansson, M. Isaksson, and L. Olsson, "Synchronizing the optical network units in a VDSL system using GPD," ETSI TM6, Lannion, France, Tech. Rep. 973t21, 1997.
- [13] A. Peled and A. Ruiz, "Frequency domain data transmission using reduced computational complexity algorithms," in *Proc. IEEE Int. Conf. Acoustics, Speech, Signal Processing*, Denver, CO, 1980, pp. 964–967.
- [14] N. Dagdeviren, R. Laroia, R. Gitlin, and S. Celebi, "High-performance, low complexity discrete multi-tone (DMT) ADSL system," UADSL, Pleasanton, CA, Tech. Rep. TG/98-033, 1998.
- [15] D. Bengtsson, P. Deutgen, N. Grip, M. Isaksson, L. Olsson, F. Sjöberg, and H. Öhman, "Zipper performance when mixing ADSL and VDSL in terms of reach and capacity," ANSI, Clearwater Beach, FL, Tech. Rep. T1E1.4/97-138, 1997.
- [16] L. Olsson, M. Isaksson, D. Bengtsson, P. Deutgen, F. Sjöberg, G. Ökvist, P. Ödling, N. Grip, H. Öhman, and P. O. Börjesson, "Influence of the zipper duplex scheme on the receiver dynamic range," ANSI, Clearwater Beach, FL, Tech. Rep. T1E1.4/97-139, 1997.
- [17] N. Al-Dhahir and J. M. Cioffi, "Optimum finite-length equalization for multicarrier transceivers," *IEEE Trans. Commun.*, vol. 44, pp. 56–64, Jan. 1996.
- [18] European Telecommunications Standards Institute, "Radio broadcasting systems; digital audio broadcasting (DAB) to mobile, portable and fixed receivers," ETS 300 401, ETSI, Valbonne, France, Feb. 1995.
- [19] "Digital broadcasting systems for television, sound and data services," prETS 300 744, ETSI, European Telecommunications Standards Institute, Sept. 1996.
- [20] P. S. Chow, J. M. Cioffi, and J. A. C. Bingham, "A practical discrete multitone transceiver loading algorithm for data transmission over spectrally shaped channels," *IEEE Trans. Commun.*, vol. 43, pp. 773–775, Feb. 1995.
- [21] G. Forney and M. Eyuboglu, "Combined equalization and coding using precoding," *IEEE Commun. Mag.*, vol. 29, pp. 25–34, Dec. 1991.
- [22] J. A. Bingham and M. Mallory, "RFI egress suppression for SDMT," ANSI, Colorado Springs, CO, Tech. Rep. T1E1.4/96-085, Apr. 1996.
- [23] P. Spruyt, P. Reusens, and S. Braet, "Performance of improved DMT transceiver for VDSL," ANSI, Colorado Springs, CO, Tech. Rep. T1E1.4/96-104, Apr. 1996.
- [24] S. D. Sandberg and M. A. Tzannes, "Overlapped discrete multitone modulation for high speed copper wire communications," *IEEE J. Select. Areas Commun.*, vol. 13, pp. 1571–1585, Dec. 1985.
- [25] B. Wiese and J. Bingham, "Digital radio frequency cancellation for DMT VDSL," ANSI, Sacramento, CA, Tech. Rep. T1E1.4/97-460, Dec. 1997.
- [26] F. Sjöberg, R. Nilsson, N. Grip, P. O. Börjesson, S. K. Wilson, and P. Ödling, "Digital RFI suppression in DMT-based VDSL systems," in *Proc. Int. Conf. Telecommunications (ICT)*, Chalkidiki, Greece, June 1998, vol. 2, pp. 189–193.



**Frank Sjöberg** (S'95) was born in Umeå, Sweden in 1970. He received the M.S. degree in computer science in 1995 and the Lic. Eng. degree in signal processing in 1998, both from Luleå University of Technology, Luleå, Sweden. He is currently completing the Ph.D. degree at the Division of Signal Processing, Luleå University of Technology, Luleå, Sweden.

His research interests include high-speed communication in wireline systems.



**Mikael Isaksson** was born in Kalix, Sweden in 1962. He received the M.S. degree in computer science in 1989 from Luleå University of Technology.

Since 1989, he has been employed by Telia Research AB, the research branch of the Swedish telephone company, Telia AB. From 1989 to 1995, he was active in research on radio communications. Since 1995, he has been Project Manager at Telia Research for VDSL projects.



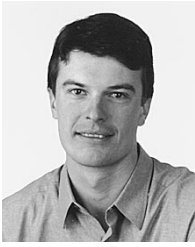

**Rickard Nilsson** (S'96) was born in Umeå, Sweden in 1971. He received the M.S. degree in computer science in 1996 and the Lic. Eng. degree in signal processing in 1999, both from Luleå University of Technology, Luleå, Sweden. He is currently working toward the Ph.D. degree at the Division of Signal Processing, Luleå University of Technology, Luleå, Sweden.

His research interests include high-speed communication in wireline systems and low complexity algorithms in different telecommunication systems.

**Per Ödling** (S'90–A'95) received the M.S.E.E. degree in 1989, the licentiate degree in 1993, and the Ph.D. degree in signal processing in 1995, all from Luleå University of Technology, Sweden.

Currently, he is an Assistant Professor at the Department of Applied Electronics, Lund Institute of Technology, Sweden. Having researched cooperatively with industry over the past ten years, he is currently developing broadband internet communication over radio and twisted copper pairs. His recent work includes contributions to the standardization of the very high bit-rate digital subscriber loop (VDSL) within the European Telecommunications Standards Institute (ETSI), the American National Standards Institute (ANSI), and the International Telecommunication Union (ITU).

**Sarah Kate Wilson** (M'95), for photograph and biography, see p. 386 of the March 1999 issue of this TRANSACTIONS.

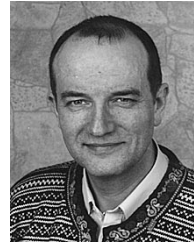

**Per Ola Börjesson** (S'70–M'80) was born in Karlshamn, Sweden, in 1945. He received the M.Sc. degree in electrical engineering in 1970 and the Ph.D. degree in telecommunication theory in 1980, both from Lund Institute of Technology (LTH), Lund, Sweden. In 1983, he received the degree of Docent in Telecommunication Theory.

Since 1998, he has been Professor of Signal Processing at Lund University, and between 1988 and 1998, he was Professor of signal processing at Luleå University of Technology. His primary research interest is in high performance communication systems, in particular, high data rate wireless and twisted pair systems. He is presently researching signal processing techniques in communication systems that use orthogonal frequency division multiplexing (OFDM) or discrete multitone (DMT) modulation. He emphasizes the interaction between models and real systems, from the creation of application-oriented models based on system knowledge to the implementation and evaluation of algorithms.