



LUND UNIVERSITY

Streptomyces sporulation - Genes and regulators involved in bacterial cell differentiation

Larsson, Jessica

2010

[Link to publication](#)

Citation for published version (APA):

Larsson, J. (2010). *Streptomyces sporulation - Genes and regulators involved in bacterial cell differentiation*. Department of Biology, Lund University.

Total number of authors:

1

General rights

Unless other specific re-use rights are stated the following general rights apply:

Copyright and moral rights for the publications made accessible in the public portal are retained by the authors and/or other copyright owners and it is a condition of accessing publications that users recognise and abide by the legal requirements associated with these rights.

- Users may download and print one copy of any publication from the public portal for the purpose of private study or research.
- You may not further distribute the material or use it for any profit-making activity or commercial gain
- You may freely distribute the URL identifying the publication in the public portal

Read more about Creative commons licenses: <https://creativecommons.org/licenses/>

Take down policy

If you believe that this document breaches copyright please contact us providing details, and we will remove access to the work immediately and investigate your claim.

LUND UNIVERSITY

PO Box 117
221 00 Lund
+46 46-222 00 00

Streptomyces sporulation

Genes and regulators involved in
bacterial cell differentiation

Jessica Larsson



LUND UNIVERSITY

Department of Biology

© Jessica Larsson, 2010

ISBN: 978-91-7473-019-7

Department of Cell and Organism Biology

Lund University

Sölvegatan 35

SE-223 62 Lund

Sweden

Printed by Media-Tryck, Lund, Sweden, 2010

Table of contents

Table of contents.....	3
List of papers.....	5
Introduction	6
Aim of this thesis	7
Outline of this thesis	7
The life cycle of <i>S. coelicolor</i>	9
Morphological differentiation in <i>S. coelicolor</i>	11
Formation of aerial hyphae.....	11
A regulatory cascade consisting of the <i>bld</i> genes	14
Differentiation of aerial hyphae to spores	16
Genes specifically required for the early stages of sporulation.....	17
Genes influencing late sporulation events	20
Regulatory pathways of sporulation in aerial hyphae	22
Developmental control of growth, morphogenesis, and cell cycle processes during sporulation.....	27
Hyphal growth, cell wall assembly, and morphogenesis	27
Bacterial cell division	29
Cell division in <i>S. coelicolor</i>	30
Assembly of FtsZ at the division site	30
Proteins of the divisome	31
Developmental regulation of cell division in <i>S. coelicolor</i>	34
Chromosome segregation and nucleoid structure during sporulation	38
Partitioning and chromosome positioning in aerial hyphae.....	38
Final stage of chromosome segregation into spore compartments	40
Genes affecting condensation of chromosomes.....	40
Summary of present investigation	43

The developmental regulator WhiH	44
WhiH-regulated genes in <i>S. venezuelae</i>	44
Developmental gene expression of <i>S. coelicolor</i>	45
The nucleoid-associated HupS protein	47
A developmental mutant blocked in cell division	48
Populärvetenskaplig sammanfattning på svenska	51
Acknowledgements	53
References.....	55

List of papers

This thesis is based on the following papers and they will be referred to in the text by their roman numerals (I-IV).

- I. Paola Salerno, Jessica Larsson, Giselda Bucca, Emma Laing, Nora Ausmees, Colin P. Smith, and Klas Flärdh **Identification of developmentally regulated genes involved in *Streptomyces coelicolor* sporulation.** Manuscript.
- II. Paola Salerno, Jessica Larsson, Giselda Bucca, Emma Laing, Colin P. Smith, and Klas Flärdh (2009) **One of the two genes encoding nucleoid-associated HU proteins in *Streptomyces coelicolor* is developmentally regulated and specifically involved in spore maturation.** *Journal of Bacteriology* **191**: 6489-6500
- III. Jessica Larsson, Keith F. Chater, and Klas Flärdh ***Streptomyces coelicolor* sporulation protein WhiH is an autoregulatory transcription factor.** Manuscript.
- IV. Jessica Larsson, Maureen Bibb, Elisabeth Barane, Mark J. Buttner, and Klas Flärdh **Mapping the regulon controlled by the transcription factor WhiH during sporulation of *Streptomyces venezuelae*.** Manuscript.

Paper II is reprinted with the permission of the publisher.

Introduction

This thesis investigates the sporulation of streptomycetes. *Streptomyces* is a genus of Gram-positive bacteria that belongs to the major bacterial phylum Actinobacteria (also referred to as actinomycetes). There are several reasons why *Streptomyces* are interesting and important to study. They are unusual among bacteria in having a complex developmental life cycle involving several morphologically distinct cell types: spherical spore, branching hyphae that form a mycelium, and aerial structures that turn into chains of spores. Although all bacteria adapt to changes in their surroundings by adjusting the pattern of gene expression, the differentiation of a new cell type as a response to altered conditions, such as nutrient limitation, is not a general feature among prokaryotes. Because they are easy to propagate and genetically manipulate, prokaryotes are excellent models for the understanding of how developmentally controlled changes in gene expression can give rise to the special properties of a differentiated cell. In addition, actinomycetes are of interest for medical reasons; several human pathogens belong to the actinomycetes, including *Mycobacterium tuberculosis* (causes tuberculosis), *Mycobacterium leprae* (causes leprosy) and *Corynebacterium diphtheriae* (causes diphtheria). Finally streptomycetes are of great industrial importance because of their ability to produce antibiotics

Streptomyces coelicolor is genetically the most studied species of the streptomycetes, and has been a subject of studies in the field of prokaryotic developmental biology since the 1960s (Chater, 2001; Chater and Chandra, 2006; Elliot *et al.*, 2008; Hopwood, 2007). An understanding of the cell biology and the regulation of fundamental cellular processes that are gained from studying morphological differentiation of *S. coelicolor* is useful in various applications. The insights that are gained about regulation of often essential cell functions, e. g. cell division, are useful in finding new drug targets and development of chemotherapeutics against *Mycobacterium* and other pathogens among

the actinomycetes. In parallel to morphological differentiation, antibiotics and a wide range of other secondary metabolites are produced. Some of the regulators of morphological differentiation also affect antibiotic production, indicating regulatory links between these processes. Findings gained by the investigation of sporulation genes may very well be useful for revealing the very complex regulatory pathways of antibiotic biosynthesis. Genetic manipulation of bacteria to improve antibiotic production yields and to produce novel compounds is a very important area, in a time when many bacteria show resistance to antibiotics that are in use. The different kinds of secondary metabolites that are produced by many streptomycetes are of great importance in the pharmaceutical industry both as antibiotics and other biologically active compounds. Thus, understanding the molecular mechanisms underlying control of growth, morphogenesis and morphological differentiation should also be valuable in the design of *Streptomyces* strains used in the large-scale industrial production of such compounds.

Aim of this thesis

The aim of this thesis is to identify new genes and mechanisms involved in developmental control of morphological differentiation in *Streptomyces*. Central sporulation regulators required for the developmental alteration of growth, morphogenesis and cell cycle-related processes, have previously been identified through the study of mutants that are blocked in an early stage of the sporulation process and cannot produce spores. However, very few target genes were known for these regulators and only a subset of sporulation induced genes have been identified. The focus of this thesis is to find additional genes with a role during sporulation, especially those with an impact on cell cycle-related processes.

Outline of this thesis

In the first part of this thesis, the developmental life cycle of *S. coelicolor* is described, with focus on morphological differentiation. I will discuss alterations of cell cycle processes, growth, and morphogenesis that take place during sporulation, the genes known to be required for these

changes, as well as genes influencing maturation of spores. The current understanding of sporulation regulators and the underlying regulatory mechanisms leading to production of spores is also presented. In the second part, a discussion and summary of my studies of the differentiation process in *Streptomyces coelicolor* is presented, based on paper I, II, III and IV of this thesis.

The life cycle of *S. coelicolor*

The decision to form spores when the supply of nutrients is running out in the surrounding environment is a survival strategy and provides bacteria belonging to the genus *Streptomyces* with the ability to reproduce. The streptomycetes are highly abundant in nature and are primarily soil organisms, where they can stay as dormant spores for long periods, until conditions become favorable for growth. *Streptomyces coelicolor* is the main model organism of this thesis and also the best characterized species among *Streptomyces*. Its lifecycle is illustrated in Figure 1. Once a spore encounters conditions favorable for growth, it germinates. This is the first step of several morphological differentiation steps in the life cycle. A germ tube grows out from the spore and elongates into long branching filamentous cells during vegetative growth, forming a mesh of hyphae called the substrate or vegetative mycelium, which grows deep into solid medium. Elongation of hyphae is accomplished through insertion of new cell wall material at the hyphal tip. Infrequent crosswalls separate the hyphae into cellular compartments. Each compartment contains multiple copies of the chromosome, and DNA is spread throughout the whole compartment with little separation of individual nucleoids. When growth of the vegetative mycelium has given rise to a colony, nutrient limitation and probably cell density signals contribute to trigger formation of an aerial mycelium on the colony surface (Fig. 1) (for reviews, see Chater, 1998; Elliot *et al.*, 2008; Flårdh and Buttner, 2009; Kelemen and Buttner, 1998). The aerial hyphae represent reproductive structures and are transformed into pigmented spore chains that mature and eventually release separated spores (Fig. 1). Sporulation in the aerial hyphae is restricted to the apical compartment (also referred to as the sporogenic cell) (Fig. 2B) in which a high level of DNA replication takes place generating up to 50 copies or more of uncondensed, evenly distributed chromosomes (Ruban-Osmialowska *et al.*, 2006). A developmentally controlled form of cell division - sporulation septation -

compartmentalizes the sporogenic cell into prespores (Fig. 2C). In coordination with this septation, the chromosomes are positioned and segregated, so that each prespore compartment receives one copy of the genome (Fig. 2C) (Flårdh, 2003a). After the completion of septation, nucleoids are condensed, the prespores become rounded and ovoid, and synthesize a thick spore wall and a grey pigment, and the spores are separated.

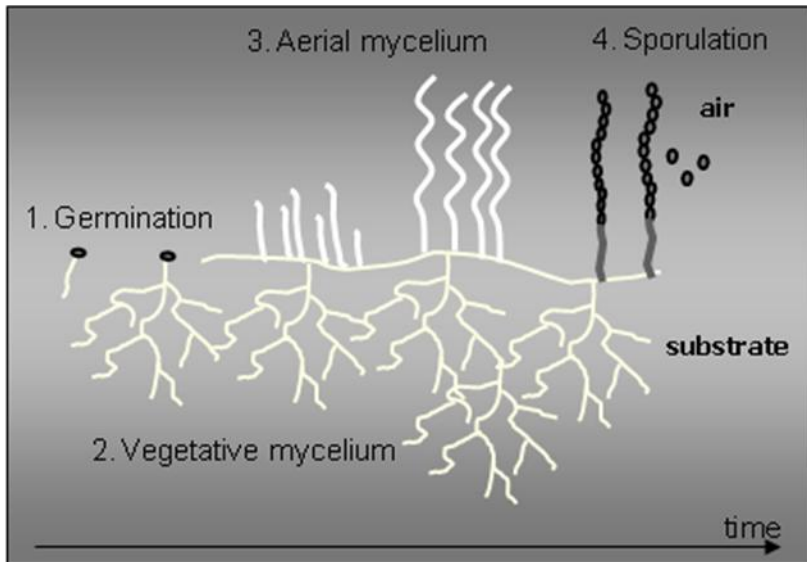

Figure 1. The developmental life cycle of *S. coelicolor* starts with spore germination (1) and the elongation of a germ tube into long branching hyphae that grow into the substrate and form the vegetative mycelium (2). Upon differentiation an aerial mycelium is formed (3), which then develop into chains of spores (4).

Morphological differentiation in *S. coelicolor*

Much of what is known about developmental control of sporulation comes mainly from studies of two major classes of regulatory genes involved in morphological differentiation in *S. coelicolor*. They have been identified through genetic studies of mutants blocked in development (Chater, 1972; Hopwood *et al.*, 1970). One group of genes, called *bld* (bald), is required for formation of the aerial hyphae and the colonies of these mutants have a shiny and bald appearance. The other group is the *whi* (white) genes, which are required for the formation of spores in the aerial mycelium. *whi* mutants produce aerial hyphae but are not able to form the grey spore-associated pigment and therefore have a white colony phenotype.

The *bld* and *whi* genes are involved in complex regulatory networks that direct development in *Streptomyces*. These networks are only partially understood, and it remains largely unclear how the *bld* genes act to bring about aerial mycelium formation and to what extent the *bld* genes and *whi* genes interact to start the further development of aerial hyphae that involves the *whi* genes and leads to formation of spores.

Formation of aerial hyphae

Besides having a wall of peptidoglycan, aerial hyphae and spores of *S. coelicolor* have an additional outer layer consisting of amphipathic proteins called chaplins (*coelicolor* hydrophobic aerial proteins) and rodmins which make the aerial hyphal surface hydrophobic (Claessen *et al.*, 2002; Claessen *et al.*, 2003; Elliot *et al.*, 2003) (reviewed in e.g. Elliot *et al.*, 2008; Flårdh and Buttner, 2009; Willey *et al.*, 2006). Fibers formed by the chaplins are organized into parallel rodlets by the rodmins, RdlA and RdlB, and give spores a characteristic “rodlet” surface structure. The rodmins have not been assigned any other function in

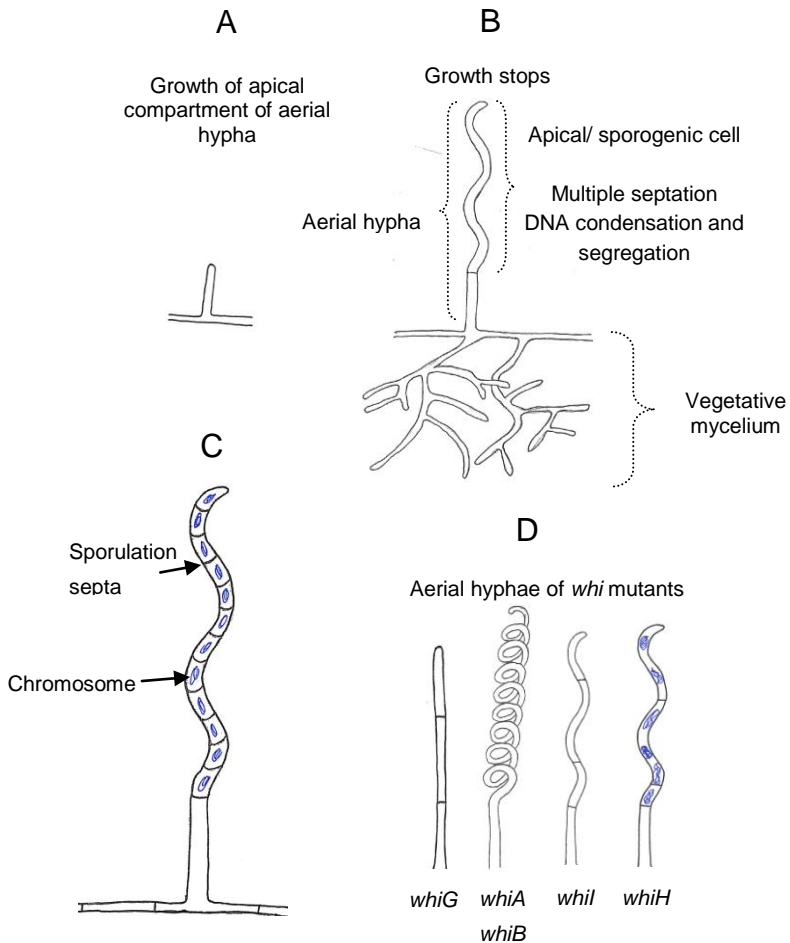

Figure 2. Differentiation of aerial hyphae into spores and phenotypes of *whiG*, *whiA*, *whiB*, *whiI* and *whiH* mutants. When an aerial hypha stops growing (A, B) it will be divided into prespore compartments by the formation of sporulation septa. Each prespore receives one copy of the chromosome (C). The blue dots indicate condensed chromosomes and septa are visualized by black lines inside hyphae. The characteristic aerial hyphal phenotypes of early *whi* mutants are shown in D.

development and do not affect the emergence of aerial hyphae, which still retains a hydrophobic sheath of chaplins (Claessen *et al.*, 2002).

In contrast to the rodlinks the formation of aerial hyphae depends on both the chaplins (Capstick *et al.*, 2007; Claessen *et al.*, 2004) and a lantibiotic-like peptide, SapB that are secreted on the surface of developing colonies and cover the aerial hyphae (Guijarro *et al.*, 1988; Kodani *et al.*, 2004; Willey *et al.*, 1991; Willey *et al.*, 1993). Their ability to lower surface tension of water is probably required for the emergence of aerial hyphae from an aqueous environment into the air (Willey *et al.*, 1991; Willey *et al.*, 1993). The genome of *S. coelicolor* encodes eight homologous chaplin proteins, ChpA-H, which all have a N-terminal signaling sequence for secretion, explaining how these proteins are targeted to the outside of the cell. A conserved hydrophobic domain is present once in each of the five smaller chaplins, ChpD-H, and twice in each of the three larger, ChpA-C. In addition ChpA-C are likely to be covalently anchored to the peptidoglycan cell wall mediated through a motif in their C-termini recognized by sortases, while the small chaplins are believed to interact with the large ones, thereby being immobilized on the cell surface (Claessen *et al.*, 2003; Di Berardo *et al.*, 2008; Elliot *et al.*, 2003). SapB is formed when a peptide, encoded by the *ramS* gene, undergoes posttranslational modifications, likely mediated by the putative lantibiotic synthetase RamC (Kodani *et al.*, 2004; Willey *et al.*, 2006). SapB is thought to be transported to the outside of the cells by RamA and RamB, components of an ATP-binding cassette transporter (Willey *et al.*, 2006). The genes required for SapB synthesis, *ramS*, *ramA*, *ramB* and *ramC* form an operon and expression is activated by a response regulator RamR. No cognate sensor kinase is known for RamR and there is no evidence of phosphorylation (Keijser *et al.*, 2002; Nguyen *et al.*, 2002; O'Connor and Nodwell, 2005).

Under rich growth conditions, both the chaplins and SapB are produced in a *bld* dependent manner and are needed for aerial hyphae to be formed at normal levels. On minimal media, on the other hand, SapB is not produced and the process is only dependent on the chaplins, which on poor media are produced independently of several of the *bld* genes (Capstick *et al.*, 2007). This leads to the suggestion that there are two regulatory pathways controlling aerial hyphal formation, one of them active on rich media and involving the *bld* genes and the production of both SapB and the chaplins and one *bld* independent pathway that gives rise to aerial hyphae on poor media via chaplins and independently of

SapB production. An answer to the question why two separate genetic regulatory pathways are used for erecting aerial hyphae could be that different surfactants are optimal in nutrient-poor and nutrient-rich environments.

The importance of SapB and the chaplins in the initiation of cellular differentiation of *S. coelicolor* leads to the question of how their synthesis is regulated. Currently, no direct regulators of *ramR* or the chaplin genes are known. Although SapB and chaplin production on rich media is *bld* dependent, no direct regulation by any *bld* gene has been demonstrated. Furthermore, nothing is known about the activation of chaplin production on poor media, where the *bld* genes are not required for aerial hyphal formation.

A regulatory cascade consisting of the *bld* genes

It has been suggested that aerial hyphal formation is initiated by an extracellular signaling cascade dependent on the *bld* genes (Willey *et al.*, 1991; Willey *et al.*, 1993) (reviewed in Chater, 2001; Kelemen and Buttner, 1998). Several *bld* mutants can be divided into different extracellular complementation groups, which can be sorted hierarchally, based on the ability of one group of *bld* mutants to rescue aerial hyphae formation of another group (Nodwell *et al.*, 1999). This phenomenon is observed when mutants from two different complementation groups are grown close together on rich media and is always unidirectional: a mutant strain can only restore formation of aerial hyphae to mutants placed lower in the hierarchy. For example for a *bld* mutant to be rescued (i.e. develop an aerial mycelium) by another *bld* mutant, it must grow close to one that is higher in the hierarchy. A reasonable explanation for the complementation is that extracellular molecules, produced and transmitted by *bld* mutants blocked in a later step of the signaling cascade, are sensed by *bld* mutants blocked earlier in the cascade, which therefore become able to continue the formation of aerial hyphae. However, most known *bld* genes encode transcriptional regulators (Elliot *et al.*, 2008), so rather than directly being involved in the production of the signals, their more likely role is the perception and/or transduction of the signals generated (Chater and Horinouchi, 2003). Other complications with this hypothetical cascade of extracellular signals is that, so far, only one of the signals has been purified and partially characterized (Nodwell

and Losick, 1998), and that several genes associated with *bld* phenotypes do not fit into the cascade, including e.g. *bldB* and *bldN* (Bibb *et al.*, 2000; Willey *et al.*, 1993). An alternative explanation for the extracellular complementation has been demonstrated for a few mutants with Bld phenotypes, including mutants defective in the tricarboxyl citric acid (TCA) cycle enzymes citrate synthase and aconitase (Viollier *et al.*, 2001a; Viollier *et al.*, 2001b). The inability of such mutants to raise an aerial mycelium seems to be due to acidification of the medium, since the mutants were unable to neutralize the culture medium that is acidified during vegetative growth when organic acids are secreted, and aerial mycelium could be restored by buffering the medium or by growth close to a wildtype strain of *S. coelicolor* (Viollier *et al.*, 2001a; Viollier *et al.*, 2001b). However, the earlier identified *bld* mutants could not be complemented by neutralization of culture media and therefore can be assigned a role as regulators of developmental processes.

Six different complementation groups are known and if the model that suggests that aerial hyphal formation is initiated by an extracellular signaling cascade is correct, it would involve five extracellular signals. The only signal identified is an extracellular oligopeptide (Nodwell and Losick, 1998), that possibly is the first signal in the signaling cascade and is proposed to be delivered to the inside of cells by an ATP-dependent transporter encoded by *bldK* (Nodwell *et al.*, 1996). A *bldJ* mutant is complemented by all *bld* mutants that fit into the cascade and the production of the first signal is proposed to be generated through the action of *bldJ*, which has not been characterized (Nodwell and Losick, 1998; Willey *et al.*, 1993).

The next step involves *bldA* and *bldH*, which fall into the same complementation group. The *bldA* gene has an unusual way of regulating the differentiation process by encoding a tRNA for leucine that recognizes and translates UUA codons. TTA codons are very rarely found in *S. coelicolor*, only being present in 2% of the genes in the genome (Chater and Chandra, 2008; Li *et al.*, 2007). The inability of a *bldA* mutant to make aerial hyphae has mainly been assigned to the presence of a TTA codon in the *bldH* (*adpA*) gene that encodes the AdpA regulator. In *S. griseus*, AdpA controls genes both involved in antibiotic production and morphological differentiation, but in *S. coelicolor* no direct targets of the AdpA orthologue BldH are known among sporulation genes (Chater and Horinouchi, 2003; Ohnishi *et al.*, 1999), although

some genes are known to be *bldH*-dependent, including SCO0762 encoding a serine protease inhibitor (Kim *et al.*, 2005).

The roles of BldG, a potential anti-anti-sigma factor (Bignell *et al.*, 2000), BldC, a small protein containing a putative DNA binding domain (Hunt *et al.*, 2005) and BldB, a small protein with unknown function (Eccleston *et al.*, 2002; Pope *et al.*, 1998), in the regulation of differentiation are so far not known (Chater and Chandra, 2006).

bldN, encoding an ECF sigma factor, directly regulates *bldM* from one of its two promoters (Bibb *et al.*, 2000). BldM is a response regulator that together with σ^{BldN} is important for normal expression of the chaplin and rodlin genes (Elliot *et al.*, 2003).

BldD, containing a predicted helix-turn-helix motif similar to the DNA binding domain of the lambda cI repressor (Kim *et al.*, 2006), developmentally regulates *bldN* expression through repression (Elliot *et al.*, 2001). Repression by BldD was also seen for *whiG*, encoding an additional sporulation sigma factor that is the first component in the regulatory pathway controlling sporulation. This is so far the only known direct connection between *bld* genes and *whi* genes (the *whi* genes are discussed in the next section) (Elliot *et al.*, 2001). Recently it was shown that *bldD* controls a large regulon that contains several *bld* genes and other genes previously known to be developmentally controlled (den Hengst *et al.*, 2010). Examples are *ftsZ*, *ssgA*, *ssgB*, and *smeA-sffA*, which are involved in sporulation and are discussed in later sections.

It has been shown that although the application of purified SapB to the colony surface of a number of *bld* mutants restores aerial mycelium formation, it does not support further development and sporulation in the aerial hyphae. This implies that the *bld* cascade, in addition to triggering SapB and maybe chaplin production, also controls other developmental events required for the differentiation process to proceed (Tillotson *et al.*, 1998). Investigation of functions and interactions of the *bld* genes will be important for understanding how aerial hyphal formation is controlled in response to nutrient limitation, extracellular signaling, and other stimuli.

Differentiation of aerial hyphae to spores

As mentioned above, isolation of mutants with a *whi* phenotype have led to the identification of several loci involved in sporulation in *S. coelicolor*. They have been classified as early and late sporulation genes

based on which stage of development they influence. *whi* genes that influence early stages of the sporulation process are required for sporulation septation and influence growth and morphology of aerial hyphae. The late *whi* genes are required for proper maturation of spores, which involves a change in cell shape of the prespores into ovoid spores, thickening of the spore wall, detachment of spores from each other, and synthesis of a grey spore pigment. Most of the known *whi* genes are predicted to be regulatory, and this section summarizes what is known about them and the regulatory pathways involved in sporulation.

Genes specifically required for the early stages of sporulation

The common features of early *whi* mutants are defects in sporulation septation and chromosome segregation, but each mutant seems to be arrested at a specific stage in the normal development and acquires its own characteristic aerial hyphal phenotype. *whiA*, *whiB*, *whiG*, *whiH*, *whiI*, and *whiJ* mutants are all affected in cell cycle processes and fail to lay down the otherwise synchronously formed sporulation septa (Fig. 2D). Furthermore, they are unable to correctly separate and condense chromosomes in the aerial hyphae (Ainsa *et al.*, 1999; Ainsa *et al.*, 2010; Flårdh *et al.*, 1999).

Analysis of the hyphal morphology of *whi* null mutants using both light and scanning electron microscopy showed that the *whiG* mutant forms long straight aerial hyphae with occasional shallow constriction of the walls (Fig. 2D). Staining of the cell wall using Fluo-WGA (fluorescein-conjugated wheat germ agglutinin) that binds oligomers of peptidoglycan showed that septa are formed but they look more like vegetative crosswalls, which are thinner than the sporulation septa and do not lead to detachment of daughter cells (Flårdh *et al.*, 1999). *whiG* encodes an RNA polymerase sigma factor with a high sequence similarity to σ^D of *Bacillus subtilis* and σ^{FliA} of *Salmonella typhimurium*, controlling transcription of genes involved in motility and chemotaxis (Chater *et al.*, 1989; Helmann, 1991).

The aerial hyphae of *whiA* and *whiB* mutants are longer and much more tightly coiled than in the wildtype (Fig. 2D). Septa are rarely observed in these structures (Flårdh *et al.*, 1999). *whiA*-like genes are present in most sequenced genomes of Gram-positive bacteria, although no function has yet been reported and a deletion of the *whiA* homologue

yvcL in *B. subtilis* resulted in no detectable phenotype (Gorke *et al.*, 2005). However, *whiA* is essential for sporulation in *Streptomyces*. The arrangement of the two genes just upstream of *whiA* appears to be conserved, except in *Mycoplasma* species, leading to the suggestion that *whiA* might be part of an operon (Ainsa *et al.*, 2000). WhiA was recently predicted to have DNA-binding properties, and the resolved structure of WhiA from *Thermotoga maritima* identified two domains that are likely to bind DNA. The N-terminal region is structurally similar to LAGLIDADG homing endonucleases and the C-terminal contains a helix-turn-helix domain similar to the ones found in sigma factors recognizing the -35 sequence of promoters (Kaiser *et al.*, 2009; Knizewski and Ginalski, 2007). WhiB is the founding member of the Wbl- (WhiB-like) family of proteins that are found among actinomycetes but in no other organisms (Soliveri *et al.*, 1992). This group has been described as putative transcription factors and they have four conserved cysteines (Davis and Chater, 1992). In WhiD, which also belongs to this group and is discussed below, the cysteines are thought to act as ligands for a 4Fe-4S cluster (Jakimowicz *et al.*, 2005b). The function of this protein family has not been determined, but some results indicate interaction with RNA polymerase sigma factors, suggesting a role as transcriptional activators (Chater and Chandra, 2006). WhiB has been predicted to contain an α -helix that could be involved in DNA interaction. Some Wbl-proteins have also been reported to have thiol-disulfide oxidoreductase activity, but the significance of this remains unclear (Alam *et al.*, 2007; den Hengst and Buttner, 2008).

The aerial hyphae of the *whiH* mutant, on the other hand, are loosely coiled and deep constrictions are occasionally observed, indicating that this mutant actually forms a few sporulation septa in contrast to the other *whi* mutants discussed above (Fig. 2D) (Flårdh *et al.*, 1999; Ryding *et al.*, 1998). The hyphal phenotype of a *whiI* disruption mutant is somewhat similar to the *whiH* mutant but fewer constrictions are noticed (Fig. 2D). WhiH has been suggested to function as a transcriptional regulator, based on similarity to members of the GntR family of regulatory proteins (Ryding *et al.*, 1998). The highest similarity is in a region where a DNA-binding helix-turn-helix motif has been predicted. WhiI is similar to response regulators of two-component systems (Ainsa *et al.*, 1999). These types of regulators function as transcription factors after receiving a signal from a sensor kinase that via phosphorylation/dephosphorylation regulates the activity of the regulator

(Hutchings *et al.*, 2004). Response regulators usually have a phosphorylation pocket containing a conserved aspartate in their N-terminal domains. The putative phosphorylation pocket of WhiI harbors two out of three conserved aspartates, including the one which is normally phosphorylated, but a threonine residue has replaced a conserved lysine. Typically for the members of this family, the gene encoding the associated sensor protein kinase is located close to the gene encoding the response regulator, however there is no known kinase gene for *whiI*. This may suggest that WhiI is regulated in another way than via aspartate phosphorylation (Tian *et al.*, 2007). The C-terminal part of response regulators often have a helix-turn-helix motif, also found among members of the FixJ subfamily to which WhiI belongs, and amino acid sequence similarity in this region indicates that this is the DNA-binding part of WhiI (Ainsa *et al.*, 1999).

whiG, *whiA*, *whiB* and *whiI* disruption mutants show no signs of nucleoid partitioning in aerial hyphae. Staining of the DNA with 4',6-diamidino-2-phenylindole (DAPI) shows that the chromosomes are in an uncondensed state and DNA is distributed evenly throughout the whole hypha (Ainsa *et al.*, 1999; Flårdh *et al.*, 1999). The *whiH* mutant is also defective in partitioning of the chromosomes, but the distribution pattern of nucleoids is different compared to *whiG*, *whiA*, *whiB* and *whiI* mutants (Flårdh *et al.*, 1999). The *whiH* mutants can produce a number of aerial hyphal fragments with spore-like characteristics (although they are poorly septated), and in these fragments the nucleoids are condensed and partially separated from each other, forming irregularly sized bodies that are unevenly distributed (Fig. 2D). Cell-type specific expression of the sporulation gene *hupS* indicates that such fragments are able to initiate at least parts of the normal developmental program in a *whiH* mutant (papers II and III).

The aerial hyphae of a *whiJ* mutant are straight and unstricted and spore chains are rarely observed (Ainsa *et al.*, 2010; Chater and Merrick, 1976). *whiJ* is predicted to encode a transcription regulator with an N-terminal DNA-binding helix-turn-helix. *whiJ* alleles in mutants unable to sporulate turned out to be partially functional since the disruption of the entire *whiJ* gene resulted in a grey wildtype phenotype with abundant sporulation. This suggests that WhiJ acts as a negative regulator of sporulation under certain conditions (Ainsa *et al.*, 2010).

Taken together, inactivation of *whiH* does not completely block sporulation, some septa are formed in the aerial hyphae and nucleoids are

condensed. In addition, a *whiH* mutant is slightly grey due to a low level of production of spore pigment, which is also true for a *whiJ* mutant (Kelemen *et al.*, 1998), while *whiG*, *whiA*, *whiB* and *whiI* mutants are completely white and show no signs of nucleoid partitioning or sporulation septation. The incorrect execution of cell cycle processes can, at least partly, be explained by the failure of these mutants to upregulate the expression of genes encoding components of the cell division machinery and chromosome segregation apparatus (see section “Regulatory pathways of sporulation in aerial hyphae”).

Genes influencing late sporulation events

When spores mature they develop a grey color due to the production of a spore-associated polyketide pigment. The production of this grey pigment has been of great importance in the investigation of morphological differentiation in *S. coelicolor* since many of the developmental mutants unable to differentiate into spores were identified due to their inability to produce the pigment and therefore were white or less grey than the wildtype strain. Mutations in some loci allow formation of sporulation septa, but still affect later stages of sporulation, including pigmentation. One example is the *whiE* locus, which encodes enzymes involved the biosynthesis of the pigment and consists of seven genes (ORFI-VII) that might form an operon and one gene (ORFVIII) that is transcribed in the opposite direction (Davis and Chater, 1990; Kelemen *et al.*, 1998). The pigment has so far not been possible to purify and chemically characterize, probably due to being cross-linked to the spore wall (Yu and Hopwood, 1995) but the clear homology of the *whiE* genes to those for type II polyketide synthesis pathways predicts that the pigment is an aromatic polyketide (Davis and Chater, 1990).

The late sporulation gene *sigF* encodes a second sporulation sigma factor, σ^F (σ^{WhiG} is described in the previous section), most similar to σ^B of *Bacillus subtilis* that is responsible for the general stress response and controls gene expression during stationary phase (Potuckova *et al.*, 1995). The light green colony phenotype of a *sigF* null mutant indicated that the spore pigment was not synthesized correctly, and this can be explained by the transcriptional dependence of the *whiE* ORFVIII on *sigF* (see section “Regulatory pathways of sporulation in aerial hyphae” and Fig. 3). Spores were formed in the *sigF* mutant but they are often slightly

deformed, have thinner spore walls, less condensed DNA, and are more sensitive to detergent than the wildtype spores (Potuckova *et al.*, 1995).

WhiD belongs to the same family of Wbl proteins as WhiB (described above), but is required for the later sporulation events (Molle *et al.*, 2000). While the formation of sporulation septa is abolished in the early *whi* mutants, e.g. a *whiB* mutant, a *whiD* mutant is able to produce spores but these are of varying sizes indicating irregularity in the placement of septa. Septa were often laid down close to the poles of the spores and in different planes resulting in mini-compartments lacking DNA in the *whiD* mutant. In addition, many spores showed lysis and uneven wall deposition, and spores were more heat sensitive than in the wildtype (Molle *et al.*, 2000).

Taken together, the *whiE* locus, *sigF*, and *whiD* are needed for maturation of spores. Except for indirectly being required for transcription from one of the promoters in the *whiE* locus no targets of σ^F are known and therefore the incorrect assembly of the spore walls and the defect in spore shape of the *sigF* mutant cannot be explained. Since the function of WhiD and the Wbl-like proteins is unknown it is difficult to give an explanation for the sporulation defects of a *whiD* mutant.

Additional genes also affecting late sporulation processes have been reported. One example is *mreB*, which affects the deposition of peptidoglycan surrounding the spores (Mazza *et al.*, 2006), and is further discussed in section “Hyphal growth, cell wall assembly and morphogenesis”. Further, the genome of *S. coelicolor* encodes seven paralogues of SsgA-like proteins (SALPs), which all (SsgA-SsgF) have been reported to control different steps in the conversion of aerial hyphae into spores (Noens *et al.*, 2005). So far SALPs have only been found in actinomycetes, in both more morphologically complex genera as well as in non sporulating species, and are small acidic proteins with no similarity to any known protein (Traag and van Wezel, 2008). Different SALPs affect many different sporulation processes, including formation of sporulation septa, chromosome segregation, as well as spore maturation processes like spore wall synthesis and separation of spores. For example, many of the spores of a *ssgD* mutant lacked a thick peptidoglycan layer surrounding normal spores, *ssgE* and *ssgF* mutants affected the efficiency of separation of adjacent spores in the spore chains (Noens *et al.*, 2005). The SALPs SsgA and SsgB affect early stages of sporulation and are discussed in “Developmental regulation of cell division in *S. coelicolor*”.

The *smeA-sffA* operon, upregulated late during development in a *whiA*, *whiG*, *whiI* and *whiH* dependent manner, pleiotropically affects spore formation (Ausmees *et al.*, 2007). Mutants lacking *smeA*, encoding a small putative membrane protein, showed reduced level of spore pigment, incorrectly placed sporulation septa, thinner sporewalls, less condensed chromosomes with a slightly higher frequency of anucleate spores. The phenotype of an *sffA* mutant was much less striking, but a role during sporulation is suggested by the specific expression in sporogenic compartments and the localization of SffA to sporulation septa, which was *smeA*-dependent. The slight defect in chromosome segregation in a *smeA-sffA* mutant, suggested a function of SffA (a member of the SpoIIIE/FtsK-family of DNA translocases) as a DNA translocase, as discussed in section "Final stage of chromosome segregation into spore compartments".

Regulatory pathways of sporulation in aerial hyphae

The present understanding of the regulatory interactions among the *whi* genes is summarized in Figure 3, where also additional genes whose expression is dependent on *whi* genes are included. σ^{WhiG} is required for the earliest known stage and may be involved in the commitment of aerial hyphae to sporulation in *S. coelicolor*. Genetic and molecular studies have shown that *whiG* is epistatic to *whiA*, *whiB*, *whiH* and *whiI* (Chater, 1975, 2001; Flårdh *et al.*, 1999) and that *whiG* expression is not dependent on any of these early sporulation genes, including *whiG* itself (Chater, 1975; Kelemen *et al.*, 1996). The fact that ectopic over-expression of *whiG* resulted in sporulation in the vegetative mycelium, in which most *Streptomyces* species do not sporulate, strengthens the interpretation of σ^{WhiG} as a master regulator of sporulation in aerial hyphae (Chater *et al.*, 1989). The *whiG* transcripts are present even before aerial hyphae are formed, which suggests that an unknown activation of σ^{WhiG} is likely to take place that commits the aerial hyphae to sporulate (Kelemen *et al.*, 1996). However, no anti-sigma factor or other mechanism for control of σ^{WhiG} activity has been identified. Although transcripts are present during vegetative growth, *whiG* expression is negatively controlled by BldD in vegetative hyphae (also mentioned in the section "A regulatory cascade consisting of the *bld* genes") (Elliot *et al.*, 2001). It is reasonable to believe that the BldD

repression is somehow relieved during an early stage of aerial hyphal development, when WhiG is known to be active.

σ^{WhiG} has been shown to directly control the promoters of two early sporulation genes, *whiH* and *whiI*, while expression of *whiA* and *whiB* is independent of *whiG*, (Fig. 3), suggesting that there are two converging regulatory pathways controlling development in *S. coelicolor* (Ainsa *et al.*, 1999; Ainsa *et al.*, 2000; Ryding *et al.*, 1998; Soliveri *et al.*, 1992). *whiH* and *whiI* transcripts are first detected during the beginning of formation of the aerial mycelium and the level of transcripts reaches a maximum when spores are produced (Ainsa *et al.*, 1999; Ryding *et al.*, 1998). Genetic data suggest that both WhiH and WhiI repress their own transcription, and this direct or indirect autorepression is thought to be released during sporulation (Ainsa *et al.*, 1999; Ryding *et al.*, 1998). WhiH and WhiI are members of different families of regulators that have a DNA-binding motif and a domain that senses signals. This has led to the speculation that the DNA-binding ability of WhiH, in similarity to several other members of the GntR family, may be affected by binding a ligand. Furthermore, the DNA binding activity of WhiI, which is homologous to response regulators, might change in response to phosphorylation or other signals (Chater, 2001). The expression of *whiH* is not only affected by WhiH itself, but also WhiI seemed to act negatively on *whiH* transcription (Ainsa *et al.*, 1999). We show in papers III and IV of this thesis that WhiH indeed binds to its own promoter, but it remains to be determined whether WhiI directly controls *whiH*.

It is not known how the *whiG*-independent regulation of *whiA* and *whiB* is achieved. Both *whiA* and *whiB* have one promoter that is constitutive and another that becomes active during formation of an aerial mycelium (Ainsa *et al.*, 2000; Davis and Chater, 1992). The sporulation specific upregulation of *whiA* was abolished in *whiA* and *whiB* disruption mutants while *whiB* expression was increased, indicating that in addition to possible autoregulation, these genes also affect the expression of each other (Jakimowicz *et al.*, 2006).

The early *whi* genes are known to influence expression of a number of genes, although few promoters under direct control have been identified, exceptions being *whiG*-dependent expression of *whiH* and *whiI*. During sporulation, the cell division protein FtsZ and chromosome partitioning proteins ParA and ParB increase in abundance (Flårdh *et al.*, 2000; Jakimowicz *et al.*, 2006). This involves increased expression from sporulation specific promoters of *ftsZ* and the *parA parB* operon, whose

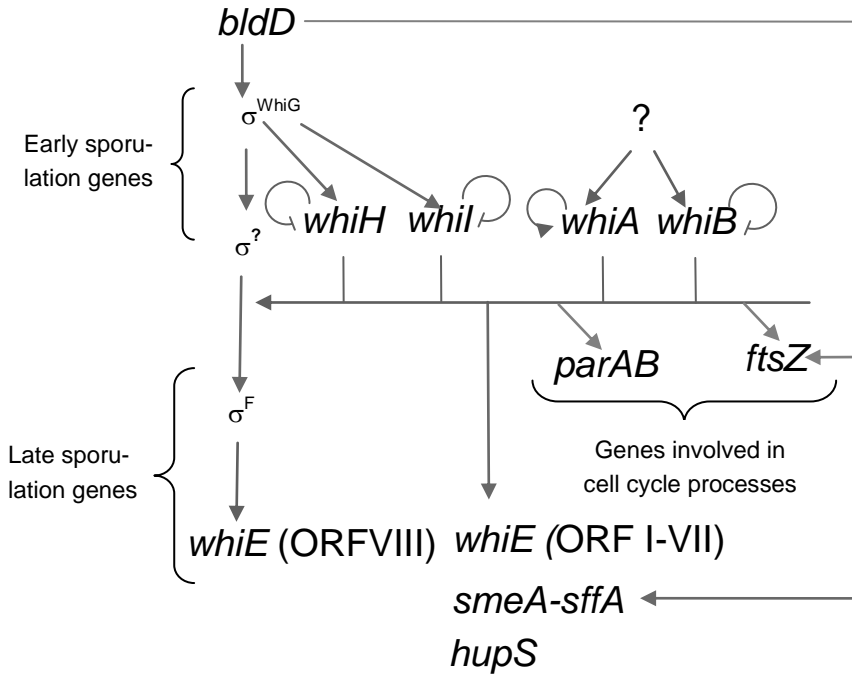

Figure 3. Summary of the current view of the regulatory pathway of sporulation in aerial hyphae of *S. coelicolor*. The sigma factor *WhiG* (σ^{WhiG}) becomes activated in aerial hyphae and controls transcription of *whiH* and *whiI*. *WhiH* and *WhiI* might function as autorepressors and this activity may be lost during development leading to an upregulation of *whiH* and *whiI* expression in the aerial mycelium. The *whiG* independent regulatory pathway consists of *whiA* and *whiB*, which also appear to affect their own transcription. All early *whi* genes are required for the developmental upregulation of *ftsZ* and *parAB* expression from specific sporulation promoters. The early *whi* genes are also required for transcription of late sporulation genes such as *whiE* ORFVIII, whose transcription is also dependent on *sigF*, encoding a sigma factor (σ^F), *whiE* OFR I-VII, *smeA-sffA* and *hupS*. Transcription of *sigF* is indirectly dependent on *whiG*, suggesting the presence of a third sigma factor in the *WhiG*-regulated pathway of sporulation. *BldD* is affecting *whiG*, *smeA-sffA* and *ftsZ* expression. Regulatory steps are indicated by lines.

activity is dependent on *whiA*, *whiB*, *whiI* and *whiH* (Fig. 3), and is described in more detail in the coming sections. BldD was recently shown to bind the upstream region of *smeA-sffA* and to the most upstream promoter of the *ftsZ* gene although the effect of this binding on the expression is still unclear (den Hengst *et al.*, 2010). The early *whi* genes also affect expression of late sporulation genes. The *whiE* locus, which directs the biosynthesis of the grey polyketide spore pigment, is controlled from two divergently oriented promoters, both being developmentally regulated. One promoter, controlling expression of *whiE* ORFI-ORFVII is dependent on the early *whi* genes for its activity, while transcription of the divergently transcribed *whiE* ORFVIII also depends on the late sigma factor σ^F for its upregulation (Fig. 3). This explains the white phenotypes of a *whiG*, *whiA*, *whiB* and *whiI* mutant. However, *whiH* and *whiJ* mutants have a slightly grey appearance, in agreement with *sigF* and *whiE* transcripts being present at a low level (Kelemen *et al.*, 1998). *smeA-sffA* transcription, which is activated during sporulation, is also dependent on the early *whi* genes (Ausmees *et al.*, 2007). *hupS*, requires *whiA*, *whiI* and *whiG* for its upregulation in aerial hyphae, but is not absolutely dependent on *whiH* (paper II). *sigF* expression is dependent on *whiG*, although a direct interaction could not be detected (Kelemen *et al.*, 1996), suggesting that a third, unidentified, sigma factor also is involved in regulating morphological differentiation (Fig. 3).

bldD is the first example of a gene that is involved both in the decision to form aerial hyphae and also in directly controlling genes involved in the further development of aerial hyphae to spores, e.g. through the negative effect on *whiG* expression (den Hengst *et al.*, 2010; Elliot *et al.*, 2001). As described above, the *whi* gene regulatory cascade influences genes involved in the developmentally controlled form of cell division and positioning of chromosomes in the aerial hyphae (alteration of cellular events during sporulation is described in the next section). Late sporulation events also depend on the early *whi* genes and a connection to the production of the spore pigment and upregulation of σ^F have been shown, but otherwise there is little known about the regulation of genes needed for the maturation of spores. For example it is not known how the developmental control of *mreB* expression is achieved (Heichlinger *et al.*, manuscript in preparation; the role of *mreB* in sporulation is discussed in section “Hyphal growth, cell wall assembly and morphogenesis“).

To summarize, very few targets of the regulatory *whi* genes are known and it is likely that only a small subset of genes involved in sporulation has been identified. To further elucidate the regulatory network that orchestrates sporulation in the aerial hyphae and to find new sporulation genes a transcriptomic analysis of gene expression during sporulation of *S. coelicolor* was performed by us. This has led to paper I of this thesis, which presents genes previously unknown to be developmentally controlled and involved in sporulation, and will hopefully be useful for the whole field studying developmental biology of *Streptomyces*. In addition, we have found a group of direct targets of WhiH in *S. venezuelae* (paper IV), including an orthologue of one of the genes identified as being developmentally regulated in *S. coelicolor* in paper I.

Developmental control of growth, morphogenesis, and cell cycle processes during sporulation

The following sections describe processes related to growth, morphogenesis, and cell cycle that occur during sporulation of *Streptomyces* and how they relate to the corresponding fundamental functions in other bacteria. The developmental control of these cellular processes is dependent on the regulatory *whi* genes discussed above, although it is largely unknown which promoters or genes that are controlled by these regulators. Thus, except for transcription factors, relatively few sporulation genes are known that are directly involved in fundamental cellular processes, leaving the underlying molecular mechanisms unclear.

Hyphal growth, cell wall assembly, and morphogenesis

Streptomycetes are mycelial bacteria that grow by incorporation of new cell wall material at the tips of the hyphae (Flärdh, 2003b, 2010). Vegetative hyphae create new sites of growth by formation of branches from the lateral wall, often in subapical cells that are separated from the tip by a cross wall. DivIVA is the first protein reported to be localized at the tips of growing vegetative hyphae of *S. coelicolor* (Flärdh, 2003b). It is also situated at places where new branches in subapical cells are formed, and has a role in recruiting or activating components of the cell wall synthesis machinery at these sites (Hempel *et al.*, 2008). *divIVA* is essential and partial depletion leads to poor growth and irregular hyphal morphology (Flärdh, 2003b). Aerial hyphae also exhibit polarized growth through tip extension and DivIVA is situated at the tips until sporulation septation starts (Klas Flärdh, personal communication). However, it is

also possible that intercalation of peptidoglycan into the lateral wall may also contribute to the rapid extension of aerial hyphae, but there is not much direct evidence for this (Chater, 2011; Jakimowicz *et al.*, 2005a).

When the aerial hyphae of *S. coelicolor* differentiate into spores, several changes in their growth and morphogenesis take place. The morphology of the sporulating aerial hyphae differs from the hyphae of the vegetative mycelium in often having a coiled shape in the apical parts (Fig. 2C). The straight appearance of the aerial hyphae of a *whiG* mutant, (Fig. 2D), indicates that the change in morphology is dependent on the WhiG sporulation sigma factor, which is likely to be one factor that commits the aerial hyphae to sporulation (see section “Genes specifically required for the early stages of sporulation”) (Chater *et al.*, 1989). The *whiG*-dependent switch from straight to coiled hyphae could be explained by a change in the peptidoglycan structure of the cell wall. One possibility would be a change in how the synthesis of new cell wall material occurs, or there could be a remodeling of the already existing peptidoglycan of the cell wall (Flårdh *et al.*, 1999).

At some point the aerial hyphae stop growing (Fig. 2A and B). *whiA* and *whiB* mutants have abnormally long and more tightly coiled aerial hyphae than the parent strain, suggesting that they are unable to properly arrest aerial hyphal extension (Fig. 2D). The coiling shows that the *whiG*-dependent change in cell shape is initiated in these two mutants, and the coiling is *whiG*-dependent since *whiA whiG* or *whiB whiG* double mutants have straight aerial hyphae like a *whiG* single mutant (Chater, 1975; Flårdh *et al.*, 1999). However, *whiA* and *whiB* mutants develop exaggerated coiling, possibly related to the inability to arrest growth and proceed to the next stage when sporulation septa are laid down (Flårdh *et al.*, 1999).

The prokaryotic MreB proteins are homologues of actin. They form actin-like cytoskeletal structures and determine cellshape in many rod-shaped bacteria, in which MreB has turned out to be essential for growth and for directing insertion of new peptidoglycan into the lateral walls of the cells (Carballido-Lopez, 2006; Margolin, 2009; Thanbichler and Shapiro, 2008). In contrast, MreB is not involved in polar growth of *Streptomyces* or other actinobacteria (Margolin, 2009), and is not even present in rod-shaped mycobacterial and corynebacterial species, which are growing by cell wall synthesis at both cell poles. Although MreB is not required for vegetative growth, the genome of *S. coelicolor* contains two *mreB* homologues, *mreB* and *mbl*, and in addition a third gene

encoding an MreB-like protein (Heichlinger *et al.*, manuscript in preparation). Transcription of *mreB* was shown to be controlled from three promoters, two of them are constitutively active, while one is developmentally regulated with an increase of activity during sporulation (Burger *et al.*, 2000). MreB has an effect on sporulation, affecting the integrity of the spore walls. An *mreB* mutant forms swollen and deformed spores that are sensitive to heat and detergent (Mazza *et al.*, 2006). The alterations in spore shape suggest that the synthesis of the peptidoglycan layers is somehow mediated by MreB. In agreement with a role in spore wall assembly, MreB localizes to sporulation septa, and later it seems to spread along the walls all around the maturing spores, and eventually disappears (Mazza *et al.*, 2006). *S. coelicolor* Mbl has a similar role to that of MreB, while the third *mreB*-like gene did not show any mutant phenotype and therefore is of unknown function (Heichlinger *et al.*, manuscript in preparation).

Bacterial cell division

In most bacteria, cell division involves the formation of a divisome, a multiprotein complex at the site of division. It is responsible for the invagination of the cell membrane, synthesis of new peptidoglycan, which is the main component of the bacterial cell wall, and finally the separation of daughter cells (Scheffers and Pinho, 2005). The first protein to localize to the future division site is FtsZ, a structural homologue to the cytoskeletal tubulins in eukaryotes. FtsZ polymerizes into protofilaments, and bundles of protofilaments assemble into a ring-like structure called the Z-ring, which is anchored to the inside of the cell membrane via interactions with other proteins (Fig. 4). The Z-ring initiates the formation of the divisome and its constriction leads to invagination of the cell membrane (Adams and Errington, 2009; Margolin, 2005). FtsZ is used for cell division by the vast majority of bacteria, with only a few groups as exceptions, including the planctomycetes and chlamydiae.

In all *ftsZ*-containing bacteria that have been tested, except *S. coelicolor*, *ftsZ* is essential. Surprisingly, *ftsZ* disruption mutants of *S. coelicolor* are viable. They do not form any cell division septa, but can still grow and be propagated (McCormick *et al.*, 1994). However, they grow poorly, form only vegetative mycelium and some aerial hyphae, and are unable to sporulate.

Cell division in *S. coelicolor*

In *Streptomyces*, two kinds of cell division structures have evolved - vegetative hyphal crosswalls (vegetative septa) and sporulation septa (for recent review, see McCormick, 2009). During vegetative growth, cell division is relatively infrequent and leads to formation of thin crosswalls of peptidoglycan that divide hyphae into individual cells. These septa do not cause separation of cells, and the cells that make up a hypha therefore remain attached to each other. During sporulation of aerial hyphae, a specialized form of cell division occurs to divide the sporogenic cell into multiple equally sized prespore compartments. These sporulation septa are synchronously formed along the cell, and give rise to thick, often double-layered crosswalls that are split after division to result in separation of adjacent spores (Chater and Losick, 1997; Wildermuth and Hopwood, 1970). Both types of cell divisions depend on *ftsZ*, which forms ring-like structures where the future septa will be laid down (Grantcharova *et al.*, 2005; McCormick *et al.*, 1994; Schwedock *et al.*, 1997). Thus, it is likely that *S. coelicolor* uses the same core cell division machinery in both kinds of divisions.

Assembly of FtsZ at the division site

In *E. coli*, where cell division has been studied extensively, the assembly and anchoring of FtsZ into a ring structure in the middle of the rod shaped cell is assisted by two proteins, FtsA and ZipA, which both interact with and are dependent on FtsZ for their localization to the division site (Pichoff and Lutkenhaus, 2002). ZipA is a membrane protein with a large cytoplasmic domain (Hale and de Boer, 1997), and FtsA seems to interact with the membrane through an amphipathic helix (Pichoff and Lutkenhaus, 2005). Both proteins interact with the extreme C-terminal tail of FtsZ, and are partially redundant for assembly and stabilization of FtsZ rings. Each of these proteins alone is sufficient to support formation of the Z-ring, but not cell division, because both proteins are needed to recruit a large division protein FtsK (Pichoff and Lutkenhaus, 2002). Conspicuously, the *S. coelicolor* genome does not encode any clear homologues of FtsA, which is present in most other bacteria, nor the less widely conserved ZipA. Furthermore, homologues of other proteins that function as modulators of FtsZ assembly in various

bacteria are also missing in streptomycetes, such as ZapA, ZapB, EzrA and SpoIIE. However, there is an apparent homologue of SepF which aids FtsZ assembly in *B. subtilis* (Flärdh and Buttner, 2009; McCormick, 2009).

During cell division in aerial hyphae, the septa need to be correctly placed between chromosomes to ensure proper chromosome segregation into prespores. However, the mechanism that defines the sites for the placement of Z-rings along the aerial hyphae in *S. coelicolor* is not known, and is probably not shared with rod-shaped model bacteria. One important example of spatial control of formation of the Z-ring is the Min system of *E. coli* and *B. subtilis* that prevents cell division from taking place close to cell poles and promotes division in the middle of the cell (Lutkenhaus, 2007). Nucleoid occlusion is an additional mechanism preventing septa to form over chromosomes by the action of specific proteins (SlmA in *E. coli* and Noc in *B. subtilis*) (Adams and Errington, 2009; Rothfield *et al.*, 2005). *S. coelicolor* lacks obvious homologues of the Min system or of proteins involved in nucleoid occlusion. In addition, there is no evidence for a clearcut nucleoid occlusion mechanism acting during sporulation since septa start to form over seemingly non-segregated chromosomes (Flärdh, 2003a). No alternative system for division site placement has been identified in *Streptomyces*.

This leaves us with an unresolved question of how Z-rings are stabilized and anchored to the membrane in streptomycetes, and particularly how the synchronized formation of multiple Z-rings is regulated during sporulation (Flärdh and Buttner, 2009; McCormick, 2009). The absence of proteins that assist in early Z-ring formation, suggests that *S. coelicolor* might have novel proteins with similar functions, which need yet to be found. Indeed, proteins have been identified with a role in developmental control of cell division, although the underlying mechanism of these genes on cell division remains unknown (discussed in section “Developmental regulation of cell division in *S. coelicolor*”).

Proteins of the divisome

In addition to FtsZ, the genome of *S. coelicolor* encodes homologues of well established cell division proteins, suggesting that *streptomyces* cell division proceeds similarly to that of the model bacteria once the Z-rings

are formed (Fig. 4). In *E. coli* FtsK is needed for both cell division and the final stage in chromosome segregation (Bigot *et al.*, 2004), the latter function involving pumping parts of the chromosome through the closing septum. The homologous protein SpoIIIE in *B. subtilis* is involved in proper translocation of chromosomes into prespore compartments (Bath *et al.*, 2000). *S. coelicolor* FtsK seems to have a similar role in chromosome segregation as in *E. coli* (described in section “Final stage of chromosome segregation into spore compartments”), but is not required for cell division (Wang *et al.*, 2007).

FtsQ (DivIB in *B. subtilis*), FtsL and FtsB (an FtsL-like protein in *E. coli*, called DivIC in *B. subtilis*) are three membrane proteins with similar topology. They have one transmembrane segment, positioning a smaller part at the cytoplasmic side of the membrane, and a larger domain on the outside of the membrane. Interaction studies suggested that they form a trimeric complex and that FtsK-independent oligomerization takes place before an FtsK-dependent localization to the divisome, but their function in cell division is still not known (Buddelmeijer and Beckwith, 2004).

FtsW, containing 10 membrane spanning helices, belongs to the SED family of proteins affecting cell division, cell shape, and cell elongation (Errington *et al.*, 2003). These proteins are typically encoded close to a gene coding for a penicillin-binding protein (PBP) with transpeptidase activity (enzyme that catalyses formation of the peptide bonds between strands of peptidoglycan) (Errington *et al.*, 2003; Scheffers and Pinho, 2005). In *E. coli* and most other bacteria, *ftsW* is involved in cell division and is localized close to *ftsI*, which encodes a PBP that is also specifically required for division. The role of FtsW in cell division is unknown, but it has been speculated that it is a candidate for transport of the lipid-linked peptidoglycan precursors through the cell membrane to FtsI and other PBPs on the outside of the membrane (Errington *et al.*, 2003).

Divisome components

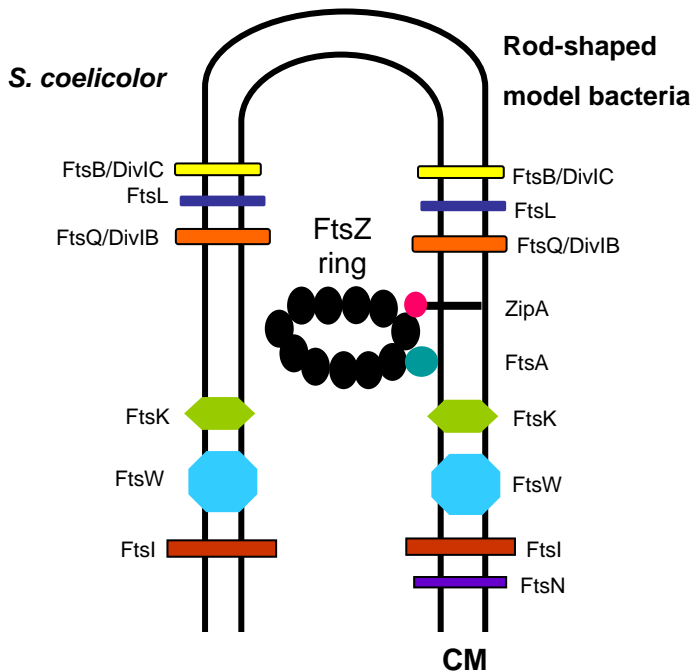

Figure 4. Components of the cell division machinery, the divisome, of *S. coelicolor* and rod-shaped model bacteria. Studies of cell division in rod-shaped bacteria like *B. subtilis* and *E. coli* have identified FtsZ to be the first protein to localize at the site of division. There FtsZ forms a ring-like structure through polymerisation, which is stabilized and anchored to the membrane by FtsA and ZipA. Note that homologues of FtsA and ZipA are absent in *S. coelicolor* and since no other proteins with the same function have been identified, it is not yet known how FtsZ interacts with the membrane in *S. coelicolor*. FtsK is not required for cell division in *S. coelicolor* but has a role in moving chromosomes. Homologues of FtsN are not known to be present in gram positive bacteria.

FtsQ, FtsL, FtsB, FtsW and FtsI all have an effect on the formation of sporulation septa in *S. coelicolor* (McCormick, 2009). Null mutants are more or less blocked in sporulation. An *ftsQ* mutant was unable to form sporulation septa in most aerial hyphae (McCormick and Losick, 1996), while *ftsL* and *ftsB* mutants formed aerial hyphae with shallow constrictions (Bennett *et al.*, 2007). *ftsI* and *ftsW* mutants formed a mixture of hyphae, one fraction with no septa and the other with partially constricted septa (Bennett *et al.*, 2009). In the four latter mutants, the phenotypes were dependent on the growth conditions and were not as severe on minimal media with low osmolarity as they were on high osmolarity medium. This indicates that under certain conditions cell division can be successful in the absence of *ftsL*, *ftsB*, *ftsI* or *ftsW*, probably due to the presence of proteins with overlapping functions (Bennett *et al.*, 2007; Bennett *et al.*, 2009). Curiously, these mutants can form septa in vegetative hyphae, which makes *S. coelicolor* unique in a sense that so many cell division genes are dispensable for proliferation.

An additional cell division protein, FtsN, has been proposed to be involved in hydrolysis of the cell wall due to weak sequence similarity to amidases (Errington *et al.*, 2003). Amidases are needed for the detachment of daughter cells during division, but since analogous proteins are not found in *S. coelicolor*, it is still unclear which proteins are involved in spore separation.

Developmental regulation of cell division in S. coelicolor

During sporulation in *S. coelicolor*, FtsZ assembles into multiple regularly spaced Z-rings in the sporogenic cells of aerial hyphae, (Fig. 5B) (Grantcharova *et al.*, 2005; Schwedock *et al.*, 1997). Before formation of regular ladders of rings along the hyphae, spiral shaped structures are detected and it has been suggested that these are intermediates which later become reorganized into Z-rings during sporulation, (Fig. 5D), (Grantcharova *et al.*, 2005). Similarly, Z-rings are formed from dynamic FtsZ helices also in other bacteria (Peters *et al.*, 2007; Thanedar and Margolin, 2004). The developmentally controlled form of cell division requires an elevated expression of *ftsZ* for sporulation septa to form at regular intervals in the aerial hyphae. Upregulation of *ftsZ* expression is controlled from a sporulation-specific promoter p2, in sporogenic hyphae both in *S. coelicolor* and in *S. griseus*

(Flärdh *et al.*, 2000; Kwak *et al.*, 2001). Low levels of expression from two other putative promoters, p1 and p3, and read-through transcription from a further upstream promoter are seen throughout development of *S. coelicolor* and this is sufficient to support formation of septa in vegetative hyphae. The upregulation of p2 is reduced or eliminated in strains having null mutations in *whiA*, *whiB*, *whiG*, *whiH*, *whiI* and *whiJ*, encoding sporulation regulators (discussed in earlier sections) (Flärdh *et al.*, 2000). This may explain why these mutants are defective in formation of septa during sporulation, leading to developmentally blocked non-sporulating strains. However, it is not known how these genes accomplish the control of expression from the sporulation-specific promoter of *ftsZ* (Flärdh *et al.*, 2000). Consistent with an effect on *ftsZ* expression, translational fusion of FtsZ to EGFP (enhanced green fluorescent protein) showed that the number of Z-rings in *whiG*, *whiA*, *whiB* and *whiI* mutants are as low as in vegetative hyphae (Grantcharova *et al.*, 2005). A *whiH* mutant formed more Z-rings, but still much less than in the wildtype. This is in agreement with the observed formation of a few sporulation septa in the *whiH* mutants (Flärdh *et al.*, 1999).

In addition to the early *whi* genes, there are other genes that affect developmental control of cell division. For example, some members of the SALP family of proteins affect the formation of sporulation septa. *ssgA* and *ssgB* deletion mutants are totally blocked in sporulation and have a white phenotype with unseptated aerial hyphae (Keijsers *et al.*, 2003; van Wezel *et al.*, 2000), while *ssgC*, *ssgD* and *ssgB* affect the placement of sporulation septa (Noens *et al.*, 2005). *WhiD* also influences the regular placement of septa (Molle *et al.*, 2000), and the integral membrane protein *CrgA* appears to negatively influence septation (Del Sol *et al.*, 2003; Del Sol *et al.*, 2006). However, the biochemical functions of these proteins are not known and it has not been established how they exert their action on septum formation - if they interact directly with FtsZ or the division machinery, or if they have indirect roles, such as controlling promoters of other genes.

The inability of the *whi* mutants to lay down sporulation septa might not solely be explained by their failure to upregulate *ftsZ*. It is likely that the *whi* genes also affect cell division in other ways and that the formation of sporulation septa requires more than an increased level of FtsZ. For example, one missense mutation in *S. coelicolor ftsZ* has been identified that abolished formation of regular Z-rings in aerial hyphae, but had much less effect on Z-ring formation during vegetative

growth (Grantcharova *et al.*, 2003). This suggests that there are different requirements for FtsZ assembly between vegetative crosswalls and sporulation septation, and that mechanisms for developmental control of FtsZ assembly may be involved in sporulation. During the course of this thesis project, genes were found that seem to have an effect on FtsZ assembly during sporulation (further discussed in “Summary of present investigation”).

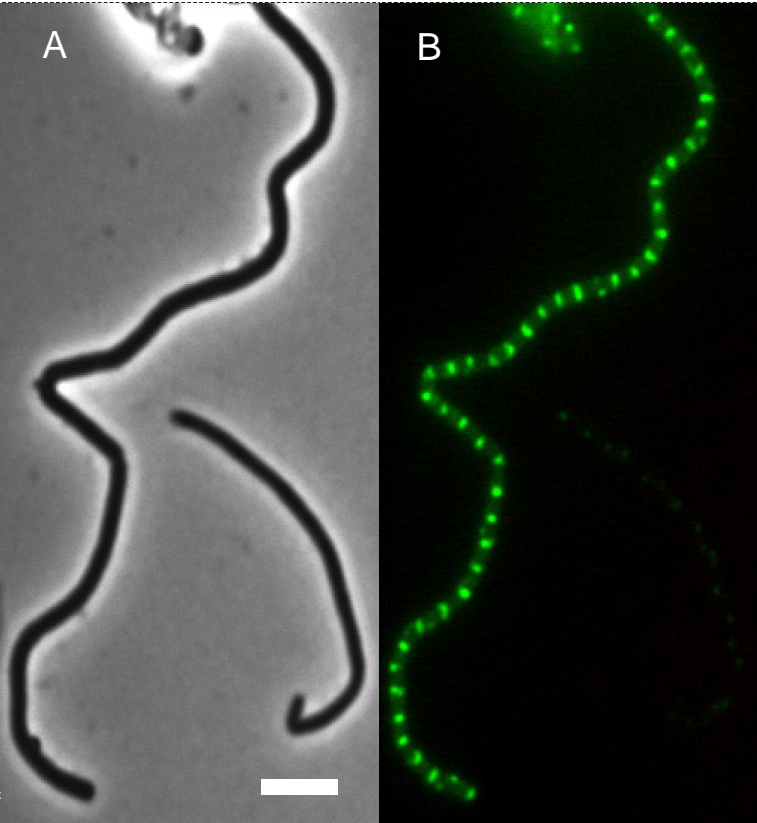

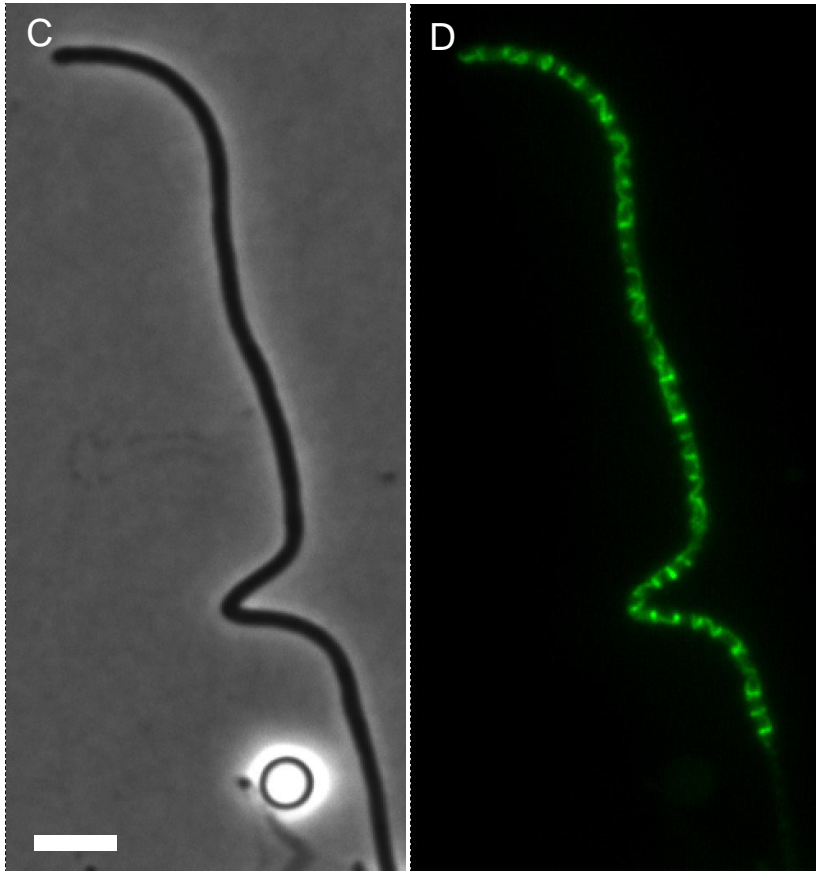

Figure 5. Aerial hyphae of *S. coelicolor* wildtype strain M145 harboring an *ftsZ-egfp* fusion at the *ftsZ* locus. A and C are phase-contrast images of aerial hyphae (Bar: 4 μm), B and C are fluorescence images. B. Multiple Z-rings formed in the aerial hyphae are visualized as ladders of FtsZ-EGFP. D. Spirals of FtsZ filaments are visualized as helical fluorescent structures.

Chromosome segregation and nucleoid structure during sporulation

Bacterial chromosome replication and partitioning have mostly been studied in unicellular model organisms that divide by binary fission and have circular chromosomes. In these bacteria replication and segregation of chromosomes takes place concurrently, and the newly replicated *oriC* regions are actively moved towards the cell poles while replication is ongoing in the middle of the cell (Reyes-Lamothe *et al.*, 2008; Thanbichler and Shapiro, 2008). The mechanisms that drive bacterial chromosome segregation are largely obscure, but a type I partitioning system of ParAB-type has been implicated in this process in several bacteria. This system is similar to partitioning systems on some plasmids and consists of a WACA ATPase (Walker A cytoskeletal ATPase) encoded by *parA*: a DNA-binding protein encoded by *parB*: and a DNA sequence motif (*parS*) to which ParB binds. By binding to multiple *parS* sites near the origin of replication, ParB forms a large nucleoprotein complex. Chromosomally encoded homologues of ParA and ParB are widespread among bacteria (although notably absent from *E. coli*) suggesting a general role in positioning of chromosomes in the prokaryotic cells (Leonard *et al.*, 2005).

S. coelicolor has a different kind of life cycle and harbors a large linear chromosome of 8.7 Mbp for *S. coelicolor*, with an origin of replication in the center of it. During vegetative growth, the genome is replicated so that each cell, separated by cross walls, contains multiple copies of the chromosome, but during this stage in the life cycle it is not known how chromosomes segregate and no overt nucleoid separation or condensation is visible by DNA staining and microscopy during this stage. Also, the dozens of chromosomes present in the sporogenic compartment are evenly distributed during the replication stage. However, at a late stage of sporulation, these become separated into regularly positioned bodies of DNA, one in each prespore (Flårdh, 2003a). This involves both chromosome segregation and condensation.

Partitioning and chromosome positioning in aerial hyphae

The genome of *S. coelicolor* encodes homologues of ParA and ParB, both having an effect on chromosome segregation into prespore compartments.

parA and *parB* form an operon, the expression of which is regulated from two promoters upstream of *parA*. In agreement with a specific role during sporulation, the expression from the most upstream promoter, p2, is upregulated during sporulation and dependent on the early sporulation genes *whiA*, *whiB*, *whiI* and *whiH* (Jakimowicz *et al.*, 2006; Kim *et al.*, 2000). The other promoter p1, has a constitutive activity throughout development, although *parA* and *parB* have not been assigned any function during vegetative growth.

A *parAB* mutant and the *parA* and *parB* single mutants show no striking defect in development and sporulate as well as their parent, but staining of DNA shows irregularity in DNA content in the spores (Jakimowicz *et al.*, 2007; Kim *et al.*, 2000). In the case of the *parAB* and *parB* mutants, ~15 % of the compartments in the spore chains are DNA-free, compared to 1.8 % in the wildtype parent. The defect in segregation is more striking in the *parA* deletion mutant, where 26 % of the spores lack DNA (Jakimowicz *et al.*, 2007). An interpretation is that in the presence of ParB in the absence of ParA has an even stronger effect on the placement of chromosomes into the prespores than its complete absence.

ParB is a DNA-binding protein and binds to *parS* sites, most of them (21 out of 24) located around the *oriC* region of the chromosome, and forms a large nucleoprotein complex (Jakimowicz *et al.*, 2002). During sporulation, ParB foci are regularly positioned between sporulation septa in aerial hyphae, overlapping with the positions of chromosomes (Jakimowicz *et al.*, 2005a). A mutation in the predicted helix-turn-helix region of ParB abolishes formation of ParB foci and its binding to chromosomal DNA, indicating that the ParB complex formation is dependent on DNA-binding (Jakimowicz *et al.*, 2005a). Also, inactivation of the sporulation-specific promoter p2 has a negative influence on formation of ParB complexes and leads to a similar frequency of anucleate spores as *parB* inactivation (Jakimowicz *et al.*, 2006), indicating the importance of an elevated level of ParB for proper chromosome segregation during sporulation. ParA localizes at the tips of young aerial hyphae and later extends along the hyphae as a spiral shaped structure, in a *parB* independent manner (Jakimowicz *et al.*, 2007). ParA is required for efficient formation and regular positioning of ParB foci, and may assist in placing the ParB-bound *oriC* region into the prespore compartments.

In addition to chromosome segregation defects, the mutants mentioned above also lay down unevenly spaced sporulation septa, resulting in minicompartment lacking DNA. This led to the suggestion that chromosome positioning might influence the positioning of FtsZ rings and that the *parAB* system may play a role in the control of spatial placement of sporulation septa.

Final stage of chromosome segregation into spore compartments

The *S. coelicolor* FtsK protein, which localizes to sporulation septa, affects the final separation of chromosomes and their transfer into spore compartments during closure of the septa. FtsK homologues in other bacteria are DNA translocases, e.g. SpoIIIE pumps the chromosome into the forespore compartment during sporulation in *B. subtilis*, and *E. coli* FtsK transports the final part of the chromosome through the closing septum (Bigot *et al.*, 2007). An *ftsK* null mutant of *S. coelicolor* showed a high degree of genetic instability, which was associated with deletions of the ends of the linear chromosome (Wang *et al.*, 2007). The *ftsK* mutant also appeared defective in moving misplaced chromosomes away from closing septa (observed in a *smeA-sffA* mutant discussed below) (Ausmees *et al.*, 2007). Taken together, this suggests that FtsK has a role in transporting the terminal parts of the chromosomes through closing septa during sporulation to ensure that they do not get trapped (Wang *et al.*, 2007). Another homologue of SpoIIIE/FtsK DNA translocases, SffA, also localizes to the sporulation septa, suggesting a possible function of SffA as a DNA translocase, but its exact role remains unclear. However, although FtsK and SffA colocalize at septa, they do not have overlapping or redundant functions related to the segregation of chromosomes (Ausmees *et al.*, 2007).

Genes affecting condensation of chromosomes

Recent reports shed light on some proteins involved in condensation and packaging of chromosomes during *S. coelicolor* sporulation. Individually they affect nucleoid compaction and in some cases influence segregation and placement of septa in aerial hyphae. These proteins all belong to the group of nucleoid-associated proteins found in bacteria (Luijsterburg *et*

al., 2006). The members of this group are structurally very diverse. Several of them show analogy to eukaryotic histones in the sense that they are small, basic, DNA-binding proteins that are abundant in the cell and influence compaction of the chromosomes. However, the structure and organization of bacterial chromatin remains, in comparison to eukaryotes, largely unclear (Luijsterburg *et al.*, 2006).

The genome of *S. coelicolor* encodes one member of the SMC (structural maintenance of chromosomes) family of proteins. As has been reported for the temperature sensitive *B. subtilis smc* mutant, *smc* deletion mutants of *S. coelicolor* have less condensed genomes in the prespore compartment around the time of sporulation septation, but not in mature spores. This is in agreement with the presence of SMC-foci overlapping uncondensed nucleoids during early stages of sporulation and the disappearance of those in prespore compartments with condensed DNA (Dedrick *et al.*, 2009; Kois *et al.*, 2009).

While SMC affects nucleoid structure during an early stage of sporulation, we discovered during the course of this thesis project a nucleoid-associated protein, HupS, that influences nucleoids in the mature spores (Salerno *et al.*, 2009; paper II). HupS is a homologue of the broadly conserved HU proteins in bacteria (Luijsterburg *et al.*, 2006). HupS-EGFP signals are associated with nucleoids, and are specifically observed in spore chains but not in aerial hyphae at an earlier stage of sporulation or in vegetative mycelium. In agreement with this, *hupS* is required for normal nucleoid compaction in spores, but has no detectable affect on chromosome segregation or earlier developmental stages (Salerno *et al.*, 2009).

The genome of *S. coelicolor* also encodes three Dps homologues. In *E. coli*, the Dps protein (DNA-binding protein from starved cells) forms a nucleoprotein complex that protects DNA from damage during stationary phase and has also been shown to be involved in stress responses (Almiron *et al.*, 1992; Frenkiel-Krispin *et al.*, 2004; Nair and Finkel, 2004). The deletion of individual *dps* genes in *S. coelicolor* influenced the chromosome compaction in prespore compartments, but in different ways. In a *dpsA* deletion mutant the DNA condensation was incomplete (Facey *et al.*, 2009). On the other hand *dpsB* or *dpsC* deletions resulted in a more compact nucleoid structure compared to the wildtype strain. This indicates that DpsB and DpsC, in the absence of DpsA, together cannot condense chromosomes, maybe because of antagonistic effects on each other's function in the absence of DpsA. This

suggests that balanced levels of the three proteins are needed for a suitable degree of DNA condensation inside the cell.

Consistent with a role during sporulation, strong signals of fluorescent fusion derivatives of SMC, HupS, DpsA and DpsC were detected in sporogenic compartments but not in vegetative hyphae, probably reflecting developmental control of their expression. *hupS* transcripts were indeed not observed during vegetative growth and reached a maximum during sporulation. Due to the high abundance in aerial hyphae, these nucleoid-associated proteins likely have a sporulation-specific role. Since condensation was still evident in each of the mutants described above none of them was solely responsible for full DNA compaction, and additional factors that may also contribute to the compaction and protection of spore DNA during sporulation remain to be identified. The fact that none of the nucleoid-associated proteins were essential for survival and the subtle phenotypes of mutants implies the presence of proteins with overlapping functions.

Summary of present investigation

In this section I summarize and discuss the results of papers I, II, III and IV of this thesis and also present some recent findings on a locus that has a strong impact on developmentally controlled cell division in *S. coelicolor*. The overall goal of the project was to identify genes and mechanisms involved in the developmental control of cell cycle-related processes of *S. coelicolor*, for example genes influencing cell division, chromosome segregation, growth or morphogenesis of the aerial hyphae. Very few sporulation genes were previously known in *Streptomyces*, and our investigation was aimed to increase understanding of how morphological differentiation is brought about in this complex bacterial system. In a broader context, we anticipate that a clarification of the molecular mechanisms that have evolved in *Streptomyces* for developmental control of fundamental cell cycle processes will also be generally valuable within bacterial cell biology. For example, it may provide insights about how essential processes in a bacterium can be controlled or inhibited, which is relevant for development of new antibiotics. I have used two main approaches to find previously unknown sporulation genes. In the first approach we searched for targets for the known sporulation regulator WhiH. Specific mutation in the cell division gene *ftsZ* (Flärdh *et al.*, 2000; Grantcharova *et al.*, 2003) abolished normal spore formation and gave rise to mainly unconstricted aerial hyphal fragments with only occasional sporulation septa and condensed, unevenly spaced chromosomes. The striking phenotypic similarity of *S. coelicolor whiH* mutants to these *ftsZ* mutants strongly suggests that WhiH somehow regulates formation of sporulation septa, in a so far unknown way. Therefore we chose to find direct targets of WhiH in order to investigate how the bacterial cell division machinery can be regulated in *Streptomyces* (paper III and IV, and section "A developmental mutant blocked in cell division"). The second approach was to find new sporulation genes by studying global gene expression during sporulation

using DNA microarrays, and through genetic analysis of these genes reveal their role in sporulation (paper I and II).

The developmental regulator WhiH

One way to reveal new sporulation genes is to identify promoters that are under the control of known sporulation regulators. To find direct targets of WhiH we asked if it was possible to find genes in the genome of *S. coelicolor* with a WhiH binding site in their upstream region. Therefore, a high priority was to test the DNA binding activity to see if WhiH functions as a transcription factor. In paper III, we show that WhiH is able to bind to the *whiH* promoter region, in agreement with a proposed autoregulatory function (Ryding *et al.*, 1998). This is also observed for WhiH in *S. venezuelae* (paper IV), where the binding site in the *whiH* promoter region is conserved and overlapping with the one identified in *S. coelicolor*, indicating the importance of this binding site in the regulation of *whiH*. However, using the identified binding site to search for similar sequences in the upstream regions of genes in the *S. coelicolor* genome did not give any significant hits, and we were not able to find WhiH-regulated genes using this approach.

WhiH-regulated genes in *S. venezuelae*

Recently, a new model system to study development in streptomycetes was established, relying on the ability of *S. venezuelae* to sporulate in liquid culture (described in the review by Flårdh and Buttner, 2009). *S. venezuelae* has some advantages compared to *S. coelicolor* when studying gene expression during sporulation. While *S. coelicolor* only sporulates on solid medium, where aerial hyphae only constitute 10% of the total biomass of a colony and cannot be separated from the vegetative mycelium, *S. venezuelae* synchronously develops in submerged cultures and sporulates almost to completion. This is preferential when analyzing gene expression at a specific stage of development.

Through collaboration with Mark Buttner and Maureen Bibb, from John Innes Centre, Norwich, we could explore this new model system to investigate the function of WhiH. We have found WhiH targets in *S. venezuelae* by combining global transcriptomic analysis using DNA

microarrays, and ChIP-on-chip experiments (chromatin immunoprecipitation-microarray) (paper IV). A subset of genes, negatively affected by *whiH*, was recognized as WhiH targets in ChIP-on-chip experiments. The expression pattern suggests that they are repressed by WhiH at a late stage of sporulation. Many of these genes were also found to share a common motif in their upstream regions, shared also by the *whiH* upstream region. Heterologously produced WhiH was shown to recognize this motif in protein-DNA binding assays. One of the repressed targets, SMD02435, has an orthologue in *S. coelicolor* (SCO1774) that is developmentally regulated and has a sporulation-induced promoter (paper I), strengthening its importance in *Streptomyces* sporulation. Moreover, DNase I footprinting has identified a second site bound by WhiH in the *whiH* upstream region.

One motif, with similarity to that revealed by the WhiH footprint, is present in the upstream regions of a group of potentially WhiH-activated genes. WhiH appears to recognize this motif, but with low affinity, and so far binding has only been tested for one of the genes, SMD03944. This gene has an orthologue in *S. coelicolor* (in this thesis referred to as *decA*), present in a locus of two genes which, according to the array data, are upregulated during sporulation of *S. coelicolor* (paper I). Our analysis of a *decA-decB* null mutant of *S. coelicolor* strongly suggests these genes to be involved in the developmentally controlled form of cell division and is further discussed in section “A developmental mutant blocked in cell division”.

Developmental gene expression of *S. coelicolor*

In order to find genes specifically active in aerial hyphae and involved in sporulation, the gene expression pattern of a *S. coelicolor* wildtype strain has been compared to those of two developmental mutants (paper I). The focus was on strains lacking either *whiH*, encoding a GntR family transcription factor (Ryding *et al.*, 1998), or *whiA* encoding a protein recently predicted to have DNA-binding properties (Ainsa *et al.*, 2000; Kaiser *et al.*, 2009; Knizewski and Ginalska, 2007). Both regulators are active in an early stage of sporulation, before sporulation septation. While a *whiA* mutant has a total block in sporulation (it has uncondensed chromosomes, does not form any sporulation septa and can not properly stop aerial growth), a *whiH* mutant forms some aerial compartments with

similarities to spores. The similarity is based on formation of sporulation septa, although much fewer than in the wildtype strain, and the ability to condense and partition the chromosomes. WhiA is therefore presumed to regulate genes involved in cellular processes at an early stage of sporulation, before or during septum formation, while *whiH* may regulate genes involved in septum formation, based on the striking similarity to specific *ftsZ* mutants, that are unable to form sporulation septa but otherwise grow normally. Genes that are specifically active in aerial hyphae and involved in sporulation were supposed to be differentially expressed in these mutants compared to the wildtype, and the experiment was designed to reveal such genes.

Analyses of the microarray data identified 114 genes with a significant change in expression in at least one of the *whiA* or *whiH* mutants compared to the parent during sporulation, most of them previously unknown to be developmentally controlled. Many of the genes were upregulated during sporulation in the wildtype but failed to do so in the mutants. No significant difference in expression was observed between wildtype and the *whiA* and *whiH* mutants during growth of vegetative mycelia, which is consistent with *whiA* and *whiH* being active during sporulation. Our analysis showed that *whiA* affects the expression of more genes than *whiH*, consistent with the more complete block of sporulation in a *whiA* mutant, and indicating that WhiA has a stronger impact on sporulation than WhiH. This is in agreement with the transcriptional analysis of *S. venezuelae* developmental mutants, where *whiA*, *whiB*, *whiG* and *whiI* were observed to effect the expression of a great number of genes during sporulation, while genes specifically affected by *whiH* were harder to find (paper IV). Overall, the observations suggest that WhiH may regulate only a small number of sporulation genes.

One complication with the microarray experiment in *S. coelicolor* is the low signal-to-noise ratio, which complicated the analysis and interpretations. The problem can be emphasized by the WhiH-repressed candidate genes that appeared overexpressed in the *whiH* mutant but whose expression patterns could not be confirmed using quantitative real time PCR or S1 nuclease mapping. Another issue is the low level of changes in gene expression between the two mutants and the wildtype strain, which is expected to be much greater than the average of a 2-3 fold change for individual genes found in the microarray. This resulted in a

low number of genes that were recognized as upregulated during sporulation. Two things are likely to contribute to this problem. First, since aerial hyphae are in minority among other hyphae in a *S. coelicolor* colony, specific changes in gene expression in this cell type might be hard to detect. Second, microarrays may have a tendency to flatten signal-to-noise ratios, but this may vary with array type. These weaknesses in the array study caused the need to confirm the expression of putative new sporulation genes also by alternative approaches. This has already been done for a number of genes, and several were confirmed to be developmentally upregulated. Consequently, a great number of genes detected in the microarray experiment to be developmentally regulated can be verified and are of interest for future examination. Furthermore, the tested genes were specifically active in sporulating hyphae, in agreement with a role during sporulation. The type of reporter gene constructs based on a red fluorescent protein that we generated in this work are of great importance to monitor transcriptional activities and identify in which cell types the genes are active. Although deletion of some of the genes had no effect on sporulation, others caused a decreased heat tolerance of spores and deficient spore pigment production, indicating roles in spore maturation. A substantial set of genes remains to be functionally analyzed for their roles in the sporulation process and overall this study has expanded the knowledge of genes involved in morphological differentiation in *S. coelicolor*. Among the genes are two loci which upon deletion have an effect on chromosome condensation and cell division, respectively. Therefore they are of highest interest in this thesis concerning regulation of cell-cycle related processes and are further discussed in the following two sections.

The nucleoid-associated HupS protein

One spin-off story from the transcriptome analysis in *S. coelicolor* deals with a nucleoid-associated HU-like protein, HupS (paper II). This protein specifically accumulates in spores where it colocalizes with the nucleoids. Absence of *hupS* results in chromosomes that are less condensed inside the spores, decreased heat tolerance of spores and deficient spore pigment production. Based on this we conclude that HupS is required for full maturation of spores. This seems to be caused by the

effect that HupS has on the nucleoids, since it does not affect the assembly of the spore wall, which is defective in several of the previously studied mutants with less resistant spores (Ausmees *et al.*, 2007; Mazza *et al.*, 2006; Molle *et al.*, 2000; Potuckova *et al.*, 1995). Because HupS is not noticeably involved in chromosome segregation and DNA condensation during earlier stages of sporulation, we tentatively suggest that it contributes to DNA packaging and protection in mature spores. It is possible that nucleoid compaction contributes to protecting genetic information from damage during long periods of spore dormancy, and HupS is the first factor known to affect DNA condensation in spores of *S. coelicolor*. It is likely that mechanisms of DNA protection together with a thick spore wall contribute to the resistance to e.g. heat, desiccation and sonication of *S. coelicolor* spores.

A developmental mutant blocked in cell division

One new sporulation locus that we identified in the microarray experiment in *S. coelicolor* caused a cell division defect in aerial hyphae upon deletion. The genes of this locus are here tentatively designated *decA* and *decB* (developmental cell division). Based on the microarray study (paper I) *decB* is significantly upregulated during sporulation, but fails to be so in a *whiA* and *whiH* mutant (the difference between *whiA* mutant and wildtype at 48h being significant). *decA* is located immediately upstream of *decB*, with a space of only three base pairs between the coding regions, and the genes are likely to be co-transcribed. In the transcriptome analysis of gene expression in *S. venezuelae*, orthologues of the genes were identified as specifically dependent on *whiH* for their upregulation during sporulation (paper IV). In this paper we also show the ability of *S. venezuelae* WhiH to bind the upstream region of the gene corresponding to *decA*, although with very low affinity. Altogether the data suggest that the expression of this locus is developmentally regulated in both *S. coelicolor* and *S. venezuelae*, and that it may be directly regulated by WhiH. However, further work is needed to clarify the last point.

An *S. coelicolor* *decA-decB* double mutant and a *decB* single mutant are deficient in formation of spores. Our initial characterization of these mutants show that the aerial hyphae are thick, uncontracted, and

contain unevenly distributed and condensed chromosomes (unpublished data). The appearance of the mutant aerial hyphae is strikingly similar to the spore-like aerial hyphal fragments that are produced by *whiH* mutants. If this locus is found to be a direct target of WhiH in *S. coelicolor*, the absence of sporulation septa in a *whiH* mutant might very well be explained by a failure to upregulate *decA* and *decB*.

It should be noted that a *whiH* mutant of *S. venezuelae* does not have as severe a sporulation phenotype as the *S. coelicolor whiH* mutants. It is able to lay down regular sporulation septa, but fails to do so sometimes, and as a result some spores are of a larger size and have multiple condensed chromosomes (Bibb, M. *et al.*, manuscript in preparation). We are at the moment constructing mutants lacking the *S. venezuelae* orthologues of *decA* and *decB* to see the effect on sporulation. The ability of the *whiH* mutant to form spores abundantly may indicate that upregulation of these genes is not required for cell division, that they are not entirely dependent on *whiH*, or that there are additional genes with overlapping functions in *S. venezuelae*. Work is in progress to investigate these alternatives.

Preliminary analysis of an FtsZ-EGFP fusion using fluorescence microscopy, suggests that aerial hyphae of the *S. coelicolor decA-decB* mutants have no regular ladders of FtsZ, which are present in the aerial hyphae of the wildtype (Fig. 5B). In the wildtype FtsZ polymerizes into helical filaments before resolving into a regular assembly of FtsZ rings. Such helical patterns were observed in aerial hyphae of *decA* and *decB* mutants but very few regular FtsZ rings were detected (Fig. 6B) (Grantcharova *et al.*, 2005). In addition, another common pattern in the aerial hyphae of the mutants was fluorescent foci of FtsZ-EGFP, much bigger and brighter than foci caused by autofluorescence (Fig. 6A). Altogether, this suggests that *decA* and *decB* are required for correct assembly of FtsZ rings during sporulation. The presence of aerial hyphae with strong fluorescent signals and helical fluorescent structures showed that FtsZ-EGFP was normally upregulated during development and that it was able to form cytoskeletal filaments. However, few regular Z-rings were formed, and the irregular bright foci suggest that some kind of aggregation may occur. The effect on FtsZ polymerization makes this locus of great interest in the control of cell division during sporulation and in the assembly of FtsZ into stable ring structures at regular intervals in aerial hyphae. Ongoing work aims to construct fusions of both proteins to EGFP, and conduct localization studies of the DecA and DecB proteins

in aerial hyphae. It will also be interesting to see if DecA and DecB directly interact with FtsZ and how they effect FtsZ polymerization *in vitro*. Studies of the biochemical properties of these proteins will be valuable for the understanding of their function in the cell. These findings could reveal their role in the sporulation process and might determine their specific involvement in the assembly of FtsZ rings.

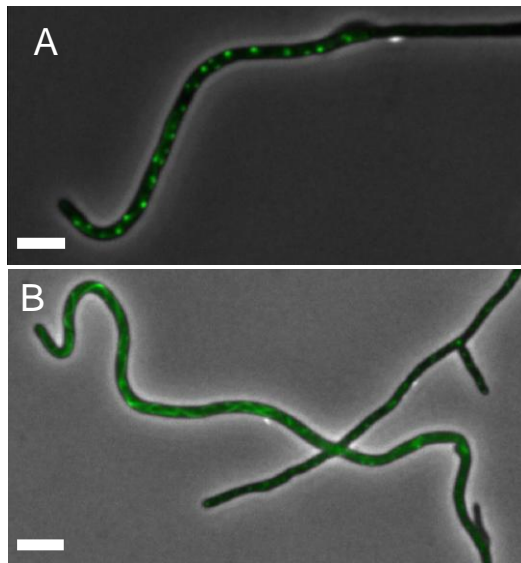

Figure 6. Aerial hyphae of a *decA-decB* deletion mutant having *ftsZ-egfp* integrated at the *ftsZ* locus, shown as a fluorescence image over a phase-contrast image. A. FtsZ-EGFP is assembled into bright foci, unevenly distributed along the hyphal length. (Bar: 3.0 μm) B. A helical pattern of FtsZ-EGFP shows the ability of FtsZ to form filamentous structures (Bar: 3.6 μm).

Populärvetenskaplig sammanfattning på svenska

Det finns många skäl till varför streptomyceter är en intressant grupp av bakterier att undersöka. Den här avhandlingen fokuserar på celldifferentieringen hos dessa organismer och deras förmåga att bilda en specialiserad typ av tåliga celler som kallas sporer. Genom att studera sporuleringsprocessen hos dessa bakterier kan man lära sig mycket om fundamentala livsprocesser som celldelning, nedärvning av kromosomer, syntes av cellvägg och cellform. Kunskapen om hur dessa cellbiologiska processer är reglerade på molekylär väg i den prokaryota cellen är begränsad och det är av stor vikt att reda ut de bakomliggande mekanismerna, dels av grundvetenskapliga skäl men också för att streptomyceterna har en stor betydelse inom områden som medicin och industri. Tillsammans producerar de en mängd olika antibiotika och används i läkemedelsindustrin för att producera dessa i stor skala. Kunskaper om biologin hos dessa bakterier och hur de reglerar tillväxt och celldelning kan vara till stor nytta för att framställa stammar lämpliga att odla i storskaliga kulturer och som ger ett högt utbyte av antibiotikum. Ett annat skäl att klargöra hur *Streptomyces* reglerar fundamentala livsprocesser är behovet av antimikrobiella läkemedel mot närbesläktade bakterier som *Mycobacterium tuberculosis*, bakterien som orsakar tuberkulos. Att förstå molekylära mekanismer bakom processer i bakteriecellen medför att läkemedel som blockerar livsviktiga funktioner kan utvecklas för att bekämpa dessa farliga patogener.

Min avhandling har klargjort några centrala delar av celldifferentieringsprocessen hos streptomyceter. Sporuleringen innebär att långa trådlika celler omvandlas till en kedja av runda sporer, och omfattas av förändringar i celldelning, kromosomdistribution och i tillväxten av cellvägg som i sin tur leder till en förändrad cellform. Syftet med denna avhandling var att hitta gener och mekanismer som reglerar dessa biologiska processer i bakteriecellen. Tidigare var bara att fåtal

gener kända som krävs för sporobildning, där ibland ett antal regulatoriska proteiner.

Streptomyces coelicolor har använts som model organism för att undersöka funktionen av en tidigare känd regulator, WhiH, som krävs för celledelning under sporuleringen. Jag har fastställt att WhiH fungerar som en transkriptionsfaktor och kan binda till DNA. WhiH binder till ett specifikt ställe i sin egen promoter och påverkar dess aktivitet på ett ännu okänt sätt. Genen som kodar för WhiH är specifikt aktiv i de celler som omvandlas till sporer vilket styrker rollen som sporuleringsregulator.

Nya gener har identifierats som tidigare inte var kända för att påverka sporulering i *S. coelicolor*. Karakterisering av några av dessa visar att de har intressanta funktioner som påverkar spormognad, kromosomstruktur och celledelning.

En ny modelorganism för actinomyceter, *S. venezuelae* har använts i ett avslutande projekt. Denna organism har några egenskaper som gör den mycket lämplig för storskaliga metoder som t.ex. transkriptionsanalys med DNA mikroarrayer. Med hjälp av detta system har gener som regleras av WhiH hittats. Fortsatta undersökningar av deras funktion och reglering kommer att ge spännande och viktiga insikter i streptomyceters cell och utvecklingsbiologi.

Acknowledgements

Det finns ett antal personer som jag vill tacka under min tid som doktorand.

Först och främst Klas, som har gett mig möjligheten att få jobba med spännande projekt och lärt mig hur forskning ska gå till. Jag är evigt tacksam för ditt engagemang, stöd och positiva inställning.

Claes för synpunkter på projekt och läsning av manuskript.

Mark Buttner and Maureen Bibb, thanks for great collaboration.

Elisabeth, tack för ovärderlig hjälp med experiment.

Alla Biologihusets forskare och personal. Lasse för att du ger stödjande kommentarer och engagerar dig i att få biologihuset att fungera. Nora tack för att du läste avhandlingen. Alla morgonpigga: Per, Lena och Ann-Margrete, biologihuset hade inte varit det samma utan er. Stefan och Per, för att ni lagar de saker som jag har sönder.

Nuvarande och tidigare doktorander. Det har varit fantastiskt att få lära känna så många olika typer av personer. Var och en av er har en egen plats i mitt minne.

Det finns många som passerat ”Flärdh labbet” genom åren och som jag minns med glädje. Special thanks to: Sheng-Bing, for guiding me in the lab during my early times as a PhD student, Paola and Antje for being such good company, I have really missed the two of you. Sara och Therese, era fina resultat finns nu med i denna bok.

Tack också till Stuart, Sebastian och Katsuya för att ni gör vistelsen i labbet underhållande med alla era tokiga upptåg, och för att ni är så snälla mot mig. Och tack för hamburgaren på min sista kämpiga dag innan inlämningen, den gjorde susen. Stuart för omsorgsfull korrekturläsning av avhandlingen.

Mamma och Pappa, ni är bäst. Tack för allt stöd som ni ger mig. Det är kanske era berättelser om konstiga forskare som har fått mig att välja denna bana? Tack också för middagar, hjälp med ogräsrensning och barnpassning. Mormor och Morfar, ni har betytt mycket för mig under min uppväxt och det är alltid lika mysigt att vara hos er.

Tack till Filippas snälla Farmor och Farfar som ställer upp i alla läge. Stefans bröder Micke och Peter med era närmaste, tack för trevliga födelsedagskalas mm.

Stefan, vi är nu dubbelt så gamla än då, när vi träffades på Polhemskolan i Lund. Då kunde vi knappast ana att vi 15 år senare skulle ha flyttat till Hörby (vem vill bo där?), bo i villa och köra volvo (gäsp). Det är trevligt att bo ihop med en före detta brottare - vem vill inte åka på ett nacksving lite då och då?

Helt plötsligt fanns hon bara här, vår lilla söta Filippa, som redan vid 2 års ålder har bildat sig en uppfattning om vad hon tycker om bakterier: ”usch, pi, äckligt”.

References

- Adams, D.W., and Errington, J. (2009) Bacterial cell division: assembly, maintenance and disassembly of the Z ring. *Nature Reviews Microbiology* **7**: 642-653.
- Ainsa, J.A., Parry, H.D., and Chater, K.F. (1999) A response regulator-like protein that functions at an intermediate stage of sporulation in *Streptomyces coelicolor* A3(2). *Molecular Microbiology* **34**: 607-619.
- Ainsa, J.A., Ryding, N.J., Hartley, N., Findlay, K.C., Bruton, C.J., and Chater, K.F. (2000) *WhiA*, a protein of unknown function conserved among gram-positive bacteria, is essential for sporulation in *Streptomyces coelicolor* A3(2). *Journal of Bacteriology* **182**: 5470-5478.
- Ainsa, J.A., Bird, N., Ryding, N.J., Findlay, K.C., and Chater, K.F. (2010) The complex *whiJ* locus mediates environmentally sensitive repression of development of *Streptomyces coelicolor* A3(2). *Antonie Van Leeuwenhoek* **98**: 225-236.
- Alam, M.S., Garg, S.K., and Agrawal, P. (2007) Molecular function of WhiB4/Rv3681c of *Mycobacterium tuberculosis* H37Rv: a [4Fe-4S] cluster co-ordinating protein disulphide reductase. *Molecular Microbiology* **63**: 1414-1431.
- Almiron, M., Link, A.J., Furlong, D., and Kolter, R. (1992) A novel DNA-binding protein with regulatory and protective roles in starved *Escherichia coli*. *Genes & Development* **6**: 2646-2654.
- Ausmees, N., Wahlstedt, H., Bagchi, S., Elliot, M.A., Buttner, M.J., and Flärdh, K. (2007) SmeA, a small membrane protein with multiple functions in *Streptomyces* sporulation including targeting of a SpoIIIE/FtsK-like protein to cell division septa. *Molecular Microbiology* **65**: 1458-1473.
- Bath, J., Wu, L.J., Errington, J., and Wang, J.C. (2000) Role of *Bacillus subtilis* SpoIIIE in DNA transport across the mother cell-precspore division septum. *Science* **290**: 995-997.

- Bennett, J.A., Aimino, R.M., and McCormick, J.R. (2007) *Streptomyces coelicolor* genes *ftsL* and *divIC* play a role in cell division but are dispensable for colony formation. *Journal of Bacteriology* **189**: 8982-8992.
- Bennett, J.A., Yarnall, J., Cadwallader, A.B., Kuennen, R., Bidey, P., Stadelmaier, B., and McCormick, J.R. (2009) Medium-dependent phenotypes of *Streptomyces coelicolor* with mutations in *ftsI* or *ftsW*. *Journal of Bacteriology* **191**: 661-664.
- Bibb, M.J., Molle, V., and Buttner, M.J. (2000) sigma(BldN), an extracytoplasmic function RNA polymerase sigma factor required for aerial mycelium formation in *Streptomyces coelicolor* A3(2). *Journal of Bacteriology* **182**: 4606-4616.
- Bignell, D.R., Warawa, J.L., Strap, J.L., Chater, K.F., and Leskiw, B.K. (2000) Study of the *bldG* locus suggests that an anti-anti-sigma factor and an anti-sigma factor may be involved in *Streptomyces coelicolor* antibiotic production and sporulation. *Microbiology* **146** 2161-2173.
- Bigot, S., Corre, J., Louarn, J.M., Cornet, F., and Barre, F.X. (2004) FtsK activities in Xer recombination, DNA mobilization and cell division involve overlapping and separate domains of the protein. *Molecular Microbiology* **54**: 876-886.
- Bigot, S., Sivanathan, V., Possoz, C., Barre, F.X., and Cornet, F. (2007) FtsK, a literate chromosome segregation machine. *Molecular Microbiology* **64**: 1434-1441.
- Buddelmeijer, N., and Beckwith, J. (2004) A complex of the *Escherichia coli* cell division proteins FtsL, FtsB and FtsQ forms independently of its localization to the septal region. *Molecular microbiology* **52**: 1315-1327.
- Burger, A., Sichler, K., Kelemen, G., Buttner, M., and Wohlleben, W. (2000) Identification and characterization of the *mre* gene region of *Streptomyces coelicolor* A3(2). *Molecular and General Genetics* **263**: 1053-1060.
- Capstick, D.S., Willey, J.M., Buttner, M.J., and Elliot, M.A. (2007) SapB and the chaplins: connections between morphogenetic proteins in *Streptomyces coelicolor*. *Molecular Microbiology* **64**: 602-613.
- Carballido-Lopez, R. (2006) The bacterial actin-like cytoskeleton. *Microbiology and Molecular Biology Reviews* **70**: 888-909.
- Chater, K.F. (1972) A morphological and genetic mapping study of white colony mutants of *Streptomyces coelicolor*. *Journal of General Microbiology* **72**: 9-28.

- Chater, K.F. (1975) Construction and phenotypes of double sporulation deficient mutants in *Streptomyces coelicolor* A3(2). *Journal of General Microbiology* **87**: 312-325.
- Chater, K.F., and Merrick, M.J. (1976) Approaches to the study of differentiation in *Streptomyces coelicolor* (A3)2. In *2nd international symposium on the genetics of industrial microorganisms*. Macdonald, K.D. (ed.) London: Academic Press, pp. 583-593.
- Chater, K.F., Bruton, C.J., Plaskitt, K.A., Buttner, M.J., Mendez, C., and Helmann, J.D. (1989) The developmental fate of *S. coelicolor* hyphae depends upon a gene product homologous with the motility sigma factor of *B. subtilis*. *Cell* **59**: 133-143.
- Chater, K.F., and Losick, R. (1997) Mycelial life style of *Streptomyces coelicolor* A3(2) and its relatives. In *Bacteria as Multicellular Organisms*. Shapiro, J.A. and Dworkin, M. (eds). New York: Oxford University Press, pp. 149-182.
- Chater, K.F. (1998) Taking a genetic scalpel to the *Streptomyces* colony. *Microbiology* **144**: 1465-1478.
- Chater, K.F. (2001) Regulation of sporulation in *Streptomyces coelicolor* A3(2): a checkpoint multiplex? *Current Opinion in Microbiology* **4**: 667-673.
- Chater, K.F., and Horinouchi, S. (2003) Signalling early developmental events in two highly diverged *Streptomyces* species. *Molecular Microbiology* **48**: 9-15.
- Chater, K.F., and Chandra, G. (2006) The evolution of development in *Streptomyces* analysed by genome comparisons. *FEMS Microbiology Reviews* **30**: 651-672.
- Chater, K.F., and Chandra, G. (2008) The use of the rare UUA codon to define "expression space" for genes involved in secondary metabolism, development and environmental adaptation in *Streptomyces*. *Journal of Microbiology* **46**: 1-11.
- Chater, K.F. (2011) Differentiation in *Streptomyces*: the properties and programming of diverse cell-types. Dyson, P. (ed). Norwich, UK: Caister Academic Press.
- Claessen, D., Wosten, H.A., van Keulen, G., Faber, O.G., Alves, A.M., Meijer, W.G., and Dijkhuizen, L. (2002) Two novel homologous proteins of *Streptomyces coelicolor* and *Streptomyces lividans* are involved in the formation of the rodlet layer and mediate attachment to a hydrophobic surface. *Molecular Microbiology* **44**: 1483-1492.

- Claessen, D., Rink, R., de Jong, W., Siebring, J., de Vreugd, P., Boersma, F.G., Dijkhuizen, L., and Wosten, H.A. (2003) A novel class of secreted hydrophobic proteins is involved in aerial hyphae formation in *Streptomyces coelicolor* by forming amyloid-like fibrils. *Genes & Development* **17**: 1714-1726.
- Claessen, D., Stokroos, I., Deelstra, H.J., Penninga, N.A., Bormann, C., Salas, J.A., Dijkhuizen, L., and Wosten, H.A. (2004) The formation of the rodlet layer of streptomycetes is the result of the interplay between rodlines and chaplins. *Molecular Microbiology* **53**: 433-443.
- Davis, N.K., and Chater, K.F. (1990) Spore colour in *Streptomyces coelicolor* A3(2) involves the developmentally regulated synthesis of a compound biosynthetically related to polyketide antibiotics. *Molecular Microbiology* **4**: 1679-1691.
- Davis, N.K., and Chater, K.F. (1992) The *Streptomyces coelicolor* *whiB* gene encodes a small transcription factor-like protein dispensable for growth but essential for sporulation. *Molecular General Genetics* **232**: 351-358.
- Dedrick, R.M., Wildschutte, H., and McCormick, J.R. (2009) Genetic interactions of *smc*, *ftsK*, and *parB* genes in *Streptomyces coelicolor* and their developmental genome segregation phenotypes. *Journal of Bacteriology* **191**: 320-332.
- Del Sol, R., Pitman, A., Herron, P., and Dyson, P. (2003) The product of a developmental gene, *crgA*, that coordinates reproductive growth in *Streptomyces* belongs to a novel family of small actinomycete-specific proteins. *Journal of Bacteriology* **185**: 6678-6685.
- Del Sol, R., Mullins, J.G., Grantcharova, N., Flärth, K., and Dyson, P. (2006) Influence of CrgA on assembly of the cell division protein FtsZ during development of *Streptomyces coelicolor*. *Journal of Bacteriology* **188**: 1540-1550.
- den Hengst, C.D., and Buttner, M.J. (2008) Redox control in actinobacteria. *Biochimica et Biophysica Acta* **1780**: 1201-1216.
- den Hengst, C.D., Tran, N.T., Chandra, G., Leskiw, B.K., and Buttner, M.J. (2010) Genes essential for morphological development and antibiotic production in *Streptomyces coelicolor* are targets of BldD during vegetative growth. *Molecular Microbiology* **78**: 361-379.
- Di Berardo, C., Capstick, D.S., Bibb, M.J., Findlay, K.C., Buttner, M.J., and Elliot, M.A. (2008) Function and redundancy of the chaplin cell surface proteins in aerial hypha formation, rodlet assembly,

- and viability in *Streptomyces coelicolor*. *Journal of Bacteriology* **190**: 5879-5889.
- Eccleston, M., Ali, R.A., Seyler, R., Westpheling, J., and Nodwell, J. (2002) Structural and genetic analysis of the BldB protein of *Streptomyces coelicolor*. *Journal of Bacteriology* **184**: 4270-4276.
- Elliot, M.A., Bibb, M.J., Buttner, M.J., and Leskiw, B.K. (2001) BldD is a direct regulator of key developmental genes in *Streptomyces coelicolor* A3(2). *Molecular Microbiology* **40**: 257-269.
- Elliot, M.A., Karoonuthaisiri, N., Huang, J., Bibb, M.J., Cohen, S.N., Kao, C.M., and Buttner, M.J. (2003) The chaplins: a family of hydrophobic cell-surface proteins involved in aerial mycelium formation in *Streptomyces coelicolor*. *Genes & Development* **17**: 1727-1740.
- Elliot, M.A., Buttner, M.J., and Nodwell, J.R. (2008) Multicellular development in *Streptomyces*. In *Myxobacteria: Multicellularity and Differentiation*. Whitworth, D.E. (ed). Washington: American Society for Microbiology Press, pp. 419-438.
- Errington, J., Daniel, R.A., and Scheffers, D.J. (2003) Cytokinesis in bacteria. *Microbiology and Molecular Biology Reviews* **67**: 52-65.
- Facey, P.D., Hitchings, M.D., Saavedra-Garcia, P., Fernandez-Martinez, L., Dyson, P.J., and Del Sol, R. (2009) *Streptomyces coelicolor* Dps-like proteins: differential dual roles in response to stress during vegetative growth and in nucleoid condensation during reproductive cell division. *Molecular Microbiology* **73**: 1186-1202.
- Flärdh, K., Findlay, K.C., and Chater, K.F. (1999) Association of early sporulation genes with suggested developmental decision points in *Streptomyces coelicolor* A3(2). *Microbiology* **145**: 2229-2243.
- Flärdh, K., Leibovitz, E., Buttner, M.J., and Chater, K.F. (2000) Generation of a non-sporulating strain of *Streptomyces coelicolor* A3(2) by the manipulation of a developmentally controlled *ftsZ* promoter. *Molecular Microbiology* **38**: 737-749.
- Flärdh, K. (2003a) Growth polarity and cell division in *Streptomyces*. *Current Opinion in Microbiology* **6**: 564-571.
- Flärdh, K. (2003b) Essential role of DivIVA in polar growth and morphogenesis in *Streptomyces coelicolor* A3(2). *Molecular Microbiology* **49**: 1523-1536.

- Flärdh, K., and Buttner, M.J. (2009) *Streptomyces* morphogenetics: dissecting differentiation in a filamentous bacterium. *Nature Reviews Microbiology* **7**: 36-49.
- Flärdh, K. (2010) Cell polarity and the control of apical growth in *Streptomyces*. *Current Opinion in Microbiology* **13**: (in press).
- Frenkiel-Krispin, D., Ben-Avraham, I., Englander, J., Shimoni, E., Wolf, S.G., and Minsky, A. (2004) Nucleoid restructuring in stationary-state bacteria. *Molecular Microbiology* **51**: 395-405.
- Gorke, B., Foulquier, E., and Galinier, A. (2005) YvcK of *Bacillus subtilis* is required for a normal cell shape and for growth on Krebs cycle intermediates and substrates of the pentose phosphate pathway. *Microbiology* **151**: 3777-3791.
- Grantcharova, N., Ubhayasekera, W., Mowbray, S.L., McCormick, J.R., and Flärdh, K. (2003) A missense mutation in *ftsZ* differentially affects vegetative and developmentally controlled cell division in *Streptomyces coelicolor* A3(2). *Molecular Microbiology* **47**: 645-656.
- Grantcharova, N., Lustig, U., and Flärdh, K. (2005) Dynamics of FtsZ assembly during sporulation in *Streptomyces coelicolor* A3(2). *Journal of Bacteriology* **187**: 3227-3237.
- Guijarro, J., Santamaria, R., Schauer, A., and Losick, R. (1988) Promoter determining the timing and spatial localization of transcription of a cloned *Streptomyces coelicolor* gene encoding a spore-associated polypeptide. *Journal of Bacteriology* **170**: 1895-1901.
- Hale, C.A., and de Boer, P.A. (1997) Direct binding of FtsZ to ZipA, an essential component of the septal ring structure that mediates cell division in *E. coli*. *Cell* **88**: 175-185.
- Helmann, J.D. (1991) Alternative sigma factors and the regulation of flagellar gene expression. *Molecular Microbiology* **5**: 2875-2882.
- Hempel, A.M., Wang, S.B., Letek, M., Gil, J.A., and Flärdh, K. (2008) Assemblies of DivIVA mark sites for hyphal branching and can establish new zones of cell wall growth in *Streptomyces coelicolor*. *Journal of Bacteriology* **190**: 7579-7583.
- Hopwood, D.A., Wildermuth, H., and Palmer, H.M. (1970) Mutants of *Streptomyces coelicolor* defective in sporulation. *Journal of General Microbiology* **61**: 397-408.
- Hopwood, D.A. (2007) *Streptomyces in nature and medicine The antibiotic makers*. New York: Oxford university press.
- Hunt, A.C., Servin-Gonzalez, L., Kelemen, G.H., and Buttner, M.J. (2005) The *bldC* developmental locus of *Streptomyces coelicolor*

- encodes a member of a family of small DNA-binding proteins related to the DNA-binding domains of the MerR family. *Journal of Bacteriology* **187**: 716-728.
- Hutchings, M.I., Hoskisson, P.A., Chandra, G., and Buttner, M.J. (2004) Sensing and responding to diverse extracellular signals? Analysis of the sensor kinases and response regulators of *Streptomyces coelicolor* A3(2). *Microbiology* **150**: 2795-5806.
- Jakimowicz, D., Chater, K., and Zakrzewska-Czerwinska, J. (2002) The ParB protein of *Streptomyces coelicolor* A3(2) recognizes a cluster of *parS* sequences within the origin-proximal region of the linear chromosome. *Molecular Microbiology* **45**: 1365-1377.
- Jakimowicz, D., Gust, B., Zakrzewska-Czerwinska, J., and Chater, K.F. (2005a) Developmental-stage-specific assembly of ParB complexes in *Streptomyces coelicolor* hyphae. *Journal of Bacteriology* **187**: 3572-3580.
- Jakimowicz, D., Mouz, S., Zakrzewska-Czerwinska, J., and Chater, K.F. (2006) Developmental control of a *parAB* promoter leads to formation of sporulation-associated ParB complexes in *Streptomyces coelicolor*. *Journal of Bacteriology* **188**: 1710-1720.
- Jakimowicz, D., Zydek, P., Kois, A., Zakrzewska-Czerwinska, J., and Chater, K.F. (2007) Alignment of multiple chromosomes along helical ParA scaffolding in sporulating *Streptomyces* hyphae. *Molecular Microbiology* **65**: 625-641.
- Jakimowicz, P., Cheesman, M.R., Bishai, W.R., Chater, K.F., Thomson, A.J., and Buttner, M.J. (2005b) Evidence that the *Streptomyces* developmental protein WhiD, a member of the WhiB family, binds a [4Fe-4S] cluster. *The Journal of Biological Chemistry* **280**: 8309-8315.
- Kaiser, B.K., Clifton, M.C., Shen, B.W., and Stoddard, B.L. (2009) The structure of a bacterial DUF199/WhiA protein: domestication of an invasive endonuclease. *Structure* **17**: 1368-1376.
- Keijsers, B.J., van Wezel, G.P., Canters, G.W., and Vijgenboom, E. (2002) Developmental regulation of the *Streptomyces lividans* ram genes: involvement of RamR in regulation of the ramCSAB operon. *Journal of Bacteriology* **184**: 4420-4429.
- Keijsers, B.J., Noens, E.E., Kraal, B., Koerten, H.K., and van Wezel, G.P. (2003) The *Streptomyces coelicolor* *ssgB* gene is required for early stages of sporulation. *FEMS Microbiology Letters* **225**: 59-67.

- Kelemen, G.H., Brown, G.L., Kormanec, J., Potuckova, L., Chater, K.F., and Buttner, M.J. (1996) The positions of the sigma-factor genes, *whiG* and *sigF*, in the hierarchy controlling the development of spore chains in the aerial hyphae of *Streptomyces coelicolor* A3(2). *Molecular Microbiology* **21**: 593-603.
- Kelemen, G.H., Brian, P., Flårdh, K., Chamberlin, L., Chater, K.F., and Buttner, M.J. (1998) Developmental regulation of transcription of *whiE*, a locus specifying the polyketide spore pigment in *Streptomyces coelicolor* A3 (2). *Journal of Bacteriology* **180**: 2515-2521.
- Kelemen, G.H., and Buttner, M.J. (1998) Initiation of aerial mycelium formation in *Streptomyces*. *Current Opinion in Microbiology* **1**: 656-662.
- Kim, D.W., Chater, K., Lee, K.J., and Hesketh, A. (2005) Changes in the extracellular proteome caused by the absence of the *bldA* gene product, a developmentally significant tRNA, reveal a new target for the pleiotropic regulator AdpA in *Streptomyces coelicolor*. *Journal of Bacteriology* **187**: 2957-2966.
- Kim, H.J., Calcutt, M.J., Schmidt, F.J., and Chater, K.F. (2000) Partitioning of the linear chromosome during sporulation of *Streptomyces coelicolor* A3(2) involves an oriC-linked *parAB* locus. *Journal of Bacteriology* **182**: 1313-1320.
- Kim, I.K., Lee, C.J., Kim, M.K., Kim, J.M., Kim, J.H., Yim, H.S., Cha, S.S., and Kang, S.O. (2006) Crystal structure of the DNA-binding domain of BldD, a central regulator of aerial mycelium formation in *Streptomyces coelicolor* A3(2). *Molecular Microbiology* **60**: 1179-1193.
- Knizewski, L., and Ginalski, K. (2007) Bacterial DUF199/COG1481 proteins including sporulation regulator WhiA are distant homologs of LAGLIDADG homing endonucleases that retained only DNA binding. *Cell Cycle* **6**: 1666-1670.
- Kodani, S., Hudson, M.E., Durrant, M.C., Buttner, M.J., Nodwell, J.R., and Willey, J.M. (2004) The SapB morphogen is a lantibiotic-like peptide derived from the product of the developmental gene *ramS* in *Streptomyces coelicolor*. *Proceedings of the National Academy of Sciences of the United States of America* **101**: 11448-11453.
- Kois, A., Swiatek, M., Jakimowicz, D., and Zakrzewska-Czerwinska, J. (2009) SMC protein-dependent chromosome condensation

- during aerial hyphal development in *Streptomyces*. *Journal of Bacteriology* **191**: 310-319.
- Kwak, J., Dharmatilake, A.J., Jiang, H., and Kendrick, K.E. (2001) Differential regulation of *ftsZ* transcription during septation of *Streptomyces griseus*. *Journal of Bacteriology* **183**: 5092-5101.
- Leonard, T.A., Moller-Jensen, J., and Löwe, J. (2005) Towards understanding the molecular basis of bacterial DNA segregation. *Philosophical Transactions of the Royal Society of London* **360**: 523-535.
- Li, W., Wu, J., Tao, W., Zhao, C., Wang, Y., He, X., Chandra, G., Zhou, X., Deng, Z., Chater, K.F., and Tao, M. (2007) A genetic and bioinformatic analysis of *Streptomyces coelicolor* genes containing TTA codons, possible targets for regulation by a developmentally significant tRNA. *FEMS Microbiology Letters* **266**: 20-28.
- Luijsterburg, M.S., Noom, M.C., Wuite, G.J., and Dame, R.T. (2006) The architectural role of nucleoid-associated proteins in the organization of bacterial chromatin: a molecular perspective. *Journal of Structural Biology* **156**: 262-272.
- Lutkenhaus, J. (2007) Assembly dynamics of the bacterial MinCDE system and spatial regulation of the Z ring. *Annual Review of Biochemistry* **76**: 539-562.
- Margolin, W. (2005) FtsZ and the division of prokaryotic cells and organelles. *Nature Reviews Molecular Cell Biology* **6**: 862-871.
- Margolin, W. (2009) Sculpting the bacterial cell. *Current Biology* **19**: R812-R822.
- Mazza, P., Noens, E.E., Schirner, K., Grantcharova, N., Mommaas, A.M., Koerten, H.K., Muth, G., Flärdh, K., van Wezel, G.P., and Wohlleben, W. (2006) MreB of *Streptomyces coelicolor* is not essential for vegetative growth but is required for the integrity of aerial hyphae and spores. *Molecular Microbiology* **60**: 838-852.
- McCormick, J.R., Su, E.P., Driks, A., and Losick, R. (1994) Growth and viability of *Streptomyces coelicolor* mutant for the cell division gene *ftsZ*. *Molecular Microbiology* **14**: 243-254.
- McCormick, J.R., and Losick, R. (1996) Cell division gene *ftsQ* is required for efficient sporulation but not growth and viability in *Streptomyces coelicolor* A3(2). *Journal of Bacteriology* **178**: 5295-5301.
- McCormick, J.R. (2009) Cell division is dispensable but not irrelevant in *Streptomyces*. *Current Opinion in Microbiology* **12**: 689-698.

- Molle, V., Palframan, W.J., Findlay, K.C., and Buttner, M.J. (2000) WhiD and WhiB, homologous proteins required for different stages of sporulation in *Streptomyces coelicolor* A3(2). *Journal of Bacteriology* **182**: 1286-1295.
- Nair, S., and Finkel, S.E. (2004) Dps protects cells against multiple stresses during stationary phase. *Journal of Bacteriology* **186**: 4192-4198.
- Nguyen, K.T., Willey, J.M., Nguyen, L.D., Nguyen, L.T., Viollier, P.H., and Thompson, C.J. (2002) A central regulator of morphological differentiation in the multicellular bacterium *Streptomyces coelicolor*. *Molecular Microbiology* **46**: 1223-1238.
- Nodwell, J.R., McGovern, K., and Losick, R. (1996) An oligopeptide permease responsible for the import of an extracellular signal governing aerial mycelium formation in *Streptomyces coelicolor*. *Molecular Microbiology* **22**: 881-893.
- Nodwell, J.R., and Losick, R. (1998) Purification of an extracellular signaling molecule involved in production of aerial mycelium by *Streptomyces coelicolor*. *Journal of Bacteriology* **180**: 1334-1337.
- Nodwell, J.R., Yang, M., Kuo, D., and Losick, R. (1999) Extracellular complementation and the identification of additional genes involved in aerial mycelium formation in *Streptomyces coelicolor*. *Genetics* **151**: 569-584.
- Noens, E.E., Mersinias, V., Traag, B.A., Smith, C.P., Koerten, H.K., and van Wezel, G.P. (2005) SsgA-like proteins determine the fate of peptidoglycan during sporulation of *Streptomyces coelicolor*. *Molecular Microbiology* **58**: 929-944.
- O'Connor, T.J., and Nodwell, J.R. (2005) Pivotal roles for the receiver domain in the mechanism of action of the response regulator RamR of *Streptomyces coelicolor*. *Journal of Molecular Biology* **351**: 1030-1047.
- Ohnishi, Y., Kameyama, S., Onaka, H., and Horinouchi, S. (1999) The A-factor regulatory cascade leading to streptomycin biosynthesis in *Streptomyces griseus* : identification of a target gene of the A-factor receptor. *Molecular Microbiology* **34**: 102-111.
- Peters, P.C., Migocki, M.D., Thoni, C., and Harry, E.J. (2007) A new assembly pathway for the cytokinetic Z ring from a dynamic helical structure in vegetatively growing cells of *Bacillus subtilis*. *Molecular Microbiology* **64**: 487-499.

- Pichoff, S., and Lutkenhaus, J. (2002) Unique and overlapping roles for ZipA and FtsA in septal ring assembly in *Escherichia coli*. *The EMBO Journal* **21**: 685-693.
- Pichoff, S., and Lutkenhaus, J. (2005) Tethering the Z ring to the membrane through a conserved membrane targeting sequence in FtsA. *Molecular Microbiology* **55**: 1722-1734.
- Pope, M.K., Green, B., and Westpheling, J. (1998) The *bldB* gene encodes a small protein required for morphogenesis, antibiotic production, and catabolite control in *Streptomyces coelicolor*. *Journal of Bacteriology* **180**: 1556-1562.
- Potuckova, L., Kelemen, G.H., Findlay, K.C., Lonetto, M.A., Buttner, M.J., and Kormanec, J. (1995) A new RNA polymerase sigma factor, σ^F , is required for the late stages of morphological differentiation in *Streptomyces* spp. *Molecular Microbiology* **17**: 37-48.
- Reyes-Lamothe, R., Possoz, C., Danilova, O., and Sherratt, D.J. (2008) Independent positioning and action of *Escherichia coli* replisomes in live cells. *Cell* **133**: 90-102.
- Rothfield, L., Taghbalout, A., and Shih, Y.L. (2005) Spatial control of bacterial division-site placement. *Nature Reviews Microbiology* **3**: 959-968.
- Ruban-Osmialowska, B., Jakimowicz, D., Smulczyk-Krawczynszyn, A., Chater, K.F., and Zakrzewska-Czerwinska, J. (2006) Replisome localization in vegetative and aerial hyphae of *Streptomyces coelicolor*. *Journal of Bacteriology* **188**: 7311-7316.
- Ryding, N.J., Kelemen, G.H., Whatling, C.A., Flårdh, K., Buttner, M.J., and Chater, K.F. (1998) A developmentally regulated gene encoding a repressor-like protein is essential for sporulation in *Streptomyces coelicolor* A3(2). *Molecular Microbiology* **29**: 343-357.
- Salerno, P., Larsson, J., Bucca, G., Laing, E., Smith, C.P., and Flårdh, K. (2009) One of the two genes encoding nucleoid-associated HU proteins in *Streptomyces coelicolor* is developmentally regulated and specifically involved in spore maturation. *Journal of Bacteriology* **191**: 6489-6500.
- Scheffers, D.J., and Pinho, M.G. (2005) Bacterial cell wall synthesis: new insights from localization studies. *Microbiology and Molecular Biology Reviews* **69**: 585-607.
- Schwedock, J., McCormick, J.R., Angert, E.R., Nodwell, J.R., and Losick, R. (1997) Assembly of the cell division protein FtsZ into

- ladder-like structures in the aerial hyphae of *Streptomyces coelicolor*. *Molecular Microbiology* **25**: 847-858.
- Soliveri, J., Brown, K.L., Buttner, M.J., and Chater, K.F. (1992) Two promoters for the *whiB* sporulation gene of *Streptomyces coelicolor* A3(2) and their activities in relation to development. *Journal of Bacteriology* **174**: 6215-6220.
- Thanbichler, M., and Shapiro, L. (2008) Getting organized-how bacterial cells move proteins and DNA. *Nature Reviews Microbiology* **6**: 28-40.
- Thanedar, S., and Margolin, W. (2004) FtsZ exhibits rapid movement and oscillation waves in helix-like patterns in *Escherichia coli*. *Current Biology* **14**: 1167-1173.
- Tian, Y., Fowler, K., Findlay, K., Tan, H., and Chater, K.F. (2007) An unusual response regulator influences sporulation at early and late stages in *Streptomyces coelicolor*. *Journal of Bacteriology* **189**: 2873-2885.
- Tillotson, R.D., Wosten, H.A., Richter, M., and Willey, J.M. (1998) A surface active protein involved in aerial hyphae formation in the filamentous fungus *Schizophyllum commune* restores the capacity of a bald mutant of the filamentous bacterium *Streptomyces coelicolor* to erect aerial structures. *Molecular Microbiology* **30**: 595-602.
- Traag, B.A., and van Wezel, G.P. (2008) The SsgA-like proteins in actinomycetes: small proteins up to a big task. *Antonie van Leeuwenhoek* **94**: 85-97.
- van Wezel, G.P., van der Meulen, J., Kawamoto, S., Luiten, R.G., Koerten, H.K., and Kraal, B. (2000) *ssgA* is essential for sporulation of *Streptomyces coelicolor* A3(2) and affects hyphal development by stimulating septum formation. *Journal of Bacteriology* **182**: 5653-5662.
- Wang, L., Yu, Y., He, X., Zhou, X., Deng, Z., Chater, K.F., and Tao, M. (2007) Role of an FtsK-like protein in genetic stability in *Streptomyces coelicolor* A3(2). *Journal of Bacteriology* **189**: 2310-2318.
- Wildermuth, H., and Hopwood, D.A. (1970) Septation during sporulation in *Streptomyces coelicolor*. *Journal of General Microbiology* **60**: 51-59.
- Willey, J., Santamaria, R., Guijarro, J., Geistlich, M., and Losick, R. (1991) Extracellular complementation of a developmental mutation implicates a small sporulation protein in aerial mycelium formation by *S. coelicolor*. *Cell* **65**: 641-650.

- Willey, J., Schwedock, J., and Losick, R. (1993) Multiple extracellular signals govern the production of a morphogenetic protein involved in aerial mycelium formation by *Streptomyces coelicolor*. *Genes & Development* **7**: 895-903.
- Willey, J.M., Willems, A., Kodani, S., and Nodwell, J.R. (2006) Morphogenetic surfactants and their role in the formation of aerial hyphae in *Streptomyces coelicolor*. *Molecular Microbiology* **59**: 731-742.
- Viollier, P.H., Minas, W., Dale, G.E., Folcher, M., and Thompson, C.J. (2001a) Role of acid metabolism in *Streptomyces coelicolor* morphological differentiation and antibiotic biosynthesis. *Journal of Bacteriology* **183**: 3184-3192.
- Viollier, P.H., Nguyen, K.T., Minas, W., Folcher, M., Dale, G.E., and Thompson, C.J. (2001b) Roles of aconitase in growth, metabolism, and morphological differentiation of *Streptomyces coelicolor*. *Journal of Bacteriology* **183**: 3193-3203.
- Yu, T.W., and Hopwood, D.A. (1995) Ectopic expression of the *Streptomyces coelicolor whiE* genes for polyketide spore pigment synthesis and their interaction with the act genes for actinorhodin biosynthesis. *Microbiology* **141**: 2779-2791.