



LUND UNIVERSITY

Vehicle Cooling Systems for Reducing Fuel Consumption and Carbon Dioxide: Literature Survey

Lin, Wamei; Sundén, Bengt

Published in:
SAE Technical Paper

DOI:
[10.4271/2010-01-1509](https://doi.org/10.4271/2010-01-1509)

2010

[Link to publication](#)

Citation for published version (APA):

Lin, W., & Sundén, B. (2010). Vehicle Cooling Systems for Reducing Fuel Consumption and Carbon Dioxide: Literature Survey. In *SAE Technical Paper* <https://doi.org/10.4271/2010-01-1509>

Total number of authors:
2

General rights

Unless other specific re-use rights are stated the following general rights apply:
Copyright and moral rights for the publications made accessible in the public portal are retained by the authors and/or other copyright owners and it is a condition of accessing publications that users recognise and abide by the legal requirements associated with these rights.

- Users may download and print one copy of any publication from the public portal for the purpose of private study or research.
- You may not further distribute the material or use it for any profit-making activity or commercial gain
- You may freely distribute the URL identifying the publication in the public portal

Read more about Creative commons licenses: <https://creativecommons.org/licenses/>

Take down policy

If you believe that this document breaches copyright please contact us providing details, and we will remove access to the work immediately and investigate your claim.

LUND UNIVERSITY

PO Box 117
221 00 Lund
+46 46-222 00 00

Vehicle Cooling Systems for Reducing Fuel Consumption and Carbon Dioxide: Literature Survey

2010-01-1509

Published
05/05/2010Wamei Lin and Bengt Sundén
Lund Univ.

Copyright © 2010 SAE International

ABSTRACT

The number of vehicles in use is increasing from year to year. It causes more fuel/energy to be consumed, and more carbon dioxide or other exhaust gases are released to the environment. But the legislations on carbon dioxide emissions have become stricter than before. In the overall effort to achieve sustainability, advanced technological solutions have to be developed to reduce fuel consumption and carbon dioxide emissions from vehicles. More than half of the energy in vehicles is lost as heat to the different cooling systems (engine cooling system, air conditioning, frictional components cooling) and exhaust gas. Reducing the amount of energy lost in vehicle cooling systems will enhance the fuel efficiency of the vehicles. This paper presents a literature survey of different cooling systems in vehicles, which includes the engine cooling system, air conditioning of the compartment, the electronic cooling system and cooling of frictionally heated parts. The usage of exhaust gas in some cooling systems is also included. Some methods or factors are presented for these different cooling systems. Flow field and thermal management are important factors in designing the engine cooling system. Whereas the exhaust gas can be circulated back to the engine, or used for driving air conditioning units. Reducing the thermal resistance can improve the electronic cooling performance. The flow field will affect the cooling of the frictional components. This literature survey is offering a starting point for future research in the vehicle cooling systems.

1. INTRODUCTION

In recent years the number of vehicles being used has constantly increased. [Table 1](#) shows that the number of registered trucks and buses in selected countries increased from 179,498 to 266,236 in the years from 1998 to 2007. The

increasing number of vehicles causes more energy/fuel to be consumed and more carbon dioxide and other exhaust gases to be released to the environment. [Table 2](#) shows the highway transportation petroleum consumption. [Table 3](#) presents the emission of carbon monoxide. Meanwhile the price of oil has also increased a lot. In 2008 the oil price was nearly 80 dollar per Barrel as shown in [Fig. 1](#). In order to keep the sustainable development of vehicles, many different alternative fuels are used, as shown in [Table 4](#). In addition, strong legislations on emissions are introduced. These force the manufacturers of vehicles to develop advanced technological solutions to satisfy the emission standards. According to the legislations in Europe, the average emission of new passenger cars registered in the European Union must not exceed 130 g CO₂/km from 2012 onwards [[1](#)].

(See [Table 1](#) after last section of paper.)

(See [Table 2](#) after last section of paper.)

(See [Table 3](#) after last section of paper.)

(See [Figure 1](#) after last section of paper.)

(See [Table 4](#) after last section of paper.)

A number of technical development has been introduced in order to meet the low fuel consumption and low carbon dioxide emission requirements for vehicles. In [[3](#)] some advanced engine technologies were discussed in view of reducing emissions. They included improving the combustion process, using a flexible fuel injection system, high rates of exhaust gas recirculation (EGR), improving the engine control systems, charge air and coolant temperature control, low friction, advanced exhaust gas aftertreatment system,

recuperation of energy contained in the exhaust gas stream and so on. More investigation about how to reduce vehicle emissions can be found in [4,5,6,7].

Concerning the energy distribution (as shown in Fig. 2) in the vehicle engine, only about one third of the total fuel energy finally becomes useful work, another one third of the total energy input is brought away by the coolant of engine cooling system, and the rest of the energy is lost to the exhaust gases. If one can reduce the energy wasted in the coolant or the exhaust gases, one can reduce the fuel consumption and the carbon dioxide emission, which is proportional to the fuel consumption. The engine cooling system has to make sure the engine works at its optimal temperature, which is about 80°C -90°C. If the engine cooling system can not bring away the heat quickly, the engine working temperature will increase. More fuel will be consumed and the life time of engine will reduce because of the high working temperature in the engine. If the cooling system brings away the heat too fast, this will lead to an unnecessary big radiator. In other words, the size and the weight of cooling system will increase. More fuel has to be used due to the increasing weight. On the other hand, a good engine cooling system can reduce the engine starting and warming up time, in which the engine reaches its working temperature [8]. A lot of hydrocarbon (HC) and carbon monoxide (CO) are produced in the starting and warming up period [9]. Thus it is important to study the vehicle engine cooling system.

(See Figure 2 after last section of paper.)

On the other hand, one third of the fuel energy is lost to the exhaust gas. Exhaust gas recirculation (EGR) not only can reduce the exhaust gas emission but also has some effect on saving the fuel energy. In the EGR process, a part of the exhaust gas goes back to the intake manifold. Before entering the intake manifold, the exhaust gas might be cooled by an EGR cooler to keep the combustion temperature below 1500°C. Then the reaction between nitrogen and oxygen that forms NO_x is reduced. The cooling extent of the exhaust gas depends on many factors. The temperature of the circulating exhaust gas can be higher than the ambient temperature. In this case, some energy is recovered from the high temperature exhaust gas in the EGR. Thus fuel energy can be saved by the EGR process. But if the EGR cooler has a high flow resistance, the combustion process will become bad and much fuel has to be consumed. Thus it is necessary to analyze EGR and EGR coolers.

The last thing to reduce fuel consumption is to optimize the energy which is converted into useful work. For this part of the energy, some is converted into the kinetic energy of vehicles. Another part is converted into thermal energy by the braking process or transmission (gearbox, bearing) process. In some vehicles, the compressor of the air conditioning in

the compartment is driven by the engine. If the air conditioning is optimized, the compressor will consume less power from the engine. That means the engine can save some energy. Considering reduction of fuel consumption, it is a good option to optimize the friction components (brake, retarder, gearbox, bearing) cooling system and the air conditioning system.

This paper summarizes some published results about the cooling systems in vehicles, which include engine cooling system, EGR cooler, air conditioning, the frictional components cooling system. Due to the contribution of electric/hybrid vehicles for reducing fuel consumption, the electronic equipment cooling system is also included. In this paper, we will introduce the engine cooling system, EGR/EGR coolers, air conditioning system, electronic cooling system and frictional components cooling system (including brakes, gearbox and bearings) in Sections 2, 3, 4, 5 and 6, separately. A summary is presented in the final section.

2. ENGINE COOLING SYSTEM

There are two major types of engine cooling systems. One is the air cooling system, the other one is the liquid cooling system. Nowadays the air cooling system is only used in older cars or some modern motorcycles. The liquid cooling system plays an important role in most automobiles. The liquid cooling system contains a coolant, a radiator or other forms of heat exchangers, a radiator cooling fan, one or more circulation pumps, a thermostat and so on. Figure 3 shows a standard liquid cooling system for the engine. The radiator is the heaviest equipment in the engine cooling system. It also occupies most space in the cooling system. Thus it has to be analyzed in detail during the optimization of the engine cooling system. The coolant is also considered here. Thus a clear comprehension of the cooling system can be given. In order to optimize the engine cooling system, some technology will be presented for the whole cooling system.

(See Figure 3 after last section of paper.)

2.1. DIFFERENT COMPONENTS ANALYSIS

2.1.1. Coolant

The engine coolant brings the excess heat from the engine, flows into the radiator where the heat is transferred to the ambient air. Then the coolant is circulated back into the engine for transporting away more heat. In order to ensure that the engine can work in cold weather, the coolant must have antifreezing capability. In this case, the coolant is a mixture of ethylene glycol and water with the ratio of 50%-50%. Debaun et al. [11] stated that the coolant should have corrosion protection and cavitation protection. Meanwhile it should be friendly to elastomer, seal, hose

compatibility. Because of the increasing power densities, the vehicle thermal loads had to increase. The coolant flow rates, turbulence and pressure drops also became serious. These conditions required improvements of the coolant quality. For the future, the extended life and extended service intervalled coolants would take the place of the conventional and traditional fully-formulated coolant. On the other hand, the nanotechnology would be used to improve the thermal conductivities of the coolant. In some case, the engine oil also dissipates heat from the engine. Abou-Ziyan [12] evaluated the thermal characteristics of five engine oils at subcooled boiling conditions. The experimental results showed that the thermal characteristic of engine oils was affected by the additive concentration in the engine oil. The oils with large concentrations of boron, magnesium, phosphorus and zinc provided good heat transfer properties.

2.1.2. Radiator or heat exchanger

If the coolant was the blood of the engine cooling system, then the radiator would be the heart of the engine cooling system. This is to illustrate that the radiator plays a very important role in the engine cooling system. Due to the space limitation in vehicles, a compact heat exchanger is a favorable type as radiators. Cowell et al. [13] introduced some common constraints for the radiator design. Compactness, low pressure drop, low weight, low cost and high volume were considered. The structure of radiators was described, in which there was an array of tubes to carry the hot engine coolant with a secondary surface attached to the outside of the tubes. Meanwhile some methods were presented to reduce the cost during the radiator manufacturing. For instance, the brazing process and the mechanical expansion were good for assembling a radiator.

Experimental or numerical methods are employed to investigate what kinds of radiator shapes are economic and efficient. Because of the high cost and the complexity of experiments, numerical methods are preferred by many researchers. Oliet et al. [14] used numerical methods to carry out parametric studies for automotive radiators. The influence of some geometrical parameters (fin spacing, louver angle and so on) and the importance of coolant flow lay-out on the radiator global performance were studied. The results showed that the air inlet temperature did not affect the overall heat transfer coefficient U_0 (as shown in Fig. 4). On the other hand the coolant flow regime (Re number) had a relationship with U_0 when coolant fluid or coolant flow arrangement varied. Fig. 5 shows that U_0 was increases with increasing Re, even under different flow arrangement (1 pass arrangement (I), 2 pass arrangement (U), 3 pass arrangement (U_{by-3})). When the flow regime was considered acceptable, the U (2 pass flow arrangement) -flow coolant arrangement was not as good as I (1 pass flow arrangement) -flow. Carluccio et al. [15] carried out a numerical study with a thermo-fluid-dynamic analysis for an air-oil compact cross

flow heat exchanger, which was used in ground vehicles. The fin configuration is shown in Fig. 6. For the oil side, the geometry of the offset fins did not cause a high level of turbulence, which can increase convective mass and heat transfer. It only increased the surface area. On the air side three different flow rates were used to estimate the influence of the air channel geometry. Based on a geometrical configuration study, it was found that the heat transfer of the suggested fins (as shown in Fig. 6) can be enhanced twice compared to the straight triangular fins.

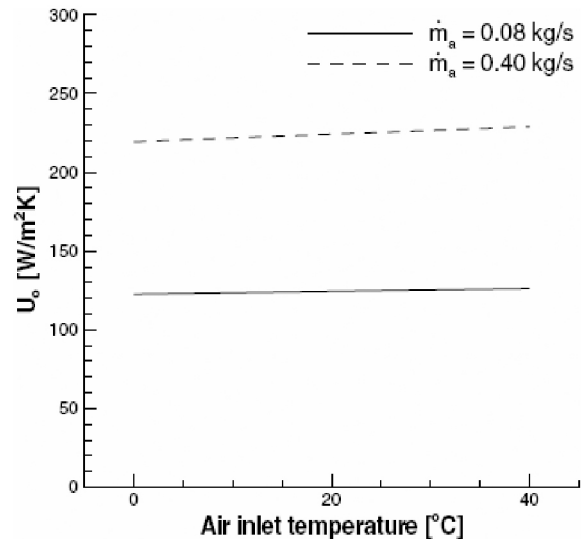

Fig. 4. Air inlet temperature influence on the overall heat transfer coefficient (U_0) [14].

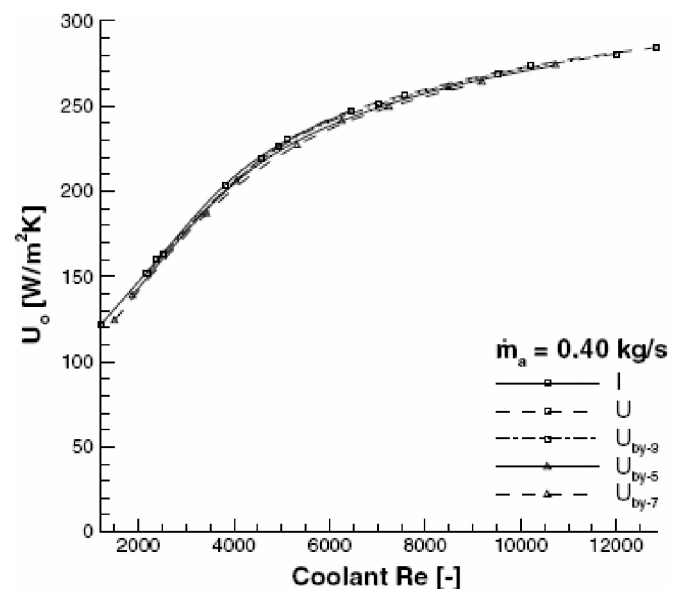

Fig. 5. Coolant lay-out influence on the U_0 [14].

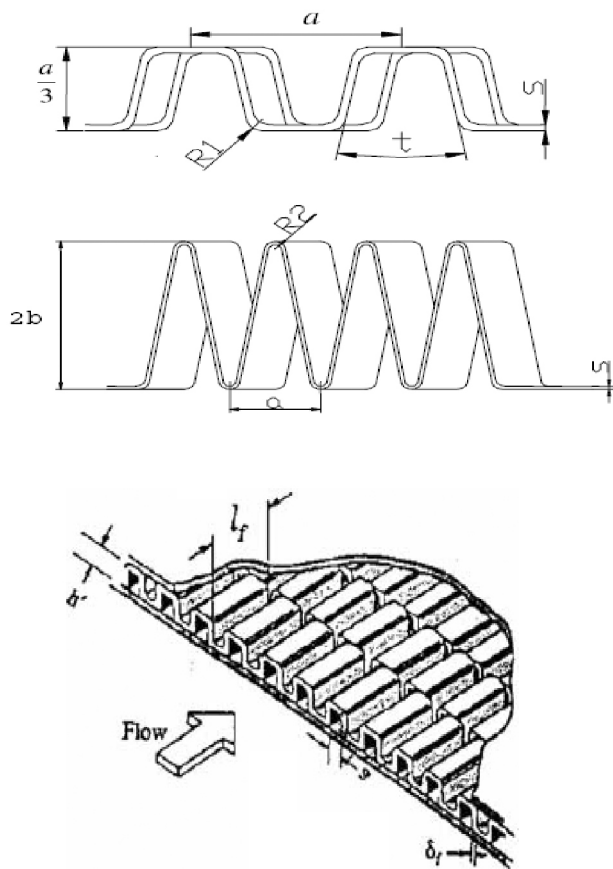

Fig. 6. The first one is the fin shape on the oil side, the second one is the fin shape on the air side, the last one is a typical offset strip fin core, for oil side [15].

The major material for a radiator is aluminum or copper, due to the high thermal conductivity. In 1997 Oak Ridge National Laboratory developed a new material (graphite foam) with very high thermal conductivity (1700 W/m.K) and high bulk apparent thermal conductivity (40-150 W/m.K). The weight of this foam is only about 1/5 that of aluminum. The open and interconnected void structure leads to a special surface area with 5000 and 50000 m²/m³. Klett et al. [16] reported the properties of carbon foams. Fig. 7 shows the photomicrographs of the foams. The bubble size affected the operating pressure. The bulk thermal conductivity was 150 W/m.K and the specific conductivity was six times that of copper. Klett et al. [17] suggested utilizing graphite foams for heat exchangers in heavy vehicles. Because of the high thermal conductivity and the low density (0.47 g/cm³) of foam, this new heat exchanger was smaller and lighter than the one made by aluminum or copper. The overall heat transfer coefficient was 2500 W/m².K, which was much higher than the one of the standard automobile radiator (30 W/m².K). But there was a very high pressure drop inside a foam heat exchanger or heat sink, because of its alveolate structure. Leong et al. [18] analyzed four different shapes of a heat sink as shown in Fig. 8. Highest pressure drop (as shown

in Fig. 9) appeared for block and baffle foams. On the other hand, the high thermal conductivity capacity of foams only exists in a special direction. More information about foam thermal performance can be found in [19-20].

(See Figure 7 after last section of paper.)

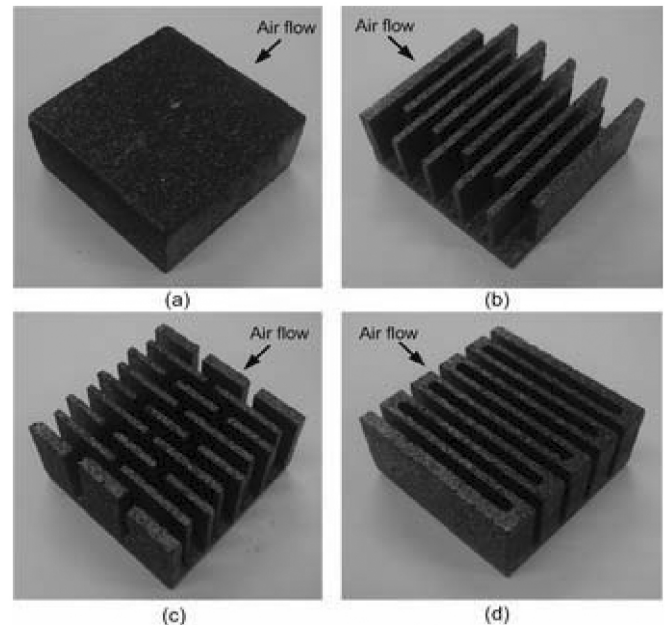

Fig. 8. Test graphite foam heat sinks of (a) block, (b) staggered, (c) baffle and (d) zigzag configurations [18].

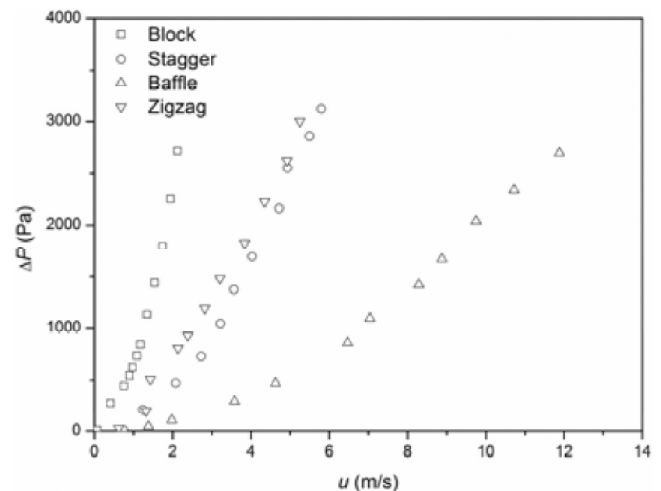

Fig. 9. Pressure drop versus inlet flow velocity of air flow through tested configurations [18].

For the radiator, it is very important to find a suitable manufacturing method, which can reduce the cost and improve the heat transfer performance. Witry et al. [21] introduced an aluminum roll-bonding technique for producing automotive radiators. Fig. 10 shows such an

aluminum roll-bonding design. This method was one of the cheapest methods for heat exchanger manufacturing. For this kind of radiator, the internal heat transfer increased because of the repeated impingement against the dimple obstructions. The heat transfer also increased for the external flow because of the wider and wavy nature of the surface area. As a whole, higher heat transfer levels, lower pressure drop levels, lower overall vehicle drag, smaller size radiators and cheaper manufacturing were the strengths of the roll-bonding heat exchanger design.

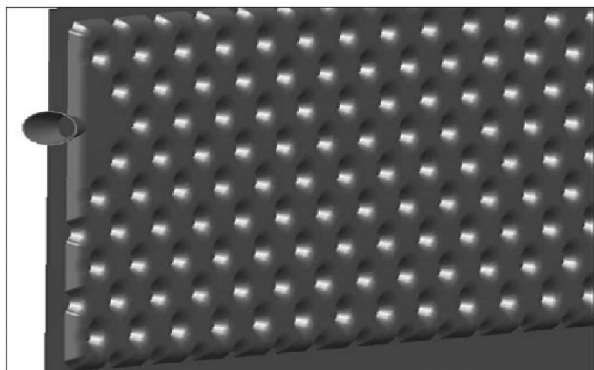

Fig. 10. Partial dimple plate geometry [21].

2.2. ANALYSIS OF THE WHOLE ENGINE COOLING SYSTEM

2.2.1. Engine cooling simulations

It is useful to analyze the different components of the engine cooling system separately. But an overall comprehensive investigation of the whole engine cooling system would have high possibility to identify the key factors that affect the fuel consumption. Computer simulation is a good tool to understand the cooling performance of a whole cooling system. Kim [22] developed a 3D CFD program to analyze the performance of the vehicle cooling system. Fig. 11 presents the simulation results of flow field around the vehicle. The simulated air speed in front of the radiator only deviated 7.9 % from the test data. The coolant inlet temperature had a linear relationship with the radiator performance. The partial displacement fan or the increased fan power at high speed had no impact on the coolant inlet temperature. Zheng et al. [23] introduced the finite-element method to calculate the thermal field so that the hot spot(s) can be found and the cooling system of the 4QT (a four-quadrant transducer) can be investigated. The result showed that the stator windings were mostly dependent on the water cooling system. However, the forced-air cooling had influence on the inner rotor winding temperature.

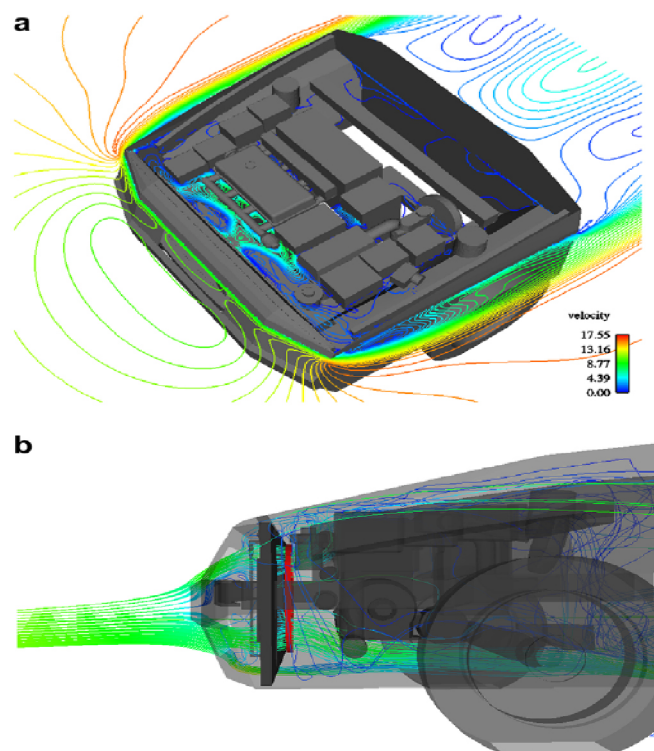

Fig. 11. “a” shows the contours of the air velocity in the vehicle model, “b” shows the air particle traces through a vehicle model [22].

2.2.2. Important aspects of the performance of engine cooling systems

Some aspects have great influence on the fuel consumption in vehicles. These include the flow field and the thermal management.

2.2.2.1. Flow field

The flow field caused by the movement of the vehicle affects the engine cooling performance. It also has influence on the fuel consumption by the mode of flow resistance. Jurng et al. [24] performed a two-dimensional simulation to analyze the characteristics of the cooling air through the radiator and the engine. The two-dimensional computation was not an excellent tool for predicting three-dimensional flow field. But it was a fast and efficient tool for predicting the flow rate of the cooling air through the radiator. Park et al. [25] also carried out a computer simulation to analyze the thermo-fluid performance of an engine cooling system. There was a good agreement between the simulation and experimental methods for predicting the radiator thermal performance, as shown in Fig. 12. On the other hand, Fig. 13 shows the different changing directions for the engine coolant temperature and the radiator downstream air temperature when the vehicle speed was changing.

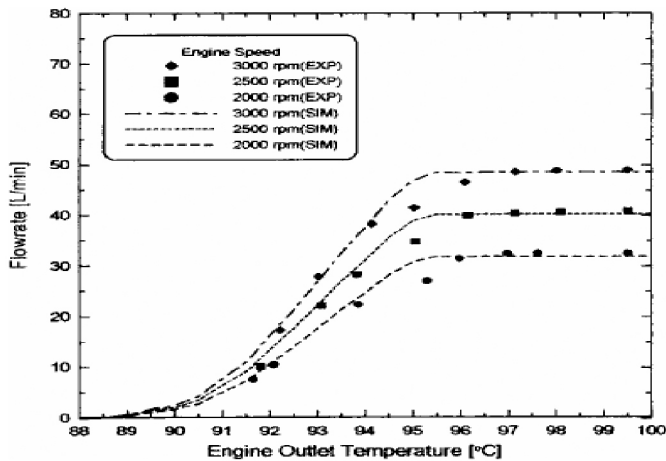

Fig. 12. Variation of coolant flowrate with engine outlet coolant temperature [25].

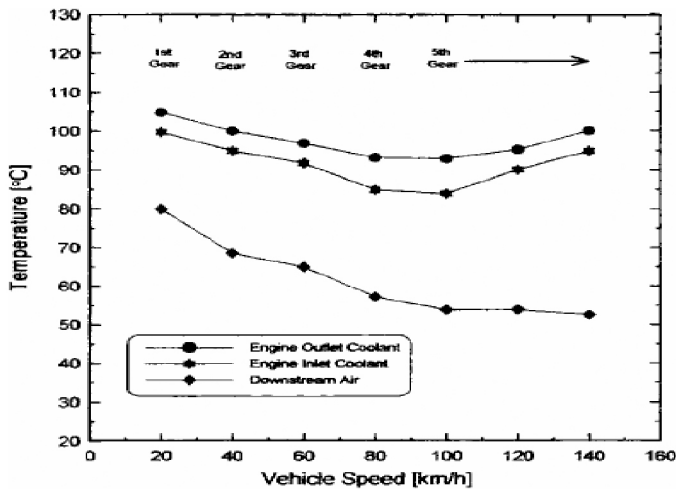

Fig. 13. Variation of coolant temperature with vehicle speed [25].

2.2.2.2. Thermal management

A good thermal management of the engine cooling system can extend the life of the engine and the life of the components in the engine cooling system. Also it has impact on the fuel consumption and carbon dioxide emissions. Electrical components in the engine cooling system have great importance in reducing the power consumption in vehicles, compared to the mechanical ones. Staunton et al. [26] carried out a study to compare several advanced thermal management systems topologies. Fig. 14 shows a thermal management system with an array of small electrical fans instead of one mechanical fan. The results showed that 17 kW power was saved in the micro-hybrid vehicle, when the engine cooling system was fully electrified. 14.5 kW was saved in the standard diesel vehicle. Cho et al. [27] studied the benefit of a controllable electric pump for the cooling performance and the pump operation. By using an electric

pump, the power consumption could be decreased more than 87 %, compared to a mechanical pump. Additionally, the radiator size could be reduced by more than 27 % as an electric pump was used. There are some other methods for thermal management. Staunton et al. [28] studied the difference in thermal loads for the parallel and series drivetrains. It was found that optimizing the cooling fan arrangement and duty cycle can save energy potentially. Salah et al. [29] used a set of servo-motors based cooling system components by a Lyapunov-based nonlinear-control technique. The engine block was maintained at the appointed temperature by the controller. At the same time the power consumption was minimized. According to thermodynamic principles and parameter identification techniques, Vermillion et al. [30] developed a dynamic model for the thermal management system involving heat exchangers and heaters.

(See Figure 14 after last section of paper.)

3. EGR/EGR COOLER

One third of the engine energy is lost to the exhaust gas. Reusing the exhaust gas has a great potential to reduce the fuel consumption. Thus EGR is a good option to achieve this goal. Hountalas et al. [31] used 3D multi-zone model to study the influence of the EGR temperature in a turbocharged DI diesel engine on performance and emissions. It was found that the EGR at high temperature had a negative influence on the brake specific fuel consumption and soot emission. However, EGR cooling had a positive influence on reducing NO_x and soot emission. At high EGR rates and low engine speed, the EGR cooling was more important. The cooler was very important for the performance of the EGR. Abu-Hamdeh [32] used spiral fin heat exchanger pipes for the EGR cooling. As shown in Fig. 15, some part of the exhaust gas was cooled by the heat exchanger pipes before it circulated back to the engine. The intake charge temperature was decreased by using heat exchanger pipes. Because of the heat exchange, the O_2 and CO_2 were reduced in the exhaust gases, while the CO was increased. The cooled EGR also reduced the percentage of NO_x . Huang et al. [33] carried out a numerical simulation to investigate the flow field and temperature distributions inside an EGR cooler. The improved cooler with a helical baffle in the cooling area not only extended the water flow path but also strengthened the swirl flow. Hendricks et al. [34-35] developed an analysis tool to integrate the heat exchanger/thermoelectric power system, so that the influence of heat exchanger and thermoelectric power generator performance would be studied in vehicle waste heat recovery applications. Chen et al. [36] proposed a CO_2 bottoming system to utilize the low-grade energy in the vehicle exhaust gas. About 20 % of the energy in the exhaust gas can be converted into useful work, when the gas heater pressure was 130 bars and the expansion

inlet temperature was 200 °C. As the gas heater pressure was increased to 300 bars, only 12 % of the exhaust gas energy was converted to useful work.

(See [Figure 15](#) after last section of paper.)

4. AIR CONDITIONING

4.1. SIMULATIONS AND EXPERIMENTAL ANALYSIS

Air conditioning is an important system in a vehicle. It includes a laminated type evaporator, a swash plate type compressor, a parallel flow type condenser, a receiver driver and an externally equalized thermostatic expansion valve. The air conditioning offers comfortable environment for passengers or drivers, so that the passengers can enjoy their travelling or the drivers can focus on driving without interaction from the high or low ambient temperature.

Providing thermal comfort is the crucial function of the air conditioning system. Thus it is important to consider the thermal comfort during the optimization of the air conditioning system. Zhang et al. [37-38] used the FLUENT software to carry out a 3D simulation of temperature distributions and flow field in a compartment with or without passengers. [Fig. 16](#) shows the simulated temperature and velocity distribution without passengers. [Fig. 17](#) shows the simulation with four passengers (chest position). It was found that the thermal comfort was affected by the number of people in the compartment under given conditions. The results also showed that a better flow field can improve the uniformity of the temperature field inside the compartment. Saiz Jabardo et al. [39] developed a steady state computer simulation model for refrigeration circuits of automobile air conditioning systems. The evaporator return air temperature affected the refrigeration capacity greatly. On the other hand, the condensing and return air temperatures and compressor speed had a linear relationship with the refrigeration capacity, mass flow rate and coefficient of performance (COP). The deviations between the simulated results and the experimental data was about 10 %, the maximum value was 20 %. Lee et al. [40] carried out a performance study for different components in an automobile air conditioning system. The study showed that an overcharge of 10 % proved to have high COP under different operating conditions. But above 10 % overcharge, the COP dropped down. Trzebinski et al. [41] presented a thermodynamic analysis of a car air cooler. The decrease of the refrigerant charge caused a reduction of the COP. For the system with a thermostatic controlled expansion valve and a controlled compressor, the value of COP was reduced more than the one in non-controlled system.

(See [Figure 16](#) after last section of paper.)

(See [Figure 17](#) after last section of paper.)

Not only simulations but also some experimental analysis have been presented for the automotive air conditioning system. Ratts et al. [42] applied the second law of thermodynamics to quantify the thermodynamic losses in different components of an automotive vapor-compression refrigeration system. They found that compressor cycling and thermal dissipation in the condenser were the biggest sources of losses. By increasing the compressor cycling, the isentropic efficiency of the compressor decreased. Kaynak et al. [43] proved that the increase of the condenser temperature and compressor speed would cause an increase of the cooling capacity. Meanwhile the increase of the air inlet temperature in the evaporator would enhance the evaporator cooling capacity.

4.2. STRATEGIES TO REDUCE FUEL CONSUMPTION

Some vehicle engines not only provide the power for the vehicle movement, but also provide the power to drive the compressor of the air conditioning in compartment. It is a good option to consider the air conditioning together with engine cooling system. Qi et al. [44] combined the air conditioning system with the engine cooling system. A vehicle climate control system model was developed for different operational conditions. It was found that the air conditioning system was affected by the engine cooling system. The value of COP in the air conditioning system was reduced about 10 %, when the air conditioning was combined with the engine cooling system. Meanwhile due to the changes of heat duty of the air conditioning system, the exit temperature of the condenser was high. Kim et al. [45] considered the relationship between a fuel cell stack cooling and air conditioning. With the aid of air conditioning, the heat release from the fuel cell stack could be increased up to 36 % compared to a conventional radiator cooling system without cabin cooling.

Based on reuse of the exhaust gas energy which makes up nearly 30 % of the total vehicle energy consumption, an absorption cooling system was developed for the air conditioning in vehicles. Mostafavi et al. [46] established a thermodynamic model for a combination of a diesel and absorption refrigeration unit. Enough energy can be obtained from the exhaust gas to operate the absorption cooling system for the air conditioning. The cooling performance depended on the cycle configuration in terms of temperature ratio and pressure ratio. Zhang et al. [47] set up a new lumped parameter non-equilibrium model to study the dynamic performance of an absorption cooling system. The results showed that the specific cooling power (SCP) was more sensitive than COP, coefficient of waste heat recovery (WCOP) and coefficient of waste heat cooling (WCOE). In the current absorption cooling system, the requirement of

WCOP can be satisfied, but SCP was not satisfied. Talbi et al. [48] carried out a theoretical analysis for four different configurations of a combined turbocharged diesel engine and an absorption refrigeration unit. The diesel absorption with pre-inter cooling had a higher power output and a thermal efficiency compared to the other configurations. Zhang [49] described an experimental test for absorption cooling systems. The COP of the system was 0.38, and the SCP was 25.7 W/kg. Additional literature about the absorption cooling system driven by exhaust heat can be found in [50,51,52,53].

5. COOLING OF ELECTRONICS AND ELECTRIC EQUIPMENT

Considering saving energy and protecting the environment, many electric vehicles and hybrid electric vehicles (HEV) are used nowadays and their number will be increased in future. Some equipment need to be cooled in a hybrid vehicle. As shown in Fig. 18, the major electric equipment include inverters, batteries and motors. Because of the low working temperature of batteries (i.e., the working temperature of Li-ion battery is 55°C) and the high power density in inverters (about 150-200 W/cm²), the cooling problems block the development of electric vehicles or hybrid electric vehicles. Thus the cooling electric equipment will play an important role in promoting the application of electric vehicles and hybrid electric vehicles, which are efficient in reducing fuel consumption and CO₂ emission.

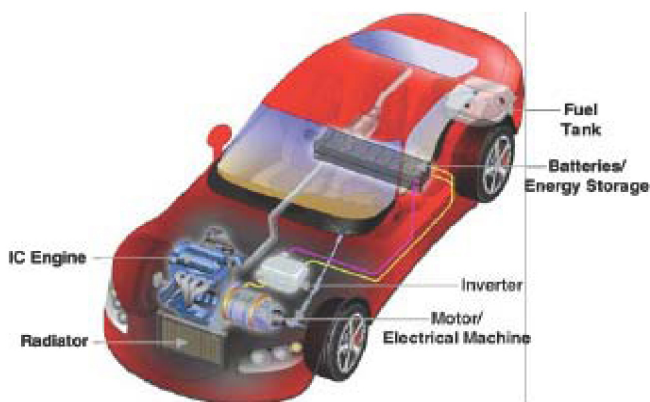

Fig. 18. Propulsion system components for a hybrid vehicle [54].

Advanced cooling techniques are used for electronics cooling in vehicles. Liang et al. [55] developed a direct cooling module for the inverter cooling, and compared it with the conventional water cooling module. The different structures of the direct cooling module and the conventional water cooling module are shown in Fig. 19. The thermal resistance between the inverter case and heat sink was reduced in the direct cooled module. A homogeneous temperature distribution was achieved on the chips. Meanwhile the temperature difference between different phase units was

small. Buttay et al. [56] also approved that the direct cooling (i.e., without a heat spreader or base-plate) can reduce the total thermal resistance between junction and ambient up to 40 %, compared to the conventional module. A light and compact inverter can be achieved by the direct cooling method. Ayers et al. [57] used the refrigerant R-134a as the cooling fluid for the electronic equipment in an HEV cooling system. This cooling fluid can be used in the air conditioning system separately. The volume of the inverters can be reduced more than 50 % and the power of the inverters was still kept at a high level. Sabbah et al. [58] compared the passive cooling by phase change materials (PCM) with the active (forced air) cooling for a compact Li-ion battery pack. The results showed that, when the current increased to 10 A and the ambient temperature was 45 °C, the active cooling did not keep the battery temperature below the working temperature of 55 °C, while the passive cooling had no problem to keep the battery temperature below 55 °C, as shown in Fig. 20. On the other hand, additional fan power was required for the active cooling. It was difficult to get uniform temperature on the battery by the active cooling. This affected the lifetime of battery. Additional literature on electronic cooling can be found in [59,60,61].

(See Figure 19 after last section of paper.)

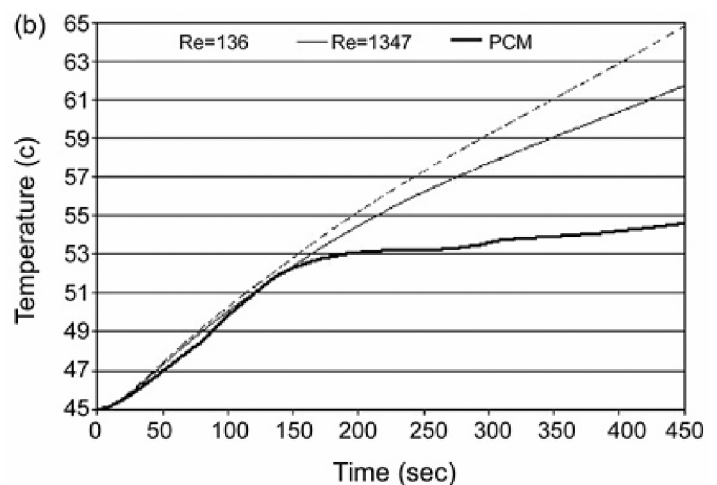

Fig. 20. Comparison of cooling systems based on volume averaged cell temperature at 10 A, $T_{amb} = 45^{\circ}\text{C}$ [58].

6. COOLING SYSTEMS FOR FRICTIONAL COMPONENTS

There are some frictional components (i.e., brake rotor, retarder, bearings and gearbox) in a vehicle. Some part of the energy from the fuel consumption in a vehicle is lost to these components due to the action of friction. To reduce this energy loss, it is necessary to carry out a thermal analysis for these frictional parts in the vehicle.

With the rapid development of modern automobile technology and highway construction, vehicle speed is increasing and braking load of vehicles is larger than before. Thus a more powerful brake system is required to ensure the vehicle safety and reliability. The brake rotor generates an opposing torque to a shaft in order to decelerate the vehicle. During the braking process, kinetic energy is converted into thermal energy. Normally the air circulating through the brake rotor can provide the cooling function. McPhee et al. [62] studied a brake rotor in which there were radial fins between the braking surfaces. In this case, some passages were formed to facilitate the air flow for cooling. The detailed structure is shown in Fig. 21. Experimental and analytical methods were used to study the heat transfer and flow field of the brake rotor. It was found that the internal convection varied linearly with the rotor rotational speed. The volume flow rate varied also linearly with the speed. But there was no direct relationship between internal heat transfer coefficients and volume flow rate. Newcomb et al. [63] studied the thermal performance of oil-immersed brakes. The oil-immersed brakes extended the energy range and met the increasing cooling requirement which was caused by the increasing vehicle load and speeds. Kubota et al. [64] carried out a parametric study which included an analysis of the airflow through the ventilation holes and a thermal stress analysis as well as a vibration analysis during braking. A lightweight brake rotor was developed and improvements in all areas of the performance were gained. Much energy in the vehicle is lost due to the heat generating from the braking. If one understands well the thermal process taking place during braking, maybe one would find out how to reduce the energy lost in braking or reuse some energy from the braking. In the end one may enhance the vehicle fuel efficiency.

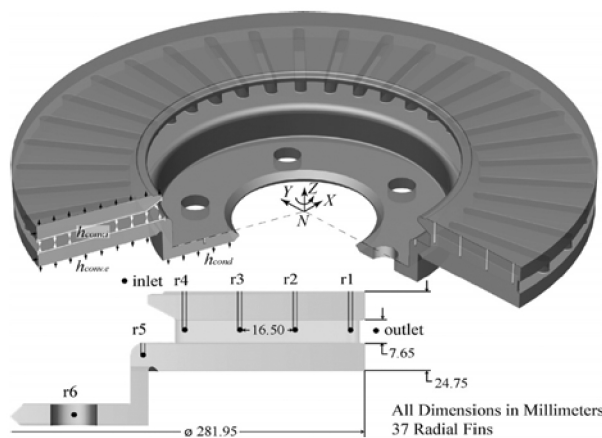

Fig. 21. Brake rotor geometry and thermocouple placement [62].

In cities or mountain area, the vehicles need to brake or reduce the speed frequently. This requirement is difficult to satisfy only by a brake rotor. Using a retarder can solve this problem. There are four types of retarders: exhaust type,

engine type, hydraulic type and eddy current type. Lai et al. [65] presented a discussion of the structure and working principles of an eddy current retarder. Tan et al. [66] used an oil-water-exchanger for cooling a hydraulic retarder. The oil-water-exchanger can extract heat from the retarder in time, when the retarder is working. But there was one problem, if the oil-water-exchanger leaked, it would pollute the cooling system. Some patents about the retarder cooling were invented. Gazyakan et al. [67] invented a retarder system with a transmission oil circuit for lubrication and a retarder cooling circuit whose coolant was oil. Enlund et al. [68] invented a cooling system for a vehicle equipped with a retarder. The retarder cooling circuit, which was arranged in a circuit parallel with the radiator, incorporated a retarder cooler and an extra cooling medium pump.

There are some other frictional components in vehicles, for instance bearings and gears. Lubrication is important for these components, not only because of lubrication function but also due to the cooling functions. Henk et al. [69] investigated the fluid flow in gear lubrication in order to optimize the gear box design and explain the mechanism of heat dissipation and power losses. Michaelis et al. [70] analyzed the effect of geometric parameters on the friction losses and cooling oil requirement for bearings and gears. Gear geometry was developed and some of the lost energy was saved.

7. SUMMARY AND CONCLUDING REMARKS

About 70 % fuel energy in vehicles is lost to the cooling systems, which include the engine cooling system, the exhaust gas, other frictional components (i.e., brake rotor), and so on. To find out opportunities to reduce the fuel consumption and carbon dioxide emission in vehicles, a literature survey concerning different cooling systems was carried out. Some important/useful results are shown as follows:

- (1). Engine cooling system keeps the engine work at an optimized temperature with minimized fuel consumption. A radiator is the most important component in the engine cooling system. Compactness, low pressure drop, low cost and new material should be considered in the radiator design.
- (2). In 10-20 years, the combustion process still will be the major method for generating power in vehicles. Even though EGR has a little effect on reducing the fuel consumption, it plays an important role in reducing emissions. An EGR cooler promotes the EGR application due to the reduced NO_x emission.
- (3). Absorption cooling is a good option for reusing the exhaust gas energy to drive the air conditioning system for

the compartment. However, the COP of the absorption cooling is very low.

(4). Electronic cooling system becomes important because of the electric/hybrid vehicles utilization. However, some electronic equipment have very low working temperature. For instance, the working temperature of a battery is about 55 °C. So some new cooling methods have to be used (i.e., using phase change material as a coolant in the battery cooling system).

(5). With increasing vehicle power, much heat is generated in the frictional components. The air around the frictional components can not supply enough cooling. A separate cooling system has to be developed to bring away the frictional heat.

The design of the engine cooling system will become more difficult because of the increasing power and the space limitation in vehicles. The radiator size will be increased so that more heat can be brought away from the engine. But the space inside a vehicle is limited. For future work, much consideration will be given to the radiator design and the arrangement. In addition, the EGR cooler will be studied too, because of the potential of reducing fuel consumption and emission in vehicles.

REFERENCES

- http://ec.europa.eu/environment/air/transport/co2/co2_home.htm.
- Davis, S. C., Diegel, S. W., and Boundy, R. G., Transportation Energy Data Book, 28th ed., <http://cta.ornl.gov/data/Index.shtml>.
- Knecht, W., "Diesel Engine Development in View of Reduced Emission Standards," *Energy*, **33**: 264-271, 2008.
- Favre, C., Bosteels, D., May, J., Souza, I. D., Beale, L., and Andersson, J., "An Emissions Performance Evaluation of State-of-the-art Motorcycles Euro 3 and WMTC Drive Cycles," <http://www.aecc.eu/en/Publications/Publications.html>.
- Searles, R. A., Bosteels, D., Such, C. H., Nicol, A. J., Andersson, J. D., and Jemma, C. A., "Investigation of the Feasibility of Achieving Euro V Heavy-duty Emissions Limits with Advanced Emission Control Systems," <http://www.aecc.eu/en/Publications/Publications.html>.
- May, J., Bosteels, D., Nicol, A., Andersson, J., and Such, C., "The Application of Emissions Control Technologies to a Low-emissions Engine to Evaluate the Capabilities of Future Systems for European and World-harmonised Regulations," <http://www.aecc.eu/en/Publications/Publications.html>.
- Bertelsen, B. I., "Future US Motor Vehicle Emission Standards and the Role of Advanced Emission Control Technology in Meeting those Standards," *Topics in Catalysis* **16**(17): 15-22, 2001.
- Torregrosa, A. J., Broatch, A., Olmeda, P., and Romero, C., "Assessment of the Influence of Different Cooling System Configurations on Engine Warm-up, Emissions and Fuel Consumption," *International Journal of Automotive Technology* **9**(4): 447-458, 2008.
- Broatch, A., Lujan, J. M., Ruiz, S., and Olmeda, P., "Measurement of Hydrocarbon and Carbon Monoxide Emissions during the Starting of Automotive DI Diesel Engines," *International Journal of Automotive Technology* **9**(2): 129-140, 2008.
- <http://www.answers.com/topic/engine-cooling>.
- DeBaun, H. J., and Alverson, F. C., "Heavy Duty Diesel Engine Coolant Technology: Past, Present, and Future," *Journal of ASTM International* **4**(1): 8-16, 2007.
- Abou-Ziyan, H. Z., "Heat Transfer Characteristics of Some Oils Used for Engine Cooling," *Energy Conversion and Management* **45**: 2553-2569, 2004.
- Cowell, T., and Achaichia, N., "Compact Heat Exchangers in the Automobile Industry," presented at Compact Heat Exchangers for the Process Industries, Utah, June 22-27, 1997.
- Oliet, C., Oliva, A., Castro, J., and Perez-Segarra, C. D., "Parametric Studies on Automotive Radiators," *Applied Thermal Engineering* **27**: 2033-2043, 2007.
- Carluccio, E., Starace, G., Ficarella, A., and Laforgia, D., "Numerical Analysis of a Cross-flow Compact Heat Exchanger for Vehicle Applications," *Applied Thermal Engineering* **25**: 1995-2013, 2005.
- Klett, J., Hardy, R., Romine, E., Walls, C., and Burchell, T., "High-thermal-conductivity, Mesophase-pitch derived Carbon Foams: Effect of Precursor on Structure and Properties," *Carbon* **38**: 953-973, 2000.
- Klett, J., Ott, R., and McMillan, A., "Heat Exchangers for Heavy Vehicles Utilizing High Thermal Conductivity Graphite Foams," SAE Technical Paper **2000-01-2207**, 2000.
- Leong, K. C., Jin, L. W., Li, H. Y., and Chai, J. C., "Forced Convection Air Cooling in Porous Graphite Foam for Thermal Management Applications," presented at 11th Intersociety Conference on Thermal and Thermomechanical Phenomena in Electronic Systems, 57-64, 2008.
- Leong, K. C., Li, H. Y., Jin, L. W., and Chai, J. C., "Convective Heat Transfer in Graphite Foams with Complex Structures," presented at Thermal Issues in Emerging Technologies, ThETA 2, Cairo, Egypt, Dec 17-20, 2008.
- Lafdi, K., Mesalhy, O., and Elgafy, A., "Graphite Foams Infiltrated with Phase Change Materials as Alternative Materials for Space and Terrestrial Thermal Energy Storage Applications," *Carbon* **46**: 159-168.
- Witry, A., Al-Hajer, M. H., and Bondok, A. A., "Thermal Performance of Automotive Aluminium Plate

- Radiator," *Applied Thermal Engineering* **25**: 1207-1218, 2005.
22. Kim, H. J., and Kim, C. J., "A Numerical Analysis for the Cooling Module Related to Automobile Air-conditioning System," *Applied Thermal Engineering* **28**: 1896-1905, 2008.
 23. Zheng, P., Liu, R., Thelin, P., Nordlund, E., and Sadarangani, C., "Research on the Cooling System of a 4QT Prototype Machine Used for HEV," *IEEE Transactions on Energy Conversion* **23**(1): 61-67, 2008.
 24. Jurng, J., Hur, N., Kim, K. H., and Lee, C. S., "Flow Analysis of Engine Cooling System for a Passenger Vehicle," *KSME Journal* **7**(4): 312-319, 1993.
 25. Park, K. S., Won, J. P., and Heo, H. S., "Thermal Flow Analysis of Vehicle Engine Cooling System," *KSME Journal* **16**(7): 975-985, 2002.
 26. Staunton, N., Pickert, V., and Maughan, R., "Assessment of Advanced Thermal Management Systems for Micro-hybrid Trucks and Heavy Duty Diesel Vehicles," presented at IEEE Vehicle Power and Propulsion Conference (VPPC), Harbin, China, September 3-5, 2008.
 27. Cho, H., Jung, D., Filipi, Z. S., Assanis, D. N., Vanderslice, J., and Bryzik, W., "Application of Controllable Electric Coolant Pump for Fuel Economy and Cooling Performance Improvement," *Journal of Engineering for Gas Turbines and Power* **129**: 239-244, 2007.
 28. Staunton, N., Maughan, R., and Pickert, V., "Controlled Cooling in Hybrid Electric Vehicles," *IET HEVC 2008 - Hybrid and Eco-Friendly Vehicle Conference*, 2008.
 29. Salah, M. H., Mitchell, T. H., Wagner, J. R., and Dawson, D. M., "Nonlinear-control Strategy for Advanced Vehicle Thermal-management Systems," *IEEE Transactions on Vehicular Technology* **57**(1): 127-137, 2008.
 30. Vermillion, C., Sun, J., Butts, K., and Hall, A., "Modeling and Analysis of a Thermal Management System for Engine Calibration," presented at Proceedings of the 2006 IEEE International Conference on Control Applications, Munich, Germany, October 4-6, 2006.
 31. Hountalas, D. T., Mavropoulos, G. C., and Binder, K. B., "Effect of Exhaust Gas Recirculation (EGR) Temperature for Various EGR Rates on Heavy Duty DI Diesel Engine Performance and Emissions," *Energy* **33**: 272-283, 2008.
 32. Abu-Hamdeh, N. H., "Effect of Cooling the Recirculated Exhaust Gases on Diesel Engine Emissions," *Energy Conversion and Management* **44**: 3113-3124, 2003.
 33. Huang, Y. Q., Yu, X. L., and Lu, G. D., "Numerical Simulation and Optimization Design of the EGR Cooler in Vehicle," *Journal of Zhejiang University Science A* **9**(9): 1270-1276, 2008.
 34. Hendricks, T. J., and Lustbader, J. A., "Advanced Thermoelectric Power System Investigations for Light-duty and Heavy Duty Applications: Part I," presented at 21st International Conference on Thermoelectronics, pp. 381-386, 2002.
 35. Hendricks, T. J., and Lustbader, J. A., "Advanced Thermoelectric Power System Investigations for Light-duty and Heavy Duty Applications: Part II," presented at 21st International Conference on Thermoelectronics, pp. 387-394, 2002.
 36. Chen, Y., Lundqvist, P., and Platell, P., "Theoretical Research of Carbon Dioxide Power Cycle Application in Automobile Industry to Reduce Vehicle's Fuel Consumption," *Applied Thermal Engineering* **25**: 2041-2053, 2005.
 37. Zhang, H. J., Dai, L., Xu, G. Q., Li, Y., Chen, W., and Tao, W. Q., "Studies of Air-flow and Temperature Fields Inside a Passenger Compartment for Improving Thermal Comfort and Saving Energy. Part I: Test/numerical Model and Validation," *Applied Thermal Engineering* **29**: 2022-2027, 2009.
 38. Zhang, H. J., Dai, L., Xu, G. Q., Li, Y., Chen, W., and Tao, W. Q., "Studies of Air-flow and Temperature Fields Inside a Passenger Compartment for Improving Thermal Comfort and Saving Energy. Part II: Simulation Results and Discussion," *Applied Thermal Engineering* **29**: 2028-2036, 2009.
 39. Saiz Jabardo, J. M., Gonzales Mamani, W., and Ianella, M. R., "Modeling and Experimental Evaluation of an Automotive Air Conditioning System with a Variable Capacity Compressor," *International Journal of Refrigeration* **25**: 1157-1172, 2002.
 40. Lee, G. H., and Yoo, J. Y., "Performance Analysis and Simulation of Automobile Air Conditioning System," *International Journal of Refrigeration* **23**: 243-254, 2000.
 41. Trzebinski, D., and Szczygiel, I., "Thermal Analysis of Car Air Cooler Unit," presented at 7th World Conference on Experimental Heat Transfer, Fluid Mechanics and Thermodynamics, Krakow, Poland, 28 June-03 July, 2009.
 42. Ratts, E. B., and Steven, B. J., "An Experimental Analysis of Cycling in an Automotive Air Conditioning System," *Applied Thermal Engineering* **20**: 1039-1058, 2000.
 43. Kaynakl, Ö., and Horuz, I., "An Experimental Analysis of Automotive Air Conditioning System," *Int. Comm. Heat Mass Transfer* **30**(2): 273-284, 2003.
 44. Qi, Z. G., Chen, J. P., and Chen, Z. J., "Analysis and Simulation of Mobile Air Conditioning System Coupled with Engine Cooling System," *Energy Conversion and Management* **48**: 1176-11784, 2007.
 45. Kim, S. C., Won, J. P., Park, Y. S., Lim, T. W., and Kim, M. S., "Performance Evaluation of a Stack Cooling System Using CO₂ Air Conditioner in Fuel Cell Vehicles," *International Journal of Refrigeration* **32**: 70-77, 2009.

46. Mostafavi, M., and Agnew, B., "Thermodynamic Analysis of Combined Diesel Engine and Absorption Refrigeration Unit-naturally Aspirated Diesel Engine," *Applied Thermal Engineering* **17**(5): 471-478, 1997.
47. Zhang, L. Z., and Wang, L., "Performance Estimation of an Adsorption Cooling System for Automobile Waste Heat Recovery," *Applied Thermal Engineering* **17**(12): 1127-1139, 1997.
48. Talbi, M., and Agnew, B., "Energy Recovery from Diesel Engine Exhaust Gases for Performance Enhancement and Air Conditioning," *Applied Thermal Engineering* **22**: 693-702, 2002.
49. Zhang, L. Z., "Design and Testing of an Automobile Waste Heat Adsorption Cooling System," *Applied Thermal Engineering* **20**: 103-114, 2000.
50. Suzuki, M., "Application of Adsorption Cooling Systems to Automobiles," *Heat Recovery Systems & CHP* **13**(4): 335-340, 1993.
51. Agnew, B., Talbi, M., and Mostafavi, M., "Combined Power and Cooling, an Analysis of the Combined Diesel-absorption Cycle," *Applied Thermal Engineering* **19**: 1097-1105, 1999.
52. Qin, F., Chen, J. P., Lu, M. Q., Chen, Z. J., Zhou, Y. M., and Yang, K., "Development of a Metal Hydride Refrigeration System as an Exhaust Gas-driven Automobile Air Conditioner," *Renewable Energy* **32**: 2034-2052, 2007.
53. Hilali, I., and Söylemez, M. S., "On the Optimum Sizing of Exhaust Gas-driven Automotive Absorption Cooling Systems," *Int. J. Energy Res.* **32**: 655-660, 2008.
54. Mudawar, I., "Two-phase Spray Cooling of Hybrid Vehicle Electronics," *IEEE Transactions on Components and Packaging Technologies* **32**: 501-512, 2009.
55. Liang, Z. H., and Li, L., "HybridPACK2-advanced Cooling Concept and Package Technology for Hybrid Electric Vehicles," presented at IEEE Vehicle Power and Propulsion Conference (VPPC), Harbin, China, September 3-5, 2008.
56. Buttay, C., Rashid, J., Johnson, C. M., Ireland, P., Udrea, F., Amaratunga, G., and Malhan, R. K., "High Performance Cooling System for Automotive Inverters," presented at 2007 European Conference on Power Electronics and Applications, pp. 1-9, 2007.
57. Ayers, C. W., Conklin, J. C., Hsu, J. S., and Lowe, K. T., "A Unique Approach to Power Electronics and Motor Cooling in a Hybrid Electric Vehicle Environment," presented at 2007 IEEE Vehicle Power and Propulsion Conference, pp. 102-106, 2007.
58. Sabbah, R., Kizilel, R., Selman, J. R., and Al-Hallaj, S., "Active (Air-Cooled) vs. Passive (Phase Change Material) Thermal Management of High Power Lithium-ion Pack: Limitation of Temperature Rise and Uniformity of Temperature Distribution," *Journal of Power Sources* **182**: 630-638, 2008.
59. Al-Hallaj, S., and Selman, J. R., "Thermal Modeling of Secondary Lithium Batteries for Electric Vehicle/hybrid Electric Vehicle Applications," *Journal of Power Sources* **110**: 341-348, 2002.
60. Zhang, L. H., Yang, X., Wang, F., and Wang, Z. A., "Pressure Contact Packaging for Hybrid Electric Vehicle Drive," presented at 2007 IEEE Power Electronics Specialists Conference, pp. 2228-2233, 2007.
61. Zhang, H. Y., Pinjala, D., and Teo, P. S., "Thermal Management of High Power Dissipation Electronic Packages: from Air Cooling to Liquid Cooling," presented at Electronics Packaging Technology, 2003 5th conference (EPTC 2003), pp. 620-625, 2003.
62. McPhee, A. D., and Johnson, D. A., "Experimental Heat Transfer and Flow Analysis of a Vented Brake Rotor," *International Journal of Thermal Sciences* **47**: 458-467, 2008.
63. Newcomb, T. P., and El-Sherbiny, M., "Liquid-cooled Disc Brakes," *Wear* **34**: 311-317, 1975.
64. Kubota, M., Hamabe, T., Nakazono, Y., Fukuda, M., and Doi, K., "Development of a Lightweight Brake Disc Rotor: a Design Approach for Achieving an Optimum Thermal, Vibration and Weight Balance," *JSAE Review* **21**: 349-355, 2000.
65. Lai, N. H., Wu, L. M., Wang, G. T., and Li, Z. G., "Research on Automotive Eddy Current Retarder and its Virtual Testing and Simulation," *ICEMI*: 166-169, 2007.
66. Tan, G., Guo, X., and Yang, T., "Simulation Based Heavy Truck Driveline Components Thermal Analysis System," presented at 9th International Conference on Electronic Measurement&Instruments, pp: 675-680, 2009.
67. Gazyakan, U., Baasch, D., and Altvater, R., "Retarder System," US Patent 6,817,455 B1, Nov. 16, 2004.
68. Enlund, B., Ångström, H., and Thoms, E., "Cooling System for a Vehicle Equipped with a Retarder", International Publication No.: WO95/01500, Jan. 12, 1995.
69. Li, L., Versteeg, H. K., Hargrave, G. K., Potter, T., and Halse, C., "A Study of Fluid Flow of Gear Lubrication in a Spur Gear Box," *VDI Berichte*: 133-146, 2008.
70. Michaelis, K., and Wimmer, A., "Gearboxes with Minimised Power Loss," *VDI Berichte*: 1451-1465, 2005.

CONTACT INFORMATION

Division of Heat Transfer, Department of Energy Sciences
Lund University
P.O.Box 118, S-22100, Lund, Sweden
Tel: 46-46-2228605
Fax: 46-46-2224717

Wamei.Lin@energy.lth.se
Bengt.Sunden@energy.lth.se

ACKNOWLEDGMENT

The authors acknowledge the financial support from the Swedish Energy Agency and industries.

NOMENCLATURE

a	Fin pitch [m]	T_{amb}	Ambient temperature [°C]
b	Half dimension triangular section [m]	U	2 pass flow arrangement
h_{conve}	Convection heat transfer coefficient [W.m ⁻² .K ⁻¹]	u	Air velocity [m.s ⁻¹]
h'	Plate spacing in offset strip fin [m]	U_{by-3}	3 pass flow arrangement
I	1 pass flow arrangement	U₀	The overall heat transfer [W.m ⁻² .K ⁻¹]
I_f	Fin length in offset strip fin [m]	δ_f	Fin metal thickness in offset strip fin [m]
m'_a	Air mass flow [kg.s ⁻¹]	ΔP	Pressure drop [Pa]
R	Radius [m]	Abbreviations	
Re	Reynolds number	CO	Carbon monoxide
R-134a	Refrigerant	COP	The coefficient of performance
s	Fin thickness [m]	CO₂	Carbon dioxide
t	Angle [rad]	EGR	Exhaust gas recirculation
		E85	A mixture of up to 85% denatured fuel ethanol and gasoline or other hydrocarbon by volume
		GDP	Gross domestic product
		HC	Hydrocarbon
		HEV	Hybrid electric vehicle

IC
Internal combustion

J
Junctions

M
Microcracking

PCM
Phase change material

P2
Opening 2

SCP
The specific cooling power

WCOE
Coefficient of waste heat cooling

WCOP
Coefficient of waste heat recovery

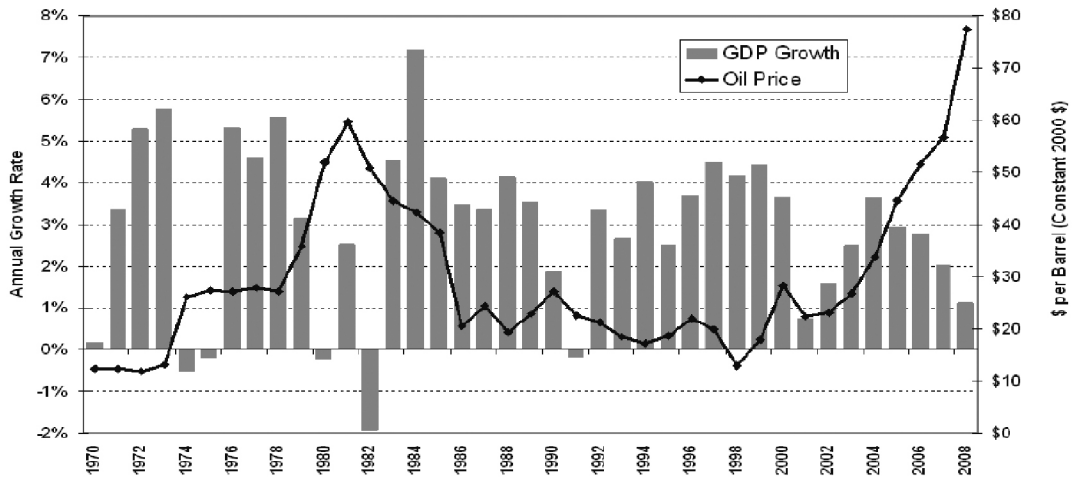

Fig. 1. Oil price and economic growth, 1970-2008 [2].

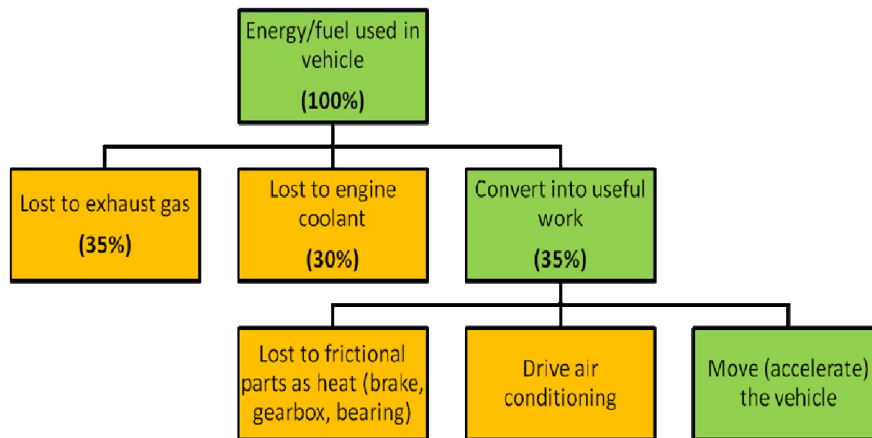

Fig. 2. Energy distribution in a vehicle

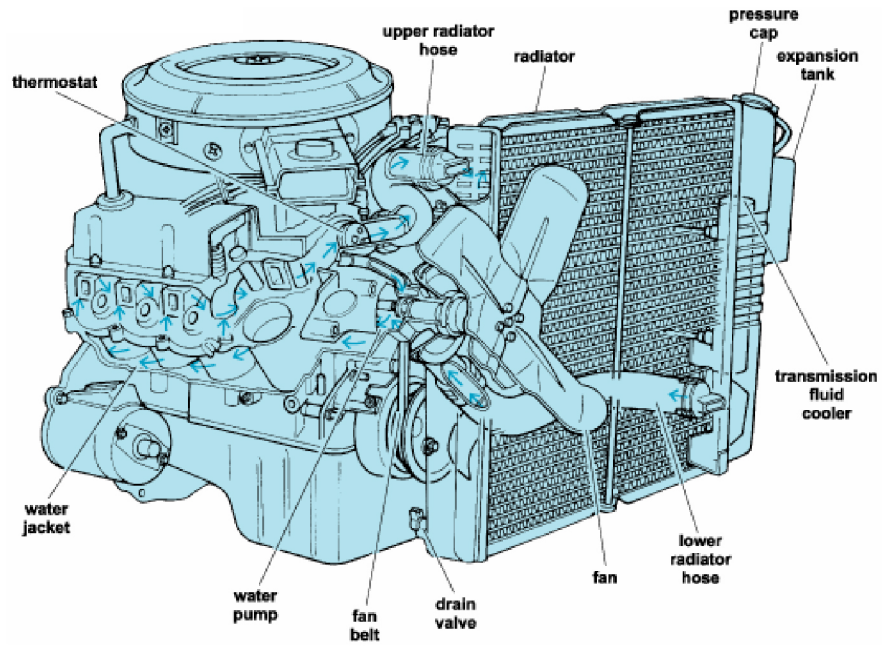

Fig. 3. Engine cooling system [10].

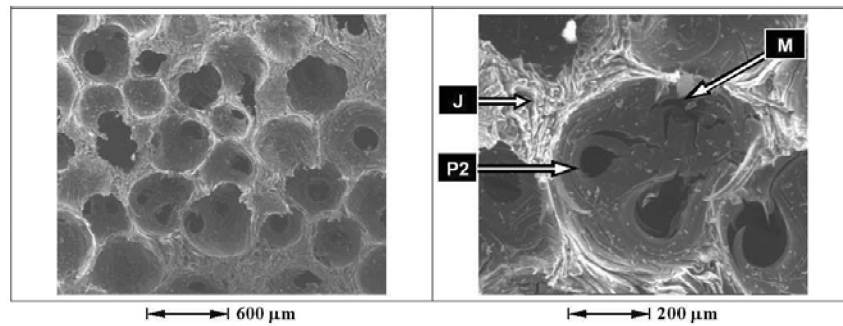

Fig. 7. Photomicrographs of the foams [16].

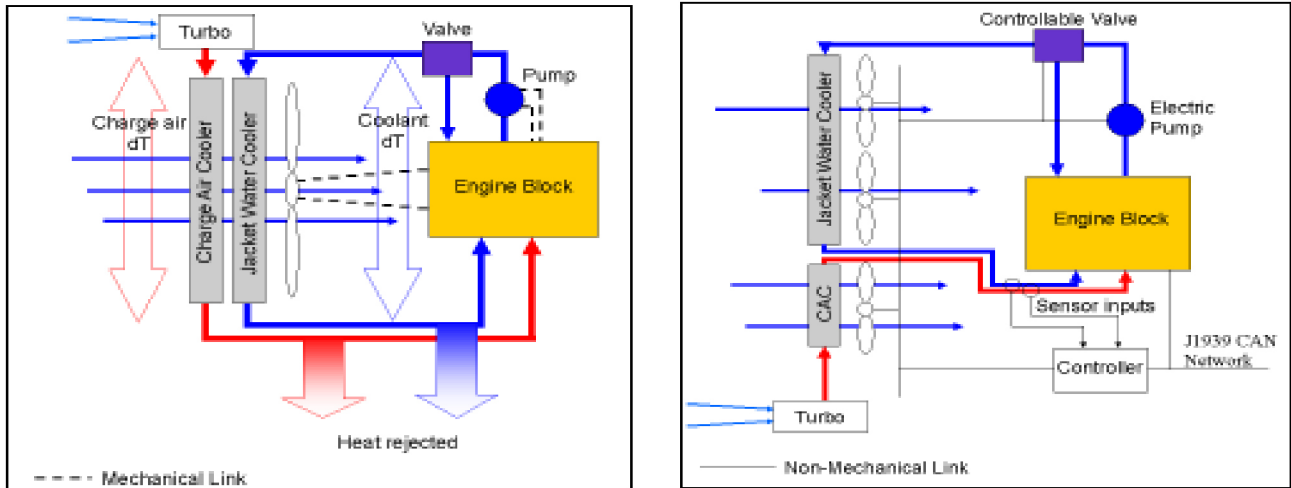

Fig. 14. Left side shows a schematic of a standard diesel engine cooling system, right side shows a fully electric advanced thermal management systems [26].

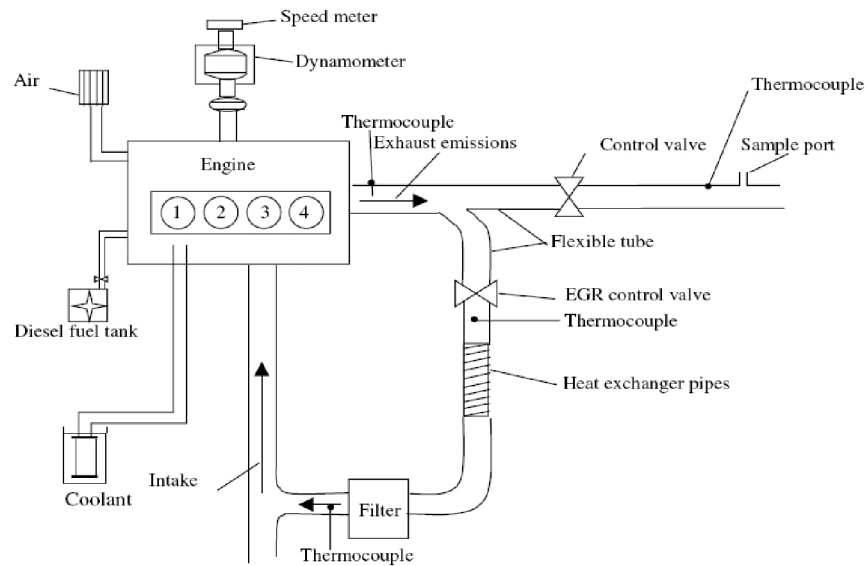

Fig. 15. Schematic arrangement of the cooled EGR system [32].

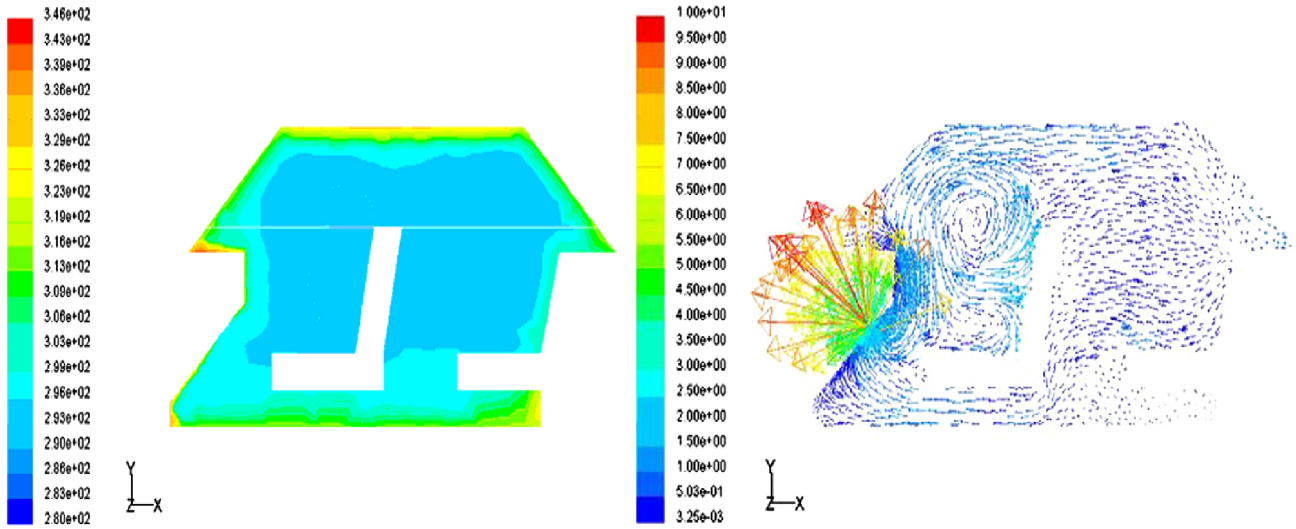

Fig. 16. Left side shows the temperature distribution of the copilot side surface ($z=-0.35$ m), right side shows velocity distribution of the copilot side surface ($z=-0.35$ m) [38].

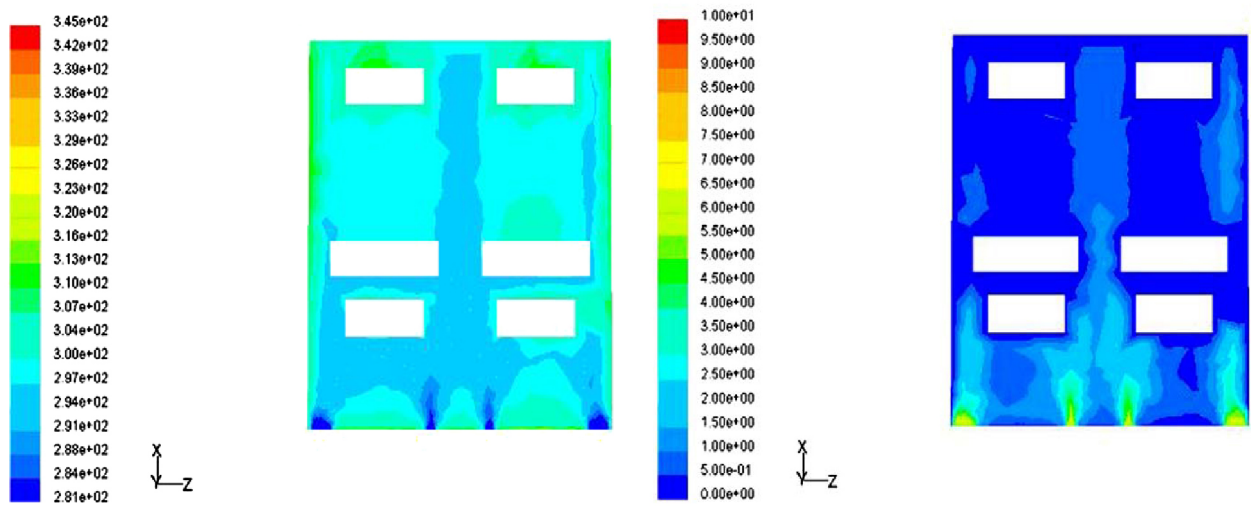

Fig. 17. Left side shows temperature distributions of chests ($Y=-0.6$ m) on horizontal plane, right side shows velocity distributions of chests ($Y=-0.6$ m) on horizontal plane [38].

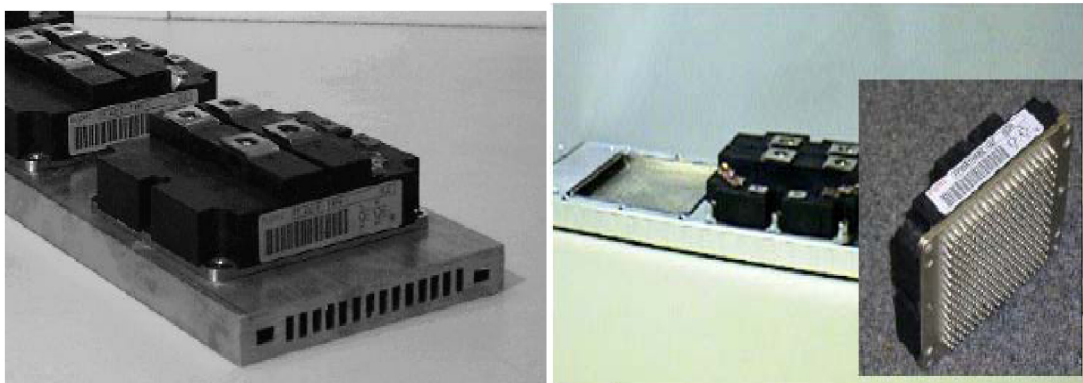

Fig. 19. Left side shows a conventional water cooling module, right side shows a direct cooled module [54].

Table 1. Truck and bus registrations for selected countries, 1998-2007 [2] (thousands)

Year	China	India	Japan	France	UK	Germany	Canada	USA	World total
1998	8313	2610	20919	5500	3169	4357	3694	79062	179498
1999	9400	3000	20559	5609	3392	3370	722	86640	188367
2000	9650	2390	20211	5753	3361	3534	739	85579	203273
2001	10212	2663	19985	5897	3412	3592	729	87969	207033
2002	10500	3535	17714	5984	3487	3568	724	91120	210776
2003	17222	4025	17312	6068	3569	3541	740	95262	223729
2004	19800	4190	17012	6139	3696	3540	745	98576	233537
2005	21750	4415	16734	6198	3943	3133	786	104788	245798
2006	24000	4850	16731	6230	4041	2766	841	109596	256222
2007	26336	5327	16505	6297	4164	2837	872	113477	266236
Average annual percentage change									
1998-2007	13.2%	7.1%	-2.6%	1.7%	1.3%	-0.9%	-11.9%	3.6%	3.3%

Table 2. Highway transportation petroleum consumption by mode, 1970-2007 [2] (thousands of barrels per day)

Year	Cars	Light trucks	Light vehicles subtotal	Motor-cycles	Buses	Heavy trucks	Highway subtotal	Total transportation
1997	4559	3222	7781	13	91	1949	9834	11777
1998	4677	3292	7969	13	93	2012	10086	12061
1999	4780	3448	8228	14	96	2212	10550	12639
2000	4766	3453	8219	14	98	2298	10630	12792
2001	4798	3491	8290	13	93	2295	10690	12672
2002	4923	3602	8525	12	91	2401	11029	12938
2003	4866	3963	8829	12	90	2334	11265	13108
2004	4919	4137	9055	13	92	2162	11323	13344
2005	5050	3840	8890	12	93	2426	11422	13537
2006	4893	3959	8852	14	94	2476	11436	13605
2007	4850	4032	8883	16	92	2515	11505	13710
Average annual percentage change								
1997-2007	0.6%	2.3%	1.3%	2.1%	0.1%	2.6%	1.6%	1.5%

Table 3. Emissions of carbon monoxide from highway vehicles, 1970-2005 [2] (million short tons)

Source category	1970	1980	1990	1995	2000	2005	Percent of total, 2005
Gasoline powered							
Light vehicles & motorcycles	119.4	98.21	67.24	46.54	36.40	24.19	50.2%
Light trucks	22.27	28.83	32.23	29.81	27.04	21.19	43.9%
Heavy vehicles	21.27	15.35	8.92	5.96	3.42	1.97	4.1%
Total	162.68	142.39	108.39	82.31	66.86	47.35	98.2%
Diesel powered							
Light vehicles	0.01	0.03	0.04	0.02	0.01	0.01	0.0%
Light trucks	0.06	0.05	0.03	0.02	0.01	0.01	0.0%
Heavy vehicles	0.49	1.36	1.81	1.53	1.19	0.85	1.8%
Total	0.56	1.43	1.87	1.57	1.20	0.87	1.6%
Total							
Highway vehicles total	163.23	143.83	110.26	83.88	68.06	48.22	100.0%
Percent diesel	0.3%	1.0%	1.7%	1.9%	1.8%	1.8%	

Table 4. Alternative fuel consumption, 2003-2007 [2] (thousand of gasoline-equivalent gallons)

	2003	2004	2005	2006	2007
Liquified petroleum gas	224697	211883	188171	173130	152360
Compressed natural gas	133222	158903	166878	172011	178585
Liquified natural gas	13503	20888	22409	23474	24594
E85 ^a	26376	31581	38074	44041	54091
Electricity ^b	5141	5269	5219	5104	5037
Hydrogen	2	8	25	41	66
Biodiesel	18220	28244	91649	260606	c
Other	0	0	2	2	2
Total	421161	456766	512427	678409	c

a: Consumption includes gasoline portion of the mixture;

b: Vehicle consumption only, does not include power plant inputs;

c: Data are not available.

The Engineering Meetings Board has approved this paper for publication. It has successfully completed SAE's peer review process under the supervision of the session organizer. This process requires a minimum of three (3) reviews by industry experts.

All rights reserved. No part of this publication may be reproduced, stored in a retrieval system, or transmitted, in any form or by any means, electronic, mechanical, photocopying, recording, or otherwise, without the prior written permission of SAE.

ISSN 0148-7191

doi:10.4271/2010-01-1509

Positions and opinions advanced in this paper are those of the author(s) and not necessarily those of SAE. The author is solely responsible for the content of the paper.

SAE Customer Service:

Tel: 877-606-7323 (inside USA and Canada)

Tel: 724-776-4970 (outside USA)

Fax: 724-776-0790

Email: CustomerService@sae.org

SAE Web Address: <http://www.sae.org>

Printed in USA