



LUND UNIVERSITY

Energy Efficient Window Development

Kiss, Bernadett

Published in:
[Host publication title missing]

2009

[Link to publication](#)

Citation for published version (APA):

Kiss, B. (2009). Energy Efficient Window Development. In E. Dahlquist, & J. Palm (Eds.), *[Host publication title missing]* (pp. 229-238) http://works.bepress.com/cgi/viewcontent.cgi?article=1003&context=dr_erik_dahlquist

Total number of authors:

1

General rights

Unless other specific re-use rights are stated the following general rights apply:

Copyright and moral rights for the publications made accessible in the public portal are retained by the authors and/or other copyright owners and it is a condition of accessing publications that users recognise and abide by the legal requirements associated with these rights.

- Users may download and print one copy of any publication from the public portal for the purpose of private study or research.
- You may not further distribute the material or use it for any profit-making activity or commercial gain
- You may freely distribute the URL identifying the publication in the public portal

Read more about Creative commons licenses: <https://creativecommons.org/licenses/>

Take down policy

If you believe that this document breaches copyright please contact us providing details, and we will remove access to the work immediately and investigate your claim.

LUND UNIVERSITY

PO Box 117
221 00 Lund
+46 46-222 00 00

**Proceedings of the Scientific Conference on Energy and IT at Alvsjo fair,
Stockholm March 11-12, 2009 in connection with the “Energitinget 2009”**

Editors: Dahlquist E. and Palm J.

2009



**MDH
Alvsjo fair, Stockholm
March 11-12, 2009
International Conference of SSSEC2009**

This is a joint scientific conference on Energy and IT between Mälardalen University and the Research School Program Energy Systems in Cooperation with Swedish Energy Agency. The papers are peer reviewed. ISBN number 978-91-977493-4-3.

International Scientific Conference on “Energy systems with IT” in connection with the Energiting 2009, March 11-12 at Älvsjö fair, Stockholm.

Proceedings of the Scientific Conference on Energy and IT at Alvsjo fair, Stockholm March 11-12, 2009 in connection with the “Energitinget 2009”

Editors: Dahlquist E. and Palm J.

This is a joint scientific conference on Energy and IT between Mälardalen University and the Research School Program Energy Systems in Cooperation with Swedish Energy Agency. The papers are peer reviewed.

ISBN number 978-91-977493-4-3.

[Energy savings potentials and social change in the use of residential electricity](#)

Mats Bladh,

[Adoption of energy efficiency measures in detached houses: Perception of homeowners](#)

Giresh Nair, Mid Sweden University

[Households, energy use and scenarios of energy efficiency of everyday life activities](#)

Anna-Lisa Lindén, Lund University

[The role of energy advisors on adoption of energy efficiency measures in detached houses](#)

Krushna Mahapatra, Mid Sweden University

[Perceptual and socio-economic factors in adoption of low energy houses](#)

Krushna Mahapatra, Mid Sweden University

[Consumption patterns today and tomorrow with respect to energy and how the energy system will be affected by this](#)

Iana Vassileva, Malardalen University

[CO2 emissions from general district heat use in Sweden – a method for justified comparisons in residential energy use](#)

Magnus Åberg,

[Applying an interdisciplinary perspective on industrial energy efficiency](#)

Jenny Palm, Dept. of Technology and Social Change, Linköping University and the national research school the Energy system Programme

[Markov-Chain Modelling of High-Resolution Activity ,Patterns and Household Electricity Demand](#)

Joakim Widén, Department of Engineering Sciences.Uppsala University

[From electricity to heat – a discourse analytic policy study of energy conversion at national, municipal and household level](#)

Karin Perman, Energi och Miljöteknik, University College Dalarna

[Case study of mobilized energy storages for distributed heating](#)

Weilong Wang, Mälardalen University and South China University of Technology

International Scientific Conference on “Energy systems with IT” in connection with the Energiting 2009, March 11-12 at Älvsjö fair, Stockholm.

Bio-refinery system of DME or CH₄ production from black liquor gasification in pulp mills

M Raza, Energy Processes, KTH

Numerical and experimental study of the inclined free fins applied for thermal management

Bijan Karimpourian, Malardalen University

Simulation of ambient temperature effect on large-scale power transformer load ability

Hasan Gholinejad, Malardalen University

Process control in steel core production to optimize of power dissipation in electrical machines and transformers

Kourosh Mousavi Takami, TDI, Malardalen University

Evaluation of magnetic aging in transformers and electrical machines cores during operation

Kourosh Mousavi Takami, TDI, ACECR, Malardalen University

A simple method for removing leakage of metal pipes, like district heating- and NG pipes

Mohammad Tabatabaeeghomi, Mälardalen University, Vasteras, Sweden also Technology Development Institute (TDI), ACECR, Tehran, Iran

Modeling of Radon Transport through Building Materials and ventilation

Keramatollah Akbari, TDI, ACECR, Malardalen University

Energy efficient window development – Historical overview of the development of energy efficient windows in Sweden

Bernadett Kiss,

Energy saving potential and social change in the use of residential electricity

Mats Bladh, Tema, Linköping University

ABSTRACT

The European Union is implementing the eco-design directive, which means for example a phase-out of inefficient equipment, such as those with stand by-function or lamps with a low lumen/Watt-ratio. How much energy will be saved from this? The Swedish Energy Agency has collected detailed measurement data from 400 households in Sweden. Based on that, and on interviews and visits, savings potentials in the use of lighting have been estimated. Possible reductions are quite big, but very diverse. Realistic estimations can be reached using real householder's possession and hours-of-use of lamps and stand by-functions. In the case of lighting two levels of reduction will be estimated and discussed: one level when incandescents are replaced by CFLs, and another when they are replaced by LEDs. The latter, however, may be associated with rebound effects since a whole new repertoire of lighting design opens up.

Social change can both promote and counteract energy savings in residential electricity use. Consumption differs between different types of households, and the household structure is changing in many countries. Based on quantitative data from Sweden the following differences will be addressed:

Are female householders thriftier than male? Single person households will be compared. This is of interest for the future if women continue to get a more economically autonomous position in many countries.

Do single person households consume more energy per person than others? Presumably this is so since co-use of electric equipment is lost when the number of people decreases in the average household. This is a tendency counteracting energy savings due to eco-design directives, and of interest if single living is becoming more common in many countries.

Do pensioners have a lower consumption than younger people? This is not obvious. Older people may combine a thrifty lifestyle with older equipment. This is of interest for the future since the elderly is a growing part of the population in many countries, and whether the thrifty lifestyle depends on lower income for pensioners, or on habits acquired during earlier years. If the latter is correct the thrifty lifestyle may disappear with coming generations of pensioners that has become used to a high consumption level.

Introduction

In many countries a phase-out of incandescent lamps is proposed or decided. The committee for eco-design within the European Union has prepared a phase-out of import of lamps with low lumen per Watt, suggested to begin in September this year. This should be seen as part of a large program of reducing carbon dioxide emissions, since about 80 per cent of power production

within EU is based on fossil fuels. Saving electric energy in the residential sector would contribute to that.

Reductions seem to be hard to achieve, however. Despite energy efficiency programmes at EU and national level electricity consumption has grown. Bertoldi and Atanasiu point at several factors behind this growth: A growing number of appliances, both of new and old types; Increased hours-of-use for some appliances; Larger dwelling areas; Older population spending more time at home.¹

Thus two tendencies are at work at the same time—one reducing end-use, and another increasing it. An obvious example from Sweden is the decision to introduce digital-TV, forcing many homeowners to buy a set-top box for the purpose in 2006 and 2007, and the eco-design directive in 2008 of limiting stand by-consumption on such appliances to 1 Watt. In this paper I will analyze these tendencies using data from Sweden, with special focus on residential lighting. Data comes from measurements in detail of electricity consumption in 400 households, arranged and collected by the Swedish Energy Authority. In principle, data for each lamp and other specific appliances six times per hour was monitored. Added to this, interviews were made with a limited number of households. I will also discuss social structure and change in social structure, based on official statistics.

A study of nine households

Quantitative data in detail and interviews results in a huge amount of information. Therefore only a small number of households could be studied. What is lost in possible generalization to the whole population is gained in detail.

Consumption of electric energy for lighting is a complex matter. In order to give a structure to the findings I will begin with a simple formula: Electric energy consumed for lighting = Number of lamps x Wattage x Hours-of-use.

The number of lamps differs a lot between households. This depends not only on the area of the dwelling, but also on the type of house and on culture. Dwellings in detached houses generally have a garden, where lighting often is installed. Out-door lighting at the garage, at the entrance, etc. is paid for by the home-owner. Residents in apartments in multi-family houses, on the other hand, make use of lights in the stairwell, in the common laundry and other collective areas, but they do not pay for it directly. It is hard to make a fair comparison between the two types living. When it comes to lighting the asymmetry should not be exaggerated, if outdoor lighting can be isolated.

Secondly, most of the householders interviewed emphasized “cosiness” as important when they were asked about their choice and use of lighting. This is perhaps an indication of a Nordic lighting culture, comparable to the Norwegian habits shown in a famous article by Wilhite et al.²

¹ Paolo Bertoldi & Bogdan Atanasiu, *Electricity Consumption and Efficiency Trends in the Enlarged European Union. Status Report 2006*. Institute for Environment and Sustainability, 2007. European Commission, Directorate-General, Joint Research Centre, EUR 22753 EN. European Communities, 2007.

² Harold Wilhite, Hidetoshi Nakagami, Takashi Masuda, Yukiko Yamaga & Hiroshi Haneda, “A cross-cultural

In such a culture many small lamps are installed, also in windows, for the sake of creating a nice and warm atmosphere in the home. Such a preference structure make Swedes accessible for new types of decorative lighting, such as glowing stripes to put around a tree, and small halogen lamps retracted in the ceiling. It is a custom in Sweden since long to put special Christmas lights in windows during December. This kind of “cosy” lighting may well be extended to new forms of decorative lightings. But the “cosy” also means a preference for tea lights and candles. However, families with children and a disabled man declared in the interviews that they were afraid of causing fire.

Another aspect on the number of lamps is a difference between lamps and lighting points. Quite a few of the lamps are turned on and off at the same time. This goes for the fashionable retractable halogen spotlights we could see at our visits in the nine homes. While each individual lamp had 20W, the user actually turned on 120 or 160 Watts.

Turning now to wattage another discrepancy between single-family and multi-family houses must be taken into account. As a general rule property-owners of multi-family houses install fluorescents in the kitchen and in the bathroom—this goes with the rented apartment and is not the choice of the householder. Householders in detached houses generally choose all lighting themselves.

In the nine households taken together there were 316 lamps measured.³ Of these 316 lamps 53% were incandescents, 27% halogens, 13% fluorescents, and 8% CFLs. A majority of the lamps, 64%, had wattage in the range between 20 and 49 (27% from 0 to 19, and 2% 100W and above). Lighting points had bigger shares for higher wattage classes (see Table 1 below), an illustration of the effect of serial coupling.

Interviews revealed that power, Watt, was associated with intensity of light, also among households with one or a few CFLs installed. Wattage is taken as a guide for replacement, so that a 40W-bulb replaces a broken 40W. Watt is not associated with electricity consumption. This is an important aspect when energy efficiency measures are to be considered. I will get back to this in the concluding discussion.

In dwellings with a large area it is possible install a larger number of lamps and higher sum of Watt, while a smaller area in general limits installations. But when only one or two persons live in a detached house, as was the case with a retired couple, the number of lamps used at the same moment in time or during a 24-hour period, is quite small. All of the households studied used only a minor share of the wattage possible to use, including the household consisting of two adults and a small child living in a small apartment. This family used 24% of its potential wattage at its highest single point in time, while the older couple had a maximum of 5%. Over a longer

analysis of household energy use behaviour in Japan and Norway”, *Energy Policy*, vol. 24, no 9, 1996, 795-803.

³ At our visits in respondent’s homes we registered a larger number of lamps than on the installation sheet used by the firm doing the actual monitoring, amounting to the sum of 391. Visits were made approximately one year after measuring period, so residents may have made changes in the meantime. But it is not probable that a bathroom with no window would have been without lighting, or that no lamps in the bedroom had been monitored while lamps in all other rooms had.

period between 2 and 11% of installed wattage was used (Watt-used = Wh per day/Hours-of-use per day).

Hours-of-use is dependent on presence in the home. As a rule both men and women are employed (77% women and 83% men) and thus spending time outside their homes.⁴ Even though the housewife has disappeared, presence in the home may have increased due to work from home in some occupations. A retired couple spent more time at home than a young working couple did. However, retirees can be active away from home as well, and young people uses parental leave benefits when the children are small. In fact, a family with three children had the highest estimated presence in the home.

Absence from home is modified by the use of timers. One respondent, a young single woman, regularly used a timer for turning on a lamp in the living room before coming home from work in the late afternoon. A more frequent use of timers, though, was for turning on and off lamps at predetermined hours during the evening (in the garden or indoors) when residents were at home. One reason for this was to scare off burglars, but more often for the atmosphere these lights brought.

Table 1. The number of lamps, lighting points and average hours-of-use in four classes of wattage for nine households.

WATTAGES	LAMPS	LIGHTING POINTS	HOURS OF USE
1-19	85	26	3.5
20-49	203	73	2.4
50-99	21	37	1.5
100-	7	24	1.4

Aggregated data for nine households. Hours with decimals.

Lighting points with lower wattage is used longer than lighting points with higher wattage (see Table 1). To a certain degree this is explained by the longer hours for CFLs. While incandescent lamps and halogen lamps were lit 1.8 hours per day, and fluorescents, 2.1 hours, CFLs were used twice as long, or 4.2 hours per day.

This is not an indication of a “rebound effect”, though. Possibly incandescents have been replaced with CFLs in lighting points with long burning hours regardless of lamp type used. Only one person, a young single woman, said that it was acceptable to use a CFL for more hours than an ordinary lamp. A careful study of this householder’s use of one of her four CFLs over a month, showed that it was impossible for her to undo the saving from replacing an incandescent with a CFL. It would have required 39 hours per day. There may be a rebound effect, but it is certainly limited.

A surprising finding was that a single lighting point consumed a very big part of total electricity consumption for lighting purposes—in one case 53% and in another 73%. In both cases a fixture very popular in Sweden, called Uplight, was used, combining one halogen lamp of 300W directed

⁴ Statistics Sweden, *Women and men in Sweden 2008. Facts and figures*. SCB, 2008.

at the ceiling, and one for reading of 50W. Since the upward lamp is used for background light it is used for a longer time than what is usual for the households in question.

Information in detail from the nine households make it possible to simulate the magnitude of savings if all remaining incandescent lamps were replaced by CFLs. The realism in this is that actual hours-of-use and actual number of lamps installed is the base for the simulation. I have assumed that the general recommendation that, for example, a 40W incandescent can be replaced by a 9W CFL holds, and that there is no rebound. The latter assumption can be questioned because interviews with householders showed dissatisfaction with the delay in reaching full illumination, and this may in turn lead people to avoid turning them off as they would have done with other types of lamps.

The simulation resulted in a substantial reduction in consumption of electric energy for lighting. Reductions varied between 16 and 78%. From this small sample it is dangerous to generalize, however, but a possible level of reduction at 50% seems probable.

Table 2. The level of energy consumption for lighting after simulated replacement of remaining incandescent lamps in nine households. Per cent of actual level.

HOUSEHOLD	SIMULATED LEVEL
SINGLE YOUNG	55
SINGLE MIDDLE-AGE	22
SINGLE OLD	78
COUPLE YOUNG	40
COUPLE MIDDLE-AGE	41
COUPLE OLD	54
FAMILY YOUNG	39
FAMILY MIDDLE 3	84
FAMILY MIDDLE 5	70

CFLs are easy to find in many shops in Sweden, and at affordable prices. It is possible to find them in shape and form suitable for existing fittings. However, CFLs contains mercury, one of the most poisonous substances we know. A better alternative would be Light-Emitting Diodes, LEDs. A similar simulation would lower the possible level even further. But this is not a realistic option today for Swedish households.

The supply of LED-lights in Sweden today is limited from a substitution point of view. What is offered now, in Spring 2009, are clamp, table, wall, pendant and floor lamps with a concentrated

ray of light and a cold, blue colour of the light. Only one bulb-shaped LED with a screw-socket was found. The cold blue light and intensity of light comparable to that of a 15W incandescent lamp, diminishes its role as a substitute. Fixtures are mostly very small and quite far from ordinary design standards. LED spotlights seem to be a possible substitute for halogen spotlights retracted in the ceiling.⁵

The supply is also broad from an extending-the-use-of-lighting point of view. Many LED-items are meant for complementary and extended use, for example stripes to be placed in staircases, thin plates to be retracted in the bathroom floor, or in the shape of stones to be put in the garden. Such items may have aesthetic value, and their energy consumption is marginal, but they do not replace high wattage lamps.

The situation for the supply of LED today will most probably change in the years to come. LED-lights are developing quickly, including adaptation to AC without additional device, and offer a potential for very low energy consumption.⁶ LED-modules at 1 or 2W and with a warmer light can in the future replace conventional lighting for many purposes. In view of such prospects for LED the CFL seem to be a transitional solution.

Social change

Electricity consumption in the residential sector has grown in the long term. Electric heating increased from 9 TWh in 1978 to 24 TWh in 1987, and then decreased to 17 TWh in 2000 (the same in 2005). Residential electricity, including electricity use in collective spaces in multi-family houses, increased from 17 TWh in 1985 to 27 TWh in 2003 (26 in 2005).⁷

A growing consumption may be the result of an increasing number and increased use of electrical devices in the home. For example, loading batteries for a large number of mobile telephone terminals, diffusion of broadband equipment, introduction of plasma display TV-sets, etc. However, new technology may not be the only cause for increasing consumption. I will here analyze changes in the social structure (household structure in regard to the number of people and to age distribution) and a possible difference between men and women.

Households comprise different number of people, one person, two persons etc. Dwelling area and basic equipment is not proportionate to the number of persons. Single person households have lighting, TV etc., which is often used collectively in households with more than one person. Thus a changing distribution on different household sizes influences consumption not only for new technology but also for mature items.

⁵ The supply of LED was mapped through study of homepages published by Ljusexperten, IKEA and Clas Ohlson in February 2009. New LED-supply was mapped from homepages published by Philips Sweden and Osram Sweden.

⁶ For an example of AC adaptation see <http://www.optoga.se>, "Acriche".

⁷ Updated time-series from Mats Bladh, *Hushållens elförbrukning*. Tema-T Working Paper, 291. Department of Technology and social change, Linköping university, 2005. Collective electricity consumption in multi-family houses is not included in "household electricity use" in statistics published by the Swedish Energy Agency.

International Scientific Conference on “Energy systems with IT” in connection with the Energiting 2009, March 11-12 at Älvsjö fair, Stockholm.

Furthermore, two different household structures result in different number of households when the total number of people is given. A thought experiment can clarify this. Let us assume a country with 10 million inhabitants. In one extreme case there are 5 million one-person households and 1 million five-person households. This gives a total of 6 million households. In another case there are 2 million five-person households. This gives a total of 2 million households. Thus, in the first case there will be a need for 6 million dwellings, and in the second case 2 million. And not only the dwelling, but all items and services that is associated with the current standard of living.

In Sweden the distribution of household size has changed in the long term. The share of small households, especially those with one person, has increased since 1945, while the biggest households have decreased. There are probably many reasons behind this development. Gainful employment among women is one important aspect, changes in legislation concerning divorce is another, changes in the care for the elderly away from institutionalized living is a third, improved financial support for students and for pensioners are other aspects.

Table 3. Distribution of household size in Sweden 1945, 1965, 1985 and 2007. Thousands.

Year	Number of persons				
	1	2	3	4	5+
1945	298	518	533	369	364
1965	620	770	585	479	323
1985	1325	1151	498	493	203
2007	1920	1328	451	475	192

Source: Statistics Sweden. Censuses 1945-1985. Household economy 2007.

The household structure in many other European countries follows the same pattern, even though data and definition of “household” differs somewhat. Data covering 25 European countries comparing the distribution of the early 1980s with the early 2000s, shows only one exception to this tendency (Estonia). In Greece the share for one-person households increased from 15 to 20% between 1981 and 2001, while the share for five and more-person households decreased from 16 to 11%. In Hungary the equivalent figures were from 20 to 26% (one person) and from 11 to 9% (five or more).⁸

From the monitoring study electricity consumption for lighting in different household sizes has been used for a counterfactual estimation. Data shows that electricity consumption is bigger in larger households, but not in proportion to the number of people. This is an indication of a loss of co-use of lighting, and this loss will add to the growth of consumption beside an increasing number of households due to a growth in population and other causes for increasing consumption.

If Sweden had the same household structure in 2007 as it did in 1980, electricity consumption for lighting would have been 0.34 TWh (12.5%) less than it actually was. Furthermore, if other countries follow the same path when it comes to household structure as Sweden has, it would be interesting to estimate what this would mean in terms of electricity consumption. Using Swedish

⁸ *Housing Statistics in the European Union 2004*. National Board of Housing, Building and Planning, Sweden & Ministry for Regional Development of the Czech Republic. Boverket, 2005, p 23.

electricity consumption data and comparing the factual Greek household structure with that of the Swedish, the aggregated consumption increases with 1 TWh or 36%. Using the same procedure for Hungary, the increase is 0.7 TWh or 24%.

However, the absolute level of the figures should not be taken as fixed facts. Data for different groups must be weighted according to population statistics first—but relative values for different households sizes holds.

Another aspect on change in the household structure is the growing share for the elderly. Data from the monitoring study is used, but in this case the whole data set cannot be used since the number of households with older people are very few in household sizes with more than two persons. I have defined the elderly as those with an age of 65 years or more at the time of measuring, and I will compare them with households in the age between 18 and 64 years. Since the monitoring study comprises only a few elderly living in detached houses (which has become common in Sweden for this age group), I have added two-person households, excluding those with one member below the age of 65.

Table 4. Electricity consumption for lighting and for all purposes in old-aged and middle-aged one- and two-person households and type of dwelling. KWh per year. Index.

HOUSEHOLD TYPE	LIGHTING	ALL CONS.	INDEX ALL	OBSERVATIONS
OLDER IN HOUSE	619	2624	82	17
MIDDLE IN HOUSE	983	3205	100	26
OLDER APARTMENT IN	422	1606	79	20
MIDDLE APARTMENT IN	469	2021	100	55

Older = 65 years of age and above. Middle = 18-64 years.

There seem to be a difference between households with older and with younger people. Intuitively this is not obvious. Eyesight usually gets worse when people get older and therefore more light is needed. Older people sleep less than middle-aged people. Pensioners stay at home more, and the elderly are used to incandescent lamps and are latecomers when new types of lighting is introduced. In favour of the hypothesis that the elderly consume less electricity we find three factors. Pensioners have lower income and are therefore forced to economize. Secondly, older people have grown up under poorer conditions, and by habit they continue to economize on lighting and other uses of electricity. Thirdly, older people move from larger to smaller dwellings where less electricity is used.

However, the result in Table 4 is not robust considering the small sample and the wide spread among households. Individual differences are very large, so that middle-aged households show a low consumption, while older householders have high (the lowest value for middle-aged households in detached houses was 683, and the highest value among the elderly in the same type of dwelling was 2142).

Are there systematic differences between men and women? It has been shown that men uses the car more often than woman, and therefore consumes more fuel.⁹ What about electricity? Gender roles tell us that women cook more and men use the computer more. If women are more concerned about creating a nice atmosphere at home by the choice of light, what would that mean in electricity consumption for lighting? Traditional gender roles exist, but individual differences are actually bigger than the difference between the average man and the average woman. Is it possible to detect gender differences in the measurement study?

In this part I have picked out only one-person households. This clears away doubts concerning compromises between men and women in mixed households. Furthermore, only households in multi-family houses, because observations are few of households in small houses, and because there are different conditions in the two types of dwellings.

Table 5. Electricity consumption among male and female one-person households. KWh per year.

	LIGHT	FRIDGE	COOK	DISH	WASH	AUVI	COMP	OTHER	TOTAL
MEN	484	493	117	12	17	363	285	321	2093
WOMEN	385	555	185	44	28	184	80	334	1818

Fridge = refrigerator, freezer, chiller. Cooking = stove, oven, microwave oven, and other cooking utensils. Dish = dishwasher. Wash = washing machine in apartment, not in common laundry. AuVi = audiovisual equipment, stereo, TV, video, set-top box, DVD, etc. Comp = computer, printer, broadband equipment, etc. Other = non-separable and not specified.

Table 5 shows 13% lower consumption for the average woman in single-person households participating in the monitoring study (and 20% lower for lighting). The table also reflects traditional gender roles in that electricity consumption among women is higher for storing food, cooking, dishing and washing, while men consumes more energy for audiovisual and computer-related equipment. The difference between men and women concerning lighting is harder to explain.

The spread is big, even when observations are narrowed down to singles in multi-family houses. The maximum value for lighting was 1252 kWh per year, while the minimum value was 48. The maximum value for all other electricity consumption except lighting was 2919, while the

⁹ Annika Carlsson-Kanyama & Anna-Lisa Lindén, “Energy efficiency in residences—Challenges for women and men in the North”, *Energy Policy* 35 (2007) 2163-2172. Annika Carlsson-Kanyama & Riitta Rätty, *Kvinnor, män och energi: makt, produktion och användning*. Rapport FOI-R-2513-SE. FOI, 2008.

minimum value was 717. Differences between individual households are huge. And there is no correlation between consumption for lighting purposes and all other purposes. A correlation coefficient of 0.15 is close to zero, and indicates a non-correlation. Such huge differences appear all over—when data is arranged according to gender, number of people in the household, type of dwelling, appliances or area. Based on 187 observations of households living in detached houses correlations between area and lighting, area and all other consumption, and area and total consumption, gave correlation coefficients in the range of 0.13 and 0.17! The main lesson from the monitoring study is that consumption of electricity varies greatly between individual households.

Concluding discussion

The main lesson from the monitoring study is that consumption of electricity varies greatly between individual households. Dispersion is huge. This does not mean that there are no patterns or correlations at all. The loss of co-use in smaller households, higher consumption in dwellings with larger areas, gender patterns and differences between older people and younger, may very well exist, but these patterns are hard to detect and prove since they drown in a sea of individual differences.

Why such a large dispersion? Probably the correlation runs not between social or subjective aspects on one hand, and energy on the other. It is mediated. People do not use energy, they use lamps, computers, washing machines etc., and these items require electricity in order to function. Technology comes in between the user and energy consumption. Let U stand for user, T for technology, and E for electricity, then relations could be illustrated in this way:

(U–T)–E

The parenthesis marks the using aspect, the active, conscious use by men and women of appliances in the home. Electricity is outside of this relation, something secondary, an effect of technology use, not use directly of electricity (or other energy carriers). Interviews with households revealed this clearly. Such things as “Watt” and “kilowatthours” is something heard of, but not reflected upon, and often confused with each other. The lack of energy-awareness has been shown in many studies.

Neither purchase nor use of appliances is free from the play of chance. Kevin Lancaster introduced the concept of “characteristic of goods”.¹⁰ This concept is helpful in our understanding when it comes to purchase. There are several characteristic of a single item, power and energy is just one of them, beside size, price, design, colour of light, etc. It is probable that choice of lamps and other appliances must fit in a particular place in the dwelling, which means that size, design and function is prioritized before energy efficiency.

Use of electric equipment is often instrumental. Appliances are used in order to prepare a meal, read a newspaper, buy tickets on-line etc. They are not used according to energy consuming criteria, criteria sometimes not even known by the user.

¹⁰ Kevin Lancaster, *Introduction to Modern Microeconomics*. Rand McNally International Company, Chicago, 1969, p 183ff.

From an energy efficiency policy perspective this is not a bad thing. If the energy characteristic of a good is downplayed in purchase and use, then regulations such as phase-out of inefficient variants will be successful. If "efficient" means that the consumer acquires the same function, design, price etc., at a lower rate of energy consumption, then the user will buy them and use them.

However, this is not a solution to the problem of innovations. During later decades we have seen several new items diffusing among the population, and there seem to be no reason why this should stop. This points at the need for energy criteria to be present already from the start in the innovation process. A reasonable rule would be a replacement rule, saying that a new type of TV, for example, must be at least as efficient as the existing one before release on the market. LED is a positive thing as a substitute, but not as a complement.

If such regulations are implemented and successful, dispersion in consumption among households will decrease. A narrower dispersion in supply will lead to a narrower dispersion in use. Variation due to gender, age, household size, dwelling type and area, individual hobbies, lighting culture and other rational factors, will appear more clearly.

Due to the large "chance" variation it cannot be proven that other factors contributes to the overall variation. However, there are indications that households with older people have a lower consumption. The elderly seem to consume less electricity both for lighting and total electricity (where "total" excludes heating and hot water), and in detached houses as well as in apartments. Looking at gender it seems as men consume more than women, when singles of both sexes living in multi-family houses were compared. Men had higher consumption for use of audiovisual, computer and lighting appliances, while women had higher on storing food, cooking, dishwasher and washing machine. Traditional gender division of labour in the home thus seem to exist even in single-person households.

The elderly's share of total population has increased or is increasing in many countries, not only in Europe. A lower level of consumption among the elderly may seem comforting from an energy savings point of view. However, it cannot be settled by this study alone that the elderly is a generation or a phase in the life cycle. If the lower consumption level is associated with a phase, then prospects for lower level in the future can be argued for. If the lower level is associated with historically lower levels of consumption, then the level will disappear when new generations of people reach retirement age.

Another change in household structure is associated with the number people in the household (household size). In Sweden change has been radical during the last 50-60 years. One-person households have increased to such an extent that it is by far the largest category today, while bigger households have decreased. This tendency can be seen in other European countries too. Household structure influences consumption. All households must have a basic material standard, including electric appliances, which means that material necessities per person increase. In smaller households co-use is lost, and at a given number of individuals in the population there will be a larger number of households. This seems to be a slow but firm tendency contributing to an increase in consumption in the future.

International Scientific Conference on "Energy systems with IT" in connection with the Energiting 2009, March 11-12 at Älvsjö fair, Stockholm.

Leaving social structure and going down to the study of individual households a big potential for energy savings has been detected, at least when it comes to lighting. A phase-out of incandescent lamps, replaced first by Compact Fluorescent Lamps, and in the future, Light-Emitting Diodes, will reduce electricity consumption radically. Even though differences between individual households are big, and the sample studied small, it is highly probable that replacements will succeed and give the intended result. A counteracting tendency, though, is a possible rebound effect. If CFLs and LEDS do not perform the same qualities of light as conventional lighting, or if the use of lighting will be extended, then hours-of-use may increase and reduce energy savings.

Paper No. 2

**ADOPTION OF ENERGY EFFICIENCY MEASURES IN SWEDISH
DETACHED HOUSES - PERCEPTION OF HOMEOWNERS**

Gireesh Nair, Leif Gustavsson and Krushna Mahapatra

Ecotechnology, Mid Sweden University, SE-83125 Östersund, Sweden

gireesh.nair@miun.se; leif.gustavsson@miun.se; krushna.mahapatra@miun.se

Tel: +46-63 165428, Fax: +46-63 165500

Abstract

The paper focuses on Swedish homeowners' need for and perceptions about adopting building envelope energy efficiency measures. The results of a questionnaire surveying of 3000 randomly selected homeowners during the summer of 2008 showed that 70-90% of the respondents had no intention of adopting such a measure over the next 10 years. The main reasons for non-adoption were that homeowners were satisfied with the physical condition, thermal performance, and aesthetics of their existing building envelope components. A greater proportion of respondents perceived that improved attic insulation has more advantages than energy efficient windows and improved wall insulation, but windows were more likely to be installed than improved attic insulation. Respondents gave high priority to economic factors in deciding on an energy efficiency measure. Hence, economic incentives could be used to increase the adoption of such measures. Interpersonal sources, construction companies, installers, and energy advisers were important sources of information for homeowners as they planned to adopt energy efficiency measures.

Keywords: Energy efficiency, building envelope components, homeowners, Sweden

Introduction

Since the oil crises of the 1970s, there have been improvements in the energy efficiency of the Swedish building stocks, but the efficiency gains made since the 1990s have not been significant compared to those of earlier periods (Nässén and Holmberg, 2005). Still the residential and service sectors accounted for 36% (about 145 TWh) of the national final energy use in 2006 (STEM, 2007). Space heating and hot water, constituting about 60% of this energy use (about 87 TWh), offer a significant energy reduction potential.

The Swedish government has a short- and medium-term target of reducing energy use per heated floor area by 20% and 50 % from 1995 to 2020 and 1995 to 2050, respectively (IEA, 2008). The techno-economical potential for decreased energy use through the adoption of energy efficiency measures in the total Swedish building stock has been estimated to be 30 TWh of heat and 15 TWh of electricity (CEC, 2005). It is important to target existing houses because most of

them were built during the 1960s and 1970s before energy efficiency was emphasised in the Swedish building codes. Also, the addition of new houses to the existing stock happens slowly. The number of residential units increased by 4.5% from 1996 to 2006 (SCB, 2008).

The two million detached houses, account for the largest share (42% in 2006) of the energy used in the residential and service sectors. The heat use in these houses has decreased from an average of 159 kWh/m²/year during the 1980-1989 period to about 129 kWh/m²/year in 2006 (IEA, 2008). However, this can be further reduced through the adoption of energy efficient windows, improved attic and wall insulation. Several studies have concluded that the adoption of such energy efficiency measures is beneficial, especially for houses in cold climates or for those in need of renovation (Joelsson and Gustavsson, 2008; Norrman and Johansson, 1995; Gustafsson and Karlsson, 1997; Erlandsson et. al., 1997; Poel et al., 2007).

Homeowners may adopt energy efficient building envelop measure in order to reduce household energy use, improve indoor comfort and to improve the aesthetic appearance of the buildings. All building envelop measures could be installed together, and that happens mostly during major renovations. It is likely that homeowners will adopt those measures that best fulfil their prioritised need. The preference for a specific option is usually based on a comparison of various alternatives in terms of ease of installation, annual cost savings, investment required, aesthetic value, etc.

Potential adopters' evaluation of alternatives is usually based on *perceptions* of the attributes of the alternatives. Hence, the Swedish homeowners' adoption of building envelope energy efficiency measures depends on their perceptions of such measures which is being analysed in this paper. The analysis is based on data collected from a survey of about 3000 Swedish homeowners during May–July 2008. Our study expands existing studies on homeowners' adoption practices for heating systems (Mahapatra and Gustavsson, 2008a, 2009; Mårtensson, 2006; Sernhed and Pyrko, 2006; STEM, 2005; Nilsson, 2004; Vinterback, 2000; Hallin, 1988) and consumer durables (Martienz et al., 1998).

CONCEPTUAL FRAMEWORK

Building envelope energy efficiency measures are usually renewed after about 30-40 years. Hence, it is likely that many Swedish homeowners have not been involved in adopting such measures. Even if they were involved previously, a new decision is influenced by existing information and circumstances. Following the definition by Rogers (2003) and Howard and Sheth, (1969) which states that innovation is an idea, practice or object that potential adopters *perceive* as new, we consider the adoption of energy efficient windows and improved insulation as *innovations*.

Potential adopters go through various stages when making adoption-decisions (Rogers, 2003; Dieperink et al., 2004; Mahapatra and Gustavsson, 2008a; Hawkins et al., 2007; Faiers et al., 2007). The common stages found in all these studies are the need for an innovation, the collection of information, and the selection of an innovation based on an evaluation of alternatives. We discuss these stages and the influence of external factors on homeowners' adoption decisions (Figure 1) to understand homeowners' adoption of energy efficiency measures for building

envelopes. There are several external factors influencing homeowners’ decisions, but we consider only government subsidies for installing energy efficient windows in existing buildings.

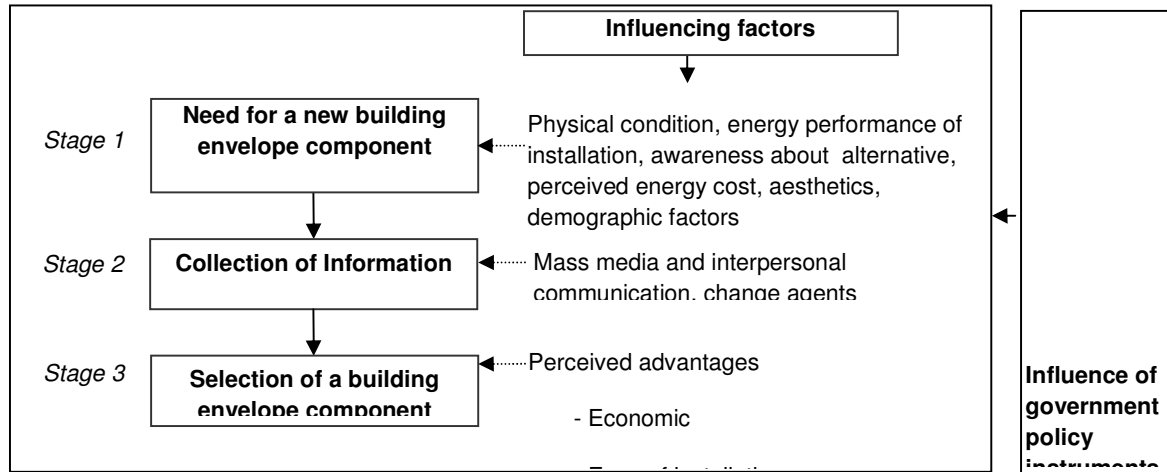

Figure 1: Schematic representation of different stages of decision making in homeowners adoption of a building envelope component (Adapted from Hawkins et al., 2007; Mahapatra and Gustavsson, 2008a)

1.1.1 Stage -1: Need for a new building envelope component

Potential adopters consider adopting an innovation if they feel a *need* for it (Hassinger, 1959). Need is a state of dissatisfaction or frustration that occurs when there is a difference between the desire and perceived actual state (Rogers, 2003), i.e., when a problem is recognised (Hawkins et al., 2007). Potential adopters, take actions that best fulfil the need in question (Hawkins et al., 2007).

In building envelope component replacement decisions, need may arise because of the physical condition, thermal performance, or the aesthetical value. These conditions generally depend on the age of component. Aesthetic aspect is limited to visibility of the component and is important for windows and façades. In addition, the perceived high cost of energy or a concern for the environment may induce the homeowners to adopt building envelope energy efficiency measures. Furthermore, homeowners’ level of awareness (Rogers, 2003) of various energy efficiency measures will influence the adoption of such measures.

Demographic variables like age, income, and education may influence potential adopters’ decision-making process (Hawkins et al., 2007). Socio-demographic analysis may be useful in understanding the environmental knowledge and attitudes of individuals (Diamantopoulos et al., 2003) and, therefore, may assist in the market segmentation of potential adopters (Wedel and Kamakura, 2000). Still, there is no conclusive evidence on the relationship between demographic factors and *green* consumer behaviour (Peattie, 2001; Diamantopoulos et al., 2003; Wagner, 1997). Some Swedish studies have shown that there exists a relationship between homeowners’

age and energy efficient behaviour (Carlsson-Kanyama et al., 2005; Mahapatra and Gustavsson, 2008a, 2008b).

1.1.2 Stage 2 – Collection of information

Potential adopters who intend to fulfil their needs collect information about alternatives from various sources. The information search could be either *internal* (from memory) or *external* (from external sources) (Hawkins et al., 2007). Typically, investment-intensive decisions such as building envelope energy efficiency measures entail external searches. The external sources of information include mass media and interpersonal channels. These information sources influence homeowners' behaviour through a change in the homeowners' cognitive attitudes (Mahapatra and Gustavsson, 2009). The influence from mass media and interpersonal sources on adoption decisions varies among categories of potential adopters. Mass media communications like television (TV) or newspaper advertisements are more likely to influence the innovators and early adopters, who constitute a small proportion of the total number of potential adopters (Rogers, 2003). Interpersonal sources are important for the majority of other adopters (Arndt, 1967; Bearden et al., 1989; Midgley, 1983). The majority rely on evaluations of friends and peers who have already adopted the innovation (Lekvall and Wahlbin, 1973; Lerviks, 1976; Rogers, 2003).

1.1.3 Stage 3 - Selection of a building envelope component

Potential adopters process the gathered information to make the adoption decision. In doing so, they usually compare various alternatives based on their perception of the alternatives' attributes: economic factors, environmental benignity, ease of installation, etc. A measure that has more *perceived* advantages compared to others is likely to be adopted. Adoption decisions are made based on perceptions because potential adopters are constrained by bounded rationality; i.e., they have a limited capacity to acquire, store, and process the vast amount of information required to make a rational decision (Simon, 1959).

1.1.4 Influence of economic instruments

Potential adopters may not realise the advantages of adopting energy efficiency measures; therefore, efforts are needed to promote such measures (Rogers, 2003). Marketing campaigns, rules and regulations, and economic instruments are some of the options. Economic policy instruments like subsidies and low interest loans are used, especially during the early phases of the diffusion process, to promote investment-intensive innovations. Grants and low-interest loans were effective in Sweden (Schipper et al., 1985) and in the United Kingdom (Boardman, 2004; Shorrock, 2001), but subsidies for wall insulation had a limited impact in the Netherlands (Kemp, 1997).

During our survey period, subsidies were available in Sweden for owners of detached houses who replaced their existing windows with energy efficient windows (U value ≤ 1.2 W/m²K). This subsidy, available from 2006 to 2008, was 30% of the investment cost exceeding 10,000 SEK¹¹, and the maximum subsidy available for each household was 10,000 SEK.

¹¹ €1 = (ca) 11 SEK in January 2009

Methodology

1.1.5 Survey

In survey research, a suitable sampling technique is required which generalise to the entire population from a small portion of the population (Rea and Parker, 2005). In Sweden, population density varies significantly from north to south, and therefore, the stratified random sampling technique is an appropriate option. In our survey, the strata consisted of 8 Nomenclature of Territorial Units for Statistics (NUTS) regions¹². The questionnaire was sent to a sample of homeowners in each of these NUTS regions. The total number of questionnaires sent out for the survey was 3059, and after two reminders, the response rate was 36%. The survey was conducted through Statistics Sweden.

1.1.6 Questionnaire

The questionnaire consisted of six parts. Section A included questions about the existing conditions of the building envelope components. Section B included questions regarding the respondent’s awareness of energy efficiency measures and their perceptions of them. Section C included questions about the respondent’s interaction with other major actors like construction companies and energy advisers. In Section D, respondents were asked to grade the level of importance of different installation-related factors like investment cost, energy cost savings, GHG emission-reduction potential and aesthetics. In Section E, respondents were asked to rank the different energy efficiency measures on a 5-point Likert scale for each of the factors mentioned in Section D. Section F included questions related to socio-economic variables.

1.1.7 Analysis

About 64% of the homeowners did not respond. The higher the refusal rate, the greater is the need to ascertain whether the non-responses were concentrated in certain groups (Weisberg et al., 1996). Hence, to generalise our survey results, we tested the presence of a non-response bias. We compared the composition of the group of homeowners sampled with that of those who responded, considering each homeowner’s NUTS region, the age of each house, the age and income of each respondent. No significant non-response bias was found with respect to those variables, except that homeowners older than 55 years were more commonly represented among the respondents.

Homeowners’ ratings of the importance of installation-related attributes (section D of the questionnaire) were ordinal in nature. Hence, the median is the appropriate measure of the central tendency (Nachmias and Nachmias, 1996). However, the median value was the same for a few attributes, making it impossible to rank the level of importance of those attributes. Therefore, we treated the ordinal responses as interval level variables and estimated the mean values of the attributes to rank them. However, we kept intact the ordinal nature of the responses by conducting a non-parametric test to verify the significance of the rankings. The Friedman test could show if at least one attribute was ranked significantly differently from the others, but this test did not allow us to know which attributes were ranked significantly differently. Hence, we conducted a

¹² The NUTS regions are: Stockholm County, Eastern-Central Sweden, Småland and the islands of Öland and Gotland, Southern Sweden, Western Sweden, North-Central Sweden, Central Norrland and Upper Norrland.

Wilcoxon signed rank test (henceforth a ‘Wilcoxon test’) of successive pairs of attributes arranged according to decreasing mean values. A significant result for the first pair of attributes automatically renders the successive attribute significantly different from the first one.

The above procedure was also used to analyse respondents’ ratings of various building envelope energy efficiency measures (section E of the questionnaire).

Results

1.1.8 Characteristics of building envelope components

Table 1 provides information about the existing building envelope components of respondents’ houses. Double glass followed by triple glass windows was common. Mineral wool was the most common insulation material used for attic and wall insulation. For attics, insulation thickness varied more or less evenly within the range of 100 – 200 mm, 200 – 300 mm and 300 – 400 mm. About 12% of respondents reported insulation thickness, above 400 mm. In the case of wall insulation, about 6% of respondents reported insulation thickness above 300 mm. The detached houses in North Sweden (i.e., Jämtland, Norrbotten, Västerbotten and Västernorrland counties) have relatively thicker attic and wall insulation compared to those in other parts of Sweden. The proportion of respondents reporting that their windows, attic insulation, or wall insulation was more than 20 years old was 42%, 43% and 50%, respectively.

Table 1: Percentage of respondents reporting on characteristics of their existing building envelope components

Characteristics	Window (%)	Attic insulation (%)	External wall insulation (%)
Most common type of component			
Windows			
Double glass	46		
Triple glass	35		
Double glass with low emission coating	9	NA	NA
Triple glass with low emission coating	19		
Do not know	0.4		
Insulation			
Mineral wool		73	66
Cellulose	NA	11	7
Fibre board		2.8	7.3
Cellplast		0.7	1.6
Others		4.3	2.5
Do not know		8.2	15.1
Thickness of insulation			
0 – 100 mm		6	14
101– 200mm		19	34
201– 300mm	NA	22	18
301– 400mm		16	6
> 400 mm		12	0.7
Do not know		21	27

Age of component			
< 10 years	29	21	14
10 –20 years	18	20	17
20 – 35 years	24	27	28
> 35 years	18	15	22
Do not know	11.6	17.6	19.6

Note: NA = Not applicable; A few respondents had more than one type of window

1.1.9 Need for a new building envelope component

About 71%, 80% and 91% of respondents had no intention of changing their windows or improving their attic or wall insulation, respectively, during the next ten years (Table 2). This shows that a vast majority of homeowners are not going to adopt such measures in the near future. This could be due to several reasons discussed in the following sections.

Table 2: Percentages of respondents (excluding “do not know” responses) reporting about their plans to adopt various building envelope energy efficiency measures.

Plan to replace or improve the existing building envelope component	No plan (%)	Yes, within 3 years (%)	Yes, 3-10 years (%)
Windows	71 (N = 690) ¹	16 (N = 158)	13 (N = 124)
Attic insulation	80 (N = 725)	11 (N = 102)	9 (N = 78)
Wall insulation	91 (N = 820)	4 (N = 37)	5 (N = 45)

1) N = Number of responses

1.1.10 Satisfaction with existing building envelope component

A potential adopter who is satisfied with an existing building envelope component is less likely to need a new component. The majority of the respondents felt that the physical condition of their windows (68%), insulation of their attic (72%) and insulation of their walls (72%) were in good condition (Table 3). About 73% and 80% of the respondents were satisfied with the aesthetics of their windows and façade, respectively.

The majority of the respondents were satisfied with the thermal performance of their windows (65%) and attic (70%) and wall (72%) insulation (Table 3). A similar percentage of respondents (82%) reported that they did not feel any cold air ingress in their house (not shown in table). Among the 18% who felt cold air ingress, 55% reported that windows were the source of the cold draft.

Table 3: Percentage of respondents (excluding “do not know” responses) reporting their perception of various attributes of existing building envelope components

Attributes	Respondent category	Window (%)	Attic insulation (%)	External wall insulation (%)
Physical condition	Bad	8 (N= 85)	8 (N= 73)	5 (N= 47)
	Neither bad nor good	24 (N=257)	20 (N= 183)	23 (N= 220)
	Good	68 (N= 737)	72 (N= 669)	72 (N= 681)
Thermal performance	Dissatisfied	12 (N= 127)	9 (N= 84)	7 (N= 74)
	Neither dissatisfied nor satisfied	23 (N= 244)	21 (N= 202)	21 (N= 206)
	Satisfied	65 (N= 681)	70 (N= 656)	72 (N= 731)
Aesthetics ¹	Bad	9 (N= 99)	NA	5 (N= 51)
	Neither bad nor good	18 (N=188)	NA	15 (N=166)
	Good	73 (N= 787)	NA	80 (N= 857)
Cold air ingress	Yes	55 (N=102)	14 (N= 26)	29 (N= 55)

1) Refers to aesthetics of windows and facade, NA = Not applicable, N = Number of responses

Dissatisfaction with existing building envelope components will encourage the adoption of new ones. Respondents would adopt a new building envelope component if they thought that the existing components were in bad physical condition, had poor aesthetics, or poor thermal performance (Table 4). For example, 83% of the respondents whose windows were in bad physical condition might replace them, while only 14% among those who had windows in good condition might do so. Respondents who felt cold air ingress were more likely to adopt a building envelope measure.

Building envelope components were more likely to be adopted as the age of the components increased. For example, about 49% of the respondents whose windows were more than 35 years old would install new windows, but only 18% of those who had windows less than 10 years old would do so (Table 4). We found that respondents were more likely to replace their windows and improve their attic or wall insulation when they had to renovate the façade.

Table 4: Attribute-wise percentage of respondents planning to replace their windows or improve insulation during the next 10 years

Attributes	Respondent category	Percentage of respondents who plan to replace windows or improve insulation during the next 10 years ¹		
		Window	Attic insulation	External wall insulation
Physical condition	Bad	83 (N = 63)	68 (N = 48)	36 (N = 14)
	Neither bad nor good	53 (N = 118)	37 (N = 55)	17 (N = 27)
	Good	14 (N = 94)	11 (N = 63)	5 (N = 28)
Thermal	Dissatisfied	62 (N = 68)	59 (N = 42)	42 (N = 23)

performance	Neither dissatisfied nor satisfied	52 (N = 109)	37 (N = 61)	14 (N = 22)
	Satisfied	15 (N = 93)	10 (N = 59)	5 (N = 31)
Aesthetics ²	Bad	71 (N = 62)	NA ³	41 (N = 13)
	Neither bad nor good	54 (N = 86)	NA	19 (N = 24)
	Good	18 (N = 126)	NA	6 (N = 42)
Cold air ingress	Yes	51 (N = 85)	37 (N = 52)	22 (N = 29)
	No	24 (N = 189)	16 (N = 120)	7 (N = 51)
Other Factors				
Age of the component	< 10 years	18 (N = 45)	14 (N = 23)	11 (N = 12)
	10 -20 years	21 (N = 31)	20 (N = 29)	8 (N = 10)
	20 – 35 years	39 (N = 81)	19 (N = 38)	10 (N = 20)
	> 35 years	49 (N = 70)	32 (N = 35)	11 (N = 16)
Plan for changing external wall	Yes	74 (N = 51)	60 (N = 36)	82 (N = 53)
	No	24 (N = 210)	16 (N = 125)	3 (N = 22)

1) Chi-square tests showed a significant relationship ($p \leq 0.01$) between respondents' perception of the attributes and their plans to replace windows or improve attic or wall insulation. However, the relationship between the age of component and respondents' plans to improve wall insulation was insignificant. N = Number of responses

2) Refers to aesthetics of windows and facade

3) NA = Not applicable

1.1.11 Awareness of existing building envelope component

If potential adopters did not know about their existing building envelope components, then it is less likely that they would adopt a new measure. Table 5 shows that the majority of the respondents knew about various attributes of their windows, attic and wall insulation. The percentage of respondents who did not know was highest for wall insulation, followed by attic insulation and windows. Respondents who knew about the type, thickness and physical condition of their building envelope component were significantly ($p \leq 0.01$ as per chi-square test) more likely to replace the component than those who did not know about these aspects (result not shown in Table).

Table 5: Percentage of respondents’ who “did not know” about various attributes of their building envelope component

Attributes of building envelope component	Percentage of respondents who “did not know” about their building envelope component		
	Window	Attic insulation	External wall insulation
Type ¹	0.4 (N = 1229)	8.2 (N=1060)	15.0 (N = 1065)
Thickness	NA	21.0 (N = 1052)	27.0 (N = 1054)
Age	11.7 (N = 943)	17.6 (N = 899)	19.6 (N = 898)
Physical condition	0.4 (N = 1083)	8.8 (N = 1014)	10.8 (N = 1063)
Thermal performance	2.0 (N= 1073)	7.2 (N = 1016)	4.3 (N = 1058)

1) Type of building envelope component refers to type of windows and insulation material for attic and external wall; see Table 1 for common types of components. N = Number of responses. NA = Not applicable.

1.1.12 Perception of energy cost and importance of reducing energy use

Homeowners were more likely to adopt building envelope energy efficiency measure if it was perceived that annual household energy costs were high (Table 6). Chi-square tests showed that the relationship between respondents’ perception of energy costs and their plans to adopt a measure was significant for the installation of windows ($p \leq 0.05$) and improved attic insulation ($p \leq 0.01$), but not for improved wall insulation.

Table 6: Respondents’ plans to adopt a building envelope energy efficiency measure during the next 10 years, in relation to their perception of household energy costs and the level of importance that they attribute to reduced household energy use

Factors that may create a need	Respondent category	Percentage of respondents who plan to replace windows or improve insulation during the next 10 years		
		Window	Attic insulation	External wall insulation
Perceived share of energy cost in annual income	Low	24 (N = 234)	12 (N = 219)	7 (N = 220)
	Neither low nor high	28 (N = 379)	20 (N = 355)	8 (N = 353)
	High	34 (N = 297)	26 (N = 280)	13 (N = 275)
Level of importance to reduce energy use in home	Not important	20 (N = 146)	9 (N = 134)	7 (N = 138)
	Moderately important	27 (N = 194)	18 (N = 188)	8 (N = 182)
	Important	32 (N = 585)	24 (N = 542)	10 (N = 542)

N = Number of respondents in each category

About 66% of the respondents did not think that their energy costs were high. Still, it was important for about 63% of the respondents to reduce household energy use. The results of Table 6 show that only 32% of the 63%, who consider it important to reduce household energy use would install a window. A lesser proportion would improve attic or wall insulation. Still, respondents who thought that it was important to reduce household energy use were more likely to adopt a building envelope energy efficiency measure than those who did not think so. A significant relationship was found between the level of importance that respondents assigned to reducing household energy use and their plan to replace windows ($p \leq 0.05$) or improve attic ($p \leq 0.01$) or wall insulation ($p \leq 0.01$).

1.1.13 Demographic factors

The influence of respondents' age, income, and education on their adoption of building envelope energy efficiency measures is presented in Table 7. A chi-square test showed that there was a significant relationship ($p \leq 0.05$) between respondents' age and their plan to install a window or improve attic or wall insulation. Younger homeowners were more likely to adopt such a measure. Respondents with higher education and higher income were found to be more inclined to adopt an energy efficiency measure, but the relationship was statistically insignificant.

Table 7: Percentage of respondents in different age, income and education categories who planned to adopt building envelope energy efficiency measures during the next 10 years

Respondent category	Percentage of respondents who planned to replace windows or improve insulation during the next 10 years		
	Window	Attic insulation	External wall insulation
Age			
< 36 years	41 (N = 56)	29 (N = 49)	12 (N = 49)
36-45 years	34 (N = 170)	24 (N = 165)	13 (N = 160)
46 -55 years	27 (N = 209)	22 (N = 194)	8 (N = 193)
56-65 years	31 (N = 290)	20 (N = 271)	12 (N = 279)
> 65 years	23 (N = 235)	13 (N = 214)	3 (N = 210)
Annual income			
≤ 150 000 SEK	20 (N = 41)	13 (N = 38)	5 (N = 37)
150 001 – 300 000 SEK	29 (N = 178)	21 (N = 160)	10 (N = 164)
300 001 – 450 000 SEK	31 (N = 236)	21 (N = 224)	11 (N = 218)
450 001 – 600 000 SEK	30 (N = 230)	20 (N = 230)	9 (N = 233)

International Scientific Conference on “Energy systems with IT” in connection with the
Energiting 2009, March 11-12 at Älvsjö fair, Stockholm.

> 600 000 SEK	252) 30 (N = 229)	= 20 (N = 220)	9 (N =217)
Education			
Primary education	25 (N = 268)	= 16 (N = 248)	8 (N = 255)
Higher secondary school	32 (N = 329)	= 20 (N = 312)	11 (N = 307)
University	29 (N = 360)	= 23 (N = 331)	9 (N = 326)

N = Number of respondents in each category

1.1.14 Information source

Most potential adopters rely on interpersonal information in their adoption decisions (Rogers, 2003). We also found that interpersonal sources were the most important source of information in respondents’ decisions to adopt energy efficiency measures. Construction companies, material suppliers and energy advisers were the second and third most important sources of information (Table 8).

Table 8: Level of importance of various information sources as respondents plan to adopt building envelope energy efficiency measures

Sources of information	Total survey respondents		Respondents who improved building envelope component(s) during the last 2 years	
	N ¹	Mean ²	N ¹	Mean ²
Interpersonal sources	940	3.58 (0.037)	125	3.66 (0.109)
Construction companies/material suppliers	916	3.45 (0.051)	124	3.51 (0.112)
Energy adviser	936	3.25 (0.043)	125	3.04 (0.126)
Installers/vendors	903	3.13 (0.041)	121	3.23 (0.109)
Internet	887	3.04 (0.045)	121	3.19 (0.127)
Energy supplier	902	2.98 (0.041)	122	3.03 (0.113)
Vi i Villa magazine	924	2.86 (0.037)	124	2.86 (0.110)
Visiting a house to see the installation	916	2.83 (0.046)	123	2.72 (0.132)
Swedish Energy Agency	900	2.73 (0.041)	122	2.55 (0.101)
Exhibition	907	2.57 (0.040)	123	2.53 (0.112)
Advertisement in TV	901	2.09 (0.033)	119	2.02 (0.088)
Home delivered leaflets	888	1.98 (0.034)	120	1.91 (0.087)

1) N = Number of respondents, Values in parentheses are standard errors

2) Mean values are based on homeowners’ ratings using an ordinal scale of 1 = Not important, 5 = Very important. Hence, an information source with a higher mean value is of greater importance.

The level of importance attributed to various sources of information could vary between the general population and those who actually retrofitted building components. Results presented in Table 8 shows that the ranking of the various sources of information, based on the mean values, was almost same among the general respondents and those who have improved their existing building envelope component(s) during the last two years (i.e. since 2006). One exception is that, compared to the total survey respondents, respondents who improved their building component gave a higher priority to installers/vendors and internet than the energy advisers.

Though the majority of respondents considered external actors like construction companies, material suppliers, installers and energy advisers as important sources of information, only a few, including those who adopted building envelop measure during last 2 years, had consulted these sources, (Table 9). However, respondents, who actually made changes in their building envelop during the last 2 years, were more likely to consult a specific source than the total survey respondents.

Table 9: Percentage of respondents’ who contacted an external actor to learn about household energy issues

Sources of information	Total survey respondents (%)	Respondents who improved building envelope component(s) during the last 2 years (%)
Construction companies / material supplier/installers	21 (N ¹ = 225)	31 (N = 41)
Local energy advisers ¹³	14 (N = 154)	20 (N = 27)

1) N = Number of respondents who contacted the respective source

1.1.15 Installation-related factors

Potential adopters typically compare various alternatives based on a number of attributes of the innovations. We term such attributes of energy efficiency measures as “installation-related factors”. The factors that are given high priority guide the decisions. A comparison of the mean values of respondents’ ratings of the factors is presented in Table 10, with the factors ranked in descending order. The results showed that savings in terms of the annual cost of energy, along with investment cost, was the most important factor in homeowners’ decisions to adopt energy efficient measures. Environmental factors were given lower importance. Aesthetics and improvements in social status were the least important factors in the decision to adopt energy efficiency measures.

Table 10: Importance of installation-related factors in respondents’ choice of building envelope energy efficiency measures (arranged according to decreasing mean value)

¹³ All the municipalities in Sweden have an energy adviser service. The energy advice service, run by municipality-sponsored energy advisers, is an informative policy instrument used by the Swedish government. The objective is to provide free and impartial information to end users on energy issues and energy policy instruments (Khan, 2006).

Installation-related factors	Total survey respondents			Respondents who improved building envelope component(s) during the last 2 years		
	N ¹	Mean ²	Wilcoxon test ³	N ¹	Mean ²	Wilcoxon test ³
Annual saving of energy cost	1026	4.52 (0.024)		134	4.53 (0.059)	
Initial investment cost	1020	4.42 (0.027)	**	131	4.43 (0.071)	NS
Functional reliability	954	4.13 (0.028)	**	125	4.18 (0.075)	**
Maintenance requirement	954	4.10 (0.028)	N.S	124	4.19 (0.070)	NS
Indoor comfort	977	3.97 (0.029)	**	126	4.10 (0.081)	NS
Environmental benefit	976	3.78 (0.031)	**	128	3.80 (0.079)	*
Increase market value of house	973	3.58 (0.034)	**	127	3.66 (0.100)	NS
Ease of installation	948	3.44 (0.033)	**	126	3.34 (0.098)	*
GHG emission reduction	937	3.38 (0.033)	N.S	125	3.42 (0.095)	NS
Time required to collect information	940	2.85 (0.035)	**	121	2.85 (0.085)	**
Aesthetics	939	2.78 (0.036)	N.S	125	2.85 (0.102)	NS
Improve status	931	1.72 (0.033)	**	123	1.57 (0.086)	**

1) N denotes the number of respondents

2) A factor with a higher mean value is of greater importance. Values in parentheses are standard errors

3) ** denotes significant at $p \leq 0.01$, * denotes significant at $p \leq 0.05$, N.S – Not significant

A Wilcoxon test was used to analyse the level of significance for each pair of adjoining factors in Table 10. For example, there was a significant difference in the respondents' ranking of the first factor (annual savings on energy cost) and the second factor (initial investment cost). However, there was no significant difference in the respondents' ranking of the factors' functional reliability and maintenance requirements. The test showed that except for a few pairs, there was a significant difference in the homeowners' rankings for most pairs of factors.

We also compared the level of importance attributed to various installation-related factors between the general population and those who actually retrofitted their building components. Results presented in Table 10 shows that the ranking of the various installation-related factors, based on the mean values, was almost same among the general respondents and those who have improved their existing building envelope component (s) since 2006. One exception is that,

compared to the total survey respondents, a higher number of respondents who improved their building component gave a higher priority to GHG emission reduction than the ease of installation.

1.1.16 Ranking of energy efficiency measures

We compared the respondents’ ranking of energy efficient windows and attic and wall insulation improvements for the first ten factors mentioned in Table 10.

Table 11: Comparison of building envelope energy efficiency measures with respect to installation-related factors

Factors and energy efficiency measures ¹	N	Mean ²	Wilcoxon test ³	% of respondents who do not know
Annual energy cost reduction				
Attic	787	3.93 (0.038)		17.4
Window	821	3.70 (0.037)	**	15.6
External wall	773	3.54 (0.039)	**	20.1
Initial investment cost				
Attic	745	3.13 (0.037)		21.6
Window	803	2.36 (0.037)	**	18.0
External wall	726	2.35 (0.042)	N.S	24.1
Functional reliability				
Attic	719	4.19 (0.037)		24.2
Window	750	4.14 (0.037)	N.S	22.0
External wall	694	4.02 (0.042)	**	27.2
Maintenance requirement				
Attic	723	4.18 (0.032)		23.7
Window	738	4.03 (0.076)	**	23.3
External wall	699	3.96 (0.034)	N.S	26.3
Indoor comfort				
Window	795	4.07 (0.031)		18.8
Attic	748	3.92 (0.035)	**	21.5
External wall	721	3.72	**	24.9

		(0.037)		
Environmental benefit				
Attic	739	3.61 (0.041)		22.1
Window	767	3.38 (0.039)	**	20.7
External wall	723	3.33 (0.041)	N.S	24.2
Market value of house				
Window	806	3.80 (0.035)		17.4
Attic	774	3.54 (0.037)	**	19.5
External wall	747	3.54 (0.037)	N.S	22.3
Ease of installation				
Attic	777	3.78 (0.038)		19.1
Window	795	3.44 (0.038)	**	18.3
External wall	746	2.80 (0.045)	**	22.5
GHG emission reduction potential				
Attic	602	3.42 (0.048)		36.7
Window	623	3.19 (0.046)	**	35.6
External wall	584	3.15 (0.046)	N.S	38.6
Time required to collect information				
Attic	735	3.38 (0.043)		23.2
Window	764	3.28 (0.042)	N.S	21.3
External wall	720	3.15 (0.045)	N.S	24.8

1) The terms “Window”, “Attic”, and “External wall” refer to energy efficient windows, improvement of attic insulation and improvement of external wall insulation, respectively; N = Number of responses other than “do not know”

2) In calculating the mean value, the “do not know” responses were considered as missing values. Values in parentheses are standard errors

3) N.S = Not significant, ** significant at $p \leq 0.01$

Table 11 shows that improved attic insulation was perceived as significantly better than energy efficient windows according to a majority of factors, except for increase in market value of the house and indoor comfort for which windows were thought to be better. The improvement of wall insulation ranked the lowest for all installation-related factors, but the Wilcoxon test

revealed that its ranking compared to its nearest alternative was not significant for some of the factors.

Several respondents did not know about at least one aspect of a building envelope energy efficiency measure. The percentage of respondents reporting "do not know" was higher for insulation improvements to attics and walls compared to that for energy efficient windows. This result is in line with respondents' response to the question "*How well aware are you of energy efficient windows and energy efficient improvement possibilities in attic and wall insulation?*" More respondents were found to be aware or very much aware about energy efficient windows (57%) than about attic (50%) or wall insulation (42%) improvement possibilities.

Energy efficiency measures that have more perceived advantages may be recommended more to others through interpersonal communication. Our results corroborate this hypothesis. We found that a higher percentage of respondents would recommend attic insulation improvement to their friends and peers (41%) than would recommend energy efficient windows (27%) or wall insulation improvement (12%).

1.1.17 Relevance of investment subsidies

About 36% of respondents reported that they knew about government support for reducing household energy use. Among them, about one-third knew about investment subsidies for the adoption of energy efficient windows. In this category, 53% considered the subsidy important in their adoption decision, while 28%, especially those having annual household income of more than 300 000 SEK, thought that it was not important.

Discussion and conclusion

The majority of homeowners did not intend to adopt a building envelope energy efficiency measure. This is largely because homeowners were satisfied with the physical condition, thermal performance, and aesthetics of their existing building envelope components. Also, a majority of respondents did not think that their energy costs were high and they did not want to adopt investment-intensive measures to reduce household energy use. Older homeowners were less likely to adopt any measures.

Economic instruments could be used to encourage homeowners to adopt energy efficiency measures because they give high priority to investment cost and annual energy cost when making such a decision. Earlier research also showed that homeowners give high priority to those economic factors when adopting a new heating system (Hallin, 1988; Mahapatra and Gustavsson, 2008a, 2008b; Mårtensson, 2006; Nilsson, 2004; Sernhed and Pyrko, 2006; STEM, 2005; Vinterbäck, 2000).

Respondents who consider their energy cost as high were more likely to adopt an energy efficiency measure. Our results support earlier studies (Nässén et al, 2008) which based on time series data showed that specific energy use for heating in existing Swedish buildings decreased when there was increase in energy prices. However majority of respondents of our survey did not consider their energy cost as high. Since, respondents gave higher priority to reduce the annual cost of energy than to environmental benefits, increasing energy prices using economic instruments to internalise the externalities could encourage people to adopt energy efficiency

measures. In Sweden, external cost of energy use is internalized through taxes on emission of CO₂, sulphur and NO_x. Moreover there are energy and electricity taxes. However as price elasticity of energy demand in Sweden is relatively low (-0.3 as reported by Nässén et al, 2008), and in such situations imposition of taxes to reduce energy use may be less effective (Ürge-Vorsatz et al, 2007). More detailed studies are needed to understand how to steer energy prices to influence homeowners to adopt energy efficiency measures.

As homeowners give high priority to initial invest cost, investment subsidies may encourage the adoption of investment-intensive energy efficiency measures. 50% of the respondents who were aware of investment subsidies for the installation of energy efficient windows also thought that the subsidy was important in their decision. However, 64% of the respondents were unaware of the existence of any government support for reducing household energy use.

Information campaigns announcing the availability of economic incentives and the cost advantages of energy efficiency measures may be helpful in adoption decision. Campaigns stressing the loss incurred by residents due to non adoption of energy efficiency measures may be more effective than the one projecting the energy/monetary saving potential (Yates and Aronson, 1983). This is because people act more to avoid a loss than to achieve a gain (Kahneman and Tversky, 1979).

According to majority of respondents, improved attic insulation entailed less investment cost as well as greater energy cost-savings and hence has a better pay back for investment compared to other alternatives. The potential adopters are likely to invest more in measures that provide faster returns (Faiers and Neame, 2006), in our case improved attic insulation. However, we found that more homeowners were likely to adopt windows rather than improving attic insulation, largely because more homeowners were dissatisfied with their windows than with attic insulation. Furthermore, windows have a higher degree of observability as compared to attic insulation. If we encounter a problem frequently, we give priority to that problem more so than to others that are less observable (Milbourne, 2001). Hence, respondents who thought that their windows were in bad condition were more likely (83%) to replace them than those who thought that their attic insulation was in bad condition (68%).

Awareness of better alternatives influences homeowners' decisions (Uitdenbogerd, 2007). About 50% of the respondents mentioned that they did not know or knew little about building envelope energy efficiency measures. More respondents were aware of energy efficient windows than of improved insulation. This may be because of the recently launched (2006) energy efficiency labelling programme, an incentive scheme supporting energy efficient windows, and also because of the Swan labelling of windows¹⁴. Since more respondents were well aware about energy efficient windows than improved insulation, the need for energy efficient windows may be higher than for other alternatives.

Many homeowners did not know about the age, thickness, physical condition, or type of material of the attic or wall insulation in their houses. Earlier studies had shown that the thermal conductivity of inorganic insulation in buildings can deteriorate significantly and that the material

¹⁴ Windows with U value ≤ 1.3 W/m²K; the Swan label is recognised and understood by 97% of the Swedish population, (www.svanen.nu).

can lose its insulating properties depending on site condition (Karamanos et al., 2008). In not knowing the condition of their home insulation, a segment of homeowners might not be aware that the thermal properties of the existing insulation have deteriorated.

Earlier studies have shown that informational strategies could be successful in promoting household energy efficiency measures (Henryson et al., 2000; Abrahamse et al., 2007). External actors like construction companies, material suppliers, installers, and energy advisers can create awareness and promote problem recognition. Respondents perceive these actors as important sources of information regarding energy efficiency measures. However, their strategy of using home-delivered leaflets to inform the homeowners about energy efficiency measures may not be successful, since respondents gave low priority to this source of information. Personal contact made with the homeowners by external actors could be effective because homeowners give the highest priority to interpersonal communication when deciding to adopt an energy efficiency measure.

A very low proportion of respondents contacted external actors like municipal energy advisers, even though such actors are perceived as an important source of information. It is important to facilitate more interaction between homeowners and such change agents. In Sweden from January 2009 onwards it is mandated to have energy declaration for new detached houses and existing houses to be sold. The energy declaration by a certified energy auditor may contain suggestions to improve the energy efficiency of buildings¹⁵. This requirement will facilitate homeowners, especially those planning to buy or sell a house, to interact with energy experts and thereby improving their awareness about energy efficiency measures in residential sector. It could also be made mandatory for homeowners to contact an energy adviser when undertaking a major household renovation. Energy advisers could also be involved in the processing of various investment subsidies meant for energy efficiency measures in detached houses. They could also organize public meetings, for example in community centres, on a regular basis, wherein experts in energy sector may be invited to give talks to homeowners and to discuss issues pertaining to energy efficiency measures. Homeowners may then pass on the information to others through interpersonal sources.

Acknowledgments

The authors gratefully acknowledge the financial support from the Swedish Energy Agency and from the European Union. We are also thankful to the anonymous reviewer and participants of Energiting 2009 conference for their comments on the earlier draft of this paper.

References

- Abrahamse, W., Steg, L., Vlek, Ch., Rothengatter, J.A., 2007. The effect of tailored information, goal setting and tailored feedback on household energy use, energy-related behaviors and behavioral antecedents. *Journal of Environmental Psychology* 27, 265–276.
- Arndt, J., 1967, Role of product related conversations in the diffusion of a new product. *Journal of Marketing Research* 4 (3), 291-295.

¹⁵ Additional insulation and energy efficient windows were cited as few examples of energy efficiency measures that can be included in the energy declaration (Regeringskansliet, 2006).

International Scientific Conference on “Energy systems with IT” in connection with the
Energiting 2009, March 11-12 at Älvsjö fair, Stockholm.

- Bearden, W, O., Netemeyer, R, G., Teel, J, E., 1989. Measurement of consumer susceptibility to interpersonal influence. *Journal of Consumer Research* 15(1), 473-81
- Boardman, B. 2004. New directions for household energy efficiency: evidence from the UK. *Energy Policy* 32, 1921–1933
- Carlsson-Kanyama, A., Lindén, A.-L., Eriksson, B., 2005. Residential energy behaviour: does generation matter?. *International Journal of Consumer Studies* 29 (3), 239–253
- CEC, 2005. Measures to improve energy efficiency of buildings [Åtgärder för ökad energieffektivisering i bebyggelsen], Report to Boverket, Chalmers EnergiCentrum, Gothenberg, Sweden.
- Diamantopoulos, A., Schlegelmilch, B, B., Sinkovics, R, R., Bohlen, G, M., 2003. Can socio-demographics still play a role in profiling green consumers? A review of the evidence and an empirical investigation. *Journal of Business Research* 56, 465–480.
- Dieperink, C., Brand, I., Vermeulen, W., 2004. Diffusion of energy-saving innovations in industry and the built environment: Dutch studies as inputs for a more integrated analytical framework. *Energy Policy* 32, 773–784
- Erlandsson, M., Levin, P. and Myhre, L., 1997. Energy and environmental consequences of an additional wall insulation of a dwelling. *Building and Environment* 32 (2), 129-136.
- Faiers, A., Neame, C., 2006. Consumer attitude towards domestic solar power systems. *Energy Policy* 34, 1797 -1806.
- Faiers, A., Cook, M., Neame, C., 2007. Towards a contemporary approach for understanding consumer behaviour in the context of domestic energy use. *Energy Policy* 35, 4381 -4390
- Gustafsson, S, I., Karlsson, B., 1997. Profitable energy saving measures in 1960s multifamily houses [Lönsamma energisparåtgärder i 60-talets flerbostadshus], Report LiTH-IKP-R-727, Linköping Institute of Technology, Linköping, Sweden.
- Hallin, P.O., 1988. Time for changeover—on households’ adaptation strategies with a changed energy situation [Tid för omställning—om hushålls anpassningsstrategier vid en förändrad energisituation]. Ph.D. Thesis, Lund University, Lund, Sweden (in Swedish).
- Hassinger, E., 1959. Stages in the adoption process, *Rural Sociology*, 24, 52-53.
- Hawkins, D, I, Mothersbaugh, D, L., Best, R, J. 2007. *Consumer Behavior: Building Marketing Strategy*. McGraw – Hill/Irwin, Newyork, USA. ISBN-13: 978-0-07-310137-8.
- Henryson, J., Håkansson, T, Pyrko, J., 2000. Energy efficiency in buildings through information – Swedish Perspective, *Energy Policy* 28 169 -180.
- Howard, J, A., Sheth, J,N., 1969. *The theory of buyer behavior*. John Wiley & Sons, Inc, New york, USA, SBN 471 41657 6
- IEA., 2008. *Energy policies of IEA countries: Sweden 2008 Review*, International Energy Agency Publications, Paris, France, ISBN: 978-92-64-04333-6
- Joelsson, A., Gustavsson, L., 2008. Perspectives on implementing energy efficiency in existing Swedish detached houses. *Energy Policy* 36 (1), 84-96.

International Scientific Conference on “Energy systems with IT” in connection with the
Energiting 2009, March 11-12 at Älvsjö fair, Stockholm.

Kahneman, D., Tversky, A., 1979. Prospect theory: An analysis of decision under risk. *Econometrica* 47, 263-291.

Karamanos, A, S. Hadjarakou b, A.M. Papadopoulos. 2008. The impact of temperature and moisture on the thermal performance of stone wool. *Energy and Buildings* 40, 1402–1411.

Kemp, R., 1997. Environmental Policy and Technical Change: A comparison of the technological impact of policy instruments, Edward Elgar, UK.

Khan, J., 2006. Evaluation of the local energy advice programme in Sweden: Within the framework of the AID-EE project, Lund university, Lund.

Lekvall, P., Wahlbin, C., 1973, A study of some assumptions underlying innovation diffusion functions. *Scandinavian Journal of Economics*. 75, 362-77.

Lerviks, A, E., 1976. A diffusion model for new consumer durables. *Scandinavian Journal of Economics*, 78, 571-586.

Mahapatra, K., Gustavsson, L., 2009. Influencing Swedish homeowners to adopt district heating system, *Applied Energy* 86, 144-154.

Mahapatra, K., Gustavsson, L., 2008a. An adopter-centric approach to analyze the diffusion patterns of innovative residential heating systems in Sweden. *Energy Policy*, 36, 577-590.

Mahapatra, K., Gustavsson, L., 2008b. Innovative approaches to domestic heating: homeowners' perceptions and factors influencing their choice of heating system. *International Journal of Consumer Studies*, 32: 75-87.

Martienz, E., Polo, Y., Flavian, C., 1998. The acceptance and diffusion of new consumer durables:differences between first and last adopters. *Journal of Consumer Marketing* 15 (4), 323 - 342.

Midgley, D, F., 1983. Patterns of interpersonal information seeking for the purchase of a symbolic product. *Journal of Marketing Research* 20, 74-83.

Milbourne, E., 2001. *Perception and Individual Decision Making* <http://home.ubalt.edu/ntsbmilb/ob/ob3/tsld001.htm>, accessed on December 05, 2008

Mårtensson, W., 2006. Effective marketing strategy for district heating in detached houses [Effektiva marknadsstrategier för fjärrvärme till småhus], *Licentiate Thesis*, Department for Energy Sciences, Lund University, Sweden (in Swedish).

Nachmias, C, F., Nachmias, D., 1996. Research Methods in the Social Sciences, Arnold publications, London/Sydney/Auckland.

Nilsson, J., 2004. The choice of new heating systems for the owners of detached houses – information and arguments [Småhusägarnas val av nytt uppvärmningssystem – information och argument]. Ecotechnology division, Mid Sweden University, Östersund, Sweden (in Swedish).

Norrman, S., Johansson, P., 1995. Economizing energy: economic evaluation of energy saving measures in detached houses [Energihushållning: ekonomisk utvärdering av energisparåtgärder i småhus], The National Board of Housing, Building and Planning, Karlskrona, Sweden.

Nässén, J., Sprei, F., Holmberg, J., 2008. [Stagnating energy efficiency in the Swedish building sector —Economic and organisational explanations](#). *Energy Policy* 36, 3814-3822.

International Scientific Conference on “Energy systems with IT” in connection with the
Energiting 2009, March 11-12 at Älvsjö fair, Stockholm.

- Nässén, J., Holmberg, J., 2005. Energy efficiency—a forgotten goal in the Swedish building sector?, *Energy Policy* 33, 1037-1051.
- Peattie, K., 2001. Golden goose or wild goose? The hunt for the green consumer. *Business strategy and the environment* 10, 187–199.
- Poel, B., Cruchten, G., Balaras, C, A., 2007. Energy performance assessment of existing dwellings. *Energy and Buildings* 39, 393-403.
- Rea, L, M., Parker, R, A., 2005. Designing and conducting survey research – A comprehensive guide. Jossey-Bass, san Francisco, United States of America.
- Regeringskansliet, 2006., Energy declaration of buildings. Government Bill 2005/06:145. Ministry of Sustainable Development, Sweden
- Rogers, E.M. (2003). Diffusion of Innovations, The Free Press, New York.
- SCB, 2008. Yearbook of Housing and Building Statistics 2008. Bostads- och byggnadsstatistisk årsbok .
- Schipper, L., Meyers, S., Kelly, H., 1985. Coming in from the Cold: Energy-Wise Housing in Sweden. Seven Locks Press, Cabin John, MD.
- Shorrock, L., 2001. Assessing the effect of grants for home energy efficiency improvements, in Proceedings of the European Council for an Energy Efficient Economy (ECEEE) Summer Study 11-16 June, Côte d’Azur, Paris, France .
- Simon, H, A., 1959. Theories of decision making in economics, *American Economic Review* 49, 253-283.
- Sernhed, K., Pyrko, J., 2006. Detached homeowners’ view on purchase of district heating: a study of applied marketing strategies and customer choice in conversion from resistance heaters [Småhusägarnas syn på att köpa fjärrvärme: En studie av tillämpade försäljningsstrategier och kundernas val vid konvertering från direktverkande el], Projekt rapport, ISRN LUTMDN/TMHP, —06/3023—SE, Department for Energy Sciences, Lund University, Sweden (in Swedish).
- STEM, 2005. Questionnaire and Field Survey of Bedrock Heat Pumps [Enkät- och fältundersökning av bergvärmepumpar]. Swedish Energy Agency <www.energimyndigheten.se> (in Swedish).
- STEM, 2007. Energy in Sweden 2007 [Energiläget 2007], *ET 2007:49*, Swedish Energy Agency, Eskilstuna, Sweden.
- Svanen, 2008. Nordic ecolabel website (Svanen). <http://svanen.nu/> accessed on December 10, 2008
- Uitdenbogerd, D., Egmond, C., Jonkers, R., Kok, G., 2007. Energy-related intervention success factors: a literature review. ECEEE summer study, 4-9 June, Côte d’Azur, Paris, France France.
- Ürge-Vorsatz, D., Koepfel, S., Mirasgedis, S., 2007. Appraisal of policy instruments for reducing buildings' CO2 emissions, *Building Research & Information*, 35:4, 458 — 477.
- Vinterbäck, J., 2000. Wood Pellet Use in Sweden: A System Approach to the Residential Sector. Ph.D. Thesis, Swedish University of Agricultural Sciences, Uppsala, Sweden.

International Scientific Conference on “Energy systems with IT” in connection with the Energiting 2009, March 11-12 at Älvsjö fair, Stockholm.

Wagner, S, A., 1997. *Understanding Green Consumer Behaviour*. Routledge, London, UK.

Wedel, M., Kamakura, W, A., 2000. *Market segmentation — conceptual and methodological foundations*. 2nd ed. Boston: Kluwer.

Weisberg, H, F., Krosnick, J, A., Bowen, B, D., 1996. *An introduction to survey research, polling and data analysis*. Sage Publications, Thousand Oaks, California, United States of America.

Yates, S, M., Aronson, E., 1983. A social psychological perspective on energy conservation in residential buildings. *American Psychologist* 38, 435-444.

Paper No. 3

**HOUSEHOLDS, ENERGY USE AND SCENARIOS OF ENERGY EFFICIENCY
OF EVERYDAY LIFE ACTIVITIES**

Anna-Lisa Lindén

Department of Sociology

Lund University¹⁶

Abstract

Households will play an important role in saving electricity in the future. Behavioural aspects in using white goods and other electric appliances are important as are the reasons for buying new white goods and a number of other appliances for cooking and washing. In a Swedish study three important aspects of energy use in households, *Washing/drying Laundry, Cooking and Eating, and Information and Entertainment* were analysed. These areas include activities performed almost daily in households. In the study, the number, make and model of all electric appliances were recorded, as was the way they were used and by which family members. Some white goods for washing and cooking were very old, but were candidates for replacement only in young households. Electricity use, behaviour, buying and replacement and number of machines differed between young and old households, with number of persons in the household and between families living in apartments and those living in houses.

Scenarios on the electricity savings potential of combining behaviour and replacement strategy for white goods were calculated for the three areas of electricity use, and discussed in relation to the need for policy instruments to bring about changes in behaviour or in replacement strategy for old appliances.

Key words: behaviour, electricity use, households, scenarios

Introduction

Electricity is involved in almost every type of consumer behaviour electricity is involved either in producing goods or in using appliances in everyday life. About 36 percent of the total energy use in Sweden derives from the housing sector (Energimyndigheten, 2007; Lindén, 2008a). However, in the housing sector energy use for heating and hot water has decreased during the past decade due to more efficient technology and to a large number of households having added different types of heat pumps to their electric heating system. In households electricity consumption for heating and hot water is as high as 60 percent. However, electricity consumption for other domestic uses has increased since the 1970s and now makes up 40 percent (Lindén, 2008a). The increasing number of households in Sweden is one factor behind that trend. Other factors are

¹⁶ Box 114, SE-221 00 Lund E.mail: anna-lisa.linden@soc.lu.se

increasing numbers of electric appliances in households and behavioural changes in using appliances, especially among young households.

1. Electricity as a product

Electricity as a consumer product is necessary to fulfil a number of important functions in everyday life, for example chilling and freezing food products, cooking, laundry, lighting the home, and using computers and TV sets. Electricity differs from other consumer goods by not being visible to consumer in the same way as a TV set, fridge or other household appliance (Lindén, 2008a). Electricity must be purchased to make appliances provide the functions required, but consumers generally have no knowledge of how much electricity is needed and thus not even of the cost. Afterwards, when the service provided is consumed, the consumer pays the electricity bill. On average a household living in a private house uses about 6 200 kWh per year at a cost of about SEK 9 000 (EUR 818).¹⁷ Families living in houses very often comprise more than two members and houses normally have more rooms than apartments. Households in apartments use about 2 800 kWh per year at a cost of about SEK 4 000 (EUR 365). These households normally contain fewer members on average, live in one- to three-room flats and comprise very young or old people. Thus electricity costs consume a substantial share of household income.

The cost of electricity has always been much lower in Sweden than in other European countries and Swedish consumers were not accustomed to considering their electricity use until recently, when prices began to steadily increase and are now approaching European levels. The need to be aware of electricity use is thus a quite new phenomenon for Swedes.

2. Households as electricity consumers

There are a number of functional areas where electricity is used to make everyday life comfortable and pleasant, e.g. food cooking/storage, dishwashing, washing/drying laundry, lighting and information/entertainment appliances (Carlsson-Kanyama A, Lindén A-L & B Eriksson. 2003a-b; Lindén, 2008a). In a national perspective these functional areas consume about 40, 20, 20 and 20 percent of household electricity, respectively (Bennich, 2007; Lindén, 2008a). There are differences in electricity use between households living in houses and those in apartments. A study in an urban area of Sweden showed that households living in apartments and houses use almost the same proportions of electricity in functional areas with one exception, lighting has a higher proportion electricity used in houses, due to their larger size and generally larger number of family members (www.vaxjo.se/vaxjo_templates/Page.aspx?id=6255). However, it should be borne in mind that the total amount of electricity used by households living in apartments is less than half that used by households living in private houses.

There are also differences in electricity use between households in relation to income and age. The older generation are more likely to adopt energy-saving strategies, e.g. always turning lights off and not leaving other appliances on standby. Behaviours like this stem from patterns learned during less affluent periods in life (Mannheim, 1952; Gram-Hansen, 2003; Lindén, 1994, 1996, 2008a). On the other, hand young people are more used to modern technology and to low-cost electricity, so using the standby mode or having computers or TVs running while doing

¹⁷ Calculated on a cost of SEK 1,42 per kWh, including taxes and transmission costs.

something else does not bother them from an economic aspect (Lindén, 2008a). Behavioural differences in using entertainment appliances and computers are a very important factor behind the higher amount of electricity use among young people (Carlsson-Kanyama A, et al., 2003a-b). Another factor is the number and age of appliances in the household.

Attitudes, behaviour and technology

A common belief is that knowledge is the most important factor in developing attitudes. Education is one way to improve knowledge, but another way is to use information strategies addressing defined problems in order to influence attitudes and behaviour. It has been claimed that attitudes must be developed before behaviour can be changed (Ajzen & Fishbein, 1980). Thus a positive attitude to using electricity in an energy-saving way ought to promote several aspects of energy efficiency in behaviour. However, a change in habits often occurs the other way around in that something new is tested more or less by chance and found to be convenient or good enough to promote a change in behaviour and attitudes (Biel, 2003; Warde, 2005).

Nine out of ten Swedes have been concerned about environmental problems for several decades (Bennulf & Gilljam, 1991; Lindén, 2004; NV, 2007). Greenhouse gases are top of that list, with global warming second and energy production and energy use third. Thus awareness is high and knowledge about the climate consequences is proving frightening for a large number of Swedes. Knowledge about what can be done by individuals in everyday life has gained high awareness in a few aspects. However, it is difficult to relate global environmental problems to behavioural aspects when it comes to using products without a visual reminder. In a survey focusing on energy use respondents were asked to rank a number of behaviours in terms of their benefits for the environment (Carlsson-Kanyama et al., 2003a). The results showed that waste recycling has become more or less a symbol of high environmental concern (Table 1). Energy-saving behaviours also have a high ranking, e.g. saving energy in general and turning off lights in empty rooms. Campaigns recommending this type of energy-saving behaviour have been introduced on several occasions since the oil crisis in the 1970s and most people know exactly which attitudes are correct and sometimes what to do, but actually doing it is another question. In spite of favourable attitudes to energy-efficient behaviour, there are obstacles to overcome in adopting such behaviour (Carlsson-Kanyama et al., 2003a-b). Other aspects of energy use may be ranked higher, e.g. lit rooms may look cosier although they are empty. Positive attitudes are not always followed by a consistent behaviour and therefore attitudes are a bad predictor of behavioural outcome.

Table 1. Ranking of important factors in terms of their benefits for the environment. Scale 1-5, where 5 indicates very important and 1 not important.

Behaviour	Mean	No answer, %
Waste recycling	4,0	1,5
Saving energy	4,0	2,5
Decrease car travel	3,8	2,5

Turning off lighting in empty rooms	3,6	2,5
Buying eco-labelled products	3,4	2,7
Decreasing meat consumption	2,1	6,4

(Carlsson-Kanyama A, Lindén A-L & B Eriksson. 2003a-b)

The technological design of appliances is sometimes a determining factor for consumer behaviour. One study found that heat regulators on radiators were used so seldom that they were impossible to turn and thus it was easier to open the window and let the heat out. Electronic appliances have standby buttons to make turning on and off easy for the user. Many appliances do not have a turn-off button at all, so it is impossible for users to turn off these machines completely without unplugging them. All appliances should be easy to use and turn off or wall sockets should have an in/off switch making it possible for those who want to save electricity to do so (Karlsson & Widén, 2008). All households have a great number of electrical appliances and decisions to buy new or replace old appliances are taken by the members of the household. Buying new appliances includes buying more electricity to serve the function intended. Although many appliances nowadays have an energy rating or at least a table of technological specifications, the determining factor for the buying decision is very often the function and design wanted. Energy efficiency plays a minor role or is not considered at all.

Although individuals have a high environmental awareness when it comes to energy use, there is room for improvement when it comes to energy efficiency. The non-visual product electricity has to be made visible and become an important determining factor in decisions on buying appliances and introducing energy-efficiency aspects of behaviour. Behavioural aspects of reducing energy use have been neglected to date, while technological aspects have been prioritised (Brown, 2008).

The research problem

The objective of this study was to analyse the electricity-saving potential of changing behaviour and/or replacing ageing electric appliances in three functional areas in households, *Washing/drying Laundry*, *Cooking and Eating*, and *Information and Entertainment*. Scenarios were calculated to exemplify the potential energy-saving capacity of combining new technology and behavioural changes (Lindén, 2008a). The number of appliances providing functions and convenience within the three study areas are very different, as are decisions about what is needed and how it should be used.

Washing/drying Laundry: Washing machines, tumble-dryers and irons rely on established, well-known and nowadays very energy-efficient. At the same time textiles have been improved so that they can be washed at lower temperatures and do not require ironing. Mature technology and improvements in textiles have brought new ways of washing and drying laundry in the home.

Cooking and Eating: Refrigerators, freezers, cookers, microwave ovens, food processors, kettles, dishwashers and a number of other machines providing convenience in storing and cooking food, as well as cleaning chinaware, represent a functional area where new appliances are constantly being introduced, especially devices such as rice steamers, egg boilers, hot dog heaters and all

sorts of small electric appliances. White products such as cookers and freezers represent mature and energy-efficient technology, while most small appliances are fashion-related but are regarded by many consumers as more or less essential tools in a modern kitchen. The number of appliances is normally high. The frequency and behaviour in using them differs between households of different ages and income groups.

Information and Entertainment: Computers, radios, TV sets, CD players, mobile phones, wireless phones and chargers are appliances belonging to the functional area of information and entertainment. The speed of development for new appliances and for new services in existing home electronic appliances is extremely fast. Having up-to-date technology is very attractive for young households, as is owning and being able to use the machines whenever time becomes available. In a substantial number of households every member has a computer, a TV set, a MP3 player etc., which has resulted in changes in behaviour and in the way home electronics are used. Consequently, electricity use for information and entertainment accounts for a growing share in households, not least due to the frequent use of standby buttons on these kinds of appliances.

Methods and empirical material

The calculations in scenarios and the analyses were based on a range of empirical material:

- 1) Attitudes to environmental problems and energy-saving behaviour. Data on number of appliances in functional areas, income groups and generations living in private houses and apartment buildings were taken from a survey of 600 households in a Swedish city. (Carlsson-Kanyama et al., 2003 a-b).
- 2) Electricity use in for different purposes in households: Data were taken from a study on 400 dwellings administered by the Swedish Energy Agency (Bennich, 2007).
- 3) Electricity use in households: National data were obtained from the National Census Bureau and the Swedish Energy Agency (www.scb.se/databases/ , www.enegimyndigheten.se)
- 4) Generations, age groups, size of households, income: Data for households living in different types of buildings and forms of tenure on a national scale have recently been calculated and were partly used in this study (Lindén, 2007a).

Results and discussion

Over ten years the proportion of electricity used for washing/drying laundry in households has decreased tremendously (Lindén, 2008a). Electricity use for cooking and eating has also decreased, while the share of electricity used by households for information and entertainment purposes has increased. Such trends reflect the rapid rate of innovation in home electronics. However, new technology is not the only factor behind the increase in overall electricity use in households. Another important factor is the impact of changing behaviour, and the frequency of replacing appliances.

The number of electric appliances in households has increased enormously over a period of about sixty years (Strandbakken, 2007, Lindén, 2008b) although the actual numbers differ between functional areas. Machinery for washing and drying of laundry has not increased at all during this long period (Table 2). However new laundry appliances are much more energy-efficient in use

than older models and a lower washing temperature is sufficient for modern textiles. Laundry washing/drying appliances represent mature technology, which means that any energy savings are dependent on replacing old machines and on practising energy-efficient behaviour in using them.

The share of electricity used for cooking and dishwashing has recently declined, in spite of technological innovations leading to an increased number of new appliances in this area. However, most of these are not in daily use. The most frequently used machines, e.g. cookers, freezers, refrigerators and dishwashers, are continually becoming more energy-efficient to use. However, there are still a large number of old appliances in use. Another relevant trend in Sweden and other European countries is for home cooking during weekdays to be replaced by dishes that can be made easily and quickly (Carlsson-Kanyama et al.; EU, 2004; Lindén, 2008a). However, the average

number of food-related appliances has increased to more than ten during the 60-year period (Table 3). The number of machines, as well as their mean age and use differs between generational groups.

Table 2. Average number of appliances in three functional areas owned by households, 1950 and 2000. (mean values for year)

Functional area	1950	2000
<i>Washing/drying Laundry</i>	1	3,0
<i>Cooking and Eating</i>	2	10,3
<i>Information and Entertainment</i>	2	18

(Lindén, 2008b)

In the third functional area, information and entertainment, the average number of appliances has grown very rapidly to 18 during two decades since their inception (Table 3). These appliances are often replaced very frequently due to innovations in all sorts of home electronics and are very common in young households, where family members often have their own appliances. Several appliances are often used at the same time or are left in standby mode (Ellegård, 2008; Karlsson & Widén, 2008). Not only the technology but also the behaviour in using them has changed in many households.

Saving electricity in households – three scenarios

Scenario 1: Washing/drying Laundry

Electricity for washing and drying laundry currently comprises about 20 percent of electricity used in households (Lindén, 2008a). At the same time washing and drying of laundry has undergone a revolution over a period of about sixty years. Every household living in a private houses has its own washing machine and tumble-dryer, as a growing number of households living in apartments. Other households living in apartment buildings have access to a laundry room in their building. In addition every household has a larger amount of laundry nowadays than previously so there has been no decrease in the time used for washing and drying, although the task has become less onerous (Lindén, 1994). The machines used are generally quite old, seven years on average. Households living in private houses, particularly households with older people, have machines that are more than ten years old on average (Lindén, 2008a). Landlords of apartment, washing machines, tumble-dryers and other equipment for drying laundry are usually new in apartment buildings. The potential for electricity savings is definitely high if most old washing machines and tumble-dryers are replaced by modern appliances in households living in private houses.

Table 3. Scenario 1 - *Washing/drying Laundry*. Potential electricity savings for the period 2008-2012.

Households living in private houses	Number ¹⁸ of households	kWh/year today ¹⁹	kWh/year modern machines ²⁰	Electricity savings
Machine change				
in 5 years	1 100 000	1 100 000 000	677 600 000	422 400 MWh
in 1 year	220 000	220 000 000	135 520 000	84 480 MWh

(Lindén, 2008)

In almost all Swedish households, environmental awareness scores high and is matched by energy- efficient behaviours, e.g. only washing full machine loads and not using the tumble-dryer

¹⁸ Number of households living in private houses 2 200 000:2 =1 100 000 replace their device in 5 years, 220 000 households per year.

¹⁹ Energy use for old machines in houses is calculated to be 1 000 kWh (STEM, 2007).

²⁰ 384 kWh in energy use for modern machines (STEM, 2008).

unnecessarily (Carlsson-Kanyama et al., 2003a). Thus the potential for energy savings in this functional area by changing behaviour in washing and drying laundry is minor.

If one-fifth of households in private houses that own machines older than seven years on average, replaced their machines within a five-year period the potential energy saving would be 422 400 MWh Table 3). Of course there is also minor potential for changes in behaviour among small households if they filled machines to a greater extent than today, which has been calculated to generate electricity savings of about 42 000 MWh within the same five-year period (Lindén, 2008a).

Scenario 2: Cooking and Eating

Electricity use for cooking and eating has a share of about 20 percent. There are differences between generations. In households with older members more time is used for cooking than among young households (Carlsson-Kanyama & Lindén, 2001; Lindén, 2008a). On the other hand the dishwashers, cookers, refrigerators and freezers are more modern and more energy-efficient in young households than in old. The number of appliances used is greater in young households than in old. For example electric kettles, which are very energy-efficient, are more often used by young people. However, differences in time for cooking and the number of old and new machines must be studied in more detail before they can be included in a scenario.

In calculating scenarios it is more important to focus on the energy-efficiency of machines used daily in young households compared with old, e.g. cookers, refrigerators, freezers and dishwashers. on average the mean age of dishwashers, cookers and refrigerators is seven years, and the mean age of a freezers is nine years (Lindén, 2008a). According to STEM (2001; 2008), replacing these machines with appliances of maximum energy-efficiency would save 995 kWh of electricity per household every year. These figures were used in scenario 2 (Table 4).

Table 4. Scenario 2 - *Cooking an Eating*. Potential electricity savings for the period 2008-2012.

Households living in houses	Number of households ²¹	kWh/year 6,5 year old appliances ²²	kWh/year new appliances	Electricity savings
for 5 years	1 100 000	2 265 000 000	1 314 500 000	1 050 500 MWh
for year	220 000	473 000 000	262 900 000	210 100 MWh

²¹ Number of households living in private houses 2 200 000/2 = 1 100 000 households replacing their machines within a five year period.

²² Old machines consume 2 150 kWh/year, household. Modern machines of best energy efficiency consume 1 195 kWh/year, household. The amount of energy saving is 955 kWh/year, household (STEM, 2008).

(Lindén, 2008)

If households with dishwashers, cookers, refrigerators and freezers older than the mean age replaced these appliances within a five-year period the calculated energy savings would be about 1 050 500 MWh (Table 4).

Scenario 3: Information and Entertainment

The rate of technological innovation in appliances for information and entertainment is very rapid. Machines introduced just 25 years ago, e.g. the video player, were old-fashioned ten years ago and cannot be bought any longer (Bladh, 2005). The functions they performed, e.g. recording TV programmes, are now being provided by new machines, DVD-players, with extended services and more modern technology. In a field with a high rate of innovation there are few old machines in use that can be compared with modern appliances in terms of electricity use. Thus it is more important to analyse the ways in which new technology is leading to changes in behaviour concerning information or entertainment equipment in families (Lindén, 2008a). As has already been stated the expanded ownership of all sorts of home electronics has reduced the time spent together in families. When several family members have their own computer, they can use their machines at the same time, a process known as parallel use (Ellegård, 2008). No-one needs to wait for their turn for the only computer in the family any more. Parallel use of appliances such as computers, TV sets, radios, CD players, MP3-players, etc. is a very dominant pattern in families owning several sets of machines. However, as these use patterns are still developing rapidly, it is not possible to find robust observations on this phenomenon in a time perspective.

Another question is what behaviour in electricity use is lost when new machines are introduced. Besides using more electricity in parallel use patterns, the behaviour of turning off machines fully has been replaced in that modern appliances, e.g. TV sets, computers, players, have standby buttons regulated by remote controls. This innovation makes it more convenient for users to turn on equipment and change channels. On the other hand it has been calculated that about 10 percent of electricity use in households comes from machines and chargers left in standby mode (Lindén, 2008a). The electricity use in standby mode is included in scenario 3 (Table 5).

Table 5. Scenario 3 - *Information and Entertainment*. Potential electricity savings by avoiding use of the standby function for the period 2008-2012.

Number of households	Electricity use TWh/year	Standby electric use TWh/year	Standby function TWh/year	50% electricity saving TWh/year	TWh/5 years
50 %	50 %	10 %	5 %		

2 300 000 TWh	40 TWh	4.0 TWh	2.0 TWh	1.0 TWh	5.0
-------------------------	--------	---------	---------	---------	------------

(Lindén, 2008a)

There are differences between households in number of appliances owned and also in the frequency of using standby mode. Households of older people have fewer appliances for information and entertainment and they are accustomed to turning off equipment fully and not using standby mode. In contrast young households and households with children have a great number of machines and more frequently use the standby function as it is convenient. Knowing the number, size and age of households, about 50 percent of Swedish households could be expected to make changes in their use of standby functions on information and entertainment equipment (Lindén, 2008a). Some devices are constantly left on standby, e.g. mobile phone chargers, built-in clocks, computers, with a calculated electricity use of 10 percent. In scenario 3, it was assumed that half this electricity use could be avoided by turning off machines fully or unplugging chargers. By changing behaviour in these respects, about 5 TWh electricity could be saved in households.

Conclusions

This study examined whether it is possible to achieve a substantial amount of electricity savings by changing behaviour in using appliances and/or replacing old machines within the functional areas *Washing/drying Laundry; Cooking and Eating* and *Information and Entertainment*. The three scenarios calculated using available data showed that in a five-year period a total of 7.7 TWh electricity could be saved (Table 6).

Table 6. Electricity savings from the three scenarios of electricity use in households over a one-year and five-year period.

Functional area	Electricity savings, TWh for
-----------------	------------------------------

	1 year	5 years
Washing/drying Laundry	0.1	0.4
Cooking and Eating (private houses only)	0.2	2.2
Information and Entertainment (only standby)	1.0	5.0
Total electricity saving, TWh	1.3	7.7

The assumptions behind changed behaviour and replacement of old machinery related to number and age of appliances and their use. If more aspects had been included in the scenarios, the electricity savings would probably have been higher. However, in order to perform such an analysis, there is a need for research and empirical data concerning use patterns and appliances in different kinds of households.

The question is how to implement new behaviour and decision-making in replacing old technology? The first answer is to make electricity a visible product, e.g. by labelling products not only with their energy-efficiency, but also with electricity use over time, e.g. the electricity needed for ten hours of computer use. Information in relation to behaviour and use patterns could be a complement to energy labelling, which is more abstract information for the consumer (Lindén, 2007b). Economic measures, e.g. subsidising new household appliances and removing and disposing of old appliances, is another example of an efficient measure (Lindén, 2007). Knowing that the old machine will be removed and that there is a reduction in price of a new appliance is normally very attractive to customers, causing them to replace machines earlier or to buy more energy-efficient machines.

References

- Ajzen I & M Fishbein. 1980. *Understanding Attitudes and Predicting Social Behaviour*. Prentice-Hall, Englewood Cliffs.
- Bennich P, 2007. *Mätning av hushållsel i 400 bostäder*. Föredrag vid Energitinget 20070320-21. Stockholm.
- Bennulf M & M Gilljam, 1991. Snacka går ju – men vem handlar miljövänligt? In L Weibull & S Holmberg (red), *Åsikter om massmedier och samhälle*. Statsvetenskapliga institutionen, Göteborgs universitet, Göteborg.
- Biel A. 2003. Environmental behaviour: changing habits in a social context. In Biel A et al. (eds). *Individual and Structural Determinants of Environmental Practice*. Ashgate Publishing, London.

International Scientific Conference on "Energy systems with IT" in connection with the
Energiting 2009, March 11-12 at Älvsjö fair, Stockholm.

Bladh M, 2005. *Hushållens elförbrukning. Utvecklingen totalt och i detalj, 1980-2000*. Arbetsnotat 291:2005, Tema T, Linköping University, Linköping.

Brown L R, 2008. *PLAN B 3.0. Uppdrag: Rädda Jorden!* Addera förlag, Stockholm.

Carlsson-Kanyama A & A-L Lindén, 2001. Trends in food production and consumption: Swedish experiences from environmental and cultural impacts. *International Journal of Sustainable Development*, vol 4/4, pp.392-406.

Carlsson-Kanyama A, Lindén A-L & B Eriksson, 2003a. *Hushållskunder på energimarknaden. Värderingar och beteenden*. Rapport 2004:2, Sociologiska institutionen, Lunds universitet, Lund.

Carlsson-Kanyama A, Lindén A-L & B Eriksson, 2003b. Residential energy behaviour: Does generation matter? *International Journal of Consumer Studies*, vol. 29, 239-253.

Ellegård K, 2008. Hushåll, energi och vardagliga aktiviteter – ett perspektiv på effektivisering av energianvändning på individnivå. In K Ellegård & J Palm (eds), *Energi och IT. Forskning om hållbar användning av samhällets IT- och energisystem*. Carlssons, Stockholm.

Energimyndigheten, 2007. *Energiläget i siffror*. Eskilstuna.

EU 2004. *How Europeans spend their time. Everyday life of women and men*. Data 1998-2002. Eurostat, Theme 3, Population and social conditions, Brussels.

Gram Hansen K. 2003. *Domestic electricity consumption – Consumers and appliances*. Paper, Nordic Conference on Environmental Social Sciences (NESS), June, Turku/Åbo.

Karlsson K & J Widén. 2008. *Hushållens elanvändningsmönster identifierade i vardagens aktiviteter*. Tema T, Linköpings universitet, Linköping.

Lindén A-L. 1994. *Framtidens pensionärer och deras boendeplaner*. Forskargruppen Boende och bebyggelse, Sociologiska institutionen, Lunds universitet, Lund.

Lindén A-L. 1996. Från ord till handling. Individuella möjligheter och samhälleliga restriktioner. In L J

Lundgren (red), *Livsstil och miljö. Fråga, forska, förändra*. Naturvårdsverket förlag, Stockholm.

Lindén, A-L. 2004. *Miljömedvetna medborgare och grön politik*. T7:2004, Formas, Stockholm.

Lindén A-L. 2007a. *Värme i bostäder – en kvantitativ analys av energiförbrukning*. Sociologiska institutionen, Lunds universitet, Lund.

Lindén A-L, 2007b. *Hushållens energianvändning och styrmedelsstrategier*. ER 2007:41, Energimyndigheten, Eskilstuna.

Lindén A-L, 2008a. *Hushållsel. Energieffektivisering I vardagen*. Research Report 2008:5. Department of Sociology, Lund University, Lund.

International Scientific Conference on "Energy systems with IT" in connection with the Energiting 2009, March 11-12 at Älvsjö fair, Stockholm.

Lindén A-L, 2008b. Producenter av elprylar behöver tänka om. *Husbyggaren* 5/2008.

Mannheim K, 1952. *Essays on the Sociology of Knowledge*. Routledge, London.

NV, 2007. Rapport 5760. *Allmänheten och klimatförändringen*. Naturvårdsverket, Stockholm.

STEM, 2001. *Minska energikostnaderna i ditt hus*. Eskilstuna.

STEM, 2008. <http://www.energimyndigheten.se>

Strandbakken P, 2007. *Produktlevetid og miljø*. Universitetet i Tromsø, Samhällsvetenskapelige fakultet, Tromsø.

Warde A, 2005. Consumption and Theories of Practice. *Journal of Consumer Culture*, vol 5/2, pp. 131-153.

www.energimyndigheten.se

www.scb.se/databases/

www.vaxjo.se/vaxjo_templates/Page.aspx?id=6255

Paper No. 4

**The role of energy advisors on adoption of energy efficiency measures in detached
houses**

Krushna Mahapatra, Gireesh Nair and Leif Gustavsson

Ecotechnology, Mid Sweden University, SE-83125 Östersund, Sweden

krushna.mahapatra@miun.se; gireesh.nair@miun.se; leif.gustavsson@miun.se

Tel: +46-63 165931, Fax: +46-63 165500

Abstract

External actors can influence potential adopters to adopt energy efficiency measures. In Sweden energy advisers are one such actor group who provides energy advice and information to the end users. Currently, all municipalities offer energy advisers' service. The success of such service for improvement of energy efficiency of detached houses depends on homeowners' perception towards it. In this context we conducted a national survey of about 3000 owners of detached houses through stratified random sampling method in 2008 summer. We found that majority of owners' of detached houses consider energy advisers as an important source of information. Furthermore, many homeowners who contacted energy advisers for advice had implemented the suggestions. However, only a few homeowners had actually contacted energy advisers. Our findings suggest that it is beneficial to continue the energy adviser service, but more efforts are needed to increase homeowners' awareness of and satisfaction with such services.

Keywords: Energy advisers, homeowners, energy efficiency

INTRODUCTION

Individuals make many decisions in their day to day life with variety of complexity, from easy decision like choosing the breakfast to more difficult ones like purchasing costly household equipment. Individuals give more weight to advice in a difficult decision situation compared to an easy one (Gino and Moore, 2007) as difficult decisions are usually associated with adoption of unfamiliar and investment intensive products. In such situations individuals seek advice to reduce high level of cognitive dissonance. External advice may help the potential consumer to clear their thoughts about the decision and improve their decision confidence (Heath and Gonzalez, 1995). Individual purchase decisions are mental exercise that may be influenced more by inputs from external sources.

Adoption of many energy efficiency and renewable energy measures (henceforth, “energy measures”) in detached houses, for example, replacing oil and electric heating systems with district heating, heat pumps or wood pellet boilers, improved wall/attic/basement insulation, and installation of energy efficient windows reduce greenhouse gas emissions that causes climate change. However, lack of information or awareness about such measures reduces their adoption by homeowners (Owens and Driffill, 2008; Birner and Martinot, 2005). Furthermore, potential adopters may have difficulties in perceiving the advantages of adopting such measures if the

economic gains are delayed or insignificant. This problem may be further accentuated in situations where homeowners do not receive the metered energy bill on a regular basis²³. Following the definitions of Rogers' (2003), energy efficiency measures may be termed as preventive innovation. Preventive innovations diffuse slower than normal innovations because the level of awareness and understanding of the advantages about such innovations is usually lower than that of normal innovations.

Homeowners rely on mass media and interpersonal sources to collect information and suggestions. Mass media communications like television (TV) or newspaper advertisement are more likely to influence the adoption decision of innovators and early adopters who together constitute a small percentage (about 16%) of the total potential adopters (Rogers, 2003). However, for the majority of potential adopters interpersonal sources like relatives, friends and peers are reliable sources for information on an innovation (Rogers, 2003; Arndt, 1967; Bearden et al, 1989; Midgley, 1983).

Informational influence may happen in two ways; either the individuals seek information from experts or they observe the behaviour of others and make inferences (Whan and Lessig, 1977). These experts are termed as change agents who influence the decision of a potential adopter in a direction desirable by the change agency (Rogers, 2003). In Sweden, local authority energy advisers (henceforth "energy advisers"), operating in all municipalities, are change agents on behalf of the state to influence homeowners to adopt energy efficiency measures. Homeowners may contact an energy adviser to reduce the burden of collecting information from number of sources and interpreting the vast amount of information.

The energy adviser concept was introduced in Sweden more than 30 years ago. During 2003-2007 the energy advisors in the municipalities have received state support of approximately 40 million euro i.e., 8 million euros per year (STEM, 2009). Owners of detached houses are the main target group of the energy advice service (Khan, 2006), but empirical understanding of homeowners' perception of such a service is mostly lacking. Some studies showed that homeowners did not give high priority to energy advisers while installing innovating heating systems such as brine/water-based heat pumps, district heating or pellet boilers (Mahapatra and Gustavsson, 2009; Mahapatra and Gustavsson, 2008; Nilsson, 2004; STEM, 2005; Vinterbäck, 2000). But, more studies are needed to understand the role of energy advisers in diffusion of energy measures. This study contributes to such an understanding through an analysis of homeowners' response to a questionnaire survey on adoption of energy measures to reduce their household thermal energy use.

²³ Traditionally, electricity and district heat suppliers in Sweden provide their customers a quarterly bill with an estimation of energy use and the cost involved, and the bill with the metered energy use and associated cost is usually provided once in a year. However, new regulations require the suppliers to provide monthly bills of actual energy use and associated cost. Moreover, smart meters are also started to be installed so that consumers can track real time energy use.

CONCEPTUAL FRAMEWORK

Homeowners pass through number of stages while implementing advices of an energy adviser (Figure 1). First of all they must have a need for adopting an energy measure (Rogers, 2003). A need is created if homeowners recognize a problem (Hawkins et al, 2007) with existing energy use or installations. Once a need is felt, homeowners may seek information or advice due to lack of knowledge about available energy measures or to get assurance about their anchored decision. In this paper we have excluded these two steps from empirical analysis and concentrated on the following steps which are enclosed in dotted lines in Figure 1.

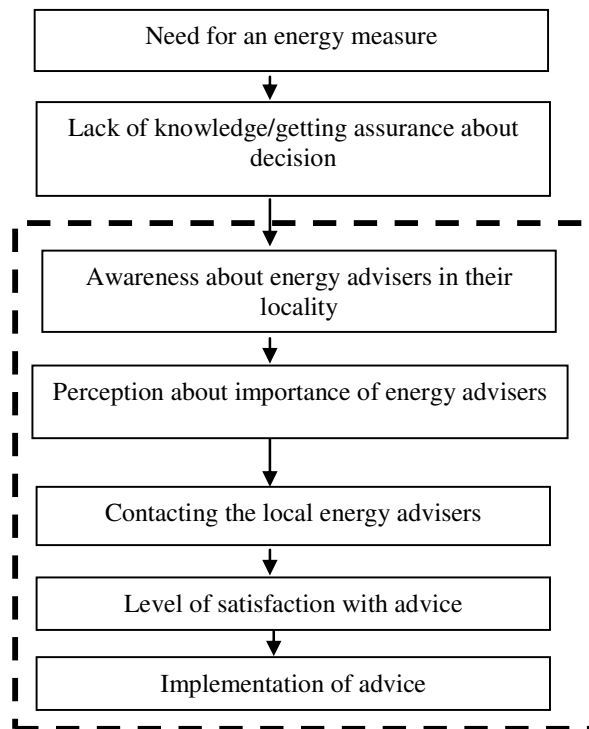

Figure 1: Steps in homeowners' implementation of advice of an energy adviser.

Homeowners collect information on energy measures from mass media and interpersonal sources. However, the available information could be too little or irrelevant for decision making. There could also be vast amount of information available about various energy measures, but individuals due to their limitation of acquiring, processing and retaining such information may find it difficult to choose the appropriate alternatives (termed as bounded rationality). Hence, they may contact change agents such as energy advisers, installers, construction firms, energy suppliers etc. Energy advisers are contacted to learn about several aspects of energy system, but more often about heating systems, subsidies, energy saving (STEM, 2007). An installer, construction firm, or energy supplier may provide information specific to their product or service.

In any case, homeowners' willing to seek advice or collect information from change agents must be aware of existence of such actors in their locality. The “locality” aspect is important because it is easy for the homeowners to make a personal visit to a local energy adviser to have a detailed discussion about energy related issues. They could use email or telephone service to

contact an energy adviser located far away, but such contacts may not be effective for complex problems.

Awareness is necessary, but not a sufficient condition for homeowners to contact an energy adviser. The probability of contacting a specific change agent depends on homeowners' perception of obtaining required and trustworthy information from such sources. The trustworthiness of a change agent working without profit motive (e.g. state agents or non-governmental organizations) is higher than one (e.g. marketing agents) working for profit motive (Rogers, 2003). Hence, theoretically, energy advisers should be contacted for impartial advice. However, if homeowners perceive that the quality of advice or information provided is not good (for example through negative feedback from other homeowners) then they may not contact the energy adviser. Furthermore, irrespective of a positive perception, homeowners may not actually contact an energy adviser if they do not have a need for implementing an energy measures.

Homeowners' implementation of advice from energy advisers depend on their level of satisfaction with such advices. If homeowners perceive that the quality of energy advice is not satisfactory then they may not implement the suggestions.

ENERGY ADVISER SERVICE IN SWEDEN

1.1.1. The concept

In Sweden energy advice services are provided by some energy companies, a few consultants, but mainly by all municipalities. Providing energy advice service through municipality operated energy advisers is an informative policy instrument used by the Swedish government. The objective is to provide free and impartial information to end users on energy issues and also about energy policy instruments (e.g. subsidies) (Khan, 2006). Some authors claim that the role of energy advisers has evolved more to inform homeowners about subsidies and taxes, but technical advice to reduce energy use were still important function (Nilsson and Mårtensson, 2003).

Since the late 1970s, municipalities have formulated energy plans periodically with an objective to improve energy efficiency, reduce oil use, and increase use of renewable energy sources (Nilsson and Mårtensson, 2003). Provision of energy adviser service to the end users helps achieve the objectives of energy plans. Municipalities either employ or hire energy advisers comprising of both full time and part time workers. The Swedish Energy Agency (STEM) manages the fund and provides training materials. Regional Energy Agencies coordinate the activities of energy adviser in their respective regions.

The work of energy adviser is heavily dependent on central subsidy as only a small percentage of municipalities support them with some sort of financial assistance. There is large difference between different municipalities' attitude towards energy advice, while some take it very seriously, others consider it just to avail some extra monetary gain from the centre (Khan, 2006).

1.1.2. History

The energy advice service in Sweden is now three decades. This service was introduced as a reaction to the oil crises in the 1970s. Swedish government gave subsidies to municipalities for providing advice to homeowners on energy related issues. The subsidies were available from

1977 – 1986 and almost all municipalities had some form of energy advice service (Khan, 2006). In 1986, subsidies were withdrawn as the central government expected that the municipalities would support such services on their own (Swedish Government, 1996). But, majority of the municipalities withdrew the services. In 1998 the subsidies for energy advice service were reintroduced by the central government under the local energy advice programme (LEAP). The potential clients for the programme were identified as households, local companies and local organization, but in practice single family detached houses were the main target group (Khan, 2006). The first phase of the LEAP programme was from 1998 – 2002 after which it continued for the second phase from 2003 – 2007. Under the LEAP programme all municipalities receive an annual grant for employment of energy adviser service. The grant covers at least a half time employment of an energy adviser, and the budget is allocated such that all 290 municipalities can avail such subsidy (Khan, 2006). Swedish government has decided to extend the programme for another three years from 2008 – 2010. At this moment (January 2009) the future of energy adviser service post-2010 is not known.

METHODOLOGY

We used a questionnaire survey to understand more about the perception of owners of detached houses about energy advice service. Several questions on homeowners’ perception of energy advisers were included in a questionnaire that was used mainly to gather information about homeowners’ attitude towards implementation of energy measures. Stratified random sampling method was used and the survey was conducted through Statistics Sweden during May –July 2008. Sweden is divided into 8 Nomenclature of Territorial Units for Statistics (NUTS) region and the questionnaire was sent to a sample of owners of detached houses in each of these NUTS region. The total number of questionnaire sent out was 3059 and after two reminders the response rate was about 36%.

Table 1: Composition of respondents in the original sample and those who responded, with respect to NUTS regions, age of house, age of homeowner, and annual household income.

NUTS Region	Age of house		Homeowner’s age			Annual household income					
	SH ¹ (N=3059) (%)	RC ¹ (N=1100) (%)	Age group (years)	SH ¹ (N=3013) (%)	RC ¹ (N=1087) (%)	Age group (years)	SH ¹ (N=3039) (%)	RC ¹ (N=1093) (%)	Income group (1000 SEK)	SH ¹ (N=3047) (%)	RC ¹ (N=1070) (%)
Stockholm county	13	11	≤5	7	6	≤35	8	5	≤ 150	4	2
Eastern-Central Sweden	13	13	6-15	10	9	36-45	21	17	150-300	15	14
Småland and the islands of Öland & Gotland	13	12	16-25	20	17	46-55	23	21	300-450	22	22
Southern Sweden	13	13	26-35	25	25	56-65	26	31	450-600	24	25

Western Sweden	13	12	36-50	17	20	>65	22	26	> 600	35	35
North-Central Sweden	13	13	>50	21	22						
Central Norrland	12	14									
Upper Norrland	12	12									
Total	100	100		100	100		100	100		100	100

1) SH = Sampled homeowners, RC= Respondent category

Since about 64% of the original sampled homeowners (SH) did not return the questionnaire there could be a non-response bias, i.e. a particular category of the survey recipients did not answer. The higher the refusal rate, the more important it is to ascertain whether the refusals are concentrated in certain groups (Weisberg, et al., 1996). We compared the composition of sampled homeowners with those who responded regarding NUTS region, age, and income (Table 1). No significant non-response bias was found from the above comparisons, except that homeowners below 45 years were under-represented and those older than 55 years were over-represented.

RESULTS

In the following we present the results of homeowners’ responses to questions on various aspects of energy advisers. Results are presented according to the conceptual framework outlined in Figure 1.

2. Awareness

Homeowners were asked if there exists any energy adviser in their locality. About 50% of respondents mentioned “yes”, while 7% indicated that there was no energy adviser service in their locality. Significantly, 43% of respondents reported that they “did not know” about the existence of such services in their locality. However, most respondents seem to be aware about the term “energy adviser” as 936 out of about 1100 respondents answered to a question on their perceived importance of energy advisers as a source of information on energy measures (see Table 2).

2.1.1. Perceived importance

Homeowners may consult various sources for collecting information prior to the implementation of energy measures. The extent to which a particular source will be consulted will depend on the perceived importance of such a source. Our survey (Table 2) showed that respondents consider interpersonal sources as the most important source of information when deciding to adopt energy measures to reduce the thermal energy use of buildings. Construction companies and material suppliers, and energy advisers were the second and third most important sources for information. Mass media channels such as advertisement in TV and home-delivered leaflets are of least importance.

Table 2: Homeowners’ perceived level of importance of various sources of information on energy measures to reduce household thermal energy use

Sources of information	Total survey respondents			Respondents who improved attic/wall/basement insulation, or installed a door/window during the last 2 years		
	N ¹	Mean	(S.E.) ²	N ¹	Mean	(S.E.) ²
Interpersonal sources	940	3.58	(0.037)	125	3.66	(0.109)
Construction companies/material suppliers	916	3.45	(0.051)	124	3.51	(0.112)
Energy adviser	936	3.25	(0.043)	125	3.04	(0.126)
Installers/vendors	903	3.13	(0.041)	121	3.23	(0.109)
Internet	887	3.04	(0.045)	121	3.19	(0.127)
Energy supplier	902	2.98	(0.041)	122	3.03	(0.113)
Vi i Villa magazine	924	2.86	(0.037)	124	2.86	(0.110)
Visiting a house to see the installation	916	2.83	(0.046)	123	2.72	(0.132)
Swedish Energy Agency	900	2.73	(0.041)	123	2.55	(0.112)
Exhibitions	907	2.57	(0.040)	122	2.53	(0.101)
Advertisement in TV	901	2.09	(0.033)	119	2.02	(0.087)
Home delivered leaflets	888	1.98	(0.034)	120	1.91	(0.086)

1) N = Number of respondents

2) Mean values are based on homeowners’ ratings using an ordinal scale of 1 = Not important, 5 = Very important. Hence, an information source with a higher mean value is of greater importance. S.E. = Standard error

The level of importance attributed to various sources of information could vary between the general population and those who actually retrofitted a building component. Results presented in Table 2 show that the ranking of the various sources of information, based on the mean values, was almost same among the general respondents and those who have installed a door or window, or improved the existing attic/wall/basement insulation during the last two years (i.e. since 2006). One exception is that, compared to the total survey respondents, respondents who have installed a building component gave a higher priority to installers/vendors and the internet than the energy advisers.

Respondents having different socio-demographic characteristics accorded varying level of importance to the sources of information (Table 3). For example, respondents who lived in

Stockholm county, university educated or less than 45 years old gave significantly higher priority to interpersonal sources, compared to the average importance attributed to that source by the total respondents. Similarly, energy advisers were more important for respondents who were more than 55 years old. Construction companies or Swedish Energy Agency was equally important for all groups of respondents.

Table 3: Socio-demographic groups which attribute significantly greater importance to an information source, compared to the average importance given to that source by the total respondents¹

Sources of information	Respondents' socio-demographic characteristics					
	NUTS Regions	Gender	Education	Age	Household income	
Interpersonal sources	Stockholm	Female	University	<45 years	>450 kSEK	
Construction company						
Energy advisor						>55 years
Installer			Basic			
Internet			University	<45 years		
Energy supplier			Basic			
Vi i Villa		Male		<36 years		
Visit a house				>65 years		
Swedish Energy Agency						
Exhibitions						
Advertisement in TV and						<36 or >65
Home-delivered leaflets						<36 years

1) Based on significance ($p \leq 0.05$) of chi-square statistic of crosstab between the variables “level of importance (5 levels)” of an information source and each “socio-demographic” characteristics of the respondents (8 NUTS regions, 2 gender groups, 3 levels of education, 5 age groups, 5 income groups)

Respondents who consulted a specific source of information accorded highest importance to that source without any major change in importance attached to other source. For example, respondents who contacted construction companies and material suppliers considered that source as of most importance. Similarly, energy advisers were most important for those respondents who contacted them. Respondents who contacted an energy supplier however, did not accord highest level of importance to that source.

2.1.2. Actual contact

Homeowners may be aware of a specific source of information, to which they may also accord higher importance, but still they may not actually consult that source. For example, we found that 25% of those who were aware about energy adviser service in their locality had ever consulted an energy adviser. Similarly, 48% of the survey respondents considered that energy advisers were important source of information on energy measures, but about 14% of the respondents had ever

contacted an energy adviser (Table 3). A greater proportion contacted builders/material supplier/installers (about 21%) and supplier of heat (18%) than an energy adviser.

Furthermore, homeowners who actually made changes in their building envelop were more likely to consult a specific source than the total survey respondents (Table 3). The proportion increased by 10% for builders/ material supplier/installers and 6% for energy advisers. Still, 70 to 80% did not consult these sources while retrofitting the building envelope.

Table 3: Percentage of respondents who ever contacted an information source to learn about household energy issues

Sources of information	Total survey respondents	Respondents who improved attic/wall/basement insulation, or installed a door/window during the last 2 years
Builders/ material supplier/installers	21 (N ¹ = 225)	31 (N = 41)
Energy adviser	14 (N = 154)	20 (N = 27)
Heat energy supplier	18 (N = 191)	17 (N = 23)

1) N = Number of respondents who contacted the respective source

2.1.3. Level of satisfaction with suggestions

Respondents’ perceived importance and degree of contact with builders/material suppliers/installers was higher than for energy advisers. This could be because the average proportion of respondents who thought that the suggestions of a particular source of information, to which they have consulted, were of good quality was higher for builders/material supplier/installers (62%) than for energy advisers (52%) (Table 4). A greater proportion of respondents in Upper Norrland (69%), who consulted an energy adviser, thought that the energy adviser’s suggestions were of good quality, while it was 62% in North-Central and 44% in Central Norrland NUTS regions.

Table 4: Percentage of respondents attributing quality of suggestions provided by various sources of information

Sources of information	Quality of suggestion		
	Good	Neither good nor bad	Bad
Builders/ material supplier/installers (N ¹ =207)	65.7	27.1	7.2
Energy Adviser (N=148)	54.0	32.4	13.6
Heat energy supplier (N=163)	49.0	36.2	14.8

1) N = Number of respondents who contacted the respective source and answered about quality of the suggestions

2.1.4. Implementation of suggestions

About 57% of respondents who consulted the energy advisers, especially those who thought that the suggestions were of good quality (69%), had implemented the energy adviser's suggestion. Those who did not implement the suggestions reasoned that the suggestions were not specific (21%) or already implemented (24%) or expensive to be implemented (33%).

Energy advisers have an important role to provide information about government programs (e.g. subsidies) to reduce energy use. Therefore, we analyzed if the proportion of respondents aware about government programs varied between those who consulted an energy adviser and the respondents in total. We found that the awareness level about government programs was higher among the respondents who consulted an energy adviser (53%) than the total survey respondents (38%).

DISCUSSION AND CONCLUSIONS

Availability of information and provision of expert advice improves the judgment accuracy of the potential adopters (Sniezek et al, 2004; Yaniv and Kleinberger, 2000). Homeowners, who intend to implement energy measures, could collect information and seek advice from various sources. Among them, energy advisers are important because they are mandated to provide impartial information without any profit motive. Our results showed that 14% of the respondents, or 23% of those who retrofitted their building envelop components during the last 2 year, have ever contacted an energy adviser. A study in 2007 also showed that about 14% of homeowners would contact an energy adviser for heating system related information (Mahapatra and Gustavsson, 2008). However, STEM (2008) reported that about 5% of Swedish adults contacted an energy adviser annually, but the report did not show how many have contacted an energy adviser ever.

A significant percentage of potential homeowners who might gain from interaction with energy advisers do not contact them for information/suggestion. One of the reasons for this could be low awareness about energy adviser service. Our results showed that 50% respondents were aware about the existence of such a service in their locality. However, STEM (2008) found that 35% of Swedish adults in 2007 were aware about availability of energy advice service in their municipality. One option to increase homeowners' awareness and interaction with energy advisers is to involve energy advisers in the processing of homeowners' applications for various investment subsidies. This will encourage more homeowners to contact energy advisers and learn about energy measures.

About 25% of respondents who were aware about energy adviser service and 25% of those who perceived energy adviser as important source for information ever contacted an energy adviser. Hence, even if respondents to our survey were aware of and giving importance to energy advisers, still they did not consult the advisers. This could be because they did not have a need for an energy measure. Nair et al. (2009) and Mahapatra and Gustavsson (2008) reported that more than 70% of the Swedish homeowners did not intend to implement building envelope energy measures or heating system measures, respectively.

About 48% respondents, particularly those who contacted an energy adviser, and 58% of the Swedish adults (STEM, 2008), considered that energy advisers were an important or a very important source of information on energy measures. Hence, this service has a good potential to influence the homeowners to adopt energy measures. However, a greater proportion of respondents thought that builders, material suppliers or installers were an important or a very important source of information on energy measures. Mahapatra and Gustavsson (2008) also found that installers were the most important source of information on heating system. This result also invalidates Rogers' (2003) assumption that profit oriented marketing change agents have less credibility in the eyes of customers. Builders, material suppliers or installers could be motivated to provide comprehensive information about energy measures, but they may not provide impartial information as they would be interested to promote their own product/service. Mass media channels may be less effective because they were considered as less important.

Homeowners may give priority to builders, material suppliers or installers while implementing a building envelope measures because these actors visit homes and indulge in interpersonal communication (the most important source of information according to our results) to make on-the-spot assessment of homeowners' requirement of various energy measures. If energy advisers would make home-visit, which is not the case currently, they might improve their influence on homeowners. Furthermore, energy advisers could interact with builders, material suppliers or installers to learn from each others experience and share latest knowledge on energy efficiency measures in buildings. Swedish Energy Agency encourages energy advisers to work on activities like meetings with community groups and electricians and other professionals who have influence on homeowners' adoption decision on energy measures so as to increase their client base (Khan, 2006). However, at present such interactions by energy advisers are not common (STEM, 2007).

It is difficult to measure the impact of energy adviser service with regard to adoption of energy measures due to several reasons. There are monitoring challenges as advice is provided to thousands of homeowners across Sweden. Furthermore, it is difficult to distinguish the influence of an information policy instrument from other instruments like subsidies (Khan, 2006). Nevertheless, extrapolating our survey findings, it may be roughly estimated that about 8% of owners of detached houses in Sweden were influenced by energy advisers. Out of 14% respondents who contacted them, 57% implemented the suggestions. STEM (2008) reported that about 9% of the Swedish adults in 2007 thought that energy advisers' suggestion was important in their decision to make energy related investments²⁴. This result is questionable since, only 5% of the respondents to that survey actually consulted an energy adviser. Another indication of energy advisers' influence on our survey respondents is that the level of awareness about government support is more among the respondents who contacted energy advisers compared to the general sample.

One of the factors that influence the implementation of suggestions is customer's perception of the quality of the advice (Jungermann, 1999; Harvey et al, 2000). Typically, customers

²⁴ 16% of the (ca) 53% of the survey respondents (STEM, 2008), who purchased an energy product/service, (≈9% of the population) reported that energy advisers' suggestion was important or very important in their decision.

dissatisfied with a product or service engage in more interpersonal communication compared to satisfied customers (Hawkins et al, 2007), and exposure to unfavourable comments results in reduced purchase of a new product (Arndt, 1967). We found that about 54% respondents considered that the suggestions of energy advisers were of good quality. This mean 46% were not satisfied with the suggestions, which could be one of the reasons why majority of homeowners did not implement such suggestions. Moreover, unsatisfied homeowners may create an unfavourable image of energy advisers among his/her peer and friends circle through interpersonal communication, which was given highest importance by the respondents. Hence, steps might be taken to improve the communication skills and knowledge of energy advisers. The current situation where there are no standard requirements for a person to be recruited as an energy adviser might be amended. Better quality suggestions will increase the number of homeowners satisfied with the energy advisers, who could spread their knowledge through interpersonal communication.

ACKNOWLEDGEMENT

The authors gratefully acknowledge financial support provided by European Union and Swedish Energy Agency.

REFERENCES

- Arndt, J., 1967. Role of product-related conversations in the diffusion of a new product. *Journal of Marketing Research* IV, 291-295.
- Bearden, W.O., Netemeyer, R.G., Teel, J.E., 1989. Measurement of consumer susceptibility to interpersonal influence. *Journal of Consumer Research* 15 (1), 473-81.
- Birnera, S., Martinot, E., 2005. Promoting energy-efficient products: GEF experience and lessons for market transformation in developing countries. *Energy Policy* 33, 1765–1779.
- Gino, F., Moore, D, A., 2007. Effects of task difficulty on use of advice. *Journal of Behavioral Decision Making*, 20, 21-25.
- Harvey, N., Harries, C., Fischer, I., 2000. Using advice and assessing its quality. *Organizational Behavior and Human Decision Processes* 81(2), 252–273.
- Hawkins, D.I., Mothersbaugh, D. L., Best, R.J., 2007. *Consumer Behavior: Building Marketing Strategy*. McGraw – Hill/Irwin, New York, USA.
- Heath, C., Gonzalez, R., 1995. Interaction with others increases decision confidence but not decision quality: Evidence against information collection views of interactive decision making. *Organizational Behavior and Human Decision Process* 61(3), 305-326.
- Jungermann, H., 1999. Advice giving and taking. In *Proceedings of the 32nd Hawaii International Conference on System Sciences (HICSS-32)*, 5-8 January, Maui, HI.
- Khan, J., 2006. Evaluation of the local energy advice programme in Sweden: Within the framework of the AID-EE project, Lund university, Lund.
- Mahapatra, K., Gustavsson, L., 2008. An adopter-centric approach to analyze the diffusion patterns of innovative residential heating systems in Sweden. *Energy Policy* 36, 577–590.

International Scientific Conference on “Energy systems with IT” in connection with the Energiting 2009, March 11-12 at Älvsjö fair, Stockholm.

- Mahapatra, K., Gustavsson, L., 2009. Influencing Swedish homeowners to adopt district heating system. *Applied Energy* 86, 144-154.
- Midgley, D.F., 1983. Pattern of interpersonal information seeking for the purchase of a symbolic product. *Journal of Marketing Research* 20, 74-83.
- Nair, G., Gustavsson, L., Mahapatra, K., 2009. Adoption of energy efficiency measures in Swedish detached houses. *International Scientific Conference on Energy systems with IT*, 11-12, March, Stockholm, Sweden.
- Nilsson, J., 2004. The choice of new heating systems for the owners of detached houses – information and arguments [Småhusägarnas val av nytt uppvärmningssystem – information och argument]. Ecotechnology division, Mid Sweden University, Östersund, Sweden (in Swedish).
- Nilsson, S, J., Mårtensson, A., 2003. Municipal energy-planning and development of local energy systems. *Applied Energy*. 76, 179-187.
- Owens, S., Driffill, L., 2008. How to change attitudes and behaviours in the context of energy. *Energy Policy* 36, 4412–4418.
- Park, C.W., Lessig, V.P., 1977. Students and housewives: Differences in susceptibility to reference group influence, *Journal of Consumer Research* 4 (2), 102-110.
- Rogers, E., M., 2003. *Diffusion of Innovations*. The Free Press, New York.
- Sniezek, J, A., Schrah, G, E., Dalal, R.S., Sniezek, J.A., Schrah, G.E., 2004. Improving judgment with prepaid expert advice. *Journal of Behavioral Decision Making* 17, 173 -190.
- STEM, 2005. Questionnaire and field survey of bedrock heat pumps [Enkät- och fältundersökning av bergvärmepumpar]. Swedish Energy Agency, Eskilstuna, www.energimyndigheten.se (in Swedish).
- STEM, 2007. Follow-up of municipality energy advise service in 2007 [2007 års, uppföljning av den kommunala energirådgivningen]. ER 2008:13, Swedish Energy Agency, Eskilstuna (in Swedish).
- STEM, 2008. General public and municipalily energy advise service in 2007 [Allmänheten och den kommunala energirådgivningen år 2007]. Report ER 2008:11, Swedish Energy Agency, Eskilstuna (in Swedish).
- STEM, 2009. Local authority energy consultancy, Swedish Energy Agency, http://www.swedishenergyagency.se/WEB/STEMEx01Eng.nsf/F_PreGen01?ReadForm&MenuSelect=CEB6309E1E0B18AFC1256F02002D179E, accessed on April 7, 2009.
- Swedish Government, 1996. Sustainable energy supply [En uthållig energiförsörjning], Prop 1996/97:84 (in Swedish).
- Vinterbäck, J., 2000. Wood Pellet Use in Sweden: A System Approach to the Residential Sector. *PhD Thesis*, Swedish University of Agricultural Sciences, Uppsala, Sweden.
- Weisberg, H, F., Krosnick, J, A., Bowen, B, D., 1996. *An introduction to survey research, polling and data analysis*. Sage Publications, Thousand Oaks, California.

International Scientific Conference on “Energy systems with IT” in connection with the
Energiting 2009, March 11-12 at Älvsjö fair, Stockholm.

Yaniv, I., Kleinberger, E., 2000. Advice taking in decision making: Egocentric discounting and reputation formation. *Organizational Behavior and Human Decision Processes* 83(2), 260-281.

Paper No. 5

Perceptual and socio-economic factors in adoption of low energy houses

Krushna Mahapatra, Gireesh Nair and Leif Gustavsson
Ecotechnology, Mid Sweden University, SE-83125 Östersund, Sweden
krushna.mahapatra@miun.se; gireesh.nair@miun.se; leif.gustavsson@miun.se
Tel: +46-63 165931, Fax: +46-63 165500

Abstract

Diffusion of low energy houses reduces greenhouse emission from residential sector. However, adoption of such houses depends on the perception of the potential buyers. In this paper we have analyzed Swedish homeowners' perception of low energy houses. Data was collected in 2008 from a mail-in questionnaire survey of about 3000 owners of detached houses. Results showed that about 39% of respondents, especially young, educated or whose household income was high, would consider buying a low energy house. Majority of the respondents agreed that a low energy house in comparison to a conventional house has lower operating energy cost, but higher investment cost. Majority thought that low energy houses do not have lower resale value, lower aesthetic appearance, or greater operational difficulty.

Keywords: Low energy house, perception

INTRODUCTION

In the quest for reducing energy use and mitigate climate change increased attention is paid to energy efficiency of buildings, because this sector accounts for about 40% of the final energy use in Europe (European Commission, 2005). As operating energy constitutes a significant percentage of the total energy use in building life cycle, the importance of reducing it is widely acknowledged. In Sweden about 60% of final energy use in houses is for space heating and hot water applications. Increasing the market share of low energy houses, very low energy houses or passive houses can reduce the operating energy of residential sector in Sweden and over the past few years several such houses are being built. There are no standard international definitions to differentiate between these types of houses. Standards for low energy, very low energy or passive houses exist in Germany, Austria, Czech Republic, Denmark, United Kingdom, Finland and France (SBI, 2008). For example, the standards for a low energy house and a passive house in Belgium specifies that annual space heating demand should not be more than 30 kWh/m² and 15 kWh/m² (Audenaert, et al, 2008), respectively. But, this may vary depending on climate conditions (Wall, 2006). In Sweden, specifications for passive houses were finalized in 2008, according to which the maximum annual bought energy (excluding household electricity) in a detached house should not be more than 55 kWh/m² and 65 kWh/m² in south and north of Sweden, respectively (FEBY, 2008).

The first passive house was built in 1991 in Darmstadt, Germany. Till the end of 2007 about 10,000 such buildings, mostly residential houses, were built in that country (STEM, 2008a). In

Sweden the first passive house project consisting of 20 row houses was completed in 2001 in Lindås, located outside Gothenburg. Since then there has been steady increase in such constructions. Preliminary estimate suggests that a total of about 350 residential units were built till end of 2008 (see <http://www.passivhuscentrum.se> for a list of projects). Hence, market for passive houses is growing slowly. The development may be similar for low energy houses (energy use lower than the stipulated in the Swedish BBR regulation) in general, though no specific statistics are available. The market for passive houses in detached house segment is virtually non-existent with the first passive detached house built in 2007 at Lidköping.

There could be several factors influencing market development of low energy houses in Sweden. There is limited knowledge and competence among the building professionals to built passive houses (Berglund, 2007), but there is increased research and development work funded by Swedish government. Project developers, mostly municipality owned housing companies (STEM, 2008a), are showing increased interest to build low energy houses (FEBY, 2007). One important factor that contributes to market transformation of low energy houses is the perception of potential buyers towards such houses. For example, it was reported that in Alingsås town occupants of rented apartments, which were planned to be renovated to passive house standard, thought that renovation cost would be very high and therefore, there would be strong increase in monthly rents after the renovation (STEM, 2008b). Such negative perceptions could act as barrier for increased adoption of low energy houses. Hence, to improve the demand for low energy houses, it is important to understand people's perception of cost, aesthetics, indoor environment, etc of such houses. Therefore, we asked a few questions on this issue to about 3000 owners of detached houses, in a questionnaire survey on adoption of energy efficiency measures in their existing houses. In the questionnaire we asked about *low energy house* which is a widely used terminology and covers passive house.

The survey however was not conducted exclusively to study the perception of low energy house, but it was rather a part of the study to understand the perception of owners of detached houses towards implementation of energy efficiency measures. Furthermore, the survey participants already own house and therefore, they may not buy a new house. Consequently, they may not statistically representative the potential buyers of low energy houses. However, as they are part of the society, they may influence others in adopting low energy houses through interpersonal communication. Hence, it was important to understand the perception of this segment towards low energy houses.

THEORETICAL BACKGROUND

Decision to buy a new house is an important occasion to majority of people and their decision are influenced by a plethora of factors which include economic and social aspects. A pre-condition for adoption of any innovation is need for that innovation (Dieperink et al., 2004; Hawkins et al., 2007; Rogers, 2003; Mahapatra and Gustavsson, 2008) which arises when potential adopters recognize some problem with their existing belonging and therefore, feel dissatisfied with the same. Dissatisfaction with the existing house may be due to, for example, deteriorating physical condition of the house, high operating energy cost, and environmental concerns. However, concern for energy efficiency may not automatically encourage homeowners

to engage in activities to reduce household energy use (Ritchie et al., 1981; Curtis et al., 1984; Holden, 2005; Aune, 2007; Olsen, 1981; Viklund, 2004), especially to implement investment-intensive majors like purchasing a low energy house. Furthermore, homeowners must be aware of low energy houses, if they will buy such a house.

Homeowners intending to buy a low energy house are likely to make a comparative assessment with a conventional house. However, such assessments are rarely carried out under perfect information (Garrett and Koontz, 2008). This is because potential adopters have limited capacity to acquire, store, and process vast amount of information required to take a rational decision. This is termed as "bounded rationality" (Simon, 1959). Nonetheless, adopters collect information from various sources which form their beliefs or perceptions about various attributes, for example, location, size, economic, and aesthetic aspects of available housing options. Between a conventional and low energy house, the one with greatest perceived advantage, particularly regarding attributes to which adopters give high priority, will be adopted and recommended to others by interpersonal communication, leading to an increased number of adoptions (Rogers, 2003). In this paper we have analyzed homeowners' perception of five attributes of a low energy house vis-à-vis a conventional house: operating energy cost, investment cost, resale value, aesthetics, and operational difficulty.

Potential buyers may buy a low energy house because the required energy to operate the house and the associated cost is lower than a conventional house. However, other attributes of a low energy house must be at least similar to a conventional house. If potential buyers have negative perceptions towards low energy houses due to the specific design features, e.g. passive houses without conventional heating systems or specific orientations to attract maximum sunlight, they are less likely to buy such houses. Hence, we asked the homeowners to answer if they thought that low energy houses have higher investment cost, lower resale value, lower aesthetics or greater operational difficulty compared to a conventional house.

Homeowners' socio-demographic characteristics may influence demand for low energy houses. Homeowners with higher income are more likely to buy a low energy houses because such houses are usually more expensive than similar conventional house. Also, young homeowners may be more willing to buy a low energy house as they can expect the extra investment to be paid back during their life time. Similarly, the probability of buying a low energy house due to energy and environmental reasons is likely to increase with increased level of education of homeowners. Moreover, gender issues play a role in the family's house purchase decision making process (Levy et al., 2008).

METHODOLOGY

Survey research is a popular tool to gather information about individuals' attitudes, perceptions, preferences and socio-demographic characteristics. In this study we used mail-in questionnaire survey which imposes no time constraint for the respondents to reply, reduces interviewer induced bias, and improves anonymity (Rea and Parker, 2005). Stratified random sampling method was used to select the sample, because the population density in Sweden

typically decreases from south to north. The strata consisted of the eight Nomenclature of Territorial Units for Statistics (NUTS) regions in Sweden²⁵. Samples in each stratum were drawn in proportion to the size of the population. The survey was conducted through Statistics Sweden during May –July 2008. After two reminders, 36% of the 3059 sampled homeowners responded.

Table 1: Comparison of composition of respondents' in the original sample and those who responded with respect to NUTS regions, age of house, age of homeowner, and annual household income.

NUTS Region			Age of house			Homeowner's age			Annual household income		
	SH ¹ (N=3059) (%)	RC ¹ (N=100) (%)	Age group (years)	SH ¹ (N=3013) (%)	RC ¹ (N=1087) (%)	Age group (years)	SH ¹ (N=3039) (%)	RC ¹ (N=1093) (%)	Income group (1000 SEK)	SH ¹ (N=3047) (%)	RC ¹ (N=1070) (%)
Stockholm county	13	11	≤5	7	6	≤35	8	5	≤ 150	4	2
Eastern-Central Sweden	13	13	6-15	10	9	36-45	21	17	150-300	15	14
Småland and the islands of Öland & Gotland	13	12	16-25	20	17	46-55	23	21	300-450	22	22
Southern Sweden	13	13	26-35	25	25	56-65	26	31	450-600	24	25
Western Sweden	13	12	36-50	17	20	>65	22	26	> 600	35	35
North-Central Sweden	13	13	>50	21	22						
Central Norrland	12	14									
Upper Norrland	12	12									
Total	100	100		100	100		100	100		100	100

1) SH = Sampled homeowners, RC= Respondent category

As some 64% of the original sampled homeowners (SH) did not return the questionnaire there could be a non-response bias, i.e. a particular category of the survey recipients did not answer. The higher the refusal rate, the more important it is to ascertain whether the refusals are concentrated in certain groups (Weisberg, et al., 1996). We compared the composition of sampled homeowners with those who responded regarding NUTS region, age, and income (Table 1). No significant non-response bias was found from the above comparisons, except that homeowners below 45 years were under-represented and those older than 55 years were over-represented.

²⁵ The NUTS regions are: Stockholm County, Eastern-Central Sweden, Småland and the islands of Öland and Gotland, Southern Sweden, Western Sweden, North-Central Sweden, Central Norrland and Upper Norrland.

RESULTS

1.1.1. Preference to buy a low energy house

An indicator of demand for low energy house is potential buyer’s preference to buy such a house over a conventional house. To a question on “Would you consider buying a low energy house when planning to purchase a new house [kommer du att överväga at köpa ett lågenergihus om du bestämmer dig för att köpa ett nytt hus]”, 39% of the 1068 respondents answered “yes”, while 61% did not have any such intention. There could be several reasons why *majority of the homeowners would not consider buying a low energy house*. These include their awareness and concern to reduce household energy use, awareness and perceptions of low energy houses, and socioeconomic conditions.

1.1.2. Awareness and concern about household energy use and willingness to consider buying a low energy house

We asked the homeowners to report the *actual* quantity and cost of electricity used in their household during 2007. About 74% of the respondents could report the quantity, but only about 41% reported the actual cost. This indicates that homeowners are more aware about quantity than cost of household energy use. In fact about 23% did not know how much of their annual income goes towards energy use (Table 2). About 1/3rd of the respondents reported that they spend less than 5% of their income towards household energy use.

Table 2: Percentage of respondents reporting their share of income spent towards annual household energy use

Share of income for cost of energy	% of respondent
Do not know	22.8
less than 1%	3.6
1-5%	29.8
5-10%	31.3
More than 10 %	12.5
Total (N=1033)	100.0

Though there is a lack of awareness among the majority of respondents about the *actual* energy expenses, but to a question “what do you *think* about your annual cost of energy”, 97% could report their perceptions (Table 3). This shows that majority people do not make decisions based on perfect information, but based on perceptions. This corroborates the notion of “bounded rationality” discussed earlier. Respondents’ answers on a 5-point ordinal scale (1 = very high, 5 = very low) were reconstructed to a 3-point scale and presented in Table 3. About 32% respondents thought that their energy cost was high, while 25% thought that it was low.

Respondents who thought that their household energy cost was *high* were expected to be more inclined to consider buying a low energy house than those who thought that their energy cost was *low*. Results in Table 3 shows that 41% among the respondents who thought that their energy cost was high would consider buying a low energy house, while the percentage was marginally lower for the other category of respondent. Chi-square test showed that the relationship between the

variables “respondents’ perception of cost of household energy use” and their “willingness to consider buying a low energy house” was not significant. *Respondents among all categories of energy use (high, medium or low cost) were equally likely to consider buying a low energy house.*

Table 3: Respondents’ perception of cost of household energy use and their willingness to consider buying a low energy house

% of respondent reporting their perceived annual household energy cost		% of respondents in each level of perceived energy cost that would consider to buy a low energy house
High	32.3	41.0
Average	39.8	38.5
Low	24.5	38.7
Do not know	3.4	
Total (N=1072)	100.0	

One of the factors that may positively influence the decision to buy a low energy house is the homeowners’ attitude towards energy efficiency. We tried to understand this aspect through respondents’ answer to the question “how important is to reduce the energy use”. Their responses on a 5-point ordinal scale (1 = not important at all, 5 = very important) was reconstructed to a 3-point scale and presented in Table 4. About 62% mentioned that it was important for them to reduce household energy use (Table 4). About 44% among them would consider buying a low energy house, while 29% among the “less important” category would do so. *The proportion of respondents who would consider purchasing a low energy house increases significantly with increased level of importance of reducing household energy use.*

Table 4: Respondents’ level of importance of reducing household energy use and their willingness to consider buying a low energy house

% of respondents attributing their level of importance to reduce household energy use		% of respondents at each level of importance that would consider to buy a low energy house ¹
Important	62.5	43.6
Neither important nor unimportant	20.4	32.5
Less important	15.0	29.3
Do not know	2.1	
Total (N=1071)	100.0	

1) Chi-square test showed that the relationship between the variables “respondents level of importance of reducing energy use” and their “willingness to consider buying a low energy house” was significant at $p < 0.05$.

Even though majority of respondent stated that reducing energy use was important, significant proportion of them (about 56%) would not consider buying a low energy house. This means *people may not be willing to take investment-intensive measures to improve household energy efficiency.* This is further corroborated from respondents answer to how much money they have invested during the last two years to reduce household energy use. Only about 19% of

respondents made investments of more than 25000 SEK²⁶, while a significant 49% did not make any investment during the last two years to reduce their energy use (Table 5). There was no difference in investment behaviour of the overall sample and those stated that reducing energy use was important. Furthermore when asked what sort of action they *may* take to reduce their energy use, only about 36% reported to take any investment oriented measures, while the rest preferred no investment measures like switch off light or appliances, and reduce thermostat .

Table 5: Percentage of respondents indicating monetary investments they made during the last two years to reduce household energy use

Amount spent	% of respondents
0 SEK	48.9
< 5000 SEK	14.7
5001 - 25000 SEK	17.3
25001 - 75 000 SEK	11.0
75001 - 125 000 SEK	4.4
> 125 000 SEK	3.7
Total (N=1062)	100

1.1.3. Awareness about and willingness to consider buying a low energy house

Potential buyers contemplating to buy a house will deliberate upon the low energy house option only if they are aware about such houses. To the question “are you *aware* about low energy house [känner du till lågenergihus]”, 56% out of 1068 respondents reported that they aware of such houses while 44% were unaware (Table 6). Among the aware respondents, 48% might consider buying a low energy house. Interestingly, 27% of the unaware respondents would also consider buying such a house. This could be because they had some knowledge about low energy house but they did not consider that was enough to report that they were aware of such houses. This explanation is plausible since the number of respondents to specific questions (see Table 7) about low energy house (ranging from 830 to 856 i.e. about 80% of the respondents to our survey) was greater than the number of respondents (594) reporting that they were aware of such houses.

Table 6: Percentage of respondents, among those aware and unaware about low energy house, who would consider buying such a house

Aware about low energy house	Consider to buy a low energy house	
	Yes	No
Yes (N=572) ¹	48%	52%
No (N=444)	27%	73%

1) “N” represents the number of respondents who answered about both awareness of and intention to buy a low energy house. These numbers are less than the number of respondents who answered each aspect.

²⁶ €1 = (ca) 11 SEK in January 2009

1.1.4. Perception towards and willingness to consider buying a low energy house

Respondents were asked to report their level of agreement to a number of statements on comparison of a low energy house vis-à-vis a conventional house. Their response on a 5-point Likert scale (1 = do not agree at all, 5 = agree completely) was re-constructed to a 3-point scale. Percentages of respondents with various levels of agreement to a statement are presented in the columns with heading “% of N” in Table 7. For example, 68% of the respondents thought that low energy houses had significantly lower operating cost

Table 7: Percentages of respondents at various level of agreement on statements about low energy house (compared to conventional house), and percentages of respondents at each level of agreement willing to consider buying a low energy house.

Statements on low energy house	Agree		Neither agree or disagree		Disagree	
	% of 'N'	% consider buying	% of 'N'	% consider buying	% of 'N'	% consider buying
Operating energy cost is much lower (N=856) ¹	68.0	50.4	16.7	32.8	15.2	25.6
Purchasing price is higher (N=836)	66.5	43.0	24.5	48.3	9.0	40.3
Resale value is lower (N=831) ¹	11.6	34.4	26.1	31.3	62.3	51.9
More difficult to operate (N=830) ¹	15.3	36.9	33.0	38.2	51.7	50.2
Aesthetic appearance is worse (N=834) ¹	15.6	27.1	31.5	37.2	52.9	53.2

1) Chi-square test shows that the relationship between respondents level of agreement to the statement and their willingness to consider buying a low energy house was significant at $p < 0.05$. N = Number of respondents.

compared to a conventional house, but 67% thought that investment cost was higher²⁷. Except for investment cost, majority of the respondents did not have a negative opinion towards other aspects of low energy house. About 62% disagreed that resale value was lower and about 50% each disagreed that aesthetic appearance was lower or operational difficulty was greater. In other words, such percentages of respondents thought that low energy houses have at least similar resale value, aesthetic appearance or operational difficulty as a conventional house. These categories of homeowners may consider buying a low energy house because such houses additionally have lower operating energy cost.

A significant 40% to 50% of the respondents had no clear opinion or a negative opinion towards aesthetics, operational difficulty or resale value of low energy house. This figure was

²⁷ In the 12 CEPHEUS projects completed in 2001, the average additional expenditure incurred to construct the buildings to passive house standard was 8% of the total building cost, however in some of the demonstrative passive houses constructed in Sweden the difference in cost was higher (Janson, 2008). However, it may be economical to make a house to passive house standard, when a major renovation is due (Janson, 2008).

30% for operating energy cost. The respondents are less likely to purchase a low energy house than those who are convinced that such houses have similar attributes as a conventional house. In columns with heading “% consider buying” in Table 7, we present the percentages of respondents, among each level of agreement to a statement on low energy house, who were willing to consider buying a low energy house. For example, about 50% of the 68% of respondents, who “agreed” that operating cost of low energy house was lower, would consider buying such a house, while only 25% of the 15% of the respondents, who “disagreed” that operating cost of low energy house was lower would buy such a house. Chi-square test showed that the relationship between respondents level of agreement to the statement on operating cost of low energy house and their willingness to consider buying a such house was significant at $p < 0.05$. From the chi-square test regarding other statements we concluded that *respondents were more likely to consider purchasing a low energy house if they agreed that low energy houses have lower operating cost, do not have lower resale value, do not have lower aesthetic appearance, and are not more difficult to operate than conventional houses*. Hence, demand for low energy houses could be increased by improving homeowners’ perception of low energy houses. No significant relationship was found between respondents’ perception of investment cost and their purchase decision of low energy house.

1.1.5. Demographic variables

There was a significant relationship between respondents’ income, age, or education and their willingness to consider buying a low energy house. With increasing income and education, and decreasing age respondents were more likely to consider buying a low energy house (Table 8). No statistically significant difference was found concerning intention of men and women respondents.

Table 8: Percentage of respondents in different income, age, education, and gender groups willing to consider buying a low energy house

Income (1000 SEK) ¹		Age (Years) ¹		Education ¹		Gender	
<150 (N=44)	27.3	<35 (N=52)	51.9	Basic (N=296)	27.4	Men (N=743)	39.7
150-300 (N=190)	31.1	36-45 (N=172)	50.0	Intermediate (N=333)	39.3	Women (N=260)	36.5
300-450 (N=251)	33.9	45-55 (N=217)	42.4	Higher (N=372)	47.8		
450-600 (N=253)	40.3	56-65 (N=314)	38.9				
>600 (N=236)	52.1	>65 (N=249)	25.3				
Total (N=974)	39.0	Total (N=1004)	38.8	Total (N=1001)	39.0	Total (N=1004)	39.0

*Chi-square test shows that the relationship between the demographical variables and respondents willingness to consider buying a low energy house was significant at $p < 0.05$. N = Number of respondents

DISCUSSION AND CONCLUSION

We found that more than 50% of the respondents were unaware about the actual annual cost of energy used in the household, but about 1/3rd of the respondent thought that cost of energy was high. Hence, for 2/3rd of respondents cost of energy may not be a motivation to take investment-intensive measures like purchasing a low energy house. We also found that there was no significant relationship between homeowners' perception of their energy cost and their willingness to consider buying a low energy house. This is further supported from the fact that about 63% of respondents reported that it was important for them to reduce the energy use, but majority of them preferred no investment measures like turning off light or appliances or reduce the thermostat to reduce household energy use.

Homeowners who were aware about a low energy house were more likely to consider buying a low energy house than those who were unaware. And about 44% respondents consider themselves unaware about low energy house. Hence, in order to improve the market for low energy houses, it is important to increase the public awareness of such houses and energy efficiency measures in general. The passive house centre [*passivhuscentrum*] is spreading knowledge and awareness about passive houses through conferences, seminars, training classes and also through their website.

Some studies on energy efficiency measures showed that Swedish homeowners while deciding to implement an energy efficiency measure in their houses give high priority to operating energy cost and investment cost (Nair et al., 2009; Mahapatra and Gustavsson, 2008). Significant percentage of respondents believed that the operating energy cost of a low energy house was very low compared to a conventional house, but it is not clear how much premium people are willing to pay for a low energy house for a certain reduction in operating energy cost. Studies in USA showed that home buyers were not at all interested to pay more than \$ (US) 5000 upfront for an annual saving of \$ (US) 1000 (Hanson et al., 2006). Though the attitude of Swedish homeowners towards low energy houses may be different than the Americans, still it seems to be difficult to generate demand for low energy houses on energy efficiency aspects alone.

Energy efficiency may not be the criteria to promote low energy house, but it could be an additional feature to the non-energy features. This is because evidence from other countries shows that people purchase a house based on aspects other than energy efficiency. For example, Farhar and Coburn (2008) reported that people in San Diego (USA) bought a zero-energy home based on features such as location, competitive price, and investment potential (i.e. resale value). Similarly, in Germany people purchased passive houses influenced by conventional features like "good location", "balcony", and "new buildings" (Schnieders and Hermelink, 2006). Hence, aesthetic aspect may be one of the factors for promotion of low energy houses. In our study as high as 40% respondents did not think that low energy houses have similar aesthetic quality or operational easiness as a conventional house.

Majority of respondents thought that low energy houses incur higher investment cost compared to a conventional house. This perception could discourage homeowners to purchase a low energy house if they give priority to investment cost in their purchasing decision. However, we did not find any significant relationship between respondents' perception of investment cost

International Scientific Conference on “Energy systems with IT” in connection with the Energiting 2009, March 11-12 at Älvsjö fair, Stockholm.

and their willingness to consider buying a low energy house. This may be because the respondents were already owners of detached house and therefore, they were not serious about buying a low energy house. Another reason could be that the monthly additional cost for a low energy house may not be substantially higher due to favourable housing loans in Sweden.

The fact that about 39% of respondents may consider buying a low energy house indicates that there exists market for such houses. Potential innovators or early adopters (Rogers, 2003) of low energy house could be young, highly educated and higher earning individuals because they were found to be more inclined to consider buying a low energy house. They may be targeted through incentive schemes and marketing campaigns for the development of a niche market.

ACKNOWLEDGMENT

The authors gratefully acknowledge the financial support from the European Union and Swedish Energy Agency.

REFERENCES

Audenaert, A., De Cleyn, S.H., and Vankerckhove, B, 2008. Economic analysis of passive houses and low-energy houses compared with standard houses, *Energy Policy*, 36: 47-55.

Aune, M., 2007. Energy comes home, *Energy Policy* 35, 5457-5465.

Berglund, E., 2007. Low energy house in Sweden – technology and economy [Lågenergihus i Sverige- Teknik och ekonomi], Masters Thesis No. 365, Department of Real Estate & Construction Management, Royal Institute of Technology (KTH), Stockholm

Curtis, F., Simpson-Housley, P. and Dewver, S., 1984. Communications on energy, *Energy Policy* 12, 452–456.

Dieperink, C., Brand, I. and Vermeulen, W. 2004. Diffusion of energy-saving innovations in industry and the built environment: Dutch studies as inputs for a more integrated analytical framework, *Energy Policy* 32, 773-784.

European Commission, 2005. Doing More With Less – Green Paper on Energy Efficiency, DG–Energy and Transport, Luxembourg, http://ec.europa.eu/energy/efficiency/doc/2005_06_green_paper_book_en.pdf, accessed on Nov. 08, 2008.

Farhar, B. C., Coburn, T. C., 2008. A new market for zero-energy homes: the comparative San Diego case study, *Environment: Science and Policy for Sustainable Development* 50, 18-32.

FEBY, 2007. Market overview of passive house and low energy house in Sweden in 2007: Increased interest for energy efficient houses and energy efficient products [Marknadsöversikt för passivhus och lågenergihus i Sverige 2007: Ökande efterfrågan på energieffektivt boende och energieffektiva produkter], Forum för Energieffektiva Byggnader, <http://www.energieffektivabyggnader.se/download/18.360a0d56117c51a2d30800050361/Marknadsöversikt.pdf>, web access on January 07, 2009.

FEBY, 2008. Demand specifications for passive houses in Sweden – Energy efficient houses [Kravspecifikation för passivhus i Sverige - Energieffektiva bostäder], LTH Rapport EBD–R-

International Scientific Conference on "Energy systems with IT" in connection with the
Energiting 2009, March 11-12 at Älvsjö fair, Stockholm.

08/21, Forum för Energieffektiva Byggnader, <http://www.vgregion.se/upload/Regionkanslierna/Milj%C3%B6sekretariatet/Energi/Energieffektiva%20byggnader/A1548%20Kravspecifikation%20f%C3%B6r%20passivhus%20Version%202008.pdf?epslanguage=sv>, web access on January 30, 2009.

Garrett, V., Koontz, T. M., 2008. Breaking the cycle: producer and consumer perspectives on the non-adoption of passive solar housing in the US, *Energy Policy* 36, 1551-1566.

Hanson, M., Bernstein, M., Hammon, R., 2006. The role of energy efficiency in home buying decision: Results of initial focus group discussion, *ACEEE Summer study on energy efficiency in buildings*, 13 -18 August, California, USA.

Hawkins, D. I., Best, R. J., Coney, K. A., 2007. *Consumer Behaviour: Building Marketing Strategy*, 10th edition, McGraw Hill, Boston.

Holden, E., 2005. One plain and two purls....three theses about environmental attitudes and household energy use [En rett og to vrang....Tre teser om miljøholdninger og husholdningers energiforbruk], *Sosiologisk Tidsskrift*, 13(3): 261-287.

Janson, U., 2008. Passive houses in Sweden: Experiences from design and construction phase, Licentiate Thesis, Lund University, Lund, Sweden.

Levy, D., Murphy, L., Lee, C. K., 2008. Influences and emotions: exploring family decision-making processes when buying a house, *Housing Studies* 23 (2), 271-289.

Mahapatra, K., Gustavsson, L., 2008. An adopter-centric approach to analyze the diffusion patterns of innovative residential heating systems in Sweden, *Energy Policy* 36, 577-590.

Nair, G., Gustavsson, L., Mahapatra, K., 2009. Adoption of energy efficiency measures in detached houses: homeowners need and perception. *International Scientific Conference on Energy systems with IT*, 11-12, March, Stockholm, Sweden

Olsen, M. E., 1981. Consumers' attitudes toward energy conservation, *Journal of Social Issues* 37(2), 108-131.

Rea, L.M. and Parker, R.A., 2005. *Designing and Conducting Survey Research: A Comprehensive Guide*, Jossey-Bass, San Francisco.

Ritchie, B., McDougall, G. and Claxton, J., 1981. Complexities of household energy consumption and conservation, *Journal of Consumer Research* 8(3), 233-242.

Rogers, E. M., 2003. *Diffusion of Innovations*, Free Press, New York.

SBI, 2008. European national strategies to move towards very low energy or passive buildings, SBI 2008:07, Danish Building Research Institute, http://www.rockwool.com/files/rockwool.com/Environment/PDF%20-%20Environment/Survey_European_national-strategies_2008.pdf, web access on January 7, 2009.

Schnieders, J., Hermelink, A., 2006. CEPHEUS results: measurements and occupants' satisfaction provide evidence for Passive Houses being an option for sustainable building. *Energy Policy* 34, 151-171.

International Scientific Conference on "Energy systems with IT" in connection with the Energiting 2009, March 11-12 at Älvsjö fair, Stockholm.

Simon, H. A., 1959. Theories of decision making in economics, *American Economic Review* 49, 253-283.

STEM, 2008a. Snart lossnar proppen för passivhus, *Energivärlden* 4, pp. 6-13, Swedish Energy Agency,

[http://www.swedishenergyagency.se/web/biblshop.nsf/FilAtkomst/EV08_4.pdf/\\$FILE/EV08_4.pdf?OpenElement](http://www.swedishenergyagency.se/web/biblshop.nsf/FilAtkomst/EV08_4.pdf/$FILE/EV08_4.pdf?OpenElement), web access on January 07, 2009

STEM, 2008b. Alingsås storsatsar på passivhus, Swedish Energy Agency,

<http://www.energimyndigheten.se/sv/Foretag/Energieffektivisering-i-foretag/Branschspecifika-atgarder/Lokaler-och-flerbostadshus/Energieffektiva-flerbostadshus/Alingsas-storsatsar-pa-passivhus/>, web access on January 07, 2009

Viklund, M., 2004. Energy policy options – from the perspective of public attitudes and risk perceptions, *Energy Policy* 32, 1159-1171.

Wall, M., 2006. Energy efficient terrace houses in Sweden: simulations and measurements, *Energy and Buildings* 38, 627-634.

Weisberg, H. F., Krosnick, J. A., Bowen, B. D., 1996. *An Introduction to Survey Research, Polling and Data Analysis*, SAGE Publications, Thousand Oaks/London/New Delhi.

Paper No. 6

**Consumption patterns today and tomorrow with respect to energy and how the
energy system will be affected by this**

Iana Vassileva, Fredrik Wallin, Erik Dahlquist

Mälardalen University, School of Sustainable Society and Technology Development

ABSTRACT

Today we can see a significant consumption of heat and hot water. This is very often produced by either district heating or electricity, in the cities respectively outside the cities. We also have a high consumption of energy for transportations and in the households and offices, for lighting, ventilation, computers etc.

For the future we can see a trend where the houses are consuming significantly less energy for heating, with thicker insulation, four glass windows and better constructions giving less unwanted diffusion of heat due to leakages. In Vasteras city the trend has been a reduced heat demand of approximately 1.5-2 % per year during the last 25 years. This means that the district heating sink has been reduced by 30 %. This makes district heating less competitive as the reduced heat demand give lower potential for electricity production in co-generation.

At the same time we have seen that heat pumps becomes more popular even in the cities, where we have district heating, mainly due to high pricing of the heat, making it economic. From a national perspective this is negative. Co-generation normally gives a very positive combination of heat and electricity with low environmental impact, especially with respect to fossil CO² emissions.

It is interesting to change patterns for 'consumption' of energy. More emphasis should be made on using hot water for dish washers, washing machines, to dry clothes etc. It is also important to reduce waste energy for lightning. LED-lamps is the long term goal, as these are very efficient.

It is also important to give the consumers a possibility to both get information about the energy consumption in an easily accessible way, e.g. by displays with information that is easy to catch. By combining with other functions it may be both interesting to use, and economical for both users and suppliers. New usages for electricity may soon be to charge electric vehicles/hybrids, and then we can have a chance to influence the power (kW) over the day, by having price models directing the outtake to times when there is more energy/power available.

INTRODUCTION

Consumers' lack of information about the relation between their behavior and the energy use is one of the biggest and most important problems to solve when assessing energy consumption (Darby, 2006). A part of the consumers assumes that energy use is related to the size of appliances: the larger the appliance, the more energy it is believed to use.

It is widely accepted that two strategies may be employed to promote household energy conservation and savings (Steg, 2008). The first set of strategies includes psychological motivation actions aimed at changing people's knowledge, perceptions, cognition and norms related to energy use. Typical examples are the provision of information, improvement of education and creation of analytical energy consumption models. Another set of measures includes structural strategies which are oriented at changing the fundamentals of decision structures in order to consolidate activities aimed at energy conservation measures. Typical examples are novel products or products and services with enhanced energy-saving characteristics, changes in infrastructure, pricing policies and legal measures.

Following the above strategies, an obvious measure to reduce household energy use is the promotion and market introduction of products and appliances with energy-efficient characteristics. However, it is important to consider possible side effects of energy-efficient appliances (such as, for example, energy-saving light bulbs) as rebound effects may occur. This may happen when consumers employ efficient appliances more often, just because they are energy efficient (Hertwich, 2005).

Personal factors such as attitudes, energy consumption values, norms and behavioral characteristics (habits) should be considered alongside contextual factors (Jensen, 2008). The latter can include the physical infrastructure, technical facilities, the availability (or not) of products, special product characteristics, advertising and shared socio-cultural objectives such as income and material growth.

In Sweden, the total energy demand is approximately 400 TWh per year, 25 per cent of which is used in the housing sector (Swedish Energy Agency, 2007). Energy consumption in buildings accounts for 39 per cent of Sweden's total final energy consumption and for about 50 per cent of the total electricity consumption in Sweden. Although the energy use has remained stable since 1970 and CO² emissions are below the established limit, in the nearest future consumers will face a serious price increase of electricity due to the novel EC directives for energy savings in buildings, adaptation of energy prices to the European market, and introduction of "pay-for-use" system instead of the actual energy payment included in the rent scheme that exist in many cases in Sweden.

Bearing in mind the above reasons, the development of different kinds of solutions aimed at changing consumer behavior is of a great importance.

TECHNICAL BACKGROUND

The objects of our study are two buildings situated in Västerås and comprise 24 apartments of a total area of 1894 m², occupied by totally 40 persons (19 and 21 residents, respectively). Three groups of 8 apartments each can be distinguished according to their floor area - 62 m², 79 m² and 80 m², and 95 m². In each building there are 12 apartments. The buildings were constructed in 2001 and are provided with energy efficient envelopes.

Data included in this study was collected over several years (from 2004 until 2008). Measurements were carried out for both electricity and hot water consumption on an hourly basis although in this study only electricity has been of interest. Further, data was sent to a central data base using servers at MIMER and at Metrima (the company which provided the meters and collected the hourly values) and were also presented to the inhabitants by displays placed next to fusebox.

Complementary information about tenants such as their income, electrical appliances per household, frequency of use, among others has been gathered in form of a paper based questionnaires sent to the tenants in October 2008.

Analysis of the energy use of each apartment has been related to the energy consumption habits of the tenants. The conclusions of this study and possible energy saving measures could be offered to the tenants depending on their interest.

RESULTS AND DISCUSSION

In this work, we analyze the energy consumption in two buildings in Västerås area during the period January 2004 - September 2008.

In the figure below electricity consumption values (in kWh) of the two buildings are compared.

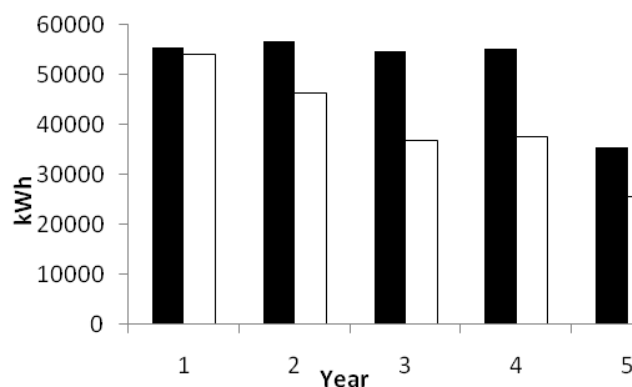

Fig. 1 Electricity consumption for buildings 1 and 2 (black and white respectively), during the years 2004 (1), 2005 (2), 2006 (3), 2007 (4) and 2008 (5, until September).

The first building is characterized by a stable consumption during the four years (therefore similar levels can be expected for year 2008). However, the second building follows a different pattern which main characteristics is a gradually decreasing annual energy consumption value reaching the lowest value in 2006. Its values are decreasing every year, being lowest in 2006. Thus, the difference in electricity consumption between Building 1 and Building 2 reached 32.5 % in 2006 (Table 1). This value is not surprising bearing in mind similar studies when 600 % difference was reported (Bahaj & James, 2007).

Table 1. Annual electricity consumption of Building 1 and Building 2 during the period 2004-2008. Differences between Building 1 and Building 2 and percentage of consumption decrease.

Year	Building 1 (kWh)	Building 2 (kWh)	Difference (kWh)	Building 2/Building 1 (% of decrease)
2004	55362	53923	1440	2.6
2005	56490	46356	10135	18.0
2006	54642	36897	17745	32.5
2007	54973	37624	17349	31.6
2008 (1-8*)	35451	25430	10021	28.3

* From January to September

Electricity consumption was lower during 2006 for both buildings. This tendency of lower consumption during 2006 can be observed in Fig.2 where all the apartments (Building 1 + Building 2) were analyzed together.

The generalized trend of decreasing levels of consumption can be explained by the global higher outdoor temperatures during the Swedish cold months.

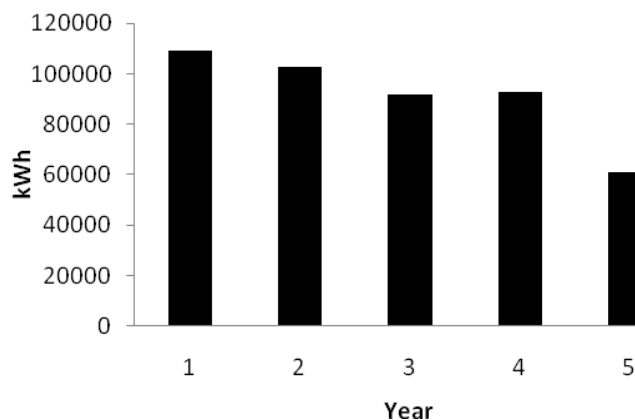

Fig. 2. Electricity consumption of all 24 apartments, during the years 2004-2008 (2008 until September).

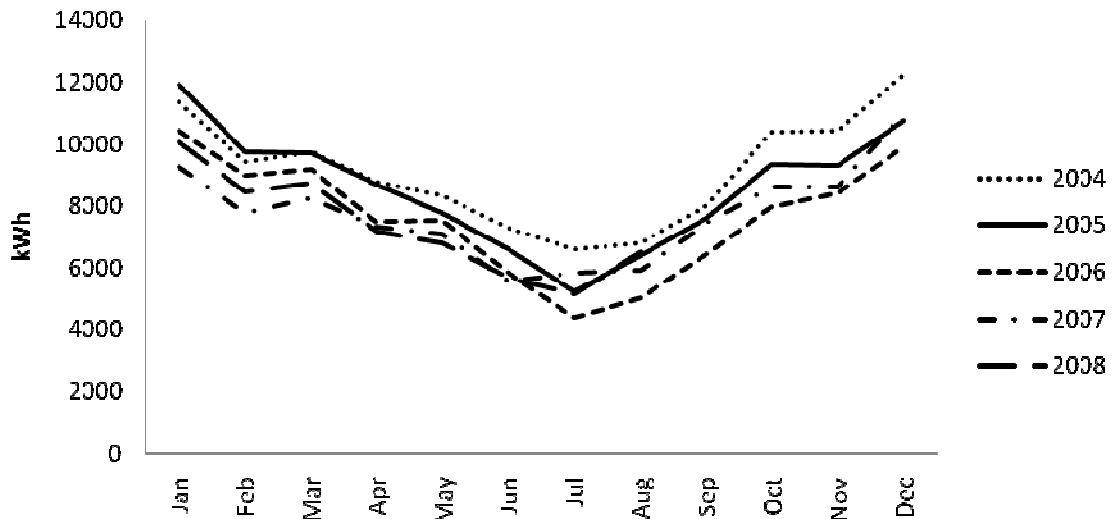

Fig.3 Total monthly electricity consumption for all apartments 2004-2008 (August – 2008)

Well defined seasonal differences between the electricity consumption values during the different years can be observed in Fig.3 with peaks during the cold months (October-March).

During the studied period of four years, the lowest peaks are registered during the month of July.

During 2005 the electricity monthly consumption is more variable, being very high during the cold periods and very low during the warm periods.

Fig. 4 shows how electricity consumption differs depending on tenants’ behavior and everyday life styles at equal other conditions. The three apartments with higher average consumption for the four years are apartments 1, 7 and 22. On the contrary the apartments with lowest consumption values are apartments number 11, 17 and 23.

Till recently, we have concentrated our studies employing quantitative approach based on measurements of energy consumption of electricity and heating water analyzing results through comparing consumption amongst households, apartments, residential areas, etc. Starting the end of 2008, we try to explain the registered large differences in energy consumption patterns by consumers’ lifestyle. Questionnaires were distributed in October 2008 and further collected and now we are analyzing them. Questions (overall number, 32) include personal social characteristics and detailed description of energy consuming devices, their frequency and mode of use, etc. (Vassileva et al., 2008)). After comparing the consumption patterns of households in the two buildings with the results of the questionnaire, apartment number 2 differs from the rest

of households by higher values in the monthly income which for the 24 households varies between $\leq 30\ 000$ SEK/month (apartment number 2) and $\geq 50\ 000$ SEK/month (rest of apartments) and in the frequency of use of washing machines and drying machines (lower in apartment number 2). The consumers of apartment number 23 do not use any dishwasher, while in the case of the high consuming apartments; they use it between 2 and 6 times per week or at least once per day.

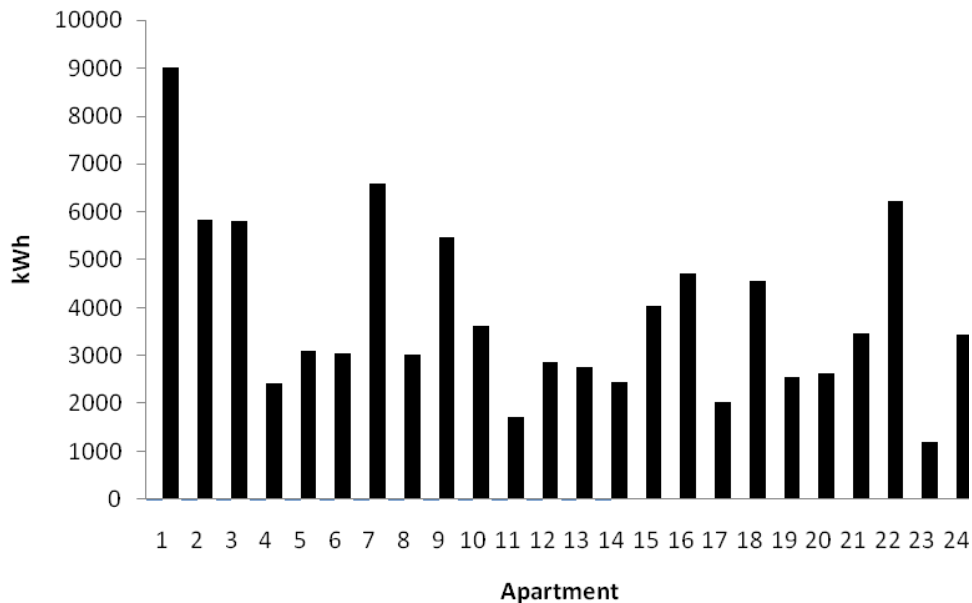

Fig. 4 Annual average electricity consumption all apartments, 2004-2008 (2008 until September)

Apartment 23 maintains a slightly lower indoor temperature (20°C) in comparison to apartments 7 and 22 (21°C). However, in apartment 23 an extra electric radiator is been used during the cold periods (approximately 15 hours per year) and during 10 hours per year an outdoors heater for the balcony.

CONCLUSIONS

- 1) People generally don't know how much energy consumed by their households depends on their behavior and everyday habits (lifestyle).
- 2) It is obvious that large differences in energy consumption values could be found between families living in technically equal buildings which should direct our studies at looking for "lifestyle level" reasons.
- 3) When analyzing energy consumption particular attention should be paid to the individual lifestyle characteristics (attitudes, habits, values and customs) that tenants have. Therefore, another approach that we can further apply in our studies may include more

International Scientific Conference on "Energy systems with IT" in connection with the Energiting 2009, March 11-12 at Älvsjö fair, Stockholm.

individualized social understandings and rationales behind the energy consumption in order to specify different consumption patterns.

- 4) Information feedback systems are needed to fulfill the above targets.

ACKNOWLEDGEMENT

The authors gratefully acknowledge financial support provided by Swedish Energy Agency, Mimer, Eskilstuna Kommunfastigheter, Mälarenergi and Eskilstuna Energi och miljö..

REFERENCES

- Darby, S., 2006. The effectiveness of feedback on energy consumption a review for defra of the literature on metering, billing and direct displays. Environmental Change Institute, University of Oxford, 1-21.
- Hertwich, E.G., 2005. Consumption and the rebound effect: an industrial ecology perspective. *Journal of Industrial Ecology* 9. 85-98
- Swedish Energy Agency, 2007. <http://www.energimyndigheten.se/>
- A.S. Bahaj, P.A.B. James. Urban energy generation: the added value of photovoltaics in social housing. *Renewable and Sustainable Energy Reviews* 11 (2007) 2121-2136
- Steg, L., 2008. Promoting household energy conservation. *Energy Policy* 36. 4449-4453
- Vassileva, I., Lundh, M., Dahlquist, E., 2008. Efficiency of interactive information on energy consumption in households in Sweden. Paper presented at Applied Energy Conference, Hong Kong, 5-7 January, 2009.

Paper No. 7

Applying an interdisciplinary perspective on industrial energy efficiency

J. Palm^{*a}, P. Thollander^b

^a Department of Technology and Social Change, Linköping University, 581 83 Linköping, Sweden

^b Department of Management and Engineering, Division of Energy Systems, Linköping University, 581 83 Linköping, Sweden

Introduction

Increased global warming resulting from the use of fossil fuels poses a major threat to the environment, and industrial energy efficiency is one of the most important means of reducing the threat of increased global warming (IPCC, 2007). Industry is the single highest energy-using sector in the world. About 30% of the energy demand in the EU-25 countries is related to industry. However, even in the most “technology optimistic” perspective, industrial energy use is estimated to increase within the next 50 years (Gielen and Taylor, 2007). How and when energy is used in industry determines society’s ability to create a long-term sustainable energy system. Industrial users in general are also ultimately the ones who have to pay for the transformation or adaptation of the energy systems, which increases their importance as a key component in the system. However, transforming the energy system towards greater sustainability also sometimes requires users to “transform” their own behavior, values and routines to conserve energy. This transformation can be facilitated by policy means and governments through for example taxation, subsidies, information campaigns and energy guidance. EU and national governments are trying, in various ways, to influence industrial energy use, and in this article we will discuss the premises on which energy efficiency in industry is discussed and on which government policy instruments in general are based.

Numerous studies of energy efficiency potential state that cost-effective energy efficiency improvements within industry are not always undertaken due to different hindrances, commonly called barriers. Previous studies discuss the great potential for energy efficiency in industry and the fact that many energy efficient measures are never implemented (Sorrell, 2000). Explanations as to why companies are not energy efficient include: energy has been cheap; lack of information; procedures and routines that do not favour energy efficiency; short time pay-back rules; lack of funds; energy costs are a relatively small part of a company’s turnover (Persson, 1990; Sanderg, 2004; Dias et al., 2004). At the same time energy efficiency in industry can be expected to be shaped by social and commercial processes and built on knowledge, routines, institutions, and methods established in networks (compare Guy & Shove, 2000). In this article we will analyze

* Corresponding author. _Tel.: +46-13 285615; fax: +4613 284461.
E-mail addresses: jenny.palm@liu.se (J. Palm).

energy efficiency in industry from a social constructive approach where energy efficient measures are regarded as negotiated in networks.

The aim of this article is to combine engineering and social science approaches in order to enhance the understanding of energy efficiency in industry and enable a widened perspective of policy making in Europe. Can a new mutual (interdisciplinary) perspective addressing new questions contribute to increased energy efficiency in European industry?

Sustainable development demands new solutions, strategies and policy-making approaches. When developing new strategies for energy efficiency in industry, one way is to compare different sectors and the various practices established in different sectors. By comparison we can identify and visualize new opportunities and new methods for different networks. This is our overall goal with this article. Focus will be on potential for improving energy efficiency in non-energy-intensive and small and medium-sized industries.

It should be noted that our purpose is not to criticize previous theoretical approaches in a dualistic fashion, but rather to address the fact that the traditional view of industrial energy efficiency and barriers to it needs to be enhanced to meet the urgent need for efficient energy policies to be (re-) designed. Beginning by presenting a theoretical baseline, we continue by addressing previous Swedish empirical work on the subject, and end with a discussion of policy implications on how energy efficiency in industry might be addressed.

Barriers to energy efficiency and energy politics

In the European Union, growing concern for increased global warming has led to the implementation of a number of policy instruments such as the EU Emission Trading Scheme (ETS) and the European Energy End-Use Efficiency and Energy Services Directive (ESD), where each member state is obliged to formulate and design a National Energy Efficiency Action Plan (NEEAP). The ESD went into effect in 2006, and proposes a reduction in energy use of 9% in each member state, to be achieved by the ninth year of application of the directive by eliminating market barriers and market imperfections to energy efficiency (EC, 2006):

- a) providing the necessary indicative targets as well as mechanisms, incentives and institutional, financial and legal frameworks to remove existing market barriers and imperfections (market failures) that impede the efficient end-use of energy and b) creating the conditions for the development and promotion of a market for energy services and for the delivery of other energy efficiency improvement measures to final consumers (EC, 2006).

Through the ESD, the EU states that in order to achieve a more energy efficient economy, market barriers and imperfections have to be removed. However, the ESD takes a leap further than traditional economic policies based on mainstream economic theory, as the directive's aim is to reduce not only *market imperfection barriers* but also *market barriers* (EC, 2006). The ESD promotes, among other things, the need to find possible energy end-use policy initiatives directed toward SMEs in a national context:

In order to enable final consumers to make better informed decisions as regards their individual energy consumption, they should be provided with a reasonable amount of information thereon and with other relevant information, such as information on available energy efficiency improvement measures (EC, 2006).

One criticism against for example industrial energy policies, is that technological advances and rising energy prices will cause energy efficiency measures to be implemented, even without governmental intervention (Geller and Attali, 2005). This argument is closely related to mainstream economic politics, see for example Sutherland (1996), relying heavily on the market and market restructuring for energy efficiency improvements to be carried out (Jaffe and Stavins, 1994). This theory is an elaboration of the 18th century economist Adam Smith, who stated that the actions of individuals acting in a decentralized market setting can lead to results that are collectively beneficial. Some of the underlying axioms or ideal conditions required to ensure efficient outcomes are:

- A complete set of markets with well-defined property rights exists such that buyers and sellers can exchange assets freely.
- Consumers and producers behave competitively by maximising benefits and minimising costs.
- Market prices are known by all consumers and firms.
- Transaction costs are zero.

If any of these axioms fails to hold, a *market failure* or market imperfection is manifested which may justify public policy intervention. According to the Swedish Energy Efficiency Investigation (EEI, 2008), only 15% of the measures that are profitable are implemented on average²⁸. This is the first time it has been possible to verify and empirically quantify the energy efficiency gap in Sweden. There are four broad types of *market failures*:

- Incomplete markets.
- Imperfect competition.
- Imperfect information.
- Asymmetric information.

The discussion of the energy efficiency gap builds on the assumption that there exists a technology, method or process that reduces energy used in an industry, but because of barriers this technology or method is not implemented. If the actors would act in a rational way, this gap would not exist. But in fact the gap does exist and to explain this gap different kinds of barriers to energy efficiency are identified. The barriers identified are often lack of information, knowledge, time or funding.

One criticism of this barrier approach is that it leads to reductionism in research (compare Palm, 2009 forthcoming). Taking an STS approach (Science, Technology & Society), the energy efficiency gap may be better understood in a social and institutional context. This will be discussed next.

²⁸ "Profitable" is defined as measures with a payback period of less than eight years.

European industrial energy efficiency in social context – theoretical background

Industrial energy efficiency is an important means of reducing the threat of increased global warming (IPCC, 2007) as industry accounts for about 78% of the world’s annual coal consumption, 41% of the world’s electricity use, 35% of the world’s natural gas consumption, and 9% of global oil consumption (IEA, 2007). Almeida (1998)’s research on the energy efficient motor market in France constitutes a cardinal approach regarding the non-adoption, or slow diffusion, of apparently cost-effective energy efficiency measures which complements the dominant view presented by e.g. Gruber and Schleich (2008) regarding barriers to energy efficiency. Barrier models are a commonly used means to describe the non-take up of cost-effective energy efficiency investments (Weber, 1997). A barrier model specifies three features: *the objective obstacle; the subject hindered; the action hindered* (Weber, 1997). The methodological questions of how to determine a barrier model are the following: what is the obstacle, to whom, and affecting what aspect of energy conservation? (Weber, 1997). When studying barriers to energy efficiency, barriers may be divided into three broad categories: the *economic*, the *organizational* and the *behavioral* perspective, see Table 1. In addition, some empirically spotted barriers may be classified as institutional barriers.

Table 1: Perspectives on barriers (Based on Sorrell et al., 2000)

Perspective	Examples	Actors	Theory
Economic	Imperfect information, asymmetric information, hidden costs, risk	Individuals and organizations conceived of as rational and utility maximizing	Neo-classical economics
Behavioral	Inability to process information, form of information, trust, inertia	Individuals conceived of as boundedly rational with non-financial motives and a variety of social influences	Transaction cost economics, psychology, decision theory
Organizational	Energy managers lacks power and influence: organizational culture lead to neglect of energy/environmental issues	Organizations conceived of as social systems influenced by goals, routines culture, power structures etc.	Organizational theory

Commonly cited barriers to energy efficiency include various information imperfections and asymmetries such as split incentives, etc., principal-agent relationships and adverse selection. The latter barriers may be classified as so-called market failure barriers, while other barriers such as heterogeneity, risk, lack of access to capital and hidden costs may be seen as rational barriers and

thus are not classified as market failure barriers. However, there is considerable dispute regarding the perception of barriers. While some researchers claim that the majority of barriers are solely a reflection of "normal" markets, others claim they are not, see for example Southerland (1996).

This research tradition, where industrial barriers are discussed and developed, is problematized by Shove (1998). Shove thinks that

"technical change is a one-way process of technology transfer, and that social obstacles or non technical barriers impede technological progress. What is missing is an appreciation of the social contexts of energy saving action and of the socially situated character of technical knowledge. As we shall see, reinstatement of these missing elements has knock-on consequences for the rest of the conventional package, so much so that the whole tidy edifice begins to crumble." (Shove, 1998, p. 1108)

Shove criticizes the tendency in research to focus upon the individual decision-maker who makes decisions in a vacuum, regardless of social and institutional context (Shove, 1998, p. 1107). Following studies of STS scientists such as Callon (1991) and Bijker (1995), Shove (1998) emphasizes that decisions concerning how we use energy and energy efficiency measures are made in social contexts. Practitioners identify and make energy-related decisions within different networks and different contexts according to Shove: "What qualifies as a reliable, cost effective, worthwhile energy saving measure in one socio-cultural domain might count for nothing in another" (Shove, 1998, p. 1109). In this perspective energy efficiency is also dependent on social relations and discussion, negotiations and agreements developed in actors' networks. One result of this is that energy saving measures in one socio-cultural domain may be worth nothing in another domain (see Guy and Shove, 2000). Experiences, routines and habits established and negotiated in a network will then decide which energy efficient measurements will be implemented. These negotiated agreements can then be both possibilities and constraints to future development in each sector.

Focusing on these social negotiations and agreements could contribute to important explanations for why energy efficiency technologies are rejected or adopted in different sectors. It will also bring attention to the fact that technology too is social in character and the idea of differentiating between technical and non-technical barriers is simply an analytical construction leading to important aspects being missing in the analysis. The barrier approach could benefit from for example including in-depth studies of how the energy efficient discourse looks like in a company, i.e. how employees talk about energy efficiency and how it relates to environmental issues and cost pictures. Also how the employees act in practical situations, and what attitudes, norms, and routines determine their actions. Then it would be possible to relate energy use and efficiency culture to social practices in the company. Barriers identified could then also be problematized in relation to the social context. This will be discussed further in the next section.

Barriers identified in earlier studies in a social context

Empirically, there exist a number of studies regarding barriers to energy efficiency. Examples of empirical studies include Gruber and Brand (1991), Sorrell et al. (2000), Brown (2001), de Groot et al. (2001), Schleich (2004), Sorrell et al. (2004), Schleich and Gruber (2008), Sardanou

International Scientific Conference on “Energy systems with IT” in connection with the Energiting 2009, March 11-12 at Älvsjö fair, Stockholm.

(2008). We will here use and do a re-analysis of earlier findings and discussion about energy barriers in industry in Sweden. An overview of these empirical Swedish studies is presented in Table 2 (Rohdin and Thollander, 2006, Rohdin et al., 2007, Thollander et al., 2007).

Table 2: Barriers identified in earlier studies of Swedish industry (based on Rohdin et al., 2006, Rohdin and Thollander, 2007, Thollander et al., 2007)

	Oskarshamn companies	Swedish foundries	Swedish Highland SMEs
1	Cost of production disruption/hassle/inconvenience	Access to capital	Lack of time or other priorities
2	Lack of time or other priorities	Technical risks such as risk of production disruptions	Other priorities for capital investments.
3	Difficulty/Cost of obtaining information on the energy use of purchased equipment	Lack of budget funding	Access to capital
4	Technical risks such as risk of production disruptions	Difficulty/Cost of obtaining information on the energy use of purchased equipment	Cost of production disruption/hassle/inconvenience
5	Other priorities for capital investments	Other priorities for capital investments	Lack of budget funding
6	Technology is inappropriate at this site	Possible poor performance of equipment	Lack of sub-metering
7	Lack of staff awareness	Lack of sub-metering	Difficulty/Cost of obtaining information on the energy use of purchased equipment
8	Lack of technical skills	Poor information quality regarding energy efficiency opportunities	Lack of technical skills
9	Access to capital	Cost of identifying opportunities analyzing cost-effectiveness and tendering	Low priority given to energy management
10	Poor information quality regarding energy efficiency opportunities	Low priority given to energy management	Lack of staff awareness
11	Possible poor performance of equipment	Lack of time or other priorities	Technical risks such as risk of production disruptions
12	Cost of identifying opportunities analyzing cost-effectiveness and tendering	Technology is inappropriate at this site	Slim organization

The table shows the largest barriers to energy efficiency in the different studies. There are of course many similarities in these studies. We can for example conclude that technical risks and lack of time are ranked highly in two of three studies. And as one of our main interests is to find general patterns for barriers that should be targeted by policy makers, this could be an area of focus. But we want to highlight the differences here and discuss explanations for these differences and implications that could have for policy-making.

So, in Oskarshamn the risk of production disruptions was considered to be the largest barrier, while this was ranked fourth by the studied Highland SMEs. Among the Highland SMEs lack of time was the largest barrier, while in Oskarshamn that barrier was placed second and for the Swedish foundries this was of less importance and only ranked 11th. For the Swedish foundries lack of capital was discussed most. In Oskarshamn this barrier came in ninth place and for the Highland SMES it was mentioned third.

In the studied foundries, technical risks such as risk of production disruptions were placed second, while these were placed low, in 11th place by the Highland SMEs. Other priorities were placed second for the Highland SMEs and Oskarshamn industry while this came in fifth place in the foundry study. Difficulty/Cost of obtaining information about the energy consumption of purchased equipment was considered to be the third largest barrier in Oskarshamn, fourth for the foundries and seventh for the Highland SMEs.

There are obvious differences between sectors regarding which barriers are perceived as most important. But why is it so and how can we understand these differences? If we see energy efficiency wrapped up and shaped by social processes and negotiated in networks, then our view on barriers can be re-evaluated. What if barriers may be viewed as social constructs established in the companies' respective networks? Perhaps a clarification is necessary here: we are not questioning the existence of barriers for energy efficiency but want to problematize on what grounds these barriers exist. Keeping in mind the importance of situated learning and that decisions concerning energy efficiency are made in social networks, it is likely that the barriers mentioned by the industrial actors may reflect traditions, value structures and rumors that the actors in some cases have never tried to verify or refute. When Swedish foundries claim that lack of access to capital is their largest barrier, then one may ask why they have more problems finding capital than the SMEs in Oskarshamn. Why is lack of time an acceptable explanation in Oskarshamn and among the Highland SMEs but not among the Swedish foundries? These are relevant questions to ask. And perhaps we will find that some barriers are real in the sense that for example the foundry industry has a harder time than other sectors finding capital for investing in energy efficiency measures as well as in different, more capital-intensive energy efficiency measures. Or we will find that this is only a routinely accepted answer that can rather easily be challenged. But how have social networks developed in different companies and sectors? That will be highlighted next.

Social networks discussed in earlier studies

In earlier studies existing social networks and their significance for energy efficiency have been touched upon when the focus has been on information dissemination and which actors are mentioned by representatives of these industries as most important when they seek information

International Scientific Conference on “Energy systems with IT” in connection with the Energiting 2009, March 11-12 at Älvsjö fair, Stockholm.

about energy efficiency (compare Stern and Aronsson, 1984). We will here discuss the empirical findings from the above-cited Swedish studies regarding perception of various sources of information. A summary of these results is presented in Table 3.

Table 3: The perception of various sources of information among the studied industries (based on Rohdin et al., 2006, Rohdin and Thollander, 2007, Thollander et al., 2007).

	Oskarshamn companies	Swedish foundries	Swedish Highland SMEs
1	Colleagues within the company	Colleagues within the sector	Consultants
2	Consultants	Staff at the Swedish Foundry Association	Governmental sponsored energy audits
3	Conferences and seminars	Consultants	Colleagues within the company
4	Product information from suppliers	Colleagues within the company	Colleagues within the sector
5	Information from power companies	Conferences and seminars	Conferences and seminars
6	Colleagues within the sector	Written sources of information, such as journals	Product information from suppliers
7	Written sources of information, such as journals	Governmental sponsored energy audits	Information from power companies

In Oskarshamn and the Swedish foundries, colleagues within the company and in the sector were the most important informants. For the SMEs the actor most often mentioned was consultants. In Oskarshamn and the foundry companies, consultants came in second and third place. In general, oral information is more important than written information and different networks are highly ranked sources of information.

When colleagues are used as information sources, then existing behaviour, perception and norms about energy efficiency tend to prevail. The information that circulates is the kind of information that is acceptable in the company and in the sector. More innovative ideas and suggestions that challenge existing values and habits for energy efficiency are more likely to be introduced through seminars and conferences. Then actors from different companies and sectors, i.e. different local communities, get together and discuss energy efficiency from different perspectives which can give new influences to a company.

When consultants are used as information sources the company is stuck with the consultants' views on and expertise in the energy area. Consultants are often experts in some aspects of the energy system and have established procedures for what aspects of a company's energy use they focus on. The consultants are often included in the energy efficiency process to answer or focus

on a specific part of the energy system. Most energy consultants often also just give advice or information on possible energy efficient measures, but do not follow up on the implementation rate of suggested measures. This then gives a limited contribution to the introduction of new ideas or innovative efficiency measures in a sector.

What we need is new forms of discussions and alternatives that challenge existing regimes. We need new policy measures and to try new combinations by letting different social networks learn from each other. That would make it possible to discuss whether the barriers in each sector can be overcome by bridging and elucidating any prejudice, bad habit or thoughtless routine that may apply to the various activities in the sector. There is a lot of existing knowledge on how to improve energy efficiency. The problem is to disseminate it, and one important part of that is to let actors learn from each other. But then we need to enhance communication between established and rather closed social networks within different sectors. To start letting actors cross traditional communication borders and actively stimulate new social arrangements, including actors from different sectors that can share their good examples with each other, should be a prioritized method for both researchers and policy-makers in the future.

An exemplification of how such closed communities could be opened up by using our approach, and which was stated by a respondent in a study among Swedish foundries (Rohdin and Thollander, 2006), is to formulate requirements to include energy figures in a company's annual report. By including the degree of potential cost-effective measures available at a company in the annual report, as well as other relevant energy figures, the sometimes rather closed company board would receive a figure of the potential for energy efficiency in the company, which may be seen as restricted capital.

Conclusions

Problems of energy efficiency in industry consist of different parts. One obvious problem is that energy efficient technology is not diffused in a satisfactory way. It is obvious that in theory there is a gap between technical potential energy efficiency and what is implemented in practice – an efficiency gap exists. Shove (1998) states that if we act as rational consumers the gap would not exist, but it does and it is time to approach this problem with new tools. What we can see in the studies is that there are different sectors of rather closed communities that have established their own tacit knowledge, truths and routines concerning energy efficiency measures. The actors in different sectors highlight different barriers to energy efficiency and why they do not implement cost-efficient solutions. We can develop these barrier studies by including questions about how the company perceives sustainability, costs, and comfort, how they act in practical situations, and what attitudes, norms, and routines determine their actions. Then it would be possible to relate energy use and efficiency culture to social practices in the company. Barriers identified could then also be problematized in relation to the social context.

To realize that there are technical, social as well as organisational reasons for why optimal energy efficiency measures are not taken among industrial companies will have consequences for policy development. Usual policy instruments such as taxation and subsidies must be combined with information and discussion across established professions and sectors. By for example actively creating actor-networks crossing established sector boundaries, established norms and routines

will be challenged. Also by realising the importance of the social construction of technological development and the spread of energy efficient solutions, other policy instruments will be relevant. Then economic benefits will perhaps prove not to be the most efficient policy instrument. Instead it may be workshops or seminars where established norm, routines and tacit knowledge are highlighted and challenged.

For example in non-manufacturing firms the fear of interruption in the process might be over-estimated and if this truth is questioned this hindrance for energy efficiency could be avoided. By discussing the social construction of these barriers in social networks and communities, researchers can take industrial energy efficiency research a step further. Researchers could also actively integrate with the development of networks and facilitate and encourage networks across sectors and traditional professions.

It is important to approach barriers or hindrances from another perspective, using non-traditional analytical tools that can contribute new understandings or questions about why a particular barrier is perceived as important in a company. Analyzing a company's energy culture, that is, understanding the context in which energy-efficiency goals and measures are discussed, is important to be able to take energy efficiency a step further in industry.

In this paper we have shown that the very perception of a barrier may itself be a barrier to the implementation of cost-effective energy efficiency measures in industry. For example, if it is argued that all barriers fit into the category of non-market failure barriers, this may lead to the non-adoption of policies towards these types of barriers. The perception of barriers, as outlined by social science researchers, may thus not be neglected and should be further emphasized in the future work of aiming towards a more energy efficient economy.

Acknowledgement

The research for this paper forms part of the Energy Systems Programme, funded by the Swedish Energy Agency.

References

- Almeida, A., 1998. Energy efficiency and the limits of market forces: The example of the electric motor market in France. *Energy Policy* 26 (8): 643-653.
- Bijker, W., Law, J. (eds), 1992. *Shaping Technology/Building Society: Studies in Sociotechnical Change*. The MIT Press, Cambridge, MA.
- Bijker, W., 1995. 'Sociohistorical Technology Studies', In Jasanoff, et al. (eds). *Handbook of Science and Technology Studies*. Sage Publications, CA, USA.
- Brown, M.A., 2001. Market failures and barriers as a basis for clean energy policies. *Energy Policy* 29 (14): 1197-1207.
- Callon, M., 1991. 'Techno-economic networks and irreversibility'. In Law J (ed), *A Sociology of Monsters: Essays on Power, Technology and Domination*, Sociological Review Monograph. Routledge and Kegan Paul, London,

International Scientific Conference on "Energy systems with IT" in connection with the
Energiting 2009, March 11-12 at Älvsjö fair, Stockholm.

- de Groot, H., Verhoef, E., Nijkamp, P., 2001. Energy saving by firms: decision-making, barriers and policies. *Energy Economics* 23 (6): 717-740.
- Dias, R, Mattos C, Balestiere J., 2004. Energy education: breaking up the rational energy use barriers. *Energy Policy* 32 (11):1339-47.
- EC, 2006. Directive 2006/32/EC of the European Parliament and of the Council of 5 April 2006 on energy end-use efficiency and energy services and repealing Council Directive 93/76/EEC, Brussels.
- EEC (Energy Efficiency Committee), 2008. Vägen till ett energieffektivare Sverige [The road to a more energy efficient Sweden]. SOU 2008:110. Stockholm.
- Geller, H., Attali, S., 2005. The experience with energy efficiency policies and programmes in IEA countries - learning from the Critics. IEA, Paris.
- Gielen, D., Taylor, M., 2007. Modelling industrial energy use. The IEAs Energy Technology Perspective. *Energy Economics* 29: 889-912.
- Gruber, E., Brand, M., 1991. Promoting energy conservation in small and medium-sized companies. *Energy Policy* 19 (3): 279-287.
- Guy, S., Shove, E., 2000. *A Sociology of Energy, Buildings and the Environment* (London: Routledge).
- IEA (International Energy Agency), 2007. Key world energy statistics 2007, Paris. Retrieved January 8, 2008, from: http://195.200.115.136/textbase/nppdf/free/2007/key_stats_2007.pdf
- IPCC, 2007. Contribution of Working Group III to the Fourth Assessment Report of the Intergovernmental Panel on Climate Change. Summary for Policymakers. Retrieved October 8, 2007, from: http://www.ipcc.ch/SPM0405_07.pdf
- Jaffe, A.B., Stavins, R.N., 1994. The energy efficiency gap: what does it mean? *Energy Policy* 22 (10): 60-71.
- Palm, J., 2009. forthcoming. Placing barriers to industrial energy efficiency in a social context: a discussion of lifestyle categorization. *Energy Efficiency*.
- Persson, A., 1990. *Nyttiga lärdomar. Erfarenheter av industriell energirådgivning* [Important lessons. Experience from industrial energy consulting]. Statens industriverk. Stockholm. [in Swedish].
- Rohdin, P., Thollander, P., 2006. Barriers to and driving forces for energy efficiency in the non-energy intensive manufacturing industry in Sweden. *Energy* 31 (12): 1836–1844.
- Rohdin P., Thollander, P., 2006. Synen på energieffektivisering, produktionssimulering, energianalyser och styrmedel - en studie av nio svenska gjuterier [Perspective on energy efficiency, manufacturing simulation, energy audits and policies]. Swedish Foundry Association, Jönköping. Working paper, download at: <http://www.energimyndigheten.se/Global/Filer%20-%20Forskning/Industri/Swecast/2-Synen%20p%C3%A5%20energieff>

International Scientific Conference on "Energy systems with IT" in connection with the Energiting 2009, March 11-12 at Älvsjö fair, Stockholm.

ektivisering,%20 produktionssimulering,%20energianalyser%20och%20styrmedel.pdf [In Swedish].

Rohdin, P., Thollander, P., Solding, P., 2007. Barriers to and drivers for energy efficiency in the Swedish foundry industry. *Energy Policy* 35 (1): 672–677.

Sandberg, P., 2004. Optimisation and co-operation perspectives on industrial energy systems. Linköping studies in Science and Technology, Dissertation No. 913, Division of Energy Systems, Linköping University, Linköping.

Sardianou, E., 2008. Barriers to industrial energy efficiency investments in Greece. *Journal of Cleaner Production* 16 (13): 1416-1423.

Schleich, J., 2004. Do energy audits help reduce barriers to energy efficiency? An empirical analysis for Germany, *International Journal of Energy Technology and Policy* 2 (3): 226-239.

Schleich, J., Gruber, E., 2008. Beyond case studies: Barriers to energy efficiency in commerce and the services sector. *Energy Economics* 30 (2): 449-464.

Shove, E., 1998. Gaps, barriers and conceptual chasms: theories of technology transfer and energy in buildings, *Energy Policy* 26: 1105-1112.

Shove, E., Lutzenhiser, L., Guy, S., Hackett, B. & Wilhite, H., 1998. Energy and social systems, in: Rayner, S. & Malone, E. (eds), *Human Choice and Climate Change*, 291-327.

Sorrell S., O'Malley, E., Schleich, J., Scott, S., 2004. *The Economics of Energy Efficiency - Barriers to Cost-Effective Investment*, Edward Elgar, Cheltenham.

Sorrell, S., Schleich, J., Scott, S., O'Malley, E., Trace, F., Boede, E., Ostertag, K. Radgen, P., 2000. *Reducing Barriers to Energy Efficiency in Public and Private Organizations*. Retrieved October 8, 2007, from the SPRU's (Science and Technology Policy Research) Retrieved October 8, 2007, from: <http://www.sussex.ac.uk/Units/spru/publications/reports/barriers/final.html>

Stern, P.C., Aronsson, E. (Eds), 1984. *Energy Use: The Human Dimension*, New York.

Sutherland, R.J., 1996. The economics of energy conservation policy. *Energy Policy* 24 (4): 361-370.

Thollander, P., Danestig, M., and Rohdin, P., 2007. Energy policies for increased industrial energy efficiency: Evaluation of a local energy programme for manufacturing SMEs. *Energy Policy* 35 (11): 5774–5783.

Weber, L., 1997. Some reflections on barriers to the efficient use of energy. *Energy Policy* 25 (10): 833-835.

Paper No. 8

**Markov-Chain Modelling of High-Resolution Activity ,Patterns and Household
Electricity Demand**

Joakim Widén^{1}, Kajsa Ellegård², Ewa Wäckelgård¹*

1. Department of Engineering Sciences, Uppsala University
P.O. Box 534, SE-751 21 Uppsala, Sweden

2. Department of Technology and Social Change, Linköping University
SE-581 83 Linköping, Sweden

* Email address: joakim.widen@angstrom.uu.se

ABSTRACT

In this paper we present briefly a model framework for generation of high-resolved and end-use-specific household electricity load profiles with a probabilistic approach. A non-homogeneous Markov-chain model is used for generation of synthetic time-use data series, from which electricity demand is calculated with a bottom-up approach. Household activities are connected to a set of appliances and the load profiles of these appliances are added together based on the distribution of activities in the time-use data. A detailed set of time use in Swedish households is used for estimation of transition probabilities in the Markov-chain model. Load profiles of individual appliances are determined from measurements on appliance level in a number of households in a recent large-scale survey by the Swedish Energy Agency (SEA). It is shown that the model realistically reproduces both load profiles for individual households and coincident load of a large number of households.

Keywords: Household electricity; Markov chain; Bottom-up; Time-use data

INTRODUCTION

Detailed simulations of distributed generation have recently prompted the need for improved models of household electricity demand (Thomson & Infield, 2007). Probabilistic methods have been used in studies of photovoltaic (PV) integration in Sweden, e.g. in (Viawan, 2008) where Monte Carlo simulations were performed, based on samplings of measured PV production and aggregate electricity demand. However, for more realistic simulations, it is important to reproduce both randomness and regularities in production and demand. For example, both PV output and load are highly time-dependent and at the same time subject to random variation and coincident behaviour.

Load modelling is a complex task and, consequently, load models often exhibit a high degree of complexity, see for example Stokes (2005) and Capasso et al. (1994). In particular, the variation and regularity caused by peoples' habits and household activities are hard to capture in a mathematical model. As shown in previous studies, *time-use data* – detailed sequences of daily activities in households, usually collected through diaries – can improve modelling of the behavioural component of the household load (Kall & Widén, 2007; Widén et al., 2009a). Richardson et al. (2008) modelled domestic occupancy patterns from time-use data with a

Markov-chain model. The same approach can be applied to all electricity-demanding household activities and combined with a conversion model to generate electricity load patterns.

1.1.1. Aim

In this paper we present briefly a model that generates high-resolved household electricity load profiles with a combined Markov-chain and bottom-up approach. All important electricity-dependent activities are described by a multi-state non-homogeneous Markov chain and are connected to appliance loads in order to generate end-use-specific load profiles. A detailed set of time-use data is used, for which a classification scheme makes it possible to identify a wide range of activities. Load data for individual appliances have been obtained from recent measurements by the Swedish Energy Agency (SEA). The model outlined in this paper is described and validated in more detail in a coming journal paper (Widén et al., 2009b).

1.1.2. Structure of the paper

The utilized data are presented in section 2. Section 3 describes the model framework and how the data are used. Features of synthetic activity and load patterns generated with the model are shown, in comparison to corresponding measured data, in section 4. Section 5 summarizes and briefly discusses the main findings.

DATA

1.1.3. Time-use data

The utilized time-use data set was collected by Statistics Sweden in a pilot study of time use from 1996, covering 431 persons in 169 households. Each person in the participating households wrote a time diary on one weekday and one weekend day, reporting the sequences of activities performed, together with various additional types of data. The time resolution is mainly 5 minutes, although some households have reported on a 1-minute basis. In the data set, the activities have been coded with activity codes referring to a categorization scheme that encompasses several levels of abstraction (Ellegård & Cooper, 2004).

The sample of households in the data covers individuals aged between 10 and 97 years, in various family constellations and geographical settings. An extensive background material gives insight into the socio-economical status of the households, for example the type of dwelling (apartments and detached houses).

1.1.4. Solar irradiation data

Data for solar irradiance are used for generation of lighting demand, through conversion of horizontal direct and diffuse irradiance to vertical global illuminance, and application of a linear model for indoor lighting. Synthetic irradiation data were generated for Stockholm, Sweden, with the climate database and simulation tool Meteotest 6.0 (Meteotest, 2009) on a one-minute resolution.

1.1.5. Power demand of appliances

Data on the power demand of individual appliances were obtained from the recent measurement study of the SEA. In a behavioural study connected to the survey, end-use-specific measurements in 14 households were analyzed and gone through for consistency (Karlsson & Widén, 2008). Representative duty cycles for washing and dishwashing machines were

determined from these data, as well as cold appliance load cycles and standby consumption of computer, tv *etc.* Active-use power demand of many appliances was taken from the previously presented activity-to-electricity conversion model (Widén et al., 2009a).

MODEL FRAMEWORK

1.1.6. Generation of synthetic activity patterns

In the time-use data the household members' days are represented as series of activities. Each individual can be seen as making a trajectory between a number of different states, corresponding to the activities. The patterns thus produced exhibit randomness, although there are obvious regularities in them. These features can be reproduced by a non-homogeneous Markov-chain model (Cinlar, 1975).

In such a model, we assume that there are N states, one of which must be occupied in every time step. In every time step the individual changes to another state or stays in the current state, with certain transition probabilities p_{jk} , where j is the current state and k is the state at the next time step. Obviously, p_{jj} is the probability of staying in the current state. In a non-homogeneous Markov chain, these probabilities are time-dependent. For example, the probability of changing from the state 'sleeping' to 'being awake' supposedly increases over the course of the morning.

The transition probabilities are easily determined from existing time-use data. In each time step, the transitions from the current state to every other state are counted and divided by the total number of changes from that state (including remaining in the current state). For a relatively small data set, as the one used in this study, the number of persons on which to calculate the transition probabilities is so small that transition probabilities cannot be determined for all time steps. Therefore, hourly means are evaluated, and the transition probabilities are assumed constant in every hourly interval. Also, because of differences found in Widén et al. (2009a), detached houses and apartments are treated separately. With a larger material, separate transition probability sets could have been determined for even more subsets of the time-use data, for example households of the same sizes, as in Richardson et al. (2008).

To keep the number of states at a minimum, activities in the time-use data set were categorized into ten main states connected to use of household electricity: 'away', 'sleeping', 'cooking', 'dishwashing', 'washing', 'drying', 'tv/vcr/dvd', 'computer', 'audio' and 'other'. Synthetic data series were generated from the set of transition probabilities by setting an initial state for each simulated individual and evaluating state changes in every time step.

1.1.7. Activity-to-power conversion schemes

The model for conversion of the generated activity patterns to electricity load data is a refinement of a previously developed model (Widén et al., 2009a). Each activity is connected to a certain appliance with a predefined load. As discussed in Widén et al. (2009a), appliance use in these basic conversion schemes occurs either *during* or *after* the activity. The former scheme holds for computer, tv, *etc.*, where the load is constant during use. When not actively used, a stand-by power is assumed. The second scheme holds for washing, dishwashing and drying, where power is demanded during a duty cycle that begins after the active use of the appliance is finished.

As in Widén et al. (2009a), two special cases have to be treated: lighting, which is modelled based on when persons are at home and awake, and cold appliances, which are unrelated to the activities. Active individuals, present in the home, are assumed to demand a lighting power dependent on the daylight level, calculated from the irradiance data. This model is based on the previously developed lighting model in Widén et al. (2009a) and is described in more detail in a coming journal paper (Widén et al., 2009c). Stochasticity is introduced in the modelled cold

appliances data through random generation of duty cycle energy use and intermediate time spans, with distributions determined from measured SEA appliance data.

For simplicity, all households are assumed to use exactly the same appliance set. In a more advanced simulation, different sets of appliances with different energy consumption could be assumed, however with a much more extensive demand of input data.

PERFORMANCE OF THE MODEL

1.1.8. Activity patterns

The most important abilities of the activity-generating part of the model is the introduction of realistic stochasticity in the synthetic activity patterns, and the reproduction of the coincident behaviour of the load. Per definition, the aggregate asymptotic frequency curve of activities, when the number of persons approaches infinity, equals that of the data used for estimation of transition probabilities (Cinlar, 1975).

As Figure 1 suggests, the randomness as well as the regularity of the activity frequency curves are reproduced by the model. The figure shows the frequency curves of the occupation of all states except the 'away' state, that is, all persons being at home, awake as well as sleeping. It also shows coincidence of activity patterns, resulting in a smoothing-out of the frequency curve for the larger number of households, both in the original time-use data and the reproduction of the model. This suggests realistic coincidence of the appliance loads thus distributed by the time-use data.

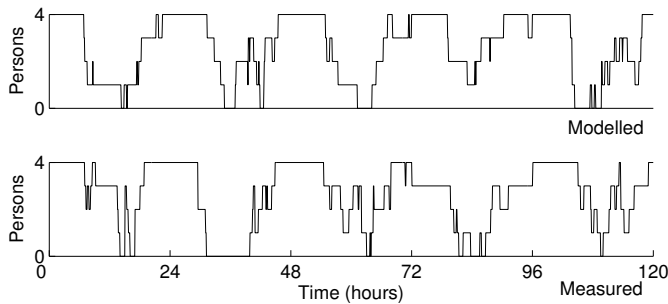

(a) 4 persons

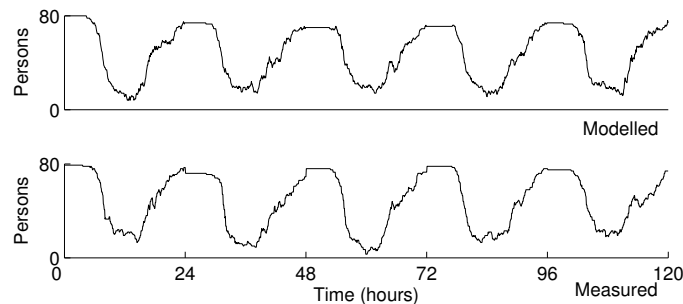

(b) 80 persons

Figure 1. Modelled and real home occupancy patterns for 4 and 80 persons, showing coincidence of activities, weekday. The measured data is the recorded time use of 4 and 80 persons,

respectively, randomly sampled into five subsets and ordered in series representing five different ‘days’.

Electricity patterns

In the following, the model output is compared to measured data for one, 13 and hundreds of households, in order to determine how realistic the generated load patterns are. For brevity, only results for detached houses are presented.

The load data generated by the model must be realistic both for a small number of households as well as for a large number of households. Figure 2 compares a modelled load curve for an individual household to a measured curve, with the end uses shown specifically. Note that the curves are totally unrelated, so they should not be identical. However, they should exhibit similar features. Indeed, the modelled and real data are highly similar. The irregular pattern of peaks from washing, dishwashing and cooking is present in both of the figures, as well as the recurring load pattern of the cold appliances and the more regular pattern of increasing power demand from actively used appliances and lighting in the evening.

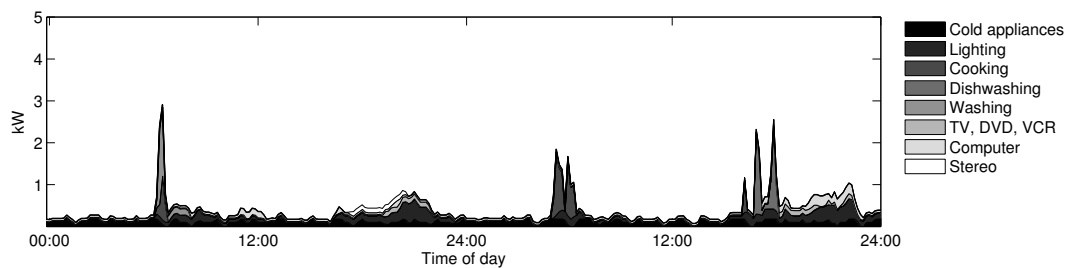

(a) Example of modeled data

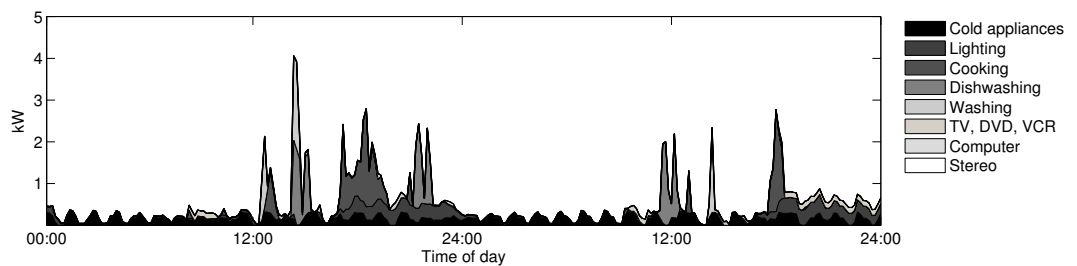

(b) Example of measured data

Figure 2. Examples of 10-minute end-use-specific load curves of individual households during two successive days. The modeled data are for a simulated 4-member household in a detached

house. The measured data are for a real 4-member detached-house household, measured during
October 2006.

In aggregate load curves, the random coincidence of the different loads evens out the heavy
power fluctuations seen in the individual households’ demand. Figure 3, comparing the aggregate
load of 13 modelled household loads to the aggregate load of the same number of measured
household loads, shows that the model reproduces this smoothing of the demand. The load is
somewhat lower in (b), which could be that it is to nearly one half based on apartment loads,
which in general are lower than the load of detached houses. Differences between weekdays and
weekend days (a more even load curve on weekends) are seen in both the modelled and the
measured data. Note also that the randomness and the peaks in both figures are similar.

Figure 4, finally, shows the correspondence between the mean hourly load curve generated by
the model for a large number of households to the mean load curve based on all finished
household measurements in the SEA’s survey in 2007. The similarity is evident for most end
uses. The differences are basically the same as those discussed in (Widén et al., 2009a), most
notably for cooking, which, in lack of detailed information about appliance use, is assumed to use
a constant power during the activity. The computer category was also problematic in Widén et al.
(2009a), because of the much lower computer use in 1996. However, in this refinement of the
model, activities that were assumed to have been ‘computerized’ during the last decade were
included, and so the resulting load curve is closer to the recent measurements. It should be noted,
also, that the transition probabilities are based on fewer data points than the SEA data, and
therefore the aggregate modelled load can appear more variable.

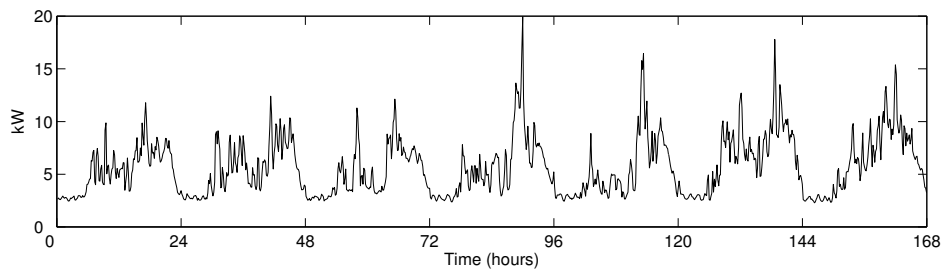

(a) Example of modeled data

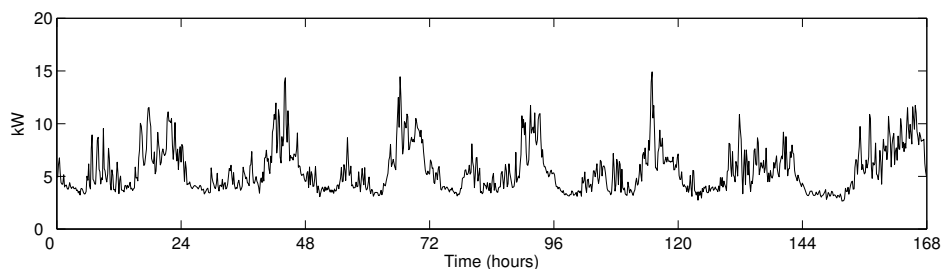

(b) Example of measured data

Figure 3. Examples of aggregate load curves for 13 households during a week (five weekdays and two weekend days). The modeled load is for 13 simulated detached houses. The measured load is for six apartments and seven detached houses, measured in the summer and autumn of 2006.

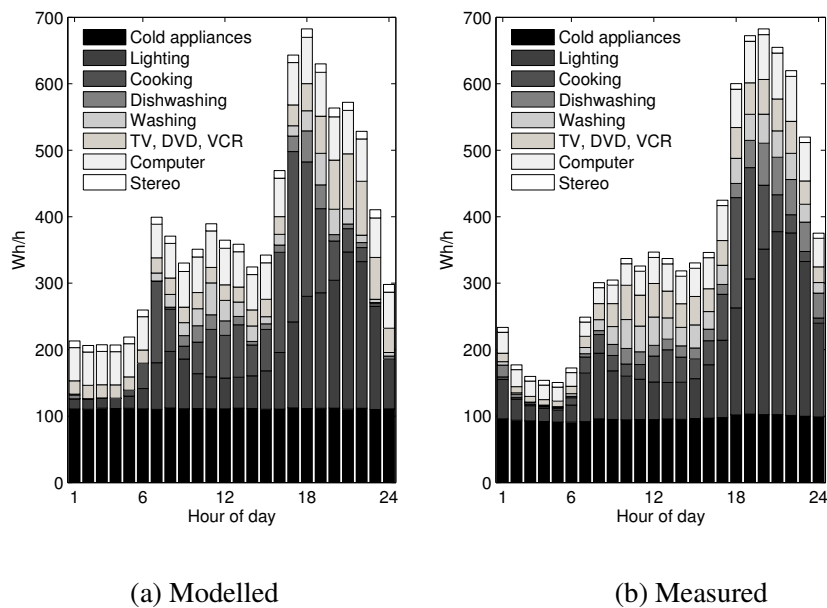

Figure 4. Mean hourly load curves, detached houses, weekday. The modelled data in (a) are based on 200 simulated households on seven summer days and seven winter days. Measured data from the SEA’s measurement survey. A close-to-constant additional load category is not shown in (b).

CONCLUDING REMARKS

It has been shown that the model generates household electricity load profiles that are realistic in all the important aspects covered here: coincidence, random variation, regularity and relative distribution on end uses.

Some points for possible improvement of the model can be identified: Firstly, the appliance set could be varied or distributed differently among households to reflect real appliance ownership. Secondly, a larger time-use data set would allow separate sets of transition probabilities to be estimated for different household types, which would make it possible to include more systematic differences between household types.

Both of these options however require more input data and increase the model complexity. There is obviously a balance between low complexity and high output detail. With the current data, the model appears to perform well despite the lack of more complex assumptions.

ACKNOWLEDGEMENTS

The work has been carried out under the auspices of The Energy Systems Programme, which is primarily financed by the Swedish Energy Agency. Part of the work with refinement of the bottom-up model for electricity demand was carried out in a project financed by Göteborg Energi. The authors also wish to thank Annica Nilsson, Department of Engineering Sciences, Uppsala University, for the irradiation-to-daylight data conversion.

REFERENCES

- Capasso, A., Grattieri, W., Lamedica, R., Prudenzi, A., 1994. A bottom-up approach to residential load modeling, *IEEE Transactions on Power Systems* 9, 957–964.
- Cinlar, E., 1975. *Introduction to stochastic processes*. Prentice-Hall.
- Ellegård, K., Cooper, M., 2004. Complexity in daily life - a 3D-visualization showing activity patterns in their context, *electronic International Journal of Time Use Research* 1 (1), 37-59.
- Kall, A.S., Widén, J., 2007. Det stora i det lilla och det lilla i det stora - teknik och politik i omställningen av energisystemet, Working Paper 37, Energy Systems Programme, Linköping University, Sweden.
- Karlsson, K., Widén, J., 2008. Hushållens elanvändningsmönster identifierade i vardagens aktiviteter, Working Paper, Department of Technology and Social Change, Linköping University, Sweden.
- Meteotest, 2009. <http://www.meteotest.ch>.
- Richardson, I., Thomson, M., Infield, D., 2008. A high-resolution domestic building occupancy model for energy demand simulations. *Energy and Buildings* 40 (8), 1560-1566.
- Stokes, M., 2005. Removing barriers to embedded generation: a fine-grained load model to support low voltage network performance analysis. PhD thesis, Institute of Energy and Sustainable Development, DeMontfort University, UK.
- Thomson, M., Infield, D.G., 2007. Impact of widespread photovoltaics generation on distribution systems. *IET Renewable Power Generation* 1, 33-40.
- Viawan, F., 2008. Voltage control and voltage stability of power distribution systems in the presence of distributed generation. PhD thesis, Department of Energy and Environment, Chalmers University of Technology, Sweden.
- Widén, J., Lundh, M., Vassileva, I., Wäckelgård, E., Ellegård, K., 2009a. Constructing load profiles for household electricity and hot water from time-use data - modelling approach and validation, resubmitted to *Energy and Buildings* after minor revisions.
- Widén, J., Wäckelgård, E., 2009b. A high-resolved stochastic model of household electricity demand, in manuscript.
- Widén, J., Nilsson, A., Wäckelgård, E., 2009c. A combined Markov-chain and bottom-up approach to domestic lighting modelling, in manuscript.

Paper No. 9

**From electricity to heat – a discourse analytic policy study of energy conversion at
national, municipal and household level**

Karin Perman, Solar Energy Research Center (SERC), Dalarna University Sweden
kpm@du.se, 023-778727

ABSTRACT

This paper describes how space heating for single-family houses and energy system conversion has been constructed and discussed at national, municipal and household levels. Results show that at all three political levels, there is consensus on the households' responsibility for energy transition. While industry tends to be considered incapable of cutting down its energy consumption, households are expected to take the responsibility seriously. At the three levels, households are perceived as being dependant on economical subsidies when making the decision to convert from electrical heating. The discourse concerning the Swedish energy transition illustrates a shift away from a definition of ecological modernisation where environmental considerations influence economic development.

Keywords: policy, energy transformation, household, municipality, national government

Introduction

Berit and Torbjörn have invested in a ground heat pump. Initially, Berit wanted a pellet boiler and a solar panel. Wood pellet is cheap and she thinks it magical to be able to have a hot shower from the sun. But Torbjörn objected. They are, after all, senior citizens. Handling wood pellet involves a great deal of carrying, and both Berit and he have had problems with their knees and backs during the last couple of years. Furthermore, Torbjörn agrees with Berit that the sun is a free energy source but he emphasis that everyone knows that investing in a solar panel is extremely expensive. Torbjörn also predicts that he will be the one that has the main responsibility, and he is not interested in looking after a pellet boiler day in and day out. But that is something he neither tells to nor discusses with Berit. But Berit and Torbjörn's neighbours have drilled for heat, and the ground heat pumps have been working just fine. Torbjörn won the argument.

But what had it meant, for example, for the household economy, the development of the community and the relationship between Berit and Torbjörn if Berit had won the argument? Had the couple had another heating system if they had been younger and/or physically stronger? Had they changed their heating system at all if the neighbours had not taken the first step?

As the example shows, the question of energy supply is complex and is discussed not only at international and national levels but also at the household level.

In this article, I present an analysis of Swedish energy policy during the period between 1997 and 2006, and the energy system transition at different political levels. A more precise aim has been to analyze how the political problem of space heating for single-family houses has been constructed at three political levels: national, municipal and household level among households in a medium sized municipality in central Sweden, the municipality of Falun.

I have asked the following questions in order to analyze similarities and differences: How is the problem of using electrical heating constructed? What causes and solutions are presented? What effects follow this formulation of the political problem? Each level includes variation, but they are all influenced by collective interests, integrating mechanisms, the possibility of making changes and internal and external representatives, and they make collective decisions. Le Galès (2002) analyses cities from the assumption that they are collective actors. In a similar way I focus on the three different actors as separate, but, to a certain extent, mutually dependent.

At the national level the focus is on how the political problem is represented in the government bill *A sustainable energy supply (En uthållig energiförsörjning) 1996/97:84*. At the municipal level the focus is on how the problem is represented by the municipality of Falun. The third and final part of the article investigates households in Falun and how they constructed the problem of electrical space heating. Political documents have been studied, and interviews have been carried out with politicians, civil servants and householders. At the municipal level, I have analysed interviews with people who have the opportunity influencing the public discourse. At the household level, I focused on 12 households that during year 2002 or 2003 have converted from electrical heating to ground source heat pumps, district heating or some form of biomass boiler. Through the conversions, these households have made an active choice to follow the policy proposal that is constructed in different political documents at national and local levels. I have analysed narratives presented by these households with the help of Carol Lee Bacchi's (1999) method in order to deconstruct the representations about the political problem of electrical heating.

My aim has been to analyze the energy conversion discourse, focusing on a reduced use of electrical heating in residential housing. Besides analyzing the empirical material about the complex of problems concerning the conversion, the article includes contributions of a more theoretical character. One is that Swedish policy studies have not, within the research field, included a deconstruction of not only policy text but the life stories of households. The second contribution also concerns the household as an object of study. In political science research there are multi-level analyses, but they tend to focus on formal institutions as state, region and municipality, and not include the households. If they are included they are often a category in a survey study. I intend to present a more complete picture of the possibility of reducing electrical heating by including the household level as a part of my empirical focus and by treating it as a political level.

Background

Today, one of our great environmental dangers is the increasing concentration of greenhouse gases, and the consequent global warming. One explanation of this increase in greenhouse gases is the use of fossil energy sources, such as coal and oil, and the emissions of carbon dioxide that come with it. The only other option to an energy supply system on this scale has been nuclear energy. But a problem with nuclear energy is radioactive contamination as experienced at Three Mile Island and Chernobyl.

In Sweden, the use of energy and the energy supply have been pressing issues for a long time. But it was not until the 1970s that politicians started to use the concept of energy politics, and the subject was thereby given a political role that it had never had before. The political debate from the 1990s and onwards has emphasized questions on replacement of electricity based on nuclear energy for domestic heating with renewable energy sources, such as solar energy and biofuels.

In Sweden, electricity is used for domestic space heating and tap water heating, and this is a unique situation in the world. In 1997 the Social Democratic Party, The Left Party of Sweden and the Centre Party came to a political agreement to end dependency on electrical heating. That plan included the closing of the nuclear power plant, Barsebäck, and a change of energy supply from dependency on nuclear fuels to renewable energy sources.

1.1.1. What's the problem?

Policy research has been concentrated on questions about the formulation and implementation of a political idea (Premfors, 1989). My research has focused on different ways of formulating the reality with regard to ways of dealing with the energy systems in transition. I have compared the political problem concerning the use of electricity for space heating at the different political levels to determine where they are similar and where they diverge. I have used Carol Lee Bacchi's *What's the problem?* approach, and therefore asked questions such as: How is the political problem constructed, what are the causes, and the solutions presented? What are the effects of the representation of the problem? (Bacchi, 1999).

The *What's the problem?* approach focuses on meaning and the formulation of meaning. Carol Lee Bacchi is inspired by Michel Foucault and he defines discourse as the practice that generates a certain type of statement. Bacchi is a social constructivist and thus it follows that she considers a political problem as something that only exists if someone defines it as a "problem". The basis of Carol Bacchi's method is that you can deconstruct a political problem through analysing policy proposals: by asking how the political problem, its causes and solutions are represented.

A policy process is complex and consists of correlations that need to be handled. One difficulty with the analysis of a policy process is that several political questions and decisions together create a stance of policy. Another difficulty is that a policy changes over time. During a

policy process, the question that is in focus is affected by decisions made earlier (Hill, 1997). Therefore one can say that it is a dynamic process, but it does not only include change, it also includes efforts to maintain stability. It is important to be aware of the fact that there are efforts within a policy process to maintain already established values. This stability is what Ernesto Laclau would call hegemony. Hegemony is a dominating discourse which defines meaning (Howarth, 2002; Winther Jørgensen & Phillips, 2000).

Discourse consists of language and practice according to Bacchi. The practice influences the language and vice versa and together these create a discourse. By looking at policy as discourse you can analyse how argument is structured and how objects and subjects are constructed in a policy process. Discourse theory can be used to trace a hegemonic public discourse expressed in policy texts and interviews (Bacchi, 1999). The empirical material that I have used to analyse the discourse of the energy transition is political documents plus interviews with politicians and civil servants and informants at household level. As I study how the political problem is being represented at national, municipal and household level, I analyse how the energy changeover concerning space heating is expressed in different narratives.

I present the conclusions through a presentation of the problem representations, that include how the problem is formulated and the causes and solutions that have been presented. The effect of these problem representations is also examined. Finally I contextualise these different problem representations.

1.1.2. The varying problem of electrical heating

Each level of analysis presents the political problem regarding energy transition differently. As a political majority in parliament introduced an energy transformation in 1997, the use of electricity produced by nuclear power was considered a problem. This was due to the reduction in the amount of electricity produced after the closure of the nuclear power plant, Barsebäck (Proposition 1996/97:84). Initially the municipality’s policy documents presented the same problem, but there is a change over time. Instead of the electricity produced by the nuclear power plant being the problem, the imported electricity, produced by fossil fuel, and the resulting emissions and how these can be reduced, become more important. The advantages and disadvantages of Swedish nuclear power became invisible by focusing on these other problems (Falun kommun, 1995a, 1995b, 2006a, 2006b, 2006c).

At household level, the problem was often perceived as the existence of an old and badly functioning space-heating system. But some households did not formulate a problem before they

converted. Instead they were influenced by their neighbours and thereby convinced. The households legitimised their change of heating system by using practical and financial arguments: which are considered to be rational and objective arguments. Thus, they did not change the heating system because they thought the use of electricity produced by nuclear power plants was a problem. However, the household narratives also revealed more emotionally affected arguments that had to do with fascination with the technical inventions or the influence of reliable neighbours (Perman, 2008,s.123ff).

Solutions and Effects

The different actors’ responsibility for the energy transition, reaching the goals through conversion of heating systems in single houses, and using different policy instruments to encourage for example household to convert are all examples of solutions presented at the three political levels.

1.1.3. The actors’ responsibility for the energy transition

At all three levels there is consensus regarding a special responsibility that household are seen to have for energy transformation. Industry versus the households is a dichotomy used at all three levels. Industry is considered incapable of changing its electricity consumption. At the national level, industry is said to need what is called “reasonable” prices for electricity. Further, by letting households take environmental responsibility by reducing their use of electricity, industry can even increase its use of electricity (Proposition 1996/97:84). The government emphasises this view, as do local policy documents (Falu kommun, 2006a) and the households (household nr 12,7). Households say that they are able to change their energy behaviour, which industry is not, therefore they emphasise that they should change their energy behaviour. This means that the discourse that is constructed at the government level is also reproduced at the local level.

All of the policy documents presenting the users of electrical heating are gender blind (e.g.Falu kommun, 1995a; Falu kommun, 1995b, 2006a, 2006b; Proposition 1996/97:84). Gender differences are thus part of the construction of the household as an actor. When it comes to handling firewood, for instance, women’s physical abilities are considered less than men’s and therefore they do not fully take part in the effort required with new heating systems (e.g. household nr 4). Looking at society in general, research shows that women’s subordination is partly created through the image of women’s inferior physical abilities. Women can be excluded because of their physique (Weitz, 1998).

Women are also excluded at the household level because of their, presumed, lack of technical knowledge and/or technical interest. The heating system is something that men have taken responsibility for. The informants present the relation between the men and the women as a dichotomy. The men have had the main responsibility and the women have only taken responsibility in a limited way, because they had other priorities and interests (e.g. household nr 3). But, at the same time, the women talk about how they have taken part in the selection of the heating system as well as looking after the energy system, if needed (Perman, 2008,s.136f). I interpret this as being a part of a gender order that limits what can and cannot be said when it comes to the energy system. That limit reproduces a gendered structure (e.g. Hirdman, 1988; West & Zimmerman, 1987). And the choice of a biomass boiler shows a situation where the traditional separation of male and female work has grown. When the men have to work with the energy system, the women have to take on correspondingly more tasks in the home and therefore women have less choice in how they spend their spare time (household nr 4). This is a result of changing from an invisible energy source, electricity, to an energy source that is visible and more labour intensive (e.g. Shove, 2003).

1.1.4. Efficiency and conversion

At the national level, district heating is presented as preferable for houses in central parts of cities, and the use of biofuel boilers for areas outside the centre. Energy efficient techniques are also stressed, and one example of this is ground source heat pumps(Proposition 1996/97:84). The municipality of Falun has expanded the district heating system, through the local energy company which is the producer and is owned by the municipality (civil servant nr 5). Local policy documents state that the municipality shall work towards reducing the number of electrical heaters (Falun kommun, 1995b). Yet a heat pump has been chosen for many houses in the central parts of the city instead of district heating. This has caused problems for the municipality – politicians and civil servants say that this is an adverse result – because when the heating system in the houses is changed to heat pumps they still rely on electricity. This also makes it more difficult for the local energy company to expand the district heating system (Falun kommun, 2006a, e.g. civil servant nr1).

The picture is even more complicated. The energy company has a double role; it is mentioned in policy documents as an important actor to facilitate the transition of the energy system (Falun kommun, 1995a). At the same time, informants from the energy company and politicians emphasise that the energy market and a solid economy is more important than their being an

active actor to make energy transformation possible (e.g. civil servant nr 5). According to some of the people interviewed this has resulted in a slower expansion of the district heating system, which has had the effect of citizens choosing a heat pump where there is no district heating system (e.g. politician nr 6, civil servant nr 7).

1.1.5. Financial incentives

At the national level the household's contribution to the energy changeover is formulated as vital but dependant on economical subsidies (Proposition 1996/97:84). At the household level, the municipality divides the households into two types: the ones that own their houses and the ones that do not. The households that rent an apartment are seen as passive actors. They are assumed not to have the same economic motivation to be careful about the energy use, and thereby the energy costs, as the owner of a house. The house owners are therefore looked upon as the group that contributes to an energy transition (Falukommun, 2006a).

The households interviewed agree with the government that households in general require incentives to change their heating systems. However, this applies to *other* households, not the ones interviewed as they assert they did not convert as a result of the subsidy. They changed because they did not have a well functioning heating system, and they did not choose a new electrical heater because of the current price of electricity and the assumed high price in the future. They had financial and practical reasons for conversion (e.g. household 12,7,9). As a result they construct themselves as active, economic and practical actors while they simultaneously define other households as passive and in need of incentives to change their heating systems. Even though the people interviewed emphasised the importance of subsidies to make people behave in an environmentally correct way, they did not have environmental arguments themselves when changing their heating system and they did not see themselves as needing help to act in an environmentally friendly way. These arguments concerning energy transition and the need for subsidies reproduce the construction of the solution of the problem as depending on economic development. The environmentally correct behaviour, in this case not to use electrical space heating, is thus constructed as depending on economic subsidies.

1.1.6. The necessity for education

Sweden is presented in the government bill *A sustainable energy supply (En uthållig energiförsörjning) 1996/97:84* as a leading country with regard to safe and clean energy production. Sweden can thus help neighbouring countries that have lower economic and technical

standards. Sweden is defined as a country that can influence other countries around the Baltic Sea, either to close their nuclear power plants or to continue operation. While the focus is on the safety of foreign nuclear power plants, safety issues of the Swedish nuclear power plants are neglected.

The household and the municipality are presented in the government bill as actors responsible for the solutions. The municipality is constructed as being a link between the state and the household (Proposition 1996/97:84). This is an identity that is reproduced at the local level (e.g. Falu kommun, 1995a, 2005). Being a link means commitment, active participation in the work with the transformation – i.e. concretisation of the national commitments and education of the households.

There are similarities between the construction of the government as an actor at the national level and the municipality as intermediary. They are seen as actors having a task to mediate knowledge to create a change of behaviour. At both the national and local level the mentees are presumed to be subordinated, because they are regarded as lacking both knowledge and sufficient economic resources.

A shift away from ecological modernisation?

The production and use of reasonably priced electricity has been considered an important part of the economic development of the country and the development of the social welfare system from the 1970s onwards. The historical context shows a hegemonic energy policy discourse dominated by an optimism concerning technical development. Value-based concepts used within the discourse of energy system transition were freedom, development, efficiency, productivity and social welfare (Perman, 2008).

Events such as the oil crises in 1973 and 1976, the Swedish referendum on nuclear power in 1980 and the accident at Chernobyl made people aware of the short-comings in the idea of the superiority of the technical development (Anshelm, 1995; Holmberg & Asp, 1984). However, instead of challenging the hegemonic modernisation discourse, the green argumentation became imbedded in the discourse. An ecological modernisation became the norm where development was conditioned by environmental concerns – epitomised by the concept ‘sustainable development’.

The discourse of the energy transition studied here illustrates a shift away from a definition of ecological modernisation where environmental considerations condition the economic development. The discourse of energy transition also joins economic and ecologic arguments, but

the partnership is not without conflicts. Examples from the government bill of 1996/97:84 show how ecological development is subjected to economic conditions. Economic growth is not to be jeopardised because of environmental considerations. The economic growth is, furthermore, supposed to secure technical development and new innovations, which in turn will save the environment. Even though technical development is considered essential for the energy transition at all three levels, there is also the view that technical development should not be rushed. The development of renewable energy sources should not come about at the cost of nuclear power. The phasing-out of nuclear power is formulated as a threat to jobs and social welfare. But there is also doubt about the ability of renewable energy techniques to develop on their own (Proposition 1996/97:84).

The article shows how economic arguments repeatedly influence environmental concerns. However, the tension between the two is played down and concealed through the lack of problematisation of the responsibility of industry, and through the focus on the need for education and future opportunities. Political dialogues concerning the use of electrical heating and the conversion of energy systems towards more renewable energies are dominated by economic arguments at the three levels. One effect of this is an assumption that energy policy instruments such as information and economic subsidies are essential for the energy transition. However, if householders are influenced by their neighbours rather than by subsidies, should the government use subsidies as the main energy policy instrument?

Closing comment

The policy problem varies between the political levels. But one solution that is presented at all three levels is the actor, the household, and the importance of their change of behaviour. Households should be convinced to convert from electrical heating through the policy instruments: information and subsidies. Policymakers often use variables as attitude, change of behaviour, choice and price which are being made concrete through, for instance, information and financial policy instruments, in their work to change citizens' behaviour. In my material there is always a present connection between price and behaviour. I interpret, for instance, the construction of the household as they are at a disadvantage because of their lack of both knowledge and financial resources. Instead of these variables attitude, change of behaviour, choice and price, there could be other variables included.

According to Elisabeth Shove (2008), there can be a change of behaviour when the dynamic structures of everyday life are observed. People transform and retransform their everyday life,

with its routines and material things. Elisabeth Shove's conclusion, in a study about the meaning of a fridge in a household, is that "people are pretty much constantly engaged in the practical challenge of negotiating symbolic and material systems and in the process constructing and reproducing what is for them a coherent way of life" (Hand & Shove, 2007,p.94). People develop habits, and a habit generates a demand. Routines and regimes do not change through persuasion and a change in price, according to Shove, but through access to a system and its service. A change in citizens' behaviour is often included in a policymaker's assignment, but the challenge is to understand change in practice (Hand & Shove, 2007) .

In my case, policymaking focus on the individual and its responsibility rather than looking at the technical structure and the importance of the infrastructure. Thus the government avoids taking responsibility for the problem, when it is mainly the individual and its behaviour which is observed. At all three political levels there is a consensus about the households' responsibility concerning energy transformation. While industry tends to be considered unable to cut down its energy consumption, households are expected to take the responsibility seriously. And by including the household as a political level it became clear that the households reproduce the economic discourse and use financial arguments, for themselves and others, to legitimize change.

References

- Anshelm, J. (1995). *Socialdemokraterna och miljöfrågan: en studie av framstegstankens paradoxer*. Stockholm: B. Östlings bokförl. Symposion.
- Bacchi, C. L. (1999). *Women, policy and politics: the construction of policy problems*. London: SAGE.
- Falu kommun. (1995a). *Energiplan 1995-1998. För ett uthålligt samhälle*.
- Falu kommun. (1995b). *Miljöprogram 1995. Lokala Agenda 21*.
- Falu kommun. (2005). *Strategi för energirådgivningen i Falu kommun, ks 050222*.
- Falu kommun. (2006a). *Energiplanen år 2006*.
- Falu kommun. (2006b). *Koncernmål för Falu Kommun, perioden 2005-2010, ks 2006-01-31*.
- Falu kommun. (2006c). *Lokala miljömål för Falu kommun, kf 2006-03-09*.
- Hand, M., & Shove, E. (2007). Condensing Practices: Ways of living with a freezer. *Journal of Consumer Culture*, 7(1), 79-104.

International Scientific Conference on "Energy systems with IT" in connection with the Energiting 2009, March 11-12 at Älvsjö fair, Stockholm.

- Hill, M. (1997). *The Policy Process in the Modern State* (3. ed.). London: Prentice Hall.
- Hirdman, Y. (1988). *Genussystemet: teoretiska funderingar kring kvinnors sociala underordning*. Uppsala: Maktutredningen.
- Holmberg, S., & Asp, K. (1984). *Kampen om kärnkraften: En bok om väljare, massmedia och folkomröstningen 1980*. Stockholm: Liber Förlag.
- Howarth, D. (2002). Discourse Theory. In D. Marsh & G. Stoker (Eds.), *Theory and Methods in Political Science* (2 ed., pp. 115-133). London Macmillan Press LTD.
- Perman, K. (2008). *Från el till värme : en diskursanalytisk policystudie av energiomställning på statlig, kommunal och hushållsnivå*. Örebro: Örebro universitet.
- Premfors, R. (1989). *Policyanalys: kunskap, praktik och etik i offentlig verksamhet*. Lund: Studentlitteratur.
- Proposition 1996/97:84. *En uthållig energiförsörjning*.
- Shove, E. (2003). *Comfort, cleanliness and convenience the social organization of normality*. Oxford, England ; New York: Berg.
- Shove, E. (2008). Muntlig presentation under en workshop vid Lancaster University.
- Weitz, R. (Ed.). (1998). *The politics of women's bodies: sexuality, appearance, and behavior*. New York: Oxford Univ. Press.
- West, C., & Zimmerman, D. H. (1987). Doing gender. In *Gender and Society* (pp. 125-151). Newbury Park , Calif.: Sage.
- Winther Jørgensen, M., & Phillips, L. (2000). *Diskursanalys som teori och metod*. Lund: Studentlitteratur.

Paper No. 10

A new mobilized energy storage system for waste heat recovery: Case study in Ärla, Sweden

Weilong Wang^{1,*}; Jinyue Yan^{1,2}; Erik Dahlquist¹; Jenny Nyström³

1. Mälardalen University, Västerås, SE 721 23, Sweden

2. Royal Institute of Technology, Stockholm, Sweden

3. Eskilstuna Energi och Miljö AB, Eskilstuna, Sweden

Email: weilong.wang@mdh.se (W.L. Wang)

ABSTRACT:

This paper introduces a new mobilized thermal energy storage (M-TES) for the recovery of industrial waste heat for distributed heat supply to the distributed users which have not been connected to the district heating network. In the M-TES system, phase-change materials (PCM) are used as the energy storage and carrier to transport the waste heat from the industrial site to the end users by a lorry. A technical feasibility and economic viability of M-TES has been conducted with the comparison of the district heating system as a reference. Thermal performance and cost impacts by different PCM materials have been analyzed compared, aiming at determining the optimum operation conditions. A case study is investigated by utilizing the waste heat from a combine heat and power (CHP) plant for the distributed users which are located at over 30 kilometers away from the plant. The results show that the M-TES may offer a competitive solution compared to building or extending the existing district heating network.

KEYWORDS: Mobile energy storage system; Energy storage materials; Industrial waste heat; Heat supply

INTRODUCTION

There is a long winter period in Sweden, and a large amount of energy is needed in dwelling district [1-3]. District heating system (DHS) is the existing energy supply network that distributes hot water to end users from the centre heating system [4-6]. Although the district heating system network has widely spread in major areas in Sweden, there are still districts without connection to the district heating system [7]. For these districts, electricity heater or some small local heat supply centre by using oil-boilers and pellets-boilers has been used to meet heat demands, with the disadvantage of consuming a large amount of oil or other fuels. This disadvantage causes lots of economic and environmental problems [8, 9]. Therefore, how to replace the fossil based fuels for heating by other alternative and innovative solutions with low costs is important to investigate.

It is reported that more than 736,000 TJ of waste heat (100°C-200°C) is generated annually and released to the ambient atmosphere or through cooling water in the world [10]. How to recover the waste heat effectively and efficiently has been investigated by developing different technologies, including, e.g., energy storage and waste heat for district heating.

Phase change materials play a key point to store sustainable energy and industrial waste heat. There are many works related to various types of energy storage materials preparation as well as experiments and investigations on PCM-based energy storage systems and technologies [11-17].

A new concept of so-called mobilized thermal energy storage system has been studied [10] [18,19]. Several companies and research institutes are involved in this area. They studied the performance of energy storage container and built some demonstration experiments. However, the past work focused on heat supply from heat source to a building (one spot to one spot). In this case, heat is supposed to be supplied to a small heating district net using M-TES system integrated with pellets boiler heating system. Moreover, some new energy storage materials will be discussed to supply in this case. In this paper, the integrated solution between transporting energy and pellets boilers heating system for small district heating net is investigated.

STUDIED SYSTEM AND METHODS

1.1.7. Background of the project

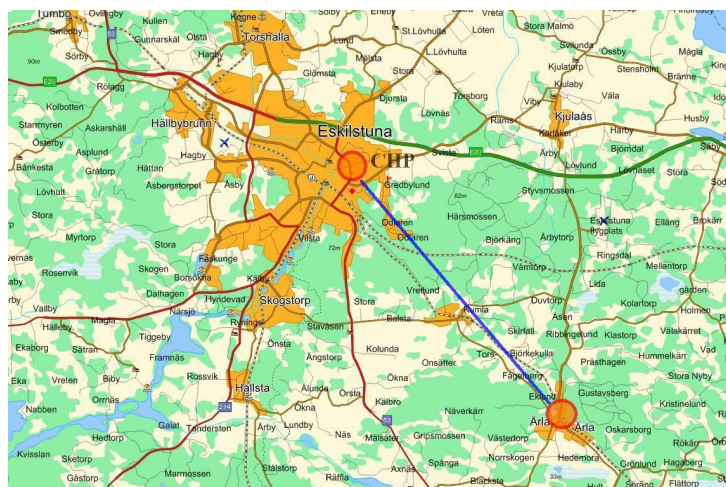

Figure 1 Location of CHP in Eskilstuna and village in Ärla

As Figure 1 shows, Ärla is a small village outside the town Eskilstuna in Sweden, which is located at 30 kilometers away from the plant. A small district heating system is used to heat tap-water during summertime, and heat house and tap-water during wintertime in the village. Currently, the village is heated by a 1 MW pellets-boiler and two oil-boilers on 4 MW each, working in redundancy (only one of them is in use at time). Because oil-boilers are frequently in use, plus oil is expensive and not sustainable, the owner (Eskilstuna Energy and Environment) wants to replace the main part of the heat sources by something cheaper and more environmentally friendly. Attention has been attracted by producing part of the heat by a cheaper heating system instead of the pellets-boiler. This paper states the key issues when the heating system in Ärla is combined with transported heat from the biomass power plant in Eskilstuna providing heat mainly during the summer and winter period in this case.

Mobilized heating system with energy storage

A concept of mobilized thermal energy storage system is shown in Figure 2. Energy storage materials are packed in a specific container loaded on the truck. Using heat exchanger and heat

transfer media, heat is stored by energy storage materials from the heat sources, like power plant and steel plant etc., where there is a big amount heat. After fully charging, heat can be transported to ender user [10] [18,19].

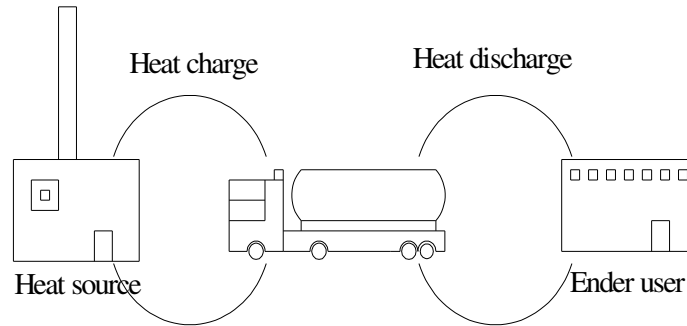

Figure 2 Diagram of mobilized thermal energy storage system

Description of the heating system

A sketch of the proposed heating system in Ärla is shown in Figure 3. In the heating system, the accumulator holds 200 m³ of medium that stores the heat produced by the system. The system is designed for a maximum heat load of 4.4 MW at the temperature of 70-100 °C under the pressure of 3.5 bars. When the accumulator is fully loaded (water is used as the accumulating medium), it holds 14 MWh of heat, which provides 5-6 hours of heat for the village if the heat load is 2.5 MW during cold winter period, and provides 20 hours if the heat load is 0.7 MW during summer period. When heat is stored in the accumulator, the outlet temperature of the accumulator is about 75 °C in summertime and 70-100 °C in wintertime. The temperature of the water that flows into the accumulator is around 40 °C.

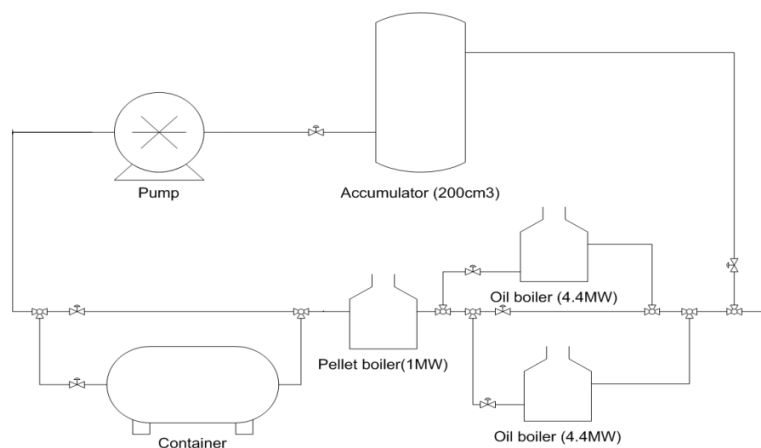

Figure 3 Description of boundaries and components at a new heating system in Ärla

The DH in Ärla is connected to a couple domestic houses including a school, a child care centre, a block of service flats (elder peoples’ home) and villas in the central village.

Methods

1.1.1. Parameters to be investigated in the study

To study feasibility of this project, firstly, annual heat demand in Ärla should be investigated. At the same time, heat supply by pellets boiler and oil boiler is also investigated. Secondly, according to the conditions of heat source, some prospective energy storage materials will be compared from several aspects, like melting temperature, density and heat latent of fusion etc. Then, the suitable material is supposed to be proposed. Finally, economic analysis and sensitivity analysis will be carried out.

1.1.2. Cost-benefit analysis

1.1.2.1. Net present value (NPV)

The NPV is a financial criterion to analyze the profitability of an investment or project. The NPV gives the value of the cash return that is expected and is calculated by summation of the present net value of the benefits for each year over expected lifetime periods and by subtracting the initial costs of the project. Suppose B_n is the present value of the net benefits of period n , C_n all costs and i the internal rate of discount. The NPV of the investment is calculated as the following formula [20-23]:

$$NPV = \sum_0^n \frac{B_n - C_n}{(1+i)^n} \quad (1)$$

If the NPV of a prospective project is positive, it should be accepted.

1.1.2.2. Internal rate of return (IRR)

Like the NPV, IRR is often used to analyze long- term investments. The IRR equals the percentage discount rate that makes the NPV of the investment equal to zero [20-23]:

$$\sum_0^n \frac{B_n - C_n}{(1+IRR)^n} = 0 \quad (2)$$

1.1.2.3. Payback period (PP)

Payback period can help to estimate the project feasibility simply and directly. It means at this time, all the income obtained from this project is totally equal to all the cost since the project starts [20-23].

$$PP = (n-1) + \frac{ABS\left(\sum_0^{n-1} \frac{B_{n-1} - C_{n-1}}{(1+i)^{n-1}}\right)}{\frac{B_n - C_n}{(1+i)^n}} \quad (3)$$

1.1.3. Sensitivity studies

Sensitivity studies will permit to add some uncertainty on those variables that could suffer changes due to various parameter fluctuations [24-26]. In this case, five factors were studied from the different material price, investment, amount of product supply, heat price and discount rate.

RESULTS AND DISCUSSIONS

1.1.4. Annual heat demand in Ärla

The annual heat demand should be investigated at first, which will decide how much of potential it is for this project. In this project, M-TES system will supply some parts of the heat demand supplied by oil boiler and pellets boiler in the current heating system. Therefore, the amount of heat demand will affect the benefit of this project.

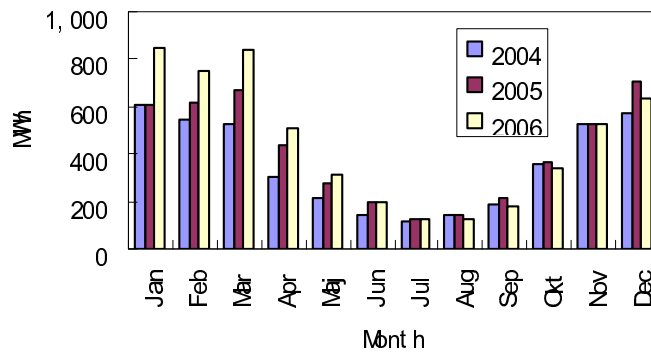

Figure 4 Heat load in Ärla from 2004 to 2006

The heat demand in Ärla is shown in Figure 4. From Figure 4, it can be seen that there is variations on monthly heat demands. Moreover, it is clear that much more heat is needed in winter period from October to April. The average amount of heat demand in winter (Oct. to Apr.) is calculated as 3,941 MWh/a, and the amount in summer is 715MWh/a.

1.1.5. Thermal performance Comparisons of different studied systems

Waste heat is available at times not necessarily coinciding with the demand for heat or cold. Thermal energy storage is a way to match the supply and the demand of thermal energy. The most common way for thermal energy storage is to utilize the sensible heat change with temperature. The advantage of such storage is its simplicity, and the disadvantage is that the large volumes are required and that the energy is released at varying temperature. Storage density for sensible heat storage in water is 10 kWh/m³, whereas storage density in the range from 40 to 130 kWh/m³ could be reached by using the latent heat technologies for storage.

Table 1 Performance of energy storage materials candidates

Materials	T _m [°C]	Density [kg/m ³]	ΔH _m [kWh/m ³]	Q _{all} [kWh/m ³]	Volume [m ³]	Q _v [MWh]
-----------	---------------------	------------------------------	---------------------------------------	--	--------------------------	----------------------

Erythritol	120	1480	139.70	235.90	23.65	4.46
Xylitol	94.5	1520	111.17	209.97	23.03	3.87
RT112	112	770	45.56	95.61	45.45	3.48
Succinic anhydride	119	1104	62.56	134.32	31.70	3.41
D- sorbitol	98	1500	77.08	174.58	23.33	3.26
Quinone	115	1318	62.61	148.28	26.56	3.15
Benzamide	127	1341	63.10	150.27	26.10	3.14
E117	117	1450	68.07	162.32	24.14	3.13
Stibene	124	1164	54.00	129.66	30.07	3.12
HDPE	125~130	940	43.61	104.71	37.23	3.12
Benzoic acid	122	1266	50.22	132.51	27.65	2.93
Acetanilide	115	1210	47.73	126.38	28.93	2.92

* Temperature range is from 40°C to 130°C

For example, the latent heat of magnesium chloride is 72.6 kWh/m³ with a density of 1550 kg/m³. The heat capacity is 101 kWh/m³ when the temperature range is from 40°C to 130°C which gives a total heat capacity for magnesium chloride of 173 kWh/m³. We are allowed to transport 35t on a truck, which gives 35,000/1,440=24.31 m³. This gives 173*24.31=4205 kWh per truck and that makes a cost of 750/4.205=178 SEK/MWh.

Performance of Various energy storage materials is showed in Table 1. Considering thermo physical performance of various materials, Erythritol is selected as a promising energy storage material for waste heat utilization due to its large latent heat. Erythritol also has a stable performance after repeated solidifications and fusions for a long period. The degradation of Erythritol is less than 10% about 70,000 hours later when it continuously is heated to 140 °C. Kakiuchi H. concluded that life time of erythritol highly depends on temperature than repeat of solidifications and fusions. Because the temperature of this case is around 130 °C, according to their investigations, the lifetime of Erythritol is more than 20 years [27].

Economic performance

1.1.6. Cost vs. benefit analysis in Ärla

The heat storage materials are loaded in containers with the loading of no more than 40 t or 100 m³. In this case, each truck holds 35t of energy storage materials. The cost for a round trip by truck is 750 SEK. According the price and amount of pellets and oil, production price in Ärla is calculated to be 330.72SEK. Therefore, the maximum cost for the transported heat is 259 SEK/MWh heat (calculated from the production cost in the current existing production units in Ärla and the production cost of the heat at the power plant. The income for production of electricity for the extra amount of heat is included.)

Table 2 Cost vs. benefit analysis for original heating system

Item	Value
Income of electricity [SEK/MWh]	500

International Scientific Conference on “Energy systems with IT” in connection with the Energiting 2009, March 11-12 at Älvsjö fair, Stockholm.

Prod. Price (CHP) [SEK/MWh]	200
Efficiency electricity	0.3
Efficiency	0.7
Production cost in Ärla	
Prod. Cost (pellets) [SEK/MWh]	300
Prod Cost (oil) [SEK/MWh]	400
Energy/year (pellets) [MWh]	4,118
Energy/year (oil) [MWh]	1,826
Production Price in Ärla [SEK/MWh]	330.72
Transport price Per MWh heat [SEK/MWh]	259.29

The operating cost and revenue of existing system are listed in Table 3. Annual maintenance in existing system is about 200000 SEK. The fuel cost each year was shared by oil and pellets, which amounts to 1965800 SEK. The price of selling heat is 445 SEK/MWh, and the revenue of existing system is calculated to be 2380305. Then, the annual profit is 214505 SEK.

Table 3 Costs vs. benefits of existing heating system

Item	Value
<i>Operating cost</i>	
Maintenance in existing system [SEK/a]	200000
Cost of oil [SEK/a]	730400
Cost of pellets [SEK/a]	1235400
<i>Revenues</i>	
Revenues from selling heating [SEK/a]	2380305
<i>Profits</i>	

Annual profits [SEK/a]	214505
-------------------------------	---------------

1.1.7. Cost vs. benefit analysis of M-TES based system

The calculation is based on several assumptions:

- The interest rate of the company is assumed to be 6%;
- The lifespan of this project is summed to be 20 years;
- The price of the TES material is summed to be \$3.5/kg in this calculation, which is the price with the purchase of larger quantities;
- The oil boiler part would be completely replaced totally, and 60% of the heat produced by existing heating system would be replaced;
- The efficiency of the M-TES is assumed to be 80%;
- The investment on the spot of the heat source and the end user is assumed to be 935150 SEK;
- One container is estimated to cost 490954 SEK;
- Annual maintenance is estimated at 93500 SEK;
- Tax for heating is not considered in the calculation;
- Bank loan is not considered in the calculation.

Investment of new heating system of M-TES is listed in Table 4. Investment of M-TES includes two parts: the cost of charging and discharging station in CHP and Ärla, respectively, and the cost of container with energy storage materials.

Table 4 Investment of the M-TES system

Item	Value
Investment [SEK]	935150
Number of container	2
Cost of a container [SEK]	490954
Energy storage material [SEK]	732917
Total invest-cost [SEK]	3382892

From Tables 3 and 4, it shows the annual operating cost and the annual income of the M-TES.

Firstly, the investment includes three parts: construction on the spot of the heat source and end-user (including pipes, heat exchanger), container, and TES materials. The total investments are calculated to be 3382892 SEK

Secondly, the running cost of the M-TES consists of annual transport costs (including labor) and annual maintenance. Based on the heat demand, the number of transport cycles is calculated to be

International Scientific Conference on “Energy systems with IT” in connection with the Energiting 2009, March 11-12 at Älvsjö fair, Stockholm.

719. In addition, considering the cost of maintenance in existing system, pellet cost in Ärla and wood chip cost in CHP, the total operating cost amounts to 2766632 SEK/a.

Finally, the annual revenues obtained are composed of two parts: selling heat and selling the more electricity produced based on transport heat. The total revenues sum up 3239966 SEK

Based on the calculation, the profit of the new heat supply system amounts to 473334 SEK/a. Compared to existing system, the annual profit of new system is increased by 1.2 times.

Table 5 Annual revenue and operating cost details of the case in Ärla

Item	Value
<i>Operating cost</i>	
Maintenance for M-TES system [SEK/a]	93500
Transportation Cost [SEK/a]	539214
Maintenance in existing system [SEK/a]	200000
Pellets fuel cost [SEK/a]	713200
Wood chips cost in CHP [SEK/a]	1220718
Total operating-cost [SEK/a]	2766632
<i>Revenues</i>	
Heat selling [SEK/a]	2380305
Electricity in CHP [SEK/a]	859661
Total revenues [SEK/a]	3239966
<i>Profits</i>	
Annual profit [SEK/a]	473334

1.1.8. NPV, IRR and PP analysis

The NPV, IRR and PP of the case of Ärla are calculated with the assumed discount of 6% and lifespan of 20years, and the results are listed in Table 5.5.

From Table 5, it can be seen that NPV is 1898623 SEK. The positive value of NPV proves that benefits can be achieved during the project lifespan. The IRR value of this case is reasonable with a value of 12.5%, and the payback period is 10.6 years. From these data, it can be concluded that this case of M-TES is feasible.

Table 5 The values of NPV, IRR and PP

Year	Cost [SEK]		Income [SEK]	Annual NPV [SEK]
	Investment	Annual Cost		
Year 0	3382892	0	0	-3382892
Year 1	0	2766632	3239966	446541

Year 2	0	2766632	3239966	421265
...
Year 20	0	2766632	3239966	156443
NPV=1898623SEK IRR = 12.5% PP=10.6year Discount rate=6%				

1.1.9. Sensitivity analysis

Sensitivity studies were carried out with the five factors, including investment, discount rate, operating cost, heat price and M-TES based heat amount. All the results are listed from Table 5 to Table 8. It can be seen that the value of NPV and IRR increased with the increase of heat price and M-TES based heat amount, and with the decrease of investment, operating cost and discount rate. Meanwhile, payback period increased with the increase of investment, operating cost and discount rate, and decreased with the increase of heat price and M-TES based heat amount. By comparison, the price of heat and the operating cost have more impacts on the benefit of project.

Table 5 Comparison of NPV, IRR and RP with investment

	NPV (SEK)	IRR (%)	PP (year)
-20%	2575200	16.5	8.2
-10%	2236911	14.3	9.3
0	1898623	12.5	10.6
+10%	1560333	11.0	10.8
+20%	1222043	9.6	12.2

Table 6 Comparison of NPV, IRR and RP with different discount rate

	NPV (SEK)	IRR (%)	PP (year)
6%	1898623	12.5	10.6
7%	1509296	12.5	11.3
8%	1162818	12.5	12.0
9%	853501	12.5	13.0
10%	576509	12.5	14.2

Table 7 Comparison of NPV, IRR and RP with different operating cost

	NPV (SEK)	IRR (%)	PP (year)
-10%	4985661	21.6	6.3
-5%	3442148	17.2	7.9
0	1898623	12.5	10.6
+5%	355099	7.3	17
+10%	<0	\	>20

Table 8 Comparison of NPV, IRR and RP with different heat prices

	NPV (SEK)	IRR (%)	PR (year)
-5%	<0	\	>20
0	1898623	12.5	10.6
+5%	3226607	16.6	8.2
+10%	4554590	20.4	6.8
+15%	5882573	24.1	5.8

Table 9 Comparison of NPV, IRR and RP with different M-TES-based heat amount

	NPV (SEK)	IRR (%)	PR (year)
40%	1268078	10.5	12.5
50%	1583351	11.5	11.4
60%	1898623	12.5	10.6
70%	2213896	10.5	9.9

CO₂ emissions reduction

Climate change is caused by greenhouse gases such as carbon dioxide (CO₂) [28,29]. According to information from Biomass Energy Centre, 264 kg of CO₂ per 1MWh is produced by oil boiler as well as 345kg of CO₂ per 1 MWh is produced by pellets combustion. Hence, instead of oil-and pellets combustion, 1,192 tons of CO₂ can be reduced annually. The truck is assumed to go as far as 15 km per 1 gallon diesel oil under the load of 40t. Based on report of Biomass Energy Centre, CO₂ emission for transport is 520 g/km. Therefore, annual CO₂ emission of transportation is calculated as 11t. Finally, the total CO₂emission can be reduced by 1181t.

CONCLUSIONS

In this paper, a proposal of using waste heat to supply heat demand of dwelling without connection to CHP district heating system is provided. The technology and the system concept are addressed as well. The objective of this study is to assess the techno-economic feasibility of this project. Several energy storage materials were discussed and compared, and Erythritol is selected as a promising energy storage material in this case due to its high heat capacity, stability of energy absorb-release cycle performance and appropriate melting point. Based on the current heating system, mobilized heating system was integrated and discussed with techno-economic evaluation. Assuming the discount rate is 6% and life time of project is 20 years, it shows that the value of NPV is 10,816,410SEK, and IRR is 30.6%, and payback period is 4.7 years, if 50% of initial heat supply is replaced by mobilized heating system. After analyzing the effects of different parameters, such as container cost, investment, running cost and heat price. In this case, it can be concluded that heat selling price has a significant effect on NPV, IRR and PR. Both the values of NPV and IRR increase, and the payback period decreases, with the increase of heat selling price. Moreover, using mobilized energy storage system can reduce over 1,181t CO₂ emissions.

ACKNOWLEDGEMENT:

Authors are greatly grateful for the support of this project by Eskilstuna Energi och Miljö AB, Eskilstuna, Sweden. Author also appreciates the financial support by China Scholarship Council.

REFERENCES:

- [1] Reidhav C, Werner S, Profitability of sparse district heating, Applied Energy 2008, (85):867-877

International Scientific Conference on "Energy systems with IT" in connection with the
Energizing 2009, March 11-12 at Älvsjö fair, Stockholm.

- [2] Nilsson SF, Reidhav C, Lygenerud K, Werner S, Sparse district-heating in Sweden, *Applied Energy* 2008, (85) 555-564
- [3] Joelsson A, Gustavsson L, Distric heating and energy efficiency in detached houses of differing size and construction, *Applied Energy* 2008
- [4] Eriksson M, Vamling L, Futrue use of heat pumps in Swedish district heating systems: short- and long-term impact of policy instruments and planned investments, *Applied Energy* 2007, (84):1240-1257
- [5] Ozgener L, Hepbasli A, Dincer I, A key review on performance improvement aspects of geothermal district heating systems and applications, *Renewable & Sustainable Energy Reviews* 2007, (11):1675-1697
- [6] Bareli L, Bidini G, Pinchi EM, Implementation of a cogenerative district heating system: dimensioning of the production plant 2007, (39):658-664
- [7] Gustavsson L, Karlsson Å, Heating detached houses in urban areas, *Energy* 2003, (28):851-875
- [8] Möllersten K, Gao L, Yan JY, CO₂ balances and mitigation costs of advanced CHP systems with CO₂ capture in pulp and paper mills, *Mitigation and Adaptation Strategies for Global Change* 2006, (11):1129-1150
- [9] Möllersten K, Gao L, Yan JY, Obersteiner M, Efficient energy systems with CO₂ capture and storage from renewable biomass in pulp and paper mills, *Renewable Energy* 2004, (29):1583-1598
- [10] Fujita Y, Shikata I, Kawai A, Kamano H, Latent heat storage and transportation system transheat container, The first workshop and expert meeting, 13th-15th November, Tokyo, Japan, 2006, pp. 1-4
- [11] Karaipekli A, Sari A, Capric-myristic acid/expanded perlite composite as form-stable phase change material for latent heat thermal energy storage, *Renewable Energy* 2008, (33):2599-2605
- [12] Fang YT, Kuang SY, Gao XN, Zhang ZG, Preparation and characterization of novel nanoencapsulated phase change materials, *Energy Conversion and Management* 2008
- [13] Cai YB, Wei QF, Huang FL, Gao WD, Preparation and properties studies of halogen-free flame retardant form- stable phase change materials based on paraffin/high density polyethylene composites, *Applied Energy* 2008, (85): 765-775
- [14] Wang WL, Yang XX, Fang YT, Ding J, Preparation and performance of form- stable polyethylene glycol/silicon dioxide composites as solid- liquid phase change materials, *Applied Energy* 2008
- [15] Kenisarin M, Mahkamov K, Solar energy storage using phase change materials, *Renewable & Sustainable Energy Reviews* 2007, (11)1913-1965

International Scientific Conference on "Energy systems with IT" in connection with the
Energiting 2009, March 11-12 at Älvsjö fair, Stockholm.

- [16] Kuznik F, Virgone J, Noel J, Optimization of a phase change materials wallboard for building use, *Applied Thermal Engineering* 2008, (28):1291-1298
- [17] Koca A, Oztop HF, Kouyun T, Varol Y, Energy and exergy analysis of a latent heat storage system with phase change materials for a solar collector, *Renewable Energy* 2008, (33):567-574
- [18] Weber J, *Balance* 2002, pp.6
- [19] Kaizawa A, Kamano H, Kawai A, Jozuka T, Senda T, Maruoka N, Akiyama T, Thermal and flow behaviors in heat transportation container using phase change materials. *Energy Conversion & Management* 2008, (49):698-706
- [20] Bojanc R, Jerman-Blazic B, An economic modeling approach to information security risk management, *International Journal of Information Management* 2008.
- [21] Perkis D, Tyner W, Dale R, Economic analysis of a modified dry grind ethanol process with recycle of pretreated and enzymatically hydrolyzed distillers' grains, *Bioresource Technology* 2008, (99):5243-5249
- [22] Chau J, Sowlati T, Sokhansanj S, Preto F, Melin S, Bi X, Techno-economic analysis of wood biomass boilers for the green house industry, *Applied Energy* 2008
- [23] Marchetti JM, Miguel VU, Errazu AF, Techno-economic study of different alternatives for biodiesel production, *Fuel Processing Technology* 2008, (89):740-748
- [24] Boonnasa S, Namprakai P, Sensitivity analysis for the capacity improvement of a combined cycle power plant (100-600MW), *Applied Thermal Engineering* 2008, (28):1865-1874
- [25] Jeong SJ, Kim KS, Park JW, Lim DS, Lee SM, Economic comparison between coal-fired and liquefied natural gas combined cycle power plants considering carbon tax: Korean case, *Energy* 2008, (33)1320-1330
- [26] Ren HB, Gao WJ, Ruan YJ, Economic optimization and sensitivity analysis of photovoltaic system in residential buildings, *Renewable Energy* 2008,1-7
- [27] Kakiuchi H, Yamazaki M, Yabe M, Chihara S, Terunuma Y, Sakata Y, Usami T, A study of Erythritol as phase change material, *Final proceedings second workshop, Sofia, Bulgaria, 1998*, pp.1-9
- [28] Möllersten K, Yan JY, Moreira JR, Potential market niches for biomass energy with CO₂ capture and storage, *Biomass and Bioenergy* 2003, (25):273-285
- [29] Möllersten K, Yan JY, Westermark M, Potential and cost-effectiveness of CO₂- reduction in the Swedish pulp and paper sector, *Energy* 2003, (28): 691-710

Paper No. 11

**Bio-refinery system of DME or CH₄ production from black liquor gasification in
pulp mills**

M. Raza ^{*1}, Jinyue Yan ^{1,2}, Morgan Fröling ³

1. *Department of Chemical Engineering and Technology/Energy Processes, Royal Institute of Technology,
SE-100 44 Stockholm, Sweden*
2. *School of Sustainable Development of Society and Technology, Mälardalen University,
Box 883
SE-721 23 Västerås, Sweden*
3. *Department of Chemical and Biological Engineering, Chalmers University of
Technology,
SE-412 96 Goteborg, Sweden*

*Corresponding author. Tel: +46 8 7906224

Email address: rnaqvi@kth.se (M. Raza)

ABSTRACT

The consumption of fossil fuels is rapidly increasing and there is an urgent need to develop technologies for renewable fuel production not only as alternatives but also as additional fuels. Efficient polygeneration of transportation fuels with heat and electricity is one of the innovative technologies which have potential to replace fossil fuels and mitigate climate change. Two potential technologies of producing dimethyl ether (DME) and methane (CH₄) as alternative fuels integrated with black liquor gasification have been studied and compared in this paper. System performance is evaluated based on: (i) Comparison with the reference pulp mill, (ii) Fuel to product efficiency (FTPE) and (iii) Biofuel Production Potential (BPP). The comparison with the reference mill shows that black liquor to biofuel route will add a highly significant new revenue stream to the pulp industry. The results indicate a large potential of DME and CH₄ production globally in terms of black liquor availability. BPP and FTPE of CH₄ production is higher than DME due to more optimized integration with the pulping process and elimination of evaporation unit in the pulp mill.

Keywords: *Black liquor gasification; pulp and paper industry; biofuels; bioenergy; dimethyl ether (DME); methane*

Introduction

1.1 Background

About 85% of world energy comes from fossil fuels and is projected to expand by 50 percent from 2005 to 2030 [1]. This rapid increase in energy use concerns issues like global warming, fuel security and depletion of non-renewable resources. There is currently much interest in putting efforts to favor the use of renewable energy resources including the increased production of bio-based fuels as one of the possible solutions to solve the problems. CO₂ neutral fuels will play an important role in the future energy supply to replace fossil fuels due to increasingly strict

regulations for greenhouse gas emission reduction. The European Union (EU) has set a target for biofuel usage in the transportation sector of 5.75% by 2010 [2]. The target is challenging but quite modest in order to meet demanding targets for greenhouse gas emission reductions. With growing transport sector, the development of innovative biofuel production technologies will help to meet these challenging targets.

Black liquor is one of bioenergy resources, especially in those countries which have pulp and paper industry. Future Kraft pulp mills have potential to become key suppliers of biofuels and can be designed to incorporate biorefinery operations, co-producing pulp and bio-based energy products. Most of the energy surplus in the pulp mill is associated with black liquor (BL); the remaining fraction of wood coming out of the digestion unit and pulping chemicals. Today, black liquor is combusted in Tomlinson recovery boiler to produce steam necessary for Kraft pulp mill operation. Moreover, the recovery boiler is also used to recover cooking chemicals for reuse in the pulping process.

Nomenclature			
ADt	Air dried tonnes	DME	Dimethyl
ether		BL	Black liquor
	EU	European Union	
	BFW	Boiler feed water	FTPE
gasification	Fuel to product efficiency	BLG	Black liquor
	DMPEG	Dimethyl Polyethylene glycol	BLS
	Black liquor solids glycol	KAM	Kretslöppts

Several studies have been made over recent years to replace recovery boilers with black liquor gasification (BLG) and integrate with the pulp mill for efficient recovery of bio-based residues (STFI, 2003; Bengtsson, 2004; Ådahl, 2004; Harvey et al., 2004; Möllersten et al., 2003a, 2003b; Ekbohm et al., 2003; Dahlquist et al., 2007; Yan et al., 2007). Integration of the black liquor gasification with a gas turbine to improve the performance of the combined heat and power has been investigated (Maunsbach et al., 2001). Various power cycles including combined cycle (CC), Steam Injected Gas Turbine (STIG) cycle, evaporative gas turbine or humid air turbine (EvGT or HAT) cycles are evaluated (Yan & Edidensten, 2000, Jonsson & Yan, 2004,). Previous results showed that the advanced power generation has the potential to increase the electricity surplus; this is especially true when the demand of steam is reduced by the innovation of the pulp and paper process. The performance of BLG is evaluated in terms of technical, economic and climate change mitigation (Näsholm & Westermarck, 1997; Maunsbach et al., 2001; Eriksson, 2004; Yan et al., 2007). Ekbohm et al. (2003) compared technical and commercial feasibility of Methanol and Dimethyl ether (DME) production from BLG as motor fuels. Möllersten & Yan et al. (2007) assess the economics of CO₂ mitigation of advanced CHP systems with CO₂ capture integrated with large scale pulp and paper mills [5,8]. Andersson and Harvey (2007) evaluated the energy consequences and application of hydrogen production from BLG to replace fossil fuels [10]. The thermal gasification process has been evaluated for many years with a number of pilot plants operated successfully. However, there is no pilot plant data available for black liquor in hydrothermal gasifier but few experimental studies were performed. Modell et al. (1985)

evaluated super critical water gasification of biomass and presented a direct route for Methane (CH_4) production replacing methanation unit [11]. Waldner (2005) presented experimental results and discussed benefits of catalytic hydrothermal gasification for renewable CH_4 production from woody biomass [12]. Sricharoenchaikul (2008) examined black liquor in supercritical water gasification to evaluate the feasibility of this technique in order to convert such waste stream to fuel products [13]. The experiments under different operating conditions showed higher gas production under increasing temperature and residence time as compared to increasing pressure.

Previous studies have investigated energy efficient BLG for electricity generation or renewable fuel production including hydrogen, methanol or DME production. In this paper, the feasibility of two different black liquor gasification technologies to replace the recovery boiler from Kraft pulp mill, generating either DME or CH_4 is evaluated and compared. The present study analyzes system performance of gasification technologies to convert BL to bio-based automotive fuels. The integration of BLG with the pulp mill would require compensating process heat and power from black liquor by additional biomass import [14].

1.1.10. Objective

The objective of this paper is to identify whether BLG for DME or CH_4 production is advantageous based on system performance indicators. In addition, the results are compared between the polygeneration of biofuels and the reference pulp mill based on energy and material flows. The emphasis is to avoid any major impacts on pulping process and maintain chemical

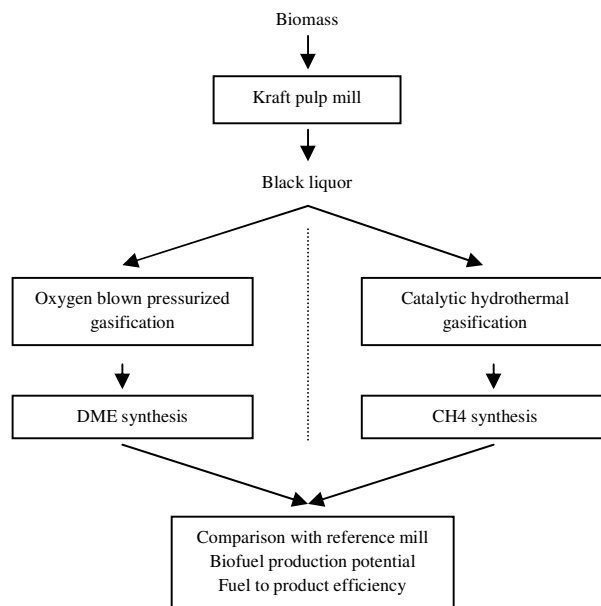

Fig. 1. Two possible routes of biofuel production from BLG.

recovery cycle similar with the case of recovery boiler. Fig. 1 presents two integrated systems with the pulp mill based on performance indicators.

Methods and Assumptions

The modeling performed in this study is based on a reference pulp mill system and possible integration with BLG for biofuel production. It is assumed that all cooking chemicals must be recovered from the gasifier and sent back to the pulp mill for digestion. The study includes two integrated systems; (A) Thermal Gasification process for DME and (B) Catalytic hydrothermal gasification for CH₄. The currently most advanced Oxygen blown pressurized entrained flow gasifier (Chemrec) is selected for DME production because it can produce synthesis gas at a high temperature and separates inorganics from the black liquor in the quench section within the gasifier. Catalytic hydrothermal gasification itself is CH₄ production unit and only separation from CO₂ is required for the purification.

The present demand of electricity and steam for the reference pulp mill is constant in system A. However, the heat demand of the pulp mill is reduced in system B due to the elimination of energy intensive evaporation unit. There is no need to concentrate black liquor and it is sent directly to hydrothermal gasifier for synthesis gas production. The overall energy balance of the mill integrated with biofuel production is assumed to affect the marginal energy supply. The studied systems including their integration with reference pulp mill system is discussed in the following sections.

1.1.11. Reference pulp mill system

Kraft pulping separates the cellulose fibers from lignin and other wood components. Wood chips and white liquor are fed into the digestion unit. The lignin and other organic material dissolve into the white liquor and exit the digester as black liquor. The weak black liquor (17-20 wt%, dry solids) is concentrated to solid content of 75-80 wt% in series of evaporators and combusted in the recovery boiler to recover cooking chemicals and generate steam and electricity for the pulp mill [15].

A modern Kraft pulp mill can be self sufficient in energy if black liquor is gasified instead of combustion in recovery boiler, and even generate a surplus of electricity and/or fuels. Fig. 2 compares the recovery boiler with integrated BLG in a conventional pulp mill. The pulping operation in the polygeneration system of biofuel is identical to that in conventional pulp mill.

However, the old bark boiler is replaced by a new bio-fuelled power boiler for the production of heat and power. The bark boiler is fired with the remaining bark present at the mill site while the power boiler utilizes the existing bark plus external biomass which is needed to replace the energy withdrawn when the black liquor is converted to biofuel. To calculate external biomass requirement, the power boiler is dimensioned primarily to meet steam demand of the pulp mill. High-pressure steam is produced and fed to a new backpressure steam turbine generating the electric power.

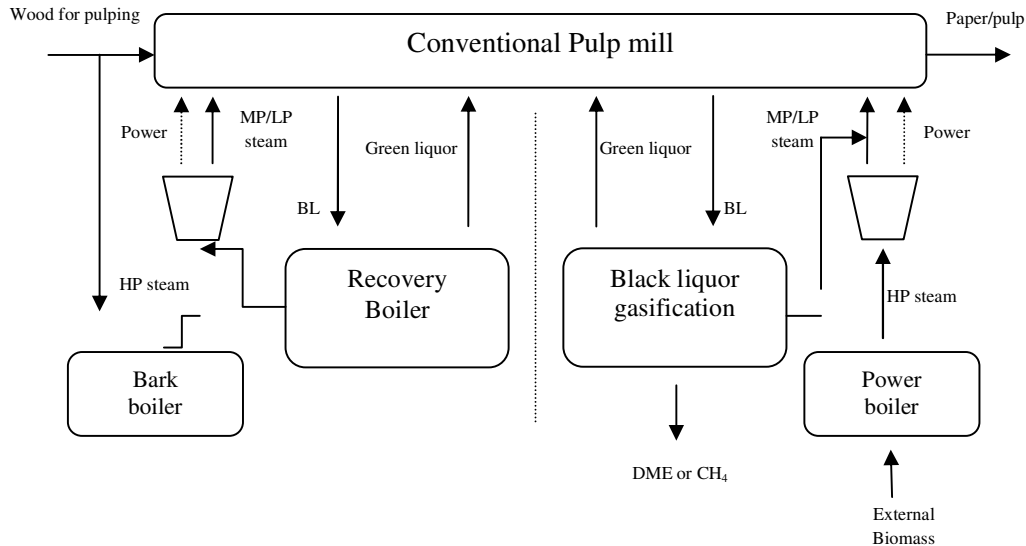
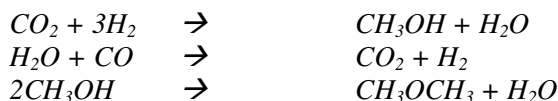

Fig. 2. Comparison of recovery boiler with BLG in the conventional pulp mill.

1.1. DME production (system A)

BLG plant for DME production is integrated with the reference pulp mill with no internal recovery boiler. A systematic material flow model with main input and output data for thermal BLG unit is shown in Fig. 3. Oxygen with a high purity (>99 %vol) is supplied as a gasifying medium to the thermal gasifier. The high temperature (950-1000 °C) in refractory lined gasifier enables high contents of H₂ and CO in the synthesis gas [6]. The green liquor is cooled from 200°C to 90°C and sent back to the pulp mill for cooking in digestion unit [18]. The heat of high temperature synthesis gas is recovered in gas cooling unit to produce medium and low pressure steam.

For purification of synthesis gas, Rectisol process coupled with CO-shift unit is used to remove sulfur components such as H₂S. After purification, the cleaned gas is then adjusted in composition required for DME synthesis in CO-shift unit and finally CO₂ formed in shift conversion is removed in the absorber unit. The cleaned and shifted gas is first compressed from 30 bar to 100 bar needed for DME synthesis loop. In the synthesis loop, the synthesis gas is converted into methanol and DME in a catalytic reactor. See the following reaction schemes for DME synthesis:



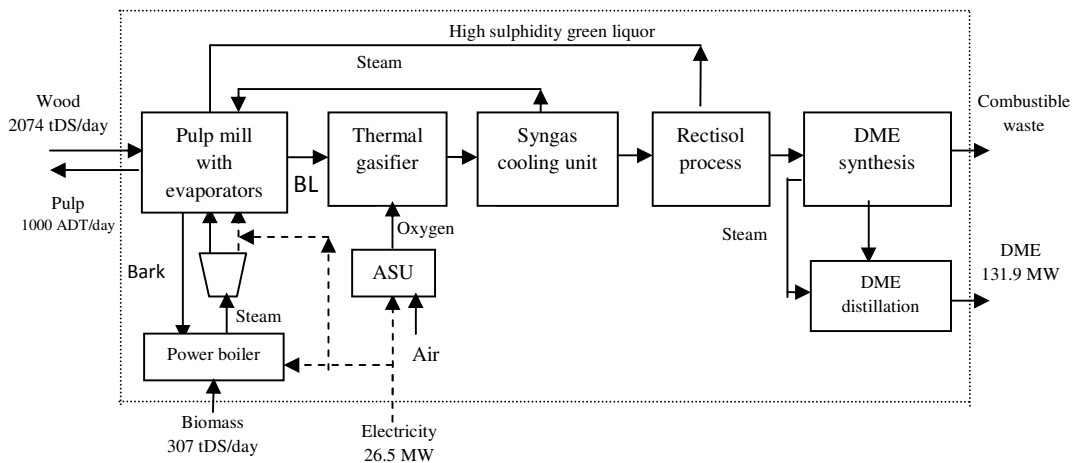

Fig. 3. System A: DME production from BLG integrated with the reference pulp mill including evaporation unit.

The mixture is then condensed by refrigeration and sent to another reactor for conversion of methanol to DME. The crude DME is purified in the distillation column before being exported as a fuel. Being exothermic, DME synthesis releases a considerable amount of heat that is utilized to preheat boiler feed water (BFW) and generate low pressure steam for DME distillation column. This decreases the net steam demand of BLG unit and fuel consumption in the power boiler. Small amounts of combustible wastes from DME synthesis loop also contribute as supplementary fuel in the power boiler.

1.2. CH_4 production (system B)

Catalytic hydrothermal gasification is considered as another alternative to replace the recovery boiler to produce CH_4 . It is important to mention that black liquor has never been tested in catalytic hydrothermal gasifier in a pilot plant but very few experimental studies are performed [13]. The present study assumes that black liquor will behave similar to wet biomass (moisture content > 70 %wt) in supercritical water conditions. Vogel (2005) and Sricharoenchaikul (2008) discussed that the heat demand for bringing water to supercritical conditions is less than that for evaporating at subcritical pressure. High water contents in the black liquor under supercritical condition would increase gasification reactions and production of synthesis gas (Calzavara et al., 2005; Williams and Onwudili et al., 2005) [19, 20]. This phenomenon helps to bring black liquor directly to hydrothermal gasifier removing energy demanding evaporation units in conventional process and thus decreases the steam demand of the pulp mill.

Fig. 4 illustrates a schematic flow model of CH_4 production including hydrothermal gasifier, gas cooling and purification units. Black liquor from the digestion unit is directly introduced to catalytic hydrothermal gasifier at supercritical water conditions (600°C, 300 bar). During heat up phase, larger molecules in black liquor hydrolyze to form coniferyl alcohols due to presence of lignin [21]. Cellulose present in lignin decomposes rapidly in water at about 250°C. The tar formation is avoided due to supercritical conditions and presence of catalyst [12]. In salt separator, inorganic salts present in black liquor precipitate and returned to the pulp mill. Peterson

(2005) examined the design of salt separator used for biomass conversion to the synthesis gas but more research is required especially for black liquor. Catalytic reactor is the actual methane synthesis unit where smaller organic molecules such as carboxylic acid, alcohols and aldehydes are converted to CH_4 , CO_2 , H_2 , and CO [23]. See following reactions for carboxylic acid conversion to CH_4 and CO_2 production.

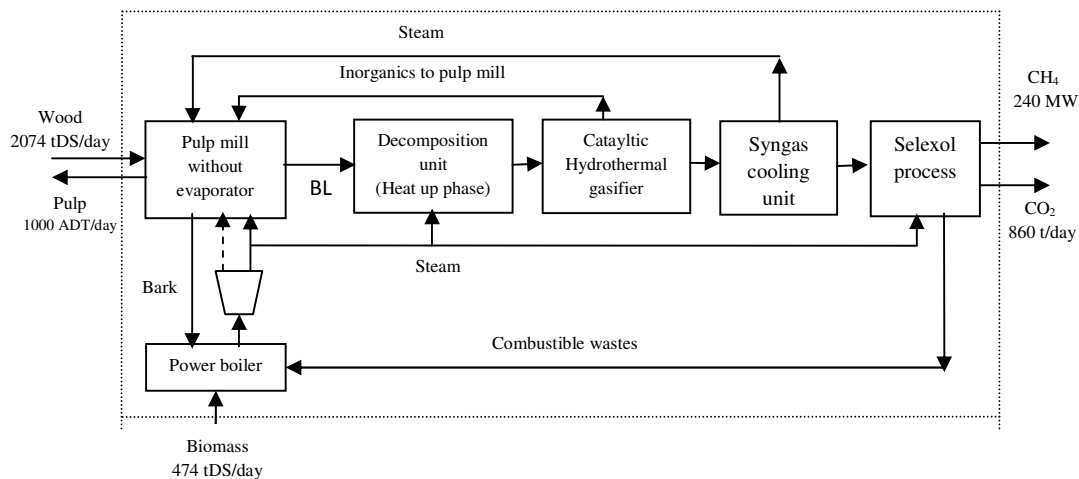

Fig. 4. System B: CH_4 production from BLG integrated with the reference pulp mill excluding evaporation unit.

The application of catalysis in reactor is mainly used to lower the desired gasification temperature to get high conversion. Savage et al. (1995) discussed the selection of suitable catalyst for methane production from organic waste streams at super critical conditions such as ruthenium and activated carbon derived from coconut shells. Waldner and Vogel (2005) suggested stabilized Raney Ni catalyst for wet biomass hydrothermal gasification. Selexol process is used for purification of CH_4 with polyethylene glycol dimethyl ether (DMPEG) as a solvent.

Energy calculations

1.1.12. The reference pulp mill

The Eco-cyclic Pulp Mill is taken as a reference for calculation, developed within the Swedish research program KAM (Kretslopps Anpassad Massafabrik) [3]. KAM mill is a theoretical and generic mill with commercially best available technologies with better integration under high environmental standards. Base capacity of KAM mill is designed with the pulp production of 2000 air dry metric tonnes (ADt) per day [3]. For energy calculations in this study, the reference mill with a base capacity of 1000 ADt/day of pulp production equivalent to 1700 tonnes per day of

black liquor solids (BLS, as dry) is selected. The reference mill is assumed to produce a surplus of bark and electricity. Input data and steam system at the reference pulp mill is reported in Table 1 and Table 2.

Table 1 Input data for reference pulp mill [3]

Pulp production	ADt pulp/day	1000
Wood consumption	tonnes/day (dry wood)	2074
Black liquor solids (BLS) per tonne pulp	tonnes/tonne	1.7
BLS available	tonnes/day	1700
BLS contents (dry)	%	80
Black liquor, LHV	MJ/kg,	12.4
Black liquor energy content	MW	243.5
Mill steam consumption	MW	125
Mill electricity consumption	MW	29.7

Table 2 Steam system at reference mill [3]

(tonnes/h)	Temperature (°C)	Pressure (bar)	Steam demand
High-pressure steam	545	140	
Intermediate-pressure steam	234	30	
Medium-pressure steam	195	12	67.5
Low-pressure steam	150	4	110.3

1.1.13. BLG modeling

Energy calculations are performed for all process units involved in the integrated gasification island. The models include black liquor input to gasifier, gas cooling and cleaning unit, synthesis gas conversion to DME or CH₄. Gasifier performance is estimated with a chemical equilibrium model based on Gibbs energy minimization [25]. The gas cooling, acid gas removal and recovery, DME unit, gas turbine and steam cycle are modeled using HYSYS simulator. The key input values used for modeling and calculations are listed in Table 3 and Table 4. The synthesis gas composition (system A) after thermal gasifier is taken from Ekbom et al., 2003 [6]. Since the

hydrothermal gasifier itself is CH₄ production unit, the input values for synthesis unit in system B is not reported.

1.1.14. Net steam production

A summary of major steam producers and consumers in BLG is reported in Table 5. The cooling units utilize heat of the synthesis gas and produce medium and low pressure steam contributing mill steam consumption. The heat generated during DME synthesis increases net steam production in system A. However, CH₄ synthesis unit consumes a large amount of internal produced steam resulting in less net steam production. This requires more biomass import to meet total steam demand of the reference pulp mill as compared to system A.

Table 3 Key input values to Model

				System
A	System B			
Gasifier	Black liquor input	tDS/hr	70	70
	Pressure	bar(a)	32	350
	Temperature °C		950	600
	BLS to gasifier	%	100	100
Gas cooler	Inlet temperature	°C	211	180
	Outlet temperature	°C	30	30
Cleaned syngas	pressure	bar(a)	30.5	21°C
Synthesis Unit	Pressure	bar	26	
	Temperature	°C	30	

Table 4 Input values for energy calculations [3, 26]

(LHV), MJ/kg	Lower heating values
Black liquor solids (dry)	12.3
Bark	19.4
DME	28.8
CH ₄	49
Methanol	21.1

Table 5 Summary of net steam production, (negative sign indicates consumption)

		System A	System
B			
BLG unit ^a	t/h	84.3	29

CO-shift	t/h	-1.9	
Purification unit ^b	t/h	-13.5	-18
Synthesis unit ^c	t/h	-6.4	-42
Power boiler	t/h	115.1	141.8

^aGasifier and gas cooling units are included in system A. For system B only gas cooling unit is included

^bRectisol and claus units in system A and Selexol unit in system B.

^cHydrothermal gasifier in case of system B

Compared scenarios for power boiler

The total electricity and heat (steam) demand of the pulp mill with biofuel production shall be fulfilled employing a power boiler using a mix of fuels (wood, existing bark, combustible wastes and synthesis gas). The boiler feed water is preheated (180°C) using heat recovered from synthesis gas in cooling unit after the gasifier [19]. Both systems are configured and compared using two scenarios in terms of fuel input to power boiler;

- (1) Biofuel production with external biomass input.
- (2) Biofuel production without external biomass input.

The first scenario is a case where maximum production of DME or CH₄ can be achieved utilizing existing bark at the pulp mill in the power boiler. The energy deficit is covered by biomass import, since available bark is not enough to meet total energy demand. Overall steam demand is marginally changed in the integrated systems as compared to present situation with recovery boiler. The existing bark, wood chips (external), synthesis gas and combustible wastes are used as a fuel mix for the power boiler. See Fig. 5 (scenario 1).

The second scenario is a tradeoff between no external biomass input and less biofuel output. The idea is to look for possible biofuel production if no biomass is imported and produced biofuel is combusted in the power boiler. See Fig. 5 (scenario 2). The overall biofuel production is limited, low thermal energy efficiency, but it reduces the environmental impacts (CO₂ emission reduction) generated by energy use in wood cultivation and transportation to the plant site.

The design fuel mix for power boiler is 80 wt% external biomass/produced biofuel and existing falling bark, 1.5 wt% combustible wastes and 18.5 wt% synthesis gas (Ekbom, 2003). The boiler feed water is preheated with warm water from gas cooling unit and boiler efficiency is assumed to be 90% at full load. An estimated performance and fuel inputs to the power boiler are reported in Table 6.

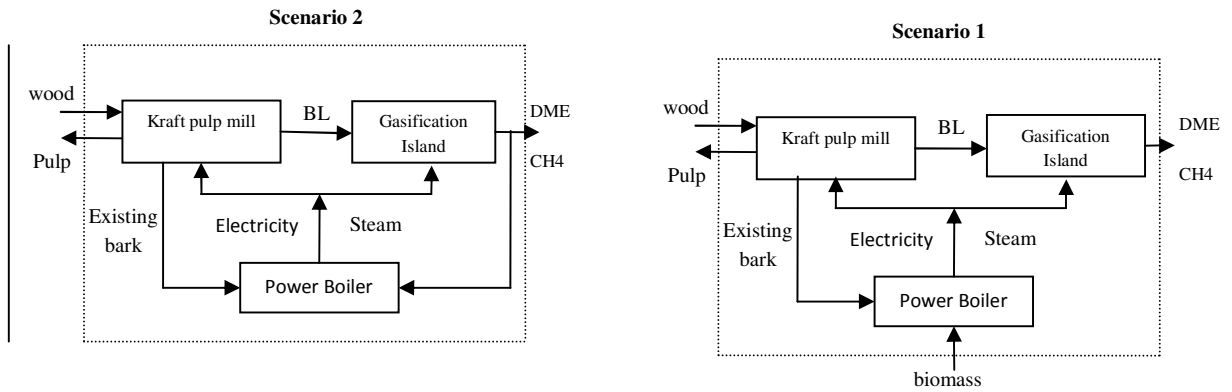

Fig. 5. Fuel input to power boiler in compared scenarios.

Table 6 Fuel inputs and performance of power boiler

		System A	System B
B			
Fuel input	External biomass (scenario 1)MW	69	106.
	Produced biofuel (scenario 2)MW	69	106.5
	Falling Bark MW	9.2	9.2
	Synthesis gas MW	16.4	18.
	Combustible wastes ^a MW	1.3	8.4
	Total fuel input MW	95.9	142.2
	Feed water temperature °C	180	12
	Steam pressure bar	140	14
	Steam temperature °C	545	545
	Steam flow kg/sec	27.4	39.4

^a Methanol from DME synthesis loop after distillation (system A) and H₂ from produced synthesis gas (system B)

Results

The results based on various performance indicators are summarized and compared in the following sections. Note that the base unit i.e. 1000 ADT/day of pulp production, remains the same for all cases.

1.1.15. Comparison with the reference mill

A summarized performance results of the reference pulp mill with recovery boiler and integrated BLG technologies are listed in Table 7. The total fuel input i.e. black liquor and external biomass, is higher for BLG technologies as compared to situation with recovery boiler. This is due to black liquor conversion to biofuel output that requires more biomass import. To

make systems comparable, the electricity export in the reference mill must be produced externally for integrated systems.

1.1.16. Fuel to product efficiency (FTPE)

FTPE is calculated as a performance indicator to compare total energy input to the integrated systems with total energy output (DME or CH₄). Both configurations are equally based on similar black liquor capacity. FTPE results are shown in Table 8.

Table 7 Results for two integrated systems: black liquor gasification for DME and CH₄ production. Comparison with reference mill with recovery boiler

			RM	System A	SystemB
Reference mill	Pulp production	ADt/day	1000	1000	1000
	Black liquor, LHV	MW	243.5	243.5	243.5
	Available bark	tonnes DS/day	181	181	181
Power	Produced	MW	52.2	21.6	35.4
	Mill consumption	MW	29.7	30.3	28.4
	BL unit consumption	MW	2.5	17.8	5.9
	Import/Export (-/+)	MW	20	-26.5	1.1
Steam	Mill consumption ^a	tonnes/hr	176.8	177.6	110.8
	BLG unit consumption	tonnes/hr	-	21.8	60
	BLG unit production ^b	tonnes/hr	-	84.3	29
	Power boiler	tonnes/hr	-	115.1	141.8
Bark	Bark to lime kiln	tonnes DS/day	93.8	132.2	132.2
	Bark to power boiler	tonnes DS/day	-	356	523
	Net bark available	tonnes DS/day	87.2	-307.2	-474.2
	Import/Export (-/+)	MW	19.6	-69	-106.5
Fuel	Scenario 1, LHV	MW	-	131.9	240.2
	Scenario 2, LHV	MW	-	62.9	133.7

^aSteam demand of the pulp mill is reduced in system B because evaporation and stripper units are not required.

^bQuality of steam produced in BLG is low in comparison with recovery boiler. It is not possible to expand the produced steam from cooling unit in the existing steam turbine but to generate HP steam using power boiler.

Table 8 Fuel to product efficiency results

			DME	CH ₄
Scenario 1	Black liquor (dry solids)	MW	243.5	243.5
	External biomass	MW	69	106.5

International Scientific Conference on "Energy systems with IT" in connection with the
Energiting 2009, March 11-12 at Älvsjö fair, Stockholm.

	Total fuel input	MW	312.5	350
	Fuel output	MW	131.9	240.2
	FTPE	%	42	69
Scenario 2	Black liquor (dry solids)	MW	243.5	243.5
	Fuel output	MW	62.9	133.7
	FTPE	%	26	55

Table 9 Annual Biofuel Production Potential (BPP) in scenario 1

		RM ^a	Sweden	Europe	World
<u>System A</u>					
BLS availability ^b	PJ ^c	7.4	177.1	821.6	2829
Biomass Import	PJ	2.1	48.4	222	760.1
DME	PJ	4.2	99.8	463.2	1583.4
<u>System B</u>					
BL availability	PJ	7.4	177.1	821.6	2829
Biomass import	PJ	3.2	76.9	358.6	1235.4
CH ₄	PJ	7.6	181.7	846.2	2913.9

^aReference mill with base capacity= 1000 ADt/day of pulp

^bBased on the Food and Agriculture Organization (FAO) data base [27]

^cPJ= 10¹⁵Joule

Table 10 Annual Biofuel Production Potential (BPP) in scenario 2

		RM ^a	Sweden	Europe	World
<u>System A</u>					
BLS availability	PJ	7.4	177.1	821.6	2829
DME	PJ	2.1	50.9	238.3	820.2
<u>System B</u>					
BL availability	PJ	7.4	177.1	821.6	2829
CH ₄	PJ	4.3	104.3	484.6	1669.8

1.1.17. Biofuel Production Potential (BPP)

BPP as a performance indicator evaluates the optimization of integrated systems calculating amount of biofuel that can be produced based on the reference unit. The results indicated that CH₄ production is significantly higher than DME but at a cost of larger biomass import. To compare the studied systems, BPP results of two scenarios for power boiler fuel input are shown in Table 9 and Table 10. The results are scaled up to investigate the potential of annual DME or CH₄ production based on black liquor availability in Sweden, Europe and world based on the year 2007 .

Discussion

Two different BLG systems for biofuel production are compared with the reference mill based on power, steam and additional biomass requirements. There is an export of 20 MW of power in the reference pulp mill. In DME production (system A), a total of 46.5 MW of power must be produced externally to meet internal pulp mill power demand and to compensate the export from the reference mill. CH₄ production (system B) is self sufficient in internal power but without power export. Steam demand of the reference mill remains approximately identical when integrated with system A but it is largely reduced in case of system B. This is due to removal of evaporation unit that accounts for 37% of total pulp mill steam demand. However, the internal BLG steam consumption is higher in system B compared to system A. This is mainly due to energy intensive decomposition unit that causes more steam to be produced in power boiler. Both system A and system B require import of 96 700 and 150 000 tonnes/year of additional biomass respectively for steam production in scenario 1 whereas no external biomass import is required in scenario 2. There is a significant reduction of 49% and 43% in DME and CH₄ production in scenario 2 respectively compared to scenario 1 since produced biofuel is combusted in power boiler.

It is noted that biomass import has affected overall FTPE results in both systems. The combustion of produced biofuel in power boiler instead of external biomass results in 33% and 18 % reduction in FTPE for system A and system B respectively. It is important to point out that there is still potential for producing biofuel without additional biomass import after meeting total steam demand of the pulp mill and BLG units. The GHG emissions and energy required for wood cultivation and transportation to the pulp mill site can be avoided.

From the material and energy balances, biofuel production potential for two scenarios has been calculated for black liquor conversion to DME or CH₄. In the reference pulp mill, DME yield from available black liquor (7.4 PJ/year) is 4.2 and 2.1 PJ/year in scenario 1 and scenario 2, which is equivalent to 57% and 28 % respectively. CH₄ production shows higher BPP results than DME i.e. the yield is 7.6 and 4.3 PJ/year. The theoretical maximum DME or CH₄ production is estimated for Sweden, Europe and world based on black liquor availability. If all black liquor available in Sweden is used, 100 and 51 PJ/year DME would be produced in two scenarios. In case of CH₄ production, it is estimated to be 182 and 104 PJ/year. For the whole Europe as much as 463 and 238 PJ/year DME could be produced in studied scenarios. There is a potential of 846 and 484 PJ/year CH₄ production. The world production of black liquor comprises approximately 2829 PJ/year which has a potential of producing more than 1583 and 2913 PJ/year of DME and CH₄ respectively in scenario 1. The other scenario accounts for a possible production of 820 and 1670 PJ/year DME and CH₄ respectively.

A comparison of various studies on black liquor gasification for different end products is shown in Table 11. To make all systems comparable, the reference data from different studies are scaled for the pulp production of 1000 ADt/day. Biofuel production in all studies require external biomass import i.e. scenario 1 of present study, to meet heat demand of the pulp mill. However, BLG with gas turbine combined cycle (BLGCC) has surplus of available bark.

The possibilities for integrated bioenergy system for combined heat and power generation with CO₂ capture and storage (CCS) has been introduced and analyzed, see Möllersten and Yan (2001), Obersteiner et al. (2001), Möllersten et al. (2003b) & (2006), Rhodes, and Keith (2005). By introducing biofuels into the bioenergy system, the performance in terms of efficiency, costs and CO₂ mitigation can be different. Integration of BLG based polygeneration integrated with CO₂ capture and storage is one of interesting topics for future studies. In addition, the biofuel production potential for various gasification technologies (e.g. BLG with direct caustization) will be investigated in future.

Conclusions

Three types of performance indicators were used to make the comparisons between studied systems, namely black liquor gasification based polygeneration for biofuel production of DME or CH₄ whilst meeting heat and power demand of the pulp mill. The study has shown that systems with DME and CH₄ production offer the improvements in the energy efficiency compared to existing state-of-the-art technology with recovery boiler. There is a large potential of black liquor conversion to biofuels globally with significant amount of energy output that can be generated in the pulp mills. However, fuel to product efficiency (FTPE) and biofuel production potential (BPP) indicated better results for production of CH₄ compared to DME in studied scenarios.

Table 11 Comparison of BLG for various biofuels and BLG with gas turbine combined cycle (BLGCC) from other studies

Parameters	BLG for biofuel production			BLGCC	
	MeOH	H ₂	DME	CH ₄	
References	Ekbom et al. (2003)	Andersson et al. (2006)	present study (2008)		
Eriksson et al. (2004)					
Product	MeOH	H ₂	DME	CH ₄	
Power					
Pulp production, ADt/day	1000	1000	1000	1000	1000
BL available, tDS/da	1700	1700	1700	1700	1700
Available bark tDS/day	181	181	181	181	181
Steam to turbine/deficit ^a , t/h	-111.5	-116	-115.1	-141.8	24
Bark, Import/Export (-/+), MW	-64.5	-61.8	-69	-106.5	10.7
Power, Import/Export (-/+), M	-28	-28.4	-26.1	1.1	43.3
Fuel production (LHV), MW	136	130.5	131.9	240.2	-

^aDeficit indicates steam that must be produced in power boiler

To this extent, DME or CH₄ produced at modern pulp mills can contribute in increasing diesel and natural gas consumption in future, thus decreasing fossil fuel dependency.

References

International Scientific Conference on “Energy systems with IT” in connection with the Energiting 2009, March 11-12 at Älvsjö fair, Stockholm.

1. World energy projections Energy Information Administration (EIA), International Energy Annual (June-October 2007), www.eia.doe.gov/iea
2. European Commission, White Paper “European Transport Policy for 2010: Time to decide”, COM (2001) 0370, ISBN 92-894-0341-1, September 2001.
3. STFI. Ecocyclic pulp mill – “KAM” Final report. KAM project, Report no. A100. Stockholm, Sweden: STFI; 2003. www.stfi-packforsk.se
4. Ådahl A., Harvey S., Berntsson T., “Process industry energy retrofits: the importance of emission baselines for greenhouse gas reductions”, Energy Policy 32 (2004), 1375-1388.
5. Möllersten K., Lin G., Yan J., and Obersteiner M., Efficient energy systems with CO₂ capture and storage from renewable biomass in pulp and paper mills, Renewable Energy, 29, pp1583-1598 (2004).
6. Ekbom T, Lindblom M, Berglin N, Ahlvik P. “Technical and commercial feasibility study of black liquor gasification with Methanol/DME production as motor fuels for automotive uses-BLGMF”. Report for contract no. 4.1030/Z/01-087/2001, European commission, Altener program. Stockholm, Sweden; 2003.
7. Dahlquist E., Thorin E., and Yan J., Alternative Pathways to a Fossil-Fuel Free Energy System in the Mälardalen Region of Sweden, International Journal of Energy Research, 2007; 31:1226–1236.
8. Yan J, Dahlquist E, Jin H, Gao L, and Tu S, Integration of Large Scale Pulp and Paper Mills with CO₂ Mitigation Technologies, The 3rd International Green Energy Conference, June 18-20, 2007, Västerås, Sweden.
9. Berglin, N., Eriksson, H., Berntsson, T., ”Performance evaluation of competing designs for efficient cogeneration from Black Liquor”, 2nd Biennial Johan Gullichsen Colloquium, Helsinki, Finland, September 9-10, 1999.
10. Andersson E.,Harvey S., Comparison of pulp-mill-integrated hydrogen production from gasified black liquor with stand-alone production from gasified biomass, Energy, 2007; 32:399-405.
11. M. Modell, R.P. Overend, T.A. Milne, L.K. Mudge, “Gasification and liquifaction of forest products in supercriticalwater”, Fundamentals of Thermochemical Biomass Conversion, 1985, p. 95.
12. Waldner M., Vogel F., “Renewable Production of Methane from Woody Biomass by Catalytic Hydrothermal Gasification”, Ind. Eng. Chem. Res., 2005, 44 (13), 4543-4551.
13. Sricharoenchaikul V., “Assessment of black liquor gasification in supercritical water”, Bioresource Technology 100 (2009) 638–643.
14. Berglin N, Lindblom M, Ekbom T. Efficient Production of Methanol from Biomass via Black Liquor Gasification. In: Tappi Engineering Conference, San Diego, California, 2002.
15. Joelsson J., Gustavsson L., “CO₂ emission and oil use reduction through black liquor gasification and energy efficiency in pulp and paper industry”, Resources, Conservation and Recycling 52 (2008), 747-763.
16. Berglin N, Lindblom M, Ekbom T. Preliminary economics of black liquor gasification with motor fuels production. In: Colloquium on black liquor combustion and gasification, Park city, Utah, USA; 13-16 May, 2003.

17. Larson E, Kreutz TG, Consonni S. A Cost-Benefit Assessment of Gasification-based biorefining in the Kraft Pulp and Paper Industry, Final report, Volume 4. Princeton University and Politecnico di Milano. 21 December 2006.
18. Axegård, P., Ledung, L., Annergren, G., Backlund, B., Delin, L., Jönsson, T., KAM2 (Ecocyclic pulp mill) Reference Mill, version 2000, KAM report A66, 2002.
19. Calzavara, Y., Jousset-Dubien, C., Boissonnet, G., Sarrade, S., “Evaluation of biomass gasification in supercritical water process for hydrogen production”, *Energy Conversion and Management* 46 (2005), 615–631.
20. Williams, P.T., Onwudili, J., “Subcritical and supercritical water gasification of cellulose, starch, glucose, and biomass waste”, *Energy & Fuels* 20 (2006), 1259–1265.
21. D.C. Elliot, G.G. Neuenschwander, T.R. Hart, R.S. Butner, A.H. Zacher, M. Engelhard and D.E. McCready, “Chemical processing in high pressure aqueous environments. Process developments for catalytic gasification of wet biomass feedstocks”, *Industrial & Engineering Chemistry Research*, 43 (2004), 1999-2004.
22. Peterson A., Maurice H., Waldnerb, Frédéric Vogelb, Jefferson W., “Fuels from biomass: Use of neutron radiography to improve the design of a salt separator in supercritical-water biomass gasification”, Massachusetts Institute of Technology, Cambridge, USA, (2005).
23. Jeremy S. Luterbacher, Morgan Froling, Frédéric Vogel, Francois Maréchal, and Jefferson W. Tester, “Hydrothermal Gasification of Waste Biomass: Process Design and Life Cycle Assessment”, *Environmental Science & Technology*, available online January 29, 2009.
24. P.E. Savage, C.J.Martino, and E.E. Brock, “Reactions at supercritical conditions, Application and fundamentals”, *AIChE Journal*, 41 (7) 1995, p 1723-1778.
25. Berglin N, Berntsson T “CHP in the pulp industry using black liquor gasification: thermodynamic analysis” *Applied Thermal Engineering*, 18 (1998), p 947-961.
26. Min S, Seoa B, Chunga H, Yong J, Hong D, “Industrial gas turbine combustion performance test of DME to use as an alternative fuel for power generation”, *Fuel* 88 (2009), p 657-662.
27. FAOSTAT, - Forestry, Food and Agriculture Organization of the United Nations, January 2008.
28. Maunsbach K., A. Isaksson, J. Yan, G. Svedberg and L. Eidensten, “Integration of Advanced Gas Turbines in Pulp and paper Mills for Increased Power Generation”, *Journal of Engineering for Gas Turbines and Power*, Transactions of ASME: 123, No. 4, 2001.
29. Yan J. and L. Eidensten.: 2000, Status and Perspective of Externally Fired Gas Turbines, *Journal of Propulsion and Power*: 16, No. 4, pp. 572-576.
30. Obersteiner M., Ch Azar., P. Kauppi, K. Möllersten, J. Moreira, S. Nilsson, P. Read, K. Riahi, B. Schlamadinger, Y. Yamagata., J. Yan, J.-P. Van Ypersele: 2001, Managing Climate Risk, *Science*: 294, No. 5543, pp 786-787, October 26.
31. Möllersten K., J. Yan and M. Westermark, “Potential and Cost-Effectiveness of CO₂-Reduction in the Swedish Pulp and Paper sector”, *Energy, The International Journal*: 28 (7) 2003a, pp 691-710.

International Scientific Conference on “Energy systems with IT” in connection with the Energiting 2009, March 11-12 at Älvsjö fair, Stockholm.

32. Möllersten K., Yan J., and Moreira J., “Potential market niches for biomass energy with CO₂ capture and storage”, *Biomass and Bioenergy*, Vol 25, No. 3, pp 273-285, 2003b.
33. Jonsson M., J. Yan, “Humidified Gas Turbine – A Review of Proposed and Implemented Cycles”, *Energy, The International Journal*: 30 (2004), 1013–1078.
34. Möllersten K, Yan J., “Economic evaluation of biomass-based energy systems with CO₂ capture and sequestration-The influence of the price of CO₂ emission quota”, *World Resource Rev* 2001; 13(4):509–525.
35. Möllersten K, Gao L. Yan J., “CO₂ balances and mitigation costs of advanced CHP systems with CO₂ capture in pulp and paper mills”, *Mitigation and Adaptation Strategies for Global Change* (2006) 11: 1129–1150.
36. James S. Rhodes, David W. Keith, “Engineering economic analysis of biomass IGCC with carbon capture and storage”, *Biomass and Bioenergy*, Volume 29, Issue 6, December 2005, 440-450.

Paper No. 12

Numerical and experimental study of the inclined free fins applied for thermal management

Jan Bijan pourian¹, Mark Irwin²

¹ industrial PhD student at Outokumpu and Malardalen University
Vasteras, Sweden

jan.pourian@mdh.se

² PhD at Outokumpu R&D, VD at TPC Components AB

Mark.irwin@tpcab.se

ABSTRACT

A new design for copper base heatsink is proposed in this work. In some experimental and numerical simulation efforts, optimizing and predicting of the thermal characterization of the heatsink with inclined free fins is developed. The proposed copper heatsink has high thermal dissipation capability and lower weight and volume compare to current aluminum and copper heatsinks.

The model is scaled up in the fluent environment to predict its application in the cooling of larger heat generated electronic devices.

Free fin denotes that the fins are not integrated chemically by casting methods and also implies that the proposed heatsink consist of individual and separated fins that are assembled and holds together. Impingement air-cooling mode of force-convection is adopted for heat dissipation from high power electronic devices in associated with the proposed inclined fin model. In addition to larger surface area and airflow velocity another solution for enhancement of heat dissipation is suggested. A numerical evaluation of thermal performance of the suggested heatsink and fluid flow around the fins is performed. The thermal performance is estimated also by experimental variables. The results of experimental investigation and CFD studies are introduced in this paper. Construction method of proposed heatsink by suggested fin design is introduced. This heat sink is fabricated mechanically and is tested by a number of heat sources and high sensitive devices such as adhesive k type thermocouple, data acquisition 34970A in associated with HP Bench Link program. Components of airflow velocity in the hollow spaces of the heatsink are discussed. Pressure drop and other thermal variables are analyzed analytical and by CFD code

Keywords

Copper heatsink, turbulent flow, performance, scale up, heat, puressre drop, velocity, numerical methods

Nomenclature

A Area, surface area, cross section
area (m²)

C1 ϵ , C2 ϵ , C3 ϵ constants

C μ Constant

D Diameter

Dh Hydraulic diameter

E Energy

Gk Generation of turbulence kinetic
energy due to mean velocity

	gradients
Gb	Generation of turbulence kinetic energy due to buoyancy
h	Heat transfer coefficient, Sensible Enthalpy
h _j	enthalpy of species j
\bar{J}_j	Diffusion flux of species j
k	Turbulent kinetic energy, thermal conductivity
K _{eff}	Effective thermal conductivity
Nu	Nusselt number
P	Power, pressure
Pe	Performance
q	Heat rate
Re	Reynolds number
Sk, S _ε	User defined source terms
S _h	Heat of chemical reaction
S _n	Surface-normal unit vector
S _φ	Amount of φ generated in control volume
T _{sou}	Source temperature
T	Temperature
U _D	Average velocity
u' _i	Fluctuating velocity of component
\bar{u}_i	Mean velocity of component i
V	Volume
Y _j	Mass fraction of species j
YM	Contribution of fluctuating dilatation in compressible turbulence to the overall dissipation rate
ρ	Air density
ν	Kinematics' viscosity of air, velocity
\bar{v}	Overall velocity vector
μ	Dynamic viscosity of air
μ _t	Turbulent (eddy) viscosity
Γ	Effective diffusivity
φ	Scalar quantity (pressure, energy, species concentration)
$\bar{\tau}_w$	Average shear stress in the channels of the heatsink
$\bar{\bar{\tau}}$	Stress tensor
ε	Turbulent dissipation rate
v	Y-component of velocity

- ω Z-component of velocity
 $\sigma_k, \sigma_\epsilon$ Turbulent Prandtl number for k and ϵ
 ∇ Differential volume

Introduction

In the following of the growth in the using of Internet services and modeling program the heat dissipation in electronic components has been of crucial important. However, the heat management in electronic devices is difficult because of the miniaturization of the heat generator processors and consequently generation of larger heat fluxes. Heatsinks are designed to lower the temperature of an electronic device by dissipating heat into the surrounding air. Development of copper heatsinks takes place slowly because of its limitations such as maximum thermal capabilities. But any improvement in heat dissipation enhancement can influence the effective parameters such as capacity of memory, number of transistors in processors, velocity, and pressure in any kind of electronic device and mechanical tools and vehicles. Increasing the airflow velocity is not a good solution for heat dissipation because it can result in the acoustical noises. The addition of surface area has good advantages but this has also its limitations such as weight, fin efficiency and effectiveness. This paper proposes a new physical model for copper heat sinks. Numerical analysis of heatsink is performed using the computational fluid mechanics.

Theoretical study

Governing equations

General transport equation

$$\frac{\partial}{\partial t} \int_V \rho \phi dV + \oint_A \rho \phi \vec{V} \cdot d\vec{A} = \oint_A \Gamma \nabla \phi \cdot d\vec{A} + \oint_V S_\phi dV \quad (1)$$

This equation includes the unsteady state, convection, diffusion and generation terms of scalar parameter ϕ .

- *Energy equation*

Fluent solve the energy equation in the following form.

$$\frac{\partial}{\partial t} (\rho E) + \nabla \cdot (\vec{v} (\rho E + p)) = \nabla \cdot \left(k_{eff} \nabla T - \sum_j h_j \vec{J}_j + (\vec{\tau}_{eff} \cdot \vec{v}) \right) + S_h \quad (2)$$

The three terms in the parenthesis on the right hand side represent energy transfer due to conduction, species diffusion, and viscous dissipation. S_h includes the heat of chemical reaction. Energy is defined as below:

$$E = h - \frac{p}{\rho} + \frac{v^2}{2}$$

For incompressible flows

$$h = \sum_j Y_j h_j + \frac{p}{\rho}$$

For ideal gases

$$h = \sum_j Y_j h_j$$

Pressure work and kinetic energy terms are negligible in incompressible flows.

- *Continuity equation*

$$\frac{\partial \rho}{\partial t} + \frac{\partial \rho u}{\partial x} + \frac{\partial \rho v}{\partial y} + \frac{\partial \rho w}{\partial z} = 0 \quad [3]$$

This equation is valid for incompressible as well as compressible flows if there is no mass added to continuous phase in other words if flow including only one phase and no vaporization or phase change takes place.

- *Integral-volume momentum conservation equation*

$$\int_A (\rho u)(u \cdot s_n) dA = - \frac{\partial}{\partial t} \int_V \rho u dV + \sum_i F_i \quad [4]$$

The first term on the left side of equation represent net rate of momentum flow out of the control surface (also called convective acceleration term).

The first and second terms on the right hand side of equation(4) illustrate respectively the rate of momentum storage in the control volume (local acceleration term) and the sum of all external forces acting on the control surface and volume; volumetric forces and surface forces: surface pressure, surface viscous stress tensor (N/m²), volumetric gravitational force, ρg (N/m³).

The above equation is applied for an inertial (non-accelerating) reference frame.

- *Transport equations for the standard k- ϵ model*

Turbulent kinetic energy and its rate of dissipation ϵ are obtained from the following transport equations.

$$\frac{\partial}{\partial t}(\rho k) + \frac{\partial}{\partial x_i}(\rho k u_i) = \frac{\partial}{\partial x_j} \left[\left(\mu + \frac{\mu_t}{\sigma_k} \right) \frac{\partial k}{\partial x_j} \right] + G_k + G_b - \rho \varepsilon - Y_M + S_k$$

[5]

$$\frac{\partial}{\partial t}(\rho \varepsilon) + \frac{\partial}{\partial x_i}(\rho \varepsilon u_i) = \frac{\partial}{\partial x_j} \left[\left(\mu + \frac{\mu_t}{\sigma_\varepsilon} \right) \frac{\partial \varepsilon}{\partial x_j} \right] + C_{1\varepsilon} \frac{\varepsilon}{k} (G_k + C_{3\varepsilon} G_b) - C_{2\varepsilon} \rho \frac{\varepsilon^2}{k} + S\varepsilon$$

[6]

- *Turbulent viscosity for the standard k-ε*

The turbulent (eddy) viscosity, μ_t , is computed by combining k and ε as follows:

$$\mu_t = \rho C_\mu \frac{k^2}{\varepsilon}$$

[7]

1.1.18. Relative performance

“Relative” in this context implies that performance of a heatsink is not an absolute character and depends on heat flux and not just heat rate in the source.

The cooling performance of the heatsink is estimated by its heat dissipation rate for a given inlet velocity and heat flux. Maximum temperature of the source is a criterion for cooling performance of the sink and that is why this variable is applied in the correlation used for determining of the cooling performance.

$$\text{Max. } T_{sou} = T_r + (P_e) (P)$$

[8]

Experimental set up

Mechanical manufacturing of the proposed heatsink is suggested. The proposed prototype is shown in figure (3). The offered heatsink consist of a number of fins that are holds together. Clustering of the fins may be performed in different optional ways such as a soldered belt around the fin foots or by applying a plate having a hole in the centre or both approaches. Horizontal inclining of the fins from zero to 180 grades creates the spacing between the fins. A fin design appropriate for this heatsink is introduced below.

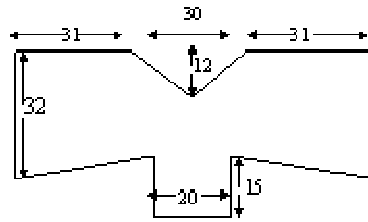
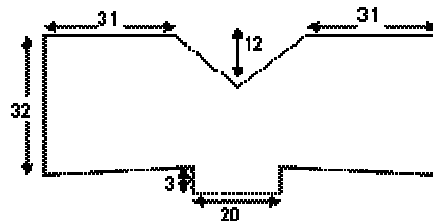

Figure (1): The primary fin geometry applied in experimental set up

Experimental results of thermal characteristic of the heatsink are obtained from the primary fin design that is shown above but some changes are introduced by optimization in CFD and the final optimized geometry of the applied fin is presented below.



Figure(2): Final fin geometry after optimization

The fin design is tried to be appropriate for further process i.e. inclination. The heat is generated in a resistor that serves as a heat source. Resistor is attached to bottom of the heatsink. Volume and cross section area of the heat source have decisive influence in determining the performance of heatsink and that is why these parameters are also reported in the table (1).

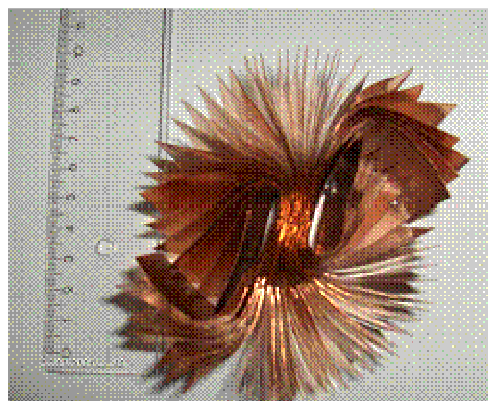

Figure (3): Mechanical constructed prototype heatsink.

Different powers are applied to the source and equilibrium or maximum temperature of the source is measured.

Table (1): Power dissipation by Copper heatsink from a heat source with a max 37w/cm^2

q (W)	$V_{\text{max}}=1,87$ $E-07\text{ m}^3$	$A_{\text{max}}=6,7E-$ 05 m^2	T_{max}
	\dot{q} (W/m ³)	q'' (W/cm ²)	
5	2,67E+07	7,46	31,8
10,5	5,61E+07	15,67	44,6
14	7,49E+07	20,89	52
22,5	1,20E+08	33,58	70,3

Grid information

The proposed sink is very complicated and tried to be modeled in the Gambit environment for further simulation by CFD. The grid comprises of 3926494 faces, 1281845 cells and 1350398 nodes. To avoid larger number of faces and volumes the shell conduction model is applied. The shell conduction model is enabled only for faces which are representative of the fins. The thickness of the fins is specified in the fluent. The center location of the sink including the fin foos and a part of the plates where the fins spacing are too small a complete solid is considered and fins are integrated in this solid zone. The faces representing the plates are attached to this solid zone where the fin spacing is getting enough wide. This situation arises due to the fact that the fins are bundled initially together and then are inclined and different angles are formed between them. The meshed grid consisting the plates and centre zone of the sink is shown in the following. The volumes representing the air flow are absent in this figure.

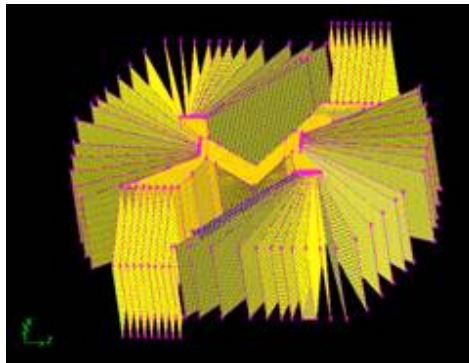

Figure (4): A meshed view of the proposed inclined free fin heatsink

The quadrate elements of map type are adopted to mesh the majority of the faces including all the fins or solid zones. The shape of elements used to mesh the volumes is hexahedral/wedge and the

meshing algorithm is cooper. About 3040 wedge volume element is used in the mesh system that belongs to the fluid volumes.

The three-dimensional mesh quality is examined by EquiAngle Skew type and when the lower value reaches 0.75 then no element is activated.

Numerical results

Energy equation is solved to investigate the thermal behavior of the physical model. Energy of chemical reaction, volumetric heat generation, species diffusion and viscous dissipation terms in the energy equation are not considered in this simulation. The first term on the left-hand side of energy equation that represents the unsteady state energy flow is also ignored because a steady state condition is adopted for this model. The segregated solver by default does not include pressure work or kinetic energy when it is about the incompressible flow. Therefore the equation (2) reduces to:

$$\nabla \cdot (\bar{v}(\rho E + p)) = \nabla \cdot (k_{eff} \nabla T) \quad [9]$$

Where

$$E = \sum Y_j h_j$$

Except the unsteady, other terms in the conservation equation for mass are taken into account under simulation process.

$$\frac{\partial \rho u}{\partial x} + \frac{\partial \rho v}{\partial y} + \frac{\partial \rho \omega}{\partial z} = 0 \quad [10]$$

Fluent uses the default value of 1.0 for under relaxation factor for energy equation in and it was not varied under simulation process.

Fluent applies additional equation when the flow is turbulent. There is no single turbulence model accepted for all classes of problems. A k-ε turbulence model [equations (5) and (6)] based on RANS model approach is solved to predict the flow behavior in the domain.

The proposed heatsink is modeled in the Gambit and simulated by Fluent in a segregated solver however some approximation is adopted for simplicity and also because of the complexity of the fin arrangements in the primary design. In some parts of the heatsink where the spacing are small, the fluid in the gaps are thought of as the solid and obviously this approximation can decline the thermal performance obtained numerically compare to the actual capability.

Radiation model impact is neglected because of the low temperatures of solid and fluid phases under operation.

Two and three dimensional temperature distribution of the source, fins and flow are predicted by the CFD modeling. Additionally, dynamic and static pressures are taken into account and these are analyzed by adopting some cross sectional areas of vertical and horizontal surfaces in the airflow direction.

Development of flow velocity between adjacent plates in some locations of heatsink is estimated and discussed. Airflow temperature at different zones inside the heatsink is demonstrated in figure (10).

Source temperature

Source temperature profiles for different foot height of fins and scaled up simulation are exhibited in figures (5), (6), (7) and (8). The thermal characteristics results of optimization of fin foot height are summarized in the table (5).

Temperature of the solid zones

Three-dimensional contour of the solid zone temperature under design condition is demonstrated in the figure (9). Heat is transferred from the bottom of the heatsink to the top however under transportation; the heat distributes in the fins and dissipates by the impingement airflow to the environment.

Y-component of air velocity

The CFD simulation performs prediction of the flow velocity at all directions in gaps of the model. Unlike the parallel plates, different flow velocity profile is observed in the domain. This is due to different angles of the inclined fins respect to z-axis that vary from zero to about 250 degree which result in unequal flow rates in the gaps of the heatsink. Non-constant angles between the fins may give rise to creation of different cooling zones and furthermore unequal temperature distributions in the domain. Y-component of flow velocity distribution is shown in figure (11).

Dynamic pressure

Figures (11) and (12) turns out that the dynamic pressure distribution accommodates with the y-component of flow velocity. Dynamic pressure is larger at locations with larger y-velocity. The contour of y-component of velocity is similar to the dynamic pressure except the colors. Contours of dynamic pressure of the flow in the gaps are exposed in the figure (12).

Static pressure and predicted pressure drop

Pressure drop may be accounted for by means of static pressure at inlet and outlet. Pressure is diminished downward in the space of adjoining fins due to frictional losses.

Pressure drop at the entrance of the heatsink deteriorate the performance of the electronic cooling devices. Fin designs and arrangements which generate lower pressure drop at entrances are desirable in cooling management. This pressure drop is due to reversible flows which give rise to flow bypasses. Flow bypasses have crucial impact on thermal characteristic of heatsinks.

Scaling up of the domain

The proposed heatsink is scaled up in the fluent environment. The purpose of scaling up is that to access a larger cross section area of bottom of the heatsink where the heat source is joined.

The thickness of the fins is kept constant in the scaling up of the model but other geometric variables of the fins involve scaling by 40 %. Accessing a higher heat flow is the next issue of scaling up.

Power of the heatsource is a function of the cross section area and the applied heat flux. Analyzing the performance requires modifying two variables i.e. cross section area and heat flux.

The results of the optimization and scaling up of the heatsink are compared in the table (2). Heat flux is constant and is equal 700000 W/m².

Table (2): Results of optimizations and scaling of the heatsink

Fin foot	3	5	12	3 (40% scale up)
Height (mm)				
Power (W)	117	117	117	230
Tmax (°C)	346	354	365	337

Calculations

Maximum temperature of the heat sources as a function of the applied powers is shown in graphs (1) and (2).

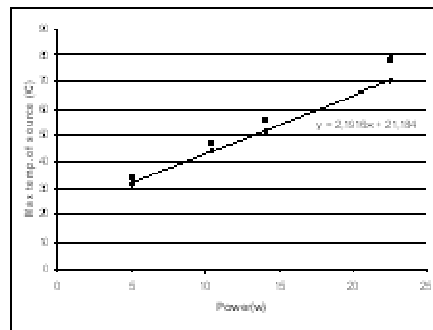

Graph (1): Relative performance of proposed heatsink accounted for source (MP925)

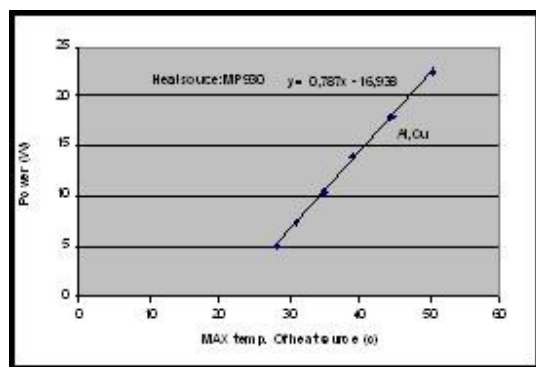

Graph (2): Relative performance accounted for MP930

Reynolds number $Re = \frac{uD}{\nu}$

Reynolds number is calculated by measuring the average air velocity at a distance about 13 mm from a fan that is fitted in the pipe. At this distance of the fan the air velocity at variety of radial distances is measured.

Table (3): Reynolds number accounted for experimental setup Heat transfer coefficient (h)

u (m/s)	ν (m ² /s)	D (m)	T (°C)	Re
4.33	15.89 ×10 ⁻⁶	9.8×10 ⁻²	22	≈26000

In the table below, h is accounted for heat source resistor of type MP925.

Table (4): Experimental heat transfer coefficient (h)

Heat source	q/ΔT (W/°C)	A _{sur.area} (m ²)	h (W/m ² k)
MP925	0.46	13.9E- 02	3.3

Predicted relative numerical thermal performance

The performance of the heatsinks is computed by means of equation (8) and the values of variables of this equation are obtained from the results of numerical solutions. A 296 K is adopted as initial or environmental temperature of the heatsinks. The thermal dissipation capability of the heatsinks is accounted and the values of variables are shown in following table.

Table (5): Thermal performance of the heatsinks

Heatsink (mm fin foot)	3	5	12	3 (scale up)
Power	117	117	117	230
T _{max} (°C)	346	354	365	337
Pe	0.42	0.49	0.59	0.18

(⁰ C/W)				
---------------------	--	--	--	--

Discussion

Fins and air flow temperature

Figure (9) shows the temperature distribution through the fins and it turns out that the temperature drops as getting further away from the centre of the heatsink. This may be thought of the heat spreading resistance through the heatsink. But it is noteworthy to recall that the copper has lower spreading resistance than the aluminum. However, the heat spreading resistance is unavoidable but it is still reducible by using the appropriate materials.

Thermal performance of the heatsink is determined by predicting the maximum temperature of the heat sources applied in the simulation. The generated heat fluxes in the source have decisive impact in determining the thermal performance of the heatsink.

Figure (5) shows the temperature gradient of the heat source when the applied heat flux is 700000W/m^2 , which is very intensive compare to the current heat flux of processors. Improvement of the performance is achieved by reducing the height of fin foot from 15 to 3 mm. This is the optimum fin foot height that results in the highest heat transfer, which is calculated by the CFD simulation. The significance of this heat sink is sensed when enhancement of heat flux or the number of the transistors per unit area of electronic equipments is intended. The only limitation for this heat sink is the total foot area, which prohibits us applying the same heat flux at larger areas. The total fin foot area is depended on the thickness and number of the applied fins. In order to have larger cross section area without increasing the number of fins, a practical solution is applying the nonuniform cross section type of straight fins by the same mechanical fabrication method as described in this paper. The cross section area needed for larger heat sources increases when using nonuniform cross sectional fins. Furthermore the gaps are more spacious which reduces the flow bypass and increases the inlet flow between the fins and therefore improves the forced-convection heat transfer coefficient. The potential of mixing of boundary layers at both sides of the air flow between each two fins diminishes and bulk flow temperature reduces.

Conclusion

A new manufacturing approach for copper heatsinks is proposed and the prototype is examined experimentally and by numerical methods as well.

Flow and thermal characteristic of the proposed inclined free fin heatsink is treated by CFD codes.

The shape of the fins has crucial influence on the thermal characteristic of the heatsink. In addition to surface area and larger flow velocity the fin shape is another solution in thermal management.

The flows around the fins are studied by CFD method.

Modifying the height of fin foot performs optimization efforts. The best result is achieved for 3mm height of fin foot.

International Scientific Conference on “Energy systems with IT” in connection with the Energiting 2009, March 11-12 at Älvsjö fair, Stockholm.

In order to examine application of this heatsink in larger heat generating electronic components a 40 % scale up of the model is performed in the numerical framework.

Acknowledgement

The author acknowledge the support of R&D unit of Outokumpu fabrication technology, Vasteras, Sweden

References

1. Adrian Bejan, Heat transfer, 1993, John Wiley & Sons page 219-245
2. J. P Holman, Heat transfer, SI Metric Edition 1989,McGRAW-HILL book company, page 43-50, 220-245
3. Frank P. Incropera, David p. Dewitt, Fundamental of heat and mass transfer, fourth edition 1996, John Wiley & Sons page 284-300
4. Fluent 6 user’s guide publications 2001 volume 1 chapter 6 page 3-90
5. Fluent 6 user’s guide publications 2001 volume 2 chapter 11 page2-20
6. Frank Kreith, Principles of heat transfer, third edition 1976Harper & Row, publishers page 309-318
7. Massoud Kaviani, Principles of heat transfer,2002,John Wiley & Sons, page 40-80, 120-123
8. R. Byron Bird, Warren E Stewart, Edwin N. Lightfoot
9. Transport phenomena second edition,John Wiley & Sons 2002, page 298-300
10. M. Necati özisik, Finite difference methods in heat transfer, page20-40
11. Fluent 6 user’s guide volume 5 December 2001 chapter22, page3-20
12. Victor L. Streeter , E. Benjamin Wylie fluid mechanics 1983, McGraw-Hill book company page 88-100 , 195-198
13. Brucer R. Munson, Donald F. Young, Theodor H. Okishi, Fundamentals of fluid mechanics third edition,1998, John Wiley & Sons pages 211-240
14. M. Necati özisik, Finite difference methods in heat transfer,1994, CRC press, page20-40
15. Barry Dagan, Pin Fin Heatsinks Supply Compact Cooling-Power,2002 Cool Innovations Inc., Concord, Ontario, Canada
16. Owen-made Jet Impingement Cooling: Part One the Slot”

Attachments

Temperature of the heat sources (optimization results)

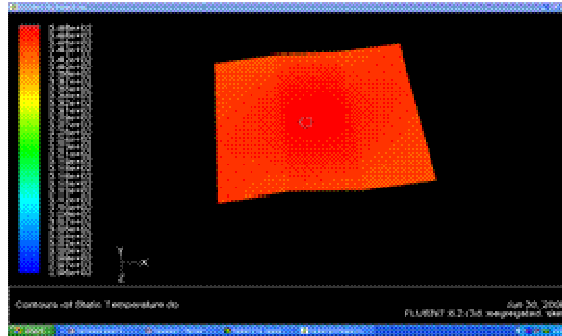

Figure (5): Maximum source temperature after adopted 7×10^5 W/m² heat flux (applied 3mm fin foot)

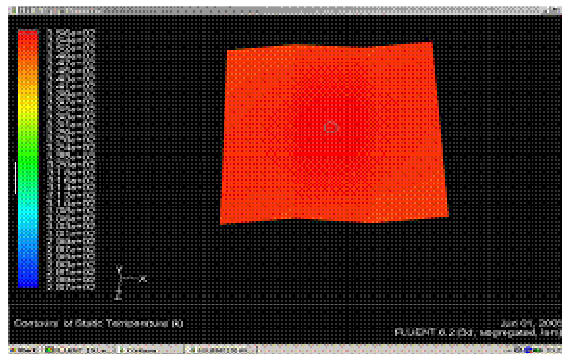

Figure (6): Maximum source temperature after adopted 7×10^5 W/m² heat flux (applied 5mm fin foot)

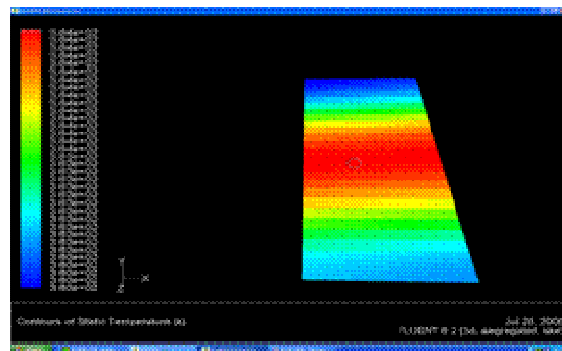

Figure (7): Maximum source temperature after adopted 7×10^5 W/m² heat flux (applied 12mm fin foot)

International Scientific Conference on “Energy systems with IT” in connection with the Energiting 2009, March 11-12 at Älvsjö fair, Stockholm.

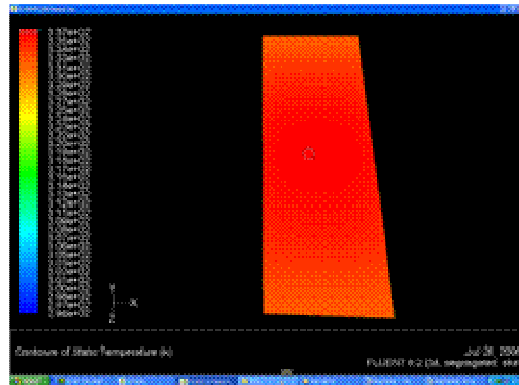

Figure (8): Maximum source temperature after adopted $7 \times 10^5 \text{ W/m}^2$ heat flux (scaled up 40%)

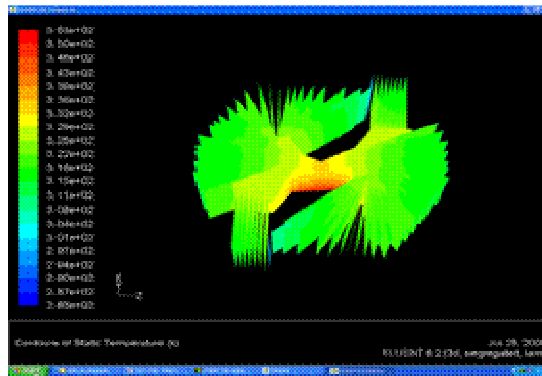

Figure (9). Temperature distribution on the fins of the prototype heatsink in the CFD environment

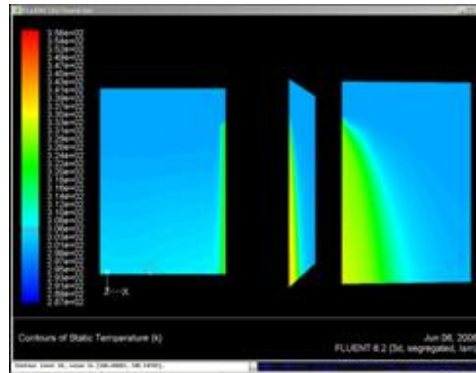

Figure (10). Temperature distribution of the air flow in the gaps

International Scientific Conference on “Energy systems with IT” in connection with the Energizing 2009, March 11-12 at Älvsjö fair, Stockholm.

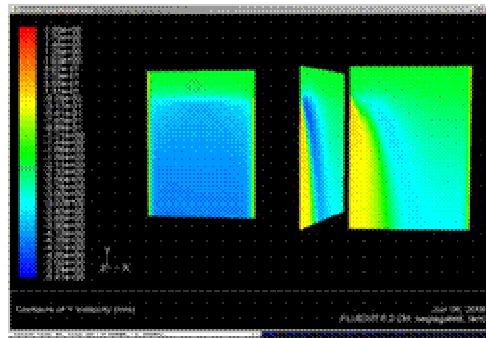

Figure (11): Contours of Y-component of air velocity in the hollow space between the fins

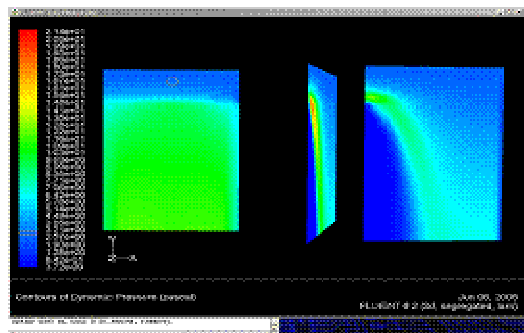

Figure (12): Contours of dynamic pressure of the flow in the gaps

Paper No. 13

**Simulation of ambient temperature effect on large-scale power transformer load
ability**

Hasan Gholinejad

School of Sustainable Society and Technology Development, Box 883, SE 721 23, Malardalen
university, Västerås, Sweden

hassan.gholinezhad@yahoo.com

ABSTRACT

Electric power consumption has rapidly increased in developed and non developed countries. Power demand increased the load of power transformer up to 16% during 2006 in two Northern provinces of Iran. High temperature occurs due to over loading in large scale power transformers. Due to overloading and highest ambient temperature in June of 2006 caused the worst black out in MREC regions in Iran. It withdraws the transformers from the networks due to over heating. A serial outage in the networks of Mazandaran caused these problems. Thermal assessment and analysis of the transformer and its heat dissipations gives help to plan the load flowing in the networks. In this paper an attempt is made to simulate the power transformer radiator and to analyse the heat transfer in the heat generating parts of the transformer. The effects of ambient temperature on the power transformers are evaluated. Using the experimental data in transmission substations the simulations have been verified.

Nomenclature

$\theta_{h(t)}$ = Wire winding hot spot temperature

$\theta_{a(t)}$ = Ambient temperature

$\Delta\theta_{h(t)}$ = Changes in hot spot temperature

γ = Expected insulation material life

A, B = Insulation material constant

T = Temperature degree Kelvin

γ = Expected insulation material life

C, P = Insulation material constant

θ = Temperature degree Celsius

Keyword: Simulation, Overloading, Power transformer, Comsol soft ware

Introduction

Overloading of power transformers can become an essential problem in open electricity markets due to economic reasons or simply to ensure continuous energy supply. During an overload circle accelerated ageing and damages have to be strictly avoided.

Constant load and the constant average temperature of the cooling system determine nominal power of the power transformer. Loads and temperatures have great impact on life of the power transformers.

As demand for power fluctuates season to season within a year, operating the power transformer at constant load and temperatures is not possible. Power delivery of the transformers changes daily and from one season to another.

In most cases over loading can be taken into account without reduction in average life of the power transformers. In other cases over loading conditions can be determined without taking into account the reduction in average life of the power transformer and from actual daily load chart and from relative cooling system temperature.

Maximum allowable loading and overloading are the most important parameters for the power transformers. Depending on how long a power transformer is under a certain load or overloaded it generates a considerable amount of heat internally. The internal heat generated in turn reduces the life of the power transformer insulation this reduces the life of the power transformer. Rise in internal temperature depends on amount of load, the time that the transformer is under load or amount of over load and the ambient temperature.

This paper evaluates the effect of the ambient temperature on ageing rate of the power transformers. To take into account the effect of ambient temperature on aging rate of the power transformers deployed in provinces of Mazandaran & Golestan, these two provinces are divided into several geographical areas with different ambient temperatures during a typical year.

Ageing rate of transformers

The ageing rate of power transformers determined using IEC-354/1991 standard and guidelines for loading of the oil filled power transformers. Typical daily ambient temperature pattern is plotted in Fig. 1. Plot of the typical daily ambient temperature in figure 1 shows sinusoidal behavior. The daily load of the power transformers of over 100MVA for 24 hours Vs temperature should also follow a sinusoidal behavior between maximum and minimum ambient temperature of the provinces.

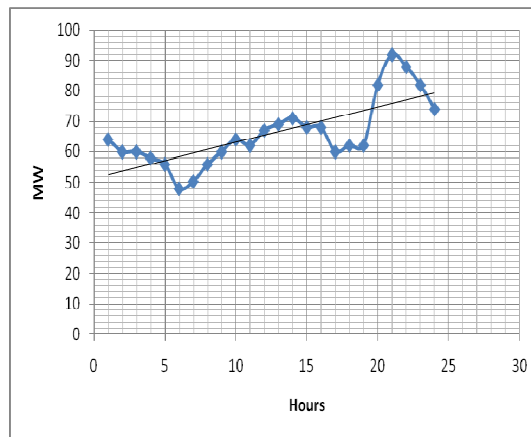

Figure 1. Daily powers in MW as a function of hours of the day, June 2008. 230/63Kv, 250 MVA power transformer output.

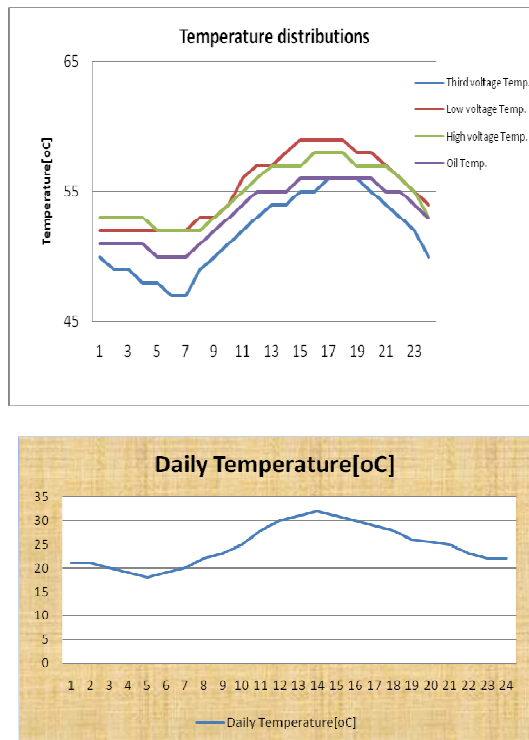

Figure 2. Daily transformer temperature as a function of the hours of the day, June 2008. 230/63Kv250 MVA power transformer output. In 35% load.

Loading power transformers due to their nominal capacity do not always follow loading capacity [1]. Power Transformers are loaded based on maximum wire winding temperature and based on nominal capacity stated on the label of the transformers. Different mathematical temperature models are being developed. Several mathematical models are currently used to determine temperature of the hot spot. Finding hot spot temperature of wire winding is used to compute the overloading limit and aging of the power transformers.

Temperature aging of power transformers is actually the aging of the insulation. Aging of the insulation is related to temperature and time. Temperature fluctuation of wire winding hot spots plays an important role in the ageing rate of power transformers. Maximum wire winding hot spots temperature and temperature fluctuations of the wire winding hot spot temperature should be taken into account in find the ageing rate of the power transformers. Wire winding hot spot temperature is given by:

$$\theta_{h(t)} = \theta_{a(t)} + \Delta\theta_{h(t)} \dots \dots \dots (1)$$

This is related to the loading and cooling system.

Eq. 1 states that there is a direct relation between ambient temperature and the loading capacity and the aging rate of the Power transformers. All these parameters are important factors for the expected life of the power transformers. A constant ambient temperature is normally used for computation of aging rate of the power transformers. For even more accurate computation of aging rate of the power transformers the daily fluctuation of the ambient temperature must be taken into account.

Effects of loading beyond nameplate Rating

With the exception of generator-transformers the load imposed on transformers varies between a higher level within the day and during the year. The most critical limitation in the loading of a transformer is the temperature reached in the hottest area of the winding, named the Hot-spot temperature (θ_h in fig 1). Every effort should be made to determine this temperature with accuracy. As the size of transformer increases, the hot-spot temperatures are more difficult to determine correctly.

With loading values beyond the nameplate rating, it is recommended that the limits stated in table (1) are not exceeded for current I , hot-spot temperature θ_h and metallic parts in contact with insulating materials and top-oil temperature.

The loading of the transformers beyond the nameplate rating cause the aging of the insulation materials and the loss of the life expectancy, which is discussed in the next parts.

Aging of insulating systems [7]

The structure of insulating materials built into transformers, mainly those based on cellulose, is subject to aging. Aging depends not just on loading, but is also significantly influenced by the heat (causing pyrolysis), moisture (hydrolysis) and oxygen content (oxidation) of insulation and depends on the duration of their influence.

Although the reduction of dielectric strength due to aging is not considerable, the modification to mechanical properties render the transformer, sensitive to the displacements of the windings caused by the electrodynamic effects of short circuit. As a result of aged insulation transformers will suffer from turn-to-turn faults.

1.1.1. Hydrolysis

Aging takes place at a higher rate in the presence of moisture. There are three ways in which moisture may find access to the insulation material. It can either be left at the end of the drying process as residual moisture, or it can enter the transformer through leaks or through the conservator or may appear as a by-product of the aging of insulating material. The result is a reduction of the degree of polymerization (DP) by shortening the length of the molecular chain and weakening of the fiber.

1.1.2. Oxidation

Oxygen enters the transformer either through leaks where the pressure in the cooling circuit is lower than the atmospheric pressure, or through the conservator. Oxygen attacks the carbon atoms in the hydrolysis effect previously mentioned.

Thus there is an obvious advantage of sealed-oil (membrane or bag) systems over free-breathing system to avoid air/oil contact.

1.1.3. Pyrolysis

Heat is the remaining accelerating agent which must be left to the control of operating personal. Heat in the extreme will result in a solid residual (mainly carbon) and gases, namely water vapor, carbon monoxide, carbon dioxide and hydrogen. Hereby DP is reduced. By measurement of (DP) a proper means of transformer aging diagnosis can be achieved.

However, the rate of aging of interterm insulation of transformers under the effect of time and temperature is depending on ambient temperature and overloading.

1.1.4. Loading of power transformers, view of standards

IEC-354/1991 standard states the loading capacity of the oil filled power transformers without taking into account the hot spot temperature of wire winding and maximum allowable oil temperature. In some national standards due to higher operational temperature of the power transformers the oil temperature, allowable wire winding temperature and heat-ageing rate were also indicated. [3], [4], [5]

Heat aging of the insulations is due to internal chemical reaction of transformers and is described by Arrhenius equation:

$$\gamma = Ae^{B/T} \dots\dots\dots(2)$$

Eq. (2) can be written for the internal temperature of the power transformers as (Montsinger estimation equation):

$$\gamma = Ce^{-P\theta} \dots\dots\dots(3)$$

In recent decades reaching the expected life of the power transformers is due to correct electrical operation of these equipments. There is no accurate way to compute the life expectancy of the power transformers. Currently it is only possible to compute the aging rate of the power transformers [5], [6].

Some power transformers evaluated using IEC-76/1976 [5], [6]. The IEC-76/1976 only accepts the heat-ageing rate (Eq. 1) for hot spot temperature of 98 degree Celsius. This temperature is the same as operating the power transformers at constant ambient temperature of 20 degree Celsius with nominal loading.

$$V = \text{Aging rate } (\theta_h)/98^\circ\text{C} = 2^{(\theta_h - 98^\circ\text{C})/\sigma} \quad (4)$$

Standards [4] predict life expectancy of the transformers with higher than 100MVA power at constant hot spot temperature of 98°C operating without interruption would be about 29 years. When load and constant ambient temperature varies, and using T to represent relative aging; Life of the power transformer is computed by

$$L = 1/T \int_0^T V dt \dots\dots\dots(5)$$

Version 1 of IEC-354/1972 & VDE-0536/1977 standards the hot spot temperatures specified to be not more than 140°C. However 2nd version of IEC-354/1991 standards indicates the hot spot temperature should not be more than 160°C. Increase in hot spot temperature from 140°C to 160°C is not acceptable in VDE-0536/1977 standard. According to these standards as hot spot temperature exceeds 140°C dielectric pressure builds up and bubble production increases. Table 1 presents the loading guideline for power transformers according to IEC-354/1991 for hot spot temperature less than 140°C.

Table 1. Load ability guides for power transformers according to IEC-354/1991 (hot spot temperature up to 140°C).

Ambient Temp. °C	HST Temp. °C	Allowed Loading limit (P.U.)			
		Distribution transformers	Transmission & sub transmission transformers		
		ONAN	NAN/ONAF	OFAF/OFW F	ODAF/ODW F
-25	123	1.37	1.33	1.31	1.24
-20	118	1.33	1.30	1.28	1.22
-10	108	1.25	1.22	1.21	1.17
0	98	1.17	1.15	1.14	1.11
10	88	1.09	1.08	1.08	1.06
20	78	1.00	1.00	1.00	1.00
30	68	0.91	0.92	0.92	0.94
40	58	0.81	0.82	0.83	0.87

1.1.5. Effect of ambient temperature on life of transformers

The most important parameters in computation of temperature build up in power transformers dielectric are the ambient temperature and the cooled airflow from the cooling system.

Unfortunately, when ordering a power transformer most companies indicate the maximum absolute temperature as ambient temperature. They believe that loading the ordered power transformers with maximum absolute temperature and nominal power is possible during the predicted lifetime of the power transformer. Based on IEC-354 standards, if hot spot temperature of the wire winding hot spot at the time of the loading is 98°C regardless of ambient temperature the relative aging of the power transformer is one.

For every 10°C increase in wire winding hot spot temperature within limit of 98°C < Y_{cu} < 140°C, either caused by ambient temperature or by loading conditions the aging rate of the power transformer doubles. Oil temperature and wire winding hot spot temperature of power transformers should not exceed 105°C and 140°C respectively. In order to derive the aging rate of the power transformers to one, power transformers must operate within the average yearly ambient temperature with specified nominal loading (Ref. Table 1). When ambient temperature drops below average yearly ambient temperature the aging rate also drops below one. In this condition it is possible to load the power transformers beyond the specified nominal loading so long as the wire winding hot spot temperature does not exceed more than 98°C. If ambient temperature is higher than average yearly ambient temperature transformer load must be reduced to keep the wire winding hot spot temperature at 98°C.

If the above loading pattern during a year is not acceptable. If it is desired to keep the loading of the power transformer at nominal during all seasons of a year; Then in hours of a year when ambient temperature is lower than average yearly ambient temperature the aging rate of the transformers are less than one and vice versa. This gives the total aging rate of one for the year that the power transformer load kept at nominal constantly. In another word over loading a power transformer operating in its designed environment accelerate its aging rate. It is not recommended by any standards including the IEC. Power transformers designed to operate at higher ambient temperature than their geographic location have capacity to accept load more than their stated nominal load.

Loading guideline for power transformers in various ambient temperatures using IEC-354 standard:

For power transformers to live for 30 to 40 years given they operate at 98°C which is equivalent to 20°C at nominal loads, IEC-354 standard gives the allowable loading limit in per unit for power transformers in different ambient temperatures according to their nominal power [1]. Table 1. is loading guideline for power transformers according to IEC-354/1991 for hot spot temperature less than 140°C. Table 2 presents the temperature variation of the different area for provinces of Mazandaran and Golestan.



Figure 3. A power transformer in a 63/20 KV substation, West of Mazandaran

Software was developed using MATLAB to compute the loading criteria according to the ambient temperature in different part of the Mazandaran & Golestan provinces. Power transformers with different power rating and cooling systems are operating throughout Mazandaran and Golestan provinces. Now more than ever these two provinces require loading regulations for the power transformers in operation.

Maximum loading capacity for power transformers

Based on BS-2757 standard when wire winding hotspot temperature reaches the critical temperature of 120°C bubbles start to form in oil surrounding the wire windings. To be at the safe side the maximum load of the power transformers must be limited such that the hot spot temperature does not exceed 125°C. As a result most new standards specified loading and maximum loading of power transformers in emergency to be 1.5 PU. The maximum amount of time allowed for these transformers to be under 1.5PU load is specified to be 20 minutes [2].

According to Table 2 Gorgan, Kordkooy, Nokandeh, Gonbad and Minoodasht with average yearly temperature of over the 20°C are considered as warm lands. Cities of Noor and Sari with average annually temperature around 20°C are considered as temperate climates. Zirab and Karmozd with average annually temperature less than 20°C are considered as cold regions.

Table 2. Recorded average temperatures in 2005-2006 in the Mazandaran & Golestan states, Iran.

Geographical Area	Min. Temp. °C	Max. Temp. °C	Ave. Temp. Warm seasons °C	Ave. Temp. Cold seasons °C	Ave. annual Temp. °C
Karozd	-15	34.5	16.5	8.2	14.8
Zirab	-4	32	19	12	17.8
Noor	5	42.6	26	12	20.6
Sari	3.2	44	27	13	20.2
Kordkooy	3.1	46	30	16	24.3
Nokandeh	5	46	30	15	24.6
Galoogah	6	44.6	30	17	24.8
Gonbad	8	48.6	30	20	25.7
Minoodasht	7	49	33	20	26.7

Loading strategies for operated power transformers at different climate locations

Temperature variations of two important Northern states of Iran are presented in Table 2. Table 1 shows the loading limit for the power transformers according to IEC-354/1991 standard. Table 3 is prepared using information given in Table 2 and Table 1. Table 3 presents the loading limit in per unit for warm and cold seasons in different locations of Mazandaran & Golestan provinces.

Table 3. Loading limit of power transformers with nominal power and in ambient temperatures according to IEC-354 standards at different geographical locations and climate in Mazandaran & Golestan provinces.

Geographical area	Allowed Loading limit (P.U.)							
	Distribution Transformers		Transmission & Over distribution Transformers					
	1 st Half Year	2 nd Half Year	Warm Seasons			Cold Seasons		
	ONAN	ONAN	ONAN/ONAF	OFA	ODAF	ONAN/ONAF	OFA	ODAF
Karozd	1	1.11	1	0.93	0.95	1.1	1.1	1.06
Zirab	0.93	1.05	0.94	0.92	0.93	1.02	1.02	1.04
Noor	0.93	1.04	0.94	0.94	0.95	1.05	1.05	1.04
Sari	0.92	1.02	0.90	0.91	0.95	1.03	1.03	1.01
Gorgan	0.91	1.02	0.92	0.92	0.94	1.01	1.02	1.02
Kordkooy	0.91	0.95	0.91	0.91	0.92	1	1	1
Nokandeh	0.91	1.02	0.92	0.92	0.94	1.02	1.02	1.03
Gonbad	0.80	0.95	0.80	0.88	0.90	0.93	0.94	0.95
Minoodasht	0.91	1.01	0.91	0.90	0.92	0.95	1.01	1.02

Ambient temperature is important phenomenon in reducing the solid and liquid insulator’s life. Reduction is insulators life in turn reduces the power transformer’s life. Power transformer’s life is estimated using nominal load and at ambient temperature of 20°C. To obtain the actual effective life of a Power Transformer, IEC-354 is used to determine the Power transformer’s loading for ambient temperature over 20°C (standard ambient temperature).

Table 3 was found using Table 1&2, Power Transformers in provinces Mazandaran & Golestan must be loaded according to Table 3.

Simulation of transformer heat dissipation

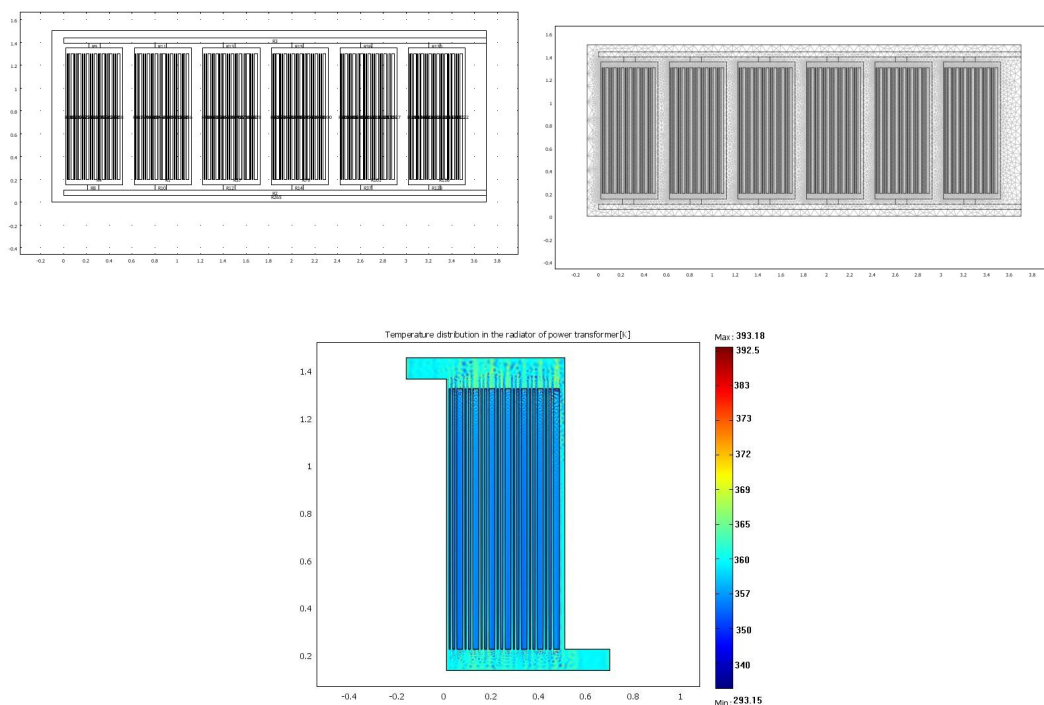

Figure 4: Transformer radiator simulation in Comsol software

A radiator with 6 windows has simulated in Comsol. The mesh number is 123129 units in triangle form. Figure 5 shows the simulated radiator in Comsol. Temperature distribution in radiator shown that in the top of the radiator temperature is highest than the bottom of radiator. This is true because of inlet gage that installed on the top side. Figure 5 shows the comparison of simulated and measured temperature in the low voltage windings. The 2.5% difference is an acceptable value in simulation.

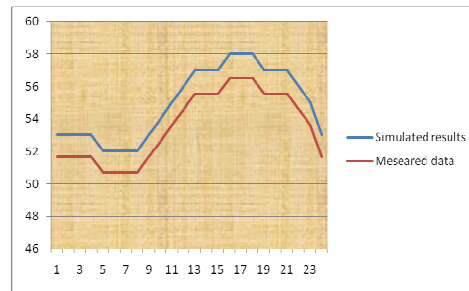

Figure 5: Comparison of measured and simulated low voltage winding temperature

Discussion

In work presented by ABB [Uno Gäfvert.....IEEE] the correlation between different factors measured on transformer oil and break downs has been determined. The conclusion was that the two most important factors were the content of bicyclic aromatics and particles in the oil. In our case we have no possibility to impact the content of bi-cyclic aromatics, but the amount of particles is directly proportionate to the pyrolysis, which will leave solid particles and thereby possible precursors for ignitions and short cuts.Make a discussion.....

Conclusions & Suggestions:

Radiator oil temperature due to overloading in power transformer active parts have simulated. It shown the heat dissipation lead to hot temperature in transformer and consequently it go to decrease of the load ability of the transformer.

Over loading the power transformers according to IEC-354 standard specially in emergency situations for long or short period of time at high ambient temperature can weaken the power transformers and reduce its effective life. Following are recommended for power transformers operating in distribution networks in Mazandaran and Golestan provinces:

- 1- Evaluation of the power transformers fails and faults based on their usage history.
- 2- Maximum allowable over load will be recommended 1.4 PU.
- 3- On base of IEEE standard recommendations, maximum allowable time under overload is 15 minuets.
- 4- Oil temperature at the upper section of the tank should not exceed 115°C.
- 5- Maximum hot spot temperature should be 130°C.
- 6- The trip thermometer wire winding must be set at 130°C.
- 7- Make sure the thermometer is calibrated.
- 8- Make sure the oil conservation level is shown correctly.
- 9- Make sure the load is reduced to its actual nominal capacity before changing transformer tap.
- 10- Reduction of load to its nominal value in corporation with substation control system.
- 11- If load reduction effort was not successful within 15 minuets the power transformer must be taken out of circuit manually.
- 12- Using the extra cooler to overcome on high temperatures.

To overcome the overloading problems in Northern provinces of Iran, the following suggestions are presented:

- 1- Using portable heat sink to remove of high temperature due to over loading in power transformers in hot and humid areas for reduction the ageing rate of the insulators.
- 2- Using the water spray system to cool of radiators.

Acknowledgment: I would like to special thanks to PhD Kourosh Mousavi takami.

References:

1. V.M. Montsinger, "Loading Transformers by Temperature", AIEE Trans, Vol.49, April 1930, pp293-297
2. E.T. Norris, 'Loading of power transformers", Proc. IEE, Vol.114, no.2, February 1969, PP 228-232
3. ANSI/IEEE C57.92-1981, "Guide for LOADING Mineral-oil-immersed overhead and pad-mounted Transformers".
4. ANSI/IEEE C57.92-1981 "Guide for LOADING Mineral-oil-immersed power transfers".
5. VDE 0536/3.77 "Belastbarkeit von Oltransformatoren".
6. IEC 354/1991 "LOADING Gulde for oil-immersed power transfers".
7. (PSC 98) "General thermal consideration for transformers"13th international power system conference Tehran IRAN
8. IEC publication 76-1" power transformer, part:1 General", Second Ed ..1993
9. IEC publication 76-2 "power transformer part2 : temperature Rise " Second Ed.,1993
10. D.HShroff and A.W. Stannet ,"A Review of paper Aging in power transformers" IEE proceeding Vol.132, pt.c, No.6 Nov.1985 , pp 312-319
11. K.Karsai, D.Kerenyi and L.Kiss,"larg power transformers" book, Elsevier . Amesterdam, second Ed.1995
12. C.A . bozzini, " transformer Aging Diagnosis by Means of Measurements of the Degree of Polymerization Results of new Experiments CIGRE paper 12-08 1968
13. IEC publication 354 "Guide to loading of oil-immersed power transformer 1991,BS,7735 1994
14. IRANTRANSFO company technical documents, 2005, Iran
15. MREC Dispatching centers Technical reports, 2006, www. Mazrec .ir
16. Golestan Province Dispatching center annually reports, 2006, Iran .
17. MREC Transmission affairs annually reports, System Studies group, Iran, 2006.

International Scientific Conference on “Energy systems with IT” in connection with the
Energiting 2009, March 11-12 at Älvsjö fair, Stockholm.

Paper No. 14

**Process control in steel core production to optimize of power dissipation in
electrical rotating machines and transformers**

Kourosh Mousavi Takami¹ Jafar mahmoudi² Erik Dahlquist³ Magnus
Lindenmo⁴

^{1,2 and 3.} K.M.T. TDI researcher, ACECR and PhD student, J.M. and E.D. Professors in
Malardalen University, Box 883, SE 721 23, Vasteras Sweden; ^{4.} M.L., Cogent Power Ltd.,
Surahammars Bruk, Box 201, SE-735 23 Surahammar, Sweden

Kourosh.mousavi.takami@mdh.se; Jafar.mahmoudi@mdh.se; erik.dahlquist@mdh.se;
magnus.lindenmo@sura.se

Key words: silicon steel, iron losses, orientation, simulation, production line, process

ABSTRACT

This paper relates to an improved process for producing oriented and non-oriented silicon steels sheets or strips of standing magnetic qualities using simulation in Comsol and calculation in Matlab software. Silicon steel strips have so far been used for iron cores of transformer and electrical machines. Many attempts have been made to control the crystal orientation of silicon steel sheet in accordance with its use. Since the silicon steel has a body cubic centred crystal structure in which three mutually vertical and transverse directions of easy magnetization or cube axes $\langle 100 \rangle$ are present and as a consequence thereof, if a magnetic is applied parallel with one of this directions, the amount of energy necessary to magnetize the silicon steel core will be at a minimum.

Typically, iron losses depend upon the grade of steel, its thickness, current frequency, magnetic flux density and weight. In addition, production processes same slab reheating temperature, hot band annealing temperature, cooling rate, impurities in core (phosphor, manganese, sulfur, carbon, nitrogen etc) and core material has the additional effects on final quality of cores.

These requirements are discussed in this paper and suggestions to improve of production lines and process in annealing furnace, cold rolling and coating are presented. To clarify the claim simulations in Comsol and Matlab have been performed.

Introduction:

Today economy is based on high quality products and processes at low cost. Driven by the need to race on price and performance, many qualities aware manufacturers are increasingly focusing on the optimization of product and process setting and design.

In industrial, handling of distribution transformer construction, iron losses constitute one of the most important parameters of transformer quality. In case of wound core type transformers, iron losses of individual cores significantly influence the quality (iron losses) of the assembled transformer.

Typically, iron losses depend upon the grade of steel, its thickness, current frequency, magnetic flux density and weight. These factors are taken into consideration during the transformer design stage. Other supplementary factors affect iron losses during manufacturing, such as the kind of lamination insulation, annealing, core construction, quality of assembly, etc.

Grain oriented or non-oriented silicon steels are broadly used in electrical apparatus since of their high permeability, high electrical resistance, and low hysteresis loss. Their production requires a vigilant control of composition since almost all elements, when added to iron, negatively have an effect on magnetic properties. Intended for example, impurities such as nitrogen, oxygen, sulfur, and carbon causes dislocations in the crystal lattice that build up detrimental internal stresses. Considered worst of all the elements is carbon.

It has been found, however, that there are certain advantages to utilizing a silicon steel with a relatively high carbon content during fabrication stages and that following working to gauge, the steel can be decarburized to a level consistent with good electrical properties. These advantages are: 1. improved magnetic properties such as lower core loss and higher permeability. 2. less iron oxide in the slag and consequently a higher metallic yield. 3. lower oxygen consumption during refining. 4. longer refractory life. 5. less breakage during cold rolling as the material is more ductile since the hot rolled band recrystallizes to a greater degree in higher carbon material. 6. higher tolerances for carbon in melting. Prior silicon steel making required melting and fabricating the steel with low carbon, i.e. less than about 0.025%. It has now been found that silicon steel meeting existing low carbon specifications can be produced by starting with a relatively high carbon steel and with advantageous results both with respect to improved fabric ability and superior electrical properties of the final product.

The magnetic properties of a grain-oriented electrical steel sheet are generally evaluated in terms of both core loss property and magnetization property. Improving the magnetization property is an effective way of reducing equipment size by increasing the designed magnetic flux density. On the other hand, lowering core loss reduces the amount of energy that a piece of electrical equipment utilizing the grain-oriented electrical steel sheet loses in the form of heat energy and is therefore an effective way of lowering power consumption. Improvement of magnetization property and reduction of core loss is also possible by aligning the $\langle 100 \rangle$ axes of the product grains in the rolling direction, see figures 1 and 2, and, in recent years, considerable research toward enhancing this alignment has led to the development of various production technologies.

Most of core losses divided into hysteresis loss and eddy current loss. Factors that affect on hysteresis loss are included grain orientation and the steel purity and internal strain. Factors that affect eddy current loss include the electrical resistance of the steel sheet (content of Si etc.), the sheet thickness, the size of the magnetic domains (grain size) and the tensile force acting on the sheet. Since eddy current loss accounts for more than three-fourths of the total core loss of ordinary grain-oriented electrical steel sheet, the total core loss can be more effectively lowered by reducing the eddy core loss than by reducing the hysteresis loss. As a reminding, two main different classes of electrical steels are:

1. Non oriented; these are electrical steels in which the magnetic properties are practically the same in any direction of magnetization in the plane of the material.
2. Grain oriented; this term is used to designate electrical steels that possess magnetic properties which are strongly oriented with respect to the direction of rolling.

Grain oriented electrical steel is used for the manufacture of magnetic cores within transformers. The best magnetic properties are only found in the rolling direction due to the nature of the manufacturing process. If the material is magnetized outside the rolling direction, the core losses increase significantly. The extent of this increase varies from a factor of three times at 90 degrees and four times at 60 degrees.

It is therefore essential that the material is magnetized as precisely as possible along the rolling direction throughout the magnetic circuit.

Grain Oriented electrical steel is an essential material in the manufacture of energy efficient transformers and large, high performance generators. Its unrivalled magnetic properties are a result of its unique grain structure, which is formed through a complex production process starting from high silicon hot rolled coil feedstock.

During the secondary recrystallisation process, some grains grow to over 30mm in length. Whereas mild steels require a microscope to view the grain structure. The orientation of the

enhanced grain structure provides significantly better magnetic properties in the rolling direction of the sheet.

By a process of rolling& annealing and alloys of suitable composition can be produced with a metallic crystal structure in which the grains are aligned so that magnetic properties are vastly superior in the direction of rolling.

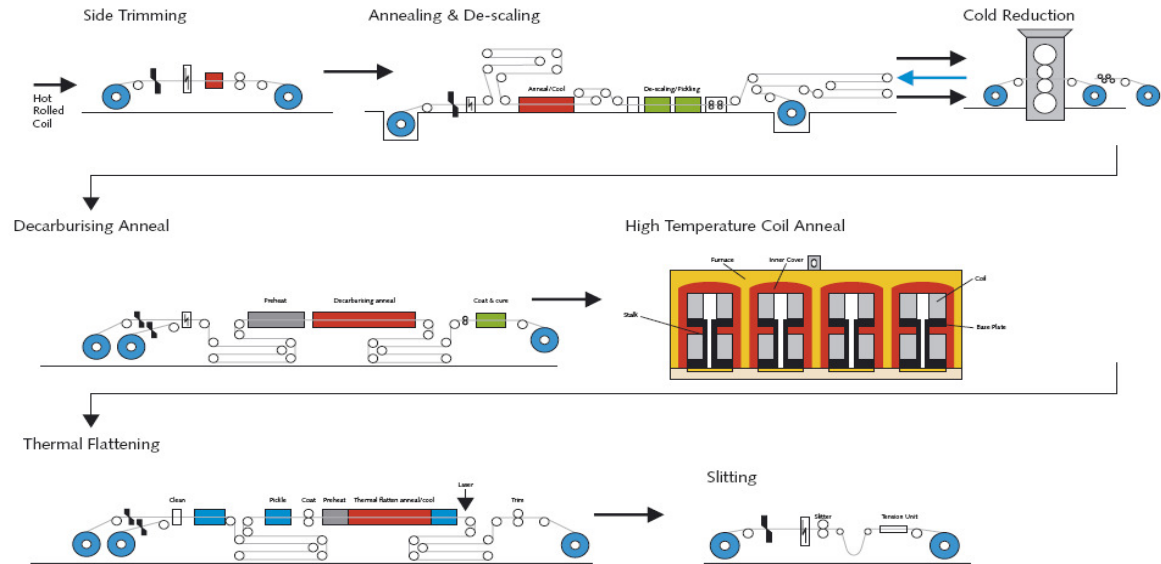

Figure1. Core production process, Surahammar Bruks AB, Sweden²⁹

This results in inferior properties in other directions, however. Good coating can help to reduce of losses, in the different form.

Also core is made of steel and silicon together with some other impurities like phosphor, aluminum, manganese, sulfur, carbon etc. many parameters have effected on core losses and polarizations like: SRT, FT, cooling rate, slab speeds, annealing temperatures etc. we have attempted to investigate of all of these factors and their effects on core final production properties.

When a metal is coldly worked, microscopic defects are nucleated throughout the deformed area.

These defects can be either point defects (a vacancy on the crystal lattice) or a line defect (an extra half plane of atoms jammed in a crystal). As defects accumulate through deformation, it becomes increasingly more difficult for slip, or the movement of defects, to occur.

This results in a hardening of the metal. These defects affect on old rolling qualities. If enough grains split apart, a grain may split into two or more grains in order to minimize the strain energy of the system.

When large grains split into smaller grains, the alloy hardens as a result of the Hall-Petch relationship. If cold work is continued, the hardened metal may fracture.

During cold rolling, metal absorbs a great deal of energy; some of this energy is used to nucleate and move defects (and subsequently deform the metal). The remainder of the energy is released as heat.

While cold rolling increases the hardness and strength of a metal, it also results in a large decrease in ductility. Thus metals strengthened by cold rolling are more sensitive to the presence of cracks and are prone to brittle fracture.

A metal that has been hardened by cold rolling can be softened by annealing. Annealing will relieve stresses, allow grain growth, and restore the original properties of the alloy. Ductility

²⁹ <http://www.sura.se>, PO Box 201, SE-735 23 Surahammar, Sweden

is also restored by annealing. Thus, after annealing, the metal may be further cold rolled without fracturing.

1.1 Process description

Mechanical properties of the material in its final 'as-rolled' form are a function: material chemistry, reheat temperature, rate of temperature decrease during deformation, rate of deformation, heat of deformation, total reduction, recovery time, re-crystallization time, and subsequent rate of cooling after deformation.

For a case study, any different studies to evaluate of impurities in strips are discussed.

We knew that ultra-low-carbon (ULC) steels produced by vacuum degassing, exhibit many advantages for application as non-oriented electrical steel. Due to their high purity, the permeability at low induction increases. Moreover, because of the reduced carbon content, they are not susceptible to magnetic aging [(1)].

1.2 Experimental tests descriptions

Two different slabs to evaluate the effect of hot rolling parameters of low-Si ULC steel, cold rolling, hot band annealing with different manganese and sulfur contents on the magnetic properties has been tested.

The first slab has been a ULC steel, containing 30 ppm C, 0.4% Si, 0.3% Al and 0.1% P.

Other one have been a ultra-low sulfur steel, with proportions of manganese as 0.12, 0.30, 0.50, 0.91 wt% and 0.0005–0.001 wt% sulfur, and the low sulfur steels with last manganese in wt% and 0.005–0.007 wt% sulfur and medium sulfur steels so with same proportions of manganese and 0.012–0.021 wt% sulfur are evaluated. The high sulfur steels with proportions of same manganese and with 0.035–0.042 wt% sulfur so evaluated. The contents of other elements were 0.30 silicon, 0.30 acid soluble aluminum, 0.10 phosphor, 0.001 carbons in weight percentage nitrogen.

Slabs hot rolled on a laboratory mill in six passes from 25 mm to approximately 2.5 mm. The reductions in the first five passes ranged from 28 to 34%.

Slabs in small specimens annealed for 2 h in nitrogen gas, for stress relieving, and cooled in the furnace.

Slab reheating temperature changed in three steps: 1250, 1150 and 1050-1000°C, for investigations.

The finishing temperature with FT: 725 to 910°C (880 °C for manganese content), and the coiling temperature with range of CT: 680 and 780°C (670°C and kept for 5 h then cooled to room temperature in the furnace for manganese content).

Hot band grain diameters ranging from 30 to 85 µm that its ASTM numbers are 4.2 to 7.4 obtained. After hot rolling, the sheets to a thickness of approximately 0.35 mm cold rolled and so annealed, using a continuous annealing simulator. The magnetic properties in the rolling and the transverse direction measured at 50 Hz and single strip tester.

Either continuous annealed³⁰ sheets cut to a width of 60mm and a length of 200mm length in dimension, either longitudinally or transversely to the rolling direction, for 20 cm miniature Epstein frame specimens.

Magnetic properties, including core loss and induction, measured on a 20 cm miniature Epstein frame³¹.

Crystallographic textures were examined by inverse pole intensity for {1 1 0}, {2 0 0}, {2 1 1} and {2 2 2} planes parallel to the sheet surface at quarter thickness with Mo-K α radiation operated at 46kV and 16mA. Investigation of precipitates done by an extraction replica method using a transmission electron microscope (TEM) attached to an EDAX for chemical analysis (Hitachi HU- 700H operating at 100 kV).

Moreover, evaluated the influence of the hot rolling and the subsequent cooling conditions on the grain refinement of hot bands using a plain extra low-carbon steel of a carbon content of around 10 ppm and the mechanism of the grain refinement from the viewpoint of the

³⁰ The continuous annealing was performed with a Shinku-Riko ULVAC CCT-QB simulator.

³¹ Yokogawa Electric Works Measuring System

recrystallization and transformation behavior of austenite. However, the proper operational conditions for achieving the grain refinement of a hot rolled.

In the real case, Surahammar Bruks AB is the one of biggest producer of cores. Unsil is one of their products. To enter the real production and define a real process, all of active process of Surahammar has been described here.

Unsil is conventional grain oriented material between 0.23mm and 0.35mm thick and Unsil-H is high permeability grain oriented steel at a maximum thickness of 0.30mm. The product range also includes laser-scribed products, which offer improved loss performance over traditional Unsil-H, through a sophisticated process of domain refinement.

Final annealing specifications in Surahammar Bruks:

Length of furnace:

Decarburising part (zone 1-14): 104 m

High temperature part (zone 15-19): 60 m

Line speeds:

0.35 mm :(high Si) 45 m/min

0.50 mm: (low Si, low C) 58 m/min, (low Si, high C) 40 m/min (high Si, low C) 40 m/min

0.65 mm: (low Si, low C): 50 m/min, (low Si, high C) 30 m/min (high Si, low C) 30 m/min

Hot band annealing and pickling:

Length of the furnace: 49 m

Line speed:

20 m/min (width < 1100 mm) = 2 min 27 s

18 m/min (width: 1100-1300 mm) = 2 min 43 s

Temperatures (°C):

Typical: zone 1-4 and 6: 950, zone 5: 970

Cold rolling specifications:

Hot band gauge: 2.0 – 2.5 mm

0.35: 5 passes, 1.30-0.86-0.62-0.45-0.35, reduction 82.5%

0.50: 4 passes, 1.35-0.90-0.65-0.50, reduction: 75%

0.65: 3 passes, 1.35-0.90-0.65, reduction: 67.5 %

Max speed 600 m/min

Hot and cold Rolling Conditions

Using the simulation in Matlab-Simulink hot rolling in which the hot rolling and cooling conditions could be controlled within a wide range by controller. The plates were reheated and kept at 1050-1000°C for 30min, then hot rolled at two different finishing temperatures of about 930 and 960°C to study the influence of the finish rolling temperature on the grain refinement. To investigate the influence of the final reduction, the final rolling reduction varied, such as 25, 40 and 50%. The corresponding rolling schedules were 25, 19, 11, 8, 6, 4 and finally to 2.5 mm; 25, 15, 10, 7, 5, 3.5 and to 2.5mm and so 25, 19, 11, 6, 4, 3 to 2.5 mm, respectively. The final thickness was 2.5mm.

The hot rolled bands were subsequently cooled at an average rate of 70°C/sec to 750°C±20°C and then air-cooled. For the investigation of the influence of the cooling rate, the cooling rate varied from 40 to 120°C/sec. The onset time of cooling set by an on-off control of the temporary cooling facilities shown in Fig. 2. The onset time of cooling was 0.1, 0.6 and 1.6sec in the case of usually employed rolling speed of 120 m/min.

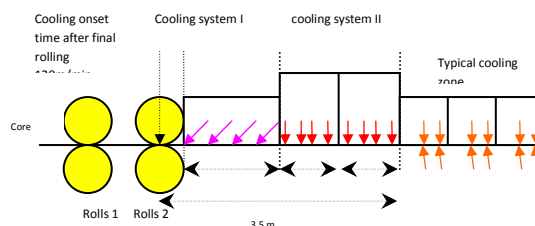

Fig. 2. Schematic depiction of the laboratory hot rolling mill used in the experiment.

In the case of the final reduction of 50%, the rolling speed reduced to 70m/min and the onset time of cooling correspondingly prolonged.

The finishing temperature is normally measured right after the final rolling, by means of an emissional thermometer. The grain size of the hot bands was determined by counting the number of grains n in five different areas of a square $250\mu\text{m} \times 250\mu\text{m}$. The grain size number (G.S.No.) was determined from $G.S.No. = (\log n / \log 2) + 1$.

Results and discussions

Experimental data in material sciences and temperature effect on the core properties have collected by last research of Taisei Nakayama et. Al in Sumitomo Metal Industries, Ltd., and Takehide Senuma et. Al in Yawata R&D Laboratories, Japan; and A. De Paepe in Labo Metallurgie, Universiteit Gent, Technologiepark-Zwijnaarde an OCAS Research Center of the Sidmar Group in Belgium. This article have basically found on their attempts.

Slab reheating temperature (SRT) is a main parameter to form of the grain constructions. Changes in SRT make the different grains in the slabs. Although, using the electron microscopic can find coarsening of hot band participates. These are the main tools to know and analyze of cores in machines and transformers.

ASTM number after cold rolling and annealing has a relationship with hot band grain size.

Study on coarsening of the hot band precipitates need to changes in SRT. Our study showed that with decreasing of the SRT lead to a coarsening of the hot band precipitates, which concluded a greater extent of grain growth after re crystallization of the cold rolled material during continuous annealing.

Figure 3 shown relationships between the ASTM number of the hot band and the ASTM number of the cold rolled and annealed sheet, it found by varied SRT.

It is obvious that final grain structure in highest SRT coarsens with increasing hot band grain size.

To explain that, how the final grain size increases with SRT decreasing, need to describe that: A smaller number of coarser precipitates do not impede the migration of the high-angle boundaries as much as a larger number of finer particles.

Because of combination of coarser grain structure of the samples in the lowest SRT with coarser precipitates, hysteresis losses at 1.5 T (Ph1.5) will be created. It showed in Fig. 4. A precise glance on this figure and comparison of that with earlier researcher shown a bit difference of our result with their, this is less than of 5%.

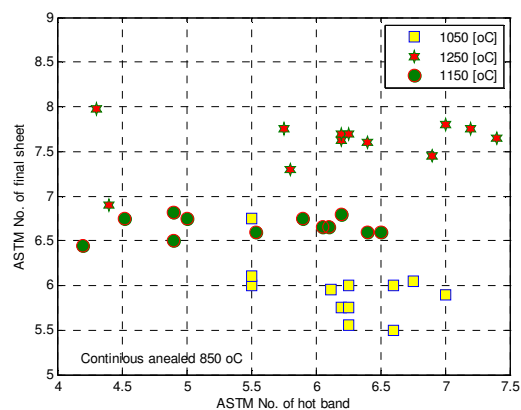

Fig. 3. ASTM number of the hot band and the ASTM number of the cold rolled versus annealed sheet by varied SRT.

Individual researchers have studied on morphology of core to define the precipitations using scanning electron microscope (SEM). They found there is a significant difference in the morphology of the Mn sulfides for the different slab reheating temperatures. In the SRT of

1250°C, MnS observed in combination with other particles such as AlN and Al₂O₃, in role of nuclei for MnS precipitation. Therefore, in the lower SRT mixed precipitates along with pure Mn sulfides found in the samples. These thin particles elongated in the rolling direction with the length of 2 to 10 μm.

Also, Taisei and his colleagues found the elliptical and spherical Mn sulfides using the transmission electron microscope (TEM). In the highest SRT, tiny precipitates with mean diameter less than 50 nm observed. Although, largest precipitates seen in mean diameter up to 500 nm was very low.

Due to deformation of dissolved grains during slab reheating in the hot rolling process, the very coarse, extended precipitates seen with the SEM.

This could explain why this kind of precipitate is not found for the highest SRT. According to [(2)] dissolution temperature of MnS is 1245°C. During the hot rolling, manganese sulfides must be participated because of that MnS dissolved in SR. Amount of tiny spherical or elliptical particles with mean diameter less than 55 nm increases during hot rolling and decreased larger particles influence, [(3)] approved this. In addition, this supported the TEM experiments that increasing of SRT lead to increase of the density of the finest MnS particles.

This claim need to more facts, so describe that last researcher found that AlN precipitates (angular or rectangular particles) only observed with the SEM. They are generally coarser for a SRT of 1150 and 1050°C (mean diameter ±6.5 μm) as compared to 1250°C (mean diameter ±4 μm).

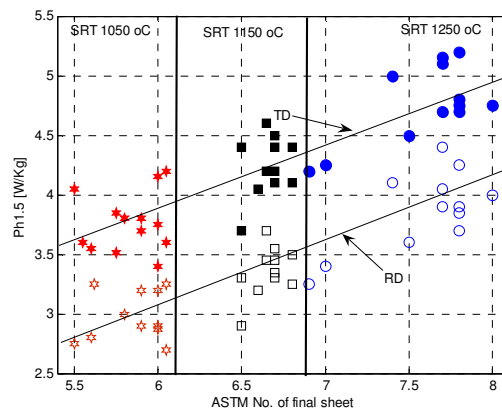

Fig. 4. Hysteresis losses at 1.5 T in the rolling direction (RD) and the transverse direction (TD) as a function of the ASTM number of the cold rolled and annealed product for various slab-reheating temperatures.

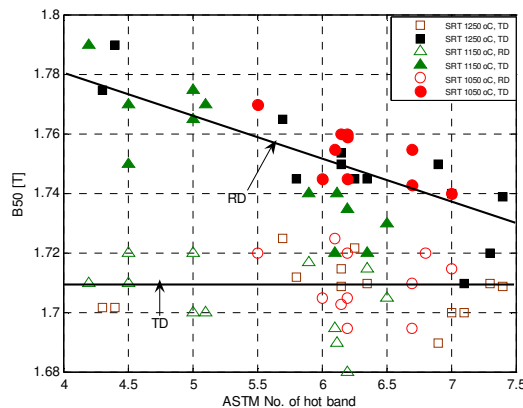

Fig. 5. Induction at 50 A/cm in the rolling direction (RD) and the transverse direction (TD) as a function of the ASTM number of the hot band for various slab-reheating temperatures.

Which parameter has the significant effect on magnetic induction in during of slab processing? Important question for all of explorers is this. Showed in Fig. 5 slab-reheating

temperature and thus the precipitate structure of the hot band, has insignificant effect on the magnetic induction at 50 A/cm (B_{50}).

According to indecency of B_{50} from hot band grain size in transverse direction, it increases with decreasing ASTM number of the hot band in rolling direction increases.

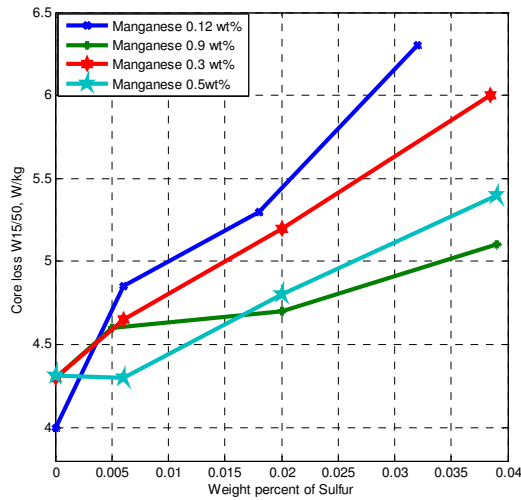

Fig. 6. Effect of manganese and sulfur contents on core loss W15/50 in steels processed at an SRT of 1 150C without HBA.

To define the relationship between core loss and impurities, need to perform experimental tests. It is obvious that with reduction of impurities help to make the larger grains. Manganese sulfur is an impurities that existed in the core alloy. Sulfur content lead to higher losses, lower sulfur make the lower hysteresis losses. Because of decrease of manganese sulfur contents and coarsened grains, decreased the hysteresis losses in the each steel with different manganese content.

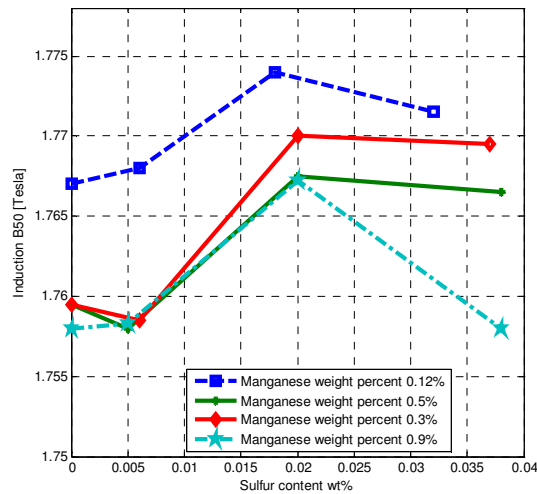

Fig. 7. Effect of manganese and sulfur contents on magnetic induction B_{50} in steels processed SRT at 1150 °C without HBA.

In other side core losses decrease with increase of manganese content in the different volume of sulfurs. Higher manganese, increase the resistivity of core and lead to decrease of eddy current losses.

Fig. 6 shows the relationship between core loss at 1.5 T and 50 Hz ($W_{15/50}$), and manganese and sulfur content after stress relief annealing in the steels processed at an SRT of 1250 °C, without HBA.

In addition, impurities have the various effects on magnetic induction of cores. Fig. 7 shows the effects of manganese and sulfur under the same conditions as in Fig. 6. On increasing the sulfur content in different manganese content in steel, magnetic induction B_{50} hardly changed at each manganese level. It shown, Increasing in manganese content decreased the magnetic induction.

Moreover, it can be concluded that the grain size of the hot band affects the magnetic induction. Fig. 9 shown that grain size of the hot band is slightly decreased with increasing the sulfur content in the steel with 0.31% manganese, while magnetic induction B_{50} decreased slightly on increasing the sulfur content.

The effect of SRTs without HBA in 0.31wt% manganese steel need to evaluation here. In this reason, a reheated slab without HBA was tested. Fig. 8 showed the results. Due to increasing of SRT from 1000 to 1250 °C, the core loss increases with an increase of sulfur content. Small grains pinned down by the small MnS are the reason of these deteriorations.

Why losses increased due to increasing of SRT and sulfur? It must to be cleared; with investigation on grain size and textures of the steel, it can be cleared.

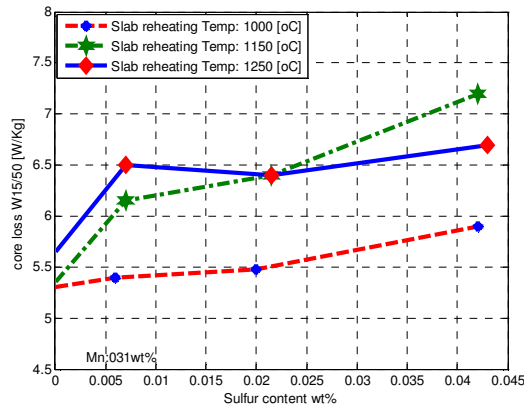

Fig. 8. Effect of sulfur content and slab reheating temperatures (SRT) on core loss $W_{15/50}$ in 0.31 wt% Mn steels processed without HBA.

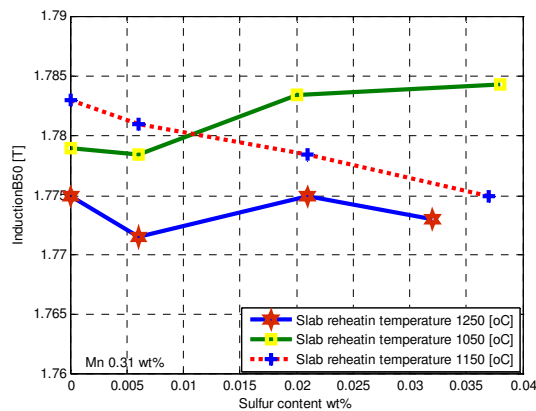

Fig. 9. Effect of sulfur content on magnetic induction B_{50} in 0.31wt% Mn steels processed without HBA.

Using the annealing, stress to hysteresis reduction will be relieved. This called stress relief annealing (SRA) of the cold rolled steels it can be without HBA. Grain size after SRA will be changed. The grain size of the steels treated at SRT of 1000 °C, which is closely related to the core loss (4), is larger than that at 1150 or 1250 °C, therefore, the core loss of the steels

treated at SRT of 1000 °C is lower than that at 1150 or 1250 °C except for ultra low sulfur steels.

Fig. 10 shows the grain size after SRA.

SRA has an effect on magnetic induction of cores. It has been investigated and the results showed in Fig. 11. It shows the textures of the steels after stress relief annealing (SRA), $\{2\ 0\ 0\} + \{1\ 1\ 0\}$, which means easy magnetization, divided $\{2\ 2\ 2\} + \{2\ 1\ 1\}$, which do not undergo easy magnetization.

Index for easy magnetization is represented by this ratio. The high index number relates to the low core loss and high magnetic induction. In steels processed at a SRT of 1000 °C, the index is higher than of the steels processed at the SRT of 1150 or 1250 °C. Therefore, steels with high sulfur content, such as LS, MS and HS steels treated at an SRT of 1000 °C have lower core loss (Fig. 8 and 4) and higher magnetic induction (Fig. 9 and 5), than that at 1150 and 1250 °C.

This difference on the index is derived from the hot band texture shown in Fig. 12. The indexes in the hot band steels processed at SRT of 1000 °C are higher than those in steels processed at SRT of 1150 or 1250 °C. This means the texture in the hot band strongly affects that in the cold rolled and annealed steels. Steels with less $\{2\ 2\ 2\}$ intensity, which are not easy for magnetization, in the hot band maintain this texture after being cold rolled in 78% reduction and recrystallization annealing. The rich magnetic easy texture was observed only in the steels processed at an SRT of 1050 °C.

SRT of 1050 make the larger grain size and less core losses than 1150 or 1250 °C. Fig. 13 showed the test results of grain sizes in hot bands. It showed, the coarse grains in hot band steels improve the core loss, the magnetic induction after cold rolling and recrystallizing annealed sheets. Define the critical SRT effects need to more jobs and is not concluded in this paper [(5), (6), (7)].

Grain size of hot band and cold rolled re crystallizing annealed sheet are the main factor of the magnetic properties. Hot band grain size have the more effect on magnetic induction and grain size after re crystallizing cold rolled annealed sheet has the considerable effect on core loss.

The effect of SRT on the magnetic properties is related to the solubility of MnS [(8), (9), (10)]. The solubility of sulfur in steel is drastically increased in high sulfur or low manganese steels in the conditions at an SRT of 1250 °C.

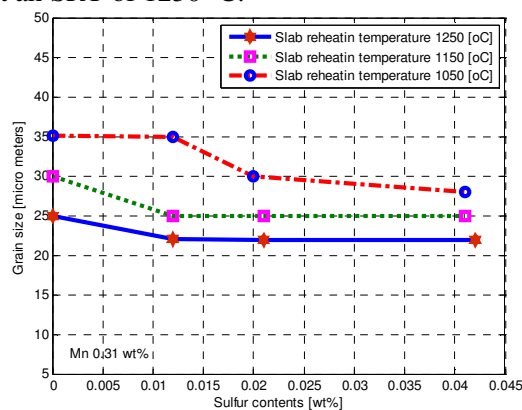

Fig. 10. Grain size of hot band without HBA with various sulfur contents in 0.31 wt% Mn.

Influence of finishing temperature (FT)

According to last individual researcher studies, the grain size decreases with reduction in cooling system onset time. Because of non-homogenous strain and cooling rate in one to other position, throughout the thickness of slab, the microstructure is no uniform.

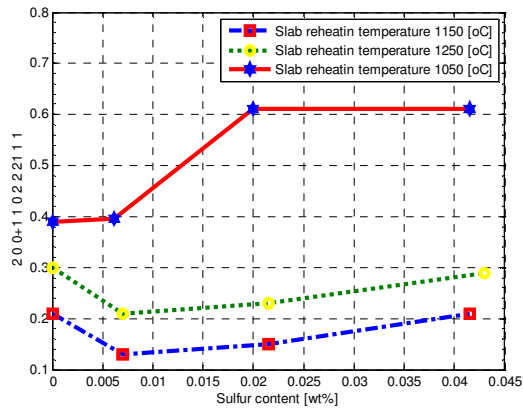

Fig. 11. Textures of cold-rolled and recrystallized sheets with processed without HBA with various sulfur contents in 0.31 wt% Mn steels processed.

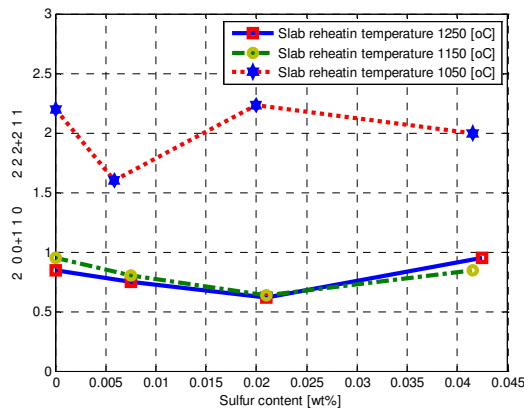

Fig. 12. Hot band textures without HBA with various sulfur contents in 0.31wt% Mn.

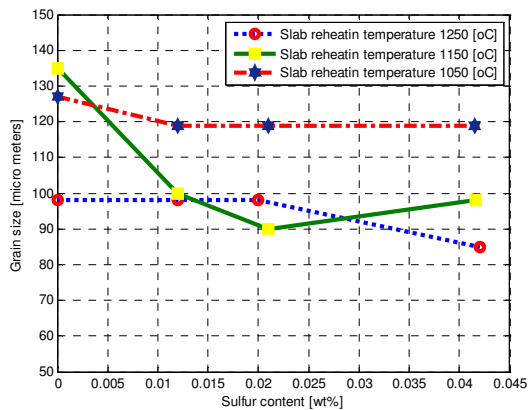

Fig. 13. Grain size of cold-rolled and recrystallized sheets processed without HBA with various sulfur contents in 0.31wt% Mn.

To evaluate of this phenomena tests performed and the gathered results shown in the following discussions.

To compare the difference between the corresponding reductions of the final rolling before installing the cooling facilities, temperature around of final rolling like after and before of that has been measured. Because of installation of temporary cooling facilities near the stand, the finishing temperature did not measure. See Figure 14 shows the results, the finishing temperature identified with the temperature measuring before the final rolling.

Two different finishing temperatures applied to evaluate of the influence of the cooling onset time (COT) on the hot band grain refinement, 930 and 960°C. (See Figure 15)

Due to short COT, the grain size reduced in both FT. Because of delay in cooling start times, the grain size in 930°C will be enlarger than 960°C.

The difference in the ferrite grain size of the hot bands of the different finishing temperatures hardly existed at an onset time for cooling of 0.1 sec while that at an onset time for cooling of 1.6 sec was more than ASTM M grain size number of 1. This finding is of industrial importance because it means that even though the finishing temperature in a hot strip fluctuates from place to place, reducing the onset time for cooling avoids a large fluctuation of ferrite grain size and consequently of the mechanical properties of the product.

Influence of final reduction and COT

Figure 16 shows the influence of the onset time for cooling on the grain refinement of hot bands for various final rolling reductions. Regardless of the amount of the final rolling reduction, the grain size is reduced if the onset time for cooling is shortened. On the other hand, the grain size is reduced if the amount of the final rolling reduction is increased regardless of the onset time for cooling.

Influence of Cooling Rate (CR)

Figure 17 shows the influence of the CR on the grain size In case of a FT of 930°C, a final reduction of 25% and an onset time for cooling of 1.6sec. The increase in the CR from 40 to 120°C/sec yields a small grain refinement of G.S.No. 0.5. This result indicates that the cooling rate is not an essential factor for the grain refinement of plain extra low carbon steel.

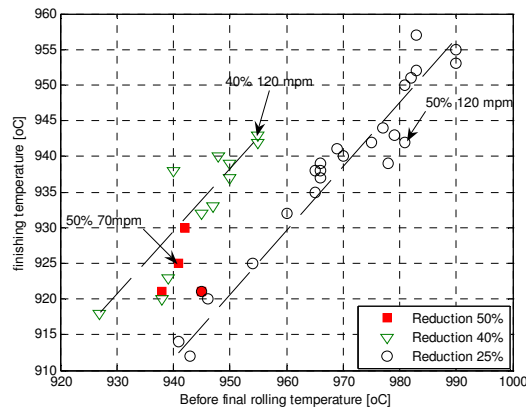

Fig. 14. Relationship of FT with the temperatures before and after final hot rolling.

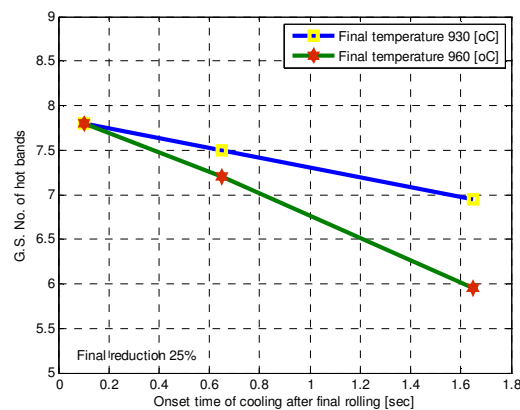

Fig. 15. Influence of the COT on the grain size of hot bands for the finishing temperatures of 930 and 960°C with Cooling rate: 70°C/sec.

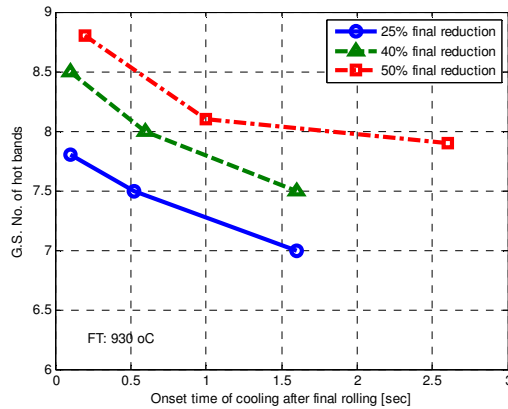

Fig. 16. Influence of the COT on the grain size of hot bands for final reductions of 25, 40 and 50% (Cooling rate: 70°C/sec).

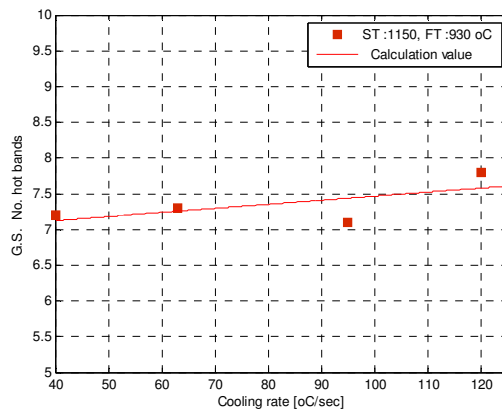

Fig 17. Influence of the CR on the grain size of hot bands. (The dotted line is the calculation result.)

Process imorovments

How can improve the annealing conditions? How can improve the cold rolling processes? These are two main questions in related to this job. To improve the final quality in annealing furnace authors simulated the slabs in passing of furnace and suggested a new furnace to increase of yields.

2.1 Hot band annealing furnace new design

Most common furnaces use the burner that installed on the wall of furnaces. This burner emitted the fire on the furnace to produce of hot temperature. This temperature is not homogenous on the strip, in the all of parts. Non-homogenous temperature makes the non-size or small size grain. The best idea is to design a wall with ceramics and emitted the fire to them and then high temperature reach to passenger strips. This can make the homogenous temperature on the strip and solve the problems.

Simulation result of this novel designed furnace with constant temperature on the wall is presented here.

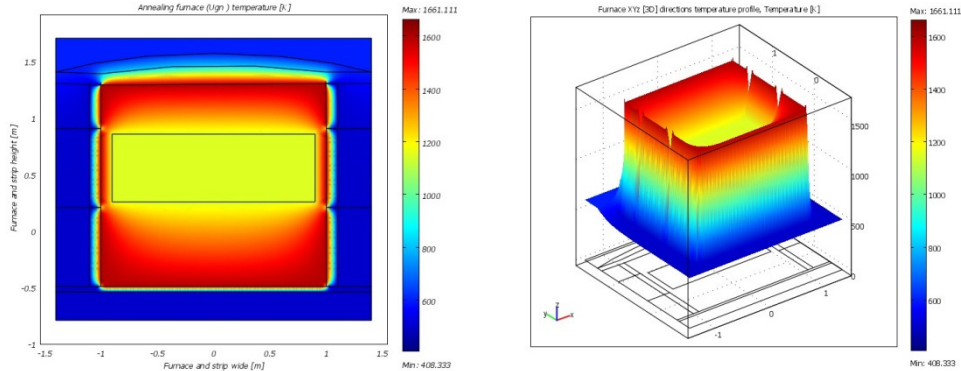

Fig. 18. Annealing furnace (Ugn) temperature simulation

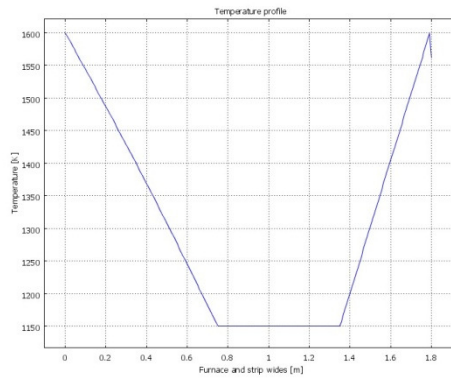
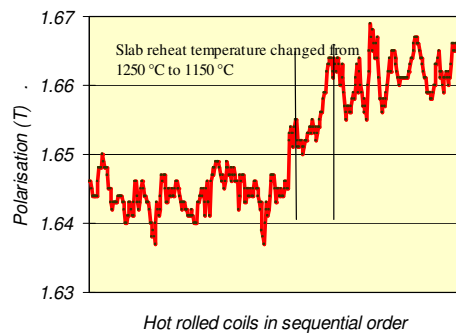

Fig 19. Temperatures profile in furnace and strip

Simulations of annealing furnace with constant temperature in every parts of furnace are shown in figure 4. Homogenous and flat temperature profile in strip showed in these figures. It means we need to four or more conductive and radiative plate that the direct flamethrowers throw the flames to these plate and consequently, blazed plate make a homogenous temperature in the furnace. In this case, strip has a same temperature in all of its parts. It leads to best-annealed strip with lower stress.

Homogenous temperature in strip showed in figure 19. From 0.75m to 1.35 m in the figure is related to strip.



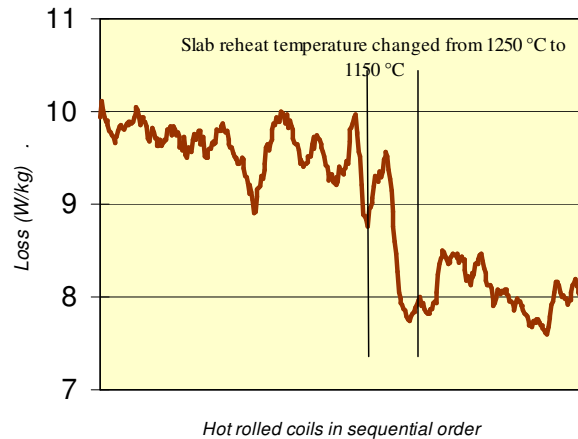

Fig 20. Parameters influence important properties a) Max. Loss and min polarisation for 0.5 electrical steel according to standards b) polarization c) losses

The influence of a $\sim 100^{\circ}\text{C}$ reduction of the slab reheat temperature on the total specific losses of a 0.65 mm 0.2%Si–0.05%Al non-oriented electrical steel, is shown in figure 20. Moving average (10 coils) loss per coil of a total of 393 coils shown in sequential order of hot rolling. The simulation results concluded to increasing of grain size, decrease the stresses, homogenous effects on slab in every effective parameters.

2.2 cold rolling process control

Thickness, flatness, grain size etc are parameters that effects on the core losses. Thickness deviation effect on the eddy current loss, grain size effect on hysteresis loss, flatness and hardness effect on noise produced in the machine and transformers. These mentioned parameters affected by cold rolling processes. The main goal of this section is control of cold rolling while obtain the lower losses.

The goals of these attempts are to: improve flatness, achieve final finish and texture, better mechanical properties and reduce the likelihood of stretcher straining during forming. To achieve the mentioned properties we should develop very flexible, efficient and reliable concepts of a rolling mill Technology Control. The concepts are realized by using a highly efficient industrial process computer stations in conjunction with adaptive direct control algorithms. For the process computer stations, an Open Control System (OCS) is used. That is also applied to other high dynamic processes, like drive control systems. Besides high computer performance, the system provides high availability, high reliability and high maintainability, together these items lead to low operating costs.

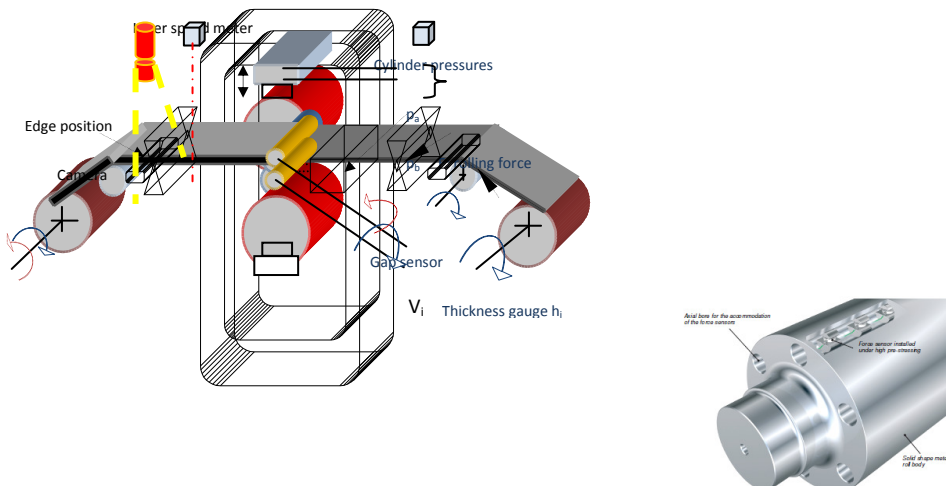

A main aspect of the control algorithm is an adaptation in order to achieve an optimal dynamical behaviour under various process conditions. This means different materials, varying in alloy, width and height, and the result is a variable material stiffness.

It should be mentioned, that the strip thickness can be controlled not only with the roll adjustment system, but also with the tensions applied to the incoming and outgoing strip. Additionally, the rolling speed has an influence. The rolling force (and associated with this, the roll gap), is the dominant control factor when rolling hot strip and thick cold strip, whereas on thin strip and foil the tension and speed are dominant. The tension on the entry side has a greater influence than on the output side.

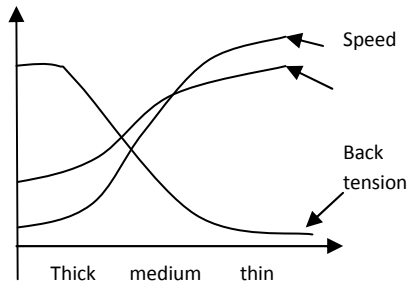

Fig. 21: Significance of the influencing variables to the thickness (adopted from DAVY, 'Automatic Gauge Control for modern Rolling mills', 1989)

The basic control strategy with respect to the tolerances is the use of the feedback control principle. In this context it is called strip thickness feedback control and guarantees very high strip thickness quality, because of the direct use of the thickness deviation, measured on the exit side of the mill, as input value of the control algorithm. Then a correction value is calculated and used to adjust the roll gap, which is adjusted either by a position or a roll force control loop. In this basic control strategy, there used to be following subsystems incorporating together: thickness feedback control, speed feedforward control, Morgoil bearing compensation (if backup roll bearing is of Morgoil type) and wedging control (if required by rolling schedule) (pls. ref. to Figure 21). The software package of this controller commonly includes the option to add a Smith Predictor feedback to the thickness feedback control loop. Using this concept of a model-based feedback improves the dynamic behaviour of the control significantly.

Using the thickness gauge at the entry side of the roll gap, the thickness feedforward control applied. It can compensate any thickness deviation caused by changing entry thickness. Once the entry thickness value is measured a shift register tracks it until it reaches the roll gap. A correction value is calculated according to the stored entry thickness deviation and forwarded to the roll gap control when the strip section reaches the roll gap. In this advanced control strategy, there can to be following subsystems incorporating together: thickness feedforward control, thickness feedback control, speed feedforward control, Morgoil bearing compensation (for backup roll bearing with Morgoil type), and wedging control (if required by rolling schedule) (pls. ref. to Figure 21).

Another advanced control concept is based on the mass flow equation. The following relation can describe the mass flow, where it is assumed that the density of the deformed material stays constant:

$$\text{input volume} = \text{output volume}$$

So in this case the mass flow equation is equivalent to the law of volume constancy. The use of the mass flow equation is modifying both control system layout and control system parameters. By means of this relationship in addition to high control system dynamics, high control accuracy can be achieved. Therefore it enhances clearly the concepts of thickness feedback and thickness feedforward concerning product quality. In this advanced control strategy, there can to be following subsystems incorporating together: tension feedforward control to Pay-Off reel, thickness feedforward control, mass flow control with thickness feedback control, speed feedforward control, Morgoil bearing compensation (if backup roll

Fig. 23. Control model diagram of the gaugemeter method

Unfortunately, this method will not be sufficient to produce a constant strip thickness on the output side. For example, the compliance of the mill stand will allow an increasing gap without a change of the cylinder position. So a number of additional control strategies have been developed to solve this problem. The most important methods concerning reversing mills are listed in the following.

In-Gap Control and Similar Methods: Since it is not possible to measure the roll gap directly, it is desirable to measure it as close as possible to the process. In reversing cold rolling mills, the most important method is a device, which takes its measurements from special cylinder surfaces on the working roll. This is called 'in-gap' measurement, although the designation is not correct.

Gaugemeter Control: When the elongation of the mill stand is known from a calibration process ('kiss rolling' without a strip), one can calculate the stand elongation from the forces, which are easy to measure. During the rolling process, a correction signal may be calculated from the measured rolling force to compensate for the elongation of the mill stand.

In the following, a possible realisation of the mill deflection monitor is presented.

Figure 23 shows the Model for the mill stand elasticity in use of Control model diagram of the gaugemeter method.

Where: h : stand deformation, Δh : small stand deformation, Δx : small cylinder elongation. C_s : stand spring constant, \tilde{C}_s : estimated stand spring constant, c_m : material (strip) spring constant, η : attenuation factor, C_{tot} total spring constant stand + strip. C_{eff} resulting spring constant after compensation, ΔF : rolling force change, $\Delta \tilde{F}$: measured rolling force change.

Considering the stand as a spring, the changes in strip thickness, cylinder elongation and rolling force fulfil Hooke's law:

$$\Delta h + \Delta x = 1/C_s \cdot \Delta F$$

The functional block 'mill deflection monitor' (see Figure 23) generates a correction signal for the cylinder elongation, using a measured value for the force and an estimated value for the spring constant of the stand. With an additional attenuation factor η , the control law follows:

$$\Delta X_{set} = \eta \frac{\Delta \tilde{F}}{\tilde{C}_s}, \quad \frac{\Delta \tilde{F}}{\tilde{C}_s} = \lambda \frac{\Delta F}{C_s}$$

That λ is a factor near to 1.

A good position control loop assumed, the actual value Δx will match with Δx_{set} . Further, the measured force and the estimated spring constant should be equal to the exact values:

$$\Delta x = \Delta x_{set} \text{ and } \lambda = 1$$

With these assumptions, below equation can be rewritten as:

$$\Delta h = \Delta F \cdot \frac{1 - \eta}{C_s}$$

From this it is easy to see, that the compensation procedure results in a change of the effective spring constant:

$$C_{eff} = \frac{C_s}{1 - \eta}$$

With the help of this equation it is possible to describe the influence of the force feedback loop simply with an increased spring constant of the mill stand. This will be a proper model for slow transient events.

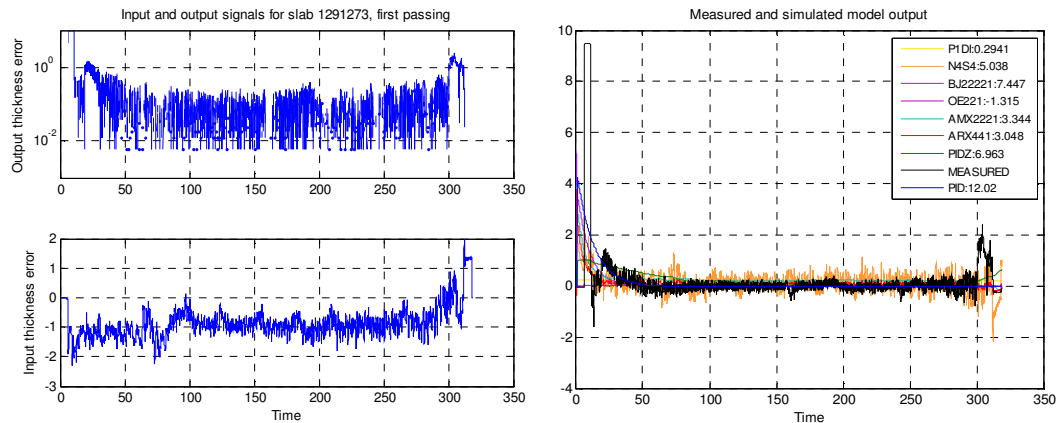

Fig. 24. Measured and simulated input-output of thickness, feedforward

To evaluate of constant parameters on controller, we have evaluated the feedback and feed forward controller here. According to figure 24, the best controller to control of input-output thickness in feedforward controller is a PID controller with $G(s) = K \exp(-T_d s)/(1 + s T_p1)$, that $k= 0.011528$, $T_d= 1.1999$ and $T_p1= 12.4605$ obtained. This simulation is found based on input-output feedforward thickness controller.

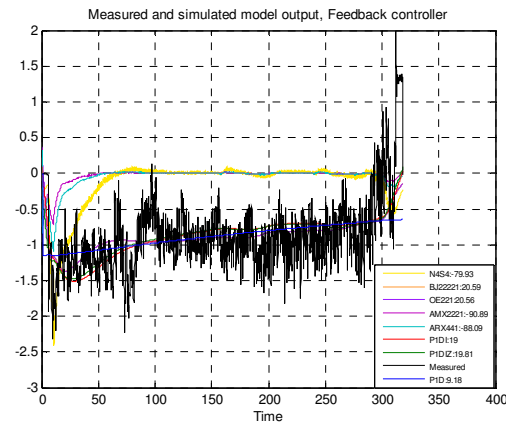

Fig. 25. Feedback controller attempts

Figure 25 shows that PIDIZ controller is the optimized controller for feedback control of thickness.

For feedback PID controller with $G(s) = K \exp(-T_d s)/(1 + s T_p1)$, that $k= -0.29493$, $T_d= 1.0584$ and $T_p1= 512.8274$ obtained.

PIDIZ transfer function is $G(s) = K/(1 + s T_z) \exp(-T_d s)/(1 + s T_p1)s$, that $k=4759.7599$, $T_z= 2.3292$, $T_d=0$, $T_p1= 1708176.0394$ obtained.

Authors future work are based on cold rolling system control to optimize of slab final quality in physic and magnetic properties. Other controller that mentioned and showed in figure 22 and 23 will be discussed in next job.

Conclusions

Simulation shown that direct flame make the torose on the strip surface. Use the some auxiliary big plate with designs reflectivity and conductivity can make a homogenous temperature in the furnace, this help to better grain merging to them, flat strengthening and better ductility.

The effects of manganese and sulfur contents and effects of the SRTs and HBA on the magnetic properties are briefed in the following:

- The magnetic properties such as the core loss $W_{15/50}$ is affected by the manganese and sulfur contents. The core loss of the steels increases with an increase of sulfur content in each steel with different manganese content. Among the steel with same range of sulfur content, the core loss decreases with an increase of manganese.
- On increasing the sulfur content at each manganese level steels, the magnetic induction B₅₀ decreased in any manganese level.
- To compare the steels processed in the condition of the SRT at 1000, 11150, and 1250 °C without hot band annealing, the core loss of the steels processed at an SRT of 1000 °C is the lowest in each steel and grains in each steel show the same trend of decrease in size with an increase in the SRT. The deterioration of the core loss was caused by the small grains pinned down by the 'fine MnS' (ca. 0.1 mm).
- The FT influences the grain refinement of hot bands remarkably, and setting the finishing temperature just above Ar₃ is an effective means for grain refinement.
- Reducing the COT is not only advantageous for the grain refinement of ferrite, but also weakens the dependence of the finishing temperature on grain refinement. Since the fluctuation of the temperature in a hot strip is unavoidable in practice, the reduction of the COT is an effective and practical means for reducing the fluctuation in microstructure and consequently in the mechanical properties of the product.
- The increase in the final reduction refines the grain size of ferrite regardless of the onset time of cooling.
- The influence of the cooling rate on the grain refinement of hot bands is relatively small. The increase of the cooling rate from 40 to 120°C/sec achieves a modest grain refinement of ASTM G.S.No. 0.5. There as on lies in the rapid progress of transformation which does not allow a large overcooling.
- AGC having a very direct impact on rolled strip quality.

For the thickness control of the considered class of rolling mills, a modern hydraulic roll adjustment system turned out to be essential for high strip quality. This system has to be equipped with modern servo valves. The automatic gap control is the dominating technique to control the strip thickness. Methods developed in the 70ies, such as the gaugemeter control, are still relevant. A thickness gauge is the ultimate quality control. Since the tolerated failure goes down below five micrometers, the mass-flow method is not sufficiently accurate today. Therefore, the monitor control method and the accompanying dead time control problem are relevant research areas. Strip flatness and profile considerations are not considered.

References

1. Report in Nippon Steel Corporation. **T. Hayashida, S. Sanagi and T. Kawano,** s.l. : Nippon Steel Corporation, 1992. p. 33.
2. **Okamoto, H. and Yashiki, A.** s.l. : IEEE Trans. , 1987, IEEE Trans. Magn. 23, Vol. Magn. 23, p. 3086.
3. **E.T. Turkdogan, S. Ignatowicz and J. Pearson, J.** Iron Steel Inst. Report. s.l. : Iron Steel, 1995. p. 349.
4. **K. Matsumura, B. Fukuda.** MAG-20, s.l. : IEEE Trans., 1984, Vol. Magn., p. 1553.
5. **B.-K. Bae, S.-Y. Yoon, J.-T. Park, J.-S. Woo.** 450, s.l. : CAMP-ISIJ, 1996, Vol. 9.
6. **H. Yashiki, A. Okamoto.** MAG-23, s.l. : IEEE Trans., 1987, Vol. Magn., p. 3086.
7. **H. Yashiki, T. Kaneko.** 136, s.l. : Tetsu-to-Hagane, 1989, Vol. 75.
8. **E.T. Turkdogan, S. Ignatowiz, J. Pearson, J.** Iron Steel Inst. Report. s.l. : Iron Steel, 1955. Technical.
9. **Takahashi, M.** s.l. : Tetsu-to-Hagane , 1974, Vol. 5, p. 501.
10. **W.P. Sun, M. Militzer, J.J. Jonas, Metall.** 23A, s.l. : Metall. Trans, Vol. A, p. 3013.

Paper No. 15

**STUDY OF MAGNETIC AGING IN ELECTRICAL STEEL AND ARTIFICIAL
NEURAL NETWORK ANALYZING IN REAL TIME MODE**

Kourosh Mousavi Takami¹ Jafar mahmoudi² Erik Dahlquist³ Magnus Lindenmo⁴
^{1,2 and 3.} K.M.T. TDI researcher, ACECR and PhD student, J.M. and E.D. Professors in Malardalen
University, Box 883, SE 721 23, Vasteras Sweden; ^{4.} M.L., Cogent Power Ltd., Surahammars Bruk,
Box 201, SE-735 23 Surahammar, Sweden
Kourosh.mousavi.takami@mdh.se; Jafar.mahmoudi@mdh.se; erik.dahlquist@mdh.se;
magnus.lindenmo@sura.se

Abstract:

Electric steels are processed to avoid the phenomenon known as magnetic aging. Non-oriented electrical steels are mostly used in rotating electrical machines and oriented steels used in transformers, which during operation generates heat. This could cause carbide precipitation/coalescence in the metallic matrix, impairing the magnetic properties of the steel, called magnetic aging. The steel has to contain very little carbon to avoid aging. This is achieved during the making of the steel or by a decarburising annealing of the final thickness strip or of the stamped laminations.

The magnetic material for cores of a transformer and electrical machines should be characterised by high permeability and low energy losses in changing magnetic flux.

In order to test that the magnetic properties do not become worse during these working conditions, the steel can be tested for magnetic ageing. The European standard defines the test cycle as 225°C for 24 hours. The American ASTM standard suggests two different cycles: 100 hours at 150°C or 600 hours at 100 °C.

A test the losses after a heat treatment of 150°C for 10 days for coils with higher carbon content than 26 ppm of the final product has performed here. This longer cycle has proved to give larger increases in the loss than the shorter one according to the European standard.

The ageing process was much faster for a higher carbon content slab with 90 ppm C than for a lower one with 30 ppm C. ANN method using LMS has performed to aging real time identification. Results showed a 97% best fit. It showed that using ANN can predict the aging and a modern advanced relay can control the loading and temperature of electrical equipments to prevent of harmful damages.

Key words: Aging, electric, carbon, ANN, LMS

Introduction

Non-oriented electrical steels are commonly used in the core of rotor and stator of electrical machines, which during operation, due to resistances and other parameter, produce losses and resulting in heat in the machines. These losses and heat causes the deterioration of insulations, aging and other side effects.

Magnetic aging is a one of these problems. Magnetic aging is defined as “the change in the magnetic properties of a material resulting from metallurgical changes with time”. The end of useful life of a core device is connected with unacceptable degradation of soft magnetic

properties due to the presence of microcrystal nuclei which occur at the onset of crystallisation and growth. Aging can be accelerated by temperatures higher than the operation temperature. Due to hot spots in the machine or overloading and heat generation, carbon in the cores can be increased. The extra Carbon content can lead to increase of aging problem in the machines.

During operation, the cores are subjected to oscillating and rotating magnetic fields, which lead to expansion and contraction of the magnetic domains inside the steel strips. Fine second-phase particles present in the electrical steel matrix are deleterious to the magnetization, since they hinder domain movement, thus causing magnetic energy dissipation [1]. This dissipated energy, referred to as magnetic loss, has a hysteretic component that is quite sensitive to the presence of such particles. The remaining two portions of the magnetic loss in such systems, namely the anomalous loss and the Eddy current loss, are virtually free from this kind of influence [2]. Magnetic losses generate heat and this effect contributes to the heating of electric cores. When the temperature of the core material is increased, precipitation or coalescence of fine second-phase particles can take place, increasing the magnetic loss, impairing the magnetic characteristics of the steel. This phenomenon is referred to as magnetic aging.

In modern electrical steels, the aluminium content (in electrical machines) is higher than the stoichiometric value required for precipitating of AlN, thus keeping nitrogen innocuous to the magnetic aging phenomenon.

This means that carbon atoms are responsible for the magnetic aging in this kind of steel, by precipitating as fine iron carbides inside the ferritic grains, [3]. Morish [4] stated that iron carbides in steel are more effective in restraining magnetic domain movement when their diameter is close to the domain wall thickness. This behaviour has been experimentally confirmed, since the highest magnetic losses in electrical steels occurred when cementite particles diameter was around 120 nm, which, according to the author, is of the same order of the domain walls thickness in this class of materials. It is generally accepted that the carbide particles are more harmful to the magnetic domain wall movement when their average diameter is in the range of 0.1–1.0 μm [5].

Cementite and the ϵ -carbide are the two types of iron carbides that cause magnetic aging in electrical steels [6] and [7]. Aging above 250 °C, or long soaking below this temperature, can lead to precipitation of cementite particles, with the basic composition Fe_3C and orthorhombic crystal structure, having an $\langle 110 \rangle$ type habit plane. Cementite particles usually form as plates oriented along the $\langle 111 \rangle$ direction in ferrite. In the early stages of aging in temperatures ranging from 100 °C to 250 °C, ϵ -carbide forms, with the approximate composition $\text{Fe}_{2.4}\text{C}$ and hexagonal crystal structure. The ϵ -carbide particles usually have the form of disks and

a habit plane of the type $\langle 100 \rangle$. Below 100 °C, very fine carbides (20–40 nm) precipitate, in the form of coherent particles whose crystal structure has not yet been determined. These very fine and coherent precipitates, referred to in the literature as low temperature carbides (LTC), are innocuous as far as magnetic aging is concerned [8].

The precipitates are most harmful for the magnetic properties if their sizes are 0.15–1.12 μm . The low temperature carbides do not contribute to ageing [2].

Leslie and Stevens did a thorough investigation of ageing and the carbides causing the effect [4]. In Fig. 1, the open circles show the increase in coercivity, ΔH_c , of Fe with 190 ppm C. The carbides corresponding to the peak in ΔH_c , were approximately 10 times larger than the domain wall width.

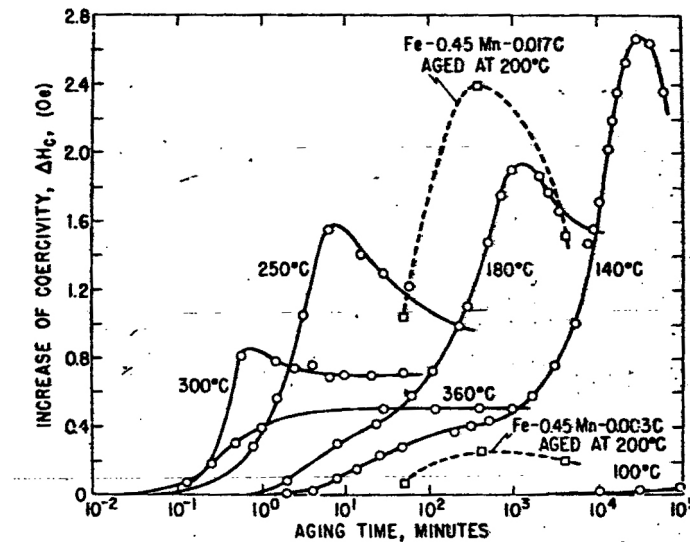

Fig. 1. The increase in the coercivity of Fe with 190 ppm C and some Fe-Mn-C samples after various ageing annealing cycles. From ref. [12].

In a more recent study, Eloit *et al.* showed that ageing is correlated to the interstitial carbon content, as is shown in Fig. 2 [13].

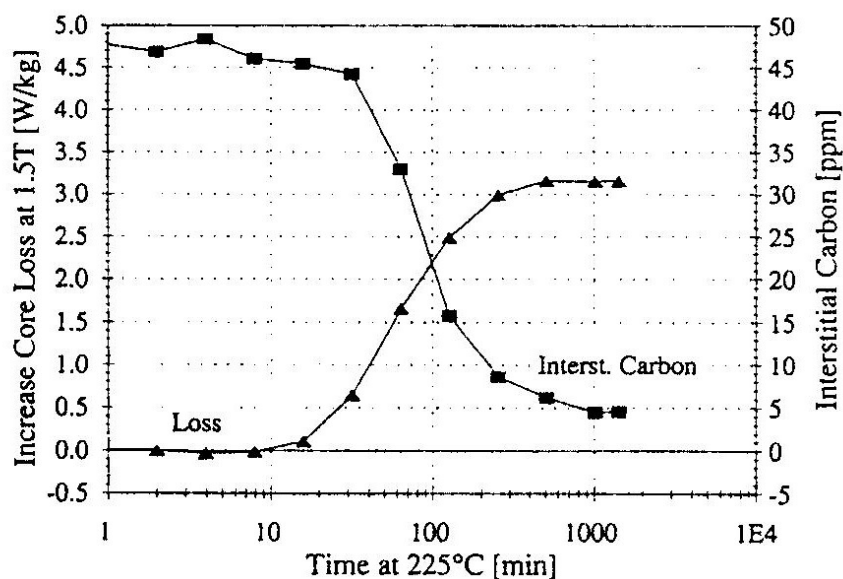

Fig. 2 Ageing and interstitial carbon content. The sample had 0.36% Si and 0.41% Al. Total carbon content: 100 ppm. From ref. [13].

Some of electrical strip (NO steel) manufacturer has defined a carbon content level in strip to perform of decarburization. In this way coils are annealed differently depending of the incoming carbon content.

In the lower level the coil does not need to be decarburized. The humidifiers are shut off. The decarburization part of the furnace is sometimes used for grain growth annealing. When carbon content is between low and a medium level the coil needs to be decarburized. If carbon content in ppm is higher than of a predefined level the annealing has to take longer time in order to get the C level down properly.

Results and discussions

In order to test that the magnetic properties do not become worse during these working conditions, the steel can be tested for magnetic ageing. For electrical steels, the term 'magnetic ageing' refers to the increase in loss after a heat treatment of the finished product. The European standard defines the test cycle as 225°C for 24 hours [9]. The American ASTM standard suggests two different cycles: 100 hours at 150°C or 600 hours at 100 °C [10].

A ultra-low carbon steel, produced under industrial conditions was used for the investigation of the magnetic aging. Its chemical composition (in wt%) was Fe-0.0084C-0.78Mn-3Si-0.063P-0.0091S-0.0067N. The strip was subjected to thermal decarburization treatment in a laboratory furnace. Rectangular steel sheets 300 mm long, 50 mm wide and with 0.35 mm in thickness, were clustered and soaked at 760 °C for 2 h under a 88% nitrogen-12% hydrogen atmosphere, with a dew point of 10 °C. The residual carbon content was 22 ppm in weight, after the decarburization treatment.

Aging tests were made for silicon steel material after thermal treatment (T=435°C, t=18 min, rapid cooling in water), which was selected earlier as the most suitable for cores application in transformer core.

The aging test of transformer core was realised by heating the sample in silicon oil up to 100°C and 10 hours later by cooling it down to 23°C in silicon oil. The process of heating up and cooling down was relatively fast (about 24 min) because of the small thermal capacity of the heating system, oil container and the sample itself. There were six cycle of temperature changes, therefore the total aging time at 100°C was about 50 hours. Test has been performed in Trans post pars (TPP) laboratory, Iran. TPP measured and compared the 50 Hz magnetic properties of the sample at 27°C before and after the test. Values of permeability μ , coercivity H_c , remanence B_r and saturation induction B_s are given in table.1. Test has been done on four different levels and it can be trace in linearly curve. H_c , B_r and B_s are parameters of a technical hysteresis loop which was measured oscillographically. As a result of aging in temperature 100°C the coercivity increased by more than 100% and the low induction permeability decreased by about 60%. Results show the permeability rise up linearity up to 1.0 T and then drop down linearity in 1.8 T, where it is noted that the low induction permeability is clearly lower in the aged condition, which usually is a sign of hindered domain wall motion.

Table 1. Influence of aging on magnetic properties

Condition	<i>H_c</i>	<i>B_r</i>	<i>B_s</i>	<i>permeability</i>
	[A/m]	[T]	[T]	Non
Before test	22.74	0.2	0.42	7000
After test	26.28	0.198	0.4158	6000
Deviation%	15.5	-1	-2.1	-14.28
Before test	47.77	0.9	1.89	1.5e4
After test	50.78	0.81	1.701	1.27e4
Deviation%	6.3	-10	-21	-15.33
Before test	109.82	1.2	2.52	8700
After test	109.24	1.18	2.478	8600
Deviation%	-0.5	-1.67	-3.5	-1.45
Before test	1194.27	1.5	3.15	1000
After test	1066.88	1.34	2.814	1000
Deviation%	-10.67	-10.67	0.42	0

Sura T30, 0.5 mm thick samples with the nominal composition (weight-%) 2.3 % Si, 0.2 % Al, 0.2 % Mn, 0.003 % S, 0.01 % P, 0.002 % N and with varying C levels were tested after aging at 150 °C for 240 h or after 225 °C for 24 h.

The longer cycle proved to give larger increases in the loss than the short one. Fig. 3 shows the results. Estimated equation for 150 °C for 240 hours is: Aging [%] = 0.13325*C² -4.2516*C + 35.375 with norm of residuals equal to 39.816 where C is carbon content in ppm.

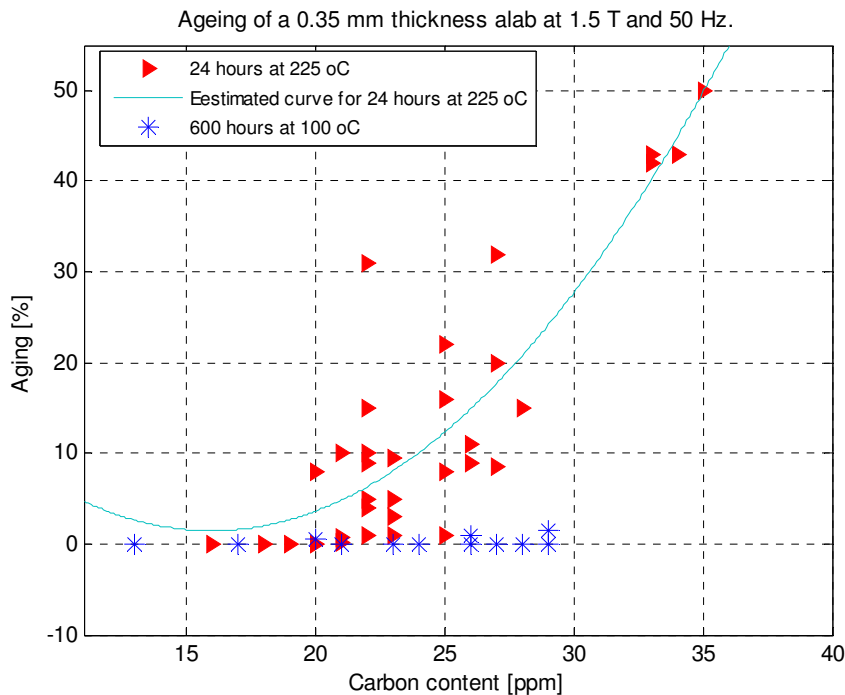

Fig. 3. Ageing of a 0.50 mm thickness slab measured at 1.5 T and 50 Hz. The red triangles and the blue curve are for 150 °C for 240 hours. The blue stars are for 225 °C for 24 h

As shows in figure 3, the ageing after the 150°C/10 day cycle measurements shows that the carbon content between 25 to 35 ppm has aging between 0 to 10 percent, between 35 to 40 is about 25% and between 40 to 60 ppm is about 30%.

A Ageing variation versus time

Aging of slabs with three different materials investigated here. Two of those are oriented steel and one is non oriented. Non oriented steel can be used in the rotational electrical machines.

First one of investigation is discussed on non oriented steel with Al content. The change in the aging index (AI, for non oriented slab) with aging time at 225 °C, measured in the rolling direction, is shown in Fig. 4. It can be seen that AI reaches 40% within 24 h, showing little variation for longer treatment times. The heat-treated strips were subsequently submitted to accelerated aging treatments at 225 °C for 10, 15, 37, 48, 120, 170, 200, 300, 400, 500 and 600 h.

It is remarkable that only the hysteretic portion changed during aging, reflecting its sensitivity to the precipitation/coalescence of the iron carbides.

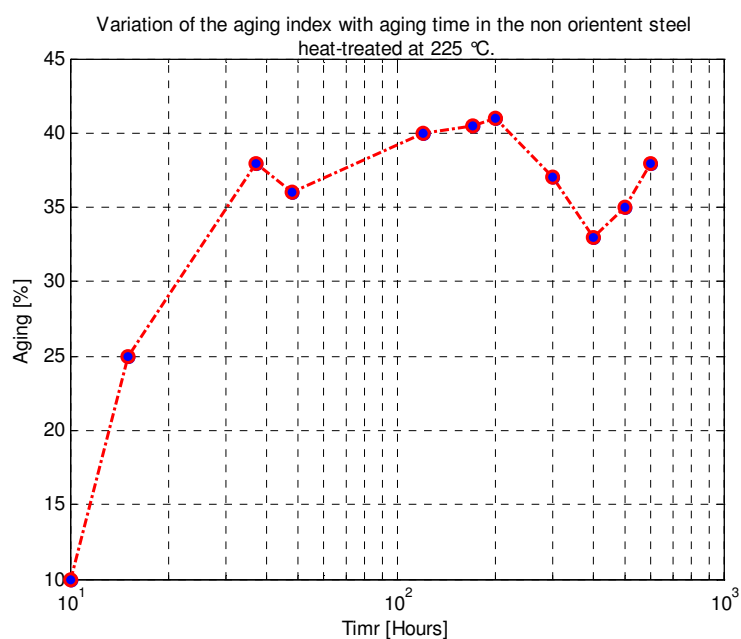

Fig. 4. Variation of the aging index with aging time, for specimens cut in the rolling direction and then heat-treated at 225 °C.

Two oriented single strips have been aged in 150°C for six weeks and been measured occasionally during that time. General information about the samples is given in Figure 5.

The final annealing cycle for the non oriented higher carbon sample was not intended to give larger grains and the lowest possible losses. The magnetic result is shown in Fig. 6. It is plotted with the time in log scale to compare with Figs. 1 and 2. The strip with higher carbon and lower Si content, ages faster. The effect of Si on the rate of aging cannot be concluded from this experiment. Four cold rolled samples with the nominal composition 3.0 % Si, 0.1 % Mn, 0.4% Al were laboratory annealed in the a tube furnace.

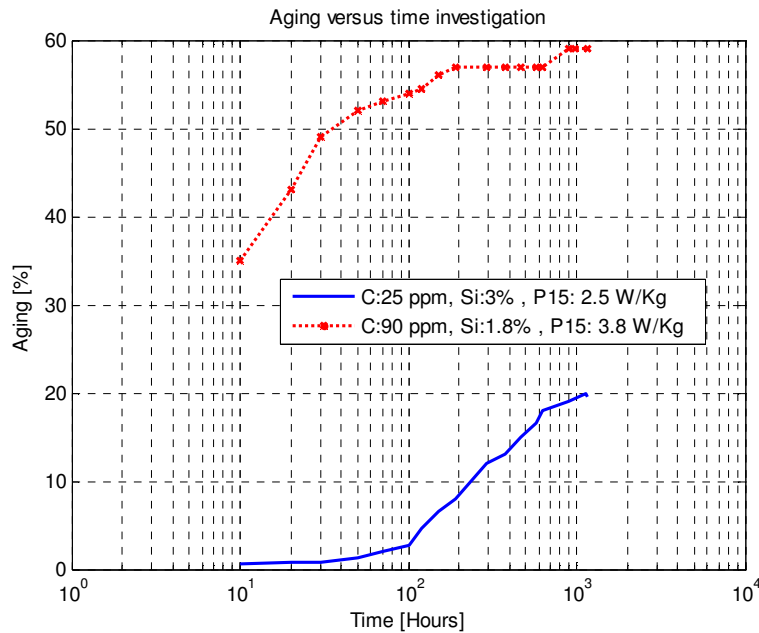

Fig. 5 Ageing vs time for the two different samples.

Artificial neural network analysis

Because of multi input of participations in slabs with multi values that has effectual impact on magnetic aging ANN analysis used to find the exact results with the optimum iteration and convergences. There are many different types of neural network architectures that can be used for non-linear system identification. They all have their strengths and weaknesses. When choosing the appropriate algorithm, there are two properties that are crucial. First, the training algorithm should be fast and the parameters space must not be too large that the architecture cannot be implemented in a real-time scenario. Multi-layer feed-forward networks has the at least one or more hidden layers. Input projects only from previous layers onto a layer.

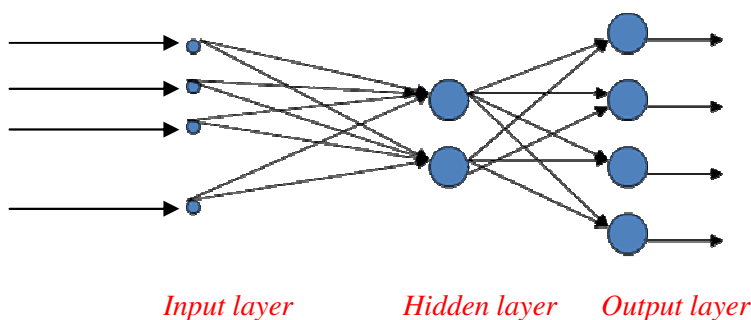

Figure 6: ANN concept

$$a_i = f(n_i) = f\left(\sum_{j=1}^i S w_{ij} x_j + b_i\right)$$

An artificial neuron:

- computes the weighted sum of its input and
- if that value exceeds its “bias” (threshold),
- it “fires” (i.e. becomes active)

ANN learning is well-suited to problems in which the training data corresponds to noisy, complex sensor data. It is also applicable to problems for which more symbolic representations are used.

The back propagation (BP) algorithm is the most commonly used ANN learning technique. It is appropriate for problems with the characteristics:

- High-dimensional input
- Output is discrete or real valued and is a vector
- Possibly noisy data
- Long training times accepted
- Fast evaluation of the learned function required.
- Not important for humans to understand the weights

A perceptron inputs is a real value by vector and it computes a linear arrangement and then out put achieves:

- a 1 if the answer is bigger than some threshold
- -1 otherwise.

x_1 is defined as real value of input up to x_n , and $o(x_1, \dots, x_n)$ is output that calculated by perceptron:

$$o(x_1, \dots, x_n) = \begin{cases} 1 & \text{if } w_0 + w_1x_1 + \dots + w_nx_n > 0 \\ -1 & \text{otherwise} \end{cases}$$

Where w_i is *weight*.

Using an additional value of input $x_0 = 1$, above equation is simplified to:

$$\sum_{i=0}^n w_i x_i > 0$$

Learning a perceptron engages finding the weights w_0, w_1, \dots, w_n .

With random weights training and learning can be started, then iteratively apply the perceptron to each learning, mitigation of the perceptron weights is a main task here. This procedure and method is run with more repetitions and will take some times until perceptron categorizes all learning and training accurately.

A cost function is needed to modify of weights:

$$w_i \leftarrow w_i + \Delta w_i$$

$$\text{where } \Delta w_i = \eta(t - o) x_i$$

Here:

t is target output value for the present training

o is perceptron output

η is called *learning rate* (e.g. 0.1)

Procedure can be converged if learning rate suitably small and if training data is linearly dividable, else convergence is not assured.

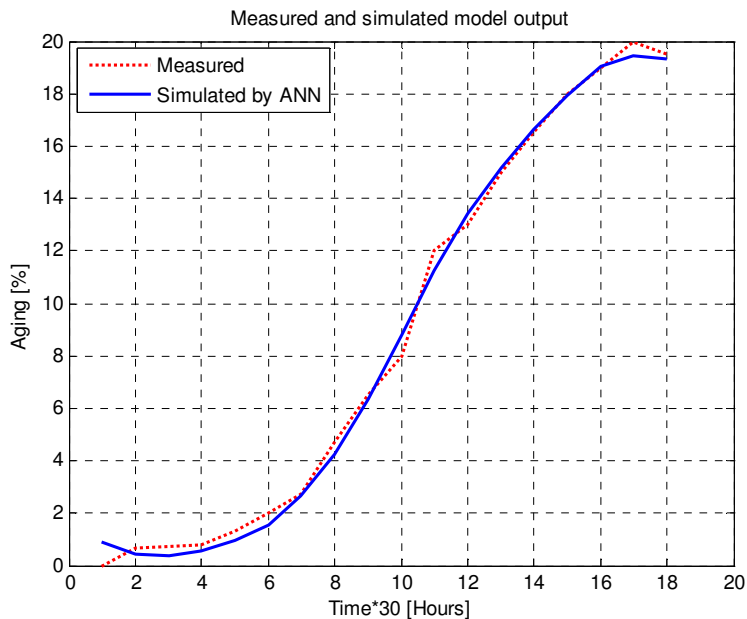

Figure8: simulated using LMS and ANN and measured values of aging.

Above mentioned about how a neural network is basically used to identify a model and to find the results by new model. Training and learning is one of the most important tasks here. To choose the appropriate inputs, outputs and hidden layers is one of skill of engineers.

Input values of impurities are in operation point: 2.3 % Si, 0.2 % Al, 0.2 % Mn, 0.003 % S, 0.01 % P, 0.002 % N. Six layer input, 2 layer output and 3 hidden layers has been used in this modelling. Sigmod function has been used as activation function in each neurone. 2350 sample for each input, output has been used to train of model. Here data generated by a random signal with 0,02 times of operation point.

$$\begin{bmatrix} Al \\ Mn \\ Si \\ P \\ S \\ N \end{bmatrix} = \begin{bmatrix} 0.2 \\ 0.2 \\ 2.3 \\ 0.002 \\ 0.003 \\ 0.002 \end{bmatrix}$$

The neural network learned 7,000 iterations and it investigated and controlled the prediction accuracy for the test patterns every 300 iterations. When learning iteration has been 5600, best prediction accuracy was achieved. Figure 8 showed the result.

Figure 8 derived by ANN model based simulation of C 25 ppm and Si 3% strip where the carbon content varied from 0.0064 to 0.0094. Identification performed with real time simulation on the carbon variation in input and aging estimated and measured as output. Using this method can calculate the carbon content of transformer and electrical machines cores and then find the aging of that.

Conclusions

Test results showed that after annealing at temperatures between 100 °C and 225 °C for times between 24 h and 600 h electrical steel will have an increase of magnetic losses. This is called magnetic aging.

The reason for the ageing is the formation of different types of iron carbides, which hinders domain wall motion.

Ageing is observed when formation of cementite or ϵ -carbides of the order 0.1-1.1 μm has occurred. That will be accompanied with a reduction in interstitial carbon. The ageing process was much faster for a higher carbon content slab with 90 ppm C than for a lower carbon content slab with 30 ppm C.

The study indicated a possibility of increased the Carbon content during annealing in dry atmosphere due to remaining emulsion on the strip at the start of the annealing process.

ANN method using LMS has performed to aging real time identification. Results showed a 97% best fit. It showed that using ANN can predict the aging and a modern advanced relay can control the loading a temperature of electrical equipments to prevent of harmful damages.

References

- [1] J.A. Slane and P.A. Labun, Energy Efficient Electrical Steels, AIME, New York (1981) pp. 193–204.
- [2] B.D. Cullity, Introduction to Magnetic Materials (1st ed.), Addison-Wesley, Reading (1972) pp. 499–508.
- [3] R.W.K. Honeycombe, Steels Microstructure and Properties (1st ed.), Edward Arnold, London (1981) pp. 1–75.
- [4] A.H. Morrish, The Physical Principles of Magnetism (2nd ed.), Krieger, New York (1980) pp. 332–416.
- [5] G.M. Michal and J.A. Slane, J. Metals 1 (1986), pp. 32–36
- [6] K. Eloit, Magnetische Veroudering Van Niet-Georienteerde Elektrische Stalen, Ph.D. Thesis, University of Ghent, Ghent, 1996, pp. 193–213.
- [7] H. Abe, Scand. J. Met. 13 (1984), pp. 226–239.
- [8] A. Zhu, I. Neife and E. Pink, Steel Res. 67 (1996), pp. 507–512.
- [9] European standard, EN10106 section.
- [10] ASTM standard, A 340 section.
- [11] K.M. Marra, E. A. Alverenga, and V.T.L. Buono, Mat. Sci. Eng. A 390 (2005) 423.
- [12] W.C. Leslie and D.W. Stevens, Trans. ASM. 57 (1964) 261.
- [13] K. Eloit, J. Dilewijns, C. Standaert, and B.C. De Cooman, J. Magn. Magn. Mater. 133 (1994) 223.

Paper No. 16

**A simple method for removing leakage of metal pipes, like district heating-
and NG pipes**

Mohammad Tabatabaeeghomi*, Jafar Mahmoudi, Gholamhossien Liaghat*****

* PhD Student in Mälardalen University, Vasteras, Sweden also Technology Development
Institute (TDI), ACCER, Tehran, Iran

**Professor in Malardalen University, Vasteras, Sweden. Email: Jafar.Mahmoudi@mdh.se

***Professor in Tarbiat Modares University, Tehran, Iran. Email: Ghlia530@modares.ac.ir

ABSTRACT

Explosive welding occur under high velocity oblique impact, though it is possible to use explosive energy to form a usual cold pressure weld. One of the advantages of this method is welding kind of materials with different shapes together. The ability of explosive welding can be used to maintenance of pipes and vessels, preventing pipe leakage especially under water in oil and gas industries. This research suggests a simple explosive welding method for removing the leakage of metal pipes that is very economy and easy for repairing pipes and vessels full of water or liquid.

Keywords: Explosive welding, impact waves, detonator, leakage, pipe

Introduction

1.1.1. Explosive welding process

Metals can be bonded together by the high pressure produced by oblique collision at high velocity. Explosive welding can be used to join most metal combinations, including those that are metallurgical incompatible and those that are non-weld able by usual process. In addition, the process can clad one or more different metal layers onto either, or both faces of a base plate. The process uses an explosion to push a flyer plate towards a parent plate in horizontal or a curve parent plate (see Fig.1).

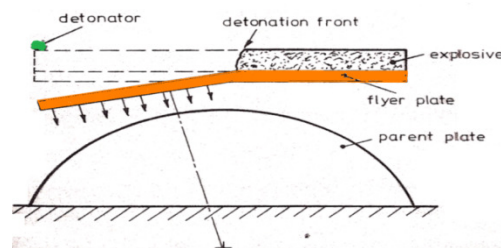

Fig.1. Arrangement with semi-cylindrical parent plate [1]

The impact velocity, V_p , and collision angle β , in Fig .2 determine the pressure and the shear stress at the collision zone.

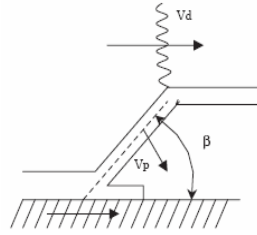

Fig. 2. Geometry of parallel arrangement [1]

From geometry at the collision point (see Fig. 2), the following equations can be obtained for a parallel set up [1]:

$$V_c = V_d = V_p / 2 \sin \beta / 2 \quad (1)$$

The combined pressure and shearing results in the formation of a jet which contains the surfaces of the two materials and serves to bring them together to create a metallurgical bond. The pressure has to be at an enough level and for an enough length of time to reach inter- atomic bonds. The rate at collision point, V_c) governs the time available for bonding. The quality of the bond depends on careful control of the process parameters, including material surface preparation, plate disconnection, the explosive load, detonation energy and velocity of detonation V_d .

Previous work on explosive leakage welding processes:

Different mechanisms have been introduced to describe the explosive welding process in the early stages of development. Some researchers considered it to be essentially a fusion welding process (Phillipchuk, [2]) which relies on the dissipation of the kinetic energy at the interface as a source of the heat sufficient to cause bilateral melting across the interface and distribution within the molten layers. Godunov et al [1] describe experiments designed to study the mechanism of initiation of waves. They noted that waves appeared at a certain distance from the start of collision between the plates, and they then grew gradually until they reached a steady state after a few oscillations.

. A stress wave mechanism of wave formation was proposed by El-Sobky and Blazynski [1]. The authors noted that waves were observed on surfaces of metals which had been subjected to oblique collision, where neither welding nor jetting has occurred. P.J. Calk made [3] designed several experiments for development deepwater pipeline repair using explosive welding technique. G.H. Liaghat and E. Zamani [4] designed some tests on pipes.

1.1.2. Welding window

The welding window includes both a straight and wavy interface domain. The establishment of a weld ability window requires the relationship between the initial conditions (the initial angle α and the characteristics of the explosive) and the collision angle β . The welding window is determinate with 7 limitations in Fig. 3 , Known values of α ; β ; V_d ; V_p ; ; V_c and the properties of the material enable the design of the weld-ability window. This diagram can be drawn in both the $V_c - \beta$ and $V_p - \beta$ plane and display an area that the weld is available.

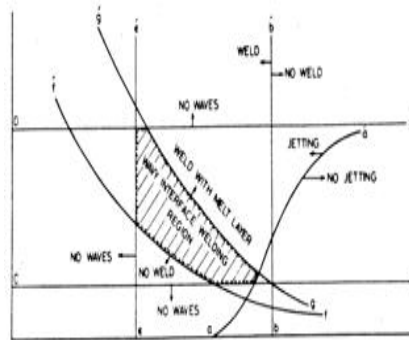

Fig. 3 A kind of welding window diagram in V_c - β plan

1: critical angle limit for jet making [line aa]:

One of the most important conditions for welding is the formation of a jet. Jetting has to occur at the collision point to achieve welding. In the theory if the velocity of collision point remains subsonic, jetting will occur. But in practice, however, a minimum angle is required to satisfy the pressure requirement. The jetting occurs to the left of the lines in Fig .3. In this figure, line “aa” represents the critical angle β_c which is necessary for jetting. Abrahamson [5] proposed the following equation for jetting:

$$\beta = 10(V_c - 5.5) \tag{2}$$

2-upper limit of V_c [line bb]:

Line “bb” in Fig. 3 , represents the upper limit of V_c estimated at 1.2–1.5 times the sound velocity It is however; experimentally evident that approaching the upper limit of V_c restricts the choice of other parameters within welding window

3-lower limit of β [line cc]:

It is 2-3 degree [6]. The lower and upper limits of the dynamic angle β were experimentally determined by Bahrani and Crossland [6].They suggested a lower limit of 2–3° and upper limit of 31° for collision angle for the parallel geometry. Maximum and minimum values of initial angles in an inclined system were suggested as 18° and 3°, respectively

4-upper limit of β [line dd]:

It is 31 degree [6].

5-lower limit of V_c [line ee]:

The Eq.(3) gives minimum collision velocity for bonding which is proposed by Simonov[7]as follows:

$$V_c = K (2H_v / \rho)^{1/2} \tag{3}$$

Cowan [8] founded the lower limit of Vc according to fluid hypothesis as follows:

$$Re = \frac{(\rho F + \rho B) V_c^2}{2(HF + HB)} \quad (4)$$

Where Re is Reynolds number, H is the Vickers hardness ($\frac{N}{mm^2}$) and F, B means upper and lower plates. Transition limit accrue in Re=10.6, therefore Vc is found able.

6-upper limit of Vp impact critical pressure limit [line ff]:

Eq. (5) gives the lower limit for welding. In Eq. (5), β is in radians, H is the Vickers hardness in N/m^2 , and ρ is the density in kg/m^3 .

$$\beta = 1.14 \left(\frac{Hv}{\rho V_c^2} \right)^{1/2} \quad (5)$$

Wittman [8] also proposed a lower limit for Vp

as follows:

$$V_p = \left(\frac{\sigma_{TU}}{C} \right)^{1/2} \quad (6)$$

Where σ_{TU} is the ultimate tensile stress, and C is the bulk sound velocity.

This is another formula for lower limit of Vp:

$$V_p(\min) \cong 10 \sigma_A \left[\frac{1 + \rho_A U_A / \rho_B U_B}{\rho_A V_A} \right] \quad (7)$$

Where A is a symbol for the plate with higher strength, σ is yield stress and U is sound velocity in the metal.

7-upper limit of Vp [line gg]:

Wittman [8] suggested an experimentally formula:

$$\sin \beta/2 = 1 / V_c^{1.25} \quad (8)$$

Experimental procedure and Results

1.1.3. Specification and setting up

The specification of experiments is indicated in Table 7. Fig. 3, Fig. 4, and Fig. 5 show three kinds of arrangements. The specification of experiments is indicated in Table 7. Fig. 3 shows a simple horizontal set up for filling a small hole .In this test flayer plate from Cu with 3 mm standoff distance, is located on Fe plate with a small hole. The hole is covered by a price of metal as filler. A mastic material holds a detonator with 1 mm distance from flayer plate, that doing such as a buffer. Fig. 4 shows set up the experiments for welding on a curve shape. Fig. 5 Shows set up the experiment for removing leakage of the small hole on a pipe. For a good result it is better to filling the hole with a piece of metal. 3 mm diameter spherical iron is used to stand off. One detonator uses as an explosive .it is inserted 1 mm above the flayer plate. In all experiments are used a mastic material as a holder of detonator.

Table-1 specification of experiments

Flayer plate	Parent plate	Stand off	Explosive
Cu 0.5×25×25 mm	Fe 3×50×80 mm	3 mm Fig. 3	Detonator VD=6600 m/s
Cu 0.5 thickness 25 mm diameter	Fe \varnothing =80 mm \varnothing is diameter of rod	3 mm Fig. 4	Detonator
Cu 0.5 thickness 25 mm diameter	Fe \varnothing =80 ,t=3 mm ,t is thickness of Pipe	3 mm Fig. 5	Detonator

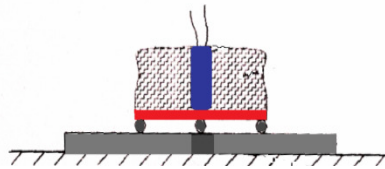

Fig. 3. Set up for filling a small hole

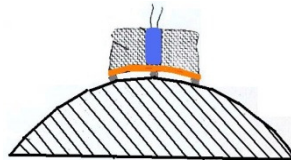

Fig. 4. Set up for welding on a curve shape

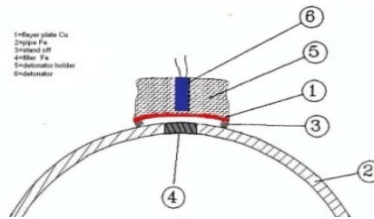

Fig. 5. Set up for removing leakage of the small hole on a pipe

1-flayer plate Cu, 2-pipe Fe, 3-standoff, 4-filler Fe, 5-detonator holder, 6- detonator

Results

1.1.4. Result of experiments

After firing, the results are showed in Fig. 6, Fig. 7 and Fig. 8. The primary result was good, and weld was accrued.



Fig. 6 Result of using detonator for welding in a parallel Set up with a hole



Fig. 7 Result of welding with detonator on a curve shape



Fig. 8 Result of welding with detonator on a pipe with a hole

1.1.5. Welding window calculation and result

The welding window is drawn for all of the experiments; the calculation for some of them is as follows:

Cu-Fe (table 1)

Flayer plate: Cu $t = 0.5\text{mm}$ $\rho = 8.9\text{ gr/cm}^3$ $H = 58\text{ kg/mm}^2$ $C = 4900\text{ m/s}$ parent

plate: Fe $t = 3\text{ mm}$ $\rho = 7.8\text{ gr/cm}^3$ $H = 80\text{ kg/mm}^2$ $C = 6000\text{ m/s}$

➤ Line aa

By using the Eq. 2, Table-2 gives the results.

$$\beta = 10(Vc - 5.5)$$

Table 2-calculation for line (aa)

β	0	5	10	15	20	25	30	35	40	45
Vc	5.5	6	6.5	7	7.5	8	8.5	9	9.5	10

➤ **Line bb**

From part 1.3 $\Rightarrow 1.3 \times 4900 = 6370 \text{ m/s}$

➤ **Line cc**

From part 1.3 $\Rightarrow \beta = 3^\circ$

➤ **Line dd**

➤ From part 1.3 $\Rightarrow \beta = 31^\circ$

➤ **Line ee**

Eq. 4 gives V_c as follows:

$$10.6 = \frac{(8900+7800)}{2(58+80)10^6 \times 9.8} V_c^2 \Rightarrow V_c = 1310 \text{ m/s}$$

➤ **Line ff**

Eq. 6 gives V_p as follows:

$$V_p = \left(\frac{45 \times 10^6 \times 9.8}{4900} \right)^{1/2} = 300 \text{ m/s}$$

Eq. 7 gives V_p as follows:

$$10 \times 40 \times 10^6 \times 9.8 \left[\frac{1 + 7800 \times 6000 / 8900 \times 4900}{7800 \times 6000} \right] \approx$$

$V_p \text{ min} = 180 \text{ m/s}$

For high safety is used $V_p = 300$ and from Eq. 1 V_c is obtained. The results are indicated in Table-3.

Table 3-calculation for line (ff)

β	3	5	10	20	30	40
V_c	5.7	3.52	1.72	0.86	0.57	0.44

➤ **Line gg**

Eq. 8 gives V_c as follows:

$$V_c = \left(\frac{1}{\sin^2 \beta / 2} \right)^{0.8}$$

Table 4-calculation for line (gg)

β	0	5	10	15	20	25	30	35
V_c	---	12.25	7	.15	4.06	3.4	2.95	2.61

With using the last results welding window is drawn. Fig. 9 shows the welding window for Cu- Fe and weld able area is indicated.

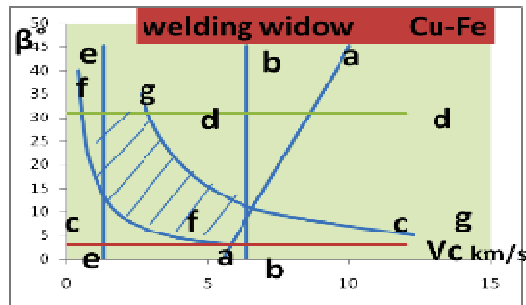

Fig. 9. Welding window for Copper-Iron welding

1.1.6. Testing

Peel off test

The bond strengths were measured by peel off and shearing tests. For all of experiment this test was good, and the copper plate is not separated from the parent plate. (See Fig. 10)



Fig. 10. Peel off test

Discussion

1.1.7. The requirements of successful bonding

The requirements for welding to occur can be summarized as follows:

- The occurrence of the jet at the interface.
- An increase in pressure associated with the dissipation of kinetic energy to an enough length of time to achieve inter-atomic bonds, and for these to reach stability. In this case, the pressure is determined by the impact velocity, where the time available for bonding is governed by the velocity of the collision point.

1.1.8. Description of package work

One of the main problems in explosive welding is set up the experiment. It becomes bigger when the test is in a wet zoon. So, a simple package is very useful. A package is including detonator, a piece of thin copper plate, a piece of mastic as holder, a price of iron as filler and some small rod for standoff. Fig.3 is a horizontal set up and the parent plate is on the grand as anvil. Fig. 4 is a curve set up and the parent plat is a full rod iron. Fig. 5 is a curve set up also, but, the parent plate is a pipe .if the pressure of explosive was very high, the pipe may be damage .Detonator has a little explosive material, also the cost is low, and it is very useful for this work. Using detonator alone is suitable for pipe and this is a good method for removing leakage of piping.

1.1.9. Limitations

This method is not suitable for a big holes and it uses only for leakage and also for a low pressure liquid pipe. For high pressure pipes it is better to use another method of explosive welding.

Concluding remarks

1.1.10. Conclusions

The main results of the paper are:

- 1- A new technique and a simple solution for removing leakage of pipes.
- 2- Using detonator alone instead of explosive material.
- 3- Mechanical experiment for testing.

1.1.11. Remarks

-Hydraulic test suggests for pipes. This test shows if the leakage is removing or not.

-For repairing very thin pipes are need to a fixture for welding, but for pipes and vessels with over 10 mm thickness, we can use a plate until 5 mm thickness without using of fixture.

-A new technique and a simple solution obtained for removing leakage of pipes. This method is useful only for low pressure and low leakage.

- Primary mechanical test such as peel off is done. - It is needed to use filler for filling a hole and in this setup must not jump the filler during the explosion.

-Both surfaces of the plates must be clean.

- It is needed to use filler for filling a hole and in this setup must not jump the filler during the explosion. Fig. 11 shows a useful set up for this operation. In this system a relative is suggested as follows:

$$\phi \leq 0.2D$$

ϕ Is diameter of hole and D is diameter of pipe.



Fig. 11. A set up for filling a hole before welding

1.1.12. Future work

- Simulation and numerical study for predict and control the parameters, also compare the numerical and experimental results.

-Underwater experiments with remote distance.

- Explosive welding for under pressure pipes.

Acknowledgements

The authors would like to acknowledge the Professor Dobroshin from PATON institute and Mr. Chavideh with the experiments. A special thanks for PhD Kourosh Mousavi Takami to help in mathematical and simulations activities.

References

- [1] H. El-Sobky, Mechanics of explosive welding. In: T.Z. Blazynski, Editor, *Explosive Welding Forming and Compaction*, Applied Science Publishers, Barking (1983).
- [2] Phillipchuk, V., 1961, Explosive welding status; ASTM Creative Manufacturing Seminar,
- [3] P.J.C. Alkemade, development deepwater pipeline repair using explosive welding technique, 8th international conference on offshore mechanics and ARCTIC Engineering, The Hague- March 19-23, 1989
- [4] G.H. Liaghat and E, Zamani [4], cladding of pipe with stainless steel, Tarbiat Modares university, Tehran, Iran, 2006
- [5] G.R. Abrahamson, Permanent periodic surface deformations due to a travelling jet, *J. Appl. Mech.* **83** (1961), pp. 519–528
- [6] Bahrani, A.S., Crossland, B., 1964. Explosive welding and cladding, An introductory survey and preliminary results. In: Proceedings of Instrumental Mechanical Engineering, pp. 264.
- [7] Simonov, V.A; Binding criterion for metals with explosive welding combustion, Explosion and shock wave, 1991
- [8] G.R. Cowan, O.R. Bergman and A.H. Holtzman, Mechanics of bond wave formation in explosive cladding of metals, *Metall. Trans.* **2** (1971), p. 3145.

Paper No. 17

Modeling of Radon Transport through Building Materials and ventilation

Keramatollah Akbari¹, Jafar Mahmoudi²

¹Mälardalen University, PhD student, School of Sustainable Development of Society and
Technology, Vasteras, Sweden and TDI researcher at ACECR, Iran

²Mälardalen University, Adj Professor at School of Sustainable Development of Society and
Technology, Vasteras, Sweden

¹keramatollah.akbari@mdh.se

²jafar.mahmoudi@mdh.se

Abstract:

Radon transport in building materials is influenced by ventilation factors and other conditions related to climate and tightness of residential buildings.

Radon after emanating through building materials by advection and diffusion forces is come out and enters room space and then is influenced by forced (mechanical) and natural ventilation (buoyancy or thermally effects) and moves throughout the room.

To reduce radon level several ways are proposed, but for existing building, ventilation method can be used to dilute radon contaminant and maintain indoor air quality, easily and cost effectively.

The aims of this paper are to model radon treatment and mechanical ventilation and to study about ventilation effects on indoor radon content with employing computational fluid dynamics (CFD) program software.

This study conducted in different sizes room in 2 and 3 dimensional approaches and with changing the type, rate and location of mechanical ventilation.

Results confirm that appropriate ventilation can reduce the value of indoor radon concentration.

CFD can be used as a cost effective tool for predicting and visualizing of radon treatments which emits through building material compared with others methods, i.e. tracer gas and full scale laboratory models.

1 Introduction:

There are several pollutants in houses and because of adverse health and comfort problems must be removed or mitigated. Radon, which is emitted from soils, rocks and buildings material in many countries has adverse health problems and can be led to lung cancer must be control and mitigated under limitation level.

Pollutant control can be obtained using ventilation to dilute pollutant concentrations. Pollutant concentrations are inversely proportional to ventilation rates. Thus reducing concentrations 50 percent (1/2 of the original values) require twice the initial ventilation. Reducing the concentration by 90 percent (1/10 of the original value) would require ten times the ventilation [1].

Whole-building ventilation is a significant contributor to annual energy use and it can consume a lot of energy more than 50% of energy in building section, especially in cold climate same as Sweden, energy consumption could be much more. so with appropriate design of ventilation system significant amount of energy can be saved [2].

Ventilation is a good method to maintain indoor air quality. The more fresh air is brought into the indoor environment, the better the indoor air quality (IAQ) can be achieved, if the fresh air comes from non polluted ambient source. Pollutants control is important for health and comfort of occupants to maintain IAQ aspect.

Ventilation has also an impact on the outdoor pollution level. Building related pollution sources represent about 40% of the total pollution load. Due to the increased thermal insulation levels of buildings, including envelope tightness, the importance of the ventilation related energy use is increasing and may represent up to 50% of the total energy use of a building, particularly for certain typologies such as office buildings [2].

Computational fluid dynamics (CFD) as an alternative of experimental method can simulate and visualizes airflow patterns, thermal comfort and concentration distributions of pollutants in a space at much less cost.

Some studies have carried out about air flow in buildings and ventilation effects with employing CFD software and also about radon modeling in the soil and material building [8,11,17,21] .

Computational fluid dynamics (CFD) makes it possible to simulate airflow patterns, thermal comfort and concentration distributions of pollutants in a space at much less cost. This technique, allowing the simulation and the visualization of environmental problems, represents a powerful tool to motivate, guide and educate about the environment [8].

CFD involves the solutions of the equations that govern the physics of the flow. Due to the limitations of the experimental approach and the increase in the performance and affordability of computers, CFD provides a practical option for computing the airflow and pollutant distributions in buildings. A more practical approach is to subdivide the space inside the room into a number of imaginary sub-volumes, or elements. These sub-volumes usually do not have solid boundaries; rather, they are open to allow gases to flow through their bounding surfaces.

The goal of the CFD program is to find the temperature, concentrations of contaminants, and the velocity throughout the room, for each of the sub-volumes. This will reveal the flow patterns and the pollution migration throughout the room.

To produce a solution, the CFD program solves the equations describing the process in the room. Each of the sub-volumes involves the conservation of mass, energy, momentum and chemical/biological species.

Since each of the equations for the conservation of mass, energy, momentum, and chemical/biological species involve the pressure, temperature, velocity, and chemical/biological concentration of an element and its neighbors, the equations for all of the elements must be solved simultaneously.

Due to the development in CFD modeling and computer technology, the CFD tool becomes more and more popular for IAQ and thermal comfort studies.

CFD analysis tools solve the system of mass, energy, and momentum conservation equations known as the Navier- Stokes equations to determine the air velocity, temperature and contaminant concentration at each of these nodes [9].

W. Zhuo (2000) used computational fluid dynamics (CFD) to study the concentrations and distributions of indoor radon (^{222}Rn) and thoron (^{220}Rn) as well as their progeny in three dimensions. According to the simulation results, in a naturally ventilated room, the activity distribution of ^{222}Rn is homogeneous except for the places near air diffuser (supply and exhaust) locations. The concentration of ^{220}Rn exponentially decreases with the distance from the source wall which is considered independently. However, as the ventilation rate increased, the concentrations of both ^{222}Rn and ^{220}Rn decreased and their activity distributions become complicated due to the effect of turbulent flow. It suggests that the impact factors of monitoring conditions (sampling site, airflow characteristics, etc.) should be taken into account in obtaining representative concentrations of ^{222}Rn for dose assessment. Both the simulation results of activities and their distributions agreed well with the experimental results in a laboratory room [10].

Whereas Computational Fluid Dynamics (CFD) gives more accurate picture of contaminant concentration behavior, the setting up of the boundary conditions and other input parameters makes CFD prohibitively difficult. CFD solves the partial differential equations governing mass, momentum and energy transport on a fine grid. But unfortunately, CFD codes are complex, expensive and quite difficult to use.

Ventilation is supply to and removal of air from a space to improve the indoor air quality. The idea is to capture, remove and dilute pollutants emitted in the space to reach a desired, acceptable air quality level. Existing ventilation guidelines or standards in European countries and elsewhere assume that the occupants of a space are the dominating or exclusive polluters.

It is well documented that ventilation has a strong influence on indoor radon concentration. Chao and his colleagues concluded that the indoor-outdoor radon ratio approached unity if the air exchange was greater than 3h^{-1} [11].

From view point of this paper, ventilation has two functions; the first is enhancement of IAQ and establishment of thermal comfort and the second is mitigation of contaminants; i.e radon.

Among from many mitigation methods to reduce radon in residential buildings, the ventilation method was chosen because of capability, facility and lower costs.

The effectiveness of ventilation (ϵ_v) is a good parameter to choose the ventilation strategy. Of different ventilation types, displacement ventilation has an upper effectiveness than others [12].

2. Acceptable ventilation rate

ASHRAE Standard 62-1989R gives two methods of determining ventilation rates, the prescriptive procedure and the analytical procedure. In the prescriptive procedure, tables of ventilation rates required diluting the pollution produced by people and buildings are given for different types of buildings. In the analytical procedure, the ventilation rates are calculated using data for pollution sources and the effectiveness of the ventilation system [13].

ASHRAE Standard 62 (ASHRAE, 2003) says living areas need "0.35 air changes per hour but not less than 15 cfm (7.5 L/s) per person." In other words, the standard is 0.35 AC/h or 15 cfm per person, excluding those with the presence of known contaminants, whichever is greater; the first guideline is based on building volume, the second on occupancy. When actual occupancy is unknown, as in the case of production homes under construction, occupancy is usually (but not always) assumed to be one more than the number of bedrooms, i.e., two occupants in the master bedroom and one in each additional bedroom

[14].

Here it is used the building volume guideline (0.35 AC/h), rather than assumed occupancy to determine minimum ventilation rates because the actual occupancy of any home will fluctuate over time. Also, the occupancy guideline is more appropriate when occupants are the principal pollutant sources, while the building volume guideline is more appropriate when the building itself is a significant source of air contaminants, as same as here which radon is a significant pollution. However, this or any "standard" ventilation rate is necessarily somewhat arbitrary, controversial, and subject to change. ASHRAE's 0.35 AC/h is a minimum rate, and some consider 0.60 AC/h a practical upper limit for mechanical ventilation because as the ventilation rate increases, so do the conditioning costs [15].

3. Radon transport mechanisms trough building materials

The indoor radon sometimes comes from the building materials. The reason is that the building materials were usually made of granite or tails of uranium mines. In this paper is assumed that the indoor radon only comes from the surface of the building materials and the outdoor air and the radon emanation rate of the building materials are neglected. Indoor radon concentrations are dependent on radon production, ventilation and outdoor radon concentration.

Radon gas in order to enter the indoor air must be firstly transported, basically through the larger air-filled pores within the building material, so that a fraction of them reaches the building-air interface before decaying and then by the air flow enters indoor. There are two basic mechanisms of transport within medium material: diffusion and advection [16].

The primary transport mechanism in a particular medium before decaying is done by the random molecular motion. Like any fluid substance there is a tendency to migrate in a direction opposite to that of the increasing concentration gradient within the material. This tendency is described by Fick’s law.

When a fluid has a sufficiently low Reynolds number (Re), as is the case of radon transport through building material (about $Re=0.01$), viscous and/or laminar fluxes may be induced due to a pressure gradient. This gradient could be created mainly by changes in meteorological conditions and the use of mechanical systems such as exhaust fans or blowers, heating and air-conditioned systems in dwellings. Pressure-driven convective flow can be characterized by Darcy’s law, which relates the apparent velocity of fluid flow through a cross-sectional area to the pressure gradient.

Ventilation of a room can significantly influence radon measurement. The relationship between radon concentrations and indoor air exchange rate is given by Thomas C. W. Tung J. Burnett [19].

The indoor concentration C at time t be expressed in terms of outdoor radon concentration C_o , initial radon concentration of the room C_i , the air exchange rate of the room q , the effective volume of the room V , the radon-222 decay constant λ , and the generation rate Ω of the room, C is then given by Equation (2).

$$C = (C_i - C_\infty)e^{-((q/V)+\lambda)t} + C_\infty \quad (2)$$

$$\Omega = \sum E_i A_i = E \sum A_i \quad (3)$$

Where E is emanation rate from wall surface and is assumed equal and constant for all walls.

$$C_\infty = \frac{qC_o + \sum E_i A_i}{V((q/V) + \lambda)} \quad (4)$$

Determination of the sampled room leakage and decay rate ($q/v + \lambda$), M : The equilibrium level of radon in the room sampled is dependent on the leakage rate, radon production rate and the outdoor radon concentration.

The room leakage rate can be deduced from the leakage and decay rate, M . The value M is obtained by transformation and use of a linear regression technique on Equation (2), as follows:

$$\ln|C_\infty - C| = -\left(\frac{q}{V} + \lambda\right)t + \ln(C_\infty - C_i) \quad (5)$$

or,

$$\ln|C_\infty - C| = -Mt + \ln(C_\infty - C_i) \quad (6)$$

where M is the absolute value of the slope of Equation (10), that is

$$M = \left(\frac{q}{V} + \lambda\right) \quad (7)$$

The radon generation rate of the room can be expressed in terms of M , C_o and C_i , for which Equations (3), (4) and (11) are used to create the expression:

$$C_\infty = \left(\frac{q}{V}\right) \left[\frac{C_o}{((q/V) + \lambda)} \right] + \frac{\sum E_i A_i}{V((q/V) + \lambda)} \quad (8)$$

Substituting Equations (4) and (7) into Equation (8) and rearranging gives:

$$\Omega = [C_{\infty} - (1 - \lambda/M) C_o]VM \quad (9)$$

The relationship between the equilibrium indoor radon concentration C_{∞} , and Ω from Equation (9) can be expressed by Equation (10):

$$C_{\infty} = (1 - \lambda/M) C_o + \Omega/VM \quad (10)$$

Replacing the leakage rate and equilibrium indoor radon concentration from Equation (12) by (q_n/V) and $(C_{\infty})_n$, respectively, gives:

$$(C_{\infty})_n = (1 - (\lambda/(q_n/V) + \lambda)) C_o + \Omega/V((q_n/V) + \lambda) \quad (11)$$

where (q_n/V) is a given air exchange rate and $(C_{\infty})_n$ is the equilibrium indoor radon concentration at a given air exchange rate and Ω/V is define as G generation rate per m^3 .

$$(C_{\infty})_n = (1 - (\lambda/(q_n/V) + \lambda)) C_o + G/((q_n/V) + \lambda) \quad (12)$$

$$\text{If } C_o=0 \text{ then } (C_{\infty})_n = G/((q_n/V) + \lambda). \quad (13)$$

$$\text{And if } (q_n/V)=0 \text{ equation (13) simply reduced to: } (C_{\infty}) = G/\lambda \quad (14)$$

4. Mathematical and numerical modeling of indoor air

Mathematical design procedures of air distribution in a room are limited to only a few ventilation methods in an empty room. But with using CFD these limitations are decreased and for it can be used for air flow analysis, simply and it is most cost benefit tools rather than full scale laboratory and tracer gas methods.

CFD programs are based on solving Navier-Stokes equations, which are equations about energy, mass and concentration transport.

In a room with ventilation ad radon concentration is needed to solve these partial differential equations.

CFD programs are employed to solve equations about velocity, temperature and species transport numerically.

4.1 Continuity and Momentum Equations in FLUENT

FLUENT models the mixing and transport of chemical species by solving conservation equations describing convection and diffusion. For all flows, FLUENT solves conservation equations for mass and momentum. For flows involving heat transfer or compressibility, an additional equation for energy conservation is solved. For flows involving species mixing or reactions, a species conservation equation is solved. Additional transport equations are also solved when the flow is turbulent [20].

Mass Conservation Equation is written as:

$$\partial \rho / \partial t + \nabla \cdot (\rho \mathbf{v}) = S_m \quad (15)$$

This Equation is the general form of the mass conservation equation and is valid for incompressible as well as compressible flows for laminar flow. The source S_m is the mass added to the continuous phase from the dispersed second phase (e.g., due to vaporization of liquid droplets) and any user-defined sources.

For 2D axisymmetric geometries, the continuity equation is given by

$$\partial \rho / \partial t + \frac{\partial}{\partial x} (\rho v_x) + \frac{\partial}{\partial r} (\rho v_r) + \frac{\rho v_r}{r} = S_m \quad (16)$$

where x is the axial coordinate, r is the radial coordinate, v_x is the axial velocity, and v_r is the radial velocity.

To solve conservation equations for chemical species, FLUENT predicts the local mass fraction of each species, Y_i , through the solution of a convection-diffusion equation for the i th species. This conservation equation takes

the following general form:

$$\frac{\partial}{\partial t}(\rho Y_i) + \nabla \cdot (\rho \mathbf{v} Y_i) = -\nabla \cdot \mathbf{J}_i + R_i + S_i \quad (17)$$

where R_i is the net rate of production of species i by chemical reaction and S_i is the rate of creation by addition from the dispersed phase plus any user-defined sources. An equation of this form will be solved for N-1 species where N is the total number of fluid phase chemical species present in the system. In this study N=2 and the second species i.e. air is selected as largest mass fraction.

4.1.1 Mass Diffusion in Laminar Flows

In Equation (1), \mathbf{J}_i is the diffusion flux of species i , which arises due to concentration gradients. By default,

FLUENT uses the dilute approximation, under which the diffusion flux can be written as

$$\mathbf{J}_i = -\rho D_{i,m} \nabla Y_i \quad (18)$$

Here $D_{i,m}$ is the diffusion coefficient for species i in the mixture.

4.1.2 Mass Diffusion in Turbulent Flows

In turbulent flows, FLUENT computes the mass diffusion in the following form:

$$\mathbf{J}_i = -\left(\rho D_{i,m} + \frac{\mu_t}{Sc_t}\right) \nabla Y_i \quad (19)$$

where Sc_t is the turbulent Schmidt number ($\frac{\mu_t}{\rho D_t}$ where μ_t is the turbulent viscosity and D_t is the turbulent diffusivity). The default Sc_t is 0.7. Note that turbulent diffusion generally overwhelms laminar diffusion, and the specification of detailed laminar diffusion properties in turbulent flows is generally not warranted.

5. CFD modeling procedure

Fluent can model species transport, in this work radon is defined as species with air to combine a mixture called air-radon mixture. Because of low velocity of indoor air, the Reynolds number is smaller than 1000 and therefore model is selected as laminar. Fluent is run in three different cases in 2 dimensional (2D) and 3 dimensional (3D) models. To investigate and express about influences of rate, location and ventilation system, these models are examined and results are compared to each other.

6. Physical properties and data used

It is assumed that the radon concentration inside the room at steady state is 270 Bqm^{-3} [21] and total volume of room is considered 150 m^3 and 110 m^3 for 2D and 3D respectively.

The polluted surfaces of the walls are considered 100 m^2 , therefore the radon flow rate would be $3.5 \cdot 100 \cdot 10^{-21} = 3.5 \cdot 10^{-19} \text{ Kg/s}$. In this geometry radon source term is selected a strip with 0.1 m thicknesses that emits radon into the room, so the volume of this strip would be 1.6 m^3 , hence the value of radon source term is calculate $3.5 \cdot 10^{-19} / 1.6 \text{ m}^3 = 2.2 \cdot 10^{-19} \text{ Kg/m}^3 \text{ s}$, in which applied as user defined value in Fluent.

Radon molecular weight=222, Radon $C_p=900 \text{ j/Kg-K}$, Air molecular weight=28.8, Air $C_p=1006 \text{ j/Kg-K}$

$C_\infty=270 \text{ Bqm}^{-3}$, $\lambda=2.1 \cdot 10^{-6} \text{ s}^{-1}$, radon diffusivity, $D=1.0 \cdot 10^{-6} \text{ m}^2 \text{ s}^{-1}$, air viscosity= $1.75 \cdot 10^{-5} \text{ Kg m}^{-1} \text{ s}^{-1}$, room volume= $V=150 \text{ m}^3$

$$1 \text{ Bqm}^{-3} = 1.75 \cdot 10^{-19} \text{ kgm}^{-3} \quad (20)$$

$$1 \text{ kg radon} = 5.7 \cdot 10^{18} \text{ Bq} \quad [22]$$

The radon exhalation rate is assumed average $E = 0.02 \text{ Bq/m}^2 \text{ s}$ [5], from equation (20), it can be calculated as:

$$E = 0.02 \text{ Bq/m}^2 \text{ s} = 0.02 \cdot 1.75 \cdot 10^{-19} = 3.5 \cdot 10^{-21} \text{ Kg/m}^2 \text{ s}.$$

Radon action level in residential buildings in some countries and organizations is about 150 Bqm^{-3} [23].

7. Geometries and boundary conditions

7.1. Three Dimensional Model:

Geometry is a room with sizes $5 \times 10 \times 2.2 = 110 \text{ m}^3$, outdoor temperature 0°C and indoor temperature 20°C . The model is selected as laminar, incompressible, steady state and species transport of mixture of air and radon.

It is assumed that the radon concentration inside the room at steady state is 270 Bqm^{-3} [20] and from equation (21), $G = 5.67 \times 10^{-4} \text{ Bqm}^{-3} \text{ s}^{-1}$, since $G = \Omega / V$, then $\Omega = 5.67 \times 10^{-4} \cdot 110 \text{ m}^3 = 6.24 \times 10^{-2} \text{ Bqs}^{-1}$, so from equation (11), $E = \Omega / \sum A_i$ in which $\sum A_i = 66 \text{ m}^2$, and the value of $E = 0.094 \times 10^{-2} \approx 10^{-3} \text{ Bqm}^{-2} \text{ s}^{-1}$.

Radon emissions from the walls are 66 m^2 and 110 m^3 , but in Fluent the boundary defined with volume 5.74 m^3 (one slice of the walls with 0.1 m thickness). The emanation rate (E) from this volume has to calculate again, from equation (22), $E = 1.75 \times 10^{-19} \cdot 10^{-3} = 1.75 \times 10^{-22} \text{ Kgm}^{-2} \text{ s}^{-1}$ for 110 m^3 , since the surface area is 66 m^2 , $E \cdot A = 115.5 \times 10^{-22} \text{ Kgs}^{-1}$, then the radon value within volume 5.74 m^3 would be $C = (115.5 / 5.74) \cdot 10^{-22} = 2 \times 10^{-21} \text{ Kgm}^{-3} \text{ s}^{-1}$.

In this case boundary condition selected with 2 different supplies once as door while is open and second time inlet supply as a diffuser. Also 2 exhaust fans installed near the ceiling one in the middle and the other one in the left corner.

The simulations have been performed with Fluent V.6.3. When radon moving by the ventilation means with the velocity between 0.1 to 0.5 m/s , the Reynolds number can be calculated as:

$$Re = \frac{\rho u_m D}{\mu} = 3000 \quad (1)$$

Where $\rho = 1 \text{ Kg/m}^3$ (air density) $u_m = 0.3 \text{ m/s}$ (indoor air mean velocity), $D = 0.3 \text{ m}$ (diameter of ventilator) and $\mu = 1.83 \times 10^{-5} \text{ Kg/ms}$ (air viscosity at 293 K) [16, 17, 18].

Since the Reynolds number is larger than 23000 , the model of air flow is chosen as turbulent model. Iterations and grid size were $10,000$ and 89783 cells respectively.

7.2. Two Dimensional Model:

The building sizes $10 \times 5 \times 3 \text{ m}^3$ in 2 storey, and different models with changing the ventilation principles were tested. Species model is selected to solve equations about radon transport through building materials. The amounts of radon in mixture are set to $2 \times 10^{-20} \text{ kg/m}^3 \text{ s}$. The model is laminar, incompressible, steady state with physical properties of air and radon. Iterations have done $10,000$ in both one and two stories cases.

8. Simulation Results

8.1. 3D modeling:

In 3D model, when selecting the door as an inlet and exhaust fan 1 (left one) as an outlet (figure 1), we can see that the maximum content of radon is located in the right corner close the door and when using supply as velocity inlet and exhaust fan 3 (middle one) as an outlet (figure 2) the polluted region is changed which show that the radon concentration is sensitive to direction of flow rate.

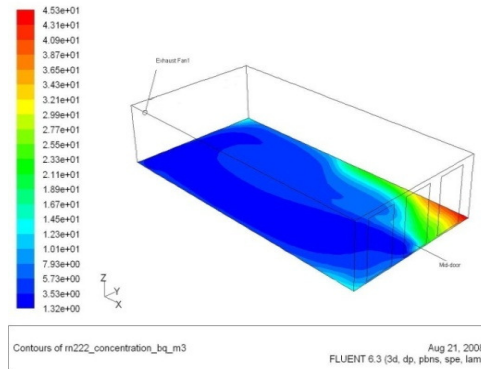

Fig.1. door as an inlet and exhaust fan 1(left one) as an outlet and result on $z=0.1$ m near the floor

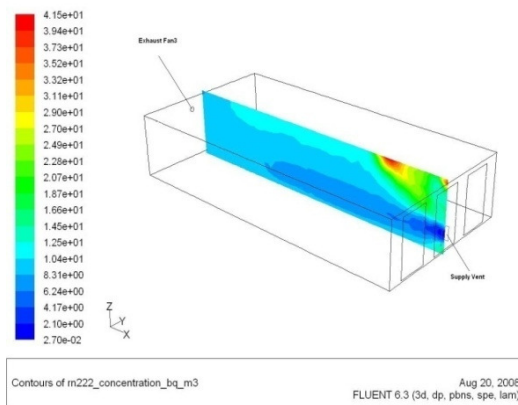

Fig.2. supply as velocity inlet and exhaust fan 3(middle one) as an outlet and result on $y=0$ m

Figure 3 shows the result on $z=1.1$ m and boundary conditions are the same as fig.2, in this case it is observed that near the sides wall there are more radon content, because in these area the air velocity has the minimum value.

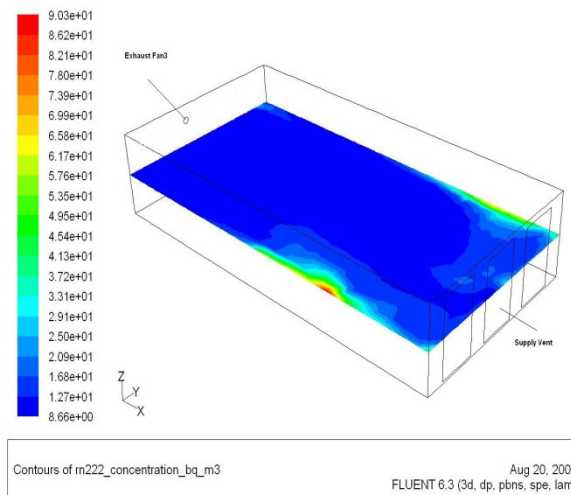

Fig.3. supply as velocity inlet and exhaust fan 3(middle one) as an outlet and result on $z=1.1$ m

Figure 4 is the simulation result on $z=2$ m near the ceiling room. We can also see that the polluted regions there in the areas which are far from inlet and outlet just the points where the air velocity is at the lowest value.

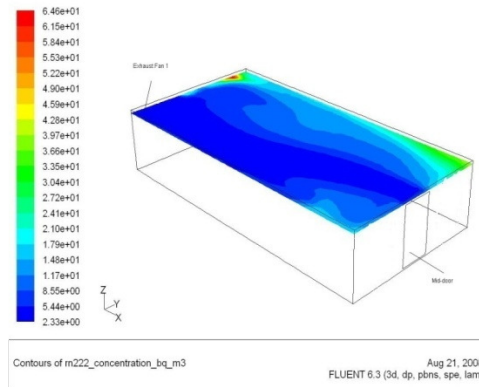

Fig.4. door as an inlet and exhaust fan 1(left one) as an outlet and result on z=2 m near the ceiling

These results show that, in residences seating level view point, the exhaust fan in the middle is more effective than when it is in the left corner and the location of the exhaust fan has direct relationship with the amount of concentration. In all cases, there is an area in the right of the door that the radon concentrations are high, because these area are far from and just the opposite of the location of exhaust fan.

8.2. 2D modeling:

In 2D model, the outlet and inlet are shown in the figures. In figure 5, (a) and (b), these boundary conditions define as:

Supply is velocity inlet at velocity magnitude 0.35 m/s and exhaust fan is exhaust fan type at pressure 3 Pascal and outlet is selected as wall. This model sets as a displacement ventilation model.

The maximum velocity magnitude yields 0.48 m/s and maximum mass fraction of radon is $1.057e^{-19}$.

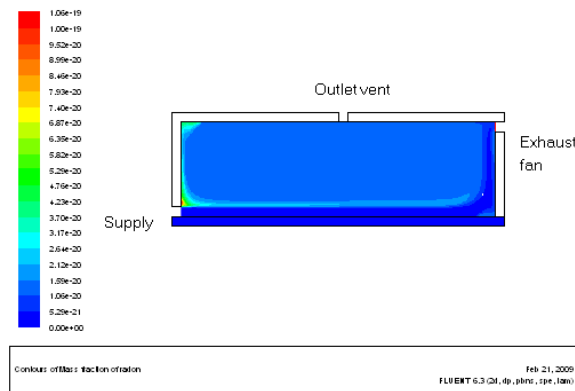

Fig.5.(a) mass fraction result of radon

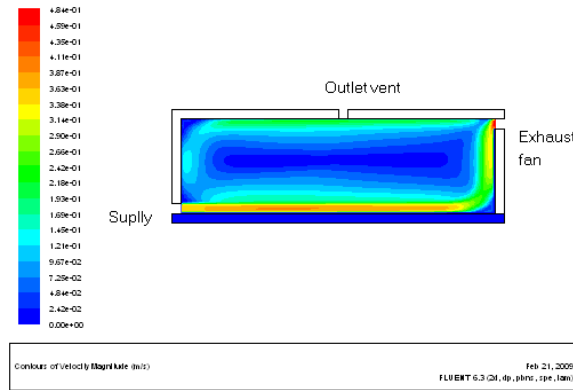

Fig 5.(b) velocity magnitude of indoor air

In figure 6 (a) and (B), the inlet and outlets defined as:

Supply =wall, exhaust fan B = inlet, exhaust fan A=Exhaust fan type with mass flow rate=0.04 kg/s and outlet is selected as inlet vent.

As we can see from these figures, the maximum velocity magnitude and mass fraction of radon are 0.15 m/s and $3.15e^{-19}$. These results confirm the influences of flow rate and effect of location of ventilation on indoor radon content.

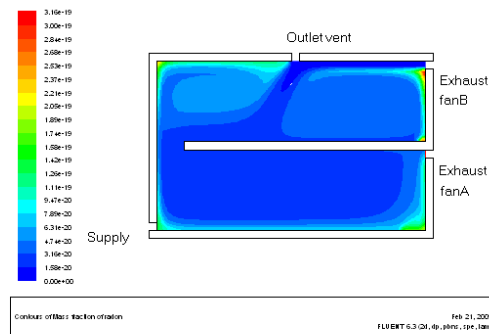

Fig.6.(a) mass fraction result of radon

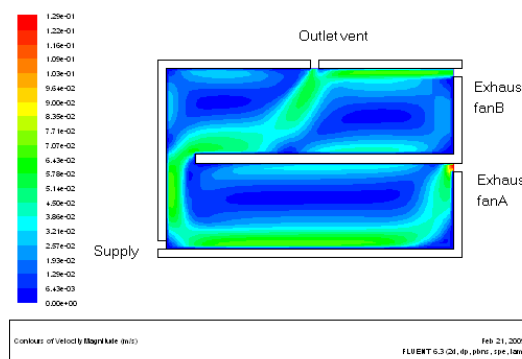

Fig 6.(b) velocity magnitude of indoor air

9. Sensitivity analysis and grid independency

For confirming the results and testing the sensitivity, we changed the model with different boundary condition values for example the value of radon exhalation rate, ventilation types and ventilation rate and location. These tests confirmed that the results are different. For checking grids independency, we increase the grid two times and five times and the results were approximately equal.

10 Conclusions and results

CFD is suitable and available tools for visualizing the behavior of harmful contaminants like radon with low cost compare with the other methods same as gas tracer or experimental methods.

With using CFD we can predict the radon treatment and polluted areas and designing ventilation system for achieving comfort situation and energy efficient point of views.

The model developed with FLUENT simulated radon entry through the material of a house in 3D and 2D models. The results showed that indoor radon concentrations are dependent on radon production, ventilation and outdoor radon concentration. Ventilation of a room can significantly influence radon measurement.

This study confirms that with increasing ventilation rate, the radon concentration is decreased, but the position of ventilation system is also important. From the simulation, it is observed that some places, are good for living and somewhere is more polluted.

The limitations of this paper are to lack of occupants, materials and other pollutants in the sampled room. If these were added the results would be changed. For simplicity it can be assumed that the second case which ventilation rate supposed 7.5 l/s has one person and the first case has 5 persons in accordance to ASHRAE's standard. In the other words it can implied that for material buildings which contain radon concentration lower than 250 Bq/m³, the minimum ventilation rate is sufficient to reduce radon concentration to reach action level.

With simulation of ventilation by means of CFD, it can be designed a desired ventilation system in the view points of energy savings and indoor air quality.

8 References

- [1] David T. Grimsrud, Daniel E. Hadlich, and Patrick H. Huelman 1996 Assessment of Radon Mitigation Methods in Low-rise Residential Buildings
- [2] European commission, Report No 23, Ventilation, Good Indoor Air Quality and Rational Use of Energy
- [3] Evaluation of increased ventilation rates and energy conservation measures at four New York state schools
<http://www.nyserda.org/publications/VENTSUM.PDF>
- [4] Designs for New Residential HVAC Systems to Achieve Radon and Other Soil Gas Reduction, 1993 International Radon Conference, by Timothy M. Dyess,
- [5] Radon Prevention in the Design and Construction of Schools and Other Large Buildings, January 1993, US Environmental Protection Agency, Office of Research and Development, Washington DC 20460, EPA/625/R-92/016, p 25.
- [6] Radon-Resistant Construction Techniques for New Residential Construction, U.S. Environmental Protection Agency, Offices of Research and Development and Air and Radiation, Washington, DC 20460, EPA/625/2-91/032, February 1991, page 3-
- [7] HVAC Systems in the Current Stock of US K-12 Schools, U.S. Environmental Protection Agency, EPA-600/R-92/125.
- [8] R.A. Pitarma J.E. Ramos M.E. Ferreira M.G. Carvalho (2004) Computational fluid dynamics An advanced active tool in environmental management and education
- [9] Cavallo, A., C. Berkner and K. Gadsby (1990). "Use of Natural Ventilation to Control Radon in Single Family Dwellings." *Indoor Air '90*, Toronto, ICIAQC Inc.
- [10] W. Zhuo, T. Iida, J. Moriizumi, T. Aoyagi and I. Takahashi, Simulation of the concentrations and distributions of indoor radon and thoron 2000
- [11] Thomas C. W. Tung J. Burnett, Radon Measurement Protocol for Residences with Different Ventilation Rates, Indoor and Built Environment, 2004
- [12] H. B. Awbi, Renewable and Sustainable Energy Reviews 2(1998) 157-188
- [13] ASHRAE Standard 62-1989 R, Ventilation for Acceptable Indoor Air Quality, Atlanta, American

- [14] ASHRAE. 2003. *Standard 62.2-2003. Ventilation and Acceptable Indoor Air Quality in Low-Rise Residential Buildings*. American Society of Heating, Refrigerating and Air-Conditioning Engineers, Inc. Atlanta GA.
- [15] Ventilation rate for improving indoor radon level, Ming-yin, Chan ; Hung-kit, Ho, 2005
- [16] <http://pr.hec.gov.pk/Chapters/396-1.pdf>
- [17] Michel van der pal, radon transport in autoclaved aerated concrete, 2003
- [18] Frank P. Incropera, et al. *Fundamentals of heat and mass transfer*, 2006
- [19] Thomas C. W. Tung J. Burnett, *Radon Measurement Protocol for Residences with Different Ventilation Rates, Indoor and Built Environment*, 2004
- [20] FLUENT 6.3 User's Guide, 2006
- [21] JBS, AB Company reports, 2006
- [22] Fan Wang, Ian C. Ward, and The development of a radon entry model for a house with a cellar *Building and Environment* 35 (2000) 615-631
- [23] http://www.ccohs.ca/oshanswers/phys_agents/

Energy efficient window development

- Historical overview of the development of energy efficient windows in Sweden -

(Draft version – not for citation)

*Bernadett Kiss, International Institute for Industrial Environmental Economics
at Lund University*

Abstract

The paper investigates the development of energy efficient windows in the past 30 years. The focus is on the development and interlinkages among technology, actors' interaction and market diffusion in a broader policy context. The paper shows that in singular development cycles, different factors and the interfaces among these factors influenced the improvement and penetration of energy efficient window technologies. Such factors includes a) surrounding factors, such as climate characteristics, oil crisis and international concerns and strategies, b) policy instruments, like building codes and technology procurement programs, as well as c) industry initiatives, including niche market strategies.

1. Introduction

The availability of sustainable energy resources, the global distribution of fossil fuel resources and the capacity to develop alternative energy services as well as the growing awareness of energy related pollution, global increase in greenhouse gas concentrations and of the changing climate have all contributed to the reconsideration of our energy use. Resources and options are available to tackle these challenges: a) replacing current fossil with renewable energy sources and/or b) reducing energy consumption by end-use energy efficiency measures are prospective response strategies with considerable potentials. The potentials of more efficient energy use is expected to grow with the introduction, development and diffusion of new technologies and with cost reductions resulting from economies of scale and learning effects.

The challenges related to sustainable development and climate change are vast and further development requires effective policy instruments for efficient energy use. There is a need for immediate actions and policy packages to support development and innovation to implement improved energy efficiency. Despite the several policy measures that have been applied to address improved energy efficiency for buildings, the housing sector still represents approximately 35% of the total energy demand in Sweden. To tackle the challenge of energy use and green house gas emissions originating from this sector, deep-analysis and evaluation on the effectiveness and efficiency of these policy instruments are needed.

Several policy measures have been applied to address improved energy efficiency of windows in Sweden. These amongst others include energy efficiency requirements in building codes, investment subsidies, research and development funding, technology procurement, tax reduction, energy labels and demonstration projects. In combination with the applied policy measures, strategic programs were running including information and education programs, exhibitions, campaigns and voluntary standards. How to design effective policy systems for energy efficient technology diffusion yet remains a challenge for policy makers.

This paper provides a description on the development of energy efficient windows from the early 1970s onwards. Special focus is given to the technology development of energy efficient products, their share of the total window market and some relevant actors being involved in

the development and diffusion of the products. The history of the development is placed in a greater policy context.

2. Development of technology, market and actors

2.1 How do we define energy efficient windows?

In Sweden, the Energy-label is defining energy efficient windows today. During the past 30 years, several measures have been taken intending to define the concept behind energy efficient windows. Technically, energy efficiency of windows is measured based on the quality of their thermal insulation, i.e. how much heat is lost through them when the indoor is higher than the outdoor temperature. Thermal performance is expressed in U-value. The heat flux (Watt) through the window per m^2 at a temperature difference between inside and outside of 1 K or $^{\circ}C$. The lower the U-value, the lower the thermal transmittance of the window, and the better the insulation, thus the more energy efficient the window is.

The definition and the scale of the U-value for energy efficient windows have been changing over the years – partly depending on where and by whom the definition has been created and used and partly on the continuously evolving new technologies (mainly low-emissivity glass coatings) available on the market. Based on the legal requirements and the view of the major market actors, the following description has been chosen to define energy efficient windows over time:

Table 1 U-value development (1970-)

Period	Energy efficient window (U-value)
1970-1988	$\leq 2,0 \text{ W/m}^2\text{K}$
1989-1997	$\leq 1,5 \text{ W/m}^2\text{K}$
1998-2005	$\leq 1,3 \text{ W/m}^2\text{K}$
2006-	$\leq 1,2 \text{ W/m}^2\text{K}$

2.2 Building codes after the oil crises (1970s-1980s)

In Sweden, due to the climate single-pane windows had been replaced by better insulating solutions early on. Already in the 17th century, single-pane windows were equipped with sashes that were mounted on the inner side of the window frame during winter and could be taken away when summer came. Towards the end of the 19th century, these sashes were hinged to the inside of the single-paned window frame. In 1889, the coupled double-pane sash was patented; and from the 1910s – 1920s double-pane replaced single-pane sashes and remained common until 1970s. By the introduction of double-pane windows the U-value dropped from approximately $6 \text{ W/m}^2\text{K}$ to $3 \text{ W/m}^2\text{K}$ (Bülow-Hübe 2001). During this period, experiments both on the frame structure and glazing¹ have been made, amongst others to improve the thermal performance of windows. In the 1940s and 1950s, insulated glass units (IGU)² appeared in the form of double-glazed and triple-glazed³ sealed and fixed sashes in

¹ Glazing is a specialized window term for pane; therefore glazing and pane are used interchangeably in this paper.

² An insulating glass unit is a multi-glass combination consisting of two or more panes enclosing a hermetically-sealed gap, which can either be air or a special gas, such as argon. The most important function of the IGU is to reduce thermal losses.

houses designed by Bruno Mathsson, furniture designer and architect (Böhn-Jullander 1992). In 1945, the first Building Code was issued, including the first official standards for windows. The code mainly aimed for standardizing window quality and design and did not have specific requirements on the energy performance (Olsson-Jonsson 1988). In the mid 1950s, for a short period governmental loans were given for better building insulation; consequently triple-pane windows, coupled in three sashes, were installed in newly built family-houses. In the background, the Suez-crisis⁴ lied coupled with the government’s fear of oil shortage; oil was the most common heating fuel for buildings that time. Even though IGUs and coupled three-pane sashes had been known and tried out, they have not become competitive and excessively used before the end of 1970s.

As a direct response to the oil crisis (1973), Sweden implemented a stringent building code (SBN 75), which came into force in 1977. SBN 75 included concrete requirements for individual building components in specific temperature zones; for windows (including sash and frame), the obligation for U-value was $2,0 \text{ W/m}^2\text{K}$ both in the southern and northern climate zones of Sweden. In the end of 1970s, with the existing technology, three-pane windows were needed to accomplish the requirements of the code (Bülow-Hübe 2001). The focus of product development was on how to incorporate three panes into the window structure so that it has longer life-time, better thermal performance and so that it requires minimum maintenance. IGUs were patented in the USA already at the end of the 19th century and sporadically used in Sweden from the 1940s. From the beginning of 1970s, these newly developed windows could be tested at SP, the Technical Research Institute of Sweden, whereby different features, such as conductivity, air tightness and moisture leakage have been under examination (Gustavsson 2009). By the mid 1970s, three different window structures were developed that could fulfill the requirements of the building code: i) triple-pane windows in three coupled sashes, ii) windows with 1+2 construction, i.e. coupled double-panes in the inner sash and single pane in the outer sash and iii) triple-pane windows within one single sash (Bülow-Hübe 2001). Together with the building code, the Swedish government, provided large subsidies for amongst others refurbishment of existing house stock, including window replacement in the frame of the “ROT” program 1975-1993 (SFS 1974:946, 2003). By the end of 1980s, 1+2 coupled double-panes and triple-panes windows were the most commonly sold window types; while triple-pane windows in three coupled sashes disappeared from the market.

After the two oil crisis (1973 and 1979), Sweden gradually shifted from oil to other energy sources. By the beginning of the 1980s, due to the rapid expansion of nuclear power, the country had a large electricity surplus. Residential houses that had oil furnace were supported to convert to electric boilers or direct electric heating. The supplement of the new building code (SBN 1980), ELAK⁵ 1984 required lower U-values for the walls of those residential houses that switched from oil to electric heating; however no stricter requirements were set to window U- in this code (Smeds 2004).

³ In 1950, when Bruno Mathsson came back from his trip from the US, based on the American design, he developed the Bruno Pane. It was a triple-glazed sealed unit used for an exposition hall he designed with entire glass façade.

⁴ In 1956, during a couple of months, Egypt took control over the Suez Canal, one of the strategically most significant knot in oil sea-transport and closed it for international oil transport.

⁵ In 1980, the Special committee on energy use (ELAnvändningsKommittén) was set up by the Swedish government and suggested stricter building codes for dwellings heated only by direct electric resistance heating.

In the late 1970s, as a response of the glass industry to the oil crisis and stricter requirements, the glass industry took energy efficiency a step further by introducing low-emissivity⁶ glass coating. Low-e glass has a thin metallic coating which reflects radiant heat back to its source. In winter months the glass reflects back heat generated within the structure, helping keep it warm. During the summer outside radiant heat is reflected away from the building, helping keep it cool. This technological development is considered to be the first breakthrough in the flat glass industry that aims at increasing the energy conservation performance of windows. Low-e glass was commercially introduced in the beginning of 1980s. At the end of the 1980s, the building industry experienced its peak. In 1990, the number of dwellings built reached almost 70 000, highest since 1975. The number of sold windows followed the upswing; almost 1,9 million windows were sold in 1989, approximately 20-23% of them with low-e coating (Bülow-Hübe 2001).

2.3 Swedish Technology Procurement Program in the 1990s

The new building code (SBN 88), instead of setting requirements on individual building components, aimed at supporting system solutions; the compulsion for an average U-value on the whole building envelope was laid down, which hypothetically allowed even higher U-values for windows than it had been outlined before in SBN 75 (i.e. $>2,0 \text{ W/m}^2\text{,K}$). The 1990s was characterized by economic downturn in the building industry; merely modest development can be seen both in the window structure and in glazing. As for the structure, the distance between the panes and the proportion between the panes and the frame changed. As for the glazing, low-emissivity glass products were available on the market from the late 1970s and since the mid 1980s significant efforts have been made in research and development for transparent chromogenic, electrochromic glazing systems and other advanced glazing systems (EU 2009); however window manufacturers did not start to use them large scale until the late 1990s. To enhance the development and diffusion of existing energy efficient technologies in windows, NUTEK implemented two technology procurement programs in 1992 and in 1994 (NUTEK 1996). The first competition set the requirement for the U-value of the total window at $0,9 \text{ W/m}^2\text{,K}$ with a bonus for a U-value lower than 0,8. The applicant companies had difficulties to comply with the requirements; the suggested solutions (quadruple-pane windows) were not concordantly welcomed by all actors on the market. During the second competition, the requirements were set in cooperation with four manufacturers and SP. SP was also assisting companies to develop products complying with the requirements by sending out U-value modeling calculation methods (Gustavsson 2009). The requirement was lowered and raised the U-value to $1,0 \text{ W/m}^2\text{,K}$. The competition had two winners: Överums Fönsterfabrik AB and NorDan Vinduer A/S (SEA 2006). The new requirements were accomplished by triple glazing, with two low-e coatings, mounted in a traditional wooden sash (SEA 2006). Between the panes, argon or krypton gas fillings were used and traditional spacer materials. Windows met with the requirement were eligible for an energy efficiency label, in many ways a forerunner of the EU's energy statement concerning white goods, “EIOff Strömsnål” devised by the former Department of Energy Efficiency at NUTEK. Although these new energy efficient windows did not gained a large market share until the beginning of 2000s, partly due to the building recession (around 1992-1998), the procurement program assured governmental recognition and the labeling scheme raised consumer awareness on energy efficient windows.

⁶ Emissivity refers to an object's power to radiate heat, light, etc. In the flat glass industry, the term is used to measure the ability of window glass to control energy and minimize heat loss in cold weather. The lower a product's emissivity, the more energy efficient it is.

A building code usually lays down the bottom line for energy efficiency. Sometimes it stimulates the market to improve the energy efficiency of products; sometimes these improvements are market-driven. In 1998, Elitfönster, the largest actor on the window manufacturer market, installed a new production line for IGUs and started to sell triple-pane windows with one low-e coating and argon gas filling (Sommansson 2008). The window U-value of $1,3 \text{ W/m}^2, \text{K}$ became company standard⁷. Introducing low-e coating to triple-pane windows as a standard product stimulated other companies on the market to follow. In 2002, SP Fönster the second biggest window manufacturer in Sweden, came out with a window U-value of $1,3 \text{ W/m}^2, \text{K}$ as company standard. The share of low-e coated windows show a gradual increase after 1995 (see Figure 1).

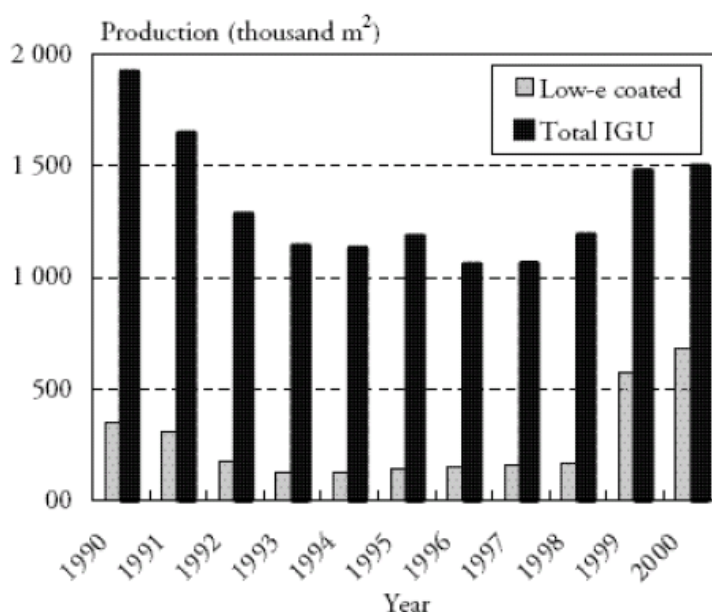

Source: Bülow-Hübe, 2001

Figure 1 Statistics over IGUs in Sweden (1990-2000)

In 2000, approximately 56% of the total windows (including both triple- and double-glazings) sold in Sweden were coated with low-emissivity layer (Bülow-Hübe 2001). The share of double-glazed windows is estimated at 20% and shows gradual decrease in the total window sales. In 2002, the building code (BBR 2002) brought along minor restrictions by setting requirements on the average U-value and the air tightness of the entire building envelop. And between 2004-2006, tax reduction (ROT) was in place for the replacement of old windows to new ones with the U-value of $1,2 \text{ W/m}^2, \text{K}$ or lower in existing single family-houses (SFS 2003:1204). Today, there are approximately 531 000 single family-houses having IGUs of more than half their window areas; in 2002, circa 16 000 of them took energy efficiency measures under ROT (Boverket (The National Board of Housing 2005)). This action accelerated the penetration of an existing technology and resulted in notable increase in the market share and the overall sales of energy efficient windows on the upward tending building market. (See Figure 2)

⁷ By company standard meant that windows with U-value of $1,3 \text{ W/m}^2, \text{K}$ are produced for stock in large volumes, any other client requests are handled individually according to the order specifications.

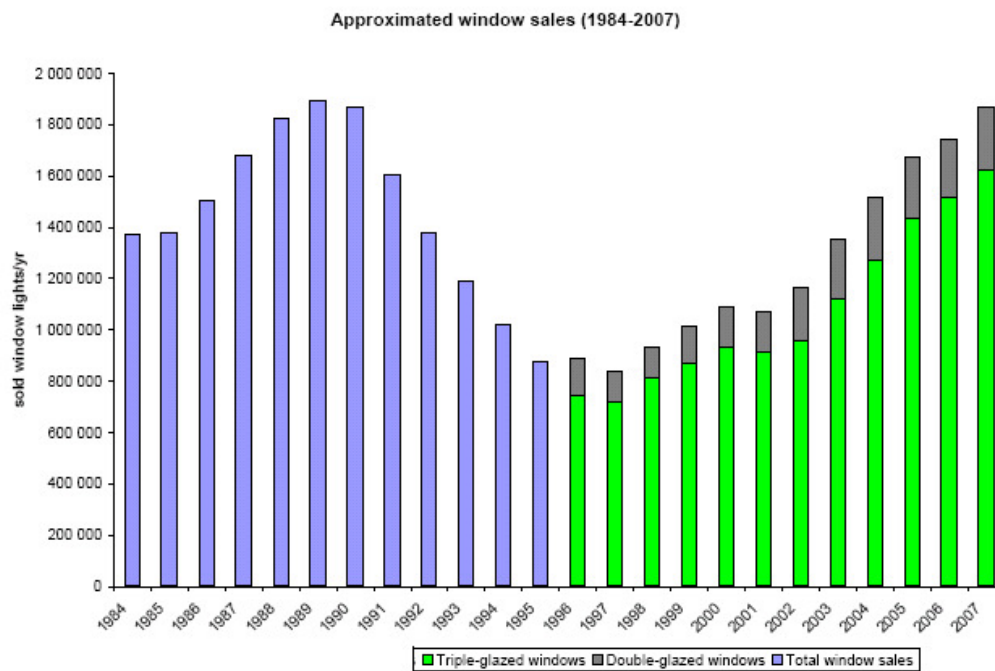

Figure 2 Statistics over window sales in Sweden (1984-2007)

2.4 Policy Mix to Combat Climate Change (2000s)

Commitments under Kyoto Protocol and the increasing dependence on external energy sources raised concerns in the European Union related to energy consumption amongst others in the building sector, which accounts for approximately one third of total EU energy consumption. In 2002, the European Union issued Directive 2002/91/EC on the energy performance of buildings as a mean to reduce energy consumption by improved energy efficiency (EU 2009)⁸. Based on this directive, Sweden issued a new building code in 2006, developed energy labeling of windows in the frame of a pilot project between 2006 and 2008 and introduced energy declaration that is in force from 2009.

The Swedish Building Code (BFS 2006:12) sets minimum standards on the energy performance of new buildings and existing buildings that are subject to major renovation (2006). Compared to the previously component (U-value) and then system (average U-value) based building codes, BBR 12 addresses the energy performance of buildings, by setting the required level of energy demand at 110 kWh/m² in the Southern zone and 130 kWh/m² in the Northern zone of Sweden. The code sets requirements for the whole building envelop and as an alternative demand for smaller residential buildings suggests an U-value of 1,3 W/m²,K for windows in new constructions (2006). In addition, ordinance 2006:1587 address the already existing window stock and offers tax reduction for replacement of old windows to new ones with the U-value of 1,2 W/m²,K or lower. This new “ROT” was in place between 2006-2008. In 2008, the market share of windows with U-values of 1,3 or lower is approximated between 70-80%.

⁸ The deadline for transposition of the directive by member states was 4 January 2006.

The law on energy declaration (2006:985) applies for both existing and new buildings. In general, it provides incentive to improve the overall energy efficiency performance of buildings; however it does not specify concrete measures for implementation and requirements for U-values of individual building components. Property taxation, especially of single family-houses, however is a contradictory measure to energy efficiency improvements in buildings. Environmental improvements in buildings, such as the installation of energy efficient windows, depending on the location and the quality of the property, could increase its taxable value and thus the property tax. Increasing costs on properties then weaken the economic incentives for property owners to invest in energy efficiency measures and give contradictory signals regarding the relevance of energy efficiency in the building sector.

As the latest development, energy labeling of windows has been introduced in 2006. Between 2001 and 2003, the Swedish Energy Agency together with other energy agencies and research institutes in seven EU member states participated in a SAVE project: European Window Energy Rating System (EWERS). By increasing the number of high performance energy efficient windows, the project aimed for improved indoor climate, energy savings and thus reduced greenhouse gas emissions. The labeling scheme follows the energy labels in place for white products; it grades windows on an A to G scale, whereby "A" indicates the most energy efficient windows ($0,9 \text{ W/m}^2\text{,K}$) and "G" stays for the "less" energy efficient ones ($1,5 \text{ W/m}^2\text{,K}$) in this ranking (SEA, 2008). EWERS provided the basis for the currently ongoing pilot project (2006-2007) with eleven volunteer companies and two testing institutes⁹ being involved from three Nordic countries: Sweden, Finland and Norway. Based on the performance of the participating companies, the market share of windows on the Swedish market with a U-value of $1,2 \text{ W/m}^2\text{,K}$ or lower was approximated to 50% in 2007 (Avasoo 2008). In the current two years period (2008-2009), the number of interested parties has increased to fourteen window manufacturers (located in four countries) representing 85% of the Swedish window sales market. Since 2000, the Swedish Energy Agency keeps records on windows with U-values of $1,2 \text{ W/m}^2\text{,K}$ and the producers; the list is continuously updated. In 2000, there were 47 products registered, today the number of listed windows is 247 from 35 manufacturers. In 2008, Elitfönster, representing 40% of the market sales, has introduced $1,2 \text{ W/m}^2\text{,K}$ as company standard.

Today, triple-pane windows still dominate the Swedish market, either with 1+2 or with triple-pane construction. In between the panes, it is filled with argon (occasionally expensive krypton) or less costly vacuum. Since with current technology (i.e. low-emissivity coating, argon filling) rather acceptable U-values can be achieved by using double-glazing, there are also window manufacturers on the market specialized on these products. As alternative solution for better thermal conductivity performance, window producers offer thermo-plastic spacers (instead of earlier used metal spacers) that is to be applied in between two panes aiming to improve the U-value with approximately $0,1 \text{ W/m}^2\text{,K}$. The recent technology development shows a tendency towards improved frame constructions by combining wooden frames with alternative materials, such as plastic and polymers to reach a better U-value for the entire window structure.

In 2007, based on the German passive house standard, specification for passive houses was issues in Sweden. Passive houses required to have windows with U-values not higher than $0,9 \text{ W/m}^2\text{,K}$ (presently category "A" by the energy label), having been approved by an accredited test laboratory. To reach these thermal insulation qualities, requires on one hand advanced low-emissivity and/or solar glazing, on the other hand sophisticated window structures,

⁹ SP from Sweden and VTT from Finland.

including high performance sashes, thermo-plastic spacers, low conductivity gases (argon, krypton, xenon) between the panes and airtight mounting. In 2006, Elitfönster introduced a new product group with such thermal behavior on the market; however due to economical reasons, it has not become widely used on the market. As 70% of the window is glass, window technology in general very much dependent on glass technology development. In the past 30 years, glaziers have significantly improved the thermal performance of glasses. Today, window technology development is facing with challenges bringing economically feasible alternative solutions for improved thermal conductivity of window structures and mounting. The actors on the market are ready to produce and market windows with improved energy efficiency under the condition of sufficient and more importantly consistent policy support for market introduction and diffusion of the new products.

3. Conclusion

The paper describes how different factors influenced the improvement and penetration of energy efficient window technologies in singular development cycles. Due to the harsh winter climate, double-pane windows were early introduced and spread in Sweden. As a consequence of the oil crisis of the 1970s, stringent requirements were set on building components in the frame of that time new building code (SBN 75). As a response for the rigorous requirements, window companies developed three-pane instead of double-pane windows. At the same time, the glass industry invested large resources in developing glasses with low-emissivity coatings. As a result of the upswing of the building cycle in the end of 1980s, beginning of 1990s, the market share of windows with low-emissivity coating reached an approximated 23%. In the 1990s, the technology procurement program of NUTEK (National Board of Technical and Industrial Development) did not only bring market actors together to improve the energy efficiency of windows by developing new technologies, but also led to the extension of quality labeling (P-labels) of windows for the enhancement of consumer awareness. The technology procurement program did not result in increased market share of windows with low U-values; however it gave an indication to window manufacturers about the “coming” requirements on thermal performance of windows. Early movers, such as Elitfönster used niche market strategy and set the level of U-value at $1,3 \text{ W/m}^2\text{K}$ as company standard in 1998. In 2002, this move was followed by the second largest actor on the market. In 2004, tax reduction was provided to single family-houses for installing energy efficient windows. As a consequence of the combination of actions from both industry and government side, the market share of energy efficient windows grew to an estimated 70%. International strategies to tackle climate change force countries to formulate national commitments with regards to mitigating greenhouse gas emissions. Strategies to address climate change include designing and implementing effective and consistent policy packages on reduced energy consumption by end-use energy efficiency measures. For a successful policy intervention, besides the development of U-values, the commitment of window industry and voluntary measures as well as intensive collaboration and networking among involved actors are needed for the market diffusion of energy efficient windows.

4. Further research

Based on this investigation of the technology, market and actors development of energy efficient windows, further research is being carried out on different learning processes¹⁰ in the socio-technical system of energy efficient windows. As a next step, learning processes will be investigated with the focus on a) the identification of the underlying factors facilitating different learning processes and b) how these facilitating factors, thus learning processes have been addressed by policy instruments over time. By delineating the facilitating factors and the interaction among them, relevant conclusions can be depicted for policy learning and recommendation can be given to policy makers on which factors to consider when designing policy packages for energy efficient window technologies.

¹⁰ Learning processes, such as learning-by-searching, learning-by-doing, learning-by-using and learning-by-interacting have been addressed by different scholars throughout the years. For more details see e.g. Kamp, L. M. (2007). "The importance of learning processes in wind power development." European Environment 17(5): 334.

References

(2006). Swedish Building Code (BBR12), BFS 2006:12.

Avasoo, D. (2008). Energy-label for windows (Energimärkning av fönster). Personal communication.

Boverket (The National Board of Housing, B. a. P. (2005). Fastighetsskatten – en miljöbov? (Property tax - environmental villain?). Karlskrona, Boverket.

Bülow-Hübe, H. (2001). Energy-Efficient Window Systems. Lund, Lund University.

Böhn-Jullander, I. (1992). Bruno Mathsson Möbelkonstnären Glashusarkitekten Människan. (Bruno Mathsson The furniture artist The glass house architect The man). Lund, Bokförlaget Signum.

EU, E. U. (2009). Energy efficiency: energy performance of buildings, EU. 2009.

Gustavsson, B. (2009). Energy efficient window development. Personal communication.

Kamp, L. M. (2007). "The importance of learning processes in wind power development." European Environment 17(5): 334.

NUTEK (1996). Utvärdering av NUTEKs program för effektivare energianvändning (Evaluation of NUTEK program for more efficient energy use). Stockholm, NUTEK.

Olsson-Jonsson, A. (1988). Förbättring av fönsters värmeisolering samt upplevelse av fönsterbyten (Improved thermal performance of windows and the experiences of window replacements). Stockholm, Byggforskningsrådet.

SEA (2006). Technical procurement. Eskilstuna, Swedish Energy Agency.

Smeds, J. (2004). Energy Aspects in Swedish Building Legislation of the 20th Century Concerning Dwellings. Lund.

Sommansson, A. (2008). Energy efficient window development. Personal Communication.

(to be completed)