



# LUND UNIVERSITY

## Calculation of moisture transport and the necessary material data : Nordic symposium, January 28-29 1991 Ystad, Sweden

Arfvidsson, Jesper; Wadsö, Lars

1991

[Link to publication](#)

### *Citation for published version (APA):*

Arfvidsson, J., & Wadsö, L. (Eds.) (1991). *Calculation of moisture transport and the necessary material data : Nordic symposium, January 28-29 1991 Ystad, Sweden*. (Report TVBM 3044). Division of Building Materials, LTH, Lund University.

### *Total number of authors:*

2

### **General rights**

Unless other specific re-use rights are stated the following general rights apply:

Copyright and moral rights for the publications made accessible in the public portal are retained by the authors and/or other copyright owners and it is a condition of accessing publications that users recognise and abide by the legal requirements associated with these rights.

- Users may download and print one copy of any publication from the public portal for the purpose of private study or research.
- You may not further distribute the material or use it for any profit-making activity or commercial gain
- You may freely distribute the URL identifying the publication in the public portal

Read more about Creative commons licenses: <https://creativecommons.org/licenses/>

### **Take down policy**

If you believe that this document breaches copyright please contact us providing details, and we will remove access to the work immediately and investigate your claim.

LUND UNIVERSITY

PO Box 117  
221 00 Lund  
+46 46-222 00 00



Lund University of Technology  
University of Lund  
Division of Building Materials

Nordic symposium

# Calculation of moisture transport and the necessary material data

January 28-29 1991 Ystad, Sweden

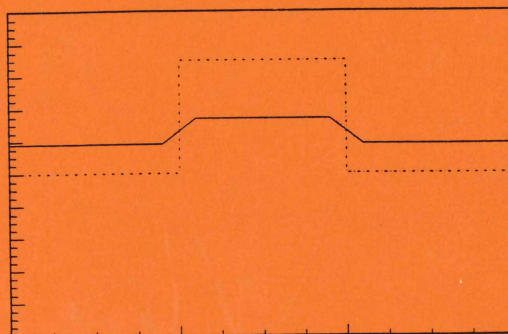

edited by

Jesper Arfvidsson

Lars Wadsö

REPORT TVBM-3044, Lund, Sweden, 1991

Nordic symposium

# Calculation of moisture transport and the necessary material data

January 28-29 1991 Ystad, Sweden

This was the second nordic seminar on moisture transport. The first meeting was held in Kopenhagen-Lyngby in 1989.

The majority of the researchers who met in Ystad works with building materials at Technical Institutes or Universities in Denmark, Finland, Norway and Sweden. We discussed different aspects of moisture transport, including:

- non-isothermal conditions
- moisture flow at surfaces
- different computer programs for moisture transport
- methods for measuring transport coefficients

The next meeting will probably be held in Finland in the summer of 1992.

This symposium was supported by the Nordic Counsel of Ministers.

Jesper Arfvidsson

Lars Wadsö

This report contains

1. List of the participants
2. A list of all the talks
3. Contributions
4. The presented testcases

## Participants

Ilmari Absetz, TKK/Talonrakennustekniikka, SF-02150 Espoo, Finland

Jesper Arfvidsson, Byggnadsfysik LTH, Box 118, S-221 00 Lund, Sverige

Johan Claesson, Byggnadsfysik LTH, Box 118, S-221 00 Lund, Sverige

Carl-Eric Hagentoft, Byggnadsfysik LTH, Box 118, S-221 00 Lund, Sverige

Kurt Kielsgaard Hansen, Laboratoriet for Bygningsmaterialer DTH,  
Bygning 118, DK-2800 Lyngby, Danmark

Stefan Hjort, Byggnadsmaterial CTH, S-412 96 Göteborg, Sverige

Håkan Håkansson, Byggnadskonstruktionslära LTH, Box 118, S-221 00 Lund, Sverige

Johnny Kronvall, Byggnadskonstruktionslära LTH, Box 118, S-221 00 Lund, Sverige

H M Künzel, Fraunhofer-Institut für Bauphysik, Postfach 11 80,  
D-8150 Holzkirchen 1, Deutschland

Annika Mårtensson, Bärande Konstruktioner LTH, Box 118, S-221 00 Lund, Sverige

Anker Nielsen, Sivilingenjørsutdanningen i Narvik, Postboks 385,  
N-8501 Narvik, Norge

Erik Nilsson, Sverige

Tuomo Ojanen, Laboratory of heating and ventilation, Technical research centre  
of Finland, Lämpömiehenkuja 3, SF-02150 Espoo, Finland

Carsten Rode Pedersen, Laboratoriet for Varmeisolering DTH, Bygning 118,  
DK-2800 Lyngby, Danmark

Peter Roots, Byggnadsfysik LTH, Box 118, S-221 00 Lund, Sverige

Liu Tong, Byggnadsmaterial KTH, S-100 44 Stockholm, Sverige

Lars Wadsö, Byggnadsmaterial LTH, Box 118, S-221 00 LUND, Sverige

## A list of the lectures

Ilmari Absetz: Capillary moisture transport modelling of softwoods

Jesper Arfvidsson: The computer programs JAM-1 and JAM-2

Johan Claesson: Introduction

Carl-Eric Hagetoft: Computer program for small air movements in constructions

Kurt Kielsgaard Hansen: CEN/TC88/WG1 Standard

Stefan Hjort: Wet cup measurements on paint+wood

Håkan Håkansson: The moment method and a new way of measuring non-isothermal vapour transport

Johnny Kronvall: Calculation procedures for forced convection

H M Künzel: Description of the facilities in Holzkirchen

Annika Mårtensson: Desired results from moisture calculation, aspects from a mechanical point of view

Anker Nielsen: Spread sheat calculations of moisture in constructions

Tuomo Ojanen: Our work in the field of modelling the hygrothermal properties of building structures

Carsten Rode Pedersen: MATCH - computer program for calculation of coupled heat and moisture transport

Liu Tong: Diffusion coefficients and sorption isotherms for spruce and pine

Lars Wadsö: The sorption method applied to wood, and measurements of the surface resistance





Teknillinen korkeakoulu  
Rakennus- ja maanmittaustekniikan osasto  
Talonrakennustekniikan laboratorio  
Ilmari Absetz

Ilmari Absetz

Nordisk forskarsymposium  
BERÄKNING AV FUKTTRANSPORT OCH MÄTNING AV  
NÖDVÄNDIGA MATERIALDATA  
28 - 29 januari 1991 YSTAD

## CAPILLARY MOISTURE TRANSPORT MODELING OF SOFTWOODS

The objective of my current research project: "THE EFFECTS OF WOOD STRUCTURE AND STRUCTURAL VARIATION ON TIMBER DRYING" is to find out the effects of heartwood, sapwood, moisture content, density and knots on the timber drying process of pine and spruce. The project is a part of a larger project: "Quality improvement of timber drying" supervised by research professor Alpo Ranta-Maunus VTT/Structural Engineering Laboratory.

The structural variation is studied by determining pore size distributions of small wood specimen of selected locations with mercury intrusion porosimeter. The results have shown that structural and moisture content variation of wood is shown in the pore size distribution results.

The pore size distributions are used as basis of capillary moisture transfer modeling with a CAPILLARY TUBE MODEL. In the CT-model the pore size distribution is converted to capillary tubes of various radius and corresponding volume proportion.

The CT-model simulates water intake from water surface to wood at present state in longitudinal direction and expresses the moisture distribution as a function of time. The model computes the moisture conductivity  $K$  ( $m^2/s$ ) as a function of moisture content. Temperature is taken into account by temperature dependences of surface tension and dynamic viscosity of water. The moisture conductivity curves can be used as calculation parameters in capillary FEM-calculations with different boundary conditions.

Results of modeling pine heartwood and sapwood water intake in longitudinal direction are presented in this seminar. The results are compared to test results and curve fittings of Hannu Koponen TKK/Mechanical Wood Technology. The moisture absorptions correlate relatively well with test results for both heartwood and sapwood. The moisture conductivities are smaller than values presented by Koponen. The effect of temperature rise from 20 to 60 C increased water absorption by about 50 % according to the model.

The test case 1. was studied experimentally and with the CT-model results.

# PORE SIZE DISTRIBUTION

## PINE SAPWOOD

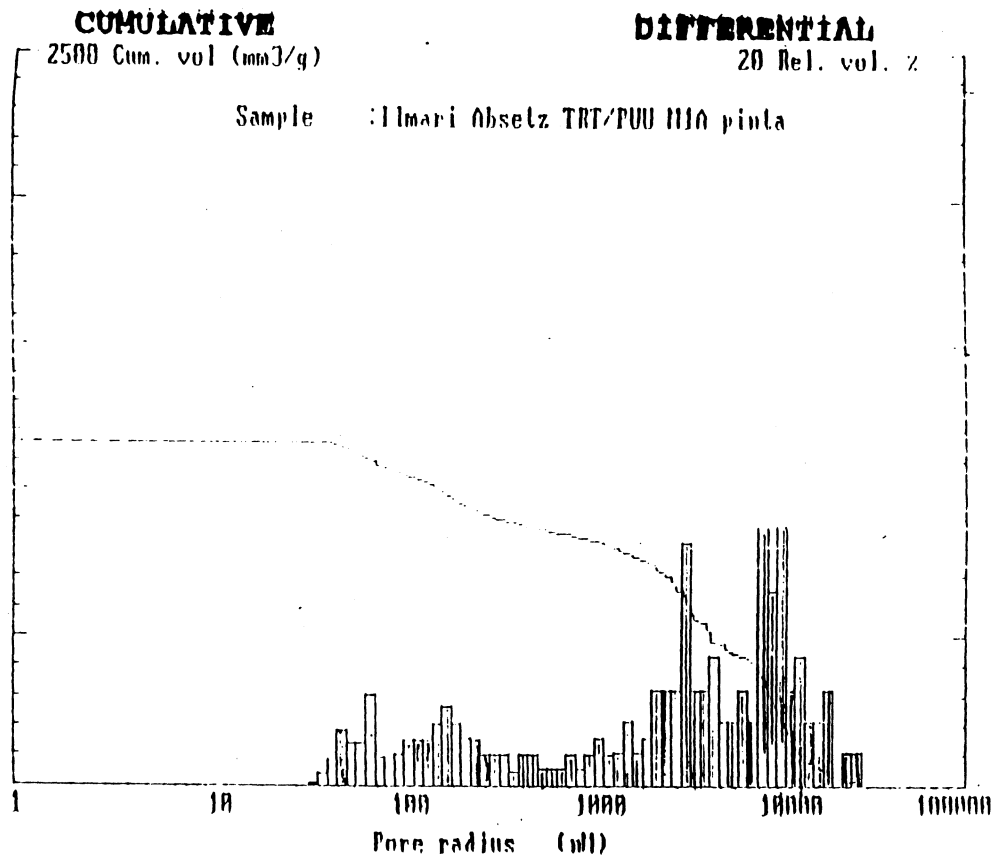

- \* density 520 kg/m<sup>3</sup>
- \* total porosity 65.6 %

# PORE SIZE DISTRIBUTION

## PINE HEARTWOOD

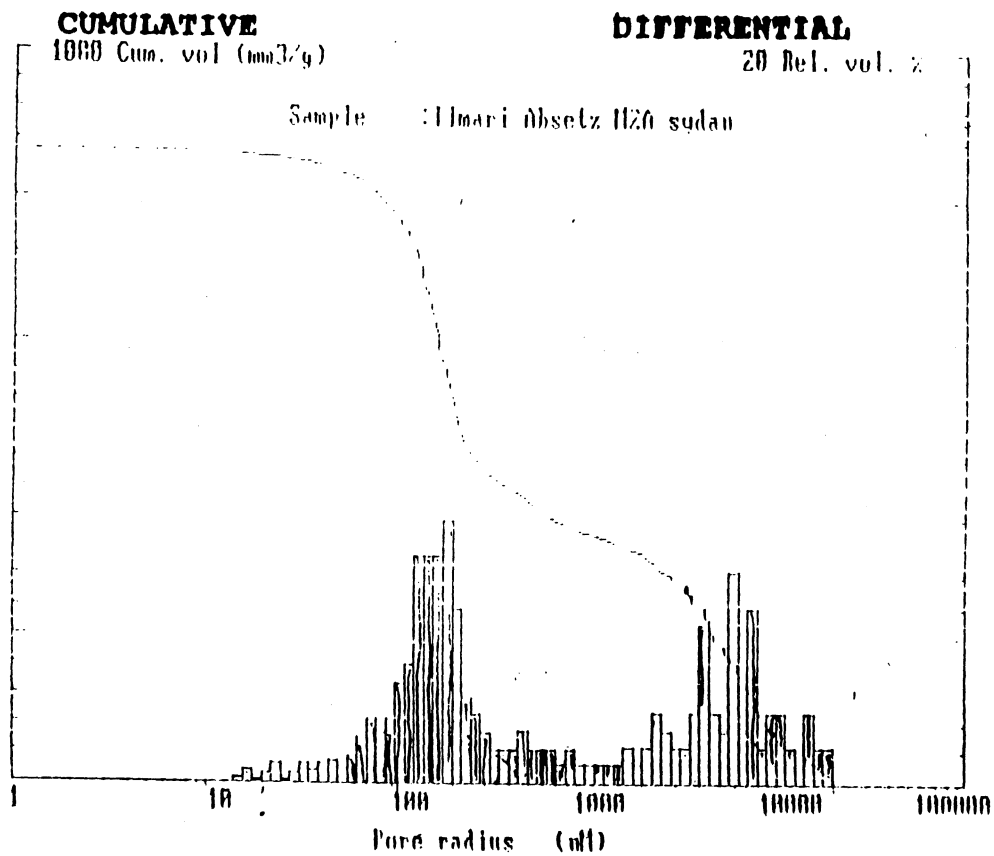

- \* density 690 kg/m<sup>3</sup> (M.C. = 35%)
- \* total porosity 59 %



MOISTURE TRANSPORT PC-PROGRAMS (JAM)

The transport PC-programs, called JAM, run under MS-DOS on IBM-PC and compatibles. The executable code requires an \*87 math co-processor, EGA video card and 512 kbytes of RAM.

• Assumptions:

- No temperature influence.
- No hysteresis.

• Program names:

- JAM-1, one-dimensional case.
- JAM-1R, one-dimensional radial case.
- JAM-2, two-dimensional case.

• Notations:

- $g$  density of moisture flow rate (kg/m<sup>2</sup>s)
- $w$  moisture content (kg/m<sup>3</sup>)
- $D$  moisture flow coefficient
- $\psi$  flow potential (kg/ms)

$\psi$  is defined by the integral:  $\psi = \int_{\phi_{ref}}^{\phi} D_{\phi}(\phi) d\phi$ , where  $\phi$  can be any of the variables  $\varphi$  (relative humidity),  $v$  (vapour concentration),  $p_l$  (pore water pressure),  $S$  (suction),  $w$  (moisture content).

• Governing partial differential equations ( $w = w(\psi)$ ):

- One-dimensional case:  $\frac{\partial w}{\partial t} = \frac{\partial^2 \psi}{\partial x^2}$
- One-dimensional radial case:  $\frac{\partial w}{\partial t} = \frac{1}{r} \frac{\partial}{\partial r} (r \frac{\partial \psi}{\partial r})$
- Two-dimensional case:  $\frac{\partial w}{\partial t} = \frac{\partial^2 \psi}{\partial x^2} + \frac{\partial^2 \psi}{\partial y^2}$

• Numerical solution method:

- Explicit forward difference method.

• Boundary conditions:

- Constant, piece-wise constant, or sinusoidal relative humidity.
- Constant, piece-wise constant, or sinusoidal moisture-flow.

• Initial conditions:

- The distribution of relative humidity at the time  $t = t_{start}$ .

• Material properties:

- The properties may be different for each computational cell.

• Material data:

- Transport coefficients are approximated as piece-wise constant for given intervals.
- The sorption isotherms are approximated as piece-wise linear for given intervals.
- The material data can be saved on a material datafile once and for all, and then be used in all the JAM programs.

## Kurt Kielsgaard Hansen

Kurt Kielsgaard Hansen  
Building Materials Laboratory (LBM)  
The Technical University of Denmark  
Building 118, DK-2800 Lyngby, Denmark

My main working fields by now:

### 1) CEC-BCR Round Robin Test on "Water vapour permeability of insulating materials"

LBM is one of about 10 laboratories from as many countries in this Round Robin Test on cup methods. Dry cup testing is on 30 mm polystyrene having skin removed. Test condition: 23°C and 0/50 %RH.

Wet cup testing is on 30 mm vermiculite. Test condition: 23°C and 50/93 %RH.

### 2) CEN/TC88/WG1 Standard: Water Vapour Permeability of Insulation Products

LBM comment the standard. For the moment I feel that the standard is too "elastic". The standard must be more restrictive on the following points: 1) The air layer thickness inside the cup must be one fixed thickness. In calculation of water vapour transmission properties the resistance of this air layer thickness must be subtracted, 2) A constant-temperature chamber within  $\pm 1$  K and  $\pm 2$  %RH have too much variation. Accredited laboratories may full-fill better conditions today, 3) A minimum air velocity at the material surface in the range 0.5 - 2.5 m/s must be specified, 4) Corrections for masked edge must be done, 5) Corrections for variations in barometric pressure during measurement may be done for insulating materials which are not very permeable for water vapour, 6) Determination of constant change in mass of the cup may be affected by the calculation technique.

### 3) LBM Cup Equipment

LBM have just finished installation of a Michell Dewpoint Hygrometer with Temperature Measuring Head Series 3000 in our cup equipment. This instruments have NAMAS calibration from U.K. Also a well calibrated HAENNI barometer is installed. The instruments are connected to our datalogger.

### 4) "Inverted - cup" method

In the inverted-cup method the vacuum saturated specimen is in direct contact with the water in the cup. With this equipment it is possible to calculate the Darcy coefficient and the water vapour permeability for the tested material. The inverted-cup method is mostly used on concrete, mortar, road materials and membrane materials on concrete.

### 5) Micro-calorimeter for pore structure characterization in hardened cement paste

The technique is based on the fact that freezing point depression of water or other adsorbates in a microporous material increases as the pore size decreases. The biggest advantage of this technique is that measurements can be carried out on virgin water saturated specimens.

**How to keep coated wood-structures dry enough to avoid rot problems**

**Abstract**

During the last ten years new types of wood rot problems have occurred in Scandinavia. Thousands of houses have been damaged by wood rot attaching the exterior wooden panel. We have been working with the problem since 1987 in order to find out what have caused the problems.

In field tests the moisture conditions have been measured in panels painted in different ways. The influence of the panel structure and end-grain sealing has also been studied. The results from these tests show a large difference in moisture balance between panels painted with different coatings.

In laboratory tests the water vapour transmission through paint films has been measured with a modified cup method which provides more realistic conditions for coated wood than the common one. One interesting observation from our studies is that latex paints seem to be much more permeable at high relative humidities than earlier research has shown.

  
Stefan Hjort

I tidigare försök med momentmetoden mäts fukttransporten mellan två halvor med olika fukthalt. I detta beskrivna försök mäts fukttransporten från en vattenmättad ändyta in i provet.

Utförande:

Provkroppen av gran lades upp på upplag och våg för momentmetoden. En avfettad glasplatta, med en skåra som var förbunden med ett tunt glaströr, vättes samtidigt med provets ändyta. Glasröret mynnade med en skål med vatten. Glasplattan pressades mot provet samtidigt som luft sögs ut från spaltens översida. Kapillärkontakt var nu etablerad mellan skålen och provets hela ändyta och momentförsöket startades.

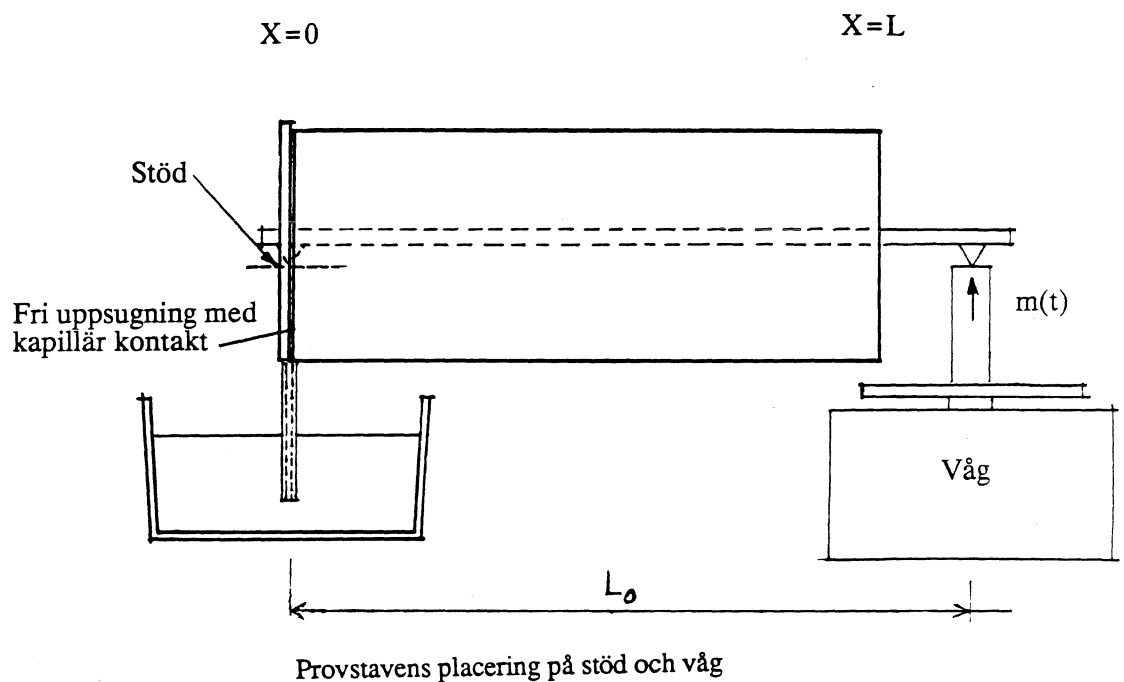

Provets uppsugande yta är placerad i samma vertikalplan som det vänstra stödet så att det uppsugna vattnet inte ger momenttillskott. Endast fukttransporten i materialet ger moment.

#### Härledning av grundsamband

Givet en stav med tvärsnitt  $A \text{ m}^2$  innesluten i en fuktät behållare. Stavens längd är  $L$  och den är upplagd på två stöd, varav det ena är placerat på en våg så att reaktionen (vikten)  $m(t) \text{ kg}$  kan mätas.

Det endimensionella fuktflödet längs staven ges av:

$$g = -D_w \frac{\partial w}{\partial x}$$

där

$$g = \text{fukttransporten, kg/m}^2\text{,s}$$

$$D_w = \text{diffusiviteten, m}^2\text{/s}$$

Fuktflödet  $g$  är det totala flödet, dvs både diffusion och kapillärtransport. Fukthalten  $w(x,t)$  uppfyller diffusionsekvationen:

$$\frac{\partial w}{\partial t} = \frac{\partial}{\partial x} \left( D_w(w) \frac{\partial w}{\partial x} \right)$$

Vikten vid högra stödet  $m(t)$ , kg, kommer att förändras på grund av fukttransporten

$$\frac{dm}{dt} = \frac{d}{dt} \{m(t) - m(0)\}$$

Om vi ställer upp en momentekvation kring det vänstra stödet får vi

$$\begin{aligned} \frac{dm}{dt} &= \frac{d}{dt} \{m(t) - m(0)\} = \frac{d}{dt} \left\{ \frac{A}{L_0} \int_0^L x (w(x,t) - w(x,0)) dx \right\} = \\ &= \frac{A}{L_0} \int_0^L x \frac{\partial w(x,t)}{\partial t} dx = \frac{A}{L_0} \int_0^L x \frac{\partial}{\partial x} \left( D_w \frac{\partial w}{\partial x} \right) dx = \\ &= \frac{A}{L_0} \left\{ \left[ x D_w \frac{\partial w}{\partial x} \right]_{x=0}^{x=L} - \int_0^L 1 D_w(w) \frac{\partial w}{\partial x} dx \right\} = \frac{A}{L_0} \int_{w(0,t)}^{w(L,t)} D_w(w') dw' \end{aligned}$$

Vi har följande helt exakta formel:

$$\frac{dm}{dt} = \frac{A}{L_0} \cdot \int_{w(0,t)}^{w(L,t)} D_w(w') dw'$$

Speciellt blir  $dm/dt$  konstant, om fukthalterna  $w(L,t)$  och  $w(0,t)$  i stavens båda ändar är konstanta.

Fukttransporten kan också beskrivas med den s k fundamentalpotentialen  $\psi$ ,  
Fuktflödet  $g$  ges av:

$$g = - \frac{\partial \psi}{\partial x}$$

Mellan  $\psi$  och  $D_w$  råder följande samband:

$$\psi = \int_{w_{ref}}^w D_w(w) dw \Rightarrow \psi_1 - \psi_2 = \tilde{D}_w(w_1 - w_2)$$

Provet är konditionerat till  $w_{initial}$  och den vänstra randen hålls konstant vid  $w_{kapillär}$ .  
För korta tider gäller då:

$$\frac{L_0}{A} \frac{dm}{dt} = \frac{A}{L_0} \int_{w_{initial}}^{w_{kapillär}} D_w(w') dw' = \psi_{initial}^{kapillär}$$

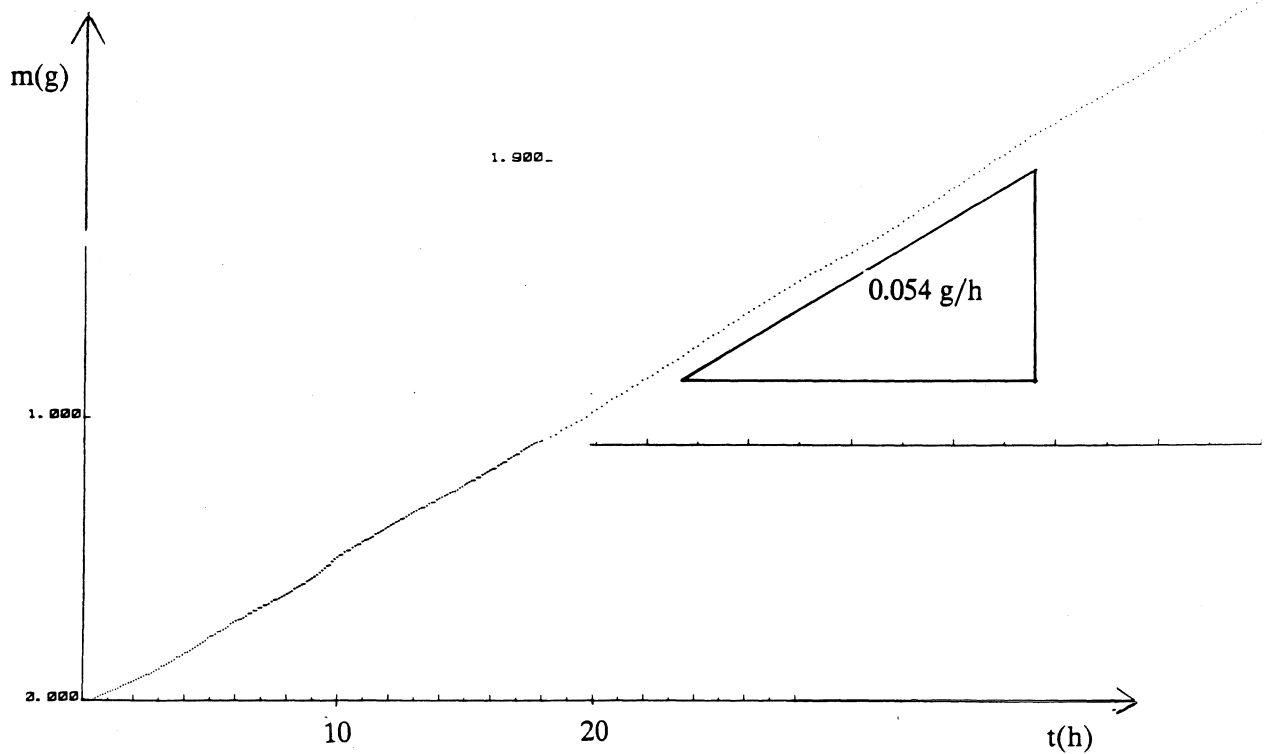

Från momentförsöket fås (initialvärde  $\varphi=0.40$ )

$$\frac{dm}{dt} = \frac{0.054 \cdot 10^{-3}}{3600} = \frac{0.092 \cdot 0,044}{0.20} \quad \Psi_{\varphi=0.40}^{\text{kapillärm.}}$$

$$\Psi_{\varphi=0.40}^{\text{kapillärm.}} = 7.4 \cdot 10^{-7} \frac{\text{kg}}{\text{m} \cdot \text{s}}$$

Från tidigare momentförsök på gran i det hygroskopiska området har erhållits:

$$\Psi_{\varphi=0.40}^{\varphi=0.70} + \Psi_{\varphi=0.70}^{\varphi=0.90} + \Psi_{\varphi=0.90}^{\varphi=0.95} = \Psi_{0.40}^{\varphi=0.95}$$

$$0.48 \cdot 10^{-7} + 0.64 \cdot 10^{-7} + 0.20 \cdot 10^{-7} = 1.32 \cdot 10^{-7} \frac{\text{kg}}{\text{m} \cdot \text{s}}$$

Subtraheras värdet från kapillärförsöket från värdena erhållna i det hygroskopiska området erhålls:

$$\Psi_{\varphi=0.95}^{\text{kapillärm.}} = 7.4 \cdot 10^{-7} - 1.32 \cdot 10^{-7} \frac{\text{kg}}{\text{m} \cdot \text{s}}$$

PERMEABLE MATERIAL

$$Q_v = \frac{B_0}{A} \cdot \frac{\Delta P}{L}$$

DUCT, CRACK

$$\Delta P = \lambda \cdot \frac{L}{d_H} \cdot \frac{\rho u^2}{2}$$

$$\lambda = \lambda(Re, \epsilon/d_H)$$

$$Re = \frac{u \cdot d_H}{\nu}$$

LAMINAR FLOW  $\Rightarrow \lambda = 96/Re$

$$\Delta P = \frac{12 \cdot u \cdot L \cdot \eta}{k^2}$$

SINGLE RESISTANCES

(ENTRANCES, EXITS, BENDS, SECTION AREA CHANGES)

$$\Delta P_s = \int_s \frac{\rho u^2}{2}$$

POWER LAW FORMULATION

(LABORATORIES OR FIELD TEST RESULTS BUILDING COMPONENTS)

$$q_v = k \Delta P^n$$

PARALLEL FLOW

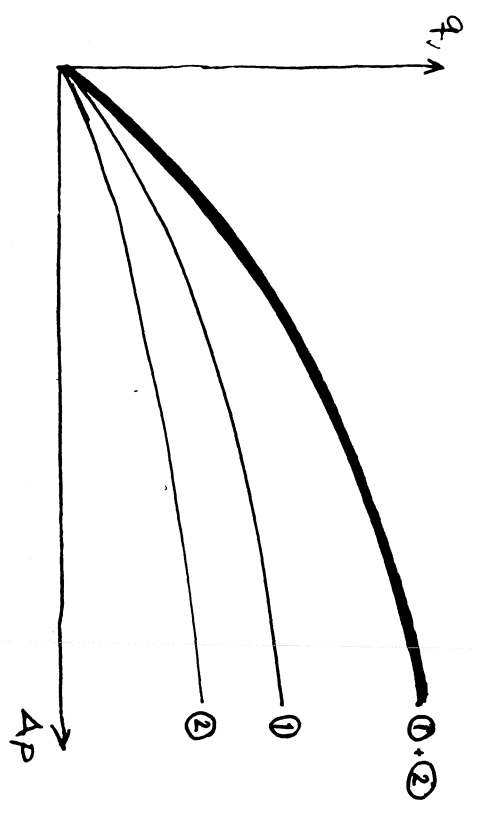

SERIES FLOW

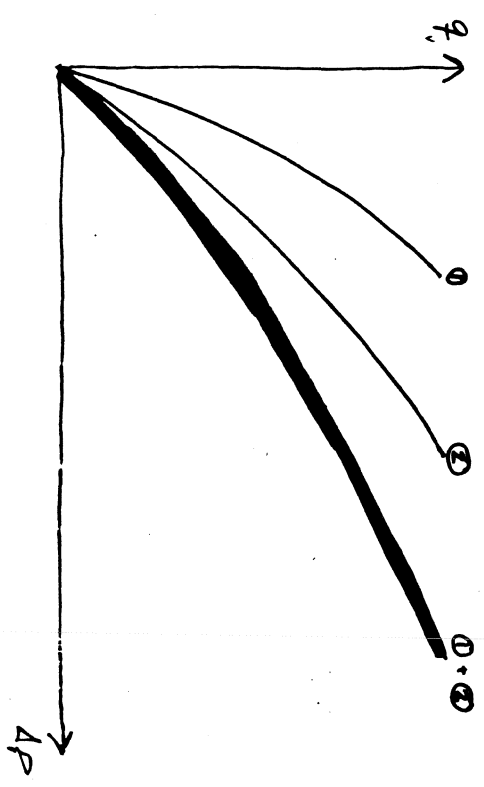



## NETWORK ANALYSES

Johnny Kronva 11 2/3

- JKCIROCS
    - PERMEABLE MATERIALS
    - CRACK & DUCT FLOW
    - SINGLE RESISTANCES
    - POWER LAW FORMULATION ( $q_i = a \cdot \Delta p^b$ )
  - A NUMBER OF MULTIZONE INFILTRATION AND VENTILATION PROGRAMS
    - "MOVECOMP"
    - "OMIS"
    - "BEBEZE"
- GENERALLY THEY REQUIRE A POWER LAW FORMULATION OF THE LEAKAGES

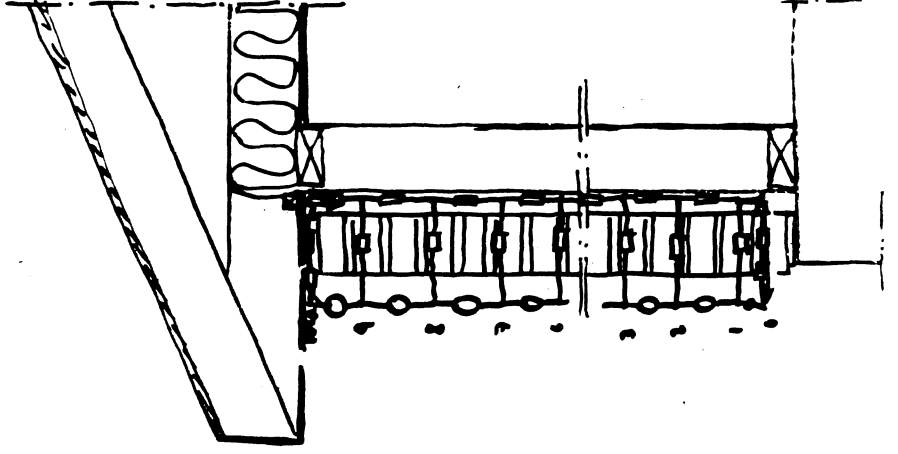
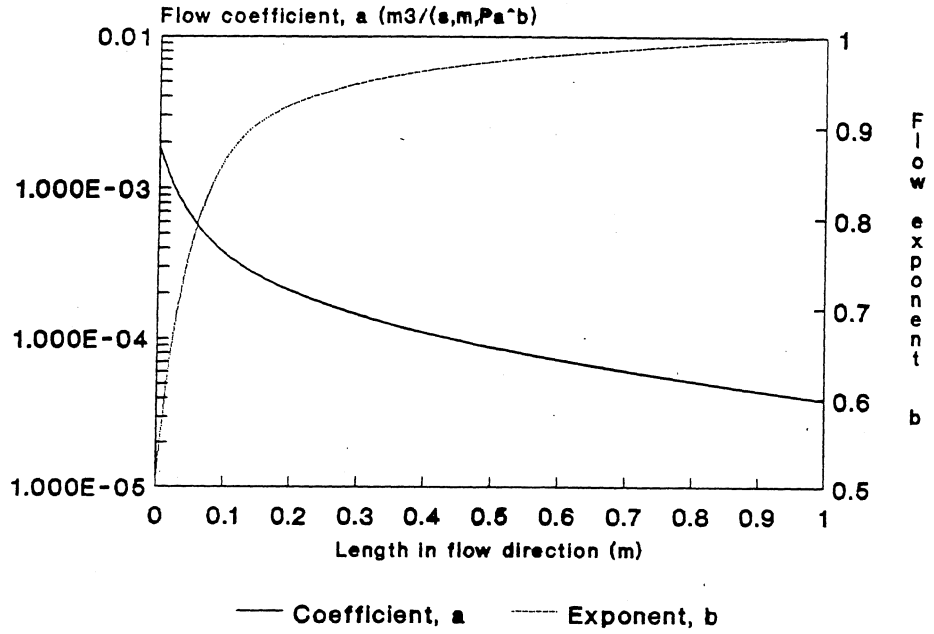

Fig. 1

### CRACK WIDTH 2 mm



2(3)

Fig. 2

### CORRECTION COEFFICIENT

Crack width 2 mm

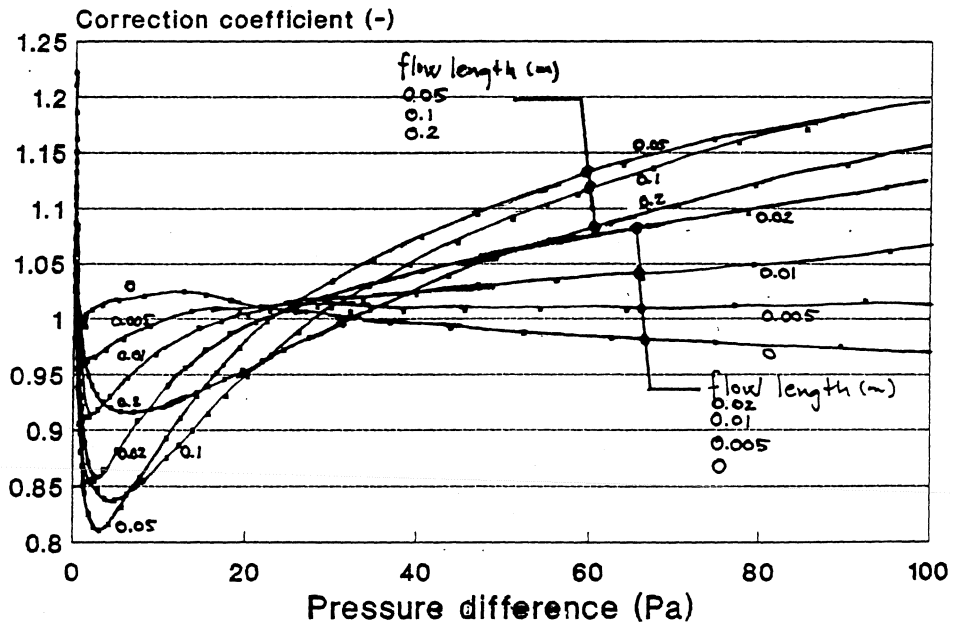

3(3)



Hartwig Künzel

**Fraunhofer-Institut für Bauphysik**  
**Bereich Wärme / Klima**

Institutsleiter: Univ.-Prof. Dr. Dr. h. c. Karl A. Gertis

Amtlich anerkannte Prüfstelle für die Zulassung neuer Baustoffe, Bauteile und Bauarten · Forschung, Prüfung und Beratung auf dem Gebiet der Bauphysik

**Calculation and Measurement**

**of Moisture Transfer in Building Physics**

Dipl.-Ing. Hartwig Künzel

## 1. Measurements of material properties in the laboratory

### 1.1 Vapour diffusion resistance ( $\mu$ -value)

- Standard cup method (DIN 52 615)

dry cup 23°C 3 - 50 % R.H.

wet cup 23°C 50 - 93 % R.H.

different ranges of rel. humidity for the determination of  $\mu = f(\varphi)$

- Transient method

Determination of the vapour resistance from a sorption experiment applicable to hygroscopic and homogenous materials

- Vapour diffusion due to temperature gradients

Similar to cup method with the possibility to study the influence of a temperature gradient on the diffusion resistance. Determination of  $\mu = f(p_{H_2O}, \varphi, \vartheta)$ . Experimental set-up see figure below.

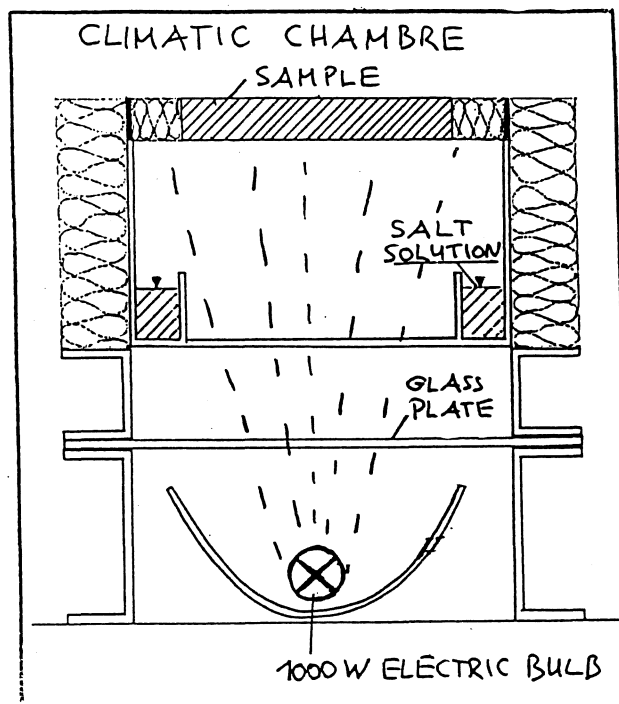

### 1.2 Sorption and water storage capacities

- Vapour sorption depending on relative humidity and temperature
- Measurement of interior surfaces with nitrogen adsorption (BET)
- Total porosity through water absorption and He-pycnometry
- Pore-size distribution with Hg-porosimetry
- Pore size distribution with pressure dehumidification

This method is especially important for the determination of the moisture equilibrium of wet building materials (R.H. > 95 %). The results can be transformed into a continuation of the hygroscopic curve for high water contents. Experimental equipment see figure below.

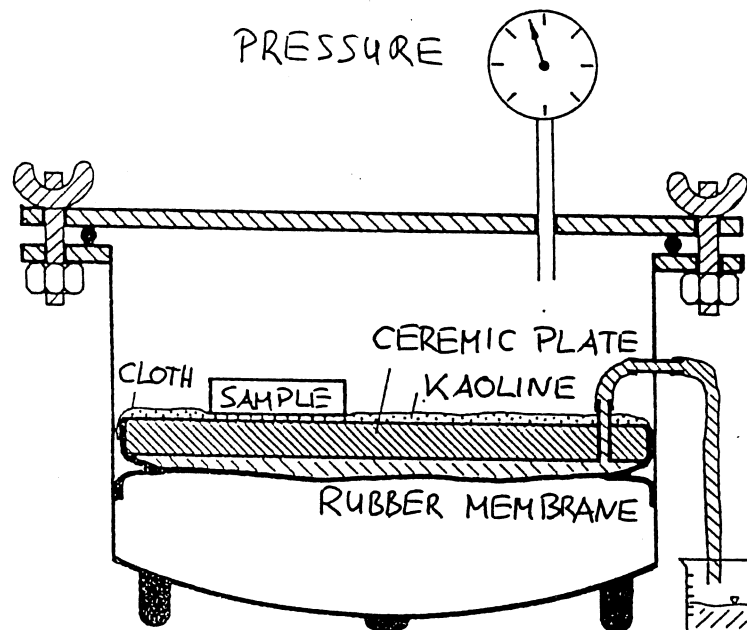

### 1.3 Capillary moisture transport

- Standard water absorption (w-value) DIN 52 617
- Continuous measurement of water uptake in order to determine inhomogeneities of material or for very absorptive material
- Determination of moisture distribution with NMR  
Signal of NMR is proportional to proton concentration in material.  
NMR-equipment see figure below.

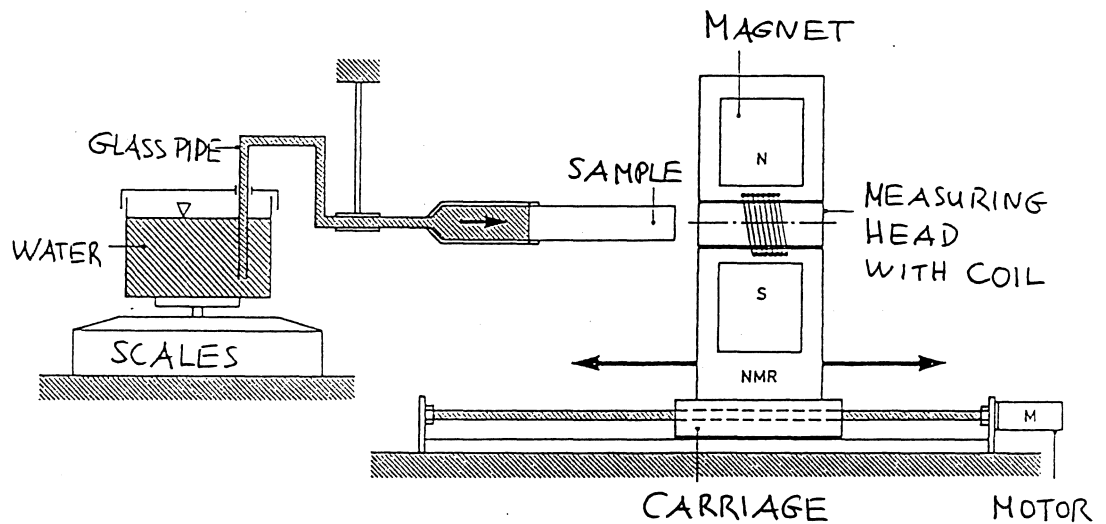



## 2. Field studies at the institute

- 2.1 Total exposure of building parts to bavarian climate with continuous measurement of water uptake, surface temperatures and meterological data.
- 2.2 Installation of building parts in testbuilding with west or east orientation and measurement as above with discontinuous measurement of water uptake.

## 3. Calculation of heat and moisture transport

- 3.1 1-dimensional (Diss. KieBl)  
Basic equations and calculation examples  
- see appendix
- 3.2 2-dimensional isothermal moisture transport
- 3.3 Simple steady state calculation (Glaser-method)

Annika Mårtensson

Desired results from moisture calculations,  
aspects from a mechanical point of view.

Annika Mårtensson, Dep. of Structural Engineering, Lund University

Within the field of wood mechanics it is very important to consider the moisture dependence of the mechanical parameters. Not only is there an effect on the absolute values of the mechanical parameters, but also an effect of moisture variations in combination with mechanical loading. The latter can for instance give rise to a significant increase in deformations in a wooden beam compared to what happens in constant humidity. The effect of drying on timber quality is also of interest, timber can be deformed and undesired cracks can occur due to dimensional changes and development of internal stresses induced by moisture variations within the wood during drying. Ongoing research at the department of Structural Engineering in Lund deals with these problems. The work is, however, restricted to testing of the mechanical behaviour and constitutive modelling concerning stress-strain relationships.

Calculations based on the derived models use information about moisture distribution in the studied structures as an input and the accuracy of the simulation results is thereby dependent on the accuracy of the moisture description. This means that there is a great interest from the mechanical researcher to get a good description of the moisture distribution in wood and the changes in moisture content with time. The interesting moisture content range is of two types: for ordinary structures in buildings, i.e. normally m.c. corresponding to 40-90% RH, and for drying conditions, i.e. from green wood to a m.c. at 10%. When it concerns drying it is also of importance to consider the effects of temperatures up to 60-80°C.

One aim with the research at the department of Structural Engineering is to be able to predict the behaviour of wooden structures subjected to moisture changes. It is of course also of interest to be able to show how to reduce undesired effects of high moisture contents or variations in moisture contents. Therefore it is also of interest to gain knowledge about what effects different types of coatings or impregnations have on moisture transport in wooden materials.

ANKER NIELSEN



## **Sivilingeniørutdanningen i Narvik**

Postboks 385 • 8301 Narvik • Telefon (+47 82) 44130 • Fax (+47 82) 44966

Nordisk forskarsymposium  
Beräkning av fukttransport och mätning av nödvändiga materialdata  
28-29 januari 1991 YSTAD

### **Moisture transport and measuring methods**

Research in moisture problems at Narvik Institute of Technology has not started. We will use computer models on old measurements of free-water intake made at the Thermal Insulation Laboratory in Copenhagen.

The measurements of moisture content was made with gamma-equipment as described in : Gamma-Ray-Attenuation used for Measuring the Moisture Content and Homogeneity of Porous Concrete, Anker Nielsen, Build. Sci. Vol 7, pp 257-263 and later publications.

An microprocessor-based measuring system has given many measurements of free-water intake in bricks, cellular concrete and limestone. The results has been used for calculation of the moisture diffusivity. This has until now been based on averaging of the moisture curves. We will try to use new methods, where we use statistical methods to get better information. The problem is that small variations in moisture distributions gives large variations in moisture diffusivity. This is seen on the next page. The upper figure gives 5 different diffusivity curves and the lower figure the calculated moisture distributions. To go from moisture distribution curves to moisture diffusivity curves is not easy, because real curves also has errors of different types.

The figures come from report: Fuktteknisk dimensjonering med statistikk, Anker Nielsen, BFR R89-1987.

The education in building physics use computers with spreadsheet programs (EXCEL running under Windows 3.0) on different problems. As an examples is shown calculations of diffusion in a wall. The method has been described in: Use of personal computers for moisture calculations, Anker Nielsen, Symposium and day of building physics, BFR D13-1988, page182-186.

ANKER NIELSEN

M<sup>2</sup>/s

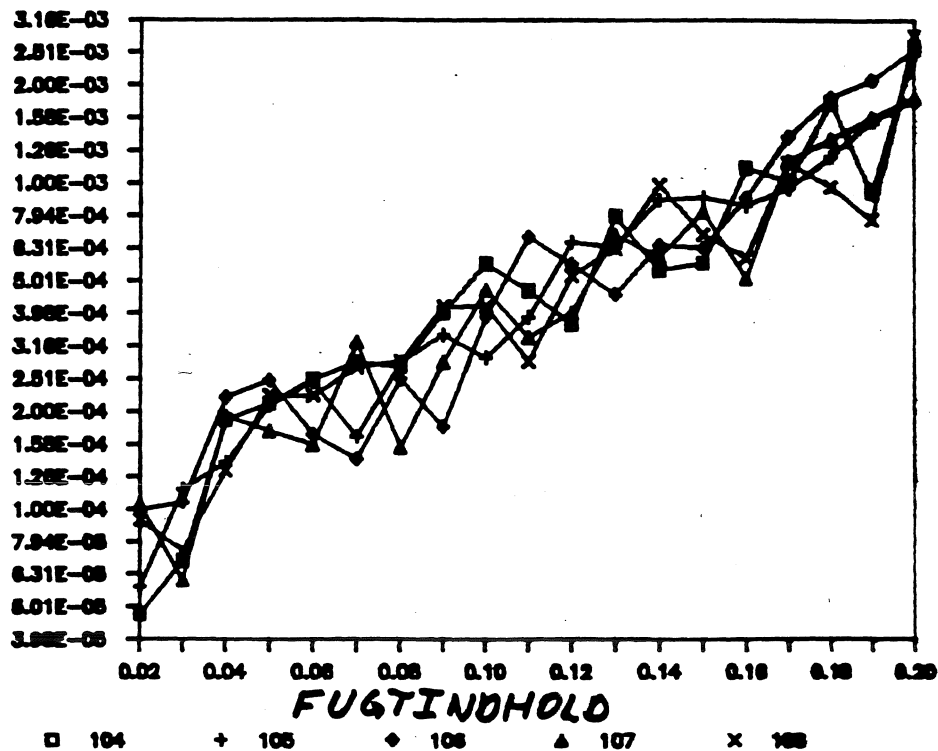

M

FUGTFORDELINGER EFTER 24 TIMER

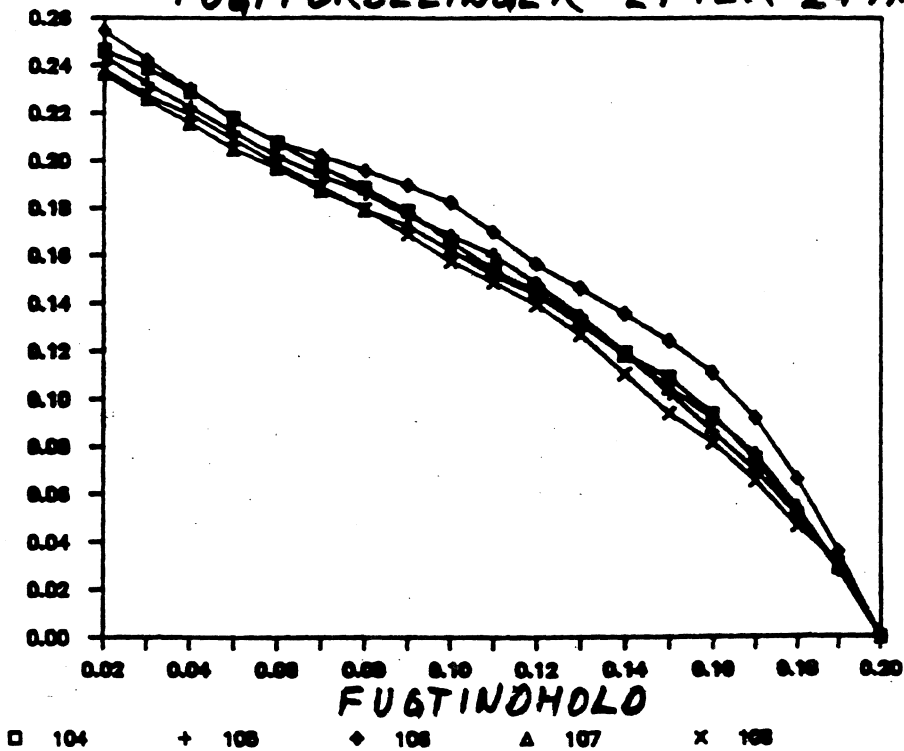

F10: (F1) +\$E10/\$E\$16\*(\$G\$15-\$G\$5)

SHEET

	A	B	C	D	E	F	G	H	I
1	Norwegian Building Research Institute							Month no 1	
2	-----								
3	No layer	Thick.	lambda	h-resist	dt	temp.	sat-conc	diff.	
4		m	W/mC	m2C/W	C	C	kg/m3	m2/s	
5						-3.2	0.004		
6	1 Outdoor			0.04	0.3				
7						-2.9	0.004		
8	2 Bricks	0.110	0.770	0.14	1.0			4.00E-06	
9						-1.9	0.004		
10	3 Min.wool	0.100	0.039	2.56	18.1			1.75E-05	
11						16.3	0.014		
12	4 Cel.concr	0.070	0.175	0.40	2.8			2.70E-06	
13						19.1	0.016		
14	5 Indoor			0.13	0.9				
15						20.0	0.017		
16			sum	3.28	23.2				
17									
18	Period:	Month	Place:	Trondheim					
19						Normal calculation			
20	No I.temp	M.prod	O.temp	O.fugt	P.length	M.inside	M.outside	Condens	

ANKER

13/08/87 09:21

Norwegian Building Research Institute  
Month no 1

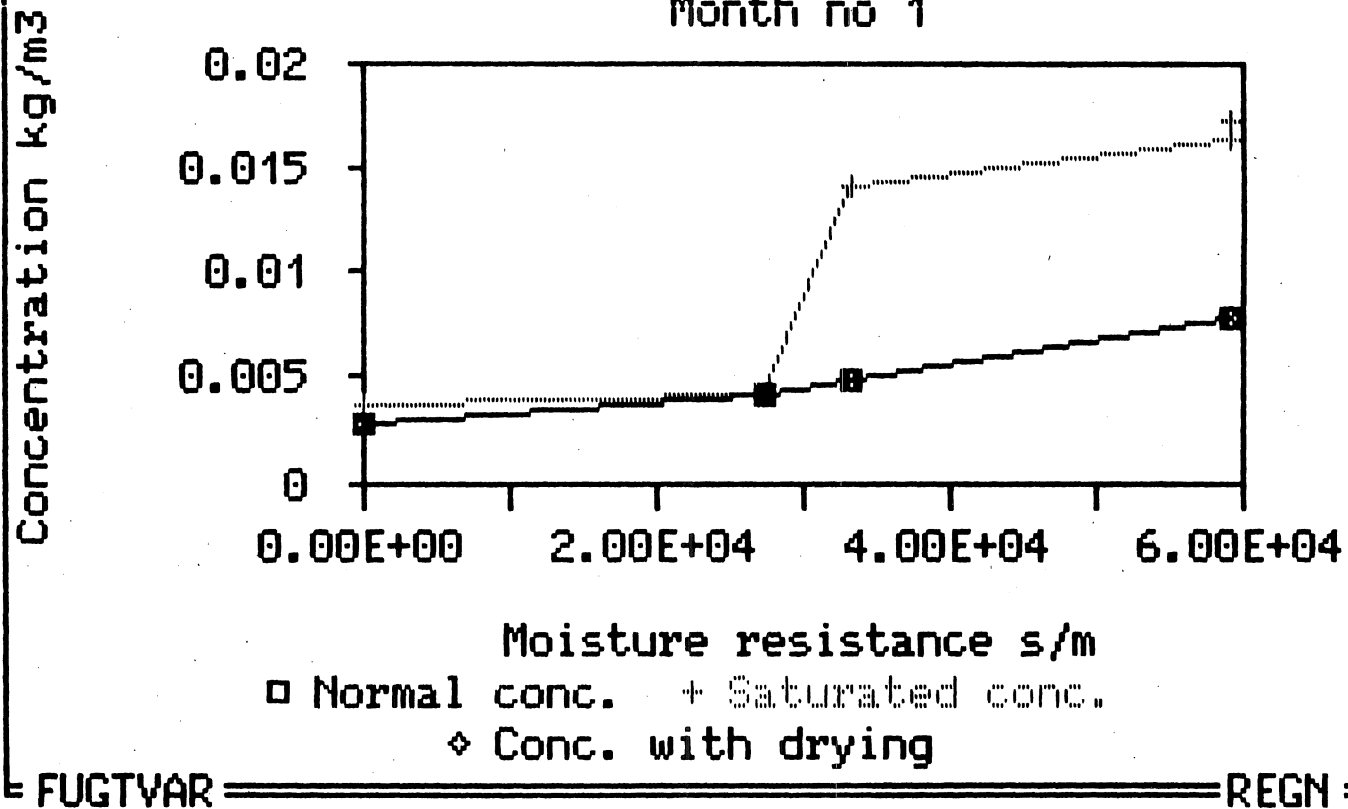

## RESEARCH OF HEAT, AIR AND MOISTURE TRANSPORT IN BUILDING ENVELOPES

In the Laboratory of Heating and Ventilation the research in the field of building physics has concentrated mainly on modelling of heat, air and moisture transport phenomena, determination of material properties and on numerical analysis of the hygrothermal behaviour of building structures. Laboratory scale experiments with structures are mostly done for verification of the models. Some standard testing facilities are also available. Full scale tests can also be done, for example, in VTT test houses.

### CALCULATION MODELS

The development of the calculation models is still going on. The calculation models (TCCC2D and TRATMO2) can now solve the hygrothermal behaviour of 2-dimensional, multilayer structures with transient boundary conditions. Structures with air convection (natural, forced, in- and exfiltration), moisture transport (capillar and/or diffusive and convective) and the thermal effects of phase changes (moisture and in general using phase-change materials) can be solved. Weather data including the temperature, relative humidity, solar radiation and driving rain can be given as boundary conditions. The latest versions can also analyse the thermal behaviour of structures with transparent thermal insulations and air gaps (closed or 'active').

### ONGOING PROJECTS

**"Development of simulation models for structures of the building envelope".**

Sponsored by The Ministry of Trade and Industry, Finland, under the research programme "Energy-efficient buildings and building components".

Goals: \* Further develop the existing models. New moduls and more efficient and user-friendly codes. New moduls are:

- latent and radiative heat transfer in material
- air convection in cracks and enclosures in structures
- effect of transparent thermal insulation

\* Application package, which includes criteria for the hygrothermal behaviour of typical wall structures. This data is based mainly on numerical simulation and also on measurements made for verification of the models.

Co-operation with the Institute for Research in Construction, NRC Canada.  
(Material properties, model verification, applications).



Carsten Rode Pedersen

**Carsten Rode Pedersen, Thermal Insulation Laboratory, Technical University of Denmark, Building 118, DK-2800 Lyngby, Denmark, ☎ +45 45 93 12 22 › 1851, fax +45 45 93 17 55.**

**Recent and current activities (January 1991).**

Ph.D. Project Feb. 1987 - Feb 1990.

Development of MATCH - a PC-program for combined heat and moisture transport (see separate page).

Experimental investigations with the Hygro Diode Membrane. Various field tests. Report 217 (to be printed).

Experiments on heat transfer in moist roofs and on downward drying in a "Large Scale Climate Simulator" at the Roof Research Center of Oak Ridge National Laboratory, TN, USA (May through Nov. 1989).

Reports of interest for this meeting:

"Koblet fugt- og varmetransport i bygningskonstruktioner - fugtfysik", rapport 89-2, april 1989.

Thesis: "Combined Heat and Moisture Transfer in Building Constructions", Report 214, Sept. 1990.

Summer 1990

Employed by "Bygge- & Miljøteknik a/s". The company now markets a user friendly version of MATCH.

Post Doc. Sept. 1990 - Aug. 1993

Models for multidimensional Heat, Air and Moisture transfer. Possible connection with a CAD system. Possible participation in the new IEA Annex 24 on HAM-transfer.

Small Current Projects

Various calculations using MATCH and related code (Continuously). One project compares calculation results with measurements in non-vented low slope roofing cassettes (July 1990 - 1992).

Inverse Heat Conduction problems (Study group Fall 1988). Program for estimation of heat transfer coefficients in casting processes (Jan. 1991).

Model for room moisture balance. Simple model available which takes the thermal conditions from a SUNCODE calculation (Jan. 1991).

## **MATCH - Computer Program for Calculation of Combined Heat and Moisture Transfer.**

Carsten Rode Pedersen, Thermal Insulation Laboratory, Technical University of Denmark, Building 118, DK-2800 Lyngby, Denmark, ☎ +45 45 93 12 22 📍 1851, fax +45 45 93 17 55.

**MATCH (Moisture and Temperature Calculations for Constructions of Hygroscopic Materials)** calculates combined heat and moisture transfer through composite constructions. Both the temperature and moisture profiles are calculated transiently thus considering not only the thermal capacity but also the very important hygrothermal capacity.

The program uses a 1-D finite control volume method. The potentials used for the moisture calculation are the vapour and suction pressures. The advantage using such a set of driving potentials is that they go continuously over material interfaces. This would not be the case if the moisture content were used as potential. To perform a MATCH calculation it is necessary to know the thermal properties, the vapour permeability, the hydraulic conductivity, the sorption ( $u - RH$ ) and the suction ( $u - P_{suc}$ ) curves for the materials. A file with some or all of these properties for most building materials is called from the MATCH preprocessor. The liquid moisture transport may be held out of the calculation if for instance the material properties are not available or if the liquid transport is considered to play only a negligible role.

Boundary conditions for the outer surface are taken from the test reference year comprising such values as outdoor temperature and humidity, solar irradiance and wind speed. Alternatively, outdoor surface temperature and humidity may be read from a file. Indoor conditions are specified month by month or read from file.

A special scheme was devised for the calculation procedure. In order to use the interval of the test reference year (1 hour) as the time step for the calculations it was desired to use an implicit scheme. However, since the moisture capacity is non-constant such a scheme would not ensure the fulfillment of the mass balance. Instead, intermediate new vapour pressures are calculated in an implicit way using the old liquid pressures in an explicitly calculated source term for the liquid flux. Similarly, intermediate new suction pressures are calculated implicitly with an explicit source term from the vapour flux. The intermediate pressures are used in the transport equation to calculate fluxes for the mass balance. The moisture content that results from this operation may now give the final new vapour pressures (using the sorption isotherm).

$P_{suc}$  may easily vary several decades when the moisture content changes. Therefore, a new formulation of Darcy's law is used in which the suction pressure has been substituted by its natural logarithm and the hydraulic conductivity has been replaced by the hydraulic conductivity multiplied by the suction pressure.

The latent heat of vapour that condenses in the control volumes may be taken into account.

An empirical method has been invented to simulate hysteresis in the moisture retention curves.

The program was originally developed as a part of the Ph.D. study for the author. Since then it has been rewritten into a commercial version which features an approach to user friendliness. It is the intention that the model should be as easy to use and not require more skills of the user than performing a traditional moisture calculation with the Glaser method. It is the hope that the introduction among practitioners of a transient method for moisture calculation will improve the level at which moisture dimensioning takes place.

Frank Lynge, Thermal Insulation Lab., Techn. Univ. of Denmark

presented by Carsten Rode Pedersen

Paper to Nordic Research Symposium,  
Ystad, Sweden 28.-29. January.

Problems in determining the vapour resistance of the Hygro-Diode-Membrane.

On the Thermal Insulation Laboratory at the Danish Technical University, three different tests are made to determine the vapour-resistance (Z-value) of the Hygro-Diode membrane.

A brief description of the three tests:

**A:** A traditional cup test. The area of the rectangular cup is  $0.5 \text{ m}^2$ . The depth is  $0.1 \text{ m}$ . The Hygro-Diode is fastened with tape along the edge.

**B:** A "bag-test". A bag is made out of  $2 \text{ m}^2$  Hygro-Diode membrane. The Hygro-Diode is folded to form a bag, which is sealed with tape along the three edges. Inside the bag is placed an aluminium cross to keep the two sides apart. During the measuring periods the bag is standing with air on both sides.

**C:** A "cylinder-test". A cylinder stretched of Hygro-Diode make the third test. The cylinder is  $0.95 \text{ m}$  high and the diameter is  $0.24 \text{ m}$ . The area of Hygro-Diode makes  $0.72 \text{ m}^2$ . The top and bottom is made by caps of aluminium.

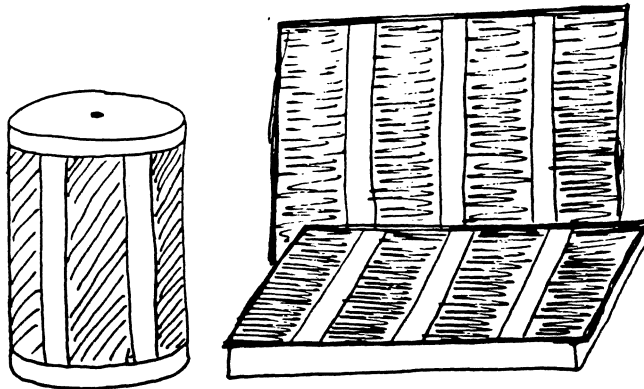

Inside the cups and bags are placed portions of silicagel to accumulate the moisture and keep the air dry. A measuring of the relative humidity inside shows  $\text{RH}=7-13\%$ . The following results of the vapour resistance are based on calculations with  $10\% \text{ RH}$ .

The air in the room is constant at  $20^\circ\text{C}$  and  $\text{RH} = 54\%$ .

### Results

The calculation of vapour resistans in the three tests are as follows:

	MIN	MIDDEL	MAX	REPETATIONS
A: Cup-test :	33	39	51	3
B: Bag-test :	81	99	119	4
C: Cylinder-test :	-	79	-	1

Question: Why do they differ so much ?



ROYAL  
INSTITUTE OF  
TECHNOLOGY

Liu Tong

Date: January, 16, 1991

Name: Liu Tong  
Status: Researcher  
Address: Division of Building Materials  
The Royal institute of Technology  
100 44 Stockholm, Sweden

Research fields:

**1). Moisture transport on wood and wood based materials**

We have made systematic measurement of moisture diffusion coefficients of Swedish spruce and pine. The measurement were carried out with cup method on samples prepared from trees felled in north, middle and south Sweden at several levels of relative humidity and temperature. In addition I have also made some theoretical analyses and model simulations of moisture transport properties in wood. Right now I am analyzing moisture migration and distribution in some typical wooden building structures in houses under various environment conditions, with numerical method by using the experimental measured diffusion coefficient.

**2). Viscoelastic properties of wood material**

We have made some theoretical and experimental studies on the viscoelastic behaviour of wood. Special attention of our research in this field is paid to the nonlinear behaviour of wood creep when mechanical loads increase from small value to relatively large, not far from the short-term ultimate strength, and the mechano-sorptive effect under changing air moisture conditions. Experiment is being performed now, and their evaluation as well as applications will be made after the experimental work.

(Prepared for Nordisk forskarsymposium: Beräkning av forkttransport och mätning av nödvändiga materialdata, to be held in 28-29 January, Ystad, Sweden )



Dr. Liu Tong  
Division of Building Materials  
Royal Institute of Technology  
100 44, Stockholm  
Sweden

Visiting address:  
Brinellvägen 34  
KTH  
(near Öststation)  
Stockholm

Telephone  
Day : 08-7908753  
Night: 08-7684672  
Int +46 8 7908753

Telegram  
Technology  
Telefax  
+ 46 8 205135

Electronic mail  
Tong@KTH.se

Östra station

## Non-equilibrium vapour flow measurements

I am making measurements of vapour flow in wood and wood based materials. The method I use is well known: I measure the weight change in a sample after I have changed the relative humidity around the sample. The sample should be in equilibrium with an old relative humidity before I make the step change to a new relative humidity.

The measurements are made in an apparatus specially developed for the purpose. It holds 120 samples at a constant temperature of  $23 \pm 0,1^\circ C$ , and a air velocity of  $3m/s$ . The relative humidity is controlled with a large area ( $> 1m^2$ ) of saturated salt solutions.

The apparatus has been running since the summer of 1990. I plan to use the following relative humidities (January 1991 I have come to the underlined relative humidity):

$\approx 50\% \rightarrow 33\% \rightarrow 54\% \rightarrow \underline{75\%} \rightarrow 85\% \rightarrow 94\% \rightarrow 85\% \rightarrow 75\% \rightarrow 54\% \rightarrow 33\% \rightarrow 54\% \rightarrow 75\%$

After this (which will take up to 2 years) I will try to check the moisture profiles of the samples while they are undergoing sorption.

The goals of my work are to

- do accurate measurements
- make a complete error analysis of the method and the measurements
- compare my measurements with steady-state cup measurements
- look for phenomena which are not accounted for by the normal theories

Lars Wadsö  
Div of Building Materials  
Lund Technical Institute  
Box 118  
S-221 00 LUND  
Sweden

## A new way to measure surface resistance to moisture flow

We have tested a new method to measure the surface resistance, which is both simple and fast. In short we try to measure the flow into a sample (equilibrated to an old RH) at time=0, when we put it into a new RH. According to the simple theory the flow at time=0 is governed only by the difference in RH and the surface resistance.

It is of course not easy to measure at time=0. We have therefore tried to evaluate the surface resistance by two methods:

- We try to find the slope of the weight(time)-curve, which equals the flow.
- We compare the weight(time)-curve to a set of simulated curves for different surface resistances.

These two methods gave approximately the same answers.

So far we have only evaluated the measurements which were made at a very low air velocity (only room convection, no forced air flow). Our measured result was  $Z_v = 1/\beta = 1200 - 3000 \text{ s/m}$ . This is a much higher resistance than Choong et al ( $70 - 300 \text{ s/m}$ ), but lower than Rosen and others ( $\approx 10000 \text{ s/m}$ ). It is however hard to draw any conclusions from this as the surface resistance should be highly dependent on air velocity, and different researchers have used different air velocities. Lewis law for an air velocity of  $0,1 \text{ m/s}$  would give approximately  $1000 \text{ s/m}$ .

The method seems to be working, but we have not evaluated all the measurements yet.

The measurement and analysis was performed by Yasmin Chohan and is published as "Surface resistance to moisture flow" (in swedish), TVBM-5017, Div of Building materials, Lund).

Lars Wadsö  
Div of Building Materials  
Lund Technical Institute  
Box 118  
S-221 00 LUND  
Sweden



Before coming to the meeting the participants were asked to try to "solve" four testcases. On the following pages are some of the solutions. In all four cases the solutions from the different participants were very similar (more similar than we would have thought).

## Testcase 1

How much does a piece of spruce increase in weight if its end grain is exposed to free liquid water for two hours? The exposed area is 93x44 mm, it is very long in the other direction, the dry density is 435  $kg/m^3$ , and it has been equilibrated with 60%RH/20°C.

Lars Wadsö (who wrote this problem) found no usable data, and had therefore to rely only on a measurement. This gave the result 5,5g and 5,8g for two pieces of wood from the same board.

**CASE #1**

**SPRUCE**

**WATER ABSORPTION ALONG THE WOOD GRAIN**

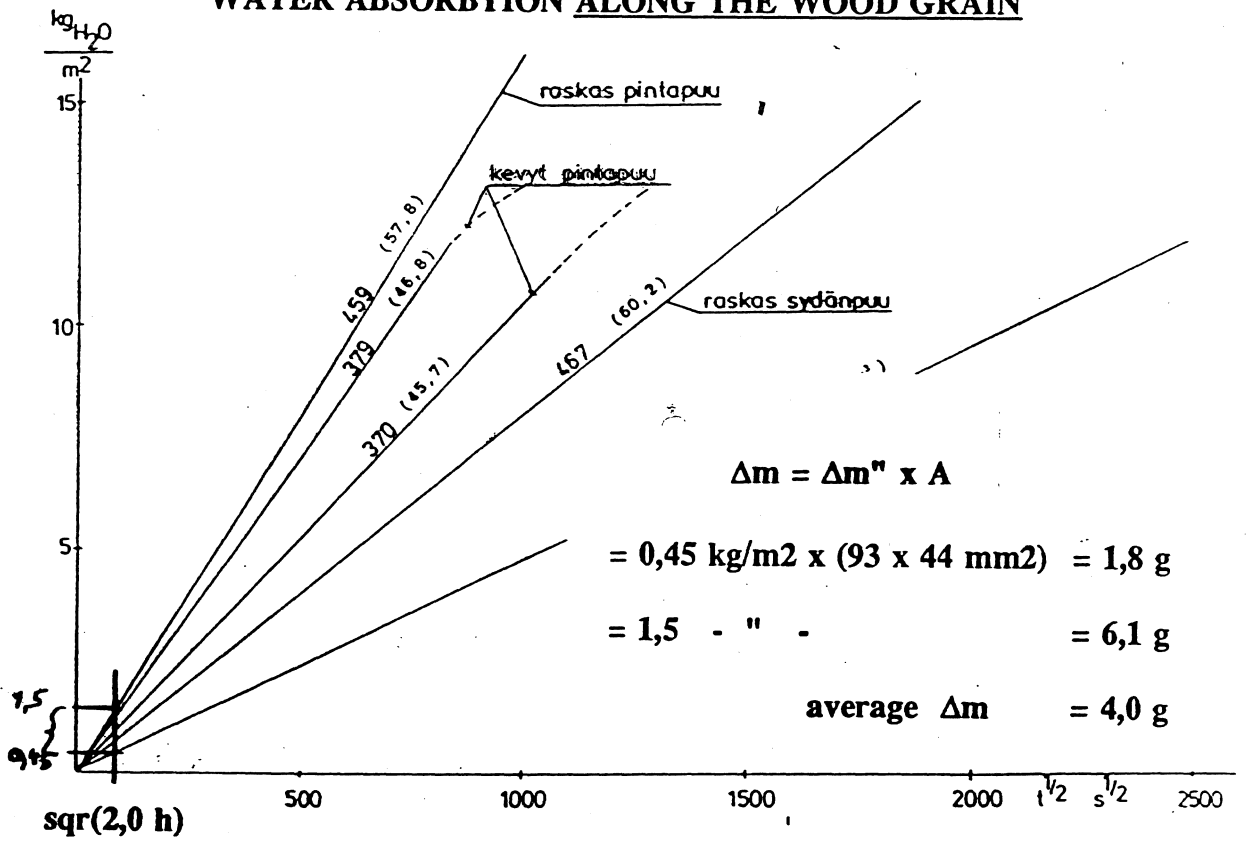

**CASE #1**

**SPRUCE**

**WATER ABSORPTION AGAINST THE WOOD GRAIN**

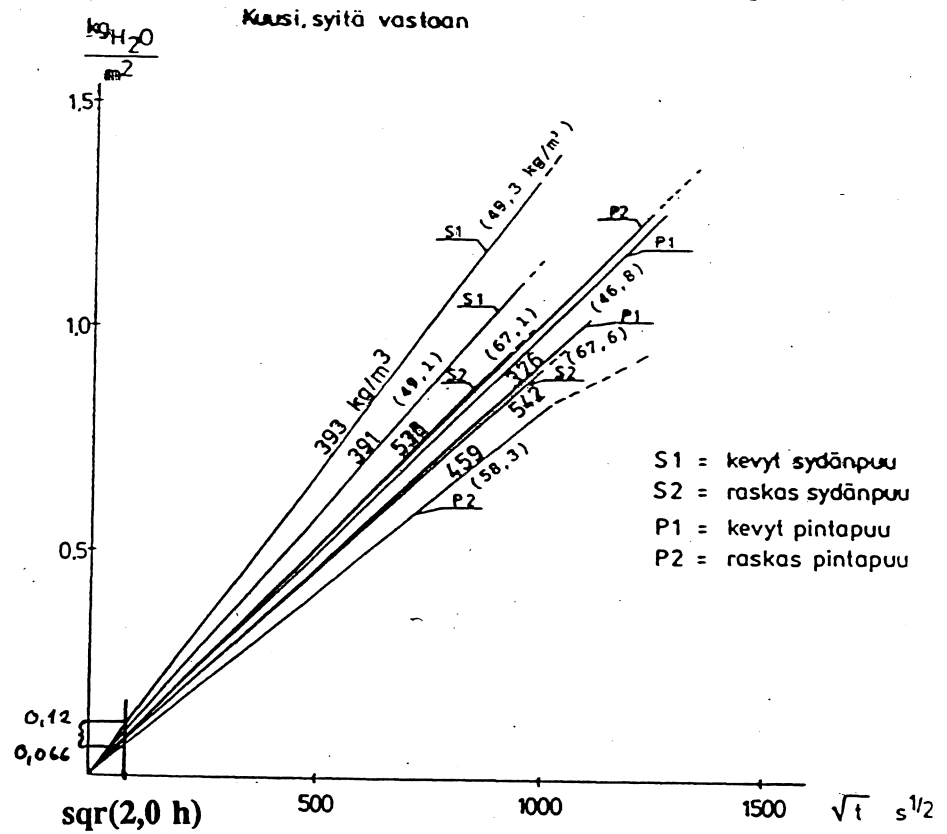

$$\Delta m = \Delta m'' \times A = 0,066 \text{ kg/m}^2 \times (93 \times 44 \text{ mm}^2) = 0,27 \text{ g}$$

$$= 0,12 \text{ - " - } = 0,49 \text{ g}$$

$$\text{average } \Delta m = 0,38 \text{ g}$$

(experiment made with six pieces of wood)

**En regel ställs med ändytan i vatten**

93\*44mm torrdens. vid 60% RF  
= 435 kg/m<sup>3</sup>

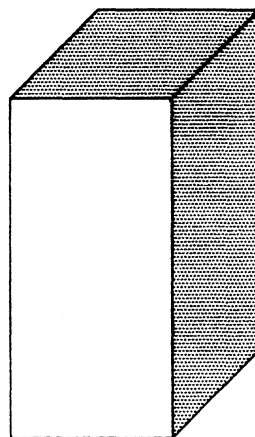

100mm

(calculation)

**Beräknad viktökning**

$$q_m = -D_w \frac{\partial w}{\partial x}$$

$$W_{total} = 160 \cdot 435 = 7000 \text{ kg/m}^3$$



**Viktökning efter 2 timmar**

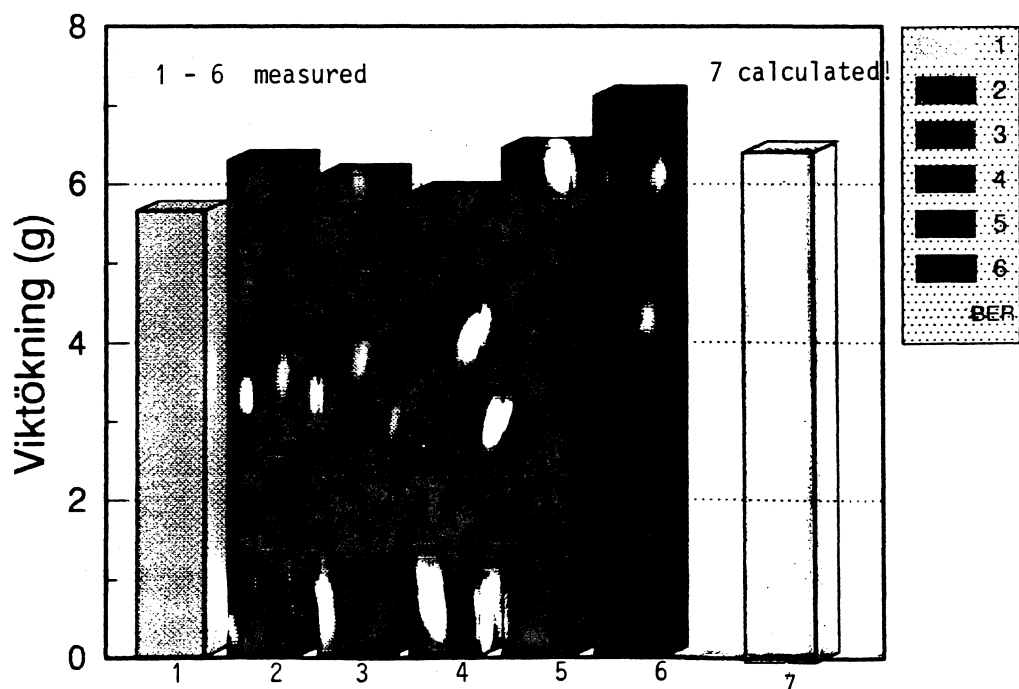

## TEST CASE 1

TEST SPECIMEN 25 X 50, LENGTH 100 MM  
2 HOURS WATER ABSORPTION

COMPARED WITH CT-MODEL RESULTS AND CURVE FITTINGS BY  
HANNU KOPONEN

**MOISTURE ABSORPTION, LONGITUDINAL PINE,**  
kg/m<sup>2</sup> (g/regel 93 x 44)

	Test case (Absetz)	CT-model	Curve fit from tests
heartwood	2.37 (9.7 g)	1.33 (5.4 g)	0.43 (1.8 g)
sapwood	3.81 (15.6 g)	4.19 (17.1 g)	4.36 (17.8 g)
50/50 heart/sap			1.09 (4.5 g)

DENSITY AT GARAGE CLIMATE:

- heartwood 716 kg/m<sup>3</sup>
- sapwood 471 kg/m<sup>3</sup>

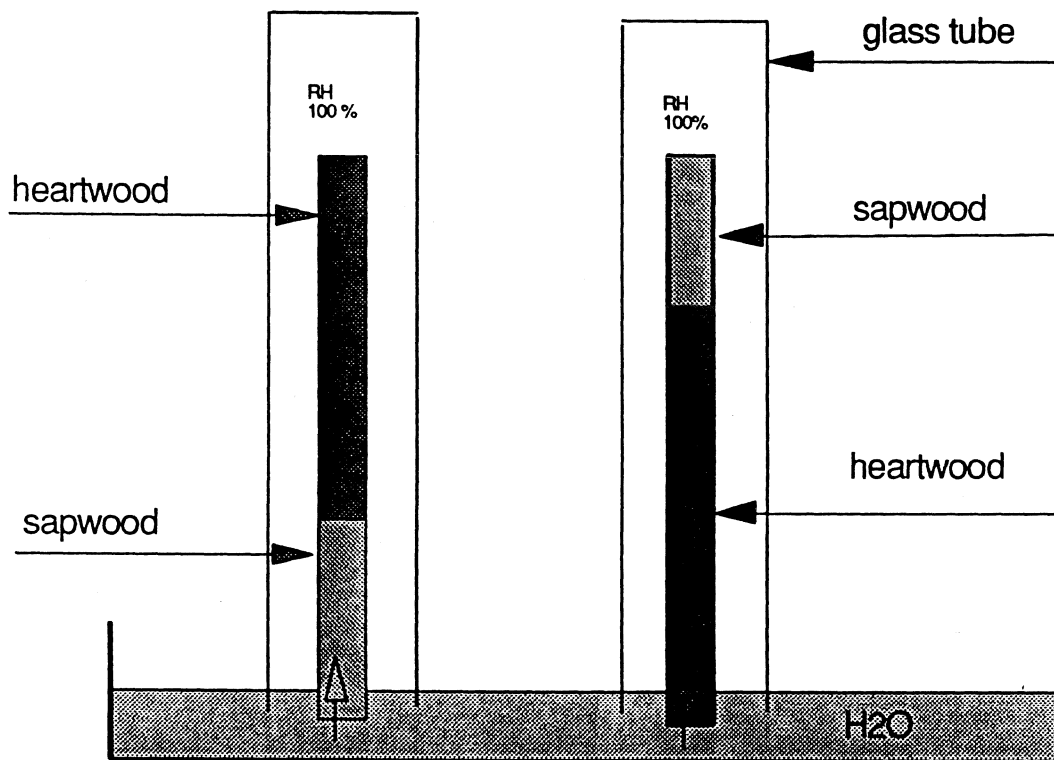

MOISTURE CONTENTS OF SPECIMEN :

- growing, (hw=35, sw=140%)
- above FSP (hw=30, sw=50%)
- below FSP (equilibrium RH 97%)
- oven dry

TEMPERATURES:

- 20 C
- 50 C

**TESTFALL 1 - Capillary Suction of Spruce.**

Carsten Rode Pedersen, Thermal Insulation Laboratory, Technical University of Denmark, Building 118, DK-2800 Lyngby, Denmark, ☎ +45 45 93 12 22 📍 1851, fax +45 45 93 17 55.

MATCH requires the suction curve and the hydraulic conductivity for this material. Since they have not been available an error function solution (for semi-infinite bodies) is attempted.

Salonvaara (IHMT, Yugoslavia 1989 - I think), estimates  $a_{mu}$  of spruce for a range of moisture contents. I use the constant value  $2.5 \cdot 10^{-10} \text{ m}^2/\text{s}$ .

$$t=0: \quad u_i = 0.125 \text{ (kg/kg)} \quad \text{for } 0 \leq x \leq \infty$$

$$t>0: \quad \begin{array}{ll} u_s = 1.72 & x=0 \\ u = 0.125 & x=\infty \end{array}$$

The moisture flux at the surface  $x=0$  is:

$$g = \frac{\rho_0 a_m (u_s - u_i)}{\sqrt{\pi a_m t}}$$

In figure 1.1  $g \cdot A \cdot \Delta t$  is added over several small time steps up to 2 hours.

After the two hours 4.25 grams have been absorbed.

Fig. 1.1

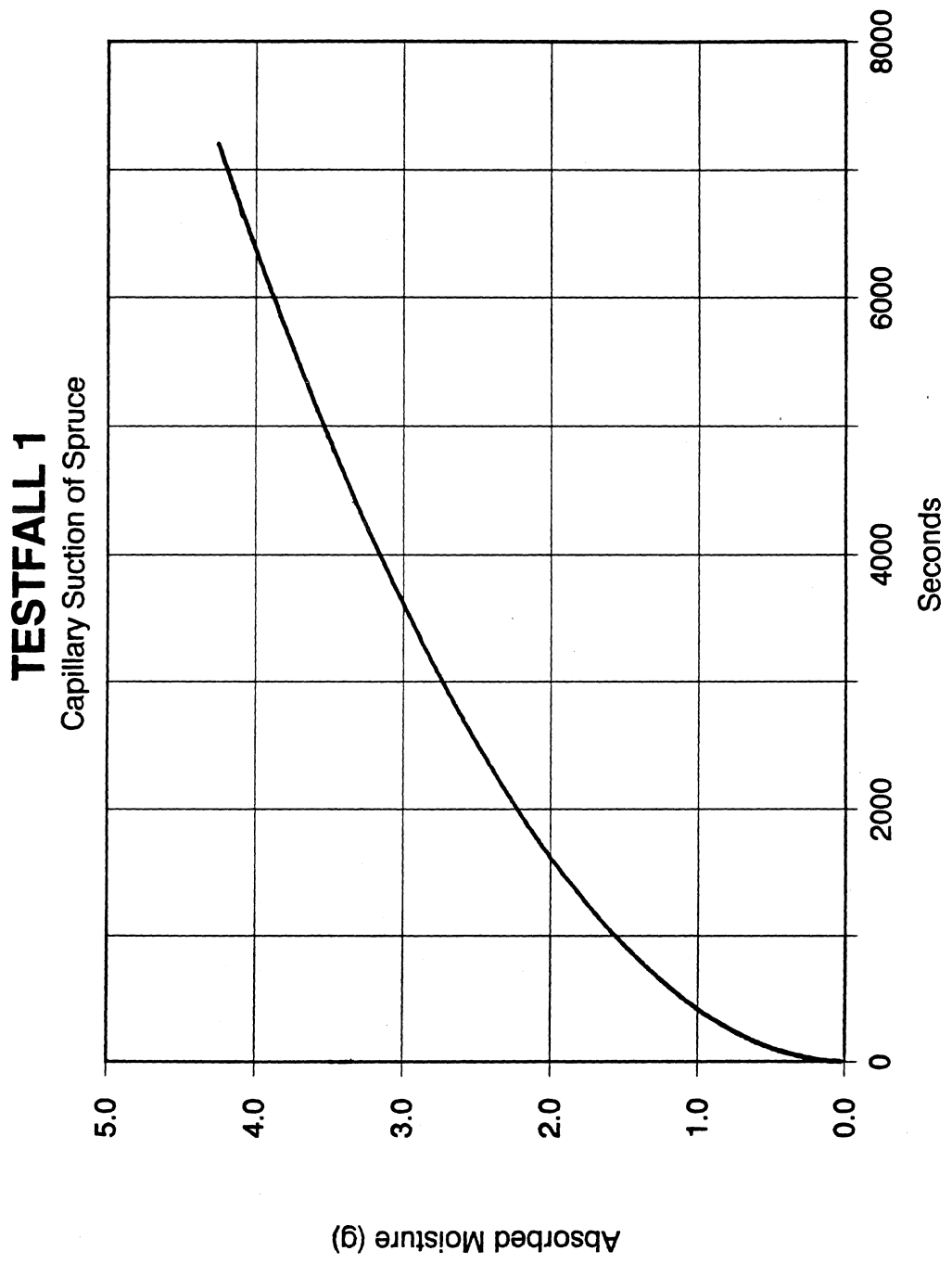



Testfall 1.  
g (H<sub>2</sub>O) 4,54 t/m<sup>3</sup>

All-förel. inpräc. av S. Tolpina. Andelen uppsugning i Free  
Andelen  $\sigma$ : 19 x 100 mm

Parabelns FK vid slut mv: 9,4

Andelen uppsug. av prop. ytan!

vid 2 h  $\frac{1900}{4092} = \frac{85}{x} \rightarrow x = 18,3$  (ca 18g)

Testfall 1

↳ Under avtagnings- och vattenupps. är densiteten för fukt och gran!

OBS! Uppsegning utan samtidig vattentäckning från sidorna!

längd

• = 5A	50 mm
⊙ = 4A	100 "
x = 4B	150 "
⊗ = 4C	200 "
* = 5B	100 "

SE FIG 4 024 S 74-8911

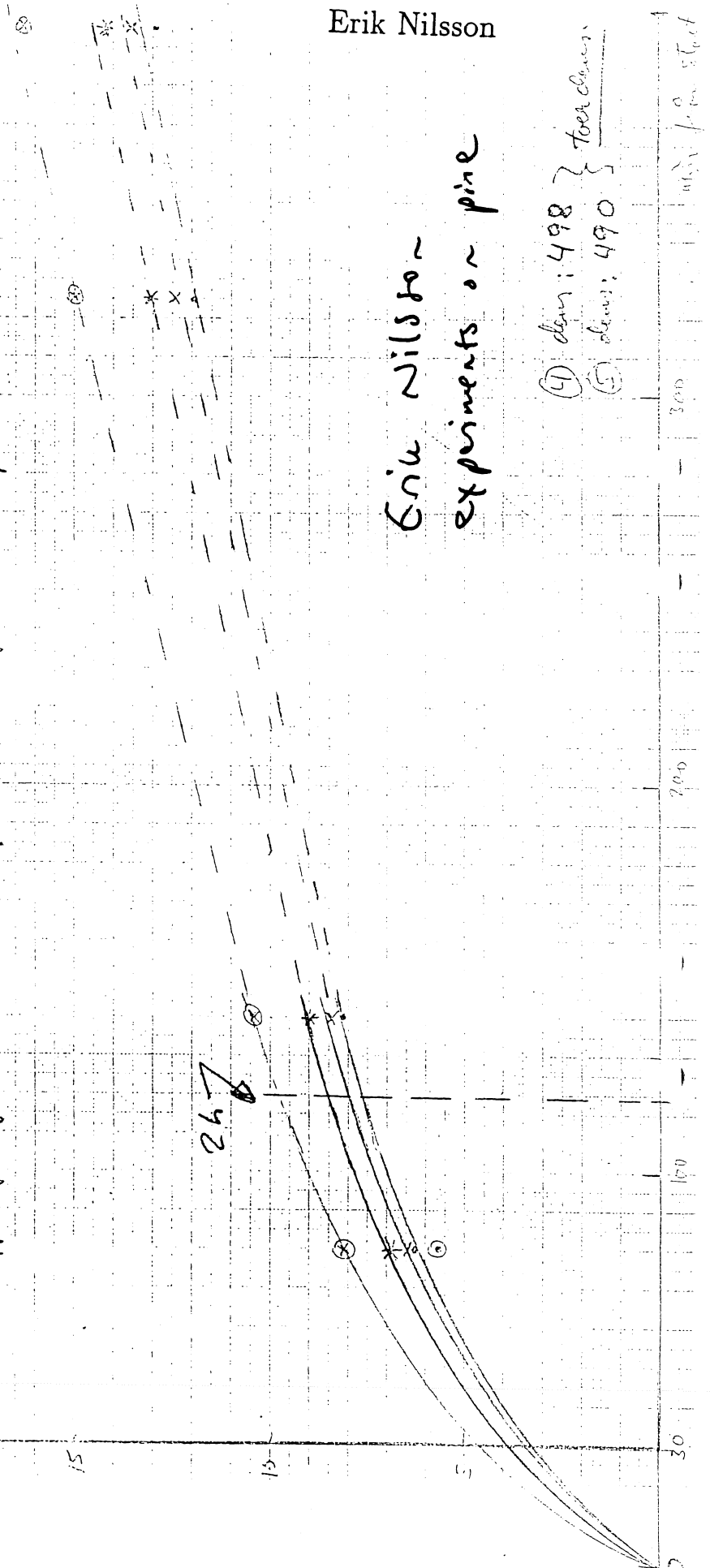

Erik Nilsson

Erik Nilsson  
experiments on pine

④ diam: 498 } Torr dens.  
⑤ diam: 490 } Torr dens.

100 200 300 t

Prov A (inpackad stolpe i Al-folie, för diam. 20x55x270 mm)  
 (Torrsvikt  $\approx 126 \rightarrow$  dens  $\approx 520$  (font))  
 (10% FK vid provstart)  
 (T4-89 M, Feg 8)

Prov A, upptagen mängd H<sub>2</sub>O (g.)

Mättid	min	?	uppt. mängd (g)
start	12 <sup>05</sup>	0	0
	13 <sup>12</sup>	67	7,347
○	14 <sup>22</sup>	137	10,496
	16 <sup>12</sup>	247	13,617

Ant. upps. prop. med gitt  
 Testfall 1

$$\frac{1100}{4092} = \frac{9,8}{x} \quad x = 36,46$$

Andelen uppsugning  
 upptagen mängd (g)

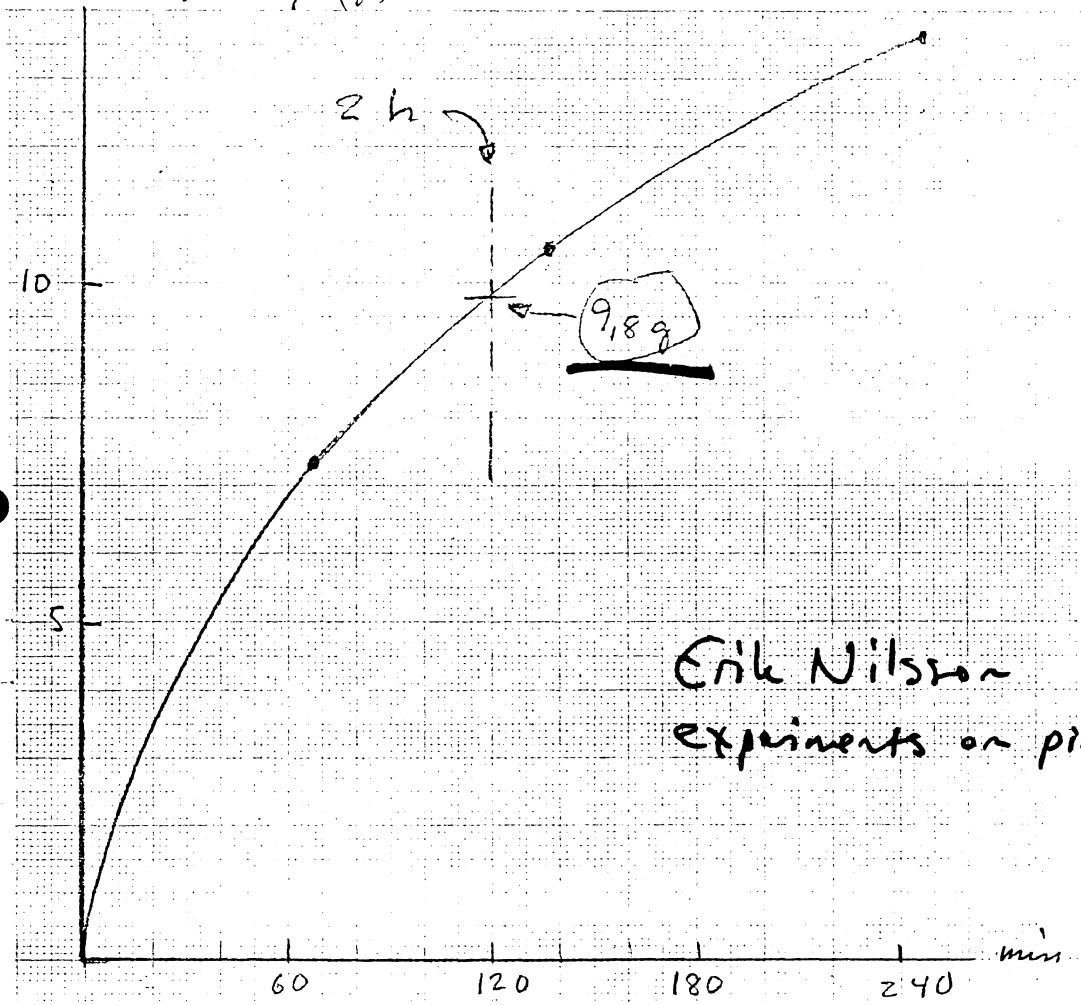

Erik Nilsson  
 experiments on pine

Test fall 1

Ändrad uppsättning (Panel diam. 17x100x450 mm)

Panel 2 är nästan helt rent om "ändrad" (Dens: 520 kg/m<sup>3</sup>)

Panel 3 är helt oändrad (Dens: 514 kg/m<sup>3</sup>)

Rapp T4-89 M fig 19, 18a(-18d).

Material	min	UPPT. g Prov 2	UPPT. g Prov 3
1) 915	0	0	0
1030	75	6,87	10,35
1300	225	11,81	16,46

Test fall 1

Ant. upps. prov system

Ant. fullt hvar system upps. prov

$$\textcircled{2} \frac{1900}{4092} = \frac{9}{x} \quad (\text{ca: } 19g)$$

$$\textcircled{3} \frac{1900}{1092} = \frac{13}{x} \quad (\text{ca } 28g)$$

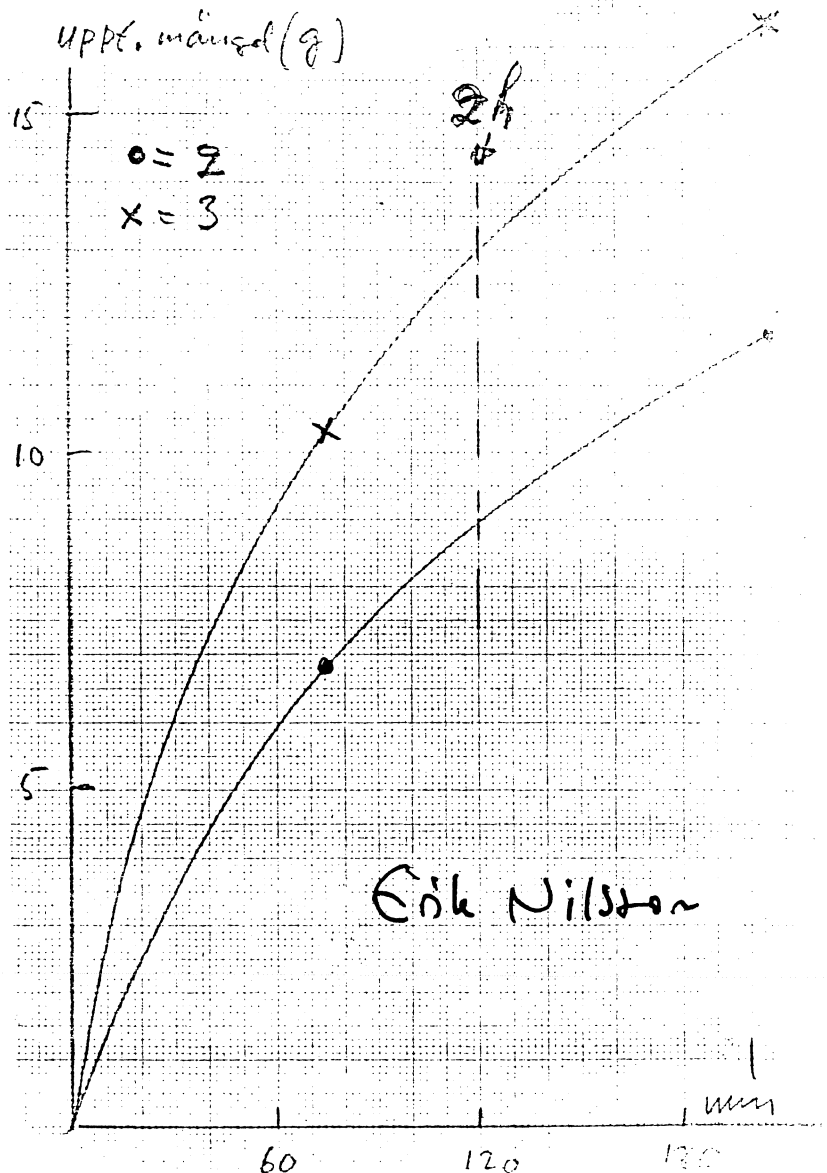



## Testcase 2

The data below is measured on a 22mm thick material. What does the weight increase curve look like when  $1m^2$  of this material absorbs water vapour from equilibrium with 80%RH to 95%RH?

Explanations: The first table shows the result of cup measurements. It gives the RH inside and outside the cup, and the flow out of the cup. The second table gives the moisture equilibrium curve (sorption isotherm). This is also shown in the diagram.

RF <sub>inne</sub> (%)	RF <sub>ute</sub> (%)	Flöde (kg/m <sup>2</sup> s)	RF (%)	w <sub>abs</sub> (kg/m <sup>3</sup> )	w <sub>des</sub> (kg/m <sup>3</sup> )
40	50	13.2 · 10 <sup>-9</sup>	40	37	44
40	55	20.0 · 10 <sup>-9</sup>	50	44	50
40	60	26.8 · 10 <sup>-9</sup>	60	50	58
40	65	34.5 · 10 <sup>-9</sup>	70	58	69
40	70	43.2 · 10 <sup>-9</sup>	80	67	80
40	75	54.5 · 10 <sup>-9</sup>	90	85	100
40	80	63.6 · 10 <sup>-9</sup>	95	100	116
40	85	77.3 · 10 <sup>-9</sup>			
40	90	90.9 · 10 <sup>-9</sup>			
40	95	113.6 · 10 <sup>-9</sup>			

for testcase 2.

for testcase 2 and 4

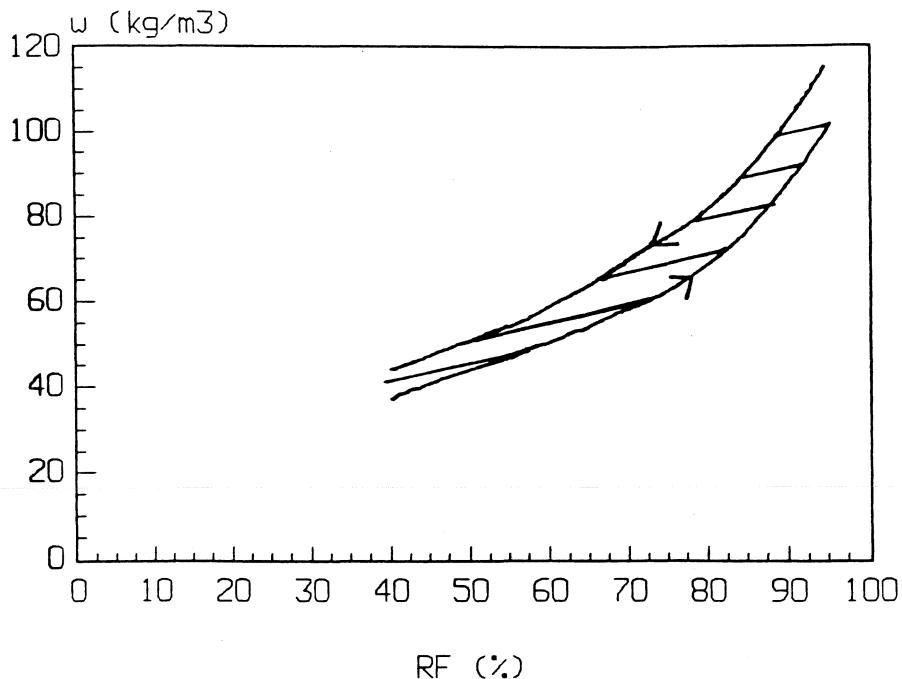

# Increase in weight (kg/m<sup>2</sup>)

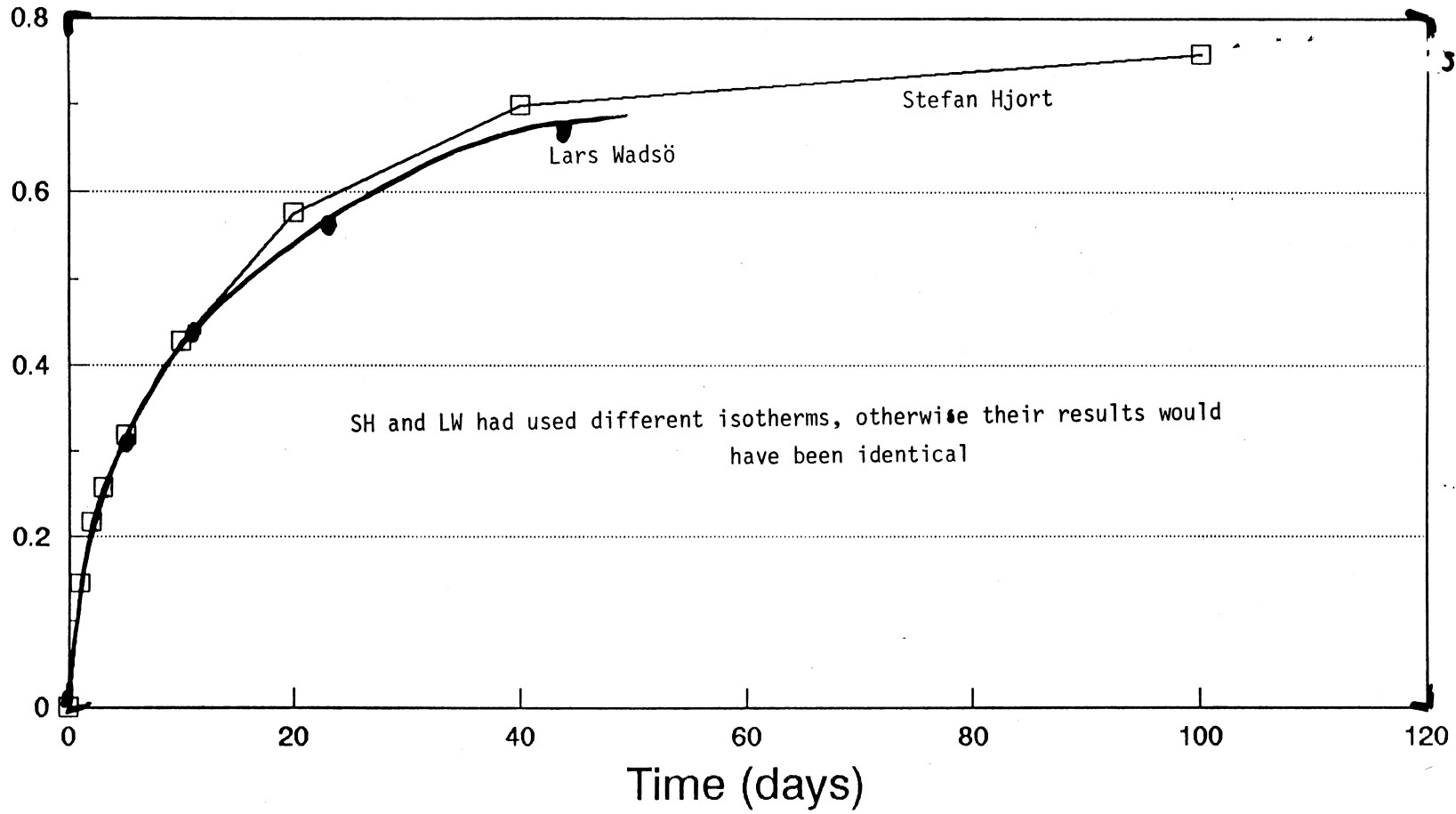

Stefan Hjort  
Lars Wadsö

**CASE #2**

\* Vapor diffusivity  $\lambda_D$  [kg/smPa] = f(RH):

- 40/50 % RH  $\lambda_D$  (45%)

- 40/55 % : 40/50% with  $\lambda_D$  (45%) (thickness dx1)  
Moisture flow known

- dx1

50/55% with  $\lambda_D$  (52,5%) (thickness 22 mm - dx1)

- value for  $\lambda_D$  (52,5%)

- 40/xx % - " -

\* Calculation with TCCC2D using  
 $\lambda_D = f(RH)$  and sorption isotherm.

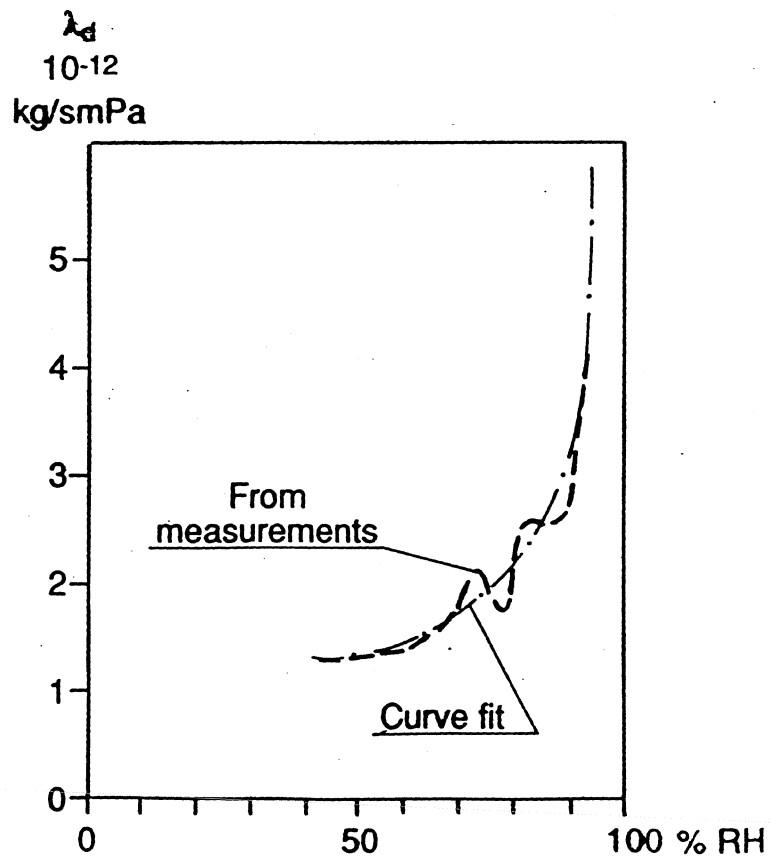

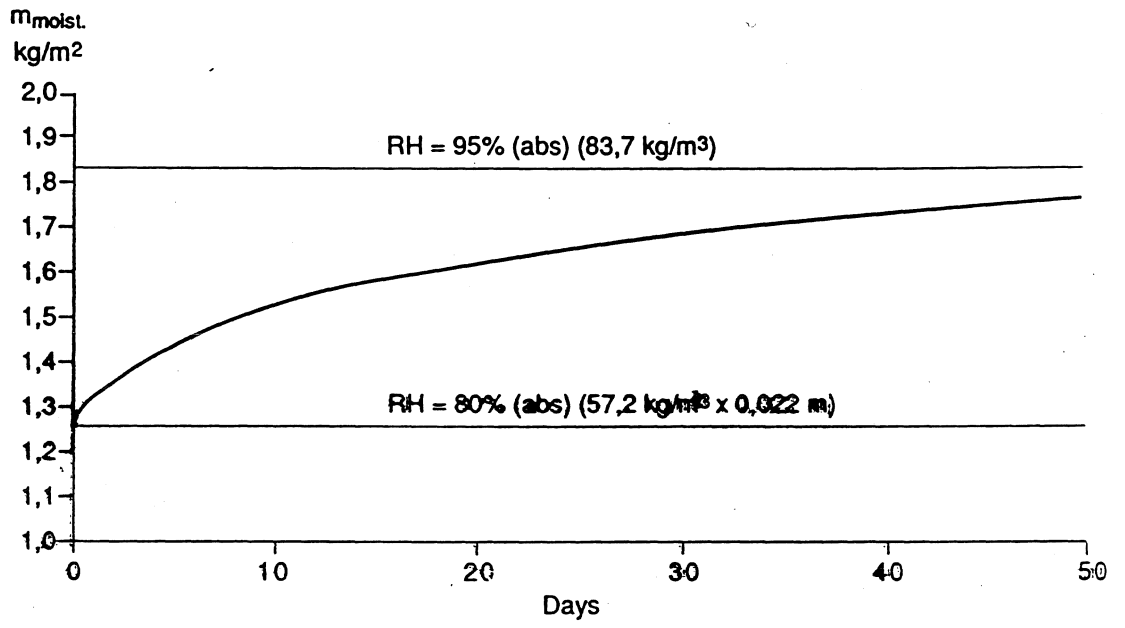



**TESTFALL 2 - Moistening of Spruce from Equilibrium at RH=80 to RH=95%.**

Carsten Rode Pedersen, Thermal Insulation Laboratory, Technical University of Denmark, Building 118, DK-2800 Lyngby, Denmark, ☎ +45 45 93 12 22 📠 1851, fax +45 45 93 17 55.

The moisture flux data are used successively to calculate the vapour permeability for small intervals of RH. The first measurement gives the vapour permeability for a piece of wood feeling RH=40 at one side and RH=50 on the other (Average: RH=45). From this result, it is possible to calculate the depth of RH=50% in the specimen of the next measurement. The remaining part senses RH=50 on one side and RH=55 on the other. Since the thickness of the remaining part is known as well as the moisture flux, the vapour permeability may be calculated (corresponding to RH=52.5). etc...

MATCH uses a constant value of the vapour permeability up to RH=60% and a linear increase from there to the end of the hygroscopic region. Linear regression gives:

$$\delta_{p,60} = 1.27 \cdot 10^{-12} \text{ kg}/(\text{Pa} \cdot \text{m} \cdot \text{s}) \quad \delta_{p,98} = 3.73 \cdot 10^{-12} \text{ kg}/(\text{Pa} \cdot \text{m} \cdot \text{s})$$

The sorption data are analyzed according to the formula in Kurt's Sorption Isotherm Catalogue, 1986:

$$u = u_h \left(1 - \frac{\ln \phi}{A}\right)^{-\frac{1}{n}}$$

The results are:

Desorption:  
 $u_h = 31.7 \text{ Weight-\%}$        $A = 0.140$        $n = 1.77$

Absorption:  
 $u_h = 38.5 \text{ Weight-\%}$        $A = 0.0922$        $n = 2.04$

Here, only the absorption data are used.

On one of the enclosed graphs the moisture content of each layer is shown. The layers have the following thicknesses: 0.5 mm, 1.0 mm, 2.0 mm, 4.0 mm and 3.5 mm (the last layer represents half of the center of the board). The other graph shows the total moisture content of the board. After three months it has increased from approximately 1.5 kg/m<sup>2</sup> to almost 2.2 kg/m<sup>2</sup>.

Fig. 2.1

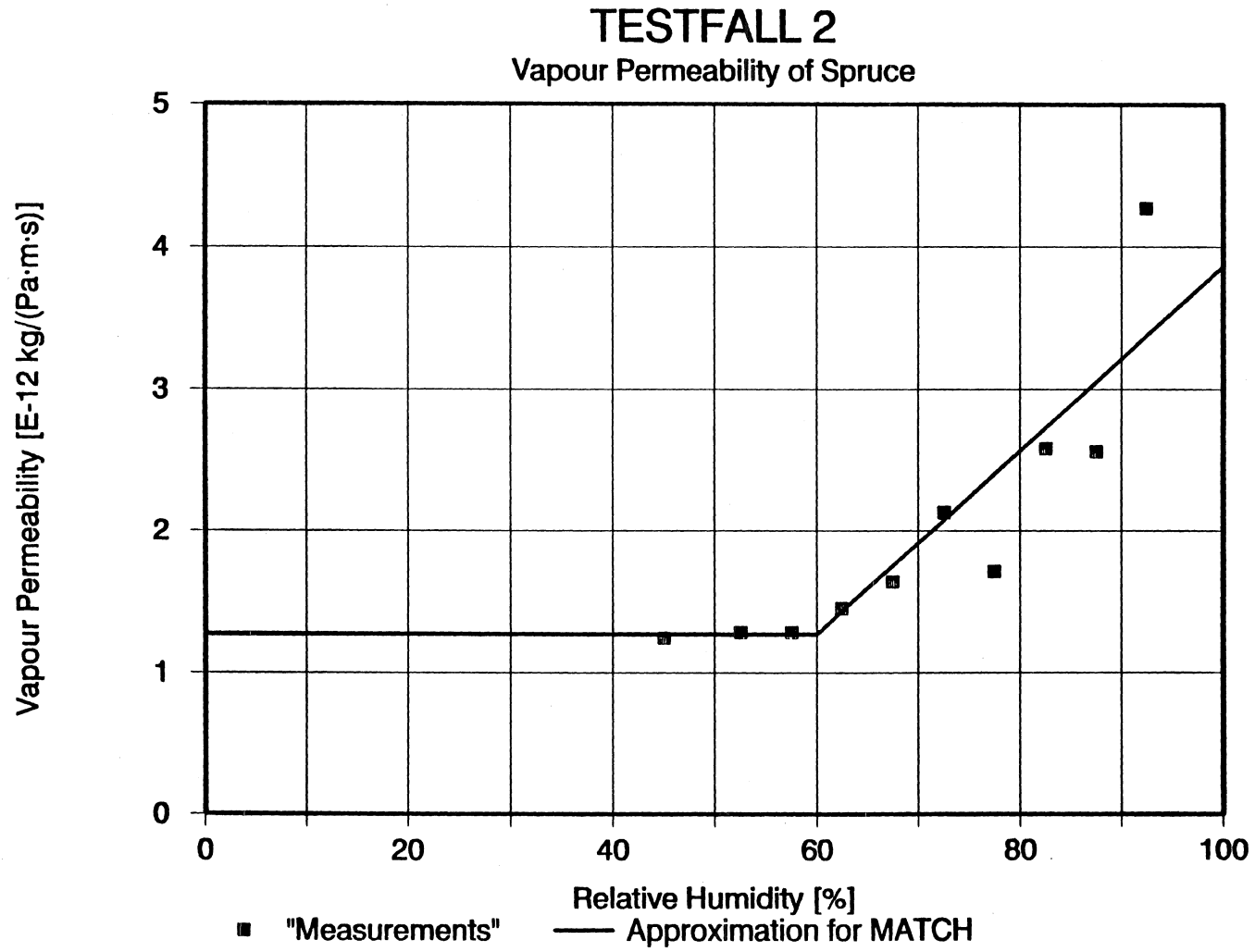

Fig. 2.2

TESTFALL 2

### Moisture Content

Moistening of Spruce from Equilibrium at RH=80 to RH=95%

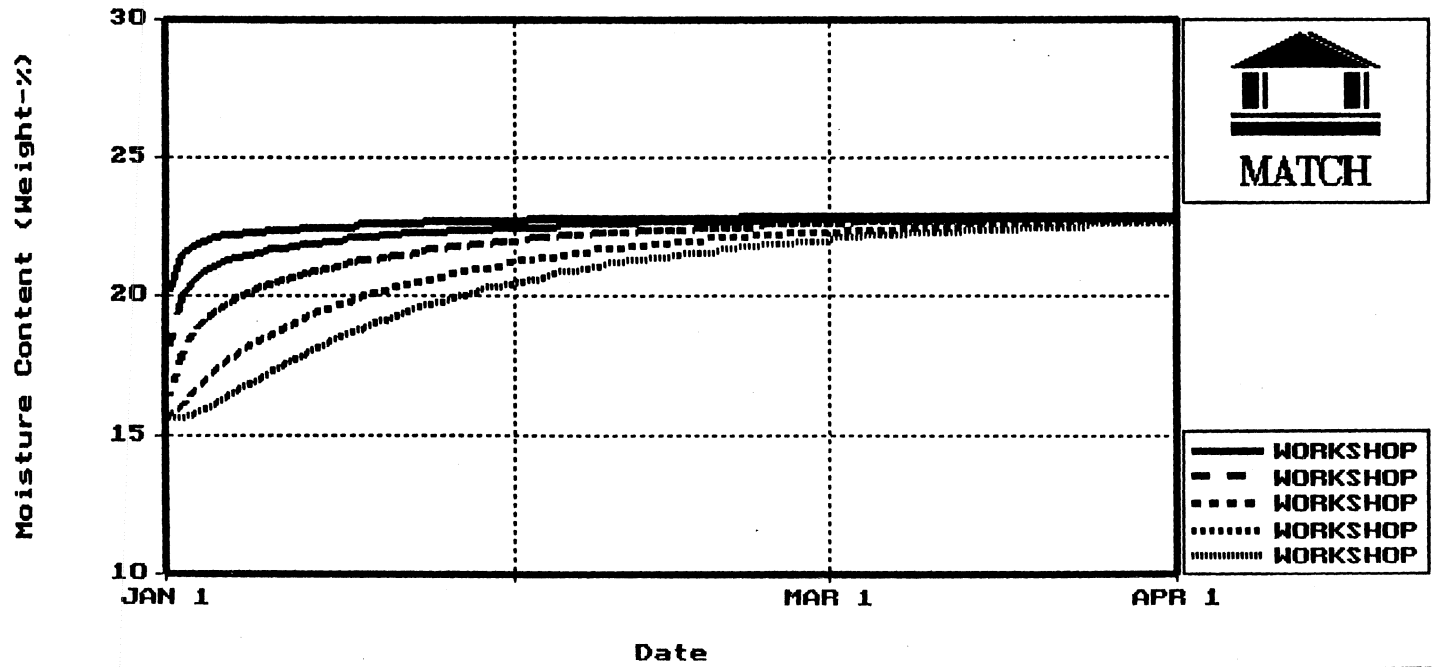
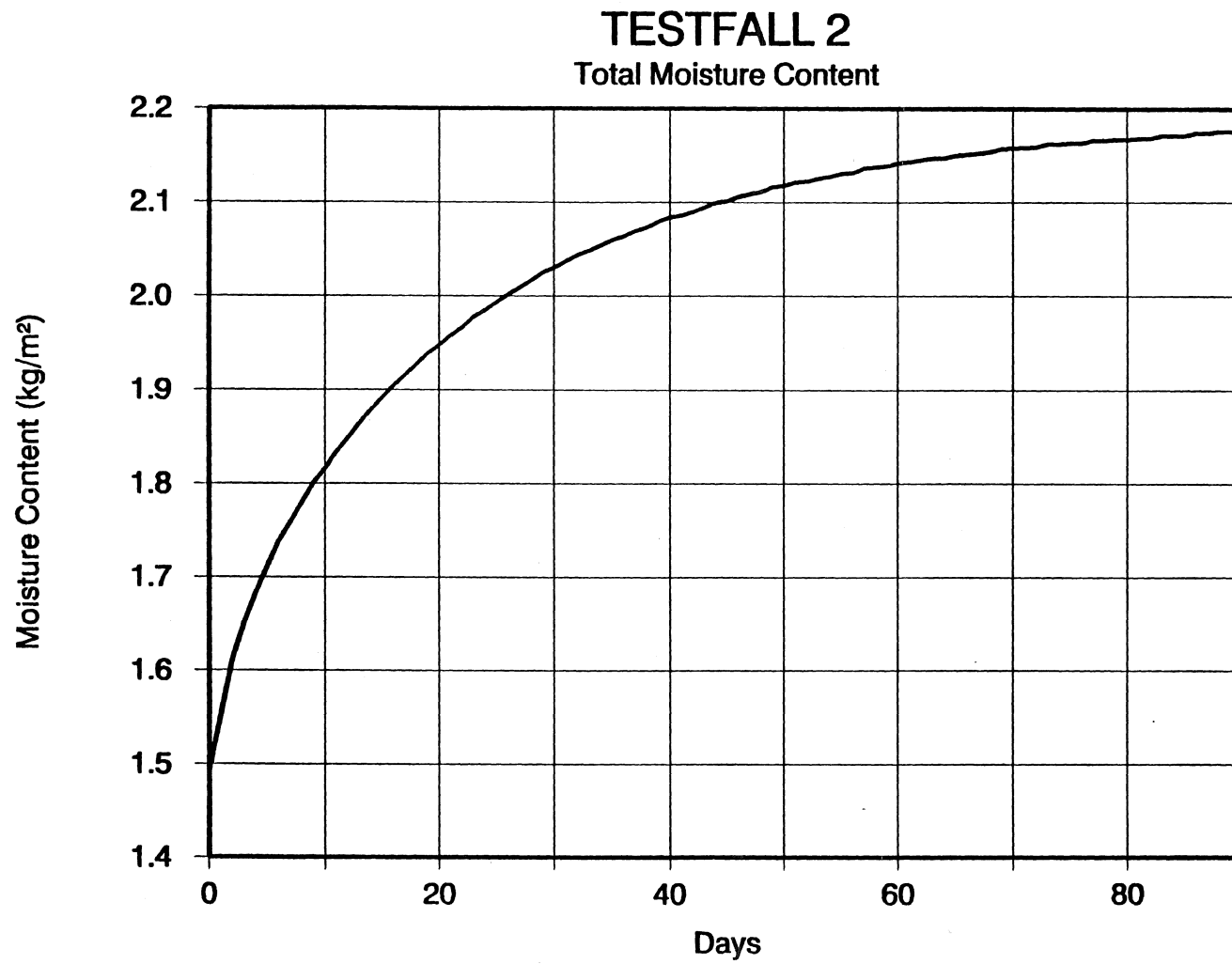

Fig. 2.3



## Testcase 3

A thin layer of a material dries out in a air gap where there is a low (not measureable) air velocity. We want to calculate the rate of drying of this material. Do we need to use a surface resistance for this surface? What numerical value shall it have? Is it the same for all materials?

Only Carsten Rode Pedersen had prepared a written answer. As there were no protests when he read it, we think it was accepted by everyone:

### TESTFALL 3 - Surface Vapour Resistance.

Carsten Rode Pedersen, Thermal Insulation Laboratory, Technical University of Denmark, Building 118, DK-2800 Lyngby, Denmark, ☎ +45 45 93 12 22 › 1851, fax +45 45 93 17 55.

- Yes, if the material is not very vapour tight itself, there should be added a surface vapour resistance.
- An estimate of its size at  $v=0$  m/s is taken from my report on moisture physics, 1989 (in Danish), assuming Lewis law to be valid even in the laminar range:

$$\beta_c = 4.8 \cdot 10^{-3} \text{ m./s} \quad \beta_p = 3.6 \cdot 10^{-8} \text{ kg}/(\text{m}^2\text{sPa})$$

This is in accordance with PI Sandberg's thesis, 1973, p.47-48.

- When the air is still there should be no influence from different surface roughnesses and therefore the same figure should be used for all materials. (What do the experiments say?)



## Testcase 4

The materials in A, B and C are the same. They all have the properties which were presented in testcase 2. A and C are in equilibrium with 50%RH and  $w = 50 \text{ kg/m}^3$ . At time  $t = 0$  B is put in between A and C. B is in equilibrium with 90%RH and  $w = 85 \text{ kg/m}^3$ . Calculate the w-profile and the RH when the "construction" comes to equilibrium. It is totally moisture-insulated on all six surfaces.

A	RF = 50%	$w = 50 \text{ kg/m}^3$	10 mm
B	RF = 90%	$w = 85 \text{ kg/m}^3$	10 mm
C	RF = 50%	$w = 50 \text{ kg/m}^3$	10 mm

TESTFALL 4  
Fukthaltsfördelning

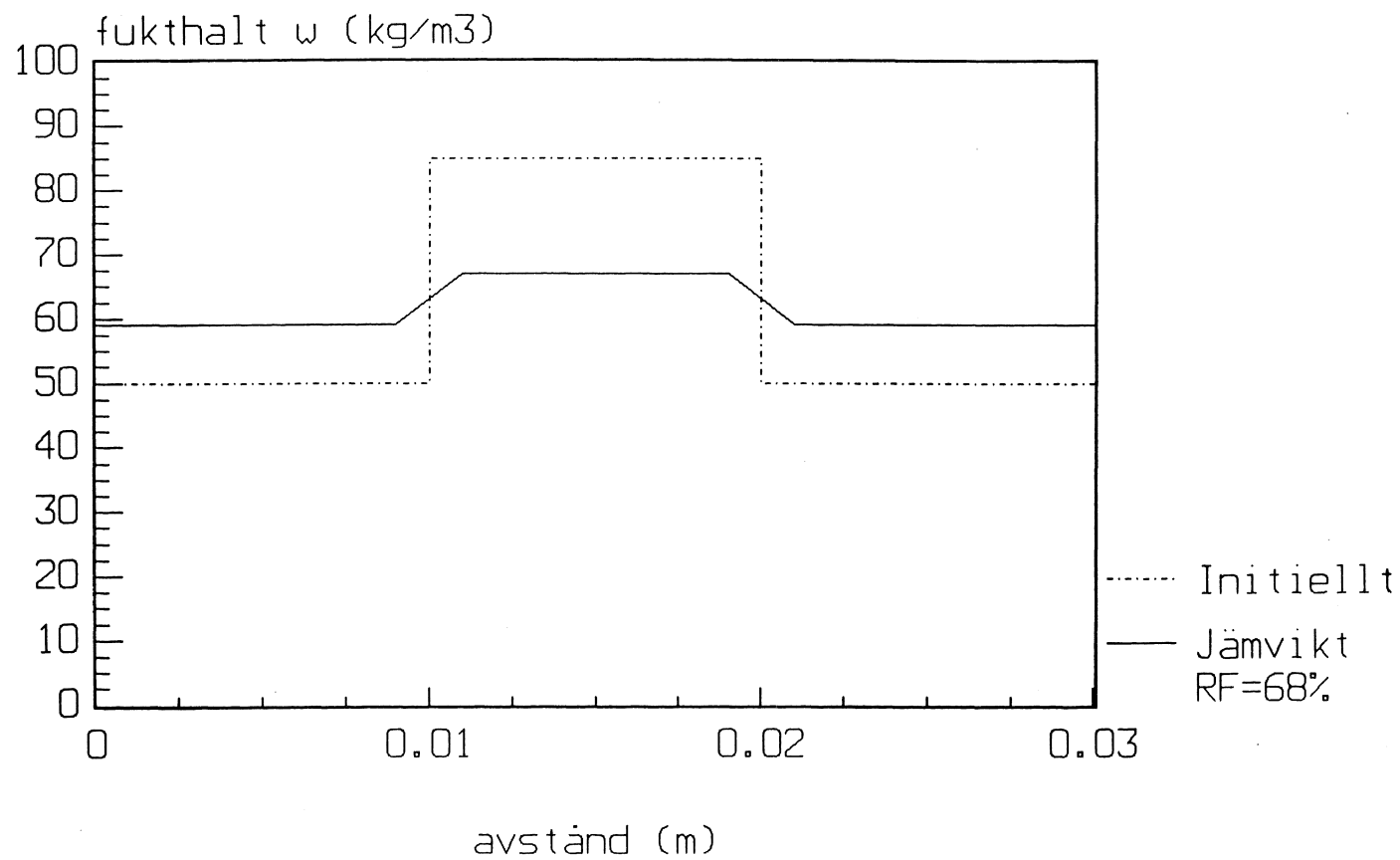



# Case #4

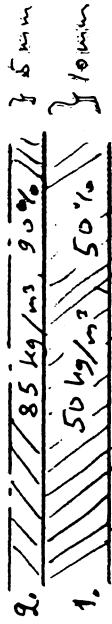

$$\bar{\rho}_m = \frac{5 \cdot 85 + 10 \cdot 50}{15} = 61,67 \text{ kg/m}^3$$

constant

## ITERATION:

Material 1. 50 → 70% RH

$$\rho_{m1} = 59,0 \text{ kg/m}^3$$

Material (2) → 80% RH

$$\rho_{m2} = 81,3 \text{ kg/m}^3$$

$$\rightarrow \bar{\rho}_{m,calc} = 66,4 > 61,67 \frac{\text{kg}}{\text{m}^3}$$

→ decrease  $\rho_{m2}$

$$80\% \rightarrow 70\%$$

$$\rho_{m2} = 70,4 \frac{\text{kg}}{\text{m}^3}$$

$$\rightarrow \bar{\rho}_{m,calc} = 62,8 \frac{\text{kg}}{\text{m}^3} > 61,67$$

→ decrease  $\rho_{m1}$  &  $\rho_{m2}$

RH	$\rho_{m1}$	$\rho_{m2}$	$\bar{\rho}_m$
68	57,6	67,7	60,97
69	58,3	69,0	61,88

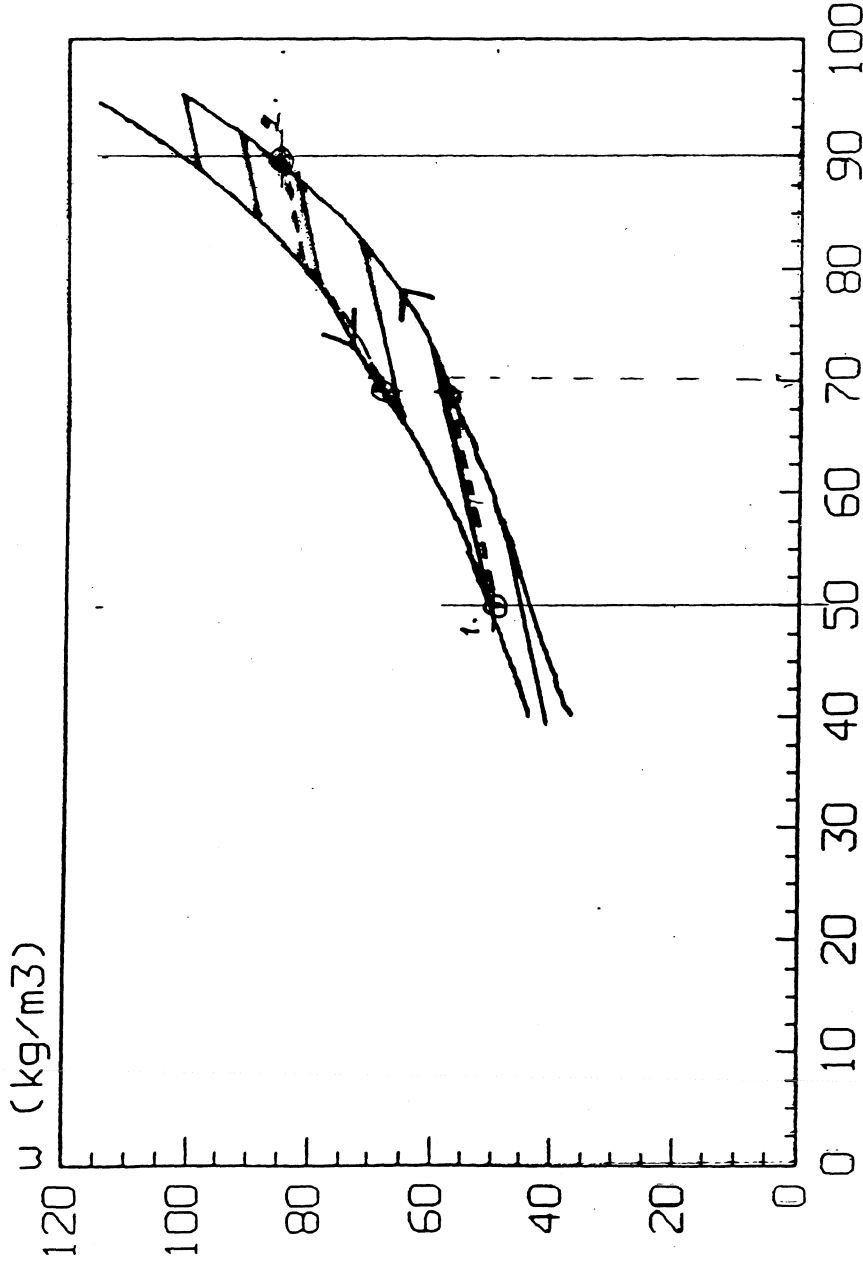

RF (%)

TESTFALL 4  
Fukthaltsfördelning

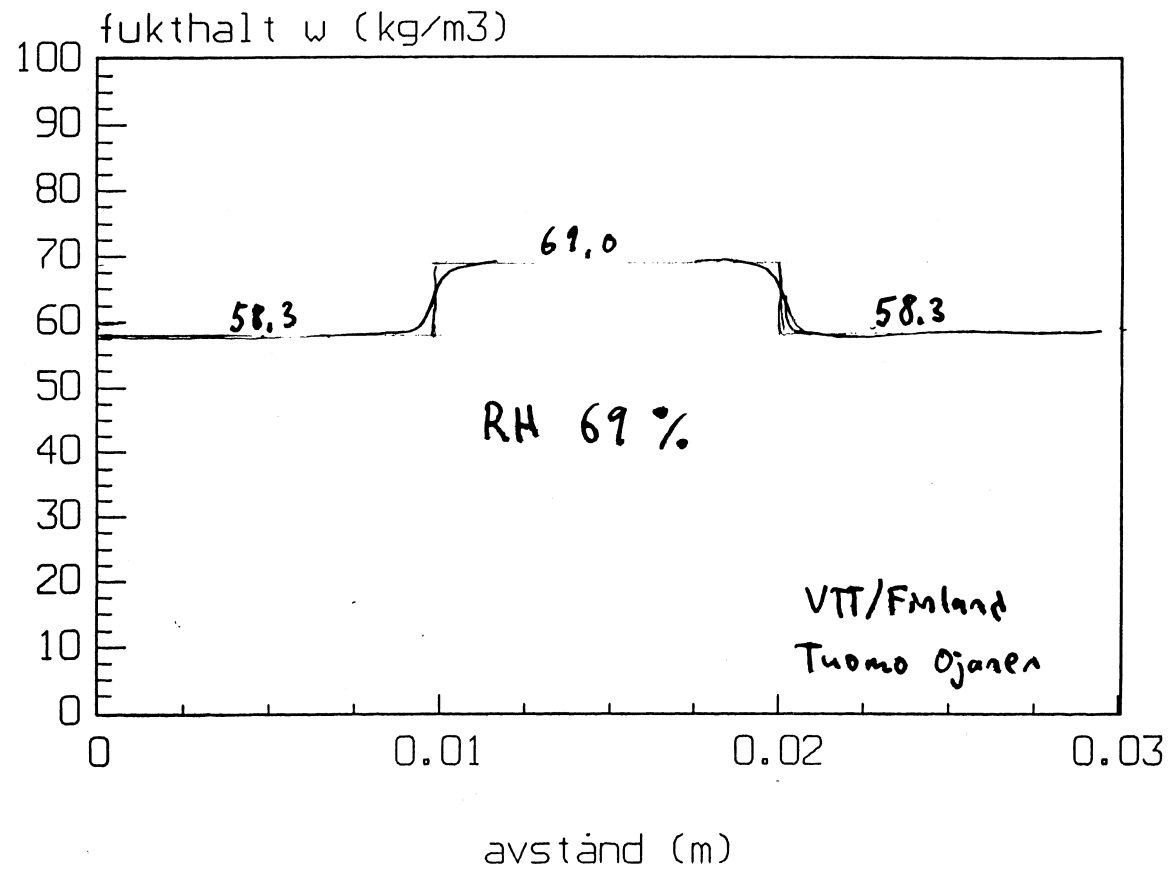

$$RF = 78\%$$

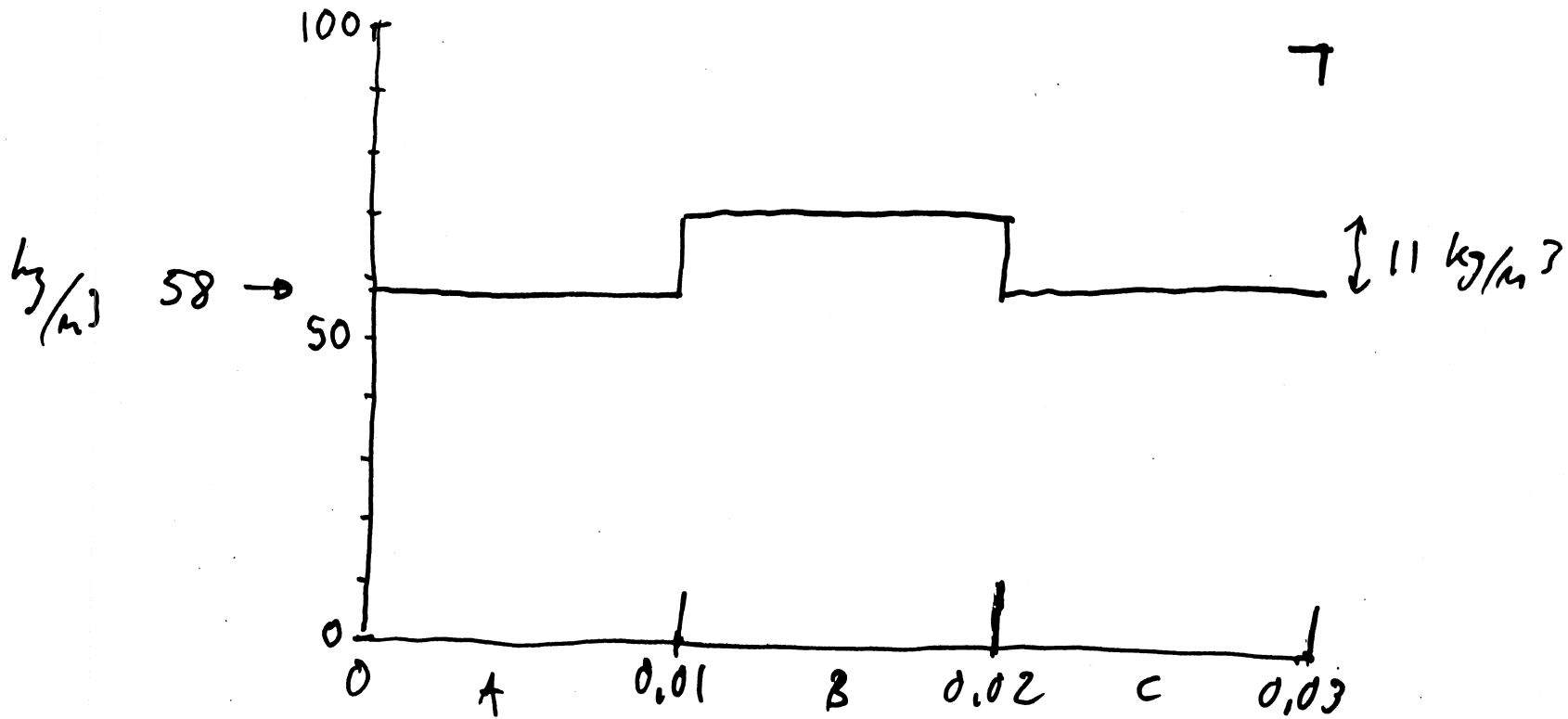

Test case 4

Lars Wadsö: simple hand calculation assuming desorption in B and absorption in A & C.

Liu Tong: independently made exactly the same calculation and got the same result

Liu Tong

Lars Wadsö

**TESTFALL 4 - Hysteresis in the sorption isotherms.**

Carsten Rode Pedersen, Thermal Insulation Laboratory, Technical University of Denmark, Building 118, DK-2800 Lyngby, Denmark, ☎ +45 45 93 12 22 📠 1851, fax +45 45 93 17 55.

The data from TESTFALL 2 are used as input for a MATCH calculation in which the outer pieces start from the desorption isotherm at 50% RH and the central piece starts from the absorption isotherm at 90% RH. The grid used for the calculation is shown in fig 4.1. The calculation is performed from one of the surfaces to the center of the middle piece (where there are impermeable and adiabatic conditions). Three layers in each piece are selected for display of the time dependencies of their RH-values and moisture content. The distribution through all layers of these values are shown after a period of one month (close to steady state).

An immediate solution to the problem would be that the RH ends up at 70% and that the moisture content in the center piece ends at  $69 \text{ kg/m}^3$  (15.9 % w/w) and in the surface pieces at  $58 \text{ kg/m}^3$  (13.3 % w/w). However, due to the non-linearity of the problem the interface between the two materials goes up higher than 70% RH in the first days. Some part of the dry board will therefore start following an absorption curve and then a drying scanning curve. The average moisture content in the surface boards will therefore end up higher than according to the assumption above (and the moisture content in the middle board ends up lower). The relative humidity ends up slightly higher than 70% because the analytical fit of the sorption curve does not exactly match the "measured" data.

Fig 4.2 and 4.3 show the development of the RH-values and the moisture content. Fig. 4.4 and 4.5 show the final distributions and figure 4.6 shows the paths followed by the two by three layers in the sorption diagram. As it is seen, the scanning curves for some of the layers do not follow a smooth line. These are the layers next to the interface. They are quite thin and are exposed to large gradients in the beginning so they cross the scanning area in one single or just a few time steps.

Fig. 4.1

### TESTFALL 4 - Grid

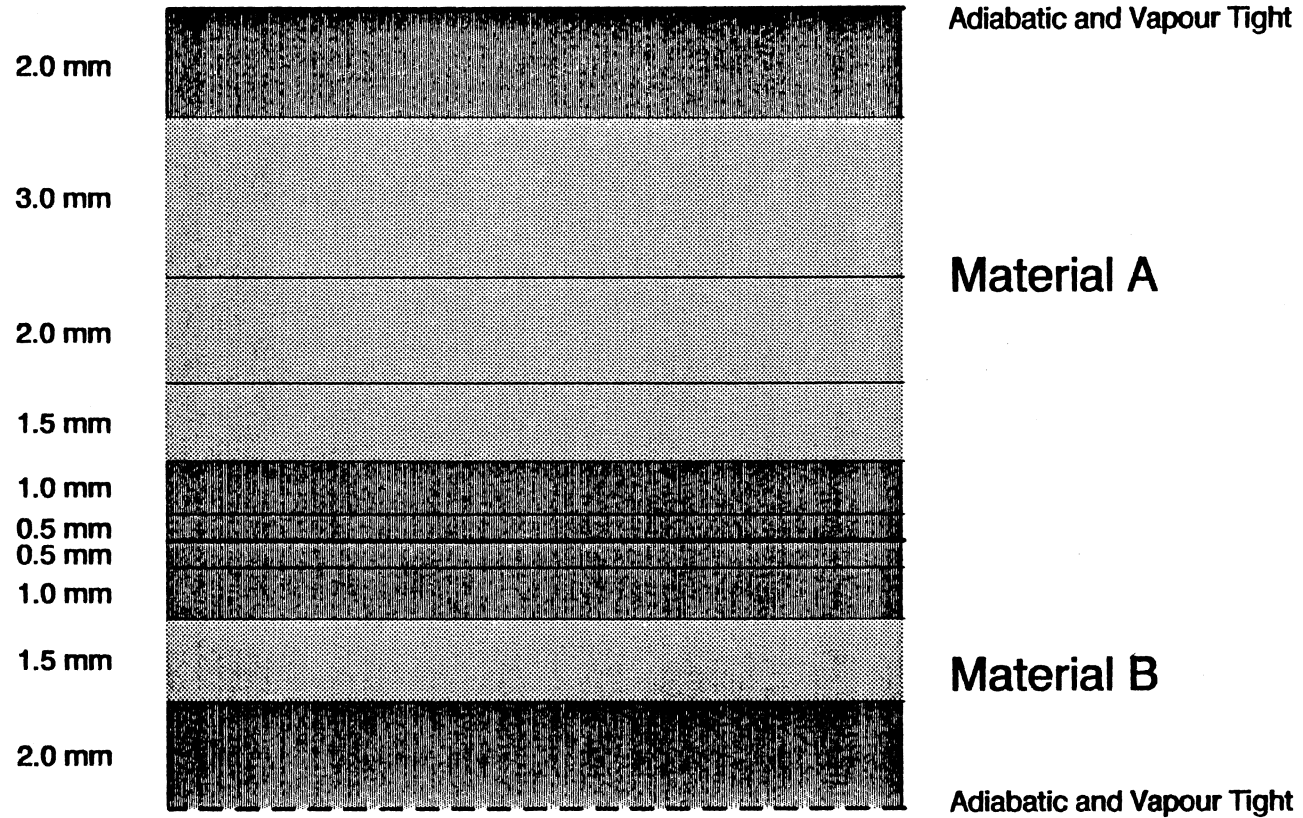

Dark layers are selected for detailed output (hour by hour)

Fig. 4.2

TESTFALL 4

### Relative Humidity

Hysteresis, Three Layers of Spruce with Different Initial MC's

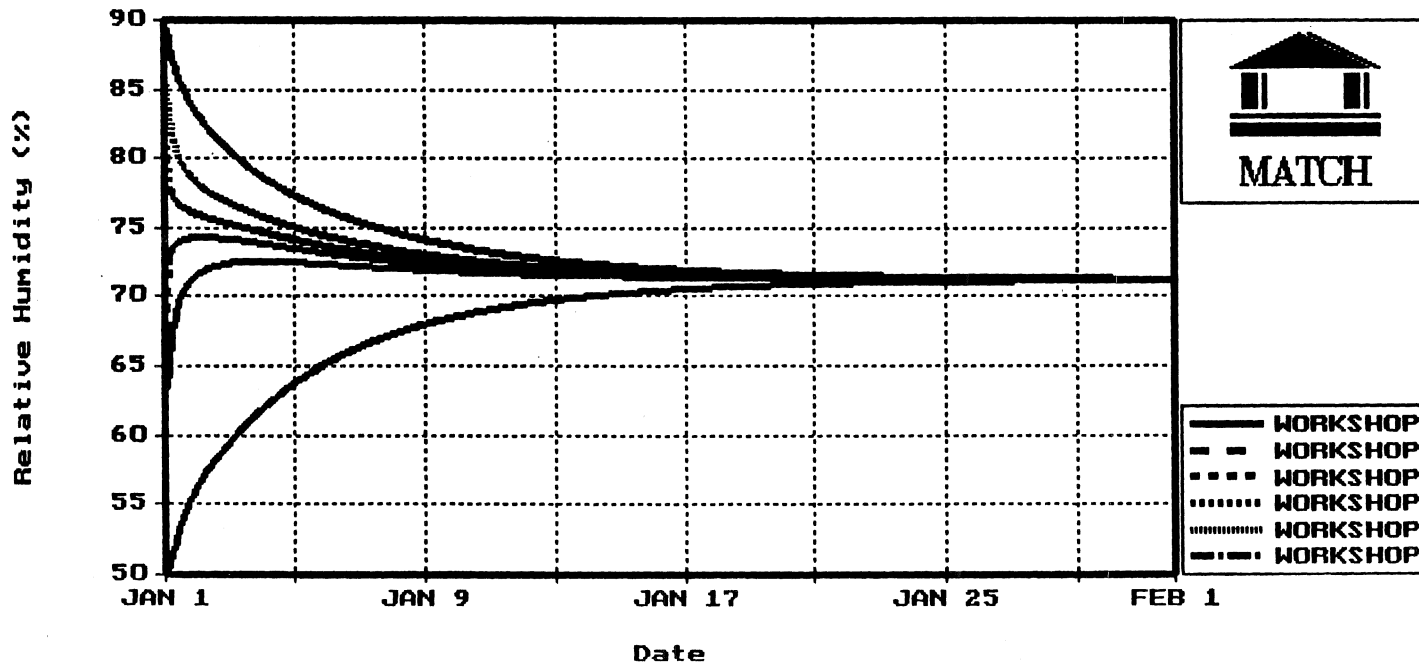

Fig. 4.3

### TESTFALL 4

## Moisture Content

Hysteresis, Three Layers of Spruce with Different Initial MC's

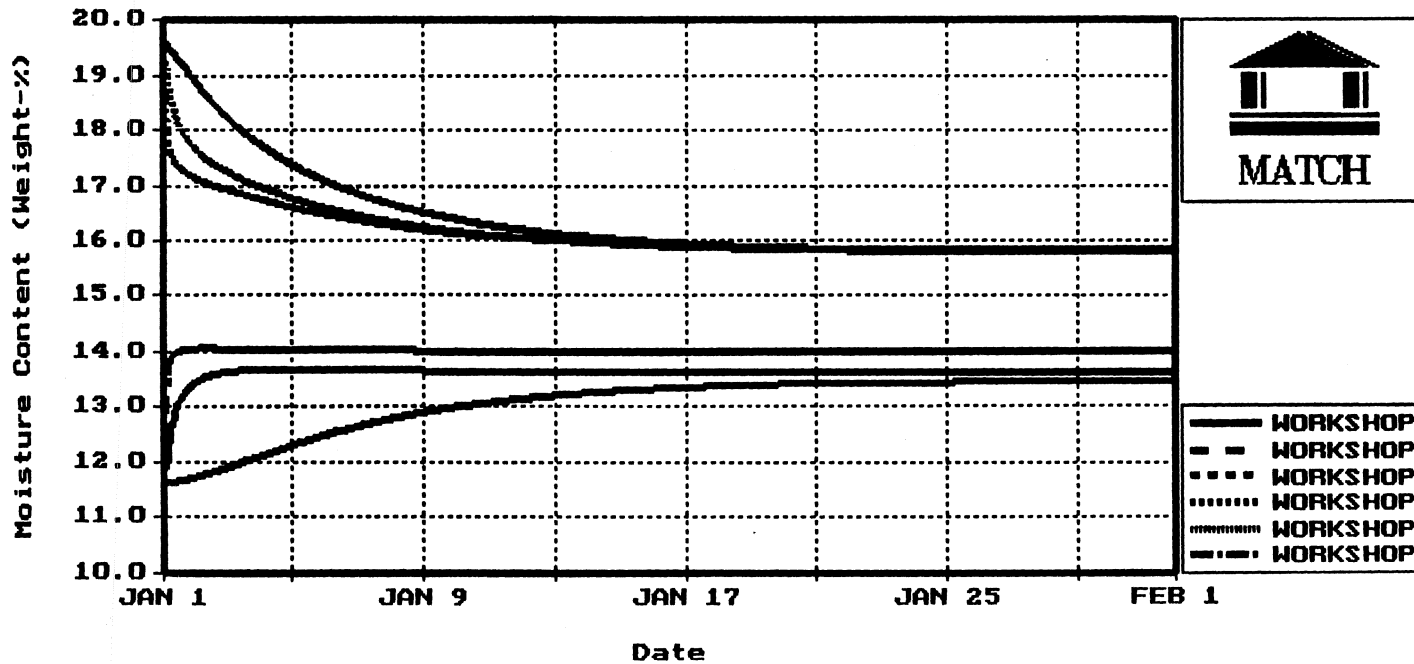

Fig. 4.4

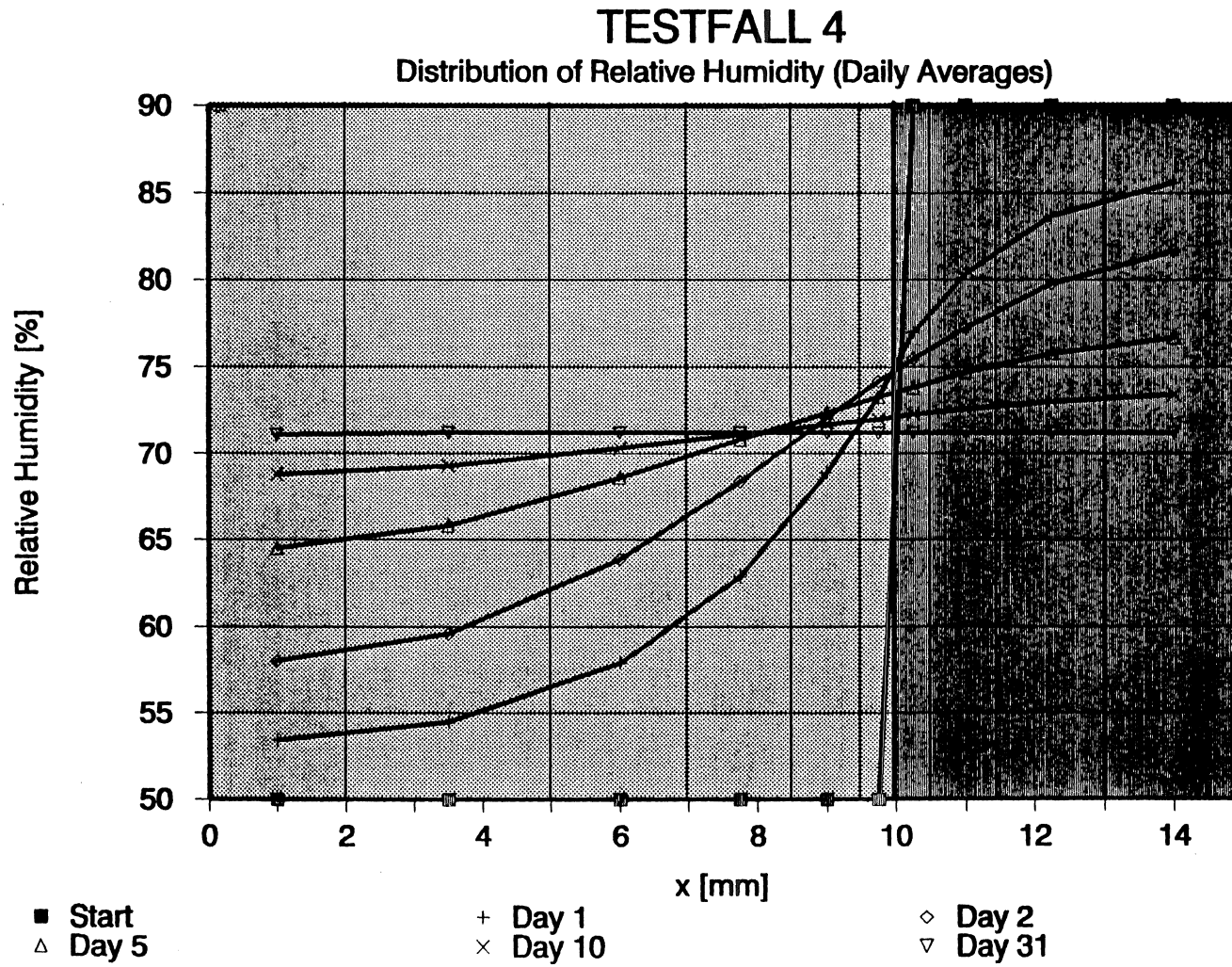



Fig. 4.5

**TESTFALL 4**  
Distribution of Moisture Content (Daily Averages)

