



LUND UNIVERSITY

Modeling of Electricity Distribution Networks and Components

Status Report for Elforsk project 3153

Möllerstedt, Erik; Mattsson, Sven Erik; Bernhardsson, Bo

1997

Document Version:

Publisher's PDF, also known as Version of record

[Link to publication](#)

Citation for published version (APA):

Möllerstedt, E., Mattsson, S. E., & Bernhardsson, B. (1997). *Modeling of Electricity Distribution Networks and Components: Status Report for Elforsk project 3153*. (Technical Reports TFRT-7557). Department of Automatic Control, Lund Institute of Technology (LTH).

Total number of authors:

3

General rights

Unless other specific re-use rights are stated the following general rights apply:

Copyright and moral rights for the publications made accessible in the public portal are retained by the authors and/or other copyright owners and it is a condition of accessing publications that users recognise and abide by the legal requirements associated with these rights.

- Users may download and print one copy of any publication from the public portal for the purpose of private study or research.
- You may not further distribute the material or use it for any profit-making activity or commercial gain
- You may freely distribute the URL identifying the publication in the public portal

Read more about Creative commons licenses: <https://creativecommons.org/licenses/>

Take down policy

If you believe that this document breaches copyright please contact us providing details, and we will remove access to the work immediately and investigate your claim.

LUND UNIVERSITY

PO Box 117
221 00 Lund
+46 46-222 00 00

ISSN 0280-5316
ISRN LUTFD2/TFRT--7557--SE

Modeling of Electricity Distribution Networks and Components

– Status Report for Elforsk Project 3153

Erik Möllerstedt
Sven Erik Mattsson
Bo Bernhardsson

Department of Automatic Control
Lund Institute of Technology
March 1997

Department of Automatic Control Lund Institute of Technology Box 118 S-221 00 Lund Sweden	<i>Document name</i> INTERNAL REPORT	
	<i>Date of issue</i> 970306	
	<i>Document Number</i> ISRN LUTFD2/TFRT--7557--SE	
<i>Author(s)</i> Erik Möllerstedt Sven Erik Mattsson Bo Bernhardsson	<i>Supervisor</i>	
	<i>Sponsoring organisation</i> Elforsk AB and Nutek	
<i>Title and subtitle</i> Modeling of Electricity Distribution Networks and Components		
<i>Abstract</i> <p>This is a status report for the Elfork project 3153, <i>Modeling of Electricity Distribution Networks and Components</i>. The project focuses on modeling and simulation of distribution networks, which are very complex with many non-linear loads and switching devices. A new method for calculation of harmonics at steady-state is presented. The method is based on harmonic balance. Since the level of distortion in distribution networks is limited, we assume that deviations from the nominal voltage affect the current harmonics linearly. The models consist of a nominal current spectrum and a Jacobian matrix, which can be pre-calculated. The method is non-iterative and the networks are solved using linear algebra, it supports aggregation and modularization and the use of model-libraries. Some promising results from simulation of simple systems are presented.</p>		
<i>Key words</i> distribution networks, modeling, harmonics, steady state analysis, harmonic balance		
<i>Classification system and/or index terms (if any)</i>		
<i>Supplementary bibliographical information</i>		
<i>ISSN and key title</i> 0280-5316		<i>ISBN</i>
<i>Language</i> English	<i>Number of pages</i> 12	<i>Recipient's notes</i>
<i>Security classification</i>		

The report may be ordered from the Department of Automatic Control or borrowed through:
University Library 2, Box 3, S-221 00 Lund, Sweden
Fax +46 46 222 44 22 E-mail ub2@uub2.lu.se

Modeling of Electricity Distribution Networks and Components

Erik Möllerstedt Sven Erik Mattsson
Bo Bernhardsson

Department of Automatic Control, Lund Institute of Technology
Box 118, S-221 00 LUND, Sweden
E-mail: {erik, svenerik, bob}@control.lth.se

1. Introduction

This is status report for the project *Modeling of electricity distribution networks and components* which is financed by Elforsk AB as project 3153.

2. Motivation and Objective

Society today relies on a reliable, high-quality supply of electricity. Modern electric power systems, which are very complex and widespread, must therefore be robust enough to withstand any conceivable disturbance. This creates a variety of design, operational and control problems for power-system engineers, who need powerful computer-aided tools to solve them.

The increased use of switched power supplies and power electronics for motor control creates disturbances in the wave form of the supplied electricity, which ideally should be sinusoidal with constant frequency and amplitude. These disturbances can be compensated for by inserting electronic devices near to the load. Furthermore, the deregulation of the electrical power market means that a distribution company must supply electrical power of high quality and it must be able to solve its customers' problems.

The simulation tools and component models available today have largely been developed either for transmission and generation systems, or for component design and development. What is needed are methods that deal with the typical problems with distribution systems, with many and very non-linear components.

The aim of this project is to develop model libraries, methods and tools for static and dynamic simulation of electricity distribution networks. Simulation of transient behavior means simulation of responses to disturbances caused by for example voltage drops in feeding power, local malfunctions or switching

user equipments on or off. Possible aims are to study voltage propagation in the network and to check for over-voltage and trip out of protection equipment. Typical simulation times are 2–3 periods. Static analysis includes calculation of wave forms and spectra. It is also of interest to investigate the risks for resonances.

3. Description

Mathematical models for static and dynamic simulation electricity distribution networks need to be non-linear and accurate up to frequencies of a few kHz. Typical network configurations are a shopping center, an office building or a local district with fifty houses, two factories, and two transformer stations. Such networks have many components.

The approach normally taken for transient studies of power transmission networks, [Dommel, 1969], is not useful, since it is assumed that voltages in the network have a sinusoidal wave form. The problem is then simplified drastically because linear models can be used. The linear models are, however, only valid in a small frequency range around the synchronous frequency, i.e., 50 or 60 Hz. Furthermore, the loads have been modeled in aggregated ways under various simplifying assumptions. When the focus is on distribution networks for control of voltage quality it is necessary to use more elaborate component models.

On the other hand straightforward uses of commonly used power electronics component models lead to unmanageable models, because a network has so many components. High fidelity models for transformers, cables, electric motors, electronic devices etc. have been developed for design purposes to check for spark-over or thermal properties or to support optimization of the design, [Massobrio and Antognetti, 1993]. Even a simple light source gives rise to complex and non-linear models and an office building may have hundreds of light sources. Consequently, these models are in most cases too complex for analysis of distribution networks.

Today's complex distribution networks need special models. When selecting a model it is very important to consider the needs imposed by the problem we are about to solve. For many reasons a model cannot describe all aspects of a system, but it has to focus on parts and phenomena that are of real importance for the problem to be solved. For other parts or phenomena we have to use simplified or idealized behavior descriptions. It is crucial to keep the models simple enough without losing their properties for describing e.g. the harmonic injection of disturbances.

To beat complexity it is necessary to develop models that are efficient to simulate. For instance the modeling of solid-state switches (diodes, thyristors and transistors) is a delicate issue. A detailed model includes extreme non-linearities, which make the model time consuming to simulate. A simulator with proper discontinuity handling as OmSim, [Mattsson *et al.*, 1993, Andersson, 1994, Andersson, 1995], can simulate a model with idealized switching elements an order of magnitude faster. We know of examples where the simulation is ten times faster. We are now trying to investigate the differences of accuracy in the two approaches.

It is also necessary to work with aggregated models. The big question is then how to make the aggregation. It would be very useful to have tools

that can take a component based model of a part of a network and make a simplified aggregated model. One difficulty is that a network includes non-linear components. For linear dynamic models there are well-established model reduction techniques.

To sum up, important subproblems in the project are *efficient modeling and simulation of switching devices* and *methods for aggregated modeling to handle complexity*.

4. Status

We are using an object oriented, equation based modeling language, Omola, to develop models, [Mattsson *et al.*, 1993, Andersson, 1994, Andersson, 1995]. Model libraries are built up hierarchically, using specialization and inheritance. This makes the models reusable and easy to modify. The behavior of a component is described by differential-algebraic equations, difference equations and discrete events. The possibility to use hybrid models, that is, combine continuous equations and discrete events, makes Omola very suitable for modeling switching devices, such as power electronics and converters. Together with Omola we use OmSim, an interactive environment for developing and simulating Omola models.

In Omola we have developed models for a number of switching devices, such as diodes, thyristors, fluorescent tubes, dimmers, converters, etc. We have used different ways to characterize the non-linear behavior. For the diode, for instance, we have models with the three different characteristics shown in Figure 1. In this way we can compare the different models regarding simulation speed, accuracy and simplicity.

A diode can, for instance, be modeled in three different ways as shown in Figure 1. These three diode models lead to very different simulation problems for the numerical solver. Modern solvers that handle discontinuities efficiently, are much faster if the diodes are modeled as piecewise linear switches (b and c). Simulations of simple circuits, with voltage levels as in distribution systems, show that the results are almost identical when using the different diode models. This is further developed in Section 5. Thus, the choice depends on which models are the most efficient to simulate.

There are, however, problems with simplifying the models too much. The models can lead to non-physical systems, that do not have a solution. Different

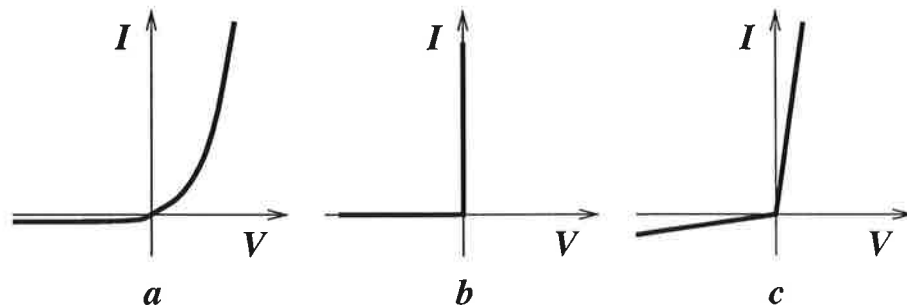

Figure 1 Different ways to model the VI -characteristics of a diode. a) The classical exponential shape. b) An ideal switch. c) A diode modeled as a two-valued resistor.

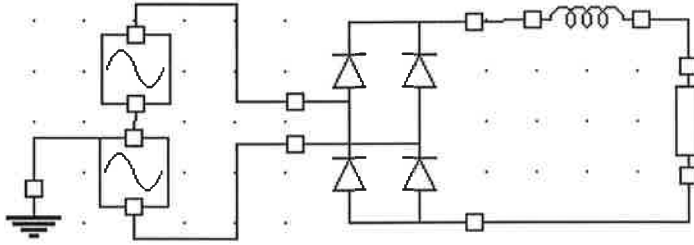

Figure 2 Since the amplitude of the voltage in distribution systems is large, the performance of the circuit is not sensitive to how the diodes in the converter is modeled.

numerical solvers do not fit efficiently with the same models. Choosing how to model the components, and what numerical solver to use are related problems.

We are also developing a method to describe non-linear elements in the frequency domain. This can be used to get the steady state solution for a network. The models are also possible to aggregate to decrease the complexity of the system.

The method works as follows: The components are described by a nominal current spectrum and an admittance matrix. The nominal current is the current through the component when applied to an undistorted voltage of nominal amplitude and frequency. The deviations from the nominal current spectrum when the voltage is distorted are described by the admittance matrix. Aggregation of loads and solving the network is done by direct calculation using linear algebra, i.e., no iterative solution is necessary. This means that convergence problems, and large computational efforts are avoided.

The models can be obtained analytically, through real measurement, or by simulating the components in time domain, using, for instance, our Omola models. The method is further discussed in Section 6.

5. Comparison of Different Diode Models

Because of the large voltage amplitudes in electrical distribution networks, the exact shape of the voltage-current characteristics of switching devices is of minor importance. To show this, we simulated the converter circuit in Figure 2, using the two different ways to model the diode shown in Figure 1a and c. The voltage source provided a 240 V, 50 Hz AC voltage. The smoothing coil had the inductance $L = 0.01$ H, and the load was resistive with $R = 1\Omega$. With an object oriented modeling language, that supports inheritance, like Omola, it is easy to compare the performance of different diode models in a network.

After the system had reached steady state, we analyzed the amplitude and phase of the different frequencies in the line current. The harmonic amplitudes are shown in Figure 3. For significant frequencies, the result is identical with the different models. This indicates that both models are accurate enough, and the choice we make depends on which one is the most efficient for the simulation.

The exponentially shaped diode in Figure 1a leads to very stiff models that

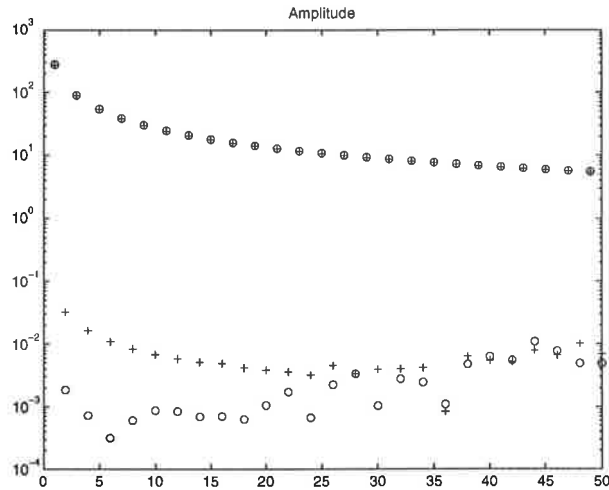

Figure 3 The periodic spectrum for the circuit using the two diode models. The spectrum marked with + corresponds to the exponentially shaped diode model, whereas the two-valued resistor model corresponds to o. For significant harmonics, the two spectra are equal.

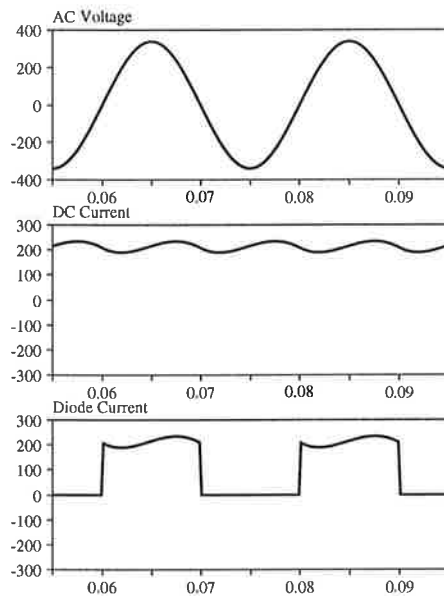

Figure 4 The curves shows the AC-voltage, the DC-current and the current through one of the diodes in an AC/DC-converter. The current through the diode changes very rapidly in the switching instances. In between the switchings, all signals are smooth.

are time-consuming to simulate. This is illustrated in Figure 4, which shows voltages and currents from the converter circuit above. The AC-voltage, and the DC-current, are very smooth signals that are easy to simulate. The current through the diode, however, is smooth until the switching occurs, where the current goes from 200 A to 0 A almost instantaneously. This means that a very small step length is required, and the simulation is inefficient. It is obvious that the exact diode characteristics in between the conducting phase, and the non-conducting phase is irrelevant.

The two other diode models lead to more efficient simulation. The ideal relay in Figure 1b is the most elegant way to model the diode, but it might lead to isolated sub-circuits, that do not have a reference value for the voltage. Such, so called, floating nodes give problems for the numerical solver. The two-valued resistor in Figure 1c avoids the problems with floating nodes.

A problem with switching elements is that they often lead to index problems for the numerical solver. It is important to model the switches so that these problems are avoided. There are numerical solvers that can treat models with index problems.

We have investigated simple systems using different models and different numerical solvers. Since all models are accurate enough it is a matter of simplicity and avoiding index problems, which model and numerical solver to choose. It is desirable to be able to say that this way to model the devices, in combination with this numerical solver, is most suitable for simulation of distribution system. That is the aim of our research.

6. Frequency Domain Methods

6.1 Harmonic Balance

Steady state harmonic analysis of *linear* power systems is often performed using the phasor method. The phasors are the coefficients in the Fourier series of voltages and currents in the system:

$$v(t) = \sum_k V_k e^{jk\omega_0 t}, \quad i(t) = \sum_k I_k e^{jk\omega_0 t}.$$

The network components are conveniently represented by admittance matrices. When the components are linear, these matrices are diagonal, and the diagonal elements are simply the admittance of the component at the frequencies considered.

With the admittance matrix, Y , and phasor vectors

$$V = [V_1 \quad V_2 \quad \dots]^T, \quad \text{and } I = [I_1 \quad I_2 \quad \dots]^T,$$

we get the relationship, $I = YV$.

When Y is diagonal, the different harmonics can be treated individually. Standard frequency domain methods do not have a convenient way to represent the non-linearities. Some methods treat them as harmonic current injectors. These injectors are assumed constant, but since most non-linear elements depend on the rest of the system, the solution is often far from correct. However, this means that we still can treat the harmonics one by one.

One way to improve the accuracy is to adjust the injected current iteratively. The solution is iterated between the linear network and the non-linear elements, which are often simulated in the time domain. This is referred to as the harmonic balance method, [Kundert and Sangiovanni-Vincentelli, 1986, Gilmore and Steer, 1991]. A problem is that it is time consuming, and convergence of the method is hard to predict. With many non-linear elements the problems become severe. Even though fast convergence have been proved for a number of specific test cases, it is impossible to say something about the general case. Another possibility to improve efficiency would be to avoid

to recalculate the Jacobian matrix every iteration, and set small values of the Jacobian to zero, [Smith *et al.*, 1996].

6.2 The Proposed Method

The fact that the harmonic balancing method is applied to electrical distribution systems creates some interesting possibilities to support modularity. The idea is that for distribution systems, the line voltage is known in advance (e.g. 230V, 50Hz) and the maximum level of distortion, e.g., energy contents in harmonics, is regulated by norms and standards not to exceed certain values. The operating conditions for loads, which are connected in parallel, are hence approximately known in advance. This makes linearization of the nonlinear algebraic relations tractable.

A non-linear device can approximately be described by the following relation:

$$I = I_0 + Y(V - V_0), \quad (1)$$

where I is a vector containing the Fourier coefficient of the current, V contains the Fourier coefficients of the voltage, and I_0 and V_0 are the nominal current spectrum and voltage spectrum respectively, i.e.,

$$\begin{aligned} i(t) &= \sum_{k=1}^N A_k \cos k\omega t + B_k \sin k\omega t \\ \Rightarrow I &= [A_1 \quad \dots \quad A_N \quad B_1 \quad \dots \quad B_N]^T \\ v(t) &= \sum_{k=1}^N a_k \cos k\omega t + b_k \sin k\omega t \\ \Rightarrow V &= [a_1 \quad \dots \quad a_N \quad b_1 \quad \dots \quad b_N]^T. \end{aligned}$$

The admittance matrix, Y , is a matrix that describes the linear relationship between the voltage and the current.

$$Y = \frac{\partial I}{\partial V} = \begin{bmatrix} \frac{\partial A_1}{\partial a_1} & \dots & \frac{\partial A_1}{\partial b_1} & \dots \\ \vdots & \ddots & \vdots & \dots \\ \frac{\partial B_1}{\partial a_1} & \dots & \frac{\partial B_1}{\partial b_1} & \dots \\ \vdots & \ddots & \vdots & \ddots \end{bmatrix}. \quad (2)$$

The non-linear device is then represented by a nominal current spectrum, I_0 , and a Jacobian matrix, Y . The Jacobian is sometimes referred to as the harmonic admittance matrix, but could also be called the linearized describing function.

The model can be seen as a Norton equivalent of the component. One advantage with this way of representing non-linear loads, is that the iterative procedure is avoided. This leads to an efficient way to solve the network. The matrix representation also makes aggregation of loads quite straightforward, which is valuable for today's complex distribution systems.

The method is a version of the Newton method of Harmonic Balancing, also called harmonic iteration. It can be seen as one iteration of the method where the nonlinear describing method has been linearized around a nominal

working condition, a network with pure sinusoidal signals. The main point is that one iteration can be achieved using precomputed, modularized information. This gives a very fast method that is interesting also for analytical investigations since only linear algebra is used. The model, (1), (2), can be obtained either by measurement, time domain simulation of simple circuits, or analytical calculations. Moreover, a global admittance matrix can be computed by interconnecting local models. The main problem to investigate is how accurate solutions we get, using only one iteration. Our first experiments show promising results. The idea is presented using two examples. The method is further discussed in [Möllerstedt *et al.*, 1997]

7. Examples

7.1 A Dimmer Circuit

To illustrate the idea, we consider a simple dimmer, consisting of two thyristors in parallel. When the current through the dimmer becomes zero, the dimmer is turned off. The current through the dimmer remains zero for a time, d , after which the dimmer is turned on again. The dimmer is connected in series with a linear resistor, see Figure 5. When connected to a stiff voltage source, the current through the dimmer will be distorted, see Figure 6. Since the current is symmetric, there will only be odd harmonics, i.e. we have

$$u_{\text{nom}}(t) = a_1^0 \cos \omega t,$$

$$i_{\text{nom}}(t) = \sum_{k \text{ odd}} A_k^0 \cos k\omega t + B_k^0 \sin k\omega t.$$

If, however, the voltage source is a bit distorted, we approximately have that the deviation from the nominal current is linearly dependent on the distortion

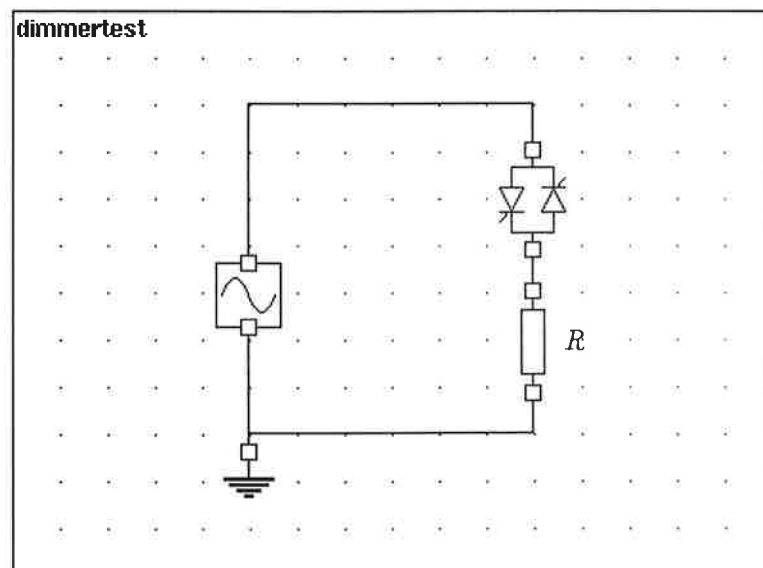

Figure 5 A dimmer in series with a resistive load.

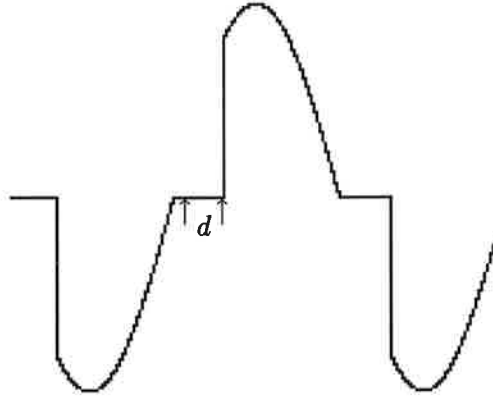

Figure 6 The current through the dimmer is turned off for a time, d , every half period.

of the voltage, i.e.,

$$v(t) = a_1^0 \cos \omega t + \sum_{k \text{ odd}} \hat{a}_k \cos k\omega t + \hat{b}_k \sin k\omega t,$$

$$i(t) = \sum_{k \text{ odd}} (A_k^0 + \hat{A}_k) \cos k\omega t + (B_k^0 + \hat{B}_k) \sin k\omega t,$$

where we have put $A_k = A_k^0 + \hat{A}_k$ etc. and

$$\begin{bmatrix} \hat{A}_1 \\ \vdots \\ \hat{B}_1 \\ \vdots \end{bmatrix} = Y \begin{bmatrix} \hat{a}_1 \\ \vdots \\ \hat{b}_1 \\ \vdots \end{bmatrix},$$

$$Y = \frac{dI}{dV} = \begin{bmatrix} \frac{\partial A_1}{\partial a_1} & \cdots & \frac{\partial A_1}{\partial b_1} & \cdots \\ \vdots & \ddots & \vdots & \cdots \\ \frac{\partial B_1}{\partial a_1} & \cdots & \frac{\partial B_1}{\partial b_1} & \cdots \\ \vdots & \ddots & \vdots & \ddots \end{bmatrix}.$$

In Figure 7, the resulting coefficients, calculated from this linearized model, are compared with the true values obtained from a simulation of the network. The results show that the linearized model is a good approximation if the deviations in voltage are limited to 10%. Note that the current is severely distorted due to the nonlinearity, as shown in Figure 6. The accuracy should be enough for investigations of common electrical networks.

7.2 A Slightly Larger System

In radial distribution networks, the loads are connected in parallel. What makes the voltage deviate from its nominal value are the line losses. The steady-state solution for the system in Figure 8 containing two dimmers is easily derived using our method to represent the dimmers. Applying Kirchoff's laws, it is a matter of solving an linear equation system. Let the two

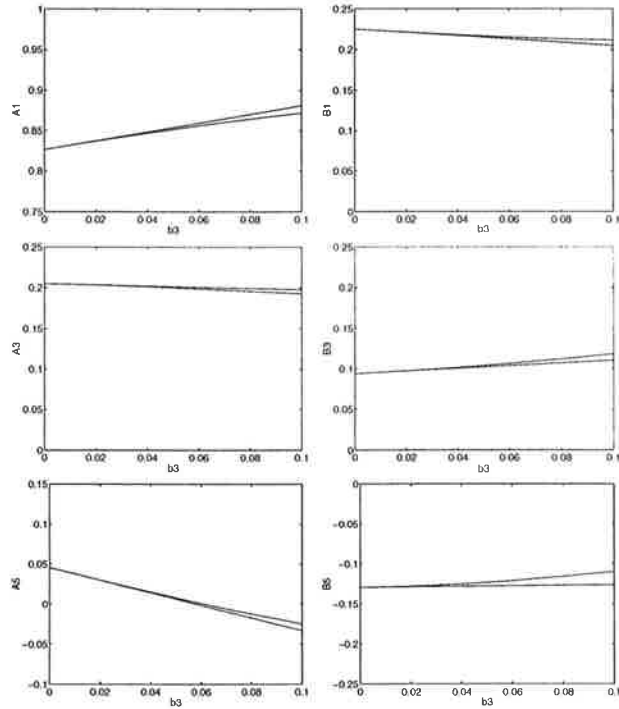

Figure 7 Plots showing how the linearized and simulated Fourier coefficients for the current in the circuit in Figure 5 depend on b_3 , when $u(t) = \cos t + b_3 \sin 3t$.

dimmers and their loads (resistive loads of 20Ω each) be represented by admittance matrices, Y_1 and Y_2 . The line impedances, $z_{l1} = (0.75 + j\omega 0.0024)\Omega$ and $z_{l2} = (0.25 + j\omega 0.0008)\Omega$, are represented by diagonal matrices, Z_{l1} and Z_{l2} , of the same size as Y . The system can then be described by the following

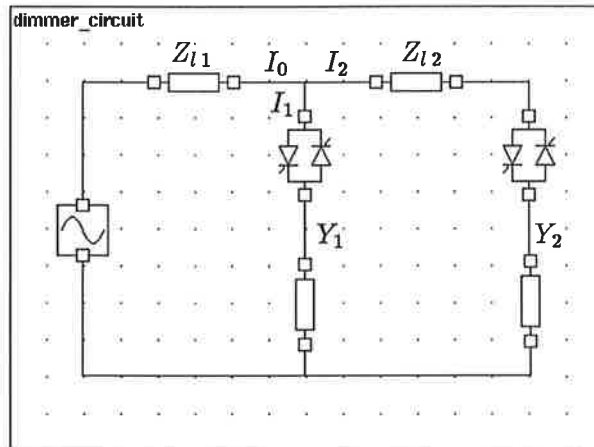

Figure 8 A circuit with two dimmers.

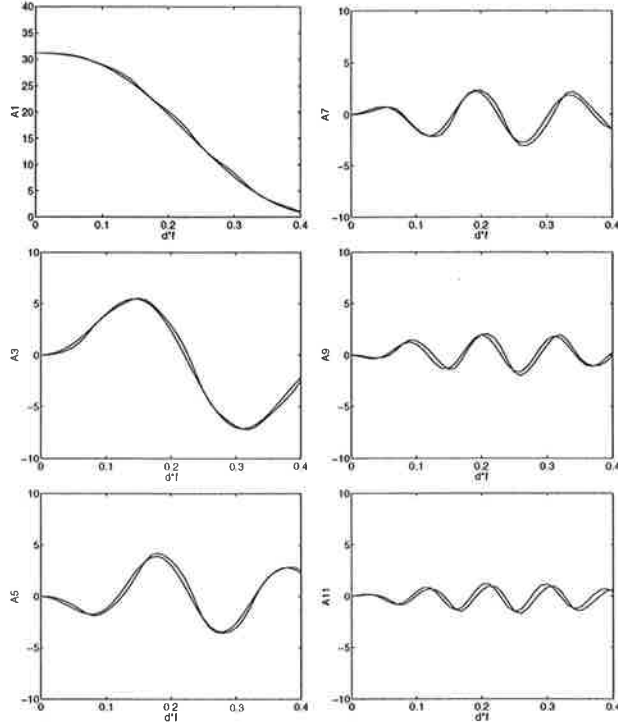

Figure 9 Plots showing how the linearized and simulated Fourier coefficients for the current in the circuit in Figure 8 depend on the turn on time, d , for the dimmers.

equation

$$\begin{bmatrix} \mathbf{I} & -\mathbf{I} & -\mathbf{I} & 0 & 0 \\ 0 & \mathbf{I} & 0 & -Y_1 & 0 \\ 0 & 0 & \mathbf{I} & 0 & -Y_2 \\ Z_{l1} & 0 & 0 & \mathbf{I} & 0 \\ 0 & 0 & Z_{l2} & -\mathbf{I} & \mathbf{I} \end{bmatrix} \begin{bmatrix} I_0 \\ I_1 \\ I_2 \\ \widehat{V}_1 \\ \widehat{V}_2 \end{bmatrix} = \begin{bmatrix} 0 \\ I_{1 \text{ nom}} \\ I_{2 \text{ nom}} \\ 0 \\ 0 \end{bmatrix}$$

Here I_0 , I_1 , and I_2 are vectors containing the Fourier coefficients of the currents and \widehat{V}_1 , and \widehat{V}_2 contain the Fourier coefficients of the deviations from the nominal voltage, $v_{\text{nom}}(t) = 240\sqrt{2} \cos 2\pi 50t$. The identity matrix of appropriate size is denoted \mathbf{I} . Instead of solving a non-linear algebraic equation system, we now have to solve a linear equation system of the same size.

The currents become more distorted the longer the dimmers are turned off. It is natural to assume that the method will be less accurate the larger d is. We therefore tested the accuracy of the method for different turn on delays, d . Figure 9 shows the first six cosine coefficients for the Fourier series of the current, when d is varied from zero to almost a half period. The plots show that the method works well for all d .

8. Summary

Analysis of electrical distribution networks requires special methods. Because of the complexity of the systems, the methods must be computationally efficient, and it must also be possible to aggregate models. For transient analysis,

we are looking on how to treat switching elements in an efficient way. Using a simulator with proper discontinuity handling, we can work with idealized models. In this way we can simulate an order of magnitude faster without losing accuracy.

For steady state simulation, we are developing a method that supports aggregation, and avoids time-consuming iterative solutions. The models are described by an admittance matrix and a nominal current spectrum. They show a close resemblance to a Norton equivalent. The models can be achieved through analytical calculations, time domain simulations, or real measurements. The results so far look very promising.

9. References

- ANDERSSON, M. (1994): *Object-Oriented Modeling and Simulation of Hybrid Systems*. PhD thesis ISRN LUTFD2/TFRT--1043--SE, Department of Automatic Control, Lund Institute of Technology, Lund, Sweden.
- ANDERSSON, M. (1995): *OmSim and Omola – Tutorial and User's Manual*. Dept. of Automatic Control, Lund Institute of Technology.
- ARRILLAGA, J., D. A. BRADLEY, and P. S. BODGER (1985): *Power System Harmonics*. John Wiley and Sons, New York, first edition.
- DOMMEL, H. W. (1969): "Digital computer solution of electromagnetic transients in single- and multiphase networks." *IEEE Trans. on Power Apparatus and Systems*, **88:4**, pp. 388–399.
- GILMORE, R. J. and M. B. STEER (1991): "Nonlinear circuit analysis using the method of harmonic balance – a review of the art. Part I. Introductory concepts." *Int J. Microwave and Millimeter-Wave Computer-Aided Eng.*, **1:1**, pp. 22–37.
- KUNDERT, K. S. and A. SANGIOVANNI-VINCENTELLI (1986): "Simulation of nonlinear circuits in the frequency domain." *IEEE Trans. on Computer-Aided Design*, **5:4**, pp. 521–535.
- MASSOBRIO, G. and P. ANTOGNETTI (1993): *Semiconductor Device Modeling with SPICE*. McGraw-Hill, second edition.
- MATTSSON, S. E., M. ANDERSSON, and K. J. ÅSTRÖM (1993): "Object-oriented modelling and simulation." In LINKENS, Ed., *CAD for Control Systems*, chapter 2, pp. 31–69. Marcel Dekker Inc, New York.
- MÖLLERSTEDT, E., S. MATTSSON, and B. BERNHARDSSON (1997): "A new approach to steady-state analysis of power distribution networks." In *Proc. IMACS WORLD CONGRESS*, Berlin, Germany.
- MOHAN, N., W. P. ROBBINS, T. M. UNDELAND, R. NILSSEN, and O. MO (1994): "Simulation of power electronic and motion control systems – an overview." *Proc. of the IEEE*, **82:8**, pp. 1287–1302.
- SMITH, B., N. R. WATSON, A. WOOD, and J. ARRILLAGA (1996): "A Newton solution for the harmonic phasor analysis of ac/dc converters." *IEEE Trans. on Power Delivery*, **11:2**, pp. 967–971.
- TASK FORCE ON HARMONIC MODELING AND SIMULATION (1996): "Modeling and simulation of the propagation of harmonics in electric power networks. Part I & II." *IEEE Trans. on Power Delivery*, **11:1**, pp. 452–474.
- XIA, D. and G. T. HEYDT (1982): "Harmonic power flow studies, Part I – Formulation and solution, Part II – Implementation and practical aspects." *IEEE Trans. on Power Apparatus and Systems*, **101:6**, pp. 1257–1270.

