

End-of-degree Project

Degree in Industrial Engineering

**Study of the Mercury M6e RFID reader for Ultra High
Frequency band and testing operations**

MEMORANDUM

Author: Álvaro González García
Director: Orestes Mas Casals
Assistant: Jan Rosell Gratacòs
Convening: January 2017



Escola Tècnica Superior
d'Enginyeria Industrial de Barcelona



Summary of contents

1	INTRODUCTION	6
1.1	Abstract.....	6
1.2	Introduction	7
1.2.1	Project Objectives	8
1.2.2	Origin of the project.....	9
1.2.3	Motivation.....	10
1.2.4	Previous requirements	10
1.3	Glossary.....	11
2	BASIC PRINCIPLES OF RFID SYSTEM	13
2.1	RFID Technology.....	13
2.1.1	Automatic identification	13
2.1.2	Radio Frequency identification	14
2.1.3	Technological alternatives.....	16
2.2	Internal operation of the radio-frequency equipment	21
3	EQUIPMENT OPERATION	23
3.1	RFID System Components	23
3.1.1	The Tag.....	23
3.1.2	EPC (Electronic Product Code).....	24
3.1.3	The reader	28
3.1.4	Database and Middleware	29
3.1.5	RFID Programmers.....	29
3.2	Mercury Kit M6e RFID UHF General Description	30
3.2.1	Workflows	31
3.2.2	Tag Results.....	31
3.2.3	Write EPC	33
3.2.4	Tag Inspector	35
3.2.5	User Memory Editor	38
3.2.6	Lock Tag	40
3.2.7	Untraceable.....	41
3.2.8	Authenticate	42
3.3	Environment condition and laboratory layout.....	44
3.4	Scope and Specifications of RFID Equipment.....	45
3.4.1	Far field and near field of RFID	45
3.4.2	Radiation diagrams for tags and the antenna.....	47
3.5	Laboratory measurements.....	49
3.5.1	Tag types comparative and subsequent classification	49
3.5.2	The backpack tag case	58



3.5.3	Data stored at tags.....	60
3.5.4	Tags selected for the experiments	61
3.5.5	Distance of reading with angle sweep	62
3.5.6	Recording possibilities.....	70
3.5.7	Tag orientation influence	71
3.5.8	Influence of overcrowding. Tag collision.....	72
3.5.9	Multipath: Metallic, wood, plastic and liquid paths	73
3.5.10	Table of equivalences distance-power signal.....	83
3.5.11	Experimental Conclusions:.....	84
4	PYTHON WRAPPERS FOR MERCURY API	88
4.1	Example of implementation.....	88
4.2	Steps to create own python wrappers from Mercury API.....	92
5	CONCLUSIONS	96
6	REFERENCES	98
7	APPRECIATIONS	100
8	ANNEX	101
8.1	Further information of the example wrappers	101
8.2	MERCURYDevKit Datasheet.....	103
8.3	M6e reader Datasheet	105



Summary of figures

Figure 1. RFID system scheme	14
Figure 2. Electromagnetic field created between reader and transponder	15
Figure 3. Passive tags	16
Figure 4. Active tags	17
Figure 5. Semi-Active tags	17
Figure 6. Line of sight UHF operation	20
Figure 7. Electromagnetic spectrum for different frequencies	20
Figure 8. RFID system internal operation	21
Figure 9. Electromagnetic field wave's directions	22
Figure 10. Tag elements	23
Figure 11. Explanation of the EPC fields	24
Figure 12. Identification cycle description	27
Figure 13. M6e RFID reader	28
Figure 14. Middleware description	29
Figure 15. Connecting starter menu - URA	30
Figure 16. Tag Results grid	30
Figure 17. Memory banks at Tag Inspector tab (yellow wire)	35
Figure 18. Memory banks at Tag Inspector tab (tag CONFIDEX)	36
Figure 19. User Memory tab analysing a tag	37
Figure 20. User Memory tab analysing a tag (2)	38
Figure 21. User Memory tab analysing a tag (3)	38
Figure 22. User Memory tab analysing tag named "Belt"	39
Figure 23. Lock Tag tab description with tag named "Belt"	40
Figure 24. Untraceable tab description with tag named "Belt"	41
Figure 25. Authenticate tab description with tag named "Belt"	42
Figure 26. Laboratory layout	44
Figure 27. Near field and far field illustration	45
Figure 28. <i>Emitting radiation diagrams from the tags</i>	47
Figure 29. Antenna's emitting radiation diagrams	48
Figure 30. 3D diagram of radiation intensities	48
Figure 31. Electromagnetic field created by a dipole	51
Figure 32. Dipole	51
Figure 33. Dipole 3D radiation diagram	51
Figure 34. Distance calculation with the Backscattering	57
Figure 35. Memory banks of the backpack tag	58
Figure 36. First layout of reading elements	62
Figure 37. Laboratory picture of the 2 meter-layout	64
Figure 38. Laboratory picture of the 4 meter-layout	66
Figure 39. Laboratory picture of the 6 meter-layout	68
Figure 40. Tag's radiation diagram	71
Figure 41. X-axis and Z-axis rotation measurements vs. Groups	71
Figure 42. Test of the wave's propagation through metal	73
Figure 43. In phase RF waves and constructive interference	81
Figure 44. Out of phase waves and destructive interference	81
Figure 45. Electromagnetic field at Faraday cage	81
Figure 46. Normal communication condition draw	82
Figure 47. Communication condition with a Metal Surface draw	82
Figure 48. Communication condition with a magnetic sheet draw	83
Figure 49. Command dmesg tail to find the name of the USB reader	88
Figure 50. Calling "mercury" module and creating "reader" object	88
Figure 51. Commands for setting region and read plan	89



Figure 52. Printing reading results	89
Figure 53. Python program implementation	89
Figure 54. Tags identified with the reading.reading() command	90
Figure 55. Example testing the function "read"	94
Figure 56. Example testing the function "readasync"	94
Figure 57. Printing supported regions by the reader system	101
Figure 58. Printing reader model by the reader system	102

Summary of tables

Table 1: Barcode and RFID characteristics	14
Table 2. Passive and active tags comparison	18
Table 3. Frequency bands comparison	19
Table 4. Communication protocols comparison	25
Table 5. Tags provided with RSSI and Surface measurements	49
Table 6. Tags not recognized at 1,5 meters of distance	52
Table 7. RSSI classifying intervals	53
Table 8. Tag classification into five different groups	55
Table 9. Tag selection for each classifying group	61
Table 10. First layout reading at 1,5 meters.	62
Table 11. Second layout reading at 2 meters	64
Table 12. Second layout reading at 4 meters	66
Table 13. Second layout reading at 6 meters	68
Table 14. Tags provided with number of recording characters measurements	70
Table 15. Radio-frequency waves propagation through metal	73
Table 16. Radio-frequency waves propagation through wood	75
Table 17. Radio-frequency waves propagation through plastic	76
Table 18. Radio-frequency waves propagation through glass	77
Table 19. Distance - power signal equivalences	83

Summary of charts

Chart 1. RSSI vs. Surface comparison	50
Chart 2. RSSI vs. Surface comparison with effective area of the yellow wire	52
Chart 3. Surface vs. Group classification	53
Chart 4. Tag number vs. Group classification	54
Chart 5. Reading at 1,5 meters vs. Groups	63
Chart 6. Reading at 2 meters vs. Groups	65
Chart 7. Reading at 4 meters vs. Groups	67
Chart 8. Reading at 6 meters vs. Groups	69
Chart 9. Radio-frequency waves comparison through metal	74
Chart 10. Radio-frequency waves comparison through wood	75
Chart 11. Radio-frequency waves comparison through plastic	76
Chart 12. Radio-frequency waves comparison through glass	77
Chart 13. Entire comparative between all the materials tested	78



1 Introduction

1.1 Abstract

In order to sum up the whole work done here, we must begin explaining with a fast overview of the contents that are going to appear below.

At the beginning of the semester, the UPC bought the M6e RFID for UHF reader from mercury in the interest of make some research at experimental level and stating constancy of the knowhow of the equipment operation.

This project defines not only the operation but also the scope and design of that knew tool, very useful in a few years but not commonly implemented nowadays. Another target of this research is to know how far can we arrive modifying some parameters from the equipment or try to implement new ones in order to optimize their functions to the maximum.

Aside from those intentions, the idea of creating some kind of Python language wrappers (bindings) in order to call functions from the library written in C of the mercury API has been raised. The final purpose is to take control of the RFID system through a Python program by calling C functions in the vendor provided library.

The reason why this study is being carried out is with the aspirations of implementing this system in a range of different possible applications. A personal aspiration is to take it to robotics applications such as mapping localization of the land and also finder stuff radar, as an example. It can be taken too for the supermarket cashier, thing that would make the job in a faster and easier way than current existing barcodes.

The methods used here are basically two: in one hand, we must name the experimental work at the IOC's Laboratory with the physical equipment which gets along with a software (Universal Reader Assistant) and in the other hand, with the help of two programming languages such as Python and C for the achievement of creating the bindings.



1.2 Introduction

This project is based on the study and comprehension of a new equipment bought by the UPC, the RFID M6e reader for UHF from Mercury.

At this report it will be found the basic principles of the RFID technology which is raising up at the current markets nowadays and its implementation at real applications.

The paper written below can be subdivided into three parts: basis and operation of this RFID reader, experimental measurements and implementation of some python bindings in order to control it.

The basis and operation of M6e RFID reader describes which are the possibilities that this device offers to users, explaining not only the multiple operations that can be done with it but also the use of the software provided by the product distributor, *ThingMagic*, and its limitations.

About the experimental measurements, it can be said that are realized with the final purpose to know how far can reach this device, defining its scope and potential in order to take them into account for a future implementation in a greater project of a system perception of mobile manipulators that must work in unstructured human environments.

To conclude, the last part of the project consists in the implementation and start-up of a binding between the reader system and a Python program with the help of wrappers to take access to the internal API program.



1.2.1 Project Objectives

The main objective of this Final Grade Project is the study of the M6e RFID reader for UHF from Mercury brand. The study contains the general operation of the equipment and its scope with the implementation of Python wrappers to get control of the reader system.

From this general objective, a series of specific objectives can be generated which are listed below:

- Comprehension and deepening in radio frequency identification technology.
- Characterization of a telecommunications system such as the RFID reader.
- Operation description of the whole functions available of the system and the software handling designed by the manufacturer, the *Universal Reader Assistant*.
- Accomplishment of several test to prove the scope of M6e reader from Mercury:
 - Tag classification: is based on grouping the different kind of tags that came with the package bought and find some parameters to group them in different categories.
 - Distance readings: once those groups have been established, measurement of the different scope distances that the reader system is able to reach with the performance of a 180° angle sweep.
 - Tag orientation: consists in make a study of the influence while tag is changing its orientation with respect X and Z axes own rotation and be able to observe the variations.
 - Materials: is going to be studied the performances of the radio-frequency wave's transmission through different materials and evaluate its effects.
- Implementation of Python wrappers in order to make a binding with the mercury API with the final purpose to take control of the system and make operations from a high-level programming language.
- Make use of part of the knowledge acquired during the Grade and extension of some of them.

This project based on a space perception system is part of a major project belonging to the IOC's research institute, which is based on research with mobile manipulators that has to work in unstructured human environments.

The labour carried out here is addressed to the people who are dedicated to the research of the project that includes this one, in order to ease the part of knowing, testing and documenting the operation of this perception system, the M6e reader from Mercury.



With the intention of subdividing the work into three large parts, the problems that we will have to deal with are also divided into three different parts:

On the one hand, *Universal Reader Assistant* documentation is not supposed to raise too many problems. There is an instruction manual of use in which the inconveniences belonging have already been faced and solved.

On the other hand, with respect to the most purely experimental part, in which tests of scope of the reading system are carried out, taking into account the layout of the laboratory, it is possible that, since it is not a totally ideal space away from possible factors that disrupt the transmission of the signal, the measures taken could not be significant.

However, it should be added that this ideal environment will rarely be found in the future real implementation of the system, so it can be simulated an approximation with enough success.

Finally, in the implementation part of Python wrappers, we could have some linking problems between both programming languages, due to that they have disparate structures.

From now on, we will try to overcome the unforeseen adversities that could present the tests described above with the greatest possible diligence, in order to establish a rigid and solid base.

1.2.2 Origin of the project

This project origin is born due to the fact that UPC has bought the RFID Kit and have come to the need to investigate on the subject with the final purpose of, in a future, implement this system in our day-to-day life to notice the profit of its advantages and develop new technologies that can help us to achieve our personal goals.

As part of a research project with movable manipulators which have to work in unstructured human environments, we need an adequate perception system. So, this RFID equipment is going to be investigated with the pretension of implementing it in the project named before.



1.2.3 Motivation

The first thing I would like to announce here is that the motivation of carrying out this project is that I am very interested at the robotics vision of life and I was looking forward to implementing something useful to the robotics world.

I talked to some professors of the IOC's Research Institute and they purposed to me the opportunity of working with that new RFID equipment release. After a bit time of searching information about the potential of RFID I decided to handle this investigation because I realized that was going to be a great chance to introduce myself at the robotics and programming world.

1.2.4 Previous requirements

The main requirements to carry out this study is first of all to have a bit of knowhow of high frequency operation and how to interpret the results that the RFID UHF can show.

It is necessary to have knowledge into the field of automatic control in order to understand what is happening around and which are the right paths to keep investigating. That means of course, in a very wide vision, that you need some engineering knowledge to have some idea what are you look upon.

By last, it is necessary to have a basic idea of programming in Python language just because at the end of the project is going to be tested how we can control the system with a Python shell background.



1.3 Glossary

- **ACK package:** It is a package to retrieve the ID of the tag that was previously identified and later send the Data required for the full recognition.
- **ASCII:** abbreviated from American Standard Code for Information Interchange, is a character encoding standard. ASCII codes represent text in computers, telecommunications equipment, and other devices. See: <http://www.asciitable.com>
- **Broadcast:** Is a way for simultaneous transmission of information from a sending node to a series of receiving nodes, without the need for the sender to have information from the rest of the nodes.
- **EPC:** Electronic Product Code designed to recognize every single tag existing. Each tag has a unique one.
- **Hexadecimal System:** In mathematics and computing, hexadecimal (also base 16, or hex) is a positional numeral system with a radix, or base of 16 (number of unique digits, including zero, used to represent numbers in this kind of numeral system). It uses sixteen distinct symbols, most often the symbols 0–9 to represent values zero to nine, and A, B, C, D, E, F (or alternatively a, b, c, d, e, f) to represent values ten to fifteen.
- **IC:** integrated circuit. Is an electronic circuit built onto a single plate of semiconductor material, normally silicon and delivers performance, memory and extended features to the tag
- **Nack package:** Is a server built on top of a node. The node does all the hard work of accepting and parsing the requests and Nack simply passes it along to a worker process as a serialized object.
- **Nanowatts** and **picowatts:** units of measurement usually employed for wear power ratings. One nanowatt (nW) equals to 10^{-9} watts and one picowatt (pW) equals to 10^{-12} watts.
- **PCMCIA card:** A PCMCIA card is a credit card-size memory or input/output device that connects to a personal computer, usually a notebook or laptop computer.



- **PDA**: It is a handheld originally designed as personal electronic agenda with a system of recognition of writing

- **dBm or dB**: They are logarithmic units used into de International System to define power relations at the reader operations of RFID. The difference between dB and dBm is that dB is a quantity that measures the relation between two arbitrary quantities, and dBm is a measure of some power quantity referenced to 1 mW (milliwatts).

They are relative measurements between two levels of power (in this case between the power of the tag read and the power of the antenna).

- **QueryRep package**: Refers to a request made by the reader to the tag. It resembles to an opened door for the tag to share its identifier number.

- **Reverse Base 36**: is a binary-to-text encoding scheme that represents binary data in an ASCII string format by translating into a base of 36 representation. The choice of 36 is convenient in that the digits can be represented using the Arabic numerals 0–9 and the Latin letters A–Z.

- **Slot**: At the programming language, a slot can be seen as a part, element or property of an object. In this context, can be understood such a phase of the identification cycle. In each phase takes place the appearance of a QueryRep and the ACK and Nack packages.

- **TID**: Transponder IDentifier. The TID is a unique serial number assigned by the chip manufacturer.

- **URA**: Universal Reader Assistant, the software used to control the RFID equipment

- **Wrapper**: is a program or script that sets the stage and makes possible the running of another, more important program.



2 Basic principles of RFID system

2.1 RFID Technology

In this chapter a theoretical introduction about the RFID technology is performed. It is going to be explained what is the automatic identification to subsequently explain the most important aspects of radio frequency identification: technological alternatives, main components, technology principles or the legislation that applies to it.

2.1.1 Automatic identification

The main purpose that many companies are willing to achieve is to recognize and identify their objects in an automatic way, in order to maintain it identified in an informatics database without having to resort to one or more employees to have to do this task manually. So, as the reader can imagine, this technology is implemented to grow up the efficiency and save money on wages to increase income.

This kind of identification makes a more secure organization, removing the errors from the humans and leading the operating system to a more optimal level. The range of options in that technology is very wide, some of them are described above:

- **Barcodes:** coding system created through lines and parallel spaces of different thickness. Generally it is used like control system, facilitating the commercial activity of the manufacturer but without offering information to the consumer. One of the main advantages is that the data stored in a barcode can be read accurately and quickly.
Its operation is very simple: a device emits a ray of direct light on the code. The device incorporates a sensor that detects reflected light and converts it into an electrical signal that can be interpreted and converted into data.
- **RFID:** Radio frequency identification is a type of wireless technology that allows communication between a reader and a tag or tag without the need for items to be in the same line of sight. This label has a small memory where certain information (typically a serial number) is stored, which will be sent to the reader when requested. RFID technology has great potential in fields as diverse as access control, payment systems (Teletag Via-T) or asset tracking among others. In the next section we study the technology in depth.



	Identification distance	Direct line of sight	Security	Memory capacity
Barcode	Very low	Yes	Low	No
RFID	A few meters	No	Medium	Yes

Table 1: Barcode and RFID characteristics

Due to the fact that RFID technology has a wide scope and higher implementation alternatives, in this project is going to be described all the functionalities and possibilities that can give to the human's world.

The main difference with its principal competitor, the barcodes, is that RFID technology doesn't need to be close and not in a direct line of sight to the object to be identified, so that give a higher grade of automation.

2.1.2 Radio Frequency identification

Radio Frequency identification, RFID, is a generic term that defines a series of technologies that use radial waves for the automatic identification of persons or objects. One of the keys is that the retrieval of the information contained in the label is done via radiofrequency and without the need for physical or visual contact.

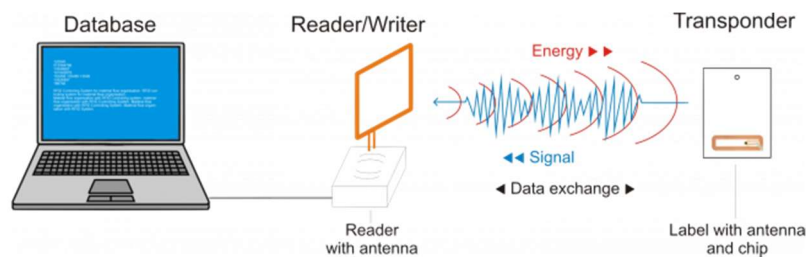

Figure 1. RFID system scheme

It is a technology of automatic capture and identification of information contained in electronic tags. When these tags fall within the coverage of a reader, this one sends a signal for that tag to transmit the information it has stored in its internal memory, as shown in the general scheme of operations of the RFID system of the figure above.

Shown below, the operation system of the electromagnetic field that is created between reader and tag to establish the identification communication. The communications



between an RFID tag and an RFID reader (via the antenna) occurs using a process known as electromagnetic coupling.

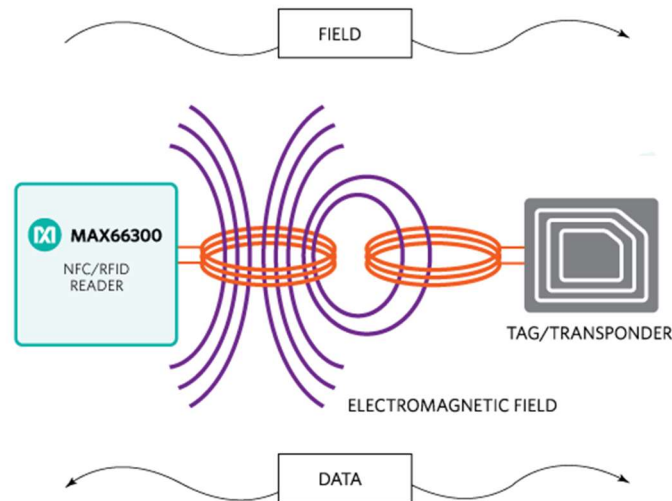

Figure 2. Electromagnetic field created between reader and transponder

When reader and tag operation waves are in the range of coverage of each other, is established the communication and the exchange of data. A further explanation is written down at the next chapter.

This type of technology is not new, it has been operating for many years. However, it is nowadays that it is beginning to receive significant relevance, with great application and greater sectoral diversity. In recent years it has been developed and technically improved, currently having international standards, as well as the Public Administrations responsible for the allocation of frequencies.

This evolution has, in turn, marked a notable advance in its applications. Whereas initially its operation was restricted to short distances, the new UHF standards now allow reading to several meters with a great reliability. In addition, its momentum from major international companies has allowed its use in supply chain applications.



2.1.3 Technological alternatives

There are several ways of identification though the most usual is to store a unique serial number into a microchip attached to an antenna that allows the microcircuit to transmit the identification information. The pack microchip-antenna is called RFID transponder or RFID tag.

These tags, and therefore the RFID system as whole, can be classified according to two criteria: on the one hand according to the **energy source** and on the other, according to the **frequency of operation**.

- According to the energy source

It is one of the most important characteristics to take into account when tags are selected for a particular application and it is one of the main factors for determine the cost and the life of a tag. Attending to this classification, it can be found three types of tags: passive and active ones.

- **PASIVE:** They get the transmission power of the reader and is the most common type, because they allow the transponder device to work without its own power supply, which makes it cheaper, smaller in size and with an unlimited life cycle. Its main disadvantage lies in the dependence on the electromagnetic field generated by the reader device and, therefore, the corresponding limitation in the identification distance.

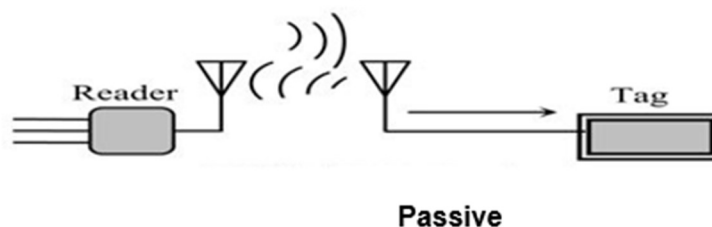

Figure 3. Passive tags



- **ACTIVE:** They are provided of its own battery and its own transmitter, what they do totally independent of the signal transmitted by the reader device. The distance of identification increases a lot in connection with the passive tags. Their life cycle will be limited by the life cycle of its own battery.

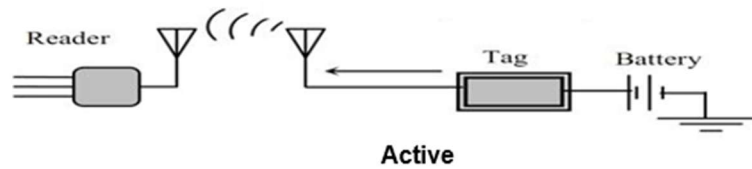

Figure 4. Active tags

- **SEMI-ACTIVE:** They dispose of its own battery too, thing that allows increasing the identification distance. However, they continue depending on the reader device signal, insomuch as they need it in order to generate the corresponding answer signal. Again, the life cycle will be limited by the life cycle of the battery.

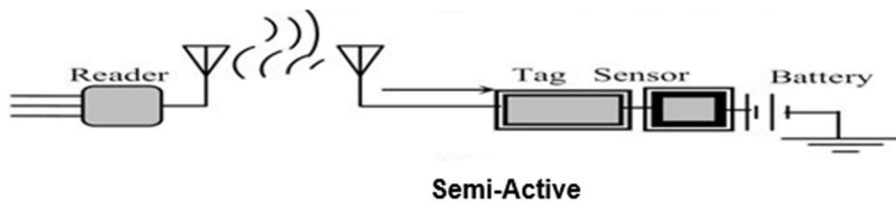

Figure 5. Semi-Active tags

At the table below, it is shown a comparative between these two type of tags with the advantages and disadvantages:

PASSIVE TAGS	ACTIVE TAGS
Operate without battery	Operate with battery
Relatively inexpensive	Relatively expensive
Unlimited life cycle	Limited life cycle by the battery
Lower weight	Higher weight
Limited scope distance	Great scope distance (until 100 meters)



Sensitivity to noise	Greater immunity to noise
Dependence of the signal with the reader	Own transmitter
Powerful reader devices required	Lower power of reading requisite
Lower transmission speed	Higher transmission speed
Lower simultaneous reading	Higher simultaneous reading
High orientation sensibility	Low orientation sensibility

Table 2. Passive and active tags comparison

- According to the frequency of operation

The physical foundations on which RFID technology is based, involve the emergence of several communication models among the basic devices of the system. This communication requires RF antenna in each of the devices involved in the communication whose shape and characteristics depends on the frequency band in which they work.

Each frequency band has specific characteristics that confer differential elements to the functionality of RFID devices, so knowing how to choose the frequency of work is a fundamental point when designing an RFID solution.

Depending on the functional requirements of the final application, the automatic identification may require, or not, a greater or lesser identification distance, generate the least possible radio interference, signal stability against hostile environments or a high penetration capacity in the materials.

Among the RFID technology, it can be distinguished four frequency differentiated bands:

- LOW FREQUENCY (LF): With a typical frequency between 125 kHz and 134 kHz, they allow a short scope NO MAYOR to a half meter as well as a low reading speed.
- HIGH FREQUENCY (HF): The operation frequency is situated above the 13.56 MHz, thing that allows a scope until three meters and a higher reader speed in comparison with LF.
- ULTRA HIGH FREQUENCY (UHF): Its operation frequency is fixed between the 860 - 960 MHz with that allows reading distances of until ten meters.
- MICROWAVE FREQUENCY: With a frequency of 2.45 GHz and 5.8 GHz allow very high detection distances. Therefore, its transmission speed is very high too.



At the next table, it can be shown the characteristics and typical applications for each frequency band used by RFID.

FREQUENCY BANDS	CHARACTERISTICS	APPLICATIONS
LF (Low Frequency) 125 kHz – 134 kHz	Low scope (45 centimetres) Low Transmission speed Relatively inexpensive Great penetration at materials Works fine with metals	<ul style="list-style-type: none"> - Access control - Animals identification - Inventory control - Anti-theft device - Car keys
HF (High Frequency) 13,56 MHz	Low/medium scope (1 – 3 meters) Moderated speed transmission Can read through liquids Problematic with metals Moderated expensive	<ul style="list-style-type: none"> - Access control - Intelligent cards - Warehouse management - Check Baggage - Laundry management - Patient identification
UHF (Ultra HF) 860 MHz – 960 MHz	Medium scope (3 – 10 meters) High transmission speed Anti-collision mechanisms Problematic with liquids and metals Moderated expensive	<ul style="list-style-type: none"> - Management identification - Supply Chain Management - Warehouse Management - Shipping Management - Traceability
Microwave frequency 2,45 GHz – 5,8 GHz	Large scope (more than 10 meters) Similar with UHF but with a higher speed transmission Higher price	<ul style="list-style-type: none"> - Rail control - Motorway tolls - Location

Table 3. Frequency bands comparison



UHF radio waves propagate mainly by line of sight, which is a characteristic of electromagnetic radiation or acoustic wave propagation.

Electromagnetic transmission includes light emissions traveling in a straight line. The rays or waves may be diffracted, refracted, reflected, or absorbed by atmosphere and obstructions with material and generally cannot travel over the horizon or behind obstacles.

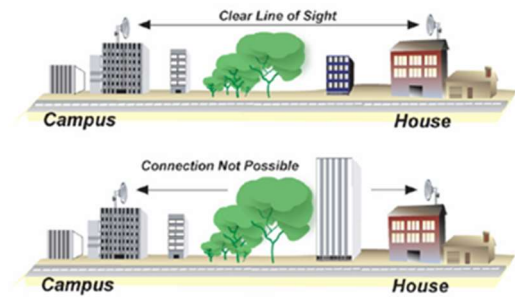

Figure 6. Line of sight UHF operation

As a consequence of its mode of propagation, the signal is blocked by hills and large buildings although the transmission through building walls is strong enough for indoor reception.

They are used for television broadcasting, cell phones, satellite communication including GPS, personal radio services including Wi-Fi and Bluetooth, walkie-talkies, cordless phones, and numerous other applications.

The main advantage of UHF operation is that there is less probability of interference due to the larger frequency spectrum available. The next picture shows the electromagnetic spectrum.

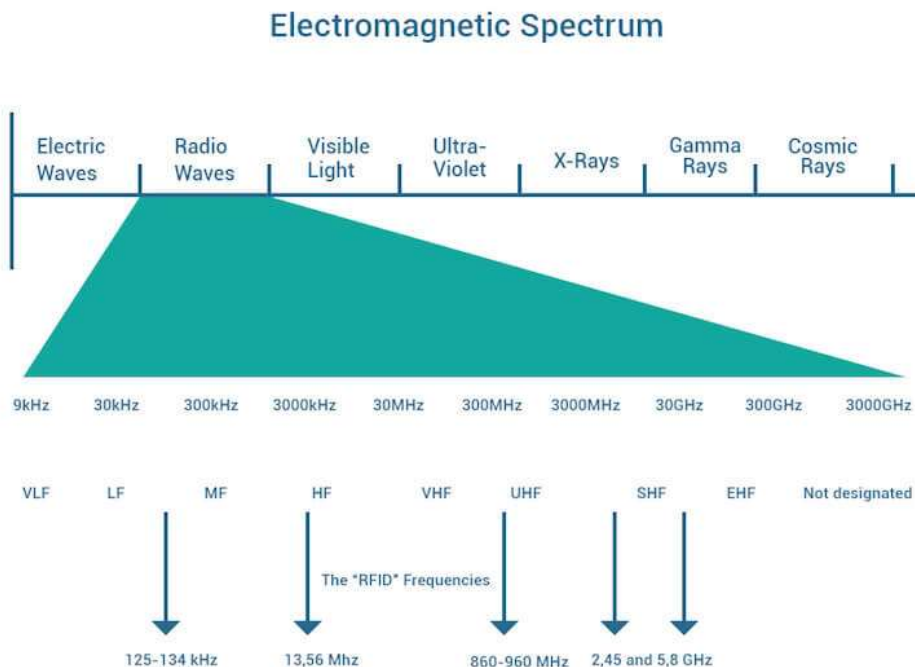

Figure 7. Electromagnetic spectrum for different frequencies



2.2 Internal operation of the radio-frequency equipment

An inductively coupled transponder comprises an electronic data-carrying device, usually a single microchip, and a large area coil that functions as an antenna. Inductively coupled transponders are almost always operated passively. This means that all the energy needed for the operation of the microchip has to be provided by the reader (Figure 1).

For this purpose, the reader's antenna coil generates a strong, high frequency electromagnetic field, which penetrates the cross-section of the coil area and the area around the coil. Because the wavelength of the frequency range used ($<135\text{kHz}$: 2400m) is several times greater than the distance between the reader's antenna and the transponder, the electromagnetic field may be treated as a simple magnetic alternating field with regard to the distance between transponder and antenna. A small part of the emitted field penetrates the antenna coil of the transponder, which is some distance away from the coil of the reader.

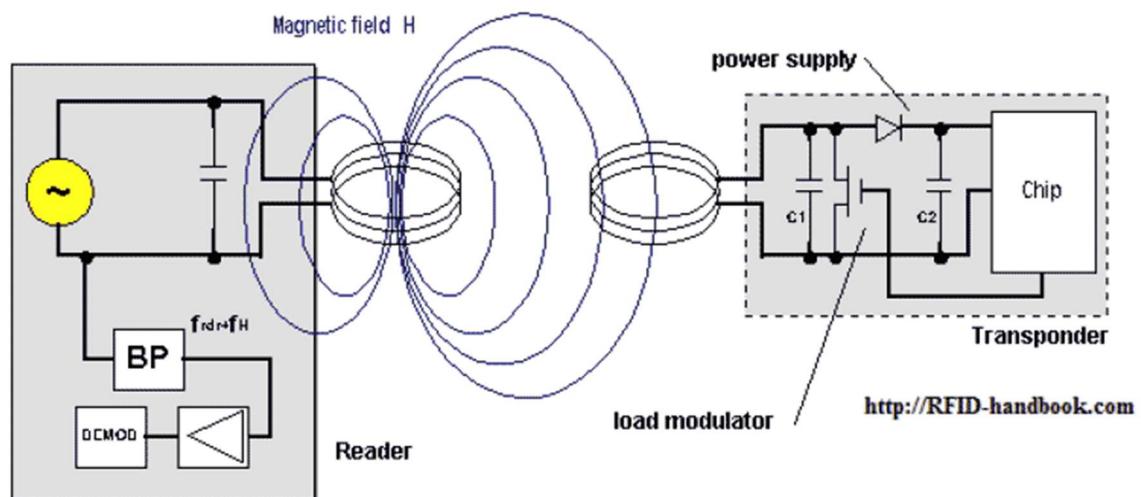

Figure 8. RFID system internal operation

A voltage U_i is generated in the transponder's antenna coil by inductance. This voltage is rectified and serves as the power supply for the data-carrying device (microchip).

A capacitor C_r is connected in parallel with the reader's antenna coil, the capacitance of this capacitor being selected such that it works with the coil inductance of the antenna coil to form a parallel resonant circuit with a resonant frequency that corresponds with the transmission frequency of the reader.



Very high currents are generated in the antenna coil of the reader by resonance step-up in the parallel resonant circuit, which can be used to generate the required field strengths for the operation of the remote transponder.

The antenna coil of the transponder and the capacitor C1 form a resonant circuit tuned to the transmission frequency of the reader. The voltage U at the transponder coil reaches a maximum due to resonance step-up in the parallel resonant circuit.

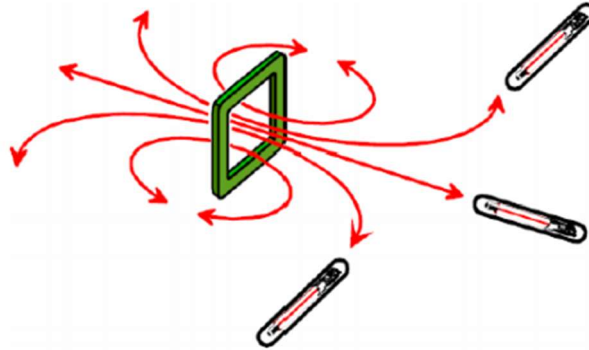

Figure 9. Electromagnetic field wave's directions

The efficiency of power transfer between the antenna coil of the reader and the transponder is proportional to the operating frequency f , the number of windings n , the area A enclosed by the transponder coil, the angle of the two coils relative to each other and the distance between the two coils.

As frequency f increases, the required coil inductance of the transponder coil, and thus the number of windings n decreases (135 kHz: typical 100-1000 windings, 13.56 MHz: typical 3-10 windings).



3 Equipment operation

3.1 RFID System Components

As it is explained above, the tags will be the ones that delimit the technological characteristics that should have the RFID system which would be implemented. However, in addition to the tags, do exist other components which are also of vital importance for the creation of a radiofrequency identification system. Straightaway, there are going to be explained the different components that participate in a RFID system.

3.1.1 The Tag

The tags of RFID are that ones that store the information that would be sent to the reader through radio waves. They are also known by the name of transponders because of the transmitter and answerer performance they are provided of. They are composed by an antenna, a radio transducer and a microchip. The first one target is to transmit the information that identifies the tag when the reader requests it. The transducer is who converts the information that transmits the antenna.

Into the microchip exists an intern memory where is stored the tag's identifier and, in some cases, certain additional information; this memory capacity vary depending on the model. The information that are capable of store the more basic ones, that don't include the microchip, it is contained in 24 bits. Currently have very affordable prices (cents of euro) and with dimensions from 0,4 mm² for what they are prepared for its integration in a wide range of objects.

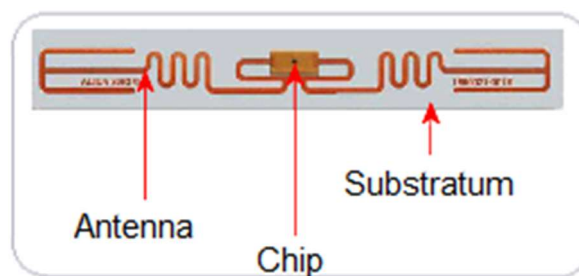

Figure 10. Tag elements



3.1.2 EPC (Electronic Product Code)

The EPC stored into the chip's memory of the tag is written by a RFID printer and takes the shape of a 96-bit chain of data.

The first 8 bits are the header that identifies the protocol version. The next 28 bits will identify the organism that manage the data of that tag; this number is assigned by the EPC global organization which is going to be talked about later.

The next 24 bits are an object class, identifying the product type. The last 36 bits are a serial number unique for each tag in particular. Those two last fields are established by the manufacturer organization. The number of total EPC can be used as a key in a global database for identify in a unique way this product in particular. The fields described above can be understand easier watching the next picture.

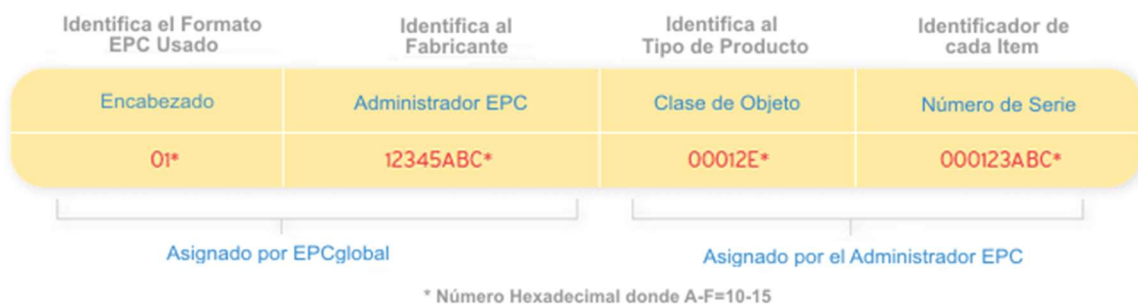

Figure 11. Explanation of the EPC fields

As it was said a few lines above, the EPC global is a non-profit worldwide organization that its labour lies on assigning the different RFID codes to the entities and companies making sure that every single code is unique. Besides of moderating the system, is in charge of advisory and homologate the different existing applications. EPC Global defines RFID standards from five different levels:

- Electronic product code (EPC): As it was described before, the EPC is a unique numeric standardized code that identifies an object.
- Communication protocol: The standard EPC Global performs a classification of the tags according to the level of complexity and capacity of these. At the table before it can be seen a summary of the different types defined by this standard.



TYPE OF CLASS	DEFINITION	PROGRAMMING
CLASS 0	Only read passive tag	Programmed as a part of semiconductor at the manufacturing
CLASS 0+	Allows one time writing. Improved version of class 0	Programmed one time before being locked
CLASS 1	Improves class 0+. Also is a one time writing structure	
CLASS 1 – GEN 2	Allows multiple writing and increases de data transmission speed	Can be programmed several times
CLASS 2	Rewriteable tags	
CLASS 3	Semi-passive tags	
CLASS 4	Active Tags	
CLASS 5	Readers	Doesn't apply

Table 4. Communication protocols comparison

- Middleware EPC:** Is about one of the critical elements from the EPC Global due to that it should ensure the integration between equipment from different companies and, in addition, because facilitates the data collected by the readers to the companies systems.

A reader can collect data from cents of tags simultaneously so it becomes necessary a filtering process and consolidation of this great amount of data for, later, sending it in an organized way.
- Information service EPC (EPCIS):** It is responsible for making a gateway between remote applications that exchange information. There is a central repository of shared data that is constantly updated by the different agents that make up the network.

Communication is performed by web services (SOAP) using the physical mark-up language. This way, any local application can communicate with remote systems.



- Object's name server (ONS): Its function is to identify, within the EPC Global network, the server that contains the information needed by an application. To do this, it uses the EPC code information in order to obtain the location of a service belonging to an EPCIS server. For their design concepts of DNS servers have been used to achieve scalability and similar functionalities.

In this project we are working with the equipment MercuryDevKit M6e for UHF which reads tags from the Class-1 Gen-2 type. So, now on, this issue is going to be deepened with further explanations of it.

EPC Global Class-1 Gen-2 is and standard from the EPC Global Institution, published at 2005, widely adopted for RFID systems manufacturers (being the main protocol nowadays) and focused in the development of industrial standards for EPC.

The tags are simple devices and all the complexity of the identification algorithm (like the synchronization) is carried out by the reader. The reasons that have led to its generalization are the following:

- It is simple and strong: the complexity of the protocol is found into the reader.
- The tags that were marketed met the minimum requirements for its implementation so it does not involve and additional hardware cost.
- It is ideal for RFID systems where the reader does not have a previous knowledge of the tag that are within their coverage.
- The reader can adapt the cycle size in each cycle by a simple algorithm, obtaining better results in mean time of identifications, use of the channel and probability of collision.

Before the beginning of the identification cycle, the reader sends a *Broadcast* package to the tag population that are in its range of coverage. One of the fields that owns this package suggests if the different tags should be identified or not. The N tags that receive the package, answer and there is then a multiple collision that the reader is able to detect.

It is at this point when an identification cycle begins, starting with the sending of a Query-type package; Including in one of its fields 4 bits, which indicate the value of the size of the Q cycle (2^Q slots). When the tags in coverage receive it, they generate a random number "r" within the interval $[0, 2^Q-1]$, which represents the slot of that cycle in which the tag will transmit its identifier. In each cycle, the start of a new slot is indicated by the *QueryRep* package, except slot 0, which starts automatically after the Query package is sent.

The tags will compete to identify themselves, using an internal counter (counter = r) to count the remaining slots unit it reaches the chosen one and send its identifier. Each time a *QueryRep* package arrives, the counter is decremented and if it reaches the value 0, it sends its ID identifier, which corresponds to the obtained value r, that is to say, the slot chosen in the cycle. After a tag transmits its identifier two things can happen.



- If two or more tags choose the same slot to transmit their ID a collision occurs. The reader detects and reacts by sending a new package. Upon receiving it, that tag that had already been transmitted assumes that there has been a collision and updates its counter to counter = $2^Q - 1$, avoiding to compete again to identify itself in that cycle.
- If the reader receives a correct ID, it responds with an ACK package. The tags in coverage receive the package, but only the tag that sent its ID answers by sending a *Data* package.
 - If the reader receives the package correctly it responds with a new *QueryRep* package starting a new slot. The tag identified ends its process.
 - If the reader does not receive the *Data* package correctly, or at a set time, it sends a *Nack* package. Only the tag that sent the data reacts by setting its counter to counter = $2^Q - 1$ thus avoiding to compete again for identifying itself in that cycle. After the *Nack* package the reader sends a *QueryRep* package again.

When the reader slot counter reaches the value $2^Q - 1$ ends a cycle. The reader sends a new *Query* package or a *QueryAdjust* package in case it implements some dynamics tuning algorithm of the Q. All tags that are still unidentified will compete again by choosing a new slot.

The figure below shows the anti-collision algorithm explained previously, with the different possibilities that can be given.

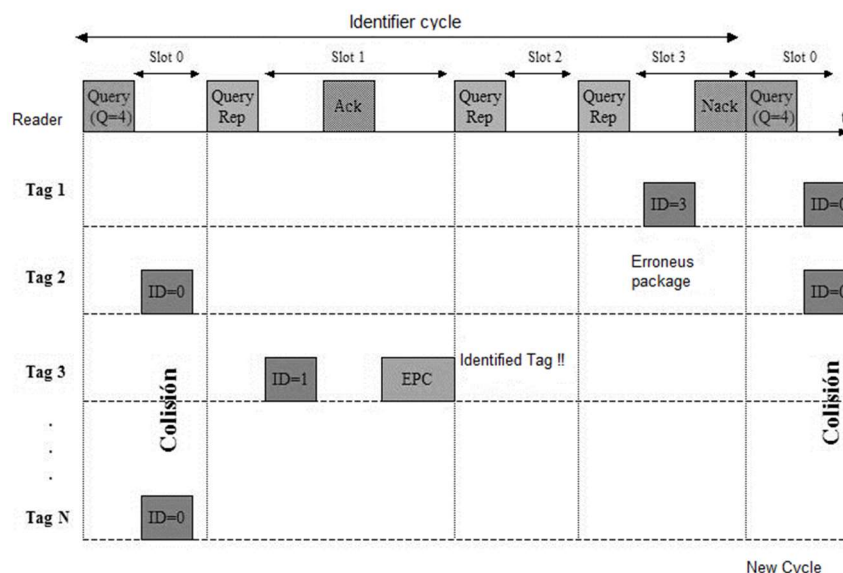

Figure 12. Identification cycle description



3.1.3 The reader

The reader acts like an identification station transmitting the signals of the requests towards the tags and receiving the answers to those requests. It is a device receptor/radio transmitter that incorporates, in addition of the subsystems of transmission and reception, a digital signals processor which gives it more functionality and complexity in its operations. A reading device, will need from one or several RF antennas in order to transmit the generated signal and receive the answer of the tag. It is possible to find reader with the RF antenna integrated in its own hardware and reader with RF antenna external connectors.

The functionality and/or complexity of calculus and operations of a reader device is totally proportional to the size of the hardware. The process capacity, memory and speed requires additional hardware and, therefore, the size of the device increases. It can be find readers from the size of a PCMCIA card for fit together to a PDA, until robust readers for hostiles environments that require physical protection, higher reading speed and multiplexing between antennas and information processing, which size increases considerably in front on the first ones.

In a similar way to the case of the antennas from the tags, the RF antennas connected to the reader device, will vary from shape and size according to the operating frequency of the system.



Figure 13. M6e RFID reader



3.1.4 Database and Middleware

The database consists in an additional software platform that allows storing, in an organized way, the information of the identification that is generated by the hardware subsystem (tag and reader).

The importance of this software subsystem lies on that an application from a customer would be incapable of manage the information generated by the reader device without it. Before running the customer application, it is necessary to store de identification information in a common format for give access to any customer application for working with it.

Between the database and the reader device it is required a middleware interface to execute a previous treatment about the raw data generated by the reader. The target of a middleware is to simplify the work of the RFID programmers in the complex task of generating the connections and synchronizations that are necessary in the distributed systems. Thus, it is provided a solution that improves the quality of the service, as well as the security, the sending messages, the service directory update, etc.

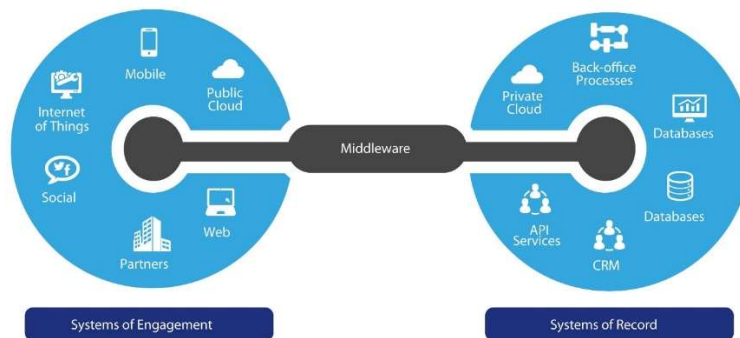

Figure 14. Middleware description

3.1.5 RFID Programmers

Those are the devices that will perform the information writing above the RFID tags, ergo, they are capable to codify different data into a microchip situated at the inside of a RFID tag.

This tag programming is carried out one unique time if the tags are read only, or several times if they are reading/writing. This is why RFID programmers are essential elements in certain applications where it is only necessary the reading of the information that is contained into the tag. As it is natural, the necessary power for writing into the tags is higher than the necessary power for reading it. Due to that, in the major of cases is required a direct contact between the programmer and the tag.



3.2 Mercury Kit M6e RFID UHF General Description

Before beginning to work with the Mercury Kit RFID for UHF, user has to initialize the Universal Reader Assistant (URA), previously installed.

In order to get the whole device started to work, user has to connect it before doing anything else. As you can see at the picture below, it has to be chosen the “Serial Reader” option and click the Refresh button to allow the system to recognize the device that is going to work with the Reader Assistant.

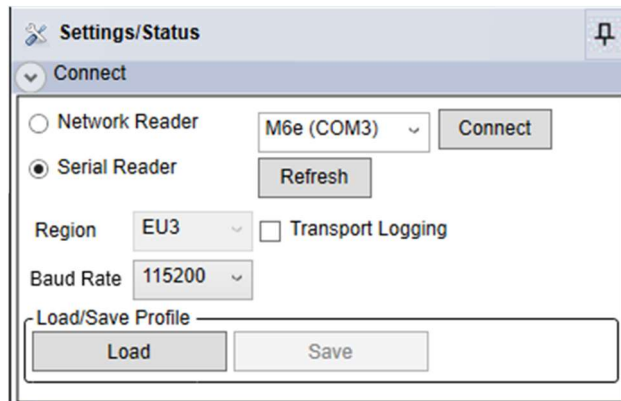

Figure 15. Connecting starter menu - URA

Note: The Settings/Status screen is situated minimized on the right top of the URA.

As it is shown at the picture, the software recognizes the M6e model. After that user clicks at the Connect button and selects “EU3” as the Region. As an option, this working profile can be saved to speed up the procedure at the start of every work session.

Next step to be taken is to read the information required to investigate, rewrite or modify some parameters of it. This would be explained better showing up a picture of the URA menu, let's see:

#	EPC	TimeStamp(msec)	RSSI(dBm)	ReadCount
1	300833B2DDD9014000000000	06:54:39.536 PM	-70	99

Figure 16. Tag Results grid



At the top of this menu you can see several tabs that are going to be explained, how they work and its potential.

3.2.1 Workflows

Although the program operation is pretty intuitive, user must know that exist two different kind of workflows, that is to say, different ways to select the tags that are going to be analysed. In each tab the program allows user to select between two options:

1. First tag to respond: The reader recognizes one of the several tags that can be at the coverage range, the one with the most powerful signal. If two or more tags have the same receiving signal, URA warns that multiple tags are in the range and shows the first one that finds.

2. Tag selected in Tag Results page: At the *Tag Results* tab, user can select one of the tags read during the identification communication and operate on it at the other tabs and functions of the URA.

3.2.2 Tag Results

The first one that appears is the “*Tag Results*” that shows a list with the different readings that the user is proceeding.

- **EPC**: is designed as a universal identifier that provides a unique identity for every physical object in the world. This name is designed by a community called EPC Global. EPC can be changed or edited by the user, respecting the criteria of shape, typically 96 bits of data shown in Hexadecimal.

Aside from EPC, there is another identifier number called TID (Transponder Identifier) which is a unique serial number assigned by the chip manufacturer. This one is not editable and is used to differentiate each tag from another.

- **TimeStamp (msec)**: shows the exact moment (hours, minutes, seconds and milliseconds) that the reading is taken and it is updated every time the antenna recognizes the same tag again. In a few words, it shows the last time the tag is read.

- **RSSI (dBm)**: calculates the power of the signal taken. It is measured with dBm.



In order to introduce to dB measurement, first of all we must define the meaning of a dB and how is it read. A dB is a relative measure of two different power levels. The formula to calculate in dB is:

$$dB = 10 * \log \frac{P1}{P2}$$

It is used to indicate the gain or loss of one power indicator (P1) relative to another (P2). Another common reference unit is the dBm (e.g.: 0dBm = 1 milliwatt). The dBm is the kind of reference unit that uses the URA for UHF RFID. The power in decibel-milliwatts is equal to 10 times base 10 logarithm of the power in milliwatts.

So, at the example given at the picture above we can see -70 dBm that is equal to say 0.0000000001 W (100 pW or 0,1 nW). That means that P1 (the power of the signal received) is 10^{-7} times 1 milliwatt, wherewith is that number of times lower than P2 (which is the power measurement of reference of 1 milliwatt).

- **ReadCount:** indicates the number of times that the device has read the tag. This number is able to increase exponentially due to the scope and potential of the reading antenna.



3.2.3 Write EPC

The second tab that appears is named “*Write EPC*” which allows the EPC of specific tags to be updated. The tag the operation will be applied to, follows the rules defined in the two Tag Operations [Workflows](#).

Into the Write EPC tab operations we can highlight some of the workflows followed:

- 1) The EPC ID read and written can be represented in several formats. The format use to display de the data in the Current and New EPC sections will be both be in the selected format:
 - a) **Hexadecimal** – direct hexadecimal representation of the raw data on the tag. This will match the cell value shown in the Tag Results Grid.
 - b) **ASCII** – Interprets the data on the tag as ASCII characters. Must see <http://www.asciitable.com/> for further information and interpretation of the characters.
 - c) **Reverse Base 36** – represents the kind of representation a bit compressed in comparison with hexadecimal one (19 characters for an EPC that would need 24 characters in hexadecimal). Contains all the uppercase letters of the alphabet plus numbers 0-9.
- 2) The **Current EPC** section will display the EPC of the tag that will be operated on based on the Write to selection. If clicking *Read* results in a warning then the tag written to cannot be guaranteed.
- 3) Once confident the desired tag is setup to be written to, clicking the *Write* button will cause the **New EPC** to be written to the tag.

As it is said a few lines above, every single tag has a different and intrinsic EPC to differ from other tags, but independently of that, user can change the name of EPC in order to recognize in an easier way the tags considered.

We are going to test the behaviour of the tag square shaped named UPM:

- EPC: 300833B2DDD90140000000000 (24 characters)
- Nueva EPC: 300833B2DDD90140000000001 (24 characters)

We are able to change de EPC name. So, we could consider that EPC is editable by the user but TAG's have a unique ID name TID which is explained a few lines above.



Hypothesis 1: EPC can be changed, as long as it does not match any existing TAG.

Let's check what happens if we put the name of a tag into another one:

- Square shaped tag (UPM) ---> EPC1: 300833B2DDD9014000000000
- Long rectangular tag (Belt) ---> EPC2: 300833B2DDD9014000000000
- 300833B2DDD9014000000000

After demonstrating that it is possible to change the EPC from a tag and put it into another one, it is easy to reach the conclusion that the reader system is not able to differentiate the two tags, which means that exists a recognition error and the tags are overlapped. That means that the information stored at the tag which EPC has been changed is lost for ever if user doesn't change EPC again.

Note: We have been able to see that the EPC can be changed for any other one taking into account that it must be the format required for (24 characters needed, only letters and numbers, etc.).

Conclusion 1: It can be edited EPC from a tag, even if it matches exactly with any other existing EPC in the world today. This causes an erroneous reading of TAG's because if two tags are named in the same way simultaneously, entails a loss of information due to the fact that two TAG's will be recognized as one.

To reach a solution for this problem, at the URA exists the *Lock Tag* tab that allows to lock some fields of the EPC in order to protect from misleading information. Its mode of operation is explained later, at the Lock Tag chapter.

Hypothesis 2: There are families of tags designated with the same EPC.

Let's read some tags in order to find similitudes among them with the purpose to designate families of tags.

Family of tags that were in the same bag:

- E20068060000000000000000000000000
- E2001AC193A2D4801033BB51
- E20010631002027414907FCF
- E2001026760F023020803E9E

Conclusion 2: Is not a right definition to call it families of tags. At the example above, the first few numbers refer to the header which is the same because of the EPC used format that defines the protocol version used in those tags.



manufacturer when the IC (integrated circuit of each TAG) is manufactured. As it is said above, this memory portion cannot be changed.

- **User Memory Bank:** It is the information that the user can store in the tag. There are two interpretations one in Hexadecimal and the other in ASCII. There are a maximum of characters that the tag can store, in particular they are 64. See next image:

The screenshot shows the 'User Memory' tab selected in a software interface. At the top, there are several tabs: 'Tag Results', 'Tag Inspector', 'Write EPC', 'User Memory', 'Lock Tag', 'Untraceable', and 'Authenticate'. Below the tabs, a note states: 'Note : User Memory Operation supports only GEN2 Tags. Rest of the protocols will be ignored'. Under the heading 'Tag to Read/Write', there are two radio buttons: 'First tag to respond' (selected) and 'Tag selected in Tag Results page'. A 'Read' button is positioned to the right. Below this, it says 'Showing tag: EPC ID = 0013098A820A01000420E312'. Under the heading 'How To Represent User Memory Data', there are two radio buttons: 'Addressed Hexadecimal' and 'ASCII Notepad' (selected). Under the heading 'ASCII Text Editor', there is a 'Write To Tag' button. At the bottom, a text input field contains the text 'Aquesta es una prova' and a red message on the right says 'Space for 64 characters available: 44 characters remaining'.

Figure 19. User Memory tab analysing a tag

Note: Variable number of characters depending on which tag is being treated:

For example: EPC: 300833B2DDD9014000000000 – Space for 4 characters available

Further information about the variable number of characters available at the next chapter *User Memory Editor*.



3.2.5 User Memory Editor

This section is on the *User Memory* tab, It is used to check how much information can be stored in each tag (supermarket products, location of a toll such as the km in which it is and the name of the highway, location of object for mapping and stuff finder) and also read this information which is addressed to the end user.

In order to write information at the tag, the exchange channel of data must be enabled (that means that the tag's signal must be received by the antenna) at the time of editing.

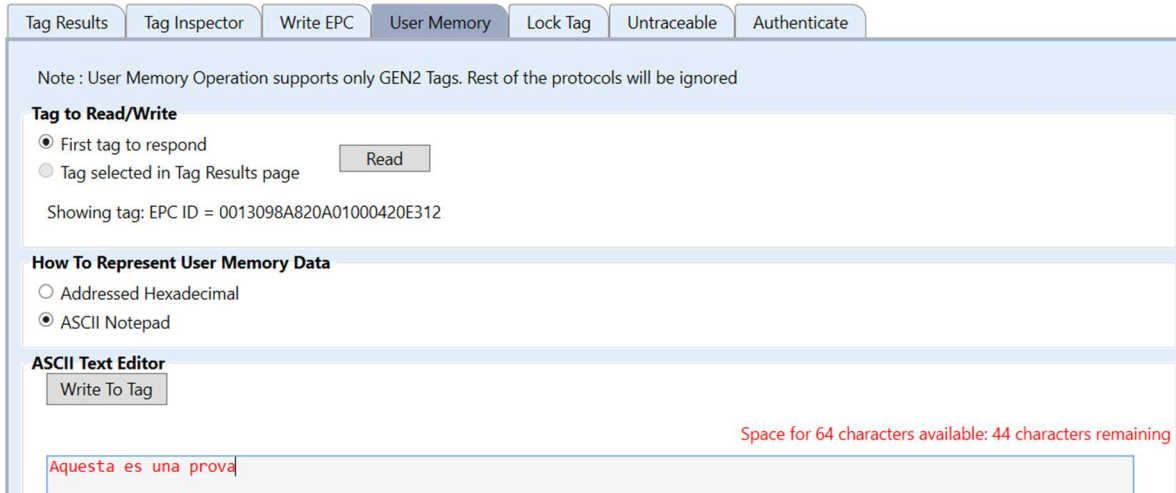

Figure 20. User Memory tab analysing a tag (2)

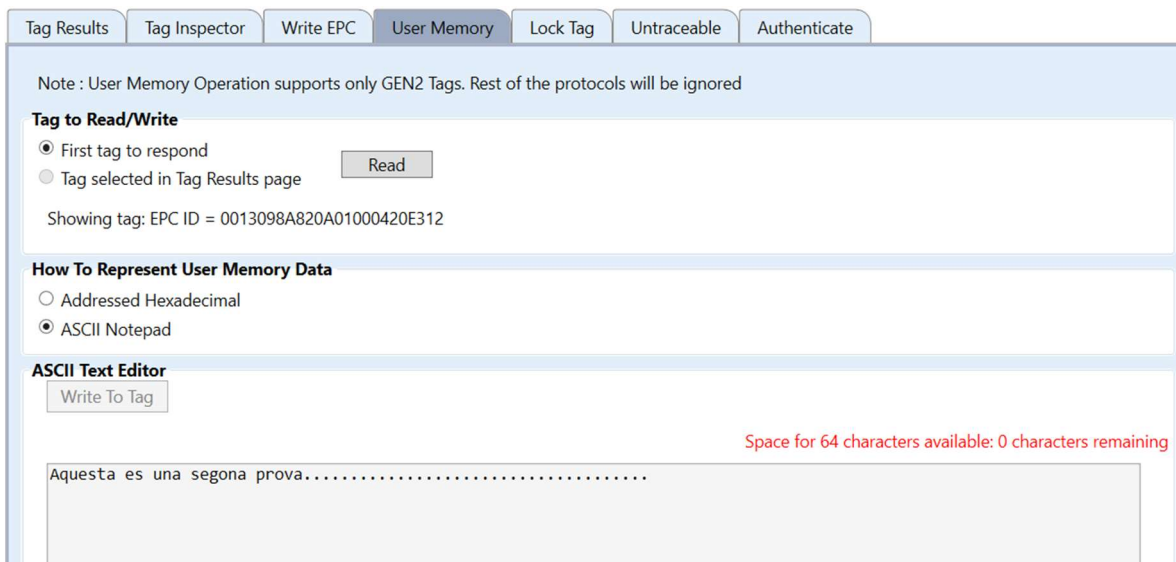

Figure 21. User Memory tab analysing a tag (3)



When the information pertaining to a tag is edited, the system is responsible for filling in all remaining empty characters. The ellipsis written after the words at the field *ASCII Text Editor* is the way the program fills the empty spaces.

This is a security measure, done because of the data protection and to avoid data disturbance from other users.

As it was said at the previous chapter, the writing length (length of storage of information) is variable among the tags. At the next picture it is possible to appreciate that the tag with EPC: 300833B2DDD9014000000000 has only 4 characters available for writing.

The screenshot shows a software interface for tag analysis. It is divided into three main sections:

- Tag to Read/Write:** Contains two radio buttons: "First tag to respond" (selected) and "Tag selected in Tag Results page". A "Read" button is positioned to the right. Below this, it displays "Showing tag: EPC ID = 300833B2DDD9014000000000".
- How To Represent User Memory Data:** Contains two radio buttons: "Addressed Hexadecimal" and "ASCII Notepad" (selected).
- ASCII Text Editor:** Features a "Write To Tag" button. Below the button is a text input field containing "....". To the right of the field, a red message states "Space for 4 characters available: 0 characters remaining".

Figure 22. User Memory tab analysing tag named "Belt"



3.2.6 Lock Tag

Note : Lock Tag Operation supports only GEN2 Tags. Rest of the protocols will be ignored

Tag to Read/Write

First tag to respond

 Tag selected in Tag Results page

Showing tag: EPC ID = 300833B2DDD9014000000000

Access Password

Enter the Access Password to use for locking. It must match the value stored in Reserved Memory. If it doesn't, Write it.

Lock Actions

	UnLock	Write Lock	Read/Write Lock	Permanent?
User Memory	<input type="checkbox"/>	<input type="checkbox"/>		<input type="checkbox"/>
EPC Memory	<input type="checkbox"/>	<input type="checkbox"/>		<input type="checkbox"/>
Access Password	<input type="checkbox"/>		<input type="checkbox"/>	<input type="checkbox"/>
Kill Password	<input type="checkbox"/>		<input type="checkbox"/>	<input type="checkbox"/>

Apply Locks

The following MercuryAPI LockActions will be applied:

Figure 23. Lock Tag tab description with tag named "Belt"

To get access to the benefits offered by the tab of the URA called "Lock Tag", as in the rest of tabs, first of all user has to read the EPC of the tag on which is going to make the operation.

Below the section available to recognize the tags on which user is going to work, it is situated the section *Access Password*. This password, in the beginning, is disabled, being its value of "0" so that, the user who acquires the system can edit and modify at his convenience.

The *Access Password*, as explained above, is the password that allows user to lock and unlock the writing capabilities of certain fields of the tag. The user can enter a custom password (4-byte length) to avoid modifications by other users.

Within the "Lock Tag" tab, user can perform various Lock Actions. Unlock editable memory banks (which are only *User Memory* and *EPC Memory*) and access and kill passwords.

It can also lock the writing of *User Memory* and *EPC Memory* as well as locking the read / write access and kill passwords. The options in the last column allow the user to permanent save the lock or unlocks that they want to perform.

For being applied these changes, the user must press *Apply* button taking into account that the antenna must be able to read the tag at the time of saving changes.



3.2.7 Untraceable

Tag Results
Tag Inspector
Write EPC
User Memory
Lock Tag
Untraceable
Authenticate

Note : Untraceable Operation supports only GEN2 Tags. Rest of the protocols will be ignored

Tag to Read/Write

First tag to respond
 Tag selected in Tag Results page

Showing tag: EPC ID = 300833B2DDD9014000000000

Access Password :

EPC

Show Entire EPC
 Show EPC to length : Words

TID

Show All
 Show Tag Info Only
 Show None

USER

Show All
 Show None

Figure 24. Untraceable tab description with tag named "Belt"

This tab serves to determine the degree of traceability that the user wants to provide the tag. We define traceability as the range of data privacy that is wanted to give to the label.

To take access to editing this data, first of all the reader must recognize the tag by reading it and the user must enter the access password in case it is previously set.

Once the access password is entered, the different options of each identifier are unlocked. As shown at the picture above user can choose to show the totality, partiality or nullity of the data referring to the different memory banks that define the tag.



3.2.8 Authenticate

The *Authenticate* tab is used to both insert and activate keys, as well as authenticate tags and obtain encrypted data using those keys.

Activating Keys

Two 16-byte keys are inserted into specific User memory locations, and are activated by writing a specific value into two other User memory locations. The keys may be freely read and edited until activated, at which point those memory locations become inaccessible.

Either may be used for authenticating the tag, but only Key1 may be used to decrypt data that has been encrypted by the tag. The key insertion and activation is controlled by the top portion of the *Authenticate* tab.

Always make sure you read the keys to confirm that the value is what you want before activating them. Once activated, you cannot change the keys or determine their current value. If you read a tag whose keys have been activated, you will get this result:

Tag Results Tag Inspector Write EPC User Memory Lock Tag Untraceable **Authenticate**

Note : Authenticate Operation supports only GEN2 Tags. Rest of the protocols will be ignored

Tag to Read/Write

First tag to respond Tag selected in Tag Results page

Showing tag: EPC ID = 300833B2DDD9014000000000

Key Insertion and Activation

Current Key0 : Key0 is inserted and activated
Key0 To Write :

Current Key1 : Key1 is inserted and activated
Key1 To Write :

Figure 25. Authenticate tab description with tag named "Belt"



Tag Authentication

Tags are authenticated by having the reader send a random challenge string to the tag, the tag uses its key to encrypt the challenge and sends the result back. The reader then uses the key to decrypt the message and, if they decrypted message is the one it sent to the tag, it declares the tag authentic.

To authenticate the tag, enter key0 or key1 for the tag and press "Authenticate Key0" or "Authenticate Key1". You will see a success message and the same "Returned Challenge" value as the "Random Challenge" field above. In addition, Key1 may also be used for tag authentication.

If the key entered into the verification field does not match that in the tag, Universal Reader Assistant will still report that the Authentication Failed, as shown below. Note that the Returned Challenge will not match the Random Challenge value.



3.3 Environment condition and laboratory layout

As already mentioned, the theoretical maximum detection distance for this type of technology is eight-ten meters in an opened space. In the laboratory, attempts have been made to recreate the most ideal conditions possible, trying to avoid obstacles although there have been several factors that have prevented this ideality, which are listed below and are represented at the picture below:

- On left and right of the figure there are tables with computers, power supplies, robots and other devices that contain metal parts that can lead to the deviation of the signal. They have also been turned off to prevent propagation of interference.
- There also are cabinets completely built with metal.
- Metallic blinds.
- Laboratory robots used for other projects.

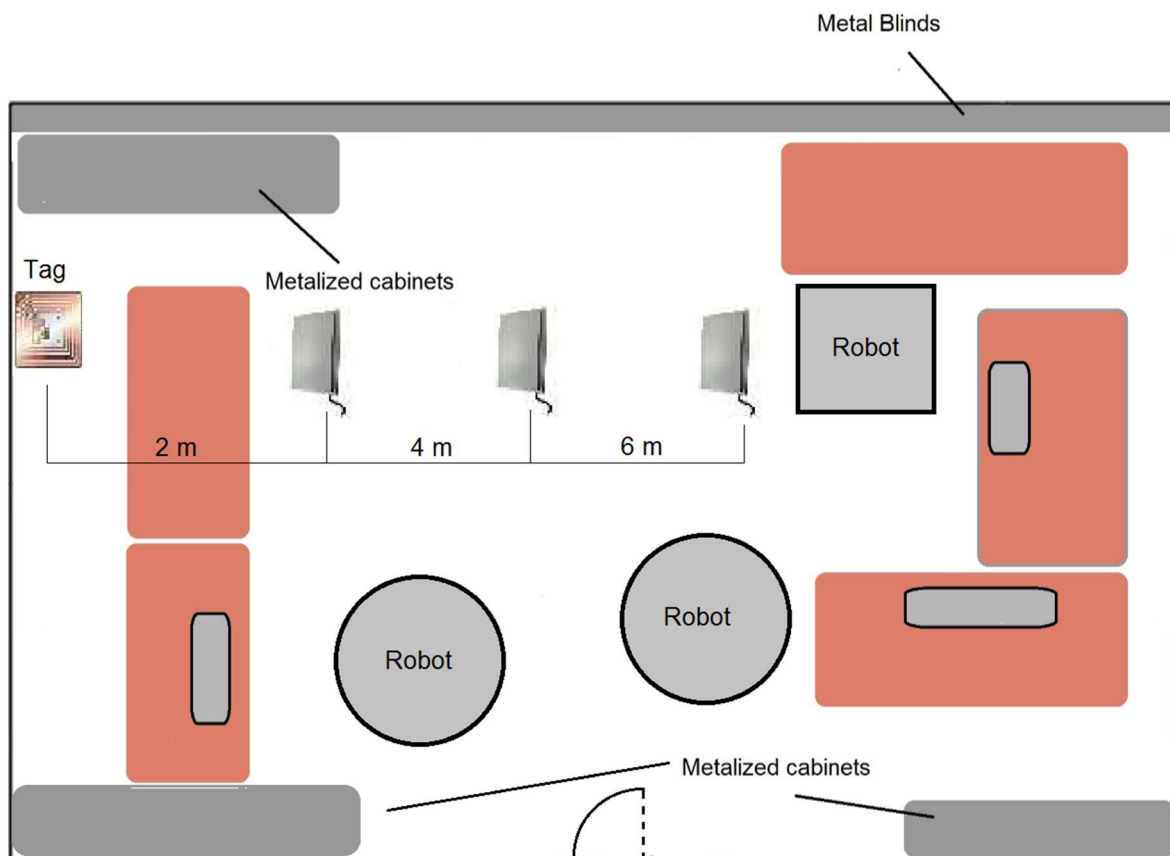

Figure 26. Laboratory layout

All of those obstacles contain parts of metal inside of them which are not good for radio-frequency waves because the signal will be reflected and will lead the tests to erroneous readings of data.



In spite of all these disadvantages, it has been tried to neutralize their effects on the readings made, turning off all the electronic devices and removing all the metallic objects outside the main radiation zone of the reader.

It should be mentioned that objects such as blinds or robots have not been possible to minimize their effect so that the reflection of the waves will be reflected in the results. Nevertheless, all these factors can be seen from the point of view of the final application, where it is unlikely think about an ideality of the environment.

The measurement that were previously thought to do are the ones that are drawn at figure 25 which shows a scheme of the laboratory layout.

3.4 Scope and Specifications of RFID Equipment

3.4.1 Far field and near field of RFID

The electromagnetic field that surrounds an RFID antenna can be broken up into two segments, the near field and the far field.

Typically, near-field is defined as the field around the antenna up to one wavelength (λ) away (approximately up to 35 centimeters). The two segments of the RF field, near-field and far-field, have different energies so they typically require a corresponding antenna type to get the best read range. (The near-field is primarily magnetic in nature, while the far-field has both electric and magnetic components.).

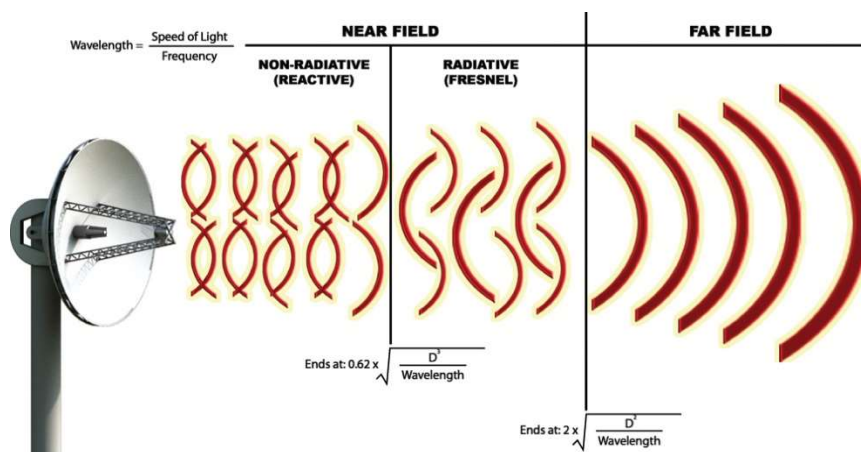

Figure 27. Near field and far field illustration

Before deciding the different distances to perform the characterization of the device, it is important to check that they will be found in what is called the far field of radiation. It can be



distinguished between near and far field depending on whether part of the power that radiates the antenna is temporarily stored in named near field or not.

At the time of making a radiation diagram, it is interesting that it is carried out in the far field so that the antenna can be characterized correctly.

If D is the antenna length and λ the wavelength, the minimum distance of radiation can be known to be considered far field:

$$R > \frac{2D^2}{\lambda}$$

The length of the antenna is not known, however it will be assumed the worst case in which can occupy the entire length of an hypothetical protective box of the reader: 25 centimeters. On the other hand, the wavelength can be obtained from the frequency of operation of the reader which, according to the datasheet, is between 865 MHz and 869 MHz when working within the European Union. So the minimum radius will be:

$$R = \frac{2D^2}{\lambda} = \frac{2 \cdot 0,25^2}{\frac{c}{867 \cdot 10^6}} = 0,36 \text{ m} = 36 \text{ cm}$$

Therefore, for a radius distance greater than 39 centimeters, it is determined that refers to a far field and the measurements for the realization of a radiation diagram may be considered correct. So being coherent with the calculations made above, it has been decided to take measurements of power at two, four and six meters of distance.



3.4.2 Radiation diagrams for tags and the antenna

Before we prepare to measure and analyze all the factors that affect the results extracted is necessary to explain how the radiation patterns of the two key elements in this study work: the tag and antenna.

These charts provide information of which scope can have these elements and how to distribute their radiation in space.

The tag

As shown in the different images, diagrams that exhibit some of the tags that have received with the reader system package have circular ring shape.

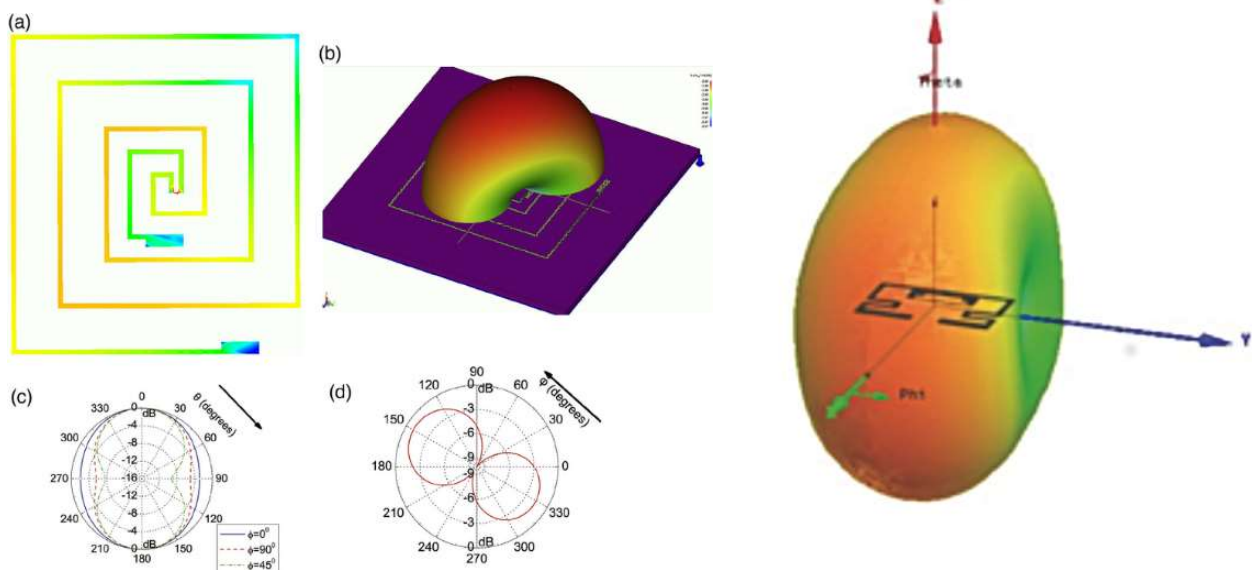

Figure 28. Emitting radiation diagrams from the tags

The intensity of propagation of the radiation field is distributed by colours as shown in the pictures, the maximum defined by the colour red and the minimum or almost zero with blue and green colours so that if we face the tag so that the perpendicular Y-axis leaves out of the paper (XZ plane at the image on the right) power transmission almost may have reduced to zero.



The antenna

The antennas also have their own radiation pattern shown in the following images:

The antennas are able to expose their radiation in almost every possible angle, obviously being so much greater in the front direction (main lobe).

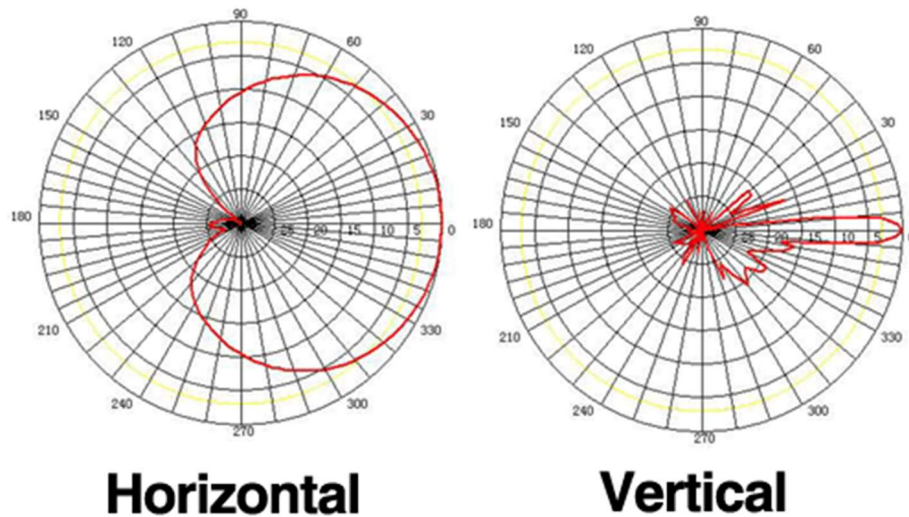

Figure 29. Antenna's emitting radiation diagrams

In the frequency band of UHF, according to what has been observed experimentally, the front has a range of up to 8-10 meters, while on the back of the diagram reaches half meter distance approximately.

When diagrams of both elements are in the space, the communication channel is established and results the beginning of the identification cycle.

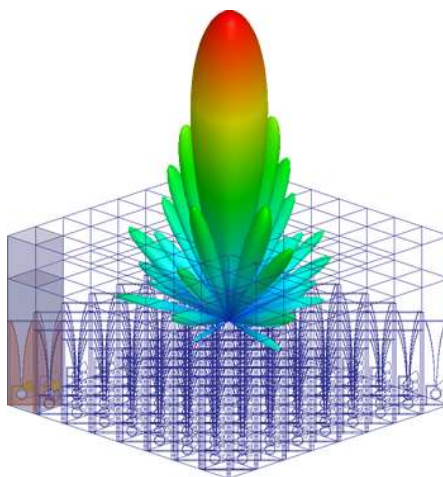

Figure 30. 3D diagram of radiation intensities



3.5 Laboratory measurements

With the purpose of experimenting the behaviour of the M6e reader and the different tags that came up with the equipment, different kind of measures have been taken at the IOC's laboratory in order to keep record of them and draw some conclusions.

The first objective that had to be carried out was to classify the tags since not all of them were of the same nature. The solution that was reached to realize this classification was to measure the surface of each label and measure its power at a fixed distance in order to be able to observe the existing differences. Several different measures would then be taken.

3.5.1 Tag types comparative and subsequent classification

The following table shows the results of measuring the surface in cm² and the RSSI (power signal) at the fixed distance of 1,5 meters:

	TAG	Surface (cm ²)	RSSI
1	E2004BA5F911E930018DF7A3	10,78	-59
2	E20010631002027414907FCF	6,25	-67
3	300833B2DDD9014000000000	11,52	-69
4	E200680600000000000000000	18,02	-77
5	300833B2DDD90140000000001	28,09	-56
6	E2003098150D002917905C63	20,9	-66
7	00000000000000000000401964	11,76	-61
8	300833B2DDD90140000000001	2,5	-
9	E200325573ADCFB12081573E	15,54	-69
10	00000000000000000000000695	5,7	-62
11	E2001AC193A2D4801033BB51	9,49	-68
12	E2001026760F023020803E9E	1,98	-
13	00000000000000000000C0001596	12,5	-72
14	E200680600000000000000000	8,4	-74
15	E200204738170080212038E4	23,5	-50
16	E28011606000020507948471	26,19	-61
17	300833B2DDD90140000000000	14,55	-58
18	0000000008002216572D1386	6,63	-71
19	000000000000221612000992	9	-75
20	20150424807103000106041E	0,1843	-
21	01094300000000000000063B7	1,71	-
22	4D6F68616D6D6564206469616220	159,25*	-55

Table 5. Tags provided with RSSI and Surface measurements



The information collected at the previous table is captured at the next chart in order to get the visual evolution of the data in front surface and RSSI parameters:

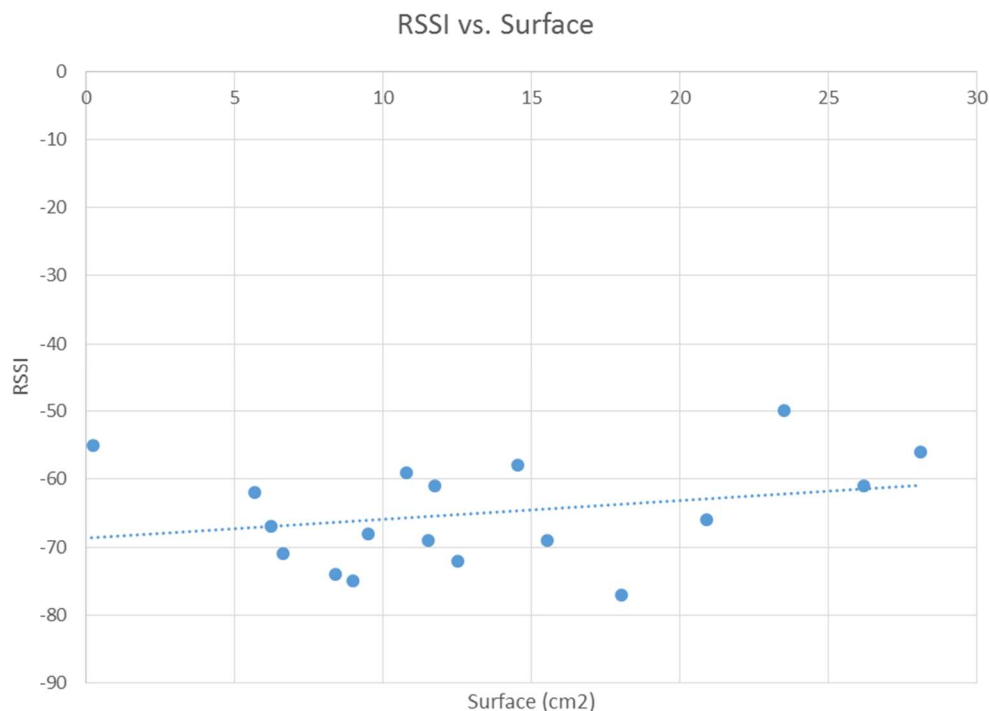

Chart 1. RSSI vs. Surface comparison

It is possible to intuit a first approximation to what is happening when comparing these two parameters: the more surface, the more power received. If we take a look carefully to the graph, we can appreciate that there is one tag with a very low surface and a worthy of consideration power signal received. Specifically we are talking about the tag with the shape of yellow cable which it is not the same kind of tag than the others but it is a dipole.

Explanation of dipole

Looking for information about the several types of tags existing, we found that the yellow wire tag's character is classified as a dipole. The dipole operating is totally a separate case in comparison with the other labels.

Initially the error of calculating the dipole surface was committed as a common area, as the typical method of a circular shape, with the formula $A = \pi \cdot r^2$, with which we obtained a result with a reduced surface and the relationship surface-power signal became incoherent.

But the tag in the form of yellow wire has a peculiarity and is that, because it is a dipole, has an effective area calculation (the effective area is defined as the ratio between the power



received and the power density incident on an antenna) calculated differently from other areas and follows the following formula:

$$A = 0,13 \cdot \lambda^2$$

Where λ is the wavelength in UHF (860 MHz - 960 MHz) which is about 35 cm. Its electromagnetic field propagation follows the next configuration reflected at the figure below which shape simulates a spherical electric charge distribution around its extension:

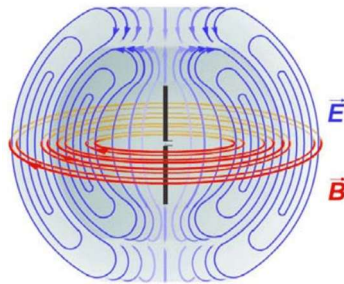

Figure 31. Electromagnetic field created by a dipole

From that point on, it is possible to draw a 3D radiation diagram of that kind of tag, where the maximum level of radiation is reflected by the red zone and, on the contrary, the minimum at the blue-green one.

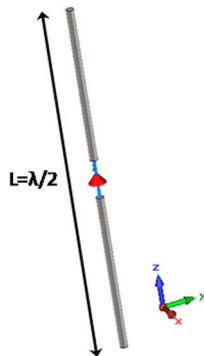

Figure 32. Dipole

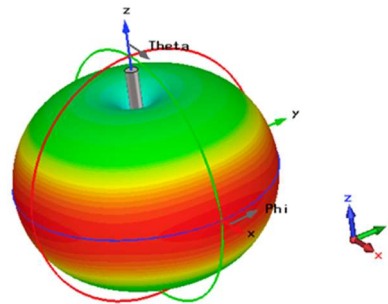

Figure 33. Dipole 3D radiation diagram

So if we dispose the placement of the dipole in a vertical way in parallel with respect to the face of the antenna we will receive the maximum power signal available. In contrast, if we face the end of the cable to the face of the antenna, the signal that we will receive will be very slight or totally zero.

Returning to the subject that lies in the classification of the tags, due to the fact that we cannot classify the wire as the same type of tags relating with all the others, the point marked with a surface of $0,24 \text{ cm}^2$ is not a valid one.



At the last chart above has not been included the tag 22 corresponding to the yellow wire due to that it would disproportionate the graph as follows:

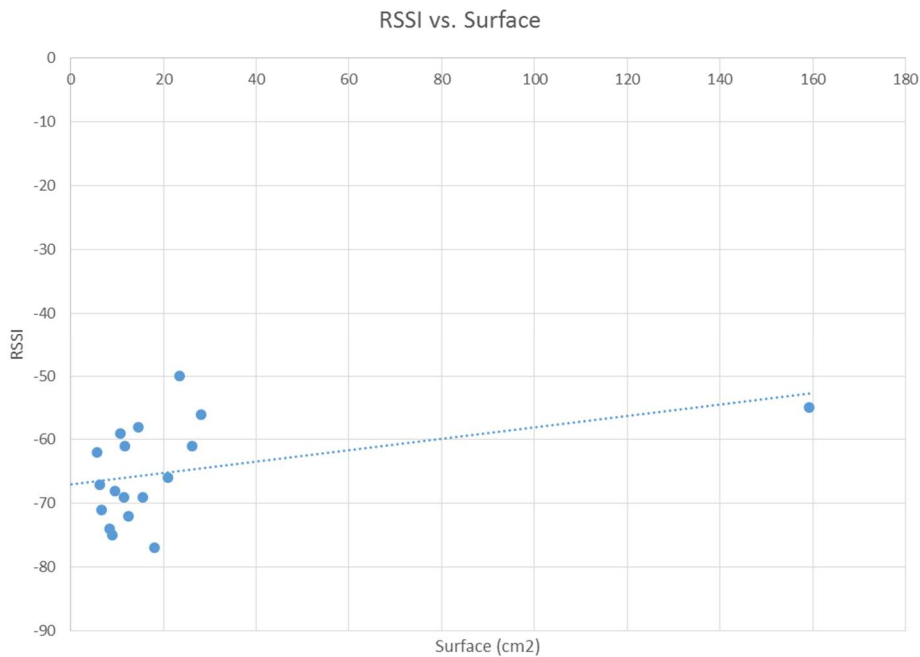

Chart 2. RSSI vs. Surface comparison with effective area of the yellow wire

Note: the reason why there are tags that have no value of RSSI is because at the distance of 1,5 meter the reader was not able to identify them. Curiously the labels that could not be recognized at that distance have a very small area.

So, as expected, if we take a look to the charts presented above, which compare RSSI in front of the surface, as it increases the surface of the label, increases the power received by the reader in some tags. There are other tags which have a great level of surface but nevertheless do not dispose of a great level of power. There is a missing parameter here that disturbs this experiment and which is going to be explained later.

At the next table are presented the tags that are not recognized at this distance. Take a look to its surfaces:

	TAG	Surface	RSSI
8	300833B2DDD9014000000001	2,5	-
1	E2001026760F023020803E9E	1,98	-
20	20150424807103000106041E	0,1843	-
21	0109430000000000000063B7	1,71	-

Table 6. Tags not recognized at 1,5 meters of distance



Partial Conclusion 1:

After seeing the trend line and the experimental results in the previous 4 tags that have not been recognized to 1,5 meters we can say that the size of the tag (surface) affects the power emitted by these tags to the reader

Continuing with the study and the target of classify the tags with the chart given above and imposing such RSSI intervals in order to be able to classify by different groups the different types of tags, a graph was made to arrange each surface in each group and observe the variation:

Range (RSSI)	Group
<60	1
60<x<65	2
65<x<70	3
70<x<75	4
75<x<80	5

Table 7. RSSI classifying intervals

With the help of those intervals we are able to draw the next chart shown:

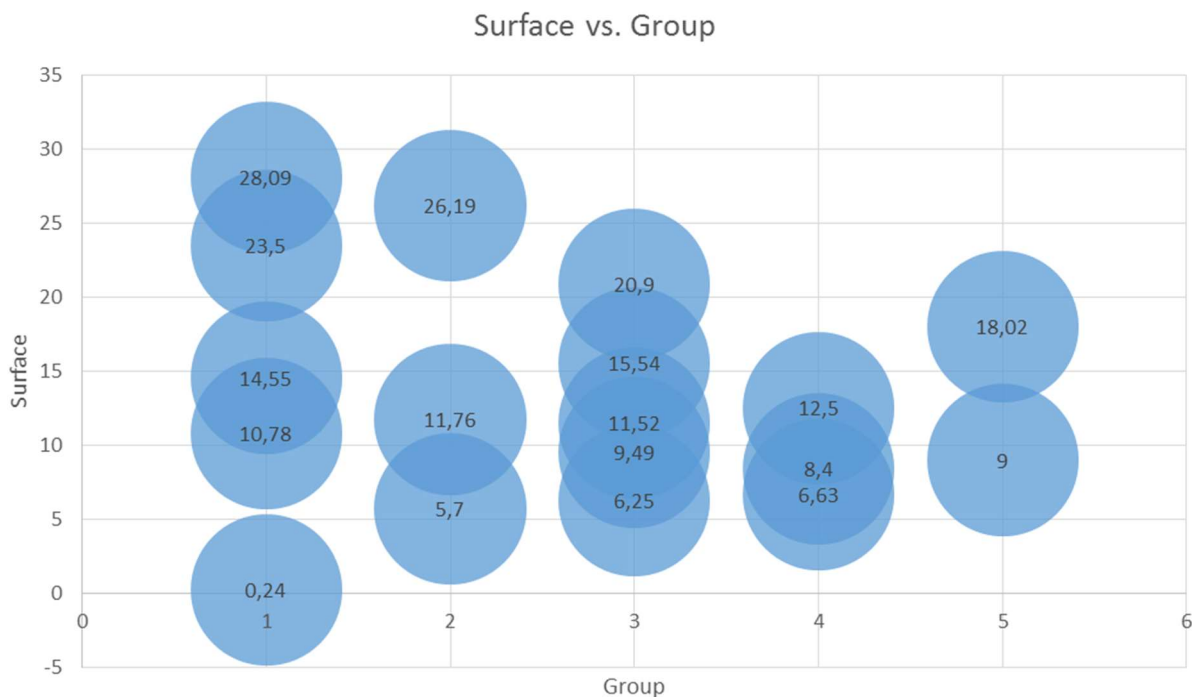

Chart 3. Surface vs. Group classification



But now, as shown in the graph, we can classify each tag in described groups marked by the intervals, and setting the surface as an independent parameter of each one.

Before searching information about the dipoles and its effective area, we arrived at the conclusion that the most extreme case was the yellow cable, which had an area of 0,24 cm² (wrong considered because it is not the same type of tag) and a power of -55 dBm below -60 dBm, which places it in the first group. Instead, the tag 5 EPC: 300833B2DDD9014000000001 with surface 28,9 cm² (being the largest area) could also be grouped into the first group because their power is -56 dBm.

But after discovering that is not a regular tag because it is a dipole and calculating the effective area of the wire it is reasonable the higher grade of power signal transmitted by this tag and the fact that can be classified at the first group.

Partial conclusion 2:

If we think of the chart above, we can conclude that in this case, the power received by the reader does not depend so much on the surface but how each tag is designed according to their own manufacturer.

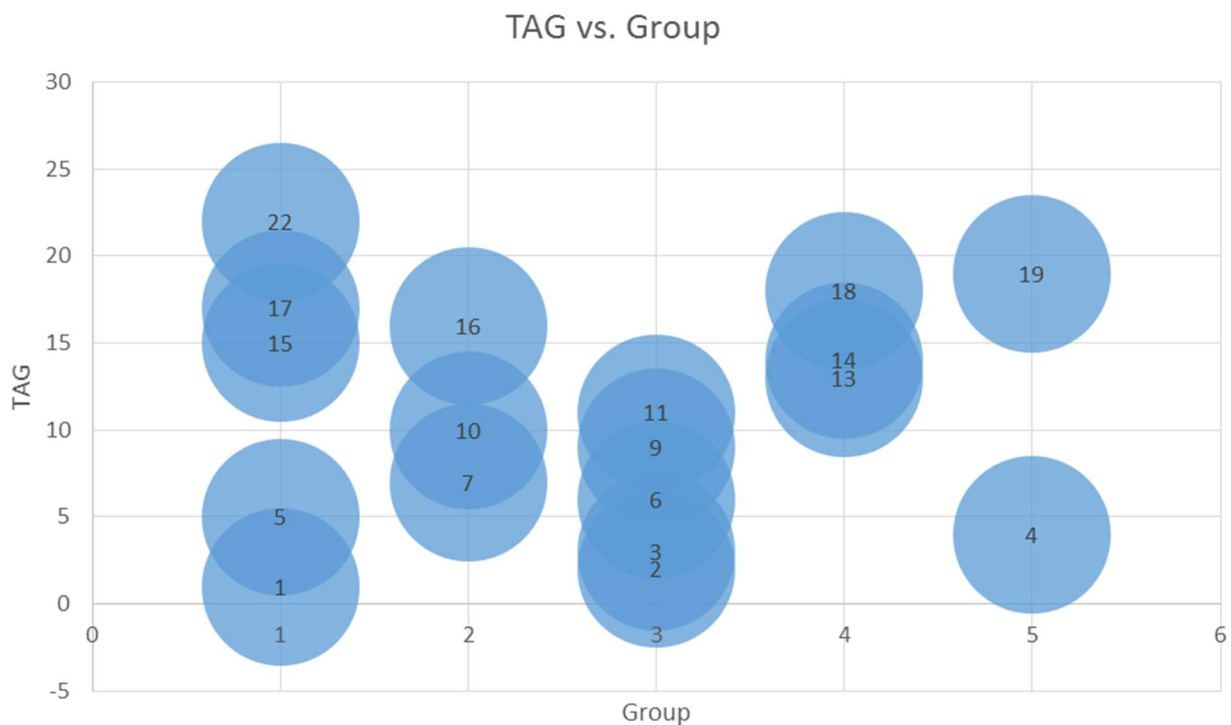

Chart 4. Tag number vs. Group classification

To ease further understanding, at the chart are some tags classified at different groups that have a similar surface (from the order of 25 cm²) and that shows us that the transmission



capability is also an important parameter to take into account which is influenced by two parameters that are going to be explained at the overall conclusions

The previous chart numbers the tags instead of showing the surface to have a slightly clearer view of which EPC correspond to each group, and this classification is picked up at the table below with de EPC, RSSI and surface values specified as follows:

Group	EPC	RSSI (dBm)	Surface (cm ²)
1	E2004BA5F911E930018DF7A3	-59	10,78
	300833B2DDD9014000000001	-56	28,09
	E200204738170080212038E4	-50	23,5
	300833B2DDD9014000000000	-58	14,55
	4D6F68616D6D6564206469616220	-55	0,24
2	0000000000000000000401964	-61	11,76
	000000000000000000000695	-62	5,7
	E28011606000020507948471	-61	26,19
3	E20010631002027414907FCF	-67	6,25
	300833B2DDD9014000000000	-69	11,52
	E2003098150D002917905C63	-66	20,9
	E200325573ADCFB12081573E	-69	15,54
	E2001AC193A2D4801033BB51	-68	9,49
4	0000000000000000C0001596	-72	12,5
	E200680600000000000000000	-74	8,4
	0000000008002216572D1386	-71	6,63
5	E200680600000000000000000	-77	18,02
	000000000000221612000992	-75	9

Table 8. Tag classification into five different groups

Overall conclusion:

At first, with the first graph, we could draw the conclusion that according to the surface, the power increased as we said and seen at the trend line that was drawn. It was logical to think that the more surface, the more power.

Then we saw that depends less on the surface when classifying into different groups according to the emitting power, the power of emission which was provided by the manufacturer.

We may conclude that it can be a collision of two factors affecting the amount of power emitted by the tag: on the one hand the surface that has the tag and on the other, the own capability of signal transmission with which each tag is provided.



In most cases, the limiting factor for the reading distance of a tag is the power given to the chip. This power depends mainly on the design of the tag (of its antenna and the adaptation circuit), as well as the environmental factors.

This transmission capability of the tags depends basically on two main factors: the sensitivity of the tag and the return signal or backscattering.

- **Sensitivity:** The amount of radiated power required to excite a tag is what is called Sensitivity. To measure the sensitivity of the tag, a signal source connected to an antenna that sends a command to the tag is used, and the transmission power is varied to find the minimum power with which the tag is able to respond.

In order to separate the results of the distance between the reader and the tag and thus to be able to compare different tags, the unit used for the sensitivity is the electric field strength (in the far field)

$$E = \sqrt{\frac{P_{EIRP} \cdot Z}{4\pi \cdot R_1^2}}$$

Where P_{EIRP} is the effective radiated power, Z is the free-air impedance (377Ω) and R is the distance between the tag and the transmitting antenna. When the sensitivity is known at a given frequency, that same equation can be used to calculate the theoretical maximum operating distance of the tag.

- **Return signal or Backscattering:** As the designs of the tags evolve, the working distance of the tags is limited by the signal transmitted to the receiver of the reader.

The signal strength that the reader can reliably detect and decode is represented as the sensitivity of the reader, measured in dBm. The signal returned by the tag must always exceed that value. The parameter to consider to determine how efficiently the tag transforms the radiated power in signal backscattering is ΔRCS (radar section differential). Thus, the following equation is used:

$$\Delta RCS = \frac{P_R}{G_R \cdot P_{EIRP}} \cdot \frac{(4\pi)^3 R_1^2 R_2^2}{\lambda^2}$$



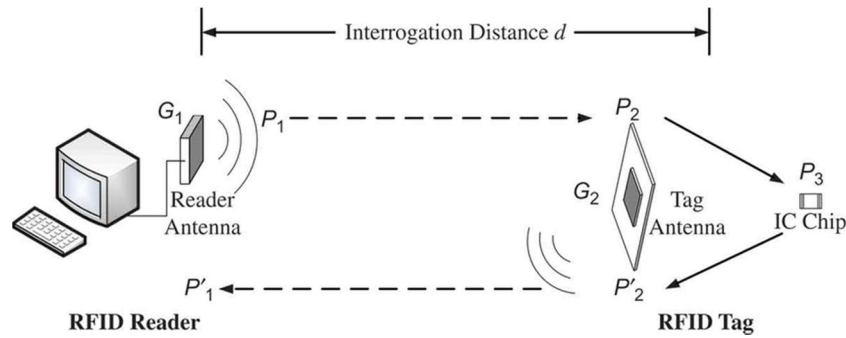

Figure 34. Distance calculation with the Backscattering

Where P_R is the power received, G is the gain of the receiving antenna, P_{EIRP} is the effective transmitted power, R_1 is the distance between the tag and the transmitting antenna, R_2 is the distance between the tag and the receiving antenna and λ is the wavelength of the carrier.

Having seen these concepts, it should be added that the sensitivity depends in turn on the inherent frequency of each tag and that the return signal depends on the power transmitted.

The data measured with these procedures are extremely valid to choose the most suitable tag for a given application or compare different antenna designs and chips. In order to perform the actual measurement of the performance of the tag an anechoic chamber and specialized instruments, of which are not currently available, should be used but we have tried to lay the foundations with which to start working.

In order to get a further study of those explained factors related with the tags we have, we would need specifications of the elements of the system reader such as the impedance of the antenna, the P_{TX} (power delivered to the transmitting antenna), S_{RX} (receiver sensitivity), G_{TX} (gain transmitting antenna from isotropic one) and G_{RX} (receiver antenna gain with respect to isotropic) which don't we have and neither don't need it for this project because these calculations are beyond our working range.



3.5.2 The backpack tag case

Note: While scanning the tags, a very strong signal appeared among the other tags. It was an inserted tag at the inside of my backpack. Showing up next the documentation of the tag:

EPC: 30396062C3AD0B800010EBF8

Reserved Memory Bank (0)				
Purpose :	Kill Password		Access Password	
Value (Hex) :	Gen2 memory locked.		Gen2 memory locked.	
Word Address (Dec) :	0	2		
EPC Memory Bank (1)				
Purpose :	CRC	PC	EPC ID	Extended EPC Memory
Value (Hex) :	48 E7	30 00	30 39 60 62 C3 AD 0B 80 00 10 EB F8	00 00 00 00
Value :	<input checked="" type="radio"/> ASCII <input type="radio"/> Reverse Base 36 09`bÃ èø			
Word Address (Dec) :	0	1	2	8
TID Memory Bank (2)				
Purpose :	ClSID	Vendor ID	Model ID	Unique ID
Value (Hex) :	E2	006	B06	1A 70 F2 14
Meaning :		NXP		
Word Address (Dec) :	0		2	
User Memory Bank (3)				
Purpose :	User Data			
Value (Hex) :	Read Error			
Value (ASCII) :				

Figure 35. Memory banks of the backpack tag

RFID as security measure

There have been times when it has been talked of systems that try to help us locate our equipment once we have suffered the robbery. In this case, RFID technology could be focalized on an application base on anti-theft preventive measures to make it more difficult for thieves.

It is a technology capable of locking the zipper of a backpack by means of an RFID sensor to avoid that anyone who is not its owner can open it. To unlock it, the owner simply passes a sensor card that is provided with the same technology.

What makes this system more valuable than any other used for this purpose is that the RFID chip allows to store identification information that give each of the tagged elements a unique character.



Privacy and security risks of RFID technology

Notice the impact to privacy of the growing deployment of radio frequency identification tags on everyday objects:

Regarding the security and privacy of RFID technology, it is emphasized that, although this technology offers great opportunities and facilities, in turn it can pose serious risks, since they can inform the location, identity and history of an individual

In this regard, there are important risks to privacy and security such as unauthorized access to personal information of users. The main attack that can suffer the privacy of the user is the attempts to read the personal and private information stored in an RFID device under his possession.

To give an example, there is the problematic of the case of a person who carries a garment of a trade that has not disabled the RFID tags or stickers, because these could offer information able to elaborate a profile with the likes or hobbies of that person from their purchases.

It can be distinguished between the main threats most relevant to privacy: unauthorized access to tags that may contain personal data of all kinds, tracking people and their tastes and using data for the analysis of individual behaviours.

In reference with security risks, they have to do with attacks or breakdowns that affect the service or the use of the technology to access personal information of users of the system. Actions aimed at deteriorating or taking advantage of the service maliciously with which the economic benefit is pursued or a deterioration of the service provided.

The simplest form to attack is to avoid communication between the tag and the reader, but there are others, such as tag isolation, impersonation, insertion, deactivation, destruction of tags or cloning of the RFID card.



3.5.3 Data stored at tags

Among the information stored inside the tags it can be distinguished a classification of four types of data:

- Identification: here it's found the ID number of the tag (EPC, TID) and which is the object the tag is attached to.
- Supplementary data: some information about the thing the tag is attached to such as height, weight, time of expiration, etc.
- Control Data: this kind of data performs the allowance of operate among various tag functions. As an example, this data can be passwords or filter values.
- Tag Manufacture Data: information about the manufacturer of the tag like the way it's been created, the model of tag, etc.

In order to englobe those kind of data we could sum it up into three different groups: identification and supplementary data would fit at *Business Data* because of the close relation with some aspects of the object you are dealing with.

Another group could be *Control Information* which includes the Control Data, suitable for access permissions. And, finally, the third group is called *Tag Manufacture Information* where de Tag Manufacture Data is stored.



3.5.4 Tags selected for the experiments

Once the classification in such the five different groups, explaining the reasons of it, we are going to select the ones of each group that are going to be used to carry out the following experiments. The criteria to select this tags is based on standing out those which do not perform an extreme behavior, that is to say, the ones of each group that take a medium level of RSSI, not the maximum as neither the minimum power signal.

Note: All measurements were made with the same scales of the axes, for that to make visible the important variations to observe.

Selected Tags:

Group	EPC	RSSI at 1,5m (dBm)	Surface (cm ²)
1	E200204738170080212038E4	-50	23,5
2	0000000000000000000401964	-61	11,76
3	E2003098150D002917905C63	-66	20,9
4	0000000008002216572D1386	-71	6,63
5	000000000000221612000992	-75	9

Table 9. Tag selection for each classifying group

Note: The tag 22 corresponding to the yellow cable is not selected as a preference in group 1 (although a very good feedback was observed regarding the propagation of waves with this tag) as it would not be appropriate with the other tags given, fact that is from a different nature (it is a dipole) and would dismount the entire study without reaching any right conclusion.

As an advance, if we take a look to the table of the tags selected we can appreciate that the tag of the group 4 although having a lower surface level than the tag of the group 5, is classified as a better transmitting power signal.

This fact will be reflected at the results of the forthcoming experiments bearing out the predictions of those factors which take influence at the receiving level of the power signal: surface and own capability of signal transmission (depending on tag's sensitivity and backscattering) with which each tag is provided.



3.5.5 Distance of reading with angle sweep

3.5.5.1 First layout of elements of the reading system

At the time of being selected the tags from the different groups established it is proceeded to take several measurements for each group with the purpose of take presence and write down the influence factors and the possible variations. At a short distance, we made two tests with different layout in order to compare it and to take position of the performances of the power levels for each group of tags.

The following table shows the first experiment carried out at 1,5 meters of distance between the pair tag-antenna and with the layout shown at the picture below:

Tags	-90°	-67,5°	-45°	-22,5°	0°	22,5°	45°	67,5°	90°
G1	-62	-57	-55	-53	-50	-54	-56	-61	-69
G2	-	-72	-64	-61	-58	-61	-69	-75	-73
G3	-	-70	-64	-62	-59	-62	-68	-76	-71
G4	-	-	-76	-72	-68	-71	-77	-	-
G5	-	-	-	-80	-76	-79	-	-	-

Table 10. First layout reading at 1,5 meters.

Taking a look at the table, it is possible to say that at the right side angles the system reads with less power because there is no metal as close as there is on the left side and the signal does not look so reflected in comparison with the opposite side.



Figure 36. First layout of reading elements

For describing a bit the layout, it is important to say that the presence of metal objects at the laboratory is strongly high, as it can be seen at the picture, at the left side there are



sockets and wiring, just behind the tag are situated some metalized shelves with robot at the inside and at the right side there is a wide space without any influencer presence although a little further there are placed some robots used for other IOC's projects.

We have observed that as the group progresses (gets worse the reception power) and is performed the angle sweep putting us away from the direct reading position (0°), measures worsen and lose reliability. This not only represents and confirms the classification in those group, but also takes into account the metal parts influence at the results thus altering the measurements and resulting in erroneous readings, especially in the more opened angles.

Looking at the graph above, we see that for the distance of 1,5 meters the difference between G2 and G3 is almost zero. We are expecting how their behavior evolves by

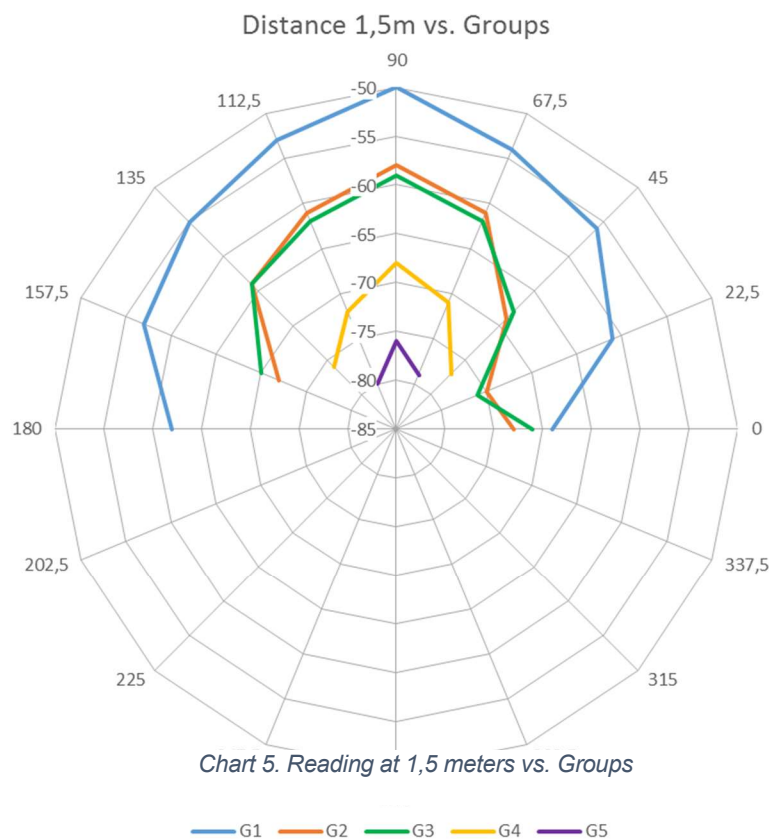

increasing distance and changing the layout. It possible that if we set a different disposition of the reading tests, the influence of the metal object could variate those results extracted and may differentiate de power levels at groups 2 and 3 in order to confirm the classification predictions previously done.



3.5.5.2 Second layout of elements of the reading system

Now, changing the layout which is described below, we are ready to begin the measurements with the target of appreciating any difference between this test and the one written down above.

It has been decided to make measurements at **2, 4, 6 and 8 meters** with sweeping 180 degrees and see the effects of radiation on each group. As far as the factors affecting the radiation are the same for the different measuring distances, measurements have been made with this layout of the space, shown at the figures of each experiment.

2 meters

Notice:

Tags	-90°	-67,5°	-45°	-22,5°	0°	22,5°	45°	67,5°	90°
G1	-	-64	-62	-60	-57	-60	-62	-64	
G2	-72	-68	-65	-62	-60	-61	-63	-66	-70
G3	-79	-75	-68	-64	-62	-64	-67	-74	-74
G4	-	-	-77	-72	-70	-73	-76	-	-
G5	-74	-70	-69	-65	-63	-66	-74	-	-

Table 11. Second layout reading at 2 meters

As the picture shows, on the right side there are shelves and metal shutters, on the left, robots and metal computer tower and at the front sockets and wiring.

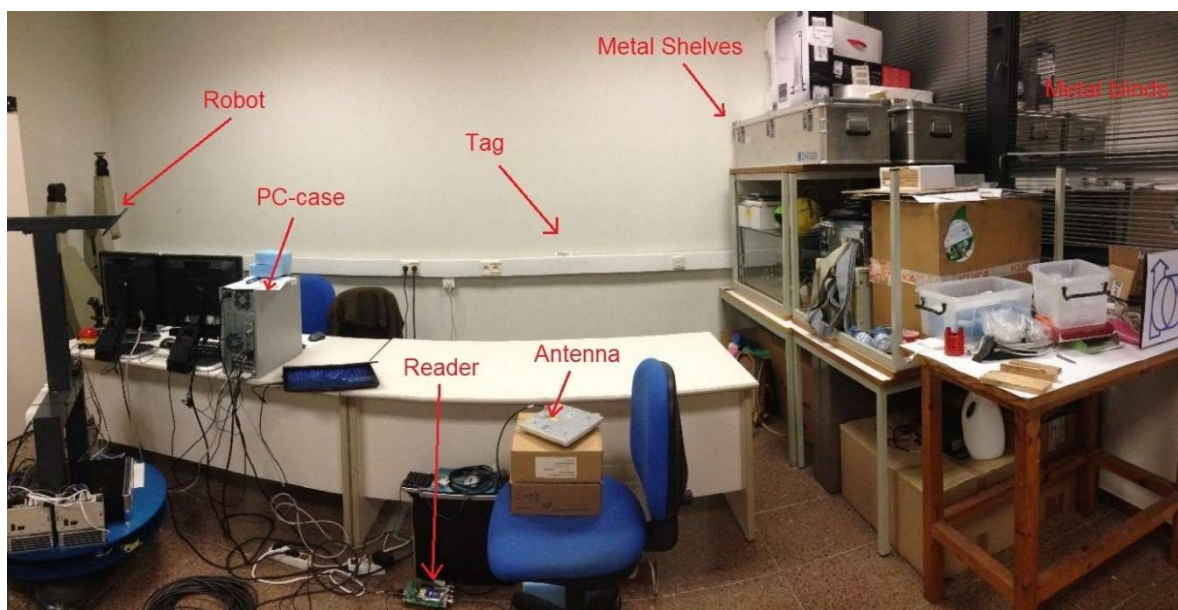

Figure 37. Laboratory picture of the 2 meter-layout



Occurs the same again, the signal is reflected on both narrow sides of the reading measurement due to the presence of metal (robot, PC-case, metal shelves, etc.).

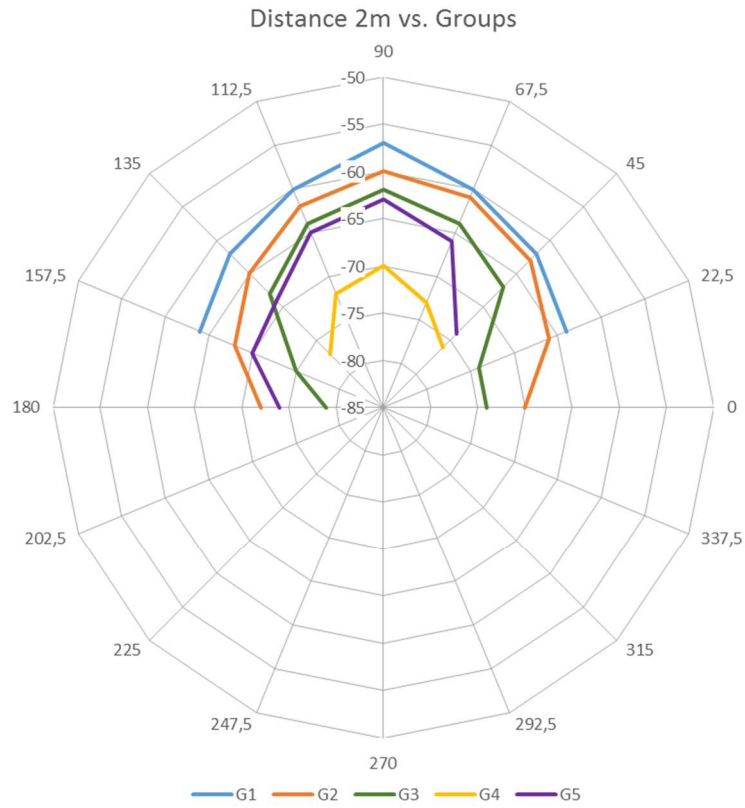

Chart 6. Reading at 2 meters vs. Groups

In comparison between G4 and G5 we can see the influence of the surface due to that G5 gives better results than G4, the two measured at the same distance (2 meters) but being G5 with greater surface than G4.

From two meters we can already appreciate that G2 and G3 send a different feedback, being higher in G2 than in G3, as planned. It would be another label to check both groups and re-measurement at 1,5 meters and 2 meters in order to safely say that, at short distances (1,5 meters) G2 and G3 behave in a similar manner.

Regarding measurements in wide angles, it can be said that due to the presence of various materials, among the most influential the metal, signal reflects on these parts and therefore the antenna is capable of detecting a power in the angles 90° and -90° .



But these readings lead to confusion because in an ideal free space from the influence of the materials, at wide angles antenna would not be able to bind its electromagnetic field with issuing the tag and therefore would not be identified.

But in return, we must say that will not exist in a future implementation of the system an ideal space free from influences, so it's interesting that the signal reflection help in some way to detect the tag, the problem is that the power with which received it is not entirely correct and cannot establish a power-distance relationship right for the detection of nearby obstacles.

4 meters

Tags	-90°	-67,5°	-45°	-22,5°	0°	22,5°	45°	67,5°	90°
G1	-	-	-	-62	-57	-59	-62	-65	-
G2				-71	-69	-67	-68	-66	-73
G3	-	-	-73	-71	-68	-72	-74	-76	-
G4				-	-75	-70	-73	-75	-
G5	-	-	-	-	-75	-71	-68	-70	-73

Table 12. Second layout reading at 4 meters

As the reading angle becomes larger, the signal tends to be reduced as it is received with less intensity, but if we look at the results of the measurements of the group 4 we appreciate at the angles of 22,5° and 45° that the power increases. This is also due to reflection of the waves due to the presence of metal. Having overcome the obstacles of metal (from 45) is seen as the signal loses intensity.

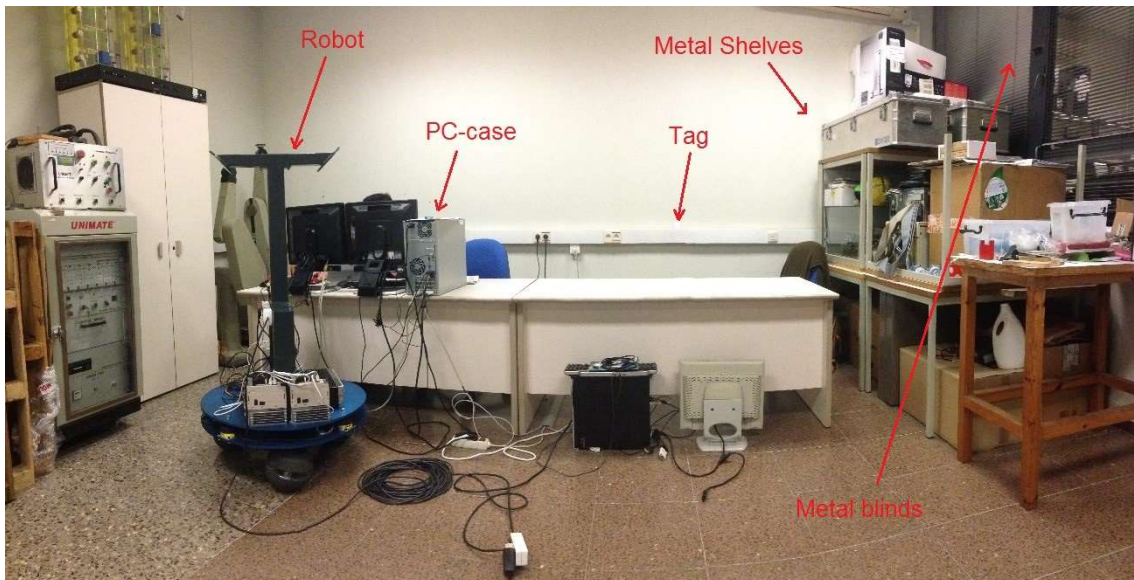

Figure 38. Laboratory picture of the 4 meter-layout



In the sweep to the left (negative angles), as shown in the table, no signal is received (the reader fails to identify the tag) result that the metal abounds in large quantity on the left side (robot, cabinet, power supply, tower PC, etc.).

As observation while we were performing the measurements, we noticed that at 4 meters group 5 signal is very weak because of tag recognition became very complicated. Only we managed to extract some result by moving the antenna from left to right, respecting at all time the distance between antenna and tag (dynamic reading).

As will be explained later, in a real situation will not be many cases in which the readings are performed in full statically way, either by movement of the antenna as by movement of the tag, which we can indicate that is an advantage for the good recognition of tags.

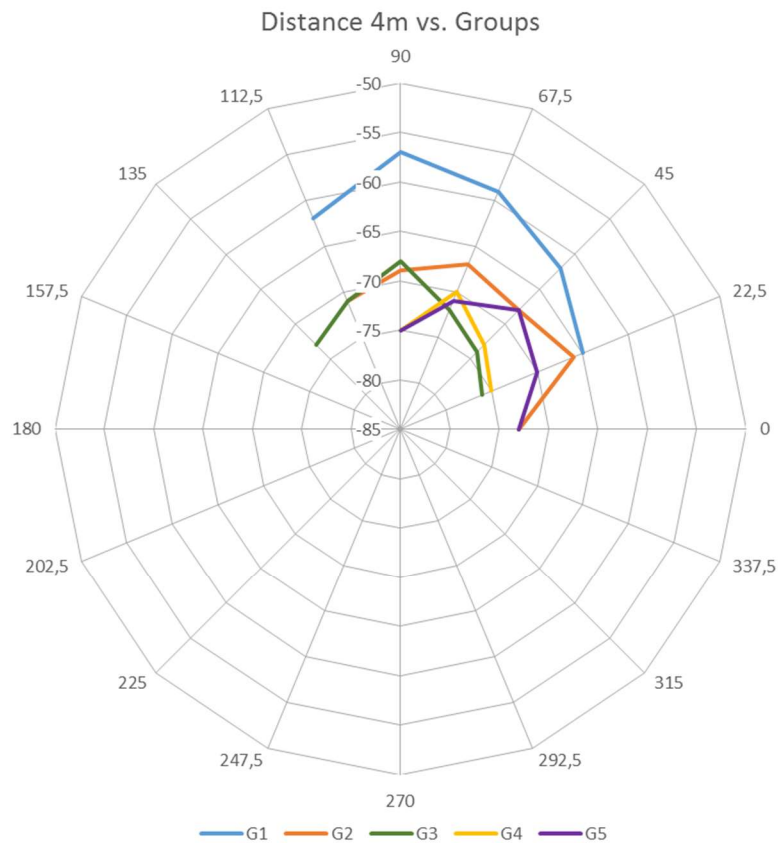

Chart 7. Reading at 4 meters vs. Groups

In the chart above we can see the influence of the large amount of metal on the left side of the laboratory, since the maximum angle at which has managed to extract results is 45° in respect to the direct line of reading of the antenna-tag layout (135° in the chart).



In addition, is possible to say that the signal at, for example, $67,5^\circ$ in respect to the direct line of reading of the antenna-tag layout ($22,5^\circ$ in the chart) is disturbed again by the metal presence at the environment, taking a higher value than at $22,5^\circ$ ($67,5^\circ$ in the chart).

6 meters

Tags	-90°	$-67,5^\circ$	-45°	$-22,5^\circ$	0°	$22,5^\circ$	45°	$67,5^\circ$	90°
G1	-	-66	-57	-64	-62	-65	-	-	-
G2	-	-	-*	-67	-65	-68	-70	-66*	-
G3	-	-75	-73	-72	-67	-74	-72	-70	-
G4	-	-	-	-	-	-	-	-	-
G5	-	-	-	-76	-74	-76	-	-	-

Table 13. Second layout reading at 6 meters

In the case of 6 meters away, a similar situation as in the case of 4 meters occurs (group 4) because as we can see in group 1 at -45° comes into play the signal reflection by the metal influence which causes an increase of the signal (-57 dBm) whose value is greater than at 0° (-62 dBm). Subsequently, from the signal $-67,5^\circ$ retakes normal values as it has overcome the area with the largest part with metal.

It turns to conclude that these measures are not quite significant because of the reasons explained and we cannot rely on the accuracy of the results but however we must take into account that on a real case can exist those material influences that disturb the results.

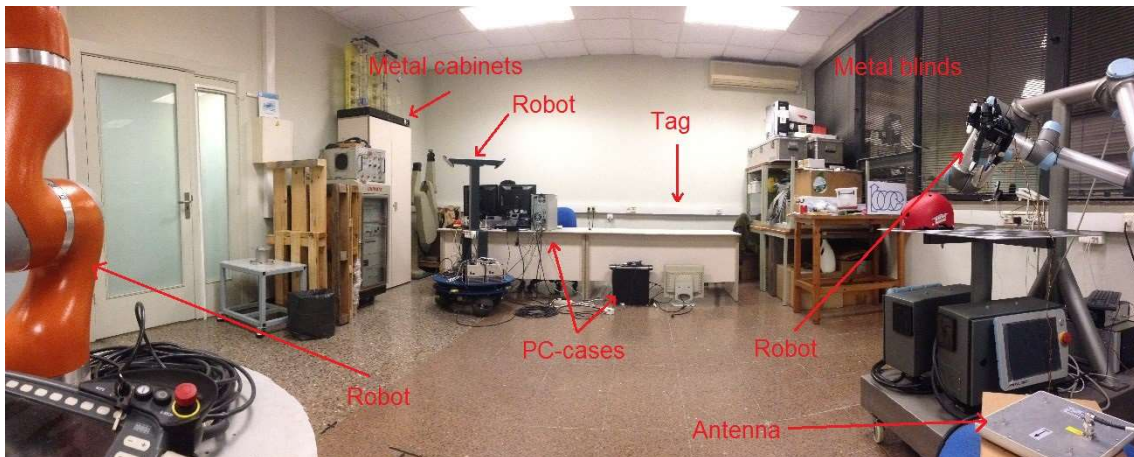

Figure 39. Laboratory picture of the 6 meter-layout

We can add as observation at a distance of 6 meters and in wide angles, signal losses of the two factors of influence are added: on the one hand because of the distance to which



is performing the experiment and another, the low grade in which the tag and antenna are facing, why the total elimination of the signal is given.

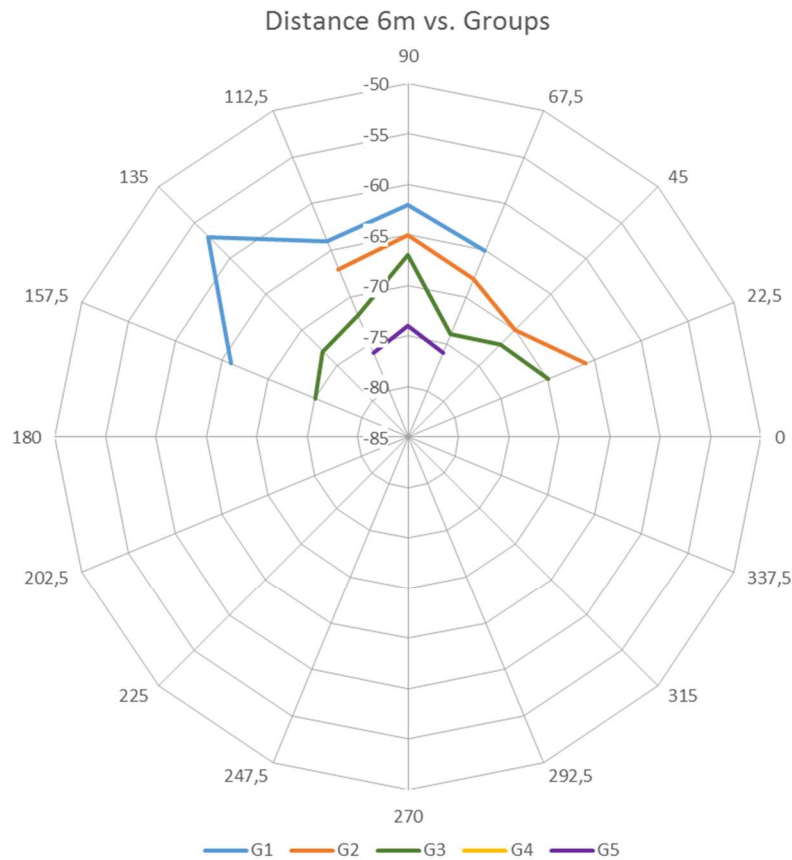

Chart 8. Reading at 6 meters vs. Groups

Again, in the measurement of group 2 from $67,5^\circ$ plays back the pattern of increase/confusion of the received signal due to the metal reflection.

In the G3 is replayed the same pattern of reflection by metallic elements and therefore leads to erroneous measurements (could be considered 6 meters and from 45° of sweeping that the reader is unable to detect the tag).

In the G5 is repeated the influence of surface factor, since the surface from the group 5 is greater than at the group 4 but the sending power is lower and even so still manages to be identified by the reader. The group 4 signal is not received by several factors: small size, reading distance (6 meters) and mild rated power.



3.5.6 Recording possibilities

Another possibility that have some of the tags inspected is to record/store information within them. With the help of the Universal Reader Assistant software we have analysed all of the several fields available at the tags. The store possibilities is specified at the next table:

	Tag	Characters	Vendor ID	Model ID
1	E2004BA5F911E930018DF7A3	16	Alien	Higgs 4
2	E20010631002027414907FCF	64	Alien	Higgs 3
3	300833B2DDD9014000000000	4	Impinj	Monza 5
4	E200680600000000000000000	0	NXP	G2iL
5	300833B2DDD90140000000001	64	Impinj	Monza 4QT
6	E2003098150D002917905C63	64	Alien	Higgs 3
7	00000000000000000000401964	64	Alien	Higgs 3
8	300833B2DDD90140000000001	4	Impinj	Monza 5
9	E200325573ADCFB12081573E	16	Alien	Higgs 4
10	00000000000000000000000695	64	Alien	Higgs 3
11	E2001AC193A2D4801033BB51	16	Alien	Higgs 4
12	E2001026760F023020803E9E	64	Alien	Higgs 3
13	00000000000000000000C0001596	16	Alien	Higgs 4
14	E200680600000000000000000	0	NXP	G2iL
15	E200204738170080212038E4	64	Alien	Higgs 3
16	E28011606000020507948471	0	Impinj	Monza R6
17	300833B2DDD90140000000000	4	Impinj	Monza 4D
18	0000000008002216572D1386	16	Alien	Higgs 4
19	000000000000221612000992	64	Alien	Higgs 3
20	20150424807103000106041E	64	Alien	Higgs 3
21	010943000000000000000063B7	64	Impinj	Monza 4QT
22	4D6F68616D6D6564206469616220	56	Alien	Higgs 3

Table 14. Tags provided with number of recording characters measurements

Explanation of results:

According to the table you can see that tags manufactured by **NXP** in any case are recordable as they have 0 characters writing.

Regarding the **Alien** brand of tags that have come with the package, we are able to distinguish between 16 and 64 characters available depending on the tag, and one in particular, the yellow cable that has 56 characters.

Finally, the **Impinj** brand subdivide the record ability of their tags in 3 different groups: 0, 4 and 64 characters available.



3.5.7 Tag orientation influence

Considering how the radiation diagrams of the tags are drawn (see the following image for a further understanding) we will perform two types of rotations: the first will be to rotate the antenna around the X axis as we have been doing so far (180° scan) And in the second we will rotate around the Z axis so that the different zones of radiation (different colours in the image) are exposed.

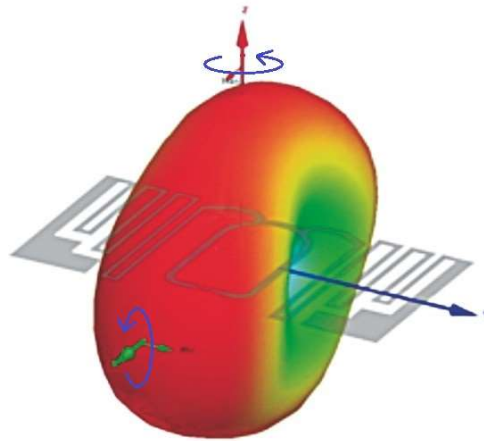

Figure 40. Tag's radiation diagram

In the following table the results of the measurements are collected for each group applying both rotations. We assume symmetry of the radiation diagram, with which, we will make elevations from 0° to 90°.

	X-axis rotation	Z-axis rotation
G1	-47 <---> -45	-45 <---> -75
G2	-50 <---> -48	-48 <---> -70
G3	-56 <---> -53	-53 <---> -75
G4	-56 <---> -54	-54 <---> -74
G5	-48 <---> -45	-45 <---> -77

Figure 41. X-axis and Z-axis rotation measurements vs. Groups

The initial position of the tag before the rotations is the one that reflects the maximum power, that is to say, the 0° one (direct line of sight, parallel tag faces and antenna).

As the results reflect, in rotation X increases in a very lower grade noticeable the power received by the reader, which makes sense since if we look at the previous drawing, the red zone is narrower in the face of the tag than in the edge of this, fact that indicates that there is greater transmission, the wider the area delimited in red is.



In the rotation in Z, however, the power decreases very noticeably (it is divided by 1000) since, as shown in the diagram, with the view of the front tag, the coloured area in red appears where the value is given the maximum power and if we turn 90° with respect to the Z axis it appears the zone coloured in green that is where the minimum power is given.

With this study it is affirmed that the orientation of the tag with respect to the Z-axis (with the references taken at the image) influences in a high degree and the reception of signal worsens, whereas in the X-axis is almost invariable the named power.

3.5.8 Influence of overcrowding. Tag collision

When you try to read many tags at once, you probably don't get the expected results due to the fact that not all tags are read correctly.

There are different power signals of sending data identification in each tag. As discussed in chapter 3.1.2 on the identification cycles of tags, a kind of "competition" is performed for each tag to send its ID to the reader and that it establishes a communication channel so that the tag can send its information stored in its circuit.

There are tags that have more power when sending its ID and those with less power are cancelled by these ones which are more powerful. So much so, that they never get identified by the reader because they always win in that "competition" those who have more power range.

This phenomenon is called *tag collision* and happens when multiple tags are energized by the RFID tag reader simultaneously, and reflect their respective signals back to the reader at the same time. This problem is often seen whenever a large volume of tags must be read together in the same RF field. Tag collision confuses the reader and is unable to differentiate these signals.

In the Universal Reader Assistant program, when is performed the simultaneous reading of many tags, the program stops reading tags and automatically gets disconnected. Presumably, this happens because there is too much information that the reader cannot handle simultaneously and as a security measure, the program disconnects the connection with the reader.

As for the implementation of the Python wrappers for the Mercury API, the disconnection of the reader does not occur even though it does not identify all the existing tags simultaneously due to what has been said before occurs, the more powerful tags overlap over the more weak ones, thus negating their opportunity to be identified by the reader system.



3.5.9 Multipath: Metallic, wood, plastic and liquid paths

It was preferred to use the distance of **1 meter** so that there was no margin of error by distance since to some measurement had problems with the group 5 since it did not detect the tag correctly.

Metal

Tags	-90°	-67,5°	-45°	-22,5°	0°	22,5°	45°	67,5°	90°
G1	-72	-70	-63	-60	-54	-57	-59	-66	-69
G2	-74	-71	-67	-62	-59	-61	-67	-70	-74
G3	-74	-70	-67	-61	-60	-62	-66	-72	-
G4	-	-	-79	-76	-70	-72	-75	-	-
G5	-	-	-81	-80	-79	-	-	-	-

Table 15. Radio-frequency waves propagation through metal

Before any conclusions, we provide the reader of this project the layout of the elements of the reader system with which we have carried out different measures for materials:

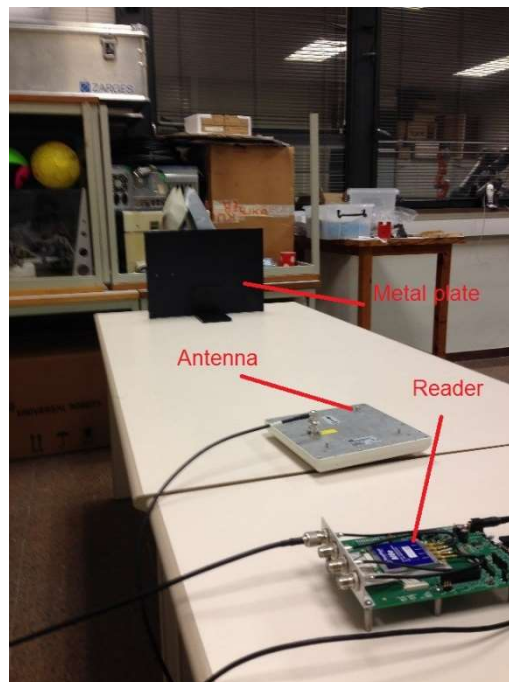

Figure 42. Test of the wave's propagation through metal

On the left side there are sockets and wiring, in the background there are shelves and small robots and at the right side there is free space with robots in the background, all built with metal elements.



Observing carefully the chart we see that on the right side, in which there is a wider free space compared to the left side, the signal is reflected by an increase in their values. This can mean two things: the first is that being more distant metal objects, its influence on the results is lower; the second is that having more operating/free space, a better propagation of radio-frequency waves is produced and therefore is reflected in the results an increases the received signal.

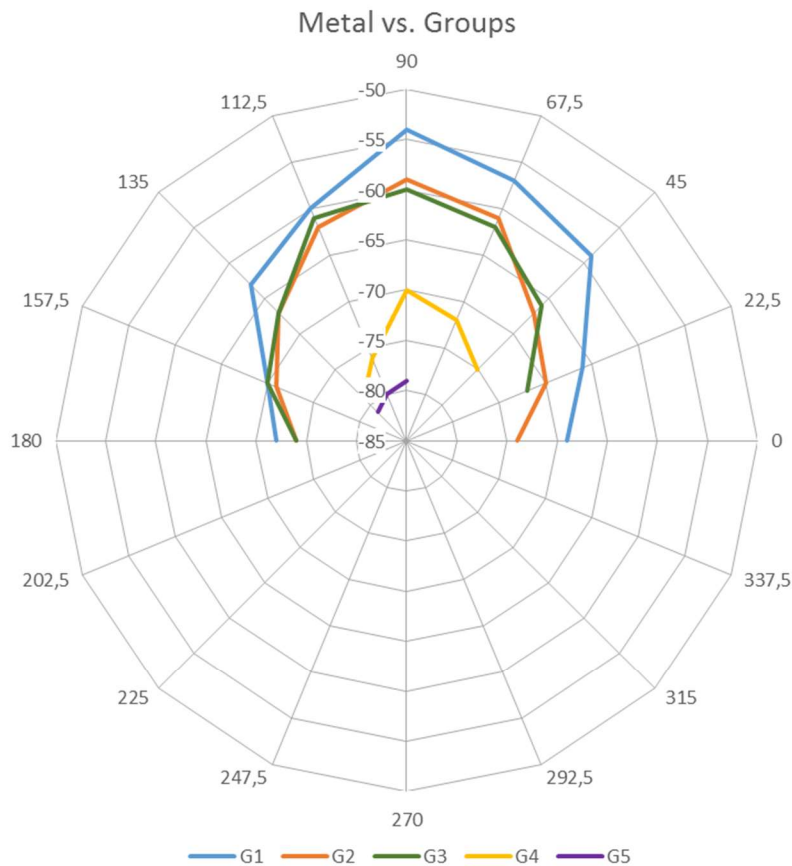

Chart 9. Radio-frequency waves comparison through metal

In order to show how it affects the metal to the identification of the tags, it has not been fully covered the tag with this material because this would mean a total elimination of the signal and also is not intended that in the future will be inserted a tag in a space totally metalized in which case will completely nullified its effect. That's why it has placed a plaque between the antenna and the tag, because in a real case it can be a situation that metal objects are halfway between tag and antenna.

If we compare the first chart (in which no material is involved) and this one (with the metal plate) we can see that the reception signal has deteriorated, concept which was already previously anticipated. It is clear then that the metal makes difficult to recognize the tags.



As we have seen before, at close range, the G2 and G3 groups have a similar behavior. It's the same now, which means that we can embrace these two groups into one in the case we are talking about close measurements, since as we have seen at distances of 4 and 6 meters the difference between the those two sets off.

As far as group 5 is concerned, the influence of the metal and the low power of which this group of tags is supplied, render the measurements virtually zero, therefore, we conclude that the group 5 has a very unreliable behavior with metal in the middle.

Wood

Tags	-90°	-67,5°	-45°	-22,5°	0°	22,5°	45°	67,5°	90°
G1	-57	-56	-53	-50	-49	-51	-54	-62	-64
G2	-72	-69	-68	-60	-57	-59	-62	-69	-72
G3	-66	-64	-62	-57	-55	-57	-63	-64	-70
G4	-74	-72	-68	-66	-63	-65	-71	-76	-
G5	-	-	-79	-75	-70	-73	-78	-	-

Table 16. Radio-frequency waves propagation through wood

The reason why the measures that are reflected in the study of the wood can be that the piece of wood used is a fair bit of measurements and in some cases the radial diagrams

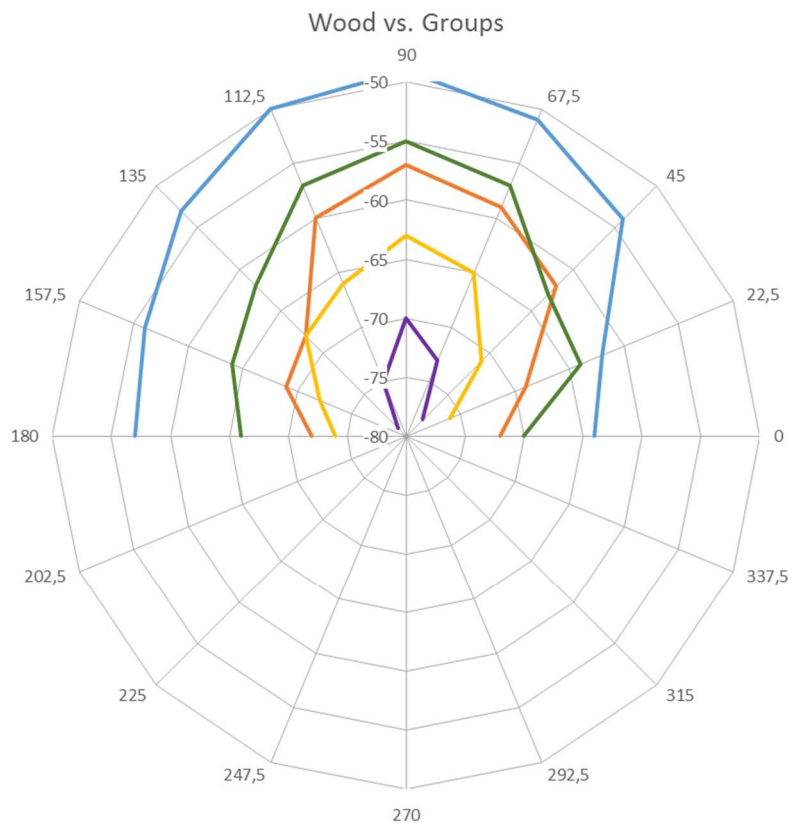

emitted by the tags are able to overcome this obstacle, allowing the total identification of the tag by the reader system.

Plastic

Tags	-90°	-67,5°	-45°	-22,5°	0°	22,5°	45°	67,5°	90°
G1	-62	-59	-56	-53	-50	-52	-55	-61	-64
G2	-70	-65	-62	-57	-55	-57	-63	-70	-73
G3	-69	-67	-62	-58	-56	-58	-62	-68	-71
G4	-80	-78	-76	-70	-67	-69	-74	-77	-
G5	-	-	-79	-75	-72	-73	-78	-	-

Table 17. Radio-frequency waves propagation through plastic

As we can see in the chart, when the material upon the radio-frequency waves are transmitted is plastic group 2 and 3 behave similarly. Power values are similar to those that have obtained when measurement is performed without materials.

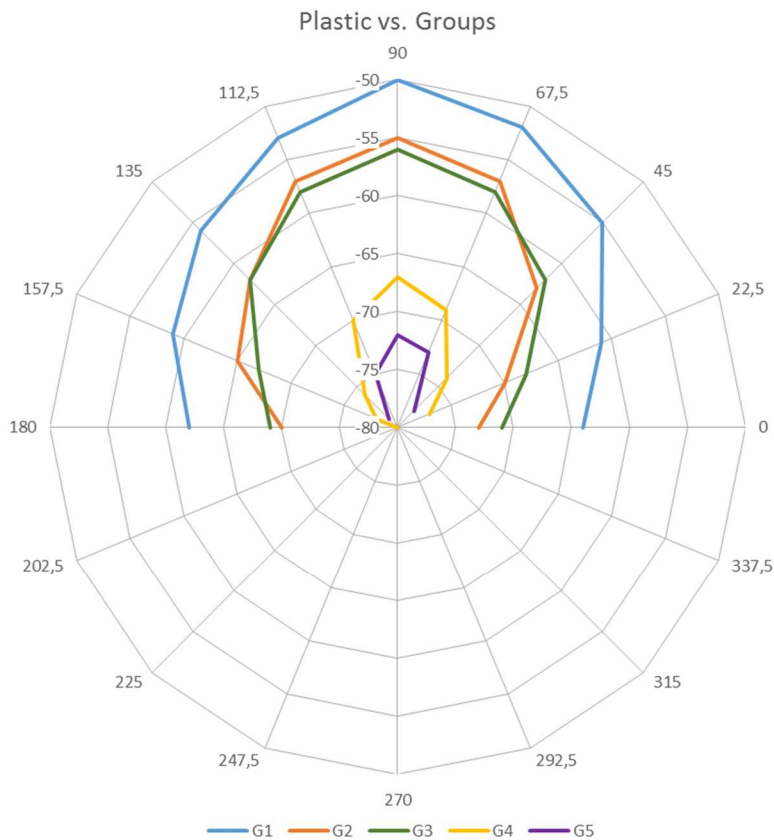

Chart 11. Radio-frequency waves comparison through plastic

We can denote the great power variation between groups 2 and 3 compared to group 4 in all studies but is maximized in this particularly when using plastic.



Glass

Tags	-90°	-67,5°	-45°	-22,5°	0°	22,5°	45°	67,5°	90°
G1	-58	-56	-53	-50	-47	-49	-52	-56	-60
G2	-66	-64	-60	-58	-57	-59	-66	-70	-73
G3	-67	-61	-63	-57	-54	-56	-64	-68	-72
G4	-80	-76	-74	-69	-66	-68	-74	-77	-
G5	-	-	-79	-77	-74	-76	-79	-	-

Table 18. Radio-frequency waves propagation through glass

If we compare the charts of plastic and glass we can see results that follow the same patterns: identification very high powers and big difference compared groups 2 and 3 with group 4.

Therefore, we can assume that in both materials radio-frequency waves are transmitted in a high similarity.

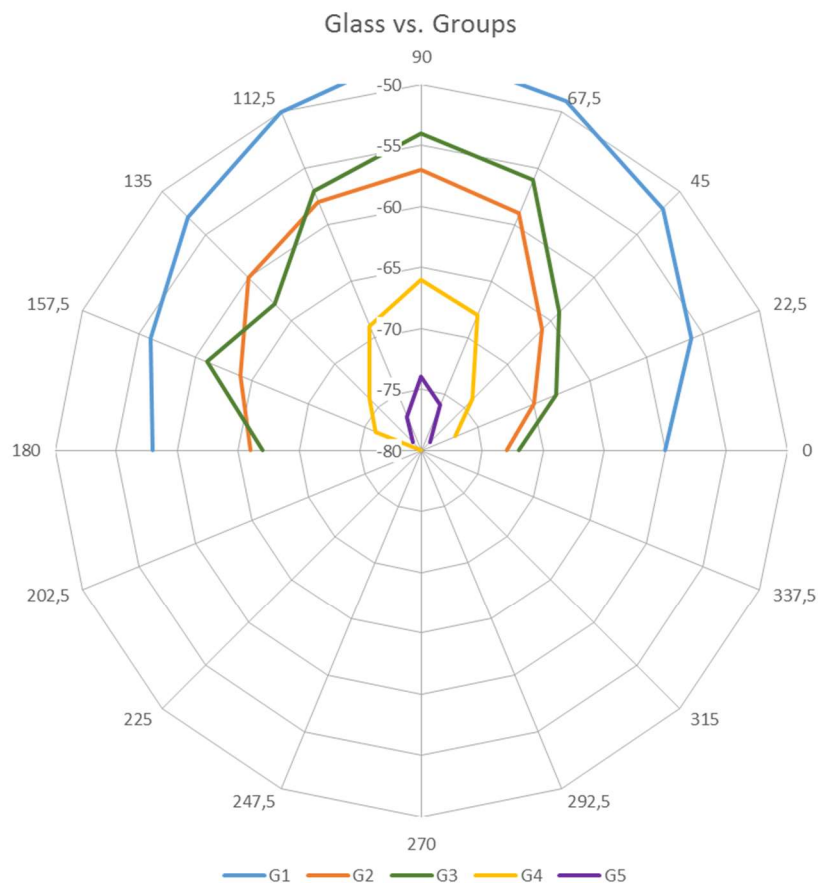

Chart 12. Radio-frequency waves comparison through glass



General comparative

With all of the charts presented here is possible to catch up a faster overview and extract conclusions of it.



Chart 13. Entire comparative between all the materials tested



Comments

As a general observation, we can reaffirm the group classification previously performed because regardless of the material, the received power decreases and the more increase the angle sweep and the group number, the worse result we have.

As expected, with regard to metal is shown a behavior with less permission as far as the power transmission is concerned. Later it will be explained why radio-frequency waves have disruptive behavior in the presence of metallic objects.

Except in group 2, the material that allows a greater degree of transmission of the waves is the wood since in almost all the studies it is placed above the others, giving higher power values.

Among the values that allow a greater degree of transmission and those that allow a smaller one, we can find the plastic and the glass. As we have seen throughout the study, these materials allow a very similar transmission of radio-frequency waves, which, although they are at levels below the wood, still reflect a good behavior if we compare the extreme case of the metal.

Multipath radio-frequency waves performance

The RF energy that the reader generates is sent out in electromagnetic (EM) waves and like any wave, their propagation is impacted greatly by their surroundings. Some travel in direct lines, and some move out at different angles from the bore sight (or centre of the antenna).

EM waves react very differently in diverse settings. Below are a few reactions that these waves have with specific objects and materials which could drastically impact the performance of the RFID system.

Reflection

EM waves reflect off of specific materials at the same angle (angle of reflection) that they approached the material (angle of incidence). Reflection can be avoided by blocking any metallic or dielectric surfaces, or adjusting your read range sensitivity on your reader.

Refraction

The EM waves pass through a specific material at an angle and changes angles when it passes through. Water and other dielectric materials between the tag and antenna can refract the EM wave.



Diffraction

When RF waves seem to bend around objects instead of passing through them, it is called diffraction. Metal poles, corners of buildings, and other corners of metallic objects are where this is seen the most.

Absorption

When an EM wave is absorbed by the object that it is sent toward it is called absorption. Water and most materials absorb RF waves to an extent as well as refracting, reflecting or diffracting.

Multipath

The definition of multipath is “when two or more favorable radio paths exist between the reader antenna and the tag.” When the reader sends a signal to the antenna to ‘ping the tag’ the antenna doesn’t just send one beam of RF waves straight forward. The reader antenna sends waves on several different paths in order to pick up the tag’s signal. This is where reflection, refraction diffraction and absorption come into play.

Here arrives the proposal of two problems:

1. Performance of paths: Each path besides the direct path is at a small angle from the center and has a high probability of experiencing reflection, refraction, diffraction or absorption depending on the materials or objects in the vicinity. That poses a problem when you have more than one tag in the read field, and you only want to read a specific subset of tags.

One way to mitigate this problem would be creating a tunnel type of enclosure with RF shielding materials.

2. Waves phases: Another problem area with multipath is if the direct RF wave intersects with another RF wave with a different phase, it will create a null spot in your read field. Null spots can occur multiple times in your read zone. In a null spot, your RFID tag will not be read by the antenna because the out of phase waves will cancel each other out.

The pictures showed below explain the waves with same and different phase and its consequences.



In phase waves

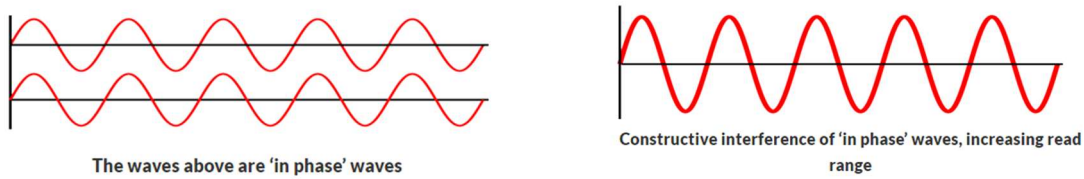

Figure 43. In phase RF waves and constructive interference

Out of phase waves

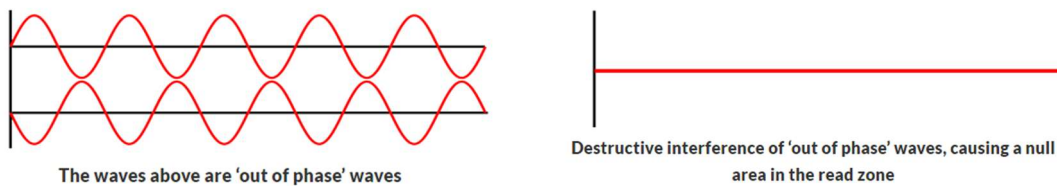

Figure 44. Out of phase waves and destructive interference

Specific case of metal

Radio waves bounce off metal and are absorbed by water at ultrahigh frequencies. That makes tracking metal products, or those with high water content, difficult. However, good system design and engineering are beginning to overcome this shortcoming. Low and high frequency tags work better on products with water and metal. In fact, there are applications in which low-frequency RFID tags are embedded in metal auto parts to track them.

While you may get a read with the correct type of tag when it is ON a metal box, you would be very unlikely to get a read while that tag is IN a metal box. The reason is that the box acts as a Faraday Cage.

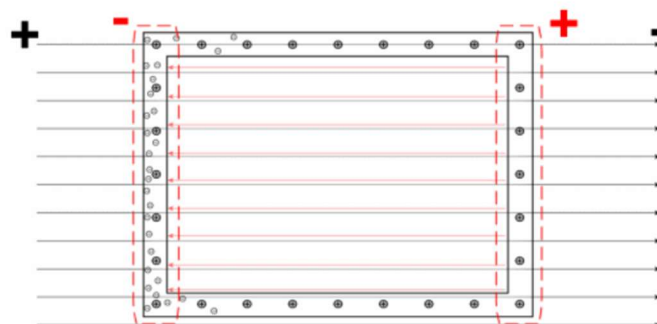

Figure 45. Electromagnetic field at Faraday cage



As the picture above shows it, a Faraday cage operates because an external electrical field causes the electric charges within the cage's conducting material to be distributed such that they cancel the field's effect in the cage's interior. This phenomenon is used to protect sensitive electronic equipment from external radio frequency interference (RFI). The pictures below explain what happens with the RF waves when metal interference appears.

Normal Communication Condition

RFID Wireless communication becomes possible by magnetic flux penetrating between two coil antennas.

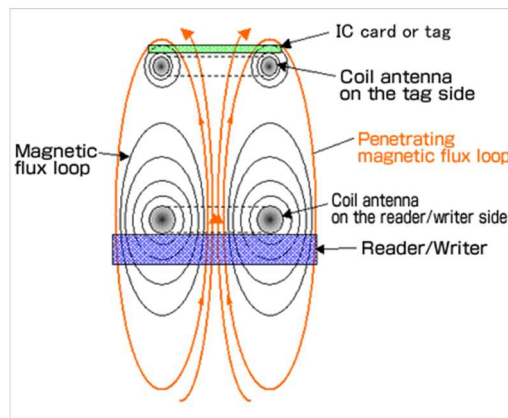

Figure 46. Normal communication condition draw

Communication Condition with a Metal Surface in the Vicinity

Eddy current (current produced when a conductor crosses a variable magnetic field or vice versa) occurs at the metal in the vicinity of a tag, caused by the Reader/Writer's magnetic field. This magnetic field (demagnetizing field) caused by the eddy current cancels the magnetic field necessary for communication.

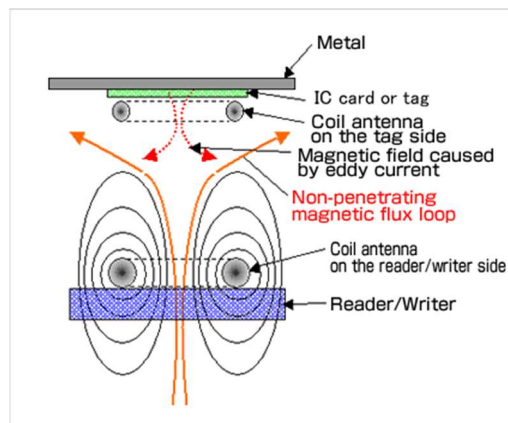

Figure 47. Communication condition with a Metal Surface draw



Communication Condition with a Magnetic Sheet Present

The appropriate solution for metal interference with RF waves is to place a magnetic sheet between the metal layer and the tag, as shown in the following image.

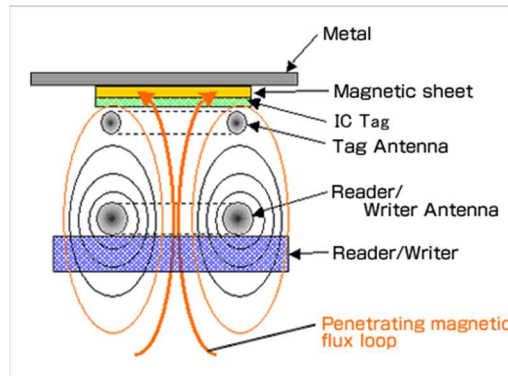

Figure 48. Communication condition with a magnetic sheet draw

3.5.10 Table of equivalences distance-power signal

The purpose of this study, in which power measurements are made from different positions and proposing scenarios is none other than determine a standardized values of distance in relation with each power signal.

For that reason, it has been built the next table in order to orientate the user of the reading system when analysing the space in which will be implemented.

Units: dBm	2 meters	4 meters	6 meters
G1	-57 <---> -62	-62 <---> -65	-65 <---> -68
G2	-61 <---> -66	-66 <---> -71	-71 <---> -75
G3	-64 <---> -66	-66 <---> -68	-68 <---> -74
G4	-68 <---> -73	-73 <---> -75	-*
G5	-69 <---> -71	-71 <---> -74	-74 <---> -76

Table 19. Distance - power signal equivalences

Note: In the box of 6 meters of the group 4 we cannot offer a measurement in a safe way since in the realization of experiments the reader was not able to detect the tag. This may be due to various factors such as the non-ideality of the environment and possible experimental human error.



3.5.11 Experimental Conclusions:

3.5.11.1 Measurement particularities

Of these tests can be extracted several peculiarities that are repeated throughout all the measures. These anomalies are due to the non-ideality of the space where the different measurements were made. The patterns that are observed are described below:

By placing the tag at ground level, it was difficult for the reader to detect it. This is due to what is known as ground effect: a loss of the operating range of the antenna when this one, or the tag, is placed near the ground. Although this effect occurs to a greater extent in VHF, it is also present in the ultra-high frequency band (UHF).

Its effect is due to a series of partial cancelations because part of the energy is reflected by the ground, mixing with the direct RF signal and producing a remarkable deterioration in the signal.

Angles located at the most abrupt sides (0° and 180°) were easier to detect than those more direct ones (specifically at largest distances). The explanation for this was already advanced at the laboratory layout chapter and is because the metal parts of all the instruments existing at the lab reflected the waves much easier than if, instead of metal, there were other materials such as wood or plastic.

3.5.11.2 Dynamic reading

The tests have been done with both the reader and the tag in static for reasons of being able to follow a clear, simple and easily reproducible methodology. The final application, however, will be implemented in a dynamic environment, where the position of the tag relative to the reader will vary over time.

That is why, even without having devised a methodology to be able to characterize it, it has been observed that a moving tag is detected mucho more easily than a fixed one in a certain position. This is because when the reader receives a weak signal from the tag, it is much easier to be detected and interpreted when its position is in change to when it is not.

This is the reason why the results obtained can be taken with some caution because they will be improved once the reading system is implemented in a changing environment, where the label will always be in motion. In fact, in most cases the tag will get closer to the reader so the power of the received signal will get larger, which will make it more easily detected.



3.5.11.3 Data obtained conclusions

Once obtained the radiation diagrams, it is possible to draw a series of conclusions where it will be assessed the general scope of the M6e reader and if the hypothetical final application is viable at a technological level.

As expected, the technology used around the 867 MHz, allows a relatively large detection distance, being that when placing the tag to six meters of the reader hardly there was inconvenience so that it was read (if we consider the reading in a direct line between antenna and tag, not talking about sweeping angles).

This is a great advantage, inasmuch as it allows some margin for maneuver when designing the final application, being able to choose whether a detection distance is so great or if a smaller one is more than enough. It can even be adapted to each situation, according to the characteristic of the environment in which the system will be located.

We could think that the problem arrives when the tag needed to read is situated at a long distance and the angle is not at the direct line of sight. As is shown at the graphs of distances and angles, the abrupt sides are difficult to recognize so, at the final application, it must be considered and modified the required parameters in order to get an easier identification of the tags.

The tests of materials not only allowed to demonstrate the low problem of detection of the signal through different materials, but also showed the few problems of reflection that a plastic or a wood cover can generate by being located around the reader antenna or at the tag. That leads us to think in possible adaptations of the tags in different places where there exist the interaction with these materials. The possibility that in the final application the tag is located inside different materials cover, makes this test more important to demonstrate the correct operation of the system.

About the different tag tests experimented, we could classify them among the different scope distances and use it for different applications. To give an example, is not the same needing for a transporting company to control the stock placed at the inside of a truck in movement that enters at the warehouse (the “yellow wire” scope would be a good option) than the needing of an access control of people for an event who carries the tag at a bracelet and this bracelet is passed by a reader antenna like at the supermarkets with the barcodes (the “blue barcode” scope would be enough to accomplish the goal needed).

As expected, metal zones negatively affect the system, producing reflections and not allowing the material to be pierced. Knowing this adverse effect can be an advantage as it



will avoid the installation of the reader behind a metal zone. But, in addition, it allows to benefit from being able to use the reflection so that you can read a tag more easily.

Despite not devising a methodology to prove it, during the test measurements it was observed as moving labels were detected more easily than static labels. As already mentioned, this can be an advantage in a large amount of several final applications, because the reading system or the tag could be implemented into an environment which would be always in motion and, therefore, the signal could be detected much easier when approaching the reader.

With all these explanations, it can be determined that the hypothetical final application is technologically viable in front of the different sources of problems raised above such as distance or angle of reading, the different kind of tags and the signal communication through different materials.

After analysing in depth all the tags and their behavior in different situations we can add the following conclusions:

- 1- As originally envisaged, the surface factor affects to the extent that the reader system receives the power of the tag; the more surface the tag has, the greater the power and the faster the identification of the tags will occur.
- 2- We have been able to observe that metal is the material that transmits radio-frequency waves the worst, with a lot of difference from all other materials. We have also been able to verify how this material alters the results of the measurements, giving way to the reflection of the waves and, therefore, to some erroneous measurements.
- 3- In relation to the previous point, we have noticed that in the narrower angles, the presence of metal causes the signal to be captured, otherwise, in an ideal space, the signal would not be captured. But this does not mean that it is a correct measurement because the values are altered and, therefore, they are not reliable results on which continue investigating.

In order to avoid this fact, a solution to find reasonable results (besides taking the measurements in an ideal place, without elements that can alter the results) would be to extrapolate the values in angles of linear way in order to obtain coherent results to establish an idea of what the reading would be like at these angles, although it would never occur with reality since this extrapolation is made through mathematical calculations.



- 4- In any scientific experiment, the human experimental error comes into play when carrying out the measurements, which explains when some result entails an inconsistency that has not been previously reasoned.
- 5- To give a more visual perspective of how the measurements vary according to the distances experienced and the materials used is shown below an example since when reading the measurements in dBm it seems that the variations are insignificant when in fact they are very remarkable:

The formula used to transfer values dBm to watts (W) is:

$$P(W) = 10^{-3} \cdot 10^{\left(\frac{p[\text{dBm}]}{10}\right)}$$

In the tables, the maximum variation observed is 27 dBm. So putting the following values as an example, we can measure this variation.

Tag 1: -70 dBm = 1×10^{-10} W

Tag 2: -43 dBm = 5.01×10^{-8} W

If we divide these two values we can see the variation between these two measures:

$$\frac{5.01 \cdot 10^{-8}}{1 \cdot 10^{-10}} = 501,8$$

This calculation implies that the power signal at tag 2 is approximately 500 times greater than at tag 1, which indicates the great difference between the two. It is important to note that each change of a hundredth in dBm is equivalent to multiplying or dividing by 10 the value obtained as shown in the conversions to watts (W).



4 Python wrappers for Mercury API

4.1 Example of implementation

In order to control through a Python terminal the Mercury M6e reader we have found some wrappers from the engineer Petr Gotthard, that are responsible for reading the headers of a code written in C language implemented for the development of the system.

As a result of reading those headers, the lines of code written in C are executed and this gives rise to the control of the M6e. Once downloaded the package of wrappers for Python from the web site and installed all the drives needed, we will highlight the steps to initialize the controller of the reader.

Before starting to work with the reader, it is necessary to know the name assigned to the USB port on which the M6e is connected, which, by executing the command `dmesg|tail`, it is obtained the name as shown in the following image:

```
pc@ubuntu:~$ dmesg|tail
[ 226.409621] sd 34:0:0:0: [sdb] Attached SCSI removable disk
[ 227.167341] FAT-fs (sdb1): Volume was not properly unmounted. Some data may be corrupt.
Please run fsck.
[ 240.500682] usb 2-2.2: new full-speed USB device number 6 using uhci_hcd
[ 240.791456] usb 2-2.2: New USB device found, idVendor=2008, idProduct=1002
[ 240.791459] usb 2-2.2: New USB device strings: Mfr=1, Product=2, SerialNumber=0
[ 240.791460] usb 2-2.2: Product: M6E1616307
[ 240.791461] usb 2-2.2: Manufacturer: ThingMagic, Inc.
[ 240.934749] cdc_acm 2-2.2:1.0: ttyACM0: USB ACM device
[ 240.937154] usbcore: registered new interface driver cdc_acm
[ 240.937156] cdc_acm: USB Abstract Control Model driver for USB modems and ISDN adapters
```

Figure 49. Command `dmesg|tail` to find the name of the USB reader

It can be seen that the name we will use to identify our RF reader at the Python terminal is designated with the name `dev/ttyACM0`.

Once the reader has been recognized, several steps must be taken:

First, goes the import of the `mercury` module and the creation of the `mercury.Reader` object in which the USB port is connected, that was found before, as shown at the next picture:

```
pc@ubuntu:~$ python
Python 2.7.12 (default, Nov 19 2016, 06:48:10)
[GCC 5.4.0 20160609] on linux2
Type "help", "copyright", "credits" or "license" for more information.
>>> import mercury
>>> reader=mercury.Reader("tmr:///dev/ttyACM0", baudrate=115200)
```

Figure 50. Calling "mercury" module and creating "reader" object

Note: See [Annex](#) for further documentation about `mercury.Reader` attributes.



Next it is convenient to set the region of the world where you are working (Europe) as well as the reading plan, which defines the antenna user is working with, the protocol (type of tags) and the power of reading that, if not specified, it gets a default value:

```
>>> reader.set_region("EU3")
>>> reader.set_read_plan([1], "GEN2", 3100)
```

Figure 51. Commands for setting region and read plan

Note: See [Annex](#) for further documentation about `set_region (region)` and `set_read_plan (antennas, protocol read_power)` attributes. Also for `get_supported_regions ()`

Once these steps are done, we can choose two different paths:

- 1- The first is to perform the command:

```
print(reader.read())
```

This command is responsible for writing in a list all the tags that are in the range of coverage. The following illustration shows an example of execution:

```
>>> print(reader.read())
['300833B2DDD9014000000000', '0000000000000000000000695', '000000000000221612000992',
'4D6F68616D6D6564206469616220', '0000000000002216572D1386']
```

Figure 52. Printing reading results

This code makes sure that the tags are listed consecutively and without repetitions.

- 2- All these previous steps can be automatized in an autonomous python program, as shown below. Also, with the help of “start_reading” and “stop_reading” functions we can launch a continuous reading process without programming a loop ourselves:

```
#!/usr/bin/env python3
from __future__ import print_function
import time
import mercury
def reading():
    reader = mercury.Reader("tmr:///dev/ttyACM0", baudrate=115200)

    reader.set_region("EU3")
    reader.set_read_plan([1], "GEN2", read_power=1900)

    reader.start_reading(lambda tag: print(tag.epc, tag.antenna, tag.read_count, tag.rssi))
    time.sleep(1)
    reader.stop_reading()
```

Figure 53. Python program implementation

As previously done in the Python terminal, the reader, the region and the reading plan are initialized. The `reader.start_reading` command is the executed, which starts the



The author of this wrappers just implemented the basic functions to operate with the system and so on, with those implementations is easy for the user to download it from the website and adapt it to its particular own application, so it makes currently possible to take use of them if user need to start up the operating of the system.

But it is needed to say that the functions that are currently available to call from a Python shell are not the whole ones that the Mercury API has at its disposal at all. If we take a look to the Mercury API Programmers guide (link referenced below at chapter 6) we can realize that the range of options it can offer is widely immense.

Lots of functions just set up the internal installation of the software and they will rarely be used by a user who need to deploy it in its application. Operations such as change the EPC, lock editable fields in order to protect information from thieves and set access and kill passwords obviously can also be done (such as the Universal Reader Assistant does) and this ones can be interesting for user to apply.

But as said previously those functions are not written down at the files needed for Python and cannot be used. In order to know the procedure to implement those missed functions that could contribute to ease the task of the user, at the next chapter are going to be described the steps for design it.



4.2 Steps to create own python wrappers from Mercury API

As discussed at the previous chapter about the wrappers found on the internet exist the possibility of creating our own wrappers in order to control the whole reading system through Python and, at this chapter, we are going to describe which are the procedures to create it and the sequences needed to follow in order to perform the launching process.

Now, are going to be listed the steps to follow in order to create those own python wrappers:

- 1) Download the source code of the library from the ThingMagic website
- 2) Unzip the downloaded ZIP file into the desired folder from the user. Immediately user gets the directory named "*mercuryapi-1.29.2.10*" with three subdirectories: "*c*", "*cs*" and "*java*" with the library written in C, C# and Java, respectively.
- 3) Enter the directory "*mercuryapi-1.29.2.10/c/src/api*" and compile the library with "*make*" (must be installed on your system compilers, development tools and adequate premises). We installed the missing library "*readline*" with "*sudo apt-get install libreadline-dev*".

The "*make*" execution compiles all the contents of the library and generates files with ".o" extension and all executable examples, the source of which are in the directory "*c/src/samples*".

Those executable examples are already listed and prepared to prove if the wrappers have been successfully created and the system reacts correctly. The way to call them is like: "*./name_file [name_reader]*" in our case with the function "*read*" would be called like: "*./read tmr:///dev/ttyACM0*". In order to succeed at calling the executables, user must be calling them from the directory were they make command was run (there is where is stored all the information installed).

But previously, is required to continue with the installation, next step at point 4.

- 4) To continue with the bindings, the wrappers can be created anywhere, but it is easier to do it in the folder "*mercuryapi-1.29.2.10/c/src/api*" so that gives us less routing problems.

The library has many functions. But, with the purpose of creating a fast start up, we planned to make available the functions that are in the "*tm_reader*" library, which it seems to be required to read tags with the M6e reader.

Then, user must create a file with ".i" extension. We have named it "*mercuryapi.i*" with the following content:



```
%module mercuryapi
{%
#include "tm_reader.h"
%}
%include "tm_reader.h"
```

And save it at the same working directory (in our case “*mercuryapi-1.29.2.10/c/src/api*”).

- 5) Exist a lot of different ways to create a Python module, but we have decided to do it with SWIG. This program processes the *mercuryapi.i* file with the source code to create wrappers in C:

```
“swig -python -o _mercuryapi.c mercuryapi.i”
```

If the system does not return any error, user will have created two files: a “*mercuryapi.py*” and a “*_mercuryapi.c*”.

- 6) Next lies in compile the “.c” file created at the previous step. It is used the next command:

```
“gcc -c -fPIC -I/usr/include/python2.7 -Ilib/LTK/LTKC/Library -
Ilib/LTK/LTKC/Library/LLRP.org _mercuryapi.c”
```

If the system does not return any error, the file “*_mercuryapi.o*” will be created.

- 7) Now user needs to link everything to create the python module, like this:

```
“ld -shared -Llib/LTK/LTKC/Library -Llib/LTK/LTKC/Library/LLRP.org *.o
lib/LTK/LTKC/Library/*.o lib/LTK/LTKC/Library/LLRP.org/*.o -o _mercuryapi.so”
```

If anything has gone wrong, the wrappers have been successfully installed and the system is prepared to begin to call functions.



We have followed the steps described above and have tested some of the executable examples. Right after is shown some images where the functions are called:

```
pc@ubuntu:~/devel2/mercuryapi-1.29.2.10/c/src/api$ ./read tmr:///dev/ttyACM0
Read power = 3150 dBm
EPC:ABABABABABAB
EPC:000000000000221612000992
EPC:E2004BA5F911E930018DF7A3
EPC:E2003098150D002917905C63
EPC:4D6F68616D6D6564206469616220
EPC:E20068060000000000000000
EPC:300833B2DDD9014000000000
EPC:E28011606000020507948471
EPC:E200325573ADCFB12081573E
EPC:300833B2DDD9014000000001
EPC:0000000000000000C0001596
EPC:20150424807103000106041E
EPC:E2001AC193A2D4801033BB51
EPC:000000000000000000401964
EPC:0109430000000000000063B7
EPC:000000000002216572D1386
EPC:E20010631002027414907FCF
EPC:E200204738170080212038E4
```

Figure 55. Example testing the function "read"

This function in particular reads tags for a fixed period of time (500ms) and prints them without repetitions. There is another function that performs and asynchronous reading, like the next figure shows:

```
pc@ubuntu:~/devel2/mercuryapi-1.29.2.10/c/src/api$ ./readasync tmr:///dev/ttyACM0
Background read: E28011606000020507948471
Background read: 300833B2DDD9014000000001
Background read: E20068060000000000000000
Background read: E2001AC193A2D4801033BB51
Background read: 4D6F68616D6D6564206469616220
Background read: 0000000000000000C0001596
Background read: 300833B2DDD9014000000000
Background read: ABABABABABAB
Background read: 300833B2DDD9014000000000
Background read: E200325573ADCFB12081573E
Background read: E2004BA5F911E930018DF7A3
Background read: E20010631002027414907FCF
Background read: 000000000000000000401964
Background read: E200204738170080212038E4
Background read: E2003098150D002917905C63
Background read: 20150424807103000106041E
Background read: 000000000000221612000992
Background read: E20068060000000000000000
Background read: 000000000002216572D1386
Background read: 300833B2DDD9014000000001
Background read: E28011606000020507948471
```

Figure 56. Example testing the function "readasync"

Exist several examples like the two ones showed before. Those examples doesn't show us if the wrappers created are working correctly because they are programs written in C and it is obvious that the execution of this ones would be successfully completed.

So, now would be necessary to call all the functions existing by calling *mercuryapi* python module but the problem is that the API uses a type structure "TMR_Reader" that passes



through other functions by reference (as a pointer) and in this case is necessary to install more contents at SWIG.

Pointers are just a special kind of variables that can hold the address of another variable at the internal memory. If this pointers are not correctly declared or some of them are missing, the binding structure remains incomplete and Python is not able to find the objects that the file written in C has. As a consequence Python cannot get access to the headers of the functions in order to execute them so the program returns an error of procedure (just because user is pretending to run without the background needed) and stops the executions remaining thus the incompleteness of the wrappers implementation.

Those explanations written down above clarify then what happens with our structure. We have not declared those missing pointers and, although the wrappers are created and the examples written in C at the address *mercuryapi-1.29.2.10c/src/samples* work fine, in the moment of calling functions through the Python way the systems returns some errors.

Although the creation of the wrappers has not been completed, it has been previously described how to reach the implementation of these (being necessary to add some complements in the SWIG). Once these necessary add-ins have been added, an exclusive linkage must be implemented for each function existing in the source code that user wants to use from a terminal using Python language so that the C code is correctly interpreted and the functions of the API are successfully executed.

Briefly, on the one hand we have seen that the possibility of creating bindings between the Python language and the functions of the firmware of the reader system belongs to a tangible reality, as we have shown the wrappers in section 4.1 created by the author Petr Gotthard, so that is reflected the reality of being able to control the M6e reader from a terminal with Python language.

On the other hand, the necessary procedures have been described to create such connections between the different programming languages, in order to implement own wrappers, customizing each function to the user's preferences.



5 Conclusions

I consider that the objectives that I marked myself at the beginning of the Project have been widely fulfilled: the documentation and start-up of the M6e reader, the scope and limitations of it and the implementation of a binding in Python have been achieved in a high grade of definition.

It has been taken a technology not previously used as is the radio frequency identification and it has been studied and documented its several operating options and its advantages in respect of barcodes. In addition, during the study my grade of knowledge of the radio frequency world has been widely increased.

The measures that have been taken at the laboratory to verify the coverage of the reader have been satisfactory. Now it is possible to make a fast overview of the limitations of the reader in connection with the range of distance and tag orientation angles available and its influences taking into account the group classification done, the differences between the several tags bought with the equipment and the performances of the radio-frequency wave's transmission through different layers of material.

Even having studied a bit of Python programming language, I have discovered the potential of a binding with those wrappers already implemented and the knowhow of the realization of adaptability to an API previously designed. Moreover, after creating my own wrappers I have discovered programs such as SWIG among other that helps us to make a great programming performance and connect two different program structures.

With regard to possible problems that could arise and compared with those we have observed the following issues stand out:

As anticipated, we have been able to analyze the operation of the *Universal Reader Assistant* without too much difficulty. As an inconvenience, we have noticed that when a multi-tag reading is performed, the program is destabilized and the system is disconnected.

Regarding the part of experimental tests and as had been foreseen, the layout of the laboratory and the objects present in it have been able to disrupt in some grade the results finally obtained.

In the study of Python wrappers, on the one hand, we have found an example of well-designed wrappers that have a good performance and indicate that there is a possibility of performing these bindings. But, when creating our own wrappers, some reference problems have arisen in relation to the transfer of information from one language to another due to that pointers are used and they have not been correctly referenced.



Moreover, on a personal level, the objective of ensuring the professional potential that has given to me the completion of my studies has been completely covered. The knowledge acquired during these four years is present when remembered quite easily and many career competencies seem to have been learned (autonomous learning, knowledge and deepening in new technologies, problem solving and decision making, among others).

In addition, it has managed to have a first contact with a new programming language such as C, widely used today and which I consider an important acquisition for my near future job.

In conclusion, it has been a great experience to have been able to experiment with a device with applications currently in growth which has awakened in me new inquiries in which to continue investigating and to have collaborated with the IOC's research institute contributing to their labour with this project.



6 References

- [1] Official ThingMagic documentation and software
<http://www.thingmagic.com/manuals-firmware>
- [2] “Preguntas frecuentes sobre RFID”. *RFID Journal en Español*
<http://espanol.rfidjournal.com/preguntas-frecuentes>
- [3] ASCII Tables and text converter
<http://www.asciitable.com/>
<http://www.rapidtables.com/convert/number/hex-to-ascii.htm>
- [4] General Description and basic information of TAGs
<http://blogsobresena.blogspot.co.uk/2010/07/rfid.html>
<http://marcusanalyst.com/author/secretanalystchamber/>
<http://blog.atlasrfidstore.com/types-of-memory-in-gen-2-uhf-rfid-tags>
- [5] RFID general information and EPC description
http://www.webddigital.com/rfid_introduccion.aspx#aplicaciones
<http://www.epc-rfid.info/>
- [6] Internal operating of RFID system
<http://www.gov.scot/Publications/2008/07/24102700/8>
- [7] Power signal units from the reader system (dBm)
<http://es.fmuser.org/news/Radio/difference-db-and-dbm.html>
<http://es.fmuser.net/content/?758.html>
- [8] Near field and Far field documentation
<http://www.drillingcontractor.org/the-abcs-of-rfid-physics-oilfield-usage-14030>
- [9] RFID anti-theft system at backpacks
<https://www.xatakafoto.com/accesorios/rfid-y-otros-sistemas-antirrobo-para-asegurar-tu-equipo-fotografico-con-pacsafe>
<http://www.elmundo.es/elmundo/2010/07/27/navegante/1280226603.html>
- [10] RF waves performance at metal surfaces
<http://blog.atlasrfidstore.com/rfid-multipath-em-waves>
https://www.nitta.co.jp/en/?post_type=sheet&p=7959
<https://www.quora.com/Would-RFID-work-if-the-tag-is-placed-in-a-metal-box>
- [11] Python wrappers for the mercury API
<https://github.com/gotthardp/python-mercurypi>



- [12] Ubuntu guide steps
<https://ubuntulife.wordpress.com/2008/10/01/conocer-el-nombre-de-un-dispositivo-o-llave-usb/>
- [13] Mercury API datasheet
http://cdn2.hubspot.net/hub/42741/file-1736345489-pdf/Collateral/Product_Datasheets/mercuryapi-datasheet.pdf?t=1470815289428
- [14] Mercury API Programmers guide
http://www.corerfid.com/rfid%20shop/thingmagic/mercuryapi_programmerguide_jan12.pdf
- [15] Programming commands needed
<https://ubuntulife.wordpress.com/2008/10/01/conocer-el-nombre-de-un-dispositivo-o-llave-usb/>
- [16] Swig operation documentation for wrappers developing
<http://www.swig.org/>
- [17] CONFIDEX Steelwave Micro II datasheet
<http://www.confidex.com/products/smart-identification/confidex-steelwave-micro-ii>
- [18] Omni-ID Curv tag datasheet
<https://www.bsr.at/mediafiles/Datenblaetter/Omni-ID/omni-id-curv-datasheet.pdf>
- [19] Yellow wired tag datasheet
<https://www.atlasrfidstore.com/embeddable-rfid-wire-tag-pack-of-10/>



7 Appreciations

There are quite a few names that come to my mind while writing this little review that I hoped to include in order to recover good memories in the future.

The first of them is my project's mentor, the professor Orestes Mas Casals, who has led me during these months and has helped me at any issue that I have needed to get this study work out. Another person I cannot forget is Leopold Palomo-Avellaneda who has always been willing to lay his hand on logistical points such as providing me all kind of hardware and software access like the key for enter at the laboratory, the computer I worked with and the programs needed.

Also thanks to the several professors who have taught me during the Industrial Engineering degree, because they are the reason why I am at this point now, so it is far that they also deserve a few lines of appreciations written down here. The knowledge that they have been instilling during these four years I think that will be very valuable for my professional future.

Another group I would like to consider is the IOC research institute in which I have been working those months. For giving me the opportunity to carry out this project with them and introduce myself at the robotics and programming world, thanks.

Special mention to my classmates and especially for the friend that I made here during the exhausting periods of working together because there have been hard study times with them, but also would like to mention those disconnection moment we had from those academic issues. I take with me very good memories of them

Already in the most personal area, my family has always been there for giving me support and they have always been proud of my efforts, I consider them the master piece of myself and main support point, without them would have been impossible to achieve it.

And ultimately for all the people who, at some point, have been able to pass through my life during these four years giving me their small contribution and that surely have influenced positively in what I am now.

To all of them, my most honest thanks. This project is also, in fact, have been made possible to all of you.



8 Annex

8.1 Further information of the example wrappers

mercury.Reader(uri, baudrate=115200)

Object constructor. Connects to the reader:

- *uri* identifies the device communication channel:
 - o "tmr:///com2" is a typical format to connect to a serial based module on Windows COM2
 - o "tmr:///dev/ttyUSB0" is a typical format to connect to a USB device named ttyUSB0 on a Unix system. In our case is "tmr:///dev/ttyACM0".
 - o "llrp://192.198.1.100" is a typical format to connect to an Ethernet device (works on Linux only)

- *baudrate* defines the desired communication speed. Supported values include 110, 300, 600, 1200, 2400, 4800, 9600, 14400, 19200, 38400, 57600 and 115200 (default).

reader.get_supported_regions():

Using the command `print(reader.get_supported_regions)` we obtain the next supported regions by our RF system as shown at the next picture:

```
>>> print(reader.get_supported_regions())  
[u'NA', u'IN', u'PRC', u'EU3', u'KR2', u'AU', u'NZ', u'open']
```

Figure 57. Printing supported regions by the reader system

reader.set_region(region)

Controls the Region of Operation for the connected device:

- *region* represents the regulatory region that the device will operate in. Supported values are:
 - o "NA", North America/FCC
 - o "NA2"
 - o "NA3"
 - o "EU", European Union/ETSI EN 302 208
 - o "EU2", European Union/ETSI EN 300 220
 - o "EU3", European Union/ETSI Revised EN 302 208
 - o "IS", Israel



- "IN", India
- "JP", Japan
- "KR", Korea MIC
- "KR2", Korea KCC
- "PRC", China
- "PRC2"
- "AU", Australia/AIDA LIPD Variation 2011
- "NZ", New Zealand

reader.set_read_plan (antennas, protocol, read_power=default)

Specifies the antennas and protocol to use for a search:

- *antennas* list define which antennas (or virtual antenna numbers) to use in the search
- *protocol* defines the protocol to search on. Supported values are:
 - "GEN2", UPC GEN2
 - "ISO180006B", ISO 180006B
 - "UCODE", ISO 180006B UCODE
 - "IPX64", IPX (64kbps link rate)
 - "IPX256", IPX (256kbps link rate)
 - "ATA"
- *read_power* defines the transmit power, in centidBm, for read operations. If not given, a reader specific default value is used.

reader.get_model()

With this command we can get the model of our RF system we are working with:

```
>>> print(reader.get_model())  
M6e
```

Figure 58. Printing reader model by the reader system

reader.start_reading(callback, on_time = 250, off_time = 0)

Starts asynchronous reading. It returns immediately and begins a sequence of reads or a continuous read. The results are passed to the *callback*. The reads are repeated until the *reader.stop_reading()* method is called

- *callback(TagReadData)* will be invoked for every tag detected
- *on_time* sets the duration, in milliseconds, for the reader to be actively querying
- *off_time* duration, in milliseconds, for the reader to be quiet while querying



8.2 MERCURYDevKit Datasheet



MERCURYDevKit

For Finished UHF RFID Readers



The Mercury DevKit for ThingMagic finished UHF RFID readers contains all the components necessary to begin reading and writing RFID tags and developing RFID-enabled applications. A powerful application programming interface (MercuryAPI) provides code examples, a graphical read-write demo program, and delivers a consistent programmatic interface for development with all ThingMagic readers and embedded module products.

Ordering Information

Unless otherwise noted, an RFID reader must be purchased separately.

M6 Reader DevKit	M6-DEVKIT
Astra-EX DevKit	A6-DEVKIT
Vega Reader DevKit (reader included)	V5-DEVKIT-NA (North America) V5-DEVKIT-EU (Europe)
USB Plus+ Reader devKit (reader included)	USB5EC-DEVKIT

Finished/Fixed Reader DevKit Contents

Hardware	<ul style="list-style-type: none"> Reader specific power supply (as required). Note: M6 power supply must be purchased separately Sample RFID tags Reader specific data cable Antenna Cable (as required) <p>Antenna (Included with DevKit)</p> <p>M6: External Wideband 12 inch 865-985 MHz: 8.5 dBiC min, 9.5 dBiC max</p> <p>Astra-EX: Integrated Wideband 10 inch 865-870 MHz: 7.0 dBiC min, 8.5 dBiC max 902-928 MHz: 7.5 dBiC min, 8.5 dBiC max</p> <p>Vega: External Wideband 7.5 inch 865-879 MHz: 7 dBiC min 902-928 MHz: 7.5 dBiC min</p> <p>USB Plus+: Internal linear polarized 860-960 MHz: 1 dBi peak gain</p>
----------	--

Software and Documents (available online)

Software and Documents	<ul style="list-style-type: none"> Reader firmware Release Notes and Users Guide MercuryAPI MercuryAPI Release Notes and Programmer Guide
------------------------	---

Application Programming Interface

The ThingMagic MercuryAPI is a powerful programming interface with example applications and sample code in C, Java and C#/.NET. The MercuryAPI provides a consistent programmatic interface across all ThingMagic finished and embedded reader products to speed development and time to market of highly complementary RFID-enabled offerings.

Supported OS platforms and application types	<ul style="list-style-type: none"> C-API designed to provide support for embedded systems .NET applications in the .NET Compact Framework v2.0 Windows applications in the .NET Framework Windows applications in the Java Framework Linux (Intel) and MacOSX applications in the Java Framework Android applications in the Java framework
Code space required	<ul style="list-style-type: none"> 32k Basic Gen2 64k Advanced Gen2 96k Multiprotocol

Specifications subject to change without notice.





MAKING RFID EASY TO USE

ThingMagic is dedicated to driving the barriers to deploying RFID technology as low as possible. We design our products to be easy to use out-of-the box and to deliver predictable, reliable, and repeatable performance. Our development tools require little RFID expertise, enabling you to rapidly design, test, and deploy your RFID solutions.

Developers Kit

Included with every ThingMagic reader Developer Kit, the Mercury API supports the entire line of ThingMagic finished readers and embedded RFID modules

- Test chassis
- Cables
- Antenna
- Sample Tags
- Full schematics to help you design your own complimentary components

Mercury API

A common development platform, supporting an extensive variety of hardware to connect, configure, and control ThingMagic readers.



Universal Reader Assistant

A utility for advanced demo, testing, and tuning of all ThingMagic readers. Reduces complexity for novice users while permitting low-level control for advanced developers.

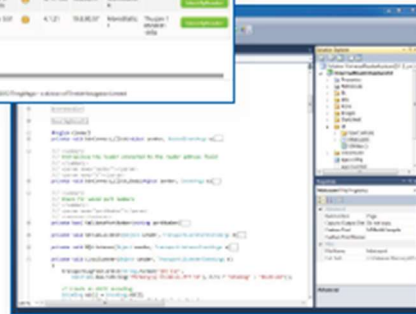

M6e Reader DevKit shown



For more information, visit www.thingmagic.com
 To purchase ThingMagic products, please email sales@thingmagic.com
 or call 1-866-833-4069 (International callers dial +1 617-499-4090)

ThingMagic, A Division of Trimble
 1 Merrill Street
 Woburn, MA 01801

©2013 ThingMagic - a division of Trimble Navigation Limited. ThingMagic and The Engine in RFID are registered trademarks of Trimble Navigation Limited. Other marks may be protected by their respective owners. All Rights Reserved. 10.15.13



8.3 M6e reader Datasheet



MERCURY6e

World-class UHF RFID Engine



Mercury6e (M6e) embedded UHF RFID reader module offers world leading performance, form factor, and time-to-market advantages to OEM, Value Added Reseller, and Solution Provider customers. It is designed to the performance standards of full size readers, but is small and efficient enough to be used in mobile applications. The M6e supports 4 ports and will operate to a level of +31.5 dBm. Serial and USB interfaces are provided to support both board-to-board and board-to-host connectivity.

Ordering Information	
Module	M6E
Development Kit	M6E-DEVKIT

Tag / Transponder Protocols	
RFID Protocol Support	EPCglobal Gen 2 (ISO18000-6C) with DRM ISO 18000-6B (optional) IP-X (optional)

RF Interface	
Antenna Connector	Four 50 Ohm MMCX connectors supporting four monostatic antennas.
RF Power Output	Separate read and write levels, command-adjustable from 5 dBm to 31.5 dBm* (1.4W) with +/-0.5 dBm accuracy above +15 dBm
Regulatory	Pre-configured for the following regions: FCC (NA, SA) 902-928 MHz ETSI (EU, IN) 865.6-867.6 MHz MIC (KR) 910-914 MHz SRRC-MII (P.R.China) 920-925 MHz 'Open' (Customizable) 865-869 MHz and 902-928 MHz

Data/Control Interface	
Physical	15-pin low-profile connector providing power, communications signals, and GPIOs
Signalling	UART with 3.3/5V logic levels; from 9600 to 921600 bps USB 2.0 full speed device port (up to 12 Mbps)
GPIO Sensors and Indicators	Four 3.3/5V serial input configurable as input (sensor) ports or output (Indicator) ports
API Support	C, C# (.NET), Java

Physical	
Dimensions	69 mm L x 43 mm W x 7.5 mm H (2.7 in L by 1.7 in W by 0.3 inches H)

Power	
DC Power Required	DC Voltage: 5.0 VDC +/- 5% DC power: 6.5 W @ 31.5 dBm < 4W @ power levels under +17 dBm
Idle Power Consumption	0.25 W in fast-response idle mode Power Saving Options: 0.07 W in ready mode 0.05 W in standby mode

Environment	
Certification	FCC 47 CFR Ch. 1 Part 15 Industrie Canada RSS-210 ETSI EN 302 208 ETSI EN 300 220
Operating Temp.	-40C to +60C
Storage Temp.	-40C to +85C
Shock and Vibration	Designed to be installed in host devices which are required to survive 5-foot drops to concrete

Architecture	
RFID Processor	Indy R2000
User-accessible Flash Memory	16 kB
Tag Buffer	Over 1000 tags under normal conditions

Performance	
Max Tag Read Rate	Up to 400 tags/second
Max Tag Read Distance	Over 30 feet (9 m) with 6 dBi antenna (36 dBm EIRP)

* Maximum power may have to be reduced to meet regulatory limits, which specify the combined effect of the module, antenna, cable, and enclosure shielding of the integrated product

Specifications subject to change without notice.





Develop

Create RFID-enabled solutions
using industry-standard tools

Deploy

Enable rapid deployment and reliable
operation of RFID solutions within a wide
variety of new and existing environments

Optimize

Maximize productivity, improve ROI,
and lower operating costs



For more information, visit www.thingmagic.com

To purchase ThingMagic products, please email
sales@thingmagic.com or call 1-866-833-4069
(International callers dial +1 617-499-4090)

ThingMagic, A Division of Trimble
One Cambridge Center
Cambridge, MA 02142

© 2010 ThingMagic - a division of Trimble Navigation Limited.
ThingMagic and The Engine in RFID are registered trademarks
of Trimble Navigation Limited. Other marks may be protected
by their respective owners. All Rights Reserved.

