



Botryosphaeriaceae associated with *Tectona grandis* (teak) in Northern Thailand

MINGKWAN DOILOM^{1,2}, LUCAS A. SHUTTLEWORTH³, JOLANDA ROUX³, EKACHAI CHUKEATIROTE^{1,2} & KEVIN D. HYDE^{1,2,4,5,*}

¹Institute of Excellence in Fungal Research, Mae Fah Luang University, Chiang Rai 57100, Thailand

²School of Science, Mae Fah Luang University, Chiang Rai. 57100, Thailand

³Department of Plant Sciences, Forestry & Agricultural Biotechnology Institute (FABI), University of Pretoria, Private Bag X20, Pretoria, 0028, South Africa

⁴Key Laboratory for Plant Diversity and Biogeography of East Asia, Kunming Institute of Botany, Chinese Academy of Sciences, 132 Lanhei Road, Kunming 650201, China

⁵World Agroforestry Centre, East and Central Asia, Kunming 650201, Yunnan, China

*Correspondence: kdhyde3@gmail.com

Abstract

Tectona grandis (teak) is one of the most important economic timbers worldwide. Limited studies exist on the potential pathogens of these trees. Fungi in the Botryosphaeriaceae are cosmopolitan opportunistic pathogens, endophytes and saprobes of numerous hosts. Both symptomatic and asymptomatic branch and stem sections, as well as leaves were collected from *T. grandis* in plantations and forests in four provinces of northern Thailand with the aim of identifying species of Botryosphaeriaceae associated with these trees. Morphology and multi-locus phylogenies (ITS, TEF1- α , β -tubulin) were used to identify the Botryosphaeriaceae species. Six species from four different genera were found on *T. grandis* in Northern Thailand. These included *Dothiorella tectonae* sp. nov., *Lasiodiplodia brasiliense*, *L. pseudotheobromae*, *L. theobromae*, *Pseudofusicoccum adansoniae* and *Sphaeropsis eucalypticola*. *Dothiorella tectonae* is introduced here as a novel species and compared with other species in the genus. *Dothiorella tectonae*, *L. brasiliense*, *L. pseudotheobromae*, *L. theobromae*, *P. adansoniae* and *S. eucalypticola* are first reports for *T. grandis* in Thailand. Variations in morphology between descriptions of previously described species and that obtained in this study are described to facilitate future identification of species.

Key words: *Dothiorella*, *Lasiodiplodia*, *Pseudofusicoccum*, *Sphaeropsis*, multi-gene phylogenetics, taxonomy

Introduction

Tectona grandis (teak) is one of the most economically valuable tropical hardwood trees globally. Natural teak forests occur in only four countries in the world including Burma, India, Lao People's Democratic Republic and Thailand (Kollert and Cherubini 2012; Thulasidas 2014). India, Lao PDR and Thailand have bans on logging of native teak forests and the export of native teak, and therefore rely on plantations for teak production (Kollert and Cherubini 2012). In 2010, teak plantations in Thailand were reported to cover an area of ~128 000 ha (Kollert and Cherubini 2012). Large areas in northern Thailand are planted with teak plantations and covered by natural teak forests (Graudal *et al.* 1999). In Chiang Rai Province, the area under productive teak plantations is ~3 321 ha with the income from teak and teak timber products reported as ~120 725 USD (80 USD/m³/year) (Elmagboul *et al.* undated). Teak has been an important trading commodity in Thailand for over 700 years (Areeya 1992). The timber has a wide range of uses including flooring, decking, framing, bargeboards, carvings, and furniture. It is also used for shipbuilding due to its resistance to sun, heat, cold, rain and seawater (Rondon *et al.* 1998).

Various fungal pathogens are reported to affect teak, including *Armillaria mellea* and *Phellinus noxius* causing root rot (Mohd Farid *et al.* 2005, Owusu 2011), *Erythricium salmonicolor* causing pink disease (stem cankers and girdling) (Akrof *et al.* 2014) and *Olivea tectonae* causing leaf rust (Daly *et al.* 2006, Pérez *et al.* 2008, Cabral *et al.* 2010). Numerous endophytic fungi have been reported from teak leaves in Thailand. These include species of *Alternaria*, *Colletotrichum*, *Daldinia eschscholtzii*, *Fusarium*, *Nigrospora*, *Penicillium*, *Phomopsis*, and *Schizophyllum commune* and members of the Xylariaceae (Mekkamol *et al.* 1997, Mekkamol 1998, Chareprasert *et al.* 2006). Several

lignicolous marine fungi have been reported on submerged teak blocks, namely *Arthrobotrys* sp., *Byssosclamyces fulva*, *Cylindrocephalum* sp., *Cytospora* sp. and *Monodictys pelagica* (Vrijimoed *et al.* 1982, 1986). Most recently, a novel species of Botryosphaeriaceae, *Barriopsis tectonae*, was described from teak in northern Thailand (Doilom *et al.* 2014).

The Botryosphaeriaceae are a cosmopolitan group of fungi containing pathogens, endophytes and saprobes of mainly woody plant hosts (Crous *et al.* 2004, Slippers & Wingfield 2007, Trakunyingcharoen *et al.* 2014, Mehl *et al.* 2013). The family currently consists of seventeen genera, defined over the last few years based on multi-gene phylogenetic analyses and morphology (Phillips *et al.* 2013, Slippers *et al.* 2013). Several species in the Botryosphaeriaceae are important pathogens of economically important crops, including commercial plantation tree species. For example, *Diplodia sapinea* is an important pathogen of plantation grown *Pinus* species in the Southern Hemisphere (Smith *et al.* 2001, Burgess *et al.* 2004, Reay *et al.* 2006), *Lasiodiplodia theobromae* causes die-back and wood discoloration in various parts of the tropics, such as on *Acacia mangium* in Indonesia (Slippers & Wingfield 2007) and *Neofusicoccum* species cause disease of Eucalyptus trees grown in plantations in the Southern Hemisphere (Smith *et al.* 2001). However, virtually no information exists for the Botryosphaeriaceae on *T. grandis*.

The aim of this study was to identify species of Botryosphaeriaceae occurring on *T. grandis* in northern Thailand. Isolates were collected from both natural forests and plantations of teak. Morphology and multigene sequence analyses were used to identify the isolates obtained from teak.

Materials and Methods

Field collection and fungal isolations

Plant materials were randomly collected from *Tectona grandis* trees from 35 sites in four provinces in northern Thailand (Chiang Rai, Chiang Mai, Phayao, Phrae Provinces) during the period 2011–2013. Sites for collection were selected to include both teak in natural forests (15 sites) and teak plantations (20 sites). At each site trees were examined for the presence of leaf spots, branch die-back and stem cankers, typical of those caused by species of Botryosphaeriaceae. Saprobes on dead twigs and dead branches were also collected. Furthermore, disease free branches and leaves were collected to isolate endophytic Botryosphaeriaceae from ten plantation sites in Chiang Rai Province.

Samples from each tree were placed into separate brown paper bags that were then sealed in larger Zip-lock bags to retain moisture. Samples were refrigerated at 4°C until they could be processed for fungal determination and isolation.

In the laboratory, all materials showing disease symptoms were cut into small pieces (1×1 cm.) and surface disinfected in 10% sodium hypochlorite (NaOCl) for 3–5 min, then washed two times with sterile distilled water (1 min each) and blotted dry on sterile filter paper. Disinfected plant tissues were placed on water agar (WA) with streptomycin (0.02 %). Plates were incubated at 25°C for 2–4 days until the onset of fungal growth. Cultures were purified by transferring single hyphal tips and maintained on malt extract agar.

For the isolation of possible endophytic Botryosphaeriaceae, disease free leaves (petioles, leaf blades, midribs) and branch samples were cut into 1cm³ sections. These sections were surface disinfested and processed according to Pérez *et al.* (2010). Colonies resembling Botryosphaeriaceae (fluffy, fast-growing, white colonies turning olive green–grey to black over a few days) were subcultured on to fresh 2% malt extract agar (MEA) and incubated at 25°C for 2–4 days.

Leaves with leaf spots containing fruiting bodies and fruiting bodies on dead branches and twigs, resembling those of species in the Botryosphaeriaceae, were isolated using the single spore technique described by Chomnunti *et al.* (2014). Representative cultures were prepared for analyses using DNA sequencing and morphological analyses and for deposition in recognized culture collections.

Type herbarium material was deposited in the herbarium of Mae Fah Luang University, Chiang Rai, Thailand (MFLU). Representative copies of all species obtained in this study have also been deposited in the culture collections of the Mae Fah Luang Culture Collection, Thailand (MFLUCC) with duplicates stored at Mycothèque de l'Université catholique de Louvain, Belgium (MUCL).

DNA extraction, PCR amplification and sequencing

Twelve representative isolates were selected for the molecular analyses (Table 1) Genomic DNA was extracted directly from actively growing mycelia using PrepMan™ Ultra (Applied Biosystems, Foster City, CA, U.S.A.) following the

manufacturer's protocol. The internal transcribed spacer regions 1 and 2 (ITS), including 5.8S region fragments of the protein coding genes, translation elongation factor 1- α (TEF1- α) and β -tubulin (BT), were used for identification of isolates. The ITS regions were amplified and sequenced with the primers ITS1/ITS4 (White *et al.* 1990), TEF1- α with EF1F/EF2R (Jacobs *et al.* 2004) and EF688F/EF1251R (Alves *et al.* 2008) for *Lasiodiplodia* isolates, and the BT region with the Bt2a and Bt2b primers (Glass & Donaldson 1995).

PCR reactions were performed in 25 μ L final volumes and consisted of 5 μ L 5x MyTaq Reaction Buffer (Bioline, U.S.A.), 0.15 μ L MyTaqTM DNA Polymerase (Bioline, U.S.A.), 0.5 μ L of each primer (10 mM stock) (Whitehead Scientific, Cape Town, South Africa), and 1 μ L of the PrepMan DNA extract. Final reaction volumes were adjusted to 25 μ L by adding sterile Sabax water (Adcock Ingram Critical Care, Johannesburg, South Africa). Thermocycling was completed on a 2720 Thermal Cycler (Applied Biosystems, Foster City, CA, U.S.A.) under the following conditions. Initial denaturation of 5 min at 95 °C, followed by 30 cycles of 30 s at 94 °C, 30 s at 52 °C, 1 min at 72 °C and a final extension period of 7 min at 72 °C. The annealing temperatures of the TEF1- α and BT reactions were changed to 55 °C. Amplification was confirmed by staining 2 μ L aliquots of PCR products with 3 μ L of GelRedTM Nucleic Acid Gel stain (Biotium, Hayward, CA, U.S.A.) and separated on a 1 % agarose gel. Fragments were visualized on a Bio-Rad GelDoc EZ system. PCR products were cleaned by gel filtration using Sephadex G-50 columns (Sigma-Aldrich, Steinheim, Germany) according to the manufacturer's instructions.

Sequencing PCR reactions were completed according to the method described by Doilom *et al.* (2014). Products were sequenced at the DNA Sequencing Facility, Bioinformatics and Computational Biology Unit, University of Pretoria, South Africa. Both forward and reverse strands were completed to ensure sequence integrity. Consensus sequences were generated using Geneious® R7 (Biomatters Ltd., New Zealand).

Phylogenetic analyses

All sequences obtained after sequencing were used for BLAST searches in the nucleotide database of GenBank ([www http://blast.ncbi.nlm.nih.gov/](http://blast.ncbi.nlm.nih.gov/)) to determine their most likely genus identity. This information was used to compile data sets for phylogenetic analyses. Reference sequences used in the phylogenetic analyses were obtained from recent relevant literature and GenBank (Lui *et al.* 2012, Phillips *et al.* 2013, Slippers *et al.* 2013, Hyde *et al.* 2014; Nilsson *et al.* 2014). Outgroups for each data set were selected from phylogenetically closely related genera of the Botryosphaeriaceae. These included *Spencermartinsia viticola* (CBS 117009, CBS 302.75), *Diplodia mutila* (CBS 112553), *D. seriata* (CBS 112555), *Neofusicoccum parvum* (CMW 9081, CBS 110301) and *Barriopsis fusca* (CBS 174.26). Three individual datasets for each of the loci, ITS, TEF1- α and BT, and one concatenated ITS/TEF1- α /BT dataset were assembled and analysed. Data sets were aligned online using the MAFFT version 7.158 server ([http://mafft.cbrc.jp/alignment/ server/](http://mafft.cbrc.jp/alignment/server/)). Alignments were checked visually and corrected for alignment errors. Potential conflict among datasets was estimated with a conditional comparison test with maximum parsimony bootstrap (BS) values $\geq 70\%$ (Kellogg *et al.* 1996, Mason-Gamer & Kellogg 1996, Johnson & Soltis 1998). The number of polymorphisms in each of the individual marker datasets was also considered when delineating species, employing genealogical concordance phylogenetic species recognition (Taylor *et al.* 2000). Phylogenetic trees were inferred with maximum parsimony (MP) and Bayesian inference (BI).

Maximum parsimony (MP) analyses were conducted using MEGA 6 (Tamura *et al.* 2013) and PAUP version 4.0 b10 (Swofford 2003). Uninformative characters were excluded. All informative characters were unordered and of equal weight. The heuristic search function was used with 1000 random stepwise addition replicates and tree bisection-reconnection (TBR) as the branch-swapping algorithm. Goodness of fit values, including the consistency index (CI), retention index (RI), rescaled consistency index (RC) and homoplasy index (HI), were calculated. Statistical support for branches was estimated using maximum parsimony bootstrap (MPBS) analysis with 1000 replicates (Felsenstein 1985). Phylogenetic trees were visualized and annotated using Treeview (Page 1996) and formatted using PowerPoint 2010 (Microsoft Corporation, WA, U.S.A.).

Bayesian inference was performed using the Markov Chain Monte Carlo (MCMC) method with MrBayes v. 3.2.2 (Huelsenbeck & Ronquist 2001). MrModeltest 2.2 (Nylander 2004) was used to select the best-fit nucleotide substitution models under the Akaike information criterion (AIC). Four chains were run for the individual and combined data sets. The MCMC algorithm was started from a random tree topology. Five million generations was selected with a sampling frequency every 100 generations. The Tracer v. 1.6 (Rambaut & Drummond 2003) programme was used to check the effective sampling sizes (ESS), which should be above 200, the stable likelihood plateaus and burn-in value. The first 5,000 generations were excluded as burn-in. Posterior probabilities were viewed with FigTree v1.3.1 (Rambaut 2009).

TABLE 1. Isolates of Botryosphaeriaceae obtained from teak in northern Thailand and reference strains used in the phylogenetic analyses.

Taxon	Culture Accession No ¹	Isolates	Country	Host	GenBank Accession No ²		
					ITS	TEF1- α	BT
<i>Barriopsis fusca</i>	CBS 174.26	Ex-type	Cuba	<i>Citrus</i> sp.	EU673330	EU673296	EU673109
<i>Diplodia mutila</i>	CBS 112553		Portugal	<i>Vitis vinifera</i>	AY259093	AY573219	DQ458850
<i>D. seriata</i>	CBS 112555	Ex- epitype	Portugal	<i>V. vinifera</i>	AY259094	AY573220	DQ458856
<i>Dothiorella americana</i>	CBS 128309/UCD2252MO	Ex- type	USA	<i>V. vinifera</i>	HQ288218	HQ288262	HQ288297
<i>Do. americana</i>	CBS 128310/UCD2272MO		USA	<i>V. vinifera</i>	HQ288219	HQ288263	HQ288298
<i>Do. brevicollis</i>	CBS 130411/CMW 36463	Ex-type	South Africa	<i>Acacia karroo</i>	JQ239403	JQ239390	JQ239371
<i>Do. brevicollis</i>	CBS 130412/CMW 36464	Ex-paratype	South Africa	<i>A. karroo</i>	JQ239404	JQ239391	JQ239372
<i>Do. casuarinae</i>	CBS 120688/CMW 4855	Ex-type	Australia	<i>Casuarina</i> sp.	DQ846773	DQ875331	DQ875340
<i>Do. casuarinae</i>	CBS 120690/CMW 4857		Australia	<i>Casuarina</i> sp.	DQ846774	DQ875333	DQ875341
<i>Do. dulcispinae</i>	CBS 130413/CMW 36460	Ex-type	South Africa	<i>A. karroo</i>	JQ239400	JQ239387	JQ239373
<i>Do. dulcispinae</i>	CBS 130414/CMW 36461	Ex-paratype	South Africa	<i>A. karroo</i>	JQ239401	JQ239388	JQ239374
<i>Do. dulcispinae</i>	CBS 121764		Namibia	<i>A. mellifera</i>	EU101299	EU101344	N/A
<i>Do. iberica</i>	CBS 115041	Ex-type	Spain	<i>Quercus ilex</i>	AY573202	AY573222	EU673096
<i>Do. iberica</i>	CBS 113188		Spain	<i>Q. suber</i>	AY573198	EU673278	EU673097
<i>Do. iranica</i>	IRAN 1587C/CBS 124722	Ex-type	Iran, Golestan	<i>Olea europaea</i>	KC898231	KC898214	N/A
<i>Do. longicollis</i>	CBS 122068/CMW 26166	Ex-type	Australia	<i>Lysiphyllum cunninghamii</i>	EU144054	EU144069	KF766130
<i>Do. longicollis</i>	CBS 122067/CMW 26165		Australia	<i>L. cunninghamii</i>	EU144053	EU144068	N/A
<i>Do. moneti</i>	MUCC 505/WAC 13154	Ex-type	Australia	<i>A. rostellifera</i>	EF591920	EF591971	EF591954

...Continued on next page

TABLE 1. (Continued)

Taxon	Culture Accession No ¹	Isolates	Country	Host	GenBank Accession No ²		
					ITS	TEF1- α	BT
<i>Do. moneti</i>	MUCC 507		Australia	<i>A. rostellifera</i>	EF591922	EF591973	EF591956
<i>Do. parva</i>	IRAN 1579C/ CBS 124720	Ex-type	Iran	<i>Corylus avellana</i>	KC898234	KC898217	N/A
<i>Do. parva</i>	IRAN 1585C/ CBS 124721		Iran	<i>C. avellana</i>	KC898235	KC898218	N/A
<i>Do. pretoriensis</i>	CBS 130404/ CMW 36480	Ex-type	South Africa	<i>A. karroo</i>	JQ239405	JQ239392	JQ239376
<i>Do. pretoriensis</i>	CBS 130405/ CMW36481	Ex-paratype	South Africa	<i>A. karroo</i>	JQ239406	JQ239393	JQ239377
<i>Do. prunicola</i>	CBS 124723/ IRAN 1541/ CAP 187	Ex-type	Portugal	<i>Prunus dulcis</i>	EU673313	EU673280	EU673100
<i>Do. santali</i>	MUCC 509/ WAC 13155	Ex-type	Australia	<i>Santalum acuminatum</i>	EF591924	EF591975	EF591958
<i>Do. santali</i>	MUCC 508		Australia	<i>S. acuminatum</i>	EF591923	EF591974	EF591957
<i>Do. sarmentorum</i>	IMI 63581b	Ex-type	England	<i>Ulmus</i> sp.	AY573212	AY573235	EU673102
<i>Do. sarmentorum</i>	CBS 115038		Netherlands	<i>Malus pumila</i>	AY573206	AY573223	EU673101
<i>Do. sempervirentis</i>	IRAN 1583C/ CBS 124718	Ex-type	Iran	<i>Cupressus sempervirens</i>	KC898236	KC898219	N/A
<i>Do. sempervirentis</i>	IRAN 1581C/ CBS 124719		Iran	<i>Cu. sempervirens</i>	KC898237	KC898220	N/A
<i>Do. striata</i>	CBS 124731/ ICMP 16824	Ex-type	New Zealand	<i>Citrus sinensis</i>	EU673321	EU673288	EU673143
<i>Do. striata</i>	CBS 124730/ ICMP 16819		New Zealand	<i>Ci. sinensis</i>	EU673320	EU673287	EU673142
<i>Do. symphoricarposicola</i>	MFLUCC 13-0497	Ex-type	Italy	<i>Symphoricarpo</i> sp.	KJ742378	KJ742381	N/A
<i>Do. symphoricarposicola</i>	MFLUCC 13-0498		Italy	<i>Symphoricarpo</i> sp.	KJ742379	KJ742382	N/A
<i>Do. tectonae</i> sp. nov.	MFLUCC 12-0382/ MUCL 55409	Ex-type	Thailand	<i>Tectonia grandis</i>	KM396899	KM409637	KM510357

... Continued on next page

TABLE 1. (Continued)

Taxon	Culture Accession No ¹	Isolates	Country	Host	GenBank Accession No ²		
					ITS	TEFI- α	BT
<i>Do. thailandica</i>	CBS 133991/ MFLUCC 11-0438	Ex-type	Thailand	<i>Bamboo culm</i>	JX646796	JX646861	JX646844
<i>Do. thripisita</i>	BRIP 51876	Ex-type	Australia	<i>A. harpophylla</i>	FJ824738	N/A	N/A
<i>Do. uruguayensis</i>	CMW 26763/ CBS 124908/ UY672	Ex-type	Uruguay	<i>Hexachlamis edulis</i>	EU080923	EU863180	N/A
<i>Do. vidmadera</i>	DAR 78992	Ex-type	Australia	<i>V. vinifera</i>	EU768874	EU768881	HM800522
<i>Do. vidmadera</i>	DAR 78993	Ex-type	Australia	<i>V. vinifera</i>	EU768876	EU768882	HM800523
<i>Do. vidmadera</i>	DAR 78994	Ex-type	Australia	<i>V. vinifera</i>	EU768877	EU768883	HM800524
<i>Lasiodiplodia brasiliense</i>	MM 4015	Ex-type	Brazil	<i>Mangifera indica</i>	JX464063	JX464049	N/A
<i>L. brasiliense</i>	MM 2257		Brazil	<i>Carica papaya</i>	KC484803	KC481533	N/A
<i>L. brasiliense</i>	MFLUCC 11-0414/ MUCL 55406		Thailand	<i>T. grandis</i>	KM396891	KM409629	KM510349
<i>L. citricola</i>	CBS 124706/ IRAN 1521C		Iran	<i>Citrus</i> sp.	GU945353	GU945339	KP872406
<i>L. citricola</i>	CBS 124707/ IRAN 1522C	Ex-type	Iran	<i>Citrus</i> sp.	GU945354	GU945340	KP872405
<i>L. crassispora</i>	CMW 14691/ WAC 12533/ CBS 118741	Ex-type	Australia	<i>S. album</i>	DQ103550	EU673303	EU673133
<i>L. crassispora</i>	CMW 13488		Venezuela	<i>Eucalyptus urophylla</i>	DQ103552	DQ103559	KP872407
<i>L. egyptiaca</i>	CBS 130992/ BOT 10	Ex-type	Egypt	<i>M. indica</i>	JN814397	JN814424	KP872410
<i>L. egyptiaca</i>	MM3648		Brazil	<i>Jatropha curcas</i>	KF234549	KF226705	KF254933
<i>L. euphorbicola</i>	MM3609	Ex-type	Brazil	<i>J. curcas</i>	KF234543	KF226689	KF254926
<i>L. euphorbicola</i>	MM3651		Brazil	<i>J. curcas</i>	KF234553	KF226711	KF254937
<i>L. exigua</i>	CBS 137785/ BL104	Ex-type	Tunisia	<i>Retama raetam</i>	KJ638317	KJ638336	N/A
<i>L. exigua</i>	PD 161		USA	<i>Pistacia vera</i>	GU251122	GU251254	N/A
<i>L. gilanensis</i>	CBS 124704/ IRAN 1523C	Ex-type	Iran	Unknown	GU945351	GU945342	KP872411

... Continued on next page

TABLE 1. (Continued)

Taxon	Culture Accession No ¹	Isolates	Country	Host	GenBank Accession No ²		
					ITS	TEF1- α	BT
<i>L. gilanensis</i>	CBS 124705/ IRAN 1501C		Iran	Unknown	GU945352	GU945341	KP872412
<i>L. gonubiensis</i>	CBS 1115812/ CMW 14077	Ex-type	South Africa	<i>Syzygium cordatum</i>	AY639595	DQ458877	DQ458860
<i>L. gonubiensis</i>	CBS 1116355/ CMW 14078		South Africa	<i>Sy. cordatum</i>	AY639594	DQ103567	EU673126
<i>L. hormozganensis</i>	IRAN 1498C/ CBS 124708		Iran	<i>M. indica</i>	GU945356	GU945344	KP872414
<i>L. hormozganensis</i>	IRAN 1500C/ CBS 124709	Ex-type	Iran	<i>Olea</i> sp.	GU945355	GU945343	KP872413
<i>L. iraniensis</i>	IRAN 1519C		Iran	<i>M. indica</i>	GU945350	GU945338	N/A
<i>L. iraniensis</i>	IRAN 1520C/ CBS 124710	Ex-type	Iran	<i>Salvadora persica</i>	GU945348	GU945336	N/A
<i>L. jatrophicola</i>	MMW 3610	Ex-type	Brazil	<i>J. curcas</i>	KF234544	KF226690	KF254927
<i>L. mahajangana</i>	CBS 124925/ CMW 27801		Madagascar	<i>Te. catappa</i>	FJ900595	FJ900641	FJ900630
<i>L. mahajangana</i>	CBS 124927/ CMW 27820	Ex-type	Madagascar	<i>Te. catappa</i>	FJ900597	FJ900643	FJ900632
<i>L. margaritacea</i>	CMW 26162/ CBS 122519	Ex-type	Western Australia	<i>Adansonia gregorii</i>	EU144050	EU144065	N/A
<i>L. margaritacea</i>	CMW 26163/ CBS 122065		Western Australia	<i>Ad. gregorii</i>	EU144051	EU144066	N/A
<i>L. macrospora</i>	MMW 3833	Ex-type	Brazil	<i>J. curcas</i>	KF234557	KF226718	KF254941
<i>L. missouriana</i>	CBS 128311/ UCD 2193MO	Ex-type	USA	<i>Vitis</i> spp.	HQ288225	HQ288267	HQ288304
<i>L. missouriana</i>	CBS 128312/ UCD 2199MO		USA	<i>Vitis</i> spp.	HQ288226	HQ288268	HQ288305
<i>L. parva</i>	CBS 456.78	Ex-type	Colombia	<i>Cassava-field soil</i>	EF622083	EF622063	KP872419
<i>L. parva</i>	CBS 494.78		Colombia	<i>Cassava-field soil</i>	EF622084	EF622064	EU673114
<i>L. plurivora</i>	CBS 120832/ STE-U 5803	Ex-type	South Africa	<i>P. salicina</i>	EF445362	EF445395	KP872421

...Continued on next page

TABLE 1. (Continued)

Taxon	Culture Accession No ¹	Isolates	Country	Host	GenBank Accession No ²		
					ITS	TEF1- α	BT
<i>L. plurivora</i>	CBS 121103/ STE-U 4583		South Africa	<i>V. vinifera</i>	AY343482	EF445396	KP872422
<i>L. pseudotheobromae</i>	CBS 116459	Ex-type	Costa Rica	<i>Gmelina arborea</i>	EF622077	EF622057	EU673111
<i>L. pseudotheobromae</i>	CBS 447.62		Suriname	<i>C. aurantium</i>	EF622081	EF622060	EU673112
<i>L. pseudotheobromae</i>	MFLUCC 12-0053/ MUCL 55407		Thailand	<i>T. grandis</i>	KM396894	KM409632	KM510352
<i>L. pseudotheobromae</i>	MFLUCC 12-0294		Thailand	<i>T. grandis</i>	KM396897	KM409635	KM510355
<i>L. pseudotheobromae</i>	MFLUCC 12-0295		Thailand	<i>T. grandis</i>	KM396898	KM409636	KM510356
<i>L. pseudotheobromae</i>	MFLUCC 12-0772/ MUCL 55410		Thailand	<i>T. grandis</i>	KM396900	KM409638	KM510358
<i>L. pseudotheobromae</i>	MFLUCC 12-0796/ MUCL 55411		Thailand	<i>T. grandis</i>	KM396902	KM409640	KM510360
<i>L. pyriformis</i>	CBS 121770/ CMW 25414	Ex-type	Namibia	<i>A. mellifera</i>	EU101307	EU101352	KP872423
<i>L. pyriformis</i>	CBS 121771/ CMW 25415		Namibia	<i>A. mellifera</i>	EU101308	EU101353	KP872424
<i>L. rubropurpurea</i>	WAC 12535/ CBS 118740	Ex-type	Queensland	<i>Eucalyptus grandis</i>	DQ103553	DQ103571	EU673136
<i>L. rubropurpurea</i>	WAC 12536/ CMW 15207		Queensland	<i>E. grandis</i>	DQ103554	DQ103572	KP872425
<i>L. theobromae</i>	CBS 124.13		USA	Unknown	DQ458890	DQ458875	DQ458858
<i>L. theobromae</i>	CBS 164.96	Ex-neotype	New Guinea	Fruit on coral reef coast	AY640255	AY640258	EU673110
<i>L. theobromae</i>	CBS 111530		Unknown	Unknown	EF622074	EF622054	KP872426
<i>L. theobromae</i>	MFLUCC 12-0293/ MUCL 55408		Thailand	<i>T. grandis</i>	KM396896	KM409634	KM510354
<i>L. venezuelensis</i>	WAC 12539/ CBS 118739	Ex-type	Venezuela	<i>A. mangium</i>	DQ103547	DQ103568	EU673129
<i>L. venezuelensis</i>	WAC12540/ CMW 13512		Venezuela	<i>A. mangium</i>	DQ103548	DQ103569	N/A
<i>L. viticola</i>	CBS 128313	Ex-type	USA	<i>Vitis</i> sp.	KP872341	KP872376	HQ288306
<i>L. viticola</i>	CBS 128314	Ex-type	USA	<i>Vitis</i> sp.	KP872342	KP872377	HQ288307
<i>Neofusicoccum parvum</i>	ATCC 58191/ CMW 9081		New Zealand	<i>Populus nigra</i>	AY236943	AY236888	AY236917

...Continued on next page

TABLE 1. (Continued)

Taxon	Culture Accession No ¹	Isolates	Country	Host	GenBank Accession No ²		
					ITS	TEFI- α	BT
<i>N. parvum</i>	CBS 110301		Portugal	<i>V. vinifera</i>	AY259098	AY573221	EU673095
<i>Pseudofusicoccum adansoniae</i>	CBS 122053 / CMW 26145/ MUCC 520		Western Australia	<i>A. synchronica</i>	EF585525	EF585569	N/A
<i>Ps. adansoniae</i>	CBS 122054 / CMW 26146/ MUCC 533		Western Australia	<i>Eucalyptus</i> sp.	EF585532	EF585570	N/A
<i>Ps. adansoniae</i>	CBS 122055 / CMW 26147/ MUCC 522	Ex-type	Western Australia	<i>Ad. gregorii</i>	EF585523	EF585571	N/A
<i>Ps. adansoniae</i>	CBS 122056 / CMW 26148/ MUCC 521		Western Australia	<i>Ficus opposita</i>	EF585524	EU295489	N/A
<i>Ps. adansoniae</i>	MFLUCC 13-0705/ MUCL 55413		Thailand	<i>T. grandis</i>	KM396904	KM396908	KM510362
<i>Ps. adansoniae</i>	MFLUCC 14-0516		Thailand	<i>T. grandis</i>	KM396905	KM409642	KM510363
<i>Ps. adansoniae</i>	MFLUCC 14-0517		Thailand	<i>T. grandis</i>	KM396906	KM409643	KM510364
<i>P. ardesiacum</i>	CBS 122062/ CMW 26159	Ex-type	Western Australia	<i>Ad. gregorii</i>	EU144060	EU144075	N/A
<i>P. ardesiacum</i>	CBS 122064/ CMW 26160		Western Australia	<i>Eucalyptus</i> sp.	EU144062	EU144077	N/A
<i>P. kimberleyense</i>	CBS 122058/ CMW 26156	Ex-type	Western Australia	<i>A. synchronica</i>	EU144057	EU144072	N/A
<i>P. kimberleyense</i>	CBS 122060/ CMW 26158		Western Australia	<i>Ad. gregorii</i>	EU144058	EU144073	N/A
<i>P. kimberleyense</i>	CBS 122061/ CMW 26161		Western Australia	<i>F. opposita</i>	EU144059	EU144074	N/A
<i>P. olivaceum</i>	CBS 124939/ CMW 20881	Ex-type	South Africa	<i>Pterocarpus angolensis</i>	FJ888459	FJ888437	N/A
<i>P. olivaceum</i>	CBS 124940/ CMW 22637		South Africa	<i>Pt. angolensis</i>	FJ888462	FJ888438	N/A
<i>Ps. stromaticum</i>	CBS 117448/ CMW 13434	Ex-type	Venezuela	<i>Eucalyptus</i> hybrid	AY693974	AY693975	N/A
<i>Ps. stromaticum</i>	CBS 117449/ CMW 13435		Venezuela	<i>Eucalyptus</i> hybrid	DQ436935	DQ436936	N/A
<i>Ps. violaceum</i>	CBS 124936/ CMW 22679	Ex-type	South Africa	<i>Pt. angolensis</i>	FJ888474	FJ888442	N/A
<i>Ps. violaceum</i>	CBS 124938/ CMW 22671		South Africa	<i>Pt. angolensis</i>	FJ888472	FJ888441	N/A

...Continued on next page

TABLE 1. (Continued)

Taxon	Culture Accession No ¹	Isolates	Country	Host	ITS	GenBank Accession No ²	
						TEFI- α	BT
<i>Spenceriartinsia viticola</i>	CBS 117009	Ex-type	Spain	<i>V. vinifera</i>	AY905554	AY905559	EU673104
<i>S. viticola</i>	CBS 302.75		France	<i>Poniciana gilliesii</i>	EU673319	EU673286	EU673135
<i>Sphaeropsis citrigena</i>	ICMP 16812	Ex-type	New Zealand	<i>Ci. sinensis</i>	EU673328	EU673294	EU673140
<i>Sp. citrigena</i>	ICMP 16818		New Zealand	<i>Ci. sinensis</i>	EU673329	EU673295	EU673141
<i>Sp. eucalypticola</i>	MFLUCC 11-0579/ CBS 133993	Ex-type	Thailand	<i>Eucalyptus</i> sp.	JX646802	JX646867	JX646850
<i>Sp. eucalypticola</i>	MFLUCC 11-0654		Thailand	<i>Eucalyptus</i> sp.	JX646803	JX646868	JX646851
<i>Sp. eucalypticola</i>	MFLUCC 13-0701/ MUCL 55412		Thailand	<i>T. grandis</i>	KM396907	KM409644	KM510365
<i>Sp. porosa</i>	CBS 110496/ STE-U 5132	Ex-type	South Africa	<i>V. vinifera</i>	AY343379	AY343340	EU673130
<i>Sp. visci</i>	CBS 186.97	Ex-type	Germany	<i>Viscum album</i>	EU673325	EU673293	EU673128
<i>Sp. visci</i>	CBS 100163		Luxembourg	<i>Vi. album</i>	EU673324	EU673292	EU673127

¹Acronyms of culture collections: **ATCC**: American Type Culture Collection, Virginia, USA; **BL**: B. T. Linaldeddu, Università degli Studi di Sassari, Italy; **BRIP**: Culture collection, Queensland Department of Agriculture and Fisheries, Queensland, Australia; **CAP**: Personal culture collection Alan J.L. Phillips, Universidade Nova de Lisboa, Portugal; **CBS**: Centraalbureau voor Schimmelcultures, Utrecht, The Netherlands; **CMM**: Culture Collection of Phytopathogenic Fungi "Prof. Maria Menezes", Universidade Federal Rural de Pernambuco, Recife, Brazil; **CMW**: Tree Pathology Cooperative Program, Forestry and Agricultural Biotechnology Institute, University of Pretoria, South Africa; **CPC**: Culture collection of P.W. Crous housed at CBS; **DAR**: Plant Pathology Herbarium, Orange Agricultural Institute, DPI, Orange, NSW, Australia; **ICMP**: International Collection of Microorganisms from Plants, Landcare Research, New Zealand; **IMI**: International Mycological Institute, CBI-Bioscience, Egham, Bournemouth, UK; **IRAN**: Iranian Fungal Culture Collection, Iranian Research Institute of Plant Protection, Iran; **MFLUCC**: Mae Fah Luang University Culture Collection, Chiang Rai, Thailand; **MUCL**: Culture Collection of Mycothèque de l'Université catholique de Louvain, Belgium; **MUCC**: Culture Collection, Laboratory of Plant Pathology, Mie University, Tsu, Mie prefecture, Japan; **PD**: Culture collection, University of California, Davis, USA; **STE-U**: Culture Collection of the Department of Plant Pathology, University of Stellenbosch, Stellenbosch, South Africa; **UCD**: Phaff Yeast Culture Collection, Department of Food Science and Technology, University of California, Davis, USA; **WAC**: Department of Agriculture Western Australia Plant Pathogen Collection, South Perth, Western Australia.

²Sequence numbers in bold are newly deposited in GenBank.

Morphological characterization of isolates

Morphological characterization of the twelve isolates was carried out according to the methods described in Doilom *et al.* (2013, 2014). Fungal structures were stained using Lactophenol Cotton Blue (LPCB). Growth rates were determined using a five mm diameter cork borer to transfer mycelium plugs to 2% MEA. Five replicates of each isolate were made and kept at 5, 15, 25 and 30 °C for new taxa. All fungal taxa were kept in the incubator in the dark at 25 °C for one week. Culture studies were completed from isolates grown at 25 °C for one week. Colony colour was then determined with the Methuen handbook of colour (Kornerup & Wanscher 1967).

Results and Discussion

Fungal isolates

Isolates resembling species of Botryosphaeriaceae were obtained from 95 isolates /12 sites. One representative isolate per site, for each colony morphotype was used for identification using DNA sequence data.

Phylogenetic analyses

Based on MP analyses of ITS data including all genera in the Botryosphaeriaceae, four genera of Botryosphaeriaceae were identified namely *Dothiorella* (1 isolate), *Lasiodiplodia* (7 isolates), *Pseudofusicoccum* (3 isolates) and *Sphaeropsis* (1 isolate) (data not shown). The datasets of each genus were then separately analysed for species identification using individual ITS, TEF1- α and BT, as well as combined phylogenies. Alignment details and nucleotide substitution models for the individual ITS, TEF1- α , BT and combined datasets are provided in Table 2.

Dothiorella group: In the ITS MP phylogeny the *Dothiorella* isolate (MFLUCC 12-0382) obtained from *T. grandis* in this study grouped sister to, but distinct from *Do. uruguayensis* (CBS 124908) and *Do. striata* (ICMP 16819 and ICMP 16824) (Figure 1a). For BI phylogeny of ITS it grouped as distinct linear (Figure 1b). In the TEF1- α and BT MP trees it grouped closest to *Do. brevicollis* (CBS 130411 and CBS 130412) and *Do. longicollis* (CBS 122067 (unavailable for BT sequence data in GenBank) and CBS 122068). In the TEF1- α analyses it was strongly supported as a distinct species (MPBS 95, PP 0.90) (Figure 1c), but in the BT tree the branch was not strongly supported for MP and PP (Figure 1d). However, resolution of species complexes of Botryosphaeriaceae can be better achieved by using combined ITS and TEF1- α gene analyses (Liu *et al.* 2012, Phillips *et al.* 2013, Abdollahzadeh *et al.* 2014). *Dothiorella* cannot be distinguished from *Spencermartinsia* using ITS sequence data alone. It is, therefore, essential to combine ITS with TEF1- α or other protein coding genes for delineating the identity of these isolates (Phillips *et al.* 2013). In the combined ITS/TEF1- α /BT MP and PP phylogenies the isolate from *T. grandis* grouped closest to, but distinct from *Do. brevicollis* and *Do. longicollis*, (MPBS 93% and PP 1.00), suggesting that it represents a novel species (Figure 1e). BI trees of individual TEF1- α and BT genes and combined genes had similar topologies to the MP trees.

The *Dothiorella* sp. from *T. grandis* showed multiple nucleotide differences between itself and closely related taxa for all gene regions analysed (Table 3). In the ITS region it differed from *Do. brevicollis* with 10 polymorphisms, 15 compared to *Do. longicollis*, 17 compared to *Do. striata* and 13 when compared to *Do. uruguayensis*. In the TEF1- α it differed from *Do. brevicollis* with 30 polymorphisms, 31, 51 and 57 compared to *Do. longicollis*, *Do. striata* and *Do. Uruguayensis* respectively. In the BT it differed with 12, 13 and 16 from *Do. brevicollis*, *Do. longicollis*, and *Do. striata*. BT sequence data for *Do. longicollis* and *Do. uruguayensis* was not available, therefore, comparisons could not be made. These differences clearly show that this isolate represents a novel species of *Dothiorella* and it is described below as *Do. tectonae*.

Lasiodiplodia group: Three species of *Lasiodiplodia* were obtained (Figure 2). Isolate MFLUCC 12-0293 grouped with *L. theobromae* in the individual (ITS, TEF1- α , BT) and combined analyses, but with weak bootstrap support for MP and PP. In the combined phylogeny MPBS of 64% and PP of 0.94 was obtained. Isolate MFLUCC 11-0414 grouped within *L. brasiliense* (MPBS = 95%, PP = 1.00 in the combined phylogeny). Individual gene trees for ITS, TEF1- α and BT analyses showed five isolates (MFLUCC 12-0053, MFLUCC 12-0294, MFLUCC 12-0295, MFLUCC 12-0772, MFLUCC 12-0796) grouped with *L. pseudotheobromae* with poor bootstrap support for MP and PP, but in the combined phylogeny they strong bootstrap support (MPBS=99%, PP =1.00) was obtained. BI trees of individual genes and combined genes had similar topologies to the MP trees.

Pseudofusicoccum group: Strains MFLUCC 13-0705, MFLUCC 14-0516 and MFLUCC 14-0517 grouped with

Ps. adansoniae (ex-type culture) in the individual ITS and TEF1- α phylogenies (MPBS: ITS = 93%, TEF1- α = 91%, PP: ITS = 0.66, TEF1- α = 0.77), as well as in the combined ITS and TEF1- α phylogenies (MPBS=100%, PP =0.93) and are therefore considered as this species (Figure 3). Individual gene trees for ITS and TEF1- α analysis gave a similar topology to the combined analyses and is not shown. BI trees of individual genes and combined genes had similar topologies to the MP tree. There are few BT sequences from *Pseudofusicoccum* species in GenBank and thus, individual BT analysis was not analyzed in this study.



FIGURE 1. Phylogenetic trees resulting from individual analyses of each dataset and combined dataset. **a.** One of >200 most parsimonious trees (CI= 0.622, HI= 0.378, RI= 0.863, RC= 0.537) resulting from ITS analysis for 40 taxa in *Dothiorella* species, **b.** Bayesian analysis tree resulting from ITS analysis, **c.** One of >200 most parsimonious trees (CI= 0.635, HI= 0.365, RI= 0.867, RC= 0.550) resulting from TEF1- α analysis, **d.** One of 24 most parsimonious trees (CI= 0.750, HI= 0.250, RI= 0.891, RC= 0.668) resulting from BT analysis for 29 taxa, **e.** One of 63 most parsimonious trees (CI= 0.642, HI= 0.358, RI= 0.863, RC= 0.554) resulting from combined ITS, TEF1- α and BT analysis for 40 taxa. The tree is rooted to two isolates of *Spencermartinsia viticola*. Maximum parsimony bootstrap values $\geq 50\%$, Bayesian posterior probabilities ≥ 0.90 (MPBS/PP) are given at the nodes. Type isolates are marked with ^T. Isolates from this study are in blue bold.

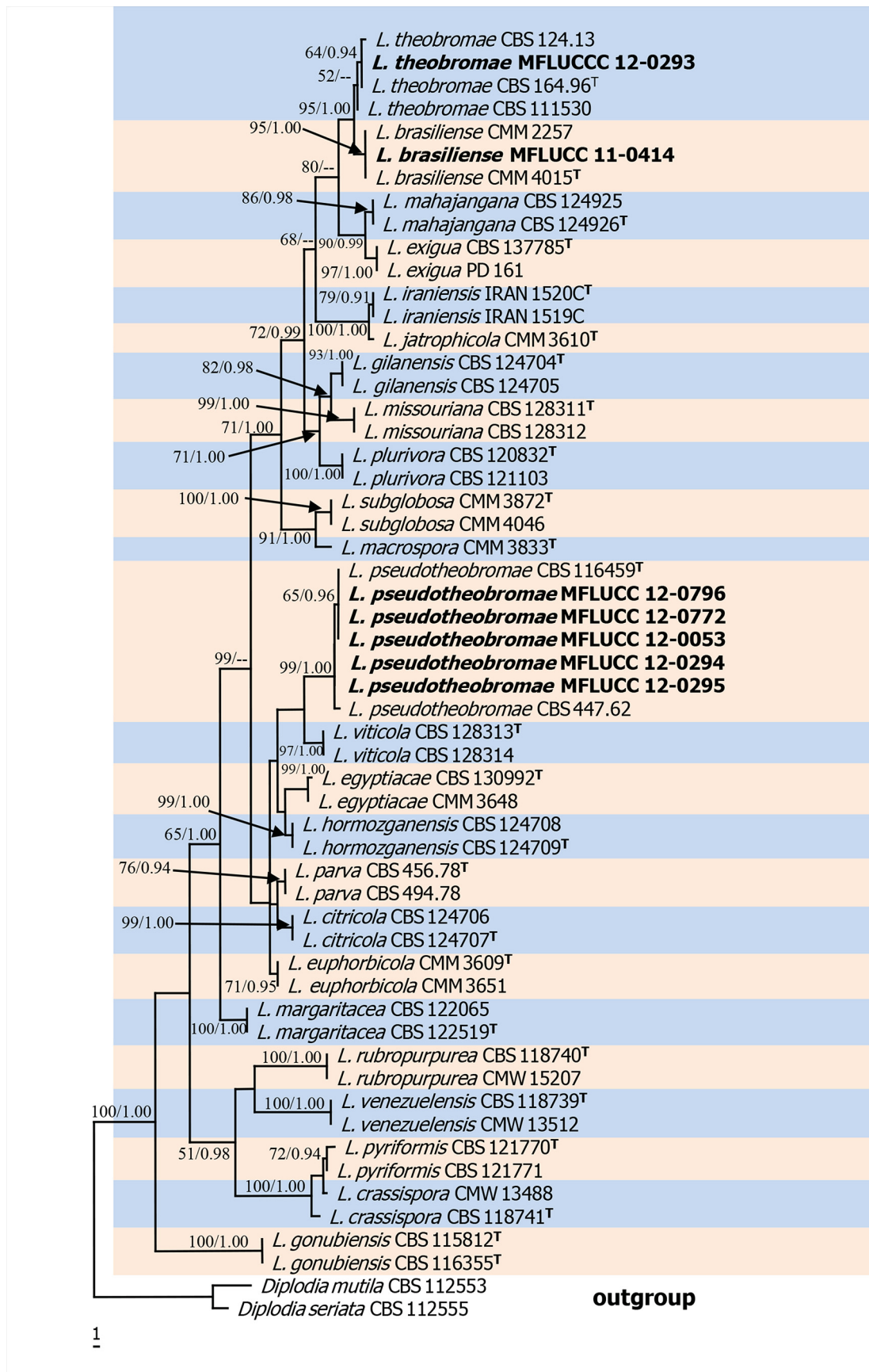

FIGURE 2. One of 48 most parsimonious trees (CI= 0.674, HI= 0.326, RI= 0.881, RC= 0.594) resulting from a combined ITS, TEF1- α and BT analysis for 56 taxa in *Lasiodiplodia* species. The tree is rooted to isolates of *Diplodia mutila* and *D. seriata*. Maximum parsimony bootstrap values $\geq 50\%$, Bayesian posterior probabilities ≥ 0.90 (MPBS/PP) are given at the nodes. Type isolates are marked with ^T. Isolates from this study are in bold.

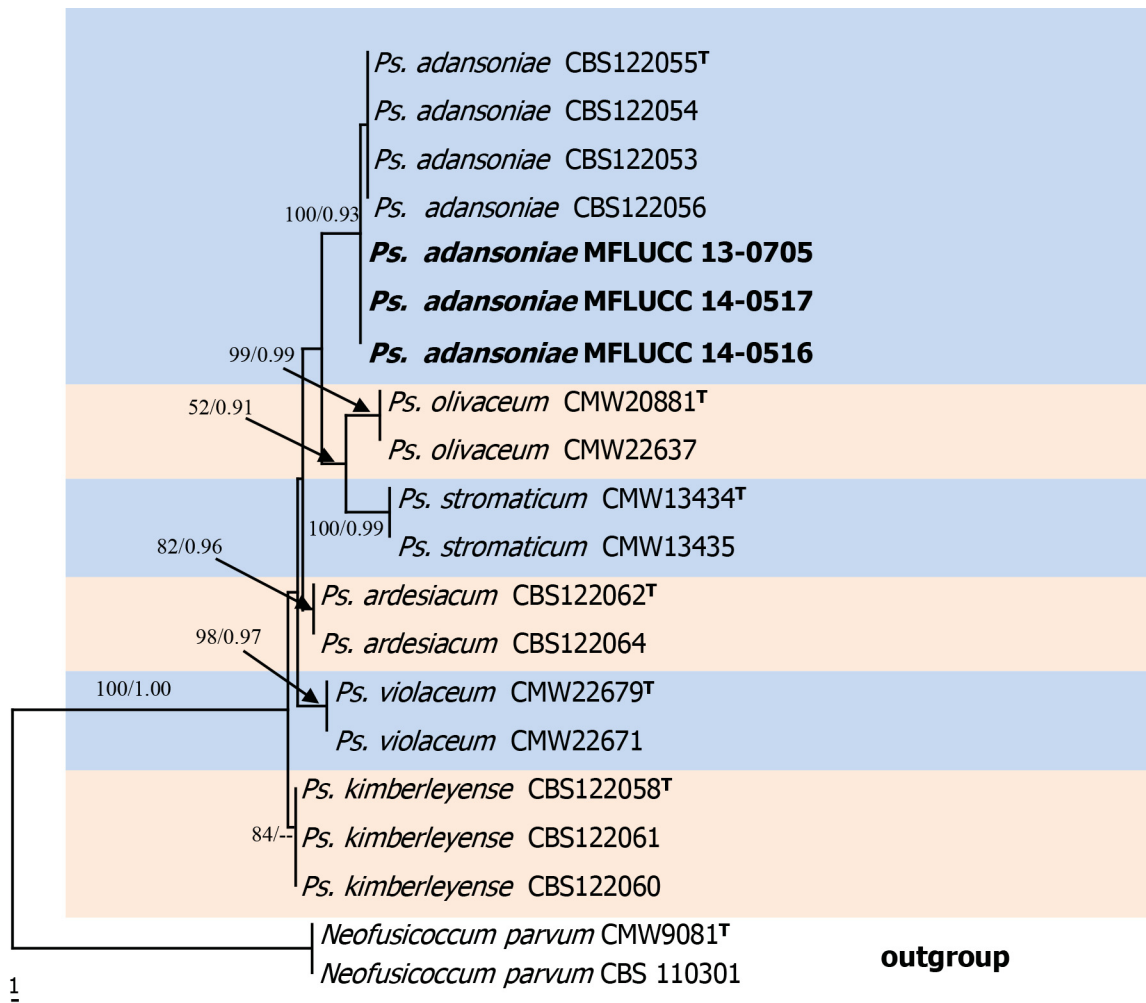

FIGURE 3. One of 12 most parsimonious trees (CI= 0.909, HI= 0.091, RI= 0.943, RC= 0.857) resulting from combined ITS and TEF1- α analysis for 20 taxa in *Pseudofusicoccum* species. The tree is rooted to two isolates of *Neofusicoccum parvum*. Maximum parsimony bootstrap values $\geq 50\%$, Bayesian posterior probabilities ≥ 0.90 (MPBS/PP) are given at the nodes. Type isolates are marked with ^T. Isolates from this study are in bold.

Sphaeropsis group: Isolate MFLUCC 13-0701 grouped with *Sp. eucalypticola* (ex-type culture) in the individual ITS, TEF1- α and BT phylogenies (MPBS: ITS = 86%, TEF1- α = 100%, BT = 98%, PP: ITS = 0.99, TEF1- α = 1.00, BT = 0.99) (tree not shown), and also grouped with *Sp. eucalypticola* (MFLUCC11-0654 and MFLUCC11-0579) in the combined phylogeny with MPBS (100%) and PP (1.00) and is therefore considered to be *Sp. eucalypticola* (Figure 4). Individual gene trees of MP and BI trees for ITS, TEF1- α and BT analysis was similar in topology to trees generated from combined analyses and is not shown. The BI tree of combined analyses was similar in topology and clades to the MP tree.

Several studies have confirmed that single gene regions are insufficient to delimit cryptic species in genera of Botryosphaeriaceae (de Wet *et al.* 2003, Slippers *et al.* 2004a, b). The combined gene analyses are required to resolve species boundaries in the genera (Alves *et al.* 2008, Abdollahzadeh *et al.* 2010). Therefore, our final phylogenetic analyses are based on the combination of multi-locus phylogenies (ITS, TEF1- α , and/or β -tubulin). These result identified six species from four different genera (*Dothiorella tectonae* sp. nov., *Lasiodiplodia brasiliense*, *L. pseudotheobromae*, *L. theobromae*, *Pseudofusicoccum adansoniae* and *Sphaeropsis eucalypticola*) of Botryosphaeriaceae associated with *T. grandis* in four provinces in northern Thailand (Figures 1–4).

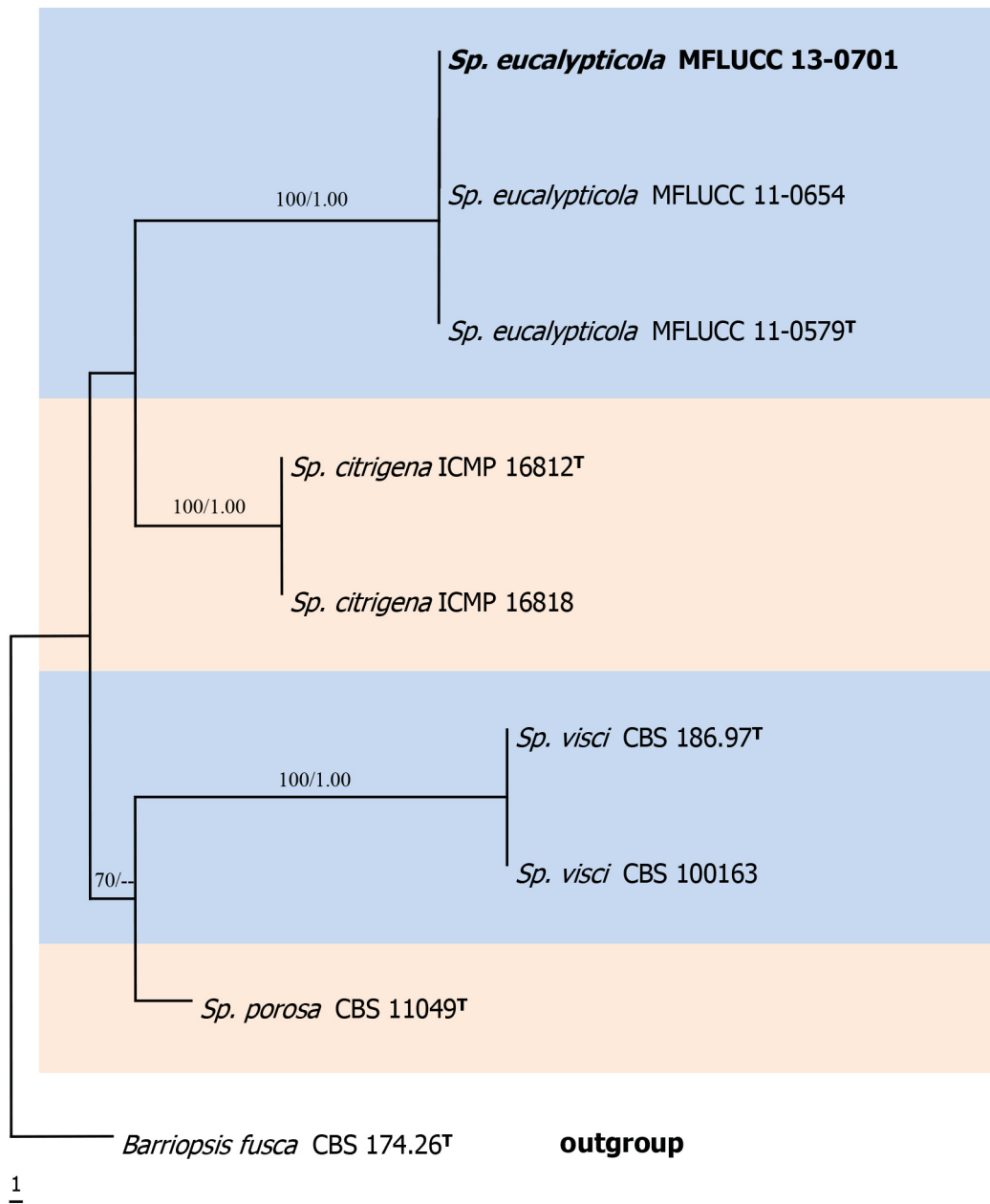

FIGURE 4. One of 4 most parsimonious trees (CI= 0.912, HI= 0.088, RI= 0.927, RC= 0.845) resulting from combined ITS, TEF1- α and BT analysis for nine taxa in *Sphaeropsis* species. The tree is rooted to *Barriopsis fusca*. Maximum parsimony bootstrap values $\geq 70\%$, Bayesian posterior probabilities ≥ 0.90 are given at the nodes (MPBS/PP). Type isolates are marked with ^T. Isolates from this study are in bold.

TABLE 2. Alignment length, parsimony analyses output and nucleotide substitution models used in the phylogenetic analyses.

Genus	Dataset	Number of ingroup taxa	Characters included with gaps (bp)	Number. of informative sites	Number of most parsimonious trees	Tree length	Nucleotide substitution models for Bayesian analysis (calculated with MrModeltest)
<i>Dothiorella</i>	ITS	38	477	59	1000	135	HKY+I+G
	TEF1- α	37	305	1000	1000	296	GTR+G
	BT	27	404	51	24	80	GTR+I
	Combined	38	1186	240	63	517	Models from individual gene partition
<i>Lasiodiplodia</i>	ITS*	54	483	38	154	64	GTR+I
	TEF1- α *	54	293	95	52	202	HKY+G
	BT*	46	409	44	1000	65	GTR+G
	Combined	54	1185	177	48	356	Models from individual gene partition
<i>Pseudofusicoccum</i>	ITS*	18	523	56	9	67	SYM+I+G
	TEF1- α *	18	312	82	34	97	HKY+I+G
	Combined	18	835	138	12	165	Models from individual gene partition
<i>Sphaeropsis</i>	ITS*	8	472	12	17	13	K80
	TEF1- α *	8	317	48	2	64	HKY+G
	BT*	8	379	19	1	24	HKY+G
	Combined	8	1168	79	4	102	Models from individual gene partition

* Phylogenetic trees not shown.

TABLE 3. Polymorphic nucleotides in the ITS, TEF1- α and BT for isolates of *Dothiorella tectonae*, *Do. brevicollis*, *Do. longicollis*, *Do. striata* and *Do. uruguayensis*.

Species	Isolate	ITS																												TEF1- α						
		99	100	101	102	103	105	106	121	122	125	148	162	318	333	363	372	373	444	448	469	471	474	475	478	479	480	25	26	27	30	31	33	34	35	
<i>Do. tectonae</i>	MFLUCC 12-0381	C	C	G	C	T	C	G	G	C	C	T	A	C	T	T	T	G	C	C	C	T	G	A	T	A	T	A	A	A	A	C	T	-	T	
<i>Do. brevicollis</i>	CMW 36463	•	•	•	•	C	A	•	A	•	•	•	-	T	•	•	C	C	•	G	•	•	•	•	•	C	•	-	•	•	•	T	T	•	C	C
	CMW 36464	•	•	•	•	C	A	•	A	•	•	•	-	T	•	•	C	C	•	G	•	•	•	•	•	C	•	-	•	•	•	T	T	•	C	C
<i>Do. longicollis</i>	CBS 122068	•	T	•	•	C	A	•	A	•	•	•	-	T	•	•	C	C	•	G	A	C	T	G	C	•	-	•	•	G	T	T	•	C	C	
	CBS 122067	•	T	•	•	C	A	•	A	•	•	•	-	T	•	•	C	C	•	G	A	C	T	G	C	•	-	•	•	G	T	T	•	C	C	
<i>Do. striata</i>	ICMP 16819	T	-	-	G	C	T	A	A	A	•	G	•	T	A	C	•	•	T	T	•	•	•	•	•	•	-	C	T	G	T	T	C	C	C	
	ICMP 16824	T	-	-	G	C	T	A	A	A	•	G	•	T	A	C	•	•	T	T	•	•	•	•	•	•	-	C	T	G	T	T	C	C	C	
<i>Do. uruguayensis</i>	UY672	T	-	-	G	C	T	A	A	A	T	•	•	T	•	•	•	•	•	•	•	•	•	•	•	•	-	C	G	•	T	T	C	C	C	

Species	Isolate	TEF1- α																																				
		36	37	38	39	40	41	44	47	50	53	54	57	60	61	63	64	65	66	74	76	83	84	86	88	89	132	134	135	156	159	174	177	178	179	180		
<i>Do. tectonae</i>	MFLUCC 12-0381	T	A	T	T	C	C	C	C	T	C	T	C	A	C	C	T	C	T	C	C	A	T	G	T	A	T	T	-	A	A	A	T	T	C	T	T	T
<i>Do. brevicollis</i>	CMW 36463	•	G	C	•	•	•	•	T	•	T	G	T	T	C	•	•	•	•	G	•	•	•	•	•	•	•	-	•	T	•	•	T	•	C	•	•	
	CMW 36464	•	G	C	•	•	•	•	T	•	T	G	T	T	C	•	•	•	•	G	•	•	•	•	•	•	•	-	•	T	•	•	T	•	C	•	•	
<i>Do. longicollis</i>	CBS 122068	•	•	C	•	•	•	T	T	•	T	G	T	T	C	•	•	•	•	T	•	•	•	•	•	•	•	-	•	T	•	•	T	•	C	•	•	
	CBS 122067	•	•	C	•	•	•	T	T	•	T	G	T	T	C	•	•	•	•	T	•	•	•	•	•	•	•	-	•	T	•	•	T	•	C	•	•	
<i>Do. striata</i>	ICMP 16819	G	C	•	C	T	T	•	•	•	G	T	•	C	•	C	T	T	•	•	A	A	•	-	-	-	G	C	•	C	•	•	C	•	C	•	C	
	ICMP 16824	G	C	•	C	T	T	•	•	•	G	T	•	C	•	C	T	T	•	•	A	A	•	-	-	-	G	C	•	C	•	•	C	•	C	•	C	
<i>Do. uruguayensis</i>	UY672	G	T	C	C	T	T	•	•	C	•	G	T	T	C	T	•	T	•	•	A	A	G	-	-	A	G	C	•	C	A	•	C	•	A	•	A	

Species	Isolate	TEF1- α																																	
		192	193	194	201	202	203	206	208	209	210	212	213	215	217	218	221	227	228	229	230	231	232	233	235	243	246	247	248	252	266	267	287		
<i>Do. tectonae</i>	MFLUCC 12-0381	C	A	A	T	-	-	G	A	T	G	C	C	T	G	C	A	T	A	T	C	A	T	G	A	A	T	C	C	T	A	T	C		
<i>Do. brevicollis</i>	CMW 36463	T	C	T	A	-	-	•	•	•	•	•	•	•	A	•	A	•	C	A	C	•	•	G	•	A	T	•	C	•	•	T			
	CMW 36464	T	C	T	A	-	-	•	•	•	•	•	•	•	A	•	A	•	C	A	C	•	•	G	•	A	T	•	C	•	•	T			
<i>Do. longicollis</i>	CBS 122068	T	C	T	C	-	-	A	•	•	•	•	•	•	A	•	A	•	C	A	C	•	•	G	•	A	T	•	C	•	•				
	CBS 122067	T	C	T	C	-	-	A	•	•	•	•	•	•	A	•	A	•	C	A	C	•	•	G	•	A	T	•	C	•	•				
<i>Do. striata</i>	ICMP 16819	T	C	•	A	-	-	G	C	T	•	G	C	C	T	C	A	G	•	-	-	C	A	G	G	A	•	•	•	T	C	T			
	ICMP 16824	T	C	•	A	-	-	G	C	T	•	G	C	C	T	C	A	G	•	-	-	C	A	G	G	A	•	•	•	T	C	T			
<i>Do. uruguayensis</i>	UY672	T	C	•	A	A	C	•	G	C	T	T	G	C	C	T	C	A	G	•	-	-	C	A	G	G	A	•	A	•	•	C	•		

Isolate in yellow highlight is newly taxon.

Taxonomy

Dothiorella tectonae Doilom, L.A. Shuttleworth, & K.D. Hyde, *sp. nov.*

Index Fungorum number: IF550706, *Facesoffungi number:* FoF00165 (Figure 5).

Etymology:—Species name refers to the host genus *Tectona*, from which the fungus was first collected.

Saprobic on dead branch of *Tectona grandis*. Sexual morph: Undetermined. Asexual morph: *Conidiomata* (225–) 365–400 (–490) μm high \times (170–) 270–300 (–325) μm diam. (\bar{X} = 355 \times 260 μm n = 10), pycnidial, black, initially immersed, becoming erumpent through bark fissures, solitary to gregarious, uniloculate, subglobose, papillate. *Papilla* up to 70 μm long, 50–60 μm diam., ostiole central, periphysate. *Conidiomata wall* 30–105 μm thick at sides, up to 100 μm thick at base, outer layers thickened and dark, inner layer dark brown to hyaline, composed of several layers of cells of *textura angularis*. *Conidiogenous cells* (6–) 10–12 (–15) \times (3.5–) 6–6.5 (–7.5) μm (\bar{X} = 10.5 \times 6 μm n = 20), holoblastic, discrete, hyaline, obovoid to ellipsoidal, smooth-walled. *Conidia* on host (16–) 21–22 (–24) \times (7.5–) 10–11 (–13) μm (\bar{X} \pm S.D. = 21 \pm 1.9 \times 10 \pm 1.2 μm , n = 50), initially hyaline and aseptate, becoming light brown to dark brown and aseptate, or 1–septate while still attached to conidiogenous cells, 1–septate at maturity, slightly constricted at the septum, oblong to ellipsoidal, ends rounded, bases obtuse, with short raised irregular striations on the surface, thick-walled, with granular content. *Spermatogenous cells* discrete, hyaline, smooth-walled, cylindrical, holoblastic. *Spermatia* 2.5–4 \times 1–2 μm hyaline, aseptate, smooth, rod-shaped, with rounded ends.

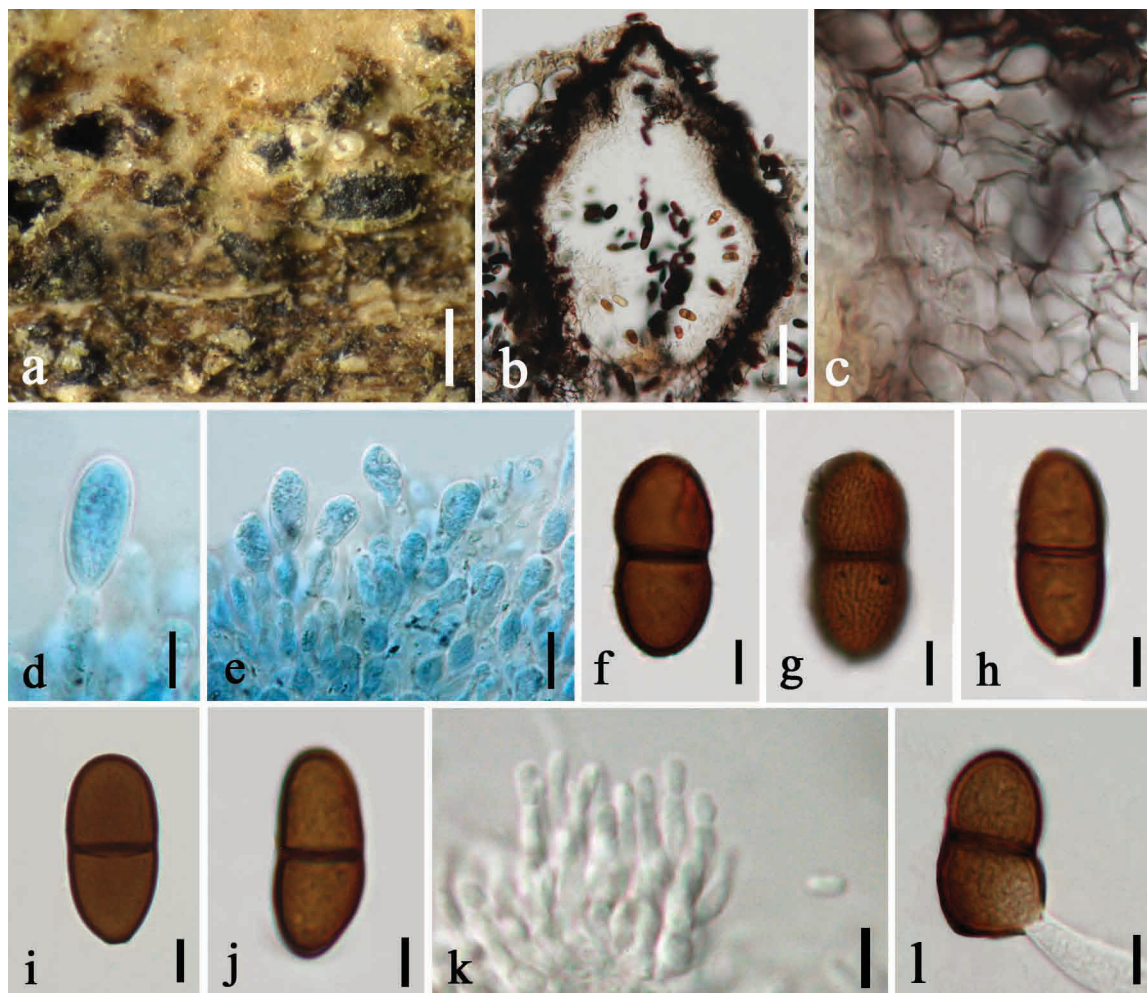

FIGURE 5. *Dothiorella tectonae* (MFLU 14-0272, holotype) **a.** Conidiomata on dead branch of *T. grandis*. **b.** Section through conidioma with conidia becoming dark and aseptate or 1–septate while still attached to conidiogenous cells. **c.** Conidioma wall. **d–e.** Conidia attached to conidiogenous cells. **f–j.** Mature conidia (arrow showing short raised irregular striations on conidia surface). **k.** Spermatogenous cells and spermatia. **l.** Germinated mature conidium. Note **d, e.** stained with lactophenol cotton blue. Scale bars: **a**=300 μm . **b**=50 μm . **c, e**=10 μm . **d, f–l**=5 μm .

Culture characteristics:—Conidia germinating on PDA after 16 h. Germ tubes produced from both ends of conidia or produced laterally in some conidia. Colonies on MEA reaching 45 mm diam after 2 days in the dark at 25 °C, flattened or effuse, undulate, initially white, after 2 days becoming brownish grey (8F2) in the centre, white at edge, reaching the edge of the Petri-dish after 4 days. Cardinal temperatures for growth after four days: optimum 25–30°C, 1 mm at 5°C, 5 mm at 15°C, 8 mm at 25°C, 7 mm at 30°C.

Material examined:—THAILAND, Phayao Province, Muang District, on dead branch of *Tectona grandis* (Lamiaceae), 12 March 2012, M. Doilom (MFLU 14-0272, **holotype**), ex-type culture, MFLUCC 12-0382, MUCL 55409.

Notes:—*Dothiorella tectonae* is introduced here as a novel species based on its morphological and phylogenetic differences from known *Dothiorella* species. *Do. tectonae* differs from *Do. brevicollis* and *Do. longicollis* in having short raised irregular striations on the surfaces of mature conidia. Conidia of *Do. tectonae* are shorter and narrower than *Do. brevicollis*, but longer and wider than those of *Do. longicollis* (Table 4). Short raised irregular striations can also be found on conidia of *Do. thailandica*, however, mature conidia of *Do. tectonae* are longer and wider than those of *Do. thailandica*. *Dothiorella tectonae* has papillate conidiomata while *Do. thailandica* conidiomata are non-papillate (Table 4).

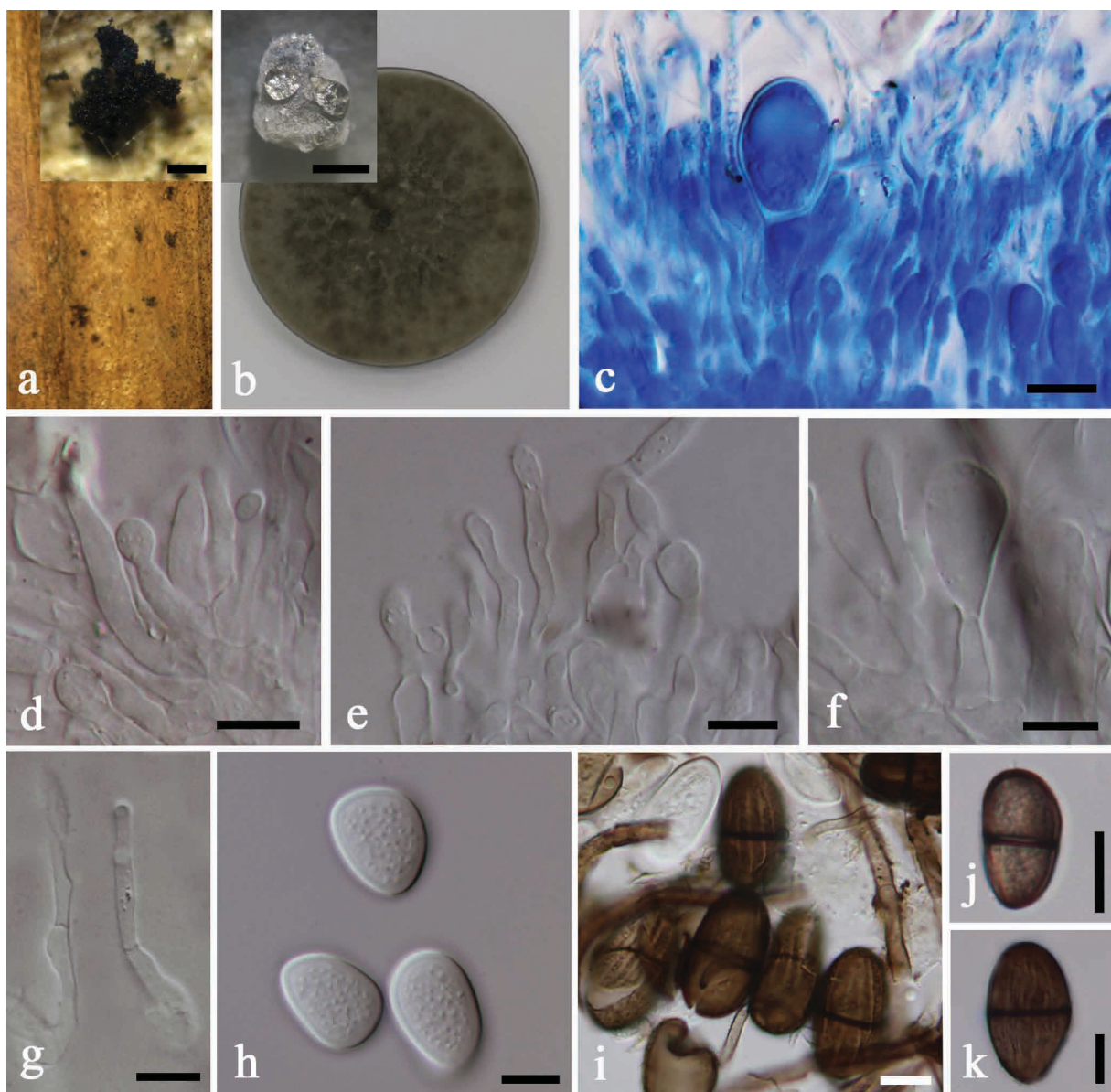

FIGURE 6. *Lasiodiplodia brasiliense* (MFLUCC 11-0414) **a.** Conidia formed on dead branches of *Tectona grandis* after incubation in a moist chamber for 10 days. **b.** Colony on MEA after 1 week, and inset a conidioma on the agar surface after 1 month. **c.** Immature conidia attached to conidiogenous cells with paraphyses. **d-f.** Immature conidia attached to conidiogenous cells. **g.** Paraphyses. **h.** Immature conidia. **i-k.** Mature conidia. Note: **c** stained with lactophenol cotton blue. **c-i, k.** Morphology in culture. **j** morphology on host. Scale bars: **a**=100 µm. **b**=300 µm. **c-k**=10 µm.

Lasiodiplodia brasiliense M.S.B. Netto *et al.* in Netto *et al.*, Fungal Diversity 67: 134 (2014)

Facesoffungi number: FoF 00628 (Figure 6).

Saprobic on dead branch of *Tectona grandis*. Sexual morph: Undetermined. Asexual morph: *Conidiomata* pycnidial formed on MEA after 1 month, dark brown, erumpent. *Paraphyses* up to 60 μm long, 1.5–5.5 μm wide, hyaline, septate, cylindrical, ends rounded, numerous. *Conidiogenous cells* 6–15 \times 1.5–6 μm (\bar{X} = 10 \times 3.5 μm n = 20), holoblastic, hyaline, cylindrical. *Conidia* on host (22–) 26–27 (–29) \times 12–16 μm (\bar{X} \pm S.D. = 26 \pm 1.6 \times 14 \pm 1 μm n = 30), in culture (19–) 25–27 (–28) \times 12–17 μm (\bar{X} \pm S.D. = 25 \pm 2 \times 15 \pm 1 μm n = 30), initially hyaline and aseptate, becoming 1-septate, dark brown, thick-walled, ellipsoid to obovoid, guttulate, apex broadly rounded, base truncate or round, with longitudinal striations from apex to base.

Culture characteristics:—Conidia germinating on PDA after 5 h. Germ tubes produced from both ends of conidia. Colonies on MEA reaching 50 mm diameter after 1 day in the dark at 25 °C, fast growing, raised, fluffy, undulate, dense, filamentous, convex with papillate surface, initially white, after 2 days becoming pale grey and becoming dark grey (1F1) after 1 week, reaching the edge of the Petri-dish after 2 days.

Material examined:—THAILAND, Chiang Rai Province, Mae Fah Luang District, on dead branches of *Tectona grandis*, 4 May 2011, M. Doilom (living culture MFLUCC11-0414, MUCL 55406).

Notes:—*Lasiodiplodia brasiliense* collected in this study differs from the type species in having septate paraphyses, although this may have been overlooked in the type (Netto *et al.* 2014). They also differ in hosts. In this study *L. brasiliense* was collected from *T. grandis*, while the type was collected from *Mangifera indica*. Our collection from *Tectona grandis* is illustrated and described here to facilitate identification from this host.

Lasiodiplodia pseudotheobromae A.J.L. Phillips *et al.*, Fungal Diversity 28: 8 (2008)

Facesoffungi number: FoF00166 (Figure 7).

Associated with trunk canker and branch dieback symptoms, and from dead twigs and branches of *Tectona grandis*. Sexual morph: Undetermined. Asexual morph: *Conidiomata* (330–) 360–385 (–450) μm high \times 230–295 μm diam. (\bar{X} = 370 \times 265 μm n = 10), pycnidial, solitary or scattered, dark brown to black, initially immersed, becoming erumpent, uniloculate, globose or subglobose, with a central ostiole. *Conidiomata wall* 30–50 μm wide, outer layers dark brown to black, inner layers thin-walled, pale brown to hyaline, composed of 4–6 cell layers of *textura angularis*. *Paraphyses* up to 50 μm long, 1.5–3 μm wide, hyaline, mostly aseptate, cylindrical, ends rounded, numerous. *Conidiogenous cells* 6–12 \times 3–4 μm (\bar{X} = 8 \times 3 μm n = 15), holoblastic, hyaline, cylindrical. *Conidia* on host (22–) 27–28.5 (–33) \times 13–15 μm (\bar{X} \pm S.D. = 27 \pm 2.7 \times 14 \pm 0.5 μm n = 20), initially hyaline and aseptate, becoming 1-septate at the centre, dark brown, thick-walled, ellipsoid to obovoid, guttulate, apex broadly rounded, base truncate or rounded, with longitudinal striations from apex to base.

Culture characteristics:—Conidia germinating on PDA after 5 h. Germ tubes produced from both lateral ends of the ascospore. Colonies on MEA reaching 40 mm diam after 1 day in the dark at 25 °C, cotton-like, fast growing, raised, fluffy, undulate, dense, filamentous, initially white, after 1 week becoming grey (4F1) at the edge, white in the centre, reaching the edge of the Petri-dish after 2 days.

Material examined:—THAILAND, Phayao Province, Chun District, Hong Hin Sub-district, on twigs of *T. grandis* with dieback symptoms, 23 November 2012, M. Doilom and J. Roux (living culture MFLUCC 12-0772, MUCL 55410); Phayao Province, Muang District, on dead branch of *T. grandis*, 12 March 2012, Phongseun Sysouphanthong, (living culture MFLUCC 12-0294); Phayao Province, Muang District, on dead branch of *T. grandis*, 12 March 2012, M. Doilom (living culture MFLUCC12-0295); Chiang Rai Province, Muang District, San Sai Sub-district, Pong Sa Lee Arboretum, from basal trunk canker symptoms of *T. grandis*, 2 December 2012, M. Doilom and K. Jatuwong (living culture MFLUCC 12-0796, MUCL 55411); Phrae Province, Song District, Ban Rainadeaw Sub-district, on dead twig of *T. grandis*, 30 December 2011, M. Doilom (MFLU 14-0270, living culture MFLUCC 12-0053, MUCL 55407).

Notes:—Conidia and paraphyses of *L. pseudotheobromae* (MFLU 14-0270) were shorter and smaller than in the holotype. The variation may be related to different hosts. The type was collected from *Gmelina arborea*. Our collection of *Lasiodiplodia pseudotheobromae* on *Tectona grandis* is illustrated and described here to amend the previous descriptions of *L. pseudotheobromae*.

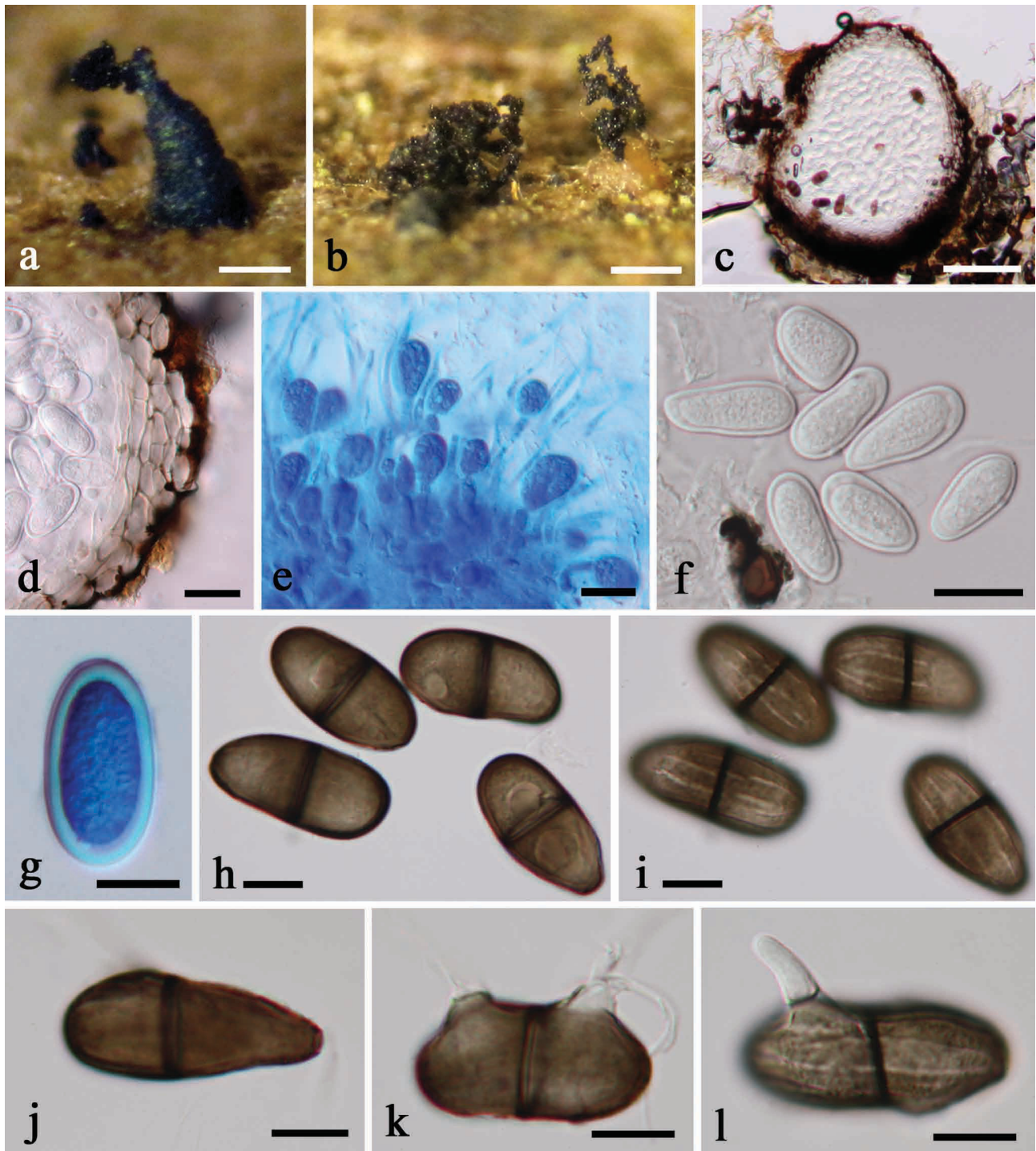

FIGURE 7. *Lasiodiplodia pseudotheobromae* (MFLU 14-0270) **a, b.** Conidiomata and conidia on surface of dead twig of *Tectona grandis*. **c.** Section through conidioma. **d.** Conidioma wall. **e.** Conidia attached to conidiogenous cells with paraphyses. **f, g.** Immature conidia. **h–j.** Mature conidia in two different focal planes showing longitudinal striations. **k, l.** Germinated mature conidia. Note **e, g** stained with lacto-phenol cotton blue. Scale bars: **a**=300 μm . **b**=200 μm . **c**=100 μm . **d, f**=20 μm . **e, g–l**=10 μm .

Pseudofusicoccum adansoniae Pavlic *et al.*, Mycologia 100(6): 855 (2008)

Facesoffungi number: FoF00168 (Figure 8).

Associated with leaf spots of *Tectona grandis*. Sexual morph: Undetermined. Asexual morph; *Conidiomata* (60–) 100–115 (–145) μm high \times (85–) 115–125 (–145) μm diam. (\bar{X} = 100 \times 115 μm n = 10), pycnidial, black, solitary or scattered, immersed to semi-immersed, globose to subglobose, uniloculate, with a central ostiole. *Ostiole* periphysate,

necks 30–40 μm long, 25–45 μm diam. *Conidiomata* wall 15–30 μm wide, outer layers dark brown to black, inner layers thin-walled, pale brown to hyaline, composed of 4–6 cell layers of *textura angularis*. *Paraphyses* not observed. *Conidiogenous cells* (6–) 10.5–15.5 (–18) \times (3.5–) 5–6 (–8) μm (\bar{X} = 11.5 \times 5.3 μm n = 15), holoblastic, cylindrical to ellipsoidal, hyaline, smooth-walled. *Conidia* (20–) 27.5–29.5 (–39) \times 6–10 μm (\bar{X} \pm S.D. = 28 \pm 4 \times 8 \pm 1.0 μm n = 40), fusiform to ellipsoidal, hyaline, aseptate, slightly bent or irregularly shaped, smooth-walled, with fine granular content, apex broadly rounded, base rounded to truncate, covered with a persistent mucus layer.

Culture characteristics:—Conidia germinating on PDA after 24 h. Germ tubes produced from the ends of the conidia. Colonies on MEA reaching 45 mm diameter after 2 days at the dark at 25 °C, initially whitened, after 3 days become greenish-grey (26F2) at the centre, white at the edge, fast growing, raise, fluffy, dense, filamentous, undulate, convex with papillate surface, reaching the edge the Petri-dish after 4 days.

Material examined:—THAILAND, Chiang Rai Province, Muang District, associated with leaf spot of *Tectona grandis*, 17 July 2013. M. Doilom (living culture MFLUCC 13-0705, MUCL 55413, MFLUCC 14-0516 and MFLUCC14-0517).

Notes:—Conidia of *P. adansoniae* collected in the current study are longer and wider (28 \times 8 μm versus 22.5 \times 5.2 μm), than those reported by Pavlic *et al.* (2008) for the type. This may be due to difference substrates and lifestyle as isolates in current study were associated with leaf spots and observed directly on the host, while those from the type were isolated from asymptomatic twigs on *Adansonia gregorii* (Pavlic *et al.* 2008) with characters observed in culture on pine needles.

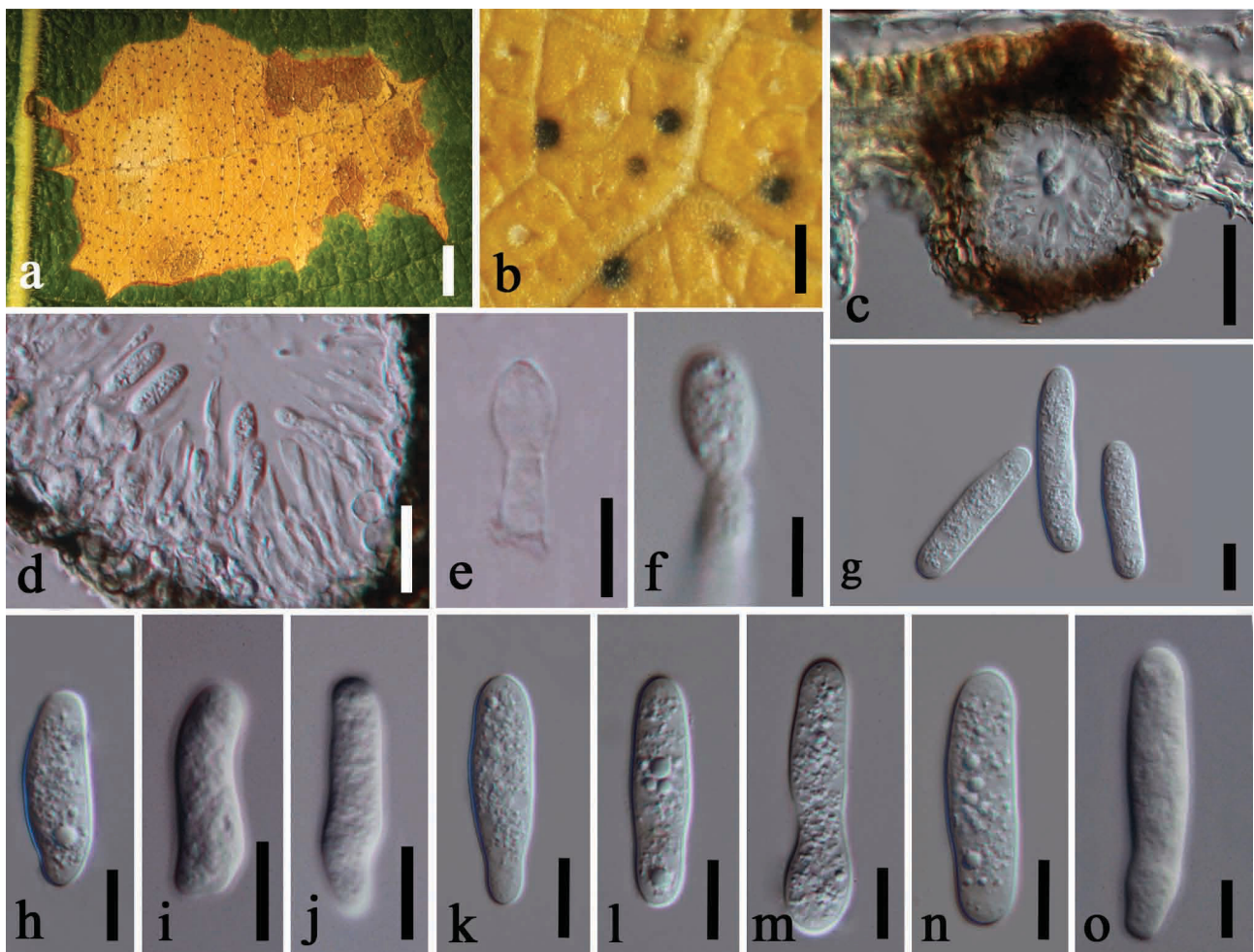

FIGURE 8. *Pseudofusicoccum adansoniae* (MFLU 15-0731) **a, b.** Leaf spot on *T. grandis* with associated conidiomata. **c.** Section through conidioma. **d–f.** Conidia attached to conidiogenous cells. **g–o.** Conidia. Scale bars: **a**=1000 μm . **b**=300 μm . **c**=30 μm . **d**=20 μm . **e, g–o**=10 μm . **f**=5 μm .

TABLE 4. Comparison of morphological characters of *Do. tectonae* and its sister taxa *Do. brevicollis*, *Do. longicollis*, *Do. striata*, *Do. thailandica* and *Do. uruguayensis*. Measurements for *Do. tectonae* are given as minimum and maximum values in parentheses, with second and third quartiles, then the average and sample number e.g. length (min-) Q2- Q3 (-max) x width (min-) Q2- Q3 (-max), av., n. All measurements are in μm , except conidiomata neck measurement is in both mm and μm .

Species	Conidiomata	Conidiomata neck	Conidia	Surface of mature conidia	Host	Reference
<i>Dothiorella tectonae</i>	Papillate	Short neck, up to 0.07 mm (70 μm high)	(16-) 21-22 (-24) \times (7.5-) 10-11 (-13) μm (av. = 21 \times 10 μm , n = 50)	Striate	<i>Tectona grandis</i>	This study
<i>Do. brevicollis</i>	Papillate	Short neck (length not reported)	(20-) 21.5-26 (-27) \times (8-) 9-12 (-13) μm . (av. and n = not reported)	Smooth	<i>Acacia karroo</i>	Jami <i>et al.</i> (2012), conidiomata mentioned in Philips <i>et al.</i> (2013)
<i>Do. longicollis</i>	Papillate	Long neck (sometimes branching), up to 1.5 mm long	(17-) 19-22 (-23) \times (7-) 8-9.5 (-10.5) μm (av. = 20.4 \times 8.7 μm , n = 50)	Not reported	<i>Lysiphylum cunninghamii</i> (Caesalpinaceae) and <i>Terminalia</i> sp. (Combretaceae).	Pavlic <i>et al.</i> (2008), conidiomata mentioned in Philips <i>et al.</i> (2013) and Abdollahzadeh <i>et al.</i> (2014)
<i>Do. striata</i>	Papillate	Short necks (< 0.5 mm)	(21-) 23-26 (-29.4) \times (8.9-) 9-12 (-15.1) (av. = 25.1 \times 10.7 n = 50)	Striate	<i>Citrus sinensis</i>	Abdollahzadeh <i>et al.</i> (2014)
<i>Do. thailandica</i>	Non-papillate	Not reported	15-20 \times 6.5-8 μm (av. = 18.5 \times 7 μm ; n = 20)	Striate	Bamboo culm	Liu <i>et al.</i> (2012), conidiomata mentioned in Philips <i>et al.</i> (2013)
<i>Do. uruguayensis</i>	Non-papillate	Not reported	(17-) 22-22.5 (-26.5) \times (7-) 9-9.5 (-12) (av. and n = not reported)	Not reported	<i>Hexalaminis edulis</i>	Pérez <i>et al.</i> (2010)

Conclusions

This was a preliminary study of Botryosphaeriaceae species from *T. grandis*, but is the most detailed to date for this host. Six species from four different genera of Botryosphaeriaceae were found, namely *Dothiorella tectonae* sp. nov., *Lasiodiplodia brasiliense*, *L. pseudotheobromae*, *L. theobromae*, *Pseudofusicoccum adansoniae* and *Sphaeropsis eucalypticola*. All taxa are first reports on *T. grandis* in Thailand. *Lasiodiplodia pseudotheobromae* associated with trunk cankers and dieback and *Pseudofusicoccum adansoniae* with leaf spots. Amendments in the previous descriptions of *Lasiodiplodia brasiliense*, *L. pseudotheobromae* and *P. adansoniae* were provided as isolates from *T. grandis* varied slightly in morphological characters from the type descriptions. More detailed investigations will most likely lead to the discovery of additional species from *T. grandis* on teak in Thailand.

Acknowledgements

This work was financially supported by the Thailand Research Fund through the Royal Golden Jubilee Ph.D. Program grant (No. Ph.D./0072/2553 in 4.S.M.F./53/A.2), Mae Fah Luang University grant for studying Dothideomycetes (No. 56101020032), the Tree Pathology Co-operative Programme (TPCP), Forestry and Agricultural Biotechnology Institute, University of Pretoria, and the National Research Foundation (NRF) of South Africa for funding to undertake the molecular work.

References

- Areeya, M. (1992) *Trading teak in Kingdom of Lanna during the reign of King Chulalongkorn the Great or Rama V (BE 2411-2453)*. M.Sc. Thesis. (History). Srinakharinwirot University, Prasan Mit campus. The Central Library: มรกต อารีเยะ. (2535) การค้าไม้สักในดินแดนล้านนา ในรัชสมัยพระบาทสมเด็จพระจุลจอมเกล้าเจ้าอยู่หัว (พ.ศ. 2411-2453). กรุงเทพฯ: มหาวิทยาลัยศรีนครินทรวิโรฒ ประสานมิตร. [in Thai]
- Abdollahzadeh, J., Javadi, A., Mohammadi, G.E., Zare, R. & Phillips, A.J.L. (2010) Phylogeny and morphology of four new species of *Lasiodiplodia* from Iran. *Persoonia* 25: 1–10.
<http://dx.doi.org/10.3767/003158510X524150>
- Abdollahzadeh, J., Javadi, A., Zare, R. & Phillips, A.J.L. (2014) A phylogenetic study of *Dothiorella* and *Spencermartinsia* species associated with woody plants in Iran, New Zealand, Portugal and Spain. *Persoonia* 32: 1–12.
<http://dx.doi.org/10.3767/003158514X678606>
- Akrof, A.Y., Amoako-Atta, I., Assuah, M. & Kumi-Asare, E. (2014) Pink Disease Caused by *Erythricium salmonicolor* (Berk. and Broome) Burdall: An Epidemiological Assessment of its Potential Effect on Cocoa Production in Ghana. *Journal Plant Pathology Microbiology* 5: 215.
<http://dx.doi.org/10.4172/2157-7471.1000215>
- Alves, A., Crous, P.W., Correia, A. & Phillips, A.J.L. (2008) Morphological and molecular data reveal cryptic speciation in *Lasiodiplodia theobromae*. *Fungal Diversity* 28: 1–13. Available from: <http://www.fungalbiodiversitycentre.com/images/ResearchGroups/Phytopathology/pdf/Aves%20etal%202008.pdf> (accessed 1 October 2015)
- Burgess, T.I., Gordon, T.R., Wingfield, M.J. & Wingfield, B.D. (2004) Geographic isolation of *Diplodia scrobiculata* and its association with native *Pinus radiata*. *Mycological Research* 108: 1399–1406.
<http://dx.doi.org/10.1017/S0953756204001443>
- Cabral, P.G.C., Capucho, A.S., Pereira, O.L., Maciel-Zambolim, E., Freitas, R.L. & Zambolim, L. (2010) First report of teak leaf rust disease caused by *Olivea tectonae* in Brazil. *Australasian Plant Disease Notes* 5: 113–114.
<http://dx.doi.org/10.1071/DN10041>
- Chareprasert, S., Piapukiew, J., Thienhirun, S., Whalley, A.J.S. & Sihanonth, P. (2006) Endophytic fungi of teak leaves *Tectona grandis* L. and rain tree leaves *Samanea saman* Merr. *World Journal of Microbiology and Biotechnology* 22: 481–486.
<http://dx.doi.org/10.1007/s11274-005-9060-x>
- Chomnunti, P., Hongsanan, S., Aguirre-Hudson, B., Tian, Q., Peršoh, D., Dhami, M.K., Alias, A.S., Xu, J., Liu, X., Stadler, M. & Hyde, K.D. (2014) The sooty moulds. *Fungal Diversity* 66 (1): 1–36.
<http://dx.doi.org/10.1007/s13225-014-0278-5>
- Crous, P.W., Denman, S., Taylor, J.E., Swart, L. & Palm, M.E. (2004) Cultivation and diseases of Proteaceae: Leucadendron, Leucospermum

- and Protea. *CBS Biodiversity Series* 2: 1–228.
- Daly, A.M., Shivas, R.G., Pegg, G.S. & Mackie, A.E. (2006) First record of teak leaf rust (*Olivea tectonae*) in Australia. *Australasian Plant Disease Notes* 1: 25–26.
<http://dx.doi.org/10.1071/DN06011>
- de Wet, J., Burgess, T., Slippers, B., Preisig, O., Wingfield, B.D. & Wingfield, M.J. (2003) Multiple gene genealogies and microsatellite markers reflect relationships between morphotypes of *Sphaeropsis sapinea* and distinguish a new species of *Diplodia*. *Mycological Research* 107: 557–566.
<http://dx.doi.org/10.1017/S0953756203007706>
- Doilom, M., Liu, J.K., Jaklitsch, W.M., Ariyawansa, H., Wijayawardene, N.N., Chukeatirote, E., Zhang, M., McKenzie, E.H.C., Geml, J., Voglmayr, H. & Hyde, K.D. (2013) An outline of the family Cucurbitariaceae. *Sydowia* 65 (1): 167–192. Available from: https://www.researchgate.net/publication/276353627_An_outline_of_the_family_Cucurbitariaceae (accessed 1 October 2015)
- Doilom, M., Shuttleworth, L., Roux, J., Chukeatirote, E. & Hyde, K.D. (2014) *Barriopsis tectonae* sp. nov. a new species of Botryosphaeriaceae from *Tectona grandis* (teak) in Thailand. *Phytotaxa* 176 (1): 81–91.
<http://dx.doi.org/10.11646/phytotaxa.176.1.10>
- Elmagboul, A., Kritsanaphan, W., Niemi, S., Priyanto, Tynkkynen, M., Ulfah, M., Zhu, J. & Varis, E. (Undated) *Plantation forestry in Thailand (teak, rubber wood, eucalypt) case study in Chiang Rai Province. Interviews from representatives of “Forest Resources Management Centre” Department of Agriculture.* The interviews took place in Chiang Mai, Thailand. Available from: http://www.helsinki.fi/vitri/research/Educational_Projects/forrsa/RE_2_Course%20and%20workshop%20proceedings/report/Group4_report.pdf (accessed 12 October 2014)
- Felsenstein, J. (1985) Confidence limits on phylogenies: an approach using the bootstrap. *Evolution* 6: 227–242.
<http://dx.doi.org/10.2307/2408678>
- Glass, N.L., & Donaldson, G.C. (1995) Development of primer sets designed for use with the PCR to amplify conserved genes from filamentous ascomycetes. *Applied and Environmental Microbiology* 61 1323–1330. Available from: <http://aem.asm.org/content/61/4/1323.full.pdf> (accessed 1 October 2015)
- Graudal, L., Kjaer, E.D., Suangtho, V., Saardavut, P. & Kaosa-ard, A. (1999) Conservation of Genetic Resources of Teak (*Tectona grandis*) in Thailand. DFSC Series of Technical Notes. TN52 Danida Forest Seed Centre, Humlebaek, Denmark. Available from: http://curis.ku.dk/ws/files/20711135/technical_note_52.pdf (accessed 1 October 2015)
- Huelsenbeck, J.P. & Ronquist, F. (2001) MRBAYES: Bayesian inference of phylogenetic trees. *Bioinformatics* 17 (8): 754–755.
<http://dx.doi.org/10.1093/bioinformatics/17.8.754>
- Jacobs, K., Bergdahl, D.R., Wingfield, M.J., Halik, S., Seifert, K.A., Bright, D.E. & Wingfield, B.D. (2004) *Leptographium wingfieldii* introduced into North America and found associated with exotic *Tomicus piniperda* and native bark beetles. *Mycological Research* 108: 411–418.
<http://dx.doi.org/10.1017/S0953756204009748>
- Jami, F., Slippers, B., Wingfield, M.J. & Gryzenhout, M. (2012) Five new species of the Botryosphaeriaceae from *Acacia karroo* in South Africa. *Cryptogamie, Mycologie*, 33 (3): *Numéro special Coelomycetes*: 245–266.
<http://dx.doi.org/10.7872/crym.v33.iss3.2012.245>
- Johnson, L.A., & Soltis, D.E. (1998) Assessing congruence: empirical examples from molecular data. In: Soltis, D.E., Soltis, P.S. & Doyle, J.J. (Eds.) *Molecular systematics of plants II*. pp. 297–348.
http://dx.doi.org/10.1007/978-1-4615-5419-6_11
- Kellogg, E.A., Appels, R. & Mason-Gamer, R.J. (1996) When genes tell different stories: the diploid genera of Triticeae (Graminae). *Systematic Botany* 21: 321–347.
<http://dx.doi.org/10.2307/2419662>
- Kollert, W. & Cherubini, L. (2012) Teak resources and market assessment (2010) FAO Planted Forests and Trees Working Paper FP/47/E. Rome, Italy. Available from: <http://www.fao.org/docrep/015/an537e/an537e00.pdf> (accessed 24 June 2014)
- Kornerup, A. & Wanscher, J.H. (1967) *Methuen handbook of colour*. 2nd edn. Methuen & Co. London, England.
- Hyde, K.D., Nilsson, R.H., Alias, S.A., Ariyawansa, H.A., Blair, J.E., Cai, L., de Cock, A.W.A.M., Dissanayake, A.J., Glockling, S.L., Goonasekara, I.D., Gorczak, M., Hahn, M., Jayawardena, R.S., van Kan, J.A.L., Laurence, M.H., Lévesque, C.A., Li, X.H., Liu, J.K., Maharachchikumbura, S.S.N., Manamgoda, D.S., Martin, F.N., McKenzie, E.H.C., McTaggart, A.R., Mortimer, P.E., Nair, P.V.R., Pawłowska, J., Rintoul, T.L., Shivas, R.G., Spies, C.F.J., Summerell, B.A., Taylor, P.W.J., Terhem, R.B., Udayanga, D., Vaghefi, N., Walther, G., Wilk, M., Wrzosek, M., Xu, J.C., Yan, J.Y. & Zhou, N. (2014) One stop shop: backbone trees for important pytopathogenic genera: I (2014) *Fungal Diversity* 67: 21–125.
<http://dx.doi.org/10.1007/s13225-014-0298-1>
- Liu, J.K., Phookamsak, R., Doilom, M., Wikee, S., Li, Y.M., Ariyawansa, H., Boonmee, S., Chomnunti, P., Dai, D.Q., Bhat, J.D., Romero, A.I., Zhuang, W.Y., Monkai, J., Gareth, Jones, E.B., Chukeatirote, E., Ko Ko, T.W., Zhang, Y.C., Wang, Y. & Hyde, K.D.

- (2012) Towards a natural classification of Botryosphaeriales. *Fungal Diversity* 57: 149–210.
<http://dx.doi.org/10.1007/s13225-012-0207-4>
- Mason-Gamer, R.J. & Kellogg, E.A. (1996) Testing for phylogenetic conflict among molecular data sets in the tribe Triticeae. *Systematic Biology* 45: 524–545.
<http://dx.doi.org/10.1093/sysbio/45.4.524>
- Mehl, J.W.M., Slippers, B., Roux, J. & Wingfield, M.J. (2013) Cankers and other diseases caused by the Botryosphaeriaceae. In: Gonthier, P. & Nicolotti, G. (Eds.) *Infectious forest diseases*. CAB International, Boston, Minnesota, pp. 298–317.
<http://dx.doi.org/10.1079/9781780640402.0298>
- Mekkamol, S., Jonglaeka, N., Hywel-Jones, N.L. & Whalley, A.J.S. (1997) Endophytic fungi of teak in Thailand: a preliminary account. *BIOTEC News* 3: 4–5.
- Mekkamol, S. (1998) *Endophytic fungi of Tectona grandis L. (Teak)*. PhD Thesis, Liverpool John Moores University, Liverpool, UK.
- Mohd Farid, A., Lee, S., Mazih, Z., Rosli, H. & Norwti, M. (2005) Basal Root Rot, a new disease of teak (*Tectona grandis*) in Malaysia caused by *Phellinus noxius*. *Malaysian Journal of Microbiology* 1 (2): 40–45. Available from: <http://web.usm.my/mjm/issues/vol1no2/research5.pdf> (accessed 1 October 2015)
- Netto, M.S.B., Assunção, I.P., Lima, G.S.A., Marques, M.W., Lima, W.G., Monteiro, J.H.A., Balbino, V. de Q., Michereff, S.J., Phillips, A.J.L. & Câmara, M.P.S. (2014) Species of *Lasiodiplodia* associated with papaya stem-end rot in Brazil. *Fungal Diversity* 67 (1): 127–141.
<http://dx.doi.org/10.1007/s13225-014-0279-4>
- Nilsson, R.H., Hyde, K.D., Pawłowska, J., Ryberg, M., Tedersoo, L., Aas, A.B., Alias, S.A., Alves, A., Anderson, C.L., Antonelli, A., Arnold, A.E., Bahnmann, B., Bahram, M., Bengtsson-Palme, J., Berlin, A., Branco, S., Chomnunti, P., Dissanayake, A., Drenkhan, R., Friberg, H., Frøslev, T.G., Halwachs, B., Hartmann, M., Henricot, B., Jayawardena, R., Jumpponen, A., Kausrud, H., Koskela, S., Kulik, T., Liimatainen, K., Lindahl, B.D., Lindner, D., Liu, J.K., Maharachchikumbura, S., Manamgoda, D., Martinsson, S., Neves, M.A., Niskanen, T., Nyländer, S., Pereira, O.L., Pinho, D.B., Porter, T.M., Queloz, V., Riit, T., Sánchez-García, M., Sousa, F.D., Stefańczyk, E., Tadych, M., Takamatsu, S., Tian, Q., Udayanga, D., Unterseher, M., Wang, Z., Wikee, S., Yan J., Larsson, E., Larsson, K.H., Kõljalg, U. & Abarenkov, K. (2014) Improving ITS sequence data for identification of plant pathogenic fungi. *Fungal Diversity* 67: 11–19.
<http://dx.doi.org/10.1007/s13225-014-0291-8>
- Nyländer, J.A.A. (2004) MrModeltest 2.0. Program distributed by the author. Evolutionary Biology Centre, Uppsala University.
- Owusu, E.O. (2011) *Role of intercrops proliferation of Armillaria root-rot of teak [Tectona grandis (Linn.f.)] in taungya plantation: A case study at the Opro forest reserve*. Kwame Nkrumah University of science and technology, Kumasi.
- Page, R.D.M. (1996) TreeView: an application to display phylogenetic trees on personal computers. *Computer Applications in the Biosciences* 12: 357–358.
- Pavlic, D., Wingfield, M.J., Barber, P., Slippers, B., Hardy, G.E.St.J. & Burgess, T.I. (2008) Seven new species of the Botryosphaeriaceae from baobab and other native trees in Western Australia. *Mycologia* 100: 851–866.
<http://dx.doi.org/10.3852/08-020>
- Pérez, M., Lopéz, M.O. & Marti, O. (2008) *Olivea tectonae*, leaf rust of teak, occurs in Cuba. *New Disease Reports* 17: 32.
<http://onlinelibrary.wiley.com/doi/10.1111/j.1365-3059.2008.01993.x/epdf>
- Pérez, C.A., Wingfield, M.J., Slippers, B., Altier, N.A. & Blanchette, R.A. (2010) Endophytic and canker-associated Botryosphaeriaceae occurring on non-native *Eucalyptus* and native *Myrtaceae* trees in Uruguay. *Fungal Diversity* 41 (1): 53–69.
<http://dx.doi.org/10.1007/s13225-009-0014-8>
- Phillips, A.J.L., Alves, A., Abdollahzadeh, J., Slippers, B., Wingfield, M.J., Groenewald, J.Z. & Crous, P.W. (2013) The Botryosphaeriaceae: genera and species known from culture. *Studies in Mycology* 76: 51–167.
<http://dx.doi.org/10.3114/sim0021>
- Rambaut, A. (2009) FigTree v1.3.1 released. Institute of Evolutionary Biology. Ashworth Laboratories, University of Edinburgh, Scotland. Available from: <http://tree.bio.ed.ac.uk/software/figtree> (accessed 24 October 2014)
- Rambaut, A. & Drummond, A.J. (2003) *Tracer [computer program]*. Available from: <http://tree.bio.ed.ac.uk/software/tracer/> (accessed 24 October 2014)
- Reay, S., Thwaites, J.M., Farrell, R.L. & Glare, T.R., (2006) The lack of persistence of Ophiostomataceae fungi in *Pinus radiata* 3 years after damage by the bark beetle *Hylastes ater*, and the subsequent colonization by *Sphaeropsis sapinea*. *Forest Ecology and Management* 233: 149–152.
<http://dx.doi.org/10.1016/j.foreco.2006.06.018>
- Rondon Neto, R.M., Macedo, R.L.G. & Tsukamoto, A.A. (1998) Formação depovoamento florestal com *Tectona grandis* L.f. *Boletim Técnico-Série Extensão* 7: 1–29.
- Slippers, B., Crous, P.W., Denman, S., Coutinho, T.A., Wingfield, B.D. & Wingfield, M.J. (2004a) Combined multiple gene genealogies

- and phenotypic characters differentiate several species previously identified as *Botryosphaeria dothidea*. *Mycologia* 96: 83–101. Available from: <http://www.mycologia.org/content/96/1/83.full.pdf+html> (accessed 1 October 2015)
- Slippers, B., Fourie, G., Crous, P.W., Coutinho, T.A., Wingfield, B.D. & Wingfield, M.J. (2004b) Multiple gene sequences delimit *Botryosphaeria australis* sp. nov. from *B. lutea*. *Mycologia* 96: 1028–1039. Available from: <http://www.mycologia.org/content/96/5/1030.full.pdf+html> (accessed 1 October 2015)
- Slippers, B. & Wingfield, M.J. (2007) Botryosphaeriaceae as endophytes and latent pathogens of woody plants: diversity, ecology and impact. *Fungal Biology Reviews* 21: 90–106. <http://dx.doi.org/10.1016/j.fbr.2007.06.002>
- Slippers, B., Boissin, E., Phillips, A.J.L., Groenewald, J.Z., Lombard, L., Wingfield, M.J., Postma, A., Burgess, T. & Crous, P.W. (2013) Phylogenetic lineages in the Botryosphaeriales: A systematic and evolutionary framework. *Studies in Mycology* 76: 31–49. <http://dx.doi.org/10.3114/sim0020>
- Smith, H., Crous, P.W., Wingfield, M.J., Coutinho, T.A. & Wingfield, B.D. (2001) *Botryosphaeria eucalyptorum* sp. nov., a new species in the *B. dothidea*-complex on *Eucalyptus* in South Africa. *Mycologia* 93: 277–284.
- Swofford, D.L. (2003) *PAUP: phylogenetic analysis using parsimony, (*and other methods)*. Version 4.0 b10. Sinauer Associates, Sunderland MA. Available from: <http://www.ncbi.nlm.nih.gov/pmc/articles/PMC3348772> (accessed 1 October 2015)
- Tamura, K., Stecher, G., Peterson, D., Filipski, A. & Kumar, S. (2013) MEGA 6: Molecular Evolutionary Genetics Analysis version 6.0. *Molecular Biology and Evolution* 30: 2725–2729. <http://dx.doi.org/10.1093/molbev/mst197>
- Taylor, J., Jacobson, D.J., Kroken, C., Kasuga, T., Geiser, D.M., Hibbett, D.S. & Fisher, M.C. (2000) Phylogenetic Species Recognition and Species Concepts in Fungi. *Fungal Genetics and Biology* 31: 21–32. <http://dx.doi.org/10.1006/fgbi.2000.1228>
- Thulasidas, P.K. (2014) Project Formulation Workshop on Sustainable Management and Genetic Conservation of Teak Resources – A Report. *Teaknet Bulletin* 7 (3): 1–5.
- Trakunyingcharoen, T., Cheewangkoon, R., To-anun, C., Crous, P.W., van Niekerk, J.M. & Lombard, L. (2014) Botryosphaeriaceae associated with diseases of mango (*Mangifera indica*). *Australasian Plant Pathology* 43: 425–438. <http://dx.doi.org/10.1007/s13313-014-0284-9>
- Vrijmoed, L.L.P., Hodgkiss, I.J. & Thrower, L.B. (1982) Factor affecting the distribution of lignicolous marine fungi in Hong Kong. *Hydrobiologia* 87: 143–160. <http://dx.doi.org/10.1007/BF00015195>
- Vrijmoed, L.L.P., Hodgkiss, I.J. & Thrower, L.B. (1986) Occurrence of fungi on submerged pine and teak blocks in Hong Kong coastal waters. *Hydrobiologia* 135: 109–122. <http://dx.doi.org/10.1007/BF00006463>
- White, T.J., Bruns, T., Lee, S. & Taylor, J. (1990) Amplification and direct sequencing of fungal ribosomal RNA genes for phylogenetics. *In: Innis, M.A., Gelfand, D.H., Sninsky, J.J. & White, T.J. (Eds.) PCR protocols: a guide to methods and applications*. San Diego, Academic Press, pp. 315–322. <http://dx.doi.org/10.1016/b978-0-12-372180-8.50042-1>