

Sensory and enzymatic factors associated with defects in low fat UHT milk

by

MELANIE DENNILL

24102785

Submitted in partial fulfilment of the requirements for the degree

PhD Food Science

In the Faculty of Natural & Agricultural Sciences

University of Pretoria

Pretoria

August 2014

DECLARATION

I, Melanie Dennill, declare that this dissertation, which I hereby submit for the degree PhD Food Science at the University of Pretoria, is my own work and has not previously been submitted by me for a degree at this or any other tertiary institution

Signature: _____

Date: _____

ACKNOWLEDGEMENTS

I wish to express my sincere gratitude to the following people and organisations for their assistance, which made this study possible.

My supervisors, Prof. Elna Buys and Prof. Henriëtte de Kock, for their patience, guidance and constant encouragement.

Friends and colleagues from the Department of Food Science at the University of Pretoria for their unbelievable support.

SAMPRO, National Research Foundation and the University of Pretoria for their financial support

My husband, Malcolm Dennill, my parents, family and friends for their all their love, support and encouragement.

SUMMARY

Sensory and enzymatic factors associated with defects in low fat UHT milk

By

Melanie Richards

Study leader: Prof. E. M. Buys

Co-study leader Prof. H. L. De Kock

Department: Food Science

Degree: PhD Food Science

Ultra-high temperature processing of milk renders a product that is bacteriologically stable for several months at ambient temperature. Various factors have been reported to induce changes in UHT milk during storage and thereby limit the shelf life of the milk. Consequently, changes in the sensory and microbiological properties of low fat UHT milk were assessed over time at different temperatures to develop a model whereby the shelf life of the milk can be predicted in a short time-period. UHT milk was stored at 25°C and accelerating temperatures of 35°C and 45°C and evaluated for changes over 195 days (d). A multivariate accelerated shelf life test (MASLT) was applied to the descriptive sensory data and allowed the successful prediction of the shelf life at various temperatures, with the shelf life of milk stored at 25°C estimated at 211 d. Higher storage temperatures negatively affected the shelf life of the milk, with estimations of 73 and 27 d for milk stored at 35°C and 45°C, respectively. The shelf life obtained from the MASLT was validated using survival analysis where the acceptance or rejection of samples by consumers gave an estimated shelf life of 214 d. The acceptability of UHT milk depends on the sensory quality of the milk. Consumer perception and physico-chemical properties of low fat UHT milk of various ages were evaluated to determine the parameters associated with the deterioration of the milk. As the consumer liking for aroma, appearance, taste and overall liking decreased over time, the detection of positive attributes in the milk decreased, while the detection of negative attributes increased. Parameters associated with the deterioration of UHT milk, including increased titratable acidity, Maillard reaction products and enzymatic reactions, decreased pH and changes in the colour of the milk, increased over storage time.

Although sufficient heat treatment and packaging with light and oxygen barriers prevent microbial and oxidative spoilage of UHT milk, there are no means of inactivating heat-stable enzymes in UHT milk. Subsequently, the ability of different protease inhibitors to reduce the activity of a native milk enzyme (plasmin) and enzymes produced by bacterial contaminants (*Pseudomonas fluorescens*, *Bacillus licheniformis* and *B. lentus*) was evaluated. Protease inhibitors extracted from soybeans (*Glycine max* (L.) Merr), marama beans (*Tylosema esculentum* (Burch) A. Schreib) and cowpeas (*Vigna unguiculata* (L.) Walp) were evaluated with regards to their ability to inhibit these enzymes in a buffer system and in low fat UHT milk. The legume protease inhibitors were effective in reducing the activity of plasmin and proteases produced by *Bacillus* spp., while it showed low inhibitory activity towards *P. fluorescens* proteases in a buffer system. In UHT milk, the same protease inhibition was observed, however, to a lesser extent as compared to inhibition in the buffer system.

Overall, the results indicate that the sensory properties of low fat UHT milk can be used to predict the shelf life of UHT milk in accelerated storage using the MASLT. Survival analysis can also be successfully employed to determine the shelf life of low fat UHT milk. Increased storage time of low fat UHT milk is associated with a reduction in the liking and positive attributes associated with the UHT milk, and an increase in negative attributes and physico-chemical and enzymatic parameters related to the deterioration of milk. Legume protease inhibitors show great potential in preventing or reducing proteolytic activity of *Bacillus* proteases and plasmin that may cause both sensory and consistency defects in the UHT milk during storage

TABLE OF CONTENTS

CHAPTER 1 : INTRODUCTION	1
1.1 References.....	3
CHAPTER 2 : LITERATURE REVIEW	6
2.1 MILK PROCESSING.....	6
2.2 UHT PROCESSING.....	6
2.2.1 Direct UHT system.....	8
2.2.2 Indirect UHT system.....	8
2.2.3 Aseptic packaging.....	10
2.3 SHELF LIFE OF UHT MILK.....	10
2.3.1 Factors affecting UHT milk quality.....	13
2.3.2 Measures taken to reduce sensory defects in UHT milk.....	24
2.3.3 Measures taken to reduce enzymatic and consistency defects in UHT milk.....	26
2.3.4 Shelf life estimation UHT milk.....	28
2.4 CONCLUSION.....	32
2.5 REFERENCES.....	32
CHAPTER 3 : MULTIVARIATE ACCELERATED SHELF LIFE TEST OF LOW FAT UHT MILK	50
3.1 INTRODUCTION.....	50
3.2 MATERIALS AND METHODS.....	52
3.2.1 Samples and sample preparation.....	52
3.2.2 Sensory evaluation of UHT milk.....	53
3.2.3 Cut-off point determination using survival analysis.....	56
3.2.4 Nutritional and microbiological analyses of low fat UHT milk.....	56
3.2.5 Statistical data analysis.....	57
3.3 RESULTS AND DISCUSSION.....	60
3.4 CONCLUSION.....	76
3.5 REFERENCES.....	76
CHAPTER 4 : SURVIVAL ANALYSIS, CONSUMER PERCEPTION AND PHYSICO-CHEMICAL ANALYSIS OF LOW FAT UHT MILK STORED FOR DIFFERENT TIME PERIODS	79
4.1 INTRODUCTION.....	79

4.2	METHODS AND MATERIALS.....	81
4.2.1	Consumer evaluation	81
4.2.2	Physico-chemical analysis	82
4.2.3	Enzymatic reactions	83
4.2.4	Statistical data analysis	84
4.3	RESULTS AND DISCUSSION.....	85
4.3.1	Survival analysis	85
4.3.2	Consumers' liking and CATA	87
4.3.3	Physico-chemical and enzymatic reactions	90
4.3.4	Correspondence analysis.....	91
4.4	CONCLUSION.....	95
4.5	REFERENCES	95
CHAPTER 5 : THE EFFECT OF LEGUME PROTEASE INHIBITORS ON NATIVE MILK AND BACTERIAL PROTEASES.....		101
	Abstract.....	101
5.1	INTRODUCTION	102
5.2	MATERIALS AND METHODS.....	103
5.2.1	Materials and chemicals.....	103
5.2.2	Protease inhibitor extraction	103
5.2.3	Characterization of protein extract.....	104
5.2.4	Inhibition of bacterial protease and plasmin activity in buffer	106
5.2.5	Inhibition of bacterial protease and plasmin activity in low fat UHT milk	107
5.2.6	Statistical analysis	108
5.3	RESULTS AND DISCUSSION.....	108
5.3.1	Characterization of the protein extracts from legume seeds.....	108
5.3.2	Inhibition of protease activity in buffer	111
5.3.3	Inhibition of protease activity in low fat UHT milk	114
5.4	CONCLUSION.....	115
5.5	REFERENCES	115
CHAPTER 6 : GENERAL DISCUSSION.....		121
6.1	SHELF LIFE METHODOLOGIES.....	121
6.2	LOW FAT UHT MILK SHELF LIFE ESTIMATION AND APPLICATION	126
6.3	PROTEASE INHIBITION IN UHT MILK.....	127

6.4	REFERENCES	129
CHAPTER 7	: CONCLUSIONS.....	130

LIST OF FIGURES

Figure 2.1: Steps involved in UHT processing of milk (Datta, Elliott, Perkins, & Deeth, 2002).	7
Figure 2.2: Schematic diagram of a) infusion and b) injection direct heating systems (Lewis & Heppell, 2000).	9
Figure 2.3: Chemical changes and bacteriological killing effects in heat treated milk (Kessler, 1981).	12
Figure 2.4: Time temperature profile of direct (A) and indirect (B) heating (Gösta, 2003)....	14
Figure 3.1 a & b: Principal component analysis of low fat UHT milk in HDPE bottles stored at different temperatures (blue = 25°C, green = 35°C and red = 45°C) of different days D (D1-D192 for milk stored at 25°C, D1-D176 for milk stored at 35°C and D1-D78 for milk stored at 45°C) as profiled by the trained sensory panel (i = scores for the sensory attributes and ii = the correlation loadings for the milk samples stored at different temperatures over time).	67
Figure 3.2: Multivariate kinetic chart of low fat UHT milk in HDPE bottles stored at 25, 35 and 45°C.	69
Figure 3.3: Percentage of consumers rejecting the product versus storage time. 50% rejection points = dotted line, 95% confidence intervals = grey solid lines, nonparametric data points = triangles.	70
Figure 4.1: Percentage of consumers rejecting the product versus storage time. 50% rejection points = dotted line, 95% confidence intervals = grey solid lines, nonparametric data points = triangles.	87
Figure 4.2: Correspondence analysis plot representing the sensory attributes (red) of the CATA question on the first two dimensions for low fat UHT milk stored at 25°C for different time periods (D, blue). Sensory attributes that showed significant change over time are in bold. Supplementary data include the physico-chemical and enzymatic data (green). (<i>n</i> = 120).	94
Figure 5.1: SDS-PAGE of crude protein crude extracts from soybean, marama bean and cowpea under a) reducing and b) non-reducing conditions on 4-12% polyacrylamide gradient gel stained with Coomassie Brilliant Blue R-250. Lane 1, molecular marker; lane 2, soybean extract; lane 3, marama bean extract; lane 4, cowpea extract.	109

Figure 5.2: Native-PAGE gel showing protease inhibitor activity of protein extracts visible as clear zones against a violet background. Lane 1, soybean extract; lane 2, marama bean extract; lane 3, cowpea extract.....109

Figure 5.3: Inhibition of Savinase (■), Alcalase (■) and *P. fluorescens* (≡) proteases in phosphate buffer by treatment with soybean extract (SB), marama bean extract (MB), cowpea extract (CP) and purified soybean trypsin inhibitor (STI). Protease inhibition was measured using azocasein as substrate ($n = 3$). Differences in bar labels (A-U) represent significant differences ($p < 0.05$).....112

Figure 5.4: Inhibition of plasmin by treatment with soybean extract (SB), marama bean extract (MB), cowpea extract (CP) and purified soybean trypsin inhibitor (STI). Plasmin activity was measured using a colorimetric assay with Val-Leu-Lys-p-nitroanilide as substrate ($n = 3$). Differences in bar labels (A-I) represent significant differences ($p < 0.05$).113

LIST OF TABLES

Table 2.1: Zero-, first-, second- and n-order integrated kinetic equations.....	30
Table 3.1: References and definitions for attributes developed in the descriptive sensory evaluation of low fat UHT milk in HDPE bottles.....	54
Table 3.2: Milk composition and microbiological quality of freshly packed low fat UHT milk in HDPE bottles.	60
Table 3.3: The effect of storage time on microbiological quality of low fat UHT milk in HDPE bottles.	61
Table 3.4: Model fit statistics ¹ , $-2 \times \text{Log likelihood}$, Akaike Information Criteria (AIC), finite-sample corrected Akaike Information Criteria (AICC) and Schwarz's Bayesian Information Criteria (BIC), with two different covariance structures, compound symmetry (CS) and ante dependence (ANTE(1)), for the milk attributes.....	62
Table 3.5: Log-likelihood values for different distributions fitted to the survival analysis data. The model with the lowest log-likelihood value shows the best adjustment to the data.	68
Table 3.6: Multivariate parameters for low fat UHT milk.....	70
Table 3.7: Parameters of the sensory attributes of low fat UHT milk.	72
Table 4.1: Log-likelihood values for different distributions.....	86
Table 4.2: Mean consumers' aroma, appearance, flavour and overall liking scores as rated on a 9 point hedonic scale ¹ for UHT milk samples stored at 25°C for different storage times ($n = 120$).	88
Table 4.3: CATA frequency table for different attributes of UHT milk samples stored at 25°C for different storage times ($n = 120$).....	89
Table 4.4: Physico-chemical and enzymatic parameters measured in low fat UHT milk stored at 25°C for various storage times.....	93
Table 5.1: Protein content and trypsin inhibitor activity (TIA) of extracts of defatted flour from soybeans, defatted flour from marama beans and flour from cowpeas ^a	110
Table 5.2: The effect of legume crude protein extracts on protease activity in low fat UHT milk ^a	114

CHAPTER 1 : INTRODUCTION

Ultra-high temperature (UHT) processing involves the heating of milk to a high temperature for a short time (140-145°C for 4-10 s) to produce a product that is bacteriologically stable at ambient temperature for several months (Valero, Villamiel, Miralles, Sanz & Martinez-Castro, 2001). The shelf-life of UHT milk is therefore not determined by the microbial safety or -quality of the milk, but rather by changes in the sensory properties (Lewis & Heppell, 2000; Corrigan, Hedderley, & Harvey, 2012). Even though UHT milk has a long shelf-life of 6 – 9 months at room temperature (Perkins, D’Arcy, Tisle & Deeth, 2005), various factors have been reported to induce changes in the UHT milk during storage resulting in a reduced shelf life (Datta & Deeth, 2003). Although the sensory properties of a product stored for several months are not expected to be exactly the same as those of a fresh standard, it should be small enough for the acceptability of the product not to be altered significantly (Garitta, Hough, & Sánchez, 2004). The main reactions that occur in the milk during storage include enzymatic and chemical reactions that are responsible for sensory and consistency changes in the UHT milk (Shipe et al., 1978; Celestino, Iyer, & Roginski, 1997; Borle, Sieber, & Bosset, 2001).

Various challenges are involved in determining the shelf-life of a shelf stable product such as UHT milk. The first challenge is that it is very time and resource consuming conducting a test over the whole estimated shelf-life of such a product. This is where accelerated shelf-life tests are often employed and the product is subjected to relatively severe storage conditions where one or more acceleration factor is held at a higher than normal level (Corrigan et al., 2012; Meeker & Escobar, 1998). Acceleration factors include temperature, relative humidity, water activity, oxygen partial pressure or combinations of these factors and are chosen based on the nature of the product and its normal storage conditions (Cardelli & Labuza, 2001; Pedro & Ferreira, 2006; Curia & Hough, 2009; Corrigan et al., 2012). By storing the product at these abuse conditions, the deterioration rate of the product will increase, resulting in a shorter shelf-life (Meeker & Escobar, 1998; Cardelli & Labuza, 2001; Pedro & Ferreira, 2006; Curia & Hough, 2009). Another challenge we are faced with is determining the critical attribute, i.e. the one that has the highest impact on the quality of the product or the one that shows the most change over time (Pedro & Ferreira, 2006). Sensory shelf life studies often consider product defects to determine the end of shelf-life. These defects may, however, not be

responsible for the product failing, but rather changes in the levels of desirable attributes or a combination of the two (Garitta et al., 2004). To overcome these challenges the multivariate accelerated shelf-life test (MASLT) may be a good method for the shelf-life estimation of UHT milk. Not only does the MASLT make use of accelerating factors, it also includes all the attributes that show significant change over time, therefore eliminating the need to identify only one critical attribute (Pedro & Ferreira, 2006). The first part of the study aimed to determine the shelf-life of low fat UHT milk using the MASLT and also to identify the attributes that may be used for end-of shelf-life predictors.

Even though trained sensory panels have the ability to detect small differences in products, these variations may not be of importance to the end-consumer (Ares, Barreiro, Deliza, Giménez, & Gámbaro, 2010; van Trijp and Schifferstein, 1995). Consumers can therefore perceive products differently to trained panels and consumer data based on simple sensory concepts may give a better understanding of the actual marketplace behaviour (Ares et al., 2010). Consumer data is especially important in shelf life studies of shelf stable products, such as UHT milk, where the sensory quality of the food, rather than the microbial safety, determine the end of shelf life. (Guerra, Lagazio, Manzocco, Barnaba, & Cappuccio, 2008) Survival analysis where consumers need to either accept or reject samples stored for different time periods is often employed to determine the shelf life of food. The shelf life is given as the time required to reach a predetermined percentage of consumer rejection (Hough, Langohr, & Gómez, 2003; Gámbaro, Garitta, Giménez, Varela, & Hough, 2004; Garitta *et al.*, 2004; Corrigan et al., 2012). This part of the study focused on the use of survival analysis to determine the shelf life of the low fat milk. In addition to this, the consumer's liking, the consumer's perception of the sensory attributes and the physico-chemical properties of the milk of various ages were also determined.

Proteolysis of UHT milk is a major shelf-limiting factor, since the proteolytic enzymes in the raw milk can partially survive the UHT process and subsequently cause defects in UHT milk during storage at room temperature (Mitchell & Ewings, 1985; Celestino et al., 1997; Santos, Ma, Caplan, & Barbano, 2003). Examples of such defects include consistency defects like coagulation, gelation or thickening (Celestino *et al.*, 1997) and sensory defects like bitterness, astringency or fustiness (Santos *et al.*, 2003). Various enzymes are responsible for the proteolysis of milk, including native milk alkaline proteinase, plasmin, and heat-stable extracellular proteinases produced by psychrotrophic bacterial contaminants such as *Bacillus*

and *Pseudomonas* spp. in the raw milk (Fox & McSweeney, 1996; Kelly & Foley, 1997; Datta & Deeth, 2003). Sufficient heat treatment and packaging with light and oxygen barriers has been developed for UHT milk to prevent microbial and oxidative spoilage, respectively. There is, however, no means of inactivating or deactivating heat-stable enzymes from UHT milk. Low levels of proteolytic enzymes in the UHT milk are sufficient to cause the degradation of undesirable amounts of protein during storage at ambient temperatures (Mitchell & Ewings, 1985). This part of the study aimed to determine the effect legume protease inhibitors will have on the activity of both native and bacterial proteolytic enzymes in UHT milk. These inhibitors are also known as anti-nutritional factors, since they reduce protein digestion and uptake (Carvalho, Almeida-Oliveira, Baross & Moreira, 1998; Lajolo & Genovese, 2002). Means of inactivating or immobilizing them should therefore be considered to eliminate them from the final product.

1.1 REFERENCES

- Ares, G., Barreiro, C., Deliza, R., Giménez, A., & Gámbaro, A. (2010). Application of a check-all-that-apply question to the development of chocolate milk desserts. *Journal of Sensory Studies*, 25, 67–86.
- Borle, F., Sieber, R. & Bosset, J.O. (2001). Photo-oxidation and photoprotection of foods, with particular reference to dairy products: An update of a review article. *Science Aliments*, 21, 571-590.
- Cardelli, C., & Labuza, T.P. (2001). Application of Weibull hazard analysis to the determination of the shelf-life of roasted and ground coffee. *Lebensmittel-Wissenschaft Technology*, 34, 273-278.
- Carvalho W.L., Almeida-Oliveira, M.G., Baross, E.G., & Moreira, M.A. (1998). Determination of genotypic classes for trypsin inhibitor in soybean seeds. *Biotechnology Techniques*, 12, 859-863.
- Celestino, E.L., Iyer, M., & Roginski, H. (1997). Reconstituted UHT-treat milk: Effects of raw milk, powder quality and storage conditions of UHT milk on its physico-chemical attributes and flavour. *International Dairy Journal*, 7, 129–140.

- Corrigan, V., Hedderley, D., & Harvey, W. (2012). Modeling the shelf-life of fruit-filled snack bars using survival analysis and sensory profiling techniques. *Journal of Sensory studies*, 27, 403-416.
- Curia, A.V., & Hough, G.E. (2009). Selection of a sensory marker to predict the sensory life of a fluid human milk replacement formula. *Journal of Food Quality*, 32, 793-809.
- Datta, N., & Deeth, H.C. (2003). Diagnosing the cause of proteolysis in UHT milk. *Lebensmittel Wissenschaft und Technologie*, 69, 173-182.
- Fox, P.F., & McSweeney, P.L.H. (1996). Proteolysis in cheese. *Food Reviews International*, 12, 457-509.
- Gámbaro, A., Garitta, L., Giménez, A., Varela, P. & Hough, G. (2004). Sensory shelf-life estimation of “alfajor” by survival analysis. *Journal of Sensory Studies*, 19, 500-509.
- Garitta, L., Hough, G., & Sánchez, R. (2004). Sensory shelf-life of dulce de leche. *Journal of Dairy Science*, 87, 1601–1607.
- Guerra, S., Lagazio, C., Manzocco, L., Barnaba, M. & Cappuccio, R. (2008). Risks and pitfalls of sensory data analysis for shelf-life prediction, Data simulation applied to the case of coffee. *LWT-Food Science and Technology*, 41, 2070–2078.
- Hough, G., Langhour, K., Gomez, G. & Curia, A. (2003). Survival analysis applied to sensory shelf-life of foods. *Journal of Food Science*, 68, 359-362.
- Kelly, A. L., & Foley, J. (1997). Proteolysis and storage stability of UHT milk as influenced by milk plasmin activity, plasmin/B-lactoglobulin complexation, plasminogen activation and somatic cell count. *International Dairy Journal*, 7, 411-420.
- Lewis, M.J., & Heppell, N. (2000). *Continuous thermal processing of foods: Pasteurization and UHT sterilization*. Aspen Publishers: Gaithersburg.
- Lajolo, F. M., & Genovese, M. I. (2002). Nutritional significance of lectins and enzyme inhibitors from legumes. *Journal of Agricultural and Food Chemistry*, 50, 6592–6598.
- Meeker, W.Q., & Escobar, L.A. (1998). *Statistical methods for reliability data*. New York, NY, USA: John Wiley & Sons.

Mitchell, G.E., & Ewings, K.N. (1985). Quantification of bacterial proteolysis causing gelation in UHT-treated milk." *New Zealand Journal of Dairy Science and Technology*, 20, 65-76.

Pedro, A.M.K., & Ferreira, M.M.C. (2006). Multivariate accelerated shelf-life testing, A novel approach for determining the shelf-life of foods. *Journal of Chemometrics*, 20, 76-83.

Perkins, M.L., D'Arcy, B.R., Lisle, A.T. & Deeth, H.C. (2005). Solid phase microextraction of stale flavour volatiles from the headspace of UHT milk. *Journal of the Science of Food and Agriculture*, 85, 2421-2428.

Santos M.V., Ma Z., Caplan Z., & Barbano D.M. (2003). Sensory threshold of off-flavours caused by proteolysis and lipolysis in milk. *Journal of Dairy Science*, 86, 1601-1607.

Shipe, W.F., Bassette, R., Deane, D.D., Dunkley, W.L., Hammond, E.G., Harper, W.J., Kleyn, D.H., Morgan, M.E., Nelson, J.H. & Scanlan, R.A. (1978). Off flavours of milk: nomenclature, standards, and bibliography. *Journal of Dairy Science*, 61, 855-869.

Valero, E., Villamiel, M., Miralles, B., Sanz, J., & Martinez-Castro, I. (2001). Changes in flavour and volatile components during storage of whole and skimmed UHT milk. *Food Chemistry*, 72: 51-58.

CHAPTER 2 : LITERATURE REVIEW

2.1 MILK PROCESSING

Milk is a complex food item consisting of different constituents with varied physico-chemical characteristics (Bylund, 1995; Haug & Høstmark, 2007) and mostly undergoes some form of heat treatment prior to consumption. Pasteurization is a mild process that produces minimal chemical, physical or sensory changes in milk and it is used to inactivate both pathogenic and spoilage bacteria present in the raw milk. Pasteurized milk will, however, spoil after a few days at refrigeration temperature (4°C) due to the survival and growth of thermotolerant bacteria and post-pasteurization contamination (Lewis, 2000). Various methods, such as ultrafiltration, microfiltration and high-temperature treatment, can be used in addition or as an alternative to pasteurization to increase the shelf life of milk. Ultrafiltration and microfiltration mechanically remove spores and bacterial cells from the milk, while high-temperature processing kills heat-resistant aerobic spores (Stack & Sillen, 1998; Hoffmann et al., 2006; De Noni, Pellegrino, Cattaneo, & Resmini, 2007). A shelf life of 3-6 weeks at suboptimal cold chain temperatures can only be achieved by high temperature pasteurization, since these temperatures can reduce critical spore formers by more than 8 log cycles compared to 1-3 log and 3 log reductions by ultrafiltration and microfiltration, respectively (Rysstad & Kolstad, 2006). Other methods also reported in literature include pulsed electric fields (Walkling-Ribeiro, Noci, Cronin, Lyng, & Morgan, 2009), ultrasound (Noci, Walkling-Ribeiro, Cronin, Morgan, & Lyng, 2009) and high hydrostatic pressure (Datta & Deeth, 1999). Although these methods can increase the shelf life of milk, it will only be effective when the milk is distributed in a good cold chain with temperatures below 6°C (Maubois, 1997; Rysstad & Kolstad, 2006).

2.2 UHT PROCESSING

To increase the shelf life of milk at ambient temperature, two different methods of sterilization, i.e. in-container sterilization or ultra-high temperature (UHT) processing, can be used. In-container sterilization of milk involves heating of both the product and packaging to

114-120°C for 20-30 minutes, while UHT treatment of milk denotes a continuous heating process where the product is heated at temperatures higher than 130°C (usually 138-145°C) for 1-10 s (usually 3-5 s) followed by aseptic packaging to produce a “commercially sterile” product (Fig. 2.1) (Bylund, 1995; Lewis, 2000; Datta & Deeth, 2003). The South African Government Notice Number R. 1555 of 21 November 1997 relating to milk and dairy products state that the UHT treatment comprise of heating above 100°C and aseptic packaging to ensure that the end product is free from spoilage microorganisms after 14 days at a storage temperature of 30°C.

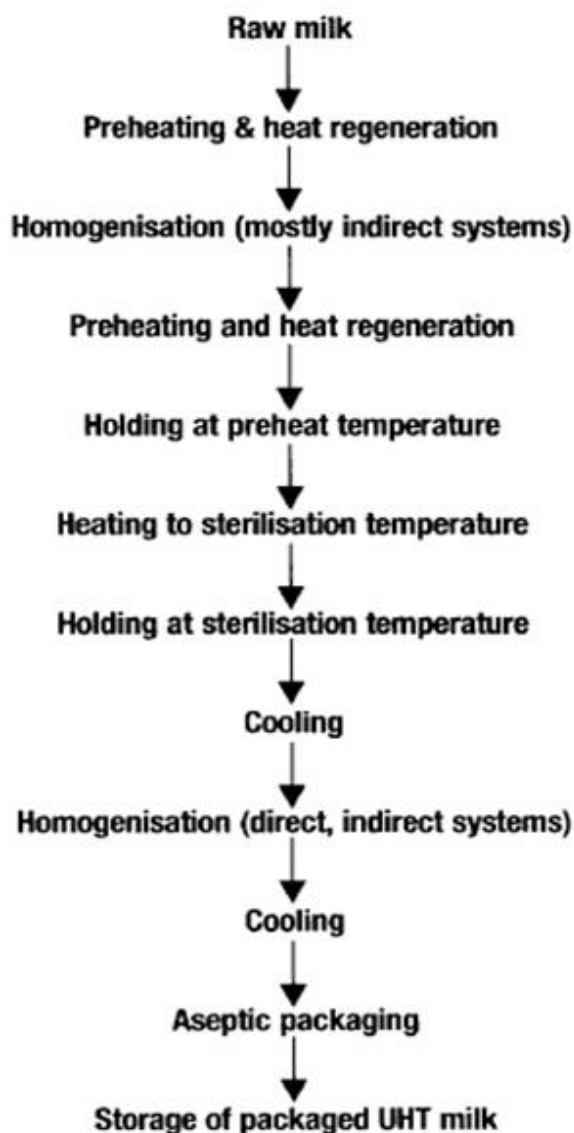

Figure 2.1: Steps involved in UHT processing of milk (Datta, Elliott, Perkins, & Deeth, 2002).

UHT treatment produces a product with superior quality compared to in-container sterilization. This is due to the continuous flow of milk and the rapid heating and cooling rates that results in less chemical damage to important nutrients and functional ingredients in the milk (Kessler, 1989; Lewis, 2000). Although the preheating and the final cooling steps of the UHT process are performed in indirect heat exchangers, the heating to sterilization temperature can be either direct or indirect.

2.2.1 Direct UHT system

With the direct UHT system, heating is performed by mixing the product and steam at high pressure of about 9 bars. In this system the heat transfer is high, residence time is very short, less fouling occurs, and less adverse chemical changes are imparted as compared to the indirect heat process (Elliot, Dhakal, Datta, & Deeth, 2003; Grijspeerd, Mortier, Block, & Van Rentrghem, 2004). Two different direct systems, known as steam infusion or steam injection, can be used (Fig. 2.2). Milk is either sprayed into superheated steam, or allowed to fall through it in thin films or streams in the steam infusion system, while superheated steam is injected into a stream of milk in the steam injection system. Both these systems raise the temperature of the milk almost instantaneously, largely due to the transfer of latent heat from the steam to the milk. The milk is diluted by the condensed steam which is later removed when the heated milk is cooled in a vacuum chamber (Lewis & Heppell, 2000). The vacuum chamber rapidly cools the milk to approximately the same temperature as that of the preheated milk. To prevent dilution or concentration of the milk, the total solids of the incoming and processed milk is monitored. It is essential that the steam used in these systems are of high-quality, culinary grade to prevent carry over of off-flavours into the milk (Burton, 1988).

2.2.2 Indirect UHT system

The indirect heating is performed by heat exchangers where heat is transferred by conduction from the heating medium (often superheated water or steam) through the surface of the metal to the milk (Bylund, 1995). When water is used, it flows in the reverse direction of that of the

milk to minimise the temperature differential between the two liquids and, in turn, minimise the amount of burn-on. In contrast to this, there is a big temperature differential when steam is used and this can cause more burn-on and flavour changes in the product (Dentener, 1984). The indirect system can be subdivided into two types, i.e. tubular or plate, depending on the nature of the heat exchanger used (Grijspeerdt et al., 2004). Heating from the preheat temperature to sterilization temperature and cooling of the sterilized milk is much slower in the indirect system than in the direct systems, therefore subjecting the milk to a greater heat load and resulting in more undesired heat-induced changes in the milk (Kessler, 1989; Datta et al., 2002). In the indirect system unwanted deposits accumulating on the surface of the heat exchangers, also known as fouling, causes resistance to heat transfer resulting in reduced efficiency of thermal processing (Swartzel, 2007).

a)

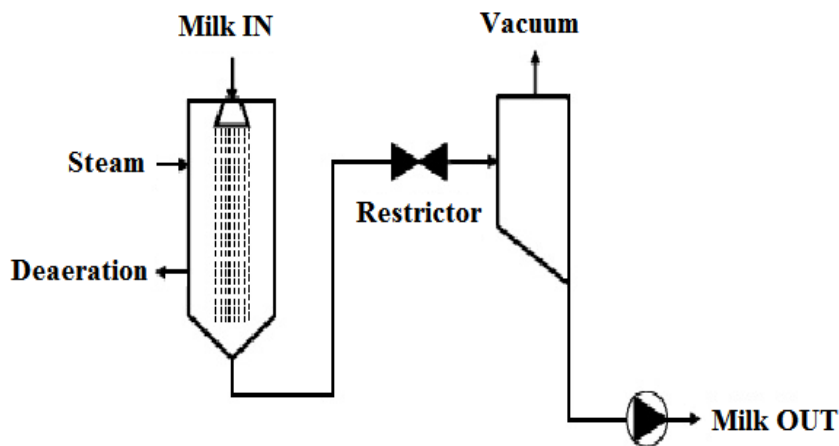

b)

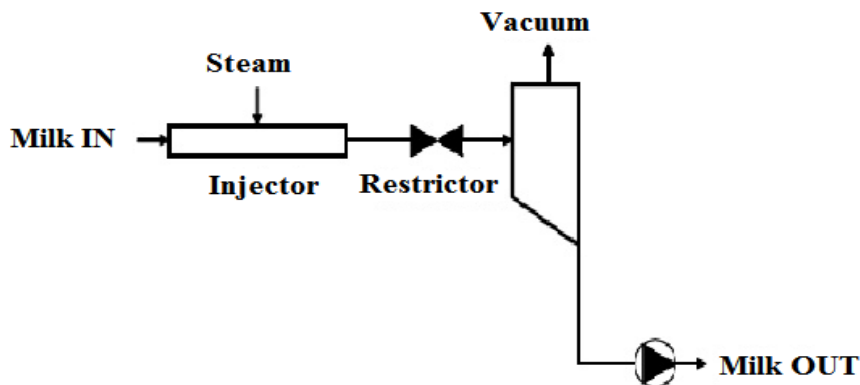

Figure 2.2 Schematic diagram of a) infusion and b) injection direct heating systems (Lewis & Heppell, 2000).

2.2.3 Aseptic packaging

During aseptic packaging, the sterile milk is cooled, packaged into sterile containers in an aseptic environment and hermetically sealed to ensure sterility is maintained throughout the handling and distribution of the processed milk. Hydrogen peroxide (35% at 75-80°C) is the main agent used to sterilize containers by allowing only short contact times and removing the residual hydrogen peroxide with hot air (Lewis, 2000). Other systems used to sterilize containers include various concentrations of hydrogen peroxide, heat, irradiation, infrared light, UV-light, peracetic acid and combinations of these systems (Ansari & Datta, 2003; Rysstad & Kolstad, 2006). The five basic types of aseptic packaging lines include: 1) Fill and seal where preformed containers made of thermoformed plastic, glass, or metal are sterilized, filled in an aseptic environment and sealed; 2) Erect, fill, and seal where knocked-down banks are erected, sterilized, filled and sealed; 3) Form, fill, and seal where the role of packaging material is sterilized, formed in a sterile environment, filled and sealed; 4) Thermoform, fill and seal; and 5) Blow mold, fill, and seal (Gedam, Prasad, & Vijay, 2007). To ensure that the product remains sterile during transfer from the processing line to the sterile container, a sterile environment need to be maintained (Burton, 1988).

2.3 SHELF LIFE OF UHT MILK

The extended shelf life and shelf stability at room temperature are definite advantages of UHT milk. The deterioration of food products is, however, inevitable and, depending on its chemical properties, physical properties and storage conditions, there will come a time when either the quality of the product will be unacceptable or it will become harmful to the consumer (Fu & Labuza, 1993; IDFS, 1993). The primary objective in producing a commercially sterile product with an extended shelf life is safety. The two most important kinetic parameters that are used to determine the temperature-time combination to be used are the rate of reaction (D value) at a constant temperature, and the effect of temperature change on the reaction rate (z value). The heat resistance of both vegetative bacteria and microbial spores are characterized by their D value at a constant temperature. The D value can be defined as the time required to reduce the microbial population by 90% or one log cycle. A 90% population reduction is usually achieved at temperatures of 60-80°C for vegetative

organisms and 100-140°C for spores. The temperature dependence of a reaction is measured by the z value and this is the temperature that would cause a tenfold change in the D value. Heat resistant spores have been found to have a z value of about 10°C. To achieve commercial sterility it is important to inactivate the most heat-resistant pathogenic spore, *Clostridium botulinum*. Since milk is a low acid food ($\text{pH} > 4.5$), the main criterion is to achieve a 12 decimal reduction of this microorganism (Lewis, 1999; Singh, 2007). *C. botulinum* is, however, rarely found in milk and more common spore formers found in milk are mainly species from *Bacillus* that produce highly resistant spores, which require more severe heat treatment for inactivation (Hammer, Lembke, Suhren, & Heeschen, 2000; Lewis & Deeth, 2009). The effective working range of UHT processing can be defined by the bacteriological effect (B^*) and chemical effect (C^*). A B^* -value of 1 represents a nine-decimal reduction of thermophilic spores, assuming a z -value of 10.5°C, and is equivalent to holding the product at 135°C for 10.1 s. The C^* -value is a chemical index and based on the conditions of 3% destruction of thiamine per unit. A C^* value of 1 is equivalent to 135°C for 30.5 s with a z -value of 31.4°C (Kessler, 1981; Kessler & Horak, 1981). The UHT process operates satisfactory with regard to the shelf life of the product when $B^* > 1$ and $C^* < 1$. When the shelf life of a shelf stable product is determined, physical or sensory quality changes, rather than microbial safety, are the deciding factors (Lewis & Heppell, 2000; Corrigan, Hedderley, & Harvey, 2012).

One of the main goals of milk preservation using UHT treatment is to obtain a desired degree of destruction of microorganisms and inactivation of enzymes, while introducing the least possible physico-chemical and sensory changes, and preserving the nutritional value (Jovanka, Nada, Jovanka, Miroljub, & Višnja, 2008). The time-temperature combination used during the UHT process is determined by the need to inactivate-heat resistant endospores and to limit chemical changes that have a negative impact on the sensory and nutrition quality of the product (Burton, 1988). In Figure 2.3 line A represents the lower limit of the time-temperature combination that will result in discolouration of the milk, while line B represent the lower limit of the time-temperature combination that will result in sterilization, i.e. destruction of thermophilic spores. When comparing UHT processing and in-container sterilization in the figure, both methods have the same sterilizing effect. There is, however, a great difference in the chemical effects, including destruction of vitamins, discolouration of the milk and destruction of amino acids. The lower temperature load of UHT processing

results in better tasting milk with higher nutritional value as compared to the in-container sterilised milk (Kessler, 1981).

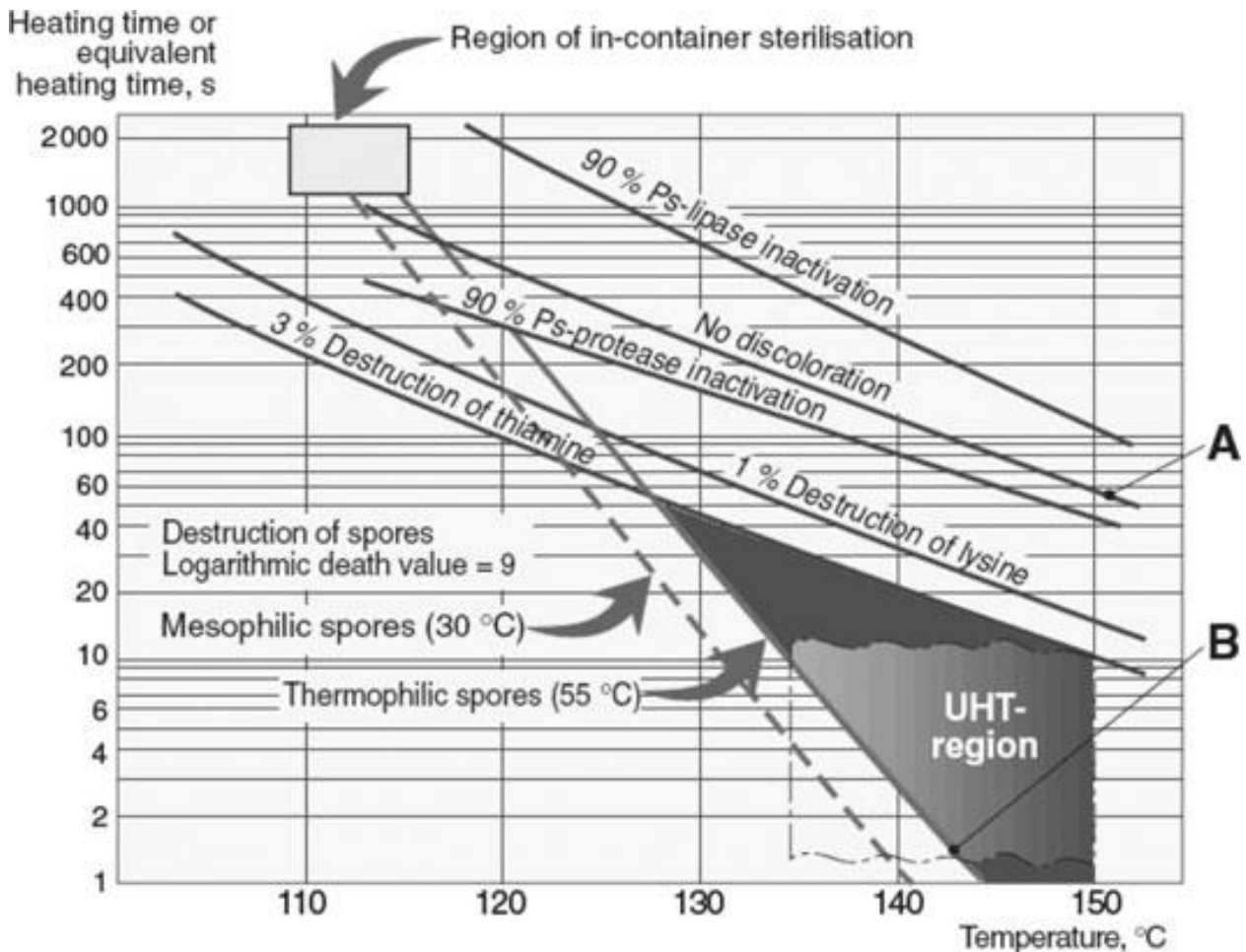

Figure 2.3: Chemical changes and bacteriological killing effects in heat treated milk (Kessler, 1981).

Although UHT milk has a reported shelf life of 6-9 months when stored at room temperature (Perkins, D’Arcy, Lisle, & Deeth, 2005), various physical and chemical changes affect its shelf life and subjective attributes used to measure the quality of the milk include taste, colour, odour, gelation, sedimentation, separation and viscosity (Azzara & Campbell, 1992; Aroonkamonsri, Aroonkamonsri, & Kakuda, 1996; Jovanka et al., 2008). The factors responsible for these changes in UHT milk are discussed in the following sections.

2.3.1 Factors affecting UHT milk quality

The sensory quality and therefore the shelf life of UHT milk is governed by the progression of various physico-chemical and biochemical changes after processing. The main changes that occur upon storage of UHT milk are due to proteolytic, lipolytic, oxidative and Maillard type reactions (Datta & Deeth, 2003). Quality changes that occur in UHT milk are due to interactions between the amino acid lateral groups, degradation reactions of proteins, restructuring of sulfhydryl groups and disulphide bonds, insolubilisation of whey proteins, interactions with lipids, interactions between κ -casein and β -lactoglobulin, and interactions between carbohydrates and proteins (Maillard reaction) (Pompei, Rossi, & Mare, 1987). An excess of 400 volatile compounds that may affect the sensory quality of milk have been reported. These compounds include acids, lactones, ketones, furans, N-containing compounds, sulphur compounds, carbonyls, alcohols, esters, and aliphatic and aromatic hydrocarbons (Al-Attabi, D'Archy & Deeth, 2009).

2.3.1.1 Raw milk

The quality of the raw milk is very important for producing UHT milk with a long shelf life. Various factors can influence the quality of milk, including the age of the cow (Datta & Deeth, 2003), the stage of lactation (Auldist, Coats, Sutherland, Hardham, McDowell, & Rogers, 1996), mastitis (Ogola, Shitandi, & Nanua, 2007) and the season (Gaucher, Boubellouta, Beaucher, Piot, Gaucheron, & Dufour, 2008; Bałowska, Litwińczuk, Brodziak & Chabuz, 2012). Raw milk with a high microbial count is more susceptible to age gelation during storage than milk with a low count. Law, Andrews, and Sharpe (1977) found that UHT milk produced from raw milk with a psychrotrophic bacterial count of less than 8×10^6 CFU.mL⁻¹ had a shelf life of 6 months, while milk with higher counts of 8×10^6 and 5×10^6 CFU.mL⁻¹ had reduced shelf lives of 63 and 12 days, respectively, due to gelation of the milk (Law et al., 1977). Storage of raw milk at high temperatures and/or for long time periods promotes the growth of psychrotrophic bacteria which produce enzymes that can have considerable heat stability and lactic acid that causes a decrease in the pH of the milk. When the pH reaches 6.6 the milk will become unstable to heat, causing fouling of the heat exchangers and sedimentation in the final product (Holdsworth, 1992; Lewis & Deeth, 2009).

Heat-stable enzymes produced by psychrotrophic bacteria, especially proteases and lipases, can cause both sensory and consistency defects in the UHT milk (Section 2.3.1.10).

2.3.1.2 Processing method

As previously discussed, two major processing methods, i.e. direct and indirect heating, are used to produce UHT milk. Direct heating employs low-severity heating resulting in small flavour changes, while indirect heating employs more severe heating which results in more pronounced cooked flavour development in the milk (Fig. 2.4) (Datta et al., 2002; Elliott et al., 2003). In addition to the cooked flavour, indirect processed milk can also have a scorched flavour resulting from exceptionally large amounts of burn on in the heat exchangers (Shipe et al., 1978). The less intense flavour changes produced by direct heating can partly be attributed to the loss of some volatile compounds during the vacuum flash cooling. This step will also reduce the oxygen level in the UHT milk (Ahrne, 1988). The effect of the oxygen level on the flavour of UHT milk during storage is discussed in Section 2.3.1.6.

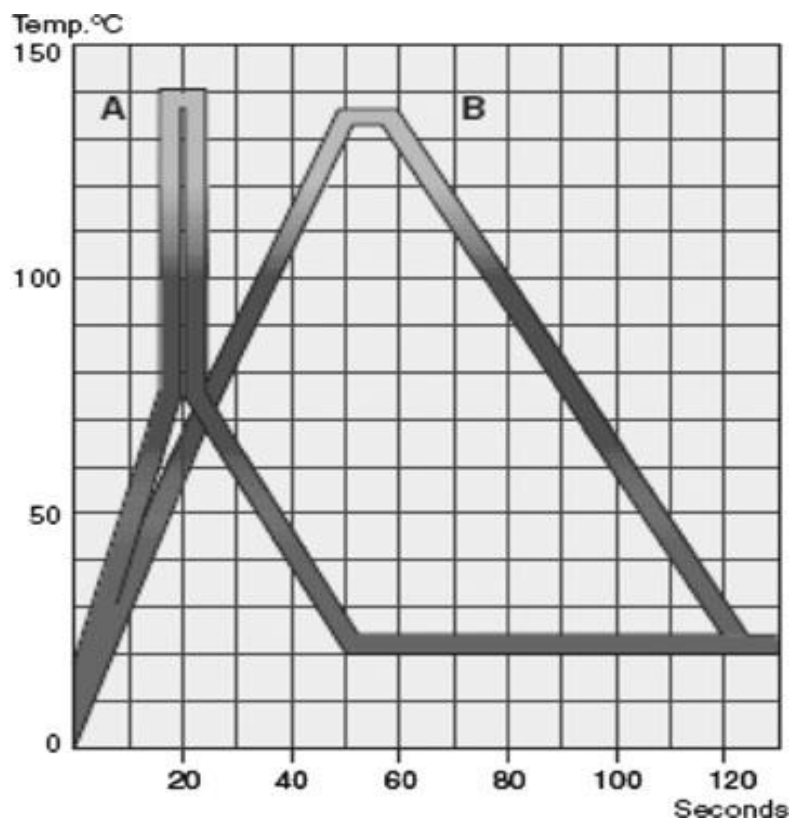

Figure 2.4: Time temperature profile of direct (A) and indirect (B) heating (Gösta, 2003).

Even though the indirectly processed milk has more intense flavour changes, it is less prone to gelation due to the inactivation of proteolytic enzymes by the higher heat load of indirect heating (Datta et al., 2002). Ramsey and Swartzel (1984) also found sediment was present in smaller quantities following indirect processing. Direct heating after homogenization causes reagglomeration of the small fat globules, resulting in the formation of a solid fat layer during storage of the milk. To prevent this homogenization in direct UHT plants are used after the final heating step and vacuum cooling. Free fatty acid production during storage is also more noticeable in milk produced in direct rather than indirect systems (Schmidt and Renner, 1978).

2.3.1.3 Processing temperature

Four distinct groups of heat induced flavours have been identified in milk: cooked or sulphurous, rich or heated, caramelised, and scorched (Shipe et al., 1978). When compared to pasteurized milk, UHT milk has more cooked, caramelized or flat flavours (Badings, 1991; Clare, Bang, Cartwright, Drake, Coronel, & Simunovic, 2005). The initial cooked flavour in UHT milk has mainly been attributed to the presence of volatile sulphur compounds (Patrick & Swaisgood, 1976; Al-Attabi et al., 2009). The whey proteins, primarily β -lactoglobulin which contains two disulphide groups and one free sulfhydryl group (Walstra, Geurts, Noomen, Jellemam & van Boekel, 1999), and the milk fat globule membrane proteins unfold during the heat process exposing the sulfhydryl groups, normally masked in the protein, and volatile sulphur compounds are formed (Hoffmann & van Mill, 1997). Chen, Hwang, Liao, Hong, and Mao (2005) demonstrated a 90% loss and denaturation of β -lactoglobulin in UHT processed and dry milks using polyacrylamide gel electrophoresis (Chen et al., 2005). The Maillard reaction is also a source of volatile sulphur compounds in heated milk with the formation of various sulphur containing compounds from methionine and hydrogen sulphide from cysteine (Badings, Neeter, & Van Der Pol, 1978; Nursten, 1981; Calvo & De la Hoz, 1992). Sulphur containing compounds identified in raw and heated milk include: hydrogen sulphide, methanethiol, dimethyl sulphide, dimethyl disulphide and, to a lesser extent, carbon disulphide, carbonyl sulphide, dimethyl trisulphide, dimethyl sulphoxide and dimethyl sulphone (Slinkard, 1976; Jaddou, Pavey, & Manning, 1978; Badings & de Jong, 1984; Steely, 1994; Vazquez-Landaverde, Torres, & Qian, 2006). The intensity of the cooked

flavour is directly related to the severity of the heat treatment and can be attributed to the increase in the levels of volatile sulphur compounds (Patrick & Swaisgood, 1976; Badings, 1991). According to Jaddou et al. (1978) the cooked/cabbage flavour of UHT milk may not only be due to these sulphur containing compounds, but perhaps due to the interaction of these compounds with unidentified compounds from the carbonyl fraction of milk. Vazquez-Landaverde, Velazquez, Torres, and Qian (2005) identified dimethyl sulphide as an important aroma contributor in UHT milk, while Vazquez-Landaverde et al. (2006) proposed that methanethiol may be the most potent sulphur containing aroma compound in UHT milk.

The reactive sulphhydryls formed during heating can react intra-molecularly to form β -lactoglobulin aggregates, or inter-molecularly to form disulphide bonds between β -lactoglobulin and other molecules containing sulphhydryl groups such as κ -casein and proteins of the milk fat globule membrane (Lyster, 1964; Dunkley & Stevenson, 1987). The major proteinaceous linkages developing during the heat treatment of the milk result in the formation of β -lactoglobulin- κ -casein complexes. The subsequent release or partial release of $\beta\kappa$ -complexes from the casein micelles and further cross-linking interactions between proteins can occur. This will cause the milk to thicken and then gel (McMahon, 1996).

During UHT treatment lactose is converted into different organic acids, leading to a decrease in the pH of the milk (Fox & McSweeney, 1996). Swartzel (1983) reported that heat treatment of above 100°C and subsequent storage leads to the degradation of lactose into acids, especially formic acid. The level and extent of pH decrease is related to age gelation of the milk. The casein micelles in milk are stable at pH 6.7, but below this pH level aggregation of the micelles occurs, resulting in consistency defects (Andrews, Brooker, & Hobbs 1977).

UHT processing also has an effect on the nutritional quality of the milk. Even though the heat treatment has a minimal effect on the fat-soluble vitamins, it can partially destroy the water-soluble vitamins (Asadullah, Omer, Syed, Khalid, Askari, 2010). B vitamins are reduced by 10%, folic acid by 15%, and vitamin C by 25%, while the proteins and fats are affected minimally (Holdsworth, 1992). Asadullah et al. (2010) reported a significant reduction in vitamin B₁ (thiamine), B₂ (riboflavin), B₃ (niacin), B₆, B₁₂, and folate under various milk processing treatments. The Maillard reaction is also responsible for protein nutritional impairment due to the destruction of essential amino acids or the decrease in their

bioavailability (Seiquer et al., 2006; Delgado-Andrade; Rufián-Henares, & Morales, 2007) Generally heating has little effect on milk salts, with the exception of carbonates and calcium phosphates (Asadullah et al., 2010). Potential carbonate, in the form of CO₂, is lost during heating with a resulting increase in pH, while the solubility of calcium phosphates decrease and precipitation onto the casein micelles occurs, resulting in a decrease in the concentration of calcium ions and pH (Solano-Lopez, Ji, & Alvarez 2005).

The intensity of the colour of UHT milk can be seen as a reflection of physico-chemical changes that occurred in the product. After UHT treatment, changes in the casein size and denaturation of whey proteins both increase the amount of light scatter (reflectance) with the result of milk appearing whiter. This is, however, balanced by browning which lowers the degree of reflectance and gives the milk a mild white colour. Dairy products with more reducing sugars are more prone to browning due to Maillard reactions and the degree of browning increases with process severity and storage temperature (Dunkley & Stevenson, 1987; Qamar, Aizad, & Ashaf, 2003; Hassan, Amjad, & Mahmood, 2009). Maillard reactions consist of a series of chemical reactions resulting in the formation of brown-coloured pigments, such as pyralysins and melanoidins, low molecular weight acids, as well as polymers, such as lactulose-lysine and fructose-lysine (Cattaneo, Masotti, & Pellegrino, 2008).

2.3.1.4 Storage temperature

Several days after UHT processing of the milk, the flavour of the milk changes from cooked to heated or rich, and then to stale (Azzara & Campbell, 1992). Changes in the UHT milk flavour are related to storage temperature, with lower temperatures inducing less change. Various volatile aldehydes, ketones and sulphur containing compounds in the UHT milk are responsible for these flavours and are derived via thermal denaturation of milk proteins, lipid oxidation or non-enzymatic reactions of the constituents of the milk's matrix, i.e. milk proteins, carbohydrates, lipids and other milk constituents (Jeon, Thomas, & Reineccius, 1978; Calvo & de la Hoz, 1992; Contarini; Povo, Leardi, & Toppino, 1997; Vazquez-Landaverde et al., 2005; Vazquez-Landaverde et al., 2006).

The main compounds that are responsible for the heated flavour in UHT milk are Maillard reaction products such as lactones, methyl ketones, diacetyl, maltol, vanillin, benzaldehyde, and acetophenone (Scanlan, Lindsay, Libbey, & Day, 1968). The greatest contributors to the heated flavour are diketones and cyclic ketones (Shibamoto, Mihara, Nishimura, Kamiya, Aitoku & Hayashi, 1980), while methyl ketones and aldehydes contribute more to the perceived stale or oxidized flavour in the UHT milk (Shipe et al., 1978; Contarini & Povolo, 2002). The concentration of methyl ketones is proportional to the extent of thermal processing, increases during storage and the rate of their formation is dependent on the storage temperature of the milk (Jeon et al., 1978; Contarini et al. 1997; Valero, Villamiel, Miralles, Sanz, & Martinez-Castro, 2001; Vazquez-Landaverde et al., 2005). Methyl ketones are produced by the hydrolysis and decarboxylation of β -ketoalkonic acid ester in milk fat during heating and since their formation requires a low activation energy, formation continues readily throughout the storage period (Parks, Keeney, Katz, & Schwarts, 1964; Schwartz, Parks, & Yoncoskie, 1966). According to Vazquez-Landaverde et al. (2005) aldehydes may strongly contribute to the flavour of UHT milk even though they occur at very low concentrations. The rate at which aldehydes are formed in milk is influenced by both the oxygen content and temperature during storage (Jeon et al., 1978). Even though the concentrations of methyl ketones are higher than aldehydes in UHT milk, the latter, particularly aliphatic aldehydes, contribute more extensively to the stale flavour of UHT milk (Rerkrai, Jeon & Bassette 1987). The rate at which aldehydes are formed in milk is influenced by both the oxygen content and storage temperature (Jeon et al., 1978). Aliphatic aldehydes are produced during storage by the oxidation of casein bound unsaturated fatty acids and the degradation of various amino acids in the milk's matrix (Morgan, Forss, & Patton, 1957; Ramshaw & Dunstone, 1969).

2.3.1.5 Light

Both artificial and sunlight effect the quality of milk by creating off-flavours and reducing vital vitamins in the milk. It is important to use packaging materials with low light permeability to prolong the shelf life of milk, since the presence of riboflavin (Vit B2) in milk make it particularly susceptible to light oxidation (Gunnar, Ebbese, & Eggestad, 1998; Min and Boff, 2002). Riboflavin is the key factor for light-induced oxidation of milk since it

is a photosensitizer that can produce methional and reactive oxygen species from methionine by visible and UV light, respectively (Min & Boff, 2002; Choe, Huang, & Min, 2005). Methional has a very low odour threshold and give rise to strong off-flavours in the milk (Gunnar et al., 1998). The reactive oxygen species that are formed, like singlet oxygen, can induce a cascade of oxidation reactions with a resultant loss in nutrients and amino acids, discolouration of the milk and the formation of strong off-flavours (Borle, Sieber, & Bosset, 2001). Singlet oxygen oxidation of the amino acid methionine results in the formation of dimethyl sulfide while typical secondary oxidation products, such as pentanal and hexanal, are formed during light-induced oxidation of unsaturated fatty acids in milk. All of these decomposition products have strong off-flavours with low threshold values and are thought to be responsible for the development of light-induced off-flavours (Jung, Yoon, Lee, & Min, 1998; Rysstad, Ebbesen, & Eggestad, 1998; Marsili, 1999).

2.3.1.6 Oxygen

The presence of oxygen in UHT milk has an effect on the flavour changes that occur in the milk during storage. High oxygen concentration in UHT milk will reduce the level of cooked flavour due to oxidation of the volatile sulphur compounds, and hasten the appearance of stale flavour due to lipid oxidation (Gaafar, 1987). This was shown in various studies where high oxygen concentrations, i.e. higher than 7 parts per million (ppm), (Zadow & Birtwistle, 1973); 5.4 ppm (Andersson & Oste, 1992); 8.4 ppm (Adhikari & Singhal, 1992); and 4-7 ppm (Perkins et al, 2005), accelerated the reduction of cooked flavour, while accelerating the appearance of oxidized flavour. Milk oxidative rancidity is the reaction between oxygen and milk fat components and results in short-chain aldehyde and ketone volatiles (Solano-Lopes et al., 2005). Even though the saturated lipids are considered stable after processing of the milk, the unsaturated lipids can be oxidized as free fatty acids or triglycerides in the presence of oxygen (Richardson & Korycka-Dahl, 1983). Hedegaard et al. (2006) found that the higher the unsaturated fatty acid content of the milk, the more free radicals (singlet oxygen) are formed and the faster oxidation occurs. The increase in oxidation products resulted in a metallic and cardboard flavour in the milk (Hedegaard et al., 2006). Generally, oxygen can be found in the headspace of containers, dissolved in milk or it can permeate through the milk container. Dissolved oxygen will decrease over time with the occurrence of various oxidation

reactions in the milk. The ability of the packaging material to prevent oxygen to enter will determine whether the oxidation reactions will continue or plateau. When oxygen is absorbed from the environment, oxidation of the milk will continue with the development of off-flavours (Gunnar, et al, 1998; Smet, De Block, De Campeneere, De Brabander, Herman, & Raes, 2009).

2.3.1.7 Fat content

The shelf-life of UHT milk can be influenced by the fat content of the milk. Studies by López-Fandiño, Olano, Corzo, and Ramos (1993) and García-Risco, Ramos, and López-Fandiño (1999) indicated that skimmed UHT milk deteriorated more than whole UHT milk due to higher levels of proteolysis and off-flavour development in skim milk during storage at room temperature. Valero et al. (2001) evaluated the changes in the flavour and volatile components during storage of whole and skimmed UHT milk. They found a greater increase in the non-casein nitrogen of the skimmed milk and that changes in the volatile components occurred sooner as compared to the whole UHT milk (Valero et al., 2001). Lower levels of non-casein nitrogen in whole milk can be attributed to a lower level of enzymatic activity due to a possible protective effect of the fat against enzymatic attack of the protein (López-Fandiño et al., 1993). The main change in the volatile composition of the whole milk during storage was increased levels of methyl ketones, while components related to both proteolysis and Maillard reaction were present in the skimmed milk samples (Valero et al., 2001).

2.3.1.8 Packaging material

Simon, Hansen, and Young (2001) studied the interactions between the flavour compounds inherent in the UHT milk and the packaging material. Flavour absorption from UHT milk stored in polyethylene and cardboard boxes take place after 16 days of storage, leading to a reduction in cooked flavour. Interactions between the flavour compounds and the packaging material may be due to the permeability of the packaging causing migration of the flavour compounds, or through absorption to the flavour by the packaging material (Hansen, Turner, & Jones, 1974). A slight cooked flavour was present in UHT milk packaged in barrier (low density polyethylene (LDPE)/cardboards/LDPE/ethylene-vinyl alcohol/LDPE) and foil

(polyethylene (PE)/cardboards/PE/aluminium/PE) boards after storage for 6 weeks, but had disappeared by week 10 (Simon et al., 2001). These packaging materials retain hydrogen sulphide and methanethiol, minimize gas transfer and have good selectivity for sulphur compound sorption (Lecanu, Ducruet, & Feigenbaum, 2003). LDPE has an affinity for various hydrophobic compounds and branched sulphur containing compounds (Arora, Hansen, & Armagost, 1991).

2.3.1.9 Post-process contamination

Post-sterilisation contamination may result from several sources. The most important ones are the seals in the homogeniser (if downstream) and the air supply to the aseptic packaging unit. Spores trapped under the seals are more heat-resistant, mainly due to a very low water activity in their microenvironment, and could act as a reservoir of contaminating spores. These spores can germinate in UHT products during storage and cause instability of the milk and subsequently reduce the shelf life. Contamination by *Geobacillus stearothermophilus*, *Bacillus stearothermophilus* and *B. licheniformis* can cause flat sour defects (Datta & Deeth, 2007). Spores produced by *B. sporothermadurans* have been found to be highly heat, exceeding the heat resistance of other *Bacillus* spp., and can also cause undesired growth in UHT milk during storage (Klijn et al., 1997; Scheldeman, Herman, Foster, & Heyndrickx, 2006). *Fusarium oxysporum* is a filamentous fungus that can produce an off-flavour in the milk, similar to blue-vine cheese. It also produces a gas and is often detected when packages become swollen or “blown”. This fungus is prevalent in the environment, on plants and in soils, and can enter the UHT milk packages through contaminated air in the filling machine when positive air pressure is lost in the aseptic zone (Datta & Deeth, 2007).

2.3.1.10 Enzymes

Various psychrotrophic bacteria, represented by both Gram-positive and Gram-negative bacteria, are capable of growing and producing enzymes at refrigeration conditions under which raw milk is stored prior to heat processing. Although UHT processing inactivates most bacteria, some heat-stable enzymes of native or bacterial origin can survive this process and

can cause shelf life limiting defects during the storage of the milk (Burton, 1988; Valero et al., 2001). The most important heat-stable enzymes from a commercial viewpoint are the proteases and lipases.

2.3.1.10.1 *Proteases*

Proteolysis of UHT milk is one of the most important shelf life limiting factors that can lead to an increase in viscosity, with the eventual formation of a gel, and the development of bitter and unclean off-flavours (Chen, Daniel, & Coolbear, 2003; Datta & Deeth, 2003). Age gelation of UHT milk limits both the shelf life and market potential of the milk (Datta & Deeth, 2001). Proteolysis of UHT milk has been attributed to heat-stable proteinases produced by psychrotrophic bacterial contaminants of raw milk and natural milk alkaline serine proteinase, known as plasmin (Visser, 1981).

Bacterial contaminants, mainly introduced into milk by the interior of the udder, the cows' teats and milking and storage equipment (Law & Mabbitt, 1983), are almost entirely psychrotrophs and mainly species of *Pseudomonas* that mainly produce only one type of proteinase, typically a neutral zinc metallo-proteinase, mainly at the end of the stationary phase of growth (Fairbairn & Law, 1986; Kohlmann, Nielsen, & Ladisch, 1991). Proteinases from psychrotrophic bacteria preferentially attack casein over whey proteins and β - and κ -casein are more susceptible than α_s -casein (Gebre-Egziabher, Humbert, & Blankenagel, 1980; Triantafyllidou & Roussis, 1999). *Bacillus* species are abundant in the environment and can contaminate milk during production, handling and processing (Phillips & Griffiths, 1990; Matta & Punj, 1999). *Bacillus* species can form spores that are resistant to heat and chemical cleaning reagents and can therefore persist on factory equipment (Griffiths & Phillips, 1990; Murphy et al., 1999). In contrast to *Pseudomonas* species, most *Bacillus* species produce diverse proteolytic activities and they may even produce more than one type of proteinase (Chopra & Mathur, 1985).

Plasmin is the main native protease in milk and is part of a complex system that not only comprise of plasmin, but also plasminogen (plasmin precursor), plasminogen activators, plasmin inhibitors and inhibitors of plasminogen activators (Crudden & Kelly, 2003;

Upadhyay, McSweeney, Magboul, & Fox, 2004). An important part of the potential plasmin activity in the milk is present as plasminogen. Plasminogen is more heat stable than its active form and can be activated by cleavage of a single peptide bond by even more heat stable activators (Lu & Nielsen, 1993; Aroonkamonsri et al., 1996). The plasmin, plasminogen and the plasminogen activators are associated with the casein micelles in milk, while the plasmin inhibitors and the inhibitors of plasminogen activators are present in the serum phase. Plasmin acts on caseins in the order α_{s2} -casein = β -casein \gg α_{s1} -casein, while κ -casein shows resistance to the trypsin-like activity of plasmin (Fox & McSweeney, 1996; Upadhyay et al., 2004).

After UHT processing the milk is stored without refrigeration, making it a favourable environment for enzyme activity. The optimum pH for proteases ranges from pH 7-8, while 85 to 90% of the maximum activity is retained at a pH of 6.5, the pH of milk (Speck & Adams, 1976) Proteinase activity is associated with the release of tyrosine in the milk that may contribute to the development of off-flavours such as bitterness (Gebre-Egziabher et al., 1980). These enzymes can also accelerate age gelation of UHT milk by hydrolysing the caseins, releasing the β -lactoglobulin- κ -casein complex ($\beta\kappa$ -complex) that are formed during heat treatment, from the micelle. Subsequent aggregation of the released complexes forms a three-dimensional cross-linked protein network which causes the milk to gel (McMahon, 1996).

2.3.1.10.2 Lipases

Hydrolysis of milk triacylglycerols is caused by thermostable bacterial lipases and the native milk lipoprotein lipase. Although milk lipoprotein lipase is inactivated by pasteurization, some bacterial lipases can survive heat treatment and cause rancid flavours in UHT milk (Perkins, Elliott, D'Arcy, & Deeth, 2005). Their presence in UHT milk depends on the microbiological quality of the raw milk and the milk heat treatment (Choi & Jeon, 1993; Chen et al., 2003). Even though native milk lipases are inactivated by heating at 98°C for 1 s, bacterial lipases from *Pseudomonas fluorescens* are only inactivated after 20 min of heating at 138°C. Griffiths, Philips, & Muir (1981) found that lipases from several different psychrotrophic bacterial species reserve about 30% of their initial activity in milk heated at

140°C for 5 s. A similar study by Andersson, Danielsson, Hedlund, and Svensson (1981) showed that *P. fluorescens* lipases preserve 50% of their initial activity after heating milk at 138°C for 3 s, resulting in lipolysis of UHT milk during storage. Lipolysis is associated with the development of off-flavours in UHT milk and the release of medium- and short-chain fatty acids give rise to soapy and tangy flavours, respectively. Choi and Jeon (1993) reported that the medium-chain fatty acids were released to the greatest extent and after storage at room temperature for 12 weeks these fatty acids increased by 45-60%. The rate of release of short- and long-chain fatty acids was significantly weaker and increased by only 9-26% under the same storage conditions. These authors also showed that the rate of release of all the aforementioned groups of fatty acids was accelerated at higher temperatures.

Free fatty acids (FFAs) released during lipolysis are also precursors for other intense flavour compounds, such as methyl ketones, esters, lactones and β -keto acids, while the unsaturated fatty acids are susceptible to oxidation and the formation of ketones and aldehydes that impart oxidised cardboard and metallic flavours (Vulfson, 1994). Other flavours associated with lipolysis of milk include rancid, butyric, bitter, unclean, soapy and astringent (Deeth & Fitz-Gerald, 1994).

2.3.1.10.3 Phospholipases

Various Gram-positive and Gram-negative psychrotrophs can produce phospholipases. Products with high numbers of *Bacillus* cells show the “bitty cream” defect (floating clumps of fat), suggesting that phospholipases from this microorganism has the unique ability to damage the fat globule membrane (Sørhaug & Stepaniak, 1997).

2.3.2 Measures taken to reduce sensory defects in UHT milk

According to Clare et al. (2005) UHT milk has poor consumer acceptability when compared to that of pasteurized milk and this can be attributed to the cooked and stale flavours of the milk (Vazquez-Landaverde et al., 2005; 2006). Several attempts to improve the sensory quality of UHT milk proved to be successful to varying degrees.

To reduce the cooked flavour in UHT milk, various studies have focused on the use of additives. In an early study, the addition of 0.5 ppm copper to milk was shown to retard the formation of sulphur compounds during heating. At concentrations of 2 ppm copper no hydrogen sulphide was produced. However, this led to the oxidation of sulphur compounds after heating and accelerated the appearance of oxidized flavour (Josephson & Doan, 1939; Boyd & Gould, 1957). The shelf life of pasteurized milk was reduced to only one day when 5 ppm copper was added due to oxidized flavour formation (Marsili, 2000). Swaisgood, Janolino, and Skudder (1987) used immobilized sulfhydryl oxidase to reduce the thiol content and Boyd and Gould (1957) reduced the concentration of hydrogen sulphide and sulfhydryl groups by adding 0.025% calcium chloride and/or disodium hydrogen phosphate. The cooked flavour was also reduced by adding organic thiosulphonates and organic thiosulphates to milk prior to heating (Ferretti, 1973), oxidizing agents, NaIO_3 or NaBrO_3 , before or after heating, and KIO_3 and KBrO_3 after heating (Samuelsson & Borgström, 1973). L-cystine was used by Badings (1977) and Renner and Berlage-Weining (1983) to reduce the intensity of cooked flavour and hydrogen sulphide concentrations. In a more recent study, 0.2% epicatechin, a flavonoid compound, was added to the milk prior to heating and found to reduce the cooked flavour. Even though this flavonoid reduced sulphur-containing methional along with other Maillard-derived compounds, it imparted a bitter note in the milk at 0.2% (Colahan-Sederstrom & Peterson, 2005). Although these additives show potential in preventing off-flavour development, legislation states that milk should be free from any additives (Department of Health, South Africa, 1997).

Other studies have shown that altered UHT process parameters, such as indirect steam injection vs. direct steam injection systems, cooling rates and storage conditions have significant impact on the sensory properties of the milk (Browning, Lewis, & MacDougall, 2001). The stale or oxidized flavour that develop during storage of UHT milk can be attributed to the oxidation of lipids with the production of methyl ketones and saturated aldehydes (Rerkrai et al., 1987). Various attempts to prevent stale flavour formation include the addition of antioxidants such as butylated hydroxyl anisole (BHA) (Vazquez-Landaverde & Qian, 2007), and ascorbic acid (Jeon et al., 1978), or to incorporate oxygen scavengers in the packaging material (Perkins, Zerdin, Rooney, D'Arcy, & Deeth, 2006). Perkins et al. (2006) incorporated an oxygen scavenging film into UHT milk packaging. This lowered the

amount of dissolved oxygen in the UHT milk, and led to the reduction of 2-hexanone, hexanal, 2-heptanone, 2-nonanone and nonanal by up to 41% after 14 weeks of storage. A sensory panel could, however, not find any significant difference between the treated and untreated samples and the oxygen scavenger used was not an approved food additive (Perkins et al., 2006).

By selecting the appropriate packaging material, packaged food can be protected from both light and oxygen. To protect UHT milk from light-induced oxidation, the International Dairy Federation determined that the light transmittance of packaging materials used for UHT milk may not exceed 2% at 400 nm and 8% at 500 nm (Mestdagh, DeMeulenaer, De Clippeleer, Devlieghere, & Huyghebaert, 2005). Rysstad et al. (1998) found that UHT milk packaged and stored in paperboard cartons without foil had a shelf life of 4 months with the formation of some off-flavours, while UHT milk in aluminium foil cartons had an increased shelf life of 6 months under the same storage condition. The increased shelf life of the milk in the aluminium foil cartons can be attributed to the low oxygen permeability of these cartons (Rysstad et al, 1998).

Schamberger and Labuza (2007) evaluated the effect of two green tea flavonoids, epicatechin and epigallocatechin gallate, on Maillard browning in UHT milk by fluorescence spectroscopy for Maillard browning, the total colour difference and sensory analysis. They found that addition of these flavanoids reduced the production of Maillard associated fluorescence and total colour difference with UHT processing. Sensory analysis also showed that samples containing these flavanoids had similar liking to control samples.

2.3.3 Measures taken to reduce enzymatic and consistency defects in UHT milk

To achieve a long shelf life UHT milk, high-quality raw milk is of utmost importance (Law et al., 1977), and storage at low temperature (<4°C) for a maximum period of 48 h will minimize the growth of psychrotrophic bacteria and, consequently, the amount of extracellular proteinases produced by these bacteria prior to heat treatment. Sørhaug and Stepaniak (1997) reported that psychrotrophic bacteria can also be successfully inhibited by treating milk with carbon dioxide and nitrogen. Similar results were reported by Vianna,

Walter, Dias, Faria, Netto, and Giante (2012) that treated raw milk with carbon dioxide and found that the raw milk maintained its physico-chemical and microbiological quality better than untreated milk. UHT milk produced from carbon dioxide treated raw milk showed less proteolysis and longer shelf life as compared to UHT milk produced from untreated milk. Low-temperature inactivation at 55°C for a prolonged period of holding (30 to 60 min) has been shown to inactivate heat-resistant enzymes in milk. This method can be applied before or after the UHT process, but is most effective when used 1 d after the UHT treatment. Even though this treatment will have minimal effect on the flavour of the milk and can prolong the shelf life along with UHT processing, some proteinases are quite resistant to heat treatment at 55°C for an hour, limiting its usefulness preventing age gelation of UHT milk (Barach, Adams, & Speck, 1976).

Adequate heat treatment inactivates plasmin. Lu and Nielsen (1993) also added serine proteinase inhibitors, aprotinin and diisopropylfluorophosphate, to UHT milk to inhibit the plasmin and observed that no proteolysis or gelation occurred after 9 months of storage at 20°C. Whey proteins are not hydrolysed by plasmin and these proteins have some inhibitory effect on plasmin activity. Politis, Zavizion, Barbano, and Gorewit (1993) showed that β -lactoglobulin A, α -lactalbumin and bovine serum albumin at concentrations of 1 mg/mL inhibited plasmin plus plasminogen activity by up to 54, 20 and 63%, respectively. Kocak and Zadow (1985) showed that the addition of 0.05% calcium chloride or 0.1% sodium hexamethaphosphate (SHMP) to milk before UHT processing resulted in an increase instability and milk showed no gelation after 500 d at 25°C. SHMP facilitates bridging between the ionized groups of casein micelles. This would hold the κ -casein more tightly to the micelle and delay the release of the $\beta\kappa$ -complexes, thus retarding the gelation of the UHT milk. Lysine was shown to inhibit plasminogen activation by competing for the lysine-binding site present of plasmin and plasminogen. In addition to this, it causes dissociation of plasmin and plasminogen from casein micelles, with 0.2 M lysine releasing 92 and 97% of plasmin and plasminogen, respectively. The concentration of lysine necessary to completely inhibit plasminogen activation is, however, very high, thus making it impractical for use in milk (Bramley, 1998).

During UHT processing, milk is commonly preheated to 80-95°C for 30-60 seconds in order to stabilise the β -lactoglobulin, before the high temperature is applied. The β -lactoglobulin

denatures at the preheating temperatures and remains stable at the high temperature heating of the UHT process. This ensures that the β -lactoglobulin does not deposit on the high temperature heating section of the UHT plant and delays gelation of the UHT milk during storage (Zadow & Chiuta, 1975). Even though indirect heating imparts a more cooked flavour in UHT milk, it tends to increase the time before gelation occurs as compared to direct heating (Manji, Kakuda, & Arnott., 1986; Manji & Kakuda, 1988). Increasing the temperature and/or time of heating during UHT processing, allows milk to be stored for longer time periods without gelation (Samuelson & Holm, 1966). This may be due to an increased level of whey protein denaturation. Manji and Kakuda (1988) found that milk with higher percentages of denatured whey proteins due to more severe heat-treatment took longer to gel than those with lower concentrations (McMahon, 1996). Whey proteins precipitate on the micellar surface and, as a consequence, the number of surface sites that are available for clotting is reduced (Payens, 1978; Corredig & Dalgleish, 1996). Chemical cross-linking within the micelles also occurs during more severe heat treatment (McMahon, 1996). This cross-linking, which includes disulphide bridges and ionic and hydrophobic interactions, modifies the properties of the casein micelles significantly and increase their resistance to coagulation by heat and age gelation (Snoeren, Van Riel, & Both, 1980; Snoeren & Both, 1981). The dissociation of the $\beta\kappa$ -complex from the micelle becomes slower, making the milk more stable (McMahon, 1996).

Other means of stabilising milk include modern membrane technology. Hirichs (2000) showed that the storage stability of milk can be improved by reducing the ash content, which can be achieved by using electro dialysis, nanofiltration or ultrafiltration. High-pressure treatment has also shown potential in milk treatment. Plasmin is very pressure stable at room temperature. The stability of plasmin is affected at pressures above 600 MPa and a synergistic effect of high pressure and temperature can be observed in the 300 to 600 MPa and 35 to 65°C ranges (Borda, Smout, Van Loey, & Hendrickx, 2004). High-pressure homogenization has also been shown to have an effect on the microbial quality of milk (Pereda, Ferragut, Quevedo, Guamis, & Trujillo, 2007).

2.3.4 Shelf life estimation UHT milk

To determine the shelf life of a product various factors need to be considered, including the nutritional deterioration, microbial growth and sensory deterioration (Singh, 2000). Since UHT milk is microbiologically stable over several months of storage, the shelf life is based on the sensory quality of the milk (Badings, 1991; Perkins et al., 2005). To design a successful shelf life study probable causes of product quality deterioration or failure need to be determined. For a shelf stable product like UHT milk, the most common mode of failure is sensory failure due to physico-chemical degradation. These modes of failure, including colour changes, loss of desirable sensory attributes and formation of undesirable sensory attributes, can be influenced by the compositional, packaging and storage factors (Azzara & Campbell, 1992; Aroonkamonsri, et al., 1996; Jovanka et al., 2008).

2.3.4.1 Accelerated shelf life

When products have long shelf lives under normal storage conditions, accelerated shelf life testing (ASLT) can be applied where the shelf life of the food is tested under environmental conditions that accelerate the quality deterioration of the food. The results obtained from the accelerated test can then be extrapolated to normal conditions of storage (Meeker & Escobar, 1998; Corrigan *et al.*, 2012). When ASLT is performed, the compositional factors must be kept constant while another factor must be chosen to accelerate the loss of quality of the food product over time. Various factors are known to be potential acceleration factors, including temperature, relative humidity, gas partial pressure and light intensity (Meeker & Escobar, 1998). Accelerated shelf life test do, however, include some limitations. These limitations include changes in the physical state of products as the temperature increases which can affect the rate of some reactions, storage at constant elevated temperatures with lower than normal relative humidity can lead to unexpected results, the mechanism of spoilage may change at elevated temperatures, and the Arrhenius model on which accelerated tests are based by not be appropriate for more complex chemical systems (IFST, 1993; Mizrahi, 2000)

2.3.4.1.1 Temperature as acceleration factor

To get an overall idea of the evolution of an attribute (A), the A value can be plotted as a function of storage time (t) with constant packaging and environmental variables. Equation 1.1 explains the kinetics of A during storage time and this can range from a simple straight line to a number of complex evolutions. The most common method for experimental data analysis to determine the rate of food quality decay is to apply the principles of classical kinetic theory. According to this approach the rate of change (r) in the attribute can be defined by:

$$r = dA/dt = kA^n \quad (1.1)$$

where k represents the reaction rate constant, t the storage time and n the reaction order (Fu & Labuza, 1993; Taoukis, Labuza, & Saguy, 1997).

Table 2.1 shows the integrated equations for $n = 0, 1, 2$ and also the general equation used for $n \neq 1$. To identify the proper reaction order the experimental values expressed as $A, \ln A, 1/A, 1/A^{n-1}$ are plotted against t and the appropriate order corresponds to a linear pattern of points. That is followed by determining the two parameters of the kinetic function, the rate constant (k) and A_0 , from the experimental data. Due to the complexity and heterogeneous nature of food, there is often not a theoretical reason to choose a specific reaction order. For this reason, alternative models of empirical nature are often considered (Corradini & Peleg, 2006).

Table 2.1: Zero-, first-, second- and n-order integrated kinetic equations.

Reaction order	Integrated rate law
$n = 0$	$A = kt + A_0$
$n = 1$	$\ln A = kt + \ln A_0$
$n = 2$	$1/A = kt + 1/A_0$
$n \neq 1$	$A^{1-n} = (n-1)kt + A_0^{1-n}$

Temperature is the most widely used environmental factor in ASLT. Not only is temperature one of the most critical factors that affect reaction kinetics in food, but a theoretical basis is available for the development of mathematical description of temperature sensitivity of quality loss rates. The Arrhenius equation (Arrhenius, 1901) was developed on the molecular basis for reversible chemical reactions and has been shown to explain a wide range of complex chemical, physical and sensory changes that occur in food (Labuza & Riboh, 1982).

$$k = k_0 \cdot e^{-E_a/RT} \quad (1.2)$$

where k is the reaction rate constant, k_0 is the pre-exponential factor, E_a is the apparent activation energy (J/mol), R is the molar gas constant (8.31 J/K/mol) and T is the absolute temperature (K).

In its linearized form:

$$\ln k = \ln k_0 - E_a/RT \quad (1.3)$$

To evaluate the effect of temperature on the reaction rate of a specific deterioration process in the food, values of k are estimated at different temperatures and $\ln k$ is plotted against the reciprocal absolute temperature. The Arrhenius behaviour is fulfilled when there is a linear relationship between these variables. By measuring the quality depletion rate at a minimum of three different temperatures, the reaction rate at the desired temperature can be extrapolated.

In the original form of the Arrhenius equation k_0 is the frequency factor and represents the number of successful collisions between reactants at 0 Kelvin, which is not a practical temperature of interest. The Arrhenius equation is therefore reparameterized by inserting a reference temperature T_{ref} , corresponding to the average of the temperature range used during the ASLT (Schwaab & Pinto, 2007)

$$k = k_{ref} \cdot e^{-E_a/R(1/T - 1/T_{ref})} \quad (1.4)$$

where k_{ref} is the rate constant at the reference temperature.

In its linearized form

$$\ln k = \ln k_{ref} - E_a/R (1/T - 1/T_{ref}) \quad (1.5)$$

If the Arrhenius equation is nonlinear, nonlinear regression can be applied to Equation 1.4, or linear regression to its linearized version in Equation 1.5. As an alternative, a one-step regression method could be applied. This method considers all data versus storage time for all the tested temperatures and in this case the reparameterized Arrhenius equation is integrated into the rate equations.

For zero-order kinetics it would be:

$$A = A_0 + t \cdot k_{ref} \exp[-E_a/R(1/T - 1/T_{ref})] \quad (1.6)$$

And for first-order kinetics it would be:

$$A = A_0 \cdot \exp[t \cdot k_{ref} \cdot \exp[-E_a/R(1/T - 1/T_{ref})]] \quad (1.7)$$

The one-step procedure has the advantage that all the different sources of uncertainty are accounted for by one equation, increasing the number of residual degrees of freedom (Calligaris, Manzocco & Lagazio, 2012).

2.4 CONCLUSION

Ultra-high temperature processing is an advanced technique used to produce milk that is microbiologically stable with a shelf life of several months at room temperature. There are various factors that can, however, induce changes in the consistency and/or the sensory properties of the UHT milk. Such changes can lead to quality deterioration of the UHT milk and thereby shorten the shelf life thereof.

2.5 REFERENCES

- Adhikari, A.K. & Singhal, O.P. (1992). Effect of dissolved-oxygen content on the flavour profile of UHT milk during storage. *Australian Journal of Dairy Technology*, 47, 1–6.
- Ahrne, L. (1988). UHT milk-an optimal product. *Modern Dairy*, 67, 23-26.
- Al-Attabi, Z., D’Arcy, B.R., & Deeth, H.C. (2009). Volatile sulphur compounds in UHT milk. *Critical Reviews in Food Science and Nutrition*, 49, 28-47.
- Andersson, R.E., Danielsson, G., Hedlund, C.B., & Svensson, G. (1981). Effect of the heat resistant microbial lipase on flavour of ultra-high temperature sterilized milk. *Journal of Dairy Science*, 64, 375–383.
- Andersson, I. & Oste, R. (1992). Sensory changes and free SH-groups in UHT milk. *Milchwissenschaft*, 47, 438–441.
- Andrews, A.T., Brooker, B.E., & Hobbs, D.G. (1977). Properties of aseptically packed UHT milk. Electron microscopic examination of changes occurring during storage. *Journal of Dairy Research*, 44, 283-285.
- Ansari, I.A., & Datta, A.K. (2003). An overview of sterilization methods for packaging materials used in aseptic packaging systems. *Transactions of IChemE*, 81, 57–65.
- Asadullah, K.N., Omer, M.T., Syed, A.A., Khalid, J., Askari, B. (2010). Study to evaluate the impact of heat treatment on water-soluble vitamins in milk. *Journal of Pakistan Medical Association*, 60, 909–912.
- Arora,, D.K., Hansen, A.P. & Armagost, M.S., 1991. Sorption of Flavour Compounds by Low Density Polyethylene Film. *Journal of Food Science*, 56, 1421-1423.
- Aroonkamonsri, J.H., Aroonkamonsri, W., & Kakuda, Y. (1996). The role of plasmin and bacterial proteinases on age gelation of UHT milk. *Scanning*, 18, 203-204.
- Arrhenius, S.A. 1901. *Larobok teoretisk elektroteknik*. Leipzig: Quando & Handel.

Auldist, M.J., Coats, S.J., Sutherland, B.J., Hardham, J.F., McDowell, G.H., & Rogers, G.L. (1996). Effect of somatic cell count and stage of lactation on the quality and storage life of ultra-high-temperature milk. *Journal of Dairy Research*, 63, 377–86.

Azzara, C.D., & Campbell, B. (1992). Off-flavours of dairy products. In G. Charalambous (Ed), *Off-Flavours in Foods and Beverages* (pp. 329-274). Amsterdam, Netherlands: Elsevier Applied Science.

Badings, H.T. (1977). A method of preventing the occurrence of cooked flavour in milk and milk products. *Nordeuropaeick Mejeri-Tidsskrift*, 43, 379-84.

Badings, H.T., Neeter, R., & Van Der Pol, J.J.G. (1978). Reduction of cooked flavour in heated milk and milk products by l-cystine. *Lebensmittel-Wissenschaft and Technology*, 11, 237–240.

Badings, H.T., & de Jong, C. (1984). Headspace analysis for the study of aroma compounds in milk and dairy products. In P. Schreier (Ed), *Analysis of Volatiles: Methods and Applications* (pp. 401-417). New York, USA: Walter de Gruyter & Co.

Badings, H.T. (1991). Milk. In H. Maarse (Ed), *Volatile Compounds in Foods and Beverage* (pp. 91-106). New York, USA: Marcel Dekker.

Barach, J.T., Adams, D.M., & Speck, M.L. (1976). Low temperature inactivation in milk of heat-resistant proteinases from psychrotrophic bacteria, *Journal of Dairy Science*, 59, 391–5.

Barłowska, J., Litwińczuk, Z., Brodziak, A. & Chabuz, W. (2012). Effect of the production season on nutritional value and technological suitability of milk obtained from intensive (TMR) and traditional feeding system of cows. *Journal of Microbiology, Biotechnology and Food Science*, 5, 1205-1220.

Borda, D. I., Smout, C., Van Loey, A., & Hendrickx, M. (2004). High-pressure thermal inactivation kinetics of a plasmin system. *Journal of Dairy Science*, 87, 2351–2358.

Borle, F., Sieber, R. & Bosset, J.O. (2001). Photo-oxidation and photoprotection of foods, with particular reference to dairy products: An update of a review article. *Science Aliments*, 21, 571-590.

Boyd, E.N. & Gould, I.A. (1957). Volatile and non-volatile sulphhydryl content of milk and milk products. *Journal of Dairy Science*, 40, 1294–1307.

Bramley, A.J. (1998). The role of lysine as an inhibitor of plasmin on protein quality. NEDFRC Annual Report.

Browning, E., Lewis, M., & MacDougall, D. (2001). Predicting safety and quality parameters for UHT-processed milks. *International Journal of Dairy Technology*, 54, 111–120.

Burton, H. (1988). *Ultra-high-temperature processing of milk and milk products*. New York, USA: Elsevier Applied Science Publications Inc.

Bylund, G. (1995). *Dairy Processing Handbook*. Lund, Sweden: Tetra Pak Processing Systems AB.

Calligaris, S., Manzocco, L., & Lagazio, C. (2012). Modeling shelf life using chemical, physical and sensory indicators. In M.C. Nicoli (Ed), *Shelf life assessment of food* (pp. 75-126). Florida, USA: CRC Press.

Calvo, M.M., & De La Hoz, L. (1992). Flavour of heated milks. A review. *International Dairy Journal*, 2, 69-81.

Cattaneo, S., Masotti, F., & Pellegrino, L. (2008). Effects of overprocessing on heat damage of UHT milk. *European Food Research and Technology*, 226, 1099–106.

Chen, L., Daniel, R.M., & Coolbear, T. (2003). Detection and impact of protease and lipase activities in milk and milk powders. *International Dairy Journal*, 13, 255–275.

Chen, W.L., Hwang, M.T., Liao, C.Y., Hong, K.C., & Mao, S.J.T. (2005). β -Lactoglobulin is a thermal marker in processed milk as studied by electrophoresis and circular dichroic spectra. *Journal of Dairy Science*, 88, 1618-1630.

Choe, E., Huang, R., & Min, D.B. (2005). Chemical reactions and stability of riboflavin in foods. *Journal of Food Science*, 70, 28-36.

- Choi, W., & Jeon I.J. (1993). Patterns of fatty acids released from milk fat by residual lipase during storage of ultra-high temperature processed milk. *Journal of Dairy Science*, 76, 78–85.
- Chopra, A. K. & Mathur, D. K. (1985). Purification and characterization of heat-stable proteases from *Bacillus stearothermophilus* RM-67. *Journal of Dairy Science*, 68, 3202–3211.
- Clare, D.A., Bang, W.S., Cartwright, G., Drake, M.A., Coronel, P., & Simunovic, J. (2005). Comparison of sensory, microbiological, and biochemical parameters of microwave versus indirect UHT fluid skim milk during storage. *Journal of Dairy Science*, 88, 4172-4182.
- Colahan-Sederstrom, P.M., & Peterson, D.G. (2005). Inhibition of key aroma compound generated during ultrahigh-temperature processing of bovine milk via epicatechin addition. *Journal of Agricultural Food Chemistry*, 53, 398-402.
- Contarini, G., & Povolò, M. (2002). Volatile fraction of milk: comparison between purge and trap and solid phase microextraction techniques. *Journal of Agricultural and Food Chemistry*, 50, 7350–7355.
- Contarini, G., Povolò, M., Leardi, R., & Toppino, P.M. (1997). Influence of heat treatment on the volatile compounds of milk. *Journal of Agricultural and Food Chemistry*, 40, 3171–3177.
- Corradini, M.M.G, & Peleg, M.M. (2006). Linear and non-linear kinetics in the synthesis and degradation of acrylamide in foods and model systems. *CRC Critical Review of Food Science and Nutrition*, 46, 489–517.
- Corredig, M., & Dalgleish, D.G. (1996). Effect of different heat treatments on the strong binding interactions between whey proteins and milk fat globules in whole milk. *Journal of Dairy Research*, 63, 441–449.
- Corrigan, V., Hedderley, D., & Harvey, W. (2012). Modeling the shelf-life of fruit-filled snack bars using survival analysis and sensory profiling techniques. *Journal of Sensory studies*, 27, 403-416.
- Crudden, A. & Kelly A.L. (2003). Studies of plasmin activity in whey. *International Dairy Journal*, 12, 987–993.

- Datta, N., & Deeth, H.C. (1999). High pressure processing of milk and dairy products. *Australian Journal of Dairy Technology*, 54, 41–48.
- Datta, N., & Deeth, H.C. (2001). Age gelation of UHT milk. *Transactions of the institute of chemical engineers C. Food and Bioproducts Processing*, 79, 197-210.
- Datta, N., & Deeth, H. C. (2003). Diagnosing the cause of proteolysis in UHT milk. *Food Science and Technology*, 36, 173-182.
- Datta, N., & Deeth, H.C. (2007). UHT and Aseptic Processing of Milk and Milk Products. In G. Tewari & V.K. Juneja (Eds.) *Advances in thermal and non-thermal food preservation* (pp. 63-90). Iowa, USA: Blackwell Publishing.
- Datta, N., Elliott, A.J., Perkins, M.L., & Deeth, H.C. (2002). Ultra-high-temperature (UHT) treatment of milk: comparison of direct and indirect modes of heating. *Australian Journal of Dairy Technology*, 57, 211-227.
- Deeth, H.C., & Fitz-Gerald, C.H. (1994). Lipolytic enzymes and hydrolytic rancidity in milk and milk products. In P.F. Fox (Ed.), *Advanced dairy chemistry, Vol. 2: Lipids* (pp. 247-308). London, UK: Chapman & Hall.
- Delgado-Andrade, C., Rufián-Henares, J.A. & Morales, F.J. (2007). Lysine availability is diminished in commercial fibre-enriched breakfast cereals. *Food Chemistry*, 2, 725–731.
- De Noni, I., Pellegrino, L., Cattaneo, S., & Resmini, P. (2007). HPLC of proteose peptones for evaluating ageing of packaged pasteurized milk. *International Dairy Journal*, 17, 12–19.
- Dentener, A. (1984). Influence of milk protein on quality aspects of UHT milk products. *Food Technology in New Zealand*, 19, 33–35.
- Dunkley, & W.L., Stevenson, K.E. (1987). Ultra-high-temperature processing and aseptic packaging of dairy products. *Journal of Dairy Science*, 70, 2192–202.
- Elliott, A.J., Dhakal, A., Datta, N., & Deeth, H.C. (2003). Heat-induced changes in UHT milks—part 1. *Australian Journal of Dairy Technology*, 58, 3–10.

- Fairbairn, D.J. & Law, B.A. (1986). Proteinases of psychrotrophic bacteria: Their production, properties, effects and control. *Journal of Dairy Research*, 53, 139–177.
- Ferretti, A. (1973). Inhibition of cooked flavour in heated milk by use additives. *Journal of Agricultural and Food Chemistry*, 21, 939–942.
- Fox, P.F., & McSweeney, P.L.H. (1996). Proteolysis in cheese. *Food Reviews International*, 12, 457-509.
- Fu B., & Labuza, T. (1993). Shelf life prediction: Theory and application. *Food Control*, 4, 125-133.
- Gaafar, A. M. M. (1987). *Investigation into the Cooked Flavour in Heat-Treated Milk*, PhD thesis, University of Reading, London, UK.
- García-Risco, M., Ramos, M., & López-Fandiño, R. (1999). Proteolysis, protein distribution and stability of UHT milk during storage at room temperature. *Journal of the Science of Food and Agriculture*, 79, 1171-1178.
- Gaucher, I., Boubellouta, T., Beaucher, E., Piot, M., Gaucheron, F., & Dufour, E. (2008). Investigation of the effects of season, milking region, sterilisation process and storage conditions on milk and UHT milk physico-chemical characteristics: a multidimensional statistical approach. *Dairy Science and Technology*, 88, 291–312.
- Gebre-Egziabher, A., Humbert, E.S., & Blankenagel, G. (1980). Hydrolysis of milkproteins by microbial enzymes. *Journal of Food Protection*, 43, 709–712.
- Gedam, K., Prasad, R., & Vijay, V.K. (2007). The study on UHT processing of milk: a versatile option for rural sector. *World Journal of Dairy and Food Sciences*, 2, 49–53.
- Gösta, B. (2003). *Dairy processing handbook. Chapter 9, 2nd ed.* (pp.227-244). Lund, Sweden: Tetra Pak Processing Systems.
- Griffiths, M. W., & Phillips, J. D. (1990). Incidence, source and some properties of psychrotrophic *Bacillus* spp found in raw and pasteurized milk. *Journal of the Society of Dairy Technology*, 43, 62–66.

- Griffiths, H.W., Philips, J.D., & Muir D.D. (1981). Thermostability of proteases and lipases from a number of species of psychrotrophic bacteria of dairy origin. *Journal of Applied Bacteriology*, 50, 289–295.
- Grijnspeerd, K., Mortier, L., Block, J.D. & Van Rentrghem, R. (2004). Applications of modelling to optimise ultra-high temperature milk heat exchangers with respect of fouling. *Journal of Food Control*, 15, 117-130.
- Gunnar, R., Ebbese, A., & Eggestad, J. (1998). Sensory and chemical quality of UHT-milk stored in paperboard cartons with different oxygen and light barriers. *Food Additives and Contaminants*, 15, 112-122.
- Hammer, P., Lembke, F., Suhren, G. & Heeschen, W. (2000) Characterisation of heat resistant mesophilic *Bacillus* species affecting the quality of UHT milk. *Bulletin of the International Dairy Federation*, 357, 9–16.
- Hansen, A.P., Turner, L.G., & Jones, V.A. (1974). Effect of ultra-high temperature steam injection on flavor acceptability of whole and fortified skim milks. *Journal of Dairy Science*, 57, 280–284.
- Haug, A., & Høstmark, A. (2007). Bovine milk in human nutrition. *Lipids in Health and Disease*, 6, 1-16.
- Hassan, A., Amjad, I., & Mahmood, S. (2009) Microbiological and physico-chemical analysis of different UHT milks available in market. *African Journal of Food Science*, 3, 100-106.
- Hedegaards, R.V., Kristensen, D., Nielsen, J.H., Frøst, M.B., Østdal, H., Hermansen, J.E., Kröger-Ohlsen, M., & Skibsted, L.H. (2006) Comparison of descriptive sensory analysis and chemical analysis of oxidative changes in milk. *Journal of Dairy Science*, 89, 495-504.
- Hirichs, J. (2000). UHT-processed milk concentrates. *Lait*, 80, 15–23.
- Hoffmann, M.A.M., & van Mill, P.J.J.M. (1997). Heat induced aggregation of β -lactoglobulin: Role of the free thiol group and disulphide bonds. *Journal of Agricultural and Food Chemistry*, 45, 2942–2948.

- Holdsworth, S.D. (1992). *Aseptic processing and packaging of food products* (pp. 1-300). New York, USA: Elsevier Science Publishing Co.
- Hoffmann, W., Kiesner, C., Clawin-Raedecker, I., Martin, D., Einhoff, K., Lorenzen, P.C., Meisel, H., Hammer, P., Suhren, G., & Teufel, P. (2006). Processing of extended shelf life milk using microfiltration. *International Journal of Dairy Technology*, 59, 229–235.
- IDFS, (1993). *Shelf life of foods: Guidelines for its determination and prediction*. London, UK: Institute of Food Science & Technology.
- Jaddou, H.A., Pavey, J.A., & Manning, D.J. (1978). Chemical analysis of flavour volatiles in heat-treated milks. *Journal of Dairy Research*, 45, 391-403.
- Jeon, I.J., Thomas, E.L., & Reineccius, G.A. (1978). Production of volatile flavour compounds in ultra-high-temperature processed milk during aseptic storage. *Journal of Agricultural and Food Chemistry*, 26, 1183-1188.
- Josephson, D.V. & Doan, F.J. (1939). Observations on cooked flavour in milk, its source and significance. *The Milk Dealer*, 29, 35–54.
- Jovanka, V.P., Nada, S.L., Jovanka, G.L., Miroljub, B.B., & Višnja, M.S. (2008). Colour changes of UHT milk during storage. *Sensors*, 8, 5961–5974.
- Jung, M.Y., Yoon, S.H., Lee, H.O., & Min, D.B. (1998). Singlet oxygen and ascorbic acid effects on dimethyl disulfide and offflavor in skim milk exposed to light. *Journal of Food Science*, 63, 408–412.
- Kessler, H.G. (1981) *Food Engineering and Dairy Technology*. Freising, Germany: A. Kessler Verlag.
- Kessler. H.G., & Horak, P. (1981). Objective evaluation of UHT-milk heating by standardization of bacteriological and chemical effects. *Milchwissenschaft*, 36, 129–133.
- Kessler, H.G. (1989). Effect of thermal processing of milk. In S. Thorne (Ed), *Developments of food preservation* (pp. 91-130). London, UK: Elsevier Applied Science.

Klijin, N., Herman, L., Langeveld, L., Vaerewijck, M., Wagendorp, A.A, Huemer, I. & Weerkamp, A. (1997). Genotypical and phenotypical characterisation of *Bacillus sporothermodurans* strains, surviving UHT sterilization, *International Dairy Journal*, 7, 421–428.

Kocak, H.R., & Zadow, J.G. (1985). Controlling age gelation of UHT milk with additives. *Australian Journal of Dairy Technology*, 40, 58–64.

Kohlmann, K. L., Nielsen, S. S., & Ladisch, M. R. (1991). Effects of a low concentration of added plasmin on ultra-high temperature processed milk. *Journal of Dairy Science*, 74, 1151–1156.

Labuza, T.P., & Riboh, D. (1982). Theory and application of Arrhenius kinetics to the prediction of nutrient losses in food. *Food Technology*, 10, 66–74.

Law, B.A., Andrews, A.T. & Sharpe, M.E. (1977). Gelation of ultra-high-temperature-sterilized milk by proteinases from a strain of *Pseudomonas fluorescens* isolated from raw milk. *Journal of Dairy Research*, 44, 145–148.

Law, B.A., & Mabbitt, L.A. (1983). New methods for controlling the spoilage of milk and milk products. In T.A. Skinner, & F.A. Roberts (Eds), *Food microbiology: Advances and prospects* (pp. 131-150). New York, USA: Academic Press Inc.

Lecanu, L.; Ducruet, V. Feigenbaum, A. (2003). Selective absorbing film to limit odour of a packaged surface smear-ripened cheese. In the 10th Weurman Flavour Research Symposium, Beaune, France, *Flavour Research at the Dawn of the Twenty first Century Proceedings* (pp.107-110). Beaune, France.

Lewis, M.J. (1999) Ultra-high temperature (UHT) treatments. In R.K. Robinson, C.A. Batt, & P.D. Patel (eds.) *Encyclopedia of Food Microbiology* (pp. 1023-1030). New York, USA: Academic Press.

Lewis, M.J. (2000). Improvements in the pasteurization and sterilization of milk. In G. Smit (ed.) *Dairy Processing: Improving Quality* (pp.81-103). Woodhead Publishing Limited, Cambridge.

- Lewis, M. J. & Deeth, H. C. (2009). Heat Treatment of Milk. In A.Y. Tamime (Ed.) *Milk Processing and Quality Management*. Oxford, UK: Wiley-Blackwell.
- Lewis, M.J., & Heppell, N. (2000). *Continuous thermal processing of foods: Pasteurization and UHT sterilization*. Gaithersburg, MD: Aspen Publishers.
- López-Fandiño, R., Olano, A., Corzo, N., & Ramos, M. (1993). Proteolysis during storage of UHT milk: differences between whole and skim milk. *Journal of Dairy Research*, 60, 339-347.
- Lu, D.D., & Nielsen, S.S. (1993). Heat inactivation of native plasminogen activators in bovine milk. *Journal of Food Science*, 58, 1010-1012.
- Lyster, R.L.J. (1964). The free and masked sulfhydryl groups of heated milk powder and a new method for their determination, *Journal of Dairy Research*, 31, 41–51.
- Manji, B., Kakuda, Y., & Arnott, D.R. (1986). Effect of storage temperature on age gelation of ultra-high temperature milk processed by direct and indirect heating systems. *Journal of Dairy Science*, 69, 2994–3001.
- Manji, B., & Kakuda, Y. (1988). The role of protein denaturation, extent of proteolysis, and storage temperature on the mechanism of age gelation in a model system. *Journal of Dairy Science*, 71, 1455–1463.
- Marsili, R. T. (1999). Comparison of solid phase micro-extraction and dynamic headspace method for the gas chromatographic-mass spectrometric analysis of light-induced lipid oxidation products in milk. *Journal of Chromatographic Science*, 37, 17–23.
- Marsili, R.T. (2000). Shelf-life prediction of processed milk by solid-phase microextraction, mass spectrometry, and multivariate analysis. *Journal of Agricultural and Food Chemistry*, 48, 3470–3475.
- Matta, H., & Punj, V. (1999). Isolation and identification of proteolytic psychrotrophic sporeforming bacteria from milk. *Indian Journal of Dairy Science*, 49, 695–699.

- Maubois, J.L. (1997). Current uses and future perspectives of MF technology in the dairy industry. *Bulletin of the International Dairy Federation*, 320, 37-40.
- Meeker, W.Q., & Escobar, L.A. (1998). *Statistical methods for reliability data*. New York, NY, USA: John Wiley & Sons.
- Mestdagh, F., De Meulenaer, B., De Clippeleer, J., Devlieghere, F., & Huyghebaert, A. (2005). Protective influences of several packaging materials on light oxidation of milk. *Journal of Dairy Science*, 88, 499-510.
- McMahon, D. J. (1996). Age-gelation of UHT milk: Changes that occur during storage, their effect on shelf life and the mechanism by which age-gelation occurs. In IDF Symposium, Vienna, *Heat treatments and alternative methods* (pp. 315–326). Brussels, Belgium: International Dairy Federation.
- Min, D.B., & Boff, J.M. (2002). Chemistry and reaction of singlet oxygen in foods. *Comprehensive Reviews in Food Science and Food Safety*, 1, 58-72.
- Mizrahi, S. (2000). Accelerated shelf-life tests. In D. Kilcast & P. Subramaniam (eds.) *The stability and shelf-life of food*. (p. 107-128). Cambridge, UK: Woodhead Publishing.
- Morgan, M.E., Fross, D.A. & Patton, S. (1957). Volatile Carbonyl Compounds Produced In Skimmilk By High-Heat Treatment. *Journal of Dairy Science*, 40, 571-578.
- Murphy, P. M., Lynch, D., & Kelly, P. M. (1999). Growth of thermophilic spore forming bacilli in milk during the manufacture of low heat powders. *International Journal of Dairy Technology*, 52, 45-50.
- Noci, F., Walkling-Ribeiro, M., Cronin, D.A., Morgan, D.J., & Lyng, J.G. (2009). Effect of thermosonication, pulsed electric field and their combination on inactivation of *Listeria innocua* in milk. *International Dairy Journal*, 19, 30–35.
- Nursten, H. (1981). Recent developments in studies of the Maillard reaction. *Food Chemistry*, 6, 263–277.

Ogola, H., Shitandi, A. & Nanua, J. 2007. Effect of mastitis on raw milk compositional quality. *Journal of Veterinary Science*, 8, 237-242.

Parks, O.W., Keeney, M., Katz, I. & Schwartz, D.P. (1964). Isolation and characterization of the methyl ketone precursor in butter fat. *Journal of Lipid Research*, 5, 232-235.

Patrick, P. S. and Swaisgood, H. E. (1976). Sulfhydryl and disulphide groups in skim milk as affected by direct ultra-high-temperature heating and subsequent storage. *Journal of Dairy Science*, 59, 594–600.

Payens, T.A.J. (1978). On different modes of casein clotting; the kinetics of enzymatic coagulation compared. *Netherlands Milk and Dairy Journal*, 32, 170–183.

Pereda, J., Ferragut, V., Quevedo, J.M., Guamis, B., & Trujillo, A.J. (2007). Effects of ultra-high pressure homogenization on microbial and physico-chemical shelf life of milk. *Journal of Dairy Science*, 90, 1081–1093.

Perkins, M. L. (2004). *Stale Flavour Volatiles in UHT Milk*, PhD thesis, University of Queensland, Australia.

Perkins, M. L., Elliott, A. J., D’Arcy, B. R., and Deeth, H. C. (2005). Stale flavour volatiles in Australian commercial UHT milk during storage. *Australian Journal of Dairy Technology*, 60, 231–237.

Perkins, M.L., Zerdin, K., Rooney, M.L., D’Arcy, B.R. & Deeth, H.C. (2006). Active packaging of UHT milk to prevent the development of stale flavour during storage. *Journal of Packaging Technology and Science*, 20, 137-146.

Phillips, J. D., & Griffiths, M. W. (1990). Pasteurized dairy products: the constraints imposed by environmental contamination. In O.J. Simmons, & M.S. Nriagu (Eds), *Food contamination from environmental sources* (pp.387-486). New York, USA: Wiley.

Politis, I., Zavizion, B., Barbano, D.M., & Gorewit, R.C. (1993). Enzymatic assay for the combined determination of plasmin plus plasminogen in milk: revisited. *Journal of Dairy Science*, 76, 1260–1267.

- Pompei, C., Rossi, M., & Mare, F.J. (1987). Protein quality in commercial milk-based infant formulas. *Journal of Food Quality*, 10, 375–391.
- Qamar, A, Aizad., A., & Ashraf, M. (2003). Effect of UHT and in-bottle sterilization temperature on storage stability of milk. *Pakistani Journal of Food Science*, 13, 25-29.
- Ramsey, J.A. & Swartzel, K.R. (1984). Effect of ultra-high temperature processing and storage conditionson rates of sedimentation and fat separation of aseptically packaged milk. *Journal of Food Science*, 49, 257-262.
- Ramshaw, E.H. & Dunstone, E.A., 1969. Volatile compounds associated with the off-flavour in stored casein. *Journal of Dairy Research*, 36, 215-223.
- Renner, E., & Berlage-Weining, L. (1983). Influence of added L-cystine on organoleptic quality of UHT milk. *Michwissenshaft*. 38, 324-327.
- Rerkrai, S., Jeon, I.J. & Bassette, R. (1987). Effects of Various Direct Ultra-High Temperature Heat Treatments on Flavour of Commercially Prepared Milks. *Journal of Dairy Science* 70, 2046-2054.
- Richardson, T., & Korycka-Dahl, M. (1983). Lipid Oxidation. In (P.F. Fox (Ed) *Developments in dairy chemistry – 2* (pp. 241-364). London, UK: Applied Science Publishers
- Rysstad, G., Ebbesen, A., & Eggestad, J. (1998). Sensory and chemical quality of UHT-milk stored in paperboard cartons with different oxygen and light barriers. *Food Additives and Contaminants*, 15, 112–122.
- Rysstad, G. and Kolstad, J. (2006). Extended shelf life milk - advances in technology. *International Journal of Dairy Technology*, 59, 85-96.
- Samuelson, E.G. and Holm, S., 1966, Technological principles for ultra-high-heat treatment of milk, *17th International Dairy Congress* (Munich, Germany), Section B (1): 57–65.
- Samuelson, E.G. & Borgström, S. (1973). Method for protecting milk against flavour deterioration when heat treated. *Milchwissenshaft*, 28, 25-26.

Scanlan, R.A., Lindsay, R.C., Libbey, L.M., & Day, E.A. (1968). Heat induced volatile compounds in milk. *Journal of Dairy Science*, *51*, 1001–1007.

Schamberger, G.P. & Labuza, T.P. (2007). Effect of green tea flavonoids on Maillard browning in UHT milk. *LWT Food Science and Technology*, *40*, 1410-1417.

Scheldeman, P., Herman, L., Foster, S. & Heyndrickx, M. (2006) *Bacillus sporothermodurans* and other highly heat-resistant spore formers in milk. *Journal of Applied Microbiology*, *101*, 542–555.

Schmidt, R., & Renner, E. (1978). Sensoric and chemical changes during the storage of sterilized milk kinds. II. Chemical changes. *Lebensmittel-Wissenschaft and Technology*, *11*, 244–248.

Schwaab, M. & Pinto, J.C. (2007). Optimum temperature for reparameterization of the Arrhenius equation. Part 1: Problems involving one kinetic constant. *Chemical Engineering Science*, *62*, 2750–2764.

Schwartz, D.P., Parks, O.W. & Yoncoskie, R.A. (1966). Quantitative Studies on Methyl Ketone Formation in Butteroil: Effect of Temperature. *Journal of The American Oil Chemists Society*. *43*, 128-129.

Seiquer, I., Díaz-Alguacil, J., Delgado-Andrade, C., López-Frías, M., Hoyos, A.M., Galdó, G., & Navarro, M.P. (2006). Diets rich in Maillard reaction products affect protein digestibility in adolescent males aged 11–14 y. *American Journal of Clinical Nutrition*, *8*, 1082– 1088.

Shibamoto, T., Mihara, S., Nishimura, O., Kamiya, Y., Aitoku, A. & Hayashi, J. (1980). Flavour Volatiles Formed By Heated Milk. *The Analysis and Control of Less Desirable Flavours in Food and Beverages* (pp. 241-256). New York, USA: Academic Press.

Shipe, W.F., Bassette, R., Deane, D.D., Dunkley, W.L., Hammond, E.G., Harper, W.J., Kleyn, D.H., Morgan, M.E., Nelson, J.H. & Scanlan, R.A. (1978). Off flavours of milk: nomenclature, standards, and bibliography. *Journal of Dairy Science*, *61*, 855-869.

- Singh, R.K. (2000). Scientific principles of shelf life evaluation. In C.M.D. Man & A. Jones (eds.) *Shelf-life evaluation of Foods* (pp.3-20). Gaithersburg, MD, USA: Aspen Publishers.
- Singh, R.K. (2007). Aseptic Processing, in Advances. In G. Tewari, & V.K. Juneja (eds.) *Thermal and Non-Thermal Food Preservation* (pp. 1023-1030). Ames, Iowa, USA: Blackwell Publishing.
- Simon, M., Hansen, A.P., & Young, C.T. (2001). Effect of various dairy packaging materials on the headspace analysis of ultrapasteurized milk. *Journal of Dairy Science*. 84, 774–783.
- Slinkard, M. S. (1976). *Changes in the Headspace Concentration of Volatile Sulfur Compounds during Aseptic Storage of Ultra-High-Temperature Processed Milk*, M.S Thesis, University of Minnesota, Minneapolis.
- Smet, K., De Block, J., De Campeneere, S., De Brabander, D., Herman, L., & Raes, K. (2009). Oxidative stability of UHT milk as influenced by fatty acid composition and packaging. *International Dairy Journal*, 19, 372-379.
- Snoeren, T.H.M., Van Riel, J.A.M., & Both, P. (1980). Some properties of a milk proteinase isolated from UHT treated milk, *Zuivelzicht*, 72, 42–43.
- Snoeren, T.H.M., & Both, P. (1981). Proteolysis during the storage of UHT-sterilized whole milk. II. Experiments with milk heated by the indirect system for 4 s at 142°C, *Netherlands Milk Dairy Journal*, 35, 113–119.
- Solano-Lopez, C.E., Ji, T., & Alvarez, V.B. (2005). Volatile compounds and chemical changes in ultrapasteurized milk packaged in polyethylene terephthalate containers. *Journal of Food Science*, 70, 407–12.
- Sørhaug T., & Stepaniak L. 1997. Psychrotrophs and their enzymes in milk and dairy products: quality aspects. *Trends in Food Science and Technology*, 8, 35–41.
- Speck, M.L., & Adams, D.M. (1976). Impact of heat-stable microbial enzymes in food processing heat-resistant proteolytic enzymes from bacterial source. *Journal of Dairy Science*, 59, 786–789.

Stack, A., & Sillen, G. (1998). Bactofugation of liquid milks. *Nutrition and Food Science*, 5, 280-282.

Steely, J.S. (1994). Chemiluminescence detection of sulphur compounds in cooked milk. In C.J. Mussinan, & M.E. Keelan (Eds) *Sulfur Compounds in Foods* (pp. 22–35). Washington D.C., USA: American Chemical Society.

Swaisgood, H.E., Janolino, V.G., & Skudder, P.J. (1987). Continuous treatment of ultrahigh temperature sterilized milk using immobilized sulfhydryl oxidase. *Methods in Enzymology*, 136, 423–431.

Swartzel, K.R. (1983). The role of heat exchanger fouling in the formation of sediment in aseptically processed and packed milk. *Journal of Food processing and Prevention*, 7, 247-251.

Swartzel, K.R. (2007). The role of heat exchanger fouling in the formation of sediment in aseptically processed and packaged milk. *Journal of Food Processing and Preservation*, 7, 247-257.

Taoukis, P.S., Labuza, T.P., & Saguy, I. (1997). Kinetics of food deterioration and shelf-life prediction. In K.J. Valentas, E. Rotstein, & R.P. Singh (Eds), *The handbook of food engineering proactive* (pp. 363-405). New York, USA: CRC Press.

Triantafyllidou, M., & Roussis, I. G. (1999). Characterization and heat inactivation of extracellular proteinase from *Pseudomonas fluorescens* TR2. *Milchwissenschaft*, 54, 316–320.

Upadhyay V.K., McSweeney P.L.H., Magboul A.A.A., & Fox P.F. (2004). Proteolysis in Cheese during Ripening. In P.H.L. Mc Sweeney, T.M. Cogan, T.P. Guinee, & P.F. Fox (Eds), *Cheese – Chemistry, Physics and Microbiology* (pp. 391–396). London, UK: Academic Press.

Valero, E., Villamiel, M., Miralles, B., Sanz, J., & Martinez-Castro, I. (2001). Changes in flavour and volatile components during storage of whole and skimmed UHT milk. *Food Chemistry*, 72: 51-58.

Vazquez-Landaverde, P.A., Velazquez, G., Torres, J.A. & Qian, M.C. (2005). Quantitative determination of thermally derived off-flavour compounds in milk using solid-phase microextraction and gas chromatography. *Journal of Dairy Science*, 88, 3764-3772.

Vazquez-Landaverde, P.A., Torres, J.A. & Qian, M.C. (2006). Quantification of trace volatile sulphur compounds in milk by solid-phase microextraction and gas chromatography-pulsed flame photometric detection. *Journal of Dairy Science*, 89, 2919-2927.

Vazquez-Landaverde, P.A., & Qian, M.C. (2007). Antioxidant impacts on volatile formation in high-pressure-processed milk. *Journal of Agricultural and Food Chemistry*, 55, 9183-9188.

Vianna, P.B.C., Ealter, E.H.M, Dias, M.E.F, Faria, J.A.F., Netto, F.M., & Gigante, M.L. (2012). Effect of addition of CO₂ to raw milk on quality of UHT-treated milk. *Journal of Dairy Science*, 95, 4256-4262.

Visser, S. (1981). Proteolytic enzymes and their action on milk proteins. A review. *Netherlands Milk and Dairy Journal*, 35, 65–88.

Vulfson, E.N. (1994) Industrial applications of lipases. In Woolley, P., & Peterson, S.B. (Eds) *Lipases—their structure, biochemistry and applications* (pp. 271-288). Cambridge, UK: Cambridge University Press.

Walkling-Ribeiro, M., Noci, F., Cronin, D.A., Lyng, J.G., & Morgan, D.J. (2009). Antimicrobial effect and shelf-life extension by combined thermal and pulsed electric field treatment of milk. *Journal of Applied Microbiology*, 106, 241–248

Walstra, P., Geurts, T.J., Noomen, A., Jellema, A., & Van Boekel, M.A.J.S. (1999). *Dairy Technology: Principles of Milk Properties and Processes*. New York, USA: Marcel Dekker, Inc.

Published in: International Dairy Journal, Volume 36, Issue 1, 2014, Pages 38–45

CHAPTER 3 : MULTIVARIATE ACCELERATED SHELF LIFE TEST OF LOW FAT UHT MILK

Melanie Richards, Henriëtte L. De Kock, Elna M. Buys*

Department of Food Science, University of Pretoria, Pretoria, 0001, South Africa

melanie.richards@up.ac.za, riette.dekock@up.ac.za, elna.buys@up.ac.za

*Corresponding author: Tel: +27 12 4203209; E-mail address: elna.buys@up.ac.za

Abstract

Real time shelf life determination of shelf stable products like UHT milk can be very time consuming and expensive and critical attributes used to determine the end of shelf life can be difficult to identify. The multivariate accelerated shelf life test (MASLT) employs all sensory attributes that show change over time and was applied to data obtained from a trained panel (n = 11) that evaluated 18 sensory attributes of low fat UHT milk samples stored at 25, 35 and 45°C over a six and a half month time period. The cut-off point that identifies the end of shelf life was obtained by survival analysis based on consumers' acceptance or rejection of samples stored for different times at 45°C. Storage at 35 and 45°C reduced the shelf life by a factor of 2.9 and 7.8, respectively. In future, changes in sensory attributes that correlate well with the UHT milk MASLT model can be used as predictors for end of shelf life. For this purpose the milk can be stored at accelerated temperatures and results can be converted to actual market condition.

3.1 INTRODUCTION

Consumers demand safe and nutritionally high-quality products with superior texture, appearance and flavour and shelf-lives of several weeks or months (Corrigan, Hedderley & Harvey, 2012; Grunert, 2005; Hugas, Garriga, & Monfort, 2002; Smith & Sparks, 2004). Quality changes, rather than microbial safety, are the deciding factors in determining the shelf life of shelf stable food products (Lewis & Heppell, 2000; Corrigan *et al.*, 2012). Conducting a complete shelf life test for shelf stable products can be very resource and time

consuming, with the result that accelerated shelf life tests are often employed (Corrigan *et al.*, 2012; Meeker & Escobar, 1998). During accelerated tests, the product is subjected to relatively severe storage conditions where one or more accelerating factors (e.g. temperature, humidity and water activity) are maintained at a higher level than normal. The accelerating factor used depends on the product and its normal storage conditions. By subjecting the food to such a controlled environment, the deterioration rate will be increased, resulting in a shorter time to product failure. Examples of accelerated shelf life tests include the use of increased temperature to accelerate the changes in human milk replacement formula (Curia & Hough, 2009), fruit-filled snack bars (Corrigan *et al.*, 2012) and tomato concentrate during storage (Pedro & Ferreira, 2006) and the use of a combination of oxygen partial pressure, temperature and water activity during the storage of coffee (Cardelli & Labuza, 2001). The results obtained from accelerated tests are extrapolated to obtain the shelf life estimates at the normal storage conditions of the product (Meeker & Escobar, 1998).

Ultra-high temperature (UHT) processed milk has a reported shelf life of between 6 - 9 months at room temperature (Perkins, D'Arcy, Lisle, & Deeth, 2005). Both the shelf life and the acceptability of UHT milk is determined by its sensory properties (Badings, 1991). The sensory quality and therefore the shelf life of UHT milk is governed by the progression of various physico-chemical and biochemical changes after processing. The main changes that occur upon storage of UHT milk are due to proteolytic, lipolytic, oxidative and Maillard type reactions (Datta & Deeth, 2003). Although UHT processing inactivates most bacteria, some heat-stable enzymes of native and bacterial origin can survive this process and cause shelf life limiting defects (Burton, 1988; Valero, Villamiel, Miralles, Sanz, Martínez-Castro, 2001). Proteolysis of UHT milk is associated with the release of tyrosine in the milk that may contribute to the development of off-flavours (Gebre-Egziabher, Humbert, & Blankenagel, 1980), while the release of β -lactoglobulin- κ -casein complexes, formed during heat treatment, from the micelle and subsequent aggregation of these complexes results in an increase in viscosity, with the eventual formation of a gel (McMahon, 1996; Chen, Daniel, & Coolbear, 2003; Datta & Deeth, 2003). Lipases can hydrolyse triacylglycerols with the release of medium and short-chain fatty acids that give rise to soapy and tangy flavours, respectively. Free fatty acids released during lipolysis are also precursors for other flavour compounds responsible for the formation of off-flavours such as oxidised, cardboard, bitter, rancid, soapy, unclean and metallic (Deeth & Fitz-Gerald, 1983; 1994). Oxidative and

Maillard reactions can result in a cascade of reaction responsible for loss in nutrients and amino acids, discolouration of the milk and development of off-flavours (Burton, 1988; Borle, Sieber, & Bosset, 2001; Hedegaard et al., 2006). Due to the long shelf life of UHT milk and the various factors that can influence the shelf life thereof, there is a need to design a model whereby the shelf life of milk can be predicted in a short time-period. The first part of this study aimed to determine the shelf life of a specific brand of low fat UHT milk in high-density polyethylene (HDPE) bottles by employing the multivariate accelerated shelf life test (Pedro & Ferreira, 2006) by using normal storage temperature (25°C) and elevated temperatures (35 and 45°C) as accelerating factor and evaluating the changes in the sensory properties over time. The second part of the study aims to identify which of the sensory attributes (when evaluated individually) can be used as predictors for the end of shelf life by comparing the univariate parameters, i.e. the activation energies and acceleration factors of these attributes, to the multivariate parameters

3.2 MATERIALS AND METHODS

3.2.1 Samples and sample preparation

Milk from three different batches (3 replicates) of a specific brand of low fat UHT milk in HDPE bottles was collected on the day of production and stored at room temperature (25°C), and elevated temperatures of 35 and 45°C. These elevated storage temperatures served as accelerating factors to speed up the deterioration process in the milk. Different batches were collected approximately 1 month apart to ensure that panellists receive both deteriorated and fresh samples, thus preventing bias from panellists realizing they are participating in a shelf life test. Milk stored at 25, 35 and 45°C was stored for 195, 176 and 78 d, respectively. One bottle from each batch was used for analysis at the various sampling points. For the sensory evaluation, milk samples were chilled in a refrigerator at 7°C after portioning (50 mL) and served at 15±1°C in 3-digit random coded glasses covered with foil. Panellists received numbered trays with samples served in an order determined by the Williams Latin Square design (Williams, 1949). Peeled, sliced fresh raw carrots and filtered water were provided for neutralising and cleansing the palate before and between sample tasting. General Good

Sensory Practices (GSP's) (Lawless & Heymann, 1998) were followed in the selection, preparation, and serving of samples to panellists.

3.2.2 Sensory evaluation of UHT milk

Sensory evaluation of the UHT milk was performed by eleven trained sensory panellists (9 females and 2 males) that were selected based on their performance in screening tests which included recognition of basic tastes and discrimination between small flavour differences. As initial guidelines for this study, attributes, references and definitions from previous studies on milk were used (Bassette, Fung, & Mantha, 1986; Chapman, Lawless, & Boor, 2001; Claassen & Lawless, 1992; Frandsen, Dijksterhuis, Brockhoff, Nielsen, & Martens, 2003; Frost, Dijksterhuis, & Martens, 2001). During six orientation sessions (2h each) panellists determined which attributes best described the UHT milk and changed some attribute definitions and references, and removed those that they did not find relevant to the UHT milk samples. A total of 18 different attributes were generated to describe the aroma, flavour, appearance, texture and aftertaste of the low fat UHT milk (Table 3.1). The Feedback Calibration Method (FCM) gives immediate graphical computerized feedback after evaluation of each sample and was used for training and calibration of the descriptive panel over eight sessions. This method has been shown to optimize proficiency by ensuring efficient panel training and also reduces the training-time (Findlay, Castura, Schlich, & Lesschaeve, 2006). The trained panellists evaluated 9 randomly presented samples (3 samples per storage temperature) twice per week. The evaluation was performed by panellists seated at individual evaluation booths under daylight conditions (Osram, Lumilux De Luxe T8 daylight tubes) in the sensory laboratory of the University of Pretoria. Panellists rated the milk samples on a structured line scales with “not intense” on the one end and “extremely intense” on the other. Compusense Five version 5.2 software (Compusense Inc., Guelph, Canada) was used to generate all random codes, questionnaires and line scales used during screening, training and evaluation.

Table 3.1: References and definitions for attributes developed in the descriptive sensory evaluation of low fat UHT milk in HDPE bottles.

Sensory attribute	Definition	Reference (10 point scale)
Aroma		
Cooked aroma	Intensity of boiled milk aroma/ The combination of brown flavour notes and aromatics associated with heated milk.	Heat fresh pasteurised milk to 80°C for 1 min = 1 Boil milk for 3 min = 8
Overall milk (dairy) aroma	A general term for the aromatics associated with cow's milk products.	Fresh cream* = 10
Fresh milk aroma	The basic aromatic of fresh milk.	Fresh low fat pasteurized milk = 10
Appearance		
Glass coating	Extent to which milk cling to the inner surface of the serving glass after swirling the sample	Cream* = 10 20% water in low fat milk = 1
Extent of visual thickness	Degree of thickness measured during swirling of glass	Cream* = 10
Texture		
Viscosity	The measure of the flow as the milk moves over the tongue.	Water = 0 Cream = 10*
Fat feel	The measure of the perceived fat content of the milk and the intensity of the oily feeling in the mouth when the milk is manipulated between the tongue and the palate.	Cream* = 10
Mouth coating	The extent to which milk cling to the inner surface of the mouth.	Cream* = 10
Dry/chalk feel	A measure of powdery, dry sensation in the mouth.	Inner surface of a banana peel = 10

Table 3.1: References and definitions for attributes developed in the descriptive sensory evaluation of low fat UHT milk in HDPE bottles. (Continued)

Sensory attribute	Definition	Reference
Flavour		
Creamy flavour	Intensity of cream flavour/ perceived creaminess of the sample evaluated in the mouth.	Cream* = 10
Overall milk (dairy) flavour	A general term describing the intensity of the aromatics associated with products made from cow's milk.	Fresh cream* = 10
Sweet taste	Fundamental taste association with the impression of all sweet substances, e.g. sucrose	1% Sucrose in water = 10
Off-flavour (Lack of freshness)	The extent to which the overall rounded dairy notes, commonly associated with fresh milk are altered. A combination of changes in amount or interactions of such attributes as sweet, bitter, sour, dairy fat, butyric acid and/or brown.	Two day old unrefrigerated pasteurized low fat milk = 10
Flavour		
Cooked flavour	The intensity of boiled milk flavour/ The combination of brown flavour notes and aromatics associated with heated milk.	Heat fresh pasteurised milk to 80°C for 1 min = 2 Boil milk for 3 min = 8
Aftertaste		
Fatty aftertaste	The intensity of the oily feeling that remains in the mouth after swallowing the sample	Cream* = 10
Metallic	The intensity of the chemical feeling on the tongue described as flat. Associated with iron, copper and/or silver spoons.	Copper 5c coins in milk overnight = 8

Table 3.1: References and definitions for attributes developed in the descriptive sensory evaluation of low fat UHT milk in HDPE bottles. (Continued)

Sensory attribute	Definition	Reference
Sweet	Fundamental taste association with the impression of all sweet substances, e.g. sucrose	Sucrose in water = 10
Dry/chalk aftertaste	A measure of dry, powdery sensation that remains in the mouth after swallowing the sample	Banana peel = 10

* Cream – Pouring cream with 18% fat content.

3.2.3 Cut-off point determination using survival analysis

Regular UHT milk consumers (120) were recruited and each consumer received 6 samples of low fat UHT milk that were stored at 45°C for different time periods (6, 12, 18, 24, 30 and 36 d) in random order. Reverse storage with a single low fat UHT milk batch was used. Milk was stored at 4°C, where no significant changes in the sensory properties occurred as evaluated by the trained sensory panel during the test period. At time zero, 6 bottles of milk was placed at 45°C, becoming the sample with the longest storage time. After 6 d the next sample was placed at 45°C. This procedure was followed repeatedly to obtain samples with decreasing storage time at 45°C. For evaluation by the consumers, the milk samples were prepared as described in Section 3.2.1. Consumers were asked to answer “yes” or “no” to the question “Would you normally consume this product?” if they had purchased the product or it was served to them in a home use situation. Filtered water was provided for neutralising and cleansing the palate before and between sample tasting. Compusense Five version 5.2 software (Compusense Inc., Guelph, Canada) was used to generate all random codes, questionnaires and to capture the consumers’ responses.

3.2.4 Nutritional and microbiological analyses of low fat UHT milk

Freshly packed UHT milk samples were sent to a South African National Accreditation System laboratory, Lactolab (Agricultural Research Council campus, Irene, South Africa) where the gross composition (protein, lactose and fat content) and microbiological quality (coliforms, *E. coli*, spore formers and total counts) were determined. The spore formers and total counts of milk stored at room temperature were also evaluated once a month throughout the study.

3.2.5 Statistical data analysis

3.2.5.1 Microbiological and Nutritional data

One-way Analysis of Variance (ANOVA) was performed to identify differences in the nutritional content of different batches of freshly packed low fat UHT milk, while repeated measures ANOVA was used to identify changes in the microbial quality over time.

3.2.5.2 Descriptive sensory analysis data

Due to public holidays and some panellists falling ill, samples could not be tasted on all the anticipated days and/or panellists were unable to attend some of the tasting sessions, thus leading to unequally spaced time points and an incomplete data set. To deal with this problem, the descriptive sensory data was analysed using the mixed model procedure (PROC MIXED) (Moser, 2004). The PROC MIXED procedure allows greater flexibility in modelling covariance structures for repeated measured data, and accounts for the within-subject time-dependent correlations (Littell, Milliken, Stroup, & Wolfinger, 2006), while handling missing observations better in repeated measures data than conventional univariate and multivariate analysis of variance approaches. A model with an appropriate covariance structure for the within-subject correlation is essential to arrive at an accurate conclusion in a repeated measures analysis. For this study, as the time points (i.e. days) were unequally spaced two different covariance structures, i.e. compound symmetry (CS) and first-order ante

dependence covariance ANTE(1), were considered for the analysis. A comparison of candidate models was achieved by running the PROC MIXED procedure with various covariance structures. The three information criteria provided by PROC MIXED, the Akaike Information Criteria (AIC), the finite-sample corrected Akaike Information Criteria (AICC) and the Schwarz's Bayesian Information Criteria (BIC) were used as a statistical tool to assist in model selection (Cody & Smith, 1991; Littell *et al.*, 2006). The lowest value of information criterion is a better model fit to the data (SAS OnlineDoc®, Version 8, Cary, NC, USA: SAS Institute Inc., 1999).

3.2.5.3 Multivariate accelerated shelf life test

Repeated measure ANOVA was performed on the complete data set to determine which attributes showed significant changes over time. All the attributes that showed time related changes were then subjected to covariance Principal Component Analysis (PCA) to allow a visual interpretation of the similarities and differences. The PC1 scores obtained from the PCA were further used in the multivariate accelerated shelf life test (MASLT) method for shelf life assessment by plotting these values against time. MASLT is based on compressing the space spanned by the original variables (sensory attributes) via PCA and then using the scores as properties for further shelf life assessment (Pedro & Ferreira, 2006).

The activation energy for the new multivariate data set was determined using the non-linear Arrhenius approach, which combines zero-order reaction rate (this was the chosen order, since the PC1 scores changed linearly with time) with the Arrhenius model (Garitta, Hough, & Sánchez, 2004; Gámbaro, Garitta, Giménez, Varela, & Hough, 2004):

$$A = A_0 + k_{ref} \times t \times \exp\left(-\frac{E_a}{R} \left(\frac{1}{T} - \frac{1}{T_{ref}}\right)\right)$$

Where, A = multivariate data point / attribute at t ;

A_0 = multivariate data point / attribute at $t=0$;

k_{ref} = reaction rate constant at T_{ref} ;

t = time

E_a = activation energy;

R = gas law constant;

T = absolute temperature; and

T_{ref} = reference temperature.

The linear regression facilities of R statistical software version 2.15.1 (The R Foundation for Statistical Computing, Vienna, Austria) were used to calculate the parameters of this model. The resulting activation energy was then further used to determine the acceleration factors at the various temperatures. The same model was used to determine the activation energy of the separate attributes.

3.2.5.4 Survival analysis

Survival analysis methodology was used to determine the end of shelf life for UHT milk stored at 45°C, using the results obtained from consumers when asked if they would normally consume the samples with different storage times. The cut-off point was then determined by using this value in the regression equation for the PC1 scores plotted against time. A random variable T can be defined as the storage time on which the consumer rejects the sample, but due to the consumers evaluating a limited number of samples with different storage times, the exact T could not be observed, thus the censored nature of the data (Hough, Langohr, & Gómez, 2003). When consumers are presented with samples stored at times $t1$, $t2$ and $t3$ and a consumer rejects the sample at the first storage time, the point of rejection for that consumer is not observed since it is before the first storage time ($T \leq t1$) and the data are left censored. If the consumer accepts the sample stored for $t1$ but rejects the sample stored for $t2$, the exact time at which the consumer rejects the product occurs between $t1$ and $t2$ ($t1 < T \leq t2$) and the data are interval censored. If, however, the consumer accepts all the samples, the point of rejection is after the last storage time observed ($T > t3$) and the data is right censored. The survival function $S(t)$ can be defined as the probability of a consumer accepting a product stored for a time period longer than t , $S(t) = P(T > t)$. Parametric models were used to obtain precise estimates of the survival function (Klein & Moeschberger, 1997). Various distributions, including log-normal, Weibull, logistic, Gaussian, log logistic and exponential, were fitted to the data using R statistical software (R Development Core team, 2010). The end of shelf life for the low fat UHT milk stored at 45°C was estimated using a 50% rejection level. Only data from consumers that did not reject the freshest sample (6 d) were included in the analysis, as per Hough, Garitta, and Gómez, (2006).

3.3 RESULTS AND DISCUSSION

The freshly packed low fat UHT milk used during this study showed satisfactory milk composition and microbiological quality (Table 3.2). Smit and Schönfeldt (2006) reported the values for the fat, protein and lactose content of low fat UHT milk as 1.86%, 3.33% and 4.9%, respectively. The nutritional values for the low fat UHT milk correlate well with these values. Literature state that UHT processing renders milk bacteriologically stable at ambient temperatures for several months (Lewis & Heppell, 2000; Valero *et al.*, 2001). The microbiological quality of the freshly packed low fat UHT milk was very high with counts of $<1 \text{ mL}^{-1}$ *E. coli*, coliforms and spore formers and counts of $<1.1000 \text{ mL}^{-1}$ for total counts. The microbiological quality was maintained throughout the duration of the study, showing no significant increase for either total counts or aerobic spores (Table 3.3). These results complied with the specifications of the South African Bureau of Standards that states that heat-treated milk should not contain more than 50 colony forming units (cfu) per mL and should be free of any coliform bacteria, while UHT milk should be free of any bacteria.

Table 3.2: Milk composition and microbiological quality of freshly packed low fat UHT milk in HDPE bottles.

	Batch 1	Batch 2	Batch 3
Milk composition			
% Fat ($\text{g} \cdot 100\text{g}^{-1}$)	1.62 (± 0.01) ^a	1.60 (± 0.02) ^a	1.57 (± 0.00) ^a
% Protein ($\text{g} \cdot 100\text{g}^{-1}$)	3.48 (± 0.02) ^a	3.48 (± 0.01) ^a	3.39 (± 0.01) ^a
% Lactose ($\text{g} \cdot 100\text{g}^{-1}$)	4.96 (± 0.01) ^a	4.91 (± 0.02) ^a	4.89 (± 0.00) ^a
Microbiological quality			
<i>E. coli</i> mL^{-1}	<1 ^a	<1 ^a	<1 ^a
Coliforms mL^{-1}	<1 ^a	<1 ^a	<1 ^a
Total count x 1000. mL^{-1}	<1 ^a	<1 ^a	<1 ^a
Aerobic spores. mL^{-1}	<1 ^a	<1 ^a	<1 ^a

*Values with same superscripts in rows represent no significant differences ($p > 0.05$).

*Standard deviations shown in parenthesis.

Table 3.3: The effect of storage time on microbiological quality of low fat UHT milk in HDPE bottles.

Microbiological analysis							
Time (days)	0	30	60	120	150	180	210
Total counts x 1000.mL⁻¹							
Batch 1	<1 ^a	<1 ^a	<1 ^a	<1 ^a	<1 ^a	<1 ^a	1 ^a
Batch 2	<1 ^a	<1 ^a	<1 ^a	<1 ^a	<1 ^a	<1 ^a	<1 ^a
Batch 3	<1 ^a	<1 ^a	<1 ^a	<1 ^a	<1 ^a	<1 ^a	<1 ^a
Aerobic spores.mL⁻¹							
Batch 1	<1 ^a	<1 ^a	<1 ^a	<1 ^a	<1 ^a	<1 ^a	<1 ^a
Batch 2	<1 ^a	<1 ^a	<1 ^a	<1 ^a	<1 ^a	<1 ^a	<1 ^a
Batch 3	<1 ^a	<1 ^a	<1 ^a	<1 ^a	<1 ^a	<1 ^a	<1 ^a

*Values with same superscripts in rows represent no significant differences ($p > 0.05$).

To deal with the missing data, two models were considered, i.e. ANTE(1) and CS, and the one that best fit the data was chosen for each of the attributes (Table 3.4). The model with the lowest value of information criteria, i.e. log likelihood, AIC, AICC and BIC, was the best fit to the data (SAS Institute, Inc. 1999). CS was chosen for the following sensory attributes; dry/chalk feel, off-flavour (lack of freshness), sweet taste, dry chalk aftertaste, metallic aftertaste and sweet aftertaste, while ANTE(1) was chosen for the overall milk aroma intensity, fresh milk aroma intensity, cooked aroma, glass coating, extent of visual thickness, viscosity, fat feel, mouth coating, overall milk flavour, cooked flavour, creamy flavour and fatty aftertaste.

Table 3.4: Model fit statistics¹, $-2 \times \text{Log likelihood}$, Akaike Information Criteria (AIC), finite-sample corrected Akaike Information Criteria (AICC) and Schwarz's Bayesian Information Criteria (BIC), with two different covariance structures, compound symmetry (CS) and ante dependence (ANTE(1)), for the milk attributes.

Attribute	Fit statistics	Covariance structure	
		CS	ANTE(1)
Overall milk aroma intensity	$-2 \times \text{Log likelihood}$	1291.7	1054.8
	AIC	1295.7	1156.8
	AICC	1295.7	1159.6
	BIC	1300.9	1289.2
Fresh milk aroma intensity	$-2 \times \text{Log likelihood}$	2291.1	1987.4
	AIC	2295.1	2089.4
	AICC	2295.1	2092.2
	BIC	2300.2	2221.7
Cooked aroma	$-2 \times \text{Log likelihood}$	1581.3	1326.1
	AIC	1585.3	1428.1
	AICC	1585.3	1430.9
	BIC	1590.5	1560.4
Glass coating	$-2 \times \text{Log likelihood}$	-182.5	-416.4
	AIC	-178.5	-314.4
	AICC	-178.5	-331.6
	BIC	-173.4	-182.0
Extent of visual thickness	$-2 \times \text{Log likelihood}$	456.2	209.6
	AIC	460.3	311.6
	AICC	460.3	314.4
	BIC	465.3	443.9
Viscosity	$-2 \times \text{Log likelihood}$	771.3	520.8
	AIC	775.3	622.8
	AICC	775.3	625.6
	BIC	780.4	755.1

Table 3.4: Model fit statistics¹, $-2 \times \text{Log likelihood}$, Akaike Information Criteria (AIC), finite-sample corrected Akaike Information Criteria (AICC) and Schwarz's Bayesian Information Criteria (BIC), with two different covariance structures, compound symmetry (CS) and ante dependence (ANTE(1)), for the milk attributes.(Continued).

Attribute	Fit statistics	Covariance structure	
		CS	ANTE(1)
Fat feel	$-2 \times \text{Log likelihood}$	1256.5	1020.8
	AIC	1260.6	1122.8
	AICC	1260.6	1125.6
	BIC	1275.6	1255.2
Mount coating	$-2 \times \text{Log likelihood}$	999.5	758.3
	AIC	1003.5	860.3
	AICC	1003.5	863.1
	BIC	1008.7	992.7
Dry/chalk feel	$-2 \times \text{Log likelihood}$	197.3	239.8
	AIC	201.3	340.8
	AICC	201.4	343.6
	BIC	206.5	473.2
Overall milk flavour	$-2 \times \text{Log likelihood}$	2412.4	2125.6
	AIC	2416.4	2227.6
	AICC	2416.4	2230.4
	BIC	2421.5	2359.9
Creamy flavour	$-2 \times \text{Log likelihood}$	1331.7	1024.7
	AIC	1335.7	1126.7
	AICC	1335.8	1129.5
	BIC	1340.9	1259.0
Cooked flavour	$-2 \times \text{Log likelihood}$	1431.3	1176.1
	AIC	1435.3	1278.1
	AICC	1435.3	1280.9
	BIC	1440.5	1410.4

Table 3.4: Model fit statistics¹, $-2 \times \text{Log likelihood}$, Akaike Information Criteria (AIC), finite-sample corrected Akaike Information Criteria (AICC) and Schwarz's Bayesian Information Criteria (BIC), with two different covariance structures, compound symmetry (CS) and ante dependence (ANTE(1)), for the milk attributes.(Continued).

Attribute	Fit statistics	Covariance structure	
		CS	ANTE(1)
Lack of freshness	$-2 \times \text{Log likelihood}$	1139.0	1220.6
	AIC	1143.0	1322.6
	AICC	1143.0	1325.4
	BIC	1148.1	1455.0
Sweet taste	$-2 \times \text{Log likelihood}$	260.3	285.3
	AIC	264.3	387.3
	AICC	264.3	390.1
	BIC	269.5	519.7
Fatty aftertaste	$-2 \times \text{Log likelihood}$	-591.2	-911.6
	AIC	-587.2	-809.6
	AICC	-587.2	-806.8
	BIC	-582.1	-677.2
Dry/chalk aftertaste	$-2 \times \text{Log likelihood}$	-314.4	-565.5
	AIC	-310.4	-463.5
	AICC	-310.4	-460.7
	BIC	-305.2	-331.1
Metallic aftertaste	$-2 \times \text{Log likelihood}$	103.3	111.2
	AIC	107.3	231.2
	AICC	107.3	216.0
	BIC	112.4	345.6
Sweet aftertaste	$-2 \times \text{Log likelihood}$	-926.5	-1199.6
	AIC	-922.5	-1097.6
	AICC	-922.5	-1094.8
	BIC	-917.4	-965.2

¹ A smaller model fit statistic value indicates a better fit to the data.

PCA was performed on all the data that showed significant changes over time. Cooked aroma, glass coating, viscosity, fat feel, mouth coating and fatty aftertaste did not present significant changes and were excluded from the PCA. Fig. 3.1 summarizes the sensory profiling results and explains in one plot the differences and similarities between the various milk samples stored at the different temperatures and time periods. Note that the milk samples stored at 35 and 45 °C were evaluated by the sensory panel only until day 176 and 78, respectively. By these time periods, the UHT milk already showed advance signs of deterioration, including discolouration, high acid degree, separation and low pH values.

In the PCA (Fig. 3.1a), Factor 1 explains 73.1% of the variation in the sensory profiles of the milk samples. It separates milk samples on the right of the plot i.e. freshly packed UHT milk samples and milk stored at 25°C, which had a more intense sweet taste and aftertaste, fresh milk aroma intensity, creamy flavour, extent of visual thickness and overall milk flavour, from those on the left. The latter samples, notably the UHT milk stored at higher temperatures and for longer time periods had a higher intensity of dry/chalk feel and aftertaste, off-flavour (lack of freshness), metallic flavour and aftertaste and cooked flavour.

Factor 2, separating samples at the top of the plot from those at the bottom of the plot, explained an additional 10.7% of the sensory variation of the milk samples. This second plane mainly described milk with a more intense overall milk aroma at the bottom. Samples at the bottom of the plot (fresher samples) had higher overall milk aroma intensities than those at the top of the plot. This attribute contributed very little to PC1 as compared to the other attributes and according to the MASLT it can be assumed that most of the information brought by this attribute is related to noise and can therefore be excluded from the MASLT.

A new PCA was performed on all the attributes that contributed to PC1 (Fig. 3.1b), i.e. all the attributes used in the first PCA except overall milk aroma, and the scores from this PCA were then further used in the MASLT. In this PCA, Factor 1 explains more than 79% of the variation in the sensory profiles of the milk and sample separation was similar to the previous PCA.

a i)

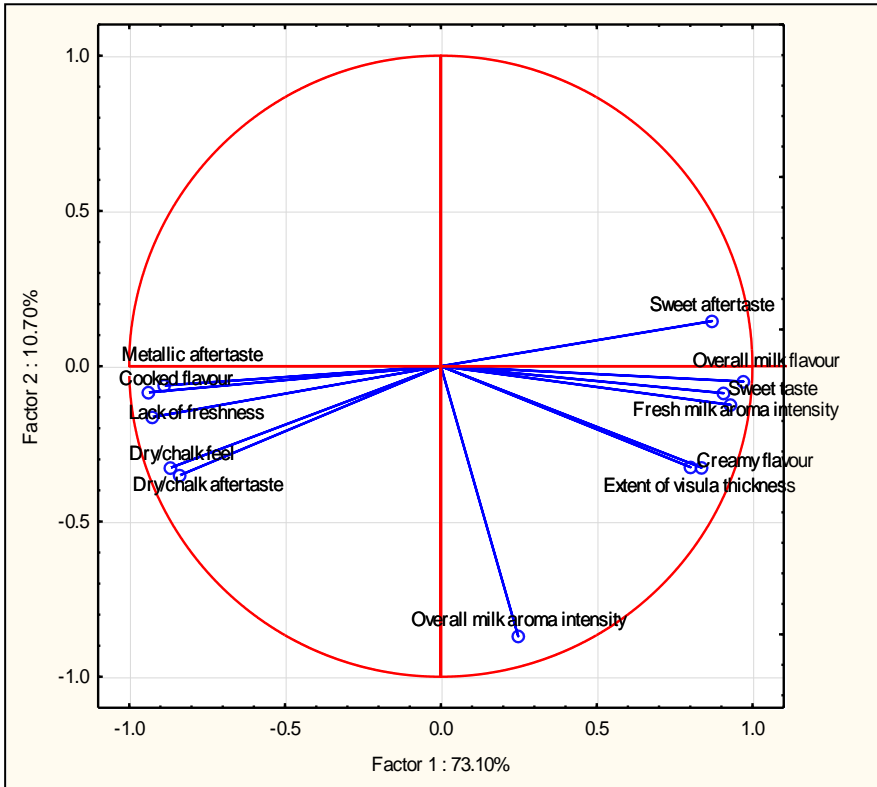

ii)

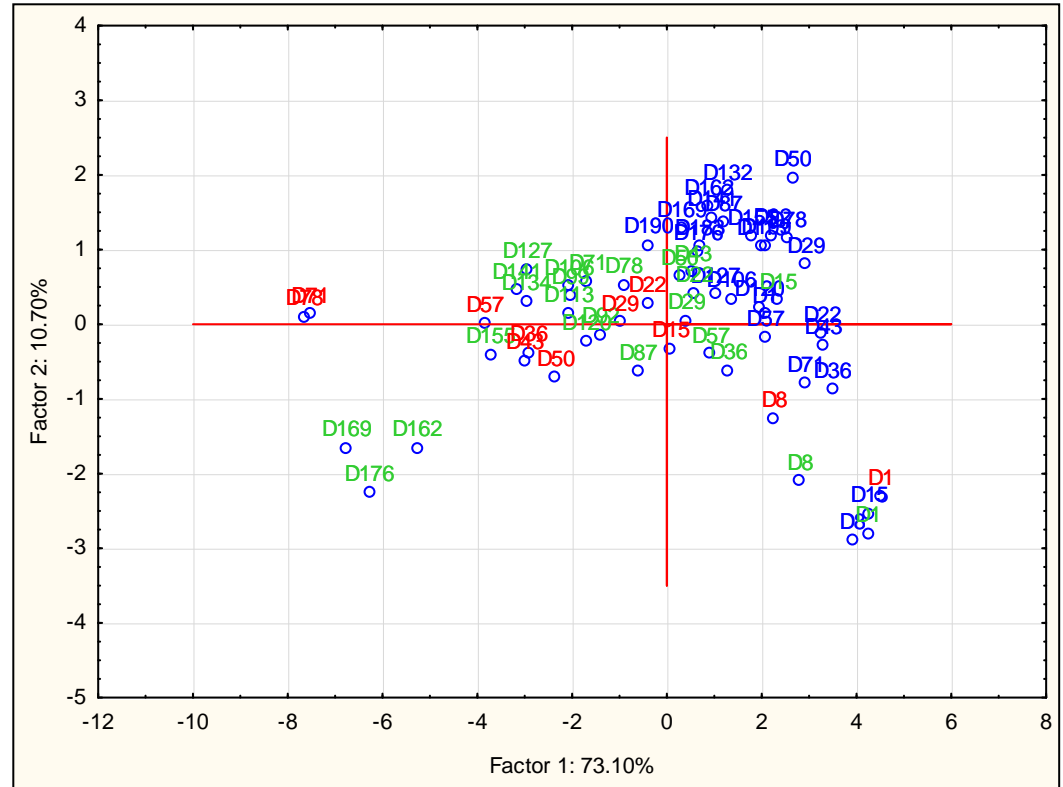

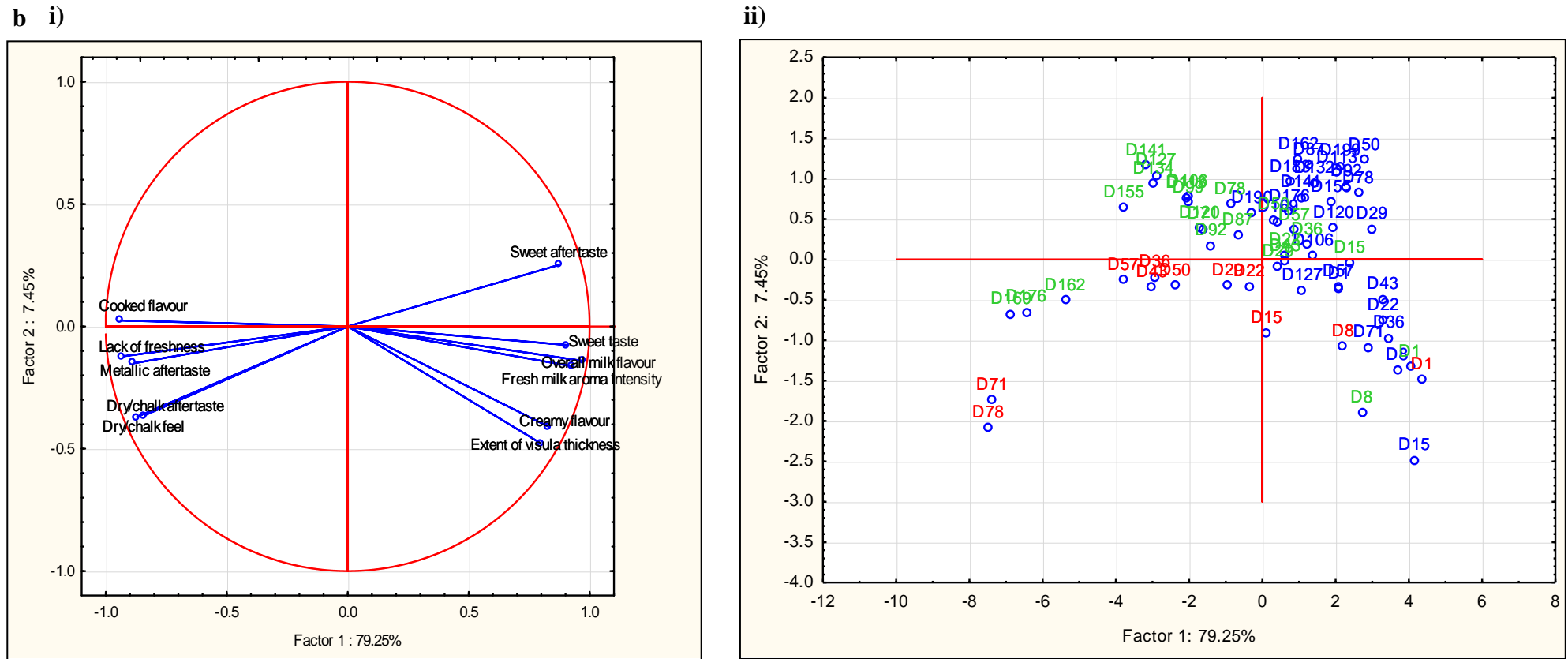

Figure 3.1 a & b: Principal component analysis of low fat UHT milk in HDPE bottles stored at different temperatures (blue = 25°C, green = 35°C and red = 45°C) of different days D (D1-D192 for milk stored at 25°C, D1-D176 for milk stored at 35°C and D1-D78 for milk stored at 45°C) as profiled by the trained sensory panel (i = scores for the sensory attributes and ii = the correlation loadings for the milk samples stored at different temperatures over time).

Shelf life studies require the identification of a critical attribute, i.e. the attribute that has the highest impact on the quality of the milk, or shows the most change over the shortest time period. This is a very hard decision to make, especially when sensory variables are included in the study (Curia & Hough, 2009; Hough *et al.*, 2002; Martínez, Mucci, Santa Cruz, Hough, & Sanchez, 1998). The multivariate accelerated shelf life approach includes all the attributes that show change over time and gives a single acceleration coefficient (Labuza & Schmidl, 1985; Pedro & Ferreira, 2006). Figure 3.2 shows the PC1 scores versus time chart together with the regression curves. It clearly shows that PC1 is time-structured, making it suitable for estimating the shelf life parameters.

To determine the end of shelf life, survival analysis was used to determine the cut-off point. For the survival analysis data, the following standard distributions were compared: Weibull, logistic, Gaussian, log-logistic, log-normal and exponential (Table 3.5). Survival analysis of the data showed that the Weibull, logistic and Gaussian distributions all fitted the shelf life data well when the lowest absolute log-likelihood value was taken as criteria in choosing between the distributions (Hough, 2010). Based on this criterion, the Weibull distribution adjusted best to the data. In addition to this, the Weibull distribution is the most commonly used distribution based on the flexibility, simplicity and good fit to survival data (Calligaris, Manzocco, Kravina, & Nicoli, 2007; Guerra, Lagazio, Manzocco, Barnaba, & Cappuccio, 2008; Hough *et al.*, 2003; Curia, Aguerrido, Langohr, & Hough, 2005) and was chosen to model the rejection of low fat UHT milk stored at 45°C (Fig. 3.3).

Table 3.5: Log-likelihood values for different distributions fitted to the survival analysis data. The model with the lowest log-likelihood value shows the best adjustment to the data.

Model	Log-likelihood
Weibull	126.1835
Logistic	126.2498
Gaussian	126.4635
Log-logistic	127.2732
Log-normal	128.1593
Exponential	153.8559

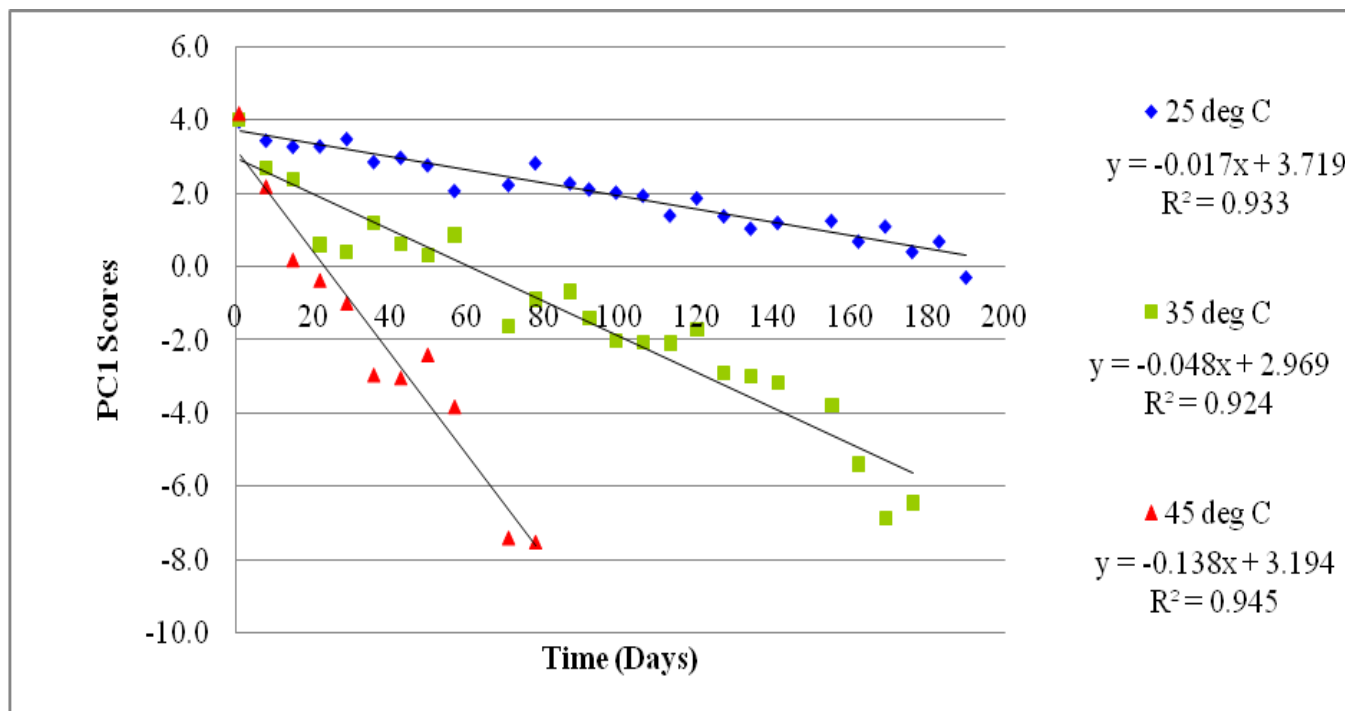

Figure 3.2: Multivariate kinetic chart of low fat UHT milk in HDPE bottles stored at 25, 35 and 45°C.

To determine the end of shelf life for the low fat UHT milk, the probability of a consumer rejecting the product was chosen at 50% for milk stored at 45°C and this was used to determine the cut-off point, i.e. the maximum level of the attributes. This level of rejection has been used in various studies, including shelf life studies of yoghurt (Curia *et al.*, 2005), coffee (Cardelli and Labuza, 2001) and minced meat (Hough *et al.*, 2006). With the end of shelf life set at the point where 50% of the consumers who had accepted the freshest sample rejected the product, the Weibull distribution (Fig. 3.3) gave a predicted end of shelf life storage time of 27 (± 1) d. This value was used in the regression equation and a resulting cut-off point of -0.532 ± 0.138 (PC1 score) was obtained.

Using the multivariate parameters calculated using non-linear regression (Table 3.6), the shelf life of the low fat UHT milk stored at 35 and 25°C was estimated at 73 (± 3) and 211 (± 7) d, respectively. The multivariate acceleration factor, also known as Q_{10} value when there are 10°C increments, was determined to be 2.89 and 2.71 when the storage temperatures increased from 25 to 35°C and from 35 to 45°C, respectively. Therefore, the rate of sensory deterioration of the milk at 35°C will be more than 2.89 times faster, and the rate at 45°C will

be 7.83 times faster, than the rate at 25°C. This means that, for an estimated shelf life of 211 d, future MASLT have to be conducted for 73 d at 35°C or only 27 d at 45°C.

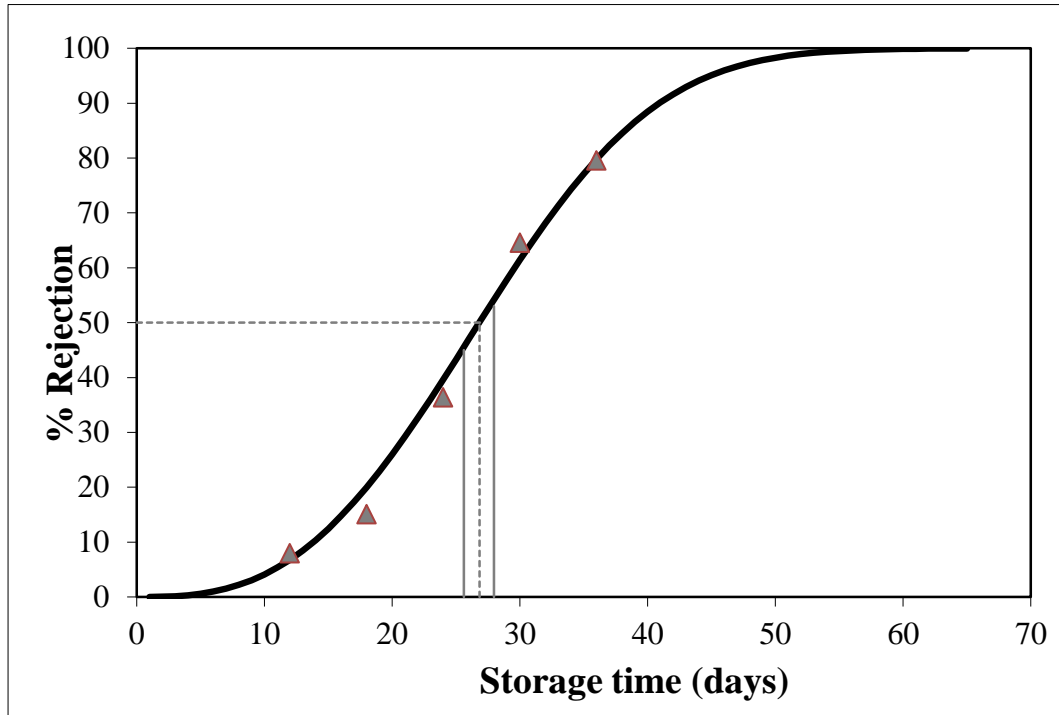

Figure 3.3: Percentage of consumers rejecting the product versus storage time. 50% rejection points = dotted line, 95% confidence intervals = grey solid lines, nonparametric data points = triangles.

Table 3.6: Multivariate parameters for low fat UHT milk.

Temperature °C	Rate constant (<i>k</i>) PC score.day ⁻¹	Activation energy (<i>E_a</i>)kJ.mol ⁻¹	Coefficient of determination (<i>R</i> ²)	Acceleration factor (<i>α</i>)	
				<i>α</i> _{35,25}	<i>α</i> _{45,35}
25°C	-0.0179	19.2964 (± 3.9640)	0.9330	2.8934	2.7136
35°C	-0.0489		0.9245		
45°C	-0.1395		0.9459		

When the activation energies for all the attributes were calculated (Table 3.7), the fresh milk aroma intensity, cooked flavour and off-flavour (lack of freshness) had activation energies of

19.08, 19.31 and 18.99 kJ.mol⁻¹, respectively, all of which are very similar to that of the multivariate results (19.30 kJ.mol⁻¹) of the UHT milk. The acceleration factors for fresh milk aroma intensity, cooked flavour and off-flavour were 2.74, 2.94 and 2.85, respectively, when the temperature was increased from 25 to 35°C, while it was 2.85, 2.71 and 2.68, respectively, when the temperature was increased from 35 to 45°C. These values are also very similar to those of the multivariate results and changes over time and temperatures for these attributes will therefore correlate well with those of the multivariate parameters. This makes all these attributes good candidates for predictors of end of shelf life and can also minimise the number of attributes to be assessed in future studies.

Table 3.7: Parameters of the sensory attributes of low fat UHT milk.

Attribute	Kinetic order n	Temperature (°C)	Rate constant k (PC score.day ⁻¹)	Acceleration factor		Activation energy (kJ.mol ⁻¹)
				$a_{35,25}$	$a_{45,35}$	
Fresh milk aroma intensity	Zero	25	-0.0015	2.7404	2.8505	19.0801 (±2.5683)
		35	-0.0042			
		45	-0.0113			
Extent of visual thickness	Zero	25	-0.0015	1.5448	1.5031	7.9042 (±2.3739)
		35	-0.0019			
		45	-0.0035			
Dry/chalk feel	Zero	25	0.0031	3.2107	2.9834	20.8779 (±3.0672)
		35	0.0143			
		45	0.0289			
Cooked flavour	Zero	25	0.0054	2.9357	2.7065	19.3089 (±5.4601)
		35	0.0169			
		45	0.0404			
Overall milk flavour	Zero	25	-0.0024	2.4141	2.2839	16.0162 (±3.0869)
		35	-0.0057			
		45	-0.0130			
Creamy flavour	Zero	25	-0.0016	1.9022	1.8268	11.6855 (±4.2451)
		35	-0.0025			
		45	-0.0057			

Table 3.7: Parameters of the sensory attributes of low fat UHT milk (Continued).

Attribute	Kinetic order n	Temperature (°C)	Rate constant k (PC score.day ⁻¹)	Acceleration factor		Activation energy (kJ.mol ⁻¹)
				$a_{35,25}$	$a_{45,35}$	
Off-flavour (Lack of freshness)	Zero	25	0.0011	2.852858	2.68497	18.9871 (±2.7423)
		35	0.0034			
		45	0.0074			
Sweet taste	Zero	25	-0.0005	3.7506	3.4513	24.0236 (±5.5764)
		35	-0.0012			
		45	-0.0033			
Dry/chalk aftertaste	Zero	25	0.0013	3.0258	2.8718	20.4585 (±6.4902)
		35	0.0086			
		45	0.0143			
Metallic aftertaste	Zero	25	0.0061	1.6098	1.5623	8.6522 (±1.2624)
		35	0.0113			
		45	0.0258			
Sweet aftertaste	Zero	25	0.0040	2.6763	2.5156	17.8076 (±4.2375)
		35	0.0081			
		45	0.0251			

3.4 CONCLUSION

The multivariate accelerated shelf life test was successfully applied to the low fat UHT milk and the shelf life of the designated low fat UHT milk in HDPE bottles was estimated to be 211 (± 7) d when stored at optimum conditions of 25 °C. Higher temperatures of storage negatively affected the shelf life of the milk and shelf life was shortened to 73 (± 3) and 27 (± 1) d when stored at accelerated temperatures of 35°C and 45°C, respectively. Storage at 35°C and 45°C reduced the shelf life by a factor of 2.9 and 2.7, respectively, for every 10°C increase in storage temperature. The activation energies and acceleration factors of the fresh milk aroma intensity, cooked flavour and off-flavour (lack of freshness) correlated the best with those of the multivariate data. In future, these attributes can be used as predictors for the end of shelf life for low fat UHT milk in HDPE bottles.

3.5 REFERENCES

- Badings, H.T. (1991). Milk. In H. Maarse (Ed), *Volatile Compounds in Foods and Beverage* (pp. 91-106). New York, USA: Marcel Dekker.
- Bassette, R., Fung, D. Y. C., & Mantha, V.R. (1986). Off-flavours in milk. *CRC Critical Review in Food Science and Nutrition*, 24, 1–5.
- Borle, F., Sieber, R., & Bosset, J.O. (2001). Photo-oxidation and photoprotection of foods, with particular reference to dairy products: An update of a review article. *Sciences des Aliments*, 21, 571-590.
- Burton, H. (1988). *Ultra-high-temperature processing of milk and milk products*. New York, NY, USA: Elsevier Applied Science Publications.
- Calligaris, S., Manzocco, L., Kravina, G., & Nicoli, C.M. (2007). Shelf life modelling of bakery products by using oxidation indices. *Journal of Agriculture and Food Chemistry*, 55, 2004-2009.

- Cardelli, C., & Labuza, T.P. (2001). Application of Weibull hazard analysis to the determination of the shelf life of roasted and ground coffee. *Lebensmittel-Wissenschaft Technology*, 34, 273-278.
- Chapman, K.W., Lawless, H.T., & Boor, K.J. (2001). Quantitative descriptive analysis and principal component analysis for sensory characterization of ultra pasteurized milk. *Journal of Dairy Science*, 84, 12-20.
- Chen, L., Daniel, R. M., & Coolbear, T. (2003). Detection and impact of protease and lipase activities in milk and milk powders. *International Dairy Journal*, 13, 255–275.
- Claassen, M., & Lawless, H.T. (1992). Comparison of descriptive terminology system for sensory evaluation of fluid milk. *Journal of Food Science*, 57, 596-600.
- Cody, R. P., & Smith, J. K. (1991). *Applied statistics and the SAS programming language*. North Holland, New York, NY: Elsevier Publishing.
- Corrigan, V., Hedderley, D., & Harvey, W. (2012). Modelling the shelf life of fruit-filled snack bars using survival analysis and sensory profiling techniques. *Journal of Sensory studies*, 27, 403-416.
- Curia, A., Aguerri, M., Langohr, K., & Hough, G. (2005). Survival analysis applied to sensory shelf life of yogurts, I. Argentine formulations. *Journal of Food Science*, 70, 442-445.
- Curia, A.V., & Hough, G.E. (2009). Selection of a sensory marker to predict the sensory life of a fluid human milk replacement formula. *Journal of Food Quality*, 32, 793-809.
- Datta, N., & Deeth, H. C. (2003). Diagnosing the cause of proteolysis in UHT milk. *Food Science and Technology*, 36, 173-182.
- Deeth, H. C., & Fitz-Gerald, C. H. (1983). Lipolytic enzymes and hydrolytic rancidity in milk and milk products. In P. F. Fox (Ed.), *Developments in dairy chemistry*, Part II, (pp. 195-239). London, UK: Applied Science.

- Deeth, H.C., & Fitz-Gerald, C.H. (1994). Lipolytic enzymes and hydrolytic rancidity in milk and milk products. In P. F. Fox (Ed.), *Advanced dairy chemistry, Vol. 2: Lipids*. (pp. 247-308). London: Chapman & Hall.
- Findlay, C.J., Castira, J.C., Schlich, P., & Lesschaeve, I. (2006). Use of feedback calibration to reduce the training time for wine panels. *Food Quality and Preference, 17*, 266-276.
- Frandsen, L.W., Dijksterhuis, G., Brockhoff, P., Nielsen, J.H., & Martens, M. (2003). Subtle differences in milk, comparison of an analytical and an affective test. *Food Quality and Preference, 14*, 515-526.
- Frost, M.B., Dijksterhuis, G., & Martens, M. (2001). Sensory perception of fat in milk. *Food Quality Preference, 12*, 327-336.
- Gámbaro, A., Garitta, L., Giménez, A., Varela, P., & Hough, G. (2004). Sensory shelf life estimation of “alfajor” by survival analysis. *Journal of Sensory Studies, 19*, 500-509.
- Garitta, L., Hough, G., & Sánchez, R. (2004). Sensory shelf life of dulce de leche. *Journal of Dairy Science, 87*, 1601–1607.
- Gebre-Egziabher, A., Humbert, E.S., & Blankenagel, G. (1980). Hydrolysis of milk proteins by microbial enzymes. *Journal of Food Protection, 43*, 709–712.
- Grunert, K.G. (2005). Food quality and safety, consumer perception and demand. *European Review of Agricultural Economics, 32*, 369-391.
- Guerra, S., Lagazio, C., Manzocco, L., Barnaba, M., & Cappuccio, R. (2008). Risks and pitfalls of sensory data analysis for shelf life prediction, Data simulation applied to the case of coffee. *LWT-Food Science and Technology, 41*, 2070–2078.
- Hedegaard, R.V., Kristensen, D., Nielsen, J.H., Frøst, M.B., Østdal, H., Hermansen, J.E., Kröger-Ohlsen, M., & Skibsted, L.H. (2006). Comparison of descriptive sensory analysis and chemical analysis for oxidative changes in milk. *Journal of Dairy Science, 89*, 495-504.

- Hough, G., Sanchez, R.H., Garbarini de Pable, G., Sánchez, R.G., Calderón Villaplana, S., Giménez, A.M., & Gámbaro, A. (2002). Consumer acceptability versus trained sensory panel scores of powdered milk shelf life defects. *Journal of Dairy Science*, *85*, 2075-2080.
- Hough, G., Langhour, K., Gómez, G., & Curia, A. (2003). Survival analysis applied to sensory shelf life of foods. *Journal of Food Science*, *68*, 359-362.
- Hough, G., Garitta, L., & Gómez, G. (2006). Sensory shelf life predictions by survival analysis accelerated storage models. *Food Quality and Preference*, *17*, 468-473.
- Hough, G. 2010. *Sensory shelf life estimation of food products*. London, UK: CRC Press.
- Hugas, M., Garriga, M., & Monfort, J.M. (2002). New mild technologies in meat processing, high pressure as a model technology. *Meat Science*, *62*, 359-371
- Klein, J. P., & Moeschberger, M. L. (1997). *Survival analysis, a self-learning text*. New York, NY, USA: Springer-Verlag.
- Labuza, T.P., & Schmidl, M.K. (1985). Accelerated shelf life testing of foods. *Food Technology*, *39*, 57-64.
- Lewis, M.J., & Heppell, N. (2000). *Continuous thermal processing of foods, Pasteurization and UHT sterilization*. Gaitersburg, MD, USA: Aspen Publishers.
- Littell, R.C, Milliken, G A., Stroup, W.W., & Wolfinger, R.D. (2006). *SAS System for Mixed Models* (second edition), Cary, NC, USA: SAS Institute Inc.
- McMahon, D. J. (1996). Age-gelation of UHT milk: Changes that occur during storage, their effect on shelf life and the mechanism by which age-gelation occurs. In IDF Symposium, Vienna, *Heat treatments and alternative methods* (pp. 315–326). Brussels, Belgium: International Dairy Federation.
- Martínez, C.A., Mucci, C., Santa Cruz, M.J., Hough, G., & Sanchez, R. (1998). Influence of temperature, fat content and package material on the sensory shelf life of commercial mayonnaise. *Journal of Sensory Studies*, *13*, 331-346.

- Meeker, W.Q., & Escobar, L.A. (1998). *Statistical methods for reliability data*. New York, NY, USA: John Wiley & Sons.
- Moser, E.B. (2004). Repeated measures modelling with PROC MIXED. *Statistics and Data Analysis*, 29, 1-19.
- Pedro, A.M.K., & Ferreira, M.M.C. (2006). Multivariate accelerated shelf life testing, A novel approach for determining the shelf life of foods. *Journal of Chemometrics*, 20, 76-83.
- Perkins, M.L., D'Arcy, B.R., Lisle, A.T., & Deeth, H.C. (2005). Solid phase microextraction of stale flavour volatiles from the headspace of UHT milk. *Journal of the Science of Food and Agriculture*, 85, 2421-2428.
- R Development Core Team. (2010). R: A Language and environment for statistical computing. Vienna, Austria: R Foundation for statistical computing.
- SAN ISO/IEC.4832. (2006). Microbiology of Food and Animal Feeding Stuff. Pretoria, South Africa: South African Bureau of Standards.
- Smith, D., & Sparks, L. (2004). Temperature Controlled Supply Chains. In M.A. Bourlakis, & P.W.H. Weightman (Eds.), *Food Supply Chain Management* (pp. 179-198). Oxford, UK: Blackwell Publishing Ltd.
- Smit, L.E., & Schönfeldt, H.C. (2006). The nutritional content of South African milk and liquid milk products. Part 2. Dairy Industry Centre, Irene, South Africa: ARC-Animal Nutrition and Animal Products Institute.
- Valero, E., Villamiel, M., Miralles, B., Sanz, J., & Martínez-Castro, I. (2001). Changes in flavour and volatile components during storage of whole and skimmed UHT milk. *Food Chemistry*, 72, 51-58.
- Williams, E.J. (1949). Experimental designs balanced for the estimation of residual effects of treatments. *Australian Journal of Scientific Research*, 2, 149-168.

CHAPTER 4 : SURVIVAL ANALYSIS, CONSUMER PERCEPTION AND PHYSICO-CHEMICAL ANALYSIS OF LOW FAT UHT MILK STORED FOR DIFFERENT TIME PERIODS

Abstract

Survival analysis methodology was used to validate the shelf life of low fat UHT milk in HDPE bottles, as determined by the multivariate accelerated shelf life test (Richards, De Kock, & Buys, 2014 – Chapter 3), using results obtained from consumers when asked if they would accept or reject milk of different storage ages. UHT milk samples were evaluated between 120 and 290 d of storage. Considering 50% of consumers rejecting the product, the shelf life of the UHT milk was estimated at 214 d, validating the shelf life of 211 d estimated by the MASLT. In addition to this, consumers were asked to complete check-all-that-apply, attribute questions and rate the acceptance of the milk. Physico-chemical and enzymatic properties of UHT milk of various ages was also evaluated. The consumers noted positive sensory attributes more frequently in fresher milk samples. The detection of these attributes decreased with an increase in negative attributes with storage. Along with this, the hedonic scores for the UHT milk also decreased and physico-chemical and enzymatic reactions associated with the deterioration of UHT milk increased as the milk was stored for longer time periods.

4.1 INTRODUCTION

Ultra-high temperature processing (UHT) of milk results in a product with a long shelf life when stored at room temperature (Valero, Villamiel, Miralles, Sanz, & Martinez-Castro, 2001). The high temperature of the UHT process and the long storage time can, however, result in changes in the sensory properties that can reach a limit beyond which the consumer will reject the product. Various enzymatic and physico-chemical reactions occur in UHT milk and are responsible for the development of various off-flavours, sedimentation, gelation and discolouration of the milk (Shipe et al., 1978; Celestino, Iyer, & Roginski, 1997; Borle, Sieber, & Bosset, 2001). Sensory shelf-life studies often consider product defects, such as rancid and oxidized flavour in milk (Lawless & Claassen, 1993), as the critical attributes. These defect are,

however, not always what determines the end of shelf life, but rather changes in the levels of the desirable attributes or a combination of the two (Garitta, Hough, & Sánchez, 2004).

Although it is not expected that a product stored for several months should be exactly the same as the fresh standard, the sensory differences should be small enough for the acceptability of the product not to be altered significantly (Garitta et al., 2004). Trained sensory panels are able to detect very small differences in products that may be very useful in quality control or other tasks where the integrity of the product needs to be maintained (Hough, 1998; Moskowitz, 1998), but these variations may be irrelevant to the end-consumer. Consumers and trained panels could perceive the product differently (Ares, Barreiro, Deliza, Giménez, & Gámbaro, 2010; van Trijp and Schifferstein, 1995). Consumer data based on simple sensory concepts can therefore ensure a better understanding of how people perceive the sensory properties of food and also predict the actual marketplace behaviour (Ares et al., 2010). Shelf life estimation using consumer panels is important for microbiologically stable products (Guerra et al. 2008), such as UHT milk. For such products the criteria for end of shelf-life will be determined less by food safety and more by the sensory quality of the food. Survival analysis has been applied in various areas of consumer research, including shelf life studies of various food products (Hough, Langohr, & Gómez, 2003; Gámbaro, Garitta, Giménez, Varela, & Hough, 2004; Garitta et al., 2004; Curia, Aguerrido, Langohr, & Hough, 2005; Corrigan, Hedderley, & Harvey, 2012). Consumers are either asked to accept or reject samples of different storage ages and the shelf life of the product is estimated as the time taken to reach a predetermined percentage of consumer rejections. The failure function $F(x)$ used in survival analysis can be defined as the probability of an individual failing before time x is reached. The “individual” in sensory shelf life studies would not be the food itself, but rather the consumer. Therefore the failure function would be defined as the probability of a consumer rejecting a product for a time shorter than x . The focus of survival analysis used in shelf life studies is therefore not on the food product and its deterioration but rather on the probability of a consumer rejecting the product stored for a certain time. (Klein & Moeschberger, 1997; Hough et al., 2003; Hough, Garitta, & Gómez, 2005; Gámbaro, Ares, & Giménez, 2006).

The objective of this study was to use survival analysis to determine the shelf life of low fat UHT milk in HDPE bottles. The shelf life was determined by consumers accepting or rejecting samples of various ages. Successful application of this methodology can be used as validation for the shelf life model developed by Richards et al. (2014) (Chapter 3). In addition, hedonic scales, check-all-that-apply (CATA) questions and physico-chemical analysis were used to determine consumers liking of aroma, appearance, flavour and overall liking of the milk, the consumer's perception of the sensory attributes; and the physico-chemical properties of UHT milk samples of different ages.

4.2 METHODS AND MATERIALS

4.2.1 Consumer evaluation

Regular UHT milk consumers (120, 52 males and 68 females) (Hough et al., 2007) were recruited and each consumer received 6 samples of low fat UHT milk that were stored at 25°C for different time periods (120, 150, 180, 210, 240 and 290 d. Samples were manufactured for each of the sampling times and stored at 25°C. Freshly packed low fat UHT milk was collected and stored at 25°C until the day of evaluation (this would be the 290d sample), after 30 days another batch of freshly packed milk was collected and stored at 25°C (this would be the 240d sample). This was repeated to have samples for all the different storage times ready on the day of evaluation. As samples comprised different batches, 32 trained sensory panellists performed triangle tests to ensure that there was no significant difference between a sample of the one batch (kept at 5°C) and that of the following batches. The milk samples (50 ml) were chilled in a refrigerator at 7°C after portioning and served at 15±1°C in random 3-digit coded glasses covered with foil. During the sensory evaluation consumers received numbered trays with samples served in an order determined by the Williams Latin Square design (Williams, 1949). General Good Sensory Practices (GSP's) (Lawless & Heymann, 1998) were followed in the selection, preparation, and serving of samples to consumers.

Consumers were asked to answer “yes” or “no” to the question “Would you normally consume this product?” if they had purchased the product or it was served to them in a home situation. In addition to this the consumers were also asked to rate the aroma, appearance, flavour and overall liking on a 9 point hedonic scale (with 1 being “like extremely” and 9 being “dislike extremely”) and provide a sensory profile of the different milk samples by answering a series of CATA questions where they received a list of attributes and were asked to select all the attributes that they found appropriate in describing the UHT milk samples. Attributes for the CATA question included: caramel smell, cooked milk smell, fresh milk smell, sour smell, off smell, caramel taste, cooked milk taste, sweet taste, sour taste, off taste, creamy taste, bitter taste, dry mouth feel, metal taste, white colour and curdling. These attributes were selected from a list generated for UHT milk by the trained sensory panel. Terms generated by a trained panel are usually more comprehensive and better described. These attributes may, however, be too complex for the average consumer to understand. Even though various studies have shown that the differences in sensory studies between trained panels and consumers are minimal, an attribute list with descriptions for each attribute was made available during the test for better understanding (Benedito, Cárcel, & Mulet, 2001; Husson & Pagés, 2003; Lelievre, Chollet, Abdi, & Valentin, 2008). Filtered water was provided for neutralising and cleansing the palate before and between sample tasting. Compusense Five version 5.2 software (Compusense Inc., Guelph, Canada) was used to generate all random codes, questionnaires and to capture the consumers’ responses.

4.2.2 Physico-chemical analysis

4.2.2.1 pH

The pH value of the low fat UHT milk samples was determined at 25°C using an electronic bench pH meter (Microprocessor pH211, HANNA® products, Italy) with a combination electrode. (AOAC, 2005). Prior to use, the pH meter was standardized with standard buffer solutions of pH 4 and 7.

4.2.2.2 Titratable acidity

The titratable acidity was expressed as the % lactic acid as determined by titration of a known amount of milk with 0.1 N NaOH using phenolphthalein as indicator.

4.2.2.3 Colour measurements

L*, a* and b*-values of the low fat UHT milk was measured using a colour meter (Konica Minolta Chroma meter CR-400). The colorimetric values corresponds to measurements based on black-white (L*- value scale of 0 – 100), red to green (a*- value scale from positive to negative results), and yellow to blue (b*- value also scale from positive to negative results). The colour meter was calibrated using a white colour tile standard supplied by the manufacturer and the milk volume was adjusted (10 mL) so the measuring head just touched the surface of the sample.

4.2.2.4 Hydroxymethylfurfural (HMF)

The method of Keeney and Bassette (1958) was used to measure free and total HMF in milk samples. The results were expressed as micromoles HMF.L⁻¹ UHT milk.

4.2.3 Enzymatic reactions

4.2.3.1 Proteolysis

Proteolysis in the UHT milk was measured by quantifying the primary amino groups using the trinitrobenzene sulfonic acid method described by McKellar et al. (1981). Results were expressed as mg glycine.mL⁻¹ UHT milk.

4.2.3.2 Lipolysis

Lipolysis in the UHT milk was determined by the acid degree value as described by Thomas, Nielson, and Olson (1955). The results were expressed as acid degree value in terms ml of 1 N base required to neutralize the acids in 100g of fat.

4.2.4 Statistical data analysis

4.2.4.1 Survival analysis

Survival analysis methodology was used to determine the shelf life of UHT milk stored at 25°C, using the results obtained from consumers when asked if they would normally consume the samples with different storage times. The exact storage time at which the consumer rejects the milk sample (T) cannot be observed due to a limited number of samples with different storage times being evaluated. Different types of censoring can therefore be expected from consumer shelf life studies (Hough et al., 2003). Supposed that consumers are presented with samples stored at times t_1 , t_2 and t_3 and a consumer rejects the sample at the first storage time, the point of rejection for that consumer is not observed since it is before the first storage time ($T \leq t_1$) and the data are left censored. If the consumer accepts the sample stored for t_1 but rejects the sample stored for t_2 , the data will be interval censored and the exact time at which the consumer rejects the product occurs between t_1 and t_2 ($t_1 < T \leq t_2$). Finally, if the consumer accepts all the samples, the point of rejection is after the last storage time observed ($T > t_3$) and the data is right censored. Parametric models, including log-linear, lognormal, Weibul were used to obtain precise estimates of the survival function (Klein & Moeschberger, 1997). To estimate the shelf life of the low fat UHT milk, the probability of a consumer rejecting the product must be chosen. Although the point of 50% rejection by consumers is mostly used (Varela, Salvador, & Fiszman, 2005; Hough, Garitta, & Gómez, 2006), a more conservative level of 25% (Gámbaro et al., 2006) or even both (Araneda, Hough, & De Penna, 2008) have been reported. In the present study, the shelf-life was estimated for 50% consumer rejection. Various distributions were fitted to the data using R statistical software (R Development Core team, 2010). Only data from

consumers that did not reject the freshest sample (120 days) was included in the analysis (Hough et al., 2006).

4.2.4.2 Hedonic ratings for liking and physico-chemical analysis

Analysis of variance (ANOVA) was performed on the hedonic ratings for aroma, taste, aftertaste and overall liking scores considering consumers as random and samples of various ages as fixed sources of variation. Mean ratings were calculated and the Fisher Least Significant Difference (LSD) test was used to investigate the nature of these differences using Statistica Version 10.0 (Statsoft, Tulsa, USA).

All the physico-chemical and enzymatic experiments were performed in triplicate and data obtained was analysed by one-way ANOVA. Mean ratings were calculated and the Fisher Least Significant Difference (LSD) test was used to investigate the nature of these differences.

4.2.4.3 Check-all-that-apply (CATA) data analysis

In order to evaluate whether the consumers were able to detect significant differences between the low fat UHT milk samples of different ages, Cochran's Q test was carried out for each of the attributes of the CATA question (Parente, Manzoni, & Ares, 2011). Frequency of mention for each word of the CATA question was determined by counting the number of consumers who used that word to describe each low fat UHT milk sample.

Then, in order to get a bi-dimensional representation of the samples correspondence analysis (CA) was used on a matrix containing the number of consumers who checked each term from the CATA question to describe each sample. Physico-chemical and enzymatic data were considered as supplementary variables. Transition formulas (Hoffmann & Franke, 1986) provided a means of fitting the supplementary data into the CA biplot by regression. This analysis provides a

sensory map of the samples, which enables to determine the similarities and differences between the samples (Ares et al., 2010).

4.3 RESULTS AND DISCUSSION

4.3.1 Survival analysis

To determine the end of shelf-life, survival analysis was used. For the survival analysis data, the following standard distributions were compared: Weibull, logistic, Gaussian, log-logistic, log-normal and exponential (Table 4.1). Survival analysis of the data showed that the loglogistic and lognormal distributions adjusted well to the shelf-life data when the lowest absolute log-likelihood value was taken as criteria in choosing between the distributions (Hough, 2010). Based on this criterion, the lognormal distribution fitted the data best and was chosen to model the rejection of low fat UHT milk stored at 25°C (Fig. 4.1).

Table 4.1: Log-likelihood values for different distributions.

Model	Log-likelihood
Weibull	137.5
Logistic	135.4
Gaussian	135.8
Loglogistic	132.6
Lognormal	132.5
Exponential	198.4

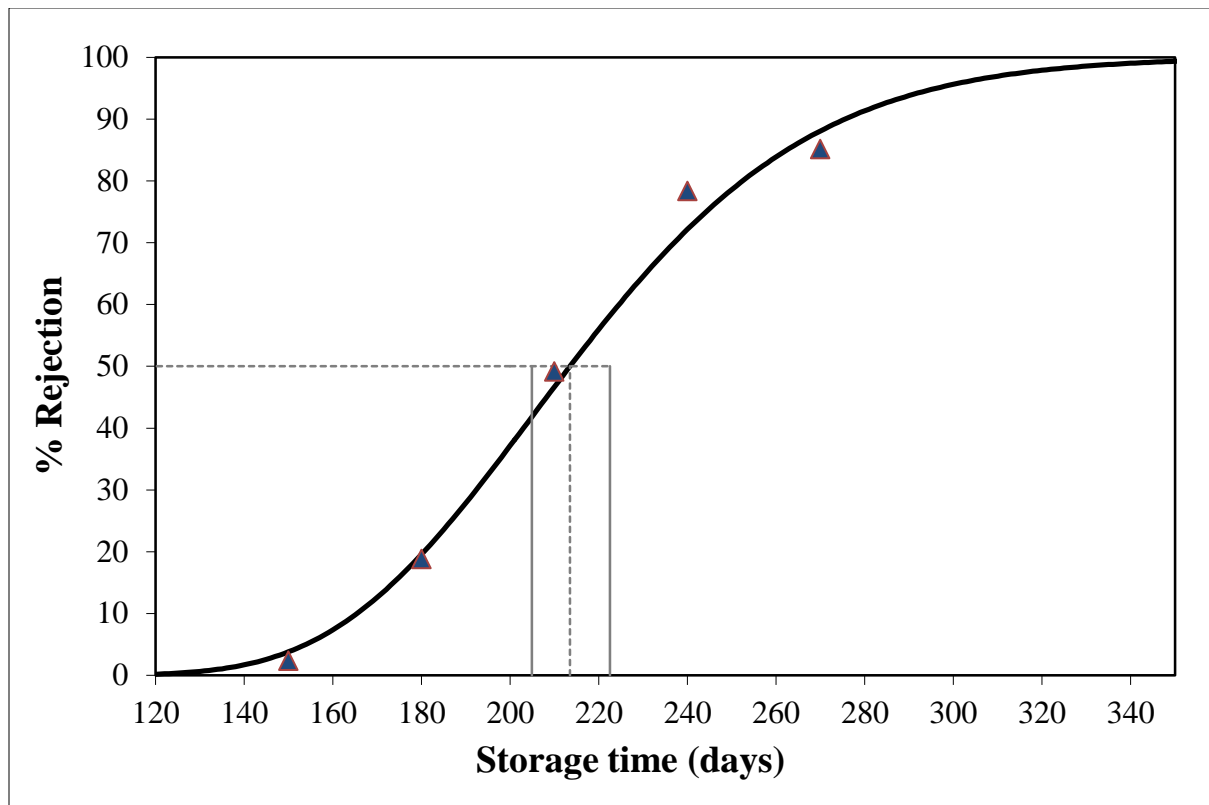

Figure 4.1: Percentage of consumers rejecting the product versus storage time. 50% rejection points = dotted line, 95% confidence intervals = grey solid lines, nonparametric data points = triangles.

With the end of shelf-life set at the point where 50% of the consumers who had accepted the freshest sample rejected the product, the lognormal distribution (Fig. 4.1) gave a predicted shelf-life of 214 d, with lower and upper confidence levels of 205 and 223 d, respectively. This compares well with the results from the multivariate accelerated shelf life test (MASLT) that estimated the shelf life of the low fat UHT milk at 211 (± 7) d (Richards et al., 2014).

4.3.2 Consumers' liking and CATA

When consumers were asked to score the UHT milk samples with different storage times on hedonic scales, significant differences were found in consumers' aroma, appearance, flavour and overall liking scores (Table 4.2). The consumers' aroma and appearance liking scores were high

for the freshest milk sample (120 d) and then progressively decreased as the age of the samples increased. Both the flavour and overall liking scores were very similar with related changes over time where significant differences were recorded for samples of 150 to 240 d. This may be an indication that flavour plays the biggest role in the overall liking of the samples. The significant differences in the consumers' liking scores suggest changes in the low fat UHT milk over time. This may be due to a decrease in the sensory quality of the milk as a result of various physico-chemical and biochemical changes that occur in the milk after processing (Datta & Deeth, 2003).

Table 4.2: Mean consumers' aroma, appearance, flavour and overall liking scores as rated on a 9 point hedonic scale¹ for UHT milk samples stored at 25°C for different storage times ($n = 120$).

Storage time	Aroma	Appearance	Flavour	Overall liking
120 d	7.3 (1.5) ^f	7.3 (1.0) ^d	7.6 (1.4) ^e	7.5 (1.4) ^e
150 d	6.5 (1.5) ^e	7.1 (1.0) ^{cd}	7.3 (1.6) ^d	7.4 (1.4) ^d
180 d	6.1 (1.6) ^d	7.1 (1.1) ^{cd}	6.6 (1.7) ^c	6.7 (1.4) ^c
210 d	5.7 (1.7) ^c	7.0 (1.3) ^c	6.1 (1.7) ^b	6.2 (1.4) ^b
240 d	5.3 (1.8) ^b	6.4 (1.4) ^b	5.6 (1.8) ^a	5.7 (1.3) ^a
270 d	4.9 (1.8) ^a	6.1 (1.4) ^a	4.8 (1.7) ^a	4.8 (1.7) ^a

¹ with 1 being "like extremely" and 9 being "dislike extremely"

*Values with same superscripts in columns represent no significant differences ($p > 0.05$).

*Standard deviations shown in parenthesis.

Table 4.3 shows the frequency with which each of the sensory attributes in the CATA question was used to describe the low fat UHT milk samples of different ages. Consumers checked between 1 and 15 sensory attributes to describe the low fat UHT milk samples presented to them. The most frequently used attributes, included white colour, fresh milk aroma, creamy taste and sweet taste, and were all positive or desirable attributes associated with fresh UHT milk samples (Richards et al., 2014), while the least-used attributes were negative or undesirable attributes like curdling, sour taste, bitter taste, metal taste and off smell. Significant differences were found in the frequencies with which nine of the 16 CATA attributes were used to describe the UHT milk samples. From this table we can also see that the frequency with which the positive and negative attributes were selected decreased and increased, respectively, as the milk aged. This may be an

indication that not only the increase in negative attributes, but also a decrease in positive attributes or a combination of the two may have an influence on consumer acceptance of the low fat UHT milk.

Table 4.3: CATA frequency table for different attributes of UHT milk samples stored at 25°C for different storage times ($n = 120$).

Attribute	Milk with different storage times (days)					
	120	150	180	210	240	270
Caramel smell*	11	11	15	19	20	26
Cooked milk smell (n.s)	20	21	21	21	22	23
Fresh milk smell***	64	57	48	40	36	34
Sour smell***	8	9	9	14	21	26
Off smell (n.s)	11	12	12	12	17	18
Caramel taste *	13	13	15	18	22	27
Cooked milk taste (n.s)	23	25	25	27	34	35
Sweet taste*	46	43	33	32	31	30
Sour taste (n.s)	10	10	10	11	12	14
Off taste**	8	8	18	21	21	22
Creamy taste (n.s)	42	45	43	42	42	41
Bitter taste*	7	8	13	16	16	18
Dry mouth feel*	11	12	15	20	22	24
Metal taste (n.s)	11	13	13	14	15	15
White colour (n.s)	73	69	65	64	62	60
Curdling***	2	2	2	6	15	16

Significant differences indicated by *** at $P \leq 0.001$, ** at $P \leq 0.01$ and * $p \leq 0.05$; (n.s.) indicates no significant difference ($p > 0.05$).

Results from the liking scores and CATA question indicate that the sensory quality of the milk deteriorates over time. This coincides well with literature that state that different aroma, flavour and textural changes occur in UHT milk during storage and ultimately limits the shelf-life of the

milk. These changes include a decrease in favourable attributes associated with the milk, e.g. the decrease in the sweet aroma and taste in UHT milk (Clare, Bang, Cartwright, Drake, Coronel, & Simunovic, 2005), and an increase in unfavourable attributes, e.g. off-flavour development and gelation (Shipe et al., 1978; Celestino et al., 1997; Borle, et al., 2001).

4.3.3 Physico-chemical and enzymatic reactions

All the physico-chemical parameters showed significant change with increasing storage time (Table 4.4). A definite effect of storage time on pH was detected for milk stored between 120 and 270 d. The maximum pH of 6.7 was recorded at 120 d, while the lowest pH of 6.5 was recorded at 270 d. Andrews, Brooker, and Hobbs (1977) reported that the level and extent of pH decrease was related to age gelation of the milk. The casein micelles in milk are stable at pH 6.7. Below this pH level aggregation of the micelles occurs and this may result in some consistency defects. Milk stored for 240 and 270 days also showed some degree of clotting as indicated by the consumers is the CATA question, and this may be due to a reduced pH. A slight increase in the titratable acidity, from 0.18 to 0.21% lactic acid, was noted during storage of the UHT milk. After high temperature treatment and subsequent storage, lactose is degraded to acids that are responsible for an increase in the titratable acidity of the milk (Swartzel, 1983).

Browning reactions, caused by the Maillard reaction, was measured by total and free HMF present in the milk and showed an increase over time, with the levels of total and free HMF increasing from 6.21 to 11.40 and 1.37 to 3.88, respectively. Vankatachalm and McMahon (1991) verified a drop in the pH and associated it with browning reactions that take place in the milk. The Maillard reaction is also a source of volatile sulphur compounds in heated milk (Badings, Neeter, & Van Der Pol, 1978; Calvo & De la Hoz, 1992), which are in turn responsible for the cooked flavour in UHT milk (Patrick & Swaisgood, 1976; Badings, 1991). Colour is an important parameter in UHT milk that may affect consumer acceptability. The Maillard reaction consists of a series of chemical reactions resulting in the formation of brown-coloured pigments, such as pyralysins and melanoidins, low molecular weight acids, as well as polymers, such as

lactulose-lysine and fructose-lysine (Cattaneo, Masotti, & Pellegrino, 2008). This may explain the change in colour for the UHT milk over time.

Even though psychrotrophic microorganisms are inactivated by UHT treatment, some heat-resistant enzymes of native and bacterial origin can survive and cause both flavour and consistency defects in the milk during storage (Burton, 1988; Valero et al., 2001). The levels of both proteolysis and lipolysis in the UHT milk increased over time. Proteolysis can result in age gelation of UHT milk by hydrolysing the caseins, releasing the β -lactoglobulin- κ -casein complex ($\beta\kappa$ -complex) that are formed during heat treatment, from the micelle. Subsequent aggregation of these complexes causes the milk to gel (McMahon, 1996). Proteolysis also causes the development of off-flavours, such as bitterness, in the milk due to the release of tyrosine in the milk (Gebre-Egziabher, Humbert, & Blankenagel, 1980). Both the increase in curdling and bitter taste recorded by the consumers for older milk samples may be due to proteolysis of the milk. Lipolysis of milk triacylglycerols causes off-flavours in the milk due to the release of short- and medium-chain fatty acids (Choi & Jeon, 1993). Free fatty acids released during lipolysis are also precursors for other flavour compounds, like esters and methyl ketones, while unsaturated fatty acids are susceptible to oxidation and the formation of ketones and aldehydes responsible for metallic and cardboard flavours in the milk (Vulfson, 1994). Free fatty acids are also responsible for the increase in titratable acidity of milk (Swartzel, 1983).

4.3.4 Correspondence analysis

Data collected in the CATA question was used to construct a correspondence analysis (CA) plot, considering physico-chemical and enzymatic data as supplementary variables (Fig. 4.2). The first and second dimension of the correspondence analysis calculated from the CATA counts accounted for 89.9% and 8.3% of the variance of the experimental data, respectively. Fresher samples are separated on the right hand side of the plot from older samples on the left. The fresh samples (D120 and D150) are described by sweet taste and fresh milk smell, typically what we would expect for the fresher samples, while in the top left corner we have the two oldest samples

(D240 and D270) that are being described by more negative attributes like caramel taste, sour smell and curdling.

Furthermore, using CA some correlations between sensory attributes and physico-chemical variables could be visualised. As shown in Fig 4.2 total HMF and free HMF, were positively correlated with the attributes caramel smell and caramel taste and negatively with the attribute fresh milk smell. Proteolysis was also positively correlated with the CATA attribute bitter, whereas L^* was positively correlated with the attribute white colour. These results show that consumers' selection of CATA attributes to describe the milk was in agreement with the physico-chemical differences between the samples. Additionally, fresher samples were associated with higher pH values, while the older samples were associated with higher acid degree values (ADV), higher levels of proteolysis and higher levels of free and total HMF.

Table 4.4: Physico-chemical and enzymatic parameters measured in low fat UHT milk stored at 25°C for various storage times.

Storage time (d)	120	150	180	210	240	270
Physico-chemical parameters						
pH	6.70 (0.02) ^d	6.68 (0.01) ^d	6.65 (0.02) ^c	6.64 (0.01) ^c	6.56 (0.01) ^b	6.50 (0.02) ^a
Titratable acidity (% lactic acid)	0.18 (0.00) ^a	0.18 (0.00) ^a	0.19 (0.00) ^b	0.19 (0.01) ^{bc}	0.20 (0.01) ^{cd}	0.21 (0.01) ^d
Total hydroxymethylfurfural (HMF.L ⁻¹)	6.21 (0.66) ^a	7.93 (0.51) ^b	8.93 (0.15) ^b	10.27 (0.48) ^c	11.62 (0.26) ^c	11.40 (0.15) ^d
Free HMF (HMF.L ⁻¹)	1.37 (0.25) ^a	1.55 (0.24) ^a	2.04 (0.13) ^{ab}	2.53 (0.09) ^b	3.25 (0.20) ^c	3.88 (0.28) ^c
L*	87.33 (0.02) ^d	86.97 (0.06) ^d	86.45 (0.04) ^c	86.02 (0.17) ^b	85.87 (0.14) ^{ab}	85.54 (0.11) ^a
a*	-3.57 (0.03) ^d	-3.46 (0.01) ^{cd}	-3.33 (0.07) ^c	-3.16 (0.05) ^b	-3.09 (0.10) ^{ab}	-2.97 (0.05) ^a
b*	5.84 (0.05) ^d	6.12 (0.02) ^{cd}	6.26 (0.07) ^c	6.57 (0.06) ^b	6.71 (0.11) ^b	6.90 (0.08) ^a
Enzymatic parameters						
Lipolysis (mg NaOH.100g ⁻¹ fat)	1.60 (0.10) ^a	2.00 (0.20) ^{ab}	2.27 (0.31) ^{bc}	2.40 (0.00) ^{bc}	2.57 (0.15) ^d	2.70 (0.10) ^d
Proteolysis (mg glycine.mL ⁻¹)	0.05 (0.00) ^a	0.05 (0.00) ^a	0.06 (0.01) ^b	0.06 (0.01) ^b	0.08 (0.00) ^c	0.10 (0.01) ^d

*Values expressed as mean values with standard deviation in parenthesis. Values with different superscripts in rows represent significant differences ($p < 0.05$). Three replicates were used for data analysis.

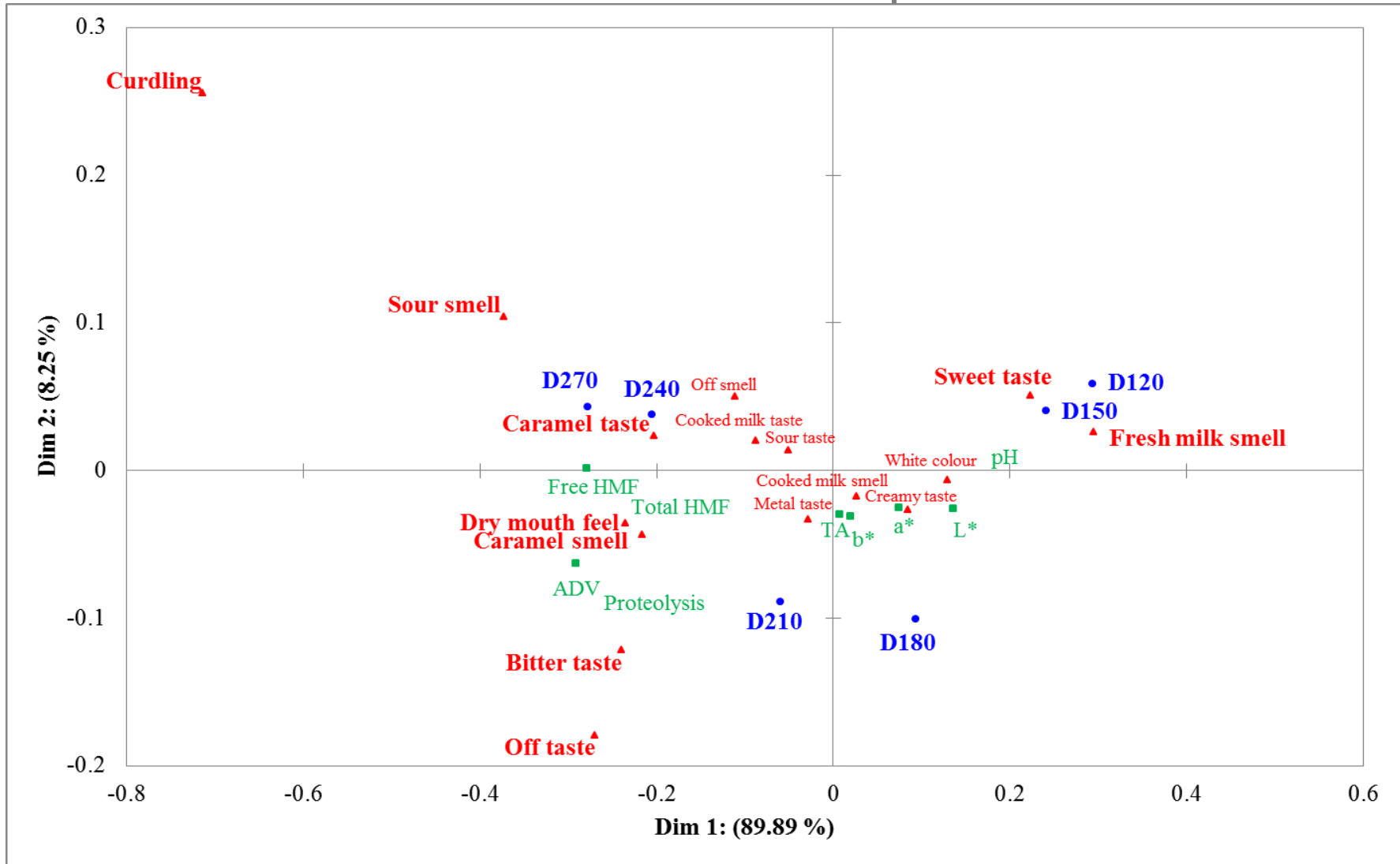

Figure 4.2: Correspondence analysis plot representing the sensory attributes (red) of the CATA question on the first two dimensions for low fat UHT milk stored at 25°C for different time periods (D, blue). Sensory attributes that showed significant change over time are in bold. Supplementary data include the physico-chemical and enzymatic data (green). ($n = 120$).

4.4 CONCLUSION

Survival analysis can successfully determine the shelf life of low fat UHT milk. The shelf life of the UHT milk based on consumers accepting or rejecting the samples with a 50% rejection rate was determined at 214 (± 9) d. This shelf life determined by survival analysis coincide well with the shelf life determined using the MASLT, which was estimated at 211 (± 7) d. The shelf life determine by survival analysis therefore validate those determined by the MASLT that has only been successfully applied to tomato puree before.

Data from consumer liking, profiling, physico-chemical parameters and enzymatic parameters show significant change in the low fat UHT milk over time. As the consumer liking for aroma, appearance, taste and overall liking decreased, the detection of positive attributes in the milk decreased, while the detection of negative attributes increased. Physico-chemical and enzymatic parameters associated with deterioration of UHT milk also increased over time.

4.5 REFERENCES

- Andrews, A.T., Brooker, B.E., & Hobbs, D.G. (1977). Properties of aseptically packed UHT milk. Electron microscopic examination of changes occurring during storage. *Journal of Dairy Research* 44, 283-285.
- AOAC (2005). Official methods of analysis of the association of official analytical chemists. 16th edition. 481. Gaithersburg, MD, USA: Association of Official Analytical Chemists International.
- Araneda, M., Hough, G. & De Penna, E.W. (2008). Current-status survival analysis methodology applied to estimating sensory shelf life of ready-to-eat lettuce (*Lactuca sativa*). *Journal of Sensory Studies* 23, 162–170.

Ares, G., Barreiro, C., Deliza, R., Giménez, A., & Gámbaro, A. (2010). Application of a check-all-that-apply question to the development of chocolate milk desserts. *Journal of Sensory Studies*, 25, 67–86.

Badings, H.T., Neeter, R., & Van Der Pol, J.J.G. (1978). Reduction of cooked flavour in heated milk and milk products by l-cystine. *Lebensmittel-Wissenschaft and Technology*, 11, 237–240.

Badings, H.T. (1991). Milk. In H. Maarse (Ed), *Volatile Compounds in Foods and Beverage* (pp. 91-106). New York, USA: Marcel Dekker.

Benedito, J., Cárcel, J. A., & Mulet, A. (2001). Cheese hardness by experts and untrained judges. *Journal of Sensory Studies*, 16, 277–285.

Borle, F., Sieber, R. & Bosset, J.O. (2001). Photo-oxidation and photoprotection of foods, with particular reference to dairy products: An update of a review article. *Science Aliments*, 21, 571-590.

Burton, H. (1988). *Ultra-high-temperature processing of milk and milk products*. New York, USA: Elsevier Applied Science Publications Inc.

Calvo, M.M., & De La Hoz, L. (1992). Flavour of heated milks. A review. *International Dairy Journal*, 2, 69-81.

Cardelli, C., & Labuza, T.P. (2001). Application of Weibull hazard analysis to the determination of the shelf-life of roasted and ground coffee. *Lebensmittel-Wissenschaft Technology*, 34, 273-278.

Cattaneo, S., Masotti, F., & Pellegrino, L. (2008). Effects of overprocessing on heat damage of UHT milk. *European Food Research and Technology*, 226, 1099–106.

Celestino, E.L., Iyer, M., & Roginski, H. (1997). Reconstituted UHT-treat milk: Effects of raw milk, powder quality and storage conditions of UHT milk on its physico-chemical attributes and flavour. *International Dairy Journal*, 7, 129–140.

- Choi, W., & Jeon I.J. (1993). Patterns of fatty acids released from milk fat by residual lipase during storage of ultra-high temperature processed milk. *Journal of Dairy Science*, 76, 78–85.
- Clare, D.A., Bang, W.S., Cartwright, G., Drake, M.A., Coronel, P. & Simunovic, J. (2005). Comparison of sensory, microbiological, and biochemical parameters of microwave verses indirect UHT fluid skim milk during storage. *Journal of Dairy Science*, 88, 4172-4182.
- Corrigan, V., Hedderley, D. & Harvey, W. (2012). Modeling the shelf-life of fruit-filled snack bars using survival analysis and sensory profiling techniques. *Journal of Sensory studies*, 27, 403-416.
- Curia, A., Aguerri, M., Langohr, K. & Hough, G. (2005). Survival analysis applied to sensory shelf-life of yogurts, I. Argentine formulations. *Journal of Food Science*, 70, 442-445.
- Datta, N., & Deeth, H. C. (2003). Diagnosing the cause of proteolysis in UHT milk. *Food Science and Technology*, 36, 173-182.
- Gámbaro, A., Garitta, L., Giménez, A., Varela, P. & Hough, G. (2004). Sensory shelf-life estimation of “alfajor” by survival analysis. *Journal of Sensory Studies*, 19, 500-509.
- Gámbaro, A., Ares, G. & Giménez, A. 2006. Shelf-life estimation of apple baby food. *Journal of Sensory Studies*, 21, 101–111.
- Garitta, L., Hough, G. & Sánchez, R. (2004). Sensory shelf-life of dulce de leche. *Journal of Dairy Science*, 87, 1601–1607.
- Gebre-Egziabher, A., Humbert, E.S., & Blankenagel, G. (1980). Hydrolysis of milkproteins by microbial enzymes. *Journal of Food Protection*, 43, 709–712.
- Guerra, S., Lagazio, C., Manzocco, L., Barnaba, M. & Cappuccio, R. (2008). Risks and pitfalls of sensory data analysis for shelf-life prediction, Data simulation applied to the case of coffee. *LWT-Food Science and Technology*, 41, 2070–2078.
- Hoffman, D., & Franke, G.R. (1986). Correspondence analysis: graphical representation of categorical data in marketing research. *Journal of Marketing Research*, 23, 213-227.

Hough, G. (1998). Experts versus consumers: a critique. *Journal of Sensory Studies*, 13, 285-289.

Hough, G., Langhour, K., Gomez, G. & Curia, A. (2003). Survival analysis applied to sensory shelf-life of foods. *Journal of Food Science*, 68, 359-362.

Hough, G., Garitta, L. & Gómez, G. (2005). Sensory shelf-life predictions by survival analysis accelerated storage models. *Food Quality and Preference*, 17: 468-473.

Hough, G., Garitta, L., & Gómez, G. (2006). Sensory shelf-life predictions by survival analysis accelerated storage models. *Food Quality and Preference*, 17, 468-473.

Hough, G., Luz Calle, M., Serrat, C. & Curia, A. (2007). Number of consumers necessary for shelf life estimations based on survival analysis statistics. *Food Quality and Preference*, 18, 771–775.

Hough, G. 2010. *Sensory shelf-life estimation of food products*. London, UK: CRC Press.

Husson, F., & Pagés, J. (2003). Comparison of sensory profiles done by trained and untrained juries: Methodology and results. *Journal of Sensory Studies*, 18, 453–464.

Keeney, M., & Bassette, R. (1958). Detection of intermediate compounds in the early stages of browning reaction in milk products. *Journal of Dairy Science*, 42, 945-960.

Klein, J. P., & Moeschberger, M. L. (1997). *Survival analysis, techniques for censored and truncated data*. New York, NY, USA: Springer-Verlag.

Lawless, H.T. & Claassen, M.R. (1993). Validity of descriptive and defect-oriented terminology systems for sensory analysis of fluid milk. *Journal of Food Science*, 58, 108-112.

Lawless, H.T. & Heymann, H. 1998. *Sensory Evaluation of Food: Principles and Practices*. Gaithersburg, MD, USA: Aspen Publications.

Lelievre, M., Chollet, S., Abdi, H., & Valentin, D. (2008). What is the validity of the sorting task for describing beers? A study using trained and untrained assessors. *Food Quality and Preference*, 19, 697–703.

McKellar, R.C. (1981). Development of off-flavour in Ultra-High Temperature and Pasteurised Milk as a function of proteolysis. *Journal of Dairy Science*, *64*, 2138-2145.

McMahon, D. J. (1996). Age-gelation of UHT milk: Changes that occur during storage, their effect on shelf life and the mechanism by which age-gelation occurs. In IDF Symposium, Vienna, *Heat treatments and alternative methods* (pp. 315–326). Brussels, Belgium: International Dairy Federation.

Moskowitz, H. (1998). Consumers versus experts in the light of psychophysics: A reply to Hough. *Journal of Sensory Studies*, *13*, 291-298.

Parente, M. E., Manzoni, A. V., & Ares, G. (2011). External preference mapping of commercial anti-aging creams based on consumers' responses to a check-all-that-apply question. *Journal of Sensory Studies*, *26*, 158–166.

Patrick, P. S. and Swaisgood, H. E. (1976). Sulfhydryl and disulphide groups in skim milk as affected by direct ultra-high-temperature heating and subsequent storage. *Journal of Dairy Science*, *59*, 594–600.

R Development Core Team. (2010). R: A Language and environment for statistical computing. Vienna, Austria: R Foundation for statistical computing.

Richards, M., De Kock, H.L., & Buys, E.M. (2014). Multivariate accelerated shelf life of low fat UHT milk. *International Dairy Journal*, *36*, 3-45.

Shipe, W.F., Bassette, R., Deane, D.D., Dunkley, W.L., Hammond, E.G., Harper, W.J., Kleyn, D.H., Morgan, M.E., Nelson, J.H. & Scanlan, R.A. (1978). Off flavours of milk: nomenclature, standards, and bibliography. *Journal of Dairy Science*, *61*, 855-869.

Swartzel, K.R. (1983). The role of heat exchanger fouling in the formation of sediment in aseptically processed and packed milk. *Journal of Food Processing and Prevention*, *7*, 247-251.

Thomas, E.L., Nielson, A.J., & Olson, J.C. (1955). Hydrolytic rancidity in milk. *American Milk Review*, *17*, 50-53.

- van Trijp, H.C.M. & Schifferstein, H.N.J. (1995) Sensory analysis in marketing practice: Comparison and integration. *Journal of Sensory Studies*, 10, 127-147
- Valero, E., Villamiel, M., Miralles, B., Sanz, J., & Martinez-Castro, I. (2001). Changes in flavour and volatile components during storage of whole and skimmed UHT milk. *Food Chemistry*, 72: 51-58.
- Vankatachalm, N., & McMahon, D.J. (1991). Effect of lactose concentration on age-gelation of UHT sterilized skim milk concentrate. *Journal of Dairy Science*, 74, 101-107.
- Varela, P., Salvador, A. & Fiszman, S. (2005). Shelf-life estimation of “Fuji” apples: Sensory characteristics and consumer acceptability. *Postharvest Biology and Technology*, 38, 18–24.
- Vulfson, E.N. (1994) Industrial applications of lipases. In Woolley, P., & Peterson, S.B. (Eds) *Lipases—their structure, biochemistry and applications* (pp. 271-288). Cambridge, UK: Cambridge University Press.
- Williams, E.J. (1949). Experimental designs balanced for the estimation of residual effects of treatments. *Australian Journal of Scientific Research*, 2, 149-168.

Published in: LWT - Food Science and Technology, Volume 57, Issue 2, 2014, Pages 628–633

CHAPTER 5 : THE EFFECT OF LEGUME PROTEASE INHIBITORS ON NATIVE MILK AND BACTERIAL PROTEASES

Richards Melanie, De Kock Henrietta Letitia, Duodu Kwaku G, Buys, Elna Maria.*

Department of Food Science, University of Pretoria, Pretoria, 0001, South Africa

melanie.richards@up.ac.za, riette.dekock@up.ac.za, elna.buys@up.ac.za

*Corresponding author: Tel: +27 12 4203209; E-mail address: elna.buys@up.ac.za

Abstract

Protease inhibitors from legume seed extracts (soybean, cowpea and marama beans) and purified soybean protease inhibitor were evaluated with regards to their abilities to inhibit proteases produced by important milk contaminating bacteria, i.e. *Bacillus* spp. and *Pseudomonas* spp., and native milk protease, plasmin. Although heat-treatment is the most common mean of inactivating enzymes, some heat-stable enzymes can survive the ultra-high temperature (UHT) processing of milk and cause sensory and consistency defects during storage at room temperature. The legume protease inhibitors reduced the activity of plasmin and proteases produced by *Bacillus* spp. by up to 94% and 97%, respectively, while it showed low inhibitory activity towards *P. fluorescens* proteases (19%) in a buffer system. The protease inhibitors reduced the activity of plasmin (41%) and *Bacillus* proteases (50%) in UHT milk, however, to a lesser extent as compared to inhibition in the buffer system; while it had little or no effect on proteases from *Pseudomonas* spp. Legume protease inhibitors show great potential in preventing or reducing proteolytic activity of *Bacillus* proteases and plasmin and may be exploited in various applications where these proteases cause sensory or consistency defects in the product.

Keywords: UHT milk, legume protease inhibitors, bacterial proteases, plasmin

5.1 INTRODUCTION

Proteolysis of UHT milk during storage at ambient temperature limits both the shelf life and market potential of the milk (Datta & Deeth, 2001) and has been attributed to extracellular heat-stable proteases produced by psychrotrophic bacterial contaminants of raw milk and natural milk alkaline serine protease, plasmin (Visser, 1981; Grufferty & Fox, 1988; Datta & Deeth, 2003). Protease activity in UHT milk is associated with changes in the flavour and viscosity of the milk, with the eventual formation of a gel (McMahon, 1995; Chen, Daniel, & Coolbear, 2003; Datta & Deeth, 2003). Off-flavors, such as bitterness, in UHT milk are associated with the release of tyrosine in the milk (Gebre-Egziabher, Humbert, & Blankenagel, 1980; Datta & Deeth, 2003), while viscosity changes are associated with the hydrolysis of caseins (Chen et al., 2003; Datta & Deeth, 2003). During the course of the latter, the enzymes release the β -lactoglobulin- κ -casein complex ($\beta\kappa$ -complex), formed during heat treatment, from the casein micelle. Subsequent aggregation of the released $\beta\kappa$ -complexes forms a three-dimensional cross-linked protein network, which causes gelation of the milk (McMahon, 1995).

Bacterial contaminants are mainly introduced into milk within the interior of the udder, the cow's teats and milking and storage equipment (Law & Mabbitt, 1983). Contaminating milk bacteria often isolated from refrigerated milk and associated with proteolysis in milk are mainly species from *Pseudomonas*, particularly *P. fluorescens* (Fairbairn & Law, 1986; Kohlmann, Nielsen, & Ladisch, 1991; Matselis & Roussis, 1998). In addition, *Bacillus* species are abundant in the environment and can contaminate milk during production, handling and processing (Phillips & Griffiths, 1990; Matta & Punj, 1999). Although the contaminating milk bacteria are mainly psychrotrophs that are eliminated by the UHT process, many of their enzymes survive and remain active in the derived dairy products where they can cause problems during storage (Sørhaug & Stepaniak, 1997; Chen et al., 2003). The plasmin system is complex and not only comprise plasmin, but also plasminogen (plasmin precursor), plasminogen activators, plasmin inhibitors and inhibitors of plasminogen activators (Upadhyay, McSweeney, Magboul, & Fox, 2004). Plasminogen is more heat stable than its active form and can be activated by cleavage of a single peptide bond by even more heat stable activators (Lu & Nielsen, 1993; Aroonkamonsri, Aroonkamonsri, & Kakuda, 1996).

Various studies show the potential of protease inhibitors in preventing or reducing adverse effects of proteases in food products. Examples of this include the use of α -2-macroglobulin to inhibit protease activity in various fish species that previously prevented the use of these species in processed fish products (Lorier & Aitken, 1990), and the use of protease inhibitors to improve the gel properties of frozen squid muscle (Peréz-Mateos, Montero & Gómez-Guillén, 2002). Legume seeds contain protease inhibitors with the ability to inactivate proteases by various mechanisms. The objective of this study was to examine the effect of protease inhibitors from legume seeds, i.e. soybeans (*Glycine max* (L.) Merr), marama beans (*Tylosema esculentum* (Burch) A. Schreib) and cowpeas (*Vigna unguiculata* (L.) Walp), on the proteolytic activity of native milk protease plasmin and proteases from bacterial contaminants previously isolated from milk, all known to cause adverse effects during the storage of UHT milk.

5.2 MATERIALS AND METHODS

5.2.1 Materials and chemicals

Savinase and Alcalase were supplied by Novozymes, Johannesburg, South Africa. Plasmin, bovine trypsin, azocasein, bovine serum albumin (BSA), purified soybean trypsin inhibitor and Tyr-Leu were obtained from Sigma-Aldrich, Kempton Park, South Africa. The rest of the chemicals and standards were of analytical grades and obtained from Sigma-Aldrich or Merck (Johannesburg, South Africa) unless otherwise stated.

5.2.2 Protease inhibitor extraction

5.2.2.1 Preparation of flours

Seeds from marama bean were dehulled using a cracker (WMC Sheet Metal Works, Tzaneen, South Africa) and soybeans were dehulled using a Tangential Abrasive Dehulling Device (TADD). After the dehulled seeds were milled in a food blender, the flour was defatted twice with n-hexane (1:5 m/v) for an hour each time, air-dried and milled again. This process was repeated and defatted flour was placed in a fume hood overnight to remove the remaining hexane. The defatted flour was milled again to pass through a 1000 μ m mesh. Due to the low

fat content of cowpeas, it was milled to pass through a 1000 μm mesh and used for protein extraction without any defatting.

5.2.2.2 Protein extraction

The protein was extracted following the protocol of Maggo, Malhotra, Dhawan, and Singh (1999), with a few modifications. Flours were extracted with 0.1 mol.L⁻¹ phosphate buffer, pH 7.5, at a ratio (flour:buffer) of 1:20 (m/v) for 4 h at room temperature in a shaking water bath. The suspension obtained was centrifuged at 10 000 $\times g$ for 30 min and the supernatant was collected and used for determining the protein and total phenolic contents and the trypsin inhibitor activity.

5.2.3 Characterization of protein extract

5.2.3.1 SDS-PAGE

The method described by Taylor, Bean, Ioerger, and Taylor (2007) was used for SDS-polyacrylamide gel electrophoresis (SDS-PAGE). Aliquots of protein extracts (15 μL) containing 15 μg protein was loaded onto 4-12 % polyacrylamide gradient gels. Gels were stained with Coomassie Brilliant Blue R-250.

5.2.3.2 Native-PAGE

Native-PAGE was performed using the NativePAGE™ Novex® Bis-Tris Gel system (Invitrogen™, Johannesburg, South Africa). The Native-PAGE gels were stained for trypsin inhibitor activity as described by Ee, Zhao, Rehman, and Agboola (2008).

5.2.3.3 Quantification of protein concentration in crude protein extracts

The method of Bradford (1976), with the following modifications, was used to determine the protein concentration of the crude protein extracts. Aliquots of these extracts (20 μL) were

pipetted into the wells of a 96-well polystyrene microtiter plate, followed by addition of 40 μL of Bradford's Reagent. The final volume in the wells was made up to 200 μL with the addition of dH_2O and the absorbance was measured at 595 nm against a reagent blank. A BSA standard curve was prepared and the protein concentration in the crude protein extracts was determined using the standard curve. Results were expressed as mg protein per mL crude extract.

5.2.3.4 Quantification of total phenolic content in crude protein extracts

The total phenolic content in the crude protein extracts was determined using the Folin-Ciocalteu procedure described by Hagerman, Harvey-Mueller, and Makkar (2000). A catechin standard curve was prepared and used to determine the total phenolic content in the protein extracts. Results were expressed as catechin equivalents (CE, mg catechin equivalents /100 mg sample) on dry basis. The dilution factor of flour to buffer (1 g: 20 mL) were taken in account in calculating the dry basis of the protein extracts.

5.2.3.5 Quantification of trypsin inhibitor activity in crude protein extracts

Equal volumes of protein extracts (60 μL) and trypsin (375 protease units (PU)/mL) were mixed and incubated for 1 h at 25 °C. The activity of trypsin inhibitor was assayed by determining the residual trypsin activity following the method of Secades, and Guijarro (1999) using azocasein as substrate and bovine trypsin as standard enzyme. A soybean trypsin inhibitor standard curve was prepared and used to determine the trypsin inhibitor activity (TIA) in the protein extracts. Results were expressed as trypsin inhibitor units (TIU) per mL by determining the trypsin units inhibited per ml extract relative to that of controls that contained only enzyme and no crude extract.

5.2.4 Inhibition of bacterial protease and plasmin activity in buffer

5.2.4.1 Bacterial protease inhibition assay

Alcalase and Savinase are alkaline proteases (E.C. 3.4.21.62) produced by *Bacillus licheniformis* and *B. lentus*, respectively. *P. fluorescens* (ATCC 13525) (Quantum Biotechnologies, Randburg, South Africa) was cultured in tryptone soy broth (TSB) for 3 days at 25 °C. Bacterial cells were removed by centrifugation at $24\ 000 \times g$ for 10 min at 5 °C. The resulting supernatants were stored at -20 °C until used as crude protease source.

One volume (60 μL) of either Savinase, Alcalase or *P. fluorescens* crude protease (at activities of 375 PU/mL as determined by the azocasein assay (Section 2.3.5) was mixed with one volume of crude extract from either soybeans or marama beans or cowpeas or purified soybean trypsin inhibitor at concentrations of 200, 287.5 and 375 TIU/mL. Inhibition of the bacterial proteases by the protease inhibitors from the various legume seeds was evaluated using the same method described in Section 2.3.5 except that bovine trypsin was replaced by the bacterial proteases. One unit of enzyme activity was defined as the amount that yielded an increase of 0.01 in the absorbance at 420 nm in 30 min at 30 °C. The protease inhibitor activity (PIA) was defined as the percentage of protease units inhibited (PUI) relative to that of controls that contained only the enzyme and no crude extract. Blanks were prepared by adding 10% trichloroacetic acid (TCA) before the addition of the substrate.

5.2.4.2 Plasmin inhibition assay

Plasmin (E.C. 3.4.21.7) and protease inhibitor mixtures were prepared as described in Section 2.4.1 for the bacterial proteases. After incubation for an hour, the remaining plasmin activity was assayed using a colorimetric method described by Baldi et al. (1996), using Val-Leu-Lys-p-nitroanilide as substrate.

5.2.5 Inhibition of bacterial protease and plasmin activity in low fat UHT milk

To determine the inhibitory effect of the crude extracts on proteases in milk, plasmin or bacterial proteases (Alcalase, Savinase or *P. fluorescens* protease) and protease inhibitors (crude protein extracts from legumes and purified soybean trypsin inhibitor) were added to low fat UHT milk at final concentrations of 375 PU/mL and 375 TIU/mL, respectively. The samples were mixed and incubated at 25 °C for 1 h.

5.2.5.1 Quantification of bacterial protease inhibition

The 4% TCA filtrates were prepared and analysed for peptides using reversed phase high performance liquid chromatography (RP-HPLC) as described by Le, Datta, and Deeth (2006). The peptides were quantified by measuring the peak areas using valley-to-valley integration and expressed as mmol Tyr-Leu equivalents by reference to a standard curve prepared with various concentrations of Tyr-Leu. The protease inhibitor activity (PIA) was defined as the percentage of protease units inhibited (PUI) relative to that of controls that contained only the enzyme and no crude extract.

5.2.5.2 Quantification of plasmin inhibition

After incubation at 25 °C for 1 h, the samples were prepared according to the method described by Richardson and Pearce (1981) with a few modifications to determine the residual plasmin activity. Sodium citrate solution (0.4 mol.L^{-1}) was added to milk samples (1 mL) in a 1:3 ratio (citrate: milk) and the mixture was centrifuged at $27\,000 \times g$ for 15 min. The supernatant was collected and centrifuged twice at $15\,000 \times g$ for 15 min. Residual plasmin activity was determined using the collected supernatant by the method described in Section 2.4.2

5.2.6 Statistical analysis

All experiments were performed in triplicate and data obtained was analysed by one-way analysis of variance (ANOVA) using the type of protease inhibitor as explanatory variable. Protease inhibition data was analysed using factorial ANOVA. Mean differences were evaluated at the 95% significance level ($p \leq 0.05$) using the significant Different test. The analyses were performed using Statistica Version 10.0 (Statsoft, Tulsa, USA).

5.3 RESULTS AND DISCUSSION

5.3.1 Characterization of the protein extracts from legume seeds

The band patterns obtained on the SDS-PAGE gel compared well with work from other researchers (Fig. 5.1), indicating that these extracts were representative of the protein of each of the respective seeds (Fotso, Aznaza, Pasquet, & Raymond, 1994; Mujoo, Trinh, & Ng, 2003; Amonsou, Taylor, Beukes, & Minnaar, 2012). The molecular weights of soybean, marama bean and cowpea Kunitz-type protease inhibitors are 21.5 kDa, 23 kDa and 18 kDa, respectively (Elfant, Bryant, & Starcher, 1985; Benjakul, Visessanguan, & Thummaratwasik, 2000), while Bowman-Birk type protease inhibitors for dicotyledonous seeds are 8 kDa (Prakash et al., 1996). Although protein bands with correlating molecular weights were visible on the gels, further analysis was required to confirm the presence of protease inhibitors in the protein extracts. Protease inhibitor activity was present in all the seed extracts and was visible as clear zones against a violet background (Fig. 5.2).

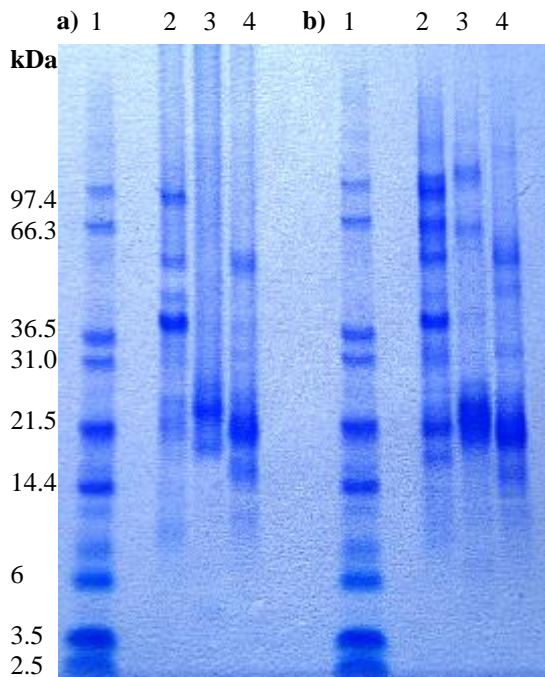

Figure 5.1: SDS-PAGE of crude protein crude extracts from soybean, marama bean and cowpea under a) reducing and b) non-reducing conditions on 4-12% polyacrylamide gradient gel stained with Coomassie Brilliant Blue R-250. Lane 1, molecular marker; lane 2, soybean extract; lane 3, marama bean extract; lane 4, cowpea extract.

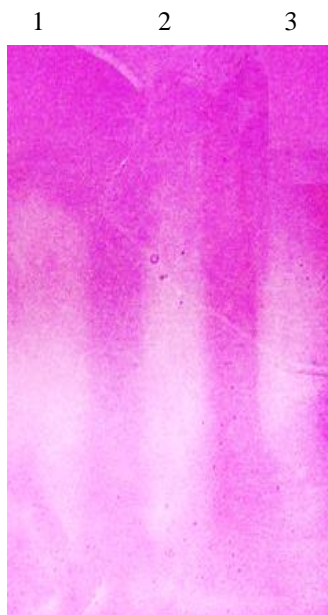

Figure 5.2: Native-PAGE gel showing protease inhibitor activity of protein extracts visible as clear zones against a violet background. Lane 1, soybean extract; lane 2, marama bean extract; lane 3, cowpea extract.

Protease inhibitors are usually found in plant storage organs, such as seeds and tubers, and may accumulate to about 1 to 10% of the total proteins of these storage tissues (De Leo et al., 2002). Trypsin inhibitor activity was present in all three seed extracts (Table 5.1). The marama bean extracts had the highest specific activity (617.4 TIU/mg protein), followed by soybean extracts with specific activity of 148.1 TIU/mg protein and then protein extracts from cowpeas (34.4 TIU/mg protein). The trypsin inhibitor activity of the soybean extracts was 52.7 TIU per mg sample and falls within the range of values for different soybean cultivars (43-85 TIU/mg sample) reported by Guillamón et al. (2008). The trypsin inhibitor activity was almost five times higher in the marama bean extracts as compared to the soybean extracts. This value is slightly higher than that reported by Maruatona (2008), but lower than values reported by Bower, Hertel, Oh, and Storey (1988), who found the trypsin inhibitor activity of marama bean to be four and a half and six times more than that found in soybeans, respectively. This variation in trypsin inhibitor activity of marama beans may be due to a difference in the extraction method or cultivars used. The trypsin inhibitor activity of the cowpea protein extracts was the lowest with a trypsin inhibitor concentration of only 7.5 TIU per mg sample and in agreement with Rivas-Vega et al. (2006) who recorded the trypsin inhibitor concentration in cowpeas to be 7.7 TIU per mg of dry sample.

Table 5.1: Protein content and trypsin inhibitor activity (TIA) of extracts of defatted flour from soybeans, defatted flour from marama beans and flour from cowpeas^a.

Legume	TIA (TIU.mL extract ⁻¹)	Protein (mg.mL extract ⁻¹)	Specific activity (TIU.mg protein ⁻¹)	TIA (TIU.mg sample ⁻¹)	Total Phenolics (mg CE.100 mg ⁻¹)
Soybeans	2636.8 (15.7) ^B	17.8 (1.5) ^B	148.1 ^B	52.7 ^B	0.5 (0.1) ^B
Marama beans	12 (30.6) ^C	780.4 20.7 (1.8) ^C	617.4 ^C	255.6 ^C	1.8 (0.1) ^C
Cowpeas	375.1 (11.4.) ^A	10.9 (0.8) ^A	34.4 ^A	7.5 ^A	0.2 (0.1) ^A

^a TIA of protein extracts in 0.1M phosphate buffer was expressed as trypsin inhibitor units (TIU) per mL. Total phenolics were expressed as mg catechin equivalents (CE) per 100 mg. Values were expressed as mean values with standard deviation in parenthesis. Values with different superscripts in columns represent significant differences ($p < 0.05$). Three replicates were used for data analysis.

Phenolic compounds may also play a role in enzyme inhibition by forming phenolic-protein complexes with the enzymes (Shahidi & Nacz, 1992), thus lowering the activity of the enzymes. The total phenolic content of the crude protein extracts showed a trend similar to that of the protease inhibitor concentration, with marama bean extract having the highest total phenolic content (1.8 mg CE/100 mg sample), followed by that of the soybean extract (0.5 mg CE/100 mg sample) and then the cowpea extract (0.2 mg CE/100 mg sample). These concentrations were lower than those reported in literature (Malenčić, Popović, & Miladinović, 2007; Van Zyl, 2007) and may be due differences in varieties used, agrotechnical and cultural conditions (Nacz & Shahidi, 2006).

5.3.2 Inhibition of protease activity in buffer

The protein extracts and purified soybean trypsin inhibitor were able to inhibit the bacterial proteases in buffer and the inhibition increased with increased protease inhibitor activities (Fig. 5.3). While the legume protease inhibitors were very effective in inhibiting the activity of serine proteases from *Bacillus* spp. (i.e. Savinase and Alcalase), reducing the activity of these enzymes by more than 91% at an activity of 375 TIU/mL, they were less effective in doing so with *P. fluorescens* proteases. Marama bean and soybean extracts showed the highest inhibitory action against *P. fluorescens* proteases with inhibition of 10, 14 and 19% over the increasing activities of the inhibitor. *Pseudomonas* species mainly produce only one type of proteinase, typically a neutral zinc metallo-protease (Fairbairn & Law, 1986; Kohlmann et al., 1991).

The protease inhibitors commonly found in legumes are serine protease inhibitors (Laskowski & Kato, 1980; Laing & McManus, 2002). Serine proteases are generally inhibited by direct blockage of the active site when a substrate-like complex is formed between the enzyme's active site and a canonical protease-binding loop formed by the inhibitor (Bode & Huber, 2000), while metallo-proteases are inhibited by various mechanisms, including one with a rigid protease-binding loop (Fernandez-Catalan et al., 1998). Even though the latter mechanism resembles that of canonical inhibitors of serine proteases, the specificity of the inhibitors is only towards some and not all of the mechanistic classes of proteases (i.e. serine, cysteine, aspartic and metallo-proteases). The two families of protease inhibitors found in legume seeds, Kunitz type and Bowman Birk protease

inhibitors, are mainly specific towards serine proteases, with the Kunitz type protease inhibitors also showing some specificity towards cysteine and aspartic proteases (Odani & Ikenaka, 1976; Ritonja et al., 1990; Laing & McManus, 2002). This may explain why the legume protease inhibitors only inhibited the activity of *P. fluorescens* protease to a limited extent.

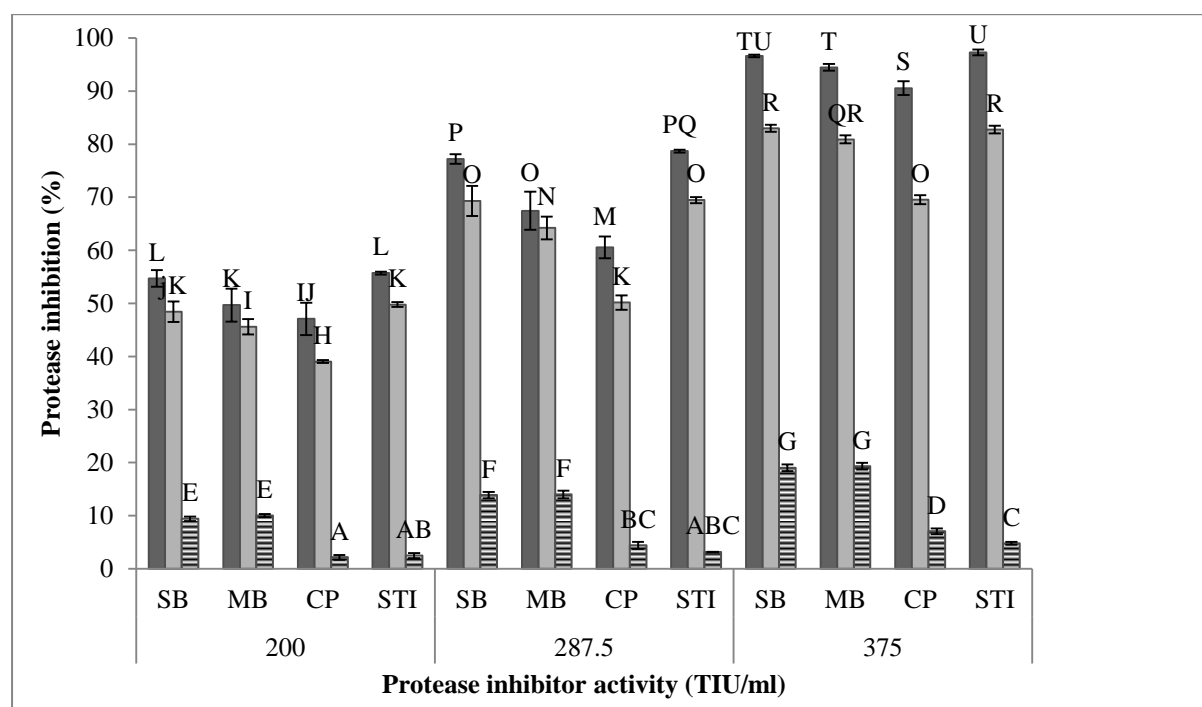

Figure 5.3: Inhibition of Savinase (■), Alcalase (■) and *P. fluorescens* (≡) proteases in phosphate buffer by treatment with soybean extract (SB), marama bean extract (MB), cowpea extract (CP) and purified soybean trypsin inhibitor (STI). Protease inhibition was measured using azocasein as substrate (n = 3). Differences in bar labels (A-U) represent significant differences (p < 0.05).

The purified soybean trypsin inhibitor was very successful in reducing the activity of Savinase and Alcalase, with inhibition of 50 – 97%, but it was less effective than any of the crude protein extracts in inhibiting the activity of *P. fluorescens* proteases, with inhibition of just over 4% at the highest inhibitor concentration. Different concentrations of the soybean and marama bean extracts reduced the activity of *P. fluorescens* protease by 9-18% and 10-19%, respectively. Even cowpea extracts showed higher protease inhibition towards *P. fluorescens* proteases as compared to the purified trypsin inhibitor. This may be due to the presence of phenolic compounds in the extracts that can form phenolic-protein complexes

with the enzymes, since soybean and marama bean extracts had the highest total phenolic contents and also showed the highest level of *P. fluorescens* protease inhibition.

Analysis of the results obtained when plasmin was treated with the legume crude extracts (Fig. 5.4) indicate that marama bean extracts were the most effective in reducing the activity of this enzyme, inhibiting 50% of the plasmin activity at a concentration of 200 TIU/ml, 70% at 285.7 TIU/mL and 94% at a activity of 375 TIU/mL. Soybean extracts and purified soybean trypsin inhibitors also showed high levels of inhibition with 45-90% and 46-92% inhibition, respectively. Although extracts from cowpeas were also able to inhibit some of the plasmin activity, the level of inhibition was lower than those of the other extracts ranging from 35-81%.

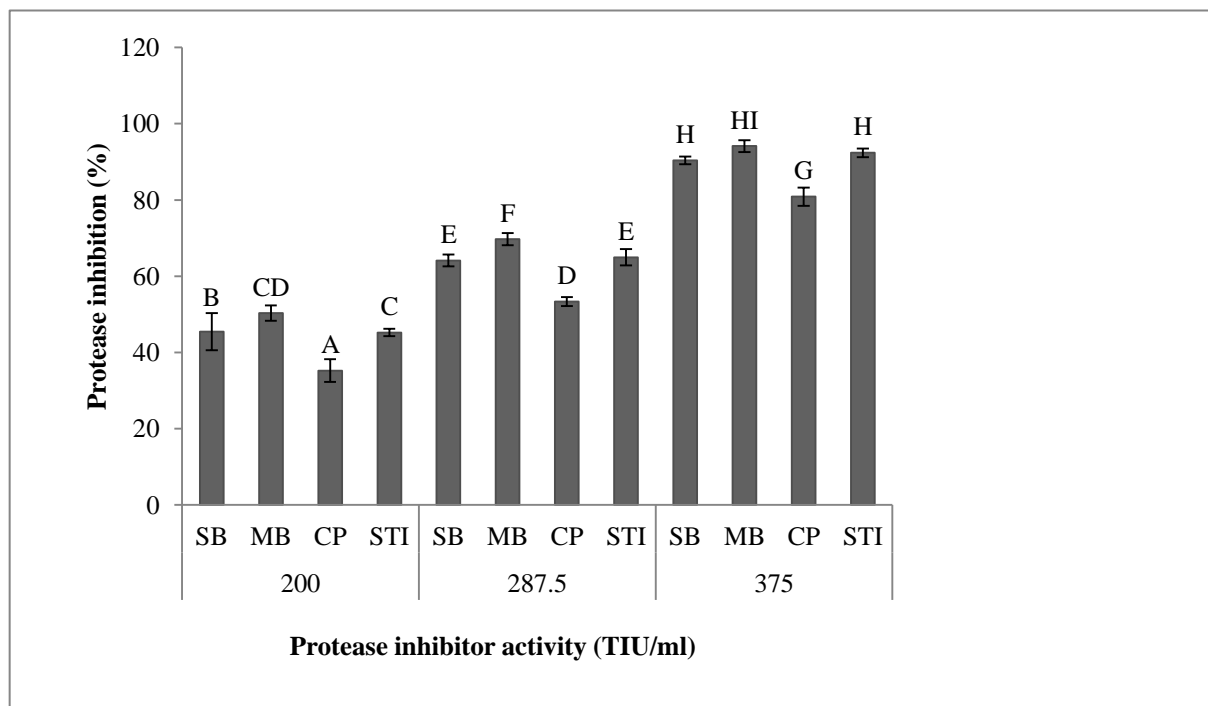

Figure 5.4: Inhibition of plasmin by treatment with soybean extract (SB), marama bean extract (MB), cowpea extract (CP) and purified soybean trypsin inhibitor (STI). Plasmin activity was measured using a colorimetric assay with Val-Leu-Lys-p-nitroanilide as substrate ($n = 3$). Differences in bar labels (A-I) represent significant differences ($p < 0.05$).

5.3.3 Inhibition of protease activity in low fat UHT milk

Since the protein extracts and the purified soybean trypsin inhibitor showed good protease inhibition towards the enzymes in buffer, the ability of these extracts to reduce the activity of these enzymes in low fat UHT milk was tested.

All the protease inhibitor extracts and the purified soybean trypsin inhibitor were able to inhibit the activity of Savinase, Alcalase and plasmin in low fat UHT milk, but to different extents (Table 5.2). The purified soybean trypsin inhibitor showed the highest protease inhibition towards Savinase, Alcalase and plasmin and reduced the activity of these enzymes by 50%, 43% and 41%, respectively. Comparing all the legume seed extracts, soybean was the most effective in reducing the activity of Savinase and Alcalase, followed by the marama bean extract and then the cowpea extract. The level of plasmin inhibition in the UHT milk was similar for marama bean and soybean extracts (39.8% and 38.5% respectively). Even though the marama bean extracts were the most effective in inhibiting the activity of plasmin in buffer, the purified soybean trypsin inhibitor was more effective in inhibiting this enzyme in the low fat UHT milk. This may be due to the presence of phenolic compounds in the extracts that had an effect on the enzymes in buffer, but less so in the UHT milk possibly due to the presence of more proteins that they could bind to.

Table 5.2: The effect of legume crude protein extracts on protease activity in low fat UHT milk^a.

Protease	% Inhibition			
	Soybean extract	Marama bean extract	Cowpea Extract	Purified soybean trypsin inhibitor
Savinase	44.7 (0.4) ^C	36.1(0.8) ^B	28.3 (3.7) ^A	49.8 (0.5) ^D
Alcalase	38.8 (1.3) ^C	34.9 (0.7) ^B	23.7 (1.5) ^A	42.5 (0.7) ^D
<i>P. fluorescens</i>	4.1 (0.2) ^C	3.6 (0.6) ^C	2.1 (0.5) ^B	1.2 (0.2) ^A
Plasmin	38.5 (1.1) ^B	39.8 (1.0) ^B	26.5 (0.9) ^A	41.2 (0.7) ^C

^a Proteases and protease inhibitors were added to low fat UHT milk and incubated at 25°C for 1 h. Activity of bacterial proteases and plasmin were determined with RP-HPLC and a colorimetric assay, respectively. Values expressed as mean values with standard deviation in parenthesis. Values with different superscripts in rows represent significant differences ($p < 0.05$). Three replicates were used for data analysis.

As shown earlier, the legume protease inhibitors had a limited effect on the activity of *P. fluorescens* proteases. None of the protease inhibitors were able to reduce the activity of the *P. fluorescens* protease by more than 4%. The highest level of inhibition was, however, again achieved with the protein extracts that contain phenolic compounds that may play a role in the inhibition.

Analysis of the results obtained when the extracts were used to inhibit proteases in UHT milk indicate that they were less effective in reducing the activity of these enzymes in milk as compared to buffer. This may be due to the milk proteins occupying the active sites of the proteases before the protease inhibitors, reducing the efficacy of the protease inhibitors in the milk as compared to the buffer system.

5.4 CONCLUSIONS

From the results obtained, it is evident that the legume protease inhibitors show great potential in preventing or reducing proteolytic activity of *Bacillus* proteases and plasmin and may be exploited in various applications where these proteases cause sensory or consistency defects in products. Defects caused by *P. fluorescens* enzymes will, however, not be reduced by these protease inhibitors. Further studies need to be conducted to determine the effect of protease inhibitors on the sensory and biochemical properties of the milk and also how it can be used to comply with laws and regulations of governing milk authorities. In addition, it should be stressed that these inhibitors are also known as anti-nutritional factors, since they can reduce protein digestion, and should be absent from the final product before consumption. This can be achieved by either inactivation of the protease inhibitors or by immobilizing them onto solid supports.

5.5 REFERENCES

Amonsou, E. O., Taylor, J. R. N., Beukes, M., & Minnaar, A. (2012). Composition of marama bean protein. *Food Chemistry*, 130, 638-643.

Aroonkamonsri, J. H., Aroonkamonsri, W., & Kakuda, Y. (1996). The role of plasmin and bacterial proteinases on age gelation of UHT milk. *Scanning*, 18, 203-204.

Aroonkamonsri, J.H., Aroonkamonsri, W., & Kakuda, Y. (1996). The role of plasmin and bacterial proteinases on age gelation of UHT milk. *Scanning*, 18, 203-204.

Baldi, A., Savoini, G., Cheli, F., Fantuz, F., Senatore, E., Bertocchi, L., & Politis, I. (1996). Changes in plasmin-plasminogen-plasminogen activator in milk from Italian Friesian herds. *International Dairy Journal*, 6, 1045-1053.

Benjakul, S., Visessanguan, W., & Thummaratwasik, P. (2000). Isolation and characterisation of trypsin inhibitors from some Thai legume seeds. *Journal of Food Biochemistry*, 24, 107-127.

Bode, W., & Huber, R. (2000). Structural basis of the endoproteinase- protein inhibitor interaction. *Biochimica et Biophysica Acta*, 1477, 241–252.

Bower, N., Hertel, K., Oh, J., & Storey, R. (1988). Nutritional evaluation of marama bean (*Tylosema esculentum*, Fabaceae): Analysis of the seed. *Economic Botany*, 42, 533-540.

Bradford, M. M. (1976). A rapid and sensitive method for the quantitation of microgram quantities of protein utilizing the principle of protein-dye binding. *Analytical Biochemistry*, 72, 248-254.

Chen, L., Daniel, R. M., & Coolbear, T. (2003). Detection and impact of protease and lipase activities in milk and milk powders. *International Dairy Journal*, 13, 255–275.

Datta, N., & Deeth, H. C. (2001). Age gelation of UHT milk – A Review. *Food and Bioproducts Processing*, 79, 197-210.

Datta, N., & Deeth, H. C. (2003). Diagnosing the cause of proteolysis in UHT milk. *LWT-Food Science and Technology*, 36, 173-182.

De Leo, F., Volpicella, M., Licciulli, F., Liuni, S., Gallerani, R., & Ceci, L. R. (2002). Plant-PIs: a database for plant protease inhibitors and their genes. *Nucleic Acids Research*, 30, 347-348.

- Ee, K.Y., Zhao, J., Rehman, A., & Agboola, S. (2008). Characterization of trypsin and α -chymotrypsin inhibitors in Australian wattle seed (*Acacia victoriae* Bentham). *Food Chemistry*, *107*, 337–343.
- Elfant, M., Bryant, L., & Starcher, B. (1985). Isolation and characterization of proteinase inhibitor from marama beans. *Experimental Biology and Medicine*, *180*, 329-333.
- Fairbairn, D. J., & Law, B. A. (1986). Proteinases of psychrotrophic bacteria: Their production, properties, effects and control. *Journal of Dairy Research*, *53*, 139–177.
- Fernandez-Catalan, C., Bode, W., Huber, R., Turk, D., Calvete, J. J., Lichte, A., Tschesche, H., & Maskos, K. (1998). Crystal structure of the complex formed by the membrane type 1-matrix metalloproteinase with the tissue inhibitor of metalloproteinases-2, the soluble progelatinase A receptor. *European Molecular Biology Organization Journal*, *17*, 5238–5248.
- Fotso, M., Azanza, J.L., Pasquet, R., & Raymond, J. (1994). Molecular heterogeneity of Cowpea (*Vigna unguiculata* Fabaceae) seed storage proteins. *Plant Systematics and Evolution*, *191*, 39-56.
- Gebre-Egziabher, A., Humbert, E. S., & Blankenagel, G. (1980). Hydrolysis of milk proteins by microbial enzymes. *Journal of Food Protection*, *43*, 709–712.
- Grufferty, M. B. & Fox, P. F. (1988). Milk alkaline proteinase. *Journal of Dairy Research*, *55*, 609-630.
- Guillamón, E., Pedrosa, M. M., Burbano, C., Cuadrado, C., de Cortes Sánchez, M., & Muzquiz, M. (2008). The trypsin inhibitors present in the seed of different grain legume species and cultivar. *Food Chemistry*, *107*, 68-74.
- Hagerman, A., Harvey-Mueller, I., & Makkar, H. P. S. (2000) *Quantification of Tannins in Tree Foliage – a Laboratory Manual*. Vienna: FAO/IAEA.
- Kohlmann, K. L., Nielsen, S. S., & Ladisch, M. R. (1991). Effects of a low concentration of added plasmin on ultra-high temperature processed milk. *Journal of Dairy Science*, *74*, 1151–1156.

- Laing, W., & McManus, M. T. (2002). Proteinase inhibitors. In M.T. McManus, W.A. Laing, & A.C. Allan (Eds.), *Protein-Protein Interactions in Plant Biology* (pp. 77-119). Florida, USA: CRC Press.
- Laskowski, M., & Kato, I. (1980). Protein inhibitors of proteinases. *Annual Reviews in Biochemistry*, 49, 593-626.
- Law, B. A., & Mabbitt, L. A. (1983). New methods for controlling the spoilage of milk and milk products. In T.A. Skinner, & F.A. Robberts (Eds.), *Food microbiology: Advances and prospects* (pp. 131-150). New York, USA: Academic Press Inc.
- Le, T. X., Datta, N., & Deeth, H. C. (2006). A sensitive HPLC method for measuring bacterial proteolysis and proteinase activity in UHT milk. *Food Research International*, 39, 823-830.
- Lorier, M. A., & Aitken, B. L. (1990). Method for treating fish with alpha-2-macroglobulin. *United States Patent 5013568*.
- Lu, D. D., & Nielsen, S. S. (1993). Heat inactivation of native plasminogen activators in bovine milk. *Journal of Food Science*, 58, 1010-1012.
- Malenčić, D., Popović, M., & Miladinović, J. (2007). Phenolic content and antioxidant properties of soybean (*Glycine max* (L.) Merr.) seeds. *Molecules*, 12, 576-581.
- Maggo, S., Malhotra, S. P., Dhawan, K., & Singh, R. (1999). Purification and characterization of protease inhibitor from rice bean (*Vigna umbellata* T.) seeds. *Journal of Plant Biochemistry and Biotechnology*, 8, 61-64.
- Maruatona, G. N. (2008). Physico-chemical, nutritional and functional properties of defatted marama bean flour. MSc Food Science dissertation, University of Pretoria, Pretoria, S.A.
- Matta, H., & Punj, V. (1999). Isolation and identification of lipolytic psychrotrophic spore forming bacteria from raw milk. *International Journal of Dairy Technology*, 52, 59-62.
- Matselis, E. & Roussis, I. G. (1998). Proteinase and lipase production by *Pseudomonas fluorescens*. Proteolysis and lipolysis in thermized ewe's milk. *Food Control*, 9, 251-259.
- McMahon, D. J. (1995). Age-gelation of UHT milk: Changes that occur during storage, their effect on shelf life and the mechanism by which age-gelation occurs. In IDF Symposium,

Vienna, *Heat treatments and alternative methods* (pp. 315–326). Brussels: International Dairy Federation.

Mujoo, R., Trinh, T. D., & Ng, K. W. P. (2003). Characterisation of storage proteins in different soybean varieties and their relationship to tofu yield and texture. *Food Chemistry*, 82, 265-273.

Naczka, M., & Shahidi, F. (2006). Phenolics in cereals, fruits and vegetables: occurrence, extraction and analysis. *Journal of Pharmaceutical and Biomedical Analysis*, 41, 1523–1542.

Odani, S., & Ikenaka, T. (1976). The amino acid sequences of two soybean double headed proteinase inhibitors and evolutionary consideration on the legume proteinase inhibitors. *Journal of Biochemistry*, 80, 641-643.

Peréz-Mateos, M., Montero, P., & Gómez-Guillén, M. C. (2002). Addition of microbial transglutaminase and protease inhibitors to improve gel properties of frozen squid muscle. *European Food Research and Technology*, 214, 377-381.

Phillips, J. D., & Griffiths, M. W. (1990). Pasteurized dairy products: the constraints imposed by environmental contamination. In O.J. Simmons, & M.S. Nriagu (Eds.), *Food contamination from environmental sources* (pp. 387-486). New York: Wiley.

Prakash, B., Selvaraj, S., Murthy, M. R., Sreerama, Y. N., Rao, D. R., & Gowda, L. R. (1996). Analysis of the amino acid sequences of plant Bowman–Birk inhibitors. *Journal of Molecular Evolution*, 42, 560–569.

Richardson, B., & Pearce, K. (1981). The determination of plasmin in dairy products. *New Zealand Journal of Dairy Science and Technology*, 16, 209-220.

Ritonja, A., Krizaj, I., Mesko, P., Kopitar, M., Lucovnik, P., Strukelj, B., Pungercar, J., Buttle, D. J., Barrett, A. J., & Turk, V. (1990). The amino acid sequence of a novel inhibitor of cathepsin D from potato. *FEBS. Letters*, 267, 13-15.

Rivas-Vega, M. E., Goytortúa-Bores, E., Ezquerro-Brauer, J. M., Salazar-García, M. G., Gruz-Suárez, L. E., Nolasco, H., & Civera-Cerecedo, R. (2006). Nutritional value of cowpea (*Vigna unguiculata* L. Walp) meals as ingredients in diets of Pacific white shrimp (*Litopenaeus vannamei* Boone). *Food Chemistry*, 97, 41-49.

Secades, P., & Guijarro, J. A. (1999). Purification and characterisation of extracellular protease from fish pathogen *Yersinia ruckeri* and effect of culture conditions on production. *Applied and Environmental Microbiology*, 65, 3969-3975.

Shahidi, F., & Naczk, M. (1992). An overview of the phenolics of canola and rapeseed: Chemical, sensory and nutritional significance. *Journal of the American Oil Chemists Society*, 69, 917-924.

Sørhaug T., & Stepaniak, L. (1997). Psychrotrophs and their enzymes in milk and dairy products: quality aspects. *Trends in Food Science & Technology*, 8, 35–41.

Taylor, J., Bean, S. R., Ioerger B. P., & Taylor, J. R. N. (2007). Preferential binding of sorghum tannins with γ -kafirin and the influence of tannin binding on kafirin digestibility and biodegradation. *Journal of Cereal Science*, 46, 22–31.

Upadhyay, V. K., McSweeney, P. L. H., Magboul, A. A. A., & Fox, P. F. 2004. Proteolysis in cheese during ripening. In P.L.H. Mc Sweeney, T.M. Cogan, T.P. Guinee, & P.F. Fox (Eds), *Cheese – Chemistry, Physics and Microbiology* (pp. 391–396). London, UK: Academic Press.

Van Zyl, L. (2007). Phenolic content and antioxidant activity of marama bean (*Tylosema esculentum*). BSc (Agric.) Food Science and Technology Project Report. University of Pretoria, Pretoria, South Africa.

Visser, S. (1981). Proteolytic enzymes and their action on milk proteins. A review. *Netherlands Milk and Dairy Journal*, 35, 65–88.

CHAPTER 6 : GENERAL DISCUSSION

The general discussion will firstly critically examine the experimental methodologies used in the shelf life studies of low fat UHT milk in HDPE bottles and some future considerations when using these methodologies will be discussed. Secondly, the accelerated shelf life of low fat UHT milk in HDPE bottles will be considered based on the findings and the application of the results will be discussed. This will be followed by a critical examination of the use of legume protease inhibitors for protease inhibition in UHT milk, a short discussion on the findings of this part of the research and the commercial potential of the protease inhibitor activity will follow.

6.1 SHELF LIFE METHODOLOGIES

During this study the sensory changes that occur in low fat UHT milk during storage at different temperatures and times, as evaluated by a trained sensory panel, were used in the multivariate accelerated shelf life test (MASLT) to predict the shelf life of low fat UHT milk when stored at room temperature (25°C). The results obtained from the MASLT was then validated using survival analysis based on consumers' acceptance or rejection of milk stored at 25°C for different time periods.

In order to meet consumers' expectation of long shelf life products with high quality, the need exists for food industries to conduct shelf life studies that often include the assessment of an array of analytical and sensory properties. For long shelf life products, accelerated studies are often conducted and the acceleration factor which defines the correlation between the different storage conditions is determined (Meeker & Escobar, 1998; Cardelli & Labuza, 2001; Pedro & Ferreira, 2006; Curia & Hough, 2009). With accelerated shelf life tests the product is stored at relatively severe storage conditions that will increase the rate of deterioration and therefore shorten the shelf life of the product. Accelerated storage conditions should be carefully considered to prevent different deterioration mechanisms to occur as compared to those that would occur under normal storage conditions. Various pitfalls for accelerated shelf life tests have been reported (Meeker & Escobar, 1998), including:

- *Multiple deterioration modes*

Accelerated storage can induce changes in the food product that would not be observed under normal storage conditions and different modes of deterioration may occur due to a fundamental change in the way the food components deteriorate. An example of this in milk is the phase change that occurs in the fat during high temperature storage. Milk fat contains a wide variety of triglycerides with a broad thermal range of melting points ranging from -50 to 80°C . The final melting point of milk fat is 37°C , where triglycerides with higher melting points dissolve in the liquid fat (Knothe & Dunn, 2009). This phase change in milk stored at accelerated temperatures may result in chemical reactions, such as lipid oxidation, evolving in a different manner as compared to milk stored at lower temperatures. The shelf life of UHT milk stored at 25°C was determined by the multivariate accelerated shelf life test (MASLT) (Chapter 3), using milk stored at 45°C to determine the shelf life cut-off point. Survival analysis was performed on the low fat UHT milk stored at 25°C to validate the results obtained from the MASLT (Chapter 4). In this case the high storage temperature of the milk used for the cut-off point determination may not have had a significant effect on the rate of deterioration, since extrapolation of the results for milk stored at higher temperatures in the MASLT to the normal storage temperature (25°C) gave a shelf life comparable to that determined by survival analysis. This may, however, be problematic when determining the shelf life of milk or other products with higher fat contents where lipid degradation may play a bigger role in the rejection of the product and it may be advised to use milk/products stored at lower temperatures for the cut-off point determination.

- *Failure in quantifying uncertainty*

Decisions on the shelf life need to be based, not only on the point estimates made, but also by the statistical confidence intervals. Using the MASLT and survival analysis the shelf life ($\pm 95\%$ confidence intervals) of the low fat UHT milk was estimated at 211 (± 7) d and 214 (± 9) d, respectively. The shelf life results obtained by these two methods are very similar. By using the lower confidence interval values determined by these two methods the shelf life is estimated at 204 and 205 d, respectively. This is a week, or more, shorter than the point estimates of 211 and 214 d. Both the shelf life determined by the point estimates and the lower confidence intervals fall within the shelf life range of 6 – 9 months reported in

literature (Perkins, D'Arcy, Tisle & Deeth, 2005). The lower confidence interval values are often used to account for uncertainty in the prediction and give a more conservative estimate of the shelf life of the product (Guillet & Rodrique, 2010).

- *Masked rejection mode*

Due to different activation energies, different sensory attributes will develop at different rates at normal and elevated temperatures. The true critical attribute at room temperature can therefore be masked at the accelerated condition, leading to over or under estimation of the shelf life. The MASLT eliminates the need to only select one critical attribute by including all the attributes that show change over time. This may reduce the risk described by this pitfall but cannot be guaranteed to eliminate the risk since many or all the attributes may evolve differently at accelerated temperatures. It is therefore important to include some means of validating the findings of results obtained from accelerated tests. In the current study, survival analysis of low fat UHT milk stored at 25°C was included to compare with the results obtained from the MASLT.

- *Rejection and degradation affected by unforeseen variables*

A simple relationship between the shelf life of a product and the accelerated variable may be assumed, while the actual factors affecting the shelf life may be more complicated. Examples of such factors would include distribution and storage conditions, brand of the product etc. The brand of the UHT milk may have an effect on the shelf life due to high expectations or high quality linked to the specific brand. Unopened UHT milk can be stored at room temperature for several months and the effect of slight fluctuations in temperature during transport and storage on the milk would be minimal. Storage of UHT milk at high temperatures for extended periods of time should be avoided since it will have a major effect on the sensory properties and also the shelf life of the low fat UHT milk as was shown by UHT milk stored at 35 and 45°C. In South Africa temperatures as high as 40°C has been recorded during summer months which will have a definite effect on the “ambient temperature” and therefore may also effect the shelf life of the low fat UHT milk. It will therefore be advised that the customer and consumer are informed that the UHT milk should

not be stored at temperatures exceeding 25°C to ensure that the product stays within its acceptable limits during the shelf life stated on the product.

- *Increased temperature can cause deceleration*

Instead of accelerating the deterioration of a product at higher temperatures, these high temperatures can have the opposite effect and decelerate certain reactions. This is especially true for food products containing microorganisms and/or enzymes. At accelerated temperatures these microbes or enzymes may become inactive and deterioration will be different from that of the product stored at normal storage conditions. Some heat-stable enzymes of native or bacterial origin can survive the high temperatures of the UHT process and cause shelf life limiting defects during the storage of the milk (Burton, 1988; Valero, Villamiel, Miralles, Sanz & Martinez-Castro, 2001). Increased storage temperatures may lead to the inactivation or denaturation of the enzymes, eliminating the defects caused by these enzymes. Storage temperature has also been shown to influence the time of gelation of UHT milk. The order of gelation at different temperatures have been reported to be 30<25<20<15<10<2<40, 50°C (Kocak & Zadow, 1985). Lack of gelation at higher temperatures may be due to protein decomposition, resulting in degraded proteins that are unable to form a gel matrix (Payens, 1978) or the regions of proteins that are involved in the protein-protein interactions to form a gel are blocked by casein-lactose interactions, which precede browning in UHT milk, involving lysine residues (Samel, Weaver, & Gammack, 1971). This can be problematic when using high storage conditions for UHT milk when age gelation is a shelf life limiting factor. Age gelation may not be evident in milk stored at accelerated storage temperatures over time and this can lead to the over estimation of the shelf life at normal storage conditions. It may be advisable to use lower accelerated storage temperatures for the shelf life studies. The UHT milk used during this study did, however, not show any gelation over prolonged periods of storage at various temperatures.

With the **MASLT** not only critical descriptors, but all those that show significant change over time are used to determine the shelf life of the product. In addition, the end of shelf life is determined by a multivariate cut-off point. This reduces the chances of selecting the wrong critical attribute and/or cut-off point, thereby reducing the risk of over or under estimation of the product's shelf life (Pedro & Ferreira, 2006).

The MASLT is a new method that has been successfully applied to tomato concentrate (Pedro & Ferreira, 2006) and on low fat UHT milk in this study. Even though the shelf life of the low fat UHT milk determined by the MASLT correlated well with that of the shelf life determined by survival analysis, which is a frequently used method in shelf life determination, it will be feasible to proof the validity of this model with a larger number of food applications. Future studies may also include the use of the MALST to determine the shelf life of other shelf stable dairy products, including UHT custard and creams, flavoured UHT milks and UHT milk in different packaging.

Some modifications to this method can also be considered. Extra constraints to the PCA model, such as maximising (weighting) the covariance of the scores with time, can be included. In this study it was assumed that all the attributes had equal importance to the acceptability and/or deterioration of the low fat UHT milk. Some of these attributes may, however, have more relevance to the shelf life of the product than others. Higher weights can be given to the loadings of attributes that are known in advance to be more relevant.

Even though the MASLT was successfully applied to low fat UHT milk in this study, the shelf life of UHT milk is influenced by the fat content in the milk (López-Fandiño, Olano, Corzo, & Ramos, 1993; García-Risco, Ramos, & López-Fandiño, 1999). It will be advisable to run additional MASLT for UHT milk with different fat contents. Milk with each fat level will therefore have its own multivariate acceleration factor at different temperatures. Attributes used for end of shelf life predictors in future studies may also vary between milk with different fat contents.

Survival analysis has been used extensively to determine the cut-off point, i.e. the point of rejection, of various products (Hough, Langhour, Gomez, & Curia, 2003; Gámbaro, Garitta, Giménez, Varela, & Hough, 2004; Hough, Garitta, & Gómez, 2005). Survival analysis was used to determine the end of shelf life for milk stored at 45°C, which was then used to determine the cut-off point for the MASLT using further correlation. In the previous section (Section 6.1.1.1) it has been reported that temperatures exceeding 37°C cause a phase change in the milk fat that may lead to different deterioration mechanisms to take place at elevated temperatures as compared to normal storage conditions. In addition, it has also been reported that gelation of the milk will be delayed by increased temperatures. Even though the low fat

content may prevent significant differences in the deterioration due to the milk fat melting at high temperatures and gelation has not been noted at any of the storage temperatures after extended periods of storage, milk stored at lower temperatures should be considered for the cut-off point determination. This will reduce or prevent any deviation in the mechanism of spoilage in the UHT milk as is often the case with accelerated storage and ensure that the cut-off point gives a correct indication of when consumers will reject the milk.

Even though survival analysis used to validate the shelf life of the milk at 25°C is a simple test requiring consumers to only accept or reject the samples, it can be very time consuming, especially when retention samples are not available, since milk samples that exceed the expected shelf life (acceptability) of the product should be included, and it can be very expensive to conduct since large numbers of consumers are required. The use of survival analysis is therefore not suitable for regular checks on the shelf life of a product, but rather for once-off shelf life estimations or validation of methods that can be conducted regularly, as was done during the study.

Consumer sensory profiling of milk using CATA, liking and physico-chemical data was also included in the study to determine how consumers perceive attributes in milk of various ages and also how the consumer liking and physico-chemical properties differ in the milk of various ages. Even though CATA is arguably not the best methodology to use when only subtle changes are present in the products, significant differences were reported for some of the CATA attributes. Results from Chapter 4 indicate that various physico-chemical and consumer liking scores showed significant change over time. These factors may also be included in the MASLT to see how they, along with the sensory data from a trained panel, affect the estimated shelf life of the UHT milk.

6.2 LOW FAT UHT MILK SHELF LIFE ESTIMATION AND APPLICATION

There are various factors that influence the shelf life of UHT milk, including the age of the cow, season, stage of lactation, microbiological quality of the raw milk, mastitis and fat content. Even though measures are taken to produce high quality UHT milk with a long shelf life, these factors may influence the sensory properties and consistency of the milk, thereby reducing its shelf life. Taking all of these factors into account it will be advantageous to have a method whereby the shelf life of the product can be tested periodically. Because the shelf

life of UHT milk is in excess of 6 months, it would be valuable if this method can predict the shelf life without having to conduct the test over the whole time span of the product's shelf life.

The shelf life of the low fat UHT milk in HDPE bottles were estimated at 204 days using the lower confidence interval as estimated by the MASLT. These results were supported by survival analysis of the low fat UHT milk stored at 25°C, where the shelf life was estimated at 205 days (lower confidence interval). The multivariate acceleration factors were determined at 2.9 and 7.8 when the temperature was increased from 25 to 35°C and 25 to 45°C, respectively. This means that for an estimated shelf life of 204 days, future MASLT for the low fat UHT milk have to be conducted for 70 and 26 days at 35 and 45°C, respectively. Therefore, by using accelerated storage the shelf life can be determined in relatively shorter time periods as compared to doing an actual test over the whole estimated shelf life.

A trained sensory panel can be used to evaluate the UHT milk samples periodically by rating the sensory properties that showed change over time in the MASLT. The maximum value for each of the attributes that showed change over time can be obtained from the trained sensory panel data at the time that the milk reached its multivariate cut-off point as determined by survival analysis of the low fat UHT milk stored at 45°C. Alternatively, to reduce the number of attributes to be evaluated, attributes that correlated the best with the multivariate data, i.e. fresh milk aroma intensity, cooked flavour and off-flavour (lack of freshness), can be used as predictors for the end of shelf life for low fat UHT milk in HDPE bottles. By being able to conduct these shelf life tests periodically, the producer will be able to identify milk with unsatisfactory shelf life.

6.3 PROTEASE INHIBITION IN UHT MILK

Age gelation is a major shelf life limiting defect in UHT milk. Even though bacterial contaminants are killed by the UHT process, some of the extracellular enzymes produced by them and also some native milk enzymes are heat stable and can survive the high temperature process and cause defects, such as off-flavour development and gelation, in UHT milk during storage. (Visser, 1981; Datta & Deeth, 2001) Although the protease inhibitors extracted from soybeans, marama beans and cowpeas showed very low or no inhibitory activity towards *P.*

fluorescens enzymes, they showed great potential in inhibiting proteases produced by *Bacillus* spp. and plasmin in buffer and in UHT milk.

The current study was carried out using UHT milk spiked with bacterial protease, at considerably higher concentrations than would generally be found in UHT milk, and different concentrations of legume protease inhibitors. Even though there was some inhibitory activity towards *P. fluorescens* protease in buffer, this might have been due to the presence of phenolic compounds in the crude protease inhibitor extracts. The possibility also exists that these phenolic compounds could have also contributed to the inhibition of the *Bacillus* protease. Therefore, to get the true inhibitory effect of the legume protease inhibitors on the bacterial protease, further purification steps need to be included. The efficiency of these inhibitors was lower in the UHT milk as compared to the buffer system. This may be due to the protease inhibitors interacting with milk components, or the proteases binding to milk proteins making them inaccessible to the protease inhibitors.

Even though the protease inhibitors show potential in reducing enzymes in UHT milk, these inhibitors are also known as anti-nutritional factors. They have the ability to inhibit the pancreatic serine proteases (trypsin), thereby reducing the nutritional value by impairing protein digestion and uptake. Protease inhibitors can also induce the pancreatic enzyme resulting in hyper secretion of digestive enzymes and fast stimulation of pancreas growth causing hypertrophy and hyperplasia. This leads to a loss of sulphur-rich endogenous proteins, trypsin and chymotrypsin, resulting in depressed growth due to legume seed proteins being generally deficient in sulphur amino acids. Consequently, these inhibitors are inactivated in food prior to consumption, usually by heat treatment, to prevent these adverse effects (Carvalho, Almeida-Oliveira, Baross & Moreira, 1998; Lajolo & Genovese, 2002).

It is important to note that this part of the study was only a preliminary study to evaluate the effect of the legume proteases on bacterial proteases found in UHT milk. For these protease inhibitors to be used for the purpose described in the study, future studies should consider the following:

- The heat stability of the protease inhibitors (should they be used prior to UHT processing) to determine if they will retain any activity after processing of the milk.

- Interaction of the protease inhibitors with other milk proteins to determine how effective they will be to inhibit target enzymes.
- The time these inhibitors remain active in the milk.
- The effect the protease inhibitors will have on sensory properties of the milk.
- The effect the protease inhibitors will have on the biochemical properties of the milk.

To eliminate the anti-nutritional factors in the final product, protease inhibitors should be inactivated prior to consumption or immobilized onto a solid support. Immobilization can be achieved by attaching (cross-linking) the protease inhibitors to a support, for example a membrane filter, which is then used in one or a few of the processing steps. Alternatively the protease inhibitors can be immobilized on the packaging of a product where it can then inactivate the proteases during storage of the product.

Even though the use of protease inhibitors is in conflict with legislation that states that milk should be free from any additives (Department of Health, South Africa, 1997), these proteins may be feasible to use in other dairy products where the addition of additives is acceptable and also other food products where proteases produced by *Bacillus* spp. have a negative effect on the product during storage.

6.4 REFERENCES

Burton, H. (1988). *Ultra-high-temperature processing of milk and milk products*. New York, USA: Elsevier Applied Science Publications Inc.

Cardelli, C., & Labuza, T.P. (2001). Application of Weibull hazard analysis to the determination of the shelf-life of roasted and ground coffee. *Lebensmittel-Wissenschaft Technology*, 34, 273-278.

Carvalho W.L., Almeida-Oliveira, M.G., Baross, E.G., & Moreira, M.A. (1998). Determination of genotypic classes for trypsin inhibitor in soybean seeds. *Biotechnology Techniques*, 12, 859-863.

Curia, A.V., & Hough, G.E. (2009). Selection of a sensory marker to predict the sensory life of a fluid human milk replacement formula. *Journal of Food Quality*, 32, 793-809.

Datta, N., & Deeth, H.C. (2001). Age gelation of UHT milk. *Transactions of the institute of chemical engineers C. Food and Bioproducts Processing*, 79, 197-210.

Department of Health, South Africa, (1997). Regulations relating to milk and dairy products. South African Government Notice No. R 1555 of 1997. Section 15(1) of the Foodstuffs, Cosmetics and Disinfectants Act, No. 54 of 1972.

Gámbaro, A., Garitta, L., Giménez, A., Varela, P. & Hough, G. (2004). Sensory shelf-life estimation of “alfajor” by survival analysis. *Journal of Sensory Studies*, 19, 500-509.

García-Risco, M., Ramos, M., & López-Fandiño, R. (1999). Proteolysis, protein distribution and stability of UHT milk during storage at room temperature. *Journal of the Science of Food and Agriculture*, 79, 1171-1178

Garitta, L., Hough, G., & Sánchez, R. (2004). Sensory shelf-life of dulce de leche. *Journal of Dairy Science*, 87, 1601–1607.

Guillet, M. & Rodrigue, N, (2010). Shelf life testing methodology and data analysis. In G.L. Robertson (Ed.), *Food packaging and shelf life* (pp. 31-57). Florida, USA: CRC Press.

Hough, G., Langhour, K., Gomez, G. & Curia, A. (2003). Survival analysis applied to sensory shelf-life of foods. *Journal of Food Science*, 68, 359-362.

Hough, G., Garitta, L. & Gómez, G. (2005). Sensory shelf-life predictions by survival analysis accelerated storage models. *Food Quality and Preference*, 17: 468-473.

Knothe, G., & Dunn, R.O. (2009). A comprehensive evaluation of the melting points of fatty acids and esters determined by differential scanning calorimetry. *Journal of American Oil Chemistry Society*, 86, 843–56.

Kocak, H. R. & Zadow, J. G. (1985). Age gelation of UHT whole milk as influenced by storage temperature, *Australian Journal of Dairy Technology*, 40, 14–21.

Lajolo, F. M., & Genovese, M. I. (2002). Nutritional significance of lectins and enzyme inhibitors from legumes. *Journal of Agricultural and Food Chemistry*, 50, 6592–6598.

López-Fandiño, R., Olano, A., Corzo, N., & Ramos, M. (1993). Proteolysis during storage of UHT milk: differences between whole and skim milk. *Journal of Dairy Research*, 60, 339-347.

Payens, T. A. J. (1978). On different modes of casein clotting; the kinetics of enzymatic coagulation compared. *Netherlands Milk and Dairy Journal*, 32, 170–183.

Pedro, A.M.K., & Ferreira, M.M.C. (2006). Multivariate accelerated shelf-life testing, A novel approach for determining the shelf-life of foods. *Journal of Chemometrics*, 20, 76-83

Perkins, M.L., D’Arcy, B.R., Lisle, A.T. & Deeth, H.C. (2005). Solid phase microextraction of stale flavour volatiles from the headspace of UHT milk. *Journal of the Science of Food and Agriculture*, 85, 2421-2428.

Meeker, W.Q., & Escobar, L.A. (1998). *Statistical methods for reliability data*. New York, NY, USA: John Wiley & Sons.

Samel, R., Weaver, R.W.V. & Gammack, D.B. (1971). Changes on storage in milk processed by ultra-high-temperature sterilization. *Journal of Dairy Research*, 38, 323–332.

Visser, S. (1981). Proteolytic enzymes and their action on milk proteins. A review. *Netherlands Milk and Dairy Journal*, 35, 65–88.

Valero, E., Villamiel, M., Miralles, B., Sanz, J., & Martinez-Castro, I. (2001). Changes in flavour and volatile components during storage of whole and skimmed UHT milk. *Food Chemistry*, 72: 51-58.

CHAPTER 7 : CONCLUSIONS

The first novel contributions of this study include the successful application of the multivariate accelerated shelf life test (MASLT) to a dairy product, i.e. low fat UHT milk in HDPE bottles. The MASLT using data from a trained sensory panel that evaluated UHT milk stored at normal and accelerated temperatures (35°C and 45°C) over time was successful in determining the shelf life of low fat UHT milk in HDPE bottles. Not only did the data show significant change for the various sensory attributes at different storage temperatures over time, it could also be combined in the MASLT to give multivariate acceleration factors ($\alpha_{35,25}$; $\alpha_{45,35}$) and activation energy (E_a). The determination of the multivariate acceleration factors is a valuable contribution to the industry, since it can be used to determine the shelf life of low fat UHT milk in a relatively short time period by storing the milk at abuse temperatures and then extrapolating the results to normal storage conditions. The activation energies and acceleration factors of the fresh milk aroma intensity, cooked flavour and off-flavour (lack of freshness) correlated well with those of the multivariate data, making these attributes possible predictors for the end of shelf life for low fat UHT milk in HDPE bottles. The shelf life determined by survival analysis using consumers to accept or reject UHT milk samples stored at 25°C for different time periods validated the shelf life results obtained from the MASLT. Quantitative descriptive analysis of the low fat UHT milk showed an increase in the negative attributes with increased storage time and temperature while there was a decrease in positive attributes. This was also noted for consumer liking scores that decreased when the storage time of the low fat UHT milk stored at 25°C increased. Detection of positive attributes by consumers was also more prevalent in fresher milk samples. The detection of these attributes decreased with an increase in negative attributes as the storage time of the samples increased. Physico-chemical results also supported these findings from the trained and consumer analysis by showing an increase in physico-chemical properties associated with negative flavours in UHT milk over time.

Legume protease inhibitors from soybeans, marama beans and cowpeas showed potential in preventing or reducing the adverse effects caused by plasmin and *Bacillus* proteases since they were able to reduce the activity of these enzymes in buffer and UHT milk. This provides a novel way to reduce or prevent the adverse effects caused by these proteases in UHT milk. This study

was, however, only a preliminary study and further research needs to be conducted to determine the effect of these protease inhibitors on UHT milk properties and also finding a means to comply with legislation set by the governing milk authorities. In addition to the use in UHT milk, these legume protease inhibitors may also be exploited in various other food applications where proteases cause sensory or consistency defects in products.