

THE PLASTIC LIMIT AND WORKABILITY OF SOILS

A thesis submitted to

The University of Manchester

for the degree of

Doctor of Philosophy in Civil Engineering

In the Faculty of Engineering and Physical Sciences

2013

GRAHAM EDWARD BARNES

School of Mechanical, Aerospace and Civil Engineering



Albert Atterberg

undated photograph
from website:
geodiendo.blogspot.com

**Atterberg's work on the plasticity properties of soils inspired
the research conducted and described in this thesis.**

CONTENTS

Abstract	14
Declaration	15
Copyright	15
Acknowledgements	15
Notation	16

Part 1 – Introduction

Chapter 1 Introduction

1.1	Introduction	23
1.2	Aims and objectives	24
1.3	Albert Atterberg	26
1.4	Variability of the standard plastic limit test results	27
1.5	The need for a better approach	29
1.6	The new thread rolling apparatus for the plastic limit and workability of soils – the Barnes apparatus and test	30
1.7	Accreditation	31
1.8	Structure of the thesis	32
1.9	Tables	35
1.10	Figures	36

Part 2 – Previous research and its relation to the Barnes test

Chapter 2 Previous alternatives to the standard thread rolling method

2.1	Introduction	37
2.2	Previous thread rolling methods	37
2.3	The strength-based plastic limit concept	40
2.4	Suction and effective stress at the plastic limit	45
2.5	Criticism of the strength-based plastic limit concept	46
2.6	Proponents of the fall cone method to determine the plastic limit	50
2.7	Criticism of the fall cone method to determine the plastic limit	56
2.8	Alternative tests proposed for the plastic limit	60
2.9	Summary	64
2.10	Tables	67
2.11	Figures	70

Chapter 3 The ductile-brittle transition and the property of toughness

3.1	Introduction	77
3.2	The ductile-brittle or brittle-plastic transition	77
3.3	Behaviour on the ductile or plastic side of the transition	80
3.4	Behaviour on the brittle side of the transition	83
3.5	The importance of the toughness property	86
3.6	Workability in the agricultural context	87
3.7	Classifications of toughness	88
3.8	Field tests for classification of toughness	89
3.9	Previous tests for the quasi-determination of toughness	91
3.10	Microstructural view of toughness of clay	94
3.11	Structure in natural soils	97
3.12	A comparison of compaction water content and the plastic limit	98
3.13	The effect of soil structure on toughness	98
3.14	The effect of water content on the structure in remoulded soils	99
3.15	Pore spaces	102
3.16	Summary	105
3.17	Tables	108
3.18	Figures	111

Part 3 – The Barnes apparatus and test

Chapter 4 The Barnes apparatus and test

4.1	History	119
4.2	Overview of operation	119
4.3	Sliding mechanism	121
4.4	Top glass plate	121
4.5	Bottom steel plate	122
4.6	Configuration of the plates	124
4.7	Loading bar and force markings	125
4.8	Back stop	127
4.9	Apparatus adjustments	128
4.10	Application of force and force control	129
4.11	Proforma	131
4.12	Determination of the thread diameter	131
4.13	Determination of strain and cumulative strain	132
4.14	The use of the split cylinder formula for the determination of nominal stress	133

4.15	Determination of nominal total stress	137
4.16	Quasi 'all-round' radial pressure	140
4.17	Determination of work/unit volume and toughness	141
4.18	Summary	143
4.19	Figures	145

Chapter 5 Test procedure and typical test results

5.1	Introduction	153
5.2	Preparation of soil thread	153
5.3	Test procedure	155
5.4	Example test procedure	156
5.5	Example calculations and the determination of toughness	159
5.6	Example plots	162
5.7	Determination of the plastic limit	162
5.8	Properties determined from the toughness vs. water content plots	163
5.9	Database of results	166
5.10	Comparison of the Barnes test and the standard method plastic limits	167
5.11	Examples of soil types tested	169
5.12	Behaviour of soil threads between 4 and 3 mm diameter	173
5.13	Tests to assess the effect of rate of loading	178
5.14	The effects of wetting up of the soil	180
5.15	The effects of drying of soil	181
5.16	Repeatability tests	182
5.17	Summary	184
5.18	Tables	186
5.19	Figures	192

Part 4 – Investigations conducted

Chapter 6 Investigation of the effect of the thread diameter in the standard plastic limit test

6.1	Introduction	207
6.2	Background	207
6.3	The 'degree of plasticity' based on the smallest thread diameter	209
6.4	Investigations into the manual thread rolling method	211
6.5	Rolling paths - London Clay	213
6.6	Rolling paths - Glacial Clay, Rixton	215
6.7	Rolling paths - Kaolinitic Clay, K-T Kaolin	216

6.8	Considerations of soil structure	217
6.9	Is the diameter of 3 mm significant?	219
6.10	Proposed improvements to the standard plastic limit test	221
6.11	Summary	223
6.12	Tables	226
6.13	Figures	227

Chapter 7 Relationship of matrix and coarse particles

7.1	Introduction	235
7.2	Linear law of mixtures	235
7.3	Published data related to the linear law	237
7.4	Example of the linear law of mixtures	239
7.5	Skempton's 'colloidal' activity	241
7.6	Granular void ratio	242
7.7	Cohesive porosity	245
7.8	Granular spacing ratio	245
7.9	Corrections for oversize particles	248
7.10	Aggregation ratio	249
7.11	Postulated effect of aggregation	250
7.12	The effect of large granular particles in a small diameter thread	253
7.13	Summary	256
7.14	Figures	258

Chapter 8 Tests on the Clay:Silt mixtures

8.1	Introduction	265
8.2	Preparation of mixtures	265
8.3	Typical toughness-water content relationships	266
8.4	The effect of high clay content on the test procedure	267
8.5	The effect of low clay content on the test procedure	268
8.6	Toughness and the matrix water content	271
8.7	Toughness and the granular spacing ratio	273
8.8	Toughness correlations	274
8.9	The effect of silt content on the plastic limit	275
8.10	Electron microscope studies of some London Clay:Silt mixtures	276
8.11	Summary	279
8.12	Figures	282

List of Figures

Figure 1.1	Repeatability tests by experienced operators (From Wintermeyer, 1926)	36
Figure 1.2	Repeatability tests by inexperienced operators (From Wintermeyer, 1926)	36
Figure 2.1	The Bobrowski and Griekspoor device (From Bobrowski and Griekspoor, 1992)	70
Figure 2.2	Relation between liquidity index and shear strength of moulded clays (Figure 11 from Skempton and Northey, 1953)	70
Figure 2.3	Suction data (From Dennehy, 1978)	71
Figure 2.4	Normalised consolidation curves (From Nagaraj and DeGroot, 2002)	71
Figure 2.5	Shear strength at the plastic limit (From Dennehy, 1978)	72
Figure 2.6	Shear strength at the plastic limit (From Stone and Phan, 1995)	72
Figure 2.7	Shear strength data (From Wasti and Bezirci, 1986)	73
Figure 2.8	Shear strength at the plastic limit (From Kayabali, 2011)	73
Figure 2.9	Shear strength above and below the A-line (data from Kayabali, 2011)	74
Figure 2.10	Water content vs. penetration (From Sivakumar <i>et al</i> , 2009)	74
Figure 2.11	Data plotted from Table 3 of Sivakumar <i>et al</i> , 2009	75
Figure 2.12	Penetration vs. water content (From Campbell, 1976)	75
Figure 2.13	Cone factors (From Brown and Downing, 2001)	76
Figure 3.1	Ductile-brittle transition related to temperature (From Wang <i>et al</i> , 2007)	111
Figure 3.2	'Critical bearing point' or ductile-brittle transition? (From Terzaghi, 1926)	111
Figure 3.3	Crack propagation for brittle and ductile specimens (From Vallejo, 1988)	112
Figure 3.4	The stiffness transition (From Black and Lister, 1979)	112
Figure 3.5	FE analysis of the ring test along the loaded diameter (From Harison <i>et al</i> , 1994)	113
Figure 3.6	Normalised stress σ_x/P along loading diameter in ring test (From Harison <i>et al</i> , 1994)	113
Figure 3.7	Fracture toughness vs. water content (From Harison <i>et al</i> , 1994)	114
Figure 3.8	Toughness classification on the plasticity chart (From NAVFAC, 1986)	114
Figure 3.9	Extrusion classes (From Vieira <i>et al</i> , 2007)	115
Figure 3.10	Torque and angle of rotation vs. water content (From Norton, 1938)	115
Figure 3.11	Effect of water content on hysteresis model parameters (Data from Astbury <i>et al</i> , 1966)	116
Figure 3.12	Unit particle arrangement	116
Figure 3.13	Elementary particle arrangements (From Barnes, 2010, adapted from Collins and McGown, 1974)	117
Figure 3.14	Particle assemblages (From Barnes, 2010, adapted from Collins and McGown, 1974)	117
Figure 3.15	Drying (suction) test and consolidation test results (From Cafaro, 2002)	118

Figure 3.16	Pore size distributions of statically compacted (ST) samples of illite (From Ahmed <i>et al</i> , 1974)	118
Figure 4.1	Overall view of apparatus	145
Figure 4.2	Side elevation of apparatus	145
Figure 4.3	Section through apparatus in line with soil thread	146
Figure 4.4	View of apparatus (with brass rod at starting point of test)	146
Figure 4.5	Bottom plate	147
Figure 4.6	Non-coaxial rolling of soil thread at the edges of the recess	147
Figure 4.7	Specimen of Oxford Clay before and after rolling (From Barnes, 2009)	148
Figure 4.8	Calculations for force markings on loading bar	149
Figure 4.9	600 gram nominal mass at the zero force mark	150
Figure 4.10	1000 gram nominal mass at the zero force mark	150
Figure 4.11	Proforma used to record test data	151
Figure 4.12	Yield line and wedges (From Olesen <i>et al</i> , 2006)	152
Figure 4.13	Stress along the loaded diameter (From Krishnayya and Eisenstein, 1974)	152
Figure 5.1	Thread maker components	192
Figure 5.2	Thread maker arrangement	192
Figure 5.3	Selected test data based on the proforma in Figure 4.11 for a sample of Alluvial Clay, Chinnor, Oxfordshire	193
Figure 5.4a	Example of the spreadsheet calculations for Test 3 of Figure 5.3, Alluvial Clay, Chinnor, Oxfordshire	194
Figure 5.4b	Example of the spreadsheet calculations for work/unit volume between 6 and 4 mm, Alluvial Clay, Chinnor, Oxfordshire	194
Figure 5.5	Nominal stress vs. diameter for the Alluvial Clay, Chinnor, Oxfordshire Tests from Figure 5.3 highlighted	195
Figure 5.6	Nominal stress vs. cumulative strain for the Alluvial Clay, Chinnor, Oxfordshire, Tests from Figure 5.3 highlighted	195
Figure 5.7	Toughness vs. water content for the Alluvial Clay, Chinnor, Oxfordshire	196
Figure 5.8	Proposed plastic regions and toughness-related properties	196
Figure 5.9	Tentative plasticity chart (Data from Table 5.2)	197
Figure 5.10	Comparison of the Barnes Test and standard method plastic limits	197
Figure 5.11	Database soils on the Casagrande plasticity chart	198
Figure 5.12	Nominal stress vs. diameter for Glacial Clay, Rixton	199
Figure 5.13	Toughness vs. water content for Glacial Clay, Rixton	199
Figure 5.14	Nominal stress vs. diameter for Clayey Silt, Flixton	200
Figure 5.15	Toughness vs. water content for Clayey Silt, Flixton	200
Figure 5.16	Nominal stress vs. diameter for Peat, Torside	201
Figure 5.17	Toughness vs. water content for Peat, Torside	201

Figure 5.18	Yield pressure/cohesion ratio for slabs of different length/thickness ratios (From Meyerhof and Chaplin, 1953)	202
Figure 5.19	Normalised work/unit volume per 100 reversals along the outer 20 mm of thread	202
Figure 5.20	Nominal stress vs. diameter for the London Clay: Fine/medium Sand 60:40	203
Figure 5.21	Toughness vs. water content for the London Clay: Fine/medium Sand 60:40	203
Figure 5.22	Effect of rate of loading – force vs. diameter	204
Figure 5.23	Effect of rate of loading – nominal stress vs. diameter	204
Figure 5.24	Effect of wetting up and drying of soil	205
Figure 5.25	Effect of air-drying and oven-drying	205
Figure 5.26	Nominal stress vs. diameter repeatability tests	206
Figure 6.1	Samples on the Casagrande plasticity chart	227
Figure 6.2	Hand rolling tests on sample of London Clay, Isle of Grain	228
Figure 6.3	Toughness vs. water content for sample of London Clay, Isle of Grain	228
Figure 6.4	Photographs of threads of London Clay, Isle of Grain	229
Figure 6.5	Hand rolling tests on sample of Glacial Clay, Rixton	230
Figure 6.6	Toughness vs. water content for sample of Glacial Clay, Rixton	230
Figure 6.7	Photographs of threads of Glacial Clay, Rixton	231
Figure 6.8	Hand rolling tests on sample of Kaolinitic Clay, K-T Kaolin	232
Figure 6.9	Toughness vs. water content for sample of Kaolinitic Clay, K-T Kaolin	232
Figure 6.10	Photographs of threads of Kaolinitic Clay, K-T Kaolin	233
Figure 6.11	Terzaghi's definition of the plastic limit	234
Figure 6.12	Two examples of different rolling paths	234
Figure 7.1	Normalised values of the liquid limit - published data	258
Figure 7.2	Normalised values of the plastic limit - published data	258
Figure 7.3	Deviation from the linear law of mixtures – total water content	259
Figure 7.4	Deviation from the linear law of mixtures – matrix water content	259
Figure 7.5	Activity <i>A</i> varying with clay content	260
Figure 7.6	Arrangement of particles for the granular spacing ratio	260
Figure 7.7	Granular spacing ratios at the various limits	261
Figure 7.8	Soil model representation for the aggregation ratio	261
Figure 7.9	Postulated clay 'bridges' formed in the continuous matrix	262
Figure 7.10	Example of extrapolation from the stiffness transition	262
Figure 7.11	Variation of the aggregation ratio and the matrix water contents	263
Figure 7.12	Effect of large granular particles in a small diameter thread	264
Figure 8.1	Particle size distributions	282

Figure 8.2	Nominal stress vs. diameter London Clay:Silt 100:0	283
Figure 8.3	Toughness vs. water content London Clay:Silt 100:0	283
Figure 8.4	Nominal stress vs. diameter London Clay:Silt 30:70	284
Figure 8.5	Toughness vs. water content London Clay:Silt 30:70	284
Figure 8.4	Transverse separation in soil thread	285
Figure 8.7	Toughness vs. total water content London Clay:Silt mixtures	286
Figure 8.8	Toughness vs. matrix water content London Clay:Silt mixtures	286
Figure 8.9	Granular spacing ratio at the water content limits	287
Figure 8.10	Granular spacing ratio and toughness	287
Figure 8.11	Toughness related to clay content for the London Clay:Silt mixtures	288
Figure 8.12	Normalised toughness and <i>the water content/plastic limit ratio</i>	288
Figure 8.13	Normalised toughness and workability index	289
Figure 8.14	Microphotographs of Thurstaston Silt	289
Figure 8.15	Microscope images of London:Clay:Silt 100:0	290
Figure 8.16	Microscope images of London:Clay:Silt 60:40	291
Figure 8.17	Microscope images of London:Clay:Silt 30:70	292
Figure 9.1	Particle size distributions of the London Clay, silt and sands	307
Figure 9.2	Particle size distributions of the Clay:Sand mixtures	307
Figure 9.3	Substitution of different sand sizes	308
Figure 9.4	Correction to water contents – London Clay:Fine Sand mixtures	308
Figure 9.5	Correction to water contents – London Clay:Fine/medium Sand mixtures	309
Figure 9.6	Matrix water contents at the liquid and plastic limits	309
Figure 9.7	Toughness vs. matrix water content – London Clay:Fine Sand mixtures	310
Figure 9.8	Toughness vs. matrix water content – London Clay:Fine/medium Sand mixtures	310
Figure 9.9	Toughness vs. matrix water content London Clay:Silt mixtures	311
Figure 9.10	Effect of different granular particle sizes $C = 38\%$	311
Figure 9.11	Effect of different granular particle sizes $C \approx 26\%$	312
Figure 9.12	Cohesive porosity at the liquid and plastic limits	312
Figure 9.13	Granular spacing ratio at the liquid and plastic limits	313
Figure 9.14	Average spacing between particles	313
Figure 9.15	Reducing thread diameter and large granular particles – Fine sand	314
Figure 9.16	Reducing thread diameter and large granular particles – Fine/medium sand	314
Figure 10.1	Particle size distributions of the Todhills Shaly Clay:Povington Ball Clay mixtures	332
Figure 10.2	Plasticity chart	332

Figure 10.3	Variation of the limits for the Todhills Shaly Clay:Povington Ball Clay mixtures	333
Figure 10.4	Matrix liquid limits	333
Figure 10.5	Nominal stress vs. diameter for the Todhills Shaly Clay	334
Figure 10.6	Toughness vs. water content for the Todhills Shaly Clay	334
Figure 10.7	Nominal stress vs. diameter for the Povington Ball Clay	335
Figure 10.8	Toughness vs. water content for the Povington Ball Clay	335
Figure 10.9	Toughness vs. total water content relationships for all mixtures	336
Figure 10.10	Toughness vs. matrix water content relationships for all mixtures	336
Figure 10.11	Toughness vs. total water content for the smaller Ball Clay contents	337
Figure 10.12	Cross section of brittle thread at end of test Todhills Shaly Clay: Povington Ball Clay 60:40	337
Figure 10.13	Matrix plastic limits	338
Figure 10.14	Particle size distributions of the N6 Fireclay:AT Ball Clay mixtures	338
Figure 10.15	Variation of the limits for the N6 Fireclay:AT Ball Clay mixtures	339
Figure 10.16	Matrix liquid limits	339
Figure 10.17	Nominal stress vs. diameter for the N6 Fireclay	340
Figure 10.18	Toughness vs. water content for the N6 Fireclay	340
Figure 10.19	Nominal stress vs. diameter for the AT Ball Clay	341
Figure 10.20	Toughness vs. water content for the AT Ball Clay	341
Figure 10.21	Toughness vs. total water content relationships for all mixtures	342
Figure 10.22	Toughness vs. total water content for the small Ball Clay contents	342
Figure 10.23	Toughness vs. matrix water content relationships for all mixtures	343
Figure 10.24	Toughness x BC clay content - matrix water content relationship	343
Figure 10.25	Matrix plastic limits	344

List of Tables

Table 1.1	Variability of the results of plastic limit tests (From Sherwood, 1970)	35
Table 2.1	Pressures at the liquid and plastic limits (Data from Schofield and Wroth, 1968)	67
Table 2.2	Undrained shear strengths (Figure 11, Skempton and Northey, 1953)	67
Table 2.3	Soil suctions (From Rollins and Davidson, 1960)	67
Table 2.4	Suction data (From Dumbleton and West, 1970)	68
Table 2.5	Suction at the plastic limit (Adapted from McBride, 1989)	68
Table 2.6	Shear strength data (From Wasti and Bezirci, 1986)	68
Table 2.7	Shear strength data (From Dumbleton and West, 1970)	68
Table 2.8	Fall cone test methods adopted by several authors	69
Table 3.1	Factors affecting soil plasticity or toughness (From Prakash and Sridharan, 2006)	108
Table 3.2	Plasticity classification (From BS5930:1999)	108
Table 3.3	Toughness descriptions (From BS5930:1999)	108
Table 3.4	Toughness classifications for ASTM soil symbols (ASTM, 2000)	109
Table 3.5	Manual tests to assess the plasticity and toughness classification (ASTM, 2000)	109
Table 3.6	Plasticity classes (From Anon, 1993)	109
Table 3.7	Toughness classes (From Anon, 1993)	110
Table 3.8	Classification of fine-grained soils (From Anon, no date)	110
Table 3.9	Relationship of optimum water content to plastic limit	110
Table 5.1	Proposed toughness classification (From Barnes, 2009)	186
Table 5.2	Database of results	187
Table 5.3	Rate of loading data	191
Table 5.4	Repeatability tests	191
Table 6.1	Burmister's (1950) classification (cited In Nuyens and Kockaerts, 1967)	226
Table 6.2	Burmister's (1970) tentative criteria for overall plasticity	226
Table 6.3	Degree of plasticity (From Karlsson and Hansbo, 1981)	226
Table 9.1	Typical mean particle sizes in Figure 9.14	306
Table 9.2	Maximum particle size for compacted specimens	306
Table 10.1	Properties of the two clays used in the mixtures	330
Table 10.2	Clay contents	330
Table 10.3	Properties of the two clays used in the mixtures	331
Table 10.4	Clay contents	331

ABSTRACT

Previous thread rolling methods for the plastic limit are shown to be inadequate and inaccurate. Alternative methods for the plastic limit are shown to be imprecise and unreliable. The strength-based concept and use of the fall-cone test to determine the plastic limit are shown to be flawed. An apparatus that replicates Atterberg's rolling technique, devised and developed by the author, is described, referred to as the Barnes Apparatus. A thread of soil is rolled between two plates configured to permit extrusion and reduction of diameter with much less operator interference than with the standard test and judgement of the crumbling condition is eliminated. Using a loading device nominal stresses are derived and from dial gauge readings diametral strains are determined for each rolling traverse of the soil thread. Toughness has previously only been studied in an empirical or qualitative manner. From plots of nominal stress vs. strain the workability or toughness of the plastic soil is determined as the work/unit volume. The apparatus and test are appropriate to a wide range of soils. Threads are tested over a range of water contents from near the sticky limit to the brittle state. Good correlations between toughness and water content display an abrupt ductile-brittle transition and give an accurate definition of the plastic limit. From the correlations useful properties are obtained such as the maximum toughness at the plastic limit, the toughness limit, the water content at zero toughness, the stiffness transition, the toughness coefficients, the toughness index and the workability index. An investigation into the significance of the soil thread diameter of 3 mm in the standard plastic limit test has found that as the water content of a soil reduces it undergoes a transition from fully plastic, to cracked, to brittle, largely regardless of the diameter of the thread. It is recommended that the 3 mm diameter requirement is withdrawn from the standard test procedure as unnecessary and emphasis placed on observing the behaviour of the soil thread as it is rolled by hand. A review of the relationship between the clay matrix and the granular particles in a soil has found that the linear law of mixtures and activity index are appropriate only at high clay contents. The terms granular spacing ratio and matrix porosity are introduced to explain the effect of the granular particles on the toughness and plastic limit. An analysis confirms that with small diameter soil threads large granular particles affect the results disproportionately. An aggregation ratio term is introduced to explain the change in toughness in the clay matrix as its water content reduces towards the plastic limit. To assess the effect of granular particles in a clay matrix on the toughness and plastic limit the results of tests conducted on mixtures of a high plasticity clay and silt, and sand particles of two different sizes are discussed. Smaller particle sizes are found to have a greater effect on reducing the toughness and the plastic limit of the clay. In the ceramics industry mixing different clays together to obtain suitable properties is common. The toughness and plastic limits of two pairs of mixed clays do not follow the linear law of mixtures but are dependent on the total clay content and the content of a dominant clay mineral.

DECLARATION

No portion of the work referred to in the thesis has been submitted in support of an application for another degree or qualification of this or any other university or other institute of learning.

COPYRIGHT

The author of this thesis (including any appendices and/or schedules to this thesis) owns any copyright in it (the "Copyright") and he has given The University of Manchester the right to use such Copyright for any administrative, promotional, educational and/or teaching purposes. Copies of this thesis, either in full or in extracts, may be made only in accordance with the regulations of the John Rylands University Library of Manchester. Details of these regulations may be obtained from the Librarian. This page must form part of any such copies made.

The ownership of any patents (but see below), designs, trade marks and any and all other intellectual property rights except for the Copyright (the "Intellectual Property Rights") and any reproductions of copyright works, for example graphs and tables ("Reproductions"), which may be described in this thesis, may not be owned by the author and may be owned by third parties. Such Intellectual Property Rights and Reproductions cannot and must not be made available for use without the prior written permission of the owner(s) of the relevant Intellectual Property Rights and/or Reproductions. Further information on the conditions under which disclosure, publication and exploitation of this thesis, the Copyright and any Intellectual Property Rights and/or Reproductions described in it may take place is available from the Head of School of Mechanical, Aerospace and Civil Engineering (or the Vice-President).

ACKNOWLEDGEMENTS

I wish to register my sincere thanks to Dr William Craig for his support and guidance in supervising me. His attention to thoroughness and detail has assisted me in producing a more robust document. Also my warm thanks to Dr Mohammed Ahmad Syed, second supervisor, for his useful comments and advice on the contents of the thesis. Dr Patrick Hill, Electron Microscopist, provided generous assistance in the preparation and production of the images from the environmental scanning electron microscope in the School of Chemical Engineering and Analytical Science, University of Manchester.

NOTATION

Different authors may use different symbols for the same property; the symbols used in this thesis are those of the author referred to. All symbols are defined in the text and the section where the symbol is first used is indicated.

a	Half-width of contact area, mm	4.15
a	Pre-formed crack length, mm	3.3
a'	Ratio, in Figure 3.4b	3.3
a_r	Aggregation ratio	7.10
a_s	Aggregation ratio at the stiffness transition	7.10
A	Activity, activity index	7.5
A	Area of extrusion cylinder, m ²	2.8
A	Half-length of internal crack, mm	3.3
A	Plan area of clay platelet, mm ²	3.10
A_0	Area of extrusion cylinder orifice, m ²	2.8
b	Parameter determining action of fines	7.6
b	Slice width, mm	7.12
bc	% of clay from the Ball Clay in each mixture	10.3
b_0	Initial slice width, mm	7.12
b_1	Slice width after strain increment	7.12
B	Width of plate, mm	5.12
B	Proportion of granular particles	7.12
c	Cohesion, kPa	5.12
c_a	Adhesion, kPa	5.12
c_u	Undrained shear strength, kPa	2.5
c_{uPL}	Undrained shear strength at the plastic limit, kPa	2.3
c_{uLL}	Undrained shear strength at the liquid limit, kPa	2.3
C	Coefficient	2.6
C	Constant in equation 3.1	3.7
C	Clay content, %	7.2
C_{bc}	Ball Clay content in the total clay content, %	10.3
C_{LL}	Shear strength at the liquid limit, kPa	2.3

d	Clay platelet separation, mm	3.10
d	Diameter of cylinder, mm	4.18
d	Diameter of spherical uniform sized particles, mm	7.8
d	Cone penetration depth, mm	2.6
d_c	Average spacing between particles centre to centre	7.8
d_c	Width of cylinder in soil thread	7.12
d_{cL}	Average spacing between particles centre to centre on the length	7.12
d_{cL0}	Initial value of d_{cL}	7.12
d_{cR}	Average spacing between particles centre to centre on the cross section	7.12
d_{cR0}	Initial value of d_{cR}	7.12
d_g	Average diameter of uniform non-clay particle	7.8
d_s	Average spacing between the surfaces of the non-clay particles	7.8
D	Diameter of cylinder, mm	4.15
D	Diameter of specimen, mm	9.6
D_i	Thread diameter at end of i^{th} traverse, mm	4.13
D_{i-1}	Thread diameter at beginning of i^{th} traverse, mm	4.13
\bar{D}_i	Mean thread diameter for the i^{th} traverse, mm	4.16
D_T	Diameter of soil thread, mm	7.12
e	Void ratio	2.4
e_g	Granular void ratio	7.6
e_{ge}	Equivalent granular void ratio	7.6
e_L	Void ratio at the liquid limit	2.4
e_P	Void ratio at the plastic limit	2.4
fc	Fines content, fraction	7.6
fc	% of clay from the Fireclay in each mixture	10.4
F	Flow index	3.7
F	Load applied to cylinder	3.3
F	Attractive force between clay platelets, N	3.10
F	Force applied to soil thread, N	4.8
F_i	Average force applied to soil thread during i^{th} traverse, N	4.16
F_{\min}	Minimum force applied to soil thread, N	4.8
F_{\max}	Maximum force applied to soil thread, N	4.8

F_{ave}	Average force applied to soil thread, N	4.8
FS	Fine sand content in a mixture, %	9.4
FMS	Fine/medium sand content in a mixture, %	9.4
g	Gradient of liquid limit water content vs. penetration line	2.9
H	Height of slab, mm	5.11
H	Height of specimen, mm	9.6
I_c	Consistency Index	3.6
I_L	Liquidity Index	3.6
I_{mP}	Plasticity Index of matrix, %	7.5
I_p	Plasticity Index, %	2.4
I_T	Toughness Index, %	5.8
I_w	Workability Index	5.8
k	Cone factor	2.6
k	Constant for stress determination	4.15
k	Constant relating attractive forces, Nmm	3.10
k	Constant in split cylinder formula	4.15
K_I	Stress intensity factor, $kNm^{3/2}$	3.3
K_{IC}	Critical stress intensity factor, $kNm^{3/2}$ or $MPa\sqrt{m}$	3.3
L	Length of soil thread between plates, mm	4.15
L	Length of rock cylinder, mm	4.15
LL	Liquid limit, %	2.4
m	Coefficient	2.6
m	Coefficient	5.12
M	Coefficient	2.3
MCA	Moisture condition apparatus	3.9
MCV	Moisture condition value	3.9
n	Individual number of cylinder	7.12
n_c	Cohesive porosity	7.7
N	Number of blows	3.7
N_c	Number of cylinders	7.12
N_p	Number of particles in each cylinder	7.12
O_s	Percentage of oversize particles, %	9.4

p	Yield pressure, kPa	5.12
p	Extrusion pressure, yield pressure, kPa	2.8
p'	Mean effective stress, kPa	3.14
p_F	Suction as log cm water	2.4
p_k'	Mean effective stress, kPa	3.14
p_{LL}	Mean total stress at the liquid limit, kPa	2.3
p_{PL}	Mean total stress at the plastic limit, kPa	2.3
P	Diametral force applied to rock cylinders, N	4.15
P	Diametral force applied in ring test per unit length, N/mm	3.3
P	Steady state punch load, kN	2.8
P	Line load, kN/m	3.3
P_L	Load per unit length of cylinder, N/mm	4.15
PI_{100}	Plasticity index based on using w_L and PL_{100} , %	2.3
PL	Plastic limit, %	2.4
$P.L.$	Plastic limit, %	2.7
PL_{100}	Water content at the undrained shear strength of $100 \times C_{LL}$, kPa	2.3
q	Deviatoric stress	2.3
q_{LL}	Deviatoric stress at the liquid limit, kPa	2.3
q_{PL}	Deviatoric stress at the plastic limit, kPa	2.3
Q	Shear force applied between clay platelets, N	3.10
R	Ratio of strengths at the plastic limit and the liquid limit	2.3
R	Dial gauge reading, mm	4.13
R_i	Dial gauge reading at end of i^{th} traverse, mm	4.13
R_i	Radius of central hole in ring, mm	3.3
R_0	Radius of ring, mm	3.3
$R_{3.0}$	Dial gauge reading with nominal 3mm diameter rod, mm	4.13
s	Average centre to centre spacing between non-clay particles, mm	7.8
sc	% of clay from the Shaley Clay in each mixture	10.3
s_c	Centre to centre spacing between non-clay particles, mm	7.8
s_g	Granular spacing ratio	7.8
s_{gR}	Granular spacing ratio on cross section of thread	7.12
s_{gL}	Granular spacing ratio on long axis of thread	7.12

s_u	Undrained shear strength, kPa	2.5
S	Specific surface or surface area per unit mass of solids, mm ² /g	3.10
t	Thickness of clay platelet, mm	3.10
T	Toughness, kJ/m ³	3.10
T	Toughness, kJ/m ³ per 100 reversals	4.18
T_C	Toughness Coefficients	5.8
T_{max}	Maximum toughness, kJ/m ³ per 100 reversals	5.6
T_S	Toughness at the stiffness transition, kJ/m ³ per 100 reversals	5.8
u_a	Pore air pressure, kPa	2.4
u_w	Pore water pressure, kPa	2.4
v_{LL}	Specific volume at the liquid limit, mm ³	2.3
v_{PL}	Specific volume at the plastic limit, mm ³	2.3
v_{PI}	Specific volume at the plasticity index, mm ³	2.3
V	Unit particle volume, mm ³	3.10
V_c	Volume of clay particles, mm ³	7.6
V_{ca}	Volume of clay particles in aggregated matrix, mm ³	7.10
V_{cc}	Volume of clay particles in continuous matrix, mm ³	7.10
V_G	Volume of non-clay particles, mm ³	7.6
V_s	Volume of solids, mm ³	3.10
V_v	Volume of voids, mm ³	3.10
V_w	Volume of water, mm ³	7.6
V_{wa}	Volume of water in aggregated matrix, mm ³	7.10
V_{wc}	Volume of water in continuous matrix, mm ³	7.10
VCL	Virgin compression line	2.9
w	Water content, % or ratio	3.7
w_a	Water content of aggregated matrix, % or ratio	7.10
w_c	Water content of continuous matrix, % or ratio	7.10
w_L	Liquid limit, %	2.4
w_{LC}	Water content of the London Clay, %	9.4
w_{LCFS}	Water content of the London Clay:Fine Sand mixtures, %	9.4
w_{LCFMS}	Water content of the London Clay:Fine/medium Sand mixtures, %	9.4
w_{Llab}	Liquid limit of laboratory test specimen, %	9.4

$w_{L_{\text{whole}}}$	Liquid limit of whole sample, %	9.4
w_{L100}	Liquid limit of soil with 100% clay content, %	7.2
w_m	Matrix water content, %	7.2
w_{mL}	Matrix liquid limit, %	7.2
w_{m0}	Matrix water content at zero toughness on upper limb, %	7.11
w_{mP}	Matrix plastic limit, %	7.2
w_{ms}	Matrix water content at the stiffness transition, %	7.10
w_{mT}	Matrix toughness limit, %	7.4
w_{opt}	Optimum water content, %	2.6
w_p	Plastic limit, %	2.4
w_{Plab}	Plastic limit of laboratory test specimen, %	9.4
$w_{P_{\text{whole}}}$	Plastic limit of whole sample, %	9.4
w_{P100}	Plastic limit of soil with 100% clay content, %	7.2
w_s	Water content at the stiffness transition, %	5.8
w_{test}	Water content in the test specimen	9.4
w_T	Toughness limit, %	5.8
w_{T100}	Toughness limit of soil with 100% clay content, %	7.4
$w_{\text{whole sample}}$	Water content in the whole sample	9.4
W	Mass of cone, g	2.6
W_{ca}	Mass of clay particles in aggregated matrix, g	7.10
W_{cc}	Mass of clay particles in continuous matrix, g	7.10
W_s	Mass of solids, g	3.10
W_G	Mass of non-clay particles, g	7.6
W_{wa}	Mass of water in aggregated matrix, g	7.10
W_{wc}	Mass of water in continuous matrix, g	7.10
x	Distance of soil thread from starting point, mm	4.8
y	Distance from end of loading bar to zero force mark, mm	4.8
α	Frictional coefficient	3.10
α_n	Angle between particles in the n^{th} cylinder, °	7.12
β	Half included angle of wedge, °	4.15
δD_T	Change in thread diameter, mm	7.12
$\delta \varepsilon_{Di}$	Diametral strain for the i^{th} increment	4.14

$\delta\varepsilon_0^*$	Plastic tensile strain at zero compressive strain	3.9
δl	Displacement, mm	3.10
ΔD	Change in diameter, mm	4.11
ΔF	Force increment, N	4.11
ΔT	Increment of toughness kJ/m ³ per 100 reversals	5.8
ΔW	Increment of water content, %	5.8
ε_{Di}	Cumulative diametral strain for i traverses	4.14
ϕ	Angle of friction, °	4.15
ϕ_r'	Residual angle of friction, °	7.2
Γ	Coefficient	2.3
λ	Coefficient	2.3
ρ_B	Particle density of large granular particles, g/mm ³	7.12
ρ_{1-B}	Particle density of remaining matrix, g/mm ³	7.12
ρ_C	Particle density of clay fraction, g/mm ³	7.6
ρ_G	Particle density of non-clay fraction, g/mm ³	7.6
ρ_s	Particle density of solids, g/mm ³	3.10
ρ_w	Unit mass of water, g/mm ³	3.10
$\sigma_{0.2}$	Stress at a strain of 0.2, kPa	3.9
σ_{nom}	Nominal or indicative stress on the soil thread, kPa	4.11
$(\sigma_{nom})_i$	Nominal or indicative stress for the i^{th} traverse, kPa	4.16
σ_θ	Circumferential stress, kPa	4.15
σ_r	Radial stress, kPa	4.15
σ_t	Tensile strength of a rock cylinder, kPa	4.15
σ_i	Tensile stress, kPa	4.15
σ_v'	Major principal (vertical) effective stress, kPa	2.3
σ_v'	Vertical effective stress, kPa	2.9
σ_x	Normal stress on the loaded diameter in the ring test, kPa	3.3
$\Sigma\delta\varepsilon_D$	Cumulative strain	4.15

CHAPTER 1

Introduction

1.1 Introduction

The plastic limit and liquid limit tests as first devised by Atterberg (1911)¹ were fairly crude attempts to investigate the water contents at two critical transitions, one each side of the plasticity range of a soil. Atterberg gave his definition of plasticity as the ability of a soil to be rolled out into threads (in German - ausrollgrenze) and described a rolling-out test which identified the plastic limit as the water content when the threads crumbled. He noted that some clays could be rolled out to much thinner threads than others but did not give a diameter to associate with the crumbling condition. He also experimented with the addition of sand to clay in reducing the degree of plasticity giving descriptions from low to high for different amounts of sand added.

The plastic limit, usually given the symbol w_p , has been standardised (ISO/TS 17892-12:2004; BS1377-1990; ASTM D4318-10) as a hand rolling test largely following Atterberg's original procedure. This entails rolling a thread of soil between the fingers of one hand and a clean glass plate, applying sufficient force to reduce the diameter of the thread, to about 3 mm, then re-forming into an ellipsoidal mass and re-rolling until the thread crumbles with longitudinal and transverse cracking.

Much less research has been conducted on the plastic limit of soils compared to the liquid limit. This is probably a reflection of the availability of standardised items of apparatus, the cup and cone methods, the easier preparation and manipulation of the soil at this high water content and the wider range of values of liquid limit for the different soil types in existence.

The research into the fundamental aspects of the plastic limit included in this thesis aims to redress the balance and to confirm the significance of this water content. In particular, it is shown to be clearly related to the ductile-brittle transition that occurs in all plastic soils as the water content decreases and the soil loses its plasticity.

Toughness and workability are terms used to explain the resistance to deformation

¹ This paper was subsequently translated into English (Atterberg, 1974).

of a soil and are applied to cohesive soils and mainly clays. Toughness has had little application in the civil engineering industry because of the inability to provide a suitable measure. The property is relevant in its relation to compactive effort and general earthworks construction and to the integrity of earthworks components formed of clay such as liners in water-retaining structures, landfill liners and cores of earth dams. Workability is perhaps of more importance in the ceramics industry, for the assessment of clays used in whiteware production, and in the brick-making industry. In the agricultural context it is important in relation to the efficiency of machinery in ploughing and tilling a clay soil.

The research described in this thesis revolves around the apparatus and test method devised by the author for the rolling of a soil thread and the measurement of nominal stresses and strains to provide a measure of toughness property and to investigate the ductile-brittle transition at the plastic limit. A large part of the research into the application of the apparatus and test method has concentrated on the effects of non-cohesive granular particles in a clay matrix. The clay matrix provides the toughness in a clay soil at water contents below the plastic limit and eventually becomes brittle at the plastic limit. However, the toughness and plastic limit are affected by interference from the non-cohesive particles.

In the ceramics industry the clays used in the various manufacturing processes, e.g. for tableware, are referred to as bodies that comprise mixtures of clays, typically fireclays and different types of ball clay. The research has investigated the toughness and plastic limit behaviour of mixtures of these typical clays.

1.2 Aims and objectives

The main aims of the thesis are to demonstrate

- 1) a new apparatus, the Barnes apparatus, that permits controlled rolling of a thread of soil and enables the measurement of nominal stresses and strains in the soil thread,
- 2) a test method, the Barnes test, that provides a measure of toughness of a plastic soil from the nominal stresses and strains and determines the plastic limit at the ductile-brittle transition,
- 3) that the apparatus and test method provide new insights into the relationship between toughness and water content and

- 4) that greater accuracy and repeatability of the plastic limit can be obtained compared to the standard thread rolling method by hand.

The first objective of the research is to investigate the current state of knowledge on:

- 1) the properties of plasticity and toughness of soils and the effects of water content, clay content and type, on these properties,
- 2) the ductile and brittle behaviour of soils and the transition between these states,
- 3) alternatives to the thread rolling method for a value of the plastic limit,
- 4) the strength-based approach for the plastic limit including the strength ratio concept comparing strength values at the liquid and plastic limits,
- 5) the use of the fall-cone test to obtain a plastic limit value,
- 6) the macro and micro structure of soils and their effects on the toughness and plastic limit.

The main objective of the research is to introduce the Barnes apparatus and Barnes test to

- 1) explain the features and mode of operation of the apparatus,
- 2) describe the procurement of the test data and processing,
- 3) obtain relationships between a nominal stress and an incremental strain, to determine values of toughness as work/unit volume,
- 4) obtain relationships between toughness and water content and to introduce new properties derived from the relationships,
- 5) determine the plastic limit as the water content at the ductile-brittle transition,
- 6) assess the suitability of the apparatus and test by conducting tests on a range of soil types and artificially prepared mixtures,

- 7) explain the limitations of the apparatus and test,
- 8) investigate the influence of loading rate on the stress-strain behaviour of a thin soil thread,
- 9) and investigate the effects of wetting up and drying of a soil on the toughness behaviour.

Associated with the main objective investigations are to be carried out into

- 1) the significance of the thread diameter in the hand rolling test method,
- 2) theoretical relationships and properties related to the presence of coarse particles, silt and sand, in a clay matrix and in a soil thread,
- 3) the effects of silt and sand particles on the toughness and plastic limit of a clay soil,
- 4) the effects of mixing different types of clay on the toughness and plastic limit properties of the mixtures.

1.3 Albert Atterberg

Albert Mauritz Atterberg was born 19 March 1846 in Hernosand, Sweden and was educated in Stockholm, later becoming an assistant in the chemistry laboratory at Uppsala University and was finally awarded a PhD degree from this University in 1872. He continued research into organic chemistry as assistant professor at the University until 1877 when he became Principal of the Chemical Station and Seed Control Institution at Kalmar. Up to the end of the 19th century he became an authority in agricultural research but from about 1900 he devoted his time to the study of soils.

His initial work involved the classification of soils, in particular assigning clay particles to sizes below 0.002 mm and soon realised that the particular property of a clay is its plasticity. This work produced many papers on the several consistency limits he proposed although nowadays only the liquid limit (his flow limit) and the plastic limit (his roll out limit) are widely used, with the less used shrinkage limit and even less used sticky or adhesive limit.

The importance of his work on plasticity was not fully recognised in his own field of agricultural science, nor in the other major user of clays, the ceramics industry. However, thanks to Terzaghi who saw the usefulness of the limits in the developing field of soil mechanics these limits survive today and form the basis of all classification systems for clays in geotechnical engineering. As well as his productive research publications in chemistry he wrote many papers and articles on soil research. His 1911 paper (Atterberg, 1911) is the classic work cited by researchers who refer to his original study on what are now referred to worldwide as the Atterberg Limits.

He received various Swedish awards in recognition of his contributions including the Knight of the Vasa Order, 1898; Member of the Agricultural Academy, 1900; Knight of the Order of Nordstjeman, 1911; Gold Medal of the Agricultural Academy, 1913; and was Chairman of the International Commission on Mechanical and Physical Soil Research 1910 – 1915. Further information can be obtained from Blackall (1952).

1.4 Variability of the standard plastic limit test results

It is well-known that the repeatability and reproducibility of the standard plastic limit test is poor, mainly as the results are affected by the operator's approach to rolling a soil thread and the operator's judgement of the crumbling condition. For example, crumbling of the soil thread manifests itself differently for different soils (ASTM D4318-10) and for some less plastic soils it is difficult to determine the crumbling condition.

Probably one of the first checks on the repeatability of the plastic limit test was conducted by Wintermeyer (1926). In order to assess the potential variation of plastic limit, w_p , within the US Bureau of Public Roads laboratories two tests (first and second) were conducted on the same soils at different times, firstly with experienced operators and then with inexperienced operators. The results were plotted as w_p first test versus w_p second test, and showed good repeatability by the experienced operators, see Figure 1.1², but poorer performance by the inexperienced operators, see Figure 1.2. Wintermeyer made no recommendations for improving the repeatability, offering only that the variability was as good as, if not better than, the variability expected from tests on other engineering materials such as cements and concrete.

² Figures are inserted at the end of each chapter.

Shook and Fang (1961) undertook an exercise to train several inexperienced technicians to make determinations of the liquid and plastic limits. One experiment to check the variance between operators comprised giving to each operator five portions of one large, carefully prepared soil sample to conduct the tests. There was variation by each operator and between operators, as would be expected.

Shook and Fang suggested that either more than one operator should be used for each determination which would be commercially uneconomic or that the operators are evaluated and to choose the operators with the least variance within their own tests and who gave a result sufficiently close to the average. For this a check test using either a 'standard' soil or comparing with an experienced operator was proposed. Again, most commercial laboratories would deem this to be uneconomic as they would use their experienced staff for the more intricate laboratory tests such as effective stress triaxial testing and treat the plastic limit test as mundane, suitable for the less experienced staff to conduct.

The results of plastic limit tests conducted on three prepared soils by eight operators from within the UK Road Research Laboratory (Transport Research Laboratory now) and from 41 laboratories across the UK are discussed by Sherwood (1970) and summarised in Table 1.1.

The repeatability (by one operator) was good but the reproducibility (between labs) was not good. Sherwood pointed out that, based on the results from different laboratories, one-third of all plastic limits "...could be more than about 3 units from the true value". It was suggested that there were errors in the test itself such as

- 1) detecting the rather subjective crumbling condition,
- 2) inadequate definition of the crumbling point,
- 3) variation in hand pressure,

and in the laboratory test procedure such as

- 1) oven-drying instead of air-drying for initial preparation,
- 2) inadequate water equilibration, mixing and curing,
- 3) production line techniques where the operator has no feedback on the results,

- 4) lack of, or variable appreciation of, the significance of the test result,
- 5) differences between temporary site laboratories and established laboratories,
- 6) pure testing houses with no interpretation of results required,
- 7) types of staff, variable experience, different attitudes.

The standard thread rolling method (ISO/TS 17892-12:2004; BS1377-1990; ASTM D4318-10) requires that the criterion for the plastic limit is taken at the first crumbling of the thread. This should not be confusing. However, the US Army Engineer's Manual (US Army, 1986) for laboratory soil testing suggests that one error in the determination can be due to stopping the rolling process too soon. This Manual recommends that if there is any doubt whether the thread has crumbled 'sufficiently', although 'sufficiently' is not an express requirement of the test, it is better to roll the thread once more than to stop the process too soon. This, however, can result in further unnecessary drying of the soil and will produce an underestimate of the plastic limit.

1.5 The need for a better approach

A transition between brittle and ductile states occurs for many metals when a certain temperature is reached. For plastic soils a similar transition between the brittle and plastic states exists when a certain water content is reached. This water content is the plastic limit.

Below the plastic limit a thread of soil will be brittle, manifested in the standard test as 'crumbling' when rolled out. This is considered to be caused by fracture failure generated along larger pores or microcracks, at boundaries between coarse particles and the clay matrix and between aggregations of clay particles that develop in the soil as the brittle state is approached. Above the plastic limit the thread will be plastic, or ductile, and will extrude and elongate during rolling due to plastic deformation. This transition has received little attention and in those technical papers that report the use of the fall-cone test for the plastic limit (e.g. Wood, 1985) the transition is not even recognised.

Alternatives to the thread rolling plastic limit test have been proposed such as the cube test, Abdun-Nur (1960); suction methods, McBride (1989); and extrusion methods, Whyte (1982). In the past thirty years much emphasis has been placed on the use of the fall cone test (Wood, 1985, Feng, 2004 and others). None of these

tests can demonstrate the significant change in behaviour from ductile to brittle at water contents each side of the plastic limit, relying instead on correlations with the thread rolling method to adjust the apparatus configurations. These tests have also been conducted on 'well-behaved' clays that lie above the A-line on the Casagrande plasticity chart (Casagrande, 1947) to corroborate their theories and results.

These methods are discussed in Chapters 2 and 3. However, none of these methods replicate Atterberg's specific requirement to define the lower limit of plasticity, i.e. the plastic limit, by rolling threads of soil until they crumble which would occur at the ductile-brittle transition.

The most appropriate approach to determine the plastic limit is considered to be

- 1) by using an apparatus that can provide controlled rolling of a thread of soil with reduction in diameter and extrusion longitudinally, that replicates Atterberg's original hand rolling approach and
- 2) adopting a test procedure and calculation method that can distinguish between a soil at a water content that imparts a plastic or ductile condition, by demonstrating its ability to be deformed (and measuring its resistance to deformation or its toughness) and a soil at a water content that causes behaviour in a brittle manner.

It would also be advantageous if the test is suitable for application to most soil types including those soils that lie below the Casagrande A-line such as silts, organic soils, kaolinites etc.

1.6 The new thread rolling apparatus for the plastic limit and workability of soils – the Barnes apparatus and test

Casagrande (1958) stated that in devising the cup method for the determination of the liquid limit of soil he tried to adhere as closely as possible to the simple hand bumping test invented by Atterberg. However, no attempt at conceiving a device was made for the plastic limit test and Atterberg's original hand rolling procedure has continued since. The test, sometimes referred to as the Casagrande method, but more distinctly as the thread rolling method, is standardised in international standard ISO/TS 17892-12:2004, in the UK in BS1377:1990, and in the US in ASTM D4318-10.

The author has devised and developed an apparatus that replicates Atterberg's

thread rolling procedure as far as possible and can produce rolling of a soil thread from a diameter of about 8 mm down to the diameter of 3 mm or less with very little interference from the operator. The rolling device replicates the hand rolling procedure in that stresses are applied to a soil thread with reversals of compression and tension assumed to occur across the diameter and elongation or extrusion produced along the length of the thread. In reality the soil thread undergoes a complex process of compression, tension, torsion and bending. Measurements of nominal stress, strain and the work/unit volume are obtained and values of toughness assigned to each thread in its plastic condition according to its water content. Brittle failure at low strains is readily identified.

By detecting the ductile-brittle transition a much more well-defined water content and a more accurate, less operator-dependent value of the plastic limit is obtained. This thesis describes the apparatus and test procedure and explains the method for determining the plastic limit and a measure of toughness of a plastic soil.

The apparatus and test method referred to in this thesis as the “Barnes apparatus and test” are the subject of UK patent GB2443537, granted December 2010.

1.7 Accreditation

Many of the concerns about variability of test results have been addressed by the introduction of accreditation of laboratories to international standards. EN ISO/IEC 17025 *General requirements for the competence of testing and calibration laboratories* is the internationally recognised standard for testing laboratories. The standard contains all of the requirements that testing and calibrations laboratories have to meet if they wish to demonstrate that they operate a quality system, are technically competent and are able to generate technically valid results. Laboratories accredited to this standard are then able to provide a measurable level of assurance.

In the UK this standard is administered by the United Kingdom Accreditation Service (UKAS) under the auspices of the Secretary of State for Business, Innovation and Skills. UKAS is the sole national accreditation body recognised by government to assess organisations that provide certification, testing, inspection and calibration services.

As the Barnes apparatus is unique (there is only one), before any formal accreditation could be pursued there would need to be production of copies of the apparatus and dispatch to several laboratories followed by a period of

acclimatisation by several operators so that they could become familiar with the apparatus operations, the test procedure, behaviour of various types of soils, calculations and reporting. Although the apparatus is found by the author to produce very good correlations for the toughness vs. water content plots and repeatable results the apparatus is undergoing continued application to acquire further test data in order to gain a thorough understanding of its abilities and limitations and to assess its applicability to a range of soil types.

The author has not pursued the development of the apparatus with a specialist manufacturer nor directly solicited the opinions of outside authorities on the worthiness of the apparatus. A paper describing the apparatus, test method and typical results has been published (Barnes, 2009) and this has received a discussion response (O'Kelly, 2011) and reply (Barnes, 2011).

1.8 Structure of the thesis

The thesis has been prepared in four parts. Part 1 comprises this introduction.

Part 2 discusses the previous research done on the plastic limit test with a critique of the strength-based approach and the use of the fall cone method to determine the plastic limit in Chapter 2. Several alternative forms of apparatus and methods that have been proposed to determine a value of the plastic limit are also discussed. The author regards the transition between the ductile condition of a soil and the brittle condition as fundamentally related to the plastic limit and this is discussed in Chapter 3 with a review of the little reported, but important, property of toughness of a clay soil and its relevance to civil engineering practice.

Part 3 describes the Barnes apparatus and its operation to produce rolling out of a thread of soil, starting with the preparation of an initial compacted soil thread, recording of the loads applied and measurements of the thread diameter taken as the thread reduces in diameter during rolling and extrudes from the sides of the apparatus. The determination of nominal values of stress and strain and the derivation of the work/unit volume as a measure of toughness of the soil are explained in Chapter 4.

In Chapter 5 the determination of the plastic limit at the ductile-brittle transition identified from the toughness vs. water content plots and other properties such as the toughness limit, stiffness transition, toughness index and maximum toughness are explained. The application of the test to a range of soil types is confirmed but the limitations of the test are also discussed including the behaviour of the soil

threads at small diameters below about 4 mm, the influence of the rate of loading, the effects of wetting up and drying of the soil and hence the significance of the method of preparation of the soil material.

Part 4 describes the investigations conducted. Terzaghi (1926) prescribed that in the thread rolling method by hand the soil thread must first be rolled to a diameter of 3 mm to demonstrate plasticity or ductility before the crumbling condition is achieved at the plastic limit. Soil threads, particularly of clay soils, can be rolled to much smaller diameters and a review of the degree of plasticity based on the thread diameter is included in Chapter 6. In this chapter an investigation into the significance of the thread diameter on the condition of a clay soil over a range of water contents is described with a discussion on whether or not the 3 mm diameter criterion is important.

A major part of the research for this thesis comprises the effects of granular particles, silt and two grades of sand, on the toughness and plastic limit of a clay soil. The author believes that the toughness of a clay soil derives from the clay particles and their arrangement, as discussed in Chapter 3, which makes up the clay matrix.

A review of the linear law of mixtures is included in Chapter 7. In soil mechanics terms this law assumes that the properties of a clay soil are determined by those of the clay matrix and the granular particles exist in this matrix as inert, inactive fragments. The granular void ratio is discussed in this chapter as a parameter to describe the proportions of granular particles and matrix. Two preferred parameters, matrix porosity and granular spacing ratio are introduced to describe the interactions between the clay matrix and the granular particles. The term aggregation ratio is introduced to demonstrate the effect of the reduction in the volume of the continuous clay matrix compared to the aggregated clay matrix as the water content decreases towards the plastic limit.

Chapter 8 presents the results of tests on prepared mixtures of clay and silt of varying proportions and proceeds to explain the effects of the silt particles on the properties of toughness and the plastic limit. The results of the tests on the mixtures of clay and sand of varying proportions are presented in Chapter 9 with a discussion on the effect of different sizes of sand particles on the toughness and plastic limit, the corrections that can be applied to the water content to allow for the elimination of coarse particles and the effect of large granular particles in a small diameter soil thread as it reduces in diameter and extrudes longitudinally.

In the ceramics industry clay bodies are made by mixing a range of materials such

as different types of clay, quartz, sand, grog³ and metallic compounds to impart particular properties. These bodies are designed to give beneficial properties in the ceramics processes such as plasticity, green strength⁴, low shrinkage, good firing qualities, colour, texture. Chapter 10 presents the results of tests on prepared mixtures of different clay types and discusses the toughness and plastic limit behaviour of these mixtures.

Chapter 11 presents the conclusions derived from the research conducted and makes some recommendations for further research.

³ Grog comprises broken fired ceramics ground to suitable ranges of particle sizes and is used to minimise shrinkage and improve firing properties.

⁴ Green strength is the strength of the body following the wet forming process and must be sufficient to maintain the shape of the product.

1.9 Tables

	Eight RRL Operators*			41 Laboratories*		
	Soil B	Soil G	Soil W	Soil B	Soil G	Soil W
Mean	18.5	25.9	24.8	18	25	25
Range	17.5 – 20.0	23.3 – 27.2	23.1 – 27.0	13 – 24	18 – 36	20 – 39
Difference	-1.0 to +1.5	-2.6 to +1.3	-1.7 to +2.2	-5 to +6	-7 to +11	-5 to +14
Standard deviation	1.0	1.3	1.4	2.4	3.2	3.1
Coefficient of variation	5.3	5.0	5.6	13.1	12.8	12.7

*The level of precision is as reported by Sherwood, 1970.

Table 1.1 *Variability of the results of plastic limit tests (From Sherwood, 1970)*

1.10 Figures

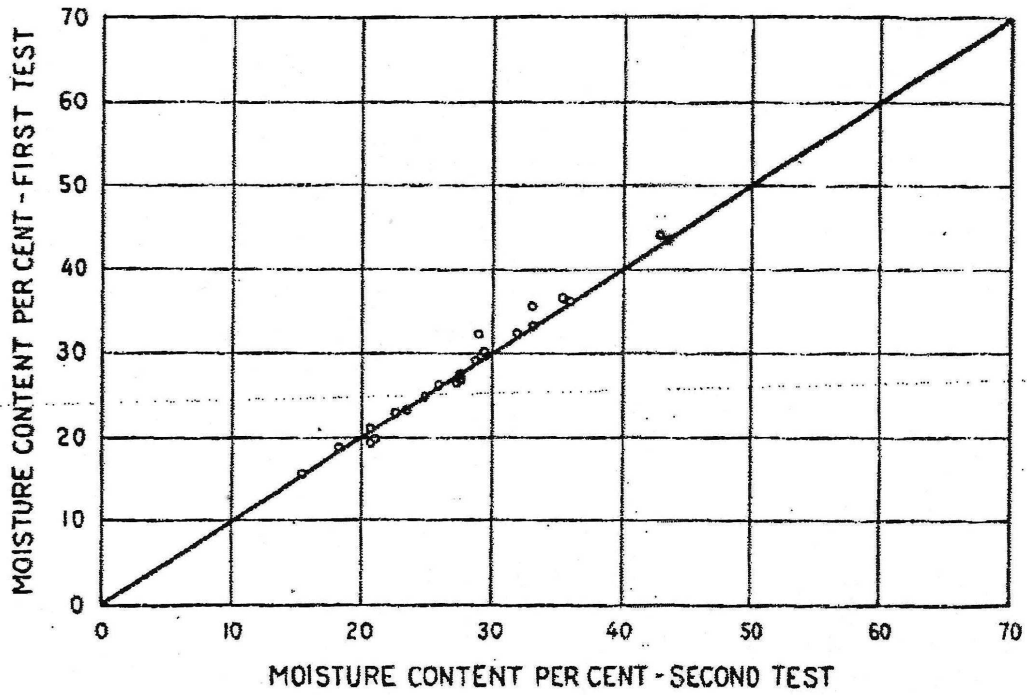

Figure 1.1 *Repeatability tests by experienced operators* (From Wintermeyer, 1926)

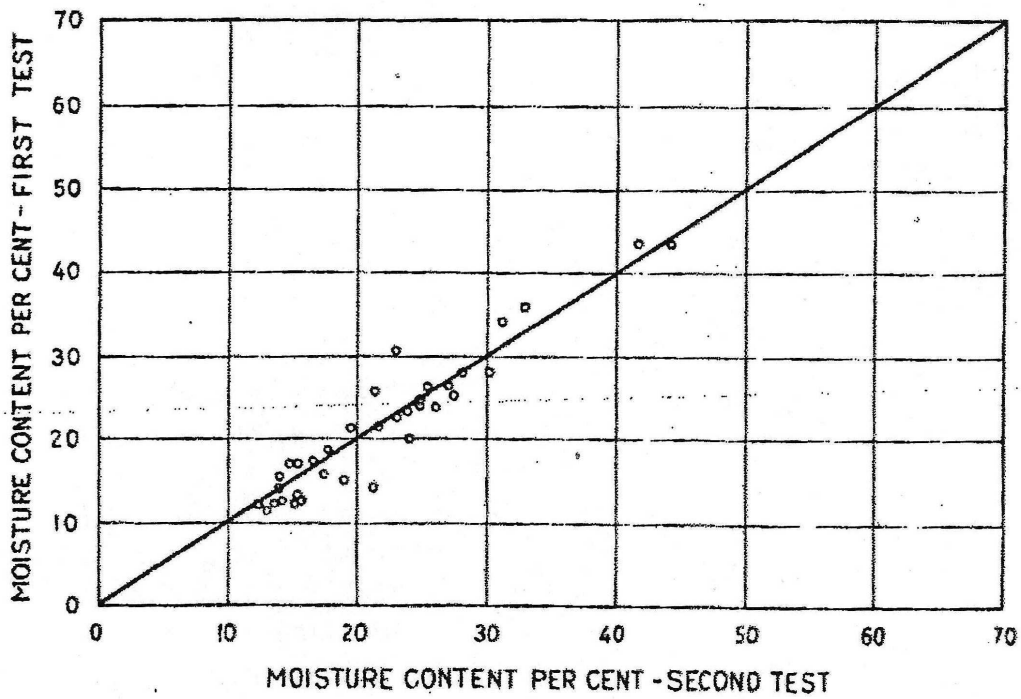

Figure 1.2 *Repeatability tests by inexperienced operators* (From Wintermeyer, 1926)

CHAPTER 2

Previous alternatives to the standard thread rolling method

2.1 Introduction

Sherwood (1970) pointed out that a substitute for the thread rolling method as devised by Atterberg, and “little changed since”, would be likely to prove difficult and so it has.

Schofield and Wroth (1968) introduced the strength-based plastic limit concept in their book ‘Critical State Soil Mechanics’. Subsequently many researchers attempted to derive the plastic limit of a soil based on this concept and using modifications of the fall cone test. The following provides a critique of the concept and the use of the fall cone test to obtain the plastic limit of soil. Some researchers have suggested that the plastic limit can be derived from alternative tests that involve no rolling out of soil threads and these are described.

2.2 Previous thread rolling methods

The apparatus described by Gay and Kaiser (1973) comprised three vertically mounted absorbent porous metal rollers driven by an electric motor. Soil at a water content close to the plastic limit was formed by hand into threads about 1/3 inch (8.5 mm) diameter and 2 inch (50.8 mm) long and fed into the top of the rollers. Due to the configuration of the rollers the soil was rolled out at the bottom at a diameter of 1/8 inch. The threads emerging broke off at different lengths depending on the water content. Gay and Kaiser stated that when the length of broken thread was 1½ inch (38.1 mm) the soil was at its plastic limit.

This is a form of tension test, with the breaking of the threads related to the tenacity of the soil, its ability to hold together, rather than the transition from ductility to brittleness. When the soil is in a brittle condition it seems unlikely that this apparatus would be able to roll out such a stiff thread of soil to the length specified. As will be shown later, in Chapter 6, the insistence on rolling soil threads to a diameter of 3 mm is not essential in assessing the ductile-brittle transition. Although there was a reasonable correlation Gay and Kaiser’s machine method tended to underestimate consistently their plastic limit compared with the hand rolling method, indicating that there was excessive drying by the machine.

The results reported were for fairly tough clay soils that would hold together and would be expected to behave reasonably well in this apparatus. However, tests on the less tough and less tenacious soils that tend to lie below the Casagrande A-line were not conducted and it is suspected that this apparatus would not be appropriate for these soil types. The main function of the apparatus appears to be to produce threads of 1/8 inch diameter. Gay and Kaiser did not state how often the apparatus needed to be disassembled for cleaning the rollers.

Bobrowski and Griekspoor (1992) (BG) designed a rolling device comprising two flat plates with the soil thread rolled between the top and bottom plate. The bottom plate has a recess to ensure that when the top plate impinges on the recess the soil threads are reduced to the diameter of 1/8 inch, see Figure 2.1. As with the Gay and Kaiser apparatus the main function of the BG device is to produce threads of 1/8 inch diameter. The remainder of the process they adopted was largely as standard with the crumbling of the thread as the criterion for the plastic limit.

Although these authors considered that a reasonable correlation with the hand rolling method was obtained this was only for soils with a plastic limit range of 12 – 20% with no tests conducted on soils with plastic limits greater than 20%. Even so, the plastic limits obtained with the BG rolling device were consistently below the hand rolling plastic limits.

Probably the main criticism of the BG rolling device and test method is that these authors emphasise that it is critical that paper, which does not add fibres to the soil, is attached to both the bottom and top plates in order to expedite the drying process and to stop the threads sliding rather than rolling. This has a number of significant disadvantages:

- 1) The soil threads cannot be seen so their behaviour cannot be continuously monitored during rolling. The top plate must be removed to view the specimens. If viewing is limited only to when the thread has reached the 1/8 inch diameter and crumbling of a thread occurs at a larger diameter this will be missed.
- 2) The roughness of the paper will resist the elongation of the threads during rolling, a phenomenon that Atterberg considered essential. The flatness of the plates will also resist the elongation of the threads.
- 3) It is not desirable to expedite the drying process. The water content should be maintained as constant as possible during rolling. The paper

will absorb water from the circumference of the thread, producing a dried crust and a non-uniform water distribution across the diameter.

These factors would explain why the BG rolling device consistently provides plastic limits lower than with the hand rolling method. A comparison of the BG rolling device with the standard hand rolling method was conducted by Rashid *et al* (2008) for soils with plastic limits greater than 20% (soils with w_p values of 23 – 51% were tested). They found that for the higher plasticity soils ($w_p > 30\%$) the BG rolling device gave plastic limit values generally lower than the standard hand rolling method by 3 – 7% points, probably as a result of excessive drying by the paper.

Conversely, one sample of lateritic soil gave a BG rolling device w_p value of 45% compared to the standard hand rolling w_p value of 34.9%. This suggests that the lateritic soil was weak and friable, with a high proportion of aggregations, typical in this type of soil. Premature crumbling of the soil thread (at a higher water content) under the pressure from the top plate in the BG rolling device probably resulted across the diameter because of restricted elongation along its length, as is fundamentally required, caused by the roughness of the paper and the flatness of the plates. With the hand rolling method elongation of the soil thread is not restricted so the thread could be rolled out by hand at lower water contents.

The BG rolling device was adapted by Temyingyong *et al* (2002) to move the top plate mechanically, with forward and back cycles at a rolling speed of between 103 and 128 cycles/min, with different weights applied to the top plate. To adjust the speed the voltage from a DC motor was varied. This motor was attached to an adapter connected to the upper plate to produce the forward and back action. The other variables investigated were different initial sizes of specimen, 5 and 7 mm diameter, and different roughness produced by a smooth and a coarse surface. It would appear that they did not use paper attached to the plates. As with the BG device a 3.2 mm rail was attached to the bottom plate to produce a soil thread of exactly this diameter. Three soil types were tested, described as a very cohesive soil, a moderately cohesive soil and a slightly cohesive soil but the origin of the soils whether inorganic or organic and classification tests such as particle size distribution, liquid limit and plastic limit of each soil were not provided.

This apparatus was not known by the author during the development of the Barnes apparatus and test. The latter apparatus is very different in that the threads are rolled between configured plates to encourage extrusion, the diameter for each traverse is recorded, the force applied for each traverse is controlled and recorded, the rate of force application is controlled, nominal stresses and strains are

determined for each traverse, a measure of toughness is obtained from the stress-strain plot for each water content, the toughness versus water content plot is produced at water contents above the plastic limit, the ductile-brittle transition is defined at the plastic limit and other toughness related properties are derived from the toughness versus water content plot.

Temyingyong *et al* (2002) used as their 'representative variable' a formula for a parameter they called 'rate of deformation' which could be seen as a rate of change of shape, being the final length to diameter ratio divided by the initial length to diameter ratio and the testing time, with units of 1/sec. Presumably the final diameter was that determined by the 3.2 mm rail. Unfortunately, it is difficult to understand the significance of their results. Their rate of deformation bears no relation to a ductile-brittle condition and no mention was made of the detection of a crumbling condition. Their statistical analysis showed that the initial diameter and the cohesiveness of the soil type were the most significant factors affecting the 'rate of deformation'. With a larger lump of more cohesive soil more work would be required to reduce its diameter and this would affect the rate of change of length to diameter ratio. The aim of their research appeared to be the control of the main influencing factors, the initial diameter and the soil cohesiveness, on the plastic limit value. The range of plastic limits before controlling these influence factors was 22 – 34% and after controlling them the plastic limits were reduced to a narrow range of between 28 and 30%. With three very different soils tested it is not clear why their plastic limits should be reduced to such a narrow range.

2.3 The strength-based plastic limit concept

Schofield and Wroth (1968) referred to the "...widely used and well-respected index test of soil engineering.", the liquid and plastic limits. They attempted to relate the strengths at the liquid and plastic limits using the critical state model by assuming that the undrained shear strengths at these limits are related by stating

"it will turn out ...that the reduction of water content is proportional to the logarithm of the ratio in which the pressure increased."

From the critical state model

$$q_{PL} = Mp_{PL} \text{ and } q_{LL} = Mp_{LL}, \quad 2.1$$

$$\therefore \frac{q_{PL}}{q_{LL}} = \frac{p_{PL}}{p_{LL}} \quad 2.2$$

and

$$v_{PL} + \lambda \ln p_{PL} = \Gamma = v_{LL} + \lambda \ln p_{LL}, \quad 2.3$$

so that the range of water contents between the liquid and the plastic limit, the plasticity index, is seen to be related to the shear strengths at these limits. In terms of the specific volume v

$$v_{LL} - v_{PL} = v_{PI} = \lambda \ln \left(\frac{p_{PL}}{p_{LL}} \right) = \lambda \ln \left(\frac{q_{PL}}{q_{LL}} \right) = \lambda \ln \left(\frac{c_{uPL}}{c_{uLL}} \right). \quad 2.4$$

The movement together of the two wedges of soil in the Casagrande cup was likened to a miniature slope failure and with a fixed number of blows applied to cause failure the soil can be deemed to have a fixed strength, q_{LL} or c_{uLL} , at the liquid limit. Now they needed to address the strength at the plastic limit. They stated

“In the plastic limit test the ‘crumbling’ of soil implies a tensile failure, rather like the split-cylinder or Brazil test of concrete cylinders: it would not seem that conditions in this test could be associated with failure at a specific strength or pressure.” but

“However, in a paper by Skempton and Northey experimental results [Figure 11 in Skempton and Northey, 1953] with four different clays give similar variation of strength with liquidity index..... From these data it appears that the liquid limit and the plastic limit do correspond approximately to fixed strengths which are in the proposed ratio of 1:100,....”

So, although they were sceptical about a fixed strength at the plastic limit they relied on the Skempton and Northey data to pursue their theory of a 100-fold strength ratio. However, they realised that the critical state model relied on the equations of straight lines in equations 2.1 and 2.3 being representative of real soils

“It is a direct consequence of the critical state model that a plot of this liquidity index against the logarithm of strength should give a straight line.”

Thus any deviation from the straightness of the q vs. p and v vs. $\ln p$ lines in the model will invalidate these authors’ model to the index properties.

In Table 6.1 of the book Schofield and Wroth presented data associated with the

critical state model for five soils and stated that for these soils the pressure p “...associated with the plastic limit are all very close to the same effective spherical pressure $p = p_{PL} \approx 80 \text{ lb/in}^2$ ”, (551.6 kPa). From the soil data the actual values p_{PL} (and p_{LL}) have been calculated and show a much wider variation, see Table 2.1. They ignored the wide range of pressures at the plastic limit and ignored the different result for the kaolin sample.

Wroth and Wood (1978) compounded this concept in the geotechnical arena and adopted the mean value of the vane shear strength at the liquid limit of 1.7 kPa from the data of Youssef *et al* (1965) and, therefore, the strength of 170 kPa at the plastic limit. Wroth (1979) argued that with the cone liquid limit method there would be expected to be virtually no variation in strength at the liquid limit, w_L , although Youssef *et al* (1965) had found that the vane shear strength at the liquid limit varied from 1.3 – 2.4 kPa over a range of liquid limits of 30 – 200%. Wroth and Wood (1978) assumed that the vane test gives the same undrained shear strength as the triaxial compression test⁵, which is not true. Using these arguments, Wroth and Wood arrived at a “best estimate” triaxial compression undrained shear strength of $1.7 \times 100 = 170 \text{ kPa}$ at the plastic limit.

Wroth (1979) suggested that the mean effective stress in a soil failing at its liquid limit can be taken as constant for all soils, at 3.3 kPa, and for a soil one-dimensionally normally consolidated to a water content equal to its liquid limit the major principal (vertical) effective stress σ'_v will be 6.3 kPa. Wroth (1979) assumed that the corresponding stress at the plastic limit will be 100 times as large, i.e. $\sigma'_v = 630 \text{ kPa}$ and, by definition, therefore, this value would pertain in all soils at the plastic limit. Wood (1983) acknowledged that the Skempton and Northey (1953) data related only to four soils⁶ and then invoked the data of Mitchell (1976) and stated “...it seems that if round numbers are shown for convenience then $R = 100$ and $C_{LL} = 1.7 \text{ kN/m}^2$ is not too bad a first shot”. This is hardly sufficient evidence on which to base a whole new concept. [R is the ratio of strengths between the liquid and plastic limits and C_{LL} is the undrained shear strength at the liquid limit].

Henceforth the 100-fold strength ratio has been adopted by several researchers into the plastic limit with the consequent development of a fall-cone method in an attempt to replace the hand rolling method. Thus it was assumed that the fall-cone is satisfactory as a means of measuring the strength at water contents approaching the plastic limit. Sharma and Bora (2003) seem quite adamant in their use of the

⁵ Also Youssef *et al* used the Casagrande percussion method to determine liquid limit which is found to deviate from the cone liquid limit beyond a liquid limit of about 60% (Sridharan and Prakash, 2000).

⁶ There were only three soils for which the data extended to the plastic limit value.

100-fold strength ratio with strengths of 1.7 and 170 kPa assumed at the liquid and plastic limits, respectively as they state

“ This⁷ has led to the redefinition of the plastic limit as the water content at which the undrained shear strength is around 170 kN/m².” .

Much justification is given by Sharma and Bora (2003) for assuming the strength of 1.7 kPa at the liquid limit but they admit that the only data used to justify the 100-fold increase is based on the results of Skempton and Northey (1953). The undrained shear strength at the plastic limit from their own data is not 170 kPa and is generally less (between 124 and 153 kPa⁸) and occasionally more (235 kPa). One of their figures even shows that for the Skempton and Northey data the undrained shear strength at the plastic limit is not 170 kPa; instead they plot the strength values between 124 and 141 kPa for the Horten, London and Shellhaven clays, see Figure 2.2.

Further examples of the application of this 100-fold strength ratio are: Harison (1988) who used the 100-fold strength ratio with undrained shear strengths of 1.1 and 110 kPa at the liquid and plastic limits, respectively, Dolinar and Trauner (2005) who cited the strength-water content data of Skempton and Northey (1953) and adopted the 100-fold strength ratio, Lee and Freeman (2009). Pandian *et al* (1993) followed the 100-fold ratio concept by assuming suctions of 5 – 6 kPa and 500 kPa at the liquid and plastic limits, respectively, from the suction data of Russel and Mickle (1970).

Stone and Phan (1995) devised a driven cone penetrometer and based their determination of the plastic limit on a 100-fold strength ratio. Stone and Kyambadde (2007) then introduced an additional parameter, PL_{100} , (additional to the standard plastic limit) equal to the water content of a soil with an undrained shear strength 100 x that at the liquid limit. Although they decry the strength ratio concept as a fallacy Haigh *et al* (2013) appear to condone the use of this parameter in the determination of a new plasticity index which they refer to as PI_{100}

$$PI_{100} = w_L - PL_{100} \quad 2.5$$

For the same soil, with two potentially different values of the liquid limit derived

⁷ Sharma and Bora state this as “The concept that plasticity index of soils can be defined as a range of water contents producing a 100-fold variation in undrained shear strength...”. Note that a ‘concept’ is defined (Collins English Dictionary) as “something formed in the mind; thought; general idea.” – not something founded on facts.

⁸ These values are scaled off Sharma and Bora’s plots of undrained shear strength vs. water content.

from the alternative tests of the cup and cone methods and two different values of the plastic limit from the rolling method and the cone method there can be four values of the plasticity index. The plasticity index is used frequently to produce correlations with other soil properties so introducing the potential for four values of the plasticity index will only produce confusion.

Koumoto and Houlsby (2001) state that Skempton and Northey (1953)⁹ suggested a strength ratio of 100. There is no indication of this suggestion or any written statement in Skempton and Northey's paper. The strength ratio of 100 could be an interpretation of one of their figures, Figure 11, but this would be flawed. Skempton and Northey's Figure 11 is cited by many researchers in the strength-based approach, and it is included herein, see Figure 2.2. It can be seen from this figure that there are no data points provided that could demonstrate the variability in the data and there are only three soil types reported which plot beyond the plastic limit. The values scaled off from Figure 11 are given in Table 2.2.

The values of undrained shear strength at the plastic limit for each of the three soils reported vary significantly and are some distance from Wroth and Wood's value of 170 kPa. The strength ratio at the plastic and liquid limits for each soil is not 100 and that the average value of the three strength ratios is close to 100 is coincidence and no justification for the many years of subsequent research founded on a strength-based approach to the plastic limit.

It is the author's contention that the plastic limit is not a strength-based water content but is the water content related to the distinction between a soil when it is ductile or plastic and when it is brittle or not plastic. There is only one plastic limit, at the ductile-brittle transition, not at an arbitrary shear strength value or at an arbitrary relation to the shear strength value at the liquid limit. This is considered further in section 2.4 below.

Another serious flaw in the previous researchers' justification for a strength-based plastic limit is that it is derived from the data for well-behaved clays, that lie above the Casagrande A-line and usually display good plasticity enabling the clay to behave as a continuum suited to the theories of shear strength expounded in the critical state approach to soil mechanics. The concept has not been tested for the more difficult soils such as those that lie below the A-line, with high silt and sand contents and soils that may be referred to as problem soils (Vaughan, 1998).

⁹ As well as "numerous subsequent authors".

2.4 Suction and effective stress at the plastic limit

The strength-based concept assumes that there is a unique value of undrained shear strength at the plastic limit and this, by definition, must apply for all soil types. The following demonstrates that at the plastic limit very different suctions and effective stresses have been determined by several researchers on a wide variety of soils.

Cronney and Coleman (1953) did not measure the suction¹⁰ at the liquid limit (it was much less than pF1¹¹ or less than 10 cm water) but at the plastic limit the suctions measured varied between pF3.3 – 3.9 (about 2 – 8 metres of water) for typical UK heavily overconsolidated soils (Gault, Kimmeridge, Lias, London, Oxford and Weald clays) and an Indian soil (Black Cotton Soil). All of these clays plot above the Casagrande A-line.

Rollins and Davidson (1960) investigated a correlation between the soil suction or soil moisture tension and the liquid and plastic limits. They found that the soil suction at these limits was far from unique but varied with the textural group of the soil, as summarised in Table 2.3. It can be seen that at the plastic limit (as well as at the liquid limit) a large difference (ten-fold) in suction values was reported between the soils that would be expected to have low toughness (the silty loam) and high toughness (clay).

Black (1961) showed that the suction at the plastic limit depended on the plasticity index, I_p , with an approximate suction pF2 (1 metre of water) at low plasticity ($I_p = 10\%$) to an approximate suction of pF3.5 (about 3.1 m of water) at high plasticity ($I_p = 75\%$). These plasticity indices reflect the clay content and the predominant clay mineral type such as the common clay minerals, kaolinite and montmorillonite.

Suction tests on samples of kaolinite and montmorillonite carried out by Dumbleton and West (1970) showed that at the respective plastic limits for these clay mineral types the suctions were about pF3.0 (10 m water) and pF3.6-3.8 (about 40 m – 63 m water) and at the respective liquid limits the suctions were pF0.6 (4 cm water) and pF0.8 (6.3 cm water). In terms of the ratios of suctions for kaolinite and montmorillonite the values are given in Table 2.4.

Using the data of Black (1962), Dennehy (1978) showed that the suction at the plastic limit varied significantly from about pF1.7 (50 cm water) for low plasticity

¹⁰ This is the matric suction represented by the difference in pore air pressure and pore water pressure, $u_a - u_w$.

¹¹ pF = log (cm water)

clays (Brickearth) to about pF 3.4 (2512 cm water) for very high plasticity clays (Gault Clay). At the liquid limit the suction is small and similar for all plasticity indices, pF0 to pF0.5 (0 to 3.2 cm water), see Figure 2.3.

From the plot of suction vs. water content in Brady (1988) it is estimated that for the sample of London Clay tested the suction at the liquid limit was pF0.8 (6.3 cm water) and at the plastic limit was pF3.4 (2512 cm water). Table 2.5, adapted from McBride (1989) also illustrates the wide variation of suction pF for various soils at the plastic limit.

Void ratio-effective stress plots from consolidation tests on clay slurries in Carrier and Beckman (1984) showed that at the plastic limit the effective stress in six clays (sodium and calcium kaolinite, illite and montmorillonite) varied between about 1500 kPa and about 4000 kPa. It seems significant that for the montmorillonite samples the plots did not reach beneath the plastic limit value even at the maximum pressure applied of 5000 kPa.

Some one-dimensional consolidation test results for four different soils (two residual soils, Black Cotton soil and a marine soil) were plotted by Nagaraj and DeGroot (2004) with the void ratio e , normalised to the void ratio at the liquid limit e_L , see Figure 2.4. By extrapolation to $e/e_L = 1$ these results show that there would be one value (or a very small range of values) of the vertical effective stress σ_v' for each soil at its liquid limit, at about 6.8 kPa. However, at the plastic limit of these soils the values of e_P/e_L , plotted on Figure 2.4, show that there is no unique effective stress at the plastic limit. With the same specific gravity the values of e_P/e_L are, in effect, equal to w_P/w_L . For these four soils the ratios of effective stresses at the plastic and liquid limits lie between about 40 and 100.

In summary, it can be seen that the suction and effective stress at the plastic limit are not constants, they vary significantly depending on the soil type, and that the ratios of suctions and effective stresses at the plastic and liquid limits do not have a single value of 100.

2.5 Criticism of the strength-based plastic limit concept

1) *Undrained shear strength at the plastic limit*

Casagrande (1932) showed that a strength-based plastic limit concept would be flawed when he stated

“There is a wide variation in the shearing resistance of different soils at the plastic limit...”.

He also confirmed that this statement was obvious to any soils specialist when he stated

“This difference may be felt by hand when performing the plastic limit test on various soils. For clays this difference is commonly expressed as difference in toughness.”

Four decades later Schofield and Wroth (1968) and then Wroth and Wood (1978) introduced their strength-based concept for the plastic limit. The following is a criticism of the strength-based plastic limit concept.

The discussion in section 2.4 demonstrates that the effective stress and the suction are not unique values for all soils at their plastic limit but they vary significantly. Also the ratio of strengths and suctions at the plastic and liquid limits is frequently different from 100, with values well above and below 100.

Feng (2001b) suggested that some of the high values of shear strength obtained at the plastic limit were a result of difficulty in using the vane test in such stiff materials. In reality, the vane test should not be used to determine the strength of stiff clays. In this respect the work of Dennehy (1978) is important. He carried out undrained triaxial compression tests on remoulded samples over a range of water contents and strengths, including very stiff clays, on a variety of clay soil types. Because this type of test produces fairly uniform stresses throughout a large mass of soil it gives the most representative value of undrained shear strength, c_u or s_u , and is preferred to the vane test.

The results of Dennehy (1978) show that the shear strength at the plastic limit of the clays tested varied widely, from about 30 to 220 kPa with no relationship between plastic limit and undrained shear strength, see Figure 2.5. In a similar vein, Black and Lister (1978, 1979) showed that at the plastic limit the undrained shear strength varied from about 50 kPa for low plasticity clay ($I_p = 15\%$) to nearly 400 kPa for extremely high plasticity ($I_p = 100\%$). The range of shear strength values at the plastic limit presented by Stone and Kyambadde (2007) was about 65 – 160 kPa even though they insisted on a 100-fold increase compared to the shear strength at the liquid limit which they assumed to be 1.7 kPa.

Stone and Phan (1995) developed a cone penetrometer with the 30° cone pushed

into the soil at a constant rate of 1 mm/s with measurement of penetration force and depth of penetration and conducted tests on a kaolin and a brown clay. Their approach was seriously affected by the inability to prepare suitable soil specimens sufficiently close to the plastic limit so specimens wet of the plastic limit were tested with extrapolation to a standard load and then to an assumed penetration at a strength-based plastic limit. The shear strength at the liquid limit was similar for the two soils but the shear strengths at their plastic limits were very different and far from the strength assumed by these authors, of 170 kPa, see Figure 2.6. For the kaolin the shear strength at the plastic limit was about 50 kPa, much less than the shear strength of 170 kPa at their PL_{100} value and for the brown clay the shear strength was about 210 kPa, higher than at their PL_{100} value.

It can be seen from Figures 2.2 and 2.7 that the plot of $\log c_u$ vs. liquidity index is not linear but displays a distinct curvature and becomes much flatter as the plastic limit is approached. This non-linearity has also been found by Wijeyakulasuriya (1990) and Wood (1985) and Stone and Phan (1995). Thus the strength ratio concept gives no information about and effectively ignores the variation of soil behaviour between the liquid limit and the plastic limit.

The flattening of the curve as the plastic limit is approached¹² may be a representation of the toughness limit found in tests using the Barnes apparatus and test. Figure 2.6 shows that a moderate break in the plot for the kaolin sample and a sharp break for the brown clay occur at a shear strength of about 10kPa, representative of a very soft consistency. It is suspected that this break occurs close to the toughness limit as found by the Barnes test, described in Chapter 4, because the soil at the start of this test, at the highest water content, has a very soft consistency but is sufficiently robust to form a soil thread for insertion in the apparatus¹³ and to develop greater toughness as its water content decreases.

Prakash (2005) criticised the use of a strength-based approach to both the liquid and plastic limits, such as at the oft-quoted values of 1.7 and 170 kPa, considering that they provided two water contents arbitrarily fixed without any rationale. Nagaraj *et al* (2012) also stated that there was no unique value at either the liquid or the plastic limit. The author agrees that the plastic limit water content is not arbitrarily fixed at a particular strength, from the tests conducted and the discussion in this thesis. However, the author does not agree that the plastic limit has no rationale as it occurs at a distinct ductile-brittle transition.

¹² A similar flattening in curvature is noted in many published plots of void ratio vs. log effective stress as the plastic limit is approached.

¹³ But not too sticky to adhere to the plates of the apparatus.

Haigh *et al* (2013) referred to the ‘strength fallacy’ by describing the assumption of a unique value of undrained shear strength at the plastic limit as invalid and the use of a strength test to find the plastic limit as highly unreliable. They found that the strength at the plastic limit could vary from 17 to 530 kPa.

In summary, it is the author’s contention that Casagrande’s (1932) account of the wide variation in shear strength at the plastic limit is confirmed.

2) The strength ratio at the plastic and liquid limits

According to Wasti and Bezirci (1986) it is too simplistic to assume a strength ratio of 100 and just rely exclusively on the Skempton and Northey data. They produced their Figure 6, see Figure 2.7, which shows that there is a much wider range of strengths at the plastic limit than given by the Skempton and Northey data. A summary of their data is given in Table 2.6. The 100-fold increase of shear strength may appear to have some meaning from the mean values obtained, but certainly not from the range of values.

Several authors have quoted the ratio as 100 and then produced contradicting data. For example, Feng (2000) cited Skempton and Northey (1953) in support of the 100-fold strength ratio but also referred to Karlsson (1961) who gave a strength ratio of between 50 and 100 for some Swedish clays and 200 for a quick clay and a varved clay and Whyte (1982) who suggested a strength ratio of about 70. Marinho and Oliveira (2012) believe that the strength ratio is “of the order of 100” but their data show a significant variation in the shear strength at the plastic limit.

Several authors have shown that the ratio is far from unique, at Schofield and Wroth’s ‘proposed’ value of 100. For example, Wijeyakulasuriya (1990) found that for kaolinitic soils the strength ratio between the hand rolling plastic limit and the cone liquid limit varied between 7 and 28 with a mean value of 18. Lawrence (cited in Wood, 1982) found a strength ratio for speswhite kaolin considerably less than 100. Nagaraj *et al* (2012) showed that the strength ratio could vary from 15 to 295. Vinod *et al* (2012) found that the strength ratio was 32 – 34. Dumbleton and West (1970) obtained very different vane shear strengths on kaolinite and montmorillonite samples and at the plastic limit and very different strength ratios at the plastic and liquid limits, see Table 2.7.

The assumption of a 100-fold increase in shear strength from the liquid to the plastic limit was considered to be a likely source of error by Brown and Downing (2001) when applied to the use of the fall cone to determine the plastic limit. These

authors found the strength ratio from their test results to vary between 15 and 397 with a mean value in the region of 140. Feng (2000) showed that the strength ratio affects the estimated plastic limit determined from his fall cone method by around 10 – 20% of w_p , except for bentonite where the data were limited.

3) *The influence of the soil type*

It appears that the clay mineral present in a clay soil results in different strengths at the plastic limit and different strength ratios, with lower values reported for soils containing kaolinite compared to soils containing montmorillonite. For natural clay soils which can contain varying proportions of kaolinite and montmorillonite (as well as illite) this may explain, to some extent, the wide variation in shear strength that is obtained at the plastic limit. It probably also explains Casagrande's (1932) view that clay soils differ in toughness (and shear strength) at the plastic limit. Thus soils with a high proportion of kaolinite in the clay portion will not comply with the relationship assumed by Wroth and Wood and their followers.

Kayabali (2011) conducted a large number of vane shear strength tests on a range of soil types at their plastic limits. He was not wrong when he stated that "...the values [of shear strength at the plastic limit] scatter around 100 kPa", implying that the values were near to 100 kPa. What he did not show was the degree of the scatter beyond the value of 100 kPa, see Figure 2.8, which shows that he was wrong when he stated "This value [of 100 kPa] appears to be in agreement with the range of 105 – 110 kPa, reported by four other researchers (i.e. BSI, 1948¹⁴; Skempton and Northey, 1953; Dennehy, 1978; Arrowsmith, 1978)".

Of interest, is that Kayabali's data show that for those soils that plot below the A-line on the Casagrande plasticity chart the shear strengths at the plastic limit are generally lower than for those soils that plot above the A-line, see Figure 2.9. There is also a general trend of decreasing shear strength at the plastic limit with increasing plastic limit.

2.6 Proponents of the fall cone method to determine the plastic limit

Wood and Wroth (1978) gave the central relationship for the fall-cone undrained shear strength, as derived by Hansbo (1957), as

¹⁴ This is the 1948 British Standard on soil testing but it does not contain the strength information Kayabali refers to.

$$c_u = \frac{kW}{d^2} \quad 2.6$$

where W is the weight of the cone, d is the depth of penetration and k is a cone factor. The cone factor is a function of the cone angle and its surface roughness according to Houlsby (1982) and Wood (1985) although soils of low plasticity ($I_p <$ about 20%) could also affect the cone factor obtained. The latter point could be due to the presence of coarser particles in the soil such as silt or sand making for a rougher interface and/or a more resistant soil to penetrate.

Thus, if a strength-based approach is assumed for the determination of the liquid and plastic limits the fall-cone test can be used to determine these water content 'limits' by adjusting the cone weight and assigning a penetration depth when the relevant 'limit' shear strength is achieved. This approach has been adopted worldwide for the liquid limit test as it is generally agreed that a soil has a near unique strength at its liquid limit. For example, Wroth and Wood (1978) proposed $c_{u1} = 1.7$ kPa at the liquid limit. However, Youssef *et al* (1965) and Wood (1982) showed that this strength was not unique but decreased slightly with increasing liquid limit. Nevertheless, the fall cone has been adopted as the preferred method to determine the liquid limit of a soil (ISO/TS17892-12:2004; BS1377:1990).

Wood and Wroth (1978) proposed from the Skempton and Northey (1953) data that the strength at the plastic limit is 100 times that at the liquid limit and this permits the use of the above equation for the fall-cone plastic limit by adjusting either the weight of the cone or the depth of penetration, or both. However, the relationship between water content and a function of cone penetration has been found to be highly non-linear (Wood, 1985; Wasti and Bezirci, 1986; Harison, 1988; Feng, 2000) and this has led to a range of cone angles, weights and penetration depths proposed by several researchers to determine the cone plastic limit. The flaws with the fall cone method to determine the plastic limit are discussed in section 2.6.

Medhat and Whyte (1986) devised a constant rate of penetration¹⁵ cone with a cone angle of 30° and produced cone force vs. penetration depth plots similar to the stress vs. strain curves in the Barnes test. The plastic limit was strength-based at a strength of 110kPa. They considered that the force on the cone required to produce a penetration of 10mm could form the basis of a plastic limit test. At least this is a measurable penetration but could require high forces for the tougher/stiffer clays at the true plastic limit. The soil was statically compacted into a container similar but stronger than the liquid limit cup. They illustrated that for Flixton Clay ($w_p =$

¹⁵ The rate of penetration was not reported.

24%) plastic penetration of 10 mm could be achieved at water contents above the plastic limit but at water contents below the plastic limit a much stiffer response was obtained. Thus a ductile-brittle transition may have been deduced from their results. They considered that their data suggested that the results were not significantly affected by the strength assumed for the plastic limit within the range 110 to 170 kPa.

Using only Skempton and Northey's data Harison (1988) observed that the plot of liquidity index vs. shear strength was not linear and proposed two straight lines with a break at the liquidity index of 0.77. On his plot of water content vs. log cone penetration he suggested that there was a straight line relationship between penetrations of 14 mm and 2 mm, the latter being where he considered that the plastic limit occurred. He proposed that BS cone tests with water contents giving penetrations of about 14, 10 and 5 mm could be used to extrapolate to 2 mm. Feng (2000) questioned this approach and found that an under-estimate of the plastic limit would occur. In his reply to Wijeyakulasuriya's discussion (1990) Harison (1990) stated that the fall-cone has a limitation because it can only give acceptable penetration measurements greater than 5 mm; below this they are unreliable.

For the driven cone penetrometer devised by Stone and Phan (1995), based on a 100-fold strength ratio and with the mass used for the liquid limit test of 80 g, these authors defined the plastic limit as the water content at which a 8 kgf load is supported by a soil at a penetration depth of 11.55 mm. Due to the depth of the cup containing the soil the penetration depth was limited to 30 mm so extrapolation is required of some of the load-penetration plots to reach the load of 8 kgf. As the soil at water contents near the plastic limit could not be prepared in the cup due to its stiffness further extrapolation was required on the water content vs. penetration plot to achieve the penetration criterion of 11.55 mm. For a sample of kaolin clay the smallest penetration measured was about 27 mm so such considerable extrapolation (to 11.55 mm) is bound to result in errors, particularly in view of Harison's (1988) results where a bilinear relationship is proposed below a penetration of 14 mm.

Stone and Kyambadde (2007) refer to the plastic limit determined from a strength basis, with a strength ratio of 100, as an additional index parameter, PL_{100} , additional to the standard plastic limit. However, for the test on the kaolin and the brown clay conducted previously (Stone and Phan, 1995) the strengths at the PL_{100} values were very different from the strengths at the thread rolling plastic limit values, see Figure 2.6. Their results showed that they extrapolated to the penetration depth of 11.55 mm from penetration data that did not extend below 25 mm, making the

results rather tenuous. In general, the cone plastic limits were less than the thread rolling values. Feng (2000) suggested plotting the water content vs. penetration data on a log-log plot. He proposed for his fall-cone apparatus that the plastic limit is the water content at a penetration depth of 2 mm and gave the expression

$$w_p = c(2)^m \quad 2.7$$

where c and m are coefficients. It is noted that very few of Feng's test results extended to a penetration of 2 mm so extrapolation was necessary. Feng's fall-cone plastic limit was found to lie within 0.8 to 1.2 times the hand rolling result with an average value of 1.0. Feng stated that the fall-cone method is much more reliable than the conventional plastic limit test. Feng (2001a, 2004) also proposed a one-point method for determining the fall-cone plastic limit by giving a general expression between water content and penetration, from equation 2.7, as

$$w = c(d)^m. \quad 2.8$$

Dividing equation 2.7 by equation 2.8 to eliminate the c value and using an average m value of 0.265 (the range of values of m was reported as 0.174 to 0.395) Feng gave an expression of

$$w_p = w \left(\frac{2}{d} \right)^{0.265} \quad 2.9$$

so that the plastic limit could be derived from one pair of water content and cone penetration values. This is a tenuous step and one too far in the author's opinion.

Dolinar and Trauner (2005) showed that the relationship between water content and depth of cone penetration was non-linear but they considered that it became linear on a log-log plot. They used Feng's (2000) relationship between water content and depth of penetration to arrive at a strength-based plastic limit value for a penetration depth of 2 mm. Again, they only cited the strength-water content data of Skempton and Northey (1953) and assumed the 100-fold strength ratio. Their fall-cone plastic limit was found to depend on the specific surface of the clay soil, and the size and quantity of the clay minerals present.

Koumoto and Houlsby (2001) proposed the use of a 60 g 60° cone with a penetration of 10 mm to give the fall-cone plastic limit. They also found that the plot of $\log c_u$ vs. water content is curved and expressed extrapolation on the $\log d$

vs. log water content plot as the clear advantage. Sharma and Bora (2003) conducted fall-cone tests for the plastic limit with a 3.92 N 30° cone and a penetration of 4.4 mm. They reported a good correlation with the standard hand rolling method but examination of their data shows that compared with the standard method their fall-cone plastic limit was often below the value from the standard thread rolling method, particularly for the bentonite samples.

The relationship between liquidity index and log cone penetration depth was found to be “clearly non-linear” by Muntohar and Hashim (2005) and they chose to use a non-linear best fit curve through their data to extrapolate to a cone penetration depth of 2.2 mm for the plastic limit value. They stated that a “very strong” correlation was obtained. However, this was based on 28 pairs of data (liquidity index and cone penetration depth values) which would be far too many for commercial application. Three of their data points were at a liquidity index value of zero (at the plastic limit) yet gave penetrations between 4 and 7 mm.

Using a 80 g 30° cone with the capability for rapidly changing the cone weight Lee and Freeman (2009) devised a dual-weight fall-cone method to determine both liquid and plastic limit. They plotted water content vs. the square root of penetration depth and obtained straight lines. They assumed the 100-fold strength ratio and used the water content at a penetration of 2 mm for their fall-cone plastic limit. Most of their fall-cone tests gave plastic limit values below the ASTM thread rolling method (ASTM D4318-10).

Based on the British Standard fall-cone apparatus for the liquid limit Sivakumar *et al* (2009) devised an apparatus that provides a force to the liquid limit cone equivalent to the application of a 54 N fast-static load via a cylinder and piston arrangement and a pressure supply applying a pressure of about 30 kPa to the piston. Their fall-cone plastic limit is derived as the water content when the cone achieves a penetration of 20 mm. On application of the force to the cone, the penetration of 20 mm occurred within the first reading, taken at 15 s, so the value of penetration at 15 s was adopted.

The samples were prepared by placing the soil in layers inside the liquid limit cup and applying compaction by tamping with a smaller diameter (25 mm) brass rod. Trials were conducted to ensure that the tamping process produced repeatable bulk densities at given water contents. At least in this way a specimen can be prepared at and even below the plastic limit unlike several of the other fall-cone methods published where the stiffest specimens were at water contents above the plastic limit and extrapolation to the plastic limit of their penetration depth vs. water

content plots was required. However, for soils below the plastic limit, from correlations with the Proctor optimum water content ($w_{opt} \approx 0.9 w_p$ is a commonly found relationship) the level of compaction needs to be comparable to the standard Proctor energy otherwise a significant air voids content may be present.

Figure 2.10 shows the cone penetration vs. water content close to the plastic limit for the soils tested by Sivakumar *et al* (2009). Linear relationships were inferred by these authors but there was no indication of a change of state above 20 mm penetration (when the soil is assumed to be ductile or plastic) and below 20 mm (when the soil is assumed to be brittle). These authors did not comment on the state of the stiffer soil specimens in the cup following such a large penetration. It is suspected that some fracturing and bodily displacement occurred instead of the neat plastic deformation assumed in the fall-cone theories.

With the previously described fall-cone methods conducted at water contents above the plastic limit the soil would be more ductile and move away from the cone. However, with Sivakumar *et al's* device, at water contents just above the plastic limit the soil will be stiff and below it will be brittle so it would be expected that rapid penetration of the cone would disrupt the soil around the cone producing cracking of the soil which is likely to affect the results obtained. There is also a possibility of the layers compacted into the cup separating under the impact of the cone as the interface between layers could be quite smooth and discontinuous; this was not reported.

Sivakumar *et al* (2009) stated that a reasonable agreement was found between the values of their fall-cone plastic limit and the thread rolling plastic limit. However, the data from Table 3 of their paper are plotted on Figure 2.11. This shows that there is little correlation between their fall-cone plastic limit and the thread rolling value, with their fall-cone method usually giving much higher plastic limits. These authors understate this: "...the cone value [of plastic limit]...may be slightly on the wet side of the standard plastic limit.". From Figure 2.11 it can be seen that their fall-cone plastic limit values are more than slightly on the wet side of the standard plastic limit. The four operators who conducted the tests are described as 'trained' but the significant differences in the hand rolling plastic limit values obtained for the same soils by these operators are unacceptable.

2.7 Criticism of the fall cone method to determine the plastic limit

Mitchell (1961) found it impossible to prepare samples at the plastic limit for the fall-cone test because, as he rightly stated, the soil crumbles at this water content.

He had to resort to preparing a ½ inch cube of soil near/at the plastic limit for the cone penetration. As a result his cone tests gave consistently higher water contents at the (apparent) plastic limit than with the standard thread rolling method and Mitchell concluded that the plastic limit could not be determined satisfactorily by the cone penetration method. This did not prevent others from trying, encouraged by the Wroth and Wood (1978) paper.

Campbell (1976) inadvertently demonstrated the severe difficulties in preparing soil specimens at water contents close to the plastic limit. He used a 80 g 30° mass “drop” cone (same as a fall-cone) on soils at water contents in the region of the plastic limit. He stated that the relationship between water content and cone penetration was non-linear at low water contents. Each specimen was prepared from air dried soil wetted to give a range of water contents (above and below the plastic limit) and then ‘packed’ into a metal cup. The results resembled an inverted compaction curve with much curvature near the plastic limit, see Figure 2.12. Campbell considered the ‘turning point’ in these figures (as with the optimum water content in the compaction test) as the relevant fall-cone plastic limit.

However, it is considered that Campbell’s ‘turning point’ is more related to the optimum water content of the soil in a compaction test. The tests conducted on the dry side of the thread rolling plastic limit (P.L. on Figure 2.12) would have low degrees of saturation and high shear strengths and high resistance to cone penetration producing a false impression of the soil behaviour. According to Campbell *et al* (1980) the fall cone approach to the plastic limit gave values consistently below those from the hand rolling method, by 3 to 12% with a mean difference of 8% points. This is unsatisfactory.

Davidson (1983) discussed Campbell’s ‘turning point’ approach, by expressing concern with the preparation of the samples, in particular:

- 1) Packing of the soil pieces into the cup, especially when stiff and brittle.
- 2) Soil water equilibration throughout the specimen before testing.
- 3) Some of the soils tested higher cone penetrations were obtained at the same water content suggesting softening due to remoulding.
- 4) Re-wetting. The soil had been allowed to partially air dry and was then re-wetted. Some aggregations within the soil or clods of soil, possibly as a

result of an organic content in the soils tested¹⁶, may have been produced during drying that were not broken down and rehydrated on wetting so insufficient water was present compared to the fully remoulded and therefore more uniformly hydrated soil used for the hand rolling plastic limit tests.

Davidson (1983) suggested a maturing/curing period of 24 hours for each sample in the cup but then stated that the test would take 3 weeks if fifteen points were to be plotted. He referred to chemical and biological processes that can take place during curing, affecting the results. He also noted a change in pH during curing for one soil tested, although these changes would be more significant because organic soils were used for the testing.

Houlsby (1982) showed theoretically that the single most important factor affecting the liquid limit test is the roughness of the cone and suggested that a cone factor k of 1.9 should be applied to the resistance to penetration between a perfectly rough cone and a smooth cone. It is not clear how rough or smooth the standard cone surface is but this analysis shows that wear of the cone surface during continued use will gradually affect the results. At water contents near the plastic limit the roughness of the cone would be expected to have a greater effect because the shear stress between the cone surface and the soil, usually referred to as adhesion, would tend to be greater for stiffer soils and rougher surfaces.

The results of Wasti and Bezirci (1986) using the fall-cone method as proposed by Wroth and Wood (1978) show inconsistent results with scatter of the fall-cone plastic limit values each side of the standard plastic limit values, with a difference of about $\pm 6\%$ points. Wijeyakulasuriya (1990) also used the fall-cone method and found the fall-cone plastic limit results to be always lower than from the thread rolling method. He suggested that the discrepancy is caused by the inaccurate linear extrapolation on the plot of water content vs. penetration and the variation in the value assumed for the strength ratio.

Wood (1983), in discussing his previous paper (Wood, 1982), admits that he was “not interested in discovering tests which might lead to values of plastic limit” and was “perhaps seeking to abandon the plastic limit”. Instead he was interested in a rational interpretation of cone tests which permit the relationship between strength and water content to be deduced. Significantly he recognised that the fall cone test was not suited to determining the plastic limit when he stated

¹⁶ Campbell was a researcher in the agricultural field.

“It is not clear how the cone penetration plastic limit gives an indication of the water content at which a soil changes from the brittle to the plastic state.”.

The main contribution of Feng (2000) to the fall-cone method was in the preparation of a suitable specimen for testing. He prepared a large well-mixed mound of soil and pushed a steel ring 55 mm diameter and 20 mm high into the soil mound for tests at penetrations less than 10 mm. Five operators each conducted a fall-cone test on a sample of clay soil and obtained plastic limits between 23 and 26% compared to a thread rolling result of 25%. Feng (2004) adapted the ring to a smaller size of 20 mm diameter and 20 mm high but still could not produce penetrations less than 3 mm as the soil was too stiff and brittle for smaller penetrations. However, Feng’s results show that the tests were stopped when the penetrations reached about 4 mm and several only reached 5 mm. Thus extrapolation to the penetration of 2 mm required for his apparatus is even more prone to error.

With so many different cone designs (mass, angle), methods of applying the force into the soil and interpretations of the water content vs. penetration data it is not surprising that different results for the plastic limit are obtained and because of this it seems unlikely that any one method would be acceptable universally. For example, Koester (1992) pointed out that the only country using the fall-cone device to derive a value of the plastic limit was the People’s Republic of China (PRC). Koester conducted a comparison of the plastic limit values using the PRC fall-cone and the ASTM thread rolling method. He found that for a wide range of soil types (mostly lying above the A-line) the PRC fall-cone gave plastic limit values comparable to the thread rolling values although some cone values were much higher than the thread rolling values.

Brown and Downing (2001) explained that the cone factor k in Equation 2.6 is not constant, particularly for the stiffer soils with vane shear strengths above about 50 kPa. They found widely varying cone factors, see Figure 2.13. The reason for much of the variation could be attributed to the use of the vane test to measure shear strength of the soil, particularly at the higher values. Note that a soil with a strength greater than 150 kPa would be described as very stiff and a soil with a strength greater than 300 kPa would be referred to as hard (BS5930:1999). They suggested that the Feng (2000) method may not commercially replace the thread rolling plastic limit test due to the considerable expertise required to prepare the stiff samples and the time required to air dry the soil to a plastic limit water content. They also believed that the Harison (1988) relationship of water content vs.

log cone penetration between penetrations of 14 mm and 2 mm does not give a good prediction of the plastic limit.

Prakash and Sridharan (2006) asserted that the cone method should not be used for the determination of the plastic limit or the liquid limit. They showed that there are distinct differences between the fall-cone method and the Casagrande (percussion cup) method for the liquid limit for soils with liquid limit above about 60%, although a reasonable correlation exists below this value. Whichever method is used the difference must be recognised, particularly if the values are plotted on the Casagrande plasticity chart. These authors suggested that the fall-cone method can give a plastic limit 'value' even for non-plastic soils because penetration can still be achieved into these soils. Instead, they considered that reproducible plastic limit results can be obtained with the thread rolling method providing the test is conducted with strict adherence to the standard procedure (ISO/TS17892-12:2004; BS1377:1990).

These authors also recognised that there are differences in behaviour between soils of low and high plasticity with the soils of low plasticity being dominated by kaolinite in the clay portion and high silt/sand contents and those of higher plasticities containing montmorillonite particles. They considered that it is perhaps not feasible to conduct the same test on both types of soil unless this difference is recognised.

Kyambadde and Stone (2012) reported the results of fall-cone tests and quasi-static cone penetration tests on mixtures of fine gravel and highly plastic clay and described their (the authors) research on the influence of gravel on the undrained shear strength and the index properties of a clay soil using cone penetration tests to give the PL_{100} value based on the 100-fold strength concept. In response to this paper the author (Barnes, n.d.) prepared a discussion contribution that was accepted for publication in the Proceedings ICE Geotechnical Engineering.

The discussor (Barnes) pointed out that with two series of extrapolations, the first to the penetration at a high load and the second to the penetration at the presumed plastic limit there was too much room for error. The authors (Kyambadde and Stone) agreed with previous researchers (Kumar, 1996; Kumar and Wood, 1999; Wood and Kumar, 2000) that the clay phase or matrix controls the liquid limit behaviour of the mixtures for clay contents above about 35% with the coarse particles (sand, gravel) making no contribution. This behaviour would comply with the relationship referred to as the 'linear law of mixtures'.

There is no reason why the plastic limit values should not follow the linear law of mixtures although with the lower water contents at this limit the plastic limit values would deviate from the linear law at lower gravel contents as there will be less clay-water matrix between the gravel particles than at the liquid limit. The discussor found that these authors' plastic limit values derived from their cone tests and the strength ratio concept, deviated from the linear law at even the lowest gravel content tested of 15%. This was due to their inaccurate extrapolations.

The authors considered that the presence of gravel contents less than 45% will have no effect on the cone penetration but the discussor showed that there is a significant measurable effect.

In summary, the discussor considered that there are important objections to applying the results of cone tests to determine the undrained shear strength of a clay soil at low water contents and to those containing gravel particles.

The main criticisms of the fall-cone test to determine the plastic limit can be summarised as:

- 1) The incorrect assumption of a unique undrained shear strength at the plastic limit.
- 2) The incorrect assumption of a 100-fold strength-based ratio at the plastic and liquid limits.
- 3) Difficulty in preparing a suitable homogeneous saturated test specimen.
- 4) The uncertain effects of differences in the cone design and test method.
- 5) The uncertain relationship between water content and penetration depth.
- 6) The need for significant extrapolation on the water content vs. penetration plots.
- 7) Tests have not been conducted on soils other than the well-behaved, above A-line clays, such as silts, organic soils, micas, halloysite etc.

2.8 Alternative tests proposed for the plastic limit

Tests other than the thread rolling method and the fall-cone method have been

proposed for the determination of the plastic limit. Some examples are given below.

The cube method was devised in the 1930's to assess the plastic limit of soils, particularly those of low plasticity that did not lend themselves to the thread rolling method (Abdun-Nur, 1960). The test comprises moulding moist soil into a cube of $\frac{3}{4}$ inch side and pressing opposite faces between the fingers or under some weight on a glass plate and remoulding and drying until the cube develops cracks under the deformation when it is assumed that the plastic limit has been reached.

Alternatively, a smaller cube, $\frac{1}{2}$ inch side, was used with crumbling as the plastic limit criterion. A good correlation with the thread rolling method was obtained. In the author's opinion, if the cube had been alternately squeezed on perpendicular faces giving it a compression-tension cycling, closer to the thread rolling cycles, a clearer assessment of cracking/crumbling could have been achieved.

Medhat and Whyte (1986) referred to a 'brittle limit' as a water content when the soil has an undrained shear strength of 110 kPa. They assumed a fairly consistent relationship between water content and $\log c_u$ and conducted extrusion tests and fall-cone tests. For the extrusion tests they stated that the steady state extrusion pressure $p = P/A$ is related to the shear yield stress of the clay and the die area reduction ratio A/A_0 where A is the area of the extrusion cylinder and A_0 is the area of the orifice and P is the steady state punch load. They produced relationships of

$$p/c_u = 0.25 + 5.3 \ln A/A_0 \quad \text{for direct extrusion} \quad 2.10$$

$$p/c_u = 0.50 + 5.8 \ln A/A_0 \quad \text{for reverse extrusion} \quad 2.11$$

The device could be designed such that a pressure p could be found at the particular c_u of 110 kPa which would be deemed to be for a soil at its plastic limit. The advantages of this device would be its simplicity and reduction of operator interference but it would suffer from uncertainties about the p/c_u ratio which could vary for different soils and the assumed strength of 110 kPa at the plastic limit, see section 2.4. The extrusion properties will be related to the ductility of the soil but the limit of this ductility (brittleness) would not be established by the apparatus. Refusal to extrude could be considered as a criterion but this would have to be at very high, probably unachievable or unsafe, pressures. Further, difficulties of sample insertion, risk of the punch jamming, and cylinder maintenance would be made more difficult as the plastic limit is approached when the soil becomes stiffer.

From void ratio vs. log pressure plots of consolidation data on remoulded clays

Youssef *et al* (1965) suggested that most of the clays tested reached their plastic limit when consolidated at a pressure of 10 kg/cm² (981 kPa). For the clays tested there was some correlation but the consolidation test plastic limits (at a pressure of 10 kg/cm²) were +5 to -7 % away from the thread rolling values. This approach gives no information about a change of state from a plastic to a brittle soil.

Also using a consolidation apparatus Nuyens and Kockaerts (1967) found that for soils with less than 40 % clay contents consolidated from a semi-liquid state the plastic limit was provided by the water content at a consolidation stress of 14.4 kg/cm² (1413 kPa). The soils tested were low plasticity soils with high silt/sand contents. This test has no relation to a ductile-brittle transition and is more relevant to a strength-based approach. Given the time required to conduct this test and the likely variation of the data (the pressure of 14.4 kg/cm² was only an average value for a range of soils) this sort of test has little chance of becoming standard.

McBride and Bober (1989) also adopted a consolidation approach using a Rowe cell to consolidate a soil along the virgin compression line (VCL). They used the same sample preparation method as Faure (1981) with air-dried pellets of soil saturated/soaked by swelling in a water bath and then transferred as slurry to the Rowe cell. It was found that the vertical effective stress σ_v' at the plastic limit for a range of soils varied between 0.26 and 1.84 MPa whereas σ_v' at the liquid limit varied between 3.9 and 268 kPa, depending on the clay and organic contents. They correlated the relevant effective stresses with the clay and organic contents and produced related equations. These authors recognised that this test, as a standard procedure had time and preparation difficulties and would require further research. McBride and Baumgartner (1992) followed this with a more refined slurry consolidometer and found that the ASTM liquid and plastic limits occupied relatively fixed positions on the VCL at mean effective stresses of about 61 and 429 kPa, respectively.

Because he considered that the plastic limit could not be defined 'scientifically' in terms of shear strength Uppal (1966) stated that the thread rolling test had remained as an empirical one since Atterberg's method was first introduced. Describing the thread rolling plastic limit test as a 'crude country test' Uppal instead attempted to show that the water content at the plastic limit had a scientific basis in terms of the suction in the soil. Based on a water content vs. suction curve he proposed that the plastic limit is the water content at a suction of pF0.5 (3.2 cm water) on the wetting curve and pF1.5 (31.6 cm water) on the drying

curve. Thus his method can give two values for the plastic limit. From section 2.3 it is shown that the suction at the plastic limit depends on the soil type. Also this test is lengthy, taking 40 – 45 hours, and has no relationship to a change of state from ductility to brittleness.

McBride (1989) used a similar suction approach with a desorption procedure based on a water retention model and produced similar equations to those of McBride and Bober (1989). Using a porous plate apparatus to determine soil water tensions Rollins and Davidson (1960) obtained a reasonable correlation for liquid limit with a soil suction value largely because the suction at the liquid limit is quite small. However, at the plastic limit much higher suctions must be measured and there is a wide variation in suction depending on the nature of the soil particles. Given the wide range of suctions found at the plastic limit for different soils, as shown in section 2.3 above, these tests and methods could not become an accepted standard.

Cannon and Wynn (1999) used a moisture analyser, which applied infra-red radiation heating, to record the rate of drying of a thin specimen (7 mm high, 90 mm diameter) of clay as the water content decreased. Their plots of rate of drying¹⁷ vs. water content give no information on the clay's plasticity behaviour. The authors tenuously claim that the plastic limit can be found at an increased rate of drying but from their data this is at such low water contents (about 5 - 6 %) to be even below typical shrinkage limit values so this test method is quite misleading.

It has been suggested that the plastic limit test need not be carried out at all because there is a relationship between the plasticity index and the liquid limit according to Fall (2000). His empirical expression is

$$I_p = w_L (1/g)^{1/3} \times (0.67 - 0.001w_L) \quad 2.12$$

where g is the gradient of the water content vs. penetration line from the cone liquid limit test, similar to Casagrande's flow index, F , the gradient of the water content vs. number of blows in the cup liquid limit test. Equation 2.12 is not dimensionally correct. A reasonable correlation was obtained for I_p values in the range 15 – 80%, although the predicted values could be within $\pm 4\%$ points of the standard thread rolling method. This approach may apply to common clays above the A-line on the Casagrande plasticity chart but has yet to be proved for those soils that lie elsewhere on the chart.

¹⁷ The units of rate of drying are given as gcm^{-1} but their work does not explain this value.

Nagaraj (2000) also proposed “dispensing with the determination of plastic limit by the thread rolling method” by means of a correlation between plasticity index and the fall-cone penetrometer flow index, the gradient of the water content vs. cone penetration plot. This correlation may apply to some extent for soils that lie above the A-line but as the plasticity index is not the only parameter related to soil type, correlations would be necessary for all of the soils below the A-line not just above.

2.9 Summary

Alternatives to the thread rolling method by hand have been devised such as the motorized rolling apparatus (GK) of Gay and Kaiser (1973) and the simple rolling device (BG) of Bobrowski and Griekspoor (1992), automated to some extent by Temyingyong *et al* (2002). These machines produce rolling of a soil thread to a specific diameter but the detection of the crumbling condition is very poorly addressed. Although the BG apparatus is permitted in the ASTM standard method it has serious flaws which are discussed.

Ever since Schofield and Wroth (1968) and, in particular Wroth and Wood (1978), proposed a strength-based concept by assuming that the undrained shear strength ratio of a soil at its plastic and liquid limits is 100 based on tests on three soils in a figure in Skempton and Northey (1953) many researchers have latched on to this concept without much criticism and have tried to devise a method to determine the plastic limit at a strength value using the fall-cone apparatus. The undrained shear strength of a soil at its liquid limit has been found to lie within a narrow range and Wroth and Wood proposed a unique value so that the strength they adopted at the plastic limit would also be a unique value. This may be a convenience to suit these authors' mathematics but it is basically flawed.

Casagrande, in 1932, reported a wide variation in strength at the plastic limit and referred to this as soils with different toughnesses. However, he has been ignored by several researchers even though others have published data that show a wide variation in strength at the plastic limit. It is shown in this chapter that the wide range of fall cone and mechanically operated cone devices adopted by the researchers provide unsatisfactory measures of the undrained shear strength and misleading values of the plastic limit of soils.

Over fifty years ago Mitchell (1961) demonstrated that it is impossible to prepare a soil specimen at its plastic limit for use with the fall-cone apparatus because at this water content the soil is in a crumbling condition. He concluded that the plastic limit could not be determined satisfactorily by a cone penetration test.

Subsequent researchers have also found difficulties in preparing soil specimens at the lower water contents when the soil is in a stiff condition. They have compromised by testing soils with a range of fall-cone devices at water contents above the plastic limit and then making a range of extrapolations to a theoretical deduction of the cone penetration at the plastic limit. If soils are not tested at water contents below the ductile-brittle transition, as in these cases, then the transition has not been found.

Several researchers have shown that the suction in a soil at its plastic limit compared to at its liquid limit is far from the 100-fold ratio. Although a small range of suction values has been found for soils at their liquid limits a much wider range of suction values has been found for soils at their plastic limits, largely depending on the clay mineral type and clay content, with particularly higher suctions at the plastic limit when montmorillonite is present.

Published results are also available to show that the effective stress at the plastic limit has widely varying values for different clay minerals. Several researchers have shown that the undrained shear strength at the plastic limit, for a wide range of soils, varies considerably from a soft consistency to a very stiff consistency with no relationship between the shear strength and the plastic limit.

Thus there is no unique value of suction, effective stress or undrained shear strength at the plastic limit for all soils.

The strength ratio concept also ignores the strength behaviour of the soil in the region between the liquid and plastic limits. The undrained shear strength – water content relationship is distinctly curved in this region and from close inspection of published data it is suspected that the relationship is mirrored in the results of the Barnes test with a distinct increase in shear strength at water contents below the toughness limit, see below. Similarly, the region between the liquid limit and the plastic limit has all been referred to as plastic, a uniform condition. However, from inspection of published data and the research described in this thesis it is considered that this region can be separated into three regions, an adhesive-plastic (or viscous-plastic) region, a soft-plastic and a stiff-plastic region.

The fall cone apparatus and its interpretation have been adapted by several researchers in an attempt to obtain a value of the plastic limit based on the strength ratio concept and a unique value of strength at the plastic limit. Table 2.8 lists a number of these approaches. They use different cone angles and masses,

different methods of plotting their data and different interpretations of the cone penetration at their plastic limit. None has identified the ductile-brittle transition.

A significant criticism of the research conducted on the fall-cone apparatus and the use of the strength ratio is that the researchers used clay soil that could be described as well-behaved, easy to manipulate and deform, typical of those soils that lie above the A-line on the Casagrande plasticity chart. The data of Kayabali (2011) show that the shear strengths of those soils that plot below the A-line on the Casagrande plasticity chart are generally lower than for those soils that plot above the A-line. Thus the test procedures proposed by researchers based only on those soils that plot above the A-line is unlikely to apply to soils that have high kaolinite and/or organic contents.

Other researchers have attempted to devise alternative tests for the plastic limit such as the cube method of Abdun-Nur (1960), extrusion methods such as Medhat and Whyte (1986) and there are several correlations with suction data and effective stresses from consolidation tests that purport to delineate the plastic limit. Apart from the cube method none of these methods recognises or attempts to ascertain the ductile-brittle transition.

Finally, some researchers have made the suggestion to even dispense with the plastic limit test by devising correlations with the plasticity index and the liquid limit. With such a fundamental change of state at the plastic limit that cannot be ignored researchers should not admit defeat because there are problems with a test for the plastic limit and research should be aimed at overcoming the difficulties, with an improved test for the plastic limit.

2.10 Tables

Soil	w_{PL} %	w_{LL} %	ρ_{PL} kPa	ρ_{LL} kPa
Kleine Belt Ton	36	127	1860.4	1.57
Wiener Tegel	22	47	500.7	1.75
London Clay	26	78	654.3	0.09
Weald Clay	18	43	432.9	0.27
Kaolin	42	74	617.8	24.9

Table 2.1 Pressures at the liquid and plastic limits (Data from Schofield and Wroth, 1968)

	Plastic limit %	Undrained shear strength kPa		Strength Ratio
		At the plastic limit	At the liquid limit	
Horten Clay	16	126	1.51	83
London Clay	25	115	1.05	109
Shellhaven Clay	32	84	0.71	113
			Average	102

Table 2.2 Undrained shear strengths from Figure 11 of Skempton and Northey (1953)

Textural Group	Suction at the liquid limit		Suction at the plastic limit		Ratio of suctions PL/LL
	Inches of water	pF	Inches of water	pF	
Silty loam	60	2.18	168	2.63	2.8
Silty clay loam	60	2.18	415	3.02	6.9
Silty clay	15	1.58	913	3.37	60.9
Clay	6	1.18	1650	3.62	275.0
Fat clay			>1650	> 3.62	>275.0

Table 2.3 Soil suctions (From Rollins and Davidson, 1960)

	pF		Suction cm water		Ratio of suctions PL/LL
	At plastic limit	At liquid limit	At plastic limit	At liquid limit	
Kaolinite	3.0	0.6	1000	4	250
Montmorillonite	3.6 – 3.8	0.8	3980 - 6310	6	660 - 1050

Table 2.4 Suction data (From Dumbleton and West, 1970)

References*	Range of suctions pF at the plastic limit
Uppal (1966)	0.5 to 1.5
Stakman and Bishay (1976)	2.2 to 3.1
Croney and Coleman (1954)	2.6 to 3.3
Rollins and Davidson (1960)	2.63 to > 3.62
Greacen (1960)	2.8
Livneh <i>et al</i> (1970)	3.0 to 3.65
Russel and Mickle (1970)	3.39 to 4.05

*Taken from McBride (1989)

Table 2.5 Suction at the plastic limit (Adapted from McBride, 1989)

	c_u at the plastic limit kPa		Ratio of strengths at the plastic and liquid limit	
	Range	Mean	Range	Mean
Plastic limit by rolling thread method	36 – 430	180	38 – 167	90
Plastic limit by cone method	35 - 600	208	17 - 295	100

Table 2.6 Shear strength data (From Wasti and Bezirci, 1986)

	Undrained vane shear strength kPa		Ratio of strengths at the plastic and liquid limit
	At plastic limit	At liquid limit	
Kaolinite	50	2	25
Montmorillonite	200	1.8	110

Table 2.7 Shear strength data (From Dumbleton and West, 1970)

Reference	Cone type and loading	Plot type	Penetration at plastic limit	Extrapolation required
Dolinar and Trauner 2005	Fall cone 30° 80 g	Log-log plot of w vs. d	2 mm	Yes
Feng 2000	Fall cone 30° 80 g	Log-log plot of w vs. d	2 mm	Yes
Harison 1988	Fall cone 30° 80 g	Log penetration vs. water content	2 mm	Yes
Koumoto and Housby 2001	Fall cone 60° 60 g	Log penetration vs. water content	1.15 mm	Yes
Lee and Freeman 2009	Fall cone 30° 80 g	Water content vs. \sqrt{d}	2 mm	Yes
Medhat and Whyte 1986	30° 80 g constant rate of penetration	Force vs. water content	10 mm	No
Muntohar and Hashim 2005	Fall cone 30° 80 g	Non-linear best fit curve	2.2 mm	Yes
Sharma and Bora 2003	Swedish fall cone 30° 3.92N	Log-log plot of w vs. d	4.4 mm	Yes
Sivakumar <i>et al</i> 2009	Force applied to 30° cone	Water content vs. penetration	20 mm	No
Stone and Phan 1995	30° cone pushed at constant rate of 1 mm/s	At 8 kgf load	11.55 mm	Yes

Table 2.8 *Fall cone test methods adopted by several authors*

2.11 Figures

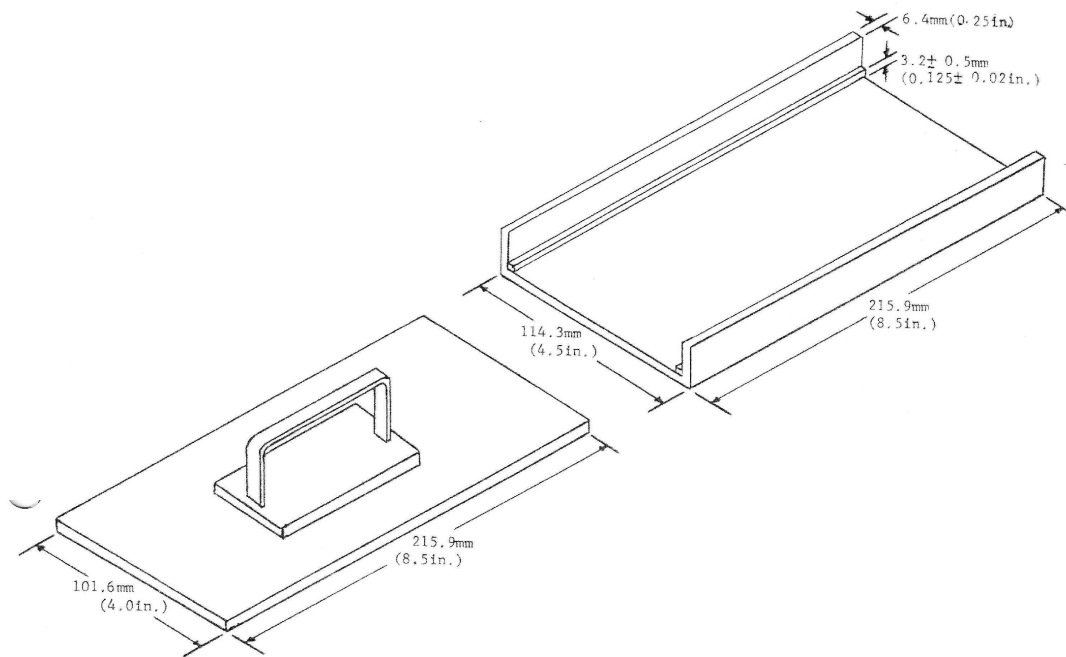

Figure 2.1 The Bobrowski and Griekspoor device (From Bobrowski and Griekspoor, 1992)

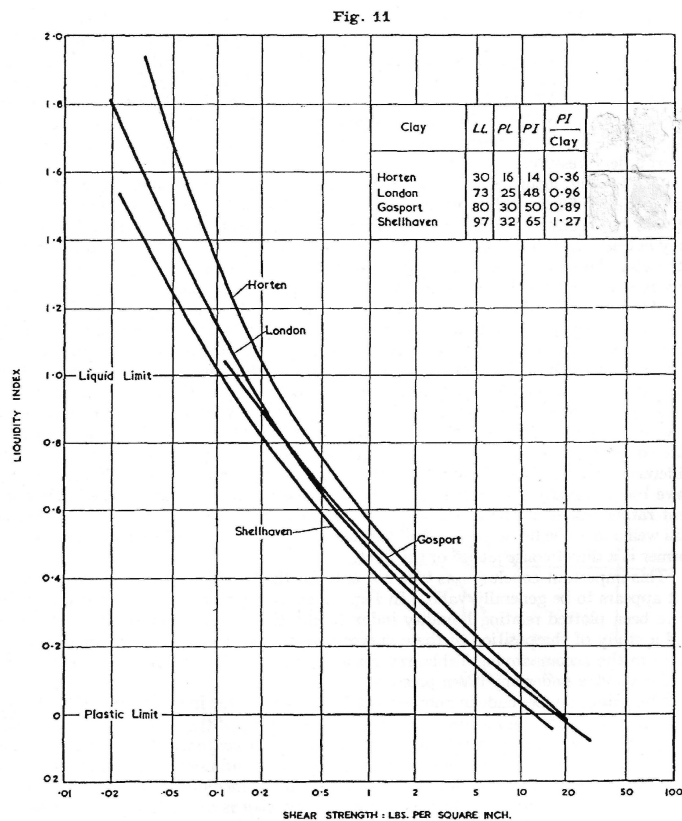

Figure 2.2 Relation between liquidity index and shear strength of moulded clays

(Figure 11 from Skempton and Northey, 1953)

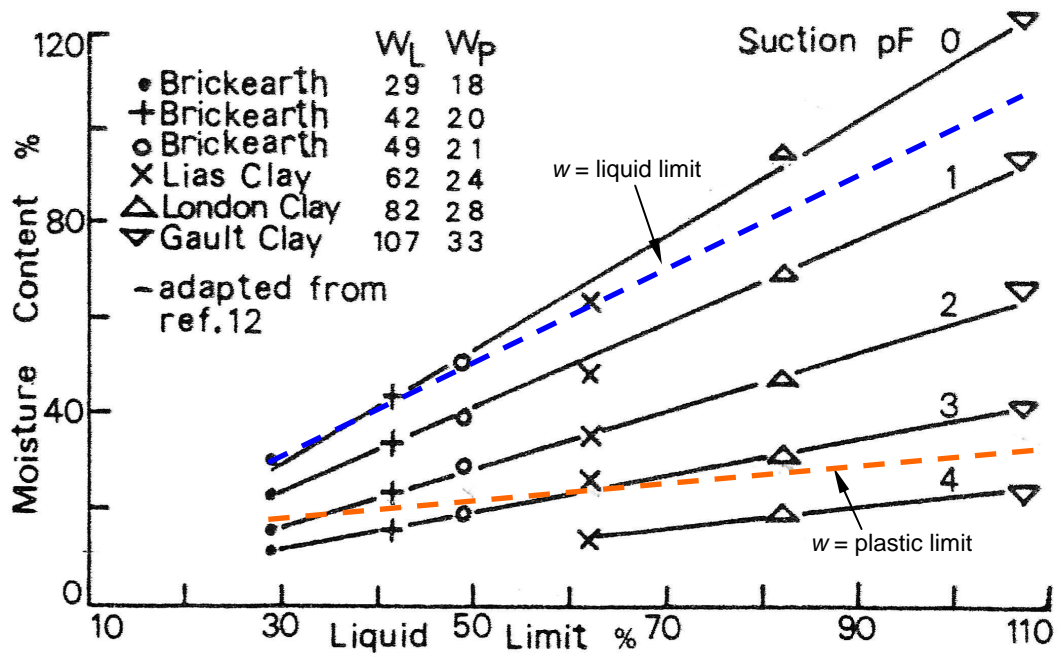

Figure 2.3 Suction data (From Dennehy, 1978)

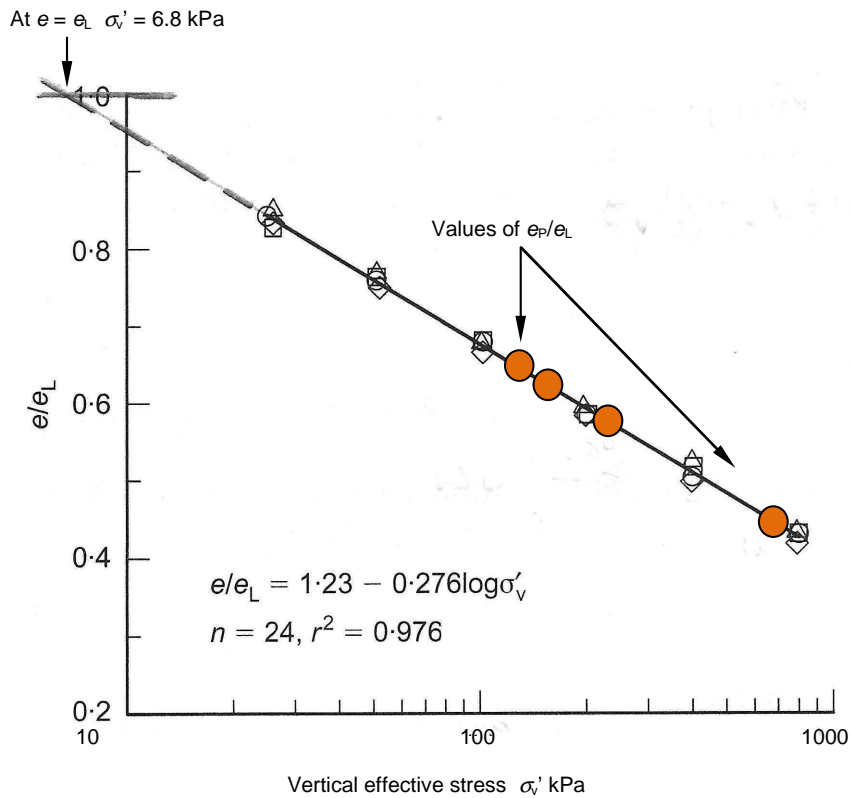

Figure 2.4 Normalised consolidation curves (From Nagaraj and DeGroot, 2002)

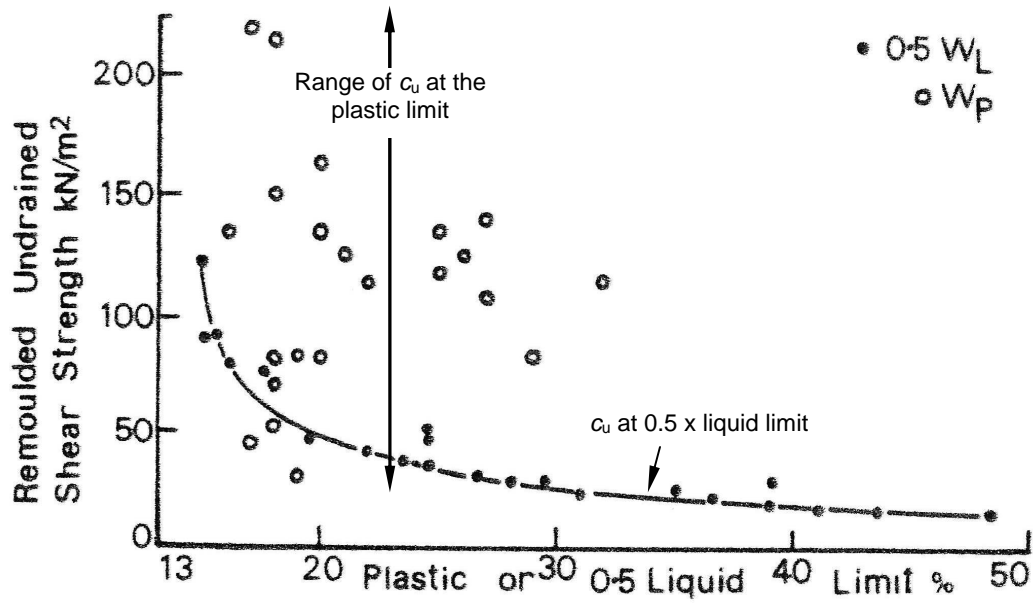

Figure 2.5 Shear strength at the plastic limit (From Dennehy, 1978)

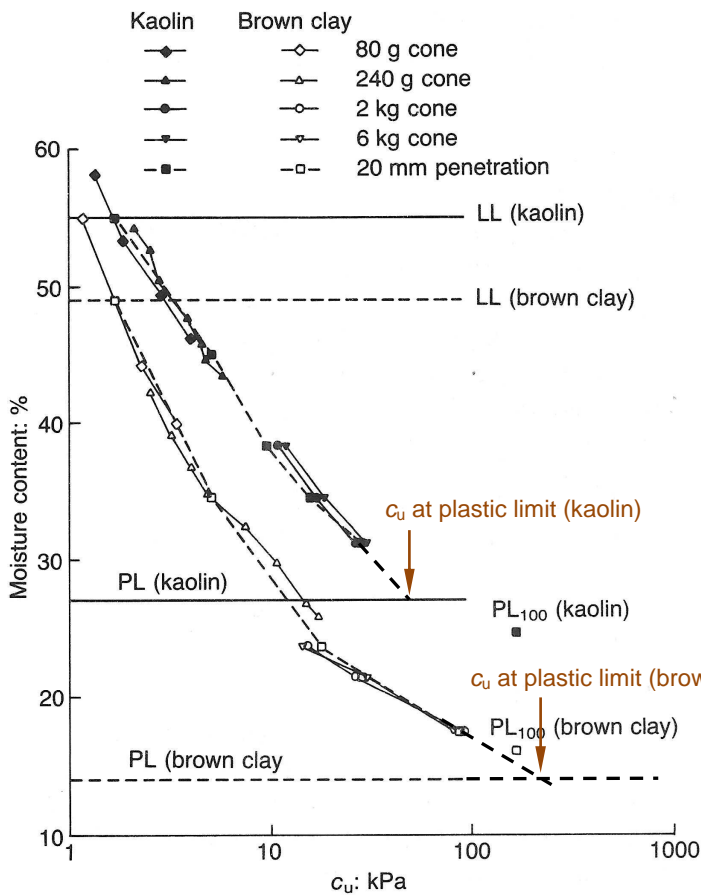

Figure 2.6 Shear strength at the plastic limit (From Stone and Phan, 1995)

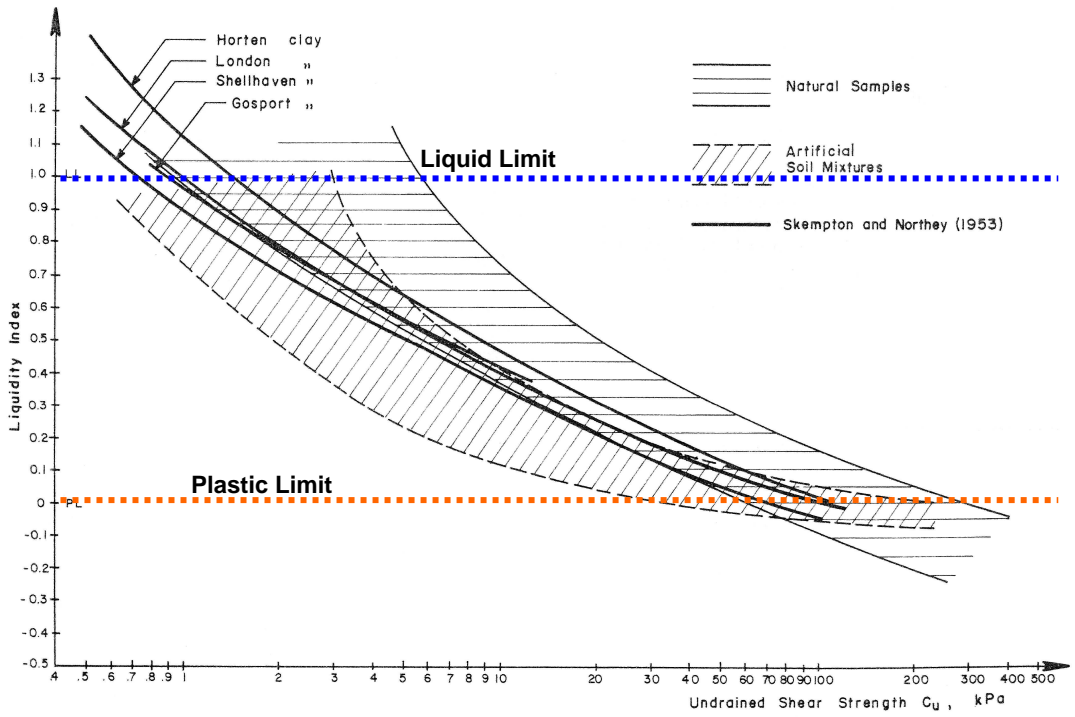

Figure 2.7 Shear strength data (From Wasti and Bezirci, 1986)

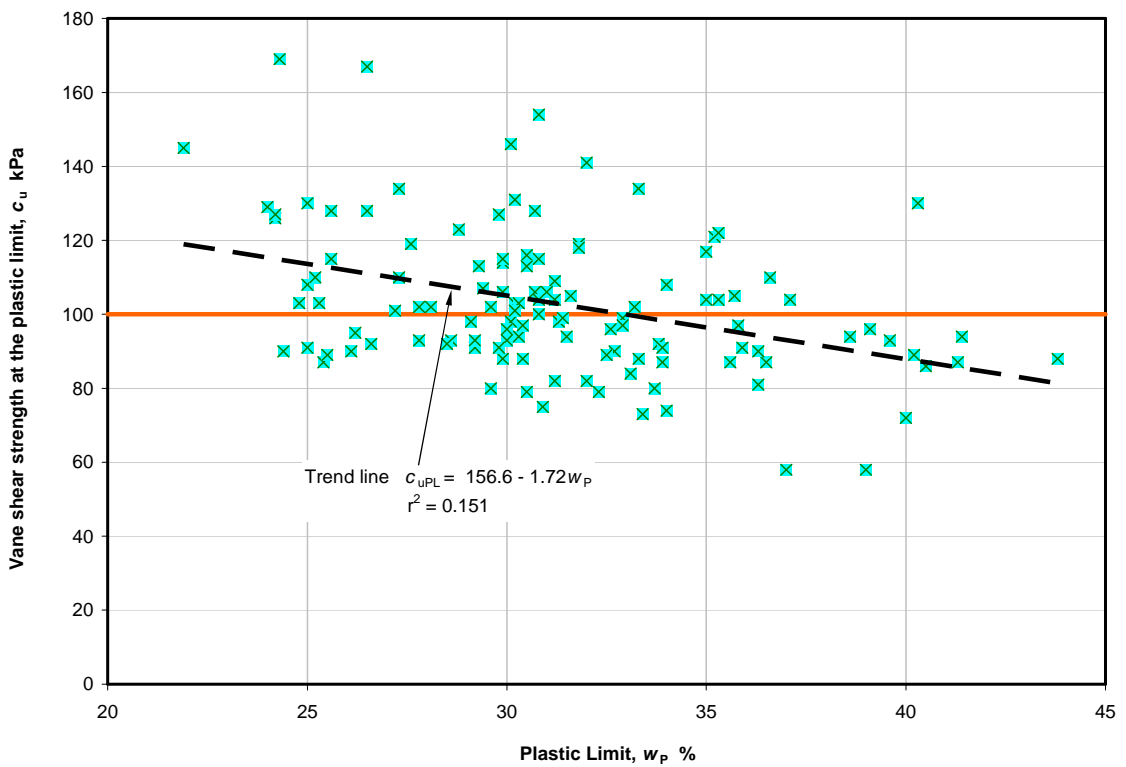

Figure 2.8 Shear strength at the plastic limit (From Kayabali, 2011)

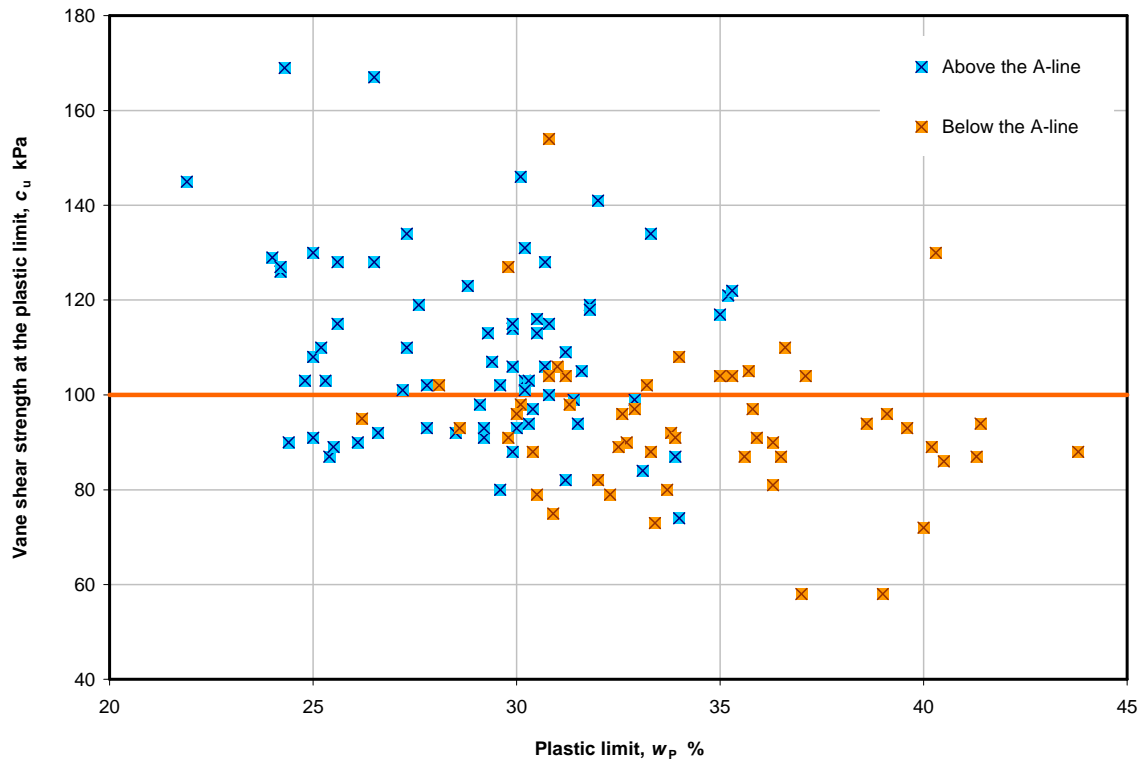

Figure 2.9 Shear strength above and below the A-line (data from Kayabali, 2011)

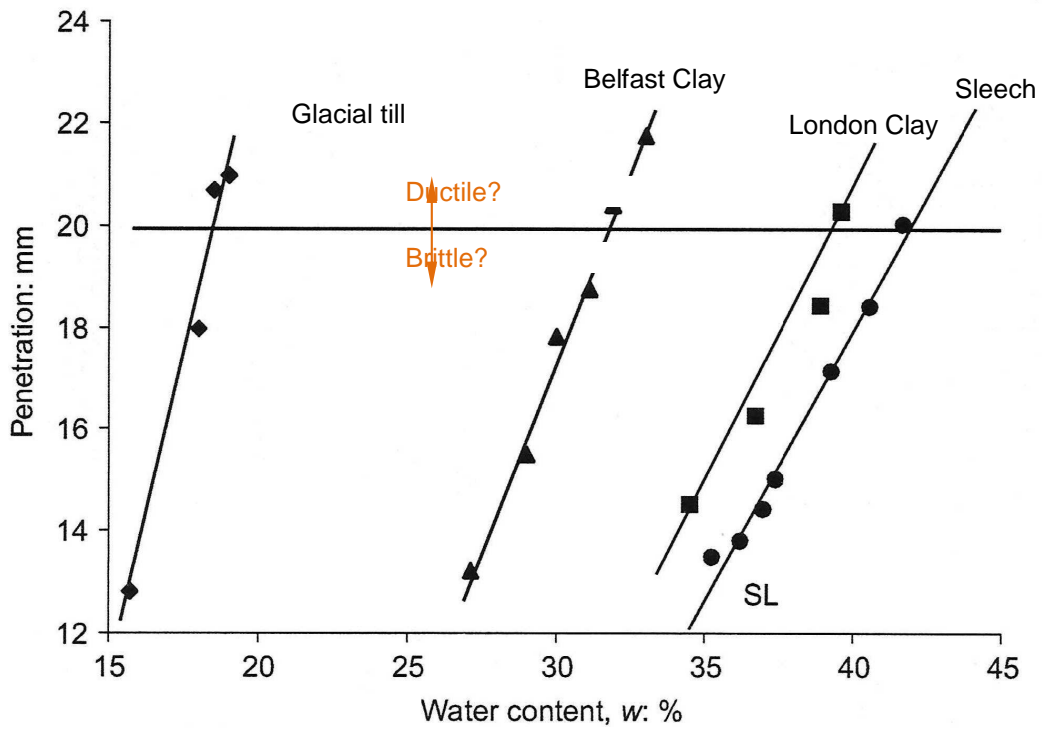

Figure 2.10 Water content vs. penetration (From Sivakumar et al, 2009)

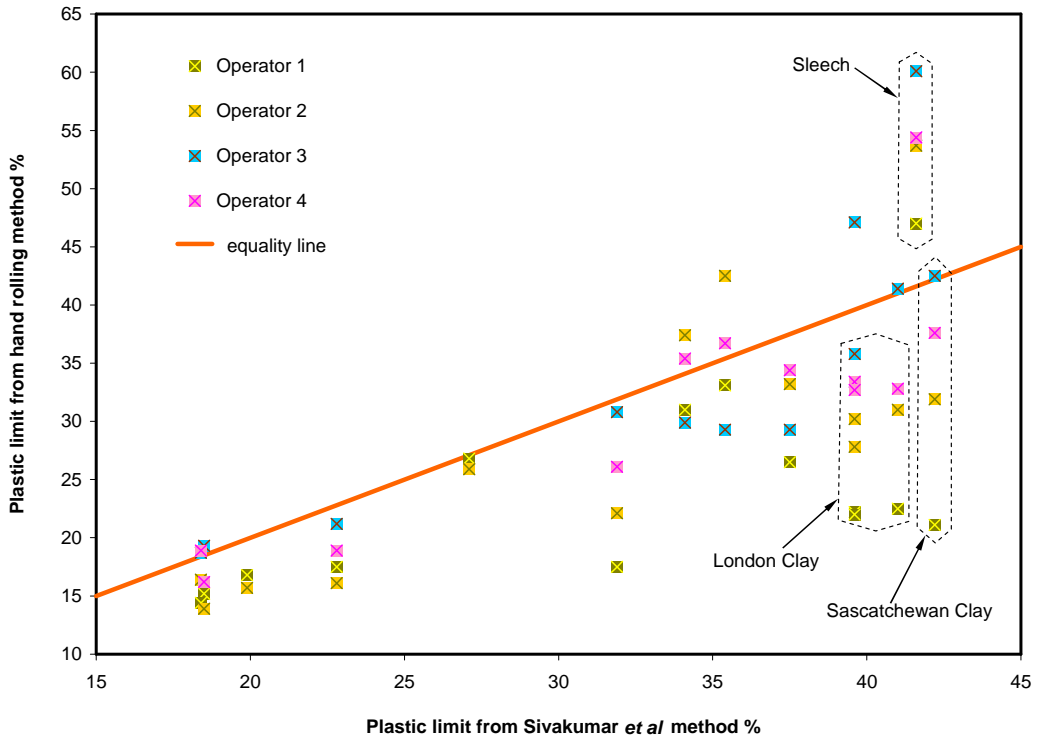

Figure 2.11 Data plotted from Table 3 of Sivakumar *et al*, 2009

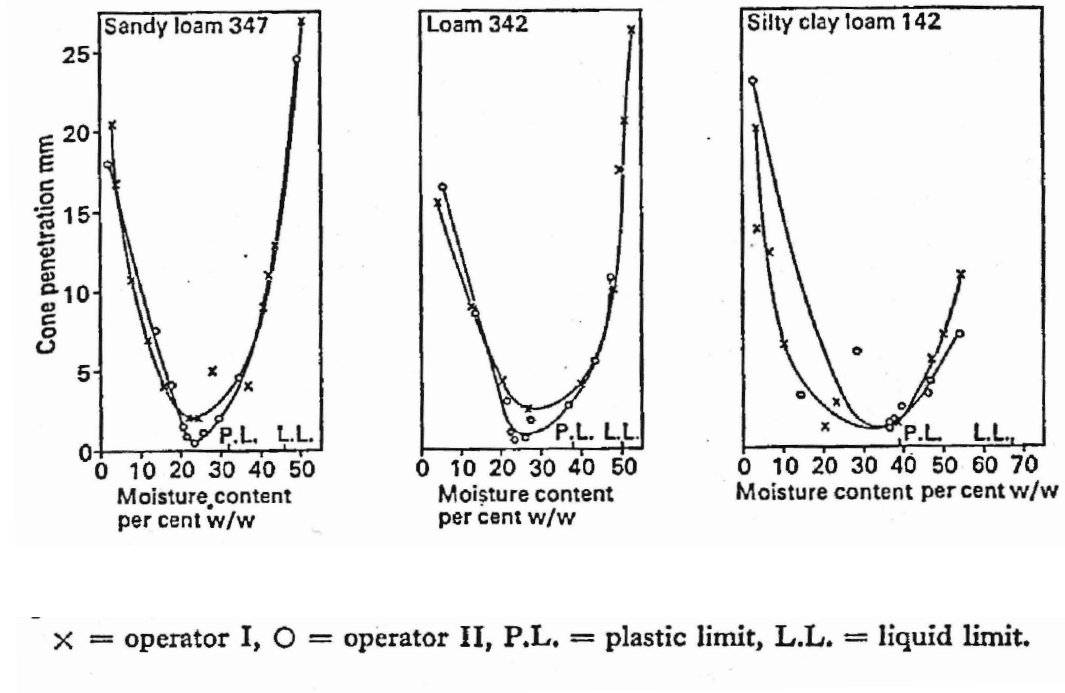

Figure 2.12 Penetration vs. water content (From Campbell, 1976)

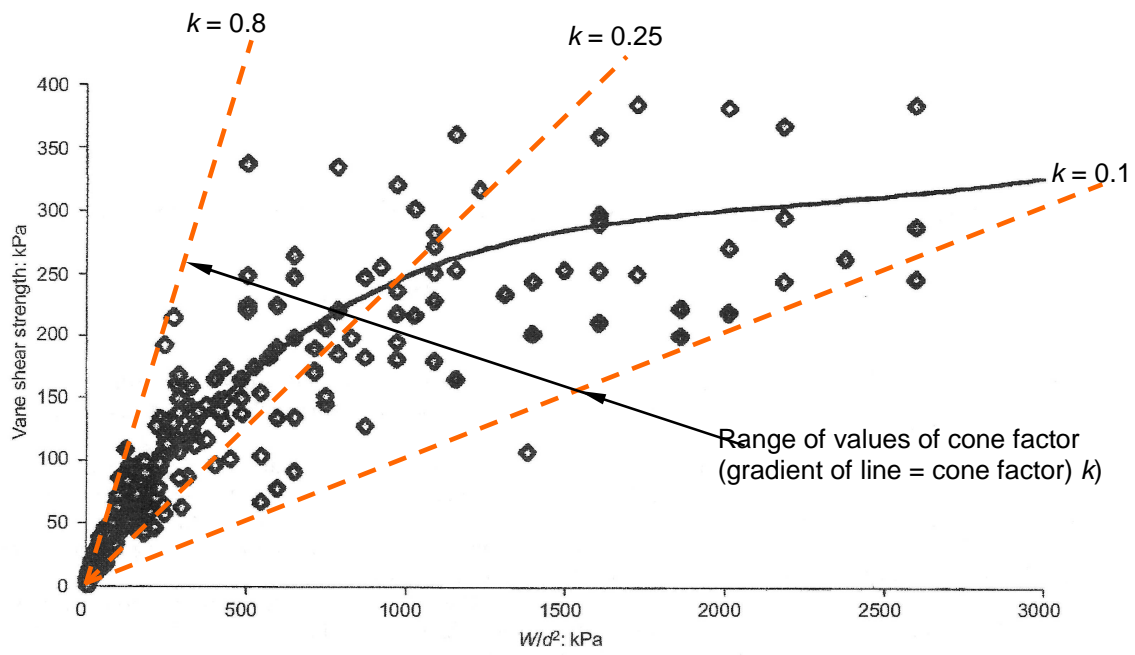

Figure 2.13 Cone factors (From Brown and Downing, 2001)

CHAPTER 3

The ductile-brittle transition and the property of toughness

3.1 Introduction

Rocks are brittle at normal temperatures but display a transition to plastic behaviour under high temperature and pressure conditions. A similar phenomenon occurs in metals such as iron and ceramics such as glass. The improvement of the plasticity properties of a paraffin wax was investigated by Wang *et al* (2007) who added small amounts of organically modified montmorillonite to a paraffin wax nanocomposite (organoclay) to improve ductility. The ductile-brittle transition was dependent on the test temperature as shown in Figure 3.1 and the effect of the clay inclusions was seen as an improvement because it lowered the temperature at the ductile-brittle transition.

The ductile-brittle transition is a fundamental feature of cohesive soils and is the basis for establishing the plastic limit of a soil. However, this is not recognised universally given the attempts by several researchers to introduce the strength-based plastic limit described in Chapter 2. The different behaviours on the ductile and brittle sides of this transition are described.

The property of toughness of soils is described with reference to workability in the agricultural context and empirical classifications of toughness and the effects of particle arrangement, pore spaces and water content in the microstructure and macrostructure of a soil are discussed.

3.2 The ductile-brittle or plastic-brittle transition

Well-respected researchers such as Seed *et al* (1964b) did not acknowledge the ductile-brittle transition at the plastic limit when they stated

“The physical significance of the plastic limit, other than a lower boundary of the range of water contents within which a soil exhibits plastic behaviour, is not nearly as apparent as that of the liquid limit.”¹⁸

and

¹⁸ The author has conducted many fall cone liquid limit tests and has found that the physical change from a plastic solid to a fluid at this water content is insignificant.

“...there has been little further progress in establishing the reason for plastic behaviour to cease in the vicinity of this boundary”.

At least they acknowledged that the plastic limit represented the cessation of plasticity. These authors, following their statements, appear to be suggesting that research into the plastic limit test would be profitable but apparently they did not pursue this work.

The ductile-brittle transition in soils has been observed by several researchers, as discussed below, although it was not always recognised as such. Brown and Downing (2001) described the thread rolling test as having a very empirical nature, not appreciating the significance of the ductile-brittle transition in soils.

Kinnison (1915), in reviewing Atterberg's limits, suggested the existence of a distinct ductile-brittle transition by stating that the crumbling condition “is recognised sharply”. In Figure 2 of Terzaghi (1926), see Figure 3.2, plots of deformation of a cube of soil versus water content are given. Terzaghi refers to a Mr Levenson who produced this Figure and who also coined the phrase ‘critical bearing point’ where the sharp break in the plot occurs. At water contents above this point large deformations occur with much lower deformations at water contents below this point. Mr Levenson explained that his critical bearing point correlated well with the plastic limit and lay close to or just below the plastic limit. Note how the transition occurs over a small range of water contents.

This is a clear illustration of a ductile-brittle transition at the plastic limit but Terzaghi did not recognise it as such. He explained the sharp break in the curves as

“It is what we may call a purely mechanical coincidence, without any deeper significance, but it seems to hold universally.”.

By dismissing this phenomenon Terzaghi could well have set back research on the plastic limit by decades. However, Terzaghi did state that in consolidation tests the pressure vs. water content curve rapidly flattens out at water contents below the plastic limit. This flattening has been shown to occur by all subsequent workers on pressure vs. void ratio plots. Terzaghi gives this as the reason for the sharp break in the curves in Figure 3.2 or Levenson's ‘critical bearing point’. A short time later, Hogentogler *et al* (1928) recognised that

“...the Atterberg method for determining the lower plastic limit is a practical means of differentiating between soils in the plastic and non-plastic states.”.

The second author to this paper was C. (later K.) Terzaghi who may well have changed his view about the plastic limit but probably went on to other things. From a qualitative view, the ductile-brittle transition at the plastic limit was recognised by Skempton (1970), who stated that a clay passes from the plastic to a friable or brittle condition at the plastic limit, and Prakash and Sridharan (2006) who stated that the soil below the plastic limit loses its plasticity and ‘develops fissures’.

Vallejo (1988) conducted uniaxial compression tests on square slabs of kaolinite clay with pre-formed cracks at various inclinations from the horizontal (15, 30, 45, 60 and 75°) and at various water contents (3, 9, 15, 22 and 27%) Unfortunately, he did not report the plastic limit of the clay but did state that samples with water contents > 20% behaved and failed like ductile (plastic) materials and the samples with water contents < 20% behaved and failed like brittle materials. Thus he demonstrated a ductile-brittle transition probably close to the plastic limit. During each test secondary cracks propagated from the ends of the pre-formed crack but different results were obtained for the brittle and ductile samples:

- 1) Ductile samples – for the samples at the water content of 27% the pre-formed cracks closed at strains of about 2 – 4% and at strains of about 4 – 5% the pre-formed cracks extended from their tips but at much smaller angles than for the brittle samples, see Figure 3.3. The angle of crack propagation α in Figure 3.3 is the angle from the direction of the pre-formed crack. Under increased stress the secondary cracks did not propagate any further, instead the samples developed an inclined failure plane in a shear mode, generally in the direction of the maximum applied shear stress, typically 45° to the direction of the compressive stress. The sample behaved in a ductile manner reaching strains of 8 – 9%.
- 2) Brittle samples – for the sample with a water content just below the plastic limit, of 15% the pre-formed cracks always remained open with secondary cracks propagating at angles near to 90° from the direction of the pre-formed crack, see Figure 3.3. The specimens failed in tension by splitting along the pre-formed crack and the secondary cracks and for the soil at the water content of 3% (rather too low) at compressive strains of 1 – 2%. Vallejo (1989) showed that for a sample of the clay on the brittle side with two pre-formed cracks close to each other the secondary cracks emanating from each pre-formed crack merged together.

Hatibu and Hettiaratchi (1993) described brittle failure in a soil as the culmination

of the progressive development of microcracks leading to slip separation along a small number of discontinuities. They adopted two methods for distinguishing the ductile-brittle transition:

- 1) From the stress-strain plots of drained triaxial compression tests the distinction was based on a comparison of work-softening plots (at the lower water contents) with reduction of strength beyond a peak value and work-hardening plots with gradually increasing strength. This method does not provide a clear distinction as many of the work-softening plots were still taken to strains of 10 – 15% so could hardly be described as brittle.
- 2) From a visual classification of the failure mode of the specimen. This approach is long-winded and subjective, although the results for a high plasticity clay soil, at zero confining stress in particular, indicated the transition to be fairly close to the plastic limit. Although stresses are applied in the plastic limit test there is a direction in which the confining stress is small, the longitudinal axis. Unfortunately, it appears that these authors did not recognise this.

Campbell *et al* (1980) carried out model ploughing tests, for agricultural research, on a clay soil at water contents above and below the plastic limit and demonstrated that there was a change in the failure pattern of the ploughed soil from brittle to plastic around the plastic limit. From the photographs in their paper, above the plastic limit the soil appeared to be cut fairly smoothly close to the plough, but below the plastic limit the soil broke into chunks when ploughed.

3.3 Behaviour on the ductile or plastic side of the transition

The term fracture toughness applies to brittle soils with water contents that lie below the plastic limit. It may be considered that the term toughness of a plastic soil should be referred to strictly as remoulding toughness to distinguish it from fracture toughness. On the ductile side of the ductile-brittle transition, i.e. ‘wet’ of the plastic limit, a cohesive soil can be deformed considerably and will retain its deformed shape. This is referred to as plasticity. BS EN ISO 14688-1:2002 refers to this as “...plasticity (toughness)...”.

The term toughness as described by Casagrande (1932), see section 2.4, applies to the shear strength of plastic soils with water contents at (or just above) the plastic limit. The classifications for toughness described later in this chapter relate to the

wet side of the plastic limit. Therefore, in this thesis the term toughness is used for soils in their plastic state.

In this chapter the term toughness of a plastic soil is used in a qualitative and descriptive manner. From the Barnes test a quantified measure for the term toughness is obtained from the data recorded during the controlled rolling and remoulding of the soil thread in the Barnes apparatus. This term is defined in detail in Chapter 5.

The relationship between the logarithm of shear strength and liquidity index is not linear but shows a distinct curvature on published plots (Skempton and Northey, 1953; Wasti and Bezirci, 1986), see Figures 2.2 and 2.7. If the shear strength was plotted with arithmetical values these curves could be interpreted to have separate limbs with transitions between flatter and steeper limbs, referred to in this thesis as the toughness limit and the stiffness transition. As discussed in section 2.4, a transition or change of slope has been noted on the water content vs. log shear strength plot of Stone and Phan (1995) for the brown clay and the kaolin, see Figure 2.6. In this figure a transition occurs at a liquidity index value of about 0.3 to 0.4 which would be close to a water content (and strength) that would be comparable to the toughness limit in the Barnes test, the state of the soil when it has no toughness, or in this case no or very little shear strength. The terms toughness limit and stiffness transition are defined formally in Chapter 5.

At water contents above the toughness limit a cylindrical specimen of soil will not be able to support itself and measurable toughness is not possible. The low shear strengths measured by Stone and Phan, Skempton and Northey and Wasti and Bezirci and others were derived from vane or cone tests on specimens confined in moulds. These tests will register resistance to rotation or to penetration but it is considered that this resistance is due to the viscosity of the soil as well as its shear strength at water contents from the toughness limit to the liquid limit.

The results of Black and Lister (1979) from their Figure 1 are re-plotted in Figure 3.4 for a clay with a plasticity index of 40% with shear strengths on a natural scale to illustrate the potential for such transitions. This figure shows that at the liquidity index of about 0.3 to 0.4 the shear strength is very small, around 10 kPa, and would be comparable to the toughness limit. At this water content the soil would not only be difficult to roll into a thread to display plasticity, it would be very sticky or adhesive, as has been found in the Barnes test near the toughness limit.

At a lower liquidity index value, although the plot in Figure 3.4 is curved, it could

be interpreted as two limbs or two regions with a transition point between, with the limbs coincident at a liquidity index of about 0.1 to 0.2. In the Barnes test a distinct transition has been found in the plots of toughness vs. water content at a similar location. This transition is referred to in this thesis as the stiffness transition because it represents a change of state which is considered to be due to changes in the soil structure associated with an increasing rate of aggregation and coalescence of the clay particles.

At water contents above the stiffness transition the soil is only gradually strengthening with decreasing water content due to stronger particle arrangements. With water contents below the stiffness transition, in the stiff-plastic region, it is postulated that stiffening or toughening is developing more quickly due to closer, stronger particle arrangements but as the plastic limit is approached some localised microcracking also commences as the particle arrangement gradually merges into aggregated clusters and the pore size distribution alters with more, larger pore sizes present.

Nagaraja Rao and Murthy (2001) discuss toughening mechanisms albeit related to fracture toughness with a view to improving the properties of brittle ceramics. However, these mechanisms could be operative in the stiffer soils below the stiffness transition as the plastic limit is approached, to a lesser but still significant extent. This is suspected as, during the preparation of the soil threads for the Barnes test, fine cracks can be seen on the outside of the threads as they are gently rolled by hand prior to insertion in the thread maker and compacted. It is suggested that the crumbling of a soil thread occurs as the result of separation of clusters of particles as tensile stresses enlarge and propagate the microcracks. Nagaraja Rao and Murthy (2001) describe toughening mechanisms that essentially resist the propagation of these cracks:

- 1) Crack deflection – this is more significant with grainy rocks and brittle ceramics. If a propagating crack is caused to deviate from its plane by deflection at, say, a cluster or grain boundary, the crack paths are made more tortuous producing increased fracture toughness.
- 2) Crack interface bridging – if a crack can be restrained from opening by means of clay bridges or clay platelets bridging across the crack walls the crack opening and/or crack propagation are restricted.
- 3) Process-zone toughening – propagation of a macrocrack occurs due to separation of the two surfaces near the tip or end of a macrocrack. A

'process-zone' can occur at and around these tips formed by groups of strongly bound clay particles. Also, zones of microcracking around the macrocrack tips that, on slight opening, have generated compression stresses on the macrocrack, will resist propagation. These process-zones shield the macrocrack tip and act as zones that can absorb some of the energy applied by the external forces.

3.4 Behaviour on the brittle side of the transition

It should be considered that there are two types of toughness, remoulding toughness (measured as work per unit volume in remoulding) occurring in ductile soils at water contents above the plastic limit and fracture toughness (measured as a stress intensity factor at a crack tip) occurring in brittle soils at water contents below the plastic limit. Fracture toughness is discussed in this section.

In the brittle condition cracking or crumbling of a soil thread will be caused by the tensile stresses induced in the thread. It is known that the tensile strength of a brittle soil depends on the size of the specimen because of the greater number of flaws present (cracks, air voids or fractures) in larger specimens. The mode of failure of a soil thread when in its brittle state can be understood as the development of fractures as described by Vallejo (1988, 1989).

Harison *et al* (1994) investigated the ring test which comprised a ring of compacted clay formed with a central hole and with or without a preformed crack emanating from this hole, loaded diametrically, see Figure 3.5a. This arrangement can be likened to the soil thread at the start of a test on a brittle soil in the Barnes apparatus, with no central hole in the cross section of the thread and no crack length a present.

Harison *et al* conducted a two-dimensional finite element analysis assuming unit thickness of a ring test for a Mode I failure, the results of which are presented in Figure 3.5b. The stress-strain assumptions made by Harison were not reported. Mode I failure represents the opening of a crack in the tensile mode where the crack surfaces move directly apart and K_I is referred to as the stress intensity factor¹⁹. Figure 3.5b shows that the stress intensity factor related to the applied load P (over unit length) increases in smaller diameter specimens and could be quite high in a

¹⁹ The stress intensity factor K_I , (units are $\text{kN/m}^{3/2}$) is used to predict the stress state (stress intensity) at the tip of a crack caused by a remote force. Its value is a function of the applied stress, the size and position of the crack and the geometry of the specimen.

soil thread in the plastic limit test where much smaller diameters pertain.

Distributions of the normalised stress σ_x/P acting on the loaded diameter of a soil ring with radius $R_0 = 50$ mm and a central hole with $R_i = 6.25$ mm are given in Figure 3.6. For an uncracked specimen with $a = 0$, see Figure 3.5a, tensile stresses are present along most of the loaded diameter but they are particularly large adjacent to the hole. It can be envisaged that this state exists within the cross section of a soil thread on the brittle side of the plastic limit where a microcrack or defect exists at the centre of the thread. The high tensile stress at the edge of this microcrack will be able to develop further cracks outwards from the centre of the thread. With cracks then propagating from the centre (such as with a increasing in Figure 3.6) the tensile stresses increase near the developing crack tip.

Thus, in this scenario, two cracks will propagate away from the centre towards the edge of the soil thread along the loaded diameter, becoming arrested near the outside of the diameter in the compressive stress region. From Figure 3.5b Harison *et al* explained that as the crack length propagates (a' in Figure 3.5b increases) the stress intensity K_I at the tip of the crack increases under the constant load P . In the Barnes apparatus, with soil threads at water contents on the brittle side of the transition, the load applied to the thread is increasing continuously during the test so the stress intensity at the tip of a crack is increasing and crack propagation is inevitable. This crack propagation will occur as soon as the water content of the soil decreases below the plastic limit when the soil first becomes brittle.

The critical stress intensity factor given by Harison *et al*, as a value of fracture toughness K_{IC} , is presented in Figure 3.7 related to water content for two low plasticity soils. The optimum water content and plastic limit of these soils are superimposed on Figure 3.7. The soils tested have measurable fracture toughnesses at and below the optimum water content probably due to the high suctions present in the unsaturated condition, but very low, if not zero, fracture toughness towards the plastic limit. It is thought that the ring test could be used to investigate the ductile-brittle transition by approaching from the brittle side.

It may be envisaged that the plastic limit could be derived by conducting ring tests on soils compacted with water contents below the plastic limit. With increasing water content towards the plastic limit the measured fracture toughnesses would decrease as the plastic limit is approached and the plastic limit could be identified as the water content with zero fracture toughness.

Vallejo (1989) reported on uniaxial compression tests conducted on specimens of

kaolinite clay with preformed cracks at various angles in the specimens. For the soils in the brittle region, with water contents much lower than the plastic limit, it was found that the compressive strength was lower when there were longer cracks, more of them and when the arrangement and inclination of the cracks reached a critical point. In the Barnes test with a continually rolling specimen the latter factors would always be exploited in a brittle soil by the rotation of the stresses applied to the soil thread. The most important finding was that for specimens under compression, cracks in clay induce tensile stresses in the intact material surrounding the cracks. The clay fails in tension with secondary cracks propagating from the tips of the existing cracks.

Morris *et al* (1992) suggested that cracking is related to a transition between tensile and shear failure. The latter is less likely to cause crack propagation, on the contrary it could close/heal cracks whereas tensile stress is required to open cracks. In considering the behaviour of cohesive soils forming earth dams and their foundations, Nishimura (2005) also explained that when a soil is in a plastic or ductile state the shear failure mode predominates with shear cracking at failure. When the soil becomes brittle the tensile failure mode takes precedence over shear failure and this is accompanied by extensile cracking.

Based on their agricultural research, Grant *et al* (1990) considered that the initiation of brittle failure of unsaturated soils and propagation of tensile fracture depends on the distribution of air-filled voids or pores. It probably also depends on their sizes. These voids are points of stress concentration and propagation of fracture surfaces will follow paths delineated by these voids. Thus, propagation depends on the concentration and closeness of the air-filled voids. These voids or pores, depending on their size, shape and orientation will provide in a brittle soil, at a microstructural level, the 'pre-existing' cracks imposed on their specimens by Vallejo (1988, 1989) and by Harison *et al* (1994). A discussion on the structure of soil and, in particular, the pore spaces is given later in this chapter.

According to Morris *et al* (1992) for an internal crack length $2A$ the uniform tensile stress transverse to the crack that is required to cause the crack to propagate is proportional to $1/\sqrt{A}$. Therefore, as the size of the microcracks increases in a soil (as it becomes drier) the required tensile stress for propagation decreases. In a soil with a range of pore sizes the larger pores are more likely to provide crack propagation and cracking then becomes concentrated in fewer larger cracks.

Tensile cracking in the central portion of a soil thread at water contents close to the plastic limit can result in the formation of a hollow tubular thread when conducting

the standard hand rolling method, particularly with kaolinitic soils and soils of low clay content and high silt/sand content. It is not a reason for discarding the plastic limit test as inappropriate, as Shankar (1967) did. This effect can be reduced by lowering the pressure applied by the hand such that with gentler rolling more effort is applied in causing elongation and a normal thread may be produced. It is then seen as a function of very low toughness of the soil. A discussion on the condition of a soil thread at water contents close to the plastic limit and the development of tubular threads is given in Chapter 6.

3.5 The importance of the toughness property

Atterberg (1911) defined plasticity as the ability to roll out a soil thread and the 'degree of plasticity' as the capacity to be rolled out. However, he then stated that the "Capacity to be rolled out does not lend itself to measurement." - until now. Atterberg fell back on using what he referred to as the 'plasticity number', now referred to as the plasticity index, to denote the degree of plasticity. The use of this parameter continues today to denote the plasticity of a soil but this is not a completely satisfactory measure. The plasticity index has no direct relation to ease of working or remoulding the soil, which is a more fundamental plasticity property. It is the author's contention that toughness of a ductile or plastic soil as measured by the amount of work per unit volume required to change shape, remould, or roll out as in Atterberg's case, would have been Atterberg's preferred 'degree of plasticity'.

Casagrande (1932) recognised the importance of the toughness property near the plastic limit when he stated

"The shearing resistance of a given soil at the plastic limit may be many times that of the same soil at the liquid limit. There is also a wide variation in the shearing resistance of different soils at the plastic limit. This difference may be felt by hand when performing the plastic limit test on various soils. For clays this difference is commonly expressed as difference in toughness. The toughness of a clay at its plastic limit may therefore be described as the maximum stiffness or shearing resistance which it can acquire without losing its plasticity. Hence, the shearing strength at the plastic limit may be considered a measure of the toughness of a clay."

It is important to recognise the difference between the terms plasticity and toughness. The British Standard on the identification and classification of soils (BS EN ISO 14688-1:2002) describes plasticity as "[the] property of a cohesive soil to

change its behaviour with change of water content”, also as “soils that are subjected to the test [the field test described in BS5930:1999, see below] and permit their consistency limits to be determined, may be identified as exhibiting plastic properties.”. However, this Standard confuses plasticity with toughness – “To establish plasticity (toughness),...”. Plasticity describes the ability of a soil to be moulded and retain its shape, toughness refers to the effort required in moulding. According to Prakash and Sridharan (2006) toughness is affected by the clay mineral – water interactions. They list factors that can affect these interactions, see Table 3.1. Although they refer to plasticity the factors relate to toughness.

Another term often used to denote toughness is workability. In the civil engineering context Anon (2004) describes workability as the ease with which soil can be placed and compacted as fill material so the degree of toughness of the soils used in earthworks construction is important. For example, Greenwood *et al* (1985) pointed out that for stiff heavily overconsolidated clays ‘under-compaction’ can occur when the water content is less than $1.1 \times w_p$ with conventional compaction plant because the lumps of clay are too stiff (too tough) to be sufficiently remoulded to combine into a homogeneous mass.

The effect of the soil structure on the property of toughness is discussed later in this chapter.

3.6 Workability in the agricultural context

In the agricultural industry the water content of the surface soil in relation to the plastic limit and the toughness at this water content are paramount factors in determining the ability and efficiency of plant to carry out its work. Unlike in the ceramics industry, where water contents above the plastic limit are relevant, the optimum water content for tillage purposes, above which the soil would be too ‘wet’ and would compact under the equipment, removing air and damaging the soil structure and texture, was found by Mueller *et al* (2003) to be at $0.9 \times w_p$. Other values such as the standard Proctor compaction test optimum water content w_{opt} and a consistency index I_c of 1.15 were also found to be appropriate values for optimum tillage.

Utomo and Dexter (1981) found that for two sandy loams the friability of the soils was greatest at water contents approximately equal to their plastic limits. Thus soil for agricultural purposes is considered workable when the water content is below the plastic limit. Hoogmoed *et al* (2003) described a ‘wet workability limit’ to identify this condition. Although they used sophisticated tests to determine

properties such as the air permeability and the suction-water content relationship they found that the wet workability limit for a loam and a clay soil lay very close to the plastic limits of these soils. Thus, in agriculture if the water content lies above the plastic limit damaging compaction is likely because the soil is in a plastic or mouldable state and air can easily be excluded.

Concerning the behaviour of soils under the action of a plough Campbell *et al* (1980) measured the draft force on a tine pushed through a clay soil to represent the ploughing mechanism and found that the draft force was highest at the plastic limit of the clay, with a plastic failure mechanism, when the clay was at its toughest. The draft force was lower at water contents above the plastic limit when the clay would have lower toughness and at water contents below the plastic limit when brittle failure occurred.

3.7 Classifications of toughness

From the results of the percussion cup method for the liquid limit Casagrande (1932) recognised that more blows are required to close the groove with tougher soils. In other words, if the relationship between water contents, w , and the number of blows, N (near to the liquid limit) is expressed as

$$w = C - F \log N . \quad 3.1$$

Tougher soils are related to smaller values of the Flow Index, F . C is the intercept and F is the gradient of the plot of water content vs. log number of blows from the Casagrande cup method but at water contents around the liquid limit. Casagrande attempted to use the Flow Index as a measure of toughness at the plastic limit by assuming that in the whole range between the liquid limit and the plastic limit the relationship of w vs. c_u was linear. However, from more recent published data such as Wasti and Bezirci 1986, see Figure 2.7, this is seen to be not the case.

Casagrande (1932) recognised that the same test (the cup method) could not be used to determine shear strength at both the plastic limit and the liquid limit when he stated

“In order to classify clays according to their toughness [at the plastic limit] it would be necessary to determine the shearing resistance at the plastic limit by means of a direct shearing test or an unconfined compression test”.

Later, Casagrande (1947) stated that the toughness near the plastic limit increases as the plastic limit decreases. He gave a classification of toughness by referring to the 'cohesiveness at the plastic limit' with terms in the order: very weak, weak, firm, medium tough, tough, very tough.

In the old German standard (DIN18196, 1970) a kneading test is described on clay that has its water content reduced so that it can no longer be rolled out but it can be kneaded; thus it is just below its plastic limit. It is described with slight plasticity if it is no longer possible to form the threads into a lump, and of marked plasticity if the lump can still be kneaded without crumbling.

BS5930:1999 gives a classification for plasticity based on the liquid limit alone, see Table 3.2. This classification is independent of the plastic limit with no acknowledgement that M soils which lie below the Casagrande A-line and C soils that lie above have different toughnesses. Based on the Casagrande plasticity chart zones or classifications of toughness at the plastic limit are given for the USCS system in a NAVFAC (1986) document. These are illustrated in Figure 3.8. This classification recognises the difference in toughness for soils above and below the A-line. Although the chart is of qualitative use the terms slight, medium and high are not defined and the chart appears over-simplified.

BS EN ISO 14688-2:2004 states that the degree of plasticity should be based on the results of laboratory tests, the liquid and plastic limits, and then classified using the terms non-plastic, low, intermediate and high plasticity but gives no guidance on the liquid limit or plastic limit values to assign to each term.

To assess the viability of using various clays in the brick and roof tile industries, Vieira *et al* (2007) used the chart produced by Bain and Highley (1979) relating the plasticity index and plastic limit of the clays to the ability to extrude the clay. However, it does not recognise that extrudability would also be a function of the water content of the clay. This chart is re-drawn on the Casagrande plasticity chart in Figure 3.9 and shows that clays mainly in the intermediate plasticity region according to BS5930:1999 ($w_L = 35 - 50\%$) and above the A-line give optimal extrusion qualities. Clays with $I_p < 10\%$ are not appropriate for building related products due to difficulties with extrusion. Clays with $I_p > 34\%$ would be tougher and more difficult to extrude and at their higher water contents in the workable range²⁰ these clays would be more prone to shrinkage and warping on drying.

²⁰ The workable range identified in the Barnes test lies between the plastic limit and the toughness limit.

3.8 Field tests for classification of toughness

BS5930:1999 gives a field procedure and descriptive terms for the toughness of fine (silt and clay) soil based on the character of a moist soil when it has been rolled, moulded and dried until it is at its plastic limit, see Table 3.3. Unfortunately, the toughness descriptions are associated with the plasticity terms when they do not necessarily mean the same.

Instead of using the Atterberg limits to classify soils with the symbols CL, ML, CH and MH, ASTM D 2488-00:2000 bases the classification on manual toughness tests, as well as dry strength and dilatancy, see Table 3.4. Unfortunately, this standard does not give as wide a range of classifications as in the British Standard, BS5930:1999. The ASTM toughness tests rely on a subjective assessment of the pressure required to roll a soil thread and the stiffness of a lump of the soil formed from the threads, i.e. just below the plastic limit once the threads have crumbled. The terms low, medium and high as defined in Table 3.5 are then assigned to the soil. According to ASTM 2488-00 a soil with medium toughness and plasticity (CL) is identified as a lean clay and one with high toughness and plasticity is described as a fat clay (CH).

In the US Department of Agriculture Soil Survey Manual (Anon, 1993) plasticity, toughness and stickiness are defined by independent tests. Plasticity is defined as the degree to which soil is permanently deformed by a continuous force, without rupturing. The plasticity classes quoted, see Table 3.6, are more associated with the tensile strength or tenacity of the soil. The results of the tests described will also be dependent on the water content at which the soil thread is rolled. It is stated that the determination is to be made at a water content where the 'maximum plasticity' is expressed. In terms of deformation without rupturing this may not be at a water content close to the plastic limit. In this condition the response of a soil to deformation could be affected by the presence of fine cracks that have developed in threads of less plastic soils. These fine cracks have been observed when preparing soil threads at water contents between the stiffness transition and the plastic limit. This so-called 'maximum plasticity' may then be at a water content just above the stiffness transition.

In the same Manual classes are given based on the relative force required to form (with the fingers) a roll 3 mm diameter at a water content at or near the plastic limit, see Table 3.7. These criteria are more related to work/unit volume, which is a better definition of toughness.

In the New South Wales USCS field method (Anon, no date) toughness is described as the consistency at the plastic limit and this document explains that the tougher the thread the more potent is the colloidal clay fraction of the soil. This potency could be a useful term in toughness descriptions. Weak threads are identified for clays of low plasticity, or kaolin type clays and organic clays. Table 3.8 (part of Table 1 of this publication) recognises the potency of the clay fraction by means of the ribbon strength, dry strength, toughness and stickiness.

Classifications based on the diameter to which a thread of soil can be rolled are discussed in Chapter 6.

3.9 Previous tests for the quasi-determination of toughness

There are some quasi-toughness tests that have been developed for the ceramics industry and purport to provide a toughness property but are at best indicative and at worst meaningless. Some of these are described below.

To determine the point at which workable plasticity was established and to eliminate the 'potter's feel' for the condition of the clay McDowell (1928) devised a simple compression device comprising a 8kg mass placed on top of a 2 inch cube of the clay for 30 seconds and measuring the resultant height of the specimen. By comparing with the performance of the clay in the works, limits for the height reduction could be set within which a clay could be deemed suitable. This approach was found to be more reproducible than the potters' judgements.

A test to determine the 'workability index' of fireclays and refractory clays is covered in ASTM C181-09. The test was originally designed to apply a set number of impacts (20) from a fixed weight and height of drop to a soil specimen inside a steel cylinder, remove the weight and then measure the deformation as a percentage of the original height following further impacts. However, Heindl and Pendergast (1947) had found that 20 impacts was insufficient to compact fully some soils, which would be those of high toughness. They considered that it would be preferable to base the workability of a soil on the number of blows required to reach full compaction or the maximum bulk density because they identified that the purpose of the test was to determine the amount of work required for compaction.

This test is very similar in function and outcome to the moisture condition apparatus (MCA) and test (Parsons and Boden, 1979). Of importance in the civil engineering industry, the performance of field compaction plant and the results of laboratory compaction tests are dependent on the toughness of the soil with

tougher lumps of soil more resistant to remoulding and requiring more energy to compact. The moisture condition apparatus is a form of remoulding device used to assess the suitability of a mainly cohesive soil for incorporation into earthworks. The moisture condition value (MCV) is measured as the log number of blows to compact a fixed mass of soil. This test could also be used to assess the toughness of a soil with tougher soils (and with lower water contents) giving higher MCVs because more compaction energy is required to remould the lumps of clay. It is envisaged that the MCV should correlate well with the toughness values obtained from the Barnes test.

Several researchers studying workability of clays have used a measure of the yield stress multiplied by the maximum deformation to denote this property (e.g. Norton, 1938, Schwartz, 1952) and this can be considered comparable to a measure of toughness. Norton (1938) carried out tests on clays using a torque machine and produced plots of torque versus angle of rotation. He stated that a plastic clay²¹ for ceramics working would need a high value of the yield point and a high extensibility. If it has a low yield point (or low strength) it will slump after working and if it has a low extensibility it will be 'short'²² and difficult to form, i.e. developing brittleness. Norton's Figure 5, reproduced as Figure 3.10, shows the variation of torque and deformation with water content. This graph can be interpreted to demonstrate

- 1) the liquid limit of the soil at a water content where the torque is minimal and the deformation is extensive,
- 2) the toughness limit of the soil at a water content where there is small but measurable torque and a maximum value of the measured deformation,
- 3) an increasing measure of toughness (product of the yield point of torque and the maximum deformation) as the water content decreases from its toughness limit,
- 4) and increasing brittleness of the clay with decreasing water content towards the plastic limit where the yield point is increasing but the maximum deformation is decreasing. Although the plastic limit of the soil tested was not reported it can be seen that the plastic limit is approached where the highest yield point and the lowest deformation occurs.

The Brabender Plastograph was described by Marshall (1955) and West and

²¹ The term 'body' is used in the ceramics industry.

²² A term also used in pastry making.

Lawrence (1959). This apparatus comprises an electrically driven mixing chamber with measurement of torque on the mixing blades as water is added to the air-dried, ground clay. This is a rather crude device but a useful result was that montmorillonite was found to require higher torques and over a wider range of water contents than kaolinite, as montmorillonite produces greater toughness in a soil and over a wider range of water contents.

Extrusion tests conducted by Fitzjohn and Worrall (1980) on several brick clays, measuring extrusion rates vs. applied pressure showed that their 'index of plasticity'²³ was reasonably well correlated with the clay content. A high clay content would be expected to provide the greatest resistance to extrusion and should provide a higher toughness. However, the plasticity of a china clay sample did not correlate with clay content, possibly because of the presence of interlocking coarser kaolinite particles.

The results of Carty and Lee (1996) show a similar phenomenon. Using a high pressure shear rheometer they determined from a plot of torsional shear stress vs. applied pressure the cohesion (or yield shear stress as the intercept of the plot) and the pressure dependence (the gradient of the plot). The kaolinite clay was found to have the highest pressure dependence, again possibly as a result of the interlocking of larger, angular particles or clusters of particles. They recognised that in the ceramics industry the property of plasticity lies between suspension rheology for which viable tests were available and soil mechanics for which remoulding tests were not available.

The Martin Flow Instrument was designed by CERAM Research (Kessel, 1998) to extrude a sample of clay through a die, measuring the flow rate and the applied pressure. As the rate of extrusion is determined by the toughness of the clay the most significant controlling factor was found to be the water content, as would be expected.

Baran *et al* (2001) defined a workability parameter for clays as $\sigma_{0.2}\epsilon_0^*$ which, at first sight, would appear to be the area beneath a stress-strain curve and a measure of work/unit volume. However, the $\sigma_{0.2}$ value was obtained from compression tests on cylinders of clay as the stress at a fixed strain of 0.2, referred to as the yield stress, hardly in the plastic region. ϵ_0^* was the plastic tensile strain obtained from a long-winded set of 'upset tests' on different specimens measured at zero compression

²³ The 'index of plasticity' was defined as the ratio of the yield stress (the applied pressure required to commence extrusion) and the 'bottom bend' (the additional amount of pressure required to promote steady extrusion).

strain. These tests are comparable to a compression test but measure the radial strain on the outside of the cylinder. Thus, with two very different tests to give a measure of stress and strain, respectively, no realistic compatible value of work/unit volume was obtained for the same specimen. Most significantly, the maximum value of their workability parameter, $\sigma_{0.2}\epsilon_0^*$, was not obtained at the plastic limit but at a higher water content, equivalent to liquidity index values of 0.28 and 0.70, for the two kaolinite soils tested.

Astbury *et al* (1966) carried out cyclic torsion tests on clays used in the ceramics industry and showed that the area of the hysteresis loop of stress vs. strain defining the amount of energy absorbed by the specimen during one cycle, was significantly dependent on water content. For a sample of Etruria Marl, a typical brick clay, their data are plotted in Figure 3.11. Unfortunately, the plastic limit of the soil tested was not reported but the range of water contents is likely to be in the workable region between the 'normal consistency' (less than the sticky limit) and near the plastic limit. From the plot of energy per hysteresis cycle vs. water content a close resemblance can be seen to the relationships obtained for work/unit volume vs. water content in the Barnes test (Barnes, 2009). A marked transition is also noted which could well be representative of the stiffness transition for the material tested.

Two plastometers, a compression device and a torsion device, were described by Moore (1963). With the former device, the specimen, originally 1.5 inches high was compressed by more than 60% during the test and the stress at 50% compression was used as a plasticity parameter. This does not give a measure of toughness and no consideration was given to the fact that the specimen had changed shape significantly at this high compression or whether strain-softening had occurred after reaching a peak value. From the torsion test a hysteresis loop was obtained by cycling the stress and measuring the angular rotation. It was considered that the area of this loop could be used as a measure of the energy required to deform a specimen, as suggested by Astbury *et al* (1966). However, the separation of elastic from plastic strains would not be possible so no meaningful measure of toughness was determined.

3.10 Microstructural view of toughness of clay

The early concepts of microstructure of a clay soil considered that the single clay platelet dominated the framework with a double layer theory controlling the attractive and repulsive forces between the particles (Mitchell, 1956). Sridharan and Dwarkanath (1992) envisaged a structure dominated by individual clay

particles and considered that clay compacted on the wet side of the optimum water content in a standard compaction test has a relatively dispersed and tortuous fabric with discontinuous micropores owing to shear deformation of the wetter and hence softer lumps of clay, under the compaction stresses. On the dry side of optimum or as optimum is approached they considered that the more shear resistant lumps of clay form a random and potentially discontinuous structure with larger more continuous macropores.

A simple representation of the toughness of a clay soil, as resistance to deformation between clay particles, has been developed by considering the interaction between individual clay particles of the same size and with a uniform parallel structural arrangement. The soil is assumed to be fully saturated with free water between the clay particles. An adsorbed water layer on the surface of the clay particles is included in the particle thickness but is assumed to determine the forces acting between the particles. By considering clay particles of thickness t and plan area A at a distance d apart, as shown in Figure 3.12, equations for surface area and water content can be derived.

For the unit particle volume $V = A(d + t)$. The volume of solids = $V_s = At$ and the volume of voids = $V_v = Ad$.

The mass of solids = $W_s = At\rho_s$. The surface area per unit mass of solids S is

$$S = \frac{2A}{At\rho_s} = \frac{2}{t\rho_s} , \quad 3.2$$

$$\therefore t = \frac{2}{S\rho_s} . \quad 3.3$$

The water content w is

$$\frac{Ad\rho_w}{At\rho_s} = \frac{d\rho_w}{t\rho_s} \quad 3.4$$

and from equation 3.3, eliminating t gives

$$w = \frac{Sd\rho_w}{2} . \quad 3.5$$

The attractive normal force F between particles is assumed to be inversely proportional to the separating distance

$$F = \frac{k}{d} \quad 3.6$$

where k is a coefficient. To deform the soil the shear force Q is applied which is assumed to be proportional to the normal force so

$$Q = \alpha F = \frac{\alpha k}{d} \quad 3.7$$

where α is a frictional coefficient. From equations 3.5 and 3.7, eliminating d gives

$$Q = \frac{S\rho_w \alpha k}{2w} \quad 3.8$$

For the unit particle volume the work required for a displacement of the particles by δl is referred to as the toughness T

$$T = \frac{Q\delta l}{V} \quad 3.9$$

So from equation 3.8 the toughness for a specified amount of displacement is

$$T = \frac{S\rho_w \alpha k \delta l}{2wV} \quad 3.10$$

Equation 3.10 illustrates the properties of a single clay platelet structure that are likely to determine the overall toughness of a soil, i.e. toughness will increase with

- 1) increasing specific surface of the clay particles (S),
- 2) increasing attraction between the clay particles (k),
- 3) increasing friction between the clay particles (α),
- 4) decreasing water content (w)

Increasing specific surface S explains why higher clay contents and more active clay minerals produce greater toughness. Increasing attraction between the clay particles explains why the toughness varies according to the exchangeable cations present and the pore water chemistry. Increasing friction between the clay particles explains why the toughness for a given displacement increases as the soil undergoes strain-hardening.

Some images of specimens of the London Clay:Silt mixtures have been taken using an environmental scanning electron microscope and these are described in Chapter 8. With semi-continuous clay strands or 'interweaving bunches' of clay particles observed running through the specimens the analysis outlined above is considered to be a viable explanation of the microstructural view of toughness.

Toughness decreasing with water content is a significant feature of the results of the Barnes test. It is clear that a measured toughness value for a soil, as obtained from the Barnes test, must be related to a specified amount of displacement and this is explained in Chapters 4 and 5.

3.11 Structure in natural soils

Research work from scanning electron microphotographs (SEMs), has shown that the single platelet is not the dominant structural form; instead clay structure is dominated by domains (or peds, clusters, aggregates) grouped together. Barden and Sides (1970) showed that micro (small – requires a microscope to view) and macro (large – can be viewed by eye) structure exists in compacted clays and that on the wet side of optimum (assumed to be near the plastic limit value) the microstructure determines the properties, macropeds are squashed and distorted and macropores are removed. On the dry side of optimum, assumed to be well below the plastic limit, the structure is dominated by macropeds and macropores.

Barden (1972) found that in most natural clays the clay particles are not arranged individually but are aggregated into face to face arrangements and where silt grains occur clay plates coat the grains in an 'onion-skin' arrangement. Failure is then controlled by progressive development of defects, e.g. microcracks or microfissures, leading to macrocracks or macrofissures between the aggregates. Barden referred to a 'defect density' that could be related to the proportion of larger pore spaces.

Collins and McGown (1974) carried out a scanning electron microscope study of normally and lightly overconsolidated natural clays and silts. They found that the single clay platelet arrangements were rare and that face to face groups of clay

platelets were dominant. They distinguished between elementary particle arrangements as shown in Figure 3.13 and particle assemblages as shown in Figure 3.14. They identified a number of particle assemblages such as:

- 1) Clay-coated silt and sand grains
- 2) Regular aggregations. Assemblages of clay and fine silt.
- 3) Clay connectors or bridges between silt/sand particles.
- 4) Interweaving bunch assemblages
- 5) Particle matrix assemblages

Although the structures identified by Barden and Collins and McGown were in natural soils it is envisaged that these fundamental arrangements²⁴ would exist in remoulded soils as used in the plastic limit test.

3.12 A comparison of compaction water content and the plastic limit

Most researchers in this subject have found that the plastic limit of a clay soil lies on the wet side of the standard or Proctor compaction test optimum water content, w_{opt} , and frequently close to w_{opt} . Some examples of the relationship observed between w_p and w_{opt} are given in Table 3.9.

A value of the ratio w_{opt}/w_p of about 0.9 appears to be typical for natural inorganic clays. Knowledge of this ratio is important as many researchers have studied the structure of compacted soil at different water contents in relation to w_{opt} , rather than w_p . Thus as the water content of a soil reduces towards the plastic limit, the approach taken in the Barnes test, the soil can be viewed to have a structure associated with the wet side of optimum tending towards the structure at w_{opt} , just below the plastic limit.

3.13 The effect of soil structure on toughness

The main factors affecting toughness of a soil are the type and amount of minerals present that can combine or interact to provide tenacity²⁵, a property more

²⁴ The connectors between particles could be of a fairly weak nature in some soils and may be more easily broken down on remoulding.

²⁵ Tenacity is defined herein as the ability of a cohesive soil to hold together firmly such as when rolled into a thread.

commonly associated with clay minerals. Organic soils, by nature of the interlocking of plant remains, may display some resistance to deformation and some retention of deformed shape, i.e. some toughness and tenacity, but this is much less significant compared to the toughness imparted by clay minerals.

In terms of the toughness of a clay soil at the micro scale the analysis given in section 3.9 illustrates the factors in a face to face clay platelet arrangement. In terms of toughness of a clay soil at a larger scale it can be visualised that the elementary particle arrangements identified by Collins and McGown (1974), see Figure 3.13 and the connectors, interweaving bunches and particle matrix, see Figure 3.14, would provide resistance to deformation but also tenacity, holding together a thread of soil as it is extruded in the plastic limit test. Chudnovsky *et al* (1988) showed that under fatigue loading²⁶ for a kaolinite soil, with fairly large particle sizes and a soil structure formed into clusters or aggregations of these particles, some of the clusters coalesced, others split into smaller units. In particular, it was observed that clusters of the clay coalesced into strips generally aligned in the direction of the fatigue torsion strain. This could be a phenomenon that occurs during extrusion of a soil thread in the plastic limit test.

3.14 The effect of water content on the structure in remoulded soils

It is well known that for metals grain size has a marked effect on ductility, toughness and brittle fracture. Grain size reduction in metals makes crack propagation more difficult, increasing the ductility and the stress required for brittle fracture. The converse of this will occur as the water content of a clay soil decreases, and clusters and aggregates of clay and other particles begin to form.

It is instructive to deduce the behaviour of a clay soil as its water content reduces towards the plastic limit. The Barnes test is conducted on soils dried gradually from the liquid limit and is commenced at a water content below the sticky limit. As the soil becomes drier it has been observed during preparation of soil threads for the test that for many soils, particularly low plasticity, kaolinitic and high silt/sand content soils an increasing friability occurs, especially at water contents below the stiffness transition identified in the Barnes test. This is considered to be due to an increasing tendency for the clay particles in the soil to form clods or large aggregates and for the pore sizes to enlarge and coalesce as a result.

For example, to prepare a soil thread for testing when very close to the plastic limit

²⁶ Fatigue loading is likely to be a form of stress application relevant below the stiffness transition in the Barnes test.

it has been necessary, for some of these soils, to place small pieces of the broken lumps into the thread maker. Following static compaction and extrusion from the thread maker the thread generally appeared homogeneous but it is highly likely that invisible micropores and perhaps smaller macropores still exist between the compacted and re-shaped lumps of clay. The following provides some background to this view.

In terms of the plastic limit of a clay soil it can be visualised from the structures in Figure 3.13 that as the soil dries towards the plastic limit some of the edge-edge and edge-face contacts in the elementary particle arrangements are broken, affecting the connectivity of the strands of particles and interweaving bunches, the clay coatings on silt and sand particles become stiffer and less interactive with surrounding particles, the aggregations grow larger, coalesce and become stiffer and where the clay content is sufficiently high these factors affect the integrity of the particle matrix.

The effect can be seen to be one of changing from a structure that holds together, can be rolled out and demonstrates tenacity and ductility to one that breaks into distinct units and crumbles under deformation. In a similar fashion to the interweaving bunches in Figure 3.14 Cetin *et al* (2007) found that the structure of the clay soil tested at water contents above the optimum water content was mainly characterised by long strings of differently oriented (or interweaving) pockets in the form of curved trajectories with mainly face-face contacts between the particles in the pockets.

In order to investigate the effect of drying on a reconstituted illitic silty clay soil Cafaro (2002) produced a plot of void ratio e vs. mean effective stress p_k for the 'drying' plot as the soil was dried gradually in a suction plate test, and compared this with a plot of void ratio vs. mean effective stress p' from isotropic consolidation in a triaxial apparatus on the same soil, see Figure 3.15. Considerable volume changes occurred during water content reduction associated with rearrangement of the soil structure. The offset between the two lines in Figure 3.15 can be explained by the presence of bridges (of clay particles) between silt grains (the clay content was about 50%) remaining intact for longer during the drying test but being broken more regularly during the consolidation test. The stepped nature of the plot with sudden drops of void ratio at particular suctions could be explained by the breakdown of the clay bridges. With frequent remoulding in the Barnes test it is envisaged that the remoulding would also break down many of these bridges and a relationship closer to the isotropic consolidation line would be appropriate for the soil in this test.

To assess the effects of desiccation in the ground Driscoll (1983) assumed that a suction of about 10 kPa (about pF2) marks the onset of desiccation and a suction of about 100kPa (about pF3) marks the onset of significant volume change, although Pugh *et al* (1995) considered these to be only a crude approximation. If these suctions are considered to be near realistic then a clay as it approaches its plastic limit (when a suction typically of the order of pF3 has been measured, see Tables 2.3 and 2.4) can be imagined to be undergoing significant structural rearrangements to produce the volume changes.

Delage *et al* (1996) studied the microstructure of an aeolian silt (fine sandy silty clay, clay content 34%) with $w_p = 19\%$ and $w_{opt} = 18\%$ so the 'optimum' samples would be indicative of the soil close to the plastic limit. On the wet side of optimum ($w = 25\%$) a matrix-type structure was observed with the clay/water matrix filling the spaces between and adhering to the silt and sand grains. At the optimum water content (close to the plastic limit) there was a skeleton of clay aggregates and silt and sand grains linked together by clayey bridges.

Therefore, as the water content approaches the plastic limit it can be deduced that there is a tendency for a more random matrix type structure to develop into an aggregated structure. It is feasible that the clay/water matrix not only forms into aggregates but these aggregates coalesce between the silt/sand grains to form the bridges. Delage *et al* (1996) postulated that the plastic limit could be the limit between a matrix structure and an aggregated structure.

When a clay soil is strongly aggregated, even with a high clay mineral content, the soil may not display plasticity. Newill (1961) found that it was difficult to determine the plastic limit on a residual, mainly halloysitic soil (Sasumua soil) because the soil thread crumbled at about ½ inch (12.7 mm) even over a 10% range of water contents. This soil was sensitive to mixing and drying due to the tubular shape of the clay particles, the presence of aggregations and iron oxide cementation. To attempt a plastic limit result Newill rolled the crumbled portions until they crumbled at the diameter of 1/8 inch whereby the aggregations broke down under the manipulation to impart some degree of plasticity. Thus the results would be affected by unknown and variable amounts of mechanical breakdown, remoulding and a certain amount of irreversible change in microstructure due to drying in the hands.

With a soil comprising clay aggregations that do not break down readily it would be more realistic to refer to and describe the soil as in its natural state which is probably non-plastic. A similar difficulty was experienced by Ruddock (1967) who

rejected the liquid limit and plastic limit tests as a means of classifying soils that were derived from the weathering of granites and phyllites in soils from Ghana. Several of the tests were deemed to be unsatisfactory because the thread in the plastic limit test crumbled through lack of cohesion rather than drying. If a soil shows no cohesion at any water content it can hardly be described as plastic.

3.15 Pore spaces

Four types of pore spaces were identified by Collins and McGown (1974):

- 1) within the elementary particle arrangements
- 2) within the particle assemblages
- 3) between particle assemblages
- 4) pores traversing the fabric.

Some of the pores will be occluded and some continuous and the pore size will generally increase from type 1 to type 4. For a soil to remain tough and tenacious (or plastic) pore types 3 and 4 must not be dominant whereas these pores can be imagined to dominate the brittleness of the soil because they provide defects in the soil around which fractures can propagate.

Bimodal pore size distributions have been obtained in samples of compacted kaolin/silt mixtures (Garcia-Bengochea *et al*, 1979 and Sivakumar *et al*, 2006) at water contents above and below the optimum water content with a group of small pore sizes present and a group of larger pore sizes. The smaller pore sizes probably exist within the aggregates while the larger ones are inter-aggregate or inter-silt pores. Diamond (1970) also showed that the clay mineral type had a marked effect with the smallest pore sizes obtained in a montmorillonite sample (typically 0.01 – 0.05 μm), larger pore sizes in kaolinite (0.1 – 0.2 μm) and much larger pore sizes in natural soils (1 – 5 μm).

According to Tanaka *et al* (2003) the mean pore size increases with increasing silt and sand content. This may be due to the prevalence of clay connectors or bridges between the coarser grains rather than continuous clay matrix. Thus, in natural soils where there is always a proportion of silt (and often sand) particles present a higher mean pore size than in mono-minerallic soils can be expected.

Diamond (1970) found that more compaction energy applied to a soil (greater numbers of blows per layer in the compaction mould) not only reduced the overall air voids content but also removed a proportion of the larger voids. Similar results were obtained by Garcia-Bengochea *et al* (1979).

During the Barnes test the soil is dried gradually starting from the liquid limit by gentle warm air blowing and hand remoulding so it is important to understand the changing state of the pore sizes in the soil during this process, particularly as it approaches and passes below the plastic limit. With the thread maker in the Barnes test some of these large pores would probably be reduced during static compaction whereas with the standard hand rolling method the loosely formed uncompacted soil thread will retain large voids and be more prone to breakdown under applied stresses.

Ahmed *et al* (1974) carried out pore size distribution tests on an illitic clay (Grundite) using standard Proctor, kneading and static compaction²⁷ with water contents at, above and below the optimum water content. The type of compaction was found to be insignificant but the moulding water content was very significant in determining the distribution of pore sizes, see Figure 3.16. These pore size distributions show that for the clay just above the plastic limit the void space comprises mostly fine voids or pores²⁸ while at the optimum water content, which should be just below the plastic limit, the very similar amount of total pore space contains fewer fine voids and more medium voids²⁹. This shows that as the plastic limit is approached larger void sizes develop and are probably enlarging as a result of coalescence of the finer voids as the water content reduces. It is noted that the medium void sizes are comparable to silt particle sizes. As all natural clay soils contain a fair proportion of silt, near the plastic limit these results show that there can be similar sized pores.

The pore size distributions obtained by Delage *et al* (1996) showed that on the wet side of optimum there were mostly small voids that were filled with water but at the optimum (close to the plastic limit) more larger voids had developed and these were poorly sorted (a wide range of diameters). Most significantly these larger voids were considered to contain air.

Similarly Cafaro (2002) stated that the suction at the plastic limit was close to the air entry value, i.e. the onset of desaturation, when the air-filled pore spaces will

²⁷ Static compaction is adopted in the Barnes Test to prepare a soil thread in the thread maker

²⁸ Fine voids or pores are defined with mean diameters of < 0.5 μm .

²⁹ Medium voids or pores are defined with mean diameters of 0.5 - 50 μm .

provide defects in the soil structure that will be preferentially exercised by externally applied stresses. In the rolling plastic limit test cyclic stressing will cause changes in the air pressure in these pores which is likely to aggravate the structural stability around the pores and promote crack propagation.

Suction test results on a compacted low plasticity clay till were presented by Vanapalli *et al* (1999). The plastic limit of the clay was 16.8%, just above the optimum water content of 16.3%. Wet of the plastic limit (and wet of optimum) the resistance to water discharge from the pores of the soil (i.e. desaturation) was found to be high with a high air entry value. In this state the pore spaces were considered to be not generally interconnected, they were in an occluded state. The microstructure controls and resists the desaturation process. With the soil compacted at the optimum water content (or very near plastic limit) and lower there are larger pore spaces located between the clods of soil as compared to the smaller pore spaces within the clods and the macrostructure then tends to dominate the ease with which this drier soil can desaturate.

Vanapalli *et al* (1999) considered that the boundary between the occluded pore space (wet of optimum water content and the plastic limit) and the open pore space (increasingly dry of optimum) occurs at water contents approximately equal to the optimum water content. Thus this boundary between the occluded pore space and open pore space will typically be close to the plastic limit from the data in Table 3.9. The author considers that the boundary between a soil with an occluded air space and a soil with open air space is not sharp, rather that there is a gradual change between these two states as the plastic limit is approached from a higher water content.

Micro and macro -pores can be visualised as micro and macro -cracks that will provide defects in the overall soil structure. In the Barnes test it is envisaged that on the wet side of the optimum water content, above the plastic limit, where the soil displays toughness the micropores do not develop into larger defects and the continuous soil structures, as shown in Figures 3.13 and 3.14, are maintained and permit plastic deformation and extrusion of the soil threads. However, as the water content approaches the plastic limit the larger voids, and particularly those containing air, can produce defective macrocracks and the microcracks can coalesce into macrocracks between the developing aggregates.

These processes will be enhanced by the intense cyclic compression-tension stressing of the soil thread and the fatigue type deformations that occur during the rolling test. Therefore, as the plastic limit approaches, the defect density increases

and the ductile-brittle transition occurs when the soil can no longer sustain a certain defect density.

Another phenomenon is considered to occur with the more colloiddally active, high clay content clays which are less affected by the presence of large void sizes. It is postulated that microcracks occur at locations of high shear stress in the soil and develop into mini-shear surfaces along which the clay particles become aligned and the residual shear strength is approached. Because the Barnes plastic limit test is load-controlled, for some tests on these clay soil types it has been found that there was too much load applied to the soil thread and the thread collapsed across its diameter prematurely rather than extruding longitudinally because of progressive failure along these mini-shear surfaces. This resulted in aborted tests.

In these circumstances it was found necessary to control more closely the straining of the thread, allowing only small load increments and small changes in diameter and when a peak stress condition was suspected the load was reduced in larger than normal decrements to prevent diametral collapse and to permit continued longitudinal extrusion. This was not always achieved.

3.16 Summary

The ductile-brittle transition has been recognised as a fundamental phenomenon for a range of materials in respect of changing temperature, such as metals, rocks, glass and wax. However, for soils this transition with respect to water content has not received the attention it deserves. On the ductile side of the transition a cohesive soil displays plasticity, in that it can be deformed considerably and can retain a deformed shape. In rolling out a soil thread the term toughness is introduced to define the amount of work per unit volume required to remould and deform the soil. The term tenacity is introduced to denote the ability of a soil to hold together, such as when rolled out into thin threads.

The behaviour of a soil on the brittle side of the transition in a plastic limit test can be explained by the generation of tensile stresses during rolling that seek out defects in the soil structure such as microcracks, air voids or fractures and develop these defects producing crack propagation until the soil specimen collapses in a brittle manner.

Casagrande (1932) recognised the importance of the toughness property of a soil at water contents near to the plastic limit and even suggested that clays could be classified according to their toughness. However, few researchers have pursued the

study of this property. Sometimes the term plasticity loses its definition and is used when toughness or tenacity would be more appropriate. Casagrande (1947) referred to the cohesiveness at the plastic limit when toughness would have been preferable.

Classifications of toughness have been published but these sometimes confuse the amount of work required in remoulding a soil with the ability to roll out threads of soil as thin as possible, best defined as tenacity. Most of the classifications for toughness or workability that have been published are based on qualitative or subjective assessments with no quantitative measure available.

In the ceramics and agricultural industries the term workability is more commonly used although in the former workability applies to clays at water contents above their plastic limits whereas in the agricultural industry a soil is only deemed workable when its water content lies below the plastic limit. Several novel, empirical tests have been applied over the years in the ceramics industry to assess workability for pressing, brick making etc. based on either a deformability or extrusion feature but none of these could give a measure of work per unit volume, instead they provide parameters with tenuous associations with workability.

It is evident that the property of toughness resides with the clay minerals in a soil and their structural arrangement and physico-chemical interactions. From a simple microstructural view of an idealized clay particle arrangement it is suggested that toughness will increase with increasing specific surface of the clay particles, attraction and/or friction between the particles and decreasing water content. In natural clay soils that usually contain silt and sand particles the clay particles are not arranged individually but are combined into face to face arrangements referred to as particle assemblages. These can comprise aggregations of clay and fine silt particles, clay bridges or connectors between the aggregations and silt and sand particles, interweaving bunches of clay particles and clay particle matrix.

It is reasonable to consider that the same structures exist in a compacted clay soil as prepared for the plastic limit test. Much published work on the effect of water content on soil structure has been based on the optimum water content from a compaction test. Regarding the plastic limit it is shown from published work that for inorganic clay soils the optimum water content is typically $0.9 \times$ plastic limit.

The plasticity properties of an individual clay soil are determined by the water content and chemical environment. On the wet side of optimum it is considered that the structure of a clay soil will comprise a continuous clay particle arrangement such as with interweaving bunches of particles, a clay matrix and clay

bridges between a smaller number of aggregates and silt and sand grains. The air voids content will be small and the size of the pores will be relatively small. This soil structure will have cohesiveness and have the ability to be rolled out into thin threads demonstrating tenacity.

As the water content decreases towards the plastic limit it is postulated that the clay matrix becomes stiffer, the aggregations coalesce, the clay bridges become stiffer or form aggregates and the air voids content and pore sizes increase. Under cycling compressive and tensile stresses the soil structure becomes more prone to crack propagation and dislocation and eventually at the plastic limit there are sufficient flaws in the structure to cause the thread to fall apart, or crumble.

Further research would be worth pursuing into the micro and macrostructure of a clay soil by means of electron microscope studies with comparisons of specimens prepared in the range of water contents in a Barnes test and before and after rolling and extrusion in the apparatus. A limited number of microphotographs have been taken of some clay:silt mixtures, described in Chapter 8.

Further research would also be worth pursuing into the effects of chemical additions used in the civil engineering field such as lime modification and stabilisation of clay soils. There could also be detrimental, or beneficial, effects of contaminants on the toughness of clays in landfill earthworks. In the ceramics industry research into the effects of chemicals such as salt solutions, gums and organic compounds and other toughness modifying compounds on kaolinitic clays could be profitable.

3.17 Tables

Factor	Plasticity (or toughness)
Increase in the quantity of expanding lattice-type clay minerals	Increases
Increase in the quantity of non-expanding lattice-type clay minerals	Decreases
Increase in surface area of soil particles	Increases
Increase in cation exchange of soil	Increases
Decrease in the valency of exchangeable cations	Increases
Decrease in the ion concentration of the pore fluid	Increases

Table 3.1 Factors affecting soil plasticity or toughness (From Prakash and Sridharan, 2006)

Liquid limit %	Plasticity term	Classification symbol
< 35	Low	CL or ML
35 – 50	Intermediate	CI or MI
50 – 70	High	CH or MH
70 – 90	Very high	CV or MV
> 90	Extremely high	CE or ME

Table 3.2 Plasticity classification (From BS5930:1999)

Condition at the plastic limit	Description
Fairly stiff and tough	Inorganic clay of high plasticity
Softer and more crumbly	Inorganic clay of low plasticity
Weak and often soft thread that breaks up, crumbles readily and may be difficult to form.	Inorganic silt
Very weak, spongy or fibrous thread which may be difficult to form at all, and their lumps crumble readily.	Organic soils

Table 3.3 Toughness descriptions (From BS5930:1999)

Soil Symbol	Toughness classification
ML	Low or thread cannot be formed
MH	Low to medium
CL	Medium
CH	High

Table 3.4 *Toughness classifications for ASTM soil symbols (ASTM, 2000)*

Criteria for describing plasticity	Term	Criteria for describing toughness
A 1/8 inch (3 mm) thread cannot be rolled at any water content	Non-plastic	Not applicable
The thread can barely be rolled; lump cannot be formed below the PL	Low	Only slight pressure is required to roll the thread near the PL; the thread and lump (formed from the crumbled pieces) are weak and soft.
The thread is easy to roll; not much time is required to reach the PL; the thread cannot be re-rolled after reaching the PL; the lump crumbles when drier than the PL	Medium	Medium pressure is required to roll the thread to near the PL; the thread and lump have medium stiffness.
It takes considerable time rolling and kneading to reach the PL; the thread can be re-rolled several times after reaching the PL	High	Considerable pressure is required to roll the thread to near the PL; the thread and lump have very high stiffness.

Table 3.5 *Manual tests to assess the plasticity and toughness classification (ASTM, 2000)*

Class	Test description
Non-plastic	A roll 4 cm long and 6 mm thick that supports its own weight held on end cannot be formed.
Slightly plastic	A roll 4 cm long and 6 mm thick can be formed and, if held on end, will support its own weight. A roll 4 mm thick will not support its own weight.
Moderately plastic	A roll 4 cm long and 4 mm thick can be formed and will support its own weight, but a roll 2 mm thick will not support its own weight.
Very plastic	A roll 4 cm long and 2 mm thick can be formed and will support its own weight.

Table 3.6 *Plasticity classes (From Anon, 1993)*

Class	Toughness criteria
Low	Can reduce the specimen diameter at or near the plastic limit to 3 mm by exertion of < 8N
Medium	Requires 8-20N to reduce the specimen diameter at or near the plastic limit to 3 mm.
High	Requires >20N to reduce the specimen diameter at or near the plastic limit to 3 mm.

Table 3.7 Toughness classes (From Anon, 1993)

Ribbon strength	Liquid limit	Dry strength	Dilatancy reaction	Toughness	Stickiness	Class
None	<50	None to slight	Rapid	Low	None	ML
Weak		Medium to high	None to very slow	Medium to high	Medium	CL
Strong	>50	Slight to medium	Slow to none	Medium	Low	MH
Very strong		High to very high	None	High	Very high	CH

Increasing potency
↓

Table 3.8 Classification of fine-grained soils (From Anon, no date)

Soil type	Ratio w_{opt} / w_p	Authors
Agricultural soils	0.55 – 0.75	Campbell <i>et al</i> , 1980
Agricultural soils	0.9	Mueller <i>et al</i> , 2003
Residual soils	Approx. 0.6	James, 1968
Residual soils	0.57 – 0.81	Menzies <i>et al</i> , 1974
Red coffee and black cotton soils	0.846	Sahu <i>et al</i> , 1984
Various soils	0.92	Nagaraj, 2000 (In Gurtug and Sridharan, 2004)
Various soils	0.92	Gurtug and Sridharan, 2004
Various soils	0.94	Howell <i>et al</i> , 1997 (based on several authors)
Various soils	0.7 – 1.1	Sahu <i>et al</i> , 1984
Various soils	0.94	Sivrikaya <i>et al</i> , 2008
Various soils	0.92	Sridharan and Nagaraj, 2005
Boulder clay	$w_p = w_{opt} + 2\%$	Penman, 1986
Calcium illite	0.93	Olson and Scott, 1960
Illite	0.88	Ramanathan and Raman, 1974
Kaolinite	1.09	
Black cotton soil	0.9, 1.1	
Natural clays	0.71, 0.97	

Table 3.9 Relationship of optimum water content to plastic limit

3.18 Figures

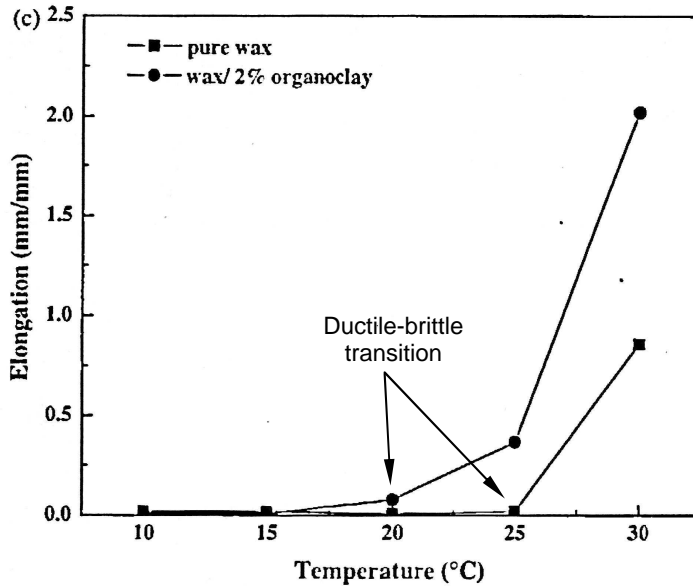

Figure 3.1 Ductile-brittle transition related to temperature (From Wang et al, 2007)

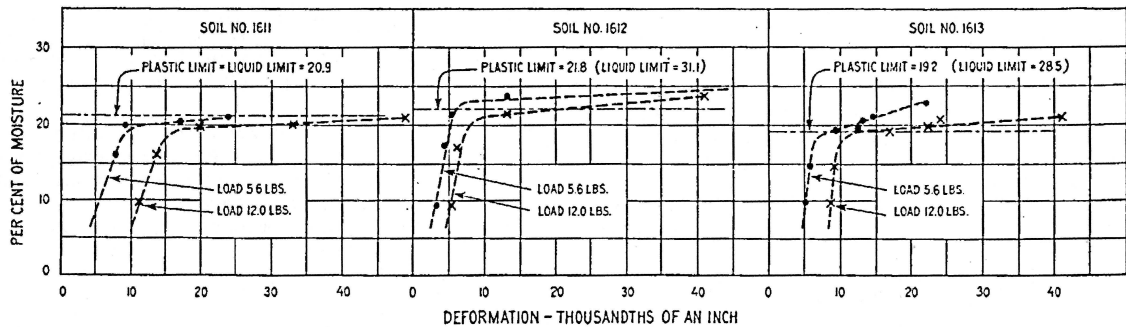

FIG. 2.—DEFORMATION DIAGRAMS FOR THREE MEDIUM PLASTIC SOILS TESTED AT ARLINGTON. THE CURVES SHOW THE DEFORMATION OF CURBS OF THE SOILS UNDER PRESSURES OF 5.6 POUNDS, RESPECTIVELY, WITH VARYING MOISTURE CONTENT. NOTE THAT THE SHARP BREAKS IN THE CURVES (CRITICAL BEARING POINTS) COINCIDE CLOSELY WITH THE LOWER PLASTIC LIMITS

(The author's highlighting)

Figure 3.2 'Critical bearing point' or ductile-brittle transition? (From Terzaghi, 1926)

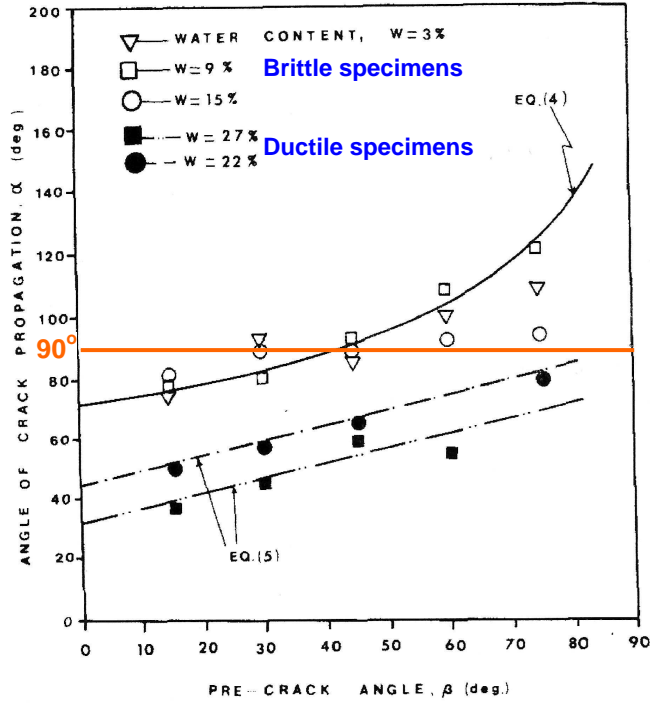

Figure 3.3 Crack propagation for brittle and ductile specimens (From Vallejo, 1988)

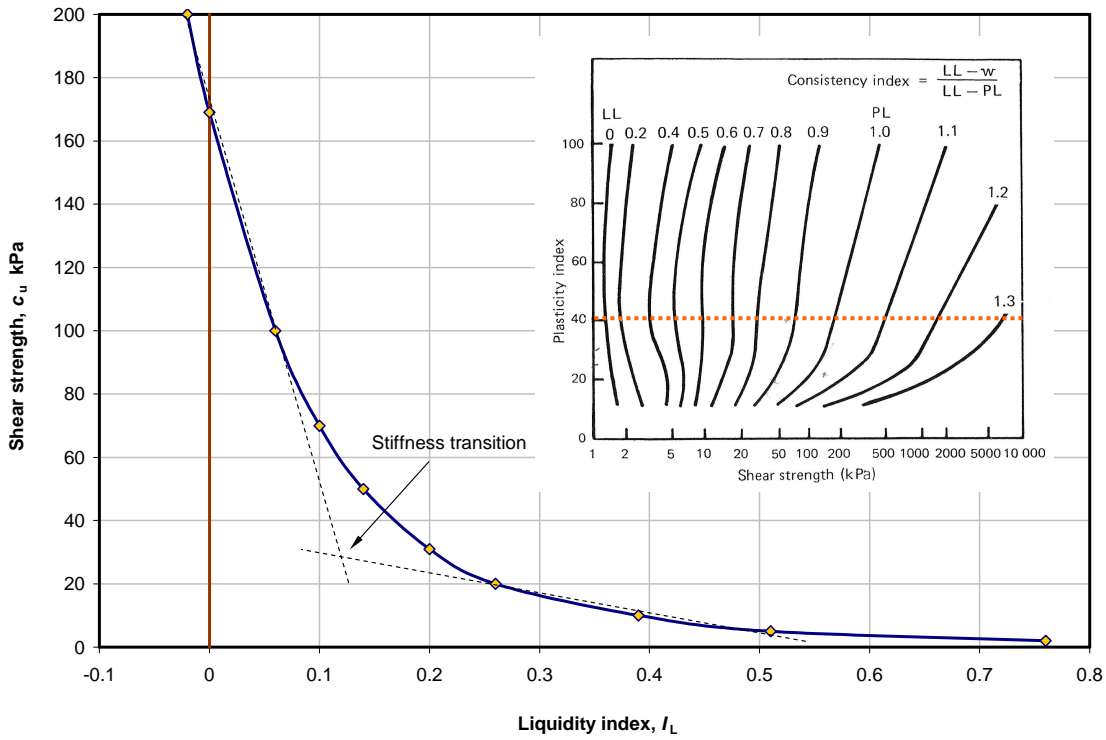

Figure 3.4 The stiffness transition (From Black and Lister, 1979)

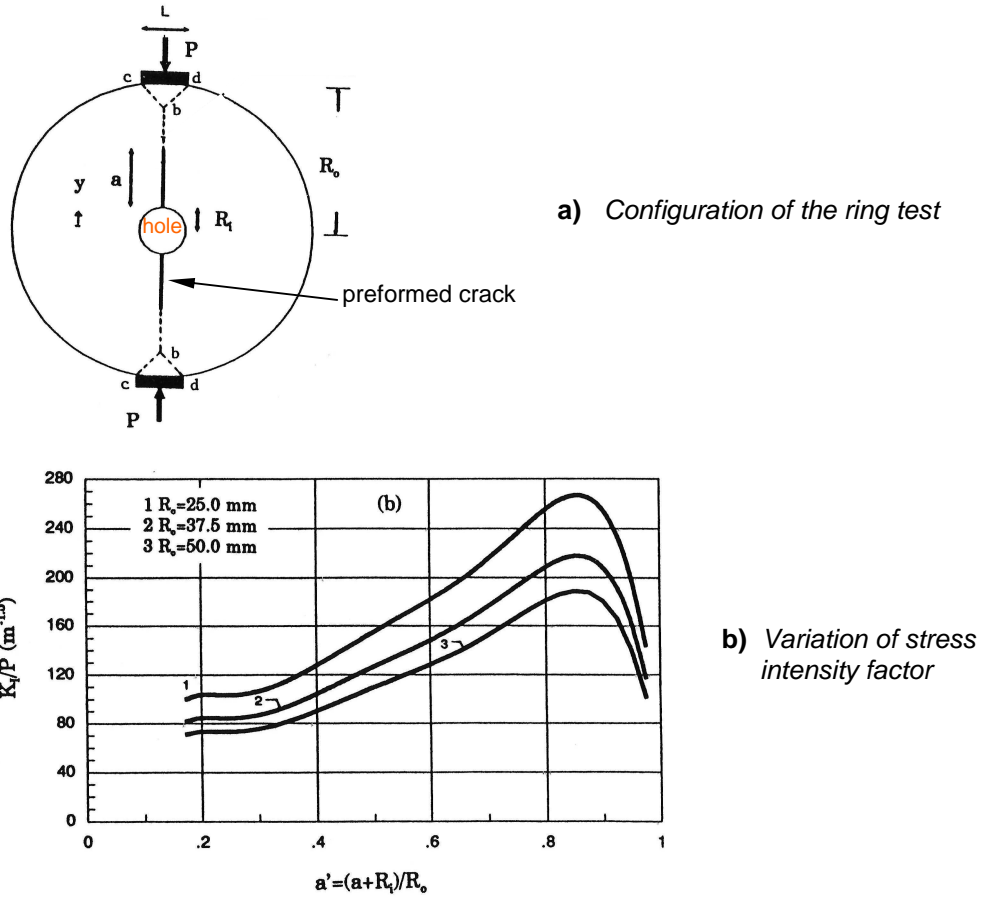

Figure 3.5 FE analysis of the ring test along the loaded diameter (From Harison et al, 1994)

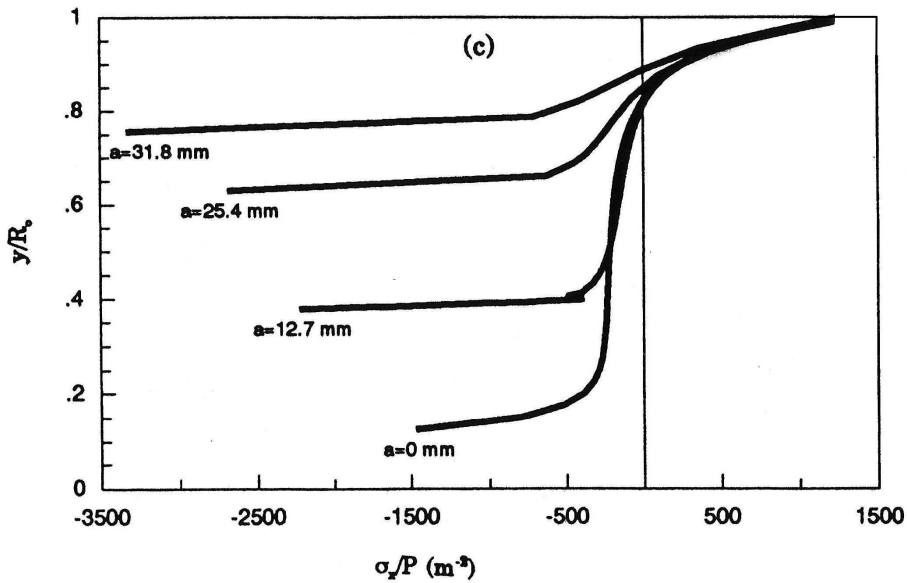

Figure 3.6 Normalised stress σ_x/P along the loaded diameter in the ring test (From Harison et al, 1994)

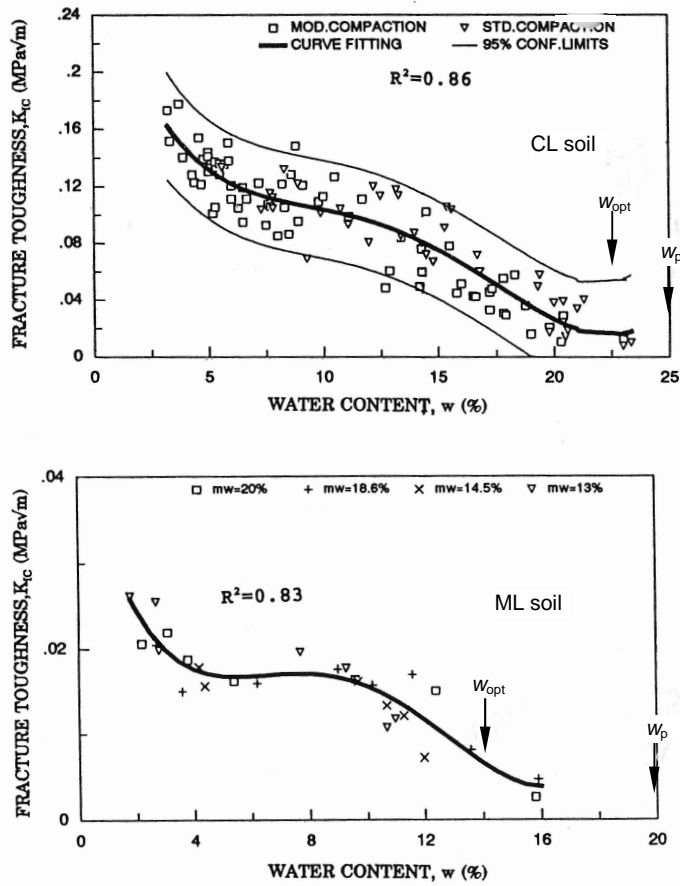

Figure 3.7 Fracture toughness vs. water content (Modified after Harison et al, 1994)

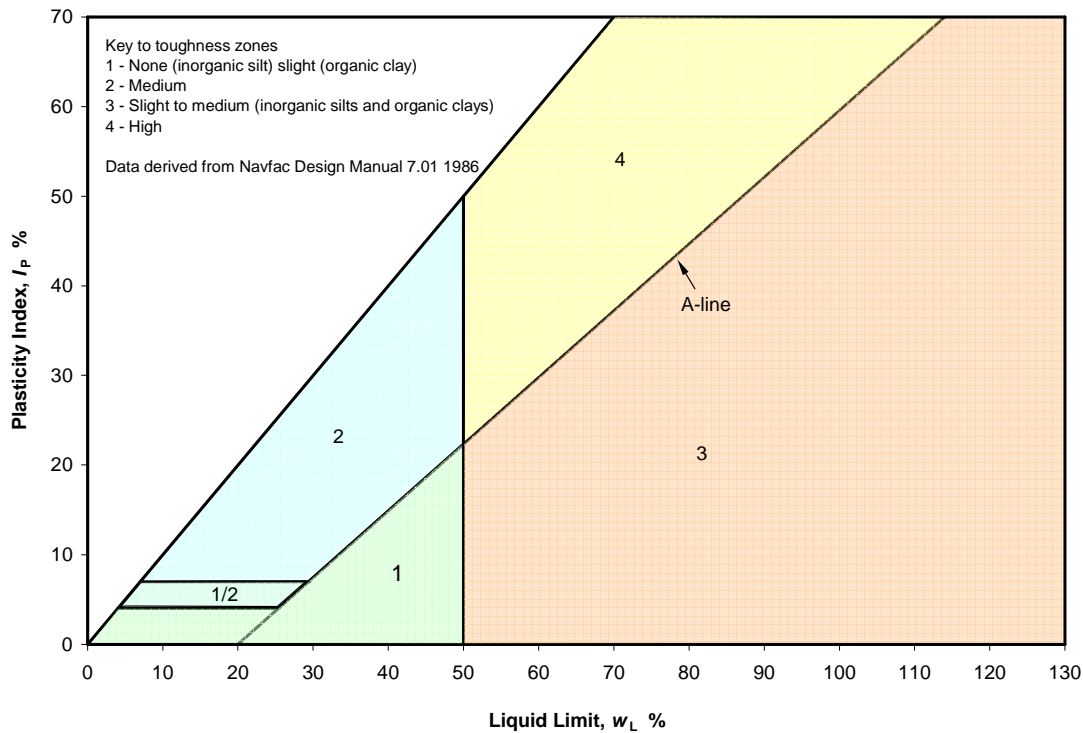

Figure 3.8 Toughness classification on the plasticity chart (From NAVFAC, 1986)

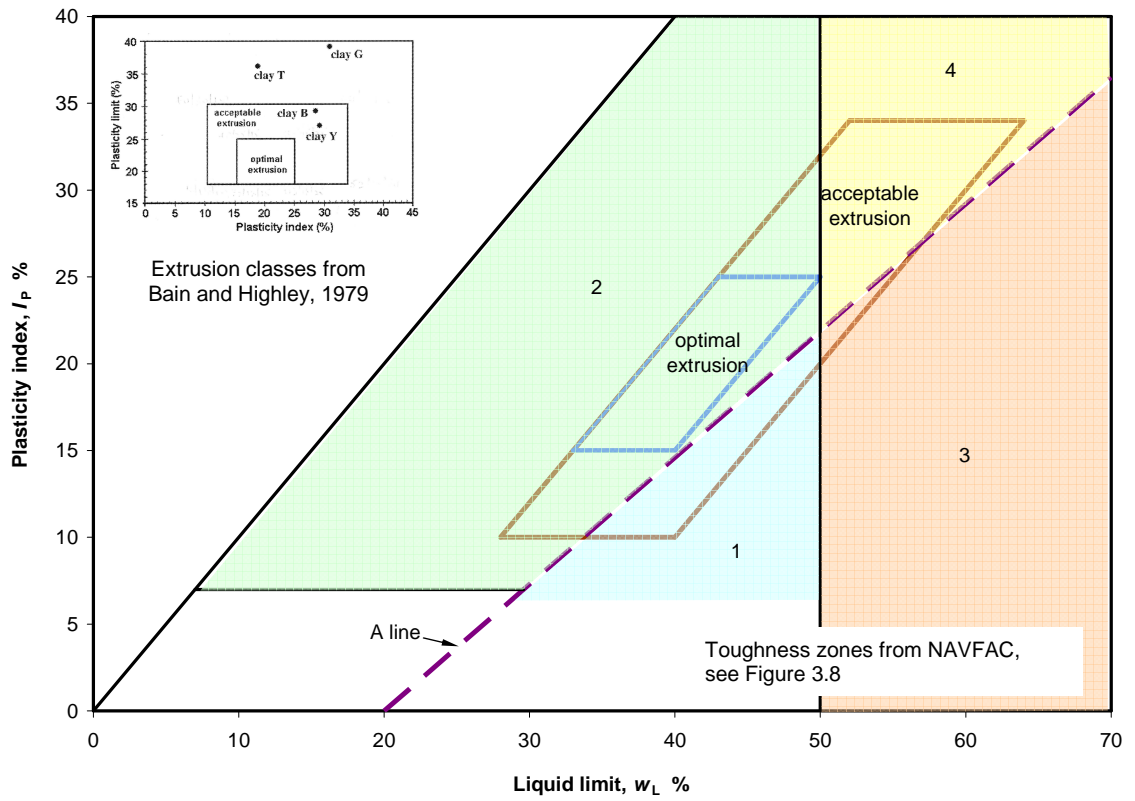

Figure 3.9 Extrusion classes (From Vieira et al, 2007)

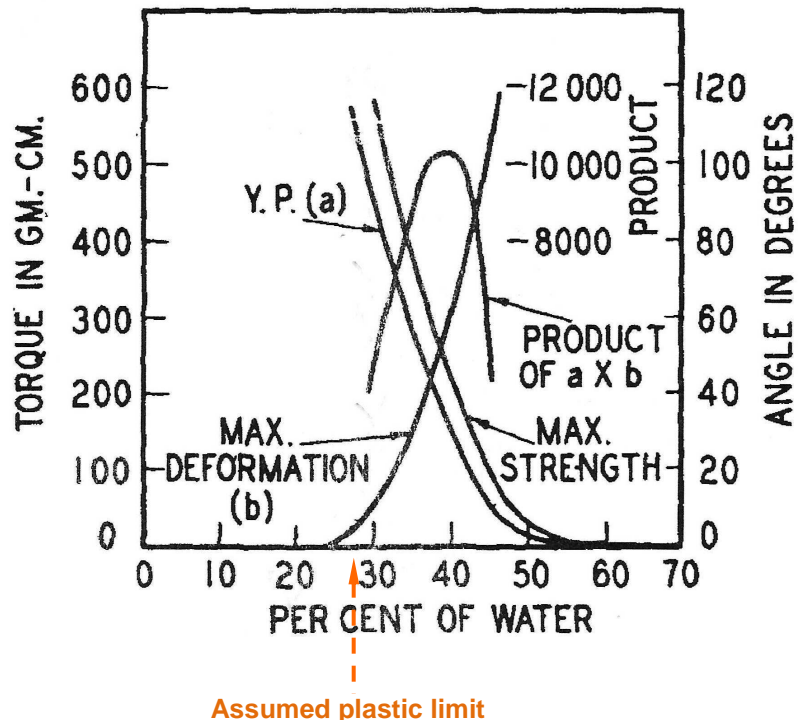

Figure 3.10 Torque and angle of rotation vs. water content (From Norton, 1938)

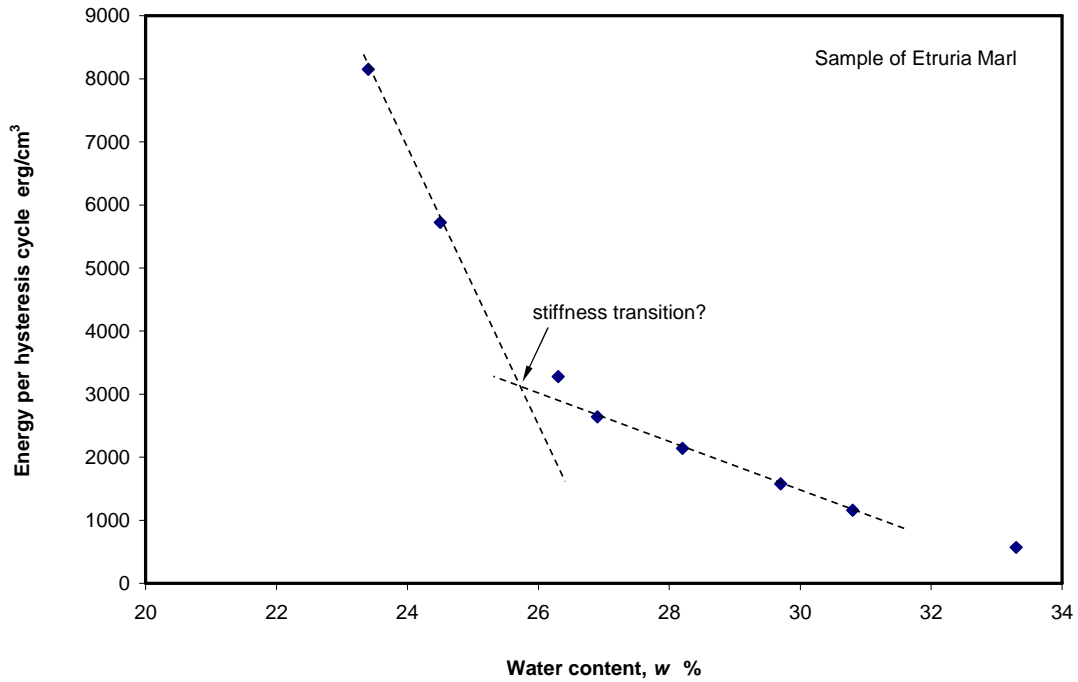

Figure 3.11 Effect of water content on hysteresis model parameters
(Data from Astbury *et al*, 1966)

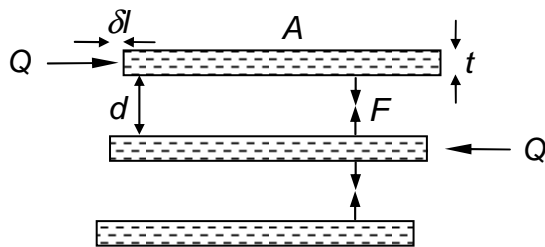

Figure 3.12 Unit particle arrangement

Elementary particle arrangements

Face to face groups of particles arranged as:

dispersed – mostly face-face arrangement of groups



flocculated – edge-face and edge-edge

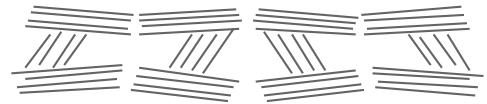

partly discernible – no strong structural tendency difficult to distinguish



Figure 3.13 *Elementary particle arrangements* (From Barnes, 2010, adapted from Collins and McGown, 1974)

Particle assemblages

clay coating
on silt and sand particles

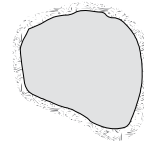

connectors
'bridges' of mostly clay particles between silt and sand particles

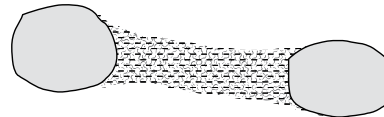

aggregations
silt to fine sand size mixtures of elementary particle arrangements



interweaving bunches
strips of clay particles interwoven around each other and around silt particles

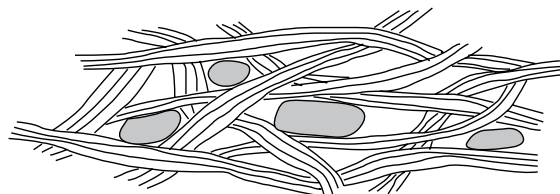

particle matrix
present where clay content is high binding other assemblages together

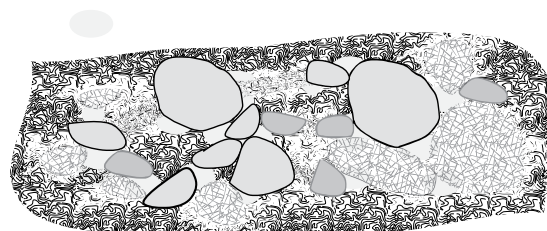

Figure 3.14 *Particle assemblages* (From Barnes, 2010, adapted from Collins and McGown, 1974)

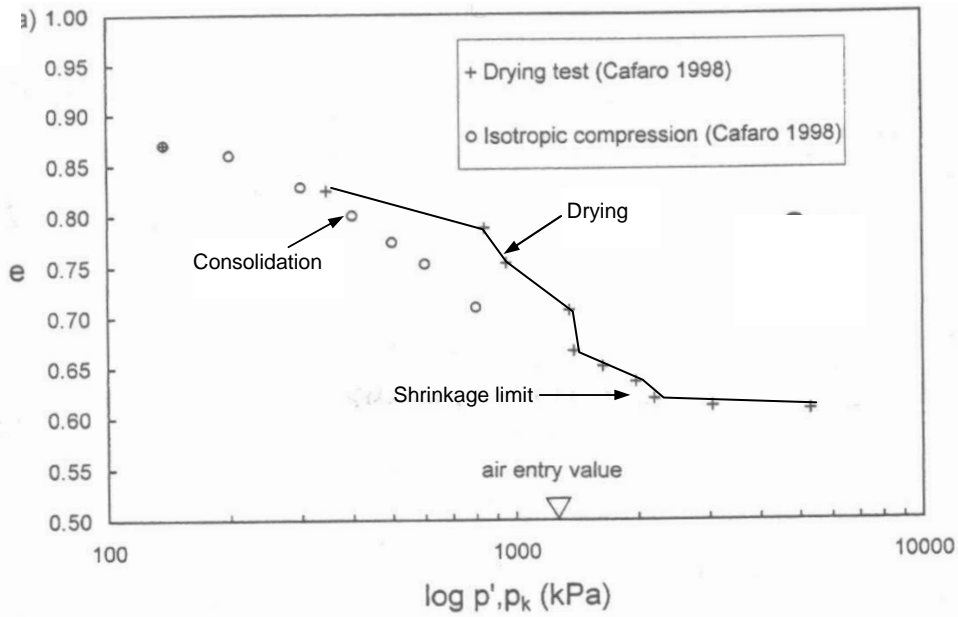

Figure 3.15 Drying (suction) test and consolidation test results (From Cafaro, 2002)

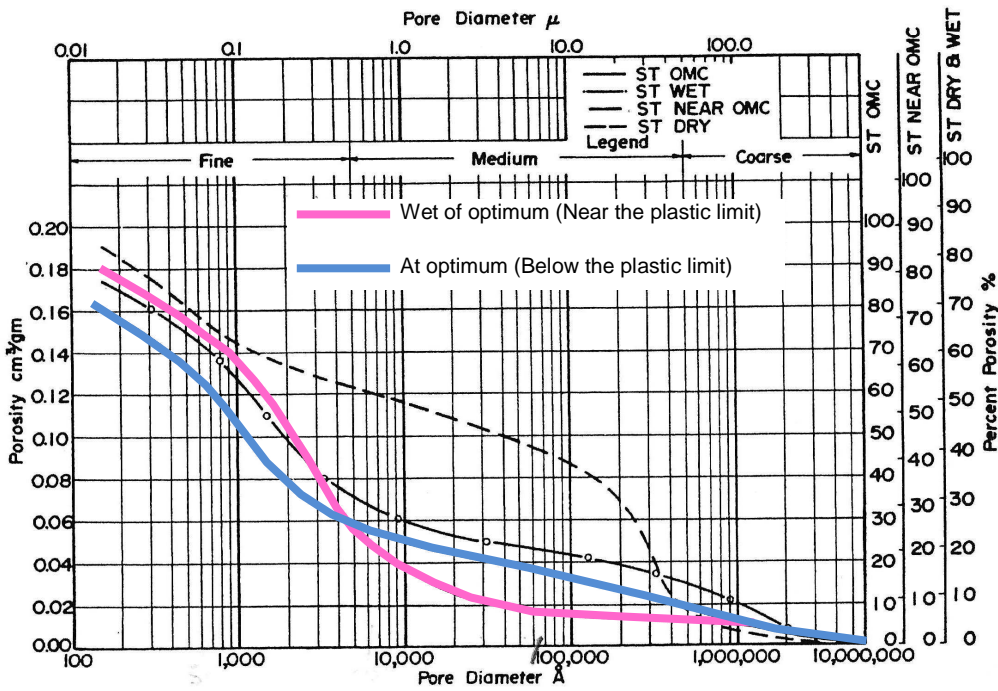

Figure 3.16 Pore size distributions of statically compacted (ST) samples of illite (From Ahmed et al, 1974)

CHAPTER 4

The Barnes apparatus and test

4.1 History

Much of the development of the apparatus was conducted over a period of about 4 years, by trial and error and in an intermittent manner, prior to the PhD research programme start date of January 2008. In summer 2007, after achieving some success with the design, several parts were machined and manufactured by others and other parts purchased as separate items to enable the assembly of an apparatus. This apparatus was finally considered suitable with 'success' measured by the adequate rolling and extrusion of a soil thread and with appropriate measurements achieved for computing nominal (but not exact) stresses and strains in the thread. Some modifications were found necessary and these have been incorporated as part of the research programme, as described below.

A photograph of the final apparatus is presented in Figure 4.1. A side elevation of the apparatus is shown in Figure 4.2, a section through the apparatus in line with the soil thread is shown in Figure 4.3 and photographs of the plates are shown in Figures 4.4 and 4.5. This apparatus has been used in the research programme commencing January 2008.

A Certificate of Grant of Patent No GB2443537 for the invention entitled "Apparatus and method for measuring plastic properties", was received, dated 22 December 2010 following the application filed, dated 30 October 2007.

4.2 Overview of operation

The initial soil thread is made with a diameter of about 8 mm and a length of about 60 mm in a specially fabricated tube referred to as the thread maker. Soil is inserted in the tube and compacted statically to remove air and to fill the tube space. A detailed description of the preparation of the soil thread is given in Chapter 5. The thread is then extruded and placed on the apparatus at the front of the bottom plate, see Figures 4.2, and where the brass rod is located in Figures 4.4 and 4.5. Starting with a diameter of about 8 mm means that by the time the soil has yielded and reached the plastic state it will have a reasonable diameter (at least 6 mm) and with an initial length of 60 mm it will extend beyond the edges of the plates so that there is always 50 mm of thread between them. These dimensions

also provide for a reasonable mass of specimen for water content determination, of 6 - 7 grams. The water content is conducted in accordance with BS1377:1990, Part 2, Classification tests by the definitive procedure of the oven-drying method with overnight drying. This British Standard confirms that between 16 and 24 hours is usually a sufficient length of time for drying most soils and that the drying time will depend on the amount of material in the oven so with a small mass of soil tested this time will be adequate.

The soil thread is rolled between a top glass plate and a bottom stainless steel plate, both 50 mm wide overall, see Figure 4.3. The top plate is stationary and the bottom plate is moved to the left over a distance of 100 mm so that the thread rolls 50 mm to the left. It is immediately rolled back to its original location making one traverse, see Figure 4.2. This process is intended to mimic the hand rolling method.

Loads are applied to the thread by placing a brass mass on the loading bar and increasing or decreasing the load by moving the brass mass along the loading bar. Traverses are continued with increasing load applied to produce plastic strains in the soil that result in reductions of diameter accompanied by longitudinal extrusion of the thread. Displacements are measured from changes in dial gauge readings, allowing the computation of the diameter of the middle of the thread after each traverse and diametral strains are then calculated.

To provide a reasonable strain control the load steps are chosen to ensure the reductions in diameter are maintained within a small range of changes in the dial gauge readings in each traverse. A yield condition is usually detected during the test and then smaller load increments are applied to produce the required reductions in diameter. Further loading is applied more gradually to achieve a controlled plastic yielding. Load control is less critical with strain-hardening soils. The test is continued until the thread has reduced below a diameter of at least 4 mm and usually to a diameter of 3 mm.

The test data of force values and dial gauge readings are input to an Excel spreadsheet, nominal stresses are computed from the split cylinder formula and from a nominal stress-strain plot the work per unit volume (as the area beneath the curve) is calculated for each traverse and the cumulative work/unit volume required to reduce the thread from a central diameter of 6 mm to a diameter of 4 mm is determined as the 'toughness³⁰' of the soil at the water content tested.

³⁰ In this thesis the term toughness is used for the work/unit volume applied to a soil when in its ductile or plastic state, with water contents above the plastic limit. It is to be distinguished from fracture toughness which is a property of a material when in its brittle state.

4.3 Sliding mechanism

The first sliding mechanism used for the bottom plate was a ball bearing roller guide. A slide rail, the sort used to support a kitchen drawer, was modified for different positions of the stop ends of the travel so that the bottom plate attached to it would roll back and forth over a distance of 100 mm. This worked well but it was thought that with the presence of dust and soil flakes falling on the apparatus and the ball bearing being slightly oiled this roller would become clogged over time.

Following a search for an alternative a portion of linear slide rail was obtained, Drylin size 80 from Igus (UK) Ltd. This is used in the production of manufacturing equipment for moving items over large distances. It comprises a low friction plastic insert moving inside an aluminium guide, see Figure 4.3. There are no other moving parts and no oil/grease is applied. This slide rail works well.

4.4 Top glass plate

The top plate is made from glass strips for several reasons. One is that the Standard test methods, for example BS 1377:1990 and ASTM D4318-10, require the soil to be rolled between the hand and a glass plate. Glass, when kept clean provides a non-varying surface texture with the same smoothness for all soil types. An important advantage is that the behaviour of the thread during rolling can be viewed at all times to check that the thread is rolling and not simply translating bodily and to detect signs of instability such as dilatancy or crumbling.

Glass strips 20 mm and 10 mm wide and 150 mm long were obtained from Instrument Glasses Ltd. To encourage extrusion from between the plates the top glass plate is provided with a central flat strip 10 mm wide with two side strips 20 mm wide and inclined upwards at 1 in 40 or 0.5 mm in 20 mm. This was considered to be the 'flattest' inclination that could be achieved practically in the assembly. The strips would be sufficiently inclined to encourage extrusion and the variation of nominal stresses along the length of the thread would be kept to a minimum so that near uniform stress is applied on the long axis. Any steeper and the thread extruded would be changing shape along its length too sharply. The middle of the thread would tend to rotate faster (with more revolutions per traverse) potentially resulting in torsion and premature, undesirable, breakage of the thread.

Previously, a specialist company of glass instrument manufacturers had been instructed to make the top glass plate out of one piece of glass, 50 mm wide and 150 mm long with the outer 20 mm strips inclined. This was not successful. The

grinding of the inclined faces was inadequately controlled such that the grinding encroached onto the central strip. This meant that the central strip was not flat, parallel, straight or clearly marked. Also a different surface texture had been produced. This approach was abandoned and the manufacture from simple parallel straight strips of glass, 10 mm and 20 mm wide, was adopted.

The central glass strip was glued to the underside of the polycarbonate loading bar with thin pieces of plastic 0.5 mm thick inserted between the glass strip and the loading bar. The 20 mm wide glass strips were then glued alongside with their edges coincident with the edges of the central strip and in contact with the outer edges of the polycarbonate bar. This provided the inclination for the outer strips.

Because of the surface tension developed between a moist soil and clean glass the soil has a tendency to stick to the glass and extrusion would be resisted. To avoid this it was found that a very thin smear of petroleum jelly applied to the surface of the outer 20 mm glass strips prevents the soil from sticking and good rolling and extrusion is achieved. No grease is applied to the central flat strip so that this strip 'grips' the thread and the grip (or friction, or adhesion) causes the soil thread to roll. If the central strip was greased there would be no means of causing the soil thread to roll, it would slide.

The polycarbonate loading bar is also transparent and this permits viewing of the soil thread. The glass plates on the apparatus are 150 mm long although the thread only rolls over a distance of 50 mm from its start point. This length could be changed in a future apparatus but the loading divisions would have to be recalculated because of the different moment provided around the knife edge support.

4.5 Bottom steel plate

Photographs of the bottom plate are shown in Figures 4.4 and 4.5. In the Patent it was referred to as the steel base plate, see Figures 4.2 and 4.3. By means of the linear slide rail the bottom plate underneath the soil thread is pushed to the left over a distance of about 100 mm, see below, with the top plate stationary so that the thread rolls forward half of this distance. The plate is then immediately pulled back so that the thread rolls backward to its original position. Front and back stops on the base prevent the bottom plate from exceeding this distance.

A traverse comprises moving the thread from the front of the bottom plate to the rear of the plate and then back to the front. As the bottom plate has a fixed length

the length of the traverse will increase slightly as the diameter of the thread decreases but this is considered to have an insignificant effect.

The bottom steel plate was chosen to be 53 mm long so that the thread can be rolled over a distance of 50 mm centre to centre (of the thread) when it is 3 mm diameter. This means that the distance of travel is somewhat less when the thread diameter is, say, 6 mm. The distance is then $53 - 6 = 47$ mm centre to centre. In a future apparatus the length of the bottom plate could be changed to say 58 mm so that the traverse of the thread at its initial diameter of 8 mm is 50 mm. The distance the thread moves is governed by the distance over which the bottom plate is moved and is, therefore, not necessarily governed by the front stop or the back stop. This variation of traverse length applies to all tests conducted with the apparatus so should not affect the comparison of results.

The author instructed the manufacturers to provide the bottom steel plate with a shallow central flat recess 0.5 mm deep across the middle 10 mm wide strip. At this stage of development it was felt that this recess would be necessary to keep the thread centrally between the plates as it rolled. The recess would 'grip' the thread centrally and prevent it from moving or extruding more on one side of the plates than the other. The outer 20 mm wide strips are inclined downwards at 1 in 40 or 0.5 mm in 20 mm. As for the glass plate these outer strips are smeared with petroleum jelly to provide a smooth surface, but not the middle 10 mm strip.

Tests using this configuration gave reasonable results but it was found that for the more colloiddally active clays and with a high clay content, e.g. Oxford Clay, too many threads split prematurely at the ends of the 10 mm wide central strip. It was realised that this splitting was due to the soil in the recess moving around the soil just outside the recess. This is illustrated in Figure 4.6 where, at the edges of the recess, with rotation of the thread from position 1 to position 5 the thread was not rolling co-axially and the soil outside the recess was shearing against the soil inside. This would mean that during each rolling cycle torsion was being applied on the cross section of the thread at the edges of the recess. With a smaller diameter the soil outside the recess would be rotating more quickly than the soil inside. Also it was observed that the threads would wriggle longitudinally during rolling. This was considered to be due to the inner 10 mm section of the thread rolling slower than the outer sections, tending to stretch the threads. The problem was thought to be the recess.

It was decided to make the top glass plate with a similar 0.5 mm deep recess in the 10 mm central strip so that the threads would roll co-axially. This made the situation

worse because on testing the Oxford Clay it was found that for the stiffer threads premature squashing occurred without adequate longitudinal extension. The restraint provided by the edges of the recesses caused resistance to the thread extending longitudinally within the central 10 mm. Also because the diameter of the thread just outside the recess was significantly smaller than just inside the recess (by $0.5 + 0.5 = 1.0$ mm) the difference in nominal stresses at this location would cause a nominal stress concentration that the soils could not sustain and would fail diametrically rather than extrude longitudinally.

To resolve this problem it was decided to revert to a flat glass middle strip without a recess and to insert and glue a thin (0.5 mm thick) strip of metal inside the recess in the steel bottom plate to make a flat central strip. The metal obtained for this strip was 10 mm wide, 0.5 mm thick brass strip. In the event the manufacture of the central recess in the bottom steel plate was considered to be a blessing in disguise. Compared to the manufacture of a full width glass plate, described above, the manufacture of the recess in the steel bottom plate meant that greater attention had to be given to the cutting of the central strip, with parallel and straight sides. Also the manufacture of the inclined surfaces had to run from the edges of the recess requiring greater control so the central strip was not encroached on.

4.6 Configuration of the plates

A cross section showing the configuration of the plates is presented in Figure 4.3. Four main problems of rolling a thread of soil by means of an apparatus were overcome:

- 1) Centralisation of thread – to prevent the thread from moving sideways out of the apparatus a central flat strip 10 mm wide is provided in both plates.
- 2) Extrusion of thread – to encourage extrusion of the thread along its longitudinal axis the outer edges of the top and bottom plates are inclined slightly outwards, at 1 in 40, or 0.5 mm in 20 mm.
- 3) Extension of thread – With an initial length of 60 mm some part of the thread always remains between the plates. It would not be possible to apply a uniform nominal stress along the whole of the thread, including the parts outside of the 50 mm wide plates, as it extends longitudinally. Because the diameter is reducing the volume of soil between the plates is reducing but the product of nominal stress and strain gives the work

done per unit volume so providing the thread retains its original properties the measure of work is not affected, see below.

- 4) Sticking of thread to plates – due to surface tension soft moist soils will stick to the surfaces, the glass³¹ in particular. To minimise this, a very thin smear of petroleum jelly is applied to the outer 20 mm strip faces of both top and bottom plates.

With this configuration successful reduction of the thread diameter and simultaneous longitudinal extrusion are achieved. The thread diameter at the outer edges of the plates is always 1 mm greater than the diameter in the central section of the thread where nominal stresses and diametral strains are computed. With the smaller thread diameters, approaching 3 mm there is sometimes a tendency for the thread to move faster in the middle than towards the edges of the plates. To avoid exaggerating this effect it has been found beneficial to conduct the traverse as quickly as possible, within about 2 to 3 seconds, and to occasionally straighten the thread by pushing it gently up against the front and rear ends of the bottom plate.

For an initial size of thread of 8 mm diameter and 60 mm length to be reduced to a uniform final diameter of 3 mm its length would be increased to about 426 mm. At the larger diameters the thread is gradually extruded and its length does not extend so far outside the top and bottom plates. However, as the soil thread exudes between the plates it is prone to flap about during rolling³² as it is not enclosed by the plates. To reduce the effects of this ‘flapping’, plastic support strips were attached each side of the bottom plate, as shown in Figure 4.5, at a level just below the edge of the bottom plate. When the length of thread emanating from the edges of the plates exceeds about 20 mm it is cut off and kept to one side for water content determination when the test is completed.

A photograph showing a test specimen of Oxford Clay before and after rolling to less than 3 mm, but not trimmed, is presented in Figure 4.7 to illustrate the change in shape and size that a thread undergoes during the test. This photograph was taken for the purposes of the paper by Barnes (2009).

4.7 Loading bar and force markings

A thick bar of polycarbonate (Perspex) was chosen for the loading bar so that it would provide the 50 mm width, be sufficiently stiff to avoid deflections when

³¹ Glass produces a larger surface tension with water (in a soil) than an oxidized and rougher metal surface.

³² This occurs when the length of the thread extends about 20 mm beyond the edges of the plates.

loaded and be transparent for viewing the thread during rolling. Taking moments about the knife edge support for the masses of all of the components, including the moveable brass mass and the dial gauge force³³, formulae were derived to give

- 1) the distance from the end of the loading bar to the position of the moveable mass where the assembly gives a zero force on the soil thread and
- 2) the distances from the zero force location to the required force values, in Newtons, see Figure 4.2.

These formulae were inserted into an Excel spreadsheet so that adjustments could be made to determine the size of the moveable masses and to obtain a suitable location on the loading bar for the point of zero force. The moveable mass must be stable when located at this point, sufficiently far from the left edge of the loading bar to prevent overbalancing. Adjustments to the size (or mass) of the moveable brass mass were also necessary to provide suitable intervals for the force increments so that they were a reasonable distance apart and the moveable mass could be positioned with sufficient accuracy. A sample of the spreadsheet used to determine the force positions for each scale is included in Figure 4.8.

From earlier experiments it was found that most soils could be accommodated within the range of force values between 0 and 8 N. However, when testing tougher soils such as those high in montmorillonite, higher forces are required, up to 13 N. To allow for two loading ranges on the same loading bar two moveable brass masses, nominally 600 and 1000 grams, were made, see Figures 4.9 and 4.10.

For the lower range of 0 to 8 N an additional balancing mass is fixed at the left end of the loading bar and the 600 gram mass is moved along the loading bar. See Figure 4.9 showing the 600 gram moveable mass at the zero force mark on the scale. For the higher range of 0 to 13 N the balancing mass is removed and the 1000 gram mass is moved along the loading bar. See Figure 4.10 showing the 1000 gram moveable mass at the zero force mark on the scale. Following manufacture of the two masses they were accurately weighed and these masses were used for the analysis of the force markings. The two brass masses were designed and made to align their mid-point (or centre of gravity) at the force position marked on the scales. The more commonly used 600 gram mass was designed to obscure the scale for the 1000 gram mass so there is no confusion over which scale to use, see Figure 4.9.

³³ This was measured by placing the dial gauge above a balance and measuring the static force applied, see Figure 4.8.

It was realised that when the soil thread is at the starting point of the test, at the front of the bottom plate, it is furthest away from the knife edge support so the force applied is a minimum, F_{\min} . When the bottom plate is moved to the left and the thread rolls 50 mm or so to the left the thread is nearer the knife edge support so the force applied to the soil thread will be a maximum, F_{\max} . For this apparatus the maximum force is about 18% higher than the minimum force.

For the purpose of the force markings on the loading bar it was decided to use the average force along the traverse, F_{ave} . The average force is about 8% lower than the maximum force. On the left hand side of the calculations in Figure 4.8 values of the force applied, F , are calculated at the location of the soil thread during its travel distance, x mm, from the starting point of its traverse. By simple integration of the area of the $F-x$ plot the value of $x = 25.71$ mm was found where F_{ave} would be applied.

This value of x was then used in the calculations for the force markings on the loading bar. On the right hand side of the calculations in Figure 4.8, from moment equilibrium, the distance y mm from the left end of the loading bar could be found where the moveable mass (or its centre of gravity) would produce a known force F_{ave} on the soil thread. For example, for the 600 gram mass placed at a distance of 276.53 mm from the left end of the loading bar the average force on the soil thread would be 5 N, see Figure 4.8.

As the distance increments on the loading bar were the same for all values of force a scale was drawn and printed on transparent film and attached on the side of the loading bar. This is the scale for the 600 gram mass (0 to 8 N), see Figure 4.9. The scale for the 1000 gram mass (0 to 13 N) is attached on the top of the loading bar, see Figure 4.10, and is obscured when the 600 gram mass is applied.

4.8 Back stop

The first back stop was a simple rotating flap that could be moved out of the way to allow the bottom plate to be moved fully to the right for cleaning and to place the soil thread on the plate for the start of the test and then closed to provide a back stop for the rolling traverse. This was later replaced by a brass window sash fastener obtained from e-Hardware.co.uk. Attached to the right end of the wooden base this provides an ideal back stop, see Figures 4.1 and 4.2, and when lowered out of the way it allows the bottom plate to be moved back away from the loading bar so that the soil thread can be placed at the front of the bottom plate for the start of a test or removed at the end of a test.

4.9 Apparatus adjustments

It is essential that the top glass plate and the bottom steel plate are aligned with their axes in the same vertical plane otherwise the soil thread tends to move out of the apparatus, to one side or the other. The knife edge support has been made to allow some movement from side to side so that the alignment of the loading bar can be adjusted to ensure that the axes (or edges) of the top and bottom plates are aligned in the same vertical plane. The parallelism of the two plates is then checked by moving the bottom plate back and forth with the brass rod in place. With the loading bar stationary the edge of the bottom plate must remain in the same vertical plane as the edge of the loading bar.

It is essential that the two plates are parallel and horizontal; otherwise the thread may extrude more on one side than the other and move out of the apparatus. To check this a spirit level is placed on the bottom plate to ensure it is level in both directions, by adjusting the levelling screws on the wooden base. With the spirit level on top of the loading bar and the 3 mm diameter brass rod (see section 4.12) inserted at the starting point between the plates the loading bar is adjusted for level in both directions using the wing nuts beneath the knife edge support to lift or lower it.

As a further check to ensure the top and bottom plates are parallel, with the brass rod in place, the bottom plate is moved forward and back allowing the brass rod to move over the traverse of 50 mm and the dial gauge is observed to ensure that the same reading is obtained throughout the traverse.

This adjustment means that when the soil thread is 3 mm diameter both plates are parallel. They will not, therefore, be parallel when soil threads of larger diameters are between the plates. However, with the knife edge support some distance from the rolling position of the soil thread the plates will not be far from parallel. At the diameter of 6 mm the angle between the two plates is very small (about 0.37°). This is the same for all tests.

The dial gauge is a back plunger dial gauge so that the scale can be viewed with the operator seated and the apparatus on a table or bench. It was purchased from Mitutoyo (UK) Ltd. The gauge obtained has a maximum travel of 5.5 mm so it is necessary to sit the gauge at the beginning of the test at a position where the scale reading is close to zero with the 3 mm brass rod in place. The prepared soil thread is initially 8 mm diameter or just less so when it is inserted between the plates the gauge reading is near its maximum. Thus there is sufficient travel for the test.

4.10 Application of force and force control

The purpose of the apparatus is to produce elongation of the thread and reduction of its diameter while the soil is in a plastic condition. To cause reduction of the thread diameter and elongation, the thread must be adequately stressed just as in the hand rolling method. The test is commenced with a small force applied for the first traverse and adjusting the force applied for each subsequent traverse. If the force applied is too large there is a risk of the thread squashing across its diameter and the purpose of the test is defeated. If the force applied is too small the thread elongates and reduces in diameter slowly so an excessive number of traverses would be required.

According to the British Standard (BS1377:1990) method the rolling starts with the thread at a diameter of about 6 mm. For the Barnes apparatus the thread is prepared at an initial diameter of about 8 mm. The first part of the test is to stress the soil up to a value where, for strain-softening soils, yield can be detected so the force values are increased for each traverse up to this point with increments chosen appropriate to the strength of the soil at the particular water content tested. For strain-softening soils, beyond a yield or peak stress value the stress applied decreases to maintain continued plastic strains. By the time the thread has reached a diameter of between about 7 and 6 mm and yielding can be detected, either smaller force increments, constant force³⁴ or even reducing force is applied to achieve the appropriate changes in diameter as plastic deformation occurs. For strain-hardening soils, a yield or peak stress value is often not detected and the force F is either kept constant or increased gradually. Tougher soils require larger force increments, ΔF .

The British Standard method (BS1377:1990, Part 2) and the ISO method (ISO/TS 17892-12:2004) for the plastic limit test require that the thread is rolled from finger-tip to the second joint and is reduced to 3 mm diameter in 5 to 10 forward and back movements, up to 15 for heavy clay soils. In this thesis the forward and back movement is referred to as a traverse. The distance between the finger-tip and the second joint of the author is about 50 mm so this was used as the traverse distance. The ASTM method (ASTM D4318-10) requires a rate of rolling of 80 to 90 'strokes' per minute taking no more than 2 minutes to reach the 3.2 mm diameter but does not define the distance of a stroke. With the Barnes apparatus it has been found preferable to complete the test, i.e. reduce the diameter to 3 mm or less,

³⁴ From the expression used to compute stresses, keeping the force value constant means that the applied stresses increase because the diameter is reducing, see section 4.15.

within 40 – 50 traverses to maintain undrained conditions, avoid drying out and to allow for a reasonable strain control.

To provide a means of strain control, or more accurately displacement control, it has been found necessary, by trial and error, to choose force values to give a change in diameter for each traverse of about 0.10 mm (10 divisions on the dial gauge, 8 to 12 divisions is an acceptable range) to achieve a satisfactory nominal stress vs. plastic strain relationship during the plastic deformation stage. The procedure for choosing the force increments is described in detail in Chapter 5.

The aim of the test procedure is to produce a reasonably smooth nominal stress vs. cumulative strain relationship while the soil is yielding between the diameters of 6 mm and 3 mm. From the formula used for nominal stress, σ_{nom} , see section 4.15, the nominal stress increases as the diameter decreases under a constant applied force F . At any stage, a second traverse may be conducted with the force held constant when the nominal stress will increase because of the reducing diameter. If the change in diameter ΔD with this small increase in nominal stress is less than the change in diameter from the previous traverse some strain-hardening has taken place and the force can be increased for the next traverse. If the change in diameter increases from the previous traverse some strain-softening has occurred and, to avoid premature squashing of the thread, the force should be reduced for subsequent traverses. Alternatively, with judgement, the force may be kept constant, providing the changes in diameter remain near to the preferred value of 0.10 mm. If the change in diameter exceeds the preferred range then, from experience, the force will be reduced.

Soils with high clay contents and of high activity in a stiffer condition with water content approaching the plastic limit frequently undergo strain-softening following yield and a peak value on the nominal stress-cumulative strain plot so as the diameter reduces the force must be reduced accordingly, in some cases by large decrements otherwise premature failure will occur. These soils may fail prematurely because it is considered that, following the large strains the thread has been subject to, they have attained or are close to their residual strength in parts of the thread, where it is suspected that mini-shear surfaces are set up. Progressive failure can then promote collapse of the thread diametrically and prevent further extrusion. In these cases it has been found that stricter displacement control is necessary to prevent overstressing of the thread, locally or otherwise. The test then proceeds with loads applied that give smaller changes in diameter, of about 0.05 – 0.10 mm (5 – 10 divisions on the dial gauge).

Soils with lower clay contents and with high silt or sand contents, also kaolinitic soils require the force to be continually increased as these soils undergo constant strain-hardening. Often, it is sufficient just to keep the force applied constant and assume nominal stress increases on the soil thread by virtue of the reducing diameter.

There have been instances when threads with water contents close to but above the plastic limit have failed by squashing diametrically. Then threads with lower water contents have been shown to be ductile with full extrusion and reduction of diameter to 3 mm. Leonards and Narain (1963) showed that the tensile strain at cracking of a soil specimen is a small fraction of the compressive strain at failure. In their tests the ratio of tensile to compressive failure strain varied from about 0.01 to 0.1 with no evidence of a consistent pattern. Therefore, in the Barnes test with a soil water content approaching but above the plastic limit the soil thread could fail prematurely due to crack (or other void) propagation under tensile stresses. Thus some care is needed with the load application when the soil water contents are in this region.

For several soil types, between the diameters of 4 and 3 mm the nominal stress-diameter plot is less stable. Reasons for this are discussed in Chapter 5.

4.11 Proforma

A proforma designed to record the data required for the calculation of nominal stresses and strains is included in Figure 4.11. The data comprise simply the force F_{ave} applied at the beginning of each traverse and the dial gauge reading R_i at the end of the i^{th} traverse. At the end of the test the pieces of the soil thread are collected for the water content determination.

The comments box is used to report on the rolling behaviour during the test, such as whether sticking to the plates occurred and observations of any rupture, cracking, splitting or crumbling. The use of this proforma is described for an example test procedure in Chapter 5.

4.12 Determination of the thread diameter

The diameter of the soil thread after each rolling traverse is determined by means of the dial gauge impinging on top of the loading bar above the initial position of the thread. The dial gauge is 'zeroed' by taking the reading, $R_{3,0}$, when a 'standard' metal rod 3 mm diameter is inserted between the plates, see Figure 4.4. The value

of $R_{3,0}$ is recorded on the proforma and from the subsequent dial gauge readings taken with the soil thread in place the diameter, D_i , of the soil thread at the end of each traverse can be determined from

$$D_i = R_i - R_{3,0} + 3.00 \quad 4.1$$

where R_i mm is the dial gauge reading at the end of the i^{th} traverse.

The brass rod was purchased as 3 mm diameter but on checking with a vernier gauge it was found to be 2.90 mm diameter. The $R_{3,0}$ reading is then taken as a nominal 3 mm diameter and the results of all tests using this rod have been calculated assuming the diameter of 2.90 mm. Thus the final diameter of the thread is obtained from

$$D_i = R_i - R_{3,0} + 2.90. \quad 4.2$$

This situation has arisen for tests conducted up to September 2012. Since then, as a temporary measure, the diameter of the rod has been increased by smearing a thin (0.05 mm thick) layer of glue around its surface to produce a rod with a diameter of exactly 3.00 mm. A brass rod turned to exactly 3 mm diameter will be obtained. The diameter calculations for all subsequent tests will be conducted using equation 4.1.

4.13 Determination of strain and cumulative strain

The diametral strain increment, $\delta\epsilon_D$ for the i^{th} traverse of the soil thread between diameters D_{i-1} to D_i is determined from

$$\delta\epsilon_{Di} = \frac{D_{i-1} - D_i}{D_{i-1}} \quad 4.3$$

where D_i is the diameter at the end of the i^{th} traverse from equation 4.2 and D_{i-1} is the diameter at the beginning of the traverse. For the initial traverses the soil thread will not be in contact with the top and bottom plates along its whole length. The strains are determined for the portion of the thread in the middle 10 mm of the plates. Until the plates are in full contact with the soil thread the strains will not reflect the behaviour of the whole thread. However, the determination of toughness, see below, is only obtained when the diameter in the middle of the thread is less than 6 mm and at this stage the thread is in full contact with the plates.

The cumulative strain is determined by summation for the traverses as

$$\varepsilon_{Di} = \sum_1^i \delta\varepsilon_{Di} . \quad 4.4$$

The change in diameter for each traverse is the same along the length of the thread but the diametral strain varies along the length of the thread because the diameter of the thread varies due to the configuration of the plate surfaces. For the purposes of the nominal stress vs. cumulative strain plots, introduced later, and the determination of work/unit volume either the strain in the central 10 mm section of the thread or an average value of the strain along the whole 50 mm length could be used. The two values are directly related so for simplicity the strain in the central section is adopted as it gives a maximum value.

4.14 The use of the split cylinder formula for the determination of nominal stress

A test is described in ASTM D3967-08 for the splitting of rock cylinders of length L and diameter D subjected to a static diametral force P . This is referred to as either the split cylinder test, split tensile test or the Brazilian test. A general expression used for the tensile strength of a rock cylinder is

$$\sigma_t = \frac{kP}{LD} . \quad 4.5$$

In ASTM D3967-08 k is given as $1/\pi$. Wood (1990) illustrated that this type of formula can be used to provide a measure of the nominal stresses in a soil thread in the plastic limit test with the coefficient k given as $-2/\pi$ for the tensile stress³⁵ on the loaded diameter (instead of $1/\pi$) and k given as $6/\pi$ for the maximum compressive stress on the perpendicular diameter. In accordance with this approach the form of equation 4.5 has been adopted in the research described in this thesis to obtain a value of nominal (or indicative) stress, σ_{nom} , in a soil thread, detailed in section 4.15 below.

The following describes some previous uses of the split cylinder formula. Alfaro and Wong (2001) used the split cylinder test as an indirect determination of the tensile strength of compacted soil using the expression³⁶

³⁵ Tensile stresses are taken as negative in this reference and in this thesis, with compressive stresses as positive.

³⁶ They referred to this formula as being based on the analysis of Timoshenko and Goodier (1951).

$$\sigma_t = \frac{2P}{\pi LD} \quad 4.6$$

which gives the same value of the coefficient k as Wood (1990) but without the negative sign. Alfaro and Wong (2001) found that the split cylinder test gives a tensile strength value higher than the direct tensile strength and these authors suggested a 30% reduction in the split cylinder strength to give comparable results, explaining that the reason for this reduction might be attributed to the compressibility of the soil compared with that of rocks³⁷. Alternatively an appropriate k value could have been adopted.

Their tests were conducted on samples of soil compacted at water contents dry of standard compaction optimum water content and, therefore, well below the plastic limit. In the Barnes test the split cylinder formula is used to compute a stress for a soil cylinder formed wet of optimum and which is, therefore, plastic and much less stiff. The effect of lower (undrained) modulus values of this soil would be expected to be much greater for soils wet of the plastic limit and this could have an even greater effect on the accuracy of the expression in equation 4.5 for the determination of a nominal stress value in the thread rolling test. Thus it is important to acknowledge that the stresses determined in the Barnes test are nominal values.

The split cylinder formula assumes a load P applied on the top of the cylinder of length L , resulting in the application of a line load. With clays wet of the plastic limit, in a ductile state, rather than a line load the load is likely to be applied over a strip, albeit narrow, at the top and bottom of the soil thread which may promote some wedging. Ramanathan and Raman (1974) pointed out that the load applied to the cylinder is not a line load but spread over a narrow band of width $2a$ on a cylinder of diameter D and they used the formula in equation 4.6. They showed that if $2a/D < 0.27$ equation 4.5 is valid with a small error (< 10%). These authors found that the ratio $2a/D$ was less than 0.27 on split tensile tests conducted on a range of soils mostly compacted dry of the optimum water content. No tests were conducted near the plastic limit. For specimens initially 36 mm diameter the band width $2a$ at failure was between about 6 and 8 mm and increased with increasing water content. Also for soils compacted dry of optimum water content they found that the ratio of tensile strength to compressive strength was between about 0.2 and 0.4, typically 0.3.

Peng (1978) also pointed out, for tests conducted on cylinders of brittle rock, that it

³⁷ Olesen *et al* (2006) suggested a reduction of 10 – 40% of the tensile strength from the split cylinder test to compare with the direct tensile strength.

is not certain whether the failure of the cylinder results from wedging at the loaded platens or from the (assumed) direct tensile stress acting on the loaded diameter. Regardless of this, in their tests on artificially cemented sands Das *et al* (1995) used metal or rubber strips at the top and bottom of the cylinder but still assumed no wedging with tensile stress across the full loaded diameter and used equation 4.6 for the determination of tensile strength. In their tests on ring samples, described in Chapter 3, Harison *et al* (1994) also applied the load over a strip, see Figure 3.4.

In the Barnes test with a minimum thread diameter of 3 mm, for the Ramanathan and Raman value $2a/D$ to be less than 0.27, $2a$ must be < 0.8 mm. With the more ductile specimens wet of the plastic limit this would seem unlikely, and wedging is a feature that could be expected to develop during a test on a statically loaded plastic cylinder or a soil thread. However, because rolling occurs quickly in the Barnes test there is insufficient time for a flat surface to develop at the points of loading on the thread and wedging is considered to be insignificant.

Observations of soil threads during rolling in the Barnes apparatus have not indicated flat surfaces immediately beneath the top glass plate even when the apparatus was stationary between traverses. Further, on removing the threads from the apparatus at the end of a test a smooth circular cross section was typically observed. This supports the view expressed in section 4.16 below that in the Barnes test with rapid rolling of the soil thread the external stresses on the thread can be visualised as a quasi all-round radial pressure with no opportunity given to develop localised flat surfaces.

An ideal plastic solution to the split cylinder mode of testing is provided by Olesen *et al* (2006) based on a yield line coincident with the loading axis for a cylinder of constant diameter D , as shown in Figure 4.12, and wedges at the top and bottom of width $2a$ and included angle 2β . P_L here is the load per unit length of cylinder in contrast to above where it is the load along the whole length of the cylinder. Assuming a modified Mohr-Coulomb material with a sliding failure mechanism given by the angle of friction, ϕ , an optimal upper-bound solution to the load carrying capacity of the cylinder is given as

$$\sigma_t = \frac{P_L}{2a \left[\frac{D}{2a} \tan(2\beta + \phi) - 1 \right]}. \quad 4.7$$

β is described as a function of ϕ , D/a and the ratio of the compressive to tensile

strength. For a perfect line load with $\alpha = 0$ the included angle β of the wedge becomes zero and equation 4.7 would revert to

$$\sigma_t = \frac{P_L}{\tan\phi D}. \quad 4.8$$

Compared to equation 4.6 $\tan\phi$ would be $\pi/2$ giving a ϕ value of 57.5° which would be appropriate for a strong cemented or rock-like material but not a ductile soil.

Krishnayya and Eisenstein (1974) presented solutions for the circumferential stress σ_θ and radial stress σ_r for line loading and strip loading, assuming an elastic cylinder, see Figure 4.13³⁸. This figure shows that the circumferential stress or the stress perpendicular to the loading axis is tensile for line loading with a small zone of compressive loading on the outside of the cylinder for strip loading. These authors carried out finite element analyses to assess the effect of the ratio of modulus values in compression and tension. As the modulus ratio increased the tensile stress decreased and the compressive stress increased, particularly within the middle half of the cylinder's diameter. On a split cylinder test conducted on a very low plasticity clay ($w_L = 18.2\%$, $w_P = 14.7\%$, $w_{opt} = 9.2\%$) compacted at a water content of 11%, at failure the tensile strain was about 3% and the axial (presumed compressive) strain was about 6%. This test also demonstrated a distinct brittle failure with a crack along the loaded diameter.

It is likely that the modulus ratio will vary with water content as the soil becomes stiffer and that the ratio of tensile strain to compressive strain will also vary. As the water content of a soil approaches its plastic limit it is considered that the tensile strains dominate the behaviour of a soil thread in the Barnes test particularly as the structure of the soil is changing towards a higher degree of aggregation or clustering and microcracks are developing.

Figure 4.13 also indicates that for a strip loading, which may be appropriate in the Barnes test, at the periphery of the soil thread, the circumferential and radial stresses are both compressive directly beneath the loaded area. This would be likely to result in an increase in positive pore pressure at the periphery of the soil thread as the loaded area passes around the rolling soil thread. In the central portion of the soil thread with high tensile and compressive nominal stresses there could be negative pore pressures developing, also suggested by Uriel and Mier (1975) for a quickly loaded undrained test. Some pore pressure redistribution is therefore,

³⁸ Note that in this figure the tensile stresses are denoted as positive and the compressive stresses as negative.

likely, across the diameter of the thread during the test, depending on the permeability of the soil. However, with most of the Barnes tests taking no more than about 3 - 4 minutes this redistribution should be limited. This is a good reason for conducting the test as quickly as possible to maintain undrained conditions throughout the thread.

It has also been noticed for soils with water contents close to the plastic limit during rolling between the hands for preparation of a soil thread that fine, mainly transverse cracks are produced on the surface of the thread. When the thread is rolled in the Barnes apparatus and also between the hand and the glass plate in the standard test these cracks are 'healed', or at least become invisible. This apparent healing could be produced by the compressive circumferential and radial stresses on the periphery of the thread.

Due to the shape of the thread along its length with a smaller diameter in the middle 10 mm and larger diameters towards the ends of the thread if equation 4.6 applies along the length of the thread and the applied force is uniformly distributed there will be a greater level of nominal stresses in the middle portion. Some pore pressure redistribution may therefore occur along the length of the thread towards its ends, again depending on the permeability of the soil. It is postulated that at the higher water contents in the Barnes test that this effect in the soil thread would be small, but pore pressure redistribution could increase with decreasing water content as the plastic limit is approached.

Split cylinder tests conducted by Krishnayya *et al* (1974) on the same very low plasticity clay as tested by Krishnayya and Eisenstein (1974) showed that the tensile stress and strain at failure were higher for faster rates of loading. If this rate of loading effect applies to the Barnes test then lower values of workability or toughness could be expected if there is too much delay in the test, although as the rate effect is based on a logarithmic variation this effect is considered to be insignificant for a normally conducted test. This is discussed further in Chapter 5.

4.15 Determination of nominal total stress

Because of the complex nature of the stress configuration in an elastic static cylinder, described in section 4.14, the different behaviour of elastic and plastic materials and the additional complication of stress rotation during the rolling of a soil thread the actual stresses in the soil thread are unknown and cannot be calculated. It was decided that a nominal, or indicative, total stress acting on the thread could be obtained by assuming that this stress is directly related to the force

applied per unit length of thread and inversely related to the diameter of the thread. The nominal total stress on the thread at the end of the i^{th} traverse is then determined from the general formula

$$(\sigma_{\text{nom}})_i = \frac{kF_i}{LD_i}. \quad 4.9$$

Equation 4.9 is adapted from the analysis of the split cylinder or Brazilian test for elastic concrete cylinders loaded statically and the use of this general formula is discussed in section 4.14.

Although the symbol P has been used by several previous researchers the symbol F is used in this thesis to denote force. F_i is the average force (F_{ave}) applied for the i^{th} traverse, in Newtons and is kept constant for each traverse. \bar{D}_i is the mean diameter of the middle section of the thread for the traverse so the nominal stress calculated from equation 4.9 is a mean value. The mean diameter is determined from

$$\bar{D}_i = \frac{D_{i-1} + D_i}{2}. \quad 4.10$$

L is the length of the thread between the plates, in this apparatus 50 mm. For the initial traverses the soil thread will not be in contact with the top and bottom plates along its whole length. The nominal stresses are determined using the value of $L = 50$ mm and not for the portion of the thread in the middle of the plates. Until the plates are in full contact with the soil thread the nominal stresses will be underestimated and will not reflect the behaviour of the whole thread. However, the determination of toughness, see below, is only obtained from the point when the diameter in the middle of the thread is 6 mm and at this stage the thread is in full contact with the plates.

Justification for the use of the type of formula in equation 4.9 to determine a nominal stress in a soil thread is given by Wood (1990) who refers to Schofield and Wroth (1968) as suggesting that the plastic limit “implies a tensile failure, rather like the split-cylinder or Brazil test of concrete cylinders”. In Wood (1990) the constant k for the uniform tensile stress (negative) acting along the loaded diameter is given by

$$k = \frac{-2}{\pi} \quad 4.11$$

and for the normal compressive stress (positive) acting on the diameter transverse to the load direction and at the centre of the thread is given by

$$k = \frac{6}{\pi}. \quad 4.12$$

The analyses for the split cylinder formula assume plane stress conditions along the length of the cylinder but with some unknown shear stresses acting along the length of the thread in the Barnes apparatus the stress on the long axis of the soil thread is not known. Assuming the total stress along the axis of the soil thread to be zero the constant k for the mean total stress at the centre of the thread would be

$$k = \frac{1}{3} \left[\frac{-2}{\pi} + \frac{6}{\pi} + 0 \right] = \frac{4}{3\pi}. \quad 4.13$$

Assuming the total stress along the axis of the soil thread to be equal to the normal compressive stress acting on the diameter the constant k for the mean total stress at the centre of the thread would be

$$k = \frac{1}{3} \left[\frac{-2}{\pi} + \frac{6}{\pi} + \frac{6}{\pi} \right] = \frac{10}{3\pi}. \quad 4.14$$

From this analysis the constant k for the mean total stress could lie between about 0.42 and 1.06. However, as stated above the actual stresses in the soil thread are not known so the constant k in equation 4.9 is not known. This is mostly because

- 1) the loading in the rolling test is not static with the tensile and compressive stresses varying within the thread during the rolling procedure and
- 2) the stresses are likely to be different for a plastic material compared to an isotropic elastic material for which the formulae were derived.

As the results obtained from the Barnes test are not absolute and are assumed to be independent of the constant k , for simplicity a value of $k = 1$ has been adopted and the calculated total stress on the thread is determined as a nominal value from

$$(\sigma_{\text{nom}})_i = \frac{F_i}{LD_i}. \quad 4.15$$

As the diameter of the thread varies along its length due to the configuration of the plate surfaces either the nominal stress in the central section or an average value of the nominal stress along the whole length can be determined. For simplicity and because it gives a maximum value the former is used. Plots of nominal stress σ_{nom} vs. cumulative strain $\Sigma\delta\epsilon_D$ and nominal stress vs. diameter are produced from the calculated data on a spreadsheet, described in Chapter 5.

In Wood (1990) it is shown that in relation to the split-cylinder or Brazilian test the tensile stress is uniform along the loaded diameter but along the transverse diameter the compressive stress varies from a maximum at the centre diminishing to zero at the periphery of the thread. Thus the maximum difference between the principal stresses (major – compressive, minor – tensile) and the maximum shear stress occur at the centre of the thread. It is in this region that a brittle soil thread can be expected to initiate and develop a shear failure mode. Although it is the tensile stresses that are likely to result in failure of a brittle soil there will be contributory compressive stresses. σ_{nom} is introduced to represent the unknown stress state within the soil thread when it is in the ductile state and when it is in the brittle state.

O’Kelly (2011) in his discussion of Barnes (2009) has pointed out that the strength and suction values in a soil thread near its plastic limit estimated from classical static soil mechanics are likely to be much higher than those adopted in the Barnes test. Barnes (2011) responded that with a complex combination of rapid cycling of compression/tension nominal stresses together with axial, bending and torsion nominal stresses the thread rolling test is reflecting more of a fatigue strength which tends to be smaller than the static strength. It is also emphasised that the stress values adopted in the Barnes test are nominal values.

4.16 Quasi ‘all-round’ radial pressure

The above equations and the discussion in section 4.14 assume static line or strip loading on the length of the tested cylinder. It is considered that it is not just the action of the tension and compression reversals of stress that causes the soil thread to extrude between the plates, when the soil is in the ductile state. Due to the rapid rolling of the soil thread in each traverse it is considered that the line or strip load in moving around the soil thread quickly could be visualised as providing a quasi ‘all-round’ radial pressure. Thus the nominal total stress determined from equation 4.15 would be an external compressive stress, with a positive sign.

With the soil thread in the ductile state, this all-round radial pressure can be considered to act on the thread in a triaxial extension mode with the radial stresses greater than the longitudinal stresses. Extrusion of a ductile soil thread between the plates could then be viewed as the deformations produced in this mode.

As the water content of the soil reduces, approaching the plastic limit when the soil becomes stiffer, it is considered that the effect of the stress cycling within the soil thread from compression to tension and vice versa probably increases. The tensile stresses in the thread, in particular, would impact on the more aggregated soil structure and promote opening of the microcracks and small air voids that are developing with reduced water content.

4.17 Determination of work/unit volume and toughness

For soil threads the work/unit volume for each traverse is determined from the product of the nominal stress for the traverse from equation 4.15 and the diametral strain for the traverse from equation 4.3, with units of kJ/m³

$$\text{Work/unit volume per traverse} = (\sigma_{\text{nom}})_i \times \delta \varepsilon_{D_i} . \quad 4.16$$

The determination of a toughness value is only relevant when the soil is in a ductile state. For soil threads in a brittle state the loading and rolling result in a brittle failure, often with the thread falling into an elliptical shape due to internal dislocations. Sliding of the thread between the plates then occurs rather than rolling and the test is terminated.

Values of the nominal stress, incremental and cumulative strain and work per unit volume per traverse are calculated in an Excel spreadsheet described in detail in Chapter 5.

It was realised that the number of reversals of stress between compression and tension increases as the thread reduces in diameter. For each traverse the travel of the soil thread is 100 mm (50 mm forward and back) and the number of reversals, N_R , is calculated by dividing this distance by a quarter of the circumference of the thread for that traverse

$$N_R = \frac{100 \times 4}{\pi D} . \quad 4.17$$

As the thread diameter reduces the number of reversals per traverse will increase. It is estimated that there are between about 20 and 30 reversals per traverse between the diameters of 6 mm ($N_R \approx 21$) and 4 mm ($N_R \approx 32$). With similar incremental changes in diameter (the typical value chosen is 0.1 mm per traverse) the total number of reversals in this range (about 400 – 600) will be very similar for all tests so it is not absolutely necessary to allow for the number of reversals applied in each traverse. Further, as the tension/compression cycling can be likened to a fatigue type loading which usually relates deformation to the logarithm of the number of reversals, the actual number of reversals is considered to have little effect on the changes in diameter from test to test. In effect, each test has very similar adjustments applied to it.

To provide a complete outcome it was decided to include the number of reversals and to determine the work/unit volume per 100 reversals for each traverse. To normalise the work/unit volume for the number of reversals in each traverse the work/unit volume per 100 reversals is determined as the work/unit volume per traverse divided by the number of reversals for the traverse and then multiplied by 100. 100 is the adopted value as it is considered to be an appropriate number of reversals so that reasonable values of the work/unit volume are obtained.

$$\text{Work/unit volume per traverse} = (\sigma_{\text{nom}})_i \times \delta \varepsilon_{\text{Di}} \times \frac{100}{\text{No. reversals}} \quad 4.18$$

per 100 reversals.

To assign a toughness value it is necessary to determine the cumulative work/unit volume per 100 reversals over a specified range of displacement or strain, as explained in section 3.9. It was decided that the toughness T to be assigned to a soil would be the cumulative work/unit volume per 100 reversals between the thread diameters of 6 mm and 4 mm. From a study of the nominal stress vs. diameter relationships for a range of soil types over a range of water contents, by commencing the test with a thread diameter of about 8 mm, at the diameter of 6 mm the threads were found to be undergoing plastic straining so this was deemed to be a suitable start point.

Plastic straining generally continues in a fairly steady fashion to the diameter of 4 mm so this was considered to be a suitable finishing point. The toughness T is then given as the amount of cumulative work/unit volume per 100 reversals (between the diameters of 6 and 4 mm) with units of kJ/m^3 per 100 reversals. A detailed description of this parameter is given in Chapter 5 together with discussion on the results of the tests at diameters below 4 mm.

The parameter with units of kJ/m^3 was the approach adopted in the author's paper published in 2009 (Barnes, 2009) but in this thesis the reference to 'per 100 reversals' in the unit descriptions for work/unit volume and toughness is retained as kJ/m^3 per 100 reversals.

4.18 Summary

Casagrande (1932) devised a mechanical means of conducting the liquid limit test as first proposed by Atterberg, the cup method, but did not attempt to mechanise the plastic limit test. The apparatus of Gay and Kaiser and that of Bobrowski and Griekspoor provide a rolling device to make a soil thread reduce in diameter but take no measurements of the behaviour of the soil during the rolling process.

The author has devised, developed and produced and patented an invention entitled "Apparatus and method for measuring plastic properties", herein referred to as the Barnes apparatus and Barnes test. The apparatus is described in detail in this chapter and the test data procurement, processing and test procedure are described in Chapter 5.

Essentially, the apparatus comprises two plates, a top glass plate and a bottom steel plate with the outer faces of the plates inclined outwards at a shallow angle so that when a thread of soil is rolled between the plates the thread will extrude longitudinally as it reduces in diameter. The top plate is kept stationary and the bottom plate is moved forward and back by means of a sliding mechanism so that the soil thread is made to roll forward 50 mm and then back 50 mm, referred to as one traverse. This process is intended to mimic the hand rolling method.

The top plate is attached to a loading bar so that during each traverse a load is applied to the soil thread with the load adjusted by means of a moveable mass. The load is varied according to the strength of the soil and to produce adequate deformation on each traverse with the load increments controlled by maintaining changes in diameter within a pre-determined range. The load increments are controlled otherwise there is a risk of premature collapse of the thread if the increments are too large or the test takes too long if the increments are too small.

The diameter of the thread is measured for each traverse by means of a back plunger dial gauge positioned on the loading bar directly above the start and finish points of each traverse. With known applied loads and diameters, values of the nominal stress in the thread and the diametral strain are determined.

The soil thread is prepared by static compaction in a specially made thread maker at a diameter of about 8 mm but with a precise circular cross section to ensure that the thread rolls smoothly between the plates. Tests are conducted over a range of water contents starting from a high water content where the soil is very soft but not sticky otherwise the surface of the thread sticks to the plates of the apparatus. Ductile threads are rolled until the diameter reduces to 3 mm or less. With decreasing water content the soil becomes stiffer or tougher and higher loads are required to produce the required changes in diameter.

The split cylinder or Brazilian test formula is considered to be appropriate to the application of force in the plastic limit test with the nominal stresses within the soil thread directly proportional to the linear load applied along the length of the thread and inversely proportional to the diameter of the thread. As the stresses in the soil thread applied by the apparatus are not known the stresses calculated from the split cylinder formula are referred to as nominal values.

With a thread diameter starting at about 8 mm increasing loads and continual traverses take the soil thread to a yield condition beyond which the thread undergoes fairly steady plastic straining as the thread is continually rolled. The product of nominal stress and diametral strain for each traverse provides a measure of the work per unit volume for that traverse. The number of compression/tension reversals increases for each traverse as the thread reduces in diameter. The work/unit volume per traverse is normalised for the number of reversals with the chosen value of 100 reversals.

In the thesis the toughness parameter T is determined as the cumulative work/unit volume per 100 reversals between the diameters of 6 mm and 4 mm with units of kJ/m^3 per 100 reversals.

4.19 Figures

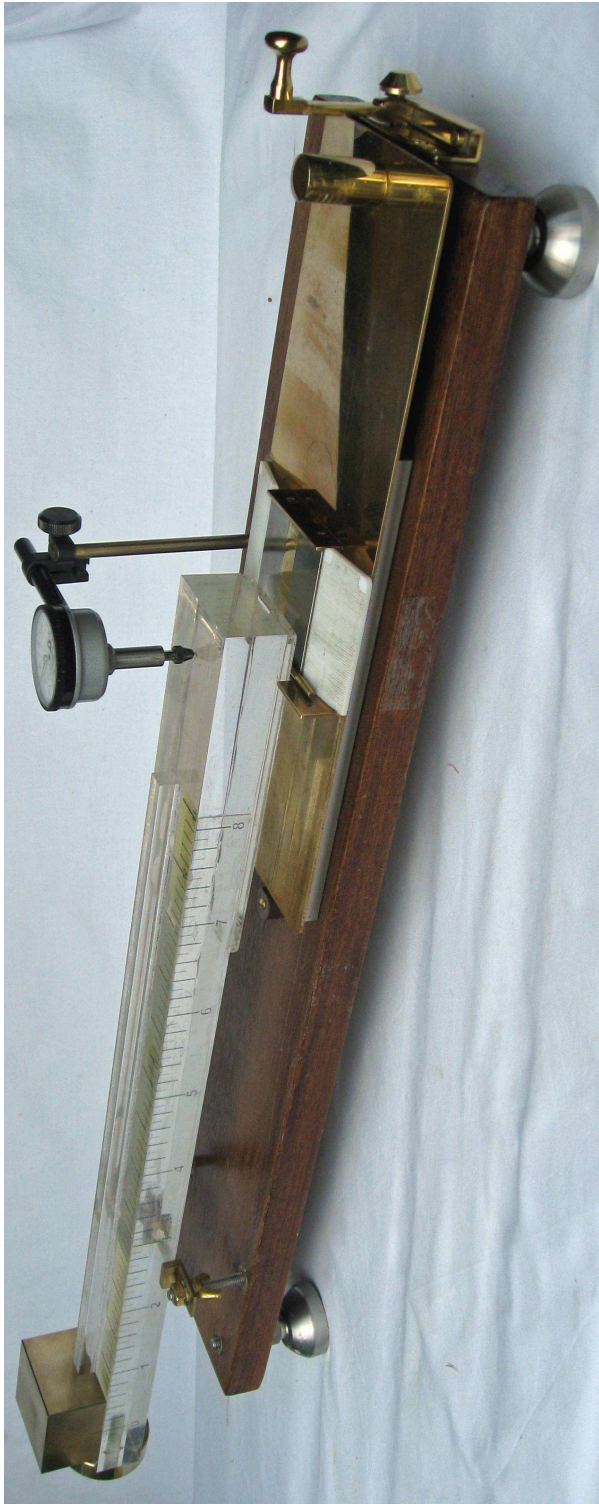

Figure 4.1 Overall view of apparatus

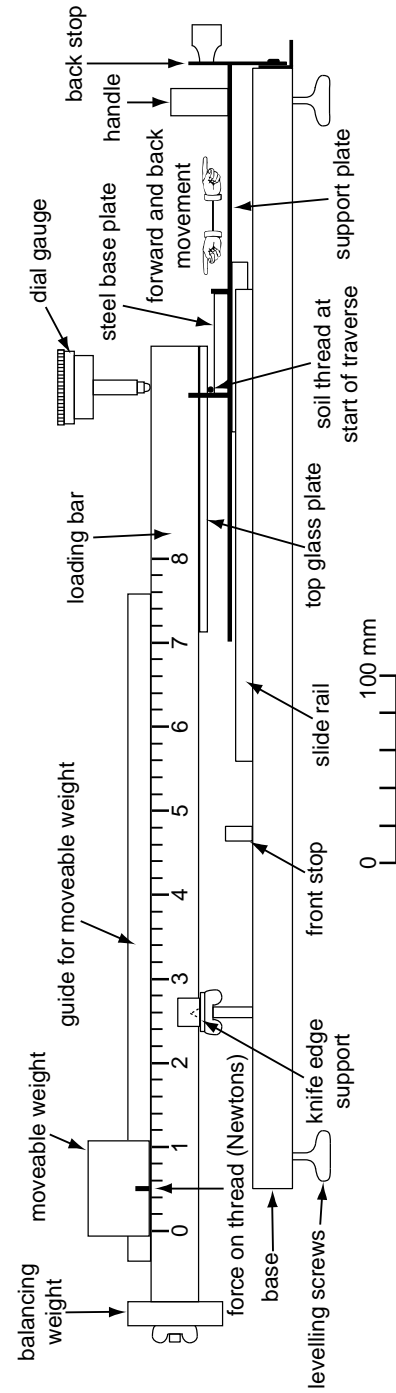

Figure 4.2 Side elevation of apparatus

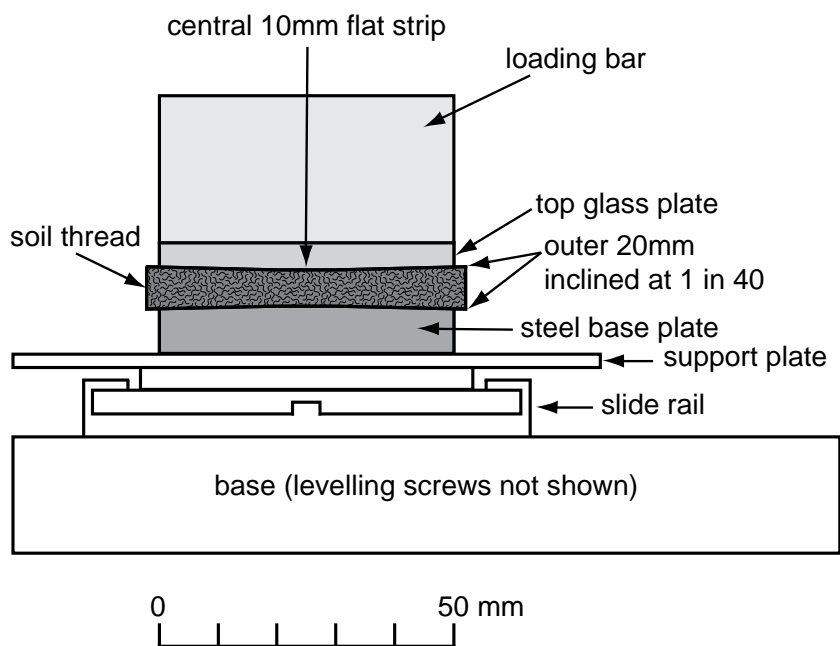

Figure 4.3 Section through apparatus in line with soil thread

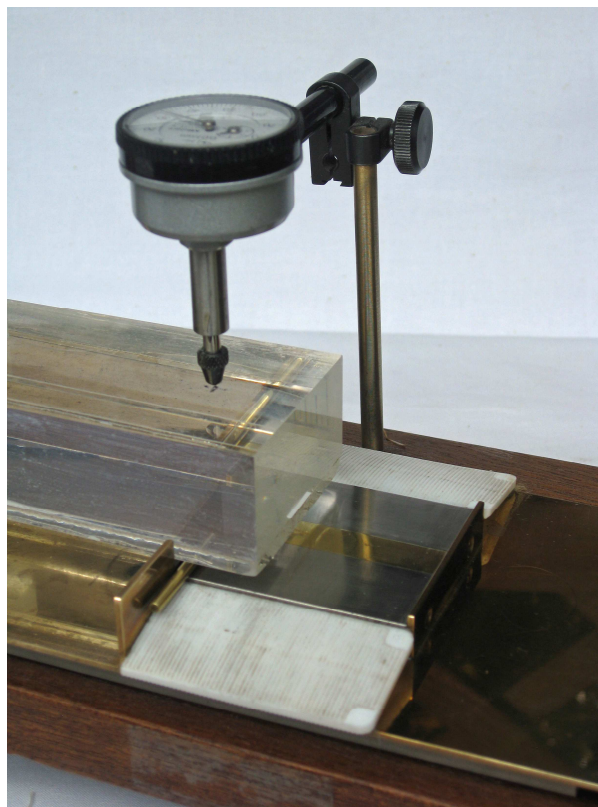

Figure 4.4 View of apparatus (with brass rod at starting point of test)

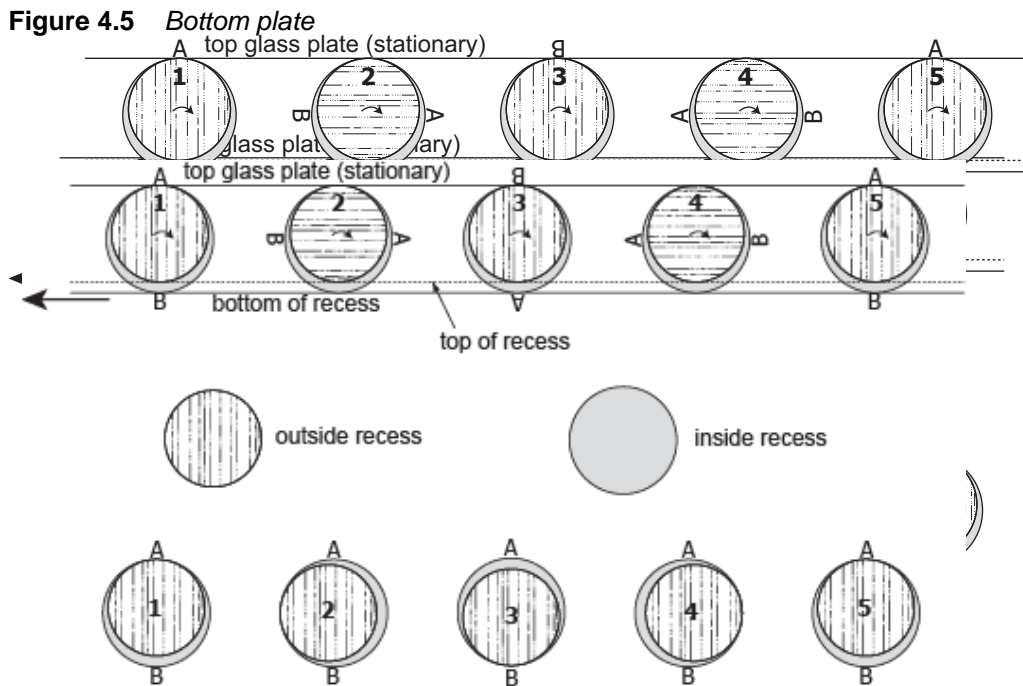
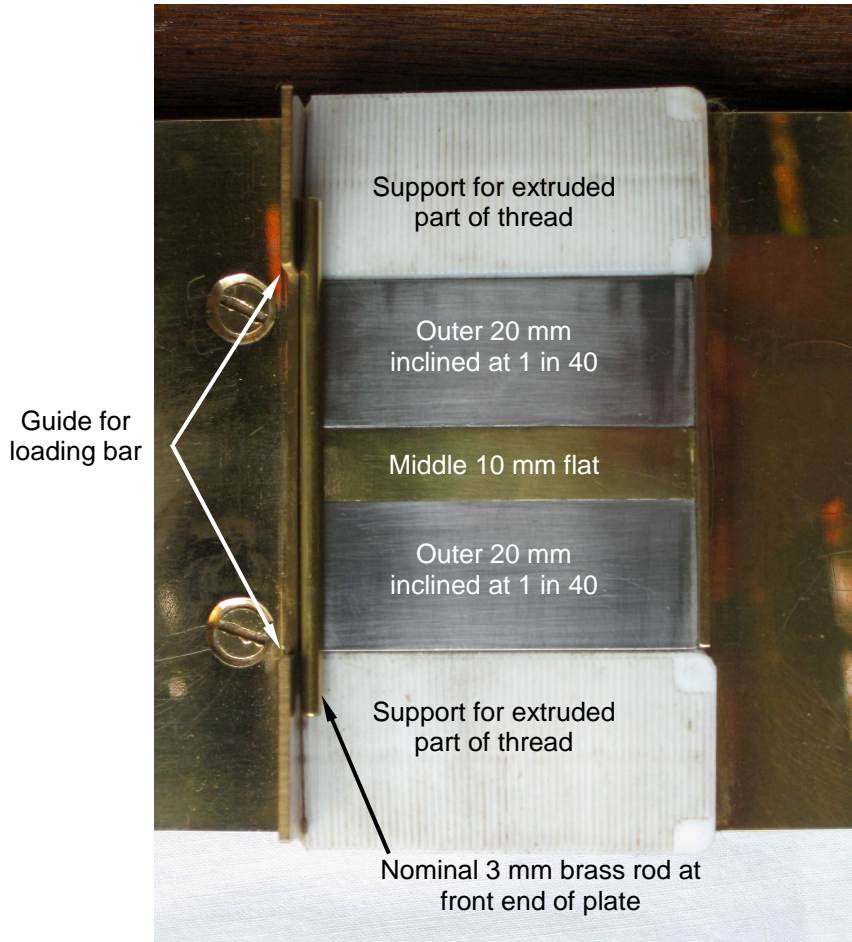

Figure 4.6 *Non-coaxial rolling of soil thread at the edges of the recess*

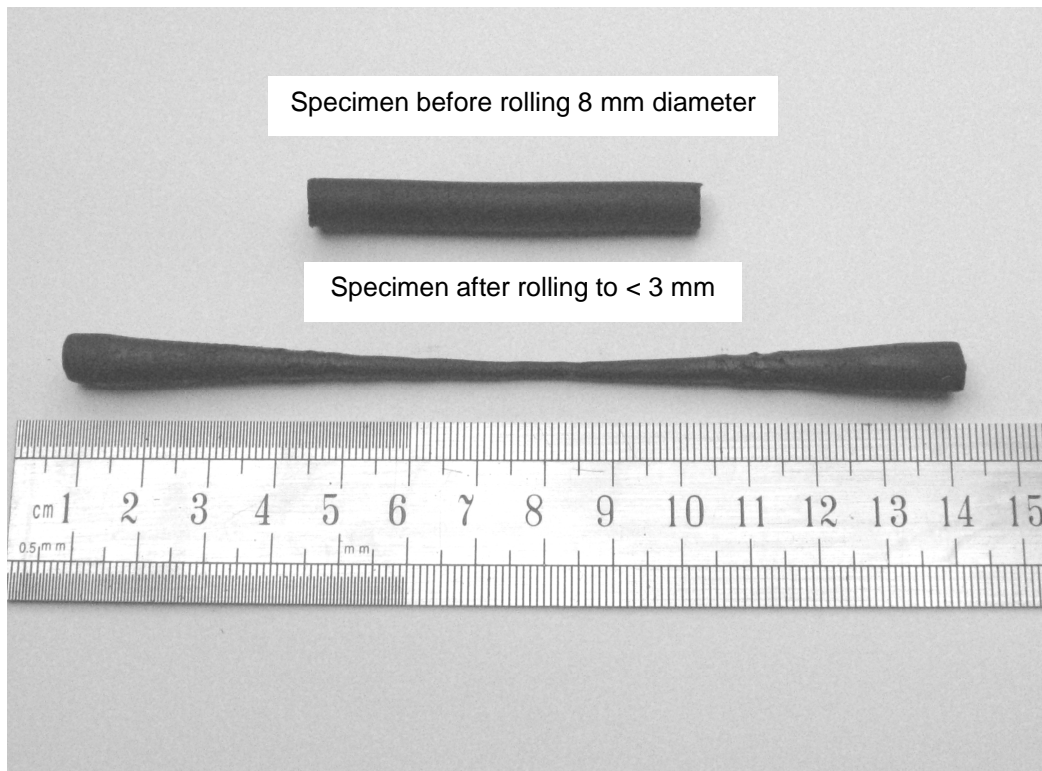

Figure 4.7 Specimen of Oxford Clay before and after rolling (From Barnes, 2009)

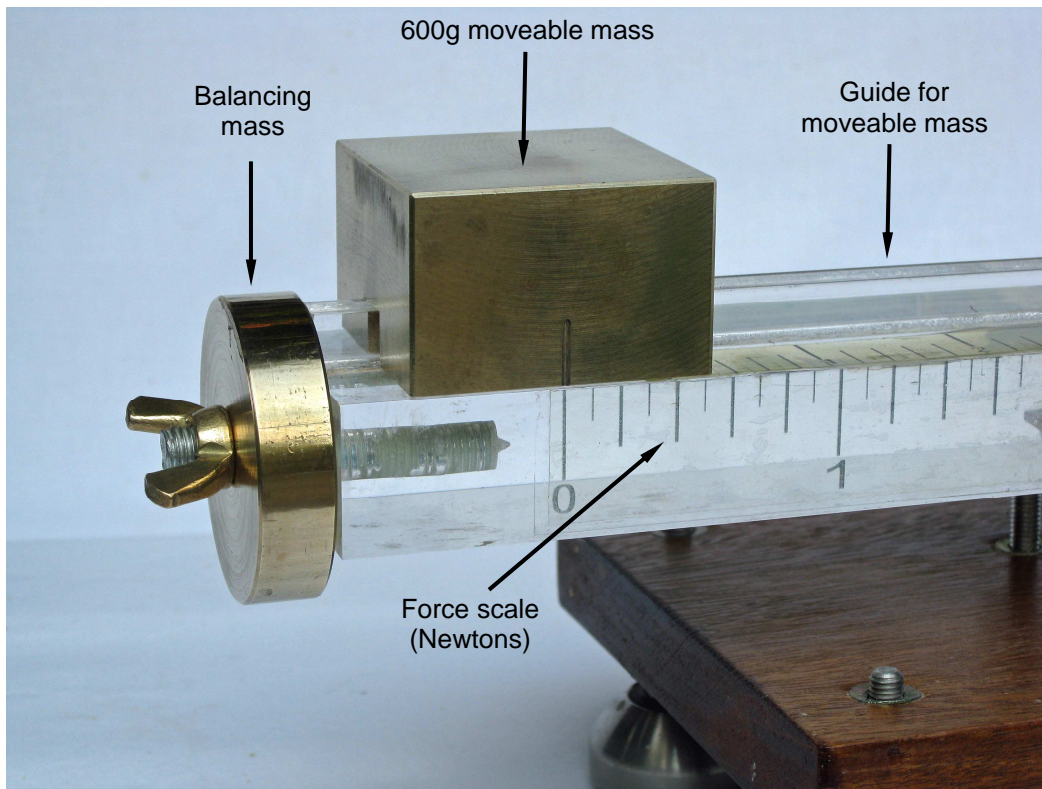

Figure 4.9 600 gram nominal mass at the zero force mark

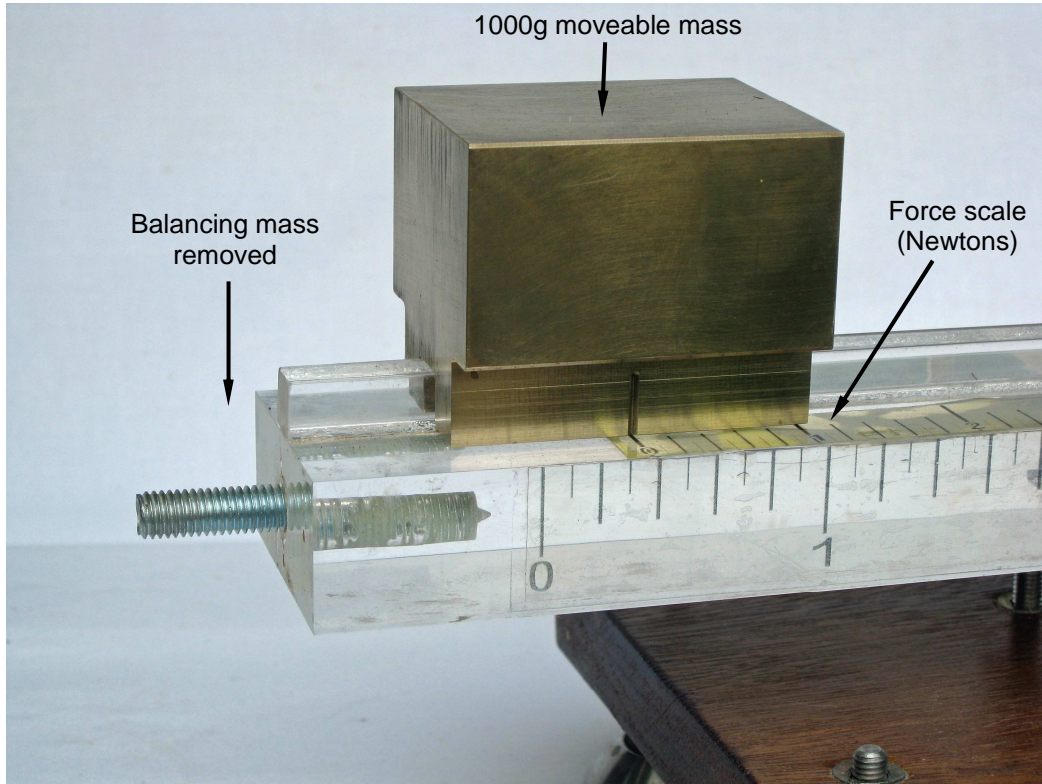

Figure 4.10 1000 gram nominal mass at the zero force mark

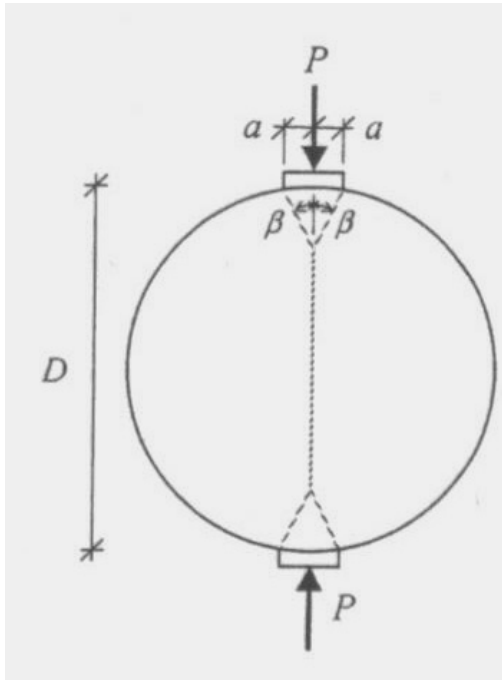

Figure 4.12 Yield line and wedges (From Olesen et al, 2006)

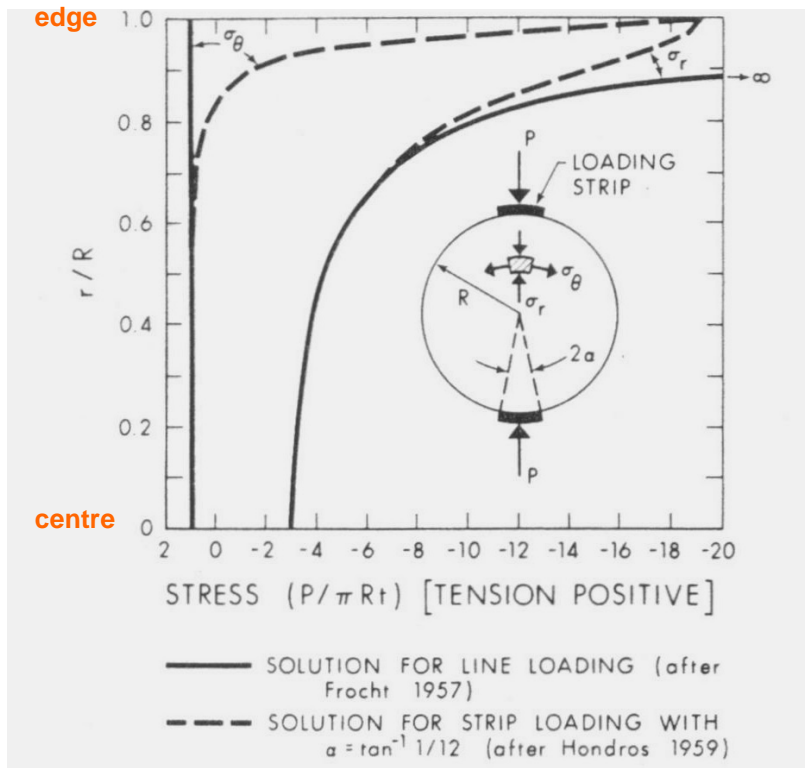

Figure 4.13 Stress along the loaded diameter (From Krishnaya and Eisenstein, 1974)

CHAPTER 5

Test procedure and typical test results

5.1 Introduction

The test procedure starts with the preparation of a soil thread which is then placed between the bottom and top plates of the apparatus. The test is conducted by applying forces to the soil thread and rolling the thread between the plates over a traverse. The force and dial gauge readings are recorded. An example test procedure, example calculations and determinations of toughness are described to illustrate how a test is conducted. The determination of the plastic limit and various properties from the toughness versus water content plot are described.

To illustrate the range of soil types for which the Barnes apparatus can provide the results from four soil types are described, chosen to represent a typical low and a high plasticity inorganic clay plotting above the A-line, a clayey silt and a peat both below the A-line. It has been found for several soil types with the Barnes test that between the diameters of 4 and 3 mm the nominal stress vs. diameter plots become less stable and some threads break (but not crumble) before reaching the diameter of 3 mm. The main causes of this instability are discussed. Tests to assess the rate of loading of the soil thread, the effects of wetting up and of drying of the soil are described.

5.2 Preparation of soil thread

In the standardised soil mechanics tests conducted (BS1377:1990) the plastic limit test involves one of the smallest specimen sizes and largest shape effect, L/D ratio. For this reason the Barnes test uses as large a specimen as possible given the constraints of the test apparatus, starting with a soil thread at a diameter of about 8 mm and a length of about 60 mm.

Some unconfined compression tests to investigate the effect of specimen size have been conducted by Krizek and Kondner (1964). A remoulded, plastic clay ($w_L = 46\%$, $w_p = 30\%$) was prepared by extrusion at several water contents above and below the plastic limit with specimen diameters and heights varied to assess the effect of specimen size on the strength and stress-strain properties at the same water content. The smallest diameter was 8.4 mm and the largest 36.5 mm. The differences were reported to be very little, if any, although the stress vs. strain plots

show that the smaller diameter specimens were slightly stiffer. Thus the use of small specimens in the Barnes test can be considered to give results representative of a clay soil. Nevertheless the strength and stress-strain properties in a uni-directional test are likely to be different from those in a rolling thread test with cycling compressive and tensile stresses. Some effect of specimen size is to be expected with the Barnes test but as the size is the same for all tests consistent results should be obtained providing a limit is placed on the maximum particle size.

The current British Standard (BS1377:1990) method of soil preparation for classification testing of clay soils involves removing particles greater than 425 μm , mixing with sufficient distilled water and curing for at least 24 hours to ensure full hydration and uniformity of water content. The plastic limit is a classification test so all soils tested are first prepared at a water content above the liquid limit and this test is carried out. For the Barnes test the soil is then dried by air drying, blow and hand drying until it is no longer sticky and a soil thread will not stick to the plates of the apparatus. A thread of soil about 8 mm diameter is prepared by static compaction in a specially made thread maker to a length of about 60 mm. The thread maker comprises a sampling tube with a stopper inserted in one end and a rammer in the other end. Compaction is applied by pressing the stopper and rammer against the soil inside the tube. The pressure is not measured. The device is illustrated in Figure 5.1 and a photograph is presented in Figure 5.2.

A thread of soil at the required water content is rolled by hand on a glass plate to a diameter of about 6-7 mm so it will fit inside the 8 mm internal diameter sampling tube. The stopper and rammer are inserted in the tube and by static compaction (pressing) the soil is made into a cylinder about 8 mm diameter. Sufficient pressure is applied to ensure that as much air as possible is expelled via a 0.5 mm diameter hole in the tube; usually some of the soil is extruded through this hole as a sign that sufficient compaction has been applied so one finger is placed over to minimise soil loss but still allow any remaining air to escape. The rammer is then pushed through the tube to the mark A, see Figure 5.1, and the stopper is ejected by soil pushing through the tube. It is not possible to measure the density of the thread with any accuracy.

With a sampling tube length of 120 mm and 60 mm of rammer inside the tube there is about 60 mm of soil inside. The exposed end of the soil thread is trimmed and the remaining thread is then pushed out of the sampling tube onto the bottom plate of the apparatus. This sample preparation method provides a sufficiently intact and saturated specimen with a circular cross section suitable for rolling. Soils at higher water contents are soft and compact or deform readily in the

sampling tube but the stiffer, lower water content, soils can be more difficult to prepare with defects appearing during the initial hand rolling, such as fine cracks. Any such defects observed are reported in the comments box on the proforma, Figure 4.11. Nevertheless this preparation method provides a well compacted thread with as much air as possible eliminated and any cracks (at least on the surface of the thread) rendered invisible. It has also been found that on extrusion from the thread maker the threads of softer soils have smaller diameters than those of the stiffer soils, as measured when inserted in the apparatus for the start of the test. This may be due to some of the soil sticking inside the tube. It affects the starting points on the nominal stress vs. diameter and strain plots, see later, with none of the threads commencing at a diameter of exactly 8 mm.

Once extruded onto the bottom plate of the apparatus it may be necessary to straighten the soil thread as it often curves on extrusion from the sampling tube. This is easily done although it is essential to retain the circular cross section of the thread, otherwise it will not roll properly. The thread overlaps the width of the plates of the apparatus to ensure a complete length of thread is always present between the plates. This larger thread size also provides a mass of soil, about 6g, suitable for the representative determination of water content of a clay soil.

Results from the apparatus appear to be more sensitive to the presence of larger particles than those from the hand rolling method. This would affect the preparation required particularly when starting a test on a soil from its natural state, as recommended in BS1377:1990. This British Standard permits the removal by hand of particles greater than 425 μm where it is practicable but otherwise the soil must be wet sieved. In most clayey soils it is not possible to remove by hand all of the oversize particles and this can have a disproportionate effect especially when rolling at the smaller diameters in the apparatus. It is considered imperative that all soils to be tested are sieved to remove particles greater than 425 μm . All of the tests reported in this thesis were conducted on soils (apart from the Peat) either wet or dry sieved³⁹ through the 425 μm sieve.

5.3 Test procedure

The complete test procedure is carried out commencing with soil at a high water content. Soil prepared for the liquid limit test is usually appropriate to ensure adequate hydration, although some clay minerals should be prepared at higher water contents for this purpose. The highest water content adopted for the rolling

³⁹ Many of the clay soils were air-dried, ground and dry sieved through the 425 μm sieve and very little material was retained on this sieve. If large amounts were retained then this component would be wet sieved.

test must be below the sticky limit⁴⁰. The water content is reduced until a thread can be prepared that is not sticky, i.e. it does not stick to the hands or to the plates of the apparatus. This soil will have a low toughness and will require small load or force increments, ΔF . For subsequent tests the water content is gradually reduced by moulding in the hands or occasionally blow drying.

The grease (petroleum jelly) applied to the outside strips of the bottom and top plates provides a form of lubricated platen that allows for freer extrusion of the thread. Moore (1963) pointed out that the use of oiled platens in his apparatus rendered the results (of stress vs. strain) less sensitive to the shape factor, L/D , following the work of Meyerhof and Chaplin (1953). The effect of the shape factor is discussed in section 5.11.

5.4 Example test procedure

To illustrate the test procedure the hand written lab data of force and dial gauge readings obtained for a typical soil, a sample of Alluvial Clay from Chinnor, Oxfordshire are presented in Figure 5.3 for the test numbers 3, 9, 14, 19 and 23. Starting with test 3 (tests 1 and 2 were slightly sticky but still feasible) the dial gauge reading, $R_{3,0}$, with the nominal 3 mm brass rod between the plates was recorded as 0.14 mm. The moveable mass was positioned at the zero point on the loading bar, so there would be no force on the thread. The back stop was lowered, the bottom plate moved back, brass rod removed, soil thread extruded from the sampling tube onto the front end of the bottom plate, loading bar raised slightly, bottom plate moved left, back stop lifted, and finally the loading bar lowered onto the soil thread with the soil thread at its starting point between the plates and beneath the dial gauge and with zero force applied.

The gauge reading (4.96 mm) was recorded as a starting point although it has little significance because the initial thread cross section may have some imperfections and the plates of the apparatus have not yet bedded into the soil thread. A judgement was then taken on how much force to apply initially and what subsequent force increments to adopt. For test 3, based on the results of the previous tests, a force of 0.4 N was applied by moving the loading bar mass and moving the bottom plate to left and right for one traverse. The thread moved 50 mm left and then right, back to its starting point. The dial gauge reading was taken (4.80 mm).

⁴⁰ The sticky limit is described by Atterberg (1911) as the water content at which the soil no longer sticks to a metal spatula. The test has not been formalized.

Small load increments were applied up to 1.0 N towards a yield condition. This force was retained for the next traverse but only 0.08 mm deflection (4.26 – 4.18 mm) ensued (the aim was for changes in diameter of about 0.10 mm) indicating that the soil was still strain-hardening so the force was increased to 1.1 N. Satisfactory deflections were obtained for subsequent traverses but, to keep deflections uniform, the force was increased to 1.2 N and later increased to 1.3 N.

During a test it has to be kept in mind that with reducing diameters the stress levels on the soil thread are increasing if the force is kept constant. At the dial gauge reading $R = 2.64$ mm the next change in deflection was 0.15 mm (2.64 – 2.49 mm). It was considered that yielding was occurring and this deflection was too large so the force was reduced to 1.2 N with a view to reduce or keep steady the stress level. Yielding was a fairly obvious phenomenon as detected by the changes in diameter and as the soil thread could be seen to be extruding from between the plates of the apparatus. To keep deflections uniform and as the soil had undergone strain-softening the force was continually reduced. This does not necessarily mean that the nominal stress was reduced, as the diameter was also reducing. At the dial gauge reading of 0.00 mm the diameter computed from equation 4.2 was 2.76 mm ($0 - 0.14 + 2.90$ mm), see equation 4.2 and Figure 5.4a. The thread was intact and had rolled well so the comment 'exc' for excellent was noted.

As the soil thread reduced in diameter the thread extruded beyond the edges of the top and bottom plates and was lightly supported during rolling by the plastic strips attached to the sides of the bottom plates, see Figure 4.5. When the thread reached a diameter in the range 4 – 5 mm there was a fair amount of thread extruded beyond the edges of the plates. To prevent this portion of the thread from affecting the rolling of the thread between the plates some of it was trimmed off and kept to one side in the water content tin. The remainder of the thread continued to roll well. It has been found that trimming has no effect on the nominal stress vs. diameter curves. The several pieces of the specimen were collected into tin no. 72 for weighing and drying in the oven. The water content determination and the calculations for the nominal stress and strain were conducted after the test was completed so there was no means of interfering with the test to affect the outcome.

Moving through to test 9 at a lower water content it can be seen that the forces were higher because the clay was tougher with the highest force of 2.3 N applied up to a yield condition, decreasing thereafter. Test 14 was similar but at the end of the test when the diameter of the soil thread D_1 was $0.02 - 0.17 + 2.90 = 2.75$ mm the thread separated transversely, as a clean, almost smooth break, at one side of the middle section. This was not a crumbling condition; it simply represented the difficulty such

a thin thread of soil had in retaining its tenacity during extrusion. The break appeared to be a result of torsion and tension in the thread at this location, a phenomenon observed with an earlier configuration of the plates, see section 4.5 and Figure 4.6. Nevertheless, a very good nominal stress vs. diameter curve was obtained, see Figure 5.5. Tests 3 and 9 were at water contents above the stiffness transition, in the soft-plastic region, with fairly flat nominal stress vs. diameter curves. Test 14 was at a water content that lies below the stiffness transition, described in section 5.7, at the beginning of the stiff-plastic region and in Figure 5.5 it can be seen that the curve is peakier with some strain-hardening and then strain-softening. Test 19 was in the stiff-plastic region. Higher forces were required (up to 5.0 N) up to a yield condition and the nominal stress vs. diameter curve was peaky.

For the tests in the stiff-plastic region (test 14 onwards) Figure 5.5 shows that between the diameters of about 3.5 and 3 mm the curves fall. This was likely to be a result of reducing the force values more frequently even though the deflection increments were small (most of them were less than 10 divisions on the dial gauge, i.e. < 0.1 mm) so a different force control was applied. This was done on purpose because it has been found that trying to extrude such a thin thread of soil with a high clay content and a high colloidal activity needs a more gentle approach with much reduced forces. Otherwise, a thin thread can be liable to separating transversely due to a combination of bending, torsion and tension forces. This tendency for separating transversely must not be considered to be related to a crumbling condition. Note that ASTM D4318-10 recognises this phenomenon by stating “It has no significance if the thread breaks into threads of shorter length.”, in other words separating transversely.

Test 23 was loaded up to 5.3 N with small radial and longitudinal deflections, i.e. very little extrusion. Without warning the loading bar of the apparatus started ‘rattling’. This is found to be a manifestation of the thread starting to lose its circular cross section, as a prelude to the thread crumbling. The change to an ellipsoidal cross section prevents the thread from rolling smoothly but instead produces the ‘rattling’, an up and down movement of the loading bar. During preparation by hand rolling, several fine transverse cracks were observed on the surface of this thread and dilation⁴¹ could be detected in the middle of the thread.

⁴¹ In some cases when a soil thread near to its plastic limit is rolled by hand the centre can be felt to dilate, considered to be caused by the action of cyclic compression and tension stresses. This is often observed as the development of a tubular thread. To insert the thread into the thread maker the thread then has to be gently squeezed radially.

5.5 Example calculations and the determination of toughness

An example of the calculations carried out for the laboratory data from test number 3, described above, is given in Figure 5.4a. This is an extract from an Excel spreadsheet where the lab data are inserted in the yellow columns (1 and 2) and in the adjacent columns calculations for the middle section of the thread, as described in Chapter 4, are carried out for

- 1) the final diameter (Column 3, from equation 4.2),
- 2) the nominal stress for the traverse (Column 4, from equation 4.15),
- 3) the incremental strain for each traverse (Column 5, from equation 4.3),
- 4) the cumulative⁴² strain (Column 6, from equation 4.4),
- 5) the number of reversals per traverse (Column 7, from equation 4.17),
- 6) the work/unit volume for the traverse (Column 8, from equation 4.16) and
- 7) the cumulative work/unit volume per 100 reversals, (Column 8, see below).

As mentioned above, the initial force (of 0.4N) is applied as a bedding force and the stress and strain values for the first traverse are not included in the test result. For the initial force the final diameter (Column 3 of Figure 5.4a) is determined from equation 4.2 as

$$D_2 = 4.80 - 0.14 + 2.90 = 7.56 \text{ mm.} \quad 5.1$$

The mean diameter for the second force of 0.6N is determined from equation 4.10 as

$$\bar{D}_2 = \frac{7.56 + 7.44}{2} = 7.50 \text{ mm} \quad 5.2$$

and the nominal stress (Column 4 of Figure 5.4a) for the second force is determined from equation 4.15 as

$$(\sigma_{\text{nom}})_2 = \frac{0.6}{50 \times 7.50} \times 1000 = 1.600 \text{ kPa.} \quad 5.3$$

⁴² Throughout the thesis strain in the Barnes test, unless otherwise stated, refers to the cumulative strain.

The incremental strain (Column 5 of Figure 5.4a) for the second force is determined from equation 4.3 as

$$\delta\varepsilon_{D2} = \frac{7.56 - 7.44}{7.56} = 0.0159 \text{ (rounded to 0.016)}. \quad 5.4$$

From equation 4.4 the cumulative strain (Column 6 of Figure 5.4a) is determined by adding the strain for each traverse to the value from the previous traverse. The work per unit volume for the second traverse (Column 8 of Figure 5.4a) is the product of the nominal stress and incremental strain, from equation 4.16

$$1.60 \times 0.0159 = 0.0254 \text{ kJ/m}^3 \text{ (rounded to 0.025)}. \quad 5.5$$

The travel of the thread in each traverse is 100 mm, 50 mm forward and back. The distance the thread travels to move from the compressive condition to the tensile condition is $\pi\bar{D}/4$ so the number of reversals N_R for the second force traverse (Column 7 of Figure 5.4a) is determined from equation 4.17

$$N_R = \frac{100 \times 4}{\pi \times 7.50} = 16.98 \text{ (rounded to 17.0)}. \quad 5.6$$

The work/unit volume for the second force traverse is converted to a normalised value of 100 reversals (first line of Column 9 of Figure 5.4a) from equation 4.18

$$\begin{aligned} \text{work/unit volume per 100 reversals} &= \frac{1.60 \times 0.016 \times 100}{17.0} \\ &= 0.150 \text{ kJ/m}^3 \text{ per 100 reversals.} \end{aligned} \quad 5.7$$

The cumulative work/unit volume per 100 reversals in Figure 5.4a is then determined by adding the value of work/unit volume per 100 reversals for each traverse to the value from the previous traverse. The values presented in the spreadsheet in Figure 5.4a are rounded to reasonable values whereas the actual calculations in each cell determine the values to more decimal places so the values presented that rely on previously calculated cells will be curtailed according to the number of decimal places assigned to the cell. From column 9 of the spreadsheet the calculations for the value of toughness T for test 3 are presented in Figure 5.4b where the cumulative work/unit volume per 100 reversals is determined by interpolation between the diameters of 6 and 4 mm. The cumulative work/unit volume per 100 reversals at the diameter of 4 mm lies between the values of 10.455 and 10.838 kJ/m³ per 100 reversals so the interpolated value of 10.664 kJ/m³ per

100 reversals at 4 mm is calculated in a cell in the spreadsheet, see Figure 5.4b. Similarly for the diameter of 6 mm. Thus the cumulative⁴³ work/unit volume per 100 reversals between the diameters of 6 and 4 mm is calculated in another cell as $10.664 - 3.708 = 6.96 \text{ kJ/m}^3$ per 100 reversals. This is the toughness T of the soil thread at this water content. Note that the number in this cell is formatted to two decimal places and rounding of the value is applied.

It has been found that for several soils the nominal stress vs. strain or diameter plots are less stable during rolling between the diameters of 4 mm and 3 mm compared to the rolling between the diameters of about 6 and 4 mm. For this reason the cumulative work/unit volume per 100 reversals is determined between the diameters of 6 mm and 4 mm to obtain a value of toughness in units of kJ/m^3 per 100 reversals. It would have been preferable to determine the work between the diameters of 6 and 3 mm as the standard test methods prescribe rolling to 3 mm but, unfortunately, between the diameters of 4 and 3 mm the nominal stress vs. diameter plots are frequently too variable and unrepresentative of the plastic deformation that is obtained between the diameters of 6 and 4 mm. This is still a significant change in state for the soil thread, from a volume of soil between the plates of 1.618 cm^3 at the diameter of 6 mm to 0.770 cm^3 at 4 mm diameter, a reduction to about 48% of the initial volume. This is deemed to be a sufficient amount of deformation to provide a representative measure of the toughness of the soil while in its fully plastic condition.

It is considered that with a similar number of traverses and reversals conducted for each test, the values of work/unit volume per 100 reversals calculated between the diameters of 6 and 4 mm will not be affected significantly by the number of traverses or reversals, see sections 4.17 and 5.12. Also, the very good correlations obtained in the toughness vs. water content plots give reinforcement to this point. A discussion on the unstable nature of the nominal stress vs. diameter plots when the soil thread diameters are less than 4 mm is given in section 5.11 below.

It is anticipated that toughness would be related to the amount of compaction energy applied in a laboratory compaction test or by an item of field compaction plant as tougher soils will require more energy to compact them. This property could be useful in assessing the suitability of compaction plant on different soils. It is expected that the toughness of a soil will be related to the number of blows applied in the moisture condition apparatus (MCA) and will be related to the moisture condition value (MCV). This could become a further research exercise.

⁴³ As described in section 4.17 the word cumulative is deleted.

Toughness could also be a useful property in relation to the efficiency and suitability of tunnelling machinery, auger piling rigs and other boring equipment, particularly in stiff clays. In the ceramics industry toughness would be an important property affecting the efficiency and economy of the processes in forming clay products.

5.6 Example plots

From the columns in the spreadsheet, Figure 5.4a, plots are obtained of the nominal stress vs. diameter and nominal stress vs. cumulative strain. Note that the starting points on these and all of the nominal stress vs. diameter and nominal stress vs. strain plots are not at the diameter of 8 mm as the diameter of the thread extruded from the thread maker is less than 8 mm and tends to be smaller for the softer soils. The starting points are also affected by the initial force applied to the soil thread for the first traverse so the nominal stress values do not commence at zero and will be larger for the stiffer soils. The values of nominal stress, strain and work/unit volume per 100 reversals in Figure 5.4a commence for the second force applied as the first force is considered to provide a bedding force. This force often results in a large change in the dial gauge reading due to the 'ironing out' of small imperfections in the circular cross section of the thread.

Typical plots of nominal stress vs. diameter and nominal stress vs. cumulative strain are presented in Figures 5.5 and 5.6, respectively, for the sample of Alluvial Clay from Chinnor, Oxfordshire, referred to above and in Figures 5.3 and 5.4. The plots numbered 1 to 22 represent ductile behaviour of a soil thread over a range of water contents. Yielding can be observed followed by continuous diametral plastic deformation (also involving longitudinal extrusion) for tests on specimens reducing to a water content of 29.2% for test 22. For each of these tests the toughness T is determined as described above and plotted against the water content from each test in Figure 5.7. On Figure 5.5 the toughness T can be seen as the area beneath each curve between the diameters of 6 and 4 mm. The relationship of toughness T increasing with decreasing water content has been found to be typical of all of the soils tested and is interpreted with new, fundamental properties of soils at water contents between the plastic and liquid limits, as described in section 5.7.

5.7 Determination of the plastic limit

The soil thread in test 22 on Figures 5.5 and 5.6, with a water content of 29.23%, behaved in a ductile manner, reducing in diameter and extruding longitudinally. For the soil thread in test 21 on Figures 5.5 and 5.6, with a water content of

29.24%, a more brittle stress-strain relationship was obtained and the thread finally crumbled/failed diametrically. The ductile-brittle transition and the plastic limit lie between the two water contents from tests 22 and 21. The ductile-brittle transition has been found to be sharp and distinct, usually within a fraction of a percentage point of water content for all of the soils tested. Formally, the plastic limit is determined as the average of the two values closest to the transition, one on the brittle side and one on the plastic side, for the Alluvial Clay, $w_p = 29.2\%$. For the purposes of accuracy and repeatability with the data obtained it is suggested that the two values should lie within $w_p/40$ from the computed plastic limit.

Sometimes the water content for the brittle sample is slightly higher than for the ductile sample. There is no doubt that these two samples lie each side of the ductile-brittle transition but their contradictory water contents are considered to be affected by small variations in the samples tested and inaccuracies in the determinations of the masses for the water content calculation. Because of the relatively small specimen size in this test it is imperative that clean working practices are adopted, particularly to avoid flakes of dried soil on the apparatus from contaminating the specimen. It is not always necessary to determine the toughness of a soil over a full range of water contents. If only the plastic limit is required then it is suggested that two tests are conducted on the brittle side, with at least three tests on the plastic side in order to extrapolate to the maximum toughness value, shown as T_{\max} in Figure 5.7.

5.8 Properties determined from the toughness vs. water content plots

The plot of toughness vs. water content in Figure 5.7 has been re-plotted in Figure 5.8 to include the water contents up to the liquid limit. Various new properties are identified on this plot and are described below. As the toughness vs. water content relationships for the soils tested are similar to this plot these properties can be used to represent each soil and to distinguish between them.

1) *Plasticity regions*

The range between the liquid limit and the plastic limit, referred to as the plasticity index, can now be subdivided into three regions, an adhesive-plastic (or sticky-plastic) region, a soft-plastic and a stiff-plastic region defined between the liquid limit, the toughness limit, the stiffness transition and the plastic limit. The zone below the plastic limit is referred to as brittle. Above the liquid limit soils can still be described as adhesive because they would stick to a steel spatula and below the toughness limit soils are found to retain some stickiness so the toughness limit

does not correspond with the sticky limit as proposed by Atterberg (1911).

The plasticity regions and the toughness property could be used to distinguish soils that will provide greater resistance to deformation while still remaining plastic. In the civil engineering industry this would be relevant for the assessment of the flexible behaviour of clay components in earthworks such as where flexible membranes are required in landfill and canal construction and in the cores of earth dams. Conversely tougher soils require more effort in placing and compaction affecting the choice of plant and the efficiency and costs of earthworks construction. In the ceramics industry toughness would be important to the forming processes of manufactured clay products.

2) *Toughness limit, w_T %*

The results of tests conducted using the Barnes apparatus show that the conventional plastic range of water contents, i.e. between the liquid limit and the plastic limit can be subdivided into an adhesive (or sticky)-plastic region which has no toughness and is virtually non-workable and a workable or tough-plastic region. These water content regions are distinguished by the toughness limit, w_T .

Due to the stickiness of soil at the higher water contents in the soft-plastic region it is not possible to extend the tests to nearly zero toughness values. From experience, the sticky limit as suggested by Atterberg (1911) lies at a water content below the toughness limit. However, extrapolation from the reasonably correlated straight line above the stiffness transition to zero toughness gives the toughness limit, the water content at zero toughness.

Although in the same range of water contents this value is considered to be not related to the sticky limit as the latter applies to a different phenomenon, associated with surface tension of a soil in contact with a metal surface. Nevertheless the toughness limit could be used to denote the upper limit of the toughness or workability of a soil.

Although rolling reasonably well, occasionally soil threads with high water contents in the soft-plastic region are found to stick to some extent to the surfaces of the plates of the apparatus. This adhesion would produce a shear stress on the longitudinal axis of the soil thread requiring higher forces to produce extrusion and resulting in higher measured, but inappropriate, toughnesses. These values are discarded in determining the toughness limit. They should already be referred to in the test proforma as producing some observed adhesion.

3) *Maximum toughness, T_{\max} kJ/m³ per 100 reversals*

In the stiff-plastic region the toughness and water content values plot on a reasonably correlated line that can be extrapolated to give the maximum toughness at the plastic limit, T_{\max} , with units of kJ/m³ per 100 reversals.

4) *Toughness classification*

A tentative classification of toughness values, T_{\max} , has been proposed, Barnes (2009) and is presented in Table 5.1.

5) *Stiffness transition, w_s % and T_s kJ/m³ per 100 reversals*

It has been found that many soils display an additional but more subtle transition on the toughness vs. water content by mass plot in the tough-plastic region, referred to as the stiffness transition. This is often observed to correspond to a noticeable change in the nominal stress-cumulative strain behaviour of the soil. The water content at this transition is referred to as w_s and T_s is the toughness at the stiffness transition. For some soils such as the Clayey Silt and some ball clays, see section 5.10 and Table 5.2, it was difficult to distinguish a stiffness transition. For these soils strain-hardening occurred at all water contents so there was no distinction between the conditions when different stress-strain behaviour may have occurred.

6) *Toughness coefficients, T_c kJ/m³ per 100 reversals*

The gradients of the straight lines each side of the stiffness transition are assigned the term, toughness coefficient, T_c . They can be defined mathematically as

$$T_c = \frac{\Delta T}{\Delta w} \cdot \quad 5.8$$

These values represent the sensitivity of a soil regarding its toughness to changes in water content. For a unit change (1%) in water content by mass the toughness would change more with a higher value of the toughness coefficient. The significance of the stiffness transition is demonstrated with generally much higher values of the toughness coefficient at water contents below the stiffness transition and lower toughness coefficients above the stiffness transition. Knowledge of this property would be particularly useful in situations such as the ceramics industry where water content adjustment and control are essential in the efficient operation of machinery.

7) Toughness index, I_T %

This is defined as the difference between the toughness limit and the plastic limit and gives the full range of water contents over which the soil would be plastic and workable. Mathematically

$$I_T = w_T - w_P. \quad 5.9$$

Casagrande (1932) introduced a term he defined as toughness index T equal to the logarithm of the ratio of the shear strength at the plastic limit (Casagrande defined this strength as toughness) and the shear strength at the liquid limit. Thus his toughness index is equal to

$$T = \log \left(\frac{c_{uPL}}{c_{uLL}} \right). \quad 5.10$$

However, Casagrande assumed that the flow index, F , (see section 3.6) the rate of change with water content of the number of blows in the Casagrande liquid limit apparatus, at the plastic limit would be the same as at the liquid limit, which is now known to be incorrect.

8) Workability index I_W

In a similar form to the liquidity index, the workability index identifies the water content, w , of a soil in relation to the toughness index. Mathematically

$$I_W = \frac{w - w_P}{w_T - w_P}. \quad 5.11$$

The plastic limit w_P in this equation is the value obtained from the Barnes test. The workability index could be used, in preference to the liquidity index, in the specification of processed clays and earthworks control for acceptability to denote the degree of workability.

5.9 Database of results

The results of tests on 26 natural soils and 33 soil mixtures conducted for the purpose of the research in this thesis are presented graphically in Appendices 1 to 4 with a summary in Table 5.2. The results of the tests on the London Clay:Silt, London Clay:Sand and ceramic clay mixtures are described in Chapters 8, 9 and 10, respectively. The results are used in this chapter to demonstrate

- 1) the new properties obtained from the toughness vs. water content plots that can provide new insights into the behaviour of soils between the plastic limit and the liquid limit and
- 2) the comparison of the plastic limits from the Barnes apparatus and the standard test.

It is anticipated that the toughness limit and toughness index could be used to develop a toughness chart similar to Casagrande's plasticity chart. For example, on a plot of toughness index vs. toughness limit, see Figure 5.9, for a range of soil types there appears to be a line that demarcates those soils with an inorganic clayey nature and those with a silty, kaolinitic and/or organic or peaty nature. An equation for this line, referred to herein as the G-Line, is tentatively given as

$$I_T = 0.5(w_T - 20). \quad 5.12$$

However, it is felt that more data on a wider range of soil types would be necessary to provide a definitive distinction comparable to Casagrande's A-Line.

5.10 Comparison of the Barnes test and the standard method plastic limits

Ballard and Weeks (1963) showed that the major factor contributing to the variance in standard plastic limit tests is the inconsistency between operators in determining the crumbling condition, what Ballard and Weeks called the 'end point'. The plastic limit occurs at the ductile-brittle transition so the Ballard and Weeks criterion is really the 'ductile-brittle' end point. With the conventional hand rolling test the crumbling condition can only be observed on the brittle side of the transition so for the standard test the water content is always determined on the brittle side of the transition. The conventional or standard plastic limit is, therefore, always underestimated compared to the plastic limit determined at the ductile-brittle transition with the Barnes apparatus and test.

The results of the plastic limit tests conducted on the database soils are plotted in Figure 5.10 and demonstrate a reasonable comparison between the Barnes test plastic limits and those from the author's hand rolling standard method. It is considered that there is a reasonable correlation, with most of the plastic limits from the Barnes test within $\pm 2.5\%$ points of the author's standard plastic limit. The author has realised that he has a tendency to make sure that the crumbling condition is unambiguously achieved when carrying out the standard method. As a result the author's values from the standard method lie below the Barnes test

plastic limit more frequently than above. It is considered that the plastic limit at the ductile-brittle transition obtained from the Barnes test is more appropriate as

- 1) it is the water content at the transition and not below it,
- 2) there is less interference with the rolling of the thread compared to the standard method,
- 3) drying during rolling is minimal in the Barnes test whereas continual, and potentially excessive, drying can occur in the standard method,
- 4) the detection of the crumbling condition is ameliorated in the Barnes apparatus.

The latter is achieved because for a brittle soil there is

- 1) a distinct change in the stress-strain behaviour of the soil thread,
- 2) much less extrusion of the soil thread,
- 3) curtailment of the test due to the thread falling into an elliptical shape and causing 'rattling' of the loading bar.

For some soils it has been noted that there is an effect of the different compaction methods applied to the soil threads, with minimal compaction by hand and static compaction in the thread maker. For soil samples with high silt or sand contents the loosely compacted threads prepared for the standard method were feeble (friable or of low toughness) and crumbled easily under the hand pressure. Because of this, premature crumbling in the standard method at a slightly higher water content results in a higher plastic limit. The threads prepared on the same soil for the Barnes apparatus were statically compacted and because they held together better they failed in a brittle, crumbled fashion at a lower water content. Thus the initial low density and minimal and variable compaction applied to a granular, low clay content soil in preparation of a thread for the standard method leaves the soil in an already friable state. These soils may be unreliably classed as non-plastic if they fail rapidly on rolling. The static compaction applied in the thread maker pushes the aggregates/clusters/clods of soil close together to make them interact and give a more dependable rolling behaviour.

It is expected that other operators would obtain different values of the plastic limit

for the soils tested when using the hand rolling method but more consistent results would be obtained with the Barnes apparatus. It should be clear from the discussion in this thesis that just as operators of the hand rolling test require experience then operators of the Barnes apparatus would require training, practice and some experience before achieving consistent, repeatable results.

5.11 Examples of soil types tested

To illustrate the range of soil types for which the Barnes apparatus can provide appropriate results the plasticity index obtained from the apparatus plastic limit and the liquid limit values for the soils from the database in Table 5.2 are plotted on the Casagrande plasticity chart in Figure 5.11. The following are comments on the results from four soil types, chosen to represent a typical low and a high plasticity inorganic clay above the A-line, a clayey silt and a peat below the A-line.

1) Alluvial Clay, Chinnor

The test results for this high plasticity soil are presented in Figures 5.5 to 5.8 and discussed above. The tests on this soil demonstrate the fundamental features of the results of the Barnes test with

- 1) yield and plastic straining displayed on the nominal stress vs. diameter and nominal stress vs. cumulative strain plots,
- 2) increasing toughness with water content, the plasticity regions on the toughness vs. water content plots and the ductile-brittle transition and
- 3) the newly identified properties from the toughness vs. water content plot of the toughness limit, stiffness transition, maximum toughness, toughness coefficients, toughness index and workability index.

2) Glacial Clay, Rixton

The results from the tests carried out on a sample of a typical low plasticity Glacial Clay obtained from the Rixton Brickworks clay pit at Rixton, Warrington are presented in Figures 5.12 and 5.13. The specimens at all water contents underwent strain-hardening, probably as a result of the high sand and silt contents, with higher rates of strain-hardening at water contents below the stiffness transition.

The sharp ductile-brittle transition can be seen at the plastic limit. A similar plastic limit value was obtained by the hand rolling method. Note that the typical features of the toughness vs. water content plot are clearly distinguished even over such a small range of water contents, between 16% and 23%.

3) *Clayey Silt, Flixton*

To investigate an inorganic soil below the A-line a sample of Clayey Silt from a site in Flixton, Manchester was tested. The results are plotted in Figures 5.14 and 5.15. The specimens at all water contents underwent continuous strain-hardening during rolling. A sharp ductile-brittle transition was found lying between tests 13 and 15, in Figure 5.15, with the water contents of the two specimens close to the plastic limit (test 13 $w = 33.08\%$ and test 15 $w = 33.12\%$). These water contents could be deemed to be on the wrong side of the transition. Test 13 was on a ductile specimen and test 15 was on a brittle specimen. However, these values are considered to be within the limits of accuracy of water content determination, as there could be small variations in the two specimens and small inaccuracies in the weighing. This demonstrates how sharp the ductile-brittle transition can be.

The behaviour of the soil during preparation of the threads is a useful guide to its state and should be recorded to assist in the assessment of the results. As the water content was reduced and the plastic limit was approached fine cracks were observed on the surface of the threads during preparation when rolled by hand before insertion into the thread maker. These cracks appeared to be closed visually following the static compaction procedure and expulsion from the thread maker. Continuance of the test should not be deterred if cracks in the soil thread are observed during preparation. The BS procedure for the plastic limit test (BS1377:1990) requires that drying of the ball of soil in the hands is continued sufficiently for slight cracks to appear on the surface of the soil. This is a means of achieving a soil at a water content close to but above the plastic limit.

In the Barnes test as the water contents approached close to the plastic limit the cracks became prominent during preparation, as in tests 13 and 14 in Figure 5.15. At a water content virtually at the plastic limit, in test 15, the soil thread was felt to be dilating as it was rolled by hand before insertion in the thread maker. Although the specimen for test 16 could not be rolled by hand and was prepared piece by piece in the thread maker it compacted well with no defects apparent in the soil thread. However, this thread would not extrude at all in the apparatus, failing by fracture denoted by the rattling of the loading bar at a diameter greater than 6 mm.

A higher plastic limit value was obtained by the manual method probably due to the premature crumbling of the threads. In the standard test soil threads, particularly with low clay content, are loosely packed when prepared by hand and become quite feeble when rolled at small diameters close to the plastic limit.

The significance of the A-line on Casagrande's plasticity chart is illustrated by this result compared with the Alluvial Clay, Chinnor. These soils have similar liquid limits, of 57.0 and 59.5%, respectively, but the Clayey Silt plots below the A-line and the Alluvial Clay plots above the A-line, see Figure 5.11. The Alluvial Clay was found to be much tougher than the Clayey Silt with T_{\max} values of 29.3 and 9.1 kJ/m³ per 100 reversals, respectively. The nominal stress vs. cumulative strain curves were quite different, with steep, continually rising nominal stress vs. diameter plots for the Clayey Silt, see Figure 5.14, compared to the flatter and more strain-softening curves for the Alluvial Clay, see Figure 5.5.

4) *Peat, Torside*

A sample of peat was obtained from the edge of Torside Reservoir, Glossop during a drawdown period in the reservoir level. This 'peat' originates from the finer particles washed into the reservoir from erosion products derived from the surrounding hill and moor peats and is formed from this debris settling in the water. It appeared to be a fine-grained and amorphous very peaty material. Although moist the soil had undergone some drying following exposure after drawdown and had developed a measure of cementation/bonding as a result, possibly from organic gel structures.

In order to break down the bonding in an attempt to reverse the effects of drying, the soil was not sieved but comminuted in a blender with additional distilled water, in preparation for the liquid limit test. Even though it was considered that the bonding or cementation had been destroyed or removed all of the tests underwent continuous strain-hardening during rolling probably due to the interlocking nature of the very fine peaty particles, see Figure 5.16. This material had a low toughness, as would be expected, but still demonstrated a stiffness transition, see Figure 5.17, in this case due to a steepening of the nominal stress vs. strain plots.

This test is an example of the effects of the diameter of the soil thread at a crumbling point in assessing the location of the ductile-brittle transition. The thread in test 9 behaved well with no indication of brittleness and reduced to a diameter of 2.86 mm when the test was stopped. This thread should then be deemed to lie on the ductile side of the plastic limit according to the 3 mm criterion in the standard methods. For the tests marked with an asterisk on Figure 5.17, tests 11 to 14, the threads could

be rolled to diameters less than 4 mm but they split and cracked, i.e. 'crumbled' before reaching the diameter of 3 mm. The diameters at crumbling are denoted against each point. In accordance with the British Standard procedure tests 11 to 14 would be considered to be on the brittle side of the transition, having sheared longitudinally and transversely at a diameter greater than 3 mm.

However, with the ASTM method a different approach can be adopted. Even though the threads are required to be rolled to a diameter of 1/8 inch (3.2 mm) when they are in a plastic condition, with this method a satisfactory 'end point' can be achieved "If crumbling occurs when the thread has a diameter greater than 3.2 mm.". An end point at a diameter greater than 3 mm was obtained for tests 11 to 14. It could be argued that none of these tests displayed brittle behaviour, see Figure 5.17, with even tests 13 and 14 reducing to diameters less than 4 mm. Toughness values (which are determined between 6 mm and 4 mm in the Barnes test method) could be obtained for these tests even though the soil threads had not been rolled to 3 mm diameter. However, during preparation by hand of the threads for tests 13 and 14 for insertion into the thread maker it was observed that there were many transverse cracks on the surface of the threads suggestive of a soil structure close to breaking down.

Thus two plastic limits and two T_{\max} values could be assigned for this soil, depending on the diameter criterion adopted for the determination of the plastic limit. Should the plastic limit be the water content

- a) between tests 8 and 11 $[(105.0 + 103.5) \div 2 = 104.2\%]$
line A-A on Figure 5.17 or
- b) between tests 9 and 13 $[(101.8 + 98.9) \div 2 = 100.4\%]$
line B-B on Figure 5.17?

During the hand rolling standard plastic limit test on this material the threads rolled well to a diameter of 3 mm or less and then on recombining into a lump for re-rolling they cracked and broke apart at a diameter of about 4 mm. Five standard plastic limit tests were conducted with a range of water contents at the crumbling condition between 102.8 and 107.9% and a mean value of 105.6%. The ASTM method refers to the 'first' crumbling point so the value of 104.2% would seem to be the most appropriate value for the plastic limit of this soil from the Barnes test.

It appears that this type of material does not behave in a clearly defined ductile and brittle fashion depending solely on the water content. Interestingly, on re-rolling by

hand the 4 mm diameter cracked threads it was found that they could be 'healed' by the rolling, with them becoming sufficiently intact to enable further rolling to a smaller diameter below 3 mm. This demonstrates a fluctuating ductile to brittle state and vice versa. It is postulated that this is due to the fine peaty particles not having flat, uniform shapes typical of clay minerals. Instead, they probably have a variety of curved, twisted, tortuous, even hooked shapes that can interlock and then separate and vice versa, producing a quasi-reversible nature.

Initially, the interlocking of the particles would enable the soil threads to coalesce and permit extrusion between the plates of the apparatus with reduction in diameter. Similarly though, because of their heterogeneous shaped nature the particles could also detach, separate and develop cracks between themselves that will allow the thread to crumble. On re-rolling a cracked thread the misshapen nature of the particles could permit 'healing' by re-interlocking and allowing the thread to continue rolling to a smaller diameter. This could have been the reason for test 9 to continue reducing in diameter to less than 3 mm although there were no visible signs of any defects in the thread before or during rolling. A simplistic corollary of these processes could be the locking and release action of the material Velcro® hook and loop fastener.

Because of the insistence of the standard methods on rolling threads to a diameter of 3 mm (or 3.2 mm) an investigation has been carried out to assess whether or not the diameter criterion is important in the determination of the ductile-brittle transition and the plastic limit. This is described in Chapter 6.

5.12 Behaviour of soil threads between 4 and 3 mm diameter

According to the British Standard method a soil thread must first be rolled to a diameter of 3 mm. If a soil thread cannot be rolled to a diameter of 3 mm, then it must be deemed to be non-plastic, or non-ductile, and, therefore, in a brittle state. It has been found for several soil types with the Barnes test that between the diameters of 4 and 3 mm the nominal stress vs. diameter plots become less stable and some threads break (but not crumble) before reaching the diameter of 3 mm. The main causes of this instability are considered to be

1) *The increased shape effect*

As the thread diameter gets smaller its shape factor, i.e. L/D ratio increases. Meyerhof and Chaplin (1953) gave an analysis of the yield pressure p in a thin slab of plastic soil as a ratio with the undrained shear strength, or cohesion, c_u of the soil when placed between two plates. They produced a figure (reproduced in Figure

5.18) relating the ratio of yield pressure to cohesion, p/c , to the width/height ratio of the slab, B/H . Note that in Figure 5.18 cohesion is denoted as c , instead of c_u . The shape factor B/H can be viewed in the case of the Barnes test to be comparable to the length/diameter ratio, L/D . For rough and partially rough plates with adhesion $c_a = mc$ (where $m \leq 1$) acting between the plate surfaces and the soil they found that the p/c ratio did depend on the width/height ratio, see Figure 5.18. However, for smooth plates with $m = 0$ the yield pressure was independent of the shape factor and directly related to the cohesion with $p = 2c_u$.

Merifield *et al* (1999) showed that the effect of roughness of the underside of a foundation on a thin layer of soft clay was to increase the bearing capacity of the foundation. For a perfectly smooth interface the bearing capacity was reduced by up to 25% compared to a rough interface.

These two papers show that if the interface between a rolling soil thread and the contacting surfaces is rough the effect of roughness can be significant. This will be a serious flaw with the Bobrowski and Griekspoor (1992) rolling device described in Chapter 2 because they insisted on fixing paper to the plates and this will produce variable amounts of roughness. The results of tests from the Barnes apparatus will also be affected by any variation in the surface roughness (or adhesion) of the two plates of the apparatus. However, the effect of adhesion is considered to be minimal. With greased outer faces on both plates of the Barnes apparatus it seems reasonable to assume that these surfaces can be deemed to be smooth.

For rough surfaces the yield pressure increases with B/H , see Figure 5.18, or L/D in the case of the Barnes test and so would increase as the thread diameter D decreases from 6 mm to 3 mm. However, for the plastic soils tested in the Barnes apparatus it is found that the nominal stress vs. diameter plots, particularly in the diameter range of 6 to 4 mm, are quite consistent throughout the test. This condition would be obtained with smooth interfaces between the soil thread and the plates of the apparatus. The middle 10 mm of the plates of the apparatus is not greased. If it is assumed that the adhesion in the middle 10 mm of the plates is $c_a = 0.5 c_u$ and on the outer 20 mm faces it is $c_a = 0$ then the average adhesion along the length of the thread would be

$$\frac{10 \times 0.5 \times c_u + 0}{50} = 0.1 c_u . \quad 5.13$$

i.e. $m = 0.1$. From Figure 5.18 this value of m would have a very small effect on the yield pressure for slabs of soil, between the L/D values of 50/6 and 50/3. A

significant factor in comparison with the Meyerhof and Chaplin results is that the effect of adhesion will be much reduced in the Barnes apparatus because with a circular cross section the contact area between the soil thread and the plates of the apparatus is much smaller than that of a slab. Also the contact between the soil thread and the plates is continually changing as the thread rotates quickly, preventing the soil from clinging to the plate surfaces.

It is considered that the thin smear of petroleum jelly applied to the plate surfaces provides a consistent surface for all tests and can be assumed to provide a smooth surface. When the water content of a soil is sufficiently low to produce a thread that does not stick to the plates of the apparatus it is noted that the grease provides a good barrier between the soil thread surface and the plates of the apparatus allowing the thread to extrude and slide out between the plates of the apparatus. At the end of a test the soil thread that has been in contact with the outer faces has a slightly shiny surface due to smearing of the grease and the plates of the apparatus also retain a grease smeared surface without it being rubbed off.

The values of calculated nominal stress, strain and work/unit volume per 100 reversals in the spreadsheet described above are maximum values, in the middle 10 mm of the soil thread, where the diameter is measured. As the diameter of the soil thread increases away from the middle 10 mm in the Barnes apparatus due to the configuration of the plates the nominal stress and strain and, hence, the work/unit volume per 100 reversals decrease towards the outer edge of the thread.

The variation of work/unit volume per 100 reversals along the outer 20 mm of the thread is plotted for a typical test in Figure 5.19, at diameters reducing from 7 to 3 mm, and normalised to the maximum values which occur within the middle 10 mm. This example is for a force of 3.0 N and a change in diameter of 0.1 mm. These not only occur in the middle 10 mm of the thread but along its whole length. It is noted that the work done to the thread is greatest in the middle of the thread decreasing towards the edges; otherwise extrusion would not occur. As the diameter of the soil thread decreases during the test the difference in the work/unit volume per 100 reversals between the central strip and the outer edge of the soil thread increases as the diameter reduces. This could be a significant factor in the relatively unstable nature of the behaviour between the diameters of 4 and 3 mm.

2) *Inappropriate changes in diameter between 4 and 3 mm*

Nearly all of the tests conducted so far have shown that the nominal stress vs. diameter behaviour is reasonably consistent between the diameters of 6 mm and 4

mm with fairly uniform plastic straining. However, between 4 mm and 3 mm the plots are less uniform and often the stress deviates from a uniform condition in this region with either decreasing stress as shown for the soil in Figure 5.5 and explained in section 5.3, or an increasing rate of stress change such as is shown in Figures 5.12, 5.14, 5.16 and 5.20. This may be largely due to less effective force control in this region. Nevertheless from the nominal stress vs. diameter plots obtained for all tests conducted so far it is clear that a distinct transition exists between threads that will reduce in diameter and extrude in a ductile manner and threads that will not reduce in diameter or extrude and ultimately fail in a brittle manner. Thus in order to obtain the ductile-brittle transition it is argued that it is not essential to reduce the ductile threads to a diameter of 3 mm.

A typical example of an increasing rate of stress change at diameters below 4 mm, following fairly uniform plastic straining, is provided by the tests on the sample of London Clay:Fine/medium Sand 60:40, see Figure 5.20; the tests on these mixtures are described in detail in Chapter 9. In many of the tests (tests 1 to 11), the nominal stress vs. diameter plots are fairly flat and consistent to the diameter of less than 4 mm. However, the stresses increased at a greater rate below the diameter of about 4 mm entailing more work/unit volume per 100 reversals per strain increment to reduce the diameter in this region.

It is considered that providing the soil thread reduces to a diameter less than 4 mm and displays plastic, or ductile, stress-diameter behaviour then it can be classed as on the ductile side of the ductile-brittle transition. The threads in the tests numbered 11 to 15 in Figure 5.20 rolled to below 4 mm diameter with reasonably uniform nominal stress vs. diameter plots but they crumbled at diameters between 3 and 3.5 mm. These tests were on soils at water contents below the stiffness transition so could have been affected by the presence of defects such as microcracks. Strictly, these tests would be classed as 'non-standard' because they did not reach the 3 mm diameter but they are still considered to be displaying ductile behaviour and are included in the overall assessment as ductile tests.

In tests 16, 17 and 18 the thread crumbled before reaching 4 mm diameter and these are deemed to be on the brittle side of the transition. Thus the plastic limit is the water content between tests 15 and 16, $(18.9 + 19.4)/2 = 19.2\%$. If crumbling at a diameter of 3 mm or so was the sole criterion adopted for brittleness regardless of the extrusion and ductility displayed beforehand, the plastic limit for the tests on Figure 5.20 would be determined as the value between tests 10 and 11, $(20.9 + 21.7)/2 = 21.3\%$, but this is not the true ductile-brittle transition. The toughnesses reported in Figure 5.21 are for the work/unit volume per 100 reversals between 6

and 4 mm so the behaviour of the test between 4 and 3 mm for tests 11 to 15 in Figure 5.20, may be considered irrelevant. However, as it is recommended in the standard test that all threads are rolled to the diameter of 3 mm some explanation for the crumbling of the threads at 4 – 3 mm must be provided.

On inspection of the data it was considered that the increase of stress below 4 mm, see Figure 5.20, was a result of maintaining too high a load on the thread even with changes in diameter kept to the recommended value of 0.10 mm. If this change in diameter is held fixed throughout the test the actual strain will increase so the strain increments are larger between 4 and 3 mm.

With loads kept high and not reduced sufficiently to reduce the change in diameter in this region the relatively thin soil threads can be overstressed and are then more likely to fail. Thus it was considered that the crumbling between 4 and 3 mm was premature and that the main cause was the overstressing of a thin thread of soil due to inappropriate changes in diameter. It is recommended that in the lower range of diameters the loads are varied to produce smaller changes in diameter of between 0.05 and 0.10 mm and avoid changes in diameter greater than 0.10 mm, particularly for soils with high silt and sand contents, see below.

Because of the doubt that may exist in the decision to assign ductility to a nominal stress vs. diameter plot whether or not the thread has been reduced to a diameter of 3 mm an investigation has been carried out into the significance of the thread diameter in the standard plastic limit test. This is described in Chapter 6.

3) *A high silt or sand content in the soil*

For these soils, such as the London Clay:Silt and London Clay:Sand mixtures summarised in Table 5.2 the effect of granular particle interference is significant. With sand size particles up to 425 μm the effect of the ratio of the maximum particle size to the smaller thread diameters approaching 3 mm becomes more significant in resisting extrusion at the smaller diameters. For the standard hand rolling method this ratio at the end of the test is about 7 (3000/425). For the oedometer consolidation test and the triaxial compression test an acceptable value of the ratio of the maximum particle size to the smallest specimen dimension is 5 (BS EN 1997-2:2007) so the value of 7 could be deemed acceptable. However, for the direct shear (shear box) test this reference (BS EN 1997-2:2007) gives the ratio as 10 so the value of 7 would not be acceptable.

It is the author's opinion that the shearing mode in the plastic limit test would be

more comparable to that in the direct shear test than in the triaxial compression test and that the ratio value of 10 would be more appropriate in the plastic limit test. This is discussed further in Chapters 8 and 9.

5.13 Tests to assess the effect of rate of loading

From experience with the test it has been found that a 'normal' rate of loading would be expected to give a typical change in diameter of about 0.1 mm per traverse. A change in diameter near to 0.05 mm would prompt an increase in the force applied and the force would be reduced when a change in diameter near to 0.15 mm occurred. To check the effect of rate of loading five tests were conducted on a sample of Lias Clay prepared at a consistent water content of about 31.7% with different force increments applied to obtain different changes in diameter per traverse and numbers of traverses. The procedural data are presented in Table 5.3 and the force vs. diameter and the nominal stress vs. diameter plots are presented in Figures 5.22 and 5.23, respectively.

For all of the tests at diameters below about 6 mm the force was reduced, Figure 5.22, because the plastic strain associated with this type of soil results in a fairly uniform stress level and, to an extent, some strain-softening. From equation 4.15 to maintain a uniform stress level as the diameter reduces the force must be reduced. The effects of the forces applied were investigated by applying the normal rate of loading (tests 1 and 3) and comparing with lower forces (test 5) and higher forces (tests 2 and 4), see Figure 5.22.

- 1) Tests 1 and 3 were conducted in the recommended manner, by keeping the load increments at values that ensured the changes in diameter were about 0.1 mm and kept between 0.08 and 0.12 mm. These tests gave fairly similar toughness values, see Table 5.3.
- 2) A loading rate 'faster' than the normal rate (test 4) with the load applied allowed to remain the same for some periods and not reduced produced a higher stress level, larger changes in diameter for each traverse and because of this, higher toughness. The average change in diameter between 6 and 4 mm (0.136 mm) was below the recommended maximum value of 0.15 mm, but above the recommended typical value of 0.10 mm. From a thread diameter of about 5 mm downwards the changes in diameter were up to 0.23 mm (average 0.18 mm) and, therefore, too large.
- 3) Test 2 was conducted in a similar manner to test 4 but was loaded slowly

to begin with. The changes in diameter were less than 0.05 mm up to yield and then the load held constant for periods when several of the changes in diameter exceeded 0.15 mm.

- 4) A loading rate 'slower' than the normal rate (test 5) with a gradually reducing load following yield gave a lower stress level, smaller changes in diameter for each traverse and lower toughness. Nearly all of the changes in diameter were below 0.10 mm.

The toughness values from tests 1 and 3 of 17.2 and 16.9 kJ/m³ per 100 reversals, respectively, would be the appropriate values for this soil. The stress levels in tests 2 and 4 were higher than for the recommended rates of loading in tests 1 and 3, see Figure 5.23 and, therefore, gave higher toughness values. The stress level in test 5 was below that in tests 1 and 3 and gave a lower toughness value. With lower force values a greater number of traverses would be required to reduce the diameter of the soil thread from 6 to 4 mm, 22 traverses for test 5, and with higher force values a smaller number of traverses would be required, 15 traverses for test 4. The number of traverses for test 2 (and, hence, the number of reversals) was similar (18) to the numbers for tests 1 and 3 (17 and 19) but the force applied was larger giving higher stress levels and a higher toughness. The work done on the soil thread and the toughness value are determined by the stress levels between the diameters of 6 and 4 mm, see Figure 5.23, which are, in turn, determined by the forces applied, with no measurable effect of the number of traverses and reversals.

It could be argued that test 5 gave the most relevant result because with the smallest load increments and smallest diameter changes the nominal stress vs. diameter plot beyond yield was flattest and lowest giving the lowest toughness which could be considered to be the value sought. However, with small changes in diameter there is a risk of the thread undergoing water migration from the middle towards the outer portions of the thread, particularly for the more permeable, more granular, more dilatancy-prone soils so undrained conditions may not be assured. Also there are too many readings, increasing the duration of the test and the number of computations. Figure 5.23 shows that a larger variation in toughness values would be obtained for the different rates of loading if it was measured between the diameters of 6 and 3 mm whereas more consistent results were obtained between the diameters of 6 and 4 mm. It is clear that control of the loading sequence is essential to produce consistent results. It is recommended that:

- 1) The initial load increments are chosen to achieve yielding within about 15 traverses with changes in diameter in the range of 0.05 – 0.15 mm.

- 2) Plastic or ductile extrusion beyond yield to 3 mm diameter, and at least 4 mm, takes place over the next 25 – 35 traverses making sure that the load increments are chosen to achieve changes in diameter of about 0.10 mm, and preferably within the range 0.08 to 0.12 mm.

It is considered that with very good linear toughness vs. water content relationships obtained in all of the tests conducted so far, with high values of the correlation coefficients, that the loading procedure and recommended change in diameter criteria adopted for the conduct of the tests give adequately repeatable results.

5.14 The effects of wetting up of soil

For the first tests conducted on the London Clay:Fine/medium Sand 60:40 material it was felt that there were insufficient points obtained. The soil prepared for the liquid limit test was fairly quickly dried in the hands and only seven tests had been conducted when the soil reached its plastic limit condition at water contents around 20%. These seven tests were referred to as Series 1 in Figure 5.24.

Because of the sensitivity of toughness of this soil to water content changes only small amounts of hand drying were necessary to reduce the water content for the next test. As the prepared soil was now in a drier condition, to obtain more points the soil was wetted up and Series 2 commenced at a higher water content, see Figure 5.24. At the time adding distilled water to the soil as opposed to drying the soil was not considered to have an effect on the toughness. At the end of Series 2 it was felt that there were still insufficient test results near to the plastic limit so the remaining soil was wetted up again and three more tests conducted, as Series 3.

Before plotting the results it was not considered that there were three series of tests, rather that all of the data would plot on the same lines, above and below the stiffness transition. On plotting the results it was found that the wetting up had an effect on the toughness values, apparently increasing them at the same water content. However, the differences in the results for the three series are considered to be due to inadequate mixing of the water into the soil sample, leaving enough clay with the original toughness present but with largely ineffective pockets of higher water content that provided the overall higher water contents.

Water was added to the soil sample by preparing a thin slab of the soil with as much surface area as possible, then spraying this surface with a thin film of water and folding and rolling the slabs together. The amount of hand rolling was restricted to

avoid excessive loss of water; otherwise an increased water content would not have been obtained. However, the results show that the mixing was insufficient.

It is not a suction effect caused by the soil undergoing a drying cycle and then a wetting cycle. On a typical suction vs. water content relationship the soil on a wetting cycle will have a lower suction than on the drying cycle at the same water content. All of the series were drying cycles. In Series 1, 2 and 3 the suctions increase on drying and toughness increases. If Series 2 was a wetting cycle following the drying cycle in Series 1 the suction and hence the toughness values in Series 2 should be lower than in Series 1 at the same water content; this is not the case.

It is recommended, therefore, that wetting up of the soil sample is avoided and all tests are conducted by gradually drying from a high water content starting point as it is more effective to homogeneously reduce the water content of the soil by hand than to wet it up by adding water. The test results reported in Figures 5.20 and 5.21 and discussed in section 5.11 were from a repeat test conducted on a freshly prepared mixture of the sand and clay components commencing by adding water to just above the liquid limit. This gave more acceptable and consistent results, comparable with the results from Series 1.

5.15 The effects of drying of soil

To investigate the effect of drying on the toughness behaviour a test was conducted on a sample of the oven-dried London Clay:Fine/medium Sand 60:40 mixture to compare with the test on the original air-dried mixture. The air-dried London Clay was prepared by pulverising and air-drying the original sample. The oven-dried material had been retained from a previous Barnes test, it was ground to pass a 425 μm sieve, mixed with distilled water and left to rehydrate. Some time elapsed (8 months) before the test was conducted because of other commitments so the soil had a good opportunity to rehydrate. Nevertheless at the same water contents the toughness of the oven-dried soil was lower than the original (air-dried) soil and the plastic limit was higher, see Figure 5.24. This suggests that some of the clay mineral content of the soil had become ineffective in providing toughness.

Some of the tests on the air-dried and oven-dried samples were conducted at very similar water contents and their nominal stress vs. diameter curves are plotted on Figure 5.25. This figure shows that the curves have fairly similar flattish shapes in the 6 mm to 4 mm range of diameters following a yield condition. The air-dried specimens sustained higher stress levels than the oven-dried specimens and, therefore, gave higher toughnesses. Another difference between the air-dried and

the oven-dried samples is in the initial part of the curves where the air-dried samples have a stiffer initial response and yield at a higher stress value. It is postulated that the effect of oven-drying on the initial stiffness and the toughness of the soil is caused by some aggregation of the clay particles in the clay matrix resulting in a smaller proportion of continuous clay matrix that provides lower initial stiffness and yields at a lower stress.

5.16 Repeatability tests

From experience in operating the apparatus and conducting the test the author has found that repeatable results are obtained. Other operators would need to become familiar with the operation of the apparatus and conduct of the test in order to obtain repeatable results. The author can confirm that repeatable results are obtained from the following.

- 1) Three tests conducted on two small batches of soil prepared at the same water content, one in the soft-plastic region and the other in the stiff-plastic region. The material used was a typical ball clay, referred to as MFB supplied by Imerys Ltd. The nominal stress-diameter plots are presented in Figure 5.26 and show that similar curves were produced at the same water contents. The toughness and water contents are given in Table 5.4 and show that similar toughnesses were obtained at the same water contents. For the stiff-plastic specimens the water content was also determined for the trimmings from the thread maker to obtain a water content prior to completion of the Barnes test. These values are included in Table 5.4 and show that some drying takes place between thread preparation and completion of the test. In terms of repeatability the water contents of the three specimens prior to and on completion of the Barnes test are similar. It is always the water content on completion of the Barnes test that is used in the test results and this is shown to be repeatable. The increased gradient of the toughness-water content plot in the stiff-plastic region compared to the soft-plastic region is not a result of drying of the specimen prior to and on completion of the test. If the water content prior to the test was used in the toughness-water content plot (take the mean values of 23.91 and 23.06%) the gradient of the plot in the stiff-plastic region would be steeper giving an even more significant 'stiffening' impression.
- 2) The test results reported in section 5.14 illustrate the repeatability of the test providing the test specimens are prepared in the same manner. The results from Series 1 in Figure 5.24 can be compared with the repeat tests conducted

on a freshly prepared mixture of the same sand and clay components prepared in the same manner by commencing with the addition of water to just above the liquid limit. The similarity of these two sets of data conducted at different times show that the test is repeatable.

- 3) There are several instances in the plots of toughness versus water content in Appendices 1, 2 and 3 where two tests were conducted at similar water contents and similar toughness values were obtained.
- 4) The good correlations obtained for all of the materials tested in the database and presented in Appendices 1, 2 and 3 between the toughness and water content illustrate that the variation of toughness with water content is rational and the use of the correlation lines to obtain the toughness coefficients, the stiffness transition and to extrapolate to zero toughness to obtain the toughness limit is valid and reasonable.

5.17 Summary

Using a specially designed and constructed thread maker soil threads are formed for use in the Barnes apparatus with a circular cross section to ensure adequate rolling behaviour, at a diameter of about 8 mm. Static compaction produces an intact and saturated thread with obvious defects such as cracks that can form during hand rolling minimised and as much air as possible removed. The size of the thread is considered sufficient to provide a mass of soil suitable for the representative determination of the water content of a clay soil. The effect of a high proportion of large particles in a small diameter thread is found to be significant so it is necessary to remove all particles greater than 425 μm from the soil, preferably by wet sieving, before preparing a soil thread.

The outer strips of the top and bottom plates are lightly smeared with petroleum jelly to provide a form of lubricated platens to ensure a consistent smooth surface in these areas that will permit freer extrusion of the thread during rolling. The soil thread is placed at the front of the bottom plate, the loading bar with the moveable mass at the zero force position is lowered onto the thread and the test commenced by moving the bottom plate to the left and back to make the thread roll back and forth to achieve one traverse. The force reading and the dial gauge reading are recorded at the end of each traverse. The test is described in detail concerning the forces to apply to give a consistent load control and to maintain the criterion for the change in diameter for each traverse of about 0.1 mm.

From the force and dial gauge readings the spreadsheet calculations are described for the nominal stress in the middle section of the thread, the diametral strain and the work/unit volume for 100 compression/tension reversals. From the plots of nominal stress vs. strain the toughness for each thread at a particular water content is determined with units of kJ/m^3 per 100 reversals between the diameters of 6 and 4 mm when the soil is undergoing plastic straining.

The test is commenced with a soil thread prepared at a water content that is close to the toughness limit but is not sticky otherwise adhesion of the soil to the plates of the apparatus will affect the results. For subsequent tests the threads are prepared at gradually reduced water contents by moulding the soil in the warmth of the hands. Judgement is required to assess how much drying should be applied between test specimens. Too much drying produces points on the toughness versus water content plot too far apart. From the moulding it is deduced that ductile responses and straining to at least 4 mm diameter, and preferably 3 mm, will be obtained in the test and tests are conducted until the soil is at a water content when it becomes brittle and a thread will no longer reduce in diameter and extrude and fails in a brittle manner. The plastic limit is the water content at the ductile-brittle transition.

The plastic limit results from the Barnes test are usually close to the results from the author's hand rolling tests. However, the crumbling condition determined by the standard hand rolling method must lie in the brittle region so the hand rolling method will give a plastic limit value below the ductile-brittle transition whereas the Barnes test gives the more appropriate plastic limit at the transition.

From the toughness vs. water content plot several new properties are determined such as the toughness limit, the water content at zero toughness and the stiffness transition where there is a distinct change in gradient of the toughness-water content plot. The water contents at these locations and the plastic limit define three regions in the conventional plastic range between the liquid and plastic limits. The adhesive-plastic region lies between the liquid and toughness limits, a soft-plastic region lies between the toughness limit and the stiffness transition with a stiff-plastic region between the stiffness transition and the plastic limit. With good correlations obtained for the toughness vs. water content plots the maximum toughness at the plastic limit and the toughness coefficients, the gradients of the plot can be determined with good accuracy. The toughness index is defined as the difference between the toughness limit and the plastic limit and the workability index identifies the water content of a soil in relation to the toughness index. To illustrate the range of soil types for which the Barnes apparatus and test is

appropriate the results of four typical soil types are described. The performance of soils can be distinguished by their nominal stress vs. diameter behaviour and the various properties associated with the toughness vs. water content plot.

For several soil types the behaviour of soil threads between the diameters of about 4 and 3 mm becomes different and is generally less stable than that between the diameters of 6 and 4 mm. Several reasons are discussed for this behaviour including an increased shape effect, less effective force control and inconsistent changes in diameter and the effects of proportions of silt and sand in the clay soil.

A 'normal' rate of loading is considered to be one that produces changes in diameter of about 0.1 mm and within a range of about 0.08 – 0.12 mm. Tests to assess the effects of different loading rates have been conducted. Different toughness values are obtained depending on the stresses applied which, in turn, are determined by the forces adopted, with an insignificant effect of the number of traverses. Consistent results are achieved by adhering to the normal rate of change of diameter.

It has been found that if the soil is allowed to dry too much and insufficient tests have been carried out to obtain a reasonable plot then wetting up of the soil can produce unrepresentative results and should be avoided. It is assumed that the added water is not completely imbibed into the moist soil leaving the soil with the initial toughness unaffected but with a higher water content. Drying of a soil affects the result of the toughness-water content plot, illustrated by comparing the results of an air-dried sample and an oven-dried sample of a London Clay:Sand mixture. The oven-dried sample gave lower toughness values at the same water content compared to the air-dried sample. The air-dried samples gave a stiffer initial response on the nominal stress-diameter curves and yielded at higher nominal stress values than the oven-dried sample. It is considered that oven-drying of a clay soil causes some aggregation of the clay particles and leaves the soil with a smaller proportion of continuous matrix resulting in the softer initial response and lower yield strength.

5.18 Tables

Toughness Classification	T_{\max} kJ/m ³ per 100 reversals
Very low	< 5
Low	5 – 10
Moderate	10 – 20
High	20 – 30
Very high	30 – 50
Extremely high	> 50

Table 5.1 *Proposed toughness classification (From Barnes, 2009)*

Soil	LLiquid limit w_L %	Toughness limit w_T %	Stiffness transition w_S %	Apparatus plastic limit w_P %	Hand plastic limit w_P %	Toughness index I_T %	T_{max} kJ/m ³ per 100 reversals	T_S kJ/m ³ per 100 reversals	Type
Terracotta clay Xian	45.7	32.2	25.5	22.6	22.3	9.6	21.7	8.6	Inorganic Natural Clays
Lias Clay	61.0	40.9	31.8	30.4	29.5	10.5	21.2	15.6	Inorganic Natural Clays
London Clay Isle of Grain	80.0	53.0	36.4	32.0	31.7	21.0	37.2	23.4	Inorganic Natural Clays
Reworked Chalk	38.6	30.6	26.6	24.4	25.6	6.2	7.5	3.4	Inorganic Natural Clays
Alluvial Clay Chinnor	59.5	44.8	33.6	29.2	27.6	15.6	29.3	14.6	Inorganic Natural Clays
Oxford Clay Scarborough	42.5	32.4	26.3	23.3	23.7	9.1	18.9	9.7	Inorganic Natural Clays
Weald Clay Lulworth Cove	74.0	45.2	34.0	29.5	28.7	15.7	34.8	20.5	Inorganic Natural Clays
Lias Clay Charmouth	57.8	43.3	32.2	28.0	NA	15.3	30.3	14.1	Inorganic Natural Clays
Marine Clay Morfa From LL	46.0	34.0	26.7	23.3	25.3	10.7	16.5	6.8	Inorganic Natural Clays
Marine Clay Morfa Natural	46.0	NA	NA	23.9	22.8	NA	16.6	NA	Inorganic Natural Clays
Fireclay Oldridge	32.4	26.0	23.0	21.0	20.9	5.0	15.2	7.6	Brick Clays
Weald Clay Ibstock Swanage	33.5	27.5	22.0	18.0	16.0	9.5	18.1	5.5	Brick Clays
Glacial Clay Rixton	31.5	22.5	17.9	16.2	15.8	6.3	13.9	8.0	Brick Clays
Etruria Marl	31.9	24.6	21.5	19.0	18.3	5.6	21.8	10.5	Brick Clays

Soil	Liquid limit w_L %	Toughness limit w_T %	Stiffness transition w_S %	Apparatus plastic limit w_P %	Hand plastic limit w_P %	Toughness index I_T %	T_{max} kJ/m ³ per 100 reversals	T_S kJ/m ³ per 100 reversals	Type
Steerpoint Shale	28.0	22.2	18.4	16.6	19.3	5.6	11.7	4.6	Brick Clays
Organic Clay Isle of Grain	100.5	76.6	61.0	50.3	50.4	26.3	21.2	7.9	Organic Clay
Peat Torside	179.0	133.6	109.3	104.2	105.6	29.4	7.2	4.5	Peat
Trigon SM Clay	32.1	25.0	20.6	18.4	18.2	6.6	8.0	4.0	Ceramic clays
Puraflo BB	42.5	29.9	23.4	21.2	20.8	8.7	13.2	6.5	Ceramic clays
Puraflo DM 3 tests	56.5	43.1	34.3	30.6	29.4	12.5	11.8	6.2	Ceramic clays
Puraflo TA	60.5	40.1	NA	30.3	29.2	9.8	14.0	NA	Ceramic clays
K-T Ball Clay	54.3	36.1	NA	30.0	28.3	6.1	10.0	NA	Ceramic clays
K-T Kaolin	63.5	47.6	36.7	33.8	33.1	13.8	15.4	9.2	Ceramic clays
Kaolin speswhite	60.5	39.0	NA	33.2	32.6	5.7	8.7	NA	Ceramic clays
Povington HPK Clay	86.0	56.9	47.0	42.8	39.1	14.1	17.2	9.9	Ceramic clays
Clayey Silt Flixton	57.0	40.4	NA	33.1	34.3	7.3	9.1	NA	Ceramic clays

Soil	Liquid limit w_L %	Toughness limit w_T %	Stiffness transition w_S %	Apparatus plastic limit w_P %	Hand plastic limit w_P %	Toughness index I_T %	T_{max} kJ/m ³ per 100 reversals	T_S kJ/m ³ per 100 reversals	Type
London Clay air dried for mixtures	78.0	49.1	35.5	29.3	30.0	19.8	45.8	19.5	Mixtures
London Clay:Silt 80:20	62.6	41.3	30.0	26.3	26.5	15.0	33.3	20.6	Mixtures
London Clay:Silt 60:40	49.8	35.6	26.4	22.7	21.9	12.9	23.6	12.6	Mixtures
London Clay:Silt 40:60	37.6	30.1	22.3	20.1	20.0	10.0	12.8	7.7	Mixtures
London Clay:Silt 30:70	32.6	27.5	21.9	18.9	20.5	8.6	9.0	4.1	Mixtures
London Clay:Silt 20:80	29.8	31.1	21.8	20.5	23.1	10.6	3.2	2.1	Mixtures
London Clay:Fine Sand 90:10	69.2	42.8	30.7	28.3	26.2	14.5	39.3	26.2	Mixtures
London Clay:Fine Sand 80:20	62.0	39.3	30.4	26.6	23.7	12.7	28.6	17.8	Mixtures
London Clay:Fine Sand 60:40	47.3	30.6	23.8	20.7	20.9	9.9	26.0	14.3	Mixtures
London Clay:Fine Sand 40:60	34.2	22.0	NA	16.9	15.5	5.1	13.90	NA	Mixtures
London Clay:F/M Sand 80:20	62.1	42.8	30.4	26.8	24.3	16.0	27.9	16.1	Mixtures
London Clay: F/M Sand 60:40	46.5	32.8	22.8	19.2	17.3	13.6	27.8	16.1	Mixtures
London Clay: F/M Sand 40:60	34.6	23.6	17.2	15.5	14.4	8.1	18.6	11.6	Mixtures
London Clay: F/M Sand 20:80	24.8	NA	NA	NA	21.0	NA	NA	NA	Mixtures

Soil	Liquid limit w_L %	Toughness limit w_T %	Stiffness transition w_S %	Apparatus plastic limit w_P %	Hand plastic limit w_P %	Toughness index I_T %	T_{max} kJ/m ³ per 100 reversals	T_s kJ/m ³ per 100 reversals	Type
Todhills Shaley Clay (TSC)	27.4	24.9	19.6	17.1	19.3	7.8	10.6	4.4	Mixtures
TSC:PBC 95:5	NA	22.7	19.4	16.3	NA	6.4	10.2	2.7	Mixtures
TSC:PBC 90:10	29.4	23.5	19.3	16.9	NA	6.6	10.0	4.0	Mixtures
TSC:PBC 80:20	32.8	24.1	20.5	19.1	21.1	5.0	10.1	5.4	Mixtures
TSC:PBC 70:30	37.7	28.0	24.2	22.3	NA	5.7	10.3	5.1	Mixtures
TSC:PBC 60:40	41.2	29.7	NA	24.1	24.7	5.6	10.9	NA	Mixtures
TSC:PBC 40:60	51.3	39.6	31.9	31.4	28.7	8.2	12.1	9.8	Mixtures
TSC:PBC 20:80	58.9	48.0	40.1	38.6	36.0	9.4	13.8	9.5	Mixtures
Povington Ball Clay (PBC)	74.5	57.7	46.3	41.8	40.6	15.9	19.8	11.1	Mixtures
N6 Fireclay	46.0	30.5	25.8	23.3	NA	7.2	18.2	9.9	Mixtures
N6 Fireclay :AT Ball Clay 95:5	46.3	32.4	26.2	22.6	NA	9.8	21.3	7.7	Mixtures
N6 Fireclay :AT Ball Clay 90:10	47.0	33.1	25.9	23.4	NA	9.7	20.8	9.2	Mixtures
N6 Fireclay :AT Ball Clay 80:20	48.8	33.1	25.2	22.5	NA	10.6	25.5	12.9	Mixtures
N6 Fireclay :AT Ball Clay 60:40	52.3	33.1	26.1	23.7	NA	9.4	26.5	17.4	Mixtures
N6 Fireclay :AT Ball Clay 40:60	58.4	37.7	29.8	25.9	NA	11.8	26.4	12.4	Mixtures
N6 Fireclay :AT Ball Clay 20:80	64.3	38.3	30.2	28.2	NA	10.1	26.6	18.2	Mixtures
AT Ball Clay	69.2	42.7	33.3	29.7	NA	13.0	30.5	17.2	Mixtures
Kaolinite: Montmorillonite 80:20	115.5	61.8	37.5	29.7	28.7	32.1	40.2	24.4	Mixtures
Kaolinite: Montmorillonite 70:30	146.0	75.8	41.0	33.1	30.9	42.7	44.0	28.0	Mixtures

Test Number	Water content %	Number of traverses from start to 6 mm	Number* of traverses from 6 to 4 mm	Average* change in diameter per traverse mm	Number* of reversals from 6 to 4 mm	Toughness T kJ/m ³ per 100 reversals
1	31.9	26	17	0.114	431	17.2
2	31.6	35	18	0.107	456	18.0
3	31.7	15	19	0.103	486	16.9
4	31.7	16	15	0.136	379	18.6
5	31.5	34	22	0.090	569	15.4

*measured between the diameter nearest to 6 and nearest to 4 mm

Table 5.3 *Rate of loading data*

	Water content at end of test %	Toughness kJ/m ³ per 100 reversals	Difference from mean %	Water content prior to commencement of test %
Soft-plastic	28.57	6.19	-1.3	--
	28.49	6.13	-2.2	--
	28.59	6.49	3.5	--
Mean	28.55	6.27	--	--
Stiff-plastic	22.93	24.23	1.2	23.70
	23.16	24.07	0.5	24.27
	23.10	23.55	-1.7	23.81
Mean	23.06	23.95	--	23.91

Table 5.4 *Repeatability tests*

5.19 Figures

Thread Maker
All dimensions in mm, not to

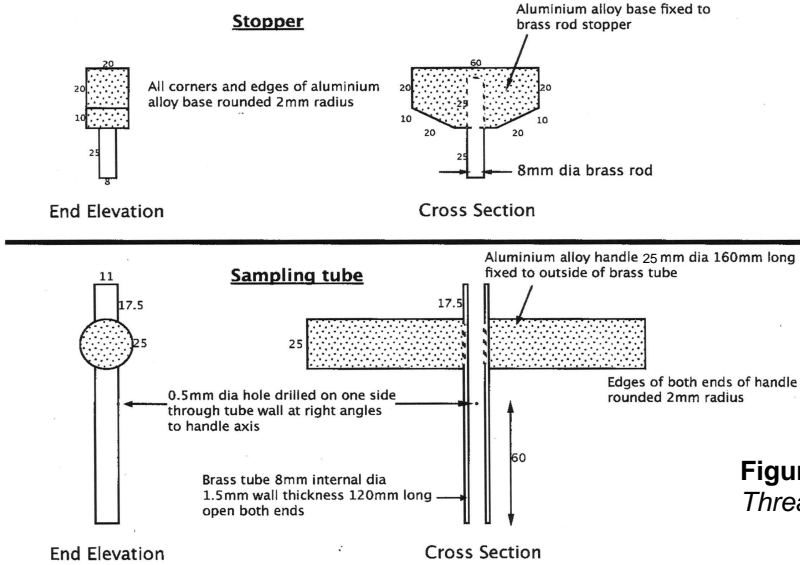
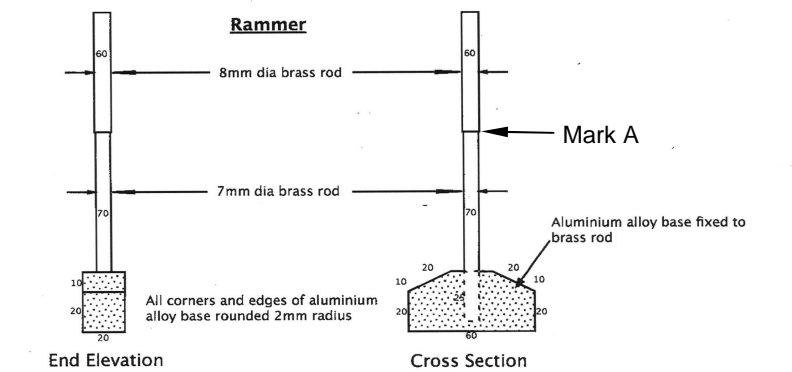

Figure 5.1
Thread maker components



©Graham Barnes

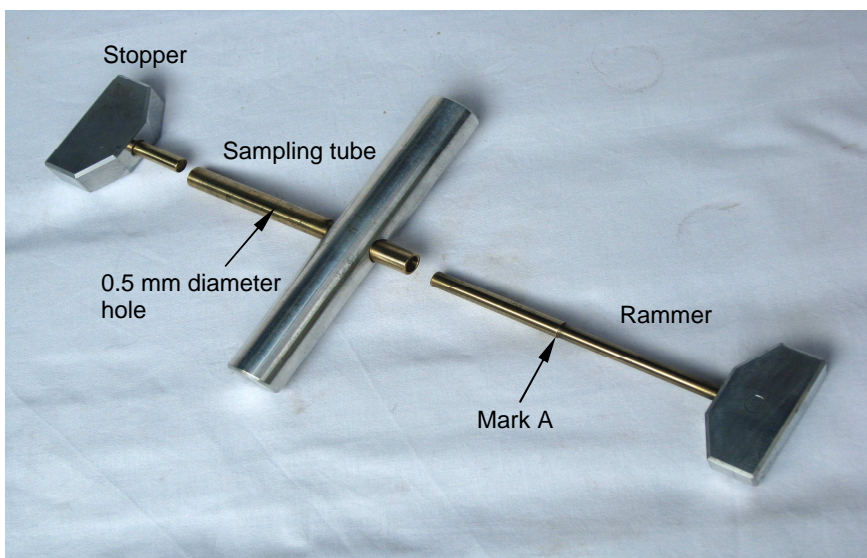

Figure 5.2 Thread maker arrangement

$$R_{3.0} = 0.14 \text{ mm}$$

Middle 10mm of thread								
1	2	3	4	5	6	7	8	9
Test Number		3						
Force N	Dial gauge R_1 mm	Final Diameter D_1 mm	Nominal stress $(\sigma_{nom})_i$ kPa	Incremental strain $\delta\epsilon_D$	Cum. strain	Reversals per traverse	Work/unit volume per traverse kJ/m^3	Cum. work/unit volume per 100 revs kJ/m^3 per 100 revs
0	4.96	Values not determined						
0.4	4.80	7.56						
0.6	4.68	7.44	1.600	0.016	0.016	17.0	0.025	0.150
0.7	4.54	7.30	1.900	0.019	0.035	17.3	0.036	0.357
0.8	4.43	7.19	2.208	0.015	0.050	17.6	0.033	0.546
0.9	4.36	7.12	2.516	0.010	0.060	17.8	0.025	0.684
1.0	4.26	7.02	2.829	0.014	0.074	18.0	0.040	0.904
1.0	4.18	6.94	2.865	0.011	0.085	18.2	0.033	1.083
1.1	4.10	6.86	3.188	0.012	0.096	18.5	0.037	1.282
1.1	3.95	6.71	3.242	0.022	0.118	18.8	0.071	1.660
1.1	3.88	6.64	3.296	0.010	0.129	19.1	0.034	1.840
1.1	3.77	6.53	3.341	0.017	0.145	19.3	0.055	2.127
1.2	3.62	6.38	3.718	0.023	0.168	19.7	0.085	2.560
1.2	3.56	6.32	3.780	0.009	0.178	20.1	0.036	2.737
1.2	3.45	6.21	3.831	0.017	0.195	20.3	0.067	3.065
1.2	3.35	6.11	3.896	0.016	0.211	20.7	0.063	3.369
1.2	3.24	6.00	3.964	0.018	0.229	21.0	0.071	3.708
1.2	3.13	5.89	4.037	0.018	0.248	21.4	0.074	4.054
1.2	3.03	5.79	4.110	0.017	0.265	21.8	0.070	4.374
1.3	2.90	5.66	4.542	0.023	0.287	22.2	0.102	4.832
1.3	2.76	5.52	4.651	0.025	0.312	22.8	0.115	5.337
1.3	2.64	5.40	4.762	0.022	0.333	23.3	0.104	5.781
1.3	2.49	5.25	4.883	0.028	0.361	23.9	0.136	6.348
1.2	2.38	5.14	4.620	0.021	0.382	24.5	0.097	6.743
1.2	2.24	5.00	4.734	0.027	0.409	25.1	0.129	7.257
1.1	2.15	4.91	4.440	0.018	0.427	25.7	0.080	7.568
1.1	2.02	4.78	4.541	0.027	0.454	26.3	0.120	8.025
1.0	1.94	4.70	4.219	0.017	0.471	26.9	0.071	8.288
1.0	1.81	4.57	4.315	0.028	0.498	27.5	0.119	8.722
1.0	1.70	4.46	4.430	0.024	0.522	28.2	0.107	9.101
1.0	1.58	4.34	4.546	0.027	0.549	28.9	0.122	9.523
0.9	1.50	4.26	4.186	0.018	0.568	29.6	0.077	9.784
0.9	1.40	4.16	4.276	0.024	0.591	30.2	0.100	10.116
0.9	1.30	4.06	4.380	0.024	0.615	31.0	0.105	10.455
0.9	1.19	3.95	4.494	0.027	0.642	31.8	0.122	10.838
0.9	1.11	3.87	4.604	0.020	0.663	32.6	0.093	11.125
0.9	1.01	3.77	4.712	0.026	0.688	33.3	0.122	11.490
0.9	0.90	3.66	4.845	0.029	0.718	34.3	0.141	11.903
0.9	0.81	3.57	4.979	0.025	0.742	35.2	0.122	12.250
0.9	0.71	3.47	5.114	0.028	0.770	36.2	0.143	12.646
0.9	0.58	3.34	5.286	0.038	0.808	37.4	0.198	13.176
0.8	0.53	3.29	4.827	0.015	0.823	38.4	0.072	13.364
0.8	0.44	3.20	4.931	0.027	0.850	39.2	0.135	13.708
0.8	0.37	3.13	5.055	0.022	0.872	40.2	0.111	13.983
0.8	0.29	3.05	5.178	0.026	0.898	41.2	0.132	14.304
0.8	0.19	2.95	5.333	0.033	0.930	42.4	0.175	14.716
0.7	0.15	2.91	4.778	0.014	0.944	43.5	0.065	14.865
0.7	0.08	2.84	4.870	0.024	0.968	44.3	0.117	15.129
0.7	0.00	2.76	4.999	0.028	0.996	45.5	0.139	15.435

Figure 5.4a
Example of the spreadsheet calculations for Test 3 of Figure 5.3, Alluvial Clay, Chinnor, Oxfordshire

Test No.		3	
6 mm	6.00	3.708	3.708
	5.89		4.054
4 mm	4.06	10.664	10.455
	3.95		10.838
Toughness = work/unit volume per 100 reversals between 6 and 4 mm			6.96 kJ/m^3 per 100 reversals

Figure 5.4b
Example of the spreadsheet calculations for work/unit volume per 100 reversals between 6 and 4 mm Alluvial Clay, Chinnor, Oxfordshire

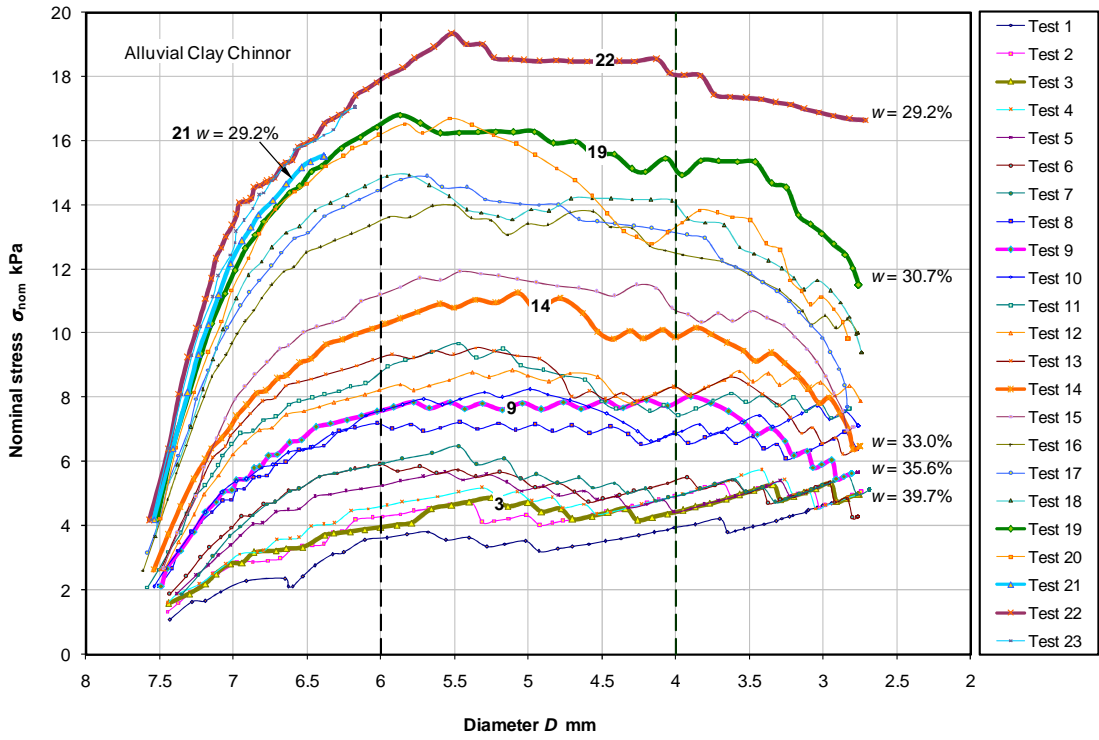

Figure 5.5 *Nominal stress vs. diameter for the Alluvial Clay, Chinnor, Oxfordshire*
Tests from Figure 5.3 highlighted.

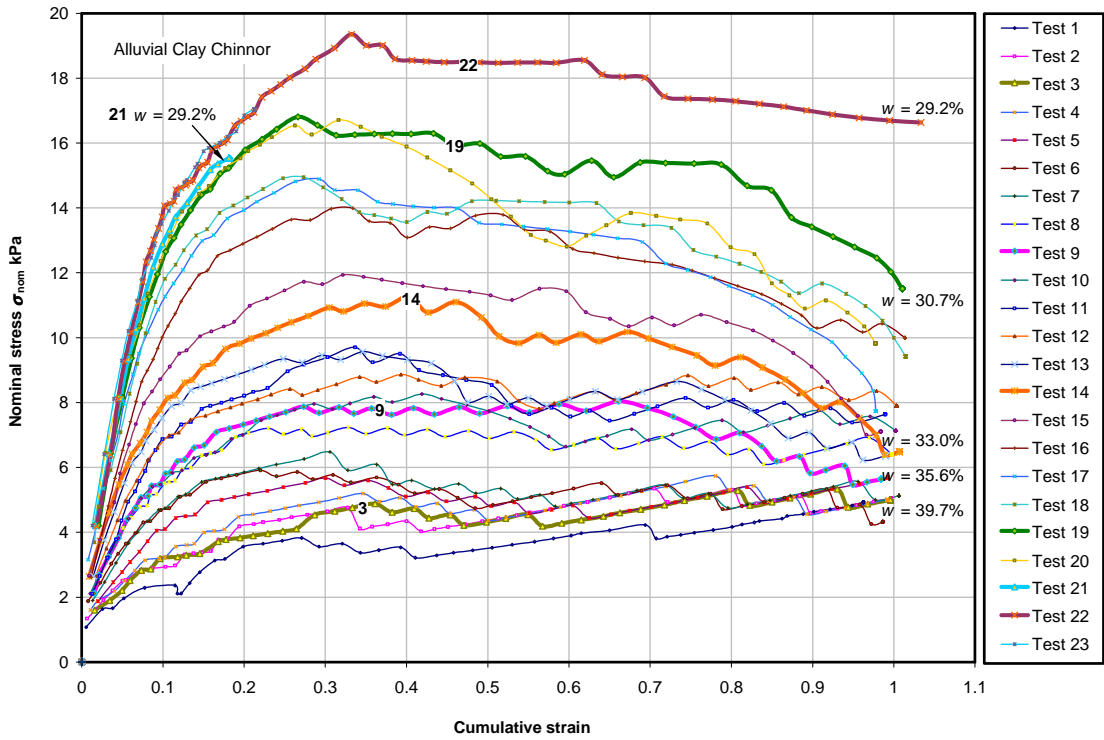

Figure 5.6 *Nominal stress vs. cumulative strain for the Alluvial Clay, Chinnor, Oxfordshire.*
Tests from Figure 5.3 highlighted.

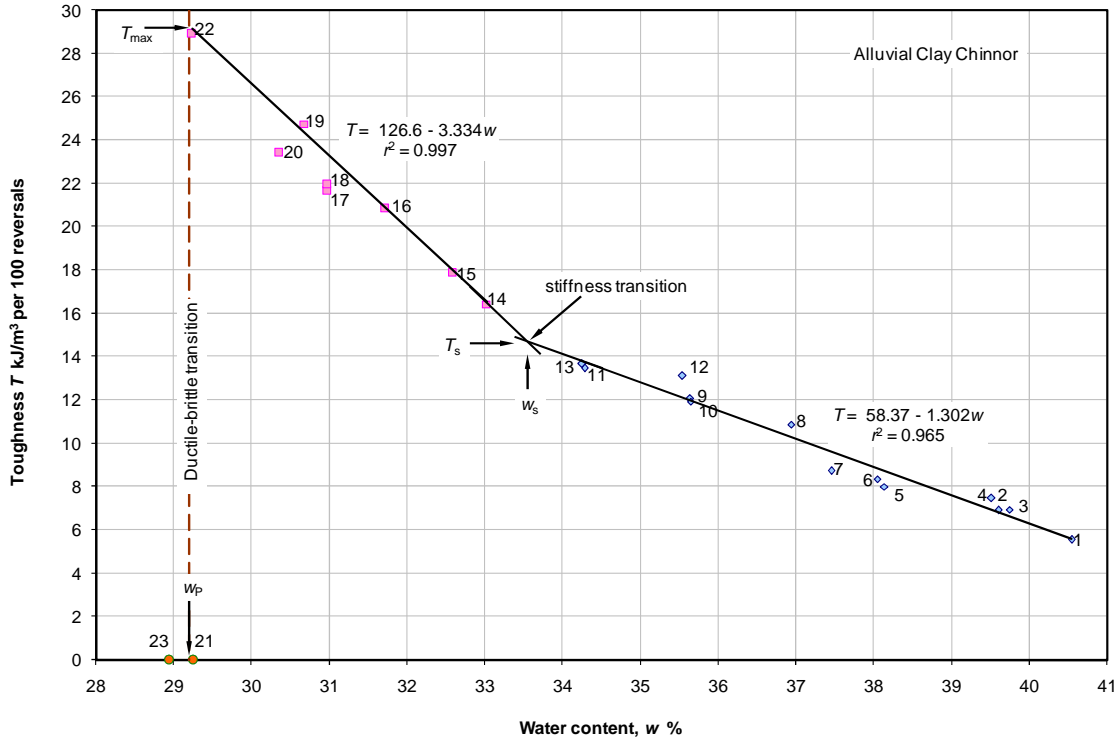

Figure 5.7 Toughness vs. water content for the Alluvial Clay, Chinnor, Oxfordshire

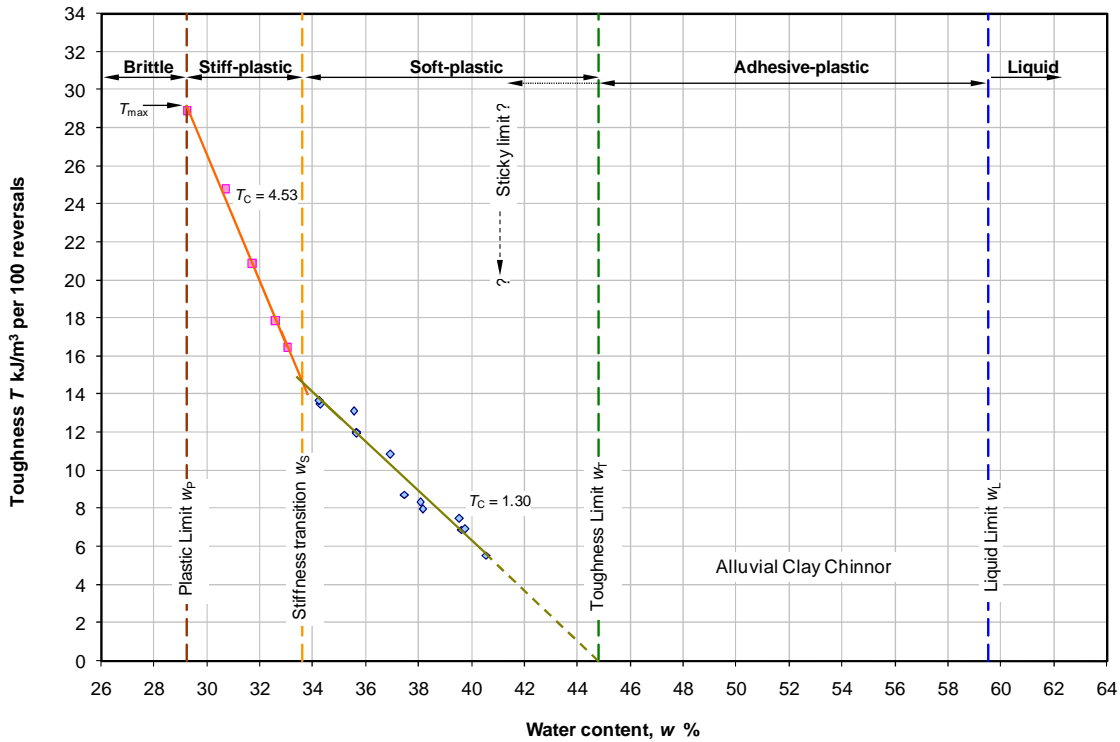

Figure 5.8 Proposed plastic regions and toughness-related properties

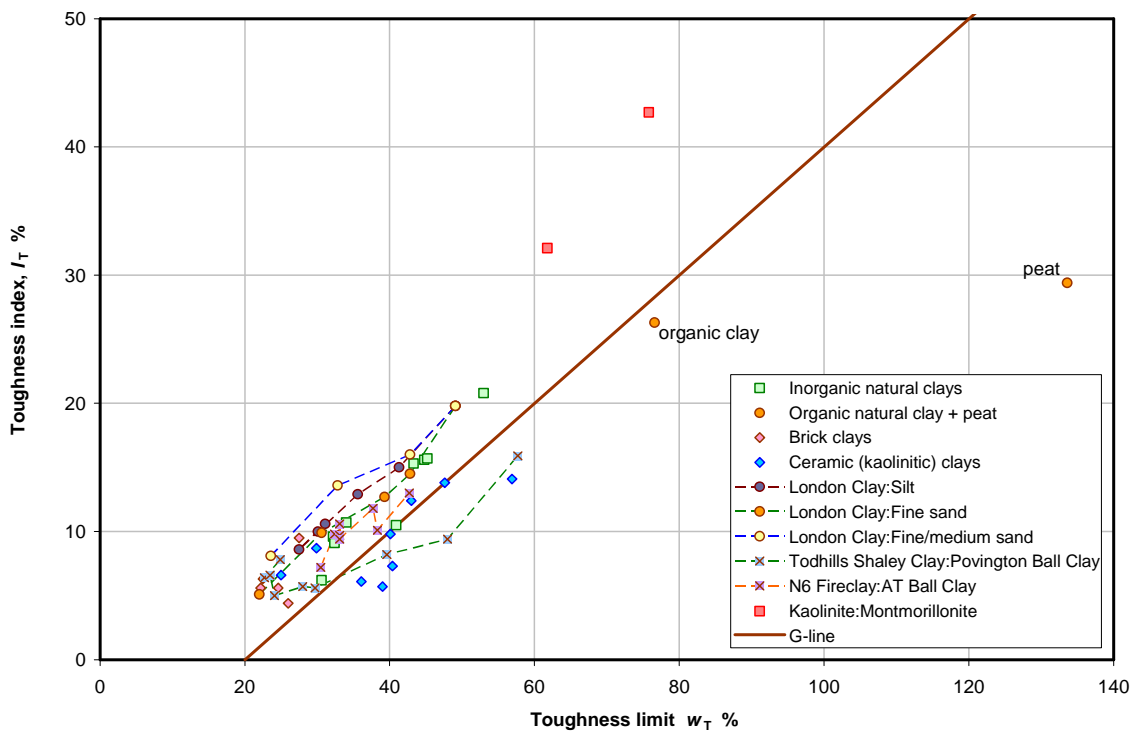

Figure 5.9 Tentative plasticity chart (Data from Table 5.2)

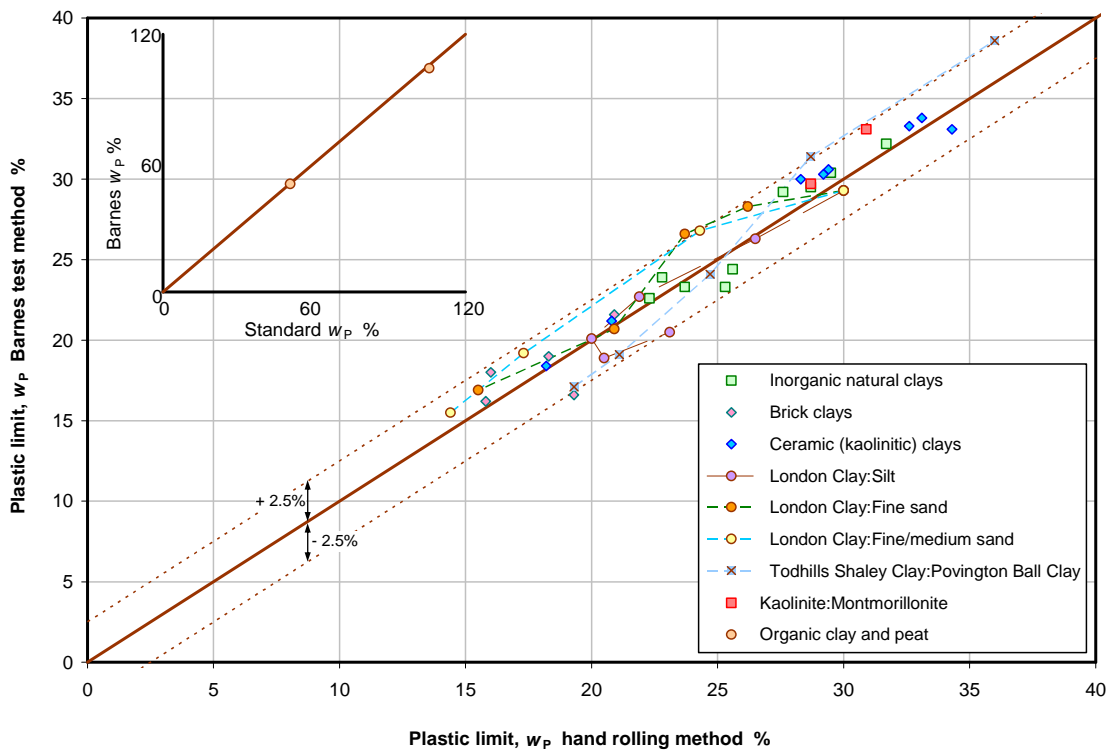

Figure 5.10 Comparison of the Barnes test and standard plastic limits (Data from Table 5.2)

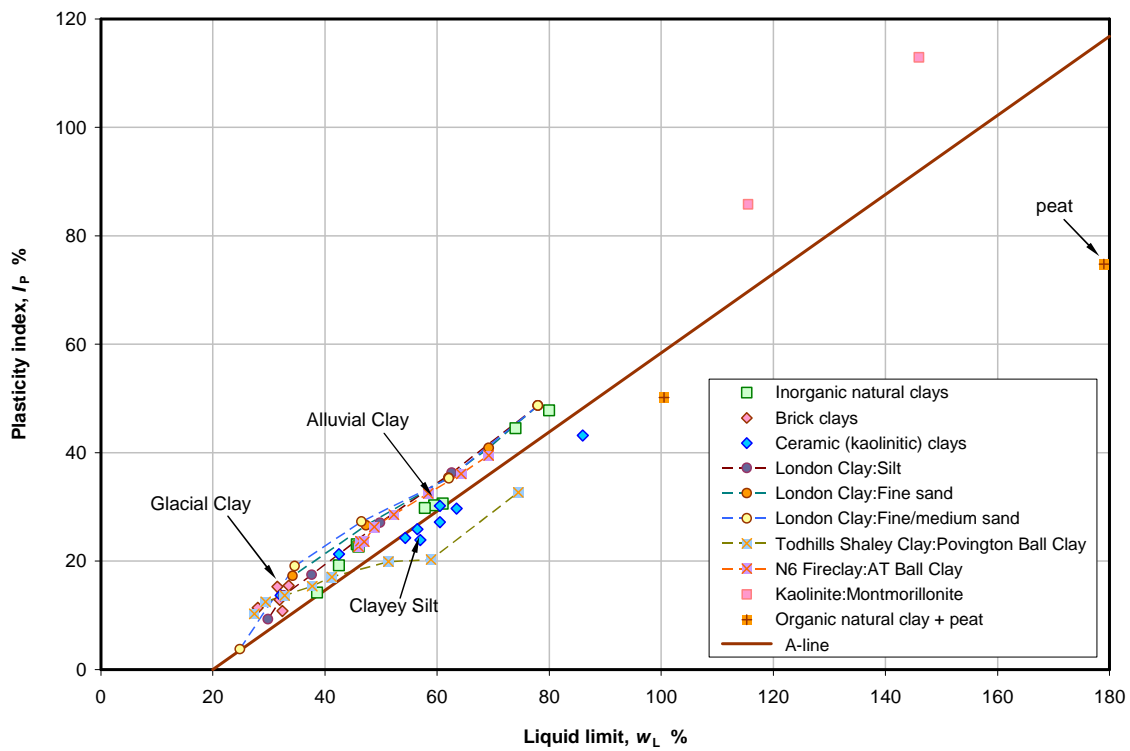

Figure 5.11 Database soils on the Casagrande plasticity chart

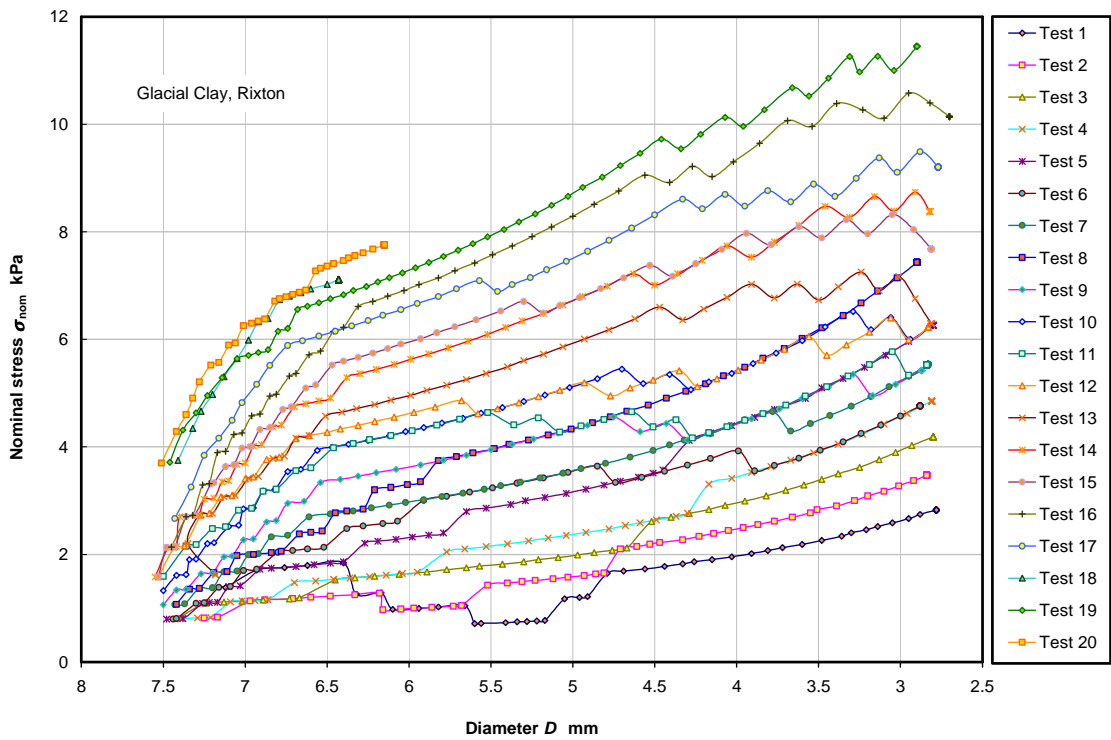

Figure 5.12 Nominal stress vs. diameter for Glacial Clay, Rixton

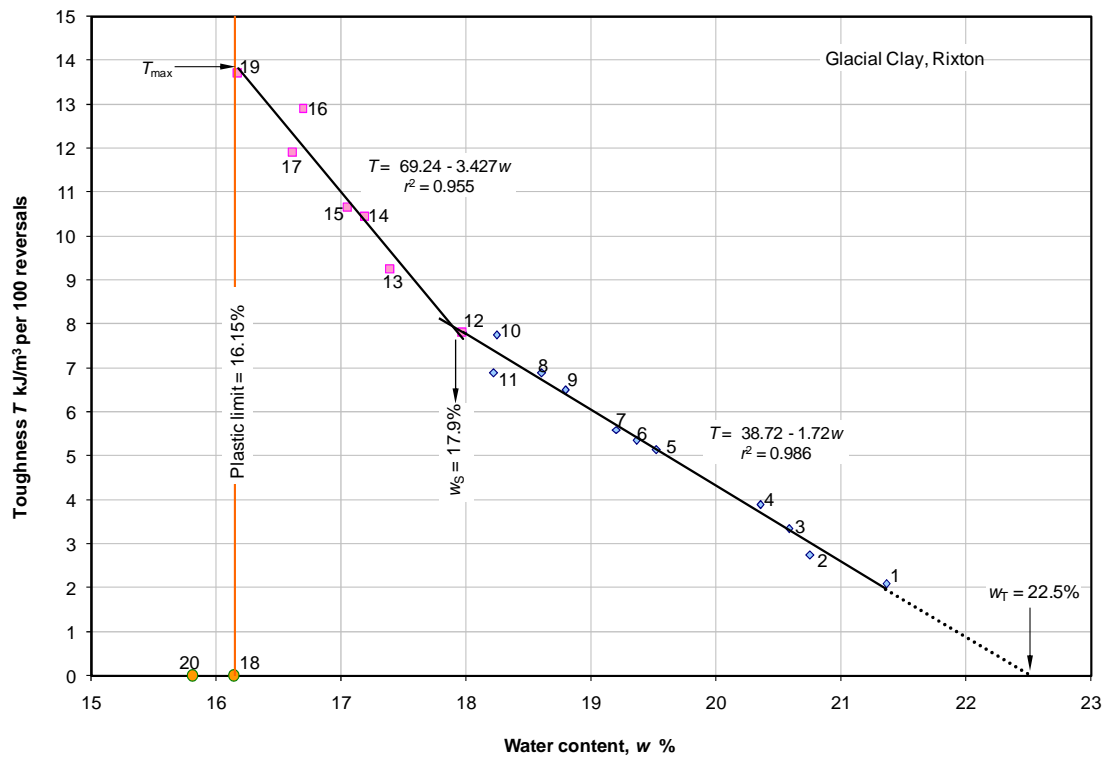

Figure 5.13 Toughness vs. water content for Glacial Clay, Rixton

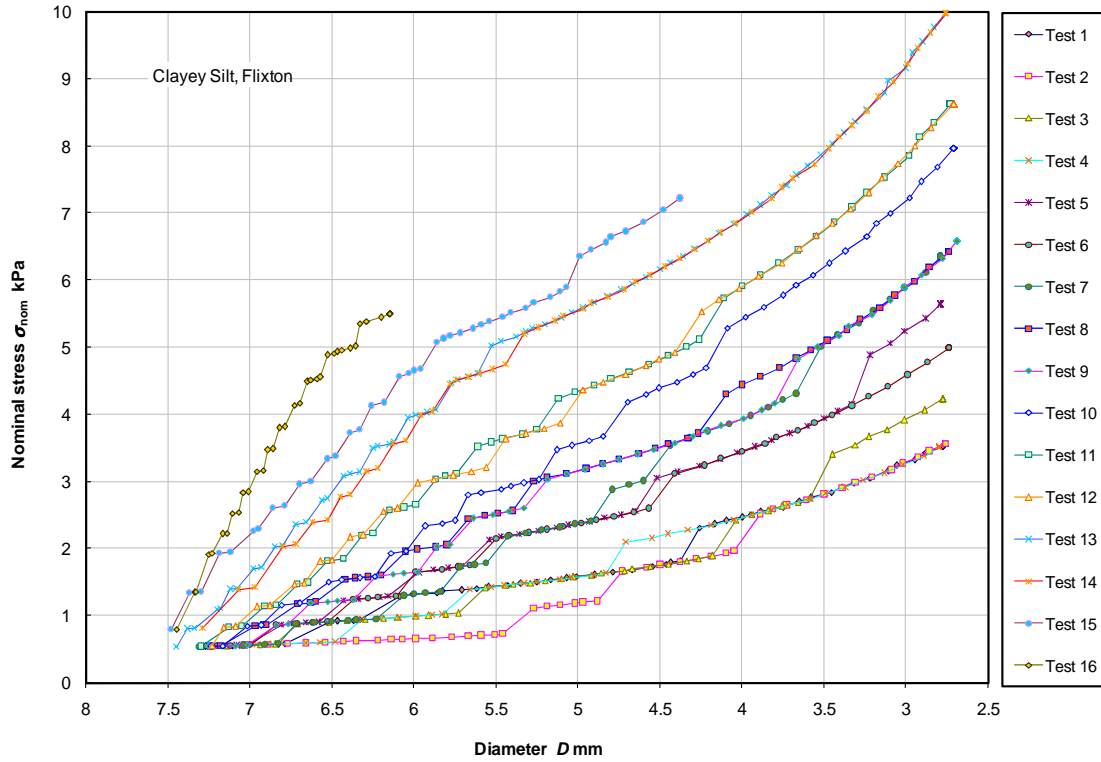

Figure 5.14 Nominal stress vs. diameter for Clayey Silt, Flixton

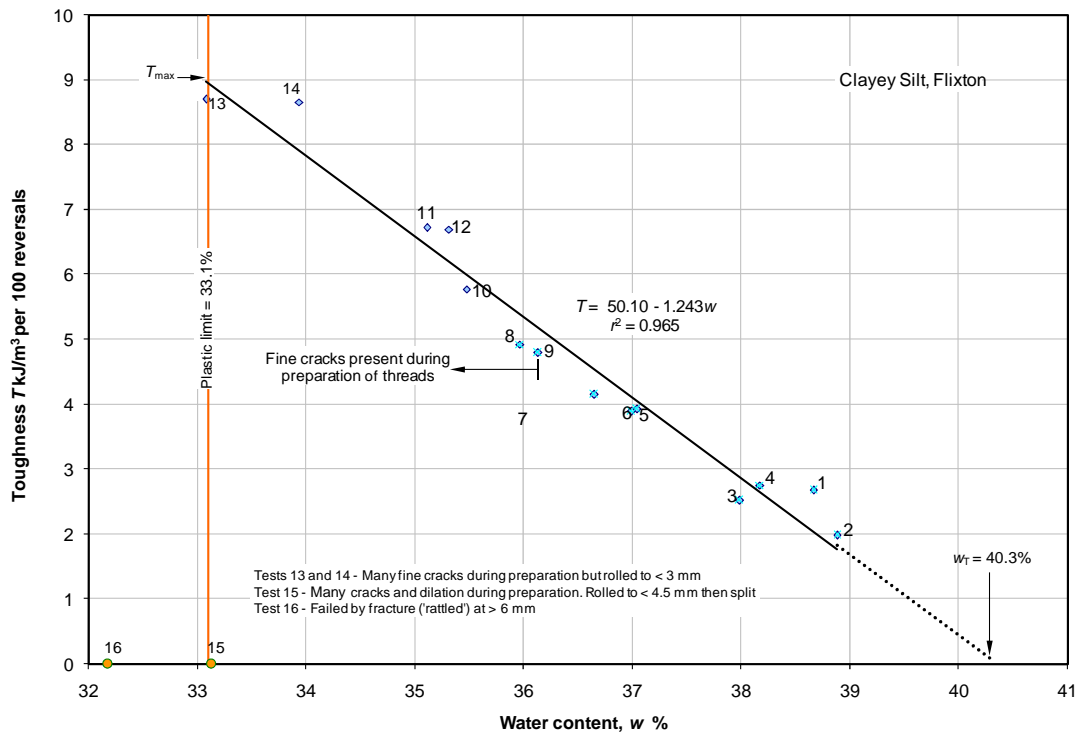

Figure 5.15 Toughness vs. water content for Clayey Silt, Flixton

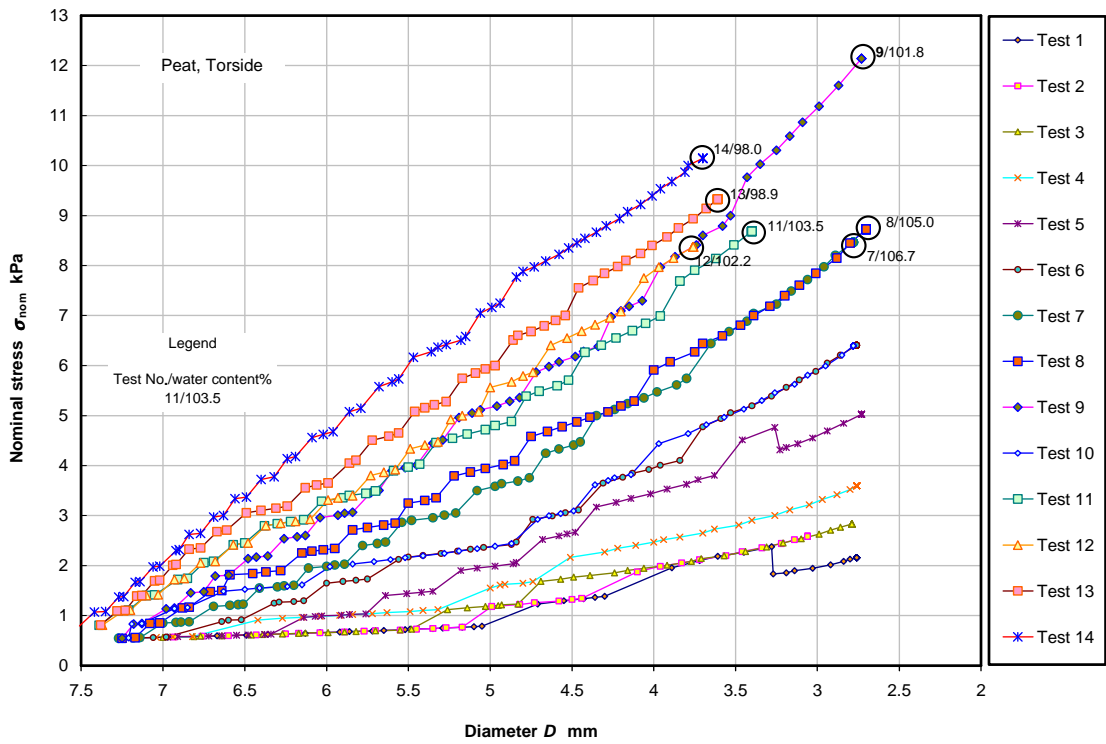

Figure 5.16 Nominal stress vs. diameter for Peat, Torside

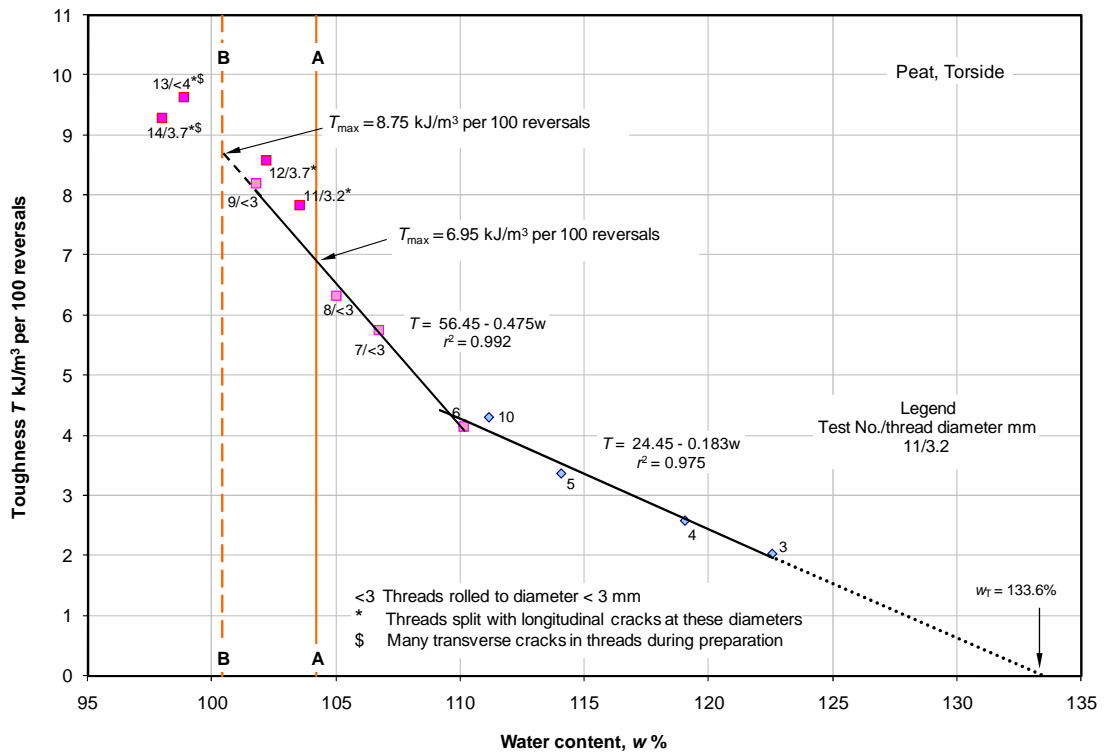

Figure 5.17 Toughness vs. water content for Peat, Torside

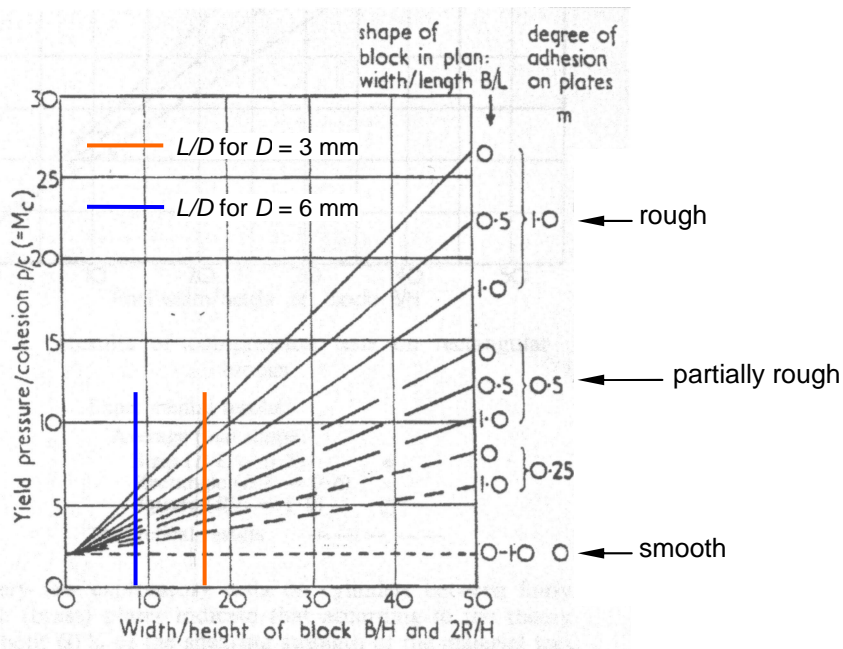

Figure 5.18 Yield pressure/cohesion ratio for slabs of different length/thickness ratios (From Meyerhof and Chaplin, 1953)

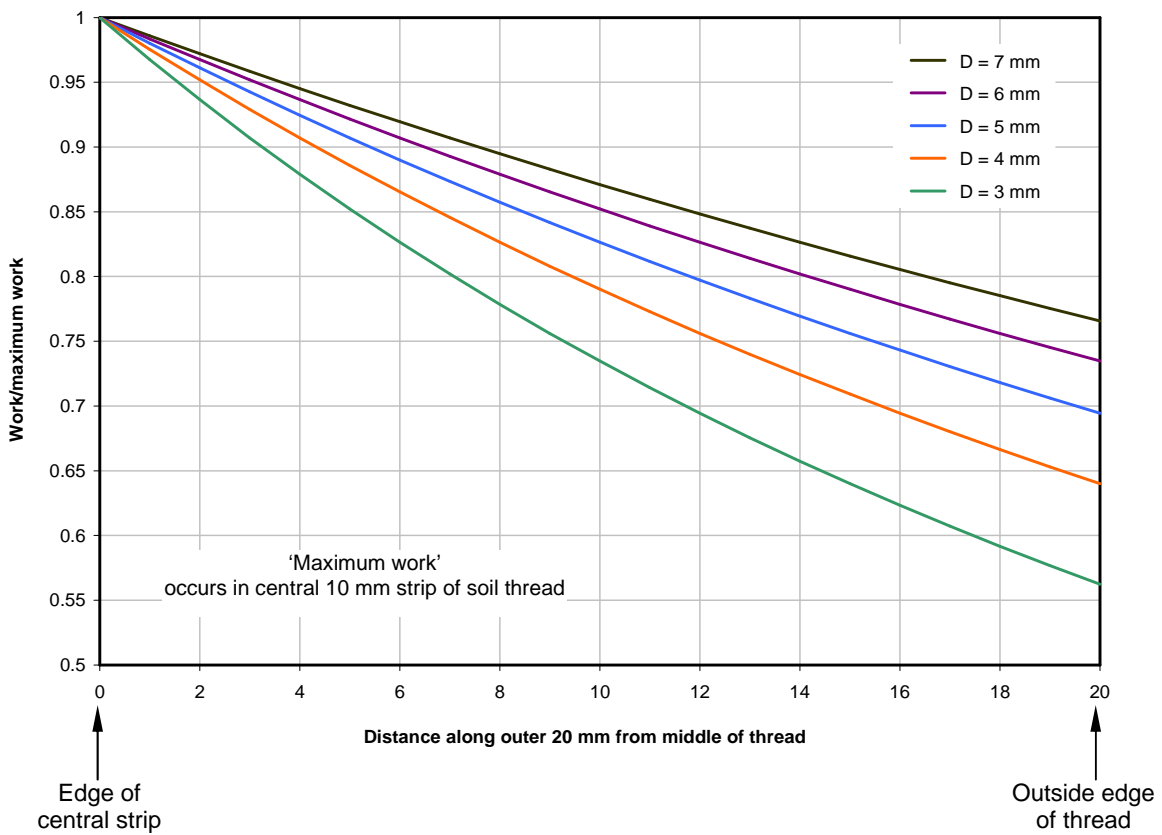

Figure 5.19 Normalised work/unit volume per 100 reversals along the outer 20 mm of thread

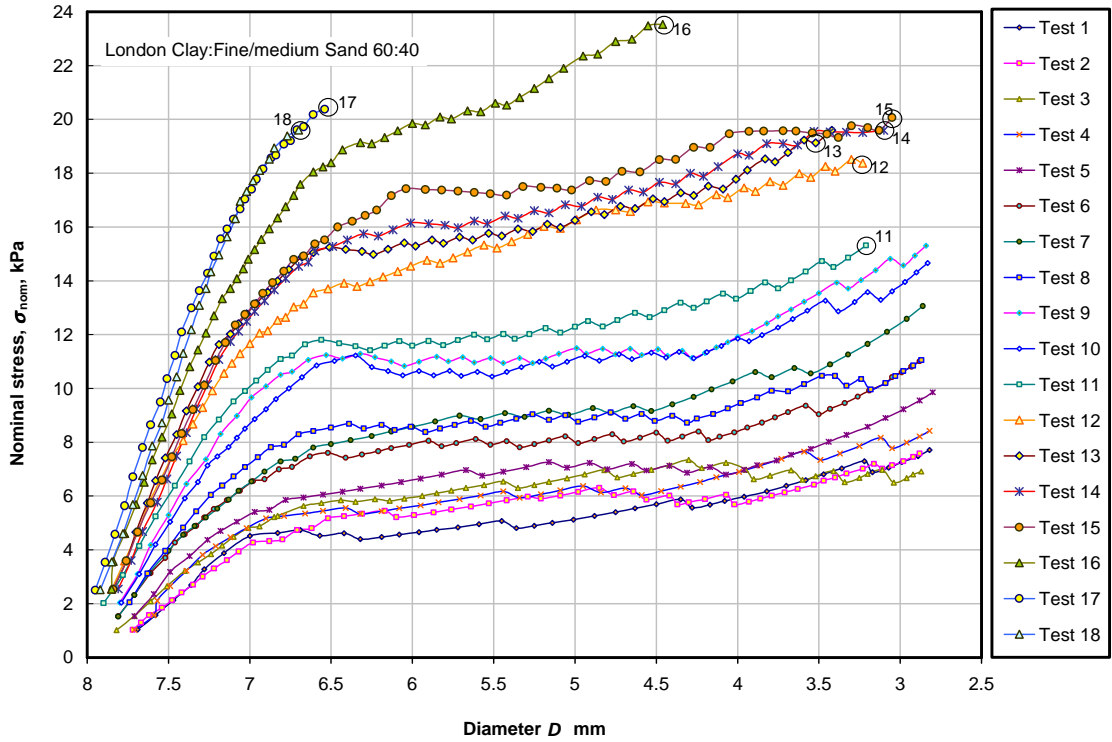

Figure 5.20 Nominal stress vs. diameter for the London Clay:Fine/medium Sand 60:40

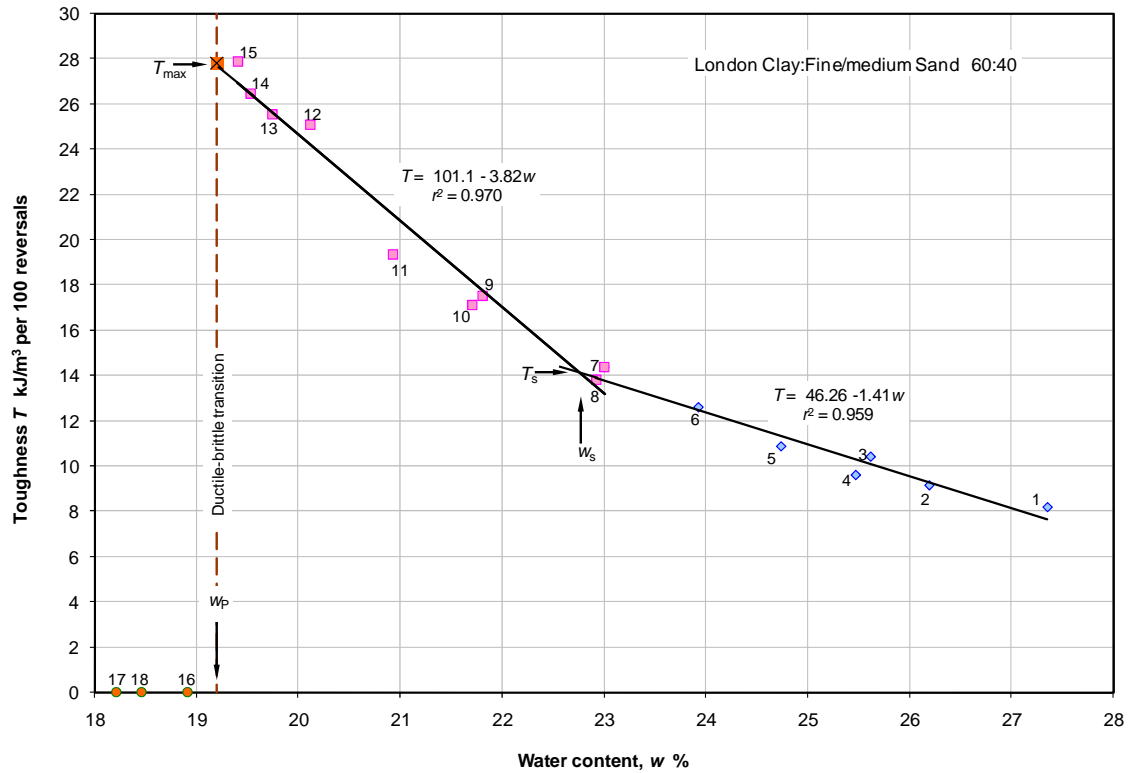

Figure 5.21 Toughness vs. water content for the London Clay:Fine/medium Sand 60:40

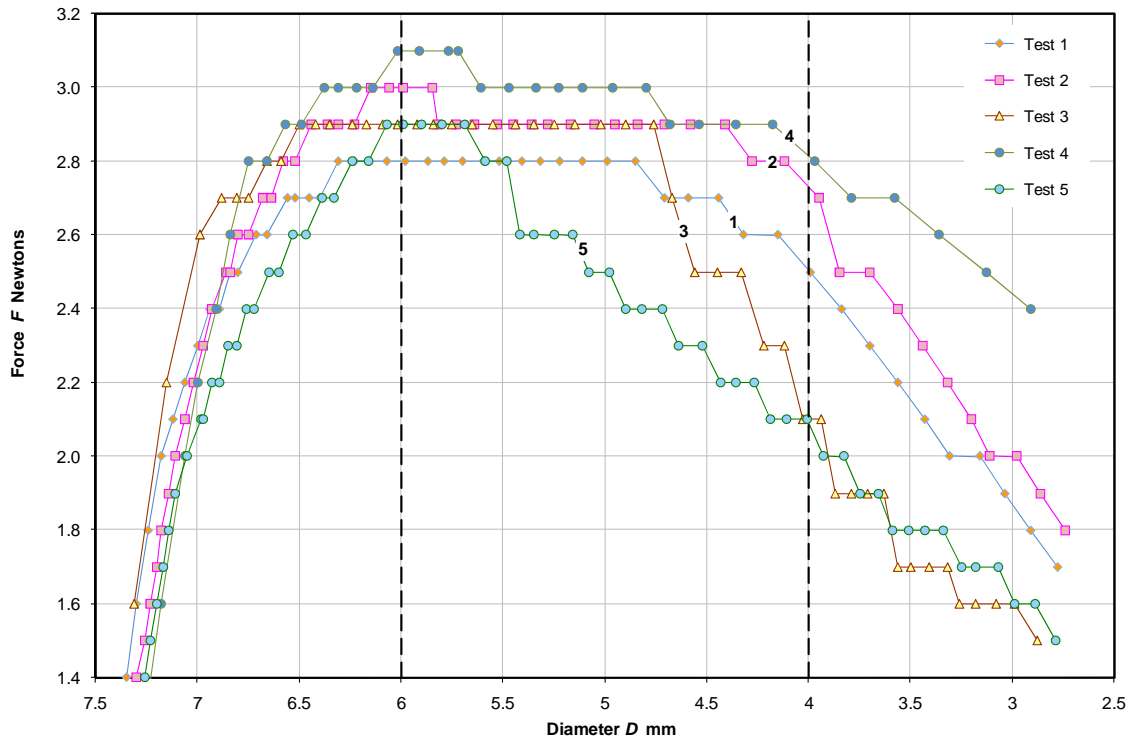

Figure 5.22 Effect of rate of loading – force vs. diameter

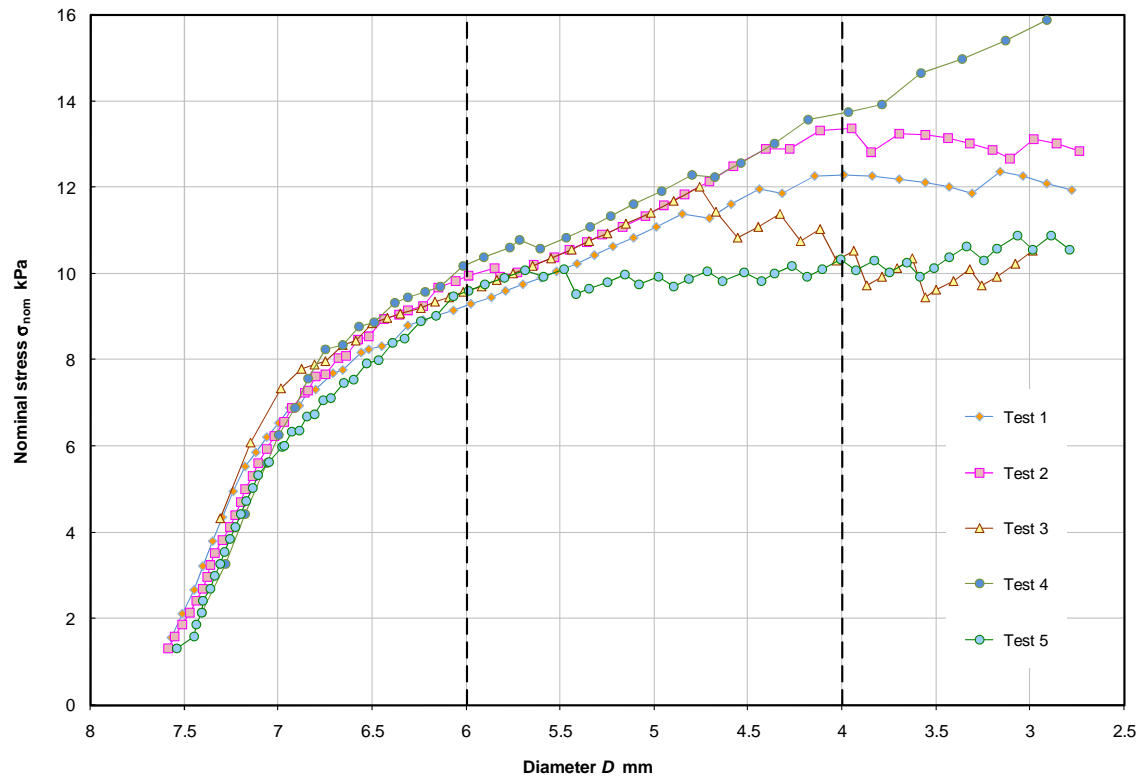

Figure 5.23 Effect of rate of loading - nominal stress vs. diameter

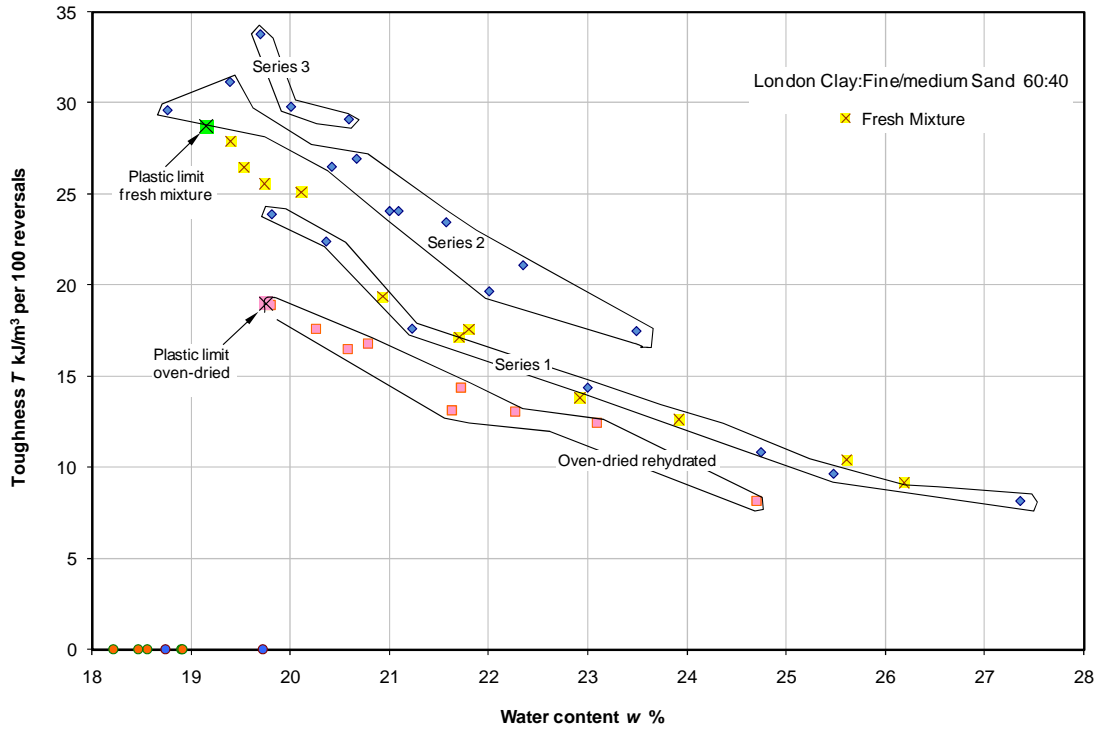

Figure 5.24 Effect of wetting up and drying of soil

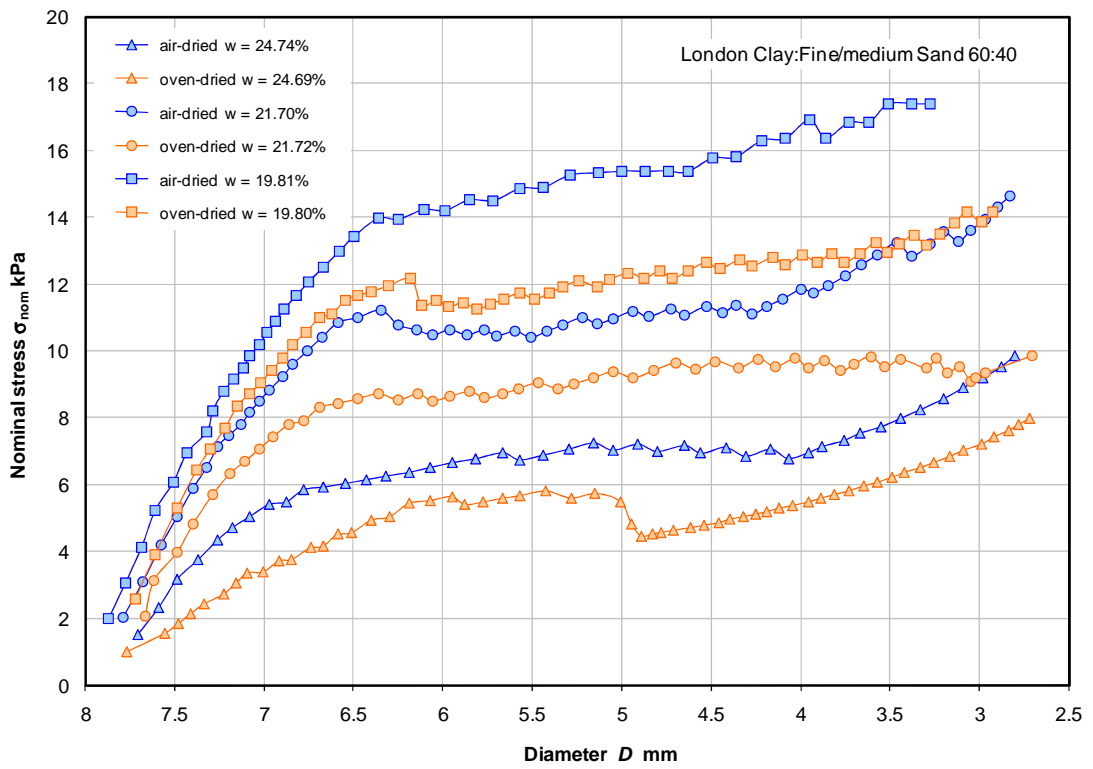

Figure 5.25 Effect of air-drying and oven-drying

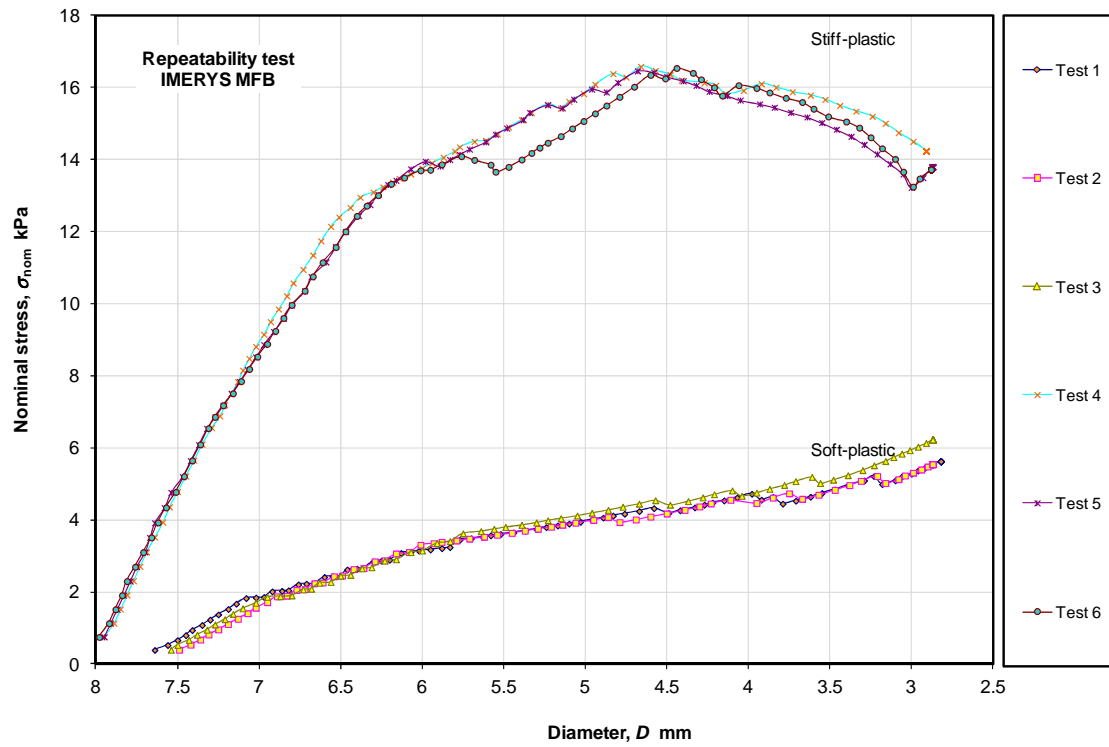

Figure 5.26 Nominal stress vs. diameter repeatability tests

CHAPTER 6

Investigation of the effect of the thread diameter in the standard plastic limit test

6.1 Introduction

The significance of the smallest diameter to which a thread can be rolled out has been related to the 'degree of plasticity' and is discussed in this chapter. Having a criterion for the diameter at which crumbling should be observed implies a high significance of the thread diameter. There appears to be nowhere in the literature that explains the significance of the diameter of a soil thread at the point when it fractures/crumbles. The purpose of the investigations described in this chapter is to determine if this is warranted. It was decided to conduct some experiments to investigate the effect of the diameter of a thread of soil as it is rolled by hand, and these are described herein as 'rolling path' tests. To provide improvements to the standard plastic limit test some suggestions are proposed.

6.2 Background

In the translation (Atterberg, 1974) of Atterberg (1911) the conduct of his plastic limit test was described as

“...the clay paste...is rolled into threads under one's fingers on a paper base. The threads were again mashed together and again rolled out until during the rolling out test, they would crumble to bits. It had no significance if the threads broke into smaller pieces. Precisely where the threads begin to disintegrate into bits, the rolling was stopped.”

The phrase 'crumbled to bits' is translated from 'bröckchen zergehen' which could also be translated as 'fall apart to chunks'. Nowadays this phrase is simply translated for convenience as 'crumbles'. Atterberg referred to the water content by mass at which a thread of soil disintegrates into bits or crumbles as the *ausrollgrenze*, the plastic limit. He did not suggest a diameter at which the thread should be found to fall apart or crumble.

Terzaghi (1925) introduced a diameter of thread to roll out, but only to describe what a 'thin thread' should be like. He stated

“The lower limit of the plastic state is determined as follows...work the sample into several thin threads (diameter about 3 mm.), put the threads together and work them out to threads again by rolling them with the palm on a smooth, clean sheet of paper. Repeat the process until no more threads can be formed, the material becoming brittle and the threads breaking to pieces while worked. Then the moisture content is determined;”

According to Casagrande (1932) the standardised procedure for the plastic limit was described by Wintermeyer *et al* (1931) and is Atterberg’s original procedure except that Casagrande stated that Terzaghi (1926) introduced a diameter criterion with his definition of the plastic limit

“The plastic limit represents the lowest water content at which the soil can still be worked into threads with a diameter of one-eighth of an inch without breaking into pieces.” (The author’s underlining).

By this definition if the soil is rolled to the diameter of 3 mm (Terzaghi, 1925) or 1/8 inch (Terzaghi, 1926) it is still on the ductile side of the ductile-brittle transition because the thread has not broken into pieces. So rolling to this diameter is repeated, with drying during remoulding in the hands, until breaking into pieces occurs. This breaking into pieces may or may not be at the diameter of 3 mm or 1/8 inch; it could be at a larger diameter. Also by this definition once the soil has broken into pieces it is on the brittle side of the ductile-brittle transition so its water content is always measured below the transition point.

According to Casagrande (1932) Terzaghi introduced this additional requirement because he had

“found that the water content at which the threads will start to crumble is also dependent upon the diameter of the threads.”

The current American Standard (ASTM D4318-10) requires the thread to be rolled to a diameter of 3.2 mm (1/8 inch) and then re-rolled until the thread crumbles and the soil can no longer be rolled into a 3.2 mm diameter thread. This follows Terzaghi’s definition because the thread is rolled and re-rolled while in its ductile state to a diameter of 3.2 mm until it is no longer ductile, it is brittle and crumbles. It does not mean that the thread has to crumble at the diameter of 3.2 mm.

The comment in ASTM D4318-10 is very pertinent in this respect

“If crumbling occurs when the thread has a diameter greater than 3.2 mm, this shall be considered a satisfactory end point, provided the soil has been previously rolled into a thread 3.2 mm in diameter”.

Thus the American Standard does not require the crumbling condition to be achieved at the diameter of 3.2 mm.

The British Standard (BS1377:1990) method requires the soil thread to be rolled until it shears both longitudinally and transversely⁴⁴ “when it has been rolled to about 3 mm diameter”. By using the word ‘when’ can be interpreted as meaning ‘after’. It is usually interpreted as meaning ‘at’ the diameter of 3 mm and this causes some difficulty in conducting the test because the thread often crumbles at a larger diameter than 3 mm. The international technical specification ISO/TS 17892-12:2004 although not a normative standard in the UK describes the procedure for the plastic limit test in a very similar way to the BS method.

Because of the small specimen size used in the standard plastic limit test, with a minimum diameter of 3 mm a limit on the maximum particle size was required. This was adopted as the US Standard No. 40 sieve or the British Standard No. 36 sieve with an aperture of 425 μm giving a minimum specimen diameter/maximum particle size ratio of $3.0/0.425 = 7.06$. If the diameter of 3.2 mm to which a thread of soil should be rolled (ASTM D4318-10) or the diameter of 3.00 mm at which it should crumble (BS1377:1990) is not significant and crumbling at larger diameters can be allowed the effect of the maximum particle size diminishes. Nevertheless a maximum particle size must be specified because the plastic limit is a water content and the presence of non-absorbent particles larger than the maximum specified particle size will affect (reduce) the water content. The effect of particle size on the plastic limit and the toughness of a soil is discussed in Chapters 7 and 8.

6.3 The ‘degree of plasticity’ based on the smallest thread diameter

Atterberg (1911, 1974) acknowledged that thinner clay threads could be rolled out for soils with a higher ‘degree of plasticity’, the latter being defined as the ‘ability to be rolled out’. The author prefers to define this as tenacity, the ability of a thin soil thread to hold together when rolled out. It is then not related to the amount of work required in remoulding the soil thread which is referred to herein as toughness, although both tenacity and toughness are related to the amount and type of clay minerals present and the water content.

⁴⁴ This can be seen as a definition of crumbling.

Atterberg decided that the only measure available from his experiments for the 'degree of plasticity' was the difference between the liquid and plastic limits, what he referred to as the plasticity number, now termed the plasticity index.

A method of identifying the plasticity index of a soil based on the smallest diameter to which a soil thread could be rolled at a particular consistency was proposed by Burmister (in Nuyens and Kockaerts, 1967). The consistency Burmister used was at the 'ball'⁴⁵ water content, on soil passing the 1/10 inch (2.54 mm) sieve. However, there would be difficulties in achieving the 'ball' water content consistently and rolling of a thread of soil by hand reduces its water content. Because it allowed for coarser materials than the standard tests there would be a difference from the standard tests if the non-absorbent particles > 425 μm were not accounted for. Burmister produced a classification of 'degree of plasticity' based on the smallest thread diameter achievable, Table 6.1. He did not state any criterion for determining the length of the thread required to be maintained at the smallest diameter which would also be a measure of tenacity.

Burmister (1970) adjusted the ball test⁴⁶ and avoided a relationship with plasticity index. He modified his approach by introducing a description for the ease of rolling of the soil threads and the smear appearance of the soil, see Table 6.2. The significance of using 'overall' plasticity in Table 6.2 compared to plasticity in Table 6.1 is not fully understood. It may represent the combination of the three assessments included in Table 6.2.

Karlsson and Hansbo (1981) gave a similar method for identifying the nature of the fines (silt and/or clay) in a soil on the basis of the diameter at which the thread crumbled, see Table 6.3, which should be at the plastic limit. The phrase 'degree of plasticity' really gives a measure of tenacity of the soil, the ability to hold together.

Application of the classifications in Tables 6.1 to 6.3 depends on the accurate determination of the soil thread diameter which would require a specialised device to measure the diameter. From the discussion in section 6.3 it is shown that for an individual clay soil, threads can be rolled to reach a crumbling point at a wide range of diameters from 1 to 6 mm, depending on the starting water content, whether in the soft-plastic or the stiff-plastic region, and the rate of rolling, making

⁴⁵ Burmister believed that all plastic soils had a constant consistency at a so-called 'ball moisture'. This water content is achieved when a wet soil ball 1.5 inch (38.1 mm) diameter is dropped 2 feet (610 mm) onto a smooth hard surface and develops a flat surface 1 inch (25.4 mm) diameter. This procedure is prone to subjective errors of judgement and further errors due to mixing difficulties to adjust the water content.

⁴⁶ To a flattened surface 2.2 cm (± 0.1) or 7/8 inch diameter and stated that this represented a shear strength of 0.5 ton/sq. ft. (about 54 kPa).

the classifications in Tables 6.1 to 6.3 meaningless.

6.4 Investigations into the manual thread rolling method

The author has conducted experiments to investigate the relationship between the diameter of a thread of soil, its water content and its condition. Five conditions were identified:

- 1) an intact plastic thread showing no signs of cracking or brittleness,
- 2) initiation of cracking in the thread,
- 3) a tubular shape to the thread,
- 4) local cracking and
- 5) crumbling and falling apart of the thread.

The tests were conducted on three soil types chosen to represent

- 1) a high plasticity clay above the A-line, London Clay, Isle of Grain,
- 2) a low plasticity clay above the A-line, Glacial Clay, Rixton and
- 3) an intermediate plasticity clay below the A-line, Kaolinitic Clay, K-T Kaolin.

A summary of the tests carried out on these soils is included in Table 5.2 and the liquid limit and plasticity index values are plotted on Figure 6.1. The samples were prepared initially at a water content above their liquid limit to ensure full hydration and gradually dried to a non-sticky condition so that threads could be formed by hand. For the starting point in the hand rolling process the soil was rolled at diameters between 6 and 8 mm on a glass plate. The rolling process, as in a standard test produces water content reduction and diameter reduction.

The aim of the investigation was to obtain a plot of thread diameter vs. water content as the thread was rolled, its diameter was reduced and the thread was gradually dried by evaporation and the warmth of the hand. The relationship between thread diameter and water content is referred to as a 'rolling path'.

The starting points for the rolling paths were at water contents in the workable

plastic region for each soil. For each rolling path a lump of soil was rolled into a thread by moving the hand along its length to gradually reduce the diameter, without re-forming into a ball and re-rolling. With rolling the length of the thread increased considerably and as not all of its length was in contact with the hand drying of the thread was kept to a minimum. This enabled specimens to be taken from the thread at various stages for water content determination and diameter measurement. The specimens were taken firstly when the thread was still in an ductile or plastic condition, secondly when cracking was observed and finally when crumbling had occurred, thus investigating the range of conditions in the region of the ductile-brittle transition.

The diameter of the thread was measured against a ruler with millimetre markings under a microscope to obtain measurements considered to be accurate to 0.1 mm. As the crumbled threads had dilated somewhat during the fracturing process the diameters may have been over-measured but where crumbling occurred locally the uncrumbled diameter was measured.

It was recognised that for a particular starting water content different rolling paths could be obtained with different gradients, with

- 1) steep paths obtained by reducing the diameter quickly, requiring high hand pressure and entailing less reduction of water content or
- 2) flatter paths by reducing the diameter slowly under lower hand pressures with more reduction of water content.

It was found that the diameter at which a thread crumbled was not only determined by the final water content but also by the starting water content and rate of drying and diameter reduction, i.e. the gradient of the rolling path.

It was suspected that excessive drying of the thread beneath the hand may allow the formation of a crust on the outside of the thread but because continuous reduction of the diameter and extrusion of the thread entailed significant deformation and remoulding of the soil it was considered unlikely that a significant crust could form.

In practice, when conducting the standard plastic limit test, there will be a range of rolling paths applied during each test depending on the operator's approach. Some operators will dry the soil more quickly during rolling, some will reduce the diameter more quickly and the same operator will produce variability of both drying

rate and diameter reduction during each test and between different tests. The range of rolling paths that operators of the standard plastic limit test can produce⁴⁷ and the range of water contents over which an 'end point' can be detected (by cracking⁴⁸, tube formation or crumbling) are probably two of the main reasons why different operators obtain different values of the plastic limit for the same soil.

6.5 Rolling paths - London Clay

The results from several rolling paths for the London Clay, Isle of Grain sample are presented in Figure 6.2 with firstly cracking and then crumbling occurring at different diameters and water contents. Paths A, B, C and D are typical paths but not all of the path lines are marked, just the diameter and water content points and the thread condition.

By producing a number of rolling paths it was found that there is a locus bounding the points for the ductile condition, the cracked condition and the crumbled condition as shown in Figure 6.2. The locus between the ductile threads and the cracked threads, referred to herein as the cracking locus and represented by the dashed line in Figure 6.2, could indicate a stiffness transition. The locus between the cracked threads and the crumbled threads, referred to herein as the crumbling locus and represented by the solid line in Figure 6.2, should represent the ductile-brittle transition.

The toughness vs. water content plot carried out on the same soil (see Table 5.2) using the Barnes test is plotted below in Figure 6.3 with the ductile-brittle transition and the stiffness transition marked. Photographs of three typical test specimens showing the cracked and crumbled threads are presented in Figure 6.4.

The fairly wide range of water contents and diameters over which the cracked specimens was observed could be due to the loosely packed condition of the soil threads when prepared by hand alone, particularly as it is envisaged that the clay particles in the soil are undergoing increased aggregation when the water content lies between the stiffness transition and the plastic limit. The test results obtained in this investigation (Figure 6.2) are compared with the toughness vs. water content plot (Figure 6.3) for the same soil but the latter was obtained with the threads prepared by static compaction in the thread maker of the Barnes apparatus where the loosely packed soil is made more intact.

⁴⁷ This would depend on the warmth of the hand and speed and pressure of rolling.

⁴⁸ More heavy handed operators could make a cracked thread quickly crumble.

Cracking on the surface of the threads was noted first, identified as transverse, fairly closely spaced cracks that could be viewed under a hand lens, see Figure 6.4a. The 'first' crumbling condition was observed and identified by fracturing on the surface of the thread with fractures at acute angles to, transverse to and in line with the longitudinal axis, see Figures 6.4b. Further rolling caused opening of the fractures and separation between the groups of particles (peds) leading to a 'falling apart' or crumbling condition, see Figure 6.4c.

At this stage the thread diameter can no longer be reduced, instead separation of the peds produces an increase in the diameter of the thread in the form of dilation and this is often felt under the hand. It was considered unnecessary to break the thread into several pieces once fracturing was obvious, as implied by using the phrase 'crumbled to pieces', as further rolling would have reduced the water content further. From Figure 6.2 it can be seen that the crumbling condition can be achieved over a range of water contents, albeit a small range.

An important outcome of these experiments is that an intact thread with a very small diameter can only be obtained if a fairly steep rolling path is pursued and when the soil is rolled from an initial water content in the soft-plastic region, above the stiffness transition which is about 36.4% from Figure 6.3. With rapid reduction of the diameter and little reduction of water content a thread can be rolled to a diameter less than 3 mm, such as the initial part of rolling path A in Figure 6.2, from the water contents of about 44% to 39%. This demonstrates the property of tenacity or 'degree of plasticity', according to the criteria in Tables 6.1 to 6.3.

The thread was then continually rolled at this small diameter to reduce the water content with the warmth of the hand, following the latter, flatter part of path A in Figure 6.2, and remained uncracked from the water content of about 39% to about 27% when a crumbling condition was observed. This is well below the ductile-brittle transition water content (the Barnes plastic limit) of 32%, from Figure 6.3. This procedure could be criticised for continual rolling and possibly producing a dried crust on the surface of the thread but with such small diameters water migration and equilibration would be expected to counter this and, besides, if a dried crust forms it should crack, shear and crumble under the rolling pressures.

Significantly, therefore, intact threads can be rolled to diameters less than 3 mm, apparently remaining ductile, as in Path A in Figure 6.2, and yet have water contents below the plastic limit. This may be due to the formation of narrow interweaving bunches and continuous strands, as shown in Figure 3.13, during rapid rolling while the soil is still plastic enabling the soil to retain cohesiveness at

small diameters. It may then be more difficult for the clay particles to develop aggregation in these narrow strands that could lead to fracturing and crumbling and significant drying is then necessary to form smaller peds. Alternatively, there may have developed sufficient coalescence between the peds when the thread was between about 2 and 3 mm diameter and that the high suctions in the merged peds could hold together the thin thread.

With flatter rolling paths starting from a water content in the soft-plastic region, such as path B in Figure 6.2, very small diameters could not be obtained. On this path the rolling was conducted to reduce the water content in preference to reducing the diameter. This soil thread was observed to undergo cracking first at a particular water content, marked by the cracking locus in Figure 6.2, and then crumbling at a lower water content, marked by the crumbling locus. Therefore, if a flat rolling path is conducted this same soil would be deemed to be much less tenacious and to have a lower 'degree of plasticity', from the criteria in Tables 6.1 to 6.3. Slower rolling and more drying would appear to promote the development of larger (or normal) size peds leading to cracking and crumbling at their boundaries.

Tests on threads formed initially at water contents in the stiff-plastic region, between the plastic limit and the stiffness transition were not conducted. It is considered that if threads were rolled from these starting points they would display much less tenacity, with a crumbling point soon reached after a small reduction of diameter during rolling and, significantly, at a much larger diameter. This could be envisaged if starting points in the latter parts of paths B and C in Figure 6.2 were adopted. Path D on Figure 6.2 could be considered as intermediate between paths A and B and C. Along this path cracked specimens were observed at water contents between the stiffness transition and the plastic limit with crumbled threads near the Barnes test plastic limit.

From the above the use of a diameter criterion to denote the 'degree of plasticity' or tenacity in accordance with Tables 6.1 to 6.3 will be misleading. For example, for the same soil starting from a high water content in the soft-plastic region one operator could produce a steep rolling path and a very small diameter indicative of a high 'degree of plasticity' but another operator could produce a flat rolling path, not achieve a small diameter and instead observe the crumbling condition at a much larger diameter, indicating a low 'degree of plasticity'.

6.6 Rolling paths - Glacial Clay, Rixton

The same investigation was conducted on a sample of 'low plasticity' Glacial Clay

and the results are presented in Figures 6.5 and 6.6 with photographs of typical threads in Figure 6.7. Similar results to those for the sample of London Clay were obtained except that some threads with water contents above the stiffness transition of 17.9% in the soft-plastic region (in the Barnes test) were observed to have transverse cracks on the surface, similar to those seen in the photograph in Figure 6.7a. It is considered that this is due to the high sand content (>40%) in this clay with the surfaces of the sand grains acting as planes along which cracking can more easily develop.

At diameters above 3 mm the locus between the crumbled and cracked conditions occurred over a small range of water contents and was largely independent of the thread diameter so the plastic limit could be determined with sufficient accuracy at diameters greater than 3 mm. The plastic limit determined from the Barnes test was somewhat less than the hand rolled plastic limit probably as a result of the greater degree of compaction of the threads in the Barnes apparatus.

6.7 Rolling paths – Kaolinitic Clay, K-T Kaolin

The experiment was also conducted on a pure kaolinitic clay mineral, K-T Kaolin, and the results are presented in Figures 6.8 and 6.9 with photographs of typical specimen conditions in Figure 6.10. Similar loci to the other clays tested were found but there was much more variation of condition between the cracking locus and the crumbling locus, particularly with some ductile threads in this region and many threads undergoing a distinct tube formation as seen in the photographs in Figures 6.10b and d. The pedal nature of the soil structure can be seen in these photographs.

Some of the apparently ductile threads in the central region in Figure 6.8 could have been developing a tubular structure but this was not detected by the hand during rolling and was not observed on splitting the thread to view the cross section. Several threads sheared and split locally directly beneath where the fingers had been in contact with the thread. This would be a result of more local drying and local stress application. The remainder of these threads were in an apparently intact condition. It is considered that the formation of a tubular thread occurs because the compression/tension cycling that is most severe in the centre of the thread cross section causes the structure of coarse grained kaolinite particles and stacks and aggregations of these particles to dilate and fracture, commencing in the centre of the thread. With continued rolling these fractures open with the soil around the centre forming the wall of a tube.

The significant result is the wide range of water contents over which a criterion for the plastic limit can be obtained. For example, on rolling path G in Figure 6.8 a tubular structure developed at a water content of 41.0% whereas for rolling path J the threads were ductile until a crumbled thread was obtained with a water content of 29.6%. In ASTM D4318-10 both of these conditions, tubular threads and crumbling are accepted as criteria for the plastic limit determination and at diameters greater than 3 mm. Therefore, on this soil one operator who causes the soil to crumble could report a plastic limit of 29.6% and another operator who found that the thread developed a tubular structure could report a value of 41.0%.

With the same liquid limit for both results the latter high plastic limit could be the reason why several kaolinitic soils are reported to lie below the A-line on the plasticity chart of Casagrande (1947) who suggested that a group of kaolinitic soils, the 'K soils', should lie in this region. On Figure 6.1 these values are plotted, with the plastic limit of 29.6% giving a point above the A-line and the plastic limit of 41.0% giving a point well below the A-line. The result of the Barnes test on this soil gave a well-defined ductile-brittle transition, at a water content (plastic limit) of 33.8% which gives a point just below the A-line, see Figure 6.1.

From Figure 6.8 it can be seen that many of the tubular threads were obtained at water contents above the Barnes plastic limit and even at water contents above the stiffness transition, in the soft-plastic region. It is suggested that a tubular structure should not be permitted as a criterion for the plastic limit as it can be obtained for water contents in the ductile state, particularly in comparison with the Barnes test. Also, there was a wide range of water contents over which crumbled threads were obtained, from about 26 to 34%, well below the ductile-brittle transition in the Barnes test.

6.8 Considerations of soil structure

It is postulated for the clay soils tested that with a water content above the stiffness transition the clay mineral structure is one of more continuous strands of interconnected clay particles, as illustrated by the elementary particle arrangements in Figure 3.13 and the interweaving bunches in Figure 3.14. These structures permit the threads to be extended and provide tenacity whereas below the stiffness transition the soil structure is tending to develop into a more clustered/aggregated clay particle arrangement, as illustrated by the particle assemblages in Figure 3.14, with reduced tenacity as a result and a propensity to separate between the aggregates/peds resulting in the cracked and eventually the crumbled condition. The increased toughness in this region is considered to be due

to the greater amount of work required to overcome the increased strength of the continuous strands of clay particles and to move and remould the clay particle aggregations.

From Figure 6.2 for the London Clay sample it can be seen that with a water content roughly above the stiffness transition for this clay ($w_s = 36.4\%$) the threads remain ductile and uncracked when rolled by hand but once the water content reduces to below the stiffness transition cracking is noticed on the surface of the thread when rolled and the thread soon crumbles at water contents in the stiff-plastic region and in the brittle region. Similar results were identified for the Glacial Clay, see Figures 6.5 and 6.6 although some of these tests were considered to be affected by the high sand content, as described above.

The difference between the results of the hand rolling method and the Barnes test is amplified when the soil threads are at water contents in the stiff-plastic region⁴⁹. With the hand rolling method the threads are formed in an uncompacted condition and during rolling and drying peds are formed and these loosely combined peds of soil are allowed to separate, dilate and loosen further producing the cracked and crumbled conditions at water contents in the stiff-plastic region. With the Barnes test the threads are prepared by static compaction in a thread maker and with water contents in the stiff-plastic region the peds and clods of soil are remoulded, pushed together and combined by the compaction making a more continuous thread that will require additional work to break down the attractive forces between the peds and clods and producing a brittle condition at a water content below that found by hand rolling.

Compared to the samples of London Clay and Glacial Clay, for the Kaolinitic Clay there was much less correlation between the hand rolling test results, Figure 6.8, and the Barnes test results, Figure 6.9. Below the Barnes test plastic limit of 33.8% there were more hand rolled threads that had cracked or crumbled locally than above this value but there were also several uncracked threads and several tubular threads with water contents below 33.8%.

The pedal nature of the soil structure in this type of clay is illustrated in Figures 6.10b, c and d and this was observed over a wide range of water contents, from 26.6 to 40.0% in Figure 6.10. It was found that the pedal structure forms at a fairly high water content, at least near to the water content when a soil thread was not sticky and a suitable test could be conducted in the Barnes apparatus just below the toughness limit. In the hand rolling tests the soil threads are in a loosely

⁴⁹ This is only defined by the Barnes test.

compacted state and it appears that this pedal nature can not only result in dilation and tube formation but can also sustain a ductile, uncracked condition at the same water content. It is considered that the difference in these outcomes may be due to the pressure applied by the hand during rolling with higher pressure resulting in tube formation and lower pressure, gentler rolling allowing the threads to remain ductile and extrude laterally.

6.9 Is the diameter of 3 mm significant?

For the determination of the plastic limit the questions being asked in this section are - which is more important?, the thread diameter of 3 mm or the water content at the crumbling point?, or both at the same time?

In the British Standard (BS1377:1990) a brass rod is part of the required apparatus for the plastic limit test, being 3 mm diameter and about 100 mm long. This British Standard gives the criterion for the crumbling condition as rolling

“...until the thread shears both longitudinally and transversely when it has been rolled to about 3mm diameter, as gauged by the rod”.

This is generally taken as crumbling at the diameter of 3 mm. By using the past tense – “when it has been rolled” – this sentence could be construed as meaning that crumbling can occur at other diameters providing the thread has been rolled previously to 3 mm. To achieve the crumbling condition at the diameter of 3 mm the phrase should read “...until the thread shears both longitudinally and transversely when it is rolled to about 3mm diameter, as gauged by the rod”.

The American Standard (ASTMD4318-10) suggests that

“A 3.2 mm (1/8 inch) diameter rod or tube is useful for frequent comparison with the soil thread to ascertain when the thread has reached the *proper* diameter.” (the author’s italics).

The ASTM method (and the AASHTO method, T90-00) gives further credence to the importance of the diameter by including as an alternative to direct hand rolling the use of the Bobrowski and Griekspoor (1992) rolling device⁵⁰ which is designed to roll the soil threads to the exact diameter of 3.2 mm. Therefore, both the British and American Standards specify a fixed diameter to which the soil thread should be

⁵⁰ The author considers that this apparatus has serious flaws, as described in section 2.1 above.

rolled but by definition a soil can only be rolled while it is in a ductile state.

Prakash *et al* (2009) conducted plastic limit determinations on a range of soil types using the ASTM method but determined the water content of the soil when it was rolled into uniform threads with diameters of 2, 4, 5 and 6 mm, as well as 3.2 mm, and crumbled at these diameters, the values being the average of three determinations. They reported that the differences in water contents at crumbling for the diameters of 2, 4, 5 and 6 mm compared to the 3.2 mm diameter thread were negligibly small so the diameter at crumbling is not important. The author is unconvinced that these authors were able to roll by hand soil threads to the exact diameters they quote and, in particular, to get them to crumble at these diameters. Their techniques were not described in detail.

It can be seen from Figures 6.2, 6.5 and 6.8 that there is a difference in behaviour of the threads at diameters above and below about 3 mm. For the threads rolled to below about 3 mm the ductile-brittle transition does not occur at a particular water content as both ductile and crumbled threads were produced at the same water contents although not at the same diameter. It is considered that the pedal nature of the soil structure develops differently when threads are rolled from a soft-plastic condition at fairly quick rates and with steep rolling paths to diameters below 3 mm. As the thread is then rolled and dries the soil structure allows the thread to remain intact over a wide range of water contents at smaller diameters. From Terzaghi's definition of the plastic limit (Terzaghi, 1926) given in section 6.1 above, there is no need to roll threads below 3 mm diameter so the indistinct character of the ductile-brittle transition below 3 mm can be ignored and only the portion of the plots above 3 mm diameter on Figures 6.2, 6.5 and 6.8 need be considered.

For the threads rolled to diameters above about 3 mm distinct transitions were obtained at the loci between ductile, cracked and crumbled threads at particular water contents for the London Clay and Glacial Clay samples. The crumbling locus for the London Clay sample, see section 6.4, above the diameter of 3 mm lies at a water content of about 33 - 34%, see Figure 6.2, and at about 17% for the Glacial Clay, see Figure 6.5, at thread diameters between 3 and 5 – 6 mm. Thus the water content at the ductile-brittle transition, the plastic limit, should be achieved over a small range of water contents that is almost independent of the thread diameter, providing it is greater than 3 mm and preferably less than 6 mm. Distinct transitions were not found for the sample of Kaolinitic Clay.

Taking Terzaghi's criterion for the plastic limit, using the London Clay as an example, the plastic limit would lie at the value shown on Figure 6.11, from which

it can be seen that the transition and the plastic limit are hardly dependent, if at all, on the diameter of the thread. A similar result was obtained for the Glacial Clay, see Figure 6.5 but the crumbling locus for the Kaolinitic Clay was less clearly defined, see Figure 6.8. Nevertheless the crumbling locus for all three soils was almost independent of the diameter, for diameters above 3 mm.

To achieve the crumbling condition exactly at the 'standardised' diameter of 3 mm the rolling path A in Figure 6.12, using the Glacial Clay result as an example, would need to be followed and from the variation of rolling paths identified in Figures 6.2, 6.5 and 6.8 achieving this path would be very fortuitous. It is much more likely during a standard plastic limit test that each operator would produce a different rolling path depending on the pressure, vigour and warmth of the hand.

Rolling of the soil thread will typically follow a path such as path B in Figure 6.12 where rolling to 3 mm diameter will confirm that the soil is ductile or plastic, then kneading it into an ellipsoidal mass and re-rolling from, say 6 mm, will take the rolling path to the crumbling locus at a diameter greater than 3 mm. Rolling and kneading will both produce some drying of the soil thread. Path B provides an acceptable test result according to ASTM D4318-10 because the soil has been rolled to a diameter of 3 mm to demonstrate that it is plastic and crumbling at a diameter above 3 mm is considered to be a satisfactory end point. BS1377:1990 does not appear to allow for crumbling at a diameter above 3 mm but on path B crumbling has occurred "when [the thread] has been rolled to 3 mm diameter".

The results from the tests on the samples of London Clay and Glacial Clay would show that providing the crumbling condition is achieved at any thread diameter above about 3 mm (and probably less than 6 mm) there is no need to be fixated on the diameter at which crumbling is found.

For the Kaolinitic Clay sample, see Figure 6.8, a similar approach could be adopted with thread diameters greater than 3 mm but there would need to be serious deliberation about whether the water content values from tubular threads are either included or discounted and whether or not crumbling locally along the thread could be accepted as a criterion. Between the cracking and crumbling loci on Figure 6.8 a wide range of values for the plastic limit of this clay would be given by these criteria, from about 31% to 40%.

6.10 Proposed improvements to the standard plastic limit test

Figures 6.2, 6.5 and, to a less distinguished extent, Figure 6.8 show that for any

rolling path at diameters greater than 3 mm there are three zones that can be identified as ductile and intact, semi-ductile or cracked and brittle or crumbled, as shown in Figure 6.11, with loci between them that are not particularly sensitive to the diameter of the thread. In the standard test, rolling until the thread has crumbled, irrespective of diameter, takes the water content below the brittle/semi-ductile (or crumbling) locus, particularly as most operators will have a tendency to make sure that the crumbling condition is achieved. This then gives an underestimated value of the true plastic limit which must lie at the ductile-brittle transition.

In conducting the standard plastic limit test it should be recognised that a rolling path is followed and that rolling to the diameter of 3 mm merely confirms that the soil is ductile. As the water content approaches the plastic limit greater emphasis should be placed on carefully observing the surface condition of the thread with the aid of a simple hand lens at frequent intervals during rolling for the signs of cracking and then crumbling, rather than just rolling the thread to the diameter of 3 mm and only then observing the condition of the thread.

From the standard definitions of the plastic limit criterion, i.e. the thread crumbling, and from the Barnes test results for the London Clay and the Glacial Clay in particular, the true plastic limit should be obtained from a rolling path that crosses the crumbling locus at diameters greater than 3 mm, and should be taken as the water content at this locus, the ductile-brittle transition.

In order to assess the true plastic limit it is proposed to modify the standard procedure with the water content determined for threads that have cracked as well as for threads that have crumbled so that there are values above and below the ductile-brittle transition. The plastic limit is then determined at the transition as a water content between the cracked and crumbled values. Providing these two values are sufficiently close, say 1/40 of their mean value, a more accurate value of the water content at the ductile-brittle transition will be obtained.

It would be useful to determine and report the diameters of these threads, at least the cracked thread, and to keep within the diameter range of, say, 3 – 6 mm although for the tests conducted it can be seen that the crumbling locus is little dependent on the thread diameter and occurs over a narrow range of water contents. It is also suggested that in standard test procedures for the plastic limit that examples using photographs of typical cracked threads and typical crumbled threads would be of considerable benefit in providing the operator with a means of identifying the criterion for the ductile-brittle transition, i.e. the plastic limit.

6.11 Summary

On rolling soil threads, different operators will produce different rates of diameter reduction and different rates of drying depending on the pressure, vigour and warmth of the hand. The relation between thread diameter and water content is referred to as a rolling path and different operators will produce different rolling paths. It has been found that the diameter at which a thread crumbled was not only determined by the final water content but also by the starting water content and the gradient of the rolling path, i.e. the rate of diameter reduction and rate of drying.

The results of the experiments described in this chapter show that there is a distinct difference in behaviour between threads rolled to diameters above and below 3 mm. For the threads rolled to less than 3 mm diameter the ductile-brittle transition occurred over a range of water contents but from Terzaghi's definition of the plastic limit the behaviour of threads below 3 mm can be ignored.

The classifications for the 'degree of plasticity' based on the smallest diameter of thread that can be rolled out are shown to be meaningless as it is shown that for an individual clay soil, threads can be rolled to reach a crumbling point at a wide range of diameters from 1 to 6 mm, depending on the rolling path taken. This approach would only be viable if the starting points for the rolling path are at water contents in the soft-plastic region and for rapid reduction of water content with minimal drying of the thread.

For the London Clay and the Glacial Clay samples, above the diameter of about 3 mm, a clear differentiation was found between ductile, intact threads, semi-ductile, cracked threads and brittle, crumbled threads, with loci distinguishing these conditions that are generally independent of the thread diameter. For the Kaolinitic Clay there was a wide range of water contents between the intact threads and the crumbled threads with a tubular thread forming frequently in this region. If this tubular thread condition is permitted as an 'end point', as in ASTM D4318-10, then a wide range of plastic limits could be reported for this type of clay. The use of this form of end point should be reviewed.

With the hand rolling method the threads are prepared in an uncompacted condition and during rolling, at water contents in the stiff-plastic region, the loosely combined peds of soil are allowed to separate, dilate and loosen further producing the cracked and crumbled conditions, above the ductile-brittle transition as identified by the Barnes test. With the latter the threads are prepared by static

compaction in a thread maker and with water contents in the stiff-plastic region the peds and clods of soil are remoulded and compacted making a more well-combined thread that will reduce in diameter and extrude in a ductile manner but will require additional work to remould the stiffer soil structure. With a statically compacted soil thread the brittle condition is found at a water content below that found by a hand compacted thread.

The water content of a crumbled thread will always lie below the ductile-brittle transition and rarely at it. Also the test results described in this chapter show that the crumbling condition in a hand rolling test can be obtained over a range of water contents some distance below the transition. Therefore, the standard test procedures will always give a water content below the true plastic limit, at the ductile-brittle transition. Terzaghi's definition of the plastic limit as the lowest water content without breaking into pieces coincides with the crumbling locus, between the semi-ductile, cracked threads and the brittle, crumbled threads, and this locus is found to be largely independent of the diameter above about 3 mm.

A modification of the standard plastic limit test is proposed with the procedure comprising firstly rolling thin threads, defined as one that can be rolled to 3 mm, to demonstrate that the soil is ductile and plastic. Emphasis should then be placed on observing the condition of the thread to establish the ductile-brittle transition, which coincides with the crumbling locus.

From a rolling path with diameters greater than 3 mm produce two threads, one that does not crumble but displays cracking (still on the semi-ductile side) and one that just crumbles (on the brittle side), bearing in mind the region of water contents over which cracking can occur. A simple hand lens would be useful to assess the condition of the thread. Determine the water contents of the two threads that are above and below the crumbling locus and take the average of the two values as the plastic limit, providing the values are within a suitable range, such as 1/40 of the average value. Measure and report the diameters of these two threads.

The findings in this chapter have implications for the water content at which clays should be placed in construction works such as landfill liners, cores of earth dams, erosion blankets etc. where the ability of the layer of clay to hold together, i.e. be tenacious, is paramount. If the clay layer is placed at a water content in the soft-plastic region, obtained from the Barnes test, and is then subjected to drying the water content of the clay will soon reach the cracking locus, and then the crumbling locus. The condition of a clay at a water content in the semi-ductile, cracked region will be exacerbated if it is subjected to stress conditions such as

fluctuating or cyclic loading, which will then accelerate the change to a brittle condition.

6.12 Tables

Degree of plasticity	Plasticity index I_p	Type of soil	Smallest diameter of thread*	
			inch	mm
Non-plastic	0	Silt	--	--
Slight	1 to 5	Clayey silt	¼	6.35
Low	5 to 10	Silt and clay	1/8	3.18
Medium	10 to 20	Clay and silt	1/16	1.59
High	20 to 40	Silty clay	1/32	0.79
Very high	40 and more	Clay	1/64	0.40

*At the 'ball' water content

Table 6.1 *Burmister's (1950) classification (cited In Nuyens and Kockaerts, 1967)*

Degree of overall plasticity	Feel and smear appearance	Ease of rolling threads of soil	Smallest diameter of thread inch
Non-plastic	Gritty or rough	No threads can be rolled	Ball cracks
Slight	Rough to smooth	Difficult	¼
Low	Rough to smooth	Less difficult	1/8
Medium	Smooth and dull	Readily	1/16
High	Shiny	Very readily	1/32
Very high	Very shiny and waxy	Very readily	1/64

Table 6.2 *Burmister's (1970) tentative criteria for overall plasticity*

Degree of plasticity	Diameter of thread at crumbling point	Fines type
No plasticity	> 4 mm	Coarse silt
Low plasticity	2 – 4 mm	Medium silt, fine silt, clayey silt
Medium plasticity	1 – 2 mm	Silty clay
High plasticity	< 1 mm	Clay

Table 6.3 *Degree of plasticity (From Karlsson and Hansbo, 1981)*

6.13 Figures

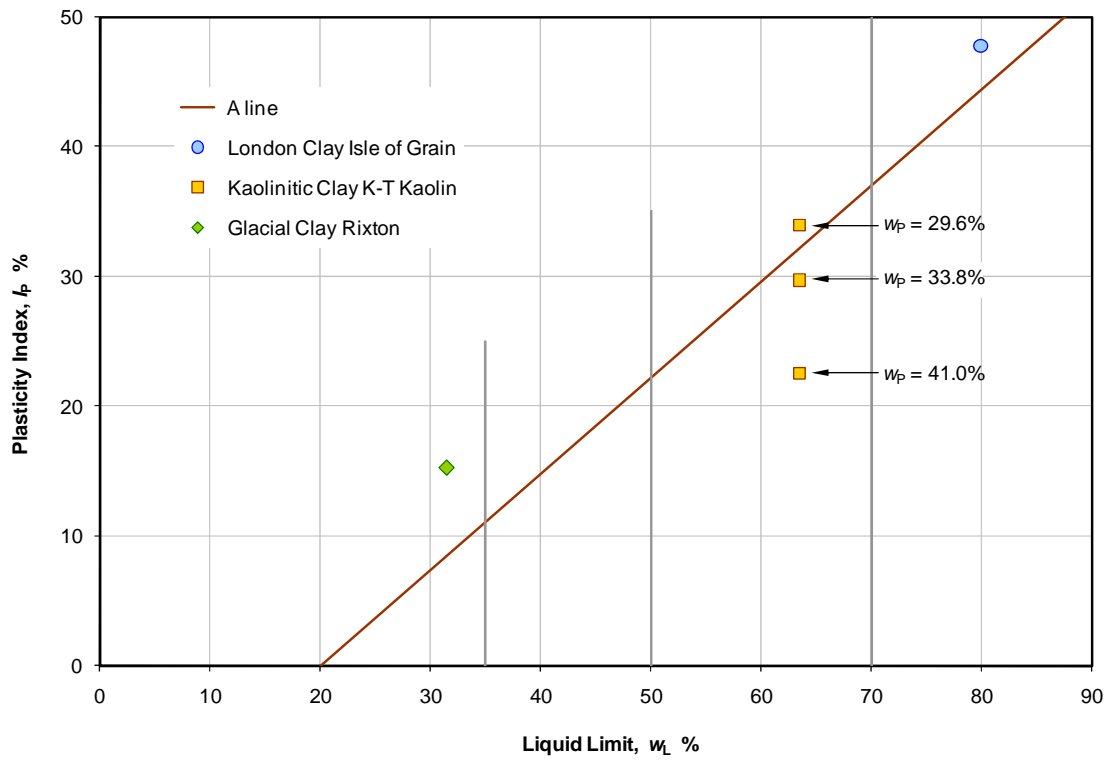

Figure 6.1 Samples on the Casagrande plasticity chart

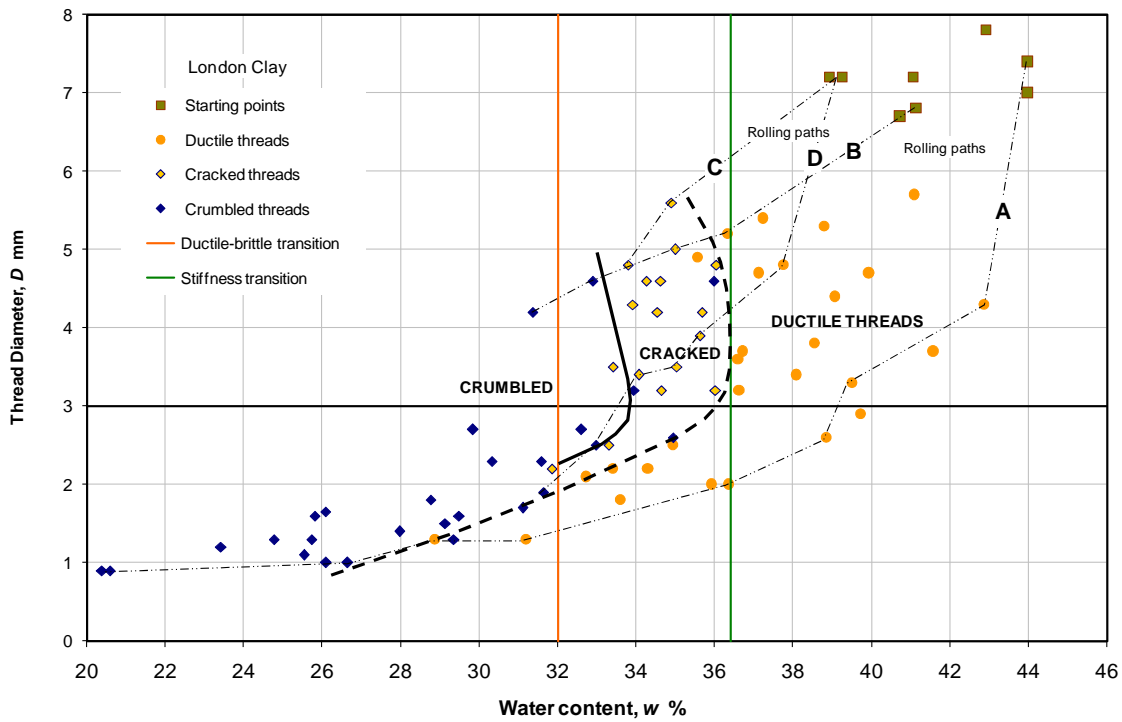

Figure 6.2 Hand rolling tests on sample of London Clay, Isle of Grain

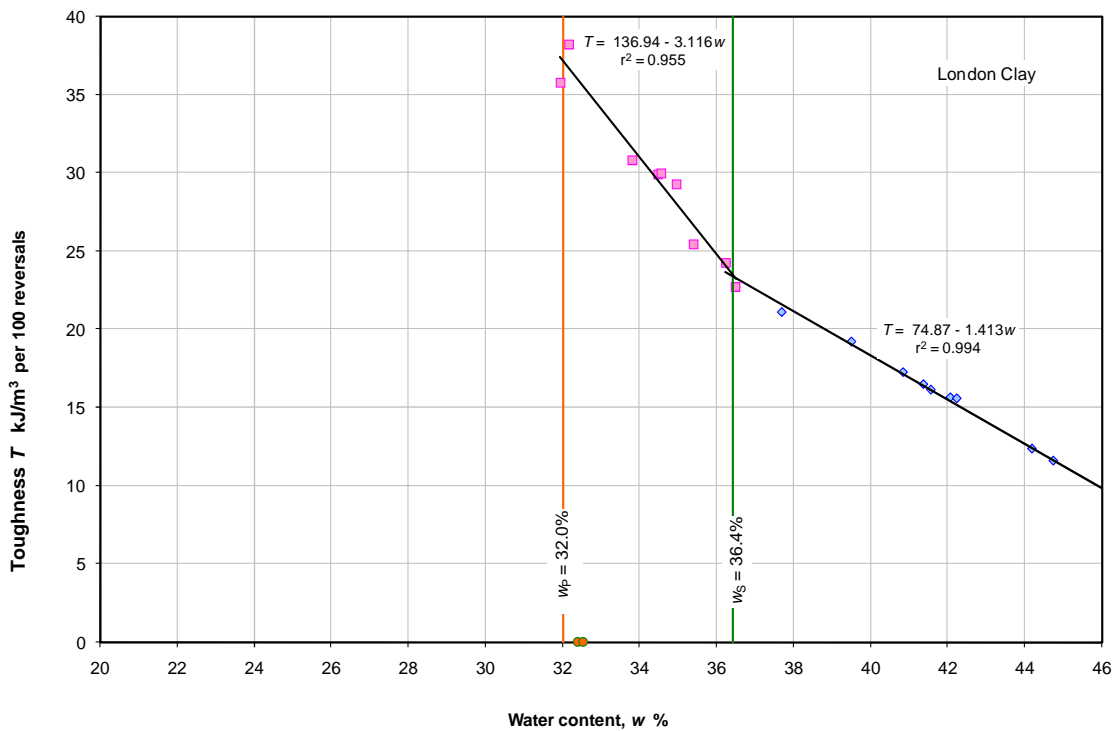

Figure 6.3 Toughness vs. water content for sample of London Clay, Isle of Grain



a

Cracked
Specimen 14B
 $D = 1.4 \text{ mm}$
 $w = 28.3\%$



b

Just crumbled
Specimen 16B
 $D = 3.9 \text{ mm}$
 $w = 31.4\%$



c

Well crumbled
Specimen 11D
 $D = 5.7 \text{ mm}$
 $w = 29.6\%$

Figure 6.4 Photographs of threads of London Clay, Isle of Grain

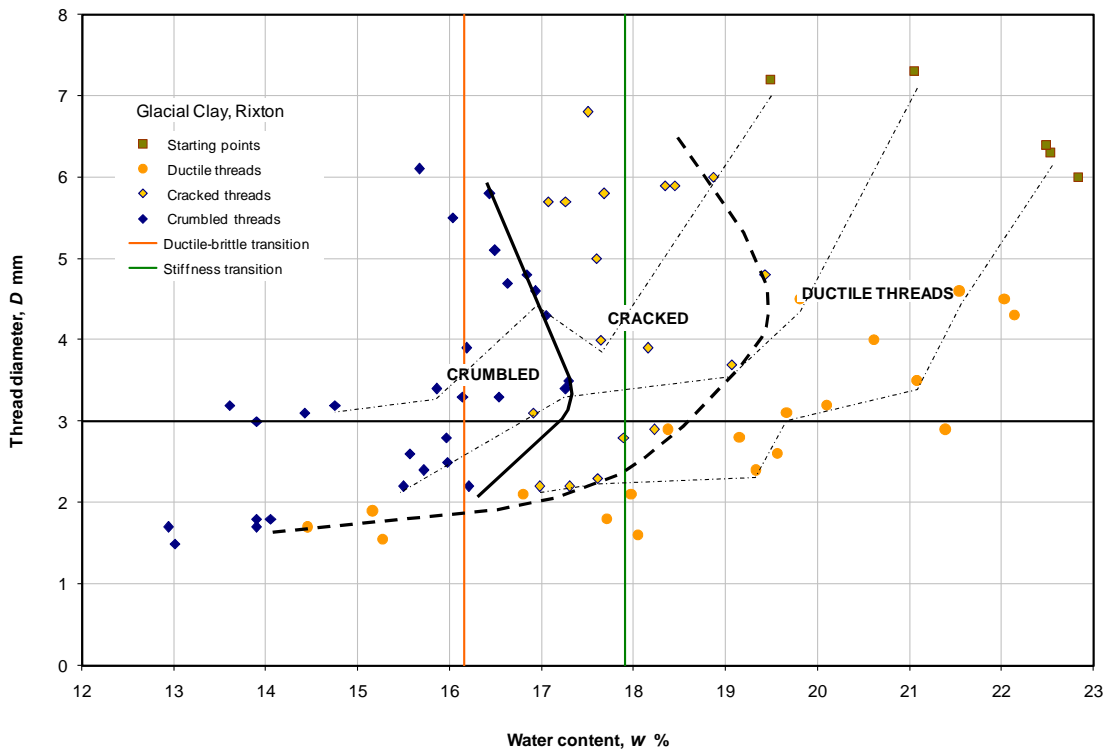

Figure 6.5 Hand rolling tests on sample of Glacial Clay, Rixton

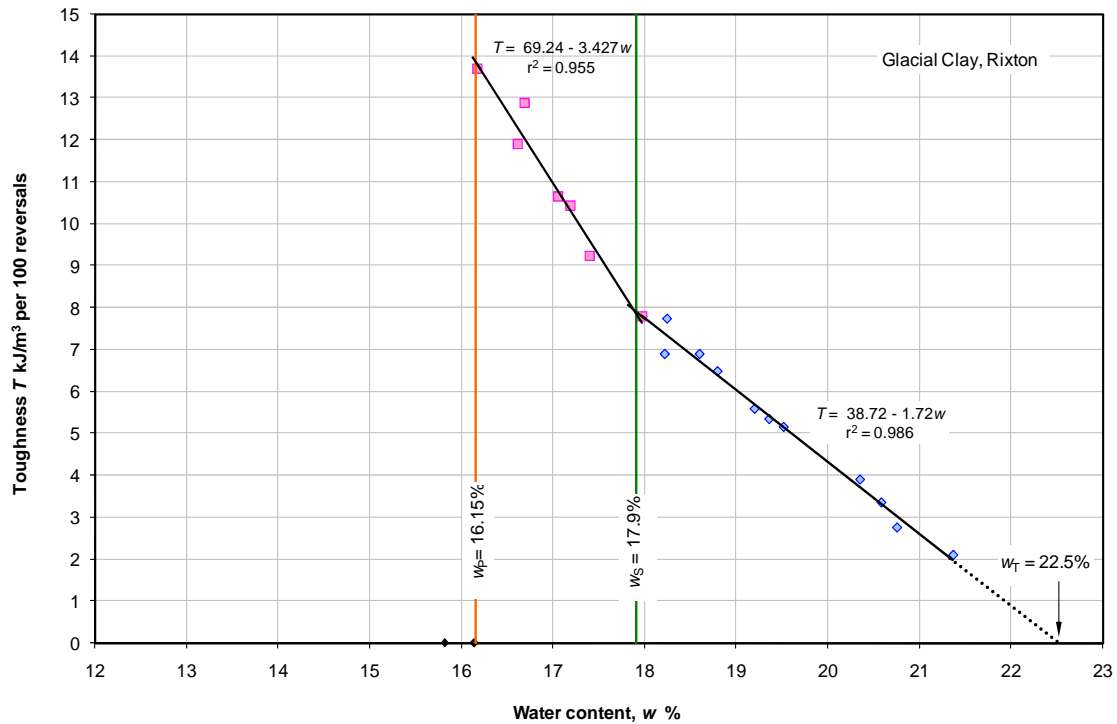

Figure 6.6 Toughness vs. water content for sample of Glacial Clay, Rixton



Figure 6.7 Photographs of threads of Glacial Clay, Rixton

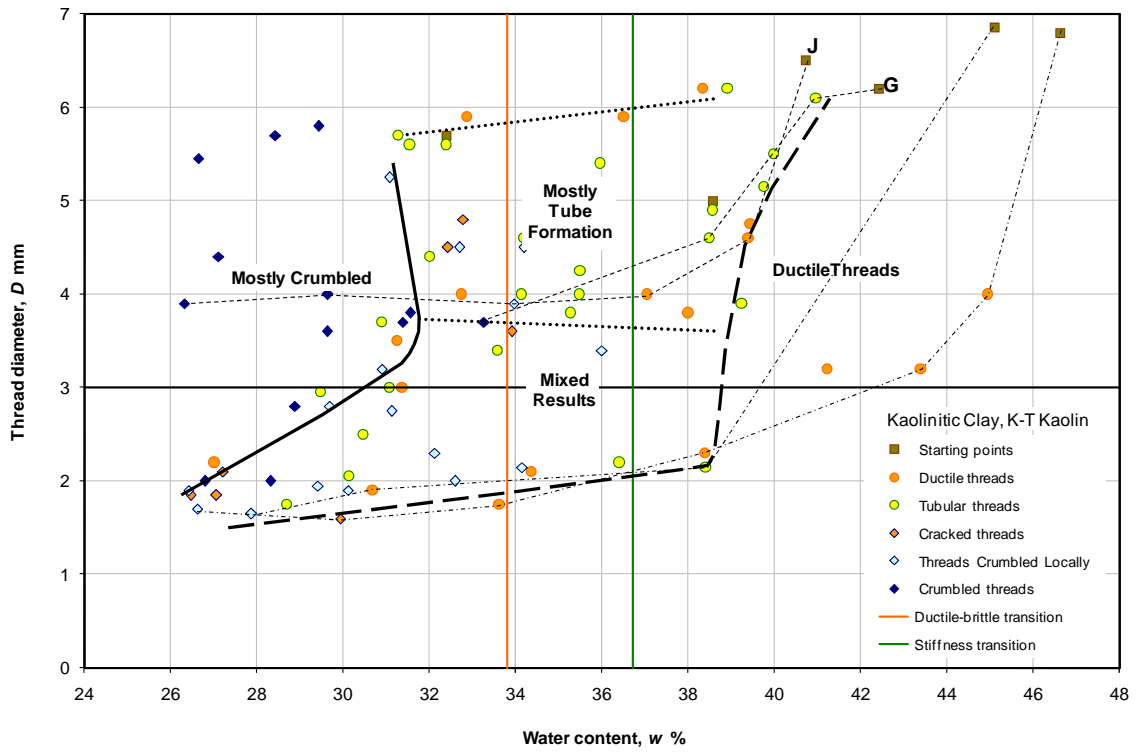

Figure 6.8 Hand rolling tests on sample of Kaolinitic Clay, K-T Kaolin

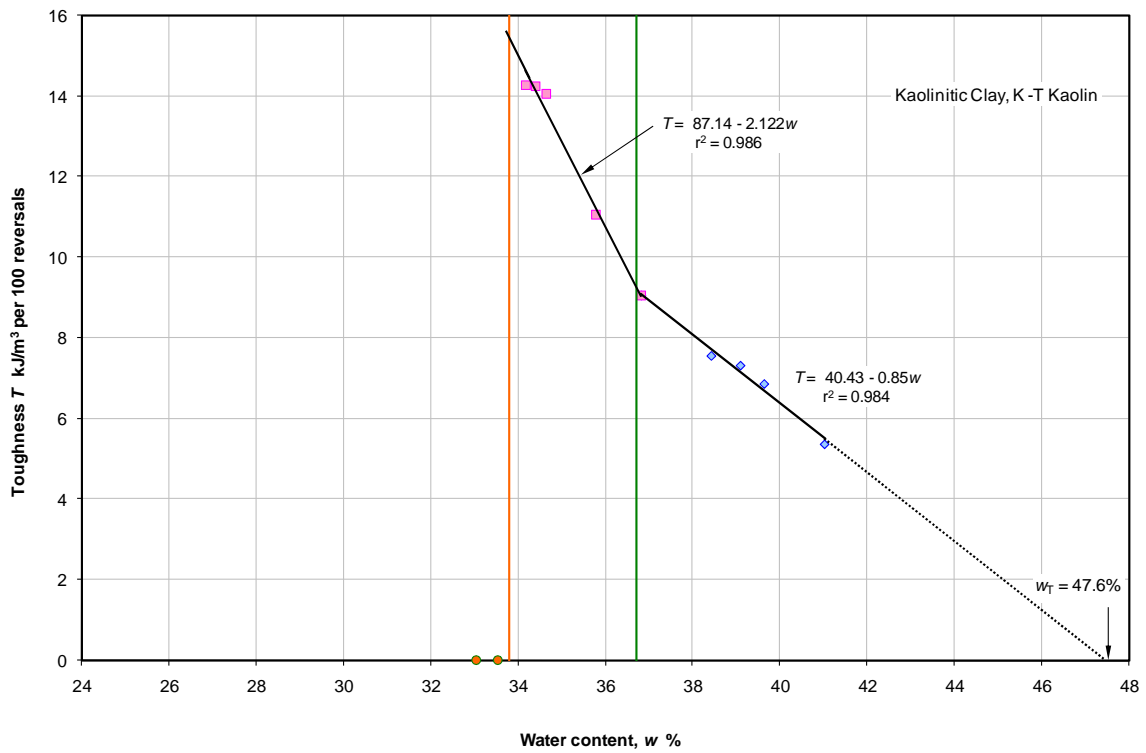

Figure 6.9 Toughness vs. water content for sample of Kaolinitic Clay, K-T Kaolin

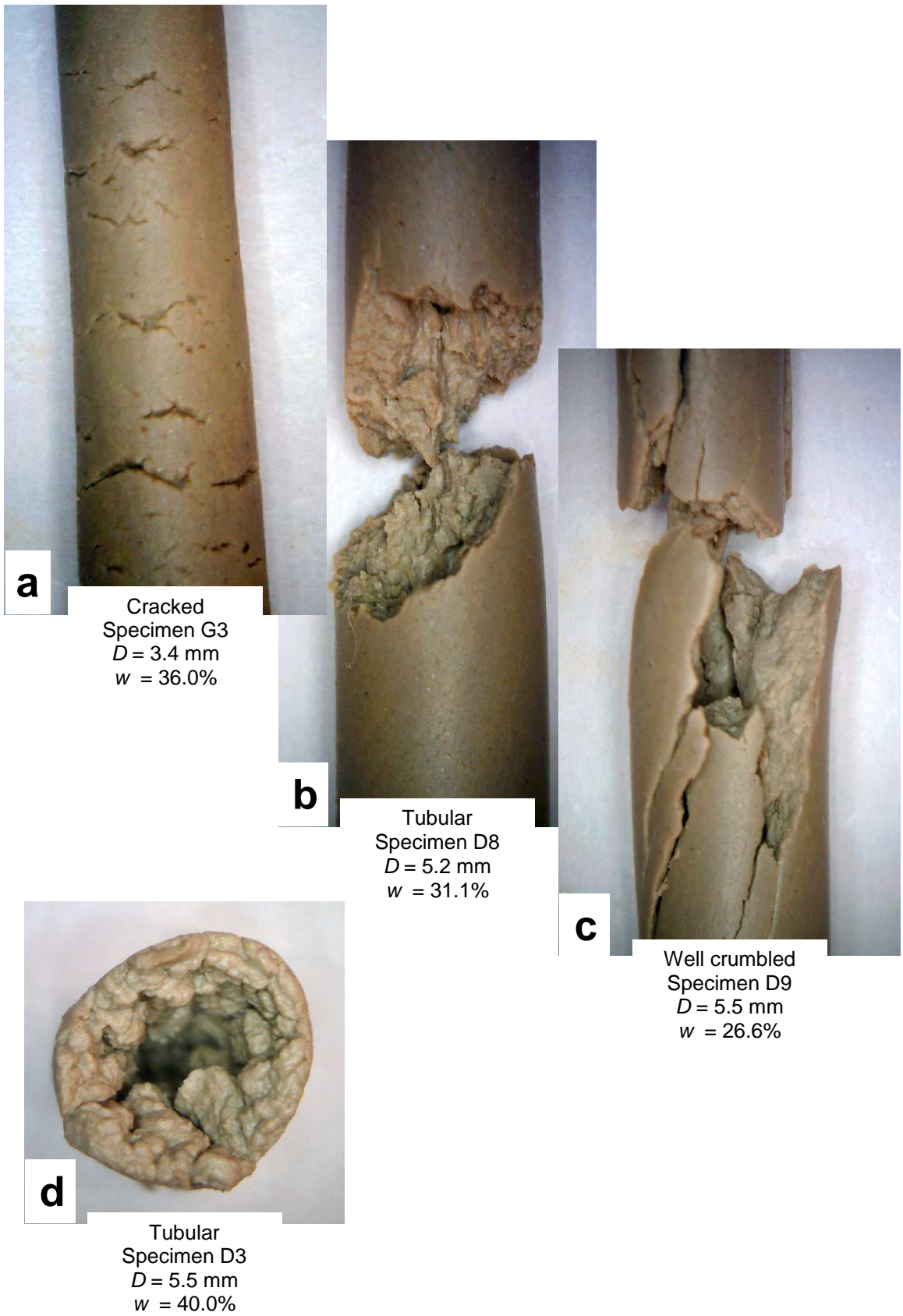

Figure 6.10 Photographs of threads of Kaolinitic Clay, K-T Kaolin

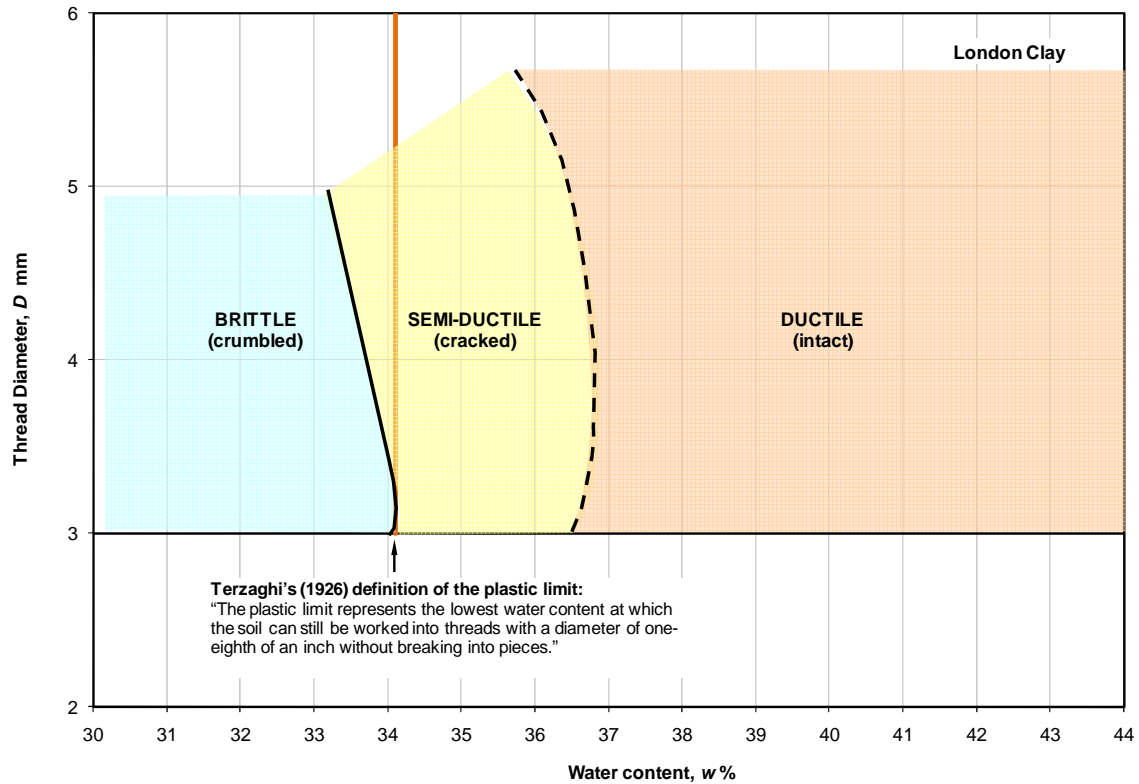

Figure 6.11 Terzaghi's definition of the plastic limit

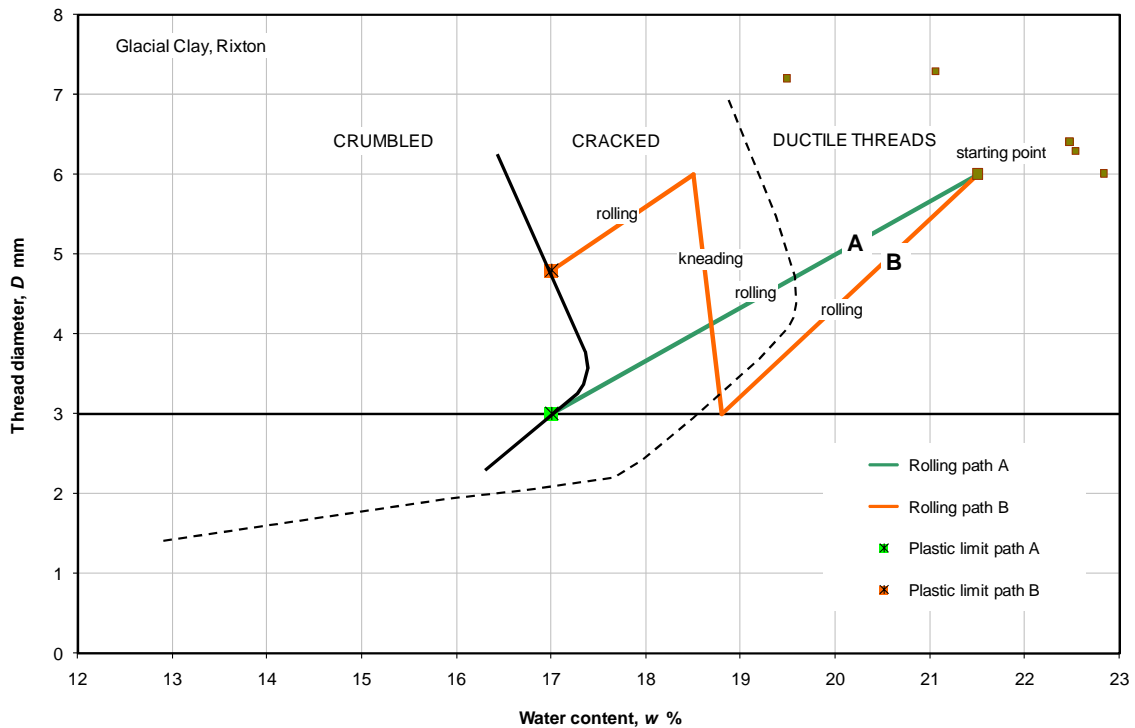

Figure 6.12 Two examples of different rolling paths (Based on the Glacial Clay, Rixton test result, see Figure 6.5 for locations of points and explanations of the loci)

CHAPTER 7

Relationship of matrix and coarse particles

7.1 Introduction

The concept of the 'linear law of mixtures' which states that the properties of a soil associated with water content, liquid limit, toughness limit and plastic limit are determined by the water content of the clay matrix, u_m , the clay minerals and the whole amount of the water in the soil. Published data are reported to illustrate this concept and an example is presented from the results of tests conducted on the London Clay and silt and sand mixtures described in Chapters 8 and 9.

The 'colloidal' activity defined by Skempton (1953) is discussed in relation to the linear law of mixtures to illustrate that his expression should only be applied for soils with high clay contents when the smaller silt and sand contents have no effect on the liquid limit, toughness limit and plastic limit.

Parameters including granular void ratio, cohesive porosity and granular spacing ratio are introduced to relate the effects of the granular components of a soil to the soil properties, the limitations of the corrections for oversize particles in laboratory test specimens are described and an analysis of the effects of large granular particles in a small reducing diameter soil thread is included to explain the behaviour of thin soil threads in the Barnes apparatus.

As the water content reduces towards the plastic limit it is postulated that aggregation commences near the stiffness transition and reaches a maximum at the plastic limit when the soil thread crumbles. A parameter referred to as the aggregation ratio is introduced to illustrate the degree of aggregation between the stiffness transition and the plastic limit.

7.2 Linear law of mixtures

The soil model (Barnes, 2010) relates the masses and volumes of solids, water and air in a soil to a range of soil properties such as water content by mass, porosity and density. Using this model and assuming that the silt (or sand) in a clay soil⁵¹ contains or retains no water of its own and all of the water is associated with the

⁵¹ A clay soil comprises a mixture of clay mineral particles and coarser particles such as silt, sand, gravel etc.

clay particles as a clay matrix⁵² the matrix water content by mass, w_m can be obtained from

$$w_m = \frac{w}{C} \times 100 \quad 7.1$$

where C is the clay content, % and w is the water content by mass of the whole soil including the silt/sand particles. Nagaraj *et al* (1987) referred to this as a 'floating matrix concept' and the 'linear law of reduction' as expounded by Seed *et al* (1964a).

In this thesis this concept is referred to as the 'linear law of mixtures'. It states that the properties of a soil that are associated with water content, the liquid limit, toughness limit and plastic limit, are determined by the water content of the clay matrix, w_m , the clay minerals and the whole amount of the water in the soil. None of the water is associated with the non-clay particles in the soil so that a linear relationship between the water content of the whole soil and the clay content is obtained by rearranging equation 7.1

$$w = w_m \times \frac{C}{100}. \quad 7.2$$

If it is assumed that the silt (or sand) content in a soil is small enough that these particles have no effect on the shear strength at the liquid limit or toughness at the plastic limit and merely act as lumps floating in a clay matrix then Equation 7.1 can be used to determine the liquid limit of the matrix, w_{mL} and the plastic limit of the matrix, w_{mP} alone as

$$w_{mL} = \frac{w_L}{C} \times 100 \text{ for the liquid limit} \quad 7.3$$

and as

$$w_{mP} = \frac{w_P}{C} \times 100 \text{ for the plastic limit.} \quad 7.4$$

Thus w_L and w_P would be linearly related to the clay content $C\%$ providing the matrix water contents, w_{mL} and w_{mP} , remain constant

⁵² A clay matrix comprises the proportion of the clay soil occupied by the clay minerals and its associated water, assuming that no water is associated with the coarser particles.

$$w_L = w_{mL} \times \frac{C}{100}, \quad 7.5$$

$$w_P = w_{mP} \times \frac{C}{100}. \quad 7.6$$

The liquid limit of a soil with 100% clay content, w_{L100} , is given by

$$w_{L100} = w_{mL} \quad 7.7$$

and the plastic limit of a soil with 100% clay content, w_{P100} , is given by

$$w_{P100} = w_{mP}. \quad 7.8$$

It should be noted that, in nature, there are few, if any, soils that have clay contents of 100%.

7.3 Published data related to the linear law

Seed *et al* (1964a) showed that for clay contents less than about 40% the plasticity index is no longer proportional to the clay content and deviates from the linear law but for the liquid limit determined from the Casagrande cup method the linear law applied down to clay contents of 10% for inorganic clays. Tan *et al* (1994) added fine sand to clay slurries and found that the linear law applied for the liquid limit determined from the cone penetrometer method with sand additions up to 60% by mass⁵³. However, the clays these authors used were mostly commercial montmorillonites and kaolinites that contained silt fractions between about 20 and 60%. For the coarsest of these mixtures with 60% sand and 24% silt, ($0.6 \times 40\%$) the clay fraction (< 0.002 mm) content would be 16% but still the liquid limits followed the linear law.

Kumar and Wood (1999) showed that a sharp change in undrained shear strength and compression response occurred when the clay content fell below about 40% and considered that for a clay content above about 35% it is the clay matrix alone that controls the undrained mechanical behaviour of kaolinite:fine gravel mixtures. However, their tests were conducted at high water contents near the liquid limit with low undrained shear strengths.

⁵³ All proportions for mixtures referred to in the thesis are by mass and not by volume.

A distinct transition of the residual angle of friction ϕ_r' at a clay content of about 45% was found by Collota *et al* (1989) with low fairly uniform ϕ_r' values at higher clay contents and values increasing significantly with decreasing clay content below 45%. Skempton (1985) stated that with clay contents less than about 25% shearing of a clay soil⁵⁴ beyond a peak value does not result in a significant drop to a residual value. Thus there is little or no reorientation of the clay particles. When the clay fraction is about 50% or greater the residual strength is controlled entirely by sliding friction and reorientation of the clay particles on a slip surface so that any coarser particles are carried along without interfering. There is a transitional zone between the two modes of shearing when the clay content lies between 25 and 50%. As discussed in section 4.10 for a soil thread comprising a high clay content and with a high colloidal activity reduction to a residual strength of parts of the thread can result in progressive failure and ultimate, but premature, collapse of the thread in the Barnes apparatus.

From the above the linear law can be considered to apply for the liquid limits of soils with low clay contents, in some cases down to about 20%, and particularly when the clay fraction is predominantly montmorillonite. With this clay mineral the matrix at the liquid limit will comprise a large amount of hydrated montmorillonite particles mixed with a large amount of water minimising interference between the non-clay particles. However, at the plastic limit the water contents are much lower so to prevent interference between the non-clay particles a larger proportion of clay particles is necessary, with clay contents above about 50 – 60%.

A number of researchers (listed in Figures 7.1 and 7.2) have published liquid and plastic limit data for samples of kaolinite and montmorillonite mixed with various proportions of silt and/or sand. For the liquid limits some researchers used the Casagrande cup method while others used the cone penetrometer method. Because of the different values of the liquid and plastic limits for the 'pure' clay (with no silt or sand added) used by each researcher the liquid and plastic limits have been normalised to the 100% value w_{L100} or w_{P100} given or derived for each paper and these normalised values, w_L/w_{L100} and w_P/w_{P100} , are plotted in Figures 7.1 and 7.2, respectively.

The straight lines on the plots represent the linear law. The liquid limits on Figure 7.1 generally lie close to the linear law even for low clay contents. This is considered to be due to the high water contents at this value that keep the silt/sand particles

⁵⁴ A clay soil behaves as a 'clay' because of its cohesiveness and plasticity even though the clay mineral content may be small, Barnes (2010).

sufficiently far apart to minimise interference. However, the normalised plastic limit values on Figure 7.2 deviate significantly from the linear law at clay contents below about 50% due to the low water contents by mass at the plastic limit that allow the silt/sand particles to be much closer and to produce interference, requiring more water to act with the clay particles to permit rolling out and extrusion of a thread of soil.

Another factor may be that complex and variable stress applications are applied to the soil during the hand rolling plastic limit test with more interaction between particles and more work/unit volume imparted compared to the fall cone liquid limit test where the soil is subjected to a simpler, single action shear mode of failure. A soil containing a large amount of silt/sand particles will be more prone to disruption under the energetic stress applications in the Barnes test.

Sivapullaiah and Sridharan (1985) were quite adamant in their rejection of the linear law as applied even to the liquid limit of mixtures of montmorillonite and sand. However, their data, plotted in Figure 7.1 show little difference from the data presented by the other researchers and lie within the overall bound of the available data, close to the linear law. Their plastic limit data also follow the general trend, see Figure 7.2, with deviation from the linear law when the clay content is less than about 50%.

7.4 Example of the linear law of mixtures

On Figure 7.3 the total water content by mass is plotted vs. the clay content for the liquid, toughness and plastic limits of mixtures of samples of London Clay and silt, referred to as London Clay:Silt mixtures. The results of the tests on these soils are summarised in Table 5.2 and discussed in detail in Chapter 8. They are used here for discussion on the linear law of mixtures. These soils comprised mixtures of a London Clay sample and a silt sample (Thurstaston Silt) mixed in the proportions 100:0, 80:20, 60:40, 40:60, 30:70 and 20:80. The clay content of the London Clay sample was 64% and of the Thurstaston Silt was 2% so the clay contents of each mixture were in similar ratios, i.e. 64.0, 51.6, 39.2, 26.8, 20.6 and 14.4%.

The linear law of mixtures provides a line passing through the origin and at the appropriate value of the limit (liquid, toughness or plastic) at the clay content of 100%, from equations 7.7 and 7.8. The linear law line can be drawn for the liquid limit data through the origin and the two points at clay contents of 64.0 and 51.6% on Figure 7.3 and is extrapolated to the value assuming 100% clay content, w_{L100} . This data deviate from the linear law at clay contents less than about 40 - 50%.

For the toughness limit and plastic limit data the values for the highest clay contents of 51.6 and 64.0% do not coincide with a linear law. Because the law of mixtures line has been found for the liquid limit data it is considered that the data for the toughness limit and the plastic limit are approaching close to the linear relationship that is assumed to exist between the toughness limit and the plastic limit and clay content at higher clay contents. Deviation from the assumed linear law can be seen to occur at clay contents between about 60 and 70% for the toughness limit and the plastic limit.

It is considered that the deviation from the linear law is caused by interference in the matrix from the silt particles such that more water is required to counter the resisting and interfering effects of the silt particles to achieve the necessary shear strength at the liquid limit and to enable threads to be rolled and extruded for the toughness limit and at the plastic limit.

The deviation from the linear law is more clearly seen when the matrix liquid and plastic limits, w_{mL} and w_{mP} as calculated from Equations 7.3 and 7.4, are plotted vs. clay content, see Figure 7.4. The liquid and plastic limits of the clay matrix must be independent of the silt content and would be represented as straight horizontal lines on Figure 7.4 at w_{L100} and w_{P100} , and at w_{T100} for the toughness limit. On Figure 7.4 the points for the matrix liquid limit, w_{mL} at $C = 51.6$ and 64% fall on the linear law line, so it is reasonable to say that for clay contents greater than about 40 – 50% the linear law applies for the liquid limit.

However, for the matrix plastic limit, w_{mP} , there are no points that lie on a horizontal line although it is considered that the point at $C = 64\%$ lies close to the linear law line. Thus for the plastic limit of the London Clay:Silt mixtures the linear law can only be assumed to apply with clay contents greater than about 65%, demonstrating that at the plastic limit interference from the silt particles commences at a lower silt content than at the liquid limit. This is due to the lower water content at the plastic limit and probably the more energetic stress applications with this test. Deviations reported from the linear law should be described in relation to both the clay content and water content, not just the clay content. A parameter that involves both of these properties should be used, see below.

For the fall cone and the Casagrande cup methods of determining the liquid limit it is assumed that there is a unique value of undrained shear strength at the liquid limit, although there is known to be some small variation, see section 2.5. Figure 7.4 shows that for the liquid limit the undrained shear strength of the mixture will remain constant for clay contents between about 50 and 100% because the matrix

water content is constant and the silt particles do not interfere and have no effect. As the clay content decreases below about 40 - 50% the undrained shear strength of the matrix decreases because the matrix water content increases. However, as far as the fall cone or Casagrande cup methods are concerned they will be related to a particular strength at the liquid limit, but this will then be derived from a combination of a weaker clay matrix enhanced by particle interference from the silt particles.

At the plastic limit, for clay contents between about 65 and 100% it is argued that the toughness should be constant because the matrix water content is constant and it is assumed that the silt particles have no interference effect. As the clay content decreases below about 65% the toughness decreases

- 1) because there is less clay and
- 2) because the matrix water content increases.

The latter is countered to some extent by the work required to move the silt/sand particles during rolling of the soil thread, as discussed in Chapters 8 and 9. On Figure 7.4 it can be seen that for the soil with clay content of 14.4% when the soil mixture is at its plastic limit the clay matrix has a water content above the matrix liquid limit, w_{L100} . It is considered that the matrix holds the granular particles together and imparts cohesiveness but the toughness developed is produced by the work required to move the silt/sand particles.

7.5 Skempton's 'colloidal' activity

Skempton (1953) defined the 'colloidal' activity, A , as the ratio of the plasticity index of the total soil and the clay fraction

$$A = \frac{I_P}{C}. \quad 7.9$$

This parameter is referred to as the activity index in BS EN 1997-2:2007. By comparison with equations 7.3 and 7.4 the activity A is really the plasticity index of the clay matrix

$$A = \frac{w_L - w_P}{C} = \frac{w_{mL}}{100} - \frac{w_{mP}}{100} = \frac{I_{mP}}{100}. \quad 7.10$$

It is presumed that Skempton used Activity to represent the contribution of the colloids in a clay soil, the clay minerals and their associated water, and not any non-clay particles such as silt or sand. These colloids, on their own, should have only one value of the liquid and plastic limit and hence one value of plasticity index. For a clay soil containing these colloids with one value of plasticity index there can only be one value of activity, A irrespective of the amount of non-clay particles present. However, the correct value of Activity will only be found when the liquid and plastic limits of the clay soil lie on the linear law, and this only occurs at the higher clay contents.

For the lower clay contents when the liquid limit and the plastic limit deviate from the linear law the value of activity A derived from equation 7.9 varies because the plasticity index deviates from the linear law. This is illustrated in Figure 7.5 where the 'colloidal' activity A , determined from equation 7.9 without consideration of the linear law, varies with the clay content which cannot be correct.

If all of the silt and sand could be removed from a clay soil leaving 100% clay minerals the 'colloidal' activity of these clay minerals would be given by the difference between liquid and plastic limits of these clay minerals, or the plasticity index of the clay minerals, from equations 7.7, 7.8 and 7.10

$$A = \frac{w_{mL}}{100} - \frac{w_{mP}}{100} = \frac{w_{L100}}{100} - \frac{w_{P100}}{100} . \quad 7.11$$

Equation 7.9 should only be applied for soils with high clay contents when the liquid and plastic limits lie on the linear law lines and the Activity is related to the clay matrix alone. Otherwise, Skempton's 'colloidal' activity of the clay fraction varies with the clay fraction content which is wrong. It is suggested that activity A should only be determined for soils with clay contents greater than about 50%.

7.6 Granular void ratio

Mitchell (1976) and Kenney (1977) introduced the parameter granular void ratio, e_g , to illustrate the effect of non-clay particles on the residual strength of clay soils. It is the ratio of the volume of matrix (clay V_c and water V_w) to the volume of the granular (silt or sand) particles V_G

$$e_g = \frac{V_c + V_w}{V_G} . \quad 7.12$$

The formula derived from the soil model (Barnes, 2010) for the granular void ratio e_g for a fully saturated soil is

$$e_g = \frac{C \frac{\rho_G}{\rho_c} + w \frac{\rho_G}{\rho_w}}{1 - C} \quad \text{or} \quad e_g = \frac{C \rho_G \left(\frac{1}{\rho_c} + \frac{w_m}{\rho_w} \right)}{1 - C} \quad 7.13$$

In this equation the clay content C is a fraction by mass. ρ_G and ρ_c are the particle densities of the non-clay and clay particles, respectively, and w and w_m are the total and matrix water contents. Thus e_g can be obtained from equation 7.13 at the liquid limit when full saturation can be assumed but at the plastic limit it is recognised that full saturation does not occur. However, it is considered that e_g is not a particularly useful parameter since when $C = 1$ (or 100%) $e_g = \infty$ and when C approaches zero e_g has a value related to the void ratio of a clean (no clay) granular but fully saturated soil and the matrix water content would tend to ∞ .

According to Chu and Leong (2002) when the fines⁵⁵ content, in their case silt, exceeds about 20 – 30% the properties of a sand may become governed by the fines content and e_g is no longer applicable except to illustrate the separation between the coarser particles. This occurs as the granular void ratio approaches 1. There was also the assumption that all of the silt particles were active in providing the mechanical properties of the soil. As Thevanayagam (1998) has pointed out for non-plastic silt fines in a sand some of the fines may be confined between coarser grains and be relatively ineffective, with other fines acting as separators between the coarser grains and, therefore, highly effective in influencing the mechanical properties of the soil, particularly the strength and stiffness. For a clay soil comprising clay particles and silt and/or sand particles this phenomenon would be particularly important where clay bridges exist between the coarser grains (as found by Collins and McGown, 1974) as opposed to clay particles that are stagnant in a void space between the coarser grains.

It would be useful, therefore, to be able to distinguish between the proportion of fines that occur in confined or stagnant voids between the coarser grains which means that they do not contribute to the overall mechanical properties, particularly shear strength and compressibility, and the remainder of the fines that act as separators, clay coatings and clay bridges, and affect these properties. To represent the beneficial 'cushioning effect' of silt grains in a sand Thevanayagam *et al* (2002) introduced a parameter b with values lying between 0 and 1. When $b = 0$ they

⁵⁵ The fines in a soil refer to the clay and silt particles, < 63 μm (Barnes, 2010).

considered that the 'fines behave as voids', i.e. they exist in the stagnant voids and do not make any contribution to the mechanical properties of the coarser grains and when $b = 1$ the fines are indistinguishable from the host coarser grains. This results in an 'equivalent granular void ratio' e_{ge} , proposed by Thevanayagam *et al* (2002)

$$e_{ge} = \frac{e + (1-b)fc}{1 - (1-b)fc} \quad 7.14$$

e is the overall void ratio and fc is the fines content, which in this case was silt. For smaller amounts (up to 20%) of plastic kaolinite fines in a sand Ni *et al* (2004) found that these fines were not simply acting as stagnant voids but 'worse than voids' as the plastic fines were causing diminished strength. They considered that the equivalent granular void ratio e_{ge} as given by Thevanayagam *et al* (2002) was insufficient and they proposed that for soils with plastic fines the value of b could be negative such that the range of values is $-\infty \leq b \leq 0$. They found a b value of -0.8 for the kaolinite fines in their tests.

Their samples were prepared by sedimenting sand through a kaolinite suspension so when they state that the presence of clay reduced the stability of the fabric of the sand this could have been caused by the development of clay coatings on the sand grains resulting in reduced shear strength around the sand-sand grain contacts and clay bridges between the sand grains which would tend to increase the granular void ratio. As the structure of a natural soil comprises a wide range of particle sizes and void sizes the representation of the effect of the fines by the b value is only an average effect.

In preference to the granular void ratio a parameter that gives the proportion of the volume of the clay matrix to the total volume of the clay soil, referred to as the cohesive porosity, is described in section 7.6.

For the consideration of the interference between the non-clay particles it is proposed that the use of a parameter that represents the average spacing between the silt/sand particles is used in the investigation of the tests conducted by the author on the mixtures of clay and silt and sand. This is referred to as the granular spacing ratio and is described in section 7.7 below. Adjustments to laboratory test results for the effect of oversize particles are described in section 7.8.

For the consideration of the property of toughness in clay soils it is proposed that a parameter is used that relates the proportion of aggregates in a clay matrix to the

proportion of continuous clay matrix. This is referred to as the aggregation ratio and is described in section 7.8 below.

7.7 Cohesive porosity

As the toughness of a clay soil depends on the amount of clay matrix (clay minerals and the associated water) present a parameter that represents the proportion of clay matrix in the soil would be useful. This is herein referred to as cohesive porosity n_c given for a fully saturated soil by

$$n_c = \frac{\text{Volume of matrix}}{\text{Total Volume}} = \frac{\text{Volume of clay} + \text{Volume of water}}{\text{Total Volume}} = \frac{V_c + V_w}{V_G + V_c + V_w} \quad 7.15$$

and the formula derived from the soil model (Barnes, 2010) is

$$n_c = \frac{C + w\rho_c}{C + w\rho_c + (1 - C)\frac{\rho_c}{\rho_G}} \quad 7.16$$

7.8 Granular spacing ratio

Lupini *et al* (1981) used a spacing ratio s/d where s was the average centre to centre distance between spherical uniform sized particles of diameter d in a clay matrix. Polidori (2007) suggested that the linear law applies for clay soils providing the volume of the clay matrix is greater than the void volume of the non-clay particles (silt and/or sand) on their own or until the non-clay particles come into contact with each other. Thus, although Polidori did not propose such a parameter, the distance (on average) between the surfaces of the non-clay particles would be a very useful marker for the interference effect. Rather than the centre to centre distance between the particles it is considered that the distance between the surfaces of the particles would give a clearer impression of the average amount of continuous matrix between the particles.

In Figure 7.6 a 2-dimensional arrangement of four single size spherical particles is shown for the base of a cubic arrangement. Imagine that for a 3-dimensional cubic arrangement there is another 2-dimensional arrangement of four particles directly above the base arrangement separated from this arrangement by a centre to centre particle distance of d_c . This 3-dimensional arrangement is assumed to extend throughout the soil specimen and although it is recognised that during the liquid limit and plastic limit tests the soil undergoes significant displacement and

distortion the calculations of the granular spacing ratio assume that the 3-dimensional arrangement is retained but the spacing reduces. In each cubic arrangement the closest surface to surface spacing between the particles is d_s , as shown in Figure 7.6; it is not the spacing on the diagonal of the cubic arrangement.

The granular spacing ratio is herein defined as the ratio of the surface to surface spacing between the particles, d_s and the diameter of the spherical, single size particles, d_g ,

$$s_g = \frac{d_s}{d_g}. \quad 7.17$$

For the calculation of the granular spacing ratio the soil is assumed to be fully saturated and the granular particles are spherical, single size and at a single closest surface to surface distance of d_s . In a real soil there will be a range of particle sizes at a range of spacings so for the calculation of the granular spacing ratio it is assumed that an average spacing is determined. The distance d_s is then referred to as the closest spacing based on the assumptions stated.

In Figure 7.6 a 2-dimensional arrangement for three spherical, single size particles is shown at the base of a tetrahedron, a tetrahedral pyramid, for a tetrahedral arrangement. Imagine that for a 3-dimensional tetrahedral arrangement a fourth particle exists above the three particles shown in Figure 7.6, at the apex of the tetrahedral pyramid and at a centre to centre particle distance d_c . The closest spacing d_s between the surfaces of the particles is on the edge of the tetrahedron, not any other distance between the particles. The same assumptions for the cubic arrangement regarding the tetrahedral arrangement extending across the soil specimen, no displacement or distortion of the soil, single sized particles compared to a range of particle sizes and a single closest surface to surface spacing compared to a range of particle spacings in a real soil are made for the tetrahedral arrangement.

The closest spacing between the surfaces of the non-clay particles, herein referred to as d_s , has been derived for single size spherical non-clay particles in a cubic arrangement and in a regular tetrahedron arrangement, in a clay matrix. For the cubic arrangement this spacing would be the distance between the particles on the side of the cube and for the tetrahedral pyramid arrangement it would be the distance between the particles situated at the corners of the pyramid. Assuming the granular particles to have an average diameter of d_g , and an average spacing centre to centre of the particles d_c , then the average spacing between the surfaces of the

particles d_s is

$$d_s = d_c - d_g. \quad 7.18$$

The granular void ratio can be represented by the volume of matrix in a unit volume to the volume of the grains in a unit volume. Considering a single spherical particle of diameter d_g arranged in a cubic formation to give a unit volume of side d_c the granular void ratio has been derived as

$$e_g = \frac{\text{volume cube} - \text{volume sphere}}{\text{volume sphere}} = \frac{d_c^3 - \pi/6 d_g^3}{\pi/6 d_g^3} = \frac{6}{\pi} \left(\frac{d_c}{d_g} \right)^3 - 1. \quad 7.19$$

The granular spacing ratio s_g represents the ratio of the closest spacing between the surfaces of the particles d_s and the average diameter of the particles d_g :

$$s_g = \frac{d_s}{d_g} = \frac{d_c}{d_g} - 1. \quad 7.20$$

From Equation 7.19 s_g for a cubic arrangement is derived as

$$s_g = \sqrt[3]{\pi/6} (1 + e_g) - 1. \quad 7.21$$

For a tetrahedral arrangement of non-clay particles with a spherical particle inside a tetrahedron the granular spacing ratio s_g has been derived as

$$s_g = \frac{1}{\sqrt{6}} \sqrt[3]{\sqrt{2\pi}(1 + e_g)} - 1. \quad 7.22$$

The granular void ratio e_g can be derived from the properties of the soil and the formula derived from the soil model in Equation 7.13 to give a value of the granular spacing ratio s_g . The granular spacing ratio is considered to be a useful parameter in that it depicts the average closeness of the grains and the amount of matrix between them and therefore the potential for interference between granular particles in a clay matrix. It includes the water as well as the clay particles so is superior to just clay content.

For the London Clay:Silt mixtures discussed in section 7.3 and described in detail in Chapter 8 the granular spacing ratios at the liquid limit, toughness limit and

plastic limit are plotted in Figure 7.7. In Figure 7.4, the linear law would relate to clay contents greater than about 45 – 50% at the liquid limit. For these clay contents in Figure 7.7 it is then argued that the linear law applies for a value of granular spacing ratio s_g greater than about 0.35 – 0.40. For the plastic limits in Figure 7.4 the linear law would apply for clay contents greater than about 65%. For this clay content in Figure 7.7 a similar granular spacing ratio s_g greater than about 0.35 – 0.40 is also observed. With granular spacing ratios greater than these values it is assumed that there is sufficient matrix between the grains to prevent particle interference.

For lower values of granular spacing ratio it is postulated that turbulence in the clay matrix occurs between the grains and around the grains. When the average spacing between the grains is close, with a granular spacing ratio s_g of about 0.1, contact and significant interference occurs, requiring the matrix water content to increase dramatically to achieve the strength at the liquid limit and the toughness at the plastic limit. This value of s_g relates to a clay content of about 30 – 40% at the plastic limit and about 20 – 30% at the liquid limit. Compared with Figure 7.4 these values correspond to the onset of significant particle interference.

Comments on the efficacy of the granular spacing ratio are given in section 8.6.

7.9 Corrections for oversize particles

In most soil laboratory tests there is a maximum particle size limit imposed to suit the available apparatus. For the standard compaction test this is 20 mm and for the Atterberg limits it is 425 μm . For soils that contain particles larger than the permitted size there is a need to make a correction or adjustment to the results of the laboratory test to attempt to give the same property value to the whole soil. Two methods are considered. The Barnes tests conducted on the London Clay:Silt and London Clay:Sand mixtures are assessed in accordance with these methods in Chapter 9, to investigate the effectiveness of these ‘corrections’.

1) *The substitution or replacement method*

This method comprises replacing the proportion of oversize particles with an equal weight of finer particles smaller than the maximum permitted particle size for the apparatus concerned, usually applied in the case of the compaction test. Trenter (2001) suggests that this approach should be limited to when the proportion of oversize particles lies between 0.05 and 0.10, or 5 and 10%, but the current version of ASTM D1557-12 (2012) states that the use of this method is inappropriate.

2) *The elimination or scalping method*

By assuming that the proportion of the oversize particles in a soil, by dry weight, is O_s (a ratio in equations 7.23 to 7.25, or it could be % if O_s in these equations is divided by 100) and that the oversize particles have no water associated with them and would not affect the liquid and plastic limit test results they can be removed from the soil and the laboratory tests, in this case the liquid and plastic limits, conducted on the remainder. The laboratory water content, w_{lab} and the laboratory liquid and plastic limits, w_{Llab} and w_{Plab} , can then be adjusted to include the oversize particles to give the 'corrected' liquid and plastic limits, w_{Lwhole} and w_{Pwhole} of the whole soil

$$w_{whole} = w_{lab} \times (1 - O_s), \quad 7.23$$

$$w_{Lwhole} = w_{Llab} \times (1 - O_s), \quad 7.24$$

$$w_{Pwhole} = w_{Plab} \times (1 - O_s). \quad 7.25$$

It must be made clear that the values derived for the whole soil are calculated from a 'correction' adjustment to the standard laboratory test results.

ASTM Standard D4718-87 (2007) gives a similar form of equation to adjust water contents from compaction tests. Based on tests on soil-rock mixtures where the oversize particles were defined as retained on the US No. 4 sieve (4.75 mm) this Standard recommends that the adjustment equation should not be used if the percentage of oversize particles is greater than 40% and for compaction tests with particles greater than $\frac{3}{4}$ inch (19 mm) removed the maximum proportion should be reduced to 30%. ASTM Standard D1557-12 (2012) requires the application of the oversize correction if the proportion of oversize particles exceeds 5% of the whole soil but this proportion must not exceed 25%.

7.10 Aggregation ratio

Considering that toughness is provided by the clay matrix, if some of this matrix has formed into aggregates then the aggregated peds in the matrix may have no more influence on the matrix than the silt/sand particles in providing toughness. The toughness of the soil is then predominantly derived from the remaining continuous matrix surrounding the aggregates or peds and the silt/sand particles. It is assumed that the clay matrix can be separated into a volume of continuous

matrix and a volume of aggregated matrix with each having different water contents according to their soil structure.

This idealised arrangement of a partly continuous and partly aggregated matrix is illustrated in Figure 7.8. By applying the soil model as shown in the RHS of Figure 7.8 a parameter can be derived to distinguish the proportion of the aggregated matrix volume, referred to herein as the aggregation ratio a_r given by

$$a_r = \frac{\text{Volume of aggregated matrix}}{\text{Volume of aggregated matrix} + \text{Volume of continuous matrix}} . \quad 7.26$$

The derivation of this parameter is given in Appendix 5 in terms of the three water contents, that of the continuous matrix w_c , the aggregated matrix w_a and the overall matrix w_m .

$$a_r = \frac{(w_c - w_m) \left(1 + w_a \frac{\rho_c}{\rho_w} \right)}{(w_c - w_a) \left(1 + w_m \frac{\rho_c}{\rho_w} \right)} . \quad 7.27$$

The water content of the continuous matrix w_c has also been derived in Appendix 5 as

$$w_c = \frac{w_m - a_r w_a + (1 - a_r) w_a w_m \frac{\rho_c}{\rho_w}}{1 - a_r - \frac{\rho_c}{\rho_w} (a_r w_m - w_a)} . \quad 7.28$$

It is assumed that the water content of the aggregated matrix w_a is less than that of the continuous matrix w_c . The water contents in equations 7.27 and 7.28 are represented as ratios.

7.11 Postulated effect of aggregation

It is considered that the stiffness transition plays a significant part in the formation of aggregates. At water contents above the stiffness transition it is postulated that aggregates grow at a slow rate with low values of a_r , and the relatively slow rate of toughness increase is due solely to the reduced water content of the continuous matrix. At water contents below the stiffness transition aggregates form at a faster rate with the greater number of aggregates (and the silt/sand particles) and smaller amount of continuous matrix producing a soil that is more prone to cracking and

eventual brittleness. This has been observed as a phenomenon during the tests conducted:

- 1) in the hand rolling investigations, described in Chapter 6 and illustrated in Figures 6.2 and 6.3 and 6.5 and 6.6. Cracks were observed in the threads rolled by hand at water contents below the stiffness transition and just above, even for a fairly 'high plasticity' London Clay sample.
- 2) using the Barnes apparatus. During the preparation of a soil thread before insertion into the thread maker for compaction fine cracks were observed on the surface of the thread at water contents below the stiffness transition, particularly for soils with low clay contents.

At water contents below the stiffness transition it is postulated that the higher rate of increase in toughness is due to

- 1) the decreasing water content of the continuous matrix, but because the volume of the continuous matrix decreases towards the plastic limit and
- 2) the development of clay 'bridges' in the continuous matrix between the aggregated peds and the silt/sand particles as suggested in Figure 7.9. The aggregates or peds will have grown in size so the clay bridges only require shorter spans. The water content in the clay bridges can also be expected to decrease, contributing to the reduced water content of the continuous matrix.

As the plastic limit is approached it is also postulated that some dislocation will occur between the bridges and their connecting peds and silt/sand particles with the bridges eventually forming aggregates accompanied by an increase in the number of larger pore sizes.

For mixtures of a natural clay and sand Tanake *et al* (2003) showed that with increasing sand content the void ratio decreases, as would be expected because sand particles are replacing clay-water matrix, but also the larger pores (the pore size distribution was bimodal) increase in size. It was suggested that this may be due to the sand particles being kept apart by bridges of clay rather than a continuous matrix since the clay content is smaller. This feature will also affect the rate of aggregation of the clay particles, the reduced resistance to dislocation at the

boundaries of the aggregates and silt/sand particles and the reduced resistance to fracture propagation and hence the significant effect on the plastic limit, phenomena that will enhance the effects of particle interference.

It has been noticed that on the plots of toughness vs. water content in the Barnes test the upper line, with water contents below the stiffness transition, extrapolates to a water content at zero toughness where the soil had just become suitable for the test, i.e. it was not too sticky and would roll and extrude without significant adhesion to the plates of the apparatus. An example of such a plot is illustrated in Figure 7.10 for the London Clay:Silt 60:40 material where the toughness values have been plotted vs. the matrix water content on the basis of a clay content of 39.2%. Extrapolation from the upper limb in this figure meets the x axis at a matrix water content of about 78.6%, very close to the water content when the soil was found to be sufficiently non-sticky to permit a successful test.

It would be reasonable to assume that at water contents above the toughness limit the matrix of a clay soil comprises entirely continuous matrix with no aggregated matrix formed. From above, the sticky condition is considered to be more appropriate than the toughness limit as it provides a water content when the soil is beginning to display reduced effects of the surface tension that causes adhesion to surfaces. At this water content, denoted w_{m0} on Figure 7.10, it is considered that the aggregation ratio is zero and the formation of aggregates in the matrix commences from this water content.

In Equations 7.27 and 7.28 there are three unknown variables, w_a , w_c and a_r . To illustrate potential relationships between these values some assumptions must be made. If it is assumed that at the plastic limit there is no continuous matrix, it is all aggregated matrix then at this point the aggregation ratio $a_r = 1$ and the matrix water content equals the matrix plastic limit, w_{mP} . Thus between the matrix water contents w_{m0} and w_{mP} the aggregation ratio increases from 0 to 1, as shown in Figure 7.11. It also seems reasonable to assume that once an aggregate forms its water content is at the matrix plastic limit and remains at this water content during the Barnes test as the soil becomes drier, until the plastic limit is reached when all of the matrix is assumed to be aggregated.

Potential relationships between the three variables, w_a , w_c and a_r , are illustrated in Figure 7.11 for the sample of London Clay:Silt 60:40. The upper part of this figure shows the variation of the continuous matrix water content and the lower half shows the aggregation ratio in relation to the water content at the stiffness transition, w_{ms} .

At water contents above the stiffness transition it is considered that little aggregate formation will occur so it has been assumed that the aggregation ratio increases from zero at w_{m0} to a nominal value of 0.1 at w_{ms} denoted by the green lines in Figure 7.11. In this region the continuous matrix water content, w_c , will decrease, and this will be the main cause of the increase in toughness. Below the stiffness transition the aggregation ratio must then increase at a faster rate towards the plastic limit where it is assumed that the entire matrix is aggregated and the water content is the aggregated water content, $w_a = w_{mP}$.

There is a range of values within which the aggregation ratio can increase as denoted by the blue and orange lines in Figure 7.11. The orange lines represent a constant continuous matrix water content, a situation that seems unlikely given the changes in soil structure described above. This would be accompanied by a uniform increase in the aggregation ratio, as shown in the lower half of Figure 7.11.

If clay bridges are formed these are likely to have water contents between w_a and w_c but they are included in the continuous matrix in the analyses conducted so that the water content of the continuous matrix is most likely to decrease and not remain constant. The blue lines in Figure 7.11 represent a decreasing continuous matrix water content, towards the value of w_{mP} . For this to occur the aggregation ratio must increase rapidly at water contents close to the plastic limit, see the lower part of Figure 7.11. This seems a reasonable scenario as it is found in practice that at water contents close to the plastic limit a soil thread is more sensitive to the cycling of compressive and tensile stresses because of the increasing instability and tendency to crack and eventually crumble which would be due to the rapid increase in the degree of aggregation.

7.12 The effect of large granular particles in a small diameter thread

For an idealised investigation of the effect of large diameter particles in a small diameter thread it is assumed that as the diameter of a soil thread decreases during the Barnes test, and the length increases at an even greater rate, granular particles will move closer together on the diametral cross section of the thread and move further apart on the long axis.

A means of visualising this is to consider a lattice framework such as a climbing plant support with the large particles at the junctions of the strips of wood. When the lattice is open and the wood strips form squares the particles will be near to equidistant. As the lattice is closed the junctions, or particles, will move closer together on one axis and further apart on the other. This means that the soil

becomes less homogeneous which could only be achieved providing the clay matrix can maintain a continuous thread. To assess how this movement could affect the state of the soil in a thread an investigation of a typical triangular arrangement of large granular particles within a matrix of the remaining smaller particles has been carried out. This is described in detail in Appendix 6.

Any large granular particles present in the soil at the start of the Barnes test are assumed to be arranged in a uniform manner within a matrix with the same average centre to centre spacing in all directions. A near triangular grouping of large granular particles in a matrix of smaller particles can be arranged in the circular cross section of the soil thread by splitting it into concentric cylinders each with a width d_c , the distance centre to centre between the granular particles on the diameter of the circle, as shown for a slice of the thread in Figure 7.12a. The granular particles can then be arranged in a circle in the middle of each cylinder by placing them equidistant d_c apart, as shown in Figure 7.12a. The diameter of the central core of the thread is d_c containing one granular particle per slice of thread.

To determine the number of particles in each cylinder, it is assumed that the particles lie at the corners of triangles defined by sides with multiples of the particle spacing d_c , as shown in Figure 7.12a. For cylinders numbered 1 to n the particles are evenly spaced at angles α_n around the centre of each cylinder and this will give the number of particles N_p in each cylinder. As there cannot be a 'part' particle in a cylinder the actual number of particles is truncated to a whole number in the calculations to obtain the number of complete particles. For example, the angle α_3 in Figure 7.12a is given by

$$\alpha_3 = 2\sin^{-1}\left(\frac{d_c}{2} \frac{1}{3d_c}\right), \quad \text{or generally,} \quad \alpha_n = 2\sin^{-1}\left(\frac{d_c}{2} \frac{1}{nd_c}\right) = \sin^{-1}\left(\frac{1}{2n}\right). \quad 7.29$$

Figure 7.12b shows 'slices' along the length of the thread containing 'columns' of granular particles. There will be a number of these slices spaced evenly along the length of the thread with an initial slice width b_0 . To provide a near triangular arrangement of the granular particles along the length of the thread if each slice is rotated slightly relative to its neighbours the particles will have the arrangement shown in Figure 7.12c with the particles d_{cR} apart on each cross section and d_{cL} apart along the length of the thread. Values of d_{cR} enable the granular spacing ratio to be determined across the cross section of the thread and values of d_{cL} enable the granular spacing ratio to be determined along the length of the thread.

Initially, the soil thread is prepared in the thread maker by static compaction at the diameter of about 8 mm so the particle spacing is assumed to be the same in all directions with the initial values of the spacings d_{cR0} and d_{cL0} being the same. To obtain a value of d_{cR0} a unit volume of a 'cell' is considered around one granular particle in a cylinder as shown in Figure 7.12d and the granular void ratio e_g is determined for this cell.

The granular void ratio of the prepared soil is calculated from the soil properties and the soil model formula in Equation 7.13. However, Equation 7.13 was produced for a matrix of clay particles and water where C represents the clay content. For a granular particle of any size but of proportion B (as a ratio, not %) in the soil, say a medium sand content of 30% then B for this medium sand would be 0.3, and Equation 7.13 must be modified such that C becomes $1-B$ (for all particles smaller than medium sand) and ρ_B is the particle density of the large granular particles (medium sand) and ρ_{1-B} is the particle density of the remaining matrix surrounding the large granular particles. As the Barnes test is conducted with the soil behaving in an assumed undrained manner the soil retains a constant granular void ratio because B and the total water content by mass, w remain the same.

d_g is the mean size of the large granular particles under consideration, such as the medium sand in the example given above. N_p is determined as the number of large granular particles in the n^{th} cylinder. The number of cylinders N_c is determined from the diameter of the soil thread D_T which would initially be the nominal value of 8 mm, taken from the diameter of the thread maker.

From the equations produced and detailed in Appendix 6 the number of particles is calculated and tabulated in an Excel spreadsheet for N_c cylinders and d_{cR0} is calculated for each cylinder both as around the cylinder and as the width of each cylinder. Only slight differences in d_{cR} were determined around each cylinder and between the cylinders so the average value was determined and taken as the average particle spacing in the cross section of the thread.

The number of cylinders remains constant during a test but for a change in diameter of δD_T the width of the cylinder decreases and the spacing between the particles on the cross section of the thread decreases. As the width of each cylinder reduces the width of the slice b increases from b_0 to b_1 , see Figures 7.12b, from which d_{cL} is determined.

It is now possible to consider changes in the spacing of the large granular particles

on the diametral and longitudinal axes as the diameter of the soil thread decreases during the Barnes test. It is assumed that each cylinder reduces in width by the same amount, and each cylinder increases in length by the same amount as the diameter decreases, as shown in Figure 7.12b.

From an initial thread diameter D_T and following each strain increment δD_T , the width of each cylinder and particle spacing around each cylinder is determined giving the values of d_{cR} and d_{cL} which decrease and increase, respectively, as the thread diameter reduces. Finally the spacing between the surfaces of the granular particles d_s is determined from equation 7.18 giving the granular spacing ratio, s_g values of s_{gR} on the cross section and s_{gL} on the long axis of the soil thread.

In Chapter 9 the effect on the test results of the sand particles, fine sand and fine/medium sand, acting as large granular particles is investigated as the diameter of the soil thread reduces during the Barnes test. In particular, this effect is significant in the soil thread below the diameter of about 4 mm.

7.13 Summary

For non-absorbent, non-plastic particles such as silt and sand in a clay soil the linear law of mixtures can be considered to apply providing there is sufficient matrix, clay and water, to prevent the silt/sand particles from interacting. Published data show that the law holds for the liquid limit test with clay contents above about 30 – 40% by mass although this can be less if there is a large proportion of the clay mineral montmorillonite present. However, the published data for the plastic limit show that the law holds only when the clay content is greater than about 50 – 60% because of the reduced proportion of clay matrix due to the lower water contents. At and near the plastic limit the interference effect of the silt/sand particles probably increases because of the more energetic stress applications with this test.

Tests conducted on mixtures of London Clay and Silt show that with clay contents greater than about 65% the plastic limit would lie on the linear law line. Because the clay matrix dominates the soil properties it is envisaged that at these clay contents the soil will have a constant toughness. With lower clay contents granular particle effects occur, initially with turbulence within the matrix followed by increasing particle interference. To counter these effects the water content of the matrix increases with decreasing clay content, even to above the matrix liquid limit for the lowest clay content tested.

Skempton's colloidal activity, A , should only be determined for clay soils that lie on the linear law of mixtures when the clay contents are above about 50%. At these clay contents the clay and water matrix dominates and the activity A is the plasticity index of the clay minerals or colloids. For clay soils with lower clay contents the activity of the clay colloids determined direct from Skempton's equation decreases with decreasing colloidal clay content.

Parameters to represent the relationship between the proportions of the matrix and the granular particles such as granular void ratio and cohesive porosity are useful but it is considered that granular spacing ratio, which represents the average closest distance between uniform sized granular particles, is to be preferred as it is more descriptive and represents the combined effect of the clay content and the water content.

The variation of toughness with water content is found to be different each side of the stiffness transition. It is postulated that with water contents above the stiffness transition the clay matrix exists in a more continuous form with strands and interweaving bunches of mostly face to face clay particles. With water contents below the stiffness transition there is a transformation into an aggregated matrix with the degree of aggregation rapidly increasing as the water content reduces towards the plastic limit. This is observed in the Barnes test and in sample preparation for this test.

The aggregation ratio is introduced to represent the degree of aggregation with a value of zero when the water content is above the sticky condition and the clay particles exist entirely as a continuous matrix. As the water content decreases towards the plastic limit the aggregation ratio increases rapidly, particularly close to the plastic limit and at the plastic limit the clay particles are assumed to be in a completely aggregated form.

For many tests conducted with the Barnes apparatus it has been found that for soils containing large granular particles the nominal stress vs. diameter curves rise disproportionately as the soil thread reduces in diameter below about 4 mm. An analysis is described that attempts to illustrate the decreasing spacing between the large granular particles across the diameter of the thread since it is suspected that this is a significant cause of the change in the stress vs. diameter behaviour when the soil thread reduces below about 4 mm. It is also shown that there can be an increase in granular spacing ratio along the length of the thread which may affect the tenacity of the thread. These factors are discussed in relation to the tests conducted on clay:sand mixtures in Chapter 9.

7.14 Figures

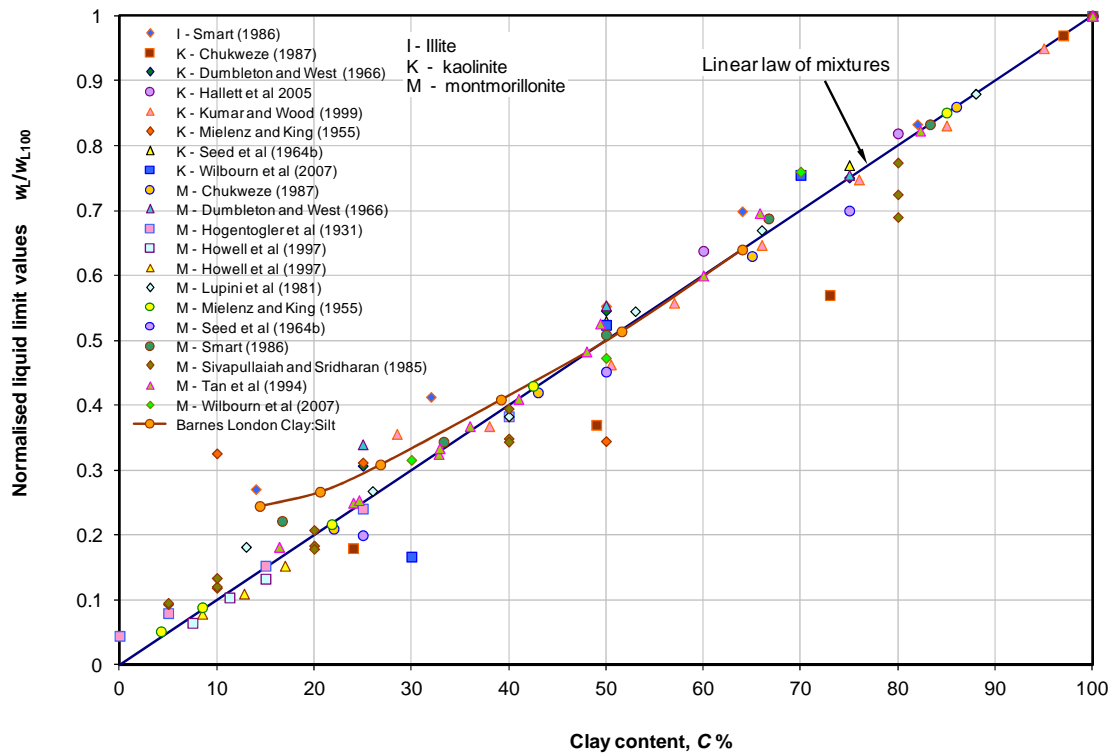

Figure 7.1 Normalised values of the liquid limit - published data

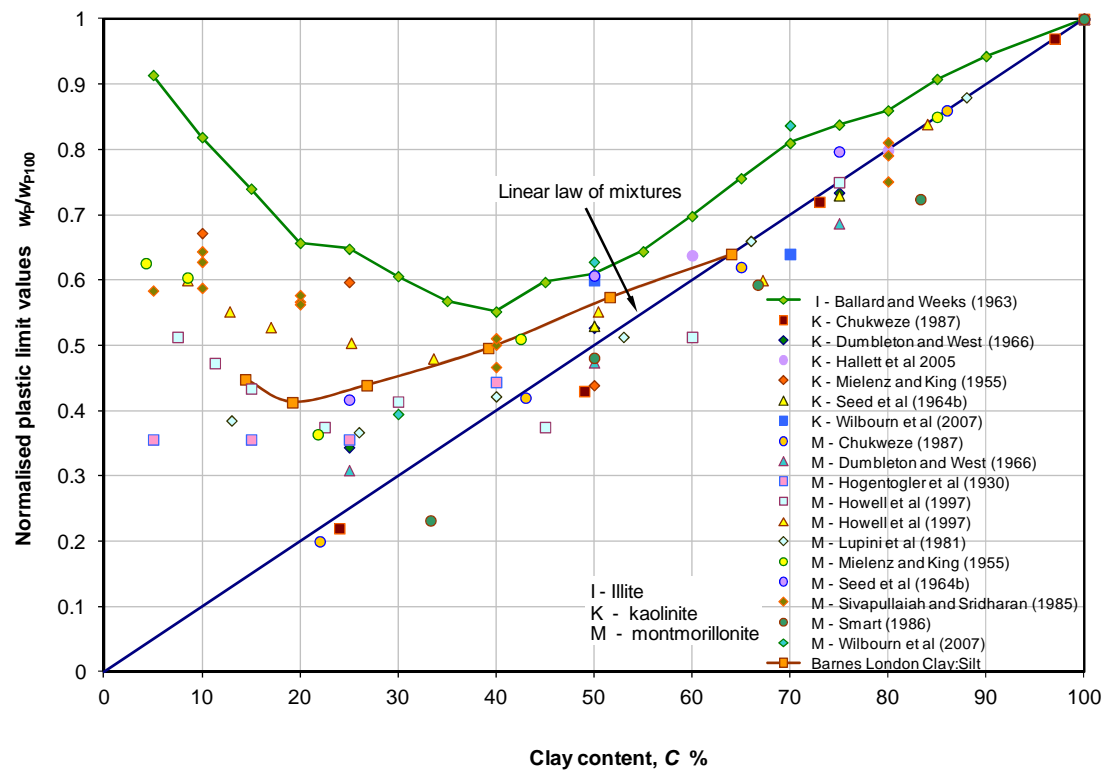

Figure 7.2 Normalised values of the plastic limit - published data

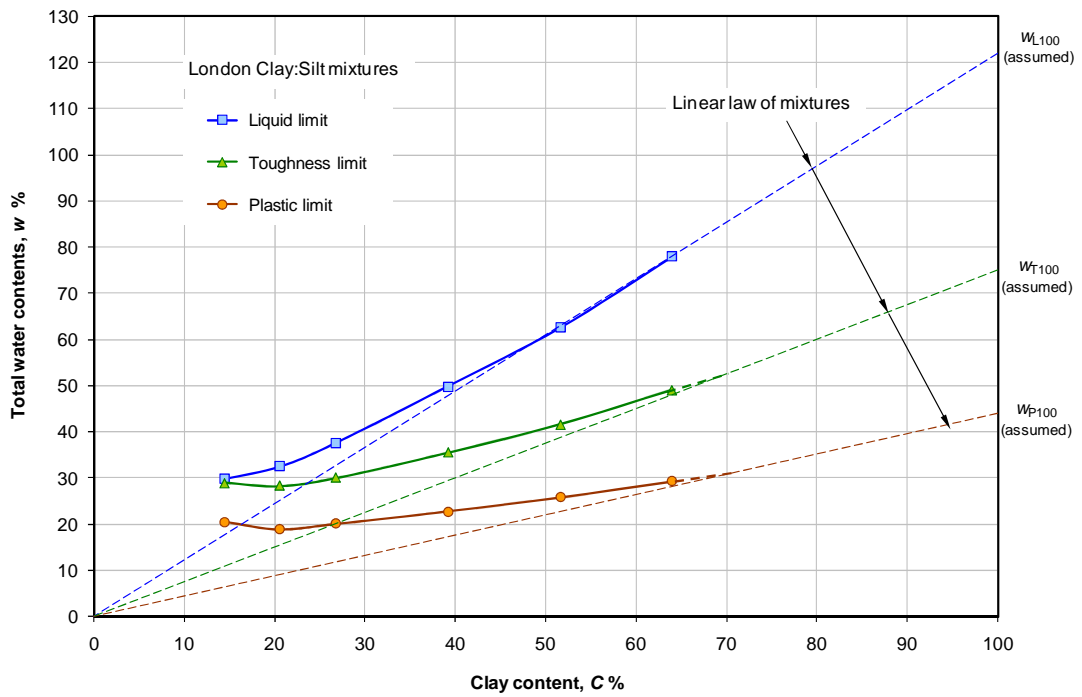

Figure 7.3 Deviation from the linear law of mixtures – total water content

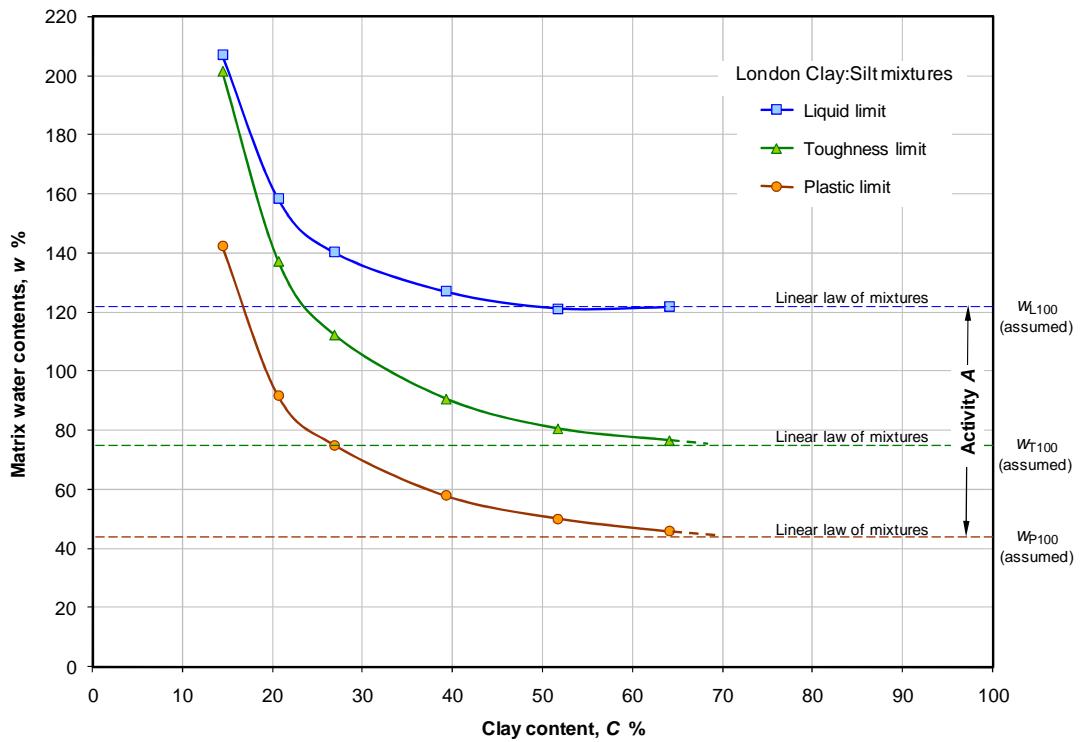

Figure 7.4 Deviation from the linear law of mixtures – matrix water content

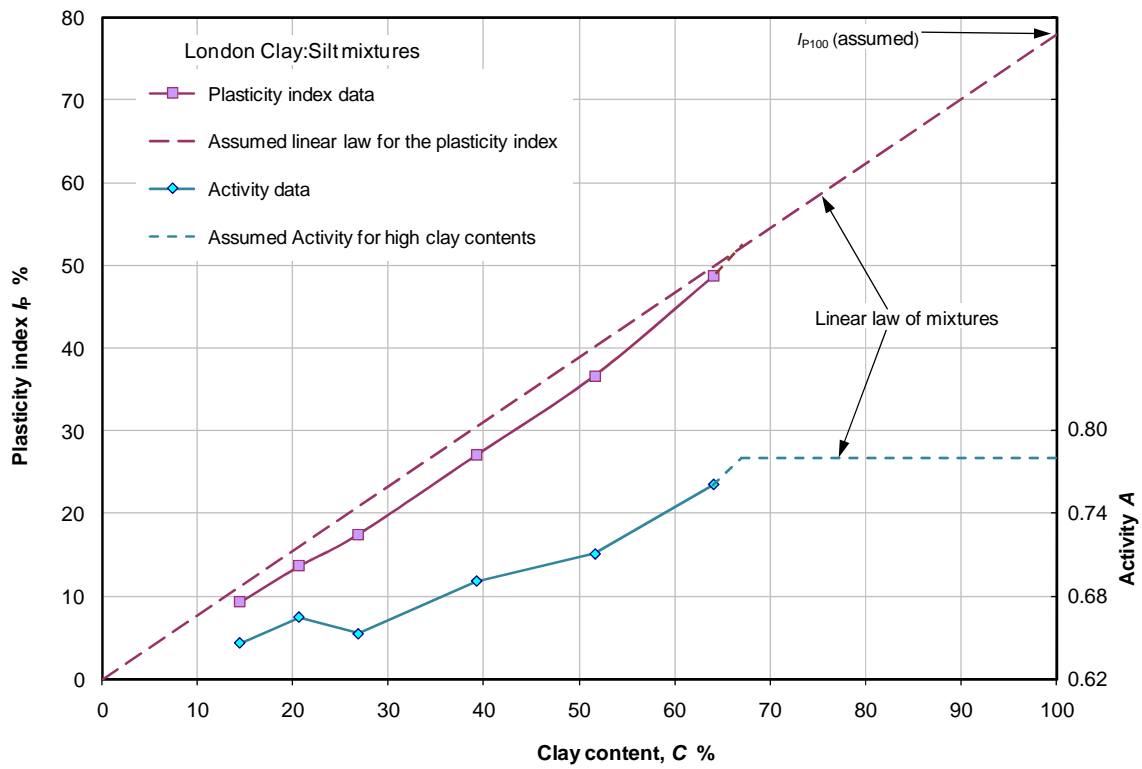

Figure 7.5 Activity A varying with clay content

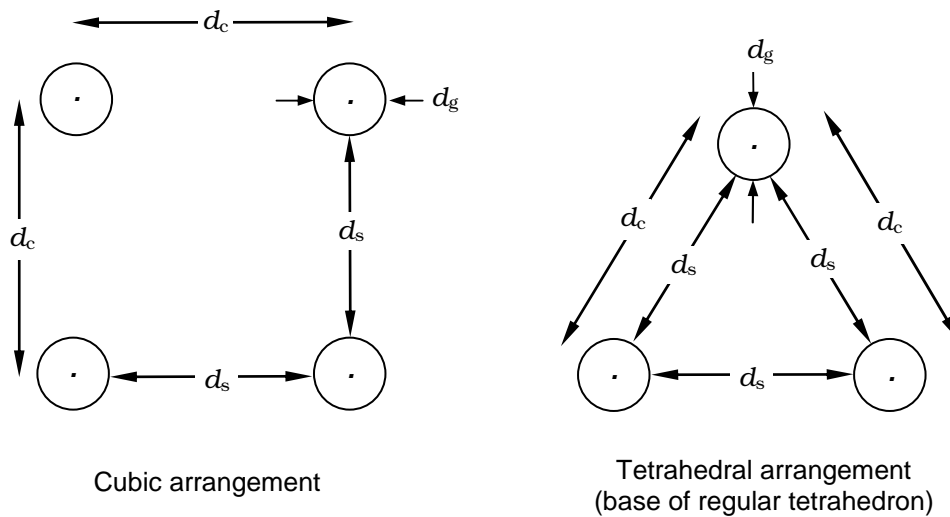

Figure 7.6 Arrangement of particles for the granular spacing ratio

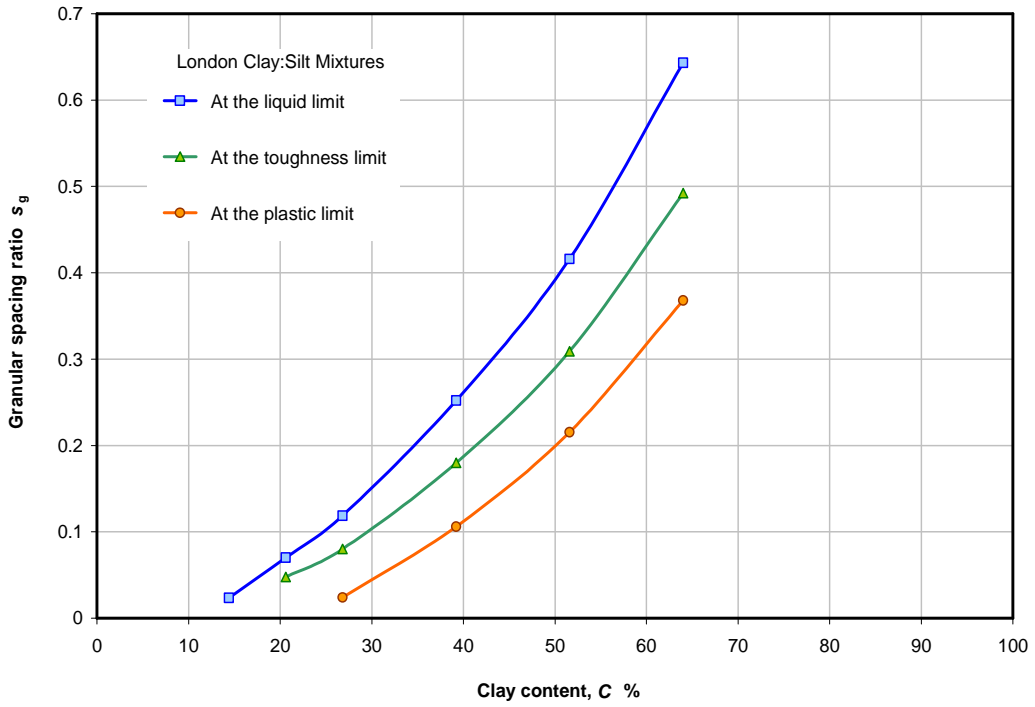

Figure 7.7 Granular spacing ratios at the various limits

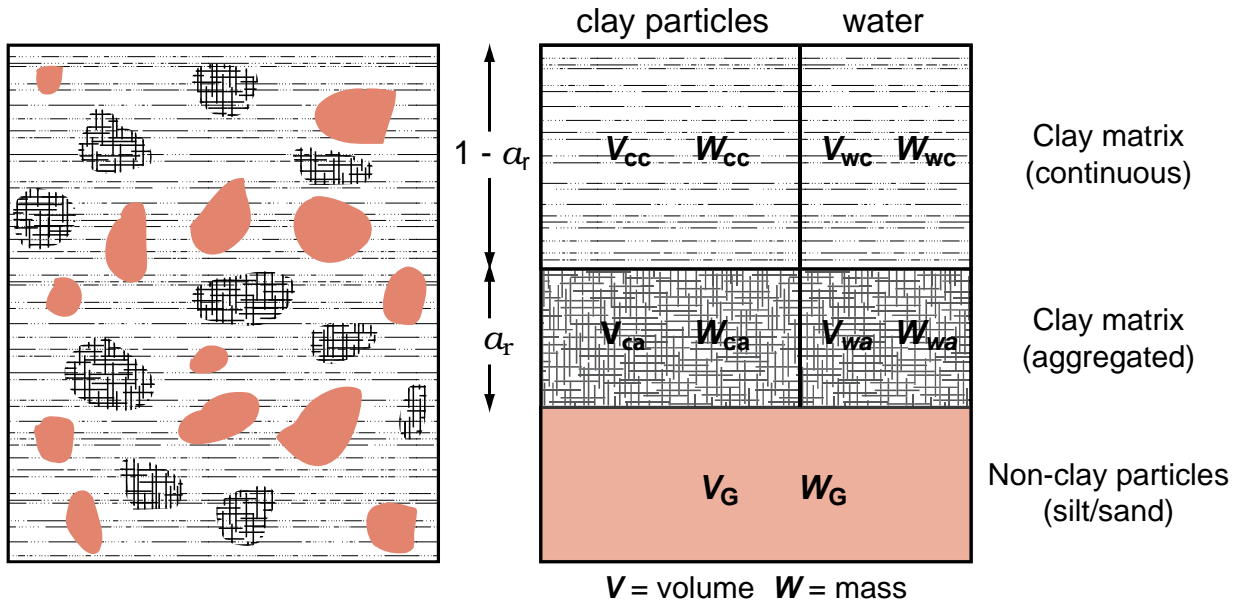

Figure 7.8 Soil model representation for the aggregation ratio

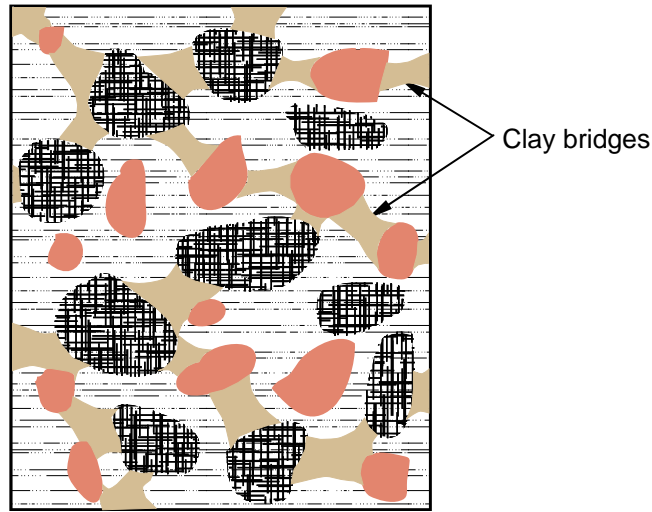

Figure 7.9 Postulated clay 'bridges' formed in the continuous matrix

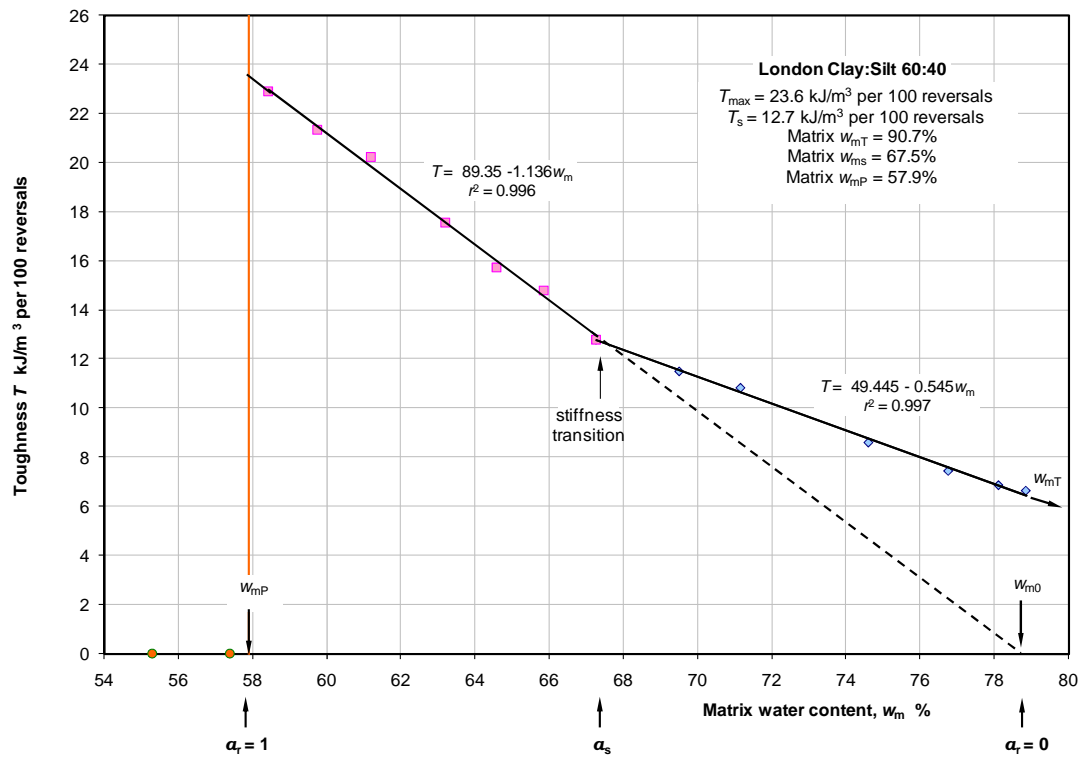

Figure 7.10 Example of extrapolation from the stiffness transition

This figure reappears as Figure A2.6 with toughness plotted vs. total water content

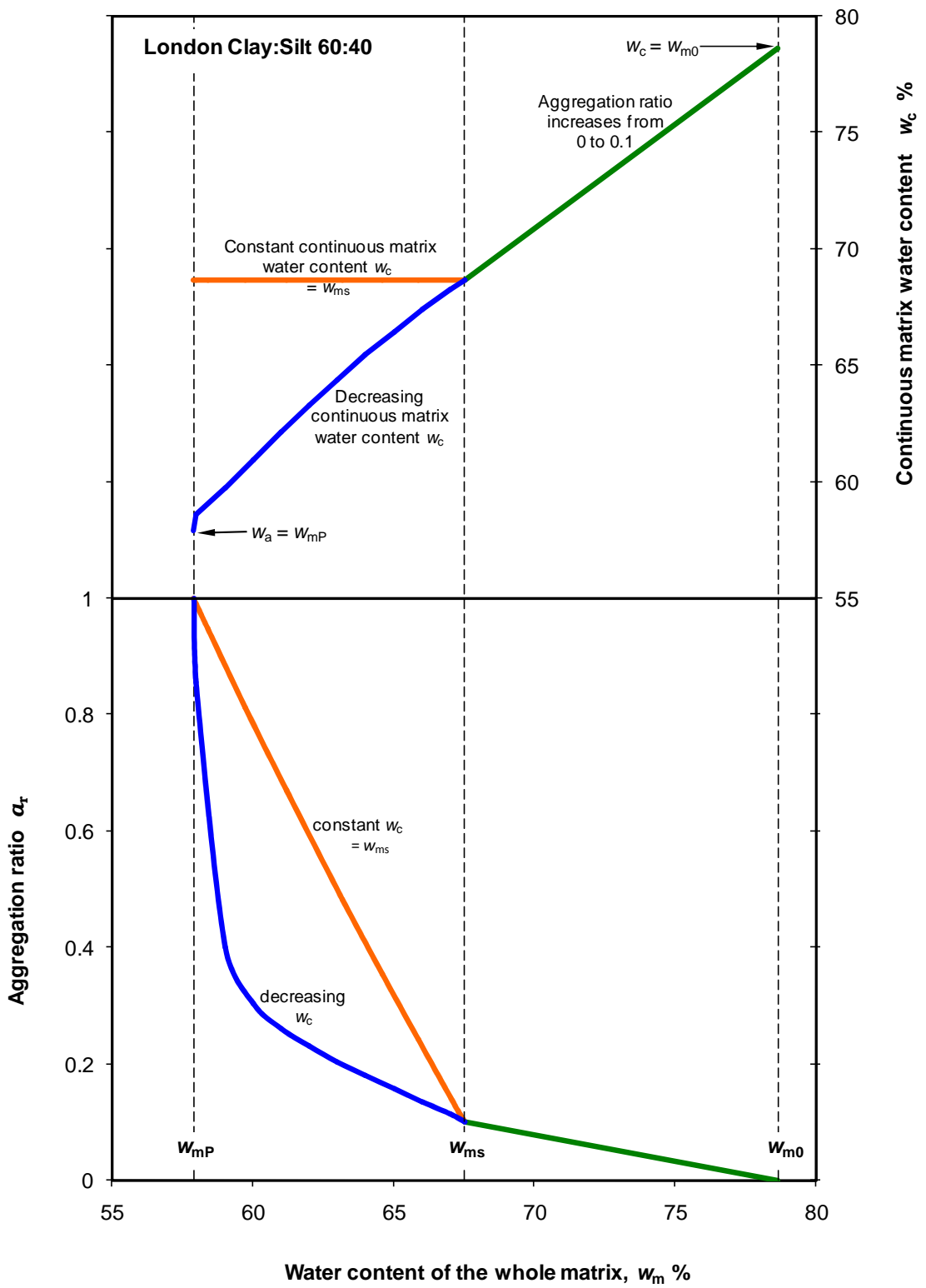

Figure 7.11 Variation of the aggregation ratio and the matrix water contents

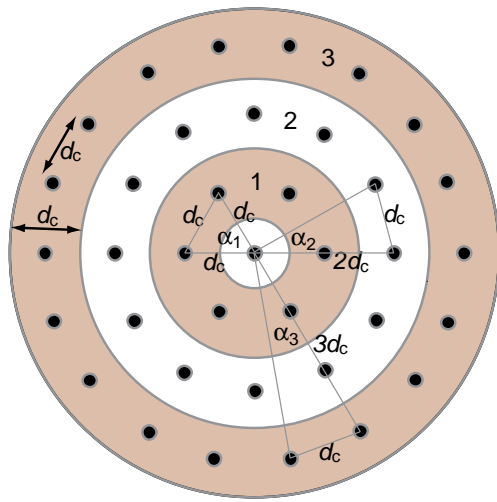

Figure 7.12a Cross section of thread through one slice

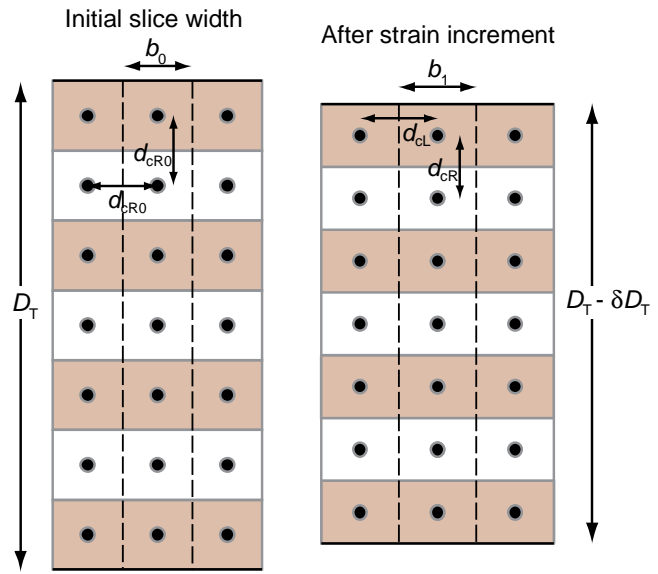

Figure 7.12b Longitudinal portion of thread for three slices

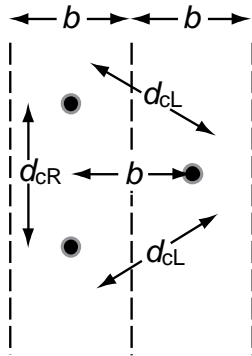

Figure 7.12c Spacing between slices

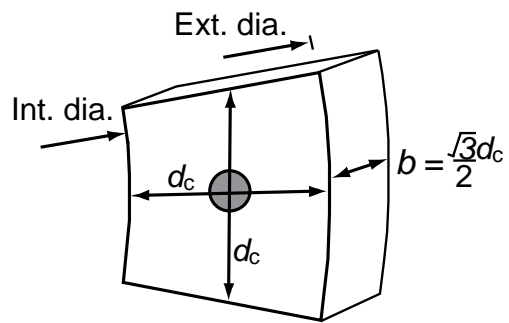

Figure 7.12d Unit cell

Figure 7.12 Effect of large granular particles in a small diameter thread

CHAPTER 8

Tests on the Clay:Silt mixtures

8.1 Introduction

The Barnes test described in Chapters 4 and 5 has been conducted on a series of mixtures of a London Clay and silt of known proportions by mass in order to investigate the effects of clay content and silt content on the toughness- water content relationships. The nature of the microscopic structure of some of the specimens tested has been investigated with the aid of an environmental scanning electron microscope.

8.2 Preparation of mixtures

A large sample of London Clay obtained from a piling scheme on the Isle of Grain, Kent was air-dried and pulverized to pass the 425 μm sieve. The sand content ($>63 \mu\text{m}$) was found to be minimal ($<2\%$) so the soil was not processed through the 63 μm sieve.

The silt particles were obtained from a lens within a glacial clay outcrop on the cliffs at Thurstaston, Wirral. This soil is referred to herein as Thurstaston Silt. It appeared to be a local zone within the clay and had a clean, light appearance with a small clay fraction. The Thurstaston Silt was washed in clean water several times, sieved through the 63 μm sieve to remove sand particles, sedimented to remove the clay fraction and then oven-dried. Electron microscope images of the London Clay and the Thurstaston Silt are discussed in section 8.9.

The London Clay and the Thurstaston Silt were mixed in known proportions to produce six mixtures with a range of clay contents. From sedimentation tests on the London Clay and the Thurstaston Silt the particle size distributions of the combined mixtures were calculated and plotted on Figure 8.1. Electron microscope images of two of these mixtures are discussed in section 8.9.

The mixtures were wetted to above the liquid limit with distilled water, mixed thoroughly and cured for at least 24 hours before testing. Following the liquid limit test the soil was dried by gentle blow drying, air drying and remoulding in the hands to a point where the soil was no longer sticky and could be rolled satisfactorily in the Barnes apparatus without sticking to or smearing the plates

8.3 Typical toughness-water content relationships

The nominal stress vs. diameter curves and the toughness vs. water content plots for all six mixtures are included in Appendix 2. The nominal stress vs. diameter curves and the plot of toughness vs. water content for the sample with the highest clay content ($C = 64\%$), i.e. the London Clay alone, are presented in Figures 8.2 and 8.3, respectively. For the latter, good linear relationships with high correlation coefficients were obtained for the upper and lower limbs each side of the stiffness transition and the sharp ductile-brittle transition was identified at the plastic limit. Similar shaped plots were obtained for the other mixtures with lower clay contents.

A good linear relationship of toughness vs. water content is usually obtained in the lower limb, in the soft-plastic region with water contents above the stiffness transition. The soil in this region is soft enough to extrude well from the apparatus with relatively straightforward load control and more uniform plastic straining beyond the yield stress, when the thread diameter is less than 6 mm. The lower, more uniform nominal stress vs. diameter curves in Figure 8.2 are for the water contents above the stiffness transition where the soft-plastic matrix permits easy rolling and extrusion of the soil threads.

It can be seen from the numbering in Figure 8.3 that when tests 2, 3, 4 and 5 had been conducted it was decided from test 5 that the soil had been dried too quickly and there would be insufficient points in the lower limb. Test 1 was abandoned because it was too soft. Tests 6 to 12 were then conducted on a moister portion of the batch of soil prepared to obtain more points. This situation is easily detected from the loads applied during each test. In the lower limb it is expected that the loads should not increase significantly from test to test as the soil becomes drier because the toughness increases relatively slowly. The loads applied in test 5 showed that there would be insufficient points as test 5 was thought to lie on the upper limb. In the event, test 5 plotted some distance from the trend of the points in the lower limb and was deemed to be a rogue value. Because good correlations are expected in this region points that lie some distance from the correlation and can be deemed to be outliers or rogue values should be checked against the nominal stress vs. diameter curves of the other points for similar behaviour and any comments that were reported on the laboratory worksheet. In this case, for test 5, the water content data appeared to be correct, there was no relevant comment on the lab worksheet and a good nominal stress vs. diameter curve was obtained, concluding that the only reason to eliminate this point was its distance from the other points. From all of the tests conducted with the apparatus this situation has been found to occur very infrequently.

More scatter is usually found on the upper limb of the toughness plot, in the stiff-plastic region with water contents below the stiffness transition. This appears to be largely due to less uniform nominal stress vs. diameter curves that are probably produced by a variable rate of aggregation and microcrack development, as described in Chapter 7, and a progressive failure mechanism within the soil thread with strain-softening and strain-hardening sequences in the plastic strain region occurring during the rolling process. This can be seen on the higher curves in Figure 8.2. Tests 19 and 20, see Figure 8.2, were clearly in the brittle region with a near linear nominal stress vs. diameter plot, no extrusion from the apparatus and ultimate failure in a brittle compression mode, with squashing across the diameter which prevented further rolling. This stage is usually detected by 'rattling' (up and down movement) of the loading bar due to the developing non-circular, or more elliptical, cross section of the thread where it reduces in diameter more on one plane than the other.

As a further check on the final state of the thread it is recommended that before its wet weight is determined the thread is split in the middle and quickly examined for signs of fracture, if necessary using a magnifying glass. In the case of Tests 19 and 20, a clear 'opening' was observed in the middle of the thread cross section, probably caused by fracturing followed by opening of the fractures in the centre of the cross section during the compression/tension cycling. A good example of this state was found for a thread of shaley clay/kaolinite clay mixture, see Figure 10.12.

For comparison the nominal stress vs. diameter curves and the toughness vs. water content plots for tests conducted on a soil with a high silt content, London Clay:Silt 30:70 ($C = 19.2\%$) are presented in Figures 8.4 and 8.5, respectively. This soil displayed much lower toughness owing to its lower clay content, compared with the London Clay:Silt 100:0, in Figure 8.3, and a much smaller range of water contents over which the clay was workable, with a smaller toughness index, I_T .

Below the stiffness transition the rate at which toughness increased with decreasing water content, as measured by the toughness coefficient, T_C , was significantly lower for the high silt content sample with $T_C = 1.614$ for the London Clay:Silt 30:70 mixture than for the high clay content sample with $T_C = 4.213$ for the London Clay:Silt 100:0 mixture because of the reduced amount of matrix⁵⁶, which provides toughness in the soil threads. The nominal stress vs. diameter curves for the high silt content sample, see Figure 8.4, show a marked difference from the uniform curves in Figure 8.2, with continual strain-hardening displayed.

⁵⁶ Also more bridges of clay particles between the aggregates and the silt particles within the matrix can be expected in the higher clay content soils.

8.4 The effect of high clay content on the test procedure

In tests numbered 4 – 6 and 8 – 10 on the London Clay:Silt 100:0 sample, see Figure 8.3, the thread separated transversely a short distance, about 3 – 4 mm, from the middle 10 mm of the apparatus, on one side, with a fairly clean, smooth break perpendicular to the longitudinal axis when the thread was close to the 3 mm diameter. There was no cracking, crumbling or longitudinal splitting of the thread. A typical sketch of this feature is presented in Figure 8.6.

The transverse separation is considered to be caused by a combination of tension, torsion and bending. It will be aggravated by wiggling of the soil thread that occasionally occurs at this stage when the thread has low longitudinal stiffness due to its small diameter. As the diameter of the thread varies along its length coaxial rotation is probably achieved by some slippage on the greased surfaces and normally the threads roll in a straight line. At small diameters the soil thread occasionally does not roll in a straight line with the outer parts lagging behind, causing some tension, torsion and bending in the thread outside the middle 10 mm.

The transverse separation does not represent the crumbling condition of the thread. From section 7.11 it is postulated that if large granular particles are present in the thread and move further apart along the length of the thread during extrusion leaving 'discs' of the clay matrix between the granular particles then the stresses, particularly the torsion stresses, through these discs could promote the transverse separation observed.

During tests 14, 16 and 18 again the thread separated transversely, as described above, when close to the 3 mm diameter. Because the soil threads in these tests were undergoing strain-softening sequences the load had to be reduced to accommodate, but it was felt that a contribution to the transverse separation was that the loads were not reduced quickly enough. Nevertheless, these tests were included in the toughness vs. water content plot because they showed ductility to below the diameter of 4 mm. Transverse separation of a thread as it reaches the diameter of 3 mm is considered to be of no significance (Atterberg, 1911) and this approach has been followed in the ASTM and British Standards.

Two tests conducted on stiffer specimens of the London Clay:Silt 100:0 were abandoned because the threads preferred to slide across the plates of the apparatus rather than rolling during the traverse. This was considered to be caused by the smooth surface of the thread resulting from the high clay content and the possibility of too much grease on the plates even though only a very thin smear of

grease was applied. These tests were conducted in a fairly hot weather period when the grease was noted to be less viscous. On reducing the amount of grease to a minimum and ensuring that the middle 10 mm strips of the plates of the apparatus were entirely free of grease the threads rolled well.

It has been found that with high clay content and more active clay minerals with water contents below the stiffness transition, when extruding in the fully plastic region, if the load is kept too high and the strain increments allowed to be too large the risk of premature failure increases. This type of failure must not be mistaken for the brittle condition as there is no indication of fracturing. It is considered to be a compression shear failure across the diameter as a result of overloading and occurs when the thread is at its most vulnerable, smaller diameters. Progressive failure is considered to be precipitated by stress transfer from overloaded portions of the soil thread to less loaded areas and is more likely to occur with the more active clay minerals such as those in the London Clay, e.g. montmorillonite.

It is considered that the large strains in the soil thread can reduce the strength of the continuous matrix locally to the residual value with the potential for weak slip fractures or planes to develop. These planes can then ultimately combine to produce a premature slip surface across the diameter of the thread before extrusion of the thread from the apparatus is complete. This premature compression mode of failure occurs fairly quickly without much warning and rapidly prevents rolling of the thread. On splitting these threads no indication of fracturing could be detected. It is different to a brittle failure: when a brittle soil thread fails it is able to maintain a slightly elliptical shape, permitting continued rolling of the thread, with rattling of the loading bar detected over a number of strain increments.

To prevent premature compression failure greater care must be exercised with the loading increments a) for high clay content soils, b) for highly active clay minerals c) at the lower water contents and d) with the smaller diameters. This is usually achieved by applying load increments that produce smaller dial gauge reading increments, of no more than about 10 divisions, or 0.1 mm. This has been discussed in detail in section 4.10.

8.5 The effect of low clay content on the test procedure

Figure 8.4 shows the effect of a high silt content (79.4%) in causing continuous strain-hardening in the plastic straining region compared with fairly uniform constant straining in the high clay content soil, shown in Figure 8.2. This makes for an easier control of the load application because the strain-softening sequences

are not present and the load can either be kept constant or increased without concern over whether to reduce the loads or risk premature compression failure. Some of the stiffer, drier threads in the tests on the London Clay:Silt 30:70 mixture separated longitudinally in the middle 20 mm length and flattened just before the diameter of 3 mm was achieved. This is considered to be due to the easier development and elongation of microcracks in the presence of a high silt content. From the discussion in Chapter 6 these samples would be expected to have been at water contents in the semi-ductile or cracking region, as illustrated in Figure 6.11.

More care of the load control to give smaller changes in diameter when the thread is extruding between 4 and 3 mm may have enabled continued satisfactory extrusion to 3 mm. These test results were used for the toughness vs. water content plots because fully plastic extrusion had still taken place to a diameter less than 4 mm.

It may also be that this separation close to the 3 mm diameter was a result of softening in the middle section of the thread due to pore water migration towards this section as a result of dilatancy caused by the high silt content. In the outer 20 mm portions of the 50 mm long thread the plates of the apparatus are lightly greased to encourage extrusion by minimising the shear stresses acting along the longitudinal axis on the outside of the thread. However, in the middle 10 mm the plates are not greased to ensure that the thread rolls and does not slip. Thus there are shear stresses on the outside of the thread in this middle region that will increase the confinement of the soil, increase the longitudinal compressive stresses and may allow dilatancy to develop more in this region. For this reason it is important to achieve the full extrusion of a soil thread in as short a time, or number of traverses, as possible. Thus there has to be a compromise with the requirement of small strain increments to enable extrusion between the diameters of 4 and 3 mm, as described above.

For the stiffest, but still plastic, soil threads in the London Clay:Silt 30:70 tests transverse fine cracks were observed on the surface of the threads during preparation by hand for insertion into the thread maker. However, these cracks were not visible following static compaction in the thread maker. It is envisaged that only a proportion of these cracks were fully healed by the static compaction. The significance of these cracks has been discussed in Chapter 6.

For the tests on the brittle side (Tests 17 and 18 in Figure 8.4) the soil was very crumbly during preparation and the thread had to be made up by inserting separate pieces of soil into the thread maker. Nevertheless, the compaction in the thread maker produced what appeared to be a viable intact thread for the test. On

splitting these threads at the end of the test the opening/fracturing was observed in the centre of the cross section, similar to the example illustrated in Figure 10.12.

8.6 Toughness and the matrix water content

The results of the tests on all of the clay:silt mixtures are plotted in Figure 8.7 as toughness vs. total water content. This plot would suggest that the toughness increases significantly with clay content for a given total water content. However, the total water content depends on the silt content and when the toughness is plotted against the matrix water content⁵⁷, see Figure 8.8, a more uniform relationship is obtained with toughness decreasing with increasing matrix water content, as would be expected. This would suggest that it is the clay fraction and its (matrix) water content that imparts toughness to a soil, particularly for high clay content soils. However, at low clay contents although toughness values are measured by the rolling of a thread in the apparatus these values are only considered to be apparent values as they are produced by the work done in displacing the silt particles, more than straining the clay matrix.

It is considered that the two straight lines plotted in Figure 8.8 are close to the toughness vs. water content relationship for the clay matrix alone, as it is assumed in Chapter 7 that with clay contents higher than about 65% for the London Clay the linear law of mixtures applies. Between clay contents of 65 and 100% according to the linear law the silt particles have no effect on the matrix plastic limit as they simply get carried along within the matrix. Similarly the silt fraction can be deemed to have no effect on the toughness properties of the matrix. From Figure 7.4 it can be seen that above the clay content of about 65% the matrix water content at the plastic limit is tending towards a horizontal straight line and the matrix can be considered to have a unique plastic limit value of just less than about 45%. Thus, it is argued that between the clay contents of 65 and 100% the toughness of the matrix at the matrix plastic limit will be constant and would be close to the value of $T_{\max} = 45.8 \text{ kJ/m}^3$ for the sample with the clay content of 64%.

With decreasing clay contents and higher silt contents, increasing interference occurs between the silt particles requiring the matrix water content to increase to compensate for the presence of these silt particles. This then imparts less toughness to the mixture, until there is insufficient clay fraction to provide any ductility although it can be seen from Figures 8.7 and 8.8 that ductility can still be achieved even with a clay fraction as low as 14%.

⁵⁷ This is the water content of the clay fraction assuming all water to be associated with this fraction, see section 7.1.

With clay contents between about 40 and 65% it is considered that the silt particles affect the clay soil by causing perturbations in the continuous matrix as it undergoes plastic straining and this would be expected to prevent the matrix from displaying its full toughness. However, by comparing the plots on Figure 8.8 for clay contents of 64, 51.6 and 39.2% it can be seen that as the silt content increases (within the range of clay contents of 40 – 65%) the toughness measured at the same matrix water content increases a moderate amount. This is considered to be due to the additional work required to move the silt particles.

Between the clay contents of about 30 and 40% more significant interactions and interference between the silt particles commences and at clay contents below about 20 - 30% the silt particle interference is dominant. From Figure 8.8 the toughness limit of the clay matrix (extrapolated from the straight line to zero toughness) is assumed to be 75%. For the soil specimens with water contents above this matrix water content the clay matrix would be expected to be in a sticky or adhesive condition. This shows that for the clay contents between about 20 and 30% the soil would comprise a sticky clay matrix binding together a high silt content. Toughness values are recorded by the apparatus for these specimens because ductility is displayed with rolling and extrusion of the threads.

The liquid limit of the London Clay with no Thurstaston Silt added is 78%. With a clay content of 64% the liquid limit of the clay matrix of the London Clay would be at least 122%. This is plotted on Figure 8.8. From this figure it can be seen that the matrix water content for the specimen with the clay content of 14% when it is at the plastic limit is actually greater than the matrix liquid limit. At this very low clay content it is envisaged that the 'liquid' clay matrix surrounds the silt particles and provides sufficient binding to hold the soil together with enough of a lubricating effect to enable extrusion of the thread and give the impression of measurable toughness.

It is likely that with low clay contents the measured toughness is hardly a feature of remoulding the clay matrix but is considered to be due to the work required in pushing and displacing the silt particles to produce extrusion of the soil thread in the apparatus. It has to be questioned whether there is any realistic toughness associated with these low clay content soils or whether the toughness displayed is really the work done in moving the silt particles.

For mixtures of a natural clay and sand Tanake *et al* (2003) showed that with increasing sand content the void ratio decreased, as would be expected, but also

the larger pores⁵⁸ increased in size. This may be due to the sand particles being kept apart by bridges of clay rather than a continuous clay matrix since the clay content is smaller. Figure 8.8 shows that for the low clay content soils the clay matrix has a very high water content if all of the water is associated with it. With the silt particles at fairly close spacings it is postulated that the soil structure comprises the silt grains held together by clay bridges and clay coatings and that a fair proportion of the water is held in larger pores between the silt grains and the bridges.

8.7 Toughness and the granular spacing ratio

Figure 8.9 is similar to Figure 7.4 but instead of plotting matrix water content vs. clay content it is plotted vs. granular spacing ratio s_g , as described in Chapter 7. These figures show that with a granular spacing ratio greater than about 0.35 – 0.40 the silt particles have no effect on the plastic limit of the clay soil but when the granular spacing ratio lies below about 0.1 the effect is significant which, to the author, is a surprisingly low value. Also for the plastic limits with the highest silt contents on Figure 8.9 and for the toughnesses with the highest silt contents on Figure 8.10 granular spacing ratios below zero were calculated, which are impossible. These low values probably reflect the simplistic merit of the granular spacing ratio as a parameter since it is based on an idealised concept of single sized particles in a matrix arranged in a cubic or tetrahedral manner. On the contrary, with a distribution of sizes in the silt range there will be a larger total number of particles and each size will have some effect on its larger partners. The locations of the particles in a real soil will not be in the uniform arrangements assumed with the particles spaced less regularly and further apart than assumed.

Figure 8.10 shows the relationship between the toughness of the samples and granular spacing ratio. This plot suggests that toughness is quite sensitive to changes in the granular spacing ratio s_g . However, as explained above, toughness is dependent predominantly on the clay content and water content of the matrix.

The distance between the silt particles appears to have some effect, assumed to be due to the presence of shorter clay bridge spans endowing them with greater stiffness. This is considered to be reasonable by comparing the specimens at points *c* and *d* on Figure 8.8. Both have nearly the same matrix water content so should display the same magnitude of stiffness but point *c* lies in the soft-plastic region and point *d* lies in the stiff-plastic region of their respective test plots. These two

⁵⁸ The pore size distribution was bimodal with a range of large pores and a range of small pores.

points are marked on Figure 8.10 which shows that the average distance between the silt particles at point *d* is less than half that at point *c*, providing shorter, and therefore stiffer, spans for the clay bridges.

8.8 Toughness correlations

The results of the tests on all six mixtures presented in Figure 8.7 show that the plastic limit and the toughness at the plastic limit, T_{\max} decrease with decreasing clay content. For clay contents above about 15% T_{\max} increases almost linearly with clay content, as plotted in Figure 8.11, but from Figure 7.2 the relationship between plastic limit and clay content is linear only for clay contents above about 60%. Neither of these relationships passes through the origin because it would be expected that a soil with zero clay content could not display toughness nor be rolled out to give a plastic limit. Figure 8.11 suggests that with a clay content of about 10% the toughness would be negligible with the soil described as non-plastic.

Figure 8.7 displays an interesting feature; the curves have a similar shape and their locations may be linked. To check this the plots have been normalised to values of T/T_{\max} on the *y*-axis and w/w_p on the *x*-axis, see Figure 8.12. The plots coincide quite well showing that there is a close link between them. This was not entirely expected even though both the values of T_{\max} and the plastic limit should increase with clay content.

In earthworks construction, prior to the introduction of the moisture condition apparatus (MCA) in the UK, the main criterion used for the acceptability of a clay fill material was that the water content of the clay w must be less than the plastic limit multiplied by a factor (Barnes, 2010):

$$w \leq w_p \times \text{factor} \quad 8.1$$

With water contents greater than this value the clay fill would be deemed to be unacceptable for use. Figure 8.12 demonstrates the relevance of this approach. A factor of 1.2 in equation 8.1 was commonly adopted for most clay types to provide a clay fill suitable to maintain the trafficability of earthmoving scrapers (Arrowsmith, 1978). From Figure 8.12 it can be seen that adopting this factor would provide for clays mostly in the stiff-plastic region which would be a feasible range of water contents for adequate trafficking over and placing in an embankment of a clay fill derived from the London Clay. A factor of 1.3 has been adopted for 'wet' clay fill (Barnes, 2010) and this can also be seen to give a feasible maximum water content, extending further into the soft-plastic region but not too far.

For tracked vehicles to move satisfactorily over a clay fill a limiting factor of 1.4 has been suggested (Farrar and Darley, 1975) because these plant items provide a lower bearing pressure, although this factor would take the clay fill to the limits of acceptable workability according to Figure 8.12. This figure shows that the 'factor' approach to the acceptability of clay fills was feasible but it was discontinued in the 1970s because of the poor accuracy of the plastic limit determination.

This approach has now been superseded by the use of the moisture condition apparatus and the moisture condition value, MCV. With a more accurate determination of the plastic limit now available with the Barnes apparatus Figure 8.12 shows that the approach could be viably resurrected although as with the standard plastic limit there is some delay in obtaining a result because of the need for a 24 hour period of oven drying.

A similarly close relationship is obtained with the normalised toughness values plotted against the workability index, see Figure 8.13. This plot shows that there is a clear link between the test results indicating that this clay, the London Clay, has a distinct toughness 'signature' and that the workability index is a fundamental property of the soil.

8.9 The effect of silt content on the plastic limit

The plastic limit decreases with decreasing clay content. This is seen clearly in Figure 8.7 with the toughness at the plastic limit, T_{\max} , also decreasing. It is considered, however, that the plastic limit is not just determined by the amount of clay minerals present. This can be illustrated by considering points *a* and *b* on Figures 8.7 and 8.8. These specimens have the same matrix water content and the same toughness, on Figure 8.8 these points coincide, but point *a* is still in the plastic region of its test plot and point *b* is at the ductile-brittle transition, i.e. at the plastic limit on its test plot. Thus the crumbling condition is not solely related to the water content of the clay matrix but is brought about by an increase in the silt content, in this case from a silt content of 36% to 48%.

The effect of the silt particles on the crumbling condition is considered to be due to greater interference between the silt particles within a reducing amount of matrix. Points *a* and *b* are plotted on Figure 8.10 where it can be seen that the silt grains at point *b* are, on average, at closer spacings than at point *a*. With closer spacings between the silt particles there will be a greater potential for microcracks to develop and enlarge between the surfaces of the silt particles and the surrounding matrix leading to a breakdown of the soil structure and crumbling.

8.10 Electron microscope studies of some London Clay:Silt mixtures

The following is a discussion of some microscopic images taken of three mixtures of London Clay:Silt using an environmental scanning electron microscope (ESEM). The equipment is a FEI Quanta 200 ESEM and was operated by Dr. Patrick Hill, Electron Microscopist, in the School of Chemical Engineering and Analytical Science, University of Manchester. This type of microscope, by running in a low vacuum mode, enables specimens to be viewed in a 'moist' condition so that they are unaffected by elaborate sample preparation methods such as freeze drying.

The opportunity to conduct the electron microscope studies occurred after the tests on the London Clay:Silt mixtures had been completed so fresh mixtures were prepared with the ratios of London Clay:Silt of 100:0, 60:40 and 30:70 with, respectively, clay contents of 64, 39.2 and 20.6%. Distilled water was added to each mixture to produce specimens at the liquid limit and then cured for at least 24 hours. The specimens were then dried to a non-sticky condition and threads prepared in the thread maker with water contents that were judged to be in the soft-plastic and stiff-plastic regions and close to the plastic limit.

The threads were rolled in the apparatus with the normal load control but were only rolled to about 5.5 mm diameter so that the ductile threads had passed the yield condition and had undergone a fair amount of plastic deformation and the test was then stopped. This was done to provide a specimen cross section that would fit the specimen support of the microscope and would provide a reasonable area to inspect. Because the threads had not been rolled out to the diameter of 4 mm values of toughness were not determined. The stress vs. diameter plots up to the diameter of 5.5 mm were comparable to the previously tested mixtures at similar water contents.

The following is a discussion of the interpretation of the microscope images based on the visual impressions of the author who does not claim to have particular expertise in their interpretation.

1) Thurstaston Silt

Images of a specimen of the Thurstaston Silt are presented in Figure 8.14. Dr. Hill, a geologist, identified the minerals as a mixture of calcite, quartz and feldspar with some dolomite and a little mica. Most of the silt was in the coarse region, 20 – 60 μm , and even though the silt had been washed and sieved there were occasional clusters of silt particles, up to 100 μm in size, see Figure 8.14b.

2) London Clay:Silt 100:0 – before rolling (Figure 8.15)

For the soft-plastic specimen continuous (at least across the photograph) and tortuous strands of face to face clay particles can be seen as a prominent structure. The clay particles appear somewhat crinkled and have a gel-like appearance suggesting hydration. In three dimensions these strands could be likened to the 'interweaving bunches' described by Collins and McGown (1974). Between, among and connected to the strands are clusters of clay-coated silt particles. In these regions the clay content would be considered to be lower than in the strands. Even in the soft-plastic condition narrow microcracks can be seen particularly at the boundaries of the clusters of clay-coated silt particles.

With a lower water content, for the specimen in the stiff-plastic condition, the same structural arrangements can be seen but with a less hydrated texture, as would be expected, with the clay coatings on the silt particles appearing to be thinner. The image shows more void space with large pore sizes for this stiff-plastic specimen compared to the soft-plastic specimen although this may just be a result of where the image was taken on each specimen. Nevertheless, some longer, continuous and tortuous microcracks can be seen on the stiff-plastic specimen. The same features can be seen on the images of the stiff-plastic cracked specimen although the microcracks appear to be more open. This specimen is described as cracked because visible cracks were present on the surface of the soil thread.

3) London Clay:Silt 100:0 – after rolling (Figure 8.15)

The images of all of the specimens after rolling show the clay strands to be significantly distorted and disrupted, as would be expected but the strands still appear to retain their continuity. With threads rolled to diameters of less than 4 mm even more distortion could be expected. The void volume also appears to have increased compared to before rolling with a large proportion of narrow, tortuous microcracks in the clay strands and similar but wider microcracks in and around the clusters of clay-coated silt particles. In parts of the images edge to face connections between clay particles can be seen making an almost honeycomb-like strand arrangement with clusters of the clay-coated silt particles within the 'honeycombs'.

4) London Clay:Silt 60:40 – before rolling (Figure 8.16)

At all water contents the strand arrangement is still present but less prominent, as would be expected with a lower clay content. The structure appears to be mostly of

a continuous clay-coated silt particle matrix with the silt particles held together by the clay coatings and short clay bridges with some clay strands. The void spaces appear to be similar to those of the London Clay:Silt 100:0 specimens although they are not as clearly identified. Long, tortuous microcracks can be seen in the stiff-plastic and plastic limit specimens, particularly running between clusters of clay-coated silt particles.

5) London Clay:Silt 60:40 – after rolling (Figure 8.16)

As for the London Clay:Silt 100:0 specimens the clay strands are significantly distorted and disrupted. Microcracks are more prevalent in the after rolling specimens compared to the before rolling specimens particularly in the stiff-plastic and plastic limit specimens. It is not easy to tell from images taken at random locations but there appears to be more void space in the specimens after rolling. With a high silt content this would be expected following a dilatant volume change.

6) London Clay:Silt 30:70 – before rolling (Figure 8.17)

With a low clay content the structure appears to be of clay-coated silt particles held together by the coatings and clay bridges. Thin clay strands cannot be seen in these images. The void spaces can be seen quite distinctly as silt-sized pores surrounded by silt particles with very few, if any long microcracks visible in the soft-plastic and stiff-plastic specimens. At the plastic limit microcracks can be detected although they are very tortuous running between around clusters of silt particles.

7) London Clay:Silt 30:70 – after rolling (Figure 8.17)

With a high silt content, generally randomly arranged in the specimens the images appear little different after rolling compared to before, with both appearing 'jumbled'. Thin clay bridges can be seen on the stiff-plastic and plastic limit specimens. At the plastic limit tortuous microcracks can be seen running roughly vertically across the image, around the silt particles.

8) The stiffness transition

The stiffness transition has been found to be a distinct feature of most of the clays tested so far with the Barnes apparatus. With water contents above the stiffness transition it is postulated that the clay strands and the clay bridges would have to be relatively weak to enable extrusion of a soil thread and would produce relatively

low toughness values. As the water content decreases to below the stiffness transition it is envisaged that the clay strands and the clay bridges become stiffer providing higher toughness values in the soil thread. This does not explain the sharp, distinct change in behaviour at the stiffness transition but it is thought that it must be associated with some change in the soil structure and perhaps changes in the suctions local to the clay strands and the clay bridges.

It is assumed that the clay strands run continuously along and across a soil thread and they enable the clay soil to display cohesion, tenacity and ductility when the soil thread in its tough-plastic condition is rolled. In Chapter 7 an explanation is given for a postulated increase in aggregation of clay particles that is postulated as the water content below the stiffness transition decreases towards the plastic limit where a high degree of aggregation is assumed. From the images examined for the mixtures, aggregation of clay particles does not appear to be significant, with the clay strands still present at the plastic limit. Where aggregation may be occurring is in the zones of clay-coated silt particles between the clay strands with the formation of aggregates of these particles and the development of microcracks between them.

Further research into the microstructure of other clay mineral types would be helpful in the investigation of the effect of microstructure on the ductility and brittleness of different clay soils.

8.11 Summary

With high clay content soils there is a risk of transverse separation of the soil thread as it approaches the smallest diameter of 3 mm. This is considered to be due to a combination of tension, torsion and bending and more care with the load control is required to enable continued rolling. It does not represent a crumbling condition. It is also found with high clay content soils that premature compression failure can occur across the diameter of the thread preventing further rolling. Again this does not represent a crumbling condition but is considered to be due to the formation of slip planes at or near to their residual strength and is most prevalent with soils of high clay content and high activity.

Soils with high silt contents produce strain-hardening nominal stress vs. diameter plots both above and below the stiffness transition whereas soils with high clay contents produce more steady plastic straining in the soft-plastic region and strain-hardening and strain-softening sequences in the stiff-plastic region.

At the higher clay contents the toughness of the clay:silt mixtures is produced by the clay matrix and its water content as would be expected but the toughness values measured for the high silt content soils are only apparent values as they are produced by the work done in displacing the silt particles more than straining the clay matrix.

When the toughness of the clay:silt mixtures was plotted vs. the matrix water content a fairly uniform relationship was obtained with toughness decreasing with increasing matrix water content for clay contents above about 60%. With clay contents between about 40 and 60% the silt particles affect the clay soil by causing perturbations in the clay matrix and rather than preventing the matrix from displaying its full toughness, somewhat higher toughness values were obtained, thought to be due to the additional work required to move the silt particles.

Between the clay contents of about 20 and 30% the silt particles cause more significant interactions and interference with lower toughness values due to the reduced amount of clay matrix. However, it is considered that the measured toughness is not a result of the stiffness of the clay matrix but of the work required to deform a clayey silt soil because at the water contents tested the clay matrix would have a water content above its toughness limit and would be expected to be in a sticky condition. For the soil with a clay content of 14% although the threads could be rolled satisfactorily the water contents of the clay matrix assuming all of the water to be associated with the clay minerals were above the liquid limit of the clay matrix. It is envisaged that the 'liquid' clay matrix surrounds the silt particles and provides sufficient cohesiveness to hold the soil together with enough of a lubricating effect to enable extrusion of the thread and give the impression of measurable toughness.

Aggregation of clay particles is expected to be a significant phenomenon in soils with high clay contents as the water content reduces below the stiffness transition but in soils with high silt contents aggregation would be less prominent and the clay content may be more associated with clay bridges between the silt particles. The distance between the silt particles then appears to be a determining factor with clay bridge spans of shorter length providing greater stiffness. With granular spacing ratios greater than about 0.35 – 0.40 the silt particles were considered to have little or no effect on the plastic limit of the soil but when the granular spacing ratio is less than about 0.1 their effect is significant.

It is considered that the crumbling condition of a soil and hence the plastic limit is affected by the silt content in the soil. It is shown that for two specimens with the same matrix water content and the same toughness the specimen with the higher

silt content is at its plastic limit whereas with the lower silt content the specimen is still in its stiff-plastic region. The effect of the silt particles on the crumbling condition is considered to be due mainly to greater interference between the silt particles within a reducing amount of continuous matrix but there is also greater potential for microcracks to develop and enlarge between the surfaces of the silt particles and the surrounding matrix leading to a breakdown of the soil structure and crumbling.

For the tests on the clay:silt mixtures T_{\max} and the plastic limit both decrease with decreasing clay content with T_{\max} linearly related to the clay content. The toughness vs. water content plots for different clay contents are near parallel and plotting them as normalised values of T/T_{\max} and w/w_p gives a more unique relationship suggesting that the toughness of this clay type is related to its plastic limit.

For some time, before it was discontinued in the 1970s, the ratio w/w_p was used as a measure of the acceptability of clay fill in earthmoving operations with a typical maximum value of 1.2 adopted for most clay types as the limit of acceptability.

Above this value the clay fill would be deemed to be unacceptable. The results of the tests on the clay:silt mixtures confirm that this criterion would ensure that most of the clay mixtures would be in the stiff-plastic region with a toughness of more than about 50% of the maximum toughness. This type of clay as a fill material would provide adequate support to earthmoving plant.

A similarly close relationship is obtained with the normalised toughness values T/T_{\max} plotted against the workability index, I_w . This plot shows that there is a clear link between the test results indicating that the clay used in the mixtures, the London Clay, has a distinct toughness 'signature' and that the workability index is a fundamental property of the soil.

Electron microscope images of three mixtures of London Clay:Silt display, for the high clay content specimens, a structure of clay mineral strands, or 'interweaving bunches', that are assumed to traverse the length and width of a clay soil thread with clusters of clay-coated silt particles between and among the strands. With low clay contents these strands are less prominent with the soil structure appearing to comprise a matrix of clay-coated silt particles held together by the coatings and short clay bridges. Microcracks are observed in the before rolling specimens, particularly in the stiff-plastic and plastic limit specimens. After rolling the clay strand structure is very distorted and disrupted with microcracks within the clay strands in the high clay content specimens and within the clusters of clay-coated silt particles in the low clay content specimens.

8.12 Figures

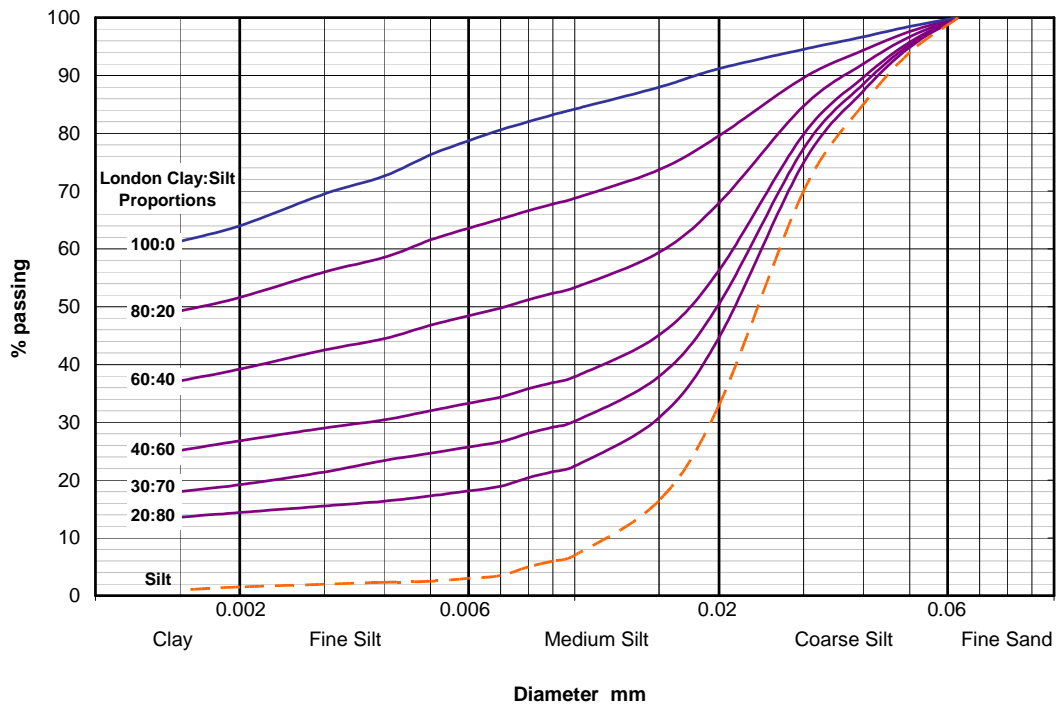

Figure 8.1 Particle size distributions

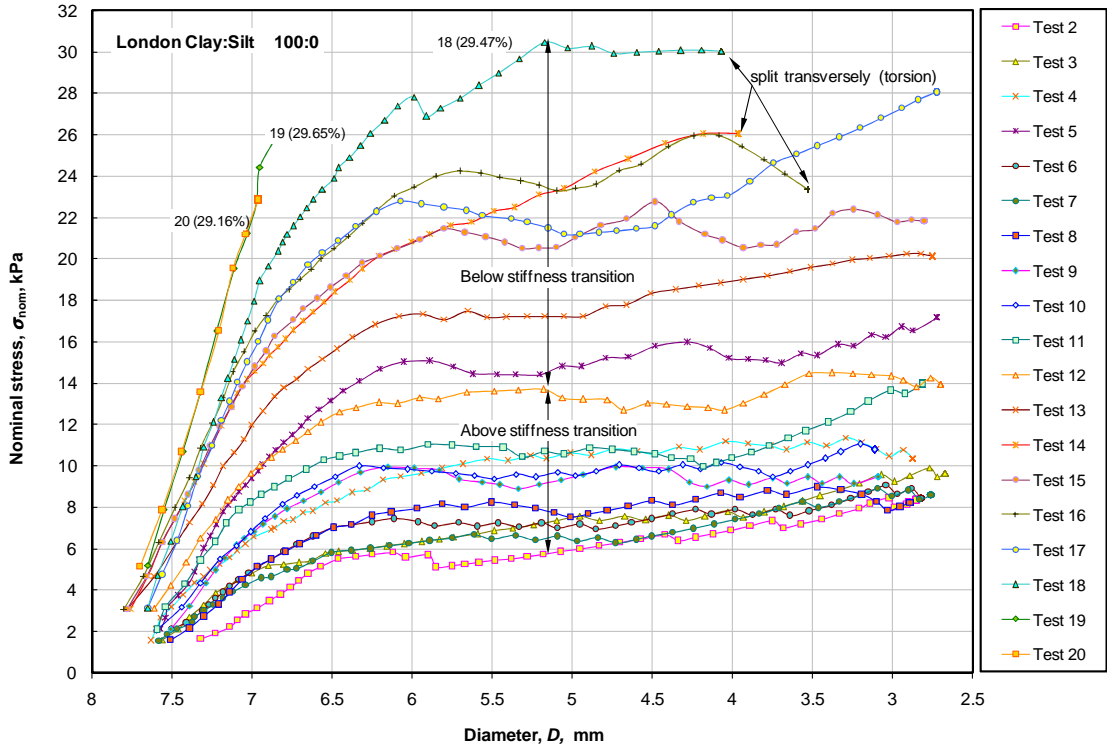

Figure 8.2 Nominal stress vs. diameter London Clay:Silt 100:0
This plot reappears as Figure A2.1.

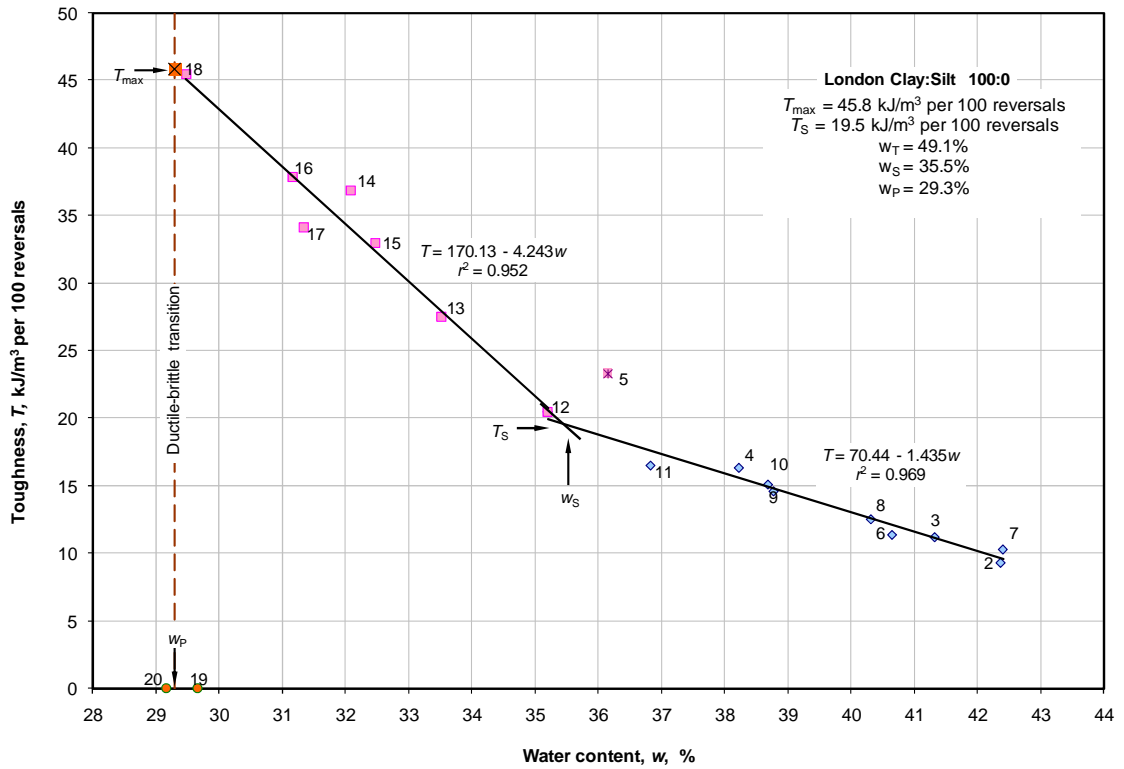

Figure 8.3 Toughness vs. water content London Clay:Silt 100:0
This plot reappears as Figure A2.2.

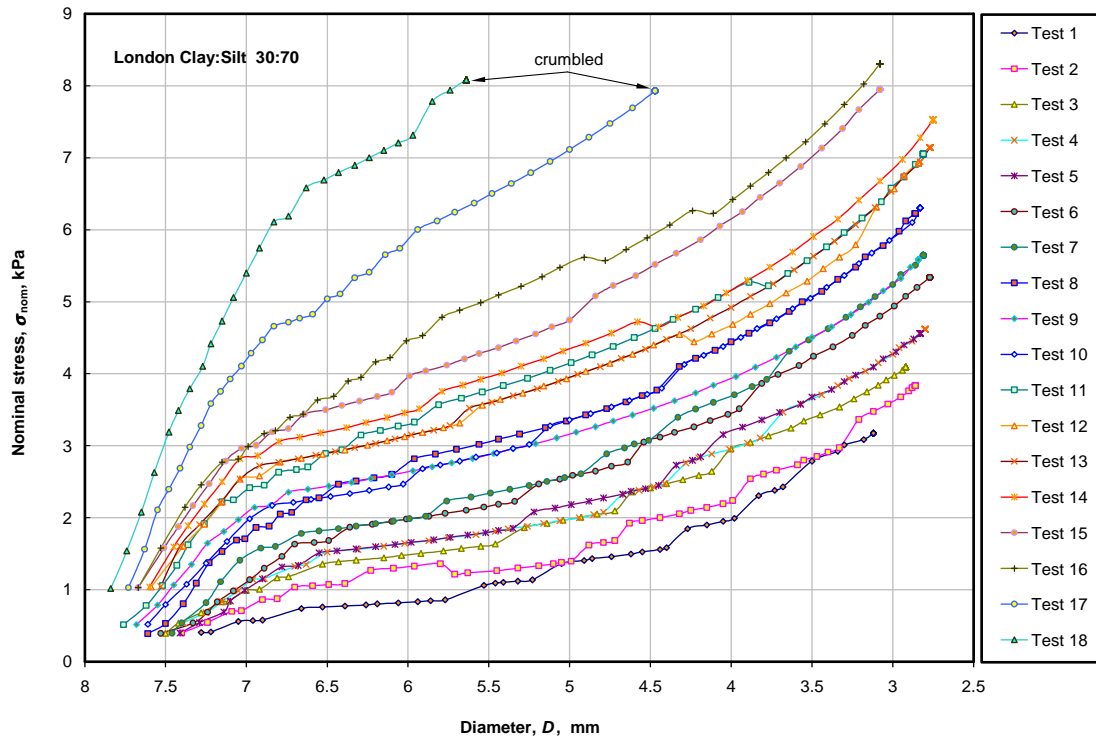

Figure 8.4 Nominal stress vs. diameter London Clay:Silt 30:70
 This plot reappears as Figure A2.9.

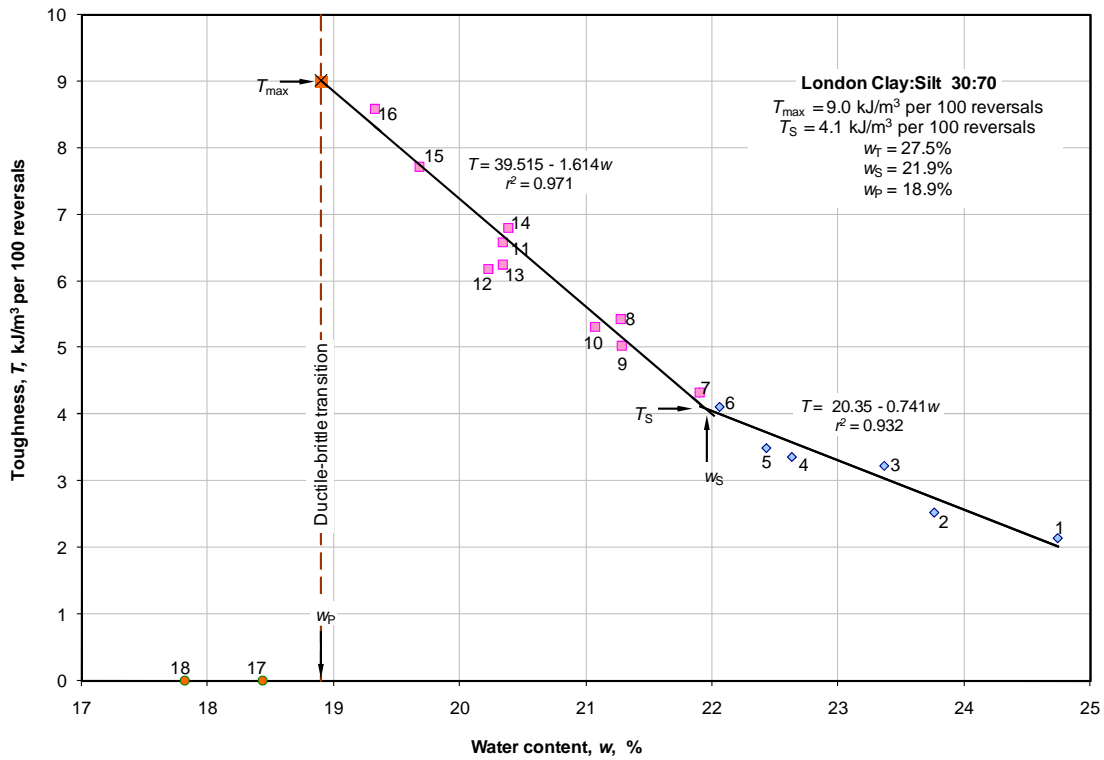

Figure 8.5 Toughness vs. water content London Clay:Silt 30:70
 This plot reappears as Figure A2.10.

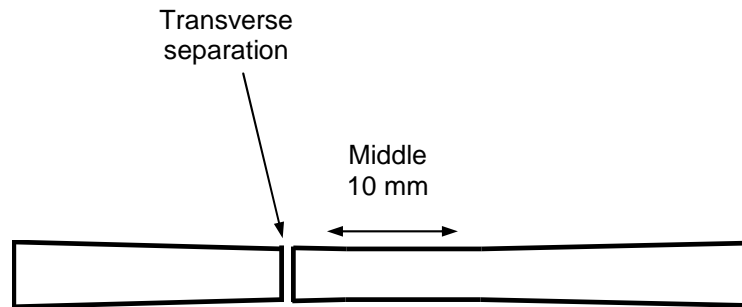

Figure 8.6 *Transverse separation in soil thread*

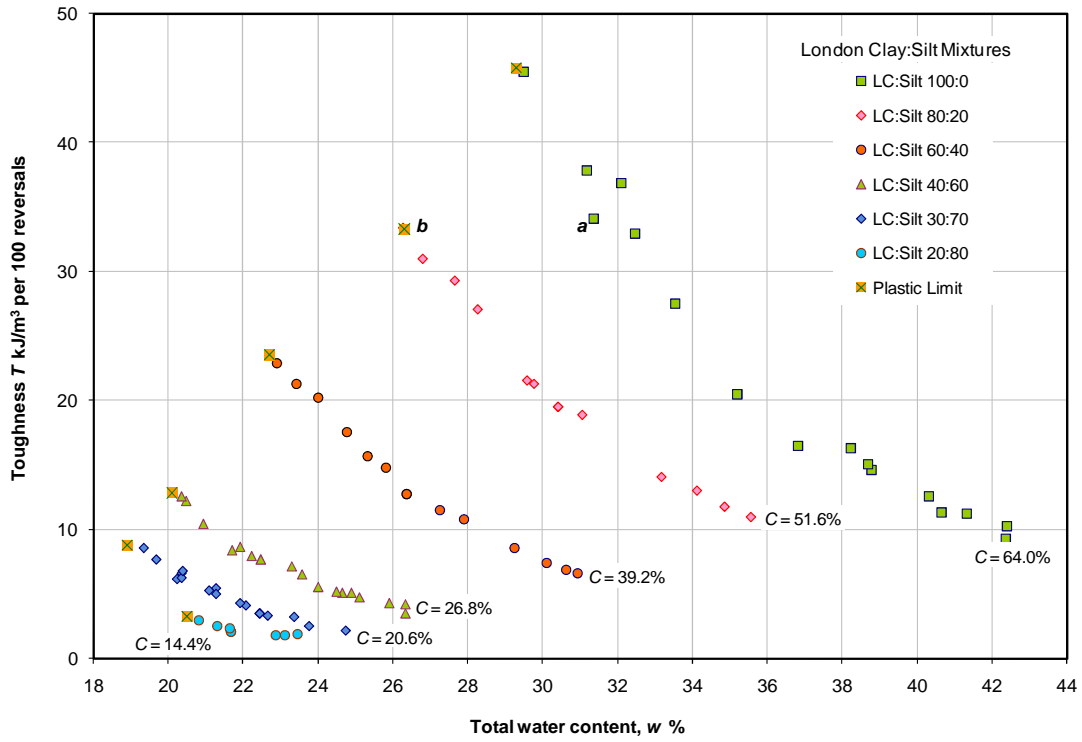

Figure 8.7 Toughness vs. total water content London Clay:Silt mixtures

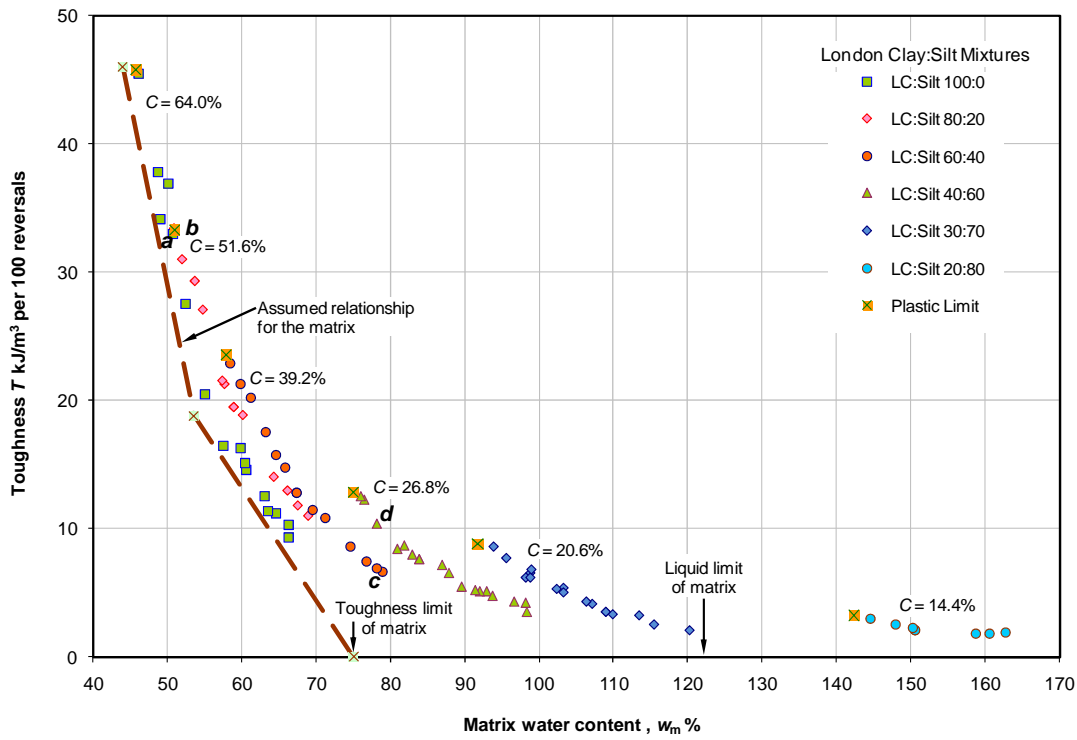

Figure 8.8 Toughness vs. matrix water content London Clay:Silt mixtures

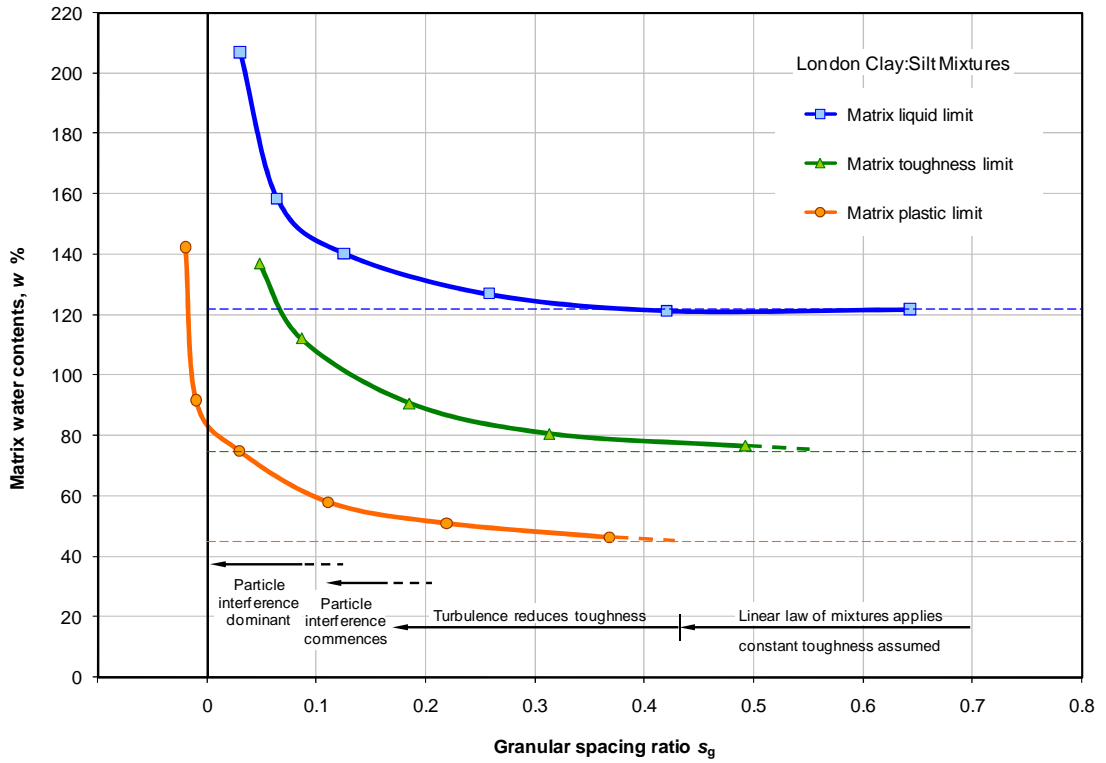

Figure 8.9 Granular spacing ratio at the water content limits

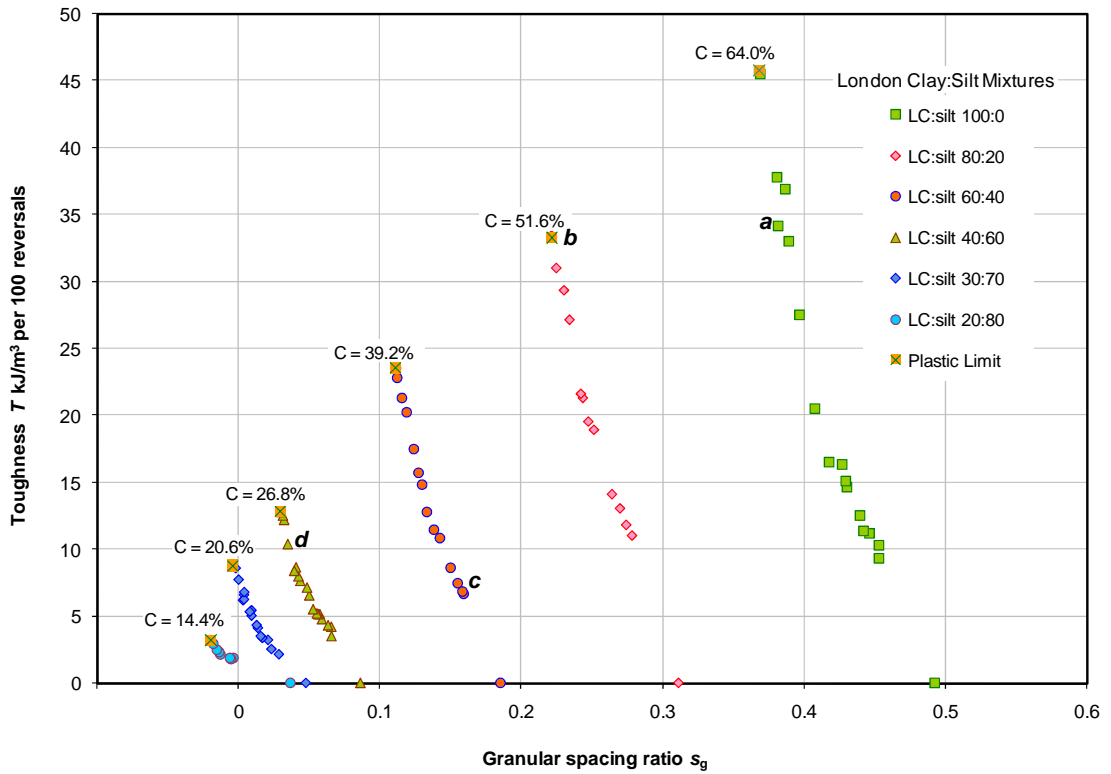

Figure 8.10 Granular spacing ratio and toughness

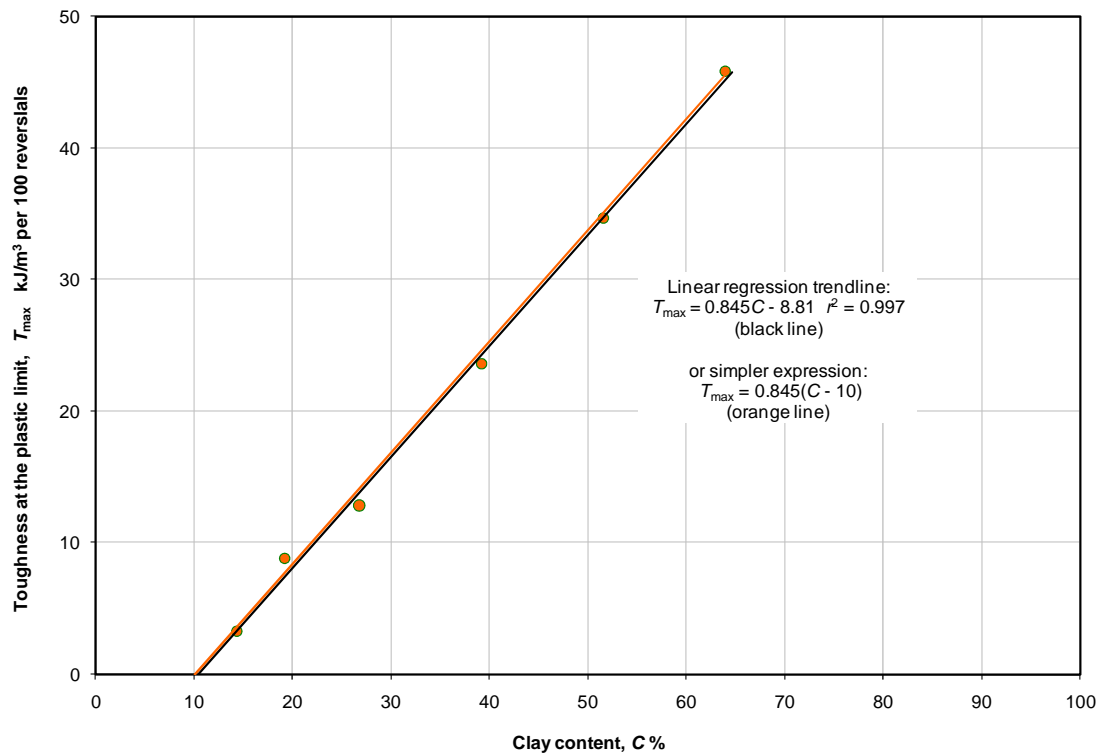

Figure 8.11 Toughness related to clay content for the London Clay:Silt mixtures

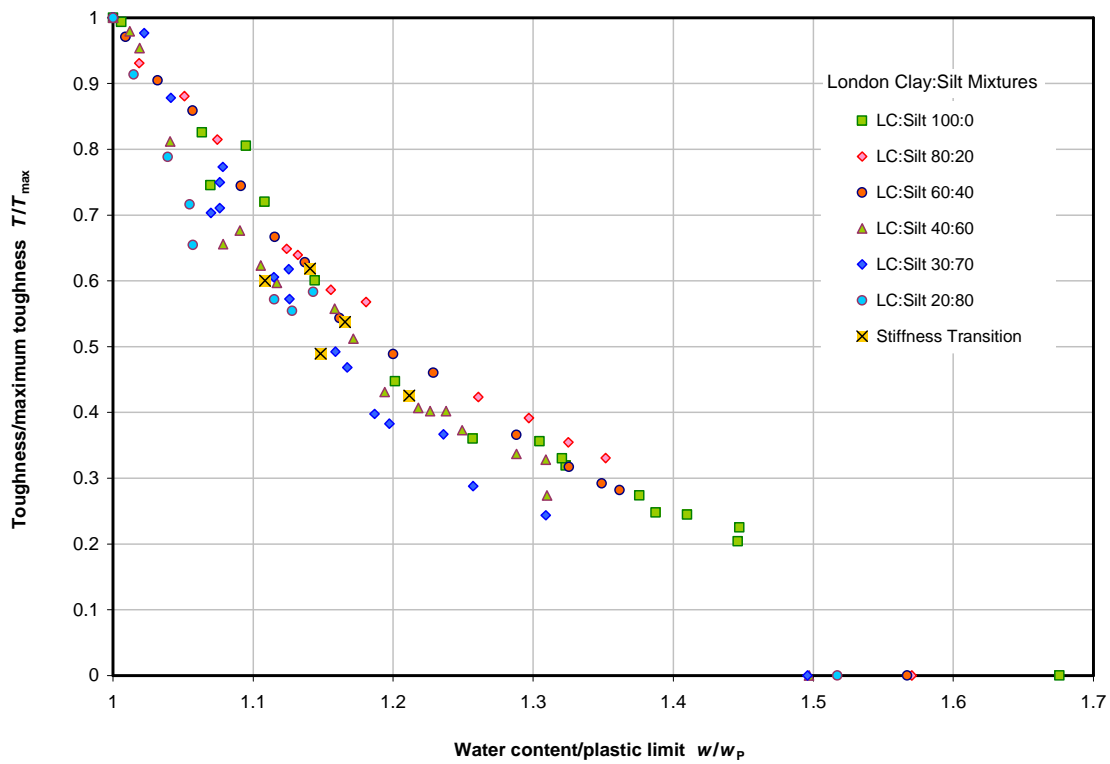

Figure 8.12 Normalised toughness and the water content/plastic limit ratio

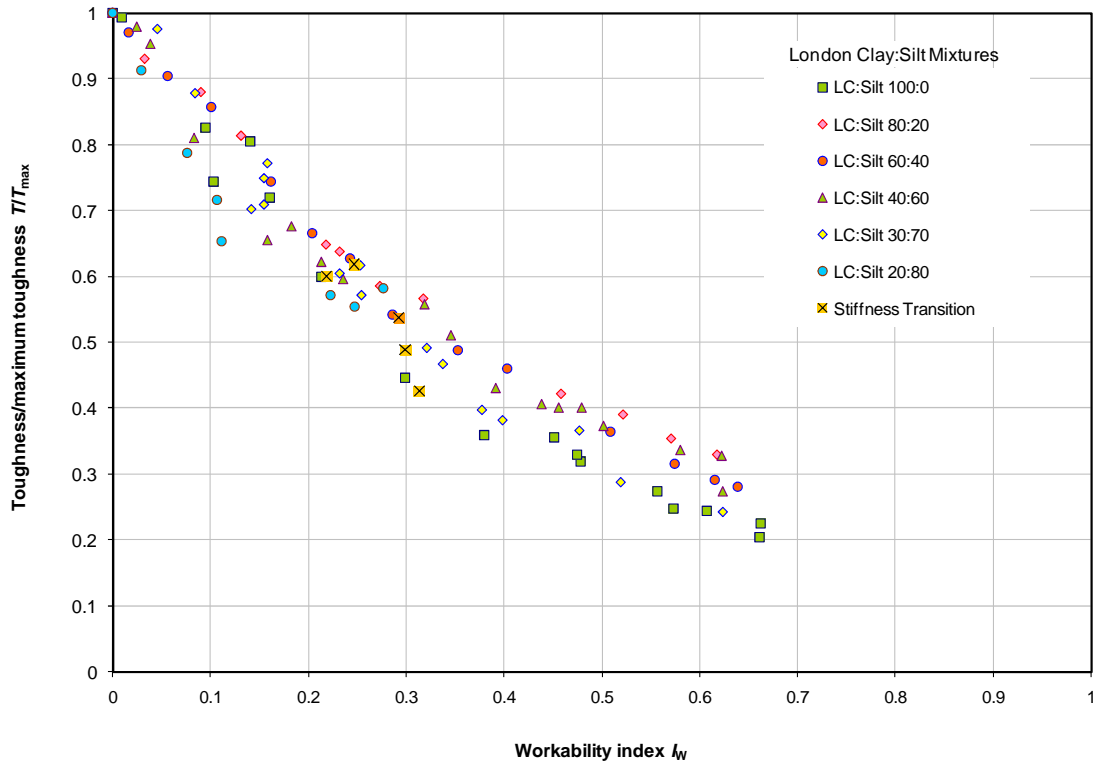

Figure 8.13 Normalised toughness and workability index

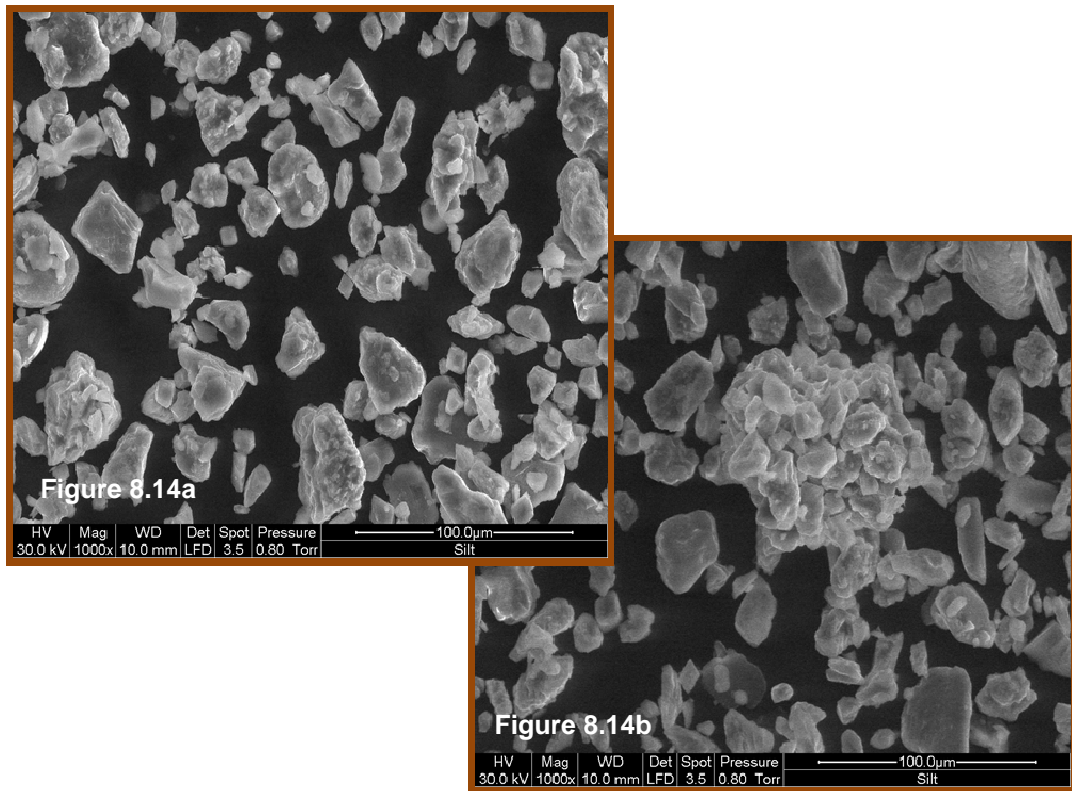
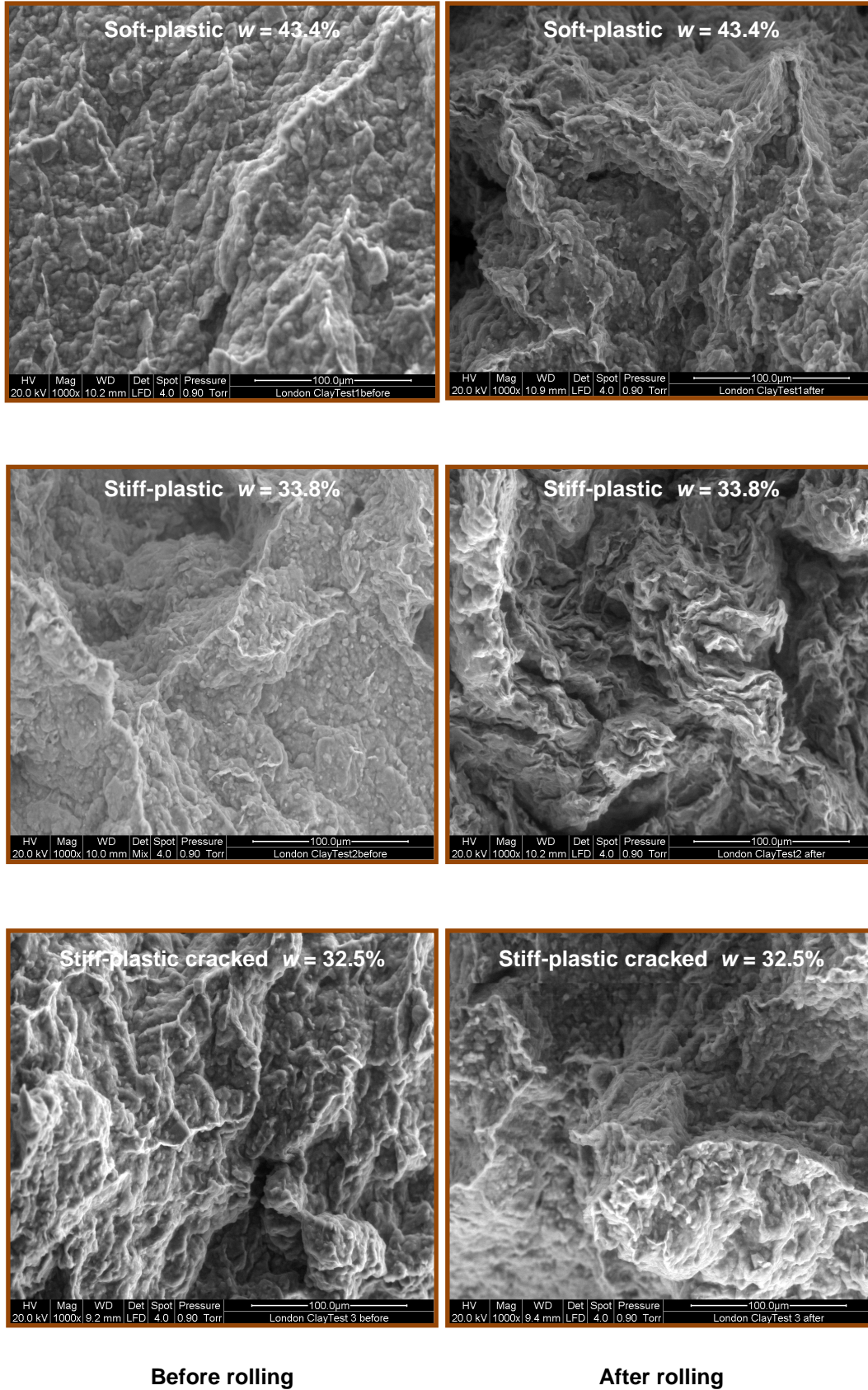

Figure 8.14 Microphotographs of Thurstaston Silt



Before rolling

After rolling

Figure 8.15 Microscope images of London:Clay:Silt 100:0 $C = 64.0\%$ $w_p = 29.3\%$

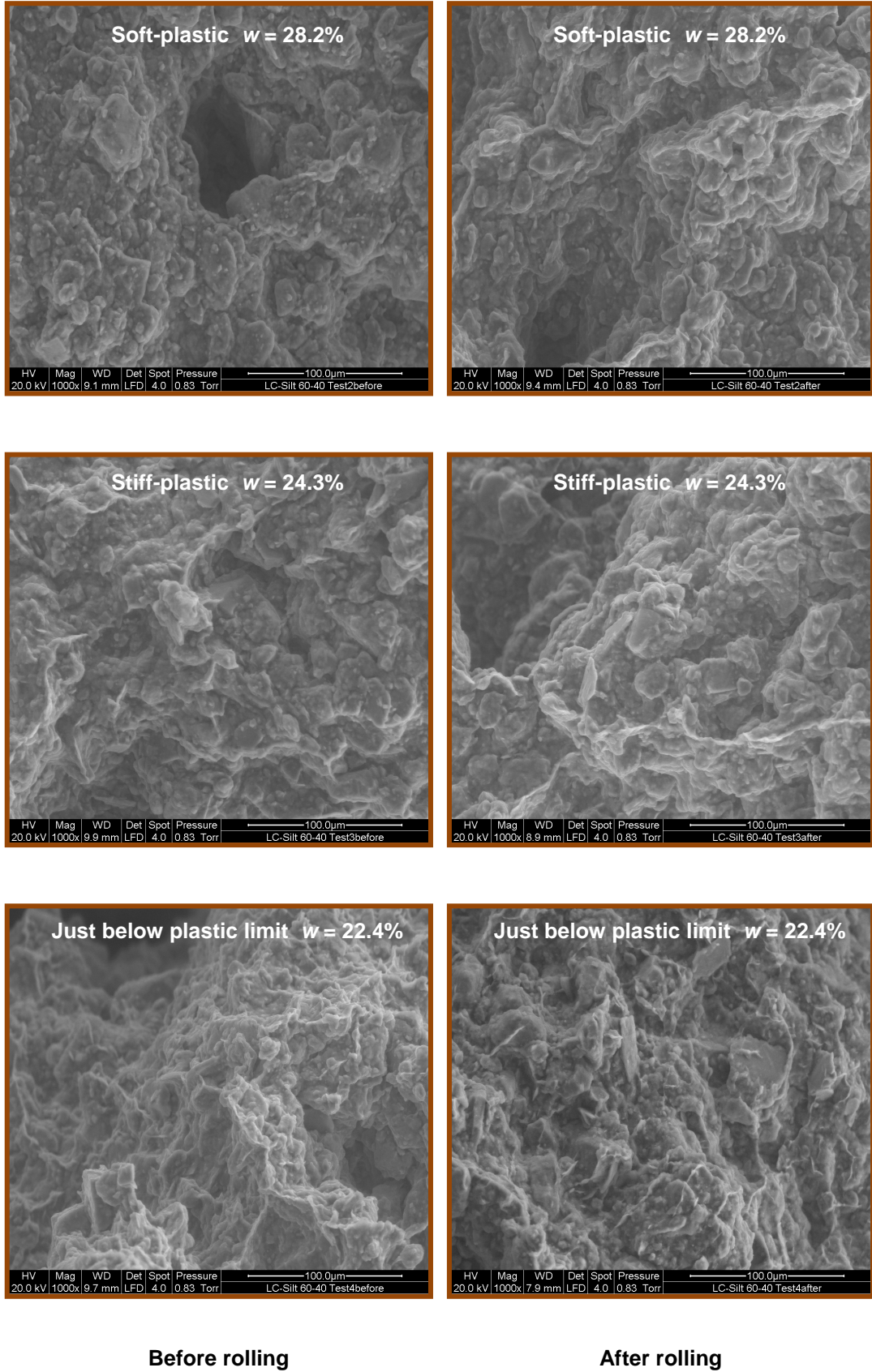
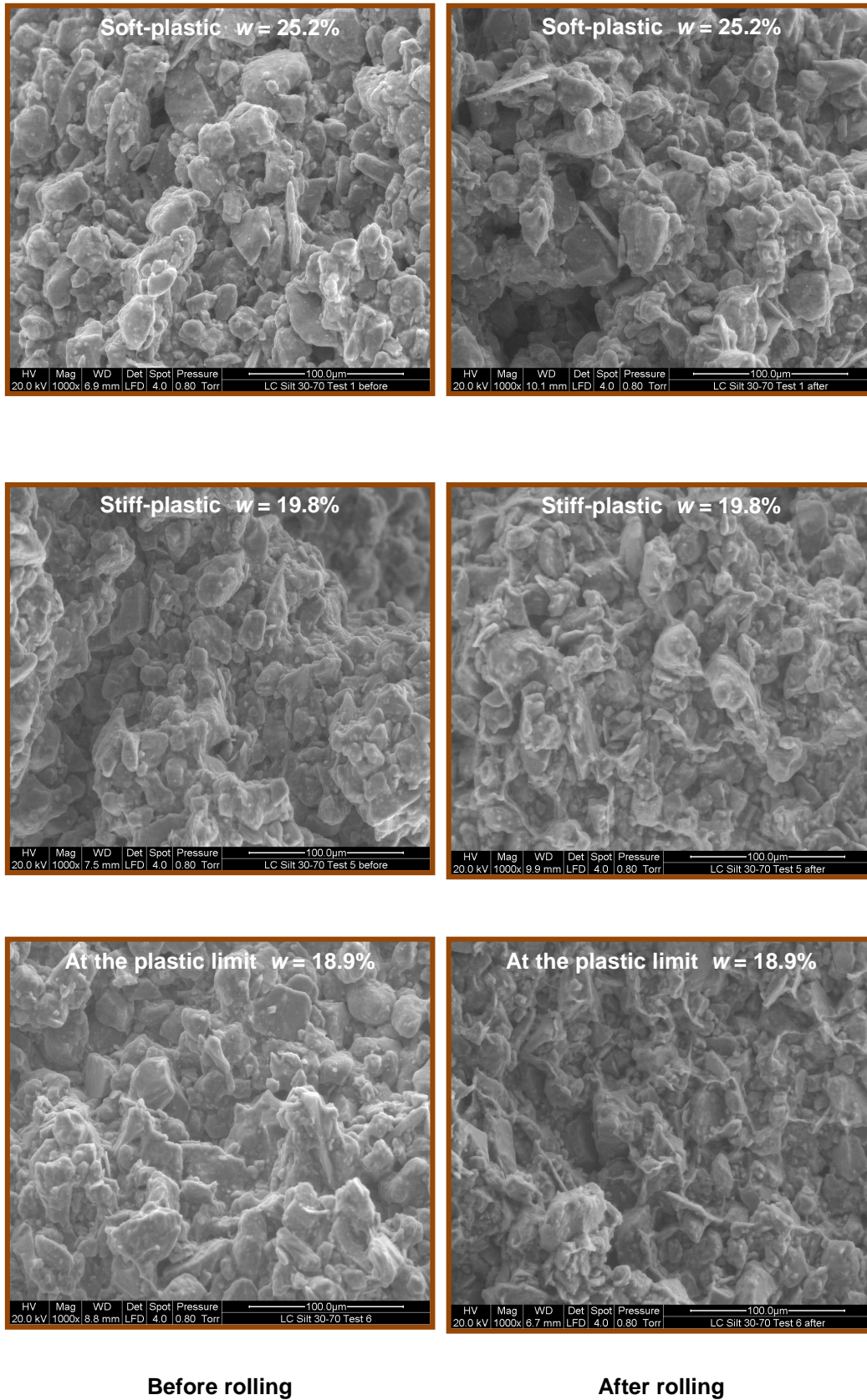

Figure 8.16 Microscope images of London:Clay:Silt 60:40 $C = 39.2\%$ $w_p = 22.7\%$



Before rolling

After rolling

Figure 8.17 Microscope images of London:Clay:Silt 30:70 $C = 20.6\%$ $w_p = 18.9\%$

CHAPTER 9

Tests on the Clay:Sand mixtures

9.1 Introduction

The maximum particle size allowed in the standard plastic limit test is 425 μm (ISO/TS 17892-12:2004, BS1377:1990, ASTM D4318-10) which lies in the middle of the medium sand range of 200 – 600 μm . To assess the effects of different sizes and quantities of sand on the toughness and the plastic limit, the Barnes test described in Chapters 4 and 5 has been conducted on a series of mixtures of a London Clay containing fine sand and fine/medium sand of known proportions by mass in order to investigate the effects of clay content and sand content on the toughness- water content relationships.

By comparison with the results of the tests on the London Clay:Silt mixture described in Chapter 8 the corrections for oversize particles and the effect of large granular particles in small diameter threads, described in Chapter 7, have been investigated.

9.2 Preparation of mixtures

For these tests commercially available sands were washed and sieved between 63 and 212 μm (fine sand) and 212 and 425 μm (medium sand) and prepared to provide smooth grading curves within each range of sizes. To make up the 63 to 425 μm fine/medium sand these two grades were mixed in equal proportions. The London Clay was obtained as a large sample from a piling scheme on the Isle of Grain as in Chapter 8. Part of this sample was tested with the Barnes apparatus from an air-dried state to determine the nature of this soil. Its results are included in Table 5.2 as London Clay, Isle of Grain. For the purposes of producing the mixtures the remainder of the sample was air-dried, ground to pass the 425 μm sieve and mixed thoroughly to produce a homogeneous sample. The particle size distributions of the sands and the London Clay used in the mixtures are presented in Figure 9.1.

Mixtures of these sands and the London Clay were then prepared with known proportions and the results of the tests conducted with the Barnes apparatus on these mixtures are presented in Appendix 3. From the particle size distributions of the sands and the London Clay the particle size distributions of the mixtures were

calculated and these are plotted in Figure 9.2. In this figure the orange curves, A to E represent the clay containing the fine sand and the green curves, A' to D' the clay containing the fine/medium sand.

The particle size distributions were designed to produce samples with the same sand content and same clay content but different sand sizes so that the effect of sand size using the substitution and elimination methods described in section 7.8 could be investigated. In combination with the results on the clay:silt mixtures described in Chapter 8 the effect of different sizes of granular particles on the clay matrix could also be investigated. Mixtures E (fine sand) and D' (fine/medium sand), see Figure 9.2, could not be made into a viable thread because the compacted soil could not be extracted from the thread maker due to friction and arching in the tube. A thread for testing was prepared by hand but due to a lack of compaction it was very loose and with a high sand content it was very weak. When placed in the Barnes apparatus it fell apart under the smallest load.

9.3 The substitution or replacement method for oversize particles

In section 7.8 two methods are described that attempt to provide a 'correction' for the presence of oversize particles in a soil sample that must be removed from the sample in order to conduct a laboratory test, because of the limitations of the specimen size in the laboratory apparatus. The substitution or replacement method is examined in this section.

To investigate the substitution method using the results of tests on the mixtures of London Clay and fine sand and fine/medium sand, mixtures A to D and A' to C', it is assumed that the maximum particle size that can be incorporated in a particular laboratory test specimen is $212\ \mu\text{m}$, near to the boundary between fine and medium sands, $200\ \mu\text{m}$. To allow for the oversize particles, the medium sand, in a mixture containing the fine/medium sand the medium sand would be removed and replaced with the same amount of fine sand. With this substitution for mixture A' the particle size distribution of mixture B would be obtained, see Figure 9.2. Using the combinations of the results from mixtures A' and B, B' and C, C' and D an assessment of the substitution method can be made.

1) A' compared with B (10% sand substitution)

By comparing the particle size distributions of these two mixtures in Figure 9.2 if the sand particles in mixture A' between 212 and $425\ \mu\text{m}$ (10% of the total) are

removed and replaced with the same amount of sand particles between 63 and 212 μm the particle size distribution for mixture B would be obtained with this 10% substitution. The two mixtures have the same sand content (20%) and the same clay content (51%) but different sand sizes.

The plots of toughness vs. water content are presented in Figure 9.3 for mixtures A' and B. The size of sand particles appears to have little effect on toughness at a particular water content with the results for both mixtures almost coinciding although mixture B frequently has slightly higher toughnesses at the same water content. The mixtures have the same sand content but the sand particles in mixture B are smaller and, therefore, more numerous. It is envisaged that the slightly higher toughnesses for mixture B are explained by a greater amount of work/unit volume required to deform the soil with the larger number of smaller sand particles. The ductile-brittle transition is similar for the two mixtures giving similar plastic limits so a 10% substitution could be deemed to give an acceptable 'correction' from these results.

2) B' compared with C (20% sand substitution)

By comparing the particle size distribution of these two mixtures in Figure 9.2 if the sand particles in mixture B' between 212 and 425 μm (20% of the total) are removed and replaced with the same amount of sand particles between 63 and 212 μm the particle size distribution for mixture C would be obtained with this 20% substitution. As above, the mixtures have the same sand content (40%) and the same clay content (38%) but different sand sizes, and similar comparisons can be made.

From Figure 9.3, at the same water content, mixture C gives higher toughnesses. It is considered that with a larger number of smaller sand particles present in mixture C to produce the same toughness the matrix water content must increase to counteract the effect of having to work against the larger number of particles. An alternative view is to consider that with the same water content and same sand content higher toughnesses are obtained because more work/unit volume is required to move the larger number of, albeit smaller, particles.

The plastic limit of mixture C is higher than that of mixture B' and the maximum toughness is somewhat lower. With the same sand contents but with a larger number of sand particles present within the clay matrix in mixture C, because the

sand particle size is smaller the average spacing between them and hence the amount of matrix between them will be smaller.

With sand particles at closer spacings the clay matrix can be expected to be less continuous and with smaller sand particles providing a larger surface area in contact with the clay matrix there will be more opportunities for dislocation of the clay matrix, particularly a) within the clay matrix itself and b) between the clay matrix and the sand particles. Cycling compressive and tensile stresses will then seek out these weaknesses and will have less difficulty in producing fracture at these locations to cause overall brittle failure. The larger number of smaller sand particles produces breakdown of the soil structure (crumbling) sooner at a higher water content (higher plastic limit) and at a lower maximum toughness. An alternative view is to consider that with the larger sand particles the spacing between them is greater so the clay matrix is more continuous; the matrix can sustain a higher toughness at a lower water content before succumbing to brittle failure. These results provide an illustration of smaller size particles producing greater interference than larger particles, perhaps contradictory to preconceptions.

These results show that a sand substitution of 20% does not give the same result and a substitution of no more than about 10% should be considered as the limit.

3) *C'* compared with *D* (30% sand substitution)

The toughness vs. water content results for the tests on these mixtures with 30% sand substitution are plotted in Figure 9.3. At the same water content similar toughnesses are obtained so the effect of sand size described for the previous mixtures appears to be counteracted because of the large amount of sand present. The higher plastic limit at a lower maximum toughness for mixture *D* compared with mixture *C'* can be explained by the disruptive effect of the smaller sand particles, as described above for mixtures *B'* and *C*.

9.4 The elimination or scalping method for oversize particles

In many tests the laboratory specimen size is insufficient to contain the larger particle sizes in the soil to be tested. In these situations the large or 'oversize' particles are removed and the laboratory test is conducted on the remainder of the soil. A good example is the standard compaction test where particles larger than 20 mm are removed from a soil and the test is conducted on the remainder. The elimination or scalping method is often seen as a means of obtaining a property for

a soil containing the oversize particles even though the test specimen cannot include these particles.

The method uses a correction to the water contents from the laboratory test for the proportion of oversize particles removed. To obtain the water content, w_{whole} , that would exist in the whole soil with the oversize particles included, a 'correction' to the laboratory test water content, w_{lab} is applied. This correction for water content is described in section 7.8. With the proportion of oversize particles, O_s given as a percentage of dry weight, the correction is

$$w_{\text{whole}} = w_{\text{lab}} \times \frac{100 - O_s}{100}. \quad 9.1$$

The test results for the London Clay:Sand mixtures can be used to represent the whole sample to assess the effect of sand particles on the London Clay alone which represents the laboratory test. It is assumed that the sands contain no water and all the water is associated with the remainder of the soil, the London Clay. In this investigation, in relation to equation 9.1, the 'lab' test specimen is the London Clay (LC) and the 'whole' samples are the LC:Fine Sand mixtures and the LC:Fine/medium Sand mixtures.

1) London Clay:Fine Sand mixtures

From equation 9.1 the water content of the London Clay, w_{LC} is 'corrected' for the 'oversize' fine sand content, FS (O_s in equation 9.1) to give the corrected water contents of the London Clay:Fine Sand mixtures, w_{LCFS} .

The plot of toughness vs. water content for the London Clay is presented in Figure 9.4 as the brown lines. The dashed green lines represent the water contents of the London Clay, w_{LC} corrected using equation 9.1 for the sand contents, FS of 10, 20, 40 and 60% to give the water contents w_{LCFS} that can be compared with the actual test results for the London Clay:Fine Sand 90:10, 80:20, 60:40 and 40:60 mixtures, i.e. for the particle size distributions A, B, C and D in Figure 9.2.

At first sight it would seem that the correction to the water content for the sand contents is appropriate in providing a test result modified for the effect of oversize particles because the relationships in Figure 9.4 for sand contents up to about 40% are close to each other. However, the maximum toughness T_{max} values are much lower than the corrected values and, consequently the plastic limits are higher. Even with the correction for the small sand content of 10% the maximum

toughness of the LC:Fine Sand 90:10 mixture is lower than for the London Clay. It is considered that the presence of sand in the mixtures in the actual tests prevents the soil from achieving the toughness of the 'corrected' London Clay and causes the soil to become brittle at an earlier stage, resulting in a higher plastic limit.

2) London Clay:Fine/medium Sand Mixtures

From equation 9.1 the water content of the London Clay, w_{LC} is 'corrected' for the 'oversize' fine/medium sand content, FMS (O_s in equation 9.1) to give the corrected water contents of the London Clay:Fine/medium Sand mixtures, w_{LCFMS} .

For these mixtures the dashed green lines in Figure 9.5 represent the water contents of the London Clay, w_{LCFMS} corrected using equation 9.1 for the sand contents, FMS of 20, 40 and 60%. These lines, which are identical to those in Figure 9.4 for the same replacement percentage, are compared with the actual test results for the London Clay:Fine/medium Sand 80:20, 60:40 and 40:60 mixtures. Again, the actual test results gave lower maximum toughnesses with higher plastic limits.

3) Conclusions

It is considered that the correction of a water content for oversize particles is inappropriate in deriving values of the plastic limit and the maximum toughness, even for sand contents of 10%.

The results demonstrate the importance of adhering to the criterion in the standard tests of a maximum particle size of 425 μm . It may be considered that the plastic limit tests could be conducted on soils containing larger particles, say up to 600 μm . However, extrapolation of the results in Figures 9.4 and 9.5 would show that the plastic limit of a soil containing particles larger than 425 μm should not be determined by correcting the plastic limit of a soil with a maximum particle size of 425 μm for the proportion of sand between 425 μm and the larger size. These figures also show that the toughness of a soil containing oversize particles would probably be much lower than for the soil tested without the oversize particles.

This is relevant in current practice where it is required that the liquid and plastic limit tests are conducted on soils starting from their natural water contents. To ensure that all particles greater than 425 μm are removed from a moist natural soil without drying, the soil must be wet sieved and the tests conducted on the material

passing the 425 μm sieve. The standards allow particles larger than 425 μm to be removed by hand but this is a laborious process. In a clay soil particles greater than 425 μm will be masked by the clay matrix making it highly unlikely that all of the coarser particles are found and removed. This means that many commercial tests may be conducted on soils containing particles greater than 425 μm and, from the tests discussed in this section, the results will be affected by these oversize particles even with small proportions.

9.5 The effect of granular particles on the clay matrix

The clay matrix water contents at the liquid and the plastic limits for the three mixtures (clay:silt (from Chapter 8), clay:fine sand and clay:fine/medium sand) are plotted vs. clay content in Figure 9.6, with the horizontal lines representing the linear law of mixtures. For the liquid limit values the linear law is followed to a relatively low clay content of about 40% mainly because of the larger volume of clay/water matrix present in this test, due to the higher water contents.

For the plastic limit values it is considered that the linear law of mixtures lies just below the point for the London Clay at a clay content of about 65%, as discussed in section 7.3. For both the liquid and the plastic limits the mixtures with the smallest granular particles, the clay:silt mixtures, deviate from the linear law at higher clay contents and have a greater effect than the sand particles. In Chapter 8 these clay contents were judged to be about 65% for the plastic limit and about 40 – 50% for the liquid limit.

The toughness vs. matrix water content plot is presented in Figure 9.7 for the clay:fine sand mixtures and in Figure 9.8 for the clay:fine/medium sand mixtures. These relationships have very similar trends with the clay:fine sand mixture having slightly higher toughness at the same matrix water content. Compared to the relationship for the clay:silt mixtures, in Figure 8.8 and reproduced here as Figure 9.9, the clay:silt mixtures with the same silt contents not only gave higher toughnesses at the same matrix water content but could display measurable plasticity (by being rolled out) with very high silt contents and at very high matrix water contents.

Plasticity, as denoted by the rolling out of a thread of soil, was present in the clay:silt mixtures with clay contents as low as 14% although the matrix water content was above the matrix liquid limit. For the clay:sand mixtures the limiting factor was the inability to prepare a soil thread in the thread maker due to arching

and friction from the high sand contents. The lowest clay content tested was 25.6%.

A thread of soil prepared by hand with this clay content was found to be very loose and weak, and could not be rolled out by hand successfully. This suggests that clay soils with high sand contents (greater than about 80%) will be deemed to be non-plastic or display minimal plasticity whereas clay soils with the same silt contents can display plasticity. This will also depend on the activity of the clay minerals.

On Figure 9.10 the toughness vs. matrix water content data are plotted for three mixtures with similar clay contents, $C = 38.4\%$ for the London Clay:Fine and Fine/medium Sand 60:40 mixtures and $C = 39.2\%$ for the London Clay:Silt 60:40 mixture. The same plot for the London Clay:Fine and Fine/medium Sand 40:60 mixtures with clay content $C = 25.6\%$ and the London Clay:Silt 40:60 mixture with $C = 26.8\%$, is presented in Figure 9.11. The mixture containing finer granular particles requires more water in the clay matrix to produce the same toughness. With the same granular content in the three samples in Figures 9.10 and 9.11 there will be more particles present as the particle size decreases. Thus

$$\begin{array}{ccccc} \text{Number of particles} & > & \text{Number of particles} & > & \text{Number of particles} \\ \text{Silt} & & \text{Fine Sand} & & \text{Fine/medium Sand} \end{array}$$

The finer particles cause the soil to become brittle at higher matrix water contents and lower maximum toughnesses due to the easier dislocation and breakdown of the soil structure. This is considered to be due to the greater number of grain:matrix interfaces as the granular particle size decreases and the reduced amount of continuous matrix between the granular particles as they become closer.

Figure 9.12 displays the cohesive porosity n_c vs. clay content for the liquid limits and plastic limits of the mixtures. This property, described in Chapter 7, denotes the proportion by volume of the clay matrix (clay minerals and water) present in the soil. For the plastic limit values similar n_c values are obtained for clay contents above about 45%. Below this clay content the n_c values diverge, demonstrating that there is increasing clay matrix present in the order of clay:fine/medium sand, clay:fine sand, clay:silt. For the same order of the mixtures this is due to the higher matrix water content at the plastic limit, as seen in Figure 9.6.

The granular spacing ratio s_g at the liquid and plastic limits is plotted vs. clay content in Figure 9.13. For the plastic limit data with clay contents below about 45%, the granular spacing ratio increases with decreasing size of granular particles

in the order: fine/medium sand, fine sand, silt. However, this can be misleading because the size of the particle determines this parameter. It is preferable to assess the effects of the amount and size of the granular particles by plotting the average spacing d_s between the surfaces of the particles with the water content at the plastic limit. This has been conducted for the typical mean granular particle sizes given in Table 9.1 and the data are plotted in Figure 9.14.

The average spacing between the surfaces of the granular particles decreases with increasing particle content for all granular particles as would be expected but there is a significant difference in the average surface to surface distance as the granular particle size decreases. Figure 9.14 gives further explanation why the clay:silt mixtures require a higher matrix water content to provide sufficient consistency to roll out a soil thread because the silt particles are much closer together. Near the plastic limit the clay:silt mixtures with the higher clay contents are more prone to fracture due to the persistent closeness of the particles, the reduced continuity in the matrix and the greater propensity for dislocations between the larger number of silt particles and the surrounding matrix.

In the author's experience apparent brittleness, manifested as crumbling and breaking apart of a soil thread, has been found to occur frequently with high silt content soils because they tend to display a higher degree of friability or ease of breakage compared to high sand content soils. This friability would be of particular relevance in the agricultural context where friability provides a soil with a good tilth, hence the agriculturalist's emphasis on the benefits of loam type soils as these contain a high proportion of silt particles.

9.6 The effect of large granular particles in small diameter threads

For the preparation of re-compacted specimens BS EN 1997-2:2007 states that the upper limit of allowable particle sizes depends on the size of the smallest dimension of the soil specimen tested and recommends that particles larger than those determined from Table 9.2 should be removed before preparation in the laboratory test specimen.

For the thread rolling plastic limit test the criteria for the direct shear and compressive strength tests would seem most appropriate, i.e. a maximum particle size between $1/5$ and $1/10 \times$ the thread diameter. For a maximum particle size of $425 \mu\text{m}$ in the standard plastic limit test the lower criterion of $1/10$ is breached when the thread diameter reduces below about 4 mm . The actual minimum ratio

for the plastic limit test of $3.0/0.425 \approx 7$ lies within the range of values for the two shear strength test specimens in Table 9.2.

For most of the clay:sand mixtures tested it has been found that once the thread has yielded a fairly flat nominal stress vs. diameter relationship is obtained down to a diameter of about 4 mm. Below the diameter of 4 mm the relationship tends to curve upwards with more stress required to produce the same strain increments. This is discussed in section 5.11, and below by considering the effect of large granular particles in small diameter threads.

An investigation has been conducted into the theoretical spacing of single sized large granular particles in a small diameter soil thread as it undergoes reduction of diameter and longitudinal extrusion during the Barnes test or the standard plastic limit test. The derivation of the formulae is described in detail in Appendix 6 and discussed in section 7.11. It is considered that a near triangular distribution of granular particles can be represented reasonably well in a circular soil thread cross section by assuming the particles lie equidistant to each other and along the centre line of equal width cylinders, as illustrated in Figure 7.12.

The particles are single sized with a diameter d_g , they are spaced centre to centre at a distance d_c and with spacing between the edges of the particles, d_s . The number of cylinders and particles within each cylinder depends on the proportion of granular particles in the soil making up the thread and the equations derived in Appendix 6 can be used to determine the spacing between the large granular particles which then gives the granular spacing ratio s_g .

The significant aspect of the analysis is that the particle spacing and hence the granular spacing ratio can be determined both across the diameter and along the long axis of the soil thread. On the cross section of the thread the particle spacing and granular spacing ratio s_{gR} decrease but on the long axis the particle spacing and granular spacing ratio s_{gL} increase as the thread diameter decreases during a Barnes test or a standard plastic limit test. For the tests on the London Clay:Sand mixtures the granular spacing ratios are plotted as follows:

- 1) In Figure 9.15 – taking the fine sand (63 – 212 μm) with a median particle size of 150 μm as the single size of the large granular particles.
- 2) In Figure 9.16 – taking the fine/medium sand (63 – 425 μm) with a median particle size of 250 μm as the single size of the large granular particles.

In these figures the matrix surrounding the single sized particles comprises the silt and clay particles. It is deduced from Figure 9.6 that when the clay content lies below about 40% the effect of the granular particles becomes increasingly significant. From Figure 9.13 this would correspond to a granular spacing ratio of the order of 0.1. This is also illustrated in Figure 8.9.

Figures 9.15 and 9.16 show the granular spacing ratio s_{gR} reducing across the diameter as the thread diameter decreases during a Barnes test. For the sand content of 20% (the LC:Fine Sand 80:20 and the LC:Fine/medium Sand 80:20 mixtures) the granular spacing ratio s_{gR} on the cross section lies above about 0.1 until the diameter reduces below 4 mm. From the above arguments about the value of the granular spacing ratio when particle interference becomes significant this would show that particle interference on the cross section of the thread only becomes significant when the soil thread diameter is less than about 4 mm. The nominal stress vs. diameter plots for these mixtures, see Figures A3.3 and particularly A3.9 in Appendix 3, show that between the diameters of 6 and 4 mm the soil threads are deforming fairly consistently and are strain-hardening at a fairly slow rate but between the diameters of 4 and 3 mm the rate of strain-hardening increases.

For the sand content of 40% (clay:sand 60:40 mixtures) Figures 9.15 and 9.16 show the granular spacing ratio s_{gR} of about 0.1 occurs at the diameter of about 5 mm. Nevertheless, the nominal stress vs. diameter plots, see Figures A3.5 and A3.11, still show consistent deformation to the diameter of 4 mm but between 4 and 3 mm diameter the rate of strain-hardening increases at a greater rate.

For the sand content of 60% (clay:sand 40:60 mixtures) the granular spacing ratio s_{gR} of about 0.1 commences from the diameter of 6 mm. This is reflected in the nominal stress vs. diameter plots, see Figures A3.7 and A3.13, where strain-hardening commences following the yield points at diameters above 6 mm and continues at a steady rate to diameters of about 4 mm. However, below the diameter of about 4 mm the rate of strain-hardening increases further.

The above gives some further explanation of the instability of the nominal stress vs. diameter curves when the diameter reduces towards 3 mm. It is also a good reason why the curves display strain-hardening at the smaller diameter with more work required to keep the closer larger granular particles moving.

In Figures 9.15 and 9.16 the granular spacing ratio s_{gL} on the long axis of the thread s_{gL} is shown to increase significantly between the thread diameters of 6 and

4 mm but increases at an even greater rate between the diameters of 4 and 3 mm. Thus longitudinal extrusion has a greater effect when the thread diameter is below 4 mm than between 6 and 4 mm. The increased granular spacing ratio s_{gl} on the long axis may contribute to the transverse separation that sometimes occurs in soils with high clay contents when the thread diameter is between 4 and 3 mm.

With widely spaced large granular particles on the long axis leaving 'discs' of matrix between them it is envisaged that torsion stresses in the thread can cause some alignment of the clay particles on a transverse cross section through these discs of matrix reducing the soil strength to a value that could approach its residual strength resulting in separation of the thread. The clay used in the mixtures is a fairly active London Clay that would be expected to develop weak planes on which the residual shear strength results, particularly where it is unrestricted by the turbulent effects of granular particles. It has been observed that the transverse faces of the separation in a soil thread had a smooth appearance, especially for the higher clay content soils.

9.7 Summary

Mixtures of clay and fine sand and clay and fine/medium sand were prepared for testing with the Barnes apparatus. The particle size distributions were designed to produce samples with the same sand content and same clay content but with different sand sizes so the effect of sand size could be investigated using the substitution method. The particle size distributions were also appropriate for investigating whether the 'correction' of the water content by eliminating the proportion of larger oversize particles would give the same toughness and plastic limit values without the oversize particles. The results of the tests on the clay:silt mixtures were included to compare the effects of silt and of sand.

These results show that a sand substitution of 20% does not give the same result and a substitution of no more than about 10% should be considered as the limit. It has been found that the 'correction' of the water content by eliminating the larger oversize granular particles from the water content calculation provides incorrect results even for small oversize contents, as the plots do not coincide, with different plastic limits, different stiffness transitions, and different maximum toughness values, even for sand contents of 10%.

The plastic limit was found to decrease with decreasing particle size in the order fine/medium sand → fine sand → silt. It is considered that even for the same granular content with a larger number of granular particles the spacing between

them decreases, the matrix becomes less continuous and with the larger number of particles providing a larger surface area there are more opportunities for dislocation of the clay matrix and between the clay matrix and the surface of the granular particles. Cycling compressive and tensile stresses will then seek out these weaknesses, preferentially in the soils with the smaller granular particles, and produce crumbling sooner.

The toughness of all of the mixtures decreases with increasing matrix water content, as would be expected, with the silt mixtures providing higher toughness values at the same matrix water content. It is significant that the clay:silt mixtures with the higher silt contents could still display measurable plasticity by being rolled out in the apparatus whereas the clay:sand mixtures with the same granular contents could not be rolled out and would, therefore, be described as non-plastic. The clay:silt mixtures with high silt contents could also provide cohesiveness and plasticity even with very high matrix water contents, at water contents above the liquid limit of the matrix.

It has been found in the Barnes test for soils containing moderate amounts of large granular particles that the nominal stress vs. strain behaviour of a soil thread as it reduces in diameter near to 3 mm is affected by the presence of these granular particles. This is considered to be due to the particles moving closer together across the cross section of the thread producing increased interference. The effect on the nominal stress vs. strain behaviour is to produce a steepening of these plots between the diameters of about 4 and 3 mm. An analysis of the spacing between large granular particles is presented to demonstrate this effect. This analysis also demonstrates that the large granular particles move further apart along the long axis of the thread as the thread diameter decreases. This could be a factor causing the phenomenon of transverse splitting that is sometimes observed in soils with high clay contents when the thread is reduced to small diameters.

9.8 Tables

Clay:mixture	Typical mean particle size of granular particles d_g μm
Silt	20
Fine Sand	150
Fine/medium Sand	250

Table 9.1 Typical mean particle sizes in Figure 9.14

Type of test specimen	Maximum particle size mm
Oedometer consolidation	$H/5$
Direct shear (shear box)	$H/10$
Compressive strength (triaxial with $H/D \approx 2$)	$D/5$
Permeability	$D/12$

H = height of specimen D = diameter of specimen

Table 9.2 Maximum particle size for compacted specimens (From BS EN 1997-2:2007)

9.9 Figures

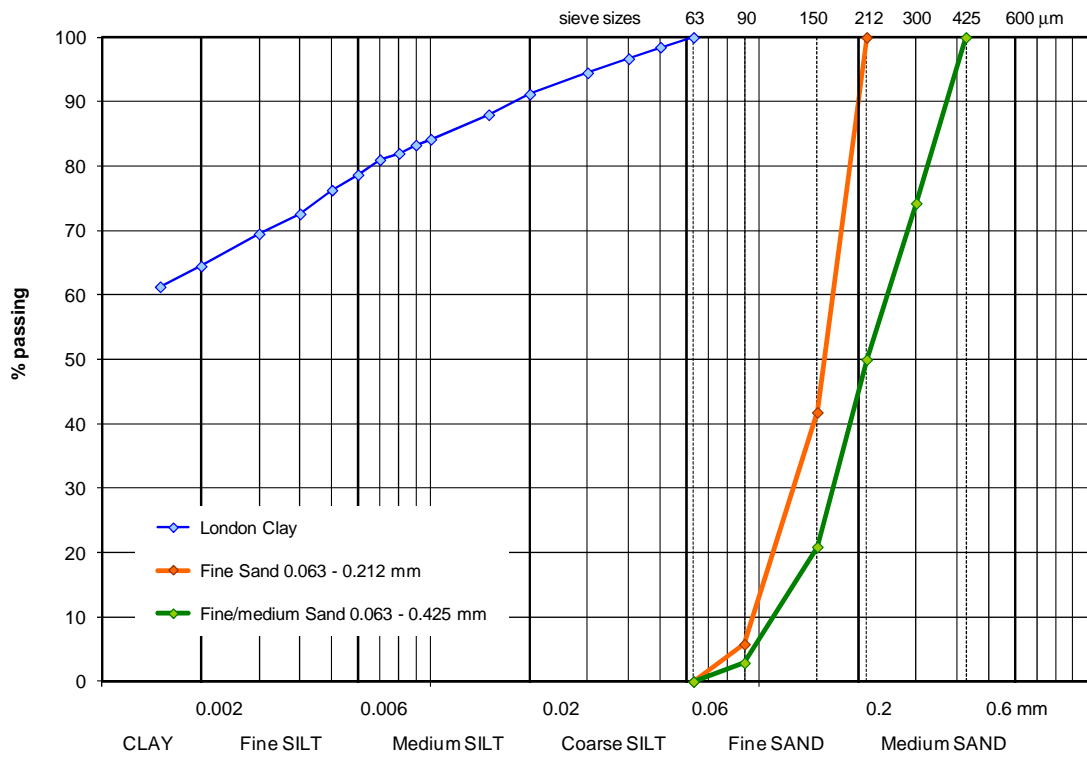

Figure 9.1 Particle size distributions of the London Clay, silt and sands

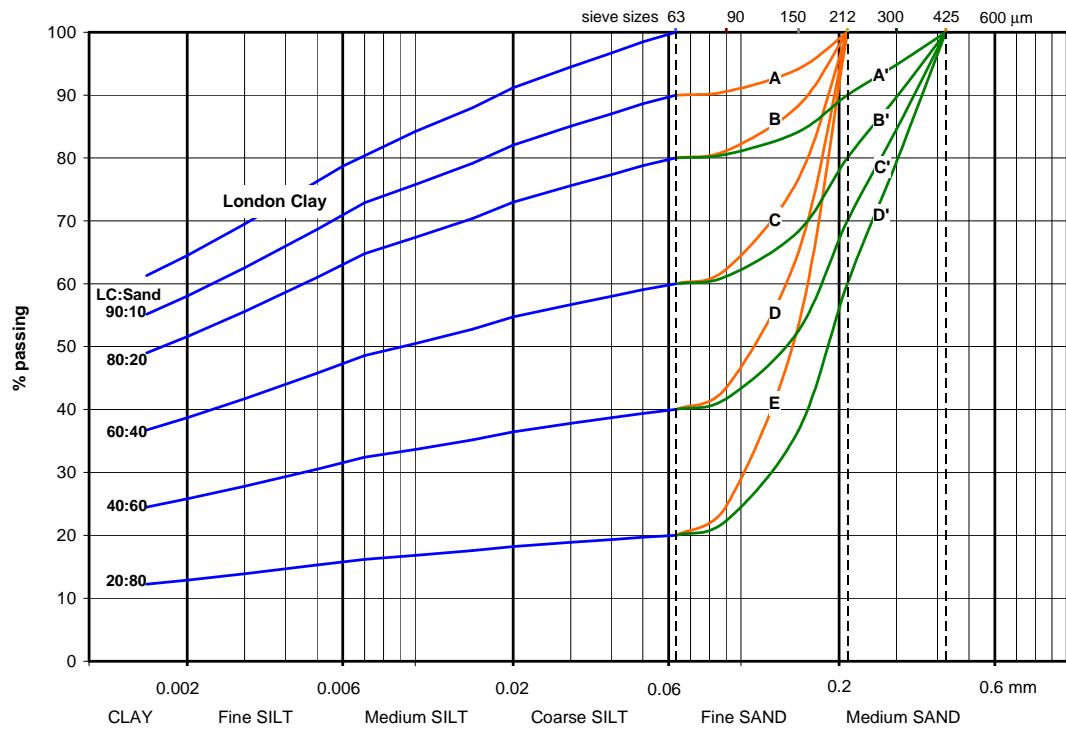

Figure 9.2 Particle size distributions of the Clay:Sand mixtures

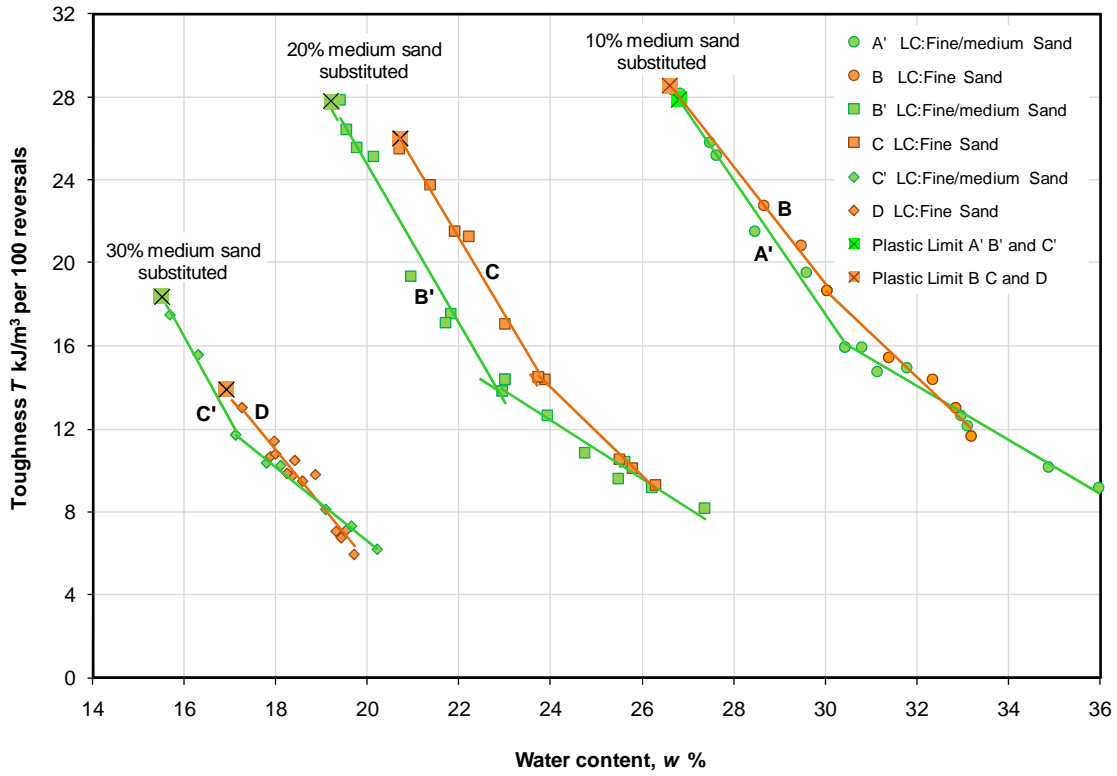

Figure 9.3 Substitution of different sand sizes

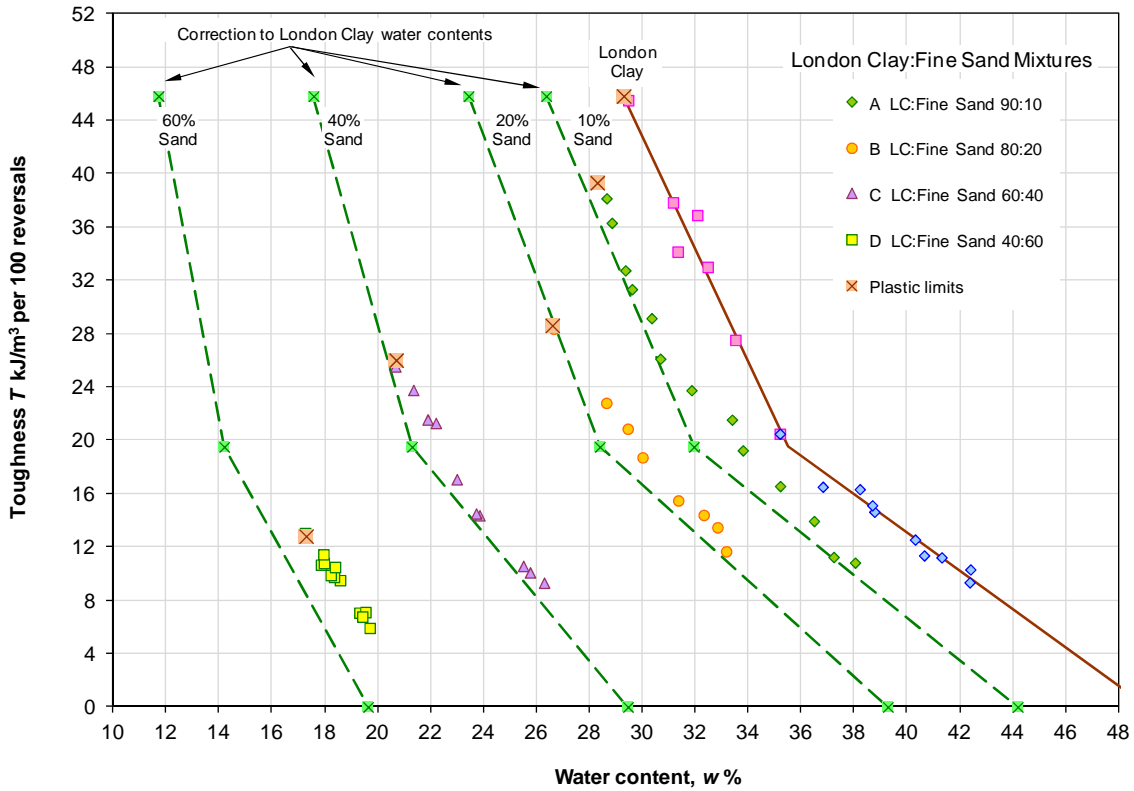

Figure 9.4 Correction to water contents – London Clay:Fine Sand mixtures

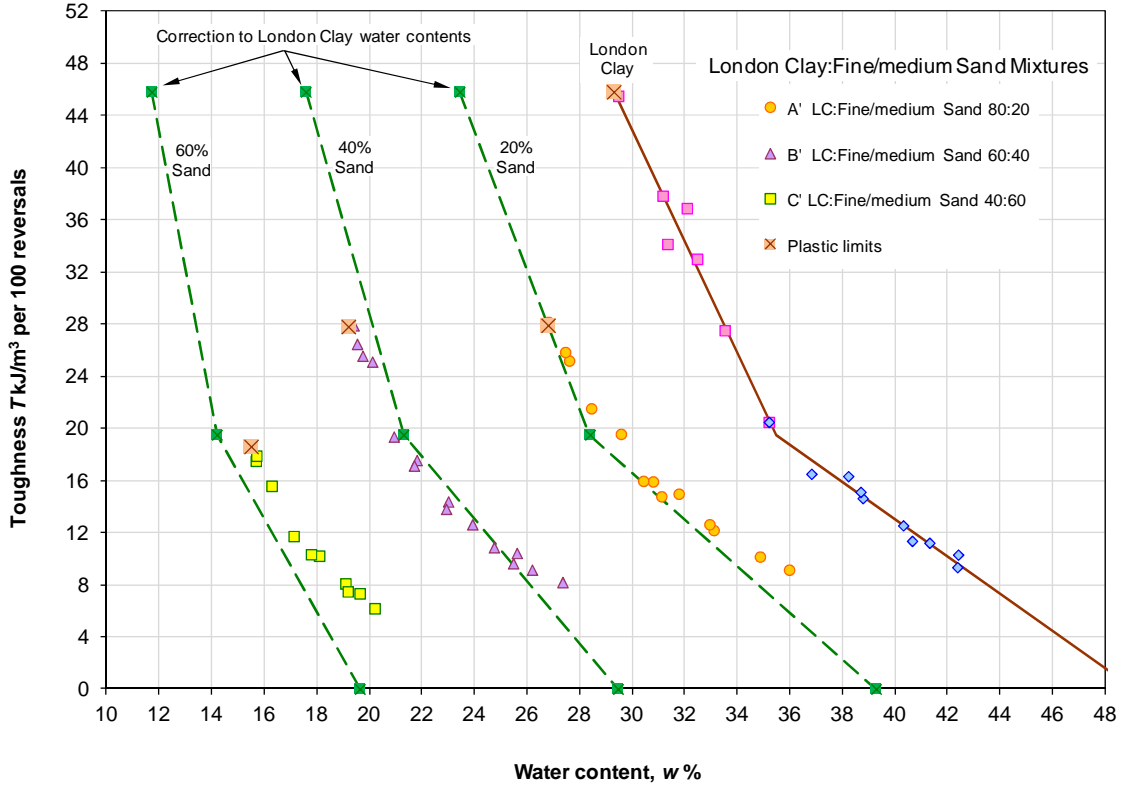

Figure 9.5 Correction to water contents – London Clay:Fine/medium Sand mixtures

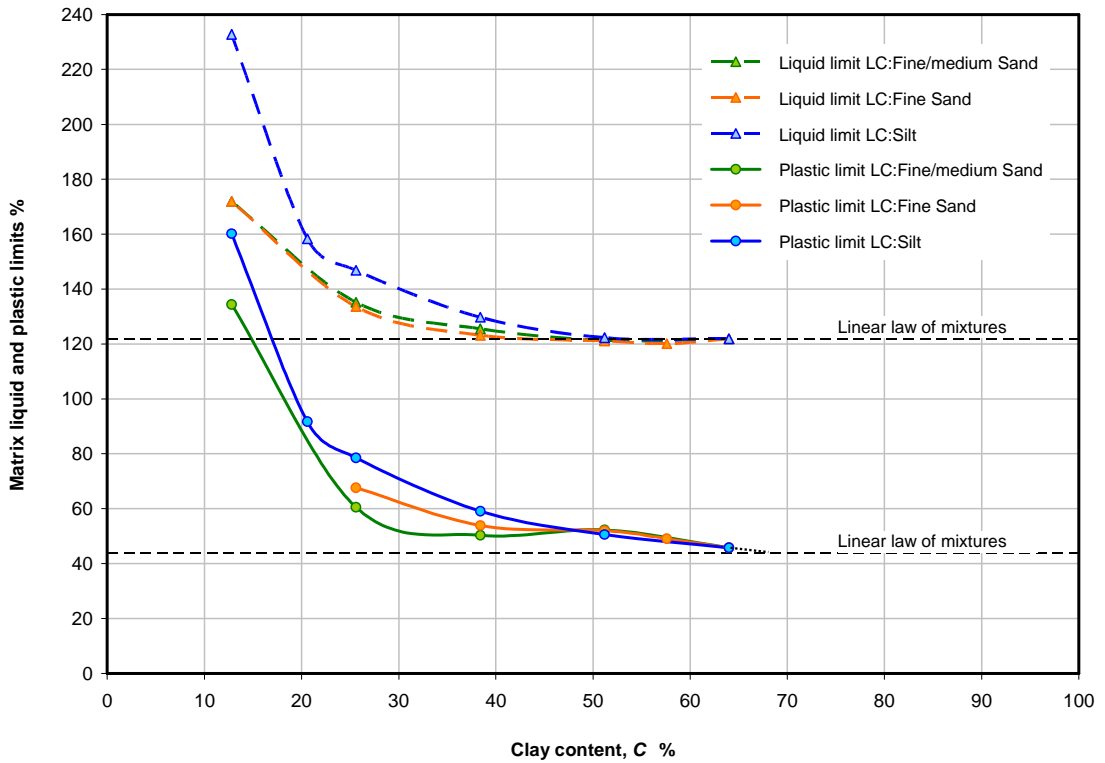

Figure 9.6 Matrix water contents at the liquid and plastic limits

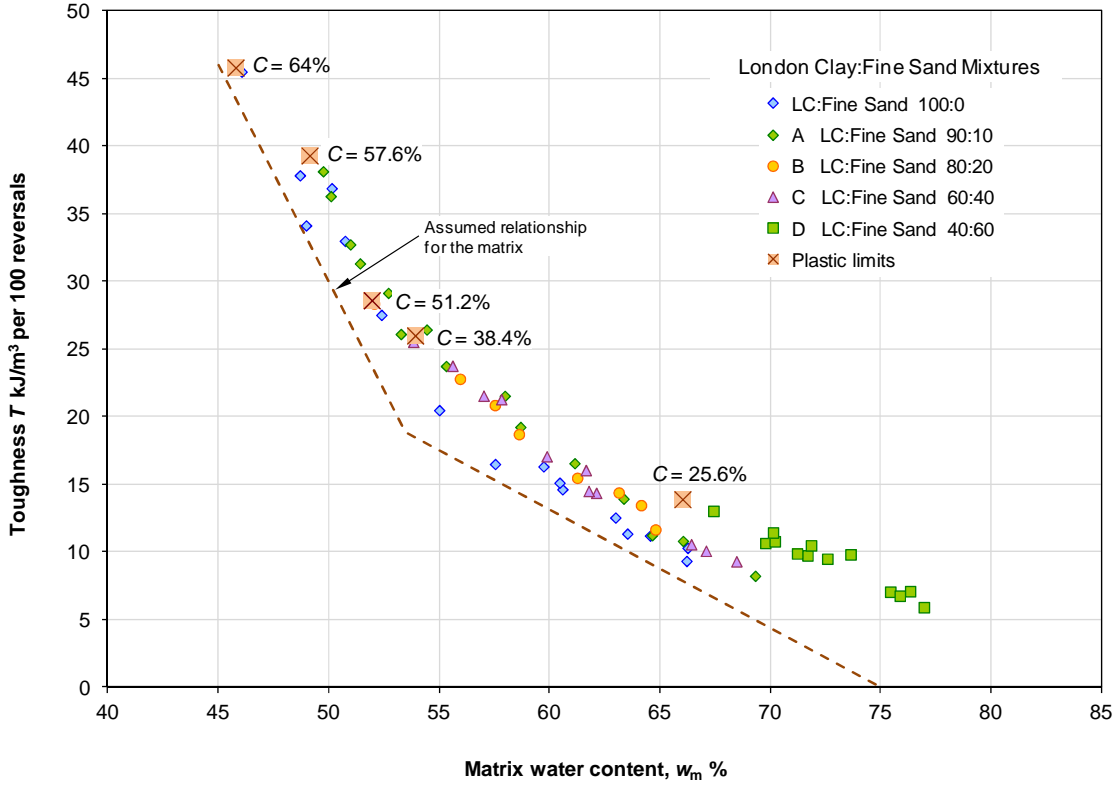

Figure 9.7 Toughness vs. matrix water content – London Clay:Fine Sand mixtures

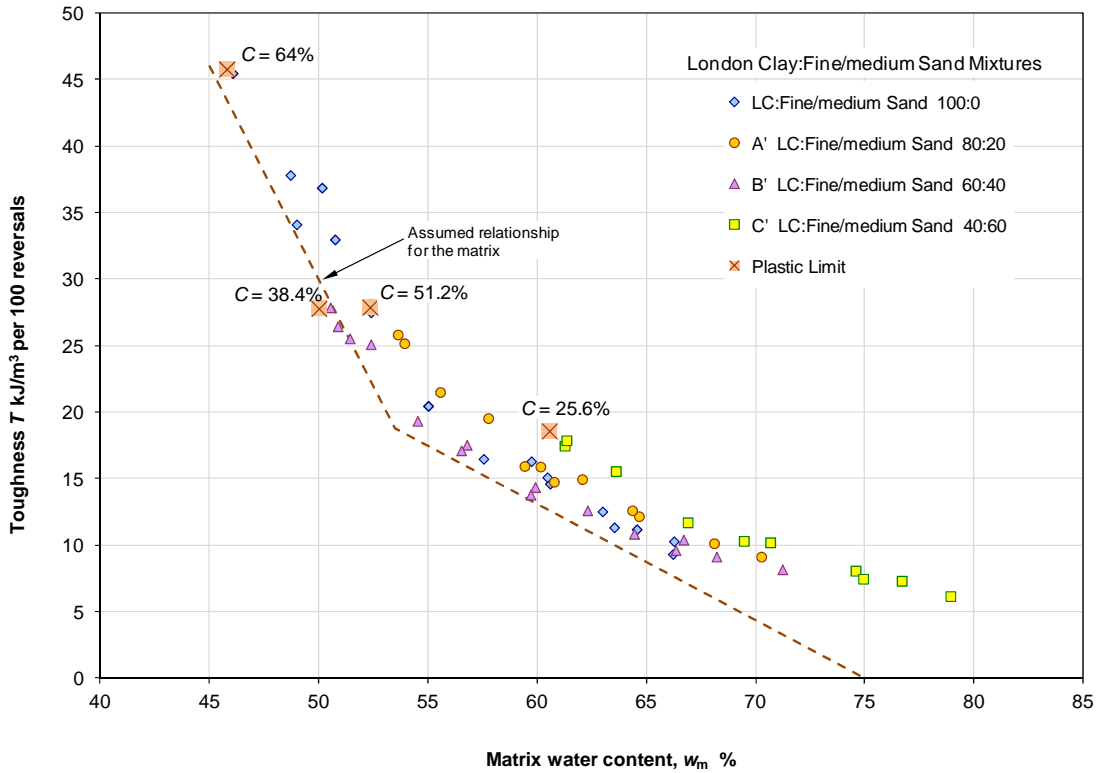

Figure 9.8 Toughness vs. matrix water content – London Clay:Fine/medium Sand mixtures

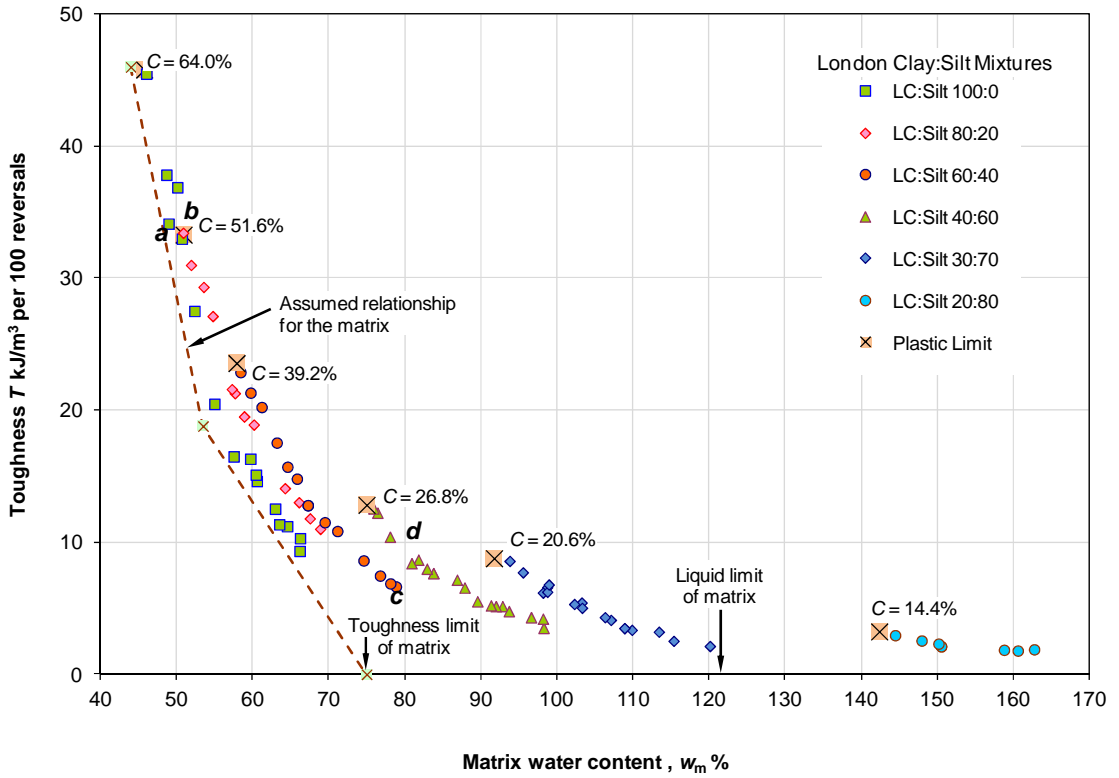

Figure 9.9 Toughness vs. matrix water content London Clay:Silt mixtures

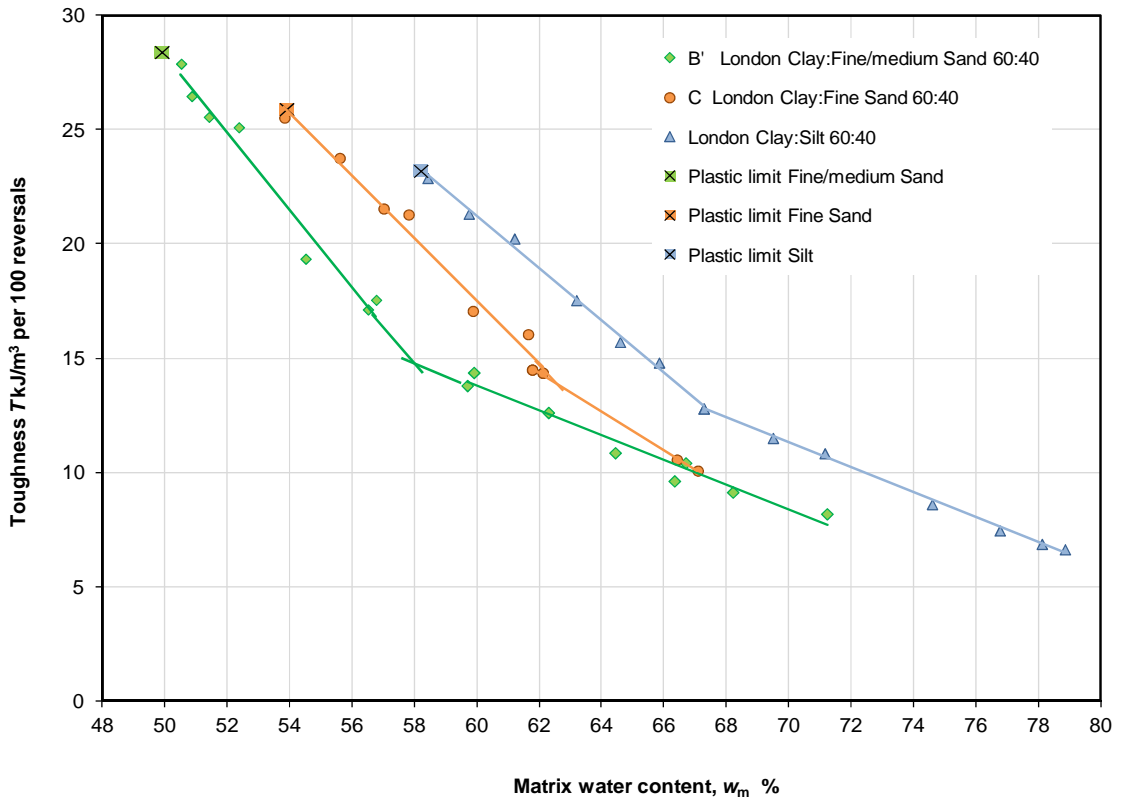

Figure 9.10 Effect of different granular particle sizes $C = 38\%$

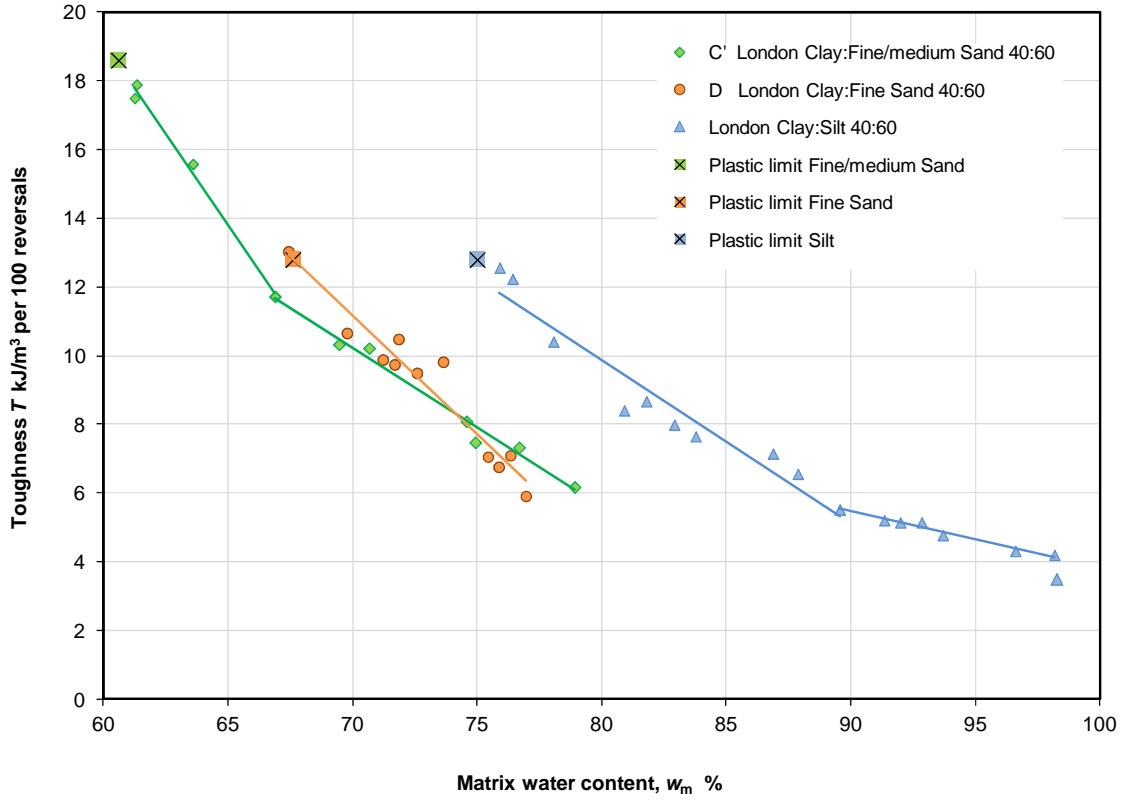

Figure 9.11 Effect of different granular particle sizes $C \approx 26\%$

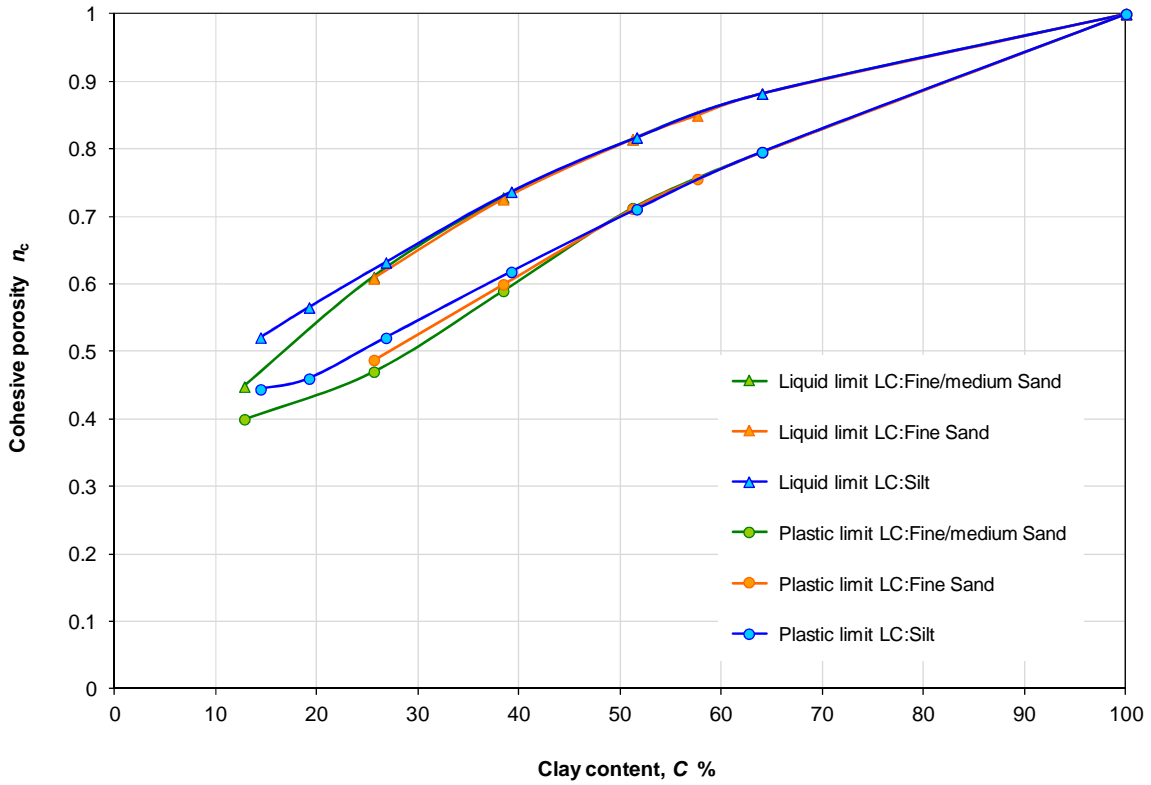

Figure 9.12 Cohesive porosity at the liquid and plastic limits

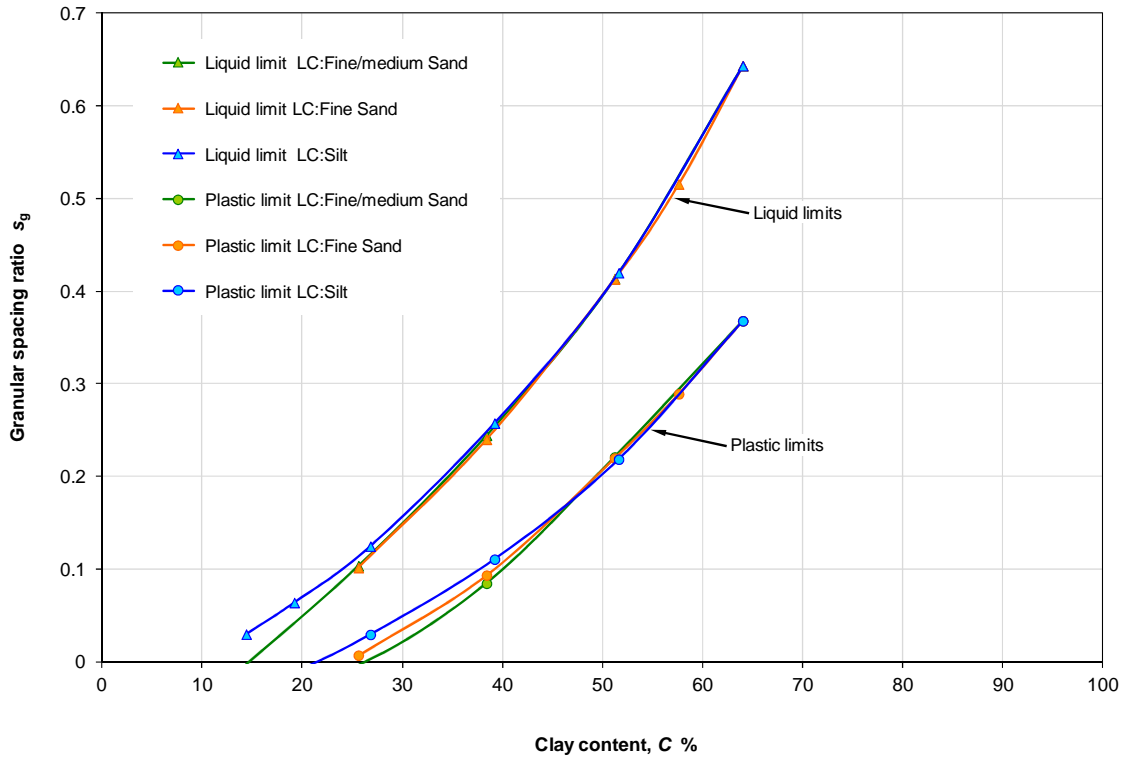

Figure 9.13 Granular spacing ratio at the liquid and plastic limits

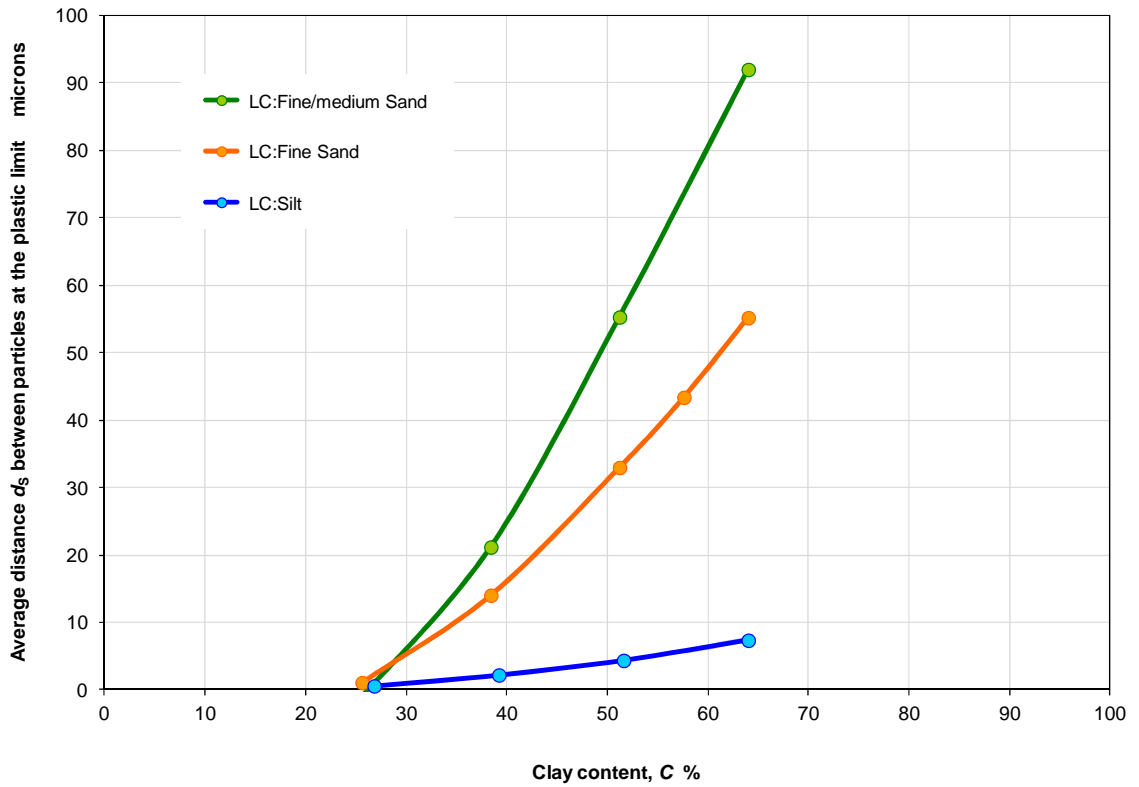

Figure 9.14 Average spacing between particles

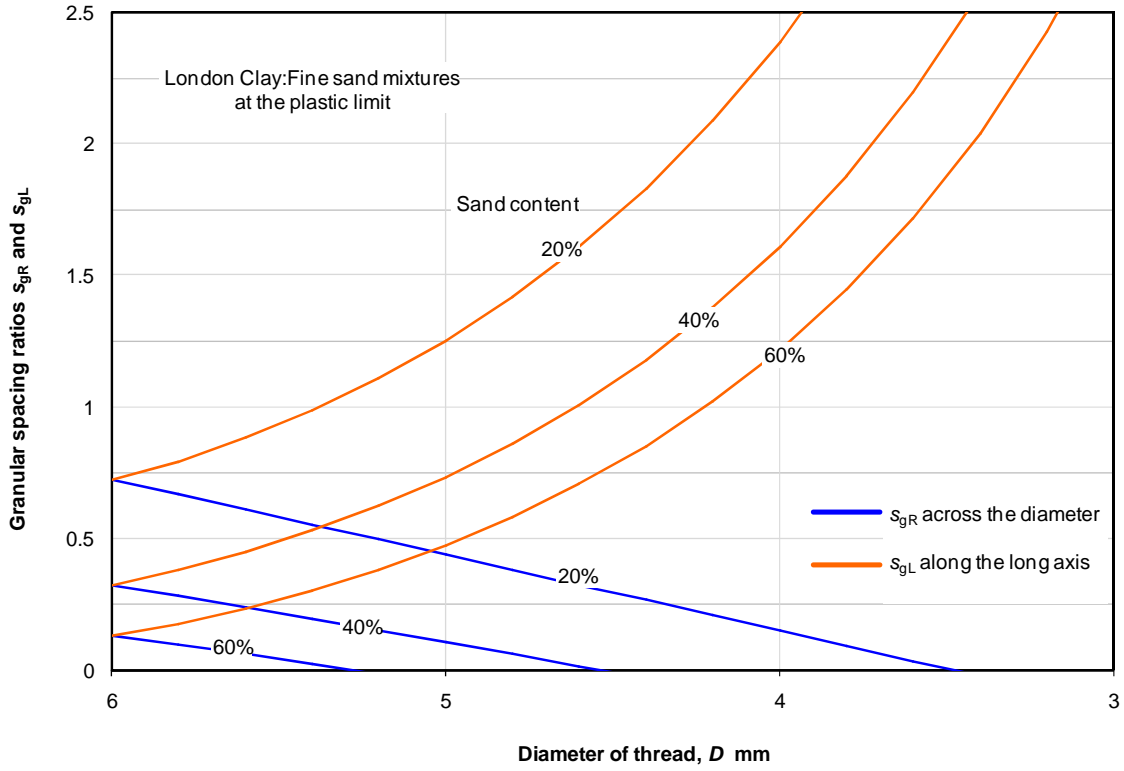

Figure 9.15 Reducing thread diameter and large granular particles – Fine sand

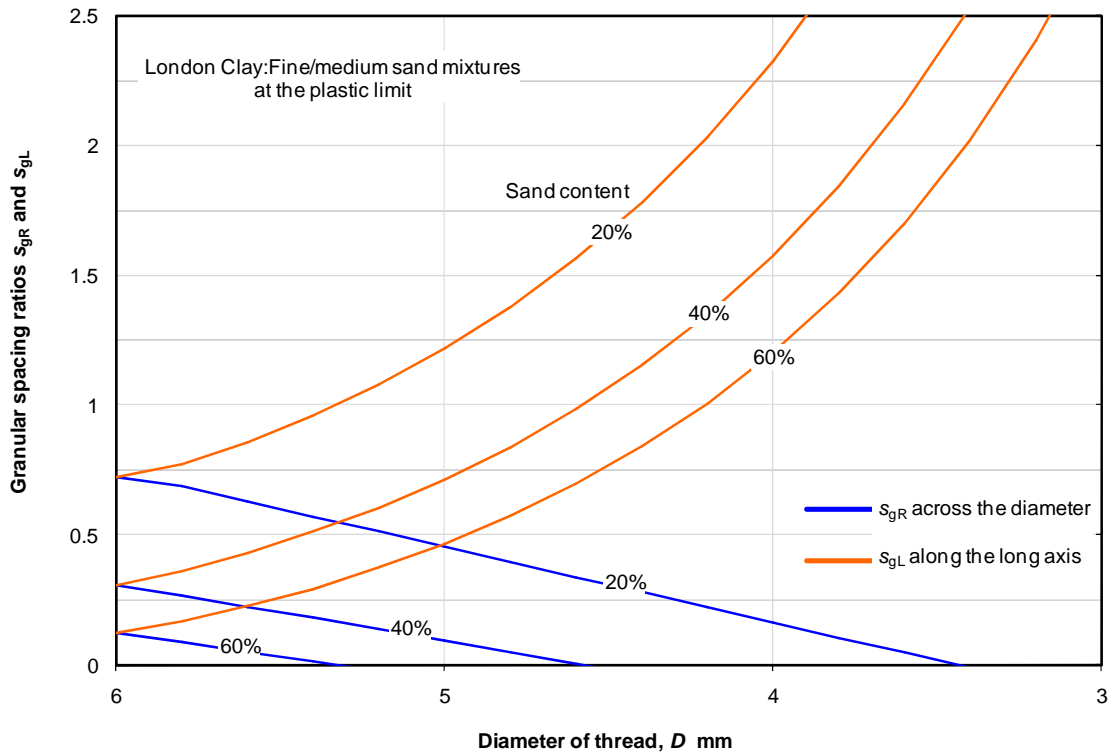

Figure 9.16 Reducing thread diameter and large granular particles – Fine/medium sand

CHAPTER 10

Tests on the ceramic clay mixtures

10.1 Introduction

In the ceramics industry the manufacturers of products ranging from tiles to tableware refer to the use of clay 'bodies'. These are mixtures of two or more different clays and other ingredients such as quartz, grog⁵⁹ and other fluxing agents to provide adequate green strength⁶⁰, low shrinkage and good firing properties. The clay types and proportions are usually chosen for their firing properties, finished colour and texture. However when these bodies are in the plastic form for moulding and shaping their toughness properties related to the water content by mass will be important and will be determined by the clay types and proportions.

In the whitewares ceramics industry (typically for bathroom, kitchen and tableware) most clays are produced for sale as air-dried powders to reduce weight for transportation and to enable the producers and manufacturers to blend different clay types for making various products. In the brick making industry the clays as dug are wetted up from their natural state and blended to form a homogeneous mass. The results of the tests described in this chapter would be relevant mostly to the whitewares industry.

The energy efficiency of the manufacturing processes, such as pressing⁶¹, will be affected by the toughness of the body so knowledge of this property will enable the best use of the individual clays to optimise energy efficiency. Improved control of the choice of clay types and their proportions, together with the mixing water contents, for optimum conditions would be available from the toughness vs. water content plots of the clay bodies.

To examine the effects on toughness and the plastic limit of mixing two different clay types used in the ceramics industry the Barnes test has been conducted on mixtures of known proportions by mass of a shaly clay, referred to as the Todhills Shaly Clay and a kaolinitic ball clay, referred to as the Povington Ball Clay and mixtures of two processed clays, a fireclay, referred to as the N6 Fireclay and a ball clay, referred to as the AT Ball Clay.

⁵⁹ Grog is ground up previously fired clay.

⁶⁰ Strength of the unfired, formed product.

⁶¹ Pressing is the process adopted for making plates, saucers, tiles, etc.

10.2 Preparation of mixtures

The Barnes test has been conducted on two mixtures of two different clay types used in the ceramics industry

- 1) mixtures of a shaly clay, referred to as the Todhills Shaly Clay (TSC), obtained from the clay pit of the Todhills brick works, Durham, provided by Weinerberger Ltd, and a kaolinitic clay, a ball clay, referred to as the Povington Ball Clay (PBC), obtained from the Creekmooor Clay deposit in the HPK seam of a ball clay pit at the Povington works, Dorset, provided by Imerys Minerals Ltd. Both clays were air-dried and ground to pass the 425 μm sieve then mixed together with proportions of the Povington Ball Clay of 100, 80, 60, 40, 30, 20, 10, 5 and 0% and
- 2) mixtures of two processed clays, a fireclay, referred to as the N6 Fireclay, sold by Potclays Ltd, Stoke-on-Trent and a ball clay, referred to as the AT Ball Clay sold by Bath Potters Supplies Ltd, Bath, Somerset. The N6 Fireclay was supplied in a moist condition, then air-dried and ground to pass the 425 μm sieve. The AT Ball Clay was delivered as a fine air-dried powder. These soils were mixed together with proportions of the AT Ball Clay of 100, 80, 60, 40, 20, 10, 5 and 0%.

The powders were wetted with distilled water to above the liquid limit, stored for at least 24 hours for water equilibration and then tested with the BS cone liquid limit device, dried gradually to a non-sticky condition and tested with the Barnes apparatus. The plots of nominal stress vs. diameter and toughness vs. water content by mass are presented in Appendix 4. From the latter plots, the plastic limit, maximum toughness and other properties described in Chapter 5 are determined.

The following discussion is based on the premise that for the two clays the particles less than 0.002 mm size⁶² are platy clay minerals and the particles greater than 0.002 mm are inert, near equi-dimensional rock fragments. This may not be the case and the test results could be affected by particles greater than 0.002 mm in the kaolinitic soils, the Povington Ball Clay and the AT Ball Clay, particularly in the fine silt sizes, that are clay minerals, albeit possibly in an aggregated form. There may also be particles greater than 0.002 mm in the Todhills Shaly Clay and the N6 Fireclay that are strongly aggregated groups of clay minerals as well as particles or

⁶² The clay content is taken as the proportion of particles with sizes less than 0.002 mm.

flakes of indurated shale. Interactions may occur between these particles that are not included in the interpretation of the results.

In the ceramics industry the phrase 'normal consistency' is used to describe the condition of a clay body that has a workability suitable for the particular manufacturing process. It is not defined by testing but appears to be qualitatively deduced as no better than the 'potter's feel'. It requires a clay body to be non-sticky and readily deformable without introducing defects such as cracks. Atterberg (1911, 1974) indicated that this consistency was close to the sticky limit. From the toughness vs. water content plots obtained from the Barnes test the 'normal consistency' would correspond to the range of water contents in the soft-plastic but non-sticky region.

10.3 Tests on the Todhills Shaly Clay:Povington Ball Clay mixtures

10.3.1 Properties

In this section, for simplicity, the two clays are referred to as Shaly Clay and Ball Clay. The two clays were chosen because of their use in the ceramics industry and because of their very different clay contents of 14% in the Shaly Clay and 78% in the Ball Clay. The various water content limits and toughness properties of the two clays are given in Table 10.1 and their particle size distribution curves are plotted in Figure 10.1.

The Ball Clay would be described as much more plastic than the Shaly Clay with a plasticity index of 32.7% compared to 10.3% for the Shaly Clay and with a much higher liquid limit, as shown on the Casagrande plasticity chart in Figure 10.2. The Ball Clay lies below the A-line as a result of its kaolinite content and possibly a small organic content and not because of a high silt content.

The total clay contents C of the mixtures vary between 14 and 78% depending on the mix proportions. From the known proportions the total clay content of each mixture has been calculated by interpolation as shown in Table 10.2. It is envisaged that the plasticity properties of the clay mixtures will be affected by the total clay content and the proportion of clay particles from the Ball Clay (BC) in the total clay content of each mixture. The BC clay content C_{bc} is calculated from

$$C_{bc} = \frac{bc}{bc + sc} \times 100 \quad 10.1$$

where

bc = % of clay from the Ball Clay in each mixture

sc = % of clay from the Shaly Clay in each mixture

C_{bc} will vary between 0 and 100% and the values calculated for each mixture are presented in Table 10.2. It is significant that the particle size distribution of the Ball Clay, in Figure 10.1, shows a fair proportion of fine silt size particles, approximately 15%. It is known that many kaolinite soils contain clay mineral particles that are larger than 0.002 mm so some of this fine 'silt' could comprise clay minerals but this has not been included in the calculations in Table 10.2.

10.3.2 Liquid limits

The liquid limit test was not carried out for the TSC:PBC 95:5 mixture. The results of the liquid limit tests conducted on the mixtures of the two clays are plotted in Figure 10.3 and show that the liquid limit does not follow a linear path in relation to the proportions of the Shaly Clay and the Ball Clay. Sivapullaiah and Sridharan (1985) showed that the liquid limit of mixtures of bentonite and illite and bentonite and kaolinite did not follow a linear path, but lay below the linear relationship, similar to the relationship in Figure 10.3. Their conclusion was that the linear law did not apply for these clay minerals because of interactions between the two clays when mixed together.

For the current mixtures for all Ball Clay contents the liquid limit of the mixtures is lower than would be expected from a proportional basis. One reason for this could be that the fall cone test used to determine the liquid limit is designed to achieve the same undrained shear strength at this water content. At the liquid limit of the mixtures lower water contents were required to achieve this shear strength suggesting that one of the clays is not at its own independent liquid limit water content and the shear strength of the mixture is controlled by the water content associated with the other clay.

If one clay predominates in proportion in the mixture and/or it has a greater attraction for water molecules it would be able to take up water more aggressively than the other. As the mixtures were prepared from air-dried powders mixed together and then wetted up, during wetting up one of the clays could have absorbed the added water more readily than the other and sufficiently to control the permeability and shear strength of the mixture.

It is feasible that this clay can quickly form a continuous matrix which will be

capable of enveloping small pockets, the powder pieces and aggregates of the other clay, restricting its water uptake and rendering the other clay less effective overall. Equilibrium of water content may never be achieved in these mixtures unless these coated pockets are broken down by thorough mixing. With natural sedimentary soils the clay minerals are more likely to be individually fully hydrated before combining during the sedimentation process.

This effect is illustrated more clearly by plotting the matrix liquid limits as determined from equation 7.3 against the total clay content C and the BC clay content C_{bc} , in Figure 10.4. From this Figure it can be seen that

- 1) at high Ball Clay contents (between points A and B in Figure 10.4) the matrix liquid limit is lower than would be expected from a linear interpolation (the dashed lines in Figure 10.4). This may be because the small amount of Shaly Clay is enveloped by the Ball Clay and is not fully hydrated.
- 2) With intermediate Ball Clay and Shaly Clay contents (between points B and C in Figure 10.4) the matrix liquid limit increases with increasing content of the Shaly Clay. With total clay contents greater than about 40% a constant matrix liquid limit would be expected with inert silt and sand particles having no effect, as found for the clay:silt and clay:sand mixtures, described in Chapters 8 and 9. However, from the lower plot in Figure 10.4 this is not the case, the matrix liquid limit increases between points B and C with increasing Shaly Clay content. It is envisaged that the Shaly Clay contains clay, silt and sand particles that have a 'shaly' nature with flat, flaky shapes and that these interfere with the matrix during shearing in the fall cone test such that the matrix now requires a higher water content to produce the unique shear strength from the fall cone at the liquid limit. There may also be some interactions between the clay minerals in the two clays that produce a stiffening effect.
- 3) At high Shaly Clay contents (between points C and D in Figure 10.4) the matrix liquid limit increases further to compensate for the large amount of silt and sand present, up to 86%. Between points D and E in Figure 10.4 the matrix liquid limit rises rapidly because these mixtures are dominated by the silt and sand in the Shaly Clay. Similar features were found in the results of the tests on the clay:silt and clay:sand mixtures described in Chapters 8 and 9.

10.3.3 Toughness

The plots of nominal stress vs. diameter are presented in Figures 10.5 and 10.7 for the Todhills Shaly Clay and the Povington Ball Clay, respectively. These plots show that strain-hardening is a common feature of both clays but the Shaly Clay strain-hardens continuously whereas the Ball Clay displays yielding followed by much less strain-hardening and some softening, particularly for the lower water content samples. Also the Ball Clay can support higher stresses in the plastic region than the Shaly Clay. For the clay mixtures the nominal stress vs. diameter plots, in Appendix 4, with up to about 60% Ball Clay have similar trends to those of the Shaly Clay while for the mixtures with more than about 60% Ball Clay the plots have similar trends to the Ball Clay.

The plots of toughness vs. water content are presented in Figures 10.6 and 10.8 for the Todhills Shaly Clay and the Povington Ball Clay, respectively. For both clays distinct soft-plastic and stiff-plastic regions were found with stiffness transitions at similar workability indices, I_w of 0.32 and 0.28 for the Shaly Clay and the Ball Clay, respectively. The difference in gradients of the plots in the two regions, as measured by the toughness coefficients, T_{CA} and T_{CB} , was greater for the Shaly Clay than for the Ball Clay with a more distinct stiffness transition.

For the clay mixtures the toughness vs. water content plots, in Appendix 4, show that with increasing Ball Clay contents the gradients of the plots (or toughness coefficients) each side of the stiffness transition become closer until at the Ball Clay content of 40% a change in gradient could not be distinguished, with no stiffness transition identified, see Figure A4.12.

With higher Ball Clay contents ($\geq 60\%$) the toughness of the clay mixtures in the soft-plastic region was higher with values up to 10 kJ/m³ per 100 reversals whereas the toughness for the clay mixtures with smaller Ball Clay contents was up to 5 kJ/m³ per 100 reversals. Thus the presence of Ball Clay increases significantly the toughness of the clay mixtures in the soft-plastic region when the proportion of Ball Clay exceeds about 60%.

On Figure 10.9 the toughness vs. water content results are plotted for all of the mixtures. Even for the Ball Clay content of 80% the toughness vs. water content plots lie some distance below the plot that would be expected for a relationship interpolated linearly (the brown dashed line in Figure 10.9) between the results of the 100% Shaly Clay and the 100% Ball Clay. This form of linear relationship is not

appropriate. It is more instructive to plot the matrix water contents determined from equation 7.1 against the toughness, as in Figure 10.10.

For the mixtures with Ball Clay contents of 40 to 100% the relationships of toughness vs. matrix water content are very close, confirming that the silt and sand in these mixtures have little effect on the toughness of the matrix. It follows that the plots for the Ball Clay contents of 40, 60 and 80% on Figure 10.9 will have similar matrix water contents at the same toughness. The plots for these Ball Clay contents in Figure 10.9 suggest that there are significant differences between these plots but this is on the basis of comparing total water contents. On the basis of the matrix water contents there is little difference, see Figure 10.10. On Figure 10.9 the plots are at locations defined by their total water contents and these are determined from fairly similar matrix water contents but multiplied by different clay contents, using equation 7.2.

To confirm this, on Figure 10.9 the result of the 100% Ball Clay test has been adjusted to provide a result for the mixtures with 40, 60 and 80% Ball Clay such that the matrix water contents of these mixtures are the same as the 100% Ball Clay but their total water contents are derived from their clay contents. For example, the point A of the 100% Ball Clay test has a total water content of 41.9% and, with a clay content of 78%, a matrix water content of 53.7%. For the mixture with 80% Ball Clay with a clay content of 65.2% and the same matrix water content of 53.7% the total water content would be 35.0%. This is point B on Figure 10.9. This approach has been applied to all of the points for the mixtures with 30, 40, 60 and 80% Ball Clay and these are plotted as the dashed lines in Figure 10.9, parallel to the 100% Ball Clay lines. It can be seen that for the mixtures with 40, 60 and 80% Ball Clay the dashed lines coincide with their respective plots confirming that the matrix water content determines the toughness. The total water contents for each mixture are simply obtained by multiplying the water contents of the 100% Ball Clay by the clay content of each mixture.

The dashed line for the mixture with 30% Ball Clay in Figure 10.9 lies some distance from its respective plot showing that for this mixture (and for lower clay contents) the silt and sand particles have an effect on the toughness. For this mixture the matrix water content has increased to obtain the same toughness, see Figure 10.10, to compensate for the work done in moving the silt/sand particles. Alternatively, at the same matrix water content the toughness increases because of the additional work required to move the silt/sand particles.

Incorporating small amounts of one clay in another clay can be a useful process in the ceramics industry if it reduces the overall plasticity or workability of the mixture, making the mixture easier to deform but still retain its shape when moulded in the various manufacturing processes. The benefits of adding small amounts of Ball Clay to the Shaly Clay are shown to be appreciable in terms of improving the 'plasticity' of the resulting mixture. The plots of toughness vs. water content for the clay mixtures with small Ball Clay contents of 0, 5, 10, 20 and 30%, presented in Figure 10.11, show that adding 5% Ball Clay to the Shaly Clay reduces considerably the toughness of the mixture at the same water content with less reduction in toughness with 10% Ball Clay in the mixture. Judging by the location of the 20% Ball Clay plot it is estimated that there is probably no effect with about 15% Ball Clay in the mixture.

These results appear contrary to the results expected because adding Ball Clay which has a higher maximum toughness than the Shaly Clay could be presumed to increase the toughness of the mixture, not decrease it. This can be explained by inspecting the plot of toughness vs. matrix water content in Figure 10.10 where it is shown that it is the matrix water content of the mixture that is reduced by adding small amounts of Ball Clay to achieve the same toughness.

Compared to the 100% Shaly Clay the mixture with 5% Ball Clay has a higher total clay content. From equation 7.2, for the 5% Ball Clay mixture the lower matrix water content multiplied by the higher clay content gives a total water content that still lies below the 100% Shaly Clay plot on Figure 10.11. Thus the reduction in matrix water content caused by including 5% Ball Clay in the mixture is sufficient to produce lower toughnesses at the same total water content; similarly for the 10% Ball clay mixture.

The toughness vs. total water content plots demonstrate the importance of controlling the water content of the mixtures to achieve a suitable (low) toughness in the soft-plastic region for moulding purposes. On Figure 10.11, by keeping the total water content within the soft-plastic region small amounts of Ball Clay will reduce the toughness of the mixture. The addition of small amounts of Ball Clay to the Shaly Clay can offer an additional beneficial effect because with lower matrix water contents the shrinkage of a moulded clay product should be lower. However, there will be a limit to this effect as the proportion of Ball Clay increases since this clay will probably have a higher tendency for shrinkage.

It is feasible that the small amounts of the Ball Clay (BC) clay particles act to reduce the attractions between and ease the movement of the Shaly Clay particles

resulting in lower toughness. However, the maximum toughness values for the mixtures with 5%, 10% and 30%⁶³ Ball Clay and possibly the 40% Ball Clay are similar to that of the Shaly Clay, at around 10 kJ/m³ per 100 reversals. They would be expected to be no lower than for the Shaly Clay and, rather, would be expected to be higher. Thus it seems that the maximum toughness of these mixtures is controlled by the Shaly Clay component of each mixture.

10.3.4 Plastic limits

A photograph of the cross section in the middle of a thread of the TSC:PBC 60:40 mixture on the brittle side of the ductile-brittle transition taken at the end of the test is presented in Figure 10.12. This photograph shows the typical 'X' type of fracturing and opening or dilatancy that often occurs in a brittle thread. The change from a circular to an elliptical cross section can be seen with more opening of the fractures on the 'squashed' side.

On Figure 10.3 the plastic limits do not follow a linear relationship according to the clay proportions. On Figure 10.9 because of the much lower maximum toughnesses for each mixture than expected from a linear interpolated relationship (the brown dashed line in Figure 10.9) between the Ball Clay and the Shaly Clay it can be seen that it would be impossible for the plastic limits of the mixtures to coincide with the linear relationship. Instead, in Figure 10.9, a ductile-brittle transition occurs at the upper end of a shorter stiff-plastic region of each mixture.

The matrix plastic limit is plotted against the total clay content and the Ball Clay clay content in Figure 10.13. Comparing the 100% Ball Clay and the mixture with 80% Ball Clay, points A and B on Figure 10.13, it is seen that the small addition of the Shaly Clay to the Ball Clay causes a small increase in the matrix plastic limit. If the clays were fully hydrated and there was no interaction between the clay minerals in the two clays there would be no difference in matrix plastic limits. If the Shaly Clay particles were not fully hydrated, as is postulated for the liquid limit, the plastic limit of the mixture with 80% Ball Clay (point B on Figure 10.13) would be lower than for the 100% Ball Clay (point A on Figure 10.13). Thus there may be some interaction between the clay minerals in the two clays.

However, on Figure 10.10 the toughness at the plastic limit, T_{\max} , for the mixture with 80% Ball Clay is much less (13.8 kJ/m³ per 100 reversals) than for the 100%

⁶³ It is suspected that the T_{\max} value for the mixture with 20% Ball Clay of 8 kJ/m³ is incorrect, too low.

Ball Clay (19.8 kJ/m³ per 100 reversals). The small amount of Shaly Clay in the 80% mixture causes a thread of the mixture to become brittle well before it could achieve the T_{\max} of the 100% Ball Clay. This results in a slightly higher plastic limit. Therefore it is the point at which the soil cannot achieve any higher toughness that determines the plastic limit.

This could be due to the presence in the 80% Ball Clay matrix of silt and sand sized 'shaly' particles that have a flat, flaky shape and can produce dislocations within the clay matrix and an earlier brittle behaviour in the stiff-plastic region. It is then assumed that the plastic limit of the mixture with 80% Ball Clay is higher than the plastic limit of the 100% Ball Clay only because of the lower T_{\max} value achieved. Subsequently there may not be much interaction between the clay minerals from the two clays in the mixture with 80% Ball Clay.

A similar explanation can be given for the mixtures with 60% and 40% Ball Clay with slightly higher matrix water contents at the ductile-brittle transition (matrix plastic limits) and lower T_{\max} values, see Figure 10.10. This is illustrated further in Figure 10.13 where the matrix plastic limits for the mixtures with 40 – 80% Ball Clay are increasing slightly between points B and C. The decreasing total plastic limits for these mixtures, in Figure 10.3, are then produced by the 'correction' for the increasing silt/sand content.

For the mixtures with Ball Clay contents of 0 – 30%, on Figure 10.10, the ductile-brittle transitions occur at similar toughnesses of 10 – 11 kJ/m³ per 100 reversals. On Figure 10.13 it is seen that the matrix plastic limit is affected considerably by the higher silt/sand contents for these mixtures with a significant increase in the matrix plastic limit between points C and D and a rapid rise between points D and E. The toughness of these mixtures is determined not only by the clay matrix but by the additional work required to move the silt/sand particles. Thus a linear variation of plastic limits between the two clays is not possible, between points A and E on Figure 10.13, mainly because of the presence of the silt/sand size 'shaly' particles, particularly in the region from C to E.

10.4 Tests on the N6 Fireclay:AT Ball Clay mixtures

10.4.1 Properties

The various water content limits and toughness properties of the N6 Fireclay and the AT Ball Clay are given in Table 10.3 and their particle size distribution curves from sedimentation tests are plotted in Figure 10.14. The AT Ball Clay would be

described as more plastic than the N6 Fireclay with a higher plasticity index, higher toughness index and a higher liquid limit. The liquid limits and plasticity indices for the mixtures are plotted in Figure 10.2 with all of the results roughly parallel to the A-line. For both clays there is a large range of water contents between the toughness limit and the liquid limit where the clays would be in a non-workable sticky condition.

As above, it is envisaged that the plasticity properties of the clay mixtures will be affected by the total clay content and the proportion of clay particles from the Ball Clay (BC) in the total clay content of each mixture. The BC clay content C_{bc} is calculated from equation 10.1 but with the % of clay, f_c from the Fireclay in each mixture replacing s_c in the equation. C_{bc} will vary between 0 and 100%. The total clay content C and the BC clay content C_{bc} of each mixture, calculated by interpolation, is given in Table 10.4.

10.4.2 Liquid limits

The results of the liquid limit and plastic limit tests on the mixtures of these clays are plotted in Figure 10.15. The liquid limits do not follow a linear path in relation to the proportions of the two clays, similar to the results for the Todhills Shaly Clay:Povington Ball Clay mixtures in Figure 10.3. As for the results discussed in section 10.2, the deviation from the linear law may be due partly to the predominance of one of the clays in attracting water molecules when wetted up from dried powders but may also be affected by the interference effects of particle attractions between the two clays.

Both the Ball Clay and the Fireclay include more than 40% clay mineral content and the Fireclay contains less than 10% sand so the mixtures should not be significantly affected by the presence of silt or sand particles from either clay.

By plotting the matrix liquid limit as determined from equation 7.3 against the total clay content C and the BC clay content C_{bc} in Figure 10.16, it is found that at high Ball Clay contents (between points A and B on Figure 10.16) the matrix liquid limit increases with increasing Fireclay content and follows the linear relationship between the two clay types. This would suggest that the Fireclay is fully hydrated, in contrast to the result for the Todhills Shaly Clay:Povington Ball Clay mixture with a small shaly clay content. From B to C on Figure 10.16 the lower matrix liquid limits may be due to a proportion of the Fireclay not being fully hydrated. Alternatively if both clays are fully hydrated then the lower matrix liquid limits may be the result of the Fireclay providing a softening effect in the mixtures.

At high Fireclay contents between points C and E on Figure 10.16 the rapidly increasing matrix liquid limit with decreasing amounts of Ball Clay would not be expected as a result of the presence of any silt/sand particles in the Fireclay because the total clay contents are still greater than about 40%. It is envisaged that the Ball Clay acts to ease the movement of the particles in the Fireclay so less water is required to obtain the same shear strength. With a lower matrix water content required to produce the shear strength in the fall cone test at the liquid limit a lower liquid limit is obtained.

10.4.3 Toughness

The plots of nominal stress vs. diameter are presented in Figures 10.17 and 10.19 for the N6 Fireclay and the AT Ball Clay, respectively. These plots show that strain-hardening is a common feature of both clays but the N6 Fireclay strain-hardens continuously whereas the AT Ball Clay displays reduced strain-hardening with some yielding and softening, for the lower water content samples. Also the AT Ball Clay can support higher stresses than the N6 Fireclay in the plastic region.

The plots of toughness vs. water content are presented in Figure 10.18 and 10.20 for the N6 Fireclay and the AT Ball Clay, respectively. Both clays have distinct soft-plastic and stiff-plastic regions with well-defined stiffness transitions. The range of water contents for which the N6 Fireclay was workable and non-sticky in the soft-plastic region was smaller than for the AT Ball Clay, about 2% points compared to about 4%. To maintain the water contents in the soft-plastic region closer control of water content would be required for the N6 Fireclay. The toughness of the AT Ball Clay in the soft-plastic region (10 – 17 kJ/m³ per 100 reversals) was much greater than for the N6 Fireclay (6 – 10 kJ/m³ per 100 reversals).

The toughness vs. total water content relationships for all of the clay mixtures are plotted in Figure 10.21. The relationships do not follow a linear interpolation between the plots for the N6 Fireclay and the AT Ball Clay, presumably due to clay particle interactions between the two clays. Similar to the tests described in section 10.2 a small amount of the AT Ball Clay (5%) added to the N6 Fireclay provides a clay mixture with a slightly lower or similar toughness than the N6 Fireclay, at the same total water content, see Figure 10.22. This could be viewed as an improvement in the plasticity of the N6 Fireclay but comparing the toughness vs. total water content plots in Figures A4.20 and A4.22, and in Figure 10.22, the 'improvement' is small, less than 1 kJ/m³ per 100 reversals in the soft-plastic region. With 10% AT Ball Clay the toughness of the clay mixture is greater than for the N6 Fireclay, at the same

total water content so this could be construed as imparting no improvement although the range of water contents in the soft-plastic workable region is increased, from about 2% to about 4%.

Plotting the toughness against the matrix water content, in Figure 10.23, the toughness T is seen to increase with decreasing matrix water content, w_m and decreasing BC clay content, C_{bc} . By plotting the parameter, TC_{bc} vs. matrix water content, w_m , in Figure 10.24, with TC_{bc} on a log scale, a well-defined relationship is obtained, with a high correlation coefficient. For the Ball Clay proportions between 10 and 100% the relationship is given as

$$\log TC_{bc} = 3.43 - 5.1w_m. \quad 10.2$$

On Figure 10.24 the maximum toughness, T_{max} for each mixture and the matrix plastic limit, w_{mP} will also lie on or close to this line, with a similar relationship of

$$\log T_{max}C_{bc} = 3.6 - 5.53w_{mP} \quad 10.3$$

or, in terms of the plastic limit as a total water content, w_p , as

$$\log T_{max}C_{bc} = 3.6 - 5.53w_p/C. \quad 10.4$$

For a wide range of BC clay contents the toughness of the mixture is dependent on the matrix water content. Close control of water content will be required to maintain the toughness of the mixture within its workable, soft-plastic region. From equation 10.2 for mixtures with the same toughness, as the BC clay content increases the matrix water content decreases. This may impart an advantage in reducing the shrinkage of moulded clay products as they dry, providing the Ball Clay is not particularly prone to shrinkage itself.

10.4.4 Plastic limits

In contrast to the Todhills Shaly Clay:Povington Ball Clay mixtures where the silt/sand particles caused the ductile-brittle transition to occur at lower maximum toughnesses and hence higher plastic limits, for the N6 Fireclay:AT Ball Clay mixtures which would be much less affected by any silt/sand particles the ductile-brittle transition occurs at higher maximum toughnesses than expected from the linear relationship, see Figure 10.21. The maximum toughnesses for the clay mixtures with 5 – 60% AT Ball Clay are higher than would be expected for a linear

interpolated relationship, as shown in Figure 10.21. Because the toughness vs. total water content plots for the clay mixtures extend above the linear interpolated plot, it is not possible for the plastic limit of each mixture to lie on the linear interpolated relationship for the plastic limits (the dashed lines between points A and E on Figure 10.25); they will lie below, as shown in Figure 10.25.

This suggests that unlike the clay mixtures described section 10.2 the AT Ball Clay can provide a continuous strand or interweaving bunch clay particle arrangement and can subdue dislocations that would otherwise be expected to develop in the mixtures as the water content reduces to the plastic limit, allowing the toughness vs. total water content plots to extend above the linear relationship. The plot of matrix plastic limit vs. clay content in Figure 10.25 is very similar to the plot for the matrix liquid limit in Figure 10.16. This suggests that the same interactions occur at the liquid limit and the plastic limit, with small Ball Clay proportions affecting the results of the N6 Fireclay and the small to moderate Fireclay contents affecting the results for the AT Ball Clay.

10.5 Summary

Mixing two or more different clays together is a common practice in the ceramics industry to produce a clay 'body' for the manufacture of a range of products. The results of liquid limit tests and the Barnes test are discussed for mixtures of a Shaly Clay used in the brick making industry and a Ball Clay, a kaolinitic clay taken from a ball clay pit and two processed clays used in the ceramics industry, a Fireclay and a Ball Clay.

The relevant water contents used in the interpretation of the results are the total water content, including all of the particles and the matrix water content allowing for the presence of an amount of inert silt and sand particles based on a clay content defined as the particles smaller than 0.002 mm. This may not be wholly correct for the soils tested as some kaolinitic clays are known to contain clay mineral particles that are larger than 0.002 mm and the Fireclay and Shaly Clay may contain fragments of shale of silt and sand sizes. The proportion of the clay minerals from the Ball Clay in the total clay content of a mixture is considered to be a useful property in assessing the test results.

The liquid limits of the mixtures do not interpolate linearly between the liquid limits of each clay. For the Shaly Clay:Ball Clay mixtures with high Ball Clay contents there may be small amounts of the Shaly Clay that are not fully hydrated because they are enveloped by the Ball Clay. At lower Ball Clay contents the liquid limits are

affected by the presence of a high silt/sand content. For the Fireclay:Ball Clay mixtures with high Ball Clay contents both clays are probably fully hydrated and that the liquid limit is affected by the Fireclay imparting a lower shear strength to the mixture. With high Fireclay contents it is envisaged that the Ball Clay acts to ease the movement of the particles in the Fireclay so less water is required to obtain the fall cone shear strength resulting in a lower liquid limit.

The toughness vs. water content (total and matrix) relationships for the mixtures do not coincide with a linear interpolation between the relationships for the two clays on their own. For the Shaly Clay:Ball Clay mixtures small amounts of Ball Clay reduce the toughness of the mixture at the same total water content. This can be viewed as an improvement in the plasticity of the mixture. This effect is insignificant for the Fireclay:Ball Clay mixtures.

For the Shaly Clay:Ball Clay mixtures with more than 40% Ball Clay in the mixture the toughness is controlled by the matrix water content. The total water content is simply obtained from the correction for the different clay (or silt/sand) contents. For the mixtures with less than 30% Ball Clay the matrix water contents are higher to compensate for the work done in moving the silt/sand particles from the Shaly Clay.

For the Fireclay:Ball Clay mixtures the percentage of Ball Clay clay in the total clay content has a significant effect. A well-defined relationship is obtained between the toughness, matrix water content and this Ball Clay clay content for the mixtures with 10 to 100% Ball Clay.

The plastic limits of the mixtures do not coincide with a linear interpolation between the two clays on their own. For the Shaly Clay:Ball Clay mixtures the ductile-brittle transition occurs on the toughness vs. total water content plots at maximum toughnesses lower than would be expected to be achieved, therefore giving higher plastic limits. This is considered to be due to dislocations within the clay matrix caused by a high silt/sand content in the mixtures and due to the flaky shape of particles in the Shaly Clay.

For the Fireclay:Ball Clay mixtures the presence of the Ball Clay results in the toughness vs. total water content plot extending above the location where the maximum toughness would be expected to be achieved, therefore giving lower plastic limits. With Ball Clay in the mixtures it is envisaged that interactions between the clay minerals maintain a continuous strand arrangement and subdue dislocations that would otherwise occur in the Fireclay and provide a higher maximum toughness at a lower plastic limit.

10.6 Tables

	Liquid limit w_L %	Toughness limit w_T %	Apparatus Plastic limit w_P %	Plasticity index I_p %	Toughness index I_T %	Maximum toughness T_{max} kJ/m^3 per 100 reversals
Todhills Shaly Clay	27.4	24.9	17.1	10.3	7.8	10.6
Povington Ball Clay	74.5	57.7	41.8	32.7	15.9	19.8

Table 10.1 *Properties of the Todhills Shaly Clay and Povington Ball Clay*

Shaly Clay proportion	Ball Clay proportion	Total clay content C %	BC clay content C_{bc} %
100	0	14.0	0
95	5	17.2	22.7
90	10	20.4	38.2
80	20	26.8	58.2
70	30	33.2	70.5
60	40	39.6	78.8
40	60	52.4	89.3
20	80	65.2	95.7
0	100	78.0	100

Table 10.2 *Clay contents of mixtures of Todhills Shaly Clay and Povington Ball Clay*

	Liquid limit w_L %	Toughness limit w_T %	Apparatus Plastic limit w_P %	Plasticity index I_p %	Toughness index I_T %	Maximum toughness T_{max} kJ/m^3 per 100 reversals
N6 Fireclay	46.0	30.5	23.3	22.7	7.2	18.2
AT Ball Clay	69.2	42.7	29.7	39.5	13.0	30.5

Table 10.3 *Properties of the N6 Fireclay and AT Ball Clay*

Fireclay proportion	Ball Clay proportion	Total clay content C %	BC clay content C_{bc} %
100	0	38.0	0
95	5	40.0	9.8
90	10	42.0	18.6
80	20	46.0	33.9
60	40	54.0	57.8
40	60	62.0	75.5
20	80	70.0	89.1
0	100	78.0	100

Table 10.4 *Clay contents of mixtures of N6 Fireclay and AT Ball Clay*

10.7 Figures

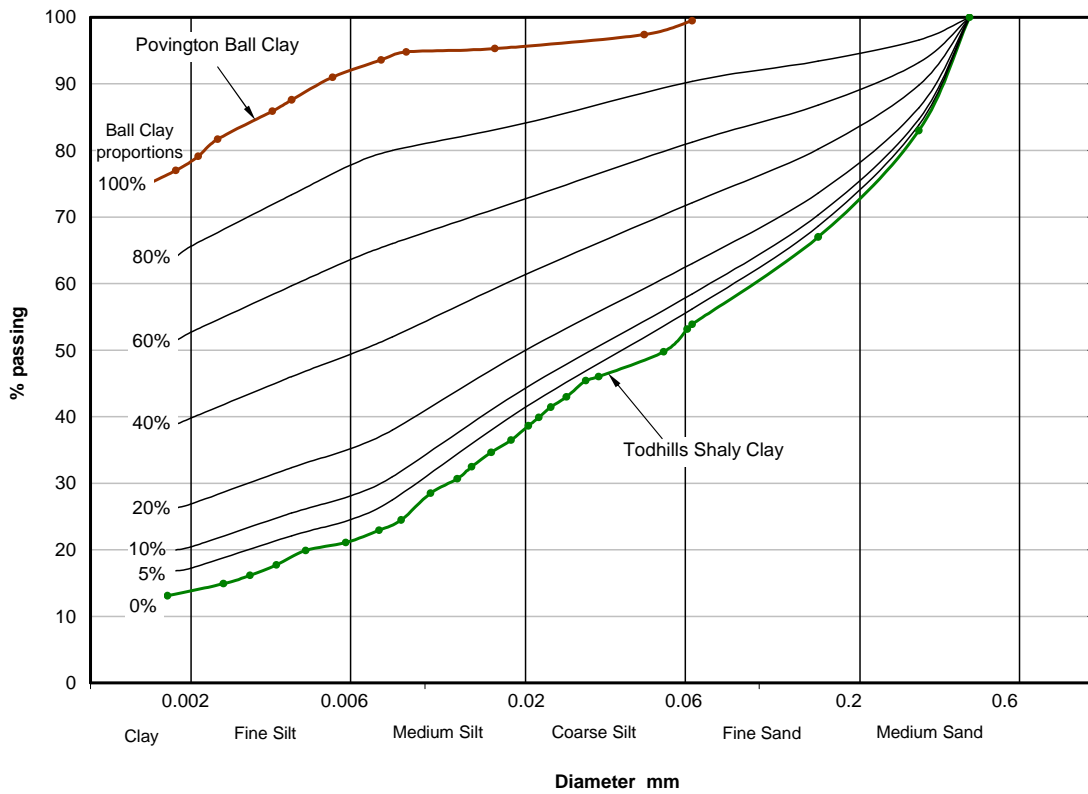

Figure 10.1 Particle size distributions of the Todhills Shaly Clay:Povington Ball Clay mixtures

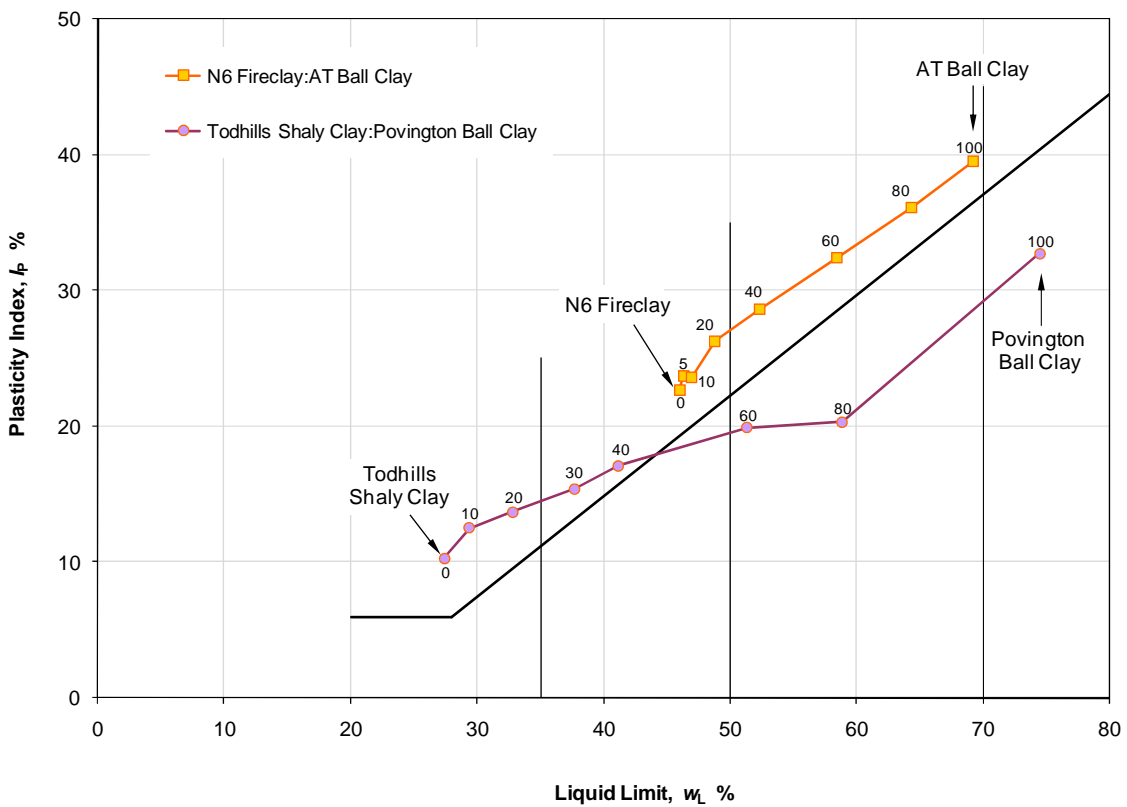

Figure 10.2 Plasticity chart

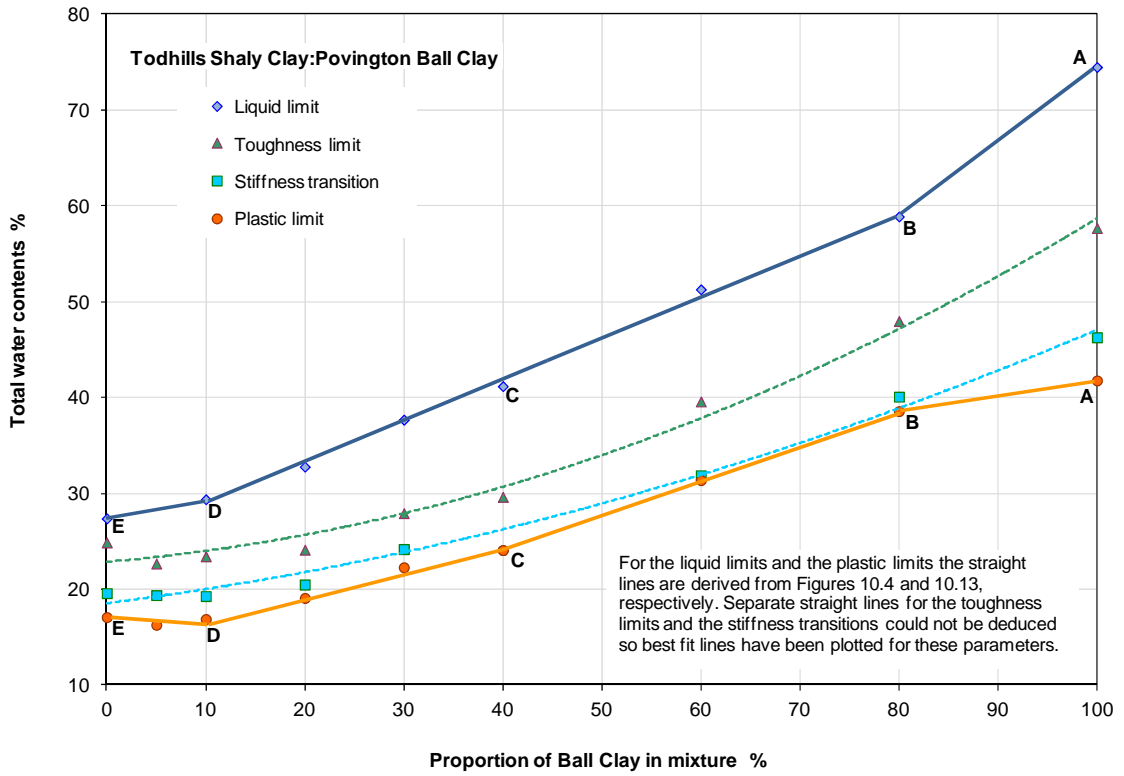

Figure 10.3 Variation of the limits for the Todhills Shaly Clay:Povington Ball Clay mixtures

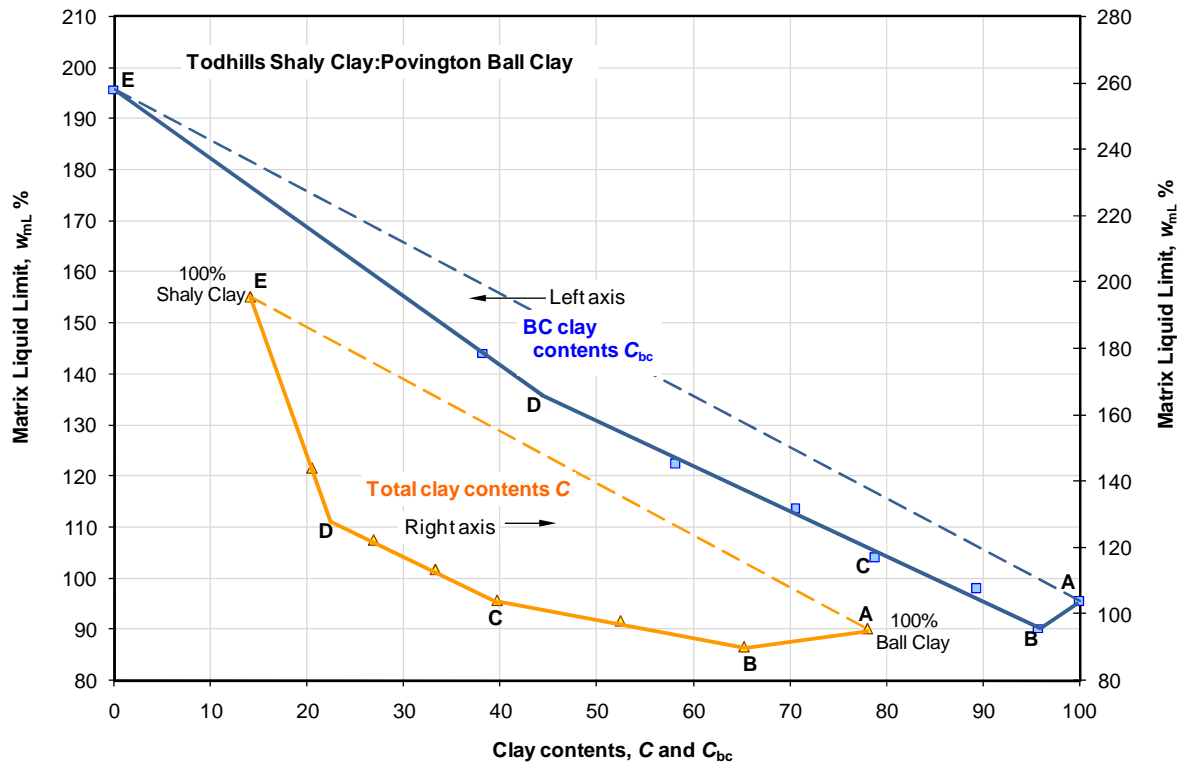

Figure 10.4 Matrix liquid limits

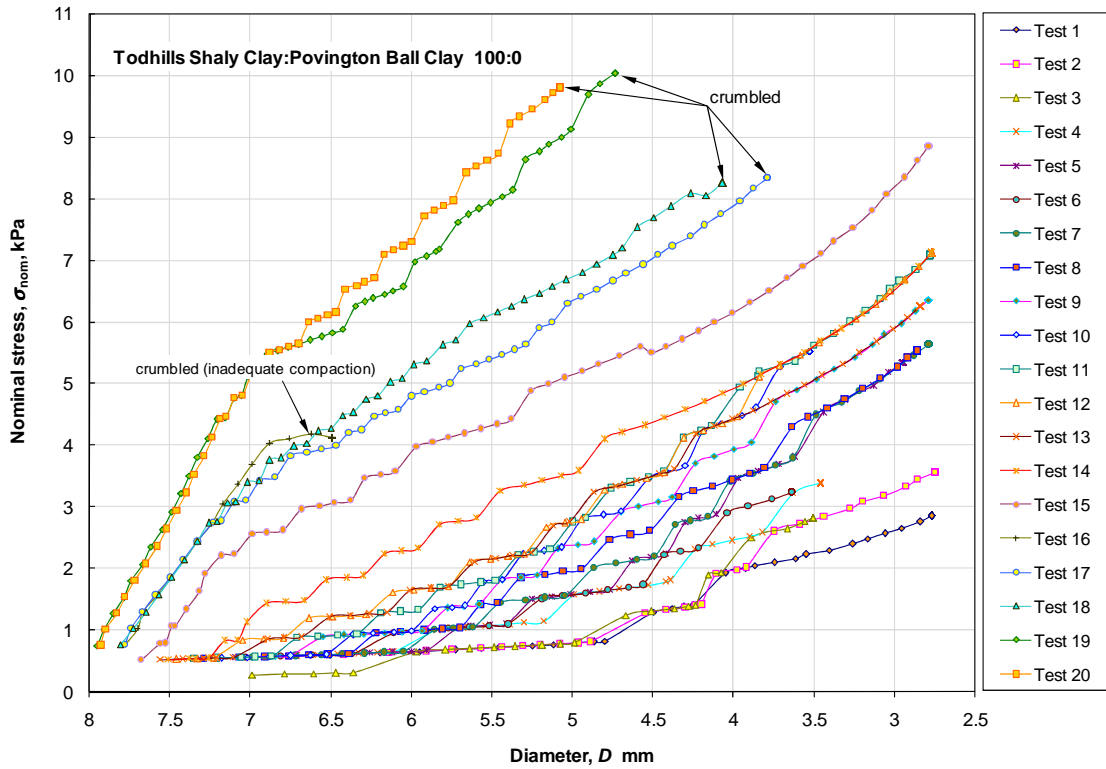

Figure 10.5 Nominal stress vs. diameter for the Todhills Shaly Clay

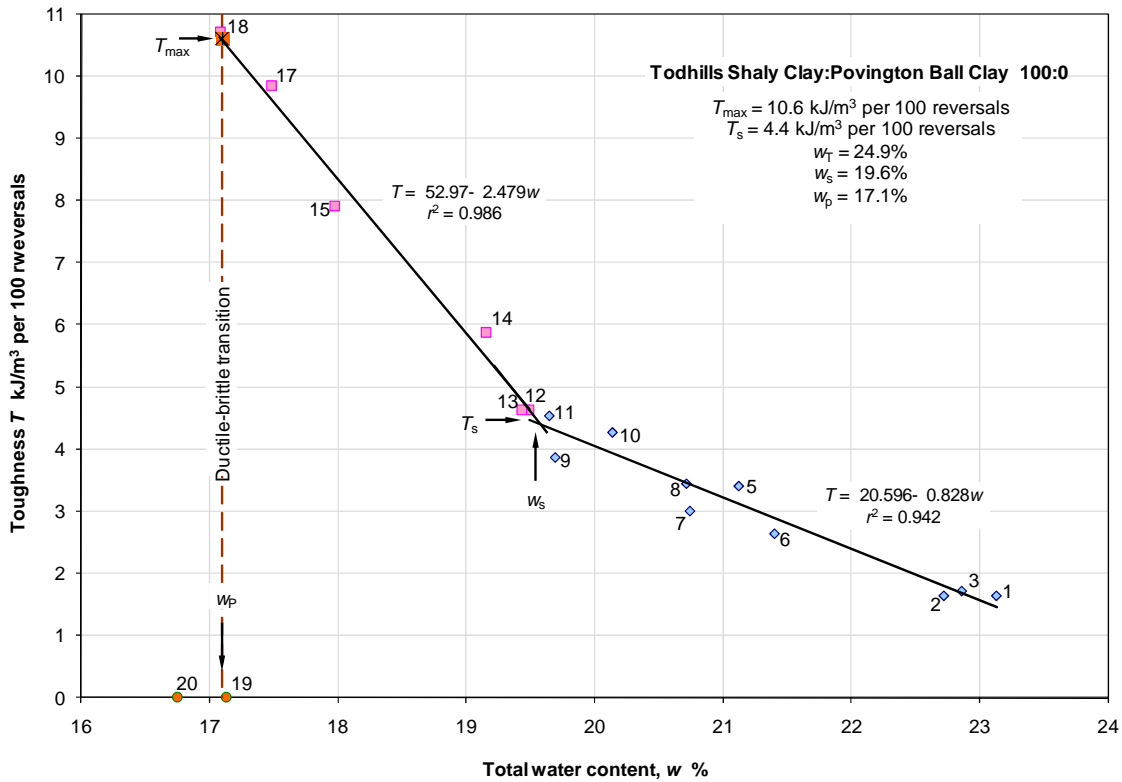

Figure 10.6 Toughness vs. water content for the Todhills Shaly Clay

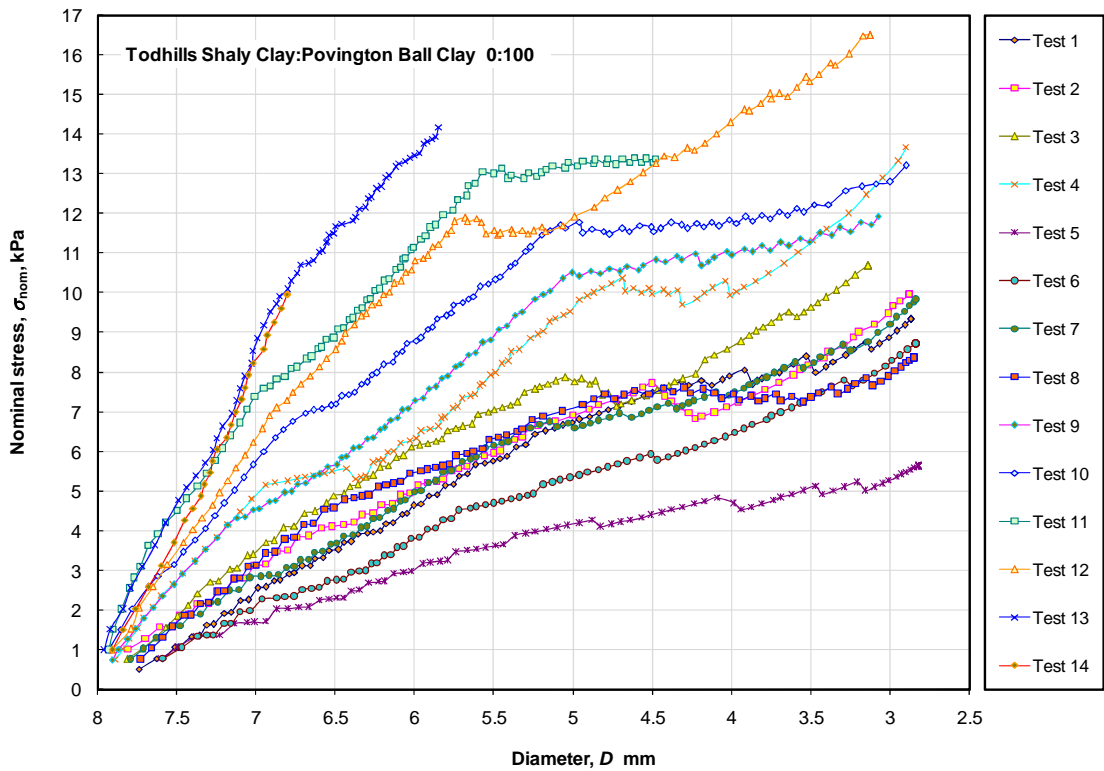

Figure 10.7 Nominal stress vs. diameter for the Povington Ball Clay

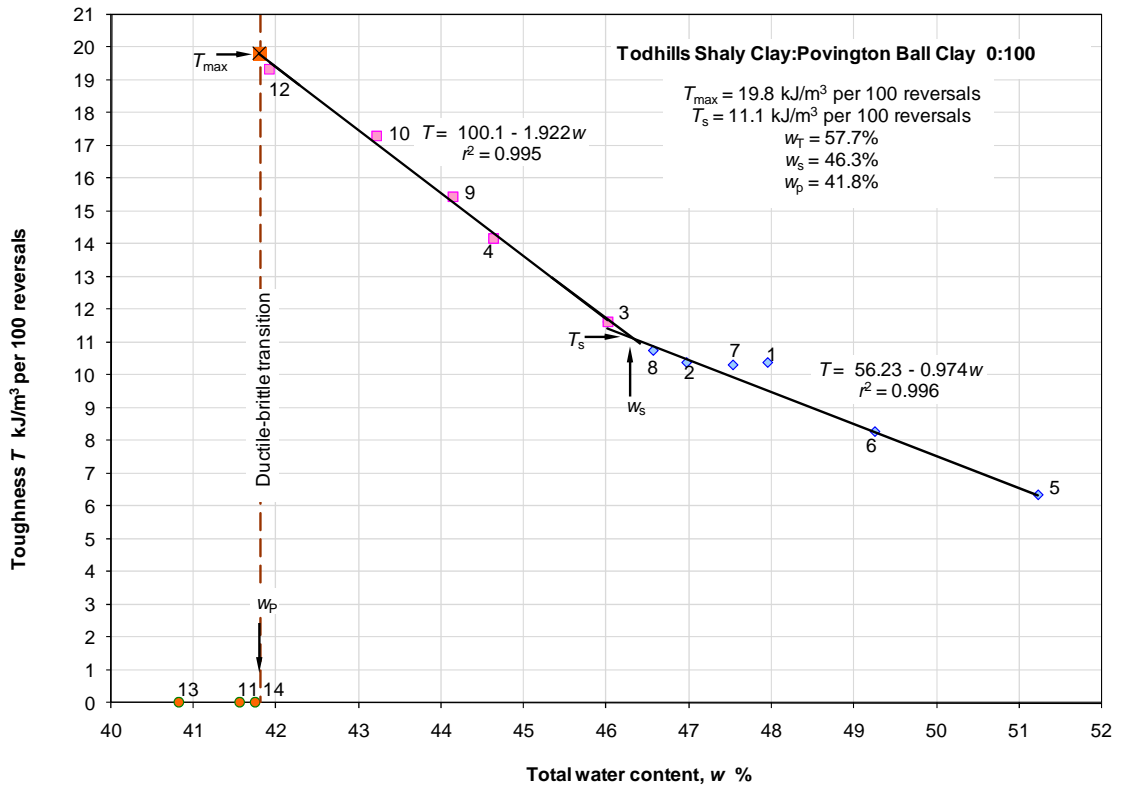

Figure 10.8 Toughness vs. water content for the Povington Ball Clay

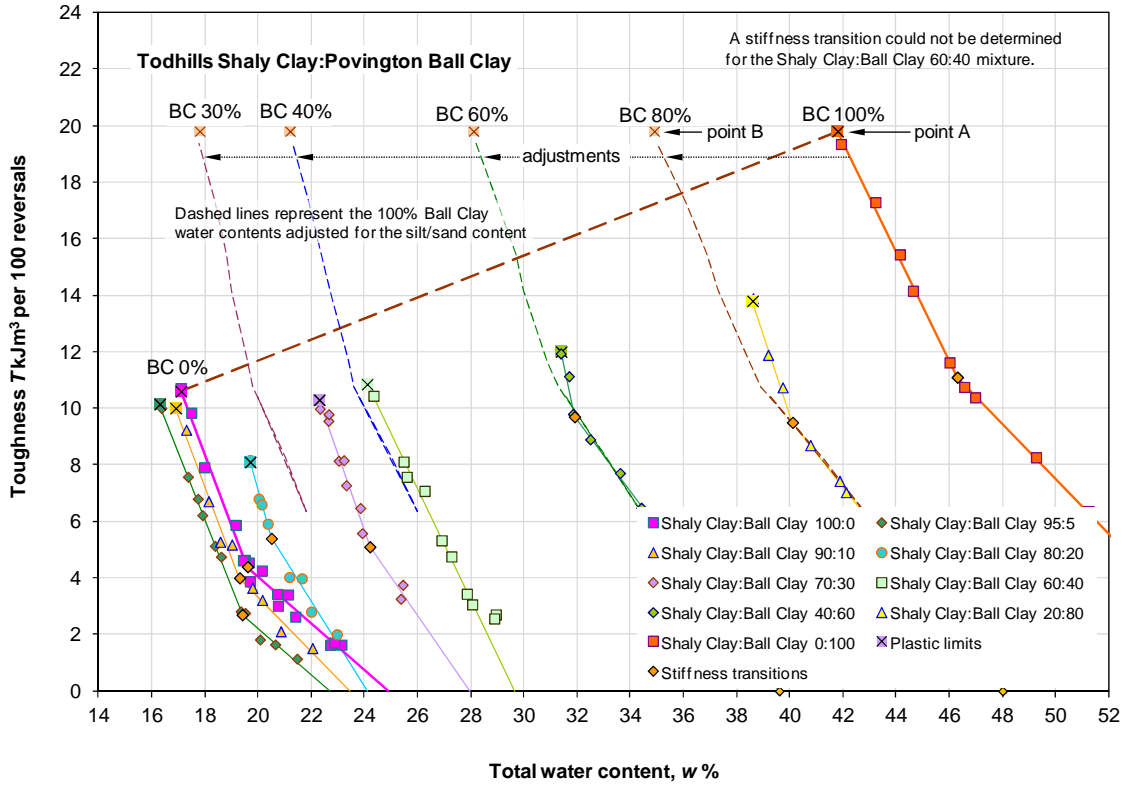

Figure 10.9 Toughness vs. total water content relationships for all mixtures

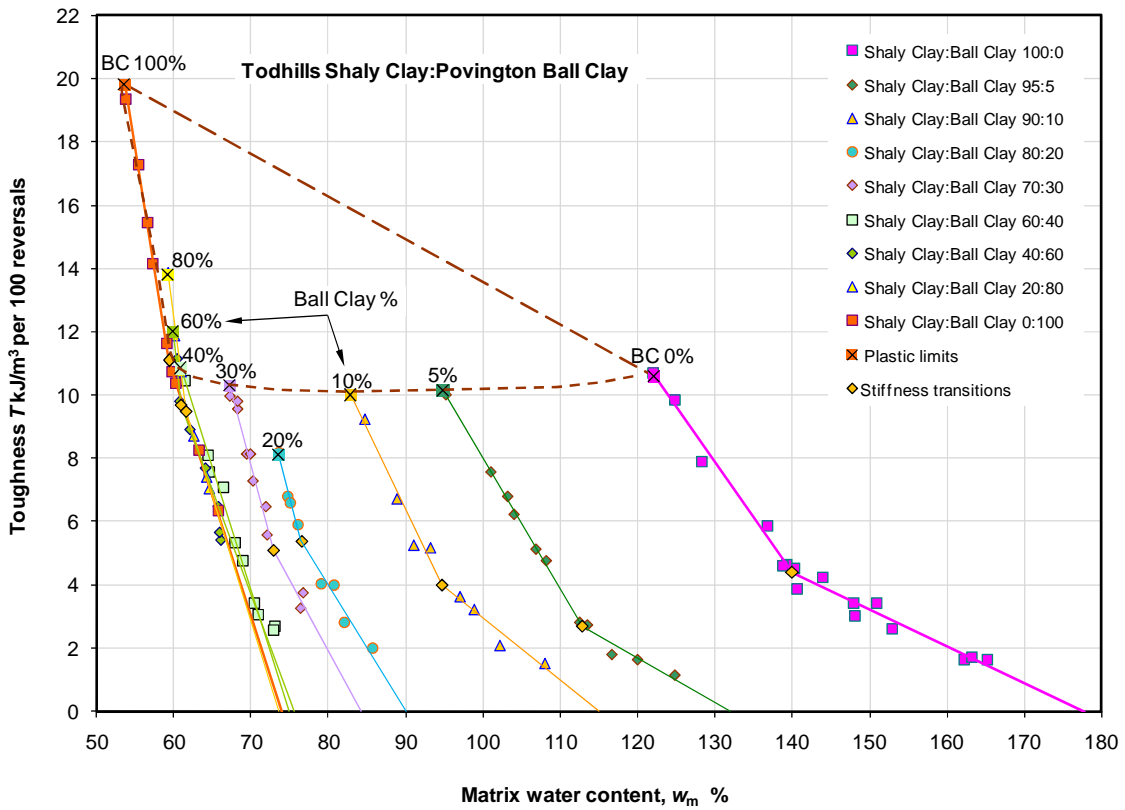

Figure 10.10 Toughness vs. matrix water content relationships for all mixtures

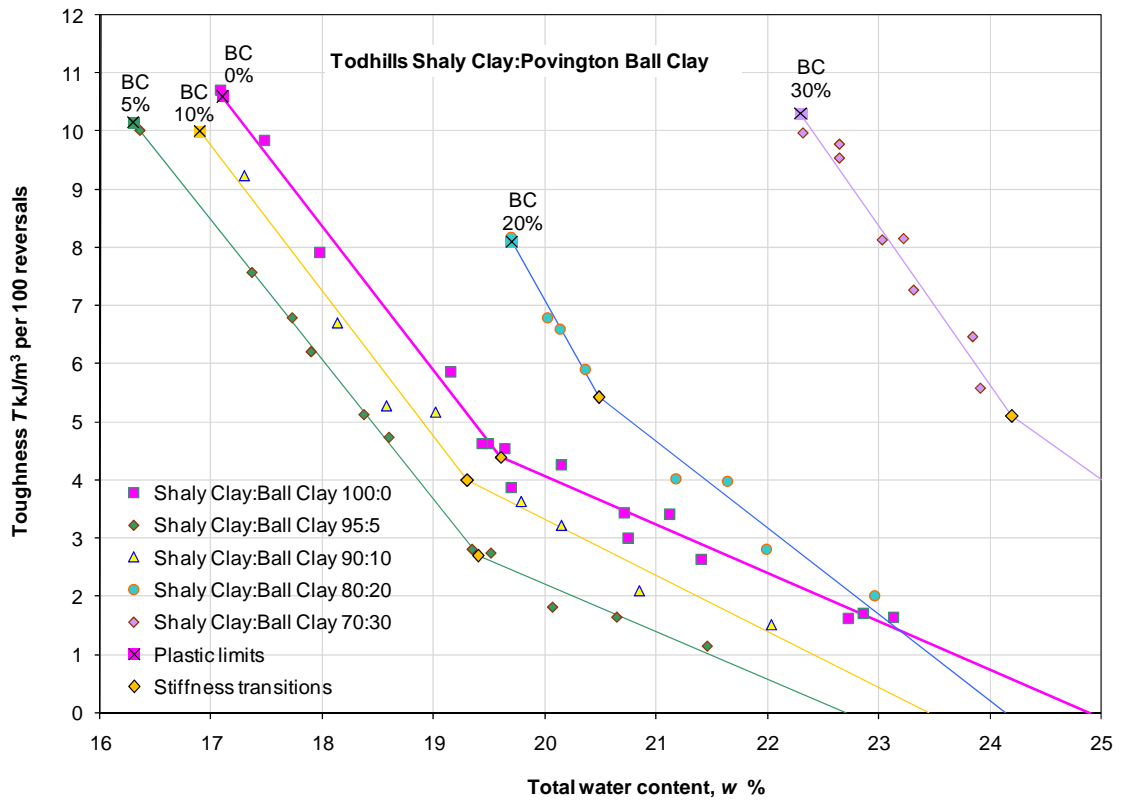

Figure 10.11 Toughness vs. total water content for the smaller Ball Clay contents

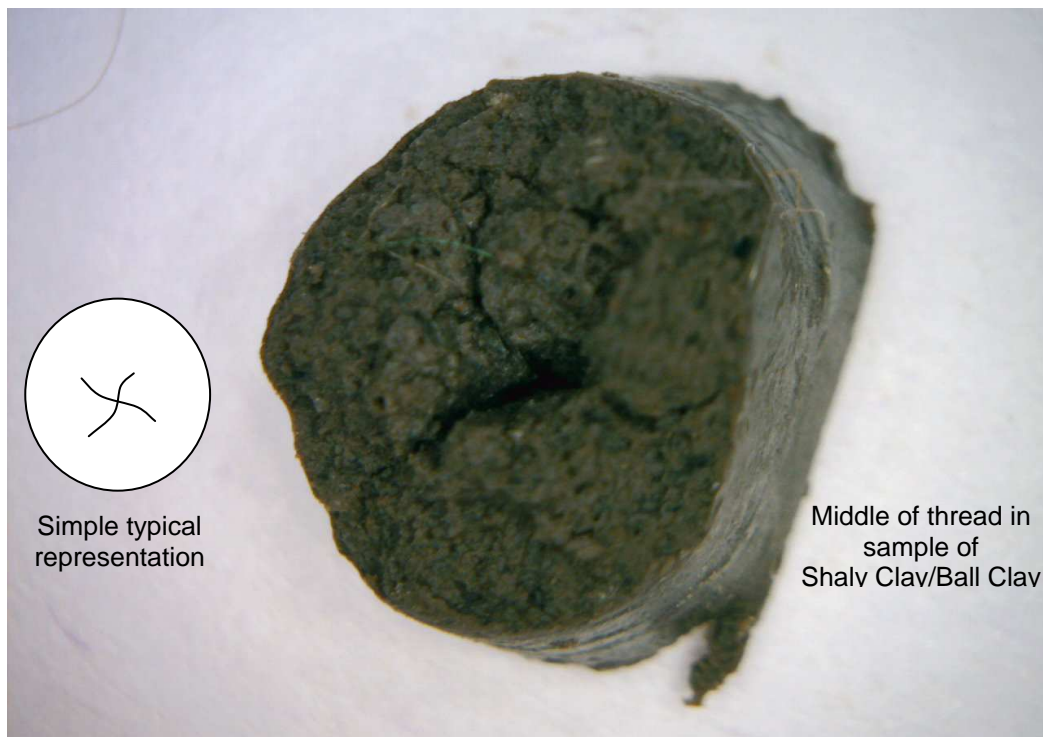

Figure 10.12 Cross section of brittle thread at end of test Todhills Shaly Clay:Povington Ball Clay 60:40

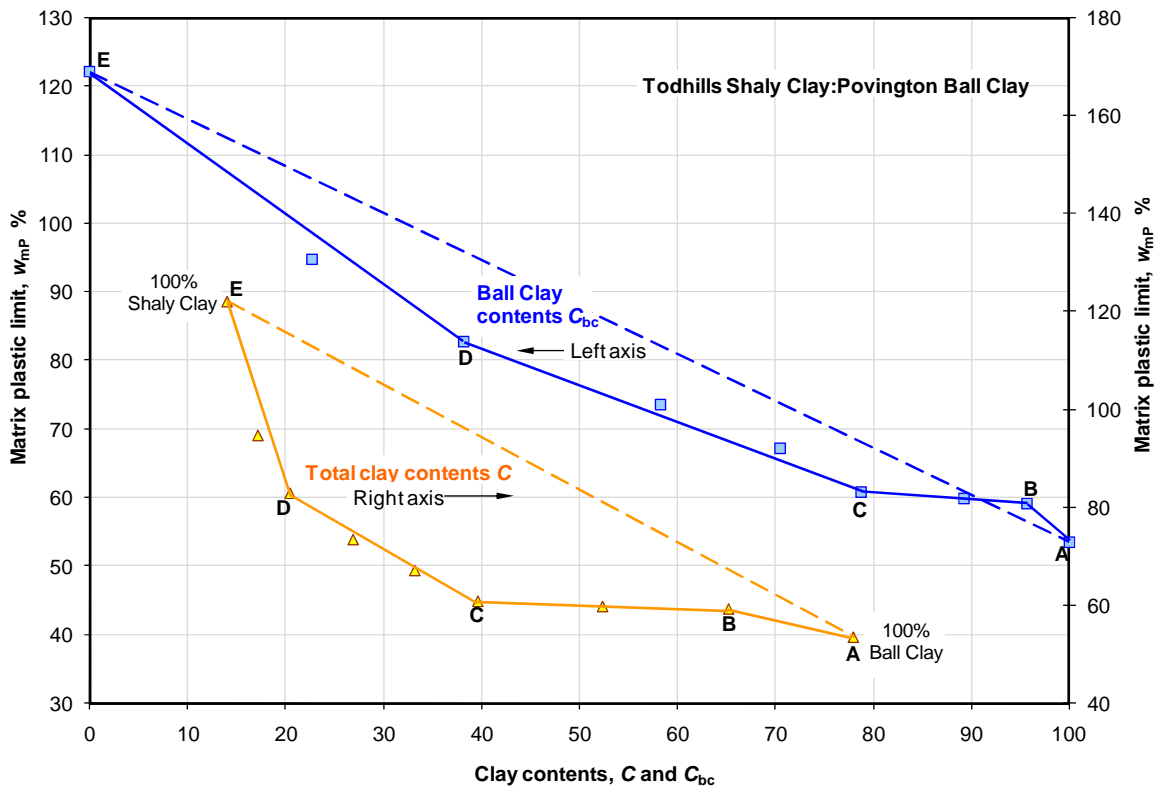

Figure 10.13 Matrix plastic limits

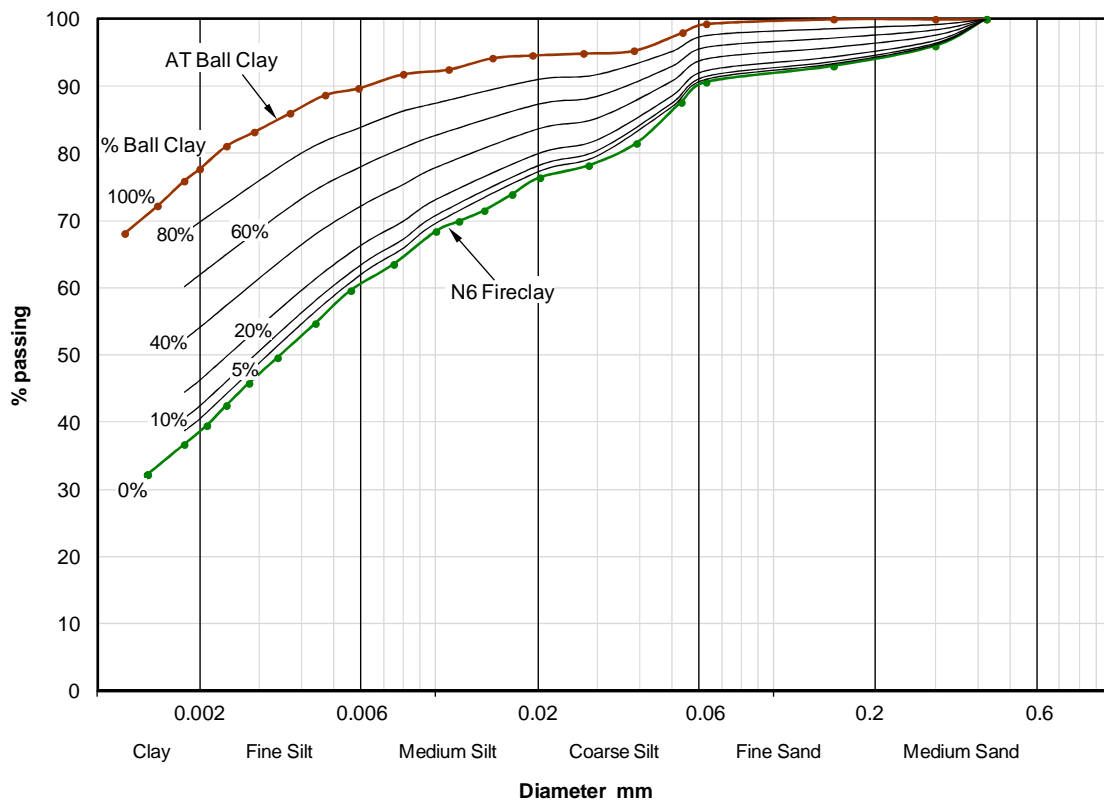

Figure 10.14 Particle size distributions of the N6 Fireclay:AT Ball Clay mixtures

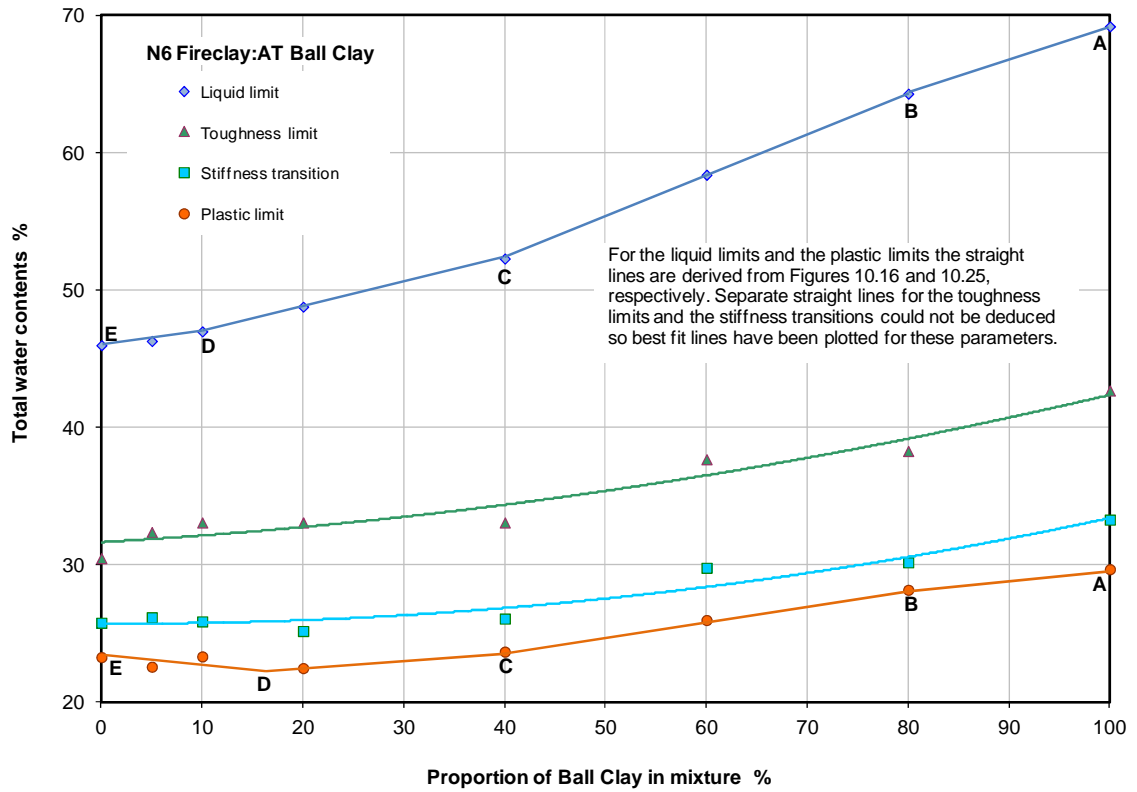

Figure 10.15 Variation of the limits for the N6 Fireclay:AT Ball Clay mixtures

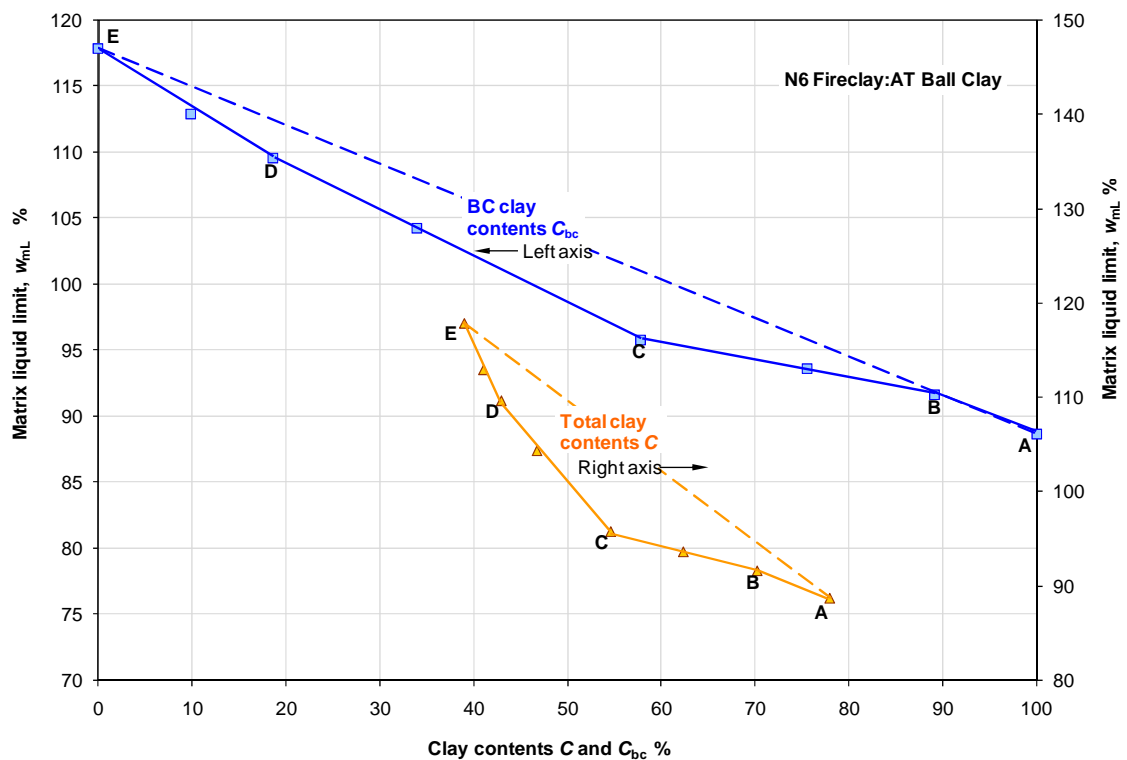

Figure 10.16 Matrix liquid limits

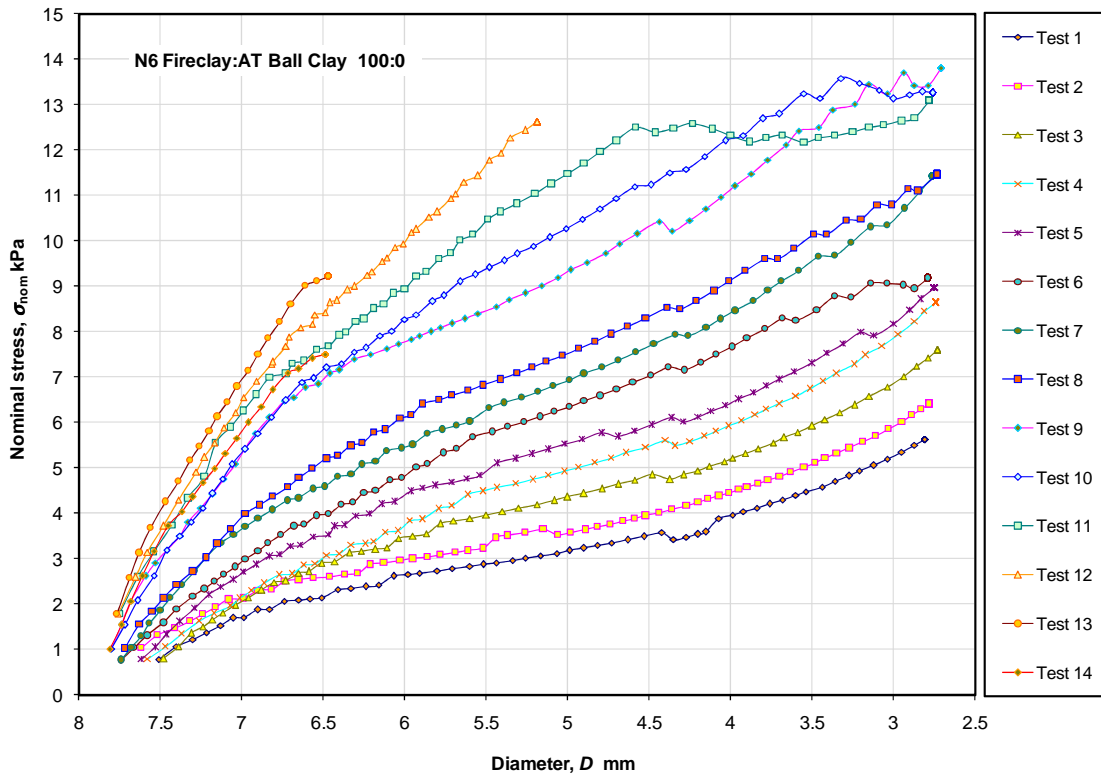

Figure 10.17 Nominal stress vs. diameter for the N6 Fireclay

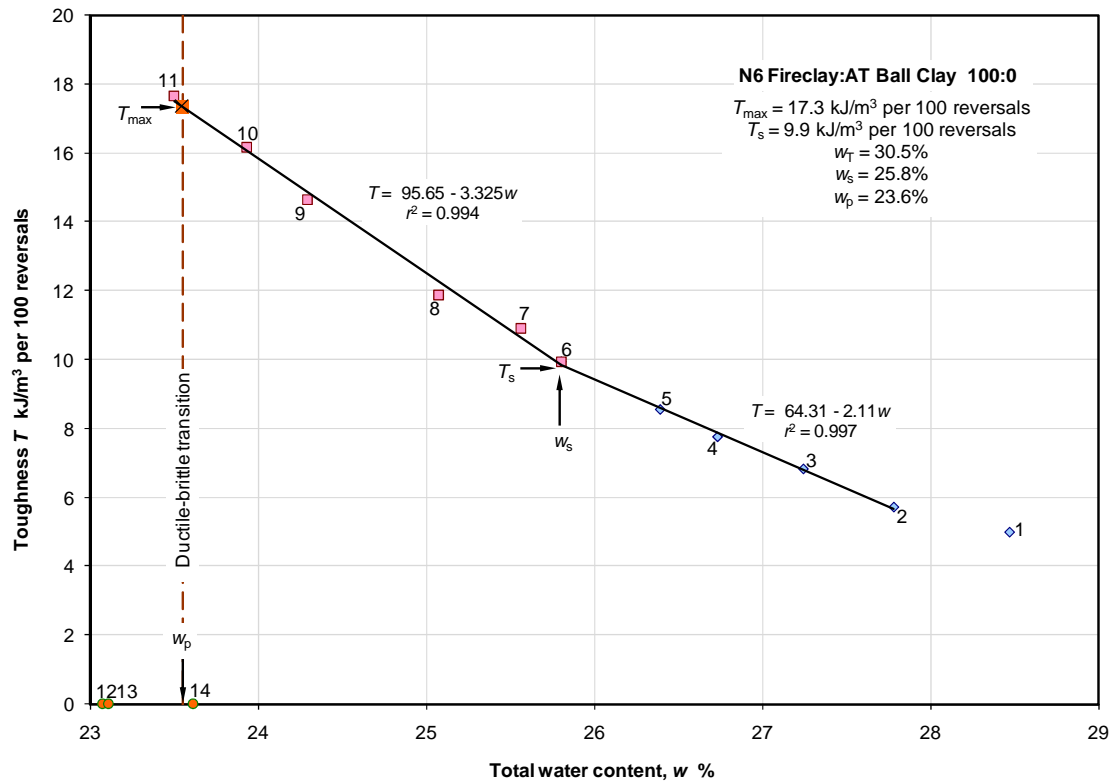

Figure 10.18 Toughness vs. water content for the N6 Fireclay

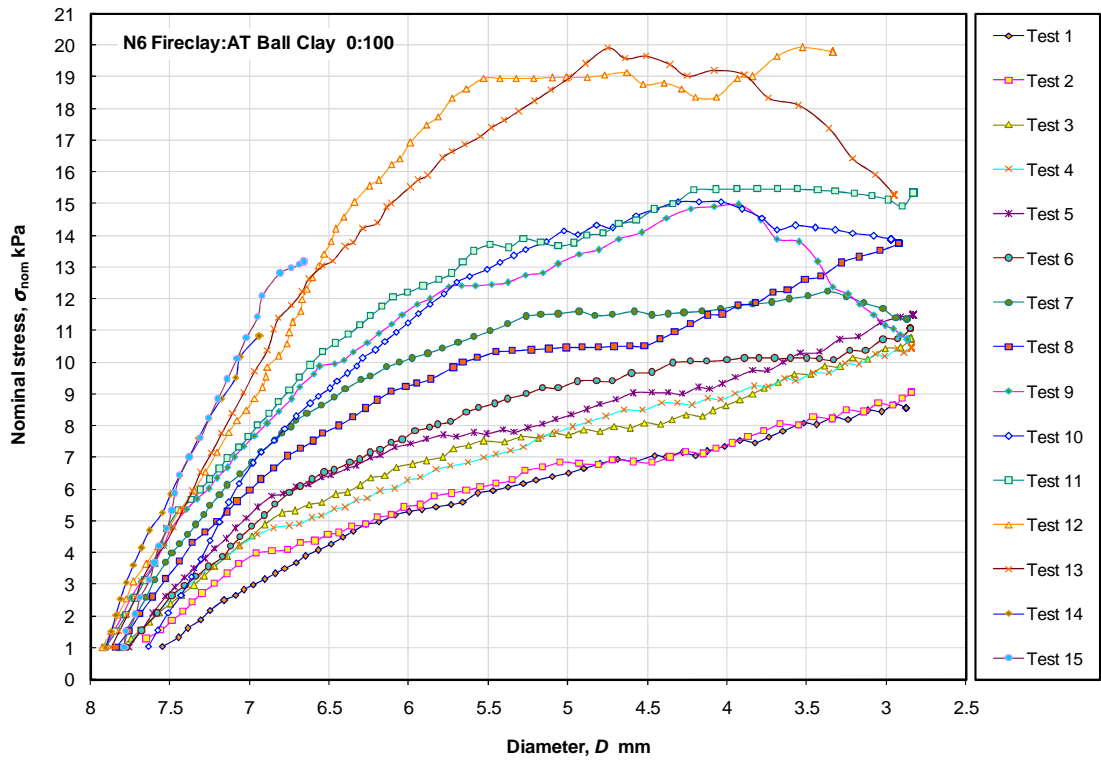

Figure 10.19 Nominal stress vs. diameter for the AT Ball Clay

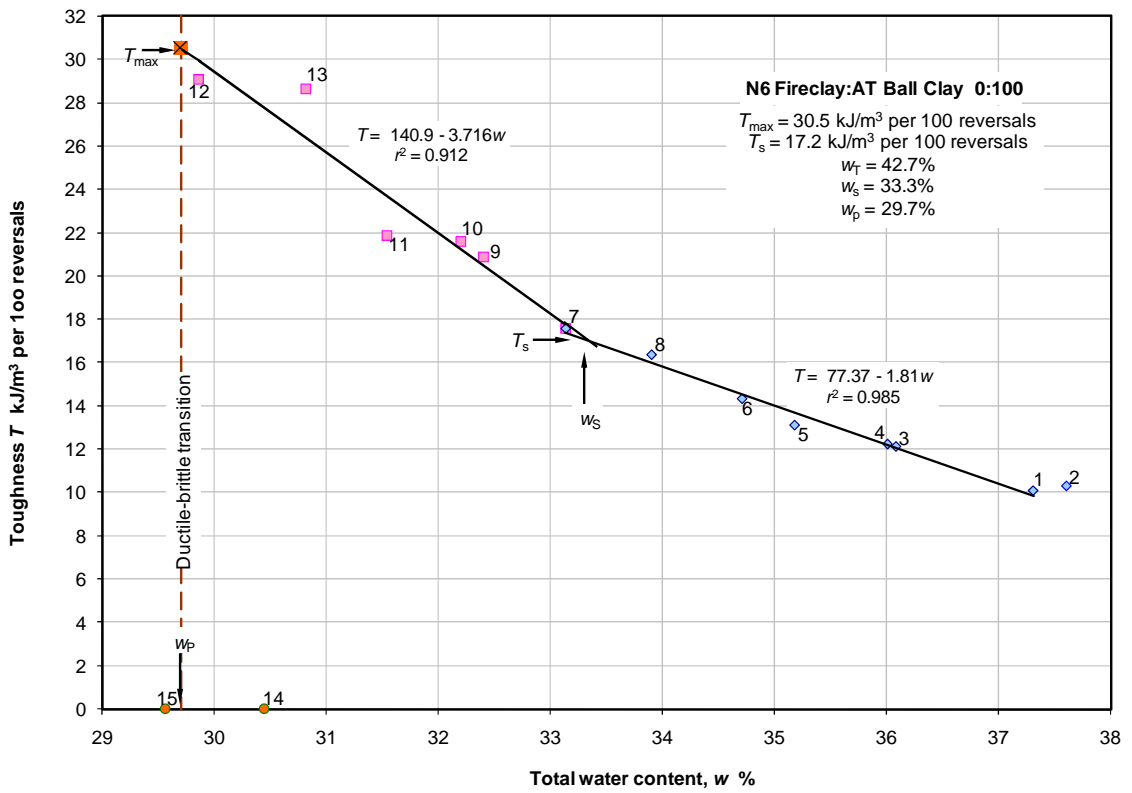

Figure 10.20 Toughness vs. water content for the AT Ball Clay

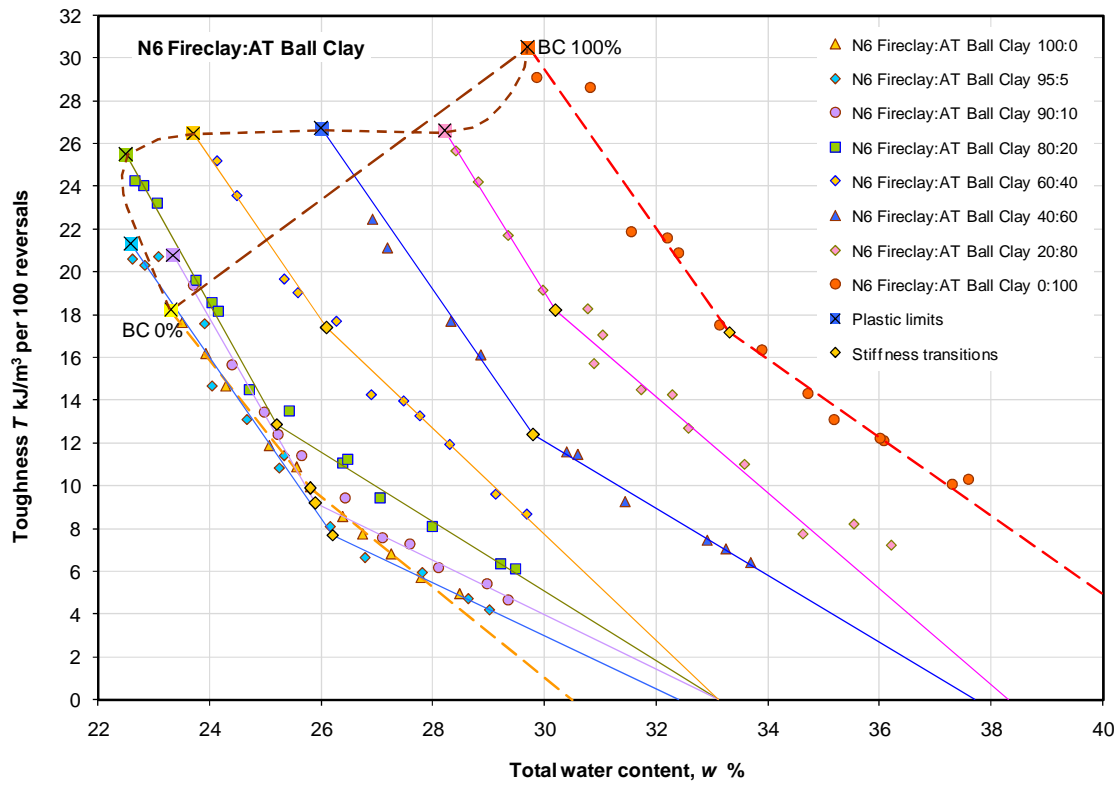

Figure 10.21 Toughness vs. total water content relationships for all mixtures

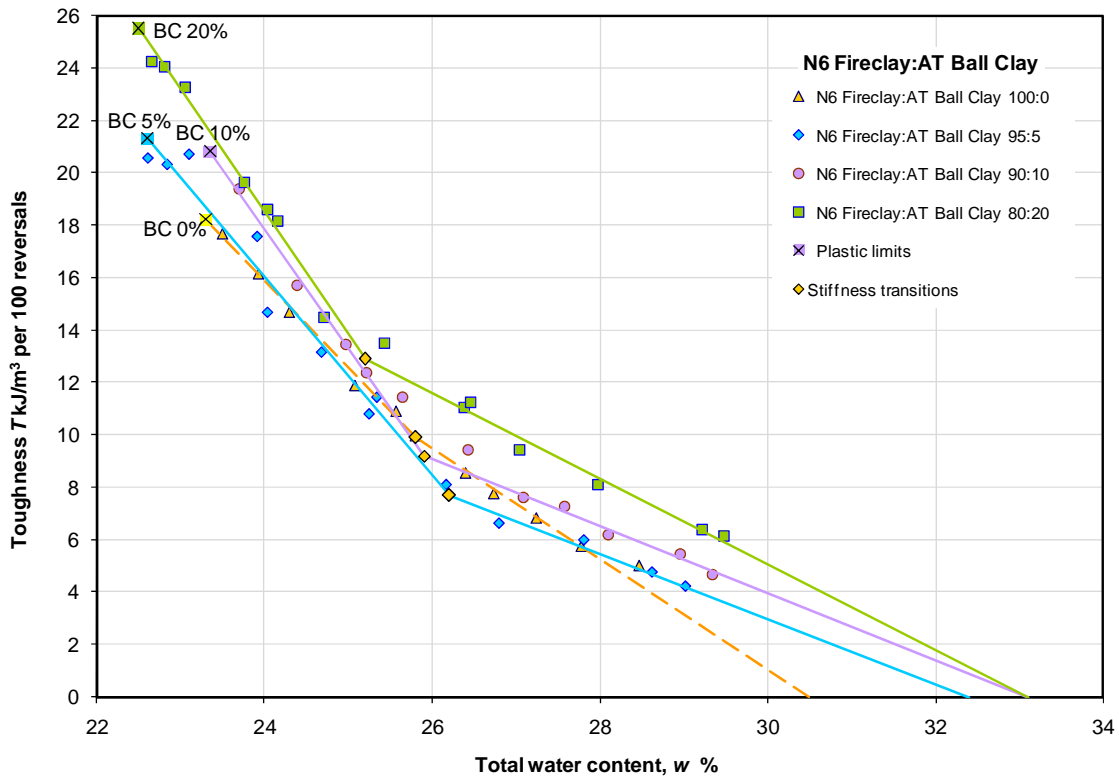

Figure 10.22 Toughness vs. total water content for the small Ball Clay contents

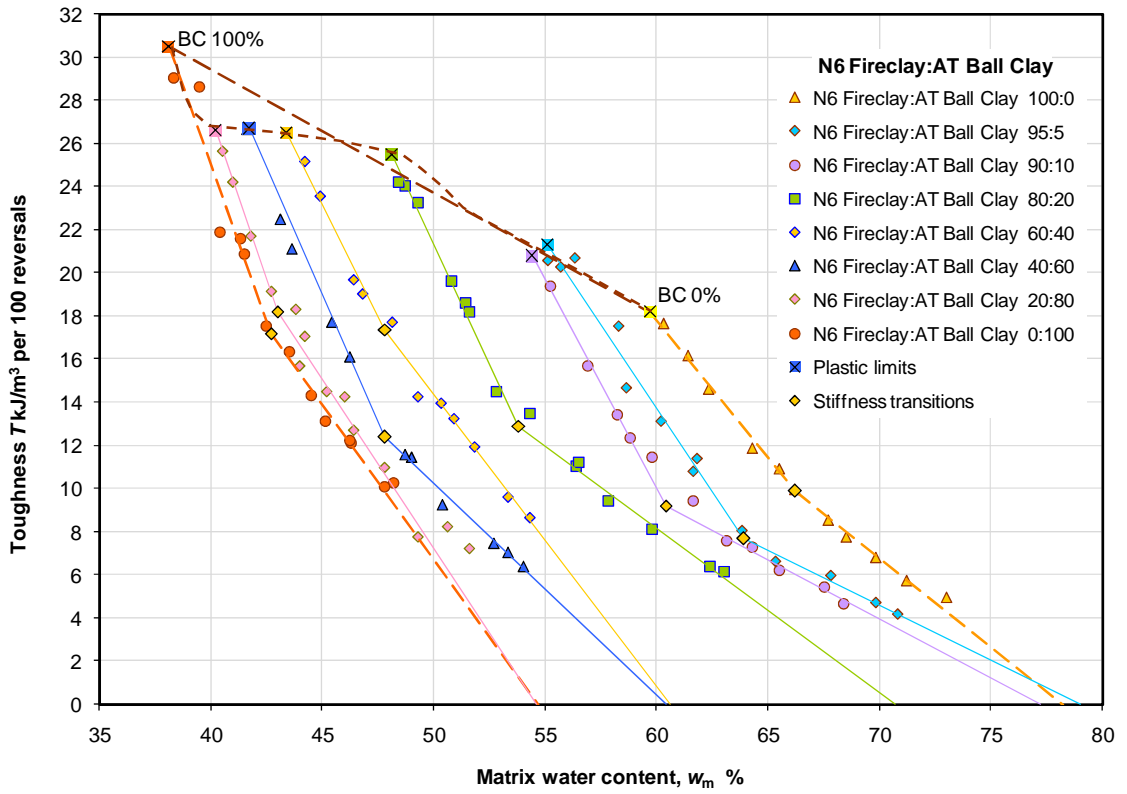

Figure 10.23 Toughness vs. matrix water content relationships for all mixtures

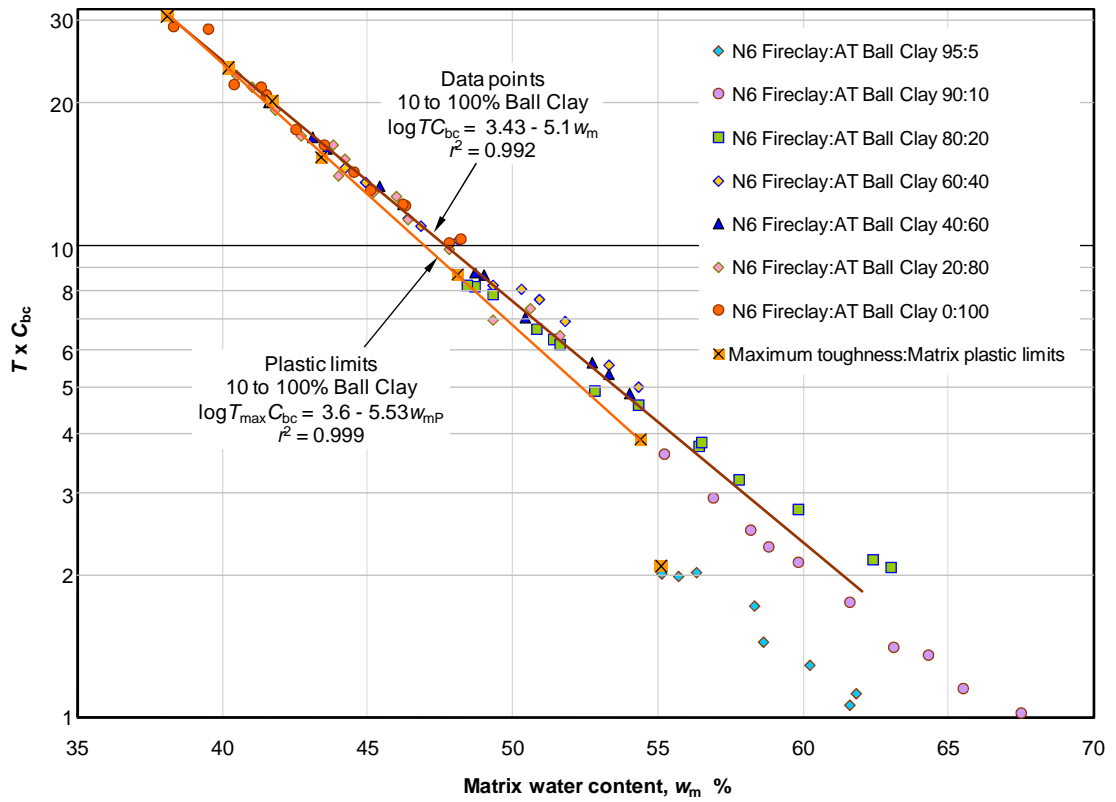

Figure 10.24 Toughness x BC clay content - matrix water content relationship

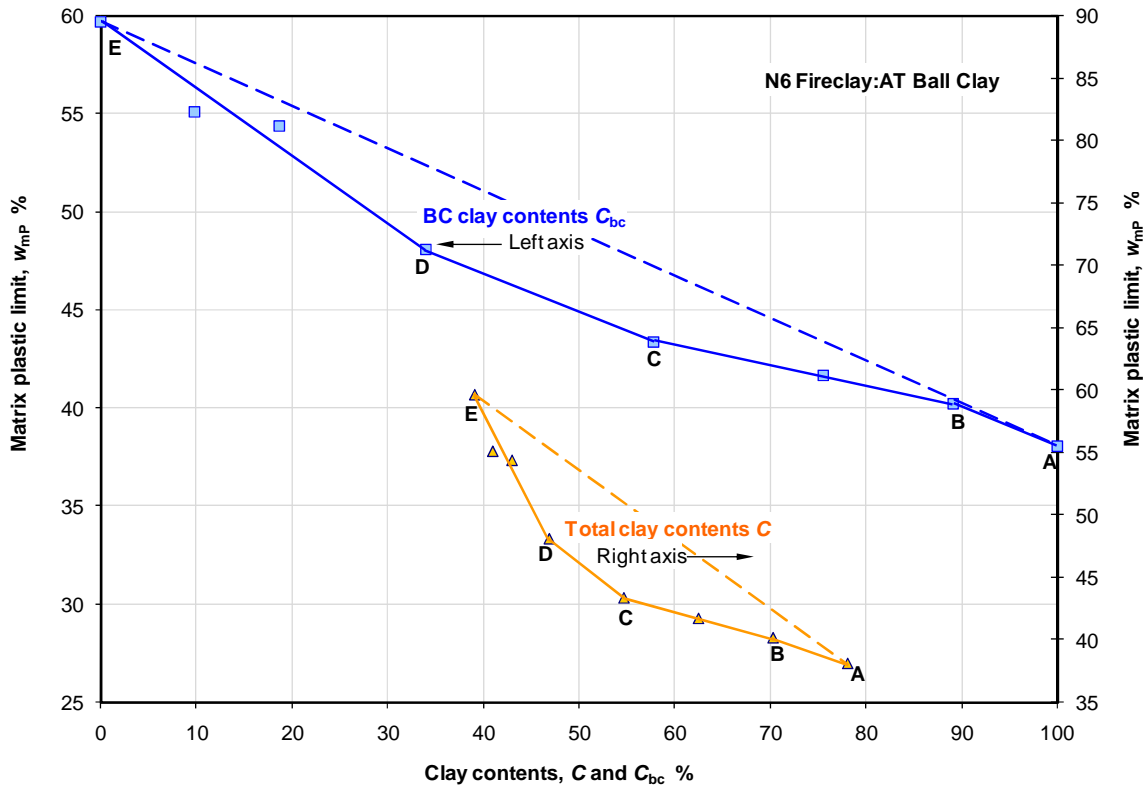

Figure 10.25 Matrix plastic limits

CHAPTER 11

Conclusions and recommendations

Conclusions drawn from the research conducted and described in this thesis are presented with recommendations for future work where they are considered pertinent.

Many researchers have pursued the strength-based concept to determine the plastic limit as a water content at a particular single undrained shear strength but this is shown to be seriously flawed. It is demonstrated that there is no unique value of undrained shear strength, suction or effective stress at the plastic limit for all soils, but that these properties vary considerably at the plastic limit depending mainly on the type and quantity of the clay minerals present.

It is also shown that the fall-cone test has serious limitations in assessing the undrained shear strength of a soil at its plastic limit, in association with the strength-based concept, due mainly to the difficulty in preparing suitable specimens at this water content and the need to extrapolate the cone penetrations to small values.

Previous thread rolling methods for the plastic limit are shown to be inadequate and inaccurate. Alternative methods for the plastic limit are shown to be imprecise and unreliable.

The main aim of the thesis is achieved by describing the apparatus devised and developed by the author, referred to as the Barnes apparatus, which identifies the ductile-brittle transition of a soil and provides the plastic limit and a measure of toughness of soils. The apparatus replicates successfully Atterberg's rolling technique for a thread of plastic soil by causing reduction of the thread diameter and longitudinal extrusion. Its operation entails much less operator interference than with the current British Standard plastic limit test and judgement of the crumbling condition is virtually eliminated.

By measuring applied loads on the soil thread and the thread diameter nominal stresses and diametral strains are derived for each rolling traverse enabling the stress-strain behaviour of the thread to be investigated as it reduces in diameter. Recording of the test measurements, data processing and derivation of the relationships and toughness properties are referred to as the Barnes test

With the Barnes apparatus and test the poor repeatability and reproducibility of the standard plastic limit test is replaced by the unmistakable detection of the ductile-brittle transition, the accurate determination of the plastic limit and additional determinations of toughness. Once operators of the apparatus have been given adequate instruction, training and practice they should be competent to achieve repeatable results.

Soil threads are prepared for the apparatus by static compaction in a specially designed thread maker to produce a consistent circular cross section suitable for rolling. A well compacted soil thread ensures that a regular, uniform soil structure is tested with as few detrimental defects as possible.

With soil threads prepared and tested at water contents from near the sticky limit to the brittle state good correlations between toughness and water content are obtained displaying an abrupt ductile-brittle transition. This transition is a fundamental feature of cohesive soils and forms the basis for establishing the plastic limit although it is not recognised widely. With the Barnes apparatus the detection of this transition between threads that are plastic and extrude well and brittle threads that do not extrude and fail by fracturing or crumbling is achieved over a small range of water contents enabling the accurate determination of the plastic limit, defined herein as the water content at the transition.

In order to provide a better understanding of the behaviour of a soil thread each side of the transition it is suggested that this could be investigated by conducting finite element analyses of a circular thread considering ductile and brittle stress-strain behaviour and investigating the effects of rotation of the stresses around the thread and the relationship between compressive and tensile stresses and strains.

Toughness has previously only been considered in an empirical or qualitative manner. Casagrande (1932) defined toughness as the undrained shear strength at the plastic limit but research on this property has not been pursued extensively, if at all. From the values of nominal stress and diametral strain determined from the Barnes test the toughness of a soil can now be determined as a measure of the work/unit volume per 100 reversals of compression and tension stresses required to reduce the diameter of a soil thread during plastic deformation from 6 mm to 4 mm.

From the correlations between toughness and water content new and potentially useful properties can be determined, in particular, the toughness limit, the water content at zero toughness, and the stiffness transition, the water content below

which, for many soils, the toughness increases at a greater rate and the maximum toughness at the plastic limit. In addition, the toughness coefficients, the gradients of the relationships, the toughness index, the difference between the toughness limit and the plastic limit and the workability index, similar to the liquidity index can be derived. The range of water contents between the plastic limit and the liquid limit was previously referred to as solely plastic. With the new limits identified of the toughness limit and the stiffness transition this range can now be separated into the adhesive-plastic, soft-plastic and the stiff-plastic regions.

A wide range of toughness values has been obtained for different soils, from organic soils with low toughness to soils of high toughness containing highly active clay minerals such as montmorillonites. The apparatus and test are appropriate for a range of soils that lie below as well as above the Casagrande A-line. It is recommended that further tests are conducted on a variety of soil types to investigate the significance of the toughness property in relation to compaction behaviour and other soil properties such as the activity index, the moisture condition value and the plasticity classifications on the Casagrande plasticity chart.

It is postulated that on the 'wet' side of the plastic limit where the soil is ductile or plastic remoulding toughness derives from the physico-chemical interactions between the clay minerals and the continuity of their structural arrangements while as a soil dries towards the plastic limit the clay matrix becomes stiffer and alters from a mainly continuous clay particle arrangement to a more aggregated matrix with the air voids content and the pore sizes increasing with the development of defects, microcracks. The soil may be completely aggregated at the plastic limit. An aggregation ratio term has been found useful to explain the change in toughness in the clay matrix as its water content reduces towards the plastic limit.

An investigation conducted into the significance of the soil thread diameter in the standard plastic limit test, particularly the requirement to roll threads to the diameter of 3 mm, has found that as the diameter and the water content reduce while the thread is rolled by hand, along a rolling path, the soil undergoes a transition from a fully plastic state, to a cracked condition and then to a brittle and crumbling state.

These states are found to occur largely regardless of the diameter of the thread so it is recommended that consideration is given to removal from the standard test procedure of the 3 mm diameter requirement when crumbling occurs and emphasis

is placed instead on carefully observing the condition of the soil thread over the range of water contents between the plastic and brittle states to identify the ductile-brittle transition.

Tubular shaped threads are sometimes formed, particularly with kaolinitic soils, within the cracked and crumbled regions. Acceptance of a tubular thread as the end point of the standard plastic limit test should be reviewed as threads in this condition can be produced over a wide range of water contents without signs of cracking or crumbling.

The effect of silt and sand particles on the crumbling condition is considered to be due not only to greater interference between the coarse particles within a reducing volume of continuous matrix but a predominantly greater potential for microcracks to develop and enlarge between the surfaces of the silt and sand particles and the surrounding matrix with crack propagation leading to brittle failure and crumbling.

From a limited electron microscope study the effects of rolling a soil thread on the structure of clay:silt mixtures has been found to be mainly significant contortion of the microstructure while retaining the continuity of the clay particle arrangements. Further research would be worth pursuing into the micro and macrostructure of a cohesive soil by means of environmental scanning electron microscope studies with comparisons of specimens prepared in the range of water contents in a Barnes test and before and after rolling and extrusion in the apparatus.

A review of the relationship between the clay matrix and the granular particles in a soil has found that the linear law of mixtures and activity index are appropriate only at high clay contents. With toughness derived from the clay matrix the terms granular spacing ratio and cohesive porosity are introduced to explain the effect of the granular particles on the toughness and plastic limit. These terms show that the average spacing between the coarse particles in a clay matrix determines the toughness and plastic limit of the soil.

To assess the effect of granular particles in a clay matrix on the toughness and plastic limit the results of tests conducted on mixtures of a high plasticity clay and silt, and sand particles of two different sizes have been discussed. Soils with high silt and sand contents display strain-hardening while soils with high clay contents produce more steady plastic straining with some strain-softening in the stiff-plastic region.

With high silt and sand contents a large proportion of the measured toughness is due to the work done in displacing these granular particles. Smaller granular particle sizes, in the order silt, fine sand, fine/medium sand, are found to have a greater effect on reducing the toughness and the plastic limit of the mixtures.

The substitution method of dealing with oversize particles in a test specimen has been found to be inappropriate for the determination of the plastic limit and toughness with no more than 10% substitution permitted. The correction of total water contents for the presence of oversize non-clay particles in order to compare with test results on soils with the oversize particles removed is considered to be inappropriate in deriving relevant values of the plastic limit and toughness.

A limit must be placed on the maximum granular particle size in a small diameter thread. The standard liquid and plastic limit tests allow particles up to 425 μm . The plastic limit tests conducted with the Barnes apparatus show that this is a reasonable value but that as the soil thread reduces below about 4 mm diameter and the large granular particles move closer together there is a disproportionate effect on the stress-strain relationships. An analysis has shown that with small diameter soil threads large granular particles are likely to affect the results disproportionately.

In the ceramics industry mixing different clays together to obtain suitable properties is common. The liquid limit, toughness and plastic limits of two pairs of mixed clays do not follow a linear law of mixtures but are dependent on the total clay content and the content of a dominant clay mineral.

For the Shaly Clay:Ball Clay mixtures dislocations within the clay matrix caused by a high silt/sand content from the Shaly Clay result in lower maximum toughnesses and higher plastic limits. For the mixtures with high Ball Clay contents the toughness is controlled by the matrix water content but with lower Ball Clay contents the effect of non-clay particles is significant.

For the Fireclay:Ball Clay mixtures with lower silt/sand contents interactions between the clay minerals in the two clays are considered to subdue the dislocations in the Fireclay resulting in higher maximum toughnesses. For these mixtures the percentage of the clay content from the Ball Clay in the total clay content has a significant effect.

Further research would be worth conducting into the effects of chemical additions on cohesive soils as experienced in the civil engineering field. These could include

investigation of the toughness and plastic limit of soils following lime modification and stabilisation and the permeation of contaminants as occurs in landfill earthworks formed from clays. In the ceramics industry investigations could be conducted into the effects of additives including dispersants, flocculants, lubricants, binders and other toughness modifying compounds on kaolinitic clay bodies.

REFERENCES

- AASHTO T90-00 (2000) Determining the Plastic Limit and Plasticity Index of Soils. American Association of State Highway and Transportation Officials
444 North Capitol Street, Suite 249 Washington, D.C. 20001.
- Abdun-Nur, E. (1960) Plastic limit comparison of cube and standard thread test methods. ASTM STP254EB, paper STP44319S.
- Ahmed, S., Lovell, C.W. and Diamond, S. (1974) Pore sizes and strength of compacted clay. *ASCE, Journal of the Geotechnical Engineering Division* 100(GT4), April, pp.407-425.
- Alfaro, M.C. and Wong, R.C.K. (2001) Laboratory studies on fracturing of low-permeability soils. *Canadian Geotechnical Journal*, 38, pp.303-315.
- Anon (1993) *Soil Survey Manual Chapter 3 Examination and description of soils*. Soil Conservation Service, US Dept. of Agriculture. Natural Resources Conservation Service, Handbook 18, Soil Survey Division Staff.
- Anon (2004) *Chapter 5, Backfill for subsurface structures*. Unified Facilities Criteria UFC 3-220-04FA, January. US Army Corps of Engineers, NAVFAC, Air Force, Department of Defense, Technical Manual TM 5-818-4/AFM 88-5,.
- Anon (2009) *Specification for Highway Works*. Manual of Contract Documents for Highway Works, Volume 1, Highways Agency, The Stationery Office, London.
- Anon (n.d.) *Unified Soil Classification System: field method*. Department of Sustainable Natural Resources, New South Wales, Australia.
- Arrowsmith, E. J. (1978). Roadwork fills – a material engineer’s viewpoint. *Proceedings Clay Fills Conference, ICE*, London, pp.25-36.
- Astbury, N.F., Moore, F. and Lockett, J.A. (1966) A cyclic torsion test for study of plasticity. *Transactions British Ceramics Society*, 65, pp.435-461.
- ASTM Standard *ASTM C181-09 Standard test method for workability index of fireclay and high-alumina plastic refractories*. ASTM International, DOI:10.1520/C181-09.
- ASTM Standard *ASTM D1557-12 (2012) Standard Test Methods for Laboratory Compaction Characteristics of Soil Using Modified Effort (56,000 ft-lbf/ft³ (2,700 kN-m/m³))*. DOI: 10.1520/D1557-12
- ASTM Standard *ASTM D2488-00 (2000) Standard practice for description and identification of soils (Visual-manual procedure)*. DOI: 10.1520/D2488-00.
- ASTM Standard *ASTM D3967-08 Standard Test Method for Splitting Tensile Strength of Intact Rock Core Specimens*. ASTM International, DOI:10.1520/D3967-08.
- ASTM Standard *ASTM D4318-10 Standard Test Methods for Liquid Limit, Plastic Limit, and Plasticity Index of Soils*. ASTM International, DOI:10.1520/D4318-10.
- ASTM Standard *ASTM D4718 - 07(2007) Standard Practice for Correction of Unit Weight and Water Content for Soils Containing Oversize Particles*, DOI: 10.1520/D4718-87R07.

- Atterberg, A. (1911) Uber die physikalische Bodenuntersuchung und uber die Plastizitat der tone. (On the physical testing of soil and the plasticity of clays) *Internationale Mitteilungen fur Bodenkunde*, 1(1), pp.10-43.
- Atterberg, A. (1974) *Plasticity of clays (Die plastizitaet der tone)* Cold Regions Research and Engineering Lab Hanover N H, Report CRREL-TL-413, Sept., 31p.
- Bain, J. A. and Highley, D. E. (1979) Regional appraisal of clay resources – A challenge to the clay mineralogist. *Developments in Sedimentology*, 27, pp. 437-446.
- Ballard, G.E.H. and Weeks, W.F. (1963) Human error in determining plastic limit of cohesive soils. *Material Research Standard*, 3(9), pp.726-729.
- Baran, B., Erturk, T., Sarikaya, Y. and Alemdaroglu, T. (2001) Workability test method for metals applied to examine a workability measure (plastic limit) for clays. *Applied Clay Science*, 20(1-2), Sept., pp.53-63.
- Barden, L. (1972) The influence of structure on deformation and failure in clay soil. *Geotechnique*, 2(1), pp.159-163.
- Barden, L. and Sides, G.R. (1970) Engineering behavior and structure of compacted clay. *ASCE, Journal Soil Mechanics And Foundation Division*, SM4, pp.1171-1200.
- Barna, G.L. (1967) Plasticity of clay minerals. *Ceramics Bulletin* 46, pp.1091-1093.
- Barnes, G.E. (1987). The moisture condition value and compaction of stoney clays. *Compaction Technology Conference ICE, London*, pp.79-90.
- Barnes, G.E. (2009) An apparatus for the plastic limit and workability of soils. *Proceedings ICE, Geotechnical Engineering*, 162(issue GE3), June, pp.175 – 185.
- Barnes, G.E. (2010) *Soil mechanics principles and practice*. Third edition, Palgrave Macmillan, Houndmills, Berkshire.
- Barnes, G.E. (2011) Author's reply: An apparatus for the plastic limit and workability of soils. *Proceedings ICE, Geotechnical Engineering*, 164 (GE1), pp.1-2.
- Barnes, G.E. (2013) An apparatus for the workability and plastic limit of clays. *Applied Clay Science*, DOI:10.1016/j.clay.2013.04.014.
- Barnes, G.E. (tba) Discussion on Kyambadde, B.S. and Stone, K.J.L. (2013). To be published.
- Barnes, G.E. and Staples, S.G. (1988). The acceptability of clay fills as affected by stone content. *Ground Engineering*. 21(1), pp.22-30.
- Barnes, G.E. and Reynolds, W.S. (1991). Lime stabilisation of glacial clays. *Journal of the Institution of Highways and Transportation* .6(36), pp.6-11.
- Black, W.P.M (1961). The calculation of laboratory and in situ values of California Bearing Ratio from bearing capacity data. *Geotechnique*, 11(1), pp.14-21.
- Black, W.P.M. (1962) A method of estimating the California Bearing Ratio of cohesive soils from plasticity data. *Geotechnique*, 12(4), pp.271-282.
- Black, W.P.M. and Lister, N.W. (1978) The strength of clay subgrades: its prediction in relation to road performance. *Proceedings Clay Fills Conference, ICE, London*, pp.37-48.

- Black, W.P.M. and Lister, N.W. (1979) The strength of clay fill subgrades: its prediction in relation to road performance. RRL Laboratory Report 889. Crowthorne, Berkshire.
- Blackall, T.E. (1952) A.M. Atterberg. *Geotechnique*, 3(1), pp.17-19.
- Bobrowski, L. J. Jr. and Griekspoor, D. M. (1992) Determination of the plastic limit of a soil by means of a rolling device. *ASTM Geotechnical Testing Journal*, 15(3), Sept., pp.284-287.
- Brady, K. C. (1988) Soil suction and the critical state. *Geotechnique*, 38(1), pp.117-120.
- British Standards Institution (1990) *BS1377:1990 Methods of test for soils for civil engineering purposes*, Part 1: General requirements and sample preparation. Part 2: Classification tests. B.S.I., London.
- British Standards Institution (1999) *BS5930:1999. Code of practice for site investigations*. B.S.I., London.
- British Standards Institution (2002) *BS EN ISO 14688-1:2002 Geotechnical investigation and testing-identification and classification of soil*. Part 1:Identification and description. B.S.I., London.
- British Standards Institution (2004) *BS EN ISO 14688-2:2004 Geotechnical investigation and testing-identification and classification of soil*. Part 2:Principles for a classification. B.S.I., London.
- British Standards Institution (2004) *BS EN 1997-1:2004 Eurocode 7: Geotechnical design - Part 1: General rules*. B.S.I., London.
- British Standards Institution (2007) *BS EN 1997-2:2007 Eurocode 7: Geotechnical design - Part 2: Ground investigation and testing*. B.S.I., London.
- Brown, P.J. and Downing, M.C. (2001) Discussion on Feng, Fall-cone penetration and water content relationships of clays. *Geotechnique*, 51(9), pp.819-821.
- Burmister, D.M. (1970) Suggested methods of test for identification of soils. ASTM, STP479-EB. Paper No. STP38522S.
- Cafaro, F. (2002) Metastable states of silty clays during drying. *Canadian Geotechnical Journal*, 39, pp.992-999.
- Campbell, D.J. (1976) Plastic limit determination using a drop-cone penetrometer. *Journal of Soil Science*. 27(3), pp.295-300.
- Campbell, D.J., Stafford, J.V. and Blackwell, P.S. (1980) The plastic limit, as determined by the drop-cone test, in relation to the mechanical behaviour of soil. *Journal of Soil Science*. 31(1), pp.11-24.
- Cannon, S.B. and Wynn, A.M. (1999) A new method for establishing the upper and lower limits of clay plastic behaviour. *Interceram*, 48(1), pp.9-15.
- Carrier, W.D. III and Beckman, J.F. (1984) Correlations between index tests and the properties of remoulded clays. *Geotechnique*, 34(2), pp.211-228.
- Carty, W.M. and Lee, C. (1996) *The characterization of plasticity*. Science of Whitewares. The American Ceramic Society, Columbus, Ohio, pp.89-101.

- Casagrande, A. (1932) Research on the Atterberg limits of soils. *Public Roads*, 13(8), pp.121-130, 136.
- Casagrande, A. (1947) Classification and identification of soils. *Proceedings American Society Civil Engineers*, 73(6), June, pp.783-810. Also Discussion. *Proceedings American Society Civil Engineers*, 74(5), May 1948, pp.819-822; also 74(1), January 1948, pp.121-138; 74(3) Part 1, March, pp.403-422; author's reply 74(6), June, pp.916-920.
- Casagrande, A. (1958) Notes on the design of the liquid limit device. *Geotechnique*, 8(2), pp.84-91.
- Cetin, H., Fener, M., Soylemez, M., and Gunaydin, O. (2007) Soil structure changes during compaction of a cohesive soil. *Engineering Geology*, 92(Issues 1-2), pp.38-48.
- Chu, J. and Leong, W.K. (2002) Effect of fines on instability behaviour of loose sand. *Geotechnique*, 52(10), pp.751-755.
- Chudnovsky, A., Saada, A. and Lesser, A.J. (1988) Micromechanisms of deformation in fracture of overconsolidated clays. *Canadian Geotechnical Journal*, 25, pp.213-221.
- Chukweze, H.O. (1987) Effects of Dextran on the Atterberg limits of some soils. *Indian Journal of Technology*, 25(2), February, pp.53-57.
- Collins, K. and McGown, A. (1974) The form and function of microfabric features in a variety of natural soils. *Geotechnique*, 24(2), pp.223-254.
- Collota, T., Cantoni, R., Pavese, U., Roberl, E. and Moretti, P.C. (1989) A correlation between residual friction angle, gradation and the index properties of cohesive soils. *Geotechnique*, 39(2), pp.343-346.
- Croney, D. and Coleman, J.D. (1953) Soil moisture suction properties and their bearing on the moisture distribution in soils. *Proceedings 3rd International Conference Soil Mechanics and Foundation Engineering*, pp.13-18.
- Croney, D. and Coleman, J.D. (1954) Soil structure in relation to soil suction (pF) *Journal of Soil Science*, 5(1), pp.75-84.
- Das, B.M., Yen, S.C. and Dass, R.N. (1995) Brazilian tensile strength test of lightly cemented sand. *Canadian Geotechnical Journal*, 32, pp.166-171.
- Davidson, D.A. (1983) Problems in the determination of plastic and liquid limits of remoulded soils using a drop-cone penetrometer. *Earth Surface Processes and Landforms*, 8(2), pp.171-175.
- Delage, P., Audiguier, M., Cui, Y-J. and Howat, M.D. (1996) Microstructure of a compacted silt. *Canadian Geotechnical Journal*, 33, pp.150-158.
- Dennehy, J.P. (1978) The remoulded undrained shear strength of cohesive soils and its influence on the suitability of embankment fill. *Proceedings Clay Fills Conference, ICE, London*, pp.87-94.
- Diamond, S. (1970) Pore size distribution in clays. *Clays and Clay Minerals*, 18, pp.7-23.
- DIN 18196 (1970) *Soil classification for civil engineering purposes*. Deutschen Institut für Normung E.V. Superseded 2011.

- Dolar, B. and Trauner, L. (2005) Impact of soil composition on fall cone test results. *ASCE, Journal of Geotechnical and Geoenvironmental Engineering*, 131(Issue 1), pp.126-130.
- Driscoll, R. (1983). The influence of vegetation on the swelling and shrinking of clay soils in Britain. *Geotechnique*, 33(2), pp.93-105.
- Dumbleton, M.J. and West, G. (1966) *The influence of the coarse fraction on the plastic properties of clay soils*. Road Research Laboratory, RRL Report No 36, Crowthorne, Berkshire.
- Dumbleton, M.J. and West, G. (1970) *The suction and strength of remoulded soils as affected by composition*. Road Research Laboratory, RRL Report LR306, Crowthorne, Berkshire.
- Fall, D. A. (2000) Numerical model for rapid determination of plasticity of fine-grained soils. *Ground Engineering*, Vol 33, No 9, 43-45.
- Farrar, D.M. and Darley, P. (1975) *The operation of earthmoving plant on wet fill*. RRL Report LR688, Crowthorne, Berkshire.
- Faure, A. (1981) A new conception of the plastic and liquid limits of clay. *Soil Tillage Research*, 1, pp.97-105
- Feng, T.-W. (2000) Fall-cone penetration and water content relationship of clays. *Geotechnique*, 50(2), pp.181-187.
- Feng, T.-W. (2001a) A linear log d-log w model for the determination of consistency limits of soils. *Canadian Geotechnical Journal*, 38, pp.1335-1342.
- Feng, T.W. (2001b) Discussion on Fall-cone penetration and water content relationships with clays. *Geotechnique*, 51(9), pp.819-821.
- Feng, T.W. (2004) Using a small ring and a fall-cone to determine the plastic limit. *ASCE, Journal of Geotechnical and Geoenvironmental Engineering*, 130(6), pp.630-635.
- Fitzjohn, W.H. and Worrall, W.E. (1980) Physical properties of raw brick clays. *Transactions and Journal of the British Ceramics Society*, 79(3), pp.74-81.
- Franks, G.V. and Lange, F.F. (1996) Plastic-to-brittle transition of saturated, alumina powder compacts. *American Ceramic Society*, 79(12), Dec., pp.3161-3168.
- Garcia-Bengochea, I., Lovell, C.W. and Altschaeffl, G. (1979) Pore distribution and permeability of silty clays. *ASCE, Journal of Geotechnical Engineering*, 105(GT7), pp.839-856.
- Gay, G.C.W. and Kaiser, W. (1973). Mechanization for remolding fine grained soils and for the plastic limit test. *ASTM Journal of Testing and Evaluation*, 1(4), July, paper ID JTE10024J.
- Grant, C.D., Dexter, A.R. and Huang, C. (1990) Roughness of soil fracture surfaces as a measure of soil microstructure. *Journal of Soil Science*, 41(1), pp.95-110.
- Greacen, E.L. (1960) Aggregate strength and soil consistence. *Transactions 7th International Congress Of Soil Science*, Madison, Wisconsin, 1, pp.256-264.
- Greenwood, J.R., Holt, D.A. and Herrick, G.W., (1985) Shallow slips in highway embankments constructed of overconsolidated clay . *ICE International Symposium on Earthwork Failures, 06-07 March*, pp.69-82.

- Gurtug, Y. and Sridharan, A. (2004). Compaction behaviour and prediction of its characteristics of fine grained soils with particular reference to compaction energy. *Soils and Foundations*, 44(5), pp.27-36.
- Haigh, S. K., Vardanega, P. J. and Bolton, M. D. (2013) The plastic limit of clays. *Geotechnique*, 63(6), pp. 435-440 DOI:10.1680/geot.11.P.123.
- Hallett, P.D. and Newson, T.A. (2005) Describing soil crack formation using elastic-plastic fracture mechanics. *European Journal of Soil Science*, 56, pp.31-38.
- Hansbo, S. (1957) A new approach to the determination of the shear strength of clay by the fall-cone test. *Proceedings Royal Swedish Geotechnical Institute*, Stockholm, 14, pp.7-47.
- Harison, J.A. (1988) Using the BS cone penetrometer for the determination of the plastic limit of soils. *Geotechnique*, 38(3), pp.433-438.
- Harison, J.A. (1990) Discussion. Using the BS cone penetrometer for the determination of the plastic limit of soils. *Geotechnique*, 40(2), pp.311-315.
- Harison, J.A. Hardin, B.O. and Mahboub, K. (1994) Fracture toughness of compacted cohesive soils using ring test. *ASCE, Journal of Geotechnical Engineering*, 120(5), May, pp.872-891.
- Hatibu, N, and Hettiaratchi, D.R.P. (1993) The transition from ductile flow to brittle failure in unsaturated soils. *Journal of Agricultural Engineering*, 54(4), pp.319-328.
- Heindl, R.A. and Pendergast, W.L. (1947) Reliability of "workability index" of fire-clay plastic refractories. *Journal of the American Ceramic Society*, 30(11), pp.329-334.
- Hogentogler, C.A. and Terzaghi, C. (1929) Interrelationship of load, road and subgrade. *Public Roads*, 10(3), May, pp.37-64.
- Hogentogler, C.A. Terzaghi, C. and Wintermeyer, A.M. (1928) Present status of subgrade soil testing. *Public Roads*, 9(1), March, pp.1-8, 24.
- Hogentogler, C.A. Terzaghi, C. and Wintermeyer, A.M. (1930) Present status of subgrade soil testing. *Roads and Road Construction*, 8(95), Nov, pp.398-403.
- Hogentogler, C.A. and Willis, E.A. (1934) Subgrade soil testing methods. *ASTM Proceedings*, 34(II), pp.693-725.
- Hoogmoed, W.B., Cadena-Zapata, M. and Perdok, U.D. (2003) Laboratory assessment of the workable range of soils in the tropical zone of Veracruz, Mexico. *Soil and Tillage Research*, 74(2), Dec., pp.169-178.
- Houlsby, G.T. (1982) Theoretical analysis of the fall cone test. *Geotechnique*, 32(2), pp.111-118.
- Houlsby, G.T. and Wood, D.M. (1983) Discussion: Cone penetrometer and liquid limit. *Geotechnique*, 33(4), p.463.
- Howard, A.K. (1987) The revised ASTM Standard on the description and identification of soils (visual-manual procedure). *Geotechnical Testing Journal*, 10(4), Dec., pp.229-234.
- Howell, J.L., Shackelford, C.D., Amer, N.H. and Stern, R.T. (1997) Compaction of sand-processed clay soil mixtures. *Geotechnical Testing Journal*, 20(4), GTJ10411J.

- International Standards Office (2004). *CEN ISO/TS 17892-12:2004 Geotechnical investigation and testing - Laboratory testing of soil - Part 12: Determination of Atterberg limits*. International Organization for Standardization, Geneva, Switzerland.
- International Standards Office (2005). *EN ISO/IEC 17025 General requirements for the competence of testing and calibration laboratories* International Organization for Standardization, Geneva, Switzerland.
- James, P.J. (1968) Atterberg limit tests for quantitative earthwork control. *Civil Engineering and Public Works Review*, pp.1005-1006.
- Karlsson, R. (1961) Suggested improvements in the liquid limit test with reference to the flow properties of remoulded clays. *Proceedings 5th International Conference Soil Mechanics Foundation Engineering* Paris, 1, pp.171-184.
- Karlsson, R. and Hansbo, S (1981) *Soil classification and identification*. Swedish Geotechnical Society, Stockholm, Sweden.
- Kayabali, K. (2011) Assessment of shear strength at consistency limits – A reappraisal. *The Electronic Journal of Geotechnical Engineering*, 16, pp.1679-1695.
- Kenney, T.C. (1977) Residual strength of mineral mixtures. *Proceedings 9th International Conference Soil Mechanics Foundation Engineering*, 1, pp.155-160.
- Kessel, S. (1998) Ceramic rheology tester gets the thumbs up. *Material World*, 16(8), pp.474-475.
- Kinnison, C.S. (1915) *A study of the Atterberg plasticity method*. Technical paper No. 46, Bureau of Standards, May.
- Koester, J.P. (1992) The influence of test procedure on correlation of Atterberg limits with liquefaction in fine-grained soils. *Geotechnical Testing Journal*, 15(4), Dec., pp.352-361.
- Koumoto, T. and Houlsby, G.T. (2001) Theory and practice of the fall cone test. *Geotechnique*, 51(8), pp.701-712.
- Krishnayya, A.V.G. and Eisenstein, Z. (1974) Brazilian test for soils. *Canadian Geot. Journal*, 11, pp.632-641.
- Krishnayya, A.V.G., Eisenstein, Z. and Morgenstern, N.R. (1974) Behavior of compacted soil in tension. *ASCE, Journal of Geotechnical and Geoenvironmental Engineering*, 100(GT9), pp.1051-1061.
- Krizek, R.J. and Kondner, R.L. (1964) Use of miniature specimen in compression tests of cohesive soils. *ASTM, Proceedings*, 64, pp.944-957.
- Kumar, G.V. (1996) *Some aspects of the mechanical behaviour of mixtures of kaolin and coarse sand*. PhD Thesis, University of Glasgow, UK, cited in Kumar, G.V. and Wood, D.M. (1999).
- Kumar, G.V. and Wood, D.M. (1999) Fall cone and compression tests on clay-gravel mixtures. *Geotechnique*, 49(6), pp.727-739.
- Kyambadde, B.S. and Stone, K.J.L. (2012) Index and strength properties of clay-gravel mixtures. *Proceedings ICE., Geotechnical Engineering*, 165(GE1), pp.13-21.

- Lee, L.T. (2004) Method to rapidly assess the index properties of fine-grained dredged materials. *Geotechnical Testing Journal*, 27(5), pp.464-468.
- Lee, L.T. and Freeman, R.B. (2009) Dual-weight fall cone method for simultaneous liquid and plastic limit determination. *ASCE, Journal of Geotechnical and Geoenvironmental Engineering*, 135(1), pp.158-161.
- Leonards, G.A. and Narain, J. (1963) Flexibility of clay and cracking of earth dams. *ASCE, Journal Soil Mechanics and Foundation Division*, 89(SM2), paper 3460, pp.47-99.
- Livneh, M, Kinsky, J. and Zaslavsky, D. (1970) Correlation of suction curves with the plasticity index of soils. *Journal of Materials*. 5(1), pp.209-220.
- Lupini, J.F., Skinner, A.E. and Vaughan, P.R. (1981) The drained residual strength of cohesive soils. *Geotechnique*, 31(2), pp.181-213.
- Marinho, F. A. M. and Oliveira, O. M. (2012) Unconfined shear strength of compacted unsaturated plastic soils. *Proceedings ICE, Geotechnical Engineering*, 165(GE2) pp. 97-106.
- Marshall, C.L. (1955) A new concept of clay plasticity. *Ceramics Bulletin*. 34, pp.54-56.
- McBride, R.A. (1989) A re-examination of alternative test procedures for soil consistency limit determination: II. A simulated desorption procedure. *Journal of the American Soil Science Society*. 53, pp.184-191.
- McBride, R.A. and Baumgartner, N. (1992) Simple slurry consolidometer designed for the estimation of the consistency limits of soils. *Journal of Terramechanics*, 29(2), March, pp.223-238.
- McBride, R.A. and Bober, M.L. (1989) A re-examination of alternative test procedures for soil consistency limit determination: I. A compression-based procedure. *Journal of the American Soil Science Society*. 53, pp.178-183.
- McDowell, S.J. (1928) Notes on a method for determination of workability of plastic clays. *Journal of the American Ceramic Society*. 1(2), pp.99-102
- McLeod, W.T. and Hanks, P. (1982) *The new Collins concise dictionary of the english language*. William Collins Sons and Co. Ltd. Glasgow.
- Medhat, F. and Whyte, I.L. (1986) An appraisal of soil index tests. *Geological Society, Engineering Geology Special Publication No. 2*, pp.317-323.
- Menzies, B.K. Looby, G. and Simons, N. E. (1974) A correlation of index tests and road performance experience of an Antigua marl. *Geotechnique*, 24(4), pp.433-438.
- Merifield, R.S. Sloan, S.W. and Yu, H.S. (1999) Rigorous plasticity solutions for the bearing capacity of two-layered clays. *Geotechnique*, 49(4), pp.471-490.
- Meyerhof, G.G. and Chaplin, T.K. (1953) The compression and bearing capacity of cohesive layers. *British Journal Of Applied Physics*, 4, pp.20-26.
- Mielenz, R.C. & King, M.E. (1955) Physical-chemical properties and engineering performance of clays. *Clays and Clay Technology*, Bull.169, Part V, pp.196-254.

- Mitchell, J.E. (1961) *Determination of liquid and plastic limits of soils by the cone penetration method* Evaluation of soil mechanics laboratory equipment. Report No. 4. Waterways Experiment Station, Report WES-MP-3-478-4, 14p.
- Mitchell, J.K. (1956) The fabric of natural clays and its relation to engineering properties. *Proceedings Highways Research Board*, 35, pp.693-713.
- Mitchell, J.K. (1976) *Fundamentals of soil behaviour*. Wiley, New York.
- Moore, F. (1963) Two instruments for studying the plasticity of clays. *Journal of Scientific Instruments*, 40, pp.228-231.
- Morris, P.H., Graham, J. and Williams, D.J. (1992) Cracking in dry soils. *Canadian Geotechnical Journal*, 29, pp.263-277.
- Mueller, L. Schindler, U. Fausey, N.R. and Lal, R. (2003) Comparison of methods for estimating maximum soil water content for optimum workability. *Soil and Tillage Research*, 72(1), July, pp.9-20.
- Muntohar, A.S. and Hashim, R. (2005) Determination of plastic limits of soils using cone penetrometer: Re-appraisal. *Journal Teknik Sipil*, 11(2), pp.1-17.
- Nagaraj, H. B., Sridharan, A. and Mallikarjuna, H. M. (2012) Re-examination of undrained strength at Atterberg limits water contents. *Geotechnical and Geological Engineering*, 30, pp. 727-736.
- Nagaraj, T.S. (2000) Discussion: Characteristic water contents of a fine-grained soil-water system. *Geotechnique*, 50(3), pp.305-306.
- Nagaraj, T.S., Murthy, B.R.S. and Bindumadhava, V. (1987) Liquid limit determination - further simplified. *Geotechnical Testing Journal*. 10(3), pp.142-145.
- Nagaraj, T.S. and DeGroot, D.J. (2004) Discussion. Determination of liquid limit from equilibrium volume. Prakash *et al*, *Geotechnique*, 54(9), pp.611-613.
- Nagaraja Rao, G.M. and Murthy, C.R.L. (2001) Dual role of microcracks: toughening and degradation. *Canadian Geotechnical Journal*, 38, pp.427-440.
- NAVFAC (1986) *Soil Mechanics Design Manual 7.01*. Naval Facilities Engineering Command, Alexandria, Virginia, USA.
- Newill, D. (1961) A laboratory investigation of two red clays from Kenya. *Geotechnique*, 11(4), pp.302-310.
- Ni, Q., Tan, T.S., Dasari, G.R. and Hight, D.W.(2004) Contribution of fines to the compressive strength of mixed soils. *Geotechnique*, 54(9), pp.561-569.
- Nishimura, S-I. (2005) Occurrence of extensile cracks in cohesive soils due to compression. *Soils and Foundations*, 45(3), pp.1-8.
- Norton, F.H. (1938) An instrument for measuring the workability of clays. *Journal American Ceramics Society*, 21, pp.33-36.
- Nuyens, J.G., and Kockaerts, R.F. (1967) Reliable technique for determining plastic limit. *Materials Research and Standards*. ASTM, 7(7), pp.295-299.
- O'Kelly, B.C. (2011) Discussion: An apparatus for the plastic limit and workability of soils. *Proceedings ICE.*, *Geotechnical Engineering*, 164(GE1), pp.1-2.

- Olesen, J.F., Ostergaard, L. and Stang, H. (2006) Nonlinear fracture mechanics and plasticity of the split cylinder test. *Materials and Structures*, 39, pp.421-432.
- Olson, R.E. and Scott, J.D. (1960) Discussion on Structure and strength characteristics of compacted clays. *ASCE, Journal of the Soil Mechanics and Foundation Division*, 86(SM4), pp.65-71.
- Pandian, N.S., Nagaraj, T.S., and Sivakumar Babu, G.L. (1991) Effects of drying on the engineering behavior of Cochin marine clays. *Geotechnique*, 41(1), pp.143-147.
- Pandian, N.S., Nagaraj, T.S., and Sivakumar Babu, G.L. (1993) Tropical clays. I: index properties and microstructural aspects. *ASCE, Journal of Geotechnical Engineering*, 119(5), May, , pp.826-839.
- Parsons, A.W. and Boden, J.B. (1979) *The moisture condition test and its potential applications in earthworks*. RRL Supplementary Report 522. RRL, Crowthorne, Berkshire.
- Peng, S.S. (1978) Method of test for determining the splitting tensile strength of rocks. *Geotechnical Testing Journal*. 1(1), March, pp.55-56.
- Penman, A.D.M. (1986) On the embankment dam. *Geotechnique*, 36(3), pp.303-348.
- Polidori, E. (2007) Relationship between the Atterberg limits and clay content. *Soils and Foundations*, 47(5), pp.887-896.
- Prakash, K. (2005) Discussion of Plastic limit etc. Sharma and Bora, *ASCE, Journal of Geotechnical Engineering*, 131(3), p.402.
- Prakash, K. and Sridharan, A. (2006) Critical appraisal of the cone penetration method of determining soil plasticity. *Canadian Geotechnical Journal*, 43, pp.884-888.
- Prakash, K., Sridharan, A. and Prasanna, H. S. (2009) A note on the determination of plastic limit of fine-grained soils. *Geotechnical Testing Journal*, 32(4), pp. 372-374.
- Pugh, R.S., Parnell, P.G. and Parkes, R.D. (1995) A rapid and reliable on-site method of assessing desiccation in clay soils. *Proceedings ICE., Geotechnical Engineering*, 113(GE1), Jan., pp.25-30.
- Ramanathan, B. and Raman, V. (1974) Split tensile strength of cohesive soils. *Soils and Foundations*, 14(1), pp.71-76.
- Rashid, A.S.A., Kassim, K.A. Katimon. A. and Noor, N.M. (2008) Determination of plastic limit of soil using modified methods. *Malaysian Journal of Civil Engineering*, 20(2), pp.295-305.
- Rollins, R.L. and Davidson, D.T. (1960) *The relation between soil moisture tension and the consistency limits of soils: Method for testing engineering soils*. Iowa Engineering Experimental Station Bulletin 192, pp.210-220.
- Ruddock, E.C. (1967) Residual soils of the Kumasi district in Ghana. *Geotechnique*, 17(4), pp.359-377.
- Russel, E.R. and Mickle, J.L. (1970) Liquid limit values by soil moisture tension. *ASCE, Journal of Soil Mechanics and Foundation Division*, 96(3), pp.967-989.

- Sahu, B.K., Gichaga, J.J. and Kimata, P.M. (1984) Compaction characteristics of Nairobi soils. *Proceedings First National Conference on the Science and Technology of Buildings*, Khartoum, pp.485-490.
- Schofield, A.N. and Wroth, C.P. (1968) *Critical state soil mechanics*. McGraw-Hill, London.
- Schwartz, B. (1952) Fundamental study of clay: XII, A note on the effect of the surface tension of water on the plasticity of clay. *Journal American Ceramics Society*, 35(2), pp.41-43.
- Seed, H.B. and Chan, C.K. (1959) Structure and strength characteristics of compacted clay. *ASCE, Journal of Soil Mechanics and Foundation Division*, 85(SM5), paper 2216, pp.87-109.
- Seed, H.B., Woodward, R.J. and Lundgren, R. (1964a) Clay mineralogical aspects of the Atterberg limits. *ASCE, Journal of Soil Mechanics and Foundation Division*, 90(SM4), pp.107-131.
- Seed, H.B., Woodward, R.J. and Lundgren, R. (1964b) Fundamental aspects of the Atterberg limits. *ASCE, Journal of Soil Mechanics and Foundation Division*, 90(SM6), pp.75-105.
- Shankar, N.B. (1967) Plastic properties of certain clays. *Indian National Society of Soil Mechanics and Foundation Engineering*, 6(3), July, pp.339-348.
- Sharma, B. and Bora, P.K. (2003) Plastic limit, liquid limit and undrained shear strength of soil – reappraisal. *ASCE, Journal of Geotechnical and Geoenvironmental Engineering*, August, 129(8), pp.774-777.
- Sherwood, P.T. (1970) *The reproducibility of the results of soil classification and compaction tests*. RRL Report LR339. RRL, Crowthorne, Berkshire.
- Shook, J.F. and Fang, H.Y. (1961) A study of operator variability in the determination of liquid and plastic limits of soil. Special paper, *Highway Research Abstracts*, 31(9), Highway Research Board, Washington DC, pp.26-28.
- Sivakumar, V., Tan, W.C., Murray, E.J. and McKinley, J.D. (2006) Wetting, drying and compression characteristics of compacted clay. *Geotechnique*, 56(1), pp.57-62.
- Sivakumar, V., Glynn, D., Cairns, P. and Black, J.A. (2009) A new method of measuring plastic limit of fine materials. *Geotechnique*, 59(10), pp.813 - 823.
- Sivapullaiah, P.V. and Sridharan, A. (1985) Liquid limit of soil mixtures. *Geotechnical Testing Journal*, 8(3), September, pp.111-116.
- Sivrikaya, O., Togrol, E. and Kayadelen, C. (2008) Estimating compaction behavior of fine-grained soils based on compaction energy. *Canadian Geotechnical Journal*, 45(6), pp.877 – 887.
- Skempton, A.W. (1953) The colloidal ‘activity’ of clays. *Proceedings Third International Conference Soil Mechanics and Foundation Engineering*, 1, pp.57-61.
- Skempton, A.W. (1970). The consolidation of clays by gravitational compaction. *Quarterly Journal of the Geological Society*, London, 125, pp.373-411.
- Skempton, A. W. (1985) Residual strength of clays in landslides, folded strata and the laboratory. *Geotechnique*, 35(1), pp.3-18.

- Skempton, A.W. and Northey, R.D. (1953) The sensitivity of clays. *Geotechnique*, 3(1), 30-53.
- Smart, P. (1986) Classification by texture and plasticity. *Geological Society Engineering Geological Special Publication*, No. 2, pp.385-390.
- Sridharan, A. and Nagaraj, H.B. (2005) Plastic limit and compaction characteristics of fine-grained soils. *Ground Improvement*, 9(1), pp.17-22.
- Sridharan, A. and Prakash, K. (1998) Characteristic water contents of a fine-grained soil-water system. *Geotechnique*, 48(3), pp.337-346.
- Sridharan, A. and Prakash, K. (1998) Discussion: liquid limit and fall cones. *Canadian Geotechnical Journal*, 35, pp.407-408.
- Sridharan, A. and Prakash, K. (2000) Percussion and Cone Methods of Determining the Liquid Limit of Soils: Controlling Mechanisms *ASTM Geotechnical Testing Journal*, 23(2), June.
- Sridharan, A. Rao, S.M. and Dwarkanath, H.N. (1992) Dispersive behavior of nonswelling clays. *ASTM Geotechnical Testing Journal*, 15(4), Dec., pp.380-387.
- Stakman, W.P. and Bishay, B.G. (1976) Moisture retention and plasticity of highly calcareous soils in Egypt. *Netherlands Journal Agricultural Science*, 24, pp.43-57.
- Stone, K.J.L. and Kyambadde, B.S. (2007) Determination of strength and index properties of fine-grained soils using a soil minipenetrometer. *ASCE, Journal of Geotechnical and Geoenvironmental Engineering*, 133(6), pp.667-673.
- Stone, K.J.L. and Phan, K.D. (1995) Cone penetration tests near the plastic limit. *Geotechnique*, 45(1), pp.155-158.
- Studds, P.G., Stewart, D.I. and Cousens, T.W. (1998) The effects of salt solutions on the properties of bentonite-sand mixtures. *Clay Minerals*, 33, pp.651-660.
- Tan, T.-S.Goh, T.-C. Karunaratne, G.P. and Lee, S.-L. (1994) Shear strength of very soft clay-sand mixtures. *ASTM Geotechnical Testing Journal*, 17(1), pp.27-34.
- Tanake, H., Shiwakoti, D.R., Omukai, N., Rito, F., Locat, J. and Tanaka, M. (2003) Pore size distribution of clayey soils measured by mercury intrusion porosimetry and its relation to hydraulic conductivity. *Soils and Foundations*, 43(6), pp.63-73.
- Temyingyong, A., Chantawarangul, K. and Sudasna-na-Ayudthya, P. (2002) Statistical analysis of influenced factors affecting the plastic limit of soils. *Kasetsar Journal (Natural Science)*, 36(1), January.
- Terzaghi, C. (1925) Principles of soil mechanics: II – Compressive strength of clay. *Engineering News-Record*, 95(20), pp.7-11.
- Terzaghi, K. (1926) Simplified soil tests for subgrades and their physical significance. *Public Roads*, 7(8), pp.153-162, 170.
- Thevanayagam, S. (1998) Effect of fines and confining stress on undrained shear strength of silty sands. *ASCE, Journal of Geotechnical and Geoenvironmental Engineering*, 124(6), pp.479-491. Also Discussion *ASCE, Journal of Geotechnical and Geoenvironmental Engineering*, 133, November, pp.1024-1027.

- Thevanayagam, S., Shenthan, T., Mohan, S. and Liang, J. (2002) Undrained fragility of coarse sands, silty sands and sandy silts. *ASCE, Journal of Geotechnical and Geoenvironmental Engineering*, 128(10), pp.849-859.
- Timoshenko, S. and Goodier, J.N. (1951) *Theory of elasticity*. 2nd edition, McGraw-Hill Book Co., New York.
- Trenter, N. A. (2001) *Earthworks: A guide*. Thomas Telford Limited, London. DOI: 10.1520/D1557-12
- Uppal, H.L. (1966) A scientific explanation of the plastic limit of soils. *ASTM Journal of Materials*, 1, pp.164-179.
- Uriel, S. and Mier, F. (1975) Discussion on behavior of compacted soil in tension. *ASCE, Journal of Geotechnical Engineering*, 101(GT6), pp.596-600.
- US Army (1986) *Laboratory Soils Testing*. Engineer Manual EM-1110-2-1906. US Department of the Army, Office of the Chief of Engineers Washington D.C.
- Utomo, W.H. and Dexter, A.R. (1981) Soil friability. *Journal of Soil Science*, 32(2), pp.203-213.
- Vallejo, L.E. (1988) Brittle and ductile behaviour of clay samples containing a crack under mixed mode loading. *Theoretical and Applied Fracture Mechanics*, 10(1), Aug., pp.73-78.
- Vallejo, L.E. (1989) Fissure parameters in stiff clays under compression. *ASCE, Journal of Geotechnical Engineering*, 115(9), pp.1303-1317.
- Vanapalli, S. K., Fredlund, D.G. and Pufahl, D.E. (1999) The influence of soil structure and stress history on the soil-water characteristics of a compacted till. *Geotechnique*, 49(2), pp.143-159.
- Vaughan, P.R. (1998) Special lecture: Problematic soil or problematic soil mechanics? *Proceedings of the International Symposium on Problematic Soils*. Sendai, Japan, October, A.A. Balkema, Rotterdam, 2, pp.803-814.
- Vieira, C. M. F., Sanchez, R. and Monteiro, S.N. (2007) Characteristics of clays and properties of building ceramics in the state of Rio de Janeiro, Brazil. *Construction and Building Materials*, 22(5), pp.781-787.
- Vinod, P., Sridharan, A. and Deepa, K.A. (2013) Remoulded shear strength of plastic and semi-solid states. *Proceedings Inst. Civil Engineers, Geotechnical Engineering*, DOI 10.1680/geng.11.00071
- Wang, J., Severtson, S.J., and Geil, P.H. (2007) Brittle-ductile transitions and the toughening mechanism in paraffin/organoclay nanocomposites. *Materials Science and Engineering*, 467(1-2), October, pp.172-180.
- Wasti, Y. (1987) Liquid and plastic limits as determined from the fall cone and the Casagrande methods. *ASTM Geotechnical Testing Journal*, 10(1), pp.26-30
- Wasti, Y., and Bezirci, M.H. (1986) Determination of the consistency limits of soils by the fall cone test. *Canadian Geotechnical Journal*, 23(2), pp.241-246.
- West, R.R. and Lawrence, W.G. (1959) The plastic behavior of some ceramic clays. *Ceramics Bulletin*, 38(4), pp.135-138.

- Whyte, I.L. (1982) Soil plasticity and strength – a new approach using extrusion. *Ground Engineering*, 15(1), pp.16-24.
- Wijeyakulasuriya, C.V. (1990) Discussion on Harison, J.A. (1988), *Geotechnique*, 40(2), pp.311 – 315.
- Wilbourn, K., Vembu, K. and Vipulanandan, C. (2007) *Index properties and strength of artificial soil using the Harvard miniature method*. Final report, Dept. Env and Civil Eng. University of Houston, Texas.
- Wintermeyer, A.M. (1926) Adaptation of Atterberg plasticity tests for subgrade soils. *Public Roads*, 7(6), August, pp.119-122.
- Wintermyer, A.M. Willis, E.A. and Thoreen, R.C. (1931) Procedures for testing soils for the determination of the subgrade soil constants. *Public Roads*, 12(8), October, pp.197-207.
- Wood, D.M. (1982) Cone penetrometer and liquid limit. *Geotechnique*, 32(2), pp.152-157.
- Wood, D.M. (1983) Discussion on cone penetrometer and liquid limit. *Geotechnique*, 33(1), pp.76-80.
- Wood, D.M. (1985) Some fall-cone tests. *Geotechnique*, 35(1), pp.64-68.
- Wood, D.M. (1990) *Soil behaviour and critical state soil mechanics*. Cambridge University Press.
- Wood, D.M. and Kumar, G.V. (2000) Experimental observations of behaviour of heterogeneous soils. *Mechanics of Cohesive-Frictional Materials*. 5(5), pp.373-398.
- Wood, D.M. and Wroth, C.P. (1978) The use of the cone penetrometer to determine the plastic limit of soils. *Ground Engineering*, 11(3), p.37.
- Wroth, C.P. (1979) Correlations of some engineering properties of soils. BOSS'79. Proceedings of the Second International Conference on Behaviour of Offshore Structures, Imperial College, London, 1, pp.121-132.
- Wroth, C.P. and Wood, D.M. (1978) The correlation of index properties with some basic engineering properties of soils. *Canadian Geotechnical Journal*, 15(2), May, pp.137-145.
- Youssef, M.S., El Ramli, A.H. and El Demery, M. (1965) Relationships between shear strength, consolidation, liquid limit, and plastic limit for remoulded clays. *Proceedings of the 6th International Conference on Soil Mechanics and Foundation Engineering*, Montreal, 1, pp.126-129.
- Zergoun, M. and Vaid, Y. P. (1994) Effective stress response of clay to undrained cyclic loading. *Canadian Geotechnical Journal*, 31(5), October, pp.714-727

Appendix 1

Results of tests on natural soils

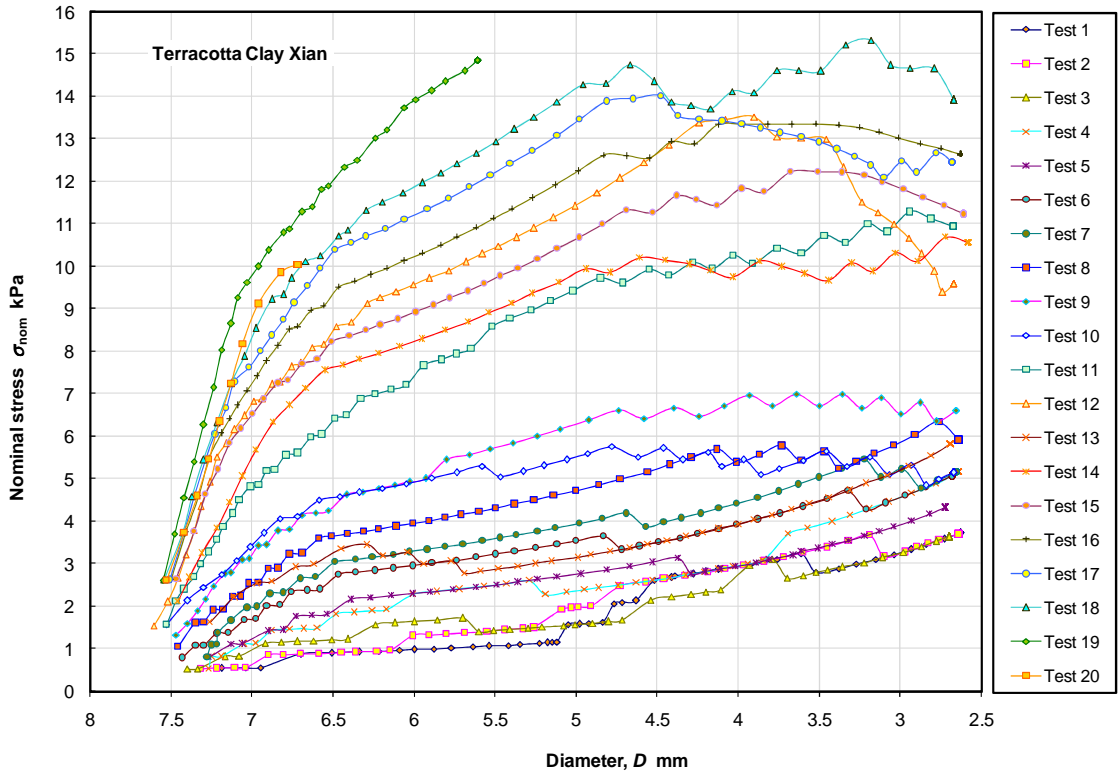

Figure A1.1 Stress – diameter Terracotta Clay Xian

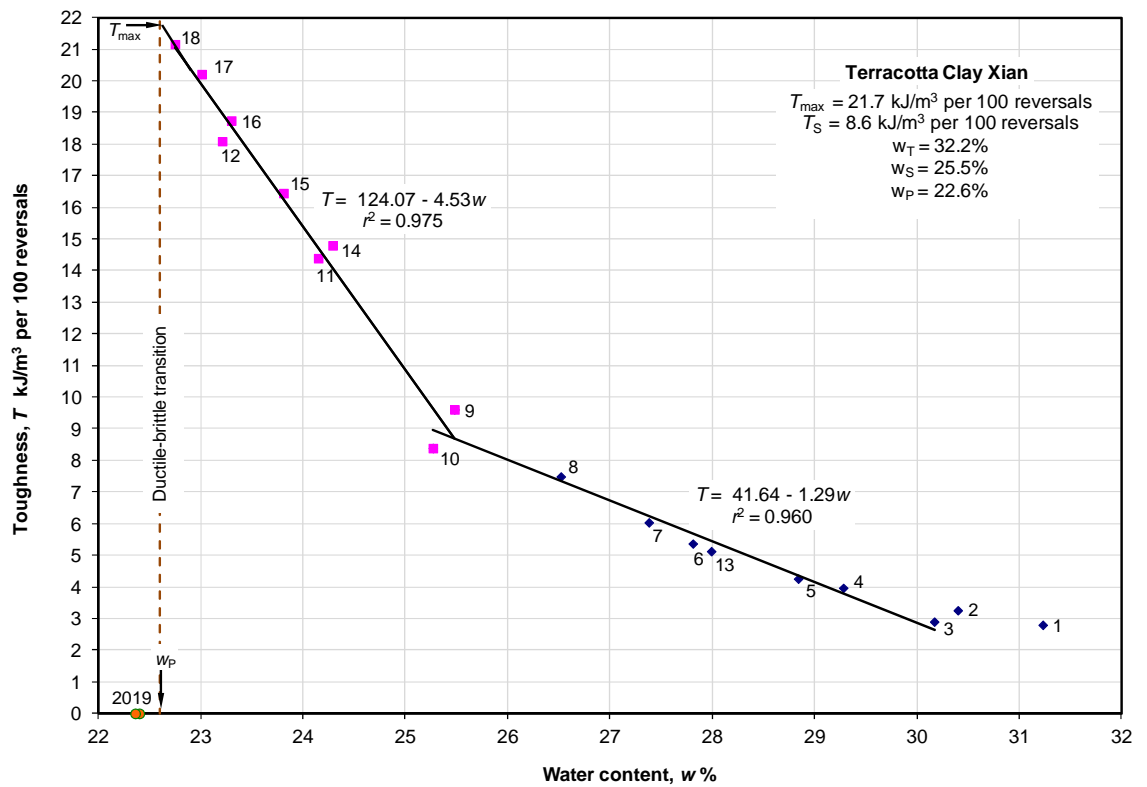

Figure A1.2 Toughness – water content Terracotta Clay Xian

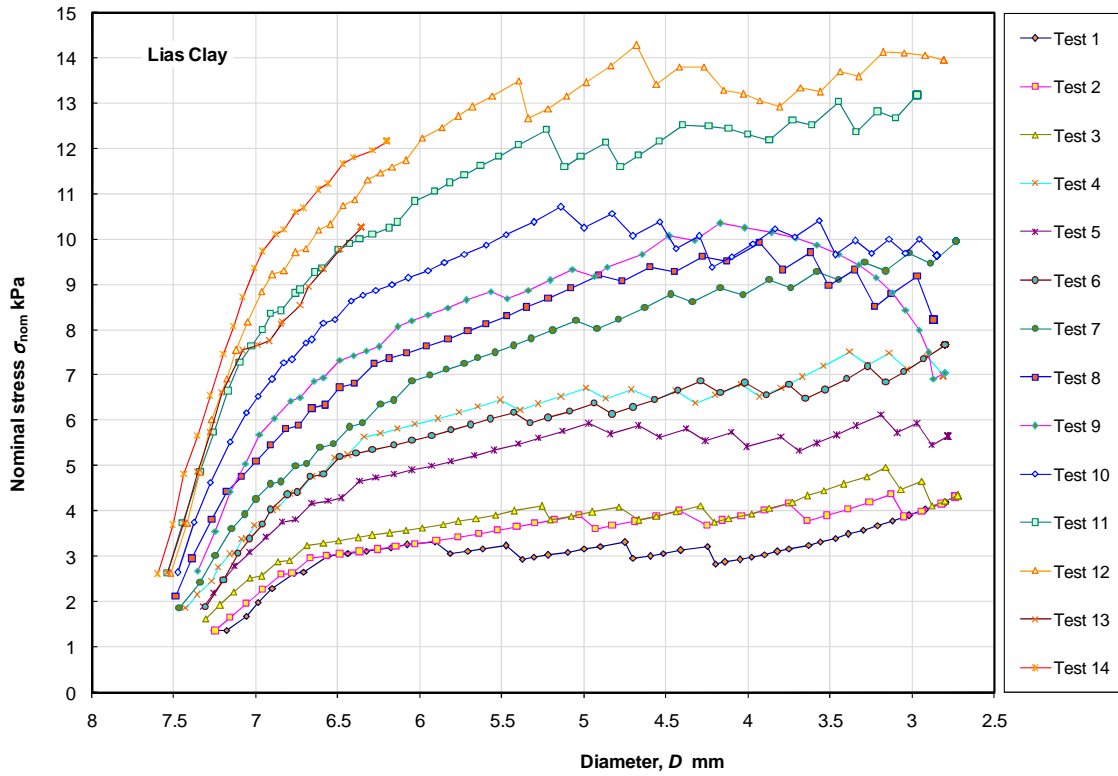

Figure A1.3 Stress – diameter Lias Clay

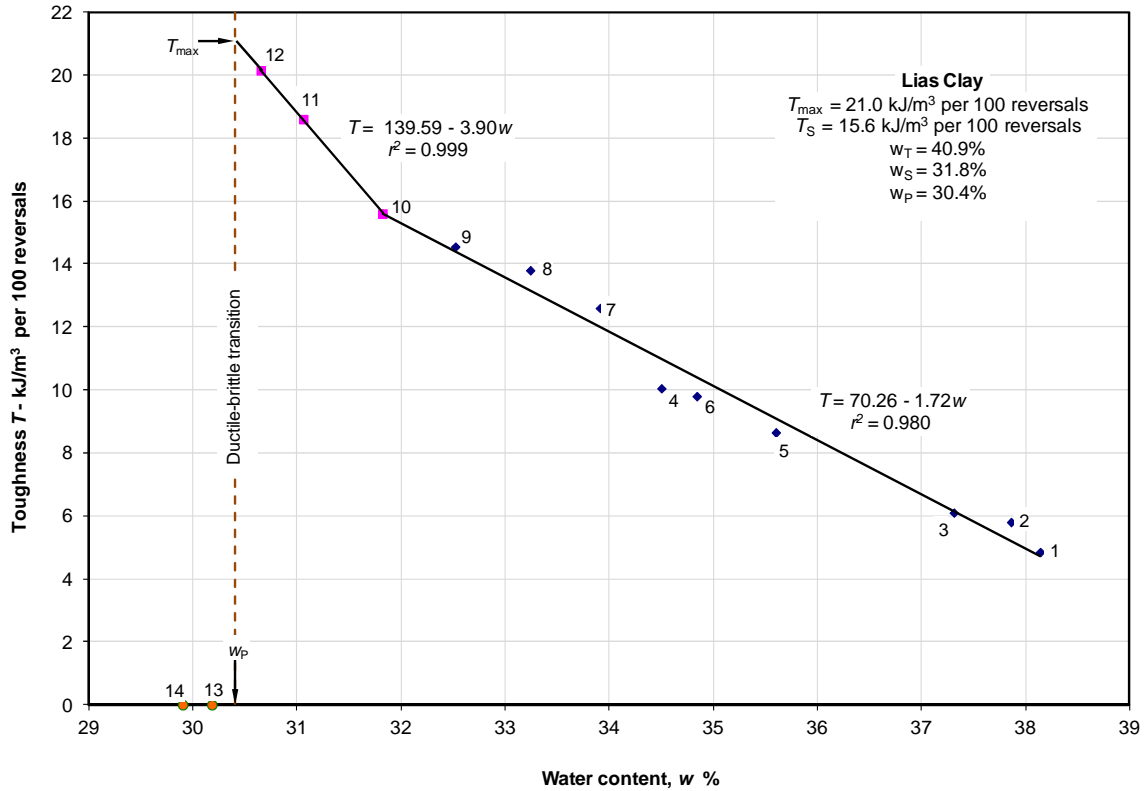

Figure A1.4 Toughness – water content Lias Clay

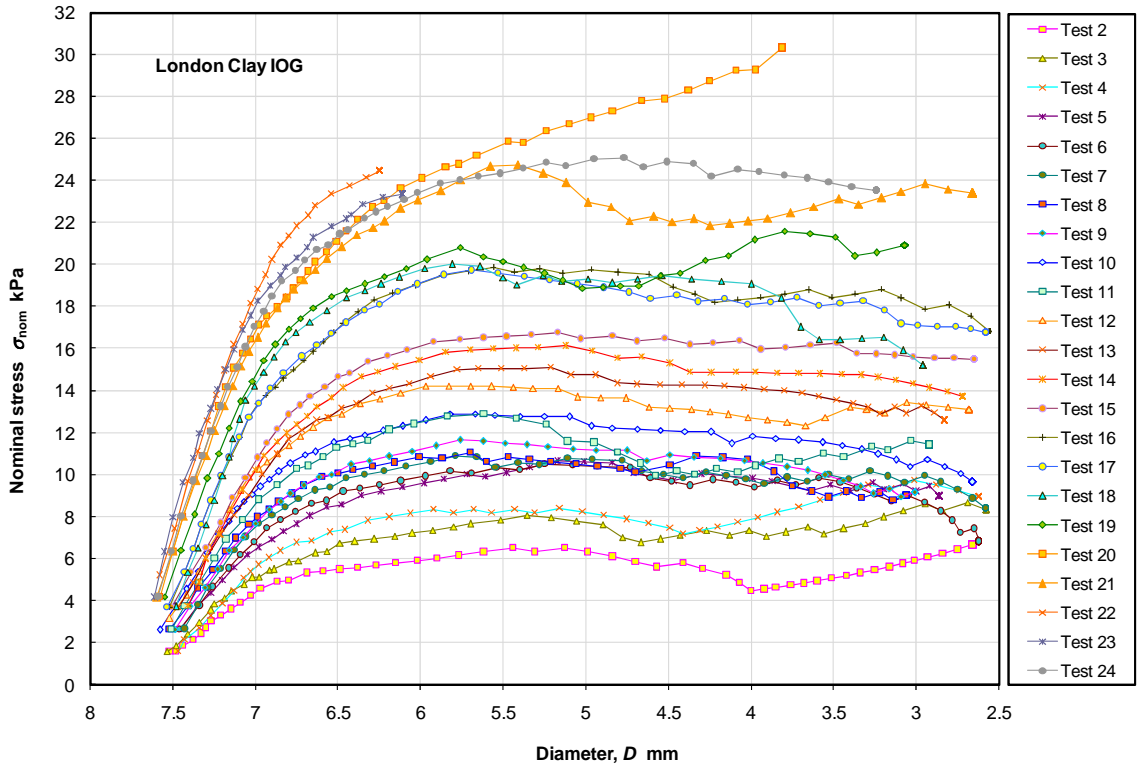

Figure A1.5 Stress – diameter London Clay, Isle of Grain

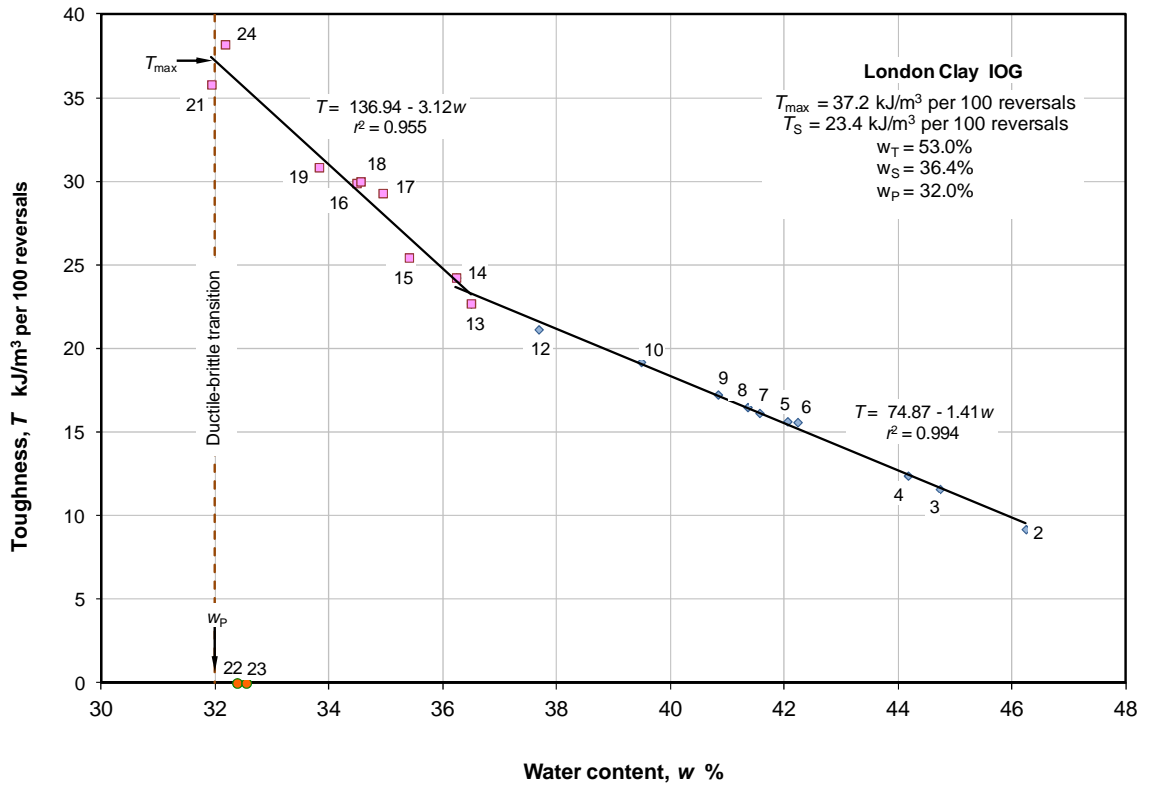

Figure A1.6 Toughness – water content London Clay, Isle of Grain

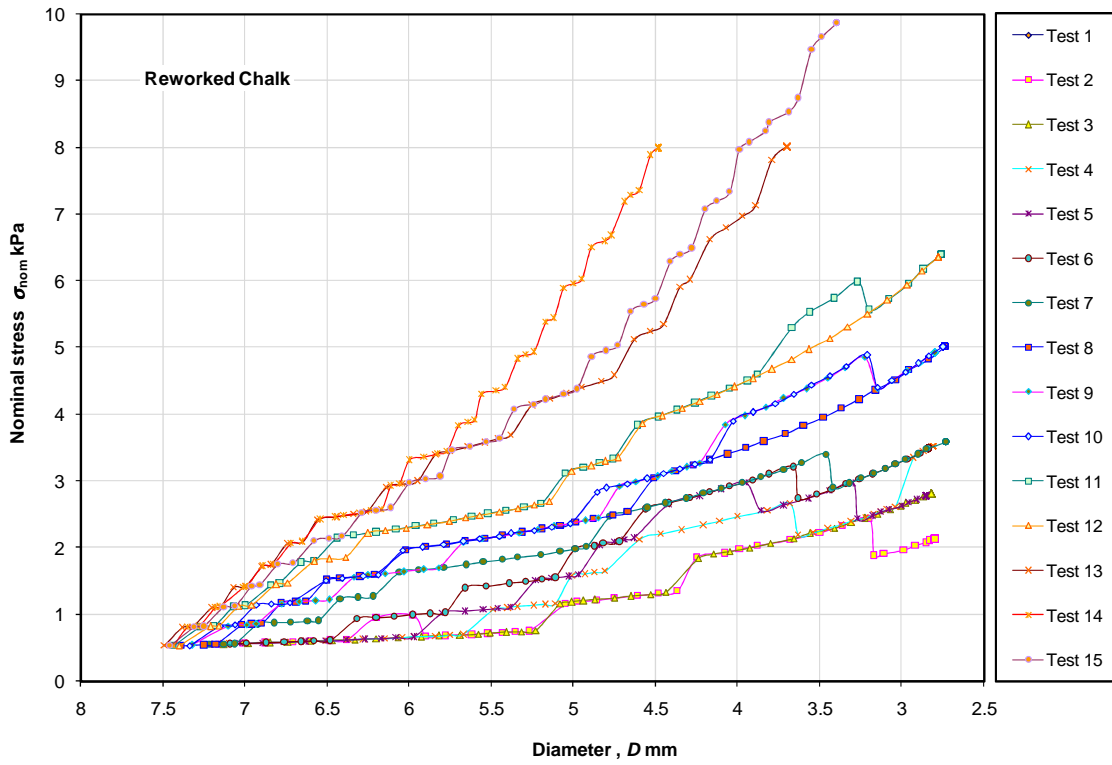

Figure A1.7 Stress – diameter Reworked Chalk

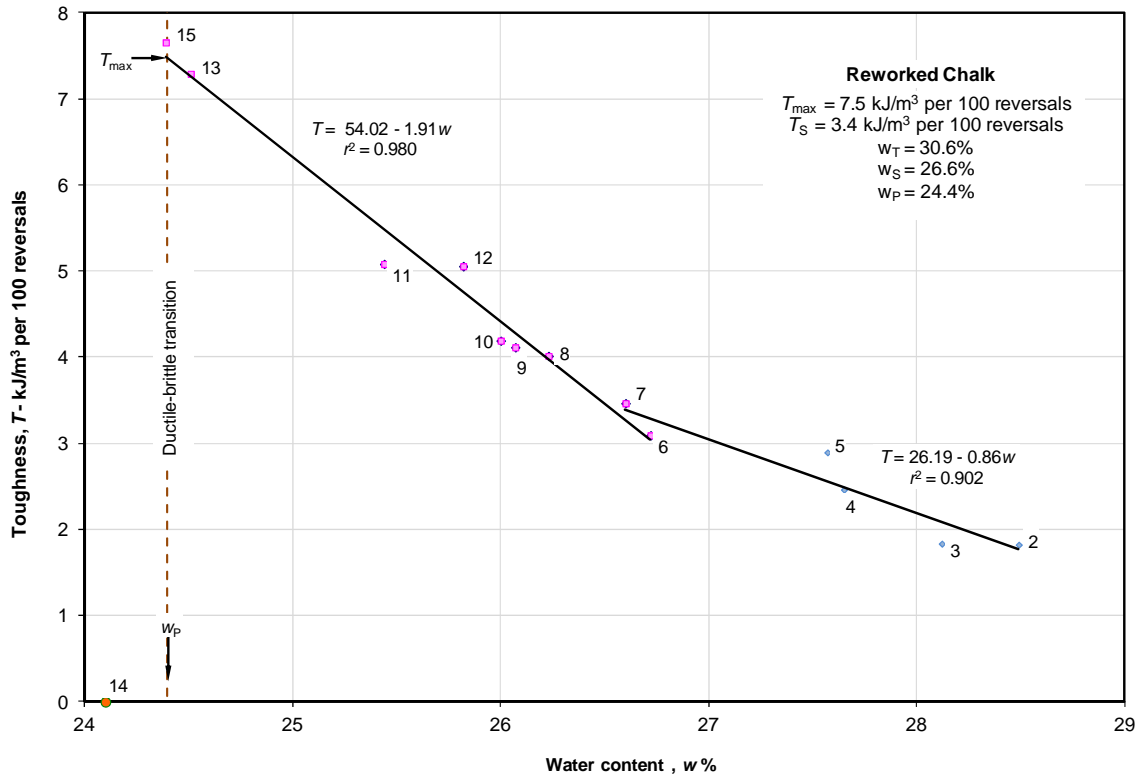

Figure A1.8 Toughness – water content Reworked Chalk

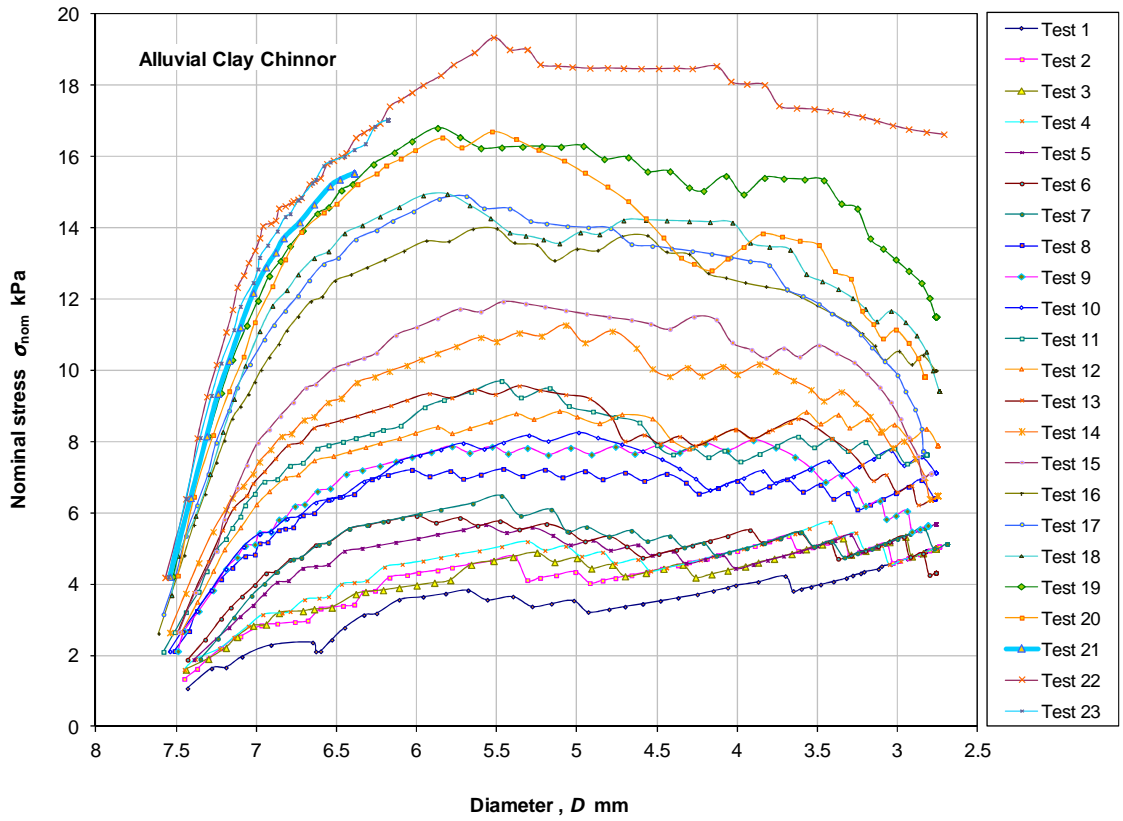

Figure A1.9 Stress – diameter Alluvial Clay Chinnor

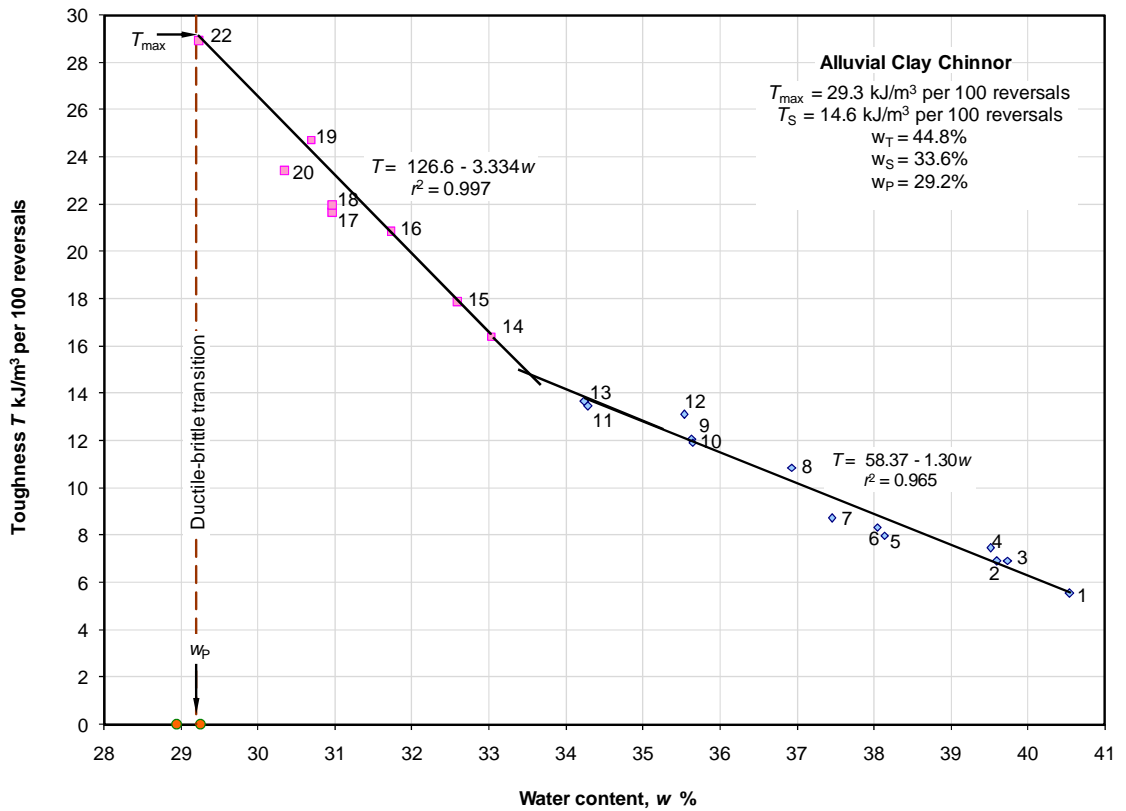

Figure A1.10 Toughness – water content Alluvial Clay Chinnor

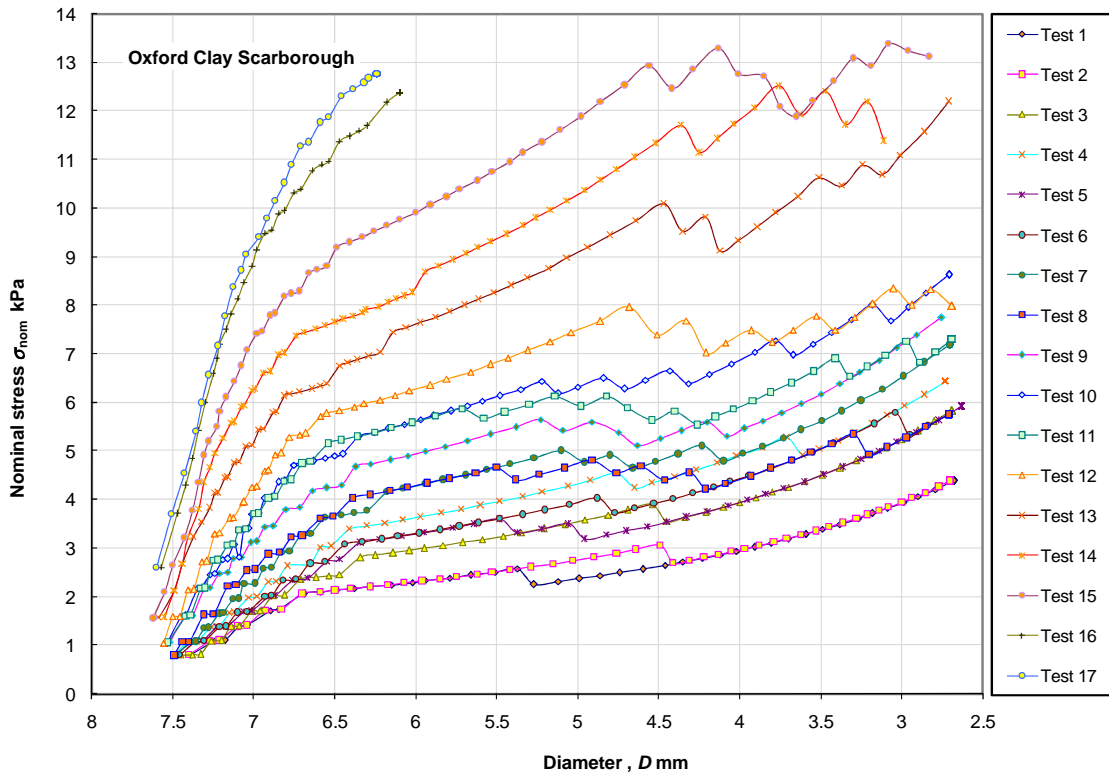

Figure A1.11 Stress – diameter Oxford Clay, Scarborough

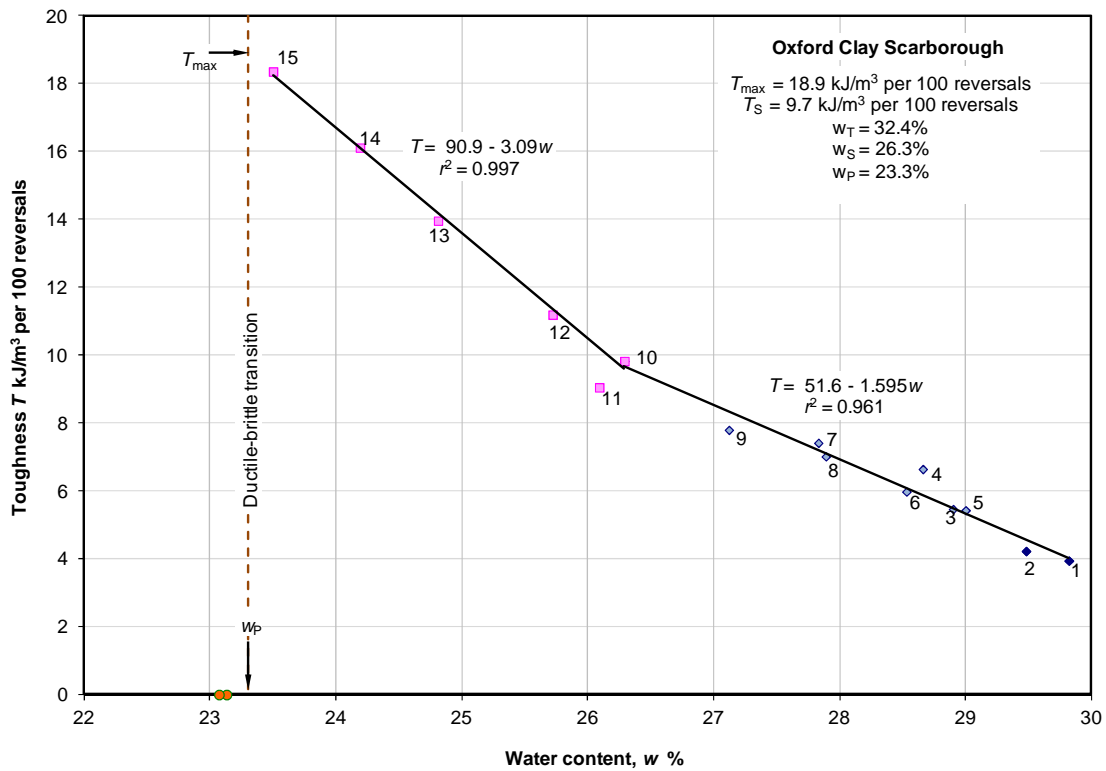

Figure A1.12 Toughness – water content Oxford Clay, Scarborough

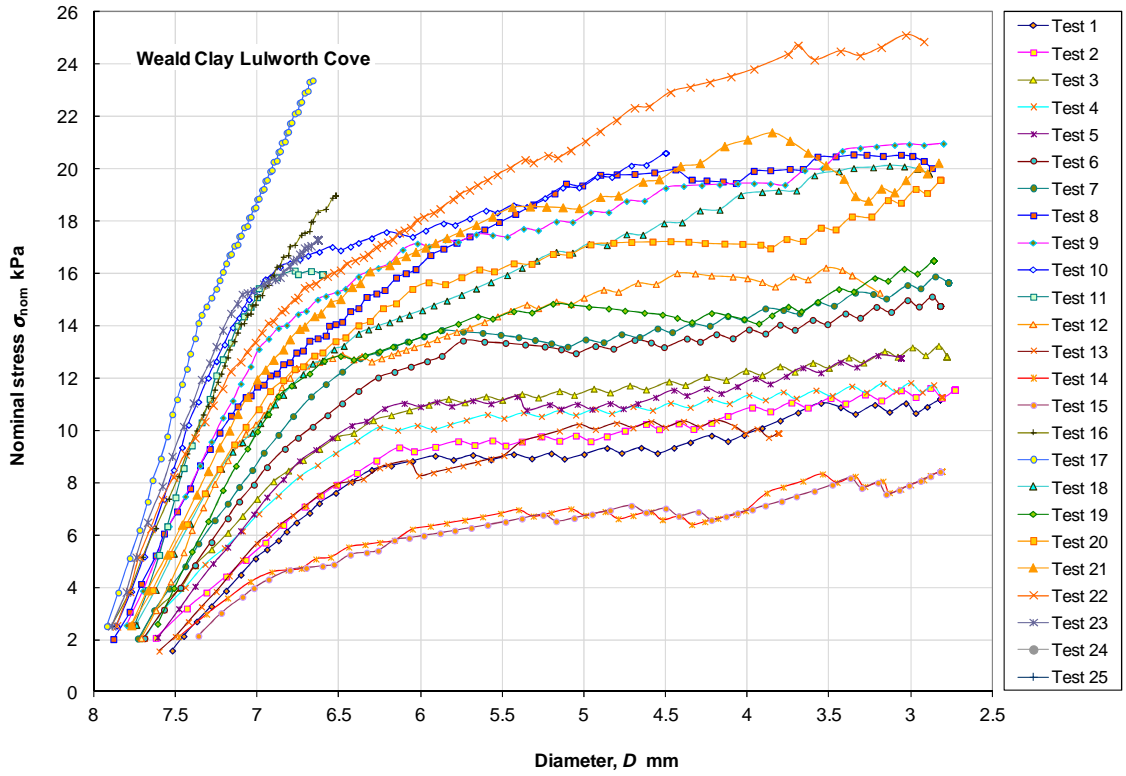

Figure A1.13 Stress – diameter Weald Clay Lulworth Cove

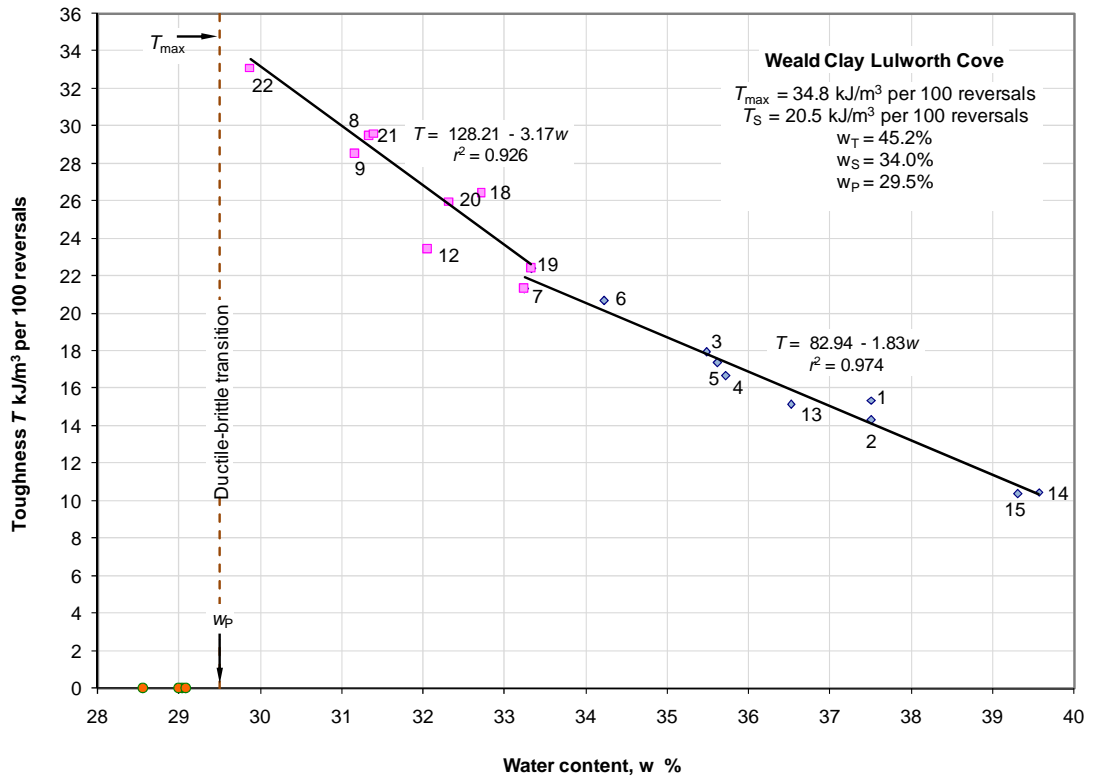

Figure A1.14 Toughness – water content Weald Clay Lulworth Cove

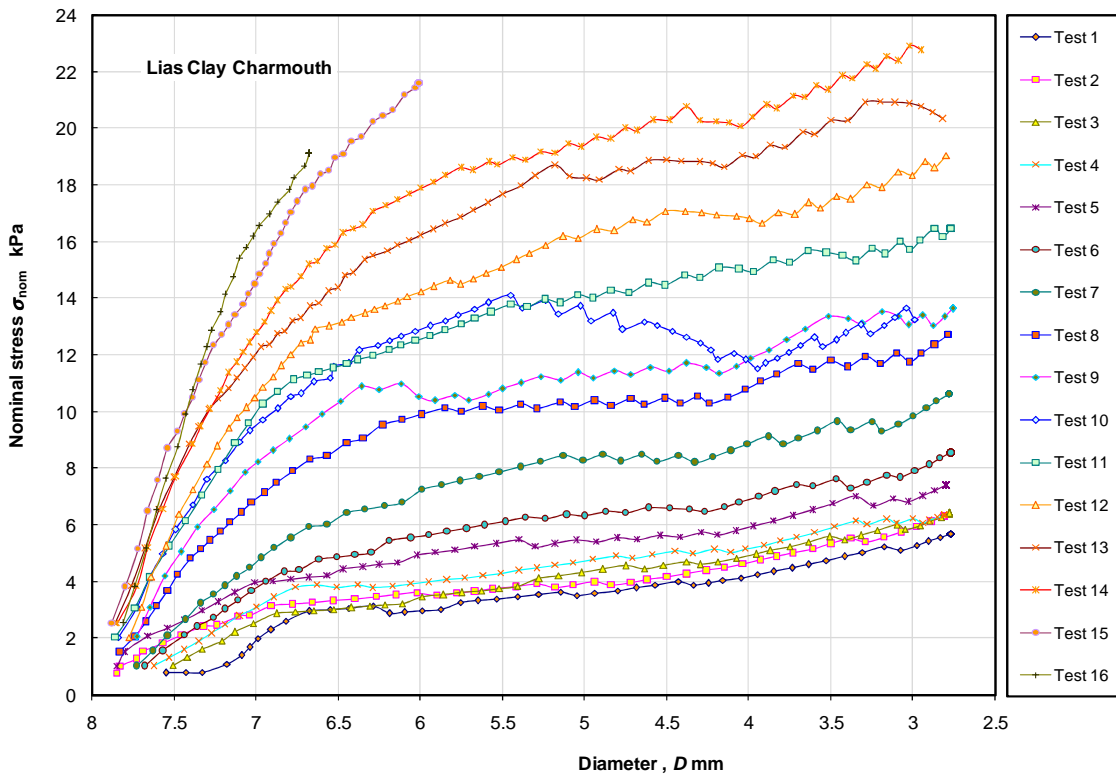

Figure A1.15 Stress – diameter Lias Clay Charmouth

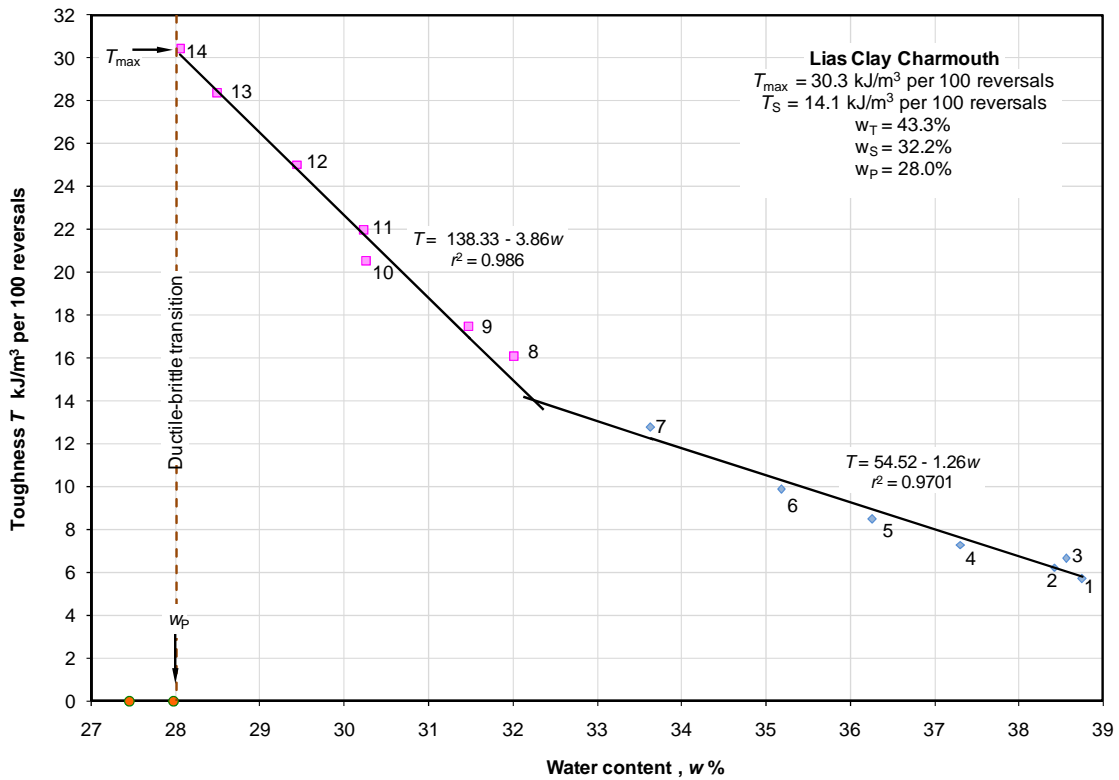

Figure A1.16 Toughness – water content Lias Clay Charmouth

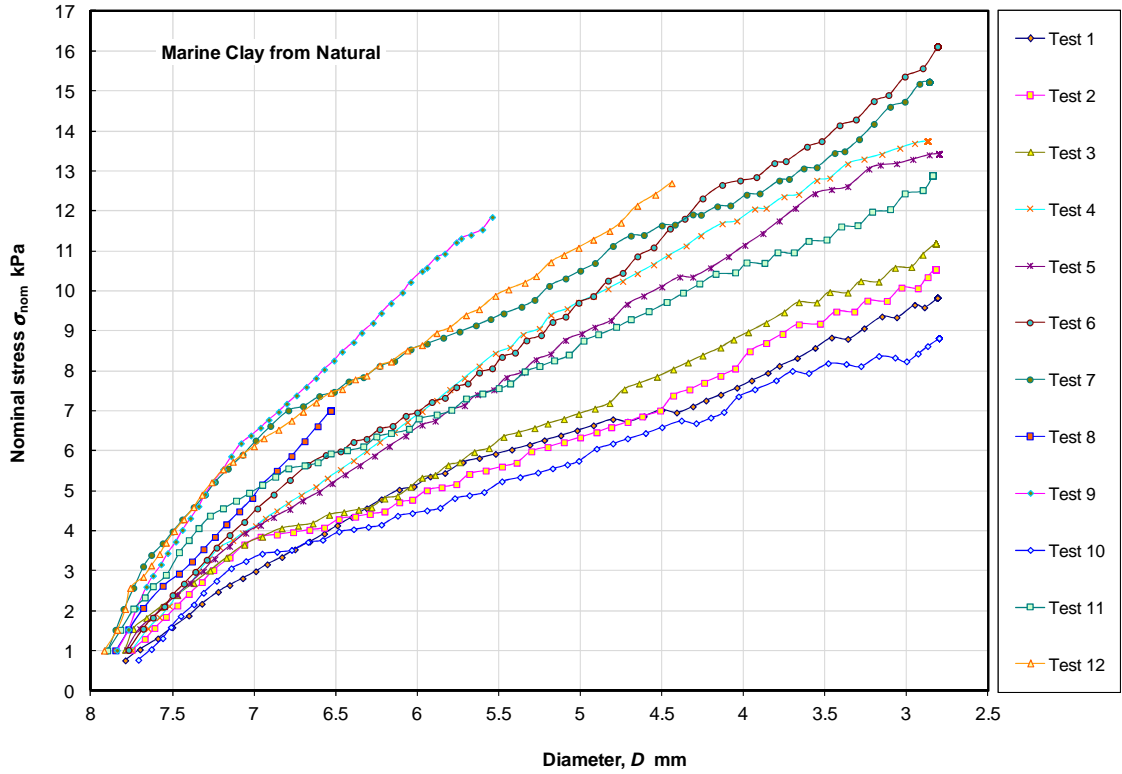

Figure A1.17 Stress – diameter Marine Clay from Natural

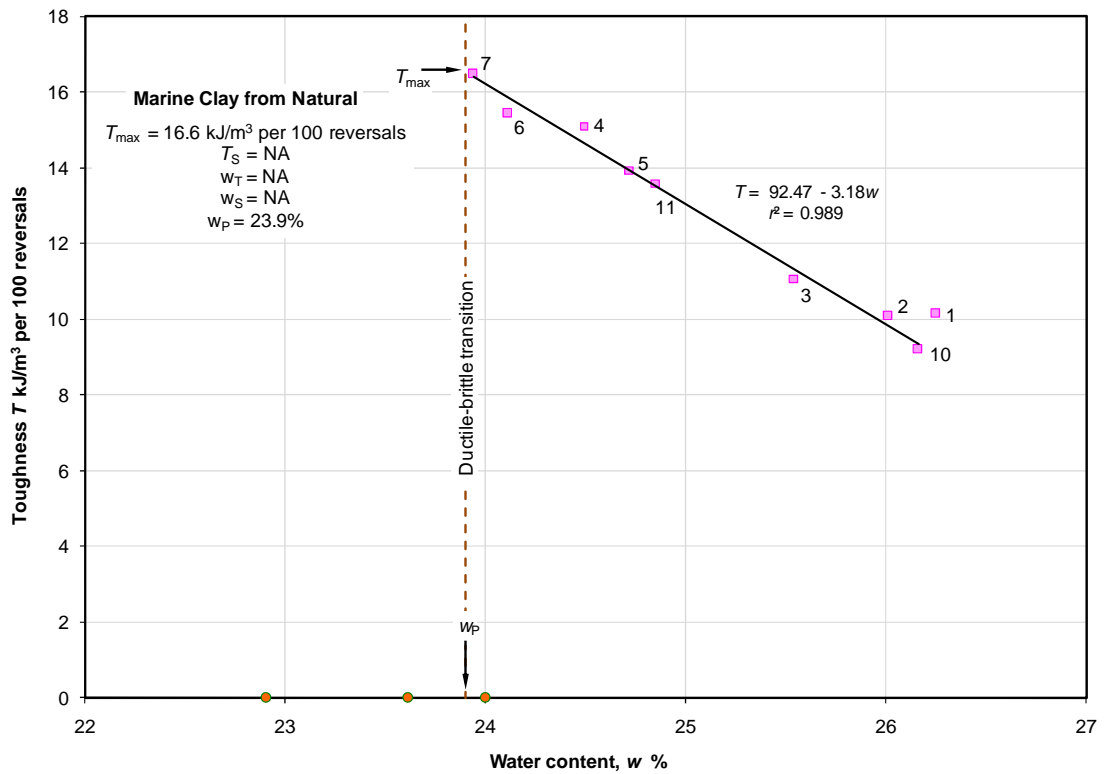

Figure A1.18 Toughness – water content Marine Clay from Natural

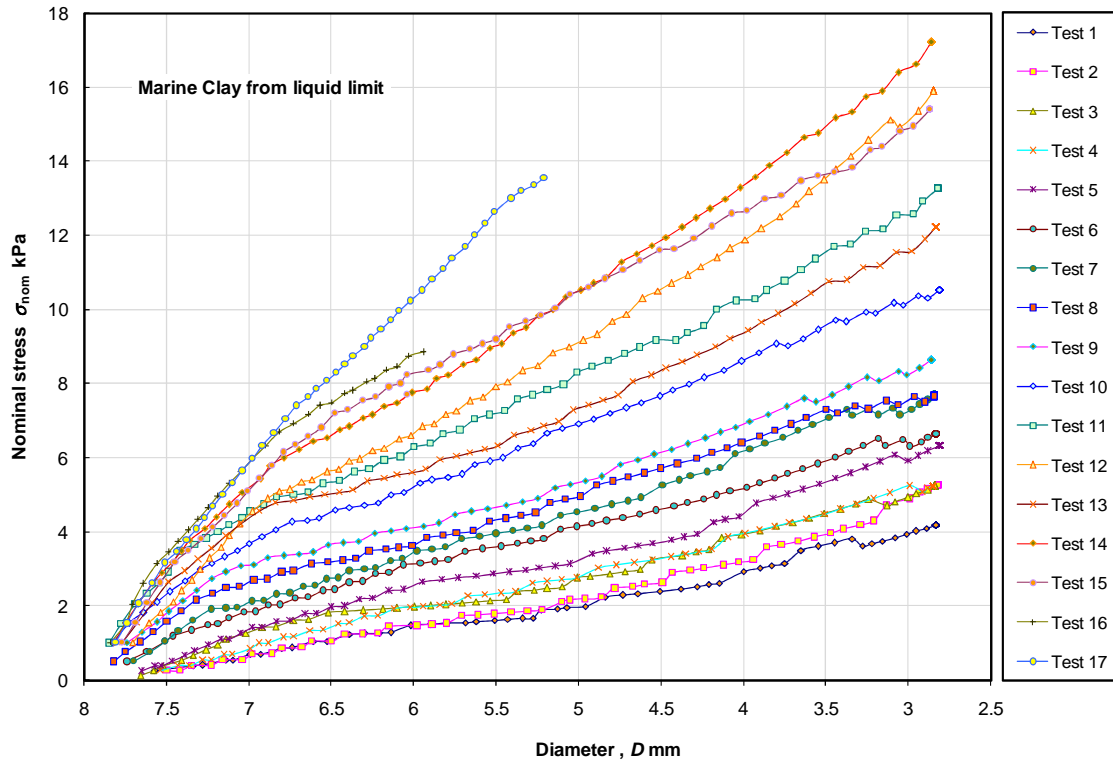

Figure A1.19 Stress – diameter Marine Clay from liquid limit

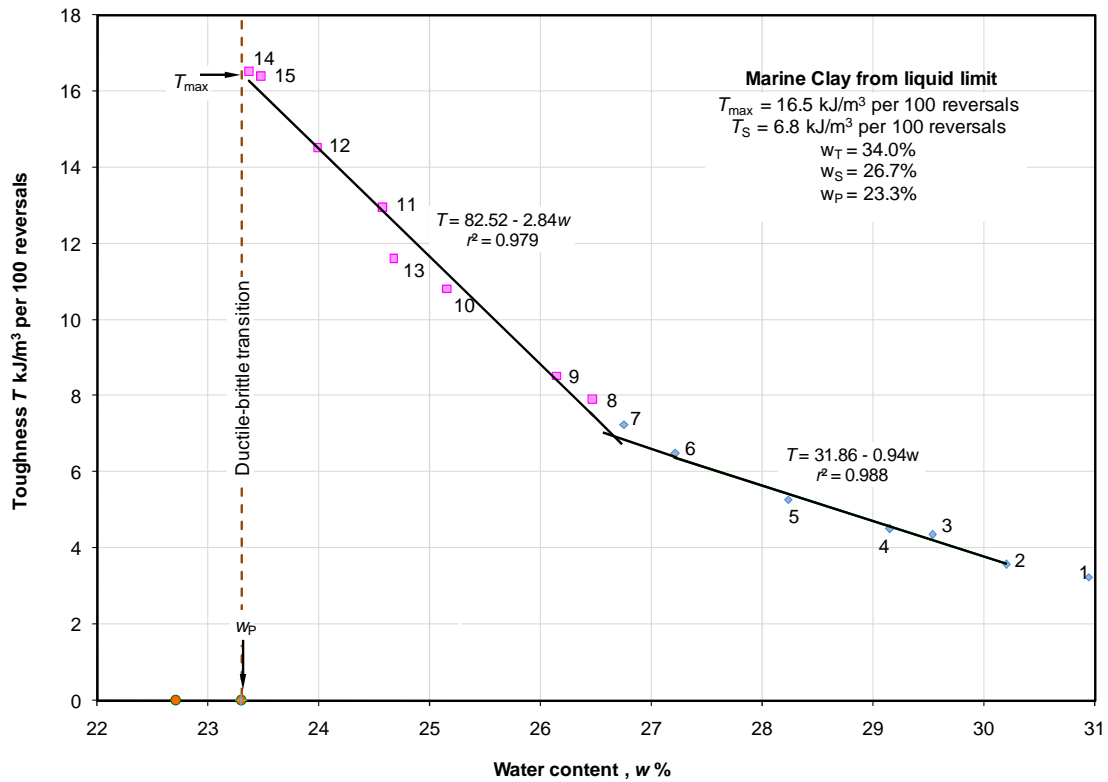

Figure A1.20 Toughness – water content Marine Clay from liquid limit

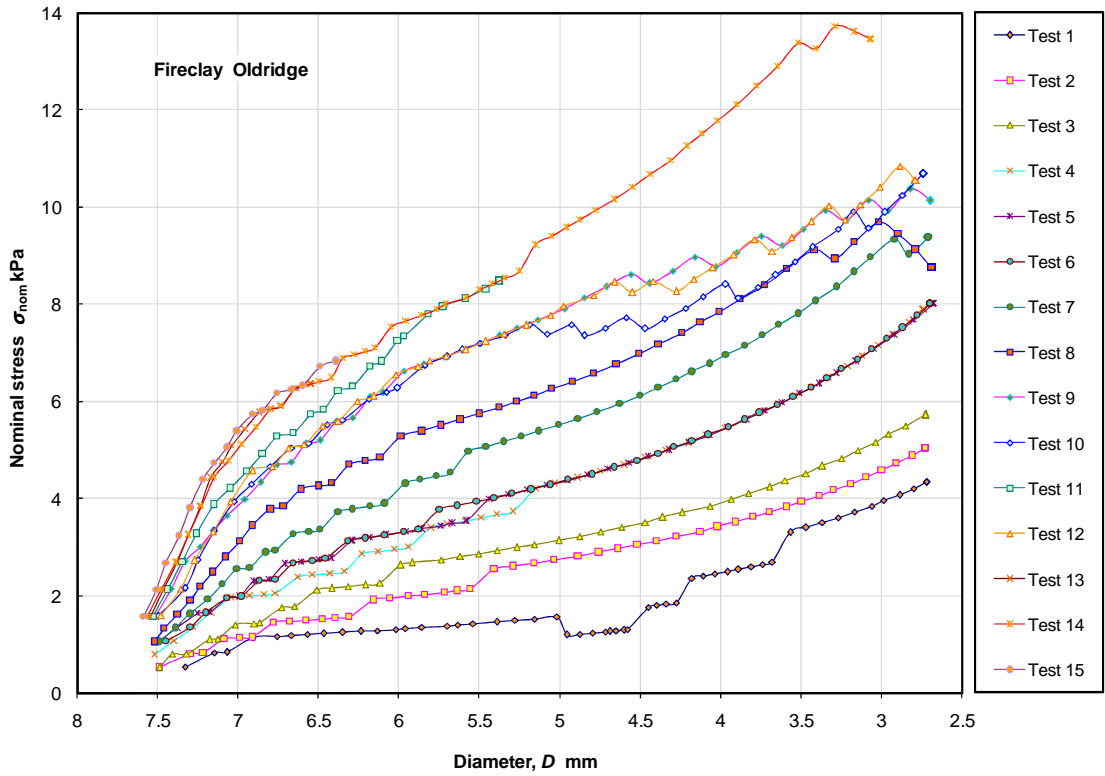

Figure A1.21 Stress – diameter Fireclay Oldridge

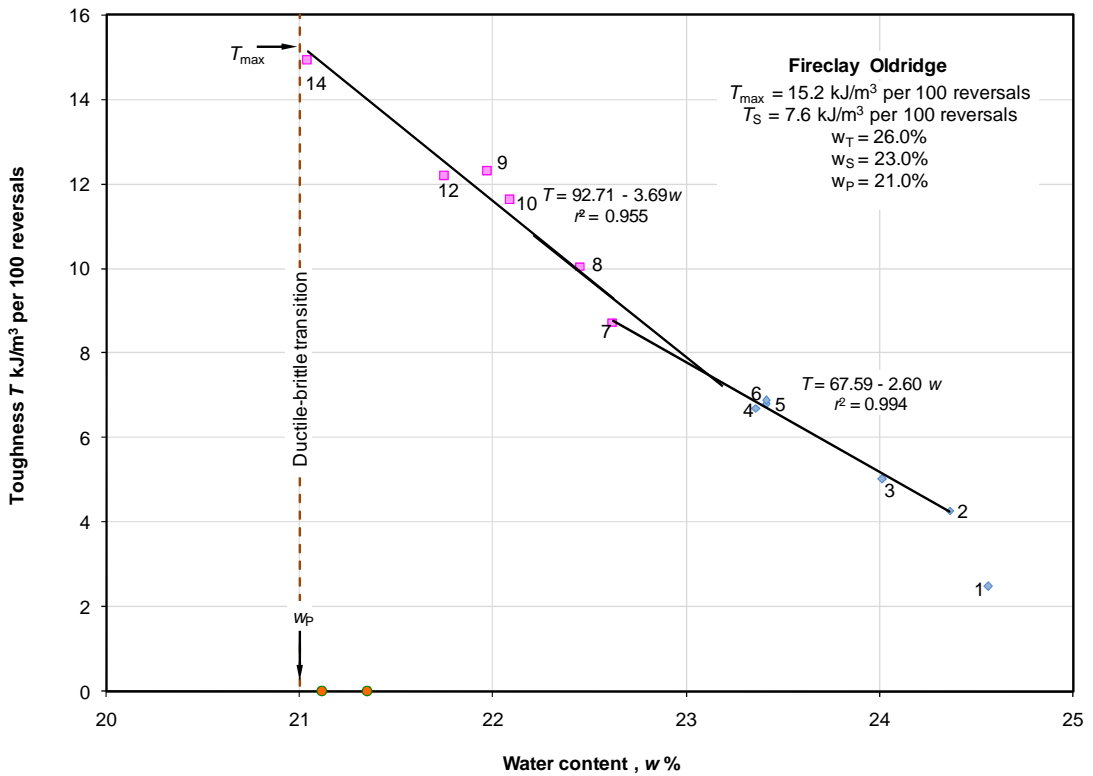

Figure A1.22 Toughness – water content Fireclay Oldridge

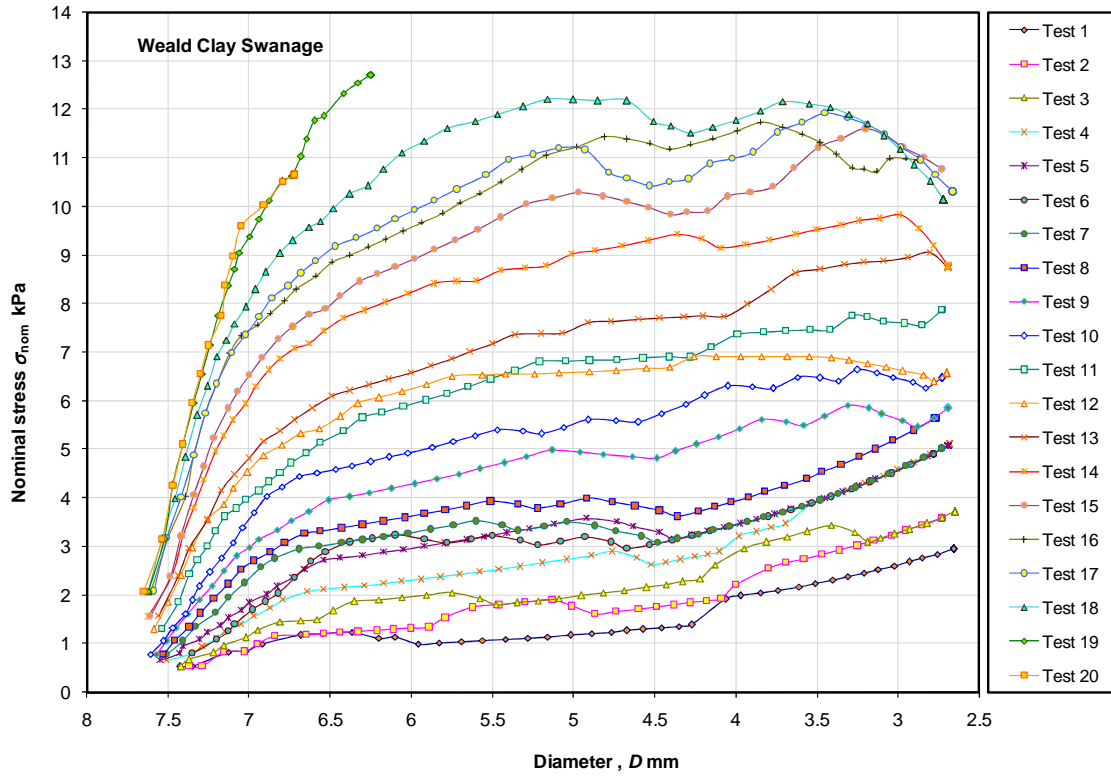

Figure A1.23 Stress – diameter Weald Clay Swanage

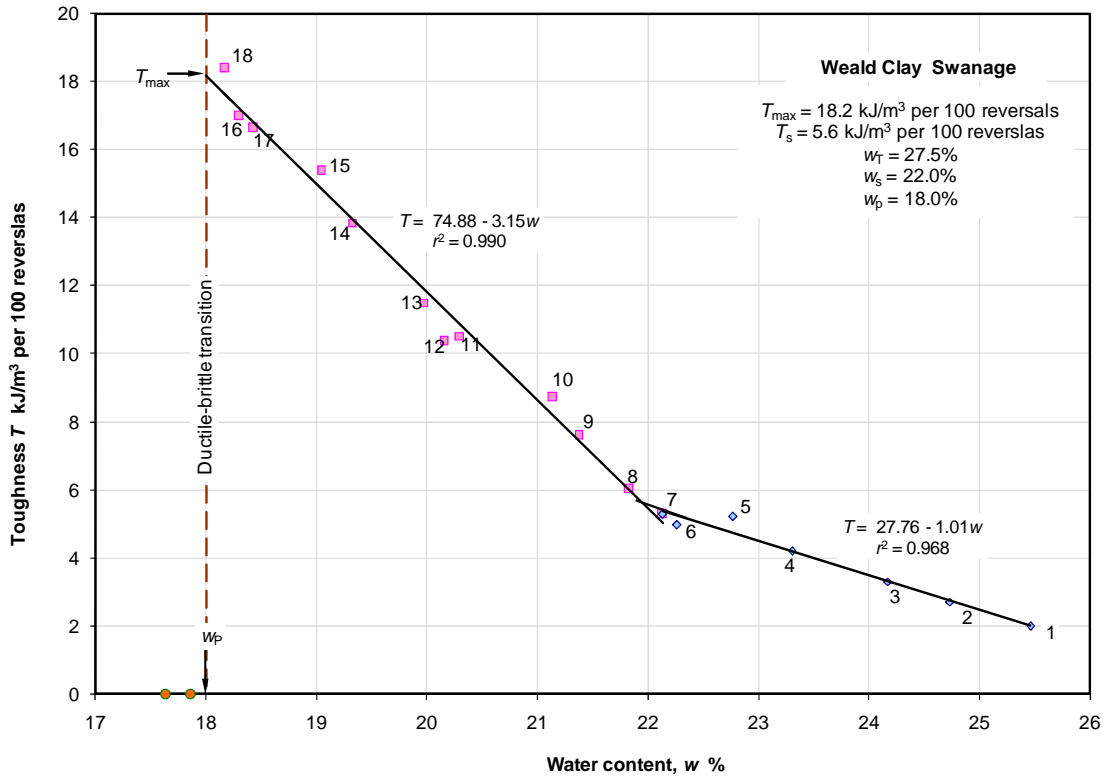

Figure A1.24 Toughness – water content Weald Clay Swanage

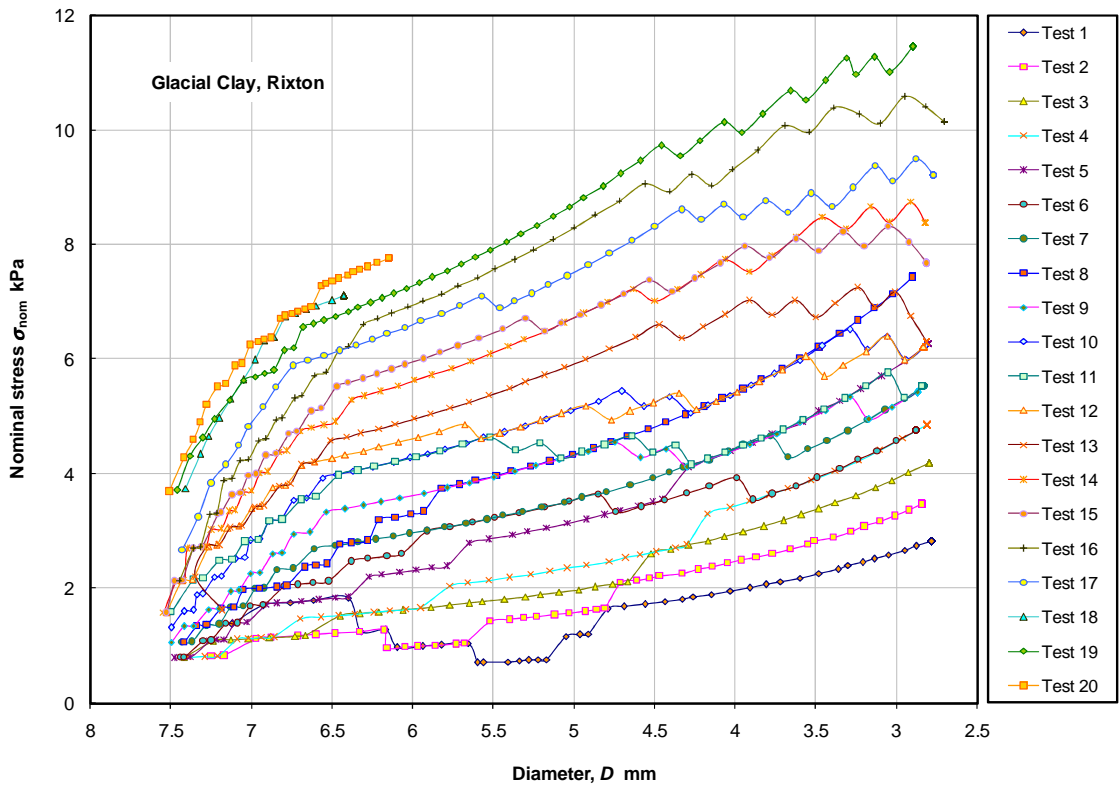

Figure A1.25 Stress – diameter Glacial Clay Rixton

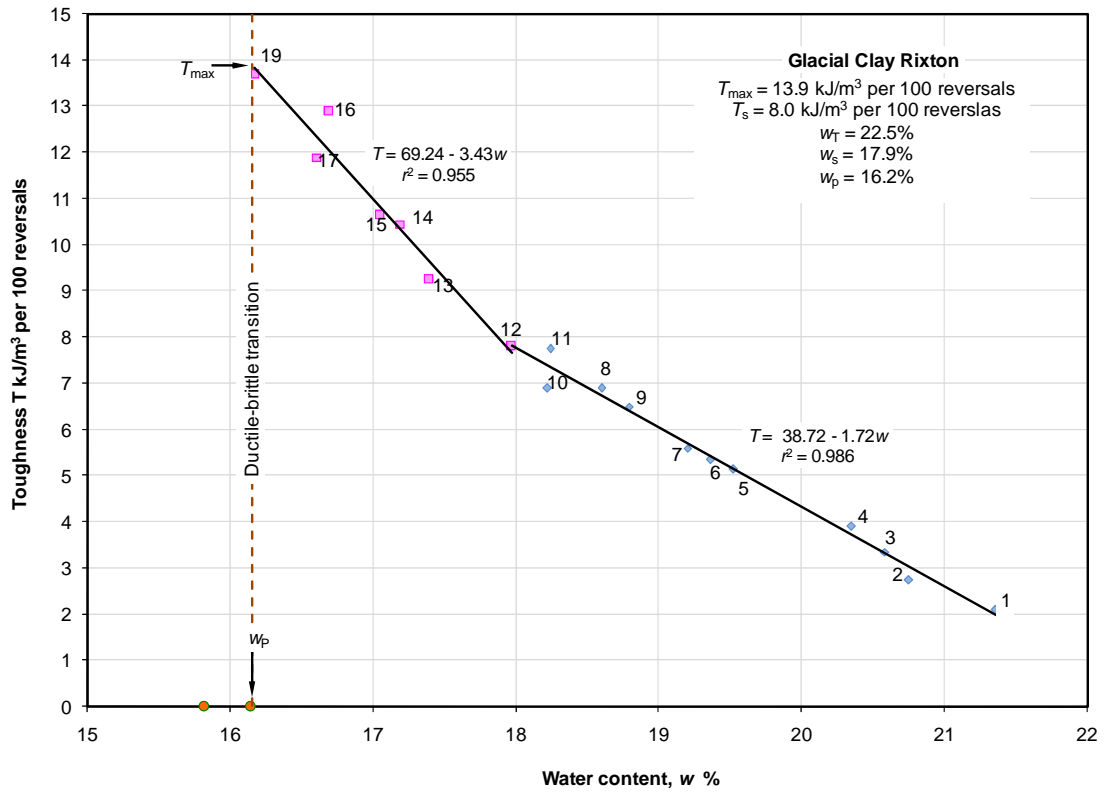

Figure A1.26 Toughness – water content Glacial Clay Rixton

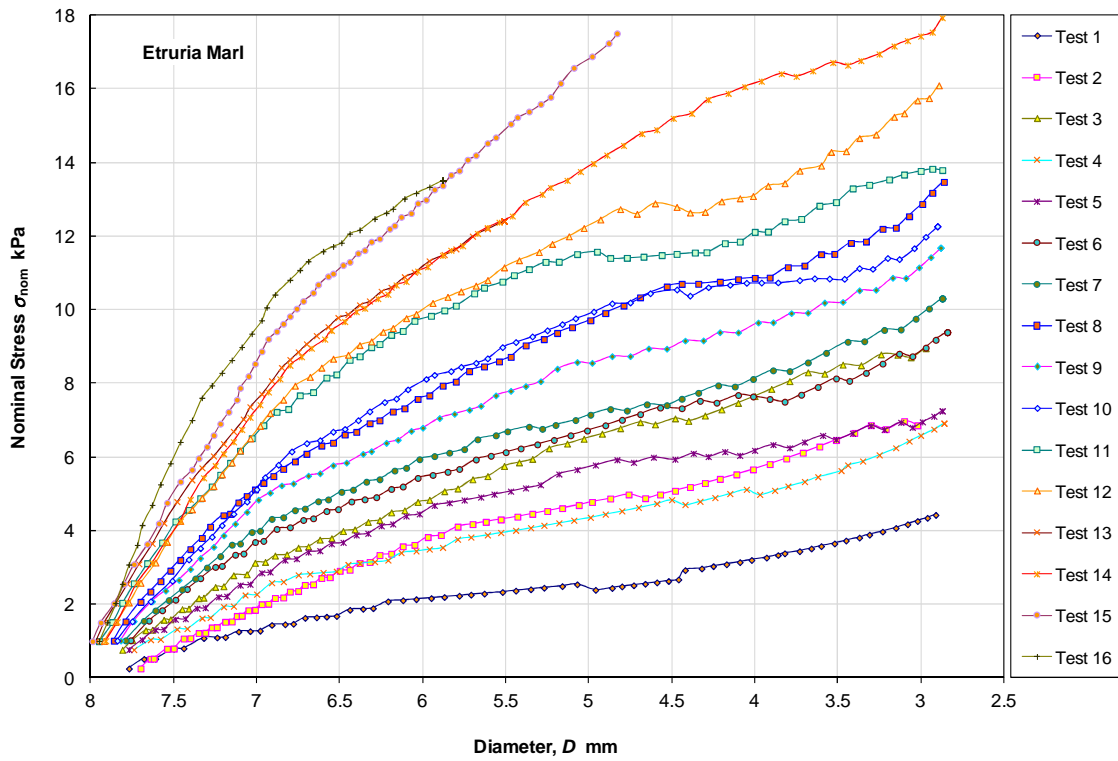

Figure A1.27 Stress – diameter Etruria Marl

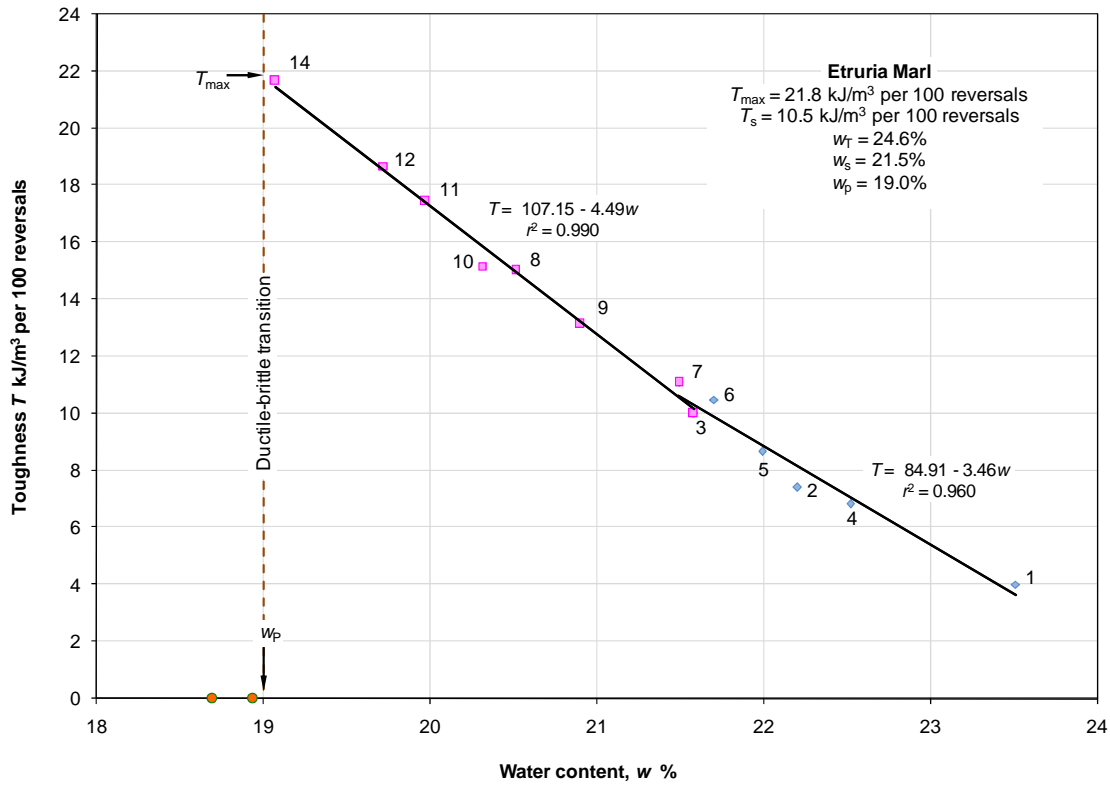

Figure A1.28 Toughness – water content Etruria Marl

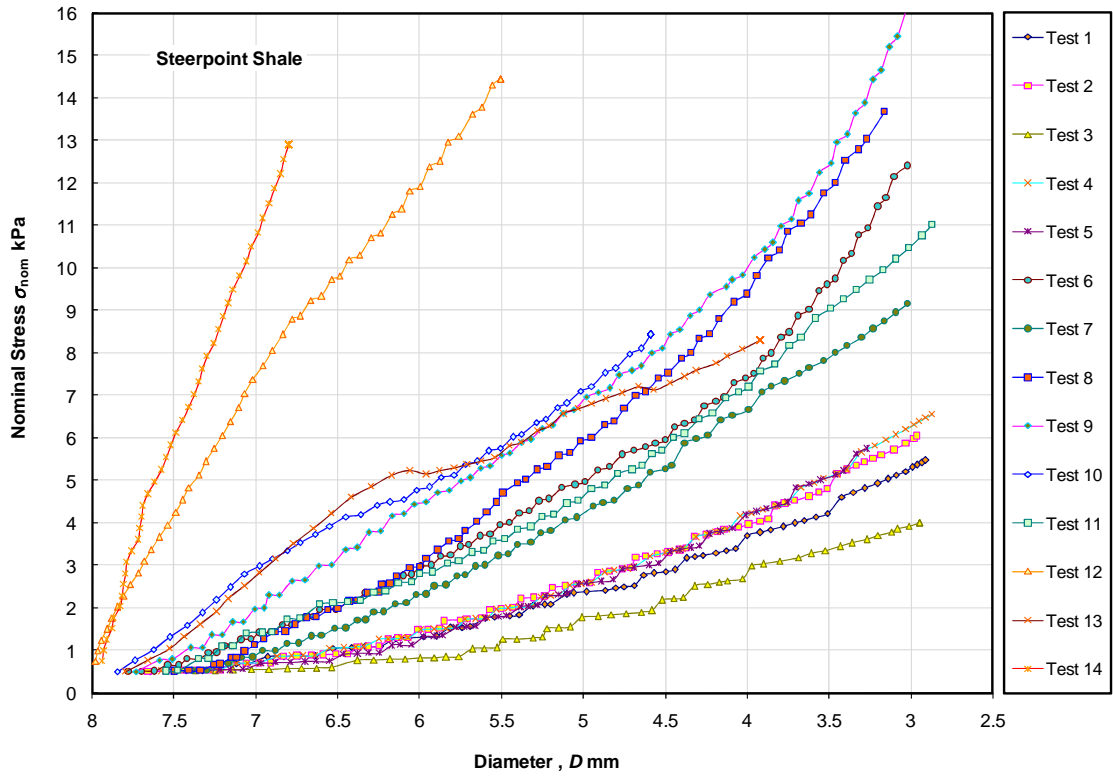

Figure A1.29 Stress – diameter Steerpoint Shale

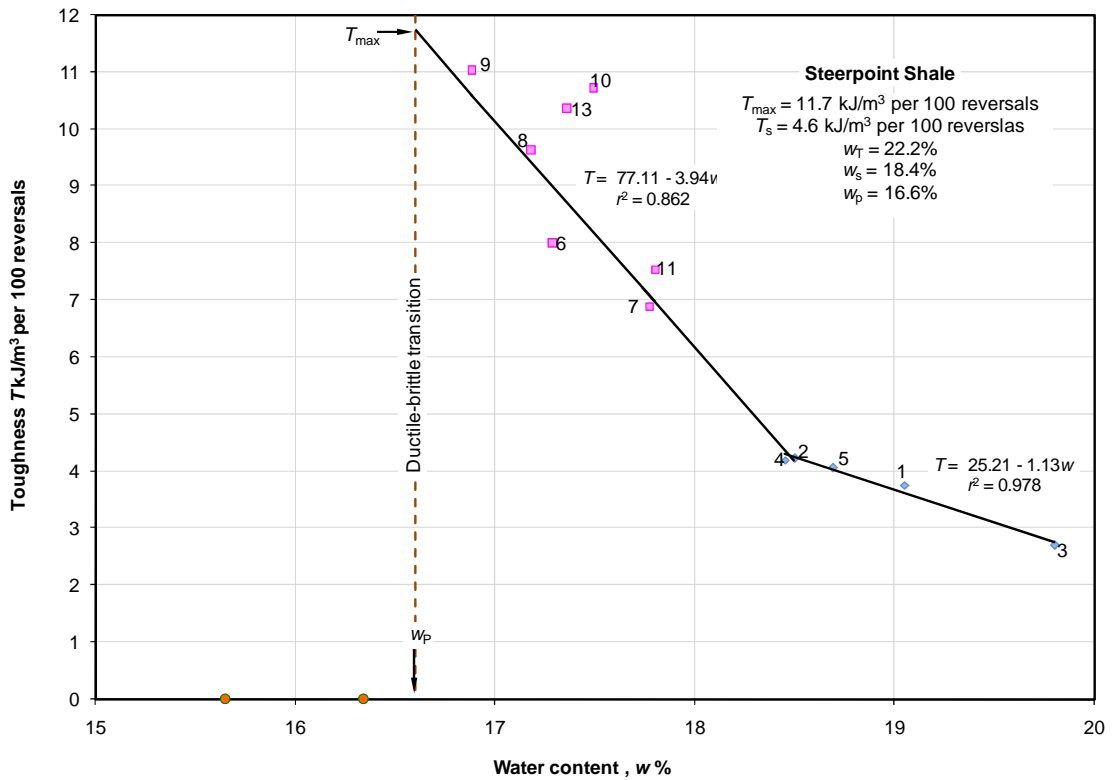

Figure A1.30 Toughness – water content Steerpoint Shale

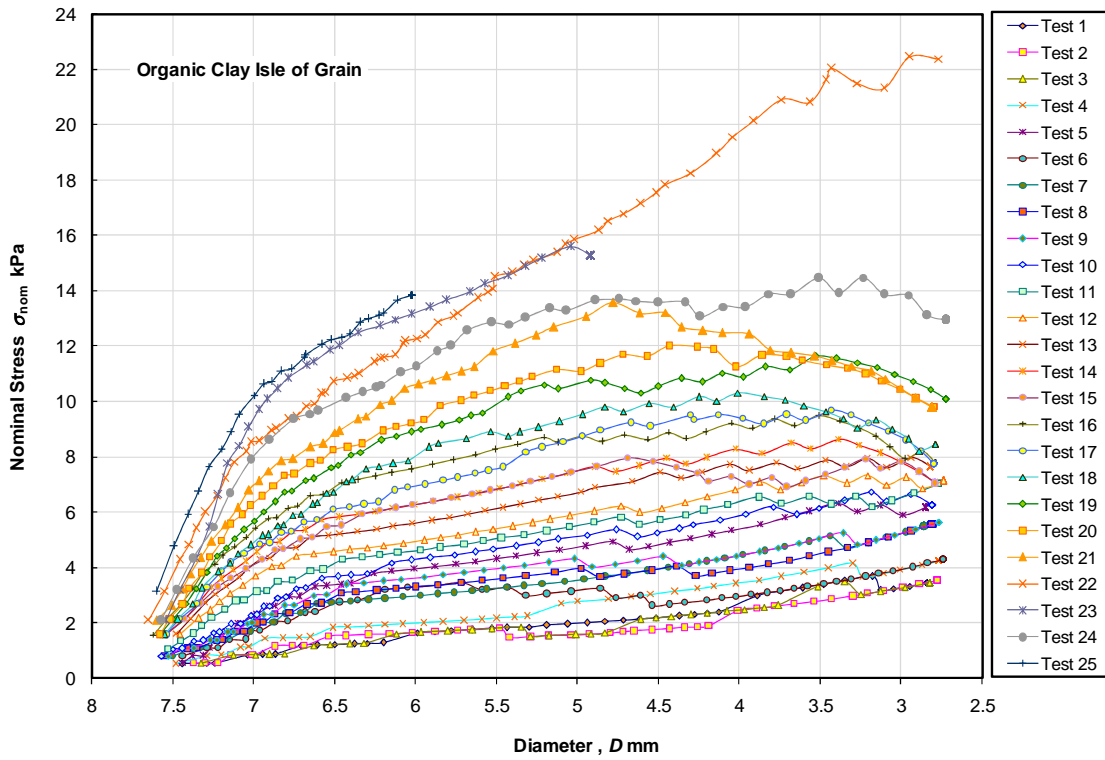

Figure A1.31 Stress – diameter Organic Clay Isle of Grain

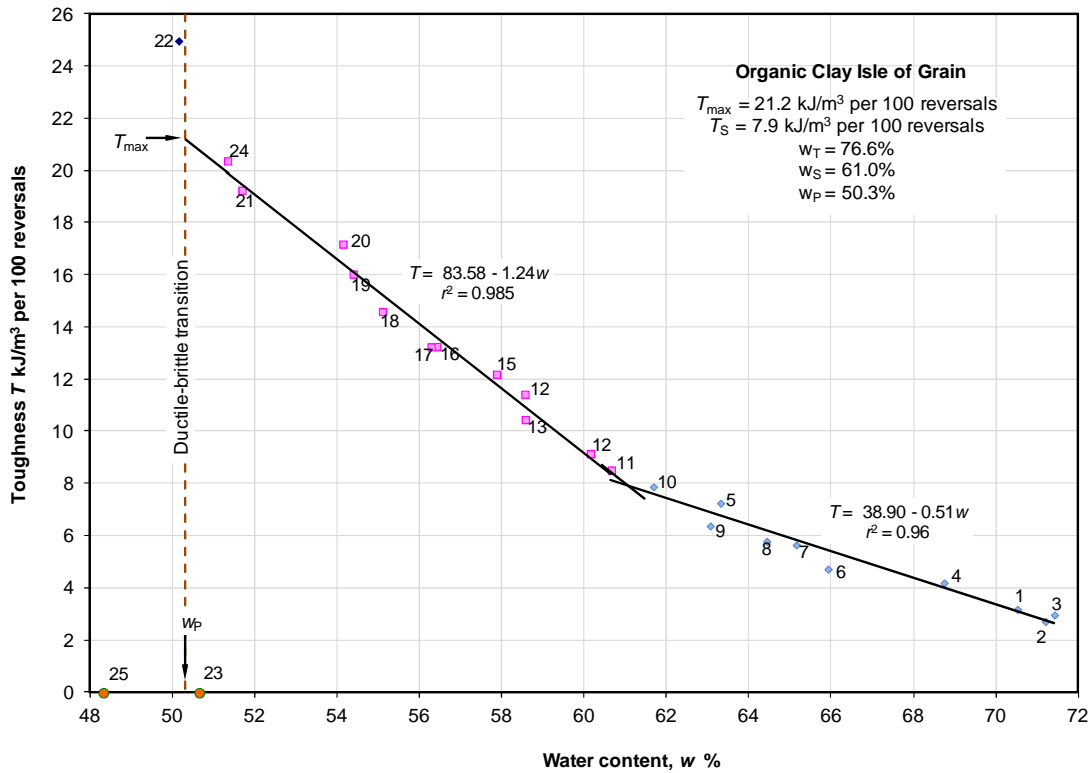

Figure A1.32 Toughness – water content Organic Clay Isle of Grain

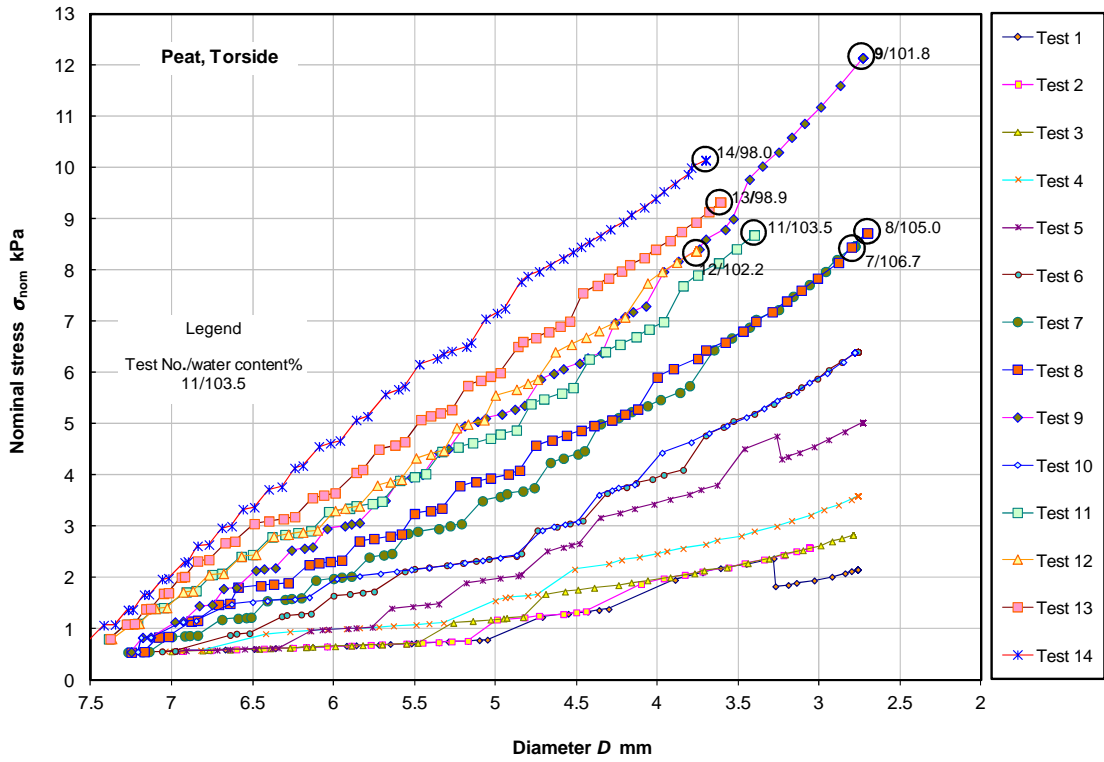

Figure A1.33 Stress – diameter Peat, Torside

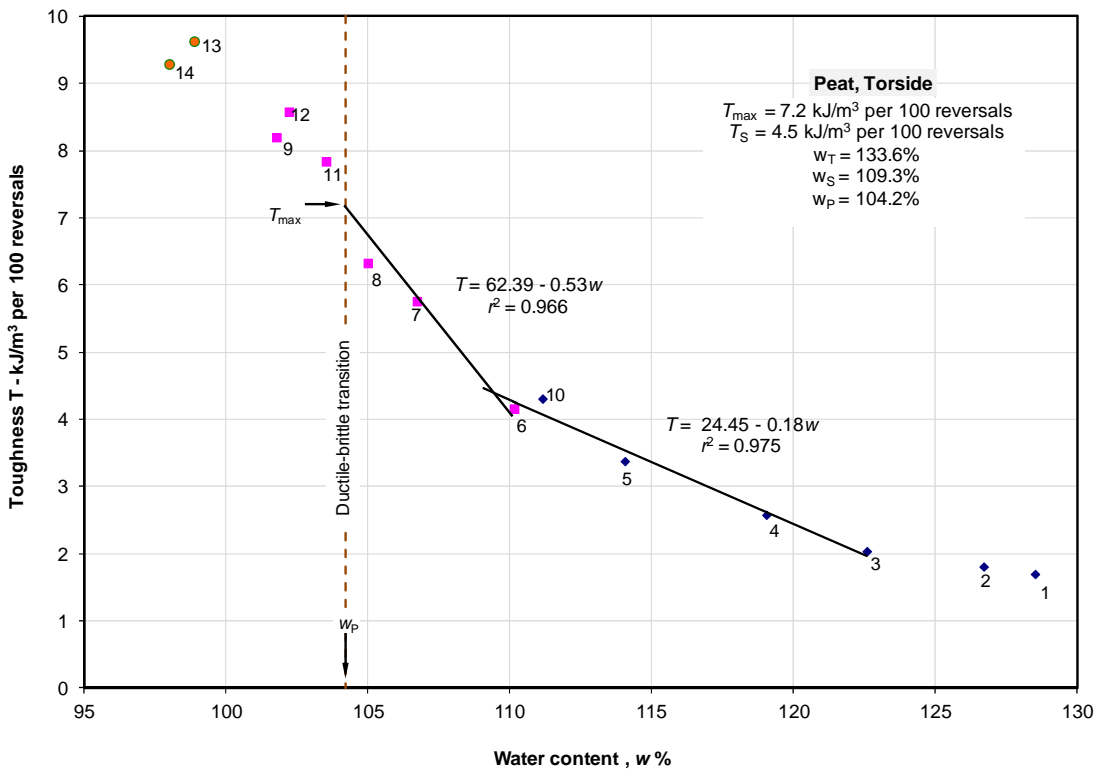

Figure A1.34 Toughness – water content Peat, Torside

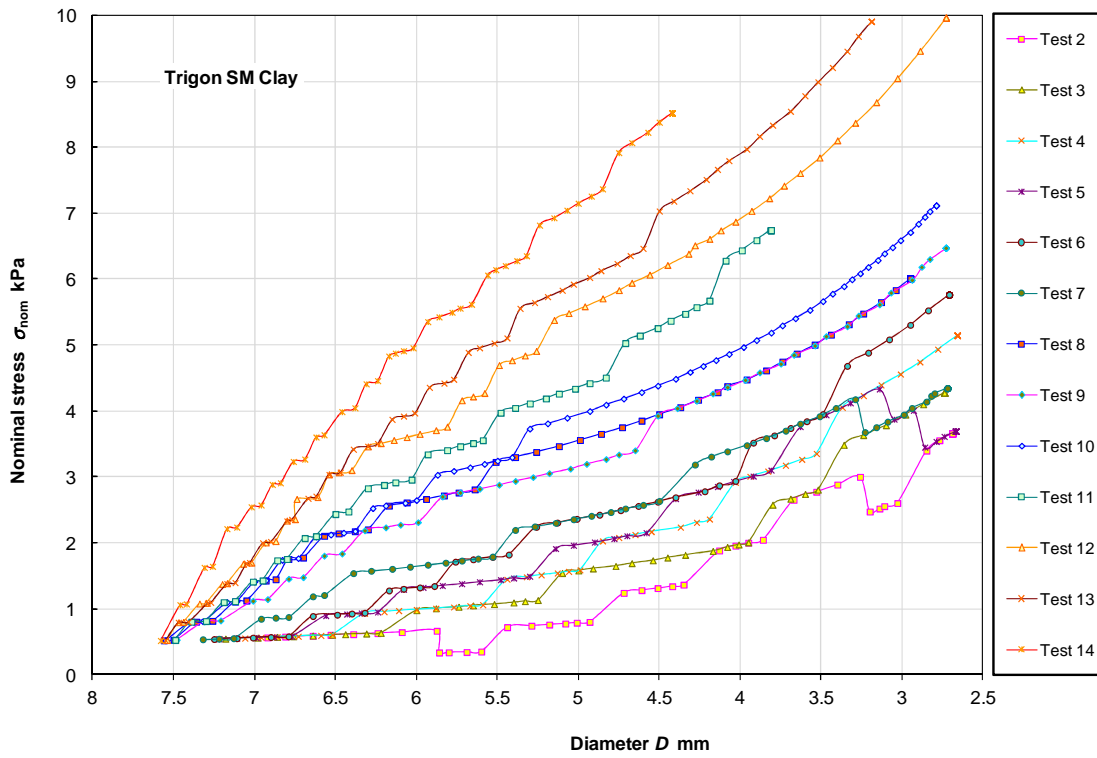

Figure A1.35 Stress – diameter Trigon SM Clay

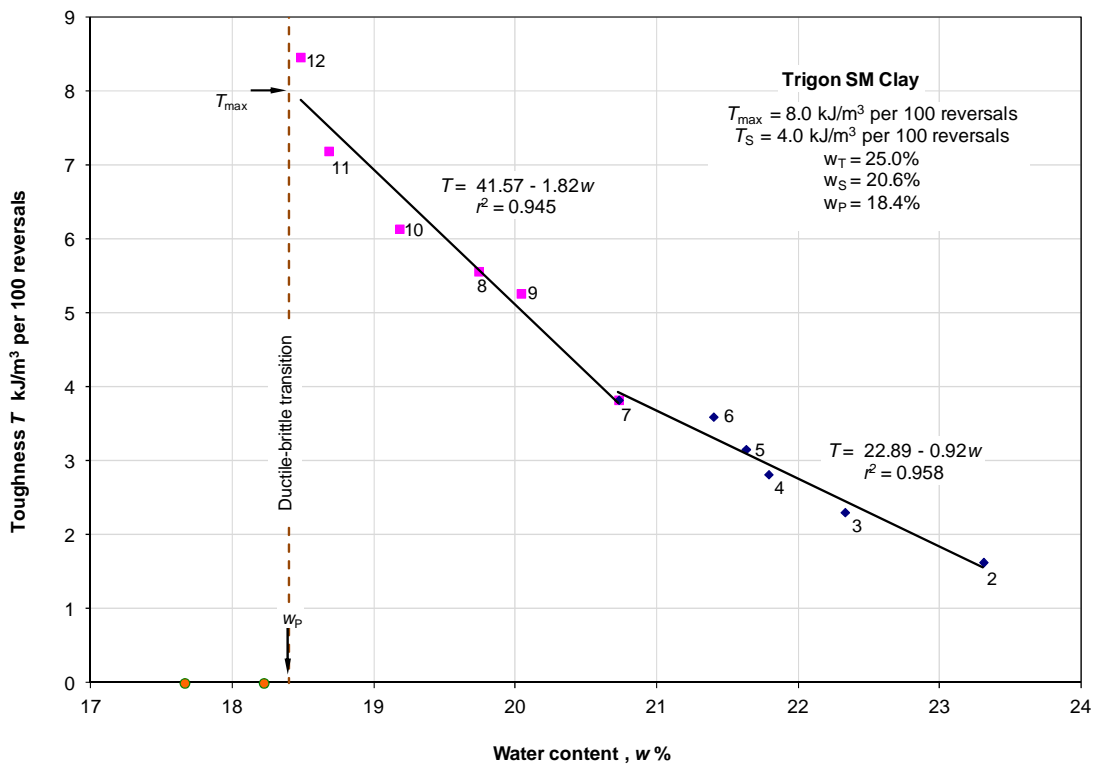

Figure A1.36 Toughness – water content Trigon SM Clay

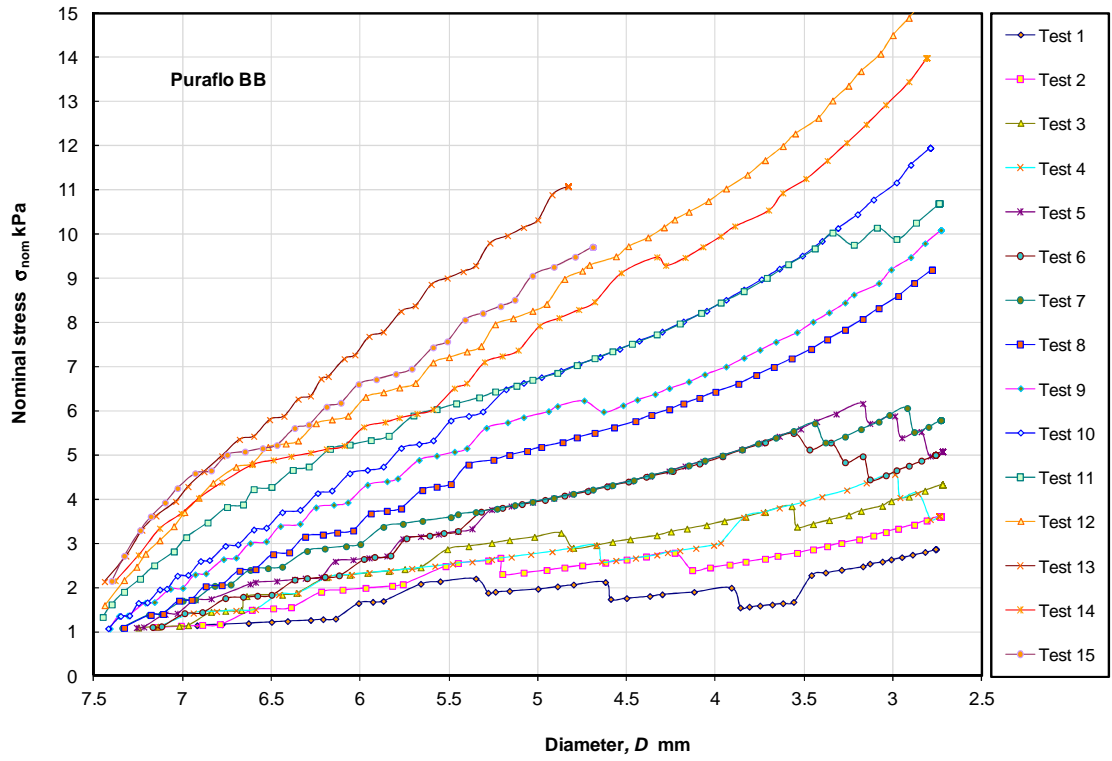

Figure A1.37 Stress – diameter Puraflo BB

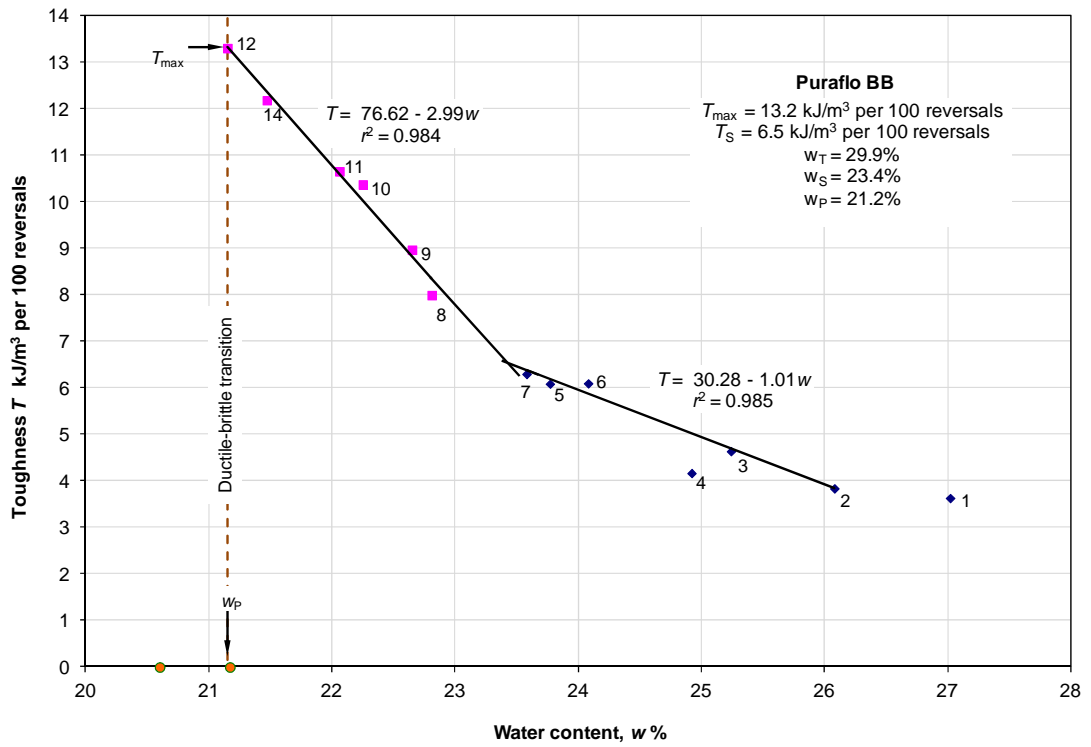

Figure A1.38 Toughness – water content Puraflo BB

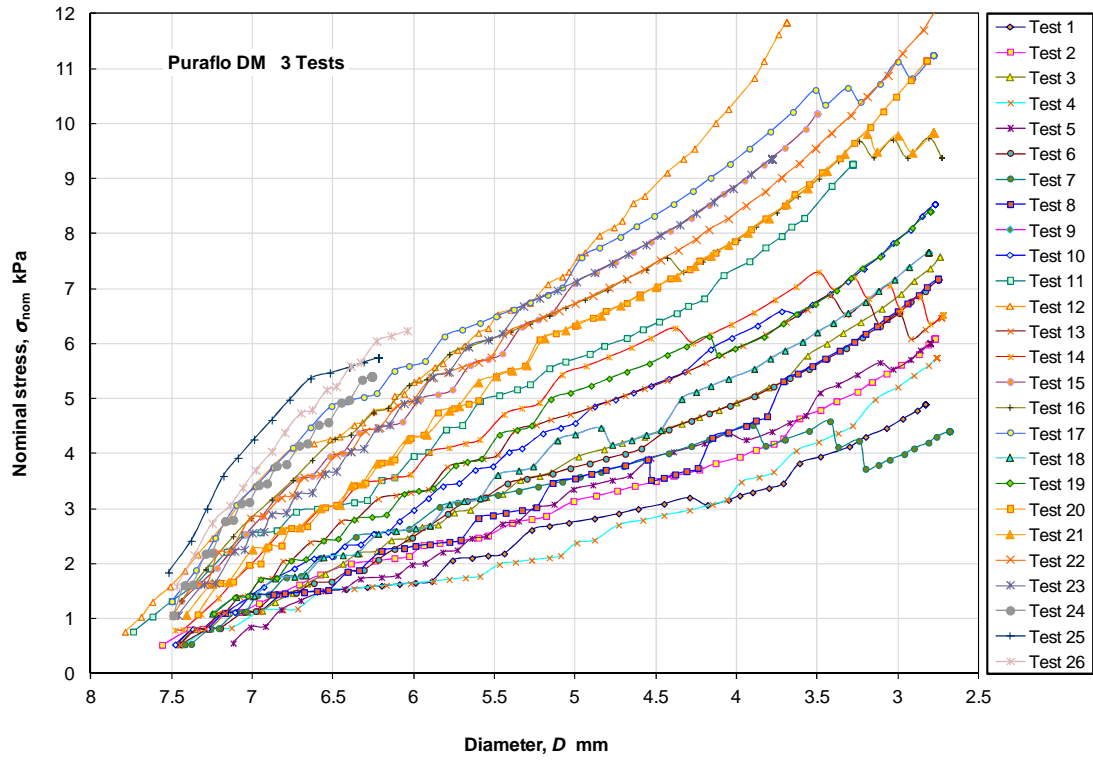

Figure A1.39 Stress – diameter Puraflo DM 3 Tests

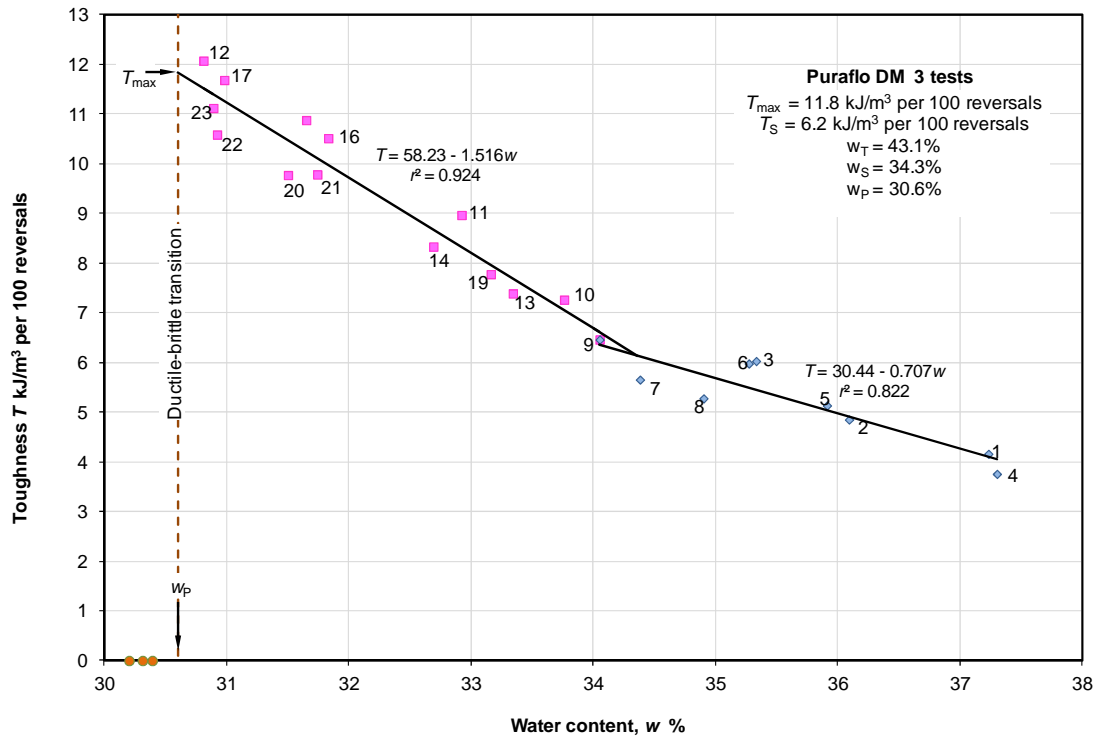

Figure A1.40 Toughness – water content Puraflo DM 3 Tests

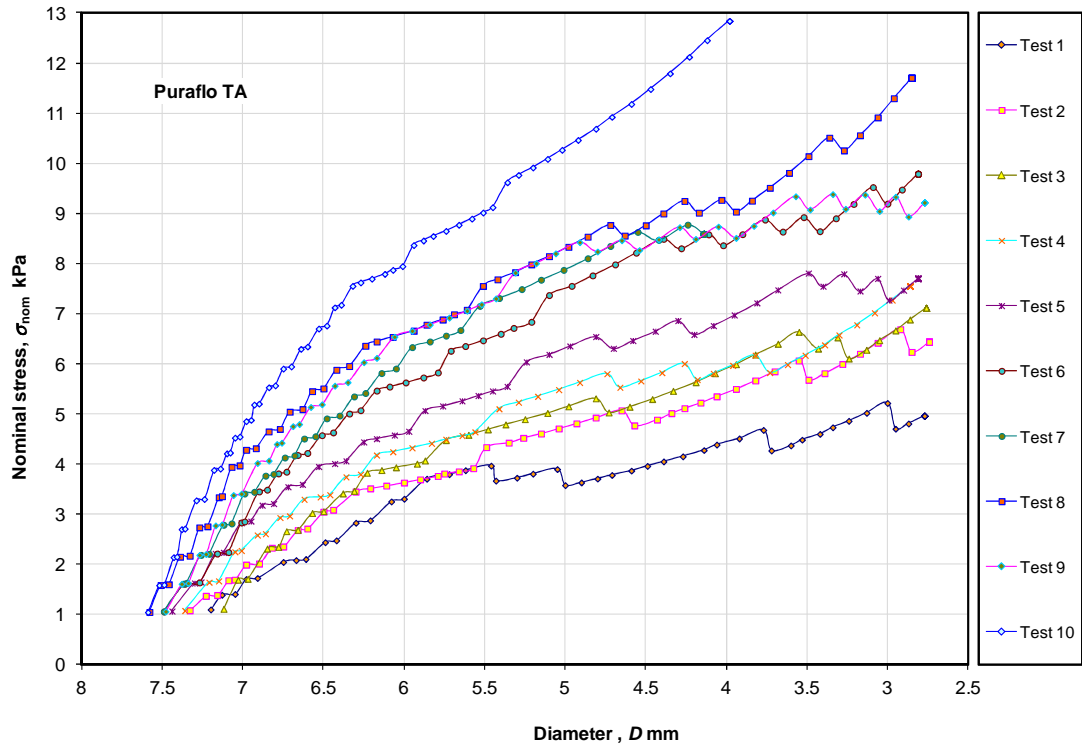

Figure A1.41 Stress – diameter Puraflor TA

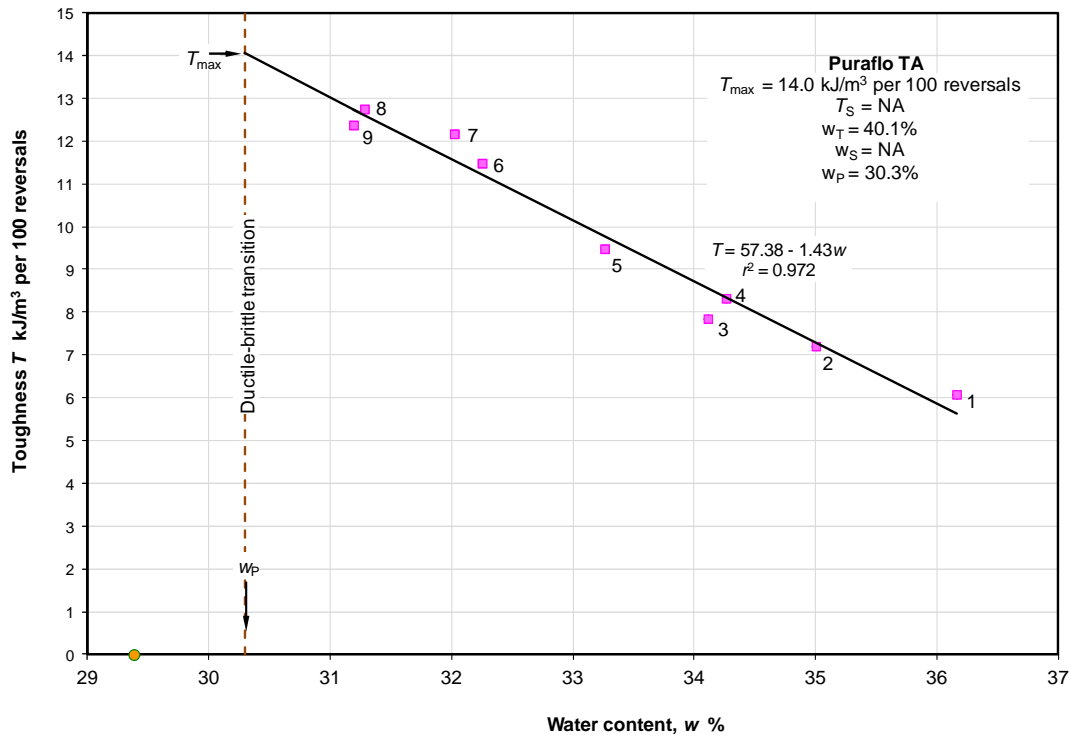

Figure A1.42 Toughness – water content Puraflor TA

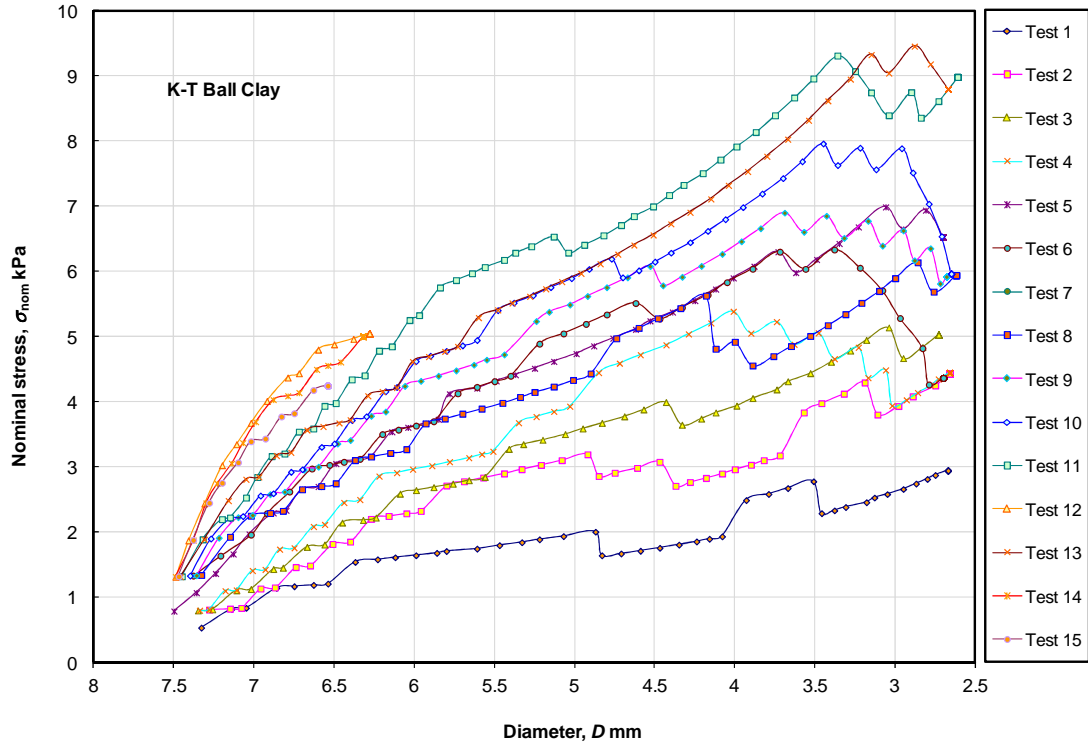

Figure A1.43 Stress – diameter K-T Ball Clay

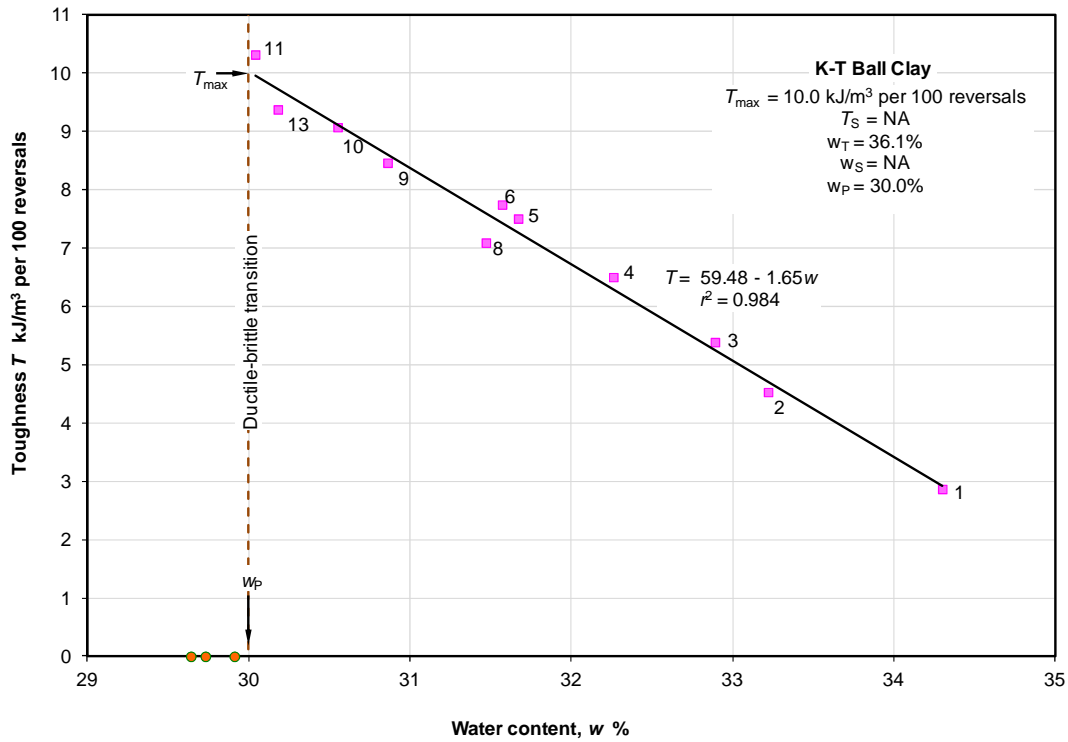

Figure A1.44 Toughness – water content K-T Ball Clay

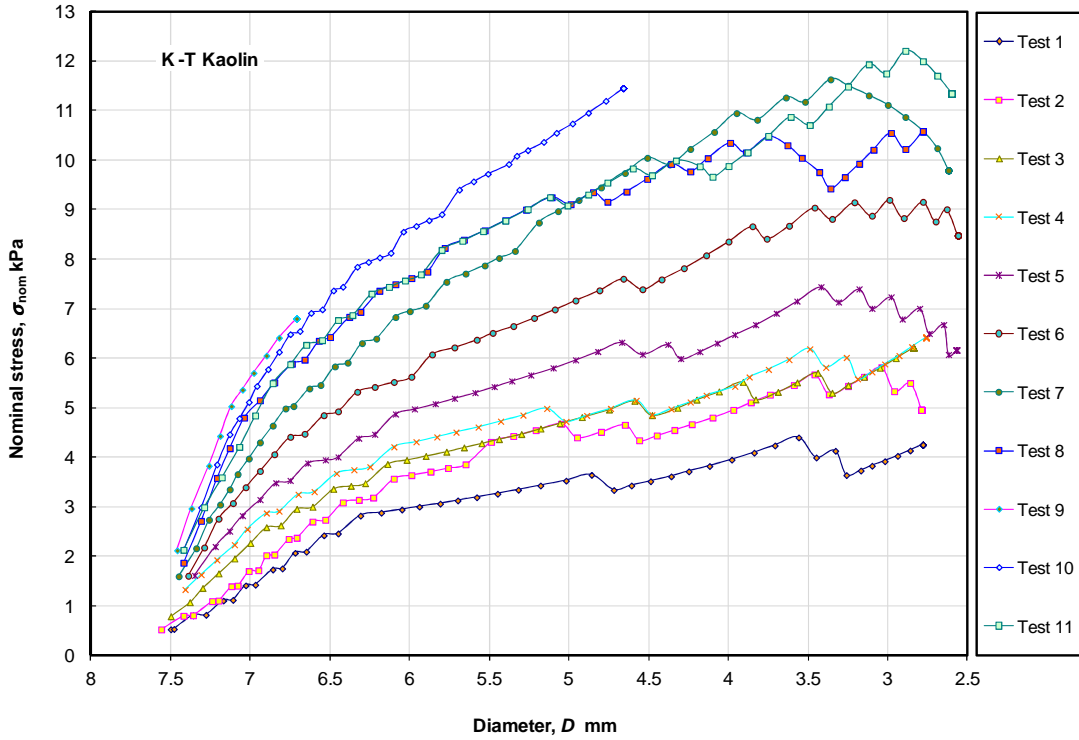

Figure A1.45 Stress – diameter K-T Kaolin

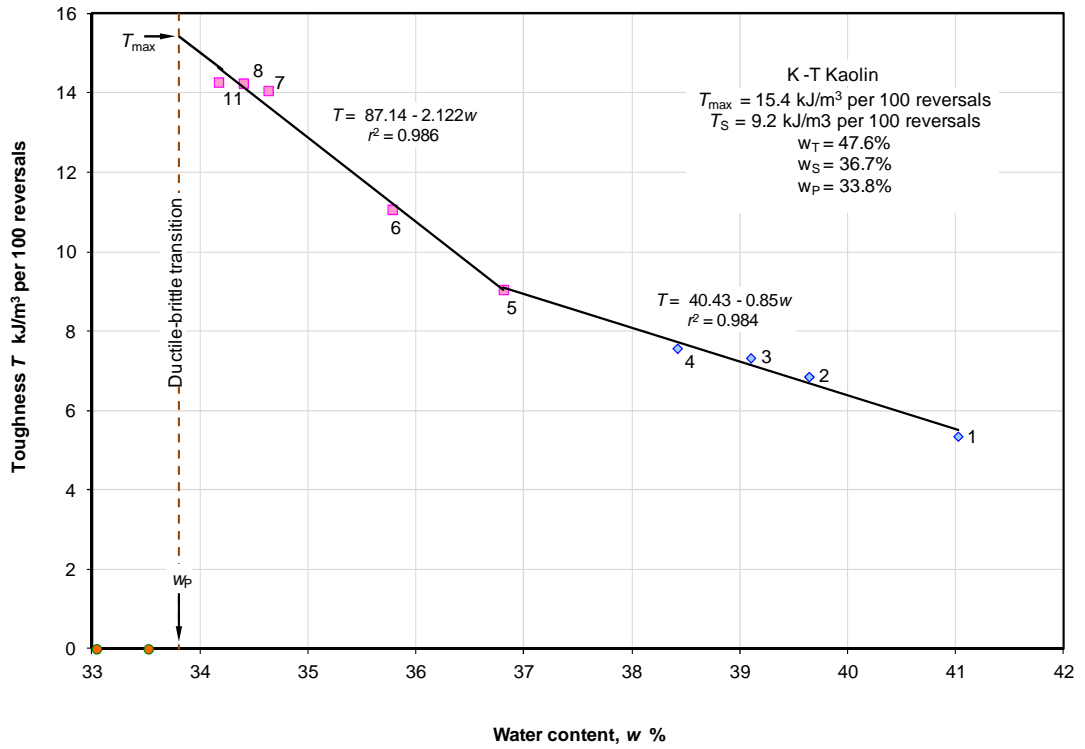

Figure A1.46 Toughness – water content K-T Kaolin

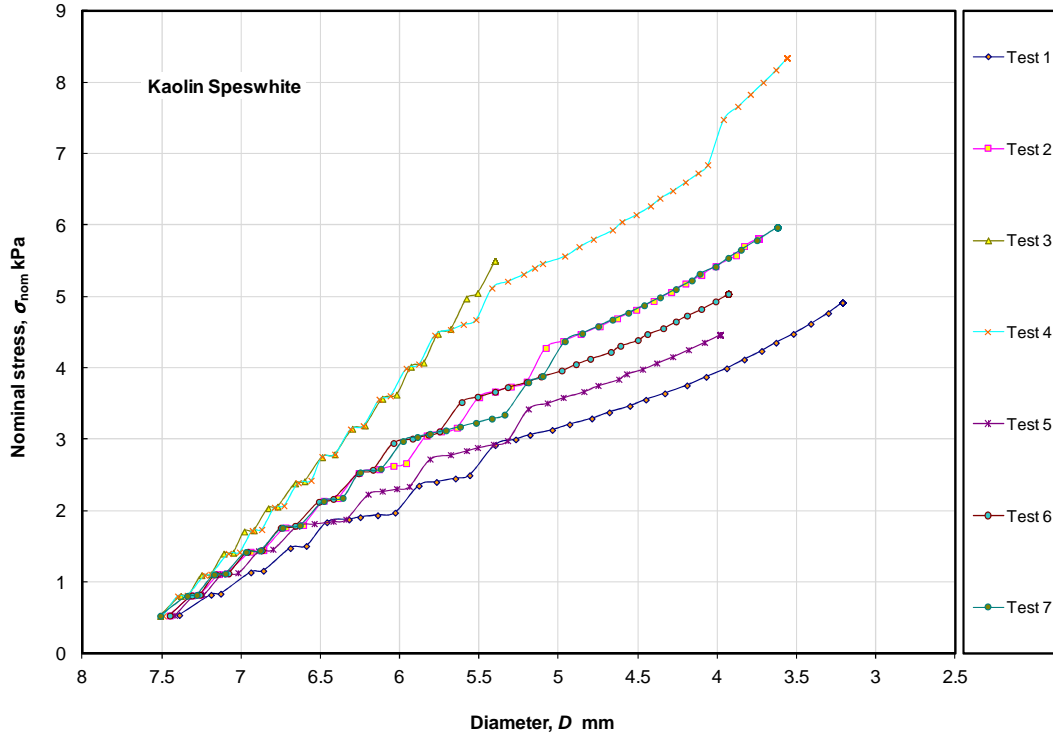

Figure A1.47 Stress – diameter Kaolin Speswhite

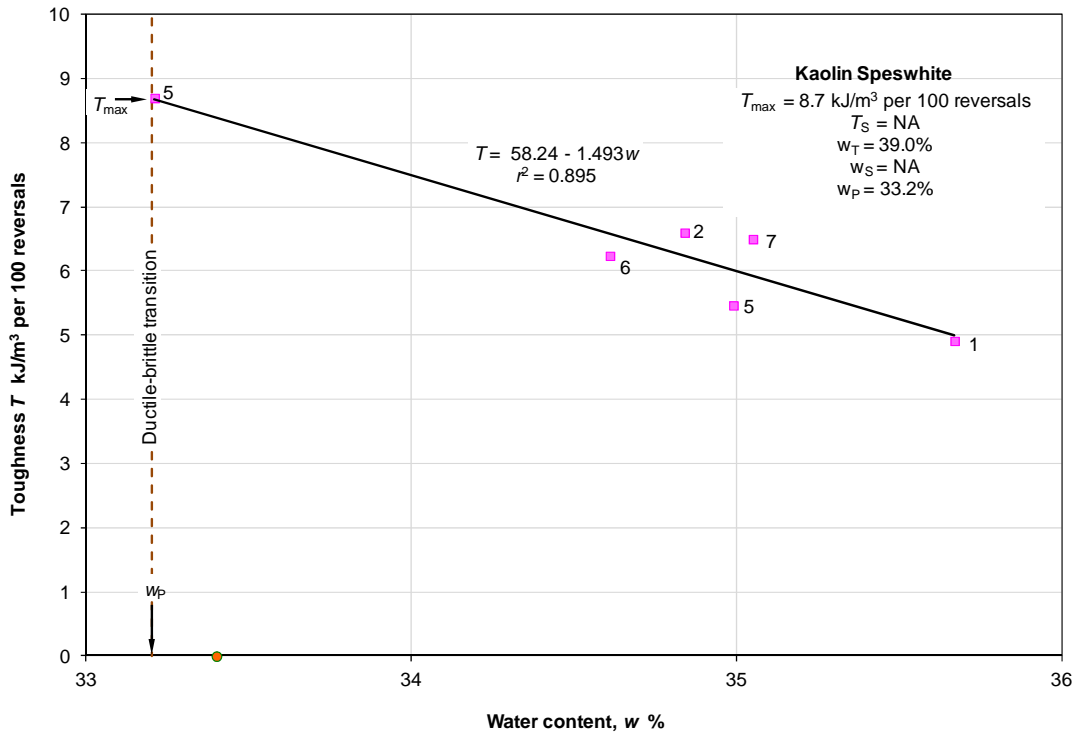

Figure A1.48 Toughness – water content Kaolin Speswhite

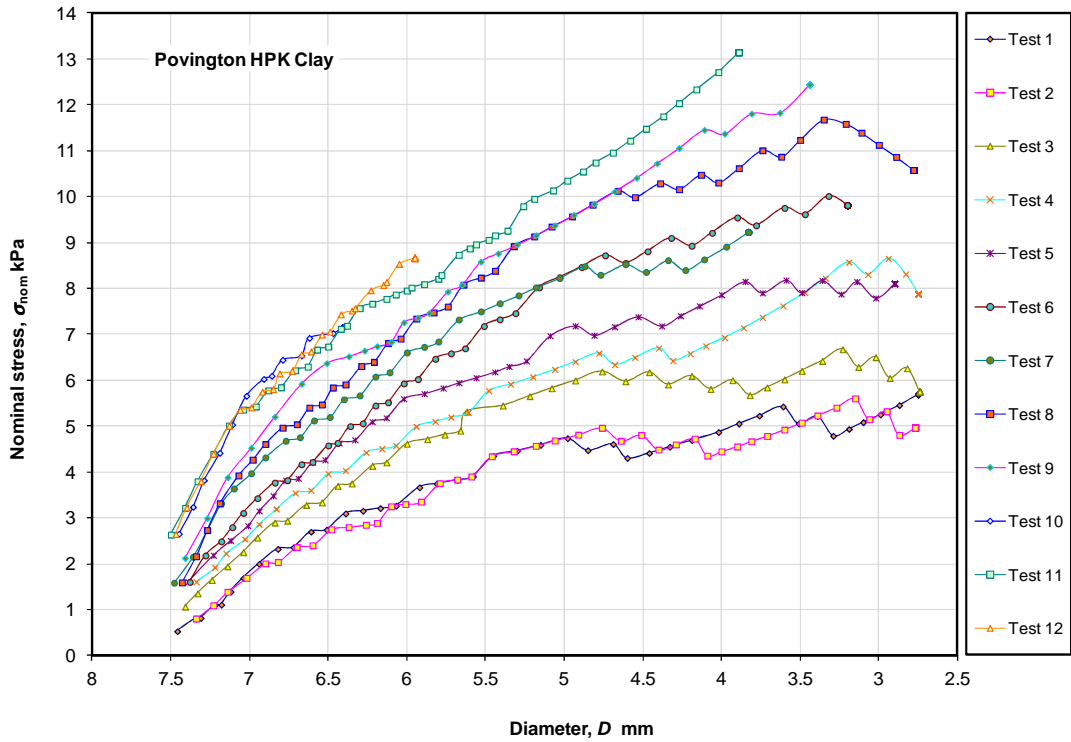

Figure A1.49 Stress – diameter Povington HPK Clay

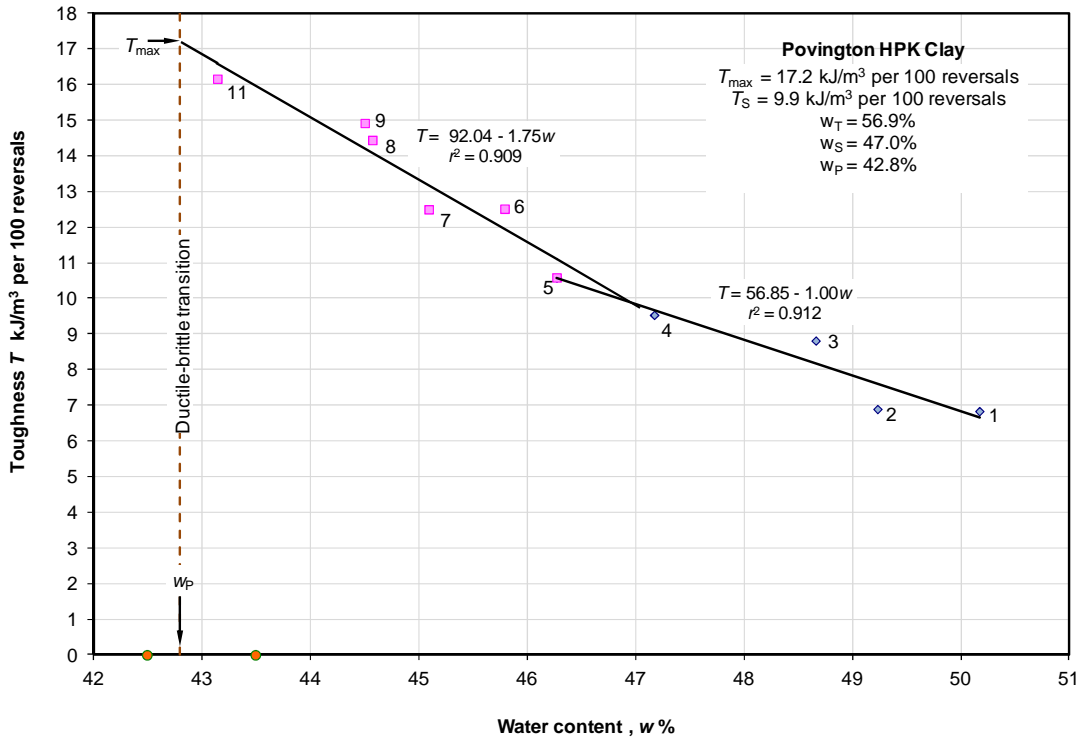

Figure A1.50 Toughness – water content Povington HPK Clay

Appendix 2

Results of tests on clay:silt mixtures

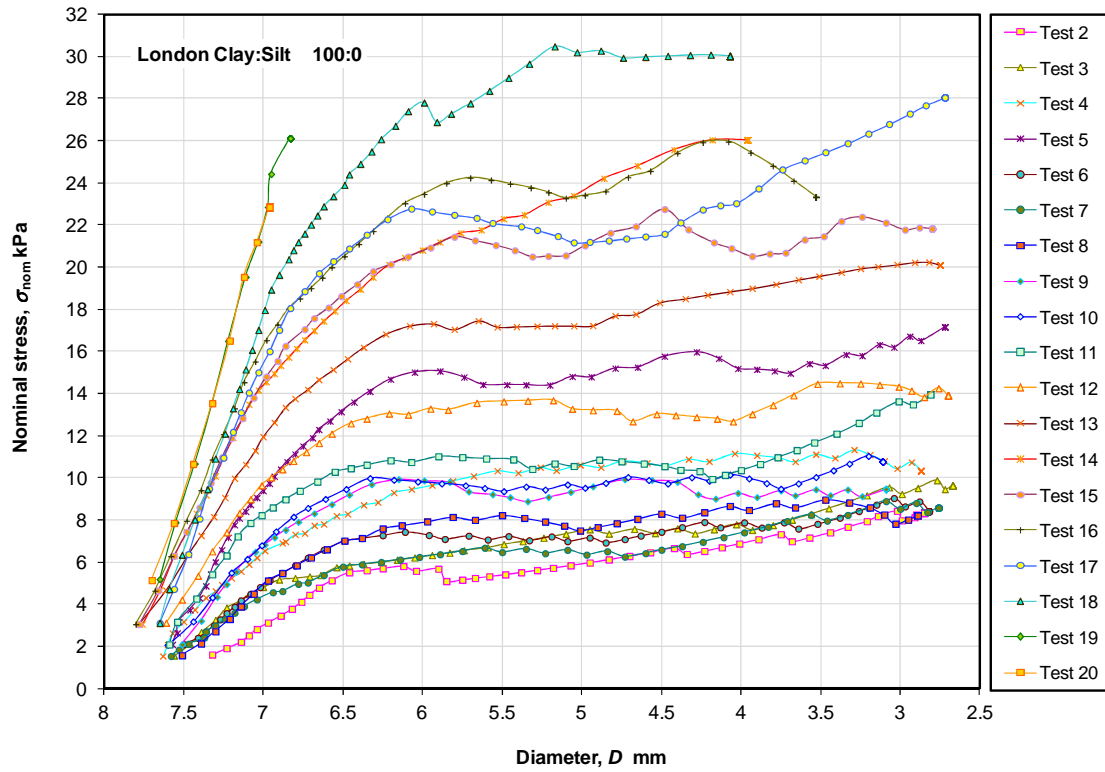

Figure A2.1 Stress – diameter for the London Clay:Silt 100:0 mixture

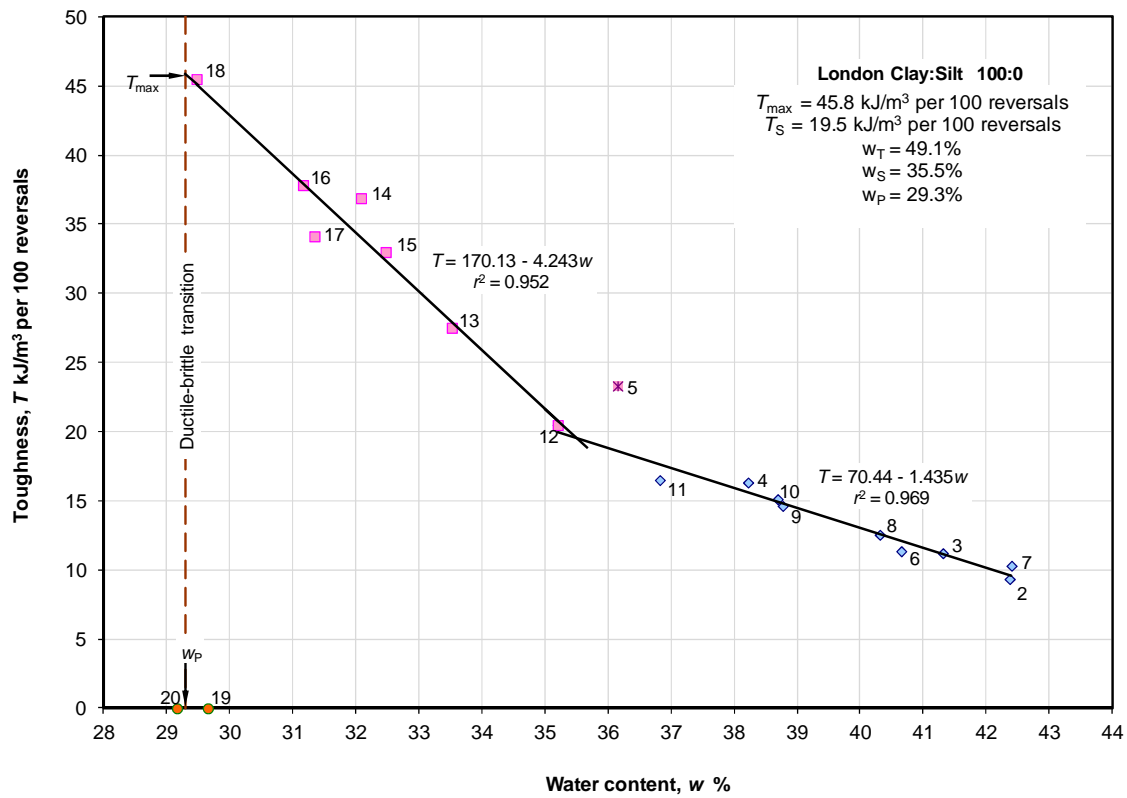

Figure A2.2 Toughness – moisture content for the London Clay:Silt 100:0 mixture

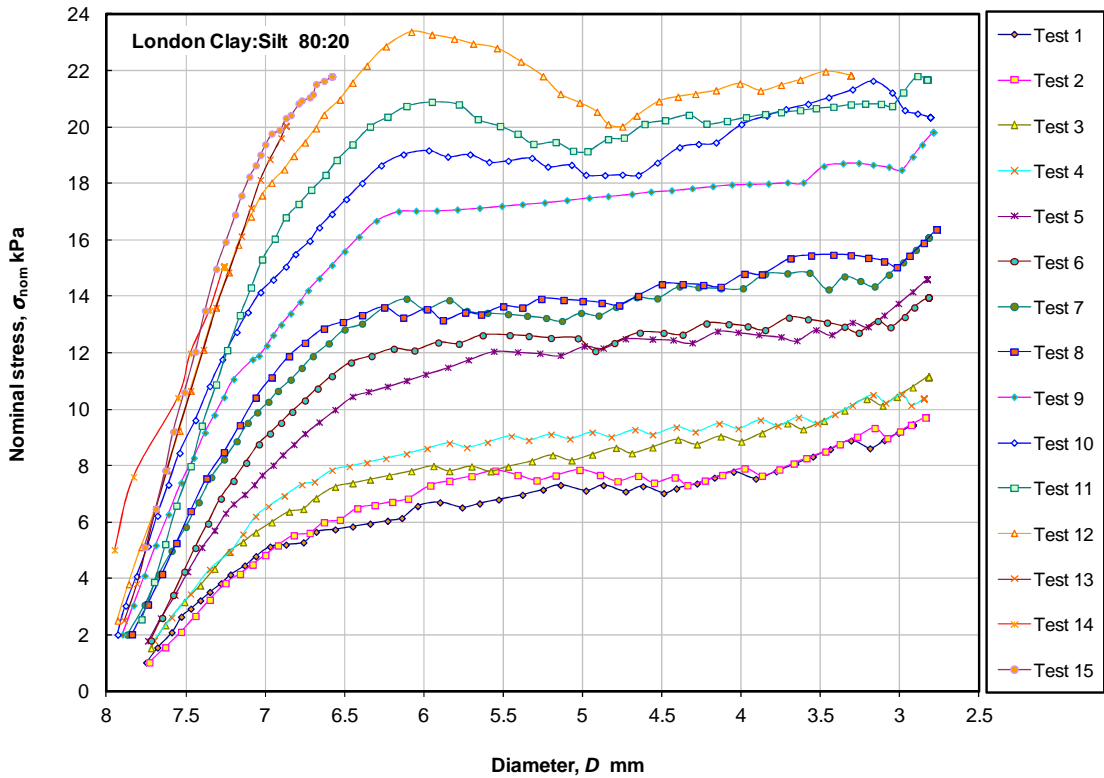

Figure A2.3 Stress – diameter for the London Clay:Silt 80:20 mixture

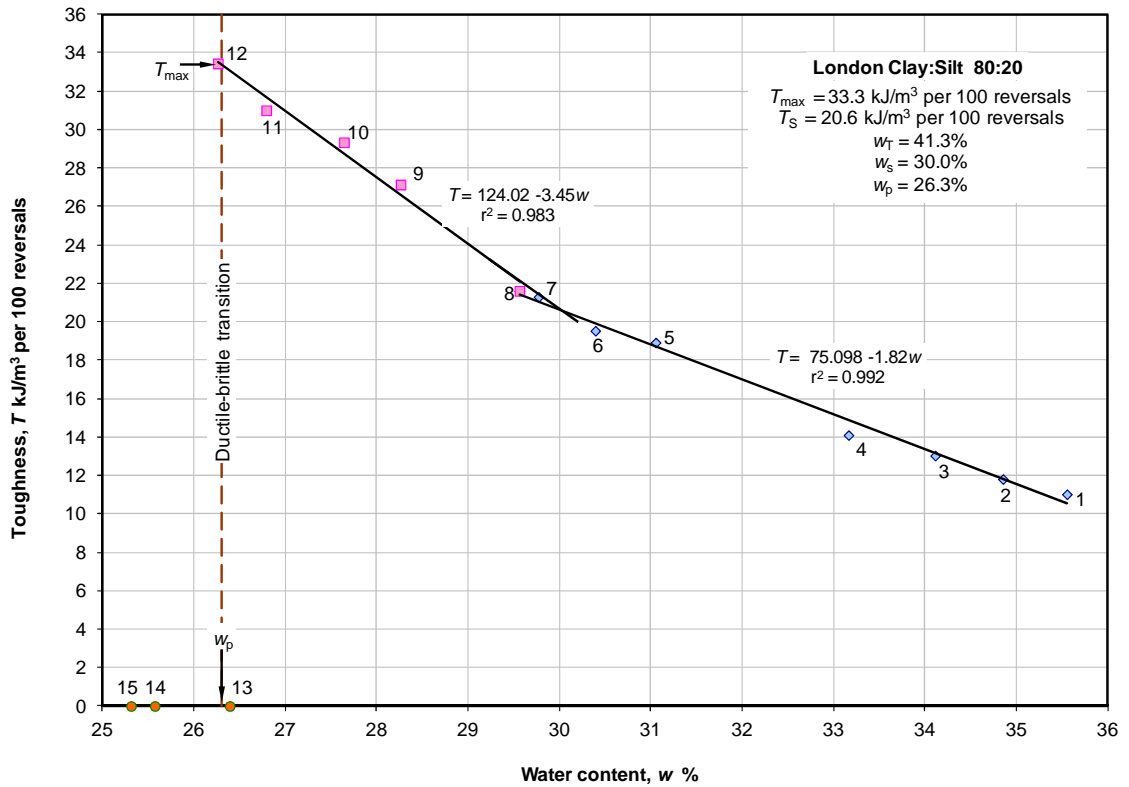

Figure A2.4 Toughness – moisture content for the London Clay:Silt 80:20 mixture

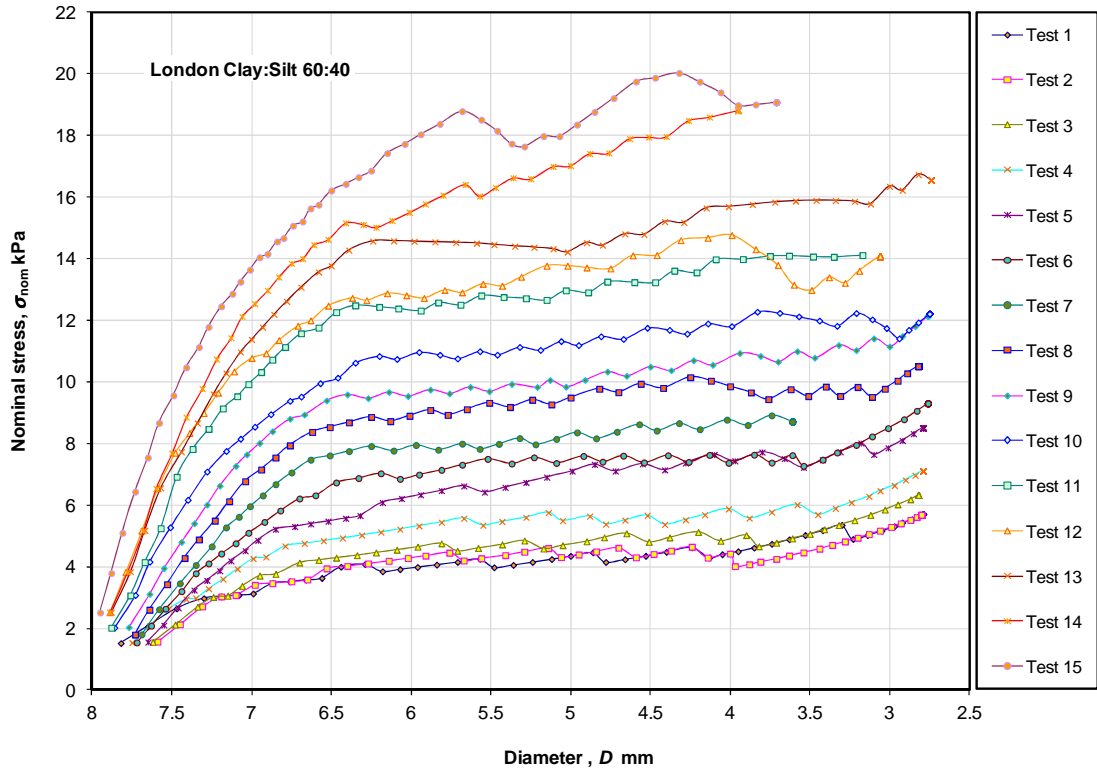

Figure A2.5 Stress – diameter for the London Clay:Silt 60:40 mixture

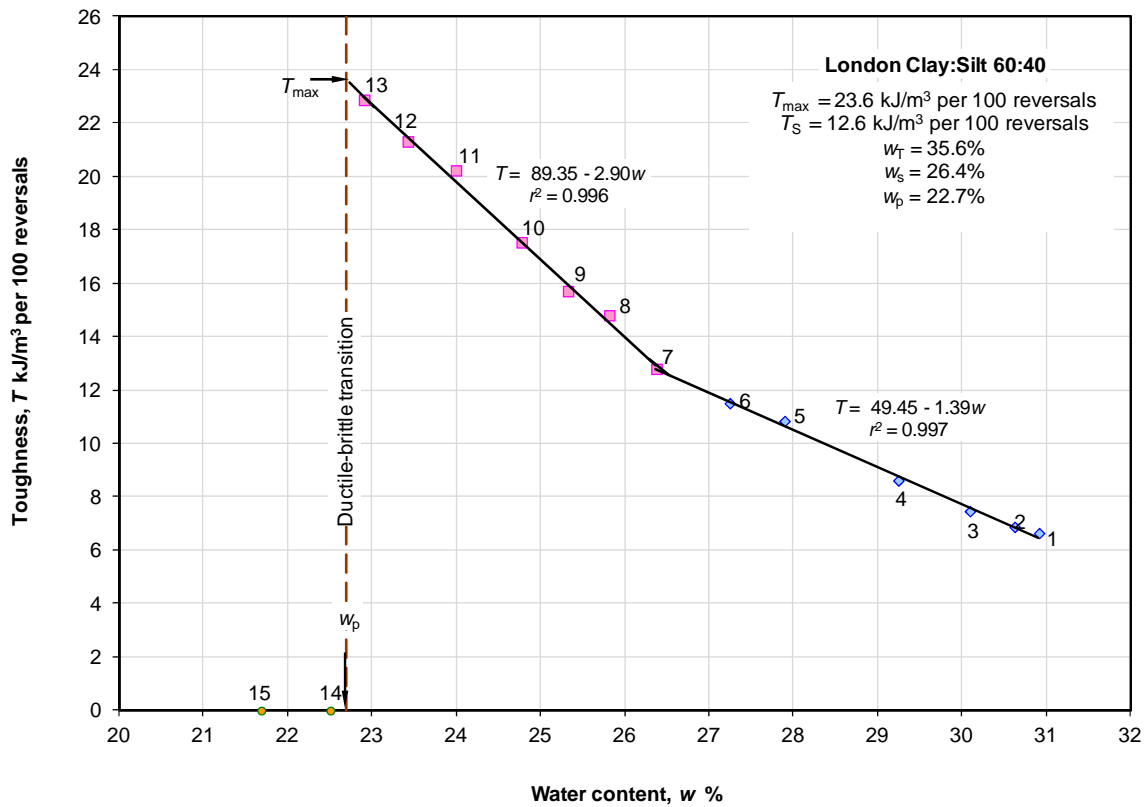

Figure A2.6 Toughness – moisture content for the London Clay:Silt 60:40 mixture

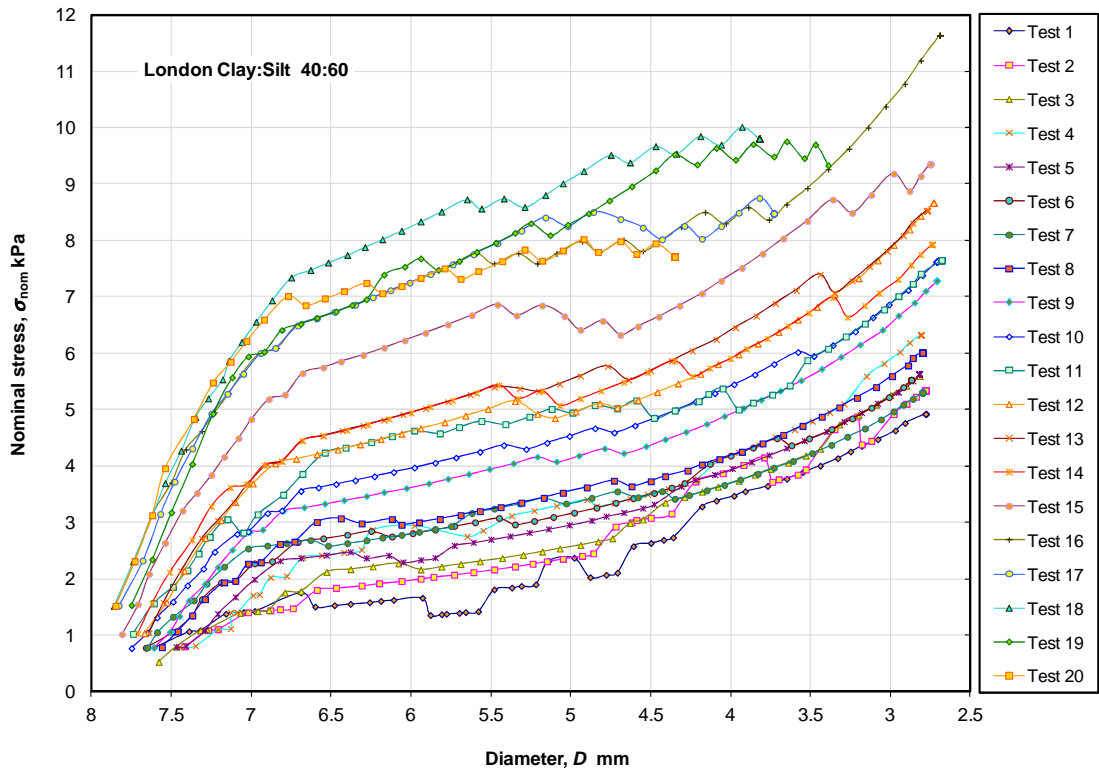

Figure A2.7 Stress – diameter for the London Clay:Silt 40:60 mixture

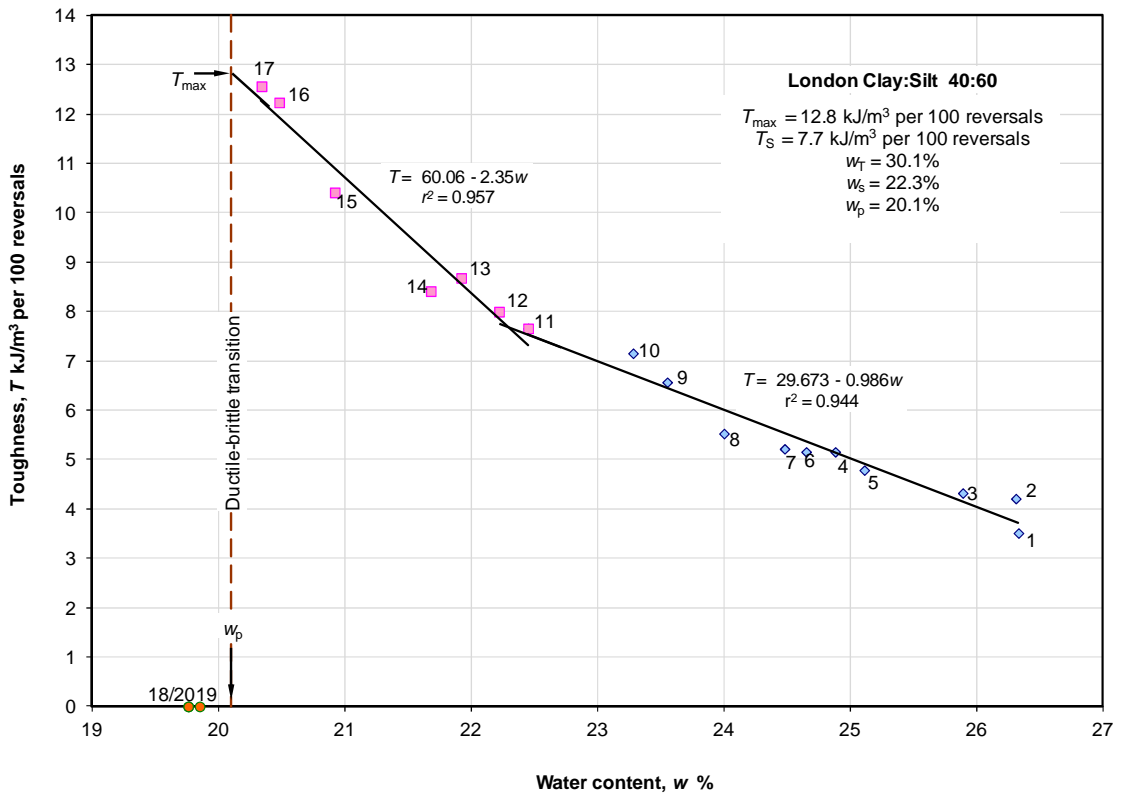

Figure A2.8 Toughness – moisture content for the London Clay:Silt 40:60 mixture

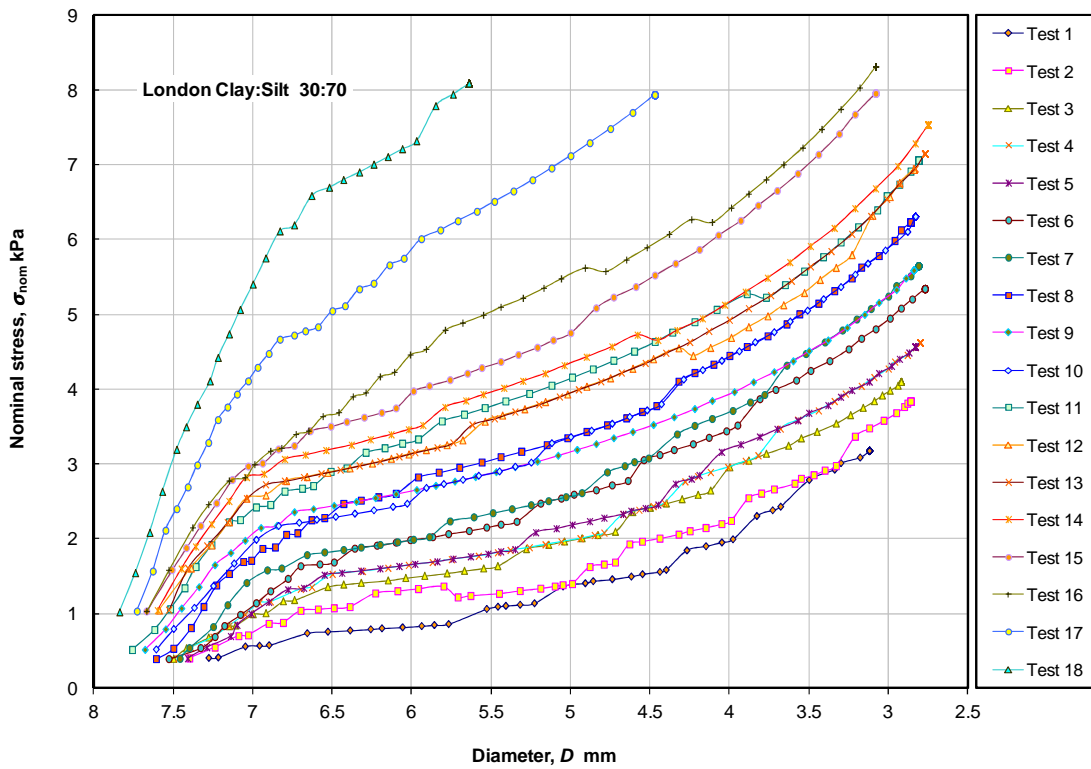

Figure A2.9 Stress – diameter for the London Clay:Silt 30:70 mixture

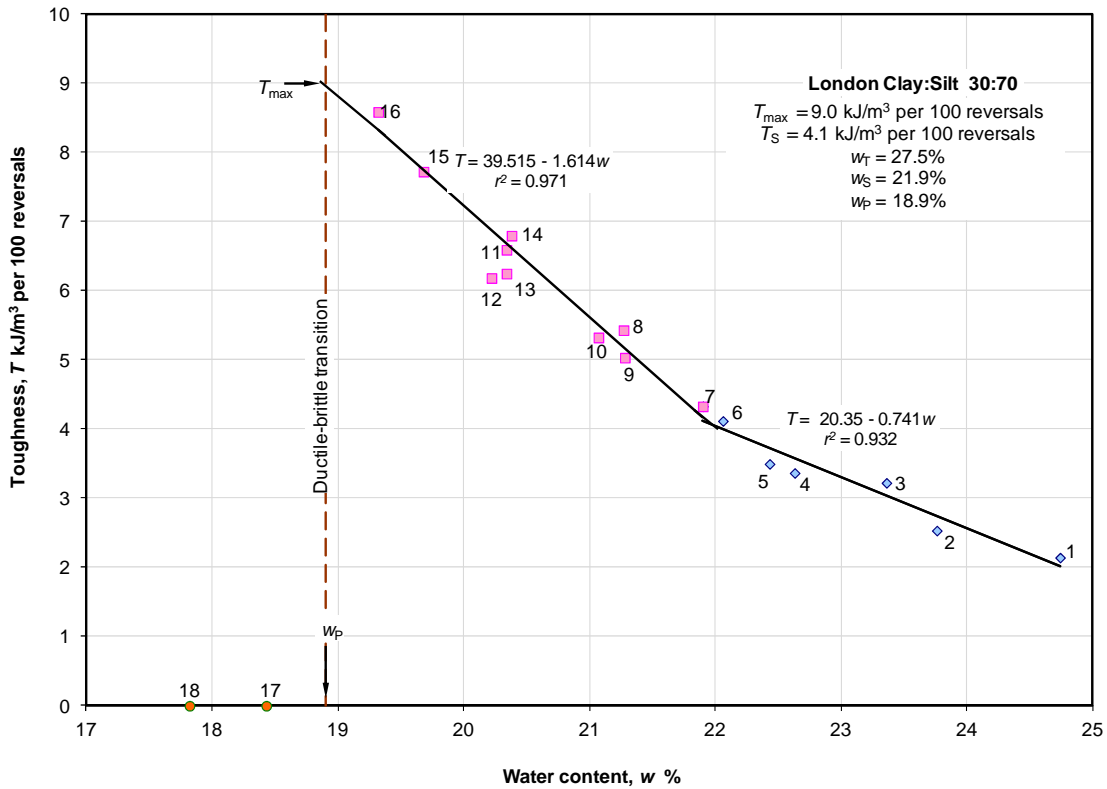

Figure A2.10 Toughness – moisture content for the London Clay:Silt 30:70 mixture

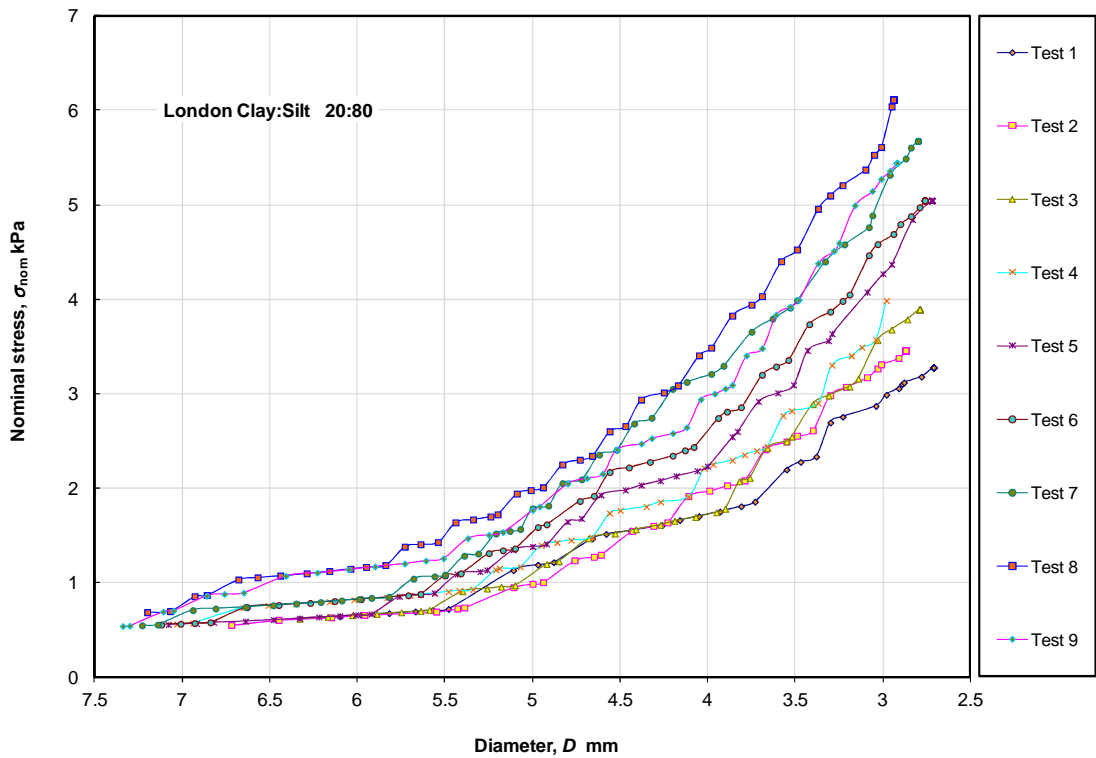

Figure A2.11 Stress – diameter for the London Clay:Silt 20:80 mixture

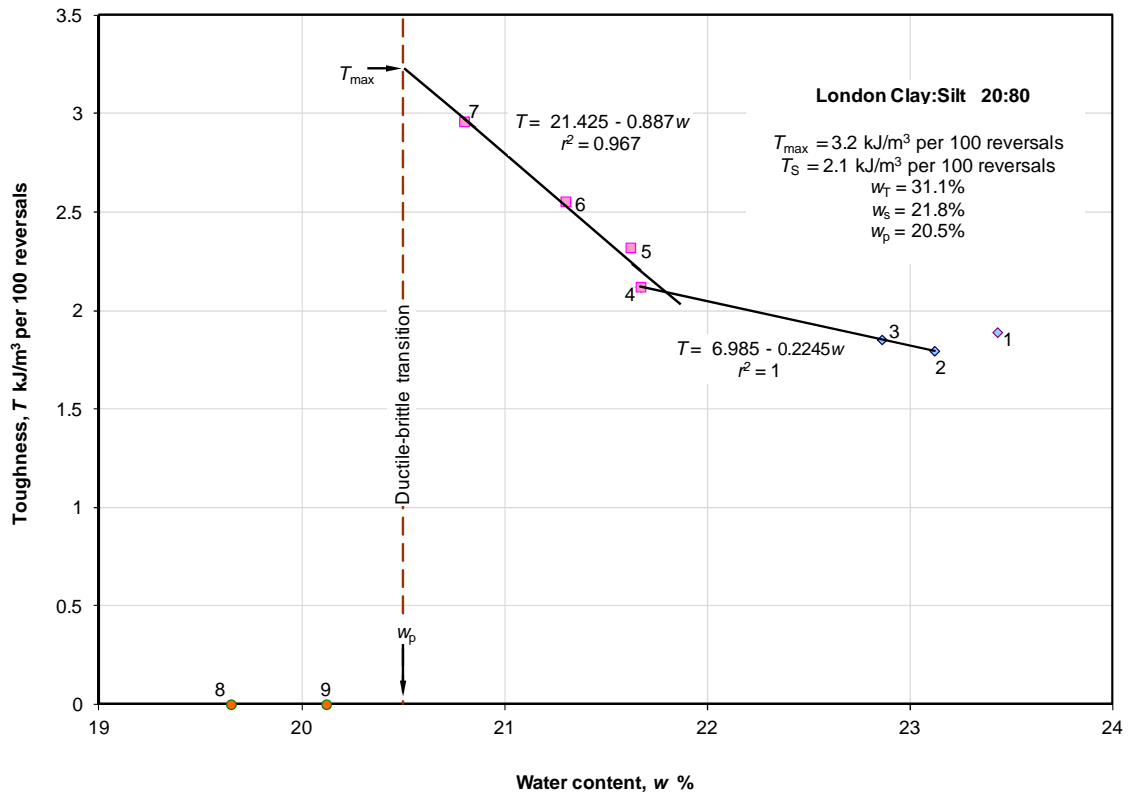

Figure A2.12 Toughness – moisture content for the London Clay:Silt 20:80 mixture

Appendix 3

Results of tests on clay:sand mixtures

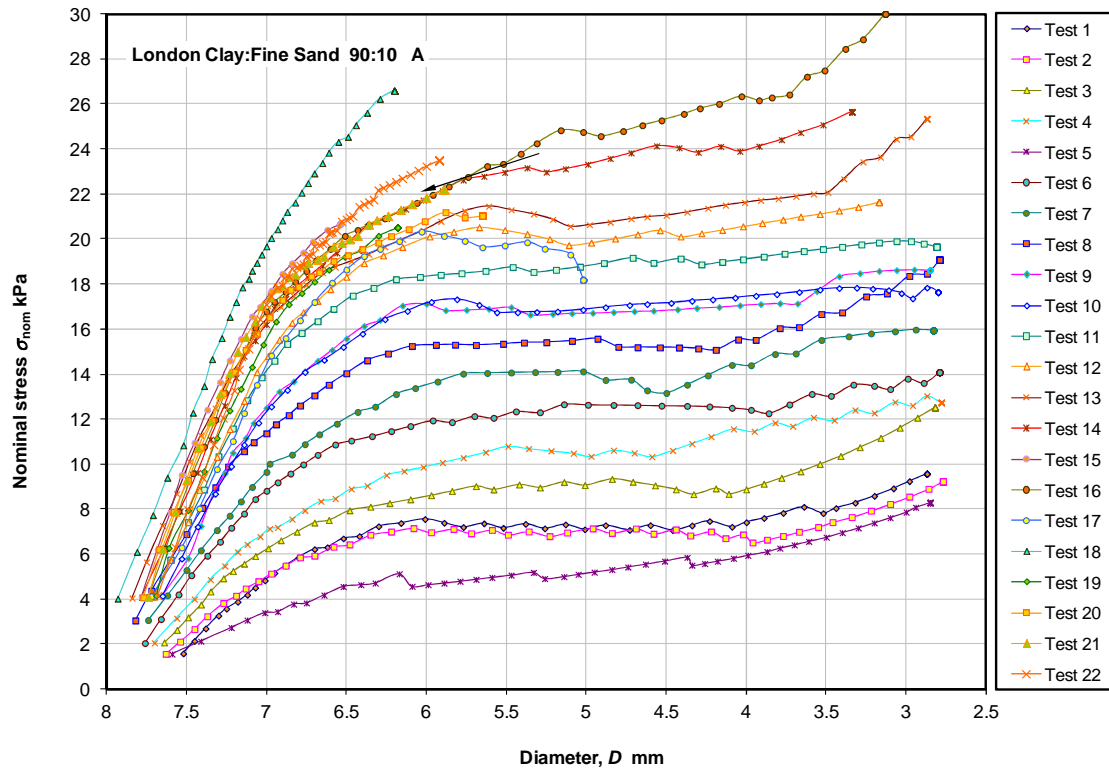

Figure A3.1 Stress – diameter for the London Clay:Fine Sand 90:10 mixture

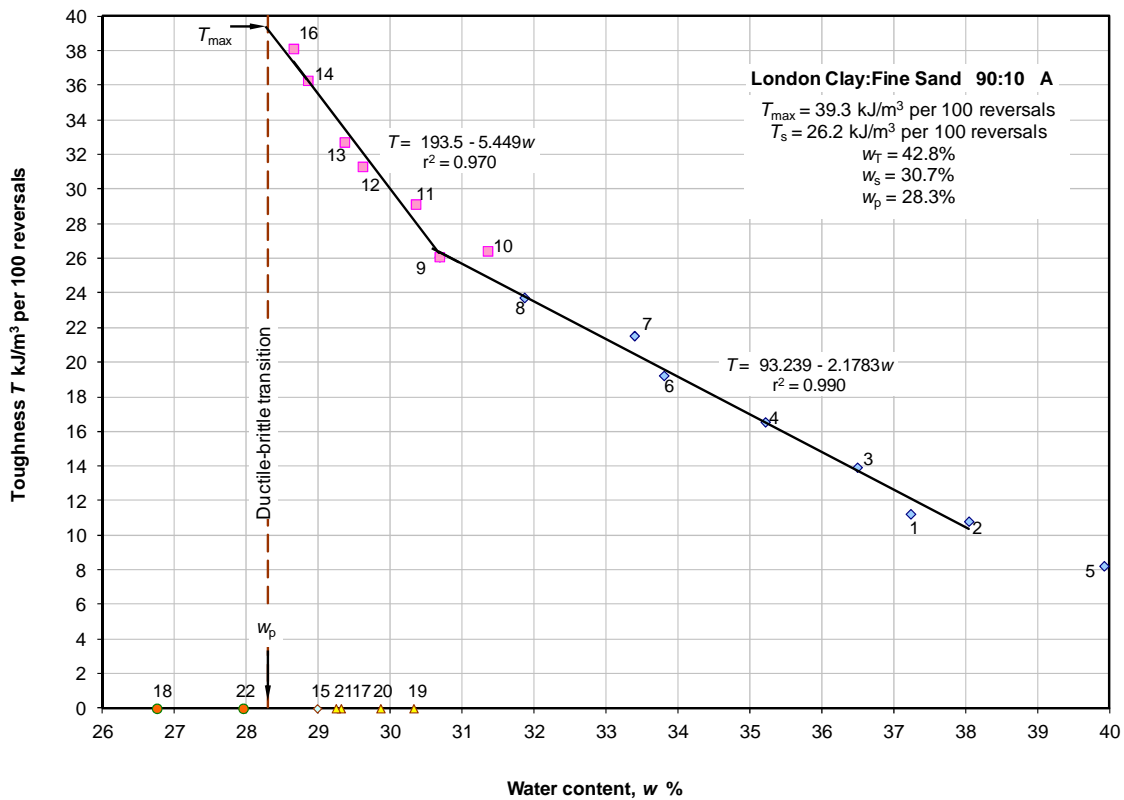

Figure A3.2 Toughness – water content for the London Clay:Fine Sand 90:10 mixture

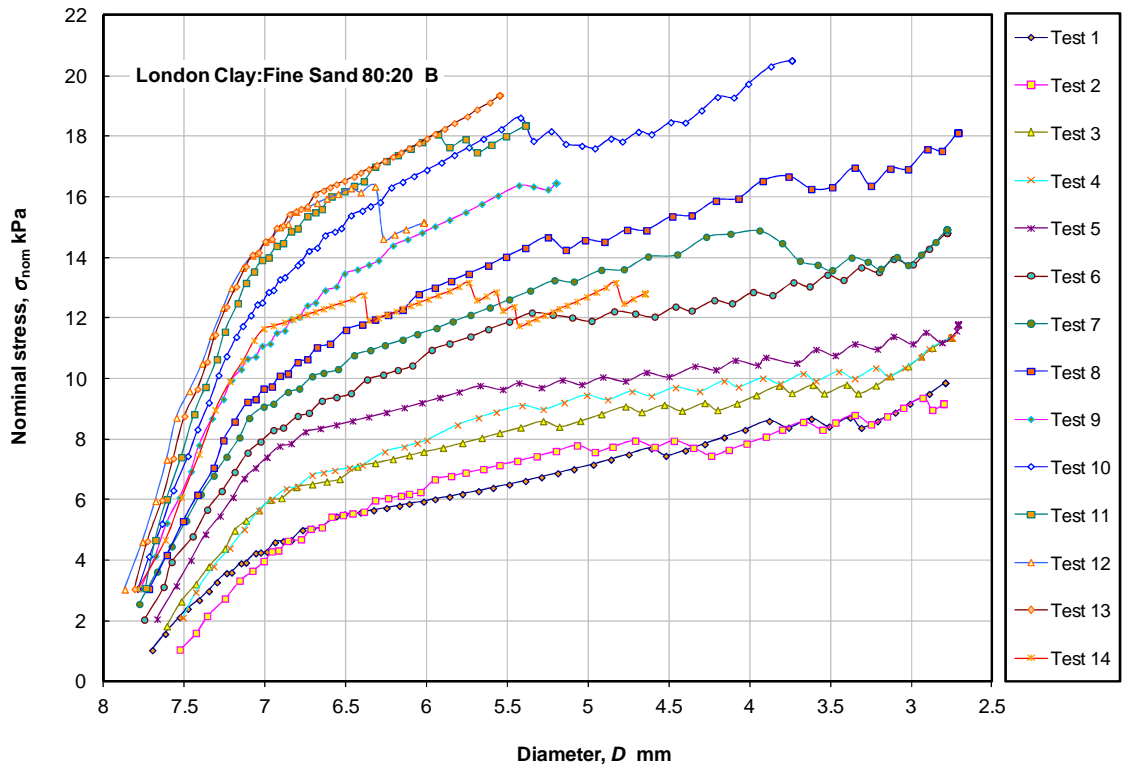

Figure A3.3 Stress – diameter for the London Clay:Fine Sand 80:20 mixture

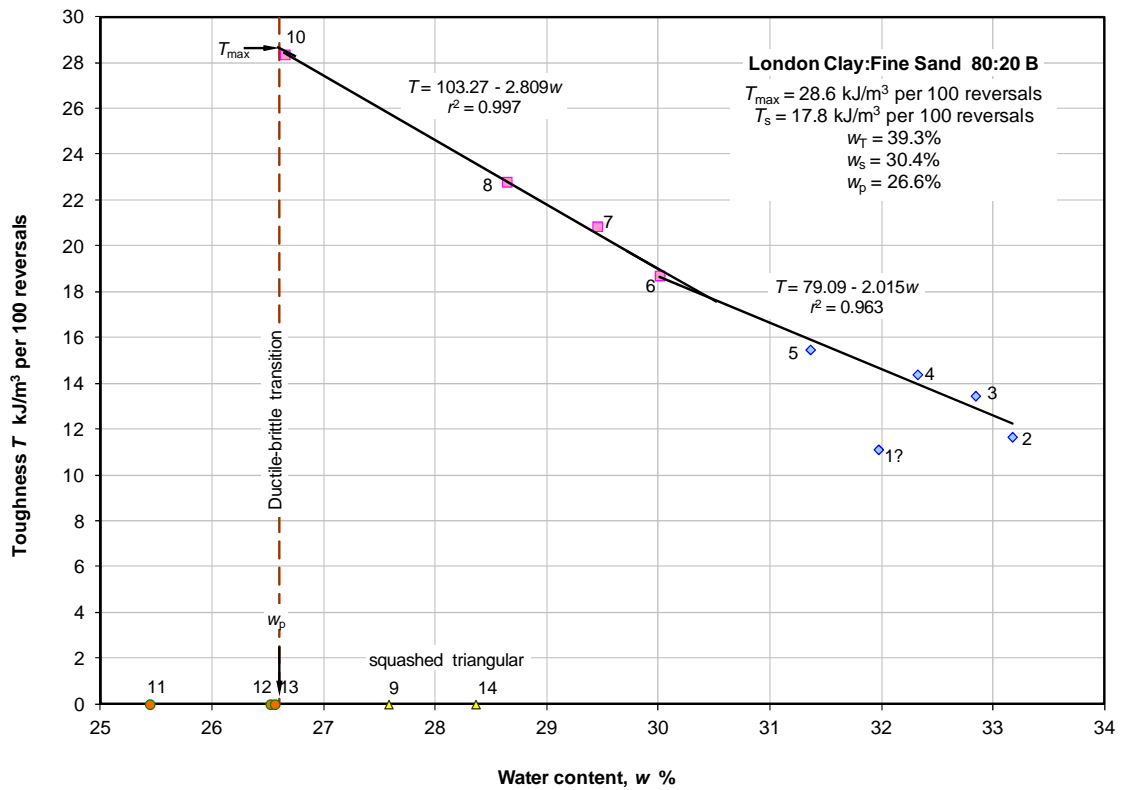

Figure A3.4 Toughness – water content for the London Clay:Fine Sand 80:20 mixture

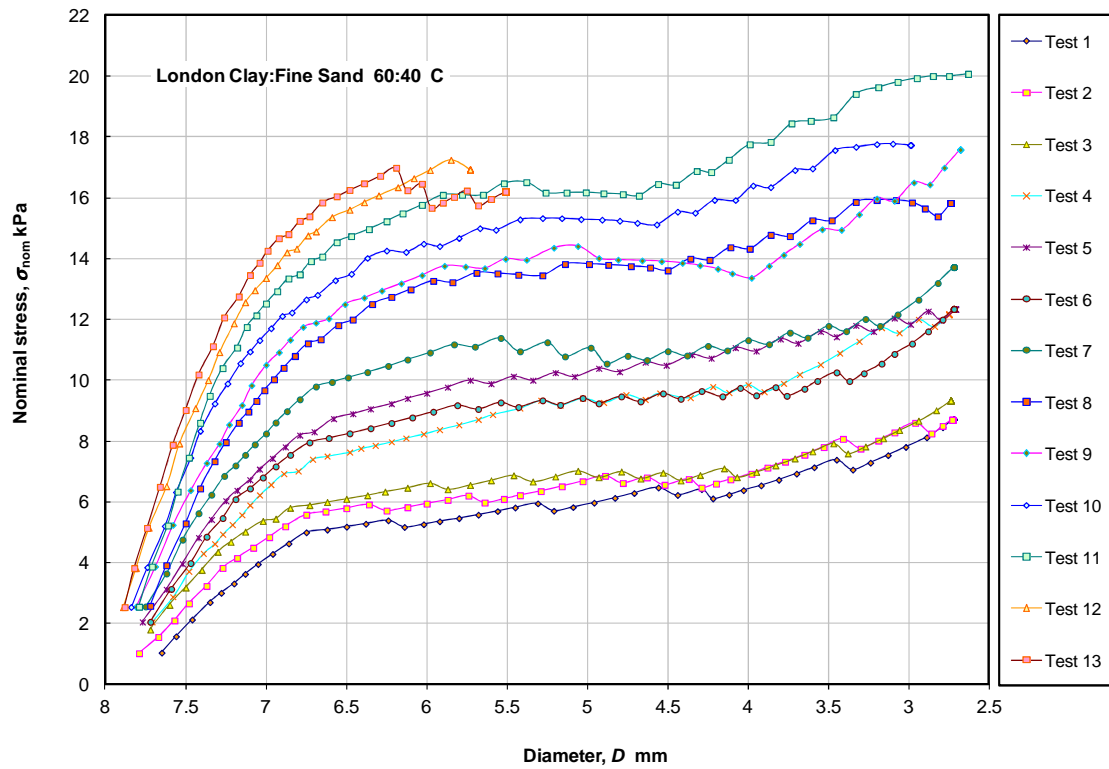

Figure A3.5 Stress – diameter for the London Clay:Fine Sand 60:40 mixture

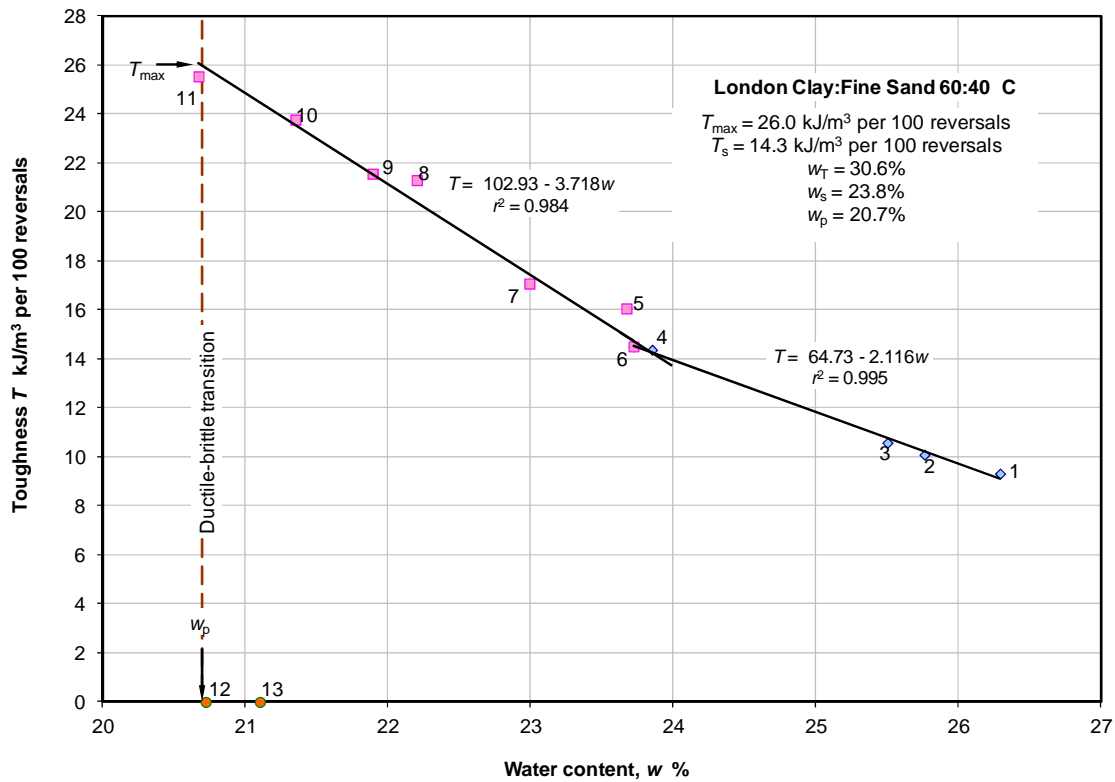

Figure A3.6 Toughness – water content for the London Clay:Fine Sand 60:40 mixture

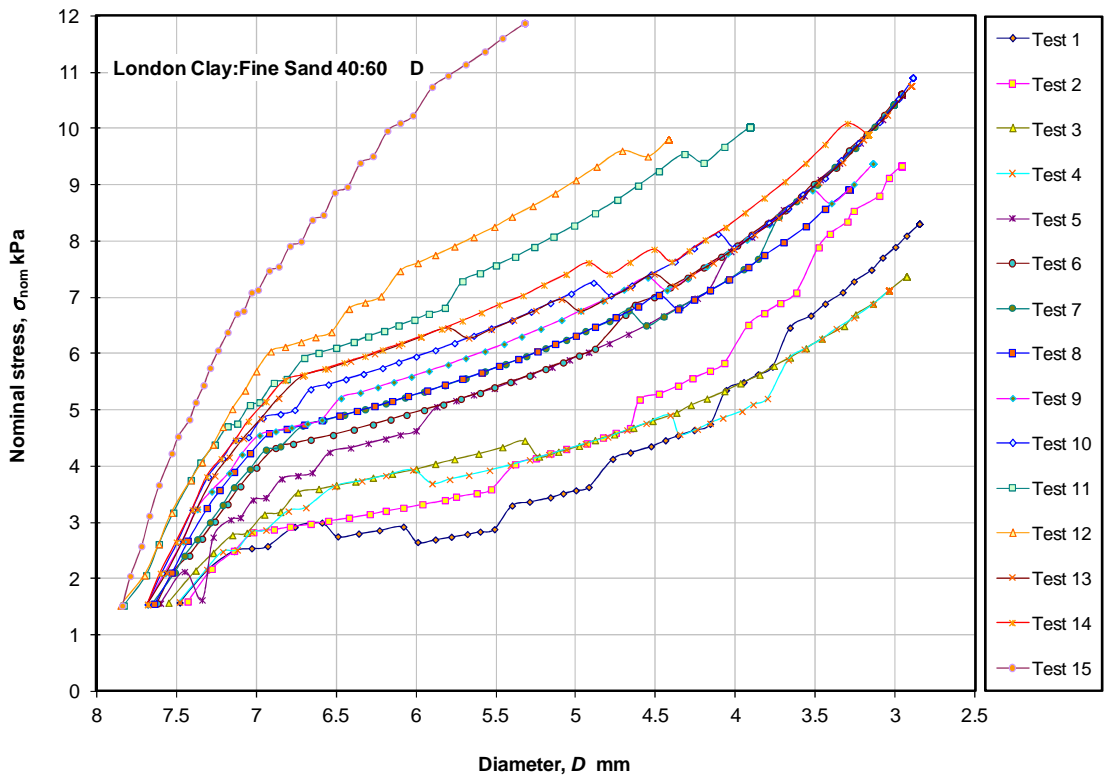

Figure A3.7 Stress – diameter for the London Clay:Fine Sand 40:60 mixture

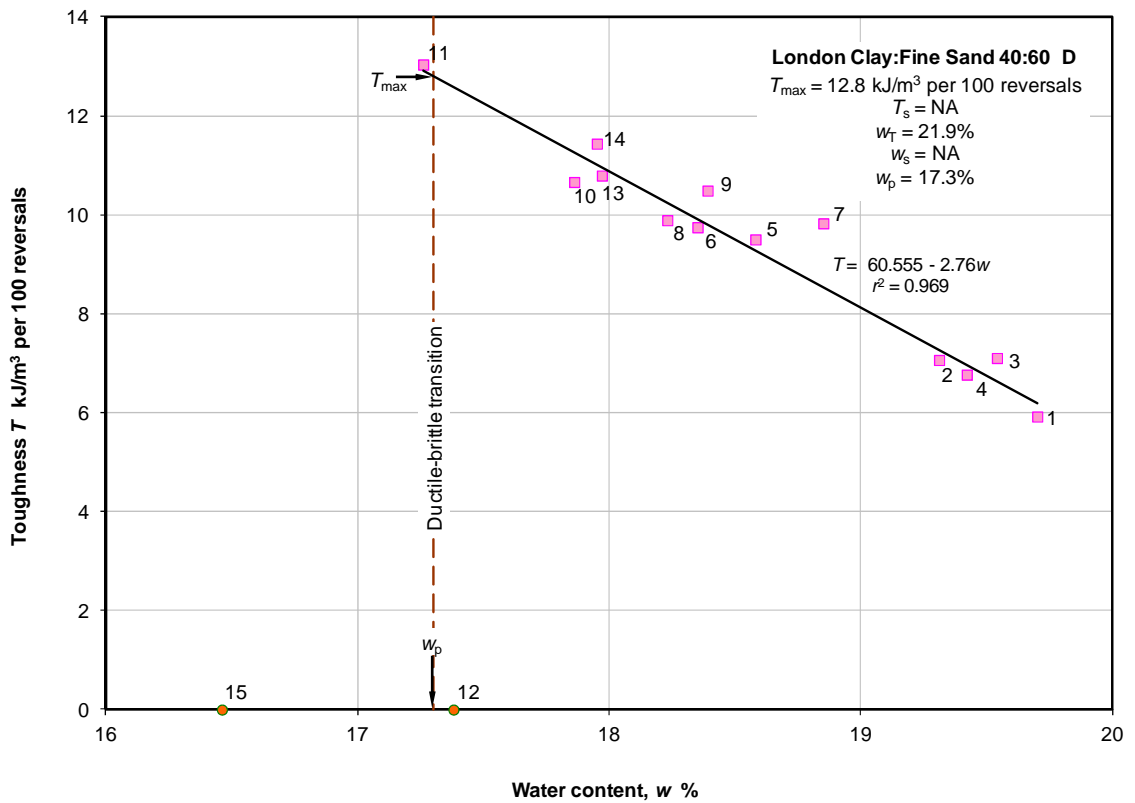

Figure A3.8 Toughness – water content for the London Clay:Fine Sand 40:60 mixture

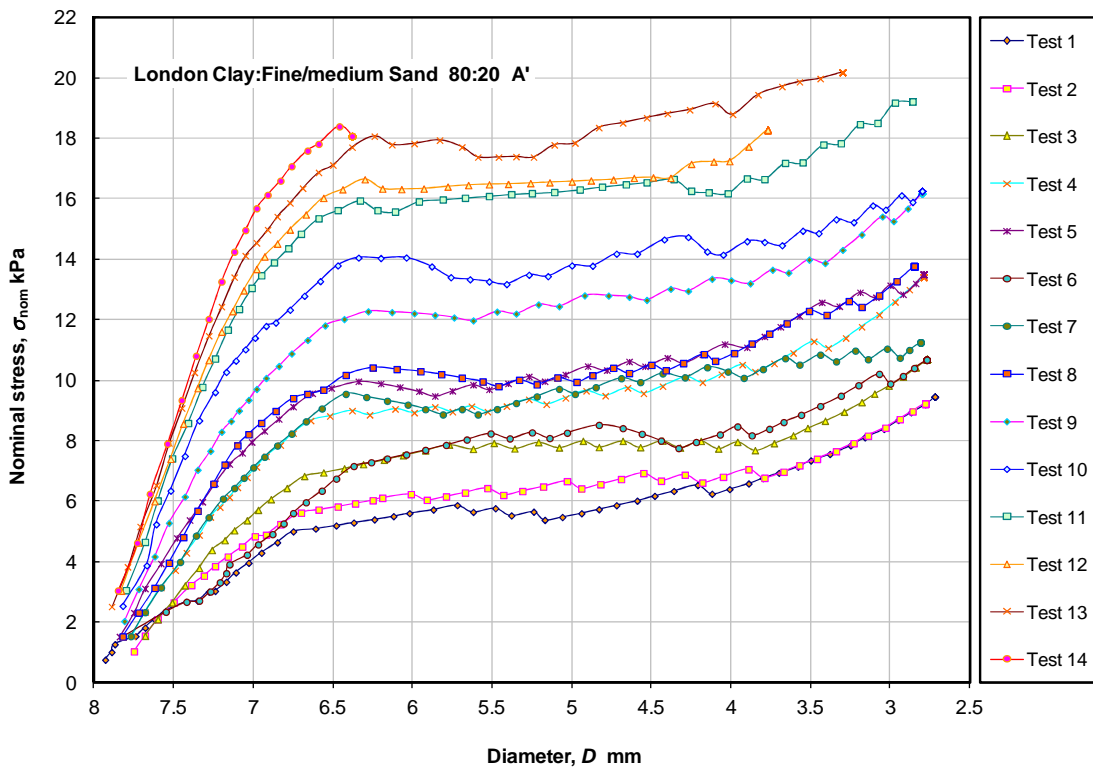

Figure A3.9 Stress – diameter for the London Clay:Fine/medium Sand 80:20 mixture

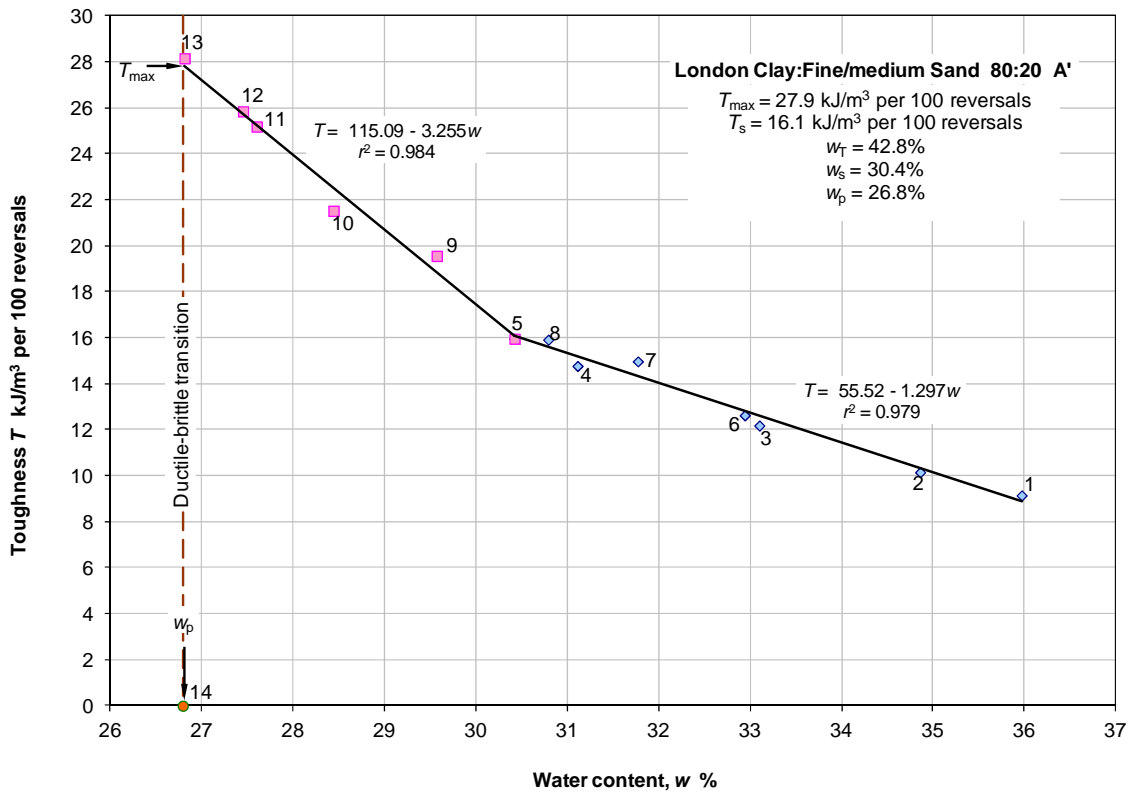

Figure A3.10 Toughness – water content for the London Clay:Fine/medium Sand 80:20 mixture

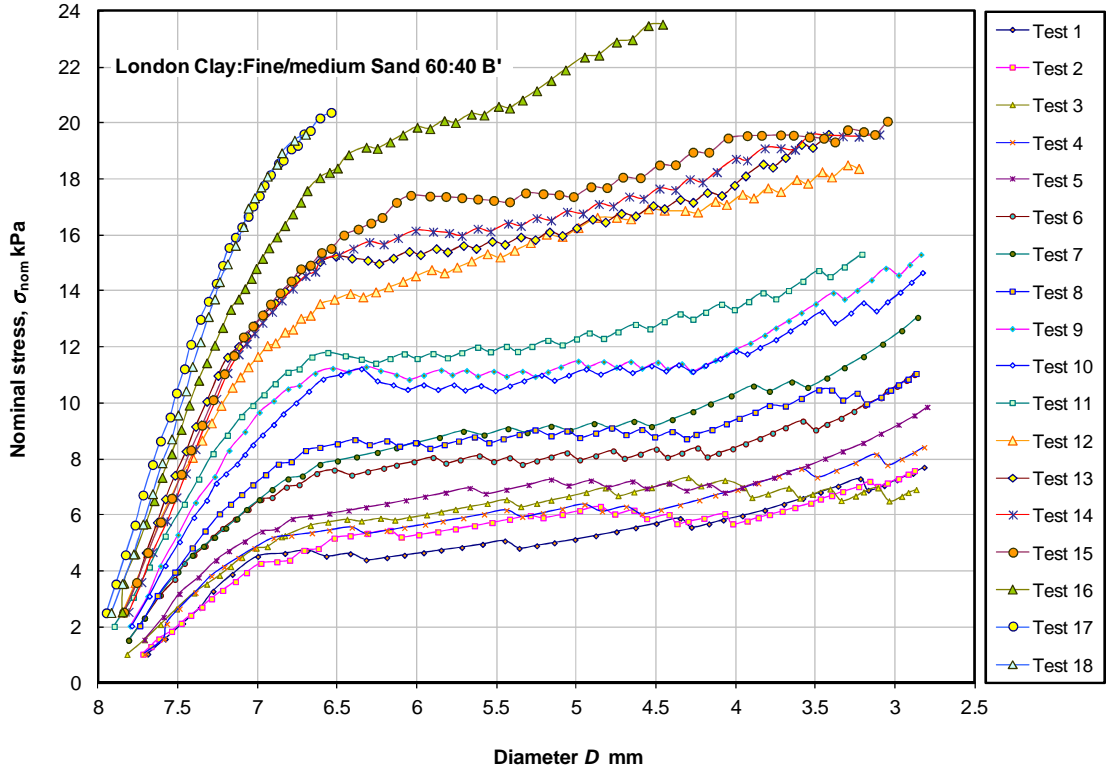

Figure A3.11 Stress – diameter for the London Clay:Fine/medium Sand 60:40 mixture

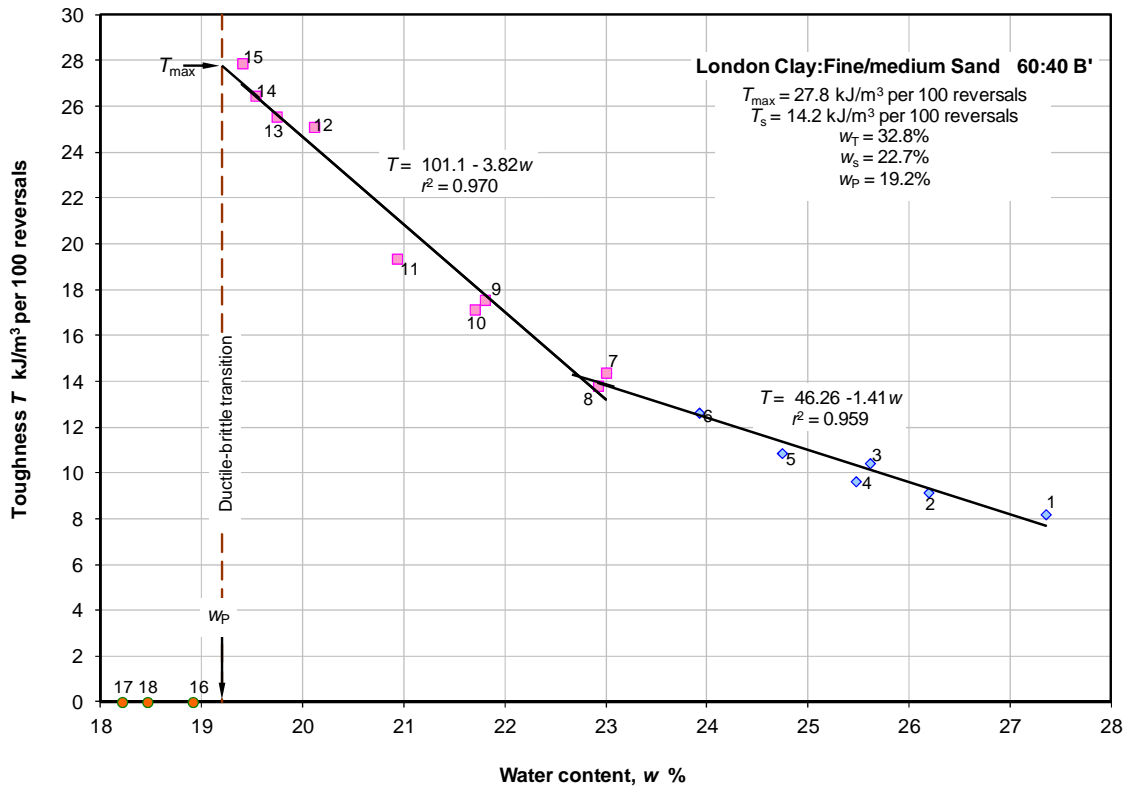

Figure A3.12 Toughness – water content for the London Clay:Fine/medium Sand 60:40 mixture

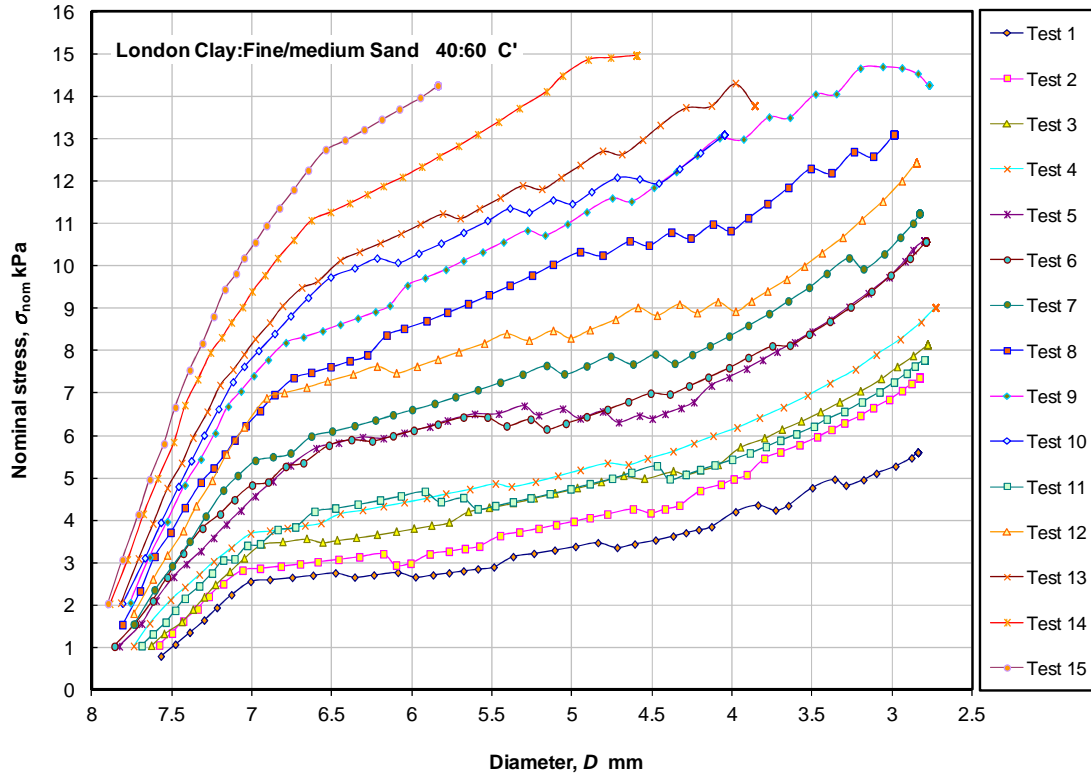

Figure A3.13 Stress – diameter for the London Clay:Fine/medium Sand 40:60 mixture

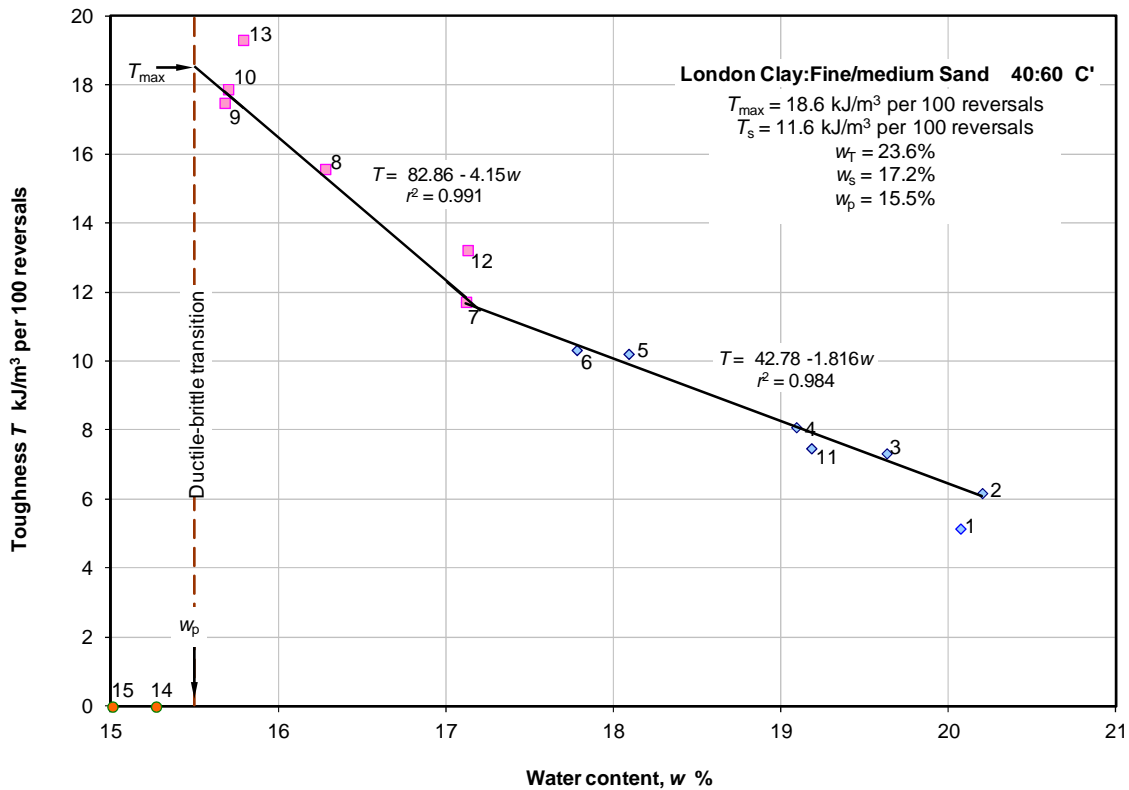

Figure A3.14 Toughness – water content for the London Clay:Fine/medium Sand 40:60 mixture

Appendix 4

Results of tests on ceramic clay mixtures

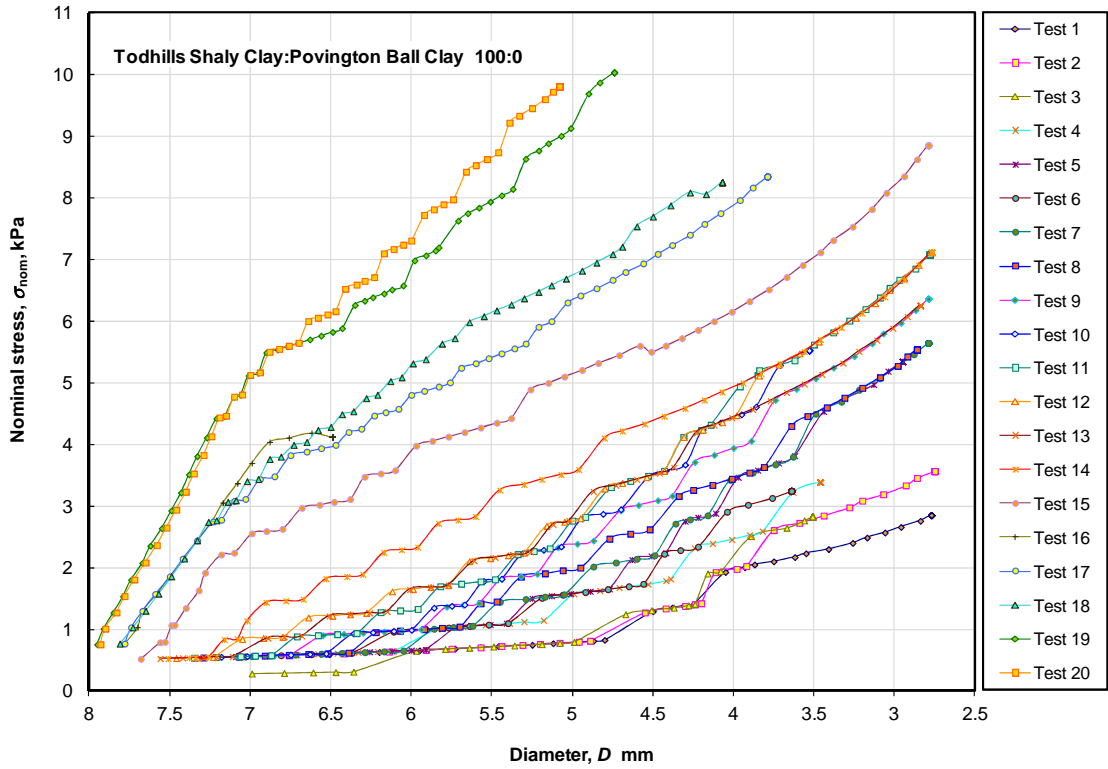

Figure A4.1 Stress – diameter for the Todhills Shaly Clay:Povington Ball Clay 100:0

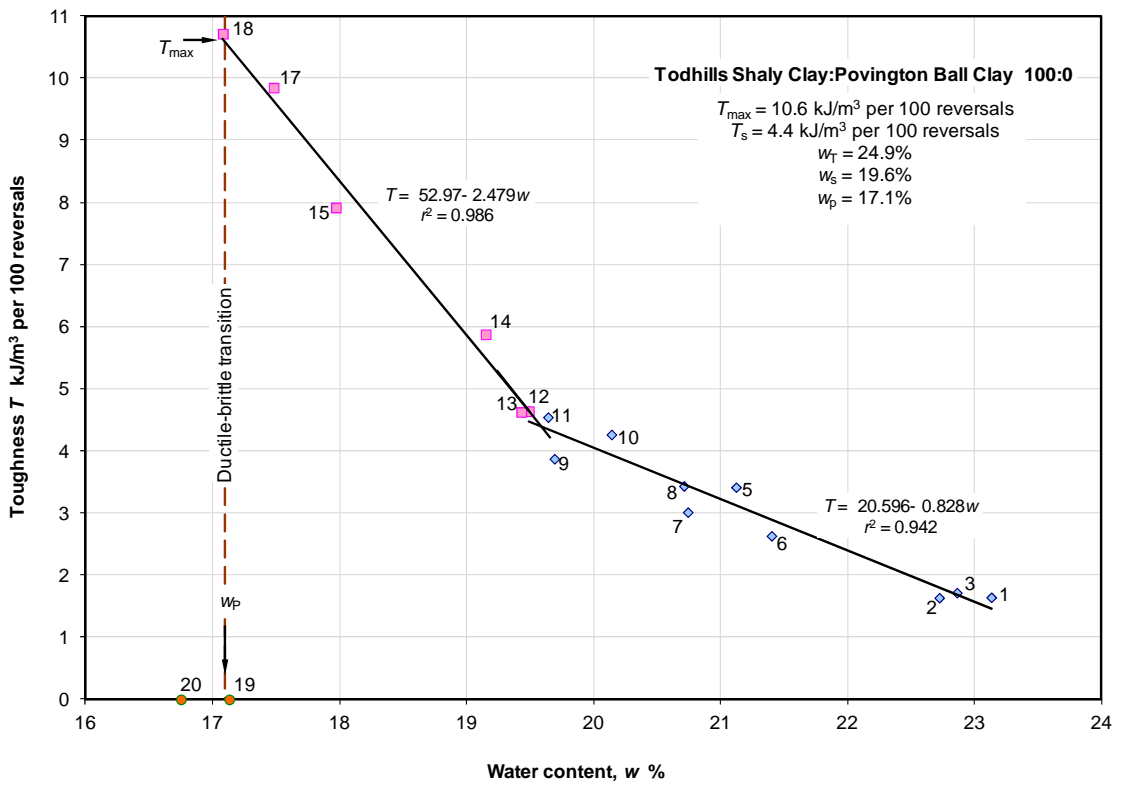

Figure A4.2 Toughness – water content for the Todhills Shaly Clay:Povington Ball Clay 100:0

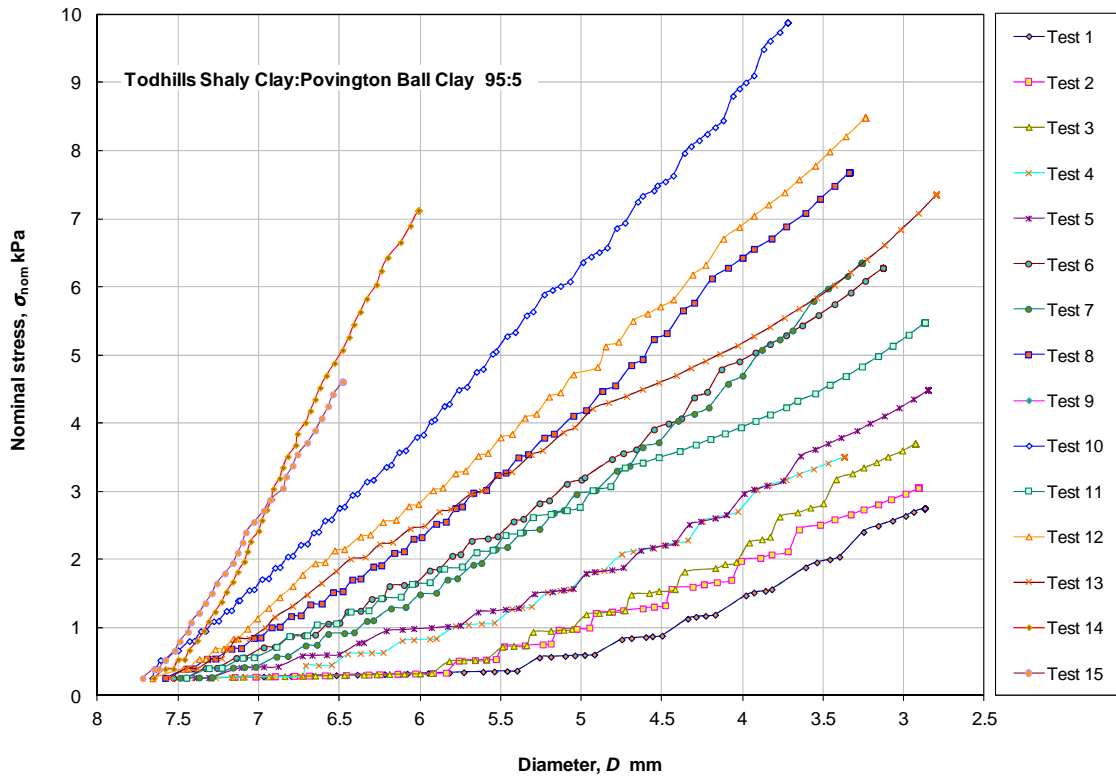

Figure A4.3 Stress – diameter for the Todhills Shaly Clay:Povington Ball Clay 95:5 mixture

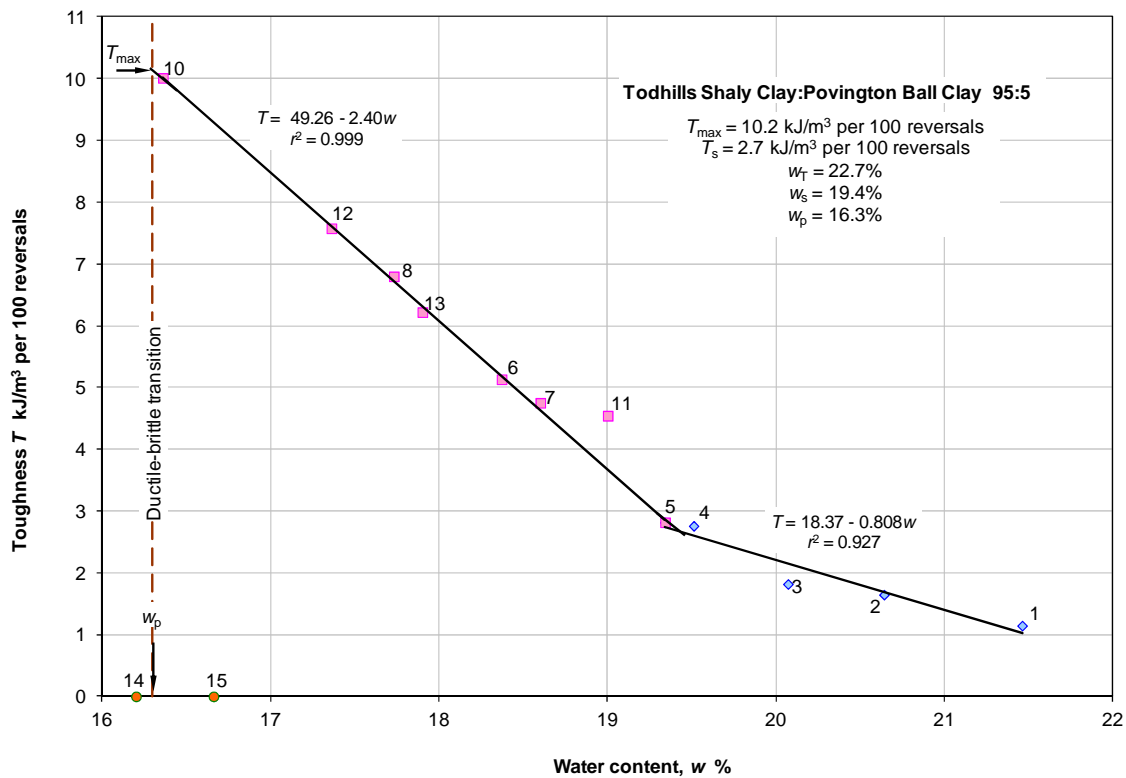

Figure A4.4 Toughness – water content for the Todhills Shaly Clay:Povington Ball Clay 95:5

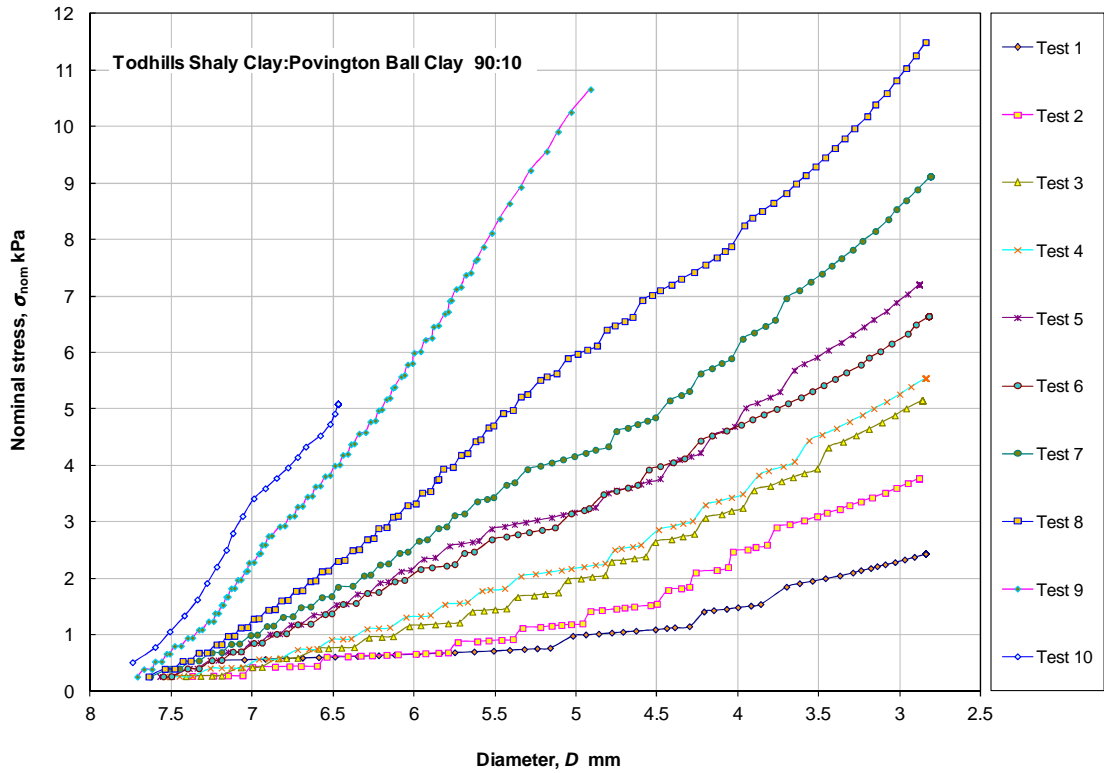

Figure A4.5 Stress – diameter for the Todhills Shaly Clay:Povington Ball Clay 90:10

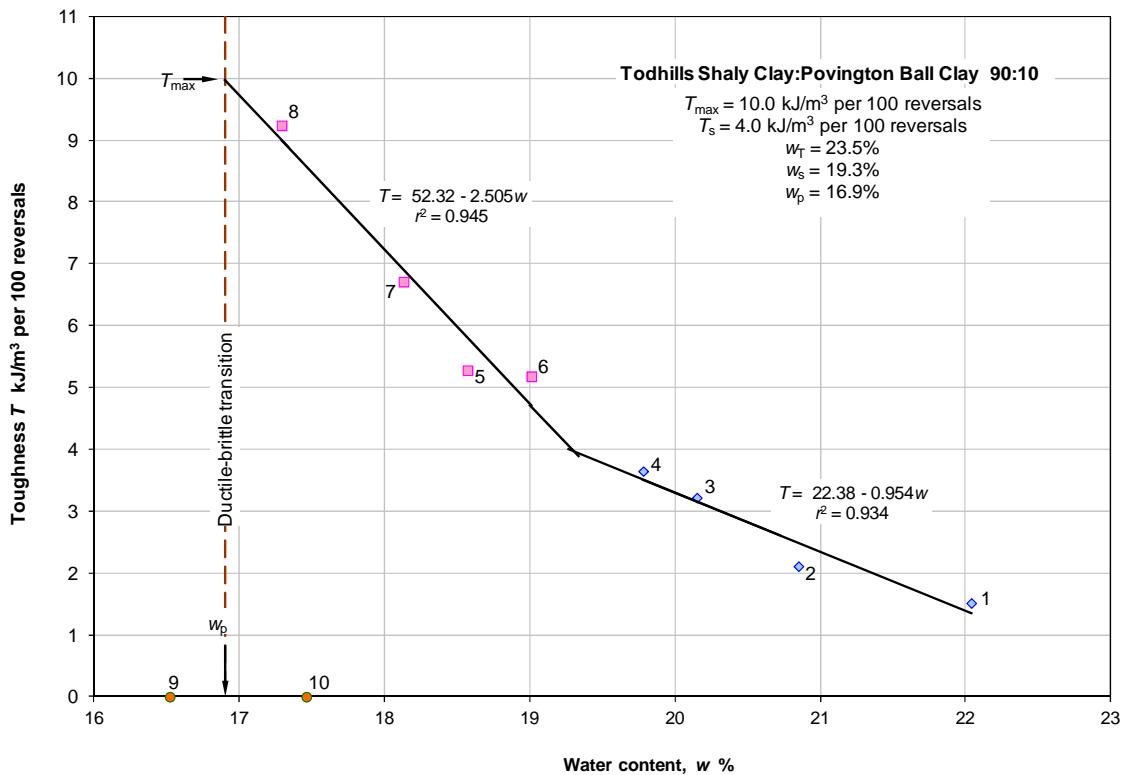

Figure A4.6 Toughness – water content for the Todhills Shaly Clay:Povington Ball Clay 90:10

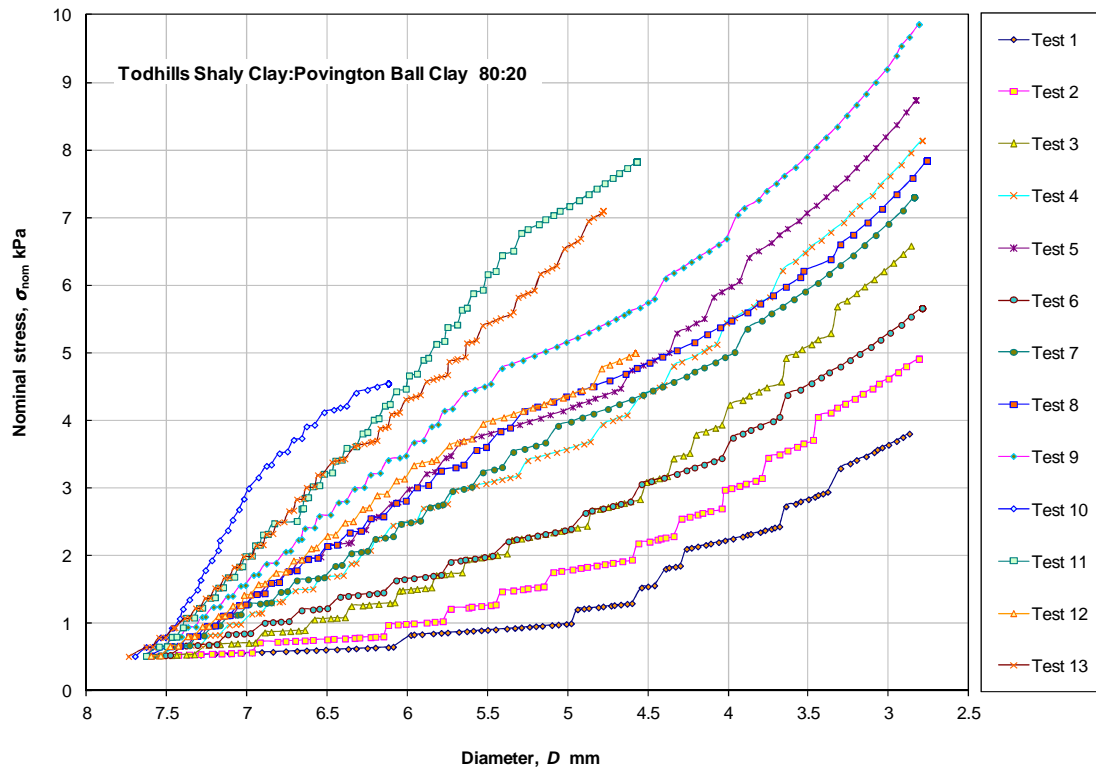

Figure A4.7 Stress – diameter for the Todhills Shaly Clay:Povington Ball Clay 80:20

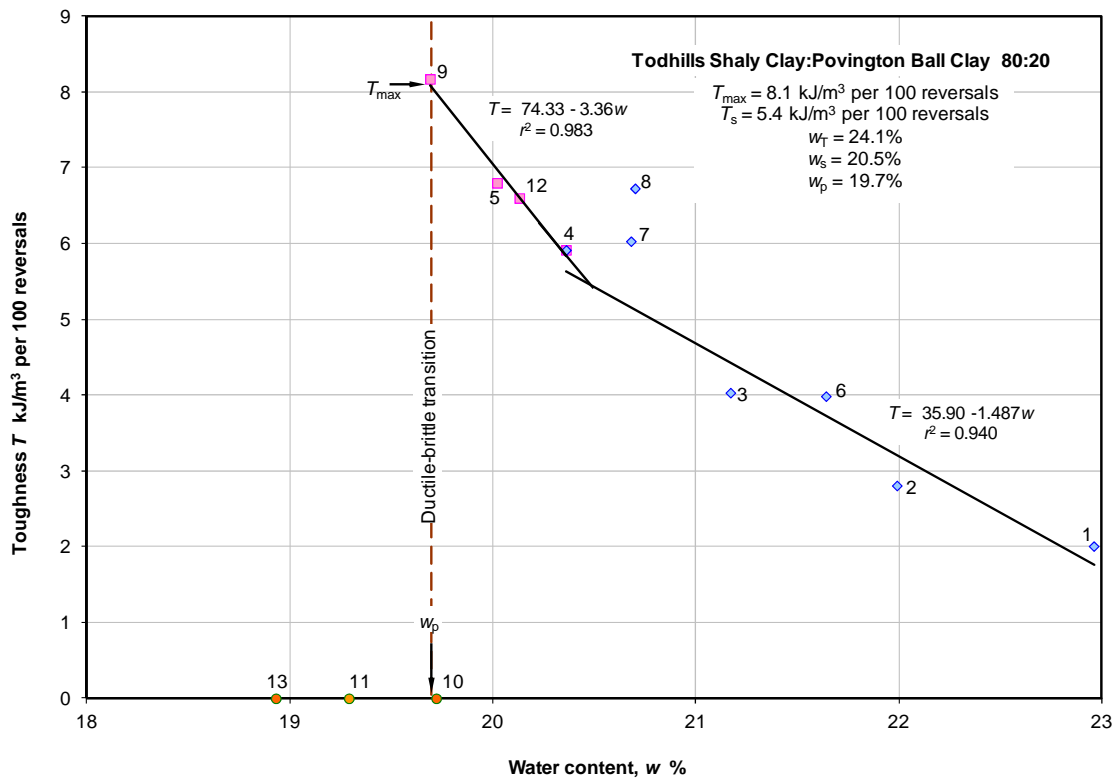

Figure A4.8 Toughness – water content for the Todhills Shaly Clay:Povington Ball Clay 80:20

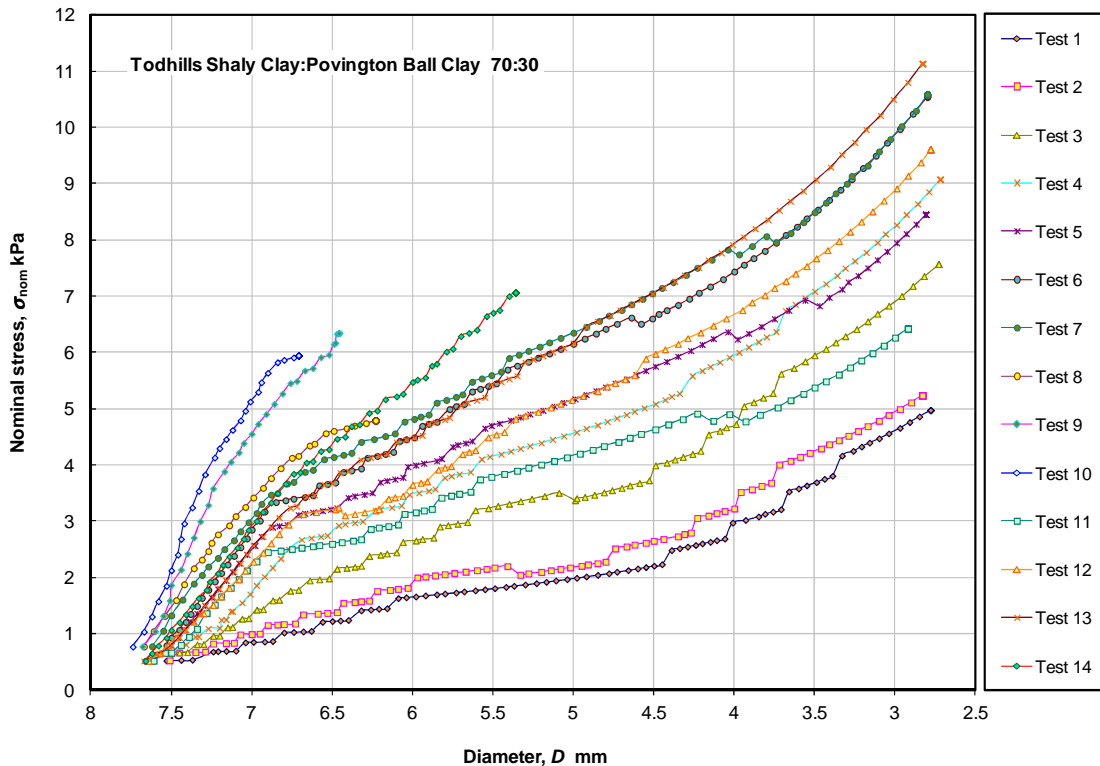

Figure A4.9 Stress – diameter for the Todhills Shaly Clay:Povington Ball Clay 70:30

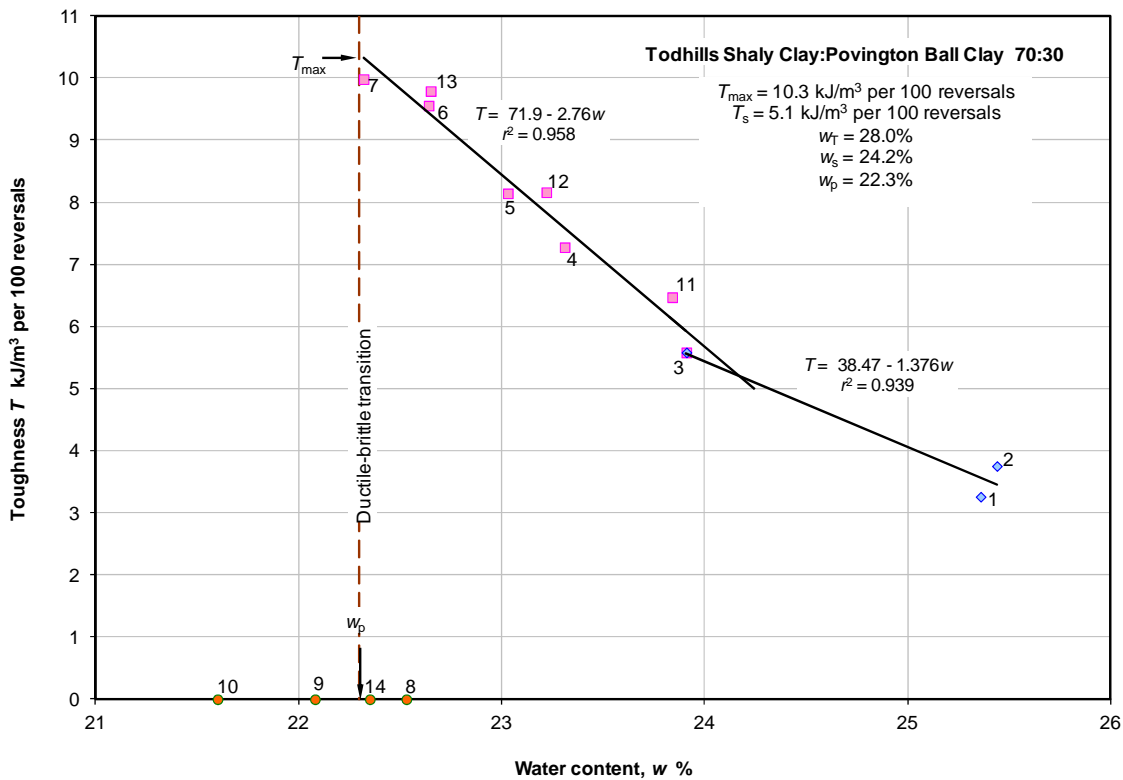

Figure A4.10 Toughness – water content for the Todhills Shaly Clay:Povington Ball Clay 70:30

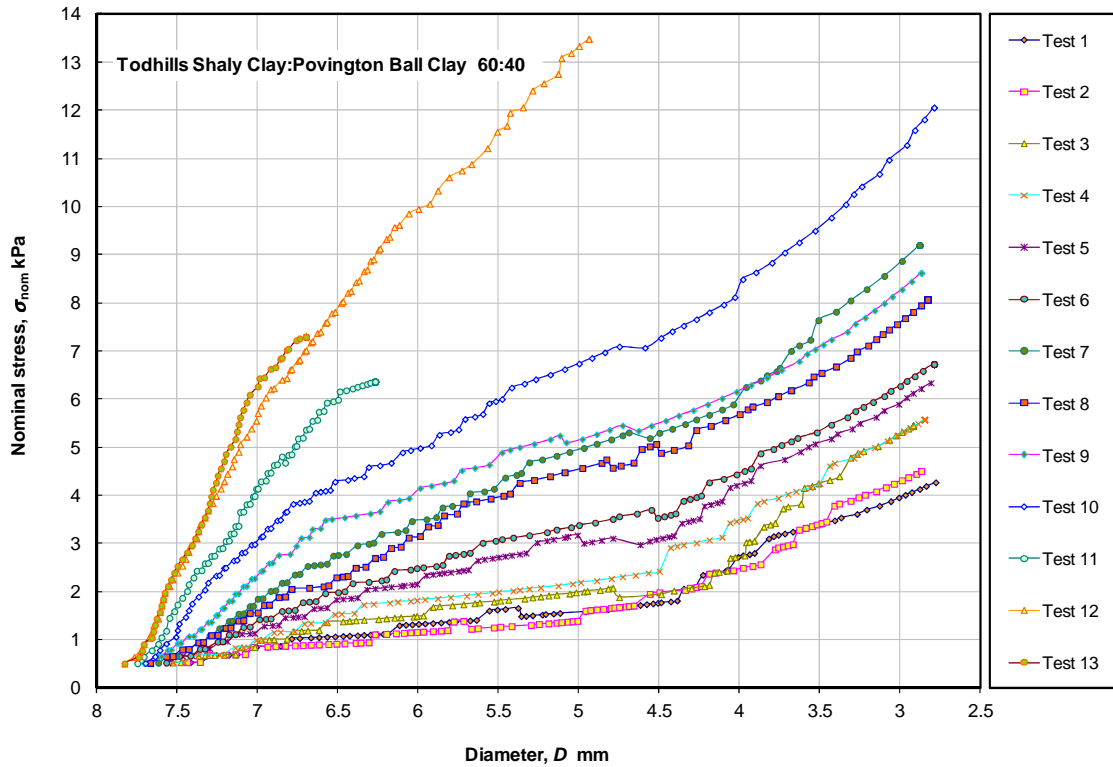

Figure A4.11 Stress – diameter for the Todhills Shaly Clay:Povington Ball Clay 60:40

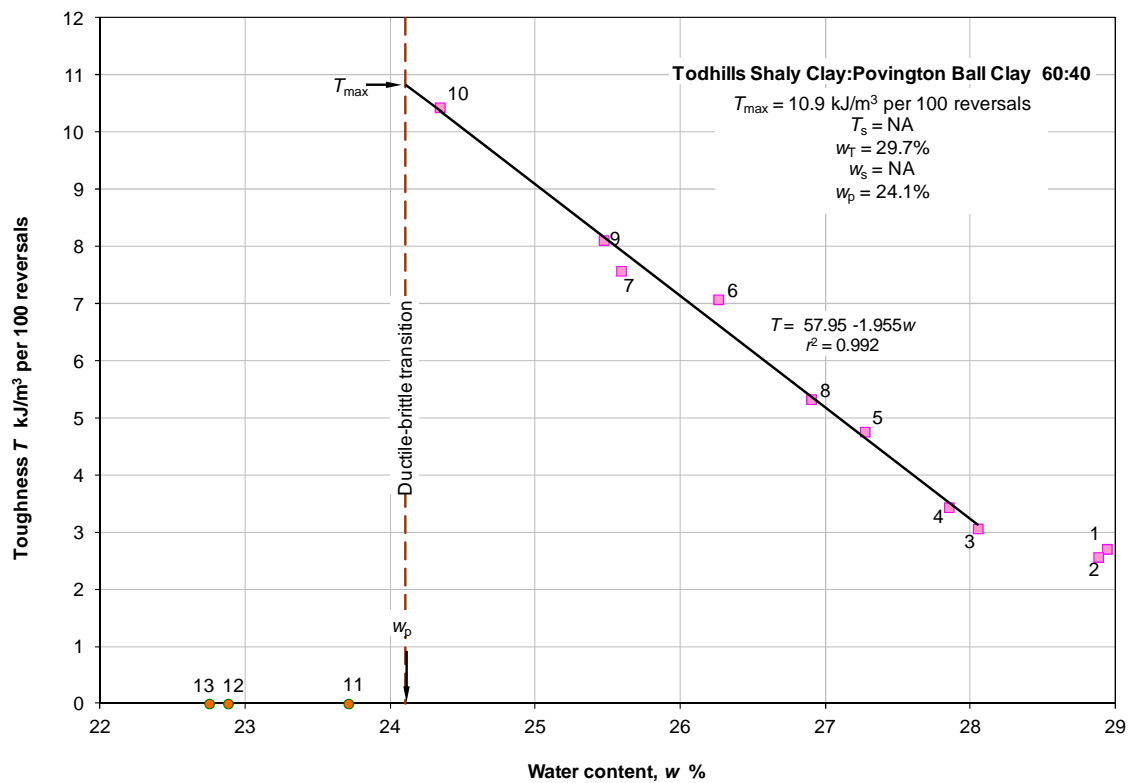

Figure A4.12 Toughness – water content for the Todhills Shaly Clay:Povington Ball Clay 60:40

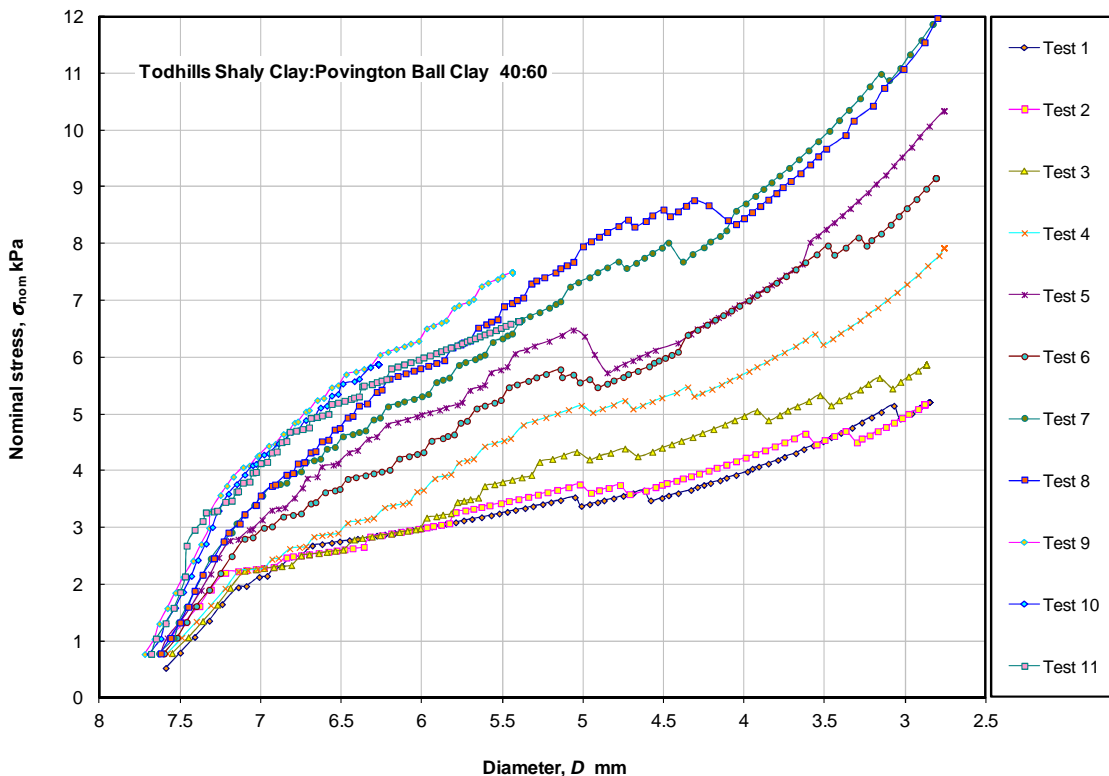

Figure A4.13 Stress – diameter for the Todhills Shaly Clay:Povington Ball Clay 40:60

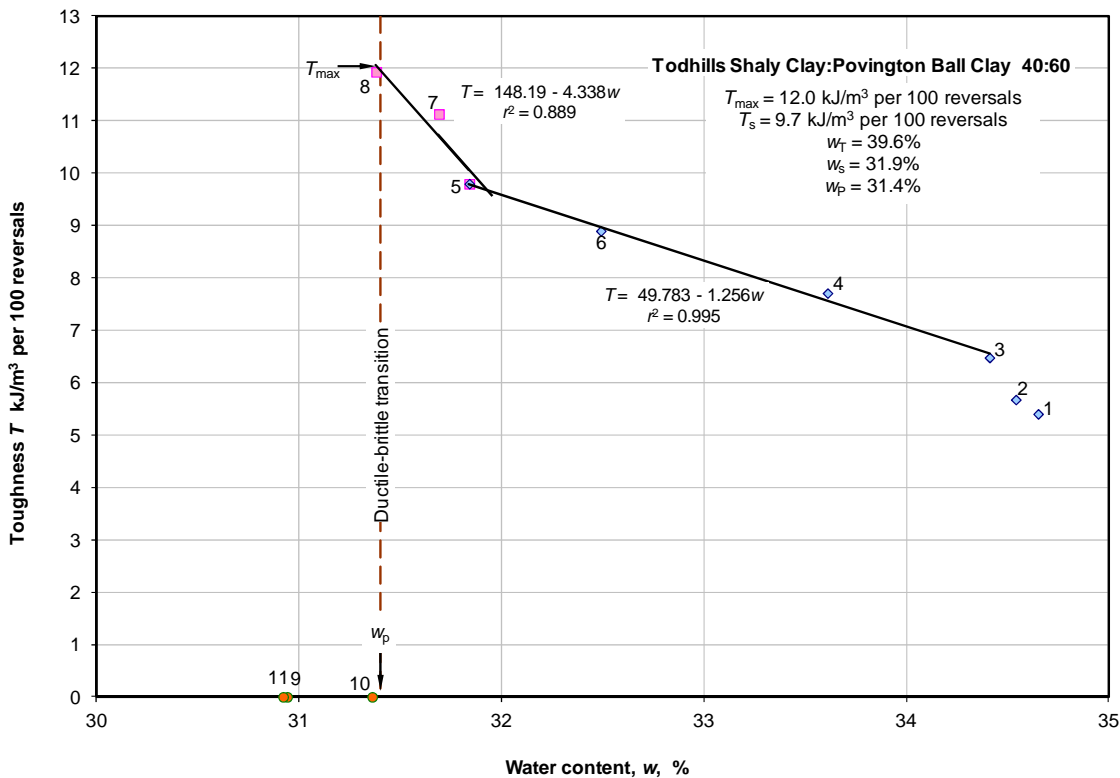

Figure A4.14 Toughness – water content for the Todhills Shaly Clay:Povington Ball Clay 40:60

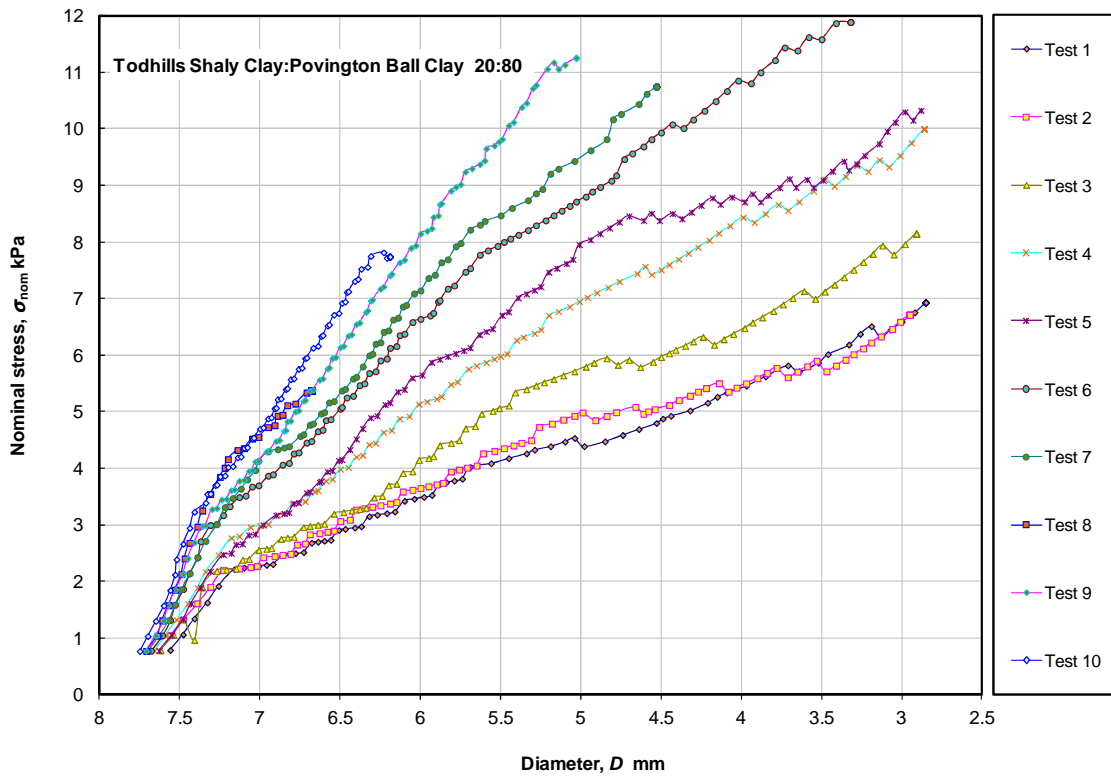

Figure A4.15 Stress – diameter for the Todhills Shaly Clay:Povington Ball Clay 20:80

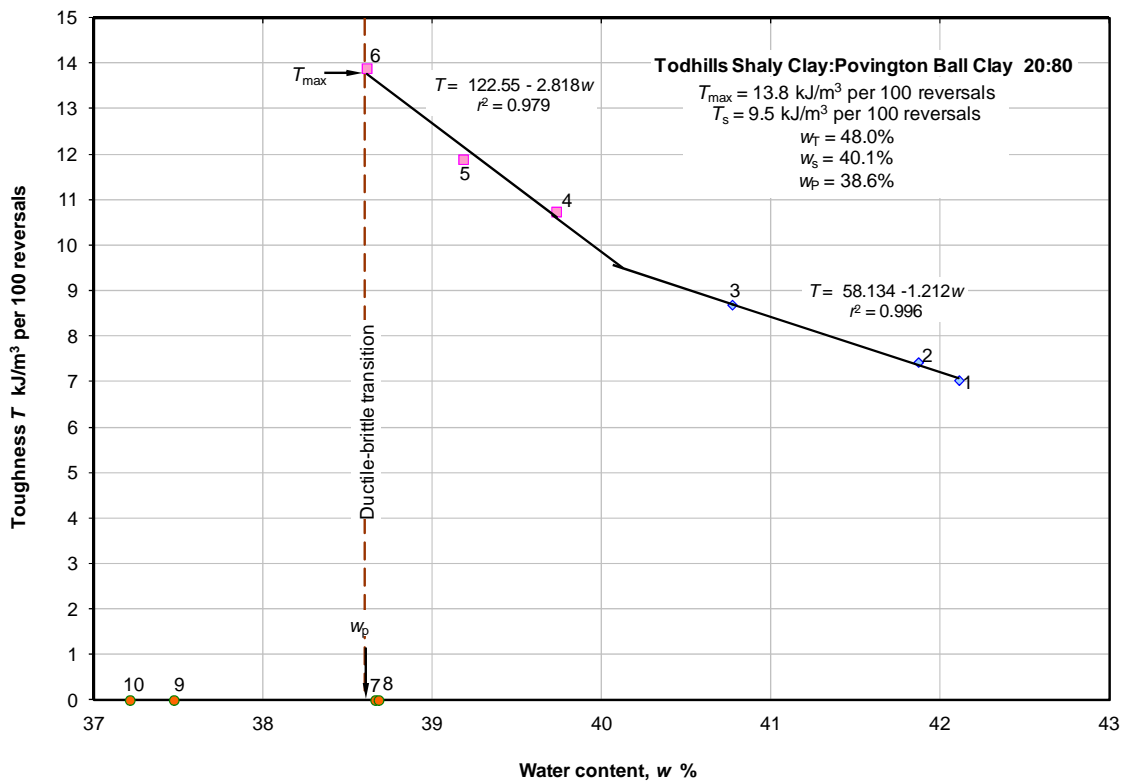

Figure A4.16 Toughness – water content for the Todhills Shaly Clay:Povington Ball Clay 20:80

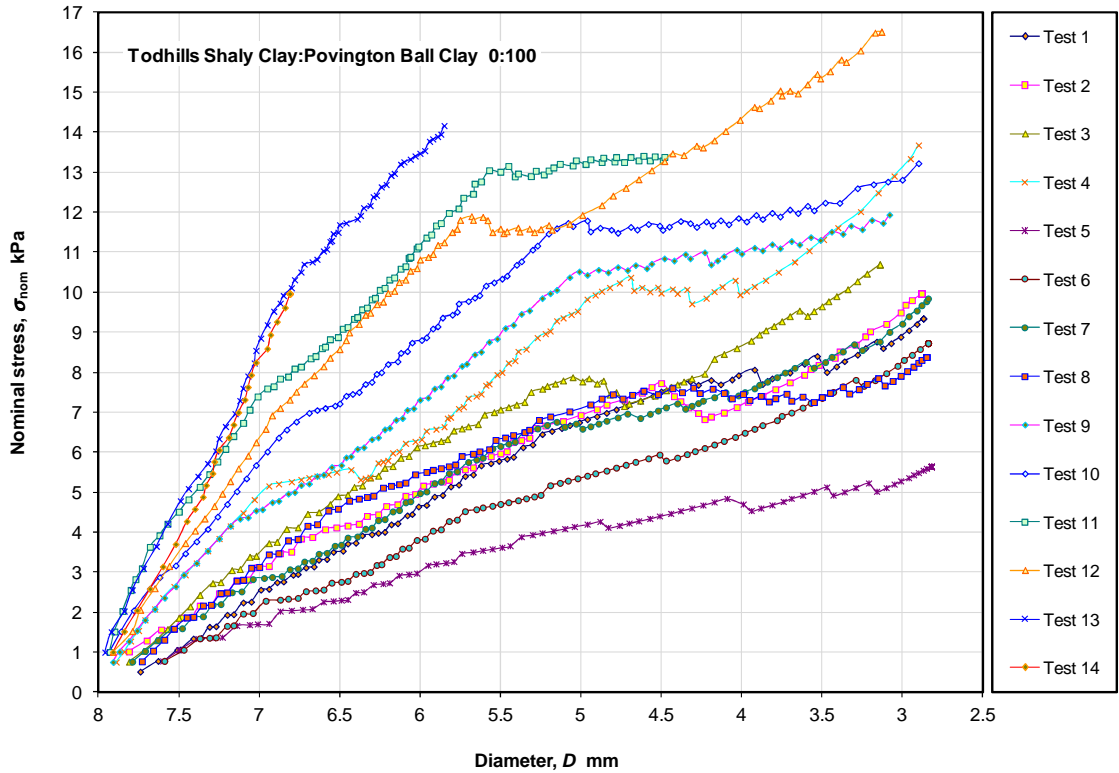

Figure A4.17 Stress – diameter for the Todhills Shaly Clay:Povington Ball Clay 0:100

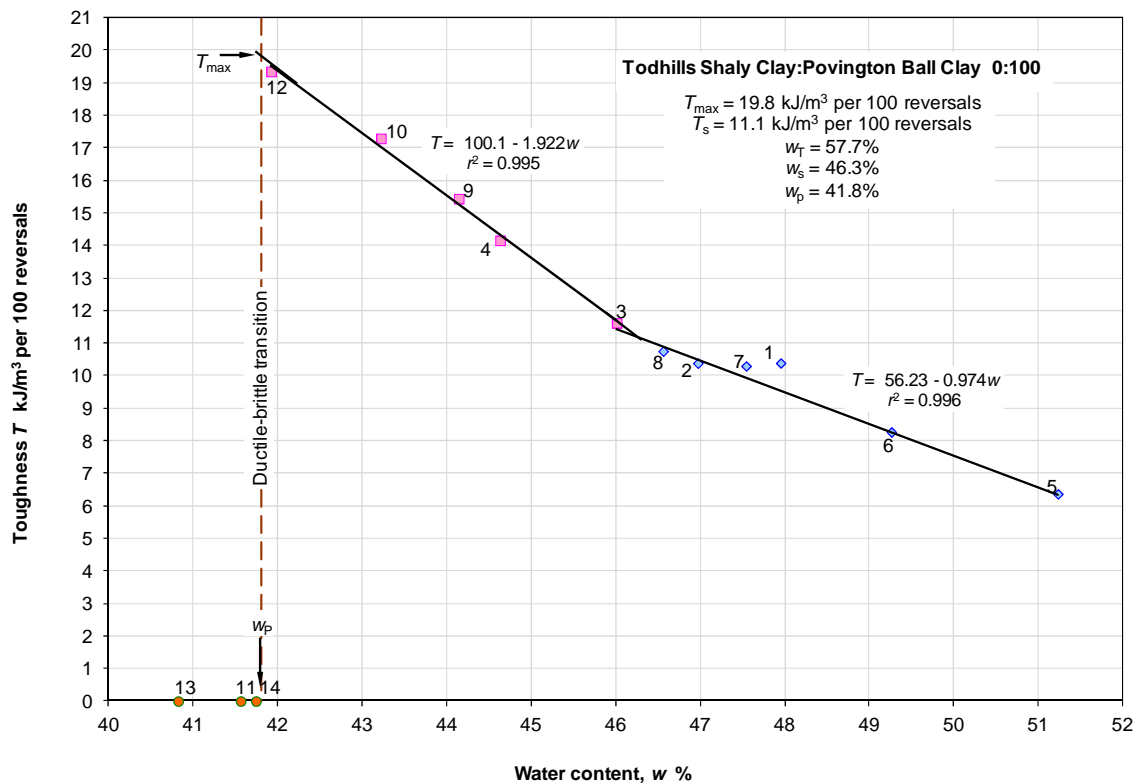

Figure A4.18 Toughness – water content for the Todhills Shaly Clay:Povington Ball Clay 0:100

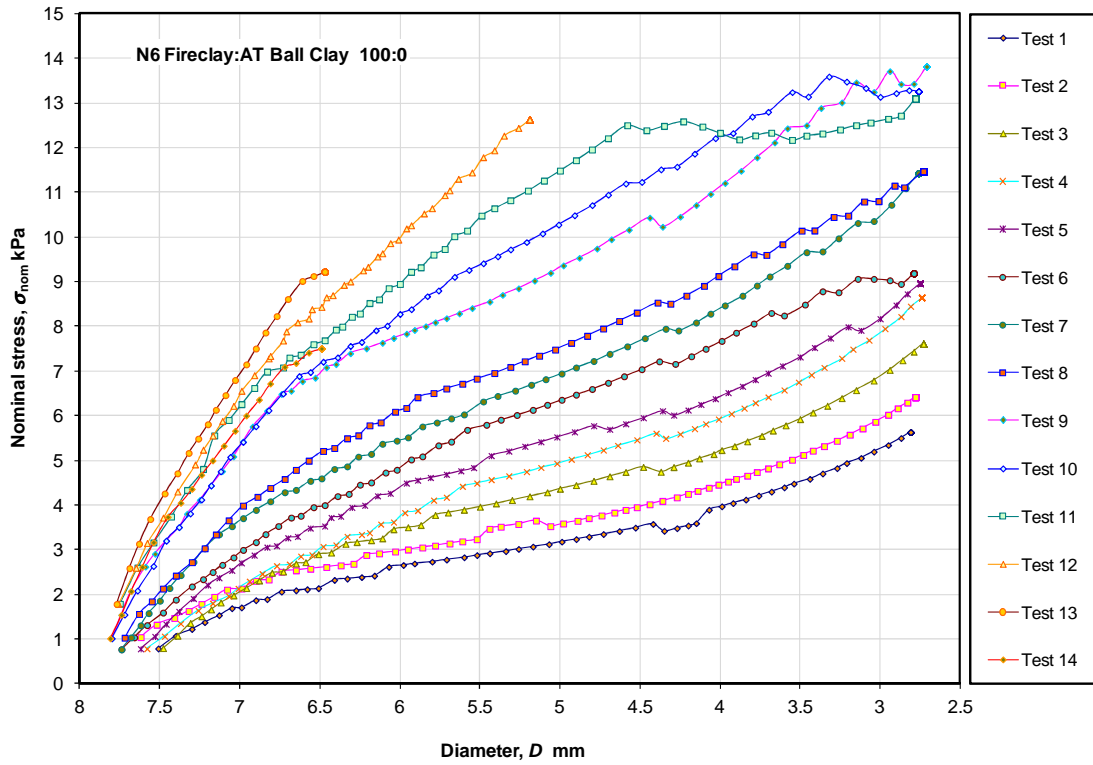

Figure A4.19 Stress – diameter for the N6 Fireclay:AT Ball Clay 100:0

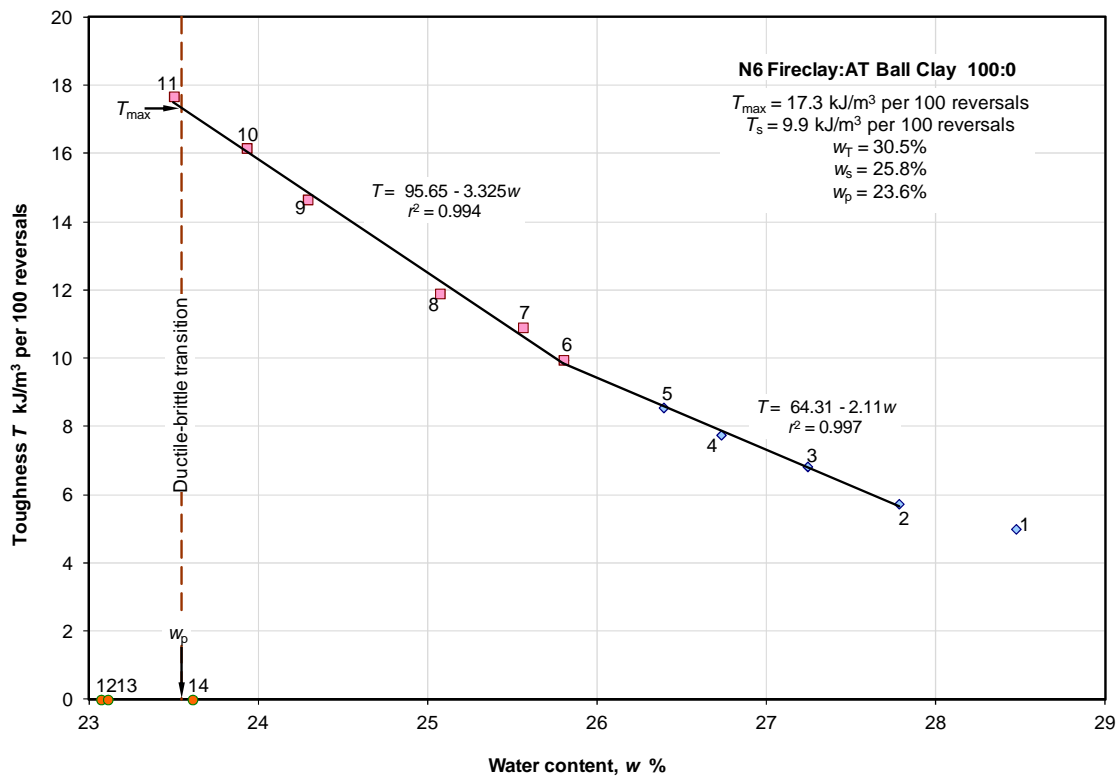

Figure A4.20 Toughness – water content for the N6 Fireclay:AT Ball Clay 100:0

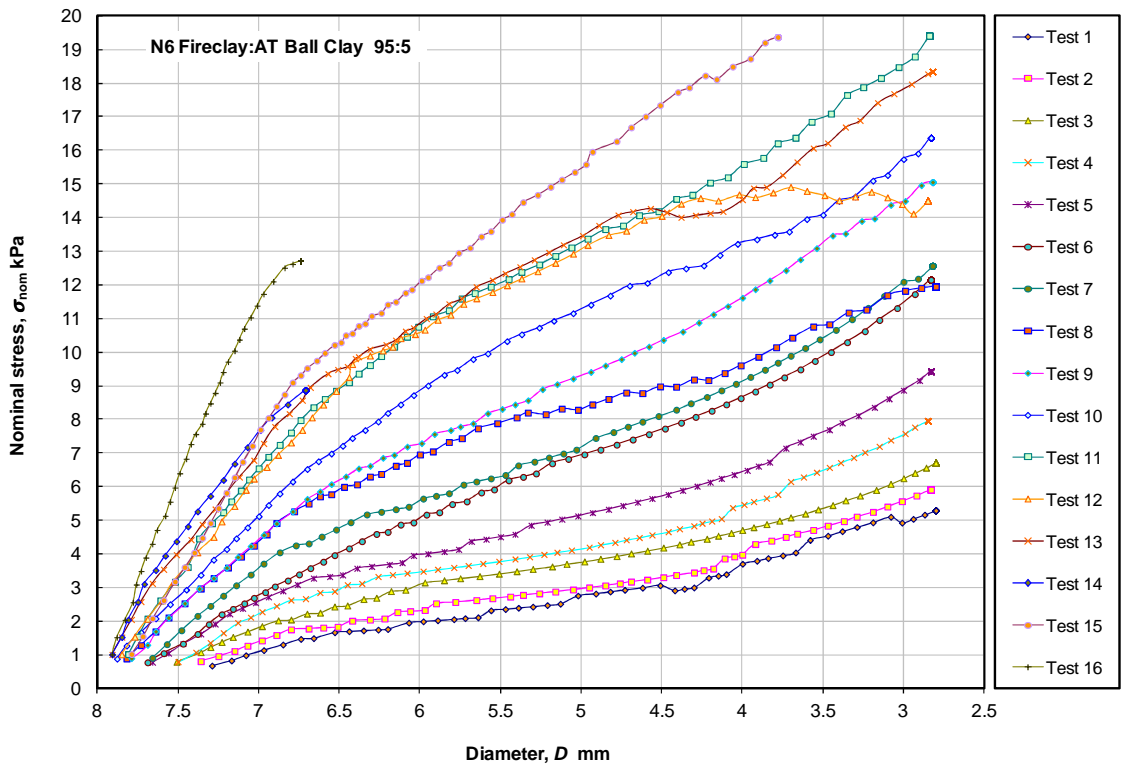

Figure A4.21 Stress – diameter for the N6 Fireclay:AT Ball Clay 95:5

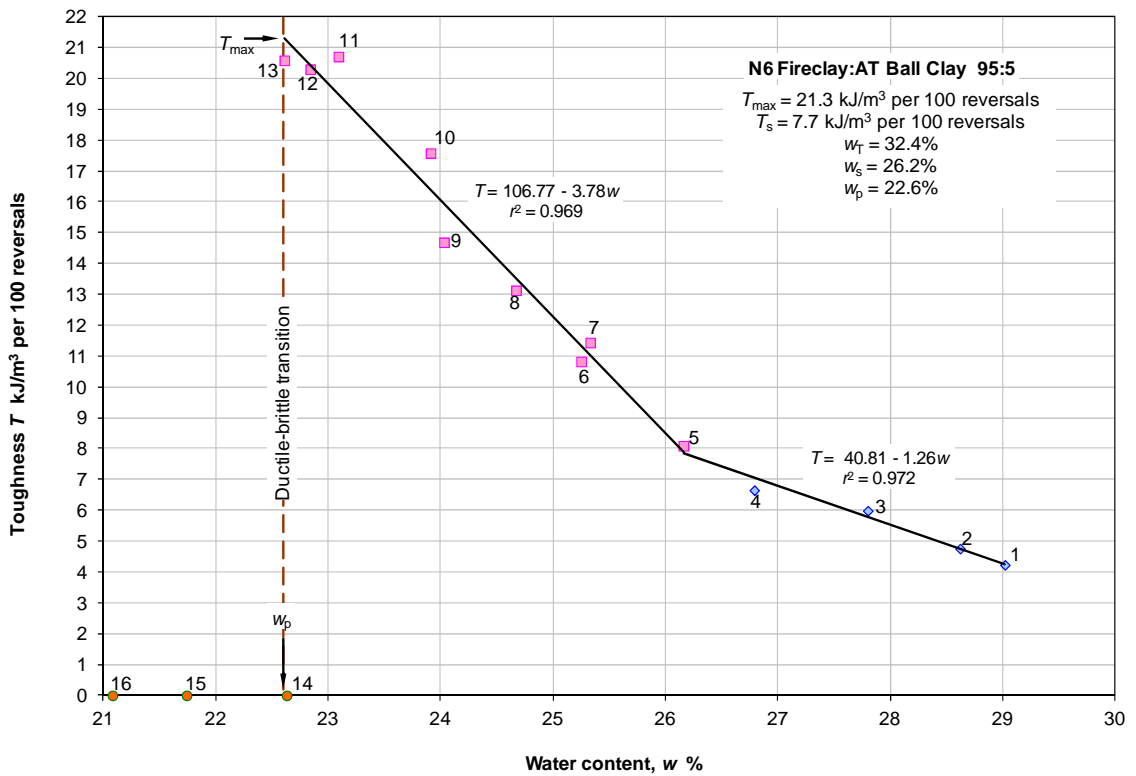

Figure A4.22 Toughness – water content for the N6 Fireclay:AT Ball Clay 95:5

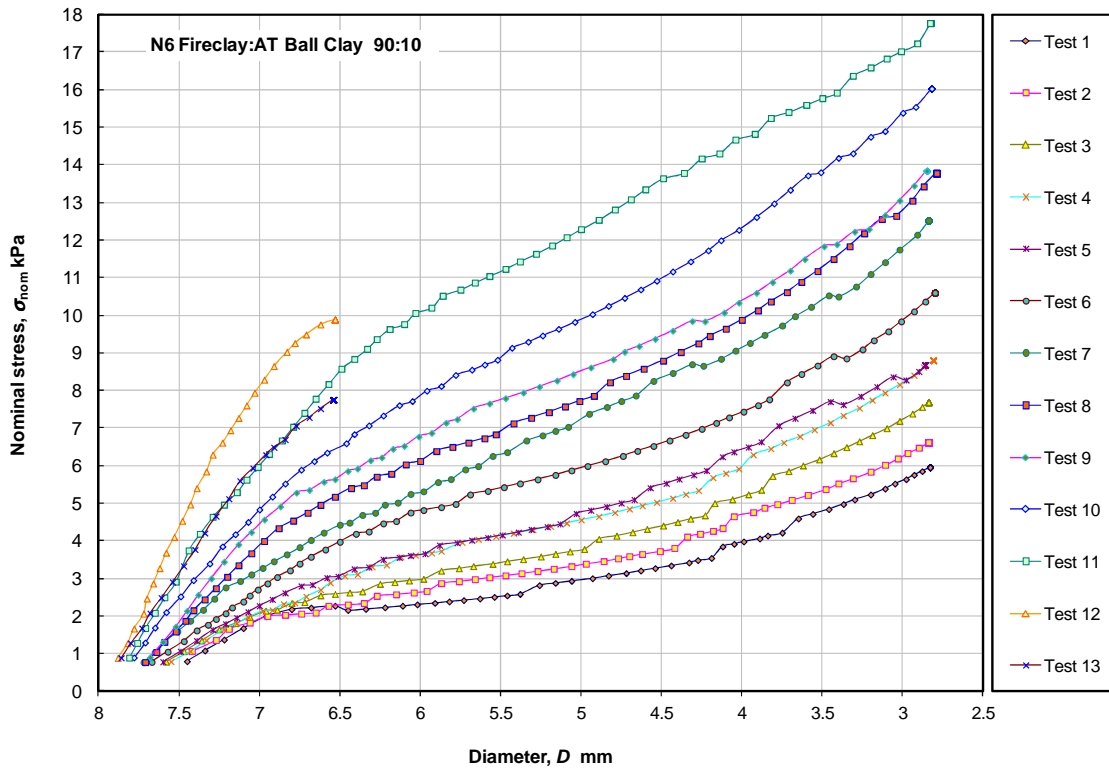

Figure A4.23 Stress – diameter for the N6 Fireclay:AT Ball Clay 90:10

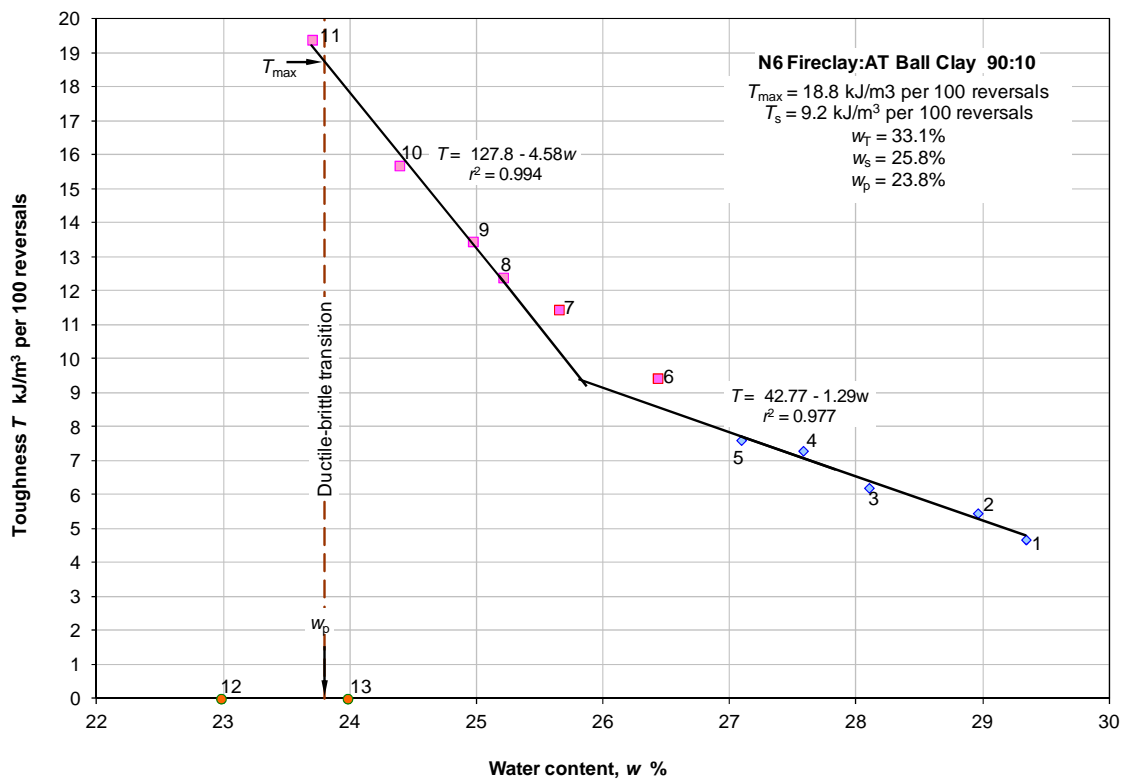

Figure A4.24 Toughness – water content for the N6 Fireclay:AT Ball Clay 90:10

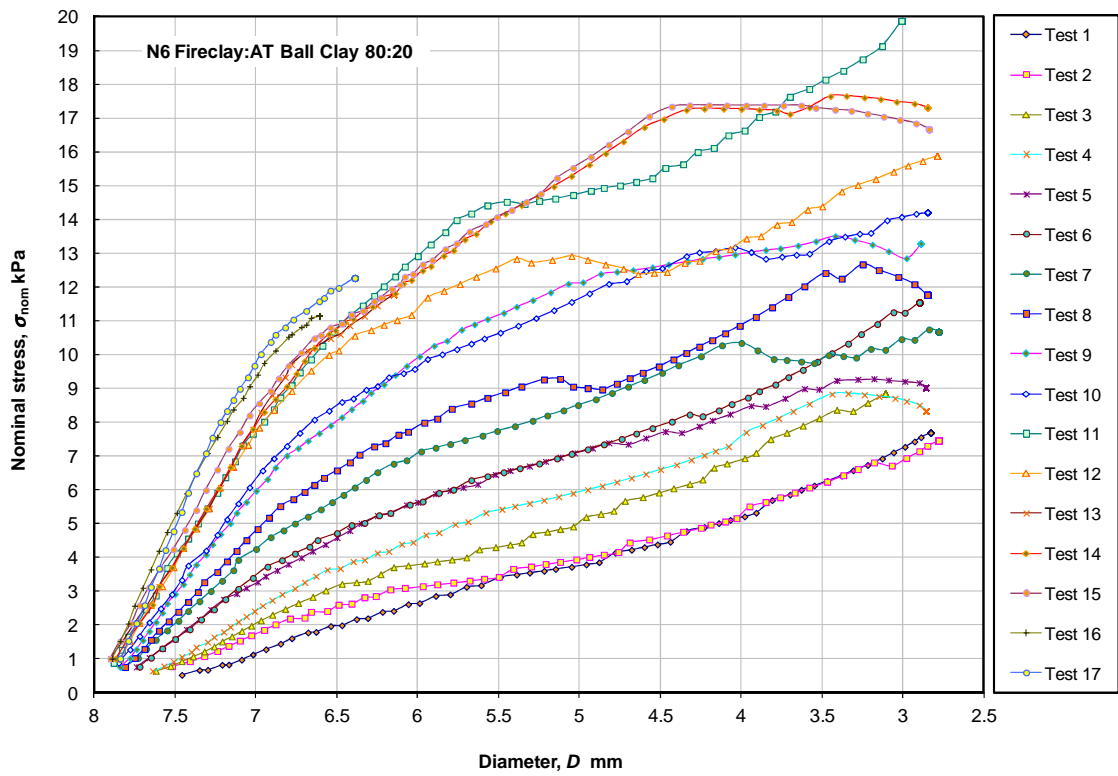

Figure A4.25 Stress – diameter for the N6 Fireclay:AT Ball Clay 80:20

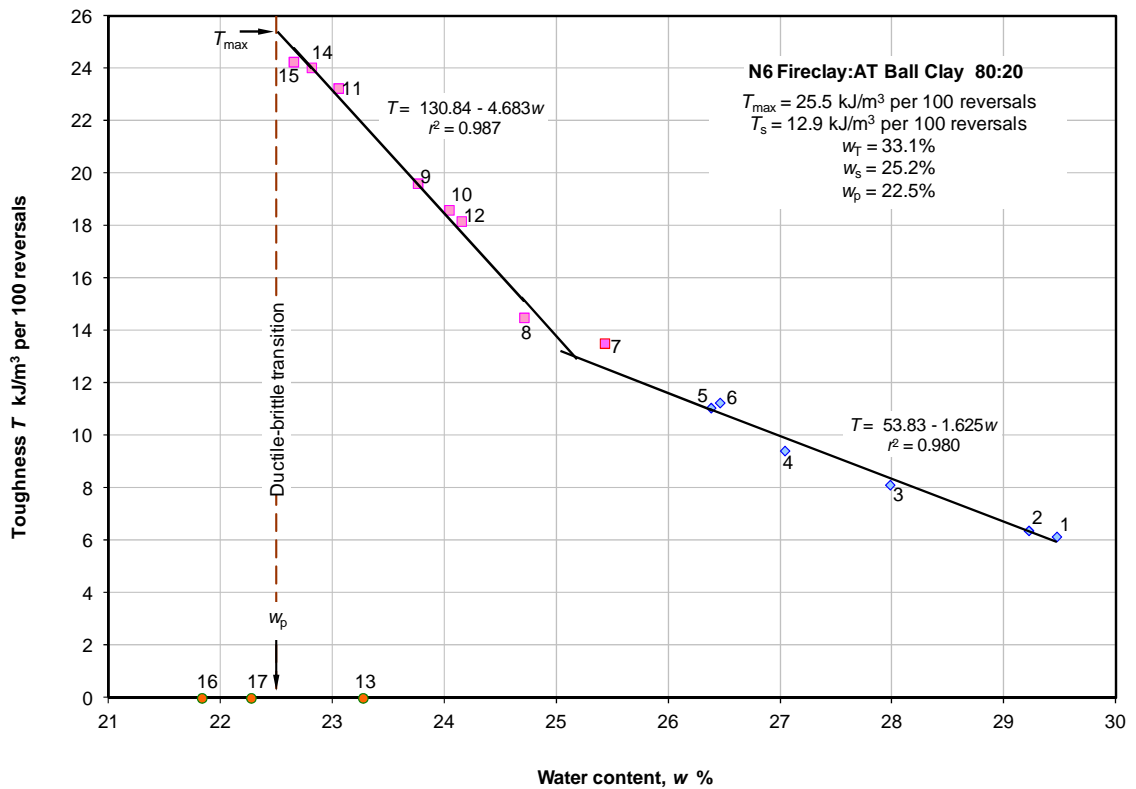

Figure A4.26 Toughness – water content for the N6 Fireclay:AT Ball Clay 80:20

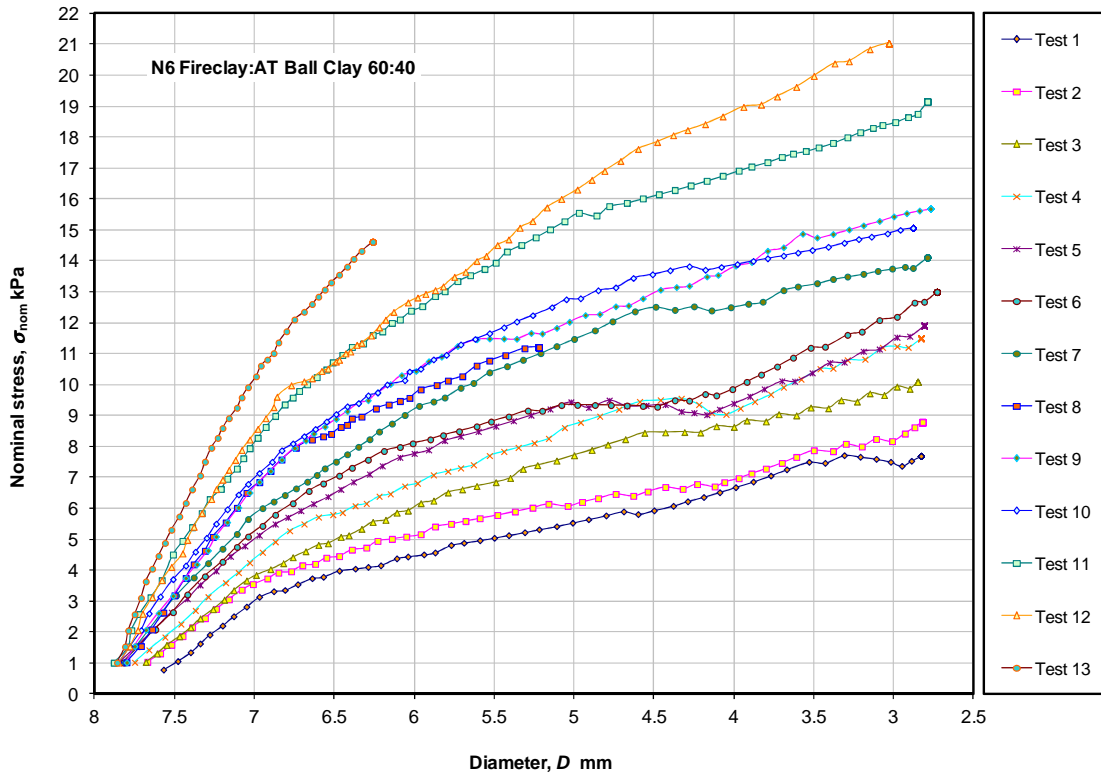

Figure A4.27 Stress – diameter for the N6 Fireclay:AT Ball Clay 60:40

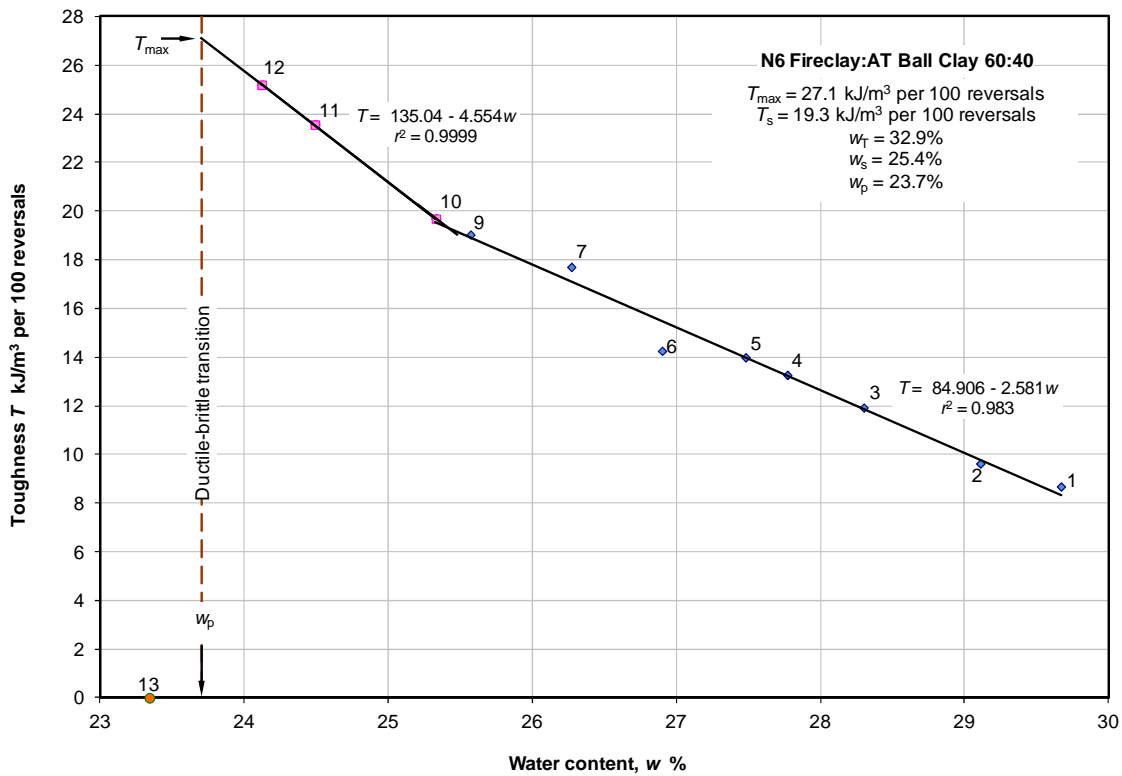

Figure A4.28 Toughness – water content for the N6 Fireclay:AT Ball Clay 60:40

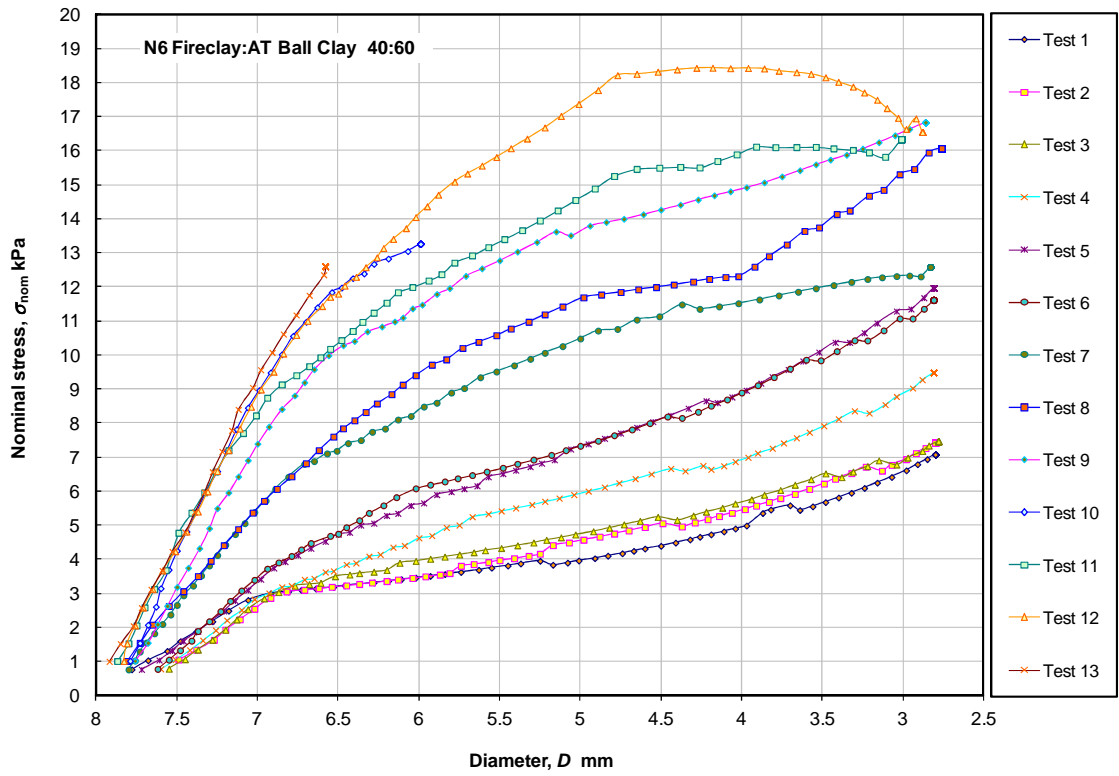

Figure A4.29 Stress – diameter for the N6 Fireclay:AT Ball Clay 40:60

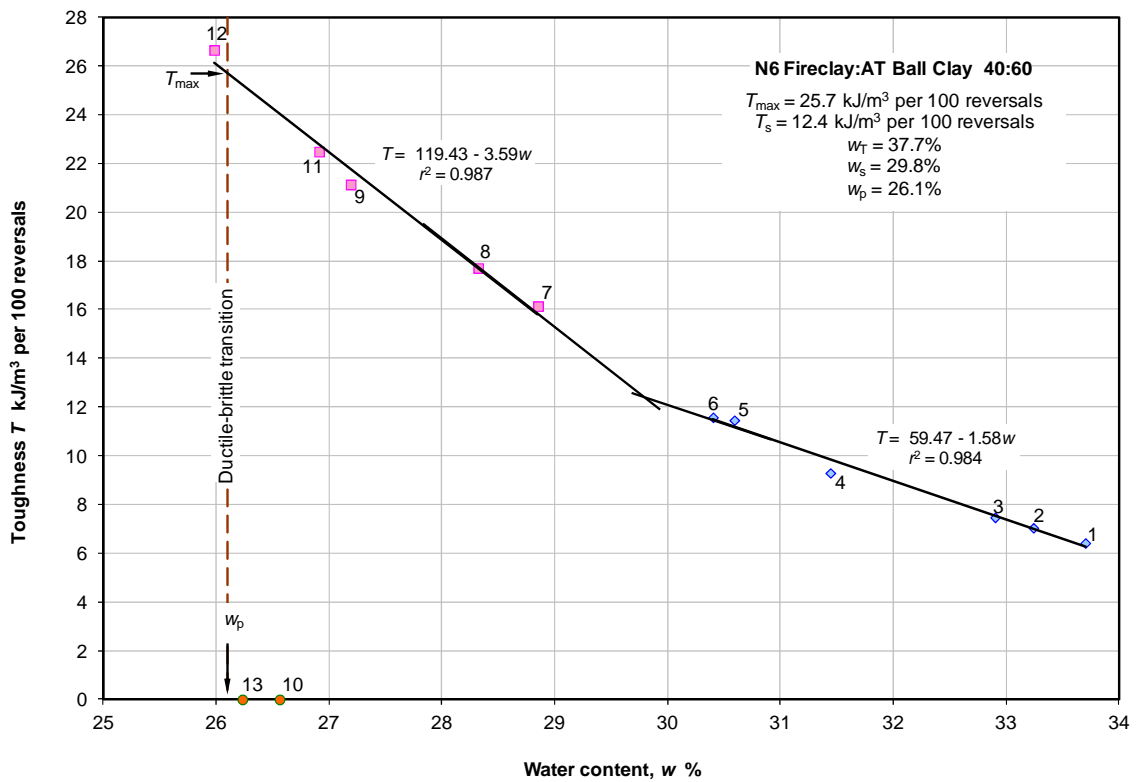

Figure A4.30 Toughness – water content for the N6 Fireclay:AT Ball Clay 40:60

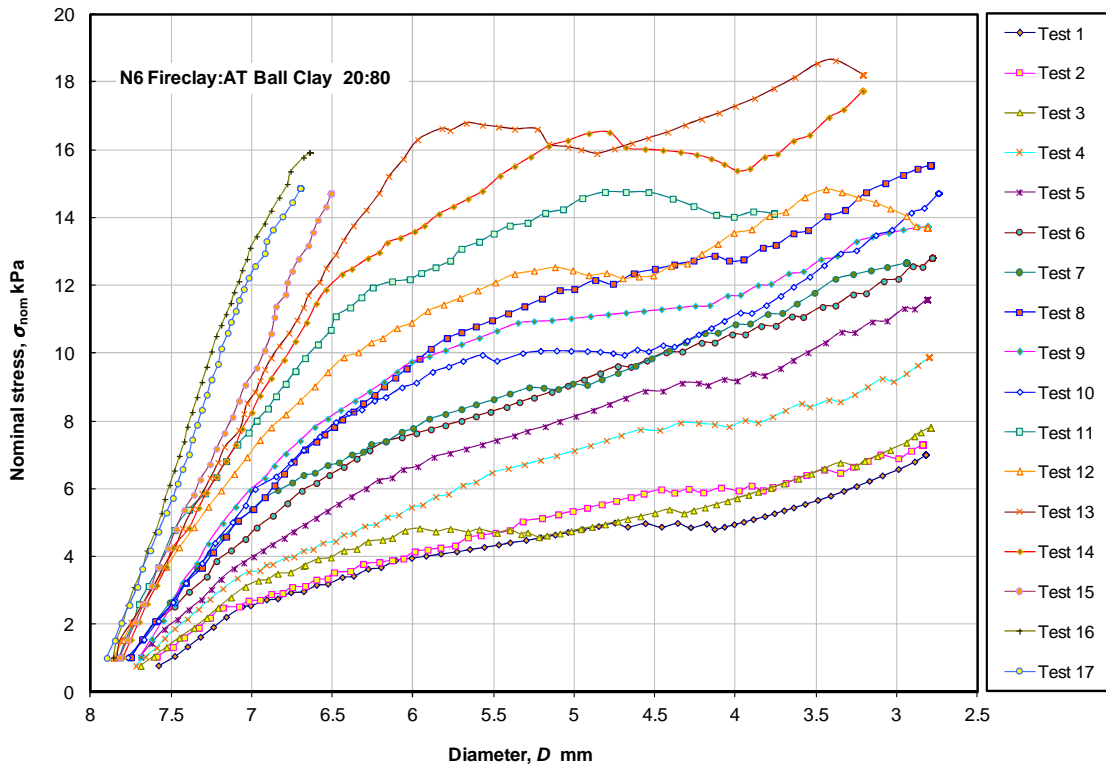

Figure A4.31 Stress – diameter for the N6 Fireclay:AT Ball Clay 20:80

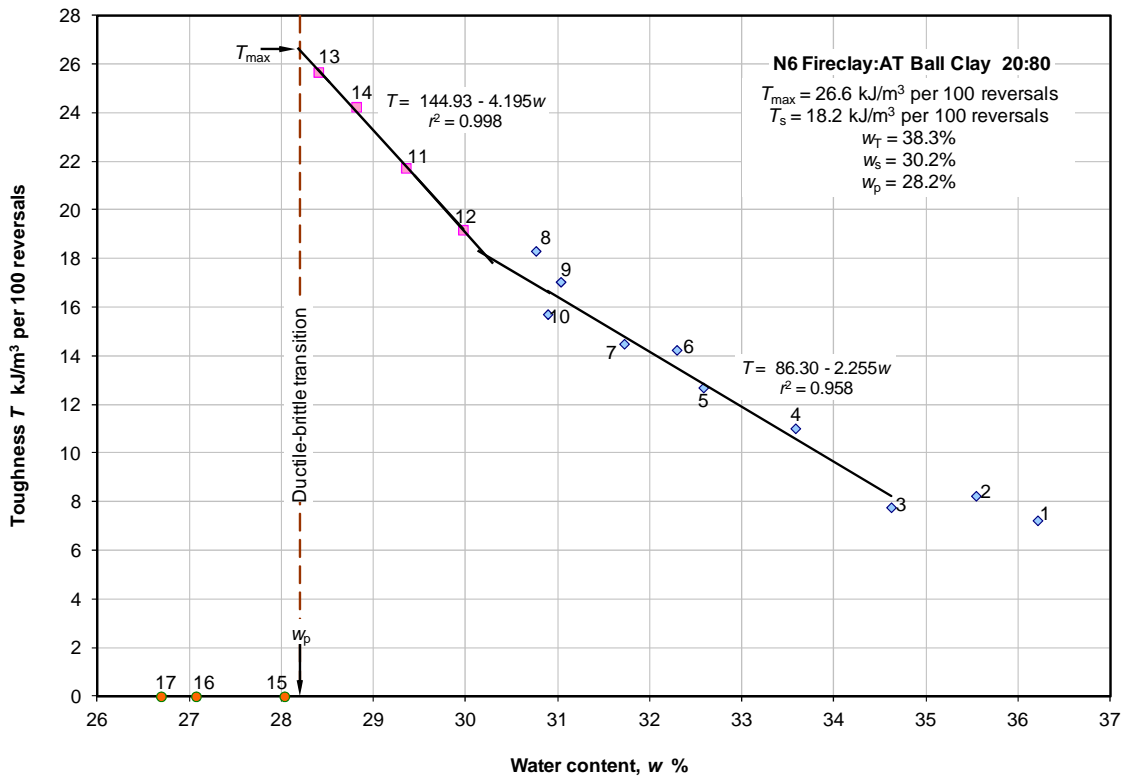

Figure A4.32 Toughness – water content for the N6 Fireclay:AT Ball Clay 20:80

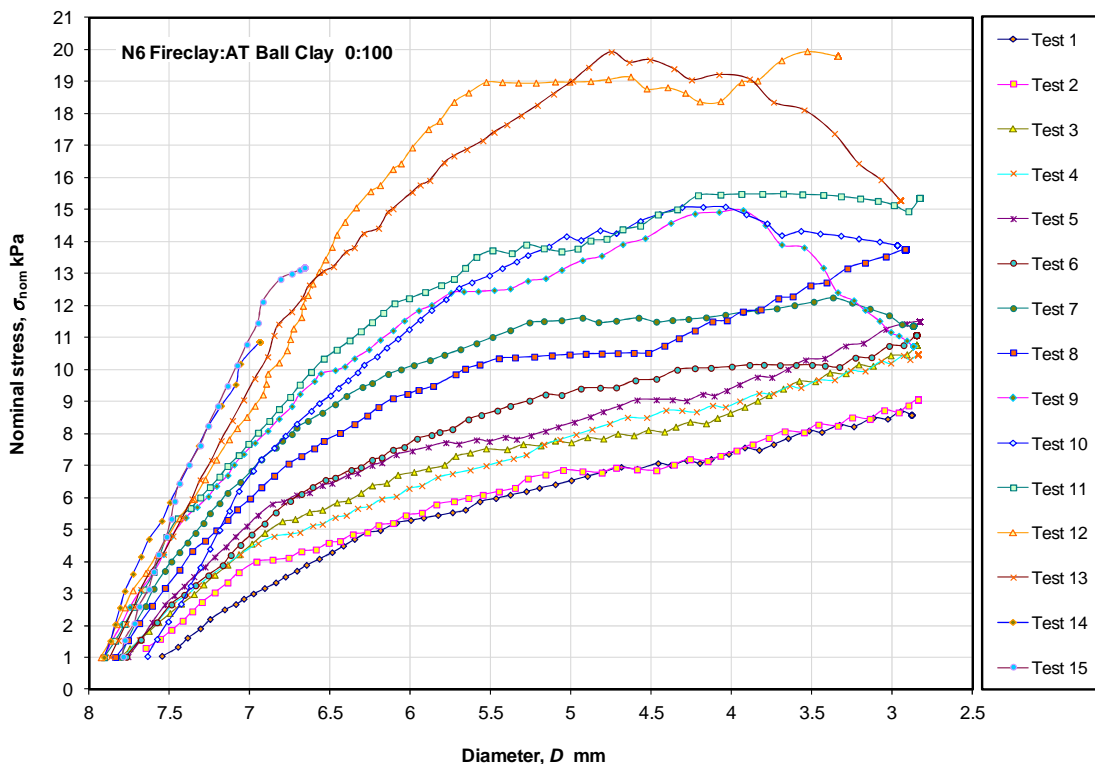

Figure A4.33 Stress – diameter for the N6 Fireclay:AT Ball Clay 0:100

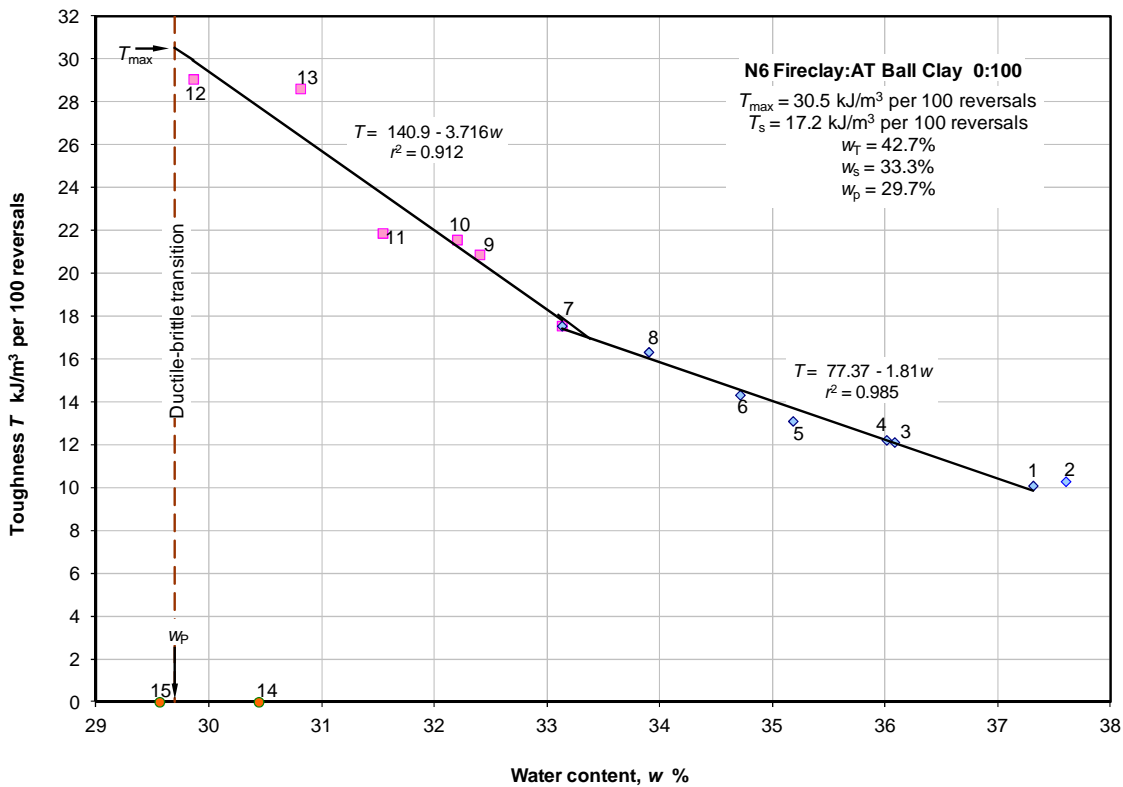

Figure A4.34 Toughness – water content for the N6 Fireclay:AT Ball Clay 0:100

Appendix 5

Derivation of the aggregation ratio

From Figure 7.8 the volumes and weights of the components of a clay soil as represented by the soil model are used to provide the derivation of the water content of the continuous matrix. The aggregation ratio is the ratio of the volume of aggregated matrix to the total matrix:

$$\text{Aggregation ratio } a = \frac{V_{ca} + V_{wa}}{V_{ca} + V_{wa} + V_{cc} + V_{wc}} \quad \text{A5.1}$$

The water content of the continuous matrix is given by

$$w_c = \frac{W_{wc}}{W_{cc}} = \frac{V_{wc} \rho_w}{V_{cc} \rho_c} \quad \text{A5.2}$$

and of the aggregated matrix by

$$w_a = \frac{W_{wa}}{W_{ca}} = \frac{V_{wa} \rho_w}{V_{ca} \rho_c} \quad \text{A5.3}$$

All water contents in these equations are ratios. From equations A1.1, 2 and 3 the aggregation ratio can be determined in terms of the ratio

$$\frac{V_{ca}}{V_{cc}} \quad \text{A5.4}$$

as

$$a = \frac{\frac{V_{ca}}{V_{cc}} + w_a \frac{V_{ca} \rho_c}{V_{cc} \rho_w}}{1 + \frac{V_{ca}}{V_{cc}} + w_a \frac{V_{ca} \rho_c}{V_{cc} \rho_w} + w_c \frac{\rho_c}{\rho_w}} \quad \text{A5.5}$$

The matrix water content of the clay soil can be derived from the total water content and the clay content. It is given by

$$w_m = \frac{V_{wa} \rho_w + V_{wc} \rho_w}{V_{ca} \rho_c + V_{cc} \rho_c} \quad \text{A5.6}$$

To separate the matrix water content into the two components the ratio $\frac{V_{ca}}{V_{cc}}$ can be derived from equation A1.6 as

$$\frac{V_{ca}}{V_{cc}} = \frac{w_c - w_m}{w_m - w_a} \quad \text{A5.7}$$

Inserting equation A1.7 into equation A1.5 and rearranging gives the aggregation ratio in terms of the three water contents, the continuous matrix, the aggregated matrix and the overall matrix.

$$a = \frac{(w_c - w_m) \left(1 + w_a \frac{\rho_c}{\rho_w}\right)}{(w_c - w_a) \left(1 + w_m \frac{\rho_c}{\rho_w}\right)} \quad \text{A5.8}$$

Rearranging again gives continuous matrix water content as

$$w_c = \frac{w_m - aw_a + (1-a)w_a w_m \frac{\rho_c}{\rho_w}}{1 - a - \frac{\rho_c}{\rho_w} (aw_m - w_a)} \quad \text{A5.9}$$

Appendix 6

Effect of large granular particles in a small diameter thread

For a near triangular grouping of granular particles in a matrix of smaller particles the circular cross section of the soil thread can be split into concentric cylinders each with a width d_{cR} , the distance centre to centre between the granular particles on the diameter of the circle, as shown in Figure 7.12a. The granular particles can then be arranged in a circle in the middle of each cylinder by placing them equidistant d_{cR} apart, as shown in Figure 7.12a. The diameter of the central core of the thread is d_{cR} containing one granular particle.

To determine the number of particles in each cylinder, starting with cylinder 1 in Figure 7.12a the particles lie on an equilateral triangle of side d_{cR} , with an included angle α_1 given by

$$\sin\left(\frac{1}{2}\alpha_1\right) = \frac{d_c}{2} \frac{1}{d_c} = \frac{1}{2} \quad \therefore \alpha_1 = 2\sin^{-1}\left(\frac{1}{2}\right). \quad \text{A6.1}$$

For cylinder 2 the triangle has sides of $2d_{cR}$ and d_{cR} with the included angle α_2 given by

$$\sin\left(\frac{1}{2}\alpha_2\right) = \frac{d_c}{2} \frac{1}{2d_c} \quad \text{or generally} \quad \sin\left(\frac{1}{2}\alpha_n\right) = \frac{d_c}{2} \frac{1}{nd_c} . \quad \text{A6.2}$$

$$\therefore \alpha_2 = 2\sin^{-1}\left(\frac{1}{2 \times 2}\right) \quad \text{or generally} \quad \alpha_n = 2\sin^{-1}\left(\frac{1}{2n}\right) \quad \text{A6.3}$$

where n is the cylinder number, 1, 2, 3, etc.

The particles are evenly spread at angles α_n around the centre of each cylinder and this will give the number of particles N_p in each cylinder. For cylinder 1 the number of particles is given by

$$N_{p1} = \frac{360}{\alpha_1} \quad \text{or generally for the } n^{\text{th}} \text{ cylinder} \quad N_{pn} = \frac{360}{\alpha_n} . \quad \text{A6.4}$$

As there cannot be a 'part' particle in a cylinder the actual number of particles is truncated in the calculations to $\text{TRUNC}N_{pn}$ to obtain a whole number of particles.

Figure 7.12b shows 'slices' of the thread containing columns of granular particles. There will be a number of these slices spaced evenly along the length of the thread a distance a apart. To provide a near triangular arrangement of the granular particles along the length of the thread if each slice is rotated slightly relative to its neighbours and then viewed from above the particles will have the arrangement shown in Figure 7.12c with the particles d_{cR} apart in each cylinder and d_{cL} apart along the length of the thread. Then

$$a^2 = d_{cL}^2 - \frac{d_{cR}^2}{4} \quad \text{and} \quad a = \sqrt{d_{cL}^2 - \frac{d_{cR}^2}{4}}. \quad \text{A6.5}$$

Initially with the soil thread as prepared in the thread maker by static compaction at the diameter of about 8 mm the spacing will be assumed to be the same in all directions so that $d_{cR0} = d_{cL0}$ and the initial value of a is given by

$$a_0 = \frac{\sqrt{3}}{2} d_{cR0}. \quad \text{A6.6}$$

To obtain a value of d_{cR0} a unit volume of a 'cell' is considered around one granular particle in a cylinder as shown in Figure 7.12d. For cylinder number n the internal diameter = $d_{cR0} (2n - 1)$ and the external diameter = $d_{cR0} (2n + 1)$.

The volume of the cell is then given by

$$V_{\text{cell}} = \left[\frac{\pi}{4} d_{cR0}^2 (2n + 1)^2 - \frac{\pi}{4} d_{cR0}^2 (2n - 1)^2 \right] \frac{\sqrt{3}}{2} \frac{d_{cR0}}{N_p}. \quad \text{A6.7}$$

The volume of the granular particle of diameter d_g is given by

$$V_g = \frac{\pi}{6} d_g^3. \quad \text{A6.8}$$

The granular void ratio is given by

$$e_g = \frac{V_{\text{cell}} - V_g}{V_g} = \frac{V_{\text{cell}}}{V_g} - 1, \quad \text{A6.9}$$

$$e_g = \frac{\frac{\pi \sqrt{3}}{4} \frac{d_{cRO}^3}{2 N_p} [(2n+1)^2 - (2n-1)^2]}{\frac{\pi}{6} d_g^3} - 1, \quad A6.10$$

$$(2n+1)^2 - (2n-1)^2 = 8n \quad A6.11$$

giving

$$1 + e_g = \frac{3\sqrt{3}}{4N_p} \frac{d_{cRO}^3}{d_g^3} 8n \quad \text{then} \quad d_{cRO} = \frac{d_g \sqrt[3]{(1+e_g)} \sqrt[3]{N_p}}{\sqrt[3]{6\sqrt{3}n}}. \quad A6.12$$

The granular void ratio is determined from the soil properties from Equation 7.8. This equation was produced for a matrix of clay particles so C represents the clay content. For a granular particle of any size but of proportion B (as a ratio, not %) in the soil, say a medium sand content of 30% then B for a medium sand would be 0.3, Equation 7.8 would be written as

$$e_g = \frac{(1-B) \frac{\rho_B}{\rho_{1-B}} + w_T \frac{\rho_B}{\rho_w}}{B}. \quad A6.13$$

ρ_B is the particle density of the granular particles, say medium sand in the example given, and ρ_{1-B} is the particle density of the remaining matrix surrounding the granular particles. As the Barnes test is conducted with the soil behaving in an assumed undrained manner the soil retains a constant granular void ratio because B and w_T remain the same.

d_g is the mean size of the granular particles under consideration, say medium sand in the example given. N_p is the number of granular particles in the n^{th} cylinder. The number of cylinders N_c is determined from the diameter of the soil thread D_T which would be the nominal value of 8mm from the initial diameter of the thread maker.

$$N_c = \frac{D_T - d_{cRO}}{2d_{cRO}}. \quad A6.14$$

For any number of cylinders in the cross section of the soil thread the number of particles is calculated from the above equations and tabulated in an Excel spreadsheet for N_c cylinders and d_{cRO} is calculated for each cylinder.

Only slight differences in d_{cR} are determined around each cylinder and between the cylinders so the average value is determined for the number of cylinders in the cross section of the thread.

The number of cylinders remains constant during a test but the width of the cylinder decreases and the spacing between the particles on the cross section of the thread or in each slice decreases. For the number of cylinders calculated the cumulative number of particles is determined in the spreadsheet as the total number for one slice N_T . To check the accuracy of the calculation for d_{cR0} the granular void ratio is determined for one slice of granular particles as

$$e_g = \frac{\text{Volume of slice}}{\text{Volume of granular particles}} - 1, \quad \text{A6.15}$$

$$1 + e_g = \frac{\frac{\pi}{4} D_T^2 \frac{\sqrt{3}}{2} d_{cR0}}{N_T \frac{\pi}{6} d_g^3} = \frac{\frac{3\sqrt{3}}{4} D_T^2 d_{cR0}}{N_T d_g^3} \quad \text{A6.16}$$

giving the total number of granular particles in one slice as

$$N_T = \frac{\frac{3\sqrt{3}}{4} D_T^2 d_{cR0}}{d_g^3 (1 + e_g)}. \quad \text{A6.17}$$

To check on the particle spacing around each cylinder which can be referred to as d_{cR0}' this is calculated from the truncated value of the number of particles, from above N_{Pn} , using the average particle spacing determined from the granular void ratio for a single cell, giving for each cylinder number n

$$d_{cR0}' = 2nd_{cR0} \sin \left[\frac{1}{2} \left(\frac{360}{\text{TRUNC} N_{Pn}} \right) \right]. \quad \text{A6.18}$$

In the Excel spreadsheet the value of d_{cR0}' and d_{cR0} are very similar so the particle spacing given by d_{cR0} is considered to be compatible both around each cylinder and between each cylinder.

It is then necessary to consider changes in the particle spacing as the diameter of the soil thread decreases during the Barnes test. It is assumed that each cylinder increases in length by the same amount as the diameter decreases and each

cylinder reduces in width by the same amount, as shown in Figure 7.12b. From an initial thread diameter D_{T0} and following one strain increment δD_1 , the new thread diameter is now $D_{T0} - \delta D_1$. The width of each cylinder is

$$\frac{D_{T0} - \delta D_1}{2N_c + 1}. \quad A6.19$$

For one slice of thread and one cylinder with constant volume, as the width of the cylinder (and the particle spacing) reduces from d_{cR0} to d_{cR1} the width of the slice increases from a_0 to a_1 , see Figure 7.12e. For any cylinder number n the initial volume is

$$V_{\text{cylinder}} = \left[\frac{\pi}{4} d_{cR0}^2 (2n+1)^2 - \frac{\pi}{4} d_{cR0}^2 (2n-1)^2 \right] \frac{\sqrt{3}}{2} d_{cR0} = \frac{\pi \sqrt{3}}{4} d_{cR0}^3 8n. \quad A6.20$$

The volume of the cylinder after the strain increment is

$$V_{\text{cylinder}} = \left[\frac{\pi}{4} d_{cR1}^2 (2n+1)^2 - \frac{\pi}{4} d_{cR1}^2 (2n-1)^2 \right] a_1 = \frac{\pi}{4} d_{cR1}^2 8na_1. \quad A6.21$$

The volumes are the same so

$$\frac{\pi \sqrt{3}}{4} d_{cR0}^3 8n = \frac{\pi}{4} d_{cR1}^2 8na_1 \quad A6.22$$

giving

$$a_1 = \frac{\sqrt{3}}{2} \frac{d_{cR0}^3}{d_{cR1}^2}. \quad A6.23$$

The particle spacing on the long axis of the soil thread, d_{cL} increases. From before,

$$d_{cL1}^2 = a_1^2 + \frac{d_{cR1}^2}{4} = \frac{3}{4} \left(\frac{d_{cR0}^3}{d_{cR1}^2} \right)^2 + \frac{d_{cR1}^2}{4} \quad A6.24$$

giving

$$d_{cL1} = \sqrt{\frac{3}{4} \left(\frac{d_{cR0}^3}{d_{cR1}^2} \right)^2 + \frac{d_{cR1}^2}{4}} \quad \text{A6.25}$$

or generally for the i^{th} strain increment $d_{cLi} = \sqrt{\frac{3}{4} \left(\frac{d_{cR0}^3}{d_{cRi}^2} \right)^2 + \frac{d_{cRi}^2}{4}}$. A6.26

The values of d_{cR} and d_{cL} can now be calculated for a test as the thread diameter reduces. Finally the spacing between the edges of the granular particles d_e is determined from

$$d_e = d_c - d_g \quad \text{A6.27}$$

giving the granular spacing ratio s_{gR} on the cross section as

$$s_{gR} = \frac{d_{eR}}{d_g} = \frac{d_{cR}}{d_g} - 1 \quad \text{A6.28}$$

and on the long axis of the soil thread as

$$s_{gL} = \frac{d_{eL}}{d_g} = \frac{d_{cL}}{d_g} - 1. \quad \text{A6.29}$$