

Department of Applied Mechanics

Fatigue assessment of thin superstructure decks

Ingrit Lillemäe



A!

DOCTORAL
DISSERTATIONS

Fatigue assessment of thin superstructure decks

Ingrit Lillemäe

A doctoral dissertation completed for the degree of Doctor of Science (Technology) to be defended, with the permission of the Aalto University School of Engineering, at a public examination held at the lecture hall 216 of the school on 5 September 2014 at 12.

**Aalto University
School of Engineering
Department of Applied Mechanics
Marine Technology**

Supervising professor

Prof. Heikki Remes

Thesis advisor

Prof. Jani Romanoff

Preliminary examiners

Dr. Inge Lotsberg, Det Norske Veritas, Norway

Prof. Vedran Zanic, University of Zagreb, Croatia

Opponent

Prof. Myung Hyun Kim, Pusan National Univeristy, South Korea

Aalto University publication series

DOCTORAL DISSERTATIONS 121/2014

© Ingrit Lillemäe

ISBN 978-952-60-5812-2

ISBN 978-952-60-5813-9 (pdf)

ISSN-L 1799-4934

ISSN 1799-4934 (printed)

ISSN 1799-4942 (pdf)

<http://urn.fi/URN:ISBN:978-952-60-5813-9>

Unigrafia Oy

Helsinki 2014

Finland



Author

Ingrit Lillemäe

Name of the doctoral dissertation

Fatigue assessment of thin superstructure decks

Publisher School of Engineering

Unit Department of Applied Mechanics

Series Aalto University publication series DOCTORAL DISSERTATIONS 121/2014

Field of research Naval Architecture

Manuscript submitted 8 May 2014

Date of the defence 5 September 2014

Permission to publish granted (date) 7 August 2014

Language English

Monograph

Article dissertation (summary + original articles)

Abstract

Economic reasons have motivated shipyards to look for new lightweight solutions. Going below the 5-mm plate thickness limit set by the classification societies for the superstructure decks of cruise ships could be one way to achieve the goal. However, the fatigue design of such large thin welded structures is challenging because of the higher initial production-induced distortions. Additionally, the fatigue assessment methods used for thicker welded plates are not fully validated for thinner ones.

In this doctoral thesis a basis for the fatigue assessment of welded thin deck structures is provided by thoroughly investigating the effect of initial distortion and geometrical nonlinearity at different levels of analysis, i.e., the welded joint, stiffened panel, and hull girder levels. Extensive geometry measurements, fatigue tests, and geometrically nonlinear finite element (FE) analyses with 3-mm thick butt and fillet welded dog-bone specimens were carried out to define the experimental fatigue strength. Different welding methods were included in the study, leading to a wide variation in the misalignments. The influence of initial distortion on the structural stress in thin stiffened panels and on the hull girder behavior was studied using geometrically nonlinear FE analysis.

The investigation showed that thin welded specimens differ from thicker ones in their larger initial distortions and curved shapes. This significantly affects the straightening effect of the specimen, i.e., the decrease of the structural-to-nominal stress ratio under tension loading. When the actual shape of the specimen and the geometrical nonlinearity were included in the analysis, a fatigue strength similar to that of thicker welded plates was obtained. The stiffened panels behaved linearly under the elastic load range, but the initial distortion shape had a major effect on the structural stress and should therefore be considered. The hull girder analyses revealed that the effect of initial distortion and geometrical nonlinearity on the load-carrying mechanism and on the panel loading is small, and that acceptable accuracy can be obtained without including them. The results show that the current industry standard for fatigue assessment is applicable for the hull girder but not for the stiffened panel and the welded joint analyses.

This thesis presents the early efforts towards thinner superstructure decks in modern cruise ships. Before their implementation becomes possible, validation with full-scale stiffened panels or even larger prototype structures is needed to obtain the actual initial distortion shapes and resulting stress distributions, as well as to understand the effects of mean and residual stress. Also, the ultimate strength of the hull girder with thin superstructure decks should be checked.

Keywords fatigue assessment, fatigue strength, angular misalignment, initial distortion, thin plate, welded joint, stiffened panel, hull girder

ISBN (printed) 978-952-60-5812-2

ISBN (pdf) 978-952-60-5813-9

ISSN-L 1799-4934

ISSN (printed) 1799-4934

ISSN (pdf) 1799-4942

Location of publisher Helsinki

Location of printing Helsinki

Year 2014

Pages 110

urn <http://urn.fi/URN:ISBN:978-952-60-5813-9>

Preface

The work presented in this thesis was carried out at the Advanced Marine Structures research group in the Department of Applied Mechanics of Aalto University between 2010 and 2014. During the process I was funded by the Aalto University School of Engineering and the national Graduate School in Engineering Mechanics, the Finnish National project FIMECC (I&N and MANU), the Finnish Maritime Foundation and the EU funded research project BESST (Breakthrough in European Ship and Shipbuilding Technologies). This financial support is gratefully acknowledged.

Firstly, I would like to thank my supervising professor, Heikki Remes, and my thesis advisor, prof. Jani Romanoff, for their support and guidance during the entire process. I also wish to thank prof. Petri Varsta, who stimulated my interest in research during my Master's thesis and encouraged me to continue with the postgraduate studies.

Secondly, I would like to acknowledge the pre-examiners of this thesis, Dr. Inge Lotsberg and prof. Vedran Zanic, and the opponent prof. Myung Hyun Kim for their efforts.

I appreciate my colleagues Markus Ahola, Anghel Cernescu, Darko Frank, Jasmin Jelovica, Mihkel Kõrgesaar and Pauli Lehto from Marine Technology and other postgraduate students from Applied Mechanics for creating a positive and supportive working atmosphere. I would especially like to thank Heikki Lammi from Marine Technology and Lars Molter from CMT, Germany, for the cooperation that resulted in my first publication. My gratitude also goes to all of the secretaries and lab technicians for their friendly help.

Finally, I would like to thank my family and friends and especially Eero for their love and support during the years it took to complete this work.

Espoo, August 2014

Ingrit Lillemäe

Contents

Preface.....	1
List of publications and author’s contributions.....	5
Original features	7
List of abbreviations and symbols.....	9
1 Introduction.....	11
1.1 Background.....	11
1.2 State of the art.....	11
1.3 Objectives and scope.....	15
1.4 Limitations.....	15
2 Thin and slender welded specimens [P1 & P2].....	17
2.1 Geometry measurements.....	18
2.2 Fatigue tests	19
2.3 FE analyses.....	19
2.4 Fatigue strength.....	20
3 Passenger ship hull girder [P4 & P5]	25
3.1 FE analyses.....	26
3.2 Hull girder response and panel loading	27
4 Stiffened panels [P3-P5].....	29
4.1 FE analyses.....	30
4.2 Influence of initial distortion shape on panel stiffness.....	31
4.3 Influence of hull girder behavior on structural stress.....	33
4.4 Influence of initial distortion shape on structural stress.....	34
5 Conclusions.....	37
References.....	39
Errata	45
Publications	47

List of publications and author's contributions

This doctoral dissertation consists of a summary and of the following publications, which are referred to in the text by their numerals.

[P1] Lillemäe, Ingrid; Lammi, Heikki; Molter, Lars; Remes, Heikki. Fatigue strength of welded butt joints in thin and slender specimens, *International Journal of Fatigue* 44 (2012) 98-106

The author carried out the geometry measurements and fatigue tests, performed the analysis of the results from the experimental investigations and finite element (FE) analyses and wrote the manuscript. Heikki Lammi assisted with the fatigue tests and FE analysis. Lars Molter developed the parametric FE model and performed part of the FE analysis. Heikki Remes designed the test setup and contributed with valuable comments and suggestions.

[P2] Fricke, W.; Remes, H.; Feltz, O.; Lillemäe, I.; Tchuindjang, D.; Reinert, T.; Nevierov, A.; Sichermann, W.; Brinkmann, M.; Kontkanen, T.; Bohlmann, B.; Molter, L. Fatigue strength of laser-welded thin-plate ship structures based on nominal and structural hot-spot stress approach, *Ships and Offshore Structures* (2013) DOI: 10.1080/17445302.2013.850208

This paper generalizes the findings of [P1] on a larger set of thin welded ship structures. The author carried out the main part of the fatigue tests, geometry measurements and structural hot spot stress calculations done by Aalto University. Lars Molter assisted with the FE analyses. Olav Feltz and Didi Tchuindjang performed the fatigue tests, geometry measurements and structural hot spot stress calculations done by Hamburg University of Technology. Thomas Reinert, Alessandro Nevierov, Wolfgang Sichermann,

Markus Brinkmann and Tuomo Kontkanen were responsible for the specimen production. Prof. Berend Bohlmann coordinated the European research project BESST (Breakthrough in European Ship and Shipbuilding Technologies), where the experiments were carried out. Prof. Wolfgang Fricke and prof. Heikki Remes wrote the manuscript and contributed to the whole process with valuable comments and suggestions.

[P3] Lillemäe, Ingrid; Remes, Heikki; Romanoff, Jani. Influence of initial distortion on the structural stress in 3 mm thick stiffened panels, *Thin-Walled Structures* 72 (2013) 121-127

The author investigated the influence of initial distortion on the structural stress in thin stiffened panels by means of extensive geometrically nonlinear FE analyses. The author wrote the manuscript and Heikki Remes and Jani Romanoff contributed with valuable comments and suggestions.

[P4] Lillemäe, Ingrid; Remes, Heikki; Romanoff, Jani. Influence of initial distortion of 3 mm thin superstructure decks on hull girder response for fatigue assessment, *Marine Structures* 37 (2014) 203-218

The author carried out the global geometrically nonlinear FE analyses of a hull girder of modern passenger ship with thin initially distorted superstructure decks incorporated into the model. The author wrote the manuscript and Heikki Remes and Jani Romanoff contributed with valuable comments and suggestions.

[P5] Lillemäe, Ingrid; Remes, Heikki; Romanoff, Jani. Fatigue assessment of large thin-walled structures with initial distortions, 11th International Fatigue Congress, Melbourne, Australia, 2-7 March 2014, in *Advanced Materials Research* Vols. 891-892 (2014) 123-129

The author made a synthesis of the four aforementioned journal papers to provide a basis for the fatigue assessment of large thin-walled structures with initial distortions and wrote the manuscript. Heikki Remes and Jani Romanoff contributed with valuable comments and suggestions.

Original features

Economic reasons have motivated European shipyards to look for new lightweight solutions. Going below the currently allowed 5-mm plate thickness limit for the superstructure decks of a cruise ship could be one attractive alternative. However, the fatigue design of such large thin welded structures is challenging due to higher initial distortions caused by welding. Additionally, the methods for fatigue assessment are not fully validated for plate thicknesses below 5 mm. The aim of this thesis is to study the structural response of welded thin deck structures by analyzing small-scale specimens, stiffened panels and the hull girder in order to provide a basis for fatigue assessment. The following features of this thesis are believed to be original.

1. Thin and slender welded fatigue test specimens straighten, i.e., the structural-to-nominal stress ratio decreases under tension loading. The effect of specimen slenderness L/t on straightening is well known and is included in the International Institute of Welding (IIW) recommendations, but the effect of a curved shape, observed in thin specimens, has not been shown before. [P1]
2. If the straightening effect is taken into account by including the actual curved shape and the geometrical nonlinearity in the analyses, then the fatigue strength of thin welded specimens is found to be equal with that of thicker ones. [P1 & P2]
3. It is shown in [P3] that in the case of thin stiffened panels, i.e., when the initial distortion is present in two directions of the plate and the web frames and stiffeners are taken into account, the straightening effect is very small due to support from the surrounding structure and redistribution of forces.
4. It is demonstrated in [P3] that the given measured initial distortion shapes influence the structural stress near the butt weld significantly, whereas the average behavior of the panels, i.e., the average stress-strain curve or load-end-shortening, is not affected.

5. For the first time in [P4], a geometrically nonlinear finite element (FE) analysis of a hull girder of modern passenger ship, where thin initially distorted superstructure decks are incorporated into the model, is performed. The redistribution of forces from thin initially distorted deck plates to other structures is demonstrated.
6. The basis for the fatigue assessment of thin superstructure decks with initial distortions is built up through papers [P1-P4] and summarized in [P5]. The panel loading for fatigue assessment can be defined from the geometrically linear FE analysis of a hull girder without including the initial distortions. The FE analysis of the panel should include the realistic distortion shape, but can still be geometrically linear. In the case of small welded fatigue test specimens, both the actual shape and the geometrical nonlinearity must be included.

List of abbreviations and symbols

b	A correction for the stress magnification factor, which accounts for the straightening of the angular misalignment under axial tension loading; it depends on the boundary conditions
CV	Conventional arc welding method
E	Young's modulus
e	Axial misalignment
F	Force
FAT	The fatigue class, i.e., the nominal, structural hot spot or effective notch stress range in MPa at 2 million load cycles to failure corresponding to a selected survival probability, e.g., 97.7%
FE	Finite element
HY	Laser-hybrid welding method
GL	Geometrically linear
GNL	Geometrically nonlinear
IACS	International Association of Classification Societies
IIW	International Institute of Welding
k_m	Stress magnification factor, i.e., the ratio between the structural and the nominal stress, which includes all the macro-geometric stress raising effects such as axial and angular misalignment
K_w	Notch factor, i.e., the ratio between the notch stress and the structural stress, which contains the additional stress increase due to weld
L	Distance between the support points or Web frame spacing
LA	Laser welding method
m	Negative inverse slope of the S-N curve

P_s	Probability of survival
R	Load ratio
s	Stiffener spacing
t	Plate thickness
T_σ	Scatter range index, a ratio between the fatigue strength at 2 million load cycles with a probability of survival of 10% and 90%.
u_x	Axial displacement in x-direction
w_o	Initial distortion
α	Angle between two welded plates describing the angular misalignment
α_L	Local angular misalignment
α_G	Global angular misalignment
β	A function of the slenderness ratio L/t , Young's modulus E and applied nominal stress σ_{Nom}
λ	Factor in the k_m equation that depends on the boundary conditions
ϵ_{Nom}	Nominal strain
σ_{HS}	Structural hot spot stress
σ_{Nom}	Nominal stress
σ_{Notch}	Notch stress
σ_{Struct}	Structural stress, i.e., membrane + bending stress

1 Introduction

1.1 Background

Due to economic reasons the industry is trying to find new lightweight solutions for large welded steel structures. For instance, European shipyards are looking for ways to reduce the weight and lower the vertical center of gravity of modern cruise ships in order to increase the energy efficiency and possibly even add one more cabin deck. Going below the current 5-mm plate thickness limit set by the classification societies for the superstructure decks could be one way to achieve this goal. However, the fatigue design of such large thin welded structures is challenging due to higher initial distortions caused by welding [1,2]. The results presented by Eggert et al. in [1] also indicate different distortion shapes. On the other hand, higher-quality laser-based welding with low heat input that induces smaller initial distortions is becoming more widely available. At present, the fatigue assessment is performed using idealized geometry and the production quality is included in the experimentally defined fatigue resistance S-N curves from thicker specimens. The validity of such a procedure becomes questionable for plate thicknesses below 5 mm, both at the local, i.e., stiffened panel or welded joint level, [3-6], and the global hull girder level, [7].

1.2 State of the art

According to common fatigue assessment methods – see, e.g., [4] – the influence of plate distortion and weld geometry on the peak stress at the weld notch is accounted for by multiplying the nominal stress by the stress magnification k_m and the notch factor K_w :

$$\sigma_{Notch} = \sigma_{Nom} \cdot k_m \cdot K_w = \sigma_{HS} \cdot K_w, \quad (1)$$

where σ_{Notch} is the notch, σ_{HS} is the structural hot spot and σ_{Nom} is the nominal stress; see also Figure 1. The stress magnification factor k_m is the ratio between

the structural hot spot and the nominal stress, which includes all the macrogeometric stress-raising effects such as axial and angular misalignment. The notch factor K_w is the ratio between the notch and the structural hot spot stress, which includes the additional stress increase resulting from the weld itself.

The stress magnification factor k_m caused by angular misalignment can be calculated as a constant value based on the basic linear-elastic beam theory [4] or as a function of the applied nominal stress $k_m = k_m(\sigma_{Nom})$ [5]. The former is applicable for thick specimens with a low slenderness ratio $L/t < 20$, where the angular misalignment is assumed to be between straight plates and where this distortion does not straighten noticeably during tension loading; L is the length of the specimen between the support points and t is the plate thickness. The second case is for thick specimens with higher slenderness ratios, i.e., $L/t > 20$ [8], where the angular misalignment is still assumed to be between straight plates but where this distortion straightens under tension loading; see Figure 1. Maddox showed in [8] that this straightening effect increases steeply together with the slenderness L/t of the specimen. The correction factor b for multiplying the traditional beam theory-based equation was proposed by Kuriyama et al. in [9] and is included in the IIW recommendations [5]:

$$k_m = 1 + \frac{\lambda}{4} \cdot \alpha \cdot \frac{L}{t} \cdot b, \quad (2)$$

where λ is the factor that depends on the boundary conditions (3 for clamped and 6 for pinned) and α is the angle between the two plates in radians. For clamped boundary conditions the correction factor is

$$b = \frac{\tanh(\beta/2)}{\beta/2}, \quad (3)$$

and for pinned boundary conditions

$$\beta = \frac{\tanh(\beta)}{\beta}, \quad (4)$$

where β is a function of the slenderness ratio L/t , Young's modulus E and applied nominal stress σ_{Nom} :

$$\beta = \frac{L}{t} \sqrt{\frac{3 \cdot \sigma_{Nom}}{E}}. \quad (5)$$

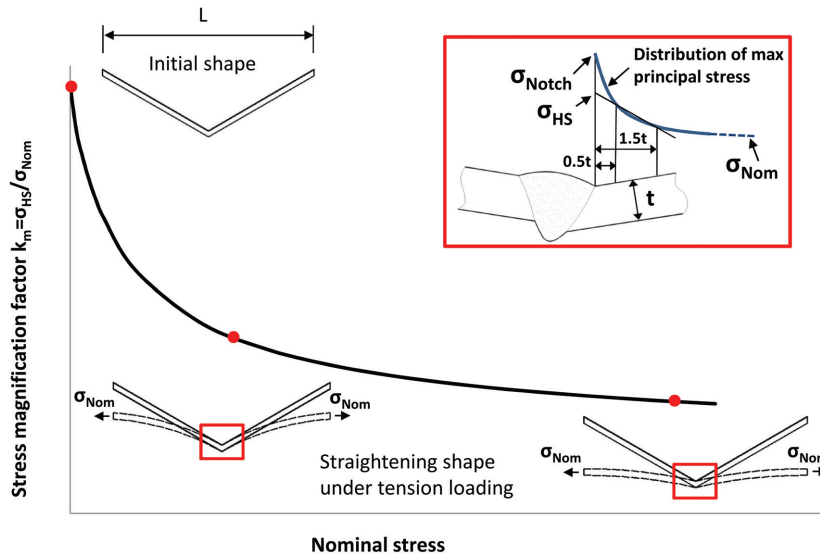

Figure 1: Straightening effect and the definition of the notch, structural hot spot and nominal stress.

However, this correction factor assumes that the angular misalignment is formed between straight plates. Moreover, it is only applicable in cases where the location of interest, i.e., the weld, is in the middle of the support length L . In the case of thin welded specimens, the angular misalignment may not only be larger but also have a different shape compared to thicker welded plates, as indicated, e.g., in [1]. Published research on the fatigue strength of thin welded plates mainly concentrates on the effect of weld geometry; see, e.g., [10-14]. Very limited attention has been given to the influence of the actual curved shape of the specimen. The reason for this is partly due to the fact that until now thin plates have not been used in such massive structures as ships and offshore structures, and therefore the initial welding-induced angular distortions have not been so problematic.

When moving from the small-scale specimens to the actual structure, i.e., the stiffened panel, then first the slenderness L/t increases as the support length equals the typical web frame spacing of the ship. Second, the initial distortion is present in two directions instead of one and the surrounding structure supports the behavior. The first point should increase the straightening effect, i.e., make the structural-to-nominal stress ratio even more nonlinear. Intuitively, the second issue should restrain the straightening. The influence of welding-induced initial distortions on the structural stress is only briefly studied in, e.g., [1,2], where the effects of the actual shape, the redistribution

of the membrane stress and the geometrical nonlinearity are indicated for 4-mm-thick stiffened panels. On the other hand, there are numerous publications about the effect of initial distortion on the buckling or ultimate strength of plates and panels; see, e.g., [15-24]. However, these typically look at the average behavior of the plate or panel, i.e., the average stress-strain or load-end-shortening curve. Therefore, further investigation is needed in order to understand the influence of initial distortion on the panel response and fatigue assessment.

The final level of interest is the actual application, i.e., the hull girder of a passenger ship, and the influence of the initial distortion of thin superstructure decks on the primary response of the hull girder and consequently on the panel boundary conditions for fatigue assessment. According to the current classification rules, the global analysis of a passenger ship hull girder can be carried out geometrically linearly using ideally straight structures [7,25,26]. The boundary conditions for panels are therefore also typically idealized. However, the validity of these assumptions should be studied further, since the initial distortions can change the axial and bending stiffness of the panel and the whole deck. This may influence the load-carrying mechanism of the hull girder in a similar way as in [27], where traditional superstructure decks were replaced by web-core sandwich panels with non-symmetric joints causing local bending. In addition, bulkheads, girders and web frames can have an influence.

To understand the boundary conditions for a stiffened deck panel, the complicated behavior of the hull girder needs to be considered. This is challenging, because the structural behavior of a modern passenger ship does not follow basic linear-elastic beam theory, i.e., the normal stress distribution in the cross-section is nonlinear, even if the geometrical nonlinearity is not included. Thus, 3D finite element (FE) analysis is still considered to be the most reliable tool [25,26,28]. The complicated interaction between the hull and the superstructure, considering the shear effects resulting from the large openings in the side shell and longitudinal bulkheads, the discontinuities between the hull and superstructure, etc. has been studied in, e.g., [29-36]. These analyses do not include the initially distorted thin superstructure decks. The other set of papers that do include the initial distortions, however, deal with simple box-like girders [37-39].

1.3 Objectives and scope

The aim of this thesis is to provide a basis for the fatigue assessment of thin superstructure decks with initial distortions. This is done by thoroughly studying the influence of initial distortion and geometrical nonlinearity at different levels using both experiments and numerical analyses. The first level is a small-scale welded specimen, the second is a stiffened panel and the third the hull girder of a modern passenger ship; see Figure 2.

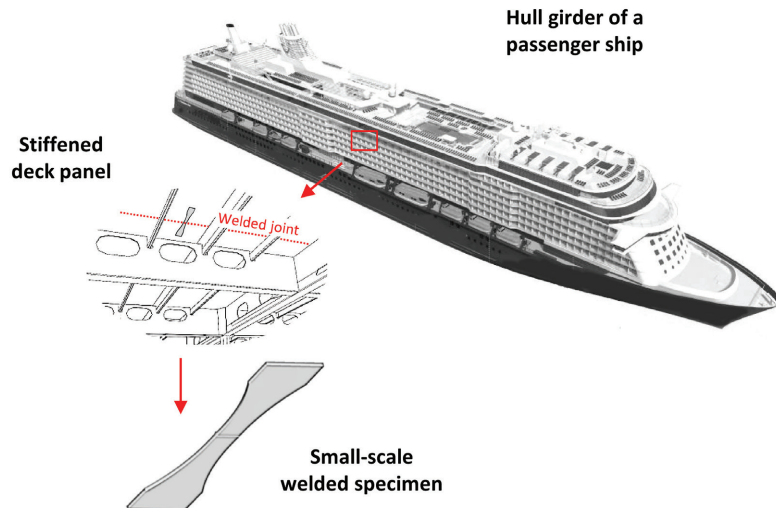

Figure 2: Framework of the thesis.

1.4 Limitations

In this thesis a simplified approach is applied in order to systematically study the influence of initial distortion on the fatigue assessment at different levels of analysis. Consequently, the effect of material nonlinearity is neglected as the observed stresses in the typical fatigue-relevant ranges are below the yield limit. The residual stresses left after welding are omitted even though initial distortions are present. This simplification enables a clear definition of the elastic stress range.

In addition, some simplifications are made to the geometry of the stiffened panels and the hull girder of a passenger ship. For example, the hull girder is prismatic with no large openings for atriums and promenades. This removes the additional stress concentration due to the hull form and large openings, and thus brings out the influence of thin decks better. Additionally, as full-

scale experiments with thin stiffened panels are not yet available, the initial distortion shapes applied are the ones reported in the literature. Finally, flat bar stiffeners are used instead of HP profiles as this saves the modeling and calculation time, but does not have a large influence on the response.

2 Thin and slender welded specimens [P1 & P2]

The specimens included in the detailed study were water-cut out of arc- and laser-welded 3-mm plates produced at European shipyards. The length of the specimens was 250 mm and the width varied from 20 mm in the middle, where the weld was positioned, to 50 mm at the ends, according to the hourglass shape with a radius of 160 mm; see Figure 3. The specimen edges were smoothed and two holes were drilled at both ends for clamping. The yield strength of the base material is 466 MPa for the arc-welded and 407 MPa for the laser-welded specimens. The chemical composition of the base materials are given in [P1]. The different welding methods lead to different weld geometries, see Figure 4.

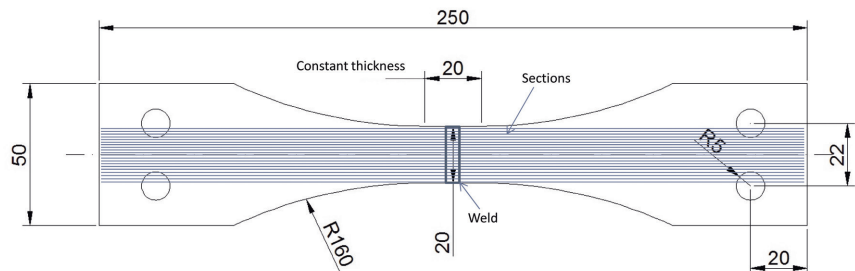

Figure 3: Fatigue test specimen [P1].

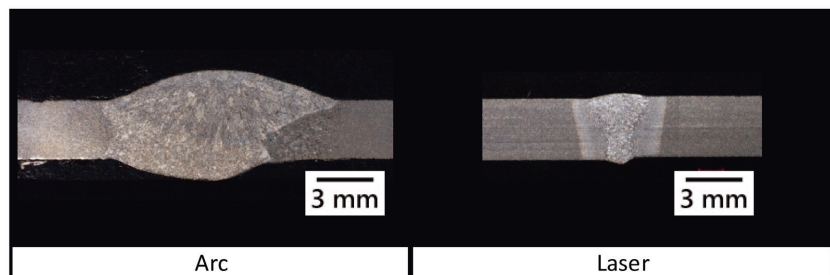

Figure 4: Macro sections of the test specimens [P1].

The generalization of the results was done in [P2], where, in total, including the specimens mentioned above, 28 series of butt welds and T-joints were measured and fatigue-tested. Out of those 28 series 10 were thin (3 or 4-mm) butt-welded specimens. In addition, three series of thickness-step (3/5-mm) and one series of 6-mm-thick butt welds were included. Out of 14 series of T-joints, six were thin (3-mm plate, 5-mm stiffener) and eight were thick (8-mm plate, 5- or 7-mm stiffener) for comparison. Conventional arc (CV), laser (LA) and laser-hybrid (HY) welding methods and different edge preparations suitable for shipyard production were included. The yield strengths of the base materials of all the specimens varied between 293 and 466 MPa.

2.1 Geometry measurements

The geometry measurements of the specimens were performed using an optical measuring system, Gom mbH Atos. According to the acceptance test described in [40], it has an accuracy of 0.02 mm. The geometry points on top of the specimen surface were recorded with two high-resolution cameras in order to obtain a numerical 3D model. For the analysis 20 2D sections perpendicular to the weld seam were generated from this 3D model. From this data the whole shape of the specimen was captured, i.e., both the weld geometry and the curvature of the plates. In addition to the optical measuring system, laser scanners were also used for measuring some of the specimen series in [P2]. The schematic difference between the angular misalignment shape in the thick and thin plates is given in Figure 5. For a more thorough description and the results of the geometry measurements the reader is referred to [P1] and [P2].

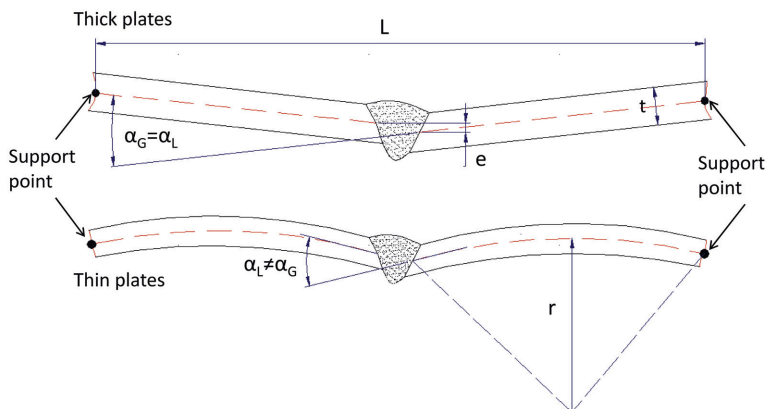

Figure 5: Definition of the initial distortion in the thick (top) and thin (bottom) specimens [P1].

2.2 Fatigue tests

Constant amplitude fatigue tests were carried out using the MTS 810 hydraulic test machine – Figure 6 – with a load frequency of 10 Hz and a load ratio of $R = 0$. In addition, some specimen series included in [P2] were tested using a resonance test machine with a load frequency of 30 Hz and a load ratio of $R = 0 \dots 0.5$. The specimens were clamped using special rotating clamping jaws in order to mitigate the additional bending during clamping due to high angular misalignment; see Figure 6. During the test the applied force, strain and number of load cycles were recorded. 5-mm strain gauges were glued to the centerline of the specimen 6-10 mm away from the fatigue-critical notch. The strains were used to validate the FE calculations, from where the membrane and bending stresses were extracted. The number of cycles to failure was defined at the occurrence of the final fracture.

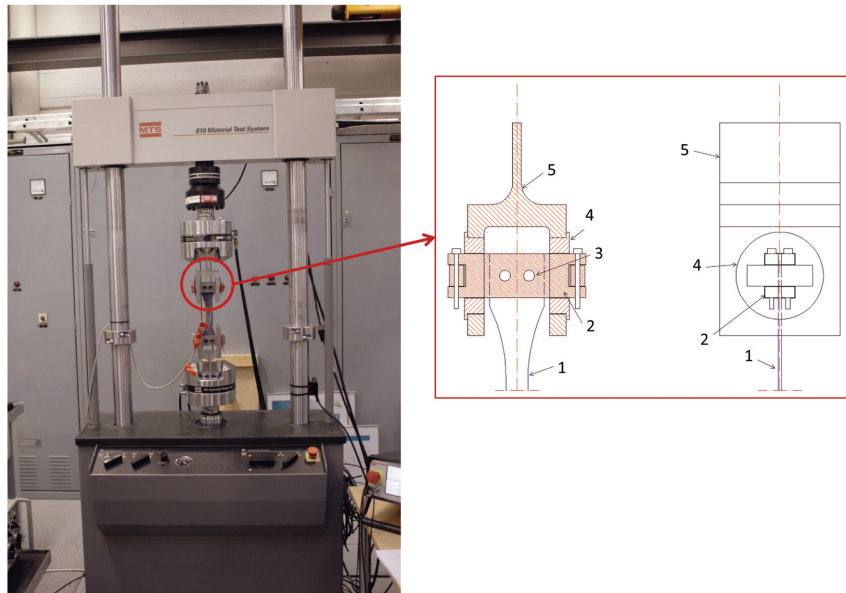

Figure 6: Test arrangement with the hydraulic test machine and the special rotating clamping jaws designed for testing the specimens with high angular misalignment (1 – test specimen, 2 – metal plates, 3 – bolts, 4 – joint that is allowed to rotate and 5 – jaw of the test machine) [P1].

2.3 FE analyses

For the tested specimens the structural hot spot and notch stresses were calculated according to the IIW guidelines [5,6] using geometrically nonlinear FE analysis; see Figure 7. The structural hot spot stress is the maximum principal stress at $0.5t$ and $1.5t$ from the weld edge extrapolated to the notch; see also Figure 1. The notch stress is the maximum principal stress at the notch

with a fictitious radius of 1 mm. The nominal stress is defined as the applied load divided by the cross-sectional area in the middle of the specimen. Both 2D plane and 3D solid models were used in the analyses. The overall response of the specimen in the 2D approach was described with the plane strain elements in the weld notches because of the geometric support, and the plane stress elements elsewhere. In addition, simplified beam models were used to investigate the influence of the shape of the specimen on the structural stress. Solid and beam elements used linear and plane stress/strain quadratic shape functions. Both the ANSYS 13.0 and Abaqus 6.11-2 software with geometrical nonlinearity were used. The maximum difference in the stresses and strains between the different modeling approaches was 2%. The FE analyses were validated with the measured strains at the specimen surface 6-10 mm from the weld notch and the average difference was 6%. The boundary conditions and loading are illustrated in Figure 7, where one end of the specimen was clamped and at the other end the tensile force from the fatigue tests was applied so that all the edge nodes moved by the same amount, i.e., with a constant displacement. For comparison, pinned boundary conditions were also used. In all of the FE analyses carried out in this thesis a linear-elastic material behavior with a Young's modulus of 206800 N/mm² and a Poisson's coefficient of 0.3 was assumed.

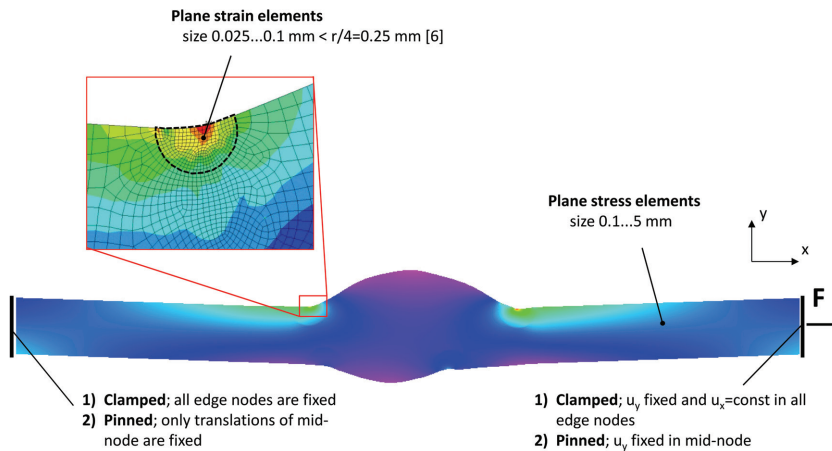

Figure 7: Example of the specimen FE model and the mesh [P1].

2.4 Fatigue strength

The structural hot spot and notch stresses as a function of fatigue life, calculated using geometrically nonlinear and linear FE analyses, are presented

in Figure 8 and Figure 9. The average axial misalignment and the actual shape of each specimen were included into the geometry of the models. Additionally, the average, maximum and minimum weld geometry cases were calculated for each specimen, resulting in very minor variation. For comparison, two relevant reference S-N curves with slopes of $m = 3$ and $m = 5$ are plotted in both figures. The slope 3 is suggested by IIW [5] and the slope 5 was found more suitable for thin welded plates in [41]. Both of these curves have been corrected to match with the $R = 0$ load ratio by multiplying the original FAT class by 1.1 according to [42].

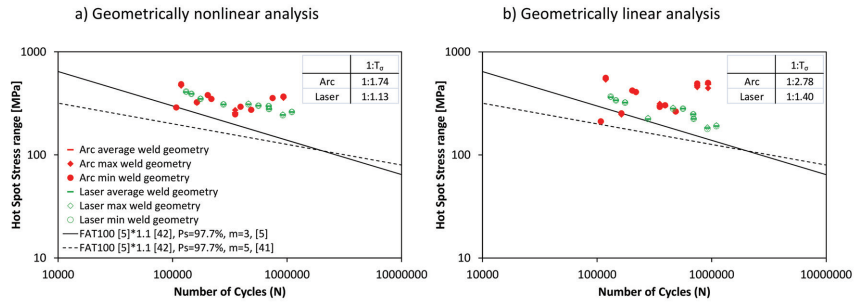

Figure 8: Fatigue test results from geometrically nonlinear (a) and linear (b) FE analyses in comparison to the structural hot spot stress S-N curves with the slopes of $m=3$ [5] and $m=5$ [41]; [P1].

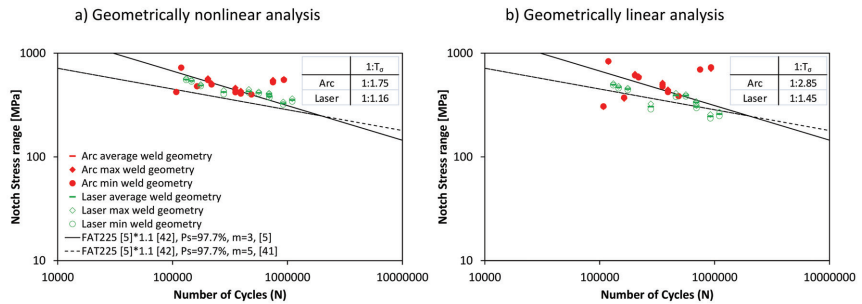

Figure 9: Fatigue test results from geometrically nonlinear (a) and linear (b) FE analyses in comparison to the notch stress S-N curves with the slopes of $m=3$ [5] and $m=5$ [41]; [P1].

It can be seen that if geometrically nonlinear FE analyses are applied then all the points except one are above the reference curves in the hot spot stress plot and all the points except one are above the curve with the slope of 5 in the notch stress S-N plot. It should also be noted that the S-N curves already conservatively include a small increase in the stress due to misalignment ($k_m = 1.05$, [5]). The mean fatigue strength in the notch stress at two million load cycles was 338 MPa for the arc-welded and 310 MPa for the laser-welded

specimens. This agrees with the values presented in the literature for thick welded plates shown in Table 1 [43-46].

Table 1: Comparison of fatigue strength of thin specimens to the values in the literature

Fatigue strength (notch stress range in MPa at 2 million load cycles, $R = 0$, as-welded, $P_s = 50\%$)		
	3 mm	Thick plates, $t > 6$ mm
Arc	338	312, [44] ... 354, [45]
Laser	310	248, [43] ... 319, [46]

In addition, the scatter in the results is smaller when geometrically nonlinear FE analysis is applied; see Figure 8 and Figure 9. The scatter in the test results was investigated by T_σ , which is the ratio between the fatigue strength at 2 million load cycles with a probability of survival of 10% and 90%. It was calculated from the test points assuming the slope of 5. In the arc-welded specimens the scatter $1:T_\sigma$ is 1:1.74 in the hot spot and 1:1.75 in the notch stresses. In the laser-welded specimens the scatter is lower, being 1:1.13 in the hot spot and 1:1.16 in the notch stresses. A typical scatter value for welded joints is 1:1.50 [45]. The larger scatter in the arc-welded specimens can be explained by the high bending ratio in some specimens with high angular misalignment, leading to higher fatigue strength; see [P1]. If geometrically linear analysis was used, then the scatter was approximately 63% and 25% larger for the arc- and laser-welded specimens, respectively.

The influence of the initial distortion shape on the structural stress in thin welded specimens was further studied with simplified beam models of curved geometries, as shown in Figure 10. The analyses included the global angular misalignment of 4° with different curvatures, pinned boundary conditions and a slenderness ratio of $L/t = 85$. The figure presents the k_m factor as a function of the applied nominal stress. For reference, the k_m factors calculated with equations by DNV [4] and IIW [5] are also plotted. The figure illustrates the effect of neglecting the straightening, as in DNV, or only having it assuming the angular misalignment between straight plates, as in IIW, on the structural stress. The former overestimates the stress magnification in all cases, while the latter can over- or underestimate it, depending on the curvature shape with respect to the fatigue-critical notch; see [P1]. This high influence of the specimen curvature on the fatigue strength assessment is also noticed later in [47].

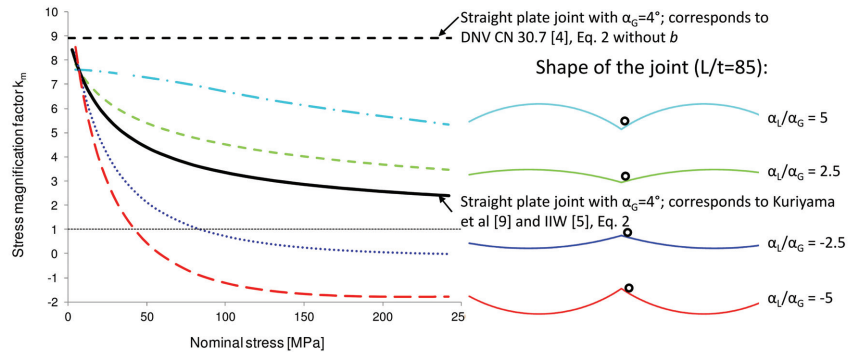

Figure 10: Stress magnification factor k_m as a function of the applied load for different specimen shapes [P1].

Applying the knowledge from the detailed analyses of two series in [P1], the findings were generalized in [P2] for the entire fatigue test program, including thin and thick specimens. The fatigue test results for all butt and T-joints, based on the structural hot spot stress, are shown in Figure 11. Different welding methods, i.e., conventional arc (CV), laser (LA) and laser-hybrid (HY), as well as different levels of misalignment, i.e., low ($e/t \leq 0.1$ and $\alpha \leq 1^\circ$), medium ($0.1 < e/t \leq 0.15$ and/or $1^\circ < \alpha \leq 2^\circ$) and high ($e/t > 0.15$ or $\alpha > 2^\circ$), are grouped separately. All the data points, both for the thin and thick specimens, are in one cloud and no obvious differences can be noticed between the welding methods and levels of misalignment. This confirms that if the actual shape of the specimen, together with the geometrical nonlinearity, is included in the analysis, the fatigue strength of the thin and thick welded specimens is equal. S-N curves FAT100 with the slopes of $m = 3$ and 5 are plotted for comparison. The data is as obtained; the $R = 0$ correction has not been done, since the experiments also include other load ratios. It can be seen that the S-N curve with the slope of 5 is still more suitable and most of the data points would be above it even if it was moved up 10% to account for the $R = 0$ load ratio according to [42].

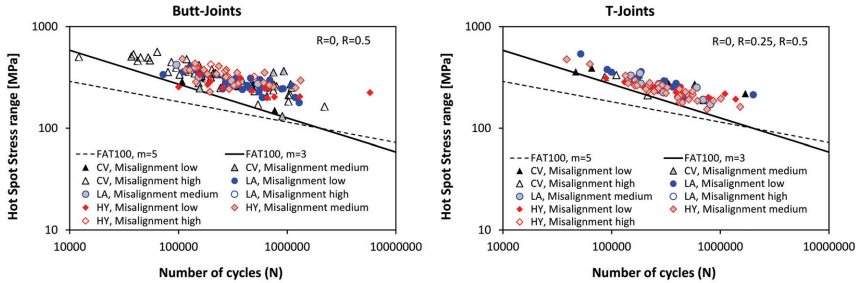

Figure 11: Fatigue test results for all butt and T-joints obtained from geometrically nonlinear FE analyses in comparison to the hot spot stress S-N curve with the slopes of $m=3$ [5] and $m=5$ [41]; [P2].

3 Passenger ship hull girder [P4 & P5]

A prismatic post-panamax passenger ship with a length of $L = 275.73$ m, breadth $B = 42.68$ m and height $H = 43.75$ m was used in this study. The web frames and longitudinal girders are T-beams 445x8/200x10. Based on the general arrangement of the ship, the web frame spacing is 2730 mm and the girder spacing is 7480 and 6120 mm. The pillars are circular tubes with a radius $r = 203$ mm and a wall thickness of $t = 12.5$ mm. The fire bulkheads are at every 40.95 m.

A typical traditional configuration of the superstructure decks is with a plate thickness $t = 5$ mm, stiffener type HP100x6 and spacing $s = 680$ mm; see, e.g., [27,34,36]. In this investigation, decks 7-9 and also partly 6 were replaced by thin decks, i.e., a plate thickness $t = 3$ mm, stiffener type FB70x4 and spacing $s = 340$ mm; see Figure 12. The decks to be thin were chosen so that they would not be in the way of the shear flow and not as part of the two upper decks, which carry most of the load, similarly to a beam flange, [36]. The dimensions of the thin decks were chosen to be such that the panel buckling calculated on the basis of Euler column formula would not precede the local plate buckling obtained from the plate theory; see, e.g., [3,48]. In addition, under lateral pressure, thin and thick panels encounter similar out-of-plane deflections. Flat bar stiffeners are used in order to save the modeling and calculation time.

A maximum initial distortion of $w_o = 0, 6$ and 12 mm was applied to the thin decks. The initial distortion of 12 mm is two times the IACS quality standard [49] limit for thicker plates and was used in order to cover the larger values reported for thin plates in the literature; see, e.g., [1]. The distortion only occurs in the plate field; the stiffeners, girders and web frames are ideally straight. The shape of the distortion is defined with an arc through three points and the direction is always downwards, i.e., the “hungry horse” shape; Figure 12. Applying only one half-wave in both directions of the plate field is justified by the shapes reported in the literature, where mainly one and two waves in the stiffener direction are observed; see, e.g., [1,50]. Furthermore,

two half-waves can be approximated by one [50]. This enables the mesh size to be kept at a manageable level in the geometrically nonlinear FE analysis of a hull girder.

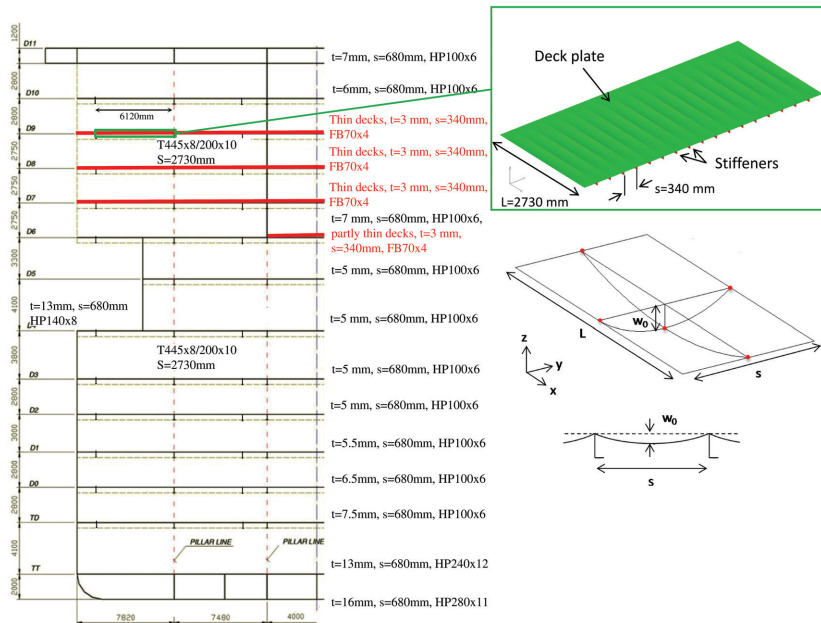

Figure 12: Midship section of the case ship (thin superstructure decks are marked in red) and the definition of the initial distortion w_0 with the web frame spacing L and stiffener spacing s [P4 & P5].

3.1 FE analyses

The load-carrying mechanism of the passenger ship hull girder with thin initially distorted superstructure decks and its influence on the panel loading were investigated in [P4] by looking at the axial membrane forces and stresses carried by the deck structures, calculated using geometrically nonlinear FE analysis. The Abaqus 6.11-2 software was used together with the RIKS solution method, which is capable of tracing the decreasing load paths by adjusting the load step; see [51]. Only 1/4 of the prismatic passenger ship was modeled due to symmetry; see Figure 13. Four-node shell elements with linear shape functions were mostly used. The flanges of the secondary stiffeners and the pillars were modeled using beam elements. The mesh size was two elements per web frame spacing (1375 mm) and one element per stiffener spacing (680 mm). The bulkheads, girders, web frames and stiffeners were meshed with a similar density. In the thin deck areas the mesh was refined four times in order to describe the initial distortion shape, resulting in 8 elements per web frame

spacing (343.75 mm) and 4 elements per new smaller stiffener spacing (85 mm).

The hogging¹ loading condition was applied as a cosine shape pressure $p = p_{max} * \cos(x\pi/(L/2))$ on the ship bottom elements with a maximum value of $p_{max} = 70.686$ kPa occurring at the midship and causing a maximum moment of $8.472 * 10^6$ kNm. In sagging condition a design wave moment of $5.199 * 10^6$ kNm was applied, using the same function with the opposite sign. These moment values are in accordance with the classification design rules [3].

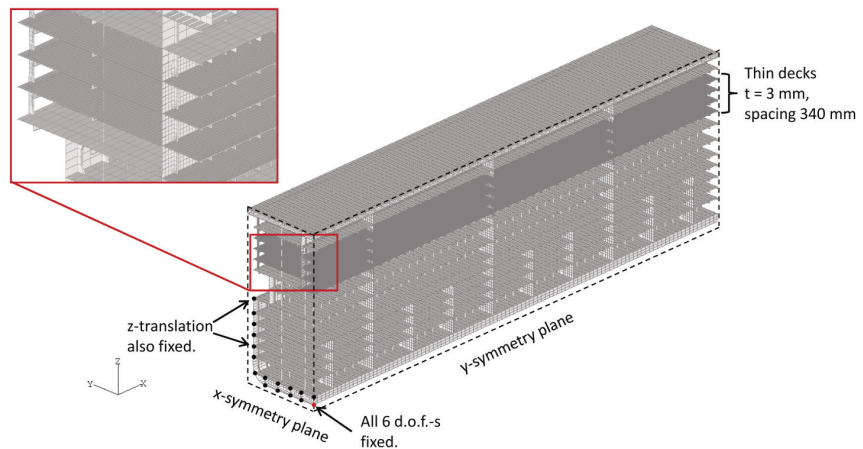

Figure 13: Global finite element model with the boundary conditions and the mesh refinement of thin decks [P4].

3.2 Hull girder response and panel loading

Replacing part of the traditional superstructure with thin decks gives a weight saving of about 43% per deck if only the main steel parts are counted, but at the same time these thin decks carried approximately 30% less of the membrane force. This load was divided in the cross-section of the ship between other decks with the traditional scantlings. The redistribution of forces also happened at the deck level between the plates, stiffeners, girders and longitudinal bulkheads. When the initial distortion with one half-wave between the web frames and stiffeners was introduced to these thin decks, an

¹ The hogging loading condition is the vertical bending moment that causes tension in the upper decks of the ship and compression in the lower ones. In sagging the upper decks are under compression and the lower ones under tension.

additional reduction of a few percent in the total forces carried was observed. Geometrical nonlinearity did not change the results significantly and the conclusions were similar under both hogging and sagging loading.

The influence of the initial distortion and geometrical nonlinearity on the panel loading is illustrated using the deck panel shown in Figure 12. The left-hand side of Figure 14 compares the average x-displacement of this panel taken from different global models as a function of the applied moment. It is calculated as a difference between the average x-displacements at two consecutive web frames, i.e., end-shortening. The right-hand side of Figure 14 shows the total axial force carried by the plates and stiffeners of this panel at the web frame closest to the midship. It can be seen that in the range of the design loads both the average axial displacement and the total force are linear and very similar in all different global models, regardless of the initial distortion and geometrical nonlinearity (GNL). These results indicate that the hull girder analysis for fatigue assessment can be carried out geometrically linearly using idealized geometry.

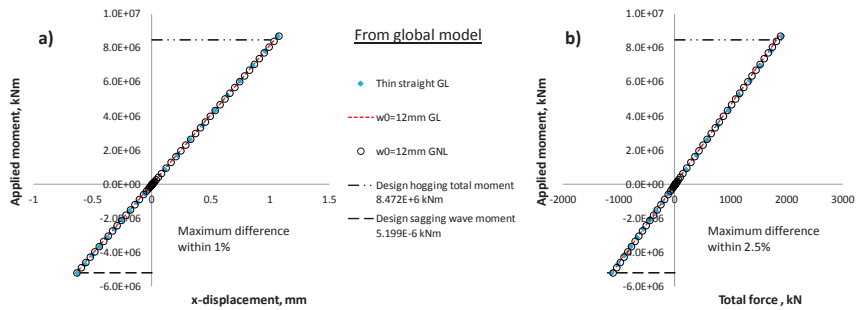

Figure 14: Average x-displacement (a) and the total force (b) of the deck panel [P4].

4 Stiffened panels [P3-P5]

Thin stiffened panels of two different sizes were included in this study. The first case is a 2730 x 6120-mm deck panel from [P4] with a plate thickness of 3 mm, stiffener type FB70x4 and spacing of 340 mm, having the simplified initial distortion shape with the maximum value of 12 mm; see Figure 12 and Figure 15. The second case includes 1200 x 2100 mm-panels from [P3] with a plate thickness of 3 mm, stiffener type FB60x4 and spacing of 300 mm, with two different measured distortion shapes reported in the literature [1]; Figure 16. The initial distortion shapes of the smaller panels are shown in Figure 17 and Figure 18. The shapes are highly influenced by the block joint located 150 mm from the panel edge, where in one case the geometry varies smoothly but in the other there is a sudden change at the weld. In both cases the initial distortion only occurs in the plate field, while the stiffeners, web frames and girders are ideally straight. All the plate fields have the same direction of the initial distortion, i.e., the “hungry horse” shape.

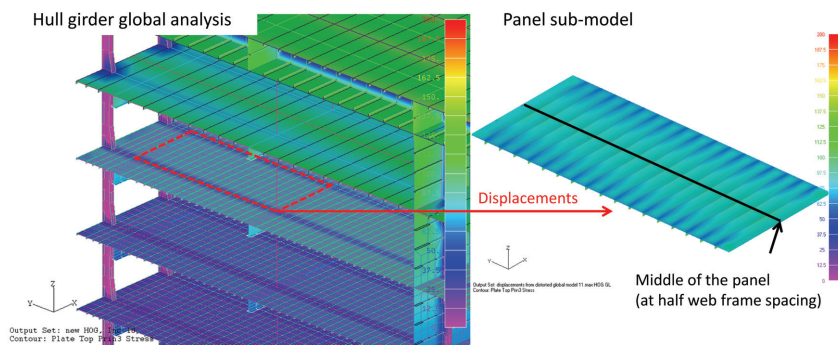

Figure 15: Sub-model of the thin stiffened deck panel in the midship area between the web frames and girders [P4].

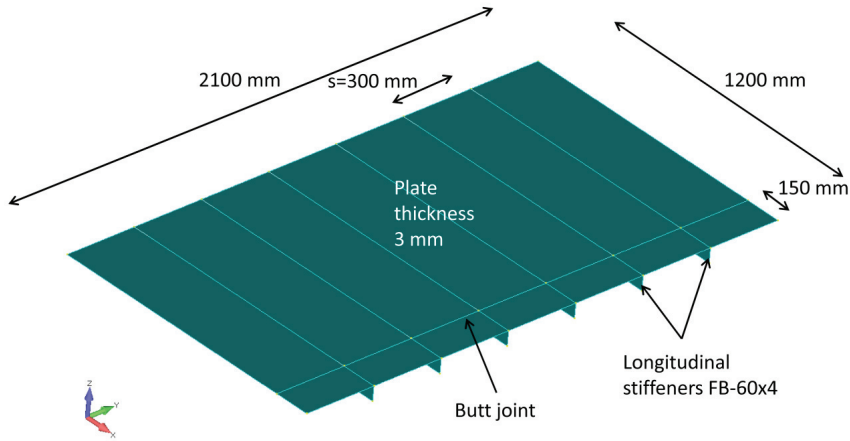

Figure 16: Smaller stiffened panel from [P3].

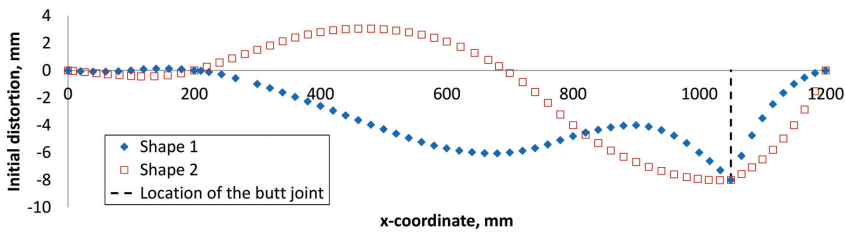

Figure 17: Initial distortion in the longitudinal, i.e., the stiffener direction, in the middle of the plate field [P3].

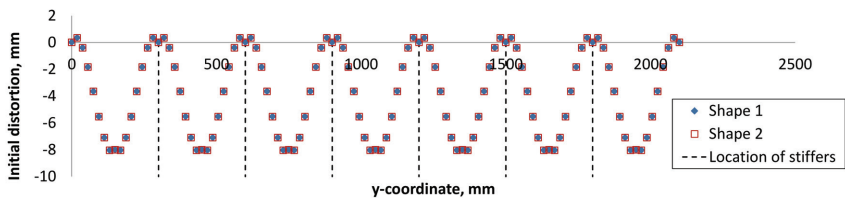

Figure 18: Initial distortion in the transverse direction in the middle of the plate field [P3].

4.1 FE analyses

For the thin stiffened panels the structural stress near the typical block joint locations was calculated using geometrically nonlinear FE analyses. The Abaqus 6.11-2 software with the RIKS solution method was used. The structural stress here is the normal stress in the load direction on the top surface of the plate element closest to the weld. The behavior of the stiffened panel was also investigated in an average sense, i.e., through nominal stress-nominal strain or load-end-shortening curves; see Figure 19. Four-node shell

elements with linear shape functions were used. The mesh size was not larger than 20 mm, resulting in three elements per stiffener web height and describing the initial distortion shape sufficiently well. The boundary conditions were either interpolated displacements from the global hull girder analysis for the larger deck panel – see Figure 15 – or idealized clamped for the smaller panels; see Figure 19. In the second case a force aiming at a nominal stress of ± 200 MPa was applied so that all the edge nodes moved by the same amount, i.e., with constant displacement.

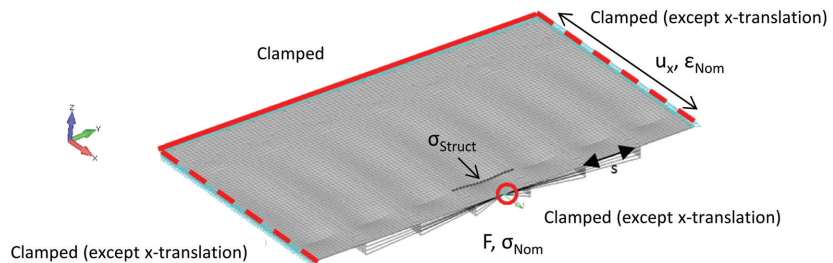

Figure 19: Example of the panel FE model with idealized boundary conditions; the darker color indicates the elements where the results are taken from [P3].

4.2 Influence of initial distortion shape on panel stiffness

Until now, no geometry measurement data on large thin prototype structures welded in shipyards is available. Based on the shapes reported for smaller 4-mm thin panels in [1] – see Figure 17 – or thicker panels in [50], it seems that one or two half-waves in the stiffener direction represent a realistic initial distortion. However, the range of validity of the results and conclusions obtained from the hull girder analysis with a simplified initial distortion shape – see Figure 12 – should be checked. This was done by varying the number of half-waves in the stiffener direction of the deck panel shown in Figure 15. One, two, four and eight half-waves in the stiffener direction were applied together with the initial distortion amplitude of 12 mm ($2 \cdot \text{IACS}$). In the extreme case of 8 half-waves, 6 mm ($1 \cdot \text{IACS}$) and 1.7 mm (0.05 times the stiffener spacing [52]) were also checked. Geometrically nonlinear (GNL) FE analyses of the panels were carried out. In all cases the boundary conditions were displacements from the geometrically linear hull girder FE analysis with thin straight superstructure decks under design hogging and sagging loading conditions.

Figure 20 shows the total axial force at the panel edge as a function of the average applied displacement and Figure 21 presents the same at the last load step as a function of the number of half-waves. It can be seen that the results for one and two half-waves in the stiffener direction are very similar. This was also the case in [P3] for two different measured shapes – Figure 17 – where one had one and the other had two half-waves in the stiffener direction. Four half-waves, together with the extreme initial distortion amplitude of 12 mm, deviate by more than 10% from the ideally straight geometrically linear (GL) case. Eight half-waves already reduce the panel stiffness significantly, by approximately one third, unless the initial distortion amplitude is very small. Regardless of the stiffness reduction, the behavior under the design loads is still linear in all cases, as shown in Figure 20. Based on this sensitivity analysis it can be determined that if in reality more than two half-waves in the stiffener direction are observed together with considerable initial distortion amplitudes, then the hull girder analysis should be redone.

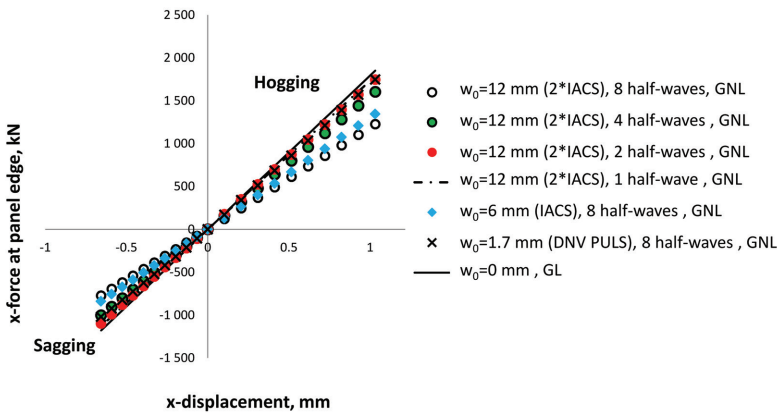

Figure 20: Total axial force at the deck panel edge at x=4095 mm from midship [P4].

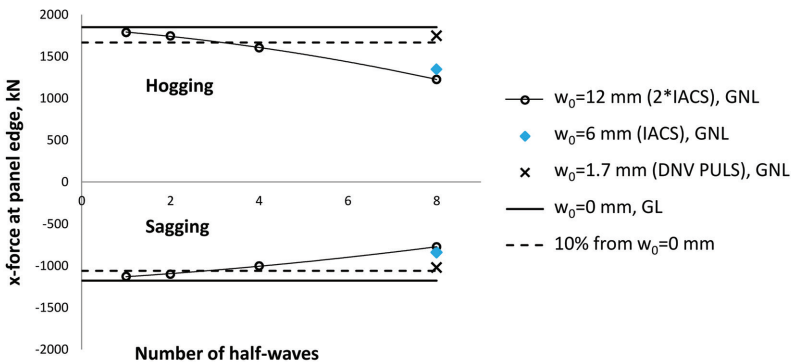

Figure 21: Sensitivity of initial distortion shape and amplitude to the deck panel stiffness [P4].

4.3 Influence of hull girder behavior on structural stress

As a result of the redistribution of the forces between the plates and stiffeners the average behavior of the thin deck panel as part of different global models was very similar and linear; see Figure 14 and [P4]. However, the effect of local differences at the panel boundaries on the structural stress was studied further using the sub-model shown in Figure 15. Figure 22 shows the membrane and the structural stress in one plate field of this panel between the stiffeners in the middle of the web frame spacing. Seven different combinations of global hull girder and panel sub-model analyses are compared. The loading condition is hogging. Case number 1 is the most complex, where both the global and the panel analyses include the initial distortion and the geometrical nonlinearity (GNL). Moving downwards, the analyses get simpler. Reference case 7 is the simplest, where both the global and the local analyses are performed geometrically linearly (GL) using ideally straight plates.

It can be seen from the figure that the fully linear case (7) clearly differs from the others. This illustrates that the panel sub-model must include the initial distortion. All the other results are in better agreement and it can be noticed that cases 1 and 2 (purple), 3 and 4 (green), as well as 5 and 6 (red), are very similar. This means that whether the panel sub-model analysis is geometrically linear or nonlinear has a very small influence on the results. The largest difference between cases 1-6 is within 6%. These results confirm that the global hull girder analysis can be carried out with acceptable accuracy using ideally straight plates and geometrically linear FE analysis, as has been done so far for passenger ships with traditional superstructures, [7], bringing considerable time saving. It also indicates that the equivalent element proposed by Avi et al. [53] can be utilized without modifications in global hull girder analysis, which further reduces the modeling and calculation time. The local panel sub-model, however, must include the initial distortion as the structural stress is highly dependent on its shape, but the geometrical nonlinearity is not significant.

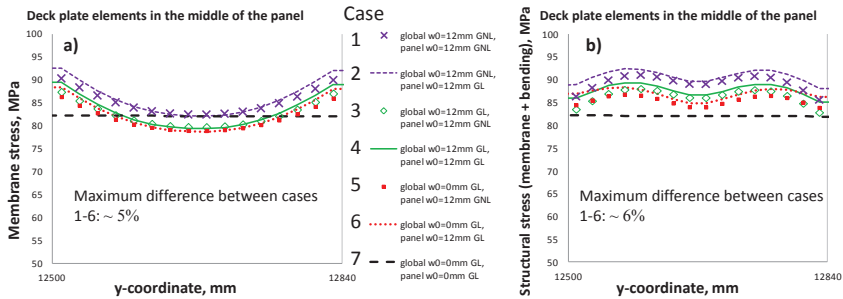

Figure 22: Membrane (a) and structural stress (membrane + bending; b) in the middle of the panel [P5].

4.4 Influence of initial distortion shape on structural stress

In the previous chapter, a simplified initial distortion shape with one half-wave between the web frames and stiffeners was used. In order to understand the influence of more complex shapes on the structural stress, the measured geometries from the literature [1] were also analyzed; see Figure 17. The simplified boundary conditions applied here – see Figure 19 – are justified by the linear behavior of the hull girder, shown in Figure 14, and by the small influence of local differences at panel boundaries; see Figure 22. The stress magnification factor k_m at the block joint location – see also Figure 19 – as a function of the y-coordinate moving from the middle of the plate field towards the stiffener is plotted in Figure 23 and Figure 24, under tension and compression, respectively.

The left-hand side of figures shows the influence of the initial distortion shape. For both shapes the maximum initial distortion is 8 mm, but in one case the geometry varies smoothly (shape 2), while in the other (shape 1) there is a sharp change at the location of the weld. This influences the structural stress by a factor of two. The importance of including the actual shape of the panel into the analysis in order to obtain reliable structural stress results, is also highlighted by Eggert et al. in [1]. The influence of the initial distortion magnitude is less significant when the maximum values are compared on the right-hand side of Figure 23 and Figure 24, where the geometry points of shape 1 were multiplied with 0.5 and 2. The influence of geometrical nonlinearity, i.e., the straightening effect under tension loading from 50 to 200 MPa, and the amplification of initial distortions from -50 to -100 MPa, indicated by the dashed lines, is the smallest. This is because of the redistribution of membrane stresses inside the panel due to initial distortion.

The distorted middle part of the plate carries less of the membrane force, while the straight parts near the stiffeners and the stiffeners themselves have to take more; see Figure 22a. The redistribution of forces is mentioned in [1] and more thoroughly discussed in [P3] and [P4]. The fact that geometrical nonlinearity is so small in panels means that Figure 10 is not directly applicable for actual structures, but should only be used to define the fatigue strength from small-scale test specimens. The link between small-scale specimens and actual structures is illustrated in Figure 25 and discussed in more detail in [P3].

The location of the maximum structural stress, i.e., membrane plus bending at the plate surface, is approximately at $1/4$ and $3/4$ of the stiffener spacing for all of the initial distortion shapes that were investigated; see Figure 22b, Figure 23 and Figure 24. The exception is the 4-mm case in Figure 23b, where the maximum structural stress occurs in the middle of the plate field. This agrees with some of the fatigue crack locations reported in [1]. Furthermore, the stress distribution in Figure 23 also explains the fatigue lives calculated in [2], where the fatigue life was found to be longer near the stiffeners than elsewhere in the plate.

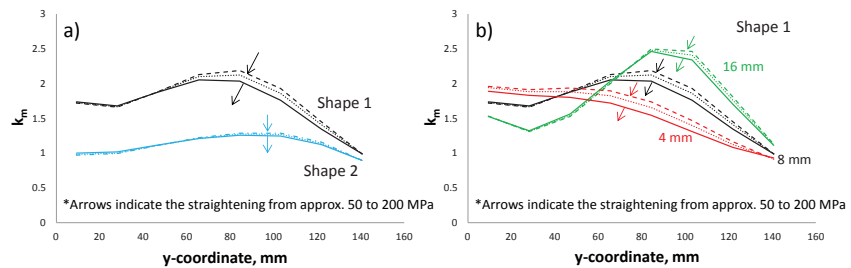

Figure 23: Influence of initial distortion shape (a) and magnitude (b) under tension as a function of y-coordinate (0 = middle of the plate, 150 = location of stiffener) [P3].

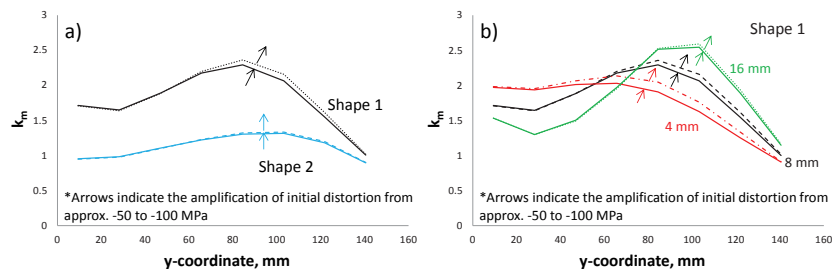

Figure 24: Influence of initial distortion shape (a) and magnitude (b) under compression as a function of y-coordinate (0 = middle of the plate, 150 = location of stiffener) [P3].

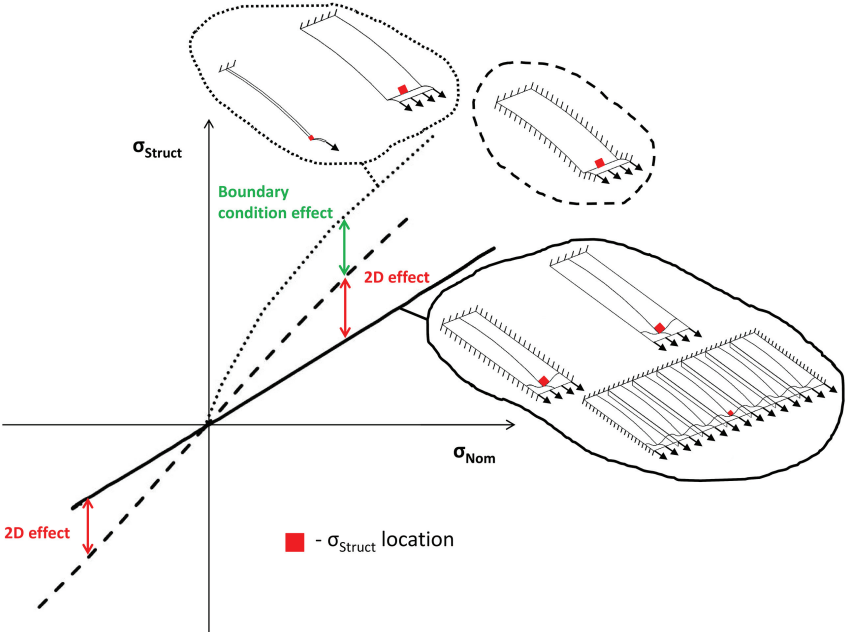

Figure 25: The link between highly nonlinear small-scale specimens and actual structures.

5 Conclusions

The outcome of the thesis is summarized in Table 2. Based on the results it can be concluded that the global hull girder response analysis for defining the panel loading for fatigue assessment can be performed with an acceptable accuracy of 10% using the ideally straight plates and geometrically linear FE analysis [P4]. This agrees with the present industry standard [7,25,26,28]. However, it must be kept in mind that the structural arrangement used here is such that it enables the forces to be redistributed with its thicker upper box that can take off the extra load from the thin decks. If the midship design is considerably different or if, in reality, initial distortion shapes with more than two half-waves in the stiffener direction are observed, then the conclusions of this work must be rechecked.

Table 2: Analysis hierarchy for the fatigue assessment of thin superstructure decks with initial distortions [P5]

Hull girder [P4]	Stiffened panel [P3]	Welded joint [P1 & P2]
Idealized straight Geometrically linear Current rules, e.g. [4; 7] → OK!	Initial distortion Geometrically linear Current rules, e.g. [4; 5; 54] → Not OK!	Initial distortion Geometrically nonlinear Current rules, e.g. [4; 5; 54] → Not OK!
<p>[P1] Lillemäe, Ingrid; Lammi, Heikki; Molter, Lars; Remes, Heikki. Fatigue strength of welded butt joints in thin and slender specimens, <i>International Journal of Fatigue</i> 44 (2012) 98-106</p> <p>[P2] Fricke, W.; Remes, H.; Feltz, O.; Lillemäe, I.; Tchuindjang, D.; Reinert, T.; Nevierov, A.; Sichermann, W.; Brinkmann, M.; Kontkanen, T.; Bohlmann, B.; Molter, L. Fatigue strength of laser-welded thin plate ship structures based on nominal and structural hot-spot stress approach, <i>Ships and Offshore Structures</i> (2013) DOI: 10.1080/17445302.2013.850208</p> <p>[P3] Lillemäe, Ingrid; Remes, Heikki; Romanoff, Jani. Influence of initial distortion on the structural stress in 3 mm thick stiffened panels, <i>Thin-Walled Structures</i> 72 (2013) 121-127</p> <p>[P4] Lillemäe, Ingrid; Remes, Heikki; Romanoff, Jani. Influence of initial distortion of thin 3 mm superstructure decks on hull girder response and fatigue assessment, <i>Marine Structures</i> 37 (2014) 203-218</p>		

Under the elastic load range, the average behavior of the panel in terms of both nominal stress and displacement was not influenced by the initial distortion shapes shown in Figure 17 [P3]. However, for the fatigue assessment the panel sub-model must include realistic initial distortion shapes since the structural stress is highly dependent on that. Using geometrically nonlinear FE analysis

is not that important since the straightening under tension and amplification of initial distortions under compression is very small in actual structures compared to small-scale specimens [P3].

For analyzing the fatigue test results of small-scale specimens, both the actual shape of the specimen and the geometrical nonlinearity must be included in the analysis in order to capture the significant straightening effect under tension loading and obtain the correct structural stress [P1]. If this is done, the fatigue strength of thin welded specimens is on the same level as that of thick welded plates [P1 & P2]. Current standards, however, do not include the straightening effect at all – [4] – or only consider it partly, i.e., by assuming that the angular misalignment occurs between straight plates [5]. As analytical formulas for accounting for the actual curved shapes of the specimens are missing, the geometrically nonlinear FE analysis is currently the only proper tool. In addition, the slope of $m = 5$ is found to be more suitable to describe the fatigue life of thin welded plates – [41] and [P1 & P2] – whereas the rules are still reluctant to change the slope of $m = 3$ [4,5,54].

The validation of the results with full-scale thin stiffened panels is left for future work. This requires the production of the panels and extensive geometry measurements in order to investigate the initial distortion shapes. Comprehensive strain gauge instrumentation would provide information on stress distribution and nonlinear effects. Such tests were carried out for 4-mm panels in [1], but some information is still missing. For example, in order to better capture and understand the effect of mean and residual stress, the larger structures should be tested instead of one-plate-field or small-scale specimens, which can buckle under compression loading and where the residual stress field has changed during cutting. These tests would also help to establish a clearer link between highly non-linear small-scale specimens and actual structures. In order to perform such laborious and expensive tests, a large project needs to be established.

Although the ultimate strength analysis of a hull girder with thin superstructure decks is beyond the scope of this thesis, it should be performed in the future in order to gain confidence in the strength reserve.

References

- [1] Eggert, L., Fricke, W., Paetzhold, H., Fatigue strength of thin-plated block joints with typical shipbuilding imperfections, *Welding in the World*, 56, Issue 11-12 (2012)
- [2] Fricke, W., Feltz, O., Consideration of influence factors between small-scale specimens and large components on the fatigue strength of thin-plated block joints in shipbuilding, *Fatigue & Fracture of Engineering Materials & Structures* 00 (2012) pp. 1-9
- [3] Det Norske Veritas. Rules for the classification of ships, Høvik, 2005
- [4] Det Norske Veritas. Classification Notes 30.7 Fatigue assessment of ship structures, Høvik, 2010
- [5] Hobbacher, A., IIW Recommendations for Fatigue Design of Welded Joints and Components, *WRC Bulletin 520, The Welding Research Council*, New York, 2009
- [6] Fricke, W., IIW Guideline for the Fatigue Assessment by Notch Stress Analysis for Welded Structures, IIW Document XIII-2240r1-08/XV-1289r1-08
- [7] Det Norske Veritas. Classification Notes 31.8 Direct strength analysis of hull structures in passenger ships, Høvik, 2007
- [8] Maddox, S.J., Fitness-for-purpose assessment of misalignment in transverse butt welds subject to fatigue loading, *The Welding Institute*, Abington Hall, Abington, Cambridge. CB1 6AL, 279/1985
- [9] Kuriyama, Y., Saiga, Y., Kamiyama, T., Ohno, T., Low-cycle fatigue strength of butt welded joints with angular distortion, IIW Document XIII-621-71, 1971
- [10] Sonsino, C.M., Fricke, W., Bruyne, F. de, Hoppe, A., Ahmadi, A., Zhang, G., Notch stress concepts for the fatigue assessment of welded joints – Background and applications, *International Journal of Fatigue*, 34 (2012) pp. 2-16

- [11] Radaj, D., Sonsino, C.M., Fricke, W., Recent developments in local concepts of fatigue assessment of welded joints, *International Journal of Fatigue* 31 (2009) pp. 2-11
- [12] Karakas, Ö., Morgenstern, C., Sonsino, C.M., Fatigue design of welded joints from the wrought magnesium alloy AZ31 by the local stress concept with the fictitious notch radii of $r_f=1.0$ and 0.05 mm, *International Journal of Fatigue* 30 (2008) pp. 2210-2219
- [13] Eibl, M., Sonsino, C.M., Kaufmann, H., Zhang, G., Fatigue assessment of laser welded thin sheet aluminium, *International Journal of Fatigue* 25 (2003) pp. 719-731
- [14] Fricke, W., Remes, H., Influencing factors on fatigue strength of welded thin plates based on structural stress assessment, *Welding in the World* (2014) DOI: <http://dx.doi.org/10.1007/s40194-014-0170-7>
- [15] Dow, R.S., Smith, C.S., Effects of Localized Imperfections on Compressive Strength of Long Rectangular Plates, *Journal of Constructional Steel Research* 4 (1984) pp. 51-76
- [16] Ueda, Y., Yao T., The influence of complex initial deflection modes on the behavior and ultimate strength of rectangular plates in compression, *Journal of Constructional Steel Research* 5 (1985) pp. 265-302
- [17] Paik, J.K., Some recent advances in the concepts of plate-effectiveness evaluation, *Thin-Walled Structures* 46 (2008) pp. 1035-1046
- [18] Sadovský, Z., Teixeira, A.P., Guedes Soares, C., Degradation of the compressive strength of rectangular plates due to initial deflection, *Thin-Walled Structures* 43 (2005) pp. 65-82
- [19] Sadovský, Z., Teixeira, A.P., Guedes Soares, C., Degradation of the compressive strength of square plates due to initial deflection, *Journal of Constructional Steel Research* 62 (2006) pp. 369-377
- [20] Xu, M.C., Guedes Soares, C., Assessment of the ultimate strength of narrow stiffened panel test specimens, *Thin-Walled Structures* 55 (2012) pp. 11-21
- [21] Xu, M.C., Guedes Soares, C., Comparisons of calculations with experiments on the ultimate strength of wide stiffened panels, *Marine Structures* 31 (2013) pp. 82-101

- [22] Paik, J.K., Thayamballi, A.K., Kim, D.H., An analytical method for the ultimate compressive strength and effective plating of stiffened panels, *Journal of Constructional Steel Research* 49 (1999) pp. 43-68
- [23] Paik, J.K., Lee, J.M., Lee, D.H., Ultimate strength of dented steel plates under axial compressive loads, *International Journal of Mechanical Sciences* 45 (2003) pp. 433-448
- [24] Özgüç, Ö., Das, P.K., Barltrop, N., The new simple design equation for the ultimate compressive strength of imperfect stiffened plates, *Ocean Engineering* 34 (2007) pp. 970-986
- [25] Payer, H.G., Hull Strength, Germanischer Lloyd, Annual Report, 1980
- [26] Gudmunsen, M.J., The Structural Design of Large Passenger Ships, Lloyd's Register of Shipping, 2000
- [27] Romanoff, J., Naar, H., Varsta, P., Interaction between web-core sandwich deck and hull girder of passenger ship, *Marine Systems and Ocean Technology* 6 (2011) pp. 39-45
- [28] ISSC. 1997. Committee II.1 – quasi-static response. Proceedings of the 13th International Ship and Offshore Structures Congress; 18-22 Aug 1997; Trondheim, Norway. Oxford (England): *Elsevier Science*. pp. 158-164
- [29] Bleich, H.H., Nonlinear distribution of bending stresses due to distortion of the cross section, *Journal of Applied Mechanics* 29 (1952) pp. 95-104
- [30] Caldwell, J.B., The effect of superstructures on the longitudinal strength of ships, *The Institution of Naval Architects* 99 (1957) pp. 664-683
- [31] Chapman, J.C., The interaction between a ship's hull and a long superstructure, *The Institution of Naval Architects* 99 (1957) pp. 618-629
- [32] Muckle, W., The influence of large side openings on the efficiency of superstructures, *Trans. RINA* (1962) pp. 301-308
- [33] Fransman, J.W., The influence of passenger ship superstructures on the response of the hull girder, *Trans. RINA* (1988)
- [34] Naar, H., Varsta, P., Kujala, P., A theory of coupled beams for strength assessment of passenger ships, *Marine Structures* 17 (2004) pp. 590-611
- [35] Andrić, J., Žanić, V., The global structural response model for multi-deck ships in concept design phase, *Ocean Engineering* 37 (2010) pp. 688-704

- [36] Romanoff, J., Remes, H., Varsta, P., Jelovica, J., Klanac, A., Niemelä, A., Bralic, S., Naar, H., Hull-superstructure interaction in optimized passenger ships, *Ships and Offshore Structures* (2012), DOI: 10.1080/17445302.2012.675196
- [37] Paik, J.K., Kim, B.J., Seo, J.K., Methods for ultimate limit state assessment of ships and ship-shaped offshore structures: Part III hull girders, *Ocean Engineering* 35 (2008) pp. 281-286
- [38] Gannon, L., Liu, Y., Pegg, N., Smith, M.J., Effect of welding-induced residual stress and distortion on ship hull girder ultimate strength, *Marine Structures* 28 (2012) pp. 25-49
- [39] Benson, S., AbuBakar, A., Dow, R.S., A comparison of computational methods to predict the progressive collapse behavior of a damaged box girder, *Engineering Structures* 48 (2013) pp. 266-280
- [40] VDI/VDE 2634 Part 3, Optical 3D-measuring systems, Multiple view systems based on area scanning, Verein Deutscher Ingenieure, December 2008
- [41] Sonsino, C.M., Bruder, T., Baumgartner, J., S-N lines for welded thin joints – suggested slopes and FAT-values for applying the notch stress concept with various reference radii, *Welding in the World*, 54, Issue 11-12 (2010)
- [42] Sonsino, C.M., A consideration of allowable equivalent stresses for fatigue design of welded joints according to the notch stress concept with $r_{ref}=1.00$ and 0.05 mm, *Welding in the World*, 53, Issue 3-4 (2009)
- [43] Remes, H., Varsta, P., Fatigue strength between arc and laser hybrid welded joints, *Journal of Ship Production*, Vol 24, No. 3 (2008) pp. 139-146
- [44] Olivier, R., Köttgen, V.B., Seeger, T., Welded joints I – Fatigue strength assessment method for welded joints based on local stresses (in German), FKM-Forschungshefte No. 143. Frankfurt: FKM (1989)
- [45] Radaj, D., Sonsino, C.M., Fricke, W., Fatigue assessment of welded joints by local approaches, 2nd Edition, Cambridge, Woodhead Publishing Ltd, 2006
- [46] Weichel, F., Petershagen, H., Fatigue strength of laserwelded structural steels with thicknesses between 8 and 20 mm, IIW Document XIII-1590-95, University of Hamburg, Germany

- [47] Molter, L., Fatigue strength of laser hybrid weld seams in ship construction, Ph. D. thesis, University of Southern Denmark, 2013
- [48] Hughes, O.F., Paik, J.K., Ship Structural Analysis and Design, *The Society of Naval Architects and Marine Engineers* (2010), Ch. 14 Elastic buckling of stiffened panels
- [49] IACS No. 47 Shipbuilding and Repair Quality Standard, Rev. 6, May 2012
- [50] Paik, J.K., Thayamballi, A.K., Ultimate Limit State Design of Steel Plated Structures, John Wiley and Sons, London, 2002
- [51] ABAQUS 2012. User's Manual ver. 6.9
- [52] Det Norske Veritas, PULS user's manual (version 2.05). Technical Report no. 2004-0406, Oslo, Norway, 2006
- [53] Avi, E., Lillemäe, I., Romanoff, J., Niemelä, A., Equivalent shell element for ship structural design, *Ships and Offshore Structures* (2013) DOI: 10.1080/17445302.2013.819689
- [54] von Selle, H., Peschmann, J., Eylmann, S., Implementation of fatigue properties of laser welds into classification rules, Analysis and Design of Marine Structures – *Proceedings of the 4th International Conference on Marine Structures*, MARSTRUCT (2013) pp. 273-280

Errata

Publication	Page	Place	Instead of	Read
[P1]	101	Figure 8	$\alpha_G = -2.06$ deg	$\alpha_G = -2.24$ deg
[P5]	127	Figure 6	[5]	[6]

Publications

The everlasting goal of scientists and engineers is to make structures cheaper and safer. Advanced new materials and higher-quality production methods are making more energy efficient and eco-friendly lightweight solutions possible. In passenger ships, for example, the utilization of higher strength steels and laser-based welding technology could lead to much thinner cabin decks than are built today. Before this becomes possible, the fatigue resistance of 3 or 4-mm thick large welded structures needs to be verified. However, the extrapolation of the design methods used for thicker welded plates to thinner ones is not trivial because of the larger initial distortions caused by welding.



ISBN 978-952-60-5812-2
ISBN 978-952-60-5813-9 (pdf)
ISSN-L 1799-4934
ISSN 1799-4934
ISSN 1799-4942 (pdf)

Aalto University
School of Engineering
Department of Applied Mechanics
www.aalto.fi

**BUSINESS +
ECONOMY**

**ART +
DESIGN +
ARCHITECTURE**

**SCIENCE +
TECHNOLOGY**

CROSSOVER

**DOCTORAL
DISSERTATIONS**