

Helsinki University of Technology
Department of Industrial Engineering and Management
Doctoral Dissertation Series 2008/3
Espoo 2008

RESOURCE CONSTRAINTS IN HEALTH CARE

- CASE STUDIES ON TECHNICAL, ALLOCATIVE AND ECONOMIC EFFICIENCY

Fredrik J. Eklund

Dissertation for the degree of Doctor of Science in Technology to be presented with due permission of the Department of Industrial Engineering and Management for public examination and debate in Auditorium TUI at Helsinki University of Technology (Espoo, Finland) on the 2nd of May, 2008, at 12 noon.

Helsinki University of Technology
Department of Industrial Engineering
P.O.Box 5500
FIN-02015 HUT, Finland
Tel. +358 - (0)9 - 4512846
Fax. +358 - (0)9 - 4513665
E-mail : fredrik.eklund@hut.fi

Internet : <http://www.bit.hut.fi/hema/>

© Fredrik J. Eklund

ISBN 978-951-22-9337-7 (print)

ISBN 978-951-22-9338-4 (electronic)

ISSN 1797-2507 (print)

ISSN 1797-2515 (electronic)

<http://lib.tkk.fi/Diss/2008/isbn9789512293384>

All rights reserved. No part of this publication may be reproduced, stored in retrieval systems, or transmitted, in any form or by means, electronic, mechanical, photocopying, microfilming, recording, or otherwise without permission in writing from the publisher.

Photo: Julius

Yliopistopaino

Helsinki 2008

ABSTRACT

The scarcity of resources and the need to produce more with less is an ever-present reality for managers of health care organisations. Trends in healthcare costs are a widely acknowledged concern among policy-makers worldwide. Many factors will contribute to the evolution of future health care systems. They include changing demand and demand patterns, developments of medical technology, citizens' expectations of readily available high-quality services, the availability and capacity of health care resources, the purchasing power of citizens, and financing mechanisms.

In the study, six cases - representing the operative and conservatory area of special care, an open care system, a major regional diagnostic support function, elderly care systems and a regional health care system – are analyzed. The main contributions of operations management to resource constraint problem are related to, but not limited to, how capacity of resources can be measured and managed. This study provides insight and a model for how resource constraints can be identified in all health care service production processes as well as in patient episodes. Applying technical, allocative and economic efficiency analysis provides tools for identifying and reducing the impact of resource constraints. Reducing the impact or eliminating bottlenecks increases the total capacity of a process or system with interdependent resources. The benefits of the analysis increase as its scope analysis is extended to include the regional service network.

Efficiency improvement efforts should focus on constrained resources, as a system's capacity can only be increased by increasing the capacity of these resources. Capacity is almost exclusively limited by personnel resources, but the capacity of personnel is rarely sufficiently analyzed. This is due to insufficient management tools and results in an inability to manage operations according to its constrained resources. Once resource constraints have been identified and quantified, the means for increasing capacity of bottlenecks are subject to improvements of technical and/or allocative efficiency. Here the benefits and potential of OM are significant.

The study shows that there may be significant room for improvement of both technical and allocative efficiency in many areas of health care. Excessive focus is placed on the efficient management of non-constrained resources for which information is more readily available. This is likely to result in optimisation of non-constrained resources, which may be synonymous to sub-optimisation. Maximizing the use of non-constrained resources may impose new resource constraints.

Economic efficiency depends on technical and allocative efficiency. Thus, improvements of technical and allocative efficiency are highly likely to render improvements of economic efficiency. On the regional level, economic efficiency improvement potential is likely to be subject to significant resource reallocation efforts. This study highlights the importance of maintaining a throughput- or process-oriented management mindset as opposed to mere focus on costs. Nevertheless, the importance of a more comprehensive state of analysis, which combines process and financial information, is strongly advocated.

Key words: operations management, health care, resource constraints, technical efficiency, allocative efficiency, economic efficiency

TIIVISTELMÄ

Resurssien niukkuus ja tarve tuottaa enemmän nykyisillä resursseilla on osa tämän päivän terveydenhuollon johtajien todellisuutta. Terveydenhuollon kustannusten kehitys on päätöksentekijöiden huolenaihe maailmanlaajuisesti. Terveydenhuollon järjestelmien kehitykseen vaikuttavat palvelujen kysynnän tason ja rakenteen muutokset, terveydenhuollon teknologian kehitys, kansalaisten palvelujen saatavuus- ja laatuvaatimukset, resurssien saatavuus ja kapasiteetti, kansalaisten ostovoima sekä rahoitusjärjestelmä.

Tutkimuksessa analysoidaan kuusi case-tutkimusta jotka edustavat sekä operatiivista että konservatiivista erikoissairaanhoidtoa, avohoitojärjestelmää, alueellisia diagnostisia tukipalveluja, vanhusten palvelujen järjestelmiä että alueellista sosiaali- ja terveydenhuollon järjestelmää. Tuotantotalouden oppeja voidaan hyödyntää resurssien olleessa niukkoja mm. resurssien kapasiteetin mittaamiseen ja johtamiseen. Tuotantoprosessien ja järjestelmien kapasiteetti usein ei tiedetä ja tässä tutkimuksessa ehdotetaan tapoja joiden avulla niukkoja resursseja (pullonkaloja) voidaan identifioida terveydenhuollon tuotantoprosesseissa sekä terveydenhuoltojärjestelmissä potilasvirtausta analysoidessa. Teknisen, allokatiivisen ja taloudellisen tehokkuuden analysoinnin menetelmät mahdollistavat pullonkalojen identifioinnin ja niiden vaikutusten lievittämisen. Menetelmien hyödyllisyys kasvaa analyysia laajentaessa esim. alueellisella tasolla koska järjestelmän kapasiteetti on riippuvainen yksittäisten resurssien kapasiteetista.

Pyrkimykset tehokkuuden parantamiseen tulisi keskittyä pullonkaloaresursseihin koska se on ainoa mahdollisuus nostaa tuotantoprosessien tai järjestelmän kapasiteettia. Pullonkaloaresursseja ovat lähes poikkeuksetta henkilöstöresurssit, mutta terveydenhuollon organisaatioiden tieto näiden resurssien kapasiteetista on useimmiten vähäistä. Tämä johtuu puutteellisista johtamisjärjestelmistä ja johtaa siihen että toiminnan tehokas johtaminen pullonkaloaresurssien mukaisesti ei ole mahdollista. Kun pullonkaloaresurssit on identifioitu ja kapasiteetti mitattu, kapasiteetti voidaan nostaa parantamalla teknistä ja/tai allokatiivista tehokkuutta.

Tutkimus osoittaa että terveydenhuollosta löytyy merkittäviä mahdollisuuksia parantaa teknistä ja allokatiivista tehokkuutta. Nykyisin keskitytään liikaa ei-pullonkaloaresurssien optimoimiseen joka yhtä kuin osaoptimointia, koska näiden optimointi ei nosta järjestelmän kapasiteettia. Lisäksi tämä voi johtaa teennäisiin pullonkaloihin tuotantoprosessissa tai järjestelmätasolla.

Taloudellinen tehokkuus on riippuvainen teknisestä ja allokatiivisesta tehokkuudesta. Teknisen ja allokatiivisen tehokkuuden parantaminen johtanee myös taloudellisen tehokkuuden parantamiseen. Alueellisella tasolla, suurin potentiaali taloudellisen tehokkuuden parantamiseen löytyy resurssien uudelleenallokoinnista. Tutkimuksessa kannustetaan vahvasti analysoimaan prosesseja ja taloutta rinnakkain, mutta kääntämään johtamisen keskipisteen vahvemmin prosessien kehittämiseen pelkän kustannusanalyysin lisäksi.

Asiasanat: tuotantotalous, terveydenhuolto, resurssien niukkuus, tekninen tehokkuus, allokatiivinen tehokkuus, taloudellinen tehokkuus

ACKNOWLEDGEMENTS

I never considered myself much of an academic. This is most certainly reflected in the research process of my dissertation and PhD studies in general. To those who helped prove me wrong along the way, I would like to extend the following thanks.

Being able to define, conceptualise and structure issues is a virtue in this complex world of ours. This was without a doubt the most challenging part of my dissertation. For helping and taming me in this struggle I am obliged to my supervisor Professor Paul Lillrank. The loose knots in the dissertation would most certainly not have found each other without his solid theoretical insight, persistence and support.

Without a doubt, this dissertation would not have come to be without the insight, inspiration, determined encouragement and fellowship of my instructor and good friend Professor Erkki Vauramo. He believed in me throughout the way and for that I am forever indebted to him.

I am very grateful for the insightful comments of my pre-examiners Professor Olli-Pekka Ryyänen, Kuopio University and Professor Barrie Dowdeswell, Durham University. They will most certainly influence my future research efforts.

I would also like to express my deep gratitude to my colleagues at the HEMA institute at Helsinki University of Technology who have played crucial roles along the way and influenced the direction and realisation of the research process. In particular, I would like to thank Professor Petri Parvinen, PhD Vesa Kämäräinen as well as my fellow researchers Paulus Torkki, Olli Tolkki, Antti Peltokorpi, Antti Alho, Kari Jalonen, Virpi Kronström, Nora Huttunen and Karita Ilvonen.

The case studies in this dissertation would not have been possible without the collaboration and support of the case organisations. From the Orton Invalid foundation I owe my thanks to Pekka Paavolainen and Seppo Seitsalo. From the Finnish Students Healthcare Services I want to thank the Eija Orpana and former Maarit Toveri. From the Centre for Laboratory of Pirkanmaa Hospital District I am grateful for the cooperation of Ari Miettinen and his team. From Helsinki and Uusimaa Hospital District, I would particularly like to thank Markku Mäkijärvi, Janne Aaltonen and Nina Fyhr. Most importantly, I wish to thank Kari Hassinen and Heikki S. von Herzen from Kymenlaakso Hospital District their open-minded, comprehensive and bold views on regional health care.

I thank the Finnish Funding Agency for Technology and Innovation (TEKES) for funding research at the HEMA Institute at Helsinki University of Technology. Moreover, I thank the Instrumentarium Scientific Foundation, the Paulo foundation and the Aarne Koskelo Foundation for financially supporting my research.

Last but not least, I would like to extend my deepest gratitude to my family. I thank Johanna, my partner in life and love, for her undivided support and my son Julius, who was born amidst the final stages of this venture. He inspired and pushed me to finish my dissertation (daddy almost made it in time, my dear).

TABLE OF CONTENTS

1	INTRODUCTION.....	12
1.1	BACKGROUND	12
1.2	FORMULATION OF THE RESEARCH PROBLEM.....	15
1.3	OBJECTIVES & RESEARCH QUESTIONS	17
1.4	THE STRUCTURE OF THE STUDY.....	18
2	THEORETICAL FRAMEWORK.....	19
2.1	AN OVERVIEW OF OM AND APPLICATIONS IN HEALTH CARE.....	19
2.2	THE THEORY OF CONSTRAINTS AND ACTIVITY-BASED COSTING.....	30
3	MATERIALS & METHODS.....	36
3.1	SELECTION OF CASES STUDIES.....	36
3.2	APPLICATION OF OM AND EFFICIENCY TYPES.....	37
3.3	DATA	40
3.4	LIMITATIONS TO OPERATIONS MANAGEMENT APPLICATION.....	41
4	ANALYSIS.....	43
4.1	PRESENTATION OF SELECTED CASE STUDIES.....	43
4.2	TECHNICAL EFFICIENCY ANALYSIS.....	53
4.3	ALLOCATIVE EFFICIENCY ANALYSIS.....	70
4.4	ECONOMIC EFFICIENCY ANALYSIS.....	85
4.5	SUMMARY OF EFFICIENCY ANALYSIS.....	106
5	DISCUSSION.....	118
5.1	QUANTIFYING FINANCIAL CONSTRAINTS	118
5.2	IDENTIFICATION OF RESOURCE CONSTRAINTS.....	118
5.3	DEALING WITH RESOURCE CONSTRAINTS	119
5.4	CONTINUOUS IMPROVEMENT.....	122
6	CONCLUSION.....	123
7	REFERENCES.....	124
7.1	EMPIRICAL REFERENCES.....	129
8	APPENDIX.....	131

LIST OF FIGURES

Figure 1 - Domestic and international estimates of Finnish health and elderly care costs as a percentage share GDP (Stakes 2006a)	13
Figure 2 - Number of employees in healthcare per 1,000 inhabitants vs. health care costs as %-share of GDP 2004 (OECD 2006).....	14
Figure 3 - Fundamentals of the resource constraints problem.....	16
Figure 4 - Framework of performance indicators for health care processes (van der Bij and Vissers 1999).....	21
Figure 5 - The objective hierarchy in regional health care resource planning (Pelletier and Weil 2003).....	23
Figure 6 - Conceptual framework of health Operations Management planning and control processes (Vissers and Beech 2005).....	25
Figure 7 - Skåne Region Vision for regional health care (Interreg IIC 2006)	26
Figure 8 - Patient episodes and related time categories – an example (Kujala et al. 2006).....	28
Figure 9 - Dimensions of throughput orientation (Boyd and Gupta 2004)	32
Figure 10 - Overview of case studies	37
Figure 11 - The different efficiency types	38
Figure 12 - Efficiency measurement under constant returns to scale (Jacobs et al. 2006).....	39
Figure 13 - Allocative efficiency with two inputs (Jacobs et al. 2006).....	39
Figure 14 - Efficiency types (Adapted from Lillrank et al. 2004).....	41
Figure 15 - Overview of FSHS units and health areas.....	46
Figure 16 - Management models in three stages.....	47
Figure 17 - Number of clients and their accumulated bed days in elderly care institutions, normal and intensive service housing and health centre hospitals – year end 2005 (Stakes 2006).....	50
Figure 18 - Cost distribution in special care 2005 in Kymenlaakso.....	52
Figure 19 - Primary health and elderly care services 2005 in Kymenlaakso.....	52
Figure 20 - Average personnel productivity vs. total personnel (per service and health area)	55
Figure 21 - Average personnel productivity vs. % of realised visits (per service and health area).....	56
Figure 22 - Share of personnel's time spent in core and non-core activities during average work day 2006.....	57
Figure 23 - Percent of time spent in laboratory sample taking vs. productivity (number of samples visits / time in sample taking) in 2006.....	58
Figure 24 - Annual number of samples per type of equipment type and utilization rate (%) in 2005.....	58
Figure 25 - Number of samples vs. throughput time when analyzed in centralized laboratory (2006).....	59
Figure 26 - Number of patients arrivals per day to emergency department and average LOS (2005).....	61
Figure 27 - Hourly demand and throughput time in emergency department for acute coronary heart disease patients (average and median) in 2005.....	61
Figure 28 - Use of inpatient department capacity (2005).....	62
Figure 29 - Use of personnel in elderly care institutions, service housing and home care in Finnish hospital district 2005 (number of personnel from beginning of 2005) (Statistics Finland 2006, Stakes 2006).....	63
Figure 30 - Average LOS in different care types in Finnish hospital districts as of year-end 2005 (Stakes 2006).....	65
Figure 31 - A regional comparison of resource use between hospital districts in 2006 (Kuntaliitto 2007).....	68
Figure 32 - Regional analysis of personnel in health and social care - year end 2004.....	69
Figure 33 - Map of Kymenlaakso hospital district - Employees in health and social care service providers in the regional health care network - year end 2004.....	70
Figure 34 - Number of nurses per inpatient bed vs. average LOS (2003-2005).....	71
Figure 35 - Number of surgeons to nurses vs. average throughput time in OR (2003-2005).....	71
Figure 36 - Proportion of nurse to doctor personnel (in full work years) vs. productivity (weighted average) in 2005.....	72
Figure 37 - Proportion of nurse/doctors vs. productivity (weighted average) in 2005.....	73
Figure 38 - Time spent in different activities outside the centralised laboratory on average working (2006).....	74
Figure 39 - Time spent in core vs. non-core activities in the centralised laboratory during the average work day (2006).....	75
Figure 40 - Flow of coronary-artery patients (first two movements) during 2004-2005.....	76
Figure 41 - Simplified analysis of patient flow (2004-2005).....	77
Figure 42 - Average coronary artery patient episode in two week period (Melin 2006).....	78
Figure 43 - Long-term care beds per 1,000 inhabitants over 65 years old (OECD 2006).....	79
Figure 44 - Number of municipalities by %-share of bed days produced for patients aged 74 years or more, in health centre hospitals, 2005 (remaining bed days in social care) (Sotka database, Stakes 2007).....	79

Figure 45 - Average LOS and care categorization for long-term care in different elderly care types within region, year-end 2005 (Stakes 2006).....	80
Figure 46 - Professionals' assessment of appropriate care and comparison with other international models.....	81
Figure 47 - Common organisation-level bottlenecks in the Finnish elderly care system.....	82
Figure 48 - Map of Kymenlaakso hospital district - Health and social care service providers in the regional health care network - year end 2004.....	84
Figure 49 - Map of Kymenlaakso hospital district - Relative cost inpatient distribution between special and primary care for stroke and coronary artery patients in different municipalities 1996 - 2005.....	85
Figure 50 - Development of average inpatient department costs and average number of inpatient days 2003-2005.....	86
Figure 51 - Development of OR costs and throughput time 2003-2005.....	87
Figure 52 - Relationship between productivity of doctor personnel and cost per doctor visit (2005).....	88
Figure 53 - Relationship between productivity of nurse personnel and cost per nurse visit (2005).....	88
Figure 54 - Doctor to nurse visits and corresponding costs per visit (weighted average) in 2005.....	89
Figure 55 - Proportion of nurse to doctor personnel vs. cost per visit (weighted average) in 2005.....	90
Figure 56 - Proportion of psychologists to psychiatrist personnel vs. average cost of mental care visit in 2005.....	90
Figure 57 - Productivity in sample taking vs. cost per taken sample (2006).....	91
Figure 58 - Laboratory equipment, degree of utilization (%) vs. annual cost including maintenance (€) in 2005.....	91
Figure 59 - Example of patient in process costs (1,300 patients) during 2004-2005.....	94
Figure 60 - Example of patient flow and cost distribution (2004-2005).....	95
Figure 61 - Number of clients in different service types by LOS- year end 2005.....	97
Figure 62 - Resource allocation in elderly care - the elderly populations' use of special care (inpatient care in internal medicine & neurology) vs. municipal elderly care (adopted from Sitra 2006).....	97
Figure 63 - Resource allocation in elderly care -institutional vs. open elderly care (adopted from Sitra 2006).....	97
Figure 64 - Population development, tax paying population 2005-2035E.....	100
Figure 65 - Demographical effects on regional tax income 2005-2035E.....	100
Figure 66 - Increasing system capacity by improving technical and/or allocative efficiency of a constrained resource.....	111
Figure 67 - Extending analysis of resource constraints to the regional network level.....	114
Figure 68 - Constraints and the process of ongoing improvement.....	115
Figure 69 - Improving economic efficiency when demand exceeds supply.....	116
Figure 70 - Improving economic efficiency when demand equals supply.....	117
Figure 71 - Improving economic efficiency when supply exceeds demand.....	117

LIST OF TABLES

Table 1 - Similarities between manufacturing and health care operations (Bertrand and de Vries 2005).....	20
Table 2 - Major differences between manufacturing and health care (Bertrand and de Vries 2005).....	20
Table 3 - Major differences between manufacturing and health care, and similarity in challenges (Bertrand and de Vries 2004).....	21
Table 4 - Framework of performance indicators for health care processes (van der Bij and Vissers 1999).....	24
Table 5 - Framework for measurements indicating lean thinking (Kollberg et al. 2007).....	27
Table 6 - WIP related costs in health care production processes (Kujala et al. 2006).....	29
Table 7 - Examples of organisational models for healthcare networks.....	29
Table 8 - Data used in case studies.....	40
Table 9 - Measures used and definitions.....	45
Table 10 - Definitions of elderly care types (Stakes 2006b).....	50
Table 11 - Process measures at ORTON Orthopaedic Hospital.....	53
Table 12 - Utilization rate of inpatient departments, average LOS and personnel per 100 bed days (9 months in 2005).....	61
Table 13 - Reason for admission to different care facilities - at the end of 2005 (Stakes 2006).....	66
Table 14 - Care need categorization - patients at the end of 2005 (Stakes 2006).....	67
Table 15 - Resource allocation measures.....	71
Table 16 - Financial measures and average cost distribution of patient episodes (2003-2005).....	86

Table 17 - Pro forma income statement, cash flow and balance sheet (2004-2005)	99
Table 18 - Income statement estimates (2005PF – 2035E).....	101
Table 19 - Cash flow and balance sheet estimates (2005PF – 2035E).....	102
Table 20 - Amount of external financing required to finance the service network depending on the extent to which demographically extrapolated use of services is realised (by 2020 and 2035).....	103
Table 21 - Amount of external financing required to finance the health care service network depending the %-share of municipal tax income allocated and annually allocated state support by 2020 and 2035.....	104
Table 22 - The amount of external financing required to finance the health care service network depending the average interest-rate on interest-bearing debt (by 2020 and 2035).....	105
Table 23 - Age distribution of personnel in the service network at year end 2005	105
Table 24 - Summary of technical efficiency analyses.....	107
Table 25 - Summary of allocative efficiency analysis.....	109
Table 26 - Summary of economic efficiency analysis.....	112

APPENDICES

A - 1 Cost coverage in Finnish health care (adopted from Stakes 2006a).....	131
A - 2 - Finnish citizens' pension distribution as of year end 2005 (Halmeenmäki 2005)	132
A - 3 Demographic development estimates (Statistics Finland 2005).....	133
A - 4 Demographic development estimates 2005-2035, %-share per age group (Statistics Finland 2005).....	133
A - 5 ICPC-distribution for patients in different health service areas	134
A - 6 Use of healthcare services by function in FSHS (2005).....	134
A - 7 FSHS key figures (2005).....	135
A - 8 Number of patients, accumulated bed days and average LOS of elderly care patients as of year-end 2005 (Stakes 2006).....	136
A - 9 Numbered hospital districts.....	137
A - 10 Distribution of clients' care need categorization in different service types in Finnish hospital districts- patients at the end of 2005.....	137
A - 11 Reason for admission to health centre hospitals – patients at the end of 2005.....	138
A - 12 Number of customers by care categorization per service type and region, year-end 2005.....	139
A - 13 Percentage share of customers by care categorization per service type and region –end of 2005.....	140
A - 14 Model for combining production process and financial analysis	141
A - 15 Special care inpatient care estimates (2005-2035).....	142
A - 16 Estimated changes in secondary care procedures (2005-2035).....	142
A - 17 Distribution of total use of inpatient days in primary and special care of selected patients (Stakes 2006).....	143
A - 18 Distribution of total use of inpatient days in primary and special care of selected patients (Stakes 2006 and Kymenlaakso municipalities and hospital district)	143

DEFINITIONS

REGION

Regions exist as historical and empirical realities. The term refers to an area with certain geographical, political or cultural characteristics that distinguish it from other regions. From a healthcare service production viewpoint, a region is a production and consumption unit where a significant amount of end-to-end health care services can be provided to demand for health care services. In this study, a Finnish hospital district is analogous to a region.

SERVICE NETWORK

In this study, a service network is a Finnish public health and social care network encompassing special care, primary care and social elderly care.

EFFICIENCY

The amount of valued output in relation to input resources.

TECHNICAL EFFICIENCY

The amount of acceptable or quality -adjusted output per resource or production unit

ALLOCATIVE EFFICIENCY

Variations in the amount of output produced depending on the distribution of resources in different activities in time and place.

ECONOMIC EFFICIENCY

The relative monetary cost of a unit of output.

PATIENT EPISODE

A sequence of events associated with being a patient in a healthcare organisation. A patient episode can be measured as the number of events and the total length of the episode.

RESOURCES

Permanent or consumable objects used in production (e.g. personnel, buildings, materials and equipment).

CONSTRAINED / BOTTLENECK RESOURCE

A resource or group of resources that limits the capacity of a process or system.

ECONOMIES OF SCALE

Increasing the number of outputs produced reduces the (fixed) cost per unit.

ECONOMIES OF SCOPE

Joint production of two or more outputs results in lower costs than producing these outputs separately.

ECONOMIES OF SPECIALISATION

Specialisation enables organisations to produce the same output with fewer resources than an unspecialised organisation.

ABBREVIATIONS

ABC	Activity-Based Costing	JIT	Just-In-Time
ABM	Activity-Based Management	LOS	Length of Stay
ABTM	Activity-Based Throughput Management	MRI	Magnetic Resonance Imagine
CAGR	Continuous Aggregate Growth Rate	MRP	Material Requirements Planning
CCU	Cardiac Care Unit	NHS	National Health Service, UK
CDU	Cardiac Diagnostic Unit	NPV	Net Present Value
CLM	Centre for Laboratory Medicine	ODS	Organized Delivery Systems
CM	Constraints Management	OM	Operations Management
CT	Computed Tomography	OR	Operating Room
DBR	Drum-Buffer-Rope	PF	Pro Forma
DMU	Decision making unit	PIP	Patient-In-Process
FSHS	Finnish Student Health Service	RDP	Reorder-Point System
ICD	International Classification of Disease	SCM	Supply Chain Management
ICPC	International Classification of Primary Care.	TBC	Time-Based Competition
ICU	Intensive Care Unit	THA	Total Hip Arthroplasty
IHCD	Integrated Health Care Delivery	TQC	Theory of Constraints
ISCO	International Standard Classification of Occupations	WIP	Work In Progress

1 INTRODUCTION

1.1 BACKGROUND

Health care systems worldwide are under pressure to contain costs. The scarcity of resources and the need to produce “more with less” is an ever-present reality for health care organisations. As in any other industry, the use of resources in service production results in costs. Listed companies must optimise resource use in order to maximize profits and shareholder value. National health or government-regulated systems must maximize the availability and quality of health care services while staying within their budgets and using constrained resources (Vissers et al. 2005).

The increase in health care costs is a widely acknowledged concern among policy-makers worldwide. Both demographic changes and medical technology advances are expected to increase costs (Thorpe et al. 2004). In Finland, major demographical changes are likely to occur during the next decade.¹ In the future, health care systems in Europe and other parts of the world will have to deal with health problems related to ageing populations. The scarcity of resources requires that health care systems be managed as effectively as possible to ensure quality and availability of care. Health care system consists of a vast number of service providers and there are numerous challenges involved with aligning objectives and incentives for service providers to benefit patients while still improving cost-efficiency. There is no such thing as an optimal system, and the changes that occur will likely depend on local characteristics.

The Finnish health care system has not changed significantly since the passing of the Citizen’s Health Law in 1972.² Municipalities are responsible for the provision of primary health and social care. Special care is arranged jointly by municipalities in hospital districts. Finnish citizens rely on the current municipality-driven health care system, and there appears to be a strong belief in a re-organisation of health care services. Expectations for preventive care and disease management are increasing and are, coupled with the development of new financing and partnership models, likely to be reflected in the structure of future health care service networks. Visions of the future of Finnish health care have been provided by various organisations, including the Decision in Principle by the Council of State on securing the future of health care (Ministry of Social Affairs and Health 2002), the Committee of the Future of the Parliament of Finland and regional visions by hospital districts. The national health project Decision in Principle by the Council of State has resulted in a large scale of municipal re-organisations currently ongoing across the country.

¹ For further analysis of demographic development, see A - 3 and A - 4.

² Kansanterveyslaki 28.1.1972/66

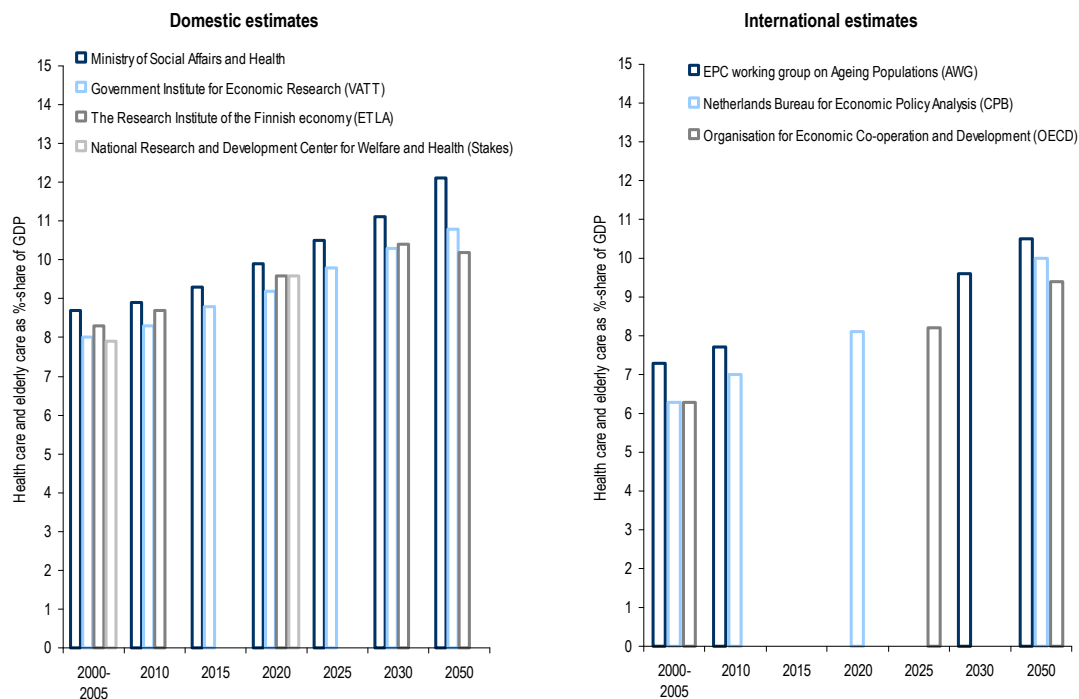

Figure 1 - Domestic and international estimates of Finnish health and elderly care costs as a percentage share GDP (Stakes 2006a)
n/a = not available

Figure 1 shows estimated costs of health and elderly care services as a percentage of Gross Domestic Product (GDP) in Finland until 2050. The estimates were made domestically and by international organisations. As seen in Figure 1, all groups have estimated a significant future increase of health care services as a percentage of GDP. Increased health care costs are mainly attributed to demographic changes. The main difference between domestic and international estimates is that domestic estimates suggest an increase of health care's share of GDP, while international estimates consider constrained resources and, thus, result in lower estimates (Stakes 2006a). Nevertheless, the upward trend is clearly predicted in both cases.

In 2006, the Organisation for Economic Co-Operation and Development (O.E.C.D.) compared health care costs as a percentage of GDP and personnel employed in health care. The findings of this study support the notion that these parameters are correlated (Figure 2). Finland is positioned close to the average in terms of healthcare personnel in relation to the population. In terms of health care share of GDP, Finland is positioned in the lower third. This is an indication that wage level (in real terms) is below average in Finland.

Though rarely explicitly discussed when estimating the development of health care costs, costs are large extent dependent on the number of personnel employed in health care. Domestic and international consensus estimates for increase in health care costs as a share of GDP by 2050 are 2.7% and 3.3%, respectively (Figure 1). Corresponding estimates for 2020 are 1.2% and 1.8%, respectively. Assuming that cost distribution (and that GDP in nominal terms) remains more or less constant, this would mean a 15% increase of personnel by 2020 and 30% by 2050 (in Figure 2).

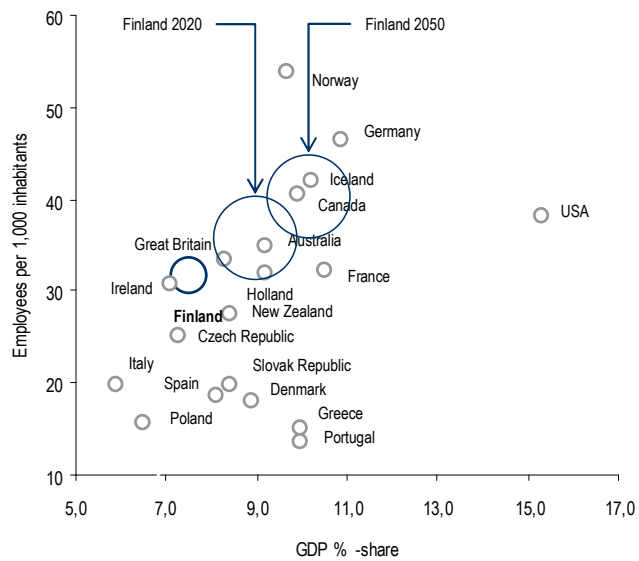

Figure 2 - Number of employees in healthcare per 1,000 inhabitants vs. health care costs as %-share of GDP 2004 (OECD 2006).

The Finnish welfare system finances health and social care through direct taxation. Health and social care in Finland is mainly financed by taxes raised by municipalities and through state support. Citizens pay taxes both to the state and to municipalities. Special care is financed by municipalities according to inhabitants' use of services. Tax-payments (municipal tax and state) set the budget of the service network and, therefore, determine the amount of resources available to health and social care.³ The system is similar to those of Sweden, Norway and Italy. The Finnish hospital district level is politically and organisationally autonomous. In this sense, the insurance fund-models in countries like the Netherlands, Germany, France and Hungary differ from the context in this study (EuHPN Capital Study [to be published]).

The size of the elderly population is also estimated to increase significantly during coming decades, both in absolute terms and as a share of the entire population.⁴ Pensions are not tax-exempt in Finland, but nevertheless, demographic changes will accentuate the financial challenges. Given the development, elderly increasingly may be required to fund the use health care services from their own pockets. In addition, the ageing population is leading to a high rate of retirement among public health care employees is likely to trigger change in Finnish health and social care. The average age of personnel in public health care is older than that of most professional groups. The retirement process has already commenced and is likely to continue during the next 10 years. Lack of personnel will become increasingly evident during the next 10 years because the retirement rate is accelerating. Almost 50,000 employees are estimated to retire from health and elderly care by the year 2020 (Halmeenmäki 2005).

³ A further overview of the funding mechanisms in Finnish public health care is provided in A - 1.

⁴ For more detailed information of demographical development, see A - 3 and A - 4.

1.2 FORMULATION OF THE RESEARCH PROBLEM

Figure 3 summarises the fundamentals of commonly perceived resource constraints in Finnish health care operations.. Demographic changes, institutional changes, citizens' expectations for quality and availability of health care services, and medical and technological developments may ultimately affect citizens' health care *needs* and *wants*. The need for health care services is likely to increase as the population ages. Simultaneously, this situation will affect financing of the services in a tax-based system. This results in relatively fewer tax-payers in relation to the retired population. Institutional changes may ultimately affect demand (e.g. health standards) as well as financing (e.g. raising the retirement age).

A common perception is that the demand for service quality and the availability of services is increasing, which is likely to increase demand. In addition, the emergence of new technologies, medical equipment and medicines may also increase demand (Ryynänen et al. 2006).

Costs are directly dependent on the cost of resources used in health care service production. Increasing the costs of resources will also increase total costs --- for example, by increasing wage levels. The other driver of costs is the amount of resource used in service production. The relationship between increasing health care expectation by citizens and the scarcity of resources has been the subject of extensive discussion among academics (Cochrane et al. 1991). As far as health care personnel resources are concerned, the common perception is that there is limited availability of qualified personnel in the public sector.

Increased demand requires increased supply unless demand is left unmet. Increased supply is often considered the result of increased resources: thus, increased demand will create pressure to increase resources. Supply of health care services may also affect the structure and amount of demand for services. Increases in health care resources must also increase health care costs. The development of health care costs is also dependent on unit-costs of resources, in addition to real monetary development. Ultimately, cost developments are subject to available financing and purchasing power.

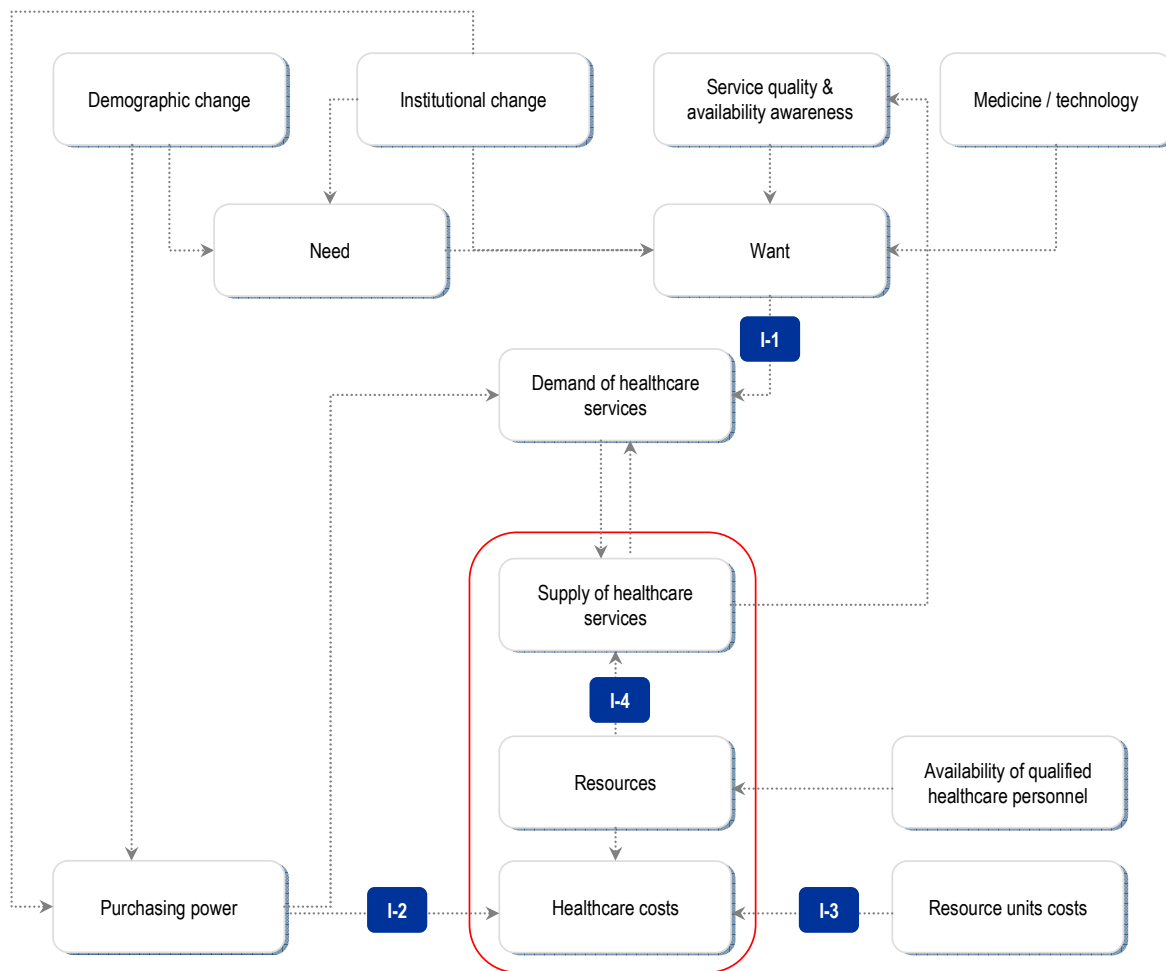

Figure 3 - Fundamentals of the resource constraints problem

Numerous complex, interacting components can create the resource constraint problem. Consequently, there may be many solutions to the problem. Figure 3 summarises these issues. They may cause at least two conflicting situations. First, the tax-based system may not be able to cover increased health care costs. Second, the likely need to increase personnel resources may not be possible, due to the lack of qualified personnel. Roughly speaking, the problem may be solved by performing one of the following interventions individually or concurrently:

- INTERVENTION 1 (I-1). Do not allow the demand for health care services to increase. This means that despite demographic changes and other drivers of health care service, the output of the system must not increase. This intervention would require an increase in preventive activities or a change in health standards). Service levels would also have to be reduced. For example, prevention and setting of health care standards affect the realised need for health care services. Citizen desire for health care services is subject to complex mechanisms that may or may not be affected.

- INTERVENTION 2 (I-2). Increase financing of health care operations. The resource constraints problem could be eliminated by simply increasing money invested in health care. The number of qualified personnel could probably be increased given sufficient financial incentives. This may not be possible in the current tax-financed system outside of increasing taxes. Other financing models may be feasible.
- INTERVENTION 3 (I-3). Decrease the cost of resources (e.g. wages). If the amount of resources is increased due to increased demand, costs could, theoretically, be kept constant by reducing the unit cost per resources. Given the recent developments in health care wage policy in Finland, this is a highly unlikely option.
- INTERVENTION 4 (I-4). Do not allow an increase in the use of resources in health care operations. Increased demand requires increased capacity, and the only means of increasing capacity is often considered the increase of resources in health care service production. This is true if assumed that the current service production system is optimal and that resources all achieve their full potential. On the other hand, improving the allocation of resources in the system may be possible, and there is also potential to improve the performance of individual resources in the system.

This study evaluates Intervention 4 from an operations management (OM) perspective. The focus of the study is on investigating whether there are alternative means of increasing capacity outside of increasing resources in health care service production.

1.3 OBJECTIVES & RESEARCH QUESTIONS

The objective of this study is to investigate how OM methods can deal with resource constraints in health care from an efficiency perspective. The study provides practical examples of how methods for operations and resource management can be applied in order to provide further insight into the resulting health care costs. The study has applied OM methods to selected case studies, to seek answers to the following research questions:

RESEARCH QUESTION 1

How can financial constraints in health care be quantified?

RESEARCH QUESTION 2

What limits the capacity of health care resources from an OM perspective?

RESEARCH QUESTION 3

How can factors limiting the capacity of health care resources be identified?

RESEARCH QUESTION 3

Does operations management provide tools or methods for health care managers to increase the capacity of resources?

1.4 THE STRUCTURE OF THE STUDY

A presentation of the background to and formulation of the research problem was presented above followed by a presentation of the objectives and research questions of the study. The theoretical framework of this study is presented in section 2. First, a general presentation of OM research in health care is provided followed by a more detail presentation of the theory of constraint (TOC) and activity-based costing (ABC) as well as OM applications in healthcare.

The method applied and materials used in the study are presented in section 3. First, process of selecting case studies is described followed by a discussion on how OM theory is applied in the study and the different efficiency types analyzed in the case studies. Then the data from the case studies and its validity is assessed. The section ends with a discussion on the limitations of applying OM theory to the case studies.

Section 4 begins with a presentation of the selected case studies. The presentation includes a background to the case, a description of the research environment, case-specific objectives as well as the methodology used in the analysis each case. The section continues with an analysis of each of the cases from the efficiency perspectives: technical, allocative and economic efficiency. Section 4 ends with a summary of the efficiency analysis.

A discussion of the analysis is provided in section 5. The discussion is divided into four main themes. The conclusion is presented in sections 6.

2 THEORETICAL FRAMEWORK

According to the O.E.C.D., equity, efficiency, effectiveness and empowerment are the main issues in reforming health care. Tensions in health care services are increasing as policymakers seek to decrease health care expenditure, at a time when waiting times for health care services are becoming central political issues. The ageing population, coupled with demand growth, is fuelling this tension further. These issues are all subject to constrained resources and a challenge for OM is to contribute to the re-design and reengineering of new health care systems (Lowther 1998).

The analytical framework of this study rests upon operations management principles for analysing processes, production planning and control, as well as the interaction between organisations in health care. A number of OM methods can be applied when analysing health care operations, but because there is no consensus as to which ones are most appropriate (Vissers et al. 2005), this section provides a general overview of OM principles.

OM is predominantly linked to product manufacturing, which may hinder innovative ways of managing service-oriented operations (Nie and Kellogg 1999). Many characteristics of service operations are different from manufacturing operations. They include customer influence, intangibility, perishability and labour intensity. Furthermore, production and consumption cannot be separated. Some researchers have suggested that service operations should be considered a separate discipline (McColgan 1997). However, the literature on health care application of service operations management is meager and, therefore, traditional OM methodologies are the main focus of this section.

2.1 AN OVERVIEW OF OM AND APPLICATIONS IN HEALTH CARE

"Of all managerial tasks the production/operations management function is the hardest to define since it incorporates so many diverse tasks that are interdependent. To divide it up, therefore, is to destroy it."(Muhlemann et al. 1992)

OM refers to the planning, controlling and organizing of production processes and their support functions. As such, it addresses a wide range of planning and decision making areas. Examples of these areas include business planning, product design and development, resource requirements planning, facility location and distribution, process design and layout, inventory design, production planning and scheduling, material and material requirements planning, and quality assurance (Evans et al. 1990).

Vissers et al. 2005 define OM in health care as "the analysis, design, planning and control of all of the steps necessary to provide a service for a client." Application of OM methods in research is still fairly limited (Yasin et al. 2002; Parvinen and Halonen 2004), but more importantly, there has been even more limited coverage of the fundamental and underlying assumptions of OM methods in a health care setting. These include the focused factory concept, just-in-time, production control concepts and hierarchical production control. There are a number of similarities to manufacturing, and many of the challenges facing health care providers are similar to those in manufacturing (Table 1). Examples of these challenges include a need for efficient resource use, cost containment, and pressures to improve quality (Bertrand and de Vries 2004).

Table 1 - Similarities between manufacturing and health care operations (Bertrand and de Vries 2005)

	Manufacturing	Health care
Object:	Material flow	Patient flow
Specification of end-product requirements:	Up-front specified	Subjective and fuzzy
Means of production:	Equipment and staff	Equipment and staff
Buffers:	Stock or lead-time	Waiting lists and lead times
Financial goal:	Profit	Cost control
Market environment:	Market competition	Limited market competition

Despite some similarities between the manufacturing and health care settings, a number of factors hinder the straightforward application of OM in health care. Table 2 provides examples. Implementing concepts developed in industrial settings in a health care management setting is extremely challenging, since health care service, unlike manufacturing, is to a large extent the result of human interaction (Vissers and Rauner 2002). In addition, health care is a politically sensitive area and subject to electoral and ideological impacts. This problem can have negative effects on the planning and production of health care services. For example, it can contribute to short term-thinking and turn focus away from long-term strategic planning (Towill and Christopher 2005, Martin et al. 2003). Furthermore, business process re-engineering projects that lack methodologies and supporting information increase political risk and can allow tactically motivated vested interests to shape outcomes in their favour (Buchanan 2004).

Table 2 - Major differences between manufacturing and health care (Bertrand and de Vries 2005)

<ul style="list-style-type: none"> ▪ Production control focused on material flows, while health care focuses on flow of patients (material flow secondary) ▪ Less price-performance interaction in health care than in production environments ▪ Management differences – health care characterized by many interest groups with potential different performance objectives, not one line of command ▪ Production control approaches assume specified requirements of end-users, while this is vague in health care ▪ Key players in core process are highly trained professionals who generate requests for services / orders and are also involved in the delivery ▪ Care is not a commodity that can be stocked, the hospital is a resource-oriented service organisation
--

Despite relatively few literary references to the management and planning of entire health care systems, OM and production control principles have been adopted in different areas of health care. They have been proven to bring powerful methods for understanding the process of care (Davis and Walley 2000) and for increasing efficiency (Rotondi et al. 1997, Vissers et al. 2001, Karvonen et al. 2004).

2.1.1 Resources and capacity management

Resources are “used, but not transformed or consumed by production” and generate capacity. (Vissers et al. 2004). Resources used in hospital production can be grouped into five categories (Table 3).

Table 3 - Major differences between manufacturing and health care, and similarity in challenges (Bertrand and de Vries 2004)

Dedicated and shared resources	Resources that are shared by product lines, which may have a positive effect on costs, quality, resource control or resource utilization
Leading and following resources	Leading resources trigger production and imply capacity requirements on following resources
Bottleneck resources	A scarce resource that limits system capacity
Continuously or intermittently available resources	Resources that are either constantly available or not
Specialist-time as a shared resource	A multi-functional resource provided by specialty and shared between patient groups

Capacity is generated through the use of resources. A distinction must be made between maximum potential capacity, capacity available for production, the amount of available capacity that can actually be put in use, capacity that is actually used and, finally, the share of capacity that is productive. The difference between these types of capacity is illustrated in Figure 4.

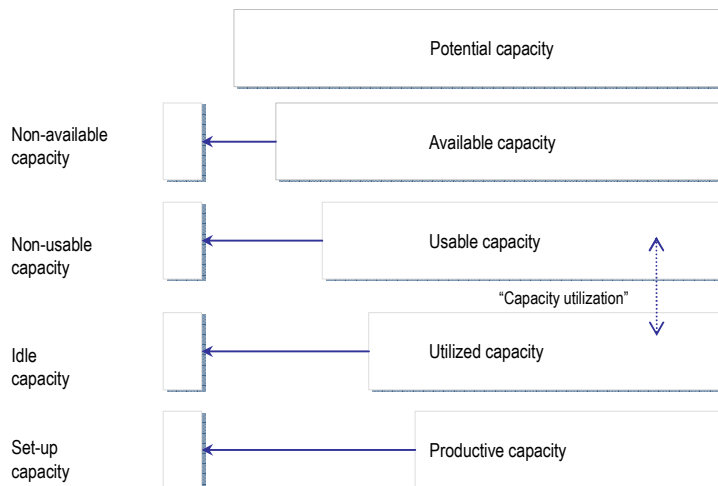

Figure 4 - Framework of performance indicators for health care processes (van der Bij and Vissers 1999)

Management of capacity in health care organisations refers to the acquisition and allocation of human resources, to equipment, and to facilities. A distinction should be made by short and long term capacity planning. In the long term, capacity planning is mainly related to the acquisition of major equipment and facilities. These items set physical boundaries for capacity (e.g. bed places) as well as the potential range of services that can be offered. Thus, size and locations are critical components in long term capacity planning. Personnel, though not an inflexible resource, is more

flexible, especially as regards over-time and subcontracting (Smith-Daniel et al. 1988). Capacity management and planning in health care are particularly challenging. In fact, there are studies indicating that capacity – or more specifically the availability of health care services – is a major determinant of demand (Martin and Smith 1996).

2.1.2 Demand management

Analysing the use of production resources is a central part of OM. Resource and capacity management has been found challenging in service industries in general, due to uncertain demand and individualized requirements. Demand chains and supply chains make the demand-supply chain and when these meet, supply is synchronized with demand (Eloranta et al. 2001).

OM methods applied to health care can provide straightforward answers and make recommendations for management as well as successful “recycling” of OM implementations (Aharonson-Daniel 1996). Naturally, the use of personnel resources is central when analysing capacity and demand in health care. Overstaffing results in unnecessary costs, while understaffing will negatively affect service quality and customer perception of quality (Adenso-Díaz et al. 2002).

Demand management requires understanding demand behaviour. Demand for health care services is often analysed from a demographical and epidemiological perspective. Demand can be observed and managed on the levels of product, unit, organisation and region. It is driven by two main elements: customer need for health care services and the opinion of clinicians concerning what services are necessary (van der Maas et al. 2004). Estimating distribution of services need in health care (e.g. disease-mix or number of elective vs. emergency patients) requires demand forecasting. Uncertainty can be addressed through flexible operational planning (Shapiro 2001). In health care, capacity demand forecasting and capacity planning is largely based on a deterministic approach using measures such as average need, length of stay (LOS), average time for surgical operations, etc. (Harper 2002). Stochasticity may, however, cause waiting lists even if average circumstances are under control (Vandaele and De Boeck 2003).

The traditional way of dealing with increasing demand or insufficient capacity in health care has been to increase resources. There are, however, strong indications that these issues are increasingly being addressed by reviewing the way services are produced. This approach is a major shift in management approaches, and it also reflects tighter budgetary constraints (Laing and Shiroyama 1995).

2.1.3 Health Care Resource Planning

A perceived need for managing health care resources led to the emergence of health care resource management activities, often referred to in the literature as *health care resource planning*. Regional uses of health care resources have been subjected to extensive research, including forecasting needed health care as well as balancing supply and demand (Pelletier and Weil 2003). Techniques used for health care resource planning have traditionally been based on optimisation models. They include, for example, multi-criteria decision models for solving resource location-allocation issues (Malczewski and Ogryczak 1990, Sinuary-Stern 1993, Carrizosa et al. 1992).

Regional health care planning refers to the planning of capacity, location and resource allocation of future services. The challenge of regional health care planning is to formulate public policy objectives in quantifiable data while accounting for resource constraints. The objectives of the region are determined using a number of factors, such as the current population's health status, reigning economic conditions, demographics, and current service offerings. The objective of regional health care resource planning is to adjust the supply of health care services to the regional care demand (Pelletier and Weil 2003). Pelletier and Weil used a model

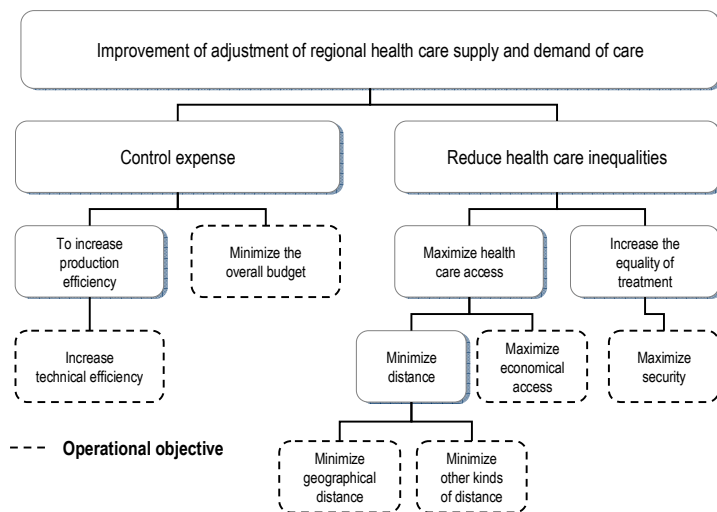

Figure 5 - The objective hierarchy in regional health care resource planning (Pelletier and Weil 2003)

first developed by Keeney and Raiffa in 1976 to structure the objectives of regional health care planning (Figure 5). They found that objectives of regional health care planning should be operationally defined in order to convey the extent to which objectives have been met. The objectives become operational when their sub-objectives can be applied. Regional health care planning objectives are then realised through operational sub-objectives. The model attempts to incorporate a number of dimensions affecting regional health care planning. This approach is unlike previously suggested models, which commonly are limited to one dimension, such as technical efficiency.

Operations management practices in health care are reflected in performance measurement currently applied in the health care context. Performance measurement is not a novel concept in health care, but is receiving an increasing amount of attention as organisations and professionals are faced with more difficult assessments (van der Bij and Vissers 1999). When re-evaluating health care systems, measurement systems are critical for monitoring quality and resource use. A complex system requires an extensive measurement system. For example, quality objectives including efficiency, efficacy, safety, patient-centeredness, timing and equality have been developed by the Committee on Quality of Health

care in America (2001). Many performance measurement methodologies have been applied to the analysis of health care. Van der Bij and Vissers (1999) suggested a framework for health care process performance indicators by grouping indicators into five categories: conditions, technical quality, relational quality, information and production control (Table 4). Though arbitrary, the framework shows the wide array of dimensions relevant from a performance indicator perspective.

Table 4 - Framework of performance indicators for health care processes (van der Bij and Vissers 1999)

Conditions	Technical quality	Relational quality	Information	Production control
Accessibility	Professionalism	Human treatment	Transfer of administrative Information	Access time
Telephone availability	Skilled staff	Client loyalty	Transfer of medical Information	Waiting time
Working conditions	Safety	Complaints addressed	Dossiers	Processing time
Job satisfaction	Effectiveness	Accountability		Resource occupancy
Facilities / privacy	Treatment and investigation plan	Co-operation		Resource utilization
Equipment				
Income material				

2.1.4 Hospital Resource Planning

Roth and van Dierdonck (1995) developed the concept of Hospital Resource Planning (HRP). This approach was based on the concepts of diagnostics related groups (DRGs) and the principles of manufacturing resource planning (MRP-II). DRGs had been introduced in the 1960s to group patients with homogenous resource needs (Fetter and Freeman 1986). This process made hospitals more mindful of patient needs for services, and improved the efficiency of hospital administration (Zelman and Parham 1990). According to Roth and van Dierdonck, HRP supplemented prior research by considering DRGs as resources incorporating both capacity and materials resources, and enabling implementation of a planning and control system on the hospital level. De Vries et al. 1999 consider the hospital as a virtual organisation of independent actors, arguing that hospital production processes are run by medical specialists rather than hospital management. Vissers and Beech (2005) developed a hierarchical framework for production control in hospitals based on the analysis of requirements for design in hospital production by De Vries et al. (1999) and the design concepts developed by Bertrand et al. (1990). The framework deals with the service-efficiency balance at different levels of production control. The hospital is viewed as a virtual organisation where patient groups are viewed as business units and a focused factory model is used for controlling production in the business units (Vissers et al. 2001).

2.1.5 The health care system

“Every system is perfectly designed to achieve the results it achieves” (Berwick 1996)

Figure 6 shows a conceptual framework for operations management planning and control in health care (Vissers and Beech 2005). This framework was originally developed for hospital settings (Vissers et al. 2001). It emphasizes the role of individual services as part of a larger health care system. Originally OM applications in health care were mainly performed at the individual service provider level. The first level, strategic planning, represents the long-term vision of the system,

which is then put into practice on the lower levels. On the second level, it is assured that the nature and amount of services needed to treat a certain amount of patients is available, including, for example, specific departments/units or resources. The lower levels pursue more detailed resource planning and allocation efforts, as well as patient flow planning efforts.

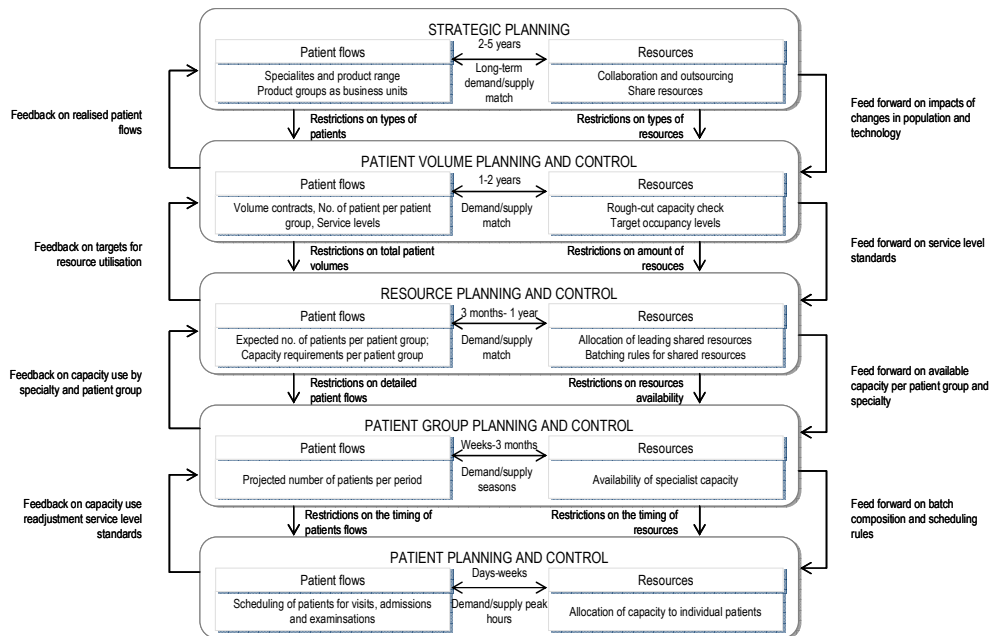

Figure 6 - Conceptual framework of health Operations Management planning and control processes (Vissers and Beech 2005)

The provision of health care service is often characterized by a complex network of organisations and professionals working together. Service engineering, which corresponds to planning and steering of these systems, is relatively undeveloped in health care, but is likely to become increasingly common in the near future as financial distress increases (Parvinen et al. 2005).

The success of health care systems has been extensively discussed in the literature. It has been proposed that challenges such as waiting list management can be conducted on different levels of health care including the national, regional, hospital and process levels (Vissers et al. 2001b). In general, a critical success factor for health care systems is the commitment to a common goal. According to Stringer (1967) and Lee (1970) successful management of organisations occurs when stakeholders 1) agree on a common agenda and are committed to it, 2) communicate and cooperate and 3) anticipate need and 4) commit to resource provision.

Integrated health care delivery (IHCD) is an example of a health care system characterized by extensive horizontal and vertical integration of health care service providers. The Health Maintenance Organisations (HMOs) in the United States are an example of an IHCD. Horizontal integration is the integration of similar organisations, such as hospitals, whereas vertical integration refers to integration of related activities (Janus and Amelung 2005). The advantages of IHCDs derive from improved access to information, decreasing incentives for opportunistic exploitation of uncertainty in the system.

Vertical integration reduces uncertainty and makes information more readily available and decreases coordination efforts (Riordan 1990, Janus and Amelung 2005). Vertically integrated health care systems have a network of organisations, such as hospitals, diagnostic facilities, nursing homes and home care. They are often referred to as organized delivery systems (ODS). An ODS commonly has one owner who is responsible for arranging, providing and coordinating a continuum of health care services. Since ODSs often are defined by a geographical area and a population base, they are often referred to as regional systems (Janus and Amelung 2005). Though ODSs may have some horizontal integration, they should be considered separate from integrated organisations only providing services in one single stage of the health care delivery process (Devers et al. 1996).

Documentation of practical implementation of health care service system thinking is limited in the literature. Interreg IIC (2006) discusses visions and aspects of European future regional health care systems. A practical example of regional health care systems is the Swedish Skåne, in which long-term regional planning began in 1999. Skåne adheres to citizen needs for health care and medical treatment and to the objectives of increased service availability, quality and cooperation (Interreg IIC 2006).

The vision is translated to resource allocation targets on the regional level. They are grouped into three levels on a continuous scale, from acute to elective care (Figure 7): 1) Highly Specialized Care, 2) Specialized (acute and planned) care and 3) Nearby care (including primary care, social care and parts of previous special care).

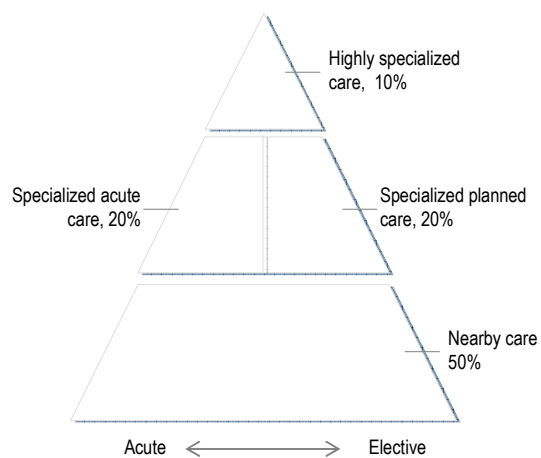

Figure 7 - Skåne Region Vision for regional health care (Interreg IIC 2006)

2.1.6 Lean thinking

The concept of lean production emerged from the Japanese manufacturing industry, primarily through the success of Toyota Motor Company (Hines et al. 2004). The term “lean” refers to a focus on eliminating waste in the production system. Lean production comprises five elements: 1) lean manufacturing, 2) lean product development, 3) supply chain management and coordination, 4) customer distribution and 5) lean enterprise management (Womack et al., 1990). Later, the concept of lean production was extended to include whole organisations as supposed to manufacturing alone (Womack and Jones 2003). Lean management refers to the management of organisations using the principles of lean thinking (Christopher 1998). One of the core objectives of lean management is the reduction of lead-time, or time elapsed between placing and receiving an order (Laursen, Gertsen and Johansen 2003).

Lean thinking is based on the idea that production happens as processes, and that processes ultimately create systems. Production creates value and waste, and reducing waste leads to improvements. Inventory, which is determined by

throughput times, is waste and cannot be reduced by sub-allocative optimisation, but rather by optimising throughput of an entire system (Womack and Jones 2003).

The terms *lean* and *lean management* have become increasingly common in health care in recent years. Lean thinking can contribute to managing health care services and, particularly, to analysing patient flow (Kollberg et al. 2007). Kollberg et al. (2007) argue that the successful implementation of lean thinking in health care has to be accompanied by a shift in management control models. The study lists critical success factors and examples of performance indicators. The authors also introduce a group of measurements indicating lean thinking (Table 5).

Table 5 - Framework for measurements indicating lean thinking (Kollberg et al. 2007)

Lean principle	Critical success factor
Specify value	Accessibility; Quality of medical services; Comfort, treatment, respect and participation;
Value stream	Process mapping; Accessibility; Interaction and participation; Delays; Overcapacity; Preparation time; Medical device down time; Transfer of patients and referrals; Referral management; Booking procedure
Flow	Just-in-time; Scheduling; Multi-skilled teams
Pull	Transparency of information; Accessibility
Perfection	Continuous improvement, process control

According to Womack and Jones (2003), in a health care setting, lean thinking means focusing on the patient, with analysing time and patient comfort as performance indicators. For example, Karlsson et al. (1995) and Young et al. (2004) advocate the relevance of lean principles in health care, as it focuses on such things as continuous improvement, delay elimination, and repetition, as well as errors and inappropriate treatment. A number of success stories of lean approaches in health care have been documented (Miller 2005, Spear 2005, Rogers et al. 2004).

As mentioned, the objective of lean thinking is to improve performance by eliminating waste. Womack and Jones (2003) list seven types of waste: 1) Mistakes requiring rectification, 2) Production of unwanted items (or services), 3) Processing unnecessary steps, 4) Moving employees, 5) Unnecessary transport of goods, 6) Idle personnel in downstream activity and 7) Production of services or goods not wanted by the customer.

Applying lean thinking to health care operations can free many resources. Measurement systems must be designed to reflect lean thinking. Increased focus on time-parameters in patient flow analysis is a significant step towards lean thinking in health care. This would significantly affect current management models in health care organisations.

2.1.7 Analysing patient flow

A fundamental cornerstone of operations management theory is the theory of swift and even flow. According to Schmenner and Swink (1997), productivity is determined by the level of swift and even flow through a process. According to the authors, the stages of this process can be divided into value-added and non-value-added work. Swiftiness is determined by movement through process bottlenecks and even flow is achieved by limiting variability in demand or process steps.

An increasingly common application of operations management methodologies is in the analysis of patient flow, or how patients move through the system. Improvements in patient flow can be obtained by improving interfaces between activities and departments on the macro, regional, centre and department level (Hall et al. 2006). A group of simultaneous or subsequent health care services constitute a patient episode (Kujala et al. 2006). Health care processes can be classified into standard, routine and non-routine processes. Each process has different quality problems (Lillrank 2003b).

Concepts of material flow, previously adopted for managing production and services, have also been applied for analysing health care delivery systems. Towill and Christopher (2005) argued that patient flow can be considered analogous to product flow and that health care pipelines refer to “the flow of patients in pursuance of all phases of their treatment from referral to full recovery”. The authors stated that the main difference between health care delivery and production logistics is that in health care the main reason prohibiting the flourishing of managerial best practices is political in nature, hindering long-term strategy improvement (see also Martin et al. 2003).

Recent publications consider the analysis of patient flow to be an important tool for evaluating resource allocation and utilization in health care. Patient flow has often been analysed in hospitals using such tools as simulation models (Isken and Rajagopalan 2002). The flow of patients through the health care system from primary consultation to system exit has also been analysed using the concepts of time-based competition (TBC). TBC is based on lean thinking and focuses on the throughput time of processes and work-in-progress (WIP). It also addresses the large amount of inventory that tends to accumulate as a result of long throughput times. Lillrank (2003a) present the case for the patient-in-process concept, where focus is placed on throughput time throughout the system, rather than measuring the efficiency of separate health care organisations or units. Rather than focusing on the processes of individual organisations or production units, focus is placed on the cooperation, interaction and interfaces between organisations participating in the entire care pathway.

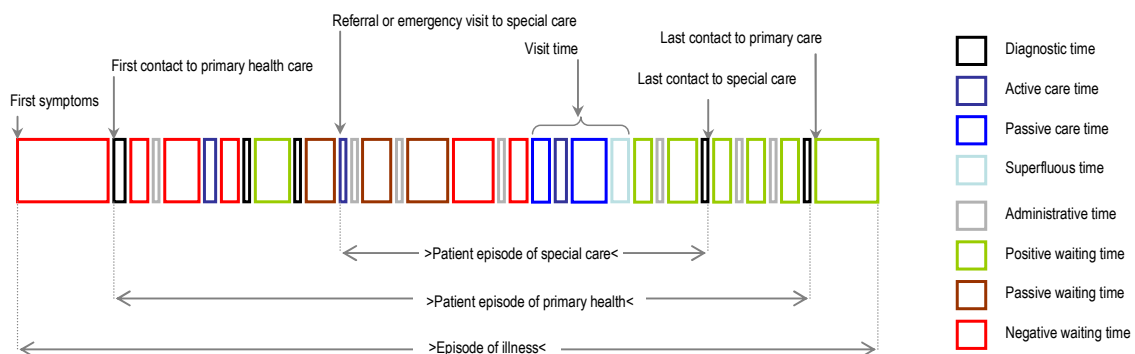

Figure 8 - Patient episodes and related time categories – an example (Kujala et al. 2006)

Kujala et al. (2006) argued that a patient episode can be considered analogous with “a customer order-to-delivery chain in industry” and that the reduction of non-value-added time in the patient episode is an effective application of both TBC and WIP in health care (Figure 8). The result is Patient in Process (PIP), which is compared to WIP in Table 6. Particular benefits from a resource allocation viewpoint can be obtained when focusing on minimizing time categories that constitute the main cost drivers of the entire patient episode. As in lean management, TBC focuses on decreasing lead-time through

by reducing non-value-adding time in the process. Non-value-adding times include waiting times, transport, excessive production and unnecessary processing.

Table 6 - WIP related costs in health care production processes (Kujala et al. 2006)

Work-in-progress (WIP) in manufacturing processes	Patient in process (PIP) in health care production processes
Direct inventory costs (space, etc.)	Use of hospital facilities (beds, etc.)
Resource spent on non-value adding activities (e.g. inventory management)	Resources used for queue management, hotel service for patients waiting in hospital, additional medical operations (e.g. new laboratory tests) Resources spent by other stakeholders for non-value adding activities (e.g. social services providers)
Inventory obsolescence	Deterioration of patient medical condition leading to additional or more costly treatments, and/or decreased quality of care outcome
Cost of working capital employed	Working capital employed due to patients in process for hospital
Decreased production capacity	Patients filling to capacity, inefficient use of bottleneck resources, extra beds in corridors, increased fixed costs per patient episode due to decreased throughput
Decreased control of production process	Overtime work, employee dissatisfaction, patient dissatisfaction
Unsatisfactory service punctuality	Decreased timely access to medical services, leading to costs for: patients (lost income, suffering), insurance companies (medical expenses), employers (lost work output) and/ or patient's family

Practical alternatives for designing health care service systems have been discussed, for example, in the Netherlands. The Netherlands Board for Healthcare Institutions presented three main categories for design of health care networks (Table 7; Interreg IIIC 2006).

Table 7 – Examples of organisational models for healthcare networks

A. Clinically oriented organisation	B. Organisation based on patient flows	C. Organisation based on treatment processes
1. Brain & nervous systems	1. Emergency & acute general care	1. Diagnostic centre
2. Cancer	2. Urgent care	2. Consultation centre
3. Metabolic system, ageing	3. Elective care	3. Treatment centre
4. General acute care & joints	4. Management of chronic illness	4. Nursing centre
5. Heart disease		5. Knowledge centre
6. Growth, reproduction		6. Technical service centre

The literature provides many cases where process bottlenecks are identified when analysing resource allocation in conjunction with patient flow. Analysis of patient flow can be a good indicator of future demand, for example in intensive care units, and thus can be an appropriate tool for resource management (McManus et al. 2004).

2.1.8 A logistics perspective of the health care service systems

The application of supply chain management (SCM) and logistics concepts to health care is fairly limited (Towill and Christopher 2005, Glouberman and Mintzberg 2001). Towill and Christopher (2005) consider health care delivery to be a pipeline where health care service providers interact in different stages from referral to recovery and consider it analogous to product flow from an industrial viewpoint. They point out the similarity between health care and commercial logistics: both strive to improve service levels, and corresponding concerns can be found regarding value-adding activities, quality management, and cycle times. In both cases, the ultimate goals are to improve total performance while containing costs (Herzlinger 2000). Disregarding total system performance and focusing on local improvement is not likely to provide financial benefits from re-engineering efforts (Towill and Christopher 2005). Reluctance towards flow concepts in the health care setting has been documented, and also found to be counter-productive (Shapiro and Smith 2003).

Towill and Christopher (2005) mapped health care requirements in a space-time matrix, according to which tasks are performed either sequentially or concurrently and in the same place or geographically separate locations. According to the authors, the model can be applied to health care delivery. They asserted that the NHS is increasingly moving towards a pipeline perspective. These points can be useful in logistics practice and can be used to avoid interference between patient flows, which has proven detrimental for supply chain performance (Mason-Jones and Towill 1999, Towill and Christopher 2005, Burbridge 1984). The authors advocated increasing the implementation of “pipeline-thinking” and provide a number of examples from National Health Service in the UK (NHS) for which the time-matrix can be implemented.

2.2 THE THEORY OF CONSTRAINTS AND ACTIVITY-BASED COSTING

The theory of constraints (TOC) was first developed in the 1980s and refers to a process of continuous improvement with a focus on managing bottlenecks in the production process (Goldratt 1990b). When introduced, the TOC provided an alternative model to activity-based costing (ABC), which had been introduced by Kaplan and Norton (Goldratt 1990a, Kee and Schmidt 2000). Both models are integrated parts of OM theory. They are separately discussed in this section in order to highlight their differing management implications. Particular attention is given to the distinction between TOC and ABC, and further developments of these concepts, because TOC is often associated with process or throughput focus while ABC reflects a more cost-focused management approach (Boyd and Gupta 2004)

2.2.1 The theory of constraints and constraints management

Goldratt (1990b) referred to a system constraint as “anything that limits a system from achieving higher performance versus its goal” and states that every system has few constraints, but always at least one. According to TOC, each production system has its bottleneck(s) and production should be managed in accordance with its constraints. Removing a bottleneck from the production process moves an organisation closer to its goal, but also means that a new bottleneck will appear. The system becomes a process of continuous improvement (Goldratt 1990a). Goldratt proposed measures for evaluating product-related decisions and questioned the assumptions of traditional cost-accounting and ABC. The measures are referred to as *throughput accounting*. They consist of three components: (1) Throughput (generated

money/sales), (2) Inventory (money invested by the system in items it intends to sell) and (3) Operating expense (money spent on turning inventory into throughput) (Goldratt 1986).

Goldratt (1986) argued that measures for dealing with bottlenecks include knowing market demand and how much time per resource is required to meet demand, as well as minimizing inventory and work in progress. The cost of bottlenecks should account for the extent to which they limit performance of the whole system, rather than considering them as separate cost centres. TOC advocates argue that labour and overhead costs are fixed and that it is irrelevant from a decision-making perspective whether these costs are allocated or not. In contrast to a cost-focused management approach (e.g. ABC/M), where the main goal is to reduce operating costs, throughput orientation aims at maximizing throughput. According to Goldratt (1992), costs are mostly fixed and focus should be placed on throughput rather than operating expense. Constraints management (CM) rejects ABC's idea of cost allocation to products (Boyd and Gupta, 2004). According to Kaplan (1992) the purpose of ABC is to identify factors that make activities consume resources and therefore result in costs, not allocate costs in a more accurate fashion.

Applications of TOC bring significant financial and operational performance improvements in manufacturing organisations and, more importantly, there is no (or very little) documentation of failed applications of TOC. For example, TOC implementation increases throughput and reduces waiting times (Lubitzsh et al. 2004)

CM originated from the development of production development software in the 1970s, but later developed into a management system for understanding the performance of complex systems and improving it (Boyd and Gupta 2004). According to Boyd and Gupta, 'throughput orientation is supported by the use of performance measurement systems and decision making systems that facilitate the maximization of throughput under resource constraints.' Goldratt (1990b) advocated five general steps for managing constraints: 1) identifying the system's constraints; 2) exploiting them; 3) subordinating everything else to 1 and 2; 4) elevating the system's constraints and, finally, 5) returning to step 1 when a bottleneck is eliminated. This process is referred to as the process of continuous improvement.

Boyd and Gupta (2004) described the throughput orientation in a 3x3x3 matrix and argued that any organisation can be positioned according to these dimensions. Throughput orientation should be viewed on a continuous scale, rather than viewing organisations as either throughput- or cost-oriented. The categorization is to a large extent adopted from a model developed by Strikanth and Robertson (1998). Throughput orientation is categorized into the dimensions shown in Figure 9:

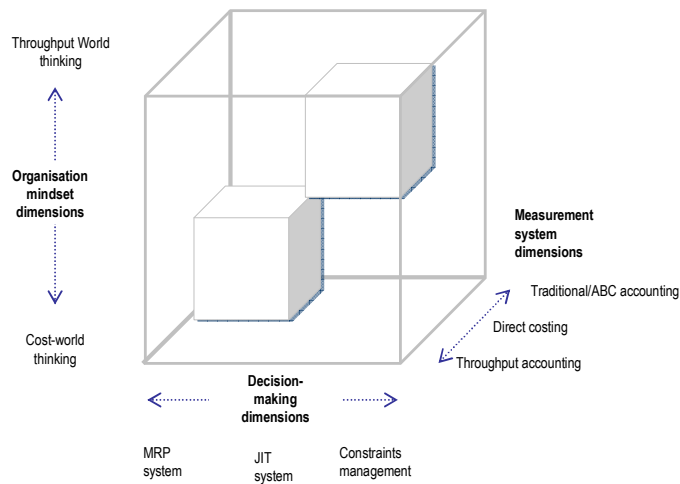

Figure 9 - Dimensions of throughput orientation (Boyd and Gupta 2004)

Details of the dimensions are as follows:

- *The organisational mindset dimension.* This dimension reflects attitudes, assumptions and beliefs of management (cost reduction strategies, growth strategies, significance of customer satisfaction etc.). At one extreme of the scale, cost-effectiveness is considered the main tool for improving performance. In extreme situations, effectiveness is often equated with cost-cutting. At the other extreme, throughput-orientation states that improvements can only be achieved by acknowledging resource constraints and accounting for them. An important distinction between cost and throughput orientation is that cost-world thinking is associated with the idea that local optimisation improves global performance. In throughput-thinking, local improvements can only optimise global performance if targeted at constrained resources.
- *The performance measurement dimension.* In terms of measures, CM adopts throughput accounting, based on throughput, inventory and operating expense. In contrast to ABC, throughput-orientation views operating costs as fixed. In OM literature, the decision making dimension commonly refers to such things as production planning and scheduling systems, capacity management and inventory process improvement.
- *The decision-making dimension.* The central systems that influence OM decision-making theory are reorder-point systems (ROP), material requirement planning systems (MRP, including manufacturing and enterprise resource planning systems), just-in-time (JIT) and CM-systems (e.g. drum-buffer-rope [DBR]). ROP and MRP advocate minimizing inventory levels while still meeting demand. They also have a strong focus on high utilization rates of key resources (primarily personnel and equipment). JIT's focus is primarily on process flow to meet demand. The focus of DBR is to balance production and demand, while accounting for resource constraints.

ABC and CM are often contrasted, as they represent different models of cost-accounting systems and provide different methods for evaluating financial consequences of production-related decisions. ABC is used to address profitability of an organisation's products, but has been criticized for its inability to account for resource constraints. The primary goal of CM is to deal with performance-reducing bottlenecks and it has proven successful for improving productivity. Contradictions between ABC and CM have been found when analysing the 'optimal product mix' of organisations, but they can co-exist (Kee and Schmidt 2000). Even if an organisation's goal is to increase throughput and reduce inventory, ABC provides a means for monitoring and controlling operating expense while doing so (Dedera 1995). Various studies have suggested that the theory of constraints approach supports decision-making optimally in the short run, while ABC is a more appropriate in the longer term (Kee and Schmidt 2000).

As pointed out by Jacobs et al. (2006) efficiency analysis in health care is forced to "settle" with analysing produced output rather than outcome. Goldratt (1990b) defines a resource constraint as "anything that limits a system for achieving higher performance versus its goal." Because the goal of health care organisations is to produce good health outcomes (defined by Jacobs et al. (2006) as quality-adjusted output), and output is only a means for reaching this goal, resource constraints should be analysed in relation to the outcome achieved rather than output. Goldratt's throughput-accounting system makes a similar distinction (1986). Goldratt defined throughput in a context where the ultimate goal of an organisation is to generate money. Goldratt claimed that the goal of a private company is to make money and, therefore, throughput is generated only when produced products (or services) are sold. In a health care, context a similar distinction can be made between output and outcome: output has no value as long as it does not lead to outcome (Lillrank et al. 2004).

RESOURCE VS BUDGET CONSTRAINTS

Literary discussion of constraints facing health care organizations appears twofold. On one hand, operations management concepts are applied to the analysis of resource constraints. This approach is characterized by a strong focus on operations planning and management. On the other hand, from a policy-making viewpoint, focus is placed on budgetary constraints, reflecting a purely financial viewpoint. Both approaches deal with the same issue, i.e. the constraint of resources whether measured in terms of resource or monetary units. This reflects two significantly different paradigms and may have significant explanatory power as to why discussions concerning resource constraints may seem so "fuzzy". Operational managers manage resources to meet demand, while policy makers manage costs according to available financing. Policy-making objectives are formulated in monetary terms and there is increasing need for formulating budget constraints in terms of resource constraints and allocation (Al et al 2004). Al et al (2004) identify six levels for budget constraints: 1) Overall constraints; 2) Constraints on budgets for partial budgets for successive periods; 3) Upper and lower budget constraints; 4) Constraints for partial budgets for specific diseases or specific patient groups; 5) Constraints on budgets due to prior commitments and 6) Constraints on budgets coming from various sources.

2.2.2 Activity-Based Costing and Management

ABC was first introduced by Cooper and Kaplan (Cooper 1988 and Cooper and Kaplan 1991). The purpose of ABC is to allocate costs to the activities required for the production of a product or service. The ABC process involves (1) identifying resources, (2) identifying resource drivers, (3) identifying activities, (4) identifying activity drivers and (5) identifying the objects of work (Cokins 1993).

The use of ABC in health care organisations became fairly common in the 1990's in Finland, when hospitals implemented new systems for cost accounting. The adoption of ABC systems in Finland has been driven by the need for more accurate pricing and increased cost awareness (Järvinen 2005).

Partridge and Perren (1998) identified three main areas where ABC data can provide important decision-making information: 1) in resource allocation decisions; 2) for cost object information for market interface decisions and 3) to generate performance measures related to activity consumptions and efficiency. The use of ABC requires an understanding of resource use in production. Taking ABC information out of its production context can lead to suboptimal decision-making. For example, a loss-making product may be required when an organisation has excess resource in other stages of the production process, which are fixed and cannot be allocated elsewhere (Kee and Schmidt 2000).

It is widely accepted that ABC information can support a wide range of management decisions (Gupta and Galloway 2003; Partridge and Perren 1998). The term Activity-based management (ABM) emerged management activities using ABC information and represent a shift from cost-assignment focus to process focus. The focus on both activities and processes is regarded as the strategic value of ABC/M systems, as it enables analysis of financial performance and distinction between value and non-value adding activities (Gupta and Galloway 2003).

Examples of specific application areas of ABC data include pricing decisions, product design, customer profitability analysis, activity-based budgeting (ABB), value chain analysis, process re-engineering, benchmarking, cost modelling and quality costing (Partridge and Perren 1998).

An example of further development of ABM, with a focus of integrating the throughput orientation advocated in TOC, is Activity-Based Throughput Management (ABTM). ABTM has been used in such situations as improving focused quality, managing cycle times, technological investment appraisal, and assessing optimal product mixes (Gupta 2001). ABM has limited applications in the health care setting, but it can improve health care provider cost and resource management efforts (Aird 1996).

The literature provides no consensus as to whether the ABC or TOC model is preferable in different management decisions. The contradictions between ABC and TOC have been pointed out in product-related decisions (Kee and Schmidt 2000). ABC has been criticized for not accounting for resource constraints, because in the short run organisations may not be able to alter the resource base and capacity (Spoede et al. 1994). Therefore, it has been suggested that decision-making based on ABC information is more appropriate in the long run, as opposed to TOC, which is better suited for decision-making in the short term (Kee and Schmidt 2000).

Several studies have found ABC and TOC to be complimentary. ABC information has also been implemented successfully with capacity analysis of production activities as well as with bottleneck analysis in product-mix decisions

(Kee 1995). Bakke and Hellberg (1991) found that TOC is a more appropriate management model in the short run, while ABC is more appropriate in the long run, though no clear distinction between the two can be made. This result is not surprising, considering the central notion in TOC that resources are mainly fixed and management is better off making utmost use of resources in place, rather than pursuing management decisions that would require changes in the resource-base. The fixed nature of health care resources is seldom discussed in cost-efficiency analysis in health care, but can be found in more thorough cost-analysis cases (Adang et al. 2005).

3 MATERIALS & METHODS

This research was conducted at the institute for Healthcare Engineering, Management and Architecture (HEMA), which is part of the Department of Industrial Engineering at Helsinki University of Technology. The department has traditionally emphasized the practical relevance of research.

This study uses case study research. Research based on case studies is common in operations management. The inductive case study approach is characterized by replication and iteration and is a suitable method for developing empirically valid and testable theories. The selection of case studies is important in order to assure the *generalisability* of results (Eisenhardt 1989). The case studies selected for this study represent components that, in one form or the other, are found in each regional health care system. Studies of this kind aim at dealing with the “utilisation problem” of management research as described by Van Aken (2004). This study deals with the health care sector and some of its fundamental challenges. It is prescription driven and tries to provide solutions for dealing with typical management problems in health care (Niiniluoto 2002).

3.1 SELECTION OF CASES STUDIES

Analysing efficiency at the organisational level requires defining a decision-making unit (DMU). Some examples of healthcare DMUs are entire health care systems, hospitals and primary care units. They differ in the amount of resources and costs used, as well as in the amount of valued output produced (Jabocs et al. 2006).

In this study, a unit of analysis depends on the case at hand. In addition to the unit, department and organisation levels, many cases are analysed from a regional perspective. The term *region* is by no means self-explanatory. Region commonly refers to an area with certain geographical, political or cultural characteristics that distinguishes it from other regions. From a health care service production viewpoint, a region is the smallest production and consumption unit, and most patient episodes are realised within the region. Finnish hospital districts meet these criteria to a large extent, since the vast majority of care and patient episodes occur within them. However, in reality, not all health care services can be accessed within a single region, making regions more or less overlapping (especially for highly specialized care).

The case studies were conducted between 2005 and 2007. The case studies were originally conducted separately in separate research teams, but have in this study been combined into one comprehensive study. The research environment and interests were mainly concerned with *regional* aspects of health care systems. This was to a large extent inspired by HEMA participation in various EU-funded development projects (e.g. Interreg programs), where challenges concerning regional health care have been extensively discussed.

The regional health care service network consists of a vast amount of service providers, mainly represented by the municipalities' own services and special care, which is commonly owned by a number of municipalities. In this study, the service networks that were analysed encompass special, primary as well as social care to the extent that it covers elderly care institutional and housing services. The regional service network consists of a number of service areas and levels.

The cases deal with different areas of the regional system and, therefore, the unit of analysis depends on the particular case.

The objective was to obtain a comprehensive selection of cases representing various aspects of the Finnish health care system. In addition to the regional perspective, the operative and conservatory area of special care, an open care system, a major regional health care support function, and a regional comparison of elderly care systems are represented. The case studies included in the study are:

- Case 1. Elective orthopaedic surgery – total joint hip arthroplasty
- Case II. Finnish Student Health Services
- Case III. Regional laboratory operations
- Case IV. Hospital patient flow
- Case V. Regional elderly care systems
- Case VI. A regional health and social care network (Figure 10)

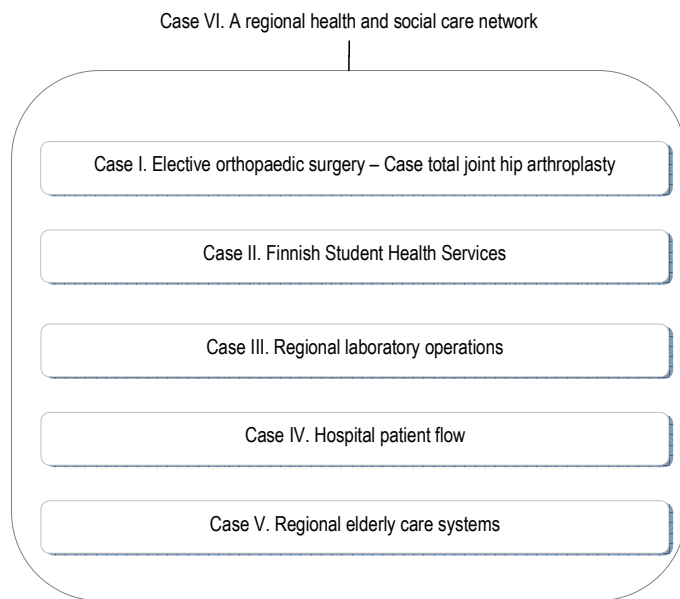

Figure 10 - Overview of case studies

3.2 APPLICATION OF OM AND EFFICIENCY TYPES

Schmenner and Swink (1997) discussed the nature of scientific inquiry and investigated what characterises operations management theory and how it can be developed. The purpose of this study is to illustrate how operations management knowledge can be turned into theory. The basic criterion for a theory is that it is testable. In this sense, this study can be considered an attempt to build theory, even if it relies on the basic laws of operations management presented here. These laws include:

- Law of variability, assuming that increased random variability will negatively affect productivity.
- Law of bottlenecks, assuming that productivity is increased by eliminating or limiting the impact of bottleneck resources.
- Law of scientific methods, which refers to a set of tools that can be applied to increase labour productivity
- Law of quality, which argues that productivity can be increased through increased quality. As quality increases the amount of waste decreases through changes in process such as product design, materials or processing.

- Law of factory focus, arguing that focusing on a limited amount of tasks will lead to higher productivity.

As opposed to microeconomic theory, operations management offers a much more detailed analysis of productivity differences. Microeconomic theory fails to account for differences in production processes, the existence of bottlenecks, variable quality, demand variability, scheduling capabilities, work force planning, morale and effort of workforce as well as characteristics of the supply chain (Schmenner and Swink 1997). In accordance with the operations management approach presented by Schmenner and Swink (1997), my study looks inside “the black box” by investigating different levels of technical and allocative efficiency and the impact on economic efficiency.

3.2.1 Efficiency types

Case study research is characterized by a search for similarities in seemingly different cases. This approach can aid deeper understanding of an issue. Part of the case study process is to design constructs for systematic case comparisons. In this process, theory and data are constantly compared and iterated in order to arrive at a theory best suiting the data. The case studies in this study were analysed from three different efficiency perspectives: technical, allocative and economic efficiency.

The theoretical framework for this study was presented Section 2. In light of the theoretical framework, a meta-analysis of six case studies was conducted. They either deal with entire regions or components of a regional network (Figure 10). Section 4.1 discusses more detailed theoretical implications of the individual case studies.

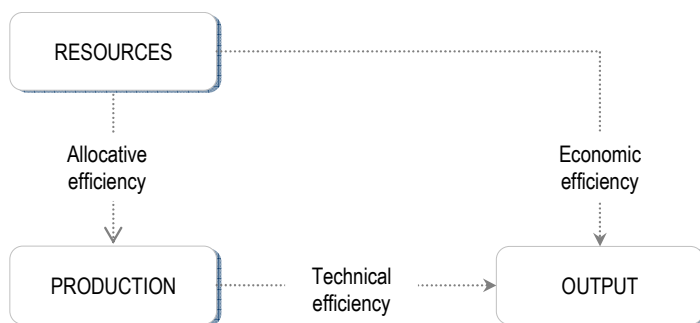

The cases are analysed from a threefold efficiency perspective. The use of operations management methodologies in each case is subordinated to three efficiency types: technical, allocative and economic (see Section 3.2.1). Figure 11 illustrates their interdependency. For example, an analysis approach focusing on the resource allocation is included in the allocative efficiency section. Each type of efficiency in each case is analysed in a

Figure 11 - The different efficiency types

separate section. First, technical efficiency is analysed. Second, the cases are analysed from an allocative efficiency viewpoint. Third, economic efficiency, particularly technical and allocative efficiency as determinants of economic efficiency are discussed.

TECHNICAL EFFICIENCY

Efficiency is associated with a wide area of activities commonly under management control (Sherman 1986), and refers to the amount or value created (output) in relation the amount of resources invested in the activity (input).

The first efficiency type analysed is technical. This refers to the amount of output produced by an input. Figure 12 depicts the basic relationship between input and output. OC describes the efficiency frontier. X_0P_0 and $X_0P_0^*$ represent different levels of efficiency—different amounts of output produced by the same input amount. If OC is not a straight line, there are economies/diseconomies of scale. In traditional efficiency analysis, the organisation is treated as a “black box.” Identifying reasons for differing efficiency levels is not attempted (Jacobs et al. 2006).

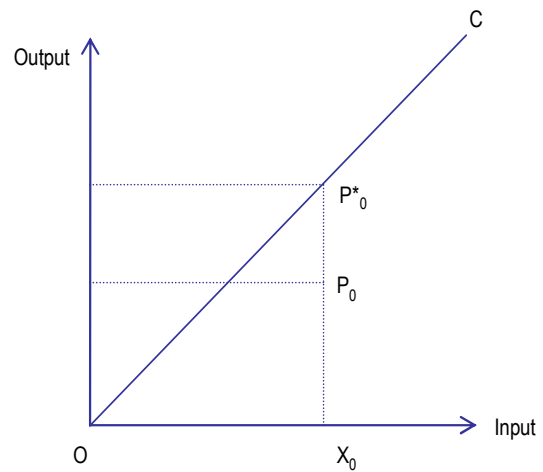

Figure 12 - Efficiency measurement under constant returns to scale (Jacobs et al. 2006)

ALLOCATIVE EFFICIENCY

According to van Peurse et al. (1995), allocative efficiency refers to variations in output depending on the distribution of resources in different activities. According to traditional efficiency analysis, allocative efficiency depends on whether an organisation has the right mix of resource inputs (or produces the right mix of output given its resources). This can only be determined with given resource prices. The organisation is regarded as a black box (Jacobs et al. 2006). Figure 13 illustrates this idea. Organisations 1 and 2 have a different input-mix and the potential difference in price efficiency for P_2 is the difference between P_2 and P_2^* . The allocative efficiency analysis in this section differs from traditional efficiency analysis in that allocation of resources are assumed to be determined factors other than unit prices, and thus reflect different operating models.

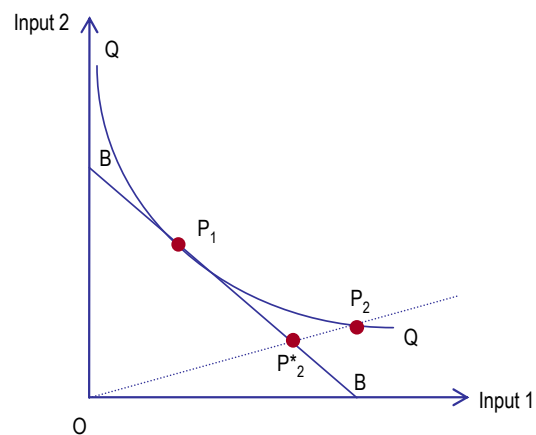

Figure 13 - Allocative efficiency with two inputs (Jacobs et al. 2006)

Allocative efficiency is closely linked to the access of health care services. Allocative efficiency within a health care organisation does not consider the fact that the allocation of resources may result in costs to other parties, such as patients in terms of time and trouble. In this sense, allocative efficiency could be achieved at the expense of other parties in a multi-channel financing system.

ECONOMIC EFFICIENCY

Both technical and allocative efficiency influence the economic efficiency of operations, since they determine the amount of resources required. Economic efficiency is analysed by investigating costs incurred with different levels of allocative decisions and technical efficiency (given certain resource unit costs). Costs of support functions such as administration, which also have an impact on total cost efficiency, are considered to the extent they affect efficiency of core operations.

3.3 DATA

Case study research is often characterized by an overlap between data collection and analysis stages. This is a clear feature of this study as well. This approach may result in a biased treatment of the data, because the researcher is likely to cling to emerging issues. However, this approach is acceptable in case study research, because its goal is not to provide comprehensive statistics of observations, but to understand cases individually and in depth (Eisenhardt 1989).

Case study research is often considered synonymous with *qualitative* research, but may also involve extensive quantitative analysis (Eisenhardt 1989). Data collection efforts in this study have focused identifying measures for the efficiency types discussed above and have, thus, included a large variety of operational and financial information. The data sources used in the case studies are presented in Table 8.

Table 8 – Data used in case studies

Case I	<ul style="list-style-type: none"> ▪ Financial information 2003 - 2005: Annual reports, department and unit level income statements and cost accounting data. Financial information was obtained directly from the financial managers of the organisation and drivers of the cost-accounting data were validated by the research team. ▪ Operational information 2003 - 2005: OR and inpatient capacity data (e.g. available hours and beds), OR and inpatient department usage, available working hours per personnel group. Data was collected using available resource and resource use data as well as electronic patient records.
Case II	<ul style="list-style-type: none"> ▪ Financial information 2005: Cost accounting by operating area (doctors visits, nurse visits, mental care visits etc) and unit ▪ Operational information 2005: Number of student per unit , electronic patient records for all students and units, visits classified according to ICPC, personnel work years by personnel group, waiting times, average treatment / visit times, number of patient e-mails and telephone calls, time spent with e-mails and telephone calls. The data was obtained from the case organisation's electronic patient record, accounting system and internal management system.
Case III	<ul style="list-style-type: none"> ▪ Financial information 2005-2006: Annual, pricing calculations and product-specific cost-accounting, activity-based costing data, annual reports, unit-specific income statements. Data was provided by the financial managers of the case organisation and the research team did not validate the data sources ▪ Operational information 2005-2006: Process maps per specialty (clinical chemistry, microbiology, genetics, and pathology as well as sample taking process in centralised laboratory, regional hospitals and health centres), equipment inventory, laboratory information system data (throughput times, demand and customer segmentation).
Case IV	<ul style="list-style-type: none"> ▪ Financial information 2004-2005: Annual reports, cost-accounting and pricing calculations, product-specific cost accounting (cardiac diagnostic unit). All financial information was obtained directly from the financial managers as well as the management of the case organisation. ▪ Operational information 2004-2005: Key operational figures were obtained from the management and financial managers of the case organisation. In addition, extensive data collection was conducted from the electronic patient records from the departments involved. Data from different years was analyzed concurrently by the research team to identify entire patient episodes during the period 2004-2005.

- Case V**
- Data consists of quantitative data considering elderly care services in Finland provided by Stakes. The register information obtained from Stakes contained data on the reason for entering elderly care, accumulated bed days, average and medium age, care need classification and personnel estimates for needed level of care. The register data (Hoitoilmoitusrekisteri) describes the static situation in public health and social care organisations as of 31.12.2005. In addition data on number of personnel by category (ISCO) were employed in Finnish hospital districts in 2004 was provided by Stakes.
- Case VI**
- Financial information 2004-2005: Annual reports, cost-accounting and pricing information from the Hospital District and Municipalities in Kymenlaakso. All figures have been used in official reporting by the hospital district and municipalities.
 - Operational information 2004-2005: Special care, primary care use of outpatient and inpatient services by age group, amount of elderly care patients and service volumes. Data on coronary artery and stroke patients were obtained from Stakes for patients treated with ICD 10 diagnoses diagnosis groups I60-I69 and I20-I25, respectively. Demographic estimates were based on population estimates obtained from Statistics Finland. In addition, information on private health and social care service providers was provided by Stakes.

3.4 LIMITATIONS TO OPERATIONS MANAGEMENT APPLICATION

The method for applying OM methodologies in this study was discussed in the previous two sections. A number of aspects relevant to production of health care services are not directly addressed by the efficiency analysis employed in this study. Moreover, many critical aspects related to health care service production have not been examined. These limitations are depicted in Figure 14 and the scope of this study is illustrated by the enclosed box.

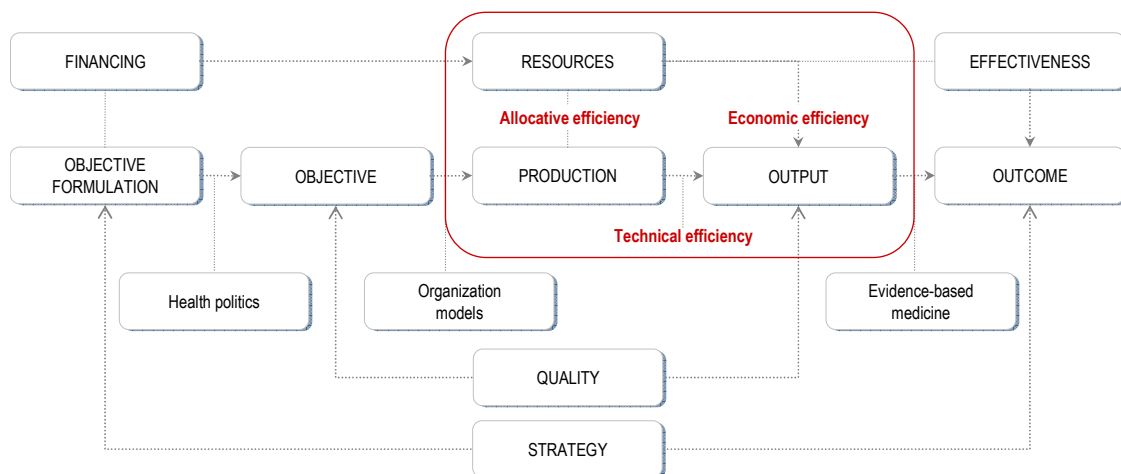

Figure 14 - Efficiency types (Adapted from Lillrank et al. 2004)

The actual outcome and value resulting from output is outside the scope of this study. Even when merely analysing output, which fails to account for effectiveness, quality and value of provided services, there are rarely any alternatives when investigating efficiency of health care. Moreover, outcome is often dependent on individual characteristics of patients, which cannot be influenced by providers (Jacobs et al. 2006). OM does not provide tools and techniques to deal with outcome-related issues. This is the main concern of evidence-based medicine.

Furthermore, the study does not comprehensively account for the impact of changes on the quality of health care services. Process re-engineering and resource allocation may affect the availability and quality of health care services. The management methods presented here may have indirect effects on health care quality and availability that cannot be fully covered in this study.

Discussion of regional networks for health and social service provision inevitably leads to the discussion of organisational structures and possible governance problems. Any operations and resource management efforts pursued in health care are subject to the reigning governance structure. Governance structures in regional health care are ultimately regulated by law, which is currently being reviewed in Finland and may be subject to significant changes in the coming decade. Potential governance implications and problems in public health care are largely outside the scope of this study. In addition, private service providers are only considered to the extent that their services are purchased by the municipalities thereby becoming integrated into the public service network.

4 ANALYSIS

4.1 PRESENTATION OF SELECTED CASE STUDIES

This section begins with a presentation of cases selected for the study. All presentations contain a description of the case organisation (the organisation where the case study was located) and background on the analysis conducted.

All case studies presented here were part of research activities in health care processes and management carried out by the HEMA (Healthcare Engineering, Management and Architecture) Institute at the Helsinki University of Technology.⁵ The case organisation has been part of other studies conducted concerning analysis of total hip arthroplasty operations from an operations management perspective.

4.1.1 Case I. The total joint hip arthroplasty process

BACKGROUND

Operating rooms (ORs) have received significant attention in healthcare OM research (Dexter and Traub 2002, Hanss et al. 2005, Karvonen et al. 2004, Sandberg et al. 2005, Sokolovic et al. 2002, Torkki et al. 2006). The OR process is relatively standardized, making it comparable with many industrial settings to a large extent. For example, the relationship between OR turnover times and productivity has been widely analysed. The most successful implementation of OM methods in the OR have applied workflow process analysis techniques, including analysis of performance measures such as throughput time (Spangler et al. 2004, Strum et al. 2003), OR scheduling (Karvonen et al. 2004, Dexter et al. 2007), and the development of OR production processes (Sokolovic et al. 2002, Harders et al. 2006). Process improvements in OR processes can increase cost-efficiency (Stahl et al. 2006).

RESEARCH ENVIRONMENT

ORTON Orthopaedic Hospital is a third sector not-for-profit hospital. The hospital concentrates mainly on orthopedic operations: endoprosthesis surgery, pediatric orthopaedics, spine surgery, hand surgery, knee surgery and sports medicine, rheumatic surgery and general orthopaedics. ORTON performs 2,200-2,500 elective operations annually. Approximately 25-35 % of operations are total joint replacement operations.

In this study, total hip arthroplasties (THA) were used as a case group. The rate of THA performed annually worldwide and especially in Western Europe and North America have increased markedly in the last decades. Furthermore, many studies have estimated that number of THAs will increase by 75-500% by 2020-2025 (Pedersen et al. 2005, Kurtz et al. 2006; Rantanen et al. 2006). The costs and lengths of stay of THA operations have been studied extensively (Antoniou et al. 2004, Bozic et al. 2005, Katz et al. 2001, Kim et al. 2003, Lavernia and Guzman 1995, Martineau et al. 2005).

⁵ The study is conducted in cooperation between Fredrik Eklund and Paulus Torkki, both researchers of the HEMA institute. Paulus Torkki has had main responsibility of research activities involving the case organisation and the process development and measurement of surgery processes is the main theme of his forthcoming dissertation. In contrast to Mr. Torkki's research focus, the patient process of surgical patients, the objective of this case study, in line with Mr. Eklund's dissertation is to analyse the relationship between process and financial management practices.

OBJECTIVE

The primary objective of the case organisation for pursuing process improvement measures was to find a means to improve quality while also increasing OR capacity in order to meet increasing demand for its services. Because the hospital is a non-profit foundation, any financial improvements are usually passed on to customers in the form of lower prices.

METHODOLOGY

We analysed the THA process by applying an efficiency analysis. The analysis was divided into the separate examination of technical, allocative and economic efficiencies. Technical efficiency refers to the relationship between input of resources and output. Allocative efficiency refers to the distribution of resources in a production process. Economic efficiency is subject to the levels of technical and allocative efficiency, as well as to the unit cost of resources (Lillrank et al. 2004).

Particular attention is given to the relationship between the reigning management model in the case organisation and to the distinction between cost and process (or throughput), as well as its implications. The mindset of management and performance monitoring tools is reflected in management decisions (Boyd and Gupta 2004). Throughput and cost orientation may result in different and even contradicting conclusions as to how an organisation's performance can be improved (Kee and Schmidt 2000). For example, using the theory of constraints has been found more appropriate the short run, while cost focus and activity-based costing are more appropriate in the long run. Although the distinction between the long and short term is not clear, TOC regards resources as fixed and advocates focus on optimising use of the current resource base (Bakke and Hellberg, 1991).

Table 8 illustrates descriptions of process measures. The weighted output of specific procedure (NOMESCO classification) was measured by calculating the historical average surgery time for a procedure based on benchmarking data from five hospitals (n=45773 operations). The standardized length of stay was calculated using the year 2003 as a baseline (100) to account for the changes in LOS.

Table 9 - Measures used and definitions

Measure	Definition	Unit
OR		
Total use of OR	Total annual throughput time (patient inside OR)	Hours
Mean throughput time of OR	Patient out of OR - Patient in OR	Hours
Mean daily output	Duration-weighted procedures per operating unit per Day	Duration-weighted operations
Total working hours	Total working hours of personnel allocated to the operating unit (Surgeons, Anaesthesiologists and Nurses)	Work years
WARD		
Total inpatient days	Sum of inpatient days per year	Days
Mean length of stay	Time from admission to discharge	Days
Standardized length of stay	Procedure-specific length of stay	Index (2003 = 100)
Total working hours	Total number of working hours of personnel allocated to the ward (Surgeons and Nurses)	Work Years

4.1.2 Case II. Finnish Student Health Services (FSHS)

BACKGROUND

There has been an increasing need for an in-depth and reliable financial and operative reporting system in Finnish Student Health Services (FSHS). Management determined that operations management methodologies were the ideal way of developing a financial and operative measurement system. The organisation also identified its own best-practices. By adopting operations management methodologies, management hoped to be able to find a means to respond to pressure from financiers as well as changes in demand.

RESEARCH ENVIRONMENT

FSHS was founded by the National Union of Finnish Students in 1954. FSHS provides Finnish university students with preventive health care, medical care, mental health care and dental health care. It conducts operations through 15 units in 16 university cities (Figure 15). Operations are financed by the Social Insurance Institution, students and student unions, university cities and the Finnish Government. Students are represented at all levels in its administration.

FSHS's 15 units are divided into 10 health service areas across Finland. Its services are similar to those provided by municipalities to its citizens and include doctors' visits, nurse visits and dental care. However, in contrast with people in the municipality's services, FSHS has a relatively homogenous patient profile.

OBJECTIVE

The case study was conducted during 2006 and the analysis was based on 2005 operational and financial information. The project was completed as a three-stage benchmarking study. The main objective was to analyse the development of demand while accounting for demographic changes as well as to use OM techniques to benchmark performance of health areas.

METHODOLOGY

The investigation of efficiency focused on internal benchmarking, i.e. a comparison conducted between units or departments within an organisation (Denkena et al., 2006). The basic stages of the benchmarking project, including planning, data collection, analysis, comparison and verification (see e.g. Fernandez et al. 2001) were conducted with FSHS management.

The operational and financial benchmarking was conducted between health areas in medical care, mental health care and dental care (Denkena et al. 2006). Due to resource sharing between and shared service provision between some units, the units were grouped into a total of ten health areas in order to improve comparability. A cost-analysis model was developed in the second stage. It was based on the existing cost-accounting system in order to assure the validity of financial benchmarking. In the third stage, financial and resource information was combined with operational key figures and benchmarked between the health areas. Based on the benchmarking study strategic targets for such areas as personnel productivity were set according to FSHS's current strategy, and translated into financial estimates. Finally, the financial estimates were compared to financing estimates.

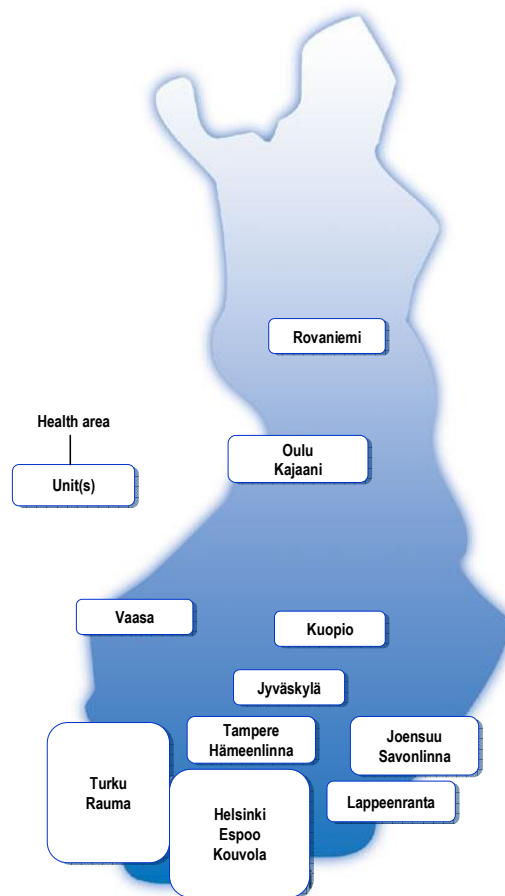

Figure 15 - Overview of FSHS units and health areas

4.1.3 Case III. Regional laboratory operations

BACKGROUND

OM tools can play a significant role in process management and improvements in hospital support functions such as laboratories and radiology (Tolkki and Parvinen 2005, Ondategui-Parra et al. 2004, Brown 2004).

RESEARCH ENVIRONMENT

The case organisation, the Centre for Laboratory Medicine (CLM), is a part of Tampere University Hospital and Pirkanmaa Hospital District financial and administrative conglomerate. It is the second largest laboratory service provider in Finland, producing more than 10% of national laboratory services. CLM is an independent profit centre of the hospital district organisation. In addition to the centralised services provided, CLM provides analysis and sample taking services in the hospitals and outpatient service laboratories in Pirkanmaa region, which has a total population of about 0.5 million people. Moreover, CLM controls the rapid response sample taking services as well as point-of-care sample services within the public health care organisations the area. Approximately half of the sample-taking services are provided for specialized health care organisations, including the 1200 bed Tampere University Hospital. The other half of samples are taken for primary health care in the area. In 2005, CLM produced 5.2 million test results and 1.0 million sample taking procedures. CLM had a turnover of 40 MEUR and employed 500 people. With its wide spectrum of laboratory services, the scope of activities and network of shareholders is very broad for a medium-sized business organisation.

OBJECTIVE

The objective was to conduct a production process-specific analysis. The objectives of the analysis included analysing productivity and utilization rates of key resources, as well as to designing a measurement and reporting system based on ABC and operational information.

METHODOLOGY

Given their high degree of standardisation and their centralisation of processes, laboratory organisations are at the forefront of the development of management practices in health care. However, laboratory processes are different and inherently less complex than most other health care processes, In spite of this fact, the findings here are still relevant to other health care organisations, as the information readiness and organisational contexts are very similar.

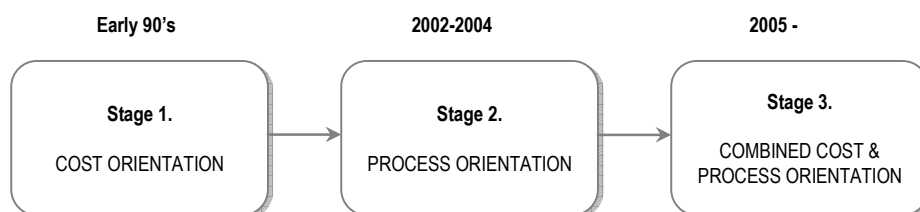

Figure 16 - Management models in three stages

The case analyses were made at CLM in 2004-2006. The research team observed the development of the organisation on a daily basis. Additionally, a process development project was performed during 2005 with the aim of identifying potential bottlenecks in the operations. A retrospective analysis of the events between 2001 and 2005 was performed in

cooperation with key personnel. Additionally, annual reports, internal communication documents, business plans and the organisation's media archive were reviewed in detail.

In order to investigate the development of dominating management models in CLM the case analysis focused on three stages (Figure 16):

- Stage 1. Management decides to pursue ABC and purchases ABC software with the aim of obtaining further information on distribution of costs and resources in service production. The background to these developments is analysed and management's perceived advantages discussed.
- Stage 2. A laboratory becomes interested in pursuing a 'process approach' for analysing and reviewing operations. At the same time, ABC is expensive and its advantages are found to be limited. Thus, ABC becomes less important in management decisions.
- Stage 3. ABC data and process representations are combined in order to deepen process analysis. Separately, ABC data and process representations are found to have limited advantages. The results of these actions are presented.

In recent years, laboratory sample analysis in the case region has largely been centralised in single laboratories. Therefore, the analysis of the centralised laboratory operations was conducted separately from the regional laboratory operations in hospitals and health centres.

4.1.4 Case IV. Hospital patient flow

BACKGROUND

Patient flow analysis is a very information-intensive process. Thus, the availability of information and efficient use of operation information as well as information systems are very important. There is limited literature available on the use of information and information systems when analysing patient flow in hospitals (Proudlove and Boaden 2005). Patient process analysis is an effective tool for process efficiency analysis in health care by providing a data-driven approach which enables such things as pinpointing of process bottlenecks. This analysis is enabled by, for example, tracing variations to individual activities in the work process (Rotondi et al. 2007).

RESEARCH ENVIRONMENT

This case study was conducted as part of the Ideal Hospital project (Ihannesairaala) in the central hospital of the Helsinki and Uusimaa hospital district in Helsinki Finland. The study examined all coronary artery patients during the years 2004 and 2005.⁶ The case examined the relationship between patient flow analysis and financial management throughout the entire hospital.

OBJECTIVE

⁶ All patient episodes from 2004 and 2005 were analysed. The data covered five inpatient departments, the cardiology and emergency polyclinics in Meilahti and Maria hospitals as well as the Cardiology Diagnostic Units in Meilahti central hospital. Patient material was limited to patients with ICD10 diagnoses I20-I25, I50 and R07. In cases where patients had been treated in the Cardiology Diagnostic Units, patients who had received a pacemaker or cardiodefibrillation were left outside the patient material.

The objective of this case study was to implement a model that could integrate process and cost information. The case study dealt with a hospital and several support functions required to provide health care services to a specific patient group. As a result, it provided an opportunity to investigate the potential value added when distinguishing between cost- and throughput orientation. Because the patient process covered numerous independent providers within the hospital, it also allowed the identification of potential differences in the degree of throughput orientation.

METHODOLOGY

Data was collected from a two year period. A total of 15,560 coronary artery patients, including elective and emergency patients, went through the department.

Processes were analysed using PIP-methodology (Lillrank et al. 2003c). The study was limited to the special care treatment episode and accounting for primary care only in terms of mean of arrival for the patients. By using the PIP-methodology our goal was to capture the time component of the patient process and link costs to each stage of the process in order to estimate total costs of the process. Cost information was based on the hospitals own financial statements and cost accounting information from the year 2005. Particular attention was given to the interaction and cooperation between different functions (internal medicine, pharmacy, laboratory, medical imaging etc.) within the hospital.

4.1.5 Case V. Regional elderly care systems

BACKGROUND

During the 1960s, European hospitals for the elderly were divided into acute care and long-term care facilities. In the 1970's long-term care began to erode into various kinds of service housing and group homes (European Observatory on Health Care Systems 2002). The current focus is on supporting independence among the elderly as far as possible. Home care services can fill this need, for example. In Finland, the pursuit of this objective lags behind many other countries. Figure 17 shows Finland's relatively large share of beds in long-term care.

In Finland, the emergence of health centre hospitals occurred in the (state decade) by combining them with municipal inpatient departments. The change from the old system was mainly financed with governmental support to health centres, and relatively little funding was allocated to social care. The change caused a shift from cramped inpatient units to more spacious health centre hospitals. This process brought about a significant improvement in care quality. However, some people questioned the soundness of this development and its impact on the development of elderly care culture. Unfortunately, inpatient departments became expensive and unsuitable long-term homes for many older people. The effects of this problem can still be found in many places and may become subject of serious scrutiny as financial problems become more evident for municipalities.

RESEARCH ENVIRONMENT

The case study was a part of the TEPRO research program conducted by the HEMA Institute at the Helsinki University of Technology. TEPRO was a two-year research program financed mainly in large part by the research program Finnwell, by the Finnish Funding Agency for Technology and Innovation (Tekes).

Table 10 – Definitions of elderly care types (Stakes 2006b)

Health Centre Hospital	Municipal hospital inpatient departments. Elderly care in the hospitals is divided into acute and long-term inpatient departments
Elderly Care Institutions	Institutions with 24/7 care service for elderly
Intensive Service Housing	Housing service for elderly with 24/7 availability of care services
Service Housing	Housing service for elderly without care personnel presents during the night

At the end of 2005 in Finland, 39,000 people were in elderly care institutions. A further 32,000 were in intensive service housing, 24,000 were in normal service housing and 40,000 were health centre hospitals (see Table 10). The vast majority of these customers are elderly.

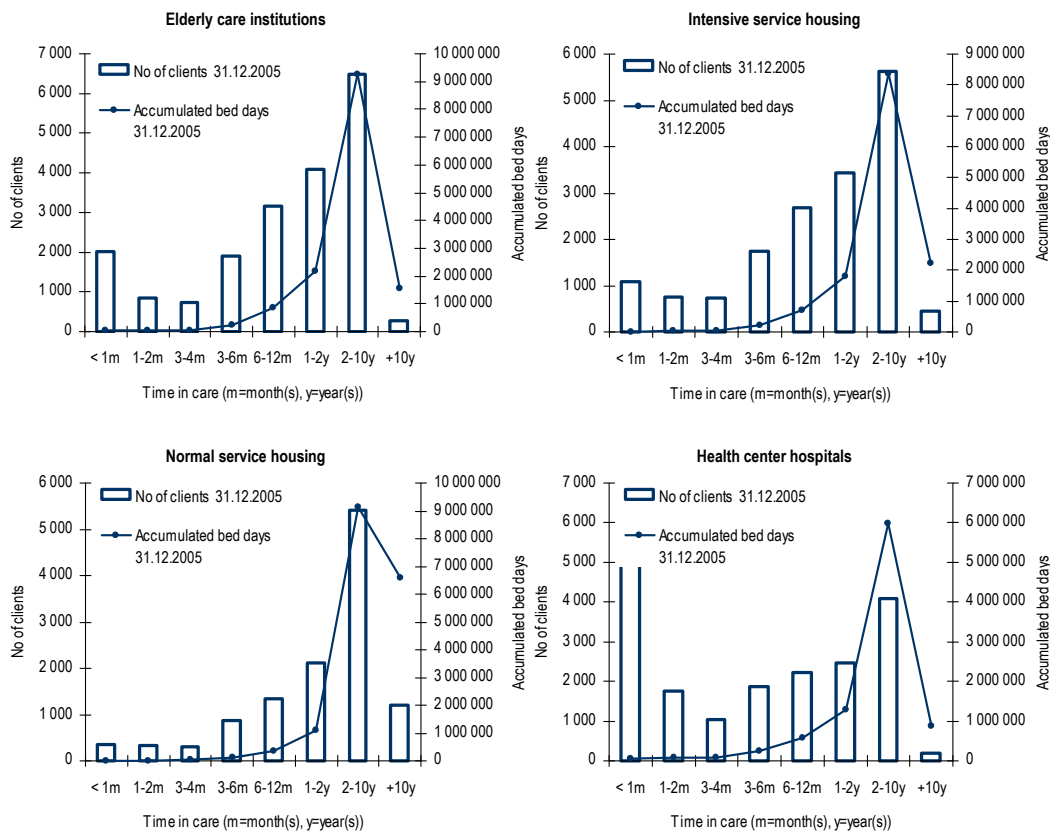

Figure 17 - Number of clients and their accumulated bed days in elderly care institutions, normal and intensive service housing and health centre hospitals – year end 2005 (Stakes 2006)

In this case study, regional models for providing elderly care were investigated through a quantitative analysis. In some cases, the level of analysis was deepened by looking into the region of Kymenlaakso.

OBJECTIVE

The objective of this case study was to investigate differences in regional elderly care systems using quantitative data provided by the National Research and Development Centre for Welfare and Health (Stakes).

METHODOLOGY

A quantitative analysis of elderly care institutions, intensive service housing, service housing, and health centre hospitals at the regional level (by hospital district) was conducted. In some cases, a closer investigation was conducted in a particular region. The results were compared to comparable data on international elderly care systems.

4.1.6 Case VI. A regional service network

BACKGROUND

Demographic changes and their resulting influences have forced public policymakers to review the structure of public health- and social care. The effects of demographic change have been widely discussed. However, so far there is limited knowledge as to the estimated financial effects of the emerging demographic trend.

In Finland, there is a trend toward increased integration of health and social care systems. In one regard, this trend will become evident as the Finnish parliament begins to fully implement its municipal reorganisation plans during 2007-2011. These changes are likely to result in significantly different structures for health and social care, with the aim of making operations more efficient. However, analyses of financial effects on the regional level are rarely made.

RESEARCH ENVIRONMENT

The Kymenlaakso region has two special care hospitals. They are located in the city of Kotka (55,000 inhabitants) and in the Kuusankoski-Kouvola district (70,000 inhabitants). Kotka central hospital produces special care for the region including normal medical specialties, 7/24 emergency, ICUs, CT-MRI imaging, operation facilities, laboratories etc. The highly specialized care is produced in Helsinki by Helsinki University Hospital. Elderly care hospitals and residential services including senior housing and nursing homes exist. The following section deals with the problems and solutions seen in Kymenlaakso.

OBJECTIVE

The objective of the Kymenlaakso project was to review the hospital district's network for health and social care services. Services offered are special care, primary care, elderly care and home services for the elderly. The figures below show the cost distribution in special care as well as primary and elderly care in 2005. Total special care costs amounted to some 163 million euros (MEUR) in 2005, while other services amounted to about 151 MEUR (Figure 18 and Figure 19). The costs are based on annual reports and cost-accounting provided by the Kymenlaakso Hospital District and its municipalities.

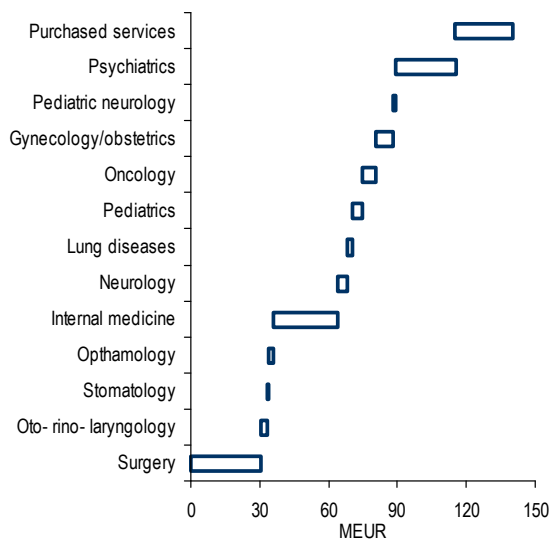

Figure 18 - Cost distribution in special care 2005 in Kymenlaakso.

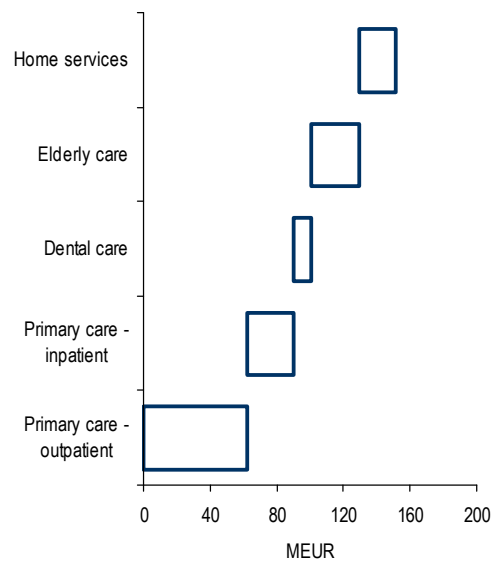

Figure 19 - Primary health and elderly care services 2005 in Kymenlaakso.

The regional service network can be regarded as one economic unit, responsible for financing and allocating resource to health care service production. Resources available for health care networks are limited by regional financial strengths. If costs for the regional health care network exceed allocated income, it faces resource constraints.

METHODOLOGY

We developed a financial model in order to estimate regional financial performance and required external financing, as well as to provide a comprehensive framework for analysing the effect of re-organisation in the service network. Using financial engineering techniques and basic accounting rules, the whole region was viewed as one financial entity with a pro forma (PF)⁷ income statement, balance sheet and cash-flow statement (Penman, 2001, pp. 38-39). Costs were estimated until the year 2035 and based on the extrapolation of current service use and use of resources in the region, and accounting for demographic changes. Service network income was calculated as a share of regional municipal tax income. Changes in tax paying capacity were also based on anticipated demographic changes. Nominal service production costs were assumed to remain constant, reflecting the assumption of constant capacity per resource unit.

⁷ Pro forma refers to financial statements with one or more assumptions or hypothetical conditions built into the data. The term is often used with balance sheets and income statements as well as to simulate the financial statement after larger restructuring measures, such as describing a company after a merger or acquisition.

4.2 TECHNICAL EFFICIENCY ANALYSIS

4.2.1 Technical efficiency elective orthopaedic surgery – Total joint hip arthroplasty

Between 2003 and 2005 the total use of ORs at ORTON Orthopaedic Hospital increased 13%, with mean daily output increasing by 16.7%. The increased output related to increased use rather than to improved throughput time. In the ward, the mean length of stay increased 12% but the standardized length of stay decreased. The case mix changed to operations needing longer LOS but the procedure-specific LOS was decreased. Key process measures are found in Table 11. The measures have been calculated based on time and resource information provided by the case organisation.

Table II - Process measures at ORTON Orthopaedic Hospital

YEAR	2003	2004	2005
OR			
Total use of OR (patient in OR) [h]	5832	6264	6575
Mean throughput time of OR [h:mm]	2:57	2:58	2:51
Mean daily output [h:mm]	14.4	14.9	16.8
WARD			
Total inpatient days [days]	11356	11921	13194
Mean LOS [days]	4.1	4.3	4.6
Standardized LOS [days]	100	92	94
Total Hip Arthroplasty (NFB50) Operation			
Throughput time in OR [h:mm]	3:13	3:22	3:05
LOS [days]	8.1	7.8	7.6

Critical resources in the operating process are personnel, equipped rooms and inpatient departments. Consequently, any analysis of allocative efficiency should focus on these resources. During the investigation period, the number of ORs remained constant and the average use rate increased from 70.7% to 79.7%.⁸ Similarly, inpatient bed capacity remained at the same level, and use rates increased from 57.6% to 66.9%.⁹ Nevertheless, the inpatient department still appeared to have significant free capacity.

SUMMARY

- Performance improvement in terms of technical efficiency were realised both in the inpatient and OR episodes during the investigation period.
- From a technical efficiency perspective, there appears to be significant potential for capacity improvement. This observation is reinforced by analysing benchmarking results.

⁸ OR utilization rate = Total use of OR (patient in OR) [h] / (200 days * 5 days * 7,5 hours)

⁹ Inpatient department utilization rate = Total inpatient days [d] / (number of beds m* 44 weeks * 7 days)

4.2.2 Technical efficiency in FSHS

The investigation of technical efficiency began with an analysis of various operational measures and the relationships between them. Key measures analysed were:

- Output: the number of patient contacts (visits, telephone calls and e-mails correspondence);
- Size (total number of customers and covered students, total amount of visits, total amount of personnel)
- Throughput-time;
- Allocated time for visits;
- Demand (in relation to the number of students and distribution between different ICPC- categories¹⁰);
- Personnel resources (work years);
- Waiting time (days).

FSHS personnel were divided into three categories: 1) personnel directly involved in service production (doctors, dentists), 2) personnel indirectly involved in producing the services (nurses) and 3) administrative personnel. Though not entirely straightforward, productivity was defined as the number of services provided per direct personnel. The implications of using direct personnel are further discussed in the section on allocative efficiency.

The ICPC- classification of patients in 2005 (as a proxy for demand segmentation) was reviewed and found to be similar in all health service areas.¹¹ The most significant local variations related to the use of mental services and pregnancy related services. The latter difference was due to larger numbers of female students in certain areas.

In terms of productivity, a critical assumption is related to what is actually considered produced output: actual visits or telephone calls and e-mails with patients? In this case, visits were the only things considered to be actual service production. This was because it was not possible to determine the extent to which telephone calls and e-mail correspondence contained a health care service or substituted an on-site visit.

This approach was justified as follows. First, we analysed productivity in relation to the proportion of visits, and related it to the number of telephone calls and e-mails made by professionals. The number of other contacts did not have a significant relationship to productivity within the different service areas. Thus, we concluded that investigating productivity by relying on visits would not significantly influence the results when comparing productivity with other operational figures.

Second, we investigated the relationship between the size of a health area and its productivity. The total number of students and the number of employees were used as proxies for health care area size. Figure 20 shows the relationship between personnel productivity, resource allocation (in terms of personnel in relation to the number of students in the health area) as well as the total number of personnel for each health service area and function. The results indicated that productivity was normally lower in areas with more students and more personnel resources. This indicates that scale

¹⁰ ICPC = International Classification of Primary Care.

¹¹ For more details on demand segmentation, see Å - 5.

benefits did not occur, a conclusion also found by Bojke et al. (2001). However, a number of studies in health care indicate that size and quality are positively related (Katz et al. 2001, Lavernia and Guzman 1995).

Apart from nurse visits, the use of services in relation to student numbers was not significantly related to productivity. The most significant result apart from nurse visits was productivity against total personnel resources per student in the health area. Productivity in health areas with a relatively large personnel resource-base was poorer than that in less resource-intensive health areas.

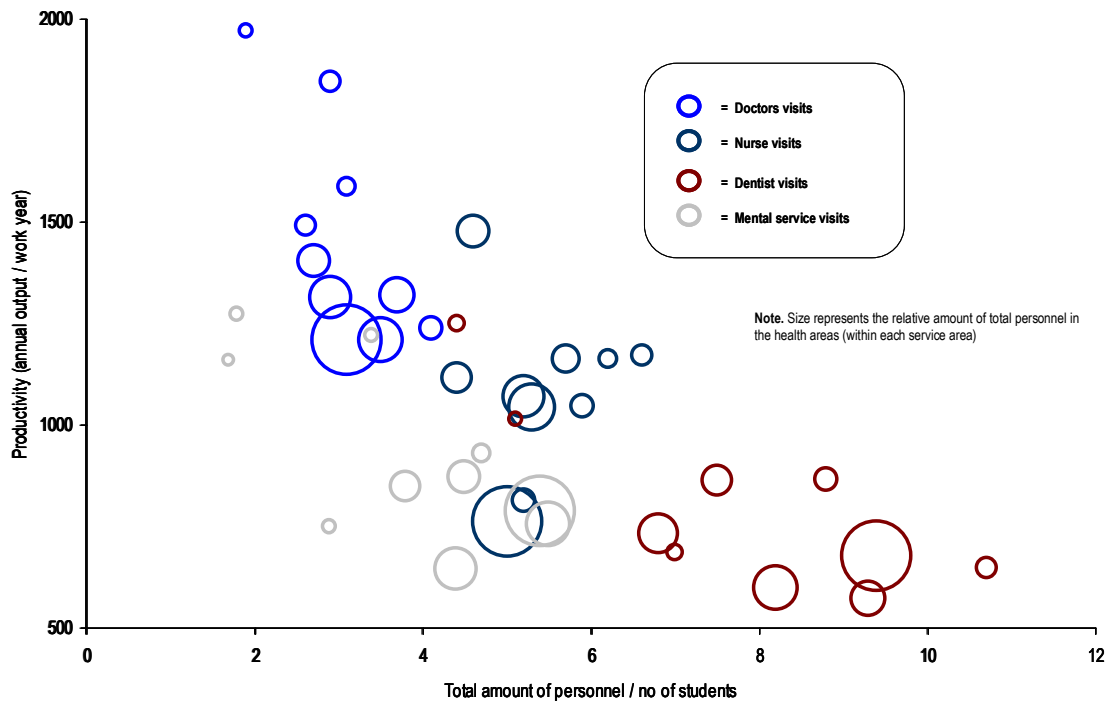

Figure 20 – Average personnel productivity vs. total personnel (per service and health area)

The relationship between productivity and customer waiting times was investigated. To some extent, lower productivity was associated with longer waiting times. Furthermore, areas with relatively more personnel resources per student had longer waiting times.

Finally, we investigated the relationship between time reserved for visits and productivity. We found a weak correlation between shorter visits and a positive effect on productivity. However, no definite conclusions could be made. This indicates that reasons for productivity differences should be sought in the time between visits. In outpatient primary care, a significant amount of time is consumed waiting for patients. Also, time lost due to cancellations cannot be regained (Alho 2004).

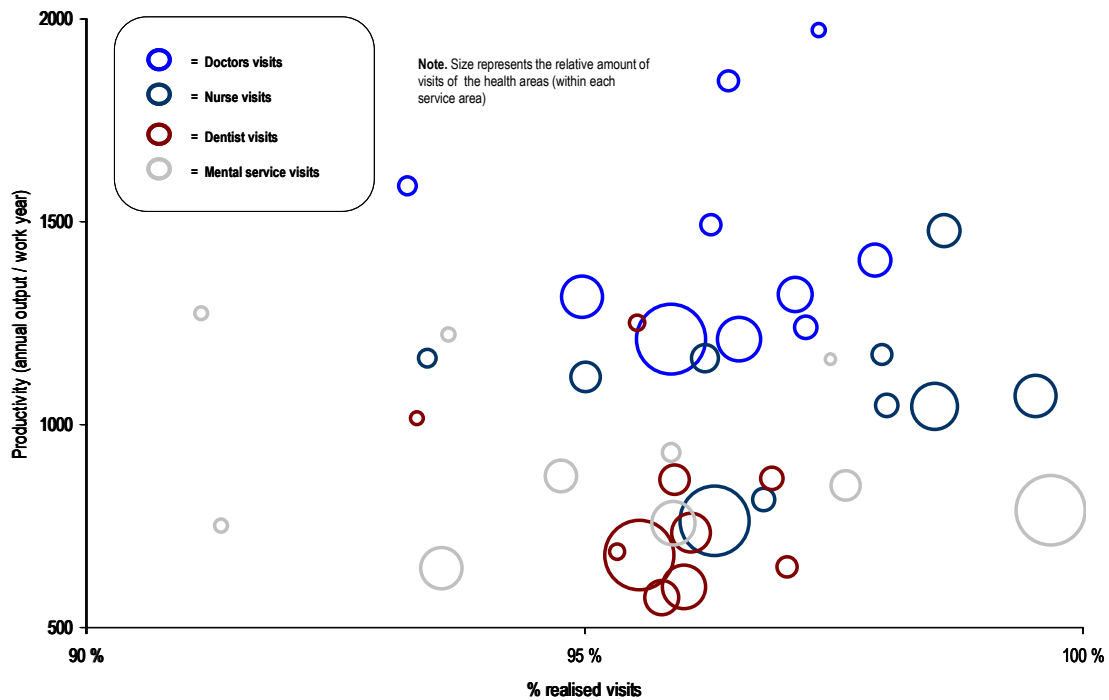

Figure 21 – Average personnel productivity vs. % of realised visits (per service and health area)

Figure 21 shows the productivity of personnel in each area in relation to the amount of visits that actually occurred. No-show visits and last minute cancellations were not included in the analysis. A loss of productivity due to the number of no-shows and late-cancellations was not found.

SUMMARY

- Larger units (in terms of personnel and/or covered population) had slightly lower productivity than smaller units. Low productivity seemed to be coupled with longer waiting times. Similarly, larger units had longer waiting lines.
- Productivity differences could be explained by systematic differences in work scheduling. Low productivity could not be explained by a high proportion of no-shows or late cancellations.
- A strong management implication was that waiting lists would no longer serve as a valid means for units in pursuit of more resources. Historically, this had been considered a critical factor in resource negotiations between central and local management.
- The role of benchmarking in strategy formulation increased, but still requires more in-depth methods for interpreting and truly benefiting from the results. §

4.2.3 Technical efficiency in regional laboratory services

The regional laboratory network employed almost 400 full-time employees in 2005, of which 250 were employed in the central laboratory (excluding administrative functions). Figure 22 shows the distribution of employee time spent in core operations vs. other non-core activities time during the week. "Core activities" depend on each person's particular job description. Processes analysed were centralised clinical chemistry, pathology, microbiology, genetics and pre-analytics as well as regional laboratory sample taking.

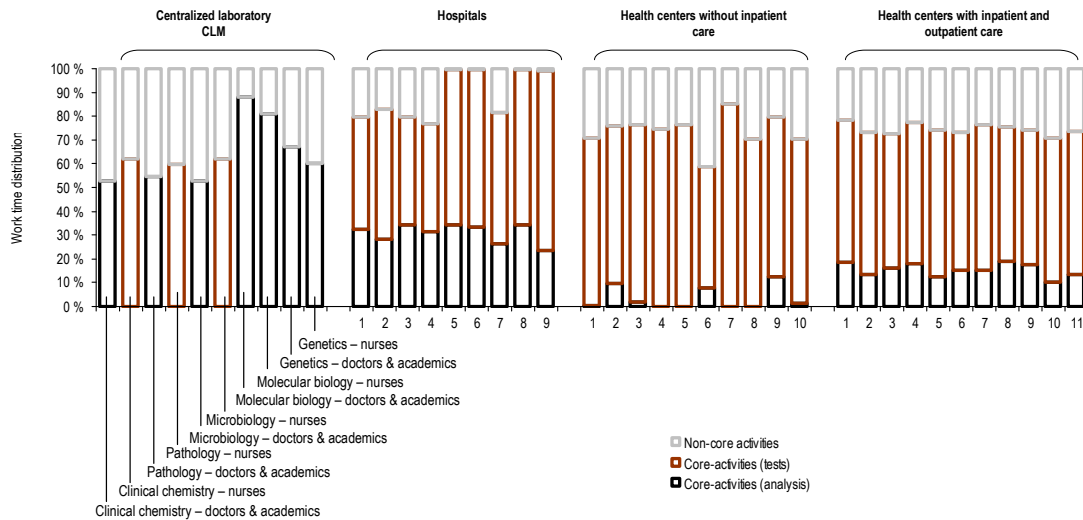

Figure 22 - Share of personnel's time spent in core and non-core activities during average work day 2006

As can be seen in Figure 22, the amount of time spent in core activities varied widely among different units in the region. In the centralised laboratory, doctors and academics spent on average 63% in core activities (including education) and nurses, 65%. The corresponding figures in hospitals, health centres without inpatient patient, and health centres with in- and outpatient operations were 89%, 74% and 74% respectively. In the last group, laboratory samples are obtained in the inpatient department. These centres are thus not comparable to pure inpatient operations.

In the region, laboratory samples are taken in a total of 30 units outside the central laboratory. Nine of the units are hospitals: 3 are polyclinics focused on samples, 10 are units in health centres without inpatient departments, and 11 have both inpatient and outpatient care.

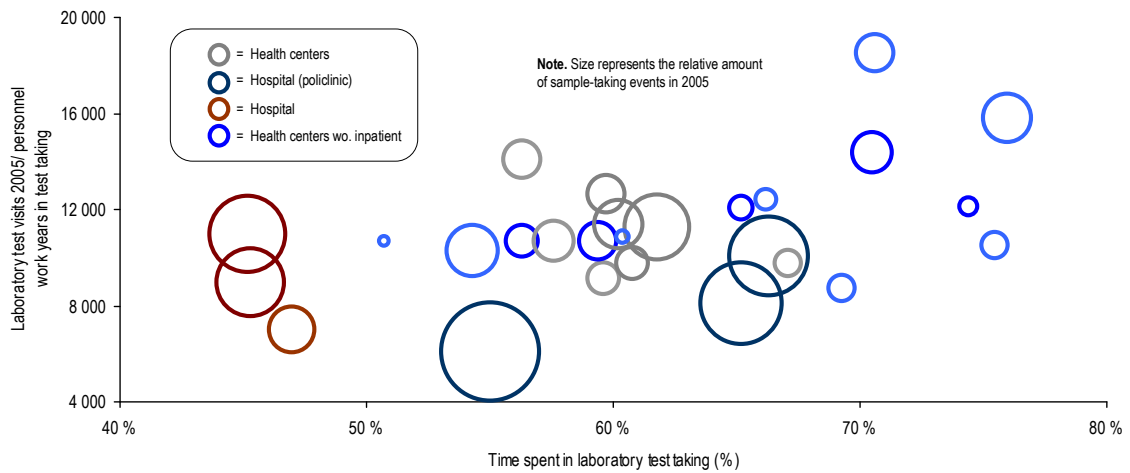

Figure 23 - Percent of time spent in laboratory sample taking vs. productivity (number of samples visits / time in sample taking) in 2006

Figure 23 shows the average percentage of time spent in the laboratory by laboratory personnel (y-axis) and productivity (x-axis).¹² Productivity differences between units were to some extent explained by the fact that in health centres with inpatient departments and hospitals, many samples are taken in inpatient departments, a process that is more time-consuming. Productivity differences are significant, and clearly best practices can be identified. Moreover, it appears that proportionally more time spent in sample taking is associated with higher productivity (specialisation). However, the total volume in the unit seems to be negatively associated with productivity.

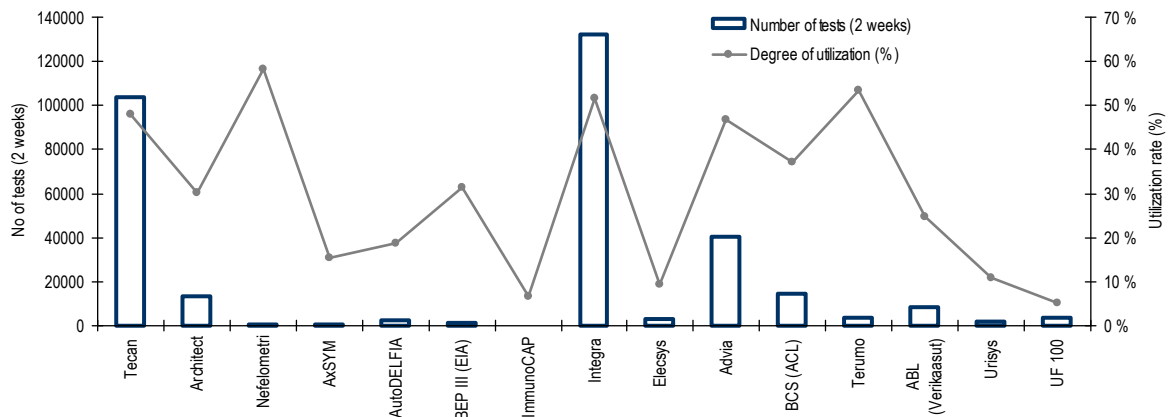

Figure 24 - Annual number of samples per type of equipment type and utilization rate (%) in 2005

¹² Note: work time analysed is only the time spent in sample taking (not total work time).

In addition to personnel, the equipment in laboratory operations is a central resource. Figure 24 shows the most significant pieces of equipment in financial terms and their average degrees of utilization (X-axis). The Y-axis shows the yearly costs associated with the equipment, including maintenance and depreciation costs. The sizes of the circles represent the number of examinations per two-week period. Even if the equipment is a highly integrated part of processes, its cost is relatively low.

Figure 25 shows throughput time (time from sample to answer) for clinical chemistry tests for different units in the region sent for analysis to the CLM. The number of total tests is on the y-axis and circle sizes are proportional to the numbers of samples.

A significant portion of throughput time was taken by transporting samples when they were taken outside the centralised laboratory. Transportation time varied from five minutes to more than four hours. A noteworthy portion of total throughput time also was taken by preparing the sample and packing it, as well as unpacking in the centralised laboratory.

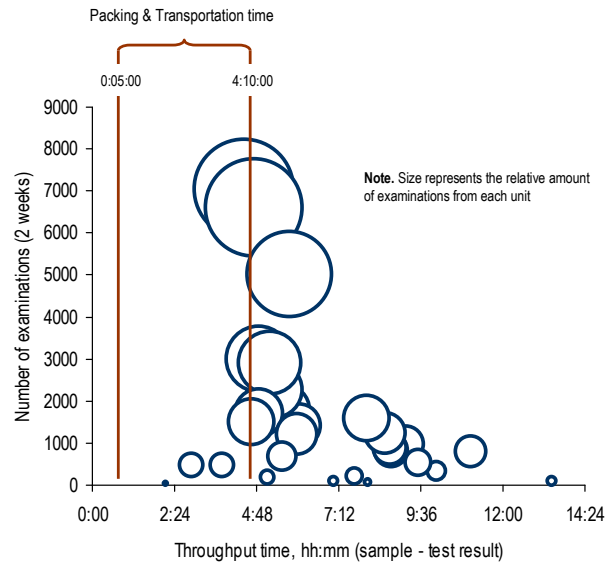

Figure 25 - Number of samples vs. throughput time when analyzed in centralized laboratory (2006)

When analysing technical efficiency, focus is placed on the output of resources in use. The analysis of allocative efficiency in section 4.3.3 provides further analysis as to how well the resources were actually allocated. These represent different aspects of production control measures (van der Bij and Vissers 1999) and using benchmarking helps management set performance objectives (Spendolini 1992 and Allan 1993).

SUMMARY

- A relatively small proportion of employee time is spent in non-core activities. A large portion of time is spent in administrative or equivalent tasks.
- Units with a stronger focus on laboratory sample-taking had higher productivity. The reasons for these differences likely result from differences in demand management.
- Utilisation rates of laboratory equipment were relatively low. Equipment was not found to be a constrained resource limiting system capacity.
- ABC data was critical role when analysing the utilization of resources, as well as for linking financial information with analysis of production process. The relationship between cost drivers and production process drivers was unclear: for example, changes in the production process were not necessarily seen in costing practices.
- Centralisation of analysis has caused numerous additional stages in the production process. A significant portion of throughput time is spent in transportation and sample packing. Centralisation efforts have been driven by pursuit of cost-efficiency. However, the fixed nature of resources has, at least to some extent, hindered the realisation of these savings.
- Management would benefit significantly from benchmarking information.

4.2.4 Technical efficiency of patient flow in hospitals

Table 12 shows a basic analysis of technical efficiency. The table shows the monthly utilization rates of the inpatient departments, which, in accordance with the hospital's management, were to be analysed in more detail. Patients admitted to these departments were largely segmented according to their needs. Departments 151 (acute and elective patients) and 152 (mainly patients from the emergency department) had the longest average LOS. Utilization rates in these departments were ~100% during the period. Interestingly, utilization rates were significantly lower in periods when the average LOS was shorter. Utilization rates in departments CCU (surveillance) and 142 (elective patients admitted for procedure or investigation) were significantly lower.

An investigation of nurse use found significant differences, on average, in the way operations were resourced. For example, in department 151, three times the personnel were used for provision of one bed day in comparison with department 152. The corresponding relation with department 142 was double the personnel.

Table 12 - Utilization rate of inpatient departments, average LOS and personnel per 100 bed days (9 months in 2005)

2005 (9 months)	I	II	III	IV	V	VI	VII	VIII	IX
Utilization rate in inpatient departments (%)									
CCU	74,9	78,6	72,8	74,8	76,7	75,2	72,4	76,0	71,9
142	65,8	65,0	57,0	63,5	61,1	51,2	51,2	56,1	60,3
151	95,2	94,4	94,5	102,1	102,8	94,8	85,0	89,4	99,5
152	95,4	99,0	94,5	98,1	97,3	93,9	85,9	89,9	96,3
Average LOS in inpatient departments (days)									
CCU	1,5	1,6	1,6	1,6	1,6	1,7	1,5	1,5	1,5
142	1,2	1,2	1,0	1,1	1,1	1,1	1,1	1,1	1,1
151	3,6	2,8	2,8	3,2	3,6	2,6	2,3	2,9	3,1
152	4,2	4,7	4,2	4,2	3,9	3,4	3,4	3,8	4,5
Average personnel per 100 bed days in inpatient departments									
142	5,2	3,8	5,3	5,3	4,5	5,3	5,3	4,0	4,1
151	7,2	7,6	7,1	6,7	6,4	7,2	7,7	7,6	6,8
152	2,8	2,9	2,8	2,7	2,7	2,9	3,0	2,9	2,7

The type of technical efficiency analysis provided above allows management to follow performance development over time. However, making decisions based on this information is entirely at the discretion of the managers and promotion of out-of-the box thinking is hindered by the scarcity of comparative information on this level of operations. Analysing the demand of the entire group of patients in the case, allowed us to draw a conclusion that the amount of time spent by a patient is to a significant extent determined by factors such as the day or time of arrival (Figure 26 and Figure 27).

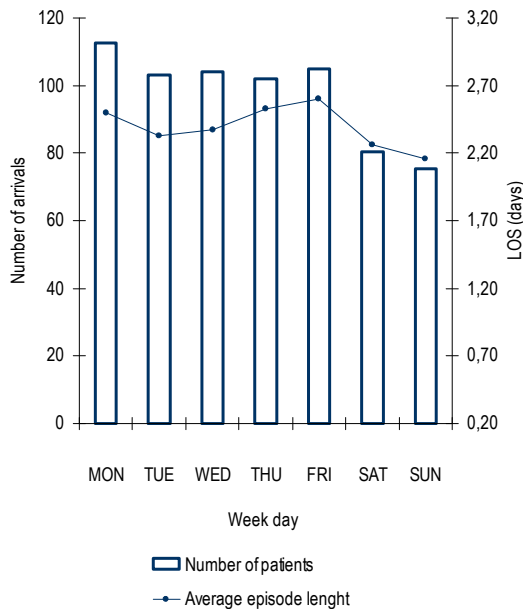

Figure 26 - Number of patients arrivals per day to emergency department and average LOS (2005)

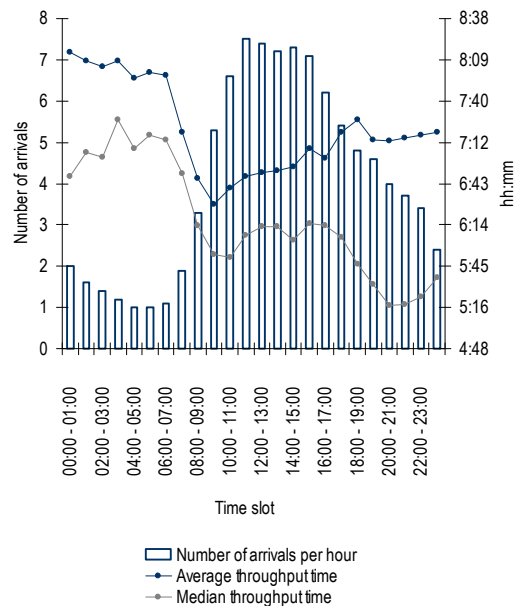

Figure 27 - Hourly demand and throughput time in emergency department for acute coronary heart disease patients (average and median) in 2005

All inpatient departments analysed seemed to have similar patterns in terms of capacity usage. On average, 20% of patients use 60% of inpatient days. Figure 28 reflects the varying characteristics of patients in the same department. It indicates that all departments treated routine and non-routine patients to the same extent. Potential benefits could be obtained by focusing and segmenting capacity and resources (Skinner 1974, Yang et al. 1992). From a process perspective, homogeneity refers to similar characteristics in terms of resource use, not necessarily such things as diagnosis (Vissers and Beech 2005). In fact, the planning of a conservative day-hospital has commenced. Officials estimate that it will be ready in connection with the current facilities in 2009.

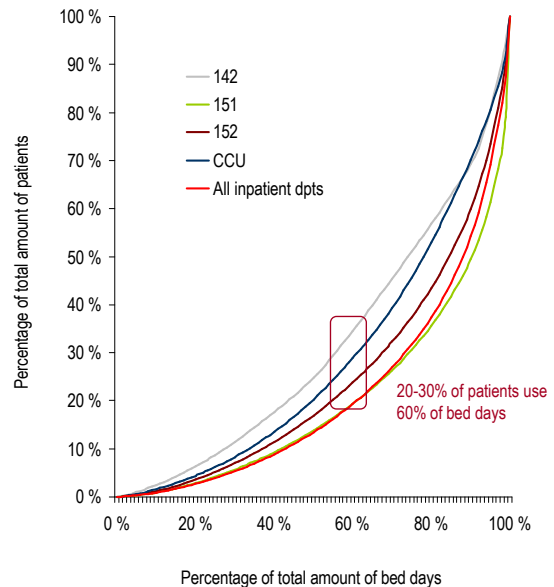

Figure 28 - Use of inpatient department capacity (2005)

SUMMARY

- The utilization rates of inpatient departments were high. Utilization was found to correlate with average LOS in the departments. Inpatient departments were likely to become bottlenecks.
- It was difficult to determine the technical efficiency of personnel resources. Personnel are constrained resources, yet utilization was not explicitly measured by management. This indicates that management prioritised the maximum utilization of facility resources over personnel resources.
- There were significant differences in LOS depending on the time and day of arrival in hospital. Demand and capacity management are critical. Different resources are likely to be constrained at different times.
- The majority of capacity in inpatient departments was used by a small fraction of patients. There is potential for improved segmentation according to the nature of patient needs (routine / non-routine).

4.2.5 Technical efficiency in elderly care services

The investigation of technical efficiency in elderly care services focuses on comparing municipalities and regions (considered equivalent to hospital districts) in Finland, though it also uses international references. The data used for the analysis of Finnish regions was obtained from Stakes (Hilmo and Sotka databases, 2006) and Statistics Finland (2006). International data was obtained from the OECD (cite specific publication here).

Figure 29 shows a comparison of personnel use in elderly care services (elderly care institutions, service housing and home services) in Finnish hospital districts. An analysis of health centre hospitals has not been included due to difficulties in identifying personnel treating the elderly at those institutions. Four different measures were reviewed.¹³ First, the number of personnel allocated to elderly care services varied significantly between Finnish hospital districts. This number ranged from 33 to 68 employees per 1,000 inhabitants (bars in the figure). The figure provides information about resource supply in the hospital districts, but does not account for demand. Second, in elderly care institutions and services housing, the number of personnel varied from less than one to more than three employees per 1,000 inhabitants (green line). The difference was fivefold and the average was 1.4. Third, the same variations occurred in the number of personnel per bed days (red line). Fourth, differences in resource use in home services was observed, and ranged from ~4 to ~8 employees per serviced elderly home (brown line). However, the differences are not as significant as for elderly care institutions and service housing.

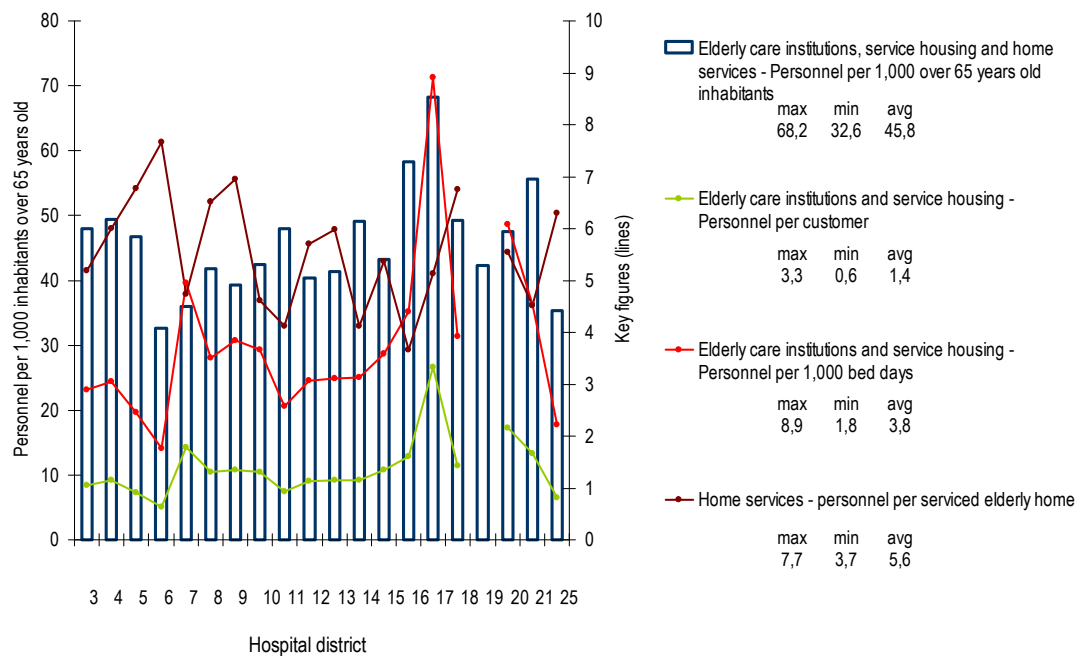

Figure 29 - Use of personnel in elderly care institutions, service housing and home care in Finnish hospital district 2005 (number of personnel from beginning of 2005) (Statistics Finland 2006, Stakes 2006).¹⁴

The quantitative analysis of personnel in Figure 29 gives clear indications that there may be significant personnel productivity differences between regions in Finland. The result is surprising, given the national recommended standards for resources, such as the number of personnel in various elderly care facilities (Ministry of Social Affairs and Health 2001). The results do not allow the formation of more specific conclusions as to what enabled higher productivity in some

¹³ Personnel from elderly care institutions and service housing could not be separated and are reported as one. The number of personnel does not account for partial work years and does not represent the exact number of personnel used during the period.

¹⁴ The names of the hospital districts are listed in A - 9.

regions and to what extent these factors were dependent on the structure of the elderly care system. This study does not include a more thorough analysis of personnel productivity, but there is reason to believe that productivity differences in elderly care are significant and that best-practice models focusing on the utilization rates of personnel are needed (Morin and Widell-Norström 2004).

A number of Finnish studies suggest that a large number of elderly care customers are waiting for transfer to less intensive types of care. The majority of these patients are enrolled in health centre hospitals (Torkki et al. 2006; Ekroos and Vauramo 2004). Flow in elderly care suffers from internal and external deficiencies. The internal deficiencies are part of technical efficiency, while the external factors are primarily related to resource allocation in the system. For further discussion on allocative efficiency in elderly care services, see section 4.3.5. Flow problems can partially be attributed to the allocation mechanisms in use, which are responsible for placing customers in the most appropriate type of care. The problems in elderly care are not related to inefficient use of existing resources. Bed capacity is commonly full in health centre hospitals (Torkki et al. 2006).

When analysing health care professionals' view of the correct care type, it is evident that a notable share of patients are not receiving the care deemed by professionals to best suit their needs. Stark regional differences are evident when analysing admission criteria to, for example, health centre hospitals. Of patients in these hospitals at the end of 2005 the portion admitted due to somatic disease varied from 10% to 83% among regions. On average, the share was 63%.¹⁵ At most, 52% of patients were admitted for physical reasons.

From a resource management perspective, understanding current resource allocation in elderly care is critical. Resource use and, consequently, costs differ between different care forms. This fact correlates strongly with the number of personnel required to provide a certain level of care. The most expensive facilities by cost per inpatient day are health centre hospitals, followed by elderly care and intensive service housing. Normal service housing is generally the most cost-efficient alternative.

¹⁵ For more specific information on the admission criteria in Finnish regions, see A - 11.

Figure 30 shows the average LOS for patients admitted in different care facilities at the end of 2005. The average LOS in health centre hospitals for was 461 days for these patients. The corresponding figure for elderly care institutions, intensive service housing and normal service housing was 726, 812 and 1,451, respectively. The smallest regional variations are found in elderly care institutions, but variations in the other care forms are very significant.

There are significant regional differences as to why clients are admitted to different types of facilities. This is a demand segmentation issue. Table 13 reviews criteria for entering the service system. The table shows that, on the day of the patient count, relatively few patients (1.5%) were admitted for rehabilitation. The fact that the number of resident patients is a static view of the situation at the end of the year does not explain the low portion of rehabilitation.

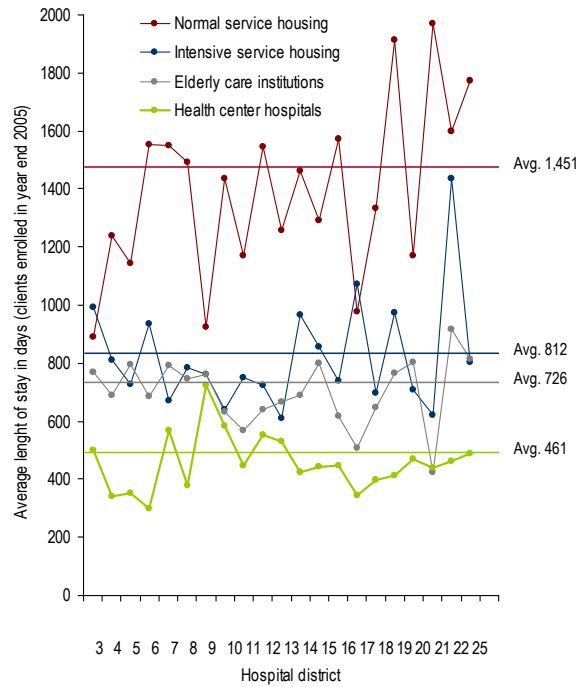

Figure 30 - Average LOS in different care types in Finnish hospital districts as of year-end 2005 (Stakes 2006)¹⁶

¹⁶ The names of the hospital districts can be found in A - 9.

Table 13 - Reason for admission to different care facilities – at the end of 2005 (Stakes 2006)

Reason for admission (no of patients)	Elderly care insitutions	Intensive service housing	Normal service housing	Health center hospitals	Total
Physical reasons	10 579	7 647	6 505	4 639	29 370
Nervous system reasons	4 532	5 408	1 159	948	12 047
Psychic-social reasons	2 886	3 123	4 062	1 183	11 254
Rehabilitation	149	57	20	812	1 038
Incident	23	19	29	327	398
Investigation and care of somatic disease	1 319	243	126	12 012	13 700
No information				71	71
Total	19 488	16 497	11 901	19 992	67 878

Reason for admission (%)	Elderly care insitutions	Intensive service housing	Normal service housing	Health center hospitals	Total
Physical reasons	54,3 %	46,4 %	54,7 %	23,2 %	43,3 %
Nervous system reasons	23,3 %	32,8 %	9,7 %	4,7 %	17,7 %
Psychic-social reasons	14,8 %	18,9 %	34,1 %	5,9 %	16,6 %
Rehabilitation	0,8 %	0,3 %	0,2 %	4,1 %	1,5 %
Incident	0,1 %	0,1 %	0,2 %	1,6 %	0,6 %
Investigation and care of somatic disease	6,8 %	1,5 %	1,1 %	60,1 %	20,2 %
No information	0,0 %	0,0 %	0,0 %	0,4 %	0,1 %
Total	100,0 %	100,0 %	100,0 %	100,0 %	100,0 %

As shown in Table 14, elderly care homes require 24/7 services, as do service housing and health centre wards. Slightly more than a quarter of patients are treated in health centre wards. The table also shows that 2,855 nearly or totally independent people receive care. The average LOS for these people was 883 days — more than two years. This indicates that the service system is functioning in part to provide apartments for elderly people, and that more appropriate use of this portion of their capacity could be found. These people may have had difficulties arranging their housing or simply lacked the help of relatives. However, their care is the municipality's responsibility. This problem may ultimately come down to problems in initial demand segmentation, but, most certainly, reflects a serious (and expensive) resource allocation problem. More importantly, customers may not be receiving the kind of care they need — and likely prefer — due to inefficient resource allocation. The “push-effect” from more intensive care is not realised because that resource in place will be used and the “pull-effect” from less intensive care forms is not realised due to relatively small resources. Measurement systems supporting improvement of “downstream” flow are rarely in use.

Table 14 - Care need categorization – patients at the end of 2005 (Stakes 2006)

Care need categorization (Finnish: hoitoisuusluokitus)	Elderly care institutions	Intensive service housing	Normal service housing	Health center hospital	Total
0 = No information	389	67	86	256	798
1 = Totally or nearly independent	192	679	1 355	629	2 855
2 = In temporary need of care	742	1 010	1 742	1 927	5 421
3 = Repetitive need of care	2 542	2 694	4 665	3 662	13 563
4 = Nearly continuous need of care	2 971	2 489	2 460	3 972	11 892
5 = Continuous (24/) need of care	12 652	9 558	1 593	9 546	33 349
Total	19 488	16 497	11 901	19 992	67 878

Regional differences were evident. In normal service housing, on average, 10% of customers were nearly or fully independent. Regionally, the share ranged from 0% to 40% of customers. In health centre hospitals and intensive service housing, 3% were nearly or fully independent, but their share reached 10% in some regions. The smallest difference between people occurred with nearly continuous care. On average, it seems that like the portion of patients requiring nearly continuous care was almost the same in all care types. The share was slightly higher in normal service housing and health centre hospitals. There seems to be no other explanation that, on average, customers were more or less randomly directed to different types of services.¹⁷

The smallest number of people needing continuous care was found in normal service housing. Nevertheless, on average, 14% of this group required continuous attention, a level of service not normally available in this type of facility. What is staggering is that, on average, customers in intensive service housing require more attention than those in health centre hospitals. Again, this leaves the question if health centre resource are used *correctly* or simply *used*.

SUMMARY

- Despite national recommendations as to resources use in differences elderly care types, significant regional differences were observed, implying that large productivity differences exist. However, this result should be considered with care due to potential flaws in the original data.
- Demand segmentation practices differed significantly. This had a negative impact on the comparability of regions and their service systems. This, in turn, combined with low transparency in management information, hinders the spread of best practices.
- The longest LOS was in elderly care institutions. LOS in health centre hospitals is very long despite hospital-like-conditions.
- Nearly 3,000 nearly or fully independent elderly care clients were in health centre hospitals, elderly care institutions, intensive service housing and normal service housing as of year-end 2005.
- The current system is likely to tie up significantly more personnel resources than an alternative system. The availability and allocation of resources is likely to be a significant determinant of where clients receive care (capacity determines demand). Historically, vast resources have been allocated to health centre hospitals.

¹⁷ For more detailed information on care categorization in different care types, see A - 13.

4.2.6 Technical efficiency in regional network

Comparison of technical efficiency of regional networks is very challenging. The number of variables that could be used to measure performance is nearly limitless, and no individual one can fully captured regional performance. Figure 31 shows a regional comparison of resource use in different hospital districts. It indicates that significant differences existed between regions in Finland in 2006.

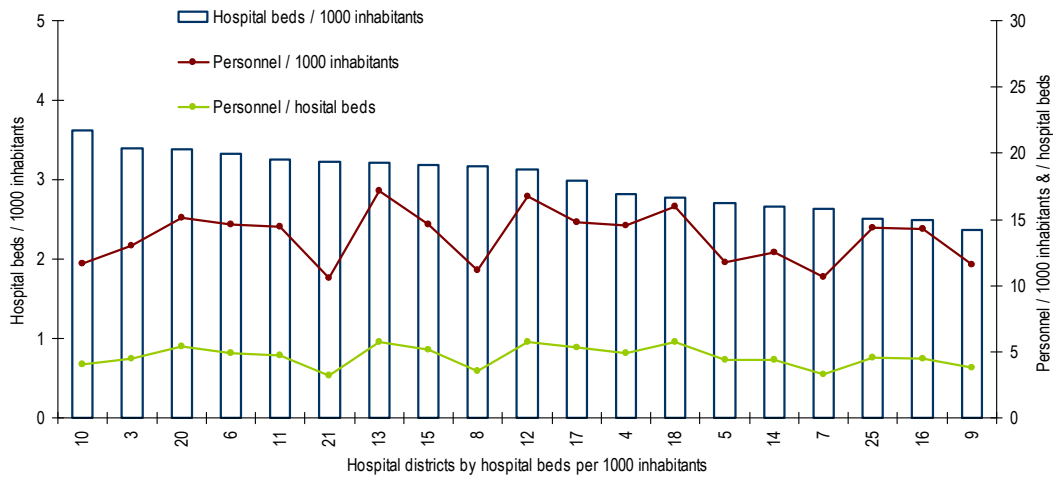

Figure 31 – A regional comparison of resource use between hospital districts in 2006 (Kuntaliitto 2007).

From a technical efficiency perspective, the use of personnel is a significant variable. The amount of personnel may vary due to factors including epidemiological reasons, but are likely to also reflect differences in regional service networks. Data on the personnel employed in health and social care 2004 was obtained from Stakes (Figure 32).¹⁸ The personnel categories analysed are personnel in primary care, special care, institutional care as well as social and health care administration.

¹⁸ Personnel were grouped according to the ISCO (International Standard Classification of Occupation) classification system (Stakes 2005b and 2005c)

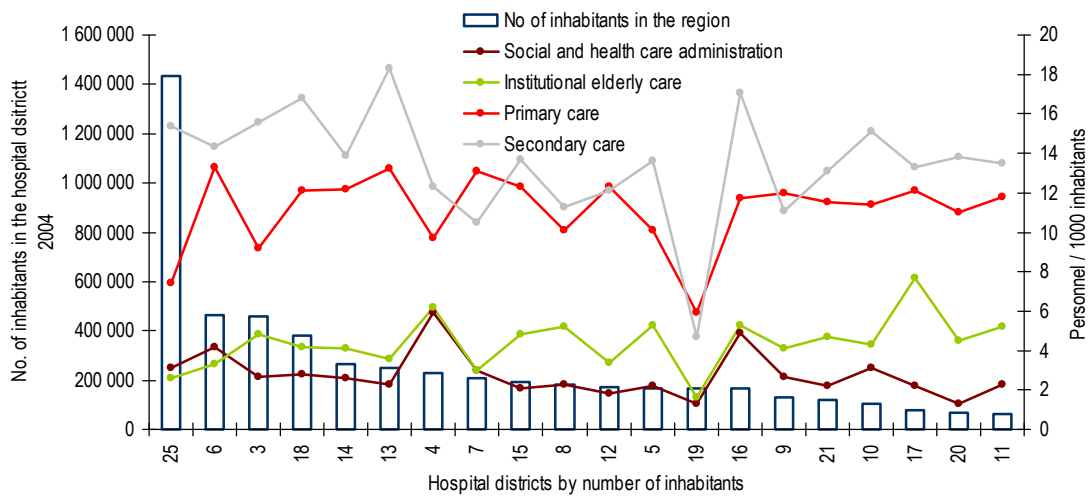

Figure 32 - Regional analysis of personnel in health and social care - year end 2004.¹⁹

Figure 36 gives reason to believe that regional differences were significant. The case organisation, Kymenlaakso, proved to be close to average in all the categories analysed.

An inventory of the Kymenlaakso service network was conducted by reviewing records of public and private service providers. The inventory identified 400 separate organisations, of which 250 were public. Some 150 of the organisations had three employees or less. The service network employed a total of 8,100 people, equivalent to 42 employees per 1,000 inhabitants. The majority (6,700) was employed in the public sector (Figure 33).

¹⁹ The names of the hospital districts are listed in A - 9.

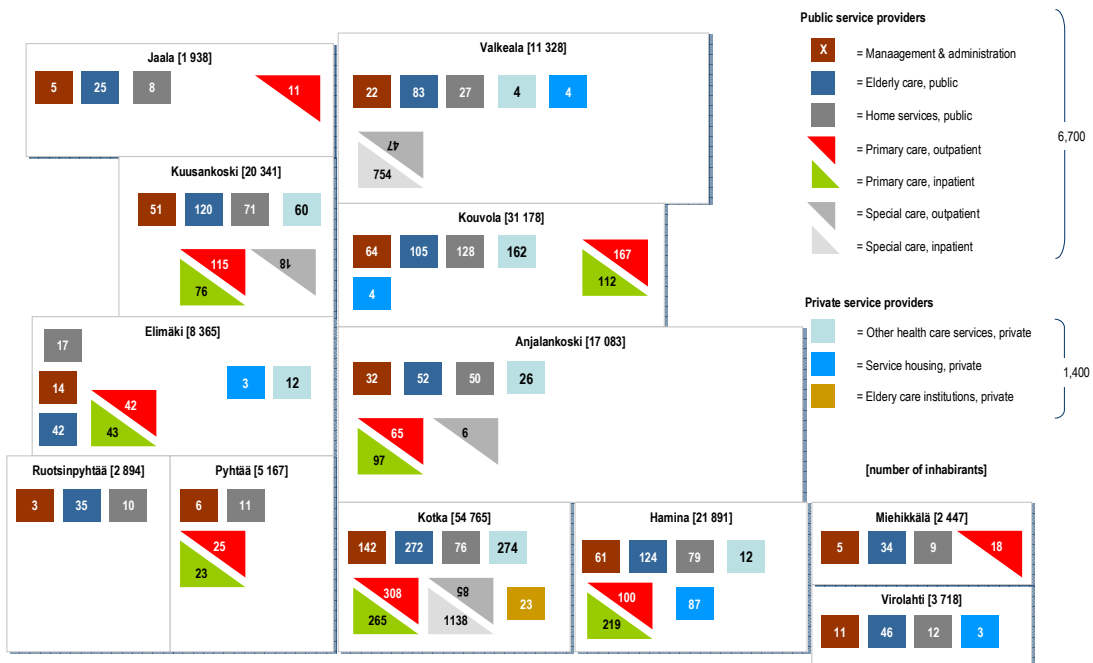

Figure 33 – Map of Kymenlaakso hospital district - Employees in health and social care service providers in the regional health care network - year end 2004.

SUMMARY

- Significant regional healthcare differences in technical efficiency were observed, but explaining the differences requires more in-depth analysis of its constituents.
- The regional network was extremely complex in its resource distribution.
- In the case region there was no coordinated systematic way for analysing demand and planning supply.

4.3 ALLOCATIVE EFFICIENCY ANALYSIS

4.3.1 Allocative efficiency in elective orthopaedic surgery – Case total joint hip arthroplasty

Table 15 shows the absolute and relative amounts of key resources in the OR and inpatient department at ORTON Orthopaedic Hospital. In terms of resource allocation, there was an evident increase of personnel in relation to the number of ORs and inpatient beds during 2003-2005 indicating a fairly large change in resource allocation. In terms of personnel, Table 15 shows that neither the relationship between different professional groups in the OR and inpatient department nor the allocation of resources between OR and the inpatient department changed noticeably.

Table 15 - Resource allocation measures

Resources	2003	2004	2005
OR, no. of surgeons	9,0	10,0	10,0
OR, no. of Anaesthesiologists	5,0	5,0	5,0
OR, no. of nurses	35,0	36,9	39,3
No. of ORs	6,0	6,0	6,0
Ward, no. of surgeons	3,6	4,0	4,0
Ward, no. of nurses	42,2	46,6	48,7
No. of inpatient beds	64,0	64,0	64,0
Resource allocation			
OR, Surgeon / Nurses	0,26	0,27	0,25
OR, (Surgeon & Anaesthesiologists) / Nurses	0,40	0,41	0,38
OR, Surgeons / ORs	1,50	1,67	1,67
OR, (Surgeons & Anaesthesiologists) / OR	2,33	2,50	2,50
OR, Nurses / OR	5,83	6,15	6,55
Ward, Surgeons / Nurse	0,09	0,09	0,08
Ward, Surgeons / Inpatient bed	0,06	0,06	0,06
Ward, Nurses / Inpatient bed	0,66	0,73	0,76

Figure 34 and Figure 35, analyse resource allocation measures in relation to technical efficiency measures. Figure 34 indicates that the shorter average LOS may be explained by the amount of nurses per inpatient bed. Similarly, Figure 35 indicates that throughput time is decreased by increasing the relative number of nurses in the OR in relation to surgeons.

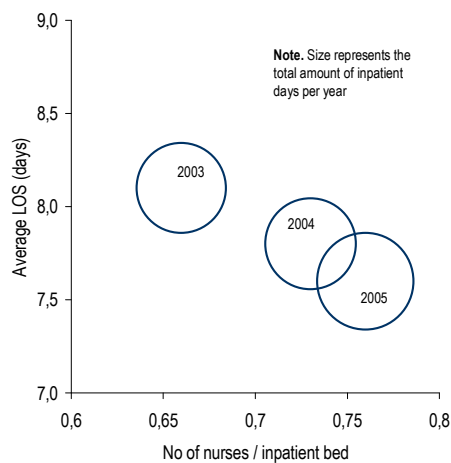

Figure 34 - Number of nurses per inpatient bed vs. average LOS (2003-2005).

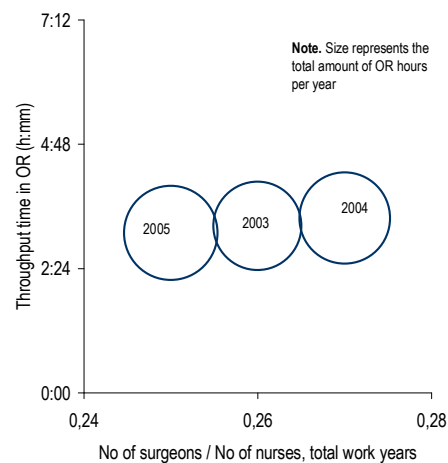

Figure 35 - Number of surgeons to nurses vs. average throughput time in OR (2003-2005).

As argued by TOC advocates, bottleneck resources limit the capacity of the whole system. In this case, it is evident that facilities (OR and inpatient department) were not bottlenecks, switching the focus to personnel development. Given the proportional increase of personnel, it can be concluded that personnel capacity limited system capacity, and that increasing personnel can increase system capacity. Developments during the investigation period support this idea.

SUMMARY

- A clear relative increase of OR personnel (particularly nurses) was observed. Thus, the capacity increase is likely to be due to the personnel increase, which constituted the bottleneck in the production process. Within personnel, this was coupled with a relative increase in OR nurses relative to surgeons.
- A similar result was found in the inpatient department, where shortening LOS was coupled with a relative increase of nurses to the number of beds.
- Improvement potential of technical efficiency of nurse personnel suggests that further resource allocation improvements could be achieved by further shifting nurse personnel from the inpatient department to the OR.

4.3.2 Allocative efficiency in FSHS

In the case of FSHS, allocative efficiency was investigated by comparing 1) the distribution of resources within a specific service and 2) the distribution of resources between services in the health care units. Primary focus was placed on the distribution of personnel resources.

The number and distribution of personnel resources was partly due to differences in operating models. Five health areas took their own laboratory samples, while the rest outsourced these services. Only the largest health area had its own radiology operations. Therefore, laboratory and x-ray personnel have been removed from analysis in order to identify only administrative and support personnel within the different services areas.

The comparison between providers and those indirectly involved with care in the different service areas did not seem to follow a clear pattern. However, a surprising finding was that the largest health areas commonly had a larger proportion of administrators. Synergies in administrative tasks did not occur in larger units. Considering current developments in primary care, where there is a clear trend towards larger service entities, the results seem somewhat worrying.

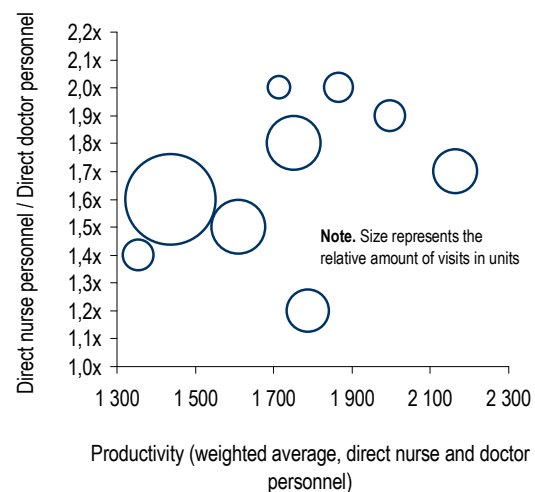
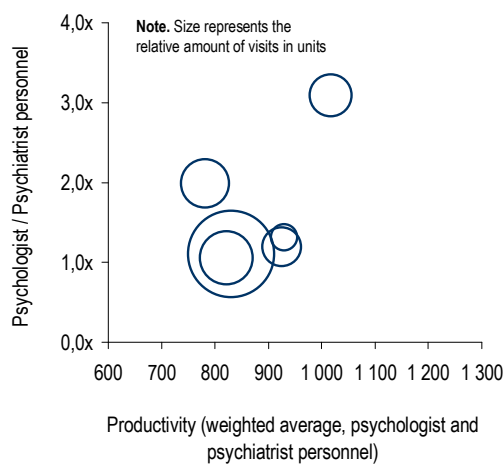

Figure 36 - Proportion of nurse to doctor personnel (in full work years) vs. productivity (weighted average) in 2005.

In the technical efficiency analysis, productivity (calculated as visits per health care providers), on average, was lower than in larger health areas (the size of the circles represents the relative number of visits in the health area). In this section, indirect personnel were added to the analysis. Considering that the proportion of administrators was also larger in larger health areas, it accentuated the finding that larger health areas are outperformed by smaller units. Therefore, productivity differences could be attributed to both the productivity of direct providers as well as the allocative efficiency of administrator.

Allocative efficiency can also be investigated from the point of resources allocation, given that some services can be complementary to some extent (nurse vs. doctor visits). Figure 36 shows the relationship between productivity (doctor and nurse visits) in relation to personnel distribution



(nurse vs. doctor personnel years). Circle size represents the relative number of visits in the health area. The difference in personnel allocation does not explain the productivity differences, despite the slight indication areas allocating 1.7 to 2.0 nurses per doctor were the most productive.

A similar analysis conducted for mental health care indicated that productivity increased as the proportion of psychologists to psychiatrists increased (Figure 37). However, the number of health areas included in the analysis is small due to the fact that many health areas do not employ psychiatrists. In general, resource allocation in the units appears to be relatively similar, apart in one health area, which displayed significantly higher productivity.

Figure 37 - Proportion of nurse/doctors vs. productivity (weighted average) in 2005.

SUMMARY

- Benchmarking may enable finding resource allocation standards, such as the number of nurses vs. doctors or psychologists vs. psychiatrists, producing the largest output.
- Determining the optimal relationship for nurse vs. doctor visits was not possible. However, areas with relatively more personnel in nurse visits had higher levels of productivity. A similar relationship was found for units with relatively more psychologists in relation to psychiatrists.
- The analysis of allocative efficiency may provide some insight into “optimal” ways of allocating resources. However, the small sample and somewhat unclear results makes it nearly impossible to draw any conclusions.

4.3.3 Allocative efficiency in regional laboratory services

The analysis of allocative efficiency in the CLM case was conducted in two parts. First, allocative efficiency of the central laboratory unit was analysed. Second, allocative efficiency of personnel resources in regional laboratory sample taking was analysed by focusing on distribution of work efforts during the work day.

Outside the central laboratory, the fairly low degree of use could largely be attributed to demand behaviour and difficulties in matching demand with supply. This concept is evident with employees whose main role is to take laboratory samples. This task is mainly done in the mornings, leaving less work for the afternoons (Figure 38). This is mainly an indication of weak allocative efficiency, even if it also indicates significant technical efficiency improvements potential. The limited possibility of using part-time employees makes personnel resources relatively fixed and not able to flex according to demand. Some analysis work is conducted in the smaller units, but due to centralisation, the majority of analysis work is conducted in centralised laboratories.

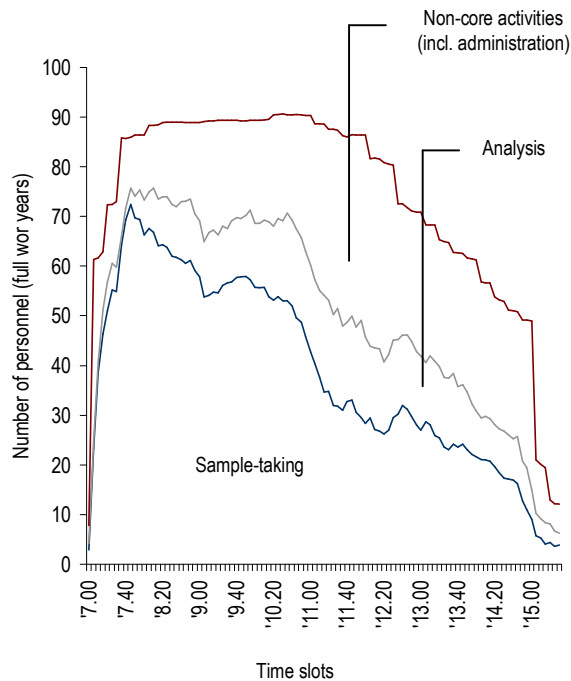

Figure 38 - Time spent in different activities outside the centralised laboratory on average working (2006).

Centralisation of analysis work is a common trend in laboratory operations because it is associated with improved cost-efficiency, mainly due to assumed economies of scale. This reasoning has also been the rationale for centralisation efforts in Finland, rather than focusing on maximizing use of existing resources, as argued by TOC advocates (Goldratt 1990a, 1990b). Unfortunately, cost-efficiency efforts such as centralisation of sample analysis have left resources idle, making allocative efficiency low. The case at hand provides a typical example of how the fixed nature of personnel resources hinders success of cost-driven restructuring efforts.

When applying the throughput-orientation advocated by Boyd and Gupta (2004), it can be said that the organisational mindset when dealing with the analysis of laboratory samples in the region has been characterized by cost-orientation. The success of cost-orientation is limited in the short run due to the fixed nature of resources. The fixed nature of resources makes throughput-orientation more appropriate in the shorter term (Bakke and Hellberg 1991). In the case at hand, the fixed nature of resources can be attributed to inflexibility in use of workforce. However, this should not come as a surprise to management. Ironically, from a performance measurement perspective, ABC was the leading management

tool when centralisation efforts were commenced. This reflects the management mindset and may have had significant impact on decisions.

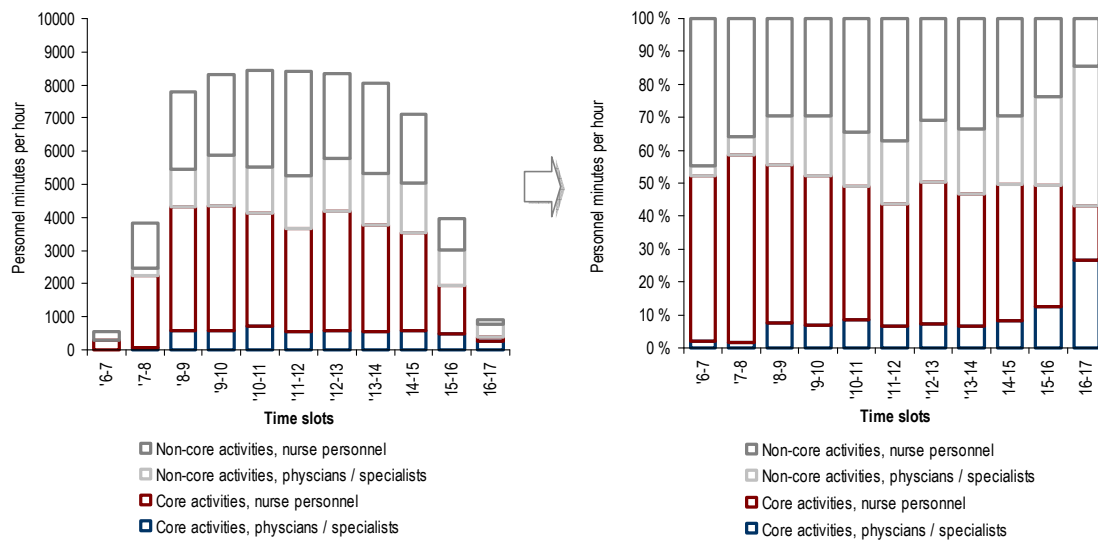

Figure 39 Time spent in core vs. non-core activities in the centralised laboratory during the average work day (2006).

Figure 39 shows the corresponding use of time in the centralised laboratory. Core and non-core activities were defined together with management. The analysis shows that a significant portion of personnel resources were tied up in non-core activities. Non-core activities are mainly administrative tasks, but physician education and development work was also included. This task amounted to an average of 1/3 of total non-core activities.

SUMMARY

- Variations in resource use may be significant at different times of the day. Idle time of resources may have been caused by the inflexible nature of resources (primarily personnel).
- Resource allocation problems are likely to be caused by larger developments and the “mindset” of the organisation. Different management models are likely to be present at different times affecting the management’s mindset.
- ABC data are useful for detailed analyses of resource allocation (particularly personnel).

4.3.4 Allocative efficiency of patient flow in hospitals

This analysis was conducted by analysing patient flow during a two year period. Figure 40 shows the first two movements of patients after they entered the hospital and helps to understand the complex flow of coronary artery patients there.

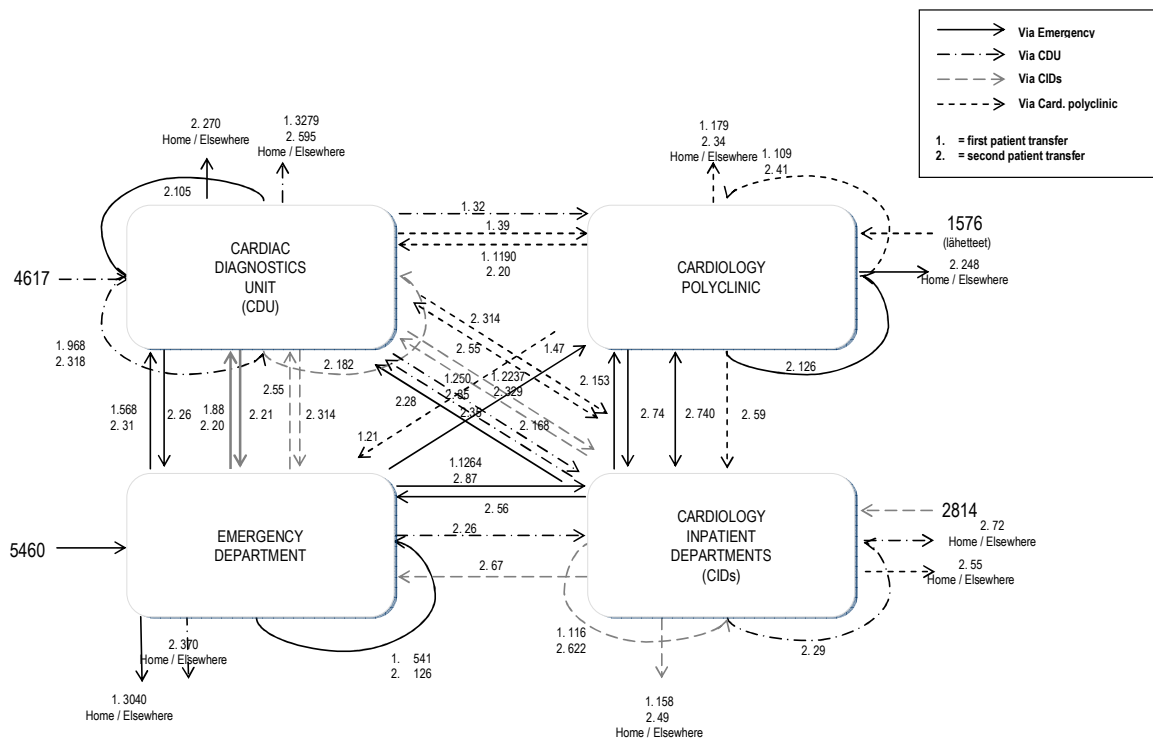

Figure 40 - Flow of coronary-artery patients (first two movements) during 2004-2005.

Bertrand and de Vries (2004) investigated the fundamental assumptions underlying a wide range of operations management methodologies and found that, although often not directly applicable, industrial production control concepts can make valuable contributions to health care and to the hospital context. The main reasons for questioning the applicability of operations management to hospitals is the high uncertainty of demand and variability of processes, the use of specialist resources in many steps of the processes and varying levels of urgency. Figure 40 supports this notion. However, a number of potential performance improvement areas can be identified, including 1) arrival to and departure from an inpatient department, 2) transfer from an inpatient department to emergency departments. In general, special attention should be given to the largest patients flows. These factors are represented here by transfers from inpatient departments to cardiac units, and the other way around (Figure 41). Potential system problems occur at the arrival of patients at emergency departments, patient transfers from cardiac diagnostics unit, polyclinic and inpatient departments to the emergency unit, and transfers of patients from inpatient department to emergency departments.

The data, which included 15,560 patients, found 1,200 different patient routes. The seven most common ones were taken by 75% of the patients, indicating that there were clear processes followed by the majority of patients. However, a large portion of patient flow could be categorized as non-routine. Note that this case represents just one stage in the visit and analysing interfaces between the hospital and primary care (primarily for patients with referral waiting for transfer) requires extensive analysis.

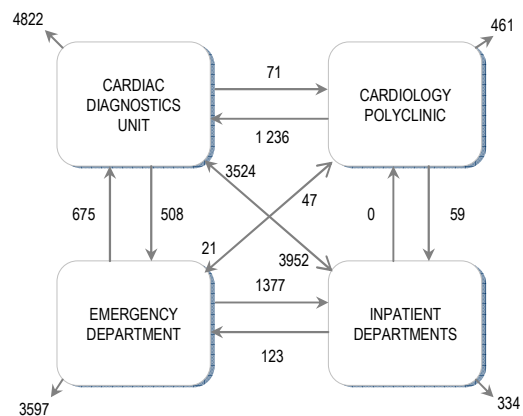

Figure 41 – Simplified analysis of patient flow (2004-2005).

According to organisation theory, the trade-off between efficiency and flexibility should be reflected in organisational structure. Organisations can be structured to conduct repetitive, routine tasks or innovative, non-routine tasks (Adler et al. 1999). They can also assume a hybrid structure, with one part of the organisation doing routine work and another one doing non-routine tasks. For example, hospitals perform routine and non-routine processes, and are clearly hybrid (van Merode et al. 2004).

A vast number of units and departments across a hospital participate directly or indirectly in patient treatment. In the case of clear, high-volume processes, process analysis on the hospital level should focus on flow between units in the hospital. The efficient management of unsystematic, low-volume patient flows requires a different focus. Figure 41 shows major patient flows including the first two transfers. In some interfaces between units or departments, volumes are significant and gains from focusing on the flow through these interfaces become significant from a resource-use viewpoint. Analysing actual patient flow also enables identification of illogical elements.

In a separate study, four of the units of internal medicine in a hospital were analysed (Melin 2006). Elective patients arriving for their first procedures waited an average of seven hours. Their actual departure times occurred an average of nearly two hours after departure decision were made. In patient transportation between the cardiac diagnostic unit and inpatient departments (and vice versa) unnecessary waiting time was identified (Figure 42). This resulted in idle resources and considering the large volumes in this interface (Figure 41), the accumulated effects are significant.

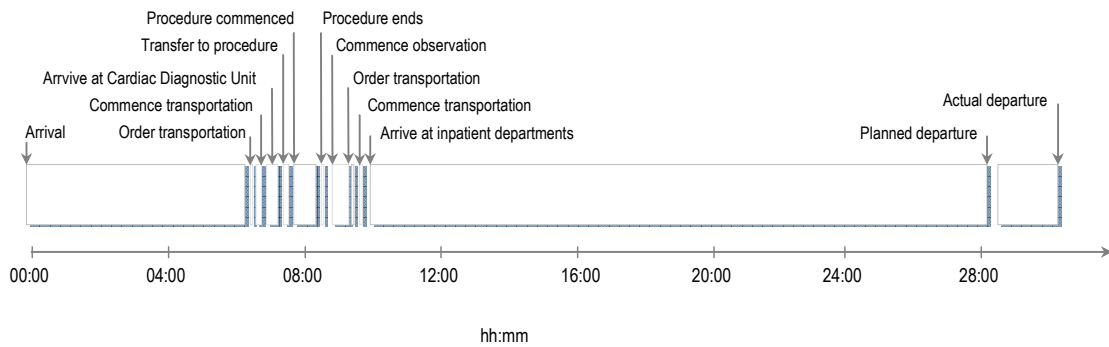

Figure 42 - Average coronary artery patient episode in two week period (Melin 2006).

In the hospital studied here, patient flow analysis is very uncommon and was only performed on one other occasion in relation to specific issues. The same organisation has invested significant resources in production process representation for many years. This may be the result of management focus, but, most certainly, also due to the lack of tools for conducting flow analysis. Undoubtedly, there may be gains from further analysis of patient flow and the use of lean management tools in hospitals and other, transaction-intensive, environments in health care.

SUMMARY

- Analysing patient flow promotes a different perspective on allocative efficiency. It may also help identify reasons for uncertainty and variability of processes.
- Allocation of resources in a hospital should account for support functions in order to avoid support functions becoming bottlenecks in patient flow.
- Resource allocation decisions should account for the patient flow in order to make transitions within the hospital interfaces.
- Performance can suffer significantly if key interfaces are not optimally planned and managed.

4.3.5 Allocative efficiency in elderly care services

A significant variety of elderly care systems exists internationally. These differences reflect policy-making differences in resource allocation between different care types.

Figure 43 illustrates the bed-centred care culture in Finland in comparison with other countries. In particular, the density of long-term care beds for elderly in relation to the population is very high.. Allocative differences within Finland are also significant. Figure 44 shows the share of people aged 75 years and up who were treated in health centres, as opposed to social care. The figure shows that more than 50 Finnish municipalities treated >60% of patients in health centres. This reflects the heterogeneity of elderly care service network in municipalities with respect to the distribution of people in long-term institutions, health centres, service homes or other services forms.

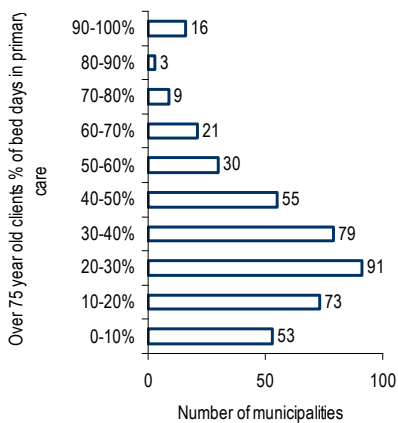
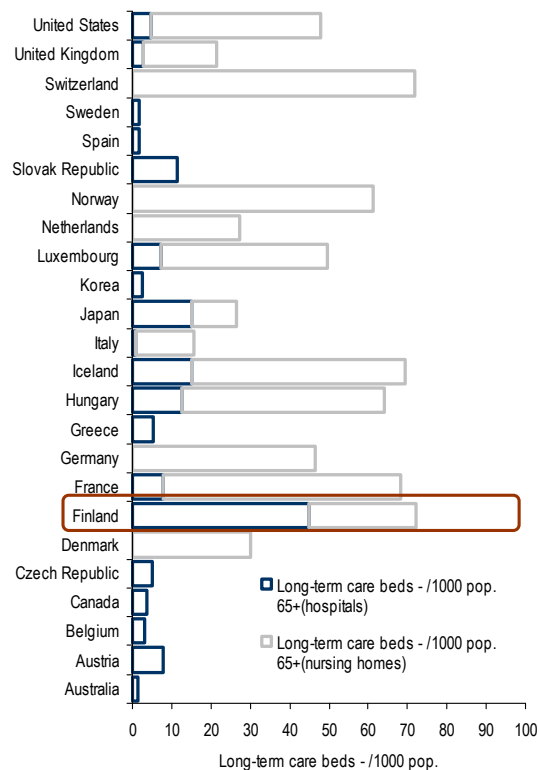

Figure 43 - Long-term care beds per 1,000 inhabitants over 65 years old (OECD 2006).

The data in Figure 43 must be considered with caution. For example, in Sweden, elderly care is strongly focused on home care, and this information is not included in the data. Figure 44 indicates that Finnish municipalities position themselves on a continuous scale from institutionalized to open elderly care. Either elderly care is conducted entirely or to a large extent in health care hospitals or in systems focusing on long-term care and service homes. The majority of municipalities produced less than half of bed days for patients aged 74 years and up in health centre hospitals. However, many municipalities still rely on health centre hospitals for elderly care. This can also be discerned when analysing

Figure 44 - Number of municipalities by %-share of bed days produced for patients aged 74 years or more, in health centre hospitals, 2005 (remaining bed days in social care) (Sotka database, Stakes 2007).

the need for care categorization of elderly care clients.²⁰ The need of care should be reflected in the care provided. Elderly care services are obtained where the capacity is, i.e. where resources historically have been allocated.

Figure 45 shows the positioning of Kymenlaakso municipalities by service type, average LOS, and average care categorization at year end 2005. All patients were long-term patients who had been admitted for at least 90 days. The significant differences in segmentation are easily identifiable. Admissions criteria varied considerably. In the case of elderly care institutions, segmentation seemed to be most aligned between municipalities. A surprising finding was that, on average, the condition of clients in elderly care and intensive service housing was more severe than in health centre hospitals.

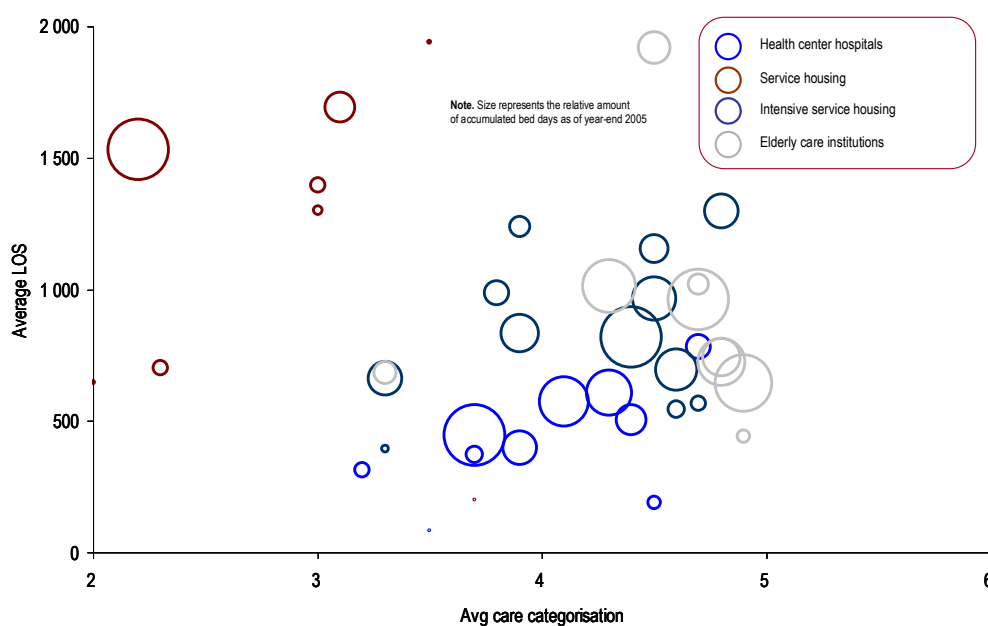

Figure 45 - Average LOS and care categorization for long-term care in different elderly care types within region, year-end 2005 (Stakes 2006).

A review of admissions criteria in health centre hospitals indicated that the health centre models have different operative models. The selected hospitals used more resources for care (as supposed to cure) services than the national average.

In a study of elderly care services in Helsinki in 2004, Ekroos and Vauramo showed that insufficient capacity in less-intensive care contributed to keeping elderly care patients in bed. Due to insufficient resources in less-intensive care, the condition of many elderly waiting to be replaced worsened to the extent that they become bed-dependent and, thus, forced to remain in health centre hospitals.

The approach in Finland may stem from the perception that 24/7 care is always good. When health centre hospitals were built, municipal inpatient departments were moved to them. Health centre hospitals were planned for short-term patient

²⁰ For further information on care categorisation in Finnish elderly care, see A - 10.

treatment, but became the cornerstone of a bed-centred system. However, the ability of the health centres to rehabilitate, and their willingness to do so can be questioned. One problem is limited space in rooms, which encourages bed-rest. Several studies have shown the negative impact of long-term bed-rest. Doctors are aware that a patient's muscle strength can decrease 10-20% in 10 days. If a daily rehabilitation routine lasts for only 20 – 30 minutes, a patient may spend 22 hours in bed. If a room has 6-8 m² surrounding the bed, it can barely accommodate a chair. Common space is rarely available. As a result, the condition of some elderly can worsen to the extent that they can no longer be sent to less-intensive care facilities. The process becomes a vicious circle that creates more long-term bed-patients.

Different approaches to elderly care can be found elsewhere, for example, in Sweden. Sweden has a long tradition of emphasizing self-care and various kinds of service housing systems. The core of its system is to allow elderly people to participate in their own care to the extent of their capabilities. Self-care refers to taking responsibility for one's own health, not being neglected by the system. In Sweden, only 3% of elderly care clients share rooms with others, while 85% of them live in facilities with kitchens as well as their own toilets and showers. These elements are important parts of self-care. These elderly are mainly self-caring with some supporting services. Sweden has a total of 2,500 geriatric bed places, compared Finland's total of 20,400 health centre hospital bed places in 2005. Of this total, only 7,000 were used for acute care (LOS <30 days) in 2004 and 2005. Many European countries have limited hospital bed days to 30 days.

Figure 46 shows a hypothetical example of elderly care segmentation according to principles fully or partially employed in e.g. Denmark, Great-Britain, Sweden, Norway, the Netherlands and Estonia. In 2005, 20,000 patients were enrolled in Finnish health centre hospitals of which more than half (54%) stayed for longer than 30 days. In the countries mentioned above, 30 days is the targeted maximum LOS for an elderly in hospital-like conditions (Ryhänen et al. 2007). The accumulated amount of bed days for Finnish elderly care clients in was more than 11 million (99% of the total amount of bed days used by them). For all patients enrolled in 2005, the opinion of health care professionals was that, out of the patient enrolled in health centre hospital, 26% would have been better off receiving less intensive care.

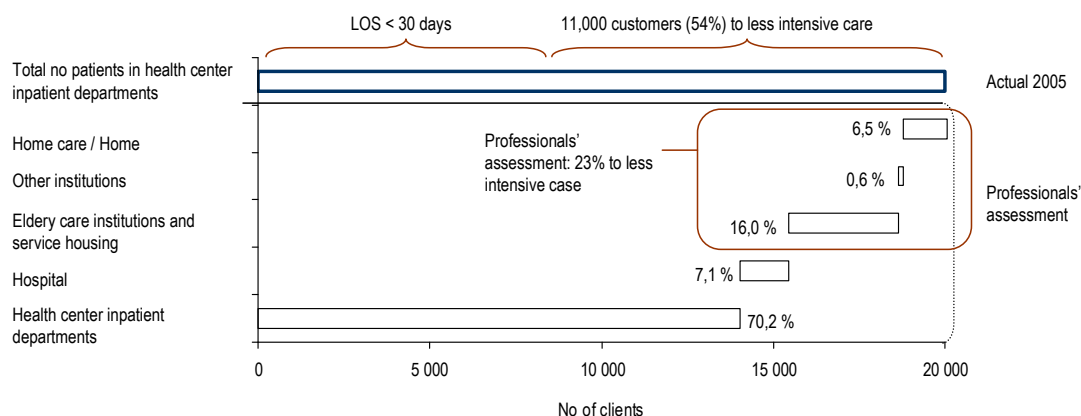

Figure 46 - Professionals' assessment of appropriate care and comparison with other international models.

Finland exercises bed-centred elderly care. This was shown in Figure 43. There are significant differences in care systems within Finland. The structure of the system leads to a relatively large need for personnel and the need for personnel could be decreased by shifting towards a less bed-centred system. The need for re-structuring is accentuated by demographic changes. Resource constraints and financial boundaries mean that the current service system will have to manage with the current number of personnel. Elderly care and cure should be separated, and long-term care should be directed to social care institutions as much as possible.

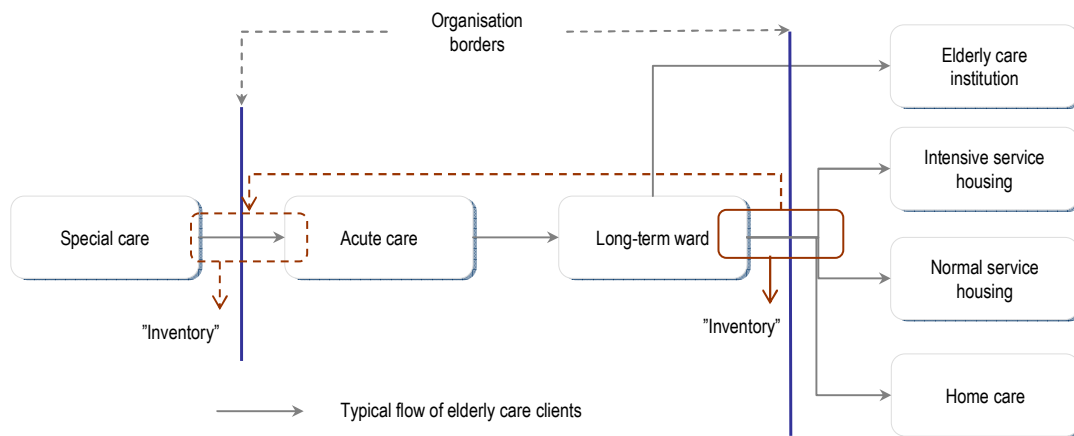

Figure 47 - Common organisation-level bottlenecks in the Finnish elderly care system.

From an allocative efficiency viewpoint, there are clear indications that facilities for less-intensive elderly care lack resources. This is creating a system-level bottleneck (Figure 47). The bottleneck tends to create problems in health centre hospitals, creating further waiting, such as for patients waiting for admission to internal medicine departments at health centre hospitals. This problem cannot be dealt with locally, but must be analysed from a regional viewpoint and across organisational borders. Current problems can be attributed to lack of coordination across organisational boundaries and lack of incentives to increase flow of clients as well as to share/re-allocate resources.

An inventory of the Kymenlaakso region's elderly care system was conducted by the research team in the spring of 2006 and covered 1,100 bed places out of a total of 2,000. Both public and private institutions were reviewed. The investigation showed that the majority of facilities are small and encourage bed-stay rather than independent activity, such as restroom use. Common spaces were also limited. This finding supports the notion that the system may actually contribute to making people bed-bound. Queues from inpatient departments to service housing are very common. The investigation has resulted in a major review of elderly care services in the Kymenlaakso region.

The investigation showed that all health centre hospitals were fully utilized and extra beds had been planned for the already small spaces. Nearly half of the patients were considered wrongfully placed and waiting for places in elderly care institutions. For example, in Kuusankoski health centre, 24 of 53 patients were waiting for removal to an elderly care institution. This indicates a typical resource allocation problem, due to the relatively large amount of resource in health centre hospitals and relatively small number of resources in the subsequent facilities. The economic impact is significant, since the average cost per day in a health centre may be twice that in the appropriate facility. The resource allocation

problems observed in Kymenlaakso are common throughout Finland. Dealing with the resource allocation problems could provide significant positive financial benefits, and would mean that personnel would have to be reallocated within the services system. Naturally, restructuring efforts would also require large investment efforts and a difficult change management process.

SUMMARY

- The structure of Finnish elderly care systems varies significantly. The differences are reflected and caused by different resource allocation in elderly care. The large portion of institutional care in Finland becomes evident in an international comparison.
- Analysis of customer segmentation indicates that a significant amount of clients receive care that is too intensive. This system is likely to tie up more personnel resources than an alternative system. The availability and allocation of resources is likely to be a significant determinant of where clients receive care. Historically, vast resources have been allocated to health centre hospitals.
- Elderly care segmentation is driven by the current capacity. Changing this capacity would require significant resource reallocation to less intensive care forms. In many municipalities, this would mean a resource reallocation across organisational boundaries, which is extremely challenging. Reallocation will also require significant renovation and investment of facilities in place. This trend has begun to varying degrees in many regions.
- The relatively low amount of resources in less intensive care forms (including home care, which was outside the scope of the case) causes a bottleneck at the interface between municipal health and social care. The effects of the bottleneck can be seen in the interface between special care and primary care, where many elderly care are forced to wait for transfer after a special care episode.

4.3.6 Allocative efficiency in elderly care services

A service network can be characterized as complex machinery where small service providers function as oil to keep it running smoothly. The amount of service providers was surprisingly large and fragmented (Figure 48). A total of 400 organisations were identified, of which some 250 were public. Addressing allocative efficiency of an entire network is very challenging, particularly without very detailed comparative information from other, comparable regions.

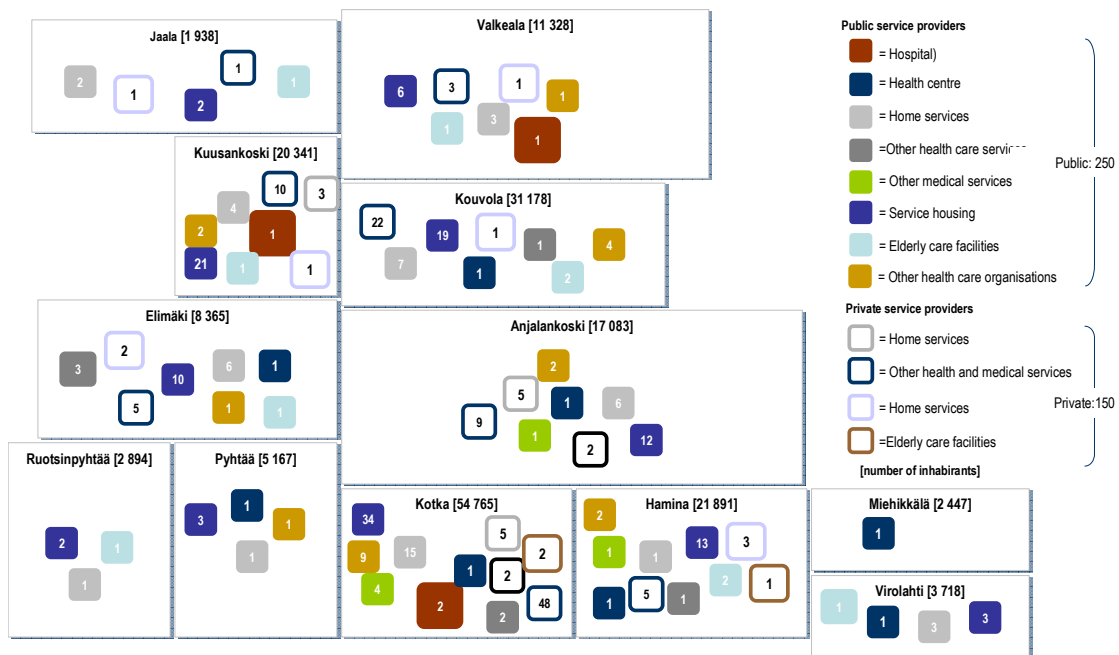

Figure 48 – Map of Kymenlaakso hospital district - Health and social care service providers in the regional health care network - year end 2004.

An inventory of the regional elderly care network was conducted and 1,100 bed places and 2,000 care places were reviewed. Both public and private organisations were part of the review. The inventory clearly indicated that the majority of facilities were small and encouraged laying in bed, rather than independent activity. Common facilities for clients were undersized. Queuing from wards to service housing was common, indicating that the current service network was expensive and unpleasant from the perspective of the customer.

A comprehensive analysis of the service network may provide insight into planning a service system, improving patient flow management, and making total resource management more efficient. Figure 49 provides an example. It shows the distribution of inpatient care costs in secondary and primary care for stroke²¹ and coronary artery²² patients over period of ten years.²³ This is mere illustration of use of inpatient services recorded by Stakes and does not allow for drawing any conclusions as the regional planning of patient flow for these patient groups.

²¹ ICD10 diagnosis groups I60-I69.

²² ICD10 diagnosis groups I20-I25.

²³ The analysis was conducted for 114 coronary artery patients (I20-I25) and 334 stroke patients (I60-I69) who were admitted to care in 2005. For further information on the cost distribution of inpatient care in secondary and primary care, see AAA.

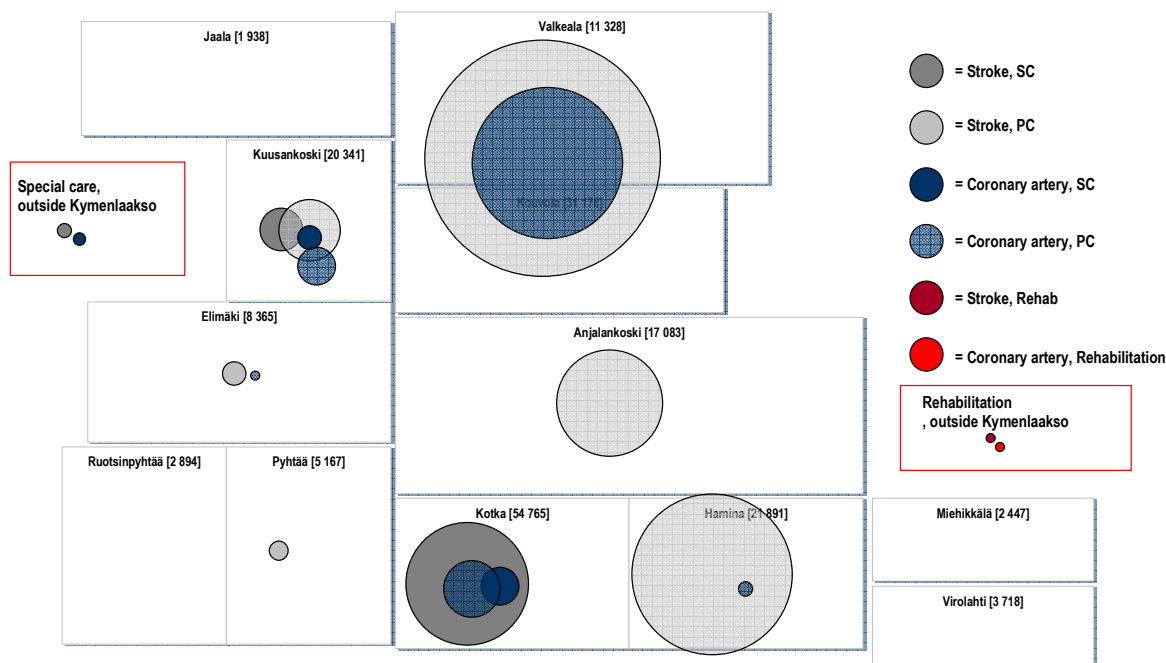

Figure 49 – Map of Kymenlaakso hospital district - Relative cost inpatient distribution between special and primary care for stroke and coronary artery patients in different municipalities 1996 – 2005.²⁴

SUMMARY

- Regional health care networks are very complex in their allocation of resources
- An closer investigation of the elderly care system in the region indicated that there is no or very little regional coordination of resource allocation

4.4 ECONOMIC EFFICIENCY ANALYSIS

4.4.1 Economic efficiency in elective orthopaedic surgery – Total joint hip arthroplasty

In terms of financial analysis, particular attention is given to the analysis of process time and costs, assuming that realised costs more or less are determined by the amount of time resource are used. The financial analysis here was based on the cost-accounting system in place in the organisation where the case study was performed. Drivers in the cost accounting system were reviewed to match the development of the production process. Costs were divided into process dependent costs (operating time) and non-process dependent costs (material and administrative costs) (Roth, 2004). Costs were analysed in four separate stages: the preoperative phase, the operation phase, the recovery phase and the postoperative

²⁴ Costs are as of year-end 2005. Consequently, cost distribution reflects the structure of the service system at that time.

phase and checked against the organisation's accounting information. When comparing costs over a period of several years, the year-on-year increase of resource costs (surgeon and nurse wages) was obtained and then used as a discount factor in order to obtain comparable costs over the investigation period.

Table 16 - Financial measures and average cost distribution of patient episodes (2003-2005).

Financial measures (EUR)	2003	2004	2005	Cost per episode (EUR)	2003	2004	2005
Avg. cost per inpatient day	517.5	517.4	504.5	Avg. preoperative cost	414.9	414.8	404.4
OR cost per hour	543.2	549.9	591.4	Avg. cost per surgery	2884.3	3045.1	3007.4
Recovery room cost per patient	183.7	203.8	179.3	Avg. recovery room cost	416.3	461.9	406.4
				Avg. postoperative cost	2980.7	2843.7	2669.3
				Total (excl. implant)	6696.2	6765.5	6487.5
				Avg. cost of implant	1262.7	1218.4	1028.0
				Total	7958.9	7983.9	7515.5

Process improvements in the OR can increase cost-efficiency (Stahl et al. 2006). In the case studies here, a model for cost-analysis was first developed based on the case organisation's own cost-accounting system. The cost developments from 2003-2005 were reviewed in retrospect to investigate whether the process development efforts had had financial effects (Table 16).

Figure 50 shows the development of average LOS and average inpatient costs in 2003-2005. The average LOS decreased by 0.5 days during that time. The corresponding decrease in discounted costs was 463 euros²⁵ or 322 euros in real terms.

The length of the preoperative phase remained the same during the investigation period, but the length of the postoperative phase decreased by an average of 0.3 days in the first year and a further 0.2 in the second. The average utilization rate of the inpatient department ranged from 57.6% to 66.9% during the corresponding period.

As previously stated, there was capacity in the inpatient department. Thus, there was no need to increase bed capacity despite the significant increase in total number of bed days. Moreover, as found in the analysis of allocative efficiency, the amount of personnel in relation to beds remained stable, indicating a clear productivity

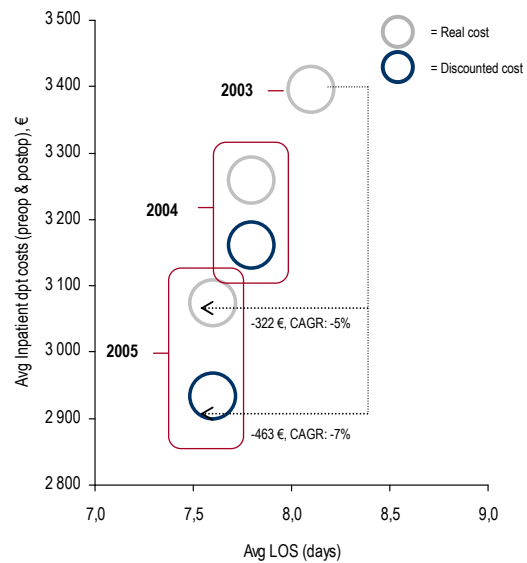

Figure 50 - Development of average inpatient department costs and average number of inpatient days 2003-2005.

Note: CAGR = Continuous Aggregate Growth Rate

²⁵ Discount rates were calculated separately for different costs items (e.g. nurse and surgeon wages) using actual development of these costs.

increase of personnel resources in the inpatient department.

A corresponding analysis of the OR (Figure 51) shows the development of average OR time and OR cost per patient in 2003-2005. The average discounted cost increased by 103 EUR in 2004, but decreased by 38 EUR (-1%) in 2003-2005.

The average OR throughput time increased by 9 minutes in 2004 and decreased by 17 minutes in 2005. The OR utilization rate increased by 9.3%. The improved throughput and utilization rate appears to have occurred through changes in resource allocation, such as by increasing personnel in the OR. The increased personnel, particularly nurses increased costs, but in nominal terms costs appeared to be correlated with the average throughput time.

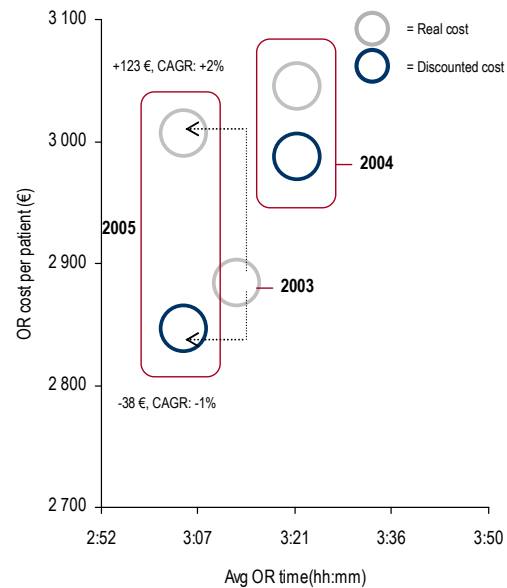

Figure 51 - Development of OR costs and throughput time 2003-2005.

Note: CAGR = Continuous Aggregate Growth Rate

SUMMARY

- The hospital decreased costs through process development efforts. The increased economic efficiency was directly linked to improvements in technical and allocative efficiency.
- Changes in production processes likely result in changes in production costs. The results show that there appears to be a strong relationship between process measures and unit costs. Lower unit costs are achieved by increasing production without increasing resources to the same extent.

4.4.2 Economic efficiency in FSHS

The importance of cost analysis has increased in the last decades due to increased cost-awareness in health care. Costing methodologies can roughly be categorized into top-down or bottom-up methods. Health care managers have traditionally preferred top-down methodologies, because they are less time- and resource-consuming (Negrini et al. 2004). The most common bottom-up costing method is ABC, which – at times – has been extensively used in health care organisations. ABC can add significant value to management activities in health care (Evans and Bellamy 1995). However, in the longer term, upholding ABC systems has proven unsuccessful in health care organisations, and has increased dissatisfaction with the system (Lawson 2005).

In the FSHS case study, a cost-accounting model based on the existing accounting structure was developed in order to enable a detailed comparison of financial performance between the health areas. Costs were categorised into direct costs, service-specific indirect costs, health area overhead costs and FSHS overhead costs. Sensitivity analysis of allocation rules was made, and in accordance with management preferences, a combination of volume and direct-cost based allocation was finally used. The sensitivity analysis showed that allocation rules did not affect results from the comparison of health areas.

First, the relationship between economic efficiency and productivity was investigated. Economic efficiency was defined as costs per visit, based on the developed cost-accounting model. The relationship between direct costs per visit and visit per direct personnel was investigated, as was the relationship between total costs per visit in relation to visits per total personnel. In both cases, it was evident that productivity was negatively correlated with economic efficiency: higher productivity was associated with lower costs per visit (Figure 52 and Figure 53). The result is logical considering the large share of personnel costs, which makes personnel productivity the main cost driver. Discussions with management confirmed the idea that health areas with lower productivity were also areas that, in previous years, had been allocated more personnel resources. Management had, however, not been aware that the productivity of these units was worse, thus making the perceived need for more personnel resources greater. Had management had reliable productivity figures and area comparisons the perceived lack of personnel resources would have been dealt with by focusing on reasons for productivity differences.

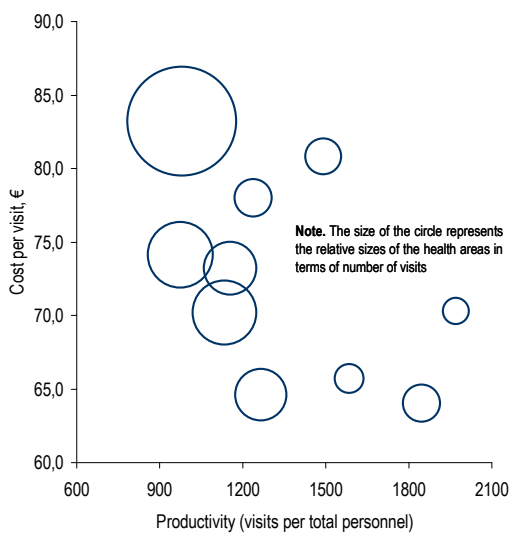

Figure 52 - Relationship between productivity of doctor personnel and cost per doctor visit (2005).

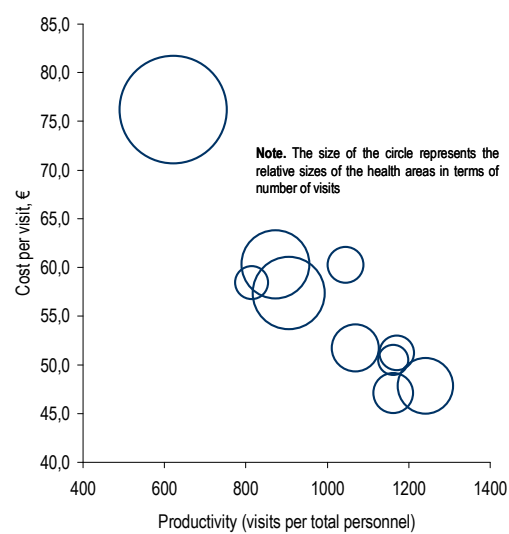

Figure 53 - Relationship between productivity of nurse personnel and cost per nurse visit (2005).

The relationship between economic efficiency and other operational figures was also investigated. Though the relationship was not as evident as that with productivity, higher costs per visits were also associated with larger health areas in terms of student numbers, longer waiting times and total personnel resources in relation to the number of students. Larger health areas (in terms of number of visits), also had higher costs per visit than the smaller health areas. This finding aligned with the findings in the technical and allocative efficiency analysis.

Figure 54 shows the relative number of doctor vs. nurse visits in the different areas. The difference has a clear impact on costs. Costs were higher in areas with more doctor visits. Given the similarity in patient profiles in FSHS,²⁶ the differences were unlikely to be caused by demand, but rather by local management principles and available capacity. The portion of doctors was, on average, higher in larger health areas.

The main costs drivers in FSHS were both the technical efficiency of personnel resources as well as the use of indirect personnel. Lower productivity of personnel was clearly reflected in higher production costs. Larger health areas are outperformed by smaller units in terms of productivity.

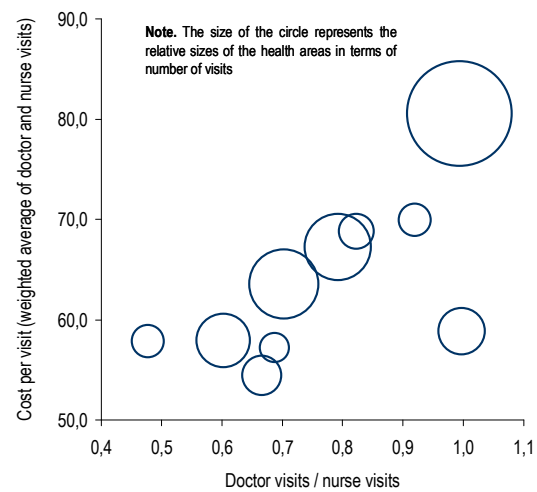

Figure 54 - Doctor to nurse visits and corresponding costs per visit (weighted average) in 2005.

²⁶ For more detailed ICPC-distribution of patients in the health areas, see A - 5.

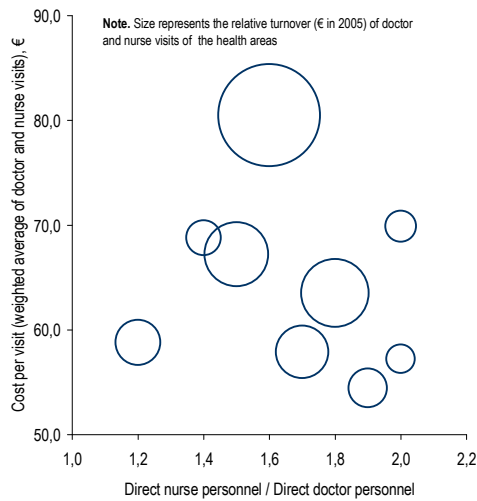

Figure 55 - Proportion of nurse to doctor personnel vs. cost per visit (weighted average) in 2005

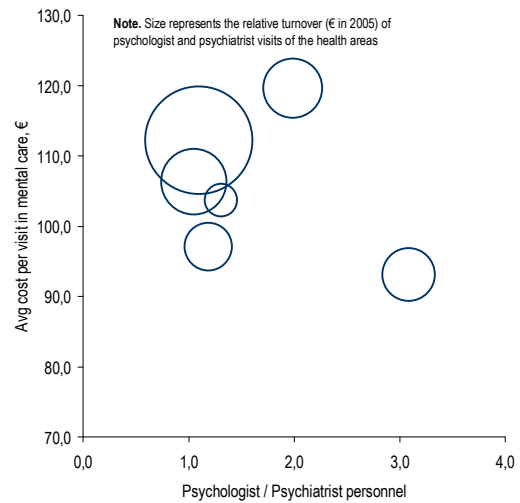

Figure 56 - Proportion of psychologists to psychiatrist personnel vs. average cost of mental care visit²⁷ in 2005

Figure 55 and Figure 56 show the proportion of nurses to doctors and psychologists to psychiatrists, respectively, and corresponding costs per visit. No definite conclusion can be drawn. However, the analysis indicates production costs are lower if there are relatively more nurses in relation to the number of doctors, and if there are more psychologists in relation to psychiatrists. If assumed that the patient profile, on average, is very similar this reflects differences in operating models and resource allocation, and its corresponding effects on cost-efficiency.

SUMMARY

- Larger units were, on average, less cost-efficient.
- Productivity as well as allocation of resources were the main determinants of cost-efficiency.
- Cost-efficiency was highly dependent on demand segmentation practices. Demand segmentation practices varied significantly.
- Economies of scale and scope were not realised in larger service production units. Some areas were historically extensively resourced, and size was used as a bargaining tool against smaller units in the quest for scarce resources within the organisation.

²⁷ No information separate cost information of psychiatrist and psychologist costs available.

4.4.3 Economic efficiency in regional laboratory services

The amount and type of resources used in production determine costs. A simple method for calculating cost-efficiency is to divide total costs by output. In analysis operations, the required amount of work and resources may vary by specialty area, but taking laboratory samples is a significant part of operations requiring significant personnel resources.

Figure 57 compares costs per sample in units throughout the region. At most, the difference was 12 euros. Furthermore, unit size was negatively correlated with cost-efficiency and productivity. Figure 58 shows utilization rates for central equipment in CLM in relation to annual costs (2005). Rates were calculated by dividing by the total possible number of samples during a full 8 hour workday. These rates indicate that process capacity

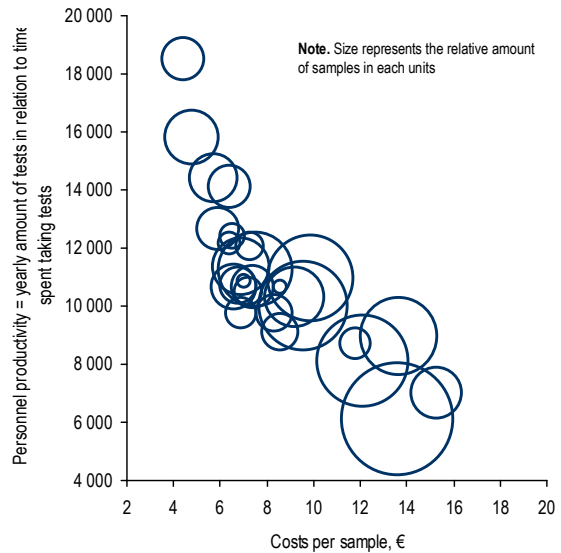

Figure 57 - Productivity in sample taking vs. cost per taken sample (2006).

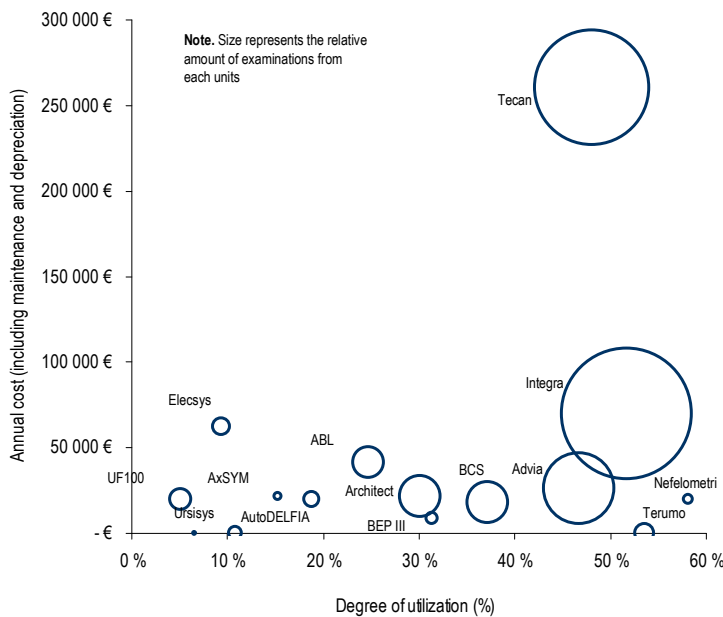

Figure 58 - Laboratory equipment, degree of utilization (%) vs. annual cost including maintenance (€) in 2005.

is not limited by equipment.

As discussed in section 4.3.3, many personnel in regional health centre units are idle in the afternoon. This situation is primarily due to the high degree of centralisation of laboratory analysis. Considering the low costs of laboratory equipment, the cost-efficiency of centralised analysis must be questioned, especially if equipment could be allocated locally. This approach would also solve the problem of idle afternoon time. It also supports the notion that personnel constitute a bottleneck resource in the operation.

FINANCIAL PROCESS MANAGEMENT

In general, coverage of the explicit relationship between ABC and process analysis in the published literature is limited. However, the use of ABC information is common in process re-engineering and design (Gupta and Galloway 2003, Partridge and Perren 1998). Using ABC in conjunction with process analysis assumes that one or several cost drivers (Babad and Balachandran 1993) are equivalent to a stage of the production process.

In order to evaluate process re-engineering efforts in CLM, ABC data was combined with analysis of the production process.²⁸ The ABC data was linked to each stage of the production process. The organisation used in the case study had not previously integrated process analysis with ABC data, and a model was developed so that the financial impact of process changes could be evaluated. The tool was useful for simulating the financial effects of changes in the production process. However, its weakness was that it did not account for the inflexibility of resources. Thus, the model tended to overestimate positive financial effects of changes to the production process.

The case study presented here addressed the applicability of ABC data to production process analysis. According to available knowledge, CLM is unique, due to its early and stringent adoption of ABC previous to pursuing process analysis and tilting towards becoming a process organisation. Due to the structure of ABC, it is easily applicable to process analysis. This assumes that a stage of the process is equivalent to one or several activities in the ABC data. also It is important to note that ABC had been conducted for several years before the process development project began, and that the ABC cost drivers also were used for the process analysis. In retrospect, the results of the process analysis may have been different if it had not been designed to adhere to the ABC structure.

The practical implications, at least in Finnish health care organisations, are fairly limited due to fact that financial management in these organisations is generally undeveloped. Therefore, the discussion here is a guideline for future efforts to pursue process analysis and management. However, the case studies provide an example of how health care organisations can reach a more comprehensive state of process analysis and understanding by linking operational and financial information to process representations. This naturally involves increased cooperation between financial and process management functions within an organisation. The interface between process representations - which commonly are a combination of empirical and normative observations – and actual operational and financial information may not be fully straightforward. Therefore, the implications of process representation and actual financial and operational information are discussed. Comprehensive process analysis enables, but also requires, deeper cooperation between financial and non-financial managers. It has been found that familiarising non-financial managers with ABC can turn them into enthusiastic users of ABC data. In addition, ABC implementation has enforced the relationship between financial and non-financial managers (Partridge and Perren 1998).

A health care-specific feature is complex processes often involving numerous organisations. The case study presented here deals with processes in one laboratory, which is part of the patient episode. This is naturally also reflected in organisational mindset and objectives of the laboratory managers. Though active process management and optimisation across entire care pathways, such as from primary care to special care and back, is practically unheard of, laboratory

²⁸ For an illustration, see A - 14.

managers are forced to balance between cost- and throughput-thinking. The impact on changes in laboratory operations on, for example, the hospital episode has not been investigated here. However, the results support the notion that process development (as opposed to cost-saving) efforts may have more positive effects on the patient episode as a whole and, thus positively affect costs on a larger scale.

SUMMARY

- Productivity appears to be the main determinant of cost efficiency.
- ABC data combined with production process enables financial process control, such as simulation of financial effects of process re-engineering. However, this approach is likely to overestimate financial gains from process re-engineering efforts due to the fixed nature of resources.
- Cost-efficiency may not improved by management through simply by focusing on cost. Due to the fixed nature of resources, reaping financing benefits may be challenging. The laboratory analysis centralisation trend is an example of how financial benefits are unlikely to be fully realised.

4.4.4 Economic efficiency of patient flow in hospitals

Traditionally, financial process management refers to the analysis of resource use and cost distribution in the production process. In health care, this approach is not informative about patient process costs. The cost-analysis conducted in the case at hand aimed at developing a model that could link patient process to production costs, given current information availability and structures. Particular attention was given to support functions involved in the patient process.

Due to the large number of units directly or indirectly involved in the patient process, costs were analysed from the internal medicine department's perspective. This was possible due to the internal purchasing method employed, i.e. the department of internal medicine purchases service from different service providers, and as prices should be based on production costs it is synonymous to cost allocation from the units contributing to the service production.²⁹

The patient process analysis was conducted using the Patient In Process concept (PIP), which focuses on time in the process. Economic efficiency was analysed by linking cost information to services produced in different stages of the patient process. Financials were reviewed separately for internal medicine departments (including cardiac surgery departments, inpatient departments, CCU, & acute care). This information is used to calculate average costs per visit, inpatient days and more specifically, using cost accounting, for procedures in the cardiac surgery department.

The cost of hospital wards has been subject to extensive discussion in literature, but comparing studies is difficult because of variations in costing methodologies, both internationally and domestically. Generally, the confusion about costing methodologies is reflected in discussions of indirect vs. direct costs as well as intangible, marginal and overhead costs (Negrini et al. 2004). Traditionally, departments directly involved in the patient process are called *revenue centres* (Garattini et al. 1999, Roberts et al. 1999, St. Hilaire and Crépeau 2000). They have been separated from those that provide support functions, which are called *cost centres*. (Garattini et al. 1999, Norris et al. 1995, Oostenbrink et al. 2003).

²⁹ Cost based pricing is a cornerstone used throughout Finland in municipality funding of special care operations. This is, however, not as straightforward as it seems. Many cases indicate that prices are not actually based on true production costs, resulting mainly from lackluster financial accounting techniques in special care.

The difficulty in making comparisons means that it is difficult to draw conclusions regarding the economic efficiency of patient processes. However, adding cost information to the analysis provides a good view of resource consumption in the patient process and its cost drivers. First, targets for resource management in entire patient processes may differ from those of individual support functions. For example, implementing radical cost-reduction efforts in radiology and laboratory functions may not be optimal, as doing so may have detrimental effects both financially and on the overall patient process. Furthermore, depending on the nature of the support function, such as whether it is linked to the patient process or not, may be an important consideration when making resource-related decisions.

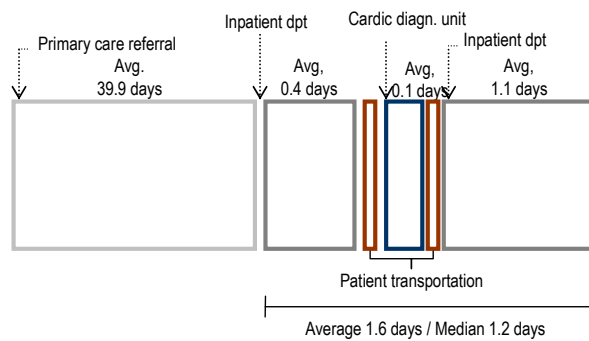

	Inpatient dpt.		Cardiac diagn. unit		Inpatient dpt.		Total	
	Euros	%	Euros	%	Euros	%	Euros	%
Internal medicine unit	233 613	59,9 %	786039	36,9 %	317 758	56,9 %	1 337 410	43,5 %
Surgical unit	20 695	5,3 %	510	0,0 %	246	0,0 %	21 451	0,7 %
Laboratory	23 989	6,1 %	2904	0,1 %	111 641	20,0 %	138 534	4,5 %
Radiology	21 353	5,5 %	4181	0,2 %	45 463	8,1 %	70 997	2,3 %
Service center	50 129	12,8 %	167037	7,9 %	36 992	6,6 %	254 158	8,3 %
Pharmacy	9 246	2,4 %	105044	4,9 %	9 369	1,7 %	123 659	4,0 %
Nutrition center	14 798	3,8 %	1896	0,1 %	6 570	1,2 %	23 264	0,8 %
Materials center	2 613	0,7 %	1034272	48,6 %	12 413	2,2 %	1 049 298	34,1 %
Central administration	9 189	2,4 %	11418	0,5 %	12 896	2,3 %	33 503	1,1 %
IT administration	4 654	1,2 %	14423	0,7 %	5 538	1,0 %	24 615	0,8 %
Total	390 279	100 %	2 127 724	100 %	558 886	100 %	3 076 889	100 %

Figure 59 - Example of patient in process costs (1,300 patients) during 2004-2005.

PIP provides a tool for analysing patient episodes and their costs. Figure 59 shows the cost of one of the most common episodes for a total of 1,300 patients (elective patients first admitted to inpatient department, followed by treatment in the cardiac diagnostic unit and exit from hospital via inpatient department). Potential problems with this methodology are linked to the nature and quality of cost-accounting information, as well as to information obtained from current electronic patient records. The potential problems involved with the costing information are obvious, since hospital cost-accounting systems have traditionally not been designed for analysis of process cost. However, as long as the patient process can be linked to the use of specific services and products, PIP provides a starting point for financial analysis of processes.

Figure 60 shows five similar patient pipelines and the cost distribution per pipeline and per stage in the patient flow. One pipeline (PIP 1) represents 70% of patients and 58% of costs. Nevertheless, the remaining pipelines (PIP 1a – PIP 1d) followed the same first three stages as PIP 1. They accounted for 42% of costs, with 20% of costs being realised after the second inpatient department admission.

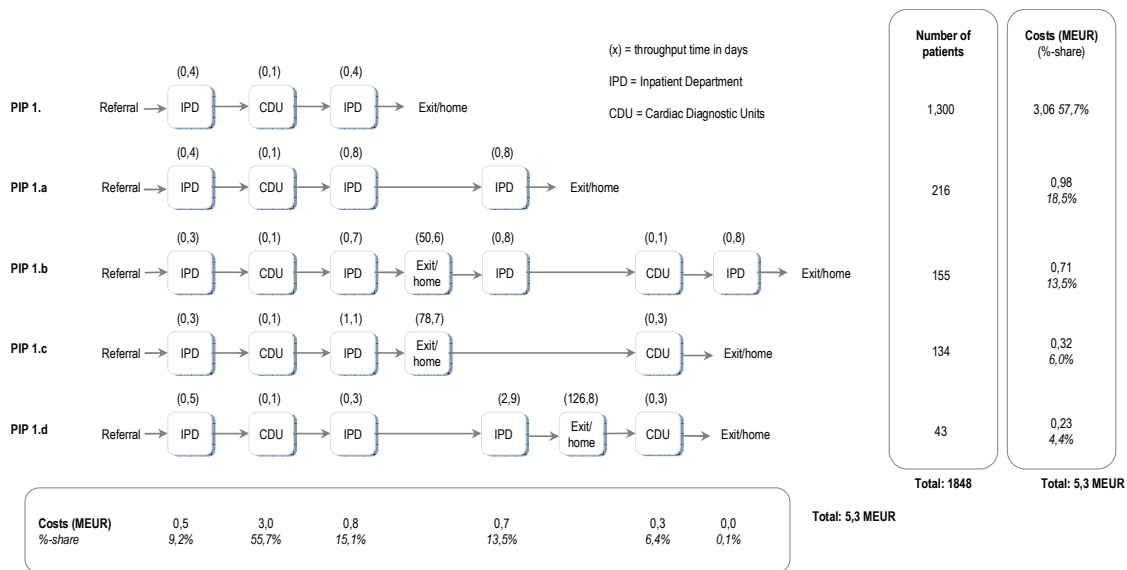

Figure 60 – Example of patient flow and cost distribution (2004-2005).

HOSPITAL SUPPORT FUNCTION

Decision-making by managers is largely driven by their work environments and their incentives. These factors are also reflected in operational targets set by managers and ultimately in the types of information is used as a basis for decision making. For example, if a manager of radiology operations is evaluated on the basis of her operation's cost efficiency, she will naturally focus on improving this parameter. However, restrained resources in radiology due to cost reduction efforts may have a detrimental effect on the process as a whole.

Hospital managers must understand the risk of formulating operative targets for hospital support functions. As indicated by Vissers et al. (2004), inadequate planning of ancillary processes affects other units and departments and can ultimately affect patient flow negatively. Successful and comprehensive resource management requires understanding the potential bottlenecks in a hospital and making sure that the level of productivity in these functions is sufficient.

FINANCIAL MANAGEMENT LESSONS

One of the key objectives of the case studies examined here was to understand how the gap between process and financial control could be bridged for the analysis of a major patient group. After an initial review of process representations made in the organisation as well as the structure of financial information systems and other financial reporting, it became evident that linking financial information to the production process was not possible given the current state of information-readiness. Furthermore, discussions with hospital management indicated this would not necessarily support the need for information, but that linking financial information to the patient episode better suited the objectives of management.

Financial process control was not possible due to insufficient information tracing resource used in production process activities. Financial patient process control was enabled by PIP methodology and allocating costs of services used in the patient process. Using this methodology to describe characteristics of patient flow may be useful for hospital managers, but requires extensive involvement of clinical expertise.

SUMMARY

- Financial analysis can be integrated with patient flow analysis.
- Organisation structures and limited cooperation in the hospital impeded management of patient flow. Departments and units strive to optimise their own operations within these limitations.
- Cost-accounting problems identified in the hospital were: **1)** Cost-accounting and other financial management practices were performed strictly on a functional basis, commonly by department; **2)** The main objective in cost-accounting is to ensure that costs get allocated for billing purposes, not that they reflect true use of resources; **3)** Cost-accounting has traditionally been found unreliable and has never gained the role it deserves as a management tool. Skepticism results from allocation of personnel resources. Sufficient information on this subject is not structurally gathered for financial or operations and process management purposes and does, thus, not support analysis of technical and allocative efficiency sufficiently. Alternatively, exact figures produced by cost-accounting create the notion that “we know our costs to the penny”; **4)** Resource allocation flaws in cost-accounting results in departments or units cross-financing each other’s operations; **5)** In some areas, functions face external competition, e.g. in radiology. Financial management practices do not support the evaluation of competitive positioning in terms of costs and prices; **6)** Cost-accounting assumptions are hidden in cost-accounting systems. Financial managers are not sufficiently informed of assumptions affecting cost-accounting results, such as the allocation of personnel.

4.4.5 Economic efficiency in elderly care services

As was discussed in section 4.3.5, elderly care in Finland is very bed-centred. This approach has significant financial implications (Marshall et al. 2004). In addition, the accelerating pace of retirement is considered a threat to the health care system, as it reinforces the current perceived lack of personnel. Given that the financial problems of current health care systems are real, it should be carefully evaluated whether the health care system could manage with less personnel resources. The threat posed by Finland’s ageing population could even be considered as an opportunity.

In order to address the financial efficiency of the current elderly care system, an alternative-cost analysis was conducted. The analysis is based on the findings in section 4.3.5 on allocative efficiency in elderly care.

The current structure of elderly care is a result of historical resource allocation decisions. The alternative cost-analysis is hypothetical in the sense that it is assumed that elderly care clients could be reallocated between service types according to information on their conditions. The accumulated financial effect of directing elderly clients could be significant. Many elderly currently are treated in health care hospitals could live at home or in various types of service housing.

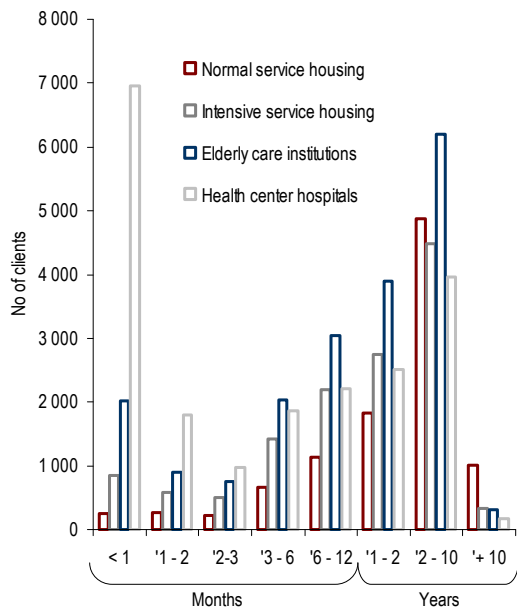

Figure 61 - Number of clients in different service types by LOS - year end 2005.

A static analysis of elderly care patients was not sufficient. In elderly care institutions, the average treatment time during one year is the number of care days used by its customers, and the maximum treatment time cannot exceed 365 days. This figure provides information about capacity utilization, but not the total amount of resources used by a patient. Process analysis requires investigation from the time a process begins until its end. The cost of care is determined by the resources required for care, as well as the amount of time that the resources are used. Individual care events can be expensive due to a vast accumulation of resources. In the case of elderly care, accumulated care time is the main determinant of cost. Perhaps as a result, elderly care cost-efficiency has not received as much attention as very expensive treatments.

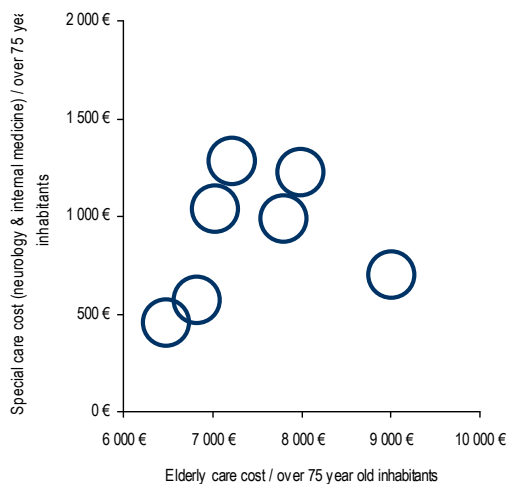

Figure 62 - Resource allocation in elderly care - the elderly populations' use of special care (inpatient care in internal medicine & neurology) vs. municipal elderly care (adopted from Sitra 2006).

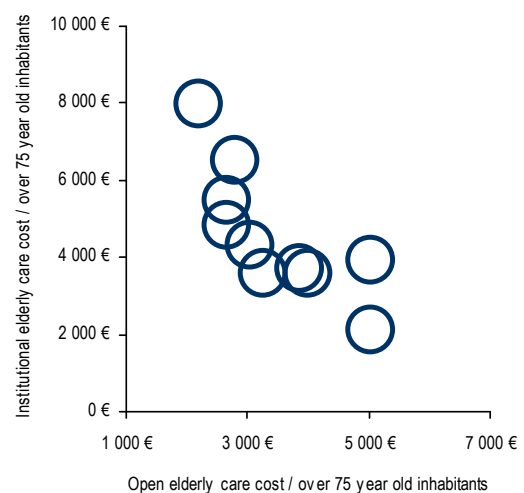

Figure 63 - Resource allocation in elderly care -institutional vs. open elderly care (adopted from Sitra 2006).

Figure 61 shows the number of clients in different elderly care service categories at the end of 2005. Fifty-three percent of clients had been in care for over one year. The corresponding figure in elderly care institutions was 56%, with 58% in intensive service housing, 73% in normal service housing, and 34% in health centre hospitals.

Figure 62 and Figure 63 compare elderly care service networks in a number of Finnish municipalities. Figure 62 indicates that the care of elderly in special care varies significantly in Finland and should be considered when analysing elderly care systems as a whole (Sitra 2006). Moreover, when only analysing open and institutional care within the municipalities they seem to position themselves on a continuous scale of institutional and open care (allocative efficiency), but also display different levels of technical efficiency (Figure 63). That is, municipalities may have the proportion of resources allocated in institutional and open care, but have different levels of total cost efficiency. Moreover, some municipalities have been more successful than others in reallocating resources when, for example, trying to focus more on open care for elderly. Differences in total economic efficiency of the systems can, to a large extent, be attributed to differences in resource allocation practices.

As was shown in section 4.3.5, the Finnish elderly care system is relatively bed-centred and there is reason to believe that a large portion of bed-rested clients would be better off in more active settings. Roughly estimating bed day costs (in nominal terms) at 120 euros in health centre hospitals, 100 euros in elderly care institutions, 80 euros in intensive service housing and 50 euros in normal service housing, there could be a savings of 4 billion euros in only the patients enrolled in the various kinds of service types in the end of 2005.

SUMMARY

The development of the Finnish elderly care system has been lagging behind the development observed in Europe during the last two decades. The dissolving of long-term care into elderly care and service housing is underway and the transformation into increasing home care is still ahead. According to elderly care personnel, 5,000 patients are waiting for less intensive forms of care in health centre hospitals, which signals a serious structural problem.

4.4.6 Economic efficiency in a regional network

Hospital districts are owned by a group of municipalities that together own and are responsible for financing special care to its inhabitants. The provision of primary and social care is the responsibility of individual municipalities, though many municipalities have entered into various levels of cooperation in this regard. The main sources of regional financing are municipal tax from member municipalities and municipality-specific state support. The latter source is not directly allocated, but is given to the municipality's service provision as a whole. Primary and social care are provided and financed by individual municipalities or by groups when co-operation arrangements exist. Special care is owned and financed by a group of municipalities.

The financial situation of the region was reviewed by analysing 2004 and 2005 financial and operative statements for Kymenlaakso and each municipality in it. , Table 17 shows accumulated costs of the public service network.

Based on the financial statements, a pro forma financial statement of the entire service network was calculated. It enabled viewing the entire service network as a single financial entity with one income statement, one cash-flow statement and

one balance sheet. Furthermore, the equity stake of each municipality in its own services is reported, as is each municipality's share in the hospital district. As a result, each municipality's ownership stake in the entire pro forma service network can be quantified.

The financial analysis requires a thorough understanding of the current structure of the service network, including what services are used, who uses them and how their use drives costs. The turnover of the service network was approximately 312 million euros in 2005, which is the equivalent of 63% of the region's municipal tax income in that year.

After analysing cost distribution in the service network as well as for the separate service providers, a pro forma income statement was made for the years 2004 and 2005. The 2004 and 2005 pro forma figures were calculated separately from the municipalities' combined financial statements and are not linked to each other. This means that the change in liquid funds from 2004-2005 cannot be explained by the 2005 pro forma cash-flow. Municipal funds allocated to the service were considered as income in the income statement. Table 17 shows the pro forma income statement, cash flow and balance sheet statements. The statement indicates that the service network lost 6 MEUR in 2004 and 2005.³¹

The cash flow and balance sheet analysis was based on financial statements from special care and the separate municipalities. A pro forma balance sheet and income statement was created for the entire service network using group accounting rules. Pro forma cash flow and balance sheet statements were calculated by combining financial statements from the hospitals districts and the municipalities.³² Yearly

Table 17 - Pro forma income statement, cash flow and balance sheet (2004-2005)³⁰

INCOME STATEMENT (EUR)	2004PF	2005PF
Regional tax income	469 410 000	483 815 000
Network's share of tax income	292 574 519	306 368 533
Network's %-share of tax income	62,3 %	63,3 %
Personnel costs	139 797 653	143 103 435
Purchased services	96 658 428	105 430 253
Material and foods	31 447 279	32 726 619
Other operative expenses	19 787 341	19 769 943
EBITDA	4 883 817	5 338 282
Depreciation	12 109 908	12 175 846
EBIT	-7 226 091	-6 837 564
Interest expenses, net	-774 304	-1 258 660
Extraordinary items	-5 755	-9 671
Total expenses	299 020 550	311 937 766
Net income	-6 446 032	-5 569 234
CASH FLOW (EUR)	2004PF	2005PF
Net income	-6 446 032	-5 569 234
Depreciation	12 109 908	12 175 846
Correction items	0	174 994
Change in net working capital	2 811 492	-142 597
Cash-flow from operations	2 852 384	6 924 203
Investments, net	21 151 949	18 474 023
Cash-flow for debt-services	-18 299 565	-11 549 820
Change in interest-bearing debt	8 203 952	13 185 067
Net cash flow	-10 095 613	1 635 247
BALANCE SHEET (EUR)	2004PF	2005PF
Assets		
Liquid funds	19 086 770	67 590 513
Receivables	41 075 556	31 606 850
Fixed assets	243 264 030	195 720 728
Intangible assets	1 668 494	1 666 975
Assets, total	305 094 850	296 585 066
Equity & Debt		
Interest-bearing debt	42 083 246	51 938 128
Non-interest-bearing debt	56 119 711	48 958 687
Reservations	11 954 086	10 636 394
Donation funds	158 962	159 906
Shareholders equity	198 070 778	193 871 563
Accumulated net income	-3 291 933	-8 979 612
Equity & Debt, total	305 094 850	296 585 066

³⁰ EBIT = Earnings before interest costs and taxes; EBITDA = earning before interest costs, taxes, depreciation and amortization.

³¹ The pro forma balance sheet estimates the financial effect of these losses in the service network financials. Municipalities are likely to not allow negative cash flows burden the balance sheet by shifting funds to the service providers, since they are financially responsible for carrying the costs.

³² In some cases, cash-flow and balance sheet items were not reported by individual service areas in municipalities, only for the municipality as a whole. In these cases, cash flow and balance sheet items were allocated to the services belonging to the service network using the particular service's share of total cost. This assumption is believed to provide a sufficiently accurate estimate of the cash-flows and balance sheet as the municipalities are similar in such things as their use and value of tangible assets.

investments amounted to 20 MEUR. Cash flows were kept positive through increases in interest-bearing debt. Assets comprise mainly fixed assets. The network has 50 MEUR in interest-bearing debt and equity of ~185 MEUR.

INCOME AND COST ESTIMATES

Income estimates were based on current service use and official estimates of demographical changes until the year 2035.³³ In addition, figures were treated nominally as the effect of inflation on financing, and costs were assumed to be the same. Thus, costs are only affected by changes in the use of services. Depreciation was assumed to be equal to investments and interest costs depended on interest-bearing debt in the balance sheet.

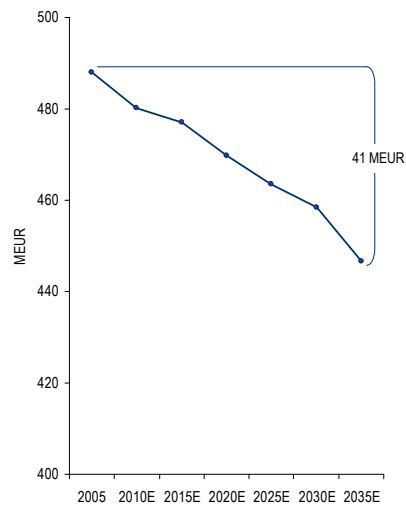
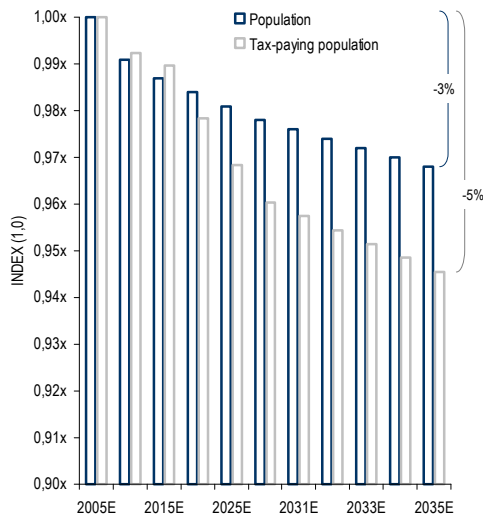

Figure 64 - Population development, tax paying population 2005-2035E.³⁴

Figure 65 - Demographical effects on regional tax income 2005-2035E.

The total population in the region is expected to decrease by 3% by 2035. When considering the ageing population, this estimate corresponds to a 5% decrease in the tax paying population (Figure 64).³⁵ The decrease in nominal tax income during the same time period is estimated to be 41 MEUR (Figure 65).

The regional financial estimates were based on estimated population development in the region. Estimated usage of health and social care services were based on the structure of usage per age-group. Income was assumed to remain fixed as a proportion of municipal tax. Table 18 provides income statement estimates.

³³ For examples, see A - 15 and A - 16.

³⁴ E=estimate.

³⁵ Calculated by using age-specific estimates of tax-paying capacity (one full time employed person = tax-paying capacity of 100%). The 25-64 year old population is assumed to have a tax-paying capacity of 100%. Inhabitants aged 18-24, 65-74 and over 75 are assumed to have a tax-paying capacity of 25%, 75% and 50%, respectively.

Table 18 - Income statement estimates (2005PF – 2035E)

INCOME STATEMENT (EUR)	2005PF	2010E	2015E	2020E	2025E	2030E	2035E
Regional tax income	483 815 000	480 195 894	477 023 386	469 796 784	463 565 061	458 433 450	446 751 538
Network's share of tax income	306 368 533	304 076 789	302 067 846	297 491 709	293 545 565	290 296 050	282 898 656
Network's %-share of tax income	63,3 %	63,3 %	63,3 %	63,3 %	63,3 %	63,3 %	63,3 %
Personnel costs	143 103 435	150 751 059	158 398 682	166 046 306	176 599 119	187 151 932	197 704 746
Purchased services	105 430 253	111 064 575	116 698 898	122 333 220	130 107 916	137 882 613	145 657 309
Material and foods	32 726 619	34 475 570	36 224 521	37 973 472	40 386 816	42 800 161	45 213 506
Other operative expenses	19 769 943	20 826 473	21 883 003	22 939 534	24 397 420	25 855 306	27 313 192
EBITDA	5 338 282	-13 040 889	-31 137 258	-51 800 821	-77 945 707	-103 393 962	-132 990 097
Depreciation	12 175 846	12 826 538	13 477 230	14 127 922	15 025 800	15 923 678	16 821 556
EBIT	-6 837 564	-25 867 427	-44 614 488	-65 928 743	-92 971 507	-119 317 640	-149 811 653
Interest expenses, net	-1 258 660	937 577	4 855 798	11 135 523	20 603 460	33 870 111	51 513 475
Extraordinary items	-9 671	0	0	0	0	0	0
Total expenses	311 937 766	330 881 793	351 538 132	374 555 975	407 120 532	443 483 801	484 223 784
Net income	-5 569 234	-26 805 004	-49 470 287	-77 064 266	-113 574 967	-153 187 751	-201 325 128

CASH-FLOW AND BALANCE SHEET ESTIMATES

The purpose of cash-flow and balance sheet analysis is to widen the financial analysis from mere income statement analysis. More extensive analysis of cash-flow and the balance sheet is relatively uncommon in Finnish public health care (Ekström 2004). Cash-flow describes the movement of liquid funds into and from the region, whereas the balance sheet provides information about a region's capital structure and financing. Table 19 shows cash-flow and balance sheet estimates for the service network.

Table 19 - Cash flow and balance sheet estimates (2005PF – 2035E)

CASH FLOW (EUR)	2005PF	2010E	2015E	2020E	2025E	2030E	2035E
Net income	-5 569 234	-26 805 004	-49 470 287	-77 064 266	-113 574 967	-153 187 751	-201 325 128
Depreciation	12 175 846	12 826 538	13 477 230	14 127 922	15 025 800	15 923 678	16 821 556
Correction items	174 994	0	0	0	0	0	0
Change in net working capital	-142 597	-235 269	-238 382	-268 463	-378 668	-422 330	-474 844
Cash-flow from operations	6 924 203	-13 743 197	-35 754 675	-62 667 881	-98 170 499	-136 841 743	-184 028 728
Investments, net	18 474 023	12 826 538	13 477 230	14 127 922	15 025 800	15 923 678	16 821 556
Cash-flow for debt-services	-11 549 820	-26 569 735	-49 231 905	-76 795 803	-113 196 299	-152 765 421	-200 850 284
Change in interest-bearing debt	13 185 067	15 218 043	49 231 905	76 795 803	113 196 299	152 765 421	200 850 284
Net cash flow	1 635 247	-11 351 692	0	0	0	-0	-0
BALANCE SHEET (EUR)	2005PF	2010E	2015E	2020E	2025E	2030E	2035E
Assets							
Liquid funds	67 590 513	0	0	0	0	0	0
Receivables	31 606 850	33 526 338	35 619 326	37 951 591	41 251 169	44 935 649	49 063 595
Fixed assets	195 720 728	195 720 728	195 720 728	195 720 728	195 720 728	195 720 728	195 720 728
Intangible assets	1 666 975	1 666 975	1 666 975	1 666 975	1 666 975	1 666 975	1 666 975
Assets, total	296 585 066	230 914 041	233 007 029	235 339 294	238 638 872	242 323 352	246 451 298
Equity & Debt							
Interest-bearing debt	51 938 128	67 156 171	267 405 864	595 174 030	1 086 771 165	1 769 888 257	2 676 098 913
Non-interest-bearing debt	48 958 687	51 931 955	55 173 972	58 786 626	63 897 639	69 604 860	75 999 008
Reservations	10 636 394	10 636 394	10 636 394	10 636 394	10 636 394	10 636 394	10 636 394
Donation funds	159 906	159 906	159 906	159 906	159 906	159 906	159 906
Shareholders equity	193 871 563	193 871 563	193 871 563	193 871 563	193 871 563	193 871 563	193 871 563
Accumulated net income	-8 979 612	-92 841 948	-294 240 670	-623 289 225	-1 116 697 794	-1 801 837 628	-2 710 314 485
Equity & Debt, total	296 585 066	230 914 041	233 007 029	235 339 294	238 638 872	242 323 352	246 451 298

Table 19 shows that financial risks are related to financing issues. Negative cash-flows need to be compensated with external financing. If funding of the service network is not increased, yearly loss may increase due to the estimated cost development. This may result in increasingly negative cash-flows, which will need to be covered. The municipalities may have mechanisms to deal with this on a year-by-year basis or even receive state support. However, these mechanisms are not predictable and cannot be accounted for in the financial estimates. The financial estimates assume that – once the service network runs out of cash – municipalities will have to turn to external interest-bearing financing. If this continues for a longer period, it will successively increase interest-expenses (the average interest rate on interest-bearing debt was 3.7% in the service network in 2005).

SENSITIVITY ANALYSIS

The extrapolation methodology used for generating financial estimates for the service network can be criticized for many reasons. For example, estimating the effect of demographical changes on the use of services is likely to overestimate service use (Batljan and Lagergren 2004) Different methods for estimating demographic changes could be employed in the financial analysis model developed above. In order to investigate how sensitive the financial estimates are to estimates of service use, sensitivity analysis was conducted.

First, the effect of cost estimates based on current use services is analysed. Sensitivity analysis was conducted to the extent to which the extrapolation of current use was realised. A figure of 100% would indicate that extrapolated service use is correct and 0% would indicate that the service use stays at the current level). The subject of analysis is the amount of external financing required by year 2020 and 2035 (Table 20).

Table 20 - Amount of external financing required to finance the service network depending on the extent to which demographically extrapolated use of services is realised (by 2020 and 2035)

Estimated required external financing depending on the extent to which demographic changes effects the change in services demand - special care cost vs. primary and elderly care cost development

		By 2020 (MEUR)										
		Primary care and elderly care										
		0 %	10 %	20 %	30 %	40 %	50 %	60 %	70 %	80 %	90 %	100 %
Special care	0 %	95	122	149	176	203	229	256	283	309	336	362
	10 %	114	141	168	194	221	248	274	301	327	354	380
	20 %	132	159	186	213	239	266	292	319	345	372	398
	30 %	151	178	204	231	258	284	311	337	364	390	417
	40 %	169	196	222	249	276	302	329	355	382	408	435
	50 %	187	214	241	267	294	320	347	373	400	426	453
	80 %	242	269	295	322	348	375	401	428	454	481	507
	90 %	260	287	313	340	366	393	419	446	472	499	525
	100 %	279	305	332	358	385	411	438	464	490	517	543
		By 2035 (MEUR)										
		Primary care and elderly care										
		0 %	10 %	20 %	30 %	40 %	50 %	60 %	70 %	80 %	90 %	100 %
Special care	0 %	531	647	764	882	1002	1123	1245	1369	1494	1621	1749
	10 %	617	732	849	967	1087	1207	1330	1454	1579	1706	1834
	20 %	703	818	935	1053	1172	1293	1415	1539	1664	1791	1919
	30 %	789	904	1021	1139	1258	1379	1501	1625	1750	1877	2005
	40 %	876	991	1108	1226	1345	1466	1588	1712	1837	1964	2092
	50 %	963	1078	1195	1313	1432	1553	1675	1799	1924	2051	2179
	60 %	1051	1166	1283	1401	1520	1641	1763	1887	2012	2139	2267
	70 %	1140	1255	1372	1489	1609	1729	1852	1975	2101	2227	2355
	80 %	1229	1344	1461	1579	1698	1819	1941	2065	2190	2316	2444
	90 %	1319	1434	1550	1668	1788	1908	2031	2154	2279	2406	2534
100 %	1410	1524	1641	1759	1878	1999	2121	2244	2370	2496	2624	

Note: The service systems share of municipality tax assumed to be constant during the whole period

The extent to which estimates are realised will affect the amount of financing required. However, the analysis shows that external funding will be required even if service use does not change (20% of the funding required in straight extrapolation).

Another assumption in the financial estimates is that the region will not be able to increase funding to the service network as a share of municipal taxes. Due to demographic changes, the tax-paying capacity will be reduced and the service network will receive less funding. The following sensitivity analysis investigates the extent to which changes in funding the service network will affect the need for external financing. The analysis assumes that state support to the service network could be obtained.

Table 21 - Amount of external financing required to finance the health care service network depending the %-share of municipal tax income allocated and annually allocated state support by 2020 and 2035³⁶

Estimated required external financing depending of the service systems %-share of municipal income and yearly allocated amount of state support to the service system

		By 2020 (MEUR)										
		Service systems' share of municipal tax income (%)										
		61 %	62 %	63 %	64 %	65 %	66 %	67 %	68 %	69 %	70 %	71 %
Annually allocated state support	0M€	740	655	571	486	399	312	222	129	31	0	0
	1M€	722	638	553	468	381	293	203	109	10	0	0
	2M€	705	620	535	450	363	274	183	88	0	0	0
	3M€	687	602	517	432	345	256	164	68	0	0	0
	4M€	669	585	500	414	326	237	144	47	0	0	0
	5M€	652	567	482	395	308	218	124	27	0	0	0
	6M€	634	549	464	377	289	198	104	6	0	0	0
	7M€	616	531	446	359	270	179	84	0	0	0	0
	8M€	599	514	428	341	252	160	64	0	0	0	0
	9M€	581	496	410	322	233	140	43	0	0	0	0
10M€	563	478	391	304	214	120	22	0	0	0	0	
		By 2035 (MEUR)										
		Service systems' share of municipal tax income (%)										
		58 %	63 %	68 %	73 %	78 %	83 %	88 %	93 %	98 %	103 %	108 %
Annually allocated state support	0M€	3052	2650	2248	1847	1445	1042	605	543	543	543	543
	1M€	3010	2609	2207	1805	1403	1000	559	525	525	525	525
	2M€	2969	2567	2165	1764	1362	958	513	508	508	508	508
	3M€	2927	2526	2124	1722	1320	916	490	490	490	490	490
	4M€	2886	2484	2082	1680	1279	873	472	472	472	472	472
	5M€	2844	2442	2040	1639	1237	830	454	454	454	454	454
	6M€	2802	2400	1999	1597	1195	787	436	436	436	436	436
	7M€	2760	2359	1957	1555	1153	744	418	418	418	418	418
	8M€	2718	2317	1915	1513	1111	700	400	400	400	400	400
	9M€	2676	2275	1873	1471	1069	657	382	382	382	382	382
10M€	2634	2233	1831	1429	1027	613	363	363	363	363	363	

There will be pressure to increase the proportion of funding to the service network as a proportion of municipal tax income in coming years. Assuming that the extrapolated cost estimates are realised, the service network's share of municipal tax would have to be increased by 5-6% by 2020. In 2035, all municipal tax would have to be allocated to the service network. If cost increases in nominal terms are not realised, there would only be marginal pressure to raise the share of funding to the service network by 2020, but by 2035 it would have to be raised by 10%.

The core of potential financial problems is the need for financing and the requirement to use external interest-bearing debt. Financing costs could become an increasingly large share of total costs. In the financial estimates, the interest rate for external long-term debt was 2%, which is low considering that actual interest costs were 3.7% in 2005 and 3.0% in 2004.³⁷ Table 22 shows a sensitivity analysis of the effects of average interest rates .

³⁶ Current level (2005) approximately 64%.

³⁷ Calculated as the amount of interest costs over the average amount of interest-bearing debt during a particular year.

Table 22 - The amount of external financing required to finance the health care service network depending the average interest-rate on interest-bearing debt (by 2020 and 2035)

Estimtaed need for external financing depending on average interest on interest-bearing debt									
Amount of external financing	By 2020 (MEUR)								
	0,0 %	0,5 %	1,0 %	1,5 %	2,0 %	2,5 %	3,0 %	3,5 %	4,0 %
	480	495	510	526	543	561	579	598	618
Amount of external financing	By 2035 (MEUR)								
	0,0 %	0,5 %	1,0 %	1,5 %	2,0 %	2,5 %	3,0 %	3,5 %	4,0 %
	2119	2231	2352	2483	2624	2778	2944	3126	3323

Interest rates have a significant impact on costs and, thus, on the need for external financing. A 1% increase in interest costs would increase the need for external financing by 7% by the year 2020 and by 12% by the year 2035.

The main resource in the service network is personnel. In the end of 2004, it employed 15.3 employees per 1,000 inhabitants in special care and 11.3 per 1,000 in primary care and elderly care. If the service network is to manage with a constant share of funding from the municipalities, there is no room for increasing the total number of personnel. If the demographic estimates are fully realised, the estimated increase in personnel costs in the service network would be 41%. Table 23 shows the current age distribution of personnel employed in the services network. It shows that there is a severe threat of personnel shortage in the future. for example, 20% of total personnel will retire during the next decade and another 26% in the one after that. Personnel shortage in health care is already today a problem, and is,thus likely to worsen.

Table 23 - Age distribution of personnel in the service network at year end 2005

Personnel by age groups	65+	60-64	55-59	50-54	45-49	40-44	35-39	30-34	25-29	20-24	<19
Home services	1	22	85	86	110	79	45	40	25	10	2
Home healthcare	0	6	39	30	43	24	21	17	10	2	1
Mental health	0	4	19	32	38	33	19	14	6	2	0
Other	2	149	674	733	813	707	505	407	302	107	6
Housing services	0	1	1	5	4	8	5	4	3	2	0
Psychiatric hospital	0	7	30	33	57	42	37	37	29	11	0
Hospital	0	61	278	270	267	253	186	161	130	29	5
Health center, vocational	0	21	53	81	119	82	41	26	15	3	0
Elderly care institutions	1	30	99	103	93	68	55	38	30	10	1
Service housing	0	11	54	74	71	39	42	44	28	10	1
Total	4	312	1332	1447	1615	1335	956	788	578	186	16
%-of total	0 %	4 %	16 %	17 %	19 %	16 %	11 %	9 %	7 %	2 %	0 %

SUMMARY

- Analysing financial pressures faced by regional service networks cannot be done on a yearly basis: it requires more comprehensive and longer term financial planning methods. The financial risks are not obvious in a simple income statement analysis, but the cash-flow and balance sheet analysis accentuate a region's financial risks. The lacklustre estimated financial performance of the service network as a whole has two interlinked consequences from a cash-flow and balance sheet point-of-view. First, negative net income has a negative effect on regional cash-flows. Second, as cash-flows turn negative, the pressure on raising external funds increases. The financial model assumes that this is done by raising interest-bearing debt. Thus the result is an increasing amount of interest-bearing debt on the balance sheet. In conclusion, the consideration of cash-flow and balance sheet effects in addition to the income statement, allows an accounting of the potential debt-spiral into which financially weakly performing municipalities/hospital districts may fall.
- The main risk to the regions is entering into a vicious cycle debt requiring the of raising more external debt. If cash-flow movement in the region is negative for a longer period of time, municipalities may be forced to raise more debt in order to finance services. This process in turn will raise interest costs. The ultimate losers are the municipalities themselves as owners of the service network. Municipalities own a certain share of the hospital district as well as their own services. Therefore, each municipality's ownership stake of the service network can be calculated. The value of each municipality's ownership stake decreases as net losses accumulate.
- Most public health care organisations are subject to yearly budgets and, thus, are forced / encouraged to live one year at a time. Naturally, this process stimulates and reinforces short-term financial thinking. In addition, organisations are usually not allowed to reap the benefits of increased cost-efficiency, which significantly decreases their incentives to pursue such actions. Given that the provision of health care services is the result of a complex web of organisations, with little or no common management, financial planning efforts become an even larger challenge.
- Larger restructuring or efforts require significant investments. Resources allocated for investment are also subject to yearly budgets implying two major problems: 1) investments must be made during the year or the funds must be returned. This would signal a need for less investment, which may jeopardize allocation of funds for investments in coming years and 2) investments cannot exceed the money allocated. The second point is in direct contradiction with recommendations for investment planning. Investment planning should not account for available funds, but focus on maximizing return. Thus, the fact that organisations are subject to investment budgets may 1) lead organisations to pass up high net-present value (NPV) projects exceeding the budgeted funds and pursue low-NPV projects, because the allocated money has to be spent or 2) totally discourage organisations from even reviewing budget-exceeding investment alternatives or proposals. The latter implies that organisations are actually dissuaded thinking 'out-of-the-box' and making decisions that may be required for improvement of cost-efficiency — or any other purpose for that matter — in the organisation.

4.5 SUMMARY OF EFFICIENCY ANALYSIS

As seen in above a number of techniques can be used to investigate technical efficiency. The methods and metrics used will obviously have to be designed to meet the objectives for which they are applied. Table 24 provides a summary of the technical efficiency analysis conducted in this study.

Table 24 - Summary of technical efficiency analyses

CASE I	<ul style="list-style-type: none"> ▪ This case illustrates a health care organisation's efforts to increase capacity through process development efforts in its operating rooms and inpatient departments. Capacity was investigated using technical and allocative efficiency. Significant improvements of technical efficiency could be observed both in the OR (e.g. improved utilization rates, throughput time and productivity) and the inpatient department (e.g. improved utilization rates and throughput time and productivity). ▪ Utilization of facilities (non-bottleneck resources) was high, whereas utilization of personnel (bottleneck resources) were either not monitored or difficult to address. There is limited understanding of the capacity of processes due to the lack of monitoring of personnel productivity. Detailed benchmarking would provide a fairly solid tool for addressing this issue. ▪ The primary focus of the development efforts were directed at the OR, leaving the inpatient department with less attention. This may be due to the fact that the OR is perceived as an expensive part of the patient episode, despite the fact that it accounts for only 40% of costs. The investigation indicated that capacity of the inpatient department was significantly higher than that of the OR. Increasing utilization of the current inpatient department resources would require an increase of surgery team and OR capacity. The optimum utilization rate has been found to be approximately 80-85% (McManus et al. 2004, Patterson 1997). Given that the organisation wishes to maintain capacity at current levels, resources could be reduced in the inpatient department, which potentially could be achieved in the longer term. Alternatively, resource reallocation from the inpatient department to the surgery team could be considered. However, in any case, managers must be sure to avoid transforming the inpatient department into the system's bottleneck. ▪ Costs of personnel incentive systems are likely to be paid back in full or more through productivity increases, given sufficient demand.
CASE II	<ul style="list-style-type: none"> ▪ Personnel efficiency appeared to be the main factor for differences in performance between areas. Structural factors such as visit lengths could not explain productivity differences, indicating that these differences can largely be attributed to various degrees of non-value added time during the average working day. Some units minimized non-value added activity of bottleneck resources and reached higher levels of technical efficiency. ▪ The technical efficiency of larger units (in terms of personnel or covered population) was slightly worse than that of smaller units. This result is surprising, as current restructuring in public health care networks often includes merging into larger operative units in pursuit of economies of scale. Larger units, using size as a bargaining tool, appear to have been more successful at obtaining scarce resources within an organisation. However, it cannot be assumed that mergers result in more inefficient operations, though obtaining scale benefits poses a challenge for management. Similarly, no signs of economies of scope, i.e. a situation where two or more products uses the same resources and infrastructure, could be identified. ▪ Low technical efficiency was coupled with longer wait times. Similarly, larger units had longer wait times. ▪ Low technical efficiency was not explained by high proportions of no shows or late cancellations, indicating that there were differences in the amount of time spent in non-value adding activities. ▪ A strong management implication was that waiting lists would no longer serve as a valid means for units to obtain more resources. Historically, this had been considered a critical factor in resource negotiations between central and local management. ▪ The role of benchmarking in strategy formulation increased, but still requires more in-depth methods for interpreting and truly benefiting from the results.
CASE III	<ul style="list-style-type: none"> ▪ A significant portion of health care professionals' time is spent in non-core activities, reflecting system-wide planning challenges. Focusing on particular work activities increases technical efficiency during the time spent in that activity. There appears to be significant potential in increasing proportion of core activities and value-creating work.

- Personnel resources appear to limit the capacity of operations and are bottlenecks, as opposed to equipment. Cost-focused management decisions may lead to organisational changes that actually limit the capacity of bottleneck resources. This may be the case particularly in the short term due to inflexibility of resources and resource managing resource reallocation.
 - Process analysis is often limited to visual representation of production processes. Process maps are static and may hinder process development or creative thinking. Process management easily becomes a self-serving exercise focused on quality control and measuring clinical outcomes rather than economical one. Exhaustive clinical process visualization exercises reduce the time and resources available for process development. In addition, production lines are blurred by the details and diversity of the disease-based process maps.
- CASE IV**
- Utilization of facilities (particularly inpatient departments) closely monitored and there is a risk of them becoming bottlenecks. Personnel utilization is, however, very loosely monitored even if this is commonly regarded as the constrained resource.
 - There are significant demand management challenges. LOS varies significantly depending on factors such as time or day of arrival and it appears to be possible to improve demand segmentation techniques by distinguishing between routine and non-routine patients.
- CASE V**
- Regional technical efficiency differences appear significant, which may result from different operations models and demand segmentation practices.
 - Unnecessarily intensive services requiring significant use of resources are produced extensively. This is likely to be due to lack of resources in alternative care types.
- CASE VI**
- Differences in technical efficiency can be observed on the regional level.
 - Analysis of technical efficiency on the regional level is extremely challenging to the fragmentation of regional networks.

The analysis of technical efficiency found variations in the amount of resources required to produce output. A number of cases presented benchmarking analysis mainly focussed on the technical efficiency of resources and, in particular, personnel resources. In these cases, differences were observed, but there was no single reason for the technical efficiency differences. These differences appear to result from differences in factors such as throughput time, but are just as likely to result from use differences such as utilised capacity in relation to usable capacity. Utilisation analysis is more commonly conducted for “easy-to-analyse” resources, such as inpatient bed capacity utilisation. Utilisation of personnel, on the other hand, is rarely analysed and also very difficult to analyse. Merely knowing the capacity of personnel, not how “good” or “bad” they are, would significantly assist any operations management efforts.

Surprisingly, there were no signs of either economies of scale or scope. However, a slight indication of economies of specialisation³⁸ was identified in one of the cases. This is quite striking given the ongoing centralisation measures that occur in many health care systems. Means for realising economies of scale or scope have to be addressed in detail in organisational changes.

³⁸ Economies of specialization assumes that the same amount of output can be produced with a smaller amount of resources in a specialized organisation than in a unspecialised organisation (Douma and Schreuder 2002).

The analysis of data for technical efficiency is not readily available and producing this kind of information requires significant efforts by organisations. However, reaping the benefits of such analysis and a support for managerial decision-making requires a clear perception of “good” technical efficiency. Managers face the task of setting targets or acquiring them through techniques such as benchmarking. Only then can it be determined what is “good” or “bad” technical efficiency. The extent to which technical efficiency measure are used in management decisions depends on the prevailing management mindset (Boyd and Gupta 2004).

In a comprehensive efficiency analysis, an analysis of allocative efficiency must be conducted alongside technical efficiency to limit the risk of drawing faulty conclusions as to differences attributable to technical and/or allocative efficiency. As seen in the case analysis, resource allocation may refer to allocation of resources both in time or space, within or across organisational, departmental and unit boundaries. Table 25 summarises the allocative efficiency analysis.

Table 25 - Summary of allocative efficiency analysis

CASE I	<ul style="list-style-type: none"> ▪ The case clearly indicates a relationship between allocation of resources and system / process efficiency. ▪ Throughput improvements and, consequently, total capacity increases could be realised by re-allocating resources to bottleneck resources minimal or no increase in resources. However, detailed identification of bottlenecks may be difficult, due the fact that they may be due to specific personnel groups, and exact determination of personnel capacity is difficult. Resource reallocation efforts will most likely be successful by re-allocating resources between stages of the process.
CASE II	<ul style="list-style-type: none"> ▪ Significant differences can be identified between units with the same resource allocation structure, indicating that technical efficiency may be an important determinant of differences. ▪ When only accounting for the number of resources, as opposed to their unit costs as well, no clear relationship between resource ratios seemed to explain total productivity. This, in turn, suggests that improvements of resource allocation decisions should account for the unit cost of resources.
CASE III	<ul style="list-style-type: none"> ▪ Resource allocation problems are likely present only during certain times of day, due to the timing of demand flow. Problems may result from organisational changes that fail to account for the nature of demand and the fixed nature of resources. ▪ Resource allocations challenges are accentuated when analysing the whole regional system. A regional approach evidently is required to get to terms with major resource allocations problems.
CASE IV	<ul style="list-style-type: none"> ▪ Analysis of patient flow promotes analysis of resource allocation on the patient-episode level as well as the importance of flow optimisation between units, departments and organisations. ▪ The patient flow analysis highlights the importance of support functions optimally supporting the flow of patient, especially since support functions are often considered non-core operations and, therefore, easily subject to e.g. cost-cutting efforts. ▪ The management of resources in a hospital results from the interaction of its numerous specialties and functions. Lack of management of the patient process and lack of comprehensive resource planning in hospitals can lead managers to pursue incorrect operative targets and sub-allocate resources.

- CASE V**
- Significantly different operating models between domestic regions reflect different resource allocation practices. An international comparison suggests even more significant differences.
 - Resources-in-place (and the structure of supply) are likely to be a main determinant in customer segmentation.
 - Resource allocation problems may interfere with patient flow and create bottlenecks at organisational boundaries. Resource reallocation is made difficult by the fact that resources would have to be re-allocated across these boundaries.
 - System improvement will require wide political support. Long-term elderly care should involve less intensive and expensive care types when possible, with an emphasis on moving the elderly straight to service housing. Health centre hospitals treatment times could be given a maximum length, such as 30 days. This policy has already been implemented in some places in Finland, for example in Oulu. This kind of development would require a significant change in attitudes toward elderly care, as well as powerful leadership.
- CASE VI**
- Analysing allocative efficiency on the regional level was extremely challenging due to the fragmented nature of the network studied. This fragmentation is likely the result of poor regional-level planning. As found in the elderly care case, the benefits of such planning can bring significant benefits.
 - A critical investigation of resource allocation on the regional level was difficult due to a lack of in-depth analyses of regional networks domestically and internationally.
 - Facilities planning may be different in the future. For example, facilities may be planned in accordance with processes and tighter monitoring of total costs. Due to tighter monitoring of health care facility planning, it is bound to become more aligned with operational functionality, including financial viability. In sum, all development efforts should be directed systematically at limiting the impact of system bottlenecks, by providing the best possible environment and structure for personnel to focus on their core activities.
 - A major challenge in financial management is related to investments. In Finnish public health care, managers are confined to yearly investment budgets, which puts a focus on rapid spending, rather than on maximizing return on investment. As pointed out by Wedig (1990), investment evaluation should not be subject to the source of financing, but rather to return maximization.

The study contains one case in which an organisation was analysed over a three year period. Three cases were units, departments, organisations or systems benchmarked against each other at the same point in time. In the first case, changes in resource allocation were observed, and the others enabled a comparison different operating models.

The analysis of allocative efficiency indicates that the distribution of resources in an organisation may have an impact on performance. However, two of the cases (III and VI) suggest that there may be even more performance improvement potential, particularly in financial terms, when considering resource allocation issues on a regional level or, at least, on a cross-organisational level. Allocative efficiency improvement potential can be identified both in terms of space (where resources are allocated) and time (when resources are allocated). In both cases, reallocation efforts must account for the fixed nature of resources.

A common observation from the cases is that efficiency can be increased by re-allocating resources to bottlenecks in the production process and in patient flow. Efforts limiting the impact of bottleneck resources are likely to have the same impact. As shown in case V (elderly care), improving allocative efficiency is a key issue for improving economic efficiency. In reality, resource reallocation is likely to be subject to major re-organizing and investments. Short-sighted investment mechanisms are inherited in current public social and health care settings in Finland, due to one-year-budgets. This is

likely to result in avoiding the most profitable investments). As shown by Wedig (1990), the financing mechanism should be separated from the evaluation of investment profitability.

Figure 66 illustrates the relationship between technical and allocative efficiency, and system capacity. Improving system capacity can be achieved through improved technical and allocative efficiency. The bottleneck resource in the example is Resource C, which limits the systems capacity. The system's capacity can be increased by improving technical efficiency of the bottleneck resource or by allocating more resources to the bottleneck in order to increase capacity (Alternative 1). Given a situation where further resources are not available, this capacity must be obtained through reallocation of resources, such as by improving allocative efficiency (Alternative 2).

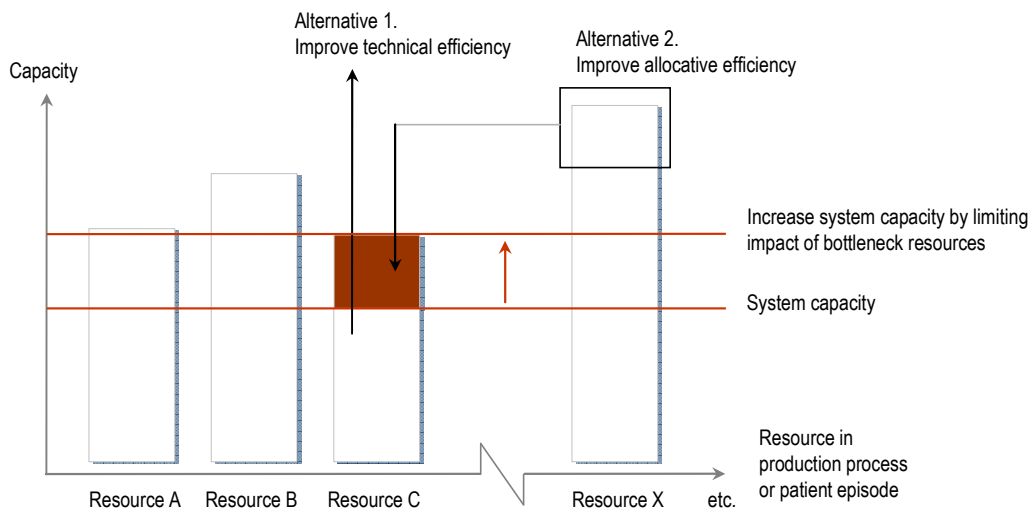

Figure 66 – Increasing system capacity by improving technical and/or allocative efficiency of a constrained resource.

Despite improvement potential in terms of allocative efficiency, the improvement process can be slowed by a lack of operational targets, such as the spread of best practices through benchmarking or clinician setting of operational targets. The same reason may hinder improvements in technical efficiency. More importantly, even if personnel resources are the most common bottleneck in a system, true capacity is not monitored or known. This is a major obstacle for being able to respond to system bottlenecks.

Technical and allocative efficiency are key determinants of economic efficiency. For example, the review of the elderly care system showed that allocative efficiency was a key determinant of cost efficiency. This is to a large extent due to the structure of the service system and resource allocation. Facilities, are non-constrained resources and do not optimally support the use of personnel, the constrained resource. A high rate of retirement may cause a shortfall of competent personnel to sustain current structures of the service network. A different elderly care system could be managed with less staff, making the retirement trend less of a threat. There are indications that the time span for action is limited to decade, meaning that planning should rather commence as soon as possible.

Table 26 - Summary of economic efficiency analysis

CASE I	<ul style="list-style-type: none"> ▪ Process improvement efforts are likely to be directed to seemingly expensive phases of the patient episode, such as the OR. Because these may fully or partially have been neglected, they may potentially hold performance improvement potential. ▪ Resource allocation efforts should aim at making or maintaining the most expensive resources (e.g. surgeons) the bottleneck resource. ▪ Changes in the production process will result in changes in production costs. There appears to be a strong relationship between process measures and unit costs. Lower unit costs (though increased total costs) are achieved by increasing production without increasing resources to the same extent. ▪ Throughput-focused process improvement efforts likely have a positive financial impact, particularly in the short term. Capacity increase and more detailed information about resource capacity in general may enable resource/total cost reduction in the longer term. ▪ Management's mindset was focused on throughput rather than cost reduction. The result of the measures was reduced unit costs. This implies that process development efforts go hand-in-hand with cost-efficiency, given that the organisation's goal is not to reduce total costs. In the short run, process development efforts are likely to prove more financially beneficial than pure financial analyses. ▪ Integration of process and financial performance requires a logical relationship between process and financial measures. This study showed that although cost-accounting systems build on indirect assumptions of production process, such as the amount of time used by a specific resource for allocation purposes, the costing system is not likely to correspond to the actual performance of the production process. Inaccuracy in cost-accounting systems may, to some extent, be due to the fact that cost-drivers are not aligned with the true performance of the production process. Integrating process and financial management practices can be facilitated by integrating process measures with cost-driver information. This process can be achieved by focusing on process components.
CASE II	<ul style="list-style-type: none"> ▪ For individual services, productivity differences which were due to different levels of technical efficiency, were the main determinants of economic efficiency. Demand segmentation (e.g. between nurse and doctors visits) appeared to be a further determinant of economic efficiency. ▪ Economies of scale and scope were not realised in larger service production units. Some areas have historically been extensively resourced and size has been used as a bargaining tool against smaller units in the quest for scarce resources within the organisation.
CASE III	<ul style="list-style-type: none"> ▪ The main determinant of economic efficiency was productivity, which, in turn, was subject to different levels of technical and allocative efficiency. ▪ Process analysis and ABC can be combined to reach a more comprehensive state of financial process management. However, applying such techniques may result in unrealistic financial impact of process re-engineering simulation. ▪ Focussing on cost while neglecting the process perspective may result in cost-inefficient decisions. An example of this problem was seen with economies of scale. In addition, the fixed nature of resources is likely to hinder realisation of cost savings in the shorter term.
CASE IV	<ul style="list-style-type: none"> ▪ Due to the functional management systems in hospitals, there is strong risk that cost-efficiency is pursued locally. Whether local optimums are actually achieved can be questioned in light of the lack of actual operations and process analysis). Management information supporting improvement of universally optimal hospital episodes is virtually non-existent. One possible exception to this statement is DRGs, which are almost

exclusively used for municipal billing purposes. Thus, no or very little cross-border management actually exists.

- Cost-efficiency on the hospital level was not determined locally in separate units, departments or support functions, but through the effective management of total patient episodes. The impediments of total cost efficiency in hospitals became more evident when considering all providers involved in the production of services. Efforts to improve total patient flow were not sufficiently encouraged on the individual service provider level. Local cost-efficiency improvements were still considered successful, referring to asymmetries of incentives on the hospital level. There was a lack of authority to implement total patient flow improving measures on the hospital level, as well as lack of ownership.
- Governance problems could be partially explained by the economic rationale in different departments and units. In the case hospital, radiology and laboratory operations are separated into market-oriented (public utility) units with financial independency / responsibility. Performance was improved by increased throughput or cost reduction. Operating expenses of the material and pharmacy centres was determined as a percentage premium on the cost of sold goods. That is, increasing cost of sold goods increased the budget for operating expenses (determined by a fixed percentage, but may be subject to adjustments on a yearly basis).
- The study shows that analysis of entire patient processes may provide insight into more effective resource management of hospital support functions. Cost savings resulting from decreased service availability and quality may be devastating patients and the hospital as a whole. Such sub-allocation can be avoided by identifying potential bottlenecks in the patient process and making sure that they are sufficiently resourced, especially because support functions may represent only a small fraction of the costs of the entire patient process within the hospital.

CASE V

- Benchmarking operations could benefit healthcare in Finland and internationally. They may provide support for improved performance in elderly care systems. Again, the challenges involved in benchmarking are related to the context within which performance is achieved.
- There are strong indications that the domestic elderly care service network requires significant restructuring and integration on the regional level. Structural changes cannot be handled with increased productivity. Such restructuring efforts would be subject to major reallocation of resources as well as regional coordination. Cost containment can be achieved by allocating personnel to less personnel-intensive care types.
- Reorganizing the elderly care system will require significant reallocation of personnel resources as well as fixed assets, particularly facilities. In the short term, this would require large investments and, in the long term, consistent redirecting of clients.
- The potential cost benefits of rearranging elderly care would be subject to the flexibility of resource reallocation in the service system and how well they could be put into use in the new service structure. A high number of employees could be reallocated from health centre hospitals to service housing. Given the same demand for elderly care services, this approach would enable decreasing the total workforce, making the predicted retirement trends less threatening. With the demographic changes, the effect on total employees could remain relatively constant.
- Dealing with the resource allocation problem would have to occur in a number of steps. The starting point would be the client and his needs. Providers would need to determine the most appropriate mode of care and find financially efficient options for meeting a client's needs.
- Investments required for changing the service structures are unlikely to be realised due to the yearly budgeting and lack of regional coordination.

CASE VI

- Regardless of demographic changes, the total costs of the domestic healthcare network cannot increase in the coming 30 years. Naturally, cost development of medical equipment, facilities and technology are important for determining the total cost level, but - more importantly - the total number of personnel working in the service network cannot increase. This fact establishes resource constraints.
 - Cash-flow and balance sheet analysis was used in addition to simple cost and income analysis. The potential
-

developments over a longer period of time were also reviewed. The actual potential financial problems facing public Finnish health care are difficult to identify without a long-time perspective on financing. Municipalities may be forced to significantly increase the amount of external (interest-bearing) financing, which may result in a severe debt circle. The potential of this problem was highlighted when the credit rating organisation Standard & Poor's indicated that Finland could be dropped to junk credit status due to demographic changes.³⁹

So why is the regional network perspective from a resource planning viewpoint? Distinguishing between the analysis of the production and patient process is important. Due to nature of patient processes and the vast number of service providers often involved in the patient process, the role of allocative efficiency becomes increasingly important as the patient passes through several stages or levels of the service system. The hypothetical rationale for broadening the level of analysis is depicted in Figure 67. The purpose of the figure is to illustrate how extending resource and capacity analysis can be affected when the level of analysis is extended. Every process or system has bottlenecks, but the definition of a bottleneck can depend on the level of analysis. In the example, a new resource constraint is identified when extending the unit level analysis to the department level. Similarly, the perception of constrained resources in the system may change when extending the level of analysis to the regional level. The role of technical and allocative efficiency, as illustrated in Figure 66, still holds, but its impact is likely to be more significant when adopting a system level perspective.

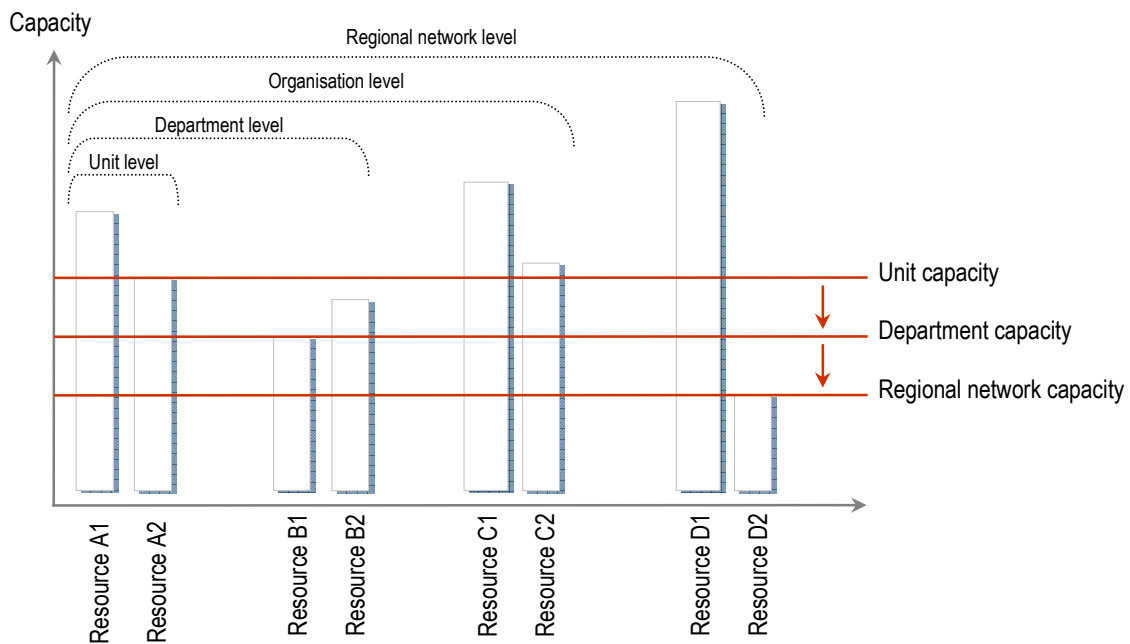

Figure 67 – Extending analysis of resource constraints to the regional network level.

Numerous factors determine the need for resources in health and social care service provision, and analysing them all comprehensively is challenging. A common denominator in all the cases presented here — and in health and social care

³⁹ Article in Helsingin Sanomat 28.6.2006

in general — is that capacity is limited by personnel. Personnel — or at least one personnel group — is and should always be the constrained resource.

Regional health care networks face two contradictory trends. On one hand, use of health care service is estimated to grow as a result of ageing populations. These demographic changes will have a negative impact on tax-paying capacity. On the other hand, the service network is likely to face difficulties in replacing personnel, which is retiring at a high rate. As long as provision of larger volumes of health care service is done at the same level of efficiency as today, demographic changes will create pressures to increase personnel. A vast challenge to the service network is that, despite the likely increase in need for health and social care services due to demographic changes, increasing the number of personnel is not a financially viable option. The increasing need for services can, to some extent, be met by increasing technical efficiency in a status quo operational model. However, in the long-term, the network is likely to require resource reallocation efforts. This effort will be coupled to a need for large investments, as well as different resource and financial management tools for monitoring and evaluating the need and success of restructuring efforts. It is clear that personnel resources, the most important resource and cost driver in the service network, cannot be significantly increased despite the pressures to do so from demographic changes.

Bottleneck resource will always exist in health care systems, and dealing with them will have to be done on a continuous basis (Figure 68). If one constraint is eliminated, a new one will emerge. This implies that a process of continuous improvement and tools for enable to performance monitoring is required. Improvements efforts can and should be pursued on all levels, but in Finland, increasing focus is on the big picture: the regional service network.

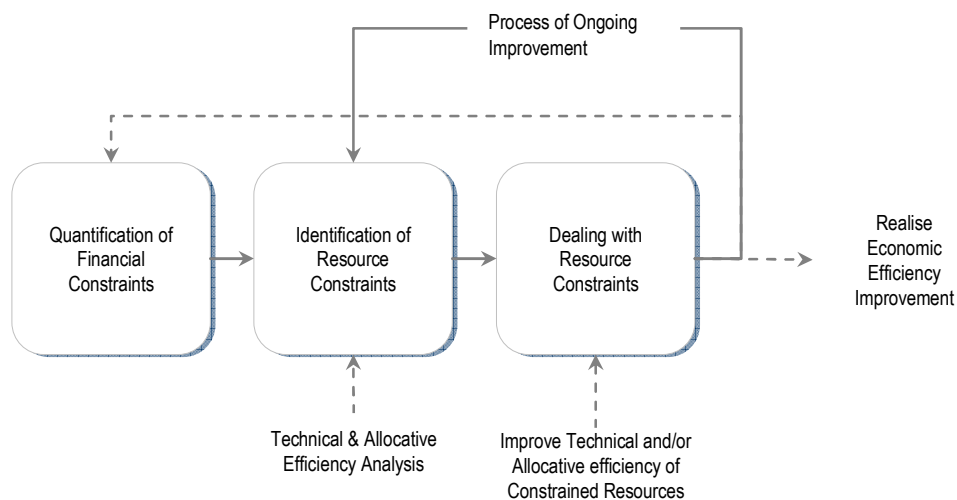

Figure 68 – Constraints and the process of ongoing improvement.

In order to reap full benefits of the model (Figure 68), an analysis should commence at the regional level. Optimising a unit's or department's performance is sub-allocation if the result does not support the objectives of the system as a whole.

The improvement process should be iterative and gradually brought to the lower levels of the system before reviewing and re-reviewing the performance of the entire system. Financial gains are bound to result from this development, given the effects of eliminating or reducing system- or process-level bottlenecks.

The relationship between process measures and economic efficiency was evident in a number of the cases studied here. This result is not surprising, as the process measures often concern key resources in the production process. These resources are often the main cost-drivers. Therefore, the process of continuous improvement presented in Figure 68 is likely to continuously render benefits in terms of economic efficiency. The mechanisms for realising improvements in economic efficiency are depicted in the figures below.

In order to investigate the potential for improvements of economic efficiency, the level of demand in relation to capacity and supply must be added to the equation. Figure 69 shows a two-resource system (a production process or patient episode) where demand exceeds supply. This situation was the case in Case I. In the example, resource group B is the constrained resource. This resource group could be nurses, physicians, facilities or equipment. Increasing capacity of (B(4)) eliminates the bottleneck and economic efficiency in terms of lower unit costs is likely to increase (Formula 1).

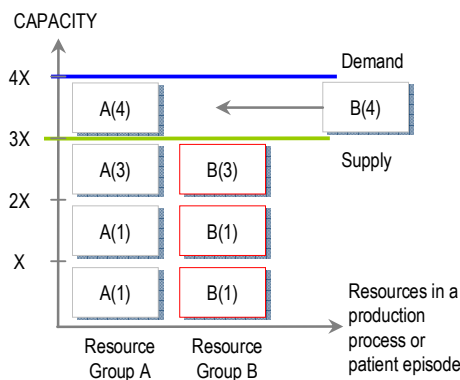

$$\frac{(C_{A(1)} + C_{A(2)} + C_{A(3)} + C_{A(4)}) + (C_{B(1)} + C_{B(2)} + C_{B(3)} + C_{B(4)})}{4X} < \frac{(C_{A(1)} + C_{A(2)} + C_{A(3)} + C_{A(4)}) + (C_{B(1)} + C_{B(2)} + C_{B(3)})}{3X}$$

Figure 69 – Improving economic efficiency when demand exceeds supply.

Formula 1. Conditions under which economic efficiency improvements is improved when demand exceeds supply.

Note: C_x= cost of resource X

Figure 70 presents the second case, where demand is equal to supply. Resource group A has overcapacity and economic efficiency can be improved by reducing capacity, such as by decreasing resources (Formula 2). Output remains constant and the efficiency per unit resource in group A increases. This process is often hindered and made difficult due to the fixed nature of resources. Therefore this economic efficiency may not be possible in the short run.

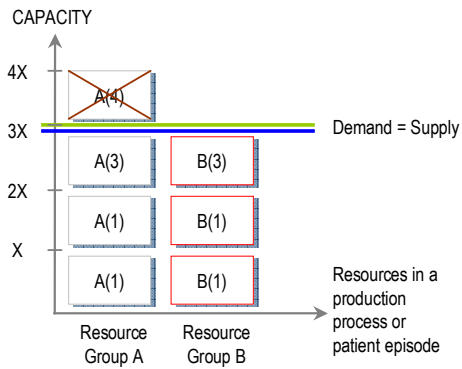

$$\frac{(C_{A(1)} + C_{A(2)} + C_{A(3)}) + (C_{B(1)} + C_{B(2)} + C_{B(3)})}{3X} <$$

$$\frac{(C_{A(1)} + C_{A(2)} + C_{A(3)} + C_{A(4)}) + (C_{B(1)} + C_{B(2)} + C_{B(3)})}{3X}$$

, true if $C_{A(4)} > 0$

Figure 70 – Improving economic efficiency when demand equals supply.

Formula 2. Conditions under which economic efficiency improvements is improved when demand equals supply.

Note: C_x = cost of resource X

In the third situation, supply exceeds demand (Figure 71). Resource group B still limits the capacity of the system, but is no longer a bottleneck because the capacity exceeds demand. In this case, economic efficiency can be increased by reducing capacity of both resource group A and B (Formula 3). Again, the possibility for resource reduction depends on the nature of the resource, and may be difficult in the short run.

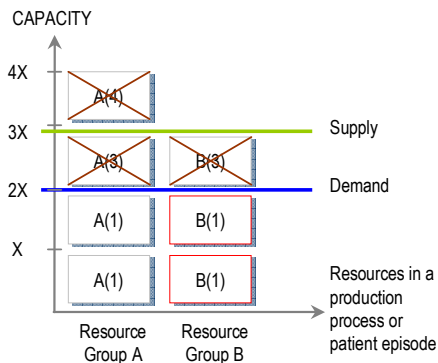

$$\frac{(C_{A(1)} + C_{A(2)}) + (C_{B(1)} + C_{B(2)})}{2X} <$$

$$\frac{(C_{A(1)} + C_{A(2)} + C_{A(3)} + C_{A(4)}) + (C_{B(1)} + C_{B(2)} + C_{B(3)})}{3X}$$

, true if $(C_{A(3)} + C_{A(3)} + C_{A(4)}) > 0$

Figure 71 – Improving economic efficiency when supply exceeds demand.

Formula 3. Conditions under which economic efficiency improvements is improved when supply exceeds demand.

Note: C_x = cost of resource X

5 DISCUSSION

5.1 QUANTIFYING FINANCIAL CONSTRAINTS

Funding constraints limit the availability of resources, including personnel, facilities, medical equipment and technology etc. Out of these, personnel resources are the most evident capacity constraint. Furthermore, through external developments, personnel may become scarcer quickly relative to other resources such as facilities and equipment.

The pessimistic financial outlook in health and social care assumes that the amount of resource used in service production will increase significantly in the coming decades. As far as the network's own personnel resources are concerned, this increase may not be plausible due to lack of personnel. Public resources are not able to increase capacity and are forced to turn to private service providers. However, increased outsourcing of services to private providers will contribute to the cost increase and will not solve the resource constraints problem. This trend is already occurring in Finland and it will not solve the resource-constraints dilemma. This is due to the fact that the health care system in its current form is assumed to be unable to increase capacity without increasing resources. This study argues that while public health care systems are facing a vast challenge in terms of meeting increased demand, the unavailability of resources and financing should be considered an opportunity to stimulate a search for more efficient ways of providing health care.

5.2 IDENTIFICATION OF RESOURCE CONSTRAINTS

Quantitative management of health care systems is relatively undeveloped. Networks are difficult to manage and need well-planned management systems. Current management systems do not fully support continuous performance improvement or monitor it. They have almost exclusively been adopted into a functional organisation and the need for process and patient flow management has often been neglected.

PRODUCTION PROCESS ANALYSIS

The application of operations and process analysis to dealing with resource constraints is information-intensive and requires extensive quantitative data analysis. The availability and quality of information is critical for successful implementation of operations management practices. This poses a major challenge for health care organisations, where operational and financial analysis methodologies have traditionally been undeveloped. In light of the results presented in this study, particular attention should be given to finding out the actual capacity of resources in the production process. Understanding the capacity of existing resources is a cornerstone of successful operations management.

PATIENT FLOW

Different organisations and units operate independently and often with separate budgets. Optimising performance locally does not necessarily result in optimal service network performance. Organisational borders, through which patients are moved by various referral systems, create problems for the care of patients. They also create waiting times, or, in the language of operations management, excess inventory..

A critical success factor for a regional health care service network is the ability of organisations to cooperate in service health care service production and coordinate it. This process includes information sharing and ensuring that patient flow across organisational and unit boundaries is as seamless as possible. Though not addressed in this study, this approach must be supported by adequate organisational structures, responsibility and incentives. Cost-efficiency is based on the functionality of the whole health care system. It is not a problem if certain services function inefficiently, as long as they do not affect the regional system as a whole.

Analysis of resource constraints on the regional level is limited due to the lack of management responsibility and the challenges involved with regional analysis (primarily information fragmentation. Current management practices and information-readiness do not support full realisation of the benefits provided by operations management. On the regional level, challenges increase due to organisational borders and lack of management responsibility. Contributions to resource constraints on the regional level will depend on the development of network and management structures as well as the availability of the information that is required to performing a proper analysis. The importance of allocative efficiency analysis increases with the number of unit, department and organisation boundaries.

FINANCIAL MANAGEMENT

The potential benefits of analysing patient flow and patient episodes have been discussed repeatedly in this study. Obtaining the full benefit of this type of analysis requires coupling it with financial analysis. This approach will only be feasible if there are sufficient financial management practices that support financial management of production processes and patient flow. Many organisations are moving towards integrated financial and process management. However, this development is slow and, in particular, primary and social care seem to be lagging behind in this regard in Finland.

Financial process control empowers process management in many ways. Linking resource and financial information is critical for the informative value of process analysis. Integration of financial and process control enables more in-depth estimation of the financial effects of process management decision, and the simulation of that decision. Moreover, financial process control brings two management systems, financial control and managerial control, closer to each other.

5.3 DEALING WITH RESOURCE CONSTRAINTS

FOCUS ON BOTTLENECKS

The capacities of systems and processes are limited by their bottlenecks. As a result, performance improvement efforts have to be directed at limiting the impact bottlenecks or eliminating them. Technical efficiency analysis enables

determination of resource capacity and improvement potential. Allocative efficiency analysis supports resource (re)allocation decisions, which may help release constrained resources. If more than one type of resource is constrained, analysis should focus on the more expensive resource in order to maximize economic efficiency. Physicians are likely to be more expensive and therefore it should be preferred that physicians constitute the bottleneck resource. Once it has been established which resources are constrained and to what extent, non-bottleneck resources can be reduced, but not to the extent that doing so limits the system's capacity.

NON-CONSTRAINED RESOURCES

Everything consumed by constraints should be supplied by non-constraints. Given that the availability of health care professionals is constrained, it is critical to increase its limiting impact on system performance. Any performance improvement efforts should be directed at releasing bottleneck resources. This includes investments in technology and IT, facilities and equipment.

Organisations put significant effort into analysing and optimising the utilisation of non-bottleneck resources. Increasing utilisation of non-bottleneck resources has two likely consequences. First, system capacity will not increase because the bottlenecks of the system are not being addressed. Consequently, there will be no improvements in cost-efficiency. Second, non-bottlenecks risk of becoming artificial bottlenecks by actively striving to optimise their use. Indications of this can be found in different inpatient departments, where management often strives to optimise utilization of beds. The results of this approach are that the utilization of personnel, the true constrained resources, will decrease.

REGIONAL HEALTH CARE MODELS

Resource constraints will force the region to plan its health care operations in disregard of organisational boundaries. In terms of responsibility, health care personnel themselves cannot be expected to improve allocative efficiency. This is a planning problem and responsibility is with the management of regional health care systems. Development efforts are too often focused on improving the performance of individual service providers, which often is sub-allocative from the perspective of the whole system.

The most important feature of the regional level analysis is that it shifts focus to patient episodes and flow. As for production processes, bottlenecks are likely to always exist in patient episodes or flow. A natural first method is to identify actual patient flows in the system. Development efforts should be prioritized both according to scale and scope of patient flows and resource consumption.

Development efforts should primarily be directed at planning the smooth flow of patients through the system and to identifying non-value adding activities. This process includes patient entrance into the system and the removal of illogical and inefficient flow of patients within the system. In addition, the efficiency of major service production stages, such as separate units and departments, should be subject to investigation and prioritized according to resource consumption or otherwise identified improvement potential. Investigation and analysis of the efficiency should focus primarily on optimising total patient flow and resource consumption and secondarily, focus on local optimisation of a particular

production process. Finally, any development should be analysed in light of current governance structure and incentive systems in order to identify potential obstacles for implementing change.

MATCHING CAPACITY AND DEMAND

Understanding how patients move through a service network and what drives costs are critical factors for managing constrained resources on the regional level. The starting point for any development project in this regard must be to understand the nature of demand and how the system is currently responding to it, and how this is realised in resource consumption through the system (e.g. what structures determines the patient flow). The challenge is to optimise resource use and capacity to meet demand. Capacity is determined by the amount of resources and their productivity. System capacity is limited by the capacity of its constrained bottleneck resources.

The practical meaning of matching demand with capacity should be reformulated as matching demand with the capacity of *bottleneck* resources. This process is difficult because the capacity of bottleneck resources is often not known.

Operations management theory has conflicting models concerning the desirability of capacity to demand. The dominating orientation in health care seems to be that maximizing resource utilization is analogous to good performance. Implicit in this assumption is that local optimisations are positive. Without a doubt, health care operations operate efficiently when capacity and demand are at par. In practice, this situation rarely occurs, and constantly striving to optimise resource use may have negative impact on performance. Merely designing and maintaining a management system for monitoring, which provides real-time utilization data of all resources in today's public health- and social care organisations would probably require significantly more resources than any organisation would be willing to invest. However, each organisation should be able to identify its own constrained resources, and focusing on improving their performance could add significant value and improve value, and simultaneously limit the resource constraints problem.

ECONOMIES AND DISECONOMIES OF SCALE AND SCOPE

Economies of scale and scope are difficult to realise because technical or allocative efficiency of operations is not automatically improved in larger units. However, potential synergistic benefits to areas such as administration are more likely to be realised. Economies of scale and scope are not automatically realised in a health care setting.

In Finland, health care operations are being centralised to larger units on all levels and within all areas. The pursuit of larger or more focused service production is often advocated as representing quality improvements and decreased vulnerability. However, a main driving force is the notion that benefits of economies of scale and scope are expected to be realised. The cases in this study, gives indication that this may not be the case indicating that health care services simply do not scale and that management faces a vast challenge in realising any benefits.

THE CAPITAL INVESTMENT DIMENSION

The means for improving allocative efficiency are situation-dependent, but a common criterion for successful reallocation is that resources are truly reallocated. A prominent risk in resource reallocation is that resources in the receiving end are

increased, yet the decrease at the other end is small or nonexistent, resulting in a net increase in resources post reallocation. An example of this problem is to shift relatively healthy elderly persons to less intensive elderly care, while failing to decrease resources in the more intensive end. Operations management methodologies can be adopted to ensure that capacity is sufficient at both ends.

Resource allocation efforts are often coupled with capital investments. For example, investments in facilities are likely to be required when changing the structure of a service network. The return on such investments depends on actual reallocation of resources, in that return depends on the alternative cost of the service provision post-investments. If resources are not reallocated, and new ones are simply added to the system, the cost post-investment will be higher than previously, and the return on investment will be negative.

5.4 CONTINUOUS IMPROVEMENT

Capacity in public social and health care networks is almost exclusively limited by personnel resources. Given this problem, the capacity of the system can only be increased by increasing the capacity of the personnel. Limitations to the system are not imposed by non-bottleneck resources and — by definition — these resources are not and should not be fully utilised. Management should focus on decreasing and eliminating bottlenecks, which means that efforts should be aimed at maximizing the use of personnel resources. The most evident solution to this problem would be to increase the amount of personnel. However, as discussed above, this solution is limited by financial constraints and the availability of trained individuals.

The analysis showed that changes that successfully decrease or limit the impact the resource constraints will render economic efficiency benefits. This is due to the fact that the total amount of resources used for each production unit decreases. In the short term, economic efficiency benefits are realised primarily by increasing the capacity of existing resources, and total costs are likely not to decrease. In the longer term, there is more potential to affect the total resource base and, thus, decrease total costs.

6 CONCLUSION

Health care will always face resource constraints and the challenge of increasing resource capacity. The results of this study suggest that capacity is increased primarily by directing efforts at constrained resources. Resource constraints can be identified both in health care production processes and in patient flow due to the interdependency of resource capacity in a sequence of events. These efforts should be directed either at improvements of either technical or allocative efficiency in individual production processes and/or in terms of patient flow on the systems level. In health care, this is, almost without exception, the personnel. The potential for improvements is mainly related to planning and management of operations. Systematic efforts to release bottleneck resources are essential, and the process will require detailed identification of constraints as well as sufficient management methodologies and systems.

Economic efficiency is explained by technical and allocative efficiency of operations, indicating that increasing focus on operations management is required in order to contain health care costs. Realisation of economic efficiency improvements may, however, be hindered in the shorter term due to the fixed nature of resources. There are strong indications that significant economic efficiency improvements may be gained through improved resource allocation on the system or regional level. This indicates that a significant shift of management mindset from cost to process orientation is required in order to deal with the fundamentals underlying the resource constraints problems.

There are clear indications that a large portion of operations management efforts in health care are being directed at increasing resource utilization on all levels and, thus, increasing economic efficiency. This is likely to be the result of insufficient management tools and not knowing the capacity of constrained resources, which are primarily personnel. The results are efforts to increase utilization of non-bottleneck resources and the creation of artificial bottlenecks. It is critical to understand that increasing the capacity of non-bottleneck resources will not increase total capacity. In fact, the more likely result of wrongful cost containment efforts is the creation of artificial bottlenecks, which end up limiting the capacity of the total system and may have detrimental effects on total economic efficiency. The economic consequences become more significant as the scope of analysis is extended to the regional level. It can be argued that a significant shift in management focus is required to really address system bottlenecks. A variety of development efforts such as investments in facilities, technology and IT should systematically be evaluated according to the extent to which they can deal with the resource constraints problem.

Many health care organisations lack tools for identifying its resource constraints. This process is the first step to realising the benefits of OM. However, a lack of specific information as to what limits capacity and performance makes dealing with these limitations difficult. This can be attributed to the information-readiness of organisations and to management focus. Nevertheless, once they have been identified, they can be dealt with through efforts directed at improving technical and allocative efficiency. If these efforts are successful, economic efficiency improvements are likely to follow.

- Adang, E., Voordijk, L., van der Wilt, G.J., Ament, A. (2005), "Cost-effectiveness analysis in relation to budgetary constraints and reallocation restrictions", *Health Policy*, 74/2, 146-156
- Adenso-Díaz, B., González-Torre, P., García, V. (2002), "A capacity management model in service industries", *International Journal of Service Industry Management*, 13/3, 286 – 302
- Adler, P.S., Goldoftas, B., Levine, D.I. (1999), "Flexibility versus Efficiency? A Case Study of Model Changeovers in the Toyota Production System", *Organisation Science*, 10/1, 43-68
- Aharonson-Daniel, L., Fung, H., Hedley, A.J. (1996), "Time studies in A&E departments – a useful tool for management", *Journal of Management in Medicine*, 10/3, 15-22
- Aird, B. (1996), "Activity-based cost management in health care - another fad?", *International Journal of Health Care Quality Assurance*, 9/4, 16-19
- Al, M.J., Feenstra, T., Brouwer, W.B.F. (2004), "Decision makers' views on health care objectives and budget constraints: results from a pilot study", *Health Policy*, 70/1, 33-48
- Alho, A. (2004), "Kysynnän hallinta suomalaisessa perusterveydenhuollossa", Master's thesis (in Finnish)
- Alho, A., Torkki, P., Torkki, M., Hietaniemi, K., Vuorinen, J., Lehto, M., Arajärvi, E., Seitsalo, S., Linna, M., Häkkinen, U., Hirvensalo, E. (2006), "Lonkan ja polven tekonivelpotilaiden hoitoprosessin benchmarking – käypä prosessi". Espoo
- Allan, C.F. (1993), "Benchmarking practical aspects for information professionals", *Special Libraries*, 84/3, 123-130
- Antoniou, J., Martineau, P., Filion, K., Haider, S., Zukor, D.J., Huk, O.L., Pilote, L., Eisenberg, M.J. (2004), "In-Hospital Cost of Total Hip Arthroplasty in Canada and the United States", *Journal of Bone and Joint Surgery (American)*, 86, 2435-39
- Babad, Y.M., Balachandran, B.V. (1993), "Cost Driver Optimization in Activity-Based Costing", *The Accounting Review*, 68/3, 563-575
- Bakke, N., Hellberg, R. (1991), "Relevance lost? A critical discussion of different cost accounting principles in connection with decision making for both short and long term production scheduling", *International Journal of Production Economics*, 24, 1/2, 1-18
- Batjjan, I., Lagergren, M. (2004), "Inpatient/outpatient health care costs and remaining years of life—effect of decreasing mortality on future acute health care demand", *Social Science & Medicine*, 59/12, 2459-2466
- Bertrand, W., de Vries, G. (2005), "Lessons to be learned from operations management". *Health operations management: patient flow logistics in health care (section 2)*, Routledge, London & New York
- Berwick, D.M. (1996), "A primer on leading the improvement in systems", *British Medical Journal*, 312/7031, 619-622
- Bojke, C., Gravelle, H., Wilkin, D. (2001) "Is bigger better for primary care groups and trusts?", *British Medical Journal*, 322/7303, 599-602
- Boyd, L., Gupta, M. (2004), "Constraints management. What is the theory?" *International Journal of Operations and Production Management*, 24/4, 350-371
- Bozic, K.J., Katz, P., Cisternas, M., Ono, L., Ries, M.D., Showstack, J. (2005), "Hospital Resource Utilization for Primary and Revision Total Hip Arthroplasty", *Journal of Bone and Joint Surgery*, 87/3, 570-576
- Brown, L. (2004), "Improving histopathology turnaround time: a process management approach", *Current Diagnostic Pathology*, 10/6, 444–452
- Buchanan D.A. (2004), "The Limitations and Opportunities of Business Process Re-engineering in a Politicized Organisational Climate", *Human Relations*, 50/1, 51-72
- Burbridge, J.L. (1984) "Automated production control with a simulation capability". Proceedings IPSP conference WG 5-7, Copenhagen
- Christopher, M. (1998), "Logistics and Supply Chain Management: Strategies for Reducing Cost and Improving Service". Financial Times Pitman Publishing
- Cochrane, M., Ham, C., Heginbotham, C., Smith, R. (1991), "Contemporary theme. Rationing: at the cutting edge", *British Medical Journal*, 303/6809, 1039–1042
- Cokins, G. (1993), "An ABC manager's primer", IMA Publication No. 93282
- Committee on Quality of Health Care in America (2001), "Crossing the Quality Chasm: A new Health System for 21st Century" The Institute of Medicine (IOM), 2-10
- Cooper, R. (1988), "The Rise of Activity-Based Costing - Part One: What is an Activity-Based Cost System?" *Journal of Cost Management*, 2/2, 45-54
- Cooper, R., Kaplan, R., (1991), "The Design of Cost Management System", Prentice-Hall International, London
- Davies, C., Walley, P. (2000), "Clinical governance and operations management methodologies", *International Journal of Health Care Quality Assurance*, 13/1, 21-26

- De Vries, G., Bertrand, J. W. M., Vissers, J. M. H. (1999), "Design requirements for health care production control systems", *Production planning & Control*, 10/6, 559-569
- Dedera, C.R (1995) "Can TOC and ABC coexist?" IEEE/ SEMI Advanced semiconductor manufacturing conference
- Lowther, J. (1998) "Managing Health Care under Resource Constraints", *Journal of the Operational Research Society*, 49/7, 767-767
- Denkena B., Aptitz R., Liedtke C. (2006), "Knowledge-based benchmarking of production performance", *Benchmarking: An international Journal*, 13, 1/2, 190-199
- Devers K.J, Shortell S.M., Anderson D.A., Mitchell J.B, Erickson K.M. (1996), "Implementing organized delivery systems: An integration scorecard", *Integrated health care delivery – Theory, practice, evaluation and prognosis*. Gaithersburg, Maryland, Aspen, 121-134
- Dexter, F., Traub, R. (2002), "How to Schedule Elective Surgical Cases into Specific Operating Rooms to Maximize the Efficiency of Use of Operating Room Time", *Anesthesia & Analgesia*, 94/4, 933-942
- Dexter, F., Macario, A., Ledolter, J. (2007), "Identification of systematic underestimation (bias) of case durations during case scheduling would not markedly reduce overutilized operating room time", *Journal of Clinical Anesthesiology*, 19/3, 198-203
- Dowdeswell, B. (2006) "Effective Health Investments", EU Seminar on Health Investment, 4-5th December, Brussels
- Eisenhardt, K.M. (1989), "Building theories from case studies", *The Academy of Management Review*, 14/4, 532-550
- Ekroos, N., Vauramo, E. (2005), "Production management in the 24-H elderly care services – A case study in Helsinki city", *International conference on the Management of Healthcare & Medical Technology*, 192-201
- Ekström, B-E. (2004), "Pelastakaa Helsinki - Globalisaatiostrategia kuntataloudelle", Finnish Business and Policy Forum EVA
- Eloranta, E., Hoover, W.E., Huttunen, K. (2001), "Managing the Demand-Supply chain: Value innovations for Customer Satisfaction", John Wiley & Sons
- EuHPN Capital Study (to be published in a series entitled "European Observatory on Health Systems and Policies")
- European Observatory on Health Care Systems (2002), "Health Care Systems in Transition – Finland", *European Observatory on Health Care Systems*, Copenhagen, 4, 1
- Evans, J.R., Anderson, D.R., Sweeney, D.J., Williams, T.A. (1990), "Applied production & operations management", 3rd edition, West Publishing Company
- Evans, P, Bellamy, S. (1995), "Performance evaluation in the Australian public sector. The role of management and cost accounting control systems" *International Journal of Public Sector Management*, 8/ 6, 30-38
- Fernandez, P., McCarthy I.P., Rakotobe-Joel, T. (2001), "An evolutionary approach to benchmarking", *Benchmarking: An International Journal*, 8/4, 281– 305
- Fetter, R.B., Freeman J.L. (1986), "Diagnostics Related Groups: product line management within hospitals", *Academy of Management Review*, 11/1, 41-54
- Garattini, L., Guiliani, G., Pagano, E. (1999), "A model for calculating costs for hospital wards: an Italian experience", *Journal of Management in Medicine*, 13/ 2-3, 71-82
- Glouberman S., Mintzberg H. (2001), "Managing the care of health and the cure of disease – Part I: differentiation", *Health Care Management Review*, 26/1, 85-90
- Goldratt E.M. (1986), "The Goal – A Process of Ongoing Improvement", Revised edition, North River Press
- Goldratt, E.M. (1990a), "The Haystack Syndrome: Sifting Information from the Data Ocean?" North River Press, Croton-on-Hudson, NY
- Goldratt, E.M. (1990b), "What Is This Thing Called Theory of Constraints and How Should It Be Implemented?", North River Press, Croton-on-Hudson, NY
- Gupta, M. (2001), "Activity-Based Throughput Management in a manufacturing company", *International Journal of Production*, 39/ 6, 1163 – 1182
- Gupta, M, Boyd, L. (2004), "Constraints management: What is the theory?", *International journal of Operations & Productions Management*, 24, 3/4, 350-371
- Gupta, M., Galloway, K. (2003), "Activity-based costing/management and its implications for operations management", *Technovation*, 23/2, 131-138.
- Hall, R., Belson, D., Murali, P., Dessouky, M. (2006), "Modeling patient flows through the Healthcare System", *Patient Flow: Reducing Delay in Healthcare Delivery (Section 1)*, Springer
- Halmeenmäki, T. (2005), "Kunta-alan eläkepoistuma 2006-2020", *Kuntien eläkevakuutus. Kuntien eläkevakuutuksen monisteita 1/2005*. Helsinki
- Hanss, R., Buttgerit, B., Tonner, P.H., Berthold, B., Schleppers, A., Steinfath, M., Scholz, J., Bauer, M. (2005), "Overlapping induction of anesthesia: an analysis of benefits and costs", *Anesthesiology*, 103/2, 391-400
- Harders, M., Malangoni, M.A., Weight, S., Sidhu, T. (2006), "Improving operating room efficiency through process redesign", *Surgery*, 140/4, 509-516
- Harper, P.R. (2002), "A Framework for operational modelling of hospital resources", *Health Care Management Sciences*, 5/3, 165–173
- Herzlinger, R. (2000), "Market driven, focused health care: the role of managers", *Frontiers of Health Service Management*, 16/3, 3-12

- Hines, P., Holwe M., Rich N. (2004), "Learning to evolve: a review of contemporary lean thinking", *International Journal of Operations & Production Management*, 24/10, 994-1012
- Interreg IIC (2006), "*Future Vision of Regional Health Care – Regional Health Care Service Network*", FutureHealth Network for Future Regional Health Care. Helsinki
- Isken, M.W., Rajagopalan, B. (2002), "Data Mining to Support Simulation Modeling of Patient Flow in Hospitals", *Journal of Medical Systems*, 26/2, 179-197
- Jacobs, R., Smith P.C., Street A. (2006), "*Measuring Efficiency in Health Care – Analytic Techniques and Health Policy*", Cambridge University Press
- Janus, K., Amelung V. (2005), "Integrated health care delivery based on transaction cost economics: experiences from California and cross-national implications", *International Health Care Management*, 5, 117-156
- Järvinen, J. (2005), "Rationale for adopting activity-based costing in hospitals – Three longitudinal case-studies", PhD thesis, Faculty of Economics and Business Administration, Department of Accounting and Finance, University of Oulu
- Kaplan, R. (1992), "In defense of activity-based cost management: ABC models can play many different roles to support a company's operational improvement and customer satisfaction programs", *Management Accounting*, 74/5, 58-63
- Karlsson, C., Rognes, J. and Nordgren, H. (1995), "En modell för Lean Production i sjukvården", Institute for Management of Innovation and Technology, Göteborg
- Karvonen, S., Rämö, J., Leijala, M., Holmström, J. (2004), "Productivity improvement in heart surgery – a case study on care process development", *Production Planning & Control*, 15/3, 238-246
- Katz, J.N., Losina, E., Barrett, J., Phillips, C.B., Mahomed, N.N., Lew, R.A., Guadagnoli, E., Harris, W.H., Poss, R., Baron, J.A. (2001), "Association between hospital and surgeon procedure volume and outcomes of total hip replacement in the United States medicare population", *Journal of Bone and Joint Surgery (American)*, 83, 1622-1629
- Kee, R. (1995), "Integrating activity-based costing with the theory of constraints to enhance production-related decision-making", *Accounting Horizons*, 9/4, 48-61
- Kee, R., Schmidt, C. (2000), "A comparative analysis of utilizing activity-based costing and the theory of constraints for making product-mix decisions", *International journal of production economics*, 63/1, 1-17
- Keeney, R.L., Raiffa, H. (1976), "*Decisions with Multiple Objectives: Preferences and Value Tradeoffs*", John Wiley and Sons, New York, NY
- Kim, S., Losina, E., Solomon, D., Wright, J., Katz, J. (2003), "Effectiveness of clinical pathways for total knee and total hip arthroplasty", *The Journal of Arthroplasty*, 18/1, 69-74
- Kollberg, B., Dahlgaard J.J., Brehmer P-O., (2007), "Measuring lean initiatives in health care services: issues and findings", *International Journal of Productivity and Performance Management*, 56/1, 7-24
- Kujala, J., Lillrank, P., Kronström, V., Peltokorpi, A. (2006), "Time based management of patient processes", *Journal of Health Organisation and Management*, 20/6, 512-524
- Kuntaliitto (2007), "Sairaalaviesti – Sjukhusinfo", 3/2007, Suomen Kuntaliitto
- Kurtz, S., Lau, E., Halpern, M., Ong, K. (2006), "Trend shows growing orthopedic surgery case load. Will surgeons be able to keep up?" *Materials Management in Health Care*, 15/7, 61-2
- Laing, A.W. and Shiroyama, C. (1995), "Managing capacity and demand in a resource constrained environment: lessons for the NHS", *Journal of Management in Medicine*, 9/5, 51-67
- Laursen, M. L., Gertsen F. G., Johansen, J. (2003), "Applying Lean Thinking in Hospitals", 3rd International Conference on The Management of Healthcare & Medical Technology Proceedings, Warwick, United Kingdom
- Lavemia, C.J., Guzman, J.F. (1995), "Relationship of surgical volume to short-term mortality, morbidity, and hospital charges in arthroplasty", *Journal of Arthroplasty*, 10/2, 133-140.
- Lawson, R.A. (2005), "The use of activity based costing in the healthcare industry: 1994:2004", *Research in healthcare financial management*, 10/1, 77-94
- Lee A. (1970), "Supranational operational research", *Operational Research Quarterly*, 21, 5-11
- Lillrank, P. (2003a), "Patient in Process", *The Finnish Medical Journal* (in Finnish), Helsinki, The Finnish Medical Association, 17.1.2003
- Lillrank, P. (2003b), "The quality of Standard, Routine and Nonroutine Processes", *Organisation Studies*, 24/2, 215–233
- Lillrank, P., Kujala, J., Kämäräinen, V., Kronström, V. (2003c), "Patient in process- a new approach to managing patient processes in health care", *The hospital of the future -3rd International Conference on The Management of Healthcare & Medical Technology*, Warwick, UK, 7-9th September 2003
- Lillrank, P., Kujala J., Parvinen P. (2004), "Keskeneräinen potilas", *Talentum*
- Lubitzh, G., Doyle C., Valentine J. (2004), "The impact of theory of constraints (TOC) in a NHS trust", *Journal of Management Development*, 24/2, 116-131

- Malczewski, J., Ogryczak, W. (1990), "An interactive approach to the central facility location problem: locating pediatric hospitals in Warsaw", *Geographical Analysis*, 22/3, 244-258
- Marshall, A.H., McClean, S.I., Millard, P.H., (2004), "Addressing Bed Costs for the Elderly: A New Methodology for Modelling Patient Outcomes and Length of Stay", *Health Care Management Science*, 7/1, 27-33
- Martin, R.M., Stearne, J.A.C., Gunnell, D., Ebrahim, M.S., Smith, G.D., Frankel, S. (2003), "*Waiting lists and evidence of national or local failure: analysis of health service data*", *British Medical Journal*, 326/7382, 188-192
- Martin S., Smith, P. (1996), "Explaining variations in inpatient length of stay in the National Health Service", *Journal of Health Economics*, 15/3, 279-295
- Martineau, P., Filion K, Huk O, et al. (2005), "Primary Hip Arthroplasty Costs Are Greater in Low-volume Than in High-volume Canadian Hospitals", *Clinical Orthopaedics and related research*, 437, 152-156
- Mason-Jones, R., Towill D.R. (1999), "Using the information de-coupling points to improve supply chain performance", *International Journal of Logistics Management*, 19/2, 13-36
- McColgan, E.A. (1997), "How Fidelity Invests in Service Professionals", *Harvard Business Review*, 75/1, 137-143
- McManus, M.L., Long, M.C., Cooper, A. Litvak, E. (2004), "Queuing Theory Accurately Models the Need for Critical Care Resources", *Anesthesiology*, 100/5, 1271-1276
- Miller, D. (2005), "Going Lean in Health Care", Institute for Healthcare Improvement, Cambridge, MA
- Ministry of Social Affairs and Health (2001), "Ikäihmisten hoitoa ja palveluja koskeva laatusuositus", Sosiaali- ja terveystieteiden oppaita. Helsinki
- Ministry of Social Affairs and Health (2002), "Decision in Principle by the Council of State on securing the future of health care", Helsinki
- Morin, A., Widell-Norström, H. (2004), "Äldre kan få mycket mer hjälp till lägre kostnad – ett exempel från Nacka kommun", Confederation of Swedish Enterprises
- Muhlemann, A., Oakland, J., Lockyer, K. (1992), "Production and Operations Management", Pitman, London
- Murray, M., Tantau, C. (1999), "Redefining open access in primary care", *Managed Care Quarterly*, 7/3, 44-55
- Negrini, D., Kettle, A., Sheppard, L., Mills G.H, Edborke D.L. (2004), "The cost of hospital ward in Europe: Is there a methodology available to accurately measure the costs?", *Journal of Health Organisation and Management*, 18/3, 195-206
- Nie, W., Kellogg, D.L. (1999), "How professors of operations management view service operations", *Production and Operations Management*, 8/3, 339-355
- Niiniluoto, I., (2002), "Critical scientific realism", Oxford University Press
- Norris, C., Jacobs, P., Rapoport J., Hamilton S. (1995), "ICU and non-ICU cost per day", *Canadian Journal of Anaesthesia*, 42/3, 192-196
- Ondategui-Parra S., Gill I. Bhagwat, J., Intrieri, L., Gogate, A., Zou, K., Nathanson, E., Seltzer, S., Ros, P. (2004), "Clinical operations management in radiology", *Journal of the American College of Radiology*, 1/9, 632-640
- Oostenbrink, J.B., Buijs-Van der Woude, T., van Aghoven, M., Koopmanchap, M.A., Rutten, F.F. (2003), "Unit costs per inpatient days", *Pharmacoeconomis*, 21/4, 263-271
- Partridge, M., Perren, L. (1998), "An integrated framework for activity-based decision making", *Management decision*, 36/9, 580-588
- Parvinen, P., Halonen, M. (2004), "Industrial Process Management Principles in Healthcare Research: A Bibliometric Study", visual presentation at the 2004 Academy of Management Meeting in New Orleans, LA
- Parvinen, P., Lillrank, P., Ilvonen, K. (2005), "Johtaminen terveydenhuollossa – Käytännöt, vastuut, valvonta", Talentum
- Patterson, P (1997), "Is an 80 % to 85 % utilization a realistic target for ORs?" *OR Manager*, 13/5, 19
- Pedersen, B., S. P. Johnsen, S. Overgaard, K. Søballe, H. T. Sørensen, U. Lucht. (2005), "Total hip arthroplasty. Incidence of primary operations and revisions 1996-2002 and estimated future demands", *Acta Orthopaedica*, 76/2, 182-189
- Pelletier, C., Weil, G. (2003), "Defining the regional healthcare planning objective using a multi-criteria approach", *Logistics Information Management*, 16, 3/4, 191-200
- Penman S.H. (2001), "Financial Statement Analysis and Security Valuation", McGraw-Hill International
- Proudlove, N.C., Boaden, R. (2005), "Using operational information and information systems to improve in-patient flow in hospitals", *Journal of Health Organisation and Management*, 19/6, 466-77
- Rantanen, P., Keinonen, A., Mäkelä, A. (2006), "Publications of the National Agency for Medicines 2/2006. The 2004 Implant Yearbook on Orthopaedic Endoprostheses", Finnish Arthroplasty Register. National Agency for Medicines
- Riordan, S.H. (1990), "What is vertical integration? The firm as a nexus of treaties", Newbury Park, CA, Sage, 94-111
- Rogers, H., Silvester, K. and Copeland, J. (2004), "NHS Modernisation Agency's way to improve health care", *British Medical Journal*, 328/7437, 463
- Roth, A., van Dierdonck R. (1995), "Hospital resource planning: concepts, feasibility, and framework", *Production and Operations Management*, 4/1, 2-29

- Rotondi, A.J., Brindis, C., Cantees, K.K., DeRiso, B.M., Ilkin, H.M., Palmer, J.S., Gunnerson, H.B., Watkins W.D. (1997), "Benchmarking the Perioperative Process. I Patient Routing Systems: A Method for Continual Improvement of Patient Flow and Resource Utilization", *Journal of Clinical Anesthesia*, 9/2, 159-169
- Ryynänen, O-P., Kukkonen, J., Myllykangas, M., Lammintakanen, J., Kinnunen, J. (2006), "Priorisointi terveydenhuollossa – Mitä maksaa, kuka maksaa", Talentum, Helsinki
- Sandberg, W.S., Daily, B., Egan, M., Stahl, J., Goldman, J.M., Wiklund, R.A., Rattner, D. (2005), "Deliberate perioperative systems design improves operating room throughput", *Anesthesiology*, 103/2, 406-418
- Schmenner, R.W., Swink, M.L. (1997), "On theory in operations management", *Journal of Operations Management*, 17/1, 97–113
- Shapiro J., Smith S. (2003), "Lessons for the NHS from Kaiser Permanente – ownership and integration are the key", *British Medical Journal*, 327/7426, 1241-1242
- Shapiro, J.F. (2001), "Modeling the Supply Chain", Duxbury, Pacific Grove
- Sherman, H.D. (1986), "Measurement of hospital performance implications for accounting", *Research in Governmental and Nonprofit Accounting*, 2, 135-150
- Sinueary-Stern, Z. (1993), "A network optimization model for budget planning in multi-objective hierarchical systems", *Journal of Operational Research Society*, 44/3, 297-308
- Skinner, W. (1974), "The Focused Factory", *Harvard Business Review*, 52/3, 113-121
- Smith-Daniels, V.L., Schweikhart, S.B., Smith-Daniels, D.E. (1988), "Capacity management in Health Care Services", *Decision Sciences*, 19/4, 889-919
- Sokolovic, E., Biro, P., Wyss, P., Werthemann, C., Haller, U., Spahn, D., Szucs, T. (2002), "Impact of the reduction of anaesthesia turnover time on operating room efficiency", *European Journal of Anaesthesiology*, 19/8, 560-563
- Spangler, W.E., Strum, D.P., Vargas, L.G., May, J.M. (2004), "Estimating procedure times for surgeries by determining location parameters for the lognormal model", *Health Care Management Science*, 7/2, 97-104
- Spear, S.J. (2005), "Fixing health care from the inside, today", *Harvard Business Review*, 83/8, 78-91
- Spendolini, M. (1992), "The benchmarking book", New York, Amacom
- Spoede C., Henke E., Umble M. (1994), "Using activity analysis to locate profitability drivers: ABC can support a theory of constraints management process", *Management Accounting*, 75/11, 43-48
- St. Hilaire C., Crépeau P.K. (2000), "Hospital and unit cost allocation methods", *Health Care Management Forum*, 13/2, 12-32
- Stahl J.E., Sandberg E.S., Daily B., Wiklund R., Egan M.T., Goldman J.M., Isaacson K.B., Gazelle S., Rattner D.W. (2006), "Reorganizing patient care and workflow in the operating room: a cost-effectiveness study", *Surgery*, 139/6, 717-28
- Stakes (2006a), "Hyvinvointivaltion rajat. Hoivan ja hoidon taloudellinen kestävyys – Arvioita sosiaali- ja terveyspalveluiden kustannusten kehityksestä", Stakes, Helsinki
- Stakes (2006b), "Hilmo - Sosiaalihuollon ja terveydenhuollon hoitoilmoitus 2007 - Sairaaloiden hoitotoiminnan tuottavuus 2007", Stakes, Helsinki
- Stringer, J. (1967), "Operational research for multi-organisations", *Operational Research Quarterly*, 18/2, 105-120
- Strum D.P., May, J.H., Sampson, A.R., Vargas, L.G., Spangler, W.E. (2003), "Estimating times of surgeries with two component procedures: comparison of the lognormal and normal models", *Anesthesiology*, 98/1, 232-240
- Thorpe, K.E., Florence, C.S., Joski, P. (2004), "Which medical conditions account for the rise in health care spending?", *Health Affairs Web Exclusive*, W4, 437-445
- Tolkki, O., Parvinen, P. (2005), "Primary and Secondary Technologies in Radiology: a Lean Management Perspective", HCTM Conference, Aalborg, Denmark, 25-26th August 2005
- Torkki, P.M., Alho, A.I., Peltokorpi, A.V., Torkki, M.I., Kallio, P.E. (2006), "Managing urgent surgery as a process: Case study of a trauma centre", *International Journal of Technology Assessment in Health Care*, 22/2, 255-60
- Torkki, P.M., Ekroos, N., Brax, S. (2006), "Selvitys Hyvinkään vanhuspalveluiden hoitoketjusta". Teknillinen Korkeakoulu, HEMA instituutti
- Towill D.R., Christopher M. (2005), "An evolutionary approach to the architecture of effective healthcare delivery systems", *Journal of Health Organisations and Management*, 10/2, 130-147
- Towill, D.R., Christopher, M. (2003), "Designing Healthcare Delivery Systems", 8th International Symposium on Logistics, Paper no.6, Seville, Spain 6-8 July
- van Aken, J.E. (2004), "Management Research Based on the Model of the Design Sciences: The Quest for Field-Tested and Grounded Technological Rules", *Journal of Management Studies*, 41/2, 220-246
- van der Bij, J., Vissers, J. (1999), "Monitoring health-care processes: a framework for performance indicators", *International Journal of Health Care Quality Assurance*, 12/5, 214-221
- van der Maas, P. J., Meerding W. J., Bonneux L., Polder, J. J., Koopmanschap M. A. (1998), "Demographic and epidemiological determinants of healthcare costs in Netherlands: cost of illness study", *British Medical Journal*, 317/7151, 111-115

- van Merode, G.G., Groothuis, S. and Hasman, A. (2004), "Enterprise resource planning for hospitals", *International Journal of Medical Informatics*, 73/6, 493-501
- van Peurse, K.A, Pratt, M.J. Lawrence, S.R (1995), "Health management performance – A review of measures and indicators", *Accounting, Auditing & Accountability Journal*, 8/5, 34-70
- Vandaele, N. De Boeck L. (2003), "Advanced resource planning", *Robotics and Computer-Integrated Manufacturing*, 19/1, 211–218
- Ryhänen, F., Kymänen-Kurkela, E., Rysti, M., Valvanne, J., Vistala, V., Laakso-Salmenvaara, L., Allev, R., Meigas, K., Alanko, U., Autio A., Kekäköinen, K., Kjisik, H., Vauramo, E. (2007) "Uudistettu vanhustenhuolto – malliksi muille?, Teknillinen Korkeakoulu, HEMA insituutti, 2007
- Vissers, J.M.H, Rauner, M.S. (2002), "OR applied to health services: Planning for the future with scarce resources", *European Journal of Operational Research*. Editorial, 150/1, 1-2
- Vissers J.M.H., Bertrand J.W.M., De Vries G. (2001a), "A framework for production control in health care organisations", *Production Planning & Control*, 12/6, 591-604
- Vissers J.M.H., Van Der Bij J.D., Kusters R.J. (2001b), "Towards Decision Support for Waiting Lists: An Operations Management View", *Health Care Management Science*, 4/2, 133-142
- Vissers, J.M.H. (1998), "Health care management modeling: a process perspective", *Health Care Management Science*, 1/2, 77-85
- Vissers, J.M.H. (1998), "Patient flow-based allocation of inpatient resources: a case study", *European Journal of Operational Research*, 105/2, 356-370
- Vissers, J., Beech, R. (2005), "Health operations management - patient flow logistics in health care", *Routledge Health Management Series*, London & New York
- Wedig, G.J. (1990), "Hospital Capital Structure and Prospective Payments: Theory and Evidence of Hospital Behavior under Financial Risk", *Journal of Midwest Financial Association*, 19, 69-84
- Womack J.P. and Jones D.T. (1996), "Beyond Toyota: how to root out waste and pursue perfection", *Harvard Business Review*, 74/ 5, 140-153
- Womack, J.P. and Jones, D.T. (2003), "Lean Thinking", Simon & Schuster, London
- Yang, Shitao, McLaughlin, Curtis P., Vaughan, Robert W., Aluise, John J. (1992), "Factory Focus in Hospital-owned Ambulatory Surgery", *International Journal of Service Industry Management*, 3/4, 63-75
- Yasin, M., Zimmerman, L., Miller, P., Simmerer, T. (2002), "An empirical investigation of the effectiveness of contemporary managerial philosophies in a hospital operational setting", *International Journal of Health Care Quality Assurance*, 15/ 6-7, 268-276
- Young, T., Brailsford, S., Connell, C., Davies, R., Harper, P. and Klein, J.H. (2004), "Using industrial processes to improve patient care", *British Medical Journal*, 328/7432, 162-164
- Zelman W.N., Parham D.L. (1990), "Strategic, operational and marketing concerns of product-line management in health care", *Health Care Management Review*, 15/1, 29-35

7.1 EMPIRICAL REFERENCES

- Kuntaliitto (2005), Yksityislääkäreiden palkat 2003-2004.
- OECD Health Data (2006), A comparative analysis of 30 countries, 2006 edition (CD-ROM)
- Statistics Finland (2005). Kuntien tunnusluvut 2004.
- Statistics Finland (2006). Kuntien tunnusluvut 2005.
- Stakes, National Research and Development Centre for Welfare and Health (2006), Hoitoilmoitusrekisteri
- Stakes, National Research and Development Centre for Welfare and Health (2005a) Kymenlaakson terveystalujen käyttö 2002-2004, Hoitoilmoitusrekisteri
- Stakes, National Research and Development Centre for Welfare and Health (2005b), Sosiaali- ja terveydenhuollon henkilöstö sairaanhoitopiireittäin 2004
- Stakes, National Research and Development Centre for Welfare and Health (2005c) Sosiaali- ja terveydenhuollon henkilöstö ammattiryhmittäin ja tehtäväalueittain 2004.
- Stakes, National Research and Development Centre for Welfare and Health (2005d) Sosiaali- ja terveydenhuollon palvelutuottajat 2004.
- Tilastokeskus (2005) Väestö sairaanhoitopiireittäin ja ikäryhmittäin 31.12.2004.
- WHO Health for All Database 2007
- Toiminnallinen tilinpäätös (Annual Report) (2005), Elimäki municipality
- Toiminnallinen tilinpäätös (Annual Report) (2005), Hamina municipality

Toiminnallinen tilinpäätös (Annual Report) (2005), Kotka municipality

Toiminnallinen tilinpäätös (Annual Report) (2005), Kouvola municipality

Toiminnallinen tilinpäätös (Annual Report) (2005), Kotka municipality

Eläketurvakeskus (Finnish Centre for Pension), Kansaneläkelaitos (The Social Insurance Institution of Finland) (2006), Tilasto Suomen eläkkeensaajista
2005

A - I Cost coverage in Finnish health care (adopted from Stakes 2006a)

Note: The figure provides an overview of the funding mechanism for public health care funded by patients, citizens and employers (sum of %-shares from these amounts to 100%). Arrows from service providers sum to 94% and the remainder is social insurance refunds from the Social Insurance Institution of Finland to patients using private sector services (Stakes 2006a).

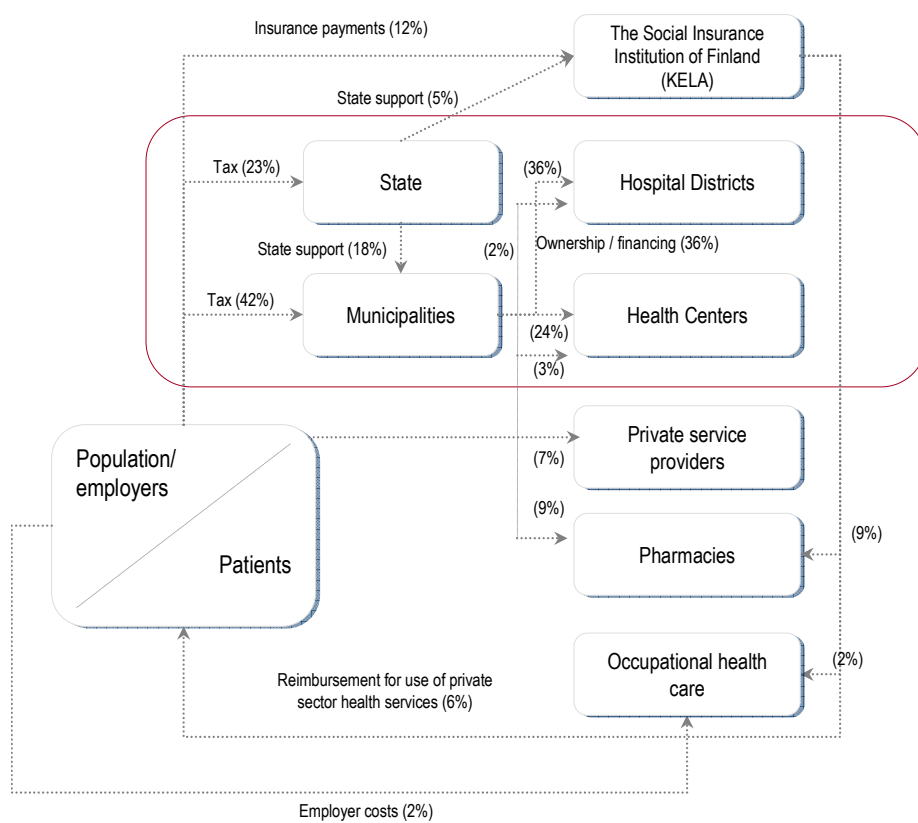

A - 2 - Finnish citizens' pension distribution as of year end 2005 (Halmeenmäki 2005)

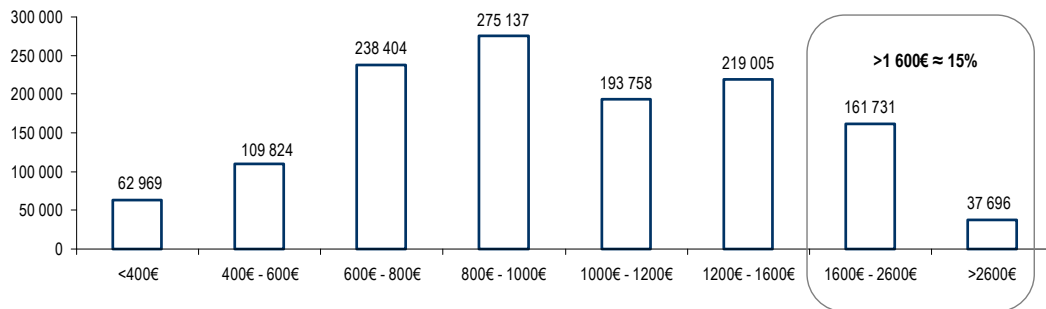

The average pension in Finland is about 1,000 euros (EUR) per month, and, out of 1,300,000 retired people in Finland only some 38,000 (some 2.8%) received a monthly pension exceeding 2,600 EUR in 2005. (Figure 3). Pensions are spent primarily on living expenses, food and clothing. They are not sufficient to cover private medical expenses, which are only partly covered by the health insurance system. Private medical procedures may only be financially feasible for a fraction of the elderly population. Given the current pension structure, it seems unlikely that elderly would be able to allocate a significant amount to health and social care services. Thus, the main responsibility for provision of health care service provision will remain with the public health care system.

A - 3 Demographic development estimates (Statistics Finland 2005)

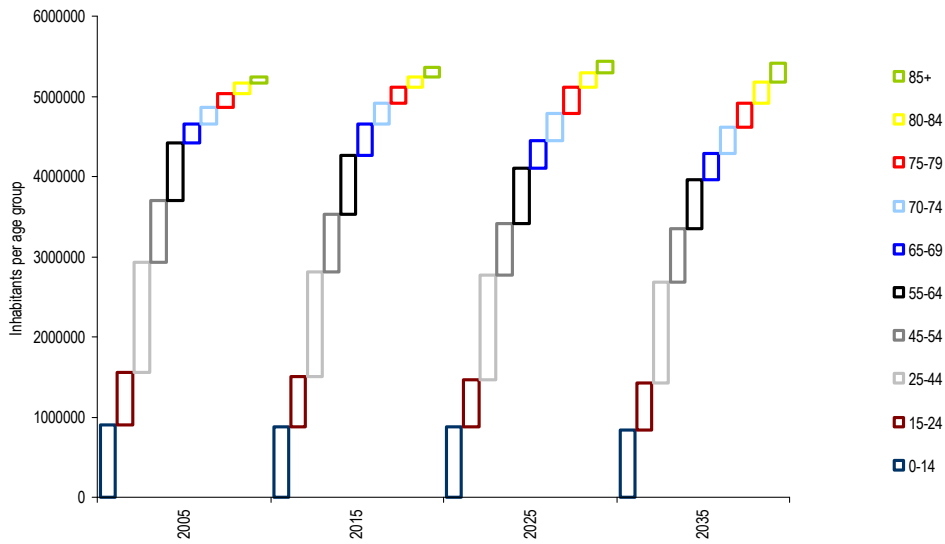

A - 4 Demographic development estimates 2005-2035, %-share per age group (Statistics Finland 2005)

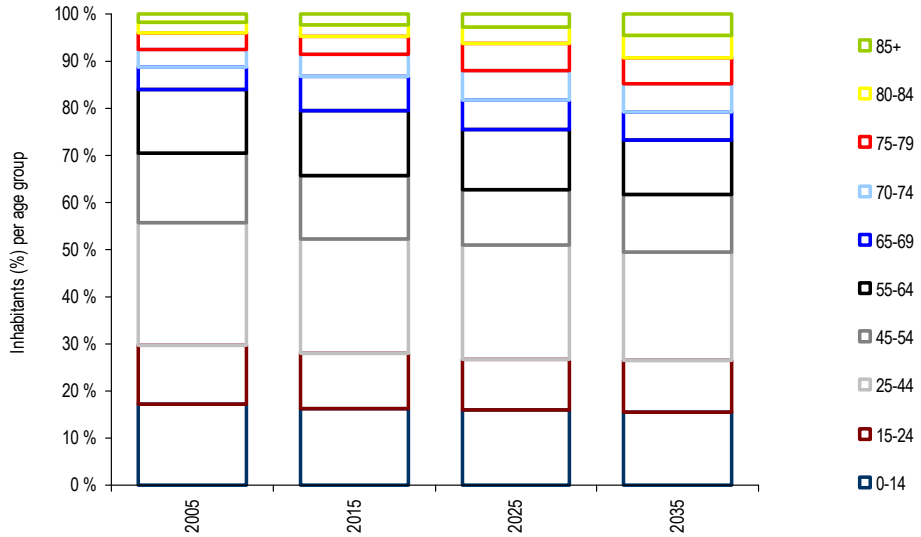

A - 5 ICPC-distribution for patients in different health service areas

	1	2	3	4	5	6	7	8	9	10
Musculoskeletal system	17,0 %	13,6 %	18,0 %	17,2 %	15,4 %	16,0 %	13,5 %	17,6 %	16,6 %	15,5 %
Respiratory	16,1 %	14,2 %	18,0 %	14,5 %	16,6 %	16,8 %	17,0 %	14,5 %	11,7 %	15,0 %
Mental health	18,4 %	6,1 %	9,8 %	10,3 %	4,4 %	8,1 %	8,9 %	4,1 %	6,7 %	12,0 %
Pregnancy / family	8,2 %	15,1 %	6,6 %	14,2 %	12,6 %	11,5 %	13,6 %	5,3 %	21,3 %	4,4 %
Skin	8,5 %	10,3 %	8,2 %	10,6 %	13,6 %	13,8 %	9,6 %	20,0 %	12,0 %	11,3 %
Digestive system	7,1 %	7,5 %	8,2 %	5,6 %	7,6 %	6,4 %	5,8 %	7,0 %	5,7 %	5,8 %
Gynaecological	4,3 %	9,5 %	4,9 %	8,1 %	6,9 %	8,8 %	12,2 %	11,0 %	10,0 %	17,2 %
General	4,9 %	3,2 %	6,6 %	4,9 %	4,7 %	4,7 %	3,9 %	4,9 %	3,4 %	2,6 %
Others	15,5 %	20,5 %	19,7 %	14,6 %	18,3 %	13,9 %	15,6 %	15,7 %	12,3 %	16,1 %

A - 6 Use of healthcare services by function in FSHS (2005)

	A	B	C	D	E	F	G	H	I	J	Min	Max	Avg
Medical services, doctors visits per student													
2001	0,61	0,68	0,68	0,95	0,64	0,86	0,79	0,71	0,99	0,67	0,61	0,99	0,76
2002	0,62	0,63	0,67	0,86	0,61	0,79	0,75	0,72	0,84	0,59	0,59	0,86	0,71
2003	0,60	0,59	0,67	0,78	0,59	0,79	0,73	0,66	0,77	0,64	0,59	0,79	0,68
2004	0,62	0,57	0,60	0,83	0,61	0,79	0,67	0,56	0,80	0,74	0,56	0,83	0,68
2005	0,58	0,59	0,62	0,69	0,60	0,72	0,62	0,51	0,70	0,65	0,51	0,72	0,63
Medical services, nurse visits per student													
2001	0,52	0,92	0,85	1,44	0,97	1,05	1,16	1,04	1,29	1,27	0,52	1,44	1,05
2002	0,50	0,87	0,81	1,33	0,93	0,89	0,81	1,04	1,20	1,31	0,50	1,33	0,97
2003	0,51	0,93	0,74	1,23	1,00	0,78	0,76	1,02	1,10	1,22	0,51	1,23	0,93
2004	0,53	0,85	0,73	1,13	0,97	0,77	0,74	1,00	0,89	1,09	0,53	1,13	0,87
2005	0,58	0,84	0,79	1,04	0,99	0,72	0,75	1,07	0,76	0,95	0,58	1,07	0,85
Dental services, dentists visits per student													
2001	0,81	0,76	0,76	0,85	0,87	0,95	0,65	0,91	0,80	0,98	0,65	0,98	0,83
2002	0,79	0,78	0,71	0,71	0,84	0,87	0,68	0,91	0,78	1,00	0,68	1,00	0,81
2003	0,81	0,88	0,72	0,84	0,85	0,92	0,72	0,90	0,70	0,93	0,70	0,93	0,83
2004	0,79	0,80	0,70	0,79	0,76	0,82	0,64	0,78	0,72	0,92	0,64	0,92	0,77
2005	0,77	0,68	0,75	0,95	0,65	0,80	0,80	0,52	0,74	0,68	0,52	0,95	0,73
Dental services, hygienist visits per student													
2001	0,16	0,15	0,15	0,21	0,20	0,15	0,03	-	0,25	0,18	0,03	0,25	0,16
2002	0,14	0,12	0,14	0,20	0,19	0,13	-	-	0,26	0,17	0,12	0,26	0,17
2003	0,17	0,11	0,14	0,16	0,18	0,14	-	-	0,23	0,16	0,11	0,23	0,16
2004	0,16	0,11	0,14	0,17	0,19	0,14	0,01	0,06	0,20	0,15	0,01	0,20	0,13
2005	0,19	0,11	0,13	0,11	0,18	0,13	0,09	0,19	0,16	0,15	0,09	0,19	0,14
Mental service visits per student													
2001	0,34	0,35	0,36	0,33	0,28	0,36	0,11	0,15	0,39	0,33	0,11	0,39	0,30
2002	0,36	0,37	0,38	0,29	0,30	0,39	0,14	0,15	0,32	0,33	0,14	0,39	0,30
2003	0,41	0,34	0,38	0,23	0,33	0,39	0,17	0,16	0,39	0,38	0,16	0,41	0,32
2004	0,48	0,33	0,43	0,24	0,34	0,41	0,20	0,16	0,44	0,39	0,16	0,48	0,34
2005	0,45	0,34	0,45	0,23	0,35	0,46	0,19	0,22	0,44	0,41	0,19	0,46	0,35

A - 7 FSHS key figures (2005)

	A	B	C	D	E	F	G	H	I	J	Min	Max	Avg
Medical services, doctors visits	29782	12506	12015	4824	7905	8852	3757	2240	3503	2711	2240	29782	8810
Total personnel (total work years)	24,6	9,5	9,9	2,6	5,6	6,7	3,0	1,1	2,3	1,7	1,1	24,6	6,7
Visits per direct personnel	1878	2043	1759	2353	2190	1954	1491	2732	2674	2085	1491	2732	2116
Visits per total personnel	1208	1314	1209	1846	1405	1321	1238	1971	1492	1587	1208	1971	1459
Indirect personnel per direct personnel	0,36x	0,36x	0,31x	0,22x	0,36x	0,32x	0,17x	0,28x	0,44x	0,24x	0,17x	0,44x	0,31x
Medical services, nurses visits	29976	17796	15155	7246	13128	8877	4562	4689	3810	3940	3810	29976	10918
Total personnel (total work years)	39,3	17,1	14,2	6,2	8,9	8,0	4,4	4,0	4,7	3,4	3,4	39,3	11,0
Visits per direct personnel	1165	1592	1508	1816	2149	1650	1260	1622	1460	1527	1165	2149	1575
Visits per total personnel	763	1043	1070	1163	1476	1115	1046	1171	814	1162	763	1476	1082
Indirect personnel per direct personnel	0,35x	0,34x	0,29x	0,36x	0,31x	0,32x	0,17x	0,28x	0,44x	0,24x	0,17x	0,44x	0,31x
Dental services, dentists visits	39831	14476	14448	6593	8645	9904	4876	2281	3711	2842	2281	39831	10761
Total personnel (total work years)	58,9	19,7	24,1	7,6	15,1	11,5	3,9	3,3	5,7	2,8	2,8	58,9	15,3
Visits per direct personnel	819	1006	909	1076	699	1078	1799	748	692	1341	692	1799	1017
Visits per total personnel	676	734	599	866	573	862	1249	685	648	1014	573	1249	791
Indirect personnel per direct personnel	0,17x	0,27x	0,34x	0,20x	0,18x	0,20x	0,31x	0,08x	0,06x	0,24x	0,06x	0,34x	0,21x
Dental services, dental hygienists visits	9 659	2 355	2 596	758	2 437	1 630	528	835	795	636	528	9 659	2 223
Total personnel (total work years)	4,7	2,1	4,4	-	-	0,9	-	1,1	-	1,3	0,9	4,7	2,4
Visits per direct personnel	2470	1539	898	-	-	2145	-	835	-	636	636	2470	1421
Visits per total personnel	2048	1122	592	-	-	1716	-	765	-	481	481	2048	1121
Indirect personnel per direct personnel	0,17x	0,27x	0,34x	-	-	0,20x	-	0,08x	-	0,24x	0,08x	0,34x	0,22x
Mental services	23 370	7 235	8 741	1 592	4 692	5 620	1 183	945	2 194	1 723	945	23 370	5 730
Total personnel (total work years)	29,7	11,2	11,6	1,3	5,5	6,4	1,0	1,3	2,4	1,4	1,0	29,7	7,2
Visits per direct personnel	831	782	822	1274	925	1018	1160	750	930	1222	750	1274	971
Visits per total personnel	787	645	757	1274	848	873	1160	750	930	1222	645	1274	924
Indirect personnel per direct personnel	0,05x	0,17x	0,08x	0,00x	0,08x	0,14x	0,00x	0,00x	0,00x	0,00x	0,00x	0,17x	0,05x

A - 8 Number of patients, accumulated bed days and average LOS of elderly care patients as of year-end 2005 (Stakes 2006)

No. of clients 31.12.2005	Elderly care institutions	Intensive service housing	Normal service housing	Health center hospitals	TOTAL	%-share
No information				71	71	0,1 %
Physical reasons	3094	1647	2201	3084	10026	14,8 %
Inability to self-care	5881	4643	2814	1023	14361	21,2 %
Movement disabilities	1604	1357	1490	532	4983	7,3 %
Nervous system reasons	428	462	100	94	1084	1,6 %
Memory deficiency	3816	4578	811	692	9897	14,6 %
Confusion	205	211	41	151	608	0,9 %
Communication disability	83	157	207	11	458	0,7 %
Psychic-social reasons	909	685	923	319	2836	4,2 %
Depression	125	163	176	55	519	0,8 %
Other psychiatric condition	426	491	381	239	1537	2,3 %
Drug related	56	87	110	96	349	0,5 %
Loneliness, unsafetyness	581	940	935	64	2520	3,7 %
Living problems	144	484	1434	46	2108	3,1 %
Lack of relatives	167	126	92	76	461	0,7 %
Nurse vacation	478	147	11	288	924	1,4 %
Rehabilitation	149	57	20	812	1038	1,5 %
Incident	23	19	29	327	398	0,6 %
Investigation and care of somatic condition	1319	243	126	12012	13700	20,2 %
Total	19488	16497	11901	19992	67878	100 %

Accumulated bed days, 31.12.2005	Elderly care institutions	Intensive service housing	Normal service housing	Health center hospitals	TOTAL	%-share
No information				31598	31598	0,1 %
Physical reasons	2341745	1354877	3780952	2237955	9715529	18,0 %
Inability to self-care	4251546	3173731	2689267	940887	11055431	20,5 %
Movement disabilities	1204303	1088222	2529792	417745	5240062	9,7 %
Nervous system reasons	370400	334671	105142	76357	866570	1,6 %
Memory deficiency	2735384	3043720	605420	489477	6874001	12,7 %
Confusion	166904	148606	27786	77570	420866	0,8 %
Communication disability	71852	322604	411436	5650	811542	1,5 %
Psychic-social reasons	900184	779870	1419191	240093	3339338	6,2 %
Depression	121153	163856	237078	29294	551381	1,0 %
Other psychiatric condition	570836	680083	589486	224775	2065180	3,8 %
Drug related	44441	116129	117189	12487	290246	0,5 %
Loneliness, unsafetyness	378644	1229557	1211390	16165	2835756	5,2 %
Living problems	140627	654850	3230820	19386	4045683	7,5 %
Lack of relatives	89538	99698	119500	26341	335077	0,6 %
Nurse vacation	82758	18895	7046	54114	162813	0,3 %
Rehabilitation	68674	36491	39453	199218	343836	0,6 %
Incident	15378	17508	49406	98252	180544	0,3 %
Investigation and care of somatic condition	599718	133281	104112	4036305	4873416	9,0 %
Total	14154085	13396649	17274466	9233669	54058869	100 %

Average length of stay, 31.12.2005	Elderly care institutions	Intensive service housing	Normal service housing	Health center inpatient departments	TOTAL	%-share
No information				445	445	445
Physical reasons	757	823	1718	726	4023	1609
Inability to self-care	723	684	956	920	3282	1313
Movement disabilities	751	802	1698	785	4036	1614
Nervous system reasons	865	724	1051	812	3454	1381
Memory deficiency	717	665	747	707	2836	1134
Confusion	814	704	678	514	2710	1084
Communication disability	866	2055	1988	514	5422	2169
Psychic-social reasons	990	1138	1538	753	4419	1768
Depression	969	1005	1347	533	3854	1542
Other psychiatric condition	1340	1385	1547	940	5213	2085
Drug related	794	1335	1065	130	3324	1330
Loneliness, unsafetyness	652	1308	1296	253	3508	1403
Living problems	977	1353	2253	421	5004	2002
Lack of relatives	536	791	1299	347	2973	1189
Nurse vacation	173	129	641	188	1130	452
Rehabilitation	461	640	1973	245	3319	1328
Incident	669	921	1704	300	3594	1438
Investigation and care of somatic condition	455	548	826	336	2165	866
Total	750	945	1351	519	3406	1376

A - 9 Numbered hospital districts

- 3 Varsinais-Suomi hospital district
- 4 Satakunta hospital district
- 5 Kanta-Häme hospital district
- 6 Pirkanmaa hospital district
- 7 Päijät-Häme hospital district
- 8 Kymenlaakso hospital district
- 9 Etelä-Karjala hospital district
- 10 Etelä-Savo hospital district
- 11 Itä-Savo hospital district
- 12 Pohjois-Karjala hospital district
- 13 Pohjois-Savo hospital district
- 14 Keski-Suomi hospital district
- 15 Etelä-Pohjanmaa hospital district
- 16 Vaasa hospital district
- 17 Keski-Pohjanmaa hospital district
- 18 Pohjois-Pohjanmaa hospital district
- 19 Kainuu hospital district
- 20 Länsi-Pohja hospital district
- 21 Lappi hospital district
- 22 Ahvenanmaa hospital district
- 25 Helsinki and Uusimaa hospital district

A - 10 Distribution of clients' care need categorization in different service types in Finnish hospital districts- patients at the end of 2005

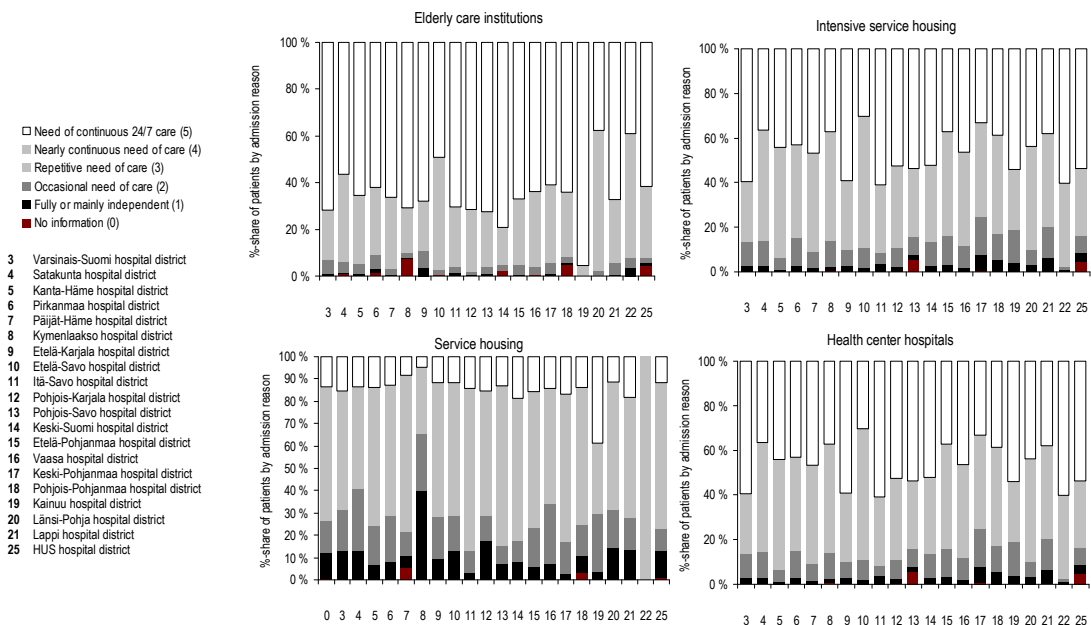

A - II Reason for admission to health centre hospitals – patients at the end of 2005

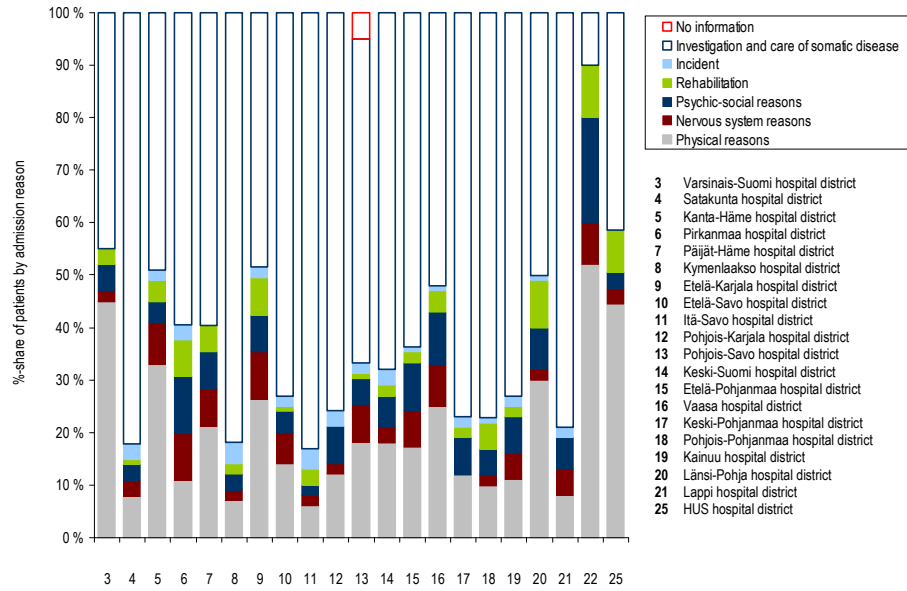

A - 12 Number of customers by care categorization per service type and region, year-end 2005

Region / hospital district	Elderly care institutions	Intensive service housing	Normal service housing	Health center hospital	Region / hospital district	Elderly care institutions	Intensive service housing	Normal service housing	Health center hospital
0 = No information					3 = Repetitive need of care				
Whole country	389	67	86	256	Whole country	2542	2694	4665	3662
Varsinais-Suomi	5		1		Varsinais-Suomi	149	264	378	158
Satakunta	13	1			Satakunta	231	75	132	203
Kanta-Häme					Kanta-Häme	99	52	177	105
Pirkanmaa	37			1	Pirkanmaa	333	116	314	349
Päijät-Häme			29	1	Päijät-Häme	59	68	197	274
Kymenlaakso	53			2	Kymenlaakso	48	132	72	177
Etelä-Karjala					Etelä-Karjala	42	66	84	120
Etelä-Savo	3				Etelä-Savo	91	73	128	90
Itä-Savo					Itä-Savo	27	108	38	47
Pohjois-Karjala			1		Pohjois-Karjala	62	54	162	169
Pohjois-Savo				64	Pohjois-Savo	67	90	216	179
Keski-Suomi	23				Keski-Suomi	79	84	146	200
Etelä-Pohjanmaa				1	Etelä-Pohjanmaa	120	139	309	259
Vaasa	2				Vaasa	100	174	42	152
Keski-Pohjanmaa				2	Keski-Pohjanmaa	47	73	70	81
Pohjois-Pohjanmaa	56	65	16		Pohjois-Pohjanmaa	100	141	194	221
Kainuu					Kainuu		66	44	56
Länsi-Pohja					Länsi-Pohja	61	45	36	40
Lappi					Lappi	30	49	56	106
Ahvenanmaa					Ahvenanmaa	33	5		12
Helsinki & Uusimaa	394	2	78	370	Helsinki & Uusimaa	1528	1640	3740	1326
Total	975	135	211	697	Total	5848	6208	11200	7986
1 = Totally or nearly independent					4 = Nearly continuous need of care				
Whole country	192	679	1355	629	Whole country	2971	2489	2460	3972
Varsinais-Suomi	20	153	142	36	Varsinais-Suomi	305	248	206	188
Satakunta	8	47	50	27	Satakunta	269	127	49	229
Kanta-Häme	11	12	33	6	Kanta-Häme	167	64	124	159
Pirkanmaa	46	28	77	47	Pirkanmaa	422	101	233	326
Päijät-Häme	3	8	28	22	Päijät-Häme	61	76	169	335
Kymenlaakso	5	10	194	18	Kymenlaakso	91	125	72	207
Etelä-Karjala	16	7	24	19	Etelä-Karjala	57	50	67	82
Etelä-Savo	1	5	46	10	Etelä-Savo	142	72	83	245
Itä-Savo	5	16	3	14	Itä-Savo	59	22	29	73
Pohjois-Karjala	3	1	110	26	Pohjois-Karjala	78	73	193	219
Pohjois-Savo	8	1	50	28	Pohjois-Savo	108	135	266	187
Keski-Suomi	1	39	43	32	Keski-Suomi	85	112	176	198
Etelä-Pohjanmaa	7	12	54	34	Etelä-Pohjanmaa	119	163	213	257
Vaasa	3	77	10	19	Vaasa	114	202	27	188
Keski-Pohjanmaa	3	9	5	18	Keski-Pohjanmaa	35	116	48	27
Pohjois-Pohjanmaa	7	16	47	62	Pohjois-Pohjanmaa	212	160	161	263
Kainuu		18	6	16	Kainuu	1	105	10	47
Länsi-Pohja		5	15	10	Länsi-Pohja	33	40	24	96
Lappi	2	6	20	37	Lappi	49	105	24	122
Ahvenanmaa	4	4		1	Ahvenanmaa	27	5	1	19
Helsinki & Uusimaa	78	410	796	294	Helsinki & Uusimaa	1074	774	570	1004
Total	423	1563	3108	1405	Total	6479	5364	5205	8443
2 = In temporary need of care					5 = Continuous (24h) need of care				
Whole country	742	1010	1742	1927	Whole country	12652	9558	1593	9546
Varsinais-Suomi	125	113	199	136	Varsinais-Suomi	1528	715	166	765
Satakunta	64	31	113	99	Satakunta	761	582	53	319
Kanta-Häme	40	17	84	26	Kanta-Häme	605	306	68	235
Pirkanmaa	148	50	195	197	Pirkanmaa	1611	433	121	693
Päijät-Häme	9	20	56	104	Päijät-Häme	259	447	44	647
Kymenlaakso	15	40	121	91	Kymenlaakso	515	448	23	295
Etelä-Karjala	35	17	46	47	Etelä-Karjala	320	212	29	390
Etelä-Savo	10	25	56	53	Etelä-Savo	239	270	42	174
Itä-Savo	9	52	9	18	Itä-Savo	238	128	13	237
Pohjois-Karjala	8	15	70	91	Pohjois-Karjala	379	236	98	563
Pohjois-Savo	22	18	53	94	Pohjois-Savo	542	487	89	638
Keski-Suomi	25	48	45	124	Keski-Suomi	808	555	94	604
Etelä-Pohjanmaa	35	62	148	142	Etelä-Pohjanmaa	567	341	133	412
Vaasa	24	89	36	75	Vaasa	426	389	19	373
Keski-Pohjanmaa	11	27	26	44	Keski-Pohjanmaa	150	255	30	85
Pohjois-Pohjanmaa	34	34	80	129	Pohjois-Pohjanmaa	730	654	81	429
Kainuu		27	45	57	Kainuu	21	459	66	206
Länsi-Pohja	4	9	18	20	Länsi-Pohja	59	258	12	130
Lappi	14	16	21	75	Lappi	194	332	27	209
Ahvenanmaa	5	5		1	Ahvenanmaa	44	52		50
Helsinki & Uusimaa	210	590	642	606	Helsinki & Uusimaa	5310	3998	770	4184
Total	1589	2315	3805	4156	Total	27958	21115	3571	21184

A - 13 Percentage share of customers by care categorization per service type and region –end of 2005

Region / hospital district	Elderly care institutions	Intensive service housing	Normal service housing	Health center hospital	Region / hospital district	Elderly care institutions	Intensive service housing	Normal service housing	Health center hospital
0 = No information					3 = Repetitive need of care				
Whole country	2.0 %	0.4 %	0.7 %	1.3 %	Whole country	13.0 %	16.3 %	39.2 %	18.3 %
Varsinais-Suomi	0.2 %	0.0 %	0.1 %	0.0 %	Varsinais-Suomi	7.0 %	17.7 %	34.6 %	12.3 %
Satakunta	1.0 %	0.1 %	0.0 %	0.0 %	Satakunta	17.2 %	8.7 %	33.2 %	23.1 %
Kanta-Häme	0.0 %	0.0 %	0.0 %	0.0 %	Kanta-Häme	10.7 %	11.5 %	36.4 %	19.8 %
Pirkanmaa	1.4 %	0.0 %	0.0 %	0.1 %	Pirkanmaa	12.8 %	15.9 %	33.4 %	21.6 %
Päijät-Häme	0.0 %	0.0 %	5.5 %	0.1 %	Päijät-Häme	15.1 %	11.0 %	37.7 %	19.8 %
Kymenlaakso	7.3 %	0.0 %	0.0 %	0.3 %	Kymenlaakso	6.6 %	17.5 %	14.9 %	22.4 %
Etelä-Karjala	0.0 %	0.0 %	0.0 %	0.0 %	Etelä-Karjala	8.9 %	18.8 %	33.6 %	18.2 %
Etelä-Savo	0.6 %	0.0 %	0.0 %	0.0 %	Etelä-Savo	18.7 %	16.4 %	36.1 %	15.7 %
Itä-Savo	0.0 %	0.0 %	0.0 %	0.0 %	Itä-Savo	8.0 %	33.1 %	41.3 %	12.1 %
Pohjois-Karjala	0.0 %	0.0 %	0.2 %	0.0 %	Pohjois-Karjala	11.7 %	14.2 %	25.6 %	15.8 %
Pohjois-Savo	0.0 %	0.0 %	0.0 %	5.4 %	Pohjois-Savo	9.0 %	12.3 %	32.0 %	15.0 %
Keski-Suomi	2.3 %	0.0 %	0.0 %	0.0 %	Keski-Suomi	7.7 %	10.0 %	29.0 %	17.3 %
Etelä-Pohjanmaa	0.0 %	0.0 %	0.0 %	0.1 %	Etelä-Pohjanmaa	14.2 %	19.4 %	36.1 %	23.4 %
Vaasa	0.3 %	0.0 %	0.0 %	0.0 %	Vaasa	14.9 %	18.7 %	31.3 %	18.8 %
Keski-Pohjanmaa	0.0 %	0.0 %	0.0 %	0.8 %	Keski-Pohjanmaa	19.1 %	15.2 %	39.1 %	31.5 %
Pohjois-Pohjanmaa	4.9 %	6.1 %	2.8 %	0.0 %	Pohjois-Pohjanmaa	8.8 %	13.2 %	33.5 %	20.0 %
Kainuu	0.0 %	0.0 %	0.0 %	0.0 %	Kainuu	0.0 %	9.8 %	25.7 %	14.7 %
Länsi-Pohja	0.0 %	0.0 %	0.0 %	0.0 %	Länsi-Pohja	38.9 %	12.6 %	34.3 %	13.5 %
Lappi	0.0 %	0.0 %	0.0 %	0.0 %	Lappi	10.4 %	9.6 %	37.8 %	19.3 %
Ahvenanmaa	0.0 %	0.0 %	0.0 %	0.0 %	Ahvenanmaa	29.2 %	7.0 %	0.0 %	14.5 %
Helsinki & Uusimaa	4.6 %	0.0 %	1.2 %	4.8 %	Helsinki & Uusimaa	17.8 %	22.1 %	56.7 %	17.0 %
Average	1,1 %	0,3 %	0,5 %	0,5 %	Average	13,7 %	15,0 %	32,5 %	18,4 %
1 = Totally or nearly independent					4 = Nearly continuous need of care				
Whole country	1.0 %	4.1 %	11.4 %	3.1 %	Whole country	15.2 %	15.1 %	20.7 %	19.9 %
Varsinais-Suomi	0.9 %	10.2 %	13.0 %	2.8 %	Varsinais-Suomi	14.3 %	16.6 %	18.9 %	14.7 %
Satakunta	0.6 %	5.4 %	12.6 %	3.1 %	Satakunta	20.0 %	14.7 %	12.3 %	26.1 %
Kanta-Häme	1.2 %	2.7 %	6.8 %	1.1 %	Kanta-Häme	18.1 %	14.2 %	25.5 %	29.9 %
Pirkanmaa	1.8 %	3.8 %	8.2 %	2.9 %	Pirkanmaa	16.2 %	13.9 %	24.8 %	20.2 %
Päijät-Häme	0.8 %	1.3 %	5.4 %	1.6 %	Päijät-Häme	15.6 %	12.3 %	32.3 %	24.2 %
Kymenlaakso	0.7 %	1.3 %	40.2 %	2.3 %	Kymenlaakso	12.5 %	16.6 %	14.9 %	26.2 %
Etelä-Karjala	3.4 %	2.0 %	9.6 %	2.9 %	Etelä-Karjala	12.1 %	14.2 %	26.8 %	12.5 %
Etelä-Savo	0.2 %	1.1 %	13.0 %	1.7 %	Etelä-Savo	29.2 %	16.2 %	23.4 %	42.8 %
Itä-Savo	1.5 %	4.9 %	3.3 %	3.6 %	Itä-Savo	17.5 %	6.7 %	31.5 %	18.8 %
Pohjois-Karjala	0.6 %	0.3 %	17.4 %	2.4 %	Pohjois-Karjala	14.7 %	19.3 %	30.4 %	20.5 %
Pohjois-Savo	1.1 %	0.1 %	7.4 %	2.4 %	Pohjois-Savo	14.5 %	18.5 %	39.5 %	15.7 %
Keski-Suomi	0.1 %	4.7 %	8.5 %	2.8 %	Keski-Suomi	8.3 %	13.4 %	34.9 %	17.1 %
Etelä-Pohjanmaa	0.8 %	1.7 %	6.3 %	3.1 %	Etelä-Pohjanmaa	14.0 %	22.7 %	24.9 %	23.3 %
Vaasa	0.4 %	8.3 %	7.5 %	2.4 %	Vaasa	17.0 %	21.7 %	20.1 %	23.3 %
Keski-Pohjanmaa	1.2 %	1.9 %	2.8 %	7.0 %	Keski-Pohjanmaa	14.2 %	24.2 %	26.8 %	10.5 %
Pohjois-Pohjanmaa	0.6 %	1.5 %	8.1 %	5.6 %	Pohjois-Pohjanmaa	18.6 %	15.0 %	27.8 %	23.8 %
Kainuu	0.0 %	2.7 %	3.5 %	4.2 %	Kainuu	4.5 %	15.6 %	5.8 %	12.3 %
Länsi-Pohja	0.0 %	1.4 %	14.3 %	3.4 %	Länsi-Pohja	21.0 %	11.2 %	22.9 %	32.4 %
Lappi	0.7 %	1.2 %	13.5 %	6.7 %	Lappi	17.0 %	20.7 %	16.2 %	22.2 %
Ahvenanmaa	3.5 %	5.6 %	0.0 %	1.2 %	Ahvenanmaa	23.9 %	7.0 %	100.0 %	22.9 %
Helsinki & Uusimaa	0.9 %	5.5 %	12.1 %	3.8 %	Helsinki & Uusimaa	12.5 %	10.4 %	8.6 %	12.9 %
Average	1,0 %	3,2 %	10,2 %	3,2 %	Average	16,0 %	15,5 %	27,1 %	21,5 %
2 = In temporary need of care					5 = Continuous (24) need of care				
Whole country	3.8 %	6.1 %	14.6 %	9.6 %	Whole country	64.9 %	57.9 %	13.4 %	47.7 %
Varsinais-Suomi	5.9 %	7.6 %	18.2 %	10.6 %	Varsinais-Suomi	71.7 %	47.9 %	15.2 %	59.6 %
Satakunta	4.8 %	3.6 %	28.5 %	11.3 %	Satakunta	56.5 %	67.4 %	13.4 %	36.4 %
Kanta-Häme	4.3 %	3.8 %	17.3 %	4.9 %	Kanta-Häme	65.6 %	67.8 %	14.0 %	44.3 %
Pirkanmaa	5.7 %	6.9 %	20.7 %	12.2 %	Pirkanmaa	62.0 %	59.5 %	12.9 %	43.0 %
Päijät-Häme	2.3 %	3.2 %	10.7 %	7.5 %	Päijät-Häme	66.2 %	72.2 %	8.4 %	46.8 %
Kymenlaakso	2.1 %	5.3 %	25.1 %	11.5 %	Kymenlaakso	70.8 %	59.3 %	4.8 %	37.3 %
Etelä-Karjala	7.4 %	4.8 %	18.4 %	7.1 %	Etelä-Karjala	68.1 %	60.2 %	11.6 %	59.3 %
Etelä-Savo	2.1 %	5.6 %	15.8 %	9.3 %	Etelä-Savo	49.2 %	60.7 %	11.8 %	30.4 %
Itä-Savo	2.7 %	16.0 %	9.8 %	4.6 %	Itä-Savo	70.4 %	39.3 %	14.1 %	60.9 %
Pohjois-Karjala	1.5 %	4.0 %	11.0 %	8.5 %	Pohjois-Karjala	71.5 %	62.3 %	15.5 %	52.7 %
Pohjois-Savo	2.9 %	2.5 %	7.9 %	7.9 %	Pohjois-Savo	72.6 %	66.6 %	13.2 %	53.6 %
Keski-Suomi	2.4 %	5.7 %	8.9 %	10.7 %	Keski-Suomi	79.1 %	66.2 %	18.7 %	52.2 %
Etelä-Pohjanmaa	4.1 %	8.6 %	17.3 %	12.9 %	Etelä-Pohjanmaa	66.9 %	47.6 %	15.5 %	37.3 %
Vaasa	3.6 %	9.6 %	26.9 %	9.3 %	Vaasa	63.7 %	41.8 %	14.2 %	46.2 %
Keski-Pohjanmaa	4.5 %	5.6 %	14.5 %	17.1 %	Keski-Pohjanmaa	61.0 %	53.1 %	16.8 %	33.1 %
Pohjois-Pohjanmaa	3.0 %	3.2 %	13.8 %	11.7 %	Pohjois-Pohjanmaa	64.1 %	61.1 %	14.0 %	38.9 %
Kainuu	0.0 %	4.0 %	26.3 %	14.9 %	Kainuu	95.5 %	68.0 %	38.6 %	53.9 %
Länsi-Pohja	2.5 %	2.5 %	17.1 %	6.8 %	Länsi-Pohja	37.6 %	72.3 %	11.4 %	43.9 %
Lappi	4.8 %	3.1 %	14.2 %	13.7 %	Lappi	67.1 %	65.4 %	18.2 %	38.1 %
Ahvenanmaa	4.4 %	7.0 %	0.0 %	1.2 %	Ahvenanmaa	38.9 %	73.2 %	0.0 %	60.2 %
Helsinki & Uusimaa	2.4 %	8.0 %	9.7 %	7.8 %	Helsinki & Uusimaa	61.8 %	53.9 %	11.7 %	53.8 %
Average	3,5 %	5,7 %	15,8 %	9,6 %	Average	64,8 %	60,3 %	14,0 %	46,8 %

A - 14 Model for combining production process and financial analysis

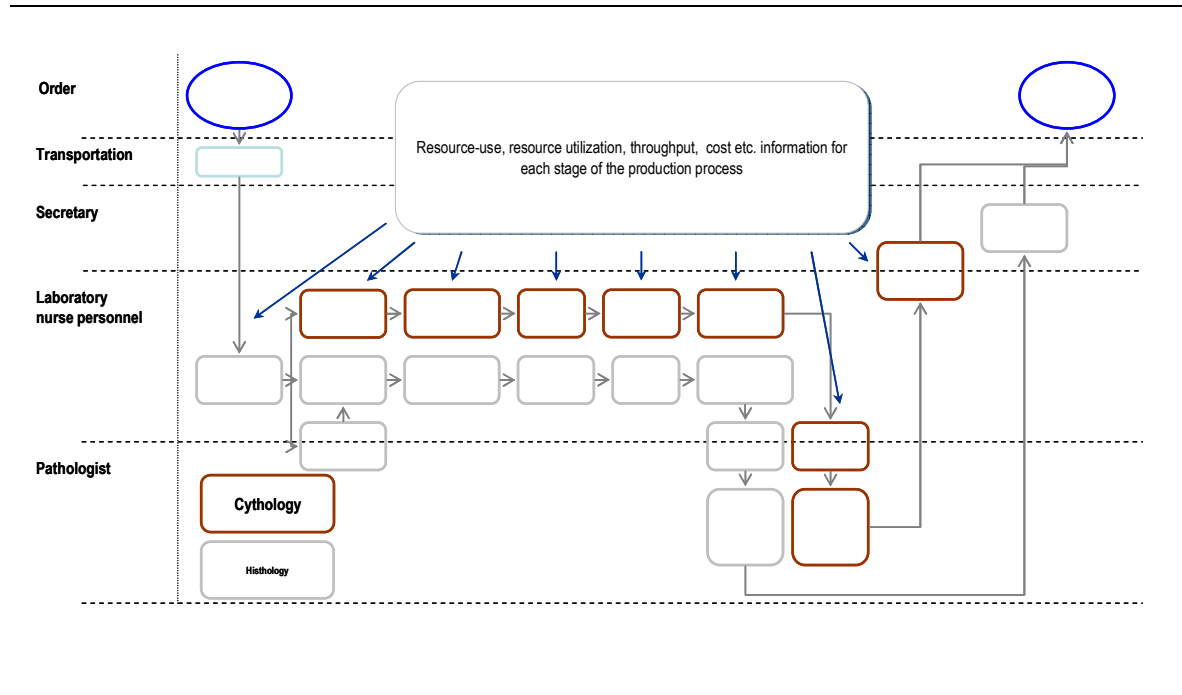

A - 15 Special care inpatient care estimates (2005-2035)

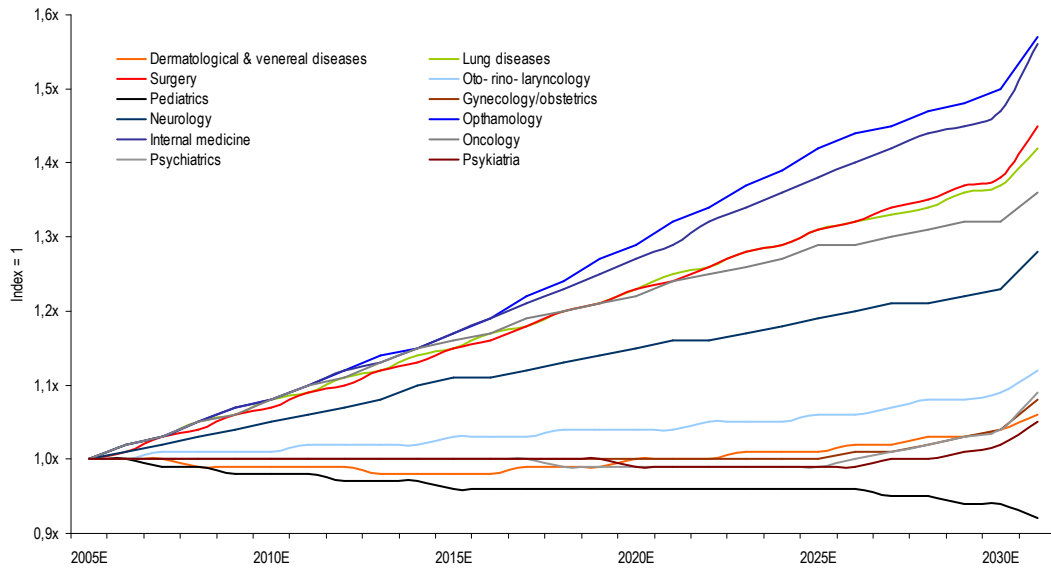

A - 16 Estimated changes in secondary care procedures (2005-2035)

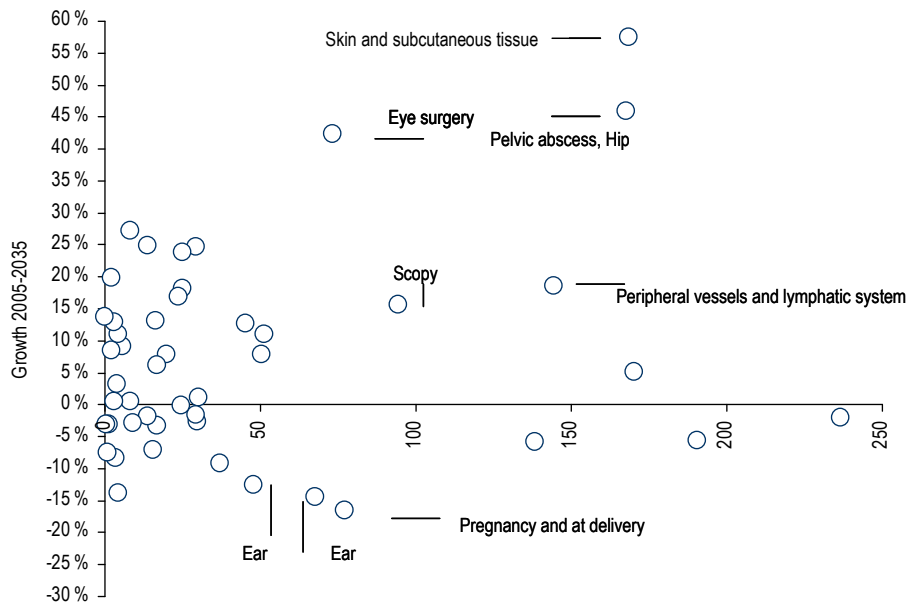

A - 17 Distribution of total use of inpatient days in primary and special care of selected patients (Stakes 2006)

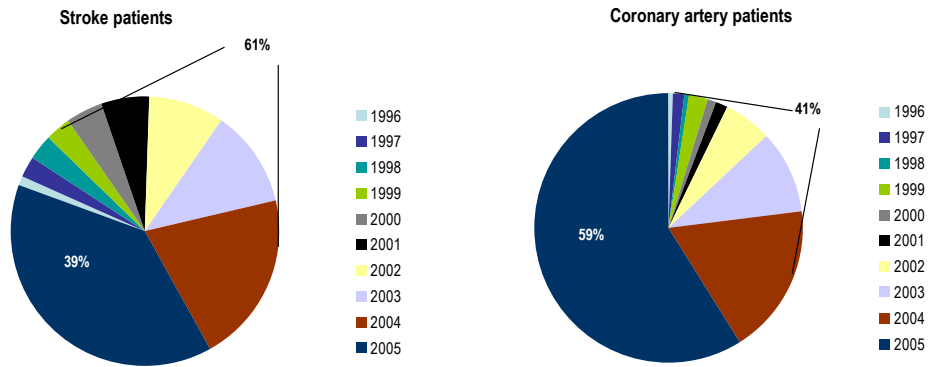

A - 18 Distribution of total use of inpatient days in primary and special care of selected patients (Stakes 2006 and Kymenlaakso municipalities and hospital district)

