

1-2016

# Evaluation of Poisson's Ratio of Asphalt Concrete

Elvis Alexander Castillo Camarena  
*University of Arkansas, Fayetteville*

Follow this and additional works at: <http://scholarworks.uark.edu/etd>



Part of the [Transportation Engineering Commons](#)

---

## Recommended Citation

Camarena, Elvis Alexander Castillo, "Evaluation of Poisson's Ratio of Asphalt Concrete" (2016). *Theses and Dissertations*. 1467.  
<http://scholarworks.uark.edu/etd/1467>

This Thesis is brought to you for free and open access by ScholarWorks@UARK. It has been accepted for inclusion in Theses and Dissertations by an authorized administrator of ScholarWorks@UARK. For more information, please contact [scholar@uark.edu](mailto:scholar@uark.edu), [ccmiddle@uark.edu](mailto:ccmiddle@uark.edu).

Evaluation of Poisson's Ratio of Asphalt Concrete

A thesis submitted in partial fulfillment  
of the requirement for the degree of  
Master of Science in Civil Engineering

by

Elvis Alexander Castillo Camarena  
Technological University of Panama  
Bachelor of Science in Civil Engineering, 2010

May 2016  
University of Arkansas

This thesis is approved for recommendation to the Graduate Council

---

Andrew F. Braham, Ph.D., P.E.  
Thesis Director

---

Kevin D. Hall, Ph.D., P.E.  
Committee Member

---

Ernest Heymsfield, Ph.D., P.E.  
Committee Member

## ABSTRACT

Poisson's ratio can be defined as the negative ratio of strains perpendicular to the load direction to the strains parallel to the loading direction. If elastic or viscoelastic models are used, Poisson's ratio, together with elastic modulus, is a main input used to predict distresses in flexible pavement structures such as rutting and cracking. In asphalt concrete, Poisson's ratio is commonly measured using two different testing configurations: indirect tension (IDT) and uniaxial. However, results from these two testing configurations can potentially have differences. Design methodologies such as the Mechanistic Empirical Design Guide (MEPDG, now PavementME) have been shown to be very sensitive to variations of Poisson's ratio. The objective of this research is to determine whether or not there are significant differences between the values of Poisson's ratio measured in indirect tension configuration and uniaxial configuration. This work also aims to investigate the potential variations of values of Poisson's ratio among a number of asphalt mixtures treated with different types of asphalt modifiers: polyphosphoric acid (PPA) alone and in combination with liquid anti-stripping agent (LAA). Cylindrical shaped samples specified in AASHTO T 342 were used to measure Poisson's ratio in uniaxial configuration, and disc shaped samples specified in AASHTO T 322 were used to measure Poisson's ratio in an IDT configuration. Samples were tested at each combination at the following temperatures, -10 °C, 4 °C, 21 °C, 37 °C, and 54 °C, and frequencies, 25 Hz, 10 Hz, 5 Hz, 1 Hz, 0.5 Hz, and 0.1 Hz. No statistical difference was found in values of Poisson's ratio measured within each testing configuration. IDT Poisson's ratio were significantly different to those of uniaxial configuration (3:1). This reduction of Poisson's ratio by about 60% could lead to an increment of predicted distresses, such as longitudinal cracking, using PavementME by more than 400% of its design limit.

© by Elvis Castillo  
All Rights Reserved

## **ACKNOWLEDGMENTS**

Thanks to my wife, Lourdes, and my family and friends who have supported and believed in me through my entire life.

Thanks to my advisor, Dr. Andrew Braham, and my committee, Dr. Kevin Hall and Dr. Ernie Heymsfield. Their guidance was invaluable.

Thanks to Shu Yang, who has been my guidance and support in the laboratory of asphalt pavements of the University of Arkansas. Shu, I am enormously grateful for you being willing to help me whenever I needed it.

Thanks to Airam Morales, Leslie Parker, and the rest of graduate and undergraduate students that worked in the laboratory who, through their support and hard work, helped in many ways in the culmination of this work.

Thanks to the Arkansas State Highway and Transportation Department (AHTD) for the generous support of this work through project TRC1501 "Performance of Asphalts Modified with Polyphosphoric Acid (PPA)."

## **DEDICATION**

This thesis is gratefully dedicated to God Almighty, and my beloved wife, Lourdes.

## TABLE OF CONTENTS

I.	INTRODUCTION.....	1
II.	BACKGROUND.....	2
III.	MATERIALS AND METHODS .....	8
IV.	RESULTS.....	9
V.	DISCUSSION.....	16
VI.	CONCLUSIONS .....	17
	REFERENCES.....	19

## LIST OF TABLES

TABLE 1 Typical Values of Poisson’s Ratio for Varying Temperatures. ....	4
TABLE 2 Values of Poisson’s Ratio for level 3 according to NCHRP 1-37A. ....	4
TABLE 3 Average values of Poisson’s ratio for each testing temperature. ....	13
TABLE 4 Summary of Statistical Analysis. ....	15

## LIST OF FIGURES

FIGURE 1 (a) Specimen tested in uniaxial configuration, (b) Specimen tested in indirect tension configuration. ....	2
FIGURE 2 Burger’s mechanical model. ....	3
FIGURE 3 Deformations caused by a uniaxial load (Maher et al., 2008) ....	5
FIGURE 4 Stress pattern caused by loads in indirect tension configuration (Kim et al., 2004) ....	6
FIGURE 5 Master curves of Dynamic Modulus in IDT configuration. ....	11
FIGURE 6 Master curves of Dynamic Modulus in uniaxial configuration ....	12
FIGURE 7 Master curves of Poisson’s ratio in IDT configuration ....	13
FIGURE 8 Master curves of Poisson’s ratio in uniaxial configuration. ....	14
FIGURE 9 Poisson’s ratio: IDT vs Uniaxial. ....	14
FIGURE 10 Equality line – IDT Poisson’s ratio vs. Uniaxial Poisson’s ratio. ....	15
FIGURE 11 Poisson’s ratio vs. Dynamic Modulus – PG 64-22 + 0.5%PPA. ....	16



## I. INTRODUCTION

Poisson's ratio can be defined as the negative ratio of strains perpendicular to the load direction to the strains parallel to the loading direction. If elastic or viscoelastic models are used, Poisson's ratio, together with elastic modulus, is a main input used to predict distresses in flexible pavement structures such as rutting and cracking (Taherkani *et al.*, 2008). Moreover, distress predictions in methodologies such as the one used by the Mechanistic Empirical Pavement Design Guide (MEPDG) have been shown to be significantly sensitive to variations in Poisson's ratio (Maher *et al.*, 2008). Poisson's ratio was classified as a hypersensitive input in the MEPDG software by The National Cooperative Highway Research Program (NCHRP) for new asphalt concrete over stiff foundation (Schwartz *et al.*, 2011). Schwartz and his team found that, for example, a decrease in 10% of the value of Poisson's ratio may increase the longitudinal cracking in a new installed asphalt concrete by approximately 69% compared to the limit allowable value of longitudinal cracking. Values of creep compliance can also be affected if values of Poisson's ratio are inaccurately assumed (Lee *et al.*, 2009).

Currently, there are two commonly used test configurations to measure the Poisson's ratio of asphalt concrete in laboratory: the uniaxial test, which usually is performed using cylindrical samples, and the indirect tension test, which uses disc-shaped samples. Beside the sample shape and size, those tests have other significant differences that include instrumentation and loading direction vs. compaction direction. In the uniaxial configuration, the load is applied in the direction in which the samples were compacted, while the load is applied perpendicular to the compaction direction in samples tested in the indirect tension test. This is especially important due to the anisotropic nature of asphalt concrete. The change in geometry also creates a different set of mathematic formulations used to compute the Poisson's ratio in asphalt concrete. Figure 1 shows specimens tested in both uniaxial and indirect tension. The factors mentioned above may lead to discrepancies in values of Poisson's ratio calculated from one test configuration to another. In addition, mixtures with modified binders may produce variations in Poisson's ratio values since the viscoelastic nature of the asphalt concrete is influenced by the binder itself (Kassem *et al.*, 2013).



(a)

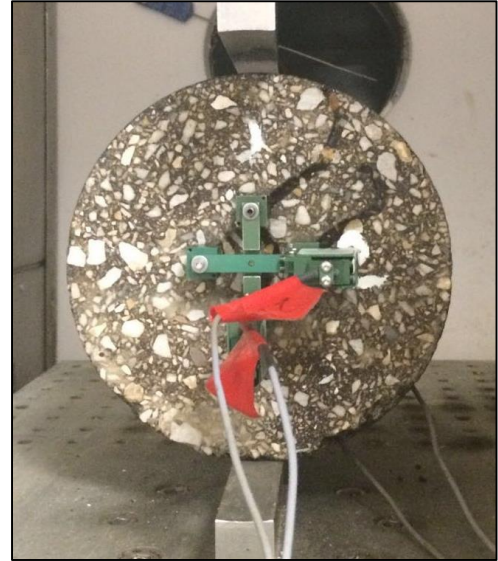

(b)

FIGURE 1 (a) Specimen tested in uniaxial configuration, (b) Specimen tested in indirect tension configuration.

The objective of this study is to evaluate the potential changes in the computed values of Poisson's ratio between the two testing configurations mentioned above, uniaxial and indirect tension. Also, three different mixtures are examined under each testing configuration: asphalt concrete containing unmodified binder, asphalt concrete containing binder modified with polyphosphoric acid (PPA), asphalt concrete containing binder modified with PPA and liquid antistripping additive (LAA), and asphalt concrete containing binder modified with Styrene-Butadiene-Styrene (SBS). This will be done in order to determine whether potential observed changes in Poisson's ratio attributed to specimen geometry are consistent across the three different mixtures. All tests will be performed with dynamic loads since they represent traffic loads more realistically (Zhang *et al.*, 2012).

## II. BACKGROUND

Asphalt concrete is a viscoelastic material; that is, its properties such as modulus and Poisson's ratio depend on temperature and loading rates to which they are subject. For instance, as temperature increases and loads are applied at longer rates, asphalt concrete starts behaving as an unbound granular material. In contrast, the same asphalt concrete behaves as pure elastic materials, close to Portland cement concrete, when they are subject to low temperatures and very short loading rates (NCHRP 1-

37A). Due to this behavior, some researchers such as Collop *et al.* (2003) and Taherkani *et al.* (2008) have modeled asphalt concrete using Burger's mechanical model, which represents viscoelastic materials as combinations of springs and dashpots connected in series and parallel, as seen in Figure 2. In the Burger's mechanical model, the springs represent the elastic part, and the dashpots represent the viscous part of the viscoelastic behavior of the system.

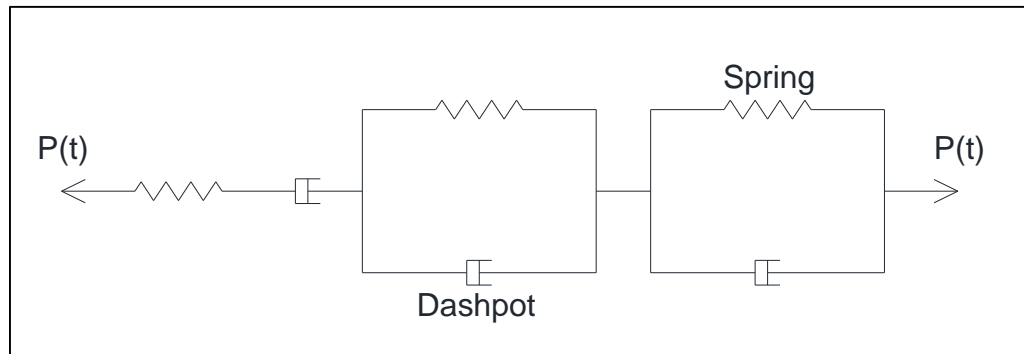

FIGURE 2 Burger's mechanical model.

This complexity is minimized in some degree since most methods used to analyze flexible pavement responses use the linear viscoelastic range of the material, which is where asphalt concrete can recover all strains once loads are released. Research has identified different deformation limits to keep samples within the linear viscoelastic range. For instance, Buttler *et al.* (1994) suggest 300 microstrains, Airey *et al.* (2004) suggest 100 microstrains, Kim *et al.* (2004) controlled deformations between 60 and 70 microstrains, Gibson (2006) limited deformations to 100 microstrains, AASHTO T 342 limits deformations from 50 to 150 microstrains, and AASHTO T 322 limits deformations to 500 microstrains.

Poisson's ratio has been found to range from 0.1 to 0.45 in asphalt concrete (Taherkhani *et al.*, 2008) when strains are kept within the viscoelastic range, and even though it decreases as the loading frequency increases (Zhang *et al.*, 2012), its dependence of loading frequency is rather weak (Kim *et al.* 2004). On the other hand, temperature variations do significantly affect Poisson's ratio values. Table 1 summarizes typical values of Poisson's ratio for varying temperatures according to Nunn *et al.* (1996) and

Kim *et al.* (2004). Table 2 shows the values of Poisson's ratio that the Mechanistic-Empirical Design Guide (NCHRP 1-37A) suggests for different temperatures in design level 3.

TABLE 1 Typical Values of Poisson's Ratio for Varying Temperatures.

Temperature	Poisson's ratio	
	Nunn <i>et al.</i> (1996)	Kim <i>et al.</i> (2004)
-10 °C	-	0.18
10 °C	0.25	0.25
20 °C	0.35	-
25 °C	-	0.45
30 °C	0.45	-

TABLE 2 Values of Poisson's Ratio for level 3 according to NCHRP 1-37A.

Temperature	Poisson's ratio
< 0 °F (< -17.8 °C)	0.15
0 - 40 °F (-17.8 – 4.4 °C)	0.20
40 - 70 °F (4.4 – 21.1 °C)	0.25
70 - 100 °F (21.1 – 37.8 °C)	0.35
100 - 130 °F (37.8 – 54.4 °C)	0.45
> 130 °F (> 54.4 °C)	0.48

Although a definition of Poisson's ratio was already given above, there are several approaches that obtain mathematic expressions to compute Poisson's ratio in the laboratory. In asphalt concrete testing, these expressions depend mainly on the geometry of the sample and testing configurations. Approaches for samples under uniaxial and indirect tension are presented in the following.

In the case when specimens behave as uniaxial loaded bodies, the deformations caused in cylindrical specimens by vertical loads are shown in Figure 3 (Maher *et al.*, 2008).

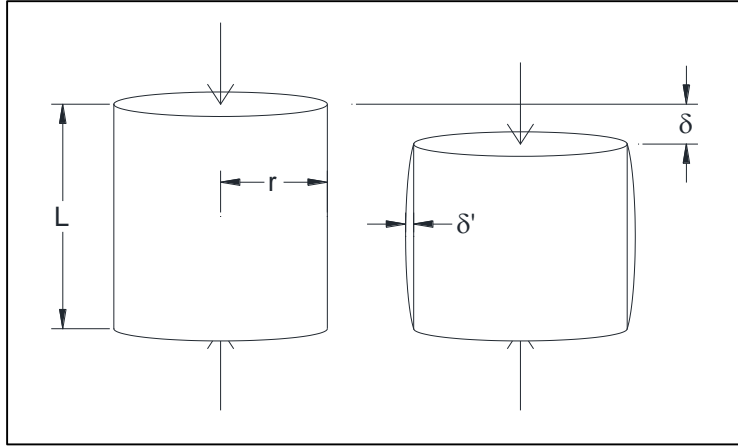

FIGURE 3 Deformations caused by a uniaxial load (Maher et al., 2008)

Here, the load is applied in the same direction as the specimen was compacted. In this configuration, Poisson's ratio ( $\mu$ ) is defined as follows (Maher *et al.*, 2008).

$$\mu = -\frac{\epsilon_{\text{lat}}}{\epsilon_{\text{long}}} \quad (1)$$

$$\epsilon_{\text{lat}} = \frac{\delta'}{r} \quad (2)$$

$$\epsilon_{\text{long}} = \frac{\delta}{L} \quad (3)$$

By using this approach, Maher *et al.* (2008) were able to calibrate the equation provided by NCHRP 1-37A that relates elastic modulus with Poisson's ratio.

In the case when specimens behave as biaxial loaded bodies in indirect tension test (IDT), the stress distribution caused in disc specimens by vertical loads are shown in Figure 4 (Kim *et al.*, 2004).

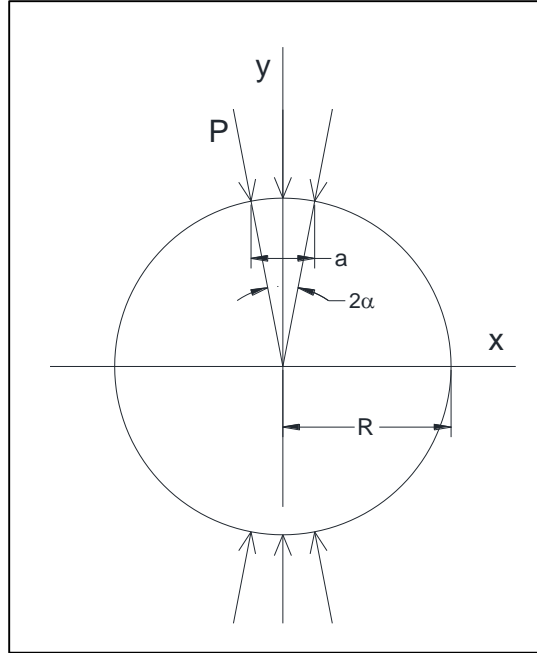

FIGURE 4 Stress pattern caused by loads in indirect tension configuration (Kim et al., 2004)

In laboratory, the load is usually applied perpendicularly to the compaction direction in IDT tests. The mathematical definition of Poisson's ratio for this configuration is more complicated than that of the uniaxial configuration. Kim *et al.* (2004) developed a procedure for computing Poisson's ratio using dynamic loads. Their approach was based on the mathematic expressions that Hondros (1959) developed for IDT specimens loaded as Figure 4 shows. The following equations that define Poisson's ratio ( $\mu$ ) are some of the results of their study.

$$\mu = \frac{\beta_1 U_0 - \gamma_1 V_0}{-\beta_2 U_0 + \gamma_2 V_0} \quad (4)$$

$V_0$  = Constant amplitude of vertical displacements

$U_0$  = Constant amplitude of horizontal displacements

$$\beta_1 = - \int_{-1}^1 n(y) dy - \int_{-1}^1 m(y) dy \quad (5)$$

$$\beta_2 = - \int_{-1}^1 n(y) dy - \int_{-1}^1 m(y) dy \quad (6)$$

$$\gamma_1 = - \int_{-l}^l f(x) dx - \int_{-l}^l g(x) dx \quad (7)$$

$$\gamma_2 = - \int_{-l}^l f(x) dx + \int_{-l}^l g(x) dx \quad (8)$$

$l$  = half length of the gauges

$$f(x) = \frac{\left(1 - \frac{x^2}{R^2}\right) \sin(2\alpha)}{1 + 2\left(\frac{x^2}{R^2}\right) \cos(2\alpha) + \frac{x^4}{R^4}} \quad (9)$$

$$g(x) = \tan^{-1} \left[ \frac{1 - \frac{x^2}{R}}{1 + \frac{x^2}{R}} \tan(\alpha) \right] \quad (10)$$

$$m(y) = \frac{\left(1 - \frac{y^2}{R^2}\right) \sin(2\alpha)}{1 - 2\left(\frac{y^2}{R^2}\right) \cos(2\alpha) + \frac{y^4}{R^4}} \quad (11)$$

$$n(y) = \tan^{-1} \left[ \frac{1 - \frac{y^2}{R}}{1 + \frac{y^2}{R}} \tan(\alpha) \right] \quad (12)$$

Despite the results of Tayebali *et al.* (1995), who claims that IDT configurations for measuring Poisson's ratio lead to inaccurate results, Kim *et al.* (2004) state that the results of their findings agree with finite element models. Kim *et al.* used the mathematical model developed by Hondros (1959) that assumes a plane stress state. Kim *et al.* (2004) also suggest that dynamic modulus testing using this configuration is a more realistic approach since the size of the samples can be obtained directly from the real thickness of pavement structures, while specimens for uniaxial configurations can only be obtained from laboratory.

Previous research has compared results of dynamic modulus and Poisson's ratio between uniaxial and IDT configuration. Kim *et al.* (2010) state that results of dynamic modulus from both tests do not have a statistical difference. In contrast, Zhang *et al.* (2012) claims that compressive modulus in uniaxial configuration is 1.2 to 2 times higher than that of IDT configuration, and the values of Poisson's ratio are different as well. Nevertheless, according with the reviewed literature, there has not been an inclusion of binder modifiers in research of this type.

Polyphosphoric acid (PPA) is the binder modifier to be used in the proposed study. The main purpose of using PPA in the asphalt concrete modification industry is to improve the performance of binder agents subjected to high temperatures without affecting its low temperature performance characteristics (Baumgardner, 2010). It is possible that the addition of PPA to asphalt binders affect dynamic modulus values of asphalt concrete specimens when compared to those with unmodified binders. Bennert *et al.* (2010) combined PPA with styrene-butadiene-styrene (SBS), which is a polymer binder modifier, and found a difference in dynamic modulus values between modified and unmodified mixture specimens especially for low frequency loading conditions, where the modified mixture was slightly stiffer. Therefore, another property, such as Poisson's ratio, may be potentially affected by the inclusion of binder modifiers in asphalt concrete as well.

### **III. MATERIALS AND METHODS**

APAC Central in Van Buren, Arkansas, was the supplier of the aggregate used in this study. This aggregate was identified by the Arkansas State and Transportation Department (AHTD) as a highly moisture susceptible aggregate. The mix design was performed by the AHTD for a 9.5 mm nominal maximum size surface mix with a traffic design between 0.3 and 30 million of ESALs. Four different types of binder were used: unmodified PG 64-22, PG 64-22+0.5%PPA (PG 70-22), PG 64-22+0.5%PPA+0.5%LAA, and PG 64-22+2.0%SBS (PG 70-22). The base PG 64-22 was the same for all four binders and the original mix design utilizing the original PG 64-22 was kept unchanged among the three different mixtures. This prevented potentially confounding factors such as a change in asphalt binder content from influencing test results. The optimal asphalt content was 6.2%. All specimens were fabricated targeting 7% of air voids using a Superpave gyratory compactor. Three specimens were fabricated for each type of mixture and each type of testing configuration.

Two types of specimens were used. Specimens tested on the uniaxial configuration were compacted and cut based on the specimen size used by AASHTO T 342. These cylindrical specimens have a height of 150 mm and a diameter of 100 mm. In order to measure vertical deformations, three LVDTs with an initial length of 100 mm were placed each 120° surrounding the specimen, using the average deformation of the three. In order to measure radial deformations, a chain or circumferential



LVDT was used since it gives more accurate results than other solutions (Kassem *et al.*, 2013) (see Figure 1-a). Radial strains were computed using the procedures provided by the manufacturer of the circumferential extensometer. Specimens tested on the indirect tension (IDT) configuration were compacted and cut based on the specimen size used by AASHTO T 322, which are discs with a thickness of 38 mm and a diameter of 150 mm. Vertical and horizontal deformations were measured using LVDTs with an initial length of 38 mm placed at the center of each face of the specimen (see Figure 1-b). Here, six readings of deformations were obtained for each direction (two faces on each specimen), where the smallest and largest reading were discarded as specified in AASHTO T 322. Thus, the average was computed using the other four readings for each direction (vertical and horizontal).

Dynamic loads were applied according to AASHTO T 342 on all samples over a range of varying temperatures and loading frequencies. Five temperatures were used: -10 °C, 4.4 °C, 21.1 °C, 37.8 °C, and 54 °C. For each temperature six different loading frequencies were applied: 25 Hz, 10 Hz, 5 Hz, 1 Hz, 0.5 Hz, 0.1 Hz.  $\epsilon_{lat}$ ,  $\epsilon_{long}$ ,  $U_o$  and  $V_o$ ; from equations (1), (2), (3), and (4); were obtained from the constant amplitudes of the sinusoidal radial and longitudinal strain history for each combination of frequency and temperature. Amplitudes were computed using the regression procedure appearing in AASHTO T 342. From equation (4), the values used for  $\beta_1$ ,  $\beta_2$ ,  $\gamma_1$ , and  $\gamma_2$  were -0.0099, -0.0032, 0.0029, and 0.0091 respectively. These values were computed and used by Kim *et al.* (2004). Finally, deformations were targeted to be between 50 and 150 microstrains in order to stay within the linear viscoelastic region of the asphalt concrete. Actual deformation ranged from 30 and 200 microstrains. ANOVA and t-statistic test were used as statistical tools to compare results of both Dynamic Modulus and Poisson's ratio.

#### **IV. RESULTS**

Asphalt concrete is a thermorheologically simple material; that is, a specific value of some mechanical property, such as Dynamic Modulus or Poisson's ratio, can be obtained with different combinations of temperature and loading frequency (Kim *et al.*, 2004). Thermorheologically simple materials behave under the time-temperature principle. This principle allows the construction of a master curve for a base single temperature that represents the whole range of temperatures and loading frequencies under which samples were tested. AASHTO PP 62 specifies two methods for constructing

master curves: MEPFG Shift Factors and Second-Order Polynomial. In this work, master curves were developed for each type of mixture using the Second-Order Polynomial method summarized in equations (13) and (14).

$$\log|E^*| = \delta + \frac{\alpha}{1+e^{\beta+\log(fr)}} \quad (13)$$

$$\log f_r = \log f + a_1(T_R - T) + a_2(T_R - T)^2 \quad (14)$$

Where

$E^*$  = predicted Dynamic Modulus

$f_r$  = the reduced frequency at the reference temperature

$f$  = the loading frequency at the test temperature

$T_R$  = the reference temperature

$T$  = The test temperature

$\delta, \alpha, \beta, \gamma, a_1,$  and  $a_2$  = fitting coefficients

Although AASHTO PP 62 is meant to construct Dynamic Modulus master curves, the same procedure was utilized to construct Poisson's ratio master curves in this work. The shape of the master curve is greatly affected by the seed values used to compute the fitting coefficients  $\delta, \alpha, \beta, \gamma, a_1,$  and  $a_2$  (Yang *et al.*, 2015). This work used the seed values provided by AASHTO PP 62:

$\delta = 0.5, \alpha = 3.0, \beta = -1.0, \gamma = -0.5, a_1 = 0.1,$  and  $a_2 = 0.0001$  for constructing all master curves. The reference temperature was 21°C for all cases since it is the temperature in the middle of the temperature range used for testing.

Figure 5 and 6 show the master curves for Dynamic Modulus in IDT and uniaxial configuration respectively. IDT  $E^*$  roughly ranges from 200 to 10,000 MPa for all three mixtures. Uniaxial  $E^*$ , however, ranges from 200 to 15,000 MPa. For the Uniaxial configurations, the PPA modified mixtures were stiffer than the neat binder, which is similar to previous studies, but this trend was not as clear with the IDT configuration (D'Angelo, J. A., 2012). An ANOVA showed that there is not statistical difference among all

three mixtures tested in IDT configuration (P-Value = 0.846). Similarly, no statistical difference was found in values of uniaxial Dynamic Modulus for all three mixtures (P-Value = 0.710). Values of Dynamic Modulus are not very different if compared between IDT and Uniaxial either. For instance, a t-statistic test between IDT E\* and Uniaxial E\* for samples containing PG 64-22 + 0.5%PPA + 0.5%LAA showed no statistical difference (P-Value = 0.755).

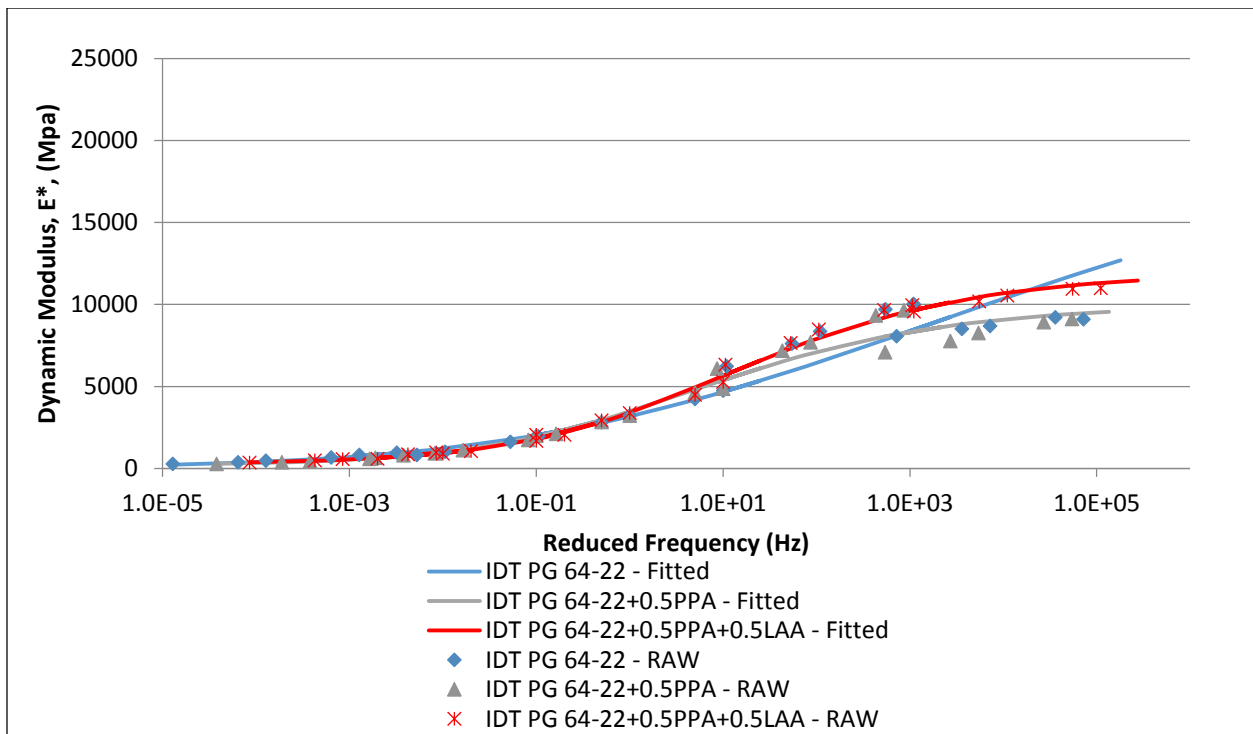

FIGURE 5 Master curves of Dynamic Modulus in IDT configuration

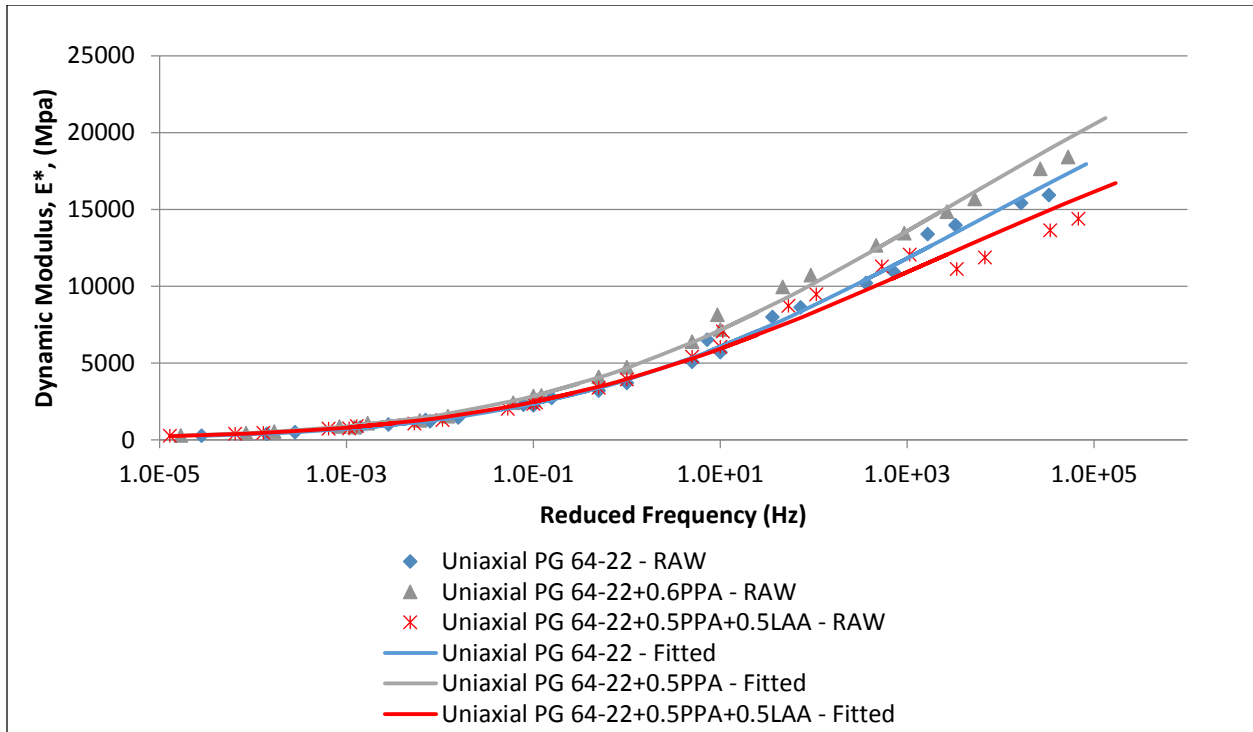

FIGURE 6 Master curves of Dynamic Modulus in uniaxial configuration

Figures 7 and 8 show the master curves for Poisson's ratio in the IDT and uniaxial configurations respectively. Here, there is a very significant difference between values of Poisson's ratio between one to another configuration. IDT Poisson's ratio roughly ranges from 0.07 to 0.50 for all three mixtures, whereas uniaxial Poisson's ratio has a much narrower range: 0.06 to 0.13, if computed using averages for each temperature as shown in table 3. A t-statistic test resulted in a significant difference between, for instance, samples containing PG 64-22 + 0.5%PPA + 0.5%LAA (P-Value < 0.0001). This difference is graphically shown in figure 9 and figure 10. However, no statistical difference was found in values of Poisson's ratio if comparing all three mixtures within the same testing configuration. P-Values of 0.183 and 0.498 of IDT and Uniaxial respectively.

TABLE 3 Average values of Poisson's ratio for each testing temperature.

T (°C)	Poisson's Ratio						Prev. Literature
	IDT			Uniaxial			
	PG 64-22	PG 64-22+0.5PPA	PG 64-22+0.5PPA+0.5LAA	PG 64-22	PG 64-22+0.5PPA	PG 64-22+0.5PPA+0.5LAA	NCHRP 1-37A
-10	0.07	0.09	0.20	0.07	0.06	0.07	0.20
4	0.29	0.26	0.28	0.07	0.08	0.07	0.20
21	0.30	0.30	0.27	0.09	0.10	0.07	0.25
37	0.44	0.34	0.43	0.12	0.12	0.11	0.35
54	0.43	0.33	0.50	0.14	0.12	0.13	0.45

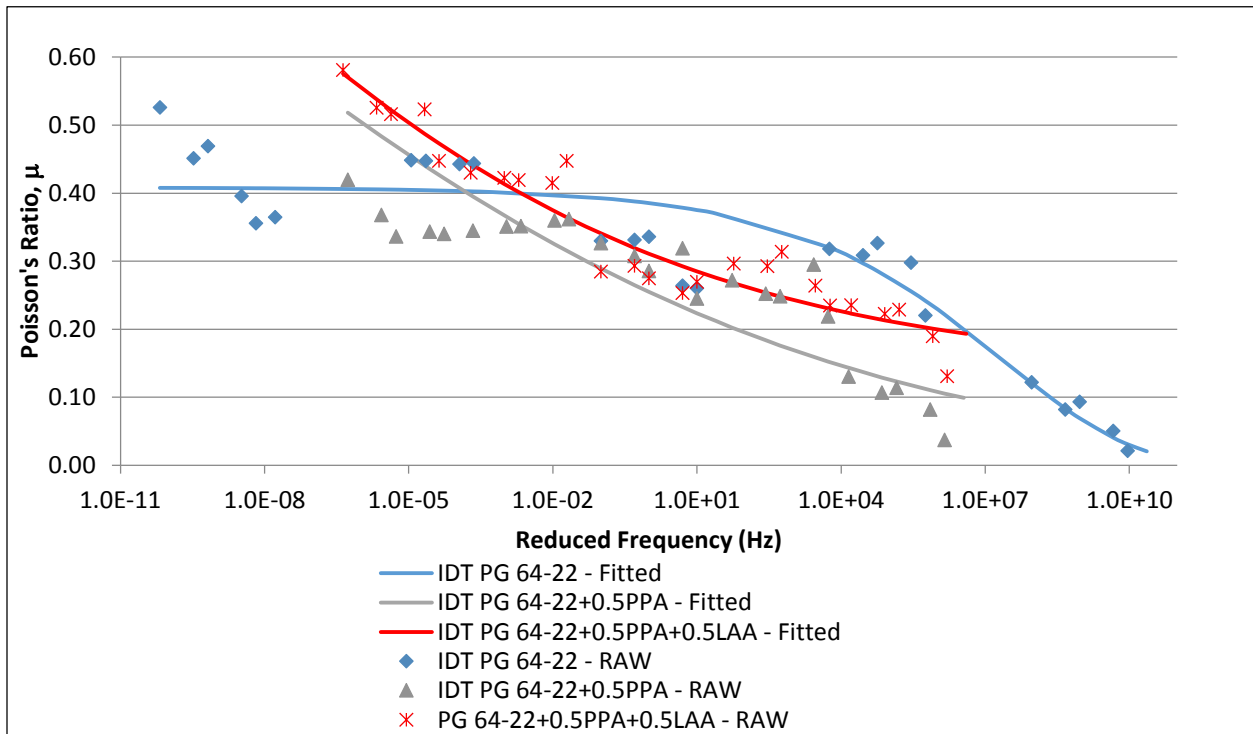

FIGURE 7 Master curves of Poisson's ratio in IDT configuration

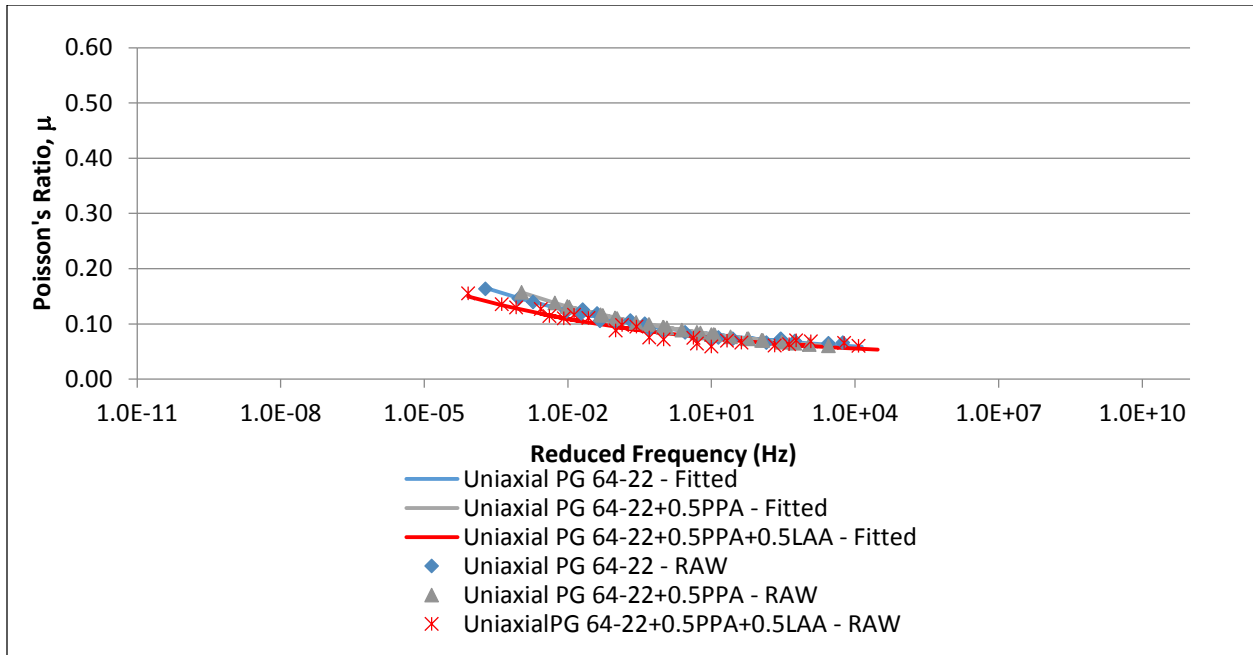

FIGURE 8 Master curves of Poisson's ratio in uniaxial configuration

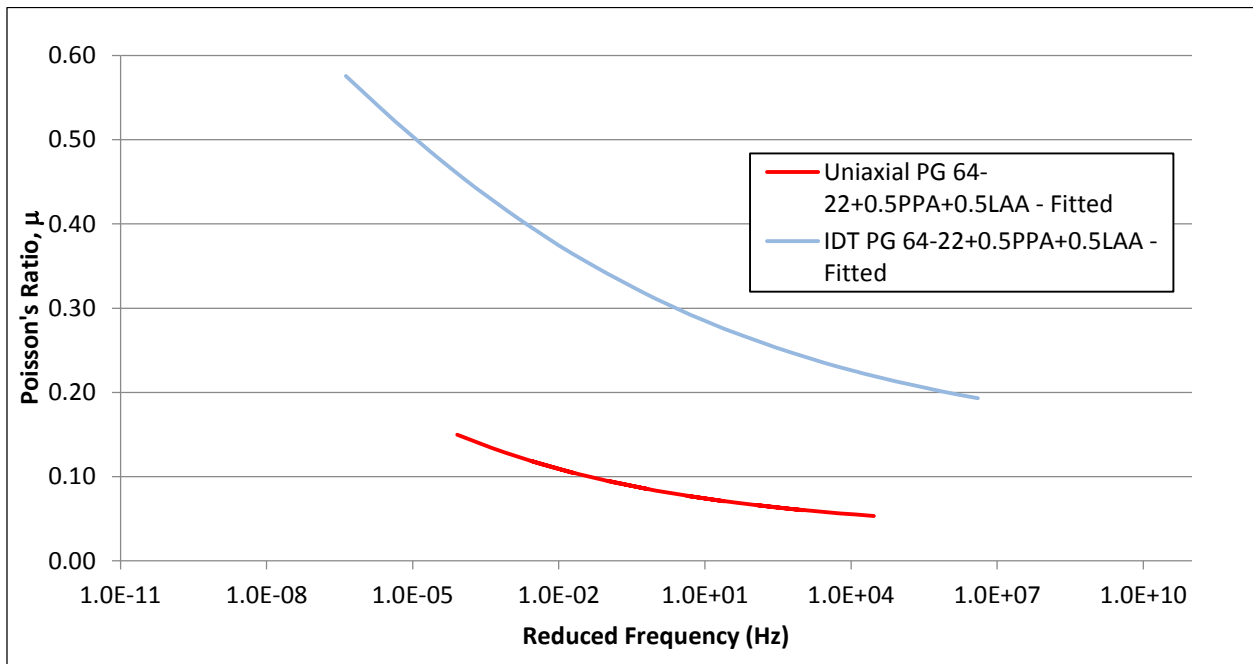

FIGURE 9 Poisson's ratio: IDT vs Uniaxial

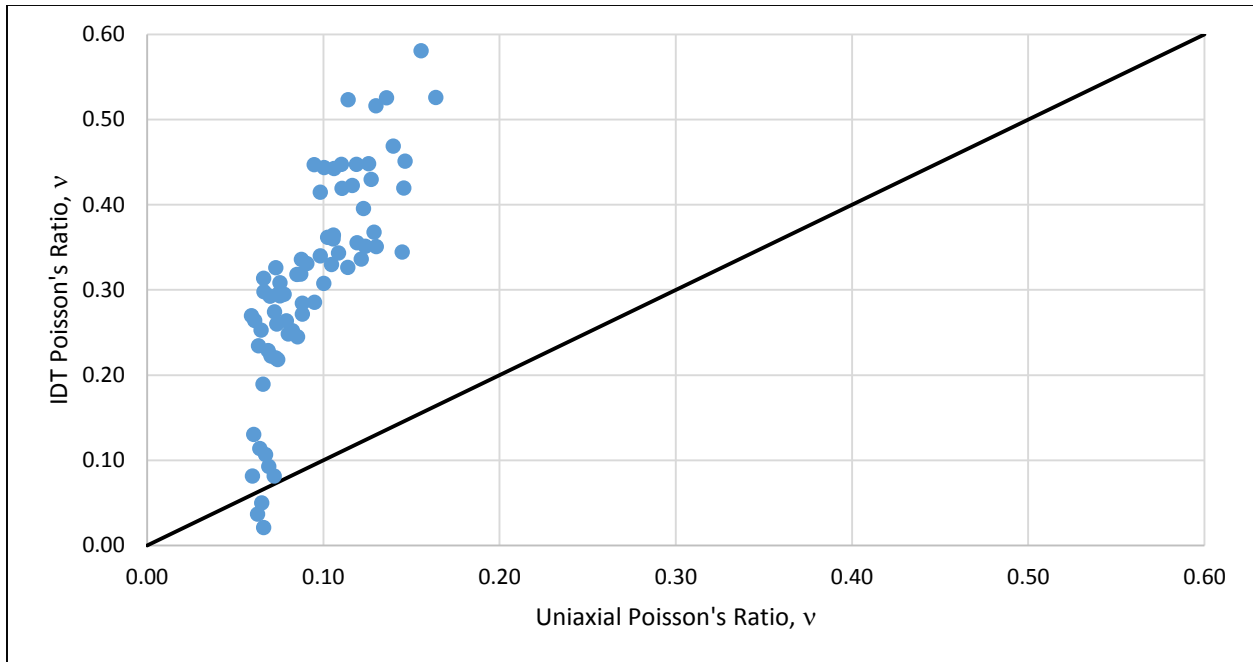

FIGURE 10 Equality line – IDT Poisson’s ratio vs. Uniaxial Poisson’s ratio

TABLE 4 Summary of Statistical Analysis.

Binder Modification	Test Configuration	Method	P-Value
Dynamic Modulus	IDT	ANOVA	0.846
	Uniaxial	ANOVA	0.71
Poisson's Ratio	IDT	ANOVA	0.183
	Uniaxial	ANOVA	0.498
Test Configuration			
PG 64 -22 + 0.5% PPA +0.5% LAA		t-test	<0.001

Figure 11 shows the values of Poisson’s ratio vs. their corresponding values of Dynamic Modulus for the mixture containing PG 64-22 + 0.5% PAA. Although IDT results are more consistent with previous research, IDT data clearly has a larger and more intuitive range than that of the Uniaxial configuration.

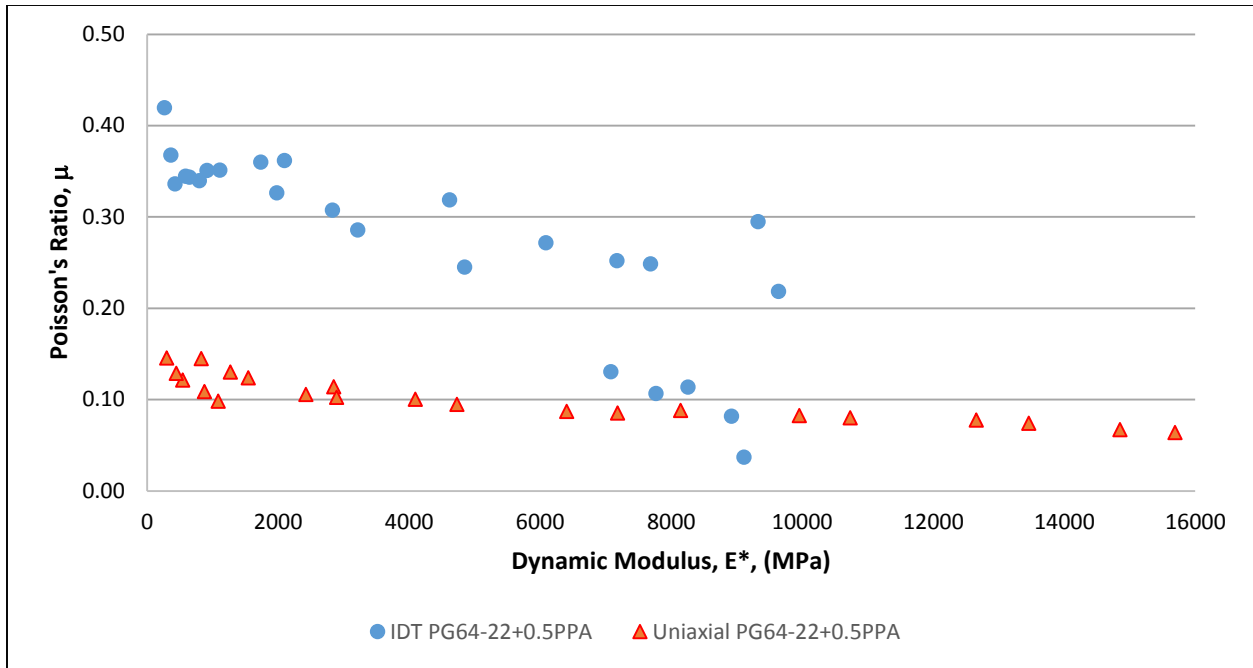

FIGURE 11 Poisson's ratio vs. Dynamic Modulus – PG 64-22 + 0.5%PPA

## V. DISCUSSION

Data from extensometers recording deformations subjected to tension stress had a larger range than deformations recorded in compression stress. Therefore, data collection on IDT configuration, which 50% of the extensometers record deformations in tension stress, exhibited the expected range of values than those of Uniaxial configuration, especially for lower temperatures – higher Dynamic Modulus (Figure 10). The final result of Poisson's ratios obtained from the IDT configuration agrees with previous research on asphalt concrete samples. Uniaxial Poisson's ratios seem to be lower than what has been found in previous research. These lower Poisson's ratios may have been the result of underestimating radial deformations as a consequence of not released friction on the upper and bottom plates despite having used silicon rubber sheets between the concrete asphalt and metal surfaces. In addition, the chain used to compute radial deformations has a working range of 0.50 inches in both directions when AASHTO T 342 specifies extensometers with 0.02 inches in both directions. All IDT extensometers meet AASHTO T 342. The IDT Poisson's ratio is roughly about three times higher than that of the Uniaxial. Nevertheless, the difference between the IDT and Uniaxial Poisson's ratio do agree with previous research. Zhang *et al.*



(2012) found a significant difference between IDT and Uniaxial Poisson's ratio by about 2:1, IDT being higher than Uniaxial. Zhang *et al.* (2012) attributed this difference to the anisotropic nature of the asphalt concrete.

Within each testing configuration, there was not a significant statistically difference in the values of Poisson's ratio in the asphalt concrete samples that were tested.

While the values of Poisson's ratio in the Uniaxial configuration were lower than what was expected based on literature, the data is believed to be robust because the values of Dynamic Modulus did lie within expected ranges based on previous literature. In addition, values of Dynamic Modulus were not statistically affected by the testing configuration (IDT and uniaxial) or by binder modification (PPA and LAA). This result agrees with findings from Kim (2010). However, these results show that the Uniaxial configuration provided anticipated results for Dynamic Modulus, while the IDT configuration provided anticipated results for Poisson's Ratio. This shows that while each test geometry is able to provide valuable information, they do not appear to be providing the same information. This clearly shows that the benefits or drawbacks of each testing geometry needs continued evaluation.

## **VI. CONCLUSIONS**

The objective of this research was to determine whether or not there are significant differences between the values of Poisson's ratio measured in the indirect tension (IDT) configuration and Uniaxial configuration. This work also aimed to investigate the potential variations of values of Poisson's ratio among a number of asphalt mixture treated with different types of asphalt modifiers. The findings of this work can be summarized as follows:

- Asphalt modifiers, such as polyphosphoric acid (PPA) and latex anti-stripping agent (LAA), did not affect values of Poisson's ratio in both IDT and Uniaxial configuration in this study.
- Values of Poisson's ratio in the indirect tension (IDT) configuration, using disc samples specified on AASHTO T 322, were about three to four times higher than those obtained from testing in the Uniaxial configuration using cylindrical samples specified on AASHTO T 342.

This reduction of Poisson's ratio by about 60% (from IDT to Uniaxial results) could lead to an increase of predicted distresses, such as longitudinal cracking by more than 400% of its design limit. (Computed based on Schwartz et al., (2011) work who used PavementME)

- Values of Dynamic Modulus were not significantly affected by either binder modification or the testing configuration use in this study.

The Dynamic Modulus values and trends matched values found in literature for similar mixtures in the Uniaxial mode. The Poisson's ratio values and trends match values in literature for similar mixtures in the IDT mode. This demonstrates that there is still more to learn about the pros and cons of each geometry, and that it is not clear that one geometry has a distinct advantage over the other.

## REFERENCES

- AASHTO. (2013). "Standard method of test for determining the creep compliance and strength of hot mix asphalt HMA using the indirect tensile test device." T-322-07 (2001), Washington, D.C.
- AASHTO. (2014). "Standard method of test for determining dynamic modulus of hot mix asphalt HMA using the indirect tensile test device." T-342-11, Washington, D.C.
- Airey, G. D., & Rahimzadeh, B. (2004). Combined bituminous binder and mixture linear rheological properties. *Construction and Building Materials*, 18(7), 535-548.
- Baumgardner, G. L. (2010). Why and How of Polyphosphoric Acid Modification - An Industry Perspective. *Journal of the Association of Asphalt Paving Technologists*. Vol. 79, 2010, pp. 663-678.
- Buttlar, W. G., & Roque, R. (1994). Development and evaluation of the strategic highway research program measurement and analysis system for indirect tensile testing at low temperatures. *Transportation Research Record*, (1454). Transportation Research Board, Washington, D.C., 163-171
- Collop, A., Scarpas, A., Kasbergen, C., & de Bondt, A. (2003). Development and finite element implementation of stress-dependent elastoviscoplastic constitutive model with damage for asphalt. *Transportation Research Record: Journal of the Transportation Research Board*, (1832), 96-104.
- D'Angelo, J. A. (2012). Polyphosphoric Acid Modification of Asphalt Binders: A Workshop. Workshop Summary. *Transportation Research E-Circular*, (E-C160).
- Gibson, N. H. (2006). A Comprehensive Model for the Compressive Behavior of Asphalt Concrete. Ph.D. dissertation. University of Maryland, College Park
- Hondros, G. (1959). The evaluation of Poisson's ratio and the modulus of materials of a low tensile resistance by the Brazilian (indirect tensile) test with particular reference to concrete. *Australian Journal of Applied Science*, 10(3), 243-268.
- Kassem, E., Grasley, Z. C., & Masad, E. (2013). Viscoelastic Poisson's ratio of asphalt mixtures. *International Journal of Geomechanics*, 13(2), 162-169.
- Kim, Y., Seo, Y., King, M., & Momen, M. (2004). Dynamic modulus testing of asphalt concrete in indirect tension mode. *Transportation Research Record: Journal of the Transportation Research Board*, (1891), 163-173.
- Kim, R. (2010). Report on IDT E\* Ruggedness Testing Plan. Presented at the February 2010 Meeting of the FHWA Asphalt Mixture and Construction Expert Task Group.
- Lee, H. S., & Kim, J. (2009). Determination of viscoelastic Poisson's ratio and creep compliance from the indirect tension test. *Journal of Materials in Civil Engineering*, 21(8), 416-425.
- Maher, A., & Bennert, T. A. (2008). Evaluation of Poisson's ratio for use in the mechanistic empirical pavement design guide (MEPDG) (No. FHWA-NJ-2008-004).
- NCHRP 1-37(2004). A Guide for Mechanistic-Empirical Design of New and Rehabilitated Pavement Structures. Final Report. NCHRP, ARA Inc., and ERES Consultant Division, Washington, D.C.,
- Nunn, M., & Transport Research Lab., Crowthorne (United Kingdom); Highways Agency, London (United Kingdom). (1996). The characterisation of bituminous macadams by indirect tensile stiffness modulus.
- Schwartz, C. W., Li, R., Kim, S., Ceylan, H., & Gopalakrishnan, K. (2011). Sensitivity evaluation of MEPDG performance prediction. Final Report for NCHRP Project 1, 47.

Taherkhani, H., & Collop, A. C. (2008). Determination of the Elastic Modulus and Poisson's Ratio of Asphaltic Mixtures Using Uniaxial Creep Recovery Tests. In *Airfield and Highway Pavements@ sEfficient Pavements Supporting Transportation's Future* (pp. 159-170). ASCE.

Tayebali, A. A., Deacon, J. A., & Monismith, C. L. (1995). Comparison of axial and diametral resilient stiffness of asphalt-aggregate mixes. *Transportation research record*, (1492), 135-143.

Yang, S., Braham, A., Underwood, S., Hanz, A., Reinke, G. Correlating Field Performance to Laboratory Dynamic Modulus from Indirect Tension and Torsion Bar, accepted to *Journal of the Association of Asphalt Paving Technologists*, November, 2015.

Zhang, Y., Luo, R., & Lytton, R. L. (2012). Anisotropic viscoelastic properties of undamaged asphalt mixtures. *Journal of Transportation Engineering*, 138(1), 75-89.