

THESIS FOR THE DEGREE OF LICENTIATE OF ENGINEERING

Winter Road Maintenance using Renewable Thermal Energy

Vinterdrift av vägar med säsongslagrad solvärme

JOSEF JOHANSSON

“Med markvärme avses anordningar för att höja markytans temperatur i avsikt att undvika halka, att hålla ytan snöfri eller att förlänga vegetationsperioden.”

(Byggnadsstyrelsen, 1976)

Department of Civil and Environmental Engineering

Division of Building Technology

CHALMERS UNIVERSITY OF TECHNOLOGY

Gothenburg, Sweden 2017

Winter Road Maintenance using Renewable Thermal Energy

JOSEF JOHNSON

© JOSEF JOHNSON, 2017

ISSN 1652-9146

Lic 2017:3

Department of Civil and Environmental Engineering
Chalmers University of Technology
SE-412 96 Gothenburg
Sweden
Telephone + 46 (0)31-772 1000

Cover: Conceptual view of the hydronic pavement using renewable energy.
Illustration: Karin Holmgren

Chalmers Reproservice
Gothenburg, Sweden 2017

Winter Road Maintenance using Renewable Thermal Energy

JOSEF JOHNSON

Department of Civil and Environmental Engineering

Division of Building Technology

Chalmers University of Technology

ABSTRACT

Winter road maintenance is costly but it is inevitable since it is necessary to keep roads accessible and safe during winter. Current winter road maintenance methods use annually 600 000 tons of salt, in the Nordic countries. The salt ends up in the environment along the roads and results in environmental challenges. This thesis proposes an alternative, winter road maintenance concept for critical parts of the road infrastructure. The proposed concept consists of a hydronic pavement (HP), utilised as solar collector, which is connected to a borehole thermal energy storage (BTES). The combination of an HP and a BTES (called renewable HP) means that the solar radiation will be harvested in the summer time and the stored energy will be used for winter road maintenance at critical parts of a road infrastructure. In existing hydronic pavements district heating or other high temperature energy sources are currently used, however, high temperature energy sources limit the implementation of HP systems. Research on using low temperature energy sources can result in a reduction of primary energy need and makes implementation of HP systems more feasible. The purpose of this thesis is to investigate the feasibility of implementing hydronic pavements using renewable energy, in the Scandinavian countries. This thesis studies how a BTES can be connected to a hydronic pavement, focusing on the design of the BTES. The studies are based on extensive literature reviews and numerical simulations considering the interaction between the hydronic pavement and the BTES. The studied systems have all been direct connected systems without supplementary heating such as boilers or heat pumps. The results revealed that BTES is a suitable thermal storage technology to be used in combination with renewable HP. The renewable HP systems are mostly suitable for areas with mild winters. For locations with harsher climates there is a need for supplementary heating or increased number of boreholes in the BTES. The studied locations of Tranarp and Studevannet revealed that the renewable HP system can reduce the annual number of hours with risk for ice formation from 400 hours and 855 hours, to 6 hours and 23 hours respectively. However, in order to reach low risk levels, further development of control systems will be needed.

Keywords: Hydronic pavements, borehole thermal energy storage, BTES, winter road maintenance, renewable energy, numerical simulations, BRIDGESIM

Vinterdrift av vägar med säsongslagrad solvärme

JOSEF JOHNSON

Institutionen för Bygg- och miljöteknik

Avdelningen för Byggnadsteknologi

Chalmers tekniska högskola

SAMMANDRAG

Vinterdrift av vägar är en stor kostnad för samhället men vinterdriften är nödvändig för att hålla våra vägar öppna. Emellertid så sprids varje år 600 000 ton vägsalt på de nordiska vägarna. Detta salt rinner ut i naturen längs med vägarna, där det har en direkt påverkan på naturen. Denna avhandling förespråkar ett alternativt vinterdriftskoncept, för miljömässigt känsliga platser eller särskilt olycksdrabbade platser. Konceptet bygger på att ett vätskebaserat markvärmesystem, placeras under trafikytan, och används som en solfångare under sommaren. Den energin som tas tillvara säsongslagras i ett borrhållager tills ett uppvärmningsbehov uppstår. Traditionella markvärmesystem använder höga framledningstemperaturer vilket begränsar vilka energikällor som är direkt användbara. Vanligen används fjärrvärme eller restvärme med relativt höga temperaturer. Syftet med denna avhandling är att undersöka möjligheterna att använda ett markvärmesystem, likt de ovan beskrivna, i ett skandinaviskt klimat. Avhandlingen fokuserar på utformningen av borrhållslaget och interaktionen mellan borrhållslaget och markvärmesystemet. Avhandlingen baseras på omfattande litteraturstudier och numeriska beräkningar. Undersökningen har begränsats till att endast studera markvärmesystem som är direktkopplade till ett borrhållslager, alltså inga värmepumpar eller annan tillskottsvärme. Resultaten av studien tyder på att konceptet med ett borrhållslager kombinerat med ett markvärmesystem kan vara en fungerande lösning. Konceptet lämpar sig bäst för platser med ett relativt mildt kustklimat. För platser med strängare klimat måste lösningar med tillskottsvärme studeras. Fallstudierna för Tranarp och Studevannet visade på att markvärmesystemet kunde reducera antalet timmar med risk för halka på grund av kondensering till sex respektive åtta timmar. Men för att nå dessa låga risknivåer krävs ytterligare utveckling av styrfunktionen för markvärmesystemen.

PREFACE

In 2013 a collaboration was established between the Chalmers University of Technology and the Norwegian Public Road Administration (Statens Vegvesen), aiming at supporting the Norwegian road project E39. As a part of this collaboration the road administration funded a number of research projects at Chalmers. One of these projects is “Safe and ice-free bridges using renewable thermal energy sources”. The project aims at developing a concept for a surface heating system using renewable energy for de-icing and anti-icing of critical parts of the road infrastructure. At the same time I was working as a consultant and had just made a pre-study on hydronic pavements for a client. It had struck me how blunt the hydronic heating systems were designed. The designs simply used high heat fluxes and by that kept the pavement nice and dry. I thought that there must be a better way that could reduce the need for high heat fluxes.

By coincidence, I met my supervisor Bijan Adl-Zarrabi when visiting the university. We started to discuss the challenge of developing hydronic pavements and I got caught. That was three years ago and I am very glad that I took the opportunity of going for a PhD.

I would like to thank all my colleagues at the division of Building Technology for their help and guidance. A special thought goes to my supervisor for the support you have provided me with and for always challenging me. Jan Sundberg, Göran Hellström and Björn Modin, thank you for sharing your knowledge and for all valuable discussions. Paula Wahlgren, thank you for being a support and a role model.

At last, I would like to thank my family for supporting me, even when you are not sure of what I am doing, or even why.

Josef Johnsson

Gothenburg, 2017-02-13

LIST OF PUBLICATIONS

This thesis includes the following publications, referred to by Roman numerals:

Papers appended to the thesis

- I. Adl-Zarrabi, B., Ebrahimi, B., Hoseini, M., Johnsson, J., Mirzanamadi, R., Taljegard, M., (2016). Safe and Sustainable Coastal Highway Route E39. *Transp. Res. Procedia* 14, 3350–3359. doi:10.1016/j.trpro.2016.05.286
- II. Adl-Zarrabi, B., Mirzanamadi, R., Johnsson, J., (2016). Hydronic Pavement Heating for Sustainable Ice-free Roads. *Transp. Res. Procedia* 14, 704–713. doi:10.1016/j.trpro.2016.05.336
- III. Josef Johnsson, Bijan Adl-Zarrabi, (2017). Hydronic pavement using low temperature borehole thermal energy storage. Presented at Advances in Civil, Environmental and Materials Research (ACEM16). South Korea. Submitted to *Geomechanics and Engineering*
- IV. Raheb Mirzanamadi, Josef Johnsson, Pär Johansson, Carl-Eric Hagentoft, (2017). Anti-icing of road surfaces using low temperature hydronic heating pavements. To be submitted

Division of work between the authors

Paper I introduced the initial findings related to the research in the infrastructure project coastal highway route E39. The initial studies on energy demand and energy harvesting potential revealed that more energy could be harvested than would be needed to heat the pavement. I have developed the methodology and made the study while only doing a minor part of the writing.

Paper II focuses solely on hydronic pavements. The author developed the methodology and made a study on combining a seasonal thermal energy storage with a short-term thermal energy storage. However, the result indicated that the added performance was not worth the added cost and system complexity. The author took a major part in the writing of the paper.

Paper III studies the combination of a borehole thermal energy storage and a hydronic pavement. The concept was studied for a test site located in Östersund. The results from the paper introduces a design method, using the simulation tool BRIDGESIM. I have developed the idea for the paper and made the study.

Paper IV discussed the heat balance of a pavement surface and the interaction with the embedded pipes in the pavement. A numerical model was presented and validated against measured data and an analytical model. The role of the author of this thesis has contribute with ideas on how to develop the surface balance model and how the results could be interpreted.

The result from this thesis is based on two report which is not appended with the thesis:

- i. Josef Johnsson (2017) Winter road maintenance a review: Literature Review Report 2017:4
- ii. Almqvist, Esben, Johnsson, Josef, (2017) Identifying critical road sections related to winter road maintenance: Report 2017:5

TABLE OF CONTENTS

ABSTRACT.....	V
PREFACE.....	VII
LIST OF PUBLICATIONS.....	IX
TABLE OF CONTENTS.....	XI
LIST OF NOTATIONS.....	XIII
1 INTRODUCTION.....	1
1.1 Project background.....	3
1.2 Scope.....	6
1.3 Limitations.....	6
1.4 Methodology.....	6
2 SEASONAL THERMAL ENERGY STORAGE.....	9
2.1 Thermal storage technologies.....	9
2.2 Selection of suitable TES for an HP system.....	11
2.3 Underground seasonal storage technologies.....	13
2.4 Borehole thermal energy storages.....	14
3 HYDRONIC PAVEMENT SYSTEMS.....	17
3.1 Surface heat balance of a pavement.....	17
3.2 Preliminary Energy balance for an HP system.....	19
4 HYDRONIC PAVEMENT COMBINED WITH A BOREHOLE THERMAL ENERGY STORAGE.....	21
4.1 Short introduction to the simulation software BRIDGESIM.....	21
4.2 Influence of the center-to-center distance between pipes and supply fluid temperatures.....	25
4.3 Influence of the BTES design on the hydronic pavement.....	27
4.4 Case study of using a renewable HP system.....	30
5 CONCLUSIONS.....	37
6 FURTHER RESEARCH.....	38
REFERENCES.....	39

APPENDIX A

PUBLICATIONS I-IV

LIST OF NOTATIONS

Roman Letters

R_{down}	$\left[\frac{m^2 K}{W}\right]$	Total thermal resistance downward from pipe depth
R_p	$\left[\frac{m^2 K}{W}\right]$	Thermal resistance from the fluid to the pipe depth
R_{up}	$\left[\frac{m^2 K}{W}\right]$	Total thermal resistance upward from pipe depth
T_{air}	$[^{\circ}C]$	Air temperature
$T_{ekv,down}$	$[^{\circ}C]$	Equivalent temperature affecting the lower boundary of the road
$T_{ekv,up}$	$[^{\circ}C]$	Equivalent temperature affecting the road surface
T_f	$[^{\circ}C]$	Fluid temperature inside the pipes
$T_{f,supply}$	$[^{\circ}C]$	Supply fluid temperature
T_m	$[^{\circ}C]$	Mean temperature at the pipe depth
T_{setx}	$[^{\circ}C]$	Set point temperatures defining the control curve.
T_{airx}	$[^{\circ}C]$	Air temperatures defining the control curve
T_{surf}	$[^{\circ}C]$	Surface temperature of the road
c_p	$\left[\frac{J}{kg K}\right]$	Specific heat capacity
$d_{up},$ d_{down}	$[m]$	Distance from upper and lower boundary to pipe depth
r_p	$[m]$	Pipe radius of pipes in the road
cc	$[m]$	Centre-to-centre distance between parallel pipes in road
DH_{fail}	$[Kelvin \cdot hours]$	Number of degree-hours when system fails to meet demands
L	$\left[\frac{J}{m^3}\right]$	Phase change enthalpy
Q	$[J], [Wh]$	Energy
q	$\left[\frac{J}{s}\right], [W]$	Power or heat flux

Greek letters

ρ	$[kg/m^3]$	Density of material
λ	$[W/mK]$	Thermal conductivity

Nomenclatur

Anti-icing	Spreading of salt in order to prevent ice formation
De-icing	Spreading of salt in order to melt ice on roads
HP	Hydronic Pavement

STES, UTES, Seasonal-, Underground-, Borehole-, Thermal Energy Storage
BTES, TES
WRM Winter Road Maintenance

1 INTRODUCTION

Traffic safety is a global challenge. Likewise, low friction on roads is a great challenge in countries with harsh winters, causing accidents and low accessibility of the road infrastructure. To prevent these accidents, winter road maintenance activities are performed which causes environmental problems due to the usage of salt and abrasives. Alternative methods need to be studied. This thesis proposes an alternative winter maintenance method based on hydronic pavements using renewable energy.

Traffic safety is a global challenge with more than 1.2 million fatalities worldwide, making road traffic the main cause of death for young people. Annually 50 million people suffer from non-fatal traffic accidents. The global financial cost for these traffic accidents are estimated to reduce the GDP by 3 % (WHO, 2015). During recent years the fatalities has been constant while the global traffic is increasing. This indicates that the global traffic safety measures is effective for reducing the number of fatalities.

Traffic safety during winter conditions is globally not a major problem. However, in countries with harsh winters such as the Scandinavian countries, winter conditions are considered as a major safety issue. Since driving during winter conditions is known to be more dangerous, due to increased risk for accidents, compared to driving during bare road conditions (Andersson, 2010; Johansson, 2000; Norrman, Eriksson, & Lindqvist, 2000; Wallman, Öberg, & Wretling, 1997). The increased probability of accidents during winter conditions motivates traffic safety measures to mitigate slippery conditions on the road surface.

Winter road maintenance (WRM) is the method that has been found to be effective to counter the increased accident risk during winter conditions (Kuemmel & Hanbali, 1992; Norrman et al., 2000; Usman, Fu, & Miranda-Moreno, 2010). Modern WRM constitutes of different winter maintenance activities, aiming at either snow and ice removal, or friction control. Snow removal aims at maintaining the accessibility of the roads, keeping them open to traffic while the friction control aims mostly at maintaining the safety and friction between the tires of the vehicle and the road surface. The most common winter maintenance activity in the Scandinavian countries is friction control, which is typically done by spreading either one or both, of the following: (i) a freezing point depressant like sodium chloride (salt) or (ii) an abrasive like sand (Klein-Paste, 2008; Lysbakken, 2013; Minsk, 1998). Further details on WRM can be found in report (i). The WRM and the usage of salt and abrasives has been proved to be effective in reducing the risk for accidents. Nonetheless, the use of salt is questioned.

Annually the Nordic countries spread 600 000 tons of salt and 1 650 000 tons of abrasives on the roads at a financial cost of about 6 400 million NOK/year (Knudsen et al., 2016). This salt commonly ends up in the environment along the road, causing damage to vegetation, saltification of fresh water and facilitates leaching of toxic heavy metals (Fay & Shi, 2012). The abrasives used are mainly sand or crushed rocks which are finite resources. Furthermore, the use of abrasives is connected to environmental issues like the increase of fine PM10 particles in the air (Ketzel et al., 2007). The fine particles originating from abrasives and traffic-related emissions are also connected to health risk in numerous studies (Valavanidis, Fiotakis, & Vlachogianni, 2008). To sum up, WRM is costly (Knudsen et al., 2016), while the benefits from WRM are much greater than the cost for the society (Kuemmel & Hanbali, 1992). However, there are local environmental concerns that need to be addressed.

A common environmental concern related to WRM are saltification of fresh water streams which typically are located at low points in the landscape. Roads passing through these low points are predisposed to suffer from slippery road conditions (Lindqvist, Mattson, & et al, 1983) since these sites would have higher dew point temperatures and lower air temperatures. Other parts of the road infrastructure with increased risk for slippery road conditions are bridges and highway junctions, because these structures lack the thermal heat flow from the underground. If these sites can be ice controlled by alternative means, the CO₂ emission from winter maintenance can be reduced (Nordin, 2015; Ye, Wu, Ferradi, & Shi, 2013).

A more environmental friendly approach is to use thermal methods for local winter road maintenance. Thermal methods imply the addition of thermal energy to the pavement by the means of a surface heating system, thereby melting ice and snow on the road. The method is suitable for both friction control and snow and ice removal since it creates a bare road surface (Lysbakken, 2013). Research on hydronic pavements has been performed since the introduction of the technology in 1948 Oregon, USA (Adlam, 1950; Lund, 2000; Magnusson, 1977; Pan, Wu, Xiao, & Liu, 2015). The hydronic pavement (HP) consists of a pipe network embedded in the pavement. A warm fluid is circulated in the pipes thereby facilitating the transport of thermal energy into the pavement. Frequently used energy systems are boilers or district heating, which restricts the sites suitable for hydronic pavement systems and the environmental gains. If used to further reduces the environmental impacts. Reductions of the environmental impact can be achieved if HP systems used renewable energy sources.

Solar thermal energy is a renewable energy source that is available in abundance. In 1994 a hydronic pavement system that utilised solar energy was installed on a bridge near Därlingen in Switzerland (Eugster, 2002, 2007; Lund, 2000). This project, SERSO, proved the feasibility of such a system (Pahud, 2007). They overcame the obvious problem associated

with using solar energy in the winter by merging a seasonal thermal energy storage with an HP system. The working principle of the system used in the SERSO project can be divided in three parts: (I) During summer the solar radiation heats the pavement and by the embedded pipe network the heat is harvested and transferred to a seasonal thermal energy storage. (II) The system is dormant when no more heat could be gained from the pavements surface. (III) When there is a need for anti-icing, friction control, the pumps are started and the stored heat is transferred to the pavement thereby mitigating the slippery conditions.

This thesis will investigate the feasibility of using an HP system using renewable energy in a Scandinavian climate.

1.1 Project background

In 2013, a collaboration was established between the Chalmers University of Technology and the Norwegian Public Road Administration (NRPA), aiming at supporting the Norwegian road project E39 Coastal Highway Route. The road project aims at improving the existing E39 and replace ferry connections with fixed connections, thereby reducing the travel time from 21 to 11 hours. One of the focus areas of the collaboration is to investigate how the Coastal Highway Route E39 could become carbon neutral and how infrastructure can be utilised for energy production (Adl-Zarrabi et al., 2016; Chalmers University of Technology, 2013; Statens Vegvesen, 2013). NRPA initiated the research area “Safe and ice-free bridges using renewable thermal energy sources”. With the main concept of utilising renewable thermal energy to mitigate slippery conditions on roads.

At the same time, the Swedish Transport Administration (Trafikverket), was fostering the idea of developing their winter road maintenance methods by using heated pavement surfaces. Trafikverket had funded a pilot study on how solar energy could be utilised for de-icing of critical parts of the road infrastructure (Orring, 2012; Sundberg, 2012). The pilot study identified a number of successful international examples and suggested additional studies with a Nordic climate. In 2014 the results from the additional studies was published and revealed that a system utilising the pavement as an asphalt solar collector in combination with a borehole thermal energy storage would be a feasible solution (Sundberg & Lidén, 2014). However, Sundberg concluded that further research and testing would be needed to validate the concept.

Based on the SERSO project a concept, for the renewable hydronic pavement system proposed by this thesis, is presented in Figure 1. The road section with the hydronic pavement has an embedded pipe network, similar to a modern underfloor heating system. Through the pipes a heat transfer fluid is circulated, transferring heat to the pavement surface from an energy source. The energy source can vary depending on available sources at the geographical location. Possible sources are low temperature (10 °C) industrial waste heat, ground water, sea water or a seasonal thermal energy storage.

The proposed system has a simple main concept, nonetheless it contains a number of interconnected research topics that need to be addressed.

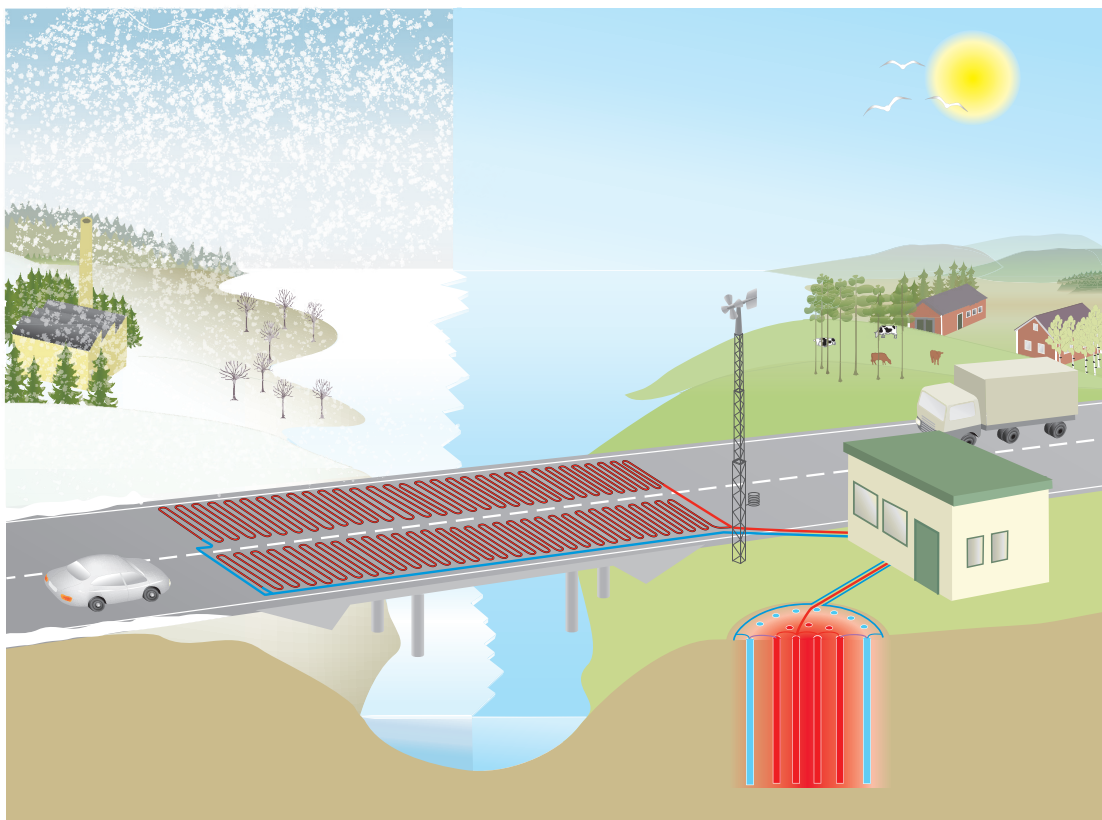

Figure 1. Conceptual idea for the studied system, the hydronic pavement is connected to a thermal energy storage that could store the harvested solar energy from the summer into the winter. (Karin Holmgren)

During the start-up phase of the research area a number of research topics were identified in order to develop a systematic structure for working with “safe and ice-free bridges using renewable energy”, see Figure 2.

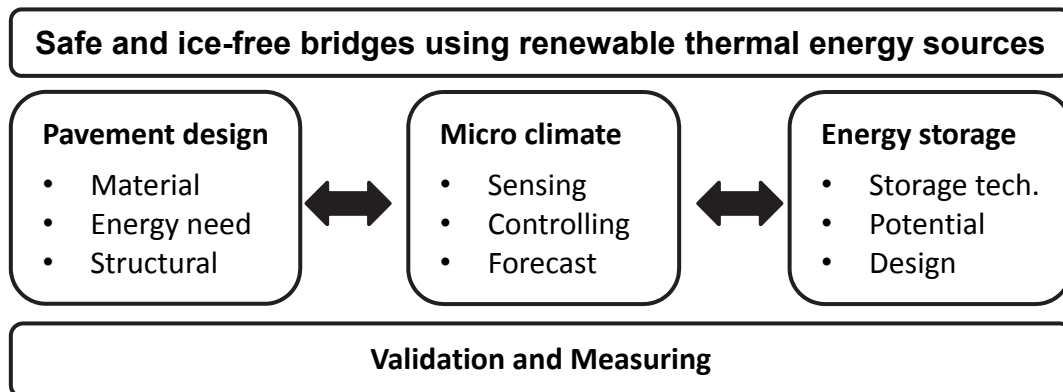

Figure 2. Research topics within the research area “Safe and ice-free bridges using renewable energy sources”.

The research area was divided into three research topics with a strong interaction between them. Namely: *pavement design*, *micro climate* and *energy storage*. The research topic *pavement design* focuses on the material properties and design of the pavement section for optimal energy performance. The research topic *micro climate* focuses on sensors for monitoring and controlling the road surface conditions and forecasting the micro climate. The research topic *energy storage* focuses on available storage technology and energy sources, design of seasonal thermal energy storages and design of a combined system using hydronic pavement. The results of the three research topics will be validated by measurements performed at a test site described in paper III. The complete research area covers a multi-disciplinary field, recognised as being too complex to be covered in one single project. Therefore, the research area was separated into project I and II, see Figure 3.

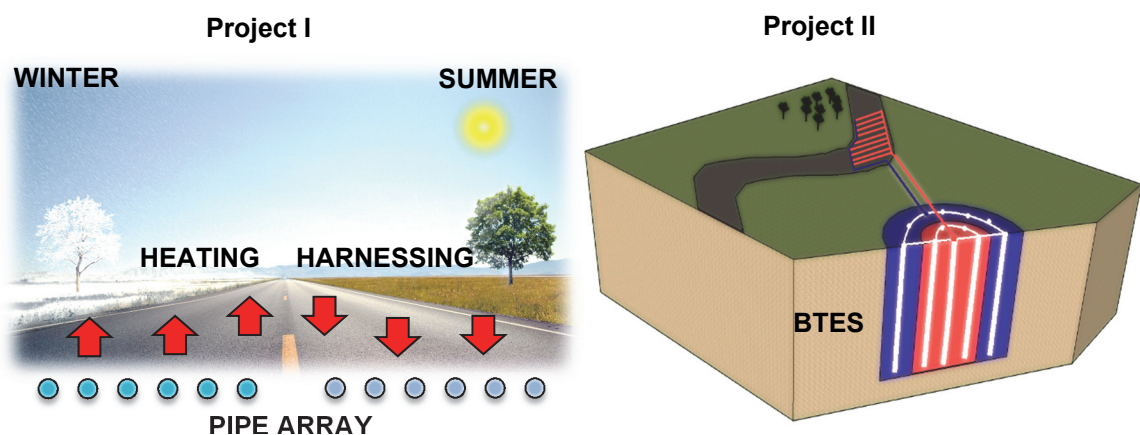

Figure 3. Division of research area between project I – *Pavement design* and project II – *Energy storage*.

The results from project I can be found in the licentiate thesis by Raheb Mirzananadi (2017). The results from the work performed in project II forms the foundation for this thesis.

1.2 Scope

Studying the feasibility of using hydronic pavement that utilise renewable energy, in the Scandinavian countries, is the main scope of the research area “Safe and ice-free bridges using renewable thermal energy sources”.

The purpose of this thesis is to identify and study a proper combination of seasonal thermal energy storage and hydronic pavement using solar energy as a part of the planned activities in the research area.

1.3 Limitations

The studied concept in this thesis considers a direct connection between the thermal energy storage and the hydronic pavement excluding the possibilities of using heat pumps, external solar panels and supplementary boilers.

The proposed concept should be used at critical sections of the road infrastructure. Those critical sections can have a higher maintenance cost or need due to e.g. increased risk for accidents. The critical sections should be maintained, by the hydronic pavement, to have the same surface conditions as the rest of the road; it should not be better, since improving the surface condition above what could be expected on the rest of the road will neither improve the accessibility nor the safety. This means that it is assumed that snow will be handled by traditional WRM and that the HP system should be used for anti-icing.

The studies made on borehole thermal energy storage in this thesis have been made under the assumption that there is no or a low ground water flow at the location of the BTES. The reason being that ground water flow could severely reduce the performance of a BTES and locations with above normal ground water flow should be avoided.

The results presented in this thesis are based on using an HP system for a heated area of at least 1000 m².

1.4 Methodology

The methodology of this project is based on three methods: literature review, numerical simulations and a future validation at a test site. The literature review on winter road maintenance opened up the field of winter road engineering and identified competing technologies as well as how thermal methods can be utilised for winter road maintenance, see report (i). The different available thermal energy storage technologies were investigated in literature review, see section 2.

A simplified model was developed to estimate the energy demand for a hydronic pavement. Furthermore, a method was developed for estimating the potential for solar energy harvesting and presented in paper I.

A numerical model was used to investigate, (i) the interaction between the climate and the hydronic pavement, and (ii) the interaction between a borehole thermal energy storage and the hydronic pavement. Finally the numerical model was used to evaluate the feasibility of utilising HP system in the Scandinavia climate, see paper III and section 4.

Further research will be focused on performing field measurements in order to validate the numerical simulations. Thereby forming a strong foundation to evaluate the feasibility of hydronic pavement combined with renewable energy for the Scandinavian climate.

2 SEASONAL THERMAL ENERGY STORAGE

The conceptualised system for local winter road maintenance involves utilisation of any sources of renewable energy. However, when there are no pre-existing energy sources, the conceptualised system should use solar energy, harvested by the HP system, and stored in a seasonal thermal energy storage. This chapter constitutes of a general introduction to available thermal energy storage technologies and the selection of a proper thermal storage technology for an HP system.

2.1 Thermal storage technologies

Thermal energy storages (TES) can be divided into different categories depending on their usage and characteristics. The time between charging and discharge of a TES separates the storage methods into short term and long term. Furthermore, TES can be divided into two main categories, namely sensible and latent heat storage technologies (ASHRAE, 2003a; Cabeza, 2014; Dincer & Rosen, 2011). A third thermal energy storage technology should also be mentioned: namely thermochemical storage technologies (Cabeza, 2014). However, for thermochemical energy storages to be an alternative for the future, they need to increase their technical readiness in order to be widely commercialised (Aydin, Casey, & Riffat, 2015). Thermochemical storage technologies are therefore not further covered.

2.1.1 Sensible TES

Sensible storages utilise the heat capacity of a material to store energy. The system commonly used today utilise large water tanks, underground aquifers or the underground (UTES). The potential for energy storage in a material is calculated by using Equation 1.

$$Q_{Storage}^{Sensible} = \rho V c_p \Delta T \quad (1)$$

Where, $Q_{Storage}^{Sensible}$ is the amount of energy that can be stored, ρ is the density, V is the volume, c_p is the specific heat capacity of the material, and ΔT is the temperature difference for the TES. The temperature difference ΔT depends on the application of the thermal storage e.g. the temperatures of the heat source and the heat sink. Selection of a material for use in a thermal energy storage, within a predefined temperature range ΔT , is based on available space V and volumetric heat capacity (ρc_p) of the material. The material could be a solid or a liquid. However, it should be stable, locally available and it should be implementable at a reasonable cost.

Water is usually a preferred TES material, due to its high storage density, availability and low cost. The storage density for a certain temperature difference and volume depends on its volumetric heat capacity. A comparison between different materials was performed, see Table 1. Water has a volumetric heat capacity of almost twice as large compared to concrete. Thus the volume of the storage can be reduced by 50%, when using water instead of concrete.

However, water based TES need carefully designed containers, to minimise the heat losses and to increase the efficiency of the storage.

The selection of a TES material must be based on the local conditions for each specific project. Commonly, the underground materials are used as a TES. Because, clay, sandstone and granite are common underground materials and available in large volumes. Further on, they have an acceptable storage density (see Table 1) making the underground suitable as a sensible thermal energy storage.

Table 1. Thermal storage density for a few commonly available materials. Data is specified at 20 °C. (Dincer & Rosen, 2011)

Material	Density [kg/m³]	Specific heat capacity [J/kgK]	Volumetric heat capacity [MJ/m³K]	Storage density ΔT = 10°C [kWh/m³]
Clay	1458	879	1.28	3.6
Brick	1800	837	1.51	4.2
Sandstone	2200	712	1.57	4.4
Wood	700	2390	1.67	4.6
Granite	2750	790	2.17	6.0
Concrete	2710	880	2.38	6.6
Aluminium	2710	896	2.43	6.7
Steel	7840	465	3.65	10.1
Gravelly earth	2050	1840	3.77	10.5
Magnetite	5177	752	3.89	10.8
Water	988	4182	4.13	11.5

2.1.2 Latent TES

Latent thermal energy storages mainly utilise the energy (released/absorbed) when a material changes phase e.g. liquid to solid (water to ice) and solid to liquid (ice to water). In the TES application, focus is mainly on the energy required for a phase change from solid to liquid or (liquid to solid), called phase change enthalpy. This change takes place at nearly constant temperature e.g. pure ice melts at 0 °C while requiring the additional heat of 330 [MJ/m³]. The potential for energy storage in such a latent TES is calculated by using equation 2.

$$Q_{Storage}^{Latent} = VL \tag{2}$$

Where, $Q_{Storage}^{Latent}$ is the amount of energy that can be stored, L is the volume specific phase change enthalpy, V is the volume of the material. The main governing property for a latent storage material is the phase change enthalpy. However, there are also other properties which are important in the design of a latent TES such as stability, thermal conductivity of the storage material and environmental concerns.

The materials used in the latent TES are called phase change materials (PCM). PCMs have different properties e.g. melting temperature and phase change enthalpy, see Table 2. The melting temperature defines which PCM that is suitable for a specific TES. Because, HP systems work in the temperature range of about 5-40 °C the suitable PCMs are *Paraffins*, *Salt hydrates*, and *Sugar alcohols*. There are also other challenges that limit the utilisation of PCMs such as supercooling, long-term stability, and the low thermal conductivity. The low thermal conductivity limits the heat transfer rate when using the TES, hence limiting the maximum thermal power that can be charged or discharged from the storage. This problem can only partly be solved, by using complex geometrical designs for the heat exchanger (Cabeza, 2014).

Table 2. Thermal storage density for materials used as PCM in TES. (Cabeza, 2014)

Material - PCM	Melting Temperature [°C]	Phase change enthalpy [MJ/m³]	Storage density¹ [kWh/m³]
Water-salt solutions	-100-0	200-300	56
Water	0	330	92
Clathrates	-50-0	200-300	56
<i>Paraffins</i>	-20-100	150-250	42
<i>Salt hydrates</i>	-20-80	200-600	56
<i>Sugar alcohols</i>	20-450	200-450	56
Nitrates	120-300	200-700	56
Hydroxides	150-400	500-700	139
Chlorides	350-750	550-800	153
Carbonates	400-800	600-1000	167
Fluorides	700-900	>1000	278

¹⁾ Storage density was calculated for the lower values of phase change enthalpy.

2.2 Selection of suitable TES for an HP system

Comparing latent and sensible TES materials is a challenging task, since there is a constant development of new materials and methods. However, a limited survey was made to understand the differences between the two technologies and to study the feasibility of the technologies in combination with an HP system.

Four possible TES materials were selected for further study. The selection of the materials were based on the data presented in Table 1 and Table 2. Clay and granite were selected for representing a sensible underground TES. Salt hydrates and paraffins were selected as latent TES materials, since they operate in the temperature range of an HP system.

The evaluation of suitable TES materials for an HP system was performed by designing a case study based on a simplified heat demand model described in paper I. The climate data of Gothenburg was used as input data for the calculations. The annual heat demand was calculated to be 75MWh for the arbitrary selected area of 1000 m². (Adl-Zarrabi et al., 2016).

The calculated annual heat demand was then used for investigating the volume, type and cost of the TES. The cost estimation covered drilling an underground thermal energy storage (UTES) and the cost for latent storage material. The results of calculation are presented in Table 3.

Table 3. Cost comparison between latent and sensible TES material.

Material	Storage density [kWh/m³]	TES Volume [m³]	Borehole depth [m]	Drilling cost [\$/m]	Estimate cost
Sensible TES					
Clay	3.6	20833	10417	24	\$254 600
Granite	6	12500	6250	24	\$152 800
Latent TES			Mass of TES [tonne]	FOB price [\$/ton]	Material cost
Salt hydrates (ClimSel C7) ^a	49	1531	2143	6900	\$14 785 700
Salt hydrates from India				100	\$214 300
Paraffins (Rubitherm T8) ^a	42.8	1753	1543	5750	\$8 871 400

^a) Product representing the selected material.

The results presented in Table 3 were calculated by using Equation 1 and 2 assuming $Q_{storage} = 75 \text{ MWh}$ and a modest temperature difference in the sensible TES of $\Delta T = 10 \text{ }^\circ\text{C}$. The borehole depth was calculated assuming that 1 meter of borehole would be equivalent to 2 m^3 of TES material. This assumption overestimates the borehole depth, since in reality there will be a much larger active volume around the borehole. The drilling cost was assumed to be the same for clay and granite and it was based on a borehole depth of 200 meters for each single bore hole. The cost for PCM storages vary depending on the quantity bought and the purity of the material. There is a very large price difference which is illustrated in Table 3 for salt hydrates from India compared to ClimSel C7 (Climator Sweden AB, 2015; Kenisarin & Mahkamov, 2016).

The large cost difference presented in Table 3 reveals that commercial PCMs manufactured in Europe is not an economically feasible TES alternative for an HP systems. However, salt hydrates manufactured in India has been quoted for a cost of 100 \$/ton (Kenisarin & Mahkamov, 2016) which would give a cost of \$214 000 for a storage holding 75 MWh. At this price level, latent TES could be an alternative to sensible UTES. However, other technical demands such as stability and availability should be fulfilled too.

The costs presented in Table 3 covers materials (latent) and drilling (sensible). However, there are also additional cost to be considered. For the sensible TES the additional costs are the construction cost i.e. piping, pumps and land usage. The additional cost for a latent TES are related to storage facility, heat exchangers, pumps and piping. Because of the cost for the storage facility, it is likely that the construction cost for the latent TES would be higher than the cost for a sensible TES. Especially since the cost for the storage facility is added to the already higher cost for the material.

When comparing sensible and latent TES, the maturity of the technology should be taken into account as well. Sensible TES have been built as underground storages for a long time and the technology is widely commercial available. Latent TES have been in limited use since the late 1800s and in the 1980s latent TES products became available (Dincer & Rosen, 2011). However, there are still challenges that need to be addressed, like the low thermal conductivity of PCMs (Cabeza, 2014), before PCMs can be suitable for an HP system.

To conclude, a sensible TES, like an UTES, appears to be a proper storage technology for an HP system due to the technical maturity level and also the costs efficiency.

2.3 Underground seasonal storage technologies

Underground thermal energy storage (UTES) is a thermal energy storage technology that utilises the underground materials as a storage medium. Three different storage technologies will be discussed in this section. Namely aquifer thermal energy storages (ATES), borehole thermal energy storages (BTES), and cavern thermal energy storage (CTES). The basic principles of these technologies will be introduced and further studies for BTES will be motivated.

Aquifer thermal energy storage (ATES) utilise underground aquifers as thermal energy storage and heat transfers through the storage by the means of advection. A prerequisite for an ATES is a suitable geology with an aquifer that can be utilised. Commonly at least two wells are drilled into the aquifer one for injection and one for extraction of water. The aquifer should have a low natural flow otherwise the stored heat would be transported out of the storage due to unintended advection. ATES are used to cover both cooling and heating demands. During summer, cold water is extracted from the cold well, used for cooling and pumped back to the warm well at an elevated temperature. When there is a demand for heat, the system is reversed and water is extracted from the warm well and pumped back to the cold well, thereby transferring the thermal energy between the seasons (Cabeza, 2014). Theoretically, ATES have a large potential for energy storage but the scarcity of suitable locations makes the practical usage for hydronic pavements low.

Borehole thermal energy storage (BTES) utilise the soil or rock material of the underground as the heat storage medium. This means that BTES can be widely used since the storage

material is locally available, however, the design may vary depending on different demands and sites. BTES constitutes of a number of boreholes, densely drilled into the underground. Each borehole contains a heat exchanger through which the heat is charged or discharge, see Figure 4. The working fluid of the system is pumped through the borehole heat exchanger (BHE). Heat is transferred between the fluid and the storage depending on the temperature difference, between the borehole wall and the fluid temperature. Inside a BTES the heat is mainly transferred by heat conduction. However, if there is a groundwater flow, the performance of a BTES could be reduced due to the increased losses due to advection. Therefore, the local hydrological conditions are crucial for the location of a BTES (Cabeza, 2014).

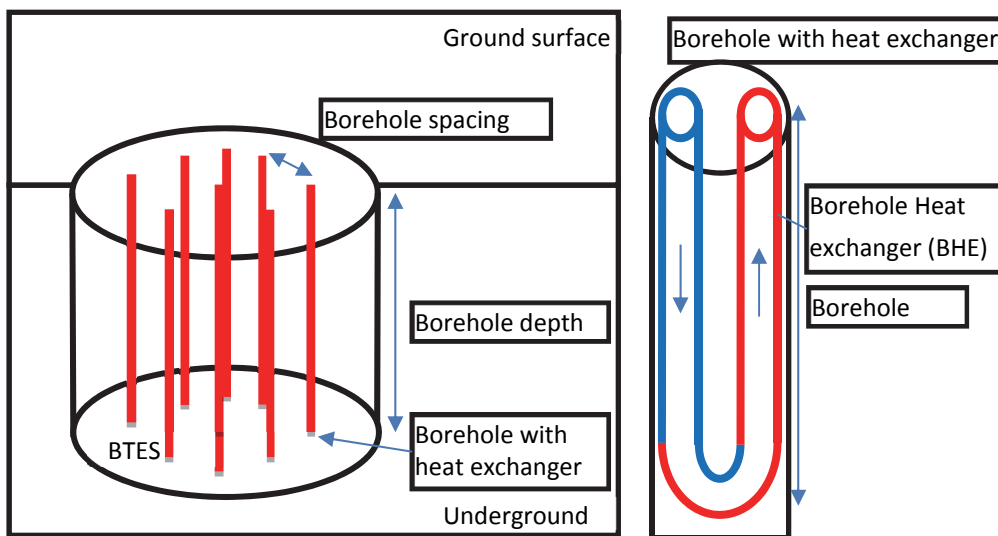

Figure 4. Schematic sketch representing a BTES (Left) and a borehole with a heat exchanger made out of a standard plastic U-pipe (Right).

While ATES and BTES being the most commonly used underground thermal storage other types also exist e.g. cavern thermal energy storages (CTES). CTES are made out of large underground caverns or pits, which can be filed with water or crushed rock and water. The benefit is that large amounts of heat can be transferred in a short period of time while the drawbacks is high initial costs and demands on good rock quality (Nordell, 1994). The initial cost and the demand for suitable geological conditions limits the possibility to utilise CTES in combination with an HP system.

ATES and CTES are generally preferred as seasonal TES, due to their ability to handle high peak loads. However, the scarcity of suitable locations limits the prospects of combining them with an HP system. Thus, BTES are selected for further investigations.

2.4 Borehole thermal energy storages

The research of borehole thermal energy storages (BTES) started in the 1960s (Gao, Zhao, & Tang, 2015; Hellström, 1989) and gained interest in Sweden in the late 1970s after the oil

crises. Sweden took a leading role in the early development of the research field. This resulted in a number of research papers collected in the report series “Markvärme – En handbok om termiska analyser” (Claesson, Efring, Eskilson, & Hellström, 1985). Which, covers the topic of UTES. The research in the field payed off and today 20-25 % of the residential buildings in Sweden are heated using shallow geothermal energy. However, still the number of BTES systems are limited to about 400 operational systems in Sweden (Gehlin, Andersson, Bjelm, Alm, & Rosberg, 2015).

BTES uses the underground as a storage medium and heat is charged and discharged through borehole heat exchangers (BHE), see Figure 4. The major concerns regarding a BTES are the thermal losses from the storage and the heat transfer rate. The heat transfer rate is controlled by the interaction between the BHE and the borehole wall. Thermal losses can be limited by insulating the top part of the storage and by adjusting the surface-to-volume ratio of the storage. Due to the moderate thermal conductivity of the ground, ranging from 1-5 W/m·K, and by limiting the surface-to-volume ratio, the losses can be reduced, thereby increasing the storage efficiency. The storage efficiency is generally defined by the ratio of extracted energy divided by injected energy.

$$\eta_{storage} = Q_{extracted}/Q_{injected} \quad (3)$$

The storage efficiency are typically in the range of 50-60% for storages in the size of 30 000 m³ while for larger storages $\eta_{storage}$ can reach 80-90 %. The storage efficiency usually increases over time since the underground temperature outside the storage will increase, thereby reducing the losses from the storage. Normally it takes a couple of years before the temperature in the storage is stable over the year and to achieve a high storage efficiency (Cabeza, 2014; Milewski, Wołowicz, & Bujalski, 2014).

2.4.1 Geometry of BTES

The geometrical design of a BTES strives after creating an as dense storage as possible with a low surface-to-volume ratio. Thereby minimising the surface area through which the heat losses could occur. The most effective design geometry would be a sphere, but due to impracticalities normally rectangular, hexagonal or cylindrical storages are used. The top area of the BTES depends on the individual pipe spacing and the total number of boreholes in the storage. Using a hexagonal shape reduces the surface area by 25 % compared to a rectangular shape, thereby lowering the losses. In order to achieve a low surface-to-volume ratio the diameter and the depth of the storage should be equal. The depth of the storage is usually in the range of 30-200 m. The diameter of the storage depends on the number of boreholes (N_{bore}) and the distance between the individual boreholes. The spacing between the boreholes depends on the thermal properties of the ground and is usually in the range of 2-5 m (Cabeza, 2014).

2.4.2 Borehole heat exchanger

The design of the borehole heat exchanger (BHE) influences the specific heat transfer rate q_b [W/m] thereby, affecting the total heat transfer rate from the BTES and the performance of a BTES. The most common BHE is the single U-tube design seen in Figure 4 (Right) while double U-tube also exists. The single U-tube consists of a plastic pipe with spacers connected to keep the distance between the two parallel pipes. The diameter of the borehole is in the range of 150 mm and the outside pipe diameter is about 40 mm. The design of the BHE and the specific heat transfer rate q_b are connected through the borehole thermal resistance R_b and the temperature difference between the mean fluid temperatures in the pipe T_f and the temperature of the borehole wall T_{bw} .

$$T_f - T_{bw} = R_b \cdot q_b \quad (4)$$

The borehole thermal resistance R_b depends on the position of the pipes in the borehole, the pipe material, and the filling material between the U-tube and the borehole wall (Gehlin, 2002). The borehole thermal resistance is determined by the thermal response test (TRT) method which is an in-situ method based on that a constant heat rate is injected into the BHE while fluid and ground temperatures are monitored. The resulting heat rates and temperatures are used for calculating R_b as well as the thermal properties of the ground. The relation in Equation 4 reveals that a low R_b -value gives a high q_b -value. Common values for R_b are in the range of 0.05-0.06 [K/Wm⁻¹] (Gehlin, 2002).

The results of the literature review and the technical assessments related to the selection of a proper thermal storage technology indicate, that underground thermal energy storages are most suitable for combining with a hydronic pavement system. The selection is based on the availability and ease of access to borehole thermal energy storages but also the cost and maturity of the technology

3 HYDRONIC PAVEMENT SYSTEMS

The hydronic pavement (HP) is closely connected to the thermal energy storage. Since the hydronic pavements sets the demands for power and annual energy supply from the thermal storage. The main link between the thermal storage and the hydronic pavement is the temperature difference between the required mean fluid temperature in the hydronic pavement and the mean temperature in the storage.

The interaction between the thermal storage and the HP system were investigated by preliminary studies, concerning energy demand and harvesting potentials for solar energy. The studies established the importance of the surface heat balance of the pavement surface which is the heat source and heat sink for the thermal energy storage.

3.1 Surface heat balance of a pavement

The surface heat balance is the main governing expression that influence the heat exchange on a pavement surface. Therefore it is of great importance for the hydronic pavement system especially when the pavement is used as solar collector. However, detail studies of the interaction between the pavement and the local climate is outside the scope of this thesis. Research on the surface heat balance has been performed in a wide number of studies for instance Pan et al. (2015) and Nuijten (2016). This section will give a brief introduction to the surface heat balance, for further reading see paper IV.

The pavement surface is influenced by a number of heat transfer processes, see Figure 5. These heat transfer processes are: conductive heat transfer involving the heat transfer from the underground to the surface and pipes embedded in the pavement (q_{cond}), convective heat transfer by ambient air (q_{conv}), sensible heat from precipitation like rain or snow (q_{precip}), sensible heat from the traffic ($q_{traffic}$), longwave radiation (q_{lw}), shortwave radiation (q_{sw}), latent heat due to evaporation and condensation ($q_{evap/con}$), latent heat due to sublimation and deposition ($q_{sub/depo}$) and latent heat due to freezing and thawing of moisture on the road surface ($q_{freeze/thaw}$). The total heat balance on the road surface (q_{total}) is calculated by using Equation 5:

$$q_{total} = q_{cond} + q_{conv} + q_{precipitation} + q_{traffic} + q_{lw} + q_{sw} + q_{evap/con} + q_{freeze/thaw} + q_{sub/depo} \quad (5)$$

All heat transfer parameters presented in Equation (5) have an influence on the pavement surface and the surface conditions. However, commonly the surface heat balance is simplified by excluding some of these parameters. For instance the sensible heat from the traffic $q_{traffic}$ or the latent heat $q_{evap/con}$, $q_{sub/depo}$ and $q_{freeze/thaw}$. Different simplifications could be made depending on which phenomena studied. Further details regarding the pavement heat balance is discussed in paper IV.

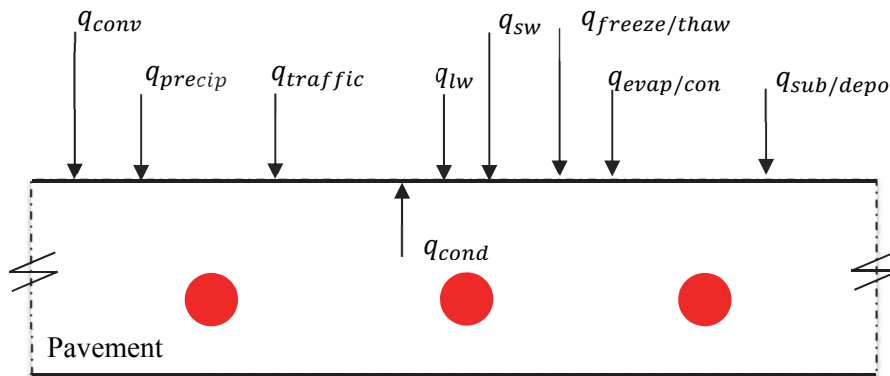

Figure 5. Outline of a pavement section with embedded pipes and the heat fluxes that effects the surface heat balance of a pavements.

3.2 Preliminary Energy balance for an HP system

The energy demand and harvesting potentials were studied in paper I. The research question was whether harvested energy would be larger than the energy demand for an HP system. Based on a literature review it was found that about 30 % of the incoming solar radiation during the summer can be harvested from the pavement surface, by using the hydronic pavement as a solar collector. The results of energy harvesting potential in ten cities, nine cities in Nordic countries and one in Swiss, are presented in Figure 6. The results indicate that the mean value of the harvested energy is 131 kWh/m²-year with a standard deviation of 7 kWh/m²-year.

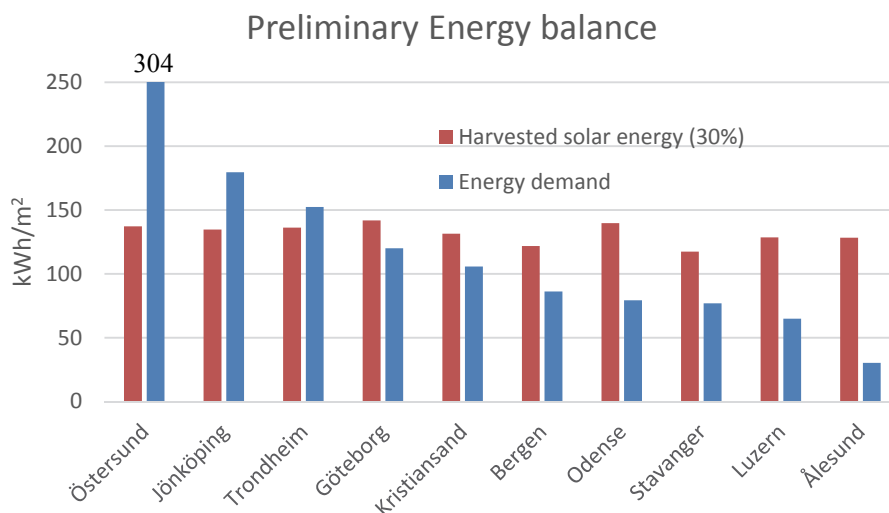

Figure 6. Energy balance for ten cities. The harvesting solar energy is based on that 30 % of the incoming solar radiation could be harvested during a 3 month period while the energy demand is based on the ASHRAE method.

Furthermore, for the same cities the energy demand for an HP system was calculated based on a modified ASHRAE method for snow/ice melting (ASHRAE, 2003b). The ASHRAE method was developed to design hydronic pavements for snow melting and is known to overestimate the energy demand.

The calculated results are a reasonable estimation of the energy demand. Even though the model does not consider the influence of evaporation and condensation. Furthermore, the results presented in Figure 6 revealed that all sites are not suitable, for an HP system directly connected to BTES. Some locations have harsher winter conditions which would require more energy than can be provided by the incoming solar radiation, therefore needing a backup energy source. The energy demand varies between 30 - 304 kWh/m²-year for the locations of Ålesund and Östersund respectively. The mean energy demand is 119 kWh/m²-year with a standard deviation of 73 kWh/m²-year. This means that there are rather

larger variations in the energy demand between different locations which shows to the importance of the local climate.

Using the results of paper I, it can be concluded that southern locations with a costal climate has a potential for the combination of using BTES directly with an HP system, since the harvested energy exceeds the energy demand for the HP system, resulting in a positive heat balance.

4 HYDRONIC PAVEMENT COMBINED WITH A BOREHOLE THERMAL ENERGY STORAGE

The strong interaction between hydronic pavement and seasonal thermal energy storage means they need to be studied as one system with two components. The system will be referred to as the renewable hydronic pavement system.

A numerical simulation model was developed, based on existing software, and used for further analyses of renewable hydronic pavements. The analyses were focused on the influence of the BTES geometry and the thermal properties of the underground material.

4.1 Short introduction to the simulation software BRIDGESIM

A literature study was performed to identify proper software for analysing hydronic pavement with BTES. Two software were identified. The first software, ‘Geothermal smart bridge’, was built on the software engine HVACSIM+ (Chiasson, Spitler, Rees, & Smith, 2000; Spitler et al., 2004). The second software was BRIDGESIM built on the TRNSYS engine and developed by Daniel Pahud for evaluating systems similar to the SERSO project (Pahud, 2007, 2008). Both software have their advantages and disadvantages. The HVACSIM+ provides a model for HP that utilises BTES and heat pumps. However, the software could not be used without time demanding and complex modificationsⁱ. BRIDGESIM uses a modified building energy simulation tool as a representative model for the pavement surface. It also incorporates a BTES but the influence of wind, precipitation and latent heat are neglected.

BRIDGESIM was selected and modified for numerical simulation for the system proposed in the thesis. The simulation software, BRDIGESIM, combines a number of components into an application for calculating the energy flows in a hydronic pavement system using renewable energy. Figure 7 presents the hydronic pavement system used in BRIDGESIM and the major components, i.e. hydronic pavement, short term thermal energy storage and borehole thermal energy storage as well as minor components like valves, pumps, control module and post-processing module.

ⁱ Discussion with Spitler, Jeffrey D. 2014-10-13

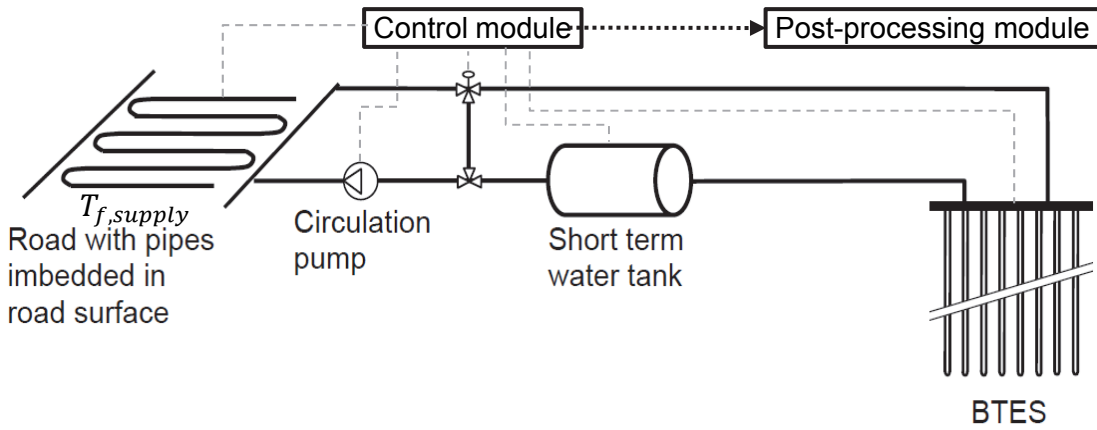

Figure 7. System layout used by BRIDGESIM with major modules, based on Pahud (2008)

The interaction between the fluid inside the pipe and the exterior climate is handled by the hydronic pavement module in BRIDGESIM. The HP module simplifies the 2-D heat transfer problem of the pipes embedded in the pavement into a 1-D problem, see Figure 8. The approach is based on the work done by Koschenz and Dorer (1996) and it was originally used for simulating thermally activated building systems or underfloor heating systems. The upper surface boundary in BRIDGESIM takes convection, shortwave radiation, and longwave radiation into account and neglects wind, precipitation, and latent heat as a result of condensation (Pahud, 2007).

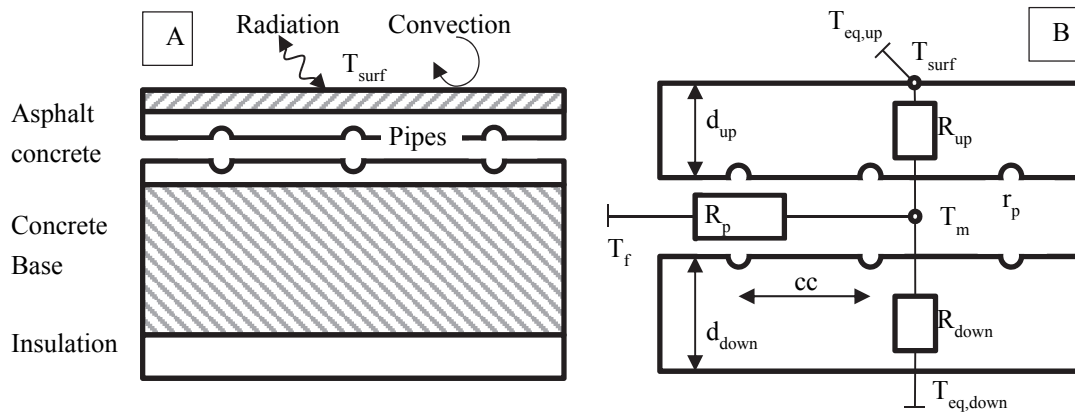

Figure 8. A, simplified 2-D case describing the heat transfer problem. B, 1-D thermal network for the road model.

In Figure 8A, the different material layers in the road section are presented, the thickness and thermal properties of each layer could be varied in order to adapt the model to site-specific designs. In Figure 8B, the temperatures $T_{eq,up}$, $T_{eq,down}$, T_{surf} , T_f , T_m respectively, refer to the upper and lower equivalent temperature, the surface temperature, the fluid temperature, and the mean temperature at the depth of the pipes. The thermal resistances R_{up} and R_{down} represent the thermal resistance between the upper and lower boundaries to the depth of the pipes. R_p is the thermal resistance between the fluid in the

4. Hydronic pavement combined with a borehole thermal energy storage

pipe and the mean temperature at pipe depth T_m . R_p takes into account the resistance from the fluid through the pipe material, as well as the geometrical influence of the pipe diameter r_p and the spacing between the pipes, i.e. the distance cc . Furthermore, d_{up} and d_{down} represent the distance from the boundaries to the pipe depth. A more detailed description together with an evaluation of the module can be found in (Pahud, 2007).

4.1.1 Control module used in BRIDGESIM

The control module controls the heat exchange between the road and the storage. The module consists of two different elements, presented in the following paragraphs. The first element controls the supply temperature to the road at different air temperatures and the second element controls the circulation pump for harvesting of solar energy.

The control settings for harvesting were studied in paper III. It was found to be preferable to adjust the settings in such a way that maximum solar radiation could be harvested. However, this means the circulation pump would be active for longer durations, increasing the electric consumption for pumping. While the increased consumption of electricity is negative, the extra harvested solar energy is needed in the winter. Further details can be found in paper III.

The control settings for de-icing were also studied in paper III. The supply fluid temperature, $T_{f, supply}$ is controlled according to a heating curve. The heating curve defines the set point temperature that is used to control the supply fluid temperature to the pavement at different air temperatures. The system is stopped when the air temperature is below $-8\text{ }^\circ\text{C}$, thereby stopping the heat flow from the storage. Selection of the temperature level ($-8\text{ }^\circ\text{C}$) is based on the low probability of ice formation at this level because of the low humidity content of the air (Pahud, 2007).

4.1.2 Evaluation and post-processing module

Different system configurations, e.g. varying pipe spacing and the number of boreholes, were compared in order to find the optimum configuration. The comparisons between different configurations were performed by introducing a parameter, DH_{fail} , which is a measure of how many degree-hours the system fails to meet the prescribed surface temperature.

When the temperature of the road surface T_{surf} is lower than $0\text{ }^\circ\text{C}$, there is a risk for ice formation on the road surface. However, when the air temperature is lower than $-4\text{ }^\circ\text{C}$ the frequency of snow fall is greatly reduced, as well as the moisture content in the air; this reduces the risk for slipperiness. Therefore the critical conditions for creating slipperiness is when T_{surf} is below $0\text{ }^\circ\text{C}$ and T_{air} above $-4\text{ }^\circ\text{C}$. The performance of the HP system is, therefore, evaluated at these temperature levels.

There will be times when the HP system cannot prevent ice formation at the critical temperature condition and the system should be designed to reduce this time, i.e. minimising DH_{fail} . The factor DH_{fail} is defined as:

$$DH_{fail} = \int_0^{1\text{ year}} (0 - T_{surf}) dt \quad \text{if } T_{surf} < 0 \text{ }^\circ\text{C and } T_{air} > -4 \text{ }^\circ\text{C} \quad (6)$$

DH_{fail} is the sum of the degree-hours over a year when there is a high risk for ice formation and the system could not meet the demand. The unit for DH_{fail} is K·h/year. For further details, see paper III.

4.2 Influence of the center-to-center distance between pipes and supply fluid temperatures

In paper III BRIDGESIM was used to study an HP system for a test site for hydronic pavements outside Östersund in Sweden. The main findings are presented in this section and reveal how the energy demand is influenced by the supply temperatures and the centre-to-centre distance between the pipes. For details on simulations and the input data, see paper III.

The supply fluid temperature $T_{f, supply}$ and the pipe centre-to-centre distance cc are two of the main parameters affecting the heat output from an HP system and thereby affecting the risk for ice on the surface. Commonly, HP systems are designed for supply fluid temperatures $T_{f, supply}$ of about 35 °C and cc distance of about 25 cm (Uponor, 2013). Many studies have been focused on using supply fluid temperatures in the range of 25-40 °C and cc distance in the similar range of 20-30 cm (Boyd, 2003; Chen, Wu, Wang, & Zhang, 2011; Magnusson, 1977; Pan et al., 2015). However, in order to combine an HP system with a seasonal storage, the systems need to be adopted to utilise lower supply fluid temperatures.

When using lower $T_{f, supply}$, the heat flux at the surface needs to be maintained so the surface temperature prevents ice formation. This can be achieved by reducing the thermal resistance R_p . By reducing the pipe centre-to-centre distance (cc), the resistance between fluid and the pavement surface is reduced and the higher heat flux can be maintained. There are a number of examples of systems that utilise lower $T_{f, supply}$ and smaller cc distance of about 6 °C and 10-15 cm, respectively (Fukuhara, Goodrich, Wantabe, & Moriyama, 2000; Iwamoto et al., 1998; Yoshitake, Yasumura, Syobuzako, & Scanlon, 2011).

The influence of the supply fluid temperature $T_{f, supply}$ entering the pipe network embedded in the pavement was studied by varying the maximum and minimum supply set point temperatures T_{set2} and T_{set3} , thereby altering $T_{f, supply}$ at different outdoor conditions. The influence of $T_{f, supply}$ was studied for a fixed pipe centre-to-centre distance (cc) of 10 cm. The results are presented in Figure 9 with two sets of graphs representing the energy supply and the number of degree-hours (DH_{fail}) that the system fails to meet the requirement, $T_{surf} > 0$ °C if the $T_{air} > -4$ °C, see section 4.1.2. The arrows embedded in the figures refers to the varied parameter, T_{set3} , (see Figure 16 for an example of a control curve with T_{set3}) with the base of the arrow representing the first value (9 °C) in the sequence.

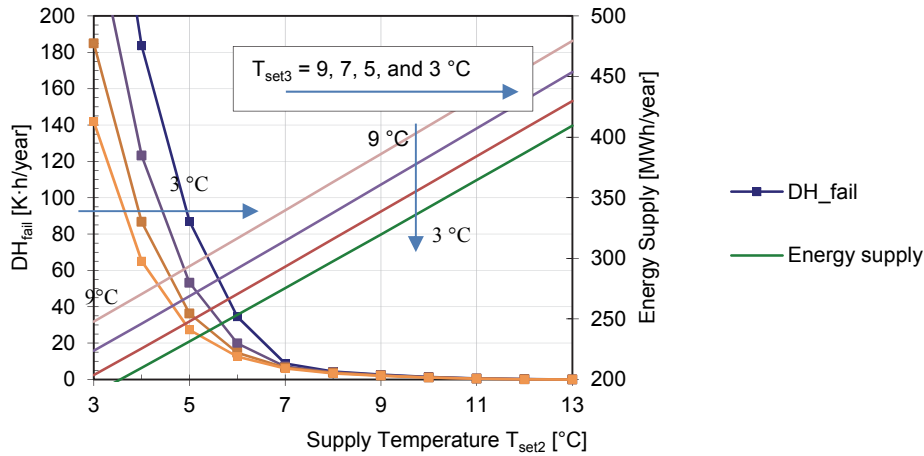

Figure 9. Variations of T_{set3} for fixed value of $cc = 10$ cm.

It was found that by varying T_{set3} for values of T_{set2} less than 7 °C, T_{set3} has a major impact on DH_{fail} , see Figure 9. With T_{set2} above 7 °C, there was a low decrease of DH_{fail} ; however, the required energy supply displayed a stable increase. From the results in Figure 9, it is evident that low supply fluid temperatures ($T_{f,supply}$) of 5 - 10 °C can be used with an acceptable performance of an HP system with DH_{fail} in the range of 5 - 40 K·h/year.

The pipe centre-to-centre distance (cc) in the pavement was studied for the cc distances of 5 , 10 , 15 , and 20 cm. $T_{f,supply}$ was varied by altering T_{set2} for a constant T_{set3} of 4 °C, see Figure 10. The results presented in figure 4 indicate that by decreasing the pipe distance, the value of DH_{fail} will decrease. Decreasing cc from 10 cm to 5 cm, the T_{set2} can be lowered by one degree to 6 °C with equal or better system performance. However, even for a spacing of 5 cm, lower values of T_{set2} than 5 °C will substantially increase the value of DH_{fail} .

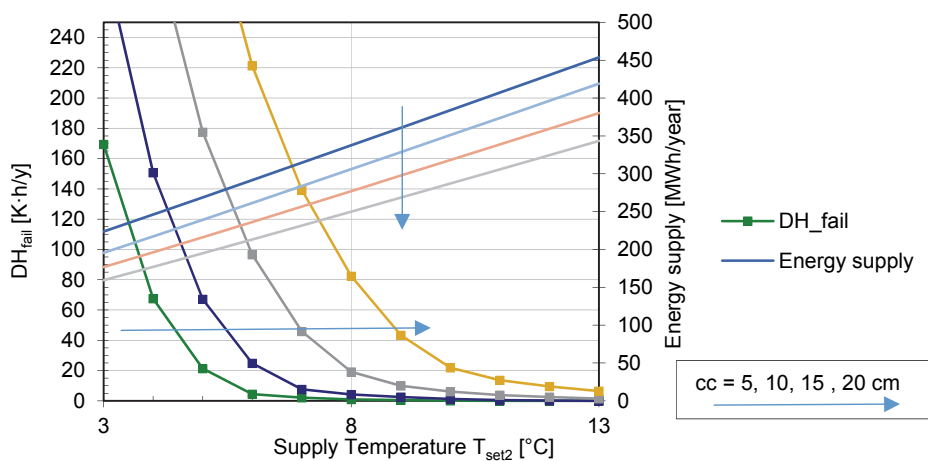

Figure 10. Varying pipe spacing (cc) for different T_{set2} , fixed $T_{set3} = 4$ °C.

4. Hydronic pavement combined with a borehole thermal energy storage

The presented results indicate that it is possible to compensate for a low supply fluid temperature by using smaller cc distance. This is in good agreement with previous studies. Thus, HP systems using supply temperatures of about 5-10 °C can be considered as a feasible solution. Reductions of the cc distance below 10 cm will be beneficial. However, three challenges have been identified. Firstly, reductions of cc will be associated with an increased cost of the material in a pipe network. Secondly, the structural behaviour of a pavement can be affected by decreasing the pipe's cc distance. Thirdly, the thermal contact between the asphalt concrete and the pipes needs to be investigated. While further research is needed for handling these challenges, in the current thesis, a pipe spacing of 10 cm was selected for further investigation.

4.3 Influence of the BTES design on the hydronic pavement

The geological conditions could vary greatly in the same area. These variations of the underground would affect the design of a BTES, thereby affecting the performance of the renewable HP-system. The influence of borehole spacing, borehole depth, total borehole length, and thermal properties of the underground on the HP-system were studied. Ground water flow was neglected in the study as locations with large ground-water flow are not suitable for holding a BTES because of increased thermal losses.

The BTES should be able to deliver the power demand to the hydronic pavement in order to reduce DH_{fail} . The power that the BTES can supply depends on the total borehole length and the specific heat transfer rate, q_b , and it can be calculated by using equation 4. The specific heat transfer rate q_b is in the range 20-40 W/m given a borehole resistance of 0.05 K/Wm⁻¹ and a temperature difference between the fluid in the borehole heat exchanger (BHE) and the borehole wall of 1-2 °C. The specific heat transfer rate can be used to estimate the required total borehole length in a BTES. The total borehole length would be between 2500-5000 m given that the hydronic pavement is designed to deliver 100 W/m², a heated area of 1000 m². The number of needed boreholes would be in the range of 25-100 boreholes, considering borehole depths of 50 and 100 m. The simplified approach presented above is used as an initial estimate of the needed borehole size for a heated area of 1000 m².

4.3.1 Influence of spacing between boreholes

The spacing between the boreholes affects the borehole storage in different ways. Firstly, the individual spacing between the boreholes influences the total storage volume. Smaller borehole spacing would mean higher temperature differences in the storage because of the lower thermal mass of the storage, see equation 1. Secondly, if the borehole spacing is large, the boreholes will not influence each other. Without the influence between boreholes, the storage temperature would not meet the temperature demand of the hydronic pavement. Thereby increasing DH_{fail} . Commonly, the borehole spacing is in the range of 2-5m

(Cabeza, 2014). Further reduction would increase the risk of hitting an adjacent borehole with the risk of causing damage to the equipment.

The influence of the borehole spacing was studied by comparing four different distances (1.5, 2, 3, 4 m) for different numbers of boreholes (NBore) in the BTES, see Figure 11. Two different borehole depths were studied. The results of the study indicated that for a BTES with a depth of 100 m and with more than 50 boreholes, the spacing only has a minor influence. This low influence could be explained as that the storage system was oversized. For NBore less than 50, increasing the spacing was beneficial as this would increase the storage volume. There was no difference between using a spacing of three and four meters. Thus the borehole spacing should be kept below 3 meters.

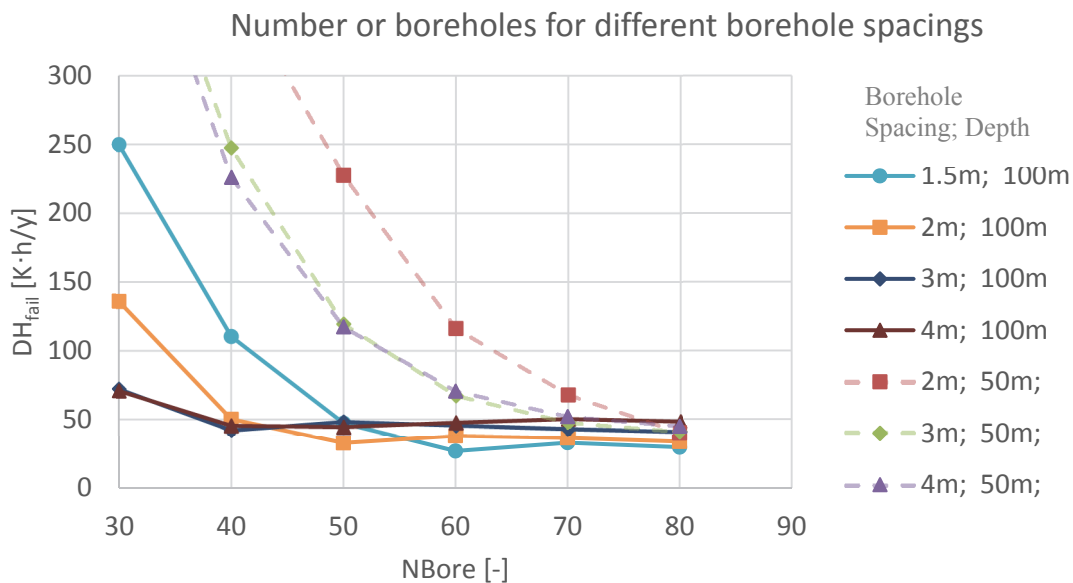

Figure 11. The influence of the borehole spacing on DH_{fail} for the borehole spacing of 1.5, 2, 3, 4 m, borehole depth of 50 m and 100 m, underground constitutes of gneiss, heated area 1000 m².

The sufficient dimension of the storage can be determined by selecting a proper DH_{fail} . The results presented in Figure 11 indicates that there are a number of alternatives that fulfil a system performance, DH_{fail} , of about 50 (K·H/y).

The results reveal that the borehole spacing influences the total cost of the system. The borehole spacing should be in the range of 2-3 m for a case of thermal properties similar to gneiss.

4.3.2 Thermal properties of the underground material

The thermal properties of the underground material can vary in a small geographical area. Four different underground materials were selected. The thermal properties of the selected materials are presented in Table 4.

Table 4. Thermal properties of the four different underground materials studied.

Material	Thermal conductivity [W/mK]	Volumetric heat capacity [MJ/m ³ K]	Thermal diffusivity [m ² /s]
Clay, Wet-moist	1.6	2.4	$6.66 \cdot 10^{-7}$
Shale	2.1	2.3	$9.13 \cdot 10^{-7}$
Gneiss	2.9	2.1	$1.38 \cdot 10^{-6}$
Granite	3.4	2.4	$1.41 \cdot 10^{-6}$

The influence of the thermal properties of underground material on DH_{fail} were investigated for a different number of boreholes (NBore) with a borehole spacing of 2.5 m and a borehole depth of 50 m and 100 m, see Figure 12. Clay has the highest DH_{fail} and granite has the lowest DH_{fail} . The results reflect that an increased diffusivity, because of higher thermal conductivity, increases the borehole wall temperature, thereby increasing the specific heat transfer rate, q_b . The higher specific heat transfer rate, means that the number of boreholes could be reduced while maintaining DH_{fail} . The results are consistent with the literature (Nordell, 1994).

The thermal properties of gneiss and clay, and the pipe spacing of 2.5 m were used in the following case study.

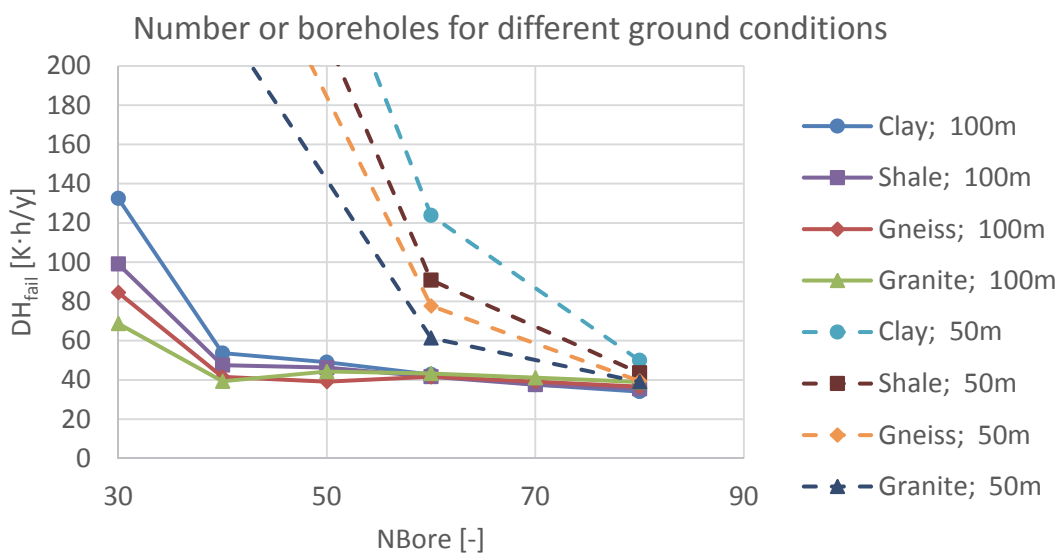

Figure 12. Influence of different ground conditions on DH_{fail} . The borehole spacing was fixed at 2.5 m and the borehole depth to 50 and 100 m, heated area 1000 m².

4.4 Case study of using a renewable HP system

HP systems using renewable energy should be used at critical sections of the road infrastructure. Two critical sections were selected for performing case studies related to the utilisation of HP system. The selected locations were Tranarp and Studevannet. Tranarp was selected because, in 2013 a major accident happened on a highway bridge outside Tranarp, Sweden (Togård, 2014). The other location, Studevannet, was selected as the bridge on highway E18, crossing Studevannet, in southern Norway was identified as a location with high risk for slippery conditions according to report ii. For both locations the surface conditions were studied when using a renewable HP system.

4.4.1 Climate data

The climate data used in this study originates from the software Meteonorm, which generates weather data for any given location (Meteotest, 2015). The climate data for selected locations and Östersund are presented in Table 5. Studevannet has lower air temperatures and a lower amount of incoming global radiation than Tranarp. The higher wind speeds and higher relative humidity can be explained by the fact that Studevannet is located closer to the coast compared to Tranarp.

Table 5. Climate for the two locations studied and from Östersund as a reference for the location used in paper III.

	Tranarp	Studevannet	Östersund
Latitude., Longitude	56.184°, 13.01°	58.19°, 8.18°	63.18°, 14.5°
Mean air temperature [°C] (Std. dev)	7.76 (7.21)	7.56 (7.21)	2.53 (9.13)
Mean Global horizontal radiation [W/m2] (Std. dev)	215 (205)	206 (197)	195 (190)
Mean Relative humidity % (Std. dev)	82 (14)	87 (12)	85 (15)
Mean wind speed at 10 m [m/s] (Std. dev)	4.8 (2.8)	5.1 (3.0)	-

4.4.2 Case study Östersund

The energy demand and number of boreholes for an HP system in Östersund were investigated in paper III. The results revealed that 120 boreholes were needed with a depth of 200 m, see Figure 13. The conclusions were that a renewable HP system was not economically feasible because of the needed number of the boreholes. Thus a supplementary energy source was needed for locations with harsh winters.

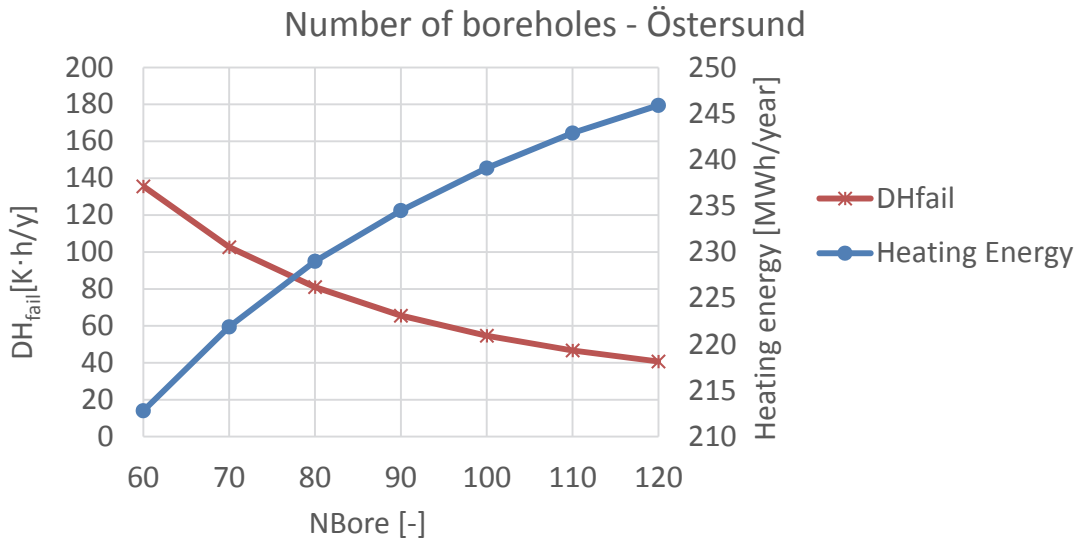

Figure 13. Number of boreholes needed for an HP system in Östersund from paper III. Borehole depth of 200 m, heated area 1000 m².

4.4.3 Case study Tranarp and Studevannet

These case studies aim at reducing DH_{fail} to about 0 K · h/y. The experiences from the case study in Österstund were used for selection of the supply fluid temperature and control setting in Tranarp and Studevannet. The pipe spacing cc was fixed at 10 cm and T_{set3} at 3 °C. The results related to Tranarp are presented in Figure 14. DH_{fail} equal to zero was achieved with the following control settings $T_{set3} = 3$ °C, $T_{set2} = 7$ °C, $T_{air3} = 2$ °C.

The control settings for the bridge at Studevannet were $T_{set3} = 3$ °C, $T_{set2} = 7$ °C, $T_{air3} = 2$ °C with DH_{fail} of 4 Kh/y, see Figure 15.

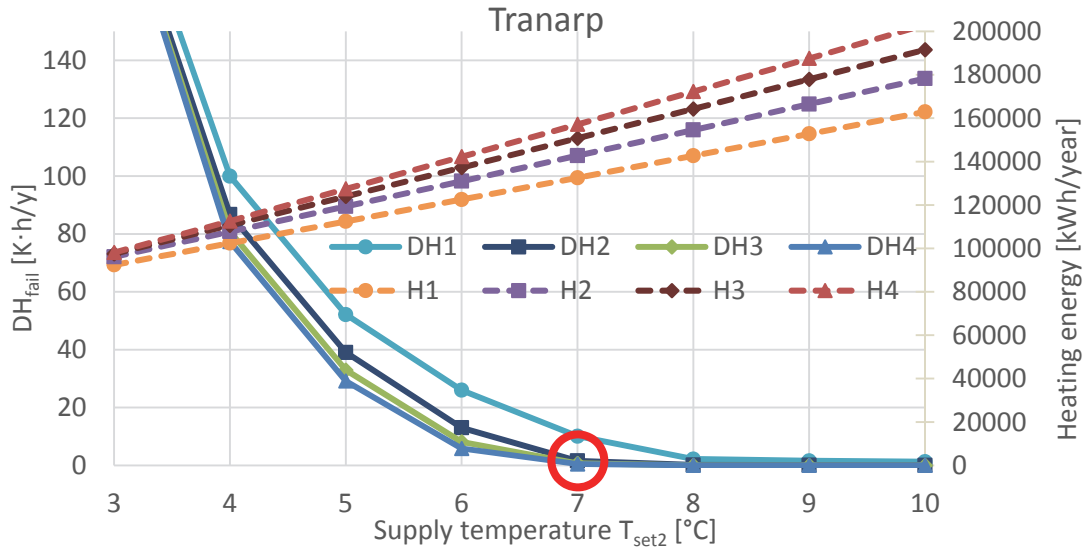

Figure 14. Evaluation of different control settings for the bridge located at Tranarp. $T_{set3} = 3$ °C, $T_{set2} = 7$ °C, $T_{air3} = 2$ °C resulting in an energy need of 142 kWh/m² and DH_{fail} of 0 K·h/y

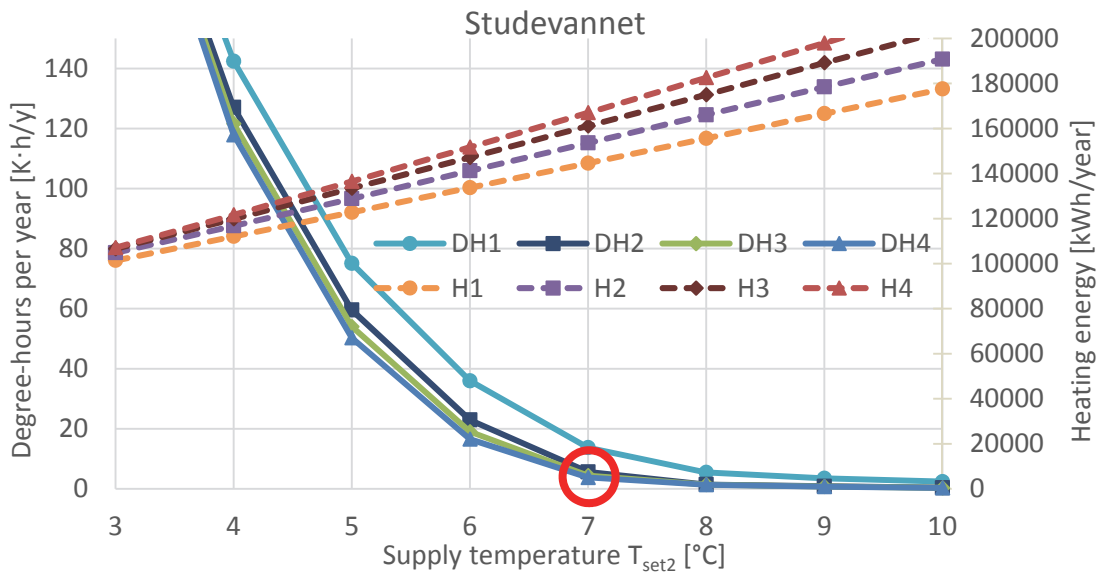

Figure 15. Evaluation of different control settings for the bridge located at Studevannet. $T_{set3} = 3$ °C, $T_{set2} = 7$ °C, $T_{air3} = 2$ °C resulting in an energy need of 153 kWh/m² and DH_{fail} of 4 K·h/y

The control curve of this case study is presented in Figure 16. The supply fluid temperature, $T_{f, supply}$ is controlled according to the control curve. The renewable HP system should be started when the air temperature is below T_{air3} . Depending on the air temperature, the supply fluid temperature is then adjusted according to the curve confined by $T_{set1} - T_{set3}$, see Figure 16. When the air temperature is below -8 °C, the renewable HP system should be stopped.

4. Hydronic pavement combined with a borehole thermal energy storage

The temperature level (-8 °C) is based on the low likelihood of ice formation at those temperatures because of the low humidity content of the air (Pahud, 2007).

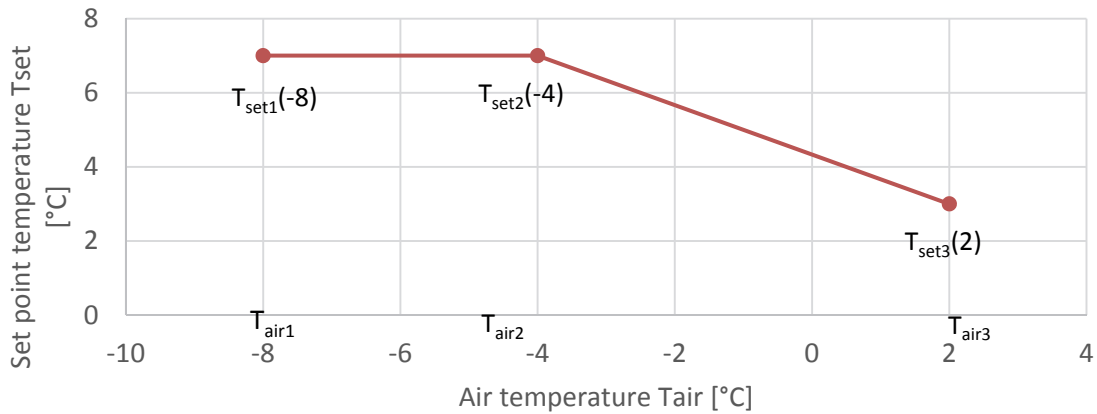

Figure 16. Control curve defining the set point temperatures used by BRIDGESIM to control the supply fluid temperature to the pavement $T_{f,supply}$.

4.4.3.1 Surface and dew point temperatures and system response

The control system was set according to Figure 16 and the number of boreholes in the BTES was 50 for both Tranarp and Studevannet, see appendix A. The resulting surface temperatures T_s , dew point temperatures T_{dew} , air temperature T_{air} and the heat supplied to the bridge q_{supply} are presented in Figure 18 (Tranarp) and Figure 19 (Studevannet). Surface temperatures T_s for a full year in Tranarp are presented in Figure 17.

Figure 17 represents the results for a full year of simulations for Tranarp with and without an HP system. The bridge with an HP system revealed more even surface temperatures that were the result of the pavement being cooled during summer and heated during winter. The surface temperatures were rather moderate, which limited the available temperature that could be harvested to the BTES. Further on the results also indicated that the HP system reduces the surface temperature fluctuations, which would reduce the thermal stresses that degrade the pavement. Thereby, increasing the life-time of the pavement. The results for Studevannet were similar to these presented for Tranarp in Figure 17.

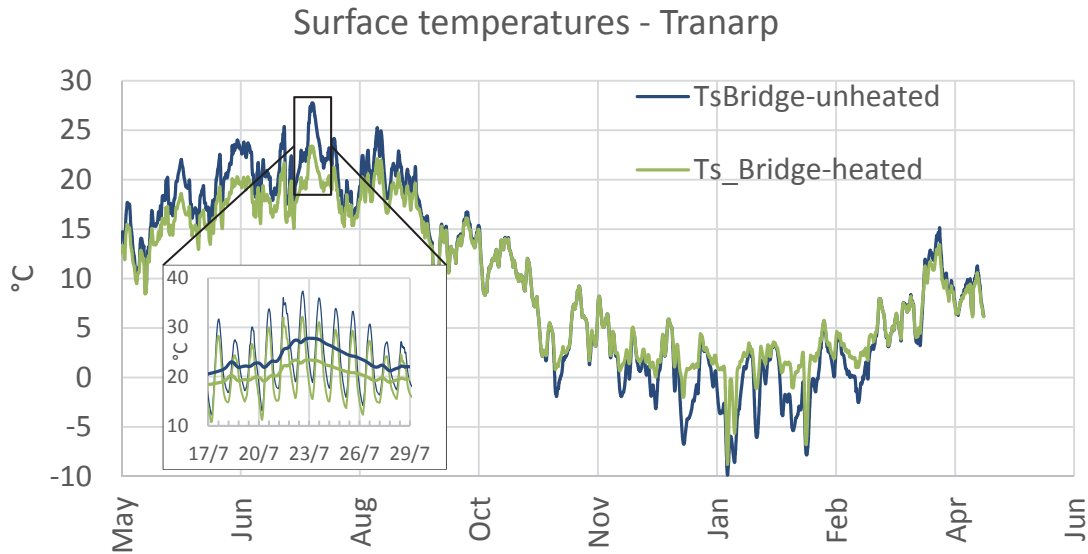

Figure 17. Surface temperatures (running daily mean) from Tranarp for an unheated and heated case. The system with a HP system reveals lower surface temperatures during summer and higher surface temperatures during winter.

The results for the studied system for Tranarp and Studevannet indicated that the number of critical hours were significantly reduced by 91 % and 86 % respectively, leaving 100 hours and 147 hours that might possess a risk for the traffic. The results for DH_{fail} were 41, respectively 77 K·h/year. These reductions are large while there are still a few hours that could still possess a risk for the traffic. However, in order for condensation and ice formation to take place, the following condition must hold: $T_s < T_{dew} & T_s < 0\text{ }^\circ\text{C}$, given that pure water is considered. Comparing surface temperatures with the dew point temperature will be done in the following paragraphs.

Figure 18 represents the results from Tranarp for a week in February during which there were two cold spells after 6825 hours and 6950 hours. During these cold spells, the temperature T_{air} dropped below $-8\text{ }^\circ\text{C}$. The HP system stopped supplying heat and q_{supply} dropped to 0 kWh/h, which resulted in an immediate drop in the surface temperature $T_{s-heated}$. However, there was no risk for condensation since the surface temperature was above T_{dew} . The peak heat fluxes occurred just after the cold spells. Because when the heating was started the whole bridge deck needs to be heated from almost ambient temperature, requiring a large heat supply. Commonly, q_{supply} were in the range of 70-120 kWh/h.

4. Hydronic pavement combined with a borehole thermal energy storage

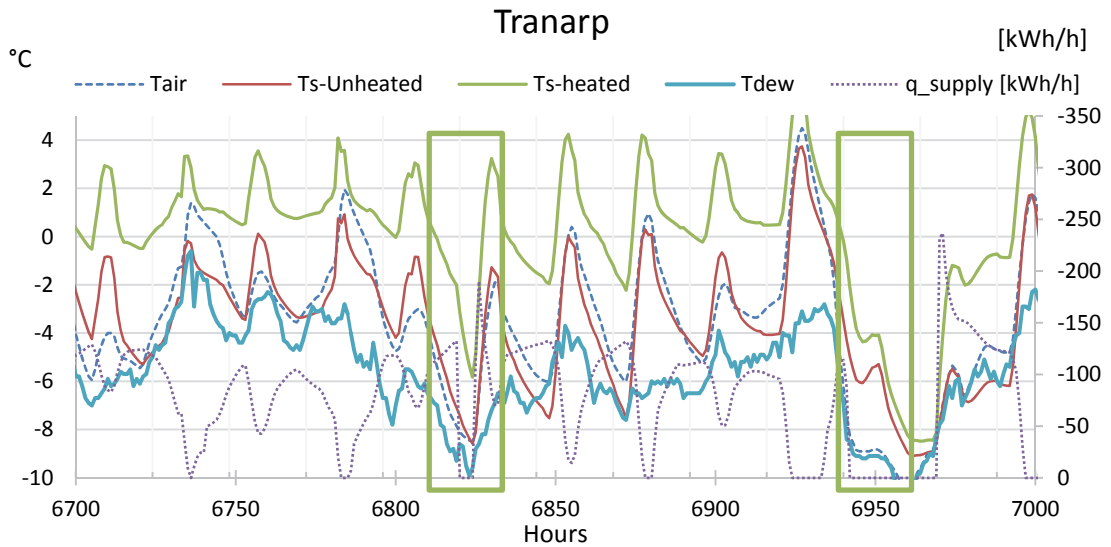

Figure 18. Resulting surface conditions for the month of February at the bridge in Tranarp. Notice the cold spells around 6825 hours and 6950 hours when the system is off because of low air temperatures.

Studying the results from Studevannet for a week in December indicated how the renewable HP system prevented condensation during the night around 5300 hours and during the evening around 5400 hours. During these two events, the unheated surface temperature $T_{s-unheated}$ dropped below T_{dew} with the risk for ice formation. However, as can be seen the HP system maintains $T_{s-heated}$ well above T_{dew} and 0 °C.

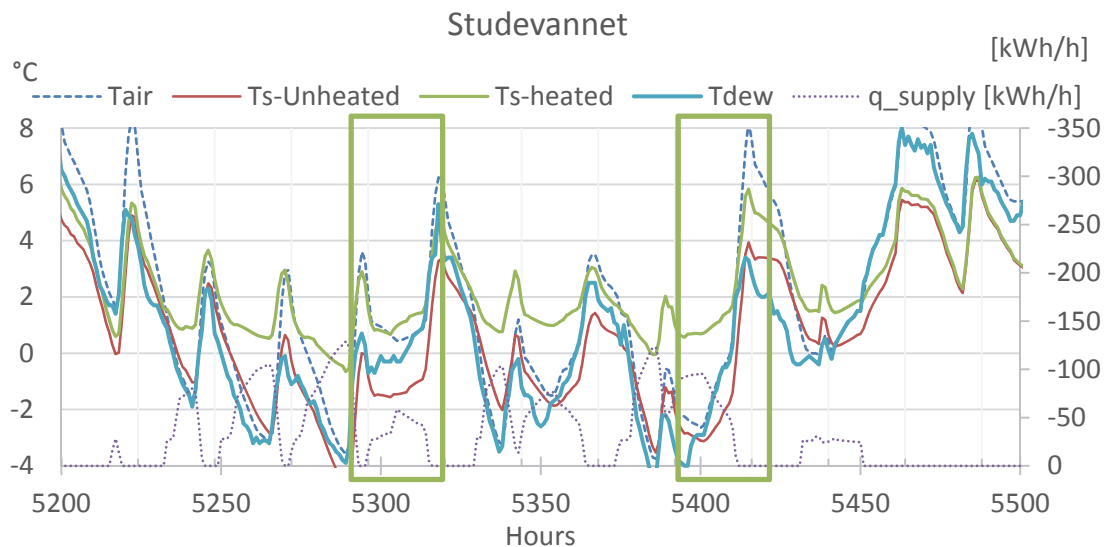

Figure 19. Resulting surface conditions for the month of December at the bridge at Studevannet. Notice how the HP system prevents ice formation after 5300 hours and after 5400 hours.

The results presented in Figure 18 and Figure 19 give a representative picture of how well the renewable HP system performs. However, there are still a few hours when the surface temperature is lower than the dew point temperature. The total hours with risk for ice formation with an active HP system are presented in Table 6. The risk for ice formation because of condensation is greatly reduced for both Tranarip and Studevannet, see Table 6.

Table 6. Hours with risk for ice formation because of condensation, with and without an HP system, and the mean heat supply to the bridge, heated area 1000 m²..

	Tranarip	Studevannet
With HP system $T_s < T_{dew}$ & $T_s < 0\text{ }^{\circ}\text{C}$	6 [h]	23 [h]
Without HP system $T_s < T_{dew}$ & $T_s < 0\text{ }^{\circ}\text{C}$	400 [h]	855 [h]
Mean heat supply q_{supply}	71 [kWh/h]	77 [kWh/h]

Based on the case study of Tranarip and Studevannet it is concluded that when using a renewable HP system, and considering the dew point temperature, the risk for slippery conditions reduces dramatically. Because condensation and deposition on the bridge could successfully be prevented, by the HP system using renewable energy. Thereby increasing the safety because of the increased friction.

The presented results are based on numerical simulations and indicate how a renewable hydronic pavement would behave under operation. However, the numerical model should be validated, by comparing the numerical result with measured results obtained in a field station. This will be done in the future by using the test site presented in paper III.

5 CONCLUSIONS

The purpose of this thesis is to study the feasibility of implementing hydronic pavements that utilise renewable energy in the Scandinavian climate. The concept that this thesis suggest consists of a hydronic pavement (HP), utilised as solar collector, connected to a borehole thermal energy storage (BTES). The combination of an HP and a BTES means that the solar energy harvested in the summer will be stored and used for winter road maintenance at critical parts of road infrastructure.

The literature study and comparison of different storage technologies confirms that BTES is a suitable storage technology for combination with an HP system. The preliminary investigations concludes that an HP system using BTES should be used in areas with rather mild winters, since in areas with mild winters the energy balance of the system will be positive. Paper III supports this conclusion, finding that for the cold winters of Östersund a supplementary energy source for heating is needed e.g. using industrial waste heat or heat pumps.

The thermal properties of the underground material have a major impact on the size of the BTES. The specific heat transfer rate of a borehole increases in an underground material with higher thermal diffusivity, being beneficial for charging and discharging the BTES. This reduces the total borehole length while the BTES can still deliver the same heat flux to the pavement. Locations with gneiss, granite or other types of rocks with similar thermal properties are suitable for a combination of an HP system with BTES. The recommended borehole spacing for these kind of rock materials, based on numerical simulations in section 4, are in the range of 2-3 meters.

An HP system with BTES reduces the number of hours with critical temperature conditions for ice formation. The critical temperature condition is defined as when surface temperature is below zero and air temperature is larger than $-4\text{ }^{\circ}\text{C}$. The reduction of hours with critical temperatures for two locations, Tranarp and Studevannet, are about 91 % and 86 %, respectively. However, there are still 100 and 147 hours, respectively in these locations, with critical temperature conditions. When also considering when the surface temperature is below dew point temperature and at the same time below zero, the number of hours with risk for ice formation reduces to 6 hours for Tranarp and 23 hours for Studevannet. The results reveal that an HP system can be used to substantially reduce the critical road conditions due to condensation.

Finally, based on the results presented in this thesis, it can be concluded that the proposed concept would increase the safety on our roads if used in combination with traditional winter road maintenance. The concept is more efficient and feasible in areas with mild Scandinavia winters.

6 FURTHER RESEARCH

Further research activities are:

- Performance of hydronic pavements
The performance of an HP system (how many hours the HP system is allowed to fail) is crucial for the design of the system. The system requires substantially more power and energy during extreme weathers. However, the amount of energy is limited, which means the performance of the system will be reduced. A study should be performed to determine the acceptable risk levels. A qualitative interview study will be made.
- Identification of suitable locations
The results presented in the thesis have revealed that using HP system in combination with a BTES is a feasible concept for the southern part of Sweden and Norway. Further research is needed to identify the critical sections that are prone to ice formation and located far from winter maintenance depots. A methodology for identifying the critical location should be developed based on the results presented in report ii.
- Control system
The results reveal that the dew point temperature should be used as a part of the control system for hydronic pavements. However, addition of a weather forecasting to the control system increases the potential of using renewable HP systems with low temperature heat sources. A forecasting model based on existing models will be developed.
- Cost benefit analyses
The cost of implementing a hydronic pavement system needs to be evaluated. A cost benefit analysis needs to be performed in order to determine when the concept should be used. A methodology should be developed so that financial evaluations can be made on the viability of the proposed concept.
- Supplementary heat sources
Supplementary heat sources are needed in the locations with insufficient energy harvesting. How to combine the supplementary heat sources with the system should be studied.

REFERENCES

- Adl-Zarrabi, B., Ebrahimi, B., Hoseini, M., Johnsson, J., Mirzanimadi, R., & Taljegard, M. (2016). Safe and Sustainable Coastal Highway Route E39. *Transportation Research Procedia*, *14*, 3350–3359. <http://doi.org/10.1016/j.trpro.2016.05.286>
- Adlam, T. N. (1950). *Snow melting; design, installation and control of systems for melting snow*. New York: Industrial Press.
- Andersson, A. K. (2010). *Winter Road Conditions and Traffic Accidents in Sweden and UK: Present and Future Climate Scenarios (A131)*. Göteborg University, Göteborg.
- ASHRAE. (2003a). Chapter 34 - Thermal Storage. In *ASHRAE handbook: 2003 (SI)*. Atlanta, GA: American Society of Heating Refrigerating and Air Conditioning Engineers.
- ASHRAE. (2003b). Chapter 50 - Snow Melting and Freeze Protection. In *ASHRAE handbook: 2003 HVAC applications (SI)*. Atlanta, GA: American Society of Heating Refrigerating and Air Conditioning Engineers.
- Aydin, D., Casey, S. P., & Riffat, S. (2015). The latest advancements on thermochemical heat storage systems. *Renewable and Sustainable Energy Reviews*, *41*, 356–367. <http://doi.org/10.1016/j.rser.2014.08.054>
- Boyd, T. L. (2003). New Snow Melt Projects in Klamath Falls , Oregon. *Geo-Heat Center Quarterly Bulletin*, *24*(No. 3), 12–15.
- Byggnadsstyrelsen. (1976). *Markvärme (KBS rapport nr 137) (Vol. 137)*. Stockholm: Byggnadsstyrelsen.
- Cabeza, L. F. (Ed.). (2014). *Advances in Thermal Energy Storage Systems : Methods and Applications*. Burlington: Woodhead Publishing.
- Chalmers University of Technology. (2013). Chalmers helps Norway bridge the fjords. Retrieved December 19, 2016, from <https://www.chalmers.se/en/departments/cee/news/Pages/Chalmers-helps-Norway-bridge-the-fjords.aspx>
- Chen, M., Wu, S., Wang, H., & Zhang, J. (2011). Study of ice and snow melting process on conductive asphalt solar collector. *Solar Energy Materials and Solar Cells*, *95*(12), 3241–3250. <http://doi.org/10.1016/j.solmat.2011.07.013>
- Chiasson, A. D., Spitler, J. D., Rees, S. J., & Smith, M. D. (2000). A model for simulating the performance of a pavement heating system as a supplemental heat rejecter with closed-loop ground-source heat pump systems. *Journal of Solar Energy Engineering, Transactions of the ASME*, *122*(4), 183–191.
- Claesson, J., Efring, B., Eskilson, P., & Hellström, G. (1985). *Markvärme en handbok om termiska analyser: en handbok om termiska analyser : Del 1-3. BFR T-skrift*. Byggnadsstyrelsen (BFR).
- Climator Sweden AB. (2015). Product data sheets. Retrieved December 1, 2016, from <http://climator.com/product-data-sheets/?lang=en>

- Dincer, I., & Rosen, M. A. (2011). *Thermal energy storage : systems and applications* (2nd ed.). Wiley.
- Eugster, W. J. (2002). SERSO PLUS – Neue Wege in der Belagsbeheizung. *Geothermische Energie : Mitteilungsblatt Der Geothermischen Vereinigung e.V.*, 10(38–39).
- Eugster, W. J. (2007). Road and Bridge Heating Using Geothermal Energy Overview and Examples. *European Geothermal Congress*, (June), 5.
- Fay, L., & Shi, X. (2012). Environmental Impacts of Chemicals for Snow and Ice Control: State of the Knowledge. *Water, Air, & Soil Pollution*, 223(5), 2751–2770. <http://doi.org/10.1007/s11270-011-1064-6>
- Fukuhara, T., Goodrich, L., Wantabe, H., & Moriyama, K. (2000). Snow melting systems using a conducting pavement and an aquifer penetrating bore-hole. In E. Hjorth-Hansen, I. HOLLAND, S. Loset, & H. Norem (Eds.), *Snow Engineering: Recent Advances And Developments* (p. 468p).
- Gao, L., Zhao, J., & Tang, Z. (2015). A Review on Borehole Seasonal Solar Thermal Energy Storage. *Energy Procedia*, 70, 209–218. <http://doi.org/10.1016/j.egypro.2015.02.117>
- Gehlin, S. (2002). *Thermal response test method development and evaluation* (Doctoral thesis). Luleå University of Technology.
- Gehlin, S., Andersson, O., Bjelm, L., Alm, P.-G., & Rosberg, J.-E. (2015). Country Update for Sweden. In *Proceedings World Geothermal Congress 2015*. Melbourne,, Australia,.
- Hellström, G. (1989). *Duct ground heat storage model: Manual for Computer Code*. Lund: University of Lund.
- Hermansson, Å. (2004). Mathematical model for paved surface summer and winter temperature: comparison of calculated and measured temperatures. *Cold Regions Science and Technology*, 40(1–2), 1–17. <http://doi.org/http://dx.doi.org/10.1016/j.coldregions.2004.03.001>
- Iwamoto, K., Nagasaka, S., Hamada, Y., Nakamura, M., Ochifuji, K., & Nagano, K. (1998). Prospects of snow melting systems (SMS) using underground thermal energy storage (UTES) in Japan. In *The Second Stockton International Geothermal Conference*. Kita-ku: Hokkaido University.
- Johansson, A. (Ed.). (2000). *Vinterdrift vägar, gator, järnvägar och flygfält*. Göteborg: Chalmers Lindholmen University.
- Kenisarin, M., & Mahkamov, K. (2016). Salt hydrates as latent heat storage materials: Thermophysical properties and costs. *Solar Energy Materials and Solar Cells*, 145, 255–286. <http://doi.org/10.1016/j.solmat.2015.10.029>
- Ketzel, M., Omstedt, G., Johansson, C., Düring, I., Gidhagen, L., Lohmeyer, A., ... Wählin, P. (2007). Estimation and validation of PM 2.5 /PM 10 exhaust and non-exhaust emission factors for street pollution modelling. *Atmospheric Environment*, 41(40), 9370–9385.

- Klein-Paste, A. (2008). Physical Processes That Affect Runway Surface Conditions During Winter Time: A Conceptual Model. In A. E. Petty (Ed.), *Transportation Research E-Circular* (p. pp 537-543). Washington, D.C.: Transportation Research Board.
- Knudsen, F., Natanaelsson, K., Arvidsson, A., Kärki, O., Jacobsen, Á., Guðmundsson, G., ... Knut Magne, R. (2016). *Vintertjeneste i de Nordiske land: Statusrapport 2016* (NVF-rapporter 1/2016). Norge: NVF.
- Koschenz, M., & Dorer, V. (1996). Design of Air Systems with Concrete Slab Cooling. In S. Murakami (Ed.), *5th International Conference on Air Distribution in Rooms ROOMVENT 96*. Yokohama, Japan.
- Kuempel, D., & Hanbali, R. (1992). *Accident analysis of ice control operations: Final Report*. Milwaukee: Marquette University.
- Lindqvist, S., Mattson, J.-O., & et al. (1983). *Väglimatologi* (TU-Rapport 151). Borlänge, Sweden: Statens Vägverk.
- Lund, J. W. (2000). Pavement Snow Melting. *Geo-Heat Center Quarterly Bulletin*, 21(No. 2).
- Lysbakken, K. R. (2013). *Salting of Winter Roads : The Quantity of Salt on Road Surfaces after Application* (Ph.D. Dissertation). Norwegian University of Science and Technology.
- Magnusson, R. (1977). *Uppvärmning av vägar : energiförbrukning och effektbehov som funktion av klimatfaktorer, konstruktion, krav på ytförhålland och uppvärmningsstrategi* (Rapport nr 29). Chalmers tekniska högskola, Göteborg.
- Meteotest. (2015). *Meteonorm*. Bern: Meteotest.
- Milewski, J., Wołowicz, M., & Bujalski, W. (2014). Methodology for choosing the optimum configuration of STES system. In N. D. Lagaros, M. G. Karlaftis, & M. Papadrakakis (Eds.), *1st International Conference on Engineering and Applied Sciences Optimization, OPT-i 2014* (pp. 222–239). National Technical University of Athens.
- Minsk, L. D. (1998). *Snow and ice control manual for transportation facilities*. New York: McGraw-Hill.
- Mirzananadi, R. (2017). *Ice free roads using hydronic heating pavement with low temperature: Thermal properties of asphalt concretes and numerical simulations* (Licenciate Thesis 2017:2 - BoM). Chalmers University of Technology, Gothenburg.
- Nordell, B. (1994). *Borehole heat store design optimization* (Doctoral thesis 1994:137). Luleå tekniska universitet, Luleå.
- Nordin, L. (2015). *Energy Efficiency In Winter Road Maintenance A Road Climatological Perspective* (Ph.D. Dissertation A154). University of Gothenburg, Gothenburg.
- Norrman, J., Eriksson, M., & Lindqvist, S. (2000). Relationships between road slipperiness, traffic accident risk and winter road maintenance activity. *Climate Research*, 15(3), 185–193. <http://doi.org/10.3354/cr015185>

- Nuijten, A. D. W. (2016). Runway temperature prediction, a case study for Oslo Airport, Norway. *Cold Regions Science and Technology*, 125, 72–84. <http://doi.org/10.1016/j.coldregions.2016.02.004>
- Orring, A. (2012). Sommarvärme mot blixthalkan | NYTEKNIK. Retrieved December 20, 2016, from <http://www.nyteknik.se/fordon/sommarvarme-mot-blixthalkan-6405769>
- Pahud, D. (2007). *Serso, stockage saisonnier solaire pour le dégivrage d'un pont* (Rapport final). Bern: Bundesamt für Energie BFE.
- Pahud, D. (2008). *BRIDGESIM: Simulation Tool for the System Design of Bridge Heating for Ice Prevention with Solar Heat Stored in a Seasonal Ground Duct Store* (User Manual). Lugano, Switzerland: SUPSI.
- Pan, P., Wu, S., Xiao, Y., & Liu, G. (2015). A review on hydronic asphalt pavement for energy harvesting and snow melting. *Renewable and Sustainable Energy Reviews*, 48, 624–634. Journal Article. <http://doi.org/10.1016/j.rser.2015.04.029>
- Spitler, J. D., Ahmed, S., Arndt, D. S., Elliott, R. L., Fisher, D. E., Smith, M. D., & Whiteley, J. R. (2004). *Geothermal Smart Bridge Project*. Oklahoma State University.
- Statens Vegvesen. (2013). Vegvesen-avtale med Chalmers. Retrieved December 19, 2016, from <http://www.vegvesen.no/om+statens+vegvesen/presse/Pressemeldingsarkiv/Vegdirektoratet/vegvesen-avtale-med-chalmers>
- Sundberg, J. (2012). *Halkfria vägar: Solvärme och värmelagring för miljöanpassad halkbekämpning* (Rapport 2014:120). Borlänge, Sweden: Trafikverket.
- Sundberg, J., & Lidén, P. (2014). *Halkfria vägar – Etapp 2. Energi- och systemanalys med kostnader. Solvärme och värmelagring för miljöanpassad halkbekämpning* (Rapport 2014:121). Borlänge, Sweden: Trafikverket.
- Togård, C. (2014). *Geoenergisystem för uppvärmning av broar : En fallstudie över Tranarpsbron* (MSc Thesis). KTH, Stockholm.
- Uponor. (2013). Ytvärmesystem. In *VVS Handboken edition 2*. Västerås: Uponor VVS AB.
- Usman, T., Fu, L., & Miranda-Moreno, L. F. (2010). Quantifying safety benefit of winter road maintenance: accident frequency modeling. *Accident; Analysis and Prevention*, 42(6), 1878–87. <http://doi.org/10.1016/j.aap.2010.05.008>
- Valavanidis, A., Fiotakis, K., & Vlachogianni, T. (2008). Airborne Particulate Matter and Human Health: Toxicological Assessment and Importance of Size and Composition of Particles for Oxidative Damage and Carcinogenic Mechanisms. *Journal of Environmental Science and Health, Part C*, 26(4), 339–362. <http://doi.org/10.1080/10590500802494538>
- Wallman, C.-G., Öberg, G., & Wretling, P. (1997). *Effects of winter road maintenance: state-of-the-art* (VTI rapport 423A). Linköping: Statens väg- och transportforskningsinstitut.
- WHO. (2015). *Global Status Report on Road Safety 2015*. Switzerland: World Health Organization.

- Ye, Z., Wu, J., Ferradi, N. El, & Shi, X. (2013). Anti-icing for key highway locations: fixed automated spray technology. *Canadian Journal of Civil Engineering*, 40(1), 11–18. <http://doi.org/10.1139/cjce-2012-0226>
- Yoshitake, I., Yasumura, N., Syobuzako, M., & Scanlon, A. (2011). Pipe Heating System with Underground Water Tank for Snow Thawing and Ice Prevention on Roads and Bridge Decks. *Journal of Cold Regions Engineering*, 25(2), 71–86. [http://doi.org/10.1061/\(ASCE\)CR.1943-5495.0000023](http://doi.org/10.1061/(ASCE)CR.1943-5495.0000023)

APPENDIX A-INPUT DATA BRIDGESIM

Table A1 Simulation parameters fixed during the simulations.

Parameter	Value	Unit
Heated bridge surface	1000	[m ²]
Road solar absorption	0.7	[-]
Surface convective heat transfer coefficient	15	[W/m ² K]
External diameter of the embedded pipes	25	[mm]
Internal diameter of the embedded pipes	20.4	[mm]
Thermal conductivity of the pipe material	0.40	[W/(m·K)]
Thermal conductivity of the heat carrier fluid	0.43	[W/(m·K)]
Fluid flow rate per square meter of heated bridge surface	30	[litre/(h·m ²)]
Heat carrier fluid density	970	[kg/m ³]
Heat carrier fluid heat capacity	4.250	[kJ/(kg·K)]
Harnessing start temperature difference ΔT_{START}	1	[°C]
Harnessing stop temperature difference ΔT_{STOP}	0.5	[°C]

The heat carrier fluid consist of water mixed with bioethanol to a 25 % concentration in order to prevent freezing when the air temperature is below -8 °C. At this temperature level the system is stopped in order to save energy. Without the antifreeze the expansion of the frozen fluid would damage the HP system. Fluid flow rate per square meter of heated bridge surface was set to 30 l/h·m². With a temperature difference of 3 °C the design power was then about 100 W/m². This means that the system is not designed for snow melting. However, anti-icing should be possible

Table A2 Storage properties

Parameter	Value	Unit
U-tube configuration	Single	-
Borehole heat exchanger inner diameter	28	[mm]
Thermal resistance of borehole	0.1	[m·K/W]
Internal resistance of borehole	0.4	[m·K/W]
Number of boreholes connected in series	1	[-]
Insulation thickness on top of storage	0.4	[m]
Thermal conductivity insulation	0.38	[W/(m·K)]
Mean borehole depth	200	[m]
Average spacing between the boreholes	5.0	[m]
Mean undisturbed ground temperature at surface	4.0	[°C]
Mean temperature gradient in ground	20	[K/km]

The surface convective heat transfer coefficient h_c was set to 15 [W/m²K] based on the mean air speed at the two locations and utilising the equation for h_c based on (Hermansson, 2004). The air speed used in the calculation is based on about 4 m/s because of the screening effect of the guardrails.

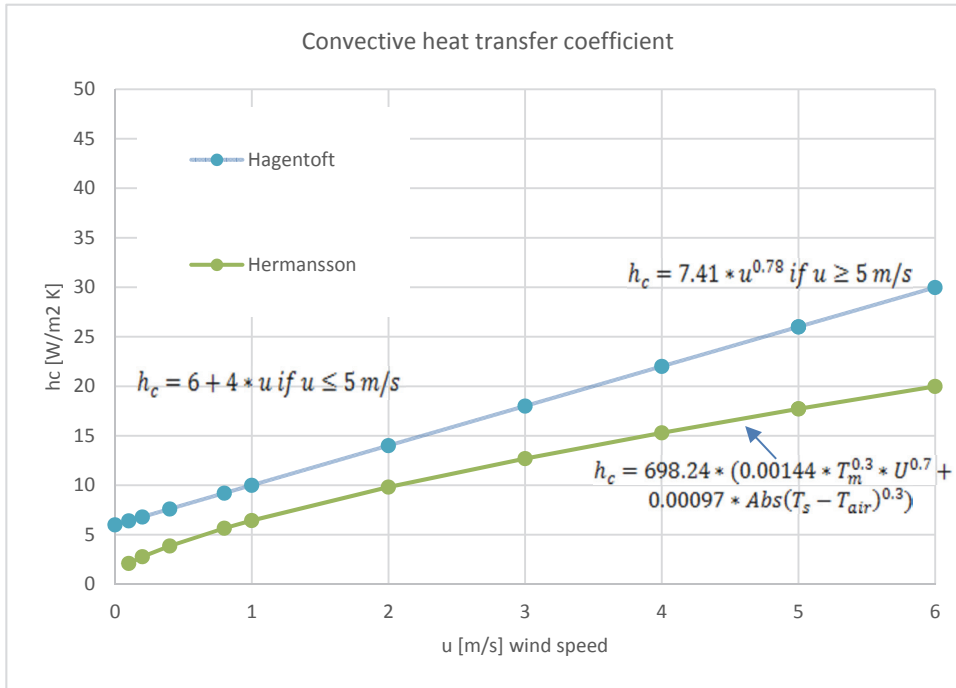

Table A3. Bridge construction used in BRIDGESIM

Layer (Top to bottom)	Thickness [mm]	Thermal conductivity [W/m·K]	Volumetric heat capacity [kJ/K·m ³]
Asphalt concrete	50	3.0	2000
Pipe layer	50	2.4	2400
Base of concrete	200	2.1	2400
Insulation	50	0.056	200

Selection of storage size

Based on the evaluation of borehole depth and borehole spacing, clay and granite were considered for the locations, Tranarp and Studevannet. Thereby studying the two extremes of the selected underground materials. The systems were simulated with settings according to input data presented in appendix A and using a borehole depth of 100 m and borehole spacing of 2.5 m. The control curve used is presented in Figure 16. The results of the simulations are presented in Figure A20. Both the results for Studevannet and Tranarp reveal that it is possible to reach a DH_{fail} of around 50 Kh/year. However, to reach that level in Studevannet there is a need for about 60 boreholes with a BTES constructed in granite.

Comparing with Tranarpp which needs 40 boreholes with granite or 50 boreholes with clay as underground material. This results reveal that reaching the same level of DH_{fail} would be costlier in Studevannet compared to Tranarpp.

In order to be able to study the surface conditions on the pavement and to compare both locations, a BTES size with 50 boreholes was selected for detailed studied for the both locations. This decision means that Tranarpp would then have a slightly over sized BTES while the BTES for Studevannet is near its optimal solution.

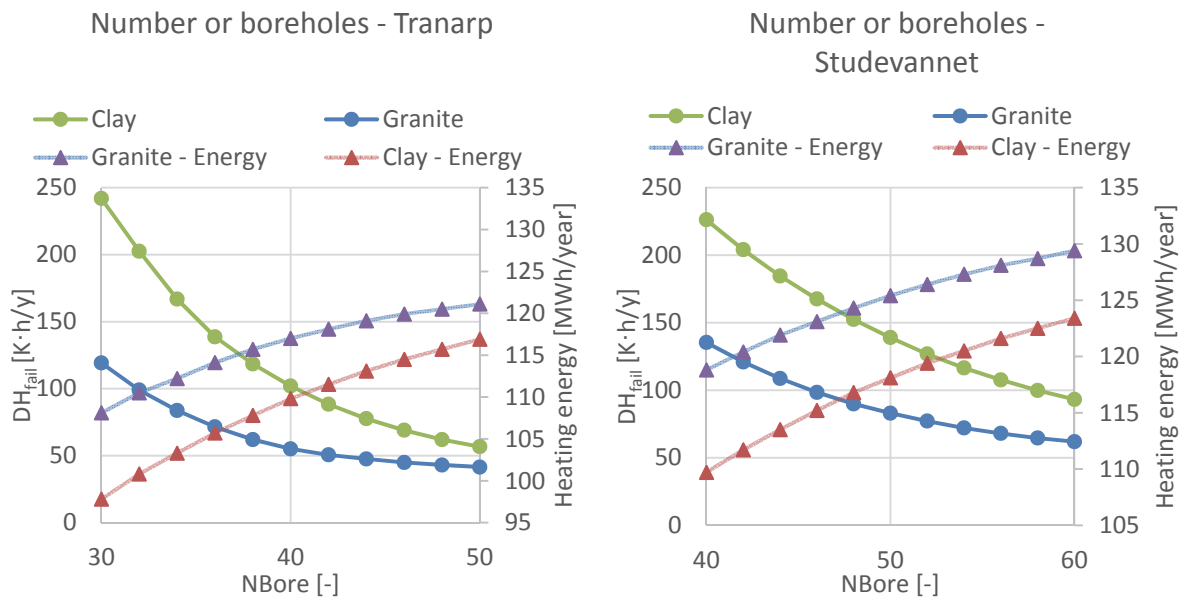

Figure A20. Number of boreholes and resulting heating energy and DH_{fail} for Tranarpp (Left) and Studevannet (Right). Borehole depth 100 m and borehole spacing 2.5 m.

Influence of renewable HP-system on road surface conditions

The effect that an HP-system would have on the surface conditions of the road was studied by comparing the surface temperatures for a heated and an unheated bridge. The aggregated number of hours with different surface temperatures are presented in Table A4. The case studies were made using a heated area of 1000 m² and a BTES with 50 boreholes at both locations.

Studying the air temperatures in Table A4 it can be seen that the climate of Studevannet has more hours with low air temperatures. This means that the winter climate is harsher in Studevannet compared with Tranarpp. When comparing the surface temperatures T_s for the unheated case it can be seen that the lower air temperatures of Studevannet are reflected in

higher number of hours with low surface temperatures for Studevannet. In Studevannet, there are 130 hours more with T_s lower than 0 °C and 180 hours with T_s lower than -1 °C, compared to Tranarp. However, for the critical temperature condition when T_a is above -4 °C and when T_s are lower than 0 °C the number of hours are rather similar. This condition is seen as critical since the air could hold high amounts of moisture which rapidly could create an ice layer on a cold road surface. When the air temperature decreases below -4 °C the moisture content in the air will be lower and the growth of an ice layer would be slower. Decreasing the risk for unexpected, slippery conditions.

To investigate the correctness of the results from BRIDGESIM the number of hours with critical temperature conditions was compared, with result from a study of frost warnings for the south-west part of Sweden from 2011. Based on data from the road weather stations about 300 -1000 frost warnings are representative for road weather station, with a mean of 608 frost warning during a winter (Nordin, 2015). The higher number of about 1000 should be representative for more frost sensitive locations such as Tranarp and Studevannet. The results by Nordin could be compared with the values of the inactive HP system in Table A4. It can be seen that the number of critical hours with risk for ice formation are comparable (about 1000 hours) with what could be expected from the study by Nordin. This indicates that the results from BRIDGESIM can be considered as truthful.

Table A4. The number of hours for different temperature levels for Tranarp and Studevannet.

	Tranarp		Studevannet	
	Unheated [hr]	Heated [hr]	Unheated [hr]	Heated [hr]
$T_a < 1\text{ }^\circ\text{C}$	1718		1714	
$T_a < -1\text{ }^\circ\text{C}$	998		1079	
$T_a < -4\text{ }^\circ\text{C}$	328		487	
$T_s < 1\text{ }^\circ\text{C}$	1726	906	1810	1091
$T_s < 0\text{ }^\circ\text{C}$	1401	380	1532	551
$T_s < -1\text{ }^\circ\text{C}$	1066	183	1247	338
$T_s < 0\text{ }^\circ\text{C} \ \& \ T_a > -4\text{ }^\circ\text{C}$	1070	100	1033	147
$DH_{fail} \left[\frac{\text{K}\cdot\text{h}}{\text{year}} \right]$		41		77
Heat energy [kWh]		121100		125400
Heat storage [kWh]		114900		121000
Harvested [kWh]		178800		184300

For the case of Tranarpp, the effect of the renewable HP system can be seen in Table A4 and in Figure A21, left. The number of hours with surface temperatures below 0 °C were reduced by 73 % and from 1401 to 380 hours. Considering the critical conditions of T_s below 0 °C and air temperatures above -4 °C, the reduction was 91 %, leaving only 100 critical hours. Those critical hours occurred at 22 events compared to 70 critical events for the unheated case. One event is defined as when there are more than 1 consecutive critical hours which would require treatment. This means that an unheated bridge would require winter maintenance activities at 70 occasions compared to 22 occasions for a heated bridge. However, for the unheated bridge multiple treatments might be needed depending on the length of the event.

For the case of Studevannet the number of hours with surface temperatures below 0 °C were reduced by about 1000 hours 64 %. While for the critical conditions, the reduction was 86 % leaving 147 hours with risk for slippery conditions, see Table A4 and Figure A21 right. Those critical hours took place at 36 events during the studied period compared with 89 events for an unheated bridge. Meaning that the bridge would need treatment at 89 occasions without heating and 36 occasions with heating.

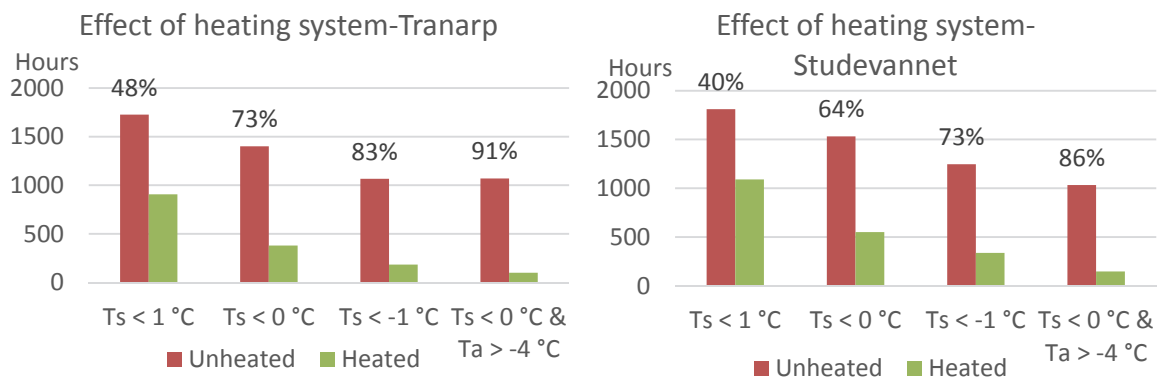

Figure A21. Hours with different surface temperatures, Tranarpp (Left) and Studevannet (Right). The effect of using an HP system is indicated by the relative reduction of hours between the heated and unheated case.

The results from Tranarpp and Studevannet reveal that the number of critical hours were significant reduced by 91 % and 86 % respectively. The result for DH_{fail} were 41 respectively 77 K·h/year. These reductions are large while there are still a few hours that still could possess a risk for the traffic. However, in order for condensation and ice formation to take place the following condition must hold: $T_s < T_{dew}$ & $T_s < 0\text{ °C}$ given that pure water is considered, results are presented in the thesis.